

# Encap DOE - LIV Measurements pre and post barrier dep and after 1600 hours in ambience

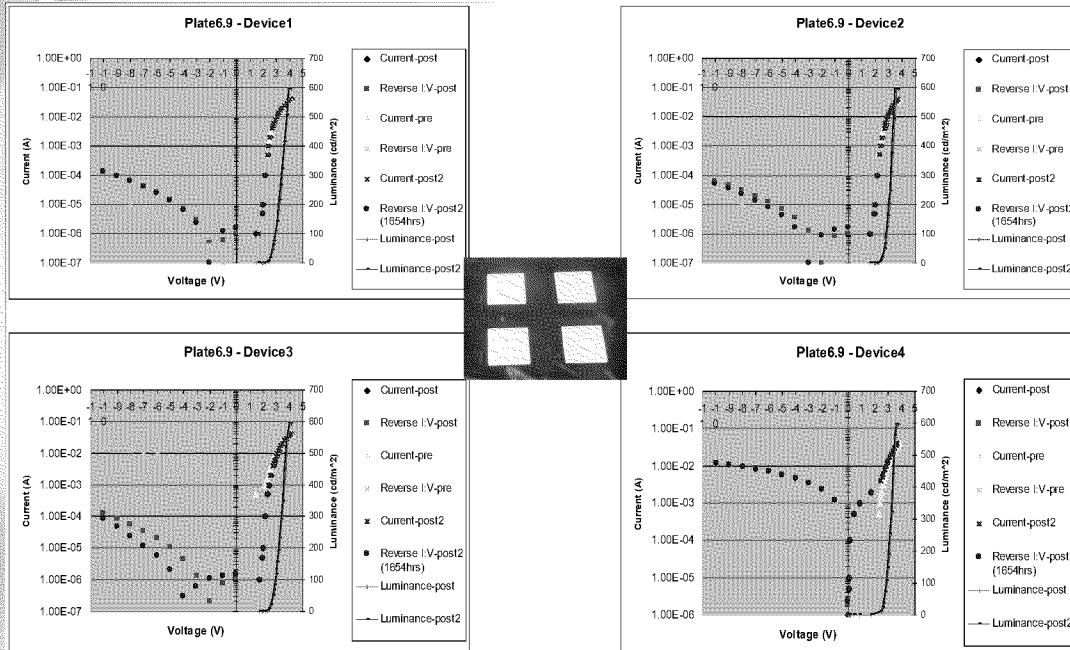

**Minimize I-V Shift due to Barrier Deposition**

SLIDE 42 [DateTime]



<Presentation Name>

1/15/2021

COMPANY CONFIDENTIAL

# Encap DOE – Optimize Luminance Change on Pixelated OLED test Devices > 1600 Hours in Ambience

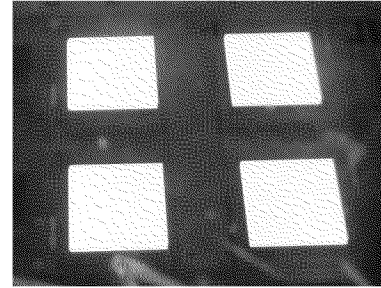
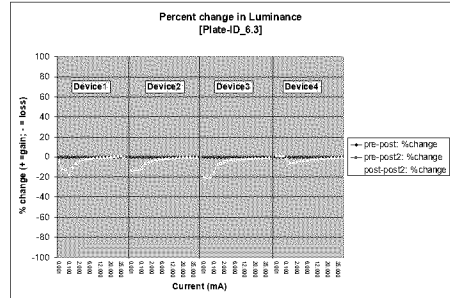
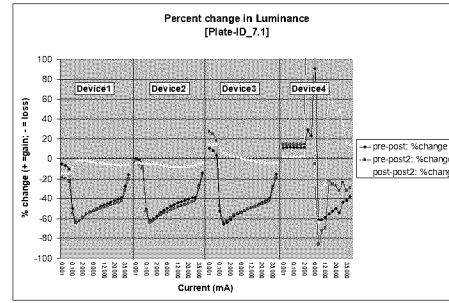
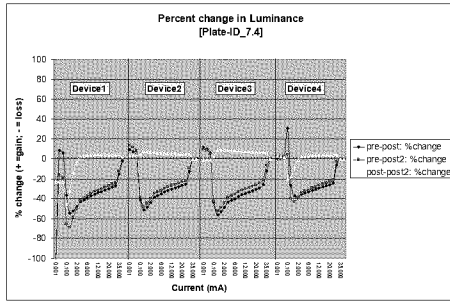

Thin-film encapsulated OLEDs lighting up with minimal luminance change after 1654 hours in damp heat

Ready for Accelerated Testing at Dupont

SLIDE 43 [DateTime]



<Presentation Name>

1/15/2021

COMPANY CONFIDENTIAL

## Substrate Cleaning: Pinhole Reduction

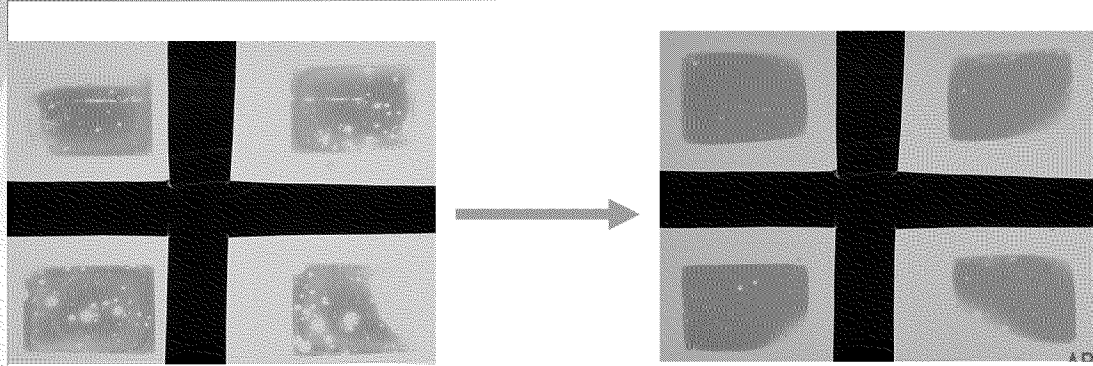

As received substrate

Cleaned substrate  
before barrier dep

**Ca Test Results After 569 hours in 50 °C / 95% RH**

Substrate cleaning reduces pinholes from external causes

SLIDE 44 [Date/Time]



# Ca OD Results

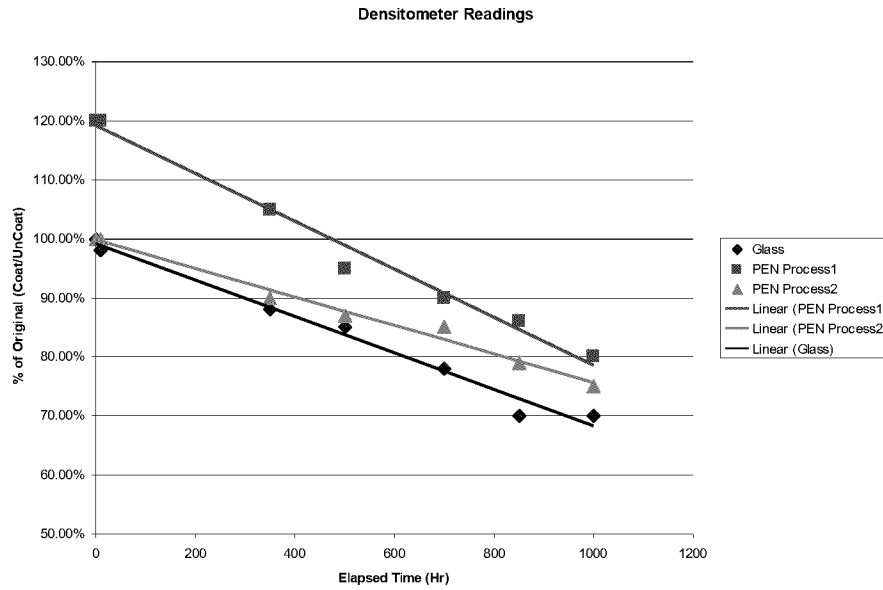

SLIDE 45 [Date/Time]



## Feasible Test

### As-received Substrates for test

- Two kinds of substrates will be transported to Symmorphix
  - OLED's substrate (ca.  $27 \times 20 \text{ mm}^2$ , 5 ea)
  - OLED's substrate with evaporated Al layer (ca.  $27 \times 20 \text{ mm}^2$ , 5 ea)
- Images of OLED's substrate

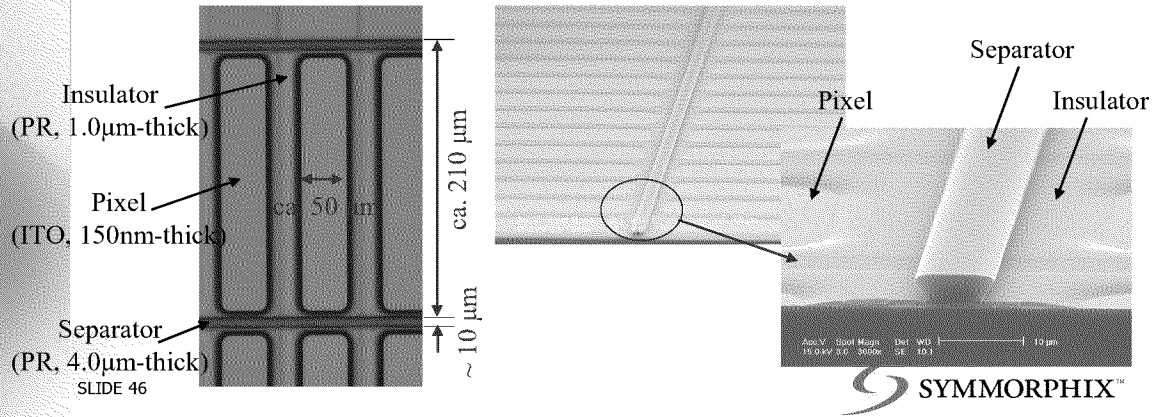

<Presentation Name>

1/15/2021

COMPANY CONFIDENTIAL

# Explore Litigation Insights

Docket Alarm provides insights to develop a more informed litigation strategy and the peace of mind of knowing you're on top of things.

## Real-Time Litigation Alerts



Keep your litigation team up-to-date with **real-time alerts** and advanced team management tools built for the enterprise, all while greatly reducing PACER spend.

Our comprehensive service means we can handle Federal, State, and Administrative courts across the country.

## Advanced Docket Research



With over 230 million records, Docket Alarm's cloud-native docket research platform finds what other services can't. Coverage includes Federal, State, plus PTAB, TTAB, ITC and NLRB decisions, all in one place.

Identify arguments that have been successful in the past with full text, pinpoint searching. Link to case law cited within any court document via Fastcase.

## Analytics At Your Fingertips



Learn what happened the last time a particular judge, opposing counsel or company faced cases similar to yours.

Advanced out-of-the-box PTAB and TTAB analytics are always at your fingertips.

## API

Docket Alarm offers a powerful API (application programming interface) to developers that want to integrate case filings into their apps.

## LAW FIRMS

Build custom dashboards for your attorneys and clients with live data direct from the court.

Automate many repetitive legal tasks like conflict checks, document management, and marketing.

## FINANCIAL INSTITUTIONS

Litigation and bankruptcy checks for companies and debtors.

## E-DISCOVERY AND LEGAL VENDORS

Sync your system to PACER to automate legal marketing.