

# EXHIBIT 7

(12) **United States Patent**  
**Matsuda et al.**

(10) **Patent No.:** **US 6,928,306 B2**  
(45) **Date of Patent:** **Aug. 9, 2005**

(54) **PORTABLE MOBILE UNIT**

(75) Inventors: **Masayuki Matsuda**, Tokyo (JP);  
**Tomohiro Esaki**, Tokyo (JP);  
**Kazuyuki Takizawa**, Tokyo (JP); **Akio Shinagawa**, Tokyo (JP); **Chikako Takada**, Tokyo (JP)

5,771,001 A	*	6/1998	Cobb	340/573.1
5,870,684 A	*	2/1999	Hoashi et al.	455/567
6,175,721 B1	*	1/2001	Hayato	340/7.58
RE37,281 E	*	7/2001	Motegi	340/636.15
6,308,086 B1	*	10/2001	Yoshino	455/567
6,463,278 B2	*	10/2002	Kraft et al.	455/418
2001/0051536 A1	*	12/2001	Muramatsu	455/567
2003/0110928 A1	*	6/2003	Yamaki et al.	84/615

(73) Assignee: **Hitachi, Ltd.**, Tokyo (JP)

\* cited by examiner

(\*) Notice: Subject to any disclaimer, the term of this patent is extended or adjusted under 35 U.S.C. 154(b) by 575 days.

*Primary Examiner*—Nay Maung  
*Assistant Examiner*—Tu X Nguyen  
(74) *Attorney, Agent, or Firm*—Townsend and Townsend and Crew LLP

(21) Appl. No.: **09/755,878**

(22) Filed: **Jan. 4, 2001**

(65) **Prior Publication Data**

US 2001/0014616 A1 Aug. 16, 2001

(30) **Foreign Application Priority Data**

Jan. 7, 2000 (JP) ..... 2000-005858

(51) **Int. Cl.**<sup>7</sup> ..... **H04B 1/38**

(52) **U.S. Cl.** ..... **455/567; 455/418**

(58) **Field of Search** ..... 455/567, 450, 455/564, 418, 90, 189.1, 209, 326; 381/24; 379/88.19, 252, 418; 84/615

(56) **References Cited**

**U.S. PATENT DOCUMENTS**

5,563,951 A \* 10/1996 Wang et al. .... 455/100

(57) **ABSTRACT**

A portable mobile unit for alerting on incoming of a signal by a ringing sound, comprises: a ringing sound generator for generating the ringing sound in a plurality of patterns; and a controller for controlling operations of the portable mobile unit, wherein the controller select one pattern from the a plurality of patterns based on conditions which are set up in advance, when the signal comes in, so as to control the ringing sound generator to generate the ringing sound for alerting a user of the incoming call, thereby providing the portable mobile unit being superior in the usability, with which various conditions can be grasped by means of change in the ringing sound when the telephone call comes in, while achieving the discrimination of the ringing sound for alerting of the incoming call.

**15 Claims, 8 Drawing Sheets**

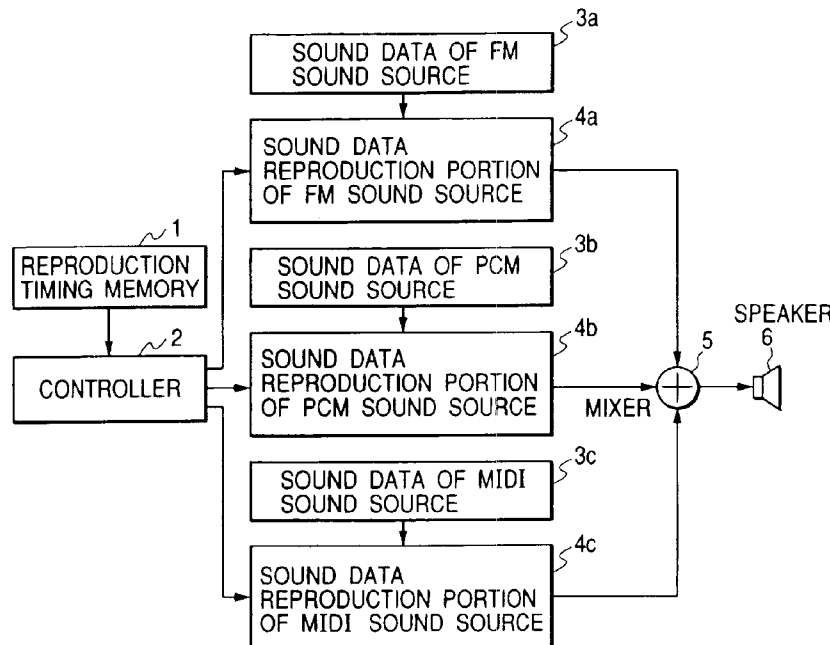


FIG. 1

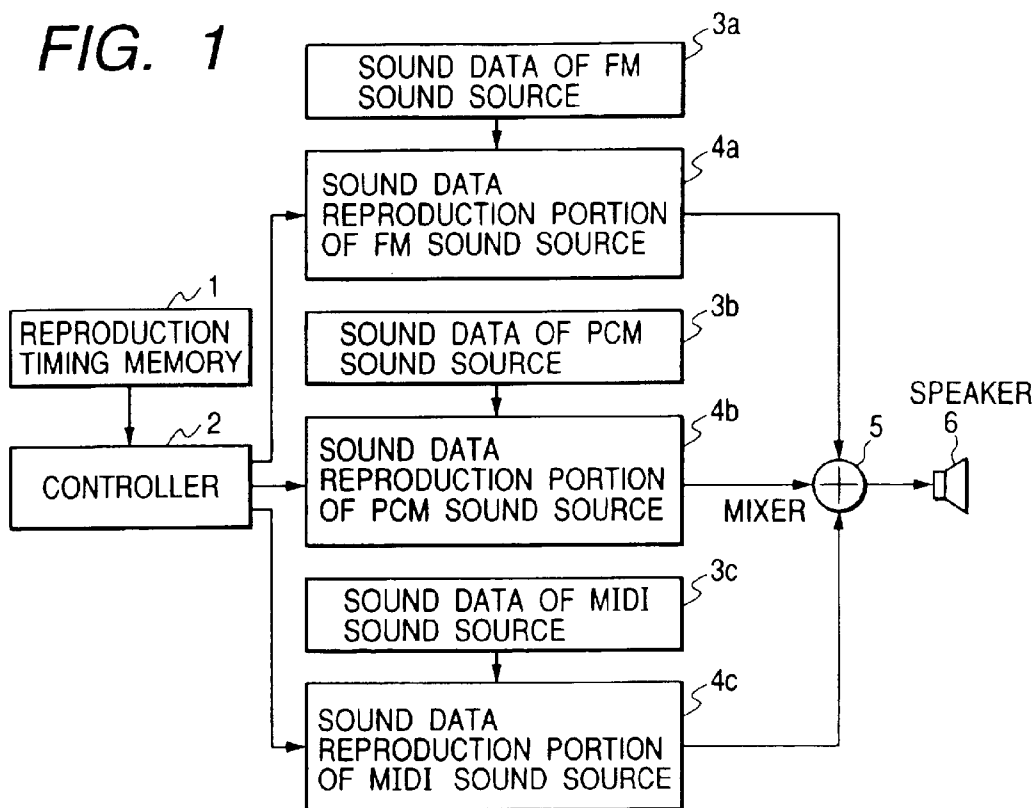


FIG. 2

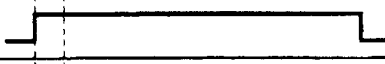

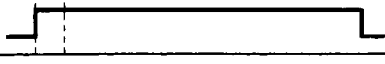
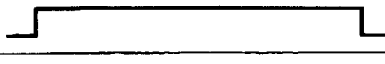


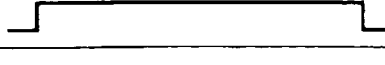
PATTERN NUMBER	SOUND DATA NUMBER	REPRODUCTION TIMING
PATTERN 1	1	ON OFF 
	2	ON OFF 
	3	ON OFF 
PATTERN 2	1	ON OFF 
	2	ON OFF 
	4	ON OFF 
PATTERN 3	3	ON OFF 
⋮	⋮	⋮

FIG. 3

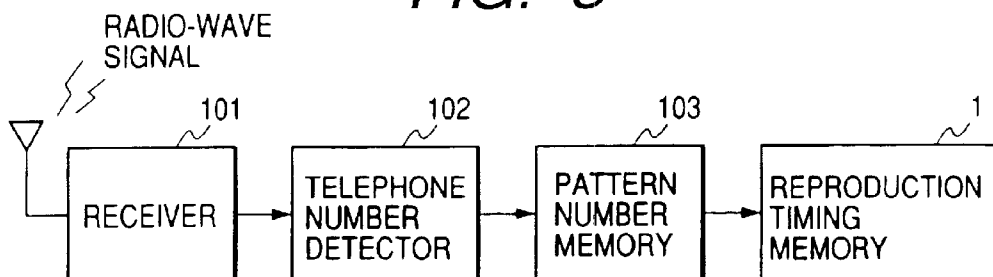


FIG. 4

PATTERN NUMBER MEMORY

TELEPHONE NUMBER	PATTERN NUMBER
012-345-6789	1
090-1234-5678	2
UPPER 3 DIGITS 045	3
UPPER 4 DIGITS 0965	4
⋮	⋮

103a  
 103b  
 103c  
 103d

FIG. 5

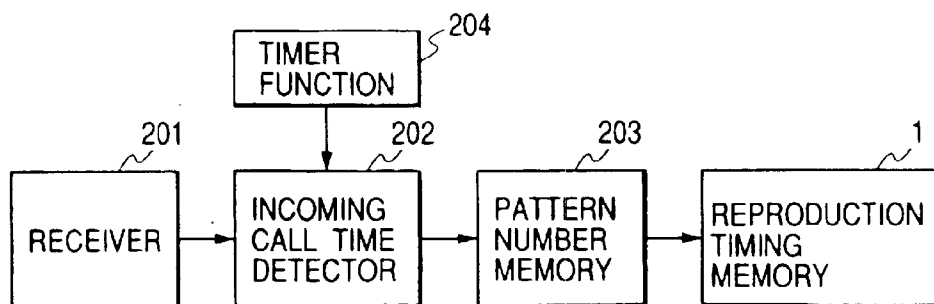


FIG. 6

PATTERN NUMBER MEMORY

SET-UP TIME	PATTERN NUMBER
0:00 ~ 8:00	1
17:15 ~ 21:30	2
⋮	⋮

203a

203b

FIG. 7

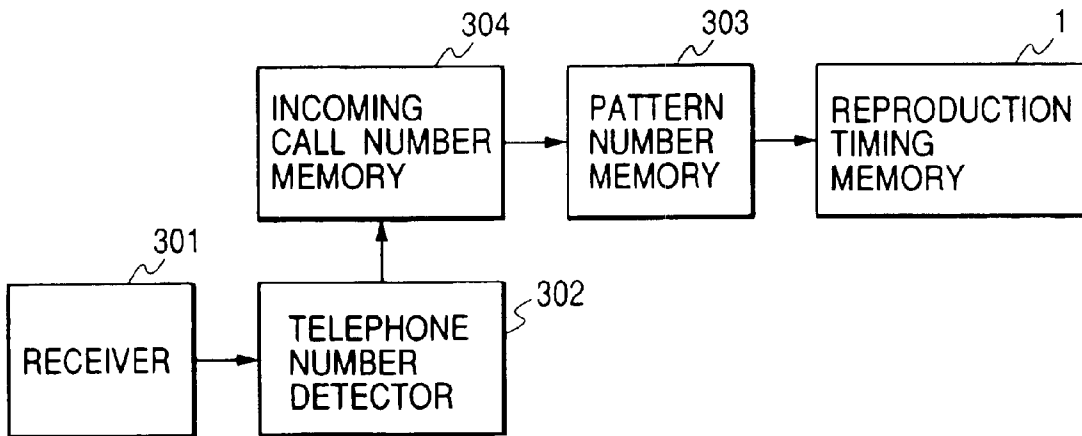


FIG. 8

PATTERN NUMBER MEMORY

INCOMING CALL NUMBER	PATTERN NUMBER
1st TIME	1
2nd TIME	2
3rd TIME	3
⋮	⋮

303a

303b

303c

# Explore Litigation Insights

Docket Alarm provides insights to develop a more informed litigation strategy and the peace of mind of knowing you're on top of things.

## Real-Time Litigation Alerts



Keep your litigation team up-to-date with **real-time alerts** and advanced team management tools built for the enterprise, all while greatly reducing PACER spend.

Our comprehensive service means we can handle Federal, State, and Administrative courts across the country.

## Advanced Docket Research



With over 230 million records, Docket Alarm's cloud-native docket research platform finds what other services can't. Coverage includes Federal, State, plus PTAB, TTAB, ITC and NLRB decisions, all in one place.

Identify arguments that have been successful in the past with full text, pinpoint searching. Link to case law cited within any court document via Fastcase.

## Analytics At Your Fingertips



Learn what happened the last time a particular judge, opposing counsel or company faced cases similar to yours.

Advanced out-of-the-box PTAB and TTAB analytics are always at your fingertips.

## API

Docket Alarm offers a powerful API (application programming interface) to developers that want to integrate case filings into their apps.

## LAW FIRMS

Build custom dashboards for your attorneys and clients with live data direct from the court.

Automate many repetitive legal tasks like conflict checks, document management, and marketing.

## FINANCIAL INSTITUTIONS

Litigation and bankruptcy checks for companies and debtors.

## E-DISCOVERY AND LEGAL VENDORS

Sync your system to PACER to automate legal marketing.