

**To:** CLARK A. PUNTIGAM([clark@jensenpuntigam.com](mailto:clark@jensenpuntigam.com))  
**Subject:** U.S. Trademark Application Serial No. 97060107 - TRUCKVAULT - 301-27 Remand Request to TTAB  
**Sent:** July 26, 2023 11:31:21 AM EDT  
**Sent As:** [tmng.notices@uspto.gov](mailto:tmng.notices@uspto.gov)

---

## Attachments

[screenshot-www-therelector-com-stories-the-big-one-is-southwest-washington-prepared-32536-16902931159041](#)  
[screenshot-securevehiclesolutions-com-16902933054481](#)  
[screenshot-www-freep-com-story-money-cars-2020-06-13-console-vault-hidden-safe-vehicles-5344304002-16902936348321](#)  
[screenshot-taskandpurpose-com-gear-best-car-gun-safes-16902937964871](#)  
[screenshot-www-motorbiscuit-com-consider-a-truck-gun-safe-16902939583771](#)  
[screenshot-rocklandcustomproducts-com-truck-gun-safes-16902942422601](#)  
[screenshot-accessories-ford-com-products-console-vault-floor-vehicle-safe-1-16902943956111](#)  
[screenshot-www-concealedcarry-com-training-2-edc-every-day-carry-16902945821601](#)  
[screenshot-www-motortrend-com-features-celebrity-drive-dusk-dynasty-star-willie-robertson-16902947172251](#)  
[screenshot-www-motortrend-com-features-celebrity-drive-dusk-dynasty-star-willie-robertson-16902947715351](#)  
[screenshot-decked-com-blogs-decked-decked-truck-gun-storage-3460-16902950400331](#)  
[screenshot-www-michigan-sportsman-com-threads-truck-gun-vault-539609-16902952538801](#)  
[screenshot-www-retrievertraining-net-threads-advice-on-truck-vault-dog-boxes-other-accessories-for-a-yukon-xl-suburban-111382-16902953317211](#)  
[screenshot-www-refugeforums-com-threads-homemade-truck-vault-917202-16902954024361](#)  
[screenshot-www-forbes-com-home-improvement-garage-car-accessories-best-vehicle-gun-safes-16902928819601](#)  
[screenshot-karkraftautomotive-com-truck-bed-cargo-slides-vaults-16897642003801](#)  
[screenshot-danasafetysupply-com-troy-products-cp-gb4430-pb-storage-vault-with-two-draw-tight-locking-handles-and-push-button-lock-for-trucks-suvs-16897642499181](#)  
[screenshot-danasafetysupply-com-troy-products-cp-gb4430-pb-storage-vault-with-two-draw-tight-locking-handles-and-push-button-lock-for-trucks-suvs-16897642499182](#)  
[screenshot-www-gunsafes-com-Truck-Vaults.html-16897643714111](#)  
[screenshot-www-s-scampers-com-are-16897644712991](#)  
[screenshot-www-unitedcommercegroup-com-gunsafes-com-announces-the-availability-of-br5930-old-glory-battle-ready-tactical-gun-safe-16897653562141](#)  
[screenshot-www-consolevault-com-chevy-console-safes.html-16897658611861](#)  
[screenshot-alphaoutdoorspecialties-com-products-dakota-badlands-truck-vault-lite-16897659185291](#)  
[screenshot-truckvault-com-faq-16897662625521](#)  
[screenshot-truckvault-com-post-best-truck-bed-storage-system-period-16897663393421](#)

screencapture-truckvault-com-post-all-weather-all-time-truck-bed-storage-any-conditions-16897664031091

Copy of Global Broadcast Database Article1.jpg

Copy of Global Broadcast Database Article2.jpg

Copy of States News Service Article1.jpg

Copy of States News Service Article2.jpg

Copy of States News Service Article3.jpg

TruckVault Website 1.jpg

TruckVault Website 2.jpg

**United States Patent and Trademark Office (USPTO)**

**U.S. Application Serial No.** 97060107

**Mark:** TRUCKVAULT

**Correspondence Address:**

CLARK A. PUNTIGAM

JENSEN & PUNTIGAM, P.S.

2033 6TH AVE, SUITE 990

SEATTLE WA 98121

UNITED STATES

**Applicant:** Truckvault, Inc.

**Reference/Docket No.** 301-27

**Correspondence Email Address:** clark@jensenpuntigam.com

**MOTION TO REQUEST SUSPENSION OF THE APPEAL**

**AND REMAND OF THE APPLICATION**

**Before the Trademark Trial and Appeal Board on Appeal**

The Office has reassigned this application to the undersigned trademark examining attorney. The trademark examining attorney requests that the Trademark Trial and Appeal Board suspend the appeal proceeding and remand the application to the examining attorney under 37 C.F.R. §2.142(d) in order to submit additional evidence into the record relevant to the issue(s) on appeal.

The examining attorney is making this request at this time because a new examining attorney has taken over the case and wishes to supplement the evidence of record. The evidence consists of the following:

Evidence of the phrase "truck vault" used descriptively. *See*

- The Reflector [The Big One: Is Southwest Washington prepared? | The Reflector](#)
- GunSafes.com [Truck Vaults - GunSafes.com | GunSafes.com](#)
- S&S Canopies & Campers [ARE - S&S Canopies and Campers - Kalispell, MT \(s-scampers.com\)](#)
- United Commerce Group [GunSafes.com Announces the Availability of BR5930 Old Glory “Battle Ready” Tactical Gun Safe – United Commerce Group](#)
- Alpha Outdoor Specialties [Dakota Badlands 283 Truck Vault Lite – Alpha Outdoor Specialties](#)
- Concealed Carry <https://www.concealedcarry.com/training-2/edc-every-day-carry/>
- MotorTrend <https://www.motortrend.com/features/celebrity-drive-dusk-dynasty-star-willie-robertson/>
- Decked <https://decked.com/blogs/decked/decked-truck-gun-storage-3460>
- Michigan Sportsman <https://www.michigan-sportsman.com/threads/truck-gun-vault.539609/>
- Retriever Training <https://www.retrievertraining.net/threads/advice-on-truck-vault-dog-boxes-other-accessories-for-a-yukon-xl-suburban.111382/>
- Refuge Forums <https://www.refugeforums.com/threads/homemade-truck-vault.917202/>
- States News Service (news article attached)
- Global Broadcast Database (news article attached)

Evidence of applicant's descriptive use of the word "vault". *See*

- TruckVault [TRUCKVAULT EXTREME SERIES - PUT TO THE TEST | TruckVault](#)
- TruckVault [FAQ | TruckVault](#)
- TruckVault [The Best Truck Bed Storage System. Period. | TruckVault](#)
- TruckVault [All Weather All the Time: Truck Bed Storage for Any Conditions | TruckVault](#)

Evidence of third parties using the word “vault” descriptively in connection with goods similar to those identified by applicant. *See*

- Kar Kraft [Cargo Slides & Vaults - Kar Kraft Automotive](#)
- Dana Safety Supply [Troy Products CP-GB4430-PB, Storage Vault With Two Draw-Tight Locking Handles And Push-Button Lock, For Trucks/SUVs - Dana Safety Supply](#)
- Guardian Safe and Vault [Truck Gun Safes - Protect What Matters in a Truck Safe](#)

(guardiansafeandvault.com)

- Console Vault [Chevy Console Safe | Chevy Truck Safe | Console Vault](#)
- Forbes <https://www.forbes.com/home-improvement/garage/car-accessories/best-vehicle-gun-safes/>
- Secure Vehicle Solutions <https://securevehiclesolutions.com/>
- Detroit Free Press <https://www.freep.com/story/money/cars/2020/06/13/console-vault-hidden-safe-vehicles/5344304002/>
- Task and Purpose <https://taskandpurpose.com/gear/best-car-gun-safes/>
- Motor Biscuit <https://www.motorbiscuit.com/consider-a-truck-gun-safe/>
- Rockland Custom Products <https://rocklandcustomproducts.com/truck-gun-safes/>
- Ford <https://accessories.ford.com/products/console-vault-floor-vehicle-safe-1>

Respectfully submitted,

/Abigail Sue/  
Abigail Sue  
Examining Attorney  
LO117--LAW OFFICE 117  
(571) 272-9283  
Abigail.Sue@uspto.gov

Tuesday, July 25, 2023

Log in Register About Us Newsroom Staff Careers Submit Letters to the Editor Contact Us



64° F Overcast

Observed from Battle Ground

# The Reflector

Subscribe

The Newspaper With Integrity Since 1909

News - Sports - Life - Opinion - Obituaries - Community Advertising - Subscribe - Send Us News - Q

## The Big One: Is Southwest Washington prepared?

Cascadia earthquake sources

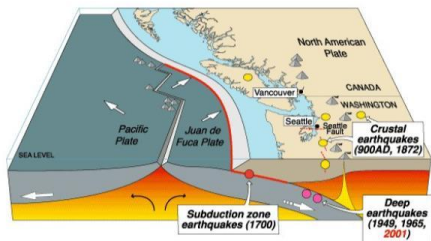

Source	Affected area	Max. Size	Recurrence
● Subduction Zone	W.WA, OR, CA	M 9	500-600 yr
● Deep Juan de Fuca plate	W.WA, OR,	M 7+	30-50 yr

**BATTLE GROUND CINEMA**

Showtimes (360) 666-7200  
1700 SW 9th Avenue | www.BattleGroundCinema.com

Locally owned and operated since 2008!

Barbie  
Mission: Impossible  
The Flash

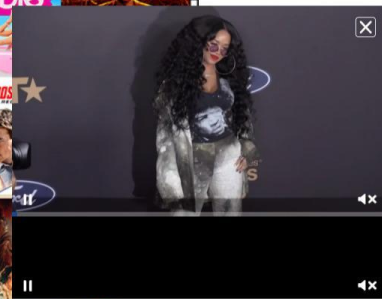

Learn More

Crustal faults WA, OR, CA M 7+ Hundreds of yr?

### The Cascadia Subduction Zone and the earthquakes near the fault over the years.



Posted Monday, August 26, 2019 6:05 am

Cameron Kast/cameron@thereflector.com

Five and a half minutes is about how long it takes to microwave a pot pie or listen to Billy Joel's "Piano Man" once through. It's also how long the intense shaking from the Cascadia Earthquake — often referred to simply as "The Big One" — is expected to last.

Nearly nine years ago, a magnitude 9 earthquake shook the northeastern corner of Japan for close to six full minutes. The March 11, 2011, earthquake with an epicenter near Tohoku destroyed more than 120,000 buildings and, according to Japan's Reconstruction Agency, caused an estimated \$199 billion dollars of damage, making it the most expensive natural disaster in world history.

Experts say a similar earthquake is "overdue" and should be expected to hit the Pacific Northwest within the next century, if not sooner.

Researchers from regional universities, geotechnical engineers and emergency response agencies expect the earthquake to wreak havoc when it hits, bringing about the collapse of roads and bridges and rendering electricity and water infrastructure useless.

Learn More

While some effects from natural disasters are unavoidable, experts are growing increasingly concerned about the lack of preparation by both governing bodies and individuals.

#### A ticking subduction zone

The Pacific Northwest sits on the Cascadia Subduction Zone, which stretches from the north end of Vancouver Island in British Columbia to Cape Mendocino, California, a distance of 620 miles. Cascadia is the meeting point of the smaller Juan de Fuca plate and the large North American plate. As the two tectonic plates converge, one is forced under the other.

This causes the oceanic crust of the Pacific Ocean to move under the continent of North America at a rate of about 40 millimeters (1 1/2 inches) per year.

The 2011 earthquake in Japan was due to this same type of fault line.

Alison Pvrch, an associate geotechnical engineer at Hart Crowder, explained that the deeper an earthquake is the

GET TICKETS \$5 SUPER TUESDAY | ALL MOVIES | EVERY TUESDAY

#### READ THE E-EDITION



The Reflector July 26, 2023

View this issue

Browse other issues

Ad by STAR AMERICA

Introducing Extended Stay America Premier Suites

Extended Stay America Premier Suites

The solution to your car problem.

Think of us as a listing agent for your vehicle. Here, at CarSale, we provide more money for your vehicle! It's simple, we create a 72-hour dealership bidding war.

360-778-7424 | info@carsale.com  
1499 SE Tech Center Dr Suite 270  
Hillsboro, OR 97123  
www.carsale.com

#### MORE LOCAL NEWS



#### World War II re-enactors provide a taste of life at Fort Vancouver

World War II reenactors brought their own equipment and wore their own uniforms to provide a glimpse of what Fort Vancouver would have looked like during that time period on Saturday, July 22, ...



longer it causes shaking at the surface. The creates a much higher potential for damage. A 30-second earthquake usually reaches a 7 or higher on the Richter scale, while a two-minute quake reaches an 8 or higher. By four minutes, an earthquake is at 9.0.

Along with depth, seismologists use the size of crustal breaks to indicate how powerful an earthquake could be. The 1989 Loma Prieta, California, earthquake had a magnitude of 6.9, enough to cause more than \$6 billion in damage and kill 63 people. Loma Prieta sits on one of the most well-known and studied fault lines in the United States, the San Andreas Fault. According to the United States Geological Survey, the San Andreas Fault is capable of producing an earthquake no larger than a magnitude 8.3 due to its close proximity to both the surface (10 to 12 miles deep) and the size of crust that can break during an earthquake on the San Andres.

[Learn More](#)



More than 40 miles below the earth's crust, the Juan de Fuca plate is moving under North America and melting into the earth. However, around 30 miles down, the North American plate is stuck, causing pressure to build up underneath the surface of the earth. As the Juan de Fuca plate continues to move, the North American plate gets put under more pressure. Eventually, the pressure will become too much and the North American plate will snap upward, much like a breaking rubber band. Since the Cascadia Subduction Zone sits anywhere from 7 to 18 miles deeper than the San Andreas, if the entire plate breaks off, an earthquake larger than a 9.0 is more than likely.

"Geology works on a really long time scale, and we've been around for an eyelash of that really long time scale," Pyrch said at "Science on Tap," a seminar on earthquakes at Kiggins Theatre last month.

Pyrch explained how due to this larger-than-life timescale developing exact data on where and when an earthquake will happen is not possible.

Pyrch said the only way to make a prediction is to look at history. On average, a rupture in the Cascadia Subduction Zone happens once every 243 years, putting it around 75 years overdue. A large scale earthquake hasn't happened since January 26, 1700, 76 years before the Declaration of Independence was signed.

Seismologists and geologists are able to determine these estimates by looking at the limestone of the seafloor and comparing it with the highly documented tsunami records of Japan. Before 1700, there was about a 780-year gap between the Cascadia earthquakes (920 to January 26, 1700).

According to an Oregon State University research team led by marine biologist Chris Goldfinger, throughout the past 10,000 years there have been at least 41 earthquakes on the Cascadia Fault Zone with 19 being a "full margin rupture" where the entire zone snaps.

Goldfinger said there's a 33% chance of this "megaquake" hitting the Pacific Northwest in the next 50 years.

"Perhaps more striking than the probability numbers is that we can now say that we have already gone longer without an earthquake than 75% of the known times between earthquakes in the last 10,000 years," Goldfinger said in a statement earlier this summer. "And 50 years from now, that number will rise to 85 percent."

[Learn More](#)

#### What a quake will look like

Portland, Oregon, Oregon



Transportation crews on Interstate 5 and in nighttime work will he

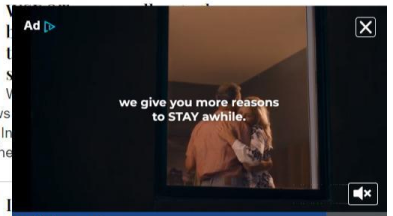

#### until the 2060s

One of the largest sources of funding to replace the aging Interstate 5 bridge over the Columbia River will tax travelers a few bucks as they cross the water. During its meeting July 18, the ...



#### Death of Oregon woman discovered in Ridgefield not currently linked to other cases

The death of 32-year-old Joanna Speaks, of Oregon, hasn't been connected to the deaths of four other area women where the Multnomah County District Attorney's Office found links, the ...



#### Uncertainty over tax

apartment complex o seeking a property ta city leaders still have plan ...



[More Local News](#)

#### OBITUARIES



Pyrch says the Pacific Northwest is not at all prepared for an earthquake of this magnitude. She rates cities such as Portland at a 2.5 to 3 on a scale of 10 in terms of preparedness.

“Our biggest lack is public education and public preparedness,” she said.

Pyrch says populations around the world that are accustomed to a lack of electricity and water are significantly more prepared for a disaster such as an earthquake.

Pyrch offered Mexico and Japan as examples of countries well prepared in 2019. Both countries have earthquake early warning systems and a large culture built around the idea that a quake could hit at any moment.

“If people are prepared for an event and they know it’s going to happen and they are educated, they are significantly better when it comes to handling an event,” she said. “As it is, we are not prepared simply because our society will not be bouncing back as quickly because we depend on all those utilities.”

Pyrch’s second problem with preparedness in the region is infrastructure. If the “Big One” were to hit this year, she believes most of the transportation hubs — land, sea and air — would all be compromised. Along with this, she mentioned that there will be significant landslide damage as well as the explosion of natural gas and liquid fuel lines and ruptured water pipes.

Liquid fuel in Southwest Washington is refined in the Seattle-Tacoma area and is transported through a pipeline that is “not seismically sound,” Pyrch said. She added that fuel for the area is stored near the Willamette River where there is an expected movement of 25 feet. The spread of fire is also a major concern given that many of the water lines will likely break, Pyrch said.

[Learn More](#)



Pyrch noted how most of the electricity in the area is supplied by the Bonneville Power Administration. If its power and energy network falls due to an earthquake, power in the area is expected to go out for an indefinite period of time.

“We are spoiled and we expect everything to work on demand,” she said. “Our society does not function without running water, electricity and our cellphones and communication networks working.”

In her seminar, Pyrch said soils in the Pacific Northwest are subject to liquefaction, the process of soils with a large water content losing strength due to a strongly applied force such as an earthquake. Under this force, sand and mud sink into the ground causing the buildings and structures on top of them to follow. Pyrch said soil underneath large economic hubs such as the Interstate 5 Bridge, the Glenn Jackson Bridge and the Portland International Airport all sit on liquefiable soil.

Pyrch expanded on liquefaction damage in a followup interview, explaining that the I-5 Bridge is “pretty much toast” if a large earthquake were to hit, but the bridge across I-205 might be salvageable.

“From what I understand there is a chance that it will be repairable,” Pyrch said about I-205, adding that while it



### Death notices, July 26, 2023

Carol Maurits, 80, of Vancouver, passed away on July 18, 2023, in Vancouver. The funeral home is Northwood Park Funeral Home & Cemetery, 360-574-4252. Susan Chenette, 69, of ...



[More obituaries](#)





might be repairable, it will not be a structure people are going to be able to drive over immediately.

The destruction of these bridges and economic trade hubs such as the Port of Portland and Portland International Airport (PDX) is expected to dramatically impact the surrounding area's economy.

"One of the points of the (2011) Japan earthquake was that their economy took a big hit. In fact, the world economy took a big hit," Pyrch said while explaining that one of the reasons the area needs to get ready for an earthquake is the fact that not everybody is going to die in the initial shock of the quake. Most people will survive, and building infrastructure for that survival period is key to withstanding the earthquake, she said.

[Learn More](#)

### Preparing

Timothy "T.J." Miller, of Battle Ground, has a degree in power systems and works for BPA. He echoed Pyrch's statements while pointing to the solar panels and generators he has installed in his earthquake-proof shop.

"The irony of it is that I work for the power grid and yet I have solar and a generator because I know the grid is going down," he said.

Miller has spent nearly his whole life preparing for disaster to strike.

"I don't really know what made me want to be a survivalist other than the fact that I have five sisters and my mom always said, 'you're the man of the house, you're going to have to protect your sisters,'" he said. "I grew up in fear that I wouldn't be able to protect (them). It's an overcompensated thing about me and I can't help it."

Miller built a shop on his property for his business, Silenced Weapons. The shop doubles as his survival shelter, and he said it is structurally sound and can withstand an earthquake.

"This shop is built better than any of the houses around here," he said. "The inspector said if we were to have the subduction zone earthquake, all the houses (nearby) would be gone and this shop would still be here."

Miller believes a lack of food, water and shelter will be the biggest problems facing citizens in the Clark County area if disaster were to strike. He suggests bolting down everything in houses and shops and having enough food and water to sustain yourself and dependents.

"Water, water, water," Miller said when asked about what he feels is the most important thing people can do to prepare.

Miller's shop is equipped with a two-year supply of food and water for him and his wife. Some of his equipment includes a

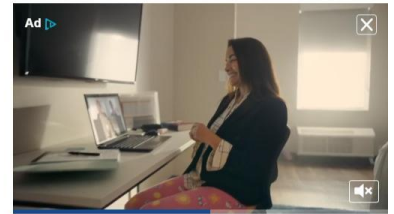
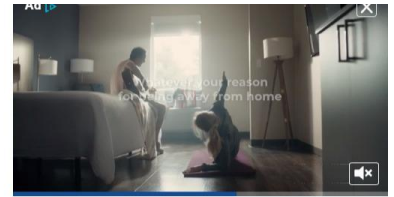

[Learn More](#)



### Government to pay Camp Lejeune victims \$21 billion

Camp Lejeune Water Claims

[Sign Up](#)

SPONSORED LINK BY TABoola



...water for him and his wife. Some of his equipment includes a sun oven, more than 10,000 gallons of fresh water and a system to brew his own beer.

"Some people say it's not a key part of preparedness, but I think it is," Miller said as he opened a door in the back of his shop revealing a home brewery where he makes India Pale Ale.

Also in Miller's shop is an old ambulance from the Los Angeles Police Department that he is renovating to be a disaster vehicle complete with a few days worth of food, a fire ax and a truck vault, something he builds to securely store items in a vehicle. Also equipped with a truck vault is Miller's Jeep Wrangler, which has everything from a snorkeling system to an air compressor.

"It's got everything I think people should have on their car in case of a disaster," Miller said before pulling out the truck vault containing a flare gun, hiking equipment and enough food and water to survive for a week. Miller said a lot of the ideas for his Jeep came after he experienced the 1989 Loma Prieta earthquake and realized how unprepared people in the area were.

"The only thing that made it out of the city were the 4-by-4's," Miller said.

While Miller and his wife may be prepared if the Cascadia Subduction Earthquake were to strike, a good majority of the Clark County and the Portland Metro Area has not started preparing. Pyrch believes this lack of preparedness can be changed by working together to build an "earthquake culture."

[Learn More](#)



While Miller may have a two-year supply of food, Savannah Brehmer of the Federal Emergency Management Agency (FEMA) recommends having a minimum of 72 hours, but encourages a supply of up to two weeks of food, water and necessary medicine.

"We also recommend people know their community because if you know them in advance, it's going to help out in terms of sharing resources," Brehmer said. "Resources may be spread thin in the event of an earthquake."

FEMA's website outlines a three-step plan citizens should have to prepare themselves for disaster. First, protect yourself before an earthquake. To do this, FEMA recommends practicing what to do during in an earthquake, gathering critical documents and building a preparedness kit that lasts at least three days. Second, protect yourself during an earthquake and drop, cover and hold on. Lastly, protect yourself after an earthquake by monitoring local news reports, exiting damaged buildings and staying away from damaged areas. If your home has been damaged after a disaster or is no longer safe and you need a place to stay, text SHELTER and your ZIP code to 43362 to find the nearest public shelter in the area.

Pyrch recommends doing everything possible to secure your home, such as strapping it to the foundation and knowing how to turn off the gas and water lines leading to your home. "Make sure your home is safe and somewhere you can be for two to four weeks without help," Pyrch said. Along with this, he recommends building emergency lists and getting what you need whenever you're at the grocery store.

"If you have an extra five bucks, get that extra gallon of water," she said.



If you are in your car, get out and get out of there," she said.

Eric Frank, the Public Information Officer of the Clark Regional Emergency Services Agency (CRESA), recommends doing all of the above and repeating it for your workplace and your vehicle, mentioning how not everyone will be at home when disaster strikes.

[Learn More](#)



### Building an 'Earthquake Culture'

During "Science on Tap" and in subsequent interviews, Pyrch stressed the importance of building a culture around preparedness for earthquakes. This culture, dubbed "earthquake culture," revolves around education about earthquakes and the substantial followup damage they will cause.

"Educate yourself and your neighbors because until we are educated about the problem, we

are not going to make any progress," Pyrch said. "Until it is a priority within our society and in our communities to be ready to handle a large earthquake, we are not going to be ready."

To discuss this "earthquake culture" Pyrch uses the example of other countries such as Japan and Mexico around the Pacific Ring of Fire that she believes are prepared if disaster were to strike tomorrow. She mentioned activities such as occasional statewide earthquake drills.

"They can evacuate a building in under two minutes," Pyrch explained.

She later used the example of a fire drill at a public high school to show how unprepared the United States is in terms of a disaster.

"Do adults make it out in two minutes?" she asked.

Pyrch pressed the need for educating yourself, your family and your neighbors about the importance of preparing for an earthquake, something CRESA believes to be just as important as building your own personal disaster kit.

"Having the mindset (for disaster) is the biggest piece," Frank said. "A positive attitude and connecting with your neighbors ... are what is going to make our communities stronger and more disaster-resilient."

[Learn More](#)



Frank noted that images from recent disasters show neighbors helping neighbors, not first responders in uniform.

Frank said connecting with neighbors before a disaster is important because the area as we know it will end up with fractured roads and downed bridges, making it harder for first responders to reach disaster sites.

"It's going to be neighbors relying on each other for the first few hours and days of a disaster until we (emergency response) can make that connection again," Frank said.





CRESA Emergency Management Division Manager Scott Johnson said, in the past, the government had hard-set plans for if disaster were to strike.

“From about 1945 up until 2005, there was an idea that governments should have very detailed plans that covered every aspect of every potential thing that could go wrong,” Johnson said. “We had a very, very detailed earthquake plan and a very, very detailed flood plan.”

Now, Johnson said governments and emergency response agencies have changed their mindset from hard fixed plans to the concept of “planning” because putting emergency plans in hardset “silos” can cause confusion about which plan to use during a disaster.

“Planning is a concept that revolves around looking at what is actually going on and the impact it has on people’s life safety, the severity of the incident and the impact to our key infrastructure,” Johnson said. “Our plans have gotten much more flexible. Our plans have gotten much more responsive. That allows us to deal with things more effectively but it also means that we need a more informed and engaged citizenry because we need you (citizens) to buy us time to assess what is going on.”

Johnson and Frank recommend taking classes, building a community with neighbors and reminding elected officials to prepare for disaster before it strikes.

[Learn More](#)

“It takes educated community members to remind our elected officials all the time that this is an important topic,” Frank said.

Brehmer repeated CRESA’s thoughts about becoming more educated and even suggested talking to Community Emergency Response Teams (CERT) in the area. The CERT program educates volunteers about disaster preparedness for hazards that might impact the area, such as earthquakes. The CERT program also trains volunteers in basic disaster response skills, such as fire safety, light search and rescue, team organization and disaster medical operations.

Amanda Siok, the earthquake contact for FEMA Region X (Alaska, Idaho, Oregon and Washington), also highlighted the importance of individually preparing and gaining these skills and the impact they have on the community.

“It is really important that the public prepares themselves because the less prepared individuals are, the less prepared the community as a whole will be,” Siok concluded.



### Comments

NO COMMENTS ON THIS ITEM [PLEASE LOG IN TO COMMENT BY CLICKING HERE](#)

### OTHER ITEMS THAT MAY INTEREST YOU



Learn More



World War II re-enactors provide a taste of life at Fort Vancouver



WSDOT says goodbye to the bumpy road conditions near the Interstate 5 and I-205 split near Salmon Creek



I-5 bridge tolling could last until the 2060s



Death of Oregon woman discovered in Ridgefield not currently linked to other cases

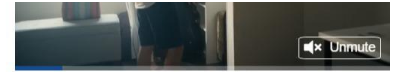

Special Discount -30%

MICHAEL KORS



Michael Kors Oversized Brecken Logo and Silver-Tone Watch Blue...

\$192.50 - Michael Kors | Sponsored

Shop now

MICHAEL KORS



Michael Kors Greyson Logo Sling Pack Black One Size

\$298.00 - Michael Kors | Sponsored

Shop now

MICHAEL KORS



Michael Kors Parker Stretch-Denim Jeans Grey 36X32

\$108.00 - Michael Kors | Sponsored

Shop now

Taboola Feed

Learn More



Government to pay Camp Lejeune victims \$21 billion

Veterans, their surviving family members, and civilians who lived or worked at Camp Lejeune can ...

Camp Lejeune Water Claims | Sponsored

Sign Up



Search For Injection Treatment For WetAMD

Macular Degeneration Treatments | Yahoo Search | Sponsored

Learn More





### Research Teeth Whiten Toothpastes Buy Online

Teeth Whitening Tool... | Sponsored [Learn More](#)



### Alexandria: Unsold BMW X7s Are Almost Being Given Away (See...

BMW Deals | Sponsored



### Incredible Electric Cars for Seniors. See Top Searches

Electric Cars | Search... | Sponsored [Learn More](#)

[Learn More](#)



### Here's How To Fly Business Class For The Price of Economy

Business Flight Deals | Sponsored



### Here Are 7 Legal Discounts Seniors Get Only If They Ask

Great list of discounts and benefits for seniors in 2023.

Senior Discounts By National Penny | Sponsored

[Learn More](#)



### Empty Alaska Cruise Cabins Cost Almost Nothing

Alaska Cruise Deals | Sponsored



### Find The Best Results For Concrete Leveling Companies Ne...

Want to learn more about concrete leveling companies near me? Browse ...

Yahoo Search | Concre... | Sponsored [Search Now](#)



### This Morning Breakfast Method Dumps Unwanted Pounds Like...

Here is a simple morning breakfast juice method to boost metabolism and drop ...

Health Truth Finder | Sponsored [Learn More](#)

[Learn More](#)





**Ridgefield School District welcomes new assistant principal**

The Reflector



**Battle Ground teen starts lawn mowing business**

The Reflector

**Unsold Diamond Rings So Cheap They're Almost Being Given Away**

Diamond Ring Deals | Search Ads | Sponsored

**The Killer New X5 SUV Is Close To Perfection (Take A Look)**

New BMW Deals | Sponsored

**New 2023 Lincoln - Clearance Sales Happening Now**

Find huge savings on Lincoln now

Lincoln Deals | Sponsored

[Click Here](#)



# THE MOST SECURE WEAPONS VAULT AVAILABLE

CONTACT US TODAY





## Why do you need a Vehicle Mounted Secure Weapons Vault?

Performance Custom Cabinets provide gun owners with a secure, portable solution for transporting their firearms. For both legal and practical reasons, you need safe storage for your guns when you travel. Even with a concealed carry permit, many places still prohibit guns. You need to be able to protect your valuable firearms while you go to church or run into the post office, or anywhere else carrying your gun is not permitted.

We provide solutions for law enforcement, fire/EMS, sportsmen, tradesmen, and more. Customize a cabinet for your vehicle with us for the ultimate in security, protection, quality, organization, and peace of mind.

**We are proud to be the ONLY  
Vehicle Mounted Secure  
Weapons Vault to be tested &  
recommended by the National  
Tactical Officers Association!**

[> About the NTOA](#)





**Safeguarded Access.  
Protected Transport.  
Keyless Entry Options.**

[> Contact Us](#)





*"...the best security weapon vault system I've seen in 43 years  
of law enforcement..."*

Sheriff Ron Stovall



*"...I can't think of a better way of securing our equipment..."*

C. D. King, Major

[READ MORE](#)



**SECURE VEHICLE SOLUTIONS**

# SATISFACTION GUARANTEED



Call us today  
**(804) 382-3870**

or

**CONTACT US TODAY**



## **Performance Custom Cabinets**

3573 Archers Ridge  
Powhatan, VA 23139

Office: (804) 382-3870  
Fax: (804) 598-2323

## **About**

As a family run business we are committed to our customer's total satisfaction. We take pride in our work, our products and our reputation.



Our Reviews  
★★★★★



[Email Us](#)

[VEHICLES](#) [LAW ENFORCEMENT](#) [FIRE / EMS](#) [SPORT / PERSONAL](#) [GALLERIES](#) [TESTIMONIALS](#) [CONTACT](#)

©2020 Performance Custom Cabinets, LLC



MARKETPLACE  
Search For & Place Classifieds

SUBSCRIBE NOW  
\$1 for the rest of the year

News Sports Autos Entertainment Advertise Obituaries eNewspaper Legals 76°F Search Subscribe Sign In

Advertisement - scroll for more content



Eastwood® Official  
Eastwood

AUTOS

## Hidden vault concealing guns and money is hot-selling accessory for pickups, SUVs



**Phoebe Wall Howard**  
Detroit Free Press

Published 6:04 a.m. ET June 13, 2020 | Updated 8:39 a.m. ET June 13, 2020

View Comments



CLOSE X

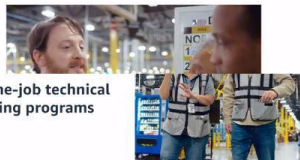

on-the-job technical training programs

Advertisement



The 5-second

AD | 0:17 SKIP

**Use code MOA100 for 10% off**

Mark Tuttle of Grandville loves removing the doors and top from his 2016 Jeep Wrangler and heading into the woods of Michigan for a weekend of hammock camping. It used to be, when he stopped at a gas station to grab a Payday candy bar, he left his belongings totally exposed.

"My vehicle is accessible to anybody who walks by," he said. "Anybody that wants to can walk up and take anything. Most of the time that's not a problem, but I'm not going to leave my wallet or phone or a handgun accessible."

So, he started looking for "something secure" and made a discovery: a hidden 12-gauge cold-rolled plate steel safe that's bolted inside the center console between his two front seats. The secret hiding place is designed to protect money, phones, credit cards, handguns or anything of value.



coffee

**TRY IT**

**More Stories**

- Ethan Crumbley doesn't want bodies of Oxford school shooting victims... NEWS
- Beyoncé's Renaissance tour comes to Detroit's Ford Field: Everything you need... ENTERTAINMENT
- Empty Alaska Cruise Cabins Cost Almost Nothing Alaska Cruise... | Sponsored Links

*We're always working to improve your experience. Let us know what you think.*

Advertisement

2023 Tiguan

**1.9% APR** for 36 months

For highly qualified customers through Volkswagen Credit.

[View offer details](#)

Offers Visit our dealerships in the Washington DC area.



Mark Tuttle, 55, of Grandville, Michigan, has a secret vault in his 2016 Jeep Wrangler and now, he said, so do most of his friends. He is pictured here at Silver Lake Sand Dunes in 2017. *Brenda Tuttle*

"I installed it myself, in the center console, underneath the armrest," said Tuttle, who works for an auto parts supplier. "Several people have bought them because of mine. They all had Wranglers. Every time you'd get out of the Jeep, you've got to grab everything of value and stuff it in your pockets and take it with you."

Advertisement

**1.9% APR** for 36 months  
For highly qualified customers through Volkswagen Credit.

[View offer details](#)

[Offers](#) Visit our dealerships in the Washington DC area.



Advertisement





Tuttle isn't alone.

In 2020, Columbus-based Console **Vault** expects to see its most profitable year in nearly two decades. Co-founder Scott Bonvissuto said people are more focused in recent months on personal safety and securing weapons in compliance with increasingly popular conceal carry laws.

"We have seen a significant trajectory in orders of the in-vehicle safe over 2019 due to the impact of COVID-19 and the increase of firearms sales since the quarantine," he said.

Advertisement



In fact, gun sales in the U.S. have surged, according to national data.

The FBI said it did 3.7 million background checks for firearm purchases in March, the most ever recorded in a single month by the bureau — exceeding sales in March 2019 by more than 1 million, according to USA Today.

Customers in Texas, California and Florida are purchasing the most **vaults** — for their Ford F-150 pickups, Ram Trucks and Chevy Silverados.



\$1 FOR THE REST OF THE YEAR

Here for keeping **our community** connected.

SUBSCRIBE NOW

Detroit Free Press



Advertisement

2023 Tiguan

**1.9% APR** for 36 months

For highly qualified customers through Volkswagen Credit.

As other companies have caught on to the trendy vehicle accessory, an estimated

			
\$329.99	\$38.99	\$15.99	\$47.99

Eastwood® Official  
Eastwood

AUTOS

# Hidden vault concealing guns and money is hot-selling accessory for pickups, SUVs

**Phoebe Wall Howard**  
Detroit Free Press

Published 6:04 a.m. ET June 13, 2020 | Updated 8:39 a.m. ET June 13, 2020

View Comments

CLOSE X



health care on day one

Scott Bonvissuto, co-founder of Console Vault, tucks a handgun into a steel vault secured to a 2016 Ford F-150. This photo was taken in Cedar City, Utah on Feb. 12, 2016. Console Vault

Advertisement

**1.9% APR** for 36 months

For highly qualified customers through Volkswagen Credit.

Console **Vault**, a trademarked brand like Kleenex tissue or Band-Aid adhesive strips, expects to sell more than 200,000 safes annually by 2024.

Ford and Toyota dealerships sell **vaults** to people who take them home to install themselves. Yet owners often buy directly from the company at a cost ranging from \$250 to \$350, depending on size of vehicle and whether the owner wants a key or combination lock.

Advertisement



The **vaults** are designed to fit most major truck and SUV brands, including Cadillac, Dodge, GMC, Lincoln, Nissan, Subaru and Volkswagen. They also have security **vaults** for a handful of passenger cars including the Dodge Charger, the Ford Fusion and the Toyota Camry. Harley Davidson is brand new.

Other companies create safes for many uses but Console **Vault** actually meets or exceeds strict specifications required by auto manufacturers for in-vehicle use only.

Law enforcement officers who buy the **vault** praise its easy installation and bolt design.

"When we first developed this, we were the only game in town," Bonvissuto said. "We'd do a trade show and people would say, 'Omigod. Where have you been all

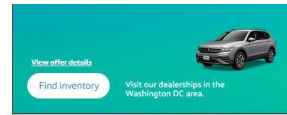

Advertisement



my life?' Now, fast forward to current times, other companies have caught on. We rely on our innovative engineering design and reputation for detail. A Chevy **vault** will not fit in a Ford and a Ford **vault** will not fit in a Chevy."

The initial idea for the company came from working with Rolls-Royce owners who wanted to protect their valuables.

"Console **Vault** is an ingenious lock box," product critic Maxwell Matthewson wrote for [offgridweb.com](http://offgridweb.com), a magazine about urban survival and preparation, on Sept. 22, 2019.

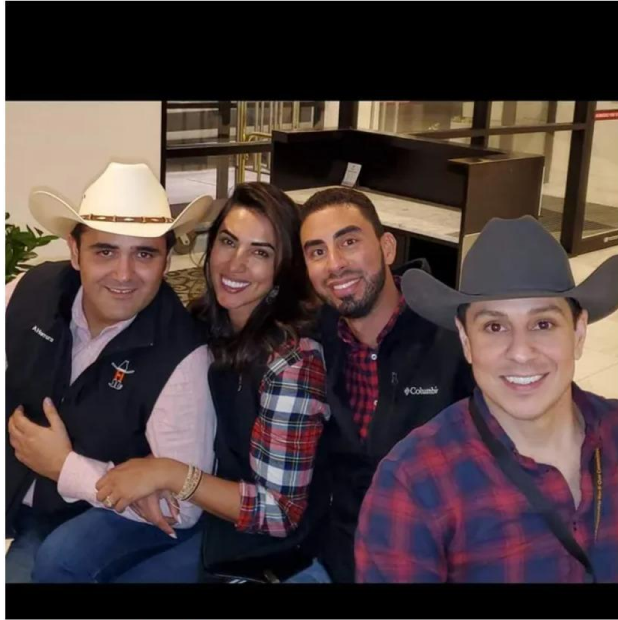

Armando Herrera and his fiancée, Erika Licon, far left, installed a security vault in their Toyota Tundra. Herrera and Licon

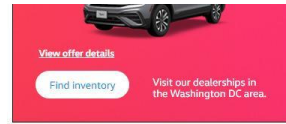

View offer details

Find inventory

Visit our dealerships in the Washington DC area.



2023 Tiguan

**1.9% APR**  
for 36 months

For highly qualified customers through Volkswagen Credit.

View offer details

Find inventory

Visit our dealerships in the Washington DC area.



2023 Tiguan

**1.9% APR**  
for 36 months

attend the Houston Livestock Show and Rodeo Bar-B-Que Cook-Off competition on March 2 with Larry Grajales and O.J. Lozano. [Erika Licon](#)

## Chewing gum risk

Women make up a growing portion of the **vault** buyers.

Erika Licon, 37, a small business owner in Houston, Texas, said she went to a charity auction and noticed the secret **vault** was an item for bid. She went home and did a little research, ordered one and surprised her fiance by installing it herself in their 2019 Toyota Tundra.

Advertisement

"My fiance carries a gun, so we had it for that," she said. "But, in my line of business, I carry a lot of important documents, like passports. You always want personal documents locked in your car. You have no idea how many people have their backpacks stolen from their car, whether they just run in to grab a Subway sandwich or go inside the gas station for a pack of gum."



For highly qualified customers through Volkswagen Credit.



[View offer details](#)

[Find inventory](#)

Visit our dealerships in the Washington DC area.



2023 Tiguan

**1.9% APR**

for 36 months

For highly qualified customers through Volkswagen Credit.



[View offer details](#)



Scott Bonvissuto, co-founder of Columbus-based Console Vault, is pictured here Tuesday in his 2019 Ford F-150 pickup. He is seeing a surge in business since COVID-19. The vault is popular among pickup truck and SUV owners. *Jordan Mescher*

### Smash test

Bonvissuto, 56, grew up in Cleveland the son of a civil engineer and an office manager. He is a street smart car guy who started out selling running boards, spoilers and pinstriping. He figured out what people wanted and needed, then built up his company focusing on security. He said customers tell him guns are increasingly common and they want a solution for when they can't carry their firearms, especially when going into schools, courthouses, post offices and fitness centers.

"We do a destructive test," Bonvissuto said. "How long does it take you to break in? We use several different tools like a car thief would use. We have a hammer, a crow bar, a screwdriver, a wrench. We tell our engineer to take this 5-pound sledgehammer and how long does it take you? Or a crowbar and try to pry open the lid. We're testing our own product. We'll try and think like a thief. What kind of tools does a smash-and-grab thief carry?"

Advertisement

[Find inventory](#) Visit our dealerships in the Washington DC area.

2023 Tiguan

**1.9% APR**  
for 36 months

For highly qualified customers through Volkswagen Credit.



[View offer details](#)

[Find inventory](#) Visit our dealerships in the Washington DC area.

2023 Tiguan

**1.9% APR**  
for 36 months

For highly qualified customers through Volkswagen Credit.



The core buyer of the **vault**, based on the company's last demographic study, is a sportsman between 35 and 55 with an income of \$125,000 or more, Bonvissuto said.

"The concealed carry community gravitates to us. Women fall into the group more than ever," he said.

### Goodbye, stress

James "Chris" Nicola, 60, of Austin, Texas, is a retired Houston police officer who works as a security adviser and recommends the covert safe to ease anxiety — especially for men and women carrying handguns, who are increasingly common.

"You just don't have to worry," said Nicola, who has led safety classes for license to carry.

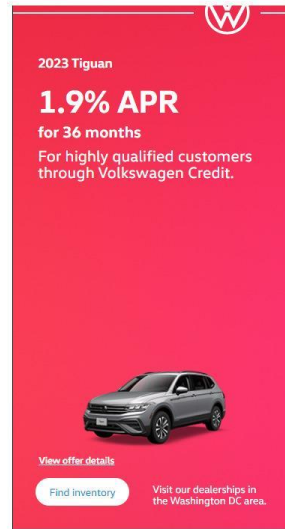
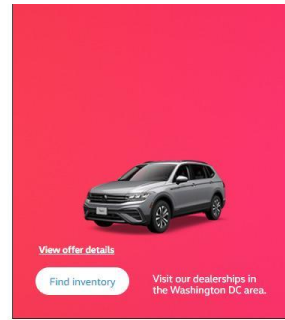



Tim Dye, 47, an Ohio law enforcement officer, installed a steel vault on his 2018 Harley Davidson Ultra Classic Limited, as well as his 2006 Dodge Ram Truck, to hide valuables. Joe McCleese

Tim Dye, 47, a law enforcement officer in Delaware County, Ohio, installed a **vault** on his 2018 Harley Davidson Ultra Classic Limited. Before that, he had one in his 2006 Dodge Ram pickup.

"Normally you get a simple box from Walmart, Meijer or a local gun shop and you put it in the back of your truck or a saddle bag. It's not secure, just setting there," he said.

Advertisement

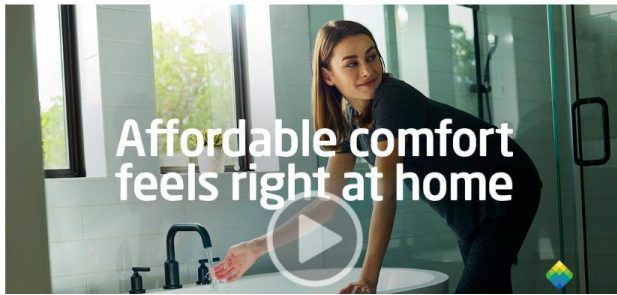

2023 Tiguan

**1.9% APR**  
for 36 months

For highly qualified customers through Volkswagen Credit.



View offer details

Find inventory

Visit our dealerships in the Washington DC area.

2023 Tiguan

**1.9% APR**  
for 36 months

For highly qualified customers through Volkswagen Credit.



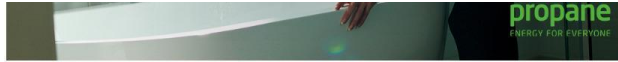

"The first thought people have is just put things in your glovebox," he said. "But they can take a screwdriver and pop that — and get your gun. Now a criminal has your gun. But this is not just for firearms. When you go to the beach, you don't want to take your wallet or your cell phone. And it's there when you get back."

**More:** [Michigan car concierge's quiet business is now getting calls from around the country](#)

**More:** [One car color projects gutsy sense of style, 'unpretentious' confidence](#)

**More:** [Ford predicts new Bronco will eat Jeep's lunch, lure customers from FCA](#)

### Kayaking, Hunting, Hiking

Marianna Magyar, 46, a high school teacher in Madera, California, does product reviews on the YouTube channel Hun.tress.308 — a nod to her Hungarian heritage. Console **Vault** sent her a safe to try out and she loved it so much she made a video in May; the response from consumers has been overwhelming.

Advertisement



**One size fits all**

Volkswagen logo, 2023 Atlas V6 SEL Premium #1 Line with 360° View

[Find a dealer](#)



[View offer details](#)

[Find inventory](#)

Visit our dealerships in the Washington DC area.



2023 Tiguan

**1.9% APR**

for 36 months

For highly qualified customers through Volkswagen Credit.



[View offer details](#)

[Find inventory](#)

Visit our dealerships in the Washington DC area.



"What I love is that nobody knows it's there," she said. "I have this big armrest in the middle, you can fold it up and it looks just like a seat. But then you open that up and it's where the console is. If I'm just trying to get out and about and go for a hike, I don't want to take my phone or my wallet. But you want things to be out of sight."

**More:** [Why Ford is heating inside of police SUVs to 133 degrees](#)

**More:** [She's the engineer behind eye-popping invention in GM's newest SUVs](#)

**More:** [GM engineers hid secret tailgate in storage room for 2 years](#)



**The Tiguan**  
with Blind Spot Monitor



View any info. 2023 Tiguan SEL R-Line with 4MOTION® in Opal White shown.

[Find inventory](#)



**The Tiguan**  
with Blind Spot Monitor



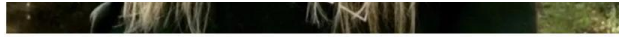

Marianna Magyar, 46, of Madera, Calif., is an adventurer whose hobbies include hunting and hiking. She has a license to carry a gun and stores her weapons and other valuables in her console vault in her 2014 Ford F-150. *Marianna Magyar*

Magyar said she took 5 to 7 minutes to install the **vault**, and uses it most often when she's camping and hunting and kayaking. She loved the product so much, she asked the company if she could become an ambassador. Now she has an arrangement where she can receive a percentage of her referrals.

Advertisement

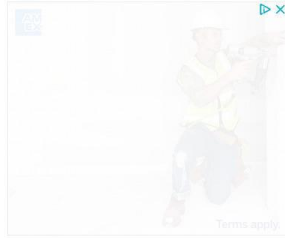

The Free Press asked to interview her after seeing the video review, Magyar was not initially suggested for the story by the company.

"All these Facebook pages and different groups, people loved it," she said. "I had men say they had a lock box but this is better. You have men who carry guns and these tomboy girls in Montana and driving trucks and hunting. I have it for my 2014 Ford F-150 Ecoboost. I'm part of a lot of groups with women hunters. They say this solves a lot of problems."

Contact Phoebe Wall Howard at 313-222-6512 or [orphoward@freepress.com](mailto:orphoward@freepress.com). Follow her on Twitter [@phoebesaid](https://twitter.com/phoebesaid). Sign up for our [autos newsletter](#).

View key info, 2023 Tiguan SEL R-Line with 4MOTION® in Opal White shown

Find Inventory



**The Tiguan**  
with Blind Spot Monitor



View key info, 2023 Tiguan SEL R-Line with 4MOTION® in Opal White shown

Find Inventory



**By your side when**

[View Comments](#)



Taboola Feed



**Empty Alaska Cruise Cabins Cost Almost Nothing**

[Alaska Cruise Deals](#) | [Ad](#)



**Cardiologist: Too Much Belly Fat? Do This Before Bed**

[Healthy Guru](#) | [Ad](#)

[Watch Now](#)



**Unsold Diamond Rings So Cheap They're Almost Being Given Away**

[Diamond Ring Deals](#) | [Search ...](#) | [Ad](#)



**No Appointment? No Problem - Upgrade to the World's Smartest CPAP Without Leaving Home**

[The Easy Blog by EasyBreat...](#) | [Ad](#)



**The Killer New X5 SUV Is Close To Perfection (Take A Look)**

[New BMW Deals](#) | [Ad](#)



**Here's How To Fly Business Class For The Price of Economy**

[Business Flight Deals](#) | [Ad](#)



**This Year's Kia Lineup Is Turning Heads -- And Finally On Sale!**

[Best Kia Deals Search](#) | [Ad](#)



**This Is How Much A New Roof Should Cost In 2023**

[Home Repair](#) | [Ad](#)

**you need it**



View key info, 2023 Tiguan SEL R-Line with 4MOTION® In Opal White shown

[Find inventory](#)



**By your side when you need it**



[Best Air Deals](#) | [Search Ads](#) | [Ad](#)

[Learn More](#)

[Home Goods](#) | [Ad](#)

[Learn More](#)



**Traeger Blaze & American Grills On Sale**  
Best Selling Grills | [Ad](#)

[Learn More](#)



**Upgrade Your CPAP Machine Today without Leaving Your Home**  
The Easy Blog by EasyBreathe.com | [Ad](#)



View key info, 2023 Tiguan SEL R-Line with 4MOTION® in Opal White shown

[Find inventory](#)

### Deal of the Day



**Smartphones Are On Sale At Tello Right Now—Save Up To \$60 On iPhones**

Buy a prepaid Tello phone, with no strings attached. Add a customized phone plan and enjoy great wireless savings. USA TODAY Network.

[View Deal](#)

Recommendations are independently chosen by our editors. Purchases you make through our links may earn us a commission.

### Recommended



**Ethan Crumbley doesn't want bodies of Oxford school shooting victims shown at hearing**  
NEWS



**By your side when you need it**

View key info, 2023 Tiguan SEL R-Line with 4MOTION® in Opal White shown

[Find inventory](#)

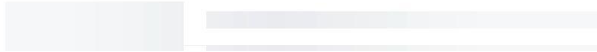

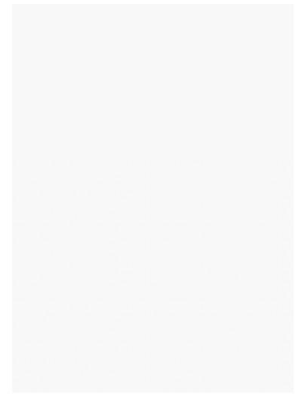
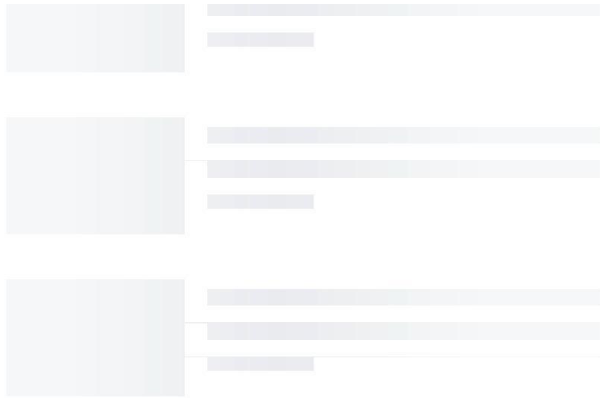

Part of the USA TODAY Network

**About**

- Staff Directory
- Careers
- Accessibility Support
- Site Map
- Legals
- Our Ethical Principles
- Subscription Terms & Conditions
- Terms of Service
- Privacy Policy

**Do Not Sell / Share / Target My Info**

**Support**

- Contact Us
- Support Local Businesses
- Advertise Your Business
- Advertising Terms and Conditions
- Buy and Sell
- Licensing & Reprints
- Help Center
- Subscriber Guide
- My Account
- Give Feedback

**Stay Connected**

- Subscribe Today
- Newsletters
- Mobile Apps
- Facebook
- Twitter
- eNewspaper
- Storytellers
- Archives
- RSS Feeds

**Our Partners**

- Jobs
- Cars
- Classifieds
- Education
- Renvy.com
- Michigan.com
- Reviewed
- 10Best
- LocalIQ Digital Marketing Solutions

© 2020 USA TODAY NETWORK, L.P.



## Subscribe to Task & Purpose Today

Get the latest in military news, entertainment and gear in your inbox daily.

JOIN NOW

TASK & PURPOSE

LINKS

[About Task & Purpose](#) [Terms & Conditions](#) [Privacy Policy](#) [Your California Privacy Rights](#) [Sitemap](#)

[Cookies Settings](#)

TASK & PURPOSE



GOT A TIP?



[NEWS](#) ▾

[CULTURE](#) ▾

[MILITARY LIFE](#) ▾

[THE GEAR LOCKER](#) ▾

[TECH & TACTICS](#) ▾

[HISTORY](#) ▾

[WRITE FOR US](#)

[The Gear Locker](#) → [Gear Reviews](#) → [Roundups](#)

UPDATED APR 18, 2022 6:19 PM EDT

# The best car gun safes for security on the road

It can be important to carry protection out on the road, and these items will help you do it



right.

BEST OVERALL



Console **Vault** Vehicle Safe



Console **Vault** Vehicle Safe

[SEE IT →](#)

Bulletproof construction and a sleek finish that appears straight from the auto manufacturers, Console **Vault** delivers a unique security option tailored just for your vehicle.

- Pros**
- Licensed Ford partnership

BEST VALUE



Hornady Lockbox



Hornady Lockbox

[SEE IT →](#)

No frills, no complications, just an honest-to-goodness box with a good old-fashioned key. Check out the available large and extra-large sizes and the premium Alpha Elite model.

- Pros**
- Fantastic price point

HONORABLE MENTION



Tuffy Console Security Safe



Tuffy Console Security Safe

[SEE IT →](#)

A simpler, less expensive alternative to a Console **Vault** product, Tuffy's offering also stands as a well-constructed, snug-fitting option available for a broad range of vehicles.

- Pros**
- Broad range of vehicle-

on the battery  
by removing  
screw with the  
ewdriver.  
"RESET" button  
der the battery  
ver.

ver.

<ul style="list-style-type: none"> <li>• for Blue Oval fans</li> <li>• Broad range of vehicle-specific applications</li> <li>• Choice of key or combo lock</li> <li>• Rigid construction</li> </ul>	<ul style="list-style-type: none"> <li>• Incredibly compact size</li> <li>• Choice of sizes to fit your use</li> <li>• Comes with cable to anchor to vehicle</li> </ul>	<ul style="list-style-type: none"> <li>• specific applications</li> <li>• Can be fixed in place or easily removed</li> <li>• Easy to source through many retailers</li> <li>• Less expensive than more premium console safes</li> </ul>
<p><b>Cons</b></p> <ul style="list-style-type: none"> <li>• Gun fitment highly dependant on specific safe</li> <li>• Not quite available for every vehicle on Earth</li> <li>• Most expensive on this list</li> </ul>	<p><b>Cons</b></p> <ul style="list-style-type: none"> <li>• Somewhat finicky lock</li> <li>• Storing some thicker handguns may create pry-able gap</li> </ul>	<p><b>Cons</b></p> <ul style="list-style-type: none"> <li>• Cheapest model is still pricier than portable safes</li> <li>• Questionable resistance to prying</li> <li>• Only once choice of locking mechanism</li> </ul>

*We may earn revenue from the products available on this page and participate in affiliate programs.*

Written By Jeric Jaleco  
Updated Apr 18, 2022 6:19 PM

**W**hether you're out on the open road or just commuting to work, it never hurts to pack a gun safe for your vehicle. Compact and typically portable, such useful storage goodies can transform your center console or door pockets into miniature vaults for documents, personal items, and small arms for personal defense. We hope you'll never have to experience the latter, but it's best to always be prepared. Maybe you need a safe place to store emergency items when roughing it in the wilderness, or perhaps you're looking to store some protection when visiting unknown places. However, buying one can be easier said than done as the market is brimming with unique and ingenious gun safes.

We've combined our real-world experience with swaths of consumer feedback to curate this list of the best car gun safes available for purchase. Consider some high-tech biometric safes or even a vault

best car gear available for purchase. Contact some high-tech specialists based on your needs tailored to your specific vehicle. Take a gander and happy shopping!

## Methodology

Task & Purpose strives to deliver the most informative yet honest reviews on every product we review. While it's not always feasible for us to source every product we'd like to get our hands on, we still manage to combine real-world experiences with strenuous research, diving deep into expert opinions and consumer reviews. Consumer input found on major retail sites such as [Amazon](#), as well as the manufacturer sites themselves, serve as invaluable treasure chests of knowledge with real-world stories. Products with little-to-no test data, consumer feedback, or available stock are often ignored as we heavily lean towards products with proven performance that people like us can actually buy.



### **Console Vault Vehicle Safe**

BEST OVERALL



SEE IT →

Perhaps the most customizable option on this list, the Console **Vault** Vehicle Safe is an ingenious method of integrating a lockable security cubby into your vehicle. You can have a model tailored to nearly any vehicle, especially most trucks and SUVs. Sizes vary to fit most center consoles and even under the cushions of bench seat trucks. While some models may be restricted in terms of locking method based on the vehicle, most will allow you to choose from a simple barrel lock or a three- or four-digit combination. The HeavyGauge steel construction results in a look that is straight off the auto manufacturer line, and it's reportedly highly resistant to drilling and prying.

As one of the most critically-acclaimed entries on this list, it's hard to find many faults outside of a few nitpicks. For starters, it's a fixed design, meaning it's not as simple to simply pull out and take on the go on a whim. Gun fitment is highly dependent on your exact model and some safes are forced to adopt shallow dimensions in some vehicles. Additionally, not every vehicle has a model of Console **Vault** for it, so make sure your car is on the list.

### **Product Specs**

Dimensions:Varies greatly; see specs  
for specific vehicle

Weight: Varies greatly; see specs for  
specific vehicle

Lock: Manual keys, 3-digit  
combination, 4-digit  
combination

Material: Cold rolled steel

**+ PROS**

- Licensed Ford partnership for Blue Oval fans
- Broad range of vehicle-specific applications
- Choices of key or combo locks
- Incredibly rigid construction

**+ CONS**

- Gun fitment highly dependant on specific safe
- Not quite available for every vehicle on Earth
- Relatively expensive

**2 Hornady Lockbox**

**BEST VALUE**



SEE IT →

No fancy-schmancy techno-wizardry here — the Hornady Lockbox is a good old-fashioned box for simple folks who demand a good old-fashioned box. You get a single lock with manual keys and three sizes to choose from. Thankfully, they're all well-constructed with dense steel shells, offering greater protection than less expensive plastic competitors. At less than six pounds, it hardly weighs anything, a plus if you have to take it elsewhere, and its largest sizes are roomy enough to conceal 1911s and four-inch revolvers. As an additional courtesy, you get a security cable that may be used to anchor your safe to the seat rail of a car.

You do get what you pay for at this price point, and what you get are some slight compromises in its build quality and gun fitment. Some owners have noted that some especially thick handguns may create a gap that is just big enough to potentially exploit. Do your measurements first. Multiple owners have also reported some annoyingly cumbersome locks. In the best-case scenario, one owner remedied theirs with a drop of gun oil. Worst case scenario, a few owners have had their locks completely break apart.

### Product Specs

Dimensions: 9.50 x 6.50 x 1.75 inches  
(large), 10 x 7 x 2 inches  
(x-large), 10.25 x 8.00 x  
2.75 inches (Alpha Elite)

Weight: 4 pounds (large, x-Large), 5.85  
pounds (Alpha Elite)

Lock: Manual keys

Material: 16-gauge steel alloy

**+** PROS

- Fantastic price point
- Incredibly compact size in smallest trim
- Choice of sizes to fit your use
- Security cable for anchoring to vehicle

**-** CONS

- Somewhat finicky lock
- Storing thicker handguns may create vulnerable gap

**3** **Tuffy Console Security Safe**

HONORABLE MENTION



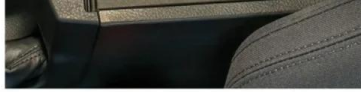

[SEE IT →](#)

Tuffy's Console Security Safe presents itself as a strong, dependable value among console-mounted safes. Like the Console **Vault** it competes with, it offers thick steel construction with a clean finish that looks like it could've come from the auto manufacturers themselves. Unlike the Console **Vault**, it's capable of being affixed in place or easily removable and can be applied to an even broader range of vehicles including some off-road novelties from as far back as 1950's Jeeps (see Tuffy's website). The product has received continuous praise for the rigid construction of its welded steel body and room for two handguns, should you desire. Price Varies greatly by vehicle, but typically runs anywhere between \$170 and \$210. Universal models for rarer and more obscure vehicles exist for anywhere between \$250 and \$360.

If there are complaints to be had, there could be the singular option of a manual key which has raised concerns over it being tampered with, but the 10-tumbler design should mitigate that. One owner has managed to swap out the manual key with a Tuffy combination lock, so that option exists for those who aren't deterred by a little extra coin and effort.

**Product Specs:**

Dimensions: Varies greatly; see specs  
for specific vehicle

Weight: Varies greatly; see specs for  
specific vehicle

Lock: Manual keys



Material: 16-gauge steel

**+** PROS

- Broad range of vehicle-specific applications
- Can be fixed in place or easily removed
- Easy to source through many retailers
- Less expensive than more premium console safes

**-** CONS

- Even cheapest model is pricier than portable safes
- Questionable resistance to prying
- Only one choice of locking mechanism

**4** **Vaultek Lifepod 2.0**

BEST FOR OVERLAND ADVENTURES





[SEE IT →](#)

A superb choice for the outdoorsman looking for quality storage solutions, the **Vaultek** Lifepod 2.0 delivers incredibly robust security and build quality in a portable size. It's quite featureful with a security cable for anchoring to a seat rail or perhaps somewhere inside a camper. There is also an interior tray for placing accessories or other valuables; however, a few consumers report that using the tray inhibits their ability to stack handguns or store certain larger firearms. The interior is illuminated, and pressure latches and rubber gaskets create an airtight, waterproof seal. The 2.0 generation reportedly addresses prior issues of being easier to pry and defeat the keypad.

A few consumers have noted a few build quality issues such as a finicky keypad – which they still believe to be far more reliable than the biometric safes they've owned – and cumbersome manual locks. One owner reported that their interior light failed to operate. Such quality concerns are few and far between with most owners raving about the overall robustness, but the issues do seem a tad less forgivable considering the Lifepod 2.0's steep price which rings in at over \$150.

#### **Product Specs**

Dimensions: 12.25 x 8.50 x 2.87 inches

Weight: 3.3 pounds

Lock: Keypad

Material: "Impact-resistant proprietary material blend"

**+** PROS

- Waterproof, airtight construction
- Surprisingly lightweight
- A nice dose of security and packaging features
- Can store multiple handguns

**-** CONS

- On the pricier end of portable safes
- Can only program a four-digit code
- Few reported build quality issues

5

**RPNB Quick Access Biometric Pistol Safe**

BEST BIOMETRIC

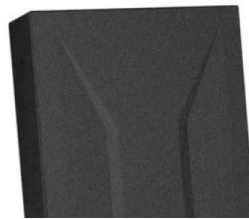



[SEE IT →](#)

A popular pick for those looking for the added high-tech security of a biometric system, RPNE's Quick Access Biometric gun safe is a well-rounded and affordable choice. While larger than the Hornady Lockbox, it's still slim enough to carry in vehicles, which some consumers specifically purchase this product for. The security cable allows for anchoring to items like seat rails, and the carbon steel body has proven incredibly strong and difficult to bust. As a portable gun safe, the scanner is powered by batteries which can be overridden with traditional manual keys in the event that they run out of juice.

Be wary of issues people have had with programming the scanner. Some have reported that family members have been able to pop the lock without ever programming the scanner themselves. A few others have reported having to input their fingerprint multiple times to open or couldn't get it opened at all. A third bandwagon expressed confusion as their safes have worked flawlessly, so it's best advised to take your time and exercise caution when programming your gun safe's scanner.

#### **Product Specs**

Dimensions: 11.80 x 7.80 x 2.20 inches

Weight: 5.8 pounds

Lock: Biometric scanner

Material: 16-gauge steel alloy

**+** PROS

- Manual keys in event of biometric scanner fault
- Compact size
- Program up to 20 fingerprints
- Security cable for anchoring to vehicle

**-** CONS

- Some hiccups with biometric scanner



**6** RPNB RP19001E Quick Access Safe

BEST QUICK ACCESS





SEE IT →

In a complete, polar-opposite departure from the simplicity of the Hornady, RPNB's RP19001E Quick Access gun safe is about as high-tech as it can possibly be. Need quick access to your firearms? You got it — and you'll get to choose one of four to five methods of doing so. The automatic lid is set free by either a manual key, a key fob, a card, a four-button keypad, or an optional biometric scanner. While large, it's slim enough to be carried inside larger vehicles and roomy enough to store a pair of smaller handguns. One consumer noted that you could even stack your guns and still manage to close the lid. Overkill? Definitely.

With this much tech, however, you're bound to have some hiccups. A couple of owners have reported lid motors and locks acting up and refusing to open even after accepting their inputs. The fix? A good slap to the side did the trick. Not ideal, but they were rare instances. Its bulk means it could better serve others as a nightstand safe, but larger trucks and SUVs could still accommodate their cavernous interiors. My family's Silverado 1500 and Highlander, for example, come to mind.

**Product Specs:**

Dimensions: 14.25 x 10.83 x 3.15  
inches

Weight: 13 pounds

Lock: Manual keys, key fob, key card,

keypad, biometric scanner  
(optional)

Material: Steel alloy

**+** PROS

- Every quick access method imaginable
- Can store multiple handguns
- Program up to eight-digit codes and 20 fingerprints

**-** CONS

- Heftier than other portable safes
- Large size may not match with some vehicles
- Rare automatic lid motor faults

**7** **Decked Drawer System**

BEST FOR TRUCK BEDS





SEE IT →

Behold! Okay, so it's more like a lockable drawer than an in-car safe, but this still deserves a peek and is something we know a handful of enthusiasts will greatly enjoy. The Decked Drawer System is a clever, multipurpose option for nearly all truck beds. Decked states that their systems are weatherproof, meaning they'll help keep your priceless antique rifles from rusting in a torrential downpour. The drawers are composed of a dense plastic encasing a galvanized steel skeleton and are rated at holding up to 2,000 pounds of gear, which you'll hopefully keep tidy using the included organizing bins.

It's easily the most acclaimed product here with consumers praising solid construction, smooth operation, and the ability to carry damn near anything from rifles to tools. Aside from being inaccessible in emergency situations and being voted the burden-bearer of your entire friend group, the biggest gut-punch this product dishes out is the eye-watering price of nearly \$1,500. Other complaints include an installation process that's a tad lengthy and overcomplicated, and a few owners report that "weatherproof" doesn't quite mean it's completely waterproof.

**Product Specs:**

Dimensions: Vary greatly; see specs for specific vehicle

Weight: Varies; 220 pounds (estimated)



Lock: Manual keys

Material: High-density plastic,  
galvanized steel

#### + PROS

- Carries rifles, ammo cans, and pepperoni sticks
- Relatively straightforward install
- Can double as storage for camping or trade jobs
- Become the pack mule for all your friends

#### ✖ CONS

- The most expensive thing on this list
- Bed access means it's unavailable in an emergency
- Become the pack mule for all your friends

## Our verdict on car gun safes

That wraps up our list of some of the hottest car gun safes on the market today. The [Console Vault Vehicle Safe](#) lands Best Overall for its highly-customizable, well-constructed approach to in-car firearm security. [Hornady's Lockbox](#) stands as the Best Value pick for offering stout construction and a choice of sizes for less than the cost of some used video games. And we honorably mention [Tuffy's Console Security Safe](#) as another acclaimed entry with a flexible price tag. That being said, drop a comment and let us know what your favorite storage solutions are for in-car firearm transport. Just like with any buyer's guide, we're always looking forward to expanding our knowledge with you.

## What to consider when buying car gun safes

Car gun safes all do the same basic thing, but they all seem to go about it quite differently. Some are big. Some are small. Some are almost permanent additions to your car, while others can be brought nearly

anywhere else. From complex designs to brainless simplicity, here are just a few ways car gun safes can distinguish themselves.

## Types of car gun safes

---

### Biometric locking

These safes define themselves by primarily unlocking with a programmable fingerprint scanner. The technology is commonly found in [high-end home safes](#), but there are plenty of smaller applications that can be taken in a personal vehicle. It's often regarded as the most secure as it will only respond to the person (or people) who program it, but that's also dependent on the construction of a specific safe and how easy it is to damage or pry.

Many biometric gun safes available come in slim, portable packages, meaning that stowing them in a vehicle is effortless. That also means they have to be powered via batteries, so be cautious not to let yourself get locked away from your firearms because of some dead Duracells. Keep those emergency manual keys handy.

### Portable

This encompasses nearly all available car gun safes. Compact, portable, and relatively inexpensive, these will give you the secure storage that you need in a package you can switch from car to car and even check in for flights. They generally won't be too cumbersome and may come in a variety of locks, but basic manual locks with a key tend to be the most common and reliable. Some models even have attached security cables for anchoring to wherever you decide to leave it.

In this range, keep a keen eye out for build quality, especially at the lower end of the price range. Many can be had with durable steel construction, but some could leave gaps making you susceptible to theft. Budget-friendly lockboxes constructed of plastic exist, but obviously won't have the resilience of steel alloys.

### Fixed

Fairly self-explanatory, these safes won't be going anywhere unless you have the time to uninstall them; Console **Vault** and Decked products fall into this category as does technically Tuffy. They'll be affixed in place, meaning that moving them will prove more of a burden, but they will typically have better storage abilities given their designs.

Some console safes may reconfigure the entire console into a miniature bomb shelter for your valuables with the entire square footage of space at the expense of obliterating your normal center console storage. Larger safes exist to fit entire rifles into the back ends of SUVs and pickups plus room for gear and ammo, but they hold the obvious drawback of being far less accessible in a cinch during emergencies. More often than not, this will also be the most expensive type.

## Key features of car gun safes

---

### Locking mechanism

There are quite a few different locking mechanisms you could opt for which seem to vary in quality and reliability.

**Keypad** and **biometric scanners** are trickier to defeat with the latter being regarded as far more secure, but they are powered and often require batteries. **Keys** and **combinations** have been far more reliable according to many customer accounts, but be aware of the quality of your lock. Some cheaper models sometimes ship with complete nuisances of a lock with stiff action and even falling apart altogether.

Fortunately, there are known workarounds for some common complaints. A drop of gun oil, for example, has been a proven fix for some stuck locks, and most electronic mechanisms include manual keys as a backup.

### Size

Here is a crucial factor in determining which product is right for you. For some, it may be the single most important. Buyers must take a gander at their firearms and their possible storage locations and decide which gun safe is the right size for their needs.

Some folks may be packing some serious big irons, so a Hornady Alpha Elite Lockbox or an RPNB RP19001E would be a more viable option. Or, perhaps the potential buyer is looking for a gun safe that fits their compact car which may not have such generous interior volume.

Also account for the interior volume of a gun safe which should always be disclosed in the product listing. You might snag a case based on its external dimensions that seem as though it would fit like a glove, only to see you're a quarter-inch short.

### Material

Keep in mind what material your chosen gun safe is composed of, especially as you dip down into the lower price brackets. It could be a thick, high-carbon steel alloy or it could be cheaper plastics. Some materials are better resistant to flexing when pried at or can be defeated with a power drill and enough brute force.

Higher-end and most mid-grade products will almost always be constructed of some sort of alloy, typically 16-gauge steel unless stated otherwise, thus delivering some added peace of mind for their price tags. As materials get stronger, it'd be wise to start looking at other variables that could affect security such as the quality of locks and hinges, etc.

## Pricing considerations for car gun safes

---

Pricing for portable car gun safes may range from mere tens of dollars to well over \$100. The higher end of that scale will present you with the best construction and an abundance of locking mechanisms including biometrics, keypads, and key fobs. Some may have lighting to illuminate the interior or keypads when entering codes. Conversely, you can get simple lockboxes with a basic key and simple construction for anywhere between \$20 and \$40, but build quality may not be so bulletproof on a few models within that realm.

For those with deeper pockets, premium fixed safes like those from Console **Vault** or Tuffy typically ring in at \$200 to \$300 before options. Drawer systems for carrying rifles and gear can vary greatly based on options, but systems like those from Decker start at nearly \$1,500. Such offerings are surely for the dedicated enthusiasts, but tradesmen have found value in having them pull double-duty as bed-mounted tool boxes.

## Tips and tricks

---

As with something you do for decades upon decades, you pick up a few tips and tricks along the way in terms of selecting the right product, and/or using it. That's the case with us and car gun safes. To help you bridge the information gap, here's a selection of what we've learned along the way.

- If you choose to legally add a portable gun safe to a camper or RV, consider hard mounting it in a drawer using the hardware that some models include.
- For Pete's sake, many of the complaints of people letting their electronic locks die and getting barred from their guns can be fixed if you keep the manual keys nearby. Don't ever lose them.

## FAQs on car gun safes

---

You've got questions. Task & Purpose has answers

### Q: Can you keep a gun in a glove box?

A: From a safety standpoint, most [experts do NOT recommend](#) storing a gun in the glove box, especially if it's not a locking glove box. From a legal standpoint, the country is [divided on the issue](#). However, in most states, you can conceal a firearm in your glove box if you are permitted to concealed carry.

### Q: What size should my vehicle gun safe be?

A: That is completely up to your specific use case. Look at one that will fit your firearm(s). How many mags will you carry? Does it have large accessories? Then check where you intend to store it. Find a safe with the right dimensions for that spot.

### Q: What's the safest way to transport a firearm in a vehicle?

A: Unless you're specifically (and [legally](#)) keeping it in your car for defense purposes, [it shouldn't be loaded](#) and hot. Keep it locked up in a hard case and away from where passengers or thieves could tamper with it. It should be unloaded with ammo stored away from the gun.

### Q: What is the difference between a car gun safe and a console safe?

A: A car gun safe encompasses most lockable storage solutions whereas console [vaults/safes](#) specifically refer to fixed storage within a vehicle's center console. When installed, it will replace or take up a good chunk of the original space with a safe that's integrated with the car and out of sight.



#### **Jeric Jaleco**

Jeric Jaleco is an AGE mechanic (2A6X2) in the Nevada Air National Guard as well as a contributor to The Drive and Car Bibles. Born in SoCal and raised in Las Vegas, he's a diehard car enthusiast and aspiring purveyor of firearms. He's journeyed far from his first deployment in East Africa to pursue a career in writing.



---

GEAR REVIEWS

ROUNDUPS

BUYING GUIDE

COMMERCE

GEAR

GEAR & TECH



GUN SAFES



**Two of the last remaining Tuskegee Airmen have died**

 GrumpyOldMan10 · 2 Jul

Cassagnol led an adventurous life! WWII flying after growing u...



 **Top Comment**  2



**Air Force Pararescue teams are looking for a new boat ...**

 chuck · 3 Jul

A RHIB would be nice but TWO RAMZ packages might be bette...



 **Top Comment** 



**OPINION: Marines look to boot 2 of MARSOC 3 and ta...**

 Rick Poffenroth · 30 Jun

After all was said and done, violating a general order not to...

 **Top Comment** 

## Conversation

We want Task & Purpose to be a nice place to chat and and swap stories, but please [read and follow our guidelines here.](#)

 [Log in](#) | [Sign up](#)







No one seems to have shared their thoughts on this topic yet  
 Leave a comment so your voice will be heard first.

## Subscribe to Task & Purpose Today

Get the latest in military news, entertainment and gear in your inbox daily.

[JOIN NOW](#)

HOME / TRUCKS



in TRUCKS

## Truck Gun Safe: Should You Buy a Gun Safe for Your Pickup?

Smash-and-grab break-ins are on the rise. It's a good idea to look into a truck gun safe to keep your gun, and other valuables, safe in your vehicle.

by **DAN MAYFIELD** | Published on June 15, 2022 | 2 min read | [View Comments](#)

SHARE:

Research shows that guns are stolen every 15 minutes, and most of those that are stolen are from vehicles. There's been a 225% rise in gun thefts from cars and [trucks](#). More guns are now stolen

### Best in Trucks



The Least Popular Full-Size Pickup Truck Could Be the Only Smart Buy in 2023



2024 Ford Maverick vs. 2024 Hyundai Santa Cruz: Small Truck Struggle



Get Excited, Used Ford F-150 Prices Are Finally Dropping



Eastwood Elite 4 x 4 CNC Plasma...

**\$8,504.97**



Eastwood CON...

**\$15.9**



East AMP...

**\$1,69**





from vehicles than anywhere else [according to a recent report](#). So if you carry your gun with you in your vehicle, there are options for you to keep it safe, from manufacturer-built safes to aftermarket safes. Though many of these are made for guns, you can of course keep any valuables in the safes away from thieves' prying eyes. It's a lot better than [just hiding your gun](#).



### Why would you want a gun safe?



This section contains three product listings from an e-commerce platform:

- Top listing:** A small, black, rectangular car safe. Price: \$8,504.97.
- Middle listing:** A collection of four different models of car safes, some with keyholes and some with combination dials. Price: \$38.99. To the right is a partial view of a dark grey RAM SUV.
- Bottom listing:** An AMP TIG Welder, a large industrial-grade machine with a control panel and various attachments. Price: \$1,699.98. The listing includes a "-10%" discount tag and the brand name "Eastwood".



An illustration of a thief breaking into a vehicle | Andia Group via Getty Images)

You don't want to carry your giant gun safe with you when you're driving around. And, while gun racks used to be a common sight in the back window of a pickup truck, it's an invitation for a criminal to break in and steal your gun today. Trucks are notoriously easy to break into. [Smash and grab break-ins](#) are common. Many trucks don't have locking consoles, and even those that do aren't fire safe so a hidden gun safe is a good idea. And, if you leave your ear protection, ammo boxes, or other telltale signs you're coming back from the range inside the truck, a thief may ransack your pickup just to find your pistol.

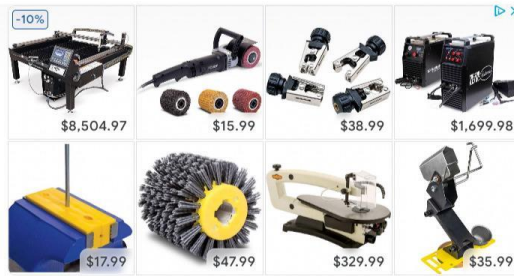

Eastwood® Official  
Eastwood

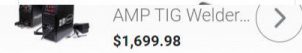

Eastwood

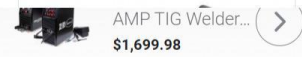

Eastwood



# Manufacturers offer locking consoles



Chevrolet sells a locking console box for its SUVs and trucks | Chevrolet



\$0,504.77

\$38.99

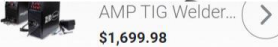

AMP TIG Welder...

\$1,699.98

Eastwood



-10%

Eastwood

\$8,504.97



\$38.99



AMP TIG Welder...

\$1,699.98

A hidden gun safe is best. After all, you don't want to advertise that you have a firearm. Many trucks do offer locking consoles that may be enough to deter a thief. The major manufacturers offer locking console vaults that are great for firearms, and any other valuables you may want to lock down. The OEM boxes often don't require drilling and they allow you to use the armrest.

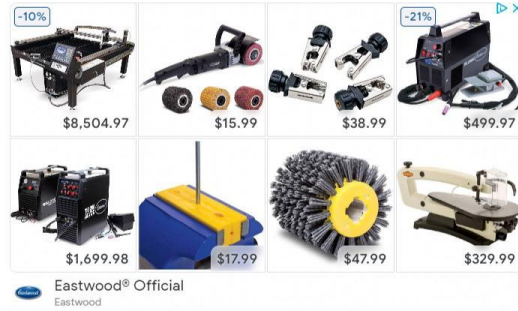

Ram owners can find a [factory-built console safe](#) from the Mopar catalog for \$230.40. [Ford](#), too,

Chevrolet sells a locking console box for its SUVs and trucks | Chevrolet

A hidden gun safe is best. After all, you don't want to advertise that you have a firearm. Many trucks do offer locking consoles that may be enough to deter a thief. The major manufacturers offer locking console vaults that are great for firearms, and any other valuables you may want to lock down. The OEM boxes often don't require drilling and they allow you to use the armrest.

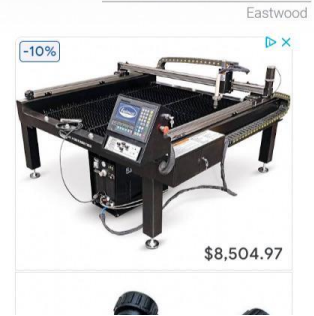
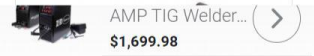
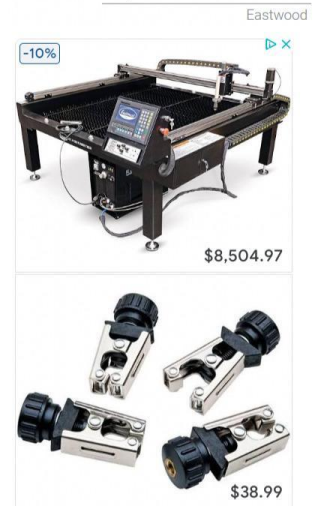

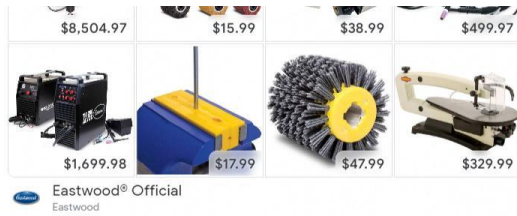

Eastwood® Official  
Eastwood

**RELATED** [Guns Replace Car Accidents as the Leading Killer of Children in the U.S.](#)

There are dozens of manufacturers [that make a hidden gun safes](#) for vehicles. Some brands include:



Lock'Er Down makes a console safe that can be fitted to F-150s, Chevy Silverado and GMC Sierra, Dodge Ram 1500, 2500 and 350, Hyundai Telluride, Toyota Tacoma and others. Each is a drop-in model that has either a tumbler, electronic, or combination lock.

Console **Vault**, too, makes a variety of console cases that are designed for trucks with full-floor consoles and under-seat consoles for a wide variety of trucks and SUVs. Console **Vault** also makes

a locking gun safe that fits Harley Davidson bagger motorcycles hard bags. The company also Lock'Er Down makes a console safe that can be fitted to F-150s, Chevy Silverado and GMC Sierra, Dodge Ram 1500, 2500 and 350, Hyundai Telluride, Toyota Tacoma and others. Each is a drop-in model that has either a tumbler, electronic, or combination lock.



\$38.99

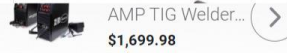

AMP TIG Welder...  
\$1,699.98

Eastwood



\$8,504.97



\$38.99



Console **Vault**, too, makes a variety of console cases that are designed for trucks with full-floor consoles and under-seat consoles for a wide variety of trucks and SUVs. Console **Vault** also makes a locking gun safe that fits Harley-Davidson bagger motorcycles hard bags. The company also offers a variety of lock options.



## Conversation

[Log in](#) | [Sign up](#)

Be the first to comment...



Powered by OpenWeb

[Terms](#) | [Privacy](#) | [Feedback](#)





Flour Tortillas  
FATTA

SKIP

AdChoices  Sponsored



**This Year's Kia Lineup Is Turning Heads -- And Finally On Sale!**

Best Kia Offers + Deals

Best Kia Deals | Search Ads | Sponsored

[Learn More](#)





**Here's How To Fly Business Class For The Price of Economy**

Business Flight Deals | Sponsored



**Empty Alaska Cruise Cabins Cost Almost Nothing**

Alaska Cruise Deals | Sponsored



**The Killer New X5 SUV Is Close To Perfection (Take A Look)**

New BMW Deals | Sponsored







### Unsold Diamond Rings So Cheap They're Almost Being Given Away

Diamond Ring Deals | Search Ads | Sponsored



### No Appointment? No Problem - Upgrade to the World's Smartest CPAP Without Leaving Home

The Easy Blog by EasyBreathe.com | Sponsored



[Redacted text]

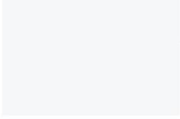

[Redacted text]

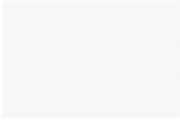

[Redacted text]



- COMPANY ▾
- INDUSTRY ▾
- PRODUCTS ▾
- VEHICLE TYPE ▾
- CATALOGS
- GET A QUOTE



# CUSTOM TRUCK GUN SAFES, CABINETS, & VAULTS

Things can go haywire in an instant any time a law enforcement officer responds to a call. Therefore, it's important for their weapons to be easy to access but safely secured away when not in use. At Rockland Custom Products, we can custom fabricate the perfect gun safe for any law enforcement, command or tactical vehicle.

Our vehicle gun safes are available in an array of styles and sizes, including single and double full-length drawers, multi-part drawers, multi-compartment cabinets and more. They're custom-fabricated using durable aluminum and steel materials and, we keep all your gear safely stowed away using the very highest quality locking mechanisms and protective foam mounts and inserts.

**WE CAN DESIGN A VEHICLE GUN CABINET THAT WORKS FOR YOU**

**SEND US A MESSAGE**

FIRST NAME \*

LAST NAME \*

EMAIL ADDRESS \*

PHONE \*

ZIP CODE \*

VEHICLE INFO \*

MESSAGE \*

The best thing about having Rockland Custom Products design and manufacture your truck gun vault is that you can be sure your new safe will fit perfectly in your vehicle and meet your needs exactly. This is because your safe was built for your unique vehicle and according to your unique specifications.

Whether you're a sheriff, patrol officer, a tactical team member or any other member of the law enforcement family, your custom gun safe will give you the peace of mind and security you need to perform your job at the highest level possible. Our cabinets feature the following additional benefits for you:

- Cabinets are manufactured from durable materials, which means they will outlast your vehicle
- Available in custom configurations so your cabinet meets your storage needs
- Secure your weapons and gear with a variety of locking options that make it easy for you to open the drawer fast
- Multiple handle options provide easy access to all your gear  
Storage drawers slide out to full extension making it easy to access your equipment
- Additional outlets can be added for a wide variety of electronics
- A variety of finishes are available to help protect your cargo and cabinet

Contact Rockland Custom Products today to learn more about our custom-built vehicle gun cabinets or to request a quote for your vehicle.

### PDF METAL COMMAND CABINETS

 [Open in a new tab.](#)



Opt-In to Receive Email Updates on New Product Features, Promos, and More!



## WANT MORE ROCKLAND?

Like Us on Facebook, follow us on Instagram, and subscribe to our YouTube Channel to see new custom designs, product sneak previews, videos, news, and other great content!



### ROCKLAND CUSTOM PRODUCTS

 2215 Wise Chapel Court  
Marion, SC  
29571

 (855) 808-2597

 [info@rocklandcustomproducts.com](mailto:info@rocklandcustomproducts.com)

### INDUSTRY

Fire  
EMS  
Law Enforcement  
Outdoor Recreation & Overland

### VEHICLE TYPE

SUV  
Pickup  
Sedan  
Jeep



Bronco | Maverick | Accessories

Performance Parts

The Road Ahead | My Account | My Garage

20% OFF ACCESSORIES PURCHASES UP TO \$1,000 ON ORDERS OF \$300 OR MORE.\*  
FOR REGISTERED CUSTOMERS. USE CODE [SUMMER23](#). ENDS 7/31/23.

[OFFER DETAILS](#)

HOME > CONSOLE VAULT VEHICLE SAFE FOR FULL FLOOR CONSOLE



Part No. VFL3Z2R06223A

### CONSOLE VAULT VEHICLE SAFE FOR FULL FLOOR CONSOLE

☆☆☆☆

\$329.00

or redeem up to 65800 Points

[VIEW FULL PRODUCT DETAILS](#)



FITS THESE VEHICLES

VIEW ACCESSORIES ON YOUR VEHICLE

Include installation (+ \$60.00)  
or redeem up to 12000 Points

1

Add to cart



Pick up at your selected dealer is free

Make the most of your vehicle - and your lifestyle

Engineered to fit your vehicle

[PRODUCT DETAILS](#)

[FITS THESE VEHICLES](#)

[TECHNICAL SPECIFICATIONS](#)

[RETURN POLICY](#)

[PRODUCT REVIEWS](#)

#### ABOUT THIS PRODUCT

##### Why Buy:

Keep your belongings safe with a locking console vault. Constructed from 12 gauge, cold rolled plate steel with a welded tab and notch seams for extra security.

##### Details:

- Providing peace of mind for those with high security needs
- Constructed from massive 12 gauge cold rolled plate steel
- Welded tab and notch seams
- Superior 3-point locking system resists prying
- Spring assisted lid
  - 4-digit combination lock with 10,000 possible combinations (Combination lock meets CADOJ compliance)
- Easy do-it-yourself installation
- Secures inside factory console

RECOMMENDED FOR YOU



Ford  
Console Vault Vehicle Safe for Base  
Seat Console, Split Bench Front  
\$329.00



Ford  
F-150 2021-2023 Console Vault  
Captain's Chair Vehicle Safe  
\$339.00



Ford  
F-150 2015-2020 Console Vault  
Vehicle Safe  
\$329.00



Ford  
Expedition 2021-2023 4pc All  
Weather Floor Liner Tray  
\$195.00

DISCLOSURES

ACCESSORIES	PERFORMANCE	MY PROFILE	RESOURCES	RELATED LINKS
<a href="#">Exterior</a>	<a href="#">Appearance</a>	<a href="#">LOGIN</a>	<a href="#">Frequently Asked Questions</a>	<a href="#">Ford Vehicles</a>
<a href="#">Electronics</a>	<a href="#">Chassis</a>	<a href="#">Create an Account</a>	<a href="#">Contact Us</a>	<a href="#">Lincoln Vehicles</a>
<a href="#">Interior</a>	<a href="#">Electrical</a>	<a href="#">Account Details</a>	<a href="#">Shipping &amp; Delivery</a>	<a href="#">Contact Ford</a>
<a href="#">Wheels</a>	<a href="#">Body</a>	<a href="#">My Orders &amp; Returns</a>	<a href="#">Return Policy</a>	<a href="#">Racing</a>
<a href="#">Off Road/Utility</a>	<a href="#">Drivetrain</a>	<a href="#">My Garage</a>	<a href="#">Make a Return</a>	<a href="#">FordDirect.com</a>

[Lincoln Accessories](#)  
[View Accessories on Your Vehicle](#)

[Terms & Conditions](#)  
[Warranty Information](#)  
[Feedback](#)

[Ford Charge Stations](#)  
[Ford Collision](#)  
[Power Stroke Diesel](#)  
[Tire Finder](#)  
[Vintage Parts](#)

© 2023 Ford Motor Company

[Site Map](#)

[Contact Us](#)

[Terms & Conditions](#)

[Privacy Notice](#)

[Cookie Settings](#)

[Your Privacy Choices](#)

[Accessibility](#)





This website uses cookies to enhance user experience and to analyze performance and traffic on our website. We also share information about your use of our site with our social media, advertising, and analytics partners. [Privacy Policy](#)

[Cookie Settings](#)



[Leave a Message](#)



# A Guide to Overcoming 27 Reasons You Don't Carry Your Gun Every Day

By Jacob Paulsen | May 5, 2022 | 23

- Facebook
- Twitter
- Pinterest
- LinkedIn
- Print

Are you one of the many gun owners who don't carry their firearm regularly? According to our surveys, most people who have concealed carry permits still don't carry concealed regularly. We've compiled a list of the reasons most often cited for not carrying regularly. But we didn't stop there. Under each "reason" section, we've included links to articles that provide information and help in overcoming the specific issue.



### Recent Articles – In Case You Missed It:

- S9E2: Setting Up Your Dry Fire Dojo
- Who Are CCW Safe's Attorneys and Advisors?
- When is a Double Feed Good?
- New Website Exclusively Offers Dry Fire Tools
- S9E1: JUSTIFIED SAVES – 14-Year-Old Defends His Mother From a Violent Attack



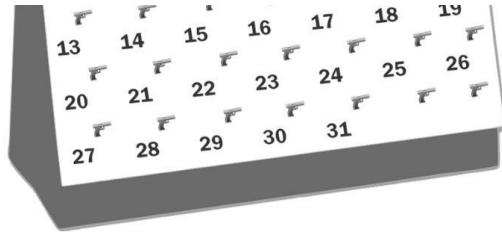

## List of Reasons People Don't Carry Their Gun Every Day —

### I Can't Find a Comfortable Holster

Even though there are thousands of [holster companies](#), finding the right holster can be challenging. First there are different methods of carrying, and then different holsters and made of different materials and configurations. Below are links to content that can assist you in finding the right holster for your needs:

- [10 Criteria for Choosing a Holster](#)
- [1 or 2 Clips on Your Holster?](#)
- [Sweatguard on Your Holster?](#)
- [Troubles with Sidecar Holster?](#)
- [Should You use a Cheap Holster?](#)
- [Gap Around the Trigger Guard?](#)
- [Choosing the Best Type of Holster Clip](#)
- [4 Things every Appendix Holster Should Have](#)



**MOST FUNCTIONAL EDC BELT EVER**

"It is by far the most comfortable concealed carry belt I've worn"  
— Ernest Langdon

◆ Stiff, But Not TOO Stiff [Click Here](#)

◆ Top Performing Low Profile Concealed Carry Belt

**EDC**  
EDC BELT CO

### Our Core Content

- [Dry Fire Practice](#)
- [Gun Control](#)
- [Gun Safety](#)
- [Medical](#)
- [Shop Talk](#)
- [Statistics and Research](#)
- [The Laws](#)
- [Travel](#)

**BARBER STOK**

**REALISM  
IN DRY FIRE  
FOR LESS THAN  
15 DOLLARS**

**START NOW >**

### Recent Videos



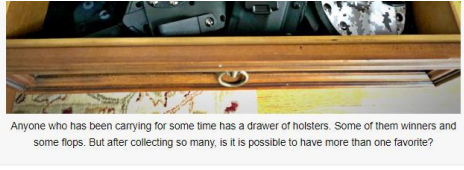

### I Can't Find a Comfortable Gun

Guns are expensive, and your choices abound. I don't think there is such a thing as a "comfortable gun" per se. However, some are certainly more comfortable than others. Some think the smaller the gun, the more comfortable. While this is somewhat true, size isn't the only consideration when selecting a gun for everyday carry (EDC).

- [Selecting a Concealed Carry Gun](#)
- [Determining What is a Reliable Gun for everyday Carry](#)
- [How Many Rounds for a Concealed Carry gun?](#)
- [Tips to make carrying more comfortable](#)



### My Employer Doesn't Allow It

Most of us spend about 36% of our waking hours at our job. If your employer doesn't allow firearms that can be a very legitimate concern.

- [Solutions for dealing with Anti-Gun Employers](#)



S9E3: Top Tips for Traveling with Guns  
9 views



Knocked Out??  
How To Help  
1:42  
How to Tell if Someone Needs Help (EMERGENCY)  
2 views

[Watch More Videos](#)



## Too Many Private Businesses I Frequent Prohibit Guns

Does it feel like everywhere you go is another anti-gun business? It can take a lot of work to find the businesses that support your rights and often can create an inconvenience to frequent them. We get it.

[Dealing with Gun Free Businesses](#)



## It Doesn't Support My Style Or The Way I Dress

Guns are big and bulky and unlikely to ever conceal well in tight fitting clothing but if you think there is no way to look good and have a gun I think you are mistaken. The key here is being willing to make some changes.

[PHLster Enigma Review](#)  
[Clothing Adjustments](#)



### I Don't Know If I Could Kill Someone

Honestly, this is going to sound like a cop out but I promise you could. If the situation were dire enough... If it was about you or someone you love living or dying you could take the life. Consider also that just because you shoot to stop a threat doesn't mean you will kill people. Modern medicine is fairly impressive and people survive gun shots all the time.

[The Moral Component of Deadly Force](#)  
[Deadly Force Dilemma](#)



### I Have Difficulty Concealing the Gun

Guns are generally not that easy to conceal and most gun owners feel strongly about ensuring others don't see or discern the weapon. Overcoming this issue could be the most critical factor in your personal defense.

[Concealing a Gun is Hard](#)



## I Have Fear of Legal and Civil Consequences

The world is full of sue-happy people and some politicians respect your rights about as much as they love taking a cold shower.

[Overcoming the fear of Civil and Criminal Legal Consequences](#)

[Do I Need Concealed Carry Insurance?](#)

[Concealed Carry Insurance Comparison Chart](#)

[CCW Safe vs USCCA](#)



## It Conflicts with My Social Life

It may be time to decide what is more important to you. Being prepared to save lives or having a few drinks with friends.

[Is the Gun Cramping Your Social Life?](#)



## I Couldn't Make it a Habit

We are all creatures of habit and learning to make your carry gun part of your life is tough.

[How to Create and Keep an Every Day Carry Habit](#)





## My Risk is Too Low to Justify It

History has proven repeatedly that evil people commit their deeds anywhere, and upon anyone. Consider listening to the bi-weekly Concealed Carry Podcast. Once time a month, we dedicate an entire episode titled "Justified Saves." to stories of people defending themselves with firearms.

[The Concealed Carry Podcast](#)



## I Never Leave the House

Really? Well, even if you stay home, depending on your risk assessment, you may consider carrying your firearm, or at the very least, having it close by.

[Home Defense Fundamentals](#)  
[Choosing the AR for Home Defence](#)  
[Should I Carry a gun at Home?](#)





## I'm Afraid it Could Be Used Against Me

This is a legitimate concern, as sometimes bad guys disarm firearm owners and use their gun against them. However, it is typically an issue for those who have limited training.

[How Close is Too Close?](#)  
[Handgun Retention Techniques](#)  
[Close Quarters Tactics](#)



## I'm Afraid of Dealing With Law Enforcement

Generally, if you obey the law, then you shouldn't have a lot of law enforcement encounters. Even when they happen, a prepared concealed carrier should know what to expect and how to proceed.

[Duty to Inform](#)  
[How to Handle a Traffic Stop While Armed](#)





## I'm a Student, or I Work at a School

If you go to a school every day that doesn't allow firearms, that is a tough issue to overcome. While not the ideal situation, find out if you may store your firearm in your car and consider that it would be better than leaving it at home. Determine if you can legally carry a less-lethal force option.

[Your Car is Not a Holster](#)

[Less Lethal Force Options](#)

[Understanding the Gun Free School Zone Act](#)



## I Only Have a Gun for Home Defence

You will use a firearm to defend yourself and loved ones while at home. Why would you decide not to

You will use a firearm to defend yourself and loved ones while at home, why would you decide not to defend those same people when you leave the home?

[Rise in Violent Crime](#)

[Number of Concealed Carry Permits Climb](#)



## My Spouse or Friends are Armed So I Don't Need to Be

Each of us needs to take responsibility for our own survival.

You can't honestly say that you are ALWAYS with someone else who is armed. Furthermore, if that someone else is injured, out of ammunition, killed or has a firearm malfunction you are now both in serious trouble.

[Concealed Carry Family](#)

[Talking to Your Family About Concealed Carry](#)



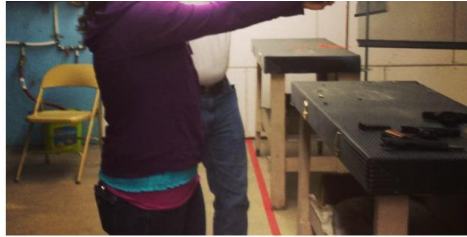

## I Don't Go Anywhere Dangerous

You are at risk everywhere you are and everywhere you go. There are no safe havens. The terrorists, attackers, criminals, and idiots are everywhere, and they love nothing more than finding people who are unsuspecting and feel safe. You need to be pro-active if you want to avoid being a victim.

[I Survived a Carjacking, Here is What I Learned](#)  
[Numbers of Carjacking Across the Country Rising](#)



## I Travel on Airplanes A Lot

Even if you could make the argument that you spend more time away from home (via airplane) than you do at home, that still wouldn't be an excuse to not carry when you are not traveling. Further, you can check guns on airplanes, you know? Almost all airports make it relatively easy.

[How to Check Guns on Planes](#)



## I Have a Physical Disability

Are you tired of your disability getting in the way of doing what needs to be done? While everyday carry may not be a possibility for you, you may need to approach it with the attitude of "how can I" and not "can I."

[Carrying with a Disability](#)  
[Disabled Man Saves Life Using Gun](#)



My Work Uniform Makes it Too Hard to Conceal

Hard or impossible? With many ankle and tuckable holsters on the market, it's likely that you just haven't tried enough options. Also consider that a smaller gun is generally easier to conceal.

[Concealed Carry Technique with Shirt and Tie](#)



## I Don't Always Take my Purse / Bag with Me

Off body carry systems come with that very issue. Where possible, you need to find and use a holster system that is attached to your body. Otherwise you need to change your habits since being without that gun is the worst idea you could have.

[Off-Body Carry Considerations](#)

[Doing Off-Body Carry Right, with Beth Alcazar](#)  
[Guide to Conceal Carry with a Purse](#)



Keeping Track of the Laws is Too Hard

Here is a perfect time to remind you about the best legal resource that you can use to determine any state's firearm laws, and much, much more. Our App called [Concealed Carry Gun Tools](#) provides legal information for every state and DC.

[The Concealed Carry Gun Tools App](#)

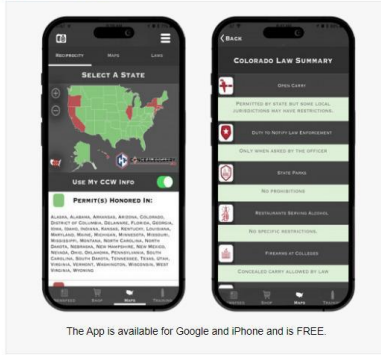

## My Family Members Don't Support Me

If you don't think you can or should "conceal" it from them, it's time to have one of those hard conversations about why this is important to you. Education, both yours and theirs, are the keys to removing the emotional and mental barriers.

[When a Family member is Against Concealed Carry](#)





## Getting a Permit Will Put Me On the Grid

A concealed carry permit doesn't mean you own a gun or guns (in most states). But I understand the reasons someone may not want to tell the government they are "pro-gun." However, ask yourself if it's worth being on "the grid" so you can legally defend yourself in a life-threatening situation? I would say it is.

[Are Guns Registered](#)



## I Don't Know How to Respond to a Threat

It takes a lot of forethought and training to be prepared to take action. One thing that is certain is that if you don't have the firearm, you have fewer options. Start with that first step and seek the training to prepare you for the next step.

[Overcoming the Fear of Taking Action](#)



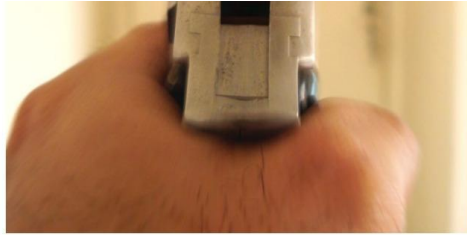

## I Don't Have An Attorney To Represent Me

Get one. Ask your instructor and gun club for recommendations and make that happen as soon as you can.

[Here is a great guide](#)  
[Concealed Carry Insurance](#)



## Closing —

There you have it. We hope we provided some help in overcoming the primary reasons people don't carry a firearm with them. Let us know what reasons you had to overcome when you first started carrying your firearm.

If you enjoy this content, please consider sharing it with those you care about. We want to help folks [become responsible in their self-defense strategy](#).



#### About Jacob Paulsen



Jacob S. Paulsen is the President of ConcealedCarry.com. ConcealedCarry.com provides in-person and online firearm training for American gun owners. The Company is currently teaching in-person classes in 25+ states with a team of more than 55 instructors. Jacob is a NRA certified instructor & Range Safety Officer, USCCA certified instructor and training counselor, Utah BCI instructor, Affiliate instructor for Next Level Training, Graduate and certified instructor for The Law of Self Defense, and a Glock and Sig Sauer Certified Armorer. He resides in the Rocky Mountains of Colorado with his wife and children.

[View all posts by Jacob Paulsen](#)

*Posted in [Training](#) and tagged [allow](#), [civil](#), [comfort](#), [conceal](#), [disability](#), [edc](#), [employer](#), [every day carry](#), [family](#), [holster](#), [law](#), [legal](#), [prohibit](#), [support](#), [uniform](#)*

#### 23 Comments



**Charles F Widmer Sr.** on April 24, 2016 at 12:16 pm

Love your resolutions for the obvious. I have a license and have carried almost daily for many,many years. I only pulled it once and that was because of an aggressive cow elk. I fired into the ground and they fled.

Most people who don't like or carry, are afraid of guns. They need free training for all aspects of being armed. Every cop I ever talked to was grateful for my abilities in maybe one day rendering him assistance. Go serious, go armed.

[Reply](#)



**John DeMonte** on July 15, 2020 at 7:30 pm

Great article Mr. Paulsen:  
I have my CCW in Illinois, yet have only carried a few times. If my business takes me into a "high crime" area, I'll carry. Most often, though, my travels are through stable neighborhoods. Well, your reasons #12 and #21 hit home. I looked more deliberately and found a holster that I am very comfortable with, I have two separate handguns (.380 and 9mm) that I train with regularly and now carry one or the other every place that local laws allow me to carry. Thanks for giving me a bump in the right direction to get off the fence on this much debated issue.

[Reply](#)



**Champagne** on July 20, 2020 at 4:09 pm

I, totally, agree! I carry everywhere I go. If I have to go to the hospital campus here, I have a good place for it beside my seat. Ready to draw it, if necessary. Heck. I even carry while at home. Never know who might come to your door....

[Reply](#)



**Danofive0** on April 27, 2016 at 9:28 am

This is all very well said....  
But remember one thing.....  
If you must use your gun, and shoot someone...  
When the police come. Stand still. Do not move. Have your hands out in front of you....  
And when they ask what happened. Just give your name. And say. I was in fear for my life. I want a lawyer. Say no more. Not one word until you have a lawyer with you. Nothing.  
Know your rights and use them. The police are NOT on your side when you shoot someone. They come after the fact. 98% of the time.. And one more thing.. Never fire a warning shot.  
You can go to jail for it... .. In English the thugs have more rights then you do..  
Be armed. Be ready. Know your rights. And use them. And have a great safe day..

[Reply](#)



**James Loder** on April 27, 2016 at 1:31 pm

Very good article, well written! I, agree we should carry every day. However I, have a compact 1911 .45 cal. Double stack sinale action. I. think it is too heavv. Need a oood holster ISB.and am

considering dropping down to a .9mm. American made. Also my wife has been through law suits with me and she thinks that I, feel like a big man, carrying. Nothing could be farther from the truth!!

[Reply](#)



**Jacob Paulsen** on April 27, 2016 at 1:33 pm

James, I'm a little bias but did you check out the Brave Response Holster? You can find it in our online store.

[Reply](#)



**Mikial** on April 27, 2016 at 7:50 pm

Yeah, lot's of typical BS excuses. And the material of regrets when the person making the excuses isn't ready and something catastrophic happens.  
Natural selection, I guess.

[Reply](#)



**jim** on April 28, 2016 at 12:45 pm

yes the man with the 1911 45 i carry my 45 in a shoulder holster and it make,s it easy too carry

[Reply](#)



**larry martin** on April 28, 2016 at 4:30 pm

yes I carry a 45 double stack that I lock in my desk five days a week but carry a 380 on my ankle all day don't go any where with out the one or two always even beside me when watching tv at night I live in a very scattered area

[Reply](#)



**Ted Goffinet** on August 24, 2017 at 11:56 am

I relate well with #20. With work and family time constraints it took me six years from having my

I have been married, went from one family into another, it took the six years from buying my first handgun until I was adequately confident to pursue my carry permit. I now carry daily and still use the range/training time to maintain my confidence.

[Reply](#)



**Kynn Morgan** on January 22, 2018 at 10:11 pm

I'm trying to figure out how to conveniently carry while wearing Suspenders. No luck yet. Help please!

[Reply](#)



**Jacob Paulsen** on January 29, 2018 at 3:37 pm

Kynn, sounds like you tuck your shirt in yes? If you are looking to carry concealed then I would recommend a belly band or the Brave Response Holster as they are all fully tuckable. Try the appendix position.

[Reply](#)



**Kynn Morgan** on May 17, 2018 at 10:35 pm

Thank you very much Jacob for the suggestions!

[Reply](#)



**RJ Finley** on July 13, 2020 at 7:08 pm

Check into Alien Gear

[Reply](#)



**Rick Bicknell** on July 15, 2020 at 5:59 pm

Amen brother . I have been carring since the 60's . Some friends say they hide guns around their home . I laugh and just say wear one . Say you are in the middle of your room and you have a gun hidden in your couch . Someone kicks your door open and points his pistol at

you . You are out of luck .

[Reply](#)



**Kevin Faulkner** on May 18, 2018 at 9:40 pm

I don't know what to do when I go to the gym?So I end up leaving it in my vehicle or sometimes my gym bag?any other options?

[Reply](#)



**Shawn H** on July 15, 2020 at 6:05 pm

Carry a small duffle bag with your towel, water bottle and handgun in it. Gyms are places you feel very exposed

[Reply](#)



**David P Rasbold** on July 15, 2020 at 6:36 pm

I carry everywhere I go except on a Military reservation. I am retired military and carrying on base is illegal under federal law. Other than that, I would not leave home without it.

[Reply](#)



**Larry** on July 15, 2020 at 7:48 pm

If you are LEO or licensed CCW and don't carry, you are one of the "sheep". Become the "sheepdog" wherever you go.  
( Thanks Col. Grossman)

[Reply](#)



**Robin Drummond** on July 15, 2020 at 9:31 pm

I went through too much training and qualifying in Sacramento County NOT to carry everyday. I am 5'3" and weigh 105 lbs. I'm a retired LE chaplain with 13 grandGrandbabies and 65 years old.

Although I have several firearms on my cow, I carry my S&W M&P Shield 9mm in my carry purse. I will protect myself and my family. I may be in the grocery store behind you, but you'd never know I'm armed unless I was certain someone was threatening my life or someone elses.

[Reply](#)



**JEFFREY L STOCK** on March 26, 2021 at 8:21 pm

I attained a CCW permit in my state of WI in 2012, since then I carry 24/7. I own my own trucking business, of the 3 states I currently travel in/through 2 of those states recognize my states CCW permit, the only exception is IL, in IL my CCW permit is recognized to "Transport Through The State Of IL" but I may not set foot on IL soil with my firearm, if I have to get out of my truck/vehicle, my firearm must remain in the vehicle inside a locked gun vault. I am a "Life Member" of USCCA, if you have a CCW permit, I strongly advise you to become a USCCA member, the training they offer is "Priceless", and if you are ever forced to use "Deadly Force" 1 phone call to them and they will be there for you with an attorney to represent you. There is always a way to correctly address the issues listed in this article.

[Reply](#)



**luis Correa** on May 7, 2022 at 4:33 pm

I carry when I'm in my home state. But, being a truck driver , do travel thru IL, and the northeast. I do own my truck. How can work around this?

[Reply](#)



**JC Findley** on May 8, 2022 at 6:04 pm

I carry every day everywhere it is legal or won't get me fired. At work I take it off in the parking lot and keep it in a **truck vault** until I leave work and strap on again.

I agree with ALL of your logic sans one. If you live in an anti-gun state and can't move for whatever reason a nonresident license will NOT help you. Anti-gun states like NY, NJ or CA don't have good reciprocity laws and almost certainly don't accept nonresident licenses. I have a non resident FL CCW and simply don't travel to those states. Those include any state that touches the Pacific and most in the NE north of Virginia.

[Reply](#)

Leave a Comment



Comment

Name (required)

Email (will not be published) (required)

Website

Submit Comment

Follow Us:



Download Our App:



### User Options

- [User Dashboard](#)
- [Login / Register](#)
- [Order History](#)
- [Affiliate Program](#)
- [Join Our Newsletter](#)

### Other Resources

- [About ConcealedCarry.com](#)
- [Become A Dealer](#)
- [Advertise With Us](#)
- [How We Work With Instructors](#)
- [What Is Guardian Nation](#)
- [Community Guidelines](#)
- [Our Contributors](#)





# Celebrity Drive: 'Duck Dynasty' Star Willie Robertson

CEO of Duck Commander is an F-150 Man

K.S. Wang - writer | Jul 15, 2015

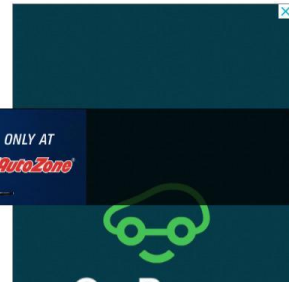

Related Video

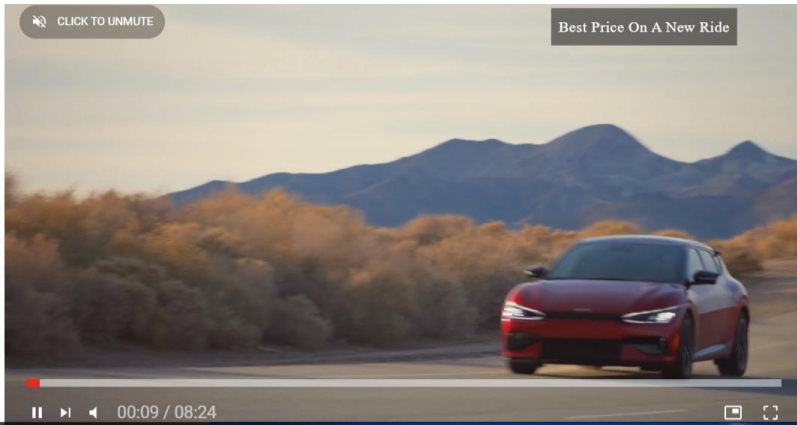

**CarBravo**  
Feel the usedphoria.

[Get an offer >](#)

**Trending Pages**

WTF? 2023 Monte Carlo ZL1? Wild Mashup Build Found on the HOT ROD Power Tour!

**Duralast** OE-STYLE NOISE ELIMINATING SLOTS & CHAMFERS

Quick Stats: Willie Robertson  
 Daily Driver: [2014 Ford F-150](#) (Willie's rating: 10 on a scale of 1 to 10)  
 Other cars: see below  
 Favorite road trip: Louisiana to Alabama  
 Car he learned to drive in: 1985 [Chevy](#) Custom  
 First car bought: 1984 [Ford Mustang](#)

[Subaru BRZ tS First Look: by STI](#)

[2025 Hiker Pear Is an Intriguing Subaru Crosstrek-Sized Affordable Electric SUV](#)

[Lamborghini Aventador Winds Up Stuffed Under a Semi](#)

[It's Here! 2024 Ford Mustang EcoBoost First Drive—Is It Better Than the GT?](#)

Shopping Tool

**MICHELIN® Tires are EV Ready.** [Find your fit](#)

Willie Robertson loves his new truck -- a [2014 Ford F-150](#) -- and viewers see it on the new season of A&E's top-rated show "Duck Dynasty," which began last month.

So far Robertson gives it a perfect 10. "I've had it since January, and I just love it. It's a great truck. I like the way it drives," he says. "It's new. I got it with a partner of mine. They build out

**AMERICAN EXPRESS**

**SAVE FOR WHATEVER COMES NEXT**

with a Certificate of Deposit or High Yield Savings Account

[GET STARTED](#)

...and the way it's built, the way the team gets into a partner or client, they build out trucks. What they do is they put these trucks together, build them, and they display them for a year, all around the country. It's built as a show truck and then I get it after that."

GET STARTED  
American Express National Bank  
Member FDIC Insured.  
Terms Apply.



**Duralast**  
**OE-STYLE**  
NOISE ELIMINATING  
SLOTS & CHAMFERS

TABLE AND  
LAND

The F-150 was hand painted in Texas, where several of Robertson's other trucks were painted as well. "This one's kind of like tree bark," he says. "It almost looks reptilian, which is why I like it. It's all hand done, and I always panic I'm going to get into an accident because I think trying to fix it would be difficult, with it being hand painted."



SEE ALL 11 PHOTOS



**CarBravo**  
Well-qualified buyers can get  
**4.9% APR\***  
for 60 months on eligible  
CarBravo Tier Vehicles.

\*Info

Shop Now >



**Duralast**  
GUARANTEED TO  
MEET & EXCEED  
YOUR EXPECTATIONS

Robertson likes the way the F-150 runs, and he also likes that it's a practical ride. "It's got a lot of pickup, which I like, and it's really spacious too, ..." he says. Robertson is especially fond of the gun storage container. "It's called a 'truck vault.' You can lock it up, and it pulls out like a long drawer. But I've got all kinds of stuff in there, stuff that I need."

He's looking forward to packing it up and getting into the woods. "I can put ammo, guns, and extra clothes, and I can have it secure when I'm driving around. And then, once you get out of hunting mode, all my hunting stuff comes out of it."

Robertson also has a [2014 Chevy Silverado 1500](#) completely covered with black Line-X, the spray-on bedliner. The Silverado was shown at SEMA and then offered as a limited-edition trim.

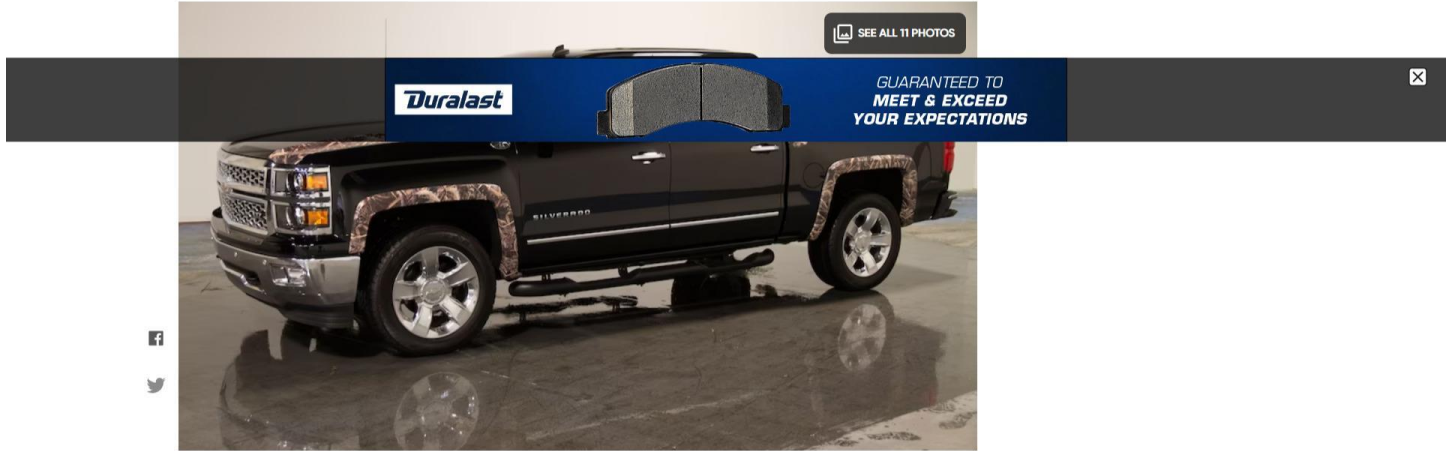

Having two trucks gives Robertson options. "If I'm going somewhere that I know I'm going to scratch the heck out of it, then I'll take the one that's been Line-Xed out. It's got the bed open -- I don't have the truck vault on it -- so if I need a deeper bed for something I need to carry, then I can use that one as well."

While the F-150 (pictured at top) will be seen for the first time on "Duck Dynasty" this season, the Chevy has gotten plenty of love. "I've had it for a while, and it's been a great truck," he says, adding that his new Ford truck that'll be pretty interesting when you see the truck.

**Duralast**



GUARANTEED TO  
**MEET & EXCEED**  
YOUR EXPECTATIONS



SEE ALL 11 PHOTOS



Robertson also has what he calls a "duckoflaged" 2007 BMW Z4. "It's like a duck camouflage," he says. "We use it in festivals, and I've loaned it out to people to drive around. It's just a fun little car."



He got permission from A&E to use the pattern they use on the show. "I got a guy that wrapped it for me, and it's funny. Now when I drive down the street in that, it really causes a stir," he says. "Although my kids like to drive it as well. If my friends come in from out of town and they don't have a vehicle, I put them in that. It's my loaner car."

Since Robertson's trucks turn heads -- and in turn gives away his TV-star identity -- he has another car to keep things low key as well. "It's my incognito car," he says, laughing. "I'm not

another car to keep things from getting weird. It's my incognito car," he says, laughing. "I'm not even going to tell you what it is, because I don't want anybody to know what it is."

The only thing Robertson would say about his incognito car is that he bought it about a year ago. "A lot of people would come over into town, which is great. We love it," he says. "But there were just some times that I needed to kind of pull into the office without everybody knowing that I was pulling into the office."



## Car He Learned To Drive In

Robertson learned to drive, as he says, "down in the country" in West Munroe, Louisiana, in a **1985 Chevy Custom**. "We had a [Chevrolet](#), a 1985 model with that column shift. So we had three on a tree. That's how I learned to drive with a column shift. Then Jase totaled that one, and we lost that one. Shoot, we were driving at 13, 14. I don't know if it was legal."

Robertson recalls being a very green driver in ninth grade when he tried to visit his girlfriend at her home. He missed the turn and got the car stuck on a hill. "I stayed on that hill for about two



hours before I finally gave it enough gas, because it kept stalling, and I ended up going home, he remembers. "I didn't even see her because of my curfew, and I missed the whole thing because I couldn't figure out how to get up that hill in first gear."



## First Car Bought

Robertson bought a 1984 Ford Mustang for \$1,000 when he was a senior in high school. "It wasn't the cool one. It was the ugly one," he says. "It was bright orange with a white top. It was hideous looking with white leather seats and had about 200,000 miles on it." He was able to buy it by pawning his baseball card collection with his girlfriend's father. "He gave me the money, and he told me when I got the money back, I could buy back the cards again."

He bought the car, but then he and his girlfriend broke up. "She told him that I couldn't buy the baseball cards back," he says. "She was not happy."



Robertson also worked at a carpentry shop in high school, and that helped pay for the car as well. "I sanded cabinets and cleaned out the shop," he says. "That's what I did to make money."



He remembers the Mustang's rear speakers vividly. "The whole back seat was a speaker," he says, laughing. The speaker took up so much space, he recalls, the car was functional only as a two-seater.

Robertson made a lot of memories in the Mustang. "I ran around everywhere, and I was proud of it, but I was glad to rid of it and finally get in a truck." His first truck? A [Jeep Comanche](#). "That was my upgrade. It was used, but it was newer."

SEE ALL 11 PHOTOS



## Favorite Road Trip

"When Korie and I were dating," he says about his wife, "we went to Gulf Shores, Alabama. She had a [Nissan 240SX](#), and it was really fancy." He drove it and ended up getting a speeding ticket on the way down and one on the way back home. "I dropped about \$800 on one trip just with the speeding tickets."

He got both speeding tickets in Mississippi. The first police officer actually confiscated

Robertson's driver's license. "When I got stopped coming back home and he asked for my driver's license, I said, 'You have to call whatever that sheriff's department is up the road, because they took it the first time coming down.' The officer told Robertson would get his license back once he pays his fines. "I guess that was a way in Mississippi of making sure they got the money."

He and wife Korie tied the knot a few months after that, and they continue to vacation in Gulf Shores Alabama. "Still go. Twenty-five years in a row we went. They call it the Red Neck Riviera."



SEE ALL 11 PHOTOS

## Season 8 Of "Duck Dynasty" On A&E

The new season of "Duck Dynasty" is now in full swing, the family is already filming the next season.

"We've incorporated some more stuff that's going on," Robertson says. "It's kind of getting bigger now. Like I've got a restaurant now. It's great. Still funny. (My oldest son) John Luke's getting married, so we're going to film an episode about that."



Robertson's daughter Sadie was on "Dancing with the Stars" last year, and she finished in second place. "She's on the show a lot," he says, "and she's back home and filming. So good to have her back."

Prior to their hit reality show, the family business – Duck Commander – has been selling duck calls, for which Robertson is its CEO. Robertson says in 2013 they sold more duck calls than ever, due to the success of the show.

"Once the show came out," he says, "I think we sold more duck calls than there were duck hunters. So I think a lot of people are buying them now just like having a little piece of this, not exactly to go hunting with."

*"Duck Dynasty" airs Wednesdays at 9:30 p.m. on A&E.*





More Celebrity Drives:

- [Run DMC's Darryl McDaniels](#)
- [Aaron Kaufman of Discovery TV's 'Fast N' Loud'](#)
- [James Maslow, actor, 'Dancing With the Stars' finalist](#)
- [Actor Robert Patrick](#)
- [R&B Artist Trey Songz](#)
- [Actor Mekhi Phifer](#)



 MotorTrend Recommended Stories





### 2020 Chevrolet Corvette Stingray: Here's How We'd Build Ours

Motor Trend Staff | Jul 22, 2019



### Tesla's V3 Supercharger, Tested

Brian Vance | Jul 22, 2019



### 2020 Hyundai Sonata Hybrid Sports a Solar Panel Roof

Stefan Ogbac | Jul 22, 2019

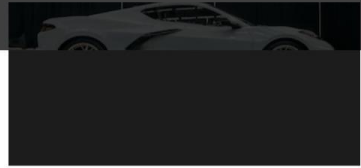

### 2020 Chevrolet Corvette Stingray vs. Ford GT: A Specs Comparison

 Sabrina Costa | Jul 19, 2019

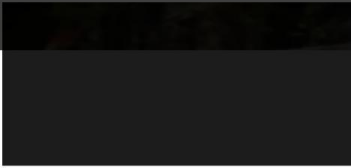

### ICYMI: Chevy Teased the 2020 Corvette C8.R Race Car

Edward Loh | Jul 19, 2019

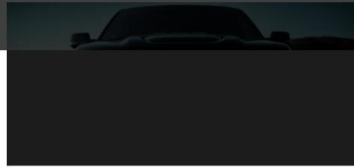

### The 2025 Ram 1500 REV Is the Toned-Down Electric Pickup

Alisa Priddle | Jul 25, 2023





## Related Pages

Celebrity Drive: Clint Robertson of HGTV's "Boise Boys"

Celebrity Drive: Nick Wechsler of 'Revenge'

Celebrity Drive: Comedian and Author Steve-O

Celebrity Drive: Ethan Hawke, star of 'Getaway'



**MOTORTREND**



[MotorTrend Group](#) | [Our Team](#) | [Careers](#) | [About Us](#) | [Contact Us](#) | [Newsletters](#) | [Advertise With Us](#) | [Magazine Subscriptions](#) |

[Discovery, Inc](#) | [Terms of Use](#) | [Privacy Policy](#) | [Cookie Policy](#) | [Ad Choices](#) | [California Privacy Notice](#) |

[Do Not Sell or Share My Personal Information](#) | [Reprints/Permissions](#)

MOTOR TREND NETWORK





2023 MAZDA CX-5  
START YOUR JOURNEY  
LOCATE A DEALER

# Celebrity Drive: 'Duck Dynasty' Star Willie Robertson

CEO of Duck Commander is an F-150 Man

K.S. Wang - writer | Jul 15, 2015



Related Video

2023 MAZDA CX-5

START YOUR JOURNEY  
LOCATE A DEALER

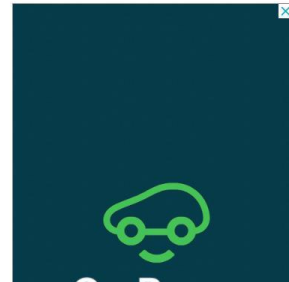



**Quick Stats:** Willie Robertson, "Duck Dynasty" star and CEO of Duck Commander

**Daily Driver:** [2014 Ford F-150](#) (Willie's rating: 10 on a scale of 1 to 10)

**Other cars:** see below

**Favorite road trip:** Louisiana to Alabama

**Car he learned to drive in:** 1985 [Chevy](#) Custom

**First car bought:** 1984 [Ford Mustang](#)

Shopping Tool

MICHELIN® Tires are EV Ready.

Find your fit

Willie Robertson loves his new truck -- a [2014 Ford F-150](#) -- and viewers see it on the new season of A&E's top-rated show "Duck Dynasty," which began last month.



So far Robertson gives it a perfect 10. "I've had it since January, and I just love it. It's a great truck. I like the way it drives," he says. "It's new. I got it with a partner of mine. They build out



CarBravo

Feel the usedphoria.

Get an offer >

Trending Pages

WTF? 2023 Monte Carlo ZL1? Wild Mashup Build Found on the HOT ROD Power Tour!

2024 Subaru BRZ tS First Look: Blessed by STI

2025 Fisker Pear Is an Intriguing Subaru Crosstrek-Sized Affordable Electric SUV

Lamborghini Aventador Winds Up Stuffed Under a Semi

It's Here! 2024 Ford Mustang EcoBoost First Drive--Is It Better Than the GT?

trucks. What they do is they put these trucks together, build them, and they display them for a year, all around the country. It's built as a show truck and then I get it after that."



SPONSORED CONTENT

### How to Know If You're Overpaying on Car Insurance

By Savvy

The F-150 was hand painted in Texas, where several of Robertson's other trucks were painted as well. "This one's kind of like tree bark," he says. "It almost looks reptilian, which is why I like it. It's all hand done, and I always panic I'm going to get into an accident because I think trying to fix it would be difficult, with it being hand painted."



GET STARTED  
American Express National Bank.  
Member FDIC Insured.  
Terms Apply.

2023 SILVERADO 1500 <sup>Important</sup>

AVAILABLE WITH SUPER CRUISE™  
DRIVER ASSISTANCE TECHNOLOGY\*

CHEVROLET Shop Silverado

Well-qualified buyers can get  
**4.9% APR\***  
for 60 months on eligible  
CarBravo Tier Vehicles.

\*Info

Shop Now >

Robertson likes the way the F-150 runs, and he also likes that it's a practical ride. "It's got a lot of pickup, which I like, and it's really spacious too, ..." he says. Robertson is especially fond of the gun storage container. "It's called a 'truck vault.' You can lock it up, and it pulls out like a long drawer. But I've got all kinds of stuff in there, stuff that I need.

He's looking forward to packing it up and getting into the woods. "I can put ammo, guns, and extra clothes, and I can have it secure when I'm driving around. And then, once you get out of hunting mode, all my hunting stuff comes out of it."



Robertson also has a [2014 Chevy Silverado 1500](#) completely covered with black Line-X, the spray-on bedliner. The Silverado was shown at SEMA and then offered as a limited-edition trim.



Having two trucks gives Robertson options. "If I'm going somewhere that I know I'm going to scratch the heck out of it, then I'll take the one that's been Line-Xed out. It's got the bed open -- I don't have the truck vault on it -- so if I need a deeper bed for something I need to carry, then I can use that one as well."



While the F-150 (pictured at top) will be seen for the first time on "Duck Dynasty" this season, the Chevy has gotten plenty of airtime. "They rolled it with toilet paper; that was on TV," he says, adding that his new [Ford](#) is the focus of another prank this season. "They do something to my truck that'll be pretty interesting. I don't want to say what it is, but by the end of the show it's funny when you see the truck."



Robertson also has what he calls a "duckoflaged" [2007 BMW Z4](#). "It's like a duck camouflage," he says. "We use it in festivals, and I've loaned it out to people to drive around. It's just a fun little car."

He got permission from A&E to use the pattern they use on the show. "I got a guy that wrapped it for me, and it's funny. Now when I drive down the street in that, it really causes a stir," he says. "Although my kids like to drive it as well. If my friends come in from out of town and they don't have a vehicle, I put them in that. It's my loaner car."

Since Robertson's trucks turn heads -- and in turn gives away his TV-star identity -- he has another car to keep things low key as well. "It's [my incognito car](#)," he says, laughing. "I'm not



another car to keep things from keying us from. It's my incognito car," he says, laughing. "I'm not even going to tell you what it is, because I don't want anybody to know what it is."

The only thing Robertson would say about his incognito car is that he bought it about a year ago. "A lot of people would come over into town, which is great. We love it," he says. "But there were just some times that I needed to kind of pull into the office without everybody knowing that I was pulling into the office."

Get an offer >



### Car He Learned To Drive In

Robertson learned to drive, as he says, "down in the country" in West Munroe, Louisiana, in a **1985 Chevy Custom**. "We had a [Chevrolet](#), a 1985 model with that column shift. So we had three on a tree. That's how I learned to drive with a column shift. Then Jase totaled that one, and we lost that one. Shoot, we were driving at 13, 14. I don't know if it was legal."

Robertson recalls being a very green driver in ninth grade when he tried to visit his girlfriend at her home. He missed the turn and got the car stuck on a hill. "I stayed on that hill for about two

nours before I finally gave it enough gas, because it kept stalling, and I ended up going home, he remembers. "I didn't even see her because of my curfew, and I missed the whole thing because I couldn't figure out how to get up that hill in first gear."



## First Car Bought

Robertson bought a 1984 Ford Mustang for \$1,000 when he was a senior in high school. "It wasn't the cool one. It was the ugly one," he says. "It was bright orange with a white top. It was hideous looking with white leather seats and had about 200,000 miles on it." He was able to buy it by pawning his baseball card collection with his girlfriend's father. "He gave me the money, and he told me when I got the money back, I could buy back the cards again."

He bought the car, but then he and his girlfriend broke up. "She told him that I couldn't buy the baseball cards back," he says. "She was not happy."

Robertson also worked at a carpentry shop in high school, and that helped pay for the car as well. "I sanded cabinets and cleaned out the shop," he says. "That's what I did to make money."



He remembers the Mustang's rear speakers vividly. "The whole back seat was a speaker," he says, laughing. The speaker took up so much space, he recalls, the car was functional only as a two-seater.

Robertson made a lot of memories in the Mustang. "I ran around everywhere, and I was proud of it, but I was glad to rid of it and finally get in a truck." His first truck? A [Jeep Comanche](#). "That was my upgrade. It was used, but it was newer."



### **Favorite Road Trip**

"When Korie and I were dating," he says about his wife, "we went to Gulf Shores, Alabama. She had a [Nissan 240SX](#), and it was really fancy." He drove it and ended up getting a speeding ticket on the way down and one on the way back home. "I dropped about \$800 on one trip just with the speeding tickets."

He got both speeding tickets in Mississippi. The first police officer actually confiscated Robertson's debit card. "When I got home, I went to the bank and had to get a new card."



Robertson's driver's license. "When I got stopped coming back home and he asked for my driver's license, I said, 'You have to call whatever that sheriff's department is up the road, because they took it the first time coming down.'" The officer told Robertson would get his license back once he pays his fines. "I guess that was a way in Mississippi of making sure they got the money."

He and wife Korie tied the knot a few months after that, and they continue to vacation in Gulf Shores Alabama. "Still go. Twenty-five years in a row we went. They call it the Red Neck Riviera."



## Season 8 Of "Duck Dynasty" On A&E

The new season of "Duck Dynasty" is now in full swing, the family is already filming the next season.

"We've incorporated some more stuff that's going on," Robertson says. "It's kind of getting bigger now. Like I've got a restaurant now. It's great. Still funny. (My oldest son) John Luke's getting married, so we're going to film an episode about that."



Robertson's daughter Sadie was on "Dancing with the Stars" last year, and she finished in second place. "She's on the show a lot," he says, "and she's back home and filming. So good to have her back."



Prior to their hit reality show, the family business – Duck Commander – has been selling duck calls, for which Robertson is its CEO. Robertson says in 2013 they sold more duck calls than ever, due to the success of the show.

"Once the show came out," he says, "I think we sold more duck calls than there were duck hunters. So I think a lot of people are buying them now just like having a little piece of this, not exactly to go hunting with."

*"Duck Dynasty" airs Wednesdays at 9:30 p.m. on A&E.*



COMPARE INSURANCE RATES  
& SAVE UP TO \$489/YR!

[CHECK YOUR RATE](#)

POWERED BY [inscre.com](#)

Well-qualified buyers can get  
**4.9% APR\***  
for 60 months on eligible  
Car Bravo Tier Vehicles.

[Shop Now >](#)

\*Info

Recommended for you [@outbrain](#)





More Celebrity Drives:

- [Run DMC's Darryl McDaniels](#)
- [Aaron Kaufman of Discovery TV's 'Fast N' Loud'](#)
- [James Maslow, actor, "Dancing With the Stars" finalist](#)
- [Actor Robert Patrick](#)
- [R&B Artist Trey Songz](#)
- [Actor Mekhi Phifer](#)

### 2023 Volkswagen Jetta

7.4<sup>10</sup>



- MPG:** 29/42
- Horsepower:** 147@5,000-6,000
- Engine:** 4-Cyl Turbo 1.5 Liter TSI®

Sponsored by Volkswagen



### Why People are So Passionate about Ka'Chava

Sponsored | Ka'Chava

**AMERICAN EXPRESS**

**WATCH YOUR SAVINGS GROW** with a High Yield Savings Account.

[Learn More](#)

American Express National Bank, Member FDIC. Terms Apply.

**AMERICAN EXPRESS**

**SAVE FOR WHATEVER COMES NEXT** with a Certificate of Deposit or High Yield Savings Account.

[GET STARTED](#)

American Express National Bank, Member FDIC. Insured. Terms Apply.





29 city/42 highway MPG (2023 Jetta 1.5L, 6-speed manual transmission). EPA estimates. Your mileage will vary and depends on several factors, including your driving habits and vehicle condition.

[Learn More](#)

**Urologists: Forget the Blue Pill, This Kills Your ED!**

Sponsored | Boostaro

### MotorTrend Recommended Stories



**2020 Chevrolet Corvette Stingray: Here's How We'd Build Ours**

Motor Trend Staff | Jul 22, 2019



**Tesla's V3 Supercharger, Tested**

Brian Vance | Jul 22, 2019



**2020 Hyundai Sonata Hybrid Sports a Solar Panel Roof**

Stefan Ogbac | Jul 22, 2019



**2020 Chevrolet Corvette Stingray vs. Ford GT: A Specs Comparison**

Sabrina Costa | Jul 19, 2019



**ICYMI: Chevy Teased the 2020 Corvette C8.R Race Car**

Edward Loh | Jul 19, 2019



**The 2025 Ram 1500 REV Is the Toned-Down Electric Pickup**

Alisa Priddle | Jul 25, 2023

### From Around the Web

Recommended by outbrain





[Gallery] Freshman Years: Unbelievable Insights From Student's Life  
<https://petsreporter.com/> | Sponsored





[Gallery] 27 Bonds Girls Ranked From Worst to Best. Can't Argue With No. 1

YourDIY | Sponsored

## Related Pages

Celebrity Drive: Clint Robertson of HGTV's "Boise Boys"

Celebrity Drive: Nick Wechsler of 'Revenge'

Celebrity Drive: Comedian and Author Steve-O

Celebrity Drive: Ethan Hawke, star of 'Getaway'





CHEVROLET  
MYWAY

**MOTORTREND**



[MotorTrend Group](#) | [Our Team](#) | [Careers](#) | [About Us](#) | [Contact Us](#) | [Newsletters](#) | [Advertise With Us](#) | [Magazine Subscriptions](#) |  
[Discovery, Inc](#) | [Terms of Use](#) | [Privacy Policy](#) | [Cookie Policy](#) | [Ad Choices](#) | [California Privacy Notice](#) |  
[Do Not Sell or Share My Personal Information](#) | [Reprints/Permissions](#)

MOTOR TREND NETWORK

[Automobile Magazine](#) | [Truck Trend](#) | [Four Wheeler](#) | [Hot Rod](#) | [Super Street](#) | [Lowrider](#)

© 2023 MotorTrend | MOTOR TREND GROUP, LLC. ALL RIGHTS RESERVED.



[Drawer Systems](#)

[Slide Systems](#) ▾

[Tool Box Systems](#)

[Accessories](#)

[Community](#) ▾

[Find a Dealer](#)

[Fleet Sales](#)

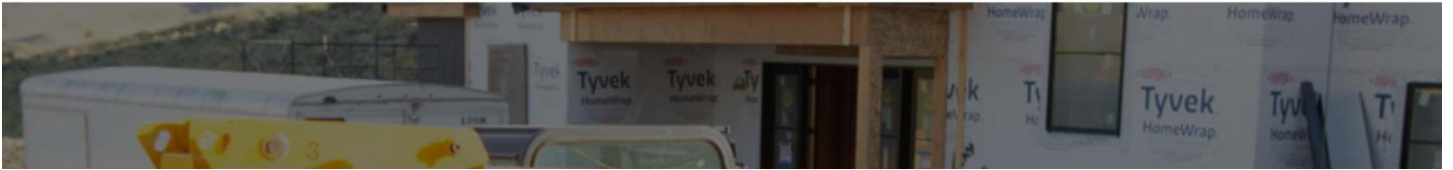



# TRUCK GUN STORAGE GUIDE - THINGS YOU SHOULD KNOW



Truck Gun Storage Guide: Things You Should Know





Can you live without a gun?

In America...?

No, can't do that!

Guns are part of our American Dream—part of our freedom. You have the freedom to defend yourself and your families in the event of any threat. Even if you don't have anything to fear, you might want to keep a gun just in case.

There are a number of reasons why 393 million civilians in America possess guns. For instance, some of you may be interested in competitive shooting sports, while some may be seasoned hunters. As said earlier, many would carry weapons for self-defense.

Regardless, it is imperative that you keep firearms out of sight, safe, and protected at all times. Otherwise, you might end up with a damaged investment or stolen firearms, and the latter is something that you wouldn't want to happen at all. To put things into perspective, thousands of guns are reported missing or stolen every year across the US, with Florida as the leading state.

Truck gun storage is your best bet to keep your firearms safe and out of sight at all times— take it from someone, DECKED, whose truck gun storage system is trusted by law enforcement, military, and other public safety departments.

In this guide, we will discuss some of the most important questions related to laws regarding keeping firearms, the importance of gun storage for trucks, and some ideas to help you decide the right truck storage for firearms.

# SOME COMMON QUESTIONS

Before you hold possession of any firearms or carry it in your vehicle, it is imperative that you first understand your state's gun laws. It should be noted that gun laws vary from state to state. For starters, if one state allows you to carry firearms with a permit, you may find other states allowing permitless carry.

Moreover, in most US states, it is prohibited to carry loaded firearms. Therefore, when you are traveling, you first need to unload the firearm and lock the magazines separately from the gun and in a place that is inaccessible to passengers.



Here's what else you need to know when it comes to carrying firearms:

## CAN I KEEP A GUN IN MY TRUCK?

Well, I just answered it above. But allow me to clarify a bit. In most cases, the answer is yes—you can concealed carry guns in your vehicle. However, before you do that, it is important that you check the gun laws in your state. In some states like California, you are permitted to conceal carry as long as the gun is secured and unloaded. Moreover, the ammunition also needs to be kept secured and inaccessible to the drivers and passengers.

## ARE TRUCK GUN RACKS LEGAL?

Again, it depends on what a specific law says in your state. If your state gun law allows open-carry of firearms on a permit, it means you will need a permit for displaying a [gun rack](#) in your truck. If the state law forbids open-carry even with a permit, it means you can't use [truck gun](#) racks. However, if the law allows open-carry without a permit, then you don't really need any permit for gun racks.

## CAN I CARRY A TRUCK GUN ACROSS STATES?

The Firearms Owners Protection Act (FOPA) allows truck owners to carry a gun across state lines if it meets two conditions:

- The owner should be legally allowed to carry a weapon in the state they are traveling from
- The owner should be legally allowed to carry a weapon in the state they are traveling to

In most cases, you are supposed to encase and unload the weapon and store it in an area that is not directly accessible to the driver or the passenger.

## WHAT STATES HONOR CONSTITUTIONAL CARRY?

Constitutional carry means permitless carry, i.e., you can carry the firearm either in an exposed or concealed state with or without a permit or license. There are about fifty states in the US, which we cannot cover in this brief guide. It would be best that you check out your state's specific constitutional carry law or refer to Wikipedia.

## WHY DO YOU NEED GUN STORAGE FOR TRUCK?

Now that we have discussed the legality of carrying truck guns, let's answer another important question: Do I need a [truck gun storage](#) box or a vault? Apart from the legal reasons that require you to carry firearms in storage in a concealed state, there are a number of other reasons as well that you need a storage vault for your truck gun.





## ENHANCES SAFETY & SECURITY

You can't have your gun leisurely lying around on your truck's floor or near the dashboard or in the back. Exposed firearms should be encased and kept locked for the safety of the driver as well as the passengers. Moreover, you can't have it around your kids at all. Even if you are a cautious driver and you don't have toddlers, you might end up inviting a thief to bash your truck's windows and steal the firearms. To ensure that your truck guns are not only out of plain sight but also secured, you need some kind of truck gun storage solution.

## PREVENTS DAMAGE TO GEARS

A Charles Daly 601 Field Semi-Auto Shotgun would cost you around \$330, while a Savage Arms 110 Apex Hunter XP Bolt-Action Rifle would cost \$600. Since you also need ammunition for your firearms, add \$100 to \$200 to the final price. Since firearms don't come cheap and require added care and attention, you wouldn't want your investment to go to waste due to dings, dents, or damages, resulting from moving and slipping in your truck while you drive.

## 4 KEY FEATURES YOU NEED TO CHECK IN A TRUCK GUN STORAGE

If you are still with me, it seems that you have made up your mind and plan to buy a truck gun storage rack or box soon. But before you do that, it is important to ensure that you consider the following aspects while shopping for gun storage for trucks.

## MATERIAL

Perhaps one of the most important aspects that you need to consider to buy top-quality gun storage for a truck is its material. We understand how much efforts go into earning money, and after putting so much sweat and blood into it, you don't want to waste it on a cheap quality product. Therefore, make sure that whatever type of storage system you opt for, it should be durable and sturdy.

For instance, if you are opting for a gun rack, you can opt for a steel-made rack with an anti-scratch coating, such as plastisol. But if you want to pick a truck bed gun storage, you may probably want to avoid steel boxes as they are prone to corrosion. You may want to go for a mix of high-impact plastic resin, with a mix of galvanized steel and aluminum, like the [DECKED Drawer System](#) that is built to keep your gear protected against all elements and secured against theft.



## SIZE

Well, size does matter, at least when it comes to gun storage for trucks. The size of your gun rack or storage box depends on the type of firearm you own. For instance, you may not want a full-length gun rack if you carry a Beretta 92FS. For storing your Beretta, you may want to consider buying a [truck vault](#) gun storage unit. If you own a hunting rifle, a [rear window gun rack](#), an overhead rack, or a crossover toolbox might be the best option.

## MOUNTING STYLE

Mounting style depends on the size of your weapon as well as your vehicle. You can't have many mounting styles in a small family vehicle, but you may get different options in a Chevy, Dodge Ram, or Ford. Moreover, some types of gun mounts require one-time installation which means you can't change their positions often. Determine the best mounting style for your vehicle that doesn't put off its looks.

## SECURITY

Amongst all the other things, security is of utmost importance because you can't risk your investment or leave it at the mercy of passersby or thieves. For instance, if you are more interested in getting a rear window gun rack of your M4, you may want to check if the rack comes with a security lock feature, like any hook and a cable that you can fasten along with a lock.

Similarly, if you are inclined towards a truck bed gun storage, make sure it has a key lock or a biometric for a truck gun vault – whatever gives you a sense of security. Take, for instance, the [DECKED](#) Drawer System that offers double the protection to your gears. The DECKED Drawer System comes with a sturdy security lock that you can fortify with the key lock of your truck tail cover.

# 4 BEST TRUCK GUN STORAGE IDEAS

So far we have discussed some important legal questions regarding truck guns, the importance of truck gun storage systems, and key features to look into. Let's check out some pickup truck gun storage ideas.

---



## TRUCK BED GUN STORAGE

If you don't feel safe carrying guns inside your cab, truck bed gun storage might be the best option for you. The DECKED Drawer System is the most feasible option for any pickup truck and gun owner looking for a secure gun storage unit. The lockable storage unit gives you ergonomic access to your tactical gear, which you can easily roll out at waist height to retrieve or load your gear. Each drawer storage box can carry 200lbs of payload, which means you can carry your weapons in one storage unit while securing the ammunition, armor, and other essentials in the other unit. The best



weapons in one storage unit while securing the ammunition, armor, and other essentials in the other unit. The best aspect of the Drawer System is that you can also make the most of the top of the deck which can carry a 2000lbs payload. With modular customizations, such as DECKED Dividers, DECKED D-Box, and DECKED Peacemakers, you can ensure the safety of your firearms at all times.

## OVERHEAD TRUCK GUN RACK

Overhead gun racks are a feasible option for gun owners who usually use their pickup for work purposes, and don't allow children anywhere near it. If you wish to carry an unloaded firearm in your pickup fasten in an overhead rack, make sure you check its material, size, and security aspects.

## RUNNING BOARD STORAGE

Running board storage units are also a great way to conceal and secure your firearms. You don't have direct access to the weapons, as per the gun laws, but you will always have peace of mind as the storage unit is always in sight. However, since running boards are used for steps to access your cab and it is frequently used, it may not be able to offer better protection than a truck bed gun storage box.

## TRUCK VAULT GUN STORAGE UNIT

If you carry a handgun, such as a Beretta, a **truck vault** gun storage unit would be the best option for you. Most of these vaults come with electronic keypads and have reinforced walls, which mean better security and accessibility for the gun owner. But since the firearm is in close proximity to the driver, you may want to check with your local laws if you can carry a vault in your vehicle.

## CONCLUSION

Regardless of what type of truck gun storage box you may want to use to carry your firearms, we advise that you first consult with a local lawyer, get detailed insights into conceal-carry, and then opt for any of the truck gun storage ideas that we discussed above.

[ALL PRODUCTS VEHICLE SELECTOR POPUP](#)

## READING NEXT



**DECIDING BETWEEN THE TRACTOR  
SUPPLY TOOL BOX OR DECKED  
DRAWER SYSTEM OR DECKED TOOL  
BOX?**



**SHOULD I GET A TONNEAU COVER  
FOR MY TRUCK OR DECKED?**

**GET GOING WITH DECKED**

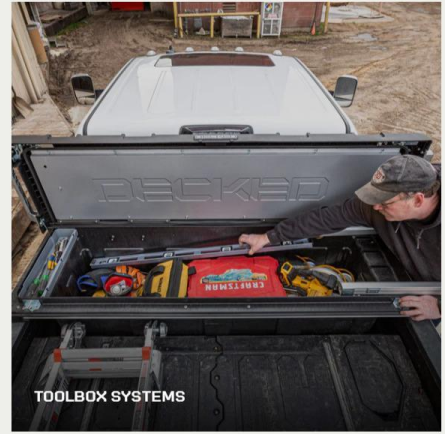
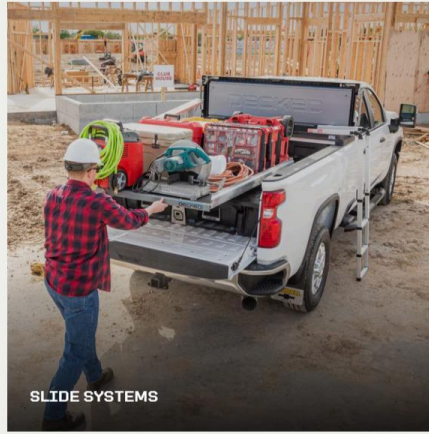
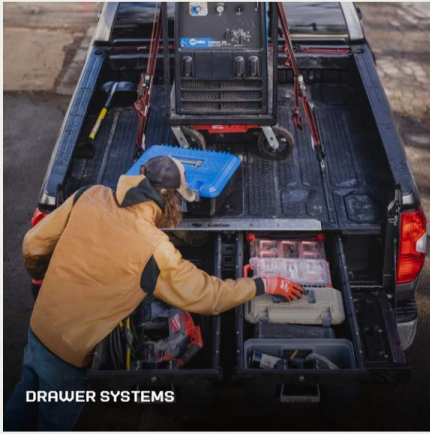

Made in the USA



100% Weatherproof



Recycled Steel



Lifetime Warranty

DECKED



SUPPORT

- Contact Us
- Shipping + Returns
- FAQ + How To

COMPANY

- Our Story
- Careers
- Stories

E-mail



Enter email, receive bacon. Or at least some great marketing from DECKED. You can cancel us like you canceled Bud Lite at anytime.

[Fleet Sales](#)

[Become a Dealer](#)

[Team](#)

[Blog](#)

**PRODUCT HELP**

[Warranty](#)

[Register Your Product](#)

[Technical Specs](#)

[Install Manuals](#)

[Affirm Financing](#)

[Replacement Parts](#)

**RESOURCES**

[Military Discount](#)

[Affiliate Program](#)

[Privacy Policy](#)

[Do Not Sell/Share Personal Info](#)

[Terms + Conditions](#)

[Accessibility](#)

[DECKED Patents](#)

 USD \$ ▾

© 2023, DECKED.

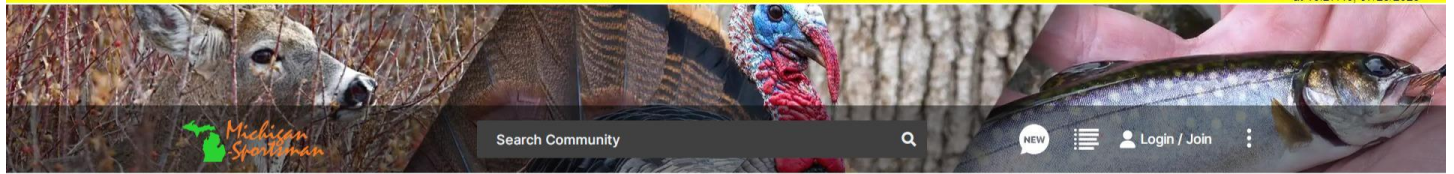

Home > Forums > Trading Post > **Sell - Buy - Trade Hunting and Fishing Goods** >

### Truck gun vault

730 Views 4 Replies 2 Participants Last post by Parkerman, May 31, 2015 [Jump to Latest](#)

**P** Parkerman Discussion starter · May 26, 2015

I have a homemade two drawer **truck vault**, that fits a five foot bed pickup. Made out of 3/4 inch wood, cost me close to \$95 in materials (no including labor) to build it, I'll let it go for \$70. Eric call me at 248-568-6916 or email at [eriseric@aol.com](mailto:eriseric@aol.com)

Reply Save Like

Advertisement

Ad (0:01)

**SAVAGE**  
BETTER COMES STANDARD.  
SAVAGEARMS.COM

Skip Ad

2020 Hunting Camp  
NOW PLAYING  
4:54  
2021 Deer Hunt

Tactical Shotgun (Review)

Robeco Micro MAN

Arrow Rest Review

Elite Verdict

Target 100 Set Up

1 - 5 of 5 Posts

**Hornady**  
**PISTOL SAFES**  
**USA Midway**  
**SHOP ALL**

Enjoy banner ad-free browsing with Michigan Sportsman Forum Plus [Learn more](#)

#### Michigan Sportsman Forum

A forum community dedicated to hunting and fishing enthusiasts in the Michigan area. Come join the discussion about safety, gear, tackle, tips, tricks, optics, hunting, gunsmithing, reviews, reports, accessories, classifieds, and more!

[Full Forum Listing](#)

#### Explore Our Forums

[Michigan Whitetail Deer Hunting](#)

**downfloat** · #2 · May 26, 2015  
Any chance for a pic and measurements?

Reply Save Like

**Parkerman** Discussion starter · #3 · May 28, 2015  
Sure send me an email and I'll send you pics. It fits between the wheel wells of a standard pickup 48"x 59 1/2" 8 1/2" deep. Base is made out of 3/4" and the drawers are 1/2" pine.

Reply Save Like

**downfloat** · #4 · May 28, 2015  
Email sent

Reply Save Like



**Parkerman** Discussion starter · #5 · May 31, 2015  
The one drawer is divided and carpeted into four sections to hold your rifles or shotguns

Reply Save Like



thread, you may not receive a response, and could be reviving an old thread. Please consider creating a

y...

⌂ R T TT C A A TT- [Icons]

Detroit River and Lake Erie  
MichiganWaterfowl.com  
Upland Game hunting, Dogs and dog training  
Saginaw Bay and its Tributaries



### Top Contributors this Month

View All →

- LGB 544 Replies
- sureshot006 522 Replies
- RHRoss 444 Replies



### Recommended Communities

- China Car Forums 215K+ members
- Lake St. Clair Forum 72K+ members

Post Reply

2017 MEMBERS

Politics  
60+ members

### Related Threads

**Truck Vault Magnum \$1, 200. (Alpena)**  
 Cars and Trucks  
 0 replies 744 views akadeadeye · updated Aug 31, 2015

**TRUCK VAULT for SUV or PICK UP TRUCK**  
 Sell - Buy - Trade Hunting and Fishing Goods  
 1 reply 2K views troutchops · updated Sep 20, 2013

**Trade Hunting and Fishing Goods**  
 462 views gonzos · updated Sep 7, 2013

**Truck Vault**  
 7 replies 1K views Barkerman · updated Oct 12, 2017

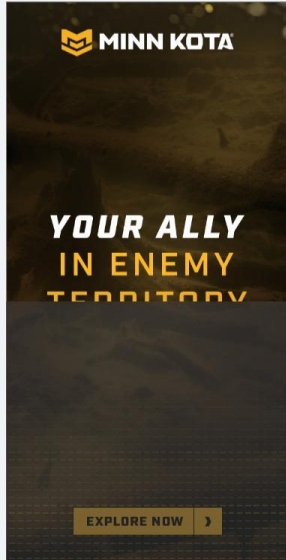
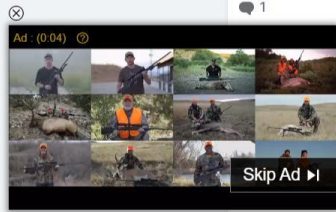

gh links on our site, we may earn an affiliate commission, which supports our community.

s forum software by XenForo.

Carbon Media Group), 30800 Telegraph Rd, Suite 1921, Bingham Farms, MI 48025 USA



[Your Privacy Choices](#)



**IT MATTERS  
WHERE YOU STAY.**



[BOOK NOW](#)

**Hilton**  
FOR THE STAY





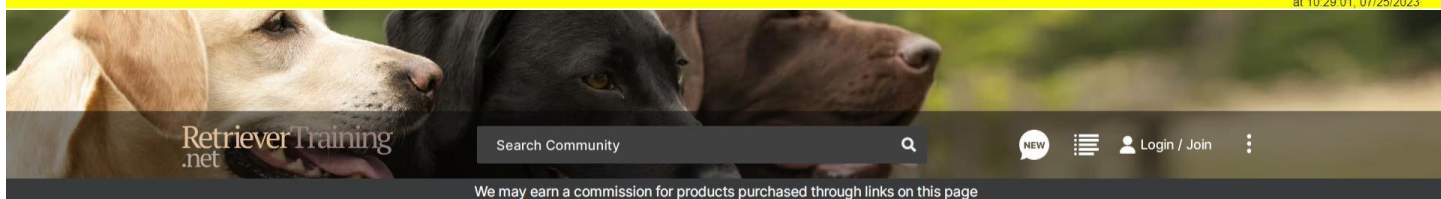

Retriever Training .net

Search Community



NEW



Login / Join



We may earn a commission for products purchased through links on this page

Home > Forums > RTF General Forums > General Retriever Training Forum >

### Advice on **Truck Vault**, Dog Boxes, & Other Accessories for a Yukon XL/Suburban

4022 Views 7 Replies 7 Participants Last post by IowaBayDog, Oct 5, 2014 [Jump to Latest](#)

**Swack** Discussion starter · Oct 4, 2014

RTF'ers,

I'm looking for input on accessories for holding guns, equipment, and dogs. I finally had to replace my old 2002 Yukon XL (264,000 miles) with a 2014 Yukon XL and I'm looking to outfit it as my dog hauler/work truck. In my old Yukon XL and past Suburban's I've gotten by pretty well with a homemade wooden deck in the back under which I could slide gun cases and some other misc. equipment. The dogs rode in four Large Pet Mate dog crates; two in the back, one by the back driver side door and one accessible through the passenger side back door.

**Truck vault** or any other type of under the crate storage units and wondered how for you good folks on RTF. Also, any input for other dog containment options that good (or not so good) in a Suburban type vehicle would be useful. And finally any input bed liners, both good or bad, would be helpful. I've heard of "Weather Tech" mats and any good.

ed thoughts you feel might be useful are welcomed. Thanks in advance for your help!

[Learn More](#)

Claim Free Gift

by uscca.deltadefense...

Skip Ad ▶

Claim Free Gift

by uscca.deltadefense...

Skip Ad ▶

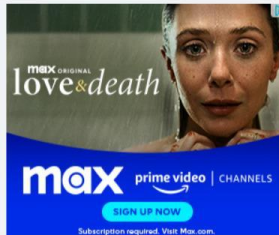

Enjoy banner ad-free browsing with RetrieverTraining.Net - the RTF Plus [Learn more](#)

#### RetrieverTraining.Net - the RTF

A forum community dedicated to retriever owners and enthusiasts. Come join the discussion about breeding, training, health, behavior, housing, adopting, care, classifieds, and more!

[Full Forum Listing](#) →

[Explore Our Forums](#)

Reply Save Like

Advertisement

**CLICK BELOW NOW**  
FOR YOUR EXCLUSIVE MEMBERSHIP OFFER

**Learn More**

**Skip Ad** ▶

NEW PLAYING

1 - 8 of 8 Posts

**BonMallari** · #2 · Oct 4, 2014

as a former Suburban owner. **Truck Vault** are nice, but they are pricey and eat up very valuable cargo space quickly..I like the flexibility of being able to make up your own figuration for your own personal needs..

As for the Weather Tech, had them in my Suburban, have them on my current ride a Nissan Pathfinder, and we got them for my nephew's new Tacoma...they fit real well...big fan

Executor of the Alanson C Brown III - Trust

Reply Save Like

**LESTER LANGLEY** · #3 · Oct 5, 2014

Swack, PM me your email address. I'll send you something that you "may" be very very interested in.

Reply Save Like

- General Retriever Training Forum
- Event Information
- Product Review
- AKC Field Trials
- Equipment, Art, Outdoor Collectibles Classifieds



**Top Contributors this Month**

- View All →
- drunkenpoacher  
214 Replies
  - Jacob Hawkes  
64 Replies
  - EdA  
62 Replies



**Recommended Communities**

- VWVortex Volkswagen Forum  
2M+ members
- Dog People World Forum

**willson** · #4 · Oct 5, 2014 (Edited)

Check out Ainley drawer systems. I have one in my truck. It's very well made and all metal. Pricing is comparable to **Truck Vault**. I think the Ainley is a better product. I am totally satisfied with mine. It also has an optional 15 gallon water tank with an electric pump.

ave Like

CLICK BELOW **NOW** Learn More  
FOR YOUR EXCLUSIVE MEMBERSHIP OFFER

Skip Ad ▶

**Our Beagle World Forums**  
51K+ members

**2024+ Toyota Tacoma Forum**  
310+ members

the brakes and easy to remove if you ever decide to rake out the accumulated debris and dog hair. We had 2 Ainley kennels on top of the drawer box - all lockable so we leave the back doors open/ajar - and two collapsible kennels between the drawer unit and front seats accessible from the rear passenger doors for a comfortable 4 dog unit. Not sure that would work in a Tahoe. Tule carrier on top for the people stuff for which there was no longer any room in the 'Burb.

The pic was taken when I had the unit temporarily on a truck but fit comfortably in the 'Burb.

See more



CLICK BELOW **NOW** Learn More  
FOR YOUR EXCLUSIVE MEMBERSHIP OFFER

Skip Ad ▶

Reply Save Like

**LESTER LANGLEY** · #6 · Oct 5, 2014  
Try me again Jeff. I cleaned out my inbox.

Reply Save Like

**Keith Stroyan** · #7 · Oct 5, 2014  
I wanted visibility over the boxes and the commercial ones are too high, so I build my own in sections that can be removed.

Reply Save Like



**CLICK BELOW NOW** Learn More  
FOR YOUR EXCLUSIVE MEMBERSHIP OFFER

Skip Ad ▶

Dog · #8 · Oct 5, 2014  
them yourself for a fraction of the cost and yes they can absolutely be lockable. You  
ential hardware for locking that those companies use online or at trailer/camper stores.  
ardwood "slides" about any DIY'er can do for probably close to 1/10 what purchased  
inside a suburban you don't need something that extravagant. I'm doing layout right  
metal ones for our suburban, its the drawer slides that drive almost 1/2 the cost but I  
xpensive prototype that will actually be better than slides. Can't let that cat out of the  
ouldn't be necessary for wood drawers anyway.

Reply Save Like

**RetrieverTraining.Net - the RTF**

Here are some related products that RetrieverTraining.Net - the RTF members are talking about. Here are some related products that RetrieverTraining.Net - the RTF members are talking about.

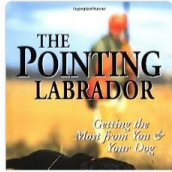

CLICK BELOW NOW  
FOR YOUR EXCLUSIVE MEMBERSHIP OFFER  
Learn More  
Skip Ad ▶

Custom Dog Knee  
Brace | CCL/ACL Stifl...

The Pointing Labrador  
\$199 USD  
Amazon

Glyde Mobility Chews  
Hip & Joint Suppleme...  
\$53 USD  
Parnell.com

COLORFUL HOC  
DADDY 5" INSE  
\$25 USD  
HYFOL

2 comments

2 comments

3 comments

thread, you may not receive a response, and could be reviving an old thread. Please consider creating a

Write your reply...

B I U S A T T

Post Reply

### Related Threads

Dog box size

General Retriever Training Forum

13

7K

Css200 · updated Dec 11, 2014

ght

er Training Forum

2K

boyetthunter · updated Feb 28, 2014

of car rides

er Training Forum

CLICK BELOW NOW  
FOR YOUR EXCLUSIVE MEMBERSHIP OFFER  
Learn More  
Skip Ad ▶



Newark - An Avnet Company  
 Discover Next-Gen Electronics [OPEN >](#)

Forums What's new Media Members Sponsors Supporting Member Newsletter Log in Register Search

New posts Search forums

THE REGION'S LEADING HEALTH SYSTEM  
 Need care at 2 a.m.? Our Advanced Urgent Care centers have you covered. [Learn more](#)  
 KAISER PERMANENTE

Forums > Refuge Forums > The Duck Hunters Forum >

- Fishdog Outdoors
- Blindgrass Camouflage Systems
- Flyway Specialties
- Crazy Bird Custom Calls
- Juvie Juke Box
- SilloSocks
- JJ. Lares Calls
- Autumn Wings
- RM Custom Calls

### Homemade truck vault ..... ???

STINGER · Sep 29, 2012

1 2 3 Next >

Sep 29, 2012 #1



**STINGER**  
Elite Refuge Member

Has anyone ever made a wooden sliding tray style box for inside their truck bed to store guns/tools in ????

if so would you be so kind as to share photos ???

NEMA4X IP66 PC BOXES  
 Indoor/outdoor versions with optional clear covers

Discover Next-Gen Electronics

Joined: Mar 11, 2002  
Messages: 9,394  
Reaction score: 0  
Location: SE Pennsylvtucky

thinking of building one for a upcoming journey to No Dak to maximize bed space

Lets hunt ..... that \$heet can wait

FEATURED VIDEOS

Powered by *[premia]*



Learn More

NEW PLAYING

Skip Ad ▶

Explore a vast Selection of Cutting-Edge Electronics and Components at Newark

Newark - An Avnet Company

Open >

Sep 29, 2012

#2



**STINGER**

Elite Refuge Member

Joined: Mar 11, 2002  
Messages: 9,394  
Reaction score: 0  
Location: SE Pennsylvtucky

something llike this just not looking o spend 3400 +

<http://www.truckvault.com/ProductsByVehicleType.aspx?CID=SO&VTID=PU>

Lets hunt ..... that \$heet can wait

Sep 29, 2012

#3



I know several carpenters that have built them. Not hard- you're just building a box. They use 4 x 8 sheets of plywood and 2 x 10's to build the box. Drawers are simple or complicated, depending on how much work you want to put into them. With short boxes, simple drawers work well because even pulled all the way out they rest substantially on the tailgate. Build a box with a center divider, then build two drawers. Nice simple setup.



HYUNDAI

New 2023 Hyundai Elantra SE

\$209 (mo.)  
\$3,499 Due at Signing  
36 Month Lease

OR

2.49% APR

Image For Illustration Purposes Only.

Pohanka Hyundai  
Audi of the Americas

**Traxion**

Elite Refuge Member  
Joined: Jun 8, 2002  
Messages: 1,989  
Reaction score: 145  
Location: South Dakota



Latest posts

- Jumping blinds**  
Latest: charlie8584 · 3 minutes ago  
Tennessee Flyway Forum
- Body Found At Obama Mansion**  
Latest: ARHHH4 · 3 minutes ago  
Political Action Forum
- The best all around TSS shot size**  
Latest: Pot Hole · 6 minutes ago  
Shooting - Reloading Forum

Sep 29, 2012

#4



**dakndug**

Moderator

Joined: Dec 24, 2002  
Messages: 7,198  
Reaction score: 6  
Location: Maryland

Like this? I have @\$400 in it total.

The plywood on top of the box was there cause I had just bought a new truck with an 8' bed and the box came out of my shortbed truck. I'm putting a new top on it and that's a sheet of the new plywood I'm gonna use.

Doug

box1.jpg

box2.jpg

box3.jpg

-----  
No better way to spend a day than in the field behind some birddogs!

Doing it with Drahts!  
Trust that Birddog!  
Nothing like a Childs Smile Behind a Full Fan!

HYUNDAI  
New 2023 Hyundai Ioniq 5 SE  
36 Month Lease **\$389** /mo  
\$4,999 Due at Signing  
OR





**waterswatter**  
Elite Refuge Member  
Joined: Aug 11, 2007  
Messages: 9,340  
Reaction score: 2,821  
Location: Oregon

I built one similar to the one above. I used 1/4" x 1" wood strips coated with wax for slickness for the drawer slides. It is a functional unit and I am not wishing I had something else.

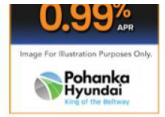

**Dedicated Veteran Support**  
National University

Apply Today



**spaightlabs**  
Elite Refuge Member  
Joined: Mar 7, 2004  
Messages: 7,836  
Reaction score: 3,093  
Location: Centennial, CO

<http://www.theoutdoorsforum.com/forums/index.php?/topic/36203-my-truck-vault-knock-off/>

Might as well make it nice...

I love my country but I fear my government.

Don't trust whitey.



**Wade Finley**  
Senior Refuge Member  
Joined: Dec 29, 2008  
Messages: 877  
Reaction score: 165

- 5D7FC6BB-01F4-4937-8C77-A81A9E786F91-876-0000006ADAEC0619.jpg
- B460348F-742C-414F-AEA1-9270A9EAC75B-876-0000006AE05569B8.jpg
- 0B54A45A-E0A5-4304-A613-6063D2681E75-876-0000006AE98F631D.jpg
- 979724B1-0A81-4F8B-A8D4-FCD18E443FDD-876-0000006AE58D449A.jpg



**Wade Finley**

Senior Refuge Member  
Joined: Dec 29, 2008  
Messages: 877  
Reaction score: 165  
Location: Puyallup, WA

- 9236ADB9-79EE-4AB7-9B77-B9A1B6987552-876-0000006AEDEC2914-1.jpg
- 7E124AC0-6856-4B44-B8D1-1D752BE3F6A9-876-0000006B0216D37E.jpg
- 9598D04C-C673-46A1-940E-F0B37943E027-876-0000006B077A2B02.jpg
- FAF5D04-5DA3-4171-B85B-5FBE760D42D3-876-0000006AF8E9CC0C.jpg



**dakndug**

Moderator

Joined: Dec 24, 2002  
Messages: 7,198  
Reaction score: 6  
Location: Maryland

Wade,

How did you attach the carpet to your top? Glue? Tacks? Both?  
Cause I'm thinking of doing that to this new top.

Thanks

Doug

-----  
No better way to spend a day than in the field behind some birddogs!

Doing it with Drahts!  
Trust that Birddog!  
Nothing like a Childs Smile Behind a Full Fan!



**STINGER**

Elite Refuge Member

Joined: Mar 11, 2002  
Messages: 9,304

Wade the top ply that you piano hinged and carpeted is \*\*\*\* ..... great idea .....

Lets hunt ..... that \$heet can wait

Reaction score: 0  
Location: SE Pennsylvania

1 2 3 Next ▶

You must log in or register to reply here.

Share:   

THE REGION'S LEADING HEALTH SYSTEM Learn more

Your care is connected to a breadth of knowledge and experience

 KAISER PERMANENTE.

Forums > Refuge Forums > **The Duck Hunters Forum** >

HYUNDAI

New 2023 Hyundai **Ioniq 5** SE



36 Month Lease **\$389** per month \$4,999 Due at Signing

OR **0.99%** APR

 Pohanka Hyundai  
King of the Weekend  
Image For Illustration Purposes Only.

[Newsletter](#) [Contact us](#) [Terms of Service](#) [Privacy policy](#) [Help](#) 



#### About us

The Duck Hunter's Refuge, aka The Refuge Forums, is the leading online community for duck and goose hunters.

#### Important Links

[Forum Guidelines](#)  
[Sponsor Directory](#)  
[Advertise With Us](#)

#### Useful Links

[Refuge Forums Main Index](#)  
[Refuge Gang Classifieds](#)  
[Flyway Reports Forums](#)

Community platform by XenForo® © 2010-2022 XenForo Ltd. | Add-Ons by © Jason Axelrod of [Pixel Exit](#) | Media embeds via s9e/MediaSites

 **STEALTH CAM**

**SCOUT LIKE A PRO**

THE MOST COMPREHENSIVE DIGITAL SCOUTING PLATFORM FOR HUNTERS





Home Improvement > Garage > Best Vehicle Gun Safes

Advertiser Disclosure

# Best Vehicle Gun Safes For 2023

By Mike Hagerty  
Contributor

Published: Jun 22, 2023, 1:41pm

We earn a commission from partner links on Forbes Home. Commissions do not affect our editors' opinions or evaluations.

Responsible gun owners often have the need to transport weapons in their vehicles. Keeping a gun secure from accidental discharge or theft is a serious responsibility that rests solely on the gun owner and requires the proper equipment to prevent injury or tragedy.

Truck gun safes offer relatively quick access to a gun while keeping it away from people in the vehicle. They eliminate the possibility of a loose firearm discharging in a crash. And, of course, they reduce the risk of theft when the vehicle is unattended. There are dozens of approaches, from very basic boxes with a key to combination locks (both analog and digital), RFID tags that limit access to specific people and even biometric locks where the user's fingerprint is the key. The more tech-oriented and innovative approaches cost more money, and some gun owners say the tech isn't 100-percent reliable and can slow or block access to a gun in an emergency.

The following list should only be taken as general product recommendations. Forbes Wheels does not recommend or imply any usage or advice that may be unlawful for your specific situation. Using a gun safe requires that you follow all local and state laws that govern weapons, ammunition, permitting, carrying, transporting and leaving a gun in a vehicle.

+ Show Summary



## Featured Products

Advertisement

1 BILLCONCH Gun Safe

2 awesafe Gun Safe

3 ONNAIS IRON SE Biometric Gun Safe

		
<a href="#">Buy Now →</a>	<a href="#">Buy Now →</a>	<a href="#">Buy Now →</a>
On Amazon	On Amazon	On Amazon
Lock type: <b>Biometric/PIN, key</b>	Lock type: <b>"Combination, Electronic"</b>	Lock type: <b>Fingerprint, Combination, Key</b>
Material: <b>Hard carbon steel</b>	Material: <b>Alloy Steel</b>	Material: <b>Aluminum</b>
Other Features: <b>1-yr warranty, USB-chargeable battery</b>	Other Features: <b>Pry resistant door, gas strut, LED lighting</b>	Other Features: <b>1-yr warranty, wall-mountable</b>

### Best Vehicle Gun Safes For 2023

- **SnapSafe Treklite XL 75241** : BEST BASIC VEHICLE GUN SAFE
- **Hornady TriPoint Lock Box** : BEST KEYED VEHICLE GUN SAFE
- **Vaultek LifePod** : BEST DIGITAL COMBINATION VEHICLE GUN SAFE
- **Hornady RApiD Vehicle Safe** : BEST RFID VEHICLE GUN SAFE
- **RPNB Gun Safe** : BEST BIOMETRIC VEHICLE GUN SAFE

### SnapSafe Treklite XL 75241

	BEST BASIC VEHICLE GUN SAFE	<a href="#">\$34.98 On Amazon →</a>
	<b>SnapSafe Treklite XL 75241</b>	On Amazon

Why We Picked It



Pros & Cons



## Hornady TriPoint Lock Box



BEST KEYED VEHICLE GUN SAFE

### Hornady TriPoint Lock Box

On Amazon



On Amazon

Why We Picked It



Pros & Cons



## Vaultek LifePod



BEST DIGITAL COMBINATION VEHICLE GUN SAFE

### Vaultek LifePod

\$109.99 On Amazon



On Amazon

Why We Picked It



Pros & Cons



## Hornady RAPID Vehicle Safe



BEST RFID VEHICLE GUN SAFE

### Hornady RAPID Vehicle Safe

\$199.99 On Amazon →

On Amazon

Why We Picked It



Pros & Cons



## RPNB Gun Safe



BEST BIOMETRIC VEHICLE GUN SAFE

### RPNB Gun Safe

\$129.99 On Amazon →

On Amazon

Why We Picked It







Pros & Cons



---

## Featured Products

Advertisement 

<p><b>1 BILLCONCH Gun Safe</b></p>  <p><a href="#">Buy Now →</a></p> <p>On Amazon</p> <table><tr><td>Lock type</td><td>Biometric/PIN, key</td></tr><tr><td>Material</td><td>Hard carbon steel</td></tr><tr><td>Other Features</td><td>1-yr warranty, USB-chargeable battery</td></tr></table>	Lock type	Biometric/PIN, key	Material	Hard carbon steel	Other Features	1-yr warranty, USB-chargeable battery	<p><b>2 awesafe Gun Safe</b></p>  <p><a href="#">Buy Now →</a></p> <p>On Amazon</p> <table><tr><td>Lock type</td><td>"Combination, Electronic"</td></tr><tr><td>Material</td><td>Alloy Steel</td></tr><tr><td>Other Features</td><td>Pry resistant door, gas strut, LED lighting</td></tr></table>	Lock type	"Combination, Electronic"	Material	Alloy Steel	Other Features	Pry resistant door, gas strut, LED lighting	<p><b>3 ONNAIS IRON SE Biometric Gun Safe</b></p>  <p><a href="#">Buy Now →</a></p> <p>On Amazon</p> <table><tr><td>Lock type</td><td>Fingerprint, Combination, Key</td></tr><tr><td>Material</td><td>Aluminum</td></tr><tr><td>Other Features</td><td>1-yr warranty, wall-mountable</td></tr></table>	Lock type	Fingerprint, Combination, Key	Material	Aluminum	Other Features	1-yr warranty, wall-mountable
Lock type	Biometric/PIN, key																			
Material	Hard carbon steel																			
Other Features	1-yr warranty, USB-chargeable battery																			
Lock type	"Combination, Electronic"																			
Material	Alloy Steel																			
Other Features	Pry resistant door, gas strut, LED lighting																			
Lock type	Fingerprint, Combination, Key																			
Material	Aluminum																			
Other Features	1-yr warranty, wall-mountable																			

### Where Do You Put A Gun Safe In A Car?

Whether bolting a gun safe in place, or attaching it with a cable, you'll want to choose a location that best suits your needs, while addressing the reason you have a gun in your vehicle in the first place. If, for example, you carry a gun for personal protection, then you'll want to store it within the passenger cabin in a place you can readily access. In this case, a console vault/safe would be a good option. Installed in the center console of your vehicle, these safes are easily accessible in an emergency situation. You might also opt to attach a gun safe via cable to the front seat for easy access. However, if you don't carry a firearm for personal protection, then you might prefer a location that's a bit more out of the way, such as in the trunk or cargo area. Some trucks have second-row seats that flip up with extra cargo capacity underneath. This could be a viable location as well.

---



## Methodology

In order to determine the best vehicle gun safes, we looked at reputable manufacturers that build the most secure locking mechanisms and storage options to handle a variety of handguns. Since an unsecured gun is an easy theft that can endanger lives, a proper gun safe is absolutely necessary if you must carry a handgun.

We evaluate all vehicle gun safes based on these weighted metrics:

- Locking mechanism (30%)
- Quality construction (30%)
- Discreet design (30%)
- Warranty (10%)

---

## Frequently Asked Questions (FAQs)

- + **Can you put a gun safe in your car?**
- + **How much is a car gun safe?**
- + **Can you keep a gun in a glove box?**
- + **Where should I put a gun safe in my car?**
- + **What's the safest way to transport a firearm in a vehicle?**

Information provided on Forbes Home is for educational purposes only. The products and services we review may not be right for your individual circumstances.

Forbes Home adheres to strict editorial integrity standards. To the best of our knowledge, all content is accurate as of the date posted, though offers contained herein may no longer be available. The opinions expressed are the author's alone and have not been provided, approved, or otherwise endorsed by our partners.



**Mike Hagerty**  
Contributor

A car-crazy California kid, I've been writing and talking about vehicles for 25 years on TV and radio, in print and online, including AAA magazines in Arizona, Oklahoma, Northwest Ohio, South Dakota and the Mountain West, as well as BBC Autos. I serve as vice president of the Western Automotive Journalists, a professional group for automotive writers based in San Francisco, and have no relation to McKeel Hagerty of Hagerty Classic Insurance, who is younger, better looking and wealthier.

**Forbes**

© 2023 Forbes Media LLC. All Rights Reserved.

[AdChoices](#) [Privacy Statement](#) [Terms and Conditions](#) [About Us](#) [Contact Us](#) [Sponsors](#) [Coupons](#) [Reprints & Permissions](#) [Forbes Press Room](#) [Forbes Quote of the Day](#) [Advertise](#)

Cookie Preferences





Phone: 919-774-4825

Financing.  
Apply Now

[Shop Now](#)

[Exterior](#)

[Interior](#)

[Services](#)

[Company](#)

[Contact Us](#)

## Truck Bed Cargo Slides & Vaults



### We Have You Covered

Ok, time to come clean. Your truck's bed area is a living mess isn't it? Tools over here, hardware over there, garbage & debris from last weeks dog house construction project, it's getting out of control. Time for a serious change. Time for a cargo slide or vault!

Optimize that bed space with specifically engineered compartments that slide out for easy access. Manufactured by popular names like Du-Ha, Decked, Bedslide, Weather Guard and more, KarKraft offers a wide array of options to get your mess organized. Cargo slides and vaults are more efficient, more secure, can optimize every bit of space your truck bed has to offer, and are built solid to last.

So go ahead, visualize the joy of never having to dig through that pile of used rags and loose drop cords again just to find your tape measure. Once installed you will wonder how you ever lived without it!

### Browse Manufacturers

View some of the Truck Cargo Slides and Vaults that are available at KarKraft by browsing the following manufacturer websites and catalogs. Just click to launch.

[BedSlide](#) | [Decked](#)

### Sample Product Types

### Bed Slide



An efficient, productive truck bed slide out storage unit built to endure.

### Cargo Glide



Easily organize, access and reach the contents of your bed with this glide out accessory.

### Pickup Vault



A convenient way to store your equipment, while maintaining adequate bed space.

### Decked Storage



Rugged and spacious, Decked Storage units bring order to your truck's bed space.

## Inquire / Request Information

Interested in purchasing a Cargo Slide or Vault? Contact Kar Kraft today by phone, form or email and we will be glad to answer any questions. Or just come by and visit us during regular business hours to browse our selection.

[Inquire Now](#)

## Brands Available



## Related Products

KarKraft wants to be your dealer for all truck and automotive accessories. Be sure to check out these related products.

[Bed Caps & Tonneaus](#)

[Hitches & Towing](#)

[Truck & Auto Lighting](#)

[Bed Liners & Mats](#)

[Bed Extenders](#)

[Interior Organizers](#)



### Address & Phone

843 Woodland Ave.  
Sanford, NC

### Main Menu

[Shop Now](#)  
[Exterior](#)



919-774-4825

**Disclaimer**

© Copyright 2020  
KarKraft Automotive  
All Rights Reserved

- Interior
- Services
- About Us
- Contact Us

*Auto & Automotive Accessories*



Hi there, have a question? Text us here.



Text us



Search Store...

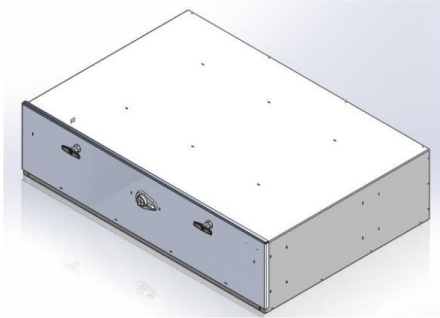

### Troy Products CP-GB4430-PB, Storage Vault With Two Draw-Tight Locking Handles And Push-Button Lock, For Trucks/SUVs

\$2,618.56

ID: #102824 SKU: CP-GB4430-PB

Availability:  
1 in stock

Free Shipping

Quantity:

- 1 +

Secure transaction

Add to Cart

Buy Now

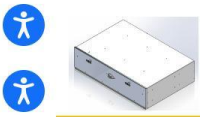

## Description Product Reviews

Troy Products heavy-duty single-drawer storage vault with heavy-duty ball-bearing slides. Exterior dimensions of 44" W x 30" L x 11" H. Includes carpet on top of box, foam in floor, two (2) draw-tight locking handles and one (1) push-button lock. Organize and secure valuable cargo gear in this rugged TROY vault! Add TROY cargo rings to top of box for bungee cord anchor points. Designed and engineered for the perfect fit. Proudly made in the USA.

- All welded construction; 16 gauge CRS housing with .062 aluminum drawer for years of longevity
- Black powder coat and wrinkle finish for durability
- 44" W x 30" L x 11" H
- Heavy-duty, quick-release ball-bearing slides
- Drawer face designed to break over top of box for added security
- Two (2) compression latch lockable handles to eliminate drawer rattle
- Drawer quickly disengages from slides for easy installation
- 1" thick rigid foam
- Includes push-button lock



44"W x 30"L x 11"H

	<b>MAKE</b>	<b>MODEL</b>	<b>YEAR</b>
	Chevrolet	Silverado 1500	2015 - 2021
	Chevrolet	Silverado 2500	2015 - 2020
	Chevrolet	Silverado 3500	2015 - 2020
	Chevrolet	Suburban	2015 - 2020
	Chevrolet	Tahoe	2015 - 2021
	Dodge	Ram 1500	2015 - 2021
	Dodge	Ram 2500	2015 - 2020
	Dodge	Ram 3500	2015 - 2020
	Ford	Expedition	2015 - 2021
	Ford	Expedition Max	2018 - 2021
	Ford	F-150	2015 - 2021
	Ford	F-250	2017 - 2020
	Ford	F-350	2015 - 2020
	Ford	F-450	2015 - 2020
	Ford	F-550	2015 - 2020



# Related Gear

Not finding what you're looking for? Try these alternatives:



TruckVault TAC Center Universal SUV Storage Unit with 1 Bottom Drawer, 3 File Cabinet Drawers, and 1 Magnetic Dry Erase Map Board Drawer, Includes 1 Combo Lock, 3 T-...

\$7,740.21

See Options



TruckVault Captain LX Universal SUV Storage Unit with 5 Drawers, Flip-up Map Board, Cubby Area for Bulk Storage, Includes T-Handle Keyed Locks & 1 Combo Lock, Divide...

\$6,322.69

See Options



TruckVault Investigator Universal SUV Storage Unit with 1 Weapon Drawers & 2 Multi-use Magnum Drawers, Includes 2 Keyed T-Handle Locks & 1 Combo Lock, Dividers (2 Sh...

\$6,294.18

See Options

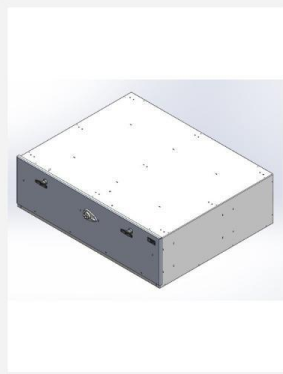

Troy Products CP-GB403212-PB, Storage Vault With Two Draw-Tight Locking Handles And Optional Push-Button Lock/Key Override, For Trucks/SUVs

\$1,964.48

See Options



# Customers Also Viewed



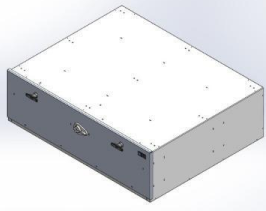

Troy Products CP-GB403212-PB, Storage Vault With Two Draw-Tight Locking Handles And Optional Push-Button Lock/Key Override, For Trucks/SUVs

\$1,964.48

See Options



Soundoff mPower Arrow and Warning LED System, 2020-2023 Ford Interceptor Utility, 3 modules per side, Warning and Traffic Advisor Functionality, Tri Color Red/Blue/A...

~~\$2,401.00~~  
\$1,392.58

See Options



SoundOff nForce Interior Rear Facing LED Light Bar, Dual Color per lighthouse, Blue/White, 2020-2023 Ford Interceptor Utility w/ 76P Option, ENFWB00DY2

~~\$1,636.00~~  
\$948.88

See Options



SoundOff Signal mPOWER Fascia 4-inch, EMPS2001B-E, Surface/Flush (Quick) Mount Light Heads with 3M Adhesive, 12 LED tri-color per light head, BLUE/WHITE

~~\$245.00~~  
\$142.10

See Options



Everything you need.  
Shop the store today.



Shop the Store



✓ Government Purchases Accepted

✓ Expedited Shipping

✓ Local Support

✓ 100% Satisfaction Guaranteed

✓ 3



Your single source for **upfitting, tactical gear, apparel, and installation**



Sign Up For news, sales & deals

Enter your e-mail



FOLLOW US



NAVIGATE

PRODUCTS

RESOURCES

POLICIES

[Home](#)

[Locations](#)

[About Us](#)

[Careers](#)

[A Message from our CEO](#)

[Customer Testimonials](#)

[Apparel](#)

[BallisTech™](#)

[Body Armor](#)

[Emergency Lights](#)

[Tactical & Duty Gear](#)

[Vehicle Equipment](#)

[Turnkey Vehicles](#)

[How to Order](#)

[GSA Ordering](#)

[FAQ](#)

[Request a Quote](#)

[Gift Certificates](#)

[News & Updates](#)

[EEO Policy](#)

[Privacy Policy](#)

[Shipping & Returns](#)

[Oklahoma City Fire Contract](#)

[COVID-19 Relief Fund](#)

© Protection with Precision | Emergency Vehicle Upfitters, Tactical Gear, and Apparel. Powered by **PHENYX**.





















































Gun Safes

Handgun Safes

Home & Office Safes

Fire Safes

Wall Safes

Gun Cabinets

Featured

- [View All Gun Safes](#)
- [View All Products](#)
- [Gift Certificates](#)
- [American Made Gun Safes](#)
- [Discounted Gun Safes](#)

Browse by Category

- Safes In Stock**
- [American Security BFX Series Gun Safes](#)
- [Browning 1878](#)
- [Discounted Gun Safes](#)
- [Remington Express](#)
- [Remington Nitro](#)
- [Remington STS](#)
- [Tactical Closet Vault](#)
- Scratch and Dent Safes**
- [Gun Safes](#)
- [SnapSafe 20% Sale](#)
- [New Arrivals](#)
- Vehicle Safes**
- [Law Enforcement and Military](#)
- [Luxury Safes](#)
- [TL Rated Safes](#)
- Handgun and Pistol Safes**
- [Fire Safes: Fire Gun Safes](#)
- Gun Safe Accessories**
- [Floor Safes](#)
- Vault Doors**
- [Wall Safes](#)
- Browning Shooting Accessories**
- [Deposit Safes](#)

Home > All Products > Truck Vaults

# Truck Vaults



Product Finder: What Is Important To You?

Brand  Height  Width  Depth

Special Features

Products 1-24 of 129

Sort By...

Show 24 Per Page

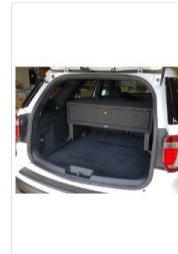
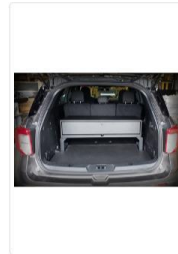

**Modular Safes**

- Gun Cabinets
- Custom Built Safes
- Tactical Gun Safes
- Waterproof Safes
- Biometric Gun Safe
- Truck Vaults
- Home Safes and Office Safes
- Safe Locks
- Security Boxes
- Gun and Bow Racks
- Home Security Products
- Diversion Safes**
- Security Mailbox
- Pharmaceutical

**Browse by Brand**

Select

**Additional Info**

- Gun Safes Blog
- Gun Safes Terminology
- Video Archive
- Gun Safe Wiki
- FAQs
- Guarantee
- Privacy Policy
- Terms Of Use
- Customer Testimonials

**Real Customer Testimonials:**

★★★★★ "I have done extensive shopping on the internet throughout the years and this was, by far the best experience I've had thus far. Product was selected, questions answered and delivery was super. I ordered on a Monday, it was in my

**USA!**  
Blac-Rac - Model 1070 -  
Weapon Retention System  
Item #: BR-1070  
Price: \$399.00



**USA!**  
Estes AWS Sportsman  
Locker  
Item #: P48-000  
Price: \$2,149.00



**USA!**  
Estes AWS SUV Locker,  
2.0 - Standard Police Ford  
Interceptor Utility 2020 +  
Item #: SUV39-2-000-  
Ford 2020+  
Price: \$1,399.00



**USA!**  
Estes AWS SUV Rapid  
Access Weapon Locker 38"  
Item #: SUV38-000  
Price: Call for Pricing



**USA!**  
Estes AWS SUV Locker,  
2.0 - Chevy Tahoe  
Item #: SUV39-2-000-  
Chevy Tahoe  
Price: \$1,399.00



**USA!**  
Estes AWS SUV Locker,  
2.0 - Dodge Durango  
Item #: SUV39-2-000-  
Dodge Durango  
Price: \$1,399.00



**USA!**  
TruckVault Secure Storage  
Solutions  
Item #: TruckVault  
Price: Call for Pricing



**Quick Ship!** **USA!**  
Console Vault Dodge Ram  
1500 Full Floor Console:  
2009 - 2017  
Item #: 1028-DR1500  
Price: \$299.00



**Quick Ship!** **USA!**  
Console Vault Dodge Ram

**Quick Ship!** **USA!**  
Dodge Ram 1500 Full

**Quick Ship!** **USA!**  
Dodge Ram 2500/3500

**Quick Ship!** **USA!**  
Console Vault Chevrolet

garage on Wednesday and was exactly what I wanted. Wow. Best price, best service. I'll be back." » — Kevin W

★★★★★ "This was one of my best internet purchases ever, from the website, to the person who answered my questions before the purchase, to the person who scheduled the delivery, to the two delivery persons, who were friendly, efficient and very helpful. Congratulations to all of you !!!" » — Mary E.

★★★★★ "Fast, professional, first-rate. The best part: I saved over \$800 on my AMSEC safe, compared with what I would have paid local retail. (I thoroughly priced it out. Watch out for retail markups on gun safes!) The pros at gunsafes.com know what they're doing. Highly recommended." » — Philip

- View all Customer Testimonials  
- submit your comments here

2500, 3500 Full Floor Console: 2010 - 2017  
Item #: 1028-DR2500  
Price: \$299.00

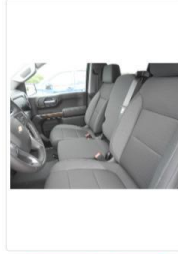

Quick Ship! USA!  
Console Vault Chevrolet Silverado 2500/3500: 2020-2023  
Item #: 1104-1  
Price: \$299.00

Floor Console: 2009 - 2018  
Item #: 1028  
Price: \$299.00  
★★★★★ (4)



Quick Ship! USA!  
Console Vault GMC Sierra 1500: 2019-2023  
Item #: 1104-2  
Price: \$299.00

Full Floor Console: 2010 - 2018  
Item #: 1028-1  
Price: \$299.00



Quick Ship! USA!  
Console Vault GMC Sierra 2500/3500: 2020-2023  
Item #: 1104-3  
Price: \$299.00

Silverado 1500: 2019-2023  
Item #: 1104  
Price: \$299.00



Quick Ship! USA!  
Chevrolet Silverado 1500: 2019-2022  
Item #: 1094  
Price: \$299.00



Quick Ship! USA!  
Chevrolet Silverado 2500/3500: 2020-2022  
Item #: 1094-1  
Price: \$299.00

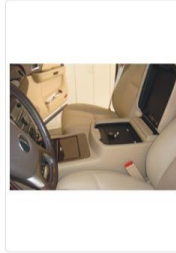

Quick Ship! USA!  
Console Vault Chevrolet Silverado Floor Console w/USB Access: 2010 - 2013

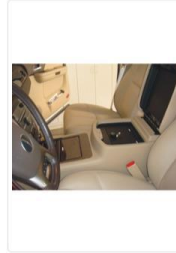

Quick Ship! USA!  
Console Vault Chevrolet Silverado Floor Console: 2007 - 2013  
Item #: GS1011-CS

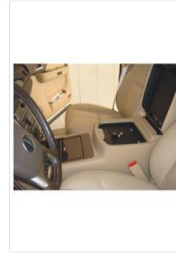

USA!  
Console Vault Chevrolet Suburban Floor Console w/USB Access: 2007 - 2013

Item #: 1011B-CS  
Price: \$299.00

Price: \$299.00  
★★★★★ (2)

Item #: GS101B1-CS  
Price: \$299.00



Quick Ship! USA!  
Console Vault GMC Sierra  
1500: 2019-2022  
Item #: 1094-2  
Price: \$299.00

Quick Ship! USA!  
Console Vault GMC Sierra  
2500/3500: 2020-2022  
Item #: 1094-3  
Price: \$299.00

Quick Ship! USA!  
Chevrolet Silverado 1500  
Floor Console: 2014 -  
2018  
Item #: 1050  
Price: \$299.00

Quick Ship! USA!  
Chevrolet Silverado  
1500/2500/3500 Floor  
Console: 2015 - 2019  
Item #: 1050-1  
Price: \$299.00

< Prev 1 2 3 4 5 6 Next >

**Order Information**

- Track Your Order
- Login To Your Account
- FAQ's
- View Receipt

**Shipping & Returns**

- Shipping Rates
- Delivery Lead Time
- Return Policy
- Installation & Setup

**General Information**

- Customer Service
- Wish List
- Strict Privacy Policy
- Why Buy from us?

**Business Center**

- Affiliate Program
- Quantity & Volume Discounts
- Site Security
- About Us



ABOUT SSL CERTIFICATES







# A . R . E .

[CAB HIGH MODELS](#)

[MID/HIGH RISE MODELS](#)

[HOW TO GET A QUOTE](#)

[CONTACT US](#)

[VISIT ARE'S WEBSITE HERE](#)

ARE truck caps, also called truck toppers and camper shells, are constructed of strong, resilient fiberglass and tough non-corrosive aluminum.

ARE offers a lifetime warranty on any manufacturer defects on structure and paint & a one year warranty on all hardware. Broken glass is not warrantied but we can answer all your questions and provide tips on how to avoid accidental window breaks.

**Base prices on all models include installation and paint to match.**

Fiberglass camper shells are painted to match using your vehicle's specific paint code.

This pricing guide is not a direct quote. It is here for informational purposes only. See "How to get a quote" below for more info.

### Common upgrades

- **Roof rack** (Thule, Yakima or Rhino Rack)
- **Roof rack tracks only** (add tracks now, get a roof rack later)
- **Keyless Entry** (Pairs topper lock w/ trucks key fob)
- **12v power block** (Three 12v outlets & two USB ports)
- **Lighting** (1-2 tube lights or strip lights added to the interior)
- **Prop switch** (Connects all lighting to power on/off when the rear door is opened & closed)
- **Interior headliner** (Marine grade interior carpeting, standard on some models)
- **Windows** (Flip-up side windows, solid glass or incorporated slider)
- **Cargo nets & clothes hangers** (For extra interior storage)
- **Front slider & fold-down slider window** (Fold-down slider window aids in cleaning behind the cab)
- **Pet screen** (Durable, coated wire screen to cover the bug screens on side slider windows)

### ARE Cab High Models

M8000 - 5'6" x 6'6" x 6'6" (1676mm x 2011mm x 2011mm) - 12000 lbs (5443kg) - 12000 lbs (5443kg)



- **V Classic** – “The value leader.” It’s functional and comes with all the standard high quality hardware you need to meet your needs. Comes standard with passenger and driver side 50/50 sliding windows, fixed front picture window, and an aluminum framed rear gate.
- **CX Classic** – “Functional and stylish.” An upgrade from the V Classic you’ll receive a truck cap with upgraded recessed passenger and driver side 50/50 sliding windows. This cap is built from a one piece mold meant to make it look sleeker, have stronger structure, and create a better seal between the cap base and your truck bed.
- **CX Evolve** - “Classic function meets modern design.” Our popular CX Evolve cap is paired with our industry’s first all glass, tailgate formed rear door, and OneMotion™ handle design to introduce the sleekest and most functional cap on the market. This cap comes standard with interior carpeting and 50/50 sliding passenger and driver side windows.
- **CX Revo** - Same great options as the CX Evolve (all glass, tail gate formed rear door, OneMotion Handle, interior carpeting) with added solid piece, frameless, recessed and contoured side windows, rather than framed 50/50 sliding windows, for the sleekest and most uniform look.
- **Z Series** – “Turn your truck into an SUV.” Well not quite... but this truck cap will be the sleekest most form fitting cap you can get from ARE. This cap comes standard with frameless, all glass, 70/30 passenger and driver side windows. The rear gate is also all glass and frameless. This creates the tightest seal possible in all areas. The rear gate has an upgraded palm handle on rear gate.
- **Z2 Series** - Giving the original Z series a few upgrades this cap includes an all glass rear gate, heavy duty C hinges, interior carpeting, front sliding window, and recessed, solid glass passenger and driver side windows.
- **The Overland** – “A tougher more rugged look.” This topper’s most noticeable feature is it’s two toned off road design: paint to match your truck with additional areas covered in black, spray on protective coating to add strength in high stress areas. All other features are standard to the V Classic model.

\*Maximum height of 20-23” from trucks base rail depending if the truck is a mini, mid, or full size truck

#### ARE Mid Rise Model

- **MX Classic** – “In a class of its own.” Similar to the CX Classic but with added head room. This topper is also capable of having the rear gate upgraded to full walk in door option which take place of the trucks tail gate.

\*Maximum height of 26-28.5” from trucks base rail depending if the truck is a mini, mid, or full size truck)

#### ARE High Rise Model

- **TW Classic** - The steady rising design of the TW Series takes full advantage of the capacity of your truck bed. Maximum head room, easy access, and aerodynamic styling make the TW Series perfect for hauling gear while

providing efficient airflow up and over any camper, trailer, or boat.

\*Maximum height of 39-45" from trucks base rail depending if the truck is a mini, mid, or full size truck)

#### Other options ARE offers

- **HD** – Heavy duty! Internal aluminum skeleton can be incorporated in to the CX and MX Classic models. This increases durability and weight pay load of the truck caps structure. Carry more, worry less.
- **OTR** – Off The Road protection! Add this option and get the exterior of your truck cap covered in a spray-on protective coating (like the stuff you'd see in truck beds). This increases strength in high stress areas and is resistant to scratches and other damages to regular paint. Cannot be added to the Overland Model.
- **DCU** – Deluxe Commercial Units are great for anyone who's looking for a more heavy duty and storage oriented unit. Great for contractors and builders.  
Please call us for pricing, options, and availability (406) 755-5080

#### How to Get a Quote

Follow this link <https://www.4are.com/> and it will direct you to ARE's website. From there you will hit "Build Your Own." This will take you to a new page and will go through the following steps:

1. **Find a dealer** – Find S&S Campers as your selected dealer using our area code or city/state option. Kalispell, MT 59901
2. Enter your truck information – You will need to know your trucks year, make, model, cab size, and bed size.
3. **Model** - Pick your truck cap model.
4. **Options** - Pick any extra truck cap features you may want such as the HD or OTR option. There are many other options in this step you can add or you may stick to all standard options.
5. **Additional accessories** – add anything extra you may want such as cargo glides, **truck vaults**, bed rugs, or topper EZ Lift.
6. **Overview** – Review all selected options and information
7. **Hit "Request a Quote"** – this will lead you to a page where it will ask for some personal contact information (this is solely used for the quote itself to allow us to contact you with our quote. It is not used for marketing, promotions, emails or calls outside of this quote unless you check ARE's promotion box stating so).

After your quote has been submitted we should receive this info within a couple days and will respond as soon as we see it. You may also get a quote by calling or coming in to our store and talking to one of our salesmen.

Mon-Fri: 8am-5pm  
Sat: Closed  
Sun: Closed

400-755-5000

2740 Hwy 93 South

© 2023 S&S Canopies & Campers

Kalispell, MT 59901



## GUNSAFES.COM ANNOUNCES THE AVAILABILITY OF BR5930 OLD GLORY “BATTLE READY” TACTICAL GUN SAFE

The America’s leading provider of gun safes, GunSafes.com has announced the availability of BR5930 Old Glory “Battle Ready” [Tactical Gun Safe](#) at the most competitive prices. This gun safe from the Old Glory has been manufactured using the highest quality materials including cold rolled steel and features continuously welded uni-body construction while meeting national security standards for theft and fire. It comes with a fire rating of 120 minutes at 1880 degrees that is more than enough to protect your valuables through a house fire. Featuring a 4-way positive deadlock locking mechanism, this gun safe is offered with full lifetime warranty for no extra charge.

Search ...



### Categories

[Blog](#)

[Company Features](#)

GunSafes.com is a renowned name in the industry for offering gun safes of the leading brands including Liberty, Winchester, Fort Knox, Heritage, Cannon, AMSEC, Stack-On, etc. All of their gun safes are quality approved and ensure long service life. The company values their relationship with their customers and strives hard to provide the best customer service. Besides BR5930 Old Glory "Battle Ready" Tactical Gun Safe, the company also offers vault doors, gun racks, diversion safes, **truck vaults**, and wall safes, just to name a few.

Talking more about their BR5930 Old Glory "Battle Ready" Tactical Gun Safe, a spokesperson of this renowned gun safe store commented, "As for Premium Heavy-Duty Gun Safes, the 1st Class Steel built BR Series 24 Gun 2-Hour Fire Gun Safe is a great choice for Gun Storage and Fire Protection. This Gun Safe by the Old Glory Safe Company is made of 100% Premium superior steel for deterrence and long lasting durability. The BR Series 24 Gun 2-Hour Fire Gun Safe has special locking features with top security in mind, to give you a gun safe to be usable and secure for your daily gun safe needs."

News Feed

Portfolio

#### INFO

[Terms and Conditions](#) |

[Privacy Policy](#)

© 2013 United Commerce Group

#### CONTACTS

Email: [info@unitedcommercegroup.com](mailto:info@unitedcommercegroup.com)

Phone: (843) 501.2115

#### SOCIAL MEDIA





Free shipping with FedEx Ground within the USA\* | Easy Install, Lifetime Warranty | Promo Sign-up

My Account

Search



[SHOP BY VEHICLE](#) [SALE](#) [EGIFT CARDS](#) [PRODUCTS](#) [BRANDS](#) [ABOUT](#) [NEWS](#) [CONTACT](#)



### Looking for a Chevy Console Safe Specific for Your Make and Model? Shop Now!

known auto brands to protect your valuables and belongings. Due to Chevy's success as an automaker, we crafted a variety of Chevy console safes specific to some of their most popular



makes, models and years.

If you're looking for a Chevy safe for your car or truck, Console Vault has you covered. We provide a variety of in-vehicle safes for the following Chevy models:



CHEVROLET BLAZER	CHEVROLET COLORADO	CHEVROLET EQUINOX	CHEVROLET SUBURBAN	CHEVROLET SILVERADO 1500
CHEVROLET SILVERADO 2500	CHEVROLET SILVERADO 3500	CHEVROLET TAHOE	CHEVROLET TRAVERSE	CHEVROLET AVALANCHE

## Chevy Console Vaults

Looking for a Console Vault for your Chevy truck or SUV? We have models designed for Avalanche, Colorado, Silverado, Suburban, and Tahoe ranging from model years 2003-2019.

Not finding your make and/or model? [Let us know](#) and we'll be happy to help you find the right Chevy console safe! We're always on the lookout to create new and innovative products for our customers and the easiest way to get your vehicle to the front of the production lines is by making your voice heard. If there are no size constraints that may impede the creation of a vault for your particular vehicle, we'll look into creating a Console Vault product that fits your need.

## Explore Our Chevy Car and Truck Safe Selection

At Console Vault, we provide a variety of Chevy safes for cars, trucks and SUVs. No matter the size of your vehicle, our Chevy console safe is intricately crafted to the dimensions and fit of the model's console. Learn more about our Chevy truck safes and Chevy car safes below.

### Our Chevy Truck Safes

The design and durability of our Chevy console safe lives up to the standards of one of the leading truck automakers in the nation. The Chevy Silverado is not only one of the most popular pickup trucks on the road, but also one of our best-selling vaults, and we supply units for the 1500, 2500, and 3500 models. In addition to the Silverado, our Chevy truck safes for the Colorado and Avalanche LS are extremely popular as well.

## Our Chevy Car Safes

Versatility, style and functionality are just a few of the things that Chevrolet cars and Console Vault's in-vehicle safes have in common. Whether you're looking for a Chevy car safe for the Blazer, Suburban, Tahoe, or Traverse, our Chevy car safe will house your belongings in a reliable and discreet manner.



### Benefits of Our Chevy Console Safe

Our team at Console Vault is committed to utilizing the latest technology for our Chevy safes and providing you with high-quality, durable solutions to protect your personal property, such as money, firearms, keys, and other belongings.

Additional advantages of purchasing a Chevy console safe at Console Vault include:

- Quick and easy [installation](#) that requires no modifications to your vehicle
- All safes composed of 12-gauge steel
- A variety of tamper-resistant [locking mechanisms](#) to choose from
- Meets stringent automotive quality standards
- Free shipping anywhere in the contiguous U.S.
- Backed by [Lifetime Warranty](#)



## Ready to Purchase One of Our Chevy Safes for Your Vehicle? Ready to Purchase One of Our Chevy Safes for Your Vehicle?

Our Chevy console safes can give you peace of mind knowing your items will remain secure and untouched in your vehicle. Be sure to shop our selection of Chevy safes, or [contact us](#) today for more information!





**FAQS**

- AFFILIATE SIGN UP FORM**
- KEYLESS COMBO INSTRUCTIONS**
- LOCK TYPES**
- OEM**

**EGIFT CARDS**

- RETURN POLICY**
- LIFETIME WARRANTY**
- TERMS AND CONDITIONS**
- PRIVACY POLICY**

*Let's stay connected!*



614.802.5563

Copyright 2023 Console Vault. All Rights Reserved. eCommerce Software by [3dcart](#).  
Digital Marketing Powered by [Sixth City Marketing](#)



HOME > DAKOTA BADLANDS 283 TRUCK VAULT ...



## DAKOTA BADLANDS 283 TRUCK VAULT LITE

**\$789.00**

Quantity

only 1 left in stock

ADD TO CART +

Buy with **shop Pay**

More payment options

4 interest-free installments, or from **\$71.21/mo** with **shop Pay**

[View sample plans](#)



Our single drawer, lockable storage vault, adds to the versatility of tailgate living built from our knowledge of military storage design.

This system allows for well thought out use of storage space for more convenient and easier organization. From camera equipment, to safely stored firearms, this storage vault was build with the 283 lifestyle in mind.

## YOU MAY ALSO LIKE



**DAKOTA 283 BADLANDS  
TRUCK VAULT**  
**\$989.00**



**DAKOTA G3 LARGE FRAMED  
KENNEL**  
**FROM \$539.00**



**PACIFIC CALLS 206 GOOSE  
CALLS**  
**\$129.99**



## CONTACT

[sales@alphaoutdoorspecialties.com](mailto:sales@alphaoutdoorspecialties.com)

931-982-5803



## ALPHA IS OUTDOORS.

Supplying you with the gear you need for everything you love to do outdoors.

© 2023, Alpha Outdoor Specialties

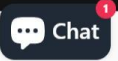

[PRIVACY SETTINGS](#)

WE USE COOKIES ON THIS SITE TO ENHANCE YOUR USER EXPERIENCE

You have given your consent for us to set cookies.

[WITHDRAW CONSENT](#)

# FREQUENTLY ASKED QUESTIONS

---

TOPICS

01

ORDERING

02

GENERAL

01

ORDERING

02

GENERAL

03

SPECS

04

LOCKS

05

INSTALL

04

LOCKS

05

INSTALL

06

CARE

ORDERING

HOW IS MY TRUCKVAULT DELIVERED IF I DO NOT BUY THROUGH A DEALER?

TruckVault products are shipped by motor freight and can be delivered to your residence or to a business address. Each TruckVault is carefully packed in cardboard and attached to a pallet.

#### **IS IT POSSIBLE TO CHECKOUT A TRUCKVAULT IN PERSON BEFORE I PURCHASE ONE?**

In many cases, yes. TruckVault has a number of dealers across the country who have a TruckVault on-site. Visit our Dealer Page to find one near you.

#### **I DON'T SEE MY VEHICLE ON YOUR WEB SITE. DO YOU MAKE A TRUCKVAULT FOR IT?**

We can build TruckVaults to fit nearly any vehicle on the road. Most require slight modifications to existing vaults, while others can require a more thorough redesign. We have also built TruckVault products to meet individual needs upon request. Please contact us with any questions you may have.

#### **HOW LONG WILL IT TAKE TO RECEIVE MY TRUCKVAULT?**

Your order is placed in the queue when your order confirmation is received at TruckVault; a ship date is then assigned. You should receive your TruckVault within three to five weeks from the date we receive your order confirmation.

#### **CAN YOU BUILD A CUSTOM TRUCKVAULT TO MEET MY SPECIFICATIONS?**

Certainly. Over the years we have built a number of custom TruckVault products, from custom office centers to modified drawer layouts, and much more. Contact us today with your needs.

#### **WHAT DO I DO WITH MY TRUCKVAULT IF I AM SELLING MY VEHICLE?**

If the TruckVault will fit in the new vehicle we recommend transferring it. Otherwise contact TruckVault at (800) 967-8107 to explore your options.

#### **CAN I BUY A USED TRUCKVAULT?**

Yes! Occasionally we have demonstrator and show models available. Someone in your area may also be trading vehicles and looking to sell their existing TruckVault. Your TruckVault sales person can help you with this, and can be reached at (800) 967-8107 or by email through our [contact page](#). Check out our [TruckVault Outlet](#) page which we update regularly with various used TruckVault products!

#### **DO YOU MAKE OR MARKET ANY OTHER PRODUCTS?**

Yes, TruckVault sells a variety of accessory items as well as our SeatVault which goes underneath the backseat of pickup trucks. We have a line of quick access gun vaults called ShotLock we make them for Shotguns, compact

carry and 1911 frame Pistols. We also sell CargoGlide's which are a platform that slides out of the truck bed allowing you easy access to the contents of your truck bed.

#### **CAN I BUY THE PLANS AND BUILD MY OWN TRUCKVAULT?**

Sorry, TruckVault does not sell plans. We do know that many handy people have built their own version of a TruckVault and we wish them well.

[RETURN TO TOP](#)

## **GENERAL**

#### **WILL MY TRUCKVAULT KEEP CROOKS OUT?**

The majority of break-ins happen to those who don't have their car locked because it's easy for crooks to get in and take valuables. By keeping your vehicle locked and having a TruckVault installed, you have 2 barriers to entry to start. Combine that with our top-of-the-line security system and you can sleep soundly at night (in your home or on the road) knowing your valuables will be there when you wake up. Secondly, it's no easy task to break into a TruckVault. A criminal with the right tools can open anything but more often than not crooks do not have the time, skill, and tools to break in. There's a reason law enforcement, firearms instructors, hunters, and fishers alike have trusted TruckVault with their guns and gear since 1995.

#### **WHERE IS TRUCKVAULT LOCATED?**

TruckVault now has 2 locations, with our headquarters located at 315 Township Street in historic Sedro-Woolley, Washington and our new manufacturing facility located at 777 Industrial Park Road in Mount Jackson, Virginia.

#### **WHERE IS THE SERIAL NUMBER?**

Each TruckVault has a serial number, which provides TruckVault with information about the product. You will find the serial number on the face of the right hand drawer (2- or multiple-drawer models), or on the right-hand side of the drawer (single drawer).

[RETURN TO TOP](#)



## **SPECS**

---

### **WHAT IS THE TRUCKVAULT MADE FROM?**

TruckVault Products are manufactured from Medium Density Overlay (MDO). This is the same material you may recognize from its use as highway sign board.

### **HOW DOES MDO COMPARE WITH METAL?**

Metal is heavier. Distinct advantages of TruckVault Products include the fact that MDO does not attract moisture, allowing you to store firearms, cameras and other sensitive valuables for long periods of time with much less risk than one would encounter using metal or plastic materials. MDO is a silent partner in your vehicle, no banging or rattling.

### **CAN I HAUL HEAVY ITEMS ON MY TRUCKVAULT?**

The top surface is 5/8 inch MDO, which is as strong as the floor in your home. Essentially, you can haul anything you can load on top of your TruckVault. The top surface can easily support as much as 2000 lbs. or more.

### **IS MY STANDARD TRUCKVAULT WATER-PROOF?**

No. Your standard TruckVault was designed to install internally in your SUV or, in the case of a pickup truck, with a canopy or cover. Spilled water will have little effect on your TruckVault, however.

### **DO YOU MAKE A WATER-PROOF TRUCKVAULT?**

TruckVault manufactures the Extreme Series All-Weather TruckVault. Under most circumstance the Extreme Series All-Weather TruckVault is waterproof. The entirety of this unit is wrapped in waterproof, protective liner, while the drawer closures are protected by rubber bulb seal. The All-Weather TruckVault series is available for pickup trucks and open vehicles such as the H-2 SUT.

[RETURN TO TOP](#)

## **LOCKS**

---

**CAN I CHANGE THE PASS CODE ON MY DIGIT BUTTON LOCK?**

#### **CAN I CHANGE THE PASS CODE ON MY PUSH BUTTON LOCK?**

TruckVault offers more than one push button lock option. Information on how to set or change your lock is shipped with the information packet. The Supra 10-button combination lock info may also be found [here](#). The Simplex 5-button combination lock info may be found [here](#).

If, for some reason, you do not have this information please refer to our [page on locks](#). You may also call TruckVault at (800) 967-8107 and speak with a technician.

We have also prepared a video walking you through the process of changing the combination of your Simplex Five Button lock. To view the video, [click here](#).

[RETURN TO TOP](#)

## **INSTALL**

#### **HOW HARD IS IT TO INSTALL MY NEW TRUCKVAULT?**

Over the years, TruckVault products have been installed by thousands of sportsmen and agencies. Your TruckVault comes fully assembled except where components must be joined. In these cases, pieces are joined with machine screws into machine receivers. Considering TruckVault products are large, we suggest two people be involved in the initial install. Installation in a Suburban takes minutes while a full-size pickup truck unit may require most of an hour.

#### **CAN MY TRUCKVAULT BE REMOVED?**

Indeed it can. Many TruckVault users do remove them from time to time. It seems the biggest issue is, "*Where do I put all of the stuff I stored in my TruckVault?*".

[RETURN TO TOP](#)

## **CARE**

#### **HOW DO I CARE FOR MY TRUCKVAULT?**

Carpeted surfaces should be vacuumed periodically. Wood or composite features should be dealt with as you would any wooden household furniture. If tracks or rollers need service, do so with a silicone spray. Oil-based lubricants will attract and hold dust and dirt particles which can effect function and cause damage.

### HOW DO I ATTACH THE TRUCKVAULT TO MY VEHICLE?

All TruckVault Products are shipped with a means of attachment. These vary from vehicle to vehicle. Your TruckVault will come with easy-to-follow installation instructions and attachment detail.

### WHAT DO I DO IF I HAVE PROBLEMS WITH MY TRUCKVAULT?

Your TruckVault is warrantied. If you should have problems please call TruckVault immediately at (800) 967-8107 and speak with one of our in-house problem solvers. Hopefully your issues can be addressed without returning the TruckVault. For further information, please see the page covering our warranty.

[RETURN TO TOP](#)

#### PRODUCTS

##### Pickup Series

All-Weather Line  
Covered Bed Line  
Base Camp Line  
Interior Cab Line

##### Sedan Series

Elevated Line  
Sedan Base Line

##### SUV Series

Responder Line  
Commander Line  
Base Line  
Elevated Line

#### ON DUTY

##### Armed Professional

Tactical  
Military

##### Public Service

Law Enforcement  
Fire/EMS  
Commercial

#### OFF DUTY

##### In The Field

Hunting  
Fishing  
Shooting Sports

##### On The Move

Photography  
Overlanding  
Outdoor Recreation  
Everyday

#### VEHICLES

Pickup  
SUV  
Sedan  
Van

#### Sales

Customize your TruckVault  
Consult with a Design Pro  
View the 2022 Catalog  
Common Builds  
Used + Discounted  
Accessories

#### Resources

Contact  
Careers  
Frequently Asked Questions  
Lock Instructions  
Privacy Policy  
TruckVault Install Instructions  
Warranty



Elevated Line  
 Sedan Base Line  
**SUV Series**  
 Responder Line  
 Commander Line  
 Base Line  
 Elevated Line  
 Drone Responder Line

Commercial

Overlanding  
 Outdoor Recreation  
 Everyday

**Resources**

Contact  
 Careers  
 Frequently Asked Questions  
 Lock Instructions  
 Privacy Policy  
 TruckVault Install Instructions  
 Warranty  
 Custom Capabilities  
 US Gun Laws

**TruckVault Media**

Media Gallery  
 Instagram  
 Dealer Zone  
 Facebook  
 YouTube

PRIVACY SETTINGS

**WE USE COOKIES ON THIS SITE TO ENHANCE YOUR USER EXPERIENCE**

You have given your consent for us to set cookies.

WITHDRAW CONSENT

- Any -  
 Commercial  
 Everyday  
 Fire/EMS  
 Fishing

# STORAGE SYSTEM. PERIOD.

WRITTEN BY

**BLOG POST INFO**

Share:     
 Posted on: June 27, 2023

-----  
**ALEX BROUWER**

Hunting  
Law Enforcement  
Military  
Outdoor  
Recreation  
Overland  
Photography  
Shooting Sports  
Tactical

Recreation  
Overland  
Photography  
Shooting Sports  
Tactical

If you've ever wished for a better way to keep your gear secure and organized in your truck bed, you're not alone. In fact, you're a lot like our CEO, Al Chandler, who, when faced with the same situation twenty-five years ago, decided to do something about it. In 1996, Al embarked on a truck bed storage DIY project, and the result was the first ever [TruckVault truck bed storage system](#).

Following in that tradition, we're still making **vaults** for nearly every truck organized in your truck bed, you're not alone. In fact, you're a lot like our CEO, Al Chandler, who, when faced with the same situation twenty-five years ago, decided to do something about it. In 1996, Al embarked on a truck bed storage DIY project, and the result was the first ever [TruckVault truck bed storage system](#).

Following in that tradition, we're still making **vaults** for nearly every truck on the market, including, but certainly not limited to, the Ford F-series, Chevrolet Silverado, Dodge Ram, and GMC Sierra.



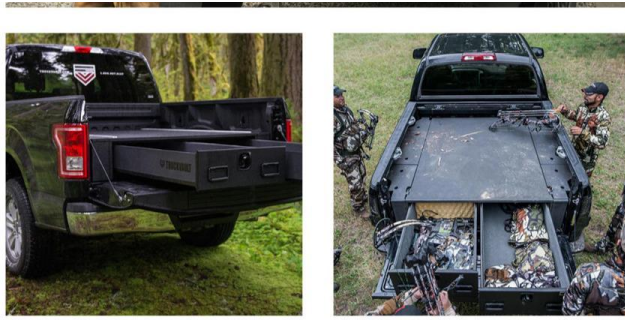

Here at TruckVault, we know that your truck is a vital component of your everyday life, whether you're in a law enforcement, military, or tactical setting or need secure transportation for your firearms, fishing rods, photography equipment, camping supplies and much more. If you own any sort of valuable gear like that, you know the importance of durability and security. By protecting from both the natural elements and thieves, TruckVault gives you the peace of mind you need to do your job with excellence or enjoy your sport or hobby to the fullest.

Regardless of your pickup bed size and length, we make a highly customizable TruckVault storage system that will not only organize but also protect and secure your gear. Further customization includes drawer height, dividers, finishes, and lighting. And though we now make TruckVaults for virtually [any vehicle on the road](#), we're staying true to our name by continuing to build custom vaults for our original customers - those with pickup trucks who have expensive gear they need to keep safe and secure.

We don't consider it bragging to say that we're good at this. Having made products for pickup trucks for twenty-five years, we hold ourselves to high

standards - from the early design process to quality craftsmanship to installation in your vehicle and every moment in between, we are committed to the highest caliber product possible for the sake of our customers satisfaction. See so for yourself: if you have a truck bed storage idea you'd like to see come to life, give us a call and see what we can do to turn that idea into reality.

**BUILD YOURS**

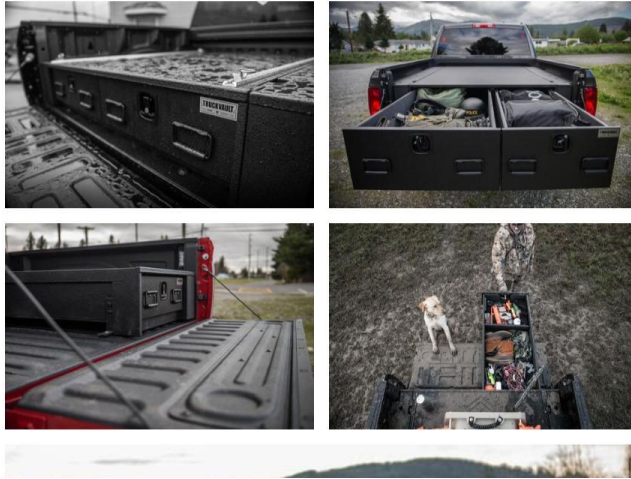





#### **PRODUCTS**

##### **Pickup Series**

All-Weather Line  
Covered Bed Line  
Base Camp Line  
Interior Cab Line

##### **Sedan Series**

Elevated Line

#### **ON DUTY**

##### **Armed Professional**

Tactical  
Military

##### **Public Service**

Law Enforcement  
Fire/EMS  
Commercial

#### **OFF DUTY**

##### **In The Field**

Hunting  
Fishing  
Shooting Sports

##### **On The Move**

Photography  
Overlanding

#### **VEHICLES**

Pickup

SUV

Sedan

Van

#### **Sales**

Customize your TruckVault  
Consult with a Design Pro  
View the 2022 Catalog  
Common Builds  
Used + Discounted  
Accessories

#### **Resources**

Sedan Base Line

**SUV Series**

Responder Line

Commander Line

Base Line

Elevated Line

Drone Responder Line

Outdoor Recreation

Everyday

Contact

Careers

Frequently Asked Questions

Lock Instructions

Privacy Policy

TruckVault Install Instructions

Warranty

PRIVACY SETTINGS

WE USE COOKIES ON THIS SITE TO ENHANCE YOUR USER EXPERIENCE

You have given your consent for us to set cookies.

WITHDRAW CONSENT

- Any -
- Commercial
- Everyday
- Fire/EMS
- Fishing
- Hunting
- Law Enforcement
- Military
- Outdoor

# TIME: TRUCK BED STORAGE FOR ANY CONDITIONS

WRITTEN BY  
JULIA HANNA



## BLOG POST INFO

Share: [f](#) [t](#) [+](#)  
Posted on: June 27, 2023

Recreation  
Overland  
Photography  
Shooting Sports  
Tactical

**ACTIVITIES**

Hunting  
Law Enforcement  
Military  
Outdoor  
Recreation  
Overland  
Photography  
Shooting Sports  
Tactical



**WRITTEN BY  
JULIA HANNA**



We offer a truly weatherproof truck bed storage solution with our All-Weather Line.

**DURABILITY, MEET VERSATILITY.**



Our All-Weather series of our pickup [TruckVaults](#) are durable, customizable, and weatherproof for all your pickup or work



Weatherproof for all your pickup or work truck needs. Sealed in Weatherproof Armour Coating, they are specifically designed to handle hard work and even harder play.

Check out some of the tests we've done to make sure we offer the best product on the market for truck bed storage:

- **Is it waterproof?**
  - Yes! We've even taken fire hoses to the front of our TruckVault Secure Storage Systems. That's more than 100 pounds of direct water pressure, and not a drop got inside.
- **Can it take the heat?**
  - We tracked down a truck-sized oven to find out. In an effort to simulate the brutal desert heat inside a vehicle at midday, we tested to see what kind of effect 150° Fahrenheit had on our **vaults**.
  - The result? After two hours in a test oven heated to 150° F, each TruckVault remained roughly 28% cooler than the leading metal competitor. TruckVault products provided superior insulation and protection across the board, making them the best option compared to competing steel or plastic products for protecting sensitive electronics, plastics, food, ammunition, and other heat-sensitive cargo.

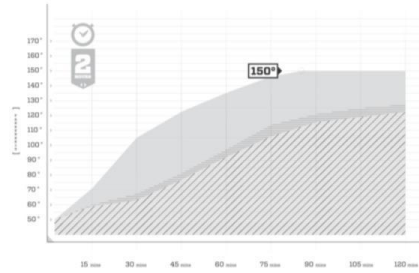

EXTREME ALL-WEATHER TRUCKVAULT    STANDARD CARPETED TRUCKVAULT    LEADING METAL COMPETITOR

See the results of our heat test!

▪ **Can it carry the load?**

- Whatever you're hauling, we're proud to say our drawers can handle 300 lbs. without reaching full capacity, and the top can bear 2,000 lbs. easily. So take your ATV out for a spin, or bring all your hunting gear on a trip, transport lumber, and more!



Commercial or recreational, don't let dirt debris and water get in your way. Our All-Weather series of our weatherproof pickup [TruckVaults](#) are durable, customizable, and weatherproof. Sealed in Weatherproof Armour Coating, they are specifically designed to handle hard work and even harder play.

Want a quote? Click the button below.

[DRONE RESPONDER LINE](#)

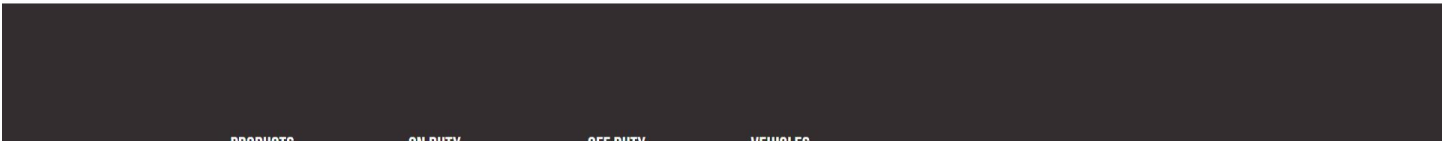

**PRODUCTS**

**Pickup Series**

All-Weather Line  
Covered Bed Line  
Base Camp Line  
Interior Cab Line

**Sedan Series**

Elevated Line  
Sedan Base Line

**SUV Series**

Responder Line  
Commander Line  
Base Line  
Elevated Line  
Drone Responder Line

**ON DUTY**

**Armed Professional**

Tactical  
Military

**Public Service**

Law Enforcement  
Fire/EMS  
Commercial

**OFF DUTY**

**In The Field**

Hunting  
Fishing  
Shooting Sports

**On The Move**

Photography  
Overlanding  
Outdoor Recreation  
Everyday

**VEHICLES**

Pickup

**SUV**

Sedan

Van

**Sales**

Customize your TruckVault  
Consult with a Design Pro  
View the 2022 Catalog  
Common Builds  
Used + Discounted  
Accessories

**Resources**

Contact  
Careers  
Frequently Asked Questions  
Lock Instructions  
Privacy Policy  
TruckVault Install Instructions  
Warranty

## No Headline In Original

Global Broadcast Database - English Noon 12:00 PM CBS

May 5, 2006 Friday

Copyright 2006 inewsnetwork Inc. All Rights Reserved



Length: 254 words

### Body

---

STATION: 7 KOSA

Odessa-Midland, TX

The mayor says several new businesses opening in fort stockton have created new jobs.. But strained housing. The latest is a hardware chain that is opening in the old k-mart building.

Odessa police are investigating a case where someone broke into a vehicle at an odessa hotel and stole three specialized rifles used in competition shooting. Susan rogers has more in this week's crime stoppers report ... This week odessa crime stoppers needs your help with a vehicle burglary. On march 31st a black ford excursion was in a parking lot at a local hotel. Unknown persons entered the vehicle which was equipped with a **truck vault** that was loaded with sporting guns. Three very unique over and under shotguns used for skeet competition were taken. One shotgun, a perazzi mx8 similar to the one in the photograph had a customized stock and the barrels were magnaported. The other perazzi was a model b2000 with a walnut stock. Also taken was a one of a kind kniedhoff



magnum... the other... k80 which was also customized. Total value of these guns is \$40,000.00 if you are the first caller with information that leads to the arrest of the person involved in this crime, it will be worth a cash reward. Call odessa crime stoppers at 333- tips and you will remain anonymous. Or go to our website at [www.Odessacrimestoppers.Org](http://www.Odessacrimestoppers.Org) and send us a secure tip. I susan rogers for odessa crime stoppers and cbs7. Coming up.... Valuable information concerning athletic scholarships ... And our produce man talks about the number one food for cinco de mayo... Set\*\*}

## Classification

---

**Language:** ENGLISH

**Document-Type:** Television

**Publication-Type:** Transcript

**Subject:** CRIME, LAW ENFORCEMENT & CORRECTIONS (90%); INVESTIGATIONS (90%); LAW ENFORCEMENT (90%); NEGATIVE PERSONAL NEWS (90%); UNSOLVED CRIMES (90%); WEAPONS & ARMS (90%); NEW BUSINESSES (78%); ARRESTS (77%); BURGLARY (77%); CRIMINAL INVESTIGATIONS (77%); MOTOR VEHICLE CRIME (77%); SHOOTING SPORTS (76%); EMPLOYMENT GROWTH (73%); JOB CREATION (73%); SCHOLARSHIPS & GRANTS (50%); SPORTS SCHOLARSHIPS (50%)

No Headline In Original

**Industry:** HOTELS & MOTELS (72%); PARKING SPACES & FACILITIES (72%)

**Load-Date:** May 8, 2006

---

End of Document

**BROWN ANNOUNCES 16 INDICTMENTS, 550 POUND DRUG SEIZURE  
FOLLOWING INFILTRATION OF SINALOA CARTEL**

States News Service

August 26, 2009 Wednesday

Copyright 2009 States News Service

**Length:** 848 words

**Byline:** States News Service

**Dateline:** IMPERIAL, Calif.

**Body**

---

The following information was released by the office of the California Attorney General:

Attorney General Edmund G. Brown Jr. announced at a news conference today that, working with Imperial County District Attorney Gilbert Otero, his office has secured indictments against 16 individuals and seized over 550 pounds of cocaine and marijuana, dealing a "body blow" to Mexico's notorious Sinaloa drug cartel.

The indictments and seizures come as part of "Operation Silver Fox," a joint investigation between the Attorney General's Bureau of Narcotic Enforcement, the Imperial County Narcotic Task Force, Imperial County District Attorney Otero, and Imperial County Sheriff Raymond Loera.

"This notorious cartel smuggled massive quantities of cocaine and marijuana into Southern California, fueling addiction and violence across the nation," Brown said. "Through a very dangerous and courageous undercover operation, the Bureau of Narcotic Enforcement and Imperial County Narcotic Task Force has dealt a body blow to

operation, the Bureau of Narcotic Enforcement and Imperial County Narcotic Task Force has dealt a body blow to this syndicate and seized hundreds of pounds of narcotics."

Initiated in January 2009, the investigation found that the Mexican cartel smuggled drugs into Southern California-often through the Calexico ports of entry using vehicles equipped with hidden compartments-and would subsequently distribute the drugs to buyers in cities throughout the United States and Canada.

The 8-month investigation included more than 100 surveillance operations (carried out in Bell Gardens, Calexico, Colton, Fontana, Los Angeles, Ontario, Pacoima, Rialto, Riverside and San Diego), 30 undercover meetings and the execution of 6 search warrants. The operations resulted in the seizure of:

- 420 pounds of cocaine and 136 pounds of marijuana, with a combined street value of more than \$19 million;
- \$1.7 million in U.S. currency; and
- 9 firearms, including 7 handguns and 2 assault rifles.

In addition to smuggling drugs across the border, the cartel also purchased cocaine from other drug traffickers in San Bernardino, Los Angeles and Imperial Counties. The drugs were ultimately distributed to local buyers in Southern California, Atlanta, Chicago, New York and Canada in large monthly shipments.

A March 2009 operation, for instance, resulted in the seizure of a large cargo truck used as a cocaine vault to distribute more than 1,000 pounds of drugs every month to Canada, for two years. The seizure came after agents followed a vehicle from Imperial County to an auto repair shop in Pomona. At the shop, agents seized 51 pounds of

BROWN ANNOUNCES 16 INDICTMENTS, 550 POUND DRUG SEIZURE FOLLOWING INFILTRATION OF SINALOA CARTEL

cocaine from hidden compartments in the vehicle and an additional 119 pounds of cocaine from the cargo truck vault.

In addition to the vehicle, cargo truck and cocaine seized in Pomona, the following vehicles were seized over the course of the investigation:

- 1996 Honda Accord with 37.4 pounds of cocaine hidden in the vehicle in February 2009;
- 2003 Ford Expedition with 37.4 pounds of cocaine hidden in the vehicle in February 2009;
- 2000 Ford Excursion with \$19,106 hidden in the vehicle in February 2009;
- 2000 Nissan Xterra with 81 pounds of cocaine hidden in the vehicle in March 2009;
- 2003 Toyota 4Runner with \$658,470 hidden in the vehicle in March 2009;
- 2007 GMC Yukon with \$738,960 hidden in the vehicle in April 2009;
- 2003 GMC Pick-up truck with 97 pounds of cocaine hidden in the vehicle in April 2009;
- 2001 Dodge Pick-up truck involved in the purchase of 22 pounds of cocaine in May 2009; and
- 2001 Dodge Dakota involved in the purchase of 22 pounds of cocaine in May 2009.

Based on the results of the investigation, the Imperial County Grand Jury indicted the following 16 suspects:

- Marco Mendoza, 43, of South Gate, Calif. was arrested in March 2009 and is being held in Los Angeles County Jail;
- Gerald William Andrews, 42, of Pacoima, Calif. was arrested in July 2009 and is being held in Imperial County Jail;
- Lorena Lara, 29, of Fontana, Calif. was arrested in August 2009 and is being held in San Bernardino County Jail;

- Juan Berumen Sandoval, 44, of Rialto, Calif. was arrested in August 2009 and is being held in Imperial County Jail;
- Juan Gabriel Molina, 28, of South Gate, Calif.;
- Hilario Lopez Rodriguez, 43, of Pacoima, Calif.;
- Norberto Ruelas Urias, 39, of Long Beach, Calif.;
- Ramon Valenzuela, 33, of South Gate, Calif.;
- Rodrigo Grijalva, 31, of Mexicali, Mexico;
- Jose Abraham Guzman, 26, of Mexicali, Mexico;
- Cesar Yaserf Lara, 21, of Mexicali, Mexico;
- Sergio Villagrana Murillo, 62, of Mexicali, Mexico; and
- Four other suspects whose names are being withheld to avoid compromising future arrests.

The investigation is ongoing. Brown's agents continue to work with U.S., Mexico and local law enforcement officials to apprehend the outstanding suspects.

## BROWN ANNOUNCES 16 INDICTMENTS, 550 POUND DRUG SEIZURE FOLLOWING INFILTRATION OF SINALOA CARTEL

In addition to the news conference, Brown today met with Mexico, U.S., state and local law enforcement officials to discuss how to improve intelligence gathering, law enforcement action and cross-border collaboration. This includes a first-of-its-kind meeting between Brown, Mexico's Baja California Attorney General, the Imperial County District Attorney and Sheriff.

### Classification

---

**Language:** ENGLISH

**Publication-Type:** Newswire

**Subject:** NEGATIVE NEWS (92%); CONTROLLED SUBSTANCES CRIME (91%); NARCOTICS ENFORCEMENT (91%); ATTORNEYS GENERAL (90%); CANNABIS (90%); CARTELS (90%); COCAINE (90%); CRIMINAL INVESTIGATIONS (90%); DRUG TRAFFICKING (90%); INDICTMENTS (90%); INVESTIGATIONS (90%); LAW ENFORCEMENT (90%); MARIJUANA (90%); NARCOTICS (90%); NEGATIVE PERSONAL NEWS (90%); PRESS CONFERENCES (90%); PUBLIC PROSECUTORS (90%); SMUGGLING (90%); ILLEGAL DRUGS (89%); WEAPONS & ARMS (88%); SEARCH WARRANTS (78%); ADDICTION (77%); CRIME, LAW ENFORCEMENT & CORRECTIONS (77%); NEGATIVE MISC NEWS (77%); SURVEILLANCE (77%); FIREARMS (67%)

**Organization:** CALIFORNIA STATE ATTORNEY GENERAL'S OFFICE (84%)

**Industry:** ATTORNEYS GENERAL (90%); CANNABIS (90%); MARIJUANA (90%); NARCOTICS (90%); PUBLIC PROSECUTORS (90%)

**Person:** JERRY BROWN (78%)

**Geographic:** LOS ANGELES, CA, USA (92%); RIVERSIDE, CA, USA (79%); SAN DIEGO, CA, USA (79%); ATLANTA, GA, USA (78%); CHICAGO, IL, USA (78%); NEW YORK, NY, USA (78%); SAN BERNARDINO, CA, USA (73%); CALIFORNIA, USA (95%); NEW YORK, USA (79%); ONTARIO, CANADA (55%); MEXICO (92%); UNITED STATES (92%); CANADA (91%); NORTH AMERICA (79%)

**Load-Date:** August 26, 2009

---

End of Document



# TRUCKVAULT EXTREME SERIES - PUT TO THE TEST





After the launch of our popular Extreme Series All-Weather **vaults** for open-bed pickups and SUVs we needed a way to prove how rugged durable and water-tight they really were.

[Back to the top](#)

## United States Patent and Trademark Office (USPTO)

### USPTO OFFICIAL NOTICE

Office Action (Official Letter) has issued  
on July 26, 2023 for  
**U.S. Trademark Application Serial No. 97060107**

A USPTO examining attorney has reviewed your trademark application and issued an Office action. You must respond to this Office action in order to avoid your application abandoning. Follow the steps below.

- (1) **[Read the Office action](#)**. This email is NOT the Office action.
- (2) **Respond to the Office action by the deadline** using the Trademark Electronic Application System (TEAS). Your response must be received by the USPTO on or before 11:59 p.m. **Eastern Time** of the last day of the response period. Otherwise, your application will be **[abandoned](#)**. See the Office action itself regarding how to respond.
- (3) **Direct general questions** about using USPTO electronic forms, the USPTO **[website](#)**, the application process, the status of your application, and whether there are outstanding deadlines to the **[Trademark Assistance Center \(TAC\)](#)**.

After reading the Office action, address any question(s) regarding the specific content to the USPTO examining attorney identified in the Office action.

### GENERAL GUIDANCE

- **[Check the status of your application periodically](#)** in the **[Trademark Status & Document Retrieval \(TSDR\)](#)** database to avoid missing critical deadlines.
- **[Update your correspondence email address](#)** to ensure you receive important USPTO notices about your application.
- **[Beware of trademark-related scams](#)**. Protect yourself from people and companies that may try to take financial advantage of you. Private companies may call you and pretend to be the USPTO or may send you communications that resemble official USPTO documents to trick you. We will never request your credit card number or social security number over the phone. Verify the correspondence originated from us by using your Serial Number in our database, **[TSDR](#)**, to confirm that it appears under the “Documents” tab, or contact the **[Trademark Assistance Center](#)**.
- **[Hiring a U.S.-licensed attorney](#)**. If you do not have an attorney and are not required to

have one under the trademark rules, we encourage you to hire a U.S.-licensed attorney specializing in trademark law to help guide you through the registration process. The USPTO examining attorney is not your attorney and cannot give you legal advice, but rather works for and represents the USPTO in trademark matters.