

# BULKY DOCUMENTS

(exceeds 300 pages)

Proceeding/Serial No: 18602017

Filed: 6-22-07

Title: Request for Reconsideration

---

---

Part 1 of 2

**IN THE UNITED STATES PATENT AND TRADEMARK OFFICE**

Applicant: Nextten Stauer, LLC

Our Reference No.: 10718.30

Serial No.: 78/602,017

Examiner: Kristin M. Dahling

Filed: April 5, 2005

Law Office: 113

Mark: DIAMONDAURA

CERTIFICATE OF MAILING 37 C.F.R. 1.8

I hereby certify that this correspondence is being deposited with the U.S. Postal Service as First Class Mail in an envelope addressed to: Commissioner for Trademarks, P.O. Box 1451, Arlington, VA 22313-1451, on the date below:

Date: April 19, 2007

Commissioner of Trademarks  
P.O. Box 1451  
Alexandria, VA 22313-1451

**REQUEST FOR RECONSIDERATION**

This Request for Reconsideration is made in response to the Final Office Action that was issued on December 20, 2006.

**SUBSTANTIVE REFUSAL**

**REMARKS**

The Examining Attorney maintained her refusal to register Nextten Stauer, LLC's ("Applicant") DIAMONDAURA mark in connection with "jewelry primarily comprised of simulated diamonds and gemstones" (Applicant's Goods). Specifically, the Examining Attorney maintains that Applicant's DIAMONDAURA mark is deceptive because its mark contains the term "diamond" and its product is not a mined diamond rather it is a simulated diamond. Relying on the Federal Trade Commission's ("FTC") Guide for the Jewelry, Precious Metals, and Pewter Industries (the "Guide"), the Examining Attorney contends that only products with the characteristics enumerated in the Guide qualify to include the term "diamond" as part of a trademark. Respectfully, the Examining Attorney has misinterpreted the requirements for



deception under the Lanham and; therefore, did not present sufficient evidence to support her position that Applicant's mark should be refused registration under Section 2(a). Applicant respectfully requests that the Examining Attorney withdraw her refusal to register Applicant's DIAMONDAURA mark and issue a Notice of Publication.

### ARGUMENT

#### I. THE EXAMINING ATTORNEY HAS IMPROPERLY DISSECTED APPLICANT'S SUGGESTIVE DIAMONDAURA MARK

Applicant fully recognizes that the Lanham Act prohibits the registration of deceptive matter. Lanham Act § 2(a), 15 U.S.C. § 1052(2)(a) (2007). However, the Board did not state, as represented by the Examining Attorney in *American Speech-Language-Hearing Assoc. v. Nat'l Hearing Aid Assoc.*, 224 U.S.P.Q. 798 (T.T.A.B. 1984), that "deception may be found 'where the offending word has been combined with a suggestive term and even where the significance of the mark as a whole is not entirely clear.'" 224 U.S.P.Q. at 808; Final Office Action p. 2. Furthermore, the Board did not state that an Examining Attorney may dissect an applicant's mark in order to analyze a mark for deception. *Id.*

It is well-settled law, that a mark is deceptive only if the following three questions are answered in the affirmative:

1. Is the term misdescriptive of the character, quality, function, composition, or use of the goods;
2. If so, are prospective purchasers likely to believe that the misdescription actually describes the goods; and
3. If so, is the misdescription likely to affect the decision to purchase (the "Deception Test")?

*In re Budge Mfg. Co., Inc.*, 857 F.2d 773, 775 (Fed. Cir. 1988). The United States Supreme Court has stated: "The commercial impression of a trademark is derived from it as a whole, not

from its elements separated and considered in detail. For this reason it should be considered in its entirety.” *Estate of P.D. Beckwith, Inc. v. Commissioner of Patents*, 252 U.S. 538, 545-46 (1920). The statement is known as the “anti-dissection rule.” While it is not a violation of the anti-dissection rule for an Examining Attorney to consider and weigh parts of a mark, the *ultimate* determination of whether a mark is misdescriptive must be made on the basis of the mark in its entirety. See *In re Oppedahl & Larson LLP*, 373 F.3d 1171, 1174 (Fed. Cir. 2004); *In re Hester Industries, Inc.*, 230 U.S.P.Q. 797, n. 5 (T.T.A.B. 1986) (THIGHSTIX for boneless chicken parts was held not to be a descriptive composite) (emphasis added).

The Examining Attorney has stated that Applicant’s mark “also meets the first prong of the more simple test for deceptive marks under Section 2(a), because the term DIAMOND misdescribes applicant’s goods which are not comprised primarily of diamonds.” Applicant’s mark is DIAMONDAURA not DIAMOND. This statement demonstrates that the Examining Attorney did not consider Applicant’s mark in its entirety when making the determination of whether Applicant’s mark is misdescriptive, which violates the anti-dissection rule.

When the United States Supreme Court created the anti-dissection rule, it did not exempt matters falling within Section 2(a), and Congress has not amended Section 2(a) to exempt the provisions contained therein from the anti-dissection rule. Furthermore, there is no case law holding that matters falling within Section 2(a) are exempt from the anti-dissection rule. Therefore, Examining Attorneys must follow the anti-dissection rule when applying the Deception Test. In other words, it is improper to only consider a portion of a mark when applying the Deception Test.

The term “aura” means: “a distinct but intangible quality that seems to surround a person or thing . . . .” See Exhibit 1. The Examining Attorney never addressed the term “aura” in her



Final Refusal except to make the conclusory and incorrect statement that “the word AURA does not qualify the term diamond.” See Final Office Action pp. 2-3. Applicant’s description of goods expressly states that its goods are “simulated” diamonds and gemstones. The phrase “simulated diamond” is commonly known by the consuming public to mean an object simulating the appearance of a mined diamond that is created by humans in a lab and is not a mined diamond. See, *infra*, Exhibits 2 – 27.

Applicant coined the term DIAMONDAURA to suggest the brilliance of Applicant’s Goods without actually describing the character, quality, function, composition, or use of a simulated diamond. Consumers will understand from Applicant’s Mark that Applicant’s Goods are brilliant and high quality simulated diamonds and will not make the illogical conclusion that Applicant’s Goods are mined diamonds. Therefore, Applicant’s DIAMONDAURA mark is suggestive of Applicant’s Goods.

Indeed, on numerous occasions, the United States Patent and Trademark Office (“USPTO”) has determined that coupling the term “diamond” with other terms can create a suggestive and non-deceptive mark worthy of registration on the Principal Register when used in connection with simulated diamonds. The following list is a representative sample of marks that are registered or were registered on the Principal Register, or were issued a Notice of Allowance in connection with simulated diamonds that incorporate the term “diamond” as part of the mark:

Mark	Registration/ Serial No.	Goods/Services	Owner
DIAMONDIQ	78639843	Simulated gemstones, namely, white and colored simulated gemstones including simulated diamonds	Diamonique Corporation
DIAMOND IQ	78639840	Simulated gemstones, namely, white and colored simulated gemstones including simulated diamonds	Diamonique Corporation

DIAMONICE	78365990	Jewelry with or without precious, semiprecious, simulated or synthetic stones	Diamonair Usa, Inc.
<i>Diamond</i>	2930801	Jewelry - namely, rings, pendants, brooches, pins, earrings, bracelets, anklets, chains, necklaces, cuff links, tie tacs, and tie clasps, with or without precious, semiprecious, simulated or synthetic stones	Diamonair Usa, Inc.
DIAMOND HYBRID	78274946	Wholesale distributorships featuring loose simulated diamond stones and finished jewelry pieces	Reese, Kim/J. Read, Steven/R.
DIAMOND IQ	76299772	Simulated gemstones, namely, white and colored simulated gemstones, including simulated diamonds	Diamonique Corporation
DIAMONDIQ	76299754	Simulated gemstones, namely, white and colored simulated gemstones, including simulated diamonds	Diamonique Corporation
DIAMONICE	1626466	Jewelry with or without precious, semiprecious, simulated or synthetic stones	Litton Systems, Inc.
DIAMONESK	1463424	Simulated gemstones, namely colored and white simulated gemstones, including simulated diamonds, and jewelry including said gemstones	MSB Industries, Inc.
DIAMONIQUE	1538103	Precious stones, namely, colored and white simulated diamonds for use in jewelry other than school class rings, recognition jewelry and sports award jewelry	Diamonique Corporation
THREE DIAMONDS	1365477	Jewelry and precious stones, not including diamonds or simulated diamonds	Mitsubishi Shoji Kaisha, Ltd.
DIAMONJEWEL	941458	Simulated diamonds	D. Nagin Mfg. Corp.
DIAMOND-ITE	843690	Imitation gems sold as finished articles of jewelry namely, finger rings, necklaces, bracelets, pins and earrings	Fleet National Bank
SDJ SURAT	3089174	Gold and silver jewelry;	Suart Diamond Jewellery

DIAMOND JEWELLERY		precious and semi-precious stone-studded jewelry; diamond and pearl jewelry; imitation and costume jewelry	P Ltd.
----------------------	--	---	--------

See Exhibits 2 - 15. Every mark on this list was registered or issued a Notice of Allowance without receiving a deceptive refusal or having to specify whether its product possessed the characteristics of diamond listed in the Guide, or was found to not deceive. These marks demonstrate that marks containing the term "diamond" can be and are suggestive of "simulated diamonds" and not deceptive. The successful passage of these "diamond" marks for goods covering "simulated diamonds" on the Principal Register demonstrates that Applicant's DIAMONDAURA mark is not deceptive and equally worthy of registration on the Principal Register.

In sum, the Examining Attorney improperly focused solely on the DIAMOND portion of Applicant's DIAMONDAURA mark and did not consider the mark in its entirety when making the ultimate decision that Applicant's mark was misdescriptive. The AURA portion of Applicant's mark adds emotional interest and distinctiveness to Applicant's mark. Because the Examining Attorney focused solely on the DIAMOND portion and failed to consider the entire coined DIAMONDAURA mark, she failed to present evidence sufficient to establish her prima facie case that Applicant's mark is misdescriptive.

Indeed, Applicant has not misdescribed its goods because Applicant is seeking registration of the DIAMONDAURA mark in connection with jewelry containing simulated diamonds. Applicant honestly and explicitly describes its goods as "jewelry primarily comprised of simulated diamonds and gemstones." The focus of Applicant's mark is on the product's impression and the human emotion surrounding it, not the product itself. Therefore, there is no

misdescription because Applicant's mark is suggestive of its goods, namely, jewelry containing *simulated diamonds*.

Purchasers will not believe that Applicant's Goods must be mined diamonds simply because Applicant's DIAMONDAURA mark contains the term DIAMOND. The listed marks above that incorporate the term "diamond" in connection with simulated diamonds also demonstrate that the market place has conditioned consumers to the use of the term "diamond" or a variation thereof in connection with products that do not possess mined diamonds. In addition, there are many third-party uses of the term "diamond" in connection with simulated diamonds on the Internet. The following is a representative list of third parties using the term "diamond" in connection with simulated diamonds:

Mark	Website	Goods/Services	Owner
Diamond Essence	<a href="http://www.diamond-essence.com">www.diamond-essence.com</a>	Simulated diamonds	Ranjit Corporation
Asha Diamond	<a href="http://www.betterthandiamond.com">www.betterthandiamond.com</a>	Simulated diamonds	BetterThanDiamond, Inc.
Ziamond	<a href="http://www.ziamond.com">www.ziamond.com</a>	Simulated diamonds	Ziamond, Inc.
Apollo Diamond	<a href="http://www.apolodiamond.com">www.apolodiamond.com</a>	Simulated diamonds	Private Registration
Sona Diamond	<a href="http://www.sonadiamondjewelry.com">www.sonadiamondjewelry.com</a>	Simulated diamonds	phillips, cleve
Diamond Nexus Labs	<a href="http://www.diamondnexuslabs.com">www.diamondnexuslabs.com</a>	Simulated diamonds	Private Registration
Created Chatham Diamond	<a href="http://www.sunning.com.hk">www.sunning.com.hk</a>	Simulated diamonds	Private Registration
RUSSIAN BRILLIANTS	<a href="http://www.russianbrilliants.net">www.russianbrilliants.net</a>	Simulated diamonds	Hadar Diamonds, Inc.
Desert Diamonds	<a href="http://www.desertdiamonds.ca/">www.desertdiamonds.ca/</a>	Simulated diamonds	DomainsAtCost Corp.
Geo Diamond	<a href="http://www.geo.org/diamonds.htm">www.geo.org/diamonds.htm</a>	Simulated diamonds	The GEO Group
Van Graff Hearts & Arrows simulated diamond	<a href="http://www.van-graff.com">www.van-graff.com</a>	Simulated diamonds	Juan Manuel Lozano Gallegos
Diamone	<a href="http://www.diamone.net">www.diamone.net</a>	Simulated diamonds	HE JIN XIN

See, Exhibits 16 - 27. These uses demonstrate that consumers are accustomed to encountering the term "diamond" in connection with simulated diamonds and that they understand the difference between a simulated diamond and a mined diamond.

Furthermore, the Examining Attorney seriously underestimates the impact price has on the purchase of diamonds. Mined diamonds are valued according to the 4Cs – Cut, Color, Clarity, and Carat. Color scores range from D, the best, to Z, the worst and Clarity scores range from F, the best, to IS3, the worst. See Exhibits 28 - 29. An Internet search for the lowest valued mined diamond revealed a mined diamond that was M in Color and SI3 in Clarity. See Exhibit 30. This particular mined diamond was approximately 1.0 Carat and the average Carat price was \$1,058.40, which did not include a setting. *Id.*

A 1.0 Carat, simulated diamond sells for \$195. See Exhibit 31. Therefore, even a very poor quality mined diamond costs about five times more than a simulated diamond of equal size. Compare Exhibit 30 with Exhibit 31. Certainly, a higher quality diamond would sell well in excess of five times the cost of a simulated diamond. This dramatic price deviation cannot be ignored by the Examining Attorney, it certainly wouldn't be ignored by consumers. Therefore, even assuming for the moment one exists, consumers are unlikely to believe or rely on the so-called "misdescription."

## II. THE EXAMINING ATTORNEY HAS IMPROPERLY USED THE FTC GUIDELINES

The Examining Attorney's reliance on the Guide is misplaced and she appears to substitute the characteristics of a diamond contained in the Guide for the Deception Test created by the Federal Circuit in the *Budge* case. In other words, the Examining Attorney appears to take the position that the term "diamond" may not be used as part of a mark for a jewelry product that does not possess the characteristics listed in the Guide because this use is per se deceptive.

On the contrary, the USPTO does not share the Examining Attorney's position because it has registered marks that contain the term "diamond" or a similar variation thereof in connection with simulated diamonds, the same goods Applicant sells under its DIAMONDAURA mark.

Indeed, if the Examining Attorney's position were correct, then almost every mark in International Class 14 that uses the term "silver" is likely deceptive and should have been denied registration. The Guide states: "It is unfair or deceptive to mark, describe, or otherwise represent all or part of an industry product as "silver" . . . unless it is at least 925/1,000ths pure silver." 16 C.F.R. §23.6 (emphasis added). The following is a representative list of the marks registered or applied for registration in International Class 14 that use the term "silver":

Mark	Registration /Serial No.	Goods/Services	Owner
ETERNAL SILVER	79030842	Hand tools and implements; cutlery; knives; forks, spoons, teaspoons, serving utensils, parts and fittings for all the aforesaid goods; all made wholly or principally of silver; precious metals and their alloys and goods in precious metals or coated therewith, not included in other classes; jewelry, horological and chronometric instruments; includes clocks and watches; costume jewelry; parts and fittings for all the aforesaid goods; all made wholly or principally of silver; stationery; office requisites (except furniture); parts and fittings for all the aforesaid goods	Forever Silver Limited; C/O Swico
SILVER PLUS	3243672	Jewelry made in whole or substantial part of silver	Commemorative Brands, Inc.
SILVERD'SIGN	3240865	Jewelry in the nature of rings, bracelets, charms, pendants, necklaces, earrings, watches, chains, pins, badges of precious metal, beads for use in the	Goldart International Inc

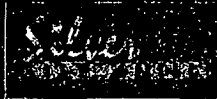

		manufacture of jewelry, brooches, buckles for watchstraps, watch winding buttons, crosses, crucifixes, cuff links, lockets, charms of saint christopher, star of david charms, tie clips, tie slides, tie pins, ashtrays and cigarette boxes of precious metal, made in whole or in significant part of silver	
J & J SILVER	78860481	Silver and its alloys	J & J Silver
PHOENIX SILVER	78687293	Precious metals, namely, silver	Gordon S Hayes
STERLING SILVER SHOPPE	3224291	Sterling silver jewelry, namely, rings, bracelets, necklaces, charms, earrings, anklets, brooches, pendants	Richard Foster Hughes, II
SILVER CANYON	78856064	Jewelry made of gold, silver and sterling silver, namely, pendants, earrings, rings, bangles, chains, bracelets, necklaces, brooches and anklets	L.A. Gem And Jewellery Design, Inc.
BABY SILVER	78859065	Jewelry made in whole or substantial part of silver	Bel-Oro International, Inc.
 Taccari FINE STERLING SILVER	3164278	Sterling silver flatware; items made of sterling silver, with or without other elements, including precious stones and semi-precious stones, beads, decorative plastic, wood and crystal, namely, decorative centerpieces, bookmarks, candlesticks, baby rattles, writing instruments, jewelry, picture frames, plates, platters and dishes, tea sets, vases, cocktail shakers, decorative statues	Adriana Escalante-Calderon
America's source for gold and silver	78653262	Precious metals such as gold, silver and platinum	Cmi Gold & Silver, Inc.
SILVER SILK	78559213	Jewelry made in whole or substantial part of silver	Silver Silk Llc
INSPIRED SILVER	3124880	Sterling silver jewelry	Ecommerce Innovations Llc
STUDIO SILVERSMITH S	3111687	Stainless and silver-plate flatware, namely knives, forks, and spoons; silver-plated	Godinger Silver Art Co., Ltd.



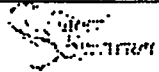
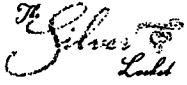

		giftware of precious metal, namely candlesticks, bowls, vases, decorative boxes, and figurines; silver-plated hollowware of precious metal, namely serving ware for serving food, pitchers, bowls, drinking vessels, charger plates, vases, and serving trays; stainless steel hollowware not of precious metal, namely serving ware for serving food, pitchers, bowls, drinking vessels, charger plates, vases, and serving trays	
SILVER ELITE	3200283	Precious metal alloys, namely, jewelry alloys consisting of silver and platinum sold as a component part of jewelry	Jostens, Inc.
SilverGolf	2881358	Silver trophy coins	Miguel Rocha Mares
	3121812	Jewelry made substantially of silver; watches	Magnolia Export Logistic Ltd.
TUSCANY SILVER	3161557	Sterling silver jewelry, namely, necklaces, bracelets, earrings, rings, pendants, and ankle bracelets produced from tuscan part of italy	International Bullion And Metal Brokers, Inc.
SILVER DESIGN	78457474	Sterling silver jewelry and gifts	Barjas, B. Dabbain
ROSE SILVER	3124240	Precious metal alloy made of copper, silver and palladium for use in musical instruments, namely, flutes and flute parts; flutes and flute parts, namely, flute headjoints and bodies made of precious metal alloy made of copper, silver and palladium	Brannen Brothers - Flutemakers, Inc.
SILVER PASSION	78425839	Sterling silver jewelry	Lailah Harrigan
SILVERALDER	2999110	Silver and gold jewelry including silver and gold plated jewelry	Paul T Westmoreland
	78280883	"Bridge" quality jewelry, specifically pearls, semi-precious stones, and silver pieces	Kelle Stephens





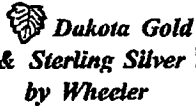

	78269210	Sterling silver and/or gold with or without precious stone and/or semi-precious stone in hair pin, earring, necklace, pendant, ring, bracelet, belt, buckle, and anklet	Star-Tex Imports, Inc. D/B/A Silver Express
NANOSILVER BG	2855953	All purpose disinfecting preparations and medicaments comprised of oily, non-watery and watery suspensions of finely dispersed metallic silver; all purpose disinfecting preparations and medicaments comprised of oily, non-watery and watery suspensions of finely dispersed metal; medicated ointments and creams containing finely dispersed metallic silver for pharmaceutical uses; medicated ointments and creams containing finely dispersed metal for pharmaceutical uses; pharmaceutical preparations comprised of powdered silver used in antibacterial and anti-inflammatory applications; pharmaceutical preparations comprised of powdered metal used in antibacterial and anti-inflammatory applications; common metal in powdered form for further manufacture; powdered precious metals; powdered silver	Bio-Gate Bioinnovative Materials GmbH
	78203783	Engravable sterling silver jewelry and related gift items	The Silver Locket, Llc
MAGNOLIA SILVER	3039869	Jewelry made substantially of silver, not including watches	Magnolia Export Logistics Ltd.
SILVER CONNECTION "JEWELRY FROM AROUND THE WORLD TO	2821170	Sterling silver jewelry-- rings, earrings, necklaces, bracelets, pendants, anklets, lockets, watches	Silver Connection, L.L.C., The

YOU"			
KARA SILVER	78155560	Non-electric sterling silver tea sets; candelabras, candle sticks, cups, goblets, salt and pepper shakers, napkin rings, and coolers and decanters for wine or water sold as a unit and separately all made of precious metal; sterling silver dress-ware comprised of brushes, combo and hand-held mirrors sold as a unit and separately; sterling silver and silver-plate serve-ware, namely, salad tongs, pie servers, cake servers, serving ladles, bowls and pitchers; sterling silver and silver-plate giftware, namely, picture frames, dispensers for pills or capsules, vases, vanity trays and decorative boxes	Kara Harun
	2784203	Silver jewelry; retail stores featuring silver jewelry	James Reigle
SILVER AVENUE	78125437	Jewelry made in whole or of substantial part of silver, namely rings, earrings, charms, pendants, chains, bracelets, pins, necklaces and broaches	Ken Craft Inc.
<i>Sterling Silver Sta</i>	78112874	A wooden plaque product with cutouts for puzzle pieces in the shape of a map, especially the states of the united states which are made from precious metals, especially sterling silver.	Trident Corporation
HERSHEY LEATHER & SILVER	78100983	Silver containing jewelry namely, bracelets, rings, necklaces, earrings and watchbands; leather purses, belts and wallets	Interim Design, Inc,
SILVER ANVIL	2773527	Jewelry; costume jewelry, precious metal and non-precious metal jewelry, jewelry with and without precious gemstones, precious gemstones, semi-precious gemstones, jewelry,	Metalsmith Master Architects Of Jewelry Inc.

		namely rings, hair ornaments, earrings, bracelets, bangles, bands, necklaces, pendants, pins, brooches and body jewelry, jewelry, namely sterling silver jewelry, watches, beads, pearls; retail jewelry store; mail order services featuring jewelry; computerized on-line retail services in the field of jewelry; telephone shop at home services in the field of jewelry; retail store services, available through computer communications, featuring jewelry	
	2978125	Costume jewelry made in whole or substantial part of silver	Merry Ann Grow
SILVERSMITH	78004868	Sterling silver jewelry; chains, necklaces, charms, pendants, bracelets, rings, earrings, as well as body piercing jewelry	Silversmith, Inc.
SILVER STANDARD	77066887	Precious metals, in particular silver; silver metal in the form of bars and ingots; retail store services and wholesale stores and distributorships services concerning precious metals; mining extraction of precious metals; processing, working, refining and polishing of precious metals	Silver Standard Resources Inc.
SILVER DREAM	76654535	Jewelry made wholly or in part of silver, namely earrings, bracelets, necklaces, rings, watches, pendants, brooches, chains, pins, medallions, cufflinks	Silver Dream, L.L.C.
 Pierre Lang Silver Trend Collect	2809861	Jewelry, precious stones, costume jewelry, necklaces, bracelets, brooches, rings, earrings of precious metal, cuff links, and tie pins, clocks, and chronometers, all made in whole of significant part of silver	Pierre Lang Europe Handelsgesellschaft M. B. H.

	2746405	Jewelry made in whole or in substantial part of silver and platinum	Commemorative Brands, Inc.
	2634259	Silver jewelry, namely, rings, wrist and ankle bracelets, necklaces, neck chains, wrist chains, ankle chains, and body chains, earrings, pins, pendants, charms, cuff links, watch fobs	Kohan & Suleminian Enterprises, Inc
HERITAGE MINT, LTD. SILVERPLATE COLLECTION	2686004	Silver-plated vanity sets comprised of mirrors, hair combs, hairbrushes, keepsake boxes, ring holders, picture frames and photo albums; mirrors and picture frames	Heritage Mint, Ltd.
SILVER BLUSH	3024175	Sterling silver jewelry namely, earrings, necklaces, bracelets, hair barrets, pendants, belly chains, rings, toe rings, ankle bracelets	Athra Trading, Inc.
CHARMING SILVER	3058529	Jewelry made substantially of silver	John Gilbert Elmassian
	3052784	Jewelry made of gold and silver	Wheeler Manufacturing Co., Inc.
	76550959	Miniature baby spoon charms, being jewelry; miniature baby spoons, being jewelry; miniature spoons, being jewelry; maternal charms, being jewelry; charms, being jewelry; gold, silver, and costume jewelry; bracelets; jewelry chains; necklaces; charm bracelets; charms for necklaces; pendants; jewelry made of precious metals; jewelry brooches; earrings; rings, being jewelry; pins, being jewelry; medallions	Frances Claude
EVERY CHILD CAN BE BORN WITH A SILVER SPOON	76550958	Miniature baby spoon charms, being jewelry; miniature baby spoons, being jewelry; miniature spoons, being jewelry; maternal charms, being jewelry; charms, being jewelry; gold, silver, and costume jewelry; bracelets;	Frances Claude

		jewelry chains; necklaces; charm bracelets; charms for necklaces; pendants; jewelry made of precious metals; jewelry brooches; earrings; rings, being jewelry; pins, being jewelry; medallions	
SILVER TATTOO	76616528	Jewelry that looks like tattooed jewels and silver on the skin	Nika Greye
ULTRAFINE SILVER	2932521	Silver jewelry	Qvc, Inc.
BORN WITH A SILVER SPOON	76550961	Miniature baby spoon charms, being jewelry; Miniature baby spoons, being jewelry; miniature spoons, being jewelry; maternal charms, being jewelry; charms, being jewelry; gold, silver, and costume jewelry; bracelets; jewelry chains; necklaces; charm bracelets; charms for necklaces; pendants; jewelry made of precious metals; jewelry brooches; earrings; rings, being jewelry; pins, being jewelry; mirrors; medallions	Frances Claude
<i>SilverWear</i>	76550960	Miniature baby spoon charms, being jewelry; miniature baby spoons, being jewelry; miniature spoons, being jewelry; maternal charms, being jewelry; charms, being jewelry; gold, silver, and costume jewelry; bracelets; jewelry chains; necklaces; charm bracelets; charms for necklaces; pendants; jewelry made of precious metals; jewelry brooches; earrings; rings, being jewelry; pins, being jewelry; mirrors; medallions	Frances Claude
	76442921	Jewelry for pets made substantially of silver or other precious metals, pearls and/or gemstones	Jeffrey Howard, Inc.
SILVER AND GOLD EXTRAORDIN	2709130	Jewelry made in whole or substantial part of silver or gold or a combination of silver and	Ag Artwear, Inc.

AIRE		gold	
 SILVER PLUS	76411192	Silver plated housewares, namely candle and wine bottle holders; bowls; jewelry boxes; vases; goblets; pitchers; napkin ring and placecard holders; ring and jewelry holders; picture frames; trinket boxes; salt and pepper cellars; sugar and cream containers; toothpick holders; and trays	Far East Brokers & Consultants, Inc.
SILVER SUPREME	2798839	Jewelry made in whole or substantial part of silver	Armbrust International Ltd.
	2768847	Jewelry, jewelry chains, amulets, crosses, jewelry boxes of precious metals, precious gemstones, precious metal money clips, precious metals, precious metals and their alloys sold in bulk, precious stones, honological and chronometric instruments, namely watches, clocks, compasses, made in whole or significant part of silver	Barrocos Of Florida, Inc.
SILVER SELECT	2809562	Jewelry made in whole or in substantial part of silver	Commemorative Brands, Inc.
	76378775	Jewelry, namely, jewelry made wholly or in part of silver	Sunstone Imports, Inc.
STERLING SILVER GENIUS	76362193	Silver; silver alloys; goods made of silver or of silver alloys and parts and fittings for all of the aforesaid goods	Mu Ventures Limited
SILVER DUETS	76349119	Jewelry made in substantial part of silver	Bel-Oro International, Inc
DIVESILVER	2609821	Sterling silver jewelry, gold and platinum jewelry	Peter Stone Co. Usa, Inc.
SILVER PARTY INTERNATIONAL	76291892	Silver jewelry	Emanuel Trading Corporation
LIQUID SILVER	76287914	Watches made in whole, or in substantial part, of silver	E. Gluck Corporation
SILVERBYGRAM.COM	76251677	Selling sterling silver jewelry and sterling silver jewelry set with gem stones and marcisite	Samuel Bert Davis
SILVER BULL	76232607	Jewelry made of silver; travel club	Silver Bull Holdings International Ltd.

SILVER SNOW CRYSTAL	2546881	Engraved medallions made of silver	David Biagini
SASSY SILVER	76134603	Sterling silver jewelry and accessories silver clothing, silver candles or silver colored items	Julie Carr
SILVER DAYDREAM	76119667	Silver jewelry	S. A. Swift, Ltd.
ARGENTA STERLING SILVER	2562443	Jewelry made in whole or part of sterling silver, namely, bracelets, ankle bracelets, watches, necklaces, earrings, rings, pendants, brooches, charms, and cuff links	Rimar, Inc.
SILVERFINGER	2477763	Silver jewelry	Charles Henry Frieder And Heidi Frieder Partnership, The
SEÑOR SILVER	76025195	Silver jewelry	Senor Silver
	2448818	Tableware, namely, knives, forks, spoons, all made of precious metals; jewelry, namely, lockets, pendants, earrings, chains and cords therefor; drinking cups and baby rattles, all made of precious metal; and sterling silver chiming bells	Sounds Of Silver LLC
	2429208	Gold and silver jewelry	Rachel Girshick
SILVER.COM	75945062	Sterling silver jewelry	Frey Imports (Usa) Inc.
	75913633	Jewelry made in whole or significant part of silver	Coronato International Corp.
	75888301	Silver jewelry, namely rings; wrist and ankle bracelets; necklaces; neck, wrist, ankle and body chains earrings; studs; pins; pendants; charms; cuff links; key chains; fobs	Kohan & Suleminian Enterprises, Inc
BATIK SILVER	75828328	Jewelry made in whole or in part of silver	Crystalline North America, Inc.
SIGNATURE SILVER	75815899	Jewelry made in whole or substantial part of silver	Home Shopping Club Lp

<i>Batik Silver</i>	75766425	Gold and silver jewelry, namely, rings, hat ornaments of precious metal, shoe ornaments of precious metal, earrings, bracelets, necklaces, brooches, precious gemstones and tie pins; hairpins made in whole or significant part of silver	P.T. Sumber Cipta Logam
SILVER LEGEND	75763879	Jewelry and watches made of or in substantial part of silver	Montgomery Ward, Llc
BATIK SILVER	75762357	Gold and silver jewelry, namely, rings, hat ornaments of precious metal, shoe ornaments of precious metal, earrings, bracelets, necklaces, brooches, precious gemstones and tie pins; hair pins	P.T. Sumber Cipta Logam
KNIGHT SILVER	75719772	Silver jewelry, namely- pendants, earrings, rings, bracelets, necklaces, pins and anklets	Otc International, Ltd.
KARA SILVER INTERNATIONAL	2955511	Non-electric sterling silver tea sets and candelabras; candlesticks, cups, goblets, salt and pepper shakers, napkin rings, coolers and decanters for wine and water all sold as unit and separately and all made of sterling silver; sterling silver dress ware comprised of brushes and hand-held mirrors all sold as a unit and separately; sterling silver and silver-plated serving ware, namely, salad tongs, pie servers, cake servers, serving ladles, bowls and pitchers; sterling silver and silver-plated giftware, namely, picture frames, dispensers for pills or capsules, vases, vanity trays and decorative boxes	Kara Harun

See Exhibits 32 - 113. None of these registrations or applications were issued an Office Action that asserted Section 2(a) as a ground for refusal. Furthermore, none of the file histories associated with these registrations include questions asking the Registrant to submit to an



additional information request regarding the actual pure silver content of their respective products.

The reason reliance on the Guide by the USPTO is not universal and a demonstrated, accepted practice is because deception under the Guide, 16 C.F.R. § 23.1, is different from deception under the Lanham Act. While the Guide may provide guidance for the deception analysis under the Lanham Act, it is clear that the USPTO does not intend for the Guide to supplant the Deception Test created by the Federal Circuit in the *Budge* case. Therefore, the Examining Attorney failed to establish a prima facie case that Applicant's DIAMONDAURA mark is deceptive because she improperly focused on the Guide and its requirements rather than the requirements for deception under the Lanham Act.

III. THE EXAMINING ATTORNEY'S EVIDENCE IS INSUFFICIENT TO ESTABLISH A PRIMA FACIE CASE OF DECEPTIVENESS

The majority of the Examining Attorney's "evidence" includes questions posted to Web pages that allow people to post comments. The Examining Attorney relies heavily on a Web page titled "Ask the Diamond Guy." The statements contained in these postings are inherently unreliable and insufficient to support a deception refusal. It is uncertain who is making the statements, whether they are reliable, what their motives might be and whether the statements are truthful.

The Examining Attorney's remaining "evidence" includes Web pages that discuss differences between a mined diamond and a simulated diamond. The physical appearance of a simulated diamond is intended to replicate a mined diamond. However, this does not demonstrate that a mark is deceptive.

Applicant's mark is DIAMONDAURA, not DIAMOND. If Applicant's goods were minded diamonds, it would be unnecessary to include AURA as part of the mark. Applicant

does not represent in its description of goods that it is selling diamonds. Rather, Applicant expressly represents that its goods are simulated diamonds. It is not deceptive to manufacture simulated diamonds. Nor is it deceptive to use DIAMONDAURA as a trademark to suggest the emotional and brilliant appearance of a mined diamond because the mark is suggestive of simulated diamonds, not mined diamonds. Indeed, the evidence of record includes Applicant's advertisements, which clearly demonstrate that Applicant is not selling mined diamonds under the DIAMONDAURA mark, rather the jewelry contains simulated diamonds. Therefore, the "how to" guides and other evidence concerning distinguishing simulated diamonds relied on by the Examining Attorney is insufficient to establish a prima facie case of deceptiveness.

#### IV. THE QUESTIONS POSED BY THE EXAMINING ATTORNEY ARE NOT RELEVANT

In the interest of moving the application toward publication, Applicant will respond to the Examining Attorney's additional questions. However, Applicant notes that these questions are irrelevant to the examination of Applicant's mark because Applicant never represented that its product is a mined or synthetic diamond. Applicant maintains that its product is a simulated diamond and that its product gives off the emotion and impression of a mined or synthetic diamond, without being a mined or synthetic diamond, and for a small fraction of the price of a mined or synthetic diamond. Again, Applicant's mark is DIAMONDAURA not DIAMOND. Therefore, Applicant states the following for its answers to the Examining Attorney's questions:

(1) Are the goods composed primarily of natural mineral?

**Answer:** No, as already stated, Applicant's goods are composed of simulated diamonds.

(2) Do the "synthetic diamonds and gemstones" consist essentially of pure carbon crystallized in the isometric system?

**Answer:** Applicant does not manufacture "synthetic" diamonds.

(3) Do the "synthetic diamonds and gemstones" have a hardness of 10 on the Mohs scale?

**Answer: Applicant does not manufacture "synthetic" diamonds.**

(4) Do the "synthetic diamonds and gemstones" have a specific gravity of approximately 3.52?

**Answer: Applicant does not manufacture "synthetic" diamonds.**

(5) Do the "synthetic diamonds and gemstones" have a refractive index of 2.42?

**Answer: Applicant does not manufacture "synthetic" diamonds.**

(6) Have the "synthetic diamonds and gemstones" been symmetrically fashioned with at least seventeen polished facets?

**Answer: Applicant does not manufacture "synthetic" diamonds.**

#### CONCLUSION

Applicant's DIAMONDAURA mark is suggestive of the goods stated in the application. Therefore, Applicant respectfully requests that the Examining Attorney withdraw her refusal to register Applicant's mark and issue the notice of publication.

Date: June 20, 2007

Respectfully submitted,

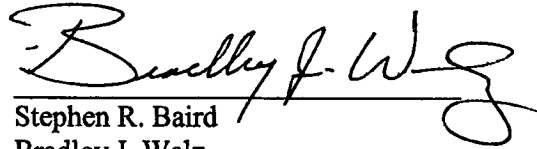

Stephen R. Baird  
Bradley J. Walz  
Winthrop & Weinstine, P.A.  
225 South 6th Street, Suite 3500  
Minneapolis, MN 55402  
Telephone: (612) 604-6400  
Facsimile: (612) 604-6800

Attorneys for Applicant

Exhibit 1



582,163,992 people served.

TheFreeDictionary  Google

aura

Word / Article  Starts with  Ends with  Text

TEXT

<input type="radio"/> Dictionary thesaurus	<input checked="" type="radio"/> Medical dictionary	<input type="radio"/> Acronym	<input type="radio"/> Columbia encyclopedia	<input type="radio"/> Wikipedia encyclopedia	<input type="radio"/> Hutchinson encyclopedia
--	---	-------------------------------	---	--	---

aura Also found in: [Medical](#), [Acronyms](#), [Columbia](#), [Wikipedia](#), [Hutchinson](#)

0.04 sec.

This is **Scary Accurate**  
 Avoid This Site if You're Frightened Easily.  
 YourFortuneRevealed.com

**Auras**  
 Find Auras Info. Fast & Easy  
 www.Aurasinfo.info

**Aura Imaging Systems**  
 Biofeedback Aura Imaging device to enhance your business / practice  
 www.aura.net

Ads by Google

Page tools

- Printer friendly
- Cite / link
- Email
- Feedback

**au-ra** <sup>4</sup> (ôr'ë)

*n. pl. au-ras or au-rae* (ôr'ë)

1. An invisible breath, emanation, or radiation.
2. A distinctive but intangible quality that seems to surround a person or thing; atmosphere: *An aura of defeat pervaded the candidate's headquarters.*
3. *Pathology* A sensation, as of a cold breeze or a bright light, that precedes the onset of certain disorders, such as an epileptic seizure or an attack of migraine.

[Middle English, *gentle breeze*, from Latin, from Greek *aurā*, *breath*; see *wer-*<sup>1</sup> in Indo-European roots.]

The American Heritage® Dictionary of the English Language, Fourth Edition copyright ©2000 by Houghton Mifflin Company. Updated in 2003. Published by Houghton Mifflin Company. All rights reserved.

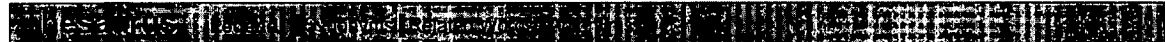

**Noun 1. aura** - a sensation (as of a cold breeze or bright light) that precedes the onset of certain disorders such as a migraine attack or epileptic seizure

**symptom** - (medicine) any sensation or change in bodily function that is experienced by a patient and is associated with a particular disease



2. **aura** - an indication of radiant light drawn around the head of a saint

**gloriole, halo, nimbus, aureole, glory**

**lightness, light** - the visual effect of illumination on objects or scenes as created in pictures; "he could paint the lightest light and the darkest dark"



3. **aura** - a distinctive but intangible quality surrounding a person or thing; "an air of mystery"; "the house had a neglected air"; "an atmosphere of defeat pervaded the candidate's headquarters"; "the place had an aura of romance"

**air, atmosphere**

**quality** - an essential and distinguishing attribute of something or someone; "the quality of mercy is not strained"—Shakespeare

**mystique** - an aura of heightened value or interest or meaning surrounding a person or thing

**note** - a characteristic emotional quality; "It ended on a sour note"; "there was a note of gaiety in her manner"; "he detected a note of sarcasm"

**vibrations** - a distinctive emotional aura experienced instinctively; "that place gave me bad vibrations"

Please bookmark with social media, your votes are noticed and appreciated:



**How Bright Is Your Aura?**

Try a Premium PhD Certified Test at Tickle & Test Yourself Today!  
web.tickle.com

**Enhance & Clear Aura**

Biofield Technology Breakthroughs Improves Aura, Chakras and Chi Flow  
www.energy-healingarts.com

**Color Therapy Penlight**

Cutting Edge European System for Holistic & Spa Professionals  
www.chromalighttherapy.com

Ads by Google

Roundtrip air travel within the continental U.S. for less.  
One way ticket each way or in August 18, 2007.  
Qwest

<u>air</u>	<u>karma</u>
<u>aroma</u>	<u>mystique</u>
<u>atmosphere</u>	<u>nimbus</u>
<u>aural</u>	<u>note</u>

It's all proteids and body-buildings, and people come up to you and beg your pardon, but you have such a beautiful **aura**.  
*Howards End* by *Forster, E. M.* **View in context**  
Clare had studied the curves of those lips so many times that he could

confer  
entrust  
facile  
halo

quality  
smell  
vibration  
vibrations

reproduce them mentally with ease; and now, as they again confronted him, clothed with colour and life, they sent an **AURA** over his flesh, a breeze through his nerves, which wellnigh produced a qualm; and actually produced, by some mysterious physiological process, a prosaic sneeze.

*Tess of the d'Urbervilles - A Pure Woman by Hardy, Thomas* [View in context](#)

Every breath of Porthos, thus vivifying the match, sent towards this heap of bodies a phosphorescent aura, mingled with streaks of purple.

*The Man in the Iron Mask by Dumas, Alexandre* [View in context](#)

[More results >>](#)

<p>▲ aunt Aunt Sally Aunter auntie Auntrous Aunter aunty ▶ aura auradin aural aurally Aurangabad Aurangzeb Aurantiaeous aurar ▼</p>	<p>▲ ● AUPE ● AUPEC ● AUPGSA ● AUPHA ● AUPM ● AUPO ■ Aupori Peninsula ■ Aupouri Peninsula ● AUPP ● AUPR ■ Auprès de ma Blonde ● AuPS ■ AUPS fragmentation mine ■ AUPS mine ● AUPSS ● AUPTR</p>	<p>● AUQ ● AUQA ■ Auquainville ● AUR ■ AUR ■ Aur Atoll ■ Aur Pyaar Ho Gaya ■ Aur Resources ▶ aura ■ Aura (.hack) ■ Aura (album) ■ Aura (Animation Software) ■ Aura (Asia album) ■ Aura (cheese) ■ Aura (CMX album) ■ Aura (disambiguation) ● AURA (disambiguation)</p>	<p>■ Aura (disambiguation) ■ Aura (disambiguation) ■ Aura (Finland) ■ Aura (Miles Davis album) ■ Aura (optics) ■ Aura (paranormal) ■ Aura (river) ■ Aura (satellite) ■ Aura (symptom) ■ Aura (woreda) ■ Aura Abbey ■ Aura analysis ■ Aura Andreea Munteanu ■ Aura Battler Dunbine ■ Aura Bogado ■ Aura Cheese ▼</p>
---	--	--	---

© TheFreeDictionary © Google



Word / Article
  Starts with
  Ends with
  Text

**Free Tools:** For surfers: [Browser extension](#) | [Word of the Day](#) | [Add the dictionary to favorites](#) | [Help](#)  
 For webmasters: [Free content NEW!](#) | [Linking](#) | [Lookup box](#) | [Double-click lookup](#) | [Partner with us](#) 

[Disclaimer](#) | [Privacy policy](#) | [Feedback](#) | Copyright © 2007 Earlex, Inc.  
 All content on this website, including dictionary, thesaurus, literature, geography, and other reference data is for informational purposes only. This information should not be considered complete, up to date, and is not intended to be used in place of a visit, consultation, or advice of a legal, medical, or any other professional.  
[Terms of Use.](#)

Exhibit 2



**Thank you for your request. Here are the latest results from the TARR web server.**

**This page was generated by the TARR system on 2007-06-13 14:59:04 ET**

**Serial Number: 78639843 Assignment Information**

**Registration Number: (NOT AVAILABLE)**

**Mark**

**DIAMONDIQ**

**(words only): DIAMONDIQ**

**Standard Character claim: Yes**

**Current Status: Abandoned: No Statement of Use filed after Notice of Allowance was issued.**

**Date of Status: 2006-08-08**

**Filing Date: 2005-05-31**

**Transformed into a National Application: No**

**Registration Date: (DATE NOT AVAILABLE)**

**Register: Principal**

**Law Office Assigned: LAW OFFICE 115**

**If you are the applicant or applicant's attorney and have questions about this file, please contact the Trademark Assistance Center at TrademarkAssistanceCenter@uspto.gov**

**Current Location: 700 -Intent To Use Section**

**Date In Location: 2006-02-07**

**LAST APPLICANT(S)/OWNER(S) OF RECORD**

---

**1. DIAMONIQUE CORPORATION**

**Address:**

DIAMONIQUE CORPORATION

1200 Wilson Drive

West Chester, PA 19380

United States

**Legal Entity Type:** Corporation

**State or Country of Incorporation:** New Jersey

---

**GOODS AND/OR SERVICES**

---

**International Class:** 014

**Class Status:** Active

SIMULATED GEMSTONES, NAMELY, WHITE AND COLORED SIMULATED GEMSTONES INCLUDING SIMULATED DIAMONDS

**Basis:** 1(b)

**First Use Date:** (DATE NOT AVAILABLE)

**First Use in Commerce Date:** (DATE NOT AVAILABLE)

---

**ADDITIONAL INFORMATION**

---

**Prior Registration Number(s):**

1532950

1538103

---

**MADRID PROTOCOL INFORMATION**

---

(NOT AVAILABLE)

---

**PROSECUTION HISTORY**

---

2006-10-12 - Abandonment Notice Mailed - No Use Statement Filed

2006-10-12 - Abandonment - No use statement filed

2006-02-07 - Notice of allowance - mailed

2005-11-15 - Published for opposition

Latest Status Info

2005-10-26 - Notice of publication  
2005-09-19 - Law Office Publication Review Completed  
2005-09-16 - Assigned To LIE  
2005-09-14 - Approved for Pub - Principal Register (Initial exam)  
2005-09-09 - Teas/Email Correspondence Entered  
2005-09-02 - Communication received from applicant  
2005-09-02 - TEAS Response to Office Action Received  
2005-09-01 - Non-final action e-mailed  
2005-09-01 - Non-Final Action Written  
2005-08-30 - Assigned To Examiner  
2005-06-07 - New Application Entered In Tram

---

**ATTORNEY/CORRESPONDENT INFORMATION**

---

**Attorney of Record**

Manny D. Pokotilow

**Correspondent**

MANNY D. POKOTILOW  
CAESAR, RIVISE, BERNSTEIN, COHEN & POKOT  
1635 MARKET ST FL CENTER11  
PHILADELPHIA, PA 19103-2217  
Phone Number: 215-567-2010  
Fax Number: 215-751-1142

---

Exhibit 3

**Thank you for your request. Here are the latest results from the TARR web server.**

**This page was generated by the TARR system on 2007-06-13 14:59:17 ET**

**Serial Number: 78639840 Assignment Information**

**Registration Number: (NOT AVAILABLE)**

**Mark**

**DIAMOND IQ**

**(words only): DIAMOND IQ**

**Standard Character claim: Yes**

**Current Status: Abandoned: No Statement of Use filed after Notice of Allowance was issued.**

**Date of Status: 2006-08-08**

**Filing Date: 2005-05-31**

**Transformed into a National Application: No**

**Registration Date: (DATE NOT AVAILABLE)**

**Register: Principal**

**Law Office Assigned: LAW OFFICE 115**

**If you are the applicant or applicant's attorney and have questions about this file, please contact the Trademark Assistance Center at [TrademarkAssistanceCenter@uspto.gov](mailto:TrademarkAssistanceCenter@uspto.gov)**

**Current Location: 700 -Intent To Use Section**

**Date In Location: 2006-02-07**

**LAST APPLICANT(S)/OWNER(S) OF RECORD**

---

**1. DIAMONIQUE CORPORATION**

**Address:**

DIAMONIQUE CORPORATION

1200 Wilson Drive

West Chester, PA 19380

United States

**Legal Entity Type:** Corporation

**State or Country of Incorporation:** New Jersey

---

**GOODS AND/OR SERVICES**

---

**International Class:** 014

**Class Status:** Active

SIMULATED GEMSTONES, NAMELY, WHITE AND COLORED SIMULATED GEMSTONES INCLUDING SIMULATED DIAMONDS

**Basis:** 1(b)

**First Use Date:** (DATE NOT AVAILABLE)

**First Use in Commerce Date:** (DATE NOT AVAILABLE)

---

**ADDITIONAL INFORMATION**

---

**Disclaimer:** "DIAMOND"

**Prior Registration Number(s):**

1532950

1538103

---

**MADRID PROTOCOL INFORMATION**

---

(NOT AVAILABLE)

---

**PROSECUTION HISTORY**

---

2006-10-12 - Abandonment Notice Mailed - No Use Statement Filed

2006-10-12 - Abandonment - No use statement filed

2006-02-07 - Notice of allowance - mailed

---

Latest Status Info

2005-11-15 - Published for opposition  
2005-10-26 - Notice of publication  
2005-09-19 - Law Office Publication Review Completed  
2005-09-16 - Assigned To LIE  
2005-09-14 - Approved for Pub - Principal Register (Initial exam)  
2005-09-09 - Teas/Email Correspondence Entered  
2005-09-02 - Communication received from applicant  
2005-09-02 - TEAS Response to Office Action Received  
2005-09-01 - Non-final action e-mailed  
2005-09-01 - Non-Final Action Written  
2005-08-30 - Assigned To Examiner  
2005-06-07 - New Application Entered In Tram

---

**ATTORNEY/CORRESPONDENT INFORMATION**

---

**Attorney of Record**

Manny D. Pokotilow

**Correspondent**

MANNY D. POKOTILOW  
CAESAR, RIVISE, BERNSTEIN, COHEN & POKOT  
11TH FLOOR  
1635 MARKET STREET SEVEN PENN CENTER  
PHILADELPHIA, PA 19103-2212  
Phone Number: 215-567-2010  
Fax Number: 215-751-1142

---

Exhibit 4



**Thank you for your request. Here are the latest results from the TARR web server.**

**This page was generated by the TARR system on 2007-06-13 14:59:27 ET**

**Serial Number: 78365990 Assignment Information**

**Registration Number: (NOT AVAILABLE)**

**Mark**

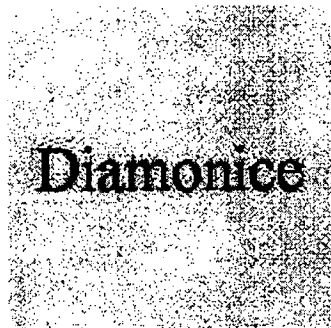

**(words only): DIAMONICE**

**Standard Character claim: Yes**

**Current Status: An opposition is now pending at the Trademark Trial and Appeal Board.**

**Date of Status: 2005-01-04**

**Filing Date: 2004-02-11**

**Transformed into a National Application: No**

**Registration Date: (DATE NOT AVAILABLE)**

**Register: Principal**

**Law Office Assigned: LAW OFFICE 111**

**Attorney Assigned:  
RINGLE JAMES W Employee Location**

**Current Location: 650 -Publication And Issue Section**

**Date In Location: 2004-11-01**

**LAST APPLICANT(S)/OWNER(S) OF RECORD**

---

1. Diamonair USA, Inc.

**Address:**

Diamonair USA, Inc.  
2 Cranberry Road  
Parsippany, NJ 07054  
United States

**Legal Entity Type:** Corporation

**State or Country of Incorporation:** New Jersey

**Phone Number:** 973-404-1000

**Fax Number:** 973-404-1030

---

**GOODS AND/OR SERVICES**

---

**International Class:** 014

**Class Status:** Active

Jewelry with or without precious, semiprecious, simulated or synthetic stones

**Basis:** 1(b)

**First Use Date:** (DATE NOT AVAILABLE)

**First Use in Commerce Date:** (DATE NOT AVAILABLE)

---

**ADDITIONAL INFORMATION**

---

(NOT AVAILABLE)

---

**MADRID PROTOCOL INFORMATION**

---

(NOT AVAILABLE)

---

**PROSECUTION HISTORY**

---

2006-09-13 - Attorney Revoked And/Or Appointed

2006-09-13 - TEAS Revoke/Appoint Attorney Received

2005-01-05 - TEAS Change Of Correspondence Received

2005-01-04 - Opposition instituted for Proceeding

**Latest Status Info**

2005-01-03 - Opposition papers filed  
2004-12-14 - Published for opposition  
2004-11-24 - Notice of publication  
2004-10-06 - Law Office Publication Review Completed  
2004-10-05 - Assigned To LIE  
2004-09-06 - Approved for Pub - Principal Register (Initial exam)  
2004-09-02 - Assigned To Examiner  
2004-02-23 - New Application Entered In Tram

---

**ATTORNEY/CORRESPONDENT INFORMATION**

---

**Attorney of Record**

John D. Cromie

**Correspondent**

JOHN D. CROMIE, ESQ.

CONNELL FOLEY LLP

85 LIVINGSTON AVENUE

ROSELAND, NJ 07068

Phone Number: 973-535-0500

Fax Number: 973-535-9217

---

Exhibit 5

**Thank you for your request. Here are the latest results from the TARR web server.**

**This page was generated by the TARR system on 2007-06-19 10:37:41 ET**

**Serial Number: 78370765 Assignment Information**

**Registration Number: 2930801**

**Mark**



**(words only): DIAMONAIR**

**Standard Character claim: No**

**Current Status: Registered.**

**Date of Status: 2005-03-08**

**Filing Date: 2004-02-19**

**Transformed into a National Application: No**

**Registration Date: 2005-03-08**

**Register: Principal**

**Law Office Assigned: LAW OFFICE 111**

**If you are the applicant or applicant's attorney and have questions about this file, please contact the Trademark Assistance Center at TrademarkAssistanceCenter@uspto.gov**

**Current Location: 650 -Publication And Issue Section**

**Date In Location: 2005-03-08**

---

**LAST APPLICANT(S)/OWNER(S) OF RECORD**

---

1. Diamonair USA, Inc.

**Address:**

Diamonair USA, Inc.  
2 Cranberry Road  
Parsippany, NJ 07054  
United States

**Legal Entity Type:** Corporation

**State or Country of Incorporation:** New Jersey

**Phone Number:** 973-404-1000

**Fax Number:** 973-404-1030

---

**GOODS AND/OR SERVICES**

---

**International Class:** 014

**Class Status:** Active

Jewelry - namely, rings, pendants, brooches, pins, earrings, bracelets, anklets, chains, necklaces, cuff links, tie tacs, and tie clasps, with or without precious, semiprecious, simulated or synthetic stones

**Basis:** 1(a)

**First Use Date:** 1969-04-30

**First Use in Commerce Date:** 2001-03-00

---

**ADDITIONAL INFORMATION**

---

**Prior Registration Number(s):**

2345366

---

**MADRID PROTOCOL INFORMATION**

---

(NOT AVAILABLE)

---

**PROSECUTION HISTORY**

---

2006-09-13 - Attorney Revoked And/Or Appointed

2006-09-13 - TEAS Revoke/Appoint Attorney Received

2006-09-12 - TEAS Change Of Correspondence Received

**Latest Status Info**

2005-03-08 - Registered - Principal Register  
2004-12-14 ° Published for opposition  
2004-11-24 - Notice of publication  
2004-10-08 - Law Office Publication Review Completed  
2004-10-05 - Assigned To LIE  
2004-09-06 - Approved for Pub - Principal Register (Initial exam)  
2004-09-06 - Examiners amendment e-mailed  
2004-09-06 - Examiners Amendment -Written  
2004-09-02 - Assigned To Examiner  
2004-03-04 - New Application Entered In Tram

---

**ATTORNEY/CORRESPONDENT INFORMATION**

---

**Attorney of Record**

John D. Cromie

**Correspondent**

John D. Cromie

85 Livingston Avenue

Roseland NJ 07068

Phone Number: 973-535-0500

Fax Number: 973-535-9217

---

Exhibit 6



**Thank you for your request. Here are the latest results from the TARR web server.**

**This page was generated by the TARR system on 2007-06-13 14:59:49 ET**

**Serial Number: 78274946 Assignment Information**

**Registration Number: (NOT AVAILABLE)**

**Mark (words only): DIAMOND HYBRID**

**Standard Character claim: No**

**Current Status: Abandoned: A petition to revive has been denied.**

**Date of Status: 2006-01-05**

**Filing Date: 2003-07-16**

**Transformed into a National Application: No**

**Registration Date: (DATE NOT AVAILABLE)**

**Register: Principal**

**Law Office Assigned: LAW OFFICE 110**

**If you are the applicant or applicant's attorney and have questions about this file, please contact the Trademark Assistance Center at TrademarkAssistanceCenter@uspto.gov**

**Current Location: 450 -Petitions Office**

**Date In Location: 2006-01-05**

---

**LAST APPLICANT(S)/OWNER(S) OF RECORD**

---

1. Reese, Kim/J.

**Address:**

Reese, Kim/J.

POB C

Michigan City, IN 46361

United States

**Legal Entity Type: Individual**

**Country of Citizenship:** United States  
**Phone Number:** 219.670.1659  
**Fax Number:** 219.879.0390

2. Read, Steven/R.

**Address:**

Read, Steven/R.  
15321 2nd Avenue West  
Lynnwood, WA 980372104  
United States

**Legal Entity Type:** Individual  
**Country of Citizenship:** United States  
**Phone Number:** 425.743.6263  
**Fax Number:** 425.787.6451

---

**GOODS AND/OR SERVICES**

---

**International Class:** 035  
**Class Status:** Active  
WHOLESALE DISTRIBUTORSHIPS FEATURING LOOSE SIMULATED DIAMOND STONES  
AND FINISHED JEWELRY PIECES  
**Basis:** 1(a)  
**First Use Date:** 1002-10-00  
**First Use in Commerce Date:** 1002-10-00

---

**ADDITIONAL INFORMATION**

---

(NOT AVAILABLE)

---

**MADRID PROTOCOL INFORMATION**

---

(NOT AVAILABLE)

---

**PROSECUTION HISTORY**

---

2005-12-22 - Petition To Revive-Denied  
2005-09-15 - Petition To Revive-Received  
2005-09-15 - PAPER RECEIVED

Latest Status Info

2004-10-15 - Abandonment Notice Mailed - Failure To Respond  
2004-10-15 - Abandonment - Failure To Respond Or Late Response  
2004-03-11 - Final refusal e-mailed  
2004-02-10 - Communication received from applicant  
2004-02-11 - Email Received  
2004-01-23 - Non-final action e-mailed  
2004-01-23 - Assigned To Examiner

---

**ATTORNEY/CORRESPONDENT INFORMATION**

---

**Correspondent**

Reese, Kim/J.

POB C

Michigan City, IN 46361

Phone Number: 219.670.1659

Fax Number: 219.879.0390

---

Exhibit 7

**Thank you for your request. Here are the latest results from the TARR web server.**

**This page was generated by the TARR system on 2007-06-13 15:00:56 ET**

**Serial Number: 76299772 Assignment Information**

**Registration Number: (NOT AVAILABLE)**

**Mark (words only): DIAMOND IQ**

**Standard Character claim: No**

**Current Status: Abandoned after mark was published for opposition in the Official Gazette.**

**Date of Status: 2005-09-02**

**Filing Date: 2001-08-15**

**Transformed into a National Application: No**

**Registration Date: (DATE NOT AVAILABLE)**

**Register: Principal**

**Law Office Assigned: LAW OFFICE 101**

**If you are the applicant or applicant's attorney and have questions about this file, please contact the Trademark Assistance Center at TrademarkAssistanceCenter@uspto.gov**

**Current Location: 700 -Intent To Use Section**

**Date In Location: 2005-01-28**

---

**LAST APPLICANT(S)/OWNER(S) OF RECORD**

---

**1. DIAMONIQUE CORPORATION**

**Address:**

**DIAMONIQUE CORPORATION**

**425 Caredean Drive**

**Horsham, PA 19044**

**United States**

**Legal Entity Type: Corporation**

**State or Country of Incorporation:** New Jersey

---

**GOODS AND/OR SERVICES**

---

**International Class:** 014

**Class Status:** Abandoned

SIMULATED GEMSTONES, NAMELY, WHITE AND COLORED SIMULATED GEMSTONES,  
INCLUDING SIMULATED DIAMONDS

**Basis:** 1(b)

**First Use Date:** (DATE NOT AVAILABLE)

**First Use in Commerce Date:** (DATE NOT AVAILABLE)

---

**ADDITIONAL INFORMATION**

---

**Disclaimer:** "DIAMOND"

**Prior Registration Number(s):**

1532950

1538103

---

**MADRID PROTOCOL INFORMATION**

---

(NOT AVAILABLE)

---

**PROSECUTION HISTORY**

---

2005-09-02 - Abandonment - After publication

2005-09-02 - TEAS Express Abandonment Received

2005-01-31 - Extension 5 granted

2004-12-02 - Extension 5 filed

2005-01-05 - PAPER RECEIVED

2004-06-02 - Extension 4 granted

2004-05-03 - Extension 4 filed

2003-12-17 - Extension 3 granted

Latest Status Info

2003-11-19 - Extension 3 filed  
2004-05-27 - Case File In TICRS  
2004-05-03 - PAPER RECEIVED  
2003-11-19 - PAPER RECEIVED  
2003-06-27 - Extension 2 granted  
2003-05-30 - Extension 2 filed  
2003-05-30 - PAPER RECEIVED  
2003-02-26 - Extension 1 granted  
2002-12-04 - Extension 1 filed  
2002-12-09 - PAPER RECEIVED  
2002-06-04 - Notice of allowance - mailed  
2002-03-12 - Published for opposition  
2002-02-20 - Notice of publication  
2001-11-07 - Approved for Pub - Principal Register (Initial exam)  
2001-10-30 - Examiner's amendment mailed  
2001-10-24 - Non-final action mailed  
2001-10-05 - Assigned To Examiner  
2001-10-04 - Assigned To Examiner  
2001-09-26 - Assigned To Examiner

---

**ATTORNEY/CORRESPONDENT INFORMATION**

---

**Attorney of Record**  
Manny D. Pokotilow

**Correspondent**  
MANNY D. POKOTILOW  
CAESAR, RIVISE, BERNSTEIN, COHEN ET AL

Latest Status Info

7 PENN CTR FL 12  
1635 MARKET ST  
PHILADELPHIA PA 19103-2217  
Phone Number: (215) 567-2010  
Fax Number: (215) 751-1142

---



Exhibit 8

**Thank you for your request. Here are the latest results from the TARR web server.**

**This page was generated by the TARR system on 2007-06-13 15:12:43 ET**

**Serial Number: 76299754 Assignment Information**

**Registration Number: (NOT AVAILABLE)**

**Mark (words only): DIAMONDIQ**

**Standard Character claim: No**

**Current Status: Abandoned after mark was published for opposition in the Official Gazette.**

**Date of Status: 2005-09-02**

**Filing Date: 2001-08-15**

**Transformed into a National Application: No**

**Registration Date: (DATE NOT AVAILABLE)**

**Register: Principal**

**Law Office Assigned: LAW OFFICE 101**

**If you are the applicant or applicant's attorney and have questions about this file, please contact the Trademark Assistance Center at TrademarkAssistanceCenter@uspto.gov**

**Current Location: 700 -Intent To Use Section**

**Date In Location: 2004-12-20**

---

**LAST APPLICANT(S)/OWNER(S) OF RECORD**

---

**1. DIAMONIQUE CORPORATION**

**Address:**

**DIAMONIQUE CORPORATION**

**425 Caredean Drive**

**Horsham, PA 19044**

**United States**

**Legal Entity Type: Corporation**

**State or Country of Incorporation:** New Jersey

---

**GOODS AND/OR SERVICES**

---

**International Class:** 014

**Class Status:** Abandoned

SIMULATED GEMSTONES, NAMELY, WHITE AND COLORED SIMULATED GEMSTONES,  
INCLUDING SIMULATED DIAMONDS

**Basis:** 1(b)

**First Use Date:** (DATE NOT AVAILABLE)

**First Use in Commerce Date:** (DATE NOT AVAILABLE)

---

**ADDITIONAL INFORMATION**

---

**Prior Registration Number(s):**

1532950

1538103

---

**MADRID PROTOCOL INFORMATION**

---

(NOT AVAILABLE)

---

**PROSECUTION HISTORY**

---

2005-09-02 - Abandonment - After publication

2005-09-02 - TEAS Express Abandonment Received

2004-12-22 - Extension 5 granted

2004-12-06 - Extension 5 filed

2004-12-06 - PAPER RECEIVED

2004-05-14 - Extension 4 granted

2004-05-03 - Extension 4 filed

2004-05-12 - Case File In TICRS

2004-05-03 - PAPER RECEIVED

Latest Status Info

2003-12-15 - Extension 3 granted  
2003-11-19 - Extension 3 filed  
2003-11-19 - PAPER RECEIVED  
2003-06-27 - Extension 2 granted  
2003-05-30 - Extension 2 filed  
2003-05-30 - PAPER RECEIVED  
2003-02-26 - Extension 1 granted  
2002-12-09 - Extension 1 filed  
2002-12-09 - PAPER RECEIVED  
2002-07-02 - Notice of allowance - mailed  
2002-04-09 - Published for opposition  
2002-03-20 - Notice of publication  
2001-10-16 - Approved for Pub - Principal Register (Initial exam)  
2001-10-05 - Assigned To Examiner  
2001-10-04 - Assigned To Examiner  
2001-09-26 - Assigned To Examiner

---

**ATTORNEY/CORRESPONDENT INFORMATION**

---

**Attorney of Record**

Manny D. Pokotilow, Esq.

**Correspondent**

MANNY D. POKOTILOW, ESQ.  
CAESAR RIVISE BERNSTEIN COHEN ET AL  
SEVEN PENN CENTER, 12TH FLOOR  
1635 MARKET STREET  
PHILADELPHIA PA 19103-2212  
Phone Number: (215) 567-2010  
Fax Number: (215) 751-1142

Exhibit 9

**Thank you for your request. Here are the latest results from the TARR web server.**

**This page was generated by the TARR system on 2007-06-13 15:13:15 ET**

**Serial Number: 74009276 Assignment Information**

**Registration Number: 1626466**

**Mark (words only): DIAMONICE**

**Standard Character claim: No**

**Current Status: Registration canceled under Section 8.**

**Date of Status: 2001-12-15**

**Filing Date: 1989-12-11**

**Transformed into a National Application: No**

**Registration Date: 1990-12-04**

**Register: Principal**

**Law Office Assigned: (NOT AVAILABLE)**

**If you are the applicant or applicant's attorney and have questions about this file, please contact the Trademark Assistance Center at TrademarkAssistanceCenter@uspto.gov**

**Current Location: 900 -File Repository (Franconia)**

**Date In Location: 1996-11-12**

---

**LAST APPLICANT(S)/OWNER(S) OF RECORD**

---

**1. LITTON SYSTEMS, INC.**

**Address:**

LITTON SYSTEMS, INC.  
200 EAST HANOVER AVENUE  
MORRIS PLAINS, NJ 07950

United States

**Legal Entity Type: Corporation**

**State or Country of Incorporation:** Delaware

---

**GOODS AND/OR SERVICES**

---

**International Class:** 014

**Class Status:** Section 8 - Cancelled

JEWELRY WITH OR WITHOUT PRECIOUS, SEMIPRECIOUS, SIMULATED OR SYNTHETIC STONES

**Basis:** 1(a)

**First Use Date:** 1990-08-10

**First Use in Commerce Date:** 1990-08-10

---

**ADDITIONAL INFORMATION**

---

(NOT AVAILABLE)

---

**MADRID PROTOCOL INFORMATION**

---

(NOT AVAILABLE)

---

**PROSECUTION HISTORY**

---

2001-12-15 - Canceled Section 8 (10-year)/Expired Section 9

1996-10-04 - Section 8 (6-year) accepted & Section 15 acknowledged

1996-07-10 - Section 8 (6-year) and Section 15 Filed

1990-12-04 - Registered - Principal Register

1990-10-19 - Allowed for Registration - Principal Register (SOU accepted)

1990-10-02 - Statement of use processing complete

1990-09-21 - Amendment to Use filed

1990-08-28 - Notice of allowance - mailed

1990-06-05 - Published for opposition

1990-05-05 - Notice of publication

Latest Status Info

1990-02-14 - Approved for Pub - Principal Register (Initial exam)

1990-02-14 - Assigned To Examiner

---

**ATTORNEY/CORRESPONDENT INFORMATION**

---

**Attorney of Record**

MICHAEL H WALLACH

**Correspondent**

MICHAEL H WALLACH

LITTON

54 HORSEHILL ROAD

CEDAR KNOLLS NJ 07927-1901

---



Exhibit 10

**Thank you for your request. Here are the latest results from the TARR web server.**

**This page was generated by the TARR system on 2007-06-13 15:13:26 ET**

**Serial Number: 73633748 Assignment Information**

**Registration Number: 1463424**

**Mark (words only): DIAMONESK**

**Standard Character claim: No**

**Current Status: Registration canceled under Section 8.**

**Date of Status: 1995-04-07**

**Filing Date: 1986-12-04**

**Transformed into a National Application: No**

**Registration Date: 1987-11-03**

**Register: Principal**

**Law Office Assigned: (NOT AVAILABLE)**

**If you are the applicant or applicant's attorney and have questions about this file, please contact the Trademark Assistance Center at TrademarkAssistanceCenter@uspto.gov**

**Current Location: 900 -File Repository (Franconia)**

**Date In Location: 1995-04-17**

---

**LAST APPLICANT(S)/OWNER(S) OF RECORD**

---

**1. MSB INDUSTRIES, INC.**

**Address:**

**MSB INDUSTRIES, INC.  
1357 LIBERTY AVENUE  
HILLSIDE, NJ 07205**

**United States**

**Legal Entity Type: Corporation**

**State or Country of Incorporation:** New Jersey

---

**GOODS AND/OR SERVICES**

---

**International Class:** 014

**Class Status:** Section 8 - Cancelled

SIMULATED GEMSTONES, NAMELY COLORED AND WHITE SIMULATED GEMSTONES, INCLUDING SIMULATED DIAMONDS, AND JEWELRY INCLUDING SAID GEMSTONES

**Basis:** 1(a)

**First Use Date:** 1970-08-01

**First Use in Commerce Date:** 1970-08-01

---

**ADDITIONAL INFORMATION**

---

(NOT AVAILABLE)

---

**MADRID PROTOCOL INFORMATION**

---

(NOT AVAILABLE)

---

**PROSECUTION HISTORY**

---

1995-04-07 - Canceled Section 8 (6-year)

1994-06-23 - Post Registration action mailed Section 8 & 15

1993-11-03 - Section 8 (6-year) and Section 15 Filed

1987-11-03 - Registered - Principal Register

1987-08-11 - Published for opposition

1987-07-11 - Notice of publication

1987-05-20 - Approved for Pub - Principal Register (Initial exam)

1987-04-17 - Communication received from applicant

1987-03-04 - Non-final action mailed

---

**ATTORNEY/CORRESPONDENT INFORMATION**

**Attorney of Record**  
LEONARD COOPER

**Correspondent**  
J. DAVID DAINOW  
ROSEN, DAINOW & JACOBS  
489 FIFTH AVENUE  
NEW YORK, NEW YORK 10017

---

Exhibit 11

**Thank you for your request. Here are the latest results from the TARR web server.**

**This page was generated by the TARR system on 2007-06-13 15:13:36 ET**

**Serial Number: 73631024 Assignment Information**

**Registration Number: 1538103**

**Mark (words only): DIAMONIQUE**

**Standard Character claim: No**

**Current Status: Section 8 and 15 affidavits have been accepted and acknowledged.**

**Date of Status: 1995-11-29**

**Filing Date: 1986-11-18**

**Transformed into a National Application: No**

**Registration Date: 1989-05-09**

**Register: Principal**

**Law Office Assigned: (NOT AVAILABLE)**

**If you are the applicant or applicant's attorney and have questions about this file, please contact the Trademark Assistance Center at TrademarkAssistanceCenter@uspto.gov**

**Current Location: 900 -File Repository (Franconia)**

**Date In Location: 2001-10-24**

---

**LAST APPLICANT(S)/OWNER(S) OF RECORD**

---

**1. DIAMONIQUE CORPORATION**

**Address:**

**DIAMONIQUE CORPORATION**

**1357 LIBERTY AVENUE**

**HILLSIDE, NJ 07205**

**United States**

**Legal Entity Type: Corporation**

**State or Country of Incorporation:** New Jersey

---

**GOODS AND/OR SERVICES**

---

**International Class:** 014

**Class Status:** Active

PRECIOUS STONES, NAMELY, COLORED AND WHITE SIMULATED DIAMONDS FOR USE IN JEWELRY OTHER THAN SCHOOL CLASS RINGS, RECOGNITION JEWELRY AND SPORTS AWARD JEWELRY

**Basis:** 1(a)

**First Use Date:** 1970-02-09

**First Use in Commerce Date:** 1970-02-09

---

**ADDITIONAL INFORMATION**

---

**Prior Registration Number(s):**

1305827

---

**MADRID PROTOCOL INFORMATION**

---

(NOT AVAILABLE)

---

**PROSECUTION HISTORY**

---

1995-11-29 - Section 8 (6-year) accepted & Section 15 acknowledged

1995-04-03 - Section 8 (6-year) and Section 15 Filed

1989-05-09 - Registered - Principal Register

1989-02-14 - Published for opposition

1989-01-17 - Notice of publication

1989-01-14 - Notice of publication

1988-10-28 - Communication received from applicant

1988-11-07 - Approved for Pub - Principal Register (Initial exam)

1988-10-26 - Examiner's amendment mailed

Latest Status Info

1988-10-26 - Allowance/count withdrawn  
1988-08-29 - Communication received from applicant  
1988-08-30 - Allowance/count withdrawn  
1988-08-01 - Jurisdiction Restored To Examining Attorney  
1988-08-01 - Ex parte appeal - Instituted  
1988-01-07 - Final refusal mailed  
1987-11-27 - Letter of suspension mailed  
1987-11-20 - Communication received from applicant  
1987-07-24 - Non-final action mailed  
1987-07-02 - Notice of publication  
1987-06-28 - Notice of publication  
1987-06-26 - Notice of publication  
1987-07-13 - Allowance/count withdrawn  
1987-04-17 - Communication received from applicant  
1987-03-04 - Non-final action mailed  
1987-03-03 - Assigned To Examiner

---

**ATTORNEY/CORRESPONDENT INFORMATION**

---

**Attorney of Record**  
J. DAVID DAINOW

**Correspondent**  
STEPHEN J. MEYERS  
SEIDEL, GONDA, LAVORGNA & MONACO, P.C.  
SUITE 1800, TWO PENN CENTER PLAZA  
PHILADELPHIA, PA 19102

---



Exhibit 12

**Thank you for your request. Here are the latest results from the TARR web server.**

**This page was generated by the TARR system on 2007-06-13 15:13:51 ET**

**Serial Number: 73438019 Assignment Information**

**Registration Number: 1365477**

**Mark (words only): THREE DIAMONDS**

**Standard Character claim: No**

**Current Status: Registration canceled under Section 8.**

**Date of Status: 1992-03-30**

**Filing Date: 1983-08-05**

**Transformed into a National Application: No**

**Registration Date: 1985-10-15**

**Register: Principal**

**Law Office Assigned: (NOT AVAILABLE)**

**If you are the applicant or applicant's attorney and have questions about this file, please contact the Trademark Assistance Center at TrademarkAssistanceCenter@uspto.gov**

**Current Location: 001 -File Destroyed**

**Date In Location: 1997-01-19**

---

**LAST APPLICANT(S)/OWNER(S) OF RECORD**

---

**1. MITSUBISHI SHOJI KAISHA, LTD.**

**Address:**

**MITSUBISHI SHOJI KAISHA, LTD.  
6-3, MARUNOUCHI 2-CHOME CHIYODA-KU  
TOKYO**

**Japan**

**Legal Entity Type: Corporation**

**State or Country of Incorporation:** Japan

---

**GOODS AND/OR SERVICES**

---

**International Class:** 014

**Class Status:** Section 8 - Cancelled

**JEWELRY AND PRECIOUS STONES, NOT INCLUDING DIAMONDS OR SIMULATED DIAMONDS**

**Basis:** 44(e)

**First Use Date:** (DATE NOT AVAILABLE)

**First Use in Commerce Date:** (DATE NOT AVAILABLE)

---

**ADDITIONAL INFORMATION**

---

**Disclaimer:** "DIAMONDS"

**Prior Registration Number(s):**

779514

781788

792656

**Foreign Registration Number:** 1512604

**Foreign Registration Date:** 1982-05-25

**Country:** Japan

**Foreign Expiration Date:** 1992-05-25

---

**MADRID PROTOCOL INFORMATION**

---

(NOT AVAILABLE)

---

**PROSECUTION HISTORY**

---

1992-03-30 - Canceled Section 8 (6-year)

1985-10-15 - Registered - Principal Register

1985-08-06 - Published for opposition

1985-07-07 - Notice of publication

1985-05-08 - Approved for Pub - Principal Register (Initial exam)

Latest Status Info

1985-04-26 - Examiner's amendment mailed  
1985-04-03 - Allowance/count withdrawn  
1985-02-28 - Examiner's amendment mailed  
1984-10-11 - Non-final action mailed  
1984-08-10 - Communication received from applicant  
1984-03-12 - Non-final action mailed

---

**ATTORNEY/CORRESPONDENT INFORMATION**

---

**Attorney of Record**  
PHILIP T. SHANNON

**Correspondent**  
PHILIP T. SHANNON  
PENNIE & EDMONDS  
330 MADISON AVENUE  
NEW YORK, NY 10017

**Domestic Representative**  
PENNIE & EDMONDS

---

Exhibit 13

**Thank you for your request. Here are the latest results from the TARR web server.**

**This page was generated by the TARR system on 2007-06-13 15:14:12 ET**

**Serial Number: 72394880 Assignment Information**

**Registration Number: 941458**

**Mark**

**DIAMONJEWEL**

**(words only): DIAMONJEWEL**

**Standard Character claim: No**

**Current Status: This registration was not renewed and is considered to be expired.**

**Date of Status: 1993-05-31**

**Filing Date: 1971-06-15**

**Transformed into a National Application: No**

**Registration Date: 1972-08-22**

**Register: Principal**

**Law Office Assigned: (NOT AVAILABLE)**

**If you are the applicant or applicant's attorney and have questions about this file, please contact the Trademark Assistance Center at TrademarkAssistanceCenter@uspto.gov**

**Current Location: 900 -File Repository (Franconia)**

**Date In Location: 1991-07-31**

---

**LAST APPLICANT(S)/OWNER(S) OF RECORD**

---

1. D. NAGIN MFG. CORP.

**Address:**

D. NAGIN MFG. CORP.  
206-208 PATERSON AVE.  
EAST RUTHERFORD, NJ  
United States

**Legal Entity Type:** Corporation

**State or Country of Incorporation:** New Jersey

---

**GOODS AND/OR SERVICES**

---

**U.S. Class:** 028 (International Class 014)

**Class Status:** Expired

SIMULATED DIAMONDS

**Basis:** 1(a)

**First Use Date:** 1971-03-15

**First Use in Commerce Date:** 1971-03-15

---

**ADDITIONAL INFORMATION**

---

**Design Search Code(s):**

26.07.01 - Diamonds with plain multiple line border; Diamonds with plain single line border

---

**MADRID PROTOCOL INFORMATION**

---

(NOT AVAILABLE)

---

**PROSECUTION HISTORY**

---

1993-05-31 - Expired Section 9

1980-02-25 - Section 8 (6-year) accepted & Section 15 acknowledged

---

**ATTORNEY/CORRESPONDENT INFORMATION**

---

**Correspondent**

Exhibit 14



Thank you for your request. Here are the latest results from the TARR web server.

This page was generated by the TARR system on 2007-06-20 17:21:33 ET

Serial Number: 72263793 Assignment Information

Registration Number: 843690

Mark (words only): DIAMOND-ITE

Standard Character claim: No

Current Status: This registration has been renewed.

Date of Status: 1988-04-27

Filing Date: 1967-02-02

Transformed into a National Application: No

Registration Date: 1968-02-06

Register: Principal

Law Office Assigned: (NOT AVAILABLE)

If you are the applicant or applicant's attorney and have questions about this file, please contact the Trademark Assistance Center at TrademarkAssistanceCenter@uspto.gov

Current Location: 900 -File Repository (Franconia)

Date In Location: 2001-11-01

---

LAST APPLICANT(S)/OWNER(S) OF RECORD

---

1. FLEET NATIONAL BANK

**Address:**

FLEET NATIONAL BANK  
100 FEDERAL STREET  
BOSTON, MA 02110  
United States

**Legal Entity Type:** NATIONAL BANKING ASSOCIATION  
**State or Country Where Organized:** (NOT AVAILABLE)

---

GOODS AND/OR SERVICES

---

**U.S. Class:** 028 (International Class 014)

**Class Status:** Active

IMITATION GEMS SOLD AS FINISHED ARTICLES OF JEWELRY-NAMELY, FINGER RINGS, NECKLACES, BRACELETS, PINS AND EARRINGS

**Basis:** 1(a)

**First Use Date:** 1959-07-01

**First Use in Commerce Date:** 1959-07-01

---

**ADDITIONAL INFORMATION**

---

(NOT AVAILABLE)

---

**MADRID PROTOCOL INFORMATION**

---

(NOT AVAILABLE)

---

**PROSECUTION HISTORY**

---

1988-02-06 - First renewal

1987-09-11 - Section 9 filed/check record for Section 8

---

**ATTORNEY/CORRESPONDENT INFORMATION**

---

**Attorney of Record**

SALTER & MICHAELSON

**Correspondent**

SALTER & MICHAELSON  
1500 FLEET NATIONAL BANK BLDG.  
PROVIDENCE, R. I. 02903

---

Exhibit 15

Thank you for your request. Here are the latest results from the TARR web server.

This page was generated by the TARR system on 2007-06-20 17:22:09 ET

Serial Number: 76617221 Assignment Information

Registration Number: 3089174

Mark



(words only): SDJ SURAT DIAMOND JEWELLERY

Standard Character claim: No

Current Status: Registered.

Date of Status: 2006-05-09

Filing Date: 2004-10-21

Transformed into a National Application: No

Registration Date: 2006-05-09

Register: Principal

Law Office Assigned: LAW OFFICE 106

If you are the applicant or applicant's attorney and have questions about this file, please contact the Trademark Assistance Center at [TrademarkAssistanceCenter@uspto.gov](mailto:TrademarkAssistanceCenter@uspto.gov)

Current Location: 650 -Publication And Issue Section

Date In Location: 2006-05-09

---

**LAST APPLICANT(S)/OWNER(S) OF RECORD**

---

1. Surat Diamond Jewellery P Ltd

**Address:**

Surat Diamond Jewellery P Ltd  
Vasant Vilas 31 DR DD SATHYE MARG  
Mumbai 400 004

India

Legal Entity Type: Corporation

**State or Country of Incorporation:** India  
**Phone Number:** 23826864

---

**GOODS AND/OR SERVICES**

---

**International Class:** 014  
**Class Status:** Active  
Gold and silver jewelry; precious and semi-precious stone-studded jewelry, diamond and pearl jewelry, imitation and costume jewelry  
**Basis:** 1(a)  
**First Use Date:** 1990-02-01  
**First Use in Commerce Date:** 1999-10-01

---

---

**ADDITIONAL INFORMATION**

---

**Disclaimer:** "DIAMOND JEWELLERY"

**Description of Mark:** The mark consists, in part, of the letters, SDJ, with the dot over the j formed by the design of a cut diamond, enclosed within a square design, the words, SURAT DIAMOND JEWELLERY, and design.

**Design Search Code(s):**  
26.09.02 - Plain single line squares; Squares, plain single line  
26.17.25 - Other lines, bands or bars

---

---

**MADRID PROTOCOL INFORMATION**

---

(NOT AVAILABLE)

---

---

**PROSECUTION HISTORY**

---

2006-05-09 - Registered - Principal Register  
2006-02-14 - Published for opposition  
2006-01-25 - Notice of publication  
2005-12-30 - Law Office Publication Review Completed  
2005-12-16 - Assigned To LIE  
2005-12-15 - Approved for Pub - Principal Register (Initial exam)  
2005-11-13 - Teas/Email Correspondence Entered  
2005-11-08 - Communication received from applicant  
2005-11-08 - TEAS Response to Office Action Received  
2005-05-27 - Non-final action mailed

2005-05-26 - Non-Final Action Written

2005-05-26 - Assigned To Examiner

2004-11-02 - New Application Entered In Tram

---

**ATTORNEY/CORRESPONDENT INFORMATION**

---

**Attorney of Record**

Martin S. Rapaport

**Correspondent**

MARTIN S. RAPAPORT

6TH FLOOR

18 EAST 48TH STREET

NEW YORK, NEW YORK 10017

Phone Number: (212) 688-1980

Fax Number: (212) 688-9374

---

Exhibit 16

# Diamond Essence

Smart alternative to mined diamond set in solid 14k Gold  
Established 1978



Sign up for Newsletters and Offers

Please Enter

Submit Sample

Keyword/Item#

No Risk 30 days 100%  
Money Back Guarantee

New Customer  
Discount 30% and  
more on Reg. Price

Home

My Account

About Us | Contact Us | FAQ | Policies | Customer Service | Advertisements

By Price

By Occasion

By Material

EARRINGS

PENDANTS

LADIES RINGS

MEN'S JEWELRY

BRACELETS

NECKLACES

WATCHES

ACCESSORIES

LOOSE STONES

Secured  
by  
2007-06-15

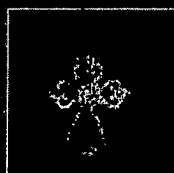
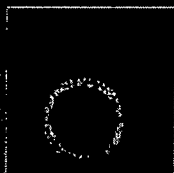
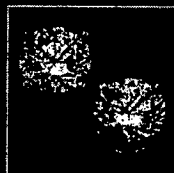

Buy Now

Buy Now

Buy Now

Buy Now

Buy Now



Buy Now

Buy Now

Buy Now

Buy Now

Buy Now



<a href="#">Visit Store</a>	<a href="#">Know DE</a>	<a href="#">Wholesale</a>	<a href="#">Faq</a>	<a href="#">Online Catalog</a>	<a href="#">International</a>	<a href="#">Corporate Gifts</a>	<a href="#">Shipping Information</a>
<a href="#">Feedback</a>	<a href="#">Testimonials</a>	<a href="#">Privacy</a>	<a href="#">Sitemap</a>	<a href="#">Resources</a>	<a href="#">Privacy Policy</a>		

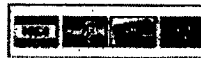

No Risk 30 days 100% Money Back Guarantee

New Customer Discount 30% and more on Reg. Price

© Diamond Essence Company 2005-2008

Best viewed at 1024 / 768 resolution.

[Disclaimer](#)

Exhibit 17



Satisfied Customers in Over 22 Countries and all 50 US States!

- Jewelry ▾
- Asha Diamond Simulant ▾
- Loose gems ▾
- Pearls ▾
- Questions? ▾
- Corporate ▾

- ◆ Currency Converter
- ◆ Track Your Shipment
- ◆ Shopping Cart
- ◆ Check Out



Earrings



Pendants



Loose



Rings

## Welcome to BetterThanDiamond

Creator of the world's most realistic diamond simulant, the diamond-infused Asha®

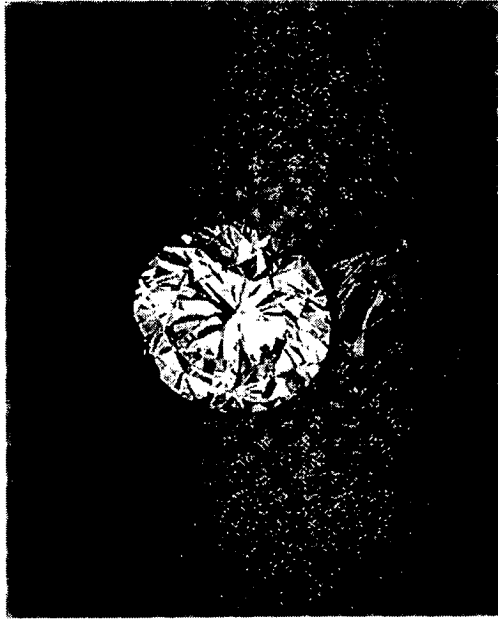

"The best cut simulant I have seen to date...  
Asha® is indeed fulfilling its claims...."

- International School of Gemology

**Why is Asha® the most realistic diamond simulant?**

Asha® is unique because it is the only simulant in the world that employs true lab created amorphous diamond (pure carbon diamond bonds) in its construction.



Ashas being loaded for the amorphous diamond infusion process

Because Asha contains actual diamond carbon bonds, the result is a diamond simulant that is at last able to truly mimic the light play, lustre and beauty of gem diamond but at diamond simulant pricing.

**The end-result:** Just as cultured pearls offer you the beauty of pearls at a fraction of the natural pearl price, Asha® is able to offer you the brilliance and beauty of real diamond, but at a fraction of the natural diamond price.

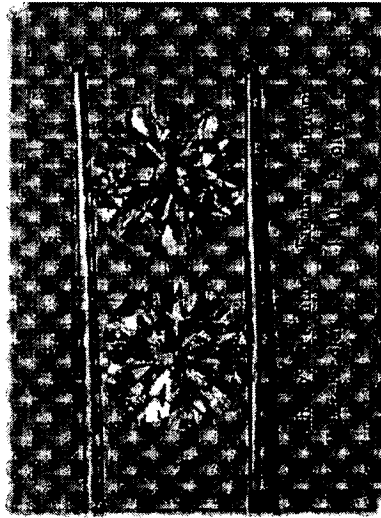

**Is the Asha realistic?**  
Seeing is believing - above is a customer photo showing an Asha® next to her Eightstar diamond.  
(photo courtesy of Marriahlyn of our message boards!)

As further, up-front proof of how realistic the Asha diamond simulant is, a 1ct Asha round was submitted for evaluation by the most objective measure of diamond beauty currently on the market, the Gemex Brilliancescope system.

The Brilliancescope utilizes a laser and computer to measure a diamonds light return and then rank its beauty according to how it compares to other natural diamonds. Diamond beauty is broken down as "White Light return", "Colored Light return" and Scintillation.

**The results?** Asha scored at at the extreme high-end for all three aspects of diamond beauty, easily outperforming the typical natural diamond.

### Asha Diamond Simulant vs. typical natural diamond:

Asha 1ct H&A round results:

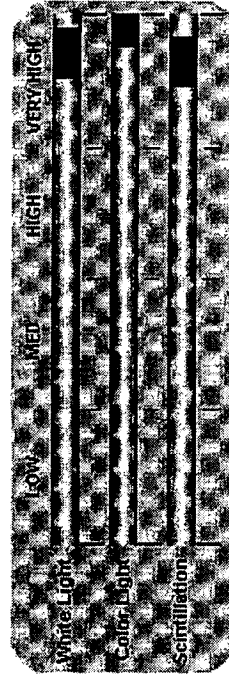
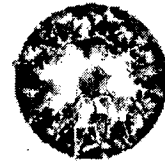

Conventional Diamond\*



\*Typical American Round Brilliant cut diamond  
(normally cut to maximize finished weight vs. optimal beauty)  
The above photos and scales are copyright Gemex Systems

We invite you to browse our website and learn more about our Asha diamond simulant.

We offer a variety of shapes for our loose Asha, as well as a selection of stunning, ready-to-wear jewelry in classic, timeless styles.

In keeping with the beauty and realism of the Asha, we only utilize high-end, heavyweight jewelry mountings suitable for holding the finest of natural diamonds for our jewelry offerings.

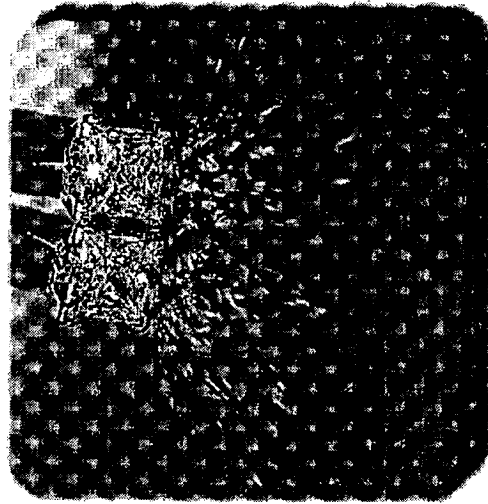

"I got my princess cut earrings today and they are **the most gorgeous earrings I have ever had!**

These diamonds are more sparkly than my engagement ring which is a natural D/VS1 diamond! They are simply breathtaking! These are classy and made to perfection.

Thanks so much! This is my second purchase with you and not my last!"

Customer testimonial, reprinted with permission. Lots more testimonials here.

All the beauty of diamond stud earrings but for only \$249?

Seeing is believing! Try our #1 selling 1.5ctw, 14k White Gold Asha® Princess stud earrings for only \$249! *save over \$150, plus free 2 day UPS shipping.*

Details here!

Recommended next steps:

Looking for a stunning gift (all the beauty of diamond stud earrings or a diamond pendant but for less than \$400?) and need it quickly?  
Visit our Ready To Ship Jewelry page here.

Just learning about diamonds and diamond simulants (moissanite, CZ, Asha, etc)?  
Visit our "Top Diamond Simulant Myths" article here.

We also invite you to browse our website for further education, shopping, read our many customer testimonials here, or even interact with some of our many customers directly on our very popular message boards (300,000+ posts!) here.

Asha® is our registered mark  
Content and images, copyright 2007, BetterThanDiamond.com

Exhibit 18



- ABOUT ZIAMOND
- F.A.Q.
- CELEBRITY SPOTLIGHT
- RING COLLECTION
- WEDDING COLLECTION
- EARRING COLLECTION
- BRACELET COLLECTION
- NECKLACES & PENDANTS
- PLATINUM COLLECTION
- SPECIAL ORDER COLLECTION
- MEN'S COLLECTION
- LOOSE STONES
- CELEBRITY INSPIRED JEWELRY
- EYEWEAR COLLECTION
- V.I.P. E-MAIL PROGRAM
- CARE & CLEANING
- GIFT CERTIFICATES
- \*\*CLEARANCE CENTER\*\*
- CUSTOMER SERVICE CENTER
- ZIAMOND BLOG

# ZIAMOND®

FINE CUBIC ZIRCONIA JEWELERS 14K, 18K & PLATINUM

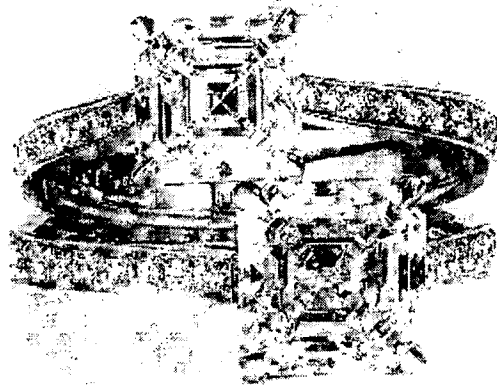

Ziamond specializes in the finest quality Cubic Zirconia set in SOLID GOLD and precious PLATINUM. All Ziamond gems are strictly the finest man made gems available today and come with a Lifetime Guarantee. Ziamond has both the technical and artistic skills to accomplish any jewelry design. Ziamond's staff has a total of over 100 years combined fine jewelry experience, assuring our customers the attention to detail, quality design and craftsmanship associated with any fine jeweler. We look forward to helping you experience Ziamond. Once you do, you will see why Ziamond is a leader in its field.

- EMAIL
- MY ZIAMOND SHOPPING CART
- ZIAMOND POLICIES
- PRIVACY POLICY
- SEARCH
- INDEX

**HACKER SAFE**  
TESTED DAILY 13-JUN



**Round With Trillions**  
**Eternity**  
Regular price: \$595.00  
Sale price: \$479.00



**Desire Earrings**  
Regular price: \$395.00  
Sale price: \$325.00



**Geo Bezel Drop Necklace**  
Regular price: \$375.00  
Sale price: \$299.00



**Meredith Vieira**



**Gabrielle Union**



**Brooke Hogan**



Vejay Pavé Solitaire©

Regular price: \$1,795.00  
Sale price: **\$1,550.00**



Winston Inspired  
Princess Cube Bracelet

Regular price: \$895.00  
Sale price: **\$725.00**



Cushion Lever Back  
Earrings

Join the **Ziamond** mailing list

Email:



Assistance provided by ZiamondAssociates

**Questions or comments?**  
Use The Ziamond Help Desk  
or Call Toll Free **1.866.ZIAMOND** (942-6663)  
International calls dial (954)341-6870

Copyright © 2001-2007 Ziamond. All rights reserved.  
All images are the property of Ziamond  
and may not be used for any purpose other than viewing.  
Ziamond is a Federal registered Trade Mark.

Exhibit 19

Apollo

APOLLO INC. 2007 Nature, Perfected

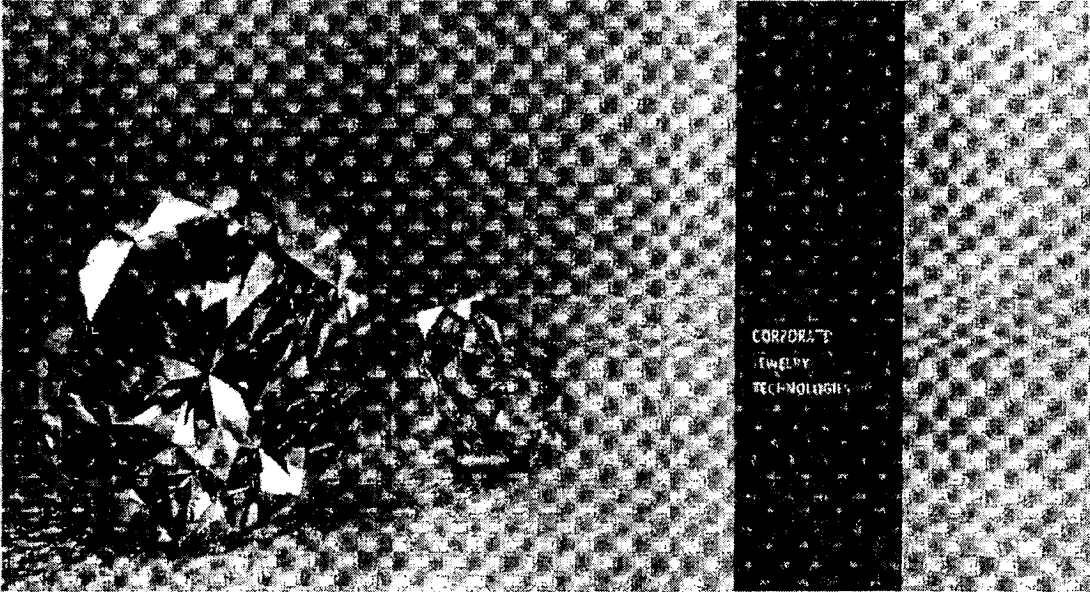

© 2007 Apollo Diamond, Inc. All Rights Reserved

Exhibit 20

# Sona Diamond Jewelry

[Wholesale Membership](#)

[Diamond Science](#)

[FAQ](#)

[Testimonials](#)

[Contact Us](#)

[Mailing List](#)

[rings](#)

[ear-rings](#)

[bracelets](#)

[pendants](#)

[designer diamond rings](#)

[new](#)

[on sale](#)

[\\$300 & less](#)

[\\$1000 & less](#)

[loose diamonds](#)

Search Our Site

[search](#)

[Diamond Engagement Ring](#)

[Diamond Stud Earrings](#)

[Diamond Pendants](#)

[Diamond Wedding Rings](#)

[Diamond Alternatives](#)

[Faux Diamonds](#)

[Designer Jewelry Online](#)

[Fine Gem Stone Jewelry](#)

[Unique Custom Jewelry](#)

[Engagement Rings](#)

[Wedding Rings](#)

[Diamond Rings](#)

[Man Made Diamonds](#)

[Lab Created Diamonds](#)

[Simulated and Synthetic Diamonds](#)

[Fake Diamonds](#)

[Wholesale Fashion Jewelry](#)

[18 Kt Gold Wedding Rings](#)

[Wedding Jewelry for Bridesmaids](#)

[Buy Gifts and Jewelry Online](#)

## RINGS FOR \$300.00 AND UNDER!!! CLICK HERE

Sona is the leading manufacturer of created fine diamond jewelry hand cut by Israel master craftsman. It's tradition encompasses generations of artisans' with a single passion. Artisan crafting the world's most beautiful and brilliant diamond rings. Be it Man Made Diamond, Synthetic Diamond or Lab Created Diamond; "The Sona Diamond" is recognized as a breakthrough science in diamond creation and mastery of diamond cutting. The unique symmetry and placement of its facets result in, dancing lights that sparkle with illuminated brilliance, that will leave you breathless.

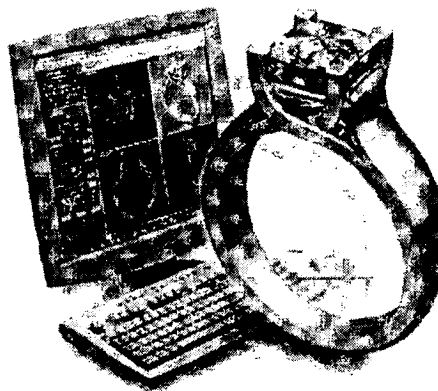

**"WORLD'S BEST ISRAEL DIAMOND SIMULANT."**

*Trusted and recognized leader specializing in designer diamond rings, earrings, pendants and bracelets online.*

**Link Exchange**

**LIMITED TIME 50% OFF SALE!**

Eternal dreams are made at Sona Diamond Jewelry. Platinum and white gold solitaire and three diamond ring settings for that special someone. Now's the time to make your dreams come true, at Sona's 50% Off All Jewelry Sale!

**Order Now and reserve your discount price.  
Call [1800-880-3112]**

Colored diamonds come in every shade of the rainbow and are extremely rare. Some, like the yellow ones, are colored by the naturally occurring addition of elements such as nitrogen, whereas pink diamonds simply reflect light differently than white diamonds. As a rule, the closer a diamond is to colorless, the more valuable and beautiful it is. Even more rare than the colorless are Sona's fancy colored diamonds. These diamonds are beyond the Gemological color scale, with colors that include pink, yellow, green, gold, orange, red, purple, lavender and cognac...highly prized, extremely rare, major showpieces!

***"Sona Diamond is the world leader in diamond color technology with nine colors of the rainbow rated [Fancy Vivid], highest appraised color grade."***

No need to look any further..Your in the best designer diamond ring store. Discover all of Sona's extraordinary creations and find the one that has a unique story to tell you. Live your dream. Buy it for yourself at Sona's 50% Off Sale!

**Call [1800-880-3112]**

Clarity is an indication of a diamond's purity. The degree to which our diamond is free from marks called blemishes and internal features called inclusions, is an art accomplished by our Israel master diamond cutters.

***" Sona diamond clarity is rated flawless at [VVS1]. A fire, sparkle and brilliance that will take your breath away."***

You've landed in the right place. Sona Diamond specialize in designer diamond rings. We have excelled in the creation of award winning ring designs. Our designer rings won the "best in the show" and Sona Diamond was designated as "Designer of the Year 2005." Now's the time to consider owning your own beautiful, designer ring at Sona's 50% Off Sale!

**Call [1800-880-3112]**

Sona Diamonds come in many shapes; Round, Oval, Princess, Radiant, Emerald, Pear, Heart, Marquise, Asscher and Cushion. A name brand, like Sona is associated with a certain style and cachet that is recognizable to you and to others who see you wearing them. Name brands also suggest better quality and higher appraised value. You may pay slightly more for a brand name, but you know exactly what you're getting - a name that stands behind the products it sells and meets high quality standards.

***"Sona Diamonds are laser branded to establish their a uthenticity and annual appreciation in value."***

Now's the opportunity to own a flawless, premium cut, loose Sona Diamond starting at \$100.00 per carat at Sona's 50% Off Sale! [See [Loose Diamonds](#)]

We have a designer ring that reflects Your delicate balance of Grace and Creativity and captures a timeless expression of elegance and glamour. Choose from our best award winning rings.

"A diamond ring setting is the throne in which the diamond sits."

**Now's the time to make your move, and buy your own  
Dream Ring at Sona's 50% Off Sale!**

**"Design your own ring"** in our computer design center [CAD]."

Just upload a ring picture and we'll do the rest. You will view 3D renderings of your design with several variations, for you to look over. Next you will indicate the changes and modifications you would like to see, and new 3D pictures will be posted for your viewing. Finally, when you are completely satisfied with your ring design, and sign off, we will start building it for you.

**Call [1800-880-3112]**

Contact us: **1 800-880-3112**

Email: [info1@sonadiamondjewelry.com](mailto:info1@sonadiamondjewelry.com)

[contact](#) | [customer feedback](#) | [affiliates](#) | [resources](#) | [sites](#)

sona diamond jewelry © 2006 [Privacy Policy](#) [Store Policy](#)

[Entry](#)

Web Site Design and Hosting by:  
[Cybermed Marketing, Inc.](#)



Exhibit 21

Diamond Nexus Labs - Flawless Lab Created Imitation Diamonds, Diamond alternative engagement rings.



# DIAMOND NEXUS LABS

CREATORS OF THE WORLD'S FINEST DIAMOND-SIMULANT GEMSTONES

SET IN 14K SOLID GOLD, 18K SOLID GOLD, OR PLATINUM

- [Go Shopping](#)
  - [Gifts For Her](#)
  - [Bracelets](#)
  - [Chains](#)
  - [Custom](#)
  - [Earrings](#)
  - [Ladies Rings](#)
  - [Loose Gemstones](#)
  - [Mens Rings](#)
  - [Pendants](#)
  - [Sets](#)
  - [Top Ten](#)
  - [Guarantees](#)
  - [Information Center](#)
  - [Feedback](#)
- Search

[LOG IN](#) [CREATE NEW ACCOUNT](#)

## The Geometries Of Brilliance

*Light enters your Diamond Nexus Labs creation through the 33 facets of the crown. Instantly it is mirrored by the 25 precisely positioned facets in the pavilion. In a symphony of perfect harmony, light explodes from your gemstone in a frenzy of extraordinary brilliance, dispersion and scintillating radiance that can be seen across a room. It is a glorious demonstration of your taste and style... It is Diamond Nexus...*

Diamond Nexus Labs gemstones are the most perfect man-made diamond clones ever created.

Diamond Nexus Labs lab-created diamond simulants cut glass, they refract light into perfect "hearts and arrows", and they have superlative fire and brilliance. They closely match the optical and physical properties of extremely expensive "flawless" mined diamonds as their clarity and color are perfect on their respective scales. In almost all measurable tests, our lab created, man-made diamond simulants match or are superior to natural diamonds.

In fact, Diamond Nexus gems are so close to natural diamonds that most gemologists require scientific testing equipment to tell the

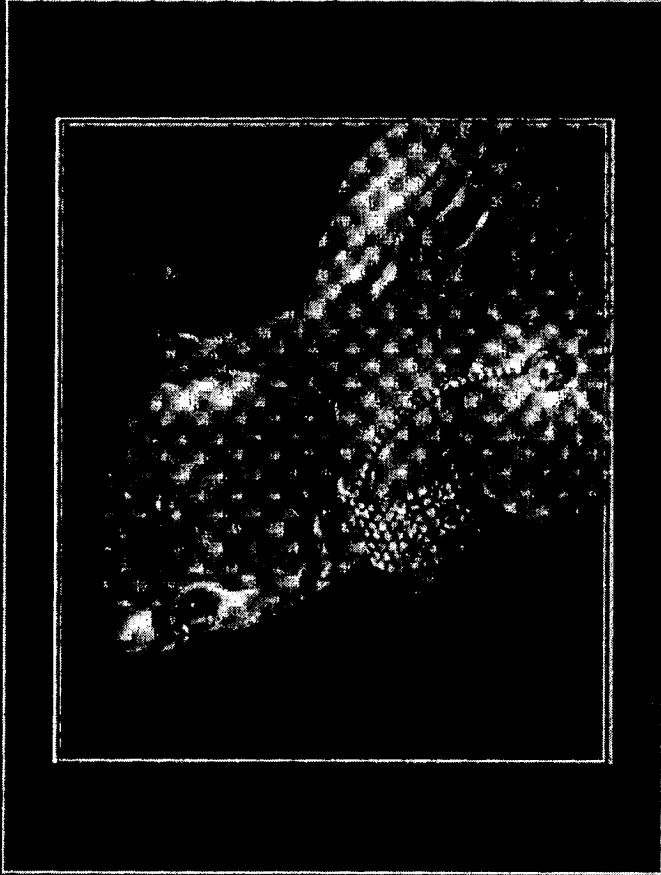

1-800-500-4900 Toll Free  
 9AM-10PM CST Mon-Sun  
 215-988-2100  
 215-988-2100

REQUEST YOURS TODAY!



difference. Yet, for all their glittering beauty, Diamond Nexus Labs gemstones cost a fraction of what mined diamonds do, allowing you to own magnificent fine jewelry at a fair and realistic price.

We invite you to learn more about lab-created diamonds in general and the Diamond Nexus Labs breakthrough in our [Information And Education Center](#). Here you can learn everything you need to know about Diamond Nexus Labs; not only the science and technical specifications of our creations, but also the history and story of man-made diamonds, as well as information about our settings, custom jewelry, our beautiful presentation boxes, our free shipping, our [100% Triple Guarantees](#) and much more.

Our customers tend to be intelligent and discerning people. After you have completed your research, we further invite you to explore the hundreds of fine jewelry items adorned with radiant Diamond Nexus Labs diamond alternatives at our [Online Store](#).

Privacy Statement

Exhibit 22

HOME  
COMPANY BACKGROUND  
OUR PRODUCTS  
PRESS & NEWS  
CONTACT US

*Sunning*  
HOLDINGS LIMITED

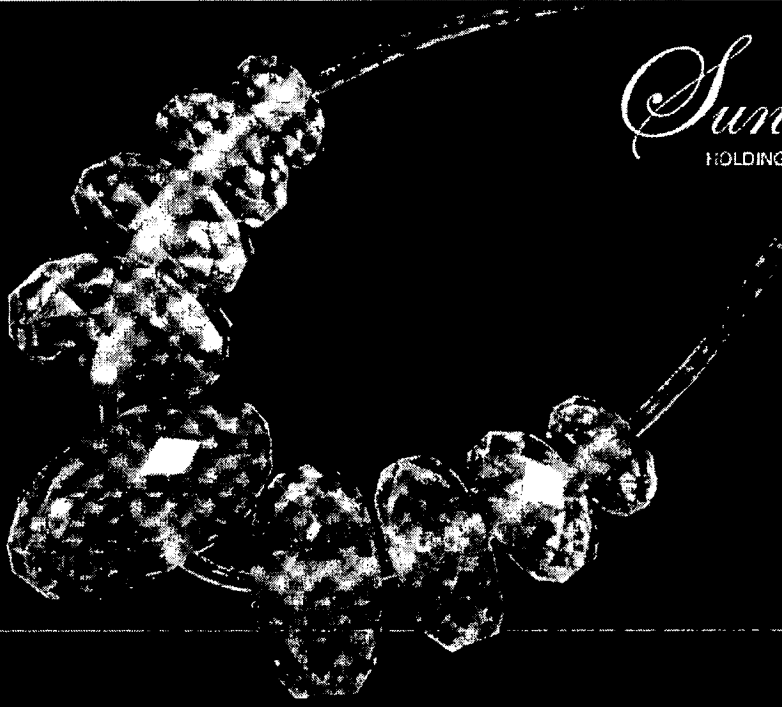

2007 © All Rights Reserved. Sunning Holdings Limited

Exhibit 23

**SPRING SALE! . . . Save 20% - 30% on Moissanite, Rings, and more  
Official Russian Brilliants® Website**

**ONLINE SINCE**

Russian Brilliants® Jewelry  
Rings & moissanite engagement ring, earrings  
moissanite rings, bridal jewelry & tennis bracelets



Russian Brilliants® are unique, hand cut and faceted—like a natural diamond. They possess the fire, brilliance and optical properties of natural & lab created diamonds.

Russian Brilliants® has a lifetime guarantee not to fog or experience internal problems witnessed in other diamond substitutes. Many Gemologists and ring designers consider Russian Brilliants the best diamond simulant available. See Rock & Gem Magazine (Dec 2002 issue) in their objets d'art. Russian Brilliants® are worn by the Hollywood set as mentioned in the May / June 2006 article in



*Look & feel*  
**successful**  
with  
*Russian Brilliants®*

*enter here >*



About Us...

Russian Brilliants® Distributor  
Moissanite Engagement Ring Supplier

© 2000-06 Hadar Company. All Rights Reserved.

*Testimonial: My ring has arrived and it is even better than I hoped it would be. It looks amazing and I am really pleased. It is a Christmas present for me from my husband (I ordered it myself to make sure I get something I like!) and I can't wait until Christmas Day when I can officially unwrap it and wear it all the time! Thank you so much for the fantastic service you have provided. I am definitely a happy customer and will certainly be buying from you again in the future. Wishing you a Merry Christmas and prosperous New Year. Julie*

[Useful Resources 1](#) / [Useful Resources 2](#) / [Useful Resources 3](#)

[Useful Resources 4](#) / [Useful Resources 5](#) / [Useful Resources 6](#)

[Useful Resources 7](#) / [Useful Resources 8](#) / [Useful Resources 9](#)

[Useful Resources 10](#) / [Useful Resources 11](#) / [Useful Resources 12](#)

[Useful Resources 13](#) / [Useful Resources 14](#) / [Useful Resources 15](#)

[Useful Resources 16](#)



[Search Open Directory](#)

Exhibit 24





# DESERT DIAMONDS™

what women want!

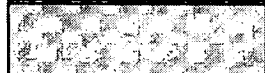

Edmonton  
Home & Garden Show  
March 22 - 25

Edmonton  
Women's Show  
April 14 & 15

Edmonton Fall  
Home Show  
September 28 - 30

Edmonton  
Women's Show  
October 13 & 14

International Christmas Market  
Spruce Meadows - Calgary  
November 16 - 18  
November 23 - 25

**Welcome to our Desert Diamonds™ web-site - the latest concept in luxurious yet affordable jewelry.**

**\*\*\* ALL PRICES ARE IN CANADIAN DOLLARS \*\*\***

"Thank you very much for my DESERT DIAMONDS™ pendant and necklace. It is beautiful. I wear it everyday with my \$7,000 diamond earrings. I love it. Thank you."

A Satisfied Customer - Penticton, BC  
DESERT DIAMONDS™ jewelry appeals to women of all ages. Classic and contemporary designs, a realistic alternative to real diamonds that you can buy for yourself. With over 500 stock items we have something to offer every woman!

Rings

Earrings

Pendants

Other

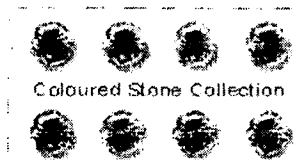

Copyright 2007 Desert Diamonds™ - what women want

Exhibit 25

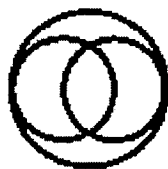

## Blessed & Sacred Diamonds, Gemstones and Jewelry.....At an Affordable Price

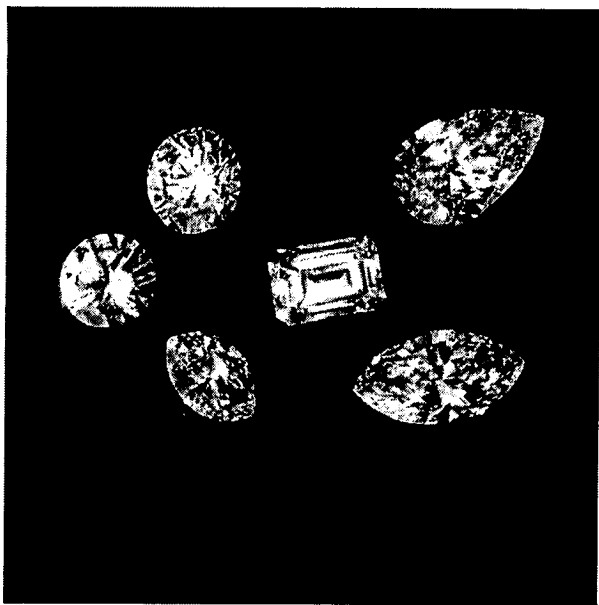

Most diamond dealers are located in malls. Their diamonds and gems have no spirit, no energy and no special sacred feeling.

All Geo Group diamonds and gems are blessed and spiritually energized.

Diamonds are the most special gem. Made of pure carbon, diamonds are literally the material of life itself. As the hardest substance known, it is appropriate that diamonds symbolize beauty, permanence, commitment, love, power and inspiration.

When making a diamond investment, don't settle for just any diamond, get a Geo Group spiritually blessed and energized diamond. You will feel the difference.

### **Blessings in Geo Group Diamonds**

Chuck Pettis, founder of The Geo Group is also founder of Earth Sanctuary, a nature reserve, meditation parkland and sculpture garden on Whidbey Island near Seattle, Washington. Author of the book, *Secrets of Sacred Space*, Chuck Pettis has created five sacred spaces at Earth Sanctuary: labyrinth, two stone circles, dolmen and Medicine Wheel.

Each of the Earth Sanctuary sacred spaces has been blessed by spiritual masters. They are sacred power centers. Each diamond and gem sold by The Geo Group is blessed and energized at each of the five sacred power centers at Earth Sanctuary.

In addition, Geo Group diamonds and gems are all blessed by His Holiness Jigdal Dagchen Sakya, H.H. Jigdal Dagchen Sakya is a Head Lama of the Sakya sect and Sakya Monastery of Tibetan Buddhism in Seattle. Dagchen Rinpoche was raised and trained as a religious leader in old Tibet. The Sakya leaders hold a position third only to His Holiness the Dalai Lama in rank. The blessing fee will be donated on your behalf to Sakya Monastery to enable you to gain merit in this lifetime and future lifetimes.

Diamonds and gems can be sold individually or custom-designed into beautiful jewelry by Chuck Pettis' long-time friend, Richard Allen, founder of Gemland in Phoenix, Arizona. If you contact Richard, please tell him that you were referred by Chuck.

For more information on purchasing Geo Group blessed and energized diamonds or gems, call Chuck Pettis at 425-637-8777 or email him at [chuckp@geo.org](mailto:chuckp@geo.org) for more information.

### **Quotes Available on Request**

Tell us what you're looking for in a diamond (i.e., cut, color, clarity, carat weight) or gem and we'll give you a quote. We price diamonds at approximately the same comparable price as Blue Nile . The difference is in the blessing! Call Chuck Pettis at 425-637-8777 or email him at [chuckp@geo.org](mailto:chuckp@geo.org) for more information.

**To First Page**

Copyright 2005, The Geo Group LLC. All Rights Reserved.  
Revised September 26, 2005

Exhibit 26



# Van Graff

Intro

Stones

Custom

Rings

Earrings

Necklaces

Tests

Orders

Mail List

News

View Cart

E-Mail @

## Van Graff Hearts & Arrows

*The best diamond simulant in the world!*

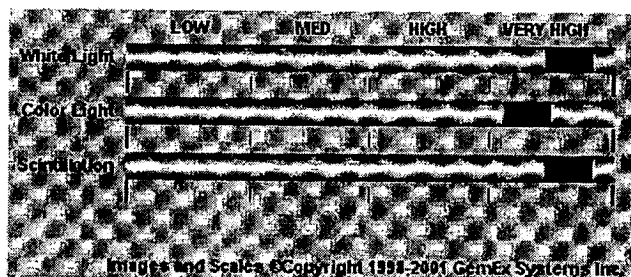
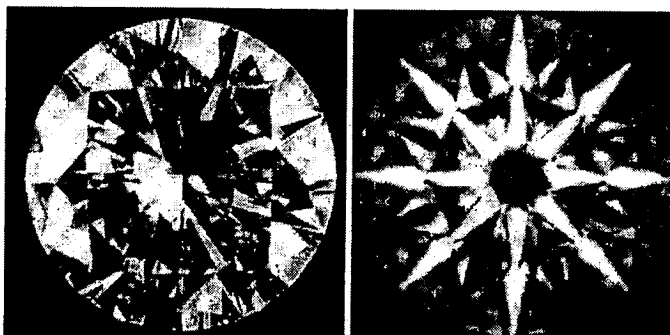

Gemex Brilliance Scope report of the Van Graff scoring "Very High" in every score of the test. The Van Graff Hearts & Arrows simulated diamond with the most perfect "D" color of the diamond, flawless and clean to the sight, the first in the world to be cut with the Super Ideal Hearts & Arrows cut, warranted for life including any change in color.

Every Van Graff is selected with gemological microscopes, Ideal-Scopes and H&A scopes.

The Van Graff is the ONLY diamond simulant that has been subjected to all kinds of gemological tests by independent expert gemologists using the most sophisticated and modern equipment including the Raman spectrophotometer analysis. You can see all these tests in the menu "VG Tests".

## *The opinion of the experts*

The Van Graff have received fantastic testimonials from expert and renown gemologists and diamond dealers that tested the stones and published the results in the diamond's discussion forum, Diamond Talk. These testimonials are genuine and public.



### **Dave Atlas - Oldminer**

<http://www.gemappraisers.com/>

Renowned gemologist and appraiser for diamonds and gems located in the area of Philadelphia USA, with impressive credentials, he is the creator of the AGA-CERT® which not only grades diamonds for carat, color, clarity, but includes a CUT GRADE for all shapes stones.

"I have done some testing and the results are very pleasing.

There still is nothing quite like diamond, but the Van Graff can fool the best trained folks in gemology if they just use their eyes.

The Van Graff simulant that I received was cut like an ideal cut diamond. Very nicely finished and as bright, face-up as any or nearly diamond. Scintillation is similar and dispersion is similar.

Compared to CZ there is no contest as you can see, if the photo posts properly. You probably can't tell which stone is the Van Graff and which is the ideal cut diamond...

I like the Van Graff product. It is an excellent diamond simulant, face-up. It will fool nearly everyone who does not give it gemological testing...."

### **Jonathan Weingarten - Good Old Gold.**

<http://www.goodoldgold.com>

Renown jeweler and gemologist in the area of New York USA, dealer of the Superb Cert (Hearts&Arrows) diamond.

"I ran the stone on my colorimeter to get this reading...the stone scored the highest color D possible. :) Even D color diamonds rarely \*ever\* get the reading this stone did. While the refractive index in this stone is different from that of diamond the guys at Van Graff have an ideal cut (in proportions) with excellent precision! The largest variance in this particular stone is in the pavilion depth which ranges from 43.3 - 44.3% (1% variance). All the other variances are well under 1%/° and when I'm purchasing super ideal cut diamonds for inventory this is a factor I look for! Brilliancy, Fire & Scintillation These results speak for themselves. Bottom line ... I'm impressed. Next factor ... cost ... that's to come. :)"

### **Corey J. England - Iceman**

<http://www.midwestgems.com/>

Renown gemologist that deals with the best quality diamonds and gems in the area of Moline, IL USA.

"I just opened my package today from Van Graff. The only word I could use is "WoW"! I couldn't believe the sparkle and light return from these!!! I hurried and put them under the hearts and arrows scope and was shocked to see how well they were cut! The same hearts and arrows I would see on an Ideal cut diamond!!! I then pulled out some Russian cut CZ's that always have been the best on the market. I could not get any arrows from them and some rough hearts on the other side. Like night and day on the look. I also liked the Note that he puts in with them so the customer does not get confused. A great product , a great price. These sparkle and look better then most diamonds I have seen in the mall !"

## *What is the Van Graff?*

The Van Graff is an Yttrium Oxide stabilized Cubic Zirconia with a secret rare earth dopant formula that makes this stone different than the rest and this was proved in a lab test against many other stones. This secret formula makes the Van Graff resistant to the flame of a torch without breaking or changing it's color. This is very important in case you need to repair or resize your rings because removing the stones to make the repair and then resetting them again can cost a lot more than the cost of a Van Graff stone.

Look at this custom ring I did, as you can see the ring was soldered with a torch after the two halves was set with the Van Graff stones because it was impossible to set the stones in the inner part of the shanks, if you try this with any other simulant you will end with burned and cracked stones!

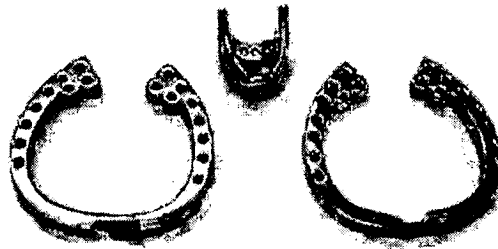

This are the parts of the ring unset

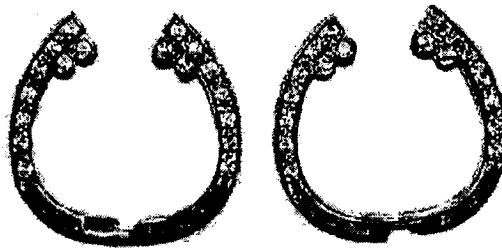

This are the shanks already set with the stones





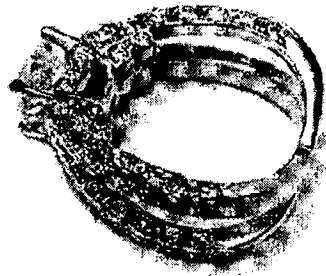

Soldered and finished ring.

This is part of the test report done by Adamas Gemological Laboratory.

"From our memory of previous experiments we had run on Cubic Zirconia, we searched our collection of colorless material and came up with 3 samples (out of 37) which showed a "rare earth" type of spectra, presumably due to trace amounts of some unknown "rare earth". Two of these samples showed what we considered as IDENTICAL spectra to the "Van Graff", using both Vis-NiR and Photoluminescence spectroscopy. One of the three CZ's showed a dissimilar "rare earth" spectra, and is shown below for comparison."

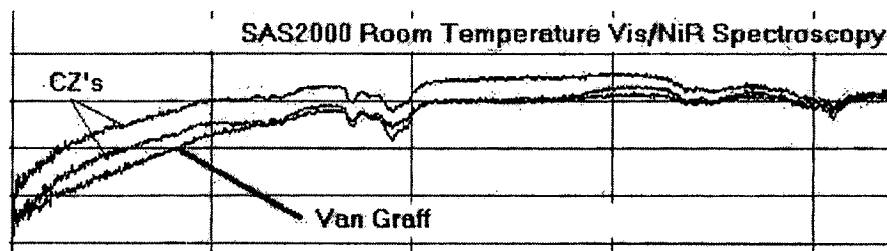

The stone that showed the dissimilar spectra was the Van Graff as is shown in this graphic

Don't be confused with the generic Cubic Zirconia found everywhere, this is the new generation of the so called Super-Simulants.

You will find some companies that sell these stones with false advertisement and claims at much higher prices, some of them are Van Graffs with another brand.

## *What is Ideal Cut?*

In the early 1900's a mathematician by the name Marcel Tolkowski did a poll because he noted that some diamonds looked different to the sight to others and he was intrigued by the angles and proportions of the diamonds with the best look and with this information he created the IDEAL CUT with certain proportions and angles that is the standard at present.

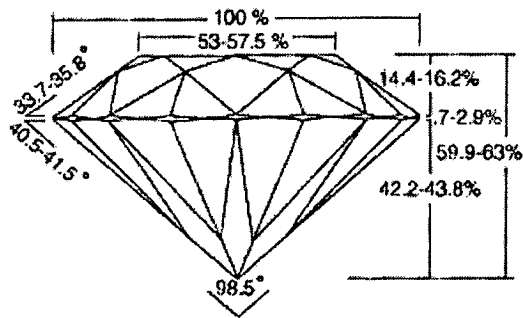

This is the diagram with the angles and proportions of the IDEAL CUT

### *What is Hearts & Arrows cut?*

Hearts & Arrows is a visual effect that was discovered in Japan by using a special visor that shows a series of eight arrows equally spaced when the stone is face up and eight hearts equally spaced when the stone is turned with the pavilion up. Not all the IDEAL cut stones show this pattern, only the ones with perfect cut symmetry and proportions.

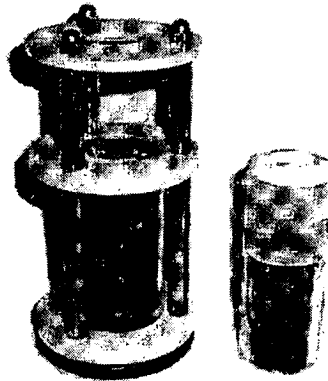

H&A scopes used to see this optical effect in the stones.

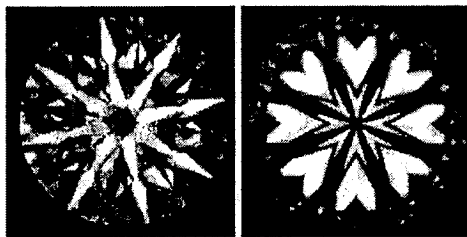

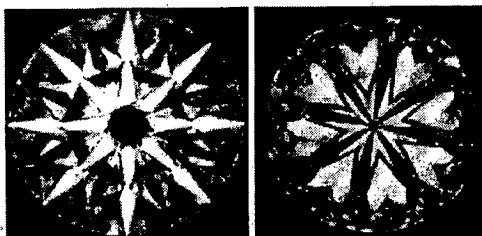

The top two pictures show the hearts & arrows effect in a super ideal diamond, The bottom two pictures are of the Van Graff stone. Please note the perfect cut and symmetry of the Van Graff, this gives the best brilliance, fire, light return and scintillation in a stone.

## *The Van Graff in the Brilliance Scope*

In a diamond the most desired characteristics are the best brilliance, fire (colored brilliance by dispersion) and scintillation, the scintillation being the dynamic effect of the brilliance or the brilliance that is the result of the movement.

Please check the Brilliance Scope results of the Van Graff and compare with any other simulant in the market, the Van Graff has "Very High" score in all three.

And also note the perfect symmetry in the cut that is shown in the perfect concentric effect of the dynamic lights and how all the lights coincide at the center at the same time, compare this with any other stone, this is perfection!

This picture is courtesy of Jonathan Weingarten - Good Old Gold.

<http://www.goodoldgold.com>

Images and Scale © Copyright 2000 GemEx Systems Inc.

**Brilliance Scope™**  
By GemEx Systems Inc.

ALL IMAGES AND LIGHT PERFORMANCE SCALE  
© COPYRIGHT 2000 GEMEX SYSTEMS INC. WWW.GEMEX.COM

## *Van Graff the intelligent choice*

The Van Graff is excellent for couples who want a beautiful ring but have a limited budget now for the wedding and all the extra expenses; they have other priorities.

With a Van Graff they can have a beautiful ring now, knowing in the future they can replace our stone with a natural diamond. Or not, who knows!!! If you want to wear fine jewelry without the risk. Van Graff is the intelligent choice because nobody will know they are not diamonds.

Many of our customers have diamonds jewelry but they have Van Graff rings and earrings to work or travel without the risk.

## *Presentation*



Each Van Graff diamond simulant is individually packaged and sealed with a certificate of authenticity. The Van Graff is a fine gift that is greatly appreciated.

The Van Graff is a gift that will last forever!

## *Van Graff, the best diamond imposter!*

by Cristina Del Moral

\* This is a short article published in the Novias (Bride) magazine

"With the high cost of weddings, honeymoons, and other expenses facing couples planning to get married, some opt for less expensive rings.

Instead of traditional diamonds, simulated diamonds can be used in engagement and wedding rings.

'We have couples who come in and don't want to start their marriage in debt (by buying a diamond),' said Juan Manuel of Van Graff.

'They want to be able to buy a fantastic ring and still have a beautiful wedding and honeymoon, my own daughter and my son-in-law chose a Van Graff, they had a beautiful wedding and honeymoon and now my daughter owns a new car, she will still have time to get a real diamond in the future if she wants to have one.'

Different types of materials have been used to simulate the look of a diamond in the past, including glass, zircon, fabulite, JAG, strontium, cubic zirconia and Moissanite.

The most believable substitute that is being used now is the Van Graff . . .

The price ranges for simulated stones are drastically lower than diamonds.

A one-carat diamond can sell from \$6,000 to \$10,000 depending on quality whereas a high-quality diamond simulant of similar shape and size can be available for less than \$300, including a gold setting.

'These diamond simulants can be judged using the same Four C's scale as genuine stones', Juan Manuel said. 'These stones are chemically stable and they do not lose their color,' or brightness he said . . . That is why they are the only ones warranted for life.

Some consumers fear that other people will be able to tell that the stone is not genuine. 'If you wear a Van Graff simulant, nobody will be able to tell by looking,' Juan Manuel said.

He does urge buyers to choose a size that is realistic. 'Stay in the realm of believability,' he said. 'If you buy a huge ring that you couldn't possibly afford in diamonds, people will suspect it is fake; but if you get a stone of a carat or less, in a quality setting, no one will know unless you tell them.' "

Of course if you are wealthy, you can wear a two or three carat stone and nobody will suspect that it is not a real diamond.

---

### WARNING!

Some Van Graff diamonds have been switched and sold as real diamonds after a natural diamond has been tested with the diamond tester.

Van Graff cannot be liable for any of our products used to commit fraud.

If you want to buy a natural diamond we advise you to contact any of the diamond dealers mentioned here, or visit the two main diamond forums [Diamond Talk](#) and [Pricescope](#) to learn everything about diamonds.



---

*Van Graff*

[ventas@van-graff.com](mailto:ventas@van-graff.com)

[www.van-graff.com](http://www.van-graff.com)

\*note: if you don't see the menu buttons at left press [HERE](#)

Exhibit 27

# Diamone.net

2007 Diamone.net. All Rights Reserved. Privacy Policy | Contact Us

## About Diamone®

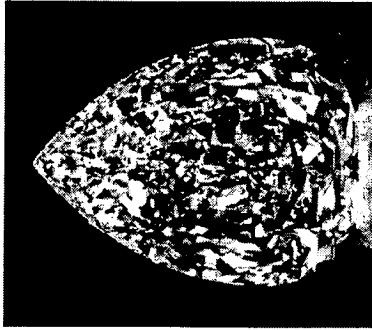

Diamone® is most beautiful patent pending simulant diamond in the world that use " Amorphous Diamond Growing Technic" which is very new hi-tech and grow tiny diamond (pure carbon) and create tiny diamond aligned combination. These microscopic diamond crystals are infiltrated into the Diamone crystal through the Amorphous Diamond Growing Tech. process to give Diamone® an pure man-made diamond layer cover whole surface of stone. To better describe how the magic stone is completed, we have begun calling it "Diamond Cultured", as through atomic force microscope, the microstructure can shows that the tiny diamond have been syncrized into the upper layer of the Diamone® crystal core, to form a new diamond stimulant, just like the way to get cultured pearl which is one core inside and one pearl layer outside.



(a)



(b)

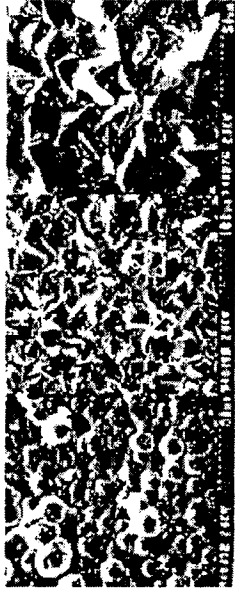

"Amorphous Diamond Growing Technic" is a universal technique that allows to produce tiny pure carbon diamond (purity is 99.9%) by means of ion spraying of pure graphite. As you know, natural pure carbon have two modalities, one is graphite, another is diamond. "Amorphous Diamond Growing Technic" control whole atmosphere to form diamond not graphite. It is the key of this Technology.





### Amorphous Diamond Growing Technic System

Diamond® are not CZs! Diamond® core crystal are created in a lab in USA, and cut by diamond cutters in China, and final "Amorphous Diamond Growing Technic" is processed in Germany .

This gemstones are in a class all by themselves. If you have a old Cubic Zirconium, and you compare the Diamond® to it, you will find a tremendous difference in the cut, and the refraction index. Standard CZs are machine cut and not cut to natural diamond standards. CZs will look very clear and glassy.

Diamond® are the closest appearance to a natural diamond and more beautiful than real diamond on the market today. Diamond® also offers same adamantite luster of a diamond's and Moissanite's luster while standard CZ's luster is sub-adamantine, and it gives the Diamond® the ability to handle light as a diamond does.

Standard CZ is hydrophilic, skin oils, soap and dirt can stick to and quickly be absorbed into the stone clouding and foggy its appearance, even within a few hours of wear. Diamond® is non-porous, are not absorbed and can be easily cleaned away.

CZ has less brilliance (white light return) than a diamond but more fire (colored light return) and is singly refractive, as diamond is. Moissanite has more brilliance, fire and luster than diamond but is doubly refractive (each single facet edge looks like two) which can lend a 'fuzzy' appearance to the stone in many lighting conditions.

Diamond® has a special pure carbon diamond skin which gives them a much harder and keep scratch away. The wonderful Chinese diamond cutting gives it the same look as a natural Diamond.

Diamond®, offers a diamond-like luster, a beautiful balance of brilliance and fire and same diamond cutting quality, is the best simulant diamond and more beautiful than diamond.



One Diamond Cutting Worker

**Facts of Diamone® :**

**Diamone® core crystal:** ZrO<sub>2</sub> mixed with Yttrium Oxide (Y<sub>2</sub>O<sub>3</sub>) or Calcium Oxide (CaO) as a stabilizing agent.

**Diamone® skin:** 99.9%, pure carbon diamond, Thickness is about 100--500um;

**Refractive Index:** 2.36; Single refraction index, same as diamond;

**Relative Density:** 5.5g /cm<sup>3</sup>;

**Dispersion:** 0.066;

**Hardness:** 9.3—9.8;

**Clarity and color:** Diamone® have two classes. VS1 in clarity and E, F in color.

Copyright (C) 2003-2006  
all right reserved

Exhibit 28



- Best Online Jewelers
- Best Local Jewelers
- How to Buy Online
- Diamonds FAQ
- Love Poems & Ecards

## Insider Secrets For Diamond Shoppers

Ask the Experts

### Diamond Clarity Grading

**Q:**

Diamond Clarity Q and A: How can I compare the clarity grading systems used by the different diamond laboratories?

**A:**

Although the GIA clarity grading system and nomenclature are the best known and most often used by dealers around the world, other systems are still popular both here and in other countries. We developed the charts below to help you understand how the diamond grading systems compare.

► See the GIA clarity scale for basic definitions of these terms.

GIA		AGS		IBS		SCANDIN	
IF Flawless	0	IF Flawless	LC Loupe Clean				
IF Internally Flawless	1	IF	IF				
VVS1 Very Very Slightly Included		VVS1	VVS1				



Tested Online Jewelers

Tested Local Jewelers













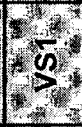



Diamond Prices

Diamond Sizes

How To Buy a Diamond

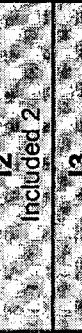
About Us

Love and Romance

	2		<b>WVS2</b>
	3		<b>VS1</b>
	4		<b>VS2</b>
	5		<b>SI1</b>
	6		<b>SI2</b>
			
	7-8		<b>P1</b> Pique 1
	8-9		<b>P2</b> Pique 2
	9-10		<b>P3</b> Pique 3

**NOTE:**

I know I say it a lot for those who are reading the whole tutorial, but it is very good to remember that knowing the 4 Cs is NOT enough to price a diamond accurately. So please don't stop at the 4 Cs is you want to learn the main points about diamond quality and pricing.

**The Fastest Way to Price a Diamond**

Today, the fastest way to price a diamond also happens to be the most accurate and current: Use the online databases to research prices for stones that are currently on the market, with all the details from the certificate (far beyond the 4 Cs). I wrote this simple, step-by-step [Diamond Pricing Tutorial](#) to teach you all the steps using one of the largest truthful online databases out there. All you need from there, is a good

Diamond Clarity Grading Charts



jeweler to help you at each step of the way. If you cannot find a good jeweler, we rate the top dealers for you.

Robert Hensley  
President  
Diamond Helpers

[Diamond Info](#) | [Love & Romance](#) | [About Us](#) | [Terms/Conditions](#)

Copyright 1999-2007. All rights reserved. Diamond Helpers is a trademark of Diamond Helpers, Inc.

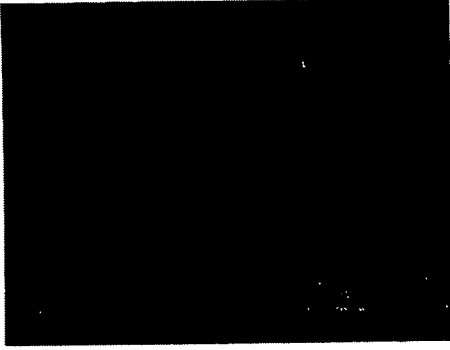

Exhibit 29



- Best Online Jewelers
- Best Local Jewelers
- How to Buy Online
- Diamonds FAQ
- Love Poems & Ecards

## Insider Secrets For Diamond Shoppers

Ask the Experts

### Diamond Color Grading Charts

**Q:** Diamond Color: How do all the other diamond color grading systems compare with the GIA color grades?

**A:** Although the GIA color grading system and nomenclature are the best known and most often used by dealers around the world, other systems are still popular in other countries. We developed the charts below to help you understand how they compare.

▶ See the [GIA color scale](#) for basic definitions of these terms.

### Color Grading Scales

for diamonds 0.46 carats and above  
(NOTE: comparisons are approximate due to limits of html)

GIA	AGS	GIBU IDC	SCAN.D.N.
D	0	Exceptional White +	River
E	1	Exceptional White	
F	2	Rare White +	Top

Diamond Questions?

Call Me: 1-888-693-7193  
Or Email Me Here

Tested Online Jewelers

Tested Local Jewelers

Diamond Prices

Diamond Sizes

How To Buy a Diamond

About Us

Love and Romance



Near Colorless	G	3	Rare White	Wesselton
	H		White	
Faint Yellow	I	5	Slightly Tinted White	Top Crystal
	J		White	Crystal
Very Light Yellow	K	7	Tinted White	Top Cape
	L		White	Cape
Light Yellow	M	8	Tinted Color	
	N			
Light Yellow	O	9		
	P			
Light Yellow	Q	10		
	R			
Light Yellow	S	10		
	T			
Light Yellow	U	10		
	V			
Light Yellow	W	10		
	X			
Light Yellow	Y	10		
	Z			

**PLEASE REMEMBER:** Knowing the 4 Cs is NOT enough to price a diamond accurately. At least 13 factors affect diamond value, including fluorescence, table percentage, symmetry and other crucial details. However, the 4 Cs are a good place to learn the basics. And learning all of it requires years of training and experience looking at diamonds.



That is why I created an easy, step-by-step Diamond Pricing Tutorial page, to guide you in using the most valuable tool in the pricing of diamonds today: the large online diamond databases. In that one lesson, I teach you how to price any diamond using live data on real diamonds in the current market. You can't any more accurate or current. The only other thing you need is a good jeweler to get the diamond for you, and integrity is the key in choosing your jeweler. If you cannot find a good jeweler, we rate the top dealers for you.



*Robert Hensley*

Robert Hensley  
President  
Diamond Helpers

[Diamond Info](#) | [Love & Romance](#) | [About Us](#) | [Terms/Conditions](#)

Copyright 1999-2007. All rights reserved. Diamond Helpers is a trademark of Diamond Helpers, Inc.

Exhibit 30

# FREE DIAMOND CALCULATOR

At 02:58:57pm on Monday, June 11<sup>th</sup>, 2007

Powered by current 'live feed' databases from the major diamond wholesalers in New York City.

Diamond Price Estimator			
Diamond Shape Round	Diamond Color M	Diamond Clarity SI3	Carat Weight 1.00
			Certified Only No <input checked="" type="checkbox"/>
<a href="#">Click Here to Find Estimated Price</a>			

Call 1-800-252-1476 or email [Info@1americandiamondcalculator.com](mailto:Info@1americandiamondcalculator.com) should you require any help using the 'diamond calculator'.

The 'Diamond Calculator' is provided as a free service to aid the consumer in the purchase of a loose diamond. Simply enter the details of the diamond you are interested in, then the approximate value will appear. This is the price that you would reasonably expect to pay when purchasing a diamond over the internet. They represent prices that are approximately 5 to 10% above the wholesale value. These prices are based on an average of all cut qualities. Ideal or Branded Ideal 'Hearts & Arrows' diamonds will be approx. 10 to 20% higher.

If a price is not available on the 'Diamond Calculator' for the particular shape, size, and quality of diamond that you are interested in, the please call 1-800-252-1476 for information concerning the price, or please fill in the form below.

For an actual list of diamonds matching or even coming in lower than the prices you have seen on the 'Diamond Calculator' please fill in the chart below. These are actual diamonds that are available.

Before purchasing any diamond regardless of source please confirm that the price shown on the 'Diamond Calculator' is correct by calling 1-800-252-1476.

Independent Gemmological Services Inc. will not be held responsible for any errors that may occur in pricing. All prices

are shown in U.S dollars. Please call 1 800 252-1476 or email to [Info@1americandiamondcalculator.com](mailto:Info@1americandiamondcalculator.com) for assistance and price confirmations. For an actual list of diamonds that match or come lower than the prices shown on the 'Diamond Calculator' please fill in the form below. You will receive the list along with proper contact information the next business day.

<b>Shape</b> <input type="text" value="Round"/>	<b>Color</b> <input type="text" value="Highest"/> <input type="text" value="Lowest"/>	<b>Clarity</b> <input type="text" value="Highest"/> <input type="text" value="Lowest"/>	<b>Weight</b> <input type="text" value="Lowest"/> <input type="text" value="Highest"/>
Please Provide a Price Range From \$ <input type="text"/> to \$ <input type="text"/>		Please narrow down your parameters as much as possible	

Should you have any questions or problems filling in the parameters above, please email directly to [Info@usacerteddiamonds.com](mailto:Info@usacerteddiamonds.com) or toll free **1-800-252-1476**

**Contact Information**

Your Full Name

Address

City

Province / State

Country

Best Time To Call

Day Phone Number

Evening Phone Number

E-mail  Required

**Enter any additional information here**

**For The Criteria: Shape: Round - Color: M - Clarity: SI3 - Carat: 0.97**

**Average Price: 1026.65, Average Carat Price: 1058.40 (from 1 Matching Stones)**

<b>Diamond Price Estimator</b>			
<b>Diamond Shape</b>	<b>Diamond Color</b>	<b>Diamond Clarity</b>	<b>Carat Weight</b>
Round <input type="checkbox"/>	F <input type="checkbox"/>	VS1 <input type="checkbox"/>	1.00 <input type="checkbox"/>
<a href="#">Click Here to Find Estimated Price</a>			

**Phone 1-800-252-1476 or email [sales@usacerteddiamonds.com](mailto:sales@usacerteddiamonds.com) in order to find out the lowest price for the diamonds of your choice.**

Exhibit 31

Better Than Diamond.com

Satisfied Customers in Over 22 Countries and all 50 US States!



- ◆ Currency Converter
- ◆ Track Your Shipment
- ◆ Shopping Cart
- ◆ Check Out

- Jewelry ▾
- Corporate ▾
- Asha Diamond Simulant ▾
- Loose gems ▾
- Pearls ▾
- Questions? ▾

Home > Loose Asha Index > Round

### Asha® Hearts & Arrows Round



**News!** New Wholesale-Direct Pricing structure is now in effect!

#### Diamonds

- ◆ Ready to ship jewelry
- ◆ Earrings
- ◆ Asha® Diamond Simulant
- ◆ Takara Cultured Diamonds
- ◆ Natural Diamonds
- ◆ Cultured Colombian Emeralds
- ◆ Cultured Rubies
- ◆ Rings
- ◆ Prongs
- ◆ Necklace & Pendants
- ◆ Care Products
- ◆ Weekly Special
- ◆ Pearls
- ◆ Amara™ Shell Pearls
- ◆ Necklace
- ◆ Earrings
- ◆ Retail Locations
- ◆ Retail Stores



Questions?

Please ...

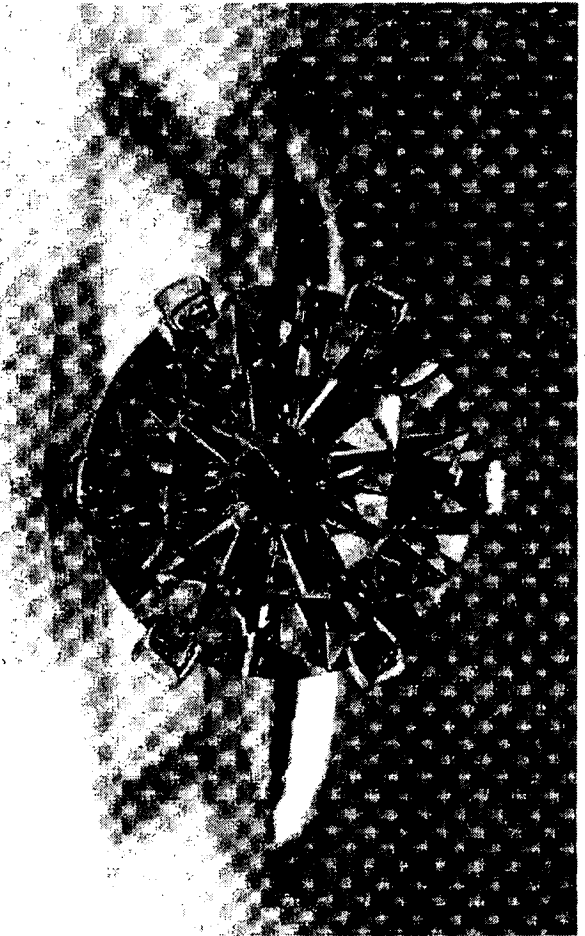

Customer photo showing the 'Arrows' in our Hearts & Arrows Asha round  
Less than 2% of all natural diamonds are cut to this precision  
The ring is our Tiffany reproduction ring. Photo by Cricketgirl

**Asha @ H&A Beauty objectively measured and compared:**

Asha @ H&A 1.00ct sample results (E color), using Gemex Brilliancescope system.

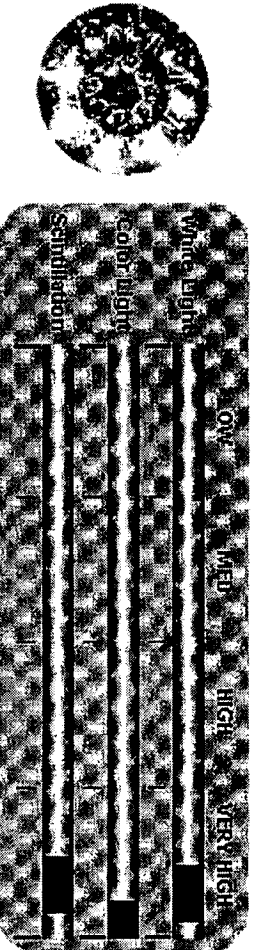

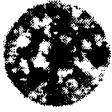

Conventional Diamond \*



\*Typical American Round Brilliant cut diamond (normally cut to maximize finished weight vs. optimal beauty)

The above photos and scales are copyright Gemex Systems

To learn more about the BrillianceScope test result of our Asha® H&A Round regarding brilliance, sparkle and fire, click here.

If you cannot decide which carat size you'd like to purchase, you may find the Asha® stone size comparison page helpful.

**Asha® Round Highlights:**

- **Precision:** It takes our cutters 8 times as long to cut an H&A Asha® as compared to a typical round brilliant.
- **Free UPS Shipping**  
All Asha® orders over \$199 ship via UPS 2 Day at no charge to you. All Asha® orders under \$199 ship via UPS 2 Day at the low charge of \$8.95.
- **You will be pleased or a full refund will be promptly issued:** See our satisfaction guarantee here - you must be thrilled with your purchase, or we will gladly return your funds.
- **Lower pricing!** In order to answer our customers #1 request of lowering the price of Asha without sacrificing quality, (and in opposite of Moissanite's recent price hike) we have introduced an additional 25% price reduction due to manufacturing

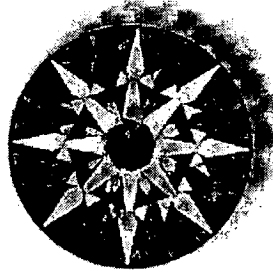

Asha H&A showing its arrows under the H&A scope

efficiencies gained by our increased volume of rounds, and by our no longer offering the lifetime limited warranty.

Customers who purchased before May 24, 2005 are still covered by the original Asha lifetime warranty. Purchases from 5/24/05 and forward still have the 14 day return policy with no lifetime warranty (but lower purchase price).

- **Learn more about Hearts and Arrows (H&A) cuts** - Heart and Arrows, Ideal cut and standard round brilliant all have the same number of facets (57) - however, the difference lies in the angles, proportions, and symmetry of the facets. These difference result in widely differing brilliance (light return), with H&A offering the best light return in exchange for significantly more weight lost during cutting, and substantially more cutting time due to the precision required. Learn more here.

**Version 5, Asha® Rounds:**

**ELLIOTT GEMOLOGICAL LABORATORY**  
 425-437-4076 ElliottGemLab.Com  
 Asha® Identification Card

Report Number: 10113 Date: Aug. 13, 2004

Shape/Cut: Round Brilliant  
 Measurements: 6.5 x 6.5 x 4.6mm  
 Weight: 1.00ct  
 Color: F  
 Clarity: VS2  
 Polarity/Symmetry: F, H&A Proportions

**Observation:**

\*Based on Diamond Simulator  
 with an Average Quality Treatment  
 (GSI) Diamond Color Worksheet.  
 \*\*Laser Inscribed Asha and this report number.

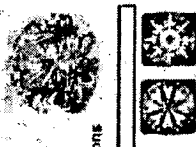

**Important note:** We earlier shipped all Asha rounds with laser engraving and an independent grading card (sample shown above).

However, the gem lab we had been working with was bought out by a larger company and closed (literally while the new batch was at their office), leaving us currently without a resource to laser engrave or card.

Thus, while the Asha's have been color graded, they will not ship with either a card or laser engraving. We have factored this into the new pricing for the Wholesale Direct pricing below.

Wondering what size would work best for you? Here are two links that can help in that decision:

- [BetterThanDiamond education: Comparison photo of 1ct, 1.25ct, 1.50ct and 2ct sizes](#)
- [Amazon.com's diamond size chart \(click to view and then print\)](#)

**H&A round cuts**

Color	Cut	Diameter (Depth)	Carat Size	Inventory	Packaging	Wholesale Direct Price (approx 50% off)
H	H&A	4.0mm (2.5mm)	.25 ct	120	Diamond Paper	was \$96 now: <b>\$48</b> <input type="button" value="ADD TO CART"/>
F	H&A	5.0mm (3.0mm)	.50 ct	530	Diamond Paper	was \$225 now: <b>\$98</b> <input type="button" value="ADD TO CART"/>
F	H&A	6.0mm (3.5mm)	.75 ct	11	Diamond Paper	was \$310 now: <b>\$146</b> <input type="button" value="ADD TO CART"/>
F	H&A	6.5mm (4.0mm)	1.00 ct	558	Diamond Paper	was \$425 now: <b>\$195</b> <input type="button" value="ADD TO CART"/>
F	H&A	7.0mm (4.25mm)	1.25 ct	19	Diamond Paper	was \$550 now: <b>\$244</b> <input type="button" value="ADD TO CART"/>
G	H&A	7.5mm (4.5mm)	1.50 ct	219	Diamond Paper	was \$640 now: <b>\$292</b> <input type="button" value="ADD TO CART"/>
H	H&A	8mm (5.0mm)	2.00 ct	27	Diamond Paper	was \$694 now: <b>\$390</b> <input type="button" value="ADD TO CART"/>
H	H&A	9mm (5.5mm)	2.75 ct	37	Diamond Paper	was \$765 now: <b>\$495</b> <input type="button" value="ADD TO CART"/>

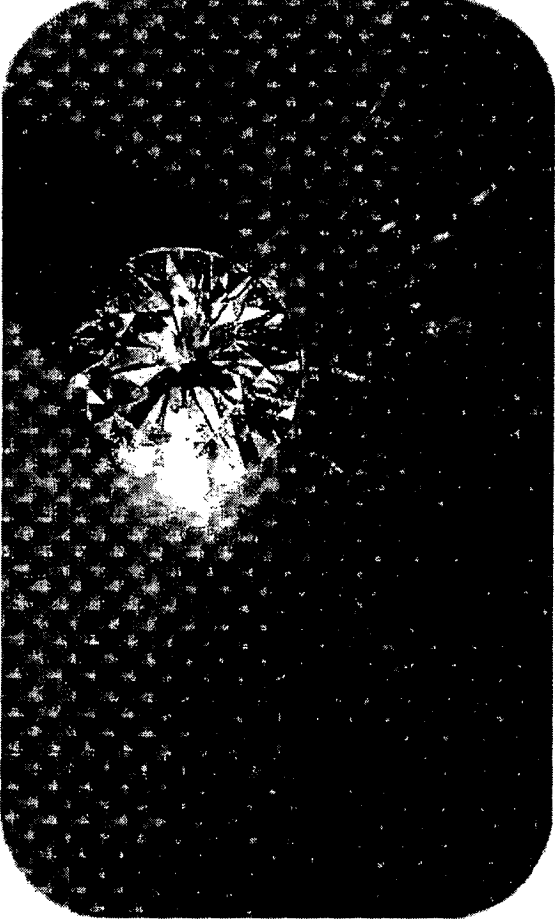

Asha, F color H&A, in the sunlight

Asha® is our registered mark  
Content and images, copyright 2007, BetterThanDiamond.com

Exhibit 32

**Thank you for your request. Here are the latest results from the TARR web server.**

**This page was generated by the TARR system on 2007-06-13 14:28:23 ET**

**Serial Number: 79030842 Assignment Information**

**Registration Number: (NOT AVAILABLE)**

**Mark**

**Eternal Silver**

**(words only): ETERNAL SILVER**

**Standard Character claim: Yes**

**Current Status:** A non-final action has been mailed. This is a letter from the examining attorney requesting additional information and/or making an initial refusal. However, no final determination as to the registrability of the mark has been made.

**Date of Status: 2007-02-28**

**Filing Date: 2006-09-27**

**Transformed into a National Application: No**

**Registration Date: (DATE NOT AVAILABLE)**

**Register: Principal**

**Law Office Assigned: LAW OFFICE 104**

**Attorney Assigned:**

**PILARO MARK F Employee Location**

**Current Location: L4X -TMEG Law Office 104 - Examining Attorney Assigned**

**Date In Location: 2007-02-27**

---

**LAST APPLICANT(S)/OWNER(S) OF RECORD**

---

1. Forever Silver Limited; c/o Swico

**Address:**

Forever Silver Limited; c/o Swico  
Meadway, Haslemere Surrey GU27 1NN  
United Kingdom

**Legal Entity Type:** Ltd Liab Co

**State or Country Where Organized:** (NOT AVAILABLE)

---

**GOODS AND/OR SERVICES**

---

**International Class:** 008

**Class Status:** Active

Hand tools and implements; cutlery; knives; forks, spoons, teaspoons, serving utensils, parts and fittings for all the aforesaid goods; all made wholly or principally of silver

**Basis:** 66(a)

**First Use Date:** (DATE NOT AVAILABLE)

**First Use in Commerce Date:** (DATE NOT AVAILABLE)

**International Class:** 014

**Class Status:** Active

Precious metals and their alloys and goods in precious metals or coated therewith, not included in other classes; jewellery, horological and chronometric instruments; includes clocks and watches; costume jewellery; parts and fittings for all the aforesaid goods; all made wholly or principally of silver

**Basis:** 66(a)

**First Use Date:** (DATE NOT AVAILABLE)

**First Use in Commerce Date:** (DATE NOT AVAILABLE)

**International Class:** 016

**Class Status:** Active

Stationery; office requisites (except furniture); parts and fittings for all the aforesaid goods

**Basis:** 66(a)

**First Use Date:** (DATE NOT AVAILABLE)

**First Use in Commerce Date:** (DATE NOT AVAILABLE)

---

**ADDITIONAL INFORMATION**

---

**Description of Mark:** Eternal Silver.

---

**MADRID PROTOCOL INFORMATION**

---

**International Registration Number:** 0903238



**International Registration Date:** 2006-09-27  
**Priority Claimed:** No  
**Date of Section 67 Priority Claim:** (DATE NOT AVAILABLE)  
**International Registration Status:** Request For Extension Of Protection Processed  
**Date of International Registration Status:** 2006-11-30  
**International Registration Renewal Date:** 2016-09-27  
**Notification of Designation Date:** 2006-11-30  
**Date of Automatic Protection:** 2008-05-30  
**Date International Registration Cancelled:** (DATE NOT AVAILABLE)  
**First Refusal:** Yes

---

**PROSECUTION HISTORY**

---

2007-03-15 - Refusal Processed By IB  
2007-02-28 - Non-Final Action Mailed - Refusal Sent To IB  
2007-02-28 - Refusal Processed By MPU  
2007-02-28 - Non-Final Action (Ib Refusal) Prepared For Review  
2007-02-27 - Non-Final Action Written  
2007-02-15 - Assigned To Examiner  
2006-12-01 - New Application Entered In Tram  
2006-11-30 - Sn Assigned For Sect 66a Appl From IB

---

**ATTORNEY/CORRESPONDENT INFORMATION**

---

**Correspondent**  
Azrights Solicitors  
81-83 Essex Road,  
Islington Green  
London N1 2SF UNITED KINGDOM

---

Exhibit 33

**Thank you for your request. Here are the latest results from the TARR web server.**

**This page was generated by the TARR system on 2007-06-13 14:29:17 ET**

**Serial Number: 78638437 Assignment Information**

**Registration Number: 3243672**

**Mark**

**SILVER PLUS**

**(words only): SILVER PLUS**

**Standard Character claim: Yes**

**Current Status: Registered.**

**Date of Status: 2007-05-22**

**Filing Date: 2005-05-26**

**Transformed into a National Application: No**

**Registration Date: 2007-05-22**

**Register: Principal**

**Law Office Assigned: LAW OFFICE 113**

**If you are the applicant or applicant's attorney and have questions about this file, please contact the Trademark Assistance Center at [TrademarkAssistanceCenter@uspto.gov](mailto:TrademarkAssistanceCenter@uspto.gov)**

**Current Location: 650 -Publication And Issue Section**

**Date In Location: 2007-05-22**

---

**LAST APPLICANT(S)/OWNER(S) OF RECORD**

---

1. Commemorative Brands, Inc.

**Address:**

Commemorative Brands, Inc.

7211 Circle S Road

Austin, TX 78745

United States

**Legal Entity Type:** Corporation

**State or Country of Incorporation:** Delaware

---

**GOODS AND/OR SERVICES**

---

**International Class:** 014

**Class Status:** Active

Jewelry made in whole or substantial part of silver

**Basis:** 1(a)

**First Use Date:** 2002-03-01

**First Use in Commerce Date:** 2002-03-01

---

**ADDITIONAL INFORMATION**

---

**Disclaimer:** "SILVER"

---

**MADRID PROTOCOL INFORMATION**

---

(NOT AVAILABLE)

---

**PROSECUTION HISTORY**

---

2007-05-22 - Registered - Principal Register

2007-03-06 - Published for opposition

2007-02-14 - Notice of publication

2007-01-22 - Law Office Publication Review Completed

2007-01-11 - Approved for Pub - Principal Register (Initial exam)

Latest Status Info

2007-01-04 - Teas/Email Correspondence Entered  
2006-11-30 - Communication received from applicant  
2007-01-04 - Assigned To LIE  
2006-11-30 - TEAS Response to Office Action Received  
2006-05-31 - Final refusal e-mailed  
2006-05-31 - Final Refusal Written  
2006-05-24 - Teas/Email Correspondence Entered  
2006-05-16 - Communication received from applicant  
2006-05-16 - TEAS Response to Office Action Received  
2005-12-22 - Non-final action e-mailed  
2005-12-22 - Non-Final Action Written  
2005-12-19 - Assigned To Examiner  
2005-06-06 - New Application Entered In Tram

---

**ATTORNEY/CORRESPONDENT INFORMATION**

---

**Attorney of Record**

Clarissa Marischen

**Correspondent**

CLARISSA MARISCHEN  
ANDREWS KURTH LLP  
111 CONGRESS AVE STE 1700  
AUSTIN, TX 78701-4069  
Phone Number: 512-320-9247  
Fax Number: 512-542-5229

---

Exhibit 34

**Thank you for your request. Here are the latest results from the TARR web server.**

**This page was generated by the TARR system on 2007-06-13 14:35:19 ET**

**Serial Number: 78672008 Assignment Information**

**Registration Number: 3240865**

**Mark**

**SILVERD'SIGN**

**(words only): SILVERD'SIGN**

**Standard Character claim: Yes**

**Current Status: Registered.**

**Date of Status: 2007-05-08**

**Filing Date: 2005-07-17**

**Transformed into a National Application: No**

**Registration Date: 2007-05-08**

**Register: Supplemental**

**Law Office Assigned: LAW OFFICE 111**

**If you are the applicant or applicant's attorney and have questions about this file, please contact the Trademark Assistance Center at [TrademarkAssistanceCenter@uspto.gov](mailto:TrademarkAssistanceCenter@uspto.gov)**

**Current Location: 650 -Publication And Issue Section**

**Date In Location: 2007-05-08**

**LAST APPLICANT(S)/OWNER(S) OF RECORD**

---

1. Goldart International Inc

**Address:**

Goldart International Inc  
Suite:245 1305 Franklin Ave  
Garden City, NY 11530  
United States

**Legal Entity Type:** Corporation

**State or Country of Incorporation:** New Jersey

**Phone Number:** 516-294-8370

**Fax Number:** 516-294-3888

---

**GOODS AND/OR SERVICES**

---

**International Class:** 014

**Class Status:** Active

Jewelry in the nature of rings, bracelets, charms, pendants, necklaces, earrings, watches, chains, pins, badges of precious metal, beads for use in the manufacture of jewelry, brooches, buckles for watchstraps, watch winding buttons, crosses, crucifixes, cuff links, locket, charms of Saint Christopher, Star of David charms, tie clips, tie slides, tie pins, ashtrays and cigarette boxes of precious metal, made in whole or in significant part of silver

**Basis:** 1(a)

**First Use Date:** 2002-03-01

**First Use in Commerce Date:** 2002-03-01

---

**ADDITIONAL INFORMATION**

---

(NOT AVAILABLE)

---

**MADRID PROTOCOL INFORMATION**

---

(NOT AVAILABLE)

---

**PROSECUTION HISTORY**

---

2007-05-08 - Registered - Supplemental Register

2007-03-28 - Law Office Publication Review Completed



Latest Status Info

2007-03-28 - APPROVED FOR REGISTRATION SUPPLEMENTAL REGISTER

2007-03-28 - Amendment From Applicant Entered

2007-03-28 - Communication received from applicant

2007-03-26 - PAPER RECEIVED

2007-03-12 - Non-final action mailed

2007-03-12 - Non-Final Action Written

2007-03-05 - Amendment From Applicant Entered

2007-03-05 - Communication received from applicant

2007-03-01 - PAPER RECEIVED

2007-02-11 - Final refusal e-mailed

2007-02-11 - Final Refusal Written

2007-01-29 - LIE Checked Susp - To Atty For Action

2007-01-29 - Assigned To LIE

2006-07-28 - LETTER OF SUSPENSION E-MAILED

2006-07-28 - Suspension Letter Written

2006-07-18 - Amendment From Applicant Entered

2006-06-16 - Communication received from applicant

2006-06-16 - PAPER RECEIVED

2006-02-06 - Non-final action e-mailed

2006-02-06 - Non-Final Action Written

2006-02-04 - Assigned To Examiner

2005-07-21 - New Application Entered In Tram

---

**ATTORNEY/CORRESPONDENT INFORMATION**

**Attorney of Record**  
Anthony J. Caseella

**Correspondent**  
ANTHONY J CASELLA  
CASELLA & HESPOS LLP  
274 MADISON AVE  
NEW YORK, NY 10016-0701  
Phone Number: 212 725-2450  
Fax Number: 212 725-2452

---

Exhibit 35

**Thank you for your request. Here are the latest results from the TARR web server.**

**This page was generated by the TARR system on 2007-06-13 14:30:15 ET**

**Serial Number: 78860481 Assignment Information**

**Registration Number: (NOT AVAILABLE)**

**Mark**

**J & J SILVER**

**(words only): J & J SILVER**

**Standard Character claim: Yes**

**Current Status: Abandoned-Failure To Respond Or Late Response**

**Date of Status: 2007-04-24**

**Filing Date: 2006-04-12**

**Filed as TEAS Plus Application: Yes**

**Currently TEAS Plus Application: Yes**

**Transformed into a National Application: No**

**Registration Date: (DATE NOT AVAILABLE)**

**Register: Principal**

**Law Office Assigned: LAW OFFICE 109**

**If you are the applicant or applicant's attorney and have questions about this file, please contact the Trademark Assistance Center at TrademarkAssistanceCenter@uspto.gov**

**Current Location: L9X -TMEG Law Office 109 - Examining Attorney Assigned**

**Date In Location:** 2007-04-24

---

**LAST APPLICANT(S)/OWNER(S) OF RECORD**

---

1. J & J Silver

**Address:**

J & J Silver  
14419 Sun Forest Drive  
Penn Valley, CA 95946  
United States

**Legal Entity Type:** Corporation

**State or Country of Incorporation:** California

**Phone Number:** 530-908-1331

**Fax Number:** 530-432-4019

---

**GOODS AND/OR SERVICES**

---

**International Class:** 014

**Class Status:** Active

Silver and its alloys

**Basis:** 1(a)

**First Use Date:** 2006-03-04

**First Use in Commerce Date:** 2006-03-04

---

**ADDITIONAL INFORMATION**

---

(NOT AVAILABLE)

---

**MADRID PROTOCOL INFORMATION**

---

(NOT AVAILABLE)

---

**PROSECUTION HISTORY**

---

2007-04-24 - Abandonment Notice Mailed - Failure To Respond

2007-04-24 - Abandonment - Failure To Respond Or Late Response

Latest Status Info

2006-09-26 - Priority Action E-Mailed  
2006-09-26 - Priority Action Written  
2006-09-20 - Assigned To Examiner  
2006-04-20 - Notice Of Pseudo Mark Mailed  
2006-04-19 - New Application Entered In Tram

---

**ATTORNEY/CORRESPONDENT INFORMATION**

---

**Correspondent**

J & J SILVER  
14419 SUN FOREST DR  
PENN VALLEY, CA 95946-9107  
Phone Number: 530-908-1331  
Fax Number: 530-432-4019

---

Exhibit 36

**Thank you for your request. Here are the latest results from the TARR web server.**

**This page was generated by the TARR system on 2007-06-13 14:30:29 ET**

**Serial Number: 78687293 Assignment Information**

**Registration Number: (NOT AVAILABLE)**

**Mark**

# Phoenix Silver

**(words only): PHOENIX SILVER**

**Standard Character claim: Yes**

**Current Status: Application was revived after being abandoned, will be forwarded for further examination.**

**Date of Status: 2007-04-17**

**Filing Date: 2005-08-07**

**Filed as TEAS Plus Application: Yes**

**Currently TEAS Plus Application: Yes**

**Transformed into a National Application: No**

**Registration Date: (DATE NOT AVAILABLE)**

**Register: Principal**

**Law Office Assigned: LAW OFFICE 105**

**Attorney Assigned:**

**BROWN TINA Employee Location**



Latest Status Info

**Current Location:** L50 -TMEG Law Office 105

**Date In Location:** 2007-04-23

---

**LAST APPLICANT(S)/OWNER(S) OF RECORD**

---

1. Hayes, Gordon, S

**Address:**

Hayes, Gordon, S

PO Box 35267

Tucson, AZ 85740

United States

**Legal Entity Type:** Sole Proprietorship

**State or Country Where Organized:** Arizona

**Phone Number:** 520-406-7446

**Fax Number:** 520-398-6803

---

**GOODS AND/OR SERVICES**

---

**International Class:** 014

**Class Status:** Active

Precious metals, namely, Silver

**Basis:** 1(a)

**First Use Date:** 2004-12-25

**First Use in Commerce Date:** 2004-12-25

---

**ADDITIONAL INFORMATION**

---

(NOT AVAILABLE)

---

**MADRID PROTOCOL INFORMATION**

---

(NOT AVAILABLE)

---

**PROSECUTION HISTORY**

---

2007-04-23 - Response To ITU Office Action Entered

2007-04-23 - Assigned To LIE

Latest Status Info

2007-04-17 - Petition Granted - Response Received  
2007-02-26 - Petition to Commissioner - Petitioner response letter received  
2007-02-26 - PAPER RECEIVED  
2007-01-30 - Petition to Revive - Incomplete petition letter mailed  
2007-01-25 - Assigned To Petition Staff  
2006-11-29 - Petition To Revive-Received  
2006-11-29 - PAPER RECEIVED  
2006-09-27 - Abandonment Notice Mailed - Failure To Respond  
2006-09-27 - Abandonment - Failure To Respond Or Late Response  
2006-03-01 - Non-final action e-mailed  
2006-03-01 - Non-Final Action Written  
2006-02-26 - Assigned To Examiner  
2005-08-12 - New Application Entered In Tram

---

**ATTORNEY/CORRESPONDENT INFORMATION**

---

**Correspondent**

HAYES, GORDON, S  
PO BOX 35267  
TUCSON, AZ 85740-5267  
Phone Number: 520-406-7446  
Fax Number: 520-398-6803

---

Exhibit 37

**Thank you for your request. Here are the latest results from the TARR web server.**

**This page was generated by the TARR system on 2007-06-13 14:35:47 ET**

**Serial Number: 78731243 Assignment Information**

**Registration Number: 3224291**

**Mark**

**STERLING SILVER SHOPPE**

**(words only): STERLING SILVER SHOPPE**

**Standard Character claim: Yes**

**Current Status: Registered.**

**Date of Status: 2007-04-03**

**Filing Date: 2005-10-11**

**Transformed into a National Application: No**

**Registration Date: 2007-04-03**

**Register: Principal**

**Law Office Assigned: LAW OFFICE 113**

**If you are the applicant or applicant's attorney and have questions about this file, please contact the Trademark Assistance Center at TrademarkAssistanceCenter@uspto.gov**

**Current Location: 650 -Publication And Issue Section**

**Date In Location: 2007-04-03**

**LAST APPLICANT(S)/OWNER(S) OF RECORD**

---

1. Hughes, Richard Foster II

**Address:**

Hughes, Richard Foster II  
738 Lee Street  
Asheboro, NC 27203  
United States

**Legal Entity Type:** Individual

**Country of Citizenship:** United States

**Phone Number:** 336.460.0056

**Fax Number:** 336.626.1295

---

**GOODS AND/OR SERVICES**

---

**International Class:** 014

**Class Status:** Active

Sterling Silver Jewelry, namely, rings, bracelets, necklaces, charms, earrings, anklets, brooches, pendants

**Basis:** 1(a)

**First Use Date:** 2000-01-01

**First Use in Commerce Date:** 2000-01-01

---

**ADDITIONAL INFORMATION**

---

**Disclaimer:** "Sterling Silver"

**Section 2(f)**

---

**MADRID PROTOCOL INFORMATION**

---

(NOT AVAILABLE)

---

**PROSECUTION HISTORY**

---

2007-04-03 - Registered - Principal Register

2007-01-16 - Published for opposition

2006-12-27 - Notice of publication

Latest Status Info

2006-11-28 - Law Office Publication Review Completed  
2006-11-22 - Approved for Pub - Principal Register (Initial exam)  
2006-11-21 - Examiner's Amendment Entered  
2006-11-21 - Assigned To LIE  
2006-11-17 - EXAMINERS AMENDMENT E-MAILED  
2006-11-17 - Examiners Amendment - Written  
2006-10-25 - Teas/Email Correspondence Entered  
2006-10-20 - Communication received from applicant  
2006-10-20 - TEAS Response to Office Action Received  
2006-04-27 - Non-final action e-mailed  
2006-04-27 - Non-Final Action Written  
2006-04-13 - Assigned To Examiner  
2005-10-17 - New Application Entered In Tram

---

**ATTORNEY/CORRESPONDENT INFORMATION**

---

**Correspondent**

RICHARD FOSTER HUGHES II  
738 LEE ST  
ASHEBORO NC 27203  
Phone Number: 336.460.0056  
Fax Number: 336.626.1295

---

Exhibit 38

**Thank you for your request. Here are the latest results from the TARR web server.**

**This page was generated by the TARR system on 2007-06-13 14:37:10 ET**

**Serial Number: 78856064 Assignment Information**

**Registration Number: (NOT AVAILABLE)**

**Mark**

**SILVER CANYON**

**(words only): SILVER CANYON**

**Standard Character claim: Yes**

**Current Status: Opposition period completed, a Notice of Allowance has been issued.**

**Date of Status: 2007-06-12**

**Filing Date: 2006-04-06**

**The Notice of Allowance Date is: 2007-06-12**

**Transformed into a National Application: No**

**Registration Date: (DATE NOT AVAILABLE)**

**Register: Principal**

**Law Office Assigned: LAW OFFICE 106**

**Attorney Assigned:**

**ELTON DAVID JONATHAN Employee Location**

**Current Location: 700 -Intent To Use Section**

**Date In Location: 2007-06-12**



---

**LAST APPLICANT(S)/OWNER(S) OF RECORD**

---

1. L.A. GEM AND JEWELRY DESIGN, INC.

**Address:**

L.A. GEM AND JEWELRY DESIGN, INC.

640 S. Hill St., Ste. 548

Los Angeles, CA 90014

United States

**Legal Entity Type:** Corporation

**State or Country of Incorporation:** California

**Phone Number:** 818-995-0300

**Fax Number:** 818-743-7785

---

**GOODS AND/OR SERVICES**

---

**International Class:** 014

**Class Status:** Active

Jewelry made of gold, silver and sterling silver, namely, pendants, earrings, rings, bangles, chains, bracelets, necklaces, brooches and anklets

**Basis:** 1(b)

**First Use Date:** (DATE NOT AVAILABLE)

**First Use in Commerce Date:** (DATE NOT AVAILABLE)

---

**ADDITIONAL INFORMATION**

---

**Disclaimer:** "silver"

---

**MADRID PROTOCOL INFORMATION**

---

(NOT AVAILABLE)

---

**PROSECUTION HISTORY**

---

2007-06-12 - Notice of allowance - mailed

2007-03-20 - Published for opposition

2007-02-28 - Notice of publication

Latest Status Info

2007-02-02 - Law Office Publication Review Completed  
2007-02-02 - Approved for Pub - Principal Register (Initial exam)  
2007-02-02 - Examiner's Amendment Entered  
2007-02-02 - EXAMINERS AMENDMENT E-MAILED  
2007-02-02 - Examiners Amendment -Written  
2007-01-11 - Amendment From Applicant Entered  
2006-11-29 - Communication received from applicant  
2007-01-06 - Assigned To LIE  
2006-12-04 - PAPER RECEIVED  
2006-11-29 - FAX RECEIVED  
2006-11-29 - FAX RECEIVED  
2006-09-18 - Non-final action e-mailed  
2006-09-18 - Non-Final Action Written  
2006-09-16 - Assigned To Examiner  
2006-04-12 - New Application Entered In Tram

---

**ATTORNEY/CORRESPONDENT INFORMATION**

---

**Attorney of Record**

NEAL N. CHILINGIRIAN

**Correspondent**

NEAL N. CHILINGIRIAN  
LAW OFFICES OF NEAL N. CHILINGIRIAN  
15760 VENTURA BLVD STE 1550  
ENCINO, CA 91436-3064  
Phone Number: 818-995-0300  
Fax Number: 818-743-7785

Exhibit 39

Thank you for your request. Here are the latest results from the TARR web server.

This page was generated by the TARR system on 2007-06-13 14:36:50 ET

Serial Number: 78859065 Assignment Information

Registration Number: (NOT AVAILABLE)

Mark

**BABY SILVER**

(words only): BABY SILVER

Standard Character claim: Yes

Current Status: A non-final action has been mailed. This is a letter from the examining attorney requesting additional information and/or making an initial refusal. However, no final determination as to the registrability of the mark has been made.

Date of Status: 2007-03-02

Filing Date: 2006-04-11

Filed as TEAS Plus Application: Yes

Currently TEAS Plus Application: Yes

Transformed into a National Application: No

Registration Date: (DATE NOT AVAILABLE)

Register: Principal

Law Office Assigned: LAW OFFICE 108

Attorney Assigned:

TURNER JASON FITZGERALD Employee Location

**Current Location:** L8X -TMEG Law Office 108 - Examining Attorney Assigned

**Date In Location:** 2007-03-02

---

**LAST APPLICANT(S)/OWNER(S) OF RECORD**

---

1. Bel-Oro International, Inc.

**Address:**

Bel-Oro International, Inc.

516 Fifth Avenue

New York, NY 10036

United States

**Legal Entity Type:** Corporation

**State or Country of Incorporation:** New York

---

**GOODS AND/OR SERVICES**

---

**International Class:** 014

**Class Status:** Active

Jewelry made in whole or substantial part of silver in International Class 14

**Basis:** 1(b)

**First Use Date:** (DATE NOT AVAILABLE)

**First Use in Commerce Date:** (DATE NOT AVAILABLE)

---

**ADDITIONAL INFORMATION**

---

**Disclaimer:** "SILVER"

---

**MADRID PROTOCOL INFORMATION**

---

(NOT AVAILABLE)

---

**PROSECUTION HISTORY**

---

2007-03-02 - NON-FINAL ACTION E-MAILED

2007-03-02 - Non-Final Action Written

Latest Status Info

2007-01-17 - Teas/Email Correspondence Entered  
2007-01-17 - Communication received from applicant  
2007-01-17 - TEAS Response to Office Action Received  
2006-09-22 - Non-final action e-mailed  
2006-09-22 - Non-Final Action Written  
2006-09-15 - Assigned To Examiner  
2006-04-18 - New Application Entered In Tram

---

**ATTORNEY/CORRESPONDENT INFORMATION**

---

**Attorney of Record**

Victoria Elliot

**Correspondent**

VICTORIA ELLIOT  
132 SANDS POINT DR  
TIERRA VERDE, FL 33715-2211

---

Exhibit 40

---

**MADRID PROTOCOL INFORMATION**

---

(NOT AVAILABLE)

---

**PROSECUTION HISTORY**

---

2006-10-24 - Registered - Supplemental Register  
2006-09-14 - Law Office Publication Review Completed  
2006-09-08 - Assigned To LIE  
2006-09-01 - APPROVED FOR REGISTRATION SUPPLEMENTAL REGISTER  
2006-09-01 - Amendment From Applicant Entered  
2006-08-09 - Communication received from applicant  
2006-08-28 - TEAS Response to Office Action Received  
2006-08-09 - PAPER RECEIVED  
2006-04-20 - Non-final action e-mailed  
2006-04-20 - Non-Final Action Written  
2006-04-12 - Assigned To Examiner  
2005-10-12 - New Application Entered In Tram

---

**ATTORNEY/CORRESPONDENT INFORMATION**

---

**Attorney of Record**

Francisco A. Laguna

**Correspondent**

FRANCISCO A. LAGUNA  
TRANSLEGAL, LLC  
3924 DUKE ST  
ALEXANDRIA, VA 22304-2604  
Phone Number: 571.244.5302  
Fax Number: 703.566.9428

---



## LAST APPLICANT(S)/OWNER(S) OF RECORD

---

1. Escalante-Calderon, Adriana

**Address:**

Escalante-Calderon, Adriana  
1498 Northern Neck Drive  
Tysons Corner, VA 22182  
United States

**Legal Entity Type:** Individual

**Country of Citizenship:** United States

**Phone Number:** 703.926.7638

**Fax Number:** 703.832.1136

---

## GOODS AND/OR SERVICES

---

**International Class:** 008

**Class Status:** Active

Sterling Silver Flatware

**Basis:** 1(a)

**First Use Date:** 2003-03-21

**First Use in Commerce Date:** 2003-03-21

**International Class:** 014

**Class Status:** Active

items made of sterling silver, with or without other elements, including precious stones and semi-precious stones, beads, decorative plastic, wood and crystal, namely, decorative centerpieces, bookmarks, candlesticks, baby rattles, writing instruments, jewelry, picture frames, plates, platters and dishes, tea sets, vases, cocktail shakers, decorative statues

**Basis:** 1(a)

**First Use Date:** 2003-03-21

**First Use in Commerce Date:** 2003-03-21

---

## ADDITIONAL INFORMATION

---

**Color(s) Claimed:** The color Silver is claimed as a feature of the mark.

**Description of Mark and Any Color Part(s):** The color silver appears in the lettering Vaccari Fine Sterling Silver

**Disclaimer:** "Fine Sterling Silver"

---

**Thank you for your request. Here are the latest results from the TARR web server.**

**This page was generated by the TARR system on 2007-06-13 14:36:20 ET**

**Serial Number: 78729525 Assignment Information**

**Registration Number: 3164278**

**Mark**

  
**FINE STERLING SILVER**

**(words only): VACCARI FINE STERLING SILVER**

**Standard Character claim: No**

**Current Status: Registered.**

**Date of Status: 2006-10-24**

**Filing Date: 2005-10-09**

**Transformed into a National Application: No**

**Registration Date: 2006-10-24**

**Register: Supplemental**

**Law Office Assigned: LAW OFFICE 101**

**If you are the applicant or applicant's attorney and have questions about this file, please contact the Trademark Assistance Center at [TrademarkAssistanceCenter@uspto.gov](mailto:TrademarkAssistanceCenter@uspto.gov)**

**Current Location: 650 -Publication And Issue Section**

**Date In Location: 2006-10-24**

Exhibit 41

**Thank you for your request. Here are the latest results from the TARR web server.**

**This page was generated by the TARR system on 2007-06-13 14:37:19 ET**

**Serial Number: 78653262 Assignment Information**

**Registration Number: (NOT AVAILABLE)**

**Mark**

**America's source for gold  
and silver**

**(words only): AMERICA'S SOURCE FOR GOLD AND SILVER**

**Standard Character claim: Yes**

**Current Status: Abandoned-Failure To Respond Or Late Response**

**Date of Status: 2006-09-06**

**Filing Date: 2005-06-17**

**Transformed into a National Application: No**

**Registration Date: (DATE NOT AVAILABLE)**

**Register: Principal**

**Law Office Assigned: LAW OFFICE 110**

**If you are the applicant or applicant's attorney and have questions about this file, please contact the Trademark Assistance Center at [TrademarkAssistanceCenter@uspto.gov](mailto:TrademarkAssistanceCenter@uspto.gov)**

**Current Location: MIX -TMO Law Office 110 - Examining Attorney Assigned**

**Date In Location: 2006-09-06**

---

**LAST APPLICANT(S)/OWNER(S) OF RECORD**

---

1. CMI Gold & Silver, Inc.

**Address:**

CMI Gold & Silver, Inc.  
3550 N. Central Avenue, Suite 1407  
Phoenix, AZ 850122112  
United States

**Legal Entity Type:** Corporation

**State or Country of Incorporation:** Arizona

**Phone Number:** 602-234-2300

**Fax Number:** 602-234-2499

---

**GOODS AND/OR SERVICES**

---

**International Class:** 014

**Class Status:** Active

Precious metals such as gold, silver and platinum

**Basis:** 1(b)

**First Use Date:** (DATE NOT AVAILABLE)

**First Use in Commerce Date:** (DATE NOT AVAILABLE)

---

**ADDITIONAL INFORMATION**

---

(NOT AVAILABLE)

---

**MADRID PROTOCOL INFORMATION**

---

(NOT AVAILABLE)

---

**PROSECUTION HISTORY**

---

2006-09-06 - Abandonment Notice Mailed - Failure To Respond

2006-09-06 - Abandonment - Failure To Respond Or Late Response

2006-01-12 - Non-final action e-mailed

2006-01-12 - Non-Final Action Written

Latest Status Info

2006-01-09 - Assigned To Examiner

2005-06-22 - New Application Entered In Tram

---

**ATTORNEY/CORRESPONDENT INFORMATION**

---

**Correspondent**

CMI GOLD & SILVER, INC.  
3550 N CENTRAL AVE STE 1407  
PHOENIX, AZ 85012-2112  
Phone Number: 602-234-2300  
Fax Number: 602-234-2499

---

Exhibit 42

**Thank you for your request. Here are the latest results from the TARR web server.**

**This page was generated by the TARR system on 2007-06-13 14:37:30 ET**

**Serial Number: 78559213 Assignment Information**

**Registration Number: (NOT AVAILABLE)**

**Mark**

**SILVERSILK**

**(words only): SILVERSILK**

**Standard Character claim: Yes**

**Current Status: A request for the first extension of time to file a statement of use has been granted.**

**Date of Status: 2007-05-07**

**Filing Date: 2005-02-02**

**The Notice of Allowance Date is: 2006-11-07**

**Transformed into a National Application: No**

**Registration Date: (DATE NOT AVAILABLE)**

**Register: Principal**

**Law Office Assigned: LAW OFFICE 117**

**Attorney Assigned:  
BALDWIN SCOTT Employee Location**

**Current Location: 700 -Intent To Use Section**

**Date In Location: 2006-11-07**



---

**LAST APPLICANT(S)/OWNER(S) OF RECORD**

---

1. Silver Silk LLC

**Address:**

Silver Silk LLC  
26 Sky Manor Road  
Pittstown, NJ 08867  
United States

**Legal Entity Type:** Ltd Liab Co

**State or Country Where Organized:** New Jersey

---

**GOODS AND/OR SERVICES**

---

**International Class:** 014

**Class Status:** Active

JEWELRY MADE IN WHOLE OR SUBSTANTIAL PART OF SILVER

**Basis:** 1(b)

**First Use Date:** (DATE NOT AVAILABLE)

**First Use in Commerce Date:** (DATE NOT AVAILABLE)

---

**ADDITIONAL INFORMATION**

---

(NOT AVAILABLE)

---

**MADRID PROTOCOL INFORMATION**

---

(NOT AVAILABLE)

---

**PROSECUTION HISTORY**

---

2007-05-07 - Extension 1 granted

2007-05-07 - Extension 1 filed

2007-05-07 - TEAS Extension Received

2006-11-07 - Notice of allowance - mailed

Latest Status Info

2006-08-15 - Published for opposition  
2006-07-26 - Notice of publication  
2006-05-26 - Law Office Publication Review Completed  
2006-05-18 - Assigned To LIE  
2006-05-02 - Approved for Pub - Principal Register (Initial exam)  
2006-04-06 - Amendment From Applicant Entered  
2006-03-16 - Communication received from applicant  
2006-03-16 - PAPER RECEIVED  
2005-09-12 - Non-final action mailed  
2005-09-12 - Non-Final Action Written  
2005-08-30 - Assigned To Examiner  
2005-02-10 - New Application Entered In Tram

---

**ATTORNEY/CORRESPONDENT INFORMATION**

---

**Attorney of Record**

Garron M. Hobson

**Correspondent**

GARRON M. HOBSON  
THORPE NORTH & WESTERN, LLP  
PO BOX 1219  
SANDY, UT 84091-1219  
Phone Number: (801) 566-6633  
Fax Number: (801) 566-0750

---

Exhibit 43

Latest Status Info

**Thank you for your request. Here are the latest results from the TARR web server.**

**This page was generated by the TARR system on 2007-06-13 14:37:43 ET**

**Serial Number: 78585012 Assignment Information**

**Registration Number: 3124880**

**Mark**

**Inspired Silver**

**(words only): INSPIRED SILVER**

**Standard Character claim: Yes**

**Current Status: Registered.**

**Date of Status: 2006-08-01**

**Filing Date: 2005-03-10**

**Transformed into a National Application: No**

**Registration Date: 2006-08-01**

**Register: Principal**

**Law Office Assigned: LAW OFFICE 101**

**If you are the applicant or applicant's attorney and have questions about this file, please contact the Trademark Assistance Center at [TrademarkAssistanceCenter@uspto.gov](mailto:TrademarkAssistanceCenter@uspto.gov)**

**Current Location: 650 -Publication And Issue Section**

**Date In Location: 2006-06-19**

---

**LAST APPLICANT(S)/OWNER(S) OF RECORD**

---

1. Ecommerce Innovations LLC

**Address:**

Ecommerce Innovations LLC  
2675 Skypark Drive suite 204  
torrance, CA 90505

United States

**Legal Entity Type:** LLC

**State or Country Where Organized:** Nevada

**Phone Number:** 310-539-5070

**Fax Number:** 310-539-5029

---

**GOODS AND/OR SERVICES**

---

**International Class:** 014

**Class Status:** Active

Sterling silver jewelry

**Basis:** 1(a)

**First Use Date:** 2003-01-01

**First Use in Commerce Date:** 2003-01-01

---

**ADDITIONAL INFORMATION**

---

**Disclaimer:** "SILVER"

---

**MADRID PROTOCOL INFORMATION**

---

(NOT AVAILABLE)

---

**PROSECUTION HISTORY**

---

2006-08-01 - Registered - Principal Register

2006-06-11 - Law Office Registration Review Completed

2006-06-02 - Assigned To LIE

2006-05-30 - Allowed for Registration - Principal Register (SOU accepted)

Latest Status Info

2006-05-18 - Teas/Email Correspondence Entered  
2006-05-11 - Communication received from applicant  
2006-05-11 - TEAS Response to Office Action Received  
2006-05-03 - NON-FINAL ACTION E-MAILED  
2006-05-03 - SU - Non-Final Action - Written  
2006-04-28 - Statement of use processing complete  
2006-04-10 - Amendment to Use filed  
2006-04-10 - TEAS Statement of Use Received  
2006-03-07 - Notice of allowance - mailed  
2005-12-13 - Published for opposition  
2005-11-23 - Notice of publication  
2005-10-17 - Law Office Publication Review Completed  
2005-10-07 - Assigned To LIE  
2005-09-30 - Approved for Pub - Principal Register (Initial exam)  
2005-09-30 - Examiners amendment e-mailed  
2005-09-30 - Examiners Amendment -Written  
2005-09-28 - Assigned To Examiner  
2005-03-16 - New Application Entered In Tram

---

**ATTORNEY/CORRESPONDENT INFORMATION**

---

**Correspondent**

ECOMMERCE INNOVATIONS LLC  
2675 SKYPARK DR STE 204  
TORRANCE, CA 90505-5330  
Phone Number: 310-539-5070  
Fax Number: 310-539-5029

---

Exhibit 44

**Thank you for your request. Here are the latest results from the TARR web server.**

**This page was generated by the TARR system on 2007-06-13 14:37:58 ET**

**Serial Number: 78640503 Assignment Information**

**Registration Number: 3111687**

**Mark**

**STUDIO SILVERSMITHS**

**(words only): STUDIO SILVERSMITHS**

**Standard Character claim: Yes**

**Current Status: Registered.**

**Date of Status: 2006-07-04**

**Filing Date: 2005-05-31**

**Transformed into a National Application: No**

**Registration Date: 2006-07-04**

**Register: Principal**

**Law Office Assigned: LAW OFFICE 108**

**If you are the applicant or applicant's attorney and have questions about this file, please contact the Trademark Assistance Center at [TrademarkAssistanceCenter@uspto.gov](mailto:TrademarkAssistanceCenter@uspto.gov)**

**Current Location: 650 -Publication And Issue Section**

**Date In Location: 2006-07-04**



---

**LAST APPLICANT(S)/OWNER(S) OF RECORD**

---

1. Godinger Silver Art Co., Ltd.

**Address:**

Godinger Silver Art Co., Ltd.

Room 230 225 Fifth Avenue

New York, NY 10010

United States

**Legal Entity Type:** Corporation

**State or Country of Incorporation:** New York

---

**GOODS AND/OR SERVICES**

---

**International Class:** 008

**Class Status:** Active

Stainless and silver-plate flatware, namely knives, forks, and spoons

**Basis:** 1(a)

**First Use Date:** 1999-02-01

**First Use in Commerce Date:** 1999-02-01

**International Class:** 014

**Class Status:** Active

Silver-plated giftware of precious metal, namely candlesticks, bowls, vases, decorative boxes, and figurines; Silver-plated hollowware of precious metal, namely serving ware for serving food, pitchers, bowls, drinking vessels, charger plates, vases, and serving trays

**Basis:** 1(a)

**First Use Date:** 1999-02-01

**First Use in Commerce Date:** 1999-02-01

**International Class:** 021

**Class Status:** Active

Stainless steel hollowware not of precious metal, namely serving ware for serving food, pitchers, bowls, drinking vessels, charger plates, vases, and serving trays

**Basis:** 1(a)

**First Use Date:** 1999-02-01

**First Use in Commerce Date:** 1999-02-01

---

**ADDITIONAL INFORMATION**

---

**Disclaimer:** SILVERSMITHS

**Section 2(f)**

**Prior Registration Number(s):**

2346215

2354207

2626768

---

**MADRID PROTOCOL INFORMATION**

---

(NOT AVAILABLE)

---

**PROSECUTION HISTORY**

---

- 2006-07-04 - Registered - Principal Register
- 2006-05-17 - Assignment Of Ownership Not Updated Automatically
- 2006-04-11 - Published for opposition
- 2006-03-22 - Notice of publication
- 2006-02-22 - Law Office Publication Review Completed
- 2006-02-17 - Assigned To LIE
- 2006-02-14 - Approved for Pub - Principal Register (Initial exam)
- 2006-02-14 - Examiner's Amendment Entered
- 2006-02-14 - EXAMINERS AMENDMENT E-MAILED
- 2006-02-14 - Examiners Amendment -Written
- 2006-02-10 - Previous allowance count withdrawn
- 2006-02-06 - Withdrawn From Pub - Og Review Query
- 2006-01-17 - Law Office Publication Review Completed
- 2006-01-13 - Assigned To LIE
- 2006-01-09 - Approved for Pub - Principal Register (Initial exam)
- 2006-01-05 - Examiner's Amendment Entered

Latest Status Info

2006-01-03 - Examiners amendment e-mailed

2006-01-03 - Examiners Amendment -Written

2005-12-21 - Assigned To Examiner

2005-06-07 - New Application Entered In Tram

---

**ATTORNEY/CORRESPONDENT INFORMATION**

---

**Attorney of Record**

Edward M. Weisz

**Correspondent**

EDWARD M. WEISZ

COHEN, PONTANI, LIEBERMAN & PAVANE

551 5TH AVE RM 1210

NEW YORK, NY 10176-0091

Phone Number: 212-687-2770

Fax Number: 212-972-5487

---

Exhibit 45

Exhibit 46

**Thank you for your request. Here are the latest results from the TARR web server.**

**This page was generated by the TARR system on 2007-06-13 14:38:12 ET**

**Serial Number: 78138235 Assignment Information**

**Registration Number: 3200283**

**Mark (words only): SILVER ELITE**

**Standard Character claim: No**

**Current Status: Registered.**

**Date of Status: 2007-01-23**

**Filing Date: 2002-06-24**

**Transformed into a National Application: No**

**Registration Date: 2007-01-23**

**Register: Principal**

**Law Office Assigned: LAW OFFICE 117**

**If you are the applicant or applicant's attorney and have questions about this file, please contact the Trademark Assistance Center at TrademarkAssistanceCenter@uspto.gov**

**Current Location: 650 -Publication And Issue Section**

**Date In Location: 2007-01-23**

---

**LAST APPLICANT(S)/OWNER(S) OF RECORD**

---

1. Jostens, Inc.

**Address:**

Jostens, Inc.  
Suite 400 3601 Minnesota Drive  
Minneapolis, MN 55435  
United States

**Legal Entity Type: Corporation**

Latest Status Info

**State or Country of Incorporation:** Minnesota

**Phone Number:** 952-830-8428

**Fax Number:** 952-830-3380

---

**GOODS AND/OR SERVICES**

---

**International Class:** 014

**Class Status:** Active

precious metal alloys, namely, jewelry alloys consisting of silver and platinum sold as a component part of jewelry

**Basis:** 1(a)

**First Use Date:** 2002-06-24

**First Use in Commerce Date:** 2002-08-05

---

**ADDITIONAL INFORMATION**

---

**Disclaimer:** "SILVER"

---

**MADRID PROTOCOL INFORMATION**

---

(NOT AVAILABLE)

---

**PROSECUTION HISTORY**

---

2007-03-01 - TEAS Change Of Correspondence Received

2007-01-29 - Ex parte appeal terminated

2007-01-23 - Registered - Principal Register

2006-11-07 - Published for opposition

2006-10-18 - Notice of publication

2006-10-14 - Review Of Correspondence Complete

2006-10-06 - TEAS Change Of Owner Address Received

2006-09-25 - Law Office Publication Review Completed

2006-09-25 - Assigned To LIE

Latest Status Info

2006-09-10 - Approved for Pub - Principal Register (Initial exam)  
2006-09-10 - Amendment to Use approved  
2006-09-10 - Teas/Email Correspondence Entered  
2006-08-21 - Communication received from applicant  
2006-08-21 - TEAS Response to Office Action Received  
2006-08-21 - Ex parte appeal - Instituted  
2006-08-21 - Jurisdiction Restored To Examining Attorney  
2006-08-21 - EXPARTE APPEAL RECEIVED AT TTAB  
2006-02-21 - Final refusal e-mailed  
2006-02-21 - Final Refusal Written  
2006-01-25 - LIE Checked Susp - To Atty For Action  
2005-07-05 - Report Completed Suspension Check Case Still Suspended  
2005-04-20 - Attorney Revoked And/Or Appointed  
2005-04-20 - TEAS Revoke/Appoint Attorney Received  
2005-03-18 - TEAS Change Of Correspondence Received  
2004-11-23 - Report Completed Suspension Check Case Still Suspended  
2004-09-20 - Unresponsive/Duplicate Paper Received  
2004-09-20 - PAPER RECEIVED  
2004-09-24 - TEAS Change Of Correspondence Received  
2003-11-19 - Letter of suspension mailed  
2003-09-26 - Communication received from applicant  
2003-10-27 - Case File In TICRS  
2003-09-26 - PAPER RECEIVED  
2003-08-26 - Non-final action mailed



Latest Status Info

2003-05-27 - Communication received from applicant

2003-05-27 - PAPER RECEIVED

2002-11-24 - Non-final action e-mailed

2002-10-25 - Assigned To Examiner

2002-10-21 - Amendment to use processing complete

2002-08-19 - Amendment to Use filed

2002-08-21 - Communication received from applicant

2002-08-19 - TEAS Amendment of Use Received

---

**ATTORNEY/CORRESPONDENT INFORMATION**

---

**Attorney of Record**

William E. Marames

**Correspondent**

Mark H. Tidman

Arent Fox LLP

1050 Connecticut Ave., NW

Washington DC 20036-5339

Phone Number: 202-715-8432

Fax Number: 202-857-6395

---

Exhibit 47

**Thank you for your request. Here are the latest results from the TARR web server.**

**This page was generated by the TARR system on 2007-06-13 14:38:27 ET**

**Serial Number: 78182759 Assignment Information**

**Registration Number: 2881358**

**Mark**

**SilverGolf**

**(words only): SILVERGOLF**

**Standard Character claim: No**

**Current Status: Registered.**

**Date of Status: 2004-09-07**

**Filing Date: 2002-11-07**

**Transformed into a National Application: No**

**Registration Date: 2004-09-07**

**Register: Principal**

**Law Office Assigned: LAW OFFICE 102**

**If you are the applicant or applicant's attorney and have questions about this file, please contact the Trademark Assistance Center at [TrademarkAssistanceCenter@uspto.gov](mailto:TrademarkAssistanceCenter@uspto.gov)**

**Current Location: 900 -File Repository (Franconia)**

**Date In Location: 2004-09-16**

---

**LAST APPLICANT(S)/OWNER(S) OF RECORD**

---

1. ROCHA MARES, MIGUEL

**Address:**

ROCHA MARES, MIGUEL  
PRIV.PROVIDENCIA No. 1 CASA 17  
MEXICO 10200

Mexico

**Legal Entity Type:** Individual

**Country of Citizenship:** Mexico

**Phone Number:** 52 55 56 81 82 64

---

**GOODS AND/OR SERVICES**

---

**International Class:** 014

**Class Status:** Active

SILVER TROPHY COINS

**Basis:** 1(a)

**First Use Date:** 2002-00-00

**First Use in Commerce Date:** 2002-00-00

---

**ADDITIONAL INFORMATION**

---

**Design Search Code(s):**

21.03.01 - Balls including playground balls, beach balls, billiard balls, tennis balls, bingo balls and lottery balls; Beach balls; Billiard balls; Bingo balls; Lottery balls; Paddle balls; Playground balls; Table tennis balls; Tennis balls

27.03.05 - Objects forming letters or numerals

---

**MADRID PROTOCOL INFORMATION**

---

(NOT AVAILABLE)

---

**PROSECUTION HISTORY**

---

2004-09-07 - Registered - Principal Register

2004-06-15 - Published for opposition

---

Latest Status Info

2004-05-26 - Notice of publication  
2004-04-06 - Approved for Pub - Principal Register (Initial exam)  
2004-03-11 - Communication received from applicant  
2004-03-11 - Email Received  
2004-03-11 - Email Received  
2004-01-07 - NON-FINAL ACTION E-MAILED  
2003-08-27 - Communication received from applicant  
2003-08-27 - FAX RECEIVED  
2003-04-15 - Non-final action e-mailed  
2003-03-28 - Assigned To Examiner

---

**ATTORNEY/CORRESPONDENT INFORMATION**

---

**Attorney of Record**  
ALBERT B. KIMBAL, JR.

**Correspondent**  
Bracewell & Patterson, LLP  
P.O. BOX 61389  
Houston, TX 77208

---

Exhibit 48

**Thank you for your request. Here are the latest results from the TARR web server.**

**This page was generated by the TARR system on 2007-06-13 14:38:39 ET**

**Serial Number: 78479286 Assignment Information**

**Registration Number: 3121812**

**Mark**



**(words only): MAGNOLIA SILVER JEWELRY**

**Standard Character claim: No**

**Current Status: Registered.**

**Date of Status: 2006-07-25**

**Filing Date: 2004-09-07**

**Transformed into a National Application: No**

**Registration Date: 2006-07-25**

**Register: Principal**

**Law Office Assigned: LAW OFFICE 114**

**If you are the applicant or applicant's attorney and have questions about this file, please contact the Trademark Assistance Center at [TrademarkAssistanceCenter@uspto.gov](mailto:TrademarkAssistanceCenter@uspto.gov)**

**Current Location: 650 -Publication And Issue Section**

**Date In Location: 2006-06-13**

---

**LAST APPLICANT(S)/OWNER(S) OF RECORD**

---

1. Magnolia Export Logistic Ltd.

**Address:**

Magnolia Export Logistic Ltd.  
23 Ta'as Street  
Kfar Saba 44425  
Israel

**Legal Entity Type:** Company

**State or Country Where Organized:** Israel

---

**GOODS AND/OR SERVICES**

---

**International Class:** 014

**Class Status:** Active

jewelry made substantially of silver; watches

**Basis:** 1(a)

**First Use Date:** 2004-10-31

**First Use in Commerce Date:** 2004-10-31

**International Class:** 035

**Class Status:** Active

retail store services in the field of jewelry and watches

**Basis:** 1(a)

**First Use Date:** 2004-10-31

**First Use in Commerce Date:** 2004-10-31

---

**ADDITIONAL INFORMATION**

---

**Color(s) Claimed:** The color(s) TAN, BLUE AND ORANGE is/are claimed as a feature of the mark.

**Description of Mark and Any Color Part(s):** The mark consists of blue lettering including a flower design with one orange petal, all on a tan field.

**Disclaimer:** "SILVER JEWELRY"

**Design Search Code(s):**

05.05.25 - Daffodils; Iris (flower); Other flowers

26.11.26 - Oblongs as carriers for words, letters or designs

---



## MADRID PROTOCOL INFORMATION

---

(NOT AVAILABLE)

---

### PROSECUTION HISTORY

---

2006-07-25 - Registered - Principal Register

2006-05-31 - Law Office Registration Review Completed

2006-05-19 - Assigned To LIE

2006-05-10 - Allowed for Registration - Principal Register (SOU accepted)

2006-05-10 - Assigned To Examiner

2006-05-08 - Statement of use processing complete

2006-04-24 - Amendment to Use filed

2006-04-24 - TEAS Statement of Use Received

2005-12-20 - Notice of allowance - mailed

2005-09-27 - Published for opposition

2005-09-07 - Notice of publication

2005-08-17 - Law Office Publication Review Completed

2005-08-12 - Assigned To LIE

2005-08-11 - Approved for Pub - Principal Register (Initial exam)

2005-08-11 - EXAMINERS AMENDMENT E-MAILED

2005-08-11 - Examiners Amendment -Written

2005-08-02 - Previous allowance count withdrawn

2005-07-22 - Law Office Publication Review Completed

2005-07-22 - Assigned To LIE

2005-07-18 - Approved for Pub - Principal Register (Initial exam)

Latest Status Info

2005-07-18 - EXAMINERS AMENDMENT E-MAILED

2005-07-18 - Examiners Amendment -Written

2005-07-18 - Assigned To Examiner

2005-03-23 - NON-FINAL ACTION E-MAILED

2005-03-23 - Non-Final Action Written

2005-03-04 - Letter of suspension e-mailed

2005-03-04 - Suspension Letter Written

2005-02-20 - Assigned To Examiner

2005-01-27 - Applicant amendment prior to exam entered

2005-01-27 - TEAS Preliminary Amendment Received

2004-09-14 - New Application Entered In Tram

---

**ATTORNEY/CORRESPONDENT INFORMATION**

---

**Attorney of Record**

Edward J. Chalfie

**Correspondent**

EDWARD J. CHALFIE

LADAS & PARRY LLP

SUITE 1200

224 SOUTH MICHIGAN AVENUE

CHICAGO, IL 60604

Phone Number: 312-427-1300

Fax Number: 312-427-6663

**Domestic Representative**

LADAS & PARRY LLP

Phone Number: 312-427-1300

Fax Number: 312-427-6663

---

Exhibit 49

**Thank you for your request. Here are the latest results from the TARR web server.**

**This page was generated by the TARR system on 2007-06-13 14:38:53 ET**

**Serial Number: 78454285 Assignment Information**

**Registration Number: 3161557**

**Mark**

**TUSCANY SILVER**

**(words only): TUSCANY SILVER**

**Standard Character claim: Yes**

**Current Status: Registered.**

**Date of Status: 2006-10-24**

**Filing Date: 2004-07-21**

**Transformed into a National Application: No**

**Registration Date: 2006-10-24**

**Register: Principal**

**Law Office Assigned: LAW OFFICE 102**

**If you are the applicant or applicant's attorney and have questions about this file, please contact the Trademark Assistance Center at [TrademarkAssistanceCenter@uspto.gov](mailto:TrademarkAssistanceCenter@uspto.gov)**

**Current Location: 650 -Publication And Issue Section**

**Date In Location: 2006-10-24**

---

**LAST APPLICANT(S)/OWNER(S) OF RECORD**

---

1. International Bullion and Metal Brokers, Inc.

**Address:**

International Bullion and Metal Brokers, Inc.  
14051 NW 14th Street  
Sunrise, FL 33323  
United States

**Legal Entity Type:** Corporation

**State or Country of Incorporation:** Florida

**Phone Number:** 954 660 6900

**Fax Number:** 954 660 6925

---

**GOODS AND/OR SERVICES**

---

**International Class:** 014

**Class Status:** Active

Sterling Silver jewelry, namely, necklaces, bracelets, earrings, rings, pendants, and ankle bracelets produced from Tuscany part of Italy

**Basis:** 1(a)

**First Use Date:** 1990-12-00

**First Use in Commerce Date:** 1990-12-00

---

**ADDITIONAL INFORMATION**

---

**Disclaimer:** "SILVER"

**Section 2(f)**

---

**MADRID PROTOCOL INFORMATION**

---

(NOT AVAILABLE)

---

**PROSECUTION HISTORY**

---

2006-10-24 - Registered - Principal Register

2006-08-08 - Published for opposition

2006-07-19 - Notice of publication

Latest Status Info

2006-06-21 - Law Office Publication Review Completed

2006-06-19 - Assigned To LIE

2006-06-12 - Approved for Pub - Principal Register (Initial exam)

2006-06-06 - Letter of suspension mailed

2006-06-06 - Suspension Letter Written

2006-03-28 - Final refusal mailed

2006-03-28 - Final Refusal Written

2006-03-02 - Amendment From Applicant Entered

2006-02-14 - Communication received from applicant

2006-02-14 - PAPER RECEIVED

2006-01-04 - Non-final action mailed

2006-01-04 - Non-Final Action Written

2005-11-29 - Amendment From Applicant Entered

2005-11-16 - Communication received from applicant

2005-11-16 - TEAS Response to Office Action Received

2005-10-17 - Correspondence Mailed

2005-10-17 - Non-Final Action Written

2005-09-22 - Amendment From Applicant Entered

2005-09-07 - Communication received from applicant

2005-09-07 - PAPER RECEIVED

2005-07-27 - Amendment From Applicant Entered

2005-07-20 - Unresponsive/Duplicate Paper Received

2005-07-20 - PAPER RECEIVED

Latest Status Info

2005-05-16 - NON-FINAL ACTION E-MAILED  
2005-05-16 - Non-Final Action Written  
2005-05-13 - Teas/Email Correspondence Entered  
2005-05-05 - Communication received from applicant  
2005-05-04 - Attorney Revoked And/Or Appointed  
2005-05-04 - TEAS Revoke/Appoint Attorney Received  
2005-05-04 - Attorney Revoked And/Or Appointed  
2005-05-04 - TEAS Revoke/Appoint Attorney Received  
2005-05-05 - TEAS Response to Office Action Received  
2005-03-01 - Non-final action e-mailed  
2005-03-01 - Non-Final Action Written  
2005-02-24 - Assigned To Examiner  
2004-12-08 - Applicant amendment prior to exam entered  
2004-12-08 - TEAS Amendment of Use Received  
2004-07-30 - New Application Entered In Tram

---

**ATTORNEY/CORRESPONDENT INFORMATION**

---

**Attorney of Record**

Robert L. Epstein

**Correspondent**

Robert L. Epstein  
EPSTEIN DRANGEL BAZERMAN & JAMES, LLP  
60 East 42nd, Suite 820  
New York, New York 10165  
Phone Number: (212) 292-5390

**Domestic Representative**

MALOU CABRERA  
Phone Number: 9546606900

Exhibit 50



**Thank you for your request. Here are the latest results from the TARR web server.**

**This page was generated by the TARR system on 2007-06-13 14:39:03 ET**

**Serial Number: 78457474 Assignment Information**

**Registration Number: (NOT AVAILABLE)**

**Mark**

**SILVER DESIGN**

**(words only): SILVER DESIGN**

**Standard Character claim: Yes**

**Current Status: Abandoned-Failure To Respond Or Late Response**

**Date of Status: 2006-09-20**

**Filing Date: 2004-07-27**

**Transformed into a National Application: No**

**Registration Date: (DATE NOT AVAILABLE)**

**Register: Principal**

**Law Office Assigned: LAW OFFICE 110**

**If you are the applicant or applicant's attorney and have questions about this file, please contact the Trademark Assistance Center at TrademarkAssistanceCenter@uspto.gov**

**Current Location: MIX -TMO Law Office 110 - Examining Attorney Assigned**

**Date In Location: 2006-09-20**

**LAST APPLICANT(S)/OWNER(S) OF RECORD**

---

1. DABBAIN, BARJAS, B.

**Address:**

DABBAIN, BARJAS, B.  
942 SOUTH MAIN STREET  
NICHOLASVILLE, KY 40356  
United States

**Legal Entity Type:** Corporation

**State or Country of Incorporation:** Kentucky

**Phone Number:** 859-881-0852

**Fax Number:** 859-881-4639

---

**GOODS AND/OR SERVICES**

---

**International Class:** 014

**Class Status:** Active

STERLING SILVER JEWELRY AND GIFTS

**Basis:** 1(b)

**First Use Date:** (DATE NOT AVAILABLE)

**First Use in Commerce Date:** (DATE NOT AVAILABLE)

---

**ADDITIONAL INFORMATION**

---

(NOT AVAILABLE)

---

**MADRID PROTOCOL INFORMATION**

---

(NOT AVAILABLE)

---

**PROSECUTION HISTORY**

---

2006-09-20 - Abandonment Notice Mailed - Failure To Respond

2006-09-20 - Abandonment - Failure To Respond Or Late Response

2006-02-22 - NON-FINAL ACTION E-MAILED

2006-02-22 - Non-Final Action Written

Latest Status Info

2006-01-20 - Teas/Email Correspondence Entered  
2005-12-30 - Communication received from applicant  
2005-12-30 - TEAS Response to Office Action Received  
2005-12-15 - NON-FINAL ACTION E-MAILED  
2005-12-15 - Non-Final Action Written  
2005-11-01 - Teas/Email Correspondence Entered  
2005-10-28 - Communication received from applicant  
2005-10-27 - TEAS Response to Office Action Received  
2005-10-27 - Petition To Revive-Granted  
2005-10-27 - TEAS Petition To Revive Received  
2005-10-13 - Abandonment Notice Mailed - Failure To Respond  
2005-10-13 - Abandonment - Failure To Respond Or Late Response  
2005-10-13 - Assigned To Examiner  
2005-03-11 - Non-final action e-mailed  
2005-03-11 - Non-Final Action Written  
2005-03-01 - Assigned To Examiner  
2004-08-05 - New Application Entered In Tram

---

**ATTORNEY/CORRESPONDENT INFORMATION**

---

**Correspondent**

DABBAIN, BARJAS, B.  
942 S MAIN ST  
NICHOLASVILLE KY 40356-2152  
Phone Number: 859-881-0852  
Fax Number: 859-881-4639

---

Exhibit 51

**Thank you for your request. Here are the latest results from the TARR web server.**

**This page was generated by the TARR system on 2007-06-13 14:39:13 ET**

**Serial Number: 78278371 Assignment Information**

**Registration Number: 3124240**

**Mark (words only): ROSE SILVER**

**Standard Character claim: No**

**Current Status: Registered.**

**Date of Status: 2006-08-01**

**Filing Date: 2003-07-24**

**Transformed into a National Application: No**

**Registration Date: 2006-08-01**

**Register: Principal**

**Law Office Assigned: LAW OFFICE 109**

**If you are the applicant or applicant's attorney and have questions about this file, please contact the Trademark Assistance Center at TrademarkAssistanceCenter@uspto.gov**

**Current Location: 650 -Publication And Issue Section**

**Date In Location: 2006-06-23**

---

**LAST APPLICANT(S)/OWNER(S) OF RECORD**

---

**1. Brannen Brothers - Flutemakers, Inc.**

**Address:**

**Brannen Brothers - Flutemakers, Inc.**

**58 Dragon Court**

**Woburn, MA 01801**

**United States**

**Legal Entity Type: Corporation**

**State or Country of Incorporation:** Massachusetts

**Phone Number:** 781/935-9522

**Fax Number:** 781/937-3058

---

**GOODS AND/OR SERVICES**

---

**International Class:** 014

**Class Status:** Active

Precious metal alloy made of copper, silver and palladium for use in musical instruments, namely, flutes and flute parts

**Basis:** 1(a)

**First Use Date:** 2003-08-06

**First Use in Commerce Date:** 2003-08-06

**International Class:** 015

**Class Status:** Active

Flutes and flute parts, namely, flute headjoints and bodies made of precious metal alloy made of copper, silver and palladium

**Basis:** 1(a)

**First Use Date:** 2003-08-06

**First Use in Commerce Date:** 2003-08-06

---

**ADDITIONAL INFORMATION**

---

**Disclaimer:** "SILVER"

---

**MADRID PROTOCOL INFORMATION**

---

(NOT AVAILABLE)

---

**PROSECUTION HISTORY**

---

2006-08-01 - Registered - Principal Register

2006-06-16 - Law Office Registration Review Completed

2006-06-02 - Assigned To LIE

2006-05-22 - Allowed for Registration - Principal Register (SOU accepted)

2006-05-19 - Statement of use processing complete

Latest Status Info

2006-05-08 - Amendment to Use filed  
2006-05-08 - TEAS Statement of Use Received  
2005-11-15 - Notice of allowance - mailed  
2005-08-24 - New Noa To Issue  
2005-08-08 - Notice of Allowance canceled  
2005-08-15 - Petition To Revive-Granted  
2005-08-15 - TEAS Petition To Revive Received  
2005-02-08 - Notice of allowance - mailed  
2004-11-16 - Published for opposition  
2004-10-27 - Notice of publication  
2004-09-17 - Law Office Publication Review Completed  
2004-08-20 - Assigned To LIE  
2004-08-18 - Approved for Pub - Principal Register (Initial exam)  
2004-02-06 - Examiner's Amendment Entered  
2004-02-06 - Examiners amendment e-mailed  
2004-02-04 - Assigned To Examiner

---

**ATTORNEY/CORRESPONDENT INFORMATION**

---

**Correspondent**

Brannen Brothers - Flutemakers, Inc.  
58 Dragon Court  
Woburn, MA 01801  
Phone Number: 781/935-9522  
Fax Number: 781/937-3058

---

Exhibit 52



**Thank you for your request. Here are the latest results from the TARR web server.**

**This page was generated by the TARR system on 2007-06-13 14:39:23 ET**

**Serial Number: 78425839 Assignment Information**

**Registration Number: (NOT AVAILABLE)**

**Mark**

**SILVER PASSION**

**(words only): SILVER PASSION**

**Standard Character claim: Yes**

**Current Status: Abandoned-Failure To Respond Or Late Response**

**Date of Status: 2005-08-02**

**Filing Date: 2004-05-27**

**Transformed into a National Application: No**

**Registration Date: (DATE NOT AVAILABLE)**

**Register: Principal**

**Law Office Assigned: LAW OFFICE 115**

**If you are the applicant or applicant's attorney and have questions about this file, please contact the Trademark Assistance Center at TrademarkAssistanceCenter@uspto.gov**

**Current Location: M6X -TMO Law Office 115 - Examining Attorney Assigned**

**Date In Location: 2005-08-02**

**LAST APPLICANT(S)/OWNER(S) OF RECORD**

---

1. Harrigan, Lailah

**Composed Of:**

Lailah Harrigan - US Alex Harrigan - French

**Address:**

Harrigan, Lailah

Apt.# 3B 101 W. 128th Street

New York, NY 10027

United States

**Legal Entity Type:** Partnership

**State or Country Where Organized:** United States

**Phone Number:** 917-273-3067

**Fax Number:** 212-749-4506

---

**GOODS AND/OR SERVICES**

---

**International Class:** 014

**Class Status:** Active

Sterling Silver jewelry

**Basis:** 1(b)

**First Use Date:** (DATE NOT AVAILABLE)

**First Use in Commerce Date:** (DATE NOT AVAILABLE)

---

**ADDITIONAL INFORMATION**

---

(NOT AVAILABLE)

---

**MADRID PROTOCOL INFORMATION**

---

(NOT AVAILABLE)

---

**PROSECUTION HISTORY**

---

2005-08-02 - Abandonment Notice Mailed - Failure To Respond

2005-08-02 - Abandonment - Failure To Respond Or Late Response

2005-01-04 - Non-final action e-mailed

Latest Status Info

2005-01-04 - Non-Final Action Written

2005-01-01 - Assigned To Examiner

2004-06-02 - New Application Entered In Tram

---

**ATTORNEY/CORRESPONDENT INFORMATION**

---

**Correspondent**

Harrigan, Lailah

Apt.# 3B

101 W. 128th Street

New York, NY 10027

Phone Number: 917-273-3067

Fax Number: 212-749-4506

---

Exhibit 53

**Thank you for your request. Here are the latest results from the TARR web server.**

**This page was generated by the TARR system on 2007-06-13 14:39:33 ET**

**Serial Number: 78343921 Assignment Information**

**Registration Number: 2999110**

**Mark**

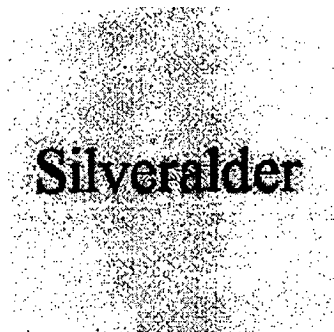

**(words only): SILVERALDER**

**Standard Character claim: Yes**

**Current Status: Registered.**

**Date of Status: 2005-09-20**

**Filing Date: 2003-12-20**

**Transformed into a National Application: No**

**Registration Date: 2005-09-20**

**Register: Principal**

**Law Office Assigned: LAW OFFICE 108**

**If you are the applicant or applicant's attorney and have questions about this file, please contact the Trademark Assistance Center at TrademarkAssistanceCenter@uspto.gov**

**Current Location: 650 -Publication And Issue Section**

**Date In Location: 2005-08-11**

**LAST APPLICANT(S)/OWNER(S) OF RECORD**

---

1. Westmoreland, Paul T.

**Address:**

Westmoreland, Paul T.  
10905 Terecita Road  
Tujunga, CA 91042  
United States

**Legal Entity Type:** Individual

**Country of Citizenship:** United States

**Phone Number:** 818-353-7039

**Fax Number:** 818-951-0919

---

**GOODS AND/OR SERVICES**

---

**International Class:** 014

**Class Status:** Active

Silver and gold jewelry including silver and gold plated jewelry

**Basis:** 1(a)

**First Use Date:** 2004-05-29

**First Use in Commerce Date:** 2005-03-09

---

**ADDITIONAL INFORMATION**

---

(NOT AVAILABLE)

---

**MADRID PROTOCOL INFORMATION**

---

(NOT AVAILABLE)

---

**PROSECUTION HISTORY**

---

2005-09-20 - Registered - Principal Register

2005-08-10 - Law Office Registration Review Completed

2005-08-05 - Assigned To LIE

2005-08-04 - Allowed for Registration - Principal Register (SOU accepted)

---

Latest Status Info

2005-07-05 - Statement of use processing complete  
2005-06-23 - Amendment to Use filed  
2005-06-23 - TEAS Statement of Use Received  
2005-04-12 - Notice of allowance - mailed  
2005-01-18 - Published for opposition  
2004-12-29 - Notice of publication  
2004-11-15 - Law Office Publication Review Completed  
2004-11-15 - Assigned To LIE  
2004-07-30 - Examiner's Amendment Entered  
2004-07-27 - Assigned To LIE  
2004-07-26 - Approved for Pub - Principal Register (Initial exam)  
2004-07-22 - Examiner's Amendment Entered  
2004-07-20 - Examiners amendment e-mailed  
2004-07-20 - Assigned To Examiner  
2004-01-07 - New Application Entered In Tram

---

**ATTORNEY/CORRESPONDENT INFORMATION**

---

**Correspondent**

Westmoreland Paul T.  
10905 Terecita Road  
Tujunga, CA 91042  
Phone Number: 818-353-7039  
Fax Number: 818-951-0919

---

Exhibit 54



**Thank you for your request. Here are the latest results from the TARR web server.**

**This page was generated by the TARR system on 2007-06-13 14:39:42 ET**

**Serial Number: 78280883 Assignment Information**

**Registration Number: (NOT AVAILABLE)**

**Mark**



**(words only): SILVER OYSTER**

**Standard Character claim: No**

**Current Status: Abandoned-Failure To Respond Or Late Response**

**Date of Status: 2004-09-21**

**Filing Date: 2003-07-30**

**Transformed into a National Application: No**

**Registration Date: (DATE NOT AVAILABLE)**

**Register: Principal**

**Law Office Assigned: LAW OFFICE 116**

**If you are the applicant or applicant's attorney and have questions about this file, please contact the Trademark Assistance Center at [TrademarkAssistanceCenter@uspto.gov](mailto:TrademarkAssistanceCenter@uspto.gov)**

**Current Location: 900 -File Repository (Franconia)**

**Date In Location: 2004-11-10**

**LAST APPLICANT(S)/OWNER(S) OF RECORD**

---

1. Stephens, Kelle

**Address:**

Stephens, Kelle  
1629 South Cobblestone Lane  
St. George, UT 84790  
United States  
**Legal Entity Type:** Individual  
**Country of Citizenship:** United States  
**Phone Number:** 435-674-0822

---

**GOODS AND/OR SERVICES**

---

**International Class:** 014  
**Class Status:** Active  
"Bridge" quality Jewelry, specifically pearls, semi-precious stones, and silver pieces  
**Basis:** 1(a)  
**First Use Date:** 2003-07-06  
**First Use in Commerce Date:** 2003-07-06

---

**ADDITIONAL INFORMATION**

---

**Design Search Code(s):**  
26.11.02 - Plain single line rectangles; Rectangles (single line)  
26.11.21 - Rectangles that are completely or partially shaded

---

**MADRID PROTOCOL INFORMATION**

---

(NOT AVAILABLE)

---

**PROSECUTION HISTORY**

---

2004-09-21 - Abandonment - Failure To Respond Or Late Response  
2004-02-20 - Non-final action e-mailed  
2003-08-20 - Assigned To Examiner

---

**ATTORNEY/CORRESPONDENT INFORMATION**

---

**Correspondent**

Stephens, Kelle

1629 COBBLESTONE LN

ST GEORGE UT 84790-8589

Phone Number: 435-674-0822

---

Exhibit 55

**Thank you for your request. Here are the latest results from the TARR web server.**

**This page was generated by the TARR system on 2007-06-13 14:40:11 ET**

**Serial Number: 78269210 Assignment Information**

**Registration Number: (NOT AVAILABLE)**

**Mark**

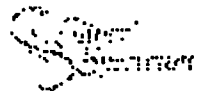

**(words only): SILVER SPECTRUM**

**Standard Character claim: No**

**Current Status: Abandoned-Failure To Respond Or Late Response**

**Date of Status: 2004-08-25**

**Filing Date: 2003-07-01**

**Transformed into a National Application: No**

**Registration Date: (DATE NOT AVAILABLE)**

**Register: Principal**

**Law Office Assigned: LAW OFFICE 116**

**If you are the applicant or applicant's attorney and have questions about this file, please contact the Trademark Assistance Center at TrademarkAssistanceCenter@uspto.gov**

**Current Location: 900 -File Repository (Franconia)**

**Date In Location: 2004-09-01**

**LAST APPLICANT(S)/OWNER(S) OF RECORD**

---

1. Star-Tex Imports, Inc. d/b/a Silver Express

**Address:**

Star-Tex Imports, Inc. d/b/a Silver Express  
6222 Richmond, Suite 490  
Houston, TX 77057  
United States

**Legal Entity Type:** Corporation

**State or Country of Incorporation:** Texas

**Phone Number:** 713-787-9898

**Fax Number:** 713-787-9292

---

**GOODS AND/OR SERVICES**

---

**International Class:** 014

**Class Status:** Active

Sterling silver and/or gold with or without precious stone and/or semi-precious stone in hair pin, earring, necklace, pendant, ring, bracelet, belt, buckle, and anklet; Sterling silver and/or gold with or without precious stone and/or semi-precious stone in hair pin, earring, necklace, pendant, ring, bracelet, belt, buckle, and anklet

**Basis:** 1(a)

**First Use Date:** 2003-06-30

**First Use in Commerce Date:** 2003-06-30

---

**ADDITIONAL INFORMATION**

---

**Design Search Code(s):**

26.17.02 - Bands, wavy; Bars, wavy; Lines, wavy; Wavy line(s), band(s) or bar(s)

26.17.04 - Bands, vertical; Bars, vertical; Lines, vertical; Vertical line(s), band(s) or bar(s)

---

**MADRID PROTOCOL INFORMATION**

---

(NOT AVAILABLE)

---

**PROSECUTION HISTORY**

---

2004-08-25 - Abandonment - Failure To Respond Or Late Response

---

Latest Status Info

2004-01-13 - Non-final action e-mailed

2004-01-12 - Assigned To Examiner

---

**ATTORNEY/CORRESPONDENT INFORMATION**

---

**Attorney of Record**

S. Bruce Hiran

**Correspondent**

S. Bruce Hiran

Monks, Monks, Monks & Hiran, P.C.

4545 Bissonnet, Suite 125

Bellaire, TX 77401

Phone Number: 713-666-7788

Fax Number: 713-666-9601

---

Exhibit 56



**Thank you for your request. Here are the latest results from the TARR web server.**

**This page was generated by the TARR system on 2007-06-13 14:40:28 ET**

**Serial Number: 78219062 Assignment Information**

**Registration Number: 2855953**

**Mark (words only): NANOSILVER BG**

**Standard Character claim: No**

**Current Status: Registered.**

**Date of Status: 2004-06-22**

**Filing Date: 2003-02-26**

**Transformed into a National Application: No**

**Registration Date: 2004-06-22**

**Register: Principal**

**Law Office Assigned: LAW OFFICE 103**

**If you are the applicant or applicant's attorney and have questions about this file, please contact the Trademark Assistance Center at TrademarkAssistanceCenter@uspto.gov**

**Current Location: 900 -File Repository (Franconia)**

**Date In Location: 2004-07-08**

---

**LAST APPLICANT(S)/OWNER(S) OF RECORD**

---

**1. Bio-Gate Bioinnovative Materials GmbH**

**Address:**

**Bio-Gate Bioinnovative Materials GmbH**

**Neumeyer Str. 48**

**Nurnberg 90411**

**Fed Rep Germany**

**Legal Entity Type: Corporation**

**State or Country of Incorporation:** Fed Rep Germany

---

**GOODS AND/OR SERVICES**

---

**International Class:** 005

**Class Status:** Active

All purpose disinfecting preparations and medicaments comprised of oily, non-watery and watery suspensions of finely dispersed metallic silver; all purpose disinfecting preparations and medicaments comprised of oily, non-watery and watery suspensions of finely dispersed metal; medicated ointments and creams containing finely dispersed metallic silver for pharmaceutical uses; medicated ointments and creams containing finely dispersed metal for pharmaceutical uses; pharmaceutical preparations comprised of powdered silver used in antibacterial and anti-inflammatory applications; pharmaceutical preparations comprised of powdered metal used in antibacterial and anti-inflammatory applications

**Basis:** 44(e)

**First Use Date:** (DATE NOT AVAILABLE)

**First Use in Commerce Date:** (DATE NOT AVAILABLE)

**International Class:** 006

**Class Status:** Active

Common metal in powdered form for further manufacture

**Basis:** 44(e)

**First Use Date:** (DATE NOT AVAILABLE)

**First Use in Commerce Date:** (DATE NOT AVAILABLE)

**International Class:** 014

**Class Status:** Active

Powdered precious metals; powdered silver

**Basis:** 44(e)

**First Use Date:** (DATE NOT AVAILABLE)

**First Use in Commerce Date:** (DATE NOT AVAILABLE)

---

**ADDITIONAL INFORMATION**

---

**Disclaimer:** "NANOSILVER"

**Foreign Application Number:** 30244197.2/0

**Foreign Registration Number:** 30244197

**Foreign Registration Date:** 2002-11-26

**Country:** Fed Rep Germany

**Foreign Filing Date:** 2002-09-04

**Foreign Expiration Date:** 2012-09-30

---

---

**MADRID PROTOCOL INFORMATION**

---

(NOT AVAILABLE)

---

**PROSECUTION HISTORY**

---

2004-06-22 - Registered - Principal Register  
2004-03-30 - Published for opposition  
2004-03-12 - Notice of publication  
2004-03-10 - Notice of publication  
2004-01-29 - Approved for Pub - Principal Register (Initial exam)  
2003-11-19 - Communication received from applicant  
2003-11-19 - ITU claim deleted  
2003-11-24 - Communication received from applicant  
2003-11-24 - PAPER RECEIVED  
2003-08-21 - Non-final action mailed  
2003-08-13 - Assigned To Examiner

---

**ATTORNEY/CORRESPONDENT INFORMATION**

---

**Attorney of Record**

Patricia A. Cigelnik

**Correspondent**

Patricia A. Cigelnik  
53 W JACKSON BLVD STE 1616  
CHICAGO IL 60604-3750  
Phone Number: 312-922-6262  
Fax Number: 312-922-7747

**Domestic Representative**

Patricia A. Cigelnik  
Phone Number: 312-922-6262

Exhibit 57

**Thank you for your request. Here are the latest results from the TARR web server.**

**This page was generated by the TARR system on 2007-06-13 14:40:38 ET**

**Serial Number: 78203783 Assignment Information**

**Registration Number: (NOT AVAILABLE)**

**Mark**

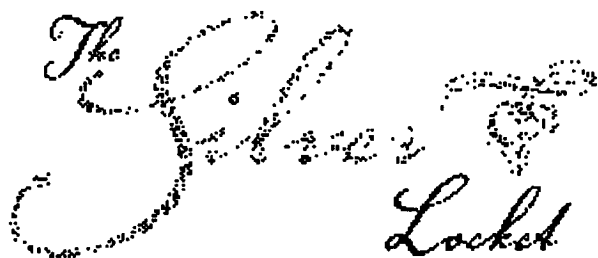

**(words only): THE SILVER LOCKET**

**Standard Character claim: No**

**Current Status: Abandoned-Failure To Respond Or Late Response**

**Date of Status: 2004-09-27**

**Filing Date: 2003-01-15**

**Transformed into a National Application: No**

**Registration Date: (DATE NOT AVAILABLE)**

**Register: Principal**

**Law Office Assigned: LAW OFFICE 111**

**If you are the applicant or applicant's attorney and have questions about this file, please contact the Trademark Assistance Center at TrademarkAssistanceCenter@uspto.gov**

**Current Location: 900 -File Repository (Franconia)**

**Date In Location: 2004-10-04**

---

**LAST APPLICANT(S)/OWNER(S) OF RECORD**

---

1. The Silver Locket, LLC

**Address:**

The Silver Locket, LLC  
2000-28 Ricerchase Galleria  
Hoover, AL 35124  
United States

**Legal Entity Type:** Ltd Liab Co

**State or Country Where Organized:** (NOT AVAILABLE)

**Phone Number:** 205-985-3370

**Fax Number:** 205-621-8451

---

**GOODS AND/OR SERVICES**

---

**International Class:** 014

**Class Status:** Active

Engravable Sterling Silver Jewelry and related gift items

**Basis:** 1(b)

**First Use Date:** (DATE NOT AVAILABLE)

**First Use in Commerce Date:** (DATE NOT AVAILABLE)

---

**ADDITIONAL INFORMATION**

---

**Design Search Code(s):**

02.11.01 - Hearts excluding hearts as carriers or depicted on playing cards

17.03.02 - Bracelets; Chains, jewelry; Chokers (jewelry); Dog tags (military identification); Necklaces; Tags, identification (metal)

---

**MADRID PROTOCOL INFORMATION**

---

(NOT AVAILABLE)

---

**PROSECUTION HISTORY**

---

2004-09-27 - Abandonment Notice Mailed - Failure To Respond

2004-09-27 - Abandonment - Failure To Respond Or Late Response

---

Latest Status Info

2004-08-12 - Assigned To Examiner

2004-02-28 - Final refusal e-mailed

2004-01-02 - Communication received from applicant

2004-01-06 - Email Received

2003-06-30 - Non-final action e-mailed

2003-06-25 - Assigned To Examiner

---

**ATTORNEY/CORRESPONDENT INFORMATION**

---

**Correspondent**

Tracy Lee

The Silver Locket, LLC

2000-28 Ricerchase Galleria

Hoover AL 35244

Phone Number: 205-985-3370

Fax Number: 205-621-8451

---

Exhibit 58



**Thank you for your request. Here are the latest results from the TARR web server.**

**This page was generated by the TARR system on 2007-06-13 14:40:50 ET**

**Serial Number: 78200579 Assignment Information**

**Registration Number: 3039869**

**Mark (words only): MAGNOLIA SILVER**

**Standard Character claim: No**

**Current Status: Registered.**

**Date of Status: 2006-01-10**

**Filing Date: 2003-01-07**

**Transformed into a National Application: No**

**Registration Date: 2006-01-10**

**Register: Principal**

**Law Office Assigned: LAW OFFICE 104**

**If you are the applicant or applicant's attorney and have questions about this file, please contact the Trademark Assistance Center at TrademarkAssistanceCenter@uspto.gov**

**Current Location: 650 -Publication And Issue Section**

**Date In Location: 2006-01-10**

---

**LAST APPLICANT(S)/OWNER(S) OF RECORD**

---

**1. Magnolia Export Logistics Ltd.**

**Address:**

Magnolia Export Logistics Ltd.

23 Ta'as Street

Kfar Saba 44425

Israel

**Legal Entity Type: Company**

**State or Country Where Organized: Israel**

---

**GOODS AND/OR SERVICES**

---

**International Class: 014**

**Class Status: Active**

**Jewelry made substantially of silver, not including watches**

**Basis: 44(e)**

**First Use Date: (DATE NOT AVAILABLE)**

**First Use in Commerce Date: (DATE NOT AVAILABLE)**

---

**ADDITIONAL INFORMATION**

---

**Disclaimer: "SILVER"**

**Foreign Application Number: 161933**

**Foreign Registration Number: 161933**

**Foreign Registration Date: 2004-02-03**

**Country: Israel**

**Foreign Filing Date: 2002-12-22**

**Foreign Expiration Date: 2009-12-22**

---

**MADRID PROTOCOL INFORMATION**

---

(NOT AVAILABLE)

---

**PROSECUTION HISTORY**

---

2006-01-10 - Registered - Principal Register

2005-10-18 - Published for opposition

2005-09-28 - Notice of publication

2005-07-01 - Law Office Publication Review Completed

2005-06-28 - Assigned To LIE

2005-06-21 - Approved for Pub - Principal Register (Initial exam)

2005-06-06 - LETTER OF SUSPENSION E-MAILED

Latest Status Info

2005-06-06 - Suspension Letter Written  
2005-06-06 - Teas/Email Correspondence Entered  
2005-05-23 - Communication received from applicant  
2005-05-23 - TEAS Response to Office Action Received  
2005-05-23 - TEAS Change Of Correspondence Received  
2004-11-24 - NON-FINAL ACTION E-MAILED  
2004-11-24 - Non-Final Action Written  
2004-11-19 - Petition To Revive-Granted  
2004-11-19 - TEAS Petition To Revive Received  
2004-11-15 - Abandonment Notice Mailed - Failure To Respond  
2004-11-15 - Abandonment - Failure To Respond Or Late Response  
2004-04-19 - INQUIRY TO SUSPENSION E-MAILED  
2003-12-24 - TEAS Change Of Correspondence Received  
2003-10-27 - LETTER OF SUSPENSION E-MAILED  
2003-09-24 - Communication received from applicant  
2003-09-24 - FAX RECEIVED  
2003-05-27 - Non-final action e-mailed  
2003-05-21 - Assigned To Examiner  
2003-03-12 - TEAS Preliminary Amendment Received

---

**ATTORNEY/CORRESPONDENT INFORMATION**

---

**Attorney of Record**  
Edward J. Chalfie

**Correspondent**  
Edward J. Chalfie

Latest Status Info

**Ladas & Parry LLP**

Suite 1600

224 South Michigan Avenue

Chicago IL 60604

Phone Number: (312) 427-1300

Fax Number: (312) 427-6663

**Domestic Representative**

Edward J. Chalfie

Phone Number: (312) 876-6656

Fax Number: (312) 876-0288

---

Exhibit 59

**Thank you for your request. Here are the latest results from the TARR web server.**

**This page was generated by the TARR system on 2007-06-13 14:41:00 ET**

**Serial Number: 78174292 Assignment Information**

**Registration Number: 2821170**

**Mark (words only): SILVER CONNECTION "JEWELRY FROM AROUND THE WORLD TO YOU"**

**Standard Character claim: No**

**Current Status: Registered.**

**Date of Status: 2004-03-09**

**Filing Date: 2002-10-14**

**Transformed into a National Application: No**

**Registration Date: 2004-03-09**

**Register: Principal**

**Law Office Assigned: LAW OFFICE 113**

**If you are the applicant or applicant's attorney and have questions about this file, please contact the Trademark Assistance Center at TrademarkAssistanceCenter@uspto.gov**

**Current Location: 900 -File Repository (Franconia)**

**Date In Location: 2004-03-15**

---

**LAST APPLICANT(S)/OWNER(S) OF RECORD**

---

1. Silver Connection, L.L.C., The

**Address:**

Silver Connection, L.L.C., The

9916 S. Roseboro Road

Sandy, UT 84092

United States

**Legal Entity Type: Ltd Liab Co**

**State or Country Where Organized:** Utah

**Phone Number:** 801-501-0087

**Fax Number:** 801-501-0087

---

**GOODS AND/OR SERVICES**

---

**International Class:** 014

**Class Status:** Active

sterling silver jewelry-- rings, earrings, necklaces, bracelets, pendants, anklets, lockets, watches

**Basis:** 1(a)

**First Use Date:** 1997-10-01

**First Use in Commerce Date:** 1997-10-01

---

**ADDITIONAL INFORMATION**

---

**Disclaimer:** "SILVER" and "JEWELRY FROM AROUND THE WORLD"

---

**MADRID PROTOCOL INFORMATION**

---

(NOT AVAILABLE)

---

**PROSECUTION HISTORY**

---

2004-03-09 - Registered - Principal Register

2003-12-16 - Published for opposition

2003-11-26 - Notice of publication

2003-10-10 - Approved for Pub - Principal Register (Initial exam)

2003-09-10 - Communication received from applicant

2003-09-10 - PAPER RECEIVED

2003-03-13 - Non-final action e-mailed

2003-03-12 - Assigned To Examiner

---

**ATTORNEY/CORRESPONDENT INFORMATION**

---

Latest Status Info

**Correspondent**

The Silver Connection, L.L.C.

9916 S. Roseboro Road

Sandy UT 84092

Phone Number: 801-501-0087

Fax Number: 801-501-0087

---



Exhibit 60

**Thank you for your request. Here are the latest results from the TARR web server.**

**This page was generated by the TARR system on 2007-06-13 14:41:15 ET**

**Serial Number: 78155560 Assignment Information**

**Registration Number: (NOT AVAILABLE)**

**Mark (words only): KARA SILVER**

**Standard Character claim: No**

**Current Status: Abandoned-Failure To Respond Or Late Response**

**Date of Status: 2004-03-25**

**Filing Date: 2002-08-19**

**Transformed into a National Application: No**

**Registration Date: (DATE NOT AVAILABLE)**

**Register: Principal**

**Law Office Assigned: LAW OFFICE 112**

**If you are the applicant or applicant's attorney and have questions about this file, please contact the Trademark Assistance Center at TrademarkAssistanceCenter@uspto.gov**

**Current Location: 900 -File Repository (Franconia)**

**Date In Location: 2004-04-14**

---

**LAST APPLICANT(S)/OWNER(S) OF RECORD**

---

**1. Harun, Kara**

**Address:**

Harun, Kara  
635 S. Hill Street Suite 601  
Los Angeles, CA 90014  
United States

**Legal Entity Type: Individual**

**Country of Citizenship:** Turkey

**Phone Number:** 213-627-0776

**Fax Number:** 213-627-0779

---

**GOODS AND/OR SERVICES**

---

**International Class:** 014

**Class Status:** Active

Non-electric sterling silver tea sets; candelabras, candle sticks, cups, goblets, salt and pepper shakers, napkin rings, and coolers and decanters for wine or water sold as a unit and separately all made of precious metal; sterling silver dress-ware comprised of brushes, combo and hand-held mirrors sold as a unit and separately; sterling silver and silver-plate serve-ware, namely, salad tongs, pie servers, cake servers, serving ladles, bowls and pitchers; sterling silver and silver-plate giftware, namely, picture frames, dispensers for pills or capsules, vases, vanity trays and decorative boxes

**Basis:** 1(b)

**First Use Date:** (DATE NOT AVAILABLE)

**First Use in Commerce Date:** (DATE NOT AVAILABLE)

---

**ADDITIONAL INFORMATION**

---

(NOT AVAILABLE)

---

**MADRID PROTOCOL INFORMATION**

---

(NOT AVAILABLE)

---

**PROSECUTION HISTORY**

---

2004-03-25 - Abandonment - Failure To Respond Or Late Response

2004-03-17 - Case File In TICRS

2003-08-05 - NON-FINAL ACTION E-MAILED

2003-06-02 - Communication received from applicant

2003-06-02 - PAPER RECEIVED

2003-01-26 - Non-final action e-mailed

2003-01-22 - Assigned To Examiner

---

**ATTORNEY/CORRESPONDENT INFORMATION**

---

**Attorney of Record**  
Raffi Nizamian

**Correspondent**  
Raffi Nizamian  
Kedikian & Nizamian  
3055 Wilshire Blvd.  
Suite 630  
Los Angeles CA 90010  
Phone Number: 213-487-7150  
Fax Number: 213-487-7160

---

Exhibit 61

**Thank you for your request. Here are the latest results from the TARR web server.**

**This page was generated by the TARR system on 2007-06-13 14:41:48 ET**

**Serial Number: 78126925 Assignment Information**

**Registration Number: 2784203**

**Mark**



**DECORATE YOUR BODY**

**(words only): SILVER EFFECTS DECORATE YOUR BODY**

**Standard Character claim: No**

**Current Status: Registered.**

**Date of Status: 2003-11-18**

**Filing Date: 2002-05-07**

**Transformed into a National Application: No**

**Registration Date: 2003-11-18**

**Register: Principal**

**Law Office Assigned: LAW OFFICE 113**

**If you are the applicant or applicant's attorney and have questions about this file, please contact the Trademark Assistance Center at TrademarkAssistanceCenter@uspto.gov**

**Current Location: 900 -File Repository (Franconia)**

**Date In Location: 2004-01-20**

---

**LAST APPLICANT(S)/OWNER(S) OF RECORD**

---

1. Reigle, James

**Address:**

Reigle, James  
8621 West Laurel Lane  
Peoria, AZ 85345  
United States

**Legal Entity Type:** Individual

**Country of Citizenship:** United States

**Phone Number:** (602) 430-3456

**Fax Number:** (623) 334-8665

---

**GOODS AND/OR SERVICES**

---

**International Class:** 014

**Class Status:** Active

Silver Jewelry

**Basis:** 1(a)

**First Use Date:** 2002-03-01

**First Use in Commerce Date:** 2002-03-01

**International Class:** 035

**Class Status:** Active

Retail stores featuring silver jewelry

**Basis:** 1(a)

**First Use Date:** 2002-03-01

**First Use in Commerce Date:** 2002-03-01

---

**ADDITIONAL INFORMATION**

---

**Disclaimer:** "SILVER"

**Design Search Code(s):**

26.03.21 - Ovals that are completely or partially shaded

---

**MADRID PROTOCOL INFORMATION**

---

(NOT AVAILABLE)

---

## PROSECUTION HISTORY

---

2003-11-18 - Registered - Principal Register  
2003-08-26 - Published for opposition  
2003-08-06 - Notice of publication  
2003-06-16 - Approved for Pub - Principal Register (Initial exam)  
2003-03-18 - Communication received from applicant  
2003-03-14 - Communication received from applicant  
2003-05-29 - Case File In TICRS  
2003-05-29 - Case File In TICRS  
2003-03-18 - PAPER RECEIVED  
2002-12-13 - Final refusal e-mailed  
2002-12-13 - Assigned To Examiner  
2002-11-14 - Communication received from applicant  
2002-11-14 - PAPER RECEIVED  
2002-08-23 - Non-final action mailed  
2002-08-22 - Assigned To Examiner

---

## ATTORNEY/CORRESPONDENT INFORMATION

---

### **Attorney of Record**

Edward Ribadeneira

### **Correspondent**

Edward Ribadeneira

The Law Offices of Wahl & Ribadeneira, P

4110 North Scottsdale Road, Suite 165

Scottsdale AZ 85251

Phone Number: (480)874-1313

Fax Number: (480)994-5141



Exhibit 62

**Thank you for your request. Here are the latest results from the TARR web server.**

**This page was generated by the TARR system on 2007-06-13 14:41:56 ET**

**Serial Number: 78125437 Assignment Information**

**Registration Number: (NOT AVAILABLE)**

**Mark (words only): SILVER AVENUE**

**Standard Character claim: No**

**Current Status: Abandoned after an inter partes decision by the Trademark Trial and Appeal Board.**

**Date of Status: 2004-12-08**

**Filing Date: 2002-05-01**

**Transformed into a National Application: No**

**Registration Date: (DATE NOT AVAILABLE)**

**Register: Principal**

**Law Office Assigned: LAW OFFICE 110**

**If you are the applicant or applicant's attorney and have questions about this file, please contact the Trademark Assistance Center at TrademarkAssistanceCenter@uspto.gov**

**Current Location: 845 -TTAB**

**Date In Location: 2004-12-08**

---

**LAST APPLICANT(S)/OWNER(S) OF RECORD**

---

**1. Ken Craft Inc.**

**Address:**

Ken Craft Inc.

303 Fifth Ave. # 2006

New York, NY 10016

United States

**Legal Entity Type: Corporation**

**State or Country of Incorporation:** New York

**Phone Number:** 2126868695

**Fax Number:** 2126843485

---

**GOODS AND/OR SERVICES**

---

**International Class:** 014

**Class Status:** Abandoned

JEWELRY MADE IN WHOLE OR OF SUBSTANTIAL PART OF SILVER, NAMELY RINGS, EARRINGS, CHARMS, PENDANTS, CHAINS, BRACELETS, PINS, NECKLACES AND BROACHES

**Basis:** 1(b)

**First Use Date:** (DATE NOT AVAILABLE)

**First Use in Commerce Date:** (DATE NOT AVAILABLE)

---

**ADDITIONAL INFORMATION**

---

**Disclaimer:** "SILVER"

---

**MADRID PROTOCOL INFORMATION**

---

(NOT AVAILABLE)

---

**PROSECUTION HISTORY**

---

2004-12-08 - Abandonment Notice Mailed - After Inter Partes Decision

2004-12-08 - Abandonment - After inter partes decision (Initial exam)

2004-12-08 - Opposition terminated for Proceeding

2004-10-05 - Opposition terminated for Proceeding

2004-10-05 - Opposition terminated for Proceeding

2004-05-13 - Abandonment - After inter partes decision (Initial exam)

2004-05-13 - Opposition sustained for Proceeding

2003-11-12 - Opposition instituted for Proceeding

2003-11-05 - Opposition papers filed

Latest Status Info

2003-11-11 - Published for opposition  
2003-10-22 - Notice of publication  
2003-03-06 - Extension Of Time To Oppose Received  
2003-01-28 - Published for opposition  
2003-01-08 - Notice of publication  
2002-11-04 - Approved for Pub - Principal Register (Initial exam)  
2002-10-15 - Communication received from applicant  
2002-10-15 - PAPER RECEIVED  
2002-09-10 - Non-final action mailed  
2002-09-06 - Assigned To Examiner

---

**ATTORNEY/CORRESPONDENT INFORMATION**

---

**Correspondent**

KEN CRAFT INC.  
303 FIFTH AVE. # 2006  
NEW YORK, NY 10016  
Phone Number: 2126868695  
Fax Number: 2126843485

---

Exhibit 63

**Thank you for your request. Here are the latest results from the TARR web server.**

**This page was generated by the TARR system on 2007-06-13 14:42:12 ET**

**Serial Number: 78112874 Assignment Information**

**Registration Number: (NOT AVAILABLE)**

**Mark**

***Sterling Silver States***

**(words only): STERLING SILVER STATES**

**Standard Character claim: No**

**Current Status: Abandoned-Failure To Respond Or Late Response**

**Date of Status: 2003-04-02**

**Filing Date: 2002-03-05**

**Transformed into a National Application: No**

**Registration Date: (DATE NOT AVAILABLE)**

**Register: Principal**

**Law Office Assigned: LAW OFFICE 102**

**If you are the applicant or applicant's attorney and have questions about this file, please contact the Trademark Assistance Center at TrademarkAssistanceCenter@uspto.gov**

**Current Location: 900 -File Repository (Franconia)**

**Date In Location: 2003-04-07**

---

**LAST APPLICANT(S)/OWNER(S) OF RECORD**

---

**1. Trident Corporation**

**Address:**

Latest Status Info

Trident Corporation  
5100 N. I-85 Service Rd. Suite 15  
Charlotte, NC 28206  
United States  
**Legal Entity Type:** Corporation  
**State or Country of Incorporation:** North Carolina  
**Phone Number:** 704 596 2250  
**Fax Number:** 704 596 9997

---

**GOODS AND/OR SERVICES**

---

**International Class:** 014

**Class Status:** Active

A wooden plaque product with cutouts for puzzle pieces in the shape of a map, especially the States of the United States which are made from precious metals, especially Sterling Silver.

**Basis:** 1(b)

**First Use Date:** (DATE NOT AVAILABLE)

**First Use in Commerce Date:** (DATE NOT AVAILABLE)

---

**ADDITIONAL INFORMATION**

---

(NOT AVAILABLE)

---

**MADRID PROTOCOL INFORMATION**

---

(NOT AVAILABLE)

---

**PROSECUTION HISTORY**

---

2003-04-02 - Abandonment - Failure To Respond Or Late Response

2002-08-12 - Non-final action e-mailed

2002-06-26 - Assigned To Examiner

---

**ATTORNEY/CORRESPONDENT INFORMATION**

---

**Correspondent**

Trident Corporation  
5100 N. I-85 Service Rd.

Latest Status Info

Suite 15

Charlotte NC 28206

Phone Number: 704 596 2250

Fax Number: 704 596 9997

---



Exhibit 64

**Thank you for your request. Here are the latest results from the TARR web server.**

**This page was generated by the TARR system on 2007-06-13 14:42:28 ET**

**Serial Number: 78100983 Assignment Information**

**Registration Number: (NOT AVAILABLE)**

**Mark (words only): HERSHEY LEATHER & SILVER**

**Standard Character claim: No**

**Current Status: Abandoned: Applicant's express request.**

**Date of Status: 2002-11-26**

**Filing Date: 2002-01-04**

**Transformed into a National Application: No**

**Registration Date: (DATE NOT AVAILABLE)**

**Register: Principal**

**Law Office Assigned: LAW OFFICE 102**

**If you are the applicant or applicant's attorney and have questions about this file, please contact the Trademark Assistance Center at TrademarkAssistanceCenter@uspto.gov**

**Current Location: 900 -File Repository (Franconia)**

**Date In Location: 2002-11-29**

---

**LAST APPLICANT(S)/OWNER(S) OF RECORD**

---

1. Interim Design, Inc,

**Address:**

Interim Design, Inc,

140 Clover Lane

Elizabethtown, PA 17022

United States

**Legal Entity Type: Corporation**

**State or Country of Incorporation:** Pennsylvania

---

**GOODS AND/OR SERVICES**

---

**International Class:** 014

**Class Status:** Active

SILVER CONTAINING JEWELRY NAMELY, BRACELETS, RINGS, NECKLACES, EARRINGS AND WATCHBANDS

**Basis:** 1(b)

**First Use Date:** (DATE NOT AVAILABLE)

**First Use in Commerce Date:** (DATE NOT AVAILABLE)

**International Class:** 018

**Class Status:** Active

LEATHER PURSES, BELTS AND WALLETS

**Basis:** 1(b)

**First Use Date:** (DATE NOT AVAILABLE)

**First Use in Commerce Date:** (DATE NOT AVAILABLE)

---

**ADDITIONAL INFORMATION**

---

(NOT AVAILABLE)

---

**MADRID PROTOCOL INFORMATION**

---

(NOT AVAILABLE)

---

**PROSECUTION HISTORY**

---

2002-11-26 - Abandonment - Express mailed

2002-10-24 - Communication received from applicant

2002-10-24 - PAPER RECEIVED

2002-05-22 - Non-final action mailed

2002-04-16 - Assigned To Examiner

---

**ATTORNEY/CORRESPONDENT INFORMATION**

---

Latest Status Info

**Attorney of Record**

G. Franklin Rothwell, Esq.

**Correspondent**

G. Franklin Rothwell, Esq.

ROTHWELL FIGG ERNST & MANBECK PC

1425 K ST NW STE 800

WASHINGTON DC 20005

Phone Number: (202) 783-6040

Fax Number: (202) 783-6031

---

Exhibit 65

**Thank you for your request. Here are the latest results from the TARR web server.**

**This page was generated by the TARR system on 2007-06-13 14:42:40 ET**

**Serial Number: 78079528 Assignment Information**

**Registration Number: 2773527**

**Mark (words only): SILVER ANVIL**

**Standard Character claim: No**

**Current Status: Registered.**

**Date of Status: 2003-10-14**

**Filing Date: 2001-08-16**

**Transformed into a National Application: No**

**Registration Date: 2003-10-14**

**Register: Principal**

**Law Office Assigned: LAW OFFICE 115**

**If you are the applicant or applicant's attorney and have questions about this file, please contact the Trademark Assistance Center at TrademarkAssistanceCenter@uspto.gov**

**Current Location: 900 -File Repository (Franconia)**

**Date In Location: 2003-10-20**

---

**LAST APPLICANT(S)/OWNER(S) OF RECORD**

---

**1. Metalsmith Master Architects Of Jewelry Inc.**

**Address:**

**Metalsmith Master Architects Of Jewelry Inc.**

**210, 9016 - 51 Avenue**

**Edmonton T6E 5X4**

**Canada**

**Legal Entity Type: Corporation**

**State or Country of Incorporation:** Canada

**Phone Number:** (780)490-5522

**Fax Number:** (780)490-1450

---

**GOODS AND/OR SERVICES**

---

**International Class:** 014

**Class Status:** Active

Jewelry; Costume jewelry, Precious metal and non-precious metal jewelry, Jewelry with and without precious gemstones, Precious gemstones, Semi-precious gemstones, Jewelry, namely rings, hair ornaments, earrings, bracelets, bangles, bands, necklaces, pendants, pins, brooches and body jewelry, Jewelry, namely sterling silver jewelry, Watches, Beads, Pearls

**Basis:** 44(e)

**First Use Date:** (DATE NOT AVAILABLE)

**First Use in Commerce Date:** (DATE NOT AVAILABLE)

**International Class:** 035

**Class Status:** Active

Retail jewelry store; mail order services featuring jewelry; computerized on-line retail services in the field of jewelry; telephone shop at home services in the field of jewelry; retail store services, available through computer communications, featuring jewelry

**Basis:** 44(e)

**First Use Date:** (DATE NOT AVAILABLE)

**First Use in Commerce Date:** (DATE NOT AVAILABLE)

---

**ADDITIONAL INFORMATION**

---

**Disclaimer:** "SILVER"

**Foreign Application Number:** 1,093,696

**Foreign Registration Number:** 575225

**Foreign Registration Date:** 2003-02-06

**Country:** Canada

**Foreign Filing Date:** 2003-02-06

**Foreign Expiration Date:** 2018-02-06

---

**MADRID PROTOCOL INFORMATION**

---

(NOT AVAILABLE)

---

## PROSECUTION HISTORY

---

2003-10-14 - Registered - Principal Register  
2003-07-22 - Published for opposition  
2003-07-02 - Notice of publication  
2003-05-23 - Approved for Pub - Principal Register (Initial exam)  
2003-05-13 - ITU claim deleted  
2003-05-13 - EXAMINERS AMENDMENT E-MAILED  
2003-05-06 - Assigned To Examiner  
2003-03-13 - Communication received from applicant  
2003-03-13 - PAPER RECEIVED  
2003-02-13 - LETTER OF SUSPENSION E-MAILED  
2002-11-18 - Communication received from applicant  
2002-10-08 - Assigned To Examiner  
2002-10-08 - Assigned To Examiner  
2002-10-08 - Assigned To Examiner  
2002-08-29 - Non-final action mailed  
2002-03-11 - Communication received from applicant  
2002-03-08 - Communication received from applicant  
2001-10-01 - Non-final action mailed  
2001-09-20 - Assigned To Examiner

---

## ATTORNEY/CORRESPONDENT INFORMATION

---

**Attorney of Record**  
Robert D. McDonald

**Correspondent**



Latest Status Info

**ROBERT D. MCDONALD**  
Miller Thomson LLP  
2700 Commerce Place  
10155 - 102 Street  
Edmonton Alberta T5J 4G8 Canada  
Phone Number: (780)429-9734  
Fax Number: (780)424-5866

**Domestic Representative**  
Edward M. Lebow  
Phone Number: (202)775-2400  
Fax Number: (202)331.7538

---

Exhibit 66

**Thank you for your request. Here are the latest results from the TARR web server.**

**This page was generated by the TARR system on 2007-06-13 14:42:53 ET**

**Serial Number: 78063290 Assignment Information**

**Registration Number: 2978125**

**Mark**



**(words only): SILVER SCROLL**

**Standard Character claim: No**

**Current Status: Registered.**

**Date of Status: 2005-07-26**

**Filing Date: 2001-05-13**

**Transformed into a National Application: No**

**Registration Date: 2005-07-26**

**Register: Principal**

**Law Office Assigned: LAW OFFICE 112**

**If you are the applicant or applicant's attorney and have questions about this file, please contact the Trademark Assistance Center at [TrademarkAssistanceCenter@uspto.gov](mailto:TrademarkAssistanceCenter@uspto.gov)**

**Current Location: 650 -Publication And Issue Section**

**Date In Location: 2005-06-15**

---

**LAST APPLICANT(S)/OWNER(S) OF RECORD**

---

1. Grow, Merry Ann

**Address:**

Grow, Merry Ann  
1170 Nelson Way  
McKinleyville, CA 95519  
United States

**Legal Entity Type:** Individual

**Country of Citizenship:** United States

**Phone Number:** (707) 839-3590

**Fax Number:** (707) 839-3699

---

**GOODS AND/OR SERVICES**

---

**International Class:** 014

**Class Status:** Active

Costume jewelry made in whole or substantial part of silver

**Basis:** 1(a)

**First Use Date:** 2001-06-01

**First Use in Commerce Date:** 2004-06-01

---

**ADDITIONAL INFORMATION**

---

**Disclaimer:** "SILVER SCROLL"

**Design Search Code(s):**

20.03.02 - Foil, aluminum (rolls); Gift wrapping paper (rolls); Paper towels (rolls); Paper, gift wrapping (rolls); Paper, rolls; Paper, toilet; Scrolls; Toilet paper; Towels, rolls of paper towels; Wallpaper, rolled  
26.11.21 - Rectangles that are completely or partially shaded

---

**MADRID PROTOCOL INFORMATION**

---

(NOT AVAILABLE)

---

**PROSECUTION HISTORY**

---

2005-07-26 - Registered - Principal Register

---

Latest Status Info

2005-05-23 - Law Office Registration Review Completed  
2005-05-23 - Assigned To LIE  
2005-05-13 - Allowed for Registration - Principal Register (SOU accepted)  
2005-05-12 - Statement of use processing complete  
2004-10-28 - Amendment to Use filed  
2004-10-28 - TEAS Statement of Use Received  
2004-07-06 - Notice of allowance - mailed  
2004-04-12 - Opposition terminated for Proceeding  
2004-04-12 - Opposition terminated for Proceeding  
2004-04-12 - Opposition dismissed for Proceeding  
2002-02-27 - Opposition instituted for Proceeding  
2002-02-20 - Opposition papers filed  
2002-01-08 - Published for opposition  
2001-12-19 - Notice of publication  
2001-10-24 - Approved for Pub - Principal Register (Initial exam)  
2001-09-19 - Communication received from applicant  
2001-08-13 - Non-final action mailed  
2001-08-03 - Assigned To Examiner

---

**ATTORNEY/CORRESPONDENT INFORMATION**

---

**Attorney of Record**  
Norman A Ehrlich

**Correspondent**  
NORMAN A EHRLICH  
4173 EXCELSIOR ROAD  
EUREKA, CA 95503-7907

Latest Status Info

Phone Number: (707) 443-5652

Fax Number: (707) 442-0110

---

Exhibit 67

**Thank you for your request. Here are the latest results from the TARR web server.**

**This page was generated by the TARR system on 2007-06-13 14:43:03 ET**

**Serial Number: 78004868 Assignment Information**

**Registration Number: (NOT AVAILABLE)**

**Mark (words only): SILVERSMITH**

**Standard Character claim: No**

**Current Status: Abandoned-Failure To Respond Or Late Response**

**Date of Status: 2001-06-04**

**Filing Date: 2000-04-19**

**Transformed into a National Application: No**

**Registration Date: (DATE NOT AVAILABLE)**

**Register: Principal**

**Law Office Assigned: LAW OFFICE 112**

**If you are the applicant or applicant's attorney and have questions about this file, please contact the Trademark Assistance Center at TrademarkAssistanceCenter@uspto.gov**

**Current Location: 900 -File Repository (Franconia)**

**Date In Location: 2002-10-30**

---

**LAST APPLICANT(S)/OWNER(S) OF RECORD**

---

**1. SILVERSMITH, INC.**

**Address:**

**SILVERSMITH, INC.**

**16520 South Tamiami Trail Ste#18-124**

**Ft. Myers, FL 33908**

**United States**

**Legal Entity Type: Corporation**



**State or Country of Incorporation:** Florida

---

**GOODS AND/OR SERVICES**

---

**International Class:** 014

**Class Status:** Active

Sterling Silver Jewelry; Chains, Necklaces, Charms, Pendants, Bracelets, Rings, Earrings, as well as body piercing jewelry

**Basis:** 1(b)

**First Use Date:** (DATE NOT AVAILABLE)

**First Use in Commerce Date:** (DATE NOT AVAILABLE)

---

**ADDITIONAL INFORMATION**

---

(NOT AVAILABLE)

---

**MADRID PROTOCOL INFORMATION**

---

(NOT AVAILABLE)

---

**PROSECUTION HISTORY**

---

2001-06-04 - Abandonment - Failure To Respond Or Late Response

2000-09-11 - Non-final action mailed

2000-08-31 - Assigned To Examiner

---

**ATTORNEY/CORRESPONDENT INFORMATION**

---

**Correspondent**

SILVERSMITH, INC.

16520 South Tamiami Trail

Ste#18-124

Ft. Myers FL 33908

Exhibit 68

**Thank you for your request. Here are the latest results from the TARR web server.**

**This page was generated by the TARR system on 2007-06-13 14:43:14 ET**

**Serial Number: 77066887 Assignment Information**

**Registration Number: (NOT AVAILABLE)**

**Mark**

**SILVER STANDARD**

**(words only): SILVER STANDARD**

**Standard Character claim: Yes**

**Current Status: An office action suspending further action on the application has been mailed.**

**Date of Status: 2007-05-09**

**Filing Date: 2006-12-18**

**Transformed into a National Application: No**

**Registration Date: (DATE NOT AVAILABLE)**

**Register: Principal**

**Law Office Assigned: LAW OFFICE 117**

**Attorney Assigned:  
ORTIGA RAMONA F Employee Location**

**Current Location: M8X -Law Office 117 - Examining Attorney Assigned**

**Date In Location: 2007-05-09**

## LAST APPLICANT(S)/OWNER(S) OF RECORD

---

### 1. Silver Standard Resources Inc.

**Address:**

Silver Standard Resources Inc.  
Suite 1180 999 West Hastings Street  
Vancouver V6C2W2  
Canada

**Legal Entity Type:** Corporation

**State or Country of Incorporation:** Canada

**Phone Number:** 604-689-3846

**Fax Number:** 604-689-3847

---

## GOODS AND/OR SERVICES

---

**International Class:** 014

**Class Status:** Active

Precious metals, in particular silver; silver metal in the form of bars and ingots

**Basis:** 1(b), 44(d)

**First Use Date:** (DATE NOT AVAILABLE)

**First Use in Commerce Date:** (DATE NOT AVAILABLE)

**International Class:** 035

**Class Status:** Active

Retail store services and wholesale stores and distributorships services concerning precious metals

**Basis:** 1(b), 44(d)

**First Use Date:** (DATE NOT AVAILABLE)

**First Use in Commerce Date:** (DATE NOT AVAILABLE)

**International Class:** 037

**Class Status:** Active

Mining extraction of precious metals

**Basis:** 1(b), 44(d)

**First Use Date:** (DATE NOT AVAILABLE)

**First Use in Commerce Date:** (DATE NOT AVAILABLE)

**International Class:** 040

**Class Status:** Active

Processing, working, refining and polishing of precious metals

**Basis:** 1(b), 44(d)

**First Use Date:** (DATE NOT AVAILABLE)

**First Use in Commerce Date:** (DATE NOT AVAILABLE)

---

**ADDITIONAL INFORMATION**

---

**Disclaimer:** "SILVER"

**Foreign Application Number:** 1305681

**Country:** Canada

**Foreign Filing Date:** 2006-06-19

---

**MADRID PROTOCOL INFORMATION**

---

(NOT AVAILABLE)

---

**PROSECUTION HISTORY**

---

2007-05-09 - LETTER OF SUSPENSION E-MAILED

2007-05-09 - Suspension Letter Written

2007-05-08 - Teas/Email Correspondence Entered

2007-05-07 - Communication received from applicant

2007-05-07 - TEAS Response to Office Action Received

2007-04-11 - Non-final action e-mailed

2007-04-11 - Non-Final Action Written

2007-04-11 - Assigned To Examiner

2006-12-21 - New Application Entered In Tram

---

**ATTORNEY/CORRESPONDENT INFORMATION**

---

**Attorney of Record**

Bruce M. Green

**Correspondent**

BRUCE M. GREEN; OYEN WIGGS GREEN & MUTAL  
SUITE 480; 601 WEST CORDOVA STREET  
VANCOUVER; BCC - BRITISH COLUMBIA

Latest Status Info

V6B1G1

CAX - CANADA

Phone Number: 604-669-3432

Fax Number: 604-681-4081

---

Exhibit 69

**Thank you for your request. Here are the latest results from the TARR web server.**

**This page was generated by the TARR system on 2007-06-13 14:43:25 ET**

**Serial Number: 76654535 Assignment Information**

**Registration Number: (NOT AVAILABLE)**

**Mark**

# **SILVER DREAM**

**(words only): SILVER DREAM**

**Standard Character claim: Yes**

**Current Status: Application has been published for opposition.**

**Date of Status: 2007-04-17**

**Filing Date: 2006-02-03**

**The Information will be/was published in the Official Gazette on 2007-04-17**

**Transformed into a National Application: No**

**Registration Date: (DATE NOT AVAILABLE)**

**Register: Principal**

**Law Office Assigned: LAW OFFICE 114**

**Attorney Assigned:**

**STINE DAVID H Employee Location**

**Current Location: 650 -Publication And Issue Section**

**Date In Location: 2007-03-15**



---

**LAST APPLICANT(S)/OWNER(S) OF RECORD**

---

1. Silver Dream, L.L.C.

**Address:**

Silver Dream, L.L.C.  
8004 Willow Street  
New Orleans, LA 70118  
United States

**Legal Entity Type:** Ltd Liab Co

**State or Country Where Organized:** Louisiana

---

**GOODS AND/OR SERVICES**

---

**International Class:** 014

**Class Status:** Active

Jewelry made wholly or in part of silver, namely earrings, bracelets, necklaces, rings, watches, pendants, brooches, chains, pins, medallions, cufflinks

**Basis:** 1(a)

**First Use Date:** 2001-01-01

**First Use in Commerce Date:** 2001-01-01

---

**ADDITIONAL INFORMATION**

---

(NOT AVAILABLE)

---

**MADRID PROTOCOL INFORMATION**

---

(NOT AVAILABLE)

---

**PROSECUTION HISTORY**

---

2007-04-17 - Published for opposition

2007-03-28 - Notice of publication

2007-03-02 - Law Office Publication Review Completed

2007-03-01 - Approved for Pub - Principal Register (Initial exam)

Latest Status Info

2007-02-23 - Amendment From Applicant Entered  
2007-02-23 - Communication received from applicant  
2007-02-23 - Assigned To LIE  
2007-01-26 - PAPER RECEIVED  
2006-07-26 - Non-final action e-mailed  
2006-07-26 - Non-Final Action Written  
2006-07-26 - Assigned To Examiner  
2006-02-14 - Application Filing Receipt Mailed  
2006-02-10 - New Application Entered In Tram

---

**ATTORNEY/CORRESPONDENT INFORMATION**

---

**Attorney of Record**

Gregory D. Latham

**Correspondent**

GREGORY D. LATHAM  
JONES, WALKER, WAECHTER, POITEVENT  
201 SAINT CHARLES AVE STE 5200  
NEW ORLEANS, LA 70170-5100  
Phone Number: (504) 582-8000  
Fax Number: (504) 582-8011

---

Exhibit 70

Exhibit 70

**Thank you for your request. Here are the latest results from the TARR web server.**

**This page was generated by the TARR system on 2007-06-13 14:43:37 ET**

**Serial Number: 76419197 Assignment Information**

**Registration Number: 2809861**

**Mark**



**P i e r r e L a n g  
S i l v e r T r e n d C o l l e c t i o n**

**(words only): PLS PIERRE LANG SILVER TREND COLLECTION**

**Standard Character claim: No**

**Current Status: Registered.**

**Date of Status: 2004-02-03**

**Filing Date: 2002-06-10**

**Transformed into a National Application: No**

**Registration Date: 2004-02-03**

**Register: Principal**

**Law Office Assigned: LAW OFFICE 108**

**If you are the applicant or applicant's attorney and have questions about this file, please contact the Trademark Assistance Center at [TrademarkAssistanceCenter@uspto.gov](mailto:TrademarkAssistanceCenter@uspto.gov)**

**Current Location: 40S -Scanning On Demand**

**Date In Location: 2007-06-04**

**LAST APPLICANT(S)/OWNER(S) OF RECORD**

---

1. Pierre Lang Europe Handelsgesellschaft m. b. H.

**Address:**

Pierre Lang Europe Handelsgesellschaft m. b. H.

Kolbegasse 70

A-1239 Vienna

Austria

**Legal Entity Type:** Corporation

**State or Country of Incorporation:** Austria

---

**GOODS AND/OR SERVICES**

---

**International Class:** 014

**Class Status:** Active

Jewelry, precious stones, costume jewelry, necklaces, bracelets, brooches, rings, earrings of precious metal, cuff links, and tie pins, clocks, and chronometers, all made in whole of significant part of silver

**Basis:** 44(e)

**First Use Date:** (DATE NOT AVAILABLE)

**First Use in Commerce Date:** (DATE NOT AVAILABLE)

---

**ADDITIONAL INFORMATION**

---

**Disclaimer:** "SILVER" and "COLLECTION"

**Name Portrait Consent:** The name "PIERRE LANG" does not identify a living individual.

**Design Search Code(s):**

26.07.01 - Diamonds with plain multiple line border; Diamonds with plain single line border

**Prior Registration Number(s):**

1852130

**Foreign Application Number:** 002508323

**Foreign Registration Number:** 2508323

**Foreign Registration Date:** 2003-01-20

**Country:** Erpn Cmnty TM Ofc

**Foreign Filing Date:** 2001-12-19

**Foreign Expiration Date:** 2011-12-19

---

---

**MADRID PROTOCOL INFORMATION**

---

(NOT AVAILABLE)

---

**PROSECUTION HISTORY**

---

2007-06-04 - Case File In TICRS

2004-02-03 - Registered - Principal Register

2003-11-11 - Published for opposition

2003-10-22 - Notice of publication

2003-09-09 - Approved for Pub - Principal Register (Initial exam)

2003-09-05 - Examiner's amendment mailed

2003-07-28 - Non-final action mailed

2003-07-25 - Previous allowance count withdrawn

2003-06-27 - Approved for Pub - Principal Register (Initial exam)

2003-06-20 - Examiner's amendment mailed

2003-05-19 - ITU claim deleted

2003-05-19 - Communication received from applicant

2003-05-19 - PAPER RECEIVED

2002-12-10 - Letter of suspension mailed

2002-10-17 - Examiner's amendment mailed

2002-10-02 - Non-final action mailed

2002-09-24 - Assigned To Examiner

---

**ATTORNEY/CORRESPONDENT INFORMATION**

---

**Attorney of Record**  
Paul I. J. Fleischut

**Correspondent**

PAUL I. J. FLEISCHUT  
SENNIGER, POWERS, LEAVITT & ROEDEL  
ONE METROPOLITAN SQUARE, 16TH FLOOR  
SAINT LOUIS, MISSOURI 63102  
Phone Number: 314-231-5400  
Fax Number: 314-231-4342

**Domestic Representative**

Senniger, Powers, Leavitt & Roedel  
Phone Number: 314-231-5400  
Fax Number: 314-231-4342

---



Exhibit 71

**Thank you for your request. Here are the latest results from the TARR web server.**

**This page was generated by the TARR system on 2007-06-13 14:43:49 ET**

**Serial Number: 76389563 Assignment Information**

**Registration Number: 2746405**

**Mark**



**(words only): BALFOUR PREMIUM SILVER WITH PLATINUM**

**Standard Character claim: No**

**Current Status: Registered.**

**Date of Status: 2003-08-05**

**Filing Date: 2002-03-29**

**Transformed into a National Application: No**

**Registration Date: 2003-08-05**

**Register: Principal**

**Law Office Assigned: LAW OFFICE 102**

**If you are the applicant or applicant's attorney and have questions about this file, please contact the Trademark Assistance Center at TrademarkAssistanceCenter@uspto.gov**

**Current Location: 900 -File Repository (Franconia)**

**Date In Location: 2003-08-12**

---

**LAST APPLICANT(S)/OWNER(S) OF RECORD**

---

1. Commemorative Brands, Inc.

**Address:**

Commemorative Brands, Inc.

7211 Circle S Road

Austin, TX 78745

United States

**Legal Entity Type:** Corporation

**State or Country of Incorporation:** Delaware

---

**GOODS AND/OR SERVICES**

---

**International Class:** 014

**Class Status:** Active

JEWELRY MADE IN WHOLE OR IN SUBSTANTIAL PART OF SILVER AND PLATINUM

**Basis:** 1(a)

**First Use Date:** 2002-01-31

**First Use in Commerce Date:** 2002-01-31

---

**ADDITIONAL INFORMATION**

---

**Disclaimer:** "PREMIUM SILVER WITH PLATINUM"

**Design Search Code(s):**

**26.01.28** - Circles with irregular circumferences; Miscellaneous circular designs with an irregular circumference

**26.07.28** - Diamond shapes (miscellaneous overall shape); Miscellaneous designs with overall diamond shape, including letters forming or comprising a diamond

**Prior Registration Number(s):**

1267451

1373682

2383837

2441434

---

**MADRID PROTOCOL INFORMATION**

---

(NOT AVAILABLE)

---

## PROSECUTION HISTORY

---

2003-08-05 - Registered - Principal Register  
2003-05-13 - Published for opposition  
2003-04-23 - Notice of publication  
2003-04-17 - TEAS Change Of Correspondence Received  
2003-02-21 - Approved for Pub - Principal Register (Initial exam)  
2003-01-28 - Communication received from applicant  
2003-01-28 - PAPER RECEIVED  
2002-08-15 - Non-final action mailed  
2002-08-07 - Assigned To Examiner  
2002-08-05 - Assigned To Examiner

---

## ATTORNEY/CORRESPONDENT INFORMATION

---

### Attorney of Record

Carla B. Oakley, Esq.

### Correspondent

Clarissa Marischen  
Andrews & Kurth LLP  
111 Congress Avenue, Suite 1700  
Austin TX 78701  
Phone Number: 512-320-9247  
Fax Number: 512-542-5229

---

Exhibit 72

**Thank you for your request. Here are the latest results from the TARR web server.**

**This page was generated by the TARR system on 2007-06-13 14:44:00 ET**

**Serial Number: 76183167 Assignment Information**

**Registration Number: 2634259**

**Mark**



**(words only): S SILVER INTERNATIONAL**

**Standard Character claim: No**

**Current Status: Registered.**

**Date of Status: 2002-10-15**

**Filing Date: 2000-12-18**

**Transformed into a National Application: No**

**Registration Date: 2002-10-15**

**Register: Principal**

**Law Office Assigned: LAW OFFICE 108**

**If you are the applicant or applicant's attorney and have questions about this file, please contact the Trademark Assistance Center at TrademarkAssistanceCenter@uspto.gov**

**Current Location: 900 -File Repository (Franconia)**

**Date In Location: 2002-11-19**

---

**LAST APPLICANT(S)/OWNER(S) OF RECORD**

---

**1. KOHAN & SULEMINIAN ENTERPRISES, INC**

**Address:**

KOHAN & SULEMINIAN ENTERPRISES, INC  
550 S. HILL STREET, SUITE 1650  
LOS Angeles, CA 90013  
United States  
**Legal Entity Type:** Corporation  
**State or Country of Incorporation:** California

---

**GOODS AND/OR SERVICES**

---

**International Class:** 014

**Class Status:** Active

Silver jewelry, namely, rings, wrist and ankle bracelets, necklaces, neck chains, wrist chains, ankle chains, and body chains, earrings, pins, pendants, charms, cuff links, watch fobs

**Basis:** 1(a)

**First Use Date:** 2000-08-25

**First Use in Commerce Date:** 2000-09-29

---

**ADDITIONAL INFORMATION**

---

**Disclaimer:** "SILVER INTERNATIONAL"

**Description of Mark:** The mark consists of an eagle crest with a ribbon banner.

**Design Search Code(s):**

01.01.10 - Stars, three or more; Three or more stars

01.01.13 - Stars - multiple stars with five points

03.15.01 - Eagles

03.15.19 - Birds or bats in flight or with outspread wings

03.15.24 - Stylized birds and bats

24.09.07 - Advertising, banners; Banners

26.01.17 - Circles, two concentric; Concentric circles, two; Two concentric circles

26.01.21 - Circles that are totally or partially shaded.

26.17.13 - Letters or words underlined and/or overlined by one or more strokes or lines; Overlined words or letters; Underlined words or letters

---

**MADRID PROTOCOL INFORMATION**