

8493908



THE UNITED STATES OF AMERICA

TO ALL TO WHOM THESE PRESENTS SHALL COME:
UNITED STATES DEPARTMENT OF COMMERCE
United States Patent and Trademark Office

June 3, 2024

THIS IS TO CERTIFY THAT ANNEXED HERETO IS A TRUE COPY FROM
THE RECORDS OF THIS OFFICE OF:

PATENT NUMBER: 9,295,288

ISSUE DATE: March 29, 2016

By Authority of the
Under Secretary of Commerce for Intellectual Property
and Director of the United States Patent and Trademark Office

Paula Smith
Paula Smith
Certifying Officer



NIKE-1003

**(12) United States Patent
Goff**

(10) Patent No.: US 9,295,288 B1
(45) Date of Patent: *Mar. 29, 2016

(54) **POCKET BRA SYSTEM**
(71) Applicant: **Sharon J. Goff**, Williamstown, MA (US)
(72) Inventor: **Sharon J. Goff**, Williamstown, MA (US)
(*) Notice: Subject to any disclaimer, the term of this patent is extended or adjusted under 35 U.S.C. 154(b) by 47 days.
This patent is subject to a terminal disclaimer.

4,263,678	A *	4/1981	Off	2/247
4,699,144	A *	10/1987	Sherwood	450/54
5,395,280	A *	3/1995	Greenberg	450/54
5,496,205	A *	3/1996	Lee	450/89
5,799,336	A *	9/1998	Cooper	2/247
7,585,200	B1 *	9/2009	McLaren	450/89
7,753,759	B2 *	7/2010	Pintor et al.	450/89
8,257,140	B2 *	9/2012	Kenny	450/89
8,597,072	B1 *	12/2013	Lucas	450/89
2008/0032600	A1 *	2/2008	Updyke	450/89
2009/0104845	A1 *	4/2009	Pintor et al.	450/31
2009/0209173	A1 *	8/2009	Arledge et al.	450/39
2010/0124869	A1 *	5/2010	Liu	450/39

* cited by examiner

(21) Appl. No.: **14/082,777**
(22) Filed: **Nov. 18, 2013**

Primary Examiner — Gloria Hale
(74) *Attorney, Agent, or Firm* — Lambert & Associates;
Gary E. Lambert; David J. Connaughton, Jr.

Related U.S. Application Data

(63) Continuation-in-part of application No. 13/066,822, filed on Apr. 26, 2011, now Pat. No. 8,597,072.

(51) **Int. Cl.**
A41C 3/00 (2006.01)

(52) **U.S. Cl.**
CPC *A41C 3/0035* (2013.01)

(58) **Field of Classification Search**
CPC A41D 27/01; A41D 27/20; A41D 27/201; A41D 27/202; A41D 27/204; A41D 27/205; A41C 3/0035
USPC 2/247-251; 450/89, 54-57, 36, 39
See application file for complete search history.

(57) ABSTRACT

A strap assembly includes a chest strap and shoulder straps. Similarly configured left and right cups are provided. The strap assembly is attached to the cups whereby the strap assembly adheres the cups to a wearer. Each cup has curved upper, lower, interior and exterior edges. Each cup has inside and outside surfaces. A patch is operatively associated with each cup. Each patch has a linear upper edge and curved lower, interior and exterior edges. Each patch has inside and outside surfaces. Stitching couples the lower, interior and exterior edges of each patch to the lower, interior and exterior edges of an associated cup. A linear opening is formed along the upper edge of each patch. Piping covers the upper edge of each patch. The piping is adapted to allow the patch to move away from and back toward the cup between open and closed orientations.

(56) References Cited

U.S. PATENT DOCUMENTS

2,624,881	A *	1/1953	Dunson	450/89
3,747,545	A *	7/1973	Nicolay et al.	112/68

17 Claims, 6 Drawing Sheets

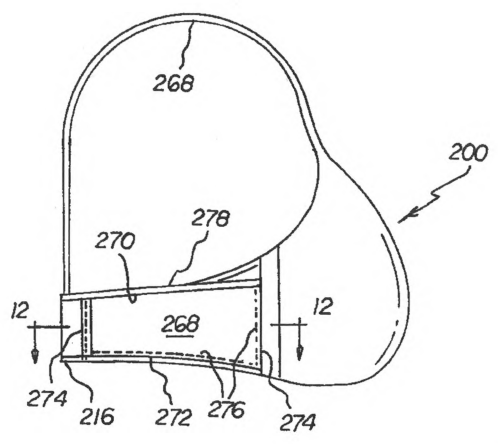
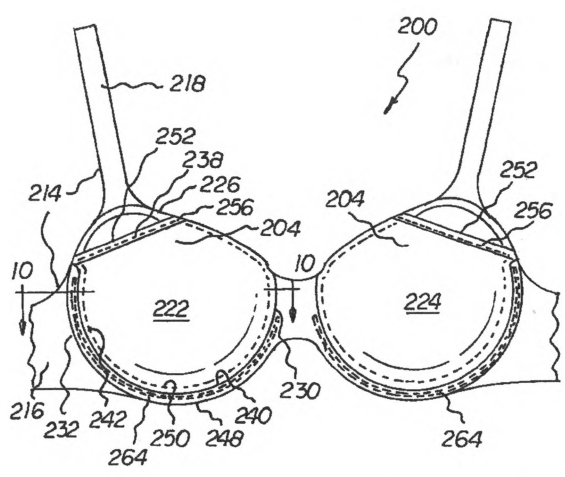

FIG. 1

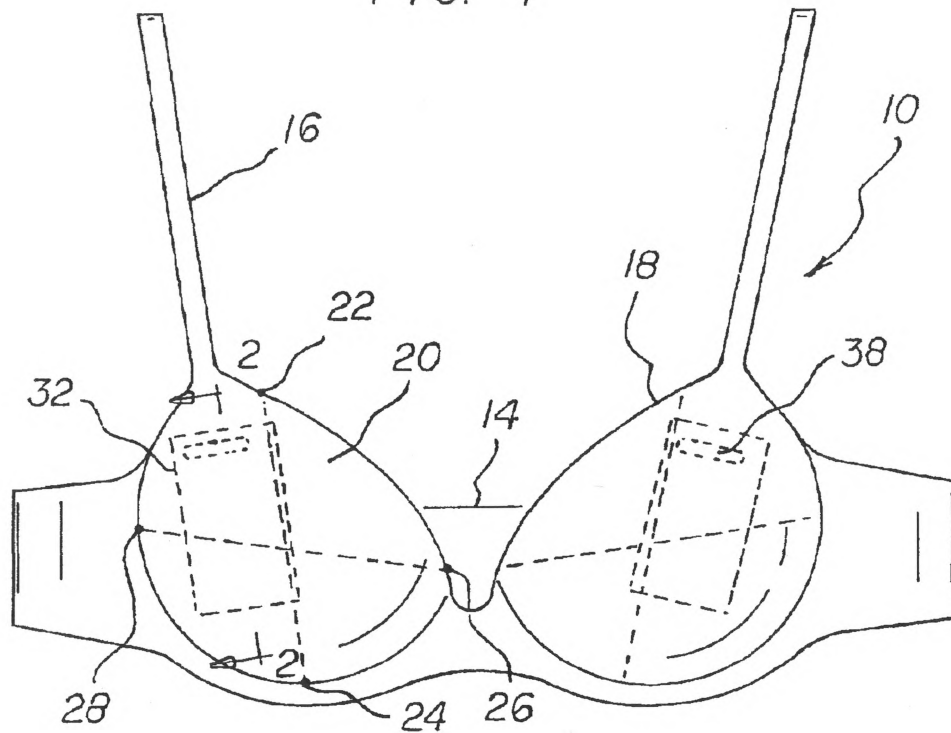

FIG. 2

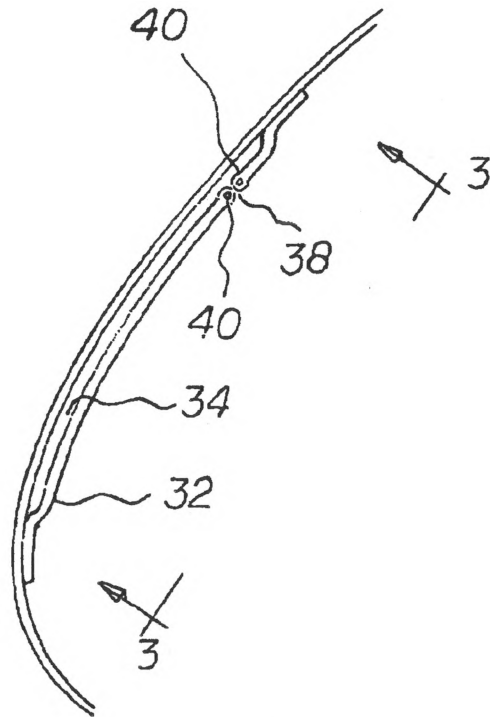
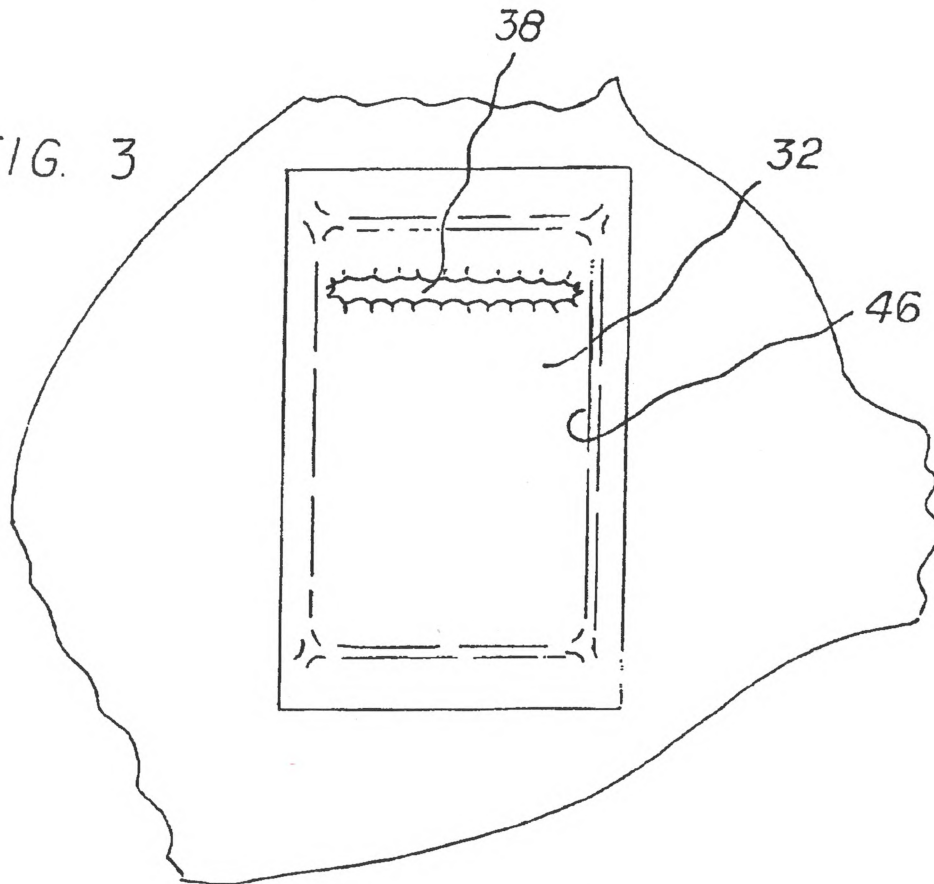

FIG. 3



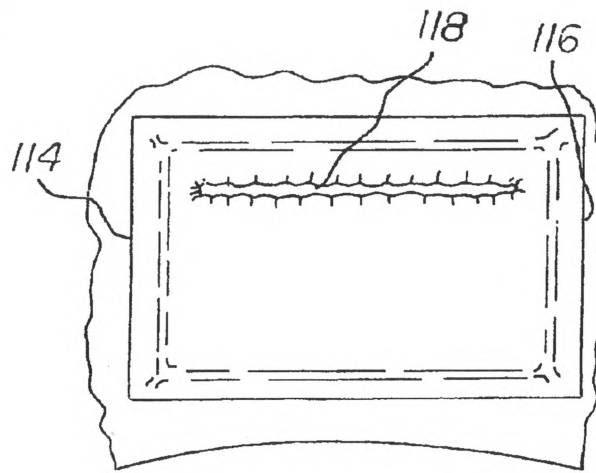
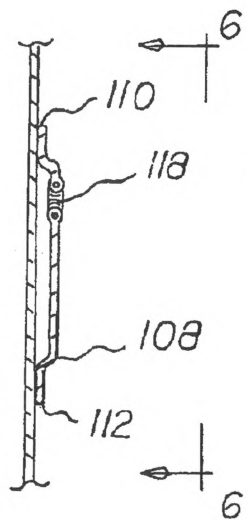
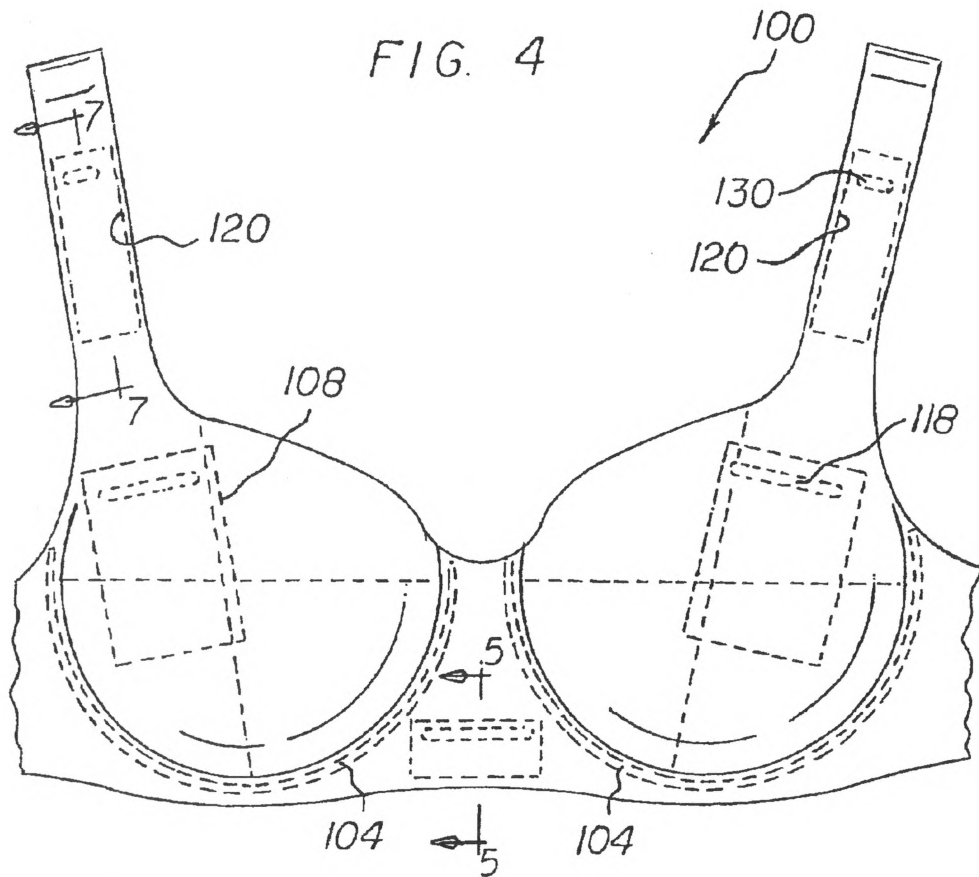

FIG. 5

FIG. 6

Explore Litigation Insights

Docket Alarm provides insights to develop a more informed litigation strategy and the peace of mind of knowing you're on top of things.

Real-Time Litigation Alerts



Keep your litigation team up-to-date with **real-time alerts** and advanced team management tools built for the enterprise, all while greatly reducing PACER spend.

Our comprehensive service means we can handle Federal, State, and Administrative courts across the country.

Advanced Docket Research



With over 230 million records, Docket Alarm's cloud-native docket research platform finds what other services can't. Coverage includes Federal, State, plus PTAB, TTAB, ITC and NLRB decisions, all in one place.

Identify arguments that have been successful in the past with full text, pinpoint searching. Link to case law cited within any court document via Fastcase.

Analytics At Your Fingertips



Learn what happened the last time a particular judge, opposing counsel or company faced cases similar to yours.

Advanced out-of-the-box PTAB and TTAB analytics are always at your fingertips.

API

Docket Alarm offers a powerful API (application programming interface) to developers that want to integrate case filings into their apps.

LAW FIRMS

Build custom dashboards for your attorneys and clients with live data direct from the court.

Automate many repetitive legal tasks like conflict checks, document management, and marketing.

FINANCIAL INSTITUTIONS

Litigation and bankruptcy checks for companies and debtors.

E-DISCOVERY AND LEGAL VENDORS

Sync your system to PACER to automate legal marketing.