



(12) **United States Patent**
Malamud et al.

(10) **Patent No.:** **US 6,437,800 B1**
(45) **Date of Patent:** **Aug. 20, 2002**

(54) **INFORMATION CURSORS**

- (75) Inventors: **Mark A. Malamud**, Seattle; **John E. Elsbree**, King County; **David A. Barnes**, Seattle, all of WA (US)
- (73) Assignee: **Microsoft Corporation**, Redmond, WA (US)
- (*) Notice: Subject to any disclaimer, the term of this patent is extended or adjusted under 35 U.S.C. 154(b) by 0 days.

- (21) Appl. No.: **08/329,724**
- (22) Filed: **Oct. 26, 1994**

Related U.S. Application Data

- (63) Continuation of application No. 08/054,564, filed on Apr. 28, 1993, now abandoned.
- (51) **Int. Cl.⁷** **G09G 5/08**
- (52) **U.S. Cl.** **345/711; 345/705**
- (58) **Field of Search** 345/145, 146, 345/156, 157, 163, 705, 711

(56) **References Cited**

U.S. PATENT DOCUMENTS

4,789,962 A	12/1988	Berry et al.	364/900
4,984,152 A	1/1991	Muller	364/200
5,157,768 A	10/1992	Hoeber et al.	395/157
5,169,342 A	12/1992	Steele et al.	434/112
5,436,637 A	* 7/1995	Gayraud et al.	345/146

OTHER PUBLICATIONS

- Meckler Corporation, Treasures of the Smithsonian, Evaluation (from Dialog), pp. 1-4, May 2002.*
- Matthies, Kurt W. G. "Balloon Help Takes Off," *Power Tools, Power Programming*, Mac User, Dec. 1991, 5 pages.
- Macintosh Reference 7*, Apple Computer, Inc., Chapter 1, "A Review of Standard Macintosh Operations," 1991, pp. 30-31.
- "Unobtrusive Application Icon Label Interface," *IBM Technical Disclosure Bulletin*, New York, Nov. 1990, vol. 33 (6A), p. 104.
- "User-Controlled Display of Hypermedia Links via Mouse Location," *IBM Technical Disclosure Bulletin*, New York, Aug. 1993, vol. 36 (8), p. 669.

* cited by examiner

Primary Examiner—Richard Hjerpe
Assistant Examiner—Henry N. Tran
 (74) *Attorney, Agent, or Firm*—Banner & Witcoff, Ltd.

(57) **ABSTRACT**

Information cursors are provided for use in an operating system and/or application programs. Each information cursor includes a pointing portion to point to objects displayed on a video display and an information portion to display information about an object to which the pointing portion points. The information displayed in an information cursor may include the name of the object, a preview of the contents of the object, or property information about the object.

13 Claims, 6 Drawing Sheets

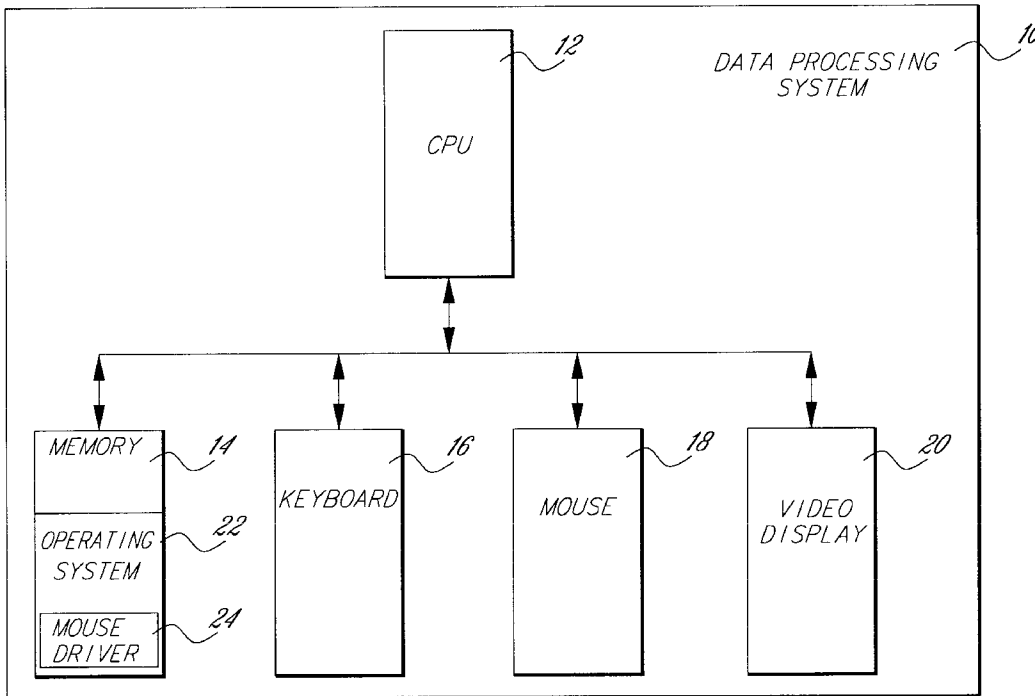

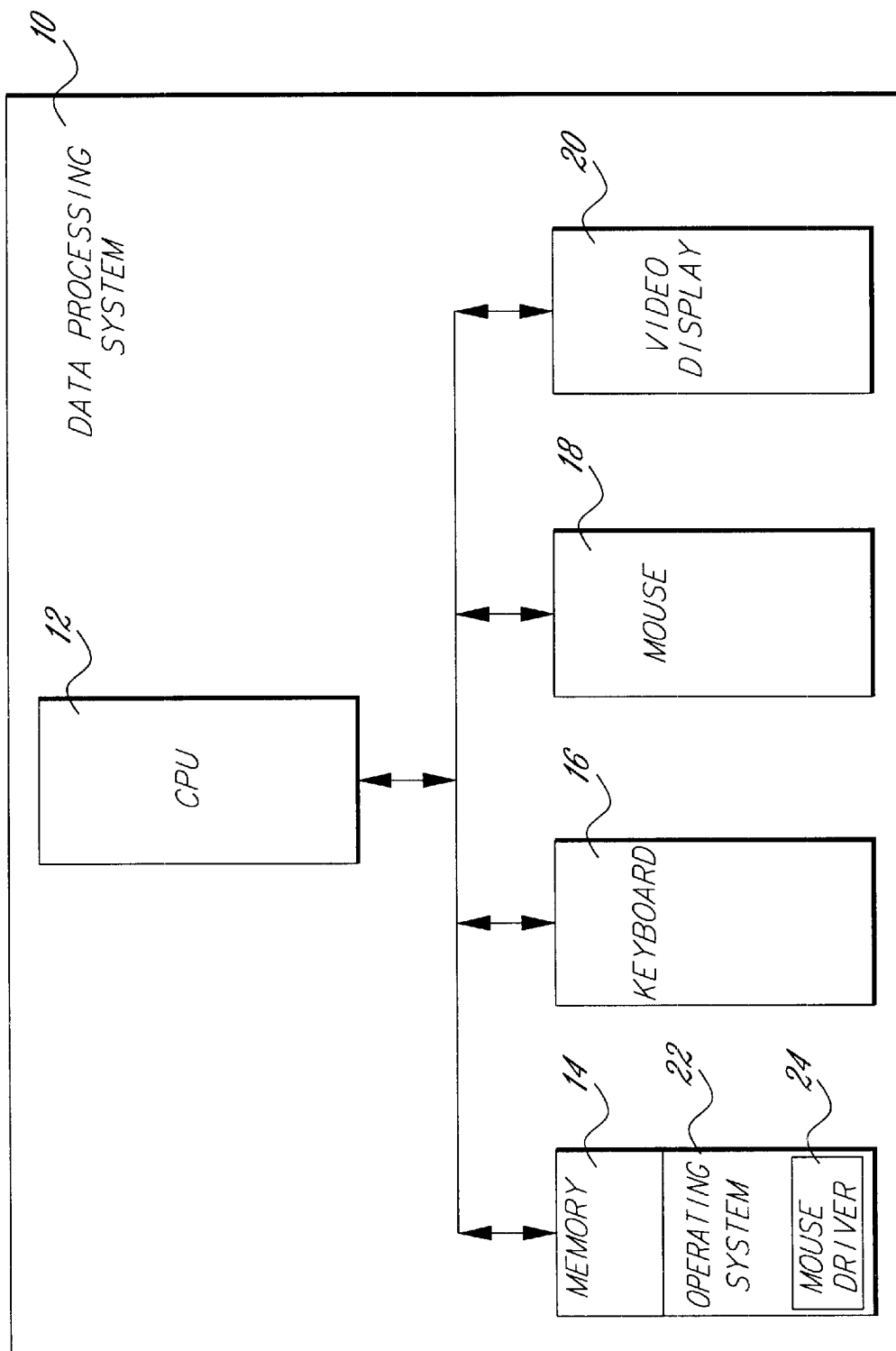

Fig. 1

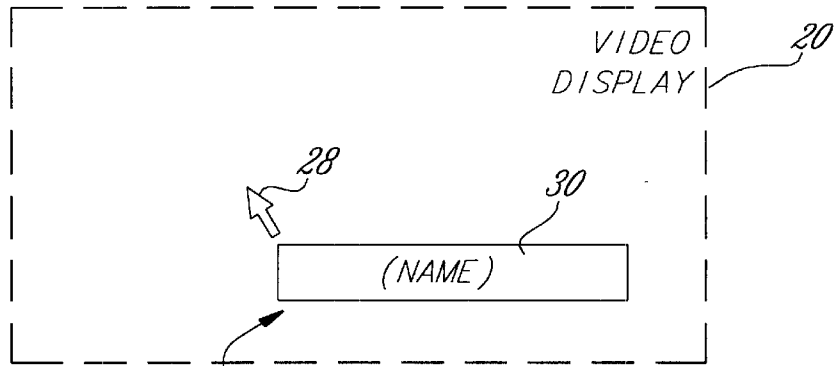

Fig. 2a
NAME CURSOR

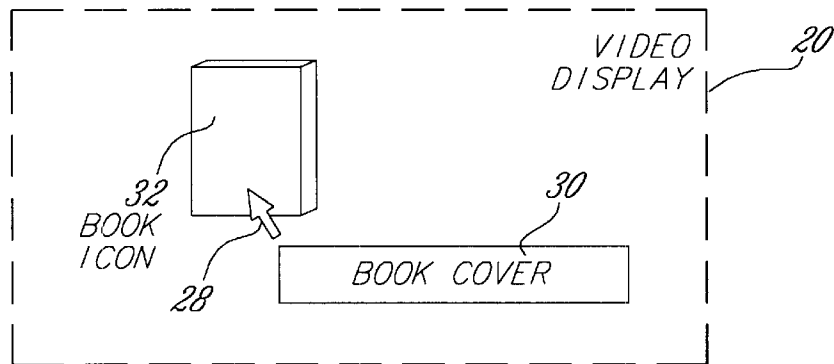

Fig. 2b
NAME CURSOR

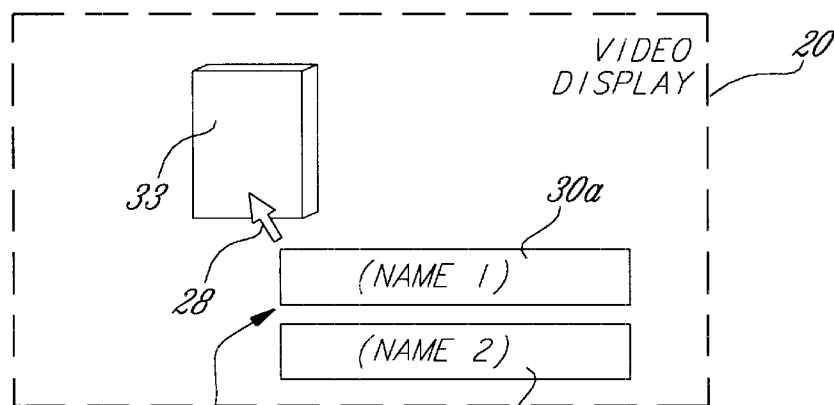
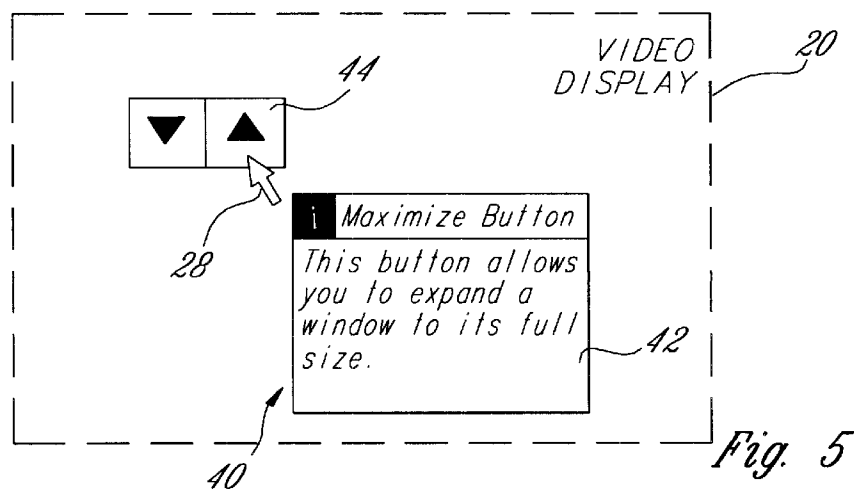
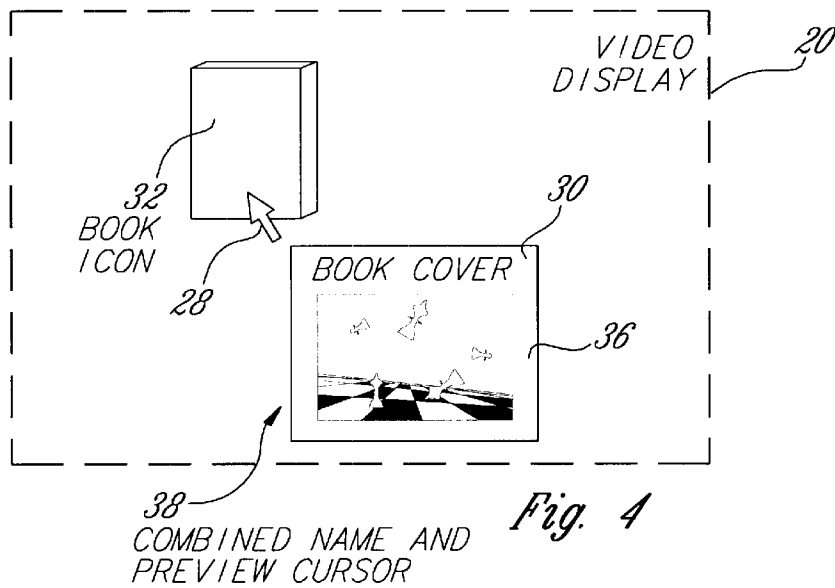
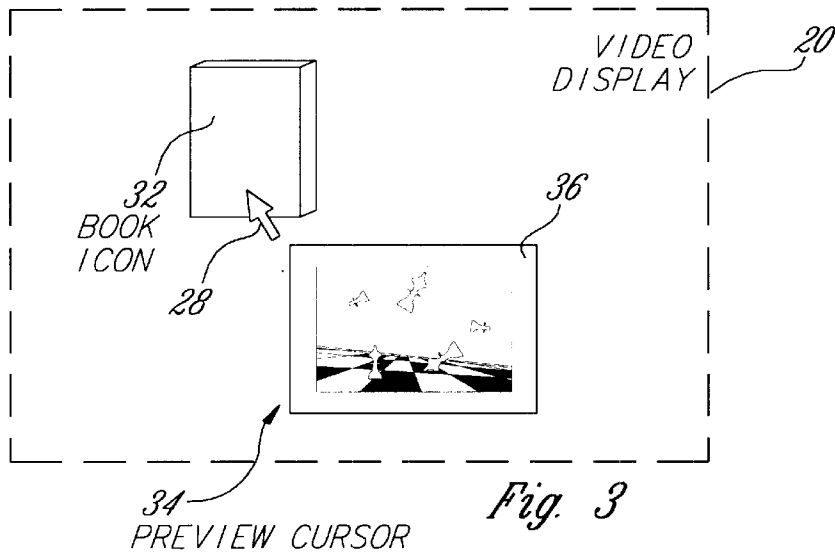

Fig. 2c
NAME CURSOR



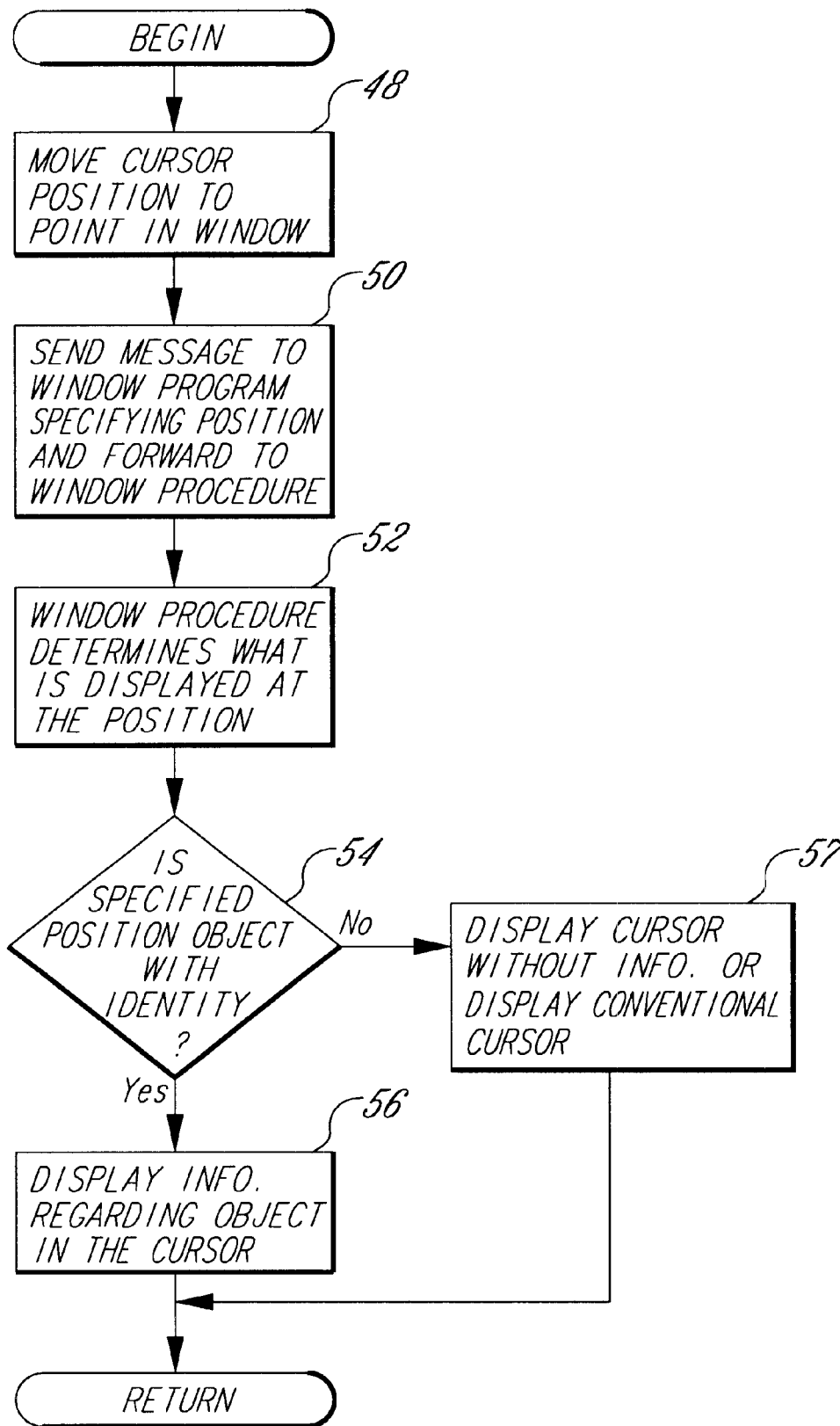

Fig. 6

Explore Litigation Insights

Docket Alarm provides insights to develop a more informed litigation strategy and the peace of mind of knowing you're on top of things.

Real-Time Litigation Alerts



Keep your litigation team up-to-date with **real-time alerts** and advanced team management tools built for the enterprise, all while greatly reducing PACER spend.

Our comprehensive service means we can handle Federal, State, and Administrative courts across the country.

Advanced Docket Research



With over 230 million records, Docket Alarm's cloud-native docket research platform finds what other services can't. Coverage includes Federal, State, plus PTAB, TTAB, ITC and NLRB decisions, all in one place.

Identify arguments that have been successful in the past with full text, pinpoint searching. Link to case law cited within any court document via Fastcase.

Analytics At Your Fingertips



Learn what happened the last time a particular judge, opposing counsel or company faced cases similar to yours.

Advanced out-of-the-box PTAB and TTAB analytics are always at your fingertips.

API

Docket Alarm offers a powerful API (application programming interface) to developers that want to integrate case filings into their apps.

LAW FIRMS

Build custom dashboards for your attorneys and clients with live data direct from the court.

Automate many repetitive legal tasks like conflict checks, document management, and marketing.

FINANCIAL INSTITUTIONS

Litigation and bankruptcy checks for companies and debtors.

E-DISCOVERY AND LEGAL VENDORS

Sync your system to PACER to automate legal marketing.