

8360351



# THE UNITED STATES OF AMERICA

**TO ALL TO WHOM THESE PRESENTS SHALL COME:**

UNITED STATES DEPARTMENT OF COMMERCE

United States Patent and Trademark Office

*March 28, 2023*

**THIS IS TO CERTIFY THAT ANNEXED IS A TRUE COPY FROM THE RECORDS OF THIS OFFICE OF THE FILE WRAPPER AND CONTENTS OF:**

**APPLICATION NUMBER:** 17/352,892  
**FILING DATE:** *June 21, 2021*  
**PATENT NUMBER:** 11253572  
**ISSUE DATE:** *February 22, 2022*



Certified by

*Kathi*

Performing the Functions and Duties of the  
Under Secretary of Commerce  
for Intellectual Property  
and Director of the United States  
Patent and Trademark Office

## SCORE Placeholder Sheet for IFW Content

Application Number: 17352892

Document Date: 06/21/2021

The presence of this form in the IFW record indicates that the following document type was received in electronic format on the date identified above. This content is stored in the SCORE database.

Since this was an electronic submission, there is no physical artifact folder, no artifact folder is recorded in PALM, and no paper documents or physical media exist. The TIFF images in the IFW record were created from the original documents that are stored in SCORE.

- Sequence Listing

At the time of document entry (noted above):

- USPTO employees may access SCORE content via DAV or via the SCORE web page.
- External customers may access SCORE content via PAIR using the Supplemental Content tab.

Form Revision Date: March 1, 2019

**Electronically Filed**

|   |                      |   |
|---|----------------------|---|
| <b>PRELIMINARY<br/>AMENDMENT<br/>Under CFR 1.115</b><br><br>Address to:<br>Mail Stop Patent Application<br>Commissioner for Patents<br>P.O. Box 1450<br>Alexandria, VA 22313-1450 | Attorney Docket No.  | REGN-008CIPCON10  |
|   | Confirmation No.     | To Be Assigned  |
|   | First Named Inventor | YANCOPOULOS, GEORGE D.  |
|   | Application Number   | To Be Assigned  |
|   | Filing Date          | June 21, 2021   |
|   | Group Art Unit       | To Be Assigned  |
|   | Examiner Name        | To Be Assigned  |
|   | Title:               | <i>“Use of a VEGF Antagonist to Treat Angiogenic Eye Disorders”</i> |

Sir:

Prior to the examination of the above-referenced application on the merits, please enter the amendments below.

**Amendments to the claims** begin on page 2.

**Remarks** begin on page 7.

**AMENDMENTS TO THE CLAIMS**

1. - 20. (Canceled)

21. (New) A method of treating an angiogenic eye disorder in a patient in need thereof comprising sequentially administering to the patient by intravitreal injection a single initial dose of 2 mg of aflibercept, followed by one or more secondary doses of 2 mg of aflibercept, followed by one or more tertiary doses of 2 mg of aflibercept;

wherein each secondary dose is administered approximately 4 weeks following the immediately preceding dose; and

wherein each tertiary dose is administered approximately 8 weeks following the immediately preceding dose;

wherein the patient achieves a gain in visual acuity within 52 weeks following the initial dose.

22. (New) The method of claim 21 wherein the patient achieves a gain in Best Corrected Visual Acuity (BCVA) according to Early Treatment Diabetic Retinopathy Study (ETDRS) letter score.

23. (New) The method of claim 22 wherein the patient gains at least 7 letters Best Corrected Visual Acuity (BCVA) according to Early Treatment Diabetic Retinopathy Study (ETDRS) letter score.

24. (New) The method of claim 23 wherein the patient achieves the gain in visual acuity within 24 weeks following the initial dose.

25. (New) The method of claim 23 wherein only two secondary doses are administered to the patient.

26. **(New)** The method of claim 23 wherein the aflibercept is formulated as an isotonic solution.

27. **(New)** The method of claim 23 wherein the aflibercept is formulated with a non-ionic surfactant.

28. **(New)** The method of claim 22 wherein the patient gains at least 8 letters Best Corrected Visual Acuity (BCVA) according to Early Treatment Diabetic Retinopathy Study (ETDRS) letter score.

29. **(New)** The method of claim 28 wherein the patient achieves the gain in visual acuity within 24 weeks following the initial dose.

30. **(New)** The method of claim 22 wherein the patient gains at least 9 letters Best Corrected Visual Acuity (BCVA) according to Early Treatment Diabetic Retinopathy Study (ETDRS) letter score.

31. **(New)** The method of claim 30 wherein only two secondary doses are administered to the patient.

32. **(New)** The method of claim 30 wherein the aflibercept is formulated as an isotonic solution.

33. **(New)** The method of claim 30 wherein the aflibercept is formulated with a non-ionic surfactant.

34. **(New)** The method of claim 21 wherein exclusion criteria for the patient include both of:

- (1) active ocular inflammation; and
- (2) active ocular or periocular infection.

35. **(New)** A method of treating diabetic macular edema in a patient in need thereof comprising sequentially administering to the patient a single initial dose of 2 mg of aflibercept, followed by one or more secondary doses of 2 mg of aflibercept, followed by one or more tertiary doses of 2 mg of aflibercept;

wherein each secondary dose is administered to the patient by intravitreal injection approximately 4 weeks following the immediately preceding dose; and

wherein each tertiary dose is administered to the patient by intravitreal injection approximately 8 weeks following the immediately preceding dose.

36. **(New)** The method of claim 35 wherein the patient achieves a gain in visual acuity within 52 weeks following the initial dose.

37. **(New)** The method of claim 36 wherein the patient gains at least 9 letters Best Corrected Visual Acuity (BCVA) according to Early Treatment Diabetic Retinopathy Study (ETDRS) letter score.

38. **(New)** The method of claim 37 wherein the aflibercept is formulated as an isotonic solution.

39. **(New)** The method of claim 37 wherein the aflibercept is formulated with a non-ionic surfactant.

40. **(New)** The method of claim 37 wherein the patient achieves a gain in visual acuity within 24 weeks following the initial dose.

41. **(New)** The method of claim 36 wherein the patient gains at least 8 letters Best Corrected Visual Acuity (BCVA) according to Early Treatment Diabetic Retinopathy Study (ETDRS) letter score.

42. **(New)** The method of claim 41 wherein the aflibercept is formulated as an isotonic solution.
43. **(New)** The method of claim 41 wherein the aflibercept is formulated with a non-ionic surfactant.
44. **(New)** The method of claim 35 wherein only two secondary doses are administered to the patient.
45. **(New)** The method of claim 35 wherein four secondary doses are administered to the patient.
46. **(New)** A method of treating age related macular degeneration in a patient in need thereof comprising sequentially administering to the patient a single initial dose of 2 mg of aflibercept, followed by one or more secondary doses of 2 mg of aflibercept, followed by one or more tertiary doses of 2 mg of aflibercept;  
wherein each secondary dose is administered to the patient by intravitreal injection approximately 4 weeks following the immediately preceding dose; and  
wherein each tertiary dose is administered to the patient by intravitreal injection approximately 8 weeks following the immediately preceding dose;  
wherein the method is as effective in achieving a gain in visual acuity as monthly administration of 0.5 mg of ranibizumab by intravitreal injection in human subjects with age-related macular degeneration at 52 weeks following the initial dose.
47. **(New)** The method of claim 46 wherein only two secondary doses are administered to the patient.
48. **(New)** The method of claim 46 wherein the gain in visual acuity is measured using the Early Treatment Diabetic Retinopathy Study (ETDRS) letter score.

49. (New) A method of treating age-related macular degeneration in a patient in need thereof comprising sequentially administering to the patient a single initial dose of 2 mg of aflibercept, followed by one or more secondary doses of 2 mg of aflibercept, followed by one or more tertiary doses of 2 mg of aflibercept;

wherein each secondary dose is administered to the patient by intravitreal injection approximately 4 weeks following the immediately preceding dose; and

wherein each tertiary dose is administered to the patient by intravitreal injection approximately 8 weeks following the immediately preceding dose;

wherein the method is as effective in maintaining visual acuity as monthly administration of 0.5 mg of ranibizumab by intravitreal injection in human subjects with age-related macular degeneration at 52 weeks following the initial dose.

50. (New) The method of claim 49 wherein maintenance of visual acuity means loss of less than 15 letters Best Corrected Visual Acuity (BCVA) as measured by using the Early Treatment Diabetic Retinopathy Study (ETDRS) letter score.



**REMARKS UNDER 37 CFR § 1.115**

**Formal Matters**

Claims 21-50 are pending after entry of the amendments set forth herein.

Original claims 1-20 are canceled without prejudice.

Claims 21-50 are added here.

Support for new claims 21-50 can be found in originally pending now canceled claims 1-20, and throughout the specification.

No new matter has been added.

**SEQUENCE LISTING**

Applicants submit herewith the attached Sequence Listing in .txt format. As set out in MPEP §2422.03(a), the Office has advised that if the sequence listing text file submitted via EFS-Web complies with the requirements of 37 CFR 1.824(a)(2)-(6) and (b) (i.e., is a compliant sequence listing ASCII text file), the text file will serve as both the paper copy required by 37 CFR 1.821(c) and the computer readable form (CRF) required by 37 CFR 1.821(e). Further, per MPEP §2422.03(a), neither (1) a second copy of the sequence listing in a PDF file; nor (2) a statement under 37 CFR 1.821(f) (indicating that the paper copy and CRF copy of the sequence listing are identical) should be submitted.

The Sequence Listing was prepared with the software FASTSEQ for Windows version 4.0, and conforms to the Patent Office guidelines. Applicant respectfully submits that the subject application is in adherence to 37 CFR §§ 1.821-1.825. I hereby certify that the enclosed submission includes no new matter.

Applicants respectfully submit that the present patent application is now in compliance with 37 CFR §§ 1.821-1.825.

**STATEMENT UNDER 37 C.F.R. §§1.56 AND 1.2**

Applicants hereby advise the Examiner of the status of a co-pending application in compliance with the Applicant's duty to disclose under 37 C.F.R. §§1.56 and 1.2 ( see also MPEP §2001.06(b)) as discussed in *McKesson Info. Soln. Inc., v. Bridge Medical Inc.*, 487 F.3d 897; 82 USPQ2d 1865 (Fed. Cir. 2007).

The Applicant wishes to bring to the Examiner's attention U.S. Patent Application No. 13/940,370, filed July 12, 2013 which issued on February 9, 2016 as U.S. Patent 9,254,338, for which *Inter Partes* Review No. IPR2021-00881 was filed on May 5, 2021.

The Applicant wishes to bring to the Examiner's attention U.S. Patent Application No. 14/972,560, filed December 17, 2015 which issued on June 6, 2017 as U.S. Patent No. 9,669,069, for which *Inter Partes* Review No. IPR2021-00880 was filed on May 5, 2021.

The Applicant wishes to bring to the Examiner's attention U.S. Patent Application No. 15/471,506, filed March 28, 2017 which issued on November 20, 2018 as U.S. Patent No. 10,130,681.

The Applicant wishes to bring to the Examiner's attention U.S. Patent Application No. 16/055,847, filed August 6, 2018 which will issue on December 8, 2020 as U.S. Patent No. 10,857,205.

The Applicant wishes to bring to the Examiner's attention U.S. Patent Application No. 16/159,282, filed October 12, 2018 which issued on November 10, 2020 as U.S. Patent No. 10,828,345, for which Post-Grant Review No. PGR2021-00035 was filed on January 7, 2021.

The Applicant wishes to bring to the Examiner's attention co-pending U.S. Patent Application No. 16/397,267, filed April 29, 2019, which issued on January 12, 2021 as U.S. Patent No. 10,888,601.

The Applicant wishes to bring to the Examiner's attention co-pending U.S. Patent Application No. 17/072,417, filed October 16, 2020 for which no actions have been mailed.

The Applicant wishes to bring to the Examiner's attention co-pending U.S. Patent Application 17/112,063, filed December 4, 2020 for which no actions have been mailed.

The Applicant wishes to bring to the Examiner's attention co-pending U.S. Patent Application No. 17/112,404 filed December 4, 2020 for which no actions have been mailed.

The Applicant wishes to bring to the Examiner's attention co-pending U.S. Patent Application No. 17/350,958 filed June 17, 2021 for which no actions have been mailed.

These documents are available on PAIR, and thus are not provided with this communication. Please inform the undersigned if there is any difficulty in obtaining the documents from PAIR.

**CONCLUSION**

Applicant submits that all of the claims are in condition for allowance, which action is requested. If the Examiner finds that a telephone conference would expedite the prosecution of this application, please telephone the undersigned at the number provided.

The Commissioner is hereby authorized to charge any underpayment of fees up to a strict limit of \$3,000.00 beyond that authorized on the credit card, but not more than \$3,000.00 in additional fees due with any communication for the above referenced patent application, including but not limited to any necessary fees for extensions of time, or credit any overpayment of any amount to Deposit Account No. 50-0815, order number REGN-008CIPCON10.

Respectfully submitted,  
BOZICEVIC, FIELD & FRANCIS LLP

Date: June 21, 2021

By: /Karl Bozicevic, Reg. No. 28,807/  
Karl Bozicevic, Reg. No. 28,807

Bozicevic, Field & Francis LLP  
201 Redwood Shores Parkway, Suite 200  
Redwood City, California 94065  
Telephone: (650) 327-3400  
Direct: (650) 833-7735  
Facsimile: (650) 327-3231

## Electronic Patent Application Fee Transmittal

|   |  |                 |               |                             |
|---|--|-----------------|---------------|-----------------------------|
| <b>Application Number:</b>  |  |                 |               |                             |
| <b>Filing Date:</b>   |  |                 |               |                             |
| <b>Title of Invention:</b>  | USE OF A VEGF ANTAGONIST TO TREAT ANGIOGENIC EYE DISORDERS |                 |               |                             |
| <b>First Named Inventor/Applicant Name:</b>   | George YANCOPOULOS   |                 |               |                             |
| <b>Filer:</b>   | Karl Bozicevic/Kimberly Zuehlke                            |                 |               |                             |
| <b>Attorney Docket Number:</b>  | REGN-008CIPCON10   |                 |               |                             |
| Filed as Large Entity   |  |                 |               |                             |
| <b>Filing Fees for Track I Prioritized Examination - Nonprovisional Application under 35 USC 111(a)</b> |  |                 |               |                             |
| <b>Description</b>  | <b>Fee Code</b>  | <b>Quantity</b> | <b>Amount</b> | <b>Sub-Total in USD(\$)</b> |
| <b>Basic Filing:</b>  |  |                 |               |                             |
| UTILITY APPLICATION FILING  | 1011   | 1               | 320           | 320                         |
| UTILITY SEARCH FEE  | 1111   | 1               | 700           | 700                         |
| UTILITY EXAMINATION FEE   | 1311   | 1               | 800           | 800                         |
| REQUEST FOR PRIORITIZED EXAMINATION   | 1817   | 1               | 4200          | 4200                        |
| <b>Pages:</b>   |  |                 |               |                             |
| <b>Claims:</b>  |  |                 |               |                             |
| CLAIMS IN EXCESS OF 20  | 1202   | 10              | 100           | 1000                        |
| <b>Miscellaneous-Filing:</b>  |  |                 |               |                             |

| Description                              | Fee Code | Quantity | Amount | Sub-Total in USD(\$) |
|--|----------|----------|--------|----------------------|
| PUBL. FEE- EARLY, VOLUNTARY, OR NORMAL   | 1504     | 1        | 0      | 0                    |
| PROCESSING FEE, EXCEPT PROV. APPLS.      | 1830     | 1        | 140    | 140                  |
| <b>Petition:</b>                         |          |          |        |                      |
| <b>Patent-Appeals-and-Interference:</b>  |          |          |        |                      |
| <b>Post-Allowance-and-Post-Issuance:</b> |          |          |        |                      |
| <b>Extension-of-Time:</b>                |          |          |        |                      |
| <b>Miscellaneous:</b>                    |          |          |        |                      |
| <b>Total in USD (\$)</b>                 |          |          |        | <b>7160</b>          |

## Electronic Acknowledgement Receipt

|   |  |
|---|--|
| <b>EFS ID:</b>                              | 43040441   |
| <b>Application Number:</b>                  | 17352892   |
| <b>International Application Number:</b>    |  |
| <b>Confirmation Number:</b>                 | 5070   |
| <b>Title of Invention:</b>                  | USE OF A VEGF ANTAGONIST TO TREAT ANGIOGENIC EYE DISORDERS |
| <b>First Named Inventor/Applicant Name:</b> | George YANCOPOULOS   |
| <b>Customer Number:</b>                     | 96387  |
| <b>Filer:</b>                               | Karl Bozicevic/Kimberly Zuehlke                            |
| <b>Filer Authorized By:</b>                 | Karl Bozicevic   |
| <b>Attorney Docket Number:</b>              | REGN-008CIPCON10   |
| <b>Receipt Date:</b>                        | 21-JUN-2021  |
| <b>Filing Date:</b>                         |  |
| <b>Time Stamp:</b>                          | 15:17:13   |
| <b>Application Type:</b>                    | Utility under 35 USC 111(a)                                |

### Payment information:

|  |                  |
|--|------------------|
| Submitted with Payment                   | yes              |
| Payment Type                             | CARD             |
| Payment was successfully received in RAM | \$7160           |
| RAM confirmation Number                  | E20216KF17320356 |
| Deposit Account                          |                  |
| Authorized User                          |                  |

The Director of the USPTO is hereby authorized to charge indicated fees and credit any overpayment as follows:

| <b>File Listing:</b>   |  |  |  |                         |                         |
|--|--|--|--|-------------------------|-------------------------|
| <b>Document Number</b>   | <b>Document Description</b>                                | <b>File Name</b>                             | <b>File Size(Bytes)/ Message Digest</b>  | <b>Multi Part /.zip</b> | <b>Pages (if appl.)</b> |
| 1  | Application Data Sheet                                     | WebADS.pdf                                   | 157184                                   | no                      | 9                       |
|  |  |  | 0e2d73a3792278a6cdcc020273a805e5dbf2e8e4 |                         |                         |
| <b>Warnings:</b>   |  |  |  |                         |                         |
| <b>Information:</b>  |  |  |  |                         |                         |
| 2  | TrackOne Request   | REGN-008CIPCON10_2021-06-21_AIA424.pdf       | 124890                                   | no                      | 2                       |
|  |  |  | 1d110eb4305e8ce3ea8cde0bdf4aa6d5485fc78f |                         |                         |
| <b>Warnings:</b>   |  |  |  |                         |                         |
| <b>Information:</b>  |  |  |  |                         |                         |
| 3  |  | REGN-008CIPCON10_2021-06-21_Appln_as fld.pdf | 159599                                   | yes                     | 25                      |
|  |  |  | bbb806b1f3f4474e60dd585dc44da88f0fdb15   |                         |                         |
|  | <b>Multipart Description/PDF files in .zip description</b> |  |  |                         |                         |
|  | <b>Document Description</b>                                |  | <b>Start</b>                             | <b>End</b>              |                         |
|  | Sequence Listing   |  | 1  | 22                      |                         |
|  | Claims   |  | 23                                       | 24                      |                         |
|  | Abstract   |  | 25                                       | 25                      |                         |
| <b>Warnings:</b>   |  |  |  |                         |                         |
| <b>Information:</b>  |  |  |  |                         |                         |
| 4  | Drawings-only black and white line drawings                | REGN-008CIPCON10_Figure.pdf                  | 105393                                   | no                      | 1                       |
|  |  |  | 2d582f645d0c5d17d717e589b029a39331991bdb |                         |                         |
| <b>Warnings:</b>   |  |  |  |                         |                         |
| The page size in the PDF is too large. The pages should be 8.5 x 11 or A4. If this PDF is submitted, the pages will be resized upon entry into the Image File Wrapper and may affect subsequent processing |  |  |  |                         |                         |
| <b>Information:</b>  |  |  |  |                         |                         |

|  |  |   |  |            |    |
|--|--|---|--|------------|----|
| 5  | Oath or Declaration filed                                  | REGN-008CIPCON10_declaratio<br>n.pdf  | 173097<br><br>6bda7272374e6af80c8c3d8cf30d012e4657<br>b588 | no         | 2  |
| <b>Warnings:</b>   |  |   |  |            |    |
| The page size in the PDF is too large. The pages should be 8.5 x 11 or A4. If this PDF is submitted, the pages will be resized upon entry into the Image File Wrapper and may affect subsequent processing |  |   |  |            |    |
| <b>Information:</b>  |  |   |  |            |    |
| 6  | Transmittal Letter   | REGN-008CIPCON10_2021-06-2<br>1_IDS_Trans.pdf                               | 53895<br><br>cb10281d6ab75af6ab0c1c92e77abe1e19ac<br>927b8 | no         | 3  |
| <b>Warnings:</b>   |  |   |  |            |    |
| <b>Information:</b>  |  |   |  |            |    |
| 7  | Information Disclosure Statement (IDS)<br>Form (SB08)      | REGN-008CIPCON10_2021-06-2<br>1_IDS_SB08A.pdf                               | 196361<br><br>3647dd330684a0efc53f68ece70170549590<br>db56 | no         | 18 |
| <b>Warnings:</b>   |  |   |  |            |    |
| <b>Information:</b>  |  |   |  |            |    |
| This is not an USPTO supplied IDS fillable form  |  |   |  |            |    |
| 8  |  | REGN-008CIPCON10_2021-06-2<br>1_Track-<br>One_Preliminary_Amendment.<br>pdf | 58360<br><br>2939ef005bd2ff14fa87d73f738ca32cf058a<br>099  | yes        | 9  |
|  | <b>Multipart Description/PDF files in .zip description</b> |   |  |            |    |
|  | <b>Document Description</b>                                |   | <b>Start</b>   | <b>End</b> |    |
|  | Preliminary Amendment                                      |   | 1  | 1          |    |
|  | Claims   |   | 2  | 6          |    |
| Applicant Arguments/Remarks Made in an Amendment   |  | 7   | 9  |            |    |
| <b>Warnings:</b>   |  |   |  |            |    |
| <b>Information:</b>  |  |   |  |            |    |
| 9  | Sequence Listing (Text File)                               | REGN-008CIPCON10_SeqList.<br>txt  | 6473   | no         | -  |
| <b>Warnings:</b>   |  |   |  |            |    |
| <b>Information:</b>  |  |   |  |            |    |



|   |                      |              |   |    |   |
|---|----------------------|--------------|---|----|---|
| 10  | Fee Worksheet (SB06) | fee-info.pdf | 41815<br><br>cea833df2cffe6106b85cd32215d976d8b89313c | no | 2 |
| <b>Warnings:</b>  |                      |              |   |    |   |
| <b>Information:</b>   |                      |              |   |    |   |
| <b>Total Files Size (in bytes):</b>   |                      |              | 1077067   |    |   |
| <p><b>This Acknowledgement Receipt evidences receipt on the noted date by the USPTO of the indicated documents, characterized by the applicant, and including page counts, where applicable. It serves as evidence of receipt similar to a Post Card, as described in MPEP 503.</b></p> <p><b><u>New Applications Under 35 U.S.C. 111</u></b><br/> <b>If a new application is being filed and the application includes the necessary components for a filing date (see 37 CFR 1.53(b)-(d) and MPEP 506), a Filing Receipt (37 CFR 1.54) will be issued in due course and the date shown on this Acknowledgement Receipt will establish the filing date of the application.</b></p> <p><b><u>National Stage of an International Application under 35 U.S.C. 371</u></b><br/> <b>If a timely submission to enter the national stage of an international application is compliant with the conditions of 35 U.S.C. 371 and other applicable requirements a Form PCT/DO/EO/903 indicating acceptance of the application as a national stage submission under 35 U.S.C. 371 will be issued in addition to the Filing Receipt, in due course.</b></p> <p><b><u>New International Application Filed with the USPTO as a Receiving Office</u></b><br/> <b>If a new international application is being filed and the international application includes the necessary components for an international filing date (see PCT Article 11 and MPEP 1810), a Notification of the International Application Number and of the International Filing Date (Form PCT/RO/105) will be issued in due course, subject to prescriptions concerning national security, and the date shown on this Acknowledgement Receipt will establish the international filing date of the application.</b></p> |                      |              |   |    |   |

|   |  |                        |                  |
|---|--|------------------------|------------------|
| <b>Application Data Sheet 37 CFR 1.76</b>   |  | Attorney Docket Number | REGN-008CIPCON10 |
|   |  | Application Number     |                  |
| Title of Invention  | USE OF A VEGF ANTAGONIST TO TREAT ANGIOGENIC EYE DISORDERS |                        |                  |
| The application data sheet is part of the provisional or nonprovisional application for which it is being submitted. The following form contains the bibliographic data arranged in a format specified by the United States Patent and Trademark Office as outlined in 37 CFR 1.76. This document may be completed electronically and submitted to the Office in electronic format using the Electronic Filing System (EFS) or the document may be printed and included in a paper filed application. |  |                        |                  |

**Secrecy Order 37 CFR 5.2:**

Portions or all of the application associated with this Application Data Sheet may fall under a Secrecy Order pursuant to 37 CFR 5.2 (Paper filers only. Applications that fall under Secrecy Order may not be filed electronically.)

**Inventor Information:**

| Inventor 1   |                                     |                      |             |                                    |
|--|-------------------------------------|----------------------|-------------|------------------------------------|
| Legal Name   |                                     |                      |             |                                    |
| Prefix   | Given Name                          | Middle Name          | Family Name | Suffix                             |
|  | George                              |                      | YANCOPOULOS |                                    |
| Residence Information (Select One) <input checked="" type="radio"/> US Residency <input type="radio"/> Non US Residency <input type="radio"/> Active US Military Service |                                     |                      |             |                                    |
| City   | Yorktown Heights                    | State/Province       | NY          | Country of Residence <sup>i</sup>  |
|  |                                     |                      |             | US                                 |
| Mailing Address of Inventor:   |                                     |                      |             |                                    |
| Address 1  | c/o Regeneron Pharmaceuticals, Inc. |                      |             |                                    |
| Address 2  | 777 Old Saw Mill River Road         |                      |             |                                    |
| City   | Tarrytown                           | State/Province       | NY          |                                    |
| Postal Code  | 10591                               | Country <sup>i</sup> | US          |                                    |
| All Inventors Must Be Listed - Additional Inventor Information blocks may be generated within this form by selecting the <b>Add</b> button.                              |                                     |                      |             | <input type="button" value="Add"/> |

**Correspondence Information:**

|  |  |
|--|--|
| Enter either Customer Number or complete the Correspondence Information section below. For further information see 37 CFR 1.33(a). |  |
| <input type="checkbox"/> An Address is being provided for the correspondence Information of this application.                      |  |
| Customer Number  | 96387  |
| Email Address  | docket@bozpat.com <input type="button" value="Add Email"/> <input type="button" value="Remove Email"/> |

**Application Information:**

|   |  |   |                          |
|---|--|---|--------------------------|
| Title of the Invention                  | USE OF A VEGF ANTAGONIST TO TREAT ANGIOGENIC EYE DISORDERS |   |                          |
| Attorney Docket Number                  | REGN-008CIPCON10   | Small Entity Status Claimed               | <input type="checkbox"/> |
| Application Type                        | Nonprovisional   |   |                          |
| Subject Matter                          | Utility  |   |                          |
| Total Number of Drawing Sheets (if any) | 1  | Suggested Figure for Publication (if any) | 1                        |

Under the Paperwork Reduction Act of 1995, no persons are required to respond to a collection of information unless it contains a valid OMB control number.

|   |  |                        |                  |
|---|--|------------------------|------------------|
| <b>Application Data Sheet 37 CFR 1.76</b> |  | Attorney Docket Number | REGN-008CIPCON10 |
|   |  | Application Number     |                  |
| Title of Invention                        | USE OF A VEGF ANTAGONIST TO TREAT ANGIOGENIC EYE DISORDERS |                        |                  |

**Filing By Reference:**

Only complete this section when filing an application by reference under 35 U.S.C. 111(c) and 37 CFR 1.57(a). Do not complete this section if application papers including a specification and any drawings are being filed. Any domestic benefit or foreign priority information must be provided in the appropriate section(s) below (i.e., "Domestic Benefit/National Stage Information" and "Foreign Priority Information").

For the purposes of a filing date under 37 CFR 1.53(b), the description and any drawings of the present application are replaced by this reference to the previously filed application, subject to conditions and requirements of 37 CFR 1.57(a).

|  |                          |  |
|--|--------------------------|--|
| Application number of the previously filed application | Filing date (YYYY-MM-DD) | Intellectual Property Authority or Country |
|  |                          |  |

**Publication Information:**

Request Early Publication (Fee required at time of Request 37 CFR 1.219)

**Request Not to Publish.** I hereby request that the attached application not be published under 35 U.S.C. 122(b) and certify that the invention disclosed in the attached application **has not and will not** be the subject of an application filed in another country, or under a multilateral international agreement, that requires publication at eighteen months after filing.

**Representative Information:**

Representative information should be provided for all practitioners having a power of attorney in the application. Providing this information in the Application Data Sheet does not constitute a power of attorney in the application (see 37 CFR 1.32).

Either enter Customer Number or complete the Representative Name section below. If both sections are completed the customer Number will be used for the Representative Information during processing.

|  |  |  |   |        |                                       |
|--|--|--|---|--------|---------------------------------------|
| Please Select One:   | <input checked="" type="radio"/> Customer Number | <input type="radio"/> US Patent Practitioner | <input type="radio"/> Limited Recognition (37 CFR 11.9) |        |                                       |
| Customer Number  | 96387  |  |   |        |                                       |
| Prefix   | <b>Given Name</b>                                | Middle Name                                  | <b>Family Name</b>                                      | Suffix | <input type="button" value="Remove"/> |
|  |  |  |   |        |                                       |
| Registration Number  |  |  |   |        |                                       |
| Prefix   | <b>Given Name</b>                                | Middle Name                                  | <b>Family Name</b>                                      | Suffix | <input type="button" value="Remove"/> |
|  |  |  |   |        |                                       |
| Registration Number  |  |  |   |        |                                       |
| Additional Representative Information blocks may be generated within this form by selecting the <b>Add</b> button. |  |  |   |        |                                       |

Under the Paperwork Reduction Act of 1995, no persons are required to respond to a collection of information unless it contains a valid OMB control number.

|   |  |                        |                  |
|---|--|------------------------|------------------|
| <b>Application Data Sheet 37 CFR 1.76</b> |  | Attorney Docket Number | REGN-008CIPCON10 |
|   |  | Application Number     |                  |
| Title of Invention                        | USE OF A VEGF ANTAGONIST TO TREAT ANGIOGENIC EYE DISORDERS |                        |                  |

**Domestic Benefit/National Stage Information:**

This section allows for the applicant to either claim benefit under 35 U.S.C. 119(e), 120, 121, 365(c), or 386(c) or indicate National Stage entry from a PCT application. Providing benefit claim information in the Application Data Sheet constitutes the specific reference required by 35 U.S.C. 119(e) or 120, and 37 CFR 1.78.

When referring to the current application, please leave the "Application Number" field blank.

|                          |                 |                          |                                    |                        |                         |
|--------------------------|-----------------|--------------------------|------------------------------------|------------------------|-------------------------|
| Prior Application Status |                 | Pending                  |                                    | <a href="#">Remove</a> |                         |
| Application Number       | Continuity Type | Prior Application Number | Filing or 371(c) Date (YYYY-MM-DD) |                        |                         |
|                          | Continuation of | 17350958                 | 2021-06-17                         |                        |                         |
| Prior Application Status |                 | Pending                  |                                    | <a href="#">Remove</a> |                         |
| Application Number       | Continuity Type | Prior Application Number | Filing or 371(c) Date (YYYY-MM-DD) |                        |                         |
| 17350958                 | Continuation of | 17112404                 | 2020-12-04                         |                        |                         |
| Prior Application Status |                 | Pending                  |                                    | <a href="#">Remove</a> |                         |
| Application Number       | Continuity Type | Prior Application Number | Filing or 371(c) Date (YYYY-MM-DD) |                        |                         |
| 17112404                 | Continuation of | 17072417                 | 2020-10-16                         |                        |                         |
| Prior Application Status |                 | Patented                 |                                    | <a href="#">Remove</a> |                         |
| Application Number       | Continuity Type | Prior Application Number | Filing Date (YYYY-MM-DD)           | Patent Number          | Issue Date (YYYY-MM-DD) |
| 17072417                 | Continuation of | 16055847                 | 2018-08-06                         | 10857205               | 2020-12-08              |
| Prior Application Status |                 | Patented                 |                                    | <a href="#">Remove</a> |                         |
| Application Number       | Continuity Type | Prior Application Number | Filing Date (YYYY-MM-DD)           | Patent Number          | Issue Date (YYYY-MM-DD) |
| 17072417                 | Continuation of | 16397267                 | 2019-04-29                         | 10888601               | 2021-01-12              |
| Prior Application Status |                 | Patented                 |                                    | <a href="#">Remove</a> |                         |
| Application Number       | Continuity Type | Prior Application Number | Filing Date (YYYY-MM-DD)           | Patent Number          | Issue Date (YYYY-MM-DD) |
| 16397267                 | Continuation of | 16159282                 | 2018-10-12                         | 10828345               | 2020-11-10              |
| Prior Application Status |                 | Patented                 |                                    | <a href="#">Remove</a> |                         |
| Application Number       | Continuity Type | Prior Application Number | Filing Date (YYYY-MM-DD)           | Patent Number          | Issue Date (YYYY-MM-DD) |
| 16159282                 | Continuation of | 15471506                 | 2017-03-28                         | 10130681               | 2018-11-20              |

Under the Paperwork Reduction Act of 1995, no persons are required to respond to a collection of information unless it contains a valid OMB control number.

|   |  |                        |                  |
|---|--|------------------------|------------------|
| <b>Application Data Sheet 37 CFR 1.76</b> |  | Attorney Docket Number | REGN-008CIPCON10 |
|   |  | Application Number     |                  |
| Title of Invention                        | USE OF A VEGF ANTAGONIST TO TREAT ANGIOGENIC EYE DISORDERS |                        |                  |

| Prior Application Status  | Patented                      |                          | Remove                             |               |                         |
|---|-------------------------------|--------------------------|------------------------------------|---------------|-------------------------|
| Application Number  | Continuity Type               | Prior Application Number | Filing Date (YYYY-MM-DD)           | Patent Number | Issue Date (YYYY-MM-DD) |
| 15471506  | Continuation of               | 14972560                 | 2015-12-17                         | 9669069       | 2017-06-06              |
| Prior Application Status  | Patented                      |                          | Remove                             |               |                         |
| Application Number  | Continuity Type               | Prior Application Number | Filing Date (YYYY-MM-DD)           | Patent Number | Issue Date (YYYY-MM-DD) |
| 14972560  | Continuation of               | 13940370                 | 2013-07-12                         | 9254338       | 2016-02-09              |
| Prior Application Status  | Expired                       |                          | Remove                             |               |                         |
| Application Number  | Continuity Type               | Prior Application Number | Filing or 371(c) Date (YYYY-MM-DD) |               |                         |
| 13940370  | Continuation in part of       | PCT/US2012/020855        | 2012-01-11                         |               |                         |
| Prior Application Status  | Expired                       |                          | Remove                             |               |                         |
| Application Number  | Continuity Type               | Prior Application Number | Filing or 371(c) Date (YYYY-MM-DD) |               |                         |
| PCT/US2012/020855   | Claims benefit of provisional | 61432245                 | 2011-01-13                         |               |                         |
| Prior Application Status  | Expired                       |                          | Remove                             |               |                         |
| Application Number  | Continuity Type               | Prior Application Number | Filing or 371(c) Date (YYYY-MM-DD) |               |                         |
| PCT/US2012/020855   | Claims benefit of provisional | 61434836                 | 2011-01-21                         |               |                         |
| Prior Application Status  | Expired                       |                          | Remove                             |               |                         |
| Application Number  | Continuity Type               | Prior Application Number | Filing or 371(c) Date (YYYY-MM-DD) |               |                         |
| PCT/US2012/020855   | Claims benefit of provisional | 61561957                 | 2011-11-21                         |               |                         |
| Additional Domestic Benefit/National Stage Data may be generated within this form by selecting the <b>Add</b> button. |                               |                          |                                    |               |                         |

### Foreign Priority Information:

This section allows for the applicant to claim priority to a foreign application. Providing this information in the application data sheet constitutes the claim for priority as required by 35 U.S.C. 119(b) and 37 CFR 1.55. When priority is claimed to a foreign application that is eligible for retrieval under the priority document exchange program (PDX) the information will be used by the Office to automatically attempt retrieval pursuant to 37 CFR 1.55(i)(1) and (2). Under the PDX program, applicant bears the ultimate responsibility for ensuring that a copy of the foreign application is received by the Office from the participating foreign intellectual property office, or a certified copy of the foreign priority application is filed, within the time period specified in 37 CFR 1.55(g)(1).

Under the Paperwork Reduction Act of 1995, no persons are required to respond to a collection of information unless it contains a valid OMB control number.

|  |  |                          |  |
|--|--|--------------------------|--|
| <b>Application Data Sheet 37 CFR 1.76</b>  |  | Attorney Docket Number   | REGN-008CIPCON10                         |
|  |  | Application Number       |  |
| Title of Invention   | USE OF A VEGF ANTAGONIST TO TREAT ANGIOGENIC EYE DISORDERS |                          |  |
| Additional Foreign Priority Data may be generated within this form by selecting the <b>Add</b> button. |  |                          |  |
| Application Number   | Country <sup>i</sup>                                       | Filing Date (YYYY-MM-DD) | Access Code <sup>i</sup> (if applicable) |
|  |  |                          |  |

### Statement under 37 CFR 1.55 or 1.78 for AIA (First Inventor to File) Transition Applications

|  |
|--|
| <p>This application (1) claims priority to or the benefit of an application filed before March 16, 2013 and (2) also contains, or contained at any time, a claim to a claimed invention that has an effective filing date on or after March 16, 2013.</p> <p><input type="checkbox"/> NOTE: By providing this statement under 37 CFR 1.55 or 1.78, this application, with a filing date on or after March 16, 2013, will be examined under the first inventor to file provisions of the AIA.</p> |
|--|

Under the Paperwork Reduction Act of 1995, no persons are required to respond to a collection of information unless it contains a valid OMB control number.

|   |  |                        |                  |
|---|--|------------------------|------------------|
| <b>Application Data Sheet 37 CFR 1.76</b> |  | Attorney Docket Number | REGN-008CIPCON10 |
|   |  | Application Number     |                  |
| Title of Invention                        | USE OF A VEGF ANTAGONIST TO TREAT ANGIOGENIC EYE DISORDERS |                        |                  |

## Authorization or Opt-Out of Authorization to Permit Access:

When this Application Data Sheet is properly signed and filed with the application, applicant has provided written authority to permit a participating foreign intellectual property (IP) office access to the instant application-as-filed (see paragraph A in subsection 1 below) and the European Patent Office (EPO) access to any search results from the instant application (see paragraph B in subsection 1 below).

Should applicant choose not to provide an authorization identified in subsection 1 below, applicant **must opt-out** of the authorization by checking the corresponding box A or B or both in subsection 2 below.

**NOTE:** This section of the Application Data Sheet is **ONLY** reviewed and processed with the **INITIAL** filing of an application. After the initial filing of an application, an Application Data Sheet cannot be used to provide or rescind authorization for access by a foreign IP office(s). Instead, Form PTO/SB/39 or PTO/SB/69 must be used as appropriate.

### 1. Authorization to Permit Access by a Foreign Intellectual Property Office(s)

**A. Priority Document Exchange (PDX)** - Unless box A in subsection 2 (opt-out of authorization) is checked, the undersigned hereby **grants the USPTO authority** to provide the European Patent Office (EPO), the Japan Patent Office (JPO), the Korean Intellectual Property Office (KIPO), the State Intellectual Property Office of the People's Republic of China (SIPO), the World Intellectual Property Organization (WIPO), and any other foreign intellectual property office participating with the USPTO in a bilateral or multilateral priority document exchange agreement in which a foreign application claiming priority to the instant patent application is filed, access to: (1) the instant patent application-as-filed and its related bibliographic data, (2) any foreign or domestic application to which priority or benefit is claimed by the instant application and its related bibliographic data, and (3) the date of filing of this Authorization. See 37 CFR 1.14(h)(1).

**B. Search Results from U.S. Application to EPO** - Unless box B in subsection 2 (opt-out of authorization) is checked, the undersigned hereby **grants the USPTO authority** to provide the EPO access to the bibliographic data and search results from the instant patent application when a European patent application claiming priority to the instant patent application is filed. See 37 CFR 1.14(h)(2).

The applicant is reminded that the EPO's Rule 141(1) EPC (European Patent Convention) requires applicants to submit a copy of search results from the instant application without delay in a European patent application that claims priority to the instant application.

### 2. Opt-Out of Authorizations to Permit Access by a Foreign Intellectual Property Office(s)

A. Applicant **DOES NOT** authorize the USPTO to permit a participating foreign IP office access to the instant application-as-filed. If this box is checked, the USPTO will not be providing a participating foreign IP office with any documents and information identified in subsection 1A above.

B. Applicant **DOES NOT** authorize the USPTO to transmit to the EPO any search results from the instant patent application. If this box is checked, the USPTO will not be providing the EPO with search results from the instant application.

**NOTE:** Once the application has published or is otherwise publicly available, the USPTO may provide access to the application in accordance with 37 CFR 1.14.

Under the Paperwork Reduction Act of 1995, no persons are required to respond to a collection of information unless it contains a valid OMB control number.

|   |  |                        |                  |
|---|--|------------------------|------------------|
| <b>Application Data Sheet 37 CFR 1.76</b> |  | Attorney Docket Number | REGN-008CIPCON10 |
|   |  | Application Number     |                  |
| Title of Invention                        | USE OF A VEGF ANTAGONIST TO TREAT ANGIOGENIC EYE DISORDERS |                        |                  |

**Applicant Information:**

|  |  |  |                                      |
|--|--|--|--------------------------------------|
| Providing assignment information in this section does not substitute for compliance with any requirement of part 3 of Title 37 of CFR to have an assignment recorded by the Office.  |  |  |                                      |
| <b>Applicant 1</b>   |  |  |                                      |
| If the applicant is the inventor (or the remaining joint inventor or inventors under 37 CFR 1.45), this section should not be completed. The information to be provided in this section is the name and address of the legal representative who is the applicant under 37 CFR 1.43; or the name and address of the assignee, person to whom the inventor is under an obligation to assign the invention, or person who otherwise shows sufficient proprietary interest in the matter who is the applicant under 37 CFR 1.46. If the applicant is an applicant under 37 CFR 1.46 (assignee, person to whom the inventor is obligated to assign, or person who otherwise shows sufficient proprietary interest) together with one or more joint inventors, then the joint inventor or inventors who are also the applicant should be identified in this section. |  |  |                                      |
|  |  |  | <input type="button" value="Clear"/> |
| <input type="radio"/> Assignee   | <input type="radio"/> Legal Representative under 35 U.S.C. 117 | <input type="radio"/> Joint Inventor                                   |                                      |
| <input checked="" type="radio"/> Person to whom the inventor is obligated to assign.   |  | <input type="radio"/> Person who shows sufficient proprietary interest |                                      |
| If applicant is the legal representative, indicate the authority to file the patent application, the inventor is:  |  |  |                                      |
|  |  |  |                                      |
| Name of the Deceased or Legally Incapacitated Inventor:  |  |  |                                      |
| If the Applicant is an Organization check here. <input checked="" type="checkbox"/>  |  |  |                                      |
| Organization Name  | REGENERON PHARMACEUTICALS, INC.                                |  |                                      |
| <b>Mailing Address Information For Applicant:</b>  |  |  |                                      |
| Address 1  | 777 Old Saw Mill River Road                                    |  |                                      |
| Address 2  |  |  |                                      |
| City   | Tarrytown  | State/Province   | NY                                   |
| Country <sup>1</sup>   | US   | Postal Code  | 10591                                |
| Phone Number   |  | Fax Number   |                                      |
| Email Address  |  |  |                                      |
| Additional Applicant Data may be generated within this form by selecting the Add button.   |  |  |                                      |



Under the Paperwork Reduction Act of 1995, no persons are required to respond to a collection of information unless it contains a valid OMB control number.

|   |  |                        |                  |
|---|--|------------------------|------------------|
| <b>Application Data Sheet 37 CFR 1.76</b> |  | Attorney Docket Number | REGN-008CIPCON10 |
|   |  | Application Number     |                  |
| Title of Invention                        | USE OF A VEGF ANTAGONIST TO TREAT ANGIOGENIC EYE DISORDERS |                        |                  |

### Assignee Information including Non-Applicant Assignee Information:

Providing assignment information in this section does not substitute for compliance with any requirement of part 3 of Title 37 of CFR to have an assignment recorded by the Office.

|  |                                 |                |       |
|--|---------------------------------|----------------|-------|
| <b>Assignee 1</b>  |                                 |                |       |
| Complete this section if assignee information, including non-applicant assignee information, is desired to be included on the patent application publication. An assignee-applicant identified in the "Applicant Information" section will appear on the patent application publication as an applicant. For an assignee-applicant, complete this section only if identification as an assignee is also desired on the patent application publication. |                                 |                |       |
| If the Assignee or Non-Applicant Assignee is an Organization check here. <input checked="" type="checkbox"/>   |                                 |                |       |
| Organization Name  | REGENERON PHARMACEUTICALS, INC. |                |       |
| <b>Mailing Address Information For Assignee including Non-Applicant Assignee:</b>  |                                 |                |       |
| Address 1  | 777 Old Saw Mill River Road     |                |       |
| Address 2  |                                 |                |       |
| City   | Tarrytown                       | State/Province | NY    |
| Country <sup>i</sup>   | US                              | Postal Code    | 10591 |
| Phone Number   |                                 | Fax Number     |       |
| Email Address  |                                 |                |       |
| Additional Assignee or Non-Applicant Assignee Data may be generated within this form by selecting the Add button.  |                                 |                |       |
|  |                                 |                |       |

Under the Paperwork Reduction Act of 1995, no persons are required to respond to a collection of information unless it contains a valid OMB control number.

|   |  |                        |                  |
|---|--|------------------------|------------------|
| <b>Application Data Sheet 37 CFR 1.76</b> |  | Attorney Docket Number | REGN-008CIPCON10 |
|   |  | Application Number     |                  |
| Title of Invention                        | USE OF A VEGF ANTAGONIST TO TREAT ANGIOGENIC EYE DISORDERS |                        |                  |

**Signature:**

**NOTE:** This Application Data Sheet must be signed in accordance with 37 CFR 1.33(b). **However, if this Application Data Sheet is submitted with the INITIAL filing of the application and either box A or B is not checked in subsection 2 of the "Authorization or Opt-Out of Authorization to Permit Access" section, then this form must also be signed in accordance with 37 CFR 1.14(c).**

This Application Data Sheet **must** be signed by a patent practitioner if one or more of the applicants is a **juristic entity** (e.g., corporation or association). If the applicant is two or more joint inventors, this form must be signed by a patent practitioner, **all** joint inventors who are the applicant, or one or more joint inventor-applicants who have been given power of attorney (e.g., see USPTO Form PTO/AIA/81) on behalf of **all** joint inventor-applicants.

See 37 CFR 1.4(d) for the manner of making signatures and certifications.

|   |                  |                  |                   |                            |       |
|---|------------------|------------------|-------------------|----------------------------|-------|
| <b>Signature</b>  | /Karl Bozicevic/ |                  | Date (YYYY-MM-DD) |                            |       |
| <b>First Name</b>   | Karl             | <b>Last Name</b> | Bozicevic         | <b>Registration Number</b> | 28807 |
| Additional Signature may be generated within this form by selecting the Add button. |                  |                  |                   |                            |       |

**CERTIFICATION AND REQUEST FOR PRIORITIZED EXAMINATION  
UNDER 37 CFR 1.102(e)** (Page 1 of 1)

|                       |  |   |  |
|-----------------------|--|---|--|
| First Named Inventor: | YANCOPOULOS, GEORGE D.                                     | Nonprovisional Application Number (if known): |  |
| Title of Invention:   | Use of a VEGF Antagonist to Treat Angiogenic Eye Disorders |   |  |

**APPLICANT HEREBY CERTIFIES THE FOLLOWING AND REQUESTS PRIORITIZED EXAMINATION FOR THE ABOVE-IDENTIFIED APPLICATION.**

1. The processing fee set forth in 37 CFR 1.17(i)(1) and the prioritized examination fee set forth in 37 CFR 1.17(c) have been filed with the request. The publication fee requirement is met because that fee, set forth in 37 CFR 1.18(d), is currently \$0. The basic filing fee, search fee, and examination fee are filed with the request or have been already been paid. I understand that any required excess claims fees or application size fee must be paid for the application.
2. I understand that the application may not contain, or be amended to contain, more than four independent claims, more than thirty total claims, or any multiple dependent claims, and that any request for an extension of time will cause an outstanding Track I request to be dismissed.
3. The applicable box is checked below:
  - I.  **Original Application (Track One) - Prioritized Examination under § 1.102(e)(1)**
    - i. (a) The application is an original nonprovisional utility application filed under 35 U.S.C. 111(a). This certification and request is being filed with the utility application via EFS-Web.  
---OR---
    - (b) The application is an original nonprovisional plant application filed under 35 U.S.C. 111(a). This certification and request is being filed with the plant application in paper.
  - ii. An executed inventor's oath or declaration under 37 CFR 1.63 or 37 CFR 1.64 for each inventor, or the application data sheet meeting the conditions specified in 37 CFR 1.53(f)(3)(i) is filed with the application.
- II.  **Request for Continued Examination - Prioritized Examination under § 1.102(e)(2)**
  - i. A request for continued examination has been filed with, or prior to, this form.
  - ii. If the application is a utility application, this certification and request is being filed via EFS-Web.
  - iii. The application is an original nonprovisional utility application filed under 35 U.S.C. 111(a), or is a national stage entry under 35 U.S.C. 371.
  - iv. This certification and request is being filed prior to the mailing of a first Office action responsive to the request for continued examination.
  - v. No prior request for continued examination has been granted prioritized examination status under 37 CFR 1.102(e)(2).

|                                   |   |
|-----------------------------------|---|
| Signature /Karl Bozicevic/        | Date 2021-06-21                         |
| Name (Print/Typed) Karl Bozicevic | Practitioner Registration Number 28,807 |

**Note:** This form must be signed in accordance with 37 CFR 1.33. See 37 CFR 1.4(d) for signature requirements and certifications. Submit multiple forms if more than one signature is required.\*

\*Total of 1 forms are submitted.

## Privacy Act Statement

The **Privacy Act of 1974 (P.L. 93-579)** requires that you be given certain information in connection with your submission of the attached form related to a patent application or patent. Accordingly, pursuant to the requirements of the Act, please be advised that: (1) the general authority for the collection of this information is 35 U.S.C. 2(b)(2); (2) furnishing of the information solicited is voluntary; and (3) the principal purpose for which the information is used by the U.S. Patent and Trademark Office is to process and/or examine your submission related to a patent application or patent. If you do not furnish the requested information, the U.S. Patent and Trademark Office may not be able to process and/or examine your submission, which may result in termination of proceedings or abandonment of the application or expiration of the patent.

The information provided by you in this form will be subject to the following routine uses:

1. The information on this form will be treated confidentially to the extent allowed under the Freedom of Information Act (5 U.S.C. 552) and the Privacy Act (5 U.S.C. 552a). Records from this system of records may be disclosed to the Department of Justice to determine whether disclosure of these records is required by the Freedom of Information Act.
2. A record from this system of records may be disclosed, as a routine use, in the course of presenting evidence to a court, magistrate, or administrative tribunal, including disclosures to opposing counsel in the course of settlement negotiations.
3. A record in this system of records may be disclosed, as a routine use, to a Member of Congress submitting a request involving an individual, to whom the record pertains, when the individual has requested assistance from the Member with respect to the subject matter of the record.
4. A record in this system of records may be disclosed, as a routine use, to a contractor of the Agency having need for the information in order to perform a contract. Recipients of information shall be required to comply with the requirements of the Privacy Act of 1974, as amended, pursuant to 5 U.S.C. 552a(m).
5. A record related to an International Application filed under the Patent Cooperation Treaty in this system of records may be disclosed, as a routine use, to the International Bureau of the World Intellectual Property Organization, pursuant to the Patent Cooperation Treaty.
6. A record in this system of records may be disclosed, as a routine use, to another federal agency for purposes of National Security review (35 U.S.C. 181) and for review pursuant to the Atomic Energy Act (42 U.S.C. 218(c)).
7. A record from this system of records may be disclosed, as a routine use, to the Administrator, General Services, or his/her designee, during an inspection of records conducted by GSA as part of that agency's responsibility to recommend improvements in records management practices and programs, under authority of 44 U.S.C. 2904 and 2906. Such disclosure shall be made in accordance with the GSA regulations governing inspection of records for this purpose, and any other relevant (*i.e.*, GSA or Commerce) directive. Such disclosure shall not be used to make determinations about individuals.
8. A record from this system of records may be disclosed, as a routine use, to the public after either publication of the application pursuant to 35 U.S.C. 122(b) or issuance of a patent pursuant to 35 U.S.C. 151. Further, a record may be disclosed, subject to the limitations of 37 CFR 1.14, as a routine use, to the public if the record was filed in an application which became abandoned or in which the proceedings were terminated and which application is referenced by either a published application, an application open to public inspection or an issued patent.
9. A record from this system of records may be disclosed, as a routine use, to a Federal, State, or local law enforcement agency, if the USPTO becomes aware of a violation or potential violation of law or regulation.

## **USE OF A VEGF ANTAGONIST TO TREAT ANGIOGENIC EYE DISORDERS**

### **CROSS-REFERENCE TO RELATED APPLICATIONS**

[0001] This application is a continuation of 17/350,958 filed June 17, 2021 which is a continuation of 17/112,404 filed December 4, 2020 which is a continuation of 17/072,417 filed October 16, 2020 which is a continuation of 16/055,847 filed August 6, 2018, now U.S. Patent 10,857,205 issued December 8, 2020 and is a continuation of 16/397,267 filed April 29, 2019, which is a continuation of 16/159,282 filed October 12, 2018, now U.S. Patent No. 10,828,345 issued November 10, 2020, which is a continuation of 15/471,506 filed March 28, 2017, now U.S. Patent No. 10,130,681 issued November 20, 2018, which is a continuation of 14/972,560 filed December 17, 2015, now U.S. Patent No. 9,669,069 issued June 6, 2017, which is a continuation of 13/940,370 filed July 12, 2013, now U.S. Patent No. 9,254,338 issued February 9, 2016, which is a continuation-in-part of International Patent Application No. PCT/US2012/020855, filed on January 11, 2012, which claims the benefit of US Provisional Application Nos. 61/432,245, filed on January 13, 2011, 61/434,836, filed on January 21, 2011, and 61/561,957, filed on November 21, 2011, the contents of which are hereby incorporated by reference in their entireties.

### **FIELD OF THE INVENTION**

[0002] The present invention relates to the field of therapeutic treatments of eye disorders. More specifically, the invention relates to the administration of VEGF antagonists to treat eye disorders caused by or associated with angiogenesis.

### **BACKGROUND**

[0003] Several eye disorders are associated with pathological angiogenesis. For example, the development of age-related macular degeneration (AMD) is associated with a process called choroidal neovascularization (CNV). Leakage from the CNV causes macular edema and collection of fluid beneath the macula resulting in vision loss. Diabetic macular edema (DME) is another eye disorder with an angiogenic component. DME is the most prevalent cause of moderate vision loss in patients with diabetes and is a common complication of diabetic retinopathy, a disease affecting the blood vessels of the retina. Clinically significant DME occurs when fluid leaks into the center of the macula, the light-sensitive part of the retina responsible for sharp, direct vision. Fluid in the macula can cause severe vision loss or blindness. Yet another eye disorder associated with abnormal angiogenesis is central retinal vein occlusion (CRVO). CRVO is caused by obstruction of the central retinal vein that leads to a back-up of blood and fluid in the retina. The retina can also become ischemic, resulting in the growth of new, inappropriate blood vessels that can cause further vision loss and more serious complications. Release of vascular endothelial growth factor (VEGF)

contributes to increased vascular permeability in the eye and inappropriate new vessel growth. Thus, inhibiting the angiogenic-promoting properties of VEGF appears to be an effective strategy for treating angiogenic eye disorders.

**[0004]** FDA-approved treatments of angiogenic eye disorders such as AMD and CRVO include the administration of an anti-VEGF antibody called ranibizumab (Lucentis®, Genentech, Inc.) on a monthly basis by intravitreal injection.

**[0005]** Methods for treating eye disorders using VEGF antagonists are mentioned in, *e.g.*, US 7,303,746; US 7,306,799; US 7,300,563; US 7,303,748; and US 2007/0190058. Nonetheless, there remains a need in the art for new administration regimens for angiogenic eye disorders, especially those which allow for less frequent dosing while maintaining a high level of efficacy.

### **BRIEF SUMMARY OF THE INVENTION**

**[0006]** The present invention provides methods for treating angiogenic eye disorders. The methods of the invention comprise sequentially administering multiple doses of a VEGF antagonist to a patient over time. In particular, the methods of the invention comprise sequentially administering to the patient a single initial dose of a VEGF antagonist, followed by one or more secondary doses of the VEGF antagonist, followed by one or more tertiary doses of the VEGF antagonists. The present inventors have surprisingly discovered that beneficial therapeutic effects can be achieved in patients suffering from angiogenic eye disorders by administering a VEGF antagonist to a patient at a frequency of once every 8 or more weeks, especially when such doses are preceded by about three doses administered to the patient at a frequency of about 2 to 4 weeks. Thus, according to the methods of the present invention, each secondary dose of VEGF antagonist is administered 2 to 4 weeks after the immediately preceding dose, and each tertiary dose is administered at least 8 weeks after the immediately preceding dose. An example of a dosing regimen of the present invention is shown in Figure 1. One advantage of such a dosing regimen is that, for most of the course of treatment (*i.e.*, the tertiary doses), it allows for less frequent dosing (*e.g.*, once every 8 weeks) compared to prior administration regimens for angiogenic eye disorders which require monthly administrations throughout the entire course of treatment. (See, *e.g.*, prescribing information for Lucentis® [ranibizumab], Genentech, Inc.).

**[0007]** The methods of the present invention can be used to treat any angiogenic eye disorder, including, *e.g.*, age related macular degeneration, diabetic retinopathy, diabetic macular edema, central retinal vein occlusion, corneal neovascularization, etc.

**[0008]** The methods of the present invention comprise administering any VEGF antagonist to the patient. In one embodiment, the VEGF antagonist comprises one or more VEGF receptor-based chimeric molecule(s), (also referred to herein as a "VEGF-Trap" or "VEGFT"). An exemplary VEGF

antagonist that can be used in the context of the present invention is a multimeric VEGF-binding protein comprising two or more VEGF receptor-based chimeric molecules referred to herein as "VEGFR1R2-Fc $\Delta$ C1(a)" or "aflibercept."

[0009] Various administration routes are contemplated for use in the methods of the present invention, including, *e.g.*, topical administration or intraocular administration (*e.g.*, intravitreal administration).

[0010] Aflibercept (EYLEA™, Regeneron Pharmaceuticals, Inc) was approved by the FDA in November 2011, for the treatment of patients with neovascular (wet) age-related macular degeneration, with a recommended dose of 2 mg administered by intravitreal injection every 4 weeks for the first three months, followed by 2 mg administered by intravitreal injection once every 8 weeks.

[0011] Other embodiments of the present invention will become apparent from a review of the ensuing detailed description.

#### BRIEF DESCRIPTION OF THE FIGURE

[0012] Figure 1 shows an exemplary dosing regimen of the present invention. In this regimen, a single "initial dose" of VEGF antagonist ("VEGFT") is administered at the beginning of the treatment regimen (*i.e.* at "week 0"), two "secondary doses" are administered at weeks 4 and 8, respectively, and at least six "tertiary doses" are administered once every 8 weeks thereafter, *i.e.*, at weeks 16, 24, 32, 40, 48, 56, etc.).

#### DETAILED DESCRIPTION

[0013] Before the present invention is described, it is to be understood that this invention is not limited to particular methods and experimental conditions described, as such methods and conditions may vary. It is also to be understood that the terminology used herein is for the purpose of describing particular embodiments only, and is not intended to be limiting, since the scope of the present invention will be limited only by the appended claims.

[0014] Unless defined otherwise, all technical and scientific terms used herein have the same meaning as commonly understood by one of ordinary skill in the art to which this invention belongs. As used herein, the term "about," when used in reference to a particular recited numerical value, means that the value may vary from the recited value by no more than 1%. For example, as used herein, the expression "about 100" includes 99 and 101 and all values in between (*e.g.*, 99.1, 99.2, 99.3, 99.4, etc.).

[0015] Although any methods and materials similar or equivalent to those described herein can be used in the practice or testing of the present invention, the preferred methods and materials are now described.

### **DOSING REGIMENS**

[0016] The present invention provides methods for treating angiogenic eye disorders. The methods of the invention comprise sequentially administering to a patient multiple doses of a VEGF antagonist. As used herein, "sequentially administering" means that each dose of VEGF antagonist is administered to the patient at a different point in time, *e.g.*, on different days separated by a predetermined interval (*e.g.*, hours, days, weeks or months). The present invention includes methods which comprise sequentially administering to the patient a single initial dose of a VEGF antagonist, followed by one or more secondary doses of the VEGF antagonist, followed by one or more tertiary doses of the VEGF antagonist.

[0017] The terms "initial dose," "secondary doses," and "tertiary doses," refer to the temporal sequence of administration of the VEGF antagonist. Thus, the "initial dose" is the dose which is administered at the beginning of the treatment regimen (also referred to as the "baseline dose"); the "secondary doses" are the doses which are administered after the initial dose; and the "tertiary doses" are the doses which are administered after the secondary doses. The initial, secondary, and tertiary doses may all contain the same amount of VEGF antagonist, but will generally differ from one another in terms of frequency of administration. In certain embodiments, however, the amount of VEGF antagonist contained in the initial, secondary and/or tertiary doses will vary from one another (*e.g.*, adjusted up or down as appropriate) during the course of treatment.

[0018] In one exemplary embodiment of the present invention, each secondary dose is administered 2 to 4 (*e.g.*, 2, 2½, 3, 3½, or 4) weeks after the immediately preceding dose, and each tertiary dose is administered at least 8 (*e.g.*, 8, 8½, 9, 9½, 10, 10½, 11, 11½, 12, 12½, 13, 13½, 14, 14½, or more) weeks after the immediately preceding dose. The phrase "the immediately preceding dose," as used herein, means, in a sequence of multiple administrations, the dose of VEGF antagonist which is administered to a patient prior to the administration of the very next dose in the sequence with no intervening doses.

[0019] In one exemplary embodiment of the present invention, a single initial dose of a VEGF antagonist is administered to a patient on the first day of the treatment regimen (*i.e.*, at week 0), followed by two secondary doses, each administered four weeks after the immediately preceding dose (*i.e.*, at week 4 and at week 8), followed by at least 5 tertiary doses, each administered eight weeks after the immediately preceding dose (*i.e.*, at weeks 16, 24, 32, 40 and 48). The tertiary



doses may continue (at intervals of 8 or more weeks) indefinitely during the course of the treatment regimen. This exemplary administration regimen is depicted graphically in Figure 1.

**[0020]** The methods of the invention may comprise administering to a patient any number of secondary and/or tertiary doses of a VEGF antagonist. For example, in certain embodiments, only a single secondary dose is administered to the patient. In other embodiments, two or more (*e.g.*, 2, 3, 4, 5, 6, 7, 8, or more) secondary doses are administered to the patient. Likewise, in certain embodiments, only a single tertiary dose is administered to the patient. In other embodiments, two or more (*e.g.*, 2, 3, 4, 5, 6, 7, 8, or more) tertiary doses are administered to the patient.

**[0021]** In embodiments involving multiple secondary doses, each secondary dose may be administered at the same frequency as the other secondary doses. For example, each secondary dose may be administered to the patient 4 weeks after the immediately preceding dose. Similarly, in embodiments involving multiple tertiary doses, each tertiary dose may be administered at the same frequency as the other tertiary doses. For example, each tertiary dose may be administered to the patient 8 weeks after the immediately preceding dose. Alternatively, the frequency at which the secondary and/or tertiary doses are administered to a patient can vary over the course of the treatment regimen. For example, the present invention includes methods which comprise administering to the patient a single initial dose of a VEGF antagonist, followed by one or more secondary doses of the VEGF antagonist, followed by at least 5 tertiary doses of the VEGF antagonist, wherein the first four tertiary doses are administered 8 weeks after the immediately preceding dose, and wherein each subsequent tertiary dose is administered from 8 to 12 (*e.g.*, 8, 8½, 9, 9½, 10, 10½, 11, 11½, 12) weeks after the immediately preceding dose. The frequency of administration may also be adjusted during the course of treatment by a physician depending on the needs of the individual patient following clinical examination.

### **VEGF ANTAGONISTS**

**[0022]** The methods of the present invention comprise administering to a patient a VEGF antagonist according to specified dosing regimens. As used herein, the expression "VEGF antagonist" means any molecule that blocks, reduces or interferes with the normal biological activity of VEGF.

**[0023]** VEGF antagonists include molecules which interfere with the interaction between VEGF and a natural VEGF receptor, *e.g.*, molecules which bind to VEGF or a VEGF receptor and prevent or otherwise hinder the interaction between VEGF and a VEGF receptor. Specific exemplary VEGF antagonists include anti-VEGF antibodies, anti-VEGF receptor antibodies, and VEGF receptor-based chimeric molecules (also referred to herein as "VEGF-Traps").

**[0024]** VEGF receptor-based chimeric molecules include chimeric polypeptides which comprise two or more immunoglobulin (Ig)-like domains of a VEGF receptor such as VEGFR1 (also referred to as Flt1) and/or VEGFR2 (also referred to as Flk1 or KDR), and may also contain a multimerizing domain (*e.g.*, an Fc domain which facilitates the multimerization [*e.g.*, dimerization] of two or more chimeric polypeptides). An exemplary VEGF receptor-based chimeric molecule is a molecule referred to as VEGFR1R2-Fc $\Delta$ C1(a) which is encoded by the nucleic acid sequence of SEQ ID NO:1. VEGFR1R2-Fc $\Delta$ C1(a) comprises three components: (1) a VEGFR1 component comprising amino acids 27 to 129 of SEQ ID NO:2; (2) a VEGFR2 component comprising amino acids 130 to 231 of SEQ ID NO:2; and (3) a multimerization component ("Fc $\Delta$ C1(a)") comprising amino acids 232 to 457 of SEQ ID NO:2 (the C-terminal amino acid of SEQ ID NO:2 [*i.e.*, K458] may or may not be included in the VEGF antagonist used in the methods of the invention; *see e.g.*, US Patent 7,396,664). Amino acids 1-26 of SEQ ID NO:2 are the signal sequence.

**[0025]** The VEGF antagonist used in the Examples set forth herein below is a dimeric molecule comprising two VEGFR1R2-Fc $\Delta$ C1(a) molecules and is referred to herein as "VEGFT." Additional VEGF receptor-based chimeric molecules which can be used in the context of the present invention are disclosed in US 7,396,664, 7,303,746 and WO 00/75319.

#### **ANGIOGENIC EYE DISORDERS**

**[0026]** The methods of the present invention can be used to treat any angiogenic eye disorder. The expression "angiogenic eye disorder," as used herein, means any disease of the eye which is caused by or associated with the growth or proliferation of blood vessels or by blood vessel leakage. Non-limiting examples of angiogenic eye disorders that are treatable using the methods of the present invention include age-related macular degeneration (*e.g.*, wet AMD, exudative AMD, etc.), retinal vein occlusion (RVO), central retinal vein occlusion (CRVO; *e.g.*, macular edema following CRVO), branch retinal vein occlusion (BRVO), diabetic macular edema (DME), choroidal neovascularization (CNV; *e.g.*, myopic CNV), iris neovascularization, neovascular glaucoma, post-surgical fibrosis in glaucoma, proliferative vitreoretinopathy (PVR), optic disc neovascularization, corneal neovascularization, retinal neovascularization, vitreal neovascularization, pannus, pterygium, vascular retinopathy, and diabetic retinopathies.

#### **PHARMACEUTICAL FORMULATIONS**

**[0027]** The present invention includes methods in which the VEGF antagonist that is administered to the patient is contained within a pharmaceutical formulation. The pharmaceutical formulation may comprise the VEGF antagonist along with at least one inactive ingredient such as, *e.g.*, a pharmaceutically acceptable carrier. Other agents may be incorporated into the pharmaceutical

composition to provide improved transfer, delivery, tolerance, and the like. The term “pharmaceutically acceptable” means approved by a regulatory agency of the Federal or a state government or listed in the U.S. Pharmacopeia or other generally recognized pharmacopeia for use in animals, and more particularly, in humans. The term “carrier” refers to a diluent, adjuvant, excipient, or vehicle with which the antibody is administered. A multitude of appropriate formulations can be found in the formulary known to all pharmaceutical chemists: Remington's Pharmaceutical Sciences (15th ed, Mack Publishing Company, Easton, Pa., 1975), particularly Chapter 87 by Blaug, Seymour, therein. These formulations include, for example, powders, pastes, ointments, jellies, waxes, oils, lipids, lipid (cationic or anionic) containing vesicles (such as LIPOFECTIN™), DNA conjugates, anhydrous absorption pastes, oil-in-water and water-in-oil emulsions, emulsions carbowax (polyethylene glycols of various molecular weights), semi-solid gels, and semi-solid mixtures containing carbowax. Any of the foregoing mixtures may be appropriate in the context of the methods of the present invention, provided that the VEGF antagonist is not inactivated by the formulation and the formulation is physiologically compatible and tolerable with the route of administration. See also Powell et al. PDA (1998) J Pharm Sci Technol. 52:238-311 and the citations therein for additional information related to excipients and carriers well known to pharmaceutical chemists.

**[0028]** Pharmaceutical formulations useful for administration by injection in the context of the present invention may be prepared by dissolving, suspending or emulsifying a VEGF antagonist in a sterile aqueous medium or an oily medium conventionally used for injections. As the aqueous medium for injections, there are, for example, physiological saline, an isotonic solution containing glucose and other auxiliary agents, etc., which may be used in combination with an appropriate solubilizing agent such as an alcohol (e.g., ethanol), a polyalcohol (e.g., propylene glycol, polyethylene glycol), a nonionic surfactant [e.g., polysorbate 80, HCO-50 (polyoxyethylene (50 mol) adduct of hydrogenated castor oil)], etc. As the oily medium, there may be employed, e.g., sesame oil, soybean oil, etc., which may be used in combination with a solubilizing agent such as benzyl benzoate, benzyl alcohol, etc. The injection thus prepared can be filled in an appropriate ampoule if desired.

#### **MODES OF ADMINISTRATION**

**[0029]** The VEGF antagonist (or pharmaceutical formulation comprising the VEGF antagonist) may be administered to the patient by any known delivery system and/or administration method. In certain embodiments, the VEGF antagonist is administered to the patient by ocular, intraocular, intravitreal or subconjunctival injection. In other embodiments, the VEGF antagonist can be administered to the patient by topical administration, e.g., via eye drops or other liquid, gel, ointment

or fluid which contains the VEGF antagonist and can be applied directly to the eye. Other possible routes of administration include, *e.g.*, intradermal, intramuscular, intraperitoneal, intravenous, subcutaneous, intranasal, epidural, and oral.

**AMOUNT OF VEGF ANTAGONIST ADMINISTERED**

[0030] Each dose of VEGF antagonist administered to the patient over the course of the treatment regimen may contain the same, or substantially the same, amount of VEGF antagonist.

Alternatively, the quantity of VEGF antagonist contained within the individual doses may vary over the course of the treatment regimen. For example, in certain embodiments, a first quantity of VEGF antagonist is administered in the initial dose, a second quantity of VEGF antagonist is administered in the secondary doses, and a third quantity of VEGF antagonist is administered in the tertiary doses. The present invention contemplates dosing schemes in which the quantity of VEGF antagonist contained within the individual doses increases over time (*e.g.*, each subsequent dose contains more VEGF antagonist than the last), decreases over time (*e.g.*, each subsequent dose contains less VEGF antagonist than the last), initially increases then decreases, initially decreases then increases, or remains the same throughout the course of the administration regimen.

[0031] The amount of VEGF antagonist administered to the patient in each dose is, in most cases, a therapeutically effective amount. As used herein, the phrase "therapeutically effective amount" means a dose of VEGF antagonist that results in a detectable improvement in one or more symptoms or indicia of an angiogenic eye disorder, or a dose of VEGF antagonist that inhibits, prevents, lessens, or delays the progression of an angiogenic eye disorder. In the case of an anti-VEGF antibody or a VEGF receptor-based chimeric molecule such as VEGFR1R2-FcΔC1(a), a therapeutically effective amount can be from about 0.05 mg to about 5 mg, *e.g.*, about 0.05 mg, about 0.1 mg, about 0.15 mg, about 0.2 mg, about 0.25 mg, about 0.3 mg, about 0.35 mg, about 0.4 mg, about 0.45 mg, about 0.5 mg, about 0.55 mg, about 0.6 mg, about 0.65 mg, about 0.7 mg, about 0.75 mg, about 0.8 mg, about 0.85 mg, about 0.9 mg, about 1.0 mg, about 1.05 mg, about 1.1 mg, about 1.15 mg, about 1.2 mg, about 1.25 mg, about 1.3 mg, about 1.35 mg, about 1.4 mg, about 1.45 mg, about 1.5 mg, about 1.55 mg, about 1.6 mg, about 1.65 mg, about 1.7 mg, about 1.75 mg, about 1.8 mg, about 1.85 mg, about 1.9 mg, about 2.0 mg, about 2.05 mg, about 2.1 mg, about 2.15 mg, about 2.2 mg, about 2.25 mg, about 2.3 mg, about 2.35 mg, about 2.4 mg, about 2.45 mg, about 2.5 mg, about 2.55 mg, about 2.6 mg, about 2.65 mg, about 2.7 mg, about 2.75 mg, about 2.8 mg, about 2.85 mg, about 2.9 mg, about 3.0 mg, about 3.5 mg, about 4.0 mg, about 4.5 mg, or about 5.0 mg of the antibody or receptor-based chimeric molecule.

[0032] The amount of VEGF antagonist contained within the individual doses may be expressed in terms of milligrams of antibody per kilogram of patient body weight (*i.e.*, mg/kg). For example,

the VEGF antagonist may be administered to a patient at a dose of about 0.0001 to about 10 mg/kg of patient body weight.

#### **TREATMENT POPULATION AND EFFICACY**

[0033] The methods of the present invention are useful for treating angiogenic eye disorders in patients that have been diagnosed with or are at risk of being afflicted with an angiogenic eye disorder. Generally, the methods of the present invention demonstrate efficacy within 104 weeks of the initiation of the treatment regimen (with the initial dose administered at "week 0"), *e.g.*, by the end of week 16, by the end of week 24, by the end of week 32, by the end of week 40, by the end of week 48, by the end of week 56, etc. In the context of methods for treating angiogenic eye disorders such as AMD, CRVO, and DME, "efficacy" means that, from the initiation of treatment, the patient exhibits a loss of 15 or fewer letters on the Early Treatment Diabetic Retinopathy Study (ETDRS) visual acuity chart. In certain embodiments, "efficacy" means a gain of one or more (*e.g.*, 1, 2, 3, 4, 5, 6, 7, 8, 9, 10, 11 or more) letters on the ETDRS chart from the time of initiation of treatment.

#### **EXAMPLES**

[0034] The following examples are put forth so as to provide those of ordinary skill in the art with a complete disclosure and description of how to make and use the methods and compositions of the invention, and are not intended to limit the scope of what the inventors regard as their invention. Efforts have been made to ensure accuracy with respect to numbers used (*e.g.*, amounts, temperature, etc.) but some experimental errors and deviations should be accounted for. Unless indicated otherwise, parts are parts by weight, molecular weight is average molecular weight, temperature is in degrees Centigrade, and pressure is at or near atmospheric.

[0035] The exemplary VEGF antagonist used in all Examples set forth below is a dimeric molecule having two functional VEGF binding units. Each functional binding unit is comprised of Ig domain 2 from VEGFR1 fused to Ig domain 3 from VEGFR2, which in turn is fused to the hinge region of a human IgG1 Fc domain (VEGFR1R2-Fc $\Delta$ C1(a); encoded by SEQ ID NO:1). This VEGF antagonist is referred to in the examples below as "VEGFT". For purposes of the following Examples, "monthly" dosing is equivalent to dosing once every four weeks.

#### **Example 1: Phase I Clinical Trial of Intravitreally Administered VEGF Receptor-Based Chimeric Molecule (VEGFT) in Subjects with Neovascular AMD**

[0036] In this Phase I study, 21 subjects with neovascular AMD received a single intravitreal (IVT) dose of VEGFT. Five groups of three subjects each received either 0.05, 0.15, 0.5, 2 or 4 mg of

VEGFT, and a sixth group of six subjects received 1 mg. No serious adverse events related to the study drug, and no identifiable intraocular inflammation was reported. Preliminary results showed that, following injection of VEGFT, a rapid decrease in foveal thickness and macular volume was observed that was maintained through 6 weeks. At Day 43 across all dose groups, mean excess retinal thickness [excess retinal thickness = (retinal thickness – 179 $\mu$ )] on optical coherence tomography (OCT) was reduced from 119 $\mu$  to 27 $\mu$  as assessed by Fast Macular Scan and from 194 $\mu$  to 60 $\mu$  as assessed using a single Posterior Pole scan. The mean increase in best corrected visual acuity (BCVA) was 4.75 letters, and BCVA was stable or improved in 95% of subjects. In the 2 highest dose groups (2 and 4 mg), the mean increase in BCVA was 13.5 letters, with 3 of 6 subjects demonstrating improvement of  $\geq$  3 lines.

**Example 2: Phase II Clinical Trial of Repeated Doses of Intravitreally Administered VEGF Receptor-Based Chimeric Molecule (VEGFT) in Subjects with Neovascular AMD**

[0037] This study was a double-masked, randomized study of 3 doses (0.5, 2, and 4 mg) of VEGFT tested at 4-week and/or 12-week dosing intervals. There were 5 treatment arms in this study, as follows: 1) 0.5 mg every 4 weeks, 2) 0.5 mg every 12 weeks, 3) 2 mg every 4 weeks, 4) 2 mg every 12 weeks and 5) 4 mg every 12 weeks. Subjects were dosed at a fixed interval for the first 12 weeks, after which they were evaluated every 4 weeks for 9 months, during which additional doses were administered based on pre-specified criteria. All subjects were then followed for one year after their last dose of VEGFT. Preliminary data from a pre-planned interim analysis indicated that VEGFT met its primary endpoint of a statistically significant reduction in retinal thickness after 12 weeks compared with baseline (all groups combined, decrease of 135 $\mu$ ,  $p < 0.0001$ ). Mean change from baseline in visual acuity, a key secondary endpoint of the study, also demonstrated statistically significant improvement (all groups combined, increase of 5.9 letters,  $p < 0.0001$ ). Moreover, patients in the dose groups that received only a single dose, on average, demonstrated a decrease in excess retinal thickness ( $p < 0.0001$ ) and an increase in visual acuity ( $p = 0.012$ ) at 12 weeks. There were no drug-related serious adverse events, and treatment with the VEGF antagonists was generally well-tolerated. The most common adverse events were those typically associated with intravitreal injections.

**Example 3: Phase I Clinical Trial of Systemically Administered VEGF Receptor-Based Chimeric Molecule (VEGFT) in Subjects with Neovascular AMD**

[0038] This study was a placebo-controlled, sequential-group, dose-escalating safety, tolerability and bioeffect study of VEGFT by IV infusion in subjects with neovascular AMD. Groups of 8 subjects meeting eligibility criteria for subfoveal choroidal neovascularization (CNV) related to AMD

were assigned to receive 4 IV injections of VEGFT or placebo at dose levels of 0.3, 1, or 3 mg/kg over an 8-week period.

[0039] Most adverse events that were attributed to VEGFT were mild to moderate in severity, but 2 of 5 subjects treated with 3 mg/kg experienced dose-limiting toxicity (DLT) (one with Grade 4 hypertension and one with Grade 2 proteinuria); therefore, all subjects in the 3 mg/kg dose group did not enter the study. The mean percent changes in excess retinal thickness were: -12%, -10%, -66%, and -60% for the placebo, 0.3, 1, and 3 mg/kg dose groups at day 15 (ANOVA  $p < 0.02$ ), and -5.6%, +47.1%, and -63.3% for the placebo, 0.3, and 1 mg/kg dose groups at day 71 (ANOVA  $p < 0.02$ ). There was a numerical improvement in BCVA in the subjects treated with VEGFT. As would be expected in such a small study, the results were not statistically significant.

#### **Example 4: Phase III Clinical Trials of the Efficacy, Safety, and Tolerability of Repeated Doses of Intravitreal VEGFT in Subjects with Neovascular Age-Related Macular Degeneration**

##### **A. Objectives, Hypotheses and Endpoints**

[0040] Two parallel Phase III clinical trials were carried out to investigate the use of VEGFT to treat patients with the neovascular form of age-related macular degeneration (Study 1 and Study 2). The primary objective of these studies was to assess the efficacy of IVT administered VEGFT compared to ranibizumab (Lucentis®, Genentech, Inc.), in a non-inferiority paradigm, in preventing moderate vision loss in subjects with all subtypes of neovascular AMD.

[0041] The secondary objectives were (a) to assess the safety and tolerability of repeated IVT administration of VEGFT in subjects with all sub-types of neovascular AMD for periods up to 2 years; and (b) to assess the effect of repeated IVT administration of VEGFT on Vision-Related Quality of Life (QOL) in subjects with all sub-types of neovascular AMD.

[0042] The primary hypothesis of these studies was that the proportion of subjects treated with VEGFT with stable or improved BCVA (<15 letters lost) is similar to the proportion treated with ranibizumab who have stable or improved BCVA, thereby demonstrating non-inferiority.

[0043] The primary endpoint for these studies was the prevention of vision loss of greater than or equal to 15 letters on the ETDRS chart, compared to baseline, at 52 weeks. Secondary endpoints were as follows: (a) change from baseline to Week 52 in letter score on the ETDRS chart; (b) gain from baseline to Week 52 of 15 letters or more on the ETDRS chart; (c) change from baseline to Week 52 in total NEI VFQ-25 score; and (d) change from baseline to Week 52 in CNV area.

##### **B. Study Design**

[0044] For each study, subjects were randomly assigned in a 1:1:1:1 ratio to 1 of 4 dosing regimens: (1) 2 mg VEGFT administered every 4 weeks (2Q4); (2) 0.5 mg VEGFT administered

every 4 weeks (0.5Q4); (3) 2 mg VEGFT administered every 4 weeks to week 8 and then every 8 weeks (with sham injection at the interim 4-week visits when study drug was not administered (2Q8); and (4) 0.5 mg ranibizumab administered every 4 weeks (RQ4). Subjects assigned to (2Q8) received the 2 mg injection every 4 weeks to week 8 and then a sham injection at interim 4-week visits (when study drug is not to be administered) during the first 52 weeks of the studies. (No sham injection were given at Week 52).

**[0045]** The study duration for each subject was scheduled to be 96 weeks plus the recruitment period. For the first 52 weeks (Year 1), subjects received an IVT or sham injection in the study eye every 4 weeks. (No sham injections were given at Week 52). During the second year of the study, subjects will be evaluated every 4 weeks and will receive IVT injection of study drug at intervals determined by specific dosing criteria, but at least every 12 weeks. (During the second year of the study, sham injections will not be given.) During this period, injections may be given as frequently as every 4 weeks, but no less frequently than every 12 weeks, according to the following criteria: (i) increase in central retinal thickness of  $\geq 100$   $\mu\text{m}$  compared to the lowest previous value as measured by optical coherence tomography (OCT); or (ii) a loss from the best previous letter score of at least 5 ETDRS letters in conjunction with recurrent fluid as indicated by OCT; or (iii) new or persistent fluid as indicated by OCT; or (iv) new onset classic neovascularization, or new or persistent leak on fluorescein angiography (FA); or (v) new macular hemorrhage; or (vi) 12 weeks have elapsed since the previous injection. According to the present protocol, subjects must receive an injection at least every 12 weeks.

**[0046]** Subjects were evaluated at 4 weeks intervals for safety and best corrected visual acuity (BCVA) using the 4 meter ETDRS protocol. Quality of Life (QOL) was evaluated using the NEI VFQ-25 questionnaire. OCT and FA examinations were conducted periodically.

**[0047]** Approximately 1200 subjects were enrolled, with a target enrollment of 300 subjects per treatment arm.

**[0048]** To be eligible for this study, subjects were required to have subfoveal choroidal neovascularization (CNV) secondary to AMD. "Subfoveal" CNV was defined as the presence of subfoveal neovascularization, documented by FA, or presence of a lesion that is juxtafoveal in location angiographically but affects the fovea. Subject eligibility was confirmed based on angiographic criteria prior to randomization.

**[0049]** Only one eye was designated as the study eye. For subjects who met eligibility criteria in both eyes, the eye with the worse VA was selected as the study eye. If both eyes had equal VA, the eye with the clearest lens and ocular media and least amount of subfoveal scar or geographic atrophy was selected. If there was no objective basis for selecting the study eye, factors such as



ocular dominance, other ocular pathology and subject preference were considered in making the selection.

**[0050]** Inclusion criteria for both studies were as follows: (i) signed Informed consent; (ii) at least 50 years of age; (iii) active primary subfoveal CNV lesions secondary to AMD, including juxtafoveal lesions that affect the fovea as evidenced by FA in the study eye; (iv) CNV at least 50% of total lesion size; (v) early treatment diabetic retinopathy study (ETDRS) best-corrected visual acuity of: 20/40 to 20/320 (letter score of 73 to 25) in the study eye; (vi) willing, committed, and able to return for all clinic visits and complete all study-related procedures; and (vii) able to read, understand and willing to sign the informed consent form (or, if unable to read due to visual impairment, be read to verbatim by the person administering the informed consent or a family member).

**[0051]** Exclusion criteria for both studies were as follows: 1. Any prior ocular (in the study eye) or systemic treatment or surgery for neovascular AMD except dietary supplements or vitamins. 2. Any prior or concomitant therapy with another investigational agent to treat neovascular AMD in the study eye, except dietary supplements or vitamins. 3. Prior treatment with anti-VEGF agents as follows: (a) Prior treatment with anti-VEGF therapy in the study eye was not allowed; (b) Prior treatment with anti-VEGF therapy in the fellow eye with an investigational agent (not FDA approved, e.g. bevacizumab) was allowed up to 3 months prior to first dose in the study, and such treatments were not allowed during the study. Prior treatment with an approved anti-VEGF therapy in the fellow eye was allowed; (c) Prior systemic anti-VEGF therapy, investigational or FDA/Health Canada approved, was only allowed up to 3 months prior to first dose, and was not allowed during the study. 4. Total lesion size > 12 disc areas (30.5 mm<sup>2</sup>, including blood, scars and neovascularization) as assessed by FA in the study eye. 5. Subretinal hemorrhage that is either 50% or more of the total lesion area, or if the blood is under the fovea and is 1 or more disc areas in size in the study eye. (If the blood is under the fovea, then the fovea must be surrounded 270 degrees by visible CNV.) 6. Scar or fibrosis, making up > 50% of total lesion in the study eye. 7. Scar, fibrosis, or atrophy involving the center of the fovea. 8. Presence of retinal pigment epithelial tears or rips involving the macula in the study eye. 9. History of any vitreous hemorrhage within 4 weeks prior to Visit 1 in the study eye. 10. Presence of other causes of CNV, including pathologic myopia (spherical equivalent of -8 diopters or more negative, or axial length of 25 mm or more), ocular histoplasmosis syndrome, angioid streaks, choroidal rupture, or multifocal choroiditis in the study eye. 11. History or clinical evidence of diabetic retinopathy, diabetic macular edema or any other vascular disease affecting the retina, other than AMD, in either eye. 12. Prior vitrectomy in the study eye. 13. History of retinal detachment or treatment or surgery for retinal detachment in the study eye. 14. Any history of macular hole of stage 2 and above in the study eye. 15. Any intraocular or periocular surgery within 3 months of Day 1 on the study eye, except lid surgery,

which may not have taken place within 1 month of day 1, as long as it was unlikely to interfere with the injection. 16. Prior trabeculectomy or other filtration surgery in the study eye. 17. Uncontrolled glaucoma (defined as intraocular pressure greater than or equal to 25 mm Hg despite treatment with anti-glaucoma medication) in the study eye. 18. Active intraocular inflammation in either eye. 19. Active ocular or periocular infection in either eye. 20. Any ocular or periocular infection within the last 2 weeks prior to Screening in either eye. 21. Any history of uveitis in either eye. 22. Active scleritis or episcleritis in either eye. 23. Presence or history of scleromalacia in either eye. 24. Aphakia or pseudophakia with absence of posterior capsule (unless it occurred as a result of a yttrium aluminum garnet [YAG] posterior capsulotomy) in the study eye. 25. Previous therapeutic radiation in the region of the study eye. 26. History of corneal transplant or corneal dystrophy in the study eye. 27. Significant media opacities, including cataract, in the study eye which might interfere with visual acuity, assessment of safety, or fundus photography. 28. Any concurrent intraocular condition in the study eye (e.g. cataract) that, in the opinion of the investigator, could require either medical or surgical intervention during the 96 week study period. 29. Any concurrent ocular condition in the study eye which, in the opinion of the investigator, could either increase the risk to the subject beyond what is to be expected from standard procedures of intraocular injection, or which otherwise may interfere with the injection procedure or with evaluation of efficacy or safety. 30. History of other disease, metabolic dysfunction, physical examination finding, or clinical laboratory finding giving reasonable suspicion of a disease or condition that contraindicates the use of an investigational drug or that might affect interpretation of the results of the study or render the subject at high risk for treatment complications. 31. Participation as a subject in any clinical study within the 12 weeks prior to Day 1. 32. Any systemic or ocular treatment with an investigational agent in the past 3 months prior to Day 1. 33. The use of long acting steroids, either systemically or intraocularly, in the 6 months prior to day 1. 34. Any history of allergy to povidone iodine. 35. Known serious allergy to the fluorescein sodium for injection in angiography. 36. Presence of any contraindications indicated in the FDA Approved label for ranibizumab (Lucentis®). 37. Females who were pregnant, breastfeeding, or of childbearing potential, unwilling to practice adequate contraception throughout the study. Adequate contraceptive measures include oral contraceptives (stable use for 2 or more cycles prior to screening); IUD; Depo-Provera®; Norplant® System implants; bilateral tubal ligation; vasectomy; condom or diaphragm plus either contraceptive sponge, foam or jelly.

**[0052]** Subjects were not allowed to receive any standard or investigational agents for treatment of their AMD in the study eye other than their assigned study treatment with VEGFT or ranibizumab as specified in the protocol until they completed the Completion/Early Termination visit assessments. This includes medications administered locally (e.g., IVT, topical, juxtасleral or

periorbital routes), as well as those administered systemically with the intent of treating the study and/or fellow eye.

[0053] The study procedures are summarized as follows:

[0054] Best Corrected Visual Acuity: Visual function of the study eye and the fellow eye were assessed using the ETDRS protocol (The Early Treatment Diabetic Retinopathy Study Group) at 4 meters. Visual Acuity examiners were certified to ensure consistent measurement of BCVA. The VA examiners were required to remain masked to treatment assignment.

[0055] Optical Coherence Tomography: Retinal and lesion characteristics were evaluated using OCT on the study eye. At the Screen Visit (Visit 1) images were captured and transmitted for both eyes. All OCT images were captured using the Zeiss Stratus OCT™ with software Version 3 or greater. OCT images were sent to an independent reading center where images were read by masked readers at visits where OCTs were required. All OCTs were electronically archived at the site as part of the source documentation. A subset of OCT images were read. OCT technicians were required to be certified by the reading center to ensure consistency and quality in image acquisition. Adequate efforts were made to ensure that OCT technicians at the site remained masked to treatment assignment.

[0056] Fundus Photography and Fluorescein Angiography (FA): The anatomical state of the retinal vasculature of the study eye was evaluated by funduscopy examination, fundus photography and FA. At the Screen Visit (Visit 1) funduscopy examination, fundus photography and FA were captured and transmitted for both eyes. Fundus and angiographic images were sent to an independent reading center where images were read by masked readers. The reading center confirmed subject eligibility based on angiographic criteria prior to randomization. All FAs and fundus photographs were archived at the site as part of the source documentation. Photographers were required to be certified by the reading center to ensure consistency and quality in image acquisition. Adequate efforts were made to ensure that all photographers at the site remain masked to treatment assignment.

[0057] Vision-Related Quality of Life: Vision-related QOL was assessed using the National Eye Institute 25-Item Visual Function Questionnaire (NEI VFQ-25) in the interviewer-administered format. NEI VFQ-25 was administered by certified personnel at a contracted call center. At the screening visit, the sites assisted the subject and initiated the first call to the call center to collect all of the subject's contact information and to complete the first NEI VFQ-25 on the phone prior to randomization and IVT injection. For all subsequent visits, the call center called the subject on the phone, prior to IVT injection, to complete the questionnaire.

[0058] Intraocular Pressure: Intraocular pressure (IOP) of the study eye was measured using applanation tonometry or Tonopen. The same method of IOP measurement was used in each subject throughout the study.

[0059]

### C. Results Summary (52 Week Data)

[0060] The primary endpoint (prevention of moderate or severe vision loss as defined above) was met for all three VEGFT groups (2Q4, 0.5Q4 and 2Q8) in this study. The results from both studies are summarized in Table 1.

**Table 1**

|   | Ranibizumab<br>0.5 mg monthly<br>(RQ4) | VEGFT<br>0.5 mg monthly<br>(0.5Q4) | VEGFT<br>2 mg monthly<br>(2Q4) | VEGFT<br>2 mg every 8<br>weeks <sup>[a]</sup> (2Q8) |
|---|--|------------------------------------|--------------------------------|---|
| Maintenance of vision* (% patients losing <15 letters) at week 52 versus baseline     |  |                                    |                                |   |
| Study 1   | 94.4%                                  | 95.9%**                            | 95.1%**                        | 95.1%**   |
| Study 2   | 94.4%                                  | 96.3%**                            | 95.6%**                        | 95.6%**   |
| Mean improvement in vision* (letters) at 52 weeks versus baseline (p-value vs RQ4)*** |  |                                    |                                |   |
| Study 1   | 8.1                                    | 6.9 (NS)                           | 10.9 (p<0.01)                  | 7.9 (NS)  |
| Study 2   | 9.4                                    | 9.7 (NS)                           | 7.6 (NS)                       | 8.9 (NS)  |

<sup>[a]</sup> Following three initial monthly doses

\* Visual acuity was measured as the total number of letters read correctly on the Early Treatment Diabetic Retinopathy Study (ETDRS) eye chart.

\*\* Statistically non-inferior based on a non-inferiority margin of 10%, using confidence interval approach (95.1% and 95% for Study 1 and Study 2, respectively)

\*\*\* Test for superiority

NS = non-significant

[0061] In Study 1, patients receiving VEGFT 2mg monthly (2Q4) achieved a statistically significant greater mean improvement in visual acuity at week 52 versus baseline (secondary endpoint), compared to ranibizumab 0.5mg monthly (RQ4); patients receiving VEGFT 2mg monthly on average gained 10.9 letters, compared to a mean 8.1 letter gain with ranibizumab 0.5mg dosed every month (p<0.01). All other dose groups of VEGFT in Study 1 and all dose groups in Study 2 were not statistically different from ranibizumab in this secondary endpoint.

[0062] A generally favorable safety profile was observed for both VEGFT and ranibizumab. The incidence of ocular treatment emergent adverse events was balanced across all four treatment groups in both studies, with the most frequent events associated with the injection procedure, the underlying disease, and/or the aging process. The most frequent ocular adverse events were conjunctival hemorrhage, macular degeneration, eye pain, retinal hemorrhage, and vitreous

floaters. The most frequent serious non-ocular adverse events were typical of those reported in this elderly population who receive intravitreal treatment for wet AMD; the most frequently reported events were falls, pneumonia, myocardial infarction, atrial fibrillation, breast cancer, and acute coronary syndrome. There were no notable differences among the study arms.

**Example 5: Phase II Clinical Trial of VEGFT in Subjects with Diabetic Macular Edema (DME)**

[0063] In this study, 221 patients with clinically significant DME with central macular involvement were randomized, and 219 patients were treated with balanced distribution over five groups. The control group received macular laser therapy at baseline, and patients were eligible for repeat laser treatments, but no more frequently than at 16 week intervals. The remaining four groups received VEGFT by intravitreal injection as follows: Two groups received 0.5 or 2 mg of VEGFT once every four weeks throughout the 12-month dosing period (0.5Q4 and 2Q4, respectively). Two groups received three initial doses of 2 mg VEGFT once every four weeks (*i.e.*, at baseline, and weeks 4 and 8), followed through week 52 by either once every 8 weeks dosing (2Q8) or as needed dosing with very strict repeat dosing criteria (PRN). Mean gains in visual acuity versus baseline were as shown in Table 2:

**Table 2**

|   | n  | Mean change in visual acuity at week 24 versus baseline (letters) | Mean change in visual acuity at week 52 versus baseline (letters) |
|---|----|---|---|
| Laser   | 44 | 2.5   | -1.3  |
| VEGFT 0.5 mg monthly (0.5Q4)                  | 44 | 8.6**   | 11.0**  |
| VEGFT 2 mg monthly (2Q4)                      | 44 | 11.4**  | 13.1**  |
| VEGFT 2 mg every 8 weeks <sup>[a]</sup> (2Q8) | 42 | 8.5**   | 9.7**   |
| VEGFT 2 mg as needed <sup>[a]</sup> (PRN)     | 45 | 10.3**  | 12.0**  |

<sup>[a]</sup> Following three initial monthly doses

\*\* p < 0.01 versus laser

[0064] In this study, the visual acuity gains achieved with VEGFT administration at week 24 were maintained or numerically improved up to completion of the study at week 52 in all VEGFT study groups, including 2 mg dosed every other month

[0065] As demonstrated in the foregoing Examples, the administration of VEGFT to patients suffering from angiogenic eye disorders (*e.g.*, AMD and DME) at a frequency of once every 8

weeks, following a single initial dose and two secondary doses administered four weeks apart, resulted in significant prevention of moderate or severe vision loss or improvements in visual acuity.

**Example 6: A Randomized, Multicenter, Double-Masked Trial in Treatment Naïve Patients with Macular Edema Secondary to CRVO**

[0066] In this randomized, double-masked, Phase 3 study, patients received 6 monthly injections of either 2 mg intravitreal VEGFT (114 patients) or sham injections (73 patients). From Week 24 to Week 52, all patients received 2 mg VEGFT as-needed (PRN) according to retreatment criteria. Thus, "sham-treated patients" means patients who received sham injections once every four weeks from Week 0 through Week 20, followed by intravitreal VEGFT as needed from Week 24 through Week 52. "VEGFT-treated patients" means patients who received VEGFT intravitreal injections once every four weeks from Week 0 through Week 20, followed by intravitreal VEGFT as needed from Week 24 through Week 52. The primary endpoint was the proportion of patients who gained  $\geq 15$  ETDRS letters from baseline at Week 24. Secondary visual, anatomic, and Quality of Life NEI VFQ-25 outcomes at Weeks 24 and 52 were also evaluated.

[0067] At Week 24, 56.1% of VEGFT-treated patients gained  $\geq 15$  ETDRS letters from baseline vs 12.3% of sham-treated patients ( $P < 0.0001$ ). Similarly, at Week 52, 55.3% of VEGFT-treated patients gained  $\geq 15$  letters vs 30.1% of sham-treated patients ( $P < 0.01$ ). At Week 52, VEGFT-treated patients gained a mean of 16.2 letters vs 3.8 letters for sham-treated patients ( $P < 0.001$ ). Mean number of injections was 2.7 for VEGFT-treated patients vs 3.9 for sham-treated patients. Mean change in central retinal thickness was  $-413.0 \mu\text{m}$  for VEGFT-treated patients vs  $-381.8 \mu\text{m}$  for sham-treated patients. The proportion of patients with ocular neovascularization at Week 24 were 0% for VEGFT-treated patients and 6.8% for sham-treated patients, respectively; at Week 52 after receiving VEGFT PRN, proportions were 0% and 6.8% for VEGFT-treated and sham-treated. At Week 24, the mean change from baseline in the VFQ-25 total score was 7.2 vs 0.7 for the VEGFT-treated and sham-treated groups; at Week 52, the scores were 7.5 vs 5.1 for the VEGFT-treated and sham-treated groups.

[0068] This Example confirms that dosing monthly with 2 mg intravitreal VEGFT injection resulted in a statistically significant improvement in visual acuity at Week 24 that was maintained through Week 52 with PRN dosing compared with sham PRN treatment. VEGFT was generally well tolerated and had a generally favorable safety profile.

**Example 7: Dosing Regimens**

[0069] Specific, non-limiting examples of dosing regimens within the scope of the present invention are as follows:

[0070] VEGFT 2 mg (0.05 mL) administered by intravitreal injection once every 4 weeks (monthly).

[0071] VEGFT 2 mg (0.5 mL) administered by intravitreal injection once every 4 weeks for the first 8 weeks, followed by 2 mg (0.05 mL) via intravitreal injection once every 8 weeks.

[0072] VEGFT 2 mg (0.5 mL) administered by intravitreal injection once every 4 weeks for the first 8 weeks, followed by 2 mg (0.05 mL) via intravitreal injection on a less frequent basis based on visual and/or anatomical outcomes (as assessed by a physician or other qualified medical professional).

[0073] VEGFT 2 mg (0.5 mL) administered by intravitreal injection once every 4 weeks for the first 8 weeks, followed by 2 mg (0.05 mL) via intravitreal injection administered *pro re nata* (PRN) based on visual and/or anatomical outcomes (as assessed by a physician or other qualified medical professional).

[0074] VEGFT 2 mg (0.5 mL) administered by intravitreal injection once every 4 weeks for the first 12 weeks, followed by 2 mg (0.05 mL) via intravitreal injection once every 8 weeks.

[0075] VEGFT 2 mg (0.5 mL) administered by intravitreal injection once every 4 weeks for the first 12 weeks, followed by 2 mg (0.05 mL) via intravitreal injection on a less frequent basis based on visual and/or anatomical outcomes (as assessed by a physician or other qualified medical professional).

[0076] VEGFT 2 mg (0.5 mL) administered by intravitreal injection once every 4 weeks for the first 12 weeks, followed by 2 mg (0.05 mL) via intravitreal injection administered *pro re nata* (PRN) based on visual and/or anatomical outcomes (as assessed by a physician or other qualified medical professional).

[0077] VEGFT 2 mg (0.5 mL) administered by intravitreal injection once every 4 weeks for the first 16 weeks, followed by 2 mg (0.05 mL) via intravitreal injection once every 8 weeks.

[0078] VEGFT 2 mg (0.5 mL) administered by intravitreal injection once every 4 weeks for the first 16 weeks, followed by 2 mg (0.05 mL) via intravitreal injection on a less frequent basis based on visual and/or anatomical outcomes (as assessed by a physician or other qualified medical professional).

[0079] VEGFT 2 mg (0.5 mL) administered by intravitreal injection once every 4 weeks for the first 16 weeks, followed by 2 mg (0.05 mL) via intravitreal injection administered *pro re nata* (PRN) based on visual and/or anatomical outcomes (as assessed by a physician or other qualified medical professional).

[0080] VEGFT 2 mg (0.5 mL) administered by intravitreal injection once every 4 weeks for the first 20 weeks, followed by 2 mg (0.05 mL) via intravitreal injection once every 8 weeks.

**[0081]** VEGFT 2 mg (0.5 mL) administered by intravitreal injection once every 4 weeks for the first 20 weeks, followed by 2 mg (0.05 mL) via intravitreal injection on a less frequent basis based on visual and/or anatomical outcomes (as assessed by a physician or other qualified medical professional).

**[0082]** VEGFT 2 mg (0.5 mL) administered by intravitreal injection once every 4 weeks for the first 20 weeks, followed by 2 mg (0.05 mL) via intravitreal injection administered *pro re nata* (PRN) based on visual and/or anatomical outcomes (as assessed by a physician or other qualified medical professional).

**[0083]** VEGFT 2 mg (0.5 mL) administered by intravitreal injection once every 4 weeks for the first 24 weeks, followed by 2 mg (0.05 mL) via intravitreal injection once every 8 weeks.

**[0084]** VEGFT 2 mg (0.5 mL) administered by intravitreal injection once every 4 weeks for the first 24 weeks, followed by 2 mg (0.05 mL) via intravitreal injection on a less frequent basis based on visual and/or anatomical outcomes (as assessed by a physician or other qualified medical professional).

**[0085]** VEGFT 2 mg (0.5 mL) administered by intravitreal injection once every 4 weeks for the first 24 weeks, followed by 2 mg (0.05 mL) via intravitreal injection administered *pro re nata* (PRN) based on visual and/or anatomical outcomes (as assessed by a physician or other qualified medical professional).

**[0086]** VEGFT 2 mg (0.5 mL) administered by intravitreal injection once every 4 weeks for the first 28 weeks, followed by 2 mg (0.05 mL) via intravitreal injection once every 8 weeks.

**[0087]** VEGFT 2 mg (0.5 mL) administered by intravitreal injection once every 4 weeks for the first 28 weeks, followed by 2 mg (0.05 mL) via intravitreal injection on a less frequent basis based on visual and/or anatomical outcomes (as assessed by a physician or other qualified medical professional).

**[0088]** VEGFT 2 mg (0.5 mL) administered by intravitreal injection once every 4 weeks for the first 28 weeks, followed by 2 mg (0.05 mL) via intravitreal injection administered *pro re nata* (PRN) based on visual and/or anatomical outcomes (as assessed by a physician or other qualified medical professional).

**[0089]** VEGFT 2 mg (0.05 mL) administered by intravitreal injection as a single initial dose, followed by additional doses administered *pro re nata* (PRN) based on visual and/or anatomical outcomes (as assessed by a physician or other qualified medical professional).

**[0090]** Variations on the above-described dosing regimens would be appreciated by persons of ordinary skill in the art and are also within the scope of the present invention. For example, the amount of VEGFT and/or volume of formulation administered to a patient may be varied based on



patient characteristics, severity of disease, and other diagnostic assessments by a physician or other qualified medical professional.

[0091] Any of the foregoing administration regimens may be used for the treatment of, *e.g.*, age-related macular degeneration (*e.g.*, wet AMD, exudative AMD, etc.), retinal vein occlusion (RVO), central retinal vein occlusion (CRVO; *e.g.*, macular edema following CRVO), branch retinal vein occlusion (BRVO), diabetic macular edema (DME), choroidal neovascularization (CNV; *e.g.*, myopic CNV), iris neovascularization, neovascular glaucoma, post-surgical fibrosis in glaucoma, proliferative vitreoretinopathy (PVR), optic disc neovascularization, corneal neovascularization, retinal neovascularization, vitreal neovascularization, pannus, pterygium, vascular retinopathy, etc.

### SEQUENCES

[0092] SEQ ID NO:1 (DNA sequence having 1377 nucleotides):

```
ATGGTCAGCTACTGGGACACCGGGTCTGCTGTGCGCGCTGCTCAGCTGTCTGCTTCTCAC
AGGATCTAGTTCCGGAAGTGATACCGGTAGACCTTTTCGTAGAGATGTACAGTGAAATCCCCGA
AATTATACACATGACTGAAGGAAGGGAGCTCGTCATTCCCTGCCGGGTTACGTCACCTAACAT
CACTGTTACTTTAAAAAAGTTTTCCAATTGACACTTTGATCCCTGATGGAAAACGCATAATCTGG
GACAGTAGAAAGGGCTTCATCATATCAAATGCAACGTACAAAGAAATAGGGCTTCTGACCTGT
GAAGCAACAGTCAATGGGCATTTGTATAAGACAACTATCTCACACATCGACAAACCAATACAA
TCATAGATGTGGTTCTGAGTCCGTCTCATGGAATTGAACTATCTGTTGGAGAAAAGCTTGTCTT
AAATTGTACAGCAAGAACTGAACTAAATGTGGGGATTGACTTCAACTGGGAATACCCCTTCTCG
AAGCATCAGCATAAGAACTTGTAACCCGAGACCTAAAACCCAGTCTGGGAGTGAGATGAAG
AAATTTTTGAGCACCTTAACTATAGATGGTGTAACCCGGAGTGACCAAGGATTGTACACCTGTG
CAGCATCCAGTGGGCTGATGACCAAGAAGAACAGCACATTTGTCAGGGTCCATGAAAAGGACA
AAACTCACACATGCCACCGTGCCACGACCTGAACTCCTGGGGGGACCGTCAGTCTTCTCTCT
TCCCCCAAACCCAAAGGACACCCTCATGATCTCCCGGACCCCTGAGGTCACATGCGTGGTG
GTGGACGTGAGCCACGAAGACCCTGAGGTCAAGTTCAACTGGTACGTGGACGGCGTGGAGGT
GCATAATGCCAAGACAAAGCCGCGGGAGGAGCAGTACAACAGCACGTACCGTGTGGTCAGCG
TCCTCACCGTCTGCACCAGGACTGGCTGAATGGCAAGGAGTACAAGTGCAAGGTCTCCAAC
AAAGCCCTCCCAGCCCCATCGAGAAAACCATCTCCAAAGCCAAAGGGCAGCCCCGAGAACC
ACAGGTGTACACCCTGCCCCATCCCGGGATGAGCTGACCAAGAACCAGGTGAGCCTGACCT
GCCTGGTCAAAGGCTTCTATCCCAGCGACATCGCCGTGGAGTGGGAGAGCAATGGGCAGCCG
GAGAACAACACTACAAGACCACGCCTCCCGTGTGGACTCCGACGGCTCCTTCTTCTCTACAGC
AAGCTCACCGTGGACAAGAGCAGGTGGCAGCAGGGGAACGTCTTCTCATGCTCCGTGATGCA
TGAGGCTCTGCACAACCACTACACGCAGAAGAGCCTCTCCCTGTCTCCGGGTAAATGA
```

[0093] SEQ ID NO:2 (polypeptide sequence having 458 amino acids):

MVSYWDTGVLLCALLSCLLLTGSSSGSDTGRPFVEMYSEIPEIIHMTEGRELVIPCRVTSPNITVTLK  
KFPLDTLIPDGKRIIWDSRKGFIISNATYKEIGLLTCEATVNGHLYKTNYLTHRQTNTIIDVVLSPSHGI  
ELSVGEKLVLNCTARTELVGIDFNWEYPSSKHQHKLVNRDLKTQSGSEMKKFLSTLTIDGVTRS  
DQGLYTCAASSGLMTKKNSTFVRVHEKDKTHTCPPCPAPELLGGPSVFLFPPKPKDTLMISRTPEV  
TCVVVDVSHEDPEVKFNWYVDGVEVHNAKTKPREEQYNSTYRVVSVLTVLHQDWLNGKEYKCKV  
SNKALPAPIEKTISKAKGQPREPQVYTLPPSRDELTKNQVSLTCLVKGFYPSDIAVEWESNGQPEN  
NYKTTTPVLDSGDSFFLYSKLTVDKSRWQQGNVFCSSVMHEALHNHYTQKSLSLSPGK

[0094] The present invention is not to be limited in scope by the specific embodiments described herein. Indeed, various modifications of the invention in addition to those described herein will become apparent to those skilled in the art from the foregoing description and the accompanying figures. Such modifications are intended to fall within the scope of the appended claims.

What is claimed is:

1. A method for treating an angiogenic eye disorder in a patient, said method comprising sequentially administering to the patient a single initial dose of a VEGF antagonist, followed by one or more secondary doses of the VEGF antagonist, followed by one or more tertiary doses of the VEGF antagonist;

wherein each secondary dose is administered 2 to 4 weeks after the immediately preceding dose; and

wherein each tertiary dose is administered at least 8 weeks after the immediately preceding dose.

2. The method of claim 1, wherein only a single secondary dose is administered to the patient, and wherein the single secondary dose is administered 4 weeks after the initial dose of the VEGF antagonist.

3. The method of claim 1, wherein only two secondary doses are administered to the patient, and wherein each secondary dose is administered 4 weeks after the immediately preceding dose.

4. The method of claim 3, wherein each tertiary dose is administered 8 weeks after the immediately preceding dose.

5. The method of claim 1, wherein at least 5 tertiary doses of the VEGF antagonist are administered to the patient, and wherein the first four tertiary doses are administered 8 weeks after the immediately preceding dose, and wherein each subsequent tertiary dose is administered 8 or 12 weeks after the immediately preceding dose.

6. The method of claim 1, wherein the angiogenic eye disorder is selected from the group consisting of: age related macular degeneration, diabetic retinopathy, diabetic macular edema, central retinal vein occlusion, branch retinal vein occlusion, and corneal neovascularization.

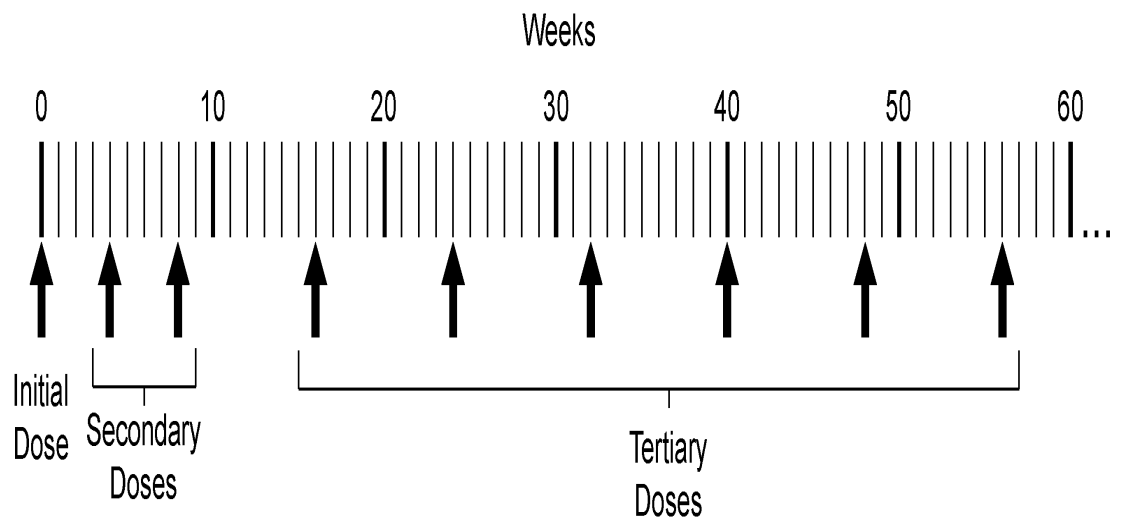
7. The method of claim 6, wherein the angiogenic eye disorder is age related macular degeneration.

8. The method of claim 1, wherein the VEGF antagonist is an anti-VEGF antibody or fragment thereof, an anti-VEGF receptor antibody or fragment thereof, or a VEGF receptor-based chimeric molecule.

9. The method of claim 8, wherein the VEGF antagonist is a VEGF receptor-based chimeric molecule.
10. The method of claim 9, wherein the VEGF receptor-based chimeric molecule comprises VEGFR1R2-Fc $\Delta$ C1(a) encoded by the nucleic acid sequence of SEQ ID NO:1.
11. The method of claim 9, wherein the VEGF receptor-based chimeric molecule comprises (1) a VEGFR1 component comprising amino acids 27 to 129 of SEQ ID NO:2; (2) a VEGFR2 component comprising amino acids 130-231 of SEQ ID NO:2; and (3) a multimerization component comprising amino acids 232-457 of SEQ ID NO:2.
12. The method of claim 1, wherein all doses of the VEGF antagonist are administered to the patient by topical administration or by intraocular administration.
13. The method of claim 12, wherein all doses of the VEGF antagonist are administered to the patient by intraocular administration.
14. The method of claim 13, wherein the intraocular administration is intravitreal administration.
15. The method of claim 11, wherein all doses of the VEGF antagonist are administered to the patient by topical administration or by intraocular administration.
16. The method of claim 15, wherein all doses of the VEGF antagonist are administered to the patient by intraocular administration.
17. The method of claim 16, wherein the intraocular administration is intravitreal administration.
18. The method of claim 17, wherein all doses of the VEGF antagonist comprise from about 0.5 mg to about 2 mg of the VEGF antagonist.
19. The method of claim 18, wherein all doses of the VEGF antagonist comprise 0.5 mg of the VEGF antagonist.
20. The method of claim 18, wherein all doses of the VEGF antagonist comprise 2 mg of the VEGF antagonist.

**ABSTRACT**

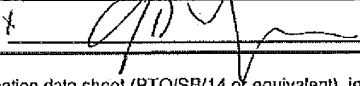
The present invention provides methods for treating angiogenic eye disorders by sequentially administering multiple doses of a VEGF antagonist to a patient. The methods of the present invention include the administration of multiple doses of a VEGF antagonist to a patient at a frequency of once every 8 or more weeks. The methods of the present invention are useful for the treatment of angiogenic eye disorders such as age related macular degeneration, diabetic retinopathy, diabetic macular edema, central retinal vein occlusion, branch retinal vein occlusion, and corneal neovascularization.



1/1

**Figure 1**

**DECLARATION (37 CFR 1.63) FOR UTILITY OR DESIGN APPLICATION USING AN  
APPLICATION DATA SHEET (37 CFR 1.76)**

|   |   |
|---|---|
| <b>Title of<br/>Invention</b>   | <b>USE OF A VEGF ANTAGONIST TO TREAT ANGIOGENIC EYE DISORDERS</b> |
| <p>As the below named inventor, I hereby declare that:</p> <p>This declaration <input type="checkbox"/> The attached application, or<br/>is directed to: <input checked="" type="checkbox"/> United States application or PCT International application number <u>13/940,370</u><br/>filed on <u>July 12, 2013</u>.</p> <p>The above-identified application was made or authorized to be made by me.</p> <p>I believe that I am the original inventor or an original joint inventor of a claimed invention in the application.</p> <p>I hereby acknowledge that any willful false statement made in this declaration is punishable under 18 U.S.C. 1001 by fine or imprisonment of not more than (5) years, or both.</p> <p style="text-align: center;"><b>WARNING:</b></p> <p>Petitioner/applicant is cautioned to avoid submitting personal information in documents filed in a patent application that may contribute to identity theft. Personal information such as social security numbers, bank account numbers, or credit card numbers (other than a check or credit card authorization form PTO-2038 submitted for payment purposes) is never required by the USPTO to support a petition or an application. If this type of personal information is included in documents submitted to the USPTO, petitioners/applicants should consider redacting such personal information from the documents before submitting them to the USPTO. Petitioner/applicant is advised that the record of a patent application is available to the public after publication of the application (unless a non-publication request in compliance with 37 CFR 1.213(a) is made in the application) or issuance of a patent. Furthermore, the record from an abandoned application may also be available to the public if the application is referenced in a published application or an issued patent (see 37 CFR 1.14). Checks and credit card authorization forms PTO-2038 submitted for payment purposes are not retained in the application file and therefore are not publicly available.</p> |   |
| <p><b>LEGAL NAME OF INVENTOR</b></p> <p>Inventor: <u>YANCOPOULOS, GEORGE D.</u> Date (Optional): <u>10/20/13</u></p> <p>Signature: </p>  |   |
| <p>Note: An application data sheet (PTO/SB/14 or equivalent), including naming the entire inventive entity, must accompany this form. Use an additional PTO/AIA/01 form for each additional inventor.</p>   |   |

This collection of information is required by 35 U.S.C. 115 and 37 CFR 1.63. The information is required to obtain or retain a benefit by the public which is to file (and by the USPTO to process) an application. Confidentiality is governed by 35 U.S.C. 122 and 37 CFR 1.11 and 1.14. This collection is estimated to take 1 minute to complete, including gathering, preparing, and submitting the completed application form to the USPTO. Time will vary depending upon the individual case. Any comments on the amount of time you require to complete this form and/or suggestions for reducing this burden, should be sent to the Chief Information Officer, U.S. Patent and Trademark Office, U.S. Department of Commerce, P.O. Box 1450, Alexandria, VA 22313-1450. DO NOT SEND FEES OR COMPLETED FORMS TO THIS ADDRESS. SEND TO: Commissioner for Patents, P.O. Box 1450, Alexandria, VA 22313-1450.

*If you need assistance in completing the form, call 1-800-PTO-9199 and select option 2.*

## Privacy Act Statement

The Privacy Act of 1974 (P.L. 93-579) requires that you be given certain information in connection with your submission of the attached form related to a patent application or patent. Accordingly, pursuant to the requirements of the Act, please be advised that: (1) the general authority for the collection of this information is 35 U.S.C. 2(b)(2); (2) furnishing of the information solicited is voluntary; and (3) the principal purpose for which the information is used by the U.S. Patent and Trademark Office is to process and/or examine your submission related to a patent application or patent. If you do not furnish the requested information, the U.S. Patent and Trademark Office may not be able to process and/or examine your submission, which may result in termination of proceedings or abandonment of the application or expiration of the patent.

The information provided by you in this form will be subject to the following routine uses:

1. The information on this form will be treated confidentially to the extent allowed under the Freedom of Information Act (5 U.S.C. 552) and the Privacy Act (5 U.S.C. 552a). Records from this system of records may be disclosed to the Department of Justice to determine whether disclosure of these records is required by the Freedom of Information Act.
2. A record from this system of records may be disclosed, as a routine use, in the course of presenting evidence to a court, magistrate, or administrative tribunal, including disclosures to opposing counsel in the course of settlement negotiations.
3. A record in this system of records may be disclosed, as a routine use, to a Member of Congress submitting a request involving an individual, to whom the record pertains, when the individual has requested assistance from the Member with respect to the subject matter of the record.
4. A record in this system of records may be disclosed, as a routine use, to a contractor of the Agency having need for the information in order to perform a contract. Recipients of information shall be required to comply with the requirements of the Privacy Act of 1974, as amended, pursuant to 5 U.S.C. 552a(m).
5. A record related to an International Application filed under the Patent Cooperation Treaty in this system of records may be disclosed, as a routine use, to the International Bureau of the World Intellectual Property Organization, pursuant to the Patent Cooperation Treaty.
6. A record in this system of records may be disclosed, as a routine use, to another federal agency for purposes of National Security review (35 U.S.C. 181) and for review pursuant to the Atomic Energy Act (42 U.S.C. 218(c)).
7. A record from this system of records may be disclosed, as a routine use, to the Administrator, General Services, or his/her designee, during an inspection of records conducted by GSA as part of that agency's responsibility to recommend improvements in records management practices and programs, under authority of 44 U.S.C. 2904 and 2906. Such disclosure shall be made in accordance with the GSA regulations governing inspection of records for this purpose, and any other relevant (*i.e.*, GSA or Commerce) directive. Such disclosure shall not be used to make determinations about individuals.
8. A record from this system of records may be disclosed, as a routine use, to the public after either publication of the application pursuant to 35 U.S.C. 122(b) or issuance of a patent pursuant to 35 U.S.C. 151. Further, a record may be disclosed, subject to the limitations of 37 CFR 1.14, as a routine use, to the public if the record was filed in an application which became abandoned or in which the proceedings were terminated and which application is referenced by either a published application, an application open to public inspection or an issued patent.
9. A record from this system of records may be disclosed, as a routine use, to a Federal, State, or local law enforcement agency, if the USPTO becomes aware of a violation or potential violation of law or regulation.
- 10.



Electronically Filed 6/21/2021

|  |                      |                       |
|--|----------------------|-----------------------|
| <b>INFORMATION<br/>DISCLOSURE STATEMENT</b><br><br>Address to:<br>Commissioner for Patents<br>P.O. Box 1450<br>Alexandria, VA 22313-1450 | Attorney Docket No.  | REGN-008CIPCON10      |
|  | Confirmation No.     | To Be Assigned        |
|  | First Named Inventor | George D. Yancopoulos |
|  | Application Number   | To Be Assigned        |
|  | Filing Date          | June 21, 2021         |
|  | Group Art Unit       |                       |
|  | Examiner Name        |                       |
| Title: <i>“Use of a VEGF Antagonist to Treat Angiogenic Eye Disorders”</i>   |                      |                       |

Sir:

Applicant submits herewith documents which may be material to the examination of this application and in respect of which there may be a duty to disclose in accordance with 37 C.F.R. § 1.56. This submission is not intended to constitute an admission that any document referred to therein is "prior art" for this invention unless specifically designated as such. A listing of the documents is shown on enclosed Form PTO/SB/08A.

The publications discussed herein are provided to comply with the duty to disclose in accordance with 37 C.F.R. § 1.56. However, nothing herein is to be construed as an admission that the present invention is not entitled to antedate such publication by virtue of prior invention. Further, the dates of publication provided may be different from the actual publication dates which may need to be independently confirmed

The Examiner is requested to make the documents listed on the enclosed PTO/SB/08A of record in this application. Applicants would appreciate the Examiner initialing and returning the initialed copy of form PTO/SB/08A, indicating the documents cited therein have been considered and made of record herein.

**All of the references identified herein were disclosed in parent application serial number 17/350,958, and as such, copies thereof are not included pursuant to the provisions of 37 CFR § 1.98(d).**

Statements

**No statement**

.....  
 **PTA Statement under 37 CFR § 1.704(d)(1):** Each item of information contained in the information disclosure statement filed herewith:

(i) Was first cited in any communication from a patent office in a counterpart foreign or international application or from the Office, and this communication was not received by any individual designated in § 1.56(c) more than thirty days prior to the filing of the information disclosure statement; or

(ii) Is a communication that was issued by a patent office in a counterpart foreign or international application or by the Office, and this communication was not received by any individual designated in § 1.56(c) more than thirty days prior to the filing of the information disclosure statement.

- 
- IDS Statement under 37 CFR § 1.97(e)(1):** Each item of information contained in the information disclosure statement was first cited in any communication from a foreign patent office in a counterpart foreign application not more than three months prior to the filing of the information disclosure statement; or
  - IDS Statement under 37 CFR § 1.97(e)(2):** No item of information contained in the information disclosure statement was cited in a communication from a foreign patent office in a counterpart foreign application, and, to the knowledge of the person signing the certification after making reasonable inquiry, no item of information contained in the information disclosure statement was known to any individual designated in § 1.56(c) more than three months prior to the filing of the information disclosure statement.
-

**Fees**

- No fee is believed to be due.
- The appropriate fee set forth in 37 C.F.R. §1.17(p) accompanies this information disclosure statement.

The Commissioner is hereby authorized to charge any underpayment of fees up to a strict limit of \$3,000.00 beyond that authorized on the credit card, but not more than \$3,000.00 in additional fees due with any communication for the above-referenced patent application, including but not limited to any necessary fees for extensions of time, or credit any overpayment of any amount to Deposit Account No. 50-0815, order number REGN-008CIPCON10.

Respectfully submitted,  
BOZICEVIC, FIELD & FRANCIS LLP

Date: June 21, 2021

By: /Karl Bozicevic, Reg. No. 28,807/  
Karl Bozicevic  
Reg. No. 28,807

BOZICEVIC, FIELD & FRANCIS LLP  
201 Redwood Shores Parkway, Suite 200  
Redwood City, CA 94065  
Telephone: (650) 327-3400  
Facsimile: (650) 327-3231

|  |   |    |                      |                        |                  |
|--|---|----|----------------------|------------------------|------------------|
| <b>INFORMATION DISCLOSURE<br/>STATEMENT BY APPLICANT</b> |   |    | Application Number   | To Be Assigned         |                  |
|  |   |    | Filing Date          | 2021-06-21             |                  |
|  |   |    | First Named Inventor | George D. Yancopoulos  |                  |
|  |   |    | Art Unit             |                        |                  |
|  |   |    | Examiner Name        |                        |                  |
| Sheet  | 1 | of | 18                   | Attorney Docket Number | REGN-008CIPCON10 |

| U.S. PATENT DOCUMENTS |          |                             |  |                          |   |   |
|-----------------------|----------|-----------------------------|--|--------------------------|---|---|
| Examiner Initial*     | Cite No. | Patent Number               |  | Issue Date<br>YYYY-MM-DD | Name of Patentee or Applicant of Cited Document | Pages, Columns, Lines, Where Relevant Passages or Relevant Figures Appear |
|                       |          | Number-Kind Code (if known) |  |                          |   |   |
|                       | 1        | 7070959                     |  | 2006-07-04               | Papadopoulos                                    |   |
|                       | 2        | 7303746                     |  | 2007-12-04               | Wiegand   |   |
|                       | 3        | 7303748                     |  | 2007-12-04               | Wiegand   |   |
|                       | 4        | 7306799                     |  | 2007-12-11               | Wiegand   |   |
|                       | 5        | 7396664                     |  | 2008-07-08               | Daly et al.                                     |   |
|                       | 6        | 8092803                     |  | 2012-01-10               | Furfine et al.                                  |   |
|                       | 7        | 9254338                     |  | 2016-02-09               | Yancopoulos                                     |   |
|                       | 8        | 9669069                     |  | 2017-06-06               | Yancopoulos                                     |   |
|                       | 9        | 10130681                    |  | 2018-11-20               | Yancopoulos                                     |   |
|                       | 10       | 10406226                    |  | 2019-09-10               | Dix et al.                                      |   |
|                       | 11       | 10464992                    |  | 2019-11-05               | Furfine et al.                                  |   |

| U.S. PATENT APPLICATION PUBLICATIONS |          |                             |  |                                |   |   |
|--------------------------------------|----------|-----------------------------|--|--------------------------------|---|---|
| Examiner Initial*                    | Cite No. | Publication Number          |  | Publication Date<br>YYYY-MM-DD | Name of Patentee or Applicant of Cited Document | Pages, Columns, Lines, Where Relevant Passages or Relevant Figures Appear |
|                                      |          | Number-Kind Code (if known) |  |                                |   |   |
|                                      | 1        | 2003/0171320                |  | 2003-09-11                     | Guyer   |   |
|                                      | 2        | 2005/0163798                |  | 2005-07-28                     | Papadopoulos et al.                             |   |
|                                      | 3        | 2005/0260203                |  | 2005-11-24                     | Wiegand et al.                                  |   |
|                                      | 4        | 2006/0058234                |  | 2006-03-16                     | Daly et al.                                     |   |
|                                      | 5        | 2006/0172944                |  | 2006-08-03                     | Wiegand et al.                                  |   |
|                                      | 6        | 2007/0190058                |  | 2007-08-16                     | Shams   |   |
|                                      | 7        | 2008/0220004                |  | 2008-09-11                     | Wiegand et al.                                  |   |
|                                      | 8        | 2019/0290725                |  | 2019-09-26                     | Vitti et al.                                    |   |
|                                      | 9        | 2019/0388539                |  | 2019-12-26                     | Dix et al.                                      |   |
|                                      | 10       | 2020/0017572                |  | 2020-01-16                     | Furfine et al.                                  |   |

| FOREIGN PATENT DOCUMENTS |          |  |  |                                |   |   |   |
|--------------------------|----------|--|--|--------------------------------|---|---|---|
| Examiner Initial*        | Cite No. | Foreign Document Number                  |  | Publication Date<br>YYYY-MM-DD | Name of Patentee or Applicant of Cited Document | Pages, Columns, Lines, Where Relevant Passages or Relevant Figures Appear | T |
|                          |          | Country Code-Number-Kind Code (if known) |  |                                |   |   |   |
|                          | 1        | WO 2006/047325                           |  | 2006-03-04                     | Genentech, Inc.                                 |   |   |
|                          | 2        | WO 2000/75319                            |  | 2000-12-14                     | Regeneron Pharmaceuticals, Inc.                 |   |   |
|                          | 3        | WO 2004/106378 A2                        |  | 2004-12-09                     | Regeneron Pharmaceuticals, Inc.                 |   |   |
|                          | 4        | WO 2005/000895 A2                        |  | 2005-01-05                     | Regeneron Pharmaceuticals, Inc.                 |   |   |
|                          | 5        | WO 2007/022101 A2                        |  | 2007-02-22                     | Regeneron Pharmaceuticals, Inc.                 |   |   |

|                    |  |                 |  |
|--------------------|--|-----------------|--|
| Examiner Signature |  | Date Considered |  |
|--------------------|--|-----------------|--|

\*EXAMINER: Initial if reference considered, whether or not citation is in conformance with MPEP 609. Draw line through citation if not in conformance and not considered. Include copy of this form with next communication to applicant.

|  |   |    |    |                        |                       |
|--|---|----|----|------------------------|-----------------------|
| <b>INFORMATION DISCLOSURE<br/>STATEMENT BY APPLICANT</b> |   |    |    | Application Number     | To Be Assigned        |
|  |   |    |    | Filing Date            | 2021-06-21            |
|  |   |    |    | First Named Inventor   | George D. Yancopoulos |
|  |   |    |    | Art Unit               |                       |
|  |   |    |    | Examiner Name          |                       |
| Sheet  | 2 | of | 18 | Attorney Docket Number | REGN-008CIPCON10      |

| FOREIGN PATENT DOCUMENTS |          |  |                                |   |   |   |
|--------------------------|----------|--|--------------------------------|---|---|---|
| Examiner Initial*        | Cite No. | Foreign Document Number                  | Publication Date<br>YYYY-MM-DD | Name of Patentee or Applicant of Cited Document | Pages, Columns, Lines, Where Relevant Passages or Relevant Figures Appear | T |
|                          |          | Country Code-Number-Kind Code (if known) |                                |   |   |   |
|                          | 6        | WO 2008/063932                           | 2008-05-29                     | Genentech, Inc.                                 |   |   |
|                          | 7        | JP 2010-509369                           | 2010-03-25                     | Genentech, Inc.                                 | See WO 2008/063932 for English Equivalent                                 |   |
|                          | 8        | WO 2012/097019                           | 2012-07-19                     | Regeneron Pharmaceuticals, Inc.                 |   |   |

| NON PATENT LITERATURE DOCUMENTS |          |  |  |  |  |   |
|---------------------------------|----------|--|--|--|--|---|
| Examiner Initials*              | Cite No. | Include name of the author (in CAPITAL LETTERS), title of the article (when appropriate), title of the item (book, magazine, journal, serial, symposium, catalog, etc.), date, page(s), volume-issue number(s), publisher, city and/or country where published.                  |  |  |  | T |
|                                 | 1        | 16/055,847 – Third Party Submissions dated May 1, 2019   |  |  |  |   |
|                                 | 2        | 16/159,282 – Third Party Submissions dated May 31, 2019  |  |  |  |   |
|                                 | 3        | ADSIS R&D Profile "Aflibercept: AVE 0005, AVE 005, AVE0005, VEGF Trap - Regeneron, VEGF Trap (R1R2), VEGF Trap-Eye." Drugs R D, 9(4):261-269 (2008)  |  |  |  |   |
|                                 | 4        | ANONYMOUS "Lucentis (rangibizymab injection) Intravitreal Injection" pp. 103 (June 2006)   |  |  |  |   |
|                                 | 5        | ANONYMOUS "Anti-VEGF 2019: The State of the Art" Review of Ophthalmology (published August 5, 2019)  |  |  |  |   |
|                                 | 6        | BARBAZETTO, "Dosing Regimen And The Frequency Of Macular Hemorrhages In Neovascular Age-Related Macular Degeneration Treated With Ranibizumab." Retina, 30(9):1376-85 (2010)   |  |  |  |   |
|                                 | 7        | Bayer Investor News, "Bayer and Regeneron Start additional Phase 3 Study for VEGF Trap-Eye in Wet Age-related Macular Degeneration." (May 8, 2008)   |  |  |  |   |
|                                 | 8        | Bayer Investor News, "VEGF Trap-Eye: New Data Confirm Successes in the Treatment of Age-related Macular Degeneration" (September 28, 2008)   |  |  |  |   |
|                                 | 9        | BENZ et al. "CLEAR-IT-2: Interim Results Of The Phase II, Randomized, Controlled Dose- and Interval-ranging Study Of Repeated Intravitreal VEGF Trap Administration In Patients With Neovascular Age-related Macular Degeneration (AMD)" ARVO Annual Meeting Abstract (May 2007) |  |  |  |   |
|                                 | 10       | BOYER, "A Phase IIIb Study to Evaluate the Safety of Ranibizumab in Subjects with Neovascular Age-related Macular Degeneration." Ophthalmology, 116(9):1731-39 (September 2009)  |  |  |  |   |
|                                 | 11       | BROWN, "Ranibizumab versus Verteporfin for Neovascular Age-Related Macular Degeneration." N Engl J Med, 355(14):1432-44 (October 5, 2006)  |  |  |  |   |
|                                 | 12       | BROWN, "Primary Endpoint Results of a Phase II Study of Vascular Endothelial Growth Factor Trap-Eye in Wet Age-related Macular Degeneration." Ophthalmology, 118(6):1089-97 (June 2011)  |  |  |  |   |
|                                 | 13       | BROWN, "Long-term Outcomes of Ranibizumab Therapy for Diabetic Macular Edema: The 36-Month Results from Two phase III Trials." Ophthalmology, 120(10):2013-22 (October 2013)   |  |  |  |   |
|                                 | 14       | BROWNING et al. "Aflibercept for age-related macular degeneration: a game-changer or quiet addition?" American Journal of Ophthalmology, 154(2):222-226 (August 2012)  |  |  |  |   |

|                    |  |                 |  |
|--------------------|--|-----------------|--|
| Examiner Signature |  | Date Considered |  |
|--------------------|--|-----------------|--|

\*EXAMINER: Initial if reference considered, whether or not citation is in conformance with MPEP 609. Draw line through citation if not in conformance and not considered. Include copy of this form with next communication to applicant.

|  |   |    |                      |                        |                  |
|--|---|----|----------------------|------------------------|------------------|
| <b>INFORMATION DISCLOSURE<br/>STATEMENT BY APPLICANT</b> |   |    | Application Number   | To Be Assigned         |                  |
|  |   |    | Filing Date          | 2021-06-21             |                  |
|  |   |    | First Named Inventor | George D. Yancopoulos  |                  |
|  |   |    | Art Unit             |                        |                  |
|  |   |    | Examiner Name        |                        |                  |
| Sheet  | 3 | of | 18                   | Attorney Docket Number | REGN-008CIPCON10 |

| NON PATENT LITERATURE DOCUMENTS |          |   |  |   |
|---------------------------------|----------|---|--|---|
| Examiner Initials*              | Cite No. | Include name of the author (in CAPITAL LETTERS), title of the article (when appropriate), title of the item (book, magazine, journal, serial, symposium, catalog, etc.), date, page(s), volume-issue number(s), publisher, city and/or country where published. |  | T |
|                                 | 15       | CAMPOCHIARO et al. "Ranibizumab for Macular Edema Due to Retinal Vein Occlusions Implication of VEGF as a Critical Stimulator" Molecular Therapy, 16(4):791-799 (2008)  |  |   |
|                                 | 16       | CAMPOCHIARO, "Ranibizumab for Macular Edema following Branch Retinal Vein Occlusion: six-month primary end point results of a phase III study." Ophthalmology, 117(6):1102-1112 (June 2010)   |  |   |
|                                 | 17       | CAMPOCHIARO, "Sustained Benefits from Ranibizumab for Macular Edema following Central Retinal Vein Occlusion: Twelve-Month Outcomes of a phase III Study." Ophthalmology, 188(10):2041-49 (October 2011)  |  |   |
|                                 | 18       | CAO, "A Subretinal Matrigel Rat Choroidal Neovascularization (CNV) Model and Inhibition of CNV and Associated Inflammation and Fibrosis by VEGF Trap" Investigative Ophthalmology & Visual Science, 51(11):6009- 6017 (November 2010)                           |  |   |
|                                 | 19       | CENTER FOR DRUG EVALUATION AND RESEARCH APPLICATION NUMBER: 21-756 MEDICAL REVIEW(S) (December 17, 2004)<br><URL:https://www.accessdata.fda.gov/drugsatfda_docs/nda/2004/21-756_Macugen_medr.pdf>   |  |   |
|                                 | 20       | CENTER FOR DRUG EVALUATION AND RESEARCH BLA APPLICATION NUMBER: 125156 MEDICAL REVIEW, (June 2006)<br><URL:https://www.accessdata.fda.gov/drugsatfda_docs/nda/2006/125156s000_Lucentis_MedR.pdf>  |  |   |
|                                 | 21       | CHARLES, Steve (Guest Lecturer) "VEGF Trap Has Positive DME Data" Tenth Annual Retina Fellows Forum Jan 29 and 30, Chicago, (Article Date 03/01/2010)   |  |   |
|                                 | 22       | CHATZIRALLI et al. "Intravitreal aflibercept for neovascular age-related macular degeneration in patients aged 90 years or older: 2-year visual acuity outcomes" Eye (2018) 32:1523-1529  |  |   |
|                                 | 23       | CHUNG et al. "Ziv-aflibercept: A novel angiogenesis inhibitor for the treatment of metastatic colorectal cancer" Am J Heath-Syst Pharm (November 1, 2013) 70:1887-1896  |  |   |
|                                 | 24       | COOPER et al., "Increased Renal Expression of Vascular Endothelial Growth Factor (VEGF) and Its Receptor VEGFR-2 in Experimental Diabetes" Diabetes (1999) 48:2229-2239   |  |   |
|                                 | 25       | CROLL et al., "VEGF-mediated inflammation precedes angiogenesis in adult brain" Experimental Neurology (2004) 187:388-402   |  |   |
|                                 | 26       | CSAKY, "Safety Implications of Vascular Endothelial Growth Factor Blockade for Subjects Receiving Intravitreal Anti-Vascular Endothelial Growth Factor Therapies." Am. J. Ophthalmology, 148(5):647-56, (November 2009)   |  |   |
|                                 | 27       | DeVRIESE et al., "Antibodies against Vascular Endothelial Growth Factor Improve Early Renal Dysfunction in Experimental Diabetes" J. Am. Soc. Nephrol (2001) 12:993-1000  |  |   |
|                                 | 28       | DIXON et al., "VEGF Trap-Eye for the treatment of neovascular age-related macular degeneration" Expert Opin. Investig. Drugs, 18(10):1573-1580 (2009)   |  |   |
|                                 | 29       | DO et al., "An exploratory study of the safety, tolerability and bioactivity of a single intravitreal injection of vascular endothelial growth factor Trap-Eye in patients with diabetic macular oedema" Br J Ophthalmol. 93(2):144-149 (February 2009)         |  |   |
|                                 | 30       | DO et al., "The DA VINCI Study: phase 2 primary results of VEGF Trap-Eye in patients with diabetic macular edema" Ophthalmology, 118(9):1819-1826 (September 2011)  |  |   |

|                    |  |                 |  |
|--------------------|--|-----------------|--|
| Examiner Signature |  | Date Considered |  |
|--------------------|--|-----------------|--|

\*EXAMINER: Initial if reference considered, whether or not citation is in conformance with MPEP 609. Draw line through citation if not in conformance and not considered. Include copy of this form with next communication to applicant.

|  |   |    |                      |                        |                  |
|--|---|----|----------------------|------------------------|------------------|
| <b>INFORMATION DISCLOSURE<br/>STATEMENT BY APPLICANT</b> |   |    | Application Number   | To Be Assigned         |                  |
|  |   |    | Filing Date          | 2021-06-21             |                  |
|  |   |    | First Named Inventor | George D. Yancopoulos  |                  |
|  |   |    | Art Unit             |                        |                  |
|  |   |    | Examiner Name        |                        |                  |
| Sheet  | 4 | of | 18                   | Attorney Docket Number | REGN-008CIPCON10 |

| NON PATENT LITERATURE DOCUMENTS |          |   |                 |   |
|---------------------------------|----------|---|-----------------|---|
| Examiner Initials*              | Cite No. | Include name of the author (in CAPITAL LETTERS), title of the article (when appropriate), title of the item (book, magazine, journal, serial, symposium, catalog, etc.), date, page(s), volume-issue number(s), publisher, city and/or country where published.   | T               | T |
|                                 | 31       | DO, "One-Year Outcomes of the DA VINCI Study of VEGF Trap-Eye in Eyes with Diabetic Macular Edema." <i>Ophthalmology</i> , 119(8):1658-65 (2012)  |                 |   |
|                                 | 32       | DO et al. "Results of a Phase 1 Study of Intravitreal VEGF Trap in Subjects with Diabetic Macular Edema: The CLEAR-IT DME Study" <i>ARVO Annual Meeting Abstract (May 2007)</i>   |                 |   |
|                                 | 33       | DO et al. "VEGF Trap-Eye Vision-specific Quality of Life through 52 Weeks in Patients with Neovascular AMD in CLEAR-IT 2: A Phase 2 Clinical Trial" <i>ARVO Annual Meeting Abstract (April 2009)</i>  |                 |   |
|                                 | 34       | EICHTEN, "Rapid decrease in tumor perfusion following VEGF blockade predicts long-term tumor growth inhibition in preclinical tumor models" <i>Angiogenesis</i> , 16:429-441 (2013)   |                 |   |
|                                 | 35       | ENGELBERT, "Treat And Extend' Dosing Of Intravitreal Antivascular Endothelial Growth Factor Therapy For Type 3 Neovascularization/Retinal Angiomatous Proliferation." <i>Retina</i> , 29(10):1424-31 (2009)   |                 |   |
|                                 | 36       | ENGELBERT, "Long-Term Follow-Up For Type 1 (Subretinal Pigment Epithelium) Neovascularization Using A Modified 'Treat And Extend' Dosing Regimen Of Intravitreal Antivascular Endothelial Growth Factor Therapy." <i>Retina</i> , 30(9):1368-75 (2010)  |                 |   |
|                                 | 37       | ENGELBERT, "The 'Treat and Extend' Dosing Regimen of Intravitreal Anti-Vascular Endothelial Growth Factor Therapy for Neovascular Age-Related Macular Degeneration." <i>Ophthalmology Management</i> , Issue 42, (June 2010) available at <a href="http://www.visioncareprofessional.com/emails/amduupdate/index.asp?issue=42">http://www.visioncareprofessional.com/emails/amduupdate/index.asp?issue=42</a> |                 |   |
|                                 | 38       | EREMINA et al., "Glomerular-specific alterations of VEGF-A expression lead to distinct congenital and acquired renal diseases" <i>Journal of Clinical Investigation</i> (March 2003) 111(5):707-716   |                 |   |
|                                 | 39       | ERIKSSON et al., "Structure, Expression and Receptor-Binding Properties of Novel Vascular Endothelial Growth Factors" <i>Vascular Growth Factors and Angiogenesis</i> , Springer (1999) pp. 41-57   |                 |   |
|                                 | 40       | THE EYETECH STUDY GROUP, "Anti-Vascular Endothelial Growth Factor Therapy for Subfoveal Choroidal Neovascularization Secondary to Age-related Macular Degeneration" <i>American Academy of Ophthalmology</i> , 110(5):979-986 (May 2003)  |                 |   |
|                                 | 41       | Eylea®, Highlights of Prescribing Information, Revised 08/2018.   |                 |   |
|                                 | 42       | FERRARA, N. "Vascular Endothelial Growth Factor: Molecular and Biological Aspects" <i>Advances in Organ Biology</i> (1999) pp. 1-30   |                 |   |
|                                 | 43       | FERRARA et al., "Clinical applications of angiogenic growth factors and their inhibitors" <i>Nature Medicine</i> (December 1999) 5(12):1359-1364  |                 |   |
|                                 | 44       | FLYVBJERG et al., "Amelioration of Long-Term Renal Changes in Obese Type 2 Diabetic Mice by a Neutralizing Vascular Endothelial Growth Factor Antibody" <i>Diabetes</i> (October 2002) 51:3090-3094   |                 |   |
|                                 | 45       | FUNG, "An Optical Coherence Tomography-Guided, Variable Dosing Regimen with Intravitreal Ranibizumab (Lucentis) for Neovascular Age-related Macular Degeneration." <i>Am J Ophthalmology</i> , 143(4):566-83 (April 2007)   |                 |   |
|                                 | 46       | GALE, "Complementary and Coordinated Roles of the VEGFs and Angiopoietins during Normal and Pathologic Vascular Formation." <i>Cold Spring Harbor Symposia on Quantitative Biology</i> , Volume LXVIL, pp. 267-73 (2002)  |                 |   |
|                                 | 47       | GARCIA-QUINTANILLA, "Pharmacokinetics of Intravitreal Anti-VEGF Drugs in Age-Related Macular Degeneration." <i>Pharmaceutics</i> , 11:365 (2019)  |                 |   |
| Examiner Signature              |          |   | Date Considered |   |

\*EXAMINER: Initial if reference considered, whether or not citation is in conformance with MPEP 609. Draw line through citation if not in conformance and not considered. Include copy of this form with next communication to applicant.

|  |   |    |                      |                        |                  |
|--|---|----|----------------------|------------------------|------------------|
| <b>INFORMATION DISCLOSURE STATEMENT BY APPLICANT</b> |   |    | Application Number   | To Be Assigned         |                  |
|  |   |    | Filing Date          | 2021-06-21             |                  |
|  |   |    | First Named Inventor | George D. Yancopoulos  |                  |
|  |   |    | Art Unit             |                        |                  |
|  |   |    | Examiner Name        |                        |                  |
| Sheet  | 5 | of | 18                   | Attorney Docket Number | REGN-008CIPCON10 |

| NON PATENT LITERATURE DOCUMENTS |          |   |  |   |
|---------------------------------|----------|---|--|---|
| Examiner Initials*              | Cite No. | Include name of the author (in CAPITAL LETTERS), title of the article (when appropriate), title of the item (book, magazine, journal, serial, symposium, catalog, etc.), date, page(s), volume-issue number(s), publisher, city and/or country where published.   |  | T |
|                                 | 48       | GOMEZ-MANZANO, "VEGF Trap induces antiglioma effect at different stages of disease." <i>Neuro-Oncology</i> , 10:940-945 (December 2008)   |  |   |
|                                 | 49       | GRAGOUDAS, "Pegaptanib for Neovascular Age-Related Macular Degeneration." <i>N Engl J Med</i> , 351(27):2805-16, (December 30, 2004)  |  |   |
|                                 | 50       | GUTIERREZ et al., "Intravitreal bevacizumab (Avastin) in the treatment of macular edema secondary to retinal vein occlusion" <i>Clin. Ophthalmol.</i> , 2(4):787,791 (2008)   |  |   |
|                                 | 51       | HALLER et al., "VEGF Trap-Eye In CRVO: Primary Endpoint Results of the Phase 3 COPERNICUS Study" ARVO Annual Meeting Abstract (April 2011)  |  |   |
|                                 | 52       | HEIER et al., "CLEAR-IT 2: Phase 2, Randomized Controlled Dose and Interval-Ranging Study of Intravitreal VEGF Trap Eye in Patients with Neovascular Age-Related Macular Degeneration: Predictive Factors for Visual Acuity" ARVO Annual Meeting Abstract (April 2009)  |  |   |
|                                 | 53       | HEIER, J., "Intravitreal VEGF Trap for AMD: An Update, The CLEAR-IT 2 Extension Study" Presented at the annual meeting of the Association for Research in Vision and Ophthalmology, <i>Retina Today</i> (2009) pp. 44-45  |  |   |
|                                 | 54       | HEIER et al., " rhuFab V2 (anti-VEGF Antibody) for Treatment of Exudative AMD" Symposium 8:Experimental and Emerging Treatments for Choroidal Neovascularization, 10 pp (2002)  |  |   |
|                                 | 55       | HEIER et al., "RhuFab V2 in Wet AMD - 6 Month Continued Improvement Following Multiple Intravitreal Injections" <i>Invest Ophthalmol Vis Sci</i> , 44(E-Abstract):972 (2003)  |  |   |
|                                 | 56       | HEIER et al., "Intravitreal Aflibercept (VEGF Trap-Eye) in Wet Age-related macular Degeneration," <i>Ophthalmology</i> , 119:2537-2548 (2012)   |  |   |
|                                 | 57       | HEIER, "Intravitreal Aflibercept for Diabetic Macular Edema: 148-Week Results from the VISTA and VIVID Studies." <i>Ophthalmology</i> , 123(11):2376-2385 (November 2016)   |  |   |
|                                 | 58       | HEIER et al., "The 1-year Results of CLEAR-IT 2, a Phase 2 Study of Vascular Endothelial Growth Factor Trap-Eye Dosed As-needed After 12-week Fixed Dosing" <i>Ophthalmology</i> 2011;118:1098-1106 (June 2011)   |  |   |
|                                 | 59       | HEIER et al., "The 1-year Results of CLEAR-IT 2, a Phase 2 Study of Vascular Endothelial Growth Factor Trap-Eye Dosed As-needed After 12-week Fixed Dosing: Erratum" <i>Ophthalmology</i> 2011;118:1700 (September 2011)  |  |   |
|                                 | 60       | HO, "VEGF Trap-Eye in Wet AMD - CLEAR-IT 2: One-Year OCT and FA Outcomes" CLEAR-IT 2 Study Group, pp 1-24 (09/28/2008)  |  |   |
|                                 | 61       | Ho et al., Slides entitled CLEAR IT 2 One-Year Key Results, <i>Retina Society</i> (2008)  |  |   |
|                                 | 62       | HOLASH et al., "Vessel Cooption, Regression, and Growth in Tumors Mediated by Angiopoietins and VEGF" <i>Science</i> (June 18, 1999) 284(5422):1994-1998  |  |   |
|                                 | 63       | HOLASH, "VEGF-Trap: A VEGF blocker with potent antitumor effects" <i>PNAS</i> 99(17)11393-11398 (8/20/2002)   |  |   |
|                                 | 64       | HOLASH, "Inhibitors of growth factor receptors, signaling pathways and angiogenesis as therapeutic molecular agents." <i>Cancer Metastasis</i> 25:243-252 (2006)  |  |   |
|                                 | 65       | Information from ClinicalTrials.gov archive History of Changes for Study: NCT00320775 "Safety and Tolerability of Intravitreal Administration of VEGF Trap in Patients With Neovascular Age-Related Macular Degeneration" 70 pages, Latest version submitted June 8, 2011 on ClinicalTrials.gov (NCT00320775_2006-2011) |  |   |

|                    |  |                 |  |
|--------------------|--|-----------------|--|
| Examiner Signature |  | Date Considered |  |
|--------------------|--|-----------------|--|

\*EXAMINER: Initial if reference considered, whether or not citation is in conformance with MPEP 609. Draw line through citation if not in conformance and not considered. Include copy of this form with next communication to applicant.



|  |   |    |                      |                        |                  |
|--|---|----|----------------------|------------------------|------------------|
| <b>INFORMATION DISCLOSURE<br/>STATEMENT BY APPLICANT</b> |   |    | Application Number   | To Be Assigned         |                  |
|  |   |    | Filing Date          | 2021-06-21             |                  |
|  |   |    | First Named Inventor | George D. Yancopoulos  |                  |
|  |   |    | Art Unit             |                        |                  |
|  |   |    | Examiner Name        |                        |                  |
| Sheet  | 6 | of | 18                   | Attorney Docket Number | REGN-008CIPCON10 |

| NON PATENT LITERATURE DOCUMENTS |          |   |  |   |
|---------------------------------|----------|---|--|---|
| Examiner Initials*              | Cite No. | Include name of the author (in CAPITAL LETTERS), title of the article (when appropriate), title of the item (book, magazine, journal, serial, symposium, catalog, etc.), date, page(s), volume-issue number(s), publisher, city and/or country where published.   |  | T |
|                                 | 66       | Information from ClinicalTrials.gov archive History of Changes for Study: NCT00320775 "Safety and Tolerability of Intravitreal Administration of VEGF Trap in Patients With Neovascular Age-Related Macular Degeneration" 10 pages, Latest version submitted March 16, 2015 on ClinicalTrials.gov (NCT00320775_2015)  |  |   |
|                                 | 67       | Information from ClinicalTrials.gov archive History of Changes for Study: NCT00320788 "Safety and Efficacy of Repeated Intravitreal Administration of Vascular Endothelial Growth Factor (VEGF) Trap in Patients With Wet Age-Related Macular Degeneration (AMD)" 71 pages, Latest version submitted December 1, 2011 on ClinicalTrials.gov (NCT00320788_2006-2011) |  |   |
|                                 | 68       | Information from ClinicalTrials.gov archive History of Changes for Study: NCT00320788 "Safety and Efficacy of Repeated Intravitreal Administration of Vascular Endothelial Growth Factor (VEGF) Trap in Patients With Wet Age-Related Macular Degeneration (AMD)" 31 pages, Latest version submitted January 27, 2012 on ClinicalTrials.gov (NCT00320788_2012)      |  |   |
|                                 | 69       | Information from ClinicalTrials.gov archive History of Changes for Study: NCT00320814 "Phase 1 Study of VEGF Trap in Patients With Diabetic Macular Edema" 30 pages, Latest version submitted June 8, 2011 on ClinicalTrials.gov (NCT00320814_2006-2011)  |  |   |
|                                 | 70       | Information from ClinicalTrials.gov archive History of Changes for Study: NCT00509795 "Double-Masked Study of Efficacy and Safety of IVT VEGF Trap-Eye in Subjects With Wet AMD (VIEW 1)" 318 pages, Latest version submitted December 1, 2011 on ClinicalTrials.gov (NCT00509795_2007-2011)  |  |   |
|                                 | 71       | Information from ClinicalTrials.gov archive History of Changes for Study: NCT00509795 "Double-Masked Study of Efficacy and Safety of IVT VEGF Trap-Eye in Subjects With Wet AMD (VIEW 1)" 200 pages, Latest version submitted December 20, 2012 on ClinicalTrials.gov (NCT00509795_2012)  |  |   |
|                                 | 72       | Information from ClinicalTrials.gov archive History of Changes for Study: NCT00527423 "Randomized, Single-Masked, Long-Term, Safety and Tolerability Study of VEGF Trap-Eye in AMD" 64 pages, Latest version submitted November 1, 2011 on ClinicalTrials.gov (NCT00527423_2007-2011)   |  |   |
|                                 | 73       | Information from ClinicalTrials.gov archive History of Changes for Study: NCT00527423 "Randomized, Single-Masked, Long-Term, Safety and Tolerability Study of VEGF Trap-Eye in AMD" 42 pages, Latest version submitted June 10, 2013 on ClinicalTrials.gov (NCT00527423_2012-2013)  |  |   |
|                                 | 74       | Information from ClinicalTrials.gov archive History of Changes for Study: NCT00637377 "Vascular Endothelial Growth Factor (VEGF) Trap-Eye: Investigation of Efficacy and Safety in Wet Age-Related Macular Degeneration (AMD) (VIEW 2)" 667 pages, Latest version submitted December 16, 2011 on ClinicalTrials.gov (NCT00637377_2008-2011)                         |  |   |

|                    |  |                 |  |
|--------------------|--|-----------------|--|
| Examiner Signature |  | Date Considered |  |
|--------------------|--|-----------------|--|

\*EXAMINER: Initial if reference considered, whether or not citation is in conformance with MPEP 609. Draw line through citation if not in conformance and not considered. Include copy of this form with next communication to applicant.

|  |   |    |                      |                        |                  |
|--|---|----|----------------------|------------------------|------------------|
| <b>INFORMATION DISCLOSURE<br/>STATEMENT BY APPLICANT</b> |   |    | Application Number   | To Be Assigned         |                  |
|  |   |    | Filing Date          | 2021-06-21             |                  |
|  |   |    | First Named Inventor | George D. Yancopoulos  |                  |
|  |   |    | Art Unit             |                        |                  |
|  |   |    | Examiner Name        |                        |                  |
| Sheet  | 7 | of | 18                   | Attorney Docket Number | REGN-008CIPCON10 |

| NON PATENT LITERATURE DOCUMENTS |          |   |  |   |
|---------------------------------|----------|---|--|---|
| Examiner Initials*              | Cite No. | Include name of the author (in CAPITAL LETTERS), title of the article (when appropriate), title of the item (book, magazine, journal, serial, symposium, catalog, etc.), date, page(s), volume-issue number(s), publisher, city and/or country where published.   |  | T |
|                                 | 75       | Information from ClinicalTrials.gov archive History of Changes for Study: NCT00637377 "Vascular Endothelial Growth Factor (VEGF) Trap-Eye: Investigation of Efficacy and Safety in Wet Age-Related Macular Degeneration (AMD) (VIEW 2)" 289 pages, Latest version submitted November 28, 2014 on ClinicalTrials.gov (NCT00637377_2012-2014) |  |   |
|                                 | 76       | Information from ClinicalTrials.gov archive History of Changes for Study: NCT00789477 "DME And VEGF Trap-Eye [Intravitreal Aflibercept Injection (IAI;EYLEA@;BAY86-5321)] INvestigation of Clinical Impact (DA VINCI)" 135 pages, Latest version submitted May 2, 2011 on ClinicalTrials.gov (NCT00789477_2008-2011)                        |  |   |
|                                 | 77       | Information from ClinicalTrials.gov archive History of Changes for Study: NCT00789477 "DME And VEGF Trap-Eye [Intravitreal Aflibercept Injection (IAI;EYLEA@;BAY86-5321)] INvestigation of Clinical Impact (DA VINCI)" 53 pages, Latest version submitted August 28, 2014 on ClinicalTrials.gov (NCT00789477_2013-2014)                     |  |   |
|                                 | 78       | Information from ClinicalTrials.gov archive History of Changes for Study: NCT00943072 "Vascular Endothelial Growth Factor (VEGF) Trap-Eye: Investigation of Efficacy and Safety in Central Retinal Vein Occlusion (CRVO)" 98 pages, Latest version submitted May 9, 2011 on ClinicalTrials.gov (NCT00943072_2009-2011)                      |  |   |
|                                 | 79       | Information from ClinicalTrials.gov archive History of Changes for Study: NCT00943072 "Vascular Endothelial Growth Factor (VEGF) Trap-Eye: Investigation of Efficacy and Safety in Central Retinal Vein Occlusion (CRVO)" 64 pages, Latest version submitted April 16, 2013 on ClinicalTrials.gov (NCT00943072_2012-2013)                   |  |   |
|                                 | 80       | Information from ClinicalTrials.gov archive View of NCT00637377 "Vascular Endothelial Growth Factor (VEGF) Trap-Eye: Investigation of Efficacy and Safety in Wet Age-Related Macular Degeneration (AMD) (VIEW 2)" <i>ClinicalTrials.gov. Web.</i> (2010-11-30).   |  |   |
|                                 | 81       | Information from ClinicalTrials.gov archive on the VIEW 2 study (NCT00637377) "VEGF Trap-Eye: Investigation of Efficacy and Safety in Wet AMD (VIEW 2)" version available (updated on 17 March 2008)  |  |   |
|                                 | 82       | Information from ClinicalTrials.gov archive on the view of NCT00509795 "Vascular Endothelial Growth Factor (VEGF) Trap-Eye: Investigation of Efficacy and Safety in Wet Age-Related Macular Degeneration (AMD)" (12-01-2009)  |  |   |
|                                 | 83       | Information from ClinicalTrials.gov archive on the view of NCT00789477 "DME and VEGF Trap-Eye: Investigation of Clinical Impact" (11-18-2010)   |  |   |
|                                 | 84       | Information from ClinicalTrials.gov archive on the view of NCT00509795 "Vascular Endothelial Growth Factor (VEGF) Trap-Eye: Investigation of Efficacy and Safety in Wet Age-Related Macular Degeneration (AMD)" (01-07-2011)  |  |   |

|                    |  |                 |  |
|--------------------|--|-----------------|--|
| Examiner Signature |  | Date Considered |  |
|--------------------|--|-----------------|--|

\*EXAMINER: Initial if reference considered, whether or not citation is in conformance with MPEP 609. Draw line through citation if not in conformance and not considered. Include copy of this form with next communication to applicant.

|  |   |    |                        |                       |
|--|---|----|------------------------|-----------------------|
| <b>INFORMATION DISCLOSURE STATEMENT BY APPLICANT</b> |   |    | Application Number     | To Be Assigned        |
|  |   |    | Filing Date            | 2021-06-21            |
|  |   |    | First Named Inventor   | George D. Yancopoulos |
|  |   |    | Art Unit               |                       |
|  |   |    | Examiner Name          |                       |
|  |   |    | Attorney Docket Number | REGN-008CIPCON10      |
| Sheet  | 8 | of | 18                     |                       |

| NON PATENT LITERATURE DOCUMENTS |          |   |   |   |
|---------------------------------|----------|---|---|---|
| Examiner Initials*              | Cite No. | Include name of the author (in CAPITAL LETTERS), title of the article (when appropriate), title of the item (book, magazine, journal, serial, symposium, catalog, etc.), date, page(s), volume-issue number(s), publisher, city and/or country where published.   | T | T |
|                                 | 85       | Information from ClinicalTrials.gov archive on the view of NCT01012973 "Vascular Endothelial Growth Factor (VEGF) Trap-Eye: Investigation of Efficacy and Safety in Central Retinal Vein Occlusion (CRVO)(GALILEO) 7 pages, first posted 11/13/2009; results first posted 11/22/2012; last update posted 11/3/14; printed 12/4/19 ( <a href="https://clinicaltrials.gov/ct2/show/study/NCT01012973">https://clinicaltrials.gov/ct2/show/study/NCT01012973</a> ) (NOTE: May correspond to "Vascular Endothelial Growth Factor Trap&#8208; Eye Investigation of Efficacy and Safety in Central Retinal Vein Occlusion title, 8 pages, 11/12/2009, US [Cited in Third Party Observations filed in parent application USSN 16/055,847 for which a copy is unavailable on PAIR]" which was cited in the Third Party Observations dated 05/01/19) |   |   |
|                                 | 86       | KAISER, "Vascular endothelial growth factor Trap-Eye for diabetic macular oedema." Br. J. Ophthalmol, 93(2):135-36 (February 2009)  |   |   |
|                                 | 87       | KARIA, Niral, "Retinal vein occlusion: pathophysiology and treatment options" Clinical Ophthalmology, 4:809-816 (2010)  |   |   |
|                                 | 88       | KOROBELNIK et al., "Intravitreal Aflibercept Injection for Macular Edema Resulting from Central Retinal Vein Occlusion" American Academy of Ophthalmology (2014) 121(1):202-208   |   |   |
|                                 | 89       | KOROBELNIK, "Intravitreal Aflibercept for Diabetic Macular Edema." Ophthalmology, 121(11):2247-54 (November 2014)   |   |   |
|                                 | 90       | KUO, "Comparative evaluation of the antitumor activity of antiangiogenic proteins delivered by gene transfer" PNAS 98(8):4605-4610 (04/10/2001)   |   |   |
|                                 | 91       | KRZYSTOLIK et al., "Prevention of Experimental Choroidal Neovascularization With Intravitreal Anti-Vascular Endothelial Growth Factor Antibody Fragment" Arch Ophthalmol., 120:338-346 (Mar. 2002)  |   |   |
|                                 | 92       | LALWANI, "All About PrONTO: Study Yielded Good Results in AMD With Treatment Guided by OCT." Retina Today (May 2007)  |   |   |
|                                 | 93       | LALWANI, 'A Variable-dosing Regimen with Intravitreal Ranibizumab for Neovascular Age-related Macular Degeneration: Year 2 of the PrONTO Study.' Am J Ophthalmology, 148(1):43-58 (July 2009)   |   |   |
|                                 | 94       | LEVINE, "Macular Hemorrhage In Neovascular Age-Related Macular Degeneration After Stabilization With Antiangiogenic Therapy." Retina, 29(8):1074-79 (2009)  |   |   |
|                                 | 95       | Lucentis Label Title, 7 pages, 30/06/2010 [Cited in Third Party Observations filed in parent application USSN 16/055,847 for which a copy is unavailable on PAIR]   |   |   |
|                                 | 96       | MAJOR et al., "DA VINCI: DME and VEGF Trap-Eye: Investigation of Clinical Impact: Phase 2 Study in Patients with Diabetic Macular Edema (DME)" ARVO Annual Meeting Abstract (April 2010)  |   |   |
|                                 | 97       | MARGOLIS, "Hemorrhagic Recurrence Of Neovascular Age-Related Macular Degeneration Not Predicted By Spectral Domain Optical Coherence Tomography." Retinal Cases & Brief Reports, 4:1-4 (2010)   |   |   |
|                                 | 98       | MASSIN, "Safety and Efficacy of Ranibizumab in Diabetic Macular Edema (RESOLVE Study*)." Diabetes Care, 33(11):2399-405 (November 2010)   |   |   |
|                                 | 99       | MITCHELL, "The RESTORE Study, Ranibizumab Monotherapy or Combined with Laser versus Laser Monotherapy for Diabetic Macular Edema." Ophthalmology, 188(4):615-25 (April 2011)  |   |   |

|                    |  |                 |  |
|--------------------|--|-----------------|--|
| Examiner Signature |  | Date Considered |  |
|--------------------|--|-----------------|--|

\*EXAMINER: Initial if reference considered, whether or not citation is in conformance with MPEP 609. Draw line through citation if not in conformance and not considered. Include copy of this form with next communication to applicant.

|  |   |    |                      |                        |                  |
|--|---|----|----------------------|------------------------|------------------|
| <b>INFORMATION DISCLOSURE STATEMENT BY APPLICANT</b> |   |    | Application Number   | To Be Assigned         |                  |
|  |   |    | Filing Date          | 2021-06-21             |                  |
|  |   |    | First Named Inventor | George D. Yancopoulos  |                  |
|  |   |    | Art Unit             |                        |                  |
|  |   |    | Examiner Name        |                        |                  |
| Sheet  | 9 | of | 18                   | Attorney Docket Number | REGN-008CIPCON10 |

| NON PATENT LITERATURE DOCUMENTS |          |   |                 |   |
|---------------------------------|----------|---|-----------------|---|
| Examiner Initials*              | Cite No. | Include name of the author (in CAPITAL LETTERS), title of the article (when appropriate), title of the item (book, magazine, journal, serial, symposium, catalog, etc.), date, page(s), volume-issue number(s), publisher, city and/or country where published.         |                 | T |
|                                 | 100      | MITCHELL, Edith P. "Targeted Therapy for Metastatic Colorectal Cancer: Role of Aflibercept" Clinical Colorectal Cancer (2013) 12(2):73-85   |                 |   |
|                                 | 101      | MITRA et al., "Review of anti-vascular endothelial growth factor therapy in macular edema secondary to central retinal vein occlusions" Expert Review in Ophthalmol, Taylor & Francis, GB 6(6):623-629 (January 2011)   |                 |   |
|                                 | 102      | MOUSA AND MOUSA, "Current Status of Vascular Endothelial Growth Factor Inhibition in Age-Related Macular Degeneration" Biodrugs; 24(3); 183-194 (2010)  |                 |   |
|                                 | 103      | N/A "Materials from June 2011 FDA Committee Mtg" (06/17/2011)   |                 |   |
|                                 | 104      | N/A "Materials from Dec 2011 FDA Committee Mtg"(12/01/2011)   |                 |   |
|                                 | 105      | NGUYEN et al., "A Phase I Study of Intravitreal Vascular Endothelial Growth Factor Trap-Eye in Patients with Neovascular Age-Related Macular Degeneration" Ophthalmology, J.B. Lippincott Co., Philadelphia, PA, US, 116(11):2141-2148 (November 1, 2009)               |                 |   |
|                                 | 106      | NGUYEN et al., "A phase I trial of an IV-administered vascular endothelial growth factor trap for treatment in patients with choroidal neovascularization due to age-related macular degeneration" Ophthalmology, 113(9):1522e1-1522e14 (Sept 2006) (epub July 28,2006) |                 |   |
|                                 | 107      | NGUYEN et al., "Randomized, Double-masked, Active-controlled Phase 3 Trial of the Efficacy and Safety of Intravitreal VEGF Trap-Eye in Wet AMD: One-year Results of the VIEW 1 Study" ARVO Annual Meeting Abstract (April 2011)   |                 |   |
|                                 | 108      | NGUYEN, "Ranibizumab for Diabetic Macular Edema, Results from 2 Phase III Randomized Trials: RISE and RIDE." Ophthalmology, 119(4):789-801 (April 2012)   |                 |   |
|                                 | 109      | NGUYEN et al., "Results of a Phase I, Dose-Escalation, Safety, Tolerability, and Bioactivity Study of Intravitreal VEGF Trap in Patients with Neovascular Age-Related Macular Degeneration" ARVO Annual Meeting Abstract (May 2006)                                     |                 |   |
|                                 | 110      | NICHOLS, EARL R., "AAO: Ranibizumab (rhuRab) May Improve Vision in Age-Related Macular Degeneration" Doctor's Guide Global Edition, www.pslgroup.com/dg/23f2aa.htm, pp. 1-2 (November 24, 2003)   |                 |   |
|                                 | 111      | NOGUERA-TROISE et al., "Blockade of D114 inhibits tumour growth by promoting non-productive angiogenesis" Nature (December 2006) 444:1032-1037  |                 |   |
|                                 | 112      | OHR, "Aflibercept in wet age-related macular degeneration: a perspective review" Ther. Adv. Chronic Dis., 3(4):153-161 (2012)   |                 |   |
|                                 | 113      | OLIVERA et al., "VEGF Trap R1R2 suppresses experimental corneal angiogenesis" European Journal of Ophthalmology, 20(1):48-54 (January 1, 2010)  |                 |   |
|                                 | 114      | PAI et al., "Current concepts in intravitreal drug therapy for diabetic retinopathy" Saudi Journal of Ophthalmology 24(4):143-149 (June 30, 2010)   |                 |   |
|                                 | 115      | PAPADPPOULOS, "Binding and neutralization of vascular endothelial growth factor (VEGF) and related ligands by VEGF Trap, ranibizumab and bevacizumab" Angiogenesis, 15:171-185 (2012)   |                 |   |
|                                 | 116      | Regeneron SEC Form 10-K (February 27, 2008)   |                 |   |
|                                 | 117      | Regeneron SEC Form 10-K (February 26, 2009)   |                 |   |
|                                 | 118      | Regeneron SEC Form 10-K (February 17, 2011)   |                 |   |
|                                 | 119      | Regeneron SEC Form 10-Q (May 8, 2006)   |                 |   |
|                                 | 120      | Regeneron SEC Form 10-Q (August 8, 2006)  |                 |   |
| Examiner Signature              |          |   | Date Considered |   |

\*EXAMINER: Initial if reference considered, whether or not citation is in conformance with MPEP 609. Draw line through citation if not in conformance and not considered. Include copy of this form with next communication to applicant.

|  |    |    |    |                        |                       |
|--|----|----|----|------------------------|-----------------------|
| <b>INFORMATION DISCLOSURE<br/>STATEMENT BY APPLICANT</b> |    |    |    | Application Number     | To Be Assigned        |
|  |    |    |    | Filing Date            | 2021-06-21            |
|  |    |    |    | First Named Inventor   | George D. Yancopoulos |
|  |    |    |    | Art Unit               |                       |
|  |    |    |    | Examiner Name          |                       |
|  |    |    |    | Attorney Docket Number | REGN-008CIPCON10      |
| Sheet  | 10 | of | 18 |                        |                       |

| NON PATENT LITERATURE DOCUMENTS |          |   |  |   |
|---------------------------------|----------|---|--|---|
| Examiner Initials*              | Cite No. | Include name of the author (in CAPITAL LETTERS), title of the article (when appropriate), title of the item (book, magazine, journal, serial, symposium, catalog, etc.), date, page(s), volume-issue number(s), publisher, city and/or country where published. |  | T |
|                                 | 121      | Regeneron SEC Form 10-Q (November 6, 2006)  |  |   |
|                                 | 122      | Regeneron SEC Form 10-Q (May 4, 2007)   |  |   |
|                                 | 123      | Regeneron SEC Form 10-Q (August 3, 2007)  |  |   |
|                                 | 124      | Regeneron SEC Form 10-Q (April 30, 2009)  |  |   |
|                                 | 125      | Regeneron SEC Form 10-Q (November 3, 2009)  |  |   |
|                                 | 126      | Regeneron SEC Form 10-Q (April 29, 2010)  |  |   |
|                                 | 127      | Regeneron SEC Form 10-Q (July 28, 2010)   |  |   |
|                                 | 128      | Regeneron SEC Form 10-Q (October 28, 2010)  |  |   |
|                                 | 129      | Regeneron SEC Form 10-Q (May 3, 2011)   |  |   |
|                                 | 130      | Regeneron SEC Form 10-Q (July 28, 2011)   |  |   |
|                                 | 131      | Regeneron SEC Form 10-Q (October 27, 2011)  |  |   |
|                                 | 132      | Regeneron SEC Form 8-K Exhibit: "Press Release of Regeneron Pharmaceuticals, Inc. dated May 1, 2006" (May 2, 2006)  |  |   |
|                                 | 133      | Regeneron SEC Form 8-K Exhibit: "Press Release of Regeneron Pharmaceuticals, Inc. dated May 3, 2006" (May 5, 2006)  |  |   |
|                                 | 134      | Regeneron SEC Form 8-K Exhibit: "Slides presented at the Company's 2006 Annual Meeting of Shareholders held on June 9, 2006" (June 9, 2006)   |  |   |
|                                 | 135      | Regeneron SEC Form 8-K Exhibit: "Press Release dated May 2, 2007" (May 3, 2007)   |  |   |
|                                 | 136      | Regeneron SEC Form 8-K Exhibit: "Overheads for presentation at Regeneron's Annual Meeting of Shareholders to be held on June 8, 2007" (June 8, 2007)  |  |   |
|                                 | 137      | Regeneron SEC Form 8-K Exhibit: "Press Release dated October 1, 2007" (October 1, 2007)   |  |   |
|                                 | 138      | Regeneron SEC Form 8-K Exhibit: "Press Release dated November 6, 2007" (November 6, 2007)   |  |   |
|                                 | 139      | Regeneron SEC Form 8-K Exhibit: "Press Release dated May 1, 2008" (May 2, 2008)   |  |   |
|                                 | 140      | Regeneron SEC Form 8-K Exhibit: "Press Release dated November 4, 2008" (November 4, 2008)   |  |   |
|                                 | 141      | Regeneron SEC Form 8-K Exhibit: "99(a) Slides that Regeneron Pharmaceuticals, Inc. intends to use in conjunction with meetings with investors at the J.P. Morgan 27th Annual Healthcare Conference in San Francisco on January 12-15, 2009." (January 9, 2009)  |  |   |
|                                 | 142      | Regeneron SEC Form 8-K Exhibit: "Press Release dated April 30, 2009" (May 1, 2009)  |  |   |
|                                 | 143      | Regeneron SEC Form 8-K Exhibit: "Press Release dated November 3, 2009." (November 4, 2009)  |  |   |
|                                 | 144      | Regeneron SEC Form 8-K Exhibit: "Press Release Reporting Positive Results for VEGF Trap-Eye in Phase 3 Study in Central Retinal Vein Occlusion (CRVO) and in Phase 2 Study in Diabetic Macular Edema (DME) dated December 20, 2010." (December 20, 2010)        |  |   |

|                    |  |                 |  |
|--------------------|--|-----------------|--|
| Examiner Signature |  | Date Considered |  |
|--------------------|--|-----------------|--|

\*EXAMINER: Initial if reference considered, whether or not citation is in conformance with MPEP 609. Draw line through citation if not in conformance and not considered. Include copy of this form with next communication to applicant.

|  |    |    |                        |                       |
|--|----|----|------------------------|-----------------------|
| <b>INFORMATION DISCLOSURE<br/>STATEMENT BY APPLICANT</b> |    |    | Application Number     | To Be Assigned        |
|  |    |    | Filing Date            | 2021-06-21            |
|  |    |    | First Named Inventor   | George D. Yancopoulos |
|  |    |    | Art Unit               |                       |
|  |    |    | Examiner Name          |                       |
|  |    |    | Attorney Docket Number | REGN-008CIPCON10      |
| Sheet  | 11 | of | 18                     |                       |

| NON PATENT LITERATURE DOCUMENTS |          |   |   |   |
|---------------------------------|----------|---|---|---|
| Examiner Initials*              | Cite No. | Include name of the author (in CAPITAL LETTERS), title of the article (when appropriate), title of the item (book, magazine, journal, serial, symposium, catalog, etc.), date, page(s), volume-issue number(s), publisher, city and/or country where published.   | T | T |
|                                 | 145      | Regeneron SEC Form 8-K Exhibit: "Press Release dated February 17, 2011" (February 18, 2011)   |   |   |
|                                 | 146      | Regeneron SEC Form 8-K Exhibit: "Press Release Reporting Positive Results for VEGF Trap-Eye in Second Phase 3 Study in Central Retinal Vein Occlusion, dated April 27, 2011" (April 27, 2011)   |   |   |
|                                 | 147      | Regeneron SEC Form 8-K Exhibit: "Press Release dated May 3, 2011." (May 3, 2011)  |   |   |
|                                 | 148      | Regeneron SEC Form 8-K Exhibit: "Press Release, dated June 17, 2011, Announcing that EYLEA™ (afibercept ophthalmic solution) Received Unanimous Recommendation for Approval for Treatment of Wet AMD from FDA Advisory Committee." (June 21, 2011)  |   |   |
|                                 | 149      | Regeneron SEC Form 8-K Exhibit: "Presentation entitled VEGF Trap-Eye in CRVO: 1-year Results of the Phase 3 COPERNICUS Study" (August 22, 2011)   |   |   |
|                                 | 150      | Regeneron SEC Form 8-K Exhibit: "Press Release Announcing FDA Approval of EYLEA™ (afibercept) Injection for the Treatment of Wet Age-Related Macular Degeneration, dated November 18, 2011" (November 21, 2011)   |   |   |
|                                 | 151      | Regeneron Press Release "Positive Interim Phase 2 Data Reported For VEGF Trap-Eye In Age-Related Macular Degeneration" (March 27, 2007)   |   |   |
|                                 | 152      | Regeneron Press Release "VEGF TRAP-Eye Phase 2 Wet AMD Results Reported At Arvo Annual Meeting" (May 9, 2007)   |   |   |
|                                 | 153      | Regeneron Press Release "Regeneron Reports Second Quarter Financial And Operating Results" (August 1, 2007)   |   |   |
|                                 | 154      | Regeneron Pharmaceuticals, Inc., "Regeneron and Bayer Healthcare Initiate Phase 3 Global Development Program for VEGF Trap-Eye In Wet Age-Related Macular Degeneration (AMD)" (August 2, 2007)  |   |   |
|                                 | 155      | Regeneron Pharmaceuticals, Inc. FORM 10-Q, published on 7 November 2007 for the period ending 30 September 2007   |   |   |
|                                 | 156      | Regeneron Press Release "Regeneron Announces Positive Primary Endpoint Results From A Phase 2 Study Of VEGF Trap-Eye In Age-Related Macular Degeneration" (October 1, 2007)   |   |   |
|                                 | 157      | Regeneron Press Release "Regeneron Reports Fourth Quarter And Full Year 2007 Financial And Operating Results" (February 27, 2008)   |   |   |
|                                 | 158      | Regeneron Pharmaceuticals, Inc., "Regeneron and Bayer HealthCare Announce Encouraging 32-Week Follow-up Results from a Phase 2 Study of VEGF Trap-Eye in Age-Related Macular Degeneration" (April 28, 2008)   |   |   |
|                                 | 159      | Regeneron, Press release "Regeneron Reports First Quarter 2008 Financial and Operating Results", May 1, 2008.   |   |   |
|                                 | 160      | Regeneron Press Release, "Bayer and Regeneron Dose First Patient in Second Phase 3 Study for VEGF Trap-Eye in Wet Age-Related Macular Degeneration." May 8, 2008  |   |   |
|                                 | 161      | Regeneron Pharmaceuticals Inc., "CLEAR-IT-2: Interim Results Of The Phase II, Randomized, Controlled Dose-and Interval-ranging Study Of Repeated Intravitreal VEGF Trap Administration In Patients With Neovascular Age-related Macular Degeneration (AMD)" poster presented at the 2007 Association for Research in Vision and Ophthalmology meeting in Ft. Lauderdale, Florida (May 2007) |   |   |

|                    |  |                 |  |
|--------------------|--|-----------------|--|
| Examiner Signature |  | Date Considered |  |
|--------------------|--|-----------------|--|

\*EXAMINER: Initial if reference considered, whether or not citation is in conformance with MPEP 609. Draw line through citation if not in conformance and not considered. Include copy of this form with next communication to applicant.

|  |    |    |    |                        |                       |
|--|----|----|----|------------------------|-----------------------|
| <b>INFORMATION DISCLOSURE<br/>STATEMENT BY APPLICANT</b> |    |    |    | Application Number     | To Be Assigned        |
|  |    |    |    | Filing Date            | 2021-06-21            |
|  |    |    |    | First Named Inventor   | George D. Yancopoulos |
|  |    |    |    | Art Unit               |                       |
|  |    |    |    | Examiner Name          |                       |
| Sheet  | 12 | of | 18 | Attorney Docket Number | REGN-008CIPCON10      |

| NON PATENT LITERATURE DOCUMENTS |          |  |  |  |   |
|---------------------------------|----------|--|--|--|---|
| Examiner Initials*              | Cite No. | Include name of the author (in CAPITAL LETTERS), title of the article (when appropriate), title of the item (book, magazine, journal, serial, symposium, catalog, etc.), date, page(s), volume-issue number(s), publisher, city and/or country where published.  |  |  | T |
|                                 | 162      | Regeneron Pharmaceuticals Inc., "An Exploratory Study of the Safety, Tolerability and Biological Effect of a Single Intravitreal Administration of VEGF Trap in Patients with Diabetic Macular Edema" poster presented at the 2007 Association for Research in Vision and Ophthalmology meeting in Ft. Lauderdale, Florida (May 2007)  |  |  |   |
|                                 | 163      | Regeneron Pharmaceuticals Inc., "Optical Coherence Tomography Outcomes of a Phase 1, Dose-Escalation, Safety, Tolerability, and Bioactivity Study of Intravitreal VEGF Trap in Patients with Neovascular Age-Related Macular Degeneration: The CLEAR-IT 1 Study" poster presented at the 2007 Association for Research in Vision and Ophthalmology meeting in Ft. Lauderdale, Florida (May 2007) |  |  |   |
|                                 | 164      | Regeneron Pharmaceuticals, Inc., "Regeneron and Bayer HealthCare Announce VEGF Trap-Eye Achieved Durable Improvement in Vision over 52 Weeks in a Phase 2 Study in Patients with Age-related Macular Degeneration" (August 19, 2008)   |  |  |   |
|                                 | 165      | Regeneron Pharmaceuticals Inc., "VIEW 1 Vascular Endothelial Growth Factor (VEGF) Trap-Eye 1-Year Results: Investigation of Efficacy and Safety in Wet Age-Related Macular Degeneration (AMD)" presented at Bascom Palmer Eye Institute's Angiogenesis, Exudation and Degeneration 2011 meeting in Miami, Florida (February 12, 2011)  |  |  |   |
|                                 | 166      | Regeneron Pharmaceuticals Inc., "VIEW 2 Vascular Endothelial Growth Factor (VEGF) Trap-Eye 1-Year Results: Investigation of Efficacy and Safety in Wet Age-Related Macular Degeneration (AMD)" presented at Bascom Palmer Eye Institute's Angiogenesis, Exudation and Degeneration 2011 meeting in Miami, Florida (February 12, 2011)  |  |  |   |
|                                 | 167      | Regeneron Pharmaceuticals Inc., "VEGF Trap-Eye CLEAR-IT 2 Final Primary Endpoint Results" presented at the 2007 Retina Society Conference in Boston, Massachusetts (September 30, 2007)  |  |  |   |
|                                 | 168      | Regeneron Pharmaceuticals Inc., "VEGF Trap-Eye Final Phase 2 Results in Age-related Macular Degeneration Presented at 2008 Retina Society Meeting" (September 28, 2008) (XP-002770952)   |  |  |   |
|                                 | 169      | Regeneron 2008 Annual Report   |  |  |   |
|                                 | 170      | Regeneron Pharmaceuticals, Inc. "Regeneron Reports Full Year and Fourth Quarter 2008 Financial and Operating Results" (February 26, 2009)  |  |  |   |
|                                 | 171      | Regeneron Pharmaceuticals, Inc. "Bayer and Regeneron Extend Development Program for VEGF Trap-Eye to Include Central Retinal Vein Occlusion" (April 30, 2009)  |  |  |   |
|                                 | 172      | Regeneron Press Release "First Patient Enrolled In Regeneron And Bayer Healthcare VEGF Trap-Eye Phase 3 Program In Central Retinal Vein Occlusion" (July 23, 2009)   |  |  |   |
|                                 | 173      | Regeneron Press Release "Enrollment Completed in Regeneron and Bayer HealthCare Phase 3 Studies of VEGF Trap-Eye in Neovascular Age-Related Macular Degeneration (Wet AMD)" September 14, 2009   |  |  |   |
|                                 | 174      | Regeneron 2009 Annual Report and 10-K  |  |  |   |
|                                 | 175      | Regeneron Press Release, "VEGF Trap-Eye Shows Positive Results in a Phase 2 Study in Patients With Diabetic Macular Edema." February 18, 2010  |  |  |   |
|                                 | 176      | Regeneron Press Release "Regeneron Schedules November 22, 2010 Teleconference And Webcast To Discuss Results Of Two Phase 3 Studies With VEGF Trap-Eye In Wet Age-Related Macular Degeneration" (November 19, 2010)  |  |  |   |

|                    |  |                 |  |
|--------------------|--|-----------------|--|
| Examiner Signature |  | Date Considered |  |
|--------------------|--|-----------------|--|

\*EXAMINER: Initial if reference considered, whether or not citation is in conformance with MPEP 609. Draw line through citation if not in conformance and not considered. Include copy of this form with next communication to applicant.

|  |    |    |    |                        |                       |
|--|----|----|----|------------------------|-----------------------|
| <b>INFORMATION DISCLOSURE STATEMENT BY APPLICANT</b> |    |    |    | Application Number     | To Be Assigned        |
|  |    |    |    | Filing Date            | 2021-06-21            |
|  |    |    |    | First Named Inventor   | George D. Yancopoulos |
|  |    |    |    | Art Unit               |                       |
|  |    |    |    | Examiner Name          |                       |
| Sheet  | 13 | of | 18 | Attorney Docket Number | REGN-008CIPCON10      |

| NON PATENT LITERATURE DOCUMENTS |          |   |  |  |   |
|---------------------------------|----------|---|--|--|---|
| Examiner Initials*              | Cite No. | Include name of the author (in CAPITAL LETTERS), title of the article (when appropriate), title of the item (book, magazine, journal, serial, symposium, catalog, etc.), date, page(s), volume-issue number(s), publisher, city and/or country where published. |  |  | T |
|                                 | 177      | Regeneron Press Release "Bayer and Regeneron Report Positive Top-Line Results of Two Phase 3 Studies with VEGF Trap-Eye in Wet Age-related Macular Degeneration" November 22, 2010  |  |  |   |
|                                 | 178      | Regeneron Press Release "Regeneron and Bayer Report Positive Results for VEGF Trap-Eye in Phase 3 Study in Central Retinal Vein Occlusion (CRVO) and in Phase 2 Study in Diabetic Macular Edema (DME)" December 20, 2010  |  |  |   |
|                                 | 179      | Regeneron 2010 Annual Report and 10-K   |  |  |   |
|                                 | 180      | Regeneron Press Release "Regeneron And Bayer Start Phase 3 Trial To Extend Ophthalmology Research & Development Program For VEGF Trap-Eye In Asia" (January 18, 2011)   |  |  |   |
|                                 | 181      | Regeneron Press Release "Regeneron To Webcast Investor Briefing On VEGF Trap-Eye Clinical Program On Sunday, February 13th At 9 Am Et" (February 9, 2011)   |  |  |   |
|                                 | 182      | Regeneron Press Release "Regeneron Submits Biologics License Application To FDA For VEGF Trap-Eye For Treatment Of Wet Age-Related Macular Degeneration" (February 22, 2011)  |  |  |   |
|                                 | 183      | Regeneron Press Release "Regeneron And Bayer Announce Start Of Phase 3 Clinical Program In Diabetic Macular Edema" (April 8, 2011)  |  |  |   |
|                                 | 184      | Regeneron Pharmaceuticals, Inc., "FDA Grants Priority Review for VEGF Trap-Eye for the Treatment of Wet Age-Related Macular Degeneration" (April 18, 2011)  |  |  |   |
|                                 | 185      | Regeneron Press Release "VEGF Trap-Eye Submitted for EU Marketing Authorization for Treatment of Wet Age-Related Macular Degeneration (June 7, 2011)  |  |  |   |
|                                 | 186      | Regeneron Pharmaceuticals, Inc., "Regeneron Announces EYLEA™ (aflibercept ophthalmic solution) Receives Unanimous Recommendation for Approval for Treatment of Wet AMD from FDA Advisory Committee" (June 17, 2011)   |  |  |   |
|                                 | 187      | Regeneron Press Release "Regeneron Announces Clinical Presentations at ASRS 2011 Annual Meeting" (August 17, 2011)  |  |  |   |
|                                 | 188      | Regeneron Pharmaceuticals, Inc., "Regeneron Announces FDA Approval of EYLEA™ (aflibercept) Injection for the Treatment of Wet Age-Related Macular Degeneration: CORRECTED (November 18, 2011)   |  |  |   |
|                                 | 189      | Regeneron Pharmaceuticals, Inc., "Regeneron and Bayer Initiate Phase 3 Clinical Program for the Treatment of Wet Age-Related Macular Degeneration in China" (November 28, 2011)   |  |  |   |
|                                 | 190      | Regeneron Pharmaceuticals, Inc., "Two Year Results of Phase 3 Studies with EYLEA™ (aflibercept) Injection in wet AMD Show Sustained Improvement in Visual Acuity" (December 5, 2011)  |  |  |   |
|                                 | 191      | REGILLO et al., "Randomized, Double-Masked, Sham-Controlled Trial of Ranibizumab for Neovascular Age-related Macular Degeneration: OIER Study Year 1" American Journal of Ophthalmology, 145(2):239-248 (2008)  |  |  |   |
|                                 | 192      | ROSENFELD, "Ranibizumab for Neovascular Age-Related Macular Degeneration." N Engl J Med, 355(14):1419-31 (October 5, 2006)  |  |  |   |
|                                 | 193      | ROSENFELD, "Lessons Learned From Avastin and OCT-The Great, the Good, the Bad, and the Ugly: The LXXV Edward Jackson Memorial Lecture." Am. J. Ophthalmology, 204:26-45 (August 2019)   |  |  |   |

|                    |  |                 |  |
|--------------------|--|-----------------|--|
| Examiner Signature |  | Date Considered |  |
|--------------------|--|-----------------|--|

\*EXAMINER: Initial if reference considered, whether or not citation is in conformance with MPEP 609. Draw line through citation if not in conformance and not considered. Include copy of this form with next communication to applicant.



|  |    |    |                        |                       |
|--|----|----|------------------------|-----------------------|
| <b>INFORMATION DISCLOSURE<br/>STATEMENT BY APPLICANT</b> |    |    | Application Number     | To Be Assigned        |
|  |    |    | Filing Date            | 2021-06-21            |
|  |    |    | First Named Inventor   | George D. Yancopoulos |
|  |    |    | Art Unit               |                       |
|  |    |    | Examiner Name          |                       |
|  |    |    | Attorney Docket Number | REGN-008CIPCON10      |
| Sheet  | 14 | of | 18                     |                       |

| NON PATENT LITERATURE DOCUMENTS |          |   |   |   |
|---------------------------------|----------|---|---|---|
| Examiner Initials*              | Cite No. | Include name of the author (in CAPITAL LETTERS), title of the article (when appropriate), title of the item (book, magazine, journal, serial, symposium, catalog, etc.), date, page(s), volume-issue number(s), publisher, city and/or country where published.   | T | T |
|                                 | 194      | RUDGE et al., "VEGF Trap complex formation measures production rates of VEGF, providing a biomarker for predicting efficacious angiogenic blockade" PNAS (November 20, 2007) 104(47):18363-18370  |   |   |
|                                 | 195      | RUDGE et al. "Clinical Development of VEGF Trap" In: Figg W.D., Folkman J. (eds) Angiogenesis (2008)  |   |   |
|                                 | 196      | SCHMIDT-ERFURTH, "Efficacy and Safety of Monthly versus Quarterly Ranibizumab Treatment in Neovascular Age-related Macular Degeneration: The EXCIE Study" Ophthalmology, 118(5):831-839 (2010)  |   |   |
|                                 | 197      | SCHMIDT-ERFURTH et al. "Primary Results of an International Phase III Study Using Intravitreal VEGF Trap-Eye Compared to Ranibizumab in Patients with Wet AMD (VIEW 2)" ARVO Annual Meeting Abstract (April 2011)   |   |   |
|                                 | 198      | SCHMIDT-ERFURTH, "Three-Year Outcomes of Individualized Ranibizumab Treatment in Patients with Diabetic Macular Edema." Ophthalmology, 121(5):1045-53,(May 2014)  |   |   |
|                                 | 199      | SCHMIDT-ERFURTH et al., "Intravitreal Aflibercept Injection for Neovascular Age-related Macular Degeneration" Ophthalmology (2014) 121:193-201  |   |   |
|                                 | 200      | SCHNICHOLS, "Comparative toxicity and proliferation testing of aflibercept, bevacizumab and ranibizumab on different ocular cells." Br. J. Ophthalmol., 97:917-923 (2013)   |   |   |
|                                 | 201      | SEMERARO et al., "Aflibercept in wet AMD: specific role and optimal use" Drug Design, Development and Therapy (August 2, 2013) 7:711-722  |   |   |
|                                 | 202      | SHARMA and S. AND KAISER, P. K., Update on VEGF TRAP-Eye Clinical Trials and Retinal. Physician, pp. 1-6 (Nov/Dec 2010) <URL: <a href="https://www.retinalphysician.com/issues/2010/nov-dec/update-on-vegf-trap-eye-clinical-trials">https://www.retinalphysician.com/issues/2010/nov-dec/update-on-vegf-trap-eye-clinical-trials</a> > |   |   |
|                                 | 203      | SIMO AND HERNANDEZ, "Advances in Medical Treatment of Diabetic Retinopathy" Diabetes Care, 32(8):1556-1562 (August 2009)  |   |   |
|                                 | 204      | SLAKTER et al., "Influence of Baseline Angiographic Classification on Outcomes in the CLEAR-IT 2 Phase 2 Study of Intravitreal VEGF Trap-Eye in Neovascular Age-Related Macular Degeneration" ARVO Annual Meeting Abstract (April 2010)   |   |   |
|                                 | 205      | SLAKTER et al., "A Phase 2, Randomized, Controlled Dose-and Interval-Ranging Study of Intravitreal VEGF Trap-Eye in Patients with Neovascular Age-Related Macular Degeneration: Optical Coherence Tomography (OCT) and Fluorescein Angiography (FA) Outcomes at 1 Year" ARVO Annual Meeting Abstract (April 2009)                       |   |   |
|                                 | 206      | Slides for the 2008 Retina Society Meeting "VEGF Trap-Eye in Wet AMD CLEAR-IT 2: Summary of One-Year Key Results", September 28, 2008.  |   |   |
|                                 | 207      | SPAIDE, "Ranibizumab According to Need: A Treatment for Age-related Macular Degeneration." Am J Ophthalmology, 143(4):679-680 (April 2007)  |   |   |
|                                 | 208      | STEWART, "The expanding role of vascular endothelial growth factor inhibitors in ophthalmology" Mayo Clin Proc. 87(1):77-88 (January 2012)  |   |   |
|                                 | 209      | STEWART et al., "Predicted biological activity of intravitreal VEGF Trap" British Journal of Ophthalmology, 92(5):667-668 (2008)  |   |   |
|                                 | 210      | STEWART, "Aflibercept" Nature Reviews: Drug Discovery 11:269-270 (04/01/2012)   |   |   |

|                    |  |                 |  |
|--------------------|--|-----------------|--|
| Examiner Signature |  | Date Considered |  |
|--------------------|--|-----------------|--|

\*EXAMINER: Initial if reference considered, whether or not citation is in conformance with MPEP 609. Draw line through citation if not in conformance and not considered. Include copy of this form with next communication to applicant.

|  |    |    |                      |                        |                  |
|--|----|----|----------------------|------------------------|------------------|
| <b>INFORMATION DISCLOSURE STATEMENT BY APPLICANT</b> |    |    | Application Number   | To Be Assigned         |                  |
|  |    |    | Filing Date          | 2021-06-21             |                  |
|  |    |    | First Named Inventor | George D. Yancopoulos  |                  |
|  |    |    | Art Unit             |                        |                  |
|  |    |    | Examiner Name        |                        |                  |
| Sheet  | 15 | of | 18                   | Attorney Docket Number | REGN-008CIPCON10 |

| NON PATENT LITERATURE DOCUMENTS |          |  |                 |   |
|---------------------------------|----------|--|-----------------|---|
| Examiner Initials*              | Cite No. | Include name of the author (in CAPITAL LETTERS), title of the article (when appropriate), title of the item (book, magazine, journal, serial, symposium, catalog, etc.), date, page(s), volume-issue number(s), publisher, city and/or country where published.  |                 | T |
|                                 | 211      | TANNOCK et al., "Aflibercept versus placebo in combination with docetaxel and prednisone for treatment of men with metastatic castration-resistant prostate cancer (VENICE): a phase 3, double-blind randomized trial" <i>Lancet Oncol</i> (2013) 14:760-768   |                 |   |
|                                 | 212      | THOMAS REUTERS INTEGRITY "VEGF Trap-Eye final phase II results in age-related macular degeneration presented at 2008 Retina Society Meeting" (September 28, 2008)  |                 |   |
|                                 | 213      | THURSTON, Gavin "Complementary actions of VEGF and Angiopoietin-1 on blood vessel growth and leakage" <i>J. Anat.</i> (2002) 200:575-580   |                 |   |
|                                 | 214      | THURSTON, "Vascular endothelial growth factor and other signaling pathways in developmental and pathologic angiogenesis." <i>International Journal of Hematology</i> , 80:7-20 (2004)  |                 |   |
|                                 | 215      | Updated Information from ClinicalTrials.gov archive History of Changes for Study: NCT01012973 "Vascular Endothelial Growth Factor (VEGF) Trap-Eye: Investigation of Efficacy and Safety in Central Retinal Vein Occlusion (CRVO)(GALILEO) 38 pages, Latest version submitted October 27, 2014 on ClinicalTrials.gov (NCT01012973_01182013_27424.1) |                 |   |
|                                 | 216      | Updated Information from ClinicalTrials.gov archive History of Changes for Study: NCT01012973 "Vascular Endothelial Growth Factor (VEGF) Trap-Eye: Investigation of Efficacy and Safety in Central Retinal Vein Occlusion (CRVO)(GALILEO) 10 pages, Latest version submitted October 27, 2014 on ClinicalTrials.gov (NCT01012973_01252011_27433.1) |                 |   |
|                                 | 217      | Updated Information from ClinicalTrials.gov archive History of Changes for Study: NCT01012973 "Vascular Endothelial Growth Factor (VEGF) Trap-Eye: Investigation of Efficacy and Safety in Central Retinal Vein Occlusion (CRVO)(GALILEO) 11 pages, Latest version submitted October 27, 2014 on ClinicalTrials.gov (NCT01012973_01262012_27428.1) |                 |   |
|                                 | 218      | Updated Information from ClinicalTrials.gov archive History of Changes for Study: NCT01012973 "Vascular Endothelial Growth Factor (VEGF) Trap-Eye: Investigation of Efficacy and Safety in Central Retinal Vein Occlusion (CRVO)(GALILEO) 38 pages, Latest version submitted October 27, 2014 on ClinicalTrials.gov (NCT01012973_01302013_27423.1) |                 |   |
|                                 | 219      | Updated Information from ClinicalTrials.gov archive History of Changes for Study: NCT01012973 "Vascular Endothelial Growth Factor (VEGF) Trap-Eye: Investigation of Efficacy and Safety in Central Retinal Vein Occlusion (CRVO)(GALILEO) 12 pages, Latest version submitted October 27, 2014 on ClinicalTrials.gov (NCT01012973_02092010_27442.1) |                 |   |
|                                 | 220      | Updated Information from ClinicalTrials.gov archive History of Changes for Study: NCT01012973 "Vascular Endothelial Growth Factor (VEGF) Trap-Eye: Investigation of Efficacy and Safety in Central Retinal Vein Occlusion (CRVO)(GALILEO) 11 pages, Latest version submitted October 27, 2014 on ClinicalTrials.gov (NCT01012973_02202012_27427.1) |                 |   |
|                                 | 221      | Updated Information from ClinicalTrials.gov archive History of Changes for Study: NCT01012973 "Vascular Endothelial Growth Factor (VEGF) Trap-Eye: Investigation of Efficacy and Safety in Central Retinal Vein Occlusion (CRVO)(GALILEO) 12 pages, Latest version submitted October 27, 2014 on ClinicalTrials.gov (NCT01012973_03162010_27441.1) |                 |   |
| Examiner Signature              |          |  | Date Considered |   |

\*EXAMINER: Initial if reference considered, whether or not citation is in conformance with MPEP 609. Draw line through citation if not in conformance and not considered. Include copy of this form with next communication to applicant.

|  |    |    |    |                        |                       |
|--|----|----|----|------------------------|-----------------------|
| <b>INFORMATION DISCLOSURE<br/>STATEMENT BY APPLICANT</b> |    |    |    | Application Number     | To Be Assigned        |
|  |    |    |    | Filing Date            | 2021-06-21            |
|  |    |    |    | First Named Inventor   | George D. Yancopoulos |
|  |    |    |    | Art Unit               |                       |
|  |    |    |    | Examiner Name          |                       |
| Sheet  | 16 | of | 18 | Attorney Docket Number | REGN-008CIPCON10      |

| NON PATENT LITERATURE DOCUMENTS |          |  |                 |  |   |
|---------------------------------|----------|--|-----------------|--|---|
| Examiner Initials*              | Cite No. | Include name of the author (in CAPITAL LETTERS), title of the article (when appropriate), title of the item (book, magazine, journal, serial, symposium, catalog, etc.), date, page(s), volume-issue number(s), publisher, city and/or country where published.  |                 |  | T |
|                                 | 222      | Updated Information from ClinicalTrials.gov archive History of Changes for Study: NCT01012973 "Vascular Endothelial Growth Factor (VEGF) Trap-Eye: Investigation of Efficacy and Safety in Central Retinal Vein Occlusion (CRVO)(GALILEO) 10 pages, Latest version submitted October 27, 2014 on ClinicalTrials.gov (NCT01012973_04082011_27432.1) |                 |  |   |
|                                 | 223      | Updated Information from ClinicalTrials.gov archive History of Changes for Study: NCT01012973 "Vascular Endothelial Growth Factor (VEGF) Trap-Eye: Investigation of Efficacy and Safety in Central Retinal Vein Occlusion (CRVO)(GALILEO) 12 pages, Latest version submitted October 27, 2014 on ClinicalTrials.gov (NCT01012973_04162010_27440.1) |                 |  |   |
|                                 | 224      | Updated Information from ClinicalTrials.gov archive History of Changes for Study: NCT01012973 "Vascular Endothelial Growth Factor (VEGF) Trap-Eye: Investigation of Efficacy and Safety in Central Retinal Vein Occlusion (CRVO)(GALILEO) 10 pages, Latest version submitted October 27, 2014 on ClinicalTrials.gov (NCT01012973_06232011_27431.1) |                 |  |   |
|                                 | 225      | Updated Information from ClinicalTrials.gov archive History of Changes for Study: NCT01012973 "Vascular Endothelial Growth Factor (VEGF) Trap-Eye: Investigation of Efficacy and Safety in Central Retinal Vein Occlusion (CRVO)(GALILEO) 12 pages, Latest version submitted October 27, 2014 on ClinicalTrials.gov (NCT01012973_07222010_27439.1) |                 |  |   |
|                                 | 226      | Updated Information from ClinicalTrials.gov archive History of Changes for Study: NCT01012973 "Vascular Endothelial Growth Factor (VEGF) Trap-Eye: Investigation of Efficacy and Safety in Central Retinal Vein Occlusion (CRVO)(GALILEO) 12 pages, Latest version submitted October 27, 2014 on ClinicalTrials.gov (NCT01012973_08252010_27438.1) |                 |  |   |
|                                 | 227      | Updated Information from ClinicalTrials.gov archive History of Changes for Study: NCT01012973 "Vascular Endothelial Growth Factor (VEGF) Trap-Eye: Investigation of Efficacy and Safety in Central Retinal Vein Occlusion (CRVO)(GALILEO) 10 pages, Latest version submitted October 27, 2014 on ClinicalTrials.gov (NCT01012973_08262010_27437.1) |                 |  |   |
|                                 | 228      | Updated Information from ClinicalTrials.gov archive History of Changes for Study: NCT01012973 "Vascular Endothelial Growth Factor (VEGF) Trap-Eye: Investigation of Efficacy and Safety in Central Retinal Vein Occlusion (CRVO)(GALILEO) 10 pages, Latest version submitted October 27, 2014 on ClinicalTrials.gov (NCT01012973_09082010_27436.1) |                 |  |   |
|                                 | 229      | Updated Information from ClinicalTrials.gov archive History of Changes for Study: NCT01012973 "Vascular Endothelial Growth Factor (VEGF) Trap-Eye: Investigation of Efficacy and Safety in Central Retinal Vein Occlusion (CRVO)(GALILEO) 10 pages, Latest version submitted October 27, 2014 on ClinicalTrials.gov (NCT01012973_09192011_27430.1) |                 |  |   |
|                                 | 230      | Updated Information from ClinicalTrials.gov archive History of Changes for Study: NCT01012973 "Vascular Endothelial Growth Factor (VEGF) Trap-Eye: Investigation of Efficacy and Safety in Central Retinal Vein Occlusion (CRVO)(GALILEO) 10 pages, Latest version submitted October 27, 2014 on ClinicalTrials.gov (NCT01012973_10042010_27435.1) |                 |  |   |
| Examiner Signature              |          |  | Date Considered |  |   |

\*EXAMINER: Initial if reference considered, whether or not citation is in conformance with MPEP 609. Draw line through citation if not in conformance and not considered. Include copy of this form with next communication to applicant.

|  |    |    |    |                        |                       |
|--|----|----|----|------------------------|-----------------------|
| <b>INFORMATION DISCLOSURE STATEMENT BY APPLICANT</b> |    |    |    | Application Number     | To Be Assigned        |
|  |    |    |    | Filing Date            | 2021-06-21            |
|  |    |    |    | First Named Inventor   | George D. Yancopoulos |
|  |    |    |    | Art Unit               |                       |
|  |    |    |    | Examiner Name          |                       |
| Sheet  | 17 | of | 18 | Attorney Docket Number | REGN-008CIPCON10      |

| NON PATENT LITERATURE DOCUMENTS |          |  |                 |  |   |
|---------------------------------|----------|--|-----------------|--|---|
| Examiner Initials*              | Cite No. |  |                 |  | T |
|                                 | 231      | Updated Information from ClinicalTrials.gov archive History of Changes for Study: NCT01012973 "Vascular Endothelial Growth Factor (VEGF) Trap-Eye: Investigation of Efficacy and Safety in Central Retinal Vein Occlusion (CRVO)(GALILEO) 38 pages, Latest version submitted October 27, 2014 on ClinicalTrials.gov (NCT01012973_10232012_27426.1)   |                 |  |   |
|                                 | 232      | Updated Information from ClinicalTrials.gov archive History of Changes for Study: NCT01012973 "Vascular Endothelial Growth Factor (VEGF) Trap-Eye: Investigation of Efficacy and Safety in Central Retinal Vein Occlusion (CRVO)(GALILEO) 38 pages, Latest version submitted October 27, 2014 on ClinicalTrials.gov (NCT01012973_10272013_27422.1)   |                 |  |   |
|                                 | 233      | Updated Information from ClinicalTrials.gov archive History of Changes for Study: NCT01012973 "Vascular Endothelial Growth Factor (VEGF) Trap-Eye: Investigation of Efficacy and Safety in Central Retinal Vein Occlusion (CRVO)(GALILEO) 10 pages, Latest version submitted October 27, 2014 on ClinicalTrials.gov (NCT01012973_11012010_27434.1)   |                 |  |   |
|                                 | 234      | Updated Information from ClinicalTrials.gov archive History of Changes for Study: NCT01012973 "Vascular Endothelial Growth Factor (VEGF) Trap-Eye: Investigation of Efficacy and Safety in Central Retinal Vein Occlusion (CRVO)(GALILEO) 12 pages, Latest version submitted October 27, 2014 on ClinicalTrials.gov (NCT01012973_11132009_27444.1)   |                 |  |   |
|                                 | 235      | Updated Information from ClinicalTrials.gov archive History of Changes for Study: NCT01012973 "Vascular Endothelial Growth Factor (VEGF) Trap-Eye: Investigation of Efficacy and Safety in Central Retinal Vein Occlusion (CRVO)(GALILEO) 10 pages, Latest version submitted October 27, 2014 on ClinicalTrials.gov (NCT01012973_11292011_27429.1)   |                 |  |   |
|                                 | 236      | Updated Information from ClinicalTrials.gov archive History of Changes for Study: NCT01012973 "Vascular Endothelial Growth Factor (VEGF) Trap-Eye: Investigation of Efficacy and Safety in Central Retinal Vein Occlusion (CRVO)(GALILEO) 38 pages, Latest version submitted October 27, 2014 on ClinicalTrials.gov (NCT01012973_12182012_27425.1)   |                 |  |   |
|                                 | 237      | Updated Information from ClinicalTrials.gov archive History of Changes for Study: NCT01012973 "Vascular Endothelial Growth Factor (VEGF) Trap-Eye: Investigation of Efficacy and Safety in Central Retinal Vein Occlusion (CRVO)(GALILEO) 12 pages, Latest version submitted October 27, 2014 on ClinicalTrials.gov (NCT01012973_12212010_27443.1)   |                 |  |   |
|                                 | 238      | Vascular Endothelial Growth Factor Trap&#8208; Eye Investigation of Efficacy and Safety in Central Retinal Vein Occlusion title, 8 pages, 11/12/2009, US <b>[Cited in Third Party Observations filed in parent application USSN 16/055,847 for which a copy is unavailable on PAIR] NOTE:</b> May correspond to "Information from ClinicalTrials.gov archive on the view of NCT01012973 "Vascular Endothelial Growth Factor (VEGF) Trap-Eye: Investigation of Efficacy and Safety in Central Retinal Vein Occlusion (CRVO)(GALILEO) 7 pages, first posted 11/13/2009; results first posted 11/22/2012; last update posted 11/3/14; printed 12/4/19 ( <a href="https://clinicaltrials.gov/ct2/show/study/NCT01012973">https://clinicaltrials.gov/ct2/show/study/NCT01012973</a> )" cited by the Examiner in the Office Action dated 12/10/19 in USSN 16/055,847 |                 |  |   |
| Examiner Signature              |          |  | Date Considered |  |   |

\*EXAMINER: Initial if reference considered, whether or not citation is in conformance with MPEP 609. Draw line through citation if not in conformance and not considered. Include copy of this form with next communication to applicant.

|  |    |    |                      |                        |                  |
|--|----|----|----------------------|------------------------|------------------|
| <b>INFORMATION DISCLOSURE<br/>STATEMENT BY APPLICANT</b> |    |    | Application Number   | To Be Assigned         |                  |
|  |    |    | Filing Date          | 2021-06-21             |                  |
|  |    |    | First Named Inventor | George D. Yancopoulos  |                  |
|  |    |    | Art Unit             |                        |                  |
|  |    |    | Examiner Name        |                        |                  |
| Sheet  | 18 | of | 18                   | Attorney Docket Number | REGN-008CIPCON10 |

| NON PATENT LITERATURE DOCUMENTS |          |   |  |   |
|---------------------------------|----------|---|--|---|
| Examiner Initials*              | Cite No. | Include name of the author (in CAPITAL LETTERS), title of the article (when appropriate), title of the item (book, magazine, journal, serial, symposium, catalog, etc.), date, page(s), volume-issue number(s), publisher, city and/or country where published. |  | T |
|                                 | 239      | WACHSBERGER, "VEGF trap in combination with radiotherapy improves tumor control in u87 glioblastoma." Int. J. Radiation Oncology Biol Phys. 67(5):1526-1537 (2007)  |  |   |
|                                 | 240      | WHO Drug Information, "International Nonproprietary Names for Pharmaceutical Substances (INN)" 20(2):115-119 (2006)   |  |   |
|                                 | 241      | WOLFSON, "Regeneron Focuses on Age-Related Macular Degeneration." Chemistry & Biology 15:303-304 (April 2008)   |  |   |
|                                 | 242      | XIA et al., "Transgenic delivery of VEGF to mouse skin leads to an inflammatory condition resembling human psoriasis" Blood (July 1, 2003) 102(1):161-168   |  |   |
|                                 | 243      | YANCOPOULOS, "Vascular-specific growth factors and blood vessel formation." Nature 407:242-48 (September 14, 2000)  |  |   |
|                                 | 244      | YANCOPOULOS, "Clinical Application of Therapies Targeting VEGF." Cell 143:13-16 (October 1, 2010)   |  |   |
|                                 | 245      | YUNG, "Moving Toward the Next Steps in Angiogenesis Therapy?" Society for Neuro-Oncology, 10:939 (2008)   |  |   |

|                    |  |                 |  |
|--------------------|--|-----------------|--|
| Examiner Signature |  | Date Considered |  |
|--------------------|--|-----------------|--|

\*EXAMINER: Initial if reference considered, whether or not citation is in conformance with MPEP 609. Draw line through citation if not in conformance and not considered. Include copy of this form with next communication to applicant.

=====

Sequence Listing was accepted.

See attached Validation Report.

If you need help call the Patent Electronic Business Center at (866) 217-9197 (toll free).

Reviewer: Saleem, Syed (ASRC)

Timestamp: [year=2021; month=6; day=25; hr=13; min=50; sec=12; ms=487; ]

=====

Validated By CRFValidator v 1.0.5

Application No: 17352892 Version No: 1.0

Input Set:

Output Set:

Started: 2021-06-21 15:17:48.104  
Finished: 2021-06-21 15:17:48.234  
Elapsed: 0 hr(s) 0 min(s) 0 sec(s) 130 ms  
Total Warnings: 2  
Total Errors: 1  
No. of SeqIDs Defined: 2  
Actual SeqID Count: 2

| Error code | Error Description  |
|------------|--|
| E 287      | Invalid WIPO ST.2 date format; Use (YYYY-MM-DD) in <141> |
| W 213      | Artificial or Unknown found in <213> in SEQ ID (1)       |
| W 213      | Artificial or Unknown found in <213> in SEQ ID (2)       |

SEQUENCE LISTING

<110> George D. Yancopoulos

<120> Use of a VEGF Antagonist to Treat Angiogenic Eye Disorders

<130> REGN-008CIPCON10

<140> US 17/352,892

<141> 2021-06-21

<150> 17/350,958

<151> 2021-06-17

<150> 17/112,404

<151> 2020-12-04

<150> 17/072,417

<151> 2020-10-16

<150> 16/055,847

<151> 2018-08-06

<150> 16/397,267

<151> 2019-04-29

<150> 16/159,272

<151> 2018-10-12

<150> 15/471,506

<151> 2017-03-28

<150> 14/972,560

<151> 2015-12-17

<150> 13/940,370

<151> 2013-07-12

<150> PCT/US2012/020855

<151> 2012-01-11

<150> 61/432,245

<151> 2011-01-13

<150> 61/434,836

<151> 2011-01-21

<150> 61/561,957

<151> 2011-11-21

<160> 2

<170> FastSEQ for Windows Version 4.0

<210> 1

<211> 1377



<212> DNA

<213> Artificial Sequence

<220>

<223> Synthetic

<400> 1

```
atggtcagct actgggacac cggggctctg ctgtgcgcgc tgctcagctg tctgcttctc 60
acaggatcta gttccggaag tgataccggt agacctttcg tagagatgta cagtgaaatc 120
cccgaatta tacacatgac tgaaggaagg gagctcgtca ttccctgccg ggttacgtca 180
cctaacaatca ctgttacttt aaaaaagttt ccacttgaca ctttgatccc tgatggaaaa 240
cgcataatct gggacagtag aaagggtctt atcatatcaa atgcaacgta caaagaaata 300
gggtctctga cctgtgaagc aacagtcaat gggcatttgt ataagacaaa ctatctcaca 360
catcgacaaa ccaatacaat catagatgtg gttctgagtc cgtctcatgg aattgaacta 420
tctgttggag aaaagcttgt cttaaattgt acagcaagaa ctgaaactaaa tgtggggatt 480
gacttcaact gggaaatacc ttcttcgaag catcagcata agaaacttgt aaaccgagac 540
ctaaaacccc agtctgggag tgagatgaag aaatttttga gcacctaac tatagatggt 600
gtaacccgga gtgaccaagg attgtacacc tgtgcagcat ccagtgggct gatgaccaag 660
aagaacagca catttgtcag ggtccatgaa aaggacaaaa ctcacacatg cccaccgtgc 720
ccagcacctg aactcctggg gggaccgtca gtcttctctt tcccccaaaa acccaaggac 780
accctcatga tctcccggac ccctgaggtc acatgcgtgg tgggtggacgt gagccacgaa 840
gacctgagg tcaagttcaa ctggtacgtg gacggcgtgg aggtgcataa tgccaagaca 900
aagcccgggg aggagcagta caacagcacg taccgtgtgg tcagcgtcct caccgtcctg 960
caccaggact ggctgaatgg caaggagtac aagtgcgaagg tctccaacaa agccctccca 1020
gcccccatcg agaaaacct ctccaaagcc aaagggcagc cccgagaacc acaggtgtac 1080
accctgcccc catcccggga tgagctgacc aagaaccagg tcagcctgac ctgcctggtc 1140
aaagccttct atcccagcga catcgcctgt gagtgggaga gcaatgggca gccggagaac 1200
aactacaaga ccacgcctcc cgtgctggac tccgacggct ctttcttctc ctacagcaag 1260
ctcaccgtgg acaagagcag gtggcagcag gggaacgtct tctcatgctc cgtgatgcat 1320
gaggctctgc acaaccacta cagcagaag agcctctccc tgtctccggg taaatga 1377
```

<210> 2

<211> 458

<212> PRT

<213> Artificial Sequence

<220>

<223> Synthetic

<400> 2

```
Met Val Ser Tyr Trp Asp Thr Gly Val Leu Leu Cys Ala Leu Leu Ser
 1                    5                10                15
Cys Leu Leu Leu Thr Gly Ser Ser Ser Gly Ser Asp Thr Gly Arg Pro
 20                    25                30
Phe Val Glu Met Tyr Ser Glu Ile Pro Glu Ile Ile His Met Thr Glu
 35                    40                45
Gly Arg Glu Leu Val Ile Pro Cys Arg Val Thr Ser Pro Asn Ile Thr
 50                    55                60
Val Thr Leu Lys Lys Phe Pro Leu Asp Thr Leu Ile Pro Asp Gly Lys
 65                    70                75                80
Arg Ile Ile Trp Asp Ser Arg Lys Gly Phe Ile Ile Ser Asn Ala Thr
 85                    90                95
Tyr Lys Glu Ile Gly Leu Leu Thr Cys Glu Ala Thr Val Asn Gly His
 100                   105                110
Leu Tyr Lys Thr Asn Tyr Leu Thr His Arg Gln Thr Asn Thr Ile Ile
 115                   120                125
Asp Val Val Leu Ser Pro Ser His Gly Ile Glu Leu Ser Val Gly Glu
```

|     |     |     |     |     |     |     |     |     |     |     |     |     |     |     |     |     |  |  |  |  |  |
|-----|-----|-----|-----|-----|-----|-----|-----|-----|-----|-----|-----|-----|-----|-----|-----|-----|--|--|--|--|--|
| 130 |     |     |     |     |     | 135 |     |     |     |     |     | 140 |     |     |     |     |  |  |  |  |  |
| Lys | Leu | Val | Leu | Asn | Cys | Thr | Ala | Arg | Thr | Glu | Leu | Asn | Val | Gly | Ile |     |  |  |  |  |  |
| 145 |     |     |     |     | 150 |     |     |     |     | 155 |     |     |     |     | 160 |     |  |  |  |  |  |
| Asp | Phe | Asn | Trp | Glu | Tyr | Pro | Ser | Ser | Ser | Lys | His | Gln | His | Lys | Lys | Leu |  |  |  |  |  |
|     |     |     |     | 165 |     |     |     |     |     | 170 |     |     |     |     | 175 |     |  |  |  |  |  |
| Val | Asn | Arg | Asp | Leu | Lys | Thr | Gln | Ser | Gly | Ser | Glu | Met | Lys | Lys | Phe |     |  |  |  |  |  |
|     |     |     | 180 |     |     |     |     |     | 185 |     |     |     |     | 190 |     |     |  |  |  |  |  |
| Leu | Ser | Thr | Leu | Thr | Ile | Asp | Gly | Val | Thr | Arg | Ser | Asp | Gln | Gly | Leu |     |  |  |  |  |  |
|     |     |     | 195 |     |     |     | 200 |     |     |     |     |     | 205 |     |     |     |  |  |  |  |  |
| Tyr | Thr | Cys | Ala | Ala | Ser | Ser | Gly | Leu | Met | Thr | Lys | Lys | Asn | Ser | Thr |     |  |  |  |  |  |
|     |     |     | 210 |     |     |     | 215 |     |     |     |     |     | 220 |     |     |     |  |  |  |  |  |
| Phe | Val | Arg | Val | His | Glu | Lys | Asp | Lys | Thr | His | Thr | Cys | Pro | Pro | Cys |     |  |  |  |  |  |
| 225 |     |     |     |     | 230 |     |     |     |     |     | 235 |     |     |     | 240 |     |  |  |  |  |  |
| Pro | Ala | Pro | Glu | Leu | Leu | Gly | Gly | Pro | Ser | Val | Phe | Leu | Phe | Pro | Pro |     |  |  |  |  |  |
|     |     |     |     |     | 245 |     |     |     |     | 250 |     |     |     |     | 255 |     |  |  |  |  |  |
| Lys | Pro | Lys | Asp | Thr | Leu | Met | Ile | Ser | Arg | Thr | Pro | Glu | Val | Thr | Cys |     |  |  |  |  |  |
|     |     |     | 260 |     |     |     |     |     | 265 |     |     |     |     | 270 |     |     |  |  |  |  |  |
| Val | Val | Val | Asp | Val | Ser | His | Glu | Asp | Pro | Glu | Val | Lys | Phe | Asn | Trp |     |  |  |  |  |  |
|     |     |     | 275 |     |     |     |     | 280 |     |     |     |     | 285 |     |     |     |  |  |  |  |  |
| Tyr | Val | Asp | Gly | Val | Glu | Val | His | Asn | Ala | Lys | Thr | Lys | Pro | Arg | Glu |     |  |  |  |  |  |
|     |     |     | 290 |     |     |     | 295 |     |     |     |     | 300 |     |     |     |     |  |  |  |  |  |
| Glu | Gln | Tyr | Asn | Ser | Thr | Tyr | Arg | Val | Val | Ser | Val | Leu | Thr | Val | Leu |     |  |  |  |  |  |
| 305 |     |     |     |     | 310 |     |     |     |     |     | 315 |     |     |     | 320 |     |  |  |  |  |  |
| His | Gln | Asp | Trp | Leu | Asn | Gly | Lys | Glu | Tyr | Lys | Cys | Lys | Val | Ser | Asn |     |  |  |  |  |  |
|     |     |     |     |     | 325 |     |     |     |     | 330 |     |     |     |     | 335 |     |  |  |  |  |  |
| Lys | Ala | Leu | Pro | Ala | Pro | Ile | Glu | Lys | Thr | Ile | Ser | Lys | Ala | Lys | Gly |     |  |  |  |  |  |
|     |     |     | 340 |     |     |     |     |     | 345 |     |     |     |     | 350 |     |     |  |  |  |  |  |
| Gln | Pro | Arg | Glu | Pro | Gln | Val | Tyr | Thr | Leu | Pro | Pro | Ser | Arg | Asp | Glu |     |  |  |  |  |  |
|     |     |     | 355 |     |     |     |     | 360 |     |     |     |     |     | 365 |     |     |  |  |  |  |  |
| Leu | Thr | Lys | Asn | Gln | Val | Ser | Leu | Thr | Cys | Leu | Val | Lys | Gly | Phe | Tyr |     |  |  |  |  |  |
|     |     |     | 370 |     |     |     | 375 |     |     |     |     |     | 380 |     |     |     |  |  |  |  |  |
| Pro | Ser | Asp | Ile | Ala | Val | Glu | Trp | Glu | Ser | Asn | Gly | Gln | Pro | Glu | Asn |     |  |  |  |  |  |
| 385 |     |     |     |     | 390 |     |     |     |     |     | 395 |     |     |     | 400 |     |  |  |  |  |  |
| Asn | Tyr | Lys | Thr | Thr | Pro | Pro | Val | Leu | Asp | Ser | Asp | Gly | Ser | Phe | Phe |     |  |  |  |  |  |
|     |     |     |     |     | 405 |     |     |     |     | 410 |     |     |     |     | 415 |     |  |  |  |  |  |
| Leu | Tyr | Ser | Lys | Leu | Thr | Val | Asp | Lys | Ser | Arg | Trp | Gln | Gln | Gly | Asn |     |  |  |  |  |  |
|     |     |     | 420 |     |     |     |     |     | 425 |     |     |     |     | 430 |     |     |  |  |  |  |  |
| Val | Phe | Ser | Cys | Ser | Val | Met | His | Glu | Ala | Leu | His | Asn | His | Tyr | Thr |     |  |  |  |  |  |
|     |     |     | 435 |     |     |     |     | 440 |     |     |     |     |     | 445 |     |     |  |  |  |  |  |
| Gln | Lys | Ser | Leu | Ser | Leu | Ser | Pro | Gly | Lys |     |     |     |     |     |     |     |  |  |  |  |  |
|     |     |     | 450 |     |     |     | 455 |     |     |     |     |     |     |     |     |     |  |  |  |  |  |



# United States Patent and Trademark Office

*Office of the Chief Financial Officer*

Document Code:WFEE

User :C43106

Sale Accounting Date:07/01/2021

---

| Sale Item Reference Number | Effective Date |
|----------------------------|----------------|
| 17352892                   | 06/21/2021     |

| Document Number  | Fee Code | Fee Code Description                 | Amount Paid | Payment Method  |
|------------------|----------|--------------------------------------|-------------|-----------------|
| I202171008042718 | 1201     | INDEPENDENT CLAIMS IN<br>EXCESS OF 3 | \$480.00    | Deposit Account |



UNITED STATES PATENT AND TRADEMARK OFFICE

UNITED STATES DEPARTMENT OF COMMERCE
United States Patent and Trademark Office
Address: COMMISSIONER FOR PATENTS
P.O. Box 1450
Alexandria, Virginia 22313-1450
www.uspto.gov

Table with 7 columns: APPLICATION NUMBER, FILING or 371(c) DATE, GRP ART UNIT, FIL FEE REC'D, ATTY.DOCKET.NO, TOT CLAIMS, IND CLAIMS. Values: 17/352,892, 06/21/2021, 3300, REGN-008CIPCON10, 30, 4

CONFIRMATION NO. 5070

FILING RECEIPT

96387
Regeneron - Bozicevic, Field & Francis
201 REDWOOD SHORES PARKWAY
SUITE 200
REDWOOD CITY, CA 94065



Date Mailed: 07/02/2021

Receipt is acknowledged of this non-provisional utility patent application. The application will be taken up for examination in due course. Applicant will be notified as to the results of the examination. Any correspondence concerning the application must include the following identification information: the U.S. APPLICATION NUMBER, FILING DATE, NAME OF FIRST INVENTOR, and TITLE OF INVENTION. Fees transmitted by check or draft are subject to collection.

Please verify the accuracy of the data presented on this receipt. If an error is noted on this Filing Receipt, please submit a written request for a corrected Filing Receipt, including a properly marked-up ADS showing the changes with strike-through for deletions and underlining for additions. If you received a "Notice to File Missing Parts" or other Notice requiring a response for this application, please submit any request for correction to this Filing Receipt with your reply to the Notice. When the USPTO processes the reply to the Notice, the USPTO will generate another Filing Receipt incorporating the requested corrections provided that the request is grantable.

Inventor(s)

George YANCOPOULOS, Yorktown Heights, NY;

Applicant(s)

REGENERON PHARMACEUTICALS, INC., Tarrytown, NY

Assignment For Published Patent Application

REGENERON PHARMACEUTICALS, INC., Tarrytown, NY

Power of Attorney: None

Domestic Priority data as claimed by applicant

This application is a CON of 17/350,958 06/17/2021
which is a CON of 17/112,404 12/04/2020
which is a CON of 17/072,417 10/16/2020
which is a CON of 16/055,847 08/06/2018 PAT 10857205
and is a CON of 16/397,267 04/29/2019 PAT 10888601
which is a CON of 16/159,282 10/12/2018 PAT 10828345
which is a CON of 15/471,506 03/28/2017 PAT 10130681
which is a CON of 14/972,560 12/17/2015 PAT 9669069
which is a CON of 13/940,370 07/12/2013 PAT 9254338
which is a CIP of PCT/US2012/020855 01/11/2012
which claims benefit of 61/432,245 01/13/2011
and claims benefit of 61/434,836 01/21/2011
and claims benefit of 61/561,957 11/21/2011

**Foreign Applications** for which priority is claimed (You may be eligible to benefit from the **Patent Prosecution Highway** program at the USPTO. Please see <http://www.uspto.gov> for more information.) - None.  
*Foreign application information must be provided in an Application Data Sheet in order to constitute a claim to foreign priority. See 37 CFR 1.55 and 1.76.*

**Permission to Access Application via Priority Document Exchange:** Yes

**Permission to Access Search Results:** Yes

Applicant may provide or rescind an authorization for access using Form PTO/SB/39 or Form PTO/SB/69 as appropriate.

**If Required, Foreign Filing License Granted:** 07/01/2021

The country code and number of your priority application, to be used for filing abroad under the Paris Convention, is **US 17/352,892**

**Projected Publication Date:** 10/07/2021

**Non-Publication Request:** No

**Early Publication Request:** No

**Title**

USE OF A VEGF ANTAGONIST TO TREAT ANGIOGENIC EYE DISORDERS

**Preliminary Class**

**Statement under 37 CFR 1.55 or 1.78 for AIA (First Inventor to File) Transition Applications:** No

## **PROTECTING YOUR INVENTION OUTSIDE THE UNITED STATES**

Since the rights granted by a U.S. patent extend only throughout the territory of the United States and have no effect in a foreign country, an inventor who wishes patent protection in another country must apply for a patent in a specific country or in regional patent offices. Applicants may wish to consider the filing of an international application under the Patent Cooperation Treaty (PCT). An international (PCT) application generally has the same effect as a regular national patent application in each PCT-member country. The PCT process **simplifies** the filing of patent applications on the same invention in member countries, but **does not result** in a grant of "an international patent" and does not eliminate the need of applicants to file additional documents and fees in countries where patent protection is desired.

Almost every country has its own patent law, and a person desiring a patent in a particular country must make an application for patent in that country in accordance with its particular laws. Since the laws of many countries differ in various respects from the patent law of the United States, applicants are advised to seek guidance from specific foreign countries to ensure that patent rights are not lost prematurely.

Applicants also are advised that in the case of inventions made in the United States, the Director of the USPTO must issue a license before applicants can apply for a patent in a foreign country. The filing of a U.S. patent application serves as a request for a foreign filing license. The application's filing receipt contains further information and guidance as to the status of applicant's license for foreign filing.

Applicants may wish to consult the USPTO booklet, "General Information Concerning Patents" (specifically, the section entitled "Treaties and Foreign Patents") for more information on timeframes and deadlines for filing foreign

page 2 of 4

patent applications. The guide is available either by contacting the USPTO Contact Center at 800-786-9199, or it can be viewed on the USPTO website at <http://www.uspto.gov/web/offices/pac/doc/general/index.html>.

For information on preventing theft of your intellectual property (patents, trademarks and copyrights), you may wish to consult the U.S. Government website, <http://www.stopfakes.gov>. Part of a Department of Commerce initiative, this website includes self-help "toolkits" giving innovators guidance on how to protect intellectual property in specific countries such as China, Korea and Mexico. For questions regarding patent enforcement issues, applicants may call the U.S. Government hotline at 1-866-999-HALT (1-866-999-4258).

**LICENSE FOR FOREIGN FILING UNDER**  
**Title 35, United States Code, Section 184**  
**Title 37, Code of Federal Regulations, 5.11 & 5.15**

**GRANTED**

The applicant has been granted a license under 35 U.S.C. 184, if the phrase "IF REQUIRED, FOREIGN FILING LICENSE GRANTED" followed by a date appears on this form. Such licenses are issued in all applications where the conditions for issuance of a license have been met, regardless of whether or not a license may be required as set forth in 37 CFR 5.15. The scope and limitations of this license are set forth in 37 CFR 5.15(a) unless an earlier license has been issued under 37 CFR 5.15(b). The license is subject to revocation upon written notification. The date indicated is the effective date of the license, unless an earlier license of similar scope has been granted under 37 CFR 5.13 or 5.14.

This license is to be retained by the licensee and may be used at any time on or after the effective date thereof unless it is revoked. This license is automatically transferred to any related applications(s) filed under 37 CFR 1.53(d). This license is not retroactive.

The grant of a license does not in any way lessen the responsibility of a licensee for the security of the subject matter as imposed by any Government contract or the provisions of existing laws relating to espionage and the national security or the export of technical data. Licensees should apprise themselves of current regulations especially with respect to certain countries, of other agencies, particularly the Office of Defense Trade Controls, Department of State (with respect to Arms, Munitions and Implements of War (22 CFR 121-128)); the Bureau of Industry and Security, Department of Commerce (15 CFR parts 730-774); the Office of Foreign Assets Control, Department of Treasury (31 CFR Parts 500+) and the Department of Energy.

**NOT GRANTED**

No license under 35 U.S.C. 184 has been granted at this time, if the phrase "IF REQUIRED, FOREIGN FILING LICENSE GRANTED" DOES NOT appear on this form. Applicant may still petition for a license under 37 CFR 5.12, if a license is desired before the expiration of 6 months from the filing date of the application. If 6 months has lapsed from the filing date of this application and the licensee has not received any indication of a secrecy order under 35 U.S.C. 181, the licensee may foreign file the application pursuant to 37 CFR 5.15(b).

## ***SelectUSA***

The United States represents the largest, most dynamic marketplace in the world and is an unparalleled location for business investment, innovation, and commercialization of new technologies. The U.S. offers tremendous resources and advantages for those who invest and manufacture goods here. Through SelectUSA, our nation works to promote and facilitate business investment. SelectUSA provides information assistance to the international investor community; serves as an ombudsman for existing and potential investors; advocates on behalf of U.S. cities, states, and regions competing for global investment; and counsels U.S. economic development organizations on investment attraction best practices. To learn more about why the United States is the best country in the world to develop technology, manufacture products, deliver services, and grow your business, visit <http://www.SelectUSA.gov> or call +1-202-482-6800.

| <b>PATENT APPLICATION FEE DETERMINATION RECORD</b>   |   |                                    |               |                 |                    | Application or Docket Number<br>17/352,892 |                         |     |                         |
|--|---|------------------------------------|---------------|-----------------|--------------------|--|-------------------------|-----|-------------------------|
| Substitute for Form PTO-875  |   |                                    |               |                 |                    |  |                         |     |                         |
| <b>APPLICATION AS FILED - PART I</b>   |   |                                    |               |                 |                    |  |                         |     |                         |
| (Column 1)   |   | (Column 2)                         |               | SMALL ENTITY    |                    | OR   | OTHER THAN SMALL ENTITY |     |                         |
| FOR  | NUMBER FILED  | NUMBER EXTRA                       | RATE(\$)      | FEE(\$)         | RATE(\$)           | FEE(\$)                                    |                         |     |                         |
| BASIC FEE<br><small>(37 CFR 1.16(a), (b), or (c))</small>  | N/A   | N/A                                | N/A           |                 | N/A                | 320  |                         |     |                         |
| SEARCH FEE<br><small>(37 CFR 1.16(k), (l), or (m))</small>   | N/A   | N/A                                | N/A           |                 | N/A                | 700  |                         |     |                         |
| EXAMINATION FEE<br><small>(37 CFR 1.16(o), (p), or (q))</small>  | N/A   | N/A                                | N/A           |                 | N/A                | 800  |                         |     |                         |
| TOTAL CLAIMS<br><small>(37 CFR 1.16(i))</small>  | 30  | minus 20 = *                       | 10            |                 | x 100 =            | 1000                                       | OR                      |     |                         |
| INDEPENDENT CLAIMS<br><small>(37 CFR 1.16(h))</small>  | 4   | minus 3 = *                        | 1             |                 | x 480 =            | 480  |                         |     |                         |
| APPLICATION SIZE FEE<br><small>(37 CFR 1.16(s))</small>  | If the specification and drawings exceed 100 sheets of paper, the application size fee due is \$310 (\$155 for small entity) for each additional 50 sheets or fraction thereof. See 35 U.S.C. 41(a)(1)(G) and 37 CFR 1.16(s). |                                    |               |                 |                    | 0.00                                       |                         |     |                         |
| MULTIPLE DEPENDENT CLAIM PRESENT <small>(37 CFR 1.16(j))</small>   |   |                                    |               |                 |                    | 0.00                                       |                         |     |                         |
|  |   |                                    |               | TOTAL           |                    | TOTAL 3300                                 |                         |     |                         |
| * If the difference in column 1 is less than zero, enter "0" in column 2.  |   |                                    |               |                 |                    |  |                         |     |                         |
| <b>APPLICATION AS AMENDED - PART II</b>  |   |                                    |               |                 |                    |  |                         |     |                         |
| (Column 1)   |   | (Column 2)                         |               | (Column 3)      |                    | SMALL ENTITY                               |                         | OR  | OTHER THAN SMALL ENTITY |
| AMENDMENT A  | CLAIMS REMAINING AFTER AMENDMENT  | HIGHEST NUMBER PREVIOUSLY PAID FOR | PRESENT EXTRA | RATE(\$)        | ADDITIONAL FEE(\$) | RATE(\$)                                   | ADDITIONAL FEE(\$)      |     |                         |
|  | Total<br><small>(37 CFR 1.16(i))</small>  | *                                  | Minus **      | =               | x =                | x =  | OR                      | x = |                         |
|  | Independent<br><small>(37 CFR 1.16(h))</small>  | *                                  | Minus ***     | =               | x =                | x =  | OR                      | x = |                         |
|  | Application Size Fee <small>(37 CFR 1.16(s))</small>  |                                    |               |                 |                    |  | OR                      |     |                         |
|  | FIRST PRESENTATION OF MULTIPLE DEPENDENT CLAIM <small>(37 CFR 1.16(j))</small>  |                                    |               |                 |                    |  | OR                      |     |                         |
|  |   |                                    |               | TOTAL ADD'L FEE |                    | TOTAL ADD'L FEE                            |                         |     |                         |
| * If the entry in column 1 is less than the entry in column 2, write "0" in column 3.                                    |   |                                    |               |                 |                    |  |                         |     |                         |
| ** If the "Highest Number Previously Paid For" IN THIS SPACE is less than 20, enter "20".                                |   |                                    |               |                 |                    |  |                         |     |                         |
| *** If the "Highest Number Previously Paid For" IN THIS SPACE is less than 3, enter "3".                                 |   |                                    |               |                 |                    |  |                         |     |                         |
| The "Highest Number Previously Paid For" (Total or Independent) is the highest found in the appropriate box in column 1. |   |                                    |               |                 |                    |  |                         |     |                         |



**To:** docket@bozpat.com,,  
**From:** PAIR\_eOfficeAction@uspto.gov  
**Cc:** PAIR\_eOfficeAction@uspto.gov  
**Subject:** Private PAIR Correspondence Notification for Customer Number 96387

Jul 02, 2021 03:46:38 AM

Dear PAIR Customer:

Regeneron - Bozicevic, Field & Francis  
201 REDWOOD SHORES PARKWAY  
SUITE 200  
REDWOOD CITY, CA 94065  
UNITED STATES

The following USPTO patent application(s) associated with your Customer Number, 96387 , have new outgoing correspondence. This correspondence is now available for viewing in Private PAIR.

The official date of notification of the outgoing correspondence will be indicated on the form PTOL-90 accompanying the correspondence.

**Disclaimer:**

The list of documents shown below is provided as a courtesy and is not part of the official file wrapper. The content of the images shown in PAIR is the official record.

| Application | Document     | Mailroom Date | Attorney Docket No. |
|-------------|--------------|---------------|---------------------|
| 17352892    | APP.FILE.REC | 07/02/2021    | REGN-008CIPCON10    |

To view your correspondence online or update your email addresses, please visit us anytime at <https://sportal.uspto.gov/secure/myportal/privatepair>.

If you have any questions, please email the Electronic Business Center (EBC) at [EBC@uspto.gov](mailto:EBC@uspto.gov) with 'e-Office Action' on the subject line or call 1-866-217-9197 during the following hours:

Monday - Friday 6:00 a.m. to 12:00 a.m.

Thank you for prompt attention to this notice,

UNITED STATES PATENT AND TRADEMARK OFFICE  
PATENT APPLICATION INFORMATION RETRIEVAL SYSTEM

|  |                                 |                 |
|--|---------------------------------|-----------------|
| SUBSTITUTE 1449<br><u>INFORMATION DISCLOSURE STATEMENT</u> | ATTY. DOCKET NO.                | APPLICATION NO. |
|  | REGN-008CIPCON10                | 17/352,892      |
|  | APPLICANT                       |                 |
|  | Regeneron Pharmaceuticals, Inc. |                 |
|  | FILING DATE                     | GROUP           |
|  | June 21, 2021                   |                 |

| U.S. PATENT DOCUMENTS |    |                 |            |                            |                                     |
|-----------------------|----|-----------------|------------|----------------------------|-------------------------------------|
|                       |    | DOCUMENT NUMBER | DATE       | NAME                       | REFERENCE PROVIDED*                 |
|                       | 1  | 6,171,586       | 1/9/2001   | Lam <i>et al.</i>          | not required per 69 Fed. Reg. 56481 |
|                       | 2  | 7,303,747       | 12/4/2007  | Wiegand <i>et al.</i>      | not required per 69 Fed. Reg. 56481 |
|                       | 3  | 7,374,757       | 5/20/2008  | Papadopoulos <i>et al.</i> | not required per 69 Fed. Reg. 56481 |
|                       | 4  | 7,374,758       | 5/20/2008  | Papadopoulos <i>et al.</i> | not required per 69 Fed. Reg. 56481 |
|                       | 5  | 7,378,095       | 5/27/2008  | Cao <i>et al.</i>          | not required per 69 Fed. Reg. 56481 |
|                       | 6  | 7,521,049       | 4/21/2009  | Wiegand <i>et al.</i>      | not required per 69 Fed. Reg. 56481 |
|                       | 7  | 7,531,173       | 5/12/2009  | Wiegand <i>et al.</i>      | not required per 69 Fed. Reg. 56481 |
|                       | 8  | 10,828,345      | 11/10/2020 | Yancopoulos                | not required per 69 Fed. Reg. 56481 |
|                       | 9  | 2003/0113316    | 6/19/2003  | Kaisheva <i>et al.</i>     | not required per 69 Fed. Reg. 56481 |
|                       | 10 | 2003/0138417    | 7/24/2003  | Kaisheva <i>et al.</i>     | not required per 69 Fed. Reg. 56481 |
|                       | 11 | 2004/0197324    | 10/7/2004  | Liu <i>et al.</i>          | not required per 69 Fed. Reg. 56481 |
|                       | 12 | 2006/0217311    | 9/28/2006  | Dix <i>et al.</i>          | not required per 69 Fed. Reg. 56481 |
|                       | 13 | 2016/0130337    | 5/12/2016  | Gekkieva <i>et al.</i>     | not required per 69 Fed. Reg. 56481 |

| FOREIGN PATENT DOCUMENTS |    |                 |            |         |             |                     |
|--------------------------|----|-----------------|------------|---------|-------------|---------------------|
|                          |    | DOCUMENT NUMBER | DATE       | COUNTRY | TRANSLATION | REFERENCE PROVIDED* |
|                          | 14 | 2663325         | 11/20/2013 | EP      | n/a         | Herewith            |
|                          | 15 | 97/04801        | 2/13/1997  | WO      | n/a         | Herewith            |

| NON-PATENT LITERATURE DOCUMENTS |    |  |                     |
|---------------------------------|----|--|---------------------|
|                                 |    | DOCUMENT (Including Author, Title, Date, Pertinent Pages, etc.)  | REFERENCE PROVIDED* |
|                                 | 16 | 7,374,758 – Patent Term Extension Application submitted December 22, 2011  | Herewith            |
|                                 | 17 | ADIS R&D Profile “Aflibercept: AVE 0005, AVE 005, AVE0005, VEGF Trap - Regeneron, VEGF Trap (R1R2), VEGF Trap-Eye.” Drugs R D, 9(4):261-269 (2008) | Herewith            |

|          |                 |
|----------|-----------------|
| EXAMINER | DATE CONSIDERED |
|----------|-----------------|

**EXAMINER:** Initial if reference considered, whether or not citation is in conformance with MPEP 609. Draw line through citation if not in conformance and not considered. Include copy of this form with next communication to Applicant.

\*Copies of the listed references are either submitted herewith or were previously cited by or submitted to, the Office in a prior application. Pursuant to 37 C.F.R. § 1.97(d) and MPEP §609, the indicated reference may have been previously cited by or submitted to, the Office in a prior application, where the prior application is identified by its U.S. Application Number in this Information Disclosure Statement.

|  |                                 |                 |
|--|---------------------------------|-----------------|
| SUBSTITUTE 1449<br><u>INFORMATION DISCLOSURE STATEMENT</u> | ATTY. DOCKET NO.                | APPLICATION NO. |
|  | REGN-008CIPCON10                | 17/352,892      |
|  | APPLICANT                       |                 |
|  | Regeneron Pharmaceuticals, Inc. |                 |
|  | FILING DATE                     | GROUP           |
|  | June 21, 2021                   |                 |

| NON-PATENT LITERATURE DOCUMENTS |    |   |                     |
|---------------------------------|----|---|---------------------|
|                                 |    | DOCUMENT (Including Author, Title, Date, Pertinent Pages, etc.)   | REFERENCE PROVIDED* |
|                                 | 18 | Andersen & Krummen, "Recombinant protein expression for therapeutic applications" Current Opinion in Biotechnology 13:117-123 (2002)  | Herewith            |
|                                 | 19 | Anderson <i>et al.</i> , "Delivery of Anti-Angiogenic Molecular Therapies for Retinal Disease" Drug Discovery Today 15: 272 (2010)  | Herewith            |
|                                 | 20 | Article in Retinal Physician, "Subspecialty News", available online at <a href="http://www.retinalphysician.com/printarticle.aspx?articleID=104007">http://www.retinalphysician.com/printarticle.aspx?articleID=104007</a> (March 2010) | Herewith            |
|                                 | 21 | Ass'n for Res. Vision & Ophthalmology, ARVO® News (Summer 2007)   | Herewith            |
|                                 | 22 | Ass'n for Res. Vision & Ophthalmology, ARVO® News (Winter/Spring 2008)  | Herewith            |
|                                 | 23 | AVASTIN® label  | Herewith            |
|                                 | 24 | Avery, R. L., D. J. Pieramici, M. D. Rabena, A. A. Castellarin, M. A. Nasir and M. J. Giust, "Intravitreal bevacizumab (Avastin) for neovascular age-related macular degeneration" Ophthalmology 113(3): 363-372 e365 (2006)            | Herewith            |
|                                 | 25 | Bashshur <i>et al.</i> , "Intravitreal Bevacizumab for the Management of Choroidal Neovascularization in Age-Related Macular Degeneration" Am J. Ophthalmology 142: 1 (2006)  | Herewith            |
|                                 | 26 | Bayer Press Release, "Bayer and Regeneron Dose First Patient in Second Phase 3 Study for VEGF Trap-Eye in Wet Age-Related Macular Degeneration." May 8, 2008  | Herewith            |
|                                 | 27 | Bayer Press Release, "VEGF Trap-Eye Shows Positive Results in Phase II Study in Patients with Diabetic Macular Edema" February 18, 2010   | Herewith            |
|                                 | 28 | Bayer Press Release, "Bayer HealthCare and Regeneron Announce Encouraging 32-Week Follow Up Results From A Phase 2 Study of VEGF Trap-Eye in Age-Related Macular Degeneration" April 28, 2008   | Herewith            |
|                                 | 29 | Bayer Press Release "Bayer HealthCare and Regeneron Announce VEGF Trap-Eye Achieved Durable Improvement in Vision Over 52 Weeks in a Phase 2 Study in Patients with Age-Related Macular Degeneration" August 19, 2008                   | Herewith            |

|  |                 |
|--|-----------------|
| EXAMINER   | DATE CONSIDERED |
| <b>EXAMINER:</b> Initial if reference considered, whether or not citation is in conformance with MPEP 609. Draw line through citation if not in conformance and not considered. Include copy of this form with next communication to Applicant.  |                 |
| *Copies of the listed references are either submitted herewith or were previously cited by or submitted to, the Office in a prior application. Pursuant to 37 C.F.R. § 1.97(d) and MPEP §609, the indicated reference may have been previously cited by or submitted to, the Office in a prior application, where the prior application is identified by its U.S. Application Number in this Information Disclosure Statement. |                 |

|  |                                 |                 |
|--|---------------------------------|-----------------|
| SUBSTITUTE 1449<br><u>INFORMATION DISCLOSURE STATEMENT</u> | ATTY. DOCKET NO.                | APPLICATION NO. |
|  | REGN-008CIPCON10                | 17/352,892      |
|  | APPLICANT                       |                 |
|  | Regeneron Pharmaceuticals, Inc. |                 |
|  | FILING DATE                     | GROUP           |
|  | June 21, 2021                   |                 |

| NON-PATENT LITERATURE DOCUMENTS |    |  |                     |
|---------------------------------|----|--|---------------------|
|                                 |    | DOCUMENT (Including Author, Title, Date, Pertinent Pages, etc.)  | REFERENCE PROVIDED* |
|                                 | 30 | BMJ Publishing Group Ltd., "Review: Ranibizumab (Lucentis) In Neovascular Age-Related Macular Degeneration: Evidence From Clinical Trials" British J. Ophthalmology (December 2020), <a href="https://bjo.bmj.com/content/94/1/2.altmetrics">https://bjo.bmj.com/content/94/1/2.altmetrics</a>   | Herewith            |
|                                 | 31 | Bontempo, "Preformulation Development of Parenteral Biopharmaceuticals" Drugs and the Pharmaceutical Sciences 85:91-108 (1997)   | Herewith            |
|                                 | 32 | Bressler, N. M. and G. Treatment of Age-Related Macular Degeneration with Photodynamic Therapy Study, "Photodynamic therapy of subfoveal choroidal neovascularization in age-related macular degeneration with verteporfin: two-year results of 2 randomized clinical trials-tap report 2." Arch Ophthalmol 119(2): 198-207 (2001)           | Herewith            |
|                                 | 33 | Brown & Regillo, "Anti-VEGF Agents in the Treatment of Neovascular Age-Related Macular Degeneration: Applying Clinical Trial Results to the Treatment of Everyday Patients" Am J. Ophthalmology 144: 627 (2007)  | Herewith            |
|                                 | 34 | Chi <i>et al.</i> , "Physical Stability of Proteins in Aqueous Solution: Mechanism and Driving Forces in Nonnative Protein Aggregation" Pharmaceutical Research Vol. 20, No. 9, 1325-1336 (September 2003)   | Herewith            |
|                                 | 35 | Ciulla & Rosenfeld, "Antivascular Endothelial Growth Factor Therapy For Neovascular Age-Related Macular Degeneration" Current Opinion Ophthalmology 20: 158 (2009)   | Herewith            |
|                                 | 36 | Clinicaltrials.gov. I-SPY 2 TRIAL: Neoadjuvant and Personalized Adaptive Novel Agents to Treat Breast Cancer. Accessed 2010; <a href="http://clinicaltrials.gov/ct2/show/NCT01042379?term=NCT01042379&amp;rank=1">http://clinicaltrials.gov/ct2/show/NCT01042379?term=NCT01042379&amp;rank=1</a>   | Herewith            |
|                                 | 37 | CMS, Local Coverage Determination (LCD) for Ranibizumab (Lucentis) (L29266, First Coast Service Options, Inc June 14, 2011)  | Herewith            |
|                                 | 38 | Controls in SCI experiments, RegenBase. Retrieved January 6, 2021, from <a href="http://regenbase.org/control-groups.html">http://regenbase.org/control-groups.html</a>  | Herewith            |
|                                 | 39 | Department of Health and Human Services, Office of Inspector General, "Questionable Billing for Medicare Ophthalmology Services" September 2015 OEI-04-12-00280  | Herewith            |
|                                 | 40 | Drug Vehicle (Code C927), National Cancer Institute (NCI). Retrieved January 6, 2021, from <a href="https://ncithesaurus.nci.nih.gov/ncitbrowser/ConceptReport.jsp?dictionary=NCI_Thesaurus&amp;code=C927&amp;ns=ncit">https://ncithesaurus.nci.nih.gov/ncitbrowser/ConceptReport.jsp?dictionary=NCI_Thesaurus&amp;code=C927&amp;ns=ncit</a> | Herewith            |

|  |                 |
|--|-----------------|
| EXAMINER   | DATE CONSIDERED |
| <b>EXAMINER:</b> Initial if reference considered, whether or not citation is in conformance with MPEP 609. Draw line through citation if not in conformance and not considered. Include copy of this form with next communication to Applicant.  |                 |
| *Copies of the listed references are either submitted herewith or were previously cited by or submitted to, the Office in a prior application. Pursuant to 37 C.F.R. § 1.97(d) and MPEP §609, the indicated reference may have been previously cited by or submitted to, the Office in a prior application, where the prior application is identified by its U.S. Application Number in this Information Disclosure Statement. |                 |

|  |                                 |                 |
|--|---------------------------------|-----------------|
| SUBSTITUTE 1449<br><u>INFORMATION DISCLOSURE STATEMENT</u> | ATTY. DOCKET NO.                | APPLICATION NO. |
|  | REGN-008CIPCON10                | 17/352,892      |
|  | APPLICANT                       |                 |
|  | Regeneron Pharmaceuticals, Inc. |                 |
|  | FILING DATE                     | GROUP           |
|  | June 21, 2021                   |                 |

| NON-PATENT LITERATURE DOCUMENTS |    |   |                     |
|---------------------------------|----|---|---------------------|
|                                 |    | DOCUMENT (Including Author, Title, Date, Pertinent Pages, etc.)   | REFERENCE PROVIDED* |
|                                 | 41 | EP 2 663 325 File History   | Herewith            |
|                                 | 42 | Eylea® Prescribing Information, Revised 05/2019   | Herewith            |
|                                 | 43 | Ferrara, N. & Kerbel, R., "Angiogenesis as a Therapeutic Target" Nature 438: 967 (2005)   | Herewith            |
|                                 | 44 | Fraser <i>et al.</i> , "Single Injections of Vascular Endothelial Growth Factor Trap Block Ovulation in the Macaque and Produce a Prolonged, Dose-Related Suppression of Ovarian Function." J. Clin. Endocrinol & Metab. 90(2): 1114-1122 (February 2005)   | Herewith            |
|                                 | 45 | Genentech, "FDA Approves Lucentis for the Treatment of Wet Age-Related Macular Degeneration," News Release dated June 30, 2006 (June 30, 2006)  | Herewith            |
|                                 | 46 | Gupta, O. P., G. Shienbaum, A. H. Patel, C. Fecarotta, R. S. Kaiser and C. D. Regillo, "A treat and extend regimen using ranibizumab for neovascular age-related macular degeneration clinical and economic impact" Ophthalmology 117(11): 2134-2140 (2010) | Herewith            |
|                                 | 47 | Heier, "Intravitreal VEGF Trap for AMD: An Update" Retina Today 44 (October 2009)   | Herewith            |
|                                 | 48 | Heier, J. S., P. A. Campochiaro, L. Yau, Z. Li, N. Saroj, R. G. Rubio and P. Lai "Ranibizumab for macular edema due to retinal vein occlusions: long-term follow-up in the HORIZON trial" Ophthalmology 119(4): 802-809 (2012)                              | Herewith            |
|                                 | 49 | HERCEPTIN® label  | Herewith            |
|                                 | 50 | Holz <i>et al.</i> , "VEGF Trap-Eye for Macular Oedema Secondary to Central Retinal Vein Occlusion: 6-Month Results of the Phase III GALILEO Study" British J. Ophthalmology 97: 278 (2013)   | Herewith            |

|  |                 |
|--|-----------------|
| EXAMINER   | DATE CONSIDERED |
| <b>EXAMINER:</b> Initial if reference considered, whether or not citation is in conformance with MPEP 609. Draw line through citation if not in conformance and not considered. Include copy of this form with next communication to Applicant.  |                 |
| *Copies of the listed references are either submitted herewith or were previously cited by or submitted to, the Office in a prior application. Pursuant to 37 C.F.R. § 1.97(d) and MPEP §609, the indicated reference may have been previously cited by or submitted to, the Office in a prior application, where the prior application is identified by its U.S. Application Number in this Information Disclosure Statement. |                 |

|   |                                 |                 |
|---|---------------------------------|-----------------|
| SUBSTITUTE 1449<br>INFORMATION DISCLOSURE STATEMENT | ATTY. DOCKET NO.                | APPLICATION NO. |
|   | REGN-008CIPCON10                | 17/352,892      |
|   | APPLICANT                       |                 |
|   | Regeneron Pharmaceuticals, Inc. |                 |
|   | FILING DATE                     | GROUP           |
|   | June 21, 2021                   |                 |

| NON-PATENT LITERATURE DOCUMENTS |    |  |                     |
|---------------------------------|----|--|---------------------|
|                                 |    | DOCUMENT (Including Author, Title, Date, Pertinent Pages, etc.)  | REFERENCE PROVIDED* |
|                                 | 51 | Ip, M. S., I. U. Scott, P. C. VanVeldhuisen, N. L. Oden, B. A. Blodi, M. Fisher, L. J. Singerman, M. Tolentino, C. K. Chan, V. H. Gonzalez and S. S. R. Group "A randomized trial comparing the efficacy and safety of intravitreal triamcinolone with observation to treat vision loss associated with macular edema secondary to central retinal vein occlusion: the Standard Care vs Corticosteroid for Retinal Vein Occlusion (SCORE) study report 5" Arch Ophthalmol 127(9): 1101-1114 (2009) | Herewith            |
|                                 | 52 | Janeway <i>et al.</i> , "The structure of a typical antibody molecule" Immunobiology: The Immune System in Health and Disease. 5th edition. New York: Garland Science (2001)   | Herewith            |
|                                 | 53 | Keane <i>et al.</i> , "Effect of Ranibizumab Retreatment Frequency on Neurosensory Retinal Volume in Neovascular AMD" Retina 29: 592 (2009)  | Herewith            |
|                                 | 54 | Kim <i>et al.</i> , "Potent VEGF Blockade Causes Regression of Coopted Vessels in a Model of Neuroblastoma" Proc. Nat'l Acad. Sci. 99: 11399 (2002)  | Herewith            |
|                                 | 55 | LUCENTIS Approval (2006)   | Herewith            |
|                                 | 56 | LUCENTIS® Label (14 pages)   | Herewith            |
|                                 | 57 | LUCENTIS® Prescribing Information (2006)   | Herewith            |
|                                 | 58 | Macular Photocoagulation Study, G., "Laser photocoagulation of subfoveal neovascular lesions in age-related macular degeneration. Results of a randomized clinical trial. Macular Photocoagulation Study Group" Arch Ophthalmol 109(9): 1220-1231 (1991)   | Herewith            |
|                                 | 59 | Massin, "Anti-VEGF Therapy for Diabetic Macular Edema: An Update" Retina Today 54 (Sept./Oct. 2008)  | Herewith            |
|                                 | 60 | Michels, S., P. J. Rosenfeld, C. A. Puliafito, E. N. Marcus and A. S. Venkatraman, "Systemic bevacizumab (Avastin) therapy for neovascular age-related macular degeneration twelve-week results of an uncontrolled open-label clinical study" Ophthalmology 112(6): 1035-1047 (2005)   | Herewith            |

|  |                 |
|--|-----------------|
| EXAMINER   | DATE CONSIDERED |
| <b>EXAMINER:</b> Initial if reference considered, whether or not citation is in conformance with MPEP 609. Draw line through citation if not in conformance and not considered. Include copy of this form with next communication to Applicant.  |                 |
| *Copies of the listed references are either submitted herewith or were previously cited by or submitted to, the Office in a prior application. Pursuant to 37 C.F.R. § 1.97(d) and MPEP §609, the indicated reference may have been previously cited by or submitted to, the Office in a prior application, where the prior application is identified by its U.S. Application Number in this Information Disclosure Statement. |                 |

|  |                                 |                 |
|--|---------------------------------|-----------------|
| SUBSTITUTE 1449<br><u>INFORMATION DISCLOSURE STATEMENT</u> | ATTY. DOCKET NO.                | APPLICATION NO. |
|  | REGN-008CIPCON10                | 17/352,892      |
|  | APPLICANT                       |                 |
|  | Regeneron Pharmaceuticals, Inc. |                 |
|  | FILING DATE                     | GROUP           |
|  | June 21, 2021                   |                 |

| NON-PATENT LITERATURE DOCUMENTS |    |   |                     |
|---------------------------------|----|---|---------------------|
|                                 |    | DOCUMENT (Including Author, Title, Date, Pertinent Pages, etc.)   | REFERENCE PROVIDED* |
|                                 | 61 | Mitchell <i>et al.</i> , "Ranibizumab (Lucentis) in Neovascular Age-Related Macular Degeneration: Evidence from Clinical Trials" <i>Brit. J. Ophthalmology</i> 94: 2 (2009)   | Herewith            |
|                                 | 62 | Ni & Hui, "Emerging Pharmacologic Therapies for Wet Age-Related Macular Degeneration" <i>Ophthalmologica</i> 223: 401 (2009)  | Herewith            |
|                                 | 63 | Parkins & Lashmar, "The formulation of biopharmaceutical products" <i>Pharmaceutical Science &amp; Technology Today</i> Vol. 3, No. 4: 129-137 (April 4, 2000)  | Herewith            |
|                                 | 64 | Phosphate buffer. <i>Cold Spring Harbor Protocols</i> 2006: pdb.rec8543 (2006)  | Herewith            |
|                                 | 65 | Randolph & Jones, "Surfactant-Protein Interactions" <i>Rational Design of Stable Protein Formulations</i> pp. 159-175, Springer, Boston, MA (2002)  | Herewith            |
|                                 | 66 | RAPTIVA® label  | Herewith            |
|                                 | 67 | Regeneron Pharmaceuticals Inc. Regeneron Receives \$20 Million Milestone Payment for Initiation of Phase 3 Study of VEGF Trap-Eye in Wet AMD. Media Release: 14 Aug 2007. Available from URL: <a href="http://www.regeneron.com">http://www.regeneron.com</a>   | Herewith            |
|                                 | 68 | Regeneron Pharmaceuticals Inc. Regeneron Reports Fourth Quarter and Full Year 2004 Financial and Operating Results. Media Release: 22 Feb 2005. Available from URL: <a href="http://www.regeneron.com">http://www.regeneron.com</a>   | Herewith            |
|                                 | 69 | Regeneron Pharmaceuticals Inc. Regeneron Reports Fourth Quarter and Full Year 2005 Financial and Operating Results. Media Release: 24 Feb 2006. Available from URL: <a href="http://www.regeneron.com">http://www.regeneron.com</a>   | Herewith            |
|                                 | 70 | Regeneron Pharmaceuticals Inc. Regeneron Reports Positive Phase Data for the VEGF Trap in Age-Related Macular Degeneration; Preliminary Results Show Improvements in Vision and Reginal Swelling; VEGF Trap Was Well Tolerated at All Dose Levels. Media Release: 1 May 2006. Available from URL: <a href="http://www.regeneron.com">http://www.regeneron.com</a> | Herewith            |
|                                 | 71 | Regeneron SEC Form 10-Q (September 30, 2009)  | Herewith            |
|                                 | 72 | Reichert, "Antibody-Based Therapeutics To Watch In 2011" <i>MABS</i> 3: 76 (2011)   | Herewith            |

|          |                 |
|----------|-----------------|
| EXAMINER | DATE CONSIDERED |
|----------|-----------------|

**EXAMINER:** Initial if reference considered, whether or not citation is in conformance with MPEP 609. Draw line through citation if not in conformance and not considered. Include copy of this form with next communication to Applicant.

\*Copies of the listed references are either submitted herewith or were previously cited by or submitted to, the Office in a prior application. Pursuant to 37 C.F.R. § 1.97(d) and MPEP §609, the indicated reference may have been previously cited by or submitted to, the Office in a prior application, where the prior application is identified by its U.S. Application Number in this Information Disclosure Statement.

|  |                                 |                 |
|--|---------------------------------|-----------------|
| SUBSTITUTE 1449<br><u>INFORMATION DISCLOSURE STATEMENT</u> | ATTY. DOCKET NO.                | APPLICATION NO. |
|  | REGN-008CIPCON10                | 17/352,892      |
|  | APPLICANT                       |                 |
|  | Regeneron Pharmaceuticals, Inc. |                 |
|  | FILING DATE                     | GROUP           |
|  | June 21, 2021                   |                 |

| NON-PATENT LITERATURE DOCUMENTS |    |  |                     |
|---------------------------------|----|--|---------------------|
|                                 |    | DOCUMENT (Including Author, Title, Date, Pertinent Pages, etc.)  | REFERENCE PROVIDED* |
|                                 | 73 | REMICADE® label  | Herewith            |
|                                 | 74 | Retina Coding Q & A, Retinal Physician, 16: 18, 54 (July/August 2019)  | Herewith            |
|                                 | 75 | Rogers <i>et al.</i> , "The prevalence of retinal vein occlusion: pooled data from population studies from the United States, Europe, Asia, and Australia" <i>Ophthalmology</i> 117(2): 313-319 e311 (2010)  | Herewith            |
|                                 | 76 | Rosenfeld, P. J., A. A. Moshfeghi and C. A. Puliafito, "Optical coherence tomography findings after an intravitreal injection of bevacizumab (avastin) for neovascular age-related macular degeneration" <i>Ophthalmic Surg Lasers Imaging</i> 36(4): 331-335 (2005)   | Herewith            |
|                                 | 77 | Rudge <i>et al.</i> , "VEGF Trap as a Novel Antiangiogenic Treatment Currently in Clinical Trials for Cancer and Eye Diseases, and VelociGene®-based Discovery of the Next Generation of Angiogenesis Targets," <i>Cold Spring Harbor Symposia on Quantitative Biology</i> 70: 411-418 (2005)  | Herewith            |
|                                 | 78 | Schmidt-Erfurth "Current Concepts in the Management of Diabetic Macular Edema" <i>Proceedings</i> 7:52 (2010)  | Herewith            |
|                                 | 79 | Scott <i>et al.</i> , "A randomized trial comparing the efficacy and safety of intravitreal triamcinolone with standard care to treat vision loss associated with macular Edema secondary to branch retinal vein occlusion: the Standard Care vs Corticosteroid for Retinal Vein Occlusion (SCORE) study report 6" <i>Arch Ophthalmol</i> 127(9): 1115-1128 (2009) | Herewith            |
|                                 | 80 | SIMULECT® label  | Herewith            |
|                                 | 81 | Spaide <i>et al.</i> , "Prospective Study of Intravitreal Ranibizumab as a Treatment for Decreased Visual Acuity Secondary to Central Retinal Vein Occlusion" <i>Am J. Ophthalmology</i> 147: 298 (2009)   | Herewith            |
|                                 | 82 | Spielberg, L. & Leys, A., "Intravitreal Bevacizumab for Myopic Choroidal Neovascularization: Short-Term and 1-Year Results" <i>Bulletin Societe Belge D'Ophthalmologie</i> 312: 17 (2009)  | Herewith            |
|                                 | 83 | Steinbrook, "The Price of Sight — Ranibizumab, Bevacizumab, and the Treatment of Macular Degeneration" <i>N. Eng. J. Med.</i> 355:1409 (2006)  | Herewith            |

|  |                 |
|--|-----------------|
| EXAMINER   | DATE CONSIDERED |
| <b>EXAMINER:</b> Initial if reference considered, whether or not citation is in conformance with MPEP 609. Draw line through citation if not in conformance and not considered. Include copy of this form with next communication to Applicant.  |                 |
| *Copies of the listed references are either submitted herewith or were previously cited by or submitted to, the Office in a prior application. Pursuant to 37 C.F.R. § 1.97(d) and MPEP §609, the indicated reference may have been previously cited by or submitted to, the Office in a prior application, where the prior application is identified by its U.S. Application Number in this Information Disclosure Statement. |                 |



|  |                                 |                 |
|--|---------------------------------|-----------------|
| SUBSTITUTE 1449<br><u>INFORMATION DISCLOSURE STATEMENT</u> | ATTY. DOCKET NO.                | APPLICATION NO. |
|  | REGN-008CIPCON10                | 17/352,892      |
|  | APPLICANT                       |                 |
|  | Regeneron Pharmaceuticals, Inc. |                 |
|  | FILING DATE                     | GROUP           |
|  | June 21, 2021                   |                 |

| NON-PATENT LITERATURE DOCUMENTS |    |  |                     |
|---------------------------------|----|--|---------------------|
|                                 |    | DOCUMENT (Including Author, Title, Date, Pertinent Pages, etc.)  | REFERENCE PROVIDED* |
|                                 | 84 | The Branch Vein Occlusion Study, G., "Argon laser photocoagulation for macular edema in branch vein occlusion" Am J Ophthalmol 98(3): 271-282 (1984)   | Herewith            |
|                                 | 85 | The Central Vein Occlusion Study, G., "Evaluation of grid pattern photocoagulation for macular edema in central vein occlusion. The Central Vein Occlusion Study Group M report" Ophthalmology 102(10): 1425-1433 (1995)   | Herewith            |
|                                 | 86 | U.S. DEP'T HEALTH & HUMAN SERVS., NAT'L INST. HEALTH, NAT'L EYE INST., "Age-Related Macular Degeneration: What You Should Know" (Sept. 2015)<br><a href="https://www.nei.nih.gov/sites/default/files/healthpdfs/WYSK_AMD_English_Sept2015_PRINT.pdf">https://www.nei.nih.gov/sites/default/files/healthpdfs/WYSK_AMD_English_Sept2015_PRINT.pdf</a>            | Herewith            |
|                                 | 87 | U.S. DEP'T HEALTH & HUMAN SERVS., NAT'L INST. HEALTH, NAT'L EYE INST., "Diabetic Retinopathy: What You Should Know" (Sept. 2015),<br><a href="https://www.nei.nih.gov/sites/default/files/2019-06/Diabetic-Retinopathy-What-You-Should-Know-508.pdf">https://www.nei.nih.gov/sites/default/files/2019-06/Diabetic-Retinopathy-What-You-Should-Know-508.pdf</a> | Herewith            |
|                                 | 88 | U.S. Department of Health and Human Services Food and Drug Administration, "Guidance for industry Q1A(R2) stability testing of new drug substances and products" Rockville, MD (November 2003)   | Herewith            |
|                                 | 89 | Vascular Endothelial Growth Factor (VEGF) Trap-Eye: Investigation of Efficacy and Safety in Wet Age-Related Macular Degeneration (AMD) (VIEW1), NCT00509795, ClinicalTrials.gov (Apr. 28, 2009),<br><a href="https://clinicaltrials.gov/ct2/show/NCT00509795">https://clinicaltrials.gov/ct2/show/NCT00509795</a> ("NCT-795")                                  | Herewith            |
|                                 | 90 | Wall Street Journal, "Genentech's Big Drug for Eyes Faces a Rival" (2007)  | Herewith            |
|                                 | 91 | Wulff <i>et al.</i> , "Prevention of Thecal Angiogenesis, Antral Follicular Growth, and Ovulation in the Primate by Treatment with Vascular Endothelial Growth Factor Trap R1R2" Endocrinology 143(7): 2797-2807 (July 2002)   | Herewith            |
|                                 | 92 | XOLAIR® label  | Herewith            |
|                                 | 93 | Zarbin & Rosenfeld, "Pathway-Based Therapies for Age-Related Macular Degeneration: An Integrated Survey of Emerging Treatment Alternatives" Retina 30: 1350 (2010)   | Herewith            |

|  |                 |
|--|-----------------|
| EXAMINER   | DATE CONSIDERED |
| <b>EXAMINER:</b> Initial if reference considered, whether or not citation is in conformance with MPEP 609. Draw line through citation if not in conformance and not considered. Include copy of this form with next communication to Applicant.  |                 |
| *Copies of the listed references are either submitted herewith or were previously cited by or submitted to, the Office in a prior application. Pursuant to 37 C.F.R. § 1.97(d) and MPEP §609, the indicated reference may have been previously cited by or submitted to, the Office in a prior application, where the prior application is identified by its U.S. Application Number in this Information Disclosure Statement. |                 |

## Electronic Acknowledgement Receipt

|   |  |
|---|--|
| <b>EFS ID:</b>                              | 43207955   |
| <b>Application Number:</b>                  | 17352892   |
| <b>International Application Number:</b>    |  |
| <b>Confirmation Number:</b>                 | 5070   |
| <b>Title of Invention:</b>                  | USE OF A VEGF ANTAGONIST TO TREAT ANGIOGENIC EYE DISORDERS |
| <b>First Named Inventor/Applicant Name:</b> | George YANCOPOULOS   |
| <b>Customer Number:</b>                     | 96387  |
| <b>Filer:</b>                               | Karl Bozicevic/Kimberly Zuehlke                            |
| <b>Filer Authorized By:</b>                 | Karl Bozicevic   |
| <b>Attorney Docket Number:</b>              | REGN-008CIPCON10   |
| <b>Receipt Date:</b>                        | 09-JUL-2021  |
| <b>Filing Date:</b>                         | 21-JUN-2021  |
| <b>Time Stamp:</b>                          | 11:41:10   |
| <b>Application Type:</b>                    | Utility under 35 USC 111(a)                                |

### Payment information:

|                        |    |
|------------------------|----|
| Submitted with Payment | no |
|------------------------|----|

### File Listing:

| Document Number | Document Description | File Name                                      | File Size(Bytes)/<br>Message Digest               | Multi Part /.zip | Pages (if appl.) |
|-----------------|----------------------|--|---|------------------|------------------|
| 1               | Transmittal Letter   | REGN-008CIPCON10_2021-07-09_SupplIDS_Trans.pdf | 53643<br>f9475189eda3f60815b73104e7f9884c75d953d2 | no               | 3                |

### Warnings:

| Information:  |  |  |  |        |   |
|---|--|--|--|--------|---|
| 2   | Information Disclosure Statement (IDS) Form (SB08) | Substitute_1449_17352892_2021-07-09_REGN-008CIPCON10.pdf | 78554                                      | no     | 8 |
|   |  |  | 972a347bete7bccce963ceee43b20cddde17b39d18 |        |   |
| Warnings:   |  |  |  |        |   |
| Information:  |  |  |  |        |   |
| This is not an USPTO supplied IDS fillable form   |  |  |  |        |   |
| <b>Total Files Size (in bytes):</b>   |  |  |  | 132197 |   |
| <p><b>This Acknowledgement Receipt evidences receipt on the noted date by the USPTO of the indicated documents, characterized by the applicant, and including page counts, where applicable. It serves as evidence of receipt similar to a Post Card, as described in MPEP 503.</b></p> <p><b><u>New Applications Under 35 U.S.C. 111</u></b><br/> <b>If a new application is being filed and the application includes the necessary components for a filing date (see 37 CFR 1.53(b)-(d) and MPEP 506), a Filing Receipt (37 CFR 1.54) will be issued in due course and the date shown on this Acknowledgement Receipt will establish the filing date of the application.</b></p> <p><b><u>National Stage of an International Application under 35 U.S.C. 371</u></b><br/> <b>If a timely submission to enter the national stage of an international application is compliant with the conditions of 35 U.S.C. 371 and other applicable requirements a Form PCT/DO/EO/903 indicating acceptance of the application as a national stage submission under 35 U.S.C. 371 will be issued in addition to the Filing Receipt, in due course.</b></p> <p><b><u>New International Application Filed with the USPTO as a Receiving Office</u></b><br/> <b>If a new international application is being filed and the international application includes the necessary components for an international filing date (see PCT Article 11 and MPEP 1810), a Notification of the International Application Number and of the International Filing Date (Form PCT/RO/105) will be issued in due course, subject to prescriptions concerning national security, and the date shown on this Acknowledgement Receipt will establish the international filing date of the application.</b></p> |  |  |  |        |   |

Electronically Filed 7/9/2021

|  |                      |                       |
|--|----------------------|-----------------------|
| <b>INFORMATION<br/>DISCLOSURE STATEMENT</b><br><br>Address to:<br>Commissioner for Patents<br>P.O. Box 1450<br>Alexandria, VA 22313-1450 | Attorney Docket No.  | REGN-008CIPCON10      |
|  | Confirmation No.     | 5070                  |
|  | First Named Inventor | George D. Yancopoulos |
|  | Application Number   | 17/352,892            |
|  | Filing Date          | June 21, 2021         |
|  | Group Art Unit       |                       |
|  | Examiner Name        |                       |
| Title: <i>“Use of a VEGF Antagonist to Treat Angiogenic Eye Disorders”</i>   |                      |                       |

Sir:

Applicant submits herewith documents which may be material to the examination of this application and in respect of which there may be a duty to disclose in accordance with 37 C.F.R. § 1.56. This submission is not intended to constitute an admission that any document referred to therein is "prior art" for this invention unless specifically designated as such. A listing of the documents is shown on enclosed Form PTO/SB/08A.

The publications discussed herein are provided to comply with the duty to disclose in accordance with 37 C.F.R. § 1.56. However, nothing herein is to be construed as an admission that the present invention is not entitled to antedate such publication by virtue of prior invention. Further, the dates of publication provided may be different from the actual publication dates which may need to be independently confirmed.

The Examiner is requested to make the documents listed on the enclosed PTO/SB/08A of record in this application. Applicants would appreciate the Examiner initialing and returning the initialed copy of form PTO/SB/08A, indicating the documents cited therein have been considered and made of record herein.

**All of the references identified herein were disclosed in parent application serial number 17/350,958, and as such, copies thereof are not included pursuant to the provisions of 37 CFR § 1.98(d).**

**Statements**

**No statement**

**PTA Statement under 37 CFR § 1.704(d)(1):** Each item of information contained in the information disclosure statement filed herewith:

(i) Was first cited in any communication from a patent office in a counterpart foreign or international application or from the Office, and this communication was not received

by any individual designated in § 1.56(c) more than thirty days prior to the filing of the information disclosure statement; or

(ii) Is a communication that was issued by a patent office in a counterpart foreign or international application or by the Office, and this communication was not received by any individual designated in § 1.56(c) more than thirty days prior to the filing of the information disclosure statement.

- 
- IDS Statement under 37 CFR § 1.97(e)(1):** Each item of information contained in the information disclosure statement was first cited in any communication from a foreign patent office in a counterpart foreign application not more than three months prior to the filing of the information disclosure statement; or
- IDS Statement under 37 CFR § 1.97(e)(2):** No item of information contained in the information disclosure statement was cited in a communication from a foreign patent office in a counterpart foreign application, and, to the knowledge of the person signing the certification after making reasonable inquiry, no item of information contained in the information disclosure statement was known to any individual designated in § 1.56(c) more than three months prior to the filing of the information disclosure statement.
-

**Fees**

- No fee is believed to be due.
- The appropriate fee set forth in 37 C.F.R. §1.17(p) accompanies this information disclosure statement.

The Commissioner is hereby authorized to charge any underpayment of fees up to a strict limit of \$3,000.00 beyond that authorized on the credit card, but not more than \$3,000.00 in additional fees due with any communication for the above-referenced patent application, including but not limited to any necessary fees for extensions of time, or credit any overpayment of any amount to Deposit Account No. 50-0815, order number REGN-008CIPCON10.

Respectfully submitted,  
BOZICEVIC, FIELD & FRANCIS LLP

Date: July 9, 2021

By: /Karl Bozicevic, Reg. No. 28,807/  
Karl Bozicevic  
Reg. No. 28,807

BOZICEVIC, FIELD & FRANCIS LLP  
201 Redwood Shores Parkway, Suite 200  
Redwood City, CA 94065  
Telephone: (650) 327-3400  
Facsimile: (650) 327-3231

|  |   |    |   |                        |                       |
|--|---|----|---|------------------------|-----------------------|
| <b>INFORMATION DISCLOSURE STATEMENT BY APPLICANT</b> |   |    |   | Application Number     | 17/352,892            |
|  |   |    |   | Filing Date            | 2021-06-21            |
|  |   |    |   | First Named Inventor   | George D. YANCOPOULOS |
|  |   |    |   | Art Unit               | To Be Assigned        |
|  |   |    |   | Examiner Name          | To Be Assigned        |
|  |   |    |   | Attorney Docket Number | REGN-008CIPCON10      |
| Sheet  | 1 | of | 2 |                        |                       |

| U.S. PATENT DOCUMENTS |          |                             |                          |   |   |
|-----------------------|----------|-----------------------------|--------------------------|---|---|
| Examiner Initial*     | Cite No. | Patent Number               | Issue Date<br>YYYY-MM-DD | Name of Patentee or Applicant of Cited Document | Pages, Columns, Lines, Where Relevant Passages or Relevant Figures Appear |
|                       |          | Number-Kind Code (if known) |                          |   |   |
|                       | 1        |                             |                          |   |   |

| U.S. PATENT APPLICATION PUBLICATIONS |          |                             |                                |   |   |
|--------------------------------------|----------|-----------------------------|--------------------------------|---|---|
| Examiner Initial*                    | Cite No. | Publication Number          | Publication Date<br>YYYY-MM-DD | Name of Patentee or Applicant of Cited Document | Pages, Columns, Lines, Where Relevant Passages or Relevant Figures Appear |
|                                      |          | Number-Kind Code (if known) |                                |   |   |
|                                      | 1        |                             |                                |   |   |

| FOREIGN PATENT DOCUMENTS |          |  |                                |   |   |   |
|--------------------------|----------|--|--------------------------------|---|---|---|
| Examiner Initial*        | Cite No. | Foreign Document Number                  | Publication Date<br>YYYY-MM-DD | Name of Patentee or Applicant of Cited Document | Pages, Columns, Lines, Where Relevant Passages or Relevant Figures Appear | T |
|                          |          | Country Code-Number-Kind Code (if known) |                                |   |   |   |
|                          | 1        |  |                                |   |   |   |

| NON PATENT LITERATURE DOCUMENTS |          |   |  |  |  |   |
|---------------------------------|----------|---|--|--|--|---|
| Examiner Initials*              | Cite No. | Include name of the author (in CAPITAL LETTERS), title of the article (when appropriate), title of the item (book, magazine, journal, serial, symposium, catalog, etc.), date, page(s), volume-issue number(s), publisher, city and/or country where published. |  |  |  | T |
|                                 | 1        | Eylea®, Highlights of Prescribing Information, Revised 11/2011  |  |  |  |   |
|                                 | 2        | IPR2021-00880, Paper 1, Petition for IPR (May 5, 2021)  |  |  |  |   |
|                                 | 3        | IPR2021-00880, Exhibit 1002, Albini Declaration (May 4, 2021)   |  |  |  |   |
|                                 | 4        | IPR2021-00880, Exhibit 1003, Gerritsen Declaration (April 30, 2021)   |  |  |  |   |
|                                 | 5        | IPR2021-00880, Paper 10, Preliminary Response of Patent Owner (August 16, 2021)   |  |  |  |   |
|                                 | 6        | IPR2021-00881, Paper 1, Petition for IPR (May 5, 2021)  |  |  |  |   |
|                                 | 7        | IPR2021-00881, Exhibit 1002, Albini Declaration (May 4, 2021)   |  |  |  |   |
|                                 | 8        | IPR2021-00881, Exhibit 1003, Gerritsen Declaration (April 26, 2021)   |  |  |  |   |
|                                 | 9        | IPR2021-00881, Paper 10, Preliminary Response of Patent Owner (August 16, 2021)   |  |  |  |   |
|                                 | 10       | IPR2021-00881, Exhibit 2001, Do Declaration (August 13, 2021)   |  |  |  |   |
|                                 | 11       | Mitchell <i>et al.</i> , "Evaluating the Impact of Intravitreal Aflibercept on Diabetic Retinopathy Progression in the VIVID-DME and VISTA-DME Studies" Ophthalmol Retina 2(10):988-96 (2018)   |  |  |  |   |
|                                 | 12       | PGR2021-00035, Paper 2, Petition for PGR (January 7, 2021)  |  |  |  |   |
|                                 | 13       | PGR2021-00035, Paper 6, Preliminary Response of Patent Owner (April 15, 2021)   |  |  |  |   |
|                                 | 14       | PGR2021-00035, Exhibit 1003 Wu Declaration (January 7, 2021)  |  |  |  |   |
|                                 | 15       | PGR2021-00035, Exhibit 2001 Do Declaration (April 14, 2021)   |  |  |  |   |
|                                 | 16       | PGR2021-00035, Exhibit 2002 D. Brown Declaration (April 14, 2021)   |  |  |  |   |
|                                 | 17       | CAO, J. R., R.; Wang, Q.; Yancopoulos, G.D.; Wiegand, S.J. (2002). Inhibition of Corneal Neovascularization and Inflammation by VEGF Trap. In "ARVO", Invest. Ophthalmol. Vis. Sci. Vol. 43. E-Abstract 1863  |  |  |  |   |

|                    |  |                 |  |
|--------------------|--|-----------------|--|
| Examiner Signature |  | Date Considered |  |
|--------------------|--|-----------------|--|

\*EXAMINER: Initial if reference considered, whether or not citation is in conformance with MPEP 609. Draw line through citation if not in conformance and not considered. Include copy of this form with next communication to applicant.

|  |   |    |   |                        |                       |
|--|---|----|---|------------------------|-----------------------|
| <b>INFORMATION DISCLOSURE<br/>STATEMENT BY APPLICANT</b> |   |    |   | Application Number     | 17/352,892            |
|  |   |    |   | Filing Date            | 2021-06-21            |
|  |   |    |   | First Named Inventor   | George D. YANCOPOULOS |
|  |   |    |   | Art Unit               | To Be Assigned        |
|  |   |    |   | Examiner Name          | To Be Assigned        |
|  |   |    |   | Attorney Docket Number | REGN-008CIPCON10      |
| Sheet  | 2 | of | 2 |                        |                       |

| NON PATENT LITERATURE DOCUMENTS |          |  |  |  |   |
|---------------------------------|----------|--|--|--|---|
| Examiner Initials*              | Cite No. | Include name of the author (in CAPITAL LETTERS), title of the article (when appropriate), title of the item (book, magazine, journal, serial, symposium, catalog, etc.), date, page(s), volume-issue number(s), publisher, city and/or country where published.    |  |  | T |
|                                 | 18       | WANG, Q. R., R.; Cao, J.; Yancopoulos, G.D.; and Wiegand, S.J. (2002). Anti-Angiogenic Properties of a New VEGF Antagonist, VEGF Trap, in a Mouse Model of Retinal Neovascularization. In "ARVO", Invest. Ophthalmol. Vis. Sci., Vol. 43. E-Abstract. 3714         |  |  |   |
|                                 | 19       | SAISHIN, Y., Saishin, Y., Takahashi, K., Lima e Silva, R., <i>et al.</i> (2003). VEGF-TRAP(R1R2) suppresses choroidal neovascularization and VEGF-induced breakdown of the blood-retinal barrier. J Cell Physiol 195:241-48  |  |  |   |
|                                 | 20       | CURSIEFEN, C., Cao, J., Chen, L., Liu, Y., Maruyama, K., <i>et al.</i> (2004). Inhibition of hemangiogenesis and lymphangiogenesis after normal-risk corneal transplantation by neutralizing VEGF promotes graft survival. Invest Ophthalmol Vis Sci 45(8):2666-73 |  |  |   |
|                                 | 21       | CURSIEFEN, C., Chen, L., Borges, L. P., Jackson, D., Cao, J., <i>et al.</i> (2004). VEGF-A stimulates lymphangiogenesis and hemangiogenesis in inflammatory neovascularization via macrophage recruitment. J Clin Invest 113(7):1040-50                            |  |  |   |
|                                 | 22       | CAO, J.; Song, H.; Renard, R.A.; Liu, Y.; Yancopolous, G.D.; Wiegand, S.J. (2005). Systemic Administration of VEGF Trap Suppresses Vascular Leak and Leukostasis in the Retinas of Diabetic Rats. In "ARVO", Vol. 46. Invest. Ophthalmol. Vis. Sci. E-Abstract 446 |  |  |   |
|                                 | 23       | NORK, T. M., Dubielzig, R. R., Christian, B. J., Miller, P. E., Miller, J. M., <i>et al.</i> (2011). Prevention of experimental choroidal neovascularization and resolution of active lesions by VEGF trap in nonhuman primates. Arch Ophthalmol 129(8):1042-52    |  |  |   |

|                    |  |                 |  |
|--------------------|--|-----------------|--|
| Examiner Signature |  | Date Considered |  |
|--------------------|--|-----------------|--|

\*EXAMINER: Initial if reference considered, whether or not citation is in conformance with MPEP 609. Draw line through citation if not in conformance and not considered. Include copy of this form with next communication to applicant.



**HIGHLIGHTS OF PRESCRIBING INFORMATION**

These highlights do not include all the information needed to use EYLEA safely and effectively. See full prescribing information for EYLEA.

**EYLEA™ (aflibercept) Injection**  
For Intravitreal Injection

Initial U.S. Approval: 2011

**INDICATIONS AND USAGE**

EYLEA is indicated for the treatment of patients with Neovascular (Wet) Age-Related Macular Degeneration (AMD). (1)

**DOSAGE AND ADMINISTRATION**

- For ophthalmic intravitreal injection only. (2.1)
- The recommended dose for EYLEA is 2 mg (0.05 mL) administered by intravitreal injection every 4 weeks (monthly) for the first 3 months, followed by 2 mg (0.05 mL) via intravitreal injection once every 8 weeks (2 months). (2.2)
- Although EYLEA may be dosed as frequently as 2 mg every 4 weeks (monthly), additional efficacy was not demonstrated when EYLEA was dosed every 4 weeks compared to every 8 weeks. (2.2)

**DOSAGE FORMS AND STRENGTHS**

40 mg/mL solution for intravitreal injection in a single-use vial (3)

**CONTRAINDICATIONS**

- Ocular or periocular infection (4.1)
- Active intraocular inflammation (4.2)
- Hypersensitivity (4.3)

**WARNINGS AND PRECAUTIONS**

- Endophthalmitis and retinal detachments may occur following intravitreal injections. Patients should be instructed to report any symptoms suggestive of endophthalmitis or retinal detachment without delay and should be managed appropriately. (5.1)
- Increases in intraocular pressure have been seen within 60 minutes of an intravitreal injection. (5.2)

**ADVERSE REACTIONS**

The most common adverse reactions (≥5%) reported in patients receiving EYLEA were conjunctival hemorrhage, eye pain, cataract, vitreous detachment, vitreous floaters, and increased intraocular pressure. (6.2)

To report SUSPECTED ADVERSE REACTIONS, contact Regeneron at 1-855-395-3248 or FDA at 1-800-FDA-1088 or [www.fda.gov/medwatch](http://www.fda.gov/medwatch).

See 17 for PATIENT COUNSELING INFORMATION.

Revised: 11/2011

**FULL PRESCRIBING INFORMATION: CONTENTS\***

1 INDICATIONS AND USAGE

2 DOSAGE AND ADMINISTRATION

2.1 General Dosing Information

2.2 Dosing

2.3 Preparation for Administration

2.4 Administration

3 DOSAGE FORMS AND STRENGTHS

4 CONTRAINDICATIONS

4.1 Ocular or Periocular Infections

4.2 Active Intraocular Inflammation

4.3 Hypersensitivity

5 WARNINGS AND PRECAUTIONS

5.1 Endophthalmitis and Retinal Detachments

5.2 Increase in Intraocular Pressure

5.3 Thromboembolic Events

6 ADVERSE REACTIONS

6.1 Injection Procedure

6.2 Clinical Studies Experience

6.3 Immunogenicity

8 USE IN SPECIFIC POPULATIONS

8.1 Pregnancy

8.3 Nursing Mothers

8.4 Pediatric Use

8.5 Geriatric Use

11 DESCRIPTION

12 CLINICAL PHARMACOLOGY

12.1 Mechanism of Action

12.2 Pharmacodynamics

12.3 Pharmacokinetics

13 NONCLINICAL TOXICOLOGY

13.1 Carcinogenesis, Mutagenesis, Impairment of Fertility

13.2 Animal Toxicology and/or Pharmacology

14 CLINICAL STUDIES

16 HOW SUPPLIED/STORAGE AND HANDLING

17 PATIENT COUNSELING INFORMATION

\*Sections or subsections omitted from the full prescribing information are not listed.

## **FULL PRESCRIBING INFORMATION**

### **1 INDICATIONS AND USAGE**

EYLEA is indicated for the treatment of patients with Neovascular (Wet) Age-Related Macular Degeneration (AMD).

### **2 DOSAGE AND ADMINISTRATION**

#### **2.1 General Dosing Information**

FOR OPHTHALMIC INTRAVITREAL INJECTION ONLY. EYLEA must only be administered by a qualified physician.

#### **2.2 Dosing**

The recommended dose for EYLEA is 2 mg (0.05 mL or 50 microliters) administered by intravitreal injection every 4 weeks (monthly) for the first 12 weeks (3 months), followed by 2 mg (0.05 mL) via intravitreal injection once every 8 weeks (2 months). Although EYLEA may be dosed as frequently as 2 mg every 4 weeks (monthly), additional efficacy was not demonstrated when EYLEA was dosed every 4 weeks compared to every 8 weeks [*see Clinical Studies (14)*].

#### **2.3 Preparation for Administration**

EYLEA should be inspected visually prior to administration. If particulates, cloudiness, or discoloration are visible, the vial must not be used.

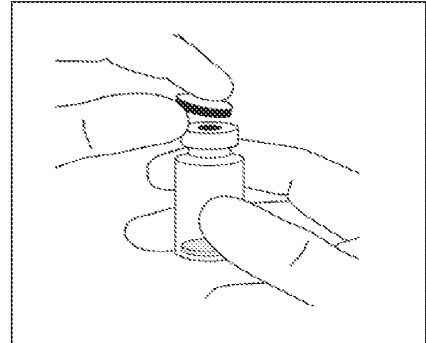
Using aseptic technique, the intravitreal injection should be performed with a 30-gauge x ½-inch injection needle.

#### **Vial**

The glass vial is for single use only.

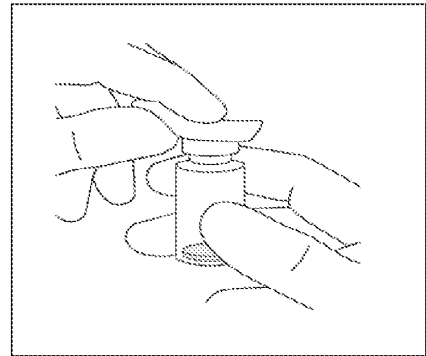
1. Remove the protective plastic cap from the vial (see Figure 1).

**Figure 1:**



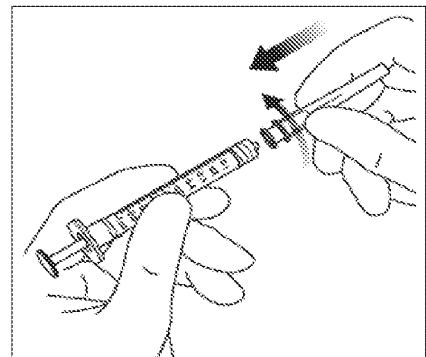
2. Clean the top of the vial with an alcohol wipe (see Figure 2).

**Figure 2:**



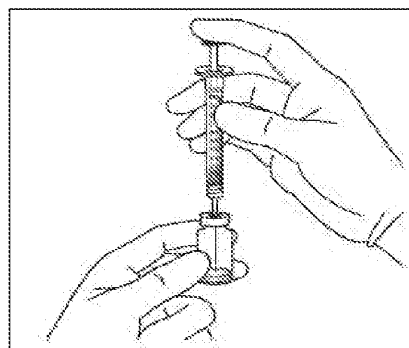
3. Remove the 19-gauge x 1½-inch, 5-micron, filter needle from its pouch and remove the 1-mL syringe supplied in the carton from its pouch. Attach the filter needle to the syringe by twisting it onto the Luer lock syringe tip (see Figure 3).

**Figure 3:**



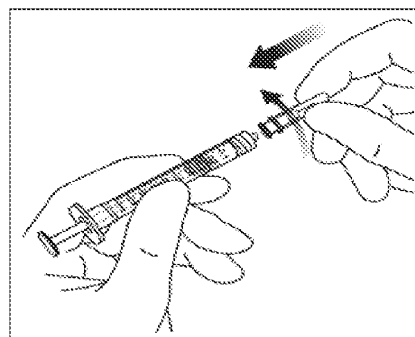
4. Push the filter needle into the center of the vial stopper until the needle touches the bottom edge of the vial.
5. Using aseptic technique withdraw all of the EYLEA vial contents into the syringe, keeping the vial in an upright position, slightly inclined to ease complete withdrawal (see Figure 4).

**Figure 4:**



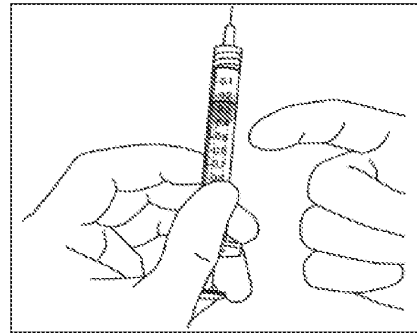
6. Ensure that the plunger rod is drawn sufficiently back when emptying the vial in order to completely empty the filter needle.
7. Remove the filter needle from the syringe and properly dispose of the filter needle.  
**Note:** Filter needle is **not** to be used for intravitreal injection.
8. Remove the 30-gauge x ½-inch injection needle from the plastic pouch and attach the injection needle to the syringe by firmly twisting the injection needle onto the Luer lock syringe tip (see Figure 5).

**Figure 5:**



9. When ready to administer EYLEA, remove the plastic needle shield from the needle.
10. Holding the syringe with the needle pointing up, check the syringe for bubbles. If there are bubbles, gently tap the syringe with your finger until the bubbles rise to the top (see Figure 6).

Figure 6:



11. To eliminate all of the bubbles and to expel excess drug, SLOWLY depress the plunger so that the plunger tip aligns with the line that marks 0.05 mL on the syringe (see Figures 7 and 8).

Figure 7:

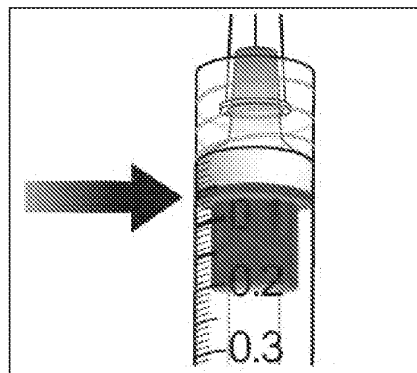
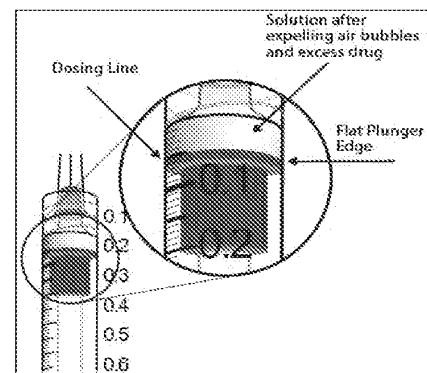


Figure 8:



## 2.4 Administration

The intravitreal injection procedure should be carried out under controlled aseptic conditions, which include surgical hand disinfection and the use of sterile gloves, a sterile drape, and a sterile eyelid speculum (or equivalent). Adequate anesthesia and a topical broad-spectrum microbicide should be given prior to the injection.

Immediately following the intravitreal injection, patients should be monitored for elevation in intraocular pressure. Appropriate monitoring may consist of a check for perfusion of the optic nerve head or tonometry. If required, a sterile paracentesis needle should be available.

Following intravitreal injection, patients should be instructed to report any symptoms suggestive of endophthalmitis or retinal detachment (e.g., eye pain, redness of the eye, photophobia, blurring of vision) without delay [see *Patient Counseling Information (17)*].

Each vial should only be used for the treatment of a single eye. If the contralateral eye requires treatment, a new vial should be used and the sterile field, syringe, gloves, drapes, eyelid

speculum, filter, and injection needles should be changed before EYLEA is administered to the other eye.

After injection, any unused product must be discarded.

No special dosage modification is required for any of the populations that have been studied (e.g., gender, elderly).

### **3 DOSAGE FORMS AND STRENGTHS**

Single-use, glass vial designed to provide 0.05 mL of 40 mg/mL solution for intravitreal injection.

### **4 CONTRAINDICATIONS**

#### **4.1 Ocular or Periocular Infections**

EYLEA is contraindicated in patients with ocular or periocular infections.

#### **4.2 Active Intraocular Inflammation**

EYLEA is contraindicated in patients with active intraocular inflammation.

#### **4.3 Hypersensitivity**

EYLEA is contraindicated in patients with known hypersensitivity to aflibercept or any of the excipients in EYLEA.

### **5 WARNINGS AND PRECAUTIONS**

#### **5.1 Endophthalmitis and Retinal Detachments**

Intravitreal injections, including those with EYLEA, have been associated with endophthalmitis and retinal detachments [*see Adverse Reactions (6.1)*]. Proper aseptic injection technique must always be used when administering EYLEA. Patients should be instructed to report any symptoms suggestive of endophthalmitis or retinal detachment without delay and should be managed appropriately [*see Dosage and Administration (2.4) and Patient Counseling Information (17)*].

#### **5.2 Increase in Intraocular Pressure**

Acute increases in intraocular pressure have been seen within 60 minutes of intravitreal injection, including with EYLEA [*see Adverse Reactions (6.1)*]. Sustained increases in intraocular pressure have also been reported after repeated intravitreal dosing with VEGF inhibitors. Intraocular pressure and the perfusion of the optic nerve head should be monitored and managed appropriately [*see Dosage and Administration (2.4)*].

### 5.3 Thromboembolic Events

There is a potential risk of arterial thromboembolic events (ATEs) following intravitreal use of VEGF inhibitors, including EYLEA. ATEs are defined as nonfatal stroke, nonfatal myocardial infarction, or vascular death (including deaths of unknown cause). The incidence in the VIEW1 and VIEW2 wet AMD studies during the first year was 1.8% (32 out of 1824) in the combined group of patients treated with EYLEA [see *Clinical Studies (14)*].

## 6 ADVERSE REACTIONS

The following adverse reactions are discussed in detail in other sections of the labeling:

- Endophthalmitis and retinal detachments [see *Warnings and Precautions (5.1)*]
- Increased intraocular pressure [see *Warnings and Precautions (5.2)*]
- Thromboembolic events [see *Warnings and Precautions (5.3)*]

The most common adverse reactions ( $\geq 5\%$ ) reported in patients receiving EYLEA were conjunctival hemorrhage, eye pain, cataract, vitreous detachment, vitreous floaters, and increased intraocular pressure.

### 6.1 Injection Procedure

Serious adverse reactions related to the injection procedure have occurred in  $<0.1\%$  of intravitreal injections with EYLEA including endophthalmitis, traumatic cataract, and increased intraocular pressure.

### 6.2 Clinical Studies Experience

Because clinical trials are conducted under widely varying conditions, adverse reaction rates observed in the clinical trials of a drug cannot be directly compared to rates in the clinical trials of another drug and may not reflect the rates observed in practice.

The data described below reflect exposure to EYLEA in 1824 patients with wet AMD, including 1223 patients treated with the 2-mg dose, in 2 double-masked, active-controlled clinical studies (VIEW1 and VIEW2) for 12 months [see *Clinical Studies (14)*].

**Table 1: Most Common Adverse Reactions ( $\geq 1\%$ ) in Phase 3 wet AMD studies**

| Adverse Reactions       | EYLEA<br>(N=1824) | Active Control<br>(ranibizumab)<br>(N=595) |
|-------------------------|-------------------|--|
| Conjunctival hemorrhage | 25%               | 28%  |
| Eye pain                | 9%                | 9%   |
| Cataract                | 7%                | 7%   |
| Vitreous detachment     | 6%                | 6%   |
| Vitreous floaters       | 6%                | 7%   |

| Adverse Reactions                            | EYLEA<br>(N=1824) | Active Control<br>(ranibizumab)<br>(N=595) |
|--|-------------------|--|
| Intraocular pressure increased               | 5%                | 7%   |
| Conjunctival hyperemia                       | 4%                | 8%   |
| Corneal erosion                              | 4%                | 5%   |
| Detachment of the retinal pigment epithelium | 3%                | 3%   |
| Injection site pain                          | 3%                | 3%   |
| Foreign body sensation in eyes               | 3%                | 4%   |
| Lacrimation increased                        | 3%                | 1%   |
| Vision blurred                               | 2%                | 2%   |
| Retinal pigment epithelium tear              | 2%                | 1%   |
| Injection site hemorrhage                    | 1%                | 2%   |
| Eyelid edema                                 | 1%                | 2%   |
| Corneal edema                                | 1%                | 1%   |

Less common serious adverse reactions reported in <1% of the patients treated with EYLEA were retinal detachment, retinal tear, and endophthalmitis. Hypersensitivity has also been reported in less than 1% of the patients treated with EYLEA.

### 6.3 Immunogenicity

As with all therapeutic proteins, there is a potential for an immune response in patients treated with EYLEA. The immunogenicity of EYLEA was evaluated in serum samples. The immunogenicity data reflect the percentage of patients whose test results were considered positive for antibodies to EYLEA in immunoassays. The detection of an immune response is highly dependent on the sensitivity and specificity of the assays used, sample handling, timing of sample collection, concomitant medications, and underlying disease. For these reasons, comparison of the incidence of antibodies to EYLEA with the incidence of antibodies to other products may be misleading.

In the phase 3 studies, the pre-treatment incidence of immunoreactivity to EYLEA was 1% to 3% across treatment groups. After dosing with EYLEA for 52 weeks, antibodies to EYLEA were detected in a similar percentage range of patients. There were no differences in efficacy or safety between patients with or without immunoreactivity.



## 8 USE IN SPECIFIC POPULATIONS

### 8.1 Pregnancy

Pregnancy Category C. Aflibercept produced embryo-fetal toxicity when administered during organogenesis in pregnant rabbits at intravenous doses of 3 to 60 mg/kg. A series of external, visceral, and skeletal malformations were observed in the fetuses. The maternal No Observed Adverse Effect Level (NOAEL) was 3 mg/kg, whereas the fetal NOAEL was below 3 mg/kg. At this dose, the systemic exposures based on  $C_{max}$  and AUC for free aflibercept were approximately 2900 times and 600 times higher, respectively, when compared to corresponding values observed in humans after an intravitreal dose of 2 mg.

There are no adequate and well-controlled studies in pregnant women. EYLEA should be used during pregnancy only if the potential benefit justifies the potential risk to the fetus.

### 8.3 Nursing Mothers

It is unknown whether aflibercept is excreted in human milk. Because many drugs are excreted in human milk, a risk to the breastfed child cannot be excluded. EYLEA is not recommended during breastfeeding. A decision must be made whether to discontinue nursing or to discontinue treatment with EYLEA, taking into account the importance of the drug to the mother.

### 8.4 Pediatric Use

The safety and effectiveness of EYLEA in pediatric patients have not been established.

### 8.5 Geriatric Use

In the clinical studies, approximately 89% (1616/1817) of patients randomized to treatment with EYLEA were  $\geq 65$  years of age and approximately 63% (1139/1817) were  $\geq 75$  years of age. No significant differences in efficacy or safety were seen with increasing age in these studies.

## 11 DESCRIPTION

EYLEA (aflibercept) is a recombinant fusion protein consisting of portions of human VEGF receptors 1 and 2 extracellular domains fused to the Fc portion of human IgG1 formulated as an iso-osmotic solution for intravitreal administration. Aflibercept is a dimeric glycoprotein with a protein molecular weight of 97 kilodaltons (kDa) and contains glycosylation, constituting an additional 15% of the total molecular mass, resulting in a total molecular weight of 115 kDa. Aflibercept is produced in recombinant Chinese hamster ovary (CHO) cells.

EYLEA is a sterile, clear, and colorless to pale yellow solution. EYLEA is supplied as a preservative-free, sterile, aqueous solution in a single-use, glass vial designed to deliver 0.05 mL (50 microliters) of EYLEA (40 mg/mL in 10 mM sodium phosphate, 40 mM sodium chloride, 0.03% polysorbate 20, and 5% sucrose, pH 6.2).

## 12 CLINICAL PHARMACOLOGY

### 12.1 Mechanism of Action

Vascular endothelial growth factor-A (VEGF-A) and placental growth factor (PlGF) are members of the VEGF family of angiogenic factors that can act as mitogenic, chemotactic, and vascular permeability factors for endothelial cells. VEGF acts via two receptor tyrosine kinases, VEGFR-1 and VEGFR-2, present on the surface of endothelial cells. PlGF binds only to VEGFR-1, which is also present on the surface of leucocytes. Activation of these receptors by VEGF-A can result in neovascularization and vascular permeability.

Aflibercept acts as a soluble decoy receptor that binds VEGF-A and PlGF, and thereby can inhibit the binding and activation of these cognate VEGF receptors.

### 12.2 Pharmacodynamics

In the phase 3 studies anatomic measures of disease activity improved similarly in all treatment groups from baseline to week 52. Anatomic data were not used to influence treatment decisions.

### 12.3 Pharmacokinetics

EYLEA is administered intravitreally to exert local effects in the eye. In patients with wet AMD, following intravitreal administration of EYLEA, a fraction of the administered dose is expected to bind with endogenous VEGF in the eye to form an inactive aflibercept: VEGF complex. Once absorbed into the systemic circulation, aflibercept presents in the plasma as free aflibercept (unbound to VEGF) and a more predominant stable inactive form with circulating endogenous VEGF (i.e., aflibercept: VEGF complex).

#### *Absorption/Distribution*

Following intravitreal administration of 2 mg per eye of EYLEA to patients with wet AMD, the mean  $C_{max}$  of free aflibercept in the plasma was 0.02 mcg/mL (range: 0 to 0.054 mcg/mL) and was attained in 1 to 3 days. The free aflibercept plasma concentrations were undetectable two weeks post-dosing in all patients. Aflibercept did not accumulate in plasma when administered as repeated doses intravitreally every 4 weeks. It is estimated that after intravitreal administration of 2 mg to patients, the mean maximum plasma concentration of free aflibercept is more than 100 fold lower than the concentration of aflibercept required to half-maximally bind systemic VEGF.

The volume of distribution of free aflibercept following intravenous (I.V.) administration of aflibercept has been determined to be approximately 6L.

#### *Metabolism/Elimination*

Aflibercept is a therapeutic protein and no drug metabolism studies have been conducted. Aflibercept is expected to undergo elimination through both target-mediated disposition via binding to free endogenous VEGF and metabolism via proteolysis. The terminal elimination

half-life ( $t_{1/2}$ ) of free aflibercept in plasma was approximately 5 to 6 days after I.V. administration of doses of 2 to 4 mg/kg aflibercept.

### **Specific Populations**

#### *Renal Impairment*

Pharmacokinetic analysis of a subgroup of patients (n=492) in one Phase 3 study, of which 43% had renal impairment (mild n=120, moderate n=74, and severe n=16), revealed no differences with respect to plasma concentrations of free aflibercept after intravitreal administration every 4 or 8 weeks. No dose adjustment based on renal impairment status is needed.

## **13 NONCLINICAL TOXICOLOGY**

### **13.1 Carcinogenesis, Mutagenesis, Impairment of Fertility**

No studies have been conducted on the mutagenic or carcinogenic potential of aflibercept. Effects on male and female fertility were assessed as part of a 6-month study in monkeys with intravenous administration of aflibercept at doses ranging from 3 to 30 mg/kg. Absent or irregular menses associated with alterations in female reproductive hormone levels and changes in sperm morphology and motility were observed at all dose levels. In addition, females showed decreased ovarian and uterine weight accompanied by compromised luteal development and reduction of maturing follicles. These changes correlated with uterine and vaginal atrophy. A No Observed Adverse Effect Level (NOAEL) was not identified. Based on  $C_{max}$  and AUC for free aflibercept observed at the lowest dose used of 3 mg/kg, the systemic exposures were approximately 4900 times and 1500 times higher, respectively, than the exposure observed in humans after an intravitreal dose of 2 mg. All changes were reversible.

### **13.2 Animal Toxicology and/or Pharmacology**

Erosions and ulcerations of the respiratory epithelium in nasal turbinates in monkeys treated with aflibercept intravitreally were observed at intravitreal doses of 2 or 4 mg/eye. At the NOAEL of 0.5 mg/eye in monkeys, the systemic exposure was 42 times and 56 times higher based on  $C_{max}$  and AUC, respectively, than the exposure observed in humans after an intravitreal dose of 2 mg. Similar effects were not seen in clinical studies [*see Clinical Studies (14)*].

## **14 CLINICAL STUDIES**

The safety and efficacy of EYLEA were assessed in two randomized, multi-center, double-masked, active-controlled studies in patients with wet AMD. A total of 2412 patients were treated and evaluable for efficacy (1817 with EYLEA) in the two studies (VIEW1 and VIEW2). In each study, patients were randomly assigned in a 1:1:1:1 ratio to 1 of 4 dosing regimens: 1) EYLEA administered 2 mg every 8 weeks following 3 initial monthly doses (EYLEA 2Q8); 2) EYLEA administered 2 mg every 4 weeks (EYLEA 2Q4); 3) EYLEA 0.5 mg administered every 4 weeks (EYLEA 0.5Q4); and 4) ranibizumab administered 0.5 mg every 4 weeks (ranibizumab 0.5 mg Q4). Patient ages ranged from 49 to 99 years with a mean of 76 years.

In both studies, the primary efficacy endpoint was the proportion of patients who maintained vision, defined as losing fewer than 15 letters of visual acuity at week 52 compared to baseline. Data are available through week 52. Both EYLEA 2Q8 and EYLEA 2Q4 groups were shown to have efficacy that was clinically equivalent to the ranibizumab 0.5 mg Q4 group.

Detailed results from the analysis of the VIEW1 and VIEW2 studies are shown in Table 2 and Figure 9 below.

**Table 2: Efficacy Outcomes at Week 52 (Full Analysis Set with LOCF) in VIEW1 and VIEW2 Studies**

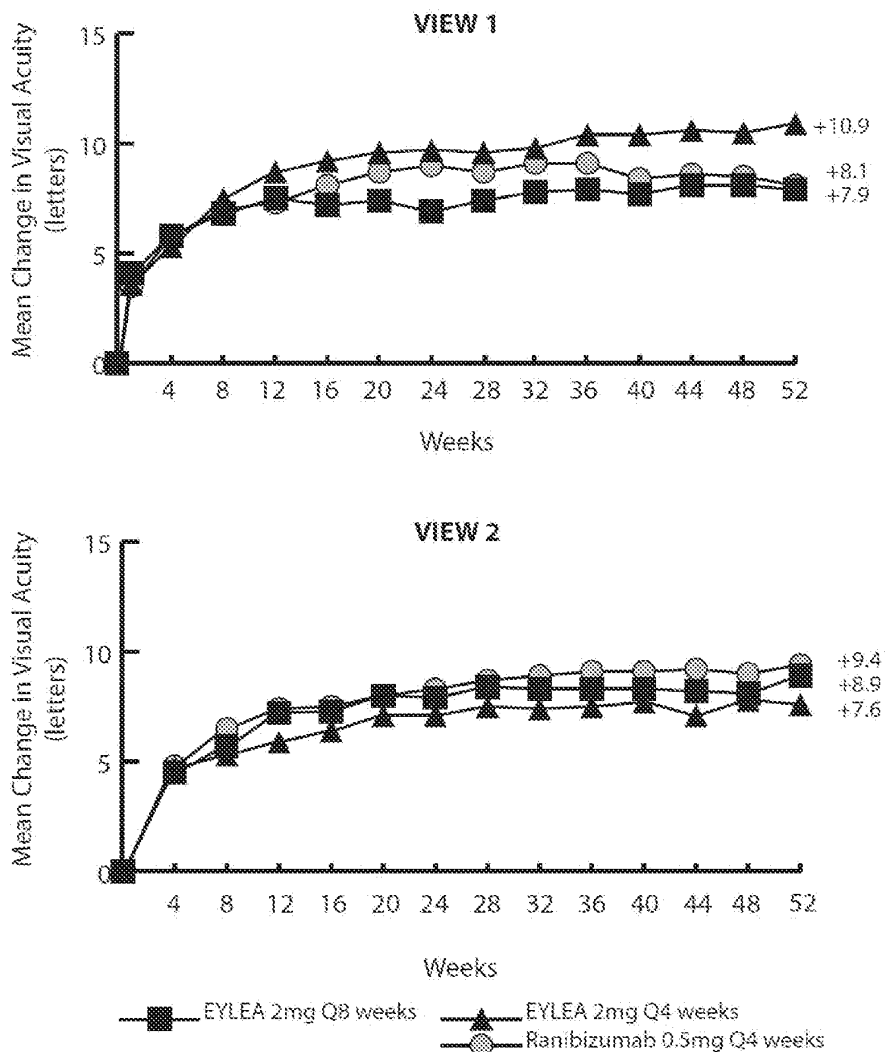
|  | VIEW1                                  |                           |  | VIEW2                                  |                           |  |
|--|--|---------------------------|--|--|---------------------------|--|
|  | EYLEA<br>2 mg Q8<br>weeks <sup>a</sup> | EYLEA<br>2 mg Q4<br>weeks | ranibizu-<br>mab<br>0.5 mg Q4<br>weeks | EYLEA<br>2 mg Q8<br>weeks <sup>a</sup> | EYLEA<br>2 mg Q4<br>weeks | ranibizu-<br>mab<br>0.5 mg Q4<br>weeks |
| Full Analysis Set  | N=301                                  | N=304                     | N=304                                  | N=306                                  | N=309                     | N=291                                  |
| <b>Efficacy Outcomes</b>   |  |                           |  |  |                           |  |
| Proportion of patients who maintained visual acuity (%) (<15 letters of BCVA loss) | 94%                                    | 95%                       | 94%                                    | 95%                                    | 95%                       | 95%                                    |
| Difference <sup>b</sup> (%) (95.1% CI)   | 0.6<br>(-3.2, 4.4)                     | 1.3<br>(-2.4, 5.0)        |  | 0.6<br>(-2.9, 4.0)                     | -0.3<br>(-4.0, 3.3)       |  |
| Mean change in BCVA as measured by ETDRS letter score from Baseline                | 7.9                                    | 10.9                      | 8.1                                    | 8.9                                    | 7.6                       | 9.4                                    |
| Difference <sup>b</sup> in LS mean (95.1% CI)                                      | 0.3<br>(-2.0, 2.5)                     | 3.2<br>(0.9, 5.4)         |  | -0.9<br>(-3.1, 1.3)                    | -2.0<br>(-4.1, 0.2)       |  |
| Number of patients who gained at least 15 letters of vision from Baseline (%)      | 92<br>(31%)                            | 114<br>(38%)              | 94<br>(31%)                            | 96<br>(31%)                            | 91<br>(29%)               | 99<br>(34%)                            |
| Difference <sup>b</sup> (%) (95.1% CI)   | -0.4<br>(-7.7, 7.0)                    | 6.6<br>(-1.0, 14.1)       |  | -2.6<br>(-10.2, 4.9)                   | -4.6<br>(-12.1, 2.9)      |  |

BCVA = Best Corrected Visual Acuity; CI = Confidence Interval; ETDRS = Early Treatment Diabetic Retinopathy Study; LOCF = Last Observation Carried Forward (baseline values are not carried forward); 95.1% confidence intervals were presented to adjust for safety assessment conducted during the study.

<sup>a</sup> After treatment initiation with 3 monthly doses

<sup>b</sup> EYLEA group minus the ranibizumab group

**Figure 9: Mean Change in Visual Acuity from Baseline to Week 52 in VIEW1 and VIEW2 Studies**



**16 HOW SUPPLIED/STORAGE AND HANDLING**

Each Vial is for single eye use only. EYLEA is supplied in the following presentation [see *Dosage and Administration (2.3) and (2.4)*].

| NDC NUMBER   | CARTON TYPE | CARTON CONTENTS   |
|--------------|-------------|---|
| 61755-005-02 | Vial        | one single-use, sterile, 3-mL, glass vial containing a 0.278 mL fill of 40 mg/mL EYLEA<br>one 19-gauge x 1½-inch, 5-micron, filter needle for withdrawal of the vial contents<br>one 30-gauge x ½-inch injection needle for intravitreal injection<br>one 1-mL syringe for administration<br>one package insert |

**Storage**

EYLEA should be refrigerated at 2°C to 8°C (36°F to 46°F). Do Not Freeze. Do not use beyond the date stamped on the carton and container label. Protect from light. Store in the original carton until time of use.

**17 PATIENT COUNSELING INFORMATION**

Patients may experience temporary visual disturbances after an intravitreal injection with EYLEA and the associated eye examinations [*see Adverse Reactions (6)*]. Patients should be advised not to drive or use machinery until visual function has recovered sufficiently.

In the days following EYLEA administration, patients are at risk of developing endophthalmitis or retinal detachment. If the eye becomes red, sensitive to light, painful, or develops a change in vision, the patient should seek immediate care from an ophthalmologist [*see Warnings and Precautions (5.1)*].

**REGENERON**

Manufactured by:

Regeneron Pharmaceuticals, Inc.

777 Old Saw Mill River Road

Tarrytown, NY 10591-6707

U.S. License Number 1760

EYLEA™ is a trademark of Regeneron Pharmaceuticals, Inc.

© 2011, Regeneron Pharmaceuticals, Inc.

All rights reserved.

V1.0

Issue Date: November /2011

Initial U.S. Approval: 2011

Regeneron U.S. Patents 7,306,799; 7,531,173; 7,608,261; 7,070,959; 7,374,757; 7,374,758, and other pending patents

FREE

ARVO Annual Meeting Abstract | December 2002

# Inhibition of Corneal Neovascularization and Inflammation by VEGF Trap

J Cao; R Renard; Q Wang; GD Yancopoulos; SJ Wiegand

+ Author Affiliations & Notes

Investigative Ophthalmology & Visual Science December 2002, Vol.43, 1863. doi:

## Abstract

**Abstract:** : **Purpose:** To determine the efficacy of a new angiogenesis inhibitor VEGF Trap on the development of corneal neovascularization. Systemic administration of the VEGF Trap (a fusion protein comprising the ligand binding domains of VEGF receptors and Human Fc) was investigated in two mouse models of corneal injury. **Methods:** Corneal neovascularization was induced by intrastromal placement of 3 nylon sutures, or by chemical injury and mechanical debridement of the corneal epithelium in male C57BL mouse. The VEGF Trap (25mg/kg body weight) was administered systemically, once or at multiple time points before or following injury. The growth of corneal neovessels was evaluated on days 4, 7, 9 and 16 by slit-lamp microscopy and histologically. The vasculature was labeled with an endothelial specific fluorescein conjugated lectin (lycopersicon esculentum), and neovascularization was evaluated in corneal flat-mount, as well as in cross sections using PECAM immunohistochemistry. Corneal edema also was evaluated with slit lamp microscopy and corneal thickness was evaluated in cross-sections. The numbers of polymorphonucleocytes (PMN) and macrophages were determined by staining cross-sections with HEMA-3 or rat anti-mouse F4/80 monoclonal antibody, respectively. The Scion Image program was used for analysis of the area and length of corneal neovessels. **Results:** VEGF Trap treatment significantly inhibited corneal neovascularization in all dosing regimens tested, in both suture ( $P < 0.001$ ) and chemical injury ( $P < 0.001$ ) models. When treatment was begun within 5 days of injury, corneal neovascularization was completely blocked. Corneal edema also was significantly reduced in VEGF Trap treated animals compare to vehicle treated controls, and histological studies showed that the infiltration of PMNs and macrophages into the damaged cornea was also dramatically reduced with VEGF Trap treatment. **Conclusion:** VEGF Trap inhibited the



development of corneal neovascularization, effectively prevented edema, and markedly reduced the infiltration of leukocytes and macrophages in both corneal injury models. These results indicate that VEGF Trap is a potent inhibitor of pathologic angiogenesis, with potential therapeutic applications in the treatment of corneal neovascularization. CR: E

**Keywords:** 390 drug toxicity/drug effects • 483 neovascularization • 437 inflammation

© 2002, The Association for Research in Vision and Ophthalmology, Inc., all rights reserved. Permission to republish any abstract or part of an abstract in any form must be obtained in writing from the ARVO Office prior to publication.

FREE

ARVO Annual Meeting Abstract | May 2005

# Systemic Administration of VEGF Trap Suppresses Vascular Leak and Leukostasis in the Retinas of Diabetic Rats

J. Cao; H. Song; R.A. Renard; Y. Liu; G.D. Yancopoulos; S.J. Wiegand

+ Author Affiliations & Notes

Investigative Ophthalmology & Visual Science May 2005, Vol.46, 446. doi:

## Abstract

**Abstract:** **Purpose:** To determine whether the VEGF Trap (a potent VEGF inhibitor comprising portions of the ligand binding domains of VEGF receptors 1 and 2 coupled to human Fc), can reverse breakdown of blood-retinal barrier and ameliorate retinal leukostasis in diabetic rats. **Methods:** Diabetes was induced in male Sprague-Dawley rats by an intraperitoneal injection of streptozotocin (STZ, 60 mg/kg). Blood glucose levels were monitored 24 hours later and weekly thereafter, and all animals used in the following experiment maintained blood glucose levels in excess of 250 mg/dL. Two or four weeks after induction of diabetes, VEGF Trap (12.5 mg/kg) or a vehicle solution was administered subcutaneously. The effect of treatment on retinal vascular permeability was determined 48 hours later by measuring retinal content of extravasated Evans Blue (EB) dye, as described previously. The effect of VEGF Trap on retinal leukostasis also was evaluated by perfusion of control and treated animals with fluoresceinated concanavalin A to label adherent leukocytes in the retina. The numbers of leukocytes were counted in flat-mounted retinas under a fluorescence microscope. **Results:** Compared with non-diabetic controls, the eyes of diabetic rats showed an ~3-fold increase in the number of adherent leukocytes and a 2~3-fold increase in EB content, indicative of increased retinal vascular permeability. Compared to vehicle treated diabetic controls, systemic administration of VEGF Trap significantly reduced EB extravasation ( $p < 0.005$ ) and substantially suppressed leukostasis ( $p < 0.001$ ) at both 2 and 4 weeks following the induction of diabetes. **Conclusions:** Systemic administration of VEGF Trap significantly reduces the retinal vascular permeability and leukostasis in diabetic rats. These results indicate that VEGF Trap may prove useful in the treatment of diabetic retinopathy and macular edema. CR: E

**Keywords:** diabetic retinopathy • growth factors/growth factor receptors • inflammation

© 2005, The Association for Research in Vision and Ophthalmology, Inc., all rights reserved.  
Permission to republish any abstract or part of an abstract in any form must be obtained in  
writing from the ARVO Office prior to publication.

# Inhibition of Hemangiogenesis and Lymphangiogenesis after Normal-Risk Corneal Transplantation by Neutralizing VEGF Promotes Graft Survival

Claus Cursiefen,<sup>1,2,3</sup> Jingtai Cao,<sup>4</sup> Lu Chen,<sup>1</sup> Ying Liu,<sup>1</sup> Kazuichi Maruyama,<sup>1</sup> David Jackson,<sup>5</sup> Friedrich E. Kruse,<sup>3</sup> Stanley J. Wiegand,<sup>4</sup> M. Reza Dana,<sup>1</sup> and J. Wayne Streilein<sup>1,6</sup>

**PURPOSE.** To evaluate the occurrence and time course of hem- and lymphangiogenesis after normal-risk corneal transplantation in the mouse model and to test whether pharmacologic strategies inhibiting both processes improve long-term graft survival.

**METHODS.** Normal-risk allogeneic (C57BL/6 to BALB/c) and syngeneic (BALB/c to BALB/c) corneal transplantations were performed and occurrence and time course of hem- and lymphangiogenesis after keratoplasty was observed, by using double immunofluorescence of corneal flatmounts (with CD31 as a panendothelial and LYVE-1 as a lymphatic vascular endothelium-specific marker). A molecular trap designed to eliminate VEGF-A (VEGF Trap<sub>R1R2</sub>; 12.5 mg/kg) was tested for its ability to inhibit both processes after keratoplasty and to promote long-term graft survival (intraperitoneal injections on the day of surgery and 3, 7, and 14 days later).

**RESULTS.** No blood or lymph vessels were detectable immediately after normal-risk transplantation in either donor or host cornea, but hem- and lymphangiogenesis were clearly visible at day 3 after transplantation. Both vessel types reached donor tissue at 1 week after allografting and similarly after syngeneic grafting. Early postoperative trapping of VEGF-A significantly reduced both hem- and lymphangiogenesis and significantly improved long-term graft survival (78% vs. 40%;  $P < 0.05$ ).

**CONCLUSIONS.** There is concurrent, VEGF-A-dependent hem- and lymphangiogenesis after normal-risk keratoplasty within the preoperatively avascular recipient bed. Inhibition of hem- and lymphangiogenesis (afferent and efferent arm of an immune

response) after normal-risk corneal transplantation improves long-term graft survival, establishing early postoperative hem- and lymphangiogenesis as novel risk factors for graft rejection even in low-risk eyes. (*Invest Ophthalmol Vis Sci.* 2004;45:2666-2673) DOI:10.1167/iov.03-1380

Corneal transplantation is the oldest, most successful, and most commonly performed tissue transplantation, with nearly 40,000 transplantations a year alone in the United States.<sup>1</sup> When corneal grafts are placed into an avascular recipient bed (so-called normal-risk keratoplasty), 2-year graft survival rates approach 90% under cover of topical steroids, even without HLA-matching.<sup>2</sup> This very successful outcome is attributable to corneal immune privilege (i.e., the phenomenon of suppressed corneal inflammation induced by an array of endogenous mechanisms that downregulate alloimmune and inflammatory responses in the cornea and its bed). These mechanisms include the lack of both afferent lymphatic and efferent blood vessels in the normal-risk recipient cornea, lack of MHC II<sup>+</sup> antigen-presenting cells (APCs), FASL-expression on corneal epithelium and endothelium, and the anterior chamber associated immune privilege (ACAID) directed at graft antigens, for example (for review see Ref. 1). In contrast, survival rates of corneal grafts placed into vascularized, not immune-privileged recipient beds (so called high-risk keratoplasty) decrease significantly to below 50% (even with local and systemic immune suppression).<sup>3,4</sup> Preexisting corneal stromal blood vessels have been identified as strong risk factors for immune rejection after corneal transplantation, both in the clinical setting<sup>4</sup> and in the well-defined mouse model of corneal transplantation.<sup>5</sup> Recently, in addition to blood vessels, biomicroscopically undetectable lymphatic vessels have been found in association with blood vessels in vascularized high-risk human corneas,<sup>6,7</sup> and it is likely that corneal lymphatic vessels enable effective access of donor and host APCs and antigenic material to regional lymph nodes where accelerated sensitization to graft antigens occurs.<sup>8</sup>

But even in the normal-risk setting (with a preoperatively avascular recipient bed), mild corneal hemangiogenesis develops after keratoplasty<sup>9-11</sup>. Outgrowth of new blood vessels from the limbal arcade toward the graft can be observed within the first postoperative year in approximately 50% of patients undergoing normal-risk keratoplasty, and in 10% of patients these new blood vessels even reach the interface or invade donor tissue<sup>11</sup> at corneal suture sites and then proceed centrally.<sup>9-11</sup>

Both hem- and lymphangiogenesis (i.e., the outgrowth of new blood vessels versus lymphatic vessels from preexisting vessels) are mediated by members of the VEGF growth factor family: VEGF (VEGF-A) induces hem- and lymphangiogenesis by binding to VEGF receptor (VEGFR)-1 and -2. VEGF-B reacts only with VEGFR1. The lymphangiogenic molecules VEGF-C and VEGF-D both bind to VEGFR2 and VEGFR3 (for review see Ref. 12). In tumor hemangiogenesis as well as in other condi-

From <sup>1</sup>The Schepens Eye Research Institute, Department of Ophthalmology, Harvard Medical School, Boston, Massachusetts; <sup>4</sup>Regeneron Pharmaceuticals Inc., Tarrytown, New York; the <sup>5</sup>Medical Research Council Human Immunology Unit, Institute of Molecular Medicine, Oxford, United Kingdom; and <sup>3</sup>the Department of Ophthalmology, Friedrich-Alexander-University Erlangen-Nürnberg, Erlangen, Germany.

<sup>2</sup>Present affiliation: Department of Ophthalmology, Friedrich-Alexander-University Erlangen-Nürnberg, Erlangen, Germany.

<sup>6</sup>Deceased March 15, 2004.

Supported by Deutsche Forschungsgemeinschaft (German Research Foundation) Grants Cu 47/1-1 and Cu 47/1-2, and National Eye Institute Grant EY10765.

Submitted for publication December 19, 2003; revised April 5, 2004; accepted April 13, 2004.

Disclosure: C. Cursiefen, None; J. Cao, Regeneron Pharmaceuticals Inc. (F); L. Chen, None; Y. Liu, None; K. Maruyama, None; D. Jackson, None; F.E. Kruse, None; S.J. Wiegand, Regeneron Pharmaceuticals Inc. (E, F); M.R. Dana, None; J.W. Streilein, None

The publication costs of this article were defrayed in part by page charge payment. This article must therefore be marked "advertisement" in accordance with 18 U.S.C. §1734 solely to indicate this fact.

Corresponding author: Joan Stein-Streilein, Schepens Eye Research Institute, Harvard Medical School, 20 Staniford Street, Boston, MA 02114; jstein@vision.eri.harvard.edu.

tions of hypoxic and inflammatory hemangiogenesis, VEGF-A through VEGFR2-ligation has emerged as the main growth factor that induces hemangiogenesis.<sup>12</sup>

Using the mouse model of normal-risk keratoplasty, the present study analyzed (1) whether lymphangiogenesis accompanies hemangiogenesis after normal-risk keratoplasty, (2) the time course of blood and lymphatic vessel outgrowth after keratoplasty, (3) whether there is a difference in postkeratoplasty angiogenesis between syngeneic and allogeneic grafting, and (4) whether inhibition of hem- and lymphangiogenesis by a molecular trap designed to eliminate VEGF-A (VEGF Trap<sub>R1R2</sub>) promotes long-term graft survival in the normal-risk keratoplasty setting.

## METHODS

### Mice and Anesthesia

Six- to 8-week-old male C57BL/6 mice were used as donors, and same-aged male BALB/c mice (Taconic, Germantown, NY) as recipients in the mouse model of normal-risk keratoplasty.<sup>13</sup> For syngeneic transplantations, 6- to 8-week-old male BALB/c mice were used both as donors and as recipients. For the dose-response studies, 8-week-old male C57BL/6 mice were used. All animals were treated in accordance with the ARVO Statement for the Use of Animals in Ophthalmic and Vision Research. Mice were anesthetized using a mixture of ketamine and xylazine (120 mg/kg and 20 mg/kg body weight, respectively).

### Dose-Response of VEGF Trap<sub>R1R2</sub>

To establish the minimum dose of VEGF Trap<sub>R1R2</sub>, a molecular trap for VEGF-A (described later), that would effectively suppress corneal neovascularization for at least 1 week, five different doses of VEGF Trap<sub>R1R2</sub> were tested in mice, which received three interrupted intrastromal sutures (10-0 nylon, 50  $\mu$ m-diameter; Sharpoint, Surgical Specialties Corp., Reading, PA;  $n = 5$  mice per dosage). Gentamicin and ophthalmic ointment were applied immediately after surgery. After surgery (day 0), mice received a single subcutaneous injection of VEGF Trap<sub>R1R2</sub> (25, 12.5, 6.25, 2.5 or 0.5 mg/kg) or human Fc (12.5 mg/kg; control). Corneas were harvested on day 9 after suture placement, after an intravenous administration of an endothelium-specific fluorescein-conjugated lectin (*Lycopersicon esculentum*; Vector Laboratories, Burlingame, CA). The isolated corneas were flatmounted on glass slides, and images of lectin-labeled vessels were captured with a digital camera (Spot RT; Diagnostic Instruments, Inc., Sterling Heights, MD) attached to a microscope (Microphot-FXA; Nikon Inc., Garden City, NY). Image-analysis software (Image 1.62c; Scion Corporation, Frederick, MD) was used to quantify the extent of corneal neovascularization.

### Corneal Transplantation in Mice

Orthotopic corneal allografting in the mouse model of normal-risk keratoplasty was performed as described previously.<sup>13</sup> Donor corneas were excised by trephination using a 2.0 mm bore and cut with curved Vannas scissors. Until grafting, corneal tissue was placed in chilled phosphate-buffered saline (PBS). Recipients were anesthetized, and the graft bed was prepared by trephining a 1.5-mm site in the central cornea of the right eye and discarding the excised cornea. The donor cornea was immediately applied to the bed and secured in place with eight interrupted sutures (11-0 nylon, 70- $\mu$ m diameter needles; Arosurgical, Newport Beach, CA). Antibiotic ointment (Oxymycin; Pharmafair, Hauppauge, NY) was placed on the corneal surface and the eyelids sutured with 8-0 suture (Sharpoint, Surgical Specialties Corp.). Recipients of grafts in which bleeding developed in the immediate postoperative period were discarded from further evaluation. All grafted eyes were examined after 72 hours, and grafts with technical difficulties (hyphema, cataract, infection, loss of anterior chamber) were excluded from further consideration. Tarsorrhaphy and corneal sutures were removed after 7 days, and grafts were then examined at least twice a

week until week 8 after transplantation by slit lamp microscopy and scored for opacity as described previously.<sup>13</sup> The survival experiment was performed twice and comprised 10 and 12 mice per experiment in both groups. Clinical scores of corneal grafts for opacity were as follows: 0, clear; +1, minimal, superficial (nonstromal) opacity; pupil margin and iris vessels readily visible through the cornea; +2, minimal, deep (stromal) opacity; pupil margins and iris vessels visible; +3, moderate stromal opacity; only pupil margin visible; +4, intense stromal opacity; only a portion of pupil margin visible; and +5, maximum stromal opacity; anterior chamber not visible. Grafts with opacity scores of +2 or greater after 2 weeks were considered to have been rejected.<sup>13</sup> Syngeneic transplantations were performed and evaluated in a similar manner.

### Immunohistochemistry and Morphometry of Angiogenesis and Lymphangiogenesis in the Cornea

Briefly, corneal flatmounts were rinsed in PBS, fixed in acetone, rinsed in PBS, blocked in 2% bovine serum albumin, stained with FITC-conjugated CD31/platelet-endothelial cell adhesion molecule (PECAM)-1 overnight (1:100; Santa Cruz Biotechnology, Santa Cruz, CA), washed, blocked, stained with LYVE-1 (1:500; a lymphatic endothelium-specific hyaluronic acid receptor),<sup>6,14</sup> washed, blocked, and stained with Cy3 (1:100; Jackson ImmunoResearch Laboratories, West Grove, PA), and analyzed by microscope (AxioPhot; Carl Zeiss Meditec). Digital pictures of the flatmounts were taken with an image-analysis system (Spot; Diagnostic Instruments). Then, the area covered by CD31<sup>3+</sup>/LYVE-1<sup>-</sup> blood vessels and CD31<sup>+</sup>/LYVE-1<sup>3+</sup> lymph vessels<sup>6</sup> was measured morphometrically on the flatmounts with NIH Image software (available by ftp at zippy.nimh.nih.gov/ or at http://rsb.info.nih.gov/nih-image; developed by Wayne Rasband, National Institutes of Health, Bethesda, MD). The total corneal area was outlined, with the innermost vessel of the limbal arcade serving as the border. The total area of blood versus lymphatic neovascularization was then normalized to the total corneal area and the percentage of the cornea covered by each vessel type calculated.

### Neutralization of VEGF-A with a Cytokine Trap: VEGF Trap<sub>R1R2</sub>

A newly designed molecular trap for VEGF-A, VEGF Trap<sub>R1R2</sub>, comprising the receptor binding domains of VEGF receptor 1 and 2 coupled to a human Fc fragment (Regeneron Pharmaceuticals Inc., Tarrytown, NY)<sup>15</sup> was used in the transplant survival experiment at a concentration of 12.5 mg/kg intraperitoneally (IP) at time of surgery (CHO hVEGFR1 [Ig domain 2], R2 [Ig domain 3]-Fc), and 3, 7, and 14 days after surgery.<sup>15</sup> Human Fc-fragment given IP at same concentration and times was used in the control mice (sCHO h Fc).

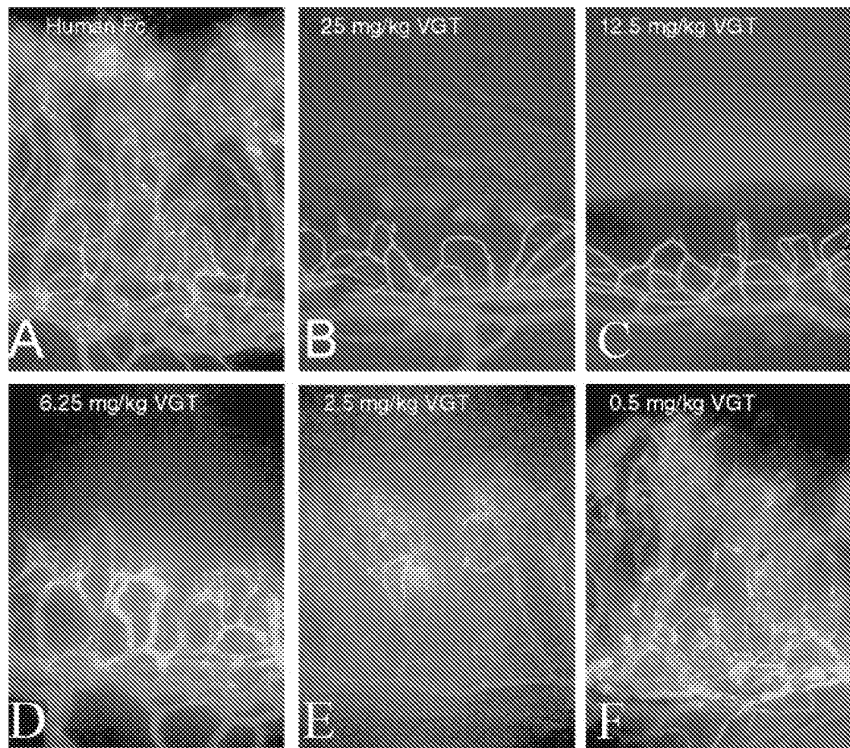
### Statistical Analysis

Statistical significance was analyzed by the Mann-Whitney test. Differences were considered significant at  $P < 0.05$ . Each experiment was performed at least twice with similar results. Graphs were drawn by computer (Prism, ver. 3.02; Graph Pad, San Diego, CA).

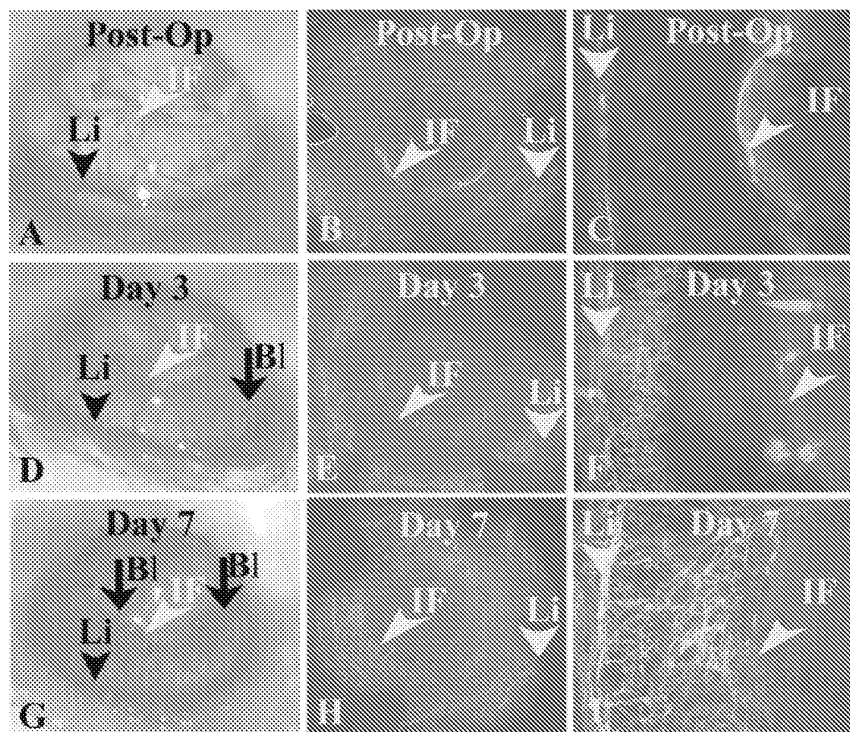
## RESULTS

### Dose-Response of Angiogenesis Inhibition by VEGF Trap<sub>R1R2</sub>

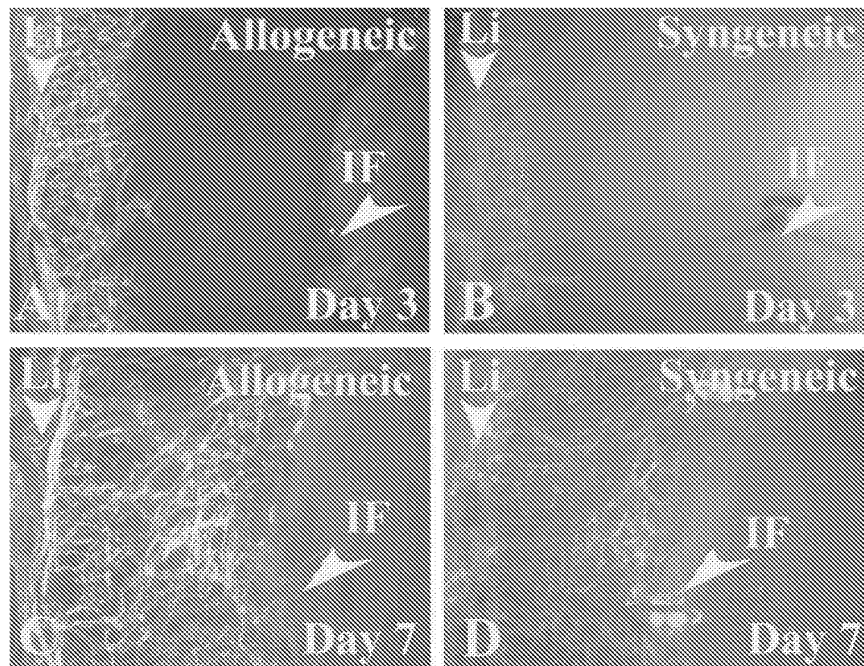
As shown in Figure 1, VEGF Trap<sub>R1R2</sub>, at doses of 25 or 12.5 mg/kg, completely inhibited suture-induced inflammatory corneal neovascularization. In contrast, doses of 6.25 and 2.5 mg/kg produced ~50% and ~20% inhibition of corneal neovascularization, respectively, whereas the lowest dose tested, 0.5 mg/kg, had a negligible effect (<5% inhibition). Therefore,



**FIGURE 1.** Dose-response of the antiangiogenic effect of VEGF Trap<sub>R1R2</sub>. Immediately after placement of intrastromal corneal sutures, mice received human Fc protein (control: **A**) or 25 (**B**), 12.5 (**C**), 6.25 (**D**), 2.5 (**E**), or 0.5 (**F**) mg/kg VEGF Trap<sub>R1R2</sub>. The dose of 12.5 mg/kg was the lowest that provided complete inhibition of suture-induced corneal neovascularization (as measured in lectin-stained corneal flatmounts 9 days after suture placement; the limbal vascular arcade is located at the bottom of each image). Magnification,  $\times 100$ .

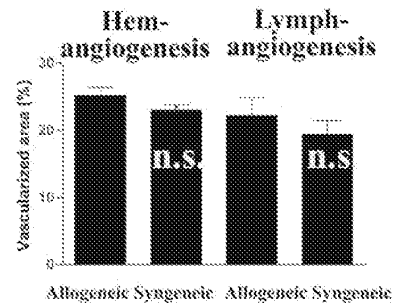


**FIGURE 2.** Early, combined induction of hem- and lymphangiogenesis after normal-risk allogeneic keratoplasty. There was neither biomicroscopically (**A**) nor immunohistochemically (**B/C**: CD31<sup>+</sup> blood vessels: green; LYVE-1<sup>+</sup> lymphatic vessels: red) detectable hem- or lymphangiogenesis immediately after normal-risk allogeneic keratoplasty (**B**: corneal flatmount; **C**: detail from **B**). By day 3 after surgery (**D-F**), corneal blood vessels (**B**) grew into the avascular recipient beds. Immunostaining revealed new blood vessels to be accompanied by lymphatic vessels (**E, F**: red vessels). Both vessel types penetrated approximately 30% to 50% from the limbus to the graft bed. One week after normal-risk keratoplasty (**G-I**) both vessel types had already reached donor tissue and spread along the interface (**H, I**), but these vessels rarely invade donor tissue. Li, limbal vascular arcade; IF, interface.



**FIGURE 3.** Combined induction of hem- and lymphangiogenesis after allogeneic and syngeneic keratoplasty. Allogeneic cornea grafts (A, C: C57BL/6 to BALB/c) and syngeneic corneal grafts (B, D: BALB/c to BALB/c) were compared. The micrographs depict representative segments from corneal flatmounts at days 3 (A, B) and 7 (C, D) after grafting. The limbal vascular arcade (Li) is at the *left*; the graft-bed-interface (IF) is at the *right*. (E) Morphometric comparison reveals no significant differences between allo- and syngeneic grafting with respect to hem- and lymphangiogenesis (either at day 3 [shown] or at day 7 [not shown];  $n = 8$  mice per group).

**E**



for subsequent experiments, a dose of 12.5 mg/kg VEGF Trap<sub>R1R2</sub> was chosen.

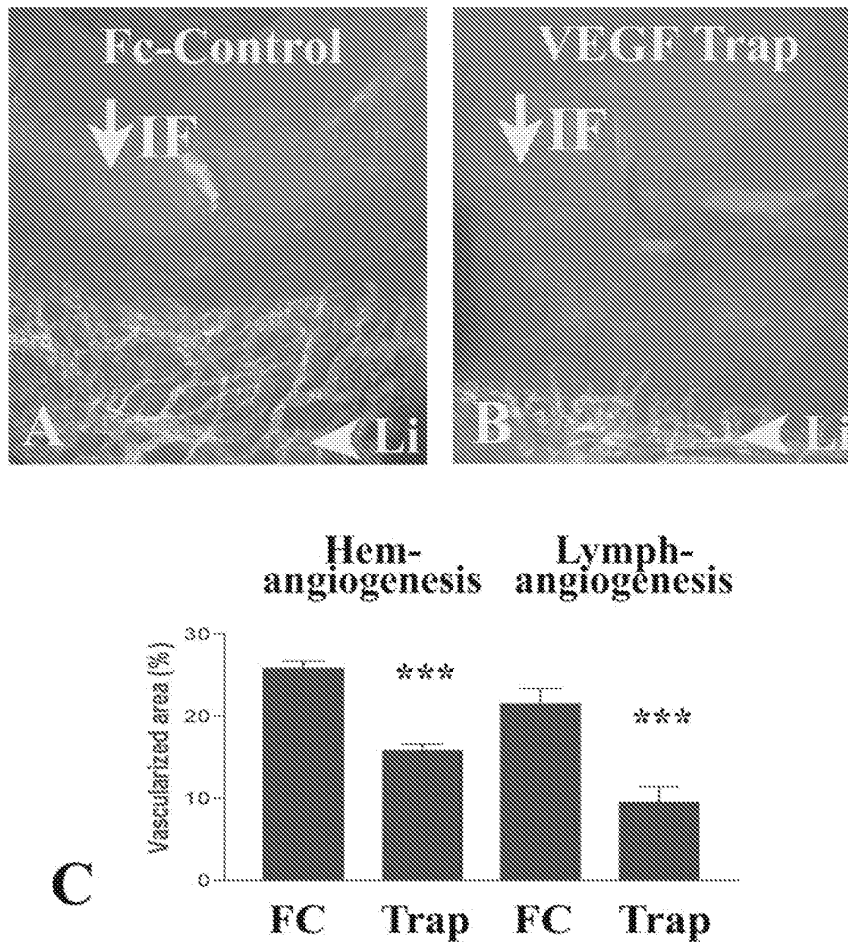
#### Rapid and Parallel Onset of Hemangiogenesis and Lymphangiogenesis after Normal-Risk Allogeneic Corneal Transplantation

To determine whether the mild and temporary hemangiogenesis occurring *after* normal-risk keratoplasty is accompanied by lymphatic vessel outgrowth from the limbus into the normally alymphatic cornea, we studied the time course of ingrowth of both vessel types at days 0, 3, 7, 14, 21, and 28 after allogeneic keratoplasty (only accepted grafts). Immediately after surgery, blood, and lymphatic vessels were not detectable either in the host or in donor tissue using biomicroscopy and immunohistochemistry on corneal flatmounts (Fig. 2). But, at day 3 after allografting, both methods revealed new blood vessels growing into the cornea already one third to one half the way toward the graft interface. By day 7, these vessels had usually reached the donor tissue, but they rarely invaded the donor tissue itself. Analyzing flatmounts stained with LYVE-1 as a lymphatic vessel-specific marker showed that CD31<sup>3+</sup>/LYVE-1<sup>-</sup> blood vessels were regularly accompanied by LYVE-1<sup>3+</sup>/CD31<sup>+</sup> lym-

phatic vessels (Fig. 2). Both vessel types reached the interface simultaneously at day 7. Thereafter, coincident with suture removal, both vessel types started to regress (if no immune rejection occurred; data not shown).

#### Difference in Postkeratoplasty Hem- and Lymphangiogenesis between Syngeneic and Allogeneic Corneal Transplantation

To determine whether the simultaneous induction of hem- and lymphangiogenesis after normal-risk keratoplasty is primarily an effect of the surgical trauma, suturing, and wound-healing processes or is secondary to early immunologic rejection reactions, we compared the speed and extent of both hem- and lymphangiogenesis occurring after keratoplasty between allogeneic (C57BL/6 into BALB/c) and syngeneic grafts (BALB/c into BALB/c) at days 3, 7, 14, 21, and 28 after transplantation (Fig. 3). In both groups, blood and lymphatic vessels grew out after keratoplasty and by day 3 reached approximately one third to one half of the limbus-interface distance. At day 7 after syngeneic and allogeneic grafting, both vessel types had reached the interface, before they started to regress. Furthermore, there was no significant difference in the hem- and



**FIGURE 4.** Effect of pharmacologic neutralization of VEGF-A on hem- and lymphangiogenesis after normal-risk allogeneic keratoplasty. Compared with the Fc-treated control (A), VEGF-A neutralization using VEGF Trap<sub>R1R2</sub> (B) inhibited both clinically visible hemangiogenesis (green) as well as biomicroscopically invisible LYVE-1<sup>+</sup> lymphangiogenesis (red; shown as detail from corneal flat-mounts; between donor at bottom and host at top). (C) Morphometry at day 3 after penetrating keratoplasty demonstrates significant inhibition of both hem- and lymphangiogenesis by VEGF-A neutralization ( $P < 0.001$ ;  $n = 6$  per group). Li, limbus; IF, interface.

lymphovascularized area, comparing syngeneic and allogeneic grafts at 3 days (allogeneic with hemovascularized area [HA]  $25.2 \pm 4.1\%$  and lymphovascularized area [LA]  $22.2 \pm 9.4\%$  vs. syngeneic HA:  $23 \pm 2.7\%$  and LA  $19.4 \pm 7.2\%$ ) and 7 days (allogeneic HA:  $53.8 \pm 11.2\%$  and LA:  $37.9 \pm 6.2\%$  vs. syngeneic HA:  $55.9 \pm 8.2\%$  and LA:  $38 \pm 22.7\%$ ) after surgery ( $n = 8$  mice per group per time point).

#### Effect of Neutralization of VEGF-A after Normal-Risk Keratoplasty on Postoperative Hemangiogenesis and Lymphangiogenesis

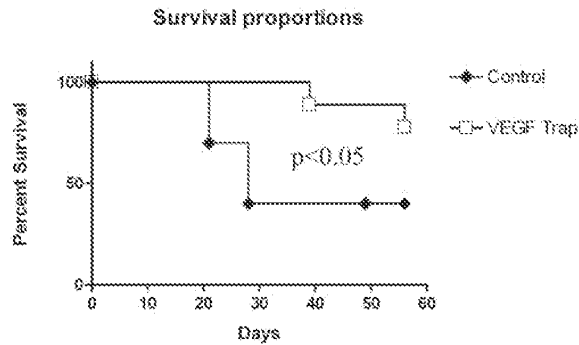
To determine the extent to which combined hem- and lymphangiogenesis occurring after keratoplasty depends on VEGF-A, we analyzed the effect of pharmacological neutralization of VEGF-A using a novel cytokine trap (VEGF Trap<sub>R1R2</sub>).<sup>15,16</sup> Mice received either intraperitoneal injections of VEGF Trap<sub>R1R2</sub> (12.5 mg/kg) at surgery and 3 days later. Control animals received the Fc-protein in the same dosage. At day 3 and 7 after surgery, the extent of hem- and lymphangiogenesis was compared between these two groups ( $n = 6$  mice per group per time point). At days 3 and 7 after surgery, the hemovascularized area was significantly smaller in trap-treated mice (day 3:  $15.8 \pm 4.0\%$ ; day 7:  $25.2 \pm 13.3\%$ ) compared with mice receiving only the Fc-fragment (day 3:  $25.8 \pm 4.4\%$ ; day 7:  $48.3 \pm 12.8\%$ ;  $P < 0.0001$ ; Fig. 4). This was also true of the lymphovascularized area comparing Trap- ( $9.5 \pm$

$9.4\%$ ) and Fc-treated mice on day 3 ( $21.5 \pm 9.3\%$ ;  $P < 0.0001$ ). At day 7, the lymphovascularized area was smaller, but not significantly different in the Trap-group ( $28.7 \pm 20.3\%$ ) compared with the Fc-group ( $51.5 \pm 23.8\%$ ;  $P = 0.06$ ). In contrast to results obtained in corneal injury models (Cao et al., manuscript submitted)<sup>16</sup> neither hem- or lymphangiogenesis was completely inhibited by the VEGF Trap<sub>R1R2</sub> after corneal transplantation. However, the number of lymphatic vessels reaching the graft-host interface ( $10.6 \pm 0.6$  vs.  $1.3 \pm 1.5$  vessels) and the number of hours that the interface was filled with draining lymphatic vessels were much more in the Fc-treated than in the Trap-treated group at day 7 ( $3 \pm 2$  vs.  $0.2 \pm 0.3$  hours; not significant due to small sample size). This may indicate that lymphovascularized area per se is less decisive for host sensitization than the contact area with donor tissue (described later).

#### Effect on Graft Survival of Partial Inhibition of Early Postoperative Hem- and Lymphangiogenesis by Trapping VEGF-A after Normal-Risk Surgery

Because hem- and lymphangiogenesis that occurred after normal-risk keratoplasty peaked around day 7, and regressed thereafter, and because both vascular processes could be significantly inhibited by early postoperative neutralization of





**FIGURE 5.** Effect of pharmacologic neutralization of VEGFA on survival of allogeneic cornea grafts. Panels of BALB/c mice received orthotopic transplants from C57BL/6 donors in one low-risk eye. The recipients in one panel were treated with VEGF Trap<sub>R1R2</sub>, whereas the other panel (control) received Fc-fragments only. Survival of grafts in mice treated with VEGF Trap was significantly greater than in control animals (78% vs. 40%;  $P < 0.05$ ;  $n = 22$  mice in both groups).

VEGF-A, we determined whether inhibition of postkeratoplasty hem- and lymphangiogenesis during this interval improved graft survival. The long-term survival of C57BL/6 grafts placed into avascular BALB/c recipient beds was compared between mice receiving an IP injection of 12.5 mg/kg VEGF Trap<sub>R1R2</sub> and those receiving Fc-fragment alone, at surgery and 3, 7, and 14 days later. As Figure 5 shows, trapping of VEGF-A caused significantly improved long-term graft survival at 8 weeks after surgery (78%), compared with grafts in eyes of Fc-treated control mice (40%;  $P = 0.044$ ;  $n = 22$  in both groups).

## DISCUSSION

Whereas *preexisting* corneal blood vessels have long been established as risk factors for immune rejection after corneal transplantation,<sup>9,13</sup> the pathogenesis, potential association with lymphangiogenesis, and immunologic importance of mild hemangiogenesis *after* normal-risk keratoplasty have yet to be determined.<sup>9-11</sup> Using the mouse model of normal-risk keratoplasty, we provide novel evidence (1) that normal-risk keratoplasty itself promotes parallel and rapid outgrowth of both blood and lymphatic vessels into the avascular recipient bed; (2) that because there was no significant difference between postoperative hem- and lymphangiogenesis comparing syngeneic and allogeneic corneal grafting, early postoperative release of hem- and lymphangiogenic growth factors seems to be triggered mainly by surgical trauma, wound-healing, and corneal suturing rather than immune rejection; (3) that neutralization of VEGF-A after surgery not only inhibited hem- and lymphangiogenesis, but promoted long-term corneal allograft survival. The results establish hem- and lymphangiogenesis occurring after normal-risk keratoplasty as *novel* risk factors for subsequent immune rejections.

The molecular trap (VEGF Trap<sub>R1R2</sub>) used in this study neutralized VEGF-A and PlGF with high affinity. Neutralization of VEGF-A has recently been shown to inhibit not only hem- and lymphangiogenesis, but also to interfere with recruitment of inflammatory cells into the cornea (Cao J, et al., manuscript submitted).<sup>16</sup> This effect of VEGF neutralization has been attributed to inhibition of neutrophil and macrophage chemotaxis mediated by ligation of VEGFR1.<sup>17,18</sup> Trapping of VEGF-A thereby exerts direct and indirect antiangiogenic effects. Therefore, the graft survival-promoting effect of VEGF-A neutralization can also be attributed to multiple mechanisms. First,

inhibition of hem- and lymphangiogenesis after keratoplasty interferes with the development of both an afferent (lymphatic vessels) and an efferent pathway (blood vessels) for a subsequent immune response.<sup>1,7</sup> In addition, trapping of VEGF-A may impede the recruitment of APCs to the graft bed.

The relative importance of heme versus lymphangiogenesis after normal-risk keratoplasty for subsequent immune rejections remains unknown, because in this study both processes were equally inhibited by VEGF Trap<sub>R1R2</sub>. On the one hand, *blood vessels* reaching the graft are essential for delivery of APCs and alloreactive T-lymphocytes to the graft. On the other hand, *lymphatic vessels* seem to facilitate escape of APCs to regional lymph nodes, enhancing allosensitization. However, studies demonstrating that removal of regional lymph nodes can promote complete survival of corneal allografts placed in high- and normal-risk settings,<sup>19,20</sup> and a study demonstrating increased transport of donor APCs to regional lymph nodes in inflamed (and probably lymphovascularized) beds,<sup>8</sup> suggest that *afferent* corneal lymphatics that promote sensitization may be equal, or even more important than *efferent* corneal blood vessels that provide an entry route for immune effector cells.

Corneal allograft survival in the normal-risk mouse model (C57BL/6 to BALB/c) is reduced from around 50% after 8 weeks to 0% after 2 weeks, if the recipient bed is prevascularized.<sup>5,21</sup> We have demonstrated parallel outgrowth of both blood and lymphatic vessels in this model,<sup>16</sup> implying that donor tissue has immediate access to draining host lymphatic vessels after high-risk grafting and is exposed to efferent host blood vessels. Because we demonstrated in the current study that 1 week after normal-risk keratoplasty both vessels types also reached donor tissue, the question arises of why the survival rates between C57BL/6 grafts placed into avascular, but neovascularizing versus already neovascularized graft beds, are so different. One explanation concerns the possibility of a time-dependent *window of opportunity* during which recipient sensitization to donor alloantigens after keratoplasty leads to graft rejection. Whereas grafts placed in high-risk eyes induce donor-specific sensitization promptly (within 7 days),<sup>5</sup> presumably because antigens have access to draining lymph nodes through preestablished lymphatics, by contrast, allografts placed in low-risk eyes do not generate sensitization until 2 to 4 weeks after grafting,<sup>22</sup> probably reflecting the time needed for lymphangiogenesis to develop. Once the drainage system is established, graft-derived antigens reach the local lymph node, and activate donor-specific alloreactive T-cells, which can cause rejection. If, however, sensitized T cells disseminate only after 14 to 21 days, these effectors must compete with the regulatory T-cells of ACAID which begin to emerge at that time.<sup>23</sup> Neutralization of VEGF-A at the time of surgery retards lymphangiogenesis in the graft bed, thus narrowing the window of opportunity during which recipient sensitization takes place and therefore may reflect a shift in the balance of the recipient alloimmune response toward acceptance (ACAID) rather than rejection. This idea is compatible with the observation that a *temporary* depletion of local macrophages by subconjunctival injection of clodronate liposomes at the time of keratoplasty in low-risk eyes achieves *permanent* survival of most of these grafts.<sup>24-25</sup> Other possible explanations include a role for the degree of antigen flow, the APC phenotype, and other related or unrelated differences between these graft types.

Inhibition of both hem- and lymphangiogenesis by neutralization of VEGF-A was incomplete in this study of keratoplasty, whereas the same dosage of VEGF Trap in a previous study completely inhibited both angiogenic processes after corneal suturing.<sup>16</sup> This may suggest that the release of angiogenic factors after corneal transplantation is greater than after suture

placement alone, and that the present dosing regimen is insufficient for complete suppression of angiogenesis in this context. Alternatively, because lymphangiogenesis is thought to be mediated mainly by VEGF-C and -D binding to their high-affinity receptor VEGFR3 on lymphatic vascular endothelium,<sup>12,26-29</sup> and because the VEGF Trap<sub>R1R2</sub> used in this study does not bind VEGF-C and -D,<sup>16</sup> adding VEGFR3-signaling inhibitors to the treatment regimen may more completely inhibit lymphangiogenesis and further improve graft survival after normal-risk keratoplasty. The fact that pharmacological neutralization of VEGF-A, which is mainly thought of as a hemangiogenic growth factor,<sup>12,26-29</sup> significantly inhibited lymphangiogenesis, suggests a novel, important role for VEGF-A in generating lymphangiogenesis and in promoting sensitization to donor antigens. In line with this interpretation, an important role for VEGF-A in another transplant setting was recently demonstrated.<sup>30</sup> For human cardiac allografts a correlation between increased *intra*graft VEGF-levels, inflammatory cell influx and all grades of acute rejection was shown.<sup>30</sup> It has been reported that topically applied anti-VEGF antibodies reduced the degree of inflammation and hemangiogenesis in the rat model of high-risk keratoplasty (Lewis to Fisher rats),<sup>31</sup> and could improve short-term survival of grafts in this high-risk model.<sup>31</sup> The occurrence of lymphangiogenesis or the effect of inhibiting hem- and lymphangiogenesis on long-term survival were not analyzed in this study.<sup>31</sup>

Our finding that there was no difference in early postoperative hem- and lymphangiogenesis after syngeneic versus allogeneic grafting suggests an important role of surgery and surgery-related wound healing in inducing these vascular responses, rather than immunologic mechanisms. This is in line with a previous study in humans in which the degree of postkeratoplasty hemangiogenesis was significantly lower in patients after nonmechanical excimer laser trephination (which induces less vigorous wound healing) than after mechanical trephination.<sup>9</sup> Taken together, the evidence suggests a novel role of surgery/wound healing itself in determining the immunologic fate of corneal grafts and a close association of immune and angiogenic responses in the cornea.<sup>32</sup>

Thinking about translating the results obtained in our study to the clinical setting, one has to keep in mind that important differences exist between penetrating keratoplasty in humans and in the mouse model: continuous suturing in human low-risk patients versus interrupted sutures in mouse surgery, suture placement for over 1 year in patients compared with 1 week in mice and longer distances between interface and vessels at the limbus in patients compared with mice, for example. Therefore, because our results establish hem- and lymphangiogenesis postkeratoplasty as *novel risk factors* for subsequent immune rejections even *after* normal-risk transplantation in the mouse model, it seems reasonable to determine whether this association also holds true for patients, whether there is postkeratoplasty lymphangiogenesis in humans, and when the association is confirmed in patients, to try to inhibit postkeratoplasty neovascularization and improve graft survival.

#### Acknowledgments

The authors thank colleagues at the Schepens Eye Research Institute, especially Jackie Doherty for general support, Don Pottle for help with confocal and immunofluorescent imaging and Stephanie Carroll and Marie Ortega for help with animal housing in the vivarium.

#### References

1. Streilein JW, Yamada J, Dana MR, Ksander BR. Anterior chamber-associated immune deviation, ocular immune privilege, and orthotopic corneal allografts. *Transplant Proc.* 1999;31:1472-1475.
2. Kuehle M, Cursiefen C, Nguyen NX, et al. Risk factors for corneal allograft rejection: intermediate results of a prospective normal-risk keratoplasty study. *Graefes Arch Clin Exp Ophthalmol.* 2002; 240:580-584.
3. Dana MR, Streilein JW. Loss and restoration of immune privilege in eyes with corneal neovascularization. *Invest Ophthalmol Vis Sci.* 1996;37:2485-2494.
4. Maguire MG, Stark WJ, Gottsch JD, et al. Risk factors for corneal graft failure and rejection in the collaborative corneal transplantation studies: collaborative Corneal Transplantation Studies Research Group. *Ophthalmology.* 1994;101:1536-1547.
5. Sano Y, Ksander BR, Streilein JW. Fate of orthotopic corneal allografts in eyes that cannot support anterior chamber-associated immune deviation induction. *Invest Ophthalmol Vis Sci.* 1995;36: 2176-2185.
6. Cursiefen C, Schlötzer-Schrehardt U, Kuehle M, et al. Lymphatic vessels in vascularized human corneas: immunohistochemical investigation using LYVE-1 and podoplanin. *Invest Ophthalmol Vis Sci.* 2002;43:2127-2135.
7. Cursiefen C, Chen L, Dana MR, Streilein JW. Corneal lymphangiogenesis: evidence, mechanisms, and implications for corneal transplant immunology. *Cornea.* 2003;22:273-281.
8. Liu Y, Hamrah P, Zhang Q, Taylor AW, Dana MR. Draining lymph nodes of corneal transplant hosts exhibit evidence for donor major histocompatibility complex (MHC) class II-positive dendritic cells derived from MHC class II-negative grafts. *J Exp Med.* 2002;195: 259-268.
9. Cursiefen C, Martus P, Nguyen NX, Langenbacher A, Seitz B, Kuehle M. Corneal neovascularization after nonmechanical versus mechanical corneal trephination for non-high-risk keratoplasty. *Cornea.* 2002;21:648-652.
10. Dana MR, Schaumberg DA, Kowal VO, et al. Corneal neovascularization after penetrating keratoplasty. *Cornea.* 1995;14:604-609.
11. Cursiefen C, Wenkel H, Martus P, et al. Impact of short-term versus long-term topical steroids on corneal neovascularization after non-high-risk keratoplasty. *Graefes Arch Clin Exp Ophthalmol.* 2001; 239:514-521.
12. Carmeliet P, Jain RK. Angiogenesis in cancer and other diseases. *Nature.* 2000;407:249-257.
13. Sonoda Y, Streilein JW. Orthotopic corneal transplantation in mice—evidence that the immunogenetic rules of rejection do not apply. *Transplantation.* 1992;54:694-704.
14. Banerji S, Ni J, Wang SX, et al. LYVE-1, a new homologue of the CD44 glycoprotein, is a lymph-specific receptor for hyaluronan. *J Cell Biol.* 1999;144:789-801.
15. Holash J, Davis S, Papadopoulos N, et al. VEGF-Trap: a VEGF blocker with potent antitumor effects. *Proc Natl Acad Sci USA.* 2002;99:11393-11398.
16. Cursiefen C, Chen L, Borges L, et al. VEGF-A stimulates lymph- and hemangiogenesis in inflammatory neovascularization via macrophage recruitment. *J Clin Invest.* 2004;113:1040-1050.
17. Shen H, Clauss M, Ryan J, et al. Characterization of vascular permeability factor/vascular endothelial growth factor receptors on mononuclear phagocytes. *Blood.* 1993;81:2767-2773.
18. Lee TH, Avraham H, Lee SH, Avraham S. Vascular endothelial growth factor modulates neutrophil transendothelial migration via up-regulation of interleukin-8 in human brain microvascular endothelial cells. *J Biol Chem.* 2002;277:10445-10451.
19. Yamagami S, Dana MR. The critical role of lymph nodes in corneal alloimmunization and graft rejection. *Invest Ophthalmol Vis Sci.* 2001;42:1293-1298.
20. Yamagami S, Dana MR, Tsuru T. Draining lymph nodes play an essential role in alloimmunity generated in response to high-risk corneal transplantation. *Cornea.* 2002;21:405-409.
21. Streilein JW, Bradley D, Sano Y, Sonoda Y. Immunosuppressive properties of tissues obtained from eyes with experimentally manipulated corneas. *Invest Ophthalmol Vis Sci.* 1996;37:413-424.

22. Sonoda Y, Sano Y, Ksander B, Streilein JW. Characterization of cell-mediated immune responses elicited by orthotopic corneal allografts in mice. *Invest Ophthalmol Vis Sci.* 1995;36:427-434.
23. Sonoda Y, Streilein JW. Impaired cell-mediated immunity in mice bearing healthy orthotopic corneal allografts. *J Immunol.* 1993;150:1727-1734.
24. Slegers TP, van der Gaag R, van Rooijen N, van Rij G, Streilein JW. Effect of local macrophage depletion on cellular immunity and tolerance evoked by corneal allografts. *Curr Eye Res.* 2003;26:73-79.
25. Slegers TP, van Rooijen N, van Rij G, van der Gaag R. Delayed graft rejection in pre-vascularised corneas after subconjunctival injection of clodronate liposomes. *Curr Eye Res.* 2000;20:322-324.
26. Veikkola T, Jussila I, Makinen T, et al. Signalling via vascular endothelial growth factor receptor-3 is sufficient for lymphangiogenesis in transgenic mice. *EMBO J.* 2001;20:1223-1231.
27. Kubo H, Cao R, Brakenhielm E, Makinen T, Cao Y, Alitalo K. Blockade of vascular endothelial growth factor receptor-3 signaling inhibits fibroblast growth factor-2-induced lymphangiogenesis in mouse cornea. *Proc Natl Acad Sci USA.* 2002;99:8868-8873.
28. Karkkainen MJ, Petrova TV. Vascular endothelial growth factor receptors in the regulation of angiogenesis and lymphangiogenesis. *Oncogene.* 2000;19:5598-5605.
29. Nagy JA, Vasile E, Feng D, et al. Vascular permeability factor/vascular endothelial growth factor induces lymphangiogenesis as well as angiogenesis. *J Exp Med.* 2002;196:1497-1506.
30. Reinders MEJ, Fang JC, Wong W, Ganz P, Briscoe DM. Expression patterns of vascular endothelial growth factor in human cardiac allografts: association with rejection. *Transplantation.* 2003;76:224-230.
31. Yatoh S, Kawakami Y, Imai M, et al. Effect of a topically applied neutralizing antibody against vascular endothelial growth factor on corneal allograft rejection of rat. *Transplantation.* 1998;66:1519-1524.
32. Cursiefen C, Masli S, Ng TF, et al. Roles of thrombospondin-1 and -2 in regulating corneal and iris angiogenesis. *Invest Ophthalmol Vis Sci.* 2004;45:1117-1124.

## **VEGF-A stimulates lymphangiogenesis and hemangiogenesis in inflammatory neovascularization via macrophage recruitment**

Claus Cursiefen, ... , Stanley J. Wiegand, J. Wayne Streilein

*J Clin Invest.* 2004;113(7):1040-1050. <https://doi.org/10.1172/JCI20465>.

Article Oncology

Lymphangiogenesis, an important initial step in tumor metastasis and transplant sensitization, is mediated by the action of VEGF-C and -D on VEGFR3. In contrast, VEGF-A binds VEGFR1 and VEGFR2 and is an essential hemangiogenic factor. We re-evaluated the potential role of VEGF-A in lymphangiogenesis using a novel model in which both lymphangiogenesis and hemangiogenesis are induced in the normally avascular cornea. Administration of VEGF Trap, a receptor-based fusion protein that binds and neutralizes VEGF-A but not VEGF-C or -D, completely inhibited both hemangiogenesis and the outgrowth of LYVE-1<sup>+</sup> lymphatic vessels following injury. Furthermore, both lymphangiogenesis and hemangiogenesis were significantly reduced in mice transgenic for VEGF-A<sup>164/164</sup> or VEGF-A<sup>188/188</sup> (each of which expresses only one of the three principle VEGF-A isoforms). Because VEGF-A is chemotactic for macrophages and we demonstrate here that macrophages in inflamed corneas release lymphangiogenic VEGF-C/VEGF-D, we evaluated the possibility that macrophage recruitment plays a role in VEGF-A-mediated lymphangiogenesis. Either systemic depletion of all bone marrow-derived cells (by irradiation) or local depletion of macrophages in the cornea (using clodronate liposomes) prior to injury significantly inhibited both hemangiogenesis and lymphangiogenesis. We conclude that VEGF-A recruitment of monocytes/macrophages plays a crucial role in inducing inflammatory neovascularization by supplying/amplifying signals essential for pathological hemangiogenesis and lymphangiogenesis.

**Find the latest version:**

<https://jci.me/20465/pdf>





# VEGF-A stimulates lymphangiogenesis and hemangiogenesis in inflammatory neovascularization via macrophage recruitment

Claus Cursiefen,<sup>1</sup> Lu Chen,<sup>1</sup> Leonardo P. Borges,<sup>1</sup> David Jackson,<sup>2</sup> Jingtai Cao,<sup>3</sup> Czeslaw Radziejewski,<sup>3</sup> Patricia A. D'Amore,<sup>1</sup> M. Reza Dana,<sup>1</sup> Stanley J. Wiegand,<sup>3</sup> and J. Wayne Strellein<sup>1</sup>

<sup>1</sup>The Schepens Eye Research Institute, Department of Ophthalmology, Harvard Medical School, Boston, Massachusetts, USA. <sup>2</sup>MRC Human Immunology Unit, Institute of Molecular Medicine Oxford, Oxford, United Kingdom. <sup>3</sup>Regeneron Pharmaceuticals Inc., Tarrytown, New York, USA.

**Lymphangiogenesis, an important initial step in tumor metastasis and transplant sensitization, is mediated by the action of VEGF-C and -D on VEGFR3. In contrast, VEGF-A binds VEGFR1 and VEGFR2 and is an essential hemangiogenic factor. We re-evaluated the potential role of VEGF-A in lymphangiogenesis using a novel model in which both lymphangiogenesis and hemangiogenesis are induced in the normally avascular cornea. Administration of VEGF Trap, a receptor-based fusion protein that binds and neutralizes VEGF-A but not VEGF-C or -D, completely inhibited both hemangiogenesis and the outgrowth of LYVE-1<sup>+</sup> lymphatic vessels following injury. Furthermore, both lymphangiogenesis and hemangiogenesis were significantly reduced in mice transgenic for VEGF-A<sup>164/164</sup> or VEGF-A<sup>188/188</sup> (each of which expresses only one of the three principle VEGF-A isoforms). Because VEGF-A is chemotactic for macrophages and we demonstrate here that macrophages in inflamed corneas release lymphangiogenic VEGF-C/VEGF-D, we evaluated the possibility that macrophage recruitment plays a role in VEGF-A-mediated lymphangiogenesis. Either systemic depletion of all bone marrow-derived cells (by irradiation) or local depletion of macrophages in the cornea (using clodronate liposomes) prior to injury significantly inhibited both hemangiogenesis and lymphangiogenesis. We conclude that VEGF-A recruitment of monocytes/macrophages plays a crucial role in inducing inflammatory neovascularization by supplying/amplifying signals essential for pathological hemangiogenesis and lymphangiogenesis.**

## Introduction

Angiogenesis, the outgrowth of new from preexisting blood vessels, is an important pathogenic aspect of tumor growth, chronic inflammatory diseases, and most blinding ocular conditions (for review see ref. 1). To clearly separate it from the process of lymphangiogenesis, we will refer to blood vascular angiogenesis as hemangiogenesis (HA). In recent years, much has been learned about the stimulators and inhibitors of HA and lymphangiogenesis, and members of the VEGF family have emerged as prime mediators of both processes (for review see refs. 2–4). The VEGF growth factor family consists of five members that bind to and activate three distinct receptors. VEGF-A binds to VEGFR1 and VEGFR2, and placental growth factor (PlGF) and VEGF-B bind only to VEGFR1. VEGF-C and VEGF-D bind to VEGFR2 and VEGFR3 (for review see ref. 2).

VEGF-A has clearly emerged as the family member principally responsible for normal vasculogenesis and HA. The direct effects of VEGF-A on vascular endothelial cells are mediated principally

via VEGFR2 ligation, while, until recently, VEGFR1 was thought to mediate mainly inhibitory or decoy functions (for review see refs. 1, 2). VEGF-A also plays a predominant role in diverse forms of pathological angiogenesis, including those requisite for the rapid growth of solid tumors (for review see refs. 1, 2). For this reason many antiangiogenic agents currently in development for the treatment of cancers have targeted VEGF-A or VEGFR2 (for review see refs. 2, 3; <http://www.cancer.gov>).

In contrast to HA, lymphangiogenesis is thought to be mediated mainly by the binding of VEGF-C and -D to their high-affinity receptor, VEGFR3 (for review see ref. 4). Like HA, lymphangiogenesis has gained much attention recently as an important initial step in tumor pathogenesis (for review see ref. 4; refs. 5–7). It has been shown that intra- and/or peritumoral lymphangiogenesis increases the risk for metastasis both in animal models and in human tumors (for review see ref. 4). The release of the lymphangiogenic growth factors VEGF-C and -D has been linked to a circulating subfraction of CD14<sup>+</sup>, VEGFR3-expressing monocytes that are recruited to and activated at the site of tumor growth (8). Antilymphangiogenic strategies targeting VEGFR3-mediated signaling have been reported to inhibit lymphangiogenesis and improve survival in animal models of metastatic cancer (5).

As noted above, VEGF-C and -D also bind to VEGFR2 and display hemangiogenic activities in certain situations (9,10). In contrast, VEGF-A is thought to act solely as a hemangiogenic

**Nonstandard abbreviations used:** chorioallantoic membrane (CAM); corneal neovascularization (CNV); hemangiogenesis (HA); placental growth factor (PlGF); platelet-endothelial cell adhesion molecule 1 (PECAM-1); resonance unit (RU).

**Conflict of interest:** J. Cao, C. Radziejewski, and S.J. Wiegand are employees of Regeneron Pharmaceuticals Inc.

**Citation for this article:** *J. Clin. Invest.* 113:1040–1050 (2004). doi:10.1172/JCI200420465.



factor, as placement of VEGF-A-impregnated pellets in the cornea (11), overexpression of VEGF-A in the skin (12–14), and VEGF-A applied to the chorioallantoic membrane (15) have all been reported to cause HA but not lymphangiogenesis. However, it has recently been shown that, like blood endothelial cells, lymphatic endothelial cells also express VEGFR2, and VEGF-A potentially promotes their survival *in vitro* (16–19). Moreover, adenoviral overexpression of VEGF-A in the rabbit ear leads to the formation of hyperplastic, “giant” lymphatic vessels, further suggesting that VEGF-A has the potential to stimulate some forms of lymphangiogenesis (20).

As several antiangiogenic agents that target VEGF-A have already entered clinical testing, the question of whether such agents might also affect lymphangiogenesis has taken on particular importance (4–7). In addition to promoting tumor metastases, induction of lymphangiogenesis is also associated with the termination of the immune-privileged state of the normally avascular cornea. The significant deterioration of corneal transplant survival under these conditions makes it imperative to determine whether antiangiogenic strategies that target VEGF-A also interfere with corneal lymphangiogenesis (for review see ref. 21).

To address this question and to resolve conflicting findings regarding the role of VEGF-A in lymphangiogenesis, we first characterized a novel model of inflammatory neovascularization in the cornea to determine whether HA is accompanied by lymphangiogenesis (22, 23). We then evaluated the effect of selectively blocking the actions of endogenous VEGF-A (and PlGF) using VEGF Trap (24) or of altering endogenous VEGF-A expression by using transgenic mice that express only VEGF-A isoform 164 or 188 (VEGF-A<sup>164/164</sup> or VEGF-A<sup>188/188</sup>, respectively) (25, 26). Finally, as VEGF-A is known to recruit VEGFR1-expressing monocytes/macrophages (27,28), which are known to release not only hemangiogenic but also lymphangiogenic growth factors (8), and as VEGF-mediated HA and lymphangiogenesis in our model was accompanied by a marked inflammatory response, we evaluated (a) systemic depletion of bone marrow-derived cells and (b) local depletion of macrophages for their effects on lymphangiogenesis and HA following corneal injury.

## Methods

**Mice and anesthesia.** The generation of knock-in mice expressing only VEGF-A isoform 164 or 188 on a Swiss Webster background has been described previously (25, 26). BALB/c mice 6–8 weeks of age were used in all experiments not involving knock-in mice (Taconic Farms, Germantown, New York, USA). All mice examined were between 8 and 12 weeks of age and were treated in accordance with the Association for Research in Vision and Ophthalmology Statement for the Use of Animals in Ophthalmic and Vision Research. Mice were anesthetized using a mixture of ketamine and xylazine (120 mg/kg body weight and 20 mg/kg body weight, respectively).

**Mouse model of suture-induced, inflammatory corneal neovascularization.** The mouse model of suture-induced inflammatory corneal neovascularization (CNV) was used as previously described (29). Briefly, a 2-mm-diameter corneal trephine was placed gently on the central cornea of anesthetized mice solely to mark the central corneal area. Three 11-0 sutures were then placed intrastromally with two stromal incursions each extending over 120° of the corneal circumference. The outer point of suture placement chosen was halfway between the limbus and

the line outlined by the 2-mm trephine; the inner suture point was at the same distance from the 2-mm trephine line to obtain standardized angiogenic responses. Sutures were left in place for 7 days. Mice were euthanized and the cornea with limbus was excised, and flat-mount double-immunohistochemistry was performed as described below.

**Immunohistochemistry and morphometry of HA and lymphangiogenesis in the cornea.** Briefly, corneal flat mounts were rinsed in PBS, fixed in acetone, rinsed in PBS, blocked in 2% BSA, stained with FITC-conjugated CD31 (platelet-endothelial cell adhesion molecule 1 [PECAM-1]) antibody overnight (1:100 dilution; Santa Cruz Biotechnology, Santa Cruz, California, USA), washed, blocked, and stained with anti-LYVE-1 (1:500 dilution; LYVE-1 is a lymphatic endothelium-specific hyaluronic acid receptor; D. Jackson, Oxford University, Oxford, United Kingdom) (22, 30), which was visualized using a indocarbocyanine-conjugated secondary antibody (1:100 dilution; Jackson ImmunoResearch Laboratories, Westgrove, Pennsylvania, USA). Double-stained sections were analyzed using a Zeiss Axiophot microscope. Digital pictures of the flat mounts were obtained using the Spot Image Analysis system (Spectra Services Inc., Webster, New York, USA), and the area covered by CD31<sup>+++</sup>LYVE-1<sup>-</sup> blood vessels and CD31<sup>+</sup>LYVE-1<sup>+++</sup> lymph vessels (22, 23) (where +++ indicates strong positivity; ++, medium positivity; and +, mild positivity) was measured using NIH Image software. The total corneal area was outlined using the innermost vessel of the limbal arcade as the border, and the area of blood and lymphatic neovascularization within the cornea was then calculated and normalized to the total corneal area (expressed as a percentage of the cornea covered by vessels). Paraffin embedding of corneas and immunostaining for LYVE-1 and counterstaining with hematoxylin and eosin was done as described previously (22).

**Histological characterization and quantification of inflammatory cells and immunohistochemistry for VEGF-C and VEGF-D.** The presence of inflammatory cells in normal corneas and their recruitment into corneas 1 week after suture placement was quantified in hematoxylin and eosin-stained serial sections of plastic-embedded corneas fixed in 10% paraformaldehyde after enucleation. In addition, for further characterization of inflammatory cells recruited to the cornea, double immunohistochemistry was performed on corneal whole mounts and frozen sections with the macrophage markers CD11b (Pharmingen, San Diego, California, USA), CD68 (Santa Cruz Biotechnology), and F4/80 (Caltec, San Francisco, California, USA), the panleukocyte marker CD45 (Pharmingen) and the neutrophil marker GR1 (Pharmingen) as described previously (22).

For identification of the intracorneal source of lymphangiogenic growth factors VEGF-C and -D, double immunohistochemistry for VEGF-C and -D (polyclonal antibody; 1:100 dilution; Santa Cruz Biotechnology) and the macrophage markers mentioned above was performed on corneal whole mounts 48 hours after corneal suture placement with additional Fc blockade (Santa Cruz Biotechnology). Sections were evaluated using confocal microscopy (Leica TCS - SP2 Confocal Laser Scanning Microscope, Leica, Wetzlar, Germany).

**Selective neutralization of VEGF-A and PlGF using VEGF traps.** VEGF Trap<sub>R1R2</sub> is a fusion protein comprising portions of the extracellular domains of human VEGFR1 (IgG domain 2) and VEGFR2 (IgG domain 3) coupled to the Fc portion of human IgG1 (Regeneron Pharmaceuticals Inc, Tarrytown, New York, USA) (24). VEGF Trap<sub>R1R2</sub> selectively binds VEGF-A and PlGF but not VEGF-C/



VEGF-D (see below). Mice received a single injection of VEGF Trap<sub>R1R2</sub> intraperitoneally at a dose of 12.5 mg/kg at time of corneal injury. Control mice received an injection of human Fc (12.5 mg/kg intraperitoneally). In one study, we used another Trap (VEGF Trap<sub>R1/A40</sub>) that comprised only portions of VEGFR1 (IgG domains 1–3) fused to Fc to completely obviate the possibility of binding to VEGF-C and -D. As this construct exhibits reduced bioavailability as well as lower affinity for binding of VEGF-A compared with the VEGF Trap<sub>R1R2</sub>, it was administered at a dose of 2.5 mg/kg (intraperitoneally).

**Biochemical characterization of binding of VEGF-A, -C, and -D to VEGF Trap<sub>R1R2</sub> and VEGF Trap<sub>R1/A40</sub>.** The specificity of binding of VEGF family members to various VEGF receptor chimeras was assessed using Biacore (Biacore, Piscataway, New Jersey, USA). Protein A (Pierce Biotechnology, Rockford, Illinois, USA) was amine-coupled (2000 resonance units [RU]) onto CM5 chips on all flow cells, and VEGF Trap<sub>R1R2</sub> and VEGF Trap<sub>R1/A40</sub> were captured onto the chip surface at levels of 1,324 and 2,315 RU, respectively. VEGFR1-Fc, VEGFR2-Fc, and VEGFR3-Fc (R&D Systems, Minneapolis, Minnesota, USA) were used as control proteins; these constructs comprise the full extracellular domain of the indicated human receptor fused to human Fc and were captured on protein A-coated chips at 530, 522 and 441 RU. A flow cell with only amine-coupled protein A was used to allow subtraction of nonspecific binding.

VEGF ligands (325 µl each) were injected at a rate of 10 µl/min in HEPES saline buffer containing 0.1 mg/ml of BSA (Fluka, Buchs, Switzerland). Human VEGF-C, human VEGF-D, and mouse VEGF-D (all from R&D) were injected at a concentration of 200 nM each. Human VEGF-A<sup>165</sup>, human VEGF-A<sup>121</sup> (Regeneron Pharmaceuticals Inc.) and mouse PlGF-2 (R&D) were injected at a concentration of 50 nM each. Two 1-minute pulses of 100 mM H<sub>3</sub>PO<sub>4</sub> were used to clean protein A surfaces, and receptor-Fc chimeras were recaptured on the chip for each ligand evaluated. Data were expressed as RU of specifically bound ligand per femtomole of receptor fusion protein captured on the protein A surface.

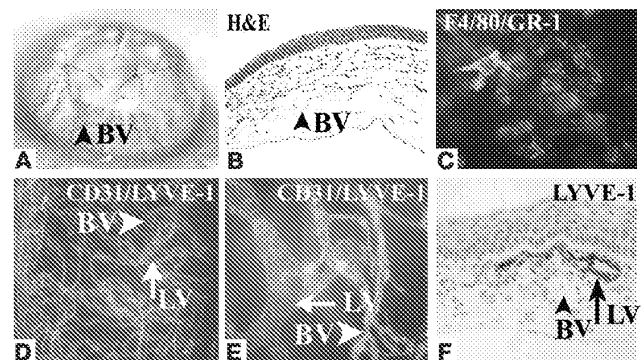
**Analysis of lymphangiogenic effects of VEGF-A and VEGF-C in the corneal micropocket assay.** The corneal micropocket assay was performed as previously described (10). Briefly, corneal micropockets were created using a modified von Graefe knife, and a micropellet (0.4 × 0.4 mm) of sucrose aluminum sulfate coated with hydron polymer containing 200 ng of VEGF-A<sub>164</sub> (R&D) or 200 ng of recombinant rat VEGF-C as a positive control (RDI, Flanders, New Jersey, USA) was implanted into each pocket. The pellet was positioned 0.6–0.8 mm from the limbus and the site was covered with antibiotic ointment (erythromycin) and was left in place for 10 days (*n* > 10 mice each). Hemangiogenic and lymphangiogenic responses were quantified as described above using double immunostaining with CD31/LYVE-1. The maximal extent of blood versus lymph vessel outgrowth between subjacent limbus and pellet was graded semiquantitatively in four categories for both vessel types: 0, no outgrowth; 1, outgrowth less than 1/3 of the limbus-pellet distance; 2, outgrowth between 1/3 and 2/3 of the limbus-pellet distance; 3, vessel reaching pellet.

**Systemic depletion of bone marrow-derived cells by  $\gamma$  irradiation of mice.** BALB/c mice were pretreated with acidified water for 3 days and then were exposed to a single dose of 9 Gy whole body  $\gamma$ -irradiation. After 18 hours, sutures

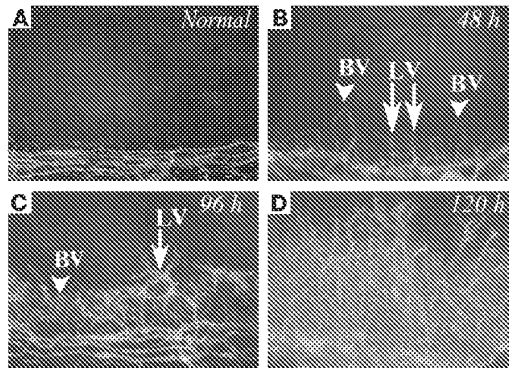
were placed into the corneas as described above. Control mice received the acidified water pretreatment and suture placement. Seven days later, the mice were euthanized and their corneas were removed for flat-mount staining and morphometry as described above (at least three mice per group per experiment).

**Local depletion of macrophages using subconjunctival clodronate liposomes.** Local depletion of monocytes/macrophages was accomplished as described previously (31, 32). Liposomes filled with dichloromethylene diphosphonate (CL2MDP-LIP; 10 µl; a generous gift from Nico van Rooijen, Vrije Universiteit, Amsterdam, The Netherlands) was injected subconjunctivally at the time of suture placement and 2, 4, and 6 days after surgery. Control group mice received either liposomes containing PBS or only PBS subconjunctivally at the same time points. To rule out the possibility of vascular endothelial uptake of clodronate liposomes and a direct effect of clodronate on blood and lymphatic endothelium, the effect of clodronate versus Fc protein injected subconjunctivally on preexisting pathological corneal vessels (previously induced by corneal suturing) and normal limbal vessels was assessed 12 hours after injection.

**Cultivation of bone marrow-derived macrophages.** Bone marrow-derived macrophages were harvested and cultured as previously described (33). Briefly, BALB/c mice 6 weeks of age were euthanized, their femur bones were dissected and cut at both ends, and the bone marrow was flushed into HBSS (Cambrex Bio Science, Verviers, Belgium) using a PBS-filled 25-gauge needle. Then, the bone marrow cells were washed and resuspended in growth medium consisting of DMEM (Sigma-Aldrich, St. Louis, Missouri, USA) with 10% horse serum (Sigma-Aldrich), 10% CPSR-1 (Sigma-Aldrich), 10% L929 cell-conditioned medium, 1% MEM vitamins (Invitrogen, Carlsbad, California, USA), 1% sodium pyruvate (Cambrex), 1% NEAA (Cambrex), 1% L-glutamine (Cambrex), and 1% penicillin/streptomycin (Cambrex).



**Figure 1** Concomitant induction of HA and lymphangiogenesis in inflammatory corneal neovascularization. (A–F) Seven days after central, intrastromal suture placement (A), a robust angiogenic response (A; blood vessel [BV]) in combination with an influx of inflammatory cells (B [H&E] and C) can be seen biomicroscopically (A) and by using CD31 (PECAM1) immunostaining (D) of corneal flat mounts (green). The CD45<sup>+</sup> inflammatory cell infiltrate (C) consists mainly of GR-1<sup>+</sup> neutrophils (red) and F4/80<sup>+</sup> macrophages (green). In addition to the CD31<sup>+</sup>LYVE-1<sup>-</sup> blood vessels (D and E; green), there is parallel outgrowth of CD31<sup>+</sup>LYVE-1<sup>+</sup> lymphatic vessels (LV; D–F; red). Blood vessels do not react with the lymphatic vascular-specific hyaluronic acid receptor LYVE-1 (F). Magnification, ×20 (A), ×200 (B and F), ×400 (C and E), and ×100 (D).



**Figure 2**  
Time course of early inflammatory HA and lymphangiogenesis. (A–D) In inflammatory corneal neovascularization, there is very early and parallel outgrowth of both blood vessels (green) as well as lymphatic vessels (red) from the limbal vascular arcade (bottom of each picture) toward the suture into the normally avascular cornea (top of each picture). Both vessel types sprout as early as 24 hours after injury and progress over time, with lymphatic vessels (red staining) often preceding blood vessels (green staining). Magnification,  $\times 100$ .

After 7 days of culture, adherent cells were then processed for RNA and RT-PCR as described above.

**Statistical analysis.** Statistical significance was analyzed by the Mann-Whitney *U* test. Differences were considered significant at  $P < 0.05$ . Each experiment was performed at least twice with similar results. Graphs were drawn using Graph Pad Prism, Version 3.02 (Graph Pad Software, San Diego, California, USA).

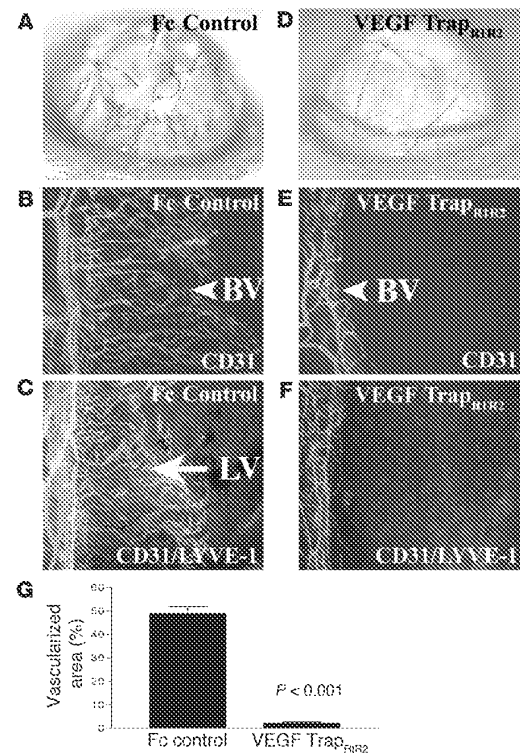
**Results**

*Suture-induced, inflammatory CNV is characterized by HA, lymphangiogenesis, and inflammatory cell infiltration.* To address the question of whether endogenous VEGF-A might be involved in lymphangiogenesis, we first studied an established model of suture-induced inflammatory CNV to evaluate the outgrowth of lymphatic vessels into the normally avascular cornea (22, 29). This model is characterized by a robust outgrowth of new blood vessels from the limbal arcade (Figure 1, A–C) and is routinely used in the mouse to create a vascularized “high-risk bed” for corneal transplantation studies. New blood vessels reached the sutures at 1 week after surgery and were accompanied by a dense inflammatory cell infiltrate. CD45<sup>+</sup> inflammatory cells within the corneal stroma mainly consisted of GR-1<sup>+</sup> neutrophils and, less prominently, also F4/80<sup>+</sup>CD11b<sup>+</sup> macrophages (Figure 1). To determine whether this early HA was accompanied by lymphangiogenesis, corneal whole mounts were double-stained using CD31 as a panendothelial marker and LYVE-1 (22, 30) as specific lymphatic vessel marker. One week after surgery, both CD31<sup>+</sup>LYVE-1<sup>+</sup> lymphatic vessels as well as CD31<sup>+</sup>LYVE-1<sup>-</sup> blood vessels grew into the cornea (Figure 1, D–F), demonstrating that a robust lymphangiogenesis is also induced in this CNV model.

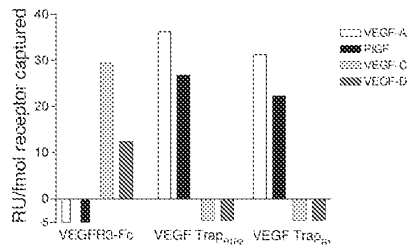
*Blood and lymphatic vessels display rapid and parallel outgrowth in CNV.* Based on wound healing studies in skin, it has been suggested the ingrowth of lymphatic vessels is delayed for several days relative to that of blood vessels (34). To determine whether this holds true for the CNV model, we conducted a time-course study comparing the outgrowth of both vessel types. As is illustrated in Figure 2, HA and lymphangiogenesis occurred contemporaneously. Small sprouts arising from pre-existing limbal vessels could be detected as early as 24 hours after surgery, and outgrowth of new vessels of both types was clearly visible at 48 hours (Figure 2). Interestingly, lymphatic vessels sometimes grew in advance of blood vessels at the leading edge of growth (Figure 2).

**Figure 3**

Neutralization of VEGF-A inhibits HA and lymphangiogenesis. (A–F) A molecular trap designed to bind VEGF-A (VEGF Trap<sub>R1R2</sub>) completely inhibits both HA and lymphangiogenesis within 1 week after injury. Whereas mice receiving an intraperitoneal injection of Fc protein at surgery (Fc control) display robust angiogenesis (A, slit-lamp picture; B, CD31 staining) and lymphangiogenesis (C, CD31 and LYVE-1 staining) 1 week later, mice treated with a single injection of VEGF Trap<sub>R1R2</sub> do not show HA (D and E; blood vessels are green) or lymphangiogenesis (F; lymph vessels are red). Magnification,  $\times 100$  (C–F). (G) Morphometric analysis of the nearly complete inhibitory effect of VEGF Trap on both HA and lymphangiogenesis ( $P < 0.001$ ). Magnification (A and B),  $\times 20$ .







**Figure 4**

VEGF Trap<sub>R1R2</sub> and VEGF Trap<sub>R1/A40</sub> bind only VEGF-A/PlGF, not VEGF-C/VEGF-D. Biacore biochemical evaluation of binding of VEGF/PlGF growth factors to VEGF Traps and VEGF receptor chimeric proteins (VEGFR1-Fc, VEGFR2-Fc, and VEGFR3-Fc), demonstrates that VEGF Trap<sub>R1R2</sub> and VEGF Trap<sub>R1/A40</sub>, used in this study, bind only VEGF-A/PlGF, not VEGF-C or -D. In contrast, VEGF-C and -D, but not VEGF-A/PlGF, bind to VEGFR3-Fc.

*Administration of VEGF Trap<sub>R1R2</sub> completely inhibits HA and lymphangiogenesis in inflammatory CNV.* To determine the extent to which VEGF-A is important for inflammation-associated lymphangiogenesis, we treated mice systemically with a molecular trap that selectively binds and neutralizes VEGF-A but not VEGF-C or -D (VEGF Trap<sub>R1R2</sub>). Administration of VEGF-Trap<sub>R1R2</sub> completely prevented both HA and lymphangiogenesis 7 days after suture placement, as determined by examination of the corneas (Figure 3; the area vascularized by blood and lymphatic vessels was 49% ± 12% in Fc-treated mice and 2.3% ± 1.5% in mice treated with VEGF Trap<sub>R1R2</sub>,  $P < 0.001$ ). Moreover, examination of corneas at days 2, 4, and 7 after suture placement revealed that blood and lymphatic vessels never grew out from the limbus in the Trap-treated group.

Although *in vitro* binding studies showed that VEGF Trap<sub>R1R2</sub> binds only VEGF-A and PlGF with high affinity, but not VEGF-C or -D (see below), we further ruled out the possibility that the observed response might be due to neutralization of VEGF-C and -D *in vivo* by repeating the above experiment using VEGF Trap<sub>R1/A40</sub>. Though it is less bioavailable and exhibits a lower affinity for VEGF-A, this reagent consists only of the ligand-binding domain of VEGFR1 but not VEGFR2, and thus it is inherently incapable of binding VEGF-C or -D. Using this agent we observed a similar parallel and significant, albeit less complete, inhibition of both HA (53.8% ± 14.6% versus 23.6% ± 6.8%) and lymphangiogenesis (45.7% ± 15.6% versus 26% ± 8.2%;  $P < 0.05$ ).

*VEGF Trap<sub>R1R2</sub> and Trap<sub>R1/A40</sub> bind only VEGF-A and PlGF but not VEGF-C/VEGF-D.* When added to tissue cultures at approximately equimolar concentrations, VEGF Trap<sub>R1R2</sub> has been shown to block VEGF-A-induced phosphorylation of VEGFR2 as well as proliferation of primary human umbilical vein endothelial cells (24). VEGF Trap<sub>R1R2</sub> binds VEGF<sub>165</sub> with very high affinity ( $K_D$ , ~1 pM). Similar results have been obtained using murine VEGF<sub>164</sub>, and in preliminary studies mouse PlGF was also found to bind to VEGF Trap<sub>R1R2</sub> with high affinity ( $K_D$ , ~1.8 pM). The results of Biacore binding studies confirmed that both VEGF Trap<sub>R1R2</sub> and Trap<sub>R1/A40</sub> selectively bound VEGF-A (VEGF<sub>165</sub> and VEGF<sub>121</sub>) and PlGF, but there was no detectable binding of VEGF-C or -D to either VEGF Trap at concentrations up to 200 nM (Figure 4 and Table 1). VEGFR1-Fc demonstrated the same pattern of binding to the above VEGF family members. In contrast, VEGFR3-Fc avidly bound VEGF-C and -D but not PlGF or either isoform of VEGF-A. Collectively, these data clearly demonstrate

that VEGF Trap<sub>R1R2</sub> and VEGF Trap<sub>R1/A40</sub> bind only VEGF-A and PlGF but not VEGF-C or -D, whereas VEGFR3-Fc binds only VEGF-C and -D but not VEGF-A or PlGF.

*Mice that express only VEGF-A<sub>188</sub> or VEGF-A<sub>164</sub> display significantly reduced HA and lymphangiogenesis.* To further evaluate the role of VEGF-A in promoting lymphangiogenesis, we studied mice that express only VEGF-A isoform 164 or 188. We hypothesized that specific genetic deletion of VEGF-A isoforms should only affect lymphangiogenesis if VEGF-A is involved in mediating lymphangiogenesis. Sutures were placed in the corneas; 1 week later, VEGF<sup>164/164</sup> mice (lacking VEGF-A isoforms 120 and 188) displayed an area of HA of 27.9% ± 12% and an area of lymphangiogenesis of 22.7% ± 13.6%. Sutured corneas of VEGF<sup>188/188</sup> transgenic animals (lacking VEGF-A isoforms 120 and 164) displayed an area of HA of 20.3% ± 10% and an area of lymphangiogenesis of 25% ± 12.7%. These represent significant reductions in areas of both lymphangiogenesis and HA compared with wild-type controls (HA, 44% ± 10.2%; area of lymphangiogenesis, 57.2% ± 9.6%;  $P < 0.05$ ; Figure 5). Thus, both HA and lymphangiogenesis can occur in the absence of VEGF-A isoforms 120 and 188 as well as in the absence of isoforms 120 and 164. However, under these circumstances the extent of both corneal HA and lymphangiogenesis is equivalently diminished, suggesting that an orchestrated action of VEGF-A isoforms is necessary for lymphangiogenesis.

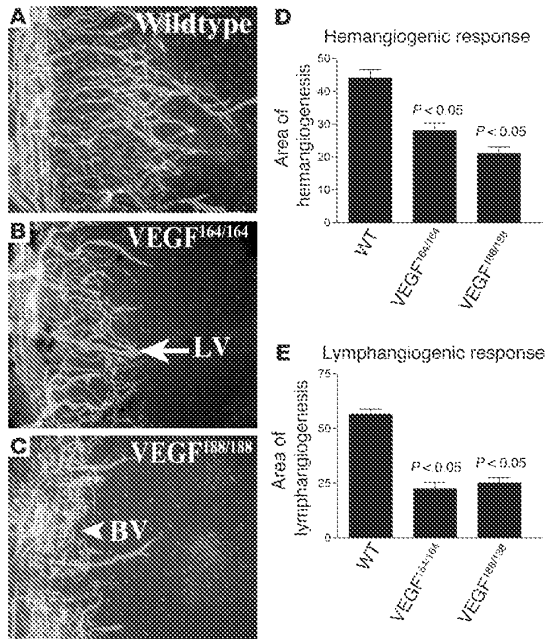
VEGF-A<sub>164</sub> can induce lymphangiogenic as well as hemangiogenic responses in the corneal micropocket assay. To determine whether exogenous VEGF-A can exert a direct lymphangiogenic effect, we studied the effect of VEGF-A<sub>164</sub> in the corneal micropocket assay. Lymphangiogenesis as well as HA was induced in 17 of 20 corneas that had been implanted with pellets (200 ng) of VEGF-A. Lymphatic vessels were noted to be appreciably shorter than the accompanying blood vessels (semiquantitative grading, 2.7 ± 0.7 versus 1 ± 0.9;  $P < 0.01$ ; Figure 6). These findings indicate that VEGF-A alone can induce lymphangiogenesis, although less

**Table 1**

VEGF Trap<sub>R1R2</sub> and VEGF Trap<sub>R1/A40</sub> selectively bind VEGF-A and PlGF, but not VEGF-C and VEGF-D

|                             | hVEGFA <sub>165</sub><br>(50 nM) | hVEGFA <sub>121</sub><br>(50 nM) | mPLGF<br>(50 nM) | hVEGFC<br>(50 nM) | hVEGFD<br>(200 nM) | mVEGFD<br>(200 nM) | Buffer<br>(200 nM) | (BSA) |
|-----------------------------|----------------------------------|----------------------------------|------------------|-------------------|--------------------|--------------------|--------------------|-------|
| VEGF Trap <sub>R1R2</sub>   | 36.3                             | 19.7                             | 26.8             | 0                 | 0                  | 0                  | 0                  | 0     |
| VEGF Trap <sub>R1/A40</sub> | 40.9                             | 22.6                             | 34.6             | 0                 | 0                  | 0                  | 0                  | 0     |
| VEGFR1-Fc                   | 31.3                             | 15.9                             | 22.3             | 0                 | 0                  | 0                  | 0                  | 0     |
| VEGFR2-Fc                   | 30.1                             | 14.1                             | 0                | 0.8               | 2.1                | 2.1                | 2.1                | 0     |
| VEGFR3-Fc                   | 0                                | 0                                | 0                | 29.5              | 12.4               | 14.4               | 14.4               | 0     |

h, human; m, murine.



**Figure 5** Importance of VEGF-A isoforms for lymphangiogenesis. (A–E) Double immunostaining CD31/LYVE-1 (blood vessels, green; lymphatic vessels, red) of corneal flat mounts of wild-type mice (A), VEGF-A<sup>164/164</sup> transgenic mice (B), and VEGF-A<sup>188/188</sup> transgenic mice (C) demonstrates significantly reduced HA (D;  $P < 0.05$ ) and lymphangiogenesis (E;  $P < 0.05$ ). Magnification,  $\times 100$  (A–C).

*Depletion of bone marrow-derived cells by whole-body irradiation inhibits lymphangiogenesis.* Macrophages can be recruited to sites of inflammation by VEGF-A via VEGFR1 interactions (27, 28), and activated macrophages are known to express a variety of cytokines and growth factors, including VEGF-A, -C, and -D (8, 35). Since the inhibition of corneal neovascularization by the VEGF Trap<sub>R1R2</sub> was associated with a marked decrease in the recruitment of inflammatory cells into the cornea, we determined whether depletion of inflammatory cells by other means would also inhibit HA and lymphangiogenesis following corneal injury. In preliminary experiments we confirmed that whole-body irradiation with a single dose of 9 Gy caused nearly complete depletion of leucocytes from the peripheral blood within 1 week of irradiation (data not shown). The results in Figure 8 show that depletion of bone marrow-derived cells by irradiation substantially inhibited both HA and lymphangiogenesis in response to corneal inflammatory stimuli. The areas of blood and lymphatic vessels in irradiated mice were  $18.4\% \pm 4\%$  and  $16.4\% \pm 3.2\%$ , respectively, compared with  $49.6\% \pm 10.4\%$  and  $38\% \pm 12.23\%$  for blood and lymph vessels, respectively, in unirradiated controls ( $P < 0.05$ ).

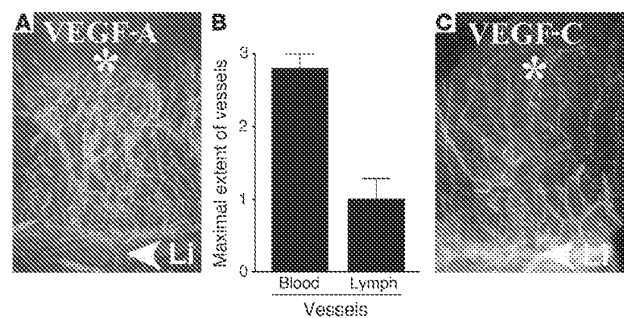
*Local macrophage depletion inhibits corneal lymphangiogenesis.* We next evaluated the effect of selective macrophage depletion in the cornea by subconjunctival injection of clodronate liposomes (31, 32). Macrophages that phagocytose clodronate liposomes rapidly die. Subconjunctival liposome injection on days 0, 2, 4, and 6 was applied to eyes with centrally sutured corneas. Local depletion of macrophages nearly completely inhibited corneal lymphangiogenesis and HA (Figure 9); the areas of blood and lymph vessels in mice receiving clodronate were  $11.3\% \pm 5.8\%$  and  $10.8\% \pm 2.5\%$ , respectively, compared with  $42.3\% \pm 11.3\%$  and  $38.8\% \pm 4.7\%$  for blood and lymph vessels, respectively, in PBS-treated controls ( $P < 0.01$ ). There was no obvious direct effect of locally applied clodronate liposomes on preexisting limbal and pathological corneal blood or lymphatic vessels. These results demonstrate that macrophages, recruited to the site of injury by ligation of VEGFR1, are critical to inflammation-associated HA and lymphangiogenesis.

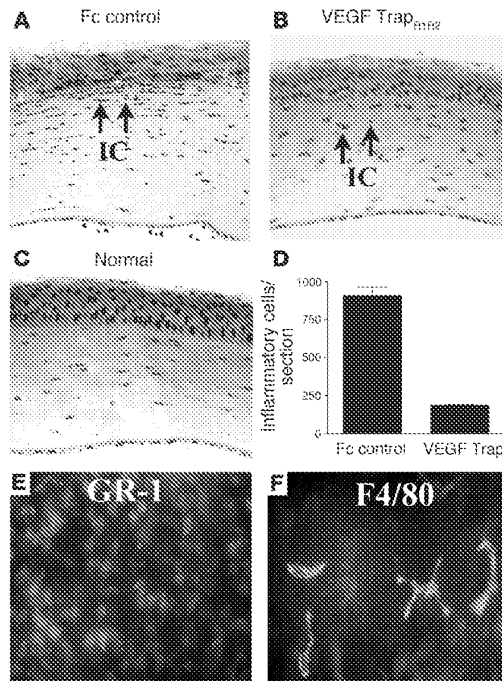
Macrophages in inflamed corneas express lymphangiogenic VEGF-C and -D. To directly assess whether macrophages recruited

robustly than HA. The same was found for VEGF-C pellets used as controls. There was no significant difference in the ratio of HA versus lymphangiogenesis between VEGF-C and -A pellets ( $P = 0.8$ ).

*VEGF Trap<sub>R1R2</sub> significantly reduces the recruitment of inflammatory cells into the cornea.* Because VEGF is chemotactic for inflammatory cells, for example, monocytes/macrophages via VEGFR1 (27, 28), and because macrophages can potentially secrete lymphangiogenic factors such as VEGF-C and -D (8, 35), we investigated whether neutralization of VEGF-A using VEGF Trap<sub>R1R2</sub> would also impair the recruitment of bone marrow-derived cells into the cornea following suture injury. Animals that received a single intraperitoneal injection of VEGF Trap<sub>R1R2</sub> at time of surgery exhibited significantly reduced numbers of stromal inflammatory cells compared with controls (Figure 7); the number of inflammatory cells per corneal cross-section in VEGF Trap<sub>R1R2</sub>-treated mice was  $188 \pm 14$  compared with  $909 \pm 167$  in Fc-treated control mice ( $P < 0.01$ ). The inflammatory infiltrate in the Fc-treated controls was composed of GR-1<sup>+</sup> neutrophils and, less often, F4/80<sup>+</sup> macrophages.

**Figure 6** Effect of VEGF-A on lymphangiogenesis in corneal micropocket assay. (A–C) Pellets (\*) containing 200 ng VEGF-A always induced a robust hemangiogenic response (A, green; L, limbal vascular arcade [arrowhead]) and in 17 of 20 pellets in addition there was a mild to moderate lymphangiogenic response (red), which was significantly less compared with the hemangiogenic response (B). Panel C shows a representative and comparable effect by a VEGF-C pellet (200 ng). Magnification (A and C),  $\times 100$ .





**Figure 7**

Anti-inflammatory effect of trapping VEGF-A. (A–C) Trapping of VEGF-A/PlGF using the molecular cytokine trap VEGF Trap<sub>R1R2</sub> significantly reduces the recruitment of inflammatory cells into the cornea in the suture-induced neovascularization model. One week after surgery, control mice treated with Fc protein (Fc control) displayed a significant influx of inflammatory cells (IC and arrows) into the central corneal stroma (A). Trapping of VEGF-A significantly reduces this influx (B; and C, normal cornea). (D) Trapping of VEGF-A reduces stromal inflammatory cells by about 80% ( $P < 0.01$ ). (E and F) The inflammatory cells found in the corneal stroma 7 days after suture placement and Fc treatment (controls) are overwhelmingly GR-1<sup>+</sup> neutrophils (E, red) and less commonly, F4/80<sup>+</sup>CD11b<sup>+</sup> macrophages (F, green). Magnification,  $\times 100$  (A–C) and  $\times 400$  (E and F).

by VEGF-A into inflamed corneas are able to release lymphangiogenic growth factors VEGF-C and -D, we performed immunohistochemical studies in inflamed corneas 48 hours after suture placement using double labeling for VEGF-C/VEGF-D and the macrophage markers CD11b and F4/80. As depicted in Figure 10, this revealed that most CD11b<sup>+</sup>F4/80<sup>+</sup> macrophages in the stroma were positive for VEGF-C and some were also positive for VEGF-D. To provide further support for the notion that mouse macrophages can express VEGF-C and -D, we performed RT-PCR studies on cultivated bone marrow-derived mouse macrophages. As shown in Figure 10, these macrophages were able to transcribe both VEGF-C and -D mRNA.

**Discussion**

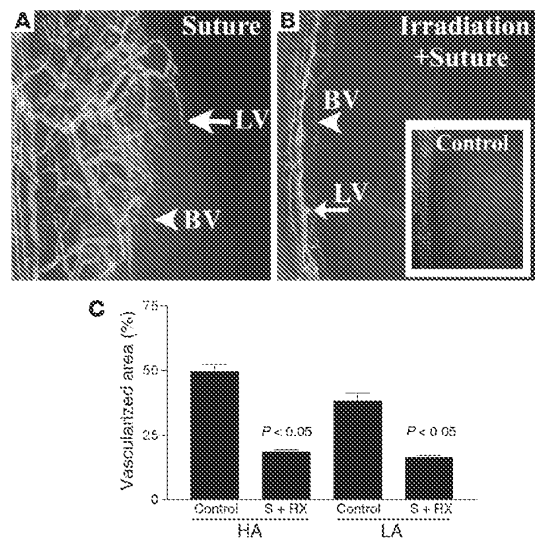
The results we have obtained in the corneal model of inflammatory neovascularization allow two important conclusions to be drawn regarding the role of VEGF-A in blood and lymphatic vessel growth. First, endogenous VEGF-A can promote lymphangiogenesis, at least in the context of inflammatory forms of neovascularization. Second,

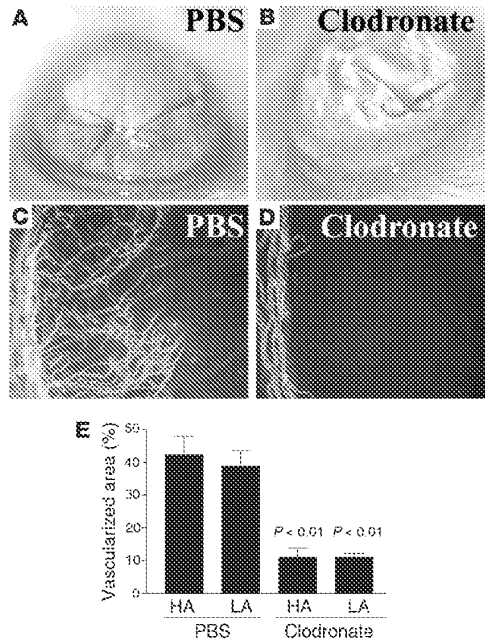
signaling via VEGFR1 on leukocytes, particularly monocytes/macrophages, is a critical step in “immune amplification” of signals that promote pathological HA and lymphangiogenesis.

The present observations, that lymphangiogenesis and HA occur contemporaneously in CNV and that both responses are equally blocked by the selective inhibition of endogenous VEGF-A, appear to contradict the established notion that the ligation of VEGF-A to VEGFR2 induces solely HA, while interactions between VEGF-C/VEGF-D and VEGFR3 discretely mediate lymphangiogenesis. Indeed, a substantial literature supports this essential dichotomy in the function of VEGF family proteins and their receptors. For example, when applied to differentiated chick chorioallantoic membrane (CAM), VEGF-A was found to stimulate HA, but not lymphangiogenesis, while VEGF-C induced only lymphangiogenesis (15). Interestingly, the VEGFR1-selective ligand PlGF was unable to induce either lymphangiogenesis or HA in the CAM assay. Similarly, in the corneal micropocket assay, VEGF-A was reported to induce HA but not lymphangiogenesis (11), and in several studies using adenoviral overexpression, VEGF-C consistently induced lymphangiogenesis, while VEGF-A did not (12–14). While these studies do demonstrate that VEGF-C/VEGFR3 and VEGF-A/VEGFR2 interactions can induce pure lymphangiogenic and

**Figure 8**

Bone marrow-derived cells mediate inflammation-associated lymphangiogenesis. (A–C) Depletion of bone marrow-derived cells induces a parallel inhibition of both HA and lymphangiogenesis in response to corneal inflammatory stimuli (blood vessels, green; lymphatic vessels, red). (A) Seven days after suture placement, control mice display parallel outgrowths of blood and lymphatic vessels from the limbal vascular arcade (left). (B and C) A single whole-body irradiation causes significant parallel inhibition of both HA and lymphangiogenesis. Inset in B shows a representative area of a normal limbal vascular arcade without vessel outgrowth. In C, controls are compared to irradiated mice (S + Rx);  $P < 0.05$ . Magnification (A and B),  $\times 100$ .





**Figure 9** Macrophages are essential for pathological HA and lymphangiogenesis. (A and C) PBS-treated controls. (B and D) Mice that received subconjunctival clodronate liposomes. Magnification,  $\times 100$  (C and D). (E) Depletion of macrophages inhibits both HA and lymphangiogenesis (LA) in inflammatory neovascularization ( $P < 0.01$ ). Magnification (A and B),  $\times 20$ .

hemangiogenic responses, respectively, under certain conditions, more recent studies are beginning to show that this dichotomy is far from complete.

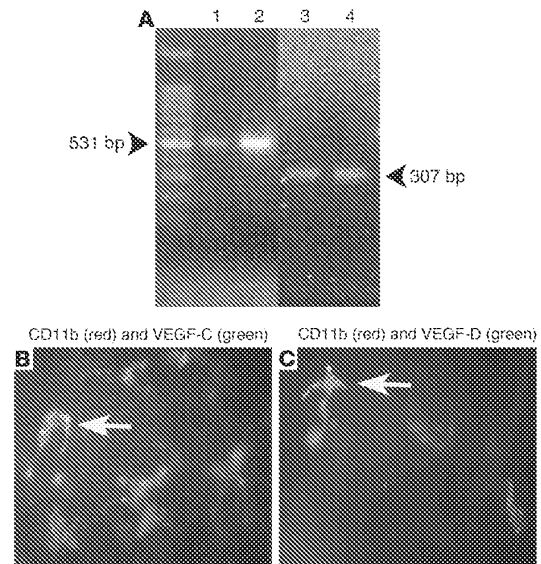
In fact, VEGF-C and -D possess dual lymphangiogenic and hemangiogenic properties (2, 9, 10, 36, 37), and VEGFR3, while universally expressed by the lymphatic endothelium, is also expressed by vascular endothelial cells under some conditions, particularly during embryonic development and periods of active vessel remodeling, including that occurring in pathology (34, 37).

In contrast to VEGF-C and -D, there is comparatively little evidence to support the notion that VEGF-A might be involved in lymphangiogenesis. However, a recent molecular profiling study has shown that lymphatic endothelial cells can express VEGFR2 and that VEGF-A is as effective as VEGF-C in supporting their survival and promoting tube formation in vitro (16–19). Another recent study has demonstrated that adenoviral overexpression of VEGF-A<sub>164</sub> in the rabbit ear leads to the formation of “giant” lymphatic vessels (20). These studies raised the possibility that endogenous VEGF-A might, under some circumstances, play a role in promoting lymphangiogenesis — a possibility that we have confirmed in the present studies.

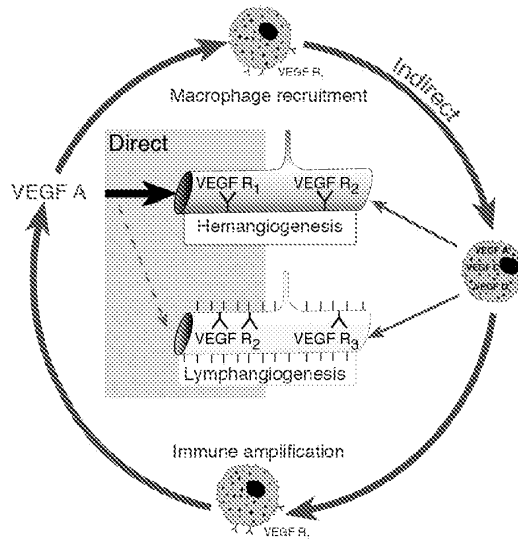
Specifically, we have demonstrated that (a) exogenous VEGF-A alone can induce lymphangiogenesis in the corneal pocket assay (different findings in a previous study [ref. 11] might be explained by the use of different mouse strains, amounts of VEGF-A and staining techniques); (b) lymphangiogenesis and HA occur contemporaneously in a corneal injury model of inflammatory neo-

vascularization; (c) selective pharmacological neutralization of VEGF-A/PlGF completely inhibited both HA and lymphangiogenesis in this model due to primary inhibition of blood and lymphatic vessel formation rather than via accelerated regression; and (d) following corneal injury, both lymphangiogenesis and HA were equivalently reduced in transgenic mice that expressed only either VEGF-A<sub>164</sub> or VEGF-A<sub>188</sub> (25, 26). Taken together, these results demonstrate that endogenous VEGF-A plays a critical role in promoting lymphangiogenesis as well as HA, at least under certain pathophysiological conditions.

We next turned our attention to mechanisms that might explain the coordinate induction of HA and lymphangiogenesis in this model and the effective suppression of both responses by selective inhibition of VEGF-A. Here we noted that in addition to suppressing CNV, administration of VEGF Trap also significantly suppressed the inflammatory response that is induced by the placement of intrastromal corneal sutures. It is well established that VEGF-A is a potent monocyte chemoattractant and that this effect is mediated by ligation of VEGFR1 (27, 38, 39). Thus, one likely scenario is that VEGF-A indirectly stimulates lymphangiogenesis in CNV by recruiting bone marrow-derived cells, particularly monocytes/macrophages, to the affected site and these cells in turn are the source of one or more lymphangiogenic factors. Activated leucocytes are known to express and secrete a large number of cytokines and other regulatory peptides and proteins, including VEGF-A (31, 40, 41). Moreover, it has recently been



**Figure 10** Macrophages in inflamed corneas express both VEGF-C and -D. (A) Cultivated, bone marrow-derived macrophages from BALB/c mice transcribe VEGF-C and -D mRNA 1 week after seeding. 1, VEGF-C positive control; 2, mouse bone marrow-derived macrophage VEGF-C; 3, VEGF-D positive control; 4, mouse bone marrow-derived macrophage VEGF-D. (B) Expression of VEGF-C (green) in red-stained CD11b<sup>+</sup> macrophages in an inflamed cornea 48 hours after injury. (C) Expression of VEGF-D (green) in red-stained CD11b<sup>+</sup> macrophages in an inflamed cornea 48 hours after injury. Arrows indicate a representative macrophage. Magnification (B and C),  $\times 600$ .



**Figure 11**  
Proposed concept of an (indirect) lymphangiogenic role of VEGF-A via recruitment of bone marrow-derived macrophages, which in turn can release both hemangiogenic and lymphangiogenic growth factors. Macrophages seem to be important for immune amplification, leading to pathological HA and lymphangiogenesis.

shown that a subfraction of circulating VEGFR3<sup>+</sup>CD14<sup>+</sup> monocytes also strongly expresses VEGF-C and VEGF-D upon recruitment to peritumoral sites or in vitro stimulation (8). Moreover, VEGF-C<sup>+</sup> macrophages colocalize with new peritumoral lymph vessels, strongly suggesting a role for these cells in lymphangiogenesis (8, 42). Furthermore, it is known that proinflammatory cytokines, rather than hypoxia, upregulate VEGF-C expression (43) and that VEGF-C consequently is highly expressed in inflammatory conditions (44) suggesting even more strongly that VEGF-A-recruited macrophages upregulate VEGF-C/VEGF-D in response to corneal inflammatory cytokines. Indeed we have demonstrated here that CD11b<sup>+</sup>F4/80<sup>+</sup> macrophages in the inflamed corneal stroma express VEGF-C (more than VEGF-D) and that bone marrow-derived mouse macrophages transcribe both VEGF-C and -D mRNA.

The results of the present study directly support the concept that VEGF-A-mediated recruitment of inflammatory cells by VEGFR1 ligation is an important step in the initiation of the lymphangiogenic response in CNV. Pharmacological neutralization of VEGF-A significantly inhibited recruitment of inflammatory cells into the cornea after suture placement. Moreover, systemic depletion of bone marrow-derived cells by irradiation significantly attenuated corneal lymphangiogenesis after an inflammatory stimulus. Furthermore, local depletion of macrophages using subconjunctival clodronate liposomes substantially inhibited lymphangiogenesis. Finally, macrophages in inflamed corneas expressed both lymphangiogenic VEGF-C and -D. Taken together, these findings provide strong evidence that macrophage recruitment is an essential mediator of the (indirect) lymphangiogenic effect of VEGF-A (Figure 11 depicts this concept). Here it is also important to note that macrophage depletion not only

suppressed lymphangiogenesis following corneal injury but also effectively suppressed concomitant HA. This observation is consistent with a previous study showing that selective macrophage depletion inhibits pathological neovascularization in other disease models (45), supporting the notion that inflammation is also a requisite component of pathological HA mediated by VEGF-A (45, 46).

While VEGF-mediated recruitment of inflammatory cells clearly plays an important and apparently predominant role in promoting pathological neovascularization, it is quite likely that other, more direct actions of VEGF-A contribute to initiating both hemangiogenic and lymphangiogenic responses. For example, VEGF-A acts directly on vascular endothelium to upregulate the expression of adhesion molecules that promote leukostasis (47, 48). Likewise, rapid VEGF-mediated increases in the permeability of resident vessels and the consequent extravasation of serum proteins also serve to promote the subsequent formation of both blood and lymphatic vessels (17, 49). It is also possible that VEGF-A acts directly on VEGFR2 to promote the growth and organization of the lymphatic endothelium (16, 50). Finally, in addition to recruiting inflammatory cells that supply cytokines and growth factors to the site of injury, VEGF-A may also amplify angiogenic responses by recruiting VEGFR1-positive hematopoietic progenitor cells to the affected site and promoting their differentiation into vascular endothelium (for review see refs. 2, 51).

While our data strongly support the concept that recruitment of monocytes/macrophages by VEGF-A, through VEGFR1, is an early and essential step in an immune amplification cascade that leads to both inflammatory HA and lymphangiogenesis (see Figure 11), it is formally possible that the VEGFR1 ligand PlGF could also be partly responsible for promoting both corneal HA and lymphangiogenesis. Indeed, both VEGF Trap<sub>R1R2</sub> and VEGF Trap<sub>R1/A40</sub> bind PlGF as well as VEGF-A. Although results of other studies indicate that PlGF can collaborate with VEGF-A in the stimulation of pathological HA (51, 52), three facts “argue against” the possibility that endogenous PlGF plays a significant role in promoting inflammatory lymphangiogenesis: (a) PlGF binds only to VEGFR1, while the lymphatic endothelium expresses only VEGFR2 and VEGFR3 (53); (b) overexpression of AD-PlGF in the rabbit ear resulted in the formation of blood vessels, but in contrast to VEGF-A it did not cause lymphangiogenesis (20); and (c) in the present study, both lymphangiogenesis and HA were comparably reduced in VEGF-A isoform-deficient transgenic mice.

Currently, the most parsimonious mechanistic explanation for VEGF-A-mediated lymphangiogenesis in CNV is that VEGF-A promotes this response indirectly by binding to VEGFR1 and recruiting macrophages that secrete VEGF-C and/or VEGF-D at the site of injury. However, in a previous study, application of an exogenous VEGF-C isoform (156S) was unable to induce lymphangiogenesis in the cornea micropocket assay (in contrast, e.g., to the skin) (11, 54). Thus, while there is evidence that VEGFR3 signaling is necessary for corneal lymphangiogenesis (11), the hypothesis that VEGFR3-signalling is sufficient for the initiation of corneal lymphangiogenesis awaits experimental confirmation.

Inflammation is a common feature of diverse conditions characterized by pathological neovascularization, so it is quite possible that VEGF-A may play an important role in promoting lymphangiogenesis as well as abnormal HA in other disease states



(42). If so, the present findings may have important ramifications for "antiangiogenesis" therapies currently in development for the treatment of a variety of diseases. As previously noted, a strong correlation exists between the degree of peritumoral inflammation and lymphangiogenesis in diverse types of human tumors (42). VEGF-A is highly expressed in most solid tumors and might serve to amplify lymphangiogenesis as well as HA in cancers by recruiting "lymphangiogenic" monocytes/macrophages. Thus, antiangiogenic strategies that target VEGF-A signaling might also prove effective in at least partially suppressing peritumoral lymphangiogenesis. In the context of corneal transplant rejection, recruitment of antigen-presenting cells into afferent lymphatic vessels is an essential step in the process by which the host immune response emerges to foreign transplant antigens. Therapeutic strategies aimed at suppressing newly outgrowing lymphatics should improve transplant survival by inhibiting allosensitization (C. Cursiefen and J.W. Streilein, unpublished observations). As immune rejection is the most important cause of corneal graft failure, our findings suggest that effective inhibitors of VEGF-A signaling have the potential to improve the survival of corneal transplants.

*Note added in proof.* J. Wayne Streilein is deceased.

#### Acknowledgments

We thank our colleagues at the Schepens Eye Research Institute, especially J. Doherty for general support, J. Gu for help with histology, D. Pottle for help with confocal and immunofluorescent imaging, M. Ortega and T. Truong for help with mouse colony, and Peter Mallen for help with art work. We thank Ashique Rafique (Regeneron Pharmaceuticals Inc.) for help with the biochemical characterization of the VEGF Traps. This work was supported by Deutsche Forschungsgemeinschaft (Cu 47/1-1 and Cu 47/1-2) and by NIH grants EY10765 and CA45548. P.A. D'Amore is a Jules and Doris Stein Research to Prevent Blindness Professor.

Received for publication November 4, 2003, and accepted in revised form January 28, 2004.

Address correspondence to: Claus Cursiefen, Schepens Eye Research Institute, Harvard Medical School, 20 Staniford Street, Boston, Massachusetts 02114, USA; Phone: (617) 912-0100; Fax: (617) 912-0101; E-mail: cursiefen@vision.eri.harvard.edu.

- Folkman, J. 1995. Angiogenesis in cancer, vascular, rheumatoid and other disease. *Nat. Med.* **1**:27-31.
- Carmeliet, P. 2003. Angiogenesis in health and disease. *Nat. Med.* **9**:653-660.
- Kerbel, R., and Folkman, J. 2002. Clinical translation of angiogenesis inhibitors. *Nat. Rev. Cancer.* **2**:727-739.
- Stacker, S.A., Achen, M.G., Jussila, L., Baldwin, M.E., and Alitalo, K. 2002. Lymphangiogenesis and cancer metastasis. *Nat. Rev. Cancer.* **2**:573-583.
- He, Y., et al. 2002. Suppression of tumor lymphangiogenesis and lymph node metastasis by blocking vascular endothelial growth factor receptor 3 signaling. *J. Natl. Cancer. Inst.* **94**:819-825.
- Skobe, M., et al. 2001. Induction of tumor lymphangiogenesis by VEGF-C promotes breast cancer metastasis. *Nat. Med.* **7**:192-198.
- Padera, T.P., et al. 2002. Lymphatic metastasis in the absence of functional intratumor lymphatics. *Science.* **296**:1883-1886.
- Schoppmann, S.F., et al. 2002. Tumor-associated macrophages express lymphatic endothelial growth factors and are related to peritumoral lymphangiogenesis. *Am. J. Pathol.* **161**:947-956.
- Rissanen, T.T., et al. 2003. VEGF-D is the strongest angiogenic and lymphangiogenic effector: among VEGFs delivered into skeletal muscle via adenovirus. *Circ. Res.* **92**:1098-1106.
- Cao, Y., et al. 1998. Vascular endothelial growth factor C induces angiogenesis in vivo. *Proc. Natl. Acad. Sci. U. S. A.* **95**:14369-14374.
- Kubo, H., et al. 2002. Blockade of vascular endothelial growth factor receptor-3 signaling inhibits fibroblast growth factor-2-induced lymphangiogenesis in mouse cornea. *Proc. Natl. Acad. Sci. U. S. A.* **99**:8868-8873.
- Byzova, T.V., et al. 2002. Adenovirus encoding vascular endothelial growth factor-D induces tissue-specific vascular patterns in vivo. *Blood.* **99**:4434-4442.
- Enholm, B., et al. 2001. Adenoviral expression of vascular endothelial growth factor-C induces lymphangiogenesis in the skin. *Circ. Res.* **88**:623-629.
- Saaristo, A., et al. 2002. Adenoviral VEGF-C overexpression induces blood vessel enlargement, tortuosity, and leakiness but no sprouting angiogenesis in the skin or mucous membranes. *FASEB J.* **16**:1041-1049.
- Oh, S.J., et al. 1997. VEGF and VEGF-C: specific induction of angiogenesis and lymphangiogenesis in the differentiated avian chorioallantoic membrane. *Dev. Biol.* **188**:96-109.
- Podgrabinska, S., et al. 2002. Molecular characterization of lymphatic endothelial cells. *Proc. Natl. Acad. Sci. U. S. A.* **99**:16069-16074.
- Hirakawa, S., et al. 2003. Identification of vascular lineage-specific genes by transcriptional profiling of isolated blood vascular and lymphatic endothelial cells. *Am. J. Pathol.* **162**:575-586.
- Petrova, T.V., et al. 2002. Lymphatic endothelial reprogramming of vascular endothelial cells by the Prox-1 homeobox transcription factor. *EMBO J.* **21**:4593-4599.
- Jeitsch, M., et al. 1997. Hyperplasia of lymphatic vessels in VEGF-C transgenic mice. *Science.* **276**:1423-1425.
- Nagy, J.A., et al. 2002. Vascular permeability factor/vascular endothelial growth factor induces lymphangiogenesis as well as angiogenesis. *J. Exp. Med.* **196**:1497-1506.
- Streilein, J.W., Yamada, J., Dana, M.R., and Ksander, B.R. 1999. Anterior chamber-associated immune deviation, ocular immune privilege, and orthotopic corneal allografts. *Transplant. Proc.* **31**:1472-1475.
- Cursiefen, C., et al. 2002. Lymphatic vessels in vascularized human corneas: immunohistochemical investigation using LYVE-1 and podoplanin. *Invest. Ophthalmol. Vis. Sci.* **43**:2127-2135.
- Chang, L., Kaipainen, A., and Folkman, J. 2002. Lymphangiogenesis new mechanisms. *Ann. N. Y. Acad. Sci.* **979**:111-119.
- Holash, J., et al. 2002. VEGF-Trap: a VEGF blocker with potent antitumor effects. *Proc. Natl. Acad. Sci. U. S. A.* **99**:11393-11398.
- Shima, D.T., et al. 1996. The mouse gene for vascular endothelial growth factor. Genomic structure, definition of the transcriptional unit, and characterization of transcriptional and post-transcriptional regulatory sequences. *J. Biol. Chem.* **271**:3877-3883.
- Stalmans, I., et al. 2002. Arteriolar and venular patterning in retinas of mice selectively expressing VEGF isoforms. *J. Clin. Invest.* **109**:327-336.
- Shen, H., et al. 1993. Characterization of vascular permeability factor/vascular endothelial growth factor receptors on mononuclear phagocytes. *Blood.* **81**:2767-2773.
- Barleon, B., et al. 1996. Migration of human monocytes in response to vascular endothelial growth factor (VEGF) is mediated via the VEGF receptor flt-1. *Blood.* **87**:3336-3343.
- Streilein, J.W., Bradley, D., Sano, Y., and Sonoda, Y. 1996. Immunosuppressive properties of tissues obtained from eyes with experimentally manipulated corneas. *Invest. Ophthalmol. Vis. Sci.* **37**:413-424.
- Banerji, S., et al. 1999. LYVE-1, a new homologue of the CD44 glycoprotein, is a lymph-specific receptor for hyaluronan. *J. Cell. Biol.* **144**:789-801.
- Van der Veen, G., et al. 1994. Prevention of corneal allograft rejection in rats treated with subconjunctival injections of liposomes containing dichloromethylene diphosphonate. *Invest. Ophthalmol. Vis. Sci.* **35**:3505-3515.
- Van Kooijen, N., and Sanders, A. 1994. Liposome mediated depletion of macrophages: mechanism of action, preparation of liposomes and applications. *J. Immunol. Methods.* **174**:83-93.
- Rutherford, M.S., and Schook, L.B. 1992. Differential immunocompetence of macrophages derived using macrophage or granulocyte-macrophage colony-stimulating factor. *J. Leukoc. Biol.* **51**:69-76.
- Paavonen, K., Puolakkainen, P., Jussila, L., Jalko, T., and Alitalo, K. 2000. Vascular endothelial growth factor receptor-3 in lymphangiogenesis in wound healing. *Am. J. Pathol.* **156**:1499-1504.
- Berse, B., Brown, L.F., Van de Weter, L., Dvorak, H.F., and Senger, D.R. 1992. Vascular permeability factor (vascular endothelial growth factor) gene is expressed differentially in normal tissues, macrophages, and tumors. *Mol. Biol. Cell.* **3**:211-220.
- Alitalo, K., and Carmeliet, P. 2002. Molecular mechanisms of lymphangiogenesis in health and disease. *Cancer Cell.* **1**:219-227.
- Partanen, T.A., Alitalo, K., and Miettinen, M. 1999. Lack of lymphatic vascular specificity of vascular endothelial growth factor receptor 3 in 185 vascular tumors. *Cancer.* **86**:2406-2412.
- Clauss, M., et al. 1996. The vascular endothelial growth factor receptor Flt-1 mediates biological activities. Implications for a functional role of placenta growth factor in monocyte activation and chemotaxis. *J. Biol. Chem.* **271**:17629-17634.
- Hirasaka, S., Minowa, O., Kuno, J., Noda, T., and Shibuya, M. 1996. Flt-1 lacking the tyrosine kinase domain is sufficient for normal development and angiogenesis in mice. *Proc. Natl. Acad. Sci. U. S. A.*



- 95:9349-9354.
40. Freeman, M.R., et al. 1995. Peripheral blood T lymphocytes and lymphocytes infiltrating human cancers express vascular endothelial growth factor: a potential role for T cells in angiogenesis. *Cancer Res.* **55**:4140-4145.
  41. Taichman, N.S., Young, S., Cruchley, A.T., Taylor, P., and Paleolog, E. 1997. Human neutrophils secrete vascular endothelial growth factor. *J. Leukoc. Biol.* **62**:397-400.
  42. Schoppmann, S.F., et al. 2001. Inflammatory stromal reaction correlates with lymphatic microvessel density in early-stage cervical cancer. *Anticancer Res.* **21**:3419-3423.
  43. Paavonen, K., et al. 2002. Vascular endothelial growth factors C and D and their VEGFR-2 and 3 receptors in blood and lymphatic vessels in healthy and arthritic synovium. *J. Rheumatol.* **29**:39-45.
  44. Ristimäki, A., Narko, K., Enholm, B., Joukov, V., and Alitalo, K. 1998. Proinflammatory cytokines regulate expression of the lymphatic endothelial mitogen vascular endothelial growth factor-C. *J. Biol. Chem.* **273**:8413-8418.
  45. Ishida, S., et al. 2003. VEGF164-mediated inflammation is required for pathological, but not physiological, ischemia-induced retinal neovascularization. *J. Exp. Med.* **198**:483-489.
  46. Fromer, C.H., and Klintworth, G.K. 1975. An evaluation of the role of leukocytes in the pathogenesis of experimentally induced corneal vascularization. II. Studies on the effect of leukocytic elimination on corneal vascularization. *Am. J. Pathol.* **81**:531-544.
  47. Melder, R.J., et al. 1996. During angiogenesis, vascular endothelial growth factor and basic fibroblast growth factor regulate natural killer cell adhesion to tumor endothelium. *Nat. Med.* **2**:992-997.
  48. Lu, M., et al. 1999. VEGF increases retinal vascular ICAM-1 expression in vivo. *Invest. Ophthalmol. Vis. Sci.* **40**:1808-1812.
  49. Boardman, K.C., and Swartz, M.A. 2003. Interstitial flow as a guide for lymphangiogenesis. *Circ. Res.* **92**:801-808.
  50. Gerhardt, H., et al. 2003. VEGF guides angiogenic sprouting utilizing endothelial tip cell filopodia. *J. Cell. Biol.* **161**:i1163-1177.
  51. Lutrun, A., Tjwa, M., and Carmeliet, P. 2002. Placental growth factor (PlGF) and its receptor Flt-1 (VEGFR-1): novel therapeutic targets for angiogenic disorders. *Ann. N. Y. Acad. Sci.* **979**:80-93.
  52. Lutrun, A., et al. 2002. Revascularization of ischemic tissues by PlGF treatment, and inhibition of tumor angiogenesis, arthritis and atherosclerosis by anti-Flt-1. *Nat. Med.* **8**:831-840.
  53. Karkkainen, M.J., and Petrova, T.V. 2000. Vascular endothelial growth factor receptors in the regulation of angiogenesis and lymphangiogenesis. *Oncogene.* **19**:5598-5605.
  54. Veikkola, T., et al. 2001. Signalling via vascular endothelial growth factor receptor-3 is sufficient for lymphangiogenesis in transgenic mice. *EMBO J.* **20**:1223-1231.

UNITED STATES PATENT AND TRADEMARK OFFICE

---

BEFORE THE PATENT TRIAL AND APPEAL BOARD

---

MYLAN PHARMACEUTICALS INC.,  
Petitioner

v.

REGENERON PHARMACEUTICALS, INC.,  
Patent Owner

---

*Inter Partes* Review No.: IPR2021-00880

---

U.S. Patent No. 9,669,069 B2  
Filed: December 17, 2015  
Issued: June 6, 2017  
Inventor: George D. Yancopoulos

Title: USE OF A VEGF ANTAGONIST TO TREAT  
ANGIOGENIC EYE DISORDERS

---

**PETITION FOR *INTER PARTES* REVIEW  
OF U.S. PATENT NO. 9,669,069 B2**



## TABLE OF CONTENTS

|   |      |
|---|------|
| TABLE OF AUTHORITIES .....  | iv   |
| EXHIBIT LIST .....  | viii |
| I. INTRODUCTION .....   | 1    |
| II. OVERVIEW .....  | 1    |
| III. MANDATORY NOTICES (37 C.F.R. § 42.8).....  | 4    |
| A. REAL PARTIES-IN-INTEREST (37 C.F.R. § 42.8(b)(1)).....   | 4    |
| B. RELATED MATTERS (37 C.F.R. § 42.8(b)(2)).....  | 5    |
| C. LEAD AND BACK-UP COUNSEL AND SERVICE INFORMATION (37<br>C.F.R. § 42.8(b)(3), (4)).....                   | 5    |
| IV. PAYMENT OF FEES UNDER 37 C.F.R. § 42.15(a) AND § 42.103.....  | 6    |
| V. GROUNDS FOR STANDING (37 C.F.R. § 42.104(a)).....  | 7    |
| VI. THRESHOLD REQUIREMENT FOR <i>INTER PARTES</i> REVIEW.....   | 7    |
| VII. OVERVIEW OF CHALLENGE AND PRECISE RELIEF<br>REQUESTED.....   | 7    |
| A. CHALLENGED CLAIMS.....   | 7    |
| B. STATUTORY GROUNDS OF CHALLENGE.....  | 7    |
| VIII. OVERVIEW OF THE '069 PATENT AND PROSECUTION<br>HISTORY.....   | 8    |
| A. THE '069 PATENT.....   | 8    |
| B. PROSECUTION HISTORY.....   | 11   |
| IX. CLAIM CONSTRUCTION (37 C.F.R. § 42.104(b)(3)).....  | 13   |
| A. "INITIAL DOSE," "SECONDARY DOSE," AND "TERTIARY DOSE." .....   | 13   |
| 1. Regeneron's contradictory construction for "tertiary<br>dose," if presented here, must be rejected. .... | 15   |

|      |   |    |
|------|---|----|
| B.   | “4 WEEKS” AND “PRO RE NATA (PRN).”  | 18 |
| C.   | “VEGFR1 COMPONENT,” “VEGFR2 COMPONENT,” AND THE<br>“MULTIMERIZATION COMPONENT.”   | 19 |
| D.   | “TREATING.”   | 20 |
|      | 1. The “method for treating” element of the preamble is <u>not</u><br>a limitation on the Challenged Claims, and therefore,<br>does not require construction. | 20 |
|      | 2. Regeneron’s anticipated argument that the “method for<br>treating” preamble is a positive limitation should be<br>rejected.                                | 22 |
|      | 3. If construed to be a limitation, the preamble’s plain and<br>ordinary meaning—which does not provide any specific<br>efficacy requirement—must govern.     | 23 |
| X.   | PERSON OF ORDINARY SKILL IN THE ART   | 25 |
| XI.  | THE SCOPE AND CONTENT OF THE PRIOR ART  | 25 |
| A.   | VEGF TRAP-EYE/AFLIBERCEPT BACKGROUND  | 26 |
| B.   | PETITIONER’S PRIOR ART REFERENCES   | 29 |
|      | 1. Dixon (Ex.1006)  | 32 |
|      | 2. Regeneron (28-April-2008) (Ex.1012)  | 34 |
|      | 3. Heier-2009 (Ex.1020)   | 35 |
|      | 4. Regeneron (30-April-2009) (Ex.1028)  | 37 |
|      | 5. The ’758 patent (Ex.1010)  | 38 |
|      | 6. Dix (Ex.1033)  | 38 |
|      | 7. Mitchell (Ex.1030)   | 39 |
|      | 8. Lalwani (Ex.1035)  | 41 |
| XII. | GROUND FOR UNPATENTABILITY—DETAILED ANALYSIS  | 42 |

|       |  |    |
|-------|--|----|
| A.    | ANTICIPATION AND OBVIOUSNESS.....  | 42 |
| 1.    | Legal standards.....   | 42 |
| 2.    | Grounds 1&2: Claims 1 and 9-12 are anticipated by both Heier-2009 and Dixon, respectively.....   | 45 |
| 3.    | Ground 3: Regeneron (30-April-2009) anticipates claims 1 and 9-12.....   | 50 |
| 4.    | Ground 4: VIEW1/VIEW2 disclosures in Dixon anticipate and/or render obvious claims 1 and 8-12.....   | 53 |
| a.    | Anticipation.....  | 54 |
| b.    | Obviousness.....   | 58 |
| 5.    | Ground 5: The Challenged Claims are obvious over Heier-2009 in combination with either Mitchell or Dixon—and, optionally, either the '758 patent or Dix..... | 60 |
| a.    | A skilled artisan would have been motivated to combine Heier-2009 with either Mitchell or Dixon.....   | 62 |
| b.    | Independent Claim 1.....   | 63 |
| c.    | Claim 8.....   | 66 |
| d.    | Claims 9 and 10.....   | 66 |
| e.    | Claim 11.....  | 67 |
| f.    | Claim 12.....  | 67 |
| g.    | A skilled artisan would have reasonably expected success.....  | 67 |
| 6.    | No Secondary Considerations.....   | 69 |
| XIII. | CONCLUSION.....  | 73 |

## TABLE OF AUTHORITIES

### Cases

|   |            |
|---|------------|
| <i>Advanced Display Sys., Inc. v. Kent State Univ.</i> ,<br>212 F.3d 1272 (Fed. Cir. 2000) .....                                | 40         |
| <i>Arctic Cat Inc. v. GEP Power Prods., Inc.</i> ,<br>919 F.3d 1320 (Fed. Cir. 2019) .....                                      | 20         |
| <i>Ariosa Diagnostics v. Verinata Health, Inc.</i> ,<br>805 F.3d 1359 (Fed. Cir. 2015) .....                                    | 25         |
| <i>Bio-Rad Lab 'ys, Inc. v. 10X Genomics Inc.</i> ,<br>967 F.3d 1353 (Fed. Cir. 2020) .....                                     | 20         |
| <i>Bristol-Myers Squibb Co. v. Ben Venue Lab 'ys, Inc.</i> ,<br>246 F.3d 1368 (Fed. Cir. 2001) .....                            | 20, 22, 41 |
| <i>Chengdu Kanghong Biotechnology Co. v. Regeneron Pharms., Inc.</i> ,<br>PGR2021-00035, Paper 6 (P.T.A.B. Apr. 15, 2021) ..... | 15         |
| <i>Cubist Pharms., Inc. v. Hospira, Inc.</i> ,<br>75 F. Supp. 3d 641 (D. Del. 2014) .....                                       | 42         |
| <i>GlaxoSmithKline LLC v. Glenmark Pharms., Inc.</i> ,<br>C.A. No. 14-877-LPS-CJB, 2016 WL 3186657 (D. Del. June 3, 2016) ..... | 23         |
| <i>Grünenthal GmbH V. Antecip Bioventures II LLC</i> ,<br>PGR2019-00026, 2020 WL 4341822 (P.T.A.B. July 28, 2020) .....         | 38         |
| <i>In re Antor Media Corp.</i> ,<br>689 F.3d 1282 (Fed. Cir. 2012) .....  | 42         |
| <i>In re Baxter Travenol Labs</i> ,<br>952 F.2d 388 (Fed. Cir. 1991) .....  | 55         |
| <i>In re Cruciferous Sprout Litig.</i> ,<br>301 F.3d 1343 (Fed. Cir. 2002) .....  | 41         |

|   |                |
|---|----------------|
| <i>In re Huai-Hung Kao</i> ,<br>639 F.3d 1057 (Fed. Cir. 2011).....   | 44, 68         |
| <i>In re Omeprazole Patent Litig.</i> ,<br>483 F.3d 1364 (Fed. Cir. 2007).....  | 41             |
| <i>In Re: Copaxone Consol. Cases</i> ,<br>906 F.3d 1013 (Fed. Cir. 2018).....   | 20, 22         |
| <i>King Pharms., Inc. v. Eon Labs, Inc.</i> ,<br>616 F.3d 1267 (Fed. Cir. 2010).....  | 24, 41, 64     |
| <i>KSR Int’l Co. v. Teleflex Inc.</i> ,<br>550 U.S. 398 (2007) .....  | 25, 43, 44, 61 |
| <i>Merck &amp; Co. v. Teva Pharms. USA, Inc.</i> ,<br>395 F.3d 1364 (Fed. Cir. 2005).....                                   | 17             |
| <i>Motorola Mobility LLC v. Arrouse</i> ,<br>IPR2013-00010, 2013 WL 12349001 (P.T.A.B. Jan. 30, 2013).....                  | 7              |
| <i>Multiform Desiccants, Inc. v. Medzam, Ltd.</i> ,<br>133 F.3d 1473 (Fed. Cir. 1998).....                                  | 17             |
| <i>Mylan Lab’ys Ltd. v. Aventis Pharma S.A.</i> ,<br>IPR2016-00712, 2016 WL 5753968, Paper 9 (P.T.A.B. Sept. 22, 2016)..... | 21             |
| <i>Ormco Corp. v. Align Tech., Inc.</i> ,<br>463 F.3d 1299 (Fed. Cir. 2006).....  | 44, 68         |
| <i>Perricone v. Medicis Pharm. Corp.</i> ,<br>432 F.3d 1368 (Fed. Cir. 2005).....   | 24, 41         |
| <i>Phillips v. AWH Corp.</i> ,<br>415 F.3d 1303 (Fed. Cir. 2005).....   | 13, 15, 23     |
| <i>Power Mosfet Techs., L.L.C. v. Siemens AG</i> ,<br>378 F.3d 1396 (Fed. Cir. 2004).....                                   | 18             |
| <i>Purdue Pharma L.P. v. Endo Pharms. Inc.</i> ,<br>438 F.3d 1123 (Fed. Cir. 2006).....                                     | 21             |

|  |    |
|--|----|
| <i>Rasmusson v. SmithKline Beecham Corp.</i> ,<br>413 F.3d 1318 (Fed. Cir. 2005).....                  | 42 |
| <i>Rosco, Inc. v. Mirror Lite Co.</i> ,<br>304 F.3d 1373 (Fed. Cir. 2002).....                         | 27 |
| <i>Ruckus Wireless, Inc. v. Innovative Wireless Sols., LLC</i> ,<br>824 F.3d 999 (Fed. Cir. 2016)..... | 17 |
| <i>Samsung Elecs. Co. v. Elm 3DS Innovations, LLC</i> ,<br>925 F.3d 1373 (Fed. Cir. 2019).....         | 16 |
| <i>Sinorgchem Co., Shandong v. Int'l Trade Comm'n</i> ,<br>511 F.3d 1132 (Fed. Cir. 2007).....         | 15 |
| <i>TomTom, Inc. v. Adolph</i> ,<br>790 F.3d 1315 (Fed. Cir. 2015).....                                 | 20 |
| <i>VidStream LLC v. Twitter, Inc.</i> ,<br>981 F.3d 1060 (Fed. Cir. 2020).....                         | 38 |
| <i>Vizio, Inc. v. Int'l Trade Comm'n</i> ,<br>605 F.3d 1330 (Fed. Cir. 2010).....                      | 20 |
| <i>Wyers v. Master Lock Co.</i> ,<br>616 F.3d 1231 (Fed. Cir. 2010).....                               | 68 |

### Statutes

|                            |        |
|----------------------------|--------|
| 35 U.S.C. § 102.....       | passim |
| 35 U.S.C. § 103(a) .....   | 49     |
| 35 U.S.C. § 314(a) .....   | 7      |
| 35 U.S.C. §§ 311-319 ..... | 1      |

**Other Authorities**

83 Fed. Reg. 197, 51340-51359 (Oct. 11, 2018) .....13

Trial Practice Guide,  
77 Fed. Reg. 48759-60 .....5

**Regulations**

37 C.F.R. § 42.10(b) .....6

37 C.F.R. § 42.100(b) .....14

37 C.F.R. § 42.103 .....7

37 C.F.R. § 42.15(a).....7

37 C.F.R. § 42.8(a)(1).....4

37 C.F.R. § 42.8(b) .....4

37 C.F.R. §§ 42 *et seq.* .....1

## EXHIBIT LIST

| Exhibit | Description   |
|---------|---|
| 1001    | U.S. Patent No. 9,669,069 B2 (“‘069 patent”)  |
| 1002    | Expert Declaration of Dr. Thomas A. Albini in Support of Petition for <i>Inter Partes</i> Review of Patent No. 9,669,069 B2, dated May 4, 2021 (“Albini”)   |
| 1003    | Expert Declaration of Mary Gerritsen, Ph.D. in Support of Petition for <i>Inter Partes</i> Review of U.S. Patent No. 9,669,069 B2, dated Apr. 26, 2021 (“Gerritsen”)  |
| 1004    | Jocelyn Holash et al., <i>VEGF-Trap: A VEGF Blocker with Potent Antitumor Effects</i> , 99 PROC. NAT’L ACAD. SCI. 11393 (2002) (“Holash”)   |
| 1005    | Quan Dong Nguyen et al., <i>A Phase I Study of Intravitreal Vascular Endothelial Growth Factor Trap-Eye in Patients with Neovascular Age-Related Macular Degeneration</i> , 116 OPHTHALMOLOGY 2141 (2009) (“Nguyen-2009”)   |
| 1006    | James A Dixon et al., <i>VEGF Trap-Eye for the Treatment of Neovascular Age-Related Macular Degeneration</i> , 18 EXPERT OPINION ON INVESTIGATIONAL DRUGS 1573 (2009) (“Dixon”)   |
| 1007    | Adis R&D Profile, <i>Aflibercept: AVE 0005, AVE 005, AVE0005, VEGF Trap – Regeneron, VEGF Trap (R1R2), VEGF Trap-Eye</i> , 9 DRUGS R&D 261 (2008) (“Adis”)  |
| 1008    | U.S. Patent No. 7,531,173 B2 (“‘173 patent”)  |
| 1009    | U.S. Patent No. 7,396,664 B2 (“‘664 patent”)  |
| 1010    | U.S. Patent No. 7,374,758 B2 (“‘758 patent”)  |
| 1011    | F Semeraro et al., <i>Aflibercept in Wet AMD: Specific Role and Optimal Use</i> , 7 DRUG DESIGN, DEV. & THERAPY 711 (2013) (“Semeraro”)   |
| 1012    | Press Release, Regeneron, Regeneron and Bayer Health Care Announce Encouraging 32-Week Follow-Up Results from a Phase 2 Study of VEGF Trap-Eye in Age-Related Macular Degeneration (Apr. 28, 2008), <a href="http://investor.regeneron.com/releasedetail.cfm?releaseid=394066">http://investor.regeneron.com/releasedetail.cfm?releaseid=394066</a> (“Regeneron (28-April-2008)”) |
| 1013    | Press Release, Regeneron, Bayer and Regeneron Dose First Patient in Second Phase 3 Study for VEGF Trap-Eye in Wet Age-Related Macular Degeneration (May 8, 2008),   |



|      |  |
|------|--|
|      | <a href="http://investor.regeneron.com/releasedetail.cfm?ReleaseID=394065">http://investor.regeneron.com/releasedetail.cfm?ReleaseID=394065</a><br>("Regeneron (8-May-2008)")  |
| 1014 | Vascular Endothelial Growth Factor (VEGF) Trap-Eye: Investigation of Efficacy and Safety in Wet Age-Related Macular Degeneration (AMD) (VIEW1), NCT00509795, ClinicalTrials.gov (Apr. 28, 2009), <a href="https://clinicaltrials.gov/ct2/show/NCT00509795">https://clinicaltrials.gov/ct2/show/NCT00509795</a> ("NCT-795") |
| 1015 | VEGF Trap-Eye: Investigation of Efficacy and Safety in Wet AMD (VIEW 2), NCT00637377, ClinicalTrials.gov (Mar. 17, 2008), <a href="https://clinicaltrials.gov/ct2/show/NCT00637377">https://clinicaltrials.gov/ct2/show/NCT00637377</a> ("NCT-377")  |
| 1016 | U.S. Patent Nos. 7,303,746 B2; 7,303,747 B2; 7,306,799 B2; and 7,521,049 B2 ("Monthly-Dosing-Patents")   |
| 1017 | File History of U.S. Patent No. 9,669,069 B2 ("069 FH")  |
| 1018 | Jeffrey S. Heier et al., <i>Intravitreal Aflibercept (VEGF Trap-Eye) in Wet Age-Related Macular Degeneration</i> , 119 OPTHALMOLOGY 2537 (2012) ("Heier-2012")   |
| 1019 | U.S. Patent No. 9,254,338 B2 ("338 patent")  |
| 1020 | Jeffrey S. Heier, <i>Intravitreal VEGF Trap for AMD: An Update</i> , RETINA TODAY, Oct. 2009, 44 ("Heier-2009")  |
| 1021 | Regeneron Pharm., Inc., Quarterly Report (Form 10-Q) (Sept. 30, 2009) ("2009 10-Q")  |
| 1022 | U.S. Patent No. 7,374,757 B2 ("757 patent")  |
| 1023 | U.S. Patent No. 7,070,959 B1 ("959 patent")  |
| 1024 | File History of U.S. Patent No. 7,374,758 B2, 12/22/2011 Patent Term Extension Application ("758 FH, 12/22/2011 PTE")  |
| 1025 | Michael Engelbert et al., <i>Long-Term Follow-Up For Type 1 (Subretinal Pigment Epithelium) Neovascularization Using A Modified "Treat And Extend" Dosing Regimen of Intravitreal Antivascular Endothelial Growth Factor Therapy</i> , 30 RETINA, J. RETINAL & VITREOUS DISEASES 1368 (2010) ("Engelbert-2010")            |
| 1026 | Michael Engelbert et al., <i>"Treat and Extend" Dosing of Intravitreal Antivascular Endothelial Growth Factor Therapy For Type 3 Neovascularization/Retinal Angiomatous Proliferation</i> , 29 J. RETINAL & VITREOUS DISEASES 1424 (2009) ("Engelbert-2009")   |
| 1027 | Richard F. Spaide et al., <i>Prospective Study of Intravitreal Ranibizumab as a Treatment for Decreased Visual Acuity Secondary to Central Retinal Vein Occlusion</i> , 147 AM. J. OPTHALMOLOGY 298 (2009) ("Spaide")  |

|      |   |
|------|---|
| 1028 | Press Release, Regeneron, Bayer and Regeneron Extend Development Program for VEGF Trap-Eye to Include Central Retinal Vein Occlusion (Apr. 30, 2009), <a href="https://investor.regeneron.com/news-releases/news-release-details/bayer-and-regeneron-extend-development-program-vegf-trap-eye">https://investor.regeneron.com/news-releases/news-release-details/bayer-and-regeneron-extend-development-program-vegf-trap-eye</a> (“Regeneron (30-April-2009)”) |
| 1029 | Vascular Endothelial Growth Factor (VEGF) Trap-Eye: Investigation of Efficacy and Safety in Central Retinal Vein Occlusion (CRVO), NCT01012973, ClinicalTrials.gov (Nov. 12, 2009), <a href="https://clinicaltrials.gov/ct2/show/NCT01012973">https://clinicaltrials.gov/ct2/show/NCT01012973</a> (“NCT-973”)   |
| 1030 | P Mitchell et al., <i>Ranibizumab (Lucentis) in Neovascular Age-Related Macular Degeneration: Evidence from Clinical Trials</i> , 94 BRIT. J. OPHTHALMOLOGY 2 (2009) (date of online publication) (“Mitchell”)  |
| 1031 | Pascale G. Massin, <i>Anti-VEGF Therapy for Diabetic Macular Edema: An Update</i> , RETINA TODAY, SEPT./Oct. 2008, 54 (“Massin”)  |
| 1032 | Press Release, Bayer AG, Bayer and Regeneron Start Additional Phase 3 Study for VEGF Trap-Eye in Wet Age-Related Macular Degeneration (May 8, 2008) (“Bayer (8-May-2008)”)  |
| 1033 | U.S. Patent Application Publication No. 2006/0217311 A1 (“Dix”)   |
| 1034 | Anne E. Fung et al., <i>An Optical Coherence Tomography-Guided, Variable Dosing Regimen with Intravitreal Ranibizumab (Lucentis) for Neovascular Age-related Macular Degeneration</i> , 143 AM. J. OPHTHALMOLOGY 566 (2007) (“Fung”)  |
| 1035 | Geeta A. Lalwani et al., <i>A Variable-dosing Regimen with Intravitreal Ranibizumab for Neovascular Age-Related Macular Degeneration: Year 2 of the PrONTO Study</i> , 148 AM. J. OPHTHALMOLOGY 43 (2009) (“Lalwani”)   |
| 1036 | Peter A Campochiaro et al., <i>Ranibizumab for Macular Edema Due to Retinal Vein Occlusions: Implication of VEGF as a Critical Stimulator</i> , 16 MOLECULAR THERAPY 791 (2008) (“Campochiaro”)   |
| 1037 | Robert Steinbrook, <i>The Price of Sight — Ranibizumab, Bevacizumab, and the Treatment of Macular Degeneration</i> , 355 N. ENG. J. MED. 1409 (2006) (“Steinbrook”)   |
| 1038 | Curriculum Vitae of Dr. Thomas Albini (“Albini CV”)   |
| 1039 | U.S. Patent No. 7,378,095 B2 (“’095 patent”)  |

|      |   |
|------|---|
| 1040 | <i>International Nonproprietary Names for Pharmaceutical Substances (INN)</i> , 20 WHO DRUG INFORMATION 115 (2006) (“WHO Drug Info”)  |
| 1041 | Press Release, Regeneron, Regeneron Reports Full Year and Fourth Quarter 2008 Financial and Operating Results (Feb. 26, 2009), <a href="https://investor.regeneron.com/news-releases/news-release-details/regeneron-reports-full-year-and-fourth-quarter-2008-financial">https://investor.regeneron.com/news-releases/news-release-details/regeneron-reports-full-year-and-fourth-quarter-2008-financial</a> (“Regeneron (26-February-2009)”) |
| 1042 | U.S. DEP’T HEALTH & HUMAN SERVS., NAT’L INST. HEALTH, NAT’L EYE INST., <i>Age-Related Macular Degeneration: What You Should Know</i> (Sept. 2015), <a href="https://www.nei.nih.gov/sites/default/files/health-pdfs/WYSK_AMD_English_Sept2015_PRINT.pdf">https://www.nei.nih.gov/sites/default/files/health-pdfs/WYSK_AMD_English_Sept2015_PRINT.pdf</a> (“NIH AMD”)  |
| 1043 | David M. Brown & Carl D. Regillo, <i>Anti-VEGF Agents in the Treatment of Neovascular Age-Related Macular Degeneration: Applying Clinical Trial Results to the Treatment of Everyday Patients</i> , 144 AM. J. OPHTHALMOLOGY 627 (2007) (“Brown”)   |
| 1044 | U.S. DEP’T HEALTH & HUMAN SERVS., NAT’L INST. HEALTH, NAT’L EYE INST., <i>Diabetic Retinopathy: What You Should Know</i> (Sept. 2015), <a href="https://www.nei.nih.gov/sites/default/files/2019-06/Diabetic-Retinopathy-What-You-Should-Know-508.pdf">https://www.nei.nih.gov/sites/default/files/2019-06/Diabetic-Retinopathy-What-You-Should-Know-508.pdf</a> (“NIH DR”)   |
| 1045 | Napoleone Ferrara & Kari Alitalo, <i>Clinical Applications of Angiogenic Growth Factors and Their Inhibitors</i> , 5 NATURE MED. 1359 (1999) (“Ferrara-1999”)   |
| 1046 | Napoleone Ferrara & Robert S. Kerbel, <i>Angiogenesis as a Therapeutic Target</i> , 438 NATURE 967 (2005) (“Ferrara-2005”)  |
| 1047 | Ziad F. Bashshur et al., <i>Intravitreal Bevacizumab for the Management of Choroidal Neovascularization in Age-Related Macular Degeneration</i> , 142 AM. J. OPHTHALMOLOGY 1 (2006) (“Bashshur”)  |
| 1048 | LUCENTIS® Prescribing Information (2006) (“Lucentis”)   |
| 1049 | L. Spielberg & A. Leys, <i>Intravitreal Bevacizumab for Myopic Choroidal Neovascularization: Short-Term and 1-Year Results</i> , 312 BULLETIN SOCIETE BELGE D’OPHTALMOLOGIE 17 (2009) (“Spielberg”)   |
| 1050 | Ursula Schmidt-Erfurth, <i>Current Concepts in the Management of Diabetic Macular Edema</i> , 7 PROCEEDINGS 52 (2010) (“Schmidt-Erfurth”)   |

|      |  |
|------|--|
| 1051 | Pearse A. Keane et al., <i>Effect of Ranibizumab Retreatment Frequency on Neurosensory Retinal Volume in Neovascular AMD</i> , 29 RETINA 592 (2009) (“Keane”)  |
| 1052 | J.S. Rudge et al., <i>VEGF Trap as a Novel Antiangiogenic Treatment Currently in Clinical Trials for Cancer and Eye Diseases, and VelociGene®-Based Discovery of the Next Generation of Angiogenesis Targets</i> , 70 COLD SPRING HARBOR SYMPOSIA QUANTITATIVE BIOLOGY 411 (2005) (“Rudge”)  |
| 1053 | Press Release, Regeneron, Positive Interim Phase 2 Data Reported for VEGF Trap-Eye in Age-Related Macular Degeneration (Mar. 27, 2007), <a href="https://newsroom.regeneron.com/news-releases/news-release-details/positive-interim-phase-2-data-reported-vegf-trap-eye-age-related?releaseid=394105">https://newsroom.regeneron.com/news-releases/news-release-details/positive-interim-phase-2-data-reported-vegf-trap-eye-age-related?releaseid=394105</a> (“Regeneron (27-March-2007)”)        |
| 1054 | Press Release, Regeneron, Regeneron and Bayer Healthcare Initiate Phase 3 Global Development Program for VEGF Trap-Eye in Wet Age-Related Macular Degeneration (AMD) (Aug. 2, 2007), <a href="https://investor.regeneron.com/news-releases/news-release-details/regeneron-and-bayer-healthcare-initiate-phase-3-global">https://investor.regeneron.com/news-releases/news-release-details/regeneron-and-bayer-healthcare-initiate-phase-3-global</a> (“Regeneron (2-August-2007)”)                 |
| 1055 | Retina Society, VEGF Trap-Eye in Wet AMD CLEAR-IT 2: Summary of One-Year Key Results, A Phase 2, Randomized, Controlled Dose-and Interval-Ranging Study of Intravitreal VEGF Trap-Eye in Patients With Neovascular, Age-Related Macular Degeneration (Sept. 28, 2008) (“Retina Society Meeting Presentation”)  |
| 1056 | Press Release, Regeneron, VEGF Trap-Eye Final Phase 2 Results in Age-related Macular Degeneration Presented at 2008 Retina Society Meeting (Sept. 28, 2008), <a href="https://investor.regeneron.com/news-releases/news-release-details/vegf-trap-eye-final-phase-2-results-age-related-macular?ReleaseID=393906">https://investor.regeneron.com/news-releases/news-release-details/vegf-trap-eye-final-phase-2-results-age-related-macular?ReleaseID=393906</a> (“Regeneron (28-September-2008)”) |
| 1057 | Press Release, Regeneron, VEGF Trap-Eye Shows Positive Results in a Phase 2 Study in Patients with Diabetic Macular Edema (Feb. 18, 2010), <a href="https://investor.regeneron.com/news-releases/news-release-details/vegf-trap-eye-shows-positive-results-phase-2-study-patients?releaseid=445521">https://investor.regeneron.com/news-releases/news-release-details/vegf-trap-eye-shows-positive-results-phase-2-study-patients?releaseid=445521</a> (“Regeneron (18-February-2010)”)            |
| 1058 | ASS’N FOR RES. VISION & OPHTHALMOLOGY, ARVO® News (Winter/Spring 2008) (“ARVONews Winter/Spring 2008”)   |

|      |   |
|------|---|
| 1059 | ASS'N FOR RES. VISION & OPHTHALMOLOGY, ARVO® News (Summer 2007) (“ARVONews Summer 2007”)  |
| 1060 | Jean-François Korobelnik et al., <i>Intravitreal Aflibercept Injection for Macular Edema Resulting from Central Retinal Vein Occlusion</i> , 121 OPHTHALMOLOGY 202 (2014) (“Korobelnik”)  |
| 1061 | Curriculum Vitae of Dr. Mary Gerritsen (“Gerritsen CV”)   |
| 1062 | EP 2 663 325 (published as WO 2012/097019 (A1)) (“EP-325”)  |
| 1063 | File History of EP 2 663 325 (“EP-325-FH”)  |
| 1064 | BMJ Publishing Group Ltd., <i>Online First</i> , BJO ONLINE, (Feb. 11, 2009), <a href="https://bjournal.bmj.com/onlinefirst.dtl">https://bjournal.bmj.com/onlinefirst.dtl</a> [ <a href="http://web.archive.org/web/20090212162702/https://bjournal.bmj.com/onlinefirst.dtl">http://web.archive.org/web/20090212162702/https://bjournal.bmj.com/onlinefirst.dtl</a> ] (“Wayback-BJO-Online First”)  |
| 1065 | BMJ Publishing Group Ltd., <i>Review: Ranibizumab (Lucentis) In Neovascular Age-Related Macular Degeneration: Evidence From Clinical Trials</i> , BRITISH J. OPHTHALMOLOGY (Dec. 2020), <a href="https://bjournal.bmj.com/content/94/1/2.altmetrics">https://bjournal.bmj.com/content/94/1/2.altmetrics</a> (“BJO-Article Metrics”)   |
| 1066 | Press Release, Bayer, VEGF Trap-Eye Shows Positive Results in Phase II Study in Patients with Diabetic Macular Edema (Feb. 18, 2010) (“Bayer (18-February-2010)”)   |
| 1067 | Press Release, Bayer, Bayer HealthCare and Regeneron Announce Encouraging 32-Week Follow Up Results From A Phase 2 Study of VEGF Trap-Eye in Age-Related Macular Degeneration (Apr. 28, 2008) (“Bayer (28-April-2008)”)   |
| 1068 | Press Release, Regeneron, Enrollment Completed in Regeneron and Bayer Healthcare Phase 3 Studies of VEGF Trap-Eye in Neovascular Age-Related Macular Degeneration (Wet AMD) (Sept. 14, 2009), <a href="https://newsroom.regeneron.com/news-releases/news-release-details/enrollment-completed-regeneron-and-bayer-healthcare-phase-3">https://newsroom.regeneron.com/news-releases/news-release-details/enrollment-completed-regeneron-and-bayer-healthcare-phase-3</a> (“Regeneron (14-September-2009)”) |
| 1069 | ClinicalTrials.gov, <i>What Is ClinicalTrials.gov?</i> , U.S. NAT’L LIBRARY MED. (Jan. 2018), <a href="https://www.clinicaltrials.gov/ct2/about-site/background">https://www.clinicaltrials.gov/ct2/about-site/background</a> (“Background-ClinicalTrials.gov”)   |
| 1070 | Affidavit of Duncan Hall (Internet Archive Records Request Processor) Regarding Vascular Endothelial Growth Factor (VEGF) Trap-Eye: Investigation of Efficacy and Safety in Central Retinal Vein Occlusion (CRVO) (GALILEO), NCT01012973, ClinicalTrials.gov (Apr. 8, 2011); Vascular Endothelial Growth Factor (VEGF) Trap-Eye: Investigation of Efficacy and Safety in  |

|      |   |
|------|---|
|      | Wet Age-Related Macular Degeneration (AMD) (VIEW1), NCT00509795, ClinicalTrials.gov (Apr. 8, 2011); and VEGF Trap-Eye: Investigation of Efficacy and Safety in Wet AMD (VIEW 2), NCT00637377, ClinicalTrials.gov (Aug. 13, 2009), dated January 20, 2021 (“Wayback-Affidavit-069”)  |
| 1071 | Frank G Holz et al., <i>VEGF Trap-Eye for Macular Oedema Secondary to Central Retinal Vein Occlusion: 6-Month Results of the Phase III GALILEO Study</i> , 97 BRITISH J. OPHTHALMOLOGY 278 (2013) (“Holz”)  |
| 1072 | Janice M. Reichert, <i>Antibody-Based Therapeutics To Watch In 2011</i> , 3 MABS 76 (2011) (“Reichert”)   |
| 1073 | Owen A. Anderson et al., <i>Delivery of Anti-Angiogenic Molecular Therapies for Retinal Disease</i> , 15 DRUG DISCOVERY TODAY 272 (2010) (“Anderson”)   |
| 1074 | Thomas A. Ciulla & Philip J. Rosenfeld, <i>Antivascular Endothelial Growth Factor Therapy For Neovascular Age-Related Macular Degeneration</i> , 20 CURRENT OPINION OPHTHALMOLOGY 158 (2009) (“Ciulla”)   |
| 1075 | Zhang Ni & Peng Hui, <i>Emerging Pharmacologic Therapies for Wet Age-Related Macular Degeneration</i> , 223 OPHTHALMOLOGICA 401 (2009) (“Ni”)   |
| 1076 | Marco A. Zarbin & Philip J. Rosenfeld, <i>Pathway-Based Therapies for Age-Related Macular Degeneration: An Integrated Survey of Emerging Treatment Alternatives</i> , 30 RETINA 1350 (2010) (“Zarbin”)  |
| 1077 | Corporate Finance Institute, <i>SEC Filings: Public Disclosures About Public Companies</i> , <a href="https://corporatefinanceinstitute.com/resources/data/public-filings/sec-filings/">https://corporatefinanceinstitute.com/resources/data/public-filings/sec-filings/</a> (last visited May 5, 2021) (“Corporate Finance Institute”) |
| 1078 | Carl W. Schneider, <i>Nits, Grits, and Soft Information in SEC Filings</i> , 121 U. PA. L. REV. 254 (1972) (“Schneider”)  |
| 1079 | Justin Kuepper, <i>The Best Investment Information Sources: Using SEC Filings, Analyst Reports, and Company Websites</i> , BALANCE (Jan. 13, 2021), <a href="https://www.thebalance.com/top-best-sources-of-investor-information-1979207">https://www.thebalance.com/top-best-sources-of-investor-information-1979207</a> (“Kuepper”)   |
| 1080 | Kristina Zucchi, <i>EDGAR: Investors' One-Stop-Shop For Company Filings</i> , YAHOO!LIFE (Jan. 31, 2014),   |

|      |  |
|------|--|
|      | <a href="https://www.yahoo.com/lifestyle/tagged/health/edgar-investors-one-stop-shop-170000800.html">https://www.yahoo.com/lifestyle/tagged/health/edgar-investors-one-stop-shop-170000800.html</a> (“Zucchi”)   |
| 1081 | Adam Hayes, <i>SEC Filings: Forms You Need To Know</i> , INVESTOPEDIA (Jan. 18, 2021), <a href="https://www.investopedia.com/articles/fundamental-analysis/08/sec-forms.asp">https://www.investopedia.com/articles/fundamental-analysis/08/sec-forms.asp</a> (“Hayes”) |
| 1082 | Amino acid sequence alignment of SEQ ID NO:2 of the '069 patent with SEQ ID NO:16 of the '758 patent and SEQ ID NO:4 of Dix (“'069 Amino Acid Sequences”)  |
| 1083 | Nucleotide sequence alignment of SEQ ID NO:1 of the '069 patent with SEQ ID NO:15 of the '758 patent and SEQ ID NO:3 of Dix (“'069 Nucleotide Sequences”)  |

## I. INTRODUCTION.

Mylan Pharmaceuticals Inc. (“Petitioner”) petitions for *inter partes* review (“IPR”) under 35 U.S.C. §§ 311-319 and 37 C.F.R. §§ 42 *et seq.*, seeking cancellation of claims 1 and 8-12 (the “Challenged Claims”) of U.S. Patent No. 9,669,069 (“’069 patent”) (Ex.1001), assigned to Regeneron Pharmaceuticals, Inc. (“Regeneron” or “Patent Owner”).

## II. OVERVIEW.

The Challenged Claims are drawn to nothing more than a known, mental step dosing regimen (i.e., “as-needed” or “*pro re nata*” (“PRN”) administration) using a drug known to persons of ordinary skill in the art (referred to herein as a “skilled artisan(s)”) to treat angiogenic eye disorders. These claims should have never issued. Each is anticipated and obvious over the prior art, which expressly disclosed skilled artisans actively practicing these exact methods on patients—with success. Indeed, Regeneron’s own clinical trials for EYLEA® (aka “VEGF Trap-Eye” or “aflibercept”)—widely published—utilized the claimed PRN dosing regimen to treat age-related macular degeneration (“AMD”) years before Regeneron filed the ’069 patent application in 2011. Regeneron withheld those publications from the Examiner, allowing the ’069 patent to issue.

By 2010, ophthalmologists were moving away from monthly dosing regimens for vitreoretinal disease therapies due to problems with patient compliance and



discomfort associated with intravitreal injections. For example, in 2007, LUCENTIS® (ranibizumab), an anti-VEGF therapy approved for monthly dosing,<sup>1</sup> was undergoing a series of clinical trials to assess less frequent dosing regimens. These clinical assessments included, *inter alia*, PRN dosing (including, PRN after three monthly loading doses). Motivated to keep pace with the LUCENTIS® trials, Regeneron initiated a clinical program for EYLEA® that implemented those same regimens—e.g., Regeneron’s Phase 2 clinical trials for age-related macular degeneration (“CLEAR-IT-2”) assessing PRN dosing after four monthly doses. The problem: this trial regimen was widely launched, published and thus known to skilled artisans long before 2011. The prior art includes numerous Regeneron press releases, which were directed to skilled artisans to attract their interest in EYLEA®, along with publications directed to practicing ophthalmologists. Many disclosed the CLEAR-IT-2 trial details, including, most notably, the later-claimed PRN dosing regimen. Those public disclosures render the Challenged Claims unpatentable.

Petitioner files this Petition and supporting expert declarations from: (i) renowned ophthalmologist, Dr. Thomas Albini (Ex.1002), to apprise the Board of invalidating prior art—much of which was not before the Examiner when prosecuting the ’069 patent; and (ii) Dr. Mary Gerritsen, a pharmacologist with over

---

<sup>1</sup> LUCENTIS® is the primary competitor to EYLEA®.

thirty years' experience, (Ex.1003) to confirm the public availability of certain prior art disclosures relied upon herein.

*Anticipation.* Challenged Claims 1 and 9-12 are anticipated by three separate prior art references: Dixon, Heier-2009, and Regeneron (30-April-2009). Dixon and Heier-2009 disclose Regeneron's Phase 2 CLEAR-IT-2 trial. Regeneron (30-April-2009) discloses Regeneron's Phase 3 RVO trial regimen.

Further, claims 1 and 8-12 are anticipated by Dixon in light of arguments that Regeneron itself made during prosecution of the '069 patent. Dixon discloses Regeneron's Phase 3 AMD (VIEW1/VIEW2) trial, which evaluated every-eight-week dosing (following a fixed monthly loading dose period)—a regimen Regeneron told the Examiner fell within the scope of the Challenged Claims.

*Obviousness.* The Challenged Claims would also have been obvious. The prior art demonstrates—and Dr. Albini confirms—monthly intravitreal injections for angiogenic eye disorders were known to be burdensome—both physically and financially. Skilled artisans were thus moving away from monthly dosing VEGF antagonists in favor of less frequent schedules. For example, Genentech—following the industry trend—had showed success with PRN dosing (after three fixed monthly injections) for LUCENTIS®. Accordingly, a skilled artisan would have (1) been highly motivated to combine such knowledge with the prior art disclosures that

VEGF Trap-Eye is a potent, high-affinity VEGF blocker<sup>2</sup>, and (ii) reasonably expected success with the PRN dosing regimen based on the results from CLEAR-IT-2. In fact, although unnecessary to prove obviousness, the prior art demonstrates *actual* success, further confirming that the Challenged Claims are invalid and the claimed dosing regimen unpatentable.

For the reasons set forth herein, Petitioner requests the Challenged Claims be cancelled.

### **III. MANDATORY NOTICES (37 C.F.R. § 42.8).**

Pursuant to 37 C.F.R. §§ 42.8(a)(1) and 42.8(b), the following mandatory notices are provided as part of this Petition.

#### **A. REAL PARTIES-IN-INTEREST (37 C.F.R. § 42.8(b)(1)).**

Viartis Inc. and Mylan Inc. are parent companies of Petitioner Mylan Pharmaceuticals Inc. Accordingly, Viartis Inc., Mylan Inc., and Mylan Pharmaceuticals Inc. are identified as real parties-in-interest to the current Petition. Momenta Pharmaceuticals, Inc. is a wholly-owned subsidiary of Johnson & Johnson, a publicly held company. Momenta Pharmaceuticals, Inc. and Johnson &

---

<sup>2</sup> (Ex.1004, Holash; Ex.1005, Nguyen-2009; Ex.1006, Dixon; Ex.1007, Adis; Ex.1008, '173 patent; Ex.1009, '664 patent; *see also* Ex.1010, '758 patent (disclosing nucleotide and amino acid sequences for aflibercept)).

Johnson are also real parties-in-interest to the current Petition. No other parties exercised or could have exercised control over this Petition; no other parties funded, directed and controlled this Petition. See Trial Practice Guide, 77 Fed. Reg. 48759-60 (Aug. 14, 2021).

**B. RELATED MATTERS (37 C.F.R. § 42.8(b)(2)).**

Petitioner identifies *Mylan Pharms. Inc. v. Regeneron Pharms., Inc.*, Case No. IPR2021-00881 (P.T.A.B.), filed concurrently herewith. To the best of Petitioner's knowledge, there are no other judicial or administrative matters that would affect, or be affected by, a decision in this proceeding; nonetheless, out of an abundance of caution, Petitioner further identifies *Chengdu Kanghong Biotechnology Co. v. Regeneron Pharms., Inc.*, Case No. PGR2021-00035 (P.T.A.B.).

U.S. Patent Nos. 10,130,681 B2, 10,857,205 B2, 10,828,345 B2, and 10,888,601 B2; and U.S. Patent Application Nos. 17/072,417, 17/112,063, and 17/112,404 claim the benefit of the '069 patent filing date.

**C. LEAD AND BACK-UP COUNSEL AND SERVICE INFORMATION (37 C.F.R. § 42.8(b)(3), (4)).**

Petitioner identifies their lead and backup counsel below. A Power of Attorney is being filed concurrently herewith under 37 C.F.R. § 42.10(b).

| Lead   | Back-Up  |
|--|--|
| <p>Paul J. Molino (Reg. No. 45,350)<br/>paul@rmmslegal.com</p> <p><u>Postal and Hand Delivery Address</u><br/>Rakoczy Molino Mazzochi Siwik LLP<br/>6 West Hubbard Street<br/>Chicago, IL 60654<br/>Telephone: (312) 222-6300<br/>Facsimile: (312) 843-6260</p> <p><i>Petitioner consents to email service at:</i><br/>MYL_REG_IPR@rmmslegal.com</p> | <p>William A. Rakoczy<br/>(<i>pro hac vice</i> to be filed)<br/>wrakoczy@rmmslegal.com</p> <p>Heinz J. Salmen<br/>(<i>pro hac vice</i> to be filed)<br/>hsalmen@rmmslegal.com</p> <p>Neil B. McLaughlin (Reg. No. 70,810)<br/>nmclaughlin@rmmslegal.com</p> <p><u>Postal and Hand Delivery Address</u><br/>Rakoczy Molino Mazzochi Siwik LLP<br/>6 West Hubbard Street<br/>Chicago, IL 60654<br/>Telephone: (312) 222-5127<br/>Facsimile: (312) 843-6260</p> |

Please direct all correspondence to lead and back-up counsel at the contact information above. Petitioner also consents to service by email at: MYL\_REG\_IPR@rmmslegal.com. Petitioner intends to file a motion seeking the admission of William A. Rakoczy and Heinz J. Salmen to appear *pro hac vice* when authorized to do so.

**IV. PAYMENT OF FEES UNDER 37 C.F.R. § 42.15(a) AND § 42.103**

The required fees are submitted herewith. The undersigned representative of Petitioner hereby authorizes the Patent Office to charge any additional fees or credit any overpayment to Deposit Account 503626.

**V. GROUNDS FOR STANDING (37 C.F.R. § 42.104(a)).**

Petitioner certifies that the '069 patent—which issued on June 6, 2017—is available for IPR and that Petitioner is not barred or estopped from requesting an IPR challenging any claim of the '069 patent on the grounds identified herein. Neither Petitioner nor any other real-party-in-interest has filed a civil action challenging the validity, or been served with a complaint alleging infringement of the '069 patent, more than one year prior to this Petition's filing. *See Motorola Mobility LLC v. Arnouse*, No. IPR2013-00010, 2013 WL 12349001, \*3 (P.T.A.B. Jan. 30, 2013).

**VI. THRESHOLD REQUIREMENT FOR *INTER PARTES* REVIEW.**

This Petition meets and exceeds the threshold required under 35 U.S.C. § 314(a). As explained below, for each ground, there is a reasonable likelihood that Petitioner will prevail with respect to at least one of the Challenged Claims.

**VII. OVERVIEW OF CHALLENGE AND PRECISE RELIEF REQUESTED.**

**A. CHALLENGED CLAIMS.**

Petitioner requests IPR of claims 1 and 8-12 of the '069 patent, and cancellation of these claims as unpatentable.

**B. STATUTORY GROUNDS OF CHALLENGE.**

Each of the following prior art references and/or combinations of references renders the Challenged Claims invalid:

| Ground | 35 U.S.C.                | References   | '069 patent Claims |
|--------|--------------------------|--|--------------------|
| 1, 2   | § 102                    | CLEAR-IT-2, as disclosed in either Heier-2009 or Dixon                           | 1, 9-12            |
| 3      | § 102                    | Regeneron (30-April-2009)  | 1, 9-12            |
| 4      | § 102<br>and/or<br>§ 103 | VIEW1/VIEW2, as disclosed in Dixon   | 1, 8-12            |
| 5      | § 103                    | Heier-2009, in view of Mitchell or Dixon, and optionally, the '758 patent or Dix | 1, 8-12            |

Petitioner's full statement of the reasons for the relief requested is set forth in greater detail below, and in the supporting declarations of Drs. Albini and Gerritsen.

## VIII. OVERVIEW OF THE '069 PATENT AND PROSECUTION HISTORY.

### A. THE '069 PATENT.<sup>3</sup>

The '069 patent claims a known dosing regimen for treating angiogenic eye disorders—including AMD—that amounts to administering a single initial dose of

---

<sup>3</sup> Solely for purposes of this IPR, Petitioner assumes a January 13, 2011 priority date.

a VEGF antagonist (VEGF Trap-Eye)<sup>4</sup>, followed by one or more “secondary doses” administered two to four weeks after the immediately preceding dose, followed by one or more “tertiary doses” administered on a PRN basis. The specification establishes that angiogenic eye disorders, such as AMD, diabetic macular edema (“DME”), and retinal vein occlusion (“RVO”), were known to be effectively treated through the inhibition of vascular endothelial growth factor (“VEGF”). (Ex.1001, ’069 patent, 1:24-53).

The specification also sets forth AMD dosing regimens employing PRN dosing disclosed in the prior art before the ’069 patent application was filed, including the Phase 2 monthly loading dose/PRN regimen and the Phase 3 loading dose/every-eight-week regimen, in which patients received PRN injections in the

---

However, Petitioner reserves all rights to challenge the extent to which Regeneron asserts application of pre-AIA standards of patentability. The ’069 patent is subject to the AIA given the inclusion of new matter in the Continuation-In-Part Application No. 13/940,370, filed July 12, 2013.

<sup>4</sup> Vascular endothelial growth factor or VEGF is a “naturally occurring glycoprotein in the body that acts as a growth factor for endothelial cells.” (Ex.1011, Semeraro, 711). Early research linked activity of VEGF-A to the development of ocular diseases such as neovascular AMD. (*Id.*).



second year. (*Id.*, 8:19-49 (Example 2, disclosing CLEAR-IT-2); *id.*, 9:11-13:49 (Example 4)).

**Example 2**, like the prior art, lists the five treatment arms in the CLEAR-IT-2 trial, including administering VEGF Trap-Eye via intravitreal injection to AMD patients at a fixed interval (e.g., four-week) for the first 12 weeks. (*Id.*, 8:26-33). After 12 weeks, subjects “were evaluated every 4 weeks for 9 months, during which additional doses were administered based on pre-specified criteria.” (*Id.*, 8:29-33). In other words, subjects assigned to the “4-week” fixed interval groups received four monthly doses, followed by PRN dosing.<sup>5</sup>

**Example 4** describes parallel Phase 3 clinical trials carried out to investigate the use of VEGF Trap-Eye to treat AMD: the VIEW1/VIEW2 trials.<sup>6</sup> (Ex.1001, '069 patent, 9:11-13:49). Example 4 discloses that patients enrolled in VIEW1/VIEW2 were assigned to one of four treatment arms employing varying dosing regimens for the first year of the study (*id.*, 9:45-58); whereas the second year

---

<sup>5</sup> The CLEAR-IT-2 PRN dosing regimen was disclosed in the prior art by at least 2008. (Ex.1012, Regeneron (28-April-2008), 1).

<sup>6</sup> The VIEW1/VIEW2 trials were fully disclosed in the prior art as early as 2008. (Ex.1013, Regeneron (8-May-2008), 1; Ex.1014, NCT-795, 8; Ex.1015, NCT-377, 6).

reverted to PRN dosing for all subjects (*id.*, 9:63-10:13 (“During the second year of the study, subjects will be evaluated every 4 weeks and will receive [intravitreal] injection of study drug at intervals determined by specific dosing criteria.”)). Most notably, Arm-2Q8 involved “2 mg VEGFT administered every 4 weeks to week 8 and then every 8 weeks.” (*Id.*, 9:45-58). That is, VEGF Trap-Eye was administered in three monthly doses, followed by eight-week dosing intervals in the first year, followed by PRN dosing in the second year.

**B. PROSECUTION HISTORY.**

During prosecution, Regeneron made several arguments against the Examiner’s rejections over Regeneron’s Monthly-Dosing Patents<sup>7</sup> for obviousness-type-double-patenting (“OTDP”). First, Regeneron argued that its Monthly-Dosing Patents did not disclose the exact regimen of the PRN dosing claims. (Ex.1017, ’069 FH, 1/30/2017 Amendment, 5). Second, Regeneron represented that once-per-month dosing was the standard of care and alleged the less frequent administration under the Challenged Claims produced unexpected results. (*Id.*, 6-8).

---

<sup>7</sup> Regeneron’s “Monthly-Dosing Patents” refers to U.S. Patent Nos. 7,303,746; 7,303,747; 7,306,799; and 7,521,049; which generally disclose doses separated by at least two weeks. (See Ex.1016, Monthly-Dosing Patents).

Third, and most notably, Regeneron presented the VIEW1/VIEW2 results—published in Heier-2012 (Ex.1018)—as purported evidence of surprising and unexpected results, in attempt to support the Challenged Claims’ patentability. (*Id.*, 6-8). Specifically, Regeneron asserted:

[T]he results show that the treatment groups which were compared with the monthly treatment groups surprisingly did not obtain an inferior result. As such, the PRN treatment protocol as encompassed by the presently pending independent claim 1 achieves results which are as good or better than the results obtained with monthly treatment.

(*Id.*). In other words, Regeneron told the Examiner that the VIEW1/VIEW2, every-eight-week dosing regimen represents a “PRN treatment protocol.” (Ex.1017, ’069 FH, 1/30/2017 Amendment, 6 (“Heier et al. paper shows results of a treatment protocol *of the type claimed.*”) (emphasis added)).

As purportedly further support, Regeneron stated that Heier-2012 echoes the ’069 patent’s conclusion that administration “at a *frequency of once every 8 weeks*, following a single initial dose and two secondary doses administered four weeks apart, resulted in significant prevention of moderate or severe vision loss or improvements in visual acuity.” (*Id.*, 7-8 (emphasis added); *id.*, 8 (alleging “the *claimed* treatment protocol provides enormous advantages to patients” based on

outcomes observed in Heier-2012 for the every-two-month VIEW1/VIEW2 dosing regimen) (emphasis added)).<sup>8</sup>

Regeneron lastly argued that Example 5 “illustrates an administration regimen encompassed by [issued] claim 1 (*i.e.*, 3 initial doses of VEGF Trap administered once every four weeks, followed by additional doses administered as needed (PRN)) for the effective treatment of diabetic macular edema.” (*Id.*, 7).

#### **IX. CLAIM CONSTRUCTION (37 C.F.R. § 42.104(b)(3)).**

In accordance with 37 C.F.R. § 42.100(b), the Challenged Claims must be “construed using the same claim construction standard that would be used to construe the claim in a civil action under 35 U.S.C. § 282(b),” *i.e.*, the *Phillips* standard. 83 Fed. Reg. 197, 51340-51359 (Oct. 11, 2018); *Phillips v. AWH Corp.*, 415 F.3d 1303, 1312 (Fed. Cir. 2005). Here, Petitioner and expert declarant, Dr. Albini, have applied this standard.

##### **A. “INITIAL DOSE,” “SECONDARY DOSE,” AND “TERTIARY DOSE.”**

The Challenged Claims recite the phrases “initial dose,” “secondary dose,” and “tertiary dose.” A skilled artisan would understand each as expressly defined in

---

<sup>8</sup> Regeneron never informed the Examiner that the VIEW dosing regimen in Heier-2012 was the subject of numerous pre-2011 public disclosures (discussed in greater detail below).

the '069 patent specification:

The terms “initial dose,” “secondary doses,” and “tertiary doses,” refer to the temporal sequence of administration of the VEGF antagonist. Thus, the “initial dose” is the dose which is administered at the beginning of the treatment regimen (also referred to as the “baseline dose”); the “secondary doses” are the doses which are administered after the initial dose; and the “tertiary doses” are the doses which are administered after the secondary doses. The initial, secondary, and tertiary doses may all contain the same amount of VEGF antagonist, but will generally differ from one another in terms of frequency of administration. In certain embodiments, however, the amount of VEGF antagonist contained in the initial, secondary and/or tertiary doses will vary from one another (e.g., adjusted up or down as appropriate) during the course of treatment.

(Ex.1001, '069 patent, 3:34-48 (emphasis added)). The specification further explains that “the immediately preceding dose” means “in a sequence of multiple administrations, the dose of VEGF antagonist which is administered to a patient prior to the administration of the very next dose in the sequence with no intervening doses.” (*Id.*, 3:54-59; *see also* Ex.1002, Albini, ¶ 40). Petitioner proposes that each claim term be construed consistent with these express definitions: “initial dose” means “the dose which is administered at the beginning of the treatment regimen”; “secondary dose(s)” means “the dose(s) which are administered after the initial dose”; and “tertiary dose(s)” means “the dose(s) which are administered after the secondary dose(s).”

**1. Regeneron’s contradictory construction for “tertiary dose,” if presented here, must be rejected.**

To the extent Regeneron proposes the same construction for “tertiary dose” that it has in the ’345 Patent PGR—i.e., “dose(s) that maintain(s) a therapeutic effect throughout the course of treatment,” (PO Preliminary Response, *Chengdu Kanghong Biotechnology Co. v. Regeneron Pharms., Inc.*, No. PGR2021-00035, Paper 6, 9 (P.T.A.B. Apr. 15, 2021) (“’345 Patent PGR”))—it should be rejected for at least the following reasons.

First and foremost, as described above, the ’069 patent specification recites an express definition that provides the patentees’ intended meaning to the claims:

the “tertiary doses” are the doses which are 40 administered after the secondary doses.

(Ex.1001, ’069 patent, 3:40-41 (emphasis added)). The term is “set off by quotation marks,” which “[is] often a strong indication that what follows is a definition”—“the patentee must be bound by the express definition.” *Sinorgchem Co., Shandong v. Int’l Trade Comm’n*, 511 F.3d 1132, 1136 (Fed. Cir. 2007). In other words, “tertiary dose” is “clearly, deliberately, and precisely defined,” (*id.*), in the ’069 patent—nothing more is needed and there is no basis for straying from that express definition.

Second, Regeneron’s proposed construction is unsupported and the intrinsic record does not suggest reading-in limitations. *Phillips*, 415 F.3d at 1323

(reaffirming the need “to avoid the danger of reading limitations from the specification into the claim”). For example, Regeneron relies exclusively on column 2 as purported support for its narrowed construction (’345 Patent PGR, 11), but that specification passage only describes a single embodiment—i.e., bimonthly dosing—and is not even relevant to the “as-needed/*pro re nata* (PRN)” dosing regimen(s) of the Challenged Claims. (Ex.1001, ’069 patent, 2:14-16 (“*[E]ach* tertiary dose is administered at least 8 weeks after the immediately preceding dose.”) (emphasis added)).<sup>9</sup> By comparison, the *express* definition recited in the specification (i.e.,

---

<sup>9</sup> The ’338 patent purportedly claims this dosing regimen, with bimonthly doses as the “tertiary doses.” However, Regeneron’s proposed construction for “tertiary doses” is in conflict with the language of the ’338 patent claims, which require “tertiary doses” administered “at least 8 weeks after the immediately preceding dose” *irrespective* of whether the injection “maintain[s] a therapeutic effect.” (See Ex.1019, ’338 patent, 23:2-18, *id.*, 24:24-25 (claims 1 and 17)). Consequently, the ’338 patent—which derives from the same parent application as the ’069 patent and the Chengdu-challenged ’345 patent—would improperly require a different construction of “tertiary dose” for those claims to have meaning, further illustrating the extent to which Regeneron’s proposed construction, if presented in this IPR,

“doses which are administered after the secondary doses”) provides the exact temporal and sequential distinction from the other doses in the regimen that the patent drafters intended. (Ex.1001, ’069 patent, 3:34-36 (“The terms . . . refer to the temporal sequence of administration.”)). *Merck & Co. v. Teva Pharms. USA, Inc.*, 395 F.3d 1364, 1372 (Fed. Cir. 2005) (“A claim construction that gives meaning to all the terms of the claim is preferred over one that does not do so.”). No further construction is necessary. *Multiform Desiccants, Inc. v. Medzam, Ltd.*, 133 F.3d 1473, 1478 (Fed. Cir. 1998) (“When the specification explains and defines a term used in the claims, without ambiguity or incompleteness, there is no need to search further for the meaning of the term.”).

Third, Regeneron’s proposal improperly injects ambiguity and indefiniteness where there is none. *Ruckus Wireless, Inc. v. Innovative Wireless Sols., LLC*, 824 F.3d 999, 1004 (Fed. Cir. 2016) (rejecting a construction encompassing subject matter that would render the claims invalid under § 112). Regeneron’s proposed construction, itself, requires construction—i.e., “maintain,” “therapeutic effect,” and

---

would inject indefiniteness into the claims. *Samsung Elecs. Co. v. Elm 3DS Innovations, LLC*, 925 F.3d 1373, 1378 (Fed. Cir. 2019) (“Where multiple patents derive from the same parent application and share many common terms, we must interpret the claims consistently across all asserted patents.”).



“throughout the course of treatment” lack definition and plain and ordinary meanings. A skilled artisan is therefore left wondering what Regeneron’s construction is supposed to mean, as well as what metrics one is supposed to use to assess each imported limitation. Moreover, Regeneron’s added language renders the “as-needed/pro re nata” element of the Challenged Claims—which a skilled artisan would already understand as administration to maintain a therapeutic benefit—duplicative and meaningless. *Power Mosfet Techs., L.L.C. v. Siemens AG*, 378 F.3d 1396 (Fed. Cir. 2004) (“[I]nterpretations that render some portion of the claim language superfluous are disfavored.”).

Finally, Regeneron notably ignores “initial” and “secondary.” Consequently, a skilled artisan, under Regeneron’s proposal, is uncertain whether those terms carry “therapeutic effect” limitations as well, or whether the specification’s express definitions apply—adding further uncertainty and ambiguity to the Challenged Claims. Petitioner’s proposal to apply the express definitions for all three terms, on the other hand, is clear to a skilled artisan and free of the ambiguity of Regeneron’s proposed construction.

**B. “4 WEEKS” AND “PRO RE NATA (PRN).”**

“4 weeks.” Challenged claims 1, 2, and 8 recite the term “4 weeks.” A skilled artisan would understand “4 weeks” as “monthly” administration. (Ex.1001, ’069 patent, 7:58-59 (“[M]onthly’ dosing is equivalent to dosing once every four

weeks.”); *id.*, 14:47-48 (patients received “monthly injections,” which “means patients who received . . . injections once every four weeks”); Ex.1002, Albini, ¶ 41).

“**Pro Re Nata (PRN).**” Independent claim 1 recites the term “pro re nata (PRN),” which is expressly defined in the claim language as “as-needed.” (Ex.1001, ‘069 patent, 21:50-51 (“administered on an as-needed/pro re nata (PRN) basis”)). The specification is consistent with the claim language and with the term’s use among skilled artisans. (Ex.1001, ‘069 patent, 14:43 (“as-needed (PRN)”); 15:43-48 (“administered pro re nata (PRN) based on visual and/or anatomical outcomes”); 16:9-49; Ex.1002, Albini, ¶ 43).

**C. “VEGFR1 COMPONENT,” “VEGFR2 COMPONENT,” AND THE “MULTIMERIZATION COMPONENT.”**

Claim 1 of the ‘069 patent recites that the “VEGF antagonist” comprises a “VEGFR1 component,” a “VEGFR2 component,” and a “multimerization component.” According to the ‘069 patent, these terms all refer to separate amino acid domains of “SEQ ID NO:2.” A skilled artisan would understand these terms to collectively refer to aflibercept (i.e., VEGF Trap, VEGF Trap-Eye, or VEGFR1R2-FcΔC1(a)). (Ex.1001, ‘069 patent, 2:34-38; Ex.1002, Albini, ¶ 39).

**D. “TREATING.”**

- 1. The “method for treating” element of the preamble is not a limitation on the Challenged Claims, and therefore, does not require construction.**

The “method for treating” element of independent claim 1 is “merely a statement of purpose or intended use” for the claimed dosing regimen(s) and is non-limiting. *Bristol-Myers Squibb Co. v. Ben Venue Lab’ys, Inc.*, 246 F.3d 1368, 1375 (Fed. Cir. 2001); *Vizio, Inc. v. Int’l Trade Comm’n*, 605 F.3d 1330, 1340-41 (Fed. Cir. 2010); *Arctic Cat Inc. v. GEP Power Prods., Inc.*, 919 F.3d 1320, 1327 (Fed. Cir. 2019) (“as a general rule preamble language is not treated as limiting”). Indeed, “method for treating”—like the “method” preamble in *Bio-Rad*—neither provides antecedent basis for any other claim element<sup>10</sup> nor gives life, meaning or vitality to the claimed dosing regimen, and thus, it is not a limitation. *Bio-Rad Lab’ys, Inc. v. 10X Genomics Inc.*, 967 F.3d 1353, 1371 (Fed. Cir. 2020) (citing *TomTom, Inc. v. Adolph*, 790 F.3d 1315, 1322-25 (Fed. Cir. 2015)) (“In *TomTom* . . . [t]he two-part preamble of the asserted claim recited: ‘[1] [a] method for generating and updating data [2] for use in a destination tracking system of at least one mobile unit comprising . . . . We held that the first part of the preamble, ‘method for generating and updating data,’ was not limiting and did not provide an antecedent basis for any

---

<sup>10</sup> “Treating” (or any form of “treat”) appears nowhere else in any of the claims.

claim terms. We also found that the term did not recite essential structure or steps, or give necessary life, meaning, and vitality to the claim; rather, it stated ‘a purpose or intended use.’” (citations omitted)); *In Re: Copaxone Consol. Cases*, 906 F.3d 1013, 1022-23 (Fed. Cir. 2018) (preamble was non-limiting where it “does not change the express dosing amount or method already disclosed in the claims, or otherwise result in a manipulative difference in the steps of the claims”). Nothing in the intrinsic record here suggests otherwise. For example, there is no evidence that Regeneron asserted the “method for treating” preamble to traverse any Examiner rejections. Instead, Regeneron relied on the dosing frequencies required in the Challenged Claims to purportedly distinguish the prior art, “standard of care.” (Ex.1017, ’069 FH, 1/30/2017 Amendment, 5-6).

Moreover, Regeneron is foreclosed by Federal Circuit precedent from arguing that its reliance on alleged “unexpected results” during prosecution demonstrates that efficacy is a necessary feature of the claimed method. *Purdue Pharma L.P. v. Endo Pharms. Inc.*, 438 F.3d 1123, 1136-37 (Fed. Cir. 2006) (en banc) (holding that patentee’s reliance on its “surprising discovery” of the four-fold dosage range to distinguish its oxycodone formulation from the prior art did not make the four-fold range a necessary feature of the claimed formulations). The Board has also rejected similar arguments. *Mylan Lab'ys Ltd. v. Aventis Pharma S.A.*, No. IPR2016-00712, 2016 WL 5753968, \*5 (P.T.A.B. Sept. 22, 2016) (holding that “method of treating

a patient” preamble was non-limiting despite patentee’s reliance on “surprising and unexpected” clinical results of efficacy to distinguish the claimed invention from the prior art).

For these reasons, Petitioner submits that the preamble is non-limiting and no construction of “treating” is necessary to ascertain the scope of the Challenged Claims.

**2. Regeneron’s anticipated argument that the “method for treating” preamble is a positive limitation should be rejected.**

In the ’345 Patent PGR, Regeneron has asserted that an analogous “method for treating” element to the claim preamble is a positive limitation requiring a therapeutically effective method of treatment. (’345 Patent PGR, 7-9). To the extent Regeneron raises the same argument here, it should be rejected. First, the “method for treating” preamble has no bearing on the dosing steps in the Challenged Claims, because “the steps . . . are performed in the same way regardless whether or not the patient experiences” treatment of their angiogenic eye disorder. *Bristol-Myers*, 246 F.3d at 1375. In other words, the preamble is merely a statement of the *intended* purpose for the claimed regimen, and therefore, is not a limitation. *Id.*; *Copaxone*, 906 F.3d at 1022-23.

Second, as stated above, “method for treating” provides no antecedent basis for any other claim element, and any argument that the claim terms “the patient” and “angiogenic eye disorders” find their respective meaning in the preamble is

meritless. Like in *Copaxone*, these terms do not “change the express dosing amount or method already disclosed in the claims, or otherwise result in a manipulative difference in the steps of the claims.” *Copaxone*, 906 F.3d at 1023. Instead, the claimed dosing regimen stays the same. Consequently, neither the “method for treating” element nor the “angiogenic eye disorder in a patient” element in the two-part preamble rise to the level of a positive claim limitation.

Third, even if the Board finds the preamble limiting, the claimed method is not *required*—as Regeneron argues—to be therapeutically effective. Instead, the preamble is “a statement of the intentional purpose for which the method must be performed.” *GlaxoSmithKline LLC v. Glenmark Pharms., Inc.*, No. 14-877-LPS-CJB, 2016 WL 3186657, at \*7 (D. Del. June 3, 2016). Therefore, to anticipate the claims, it is enough that one’s “intentional purpose” is to treat an angiogenic eye disorder—showing actual therapeutic effectiveness is not required.

**3. If construed to be a limitation, the preamble’s plain and ordinary meaning—which does not provide any specific efficacy requirement—must govern.**

If the Board determines that the claim language requires construction, or that the preamble is a limitation, the patent does not provide a definition or metric for what constitutes “treating” an angiogenic eye disorder within the context of the Challenged Claims. Given this absence of lexicography, a skilled artisan would apply the term’s plain and ordinary meaning: administering a therapeutic to a patient,

without any specific efficacy requirement. (Ex.1002, Albini, ¶ 42).

In the event Regeneron attempts to equate “efficacy” with “treating” (which, at the outset, is impermissible under Federal Circuit precedent, *see Phillips*, 415 F.3d at 1323), the Challenged Claims are still unpatentable for the reasons set forth herein. Specifically, “efficacy” in the context of the ’069 patent only requires that the patient exhibit a loss of fifteen or fewer letters on the Early Treatment Diabetic Retinopathy Study (“ETDRS”) visual acuity chart within 104 weeks of treatment initiation. (*See, e.g., Ex.1001, ’069 patent, 7:18-34*). Even the “certain embodiments” efficacy metric requires only a gain of one or more ETDRS letters within 104 weeks. Applied to the claims, efficacy far exceeding this *de minimis* level were indisputably disclosed in prior art using VEGF Trap-Eye dosing regimens that involved fewer doses than the every-8-week regimen. (*See, e.g., Ex.1020, Heier-2009, 45* (reporting mean improvements in BCVA of 9.0 letters from baseline after “three monthly doses of 2.0 mg followed by as-needed dosing”); *id.* (reporting “patients received a mean 3.5 injections” over 15-month PRN dosing phase)). To the extent efficacy is required, the “method for treating” element of the preamble is also inherently anticipated by the prior art disclosing the exact method claimed in the ’069 patent. *Perricone v. Medicis Pharm. Corp.*, 432 F.3d 1368, 1378 (Fed. Cir. 2005); *King Pharms., Inc. v. Eon Lab’ys, Inc.*, 616 F.3d 1267, 1275-76 (Fed. Cir. 2010).

## **X. PERSON OF ORDINARY SKILL IN THE ART.**

A person of ordinary skill in the art (referred to herein as a “skilled artisan”) is presumed to be aware of all pertinent art, think along the lines of conventional wisdom, and possess common sense and ordinary creativity in the pertinent field. A skilled artisan here would have: (1) knowledge regarding the diagnosis and treatment of angiogenic eye disorders, including the administration of therapies to treat said disorders; and (2) the ability to understand results and findings presented or published by others in the field, including the publications discussed in this Petition. Typically, such a person would have an advanced degree, such as an M.D. or Ph.D. (or equivalent, or less education but considerable professional experience in the medical, biotechnological, or pharmaceutical field), with practical academic or medical experience in (i) developing treatments for angiogenic eye disorders (such as AMD), including through the use of VEGF antagonists, or (ii) treating of angiogenic eye disorders (such as AMD), including through the use of VEGF antagonists. (Ex.1002, Albini, ¶¶ 26-28).

## **XI. THE SCOPE AND CONTENT OF THE PRIOR ART.**

The publications below reflect invalidating disclosures of the claimed method(s), together with knowledge that skilled artisans would bring to bear in reading the prior art at the time, i.e., January 13, 2011. *Ariosa Diagnostics v. Verinata Health, Inc.*, 805 F.3d 1359, 1367-68 (Fed. Cir. 2015). As established in



*KSR*, the knowledge of a skilled artisan is part of the store of public knowledge that must be consulted when considering whether a claimed invention would have been obvious. *KSR Int'l Co. v. Teleflex Inc.*, 550 U.S. 398, 415-22 (2007).

**A. VEGF TRAP-EYE/AFLIBERCEPT BACKGROUND.**

As an initial matter, aflibercept—also known as VEGF Trap, VEGF Trap-Eye, VEGF-Trap<sub>R1R2</sub>, and AVE0005—is an engineered prior art fusion protein consisting of domain 2 of the human VEGF receptor 1 (VEGFR1); domain 3 of the human VEGF receptor 2 (VEGFR2); fused to the Fc portion of human IgG<sub>1</sub>. (Ex.1004, Holash, 11394 (Fig.1A); Ex.1002, Albini, ¶¶ 63-69). Aflibercept, VEGF Trap, and VEGF Trap-Eye are simply different names for the same molecule. (Ex.1006, Dixon, 1575 (“VEGF Trap-Eye and aflibercept (the oncology product) have the same molecular structure”); Ex.1021, 2009 10-Q, 20 (“VEGF Trap-Eye is a specially purified and formulated form of VEGF Trap for use in intraocular applications.”); *see also id.*, 27; Ex.1007, Adis, 261 (“Aflibercept: AVE 0005, AVE 005, AVE0005, VEGF Trap - Regeneron, VEGF Trap(R1R2), VEGF Trap-Eye”)).

The coding sequence for VEGF Trap-Eye/aflibercept was widely disclosed in the prior art as well. (Ex.1022, '757 patent, SEQ ID NO:15, SEQ ID NO:16, Fig.24A-C; Ex.1010, '758 patent, SEQ ID NO:15, SEQ ID NO:16, Fig.24A-C; Ex.1023, '959 patent, Fig.24A-C; Ex.1002, Albini, ¶ 39). While the identity of VEGF Trap-Eye/aflibercept would have been readily apparent from the prior art

disclosures (*see* Ex.1007, Adis, 261-63 (conveying knowledge of the molecular structure); Ex.1006, Dixon, 1575 (same)), Regeneron also confirmed the information in a Patent Term Extension application, explaining that aflibercept is a fusion protein consisting of domain 2 of Flt1, domain 3 of Flk1, and an Fc portion of human IgG1, the amino acid sequence of which is set forth in SEQ ID NO:16 and Fig.24A-C of the '758 patent. (Ex.1024, '758 FH, 12/22/2011 PTE, 2, 6-7). Thus, the molecular structure and sequence for aflibercept was not only known to skilled artisans, and expressly disclosed in the prior art, but also would have been an inherent aspect of each of the references discussed below that disclose VEGF Trap-Eye/aflibercept. *See Rosco, Inc. v. Mirror Lite Co.*, 304 F.3d 1373, 1380 (Fed. Cir. 2002).

VEGF Trap-Eye was developed to target VEGF-related angiogenic disorders, including eye disorders, such as AMD, DME, and RVO. (Ex.1002, Albini, ¶¶ 44-52, 63-69). Earlier generation therapeutics targeted specifically at blocking VEGF included ranibizumab (LUCENTIS®) and bevacizumab (AVASTIN®), both monoclonal antibodies, which bind to, and thus inhibit the activity of VEGF-A. (Ex.1002, Albini, ¶¶ 54-58). However, the FDA-approved monthly dosing regimen for ranibizumab was costly and inconvenient, leading researchers to: (1) investigate less-frequent dosing regimens; and (2) focus on new drugs with extended duration of action. (Ex.1006, Dixon, 1574; Ex.1002, Albini, ¶¶ 58-62; Ex.1025, Engelbert-

2010, 1369; Ex.1026, Engelbert-2009, 1425, 1429; Ex.1027, Spaide, 298). The potential for VEGF Trap-Eye to “block[] all isoforms of VEGF-A and placental growth factors-1 and -2,” coupled with the need for alternative dosing schedules that might reduce the burden of monthly injections, led to the commercial development and testing of Regeneron’s VEGF Trap-Eye. (Ex.1006, Dixon, 1573). At the time, LUCENTIS® approved indications overlapped those Regeneron was exploring for EYLEA®. Both are VEGF antagonists.

VEGF Trap-Eye was placed into AMD clinical studies in the mid-2000’s, entering Phase 2 testing on or around 2007. The Phase 2 regimen involved four monthly loading doses, followed by PRN dosing. (Ex.1006, Dixon, 1573-74; Ex.1018, Heier-2012, 2573; Ex.1012, Regeneron (28-April-2008), 1). In August 2007, Phase 3 testing began. (Ex.1006, Dixon, 1576; Ex.1002, Albini, ¶ 70; Ex.1007, Adis, 263-64; Ex.1013, Regeneron (8-May-2008), 1; Ex.1014, NCT-795, 8; Ex.1015, NCT-377, 6).

VEGF Trap-Eye was also used in clinical studies involving central retinal vein occlusion (“CRVO”). In 2009, Regeneron announced Phase 3 programs, which involved six monthly injections followed by PRN dosing. (Ex.1028, Regeneron (30-April-2009), 1; Ex.1029, NCT-973, 3-5; Ex.1021, 2009 10-Q, 20, 27; Ex.1002, Albini, ¶ 70).

**B. PETITIONER'S PRIOR ART REFERENCES.<sup>11</sup>**

Because much of the prior art relates to Regeneron's VEGF Trap-Eye clinical trials, the following summary table is provided:

| <b>Trial</b>  | <b>Name</b> | <b>Prior Art Disclosures</b>                       | <b>Dosage Regimen</b>                                       |
|---------------|-------------|--|---|
| Phase 1 (AMD) | CLEAR-IT-1  | Dixon; Nguyen                                      | Single intravitreal dose (0.5, 2, and 4 mg doses)           |
| Phase 2 (AMD) | CLEAR-IT-2  | Dixon; Adis; Regeneron (28-April-2008); Heier-2009 | Four monthly doses (0.5, 2, and 4 mg doses); PRN thereafter |

---

<sup>11</sup> The asserted prior art references all qualify as publications that were available to—and indeed cited by—interested, skilled artisans before January 13, 2011. (Ex.1003, Gerritsen, ¶¶ 52, 60, 66, 72, 76-78, 85, 93, 95; Ex.1006, Dixon, 1579 (Bibliography Nos. 46-47); Ex.1007, Adis, 268 (Ref. Nos. 10-14)).

|                |                     |   |  |
|----------------|---------------------|---|--|
| Phase 3 (AMD)  | VIEW-1/VIEW-2       | Dixon; Adis; Regeneron (8-May-2008); NCT-795; NCT-377 | Three monthly doses, followed by injections every eight weeks (0.5 and 2 mg doses); PRN dosing the second year |
| Phase 3 (CRVO) | GALILEO; COPERNICUS | Regeneron (30-April-2009); NCT-973                    | Six monthly doses (2 mg); PRN thereafter   |
| Phase 2 (DME)  | DA VINCI            | Regeneron (18-February-2010)                          | Three monthly doses (2 mg); PRN thereafter   |

(Ex.1002, Albini, ¶¶ 70, 72-73).

The following summarizes Genentech’s various ranibizumab trials exploring alternative dosing schedules that reduced injection frequency—all relevant to the Challenged Claims:

| Dosing Regimen                              | Trial <sup>12</sup><br>(Disease) |
|---|----------------------------------|
| Monthly                                     | MARINA<br>(AMD)                  |
|   | ANCHOR<br>(AMD)                  |
| Quarterly after three monthly<br>injections | PIER<br>(AMD)                    |
|   | EXCITE<br>(AMD)                  |
| PRN after three monthly<br>injections       | PrONTO<br>(AMD)                  |
|   | SAILOR<br>(AMD)                  |
|   | SUSTAIN<br>(AMD)                 |
|   | RESOLVE<br>(DME)                 |

---

<sup>12</sup> See Ex.1030, Mitchell, 9-10); Ex.1031, Massin, 55 (RESOLVE study)).

(Ex.1002, Albini, ¶ 71).

**1. Dixon (Ex.1006).**

Dixon published in 2009 and thus constitutes prior art under 35 U.S.C. § 102. Dixon was not cited by the Examiner. Dixon reviews VEGF Trap-Eye in treating AMD. Dixon discusses, *inter alia*, the vitreoretinal market and the VEGF Trap-Eye molecular structure, as well as the CLEAR-IT-1, CLEAR-IT-2, and VIEW1/VIEW2 clinical trials. (Ex.1002, Albini, ¶ 74).

Dixon discloses that the “time and financial burden of monthly injections” led researchers to “examine the efficacy of alternative dosing schedules.” (Ex.1006, Dixon, 1574-77 (citing, e.g., PIER and PrONTO studies). Based upon the positive results in the ranibizumab PrONTO study (three monthly injections followed by PRN dosing), Dixon concludes that “it may be possible to extend the time between injections if the patient is frequently monitored.” (*Id.*, 1574, 1577; Ex.1002, Albini, ¶¶ 76-77).

Dixon specifically identifies the “desirab[ility]” of “decreased dosing intervals,” (Ex.1006, Dixon, 1577), as the motivation for the “development of new drugs for neovascular AMD . . . focused on both improving efficacy and extending duration of action,” (*id.*, 1574; Ex.1002, Albini, ¶ 78). To that end, Dixon calls VEGF Trap-Eye “the most promising anti-VEGF investigational drug” in Phase 3 trials. (Ex.1006, Dixon, 1577 (referring to VIEW1/VIEW2)).

Dixon discloses the VEGF Trap-Eye clinical trials, including their dosing regimens, which implemented the dosing intervals already successful with ranibizumab (LUCENTIS®). Dixon discloses the promising results from CLEAR-IT-2, which included four monthly doses (at weeks 0, 4, 8 and 12) followed by PRN administration. (*Id.*, 1576). Dixon reports that CLEAR-IT-2 subjects treated with that regimen exhibited mean improvement in visual acuity of nine letters and a mean decrease in retinal thickness of 143  $\mu\text{m}$ . (*Id.*; Ex.1002, Albini, ¶¶ 79-80). Dixon further reports that “patients dosed at 2.0 mg during the initial monthly dosing period required 1.6 injections on average during the p.r.n. dosing phase.” (Ex.1006, Dixon, 1577).

Dixon also discloses the VIEW1/VIEW2 dosing regimens. (*Id.*, 1573, 1575-76, 1579 (Bibliography Nos. 46-47) (citing ClinicalTrials.gov reports); Ex.1002, Albini, ¶¶ 81-82; Ex.1003, Gerritsen, ¶ 93). Dixon discloses that some VIEW1/VIEW2 patients were to receive intravitreal “2.0 mg [VEGF Trap-Eye] at an 8 week dosing interval (following three monthly doses),” (Ex.1006, Dixon, 1576) which can be illustrated as follows:



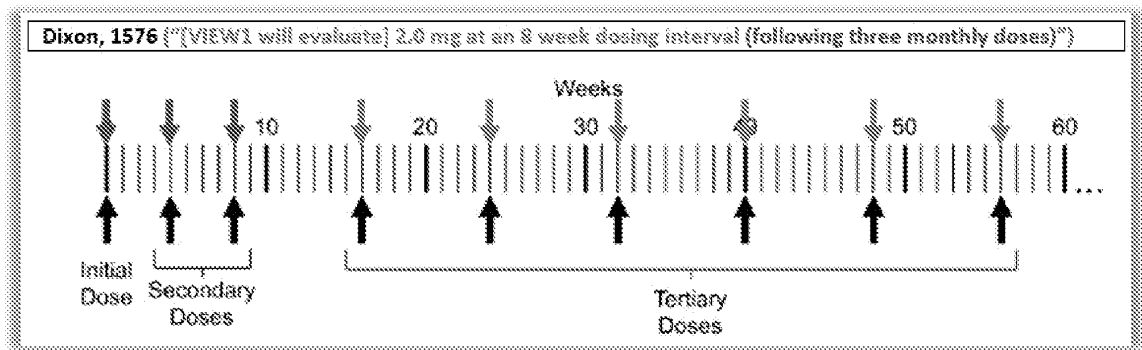


Figure 1. (Modified from Fig.1 of the '069 patent).

After the first year, all patients would “enter a second year of p.r.n. dosing evaluation.” (Ex.1006, Dixon, 1576).

Numerous other prior art references disclose Regeneron’s CLEAR-IT-2 and/or VIEW1/VIEW2 study details. (See, e.g., Ex.1007, Adis, 262-63; Ex.1013, Regeneron (8-May-2008), 1; Ex.1014, NCT-795, 3-8; Ex.1015, NCT-377, 3-7; Ex.1002, Albini, ¶¶ 83-89).

## 2. Regeneron (28-April-2008) (Ex.1012).

Regeneron (28-April-2008) published on April 28, 2008, and thus constitutes prior art under 35 U.S.C. § 102.<sup>13</sup> To Petitioner’s knowledge, Regeneron (28-April-2008) was neither submitted nor cited during prosecution, and thus never considered

---

<sup>13</sup> Bayer’s corresponding press release was also publicly available to skilled artisans before January 13, 2011. (Ex.1032, Bayer (8-May-2008), 1; Ex.1007, Adis, 268 (Ref. No. 13); Ex.1003, Gerritsen, ¶¶ 76-78; Ex.1002, Albini, ¶ 87).

by the Examiner. (Ex.1001, '069 patent, References Cited).

Regeneron (28-April-2008) discloses the CLEAR-IT-2 and VIEW regimens encompassed by the Challenged Claims. For example, Regeneron (28-April-2008) explains that patients in CLEAR-IT-2 received monthly fixed dosing through 12 weeks, followed by PRN administration. (Ex.1012, Regeneron (28-April-2008), 1; Ex.1002, Albini, ¶¶ 90-91). Regeneron also announced the dosing format for VIEW1/VIEW2 as three fixed monthly doses followed by every-eight-week dosing through the first year with PRN dosing in the second year. (Ex.1012, Regeneron (28-April-2008), 1; Ex.1013, Regeneron (8-May-2008), 1).

Regeneron (28-April-2008) also reports gains in visual acuity (10.1 letters) and decreases in retinal thickness (162  $\mu\text{m}$ ) after 32 weeks PRN dosing, maintaining the improvements seen after the 12 week loading dose phase. (Ex.1012, Regeneron (28-April-2008), 1; Ex.1002, Albini, ¶¶ 91-93). Regeneron (28-April-2008) reports Regeneron's confidence in successfully dosing "at a frequency less than once monthly," as demonstrated in its Phase 3, every-eight-week regimens. (Ex.1012, Regeneron (28-April-2008), 1-2).

### **3. Heier-2009 (Ex.1020).**

Heier-2009, published in 2009 and thus constitutes prior art under 35 U.S.C. § 102. To Petitioner's knowledge, Heier-2009 was neither submitted nor cited

during prosecution, and thus never considered by the Examiner. (Ex.1001, '069 patent, References Cited).

Heier-2009 discloses CLEAR-IT-2. (Ex.1020, Heier-2009, 44-45). Specifically, Heier-2009 describes the two treatment arms: (i) three monthly intravitreal injections followed by PRN; or (ii) quarterly intravitreal injections followed by PRN. (*Id.*, 45). Both arms included a 2.0 mg dosage strength. (*Id.*; Ex.1002, Albini, ¶¶ 94-95).

Heier-2009 reports that “[p]atients who received three monthly doses of 2.0 mg followed by as-needed dosing achieved mean improvements in BCVA of 9.0 letters from baseline”; “mean decreases in retinal thickness vs baseline”; and “a reduction in the size of the total active choroidal neovascular membrane.” (Ex.1020, Heier-2009, 45; Ex.1002, Albini, ¶ 96).

Heier-2009 further discloses a six-month extension for CLEAR-IT-2, wherein 117 patients received additional PRN dosing (2.0 mg, VEGF Trap-Eye). (Ex.1020, Heier-2009, 45). These patients achieved BCVA improvement of 7.1 letters compared to baseline. (*Id.*, (“[patients with AMD] achieved and maintained significant improvement in BCVA for 18 months with initial fixed dosing followed by 15 months of as-needed administration.”); Ex.1002, Albini, ¶¶ 97-99).

**4. Regeneron (30-April-2009) (Ex.1028).**

Regeneron (30-April-2009) published April 30, 2009, and thus constitutes prior art under 35 U.S.C. § 102.<sup>14</sup> To Petitioner’s knowledge, Regeneron (30-April-2009) was neither submitted nor cited during prosecution, and thus never considered by the Examiner. (Ex.1001, ’069 patent, References Cited).

Regeneron (30-April-2009) reports Regeneron’s development program for VEGF Trap-Eye to include CRVO—specifically, a Phase 3 program consisting of two one-year studies wherein patients receive six monthly injections, followed by six months of PRN dosing. (Ex.1028, Regeneron (30-April-2009), 1; Ex.1029, NCT-973, 3-5; Ex.1002, Albini, ¶¶ 100-01). The first was named “COPERNICUS” (Controlled Phase 3 Evaluation of Repeated Intravitreal administration of VEGF Trap-Eye In CRVO: Utility and Safety); and the second—led by Bayer—was named “GALILEO” (General Assessment Limiting Infiltration of Exudates in CRVO with

-----  
<sup>14</sup> Regeneron (30-April-2009) was publicly available to skilled artisans long before 2011. (Ex.1003, Gerritsen, ¶¶ 61-66; *see supra* note 12). More specifically, Regeneron (30-April-2009) is date stamped as follows:

PR  
-- NY08289 --  
8289 04/30/2009 02:00 EDT <http://www.prnewswire.com>

(Ex.1028, Regeneron (30-April-2009), 2; Ex.1002, Albini, ¶ 102).

VEGF Trap-Eye). (Ex.1028, Regeneron (30-April-2009), 1; Ex.1029, NCT-973, 3-5).

**5. The '758 patent (Ex.1010).**

The '758 patent issued on May 20, 2008, and thus constitutes prior art under 35 U.S.C. § 102.

The '758 patent discloses “[m]odified chimeric polypeptides with improved pharmacokinetics,” including, *inter alia*, the VEGF Trap<sub>R1R2</sub> (i.e., VEGF Trap-Eye/aflibercept) fusion protein. (Ex.1010, '758 patent, Abstract; *id.*, 19:15-17; *id.*, 29:39-56). The aflibercept sequence is disclosed in Figures 24A-C. (*Compare* Ex.1001, '069 patent, SEQ ID NO:1 & SEQ ID NO:2, *with* Ex.1010, '758 patent, Fig.24A-C, SEQ ID NO:15 & SEQ ID NO:16; *see also* Ex.1024, '758 FH, 12/22/2011 PTE, 2, 6-7; Ex.1002, Albini, ¶¶ 39, 110-11; Ex.1082; Ex. 1083).

The '758 patent also teaches that aflibercept may be useful for treating eye disorders such as AMD. (Ex.1010, '758 patent, 15:50-16:6; *see also id.*, 3:5-29; Ex.1002, Albini, ¶ 111).

**6. Dix (Ex.1033).**

Dix published in 2006, and thus constitutes prior art under 35 U.S.C. § 102. The Examiner did not consider Dix. (*See* Ex.1001, '069 patent, References Cited).

Dix teaches pharmaceutical formulations comprising agents capable of inhibiting VEGF; the VEGF-Trap fusion protein (aflibercept) disclosed in Holash

(Ex.1004) is Dix’s “preferred” VEGF antagonist. (See Ex.1033, Dix, Abstract; *id.*, [0005], [0014], [0030]).

The VEGF-Trap sequence disclosed in Dix is the same sequence for aflibercept required under the Challenged Claims. (Compare Ex.1001, ’069 patent, SEQ ID NO:1 & SEQ ID NO:2, with Ex.1033, Dix, 9-11 (SEQ ID NO:3 & SEQ ID NO:4); Ex.1002, Albini, ¶ 113; Ex.1082; Ex.1083).

#### 7. Mitchell (Ex.1030).

Mitchell first published online May 20, 2009, and thus constitutes prior art under 35 U.S.C. § 102.<sup>15</sup> To Petitioner’s knowledge, Mitchell was neither submitted nor cited during prosecution, and thus never considered by the Examiner. (Ex.1001, ’069 patent, References Cited). Mitchell discloses ranibizumab (LUCENTIS®) dosing trials, including MARINA and ANCHOR, which assessed the approved once-monthly regimen. (Ex.1030, Mitchell, 4-6). In addition, Mitchell expressly discusses the viability of less-frequent dosing, wherein monthly monitoring is

---

<sup>15</sup> A publication is routinely provided online prior to print; its public availability and dissemination online allowing access to interested artisans exercising reasonable diligence. *VidStream LLC v. Twitter, Inc.*, 981 F.3d 1060, 1065 (Fed. Cir. 2020); *Grünenthal GmbH v. Antecip Bioventures II LLC*, No. PGR2019-00026, 2020 WL 4341822, at \*8 (P.T.A.B. July 28, 2020); Ex.1003, Gerritsen, ¶¶ 39-40.

coupled with flexible retreatment—in other words, PRN dosing. (*Id.*, 2; Ex.1002, Albini, ¶¶ 103-04).

Mitchell further suggests the importance of loading doses, noting that “[i]nitiation regimens of fewer than three injections have not been assessed.” (Ex.1030, Mitchell, 2, 4 (“[I]nitiation with three consecutive monthly injections appears optimal . . . . Improvements occurred rapidly, and the largest VA gain occurred after the first injection . . . . Most VA improvement was seen during the initial 3-month phase with subsequent injections appearing to maintain the achieved benefit.”)). Nonetheless, Mitchell concludes that “[p]rospective clinical trials would be valuable for investigating fewer injections in the initiation phase.” (*Id.*, 4-5 (Fig.1(e)); Ex.1002, Albini, ¶¶ 103-06).

After MARINA and ANCHOR, researchers investigated less-frequent dosing schedules of ranibizumab. For example, Mitchell discloses the PrONTO and SUSTAIN studies, designed to deliver three initial monthly doses, followed by monthly monitoring coupled with dosing as-needed to maintain the VA gains observed during the first three months. (Ex.1030, Mitchell, 7-9; Ex.1002, Albini, ¶ 107). Mitchell reports that PrONTO and SUSTAIN delivered similar outcomes to MARINA and ANCHOR. (Ex.1030, Mitchell, 9-11; Ex.1002, Albini, ¶ 107). Mitchell thus concludes that appropriate dosing regimens may include a flexible, as-needed approach. (Ex.1030, Mitchell, 10-11; Ex.1002, Albini, ¶ 107).

Mitchell also incorporates Fung (Ex.1034) by reference. *Advanced Display Sys., Inc. v. Kent State Univ.*, 212 F.3d 1272, 1282 (Fed. Cir. 2000) (“Incorporation by reference provides a method for integrating material from various documents into a host document—a patent or printed publication in an anticipation determination.”).

**8. Lalwani (Ex.1035).**

Lalwani published in 2009 and is prior art under 35 U.S.C. § 102. To Petitioner’s knowledge, Lalwani was neither submitted nor cited during prosecution, and never considered by the Examiner. (Ex.1001, ’069 patent, References Cited).

Lalwani discloses the two-year data from PrONTO. (See Ex.1035, Lalwani, 43). Lalwani echoes the prevailing sentiment at the time, calling into question whether monthly dosing is ideal, and discloses the PrONTO OCT-guided regimens which “could result in fewer injections and similar clinical outcomes” as compared to monthly dosing. (*Id.*, 44).

Lalwani reports a mean of 9.9 injections over two years resulting in mean improvements of 11.1 letters VA and 212  $\mu\text{m}$  decreased retinal thickness, (*id.*, 43, 47-49), and concludes that the PrONTO PRN regimen was able to achieve outcomes comparable to the MARINA/ANCHOR monthly dosing regimens, (*id.*; Ex.1002, Albini, ¶¶ 108-09).



## XII. GROUNDS FOR UNPATENTABILITY—DETAILED ANALYSIS.

### A. ANTICIPATION AND OBVIOUSNESS.

#### 1. Legal standards.

*Anticipation* requires that a “single prior art reference disclose[], either expressly or inherently, each limitation of the claim.” *In re Cruciferous Sprout Litig.*, 301 F.3d 1343, 1349 (Fed. Cir. 2002).

An inherent disclosure requires that “the natural result flowing from the operation as taught would result in the performance of the questioned function.” *King Pharms., Inc. v. Eon Labs, Inc.*, 616 F.3d 1267, 1275 (Fed. Cir. 2010). Newly discovered results or new benefits of a known process directed to the same purpose are not patentable because such results are inherent. *Id.*; see also *In re Omeprazole Patent Litig.*, 483 F.3d 1364, 1373 (Fed. Cir. 2007); *Perricone*, 432 F.3d 1378 (preamble reciting “method for treating skin sunburn” was inherently anticipated where the court found that “[i]f [the prior art reference] discloses the very same methods, then the particular benefits must naturally flow from those methods even if not recognized as benefits at the time of [the prior art’s] disclosure”).

In addition, “anticipation does not require actual performance of suggestions in a disclosure. Rather, anticipation only requires that those suggestions be enabling to one of skill in the art.” *Bristol-Myers*, 246 F.3d 1379. Here, the Challenged Claims require only a dosing regimen without any particular efficacy or result

(Ex.1002, Albini, ¶ 42), and therefore, “proof of efficacy is not required in order for a [prior art] reference to be enabled for purposes of anticipation.” *Rasmusson v. SmithKline Beecham Corp.*, 413 F.3d 1318, 1326 (Fed. Cir. 2005).

Each anticipatory reference asserted herein (Heier-2009, Dixon, and Regeneron (30-April-2009), discussed below) is presumed enabling and it is Regeneron’s burden to rebut those presumptions. *See, e.g., In re Antor Media Corp.*, 689 F.3d 1282, 1287-88 (Fed. Cir. 2012); *Cubist Pharms., Inc. v. Hospira, Inc.*, 75 F. Supp. 3d 641, 659-60 (D. Del. 2014). Any attempted rebuttal here would be futile because each reference sets forth a clear method and dosing regimen that a skilled artisan would have no trouble following. Moreover, the Challenged Claims’ preamble—even if it is assumed limiting (it is not)—does not help Regeneron. The asserted references each disclose Phase 2 data of a PRN regimen “treating” AMD. (*See, e.g., Ex.1020, Heier-2009, 45* (“mean improvements in BCVA of 9.0 letters . . . mean decreases in retinal thickness”); *Ex.1006, Dixon, 1576* (“mean improvements of 9.0 . . . ETDRS letters” with 29% gaining  $\geq 15$  ETDRS letters at 52 weeks and “mean decreases in retinal thickness versus baseline of 143  $\mu\text{m}$  ( $p < 0.0001$ ) in the 2.0 mg group . . . at 52 weeks as measured by OCT”). Thus, “[n]ewly discovered results of known processes directed to the same purpose are not patentable because such results are inherent.” *Bristol-Myers*, 246 F.3d 1377. This inherency is illustrated by the very results Regeneron relied upon during prosecution,

in addition to the results obtained in the Phase 2 CLEAR-IT-2 trial (published in, e.g., Dixon). Regeneron pointed to the Phase 3 results for VEGF Trap-Eye, which reported that “intravitreal aflibercept dosed monthly or every 2 months after 3 initial monthly doses produced similar efficacy and safety outcomes as monthly ranibizumab.” (Ex.1018, Heier-2012, 2537). From these results the authors concluded that “aflibercept is an effective treatment for AMD, with the every-2-month regimen offering the potential to reduce the risk from monthly intravitreal injections.” (*Id.*) Furthermore, the ranibizumab trials had already shown that an anti-VEGF biologic known to be successful with AMD was also successful at treating CRVO. (Ex.1036, Campochiaro, 794 (“results . . . suggest that intraocular injections of ranibizumab have a substantial effect on macular edema due to CRVO or BRVO”)).

*Obviousness.* A patent claim is invalid under 35 U.S.C. § 103(a) if the differences between the claims and the prior art are such that the subject matter as a whole would have been obvious at the time the invention was made to a person having ordinary skill in the pertinent art. *KSR*, 550 U.S. at 406. Furthermore, “[w]hen there is a design need or market pressure to solve a problem and there are a finite number of identified, predictable solutions, a person of ordinary skill has good reason to pursue the known options within his or her technical grasp. If this leads to the anticipated success, it is likely the product not of innovation but of ordinary skill

and common sense.” *Id.* at 421.

The obviousness inquiry is “expansive and flexible,” and the motivation to combine teachings found in separate prior art references can come from many sources, including: “[the] interrelated teachings of multiple patents; the effects of demands known to the design community or present in the marketplace; and the background knowledge possessed by a person having ordinary skill in the art.” *Id.* at 415; *see also id.* at 418.

When relying on secondary considerations—including long-felt need, failure of others, unexpected results, commercial success, copying, licensing, and industry praise—as evidence of non-obviousness, a patentee must establish a nexus between the secondary considerations and the claimed invention. *Ormco Corp. v. Align Tech., Inc.*, 463 F.3d 1299, 1311-12 (Fed. Cir. 2006). There is no nexus unless the offered secondary consideration actually results from something that is both claimed and novel in the claim. *In re Huai-Hung Kao*, 639 F.3d 1057, 1068-70, 1072 (Fed. Cir. 2011).

**2. Grounds 1&2: Claims 1 and 9-12 are anticipated by both Heier-2009 and Dixon, respectively.**

Heier-2009 and Dixon each disclose Regeneron’s “CLEAR-IT-2” Phase 2 trial studying VEGF Trap-Eye as a therapy for treating AMD with four loading doses followed by a PRN dosing phase—thereby disclosing and thus anticipating all limitations of at least Challenged Claims 1 and 9-12.

**Independent Claim 1.** As set forth in the following table and confirmed by Dr. Albini (Ex.1002, Albini, ¶¶ 115-26), each of Heier-2009 and Dixon disclose every element of independent claim 1:

| <u>Claim 1</u>  | <u>Heier-2009:</u>  | <u>Dixon:</u>   |
|---|---|---|
| <p>I. A method for treating an angiogenic eye disorder in a patient</p> | <p>“The CLEAR-IT 2 trial was a phase 2 study of the safety and efficacy of VEGF Trap-Eye . . . in patients with [AMD].” (Ex.1020, Heier-2009, 44).</p> <p>“At 1 year . . . there was a significant improvement in BCVA from baseline . . . .” (<i>Id.</i>, 45).</p> <p>“Patients who received three monthly doses of 2.0 mg followed by as-needed dosing achieved mean improvements in BCVA of 9.0 letters from baseline.” (<i>Id.</i>) (Ex.1002, Albini, ¶¶ 116, 120).</p> | <p>“VEGF Trap-Eye is a novel anti-VEGF therapy, with Phase I and Phase II trial data indicating safety, tolerability and efficacy for the treatment of [AMD].” (Ex.1006, Dixon, 1573; <i>id.</i>, 1575).</p> <p>“Phase I data demonstrated acceptable safety and tolerability of VEGF Trap-Eye in the treatment of neovascular AMD.” (<i>Id.</i>, 1577).</p> <p>Phase 2 patients “treated with 2.0 mg or 0.5 mg of VEGF Trap-Eye monthly achieved mean improvements of 9.0 (p&lt;0.0001) and 5.4 (p&lt;0.085) ETDRS letters.” (<i>Id.</i>, 1576).</p> <p>“[P]atients . . . demonstrated stabilization of their vision that was similar to previous studies of ranibizumab at 1 year.” (<i>Id.</i>, 1577).</p> |

| <u>Claim 1</u>  | <u>Heier-2009:</u>   | <u>Dixon:</u>   |
|---|--|---|
|   |  | (Ex.1002, Albini, ¶¶ 116, 120).   |
| said method comprising sequentially administering to the patient a single initial dose of a VEGF antagonist, followed by one or more secondary doses of the VEGF antagonist, followed by one or more tertiary doses of the VEGF antagonist; | “Patients with neovascular AMD were randomly assigned to receive monthly intravitreal injections of VEGF Trap-Eye 0.5 mg or 2.0 mg . . . for an initial 3-month fixed-dose period, after which they received the same doses on [a PRN] basis at monthly visits out to 1 year.” (Ex.1020, Heier-2009, 45).<br><br>(Ex.1002, Albini, ¶¶ 121-23). | “Two groups received monthly doses of either 0.5 or 2.0 mg for 12 weeks (at weeks 0, 4, 8 and 12) . . . . Following this fixed dosing period, patients were treated with the same dose of VEGF Trap-Eye on a p.r.n. basis.” (Ex.1006, Dixon, 1576). <sup>16</sup><br><br>(Ex.1002, Albini, ¶¶ 121-123). |
| wherein each secondary dose is administered 2 to 4 weeks after the immediately preceding dose; and  | (Ex.1020, Heier-2009, 45).<br><br>(Ex.1002, Albini, ¶¶121-23).   | (Ex.1006, Dixon, 1576).<br><br>(Ex.1002, Albini, ¶¶ 121-23).  |

---

<sup>16</sup> In other words, patients received an “initial dose” (day 0), followed by sequential “secondary doses” at months 1, 2, and 3, followed by “tertiary” PRN doses thereafter. (Ex.1002, Albini, ¶ 121).

| <u>Claim 1</u>   | <u>Heier-2009:</u>  | <u>Dixon:</u>   |
|--|---|---|
| wherein each tertiary dose is administered on an as-needed/pro re nata (PRN) basis, based on visual and/or anatomical outcomes as assessed by a physician or other qualified medical professional; | (Ex.1020, Heier-2009, 45).<br><br>(Ex.1002, Albini, ¶¶ 121-23).   | “Following this fixed dosing period, patients were treated with the same dose of VEGF Trap-Eye on a p.r.n. basis. Criteria for re-dosing included an increase in central retinal thickness . . . a loss of $\geq 5$ ETDRS letters in conjunction with recurrent fluid by OCT, persistent fluid as indicated by OCT, new onset classic neovascularization, new or persistent leak on FA or new macular subretinal hemorrhage.” (Ex.1006, Dixon, 1576). |
| wherein the VEGF antagonist is a receptor-based chimeric molecule comprising (1) a VEGFR1 component comprising amino acids 27 to 129 of SEQ ID NO:2; (2) a VEGFR2 component comprising amino acids | “VEGF Trap-Eye is a purified formulation of VEGF Trap, a vascular endothelial growth factor (VEGF) receptor fusion protein that binds all forms of VEGF-A.” (Ex.1020, Heier-2009, 44-45 (Fig.1)). <sup>17</sup> | VEGF Trap-Eye is “a fusion protein of binding domains of VEGF receptors-1 and -2 attached to the Fc fragment of human IgG.” ( <i>Id.</i> , 1576 (Fig.1)).<br><br>“VEGF Trap-Eye and aflibercept (the oncology product) have the same  |

<sup>17</sup> (Ex.1002, Albini, ¶ 125; *see also* Ex.1010, ’758 patent, Fig.24A-C (setting forth the amino acid sequence and domain structure of VEGF Trap-Eye/aflibercept); Ex.1033, Dix, SEQ ID NO:4; Ex.1082).

| <u>Claim 1</u>   | <u>Heier-2009:</u>        | <u>Dixon:</u>  |
|--|---------------------------|--|
| 130-231 of SEQ ID NO:2; and (3) a multimerization component comprising amino acids 232-457 of SEQ ID NO:2. | (Ex.1002, Albini, ¶ 125). | molecular structure.” ( <i>Id.</i> , 1575).<br><br>(Ex.1002, Albini, ¶ 125). |

**Claims 9 and 10.** Claims 9 and 10 further limit the method of claim 1 to, *inter alia*, the angiogenic eye disorder, AMD. Heier-2009 discloses CLEAR-IT-2 data confirming the trial’s PRN regimen was successful at treating AMD. (*Id.*, 44). Dixon similarly discloses the PRN regimen and results of CLEAR-IT-2 (Phase 2) to treat AMD. (Ex.1006, Dixon, 1573, 1576, 1579 (Ref. No. 45 (“VEGF Trap-Eye in Wet AMD. CLEAR-IT-2: Summary of One-Year Key Results”))); Ex.1002, Albini, ¶¶ 127-31). Accordingly, Heier-2009 and Dixon disclose the additional limitation(s) of claims 9 and 10, and thus anticipate.

**Claim 11.** Claim 11 depends from claim 1 and further limits the claimed method to topical or intraocular administration. Intraocular administration refers to administration to the eye generally, while intravitreal administration, a subset of intraocular administration, refers to administration directly into the vitreous of the eye. (Ex.1002, Albini, ¶¶ 132-33; Ex.1001, ’069 patent, 2:39-41). Heier-2009 and Dixon disclose monthly intravitreal injections of VEGF Trap-Eye. (Ex.1020, Heier-2009, 44-45; Ex.1006, Dixon, 1575; Ex.1002, Albini, ¶¶ 134-35). Accordingly,



Heier-2009 and Dixon disclose the additional limitation of claim 11, and thus anticipate.

**Claim 12.** Claim 12 depends from claim 1 and specifies the VEGF Trap-Eye/aflibercept nucleotide sequence. Both the amino acid and nucleotide sequences were disclosed in the prior art and well known to skilled artisans. (Ex.1002, Albini, ¶¶ 136-37; Ex.1010, '758 patent, Fig.24A-C(disclosing the nucleotide sequence and deduced amino acid sequence); *id.*, 10:15-17 (specifying that this molecule is termed “VEGFR1R2-FcΔC1(a)”); Ex.1033, Dix, SEQ ID NO:3; Ex.1083). The studies reported in Heier-2009 and Dixon are directed to VEGF Trap-Eye, and thus, each discloses the exact “VEGF antagonist” required by claim 12. Accordingly, Heier-2009 and Dixon anticipate.

**3. Ground 3: Regeneron (30-April-2009) anticipates claims 1 and 9-12.**

Regeneron (30-April-2009) describes the Phase 3 trials of VEGF Trap-Eye in CRVO using the claimed dosing regimens—thereby disclosing and thus anticipating all of the limitations of claims 1 and 9-12. According to Regeneron (30-April-2009), patients in the Phase 3 GALILEO and COPERNICUS trials received six monthly intravitreal injections, followed by PRN dosing for another six months. (Ex.1028, Regeneron (30-April-2009), 1).

**Independent Claim 1.** As set forth in the following table and further confirmed by Dr. Albini (Ex.1002, Albini, ¶¶ 138-44), Regeneron (30-April-2009)

discloses each and every element of independent claim 1:

| <u>Claim 1</u>  | <u>Regeneron (30-April-2009):</u>   |
|---|---|
| 1. A method for treating an angiogenic eye disorder in a patient  | <p>“[A] Phase 3 program evaluating the efficacy and safety of VEGF Trap-Eye in the treatment of CRVO . . . .” (Ex.1028, Regeneron (30-April-2009), 1).</p> <p>“[A]nti-VEGF treatment may help decrease vascular permeability and edema and prevent the growth of abnormal new blood vessels in the retina in patients with CRVO.” (<i>Id.</i>).</p> |
| said method comprising sequentially administering to the patient a single initial dose of a VEGF antagonist, followed by one or more secondary doses of the VEGF antagonist, followed by one or more tertiary doses of the VEGF antagonist; | <p>“Patients in both studies will receive 6 monthly intravitreal injections . . . . At the end of the initial 6 months, all patients will be dosed on a PRN (as needed) basis for another 6 months.” (<i>Id.</i>).<sup>18</sup></p>   |
| wherein each secondary dose is administered 2 to 4 weeks after the immediately preceding dose; and  | ( <i>Id.</i> ).   |
| wherein each tertiary dose is administered on an as-needed/pro re nata (PRN) basis, based on visual and/or anatomical outcomes as   | ( <i>Id.</i> ).   |

---

<sup>18</sup> In other words, an “initial dose” (day 0) and five monthly “secondary doses,” followed by “tertiary” PRN dosing. (Ex.1002, Albini, ¶¶ 139-42).

| <u>Claim 1</u>  | <u>Regeneron (30-April-2009):</u>  |
|---|--|
| assessed by a physician or other qualified medical professional;  |  |
| wherein the VEGF antagonist is a receptor-based chimeric molecule comprising (1) a VEGFR1 component comprising amino acids 27 to 129 of SEQ ID NO:2; (2) a VEGFR2 component comprising amino acids 130-231 of SEQ ID NO:2; and (3) a multimerization component comprising amino acids 232-457 of SEQ ID NO:2. | “VEGF Trap-Eye is a fully human, soluble VEGF receptor fusion protein that binds all forms of VEGF-A along with the related Placental Growth Factor (PlGF). Investigational VEGF Trap-Eye is a specific blocker of VEGF-A and PlGF that has been demonstrated in preclinical models to bind these growth factors with greater affinity than their natural receptors.”<br>( <i>Id.</i> ). <sup>19</sup> |

**Claims 9 and 10.** Claim 9 limits the angiogenic eye disorders of claim 1 to, *inter alia*, AMD, DME, and CRVO, while claim 10 further limits to only AMD. Regeneron (30-April-2009) discloses, *inter alia*, Phase 3 trials directed to CRVO patients, and thus anticipates claim 9. (Ex.1028, Regeneron (30-April-2009), 1; Ex.1002, Albin, ¶¶ 145-49). Regeneron (30-April-2009) also discloses VEGF Trap-Eye clinical trials for AMD and thus anticipates claim 10.

**Claim 11.** Claim 11 depends from claim 1 and further limits the claimed method to topical or intraocular administration. Regeneron (30-April-2009)

---

<sup>19</sup> See *supra* note 11.

expressly discloses the intravitreal injection used in Phase 3 CRVO studies, and thus anticipates claim 11. (Ex.1028, Regeneron (30-April-2009), 1; Ex.1002, Albini, ¶¶ 150-53).

**Claim 12.** Claim 12 depends from claim 1 and specifies the VEGF Trap-Eye/aflibercept nucleotide sequence. As explained above, the amino acid and nucleotide sequences for aflibercept were disclosed in the prior art and well known to skilled artisans. (Ex.1002, Albini, ¶¶ 154-55; Ex.1010, '758 patent, Fig.24A-C; *id.*, 10:15-17; Ex.1033, Dix, SEQ ID NO:3; Ex.1083). The studies reported in Regeneron (30-April-2009) are directed to VEGF Trap-Eye, and thus, Regeneron (30-April-2009) discloses the exact “VEGF antagonist” required by claim 12. Accordingly, Regeneron (30-April-2009) anticipates.

**4. Ground 4: VIEW1/VIEW2 disclosures in Dixon anticipate and/or render obvious claims 1 and 8-12.**

During prosecution, Regeneron told the Examiner that the VIEW1/VIEW2 every-eight-week dosing regimen represented a “PRN treatment protocol” within the scope of the Challenged Claims:

[VIEW1/VIEW2] results clearly show that by administering the VEGF antagonist *in accordance with a dosage regimen as claimed in independent claim 1*, it is possible to treat angiogenic eye disorders such as AMD while administering doses on a less frequent basis.

(Ex.1017, '069 FH, 1/30/2017 Amendment, 6 (emphasis added); *id.*, 7). Based upon that representation, Regeneron expressly relied on purported “unexpected results” from VIEW1/VIEW2 (as published in Heier-2012) to secure the Challenged Claims. (*Id.*, 6-8).<sup>20</sup> Applying that same interpretation of the claims here, Dixon’s disclosure of Regeneron’s Phase 3 VIEW1/VIEW2 trials in AMD patients anticipate, or at least render obvious, Challenged Claims 1 and 8-12.

**a. Anticipation.**

**Independent Claim 1.** Dixon discloses the exact VIEW1/VIEW2 dosing regimens that Regeneron told the Examiner represented a “PRN treatment protocol” “as claimed” in independent claim 1. Applying Regeneron’s interpretation of the Challenged Claims, Dixon discloses each and every element of Challenged Claim 1 for the additional reasons set forth in the following table:

---

<sup>20</sup> *See supra* § VIII(B).

| <u>Claim 1</u>  | <u>Dixon:</u>   |
|---|---|
| 1. A method for treating an angiogenic eye disorder in a patient  | <p>“VEGF Trap Eye is a novel anti-VEGF therapy, with Phase I and II trial data indicating safety, tolerability and efficacy for the treatment of neovascular AMD.” (Ex.1006, Dixon, 1573).</p> <p>“Two Phase III studies in wet AMD, VIEW 1 and VIEW 2, are currently under way and seek to compare monthly ranibizumab to monthly or bimonthly VEGF Trap-Eye.” (<i>Id.</i>, 1577; <i>id.</i>, 1577-79 (describing DME and RVO studies)).</p> |
| said method comprising sequentially administering to the patient a single initial dose of a VEGF antagonist, followed by one or more secondary doses of the VEGF antagonist, followed by one or more tertiary doses of the VEGF antagonist; | Phase 3 study “will evaluate the safety and efficacy of . . . 2.0 mg at an 8 week dosing interval ( <i>following three monthly doses</i> )”—i.e., doses at week 0, 4, 8, 16, 24, 32, 40, and 48. ( <i>Id.</i> , 1576 (emphasis added)).   |
| wherein each secondary dose is administered 2 to 4 weeks after the immediately preceding dose; and  | ( <i>Id.</i> ).   |
| wherein each tertiary dose is administered on an as-needed/pro re nata (PRN) basis, based on visual and/or anatomical outcomes as assessed by a physician or other qualified medical professional;  | ( <i>Id.</i> ; Ex.1017, '069 FH, 1/30/2017 Amendment, 6-7 (telling Examiner VIEW1/VIEW2 represents a “PRN treatment protocol,” “as claimed in independent claim 1”); <i>id.</i> , 6 (VIEW1/VIEW2 trial regimens are “of the type claimed”)).  |
| wherein the VEGF antagonist is a receptor-based chimeric molecule   | VEGF Trap-Eye is “a fusion protein of binding domains of VEGF receptors-1   |

| <u>Claim 1</u>  | <u>Dixon:</u>   |
|---|---|
| comprising (1) a VEGFR1 component comprising amino acids 27 to 129 of SEQ ID NO:2; (2) a VEGFR2 component comprising amino acids 130-231 of SEQ ID NO:2; and (3) a multimerization component comprising amino acids 232-457 of SEQ ID NO:2. | and -2 attached to the Fc fragment of human IgG.” (Ex.1006, Dixon, 1576 (Fig.1)).<br><br>“VEGF Trap-Eye and aflibercept (the oncology product) have the same molecular structure.” ( <i>Id.</i> , 1575).<br><br>(Ex.1002, Albini, ¶ 166). |

The amino acid sequence and structural information for VEGF Trap-Eye recited in the last “wherein” clause was well known and widely-published to skilled artisans. (Ex.1010, ’758 patent, Fig.24A-C; *id.*, 10:15-17; Ex.1033, Dix, [0013]-[0014], [0030]; Ex.1033, Dix, SEQ ID NO:4; Ex.1082; Ex.1002, Albini, ¶ 166). Dixon’s express disclosure of VEGF Trap-Eye thus anticipates. *In re Baxter Travenol Labs*, 952 F.2d 388, 390 (Fed. Cir. 1991) (“extrinsic evidence may be considered when it is used to explain, but not expand, the meaning of a reference”).

**Claim 8.** Claim 8 depends from claim 1 and further limits the claimed regimen to “only two secondary doses” “wherein each secondary dose is administered 4 weeks after the immediately preceding dose”—i.e., doses at weeks 0 (initial dose), 4, and 8 (two secondary doses). Applying Regeneron’s interpretation that the Challenged Claims encompass the VIEW1/VIEW2 dosing regimen (and thus can be supported by so-called “unexpected results” from that study), Dixon

expressly discloses the claim 8 limitation. (Ex.1006, Dixon, 1576 (“three monthly doses,” i.e., an initial dose at day 0 and two secondary doses at weeks 4 and 8); Ex.1002, Albini, ¶¶ 175-78). Accordingly, Dixon anticipates.

**Claims 9 and 10.** Claims 9 and 10 further limit the method of claim 1 to, *inter alia*, the angiogenic eye disorder, AMD. Dixon expressly discloses AMD treatment regimens. (Ex.1006, Dixon, 1573 (“Phase I and II trial data indicating safety, tolerability and efficacy for the treatment of neovascular AMD”); *id.*, 1576 (the Phase 3 trial “will enroll ~1200 patients with neovascular AMD”; Ex.1002, Albini, ¶¶ 179-82). Accordingly, Dixon discloses the additional limitation(s) of claims 9 and 10, and thus, anticipates.

**Claim 11.** Claim 11 depends from claim 1 and further limits the claimed method to topical or intraocular administration. The Phase 3 studies disclosed in Dixon expressly “evaluate the safety and efficacy of intravitreal VEGF Trap-Eye.” (Ex.1006, Dixon, 1576). Intravitreal injection is a type of intraocular administration that refers to administration directly into the vitreous of the eye. (Ex.1002, Albini, ¶¶ 183-86; Ex.1001, ’069 patent, 2:39-41). Accordingly, Dixon discloses the additional limitation of claim 11 and thus, anticipates.

**Claim 12.** Claim 12 depends from claim 1 and specifies the VEGF Trap-Eye/afibercept nucleotide sequence. Both the amino acid and nucleotide sequences were disclosed in the prior art and well known to skilled artisans. (Ex.1010, ’758



patent, Fig.24A-C; *id.*, 10:15-17; *see also* Ex.1002, Albini, ¶¶ 187-89; Ex.1033, Dix, SEQ ID NO:3; Ex.1083). The Dixon studies are directed to VEGF Trap-Eye and thus Dixon discloses the exact “VEGF antagonist” required by claim 12. Accordingly, Dixon anticipates.

**b. Obviousness.**

Challenged Claims 1 and 8-12 are also invalid as obvious over Dixon.

**Motivation to Combine.** Dixon, alone, unequivocally provides the motivation to combine the skilled artisan’s knowledge and prior art teachings to achieve the method(s) of, at least, Challenged Claims 1 and 8-12. (Ex.1006, Dixon, 1577 (“significant time and financial burden falls on patients during their [monthly] treatment course” and “[d]esirable attributes for emerging therapies for neovascular AMD include . . . decreased dosing intervals”); Ex.1002, Albini, ¶ 168). Furthermore, as evidenced by the prior art, skilled artisans had been practicing the claimed regimens—and obvious variations thereof—for years before January 2011. For example, skilled artisans routinely began therapy with three monthly loading doses and followed with PRN re-treatment as determined during scheduled monthly visits—otherwise known as “PrONTO-style dosing.” (Ex.1025, Engelbert-2010, 1369 (“PrONTO-style dosing has become popular . . .”). Indeed, by 2009, such PrONTO-style regimens were widely used for intravitreal anti-angiogenesis agents

like ranibizumab and bevacizumab.<sup>21</sup> And, standard re-treatment was routinely done in accordance with predetermined criteria, such as an increase in retinal thickness or OCT-detected fluid and/or losses in visual acuity. (Ex.1002, Albini, ¶ 169). In addition, Dixon's disclosure of the positive results of the Phase 2 AMD (CLEAR-IT-2) study showed that VEGF Trap-Eye could be administered on a PRN-basis following four initial loading doses (which is only one more loading dose than the three loading doses in claim 8).

Finally, and in addition to the aforementioned invalidating disclosures, the VIEW1/VIEW2 trials incorporated a second year, wherein PRN dosing was expressly used. Accordingly, a skilled artisan would have been further motivated given that the Dixon-disclosed studies merely adopted the already popular, PrONTO-style regimens for treating vitreoretinal disease. (Ex.1002, Albini, ¶ 170).

As a result, the claimed regimen consisting of an initial dose, followed by one or more monthly loading doses and PRN dosing thereafter, was obvious to skilled artisans. This is particularly true in view of the prior art, VIEW1/VIEW2 regimens, which (i) were based on known, pre-existing treatment regimens, and (ii) Regeneron admitted fall within the scope of the Challenged Claims.

---

<sup>21</sup> Though not FDA-approved for intravitreal use, bevacizumab was widely used off-label by ophthalmologists. (Ex.1037, Steinbrook, 1409-12).

**Reasonable Expectation of Success.** Skilled artisans would have also reasonably expected success using the VIEW1/VIEW2 regimen based on the same, aforementioned prior art disclosures. For example, Regeneron’s Phase 2 trials had already generated positive results and Dixon further discloses Regeneron’s launch of Phase 3 trials involving >2000 patients based on those positive results—in other words, skilled artisans expected success. (Ex.1006, Dixon, 1576 (reporting increases in visual acuity and mean decreases in retinal thickness resulting from the Phase 2 regimen); Ex.1002, Albini, ¶¶ 171-73).

In sum, Dixon also renders Challenged Claims 1 and 8-12 obvious based on the same disclosures applied in the anticipation analysis above, in light of Regeneron’s reliance on VIEW1/VIEW2 data to secure allowance; the publicly disclosed motivation to reduce injection frequency; and the reasonable expectation of success provided by at least the positive Phase 2 data.

**5. Ground 5: The Challenged Claims are obvious over Heier-2009 in combination with either Mitchell or Dixon—and, optionally, either the ’758 patent or Dix.**

The Heier-2009 (Phase 2 AMD) disclosures are discussed in detail above (*see supra* § XII.A.2), and that discussion is incorporated by reference herein. As set forth in more detail below, a skilled artisan prior to 2011 (i) would have been motivated to combine the teachings in Heier-2009 with prior art teachings related to other methods of treating intravitreal eye disorders with anti-VEGF less-frequent

dosing regimens—the most notable (and main competitor in that market) at the time being ranibizumab (LUCENTIS®), as disclosed in, e.g., Mitchell<sup>22</sup>; and (ii) based on the combination of prior art including Heier-2009 would have reasonably expected success applying the LUCENTIS dosing regimen disclosed in Mitchell (i.e., three monthly loading doses followed by PRN) to VEGF Trap-Eye. In addition, a skilled artisan would have been motivated to combine the teachings in Dixon regarding Regeneron’s VIEW trials for VEGF Trap-Eye—which also evaluated a dosing regimen comprising three monthly loading doses—with Heier-2009 to achieve a less-frequent, PRN dosing regimen with a reasonable expectation of success.<sup>23</sup>

---

<sup>22</sup> As explained in § XI(B)(7) above, Mitchell expressly incorporates by reference Fung, which discloses the PrONTO twelve-month results. In addition, as set forth in § XI(B)(8) above, Lalwani discloses the two-year PrONTO data (including the dosing regimen) and further confirms the PrONTO, PRN dosing regimen was able to achieve outcomes comparable to the MARINA/ANCHOR monthly dosing regimens. (Ex.1035, Lalwani, 43, 47-49). Accordingly, Heier-2009 may also be combined with Lalwani to equally render the Challenged Claims invalid as obvious.

<sup>23</sup> As explained in detail above (*supra* § XII(A)(2)), both Heier-2009 and Dixon are

**a. A skilled artisan would have been motivated to combine Heier-2009 with either Mitchell or Dixon.**

Prior to January 2011, a skilled artisan would have been motivated to combine the Heier-2009 disclosures of success treating AMD with a monthly loading/PRN dosing regimen, with either one of (i) Mitchell, which disclosed anti-VEGF (ranibizumab) regimens comprising three loading doses (weeks 0, 4, and 8) followed by PRN dosing; or (ii) Dixon, which disclosed the VIEW1/VIEW2 that comprised three monthly loading doses (weeks 0, 4, and 8). It was therefore obvious to combine these teachings to arrive at the Challenged Claims. *See KSR*, 550 U.S. at 418.

---

directed toward and expressly disclose VEGF Trap-Eye, for which the molecular structure was widely published and well known to skilled artisans. As such, the amino acid and nucleic acid sequences are inherent features of the VEGF Trap-Eye disclosed in both Heier-2009 and Dixon. Notwithstanding, the aforementioned combinations (Heier-2009 plus either Mitchell or Dixon) may be further combined with either the '758 patent or Dix, which expressly disclose the VEGF Trap-Eye sequences otherwise known to skilled artisans. (*See supra* n.11; § XI(B)(5)-(6); Ex.1010, '758 patent, Fig.24A-C; Ex.1033, Dix, SEQ ID NO:3 & SEQ ID NO:4; Ex.1082; Ex.1083)).

**b. Independent Claim 1.**

**Heier-2009.** As explained in detail above (*supra* § XI(B)(3)), Heier-2009 describes Regeneron’s CLEAR-IT-2 trial, wherein patients received, *inter alia*, monthly intravitreal injections through three months (i.e., doses at weeks 0, 4, 8, and 12), followed by PRN dosing for the first year. (Ex.1020, Heier-2009, 44-45). Moreover, Heier-2009 reports significant improvements in BCVA and decreases in retinal thickness, compared to baseline. (*Id.*). Given that success, a skilled artisan would have recognized the therapeutic potential of VEGF Trap-Eye, and would have been motivated to explore less-frequent dosing regimens given the well-documented concerns over monthly dosing. (Ex.1006, Dixon, 1256-57; Ex.1002, Albini, ¶¶ 190-92).

**Mitchell.** The skilled artisan would have naturally turned to literature regarding VEGF Trap-Eye’s main competitor in anti-VEGF treatment: ranibizumab (LUCENTIS®). (Ex.1002, Albini, ¶ 193). Mitchell discloses ranibizumab clinical studies, including PrONTO and SUSTAIN, which were designed to assess less frequent dosing. (*Id.*). PrONTO specifically involved “three consecutive monthly injections,” (i.e., weeks 0, 4, and 8) followed by PRN dosing. (Ex.1030, Mitchell, 6; Ex.1034, Fung, 569-70; Ex.1002, Albini, ¶¶ 194-96). SUSTAIN also involved ranibizumab administered in three monthly injections (i.e., weeks 0, 4, and 8), followed by PRN dosing based on visual acuity and retinal thickness criteria.

(Ex.1030, Mitchell, 7; Ex.1002, Albini, ¶ 195). The gains from the three-month phase were largely maintained which suggested that “flexible, guided dosing with fewer ranibizumab injections and monthly monitoring can maintain efficacy outcomes.” (Ex.1030, Mitchell, 7; Ex.1002, Albini, ¶¶ 195-96).

Further, a skilled artisan would not have been dissuaded from Mitchell just because ranibizumab and VEGF Trap-Eye are different molecules. (Ex.1030, Mitchell, 9 (Table 3)). Despite the differences in molecular structure, clinical trials revealed similar efficacy. (*Compare* Ex.1034, Fung, 566, 577 (PrONTO regimen resulting in a mean change in visual acuity of 9.3 letters after one year), *with* Ex.1006, Dixon, 1576 (CLEAR-IT-2 patients receiving a 2.0 mg monthly loading dose regimen followed by PRN saw mean improvements of 9.0 letters after one year); Ex.1018, Heier-2012, 2537 (reporting all aflibercept groups, including monthly dosing, “were noninferior and clinically equivalent to monthly ranibizumab for the primary end point.”); Ex.1002, Albini, ¶ 198).

**Dixon.** Dixon discloses CLEAR-IT-2, wherein patients receiving VEGF Trap-Eye monthly loading doses followed by PRN experienced significant improvements. (Ex.1006, Dixon, 1576). Upon that success, and given concerns over frequent intravitreal injections, a skilled artisan also would have been motivated to drop the loading doses from the four used in CLEAR-IT-2 (Phase 2) to the three used in VIEW (Phase 3), also disclosed in Dixon. (*Id.*; Ex.1002, Albini, ¶¶ 191-92).

In sum, Heier-2009 discloses the use of VEGF Trap-Eye in treating AMD, an angiogenic eye disorder and a successful PRN dosing phase. Both Mitchell and Dixon teach anti-VEGF regimens for AMD employing an initial dose (week 0), one or more secondary doses administered four weeks after the immediately preceding dose (weeks 4 and 8)—for a total of three loading doses, and tertiary PRN dosing. A skilled artisan naturally would have been motivated to combine the successful PRN regimen of CLEAR-IT-2 from Heier-2009 with the widely used loading regimen of three monthly doses disclosed in Mitchell and Dixon—to arrive at a regimen falling squarely within Challenged Claim 1. The “assessed by a physician” limitation is a pure mental step not entitled to any patentable weight. *See, e.g., King Pharms.*, 616 F.3d at 1278 (an otherwise unpatentable method claim does not become patentable because it includes a step of “informing someone”). Notwithstanding, PRN dosing includes physician assessment (*see* Ex.1002, Albini, ¶ 119), and both Mitchell and Dixon expressly disclose the “assessed by a physician” limitation of Challenged Claim 1. (Ex.1030, Mitchell, 6-7 (“OCT-guided variable dosing”; “[r]etreatment criteria [include] . . .”; “additional treatment guided by the following criteria . . .”); Ex.1006, Dixon, 1576 (“Criteria for re-dosing included . . .”)).

Accordingly, Heier-2009 provides clear motivation to seek out and consult references setting forth extended anti-VEGF regimens, like those disclosed in



Mitchell and Dixon. Given the positive Phase 2 results, a skilled artisan would have reasonably expected a PRN regimen with three monthly loading doses to succeed in treating an angiogenic eye disorder. Consequently, Challenged Claim 1 would have been obvious over Heier-2009 in combination with either Mitchell or Dixon.

**c. Claim 8.**

Claim 8 depends from claim 1 and further limits the claimed dosing regimen to “wherein only two secondary doses are administered to the patient, and wherein each secondary dose is administered 4 weeks after the immediately preceding dose”—i.e., doses at weeks 0 (initial dose), 4, and 8 (two secondary doses). This is the exact loading dose regimen used in the ranibizumab PrONTO and SUSTAIN trials disclosed in Mitchell, (Ex.1030, Mitchell, 6-7), as well as, the VEGF Trap-Eye VIEW Phase 3 trials disclosed in Dixon. (Ex.1006, Dixon, 1576; Ex.1002, Albini, ¶¶ 204-07). Accordingly, and for the reasons discussed above for claim 1, claim 8 would have been obvious.

**d. Claims 9 and 10.**

Claims 9 and 10 further limit the method of claim 1 to treating, *inter alia*, AMD (an angiogenic eye disorder). Heier-2009, Mitchell and Dixon all disclose methods of treating AMD. (Ex.1006, Dixon; Ex.1020, Heier-2009; Ex.1030, Mitchell; Ex.1002, Albini, ¶¶ 208-10). Accordingly, and for the reasons discussed above for claim 1, claims 9 and 10 would have been obvious.

**e. Claim 11.**

Claim 11 further limits the method of claim 1 to topical or intraocular administration. Intraocular administration refers to administration to the eye generally, while intravitreal administration, a subset of intraocular administration, refers to administration directly into the vitreous of the eye and is expressly disclosed in the prior art. (Ex.1006, Dixon; Ex.1020, Heier-2009; Ex.1030, Mitchell; Ex.1002, Albini, ¶¶ 211-13; Ex.1001, '069 patent, 2:39-41). Accordingly, and for the reasons discussed above for claim 1, claim 11 would have been obvious.

**f. Claim 12.**

Claim 12 depends from claim 1 and specifies the VEGF Trap-Eye nucleotide sequence. Both the amino acid and nucleotide sequences were disclosed in the prior art and the molecule was well known to skilled artisans. (Ex.1010, '758 patent, Fig.24A-C; *id.*, 10:15-17 (specifying that this molecule is termed “VEGFR1R2-FcΔC1(a)”); Ex.1002, Albini, ¶¶ 214-16; Ex.1033, Dix, SEQ ID NO:3; Ex.1083). Therefore, through their disclosure of VEGF Trap-Eye, Heier-2009, and Dixon disclose the “VEGF antagonist” required by claim 12. Accordingly, and for the reasons discussed above for claim 1, claim 12 would have been obvious.

**g. A skilled artisan would have reasonably expected success.**

**Heier-2009 plus Mitchell.** A skilled artisan would have reasonably expected success using the Heier-2009 PRN regimen alone, or combining it with the PrONTO

loading dose regimen for ranibizumab (as disclosed in Mitchell) given the successful reports using PRN regimens for VEGF Trap-Eye, as well as for ranibizumab. (Ex.1020, Heier-2009, 45; Ex.1030, Mitchell, 9 (Table 3); Ex.1002, Albini, ¶¶ 191, 194). Further, a skilled artisan would have had a reasonable expectation of success given the similar efficacy observed between the two biologics. Specifically, the ranibizumab AMD PrONTO regimen of three monthly loading doses followed by PRN dosing resulted in a mean change in visual acuity of 9.3 letters after one year. (Ex.1030, Mitchell, 9; Ex.1034, Fung, 566, 577; Ex.1035, Lalwani, 47). Similarly, in CLEAR-IT-2, patients receiving a monthly loading dose regimen followed by PRN dosing saw mean improvements of 9.0 letters after one year. (Ex.1006, Dixon, 1576). This observed similarity in efficacy between ranibizumab and VEGF Trap-Eye also is consistent with later reports on the results of the VIEW trials, in which “[a]ll aflibercept groups were noninferior and clinically equivalent to monthly ranibizumab for the primary end point.” (Ex.1018, Heier-2012, 2537; Ex.1002, Albini, ¶¶ 197-98).

**Heier-2009 plus Dixon.** A skilled artisan would have reasonably expected success combining the PRN regimen of Heier-2009 with the loading dose regimen disclosed in Dixon, which amounts to essentially reducing the four loading doses from CLEAR-IT-2 to the three used in VIEW1/VIEW2. As described in detail above, Dixon discloses both CLEAR-IT-2 and VIEW dosing regimens, which

incorporated three and two “secondary doses,” respectively. Dixon further discloses the significant improvements observed after monthly loading doses in CLEAR-IT-2, providing skilled artisans a reasonable expectation that the VIEW loading doses would be successful. (Ex.1006, Dixon, 1576; Ex.1002, Albini, ¶¶199-201).

\* \* \*

For the reasons stated above, claims 1 and 8-12 are obvious in view of Heier-2009 alone or in combination with either Mitchell or Dixon.

#### **6. No Secondary Considerations.**

Petitioner is not aware of any secondary considerations that would support a finding of non-obviousness. Further, even if such secondary considerations exist, they are (i) not relevant or applicable to the robust anticipation grounds presented herein, and (ii) cannot overcome the strong *prima facie* cases of obviousness discussed above. *Wyers v. Master Lock Co.*, 616 F.3d 1231, 1245-47 (Fed. Cir. 2010).

As an initial matter, the Challenged Claims do not require any particular levels of efficacy. Thus, for example, Regeneron’s allegation—asserted during prosecution, (Ex.1017, ’069 FH, 1/30/2017 Amendment, 6-9)—that the less frequent regimen of Challenged Claims produced “unexpected results” is entirely irrelevant. *Ormco*, 463 F.3d at 1311-12; *Kao*, 639 F.3d at 1068-69. However, assuming

Regeneron asserts those same statements to argue unexpected results here, the arguments were inaccurate and omitted highly pertinent information.

*First*, Regeneron argued that the claimed PRN dosing regimen was exemplified by the VIEW1/VIEW2 regimen. Regeneron then argued that the VIEW1/VIEW2 regimens, as disclosed in post-art Heier-2012, yielded unexpected results—while failing to disclose that the VIEW1/VIEW2 regimen had been the subject of numerous *prior art* disclosures (e.g., Dixon, Adis) *dating back to at least 2008*. (Ex.1002, Albini, ¶¶ 218-19).

*Second*, Regeneron characterized the standard of care at the time as monthly dosing, and sought to distinguish the claims from that “standard of care,” ignoring that PRN dosing could result in monthly injections. In other words, monthly dosing falls within the scope of the issued claims of the ’069 patent.

*Third*, Regeneron’s characterization of monthly dosing as the standard of care ignored treating physicians’ actual practice at the time, which often utilized regimens with three monthly doses followed by PRN treatment. (Ex.1002, Albini, ¶ 220). Regeneron’s statements are also belied by Regeneron’s own published clinical studies reporting regimens with less frequent dosing, as well as Genentech’s approach in the ranibizumab clinical trials. (*See, e.g.*, SUSTAIN (PRN dosing after three monthly loading doses); EXCITE (quarterly dosing after three monthly loading doses); PrONTO (PRN dosing after three monthly loading doses); SAILOR (PRN

dosing after three monthly loading doses); and PIER (quarterly dosing after three monthly loading doses); Ex.1030, Mitchell, 9-10 (providing a summary of each of the above studies); Ex.1031, Massin, 55 (RESOLVE study); Ex.1002, Albini, ¶ 221).

*Fourth*, there is nothing surprising or unexpected about the every-eight-week results in light of the promising Phase 2 PRN dosing regimen results obtained by Regeneron—results that were omitted from their arguments to the Patent Office. Phase 2 data showed a mean gain in visual acuity of nine letters and a mean decrease in retinal thickness of 143  $\mu\text{m}$ . (Ex.1002, Albini, ¶ 222). This led Regeneron to announce in a press release (also withheld from the Patent Office), that “an 8-week dosing schedule may be feasible.” (Ex.1012, Regeneron (28-April-2008), 1; Ex.1002, Albini, ¶ 222).

*Fifth*, Regeneron’s claims that there were “an infinite number of different treatment protocols” (Ex.1017, ’069 FH, 1/30/2017 Amendment, 6) to choose from, ignored the practical realities facing physicians who were administering intravitreal anti-VEGF agents at the time. As Dr. Albini explains, ophthalmologists were concerned about the frequency of injections under a straight monthly regimen. (Ex.1002, Albini, ¶ 223). Thus, when considering possible VEGF Trap-Eye regimens, monthly dosing would have been avoided if possible, and anything more frequent than monthly would not have been considered. Given the prevalence of

PRN and treat-and-extend approaches already being used by ophthalmologists, it is neither surprising nor unexpected that a new entrant to the anti-VEGF market would have considered a PRN dosing regimen (which Regeneron has argued would include the bimonthly regimen used in VIEW1/VIEW2). Lastly, the choice of three initial monthly loading doses was also not surprising given the prevalence of that exact loading regimen in the anti-VEGF studies being conducted at the time. (*See, e.g.*, Ex.1030, Mitchell, 9-10 (disclosing SUSTAIN; EXCITE; PrONTO; SAILOR; and PIER); Ex.1002, Albini, ¶ 223).

*Sixth*, to the extent Regeneron argues long-felt but unmet need, it will be unable to establish a “need” or show that any such need was “long-felt.” By 2010, the claimed PRN dosing regimen was not only publicly disclosed in Regeneron’s CLEAR-IT-2 study and the extensive ranibizumab art, it also was already in use among ophthalmologists administering anti-VEGF agents. (Ex.1002, Albini, ¶ 225). Consequently, any “unmet” need had already been fulfilled well before the ’069 patent was filed. (*Id.*).

Should Regeneron argue that any purported commercial success of EYLEA® is pertinent to patentability, Regeneron will be unable to establish that such purported commercial success is attributable to the claimed regimen. (*Id.*, ¶ 226).

Petitioner reserves the right to more specifically respond to any assertions of secondary considerations that Regeneron alleges during this proceeding.

### XIII. CONCLUSION.

The Challenged Claims are unpatentable in view of the prior art. Petitioner therefore requests that trial be instituted and the Challenged Claims cancelled.

Dated: May 5, 2021

Respectfully Submitted,

RAKOCZY MOLINO MAZZOCHI SIWIK LLP

/Paul J. Molino/

Paul J. Molino

Registration No. 45,350

6 West Hubbard Street

Chicago, IL 60654

Telephone: (312) 222-6300

Facsimile: (312) 843-6260

paul@rmmslegal.com

*Counsel for Petitioner*



**CERTIFICATE OF SERVICE**

The undersigned hereby certifies that a true and correct copy of the foregoing Petitioner Mylan Pharmaceuticals Inc.'s Petition for *Inter Partes* Review of U.S. Patent No. 9,669,069 B2, and Exhibits 1001-1083 were served on May 5, 2021, via FedEx Priority Overnight on the Patent Owner at the correspondence address of record for U.S. Patent No. 9,669,069 B2 as evidenced in Public Pair:

Regeneron – Bozicevic Field & Francis LLP  
201 Redwood Shores Parkway  
Suite 200  
Redwood City, CA 94065

Regeneron Pharmaceuticals, Inc.  
770 Old Saw Mill River Road  
Tarrytown, NY 10591

/Paul J. Molino/  
\_\_\_\_\_  
Paul J. Molino (Reg. No. 45,350)

**CERTIFICATE OF COMPLIANCE**

Pursuant to 37 C.F.R. § 42.24(d), the undersigned certifies that this Petition complies with the type-volume limitation of 37 C.F.R. § 42.24(a). The word count application of the word processing program used to prepare this Petition indicates that the Petition contains 13,951 words, excluding the parts of the brief exempted by 37 C.F.R. § 42.24(a).

Dated: May 5, 2021

/Paul J. Molino/  
Paul J. Molino (Reg. No. 45,350)

UNITED STATES PATENT AND TRADEMARK OFFICE

---

BEFORE THE PATENT TRIAL AND APPEAL BOARD

---

MYLAN PHARMACEUTICALS INC.,  
Petitioner

v.

REGENERON PHARMACEUTICALS, INC.,  
Patent Owner

---

Case IPR2021-00880  
Patent No. 9,669,069 B2

---

**PRELIMINARY RESPONSE OF PATENT OWNER  
REGENERON PHARMACEUTICALS, INC.**

## TABLE OF CONTENTS

|  | Page No. |
|--|----------|
| I. INTRODUCTION .....  | 1        |
| II. THE PETITION SHOULD BE REJECTED FOR CIRCUMVENTING<br>THE WORD LIMIT AND OBFUSCATING ITS GROUNDS .....  | 4        |
| A. The Petition Violates the Word Limit .....  | 4        |
| B. The Petition Fails the Particularity Requirement .....  | 5        |
| C. Janssen Pharmaceuticals, Inc. Is a Real Party-in-Interest .....   | 9        |
| III. THE BOARD SHOULD DENY INSTITUTION UNDER<br>35 U.S.C. § 325(D) .....   | 10       |
| A. The Examiner Considered the Same or Substantially the Same Art<br>( <i>Becton, Dickinson</i> Factors (a), (b), and (d)) .....                             | 10       |
| 1. Dixon .....   | 10       |
| 2. Heier-2009 .....  | 11       |
| 3. Regeneron (30-April-2009) .....   | 13       |
| 4. Mitchell .....  | 14       |
| 5. '758 Patent and Dix .....   | 14       |
| B. Petitioner Fails to Argue that the Examiner Erred in a Manner<br>Material to Patentability ( <i>Becton, Dickinson</i> Factors (c), (e), and<br>(f)) ..... | 16       |
| IV. THE BOARD SHOULD DENY INSTITUTION BECAUSE<br>PETITIONER FAILS TO MAKE ITS THRESHOLD SHOWING THAT<br>AT LEAST ONE CHALLENGED CLAIM IS UNPATENTABLE .....  | 17       |
| A. Grounds 1-5: Petitioner Fails to Establish the “Assessed by a<br>Physician” Limitation Is Anticipated or Obvious .....                                    | 18       |

|           |   |    |
|-----------|---|----|
| 1.        | Claim Construction .....  | 18 |
| a.        | “Based On Visual and/or Anatomical Outcomes as Assessed by a Physician or Other Qualified Medical Professional” .....   | 20 |
| 2.        | Grounds 1-4: Petitioner Fails to Establish that Heier-2009, Dixon or Regeneron (30-April-2009) Inherently or Expressly Discloses the “Assessed by a Physician or Other Qualified Medical Professional” Limitation (All Challenged Claims) ..... | 24 |
| a.        | Heier-2009 (Ground 1) .....   | 24 |
| b.        | Dixon (Ground 2 and 4).....   | 27 |
| c.        | Regeneron (30-April-2009) (Ground 3) .....  | 29 |
| 3.        | Under Petitioner’s Definition of the POSA, Petitioner Fails to Show that Heier-2009, Dixon, or Regeneron (30-April-2009) Is Enabled .....   | 29 |
| 4.        | Ground 5: Petitioner Fails to Satisfy Its Burden that the “Assessed by a Physician or Other Qualified Medical Professional” Is Obvious (All Challenged Claims).....   | 31 |
| <b>B.</b> | Grounds 1-4 (§ 102 Anticipation): Petitioner Fails to Establish that the Disclosure of “VEGF Trap-Eye” in Heier-2009, Dixon, or Regeneron (30-April-2009) Anticipates the Recited Amino Acid or Nucleic Acid Sequences.....                     | 31 |
| 1.        | Petitioner Fails to Establish that “VEGF Trap-Eye” Was Known in the Art to Correspond to SEQ ID NO: 2 (Claims 1 and 8-11) .....   | 32 |
| a.        | Petitioner and Its Expert Repeatedly Equate “Aflibercept” with All Variations of “VEGF Trap” .....  | 34 |
| b.        | Petitioner Fails to Address Uncertainty in the Art as to the Amino Acid Sequence of “VEGF Trap-Eye” .....   | 38 |

|           |  |           |
|-----------|--|-----------|
| 2.        | Petitioner Fails to Establish that “VEGF Trap-Eye” Was Known in the Art to Be Encoded by SEQ ID NO: 1 (Claim 12) .....   | 40        |
| <b>C.</b> | <b>Ground 4: Petitioner Fails to Demonstrate that There Is a Reasonable Likelihood that at Least One of the Challenged Clams Is Anticipated or Rendered Obvious by VIEW1/2 as Disclosed in Dixon .....</b> | <b>41</b> |
| 1.        | Petitioner Fails to Establish that the 8-Week Dosing Arm of the VIEW Clinical Trial Anticipates the Claimed PRN Dosing Regimen (All Challenged Claims) .....   | 42        |
| 2.        | Petitioner Fails to Establish that the 8-Week Dosing Arm of the VIEW Clinical Trial Renders Obvious the Claimed PRN Dosing Regimen (All Challenged Claims) .....   | 45        |
| <b>D.</b> | <b>Ground 5: Petitioner Fails to Demonstrate that There Is a Reasonable Likelihood that at Least One of the Challenged Clams Is Rendered Obvious .....</b>   | <b>47</b> |
| <b>E.</b> | <b>Petitioner’s Argument Against Objective Evidence Should Be Rejected .....</b>   | <b>52</b> |
| <b>V.</b> | <b>CONCLUSION.....</b>   | <b>57</b> |

**TABLE OF AUTHORITIES**

|  | <b>Page(s)</b> |
|--|----------------|
| <b>Cases</b>   |                |
| <i>ABS Global, Inc. v. Cytonome/ST, LLC</i> ,<br>IPR2021-00306, Paper 13 (Jun. 7, 2021) .....  | 11, 16         |
| <i>Adaptics Ltd. v. Perfect Co.</i> ,<br>IPR2018-01596, Paper 20 (Mar. 6, 2019) .....  | 5              |
| <i>Advanced Bionics, LLC v. MED-EL Elektromedizinische Gerate GmbH</i> ,<br>IPR2019-01469, 2020 WL 740292 (Feb. 13, 2020) .....  | 16             |
| <i>Advanced Display Sys., Inc. v. Kent State Univ.</i> ,<br>212 F.3d 1272 (Fed. Cir. 2000) .....   | 42             |
| <i>Amgen, Inc. v. Alexion Pharms., Inc.</i> ,<br>IPR2019-00739, Paper 15 (Aug. 30, 2019) .....   | 41             |
| <i>Apple, Inc. v. ITC</i> ,<br>725 F.3d 1356 (Fed. Cir. 2013) .....  | 52             |
| <i>AstraZeneca AB v. Aurobindo Pharma Ltd.</i> ,<br>232 F. Supp. 3d 636 (D. Del. 2017) .....   | 46             |
| <i>Belden Inc. v. Berk-Tek LLC</i> ,<br>805 F.3d 1064 (Fed. Cir. 2015) .....   | 51             |
| <i>Boragen, Inc. v. Syngenta Participations AG</i> ,<br>IPR2020-00124, 2020 WL 2206972 (May 5, 2020) .....   | 14             |
| <i>C R Bard Inc. v. AngioDynamics, Inc.</i> ,<br>979 F.3d 1372 (Fed. Cir. 2020) .....  | 23             |
| <i>Cisco Sys., Inc. v. C-Cation Techs., LLC</i> ,<br>IPR2014-00454, Paper 12 (Aug. 29, 2014) .....   | 26             |
| <i>Continental Can Co. USA v. Monsanto Co.</i> ,<br>948 F.2d 1264 (Fed. Cir. 1991) .....   | 33             |
| <i>Dropworks, Inc. v. Univ. of Chi.</i> ,<br>IPR2021-00100, Paper 9 (May 14, 2021) .....   | 15             |
| <i>EIK Eng'g Sdn. Bhd. v. Wilco Marsh Buggies &amp; Draglines, Inc.</i> ,<br>IPR2020-00344, Paper 7 (June 23, 2020),<br><i>reh'g denied</i> , IPR2020-00344, Paper 12 (Mar. 4, 2021) ..... | 9              |

|  |                |
|--|----------------|
| <i>Elan Pharms., Inc. v. Mayo Found. for Med. Educ. &amp; Rsch.</i> ,<br>346 F.3d 1051 (Fed. Cir. 2003).....                   | 29             |
| <i>Evergreen Theragnostics, Inc. v. Advanced Accelerator Applications SA</i> ,<br>PGR2021-00003, Paper 10 (Apr. 15, 2021)..... | 12, 14         |
| <i>Forest Lab 'ys, LLC v. Sigmapharm Lab 'ys, LLC</i> ,<br>918 F.3d 928 (Fed. Cir. 2019).....                                  | 48             |
| <i>Gardner Denver, Inc. v. Utex Indus., Inc.</i> ,<br>IPR2020-00333, 2020 WL 4529832 (Aug. 5, 2020).....                       | 12, 14, 15, 16 |
| <i>Henny Penny Corp. v. Frymaster LLC</i> ,<br>938 F.3d 1324 (Fed. Cir. 2019).....   | 46             |
| <i>Hoffer v. Microsoft Corp.</i> ,<br>405 F.3d 1326 (Fed. Cir. 2005).....  | 21             |
| <i>In re Morsa</i> ,<br>713 F.3d 104 (Fed. Cir. 2013).....   | 29             |
| <i>Intelligent Bio-Systems, Inc. v. Illumina Cambridge Ltd.</i> ,<br>821 F.3d 1359 (Fed. Cir. 2016).....                       | 45             |
| <i>King Pharms., Inc. v. Eon Labs, Inc.</i> ,<br>616 F.3d 1267 (Fed. Cir. 2010).....   | passim         |
| <i>KSR Int'l Co. v. Teleflex, Inc.</i> ,<br>550 U.S. 398 (2007).....   | 48             |
| <i>Luye Pharma Grp. Ltd. v. Alkermes Pharma Ir. Ltd.</i> ,<br>IPR2016-01096, Paper 74 (Nov. 28, 2017).....                     | 52             |
| <i>Merck Sharp &amp; Dohme Corp. v. Wyeth LLC</i> ,<br>IPR2017-01211, Paper 9 (Oct. 20, 2017).....                             | 26             |
| <i>Microsoft Corp. v. Bradium Techs. LLC</i> ,<br>IPR2015-01435, Paper 15 (Dec. 23, 2015).....                                 | 25             |
| <i>NXP USA, Inc. v. Impinj, Inc.</i> ,<br>IPR2020-00519, 2020 WL 4805424 (Aug. 17, 2020).....                                  | 12, 14, 15, 16 |
| <i>Pers. Web Techs., LLC v. Apple, Inc.</i> ,<br>848 F.3d 987 (Fed. Cir. 2017).....  | 51             |
| <i>Philip Morris Prods., S.A. v. Rai Strategic Holdings, Inc.</i> ,<br>IPR2020-00921, 2020 WL 6750120 (Nov. 16, 2020).....     | 11             |



|   |            |
|---|------------|
| <i>Pi-Net Int'l, Inc. v. JPMorgan Chase &amp; Co.</i> ,<br>600 F. App'x 774 (Fed. Cir. 2015).....                   | 5          |
| <i>Rohm &amp; Haas Co. v. Brotech Corp.</i> ,<br>127 F.3d 1089 (Fed. Cir. 1997).....                                | 26         |
| <i>Samsung Elecs. Co. v. Elm 3DS Innovations, LLC</i> ,<br>925 F.3d 1373 (Fed. Cir. 2019).....                      | 19         |
| <i>Schering v. Amgen</i> ,<br>222 F.3d 1347 (Fed. Cir. 2000).....   | 37         |
| <i>Nidec Motor Corp. v. Zhongshan Broad Ocean Motor Co.</i> ,<br>868 F.3d 1013 (Fed. Cir. 2017).....                | 19, 20     |
| <i>Smiths Indus. Med. Sys., Inc. v. Vital Signs, Inc.</i> ,<br>183 F.3d 1347 (Fed. Cir. 1999).....                  | 48         |
| <i>Sony Interactive Ent. LLC v. Terminal Reality, Inc.</i> ,<br>IPR2020-00711, 2020 WL 6065188 (Oct. 13, 2020)..... | 17         |
| <i>Vanda Pharms. Inc. v. W.-Ward Pharms. Int'l Ltd.</i> ,<br>887 F.3d 1117 (Fed. Cir. 2018).....                    | 23         |
| <i>Verdegaal Bros. v. Union Oil Co. of Cal.</i> ,<br>814 F.2d 628 (Fed. Cir. 1987).....                             | 43         |
| <b>Statutes</b>   |            |
| 35 U.S.C. § 312(a)(3).....  | 2, 3, 5, 6 |
| 35 U.S.C. § 314.....  | 18         |
| 35 U.S.C. § 314(a).....   | passim     |
| 35 U.S.C. § 315.....  | 18         |
| 35 U.S.C. § 325(d).....   | 2, 10, 17  |
| <b>Other Authorities</b>  |            |
| 77 Fed. Reg. 48756 (August 14, 2012).....   | 6          |
| 77 Fed. Reg. 48763 (August 14, 2012).....   | 6          |
| Trial Practice Guide (November 2019).....   | 5          |
| <b>Regulations</b>  |            |
| 37 C.F.R. § 42.24(a)(1)(i).....   | 4          |

## TABLE OF EXHIBITS

| Ex. No. | Description  |
|---------|--|
| 2001    | Exhibit Number Unused  |
| 2002    | Exhibit Number Unused  |
| 2003    | Lucentis (ranibzumab injection) label, revised June 2010   |
| 2004    | Ex. (a)(1)(a) to Tender Offer Statement to Momenta, filed with SEC on September 2, 2020  |
| 2005    | Press Release, Johnson & Johnson, <i>Johnson &amp; Johnson to Acquire Momenta Pharmaceuticals, Inc., Expanding Janssen's Leadership in Novel Treatments for Autoimmune Diseases</i> , dated August 19, 2020  |
| 2006    | Press Release, Johnson & Johnson, <i>Johnson &amp; Johnson Completes Acquisition of Momenta Pharmaceuticals, Inc.</i> , dated October 1, 2020  |
| 2007    | Press Release, THOMAS REUTERS INTEGRITY "VEGF Trap-Eye final phase II results in age-related macular degeneration presented at 2008 Retina Society Meeting" (September 2008)   |
| 2008    | Information from ClinicalTrials.gov archive on the VIEW 2 study (NCT00637377) "VEGF Trap-Eye: Investigation of Efficacy and Safety in Wet AMD (VIEW 2)" versions available and updated on 17 March 2008.   |
| 2009    | U.S. Patent App. No. 2006/0058234  |
| 2010    | Excerpts from J.M. Berg <i>et al.</i> , <i>Biochemistry</i> (5 <sup>th</sup> Ed. 2002)   |
| 2011    | M.W. Stewart & P.J. Rosenfeld, <i>Predicted Biological Activity of Intravitreal VEGF Trap</i> , <i>Br. J. Ophthalmol</i> 92:667-68 (2008)  |
| 2012    | P. Iacono <i>et al.</i> , <i>Antivascular Endothelial Growth Factor in Diabetic Retinopathy</i> , <i>Dev. Ophthalmol.</i> 46:39-53 (2010)  |
| 2013    | D.V. Do <i>et al.</i> , <i>An Exploratory Study of the Safety, Tolerability and Bioactivity of a Single Intravitreal Injection of Vascular Endothelial Growth Factor Trap-Eye in Patients With Diabetic Macular Oedema</i> , <i>Br. J. Ophthalmol</i> 93:144-49 (2009) |
| 2014    | J.W. Moroney <i>et al.</i> , <i>Aflibercept in Epithelial Ovarian Carcinoma</i> , <i>Future Oncol</i> 5(5):591-600 (2009)  |
| 2015    | U.S. Patent Publication 2010/0160233 A1 to Bissery <i>et al.</i> , published June 24, 2010   |
| 2016    | T. Hachiya <i>et al.</i> , <i>Increase in respiratory cost at high growth temperature is attributed to high protein turnover cost in Petunia x hybrida petals</i> , <i>Plant, Cell, and Environment</i> , 30:1269-1283 (2007)  |

|      |  |
|------|--|
| 2017 | M. Piques et al., <i>Ribosome and transcript copy numbers, polysome occupancy and enzyme dynamics in Arabidopsis</i> , <i>Molecular Systems Biology</i> 5: Article number 314 (2009)   |
| 2018 | Jaffe et al., <i>Differential Response to Anti-VEGF Regimens in Age-Related Macular Degeneration Patients with Early Persistent Retinal Fluid</i> , <i>Ophthalmology</i> 2016;123:1856-1864 (2016)   |
| 2019 | Eylea (aflibercept) Injection label, revised May 2016  |
| 2020 | A Study Investigating the Safety and Efficacy of Lampalizumab Intravitreal Injections in Participants With Geographic Atrophy Secondary to Age-Related Macular Degeneration (SPECTRI), NCT02247531, ClinicalTrials.gov (August 2, 2021), <a href="https://clinicaltrials.gov/ct2/show/NCT02247531?term=lampalizumab&amp;phase=2&amp;draw=2&amp;rank=2">https://clinicaltrials.gov/ct2/show/NCT02247531?term=lampalizumab&amp;phase=2&amp;draw=2&amp;rank=2</a> |
| 2021 | A Study Investigating the Efficacy and Safety of Lampalizumab Intravitreal Injections in Participants With Geographic Atrophy Secondary to Age-Related Macular Degeneration (CHROMA), NCT02247479, ClinicalTrials.gov (August 2, 2021), <a href="https://clinicaltrials.gov/ct2/show/NCT02247479?term=lampalizumab&amp;phase=2&amp;draw=2&amp;rank=3">https://clinicaltrials.gov/ct2/show/NCT02247479?term=lampalizumab&amp;phase=2&amp;draw=2&amp;rank=3</a>  |
| 2022 | Efficacy and Safety Trial of Conbercept Intravitreal Injection for Neovascular AMD(PANDA-2), NCT03630952, ClinicalTrials.gov (August 2, 2021), <a href="https://clinicaltrials.gov/ct2/show/NCT03630952?term=NCT03630952&amp;draw=2&amp;rank=1">https://clinicaltrials.gov/ct2/show/NCT03630952?term=NCT03630952&amp;draw=2&amp;rank=1</a>   |
| 2023 | Efficacy and Safety Trial of Conbercept Intravitreal Injection for Neovascular AMD(PANDA-1), NCT03577899, ClinicalTrials.gov (August 2, 2021), <a href="https://clinicaltrials.gov/ct2/show/NCT03577899?term=NCT03577899&amp;draw=2&amp;rank=1">https://clinicaltrials.gov/ct2/show/NCT03577899?term=NCT03577899&amp;draw=2&amp;rank=1</a>   |
| 2024 | A Phase 3 Safety and Efficacy Study of Fovista® (E10030) Intravitreal Administration in Combination With Lucentis® Compared to Lucentis® Monotherapy, NCT01944839, ClinicalTrials.gov (August 2, 2021), <a href="https://clinicaltrials.gov/ct2/show/NCT01944839?term=fovista&amp;phase=2&amp;draw=2&amp;rank=1">https://clinicaltrials.gov/ct2/show/NCT01944839?term=fovista&amp;phase=2&amp;draw=2&amp;rank=1</a>  |

|      |  |
|------|--|
| 2025 | A Phase 3 Safety and Efficacy Study of Fovista® (E10030) Intravitreal Administration in Combination With Lucentis® Compared to Lucentis® Monotherapy, ClinicalTrials.gov (August 2, 2021), <a href="https://clinicaltrials.gov/ct2/show/NCT01940900?term=fovista&amp;phase=2&amp;draw=2&amp;rank=2">https://clinicaltrials.gov/ct2/show/NCT01940900?term=fovista&amp;phase=2&amp;draw=2&amp;rank=2</a> |
| 2026 | S. Elvidge, <i>Ophotech's Fovista crashes out in wet AMD</i> , BIOPHARMADIVE (Aug. 14, 2017), available at, <a href="https://www.biopharmadive.com/news/ophtotech-fovista-phase-3-failure-setback-novartis/449248/">https://www.biopharmadive.com/news/ophtotech-fovista-phase-3-failure-setback-novartis/449248/</a>  |
| 2027 | X. Li et al., <i>Safety and Efficacy of Conbercept in Neovascular Age-Related Macular Degeneration: Results from a 12-Month Randomized Phase 2 Study: AURORA Study</i> , <i>Ophthalmology</i> 2014:121:1740-1747 (2014)  |
| 2028 | Regeneron Pharmaceuticals Inc., "VEGF Trap-Eye CLEAR-IT 2 Final Primary Endpoint Results" presented at the 2007 Retina Society Conference in Boston, Massachusetts (September 30, 2007)  |
| 2029 | Bhisitkul, Robert B. and Stewart, Jay M., <i>Alternative anti-VEGF treatment regimens in exudative age-related macular degeneration</i> , <i>Expert Rev. Ophthalmol.</i> , Vol. 5, No. 6 (2010).   |
| 2030 | Park, Young Gun et al., <i>New Approach to Anti-VEGF Agents for Age-Related Macular Degeneration</i> , <i>Journal of Ophthalmology</i> (2012).   |
| 2031 | Spaide, Richard, <i>Ranibizumab According to Need: A Treatment for Age-related Macular Degeneration</i> , <i>American Journal of Ophthalmology</i> (April 2007)  |
| 2032 | Boyer, David S., <i>A Phase IIIb Study to Evaluate the Safety of Ranibizumab in Subjects with Neovascular Age-related Macular Degeneration</i> , <i>Ophthalmology</i> , Vol. 116, No. 9 (Sept. 2009)   |
| 2033 | Lucentis (ranibzumab injection) label, revised March 2018  |
| 2034 | U.S. Patent No. 7,303,746  |
| 2035 | U.S. Patent No. 7,521,049  |
| 2036 | U.S. Patent No. 7,303,747  |
| 2037 | U.S. Patent No. 7,306,799  |
| 2038 | Macugen (pegaptanib sodium injection) label submitted with NDA 21-756  |
| 2039 | Press Release, <i>Regeneron, Regeneron Reports Fourth Quarter and Full Year 2012 Financial and Operating Results</i> , dated February 14, 2013   |
| 2040 | Press Release, <i>Regeneron, Regeneron Reports Fourth Quarter and Full Year 2019 Financial and Operating Results</i> , dated February 6, 2020  |

|      |   |
|------|---|
| 2041 | Press Release, Regeneron, <i>Regeneron and Bayer Report Positive Results for VEGF Trap-Eye in Phase 3 Study in Central Retinal Vein Occlusion (CRVO) and in Phase 2 Study in Diabetic Macular Edema (DME)</i> , dated December 20, 2010 |
| 2042 | J.P. Levine <i>et al.</i> , <i>Macular Hemorrhage in Neovascular Age-related Macular Degeneration After Stabilization With Antiangiogenic Therapy</i> , <i>Retina</i> 29(8):1074-79 (2009)  |

Regeneron Pharmaceuticals, Inc. (“Patent Owner” or “Regeneron”) submits this preliminary response pursuant to 35 U.S.C. § 313 and 37 C.F.R. § 42.107 to Mylan Pharmaceuticals Inc.’s (“Petitioner’s” or “MPI’s”) request for *inter partes* review (“IPR”) of claims 1 and 8-12 (“Challenged Claims”) of U.S. Patent No. 9,669,069 (“the ’069 Patent,” Ex. 1001).

## I. INTRODUCTION

Petitioner, who is developing a biosimilar of EYLEA<sup>®</sup> for the treatment of angiogenic eye disorders, files this challenge to try to invalidate Regeneron’s ’069 Patent, which covers an alternate approved dosing regimen for EYLEA<sup>®</sup>.

Before the development of EYLEA<sup>®</sup>, the standard of care for treatment of angiogenic eye disorders was monthly intravitreal injections of ranibizumab (Lucentis<sup>®</sup>), an antibody fragment that binds Vascular Endothelial Growth Factor (“VEGF”), or monthly off-label use of bevacizumab (Avastin<sup>®</sup>), an anti-VEGF antibody. The great burden of monthly injections led to several attempts to increase intervals between injections. Ex. 1018, 1 and 9. However, existing VEGF inhibitors were not effective at maintaining vision through fixed quarterly or “as needed” (*pro re nata*) dosing regimens. Ex. 1001, 1:55-59; Ex. 2003, 5.

Regeneron sought to develop a therapy that would finally improve *and* maintain visual acuity with extended time between injections. The ’069 Patent discloses and claims the administration of a specific VEGF antagonist using a dosing regimen that includes a single initial dose of the VEGF antagonist,

followed by one or more secondary doses of the VEGF antagonist, followed by one or more tertiary doses of the VEGF antagonist, where the tertiary doses are “administered on an as-needed/*pro re nata* (PRN) basis, based on visual and/or anatomical outcomes as assessed by a physician or other qualified medical professional.”

As set forth herein and in the accompanying exhibits, the Petition should be denied for at least the following independent reasons:

*First*, Petitioner flouts the Board’s rules by circumventing word count limits and by disregarding the particularity requirement of 35 U.S.C. § 312(a)(3), presenting “catch-all” obviousness arguments that do not differentiate between six references and nine obviousness theories.

*Second*, Petitioner bases its challenges on the same or substantially the same prior art that was previously before the U.S. Patent & Trademark Office (“Office”) and was considered by the Examiner, yet Petitioner does not allege that the Examiner erred in a manner material to the patentability of the Challenged Claims, warranting discretionary denial under 35 U.S.C. §§ 325(d) and 314(a).

*Third*, Petitioner makes no effort to show that the art relied upon in any of its Grounds discloses, expressly or inherently, that the PRN dosing of the claimed VEGF Trap fusion protein be administered “based on visual and/or anatomical outcomes as assessed by a physician or other qualified medical professional.” Instead, Petitioner argues — unconvincingly — that this limitation is a “mental

step” that should be afforded no patentable weight. Because Petitioner’s claim construction position lacks merit and it has utterly failed to show this limitation in its cited art, it has not met its threshold burden under 35 U.S.C. §§ 314(a) and 312(a)(3), and the Board should deny institution for this reason alone.

*Fourth*, Petitioner’s anticipation challenges also fail because Petitioner does not demonstrate that the claims’ required nucleic acid or amino acid sequence was expressly or inherently disclosed in its cited references. Petitioner’s anticipation position depends on its unsupported theory that the alleged prior art inherently discloses aflibercept and its amino acid and nucleic acid sequences through reference to “VEGF Trap-Eye.” But Petitioner relies on inference to make a connection between “VEGF Trap-Eye” and “aflibercept” that the prior art does not support, and the Federal Circuit has repeatedly held that such mere possibilities or probabilities are insufficient for anticipation.

*Fifth*, Petitioner’s Ground 4 anticipation and obviousness challenges additionally fail because its cited art fails to disclose a “tertiary dose” that “is administered on an as-needed/*pro re nata* PRN basis” and, further, Petitioner fails to show that the person of ordinary skill in the art (“POSA”) would have been motivated to modify a fixed 8-week tertiary dosing regimen to become a PRN tertiary dosing regimen, as required by each of the Challenged Claims.

*Finally*, Petitioner’s Ground 5 obviousness challenge additionally should be rejected because Petitioner fails to show that the POSA would have been



motivated to reduce the four monthly loading doses<sup>1</sup> in Regeneron's Phase 2 clinical trials to three monthly loading doses, and further fails to address that the clinical trial results and the art as a whole would caution against such a modification.

For these reasons, as explained further below, Regeneron respectfully requests that the Board deny institution of the Petition.

## **II. THE PETITION SHOULD BE REJECTED FOR CIRCUMVENTING THE WORD LIMIT AND OBFUSCATING ITS GROUNDS**

### **A. The Petition Violates the Word Limit**

The Petition exceeds the 14,000-word limit (37 C.F.R. § 42.24(a)(1)(i)). Despite certifying that the word count for its petition is 13,951 words (Pet., Cert. of Compliance), the Petition's word count includes only the typed words of the Petition. The word count ignores words in images of text from the '069 Patent specification, including a lengthy passage of text on which Petitioner substantively relies for its arguments. *See e.g.*, Pet., 14-15. In total, Petitioner fails to account for 186 words in text images in the Petition which, when included, results in a word count of 14,137 words. Thus, Petitioner disregards the Board's rules, as further evidenced by Petitioner's use of the same tactic in its Petition filed in IPR2021-00881. Paper 1. This is a reason to deny institution. Trial

---

<sup>1</sup> The recited initial and secondary doses are also referred to as "loading doses" and the recited tertiary doses are also referred to as "maintenance doses" herein.

Practice Guide (November 2019) at 40 (“Excessive words in figures, drawings, or images, deleting spacing between words, or using excessive acronyms or abbreviations for word phrases, in order to circumvent the rules on word count, may lead to a party’s brief not being considered.”); *see Pi-Net Int’l, Inc. v. JPMorgan Chase & Co.*, 600 F. App’x 774 (Fed. Cir. 2015) (denying request to file a corrected brief and dismissing appeal because appellant violated word count).

The proper remedy here is to deny institution, thereby allowing Petitioner to refile a petition that properly conforms with the Board’s word count rules. No time bar precludes Petitioner from refiling a petition challenging the ’069 Patent.

**B. The Petition Fails the Particularity Requirement**

Despite exceeding the allowed word count, Petitioner still has not managed to state, with particularity, the grounds on which the challenge to each claim is based. Accordingly, the Petition presents an inefficient use of the Board’s time and resources, as well as procedural unfairness to Regeneron.

A petition “may be considered only if . . . the petition identifies, in writing and with particularity, each claim challenged, the grounds on which the challenge to each claim is based, and the evidence that supports the grounds for the challenge to each claim.” 35 U.S.C. § 312(a)(3); *see also Adaptics Ltd. v. Perfect Co.*, IPR2018-01596, Paper 20 at 15-24 (Mar. 6, 2019) (informative). “[T]he Board may consider whether a lack of particularity as to one or more of the

asserted grounds justifies denial of an entire petition.” *Id.* at 17. Furthermore, the Office Patent Trial Practice Guide advises practitioners to “focus on concise, well-organized, easy-to-follow arguments supported by readily identifiable evidence of record.” 77 Fed. Reg. 48756, 48763 (August 14, 2012).

Here, Petitioner has not satisfied the particularity requirements under § 312(a)(3) for at least Ground 5 because the Petition suffers from the same deficiencies identified by the Board in *Adaptics*. Specifically, Ground 5 is a “catch-all” ground that alleges that the Challenged Claims are obvious over six references under at least seven and as many as nine different theories:

1. Heier-2009 + Mitchell;
2. Heier-2009 + Mitchell + the '758 Patent;
3. Heier-2009 + Mitchell + Dix;
4. Heier-2009 + Dixon;
5. Heier-2009 + Dixon + the '758 Patent;
6. Heier-2009 + Dixon + Dix;
7. Heier-2009 + Lalwani;
8. Heier-2009 + Lalwani + the '758 Patent; and
9. Heier-2009 + Lalwani + Dix.

*See* Pet., 60-61 n.22.

Importantly, Petitioner fails to explain why each of these combinations is necessary. *Id.* at 60-67. Rather, as in *Adaptics*, Petitioner impermissibly assumes

that Heier-2009 does not disclose one or more claim limitations and leaves it to the Board and Regeneron to fill in the gaps of its Petition. Petitioner also does not explain the differences between at least independent claim 1 and the alleged primary reference, Heier-2009, much less the other secondary or tertiary references, or the differences between each of the various secondary references (Mitchell, Dixon, Lalwani) or between each of the various tertiary references (the '758 Patent and Dixon). *Id.* at 63-66. Consequently, as in *Adaptics*, Petitioner turns the Petition into an empty invitation to the Board and Regeneron to ascertain what evidence purportedly supports the full breadth of Petitioner's contentions.

Beyond its failure to identify how each combination maps to the claim limitations or the differences between each combination, Petitioner does not articulate any specific motivation to combine or modify at least: (1) Heier-2009 with Lalwani, (2) the Heier-2009 and Mitchell combination with either of the two tertiary references, or (3) the Heier-2009 and Dixon combination with either of the two tertiary references. Again, this lack of particularization leaves Regeneron and the Board to search the record for the evidence that would support Petitioner's theories.

Compounding Petitioner's lack of specificity as to the distinct combinations comprising Ground 5, Petitioner uses its cited references inconsistently. Three of the seven obviousness theories Petitioner sets out in Ground 5 involve combining

Heier-2009 (Ex. 1020) with Dixon (Ex. 1006), even though these two references are characterized elsewhere in the Petition as alternative references. *Compare* Pet., 60-67 (Ground 5) (arguing Heier-2009 and Dixon must be combined) *with* Pet., 45-50 (Grounds 1 & 2) (arguing Heier-2009 and Dixon both independently anticipate). Specifically, Petitioner argues that each of Heier-2009 and Dixon represent *alternative* disclosures anticipating claim 1. *Id.* at 46 (“[E]ach of Heier-2009 and Dixon disclose every element of independent claim 1.”); *see also, id.* at 61-62 n.23 (“[B]oth Heier-2009 and Dixon are directed toward and expressly disclose VEGF Trap-Eye.”). Yet, in Ground 5, Petitioner asserts Heier-2009 and Dixon *in combination* disclose all the elements of claim 1. *Id.* at 62-66 (“A skilled artisan naturally would have been motivated to combine the successful PRN regimen of CLEAR-IT-2 from Heier-2009 with the widely used loading regimen of three monthly doses disclosed in Mitchell and Dixon—to arrive at a regimen falling squarely within Challenged Claim 1.”); *see also, id.* at 68-69 (“Heier-2009 plus Dixon”).

This inconsistency as to whether Heier-2009 and Dixon are alternative references anticipating the Challenged Claims or are cumulative references that render the Challenged Claims obvious in combination makes Petitioner’s arguments impermissibly ambiguous and difficult to understand. The Board has previously deemed similar confusing and inconsistent arguments to lack particularity and has exercised its discretion to deny the entire Petition under these

circumstances. *See, e.g., EIK Eng'g Sdn. Bhd. v. Wilco Marsh Buggies & Draglines, Inc.*, IPR2020-00344, Paper 7 at 2 (June 23, 2020), *reh'g denied*, IPR2020-00344, Paper 12 (Mar. 4, 2021).

For at least the above reasons, Petitioner has not satisfied the requirement to state, with particularity, the grounds on which the challenge to each claim is based. Accordingly, the Petition presents procedural unfairness to Regeneron, as well as an inefficient use of the Board's time and resources. Consequently, Regeneron respectfully requests denial of the petition under 35 U.S.C. § 314(a).

**C. Janssen Pharmaceuticals, Inc. Is a Real Party-in-Interest**

Petitioner also fails to identify the correct RPIs in its Petition. Petitioner identifies Viatrix Inc., Mylan Inc., Mylan Pharmaceuticals Inc., Momenta Pharmaceuticals, Inc., and Johnson & Johnson as real parties-in-interest to the instant Petition. Pet., 4-5. Petitioner stated “[n]o other parties exercised or could have exercised control over this Petition; no other parties funded, directed and controlled this Petition.” *Id.* However, Regeneron understands from publicly available documents that Janssen Pharmaceuticals, Inc. (“Janssen”) is a real party-in-interest for the same reasons Mylan disclosed these other entities.

Multiple Johnson & Johnson press releases and Securities Exchange Commission filings indicate that Janssen, a pharmaceutical company headquartered in Beerse, Belgium, and owned by Johnson & Johnson, is managing the business and operations of Momenta, generally, and the acquired

Momenta pipeline of clinical and pre-clinical assets, including a biosimilar to EYLEA<sup>®</sup>. Ex. 2004, 46 (“the business and operations of Momenta will be managed as one of the Janssen Pharmaceuticals Companies of Johnson & Johnson.”); *see also* Ex. 2005; Ex. 2006.

While denial of institution is warranted here, if the Board grants institution, it should require Petitioner to file updated mandatory disclosures identifying Janssen as a real party-in-interest.

### **III. THE BOARD SHOULD DENY INSTITUTION UNDER 35 U.S.C. § 325(D)**

The Board should exercise its discretion and deny institution under 35 U.S.C. § 325(d) because Petitioner relies on the same or substantially the same art that was considered by the Examiner during prosecution of the '069 Patent and fails to argue the Examiner made any error material to the patentability of the Challenged Claims.

#### **A. The Examiner Considered the Same or Substantially the Same Art (*Becton, Dickinson* Factors (a), (b), and (d))**

The art relied upon in Petitioner's Grounds is the same or substantially the same as the art presented to, and considered by, the Examiner during prosecution of the '069 Patent, thus satisfying step one of the *Advanced Bionics* framework.

#### **1. Dixon**

Dixon appears on the face of the '069 Patent. Ex. 1001, 2. Petitioner fails to acknowledge that Dixon was submitted to the Office in an IDS during

prosecution and was marked “considered” by the Examiner. Ex. 1017, 121 (cited in IDS dated 1/27/2017); *id.* at 168 (marked considered by Examiner). The Board has consistently found that citation in an IDS is sufficient to satisfy step one of the *Advanced Bionics* framework. *See, e.g., ABS Global, Inc. v. Cytonome/ST, LLC*, IPR2021-00306, Paper 13 at 10 (Jun. 7, 2021); *see also Philip Morris Prods., S.A. v. Rai Strategic Holdings, Inc.*, IPR2020-00921, 2020 WL 6750120, at \*5 (Nov. 16, 2020) (“Applying the *Advanced Bionics* two-part framework to Patent Owner’s arguments, we determine that the art presented in the Petition is the same as the art previously presented to the Office during examination because all of Petitioner’s references were cited in an IDS and are listed as cited art on the front face of the ’268 Patent.”). Thus, Dixon was previously presented to and considered by the Office.

## **2. Heier-2009**

Although Heier-2009 was not previously presented to the Office, it is cumulative of at least Dixon, which was presented to the Office in an IDS that was considered by the Examiner. Ex. 1017, 121, and 168.

Petitioner asserts that “Heier-2009 and Dixon each disclose Regeneron’s ‘CLEAR-IT-2’ Phase 2 trial studying VEGF Trap-Eye as a therapy for treating AMD ... [and] thus anticipat[e] all limitations of at least Challenged Claims 1 and 9-12.” Pet., 45. Petitioner does not allege that Heier-2009 discloses material facts or information that are absent in Dixon. Indeed, Petitioner alleges that both Dixon



and Heier-2009 disclose the same prospective CLEAR-IT 2 dosing regimen. *Id.* at 45. Petitioner groups Grounds 1 (Heier-2009) and 2 (Dixon) together in its Petition, essentially admitting that Heier-2009 and Dixon are equivalent. *Id.* at 45-50. Where, as here, a petitioner fails to identify any differences between the asserted art and previously considered art, the Board has properly concluded that the asserted art is cumulative of art that was previously submitted to the Office. *See NXP USA, Inc. v. Impinj, Inc.*, IPR2020-00519, 2020 WL 4805424, at \*4-5 (Aug. 17, 2020) (institution denied where asserted reference found cumulative of previously presented reference because “Petitioner ... [did] not identify any specific information in the [asserted references] that [was] ‘additional’ to or ‘different’ than the information in the [previously presented reference]”); *see Evergreen Theragnostics, Inc. v. Advanced Accelerator Applications SA*, PGR2021-00003, Paper 10 at 10-13 (Apr. 15, 2021) (finding multiple references cumulative of those cited in IDS during prosecution because previously presented references taught same features as asserted art); *see also Gardner Denver, Inc. v. Utex Indus., Inc.*, IPR2020-00333, 2020 WL 4529832, at \*5-6 (Aug. 5, 2020) (same).

As discussed, Dixon was submitted to the Office in an IDS that was considered by the Examiner. Ex. 1017, 121, and 168. Therefore, the Office was presented with art that was “substantially the same as” Heier-2009.

### 3. Regeneron (30-April-2009)

Although Regeneron (30-April-2009) was not previously presented to the Office, it is cumulative of Regeneron (20-December-2010), which was submitted to the Office in an IDS and marked considered by the Examiner. Ex. 1017, 122, 169.

Petitioner alleges that Regeneron (30-April-2009) teaches the dosing regimen of the COPERNICUS trial. Pet., 37, 50. Regeneron (20-December-2010), which was submitted to the Office, also discloses the dosing regimen of COPERNICUS. Ex. 2042, 2. The following table compares the Regeneron (20-December-2010) disclosure of the COPERNICUS dosing regimen to the Regeneron (30-April-2009) disclosure relied upon by Petitioner in its Grounds:

| Regeneron (20-December-2010)<br>(Ex. 2042, 2)  | Regeneron (30-April-2009)<br>(Ex. 1028, 1)   |
|--|--|
| “Patients in the COPERNICUS ... stud[y] receive six monthly injections of either VEGF Trap-Eye at a dose of 2mg or sham injections. ... At the end of the initial six months, all patients randomized to VEGF Trap-Eye are dosed on a PRN (as needed) basis for another six months.” | “Patients ... will receive 6 monthly intravitreal injections of either VEGF Trap-Eye at a dose of 2 milligrams (mg) or sham control injections. ... At the end of the initial 6 months, all patients will be dosed on a PRN (as needed) basis for another 6 months.” |

As with Heier-2009 and Dixon, *supra*, Petitioner does not identify any material differences between Regeneron (30-April-2009) and Regeneron (20-December-2010). Thus, because Regeneron (20-December-2010) is cumulative of Regeneron (30-April-2009), substantially the same art was previously presented to the Office.

#### 4. Mitchell

While Mitchell was not previously presented to the Office, Mitchell is cumulative of Dixon, which, as discussed *supra*, was provided to the Office in an IDS and considered by the Examiner during the prosecution of the '069 Patent. Ex. 1017, 121, and 168.

Petitioner asserts that both Mitchell and Dixon “teach anti-VEGF regimens for AMD employing an initial dose (week 0), one or more secondary doses administered four weeks after the immediately preceding dose (weeks 4 and 8) - for a total of three loading doses, and tertiary PRN dosing.” Pet., 81. Petitioner identifies no material differences between Mitchell and Dixon. Thus, because Mitchell is cumulative of Dixon, which was provided to the Office in an IDS and considered by the Examiner, substantially the same art as Mitchell was previously presented to the Office. *See NXP USA*, 2020 WL 4805424, at \*4-5; *see also Evergreen Theragnostics*, PGR2021-00003, Paper 10 at 10-13; *Gardner Denver*, 2020 WL 4529832 at \*5-6.

#### 5. '758 Patent and Dix

Petitioner argues that the '758 Patent and Dix each purportedly “disclose the VEGF Trap-Eye sequences...” Pet., 62 n.23. When a continuation-in-part application of an asserted reference (1) includes the same disclosure as the disclosure in the asserted reference upon which the Petitioner relies, and (2) was provided to the Examiner in an IDS, the Board has determined that substantially the same reference was presented to the Office. *Boragen, Inc. v. Syngenta*

*Participations AG*, IPR2020-00124, 2020 WL 2206972, at \*8 (May 5, 2020).

Here, Regeneron provided a continuation-in-part of the '758 Patent, United States Patent Application Publication No. 2006/0058234 (Ex. 2009) (“the '234 Application”) to the Office in an IDS and the Examiner marked it considered during prosecution of the '069 Patent. Ex. 1017, 66, and 112. The '234 Application contains the same amino acid sequence that Petitioner identifies as the VEGF Trap-Eye sequence in the '758 Patent and Dix. *Compare* Ex. 2009, SEQ ID No. 7 *with* Ex. 1010, Figs. 24A-C. The '758 Patent and the '234 Application both identify this sequence as “VEGFR1R2-Fc $\Delta$ C1.” Ex. 1010, 10:15-17; Ex. 2009, [0023]. Accordingly, the '758 Patent is substantially the same as the '234 Application, which was considered by the Examiner during original prosecution. *Dropworks, Inc. v. Univ. of Chi.*, IPR2021-00100, Paper 9 at 13-14 (May 14, 2021); *NXP USA*, 2020 WL 4805424 at \*3-5; *Gardner Denver*, 2020 WL 4529832, at \*5-6.

Although Dix was not previously presented to the Office, Dix is cumulative of the '234 Application. Petitioner asserts that Dix discloses “the VEGF Trap-Eye sequences otherwise known to skilled artisans,” Paper 1 at 61 n.23, yet it is indisputable that the '234 Application discloses the exact same amino acid sequence as Dix. *Compare* Ex. 2009, SEQ ID NO. 7 *with* Ex. 1033, SEQ ID NO. 3. As discussed, the '234 Application was provided to the Office in an IDS and marked considered by the Examiner. Ex. 1017, 66, and 112. Thus, substantially

the same art as Dix was previously presented to the Office. *See NXP USA*, 2020 WL 4805424, at \*4-5; *see also Dropworks, Inc*, IPR2021-00100, Paper 9 at 13-14; *Gardner Denver*, 2020 WL 4529832 at \*5-6.

**B. Petitioner Fails to Argue that the Examiner Erred in a Manner Material to Patentability (*Becton, Dickinson* Factors (c), (e), and (f))**

Because the same or substantially the same art was previously presented to the Office, Petitioner must show that the Office erred in a manner material to the patentability of the Challenged Claims. “An example of a material error may include misapprehending or overlooking specific teachings of the relevant prior art where those teachings impact patentability of the challenged claims.”

*Advanced Bionics, LLC v. MED-EL Elektromedizinische Gerate GmbH*, IPR2019-01469, 2020 WL 740292, at \*3 n.9 (Feb. 13, 2020). “If reasonable minds can disagree regarding the purported treatment of the art or arguments, it cannot be said that the Office erred in a manner material to patentability.” *Id.* at \*3.

Petitioner never once alleges that the Examiner committed any error; indeed, the word “error” appears nowhere in the Petition. Nor does Petitioner allege that the Examiner overlooked or misapprehended something during prosecution. The Board has repeatedly determined that a petitioner’s failure to allege material error is a sufficient basis to determine that the petitioner did not carry its burden as to step two. *E.g., ABS Global*, IPR2021-00306, Paper 13 at 13-14 (“[W]here Petitioner has made no allegation of material error beyond the

allegation that the Examiner did not apply the [asserted] reference and has not pointed out any specific disclosure from [the asserted reference] that was overlooked by the Office, we agree with Patent Owner that Petitioner fails to demonstrate material error.”); *Sony Interactive Ent. LLC v. Terminal Reality, Inc.*, IPR2020-00711, 2020 WL 6065188, at \*5 (Oct. 13, 2020) (“Sony [Ppetitioner] was provided the opportunity to provide explanation [of material error], but Sony was silent in this regard.... Accordingly, Becton, Dickinson Factor (e) favors exercising our discretion to deny institution.”).

Because substantially the same art was previously presented to the Office and was considered by the Examiner, and Petitioner fails to demonstrate that the Examiner committed an error material to the patentability of the Challenged Claims, the Board should exercise its discretion and deny institution under § 325(d).

**IV. THE BOARD SHOULD DENY INSTITUTION BECAUSE PETITIONER FAILS TO MAKE ITS THRESHOLD SHOWING THAT AT LEAST ONE CHALLENGED CLAIM IS UNPATENTABLE**

For the reasons discussed below, Petitioner fails to “demonstrate that there is a reasonable likelihood that at least one of the ’069 Patent claims is unpatentable for Grounds 1 through 5, and thus, denial of the petition is warranted. 35 U.S.C. § 314(a).

**A. Grounds 1-5: Petitioner Fails to Establish the “Assessed by a Physician” Limitation Is Anticipated or Obvious**

Each of the Challenged Claims requires “each tertiary dose” to be “administered on an as-needed/*pro re nata* (PRN) basis, *based on visual and/or anatomical outcomes as assessed by a physician or other qualified medical professional.*” Ex. 1001, 50-53 (emphasis added). As explained below, this limitation is a positive limitation that should be afforded patentable weight. Consequently, Petitioner fails to satisfy its burden of proof to establish that the “assessed by a physician” limitation is disclosed expressly or inherently in any of the references relied upon in any of its grounds. Additionally, using Petitioner’s definition of the POSA, Petitioner fails to establish that Heier-2009, Dixon or Regeneron (30-April-2009) is enabled.

**1. Claim Construction**

Petitioner’s challenge should be disposed of under 35 U.S.C. § 315. However, should the Board consider it necessary to decide whether Petitioner satisfied its threshold burden under 35 U.S.C. § 314, Regeneron respectfully submits that “assessed by a physician or other qualified medical professional” is a positive limitation of the claim that should be afforded patentable weight.

For purposes of this Preliminary Response only, Regeneron has used Petitioner’s definition of the person of ordinary skill in the art (“POSA”). Pet., 9. Regeneron reserves the right to propose another definition if this IPR is instituted.

Petitioner also proposes a construction for “tertiary dose” and argues that

the preamble “A method for treating an angiogenic eye disorder in a patient” is not a positive limitation of the claim. Pet., 13-23. While Regeneron disagrees with Petitioner’s proposed constructions, Regeneron does not advance claim construction positions for these terms at this time because construction of these terms is not necessary to resolve the arguments presented in this POPR. *See Nidec Motor Corp. v. Zhongshan Broad Ocean Motor Co.*, 868 F.3d 1013, 1017 (Fed. Cir. 2017) (explaining it is only necessary to “construe terms ‘that are in controversy, and only to the extent necessary to resolve the controversy’”).<sup>2</sup>

Petitioner likewise proposes constructions for (1) “4 weeks” and “*Pro re Nata* (PRN)”; and (2) “VEGFR1 Component,” “VEGFR2 Component” and the “Multimerization Component.” Pet., 18-19. Again, Regeneron does not advance claim construction positions for these terms because construction of these terms is

---

<sup>2</sup> If the Board decides to construe “method of treating” or “tertiary dose” in this IPR, it should do so consistently with the constructions Regeneron has proposed in its contemporaneously filed Preliminary Response in IPR2021-00881 relating to the ’338 Patent, since the ’069 Patent was filed as a continuation from the ’338 Patent. *See* IPR2021-00881, Paper 10, at 31-37; *see Samsung Elecs. Co. v. Elm 3DS Innovations, LLC*, 925 F.3d 1373, 1378 (Fed. Cir. 2019) (“Where multiple patents derive from the same parent application and share many common terms, we must interpret the claims consistently across all asserted patents.”).



not necessary to resolve the arguments presented in this POPR. *Nidec*, 868 F.3d at 1017. Regeneron reserves the right to propose other constructions of these and other terms if this IPR is instituted.

**a. “Based On Visual and/or Anatomical Outcomes as Assessed by a Physician or Other Qualified Medical Professional”**

Each of the Challenged Claims requires “wherein each tertiary dose is administered on an as-needed/*pro re nata* (PRN) basis, *based on visual and/or anatomical outcomes as assessed by a physician or other qualified medical professional.*” Ex. 1001, 21:42-60 (emphasis added). In the context of its Ground 5 obviousness argument, Petitioner argues “[t]he ‘assessed by a physician’ limitation is a pure mental step not entitled to any patentable weight.” Pet., 65 (citing *King Pharms.*, 616 F.3d at 1278). However, as discussed below, “assessed by a physician” is a positive limitation of the claim that should be afforded patentable weight. Thus, Petitioner’s “mental step” argument fails.

**(i) “As Assessed by a Physician” Is a Positive Limitation of the Claim**

The phrase “as assessed by a physician or other qualified medical professional” is part of a wherein clause that recites as-needed/*pro re nata* (PRN) administration of each tertiary dose. Petitioner does not dispute that this wherein

clause is a positive limitation of the claim, nor can it.<sup>3</sup> The limitation “wherein each tertiary dose is administered on an as-needed/PRN basis...” supplies the frequency for administration of the tertiary dose, as shown below.

Claim 1 recites:

A method for treating an angiogenic eye disorder in a patient, said method comprising sequentially administering to the patient a single initial dose of a VEGF antagonist, followed by one or more secondary doses of the VEGF antagonist, followed by one or more tertiary doses of the VEGF antagonist;  
wherein each secondary dose is administered 2 to 3 weeks after the immediately preceding dose;  
wherein each tertiary dose is administered on an as-needed/pro re nata (PRN) basis, based on visual and/or anatomical outcomes *as assessed by a physician or other qualified medical professional*;  
....

Ex. 1001, 21:41-60 (emphasis added).

It is well-established that a “wherein” clause that provides structure or acts that are necessary to define the invention is a positive limitation of a claim. *See Hoffer v. Microsoft Corp.*, 405 F.3d 1326, 1329-30 (Fed. Cir. 2005) (finding clause limiting where it “is more than the intended result of a process step,” “is

---

<sup>3</sup> Indeed, Petitioner specifically identifies this wherein clause as a limitation of the claim for claim mapping purposes. *See Pet.*, 48.

part of the process itself,” and is an “integral part of the invention”). Moreover, the claim language makes clear that “assessed by a physician” is part of the process for determining the frequency of tertiary dose administration. It provides the timing of the administration of the tertiary dose by defining how (*i.e.*, assessment of visual and/or anatomical outcomes) and by whom (*i.e.*, physician or qualified medical professional) that determination is made.

**(ii) The “Mental Steps” Doctrine Does Not Apply**

Petitioner cites *King Pharmaceuticals, Inc. v. Eon Labs, Inc.*, 616 F.3d 1267 (Fed. Cir. 2010), to argue that the phrase “assessed by a physician” is purely a mental step. Pet., 65. However, *King Pharms.* and the mental step doctrine — an extension of the printed matter doctrine — do not apply to the “assessed by a physician” limitation.

In *King Pharms.*, the court considered whether “an otherwise anticipated method claim becomes patentable because it includes a step of ‘informing’ someone about the existence of an inherent property of that method.” *Id.* at 1278. Employing a § 101 analysis, the court held that the “informing” limitation was insufficient to transform or render patent eligible an otherwise invalid claim. *Id.* at 1279 (finding that the ‘informing’ limitation “in no way depends on the [method], and the [method] does not depend on the [‘informing’ limitation]”).

Here, in contrast, to satisfy the claimed methods, the administration of the tertiary dose on a PRN basis must be based on the *physical acts* of assessing

visual and/or anatomical outcomes by a physician or other qualified medical professional. Disclosure of the visual or anatomic outcomes alone without disclosure of *who* is making the assessment to determine whether and when to administer a tertiary dose is not a disclosure of the entire limitation or step. This limitation is a physical, active, and necessary step in the claimed method of treatment, carried out specifically by a physician or trained medical professional. It is not an informational or instructional step, but rather a limitation that is inexorably linked to the step of administering one or more tertiary doses. Thus, *King Pharms.* and the printed matter/mental step doctrine do not apply.

Indeed, even under a patent eligibility analysis, because the “assessed by a physician” limitation transforms the “tertiary dose” limitation, it is entitled to patentable weight. *King Pharms., Inc.*, 616 F.3d at 1277-78 (noting in dicta that the machine-or-transformation test remains a useful tool to determine whether processes are patent eligible); *Vanda Pharms. Inc. v. W.-Ward Pharms. Int’l Ltd.*, 887 F.3d 1117, 1136 (Fed. Cir. 2018) (affirming patentability of claims directed to a specific method of treatment for specific patients using a specific compound at specific doses to achieve a specific outcome); *see also C R Bard Inc. v. AngioDynamics, Inc.*, 979 F.3d 1372, 1381 (Fed. Cir. 2020) (holding asserted claims directed to “method of performing a power injection procedure” for vascular access ports were patent eligible under § 101 because the claims as a whole were not solely directed to printed matter).

Because the “as assessed by a physician or other qualified medical professional” is a necessary part of a positive limitation of the claim, it is entitled to patentable weight.

**2. Grounds 1-4: Petitioner Fails to Establish that Heier-2009, Dixon or Regeneron (30-April-2009) Inherently or Expressly Discloses the “Assessed by a Physician or Other Qualified Medical Professional” Limitation (All Challenged Claims)**

Petitioner asserts that Heier-2009 (Ground 1), Dixon (Ground 2 and 4) and Regeneron (30-April-2009) (Ground 3) anticipate the Challenged Claims. Anticipation requires “each and every claim limitation [to be] found either expressly or inherently in a single prior art reference.” *King Pharms.*, 616 F.3d at 1274 (quotations omitted). Petitioner fails to show that Heier-2009, Dixon or Regeneron (30-April-2009) discloses the “assessed by a physician or other qualified medical professional” limitation either expressly or inherently. Rather, Petitioner simply ignores this portion of the wherein limitation for purposes of anticipation and thus fails to make its threshold showing of anticipation for any of the Challenged Claims, as shown below.

**a. Heier-2009 (Ground 1)**

Petitioner relies on the following passage in Heier-2009 as allegedly disclosing the “assessed by a physician or other qualified medical professional” limitation:

Patients with neovascular AMD were randomly assigned to receive monthly intravitreal injections of VEGF Trap-Eye 0.5 mg or 2.0 mg . . . for an initial 3-month fixed-dose period, after which they received the same doses on [a PRN] basis at monthly visits out to 1 year.

Pet., 48 (citing Ex. 1020, 45). Heier-2009 fails to expressly disclose a method where the administration is “based on visual and/or anatomical outcomes as assessed by a physician or other qualified medical professional.” Indeed, Petitioner never argues that this limitation is disclosed, either expressly or inherently, in Heier-2009.

Instead, Petitioner — without making these same arguments in its Petition — relies on bare citations to its expert’s declaration. Pet., 48 (citing Ex. 1002, ¶121). Specifically, Dr. Albini opines without support that “to determine the need for an injection at each visit during the trial, a physician or other qualified medical professional would have to make an assessment, and that would have been well understood by persons of ordinary skill in the art to include visual and/or anatomical outcomes, such as visual acuity and retinal swelling measurements.” Ex. 1002, ¶121.

As an initial matter, the Board should disregard Dr. Albini’s opinions since Petitioner fails to argue, let alone establish, within the four corners of its Petition that all limitations of the claims are anticipated based on the disclosure of Dixon, Heier-2009, and/or Regeneron (April-30). *Microsoft Corp. v. Bradium Techs.*

*LLC*, IPR2015-01435, Paper 15 at 29 (Dec. 23, 2015) (“[W]e will not consider arguments that are not made in the Petition but are instead incorporated by reference to the cited paragraphs and claim charts of [the petitioner’s Expert] Declaration.”); *Cisco Sys., Inc. v. C-Cation Techs., LLC*, IPR2014-00454, Paper 12 at 7-10 (Aug. 29, 2014) (“[the Board] will not consider arguments that are not made in the Petition, but are instead incorporated by reference to the cited paragraphs and claims charts of [petitioner’s expert]”).

In any event, because Dr. Albini’s opinion at paragraph 121 is wholly unsupported by any underlying facts, the Board should not credit his testimony. *See, e.g.*, Practice Guide at 40-41 (citing *Rohm & Haas Co. v. Brotech Corp.*, 127 F.3d 1089, 1092 (Fed. Cir. 1997)); *Merck Sharp & Dohme Corp. v. Wyeth LLC*, IPR2017-01211, Paper 9 at 13-14 (Oct. 20, 2017) (explaining that “[o]ne’s expertise, even when draped with a skilled[ ]artisan veil, does not entitle a naked opinion to much weight”).

Dr. Albini asserts that Heier-2009 discloses “several measures that physicians were to use in assessing patients for PRN dosing.” Ex. 1002, ¶121 (citing Ex. 1020, 45); Ex. 1006, 1576). However, the *only* discussion of these measures — *i.e.*, best corrected visual acuity (“BCVA”) and retinal thickness — in Heier-2009 relates to the 1-year outcomes of the clinical trial, *not* PRN re-treatment criteria. Ex. 1020, 45 (“At 1 year, for all treated groups combined (n=157), there was a significant improvement in BCVA from baseline (mean

improvement 5.3 letters; P<.0001)...” and “Patients receiving initial monthly doses of VEGF Trap-Eye achieved mean decreases in retinal thickness vs baseline at 1 year.”). Thus, Heier-2009 does not disclose that PRN dosing in the clinical trial was “based on visual and/or anatomical outcomes as assessed by a physician or other qualified medical professional,” as the Challenged Claims require.

Consequently, Petitioner fails to establish that Heier-2009 anticipates, expressly or inherently, the recited limitation “based on visual and/or anatomical outcomes as assessed by a physician or other qualified medical professional.”

**b. Dixon (Ground 2 and 4)**

In Ground 2, Petitioner relies on the following passage in Dixon with respect to the “assessed by a physician or other qualified medical professional” limitation:

Following this fixed dosing period, patients were treated with the same dose of VEGF Trap-Eye on a p.r.n. basis. Criteria for re-dosing included an increase in central retinal thickness . . . a loss of  $\geq 5$  ETDRS letters in conjunction with recurrent fluid by OCT, persistent fluid as indicated by OCT, new onset classic neovascularization, new or persistent leak on FA or new macular subretinal hemorrhage.

Pet., 48 (citing Ex. 1006, 1576).

But Dixon provides no disclosure of *who* is assessing the disclosed retreatment criteria, and Petitioner has not argued, let alone made any showing



that this is inherent in Dixon. Moreover, since Petitioner’s definition of the POSA includes, *inter alia*, a person with “an advanced degree, such as an M.D. *or* Ph.D. . . . with practical *academic* or medical experience,” (Pet., 25) the POSA need not be “a physician or other medical qualified medical professional.” Consequently, it cannot be assumed and is not necessarily the case that a “physician or other qualified medical professional” assessed the disclosed retreatment criteria in Dixon.

In Ground 4 (anticipation), Petitioner relies upon Dixon’s disclosure of the VIEW dosing regimen, which is three monthly loading doses, followed by monthly or every eight-week maintenance dosing. Dixon’s disclosure of the VIEW dosing regimen does not disclose the claimed PRN dosing regimen.<sup>4</sup> As in Ground 2, Petitioner again utterly ignores its burden to establish that the cited references disclose expressly or inherently the requirement that “a physician or otherwise qualified medical professional” assesses the visual and/or anatomic outcomes to determine whether or when to administer a tertiary dose. Thus, Petitioner fails to carry its burden to show that Dixon anticipates the Challenged Claims (Ground 2) or renders them obvious (Ground 4).

---

<sup>4</sup> Petitioner asserts that Regeneron, during prosecution, equated the eight-week dosing in VIEW with the claimed PRN dosing. Pet., 54-55. Patent Owner did not. See Section IV.C.1., *supra*.

**c. Regeneron (30-April-2009) (Ground 3)**

Petitioner relies exclusively on the following passage in Regeneron (30-April-2009) with respect to the “visual and/or anatomical outcomes as assessed by a physician or other qualified medical professional” limitation:

Patients in both studies will receive 6 monthly intravitreal injections . . . . At the end of the initial 6 months, all patients will be dosed on a PRN (as needed) basis for another 6 months.

Pet., 51 (citing Ex. 1028, 1).

But this passage provides no disclosure of any retreatment criteria (*e.g.*, “visual and/or anatomical outcomes”) or *who* is assessing such retreatment criteria. And the Petition makes no attempt to establish that the requirement that the PRN administration is based on “visual and/or anatomical outcomes” by “a physician or other qualified medical professional” is disclosed expressly or inherently by this passage in Regeneron (30-April-2009). Thus, Petitioner fails to carry its burden to show that Regeneron (30-April-2009) anticipates the Challenged Claims.

**3. Under Petitioner’s Definition of the POSA, Petitioner Fails to Show that Heier-2009, Dixon, or Regeneron (30-April-2009) Is Enabled**

Anticipatory references must be enabling. *In re Morsa*, 713 F.3d 104, 110 (Fed. Cir. 2013). For purposes of §102, a prior art publication is enabling if “whether a person of ordinary skill in the art could make or use the claimed invention without undue experimentation.” *Id.*; *Elan Pharms., Inc. v. Mayo*

*Found. for Med. Educ. & Rsch.*, 346 F.3d 1051, 1055 (Fed. Cir. 2003) (remanding to district court to determine whether asserted prior art reference was enabled).

As noted above, the Challenged Claims require that each tertiary dose is administered as-needed/PRN “based on visual and/or anatomical outcomes as assessed by a physician or other qualified medical professional.” Ex. 1001, 21:50-53. Petitioner defines the POSA to include, *inter alia*, a person with “an advanced degree, such as an M.D. or Ph.D. (or equivalent, or less education but considerable professional experience in the medical, biotechnological, or pharmaceutical field), with practical academic or medical experience.” Pet., 25. Petitioner’s POSA is, by definition, not “a physician or other medical qualified medical professional.” Petitioner fails to show that this POSA, which expressly includes individuals without medical training, could have used the disclosure of Heier-2009, Dixon or Regeneron (30-April-2009) to practice the claimed method without undue experimentation.

Indeed, the Petition provides no explanation for how an individual with a Ph.D. and “practical academic” experience would be able to assess visual and/or anatomic outcomes, let alone how such a person would use that information to determine whether or when to administer a tertiary dose to carry out the claimed method without undue experimentation. And Heier-2009, Dixon, and Regeneron (30-April-2009) provide no guidance in that regard. In addition, Heier-2009 and Regeneron (30-April-2009) also provide no guidance on specific re-treatment

criteria. Petitioner provides no evidence to suggest that a Ph.D.-trained individual with no clinical training or experience would be qualified to assess visual and/or anatomical outcomes, even with the disclosure of retreatment criteria, let alone qualified to make assessments or decisions about whether or when to administer a tertiary dose. Thus, applying Petitioner’s definition of the POSA, Petitioner fails to establish that Heier-2009, Dixon and Regeneron (30-April-2009) would have enabled the POSA to practice the claimed invention without undue experimentation.

**4. Ground 5: Petitioner Fails to Satisfy Its Burden that the “Assessed by a Physician or Other Qualified Medical Professional” Is Obvious (All Challenged Claims)**

In Ground 5, Petitioner argues “[t]he ‘assessed by a physician’ limitation is a pure mental step not entitled to any patentable weight.” Pet., 65 (citing *King Pharms.*, 616 F.3d at 1278). While Petitioner cites to retreatment criteria disclosures of Mitchell and Dixon, it fails to identify any disclosure regarding *who* is assessing the retreatment criteria. Pet., 65. Just as in Grounds 1-4, Petitioner does not identify any express or inherent disclosure of this limitation. Thus, Petitioner fails to carry its burden in showing that Dixon renders the Challenged Claims obvious.

**B. Grounds 1-4 (§ 102 Anticipation): Petitioner Fails to Establish that the Disclosure of “VEGF Trap-Eye” in Heier-2009, Dixon, or Regeneron (30-April-2009) Anticipates the Recited Amino Acid or Nucleic Acid Sequences**

Petitioner asserts that Heier-2009 (Ground 1), Dixon (Grounds 2 and 4), and

Regeneron (30-April-2009) (Ground 3) anticipate the Challenged Claims. Anticipation requires “each and every claim limitation [to be] found either expressly or inherently in a single prior art reference.” *King Pharms.*, 616 F.3d at 1274 (quotations omitted).

Petitioner’s anticipation argument relies on its unproven assumption that “VEGF Trap-Eye” was known in the art to possess the same amino acid sequence as aflibercept. However, none of Petitioner’s cited references discloses the amino acid sequence of “VEGF Trap-Eye.” Petitioner must establish that the amino acid sequence of “VEGF Trap-Eye” was known to be the same as the amino acid sequence of aflibercept to show inherent anticipation of the amino acid and nucleic acid limitations of claims 1 and 14, respectively.

Petitioner’s anticipation Grounds 1-4 should be rejected because Petitioner fails to establish that “VEGF Trap-Eye” was known in the art to have the amino acid sequence of SEQ ID NO:2 or to be encoded by the nucleic acid sequence of SEQ ID NO:1.

**1. Petitioner Fails to Establish that “VEGF Trap-Eye” Was Known in the Art to Correspond to SEQ ID NO: 2 (Claims 1 and 8-11)**

Claim 1 and its dependent claims require the administration of a VEGF antagonist comprising amino acids 27-457 of SEQ ID NO:2. Ex. 1001, 21:54-60. Because Heier-2009, Dixon, and Regeneron (30-April-2009) do not expressly disclose any sequence information for “VEGF Trap-Eye,” Petitioner argues that

references to “VEGF Trap-Eye” in Heier-2009, Dixon and Regeneron (30-April-2009) inherently constitute such disclosure based on sequence information present in various other references.

But Petitioner has not identified *any* prior art that discloses the amino acid sequence for “VEGF Trap-Eye.” Therefore, Petitioner argues that Heier-2009, Dixon, and Regeneron (30-April-2009)’s use of the term “VEGF Trap-Eye” would have been understood by the POSA to refer to aflibercept — and only to aflibercept — and that aflibercept’s amino acid sequence was well-known in the art. Pet., 48-49, 52.

Petitioner’s burden to demonstrate inherent anticipation is exacting, and Petitioner does not come close to meeting it here. The prior art’s use of the term “VEGF Trap-Eye” was inconsistent, and Petitioner fails to show a clear or uniform understanding that “VEGF Trap-Eye” was just another name for “aflibercept” in the art. *Continental Can Co. USA v. Monsanto Co.*, 948 F.2d 1264, 1268 (Fed. Cir. 1991) (To establish inherency, the extrinsic evidence “must make clear that the missing descriptive matter is *necessarily present* ... and that it would be so recognized by persons of ordinary skill.”) (emphasis added).

However, Petitioner ignores evidence that the POSA would *not* have understood that “VEGF Trap-Eye” and aflibercept *necessarily* have the same amino acid sequence, such as evidence discussed below showing different molecular weights “VEGF Trap-Eye” and “aflibercept”, and inconsistent

descriptions of “VEGF Trap,” “VEGF Trap-Eye,” and “aflibercept” in the art. Consequently, Petitioner fails to show that the POSA would have understood “VEGF Trap-Eye” to necessarily have the same amino acid sequence as aflibercept and, as a result, that SEQ ID NO:2 was inherently disclosed by Heier-2009, Dixon, or Regeneron (30-April-2009).

**a. Petitioner and Its Expert Repeatedly Equate “Aflibercept” with All Variations of “VEGF Trap”**

Petitioner relies on disclosures in Heier-2009, Dixon and Regeneron (30-April-2009) that refer to administration of “VEGF Trap-Eye” as anticipating the claimed sequence information. But these references do not disclose the amino acid sequence of “VEGF Trap-Eye” and none of Petitioner’s cited references states that “VEGF Trap-Eye” and aflibercept have an identical amino acid sequence.

The full extent of Dixon’s disclosure regarding the molecular characteristics of “VEGF Trap-Eye” is that “VEGF Trap-Eye” is “a fusion protein of binding domains of VEGF receptors-1 and -2 attached to the Fc fragment of human IgG.” Ex. 1006, 1576. Nothing more is provided that would allow the POSA to differentiate Dixon’s “VEGF Trap-Eye” from any other protein comprising an hVEGF-R1 domain 2, hVEGF-R2 domain 3, and a human Fc region. For example, Dixon does not specify which amino acids of the VEGF receptor-1 or receptor-2 domains are included in “VEGF Trap-Eye,” and Dixon does not specify which amino acids of which Fc domain form “the Fc fragment” of “VEGF

Trap-Eye.” As explained below, this is not a disclosure of VEGF Trap-Eye’s amino acid sequence.

Petitioner relies heavily on a statement in Dixon that “VEGF Trap-Eye” and aflibercept (the oncology product) share a “molecular structure.” Ex. 1006, 1575. But Dixon does not state that “VEGF Trap-Eye” and aflibercept have an identical amino acid sequence. And Petitioner provides no evidence that a shared “molecular structure” indicates an identical amino acid sequence.<sup>5</sup> Indeed, in the immediately preceding paragraph, Dixon discloses that: “Structurally, VEGF Trap-Eye is a fusion protein of key binding domains of human VEGFR-1 and -2 combined with a human IgG Fc fragment (Fig. 1).” Ex. 1006, 1575. Dixon’s Figure 1 shows a stylized version of VEGF receptors 1 and 2 and the binding domains that lead to the creation of a VEGF Trap molecule. *Id.* at 1576. Thus, Dixon itself suggests that the “molecular structure” of VEGF Trap-Eye may refer to a more general selection and arrangement of receptor binding domains and an Fc region, not a precise amino acid or nucleic acid sequence.

Heier-2009 and Regeneron (30-April-2009) provide even less information

---

<sup>5</sup> A protein molecule has multiple levels of “structure:” primary (the amino acid sequence), secondary (spatial arrangement of adjacent amino acid residues), tertiary (overall three-dimensional structure), and quaternary (arrangement of several protein chains or subunits). Ex. 2010, 15-16.



regarding the nature of “VEGF Trap-Eye” than Dixon. Heier-2009 simply states: “VEGF Trap-Eye is a purified formulation of VEGF Trap, a vascular endothelial growth factor (VEGF) receptor fusion protein that binds all forms of VEGF-A.” Ex. 1020, 44-45 (Fig. 1). Likewise, Regeneron (30-April-2009) states “VEGF Trap-Eye is a fully human, soluble VEGF receptor fusion protein that binds all forms of VEGF-A along with the related Placental Growth Factor (PIGF). Investigational VEGF Trap-Eye is a specific blocker of VEGF-A and PIGF that has been demonstrated in preclinical models to bind these growth factors with greater affinity than their natural receptors.” Ex. 1028, 1.

Given the absence of any sequence disclosure in Dixon, Heier-2009 and Regeneron (30-April-2009), Petitioner tries to connect the dots by arguing that “VEGF Trap-Eye” and “aflibercept” were different names for the very same protein: “Aflibercept, VEGF Trap, VEGF Trap-Eye, VEGF-TrapR1R2, and AVE0005 are simply different names for the *same molecule*.” Pet., 26 (emphasis added); Ex. 1002, ¶39. However, by equating “VEGF Trap Eye” with all variations of “VEGF Trap” nomenclature, including VEGF Trap names that were known in the art to refer to a genus of proteins, Petitioner and Dr. Albini only underscore the uncertainty confronting the POSA regarding the identity and sequence of “VEGF Trap-Eye.”

Not only does Petitioner fail to meet its burden, but it also fails to consider evidence that would signal to the POSA that “VEGF Trap-Eye” was used to

describe many different fusion proteins. For example, “VEGF Trap” was known in the art to encompass a genus of engineered fusion proteins, each having a different amino acid sequence. Holash 2002 *et al.* describes several different Regeneron-developed VEGF-Traps (*e.g.*, VEGF Trap<sub>parental</sub>, VEGF-Trap<sub>ΔB1</sub>, VEGF-Trap<sub>ΔB2</sub>, VEGF Trap<sub>R1R2</sub>). Ex. 1004, 11394. Notably, Holash never uses the term “VEGF Trap-Eye” (or aflibercept) for any of the VEGF Trap fusion proteins it describes. *Id.* And none of VEGF Trap<sub>parental</sub>, VEGF-Trap<sub>ΔB1</sub>, VEGF-Trap<sub>ΔB2</sub> satisfies the sequence limitation of the Challenged Claims. Thus, the POSA would have known of numerous Regeneron “VEGF-Trap” molecules, including many that do not comprise SEQ ID NO:2.

To succeed on its inherency theory, Petitioner must establish that “VEGF Trap-Eye” as disclosed by Dixon and understood by the POSA as of the priority date *necessarily* referred to a *single* protein (aflibercept) having the amino acid sequence of SEQ ID NO:2.<sup>6</sup> Yet, Petitioner equates “aflibercept” with various

---

<sup>6</sup> Petitioner relies on Regeneron’s PTE Application (Ex. 1024), filed nearly a year after the priority date, to connect “VEGF Trap-Eye” to “aflibercept” (Pet., 15), but the meaning of “VEGF Trap-Eye” must be understood as the POSA would view the term as of the priority date without reference to how the term may have later changed. *See Schering v. Amgen*, 222 F.3d 1347, 1354 (Fed. Cir. 2000) (holding a term is to be understood based on knowledge in the art as of the priority date, even

names that connoted an entire class of molecules. Petitioner has not and cannot establish that the POSA understood that “VEGF Trap-Eye” *necessarily* possessed the same amino acid sequence as aflibercept.

**b. Petitioner Fails to Address Uncertainty in the Art as to the Amino Acid Sequence of “VEGF Trap-Eye”**

As of the priority date, the POSA would have been aware of inconsistent reports in the literature regarding the molecular weight of “VEGF Trap-Eye.” For example, a 2009 publication reports that “*VEGF Trap-Eye*<sup>124</sup> is a 110-kDa recombinant protein,” while a 2010 publication reports that “*VEGF Trap-Eye (Regeneron Inc.) is a 115-kDa recombinant fusion protein.*” Ex. 1075, 403; *see also* Ex. 2011, 667 (“VEGF Trap, *a 110 kDa soluble protein...*”); *cf.* Ex. 2012, 49 and Ex. 2013, 144 (“*VEGF Trap is a 115 kDa recombinant fusion protein...*”) (emphases added).

Conversely, the molecular weight of aflibercept was routinely reported as 115 kDa. *See e.g.*, Ex. 2014, 596 (“...*aflibercept* is a soluble fusion protein .... Its molecular weight is *115 kDa...*”) (emphasis added); Ex. 2015, [0003] and [0010] (explaining that “VEGF Trap” is a chimeric protein with several embodiments and “has a molecular weight which is substantially less than that of Avastin (*115 kDa* ..... if it later acquires a different meaning). Accordingly, the term “VEGF Trap-Eye” must embrace all possible molecules to which that term referred as of the priority date.

*for aflibercept* versus 160 kDa for Avastin...”) (emphases added).

The POSA would have understood that differences in protein molecular weights can reflect differences in the amino acid sequences of proteins. Specifically, 5,000 Da could equate to a sequence difference of ~42 amino acids (the average molecular weight of an amino acid is ~110-118 Da). Ex. 2016, 1272; Ex. 2017, 11. Thus, in light of a difference of 5,000 Da in the reported molecular weights of “VEGF Trap-Eye,” the POSA may have understood the term to refer to a family of fusion proteins with different amino acid sequences having molecular weights in the range of 110-115 kDa. Or the POSA may have understood “VEGF Trap-Eye” to refer to two “VEGF Trap” fusion proteins with different amino acid sequences, one weighing 110 kDa and the other weighing 115 kDa. Or, alternatively, the POSA may have understood “VEGF Trap-Eye” to refer to a single protein amino acid sequence, such as the sequence of aflibercept or that of another protein in the class of VEGF Traps. The Petition, however, is devoid of evidence indicating how the POSA would have understood these varying prior art disclosures regarding the identity of the term “VEGF Trap-Eye.”

In view of this conflicting prior art, Petitioner fails to establish that the term “VEGF Trap-Eye” was known to necessarily refer to aflibercept, and to comprise the amino acid sequence of SEQ ID NO:2. Thus, Petitioner fails to show that Heier-2009, Dixon, or Regeneron (30-April-2009) anticipates claims 1 and 8-11.

**2. Petitioner Fails to Establish that “VEGF Trap-Eye” Was Known in the Art to Be Encoded by SEQ ID NO: 1 (Claim 12)**

Claim 12 requires that the recited VEGF antagonist is a receptor-based chimeric molecule encoded by the nucleic acid sequence of SEQ ID NO:1. Ex. 1001, 22:63-66. Petitioner argues that “[b]oth the amino acid and nucleotide sequences [for VEGF Trap-Eye] were disclosed in the prior art and well known to skilled artisans.” Pet., 50 (citing Ex. 1002, ¶¶136-37). Yet, neither the amino acid sequence nor nucleic acid sequence of “VEGF Trap-Eye” is expressly disclosed in Petitioner’s cited art. Moreover, because Petitioner fails to establish that “VEGF Trap-Eye” necessarily has the amino acid sequence of aflibercept, it also fails to show that “VEGF Trap-Eye” is necessarily encoded by the nucleic acid sequence of SEQ ID. NO:1.

Petitioner and its expert Dr. Albini argue that Heier-2009 and Dixon anticipate and that the “nucleotide sequences [of claim 12] were disclosed in the prior art and well known to skilled artisans” based on the ’758 patent (Ex. 1010) and Dix (Ex. 1033). Pet., 50. However, none of these references discloses the nucleic acid sequence of “VEGF Trap Eye.”

None of Heier-2009, Dixon, or Regeneron (30-April-2009) discloses any nucleic acid sequence information, let alone the nucleic acid sequence for “VEGF Trap-Eye.” Their generic disclosures of “VEGF Trap-Eye” or aflibercept, without correlating those terms to SEQ ID NO:1, is insufficient.

Likewise, Petitioner fails to show that the nucleic acid sequences disclosed in the '758 Patent or Dix were known by the POSA to correspond to either "VEGF Trap-Eye" or "aflibercept." The '758 Patent discloses VEGF-binding construct sequences. Ex. 1010, 10:15-17 ("FIG. 24A-24C. Nucleotide (SEQ ID NO:15) and deduced amino acid sequence (SEQ ID NO:16) of the modified Flt1 receptor termed VEGFR1R2-FcAC1(a)."). But the '758 Patent does not correlate these disclosed nucleic acid sequences to the terms "VEGF Trap-Eye" or "aflibercept." Dix also discloses nucleic acid sequences of "VEGF trap proteins" or "VEGF antagonist" fusion proteins but never identifies these proteins as "VEGF Trap-Eye" or "aflibercept." Ex. 1033, [0013]-[0014], [0030].

The mere possibility that "VEGF Trap-Eye" or "aflibercept" could comprise a nucleic acid sequence meeting the limitation of claim 12 is insufficient to demonstrate inherency for anticipation. *See Amgen, Inc. v. Alexion Pharms., Inc.*, IPR2019-00739, Paper 15 at 24-25 (Aug. 30, 2019) (rejecting inherent anticipation where "eculizumab" referred to at least two different proteins in the prior art, including the unclaimed "Thomas IgG4 isotype eculizumab").

**C. Ground 4: Petitioner Fails to Demonstrate that There Is a Reasonable Likelihood that at Least One of the Challenged Claims Is Anticipated or Rendered Obvious by VIEW1/2 as Disclosed in Dixon**

Petitioner's Ground 4 also fails to show that there is a reasonable likelihood that at least one of the Challenged Claims is unpatentable for anticipation or rendered obvious by VIEW1/2 as disclosed by Dixon (Ground 4).

**1. Petitioner Fails to Establish that the 8-Week Dosing Arm of the VIEW Clinical Trial Anticipates the Claimed PRN Dosing Regimen (All Challenged Claims)**

In Ground 4, Petitioner argues that Dixon’s disclosure of an 8-week dosing regimen in VIEW1/2 anticipates the claimed PRN method of treatment. But Dixon’s VIEW1/2 disclosure fails to disclose a “tertiary dose” that “is administered on an as-needed/*pro re nata* PRN basis,” as required by each of the Challenged Claims. Tellingly, Petitioner’s claim chart does not even purport to rely on Dixon for this limitation. Pet., 55. Instead, Petitioner relies on a tortured reading of the ’069 Patent’s prosecution history to argue that 8-week dosing and PRN dosing are the same thing. Petitioner’s argument is both factually incorrect and legally unsound. Because Petitioner fails to show in Dixon’s disclosure a critical limitation of each of the Challenged Claims, its Ground 4 anticipation challenge fails. *Advanced Display Sys., Inc. v. Kent State Univ.*, 212 F.3d 1272, 1282 (Fed. Cir. 2000) (“[I]nvalidity by anticipation requires that the four corners of a single, prior art document describe every element of the claimed invention ....”).

Petitioner argues that Dixon anticipates the Challenged Claims of the ’069 Patent because Dixon discloses a two-part Phase 3 study that “will evaluate the safety and efficacy of ... 2.0 mg at an 8-week dosing interval (following three monthly doses).” Pet., 55 (citing Ex. 1006, 1576). But eight-week, fixed dosing is *not* a disclosure of the limitation “wherein each tertiary dose is administered on

an as-needed/*pro re nata* (PRN) basis.” Because Dixon does not disclose the claimed dosing regimen, it cannot anticipate the Challenged Claims of the ’069 Patent. *Verdegaal Bros. v. Union Oil Co. of Cal.*, 814 F.2d 628, 631 (Fed. Cir. 1987) (“A claim is anticipated only if each and every element as set forth in the claim is found, either expressly or inherently described, in a single prior art reference.”). Petitioner does not satisfy its threshold burden for institution of this IPR.

Petitioner instead premises its anticipation argument on Regeneron’s prosecution history statements, which Petitioner argues equated the 8-week dosing regimen of VIEW with a PRN treatment protocol:

Dixon discloses the exact VIEW1/VIEW2 dosing regimens that Regeneron told the Examiner represented a “PRN treatment protocol” “as claimed” in independent claim 1. *Applying Regeneron’s interpretation of the Challenged Claims*, Dixon discloses each and every element of Challenged Claim 1...

Pet., 54 (emphasis added).

As a threshold matter, Petitioner’s argument is factually flawed. Petitioner misconstrues Regeneron’s statements in prosecution and ignores important differences between Dixon’s disclosures, relied upon by Petitioner, and the Heier 2012 paper that was discussed in prosecution. Contrary to Petitioner’s assertion, Regeneron did not argue during prosecution that 8-week dosing and PRN dosing were the same thing. Pet. at 12. Instead, Regeneron explained that the Heier 2012



reference showed that extended dosing regimens with VEGF Trap-Eye were unexpectedly noninferior to the prevailing standard of care (*i.e.*, monthly injections of ranibizumab). Ex. 1017, 136.

While Heier 2012 reports the clinical trial results from Year 1 of the VIEW1/2 trials, which tested fixed dosing regimens (including an 8-week dosing regimen), it also sets forth the clinical trial results for Year 2, which tested PRN dosing. Ex. 1018, 10 (“The results of this second year were recently presented ... and reveal ... comparable visual acuity maintenance (91-92%) in each group at the 96-week time point”). Thus, by the time Heier 2012 published the clinical trial results for Year 2 of VIEW1/2, it was known that the second-year PRN dosing regimen resulted in extended dosing. *Id.* (“The total number of active injections (baseline to week 96) was 16.0 to 16.2 in the monthly intravitreal aflibercept groups ... and 11.2 in the original 2q8 group”).<sup>7</sup> As a consequence, Regeneron’s statements during prosecution of the ’069 Patent that “the PRN treatment protocol as encompassed by the presently pending independent claim 1 achieves results which are as good or better than the results obtained with monthly treatment” were fully supported by Heier 2012. Ex. 1017, 137

Additionally, Regeneron’s prosecution history statements about a different publication are not legally relevant to Petitioner’s anticipation arguments

---

<sup>7</sup> The actual mean number of injections in year 2 of VIEW was approximately four.

regarding the Dixon reference in this IPR. Petitioner offers no authority for its suggestion that anticipation can be based on prosecution history estoppel rather than on prior art, and Regeneron is aware of none. Because Petitioner fails to make a *prima facie* case for anticipation, its challenge must be rejected.

**2. Petitioner Fails to Establish that the 8-Week Dosing Arm of the VIEW Clinical Trial Renders Obvious the Claimed PRN Dosing Regimen (All Challenged Claims)**

Petitioner's obviousness argument fares no better. Petitioner fails to show that the POSA would have been motivated to modify monthly dosing followed by 8-week dosing to monthly dosing followed by PRN dosing. "It was [Petitioner's] burden to demonstrate ... that a skilled artisan would have been motivated to combine the teachings of the prior art references to achieve the claimed invention." *Intelligent Bio-Systems, Inc. v. Illumina Cambridge Ltd.*, 821 F.3d 1359, 1367-1368 (Fed. Cir. 2016); *see also* 35 U.S.C. § 314(a).

But here, Petitioner provides no rationale for why the POSA would replace VIEW's 8-week tertiary fixed dosing with PRN dosing. In VIEW's 8-week dosing arm, after three monthly loading doses, patients were only seen by their physicians when they were treated — *i.e.*, once every 8-weeks. In contrast, under a PRN treatment protocol, even if the patient is not treated at each visit, the patient is still required to be monitored by his/her physician on a regular (*i.e.*, monthly) basis. Thus, PRN is more burdensome than extended fixed dosing.

Indeed, as of the priority date of the '069 Patent, PRN was considered, at

best, inconvenient and, in some cases, unsafe as compared to other dosing regimens. *See e.g.*, Ex. 1025, 1369 (referring to PRN dosing: “Nonetheless, this strategy does require monthly visits, clinical examinations, and OCTs, and patients are uncertain if or when they will need treatment. In addition, there have been more recent concerns that patients who are no longer receiving regular maintenance intravitreal anti-VEGF injections can occasionally experience sudden sight-threatening macular hemorrhages within days or weeks after a stable clinical examination and an OCT showing no apparent sub- or intraretinal fluid.”).

Petitioner must provide a motivation to modify the 8-week dosing regimen — with the benefit of requiring visits only every 8 weeks — to PRN dosing, which requires patients to make monthly monitoring visits to their physician. “[T]he benefits, both lost and gained, should be weighed against one another. That is consistent with the longstanding principle that the prior art must be considered for all its teachings, not selectively.” *Henny Penny Corp. v. Frymaster LLC*, 938 F.3d 1324, 1331-32 (Fed. Cir. 2019) (affirming final IPR decision that claims were not proven invalid for obviousness where “[c]onsidering the prior art as a whole, we conclude that substantial evidence supports the Board’s finding of no motivation to combine”) (citations omitted); *AstraZeneca AB v. Aurobindo Pharma Ltd.*, 232 F. Supp. 3d 636, 646-47 (D. Del. 2017) (holding that the asserted patent claims were not obvious and finding that expert’s testimony was flawed for failing to consider the prior art as a whole, but instead only “looked to

a selection of prior art *handpicked* by [accused infringer's] counsel in order to select the compound for his obviousness analysis. This is evidence of classic hindsight bias") (emphasis in original). Petitioner provides none.

The fact that PRN dosing was practiced in the art does not mean that the POSA would have been motivated to modify an extended fixed dosing regimen to make it PRN dosing, particularly because PRN was repeatedly reported to be inferior to the monthly fixed dosing standard of care. Ex. 1030, 7 (SUSTAIN study showed a maximum visual acuity ("VA") gain after the three consecutive monthly doses and then a decrease in VA gains over time in the PRN phase.); *id.* at 9 ("However, some VA loss occurred after month 3 [in PRN], whereas fixed monthly injections resulted in further VA improvement during the maintenance phase."); Ex. 2029, 803 [HORIZON] (resulting in inferior therapeutic outcomes with PRN dosing as compared to monthly dosing of ranibizumab); Ex. 2032, 1737-38 [SAILOR] (resulting in inferior therapeutic outcomes with PRN dosing as compared to monthly dosing of ranibizumab).

Petitioner has not met its burden to show that the POSA would have been motivated to modify 8-week dosing by replacing it with PRN dosing and, thus, fails to show that Dixon renders the Challenged Claims obvious.

**D. Ground 5: Petitioner Fails to Demonstrate that There Is a Reasonable Likelihood that at Least One of the Challenged Clams Is Rendered Obvious**

Petitioner also fails to show that there is a reasonable likelihood that any

Challenged Claim is rendered obvious by Heier-2009 in combination with either Mitchell or Dixon and, optionally, either the '758 Patent or Dix (Ground 5).<sup>8</sup>

Petitioner asserts that the POSA would have been motivated to modify Regeneron's Phase 2 CLEAR-IT 2 dosing regimen by reducing the number of loading doses from four loading doses, as reported in Heier-2009, to three loading doses based on (a) ranibizumab dosing regimens, as reported in Mitchell, or (b) the prospective VIEW trial, as reported in Dixon. Pet., 65.

It is fundamental that "a patent composed of several elements is not proved obvious merely by demonstrating that each of its elements was, independently, known in the prior art." *KSR Int'l Co. v. Teleflex, Inc.*, 550 U.S. 398, 418 (2007). Here, if there is any so-called motivation to reduce the four loading doses of CLEAR-IT 2 to three, Petitioner has wholly failed to articulate "a reason, suggestion, or motivation in the prior art that would lead one of ordinary skill in the art to combine the references, and that would also suggest a reasonable likelihood of success." *Forest Lab 'ys, LLC v. Sigmapharm Lab 'ys, LLC*, 918 F.3d 928, 934 (Fed. Cir. 2019) (quoting *Smiths Indus. Med. Sys., Inc. v. Vital Signs*,

---

<sup>8</sup> Because Petitioner has not sufficiently disclosed its alternative obviousness theories (*see* Section II.B., *supra*), Regeneron addresses Petitioner's failures in Ground 5 only as it relates to Heier-2009 in combination with either Mitchell or Dixon and, optionally, either the '758 Patent or Dix.

*Inc.*, 183 F.3d 1347, 1356 (Fed. Cir. 1999)).

The Petition cites to a single paragraph in Dr. Albini's declaration in purported support of a motivation to modify CLEAR-IT 2:

Given the valid concerns over dosing frequency and the motivation to reduce the number of doses patients received, a person of ordinary skill in the art would have been motivated to reduce the four monthly loading doses of the Phase 2 CLEAR-IT-2 trial to the three monthly loading doses planned for the Phase 3 VIEW regimens.

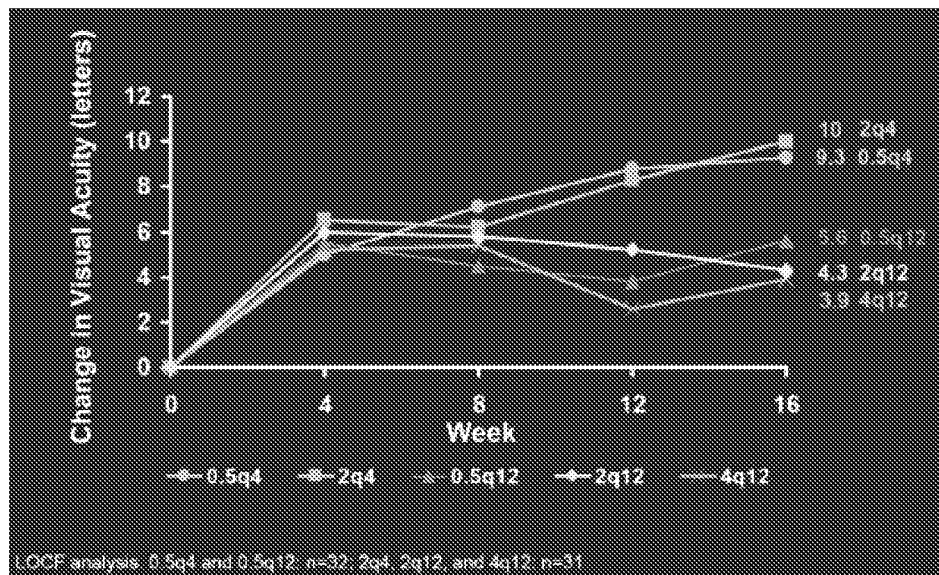
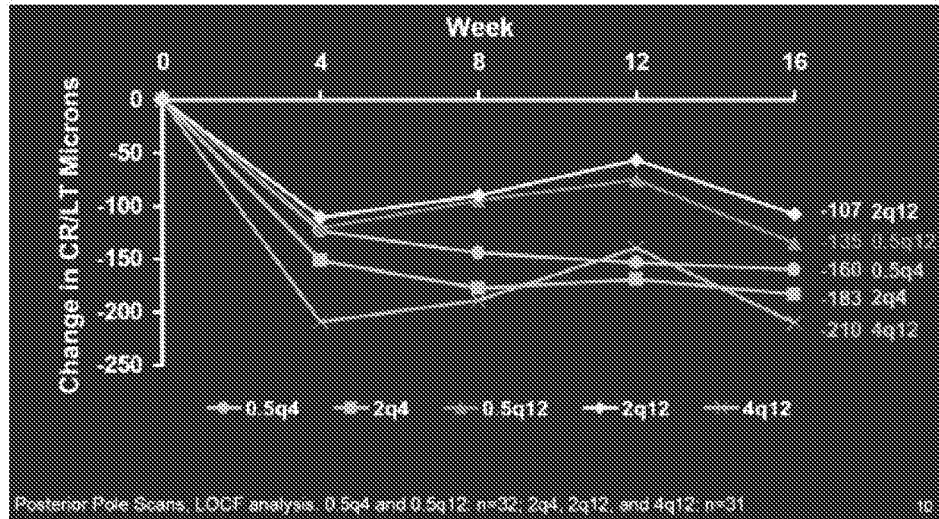
Ex. 1002, ¶199; *see also* Pet., 64. This wholly conclusory, unsupported opinion is contradicted by the evidence for the following reasons.

*First*, neither Petitioner nor Dr. Albini provides a motivation to explore fewer *loading* doses. Rather, the prior art that Dr. Albini relies upon consistently and repeatedly described a motivation to reduce the number of maintenance injections required to treat a chronic disorder. *See, e.g.*, Ex. 1006, 1577 (“However, limitations of current therapy include the need for frequent intraocular injections, as often as monthly, *without a defined stopping point*. Each injection subjects patients to risks of cataract, intraocular inflammation, retinal detachment and endophthalmitis. A significant time and financial burden falls on patients *during their treatment course.*”) (emphases added).

*Second*, the results of CLEAR-IT 2 demonstrated the importance of loading doses in establishing the best visual acuity and anatomical outcomes. The figures

below are from a 2007 report on the 12-week results from CLEAR-IT 2, presented at the September 30, 2007 Retina Society Conference in Boston, Massachusetts.

Ex. 2028, 10, 12:



The top panel reports the change in the retinal thickness and the bottom

panel reports the change in visual acuity. Importantly, the patients receiving monthly (q4) dosing experienced improvements in both anatomical outcomes and visual acuity following the injection at week 12 (*i.e.*, at the fourth loading dose) as shown by the curves at week 16. This continued improvement would have discouraged the POSA from dropping the fourth loading dose. Petitioner does not explain why the POSA would be motivated to pursue an ostensibly less efficacious treatment that required extra patient visits, all in order to save a single intravitreal injection over the course of treatment of a chronic disease.

*Third*, Petitioner fails to explain why Dixon’s disclosure of the VIEW regimen, which was designed to evaluate fixed monthly or 8-week dosing for the first year following the loading doses, would motivate the POSA to alter the loading dose period for a monthly loading dose direct-to-PRN regimen. The skilled artisan would have known that PRN dosing was less effective than fixed monthly dosing. *See, e.g.*, Ex. 1030, 7 (SUSTAIN study showed a maximum VA gain after the three consecutive monthly doses and then a decrease in VA gains over time in the PRN phase.).

It is not enough for Petitioner to explain that the two references could be combined; it must supply a motivation for why the POSA would have picked out those two references and combined them to arrive at the claimed invention. *Pers. Web Techs., LLC v. Apple, Inc.*, 848 F.3d 987, 993–94 (Fed. Cir. 2017); *Belden Inc. v. Berk–Tek LLC*, 805 F.3d 1064, 1073 (Fed. Cir. 2015) (“[O]bviousness



concerns whether a skilled artisan not only *could have made* but *would have been motivated to make* the combinations or modifications of prior art to arrive at the claimed invention.”) (emphases in original). Here, Petitioner has done nothing more than show that Heier-2009 *could* have been combined with Mitchell or Dixon. Thus, Petitioner’s Ground 5 challenge should be rejected.

**E. Petitioner’s Argument Against Objective Evidence Should Be Rejected**

The Federal Circuit has “repeatedly held that . . . objective evidence of secondary considerations . . . must be considered before determining whether the claimed invention would have been obvious.” *Apple, Inc. v. ITC*, 725 F.3d 1356, 1365 (Fed. Cir. 2013). Such objective indicia include long-felt but unsolved need, unexpected results, and commercial success. *Id.* at 1375.

Here, the Board should deny institution because Petitioner fails to establish a reasonable likelihood of establishing a *prima facie* case of obviousness regardless of objective evidence of nonobviousness. *See, e.g., Luye Pharma Grp. Ltd. v. Alkermes Pharma Ir. Ltd.*, IPR2016-01096, Paper 74 at 29 (Nov. 28, 2017) (“As we conclude that the preponderance of evidence of record does not support Petitioner’s obviousness challenge, we need not address Patent Owner’s evidence of secondary indicia”). Regeneron reserves the right to present objective evidence of nonobviousness in the unlikely event that an IPR of the ’069 Patent is instituted.

Regeneron nevertheless responds to Petitioner’s incorrect assertion that

Regeneron omitted “highly pertinent” information from the Examiner in arguing unexpected results during prosecution. Pet., 70.

*First*, Petitioner argues that Regeneron somehow misled the Examiner by relying on the VIEW1/2 clinical trial results reported in Heier 2012 for unexpected results because the VIEW1/2 dosing regimen was disclosed in the prior art. *Id.* Petitioner ignores the critical distinction that the clinical trial results of VIEW1/2 were not known in the prior art. Petitioner also incorrectly suggests that Regeneron failed to disclose the VIEW1/2 dosing regimen to the Examiner. *Id.* However, as discussed *supra* at Section III.A, this is simply untrue: Regeneron submitted numerous references to the Examiner that disclosed the design of its VIEW1/2 trials.

*Second*, Petitioner contends that Regeneron mischaracterized “the standard of care at the time as monthly dosing and sought to distinguish the claims from that ‘standard of care,’ ignoring that PRN dosing could result in monthly injections.” Pet., 70-71.

As an initial matter, before Regeneron’s invention, there were two approved anti-VEGF therapies in use in clinical practice — Lucentis® and Avastin®.<sup>9</sup> Avastin, approved only for oncology indications, was used off-label. And the

---

<sup>9</sup> Macugen, an anti-VEGF aptamer, was also approved for the treatment of AMD, but its use was largely minimal once Lucentis was approved.

FDA-approved recommended dosing regimen for Lucentis®, which was approved for the treatment of angiogenic eye disorders, was monthly intravitreal injections. Ex. 1003, 5 (“recommended to be administered by intravitreal injection once a month (approximately 28 days)”). Indeed, there was no satisfactory extended dosing regimen available at the time of the invention. Even today, the recommended administration of Lucentis remains monthly injections. Ex. 2033, 4.

Next, Regeneron’s unexpected results argument in prosecution was based on Heier 2012, which showed that, based on the Year-2 clinical trial results of VIEW 1/2, PRN dosing resulted in extended dosing as compared to monthly dosing of ranibizumab. So, while PRN dosing could have resulted in, *e.g.*, monthly injections of VEGF Trap-Eye, by the time Heier 2012 was published, it was known that the PRN dosing in the VIEW 1/2 trial in fact resulted in extended dosing relative to the standard of care.

*Third*, Petitioner attempts to point to various ranibizumab clinical trials to suggest that PRN or “less frequent dosing” was the standard of care, but those trials showed that PRN and quarterly dosing were not as effective and did not change the standard of care. Pet., 70-71.

In fact, several failed attempts to achieve extended dosing using ranibizumab had been reported by the time Regeneron undertook its Phase 3 testing of EYLEA®. For example, Heier 2012 explains: “fixed quarterly<sup>9,10</sup> or ‘as

needed’ (*pro re nata* [PRN]) dosing regimens,<sup>11,12</sup> without requiring monthly monitoring visits, were not effective at maintaining vision.” Ex. 1018, 2537. Heier 2012 cites the same clinical trials on which Petitioner attempts to rely — HORIZON (Ex. 2029, 803) (resulting in inferior therapeutic outcomes with PRN dosing as compared to monthly dosing of ranibizumab); and SAILOR (Ex. 2032, 1738) (resulting in inferior therapeutic outcomes with PRN dosing as compared to monthly dosing of ranibizumab).

These studies, and reports that some patients on a PRN regimen had developed sight-threatening macular hemorrhage, undermined the results reported for PrONTO, a small, open-label, prospective, single-center, non-randomized, investigator-sponsored clinical study. Ex. 2042, 1074. Yet, Dr. Albini relies on the PrONTO study and his own uncorroborated experience for his opinion that monthly dosing was not the standard of care as of 2010. Ex. 1002, ¶220. Regardless, the scientific evidence unequivocally demonstrated that PRN or quarterly dosing after three loading doses with ranibizumab was not as effective as monthly dosing. *Compare* Ex. 1002, ¶¶60-61, 220 *with* Ex. 2032, 1735-36 *and* Ex. 2029, 801-03.

***Fourth***, Petitioner argues that “there is nothing unexpected about the every-eight-week results in light of the Phase 2 results obtained by Regeneron — results that were omitted from their arguments to the Examiner.” Pet., 71. This argument belies the facts. Regeneron’s Phase 2 results were submitted to and considered by

the Examiner, including Dixon, which was presented to the Office in an IDS and was marked considered by the Examiner. Ex. 1017, 121, 168.

*Fifth*, Petitioner also argues that Regeneron ignored “practical realities facing physicians at the time” in explaining that an infinite number of different treatment protocols existed. Pet., 71-72. While it is unclear how this statement is relevant to unexpected results, Regeneron made this statement in response to an obviousness-type double patenting rejection based on the Weigand Patents,<sup>10,11</sup>

---

<sup>10</sup> U.S. Patent No. 7,303,746 (“the ’746 Patent”), U.S. Patent No. 7,303,747 (“the ’747 Patent”), U.S. Patent No. 7,306,799 (“the ’799 Patent”), and U.S. Patent No. 7,521,049 (“the ’049 Patent”) (collectively, “the Wiegand patents”).

<sup>11</sup> Petitioner improperly refers to the Wiegand patents as “Monthly-Dosing Patents.” Pet., 11 n.7. As noted, the Examiner recognized that the claims of the Wiegand patents did *not* “disclose the dosing schedules set forth in the instant claims.” *Id.* at 266. Indeed, the ’746 Patent does not claim any particular dosing regimen or dosing interval. Ex. 1016 at 57. Further, the ’747 Patent, the ’799 Patent, and the ’049 Patent recite a variety of dosing intervals, *e.g.*, “at least two weeks apart,” “at least 4 weeks apart,” “at least 3 months apart,” or “at least 6 months apart.” Ex. 1016 at 89-90, 122, 154-55. Thus, there is nothing to suggest that the Wiegand patents are directed to “monthly dosing regimens.”

which even the Examiner recognized did not “disclose the dosing schedules set forth in the instant claims.” Ex. 1017, 266. Additionally, Petitioner’s argument that a “new entrant to the anti-VEGF market would have considered a PRN dosing regimen” (Pet., 72) is contradicted by the fact that PRN dosing had been repeatedly shown to be inferior to fixed dosing. Petitioner’s argument and Dr. Albini’s opinions thus disregard the scientific evidence that would have led the POSA to conclude that PRN dosing would not be as effective as monthly dosing.

**V. CONCLUSION**

For the foregoing reasons, the Board should deny institution of MPI’s petition for IPR of all ’069 Patent Challenged Claims.

Dated: August 16, 2021

Respectfully Submitted,

*/s/ Deborah E. Fishman*

---

Deborah E. Fishman (Reg. No. 48,621)  
3000 El Camino Real #500  
Palo Alto, CA 94304

**Counsel for Patent Owner,  
Regeneron Pharmaceuticals, Inc.**

## CERTIFICATE OF COMPLIANCE

The undersigned certifies that this preliminary response complies with the type-volume limitations of 37 C.F.R. § 42.24(a)(1)(i). This preliminary response (including figure labels and annotations) contains 12,865 words as calculated by the “Word Count” feature of Microsoft Word 2010, the word processing program used to create it.

The undersigned further certifies that this preliminary response complies with the typeface requirements of 37 C.F.R. § 42.6(a)(2)(ii) and typestyle requirements of 37 C.F.R. § 42.6(a)(2)(iii). This preliminary response has been prepared in a proportionally spaced typeface using Microsoft Word 2010 in Times New Roman 14-point font.

/s/ Deborah E. Fishman  
Deborah E. Fishman (Reg. No. 48,621)  
3000 El Camino Real #500  
Palo Alto, CA 94304

**Counsel for Patent Owner,  
Regeneron Pharmaceuticals, Inc.**

**CERTIFICATE OF SERVICE**

Pursuant to 37 C.F.R. §§ 42.6(e)(4)(i) *et seq.* and 42.105(b), the undersigned Certifies that on April 14, 2021, a true and entire copy of this **PRELIMINARY RESPONSE OF PATENT OWNER REGENERON PHARMACEUTICALS, INC.**, and all supporting exhibits, were served via e-mail to the Petitioner at the following email addresses:

MYL\_REG\_IPR@rmmslegal.com  
paul@rmmslegal.com  
wrakoczy@rmmslegal.com  
hsalmen@rmmslegal.com  
nmclaughlin@rmmslegal.com

*/s/ Deborah E. Fishman*

Deborah E. Fishman (Reg. No. 48,621)  
3000 El Camino Real #500  
Palo Alto, CA 94304

**Counsel for Patent Owner,  
Regeneron Pharmaceuticals, Inc.**



UNITED STATES PATENT AND TRADEMARK OFFICE

---

BEFORE THE PATENT TRIAL AND APPEAL BOARD

---

MYLAN PHARMACEUTICALS INC.,  
Petitioner

v.

REGENERON PHARMACEUTICALS, INC.,  
Patent Owner

---

*Inter Partes* Review No.: IPR2021-00880

---

U.S. Patent No. 9,669,069 B2  
Filed: December 17, 2015  
Issued: June 6, 2017  
Inventor: George D. Yancopoulos

Title: USE OF A VEGF ANTAGONIST TO TREAT  
ANGIOGENIC EYE DISORDERS

---

**EXPERT DECLARATION OF DR. THOMAS A. ALBINI  
IN SUPPORT OF PETITION FOR *INTER PARTES* REVIEW OF  
U.S. PATENT NO. 9,669,069 B2**

## TABLE OF CONTENTS

|  | <u>Page</u> |
|--|-------------|
| I. QUALIFICATIONS AND BACKGROUND.....                              | 1           |
| A. Education and Experience.....                                   | 1           |
| B. Bases for Opinions and Materials Considered.....                | 4           |
| C. Scope of Work.....  | 4           |
| II. LEGAL STANDARDS.....   | 4           |
| III. PERSON OF ORDINARY SKILL IN THE ART.....                      | 9           |
| IV. SUMMARY OF OPINIONS.....                                       | 11          |
| V. THE '069 PATENT (Ex.1001).....                                  | 13          |
| A. Claim Construction.....   | 15          |
| VI. BACKGROUND.....  | 20          |
| A. Vitreoretinal Disorders.....                                    | 20          |
| 1. Age-related macular degeneration (AMD).....                     | 22          |
| 2. Diabetic retinopathy (DR).....                                  | 24          |
| 3. Diabetic macular edema (DME).....                               | 24          |
| 4. Retinal vein occlusion (RVO).....                               | 24          |
| B. Angiogenesis and Vascular Endothelial Growth Factor (VEGF)..... | 25          |
| C. VEGF Antagonists.....   | 25          |
| D. VEGF Trap-Eye/Aflibercept.....                                  | 30          |
| E. Regeneron's Press Releases and Clinical Trials.....             | 33          |
| VII. SCOPE AND CONTENT OF THE PRIOR ART REFERENCES.....            | 42          |

**TABLE OF CONTENTS**  
**(continued)**

|  | <u>Page</u> |
|--|-------------|
| A. Dixon (Ex.1006).....  | 42          |
| B. Adis (Ex.1007). ....  | 47          |
| C. Regeneron (28-April-2008) (Ex.1012).....  | 50          |
| D. Heier-2009 (Ex.1020).....   | 51          |
| E. Regeneron (30-April-2009) (Ex.1028).....  | 54          |
| F. Mitchell (Ex.1030). ....  | 55          |
| G. Lalwani (Ex.1035).....  | 57          |
| H. '758 Patent (Ex.1010). ....   | 59          |
| I. Dix (Ex.1033).....  | 60          |
| VIII. UNPATENTABILITY OF THE '069 PATENT. ....   | 61          |
| A. Claims 1 and 9-12 of the '069 Patent Are Anticipated by the<br>CLEAR-IT-2 Disclosures in Either Heier-2009 (Ex.1020) or<br>Dixon (Ex.1006)..... | 61          |
| 1. Claim 1 is anticipated by Heier-2009 and Dixon. ....  | 61          |
| 2. Dependent claims 9 and 10 are anticipated by Heier-2009<br>and Dixon. ....  | 67          |
| 3. Dependent claim 11 is anticipated by Heier-2009 and<br>Dixon.....   | 68          |
| 4. Dependent claim 12 is anticipated by Heier-2009 and<br>Dixon.....   | 70          |
| B. Claims 1 and 9-12 of the '069 Patent Are Anticipated by<br>Regeneron (30-April-2009) (Ex.1028).....   | 71          |
| 1. Claim 1 of the '069 patent is anticipated by Regeneron<br>(30-April-2009). ....   | 71          |

**TABLE OF CONTENTS**  
**(continued)**

|   | <u>Page</u> |
|---|-------------|
| 2. Dependent claims 9 and 10 are anticipated by Regeneron (30-April-2009).....  | 75          |
| 3. Dependent claim 11 is anticipated by Regeneron (30-April-2009).....  | 77          |
| 4. Dependent claim 12 is anticipated by Regeneron (30-April-2009).....  | 78          |
| C. Claims 1 and 8-12 of the '069 Patent Are Anticipated and Made Obvious by the VIEW1/VIEW2 Disclosures in Dixon. ....  | 78          |
| 1. Claim 1 of the '069 patent is anticipated by the VIEW1/VIEW2 disclosures.....  | 78          |
| 2. Claim 1 of the '069 patent is made obvious by the VIEW1/VIEW2 disclosures in Dixon.....  | 87          |
| 3. Dependent claim 8 is anticipated and made obvious by the VIEW1/VIEW2 disclosures.....  | 90          |
| 4. Dependent claims 9 and 10 of the '069 patent are anticipated and made obvious by the VIEW1/VIEW2 disclosures.....  | 91          |
| 5. Dependent claim 11 is anticipated and made obvious by the VIEW1/VIEW2 disclosures.....   | 92          |
| 6. Dependent claim 12 is anticipated and made obvious by the VIEW1/VIEW2 disclosures.....   | 93          |
| D. Claims 1 and 8-12 of the '069 Patent Are Made Obvious by Heier-2009 (Ex.1020) in View of Mitchell (Ex.1030), or Alternatively in View of Dixon (Ex.1006), and if Necessary, in View of the '758 Patent (Ex.1010) or Dix (Ex.1033)..... | 94          |
| 1. Claim 1 of the '069 patent is obvious. ....  | 94          |
| 2. Dependent claim 8 is obvious.....  | 103         |

**TABLE OF CONTENTS**  
**(continued)**

|  | <u>Page</u> |
|--|-------------|
| 3. Dependent claims 9 and 10 are obvious. .... | 105         |
| 4. Dependent claim 11 is obvious. ....         | 105         |
| 5. Dependent claim 12 is obvious. ....         | 106         |
| IX. SECONDARY CONSIDERATIONS. ....             | 107         |

1. My name is Dr. Thomas A. Albini. I have been retained by counsel for Mylan Pharmaceuticals, Inc. (“Mylan” or “Petitioner”), to provide my opinion regarding U.S. Patent No. 9,669,069 (Ex.1001, “the ’069 patent”), which I understand is assigned to Regeneron Pharmaceuticals, Inc. I understand that Petitioner intends to petition for *inter partes* review of the ’069 patent, and will request that the United States Patent and Trademark Office (“USPTO”) cancel claims 1 and 8-12 of the ’069 patent (“challenged claims”) as unpatentable. My opinions in this expert declaration support Petitioner’s request for *inter partes* review of the ’069 patent, and the cancellation of the challenged claims.

**I. QUALIFICATIONS AND BACKGROUND.**

**A. Education and Experience.**

2. I received a Bachelor of Arts degree, *Magna Cum Laude*, from Princeton University in 1994. I obtained my M.D. from Johns Hopkins University School of Medicine in 1999. I completed an internal medicine internship at Jackson Memorial Hospital in Miami, Florida, and an ophthalmology residency at the Doheny Eye Institute of the University of Southern California.

3. After my residency, I completed a uveitis and ocular pathology clinical and research fellowship at the Doheny Eye Institute followed by a vitreoretinal surgery fellowship at the Cullen Eye Institute of the Baylor College of Medicine.

4. I was an instructor in ocular inflammation, uveitis, and ophthalmic pathology at the Doheny Eye institute from 2003-2004. I joined the faculty at the Bascom Palmer Eye Institute of the University of Miami Miller School of Medicine as an Assistant Professor of Clinical Ophthalmology in 2006. I held the position of Associate Professor of Clinical Ophthalmology at the Bascom Palmer Eye Institute from 2012 to June 2018. Since July 2016, I have served as co-director of the vitreoretinal surgery fellowship. Since June 2018, I have been a Professor of Clinical Ophthalmology. In my current and prior positions, I have been involved in the teaching and training of medical students, fellows, and residents in the area of ophthalmological surgical techniques, specifically, injection protocols for the administration of therapeutics for the treatment of age-related macular degeneration (AMD) and other vitreoretinal eye disorders. Further, in 2006, I began my current roles as a staff ophthalmologist at both the Anne Bates Leach Eye Hospital of the Bascom Palmer Eye Institute as well as the Jackson Memorial Hospital.

5. I was awarded the American Academy of Ophthalmology Achievement Award in 2011 and Senior Achievement Award in 2019. In 2012, I received the Service Award from the American Society of Retina Specialists for outstanding service to the Society's scientific and educational programs. I also received the Senior Honor Award from the American Society of Retina Specialists in 2012.

6. I have served as an editor, co-editor, or on the editorial board of several publications, including Retina Today, the website for the American Society of Retina Specialists, New Retina MD, and the Journal of VitreoRetinal Diseases.

7. My clinical practice is focused on the diagnosis and treatment of patients suffering from various macular diseases, such as AMD, diabetic retinopathy and related disorders, as well as uveitis. I have experience with surgical interventions as well as the prescription and administration of various intravitreally-administered anti-angiogenesis agents.

8. I was and currently am a member in several Professional and Academic Societies, including American Academy of Ophthalmology, Association for Research in Vision and Ophthalmology, American Society of Retina Specialists, Miami Ophthalmological Society, Vitrectomy Buckle Society, American Uveitis Society, The Macula Society, Pan American Association of Ophthalmology, and The Retina Society, among others.

9. I have authored or co-authored over two hundred and fifty (250) publications, including book chapters, peer-reviewed scientific papers, abstracts, and other published works. Several of these publications pertain to AMD, retinal detachment, retinal and choroidal diseases, or diabetic macular edema (DME), among other disorders of the eye.



10. In all, I have over fifteen (15) years of hands-on clinical and research experience specializing in treating vitreoretinal disorders and the prescription, and intravitreal administration, of VEGF antagonists. I have included a copy of my *curriculum vitae* in support of my opinions. (Ex.1038, Albini CV).

**B. Bases for Opinions and Materials Considered.**

11. In addition to my education, knowledge of the relevant published art, training, and experience, in forming the opinions I provide in this declaration, I have also considered the exhibits cited herein.

**C. Scope of Work.**

12. I have been retained by Petitioner as an expert in this matter to provide various opinions regarding the '069 patent. I receive \$500 per hour for my services. No part of my compensation is dependent upon my opinions given or the outcome of this case. I do not have any current or past affiliation with Regeneron, or any of the named inventors on the '069 patent.

**II. LEGAL STANDARDS.**

13. For my opinions in this declaration, I understand that it requires applying various legal principles. As I am not an attorney, I have been informed about various legal principles that govern my analysis. I have used my

understanding of those principles in forming my opinions. I summarize my understanding of those legal principles as follows:

14. **Burden of Proof.** I understand that Petitioner bears the burden of proving unpatentability in this proceeding by a preponderance of the evidence. I am informed that this preponderance of the evidence standard means that Petitioner must show that unpatentability is more probable than not.

15. **Claim Construction.** I have also been told that when I review and consider the claims, the claim term(s) should be analyzed under their ordinary and customary meaning as understood from the perspective of one of ordinary skill in the art, taking into account the claim language itself, specification, and prosecution history pertaining to the patent, as well as relevant extrinsic evidence. I have applied this standard in formulating my opinions, and set forth my understanding of the scope of particular claim terms discussed below.

16. **Anticipation.** I have been asked to consider the question of anticipation, namely, whether the claims cover something that is new, or novel. I am told that the concept of anticipation requires that each and every element of a challenged claim is present in or otherwise taught by a single reference. I also understand that an anticipatory reference does not need to explicitly describe each

element because anticipation can occur when a claimed limitation is necessarily inherent or otherwise implicit in the relevant reference.

17. **Obviousness.** I have been asked to consider the question of obviousness/non-obviousness. Again, I am told that this analysis must be from the perspective of the person of ordinary skill in the art, and whether such person would consider any differences between the prior art and what is claimed to have been obvious. To make this assessment, I have been informed that the concept of patent obviousness involves four factual inquiries:

- the scope and content of the prior art;
- the differences between the claimed invention and the prior art;
- the level of ordinary skill in the art; and
- so-called secondary considerations of non-obviousness.

18. I have further been instructed that one cannot use the challenged patent itself (here, the '069 patent) as a guide from which to select prior art elements, or otherwise engage in hindsight. Rather, the better approach is to consider what the person of ordinary skill in the art knew, and what the art taught; suggested; or motivated the person of ordinary skill in the art to further pursue; and to differentiate between steps that were routinely done (such as in response to known problems,

steps or obstacles), and those which, for example, may have represented a different way of solving existing or known problems.

19. I am also informed that when there is some recognized reason to solve a problem, and there are a finite number of identified, predictable and known solutions, a person of ordinary skill in the art has good reason to pursue the known options within his or her technical grasp. If such an approach leads to the expected success, it is likely not the product of innovation but of ordinary skill and common sense. In addition, when a patent simply arranges old elements with each performing its known function and yields no more than what one would expect from such an arrangement, the combination is obvious.

20. I understand that before reaching any final conclusion on obviousness, the obviousness analysis requires consideration of objective indicia of non-obviousness, if offered. These must be considered to ensure that, for example, there were not some unanticipated problems, obstacles, or hurdles that may seem easy to overcome in hindsight, but which were not readily overcome prior to the relevant invention date of the patents/claims at issue here. I understand that these objective indicia are also known as “secondary considerations of non-obviousness,” and may include long-felt but unmet need and unexpected results, among others. I also understand, however, that any offered evidence of secondary considerations of non-

obviousness must be comparable with the scope of the challenged claims. This means that for any offered evidence of secondary considerations of non-obviousness to be given substantial weight, I understand the proponent of that evidence must establish a “nexus” or a sufficient connection or tie between that evidence and the merits of the claimed invention, which I understand specifically incorporates any novel element(s) of the claimed invention. If the secondary considerations evidence offered actually results from something other than the merits of the claim, then I understand that there is no nexus or tie to the claimed invention. I also understand it is the patentee that has the burden of proving that a nexus exists.

21. With respect to long-felt need, I understand that the evidence must show that a particular problem existed for a long period of time. More specifically, I understand that for a “need” to be long-felt and unmet, (1) the need must be persistent and recognized by those of ordinary skill in the art; (2) the need must not be satisfied by another before the alleged invention; and (3) the claimed invention itself must satisfy the alleged need. I also understand that long-felt need is analyzed as of the date that the problem is identified. Furthermore, I understand that long-felt need should be based upon alleged inadequacies in the technical knowledge of those skilled in the art, not due to business-driven market forces.

22. I further understand that, absent a showing of a long-felt, unmet need, the mere passage of time without the claimed invention is not evidence of non-obviousness.

23. With respect to unexpected results, I understand that any results upon which a patentee wishes to rely as an indicator of non-obviousness must be based on a comparison of the purported inventions with the closest prior art.

24. However, I understand that secondary considerations will not overcome a strong showing of obviousness.

25. **Public Availability.** I have also been asked to consider whether there is a reasonable likelihood that some of the references discussed herein would have been publicly accessible before the priority date of the '069 patent. I have been informed that a reference is “publicly accessible” if the document has been disseminated or otherwise made available to the extent that persons interested and ordinarily skilled in the subject matter or art exercising reasonable diligence, can locate it.

### **III. PERSON OF ORDINARY SKILL IN THE ART.**

26. As I mentioned above, I have been informed by counsel that my analysis is to be conducted from the perspective of a person of ordinary skill in the art at the time of the invention. I also understand that the person of ordinary skill

in the art is assumed to know, understand and be familiar with all of the relevant prior art, and that such person is not an automaton, but rather a person of ordinary creativity.

27. I have also been informed by counsel that in defining a person of ordinary skill in the art the following factors may be considered: (1) the educational level of the inventor; (2) the type of problems encountered in the art; (3) prior art solutions to those problems; (4) rapidity with which innovations are made; and (5) sophistication of the technology and educational level of active workers in the field.

28. After considering the above-mentioned factors, it is my opinion that a person of ordinary skill in the art would have: (1) knowledge regarding the diagnosis and treatment of angiogenic eye disorders, including the administration of therapies to treat said disorders; and (2) the ability to understand results and findings presented or published by others in the field, including the publications discussed herein. Typically, such a person would have an advanced degree, such as an M.D. or Ph.D. (or equivalent, or less education but considerable professional experience in the medical, biotechnological, or pharmaceutical field), with practical academic or medical experience in: (i) developing treatments for angiogenic eye disorders, such as AMD, including through the use of VEGF antagonists, or (ii) treating of same, including through the use of VEGF antagonists.

#### IV. SUMMARY OF OPINIONS.

29. It is my opinion that at least claims 1 and 9-12 of the '069 patent are anticipated through the disclosure, in references such as Heier-2009 and Dixon, of the dosage regimen used by Regeneron in their Phase 2 CLEAR-IT-2 AMD trial (monthly doses until week 12, followed by *pro re nata*, i.e., as-needed, dosing (“PRN”)), and the results reported therein.

30. It is my opinion that Regeneron’s April 2009 Press Release (“Regeneron (30-April-2009)”) anticipates at least claims 1 and 9-12 of the '069 patent through its disclosure of the dosage regimen used by Regeneron in their Phase 3 COPERNICUS and GALILEO RVO trials (6 monthly doses of 2 mg, followed by PRN dosing).

31. It is my opinion that, under Regeneron’s interpretation of the '069 patent claims, the VIEW1/VIEW2 dosing regimens disclosed in references such as Dixon and others, anticipate claims 1 and 8-12 of the '069 patent. During prosecution of the claims of the '069 patent, Regeneron argued that the VIEW1/VIEW2 dosing regimens exhibited surprising results and that the VIEW1/VIEW2 regimens were of the type claimed in the '069 patent PRN dosing regimen claims. If that interpretation is applied, then, in my opinion the pre-filing



date disclosures of the VIEW1/VIEW2 regimens anticipate claims 1 and 8-12 of the '069 patent and/or render those claims obvious.

32. It is my opinion that claims 1 and 8-12 are obvious in view of the positive results reported for Regeneron's Phase 2 AMD trial, as reported in Heier-2009, in combination with either Mitchell, which disclosed, among other things, the ranibizumab AMD PrONTO trial of 3 initial monthly doses followed by PRN dosing, or in the alternative, in view of Dixon, which disclosed the Phase 3 VIEW regimen of three monthly loading doses followed by extended dosing, and if necessary, the '758 patent or Dix, which reported the sequences and molecular structure of VEGF Trap-Eye/aflibercept.

33. It is also my opinion that there are no "secondary considerations" that would support the patentability of the claims of the '069 patent. First, it is my understanding that secondary considerations are not relevant in the context of anticipation and so should not be considered in connection with the anticipation grounds above. Second, in the context of obviousness, it is my opinion that the arguments presented by Regeneron to the USPTO do not support a finding of unexpected results or any other secondary consideration, especially given the positive and promising results reported for Regeneron's Phase 2 trials, among others.

**V. THE '069 PATENT (Ex.1001).**

34. I have read the '069 patent, which is titled "Use of a VEGF Antagonist to Treat Angiogenic Eye Disorders," as well as the issued claims. I am very familiar with the state of the art at the time this patent was first filed, which I have been asked to assume is January 13, 2011.<sup>1</sup> The '069 patent lists George D. Yancopoulos as the sole inventor.

---

<sup>1</sup> I understand the following from the cover page of the '069 patent: (i) Application No. 14/972,560 ("the '560 application") issued as the '069 patent on or about June 6, 2017; (ii) the '560 application was filed December 17, 2015; (iii) as a "continuation" of application No. 13/940,370, filed July 12, 2013; (iv) as a "continuation-in-part" of application No. PCT/US2012/020855, which was filed on January 11, 2012; and (v) the '069 patent lists three "provisional" applications filed, respectively, on (a) January 13, 2011; (b) January 21, 2011; and (c) November 21, 2011, as "Related U.S. Application Data." (*See* Ex.1001, '069 patent at cover). I have been asked to assume that the priority date of the '069 patent is January 13, 2011. I have not been asked to form an opinion regarding the merit of the '069 patent's claim to that date.

35. I have reviewed the '069 patent claims from the perspective of a person of ordinary skill in the art and applied each claim's ordinary and customary meaning in light of the claims, the specification, and the prosecution history, as well as any relevant extrinsic evidence. I understand that Petitioner is challenging all claims of the '069 patent.

36. Claim 1 recites:

1. A method for treating an angiogenic eye disorder in a patient, said method comprising sequentially administering to the patient a single initial dose of a VEGF antagonist, followed by one or more secondary doses of the VEGF antagonist, followed by one or more tertiary doses of the VEGF antagonist;  
wherein each secondary dose is administered 2 to 4 weeks after the immediately preceding dose; and  
wherein each tertiary dose is administered on an as-needed/pro re nata (PRN) basis, based on visual and/or anatomical outcomes as assessed by a physician or other qualified medical professional;  
wherein the VEGF antagonist is a receptor-based chimeric molecule comprising (1) a VEGFR1 component comprising amino acids 27 to 129 of SEQ ID NO:2; (2) a VEGFR2 component comprising amino acids 130-231 of SEQ ID NO:2; and (3) a multimerization component comprising amino acids 232-457 of SEQ ID NO:2.

(Ex.1001, '069 patent, 21:42-60).

37. Claims 2-12 further restrict the claims to, *inter alia*, specific numbers of secondary doses, dosage amounts, eye disorders and routes of administration.

**A. Claim Construction.**

38. In my opinion, a person of ordinary skill in the art would reach at least the following conclusions regarding the claim language:

39. **First**, with respect to claims 1 and 12 (and the claims that depend therefrom), a person of ordinary skill in the art would understand that the “VEGFR1 component,” “VEGFR2 component,” and the “multimerization component”—all of which refer to separate amino acid domains of “SEQ ID NO:2”—and VEGFR1R2-Fc $\Delta$ C1(a) encoded by SEQ ID NO:1, as collectively referring to aflibercept (a/k/a/ VEGF Trap or VEGF Trap-Eye), for at least the following reasons:

- The amino acid sequence provided in the '069 patent specification for “SEQ ID NO:2” is the identical amino acid sequence Regeneron previously submitted to the USPTO as referring to aflibercept (a/k/a VEGF Trap or VEGF Trap-Eye). (*Compare* Ex.1001, '069 patent, cols. 19-22, with Ex.1010, '758 patent, Fig.24A-C (disclosing the nucleotide sequence and deduced amino acid sequence, as well as a description of each molecular component therein (i.e., the signal sequence, the FLT1 Ig domain 2, the FLK1 Ig domain 3, and the Fc $\Delta$ C1 domain), 10:15-17 (specifying that this molecule is termed “VEGFR1R2-Fc $\Delta$ C1(a).”); *see also, e.g.*, Ex.1024, '758 FH, 12/22/2011 PTE, 2, 6-7 (“The name of the

active ingredient of EYLEA™ is aflibercept, also known as VEGF trap, VEGF-trap, VEGF Trap-Eye and VEGF-TRAP<sub>R1R2</sub> . . . [,] a fusion protein consisting of (a) a vascular endothelial growth factor (VEGF) receptor component having immunoglobulin-like (Ig) domains consisting of an Ig domain 2 of a first VEGF receptor that is human Fltl and an Ig domain 3 of a second VEGF receptor that is human Flkl; and (b) an Fc portion of human IgG1,” and further explaining to the USPTO that the amino acid sequence of aflibercept is set forth in Figures 24A-24C of the ’758 patent));<sup>2</sup>

- The ’069 patent specification states that “[a]n exemplary VEGF antagonist that can be used in the context of the present invention is a multimeric VEGF-binding protein comprising two or more VEGF receptor-based

---

<sup>2</sup> In the course of my analysis, I requested that exhibits be created that compare the SEQ ID NO:1 and SEQ ID NO:2 of the ’069 patent with sequences disclosed in the prior art references. I have reviewed these exhibits and confirmed that these sequences are the same. (Ex.1082 (amino acid sequences); Ex.1083 (nucleic acid sequences)).

chimeric molecules referred to herein as ‘VEGFR1R2-FcΔC1(a)’ or ‘aflibercept.’” (Ex.1001, ’069 patent, 2:33-38); and

- It was well known in the art that this fusion VEGF antagonist was commonly referred to as “VEGF Trap,” and also known as “aflibercept,” as well as “VEGF Trap-Eye” when formulated for intraocular delivery. (See, e.g., Ex.1006, Dixon, 1575 (“VEGF Trap-Eye and aflibercept (the oncology product) have the same molecular structure.”); Ex.1039, ’095 patent, 1:45-54; Ex.1040, WHO Drug Info, 118-19; Ex.1021, 2009 10-Q, 20; Ex.1041, Regeneron (26-February-2009), 1-2 (using VEGF Trap and aflibercept interchangeably and explaining that “VEGF Trap-Eye is a specially purified and formulated form of VEGF Trap for use in intraocular applications”); Ex.1007, Adis, 261 (indicating in the title that aflibercept, VEGF Trap (R1R2), and VEGF Trap-Eye, among other terms, were understood by a person of ordinary skill in the art to refer, interchangeably, to the same drug)).

40. **Second**, although the terms “initial dose,” “secondary dose,” and “tertiary dose” are not typically used in practice, a person of ordinary skill in the art would understand those terms to have the meaning expressly given to them in the ’069 patent:

The terms “initial dose,” “secondary doses,” and “tertiary doses,” refer to the temporal sequence of administration of the VEGF antagonist. Thus, the “initial dose” is the dose which is administered at the beginning of the treatment regimen (also referred to as the “baseline dose”); the “secondary doses” are the doses which are administered after the initial dose; and the “tertiary doses” are the doses which are administered after the secondary doses.

(See Ex.1001, '069 patent, 3:34-41). The '069 patent further states that “[t]he initial, secondary, and tertiary doses . . . will generally differ from one another in terms of frequency of administration.” (*Id.*, 3:41-44). For example, the '069 patent states that “each secondary dose is administered 2 to 4 . . . weeks after the immediately preceding dose, and each tertiary dose is administered at least 8 . . . weeks after the immediately preceding dose.” (*Id.*, 3:50-54). The '069 patent explains that “the immediately preceding dose” means “in a sequence of multiple administrations, the dose of VEGF antagonist which is administered to a patient prior to the administration of the very next dose in the sequence with no intervening doses.” (*Id.*, 3:54-59). These are the meanings I have applied to these terms in formulating my opinions.

41. **Third**, to a person of ordinary skill in the art, the reference to administering at “4 weeks” in the claims is synonymous in the art of treating angiogenic eye disorders with *monthly* administration. Likewise, the reference to

“administered at least 8 weeks” is synonymous in the art of treating angiogenic eye disorders with *bimonthly* (or every-other-month) administration. This is also consistent with my own experience treating angiogenic eye disorders—i.e., I consider “4 weeks” to be synonymous (or interchangeable) with “monthly,” and “8 weeks” to be synonymous (or interchangeable) with “bimonthly” (or every-other-month). (See Ex.1001, '069 patent, 7:57-59).

42. **Fourth**, although I have been informed that a claim preamble is presumed not to be a claim limitation, I have been asked for my opinion on the scope of the term “method for treating” should the Board wish to construe the term. In my opinion, without any parameters set forth in the claim or any additional guidance from the claim itself, a person of ordinary skill in the art would apply a plain and customary meaning to the term, which would include administering a therapeutic agent to a patient. I have analyzed the specification and have not seen an alternative definition for the term in the specification. I have seen a reference to “efficacy,” and if one were to equate a method for treating with a particular efficacy, the definition in the patent provides that the method demonstrate efficacy within 104 weeks from initiation, and the patients exhibit a loss of 15 or fewer letters on the ETDRS visual acuity chart. (Ex.1001, '069 patent, 7:18-34).

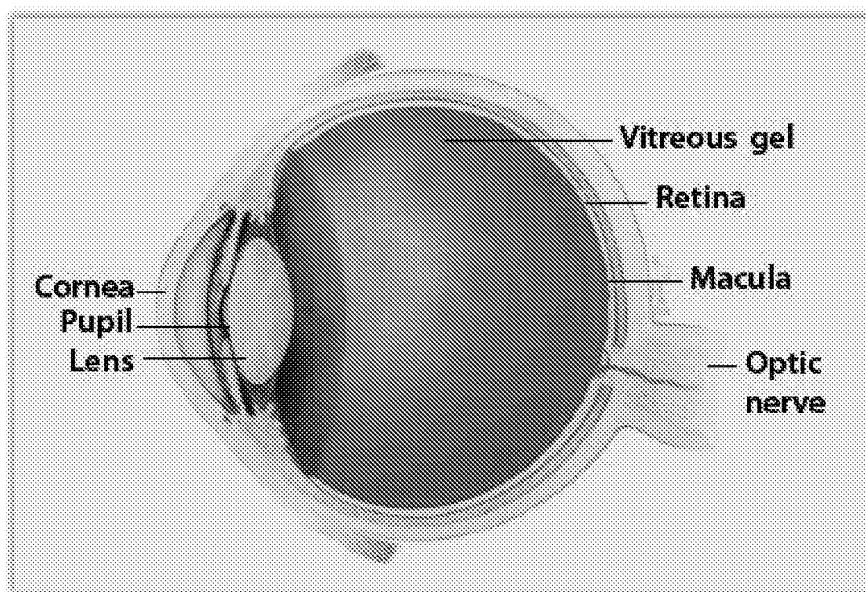


43. **Fifth**, the term “pro re nata” appearing in claim 1 is defined in the claim itself. For example, claim 1 reads: “administered on an as-needed/pro re nata (PRN) basis.” (Ex.1001, ’069 patent, 21:50-51). The specification of the patent also confirms this definition in several locations. (Ex.1001, ’069 patent, 14:43 (“as-needed (PRN”); 15:43-48 (“administered pro re nata (PRN) based on visual and/or anatomical outcomes”); 16:9-12; 16:25-28; 16:41-44 (same); 16:46-49 (same)). Also, in practice, physicians routinely use the term PRN to mean “as needed,” which, in my opinion, is consistent with the way the term is defined and used in the ’069 patent claims and specification.

## **VI. BACKGROUND.**

### **A. Vitreoretinal Disorders.**

44. The following Figure illustrates the normal anatomy of the eye:



(Ex.1042, NIH AMD, 2). Vitreoretinal disorders relate to problems involving the retina, macula, and vitreous fluid (or gel). The retina is the light-sensitive tissue lining the back of the eye, which converts light rays into impulses that travel through the optic nerve to the brain, where they are interpreted as images. The macula is the small area at the center of the retina, which, because of the high concentration of cones in that region, is responsible for high-acuity color vision, which enables one to distinguish among different colors. The vitreous fluid (or gel) is the clear, jelly-like substance that fills the inside of the eye from the lens to the retina, helping the eye maintain its shape.

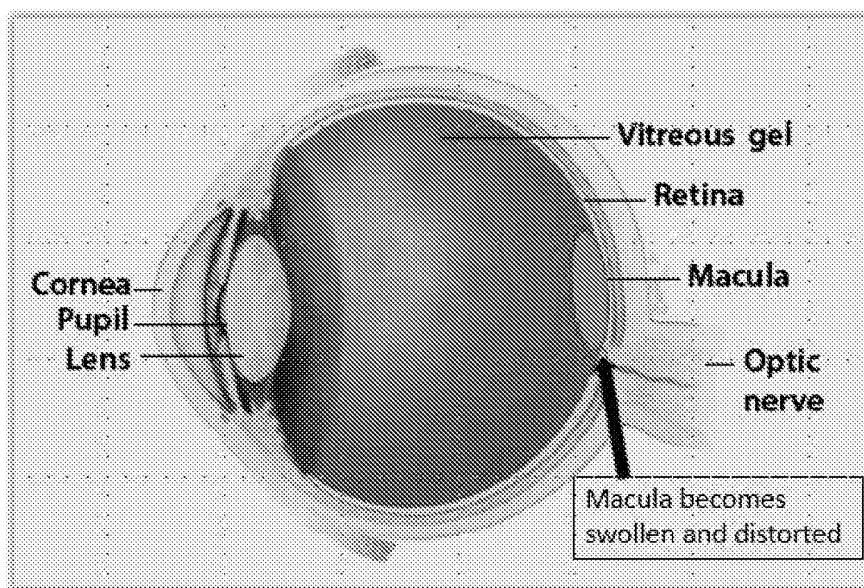
45. Vitreoretinal disorders such as AMD and diabetic retinopathy (DR) are the leading causes of visual impairment in developed countries, and the prevalence

of these disorders is expected to rise with the increase in the aged population. (See Ex.1006, Dixon, 1573).

**1. Age-related macular degeneration (AMD).**

46. The NIH's National Eye Institute describes AMD as "a common eye condition and a leading cause of vision loss among people age 60 and older. It causes damage to the macula, a small spot near the center of the retina and the part of the eye needed for sharp, central vision, which lets us see objects that are straight ahead." (Ex.1042, NIH AMD, 1).

47. AMD can be classified as either "dry" (nonexudative) or "wet" (exudative). (See, e.g., Ex.1012, Regeneron (28-April-2008), 2). In wet AMD, new blood vessels grow beneath the retina and leak blood and/or fluid, causing disruption and dysfunction of the retina, as I have illustrated in the following modification of Figure 1 from NIH AMD:



(Ex.1042, NIH AMD, 2 (modified to illustrate neovascular (wet) AMD); *see also* Ex.1012, Regeneron (28-April-2008), 2). This creates blind spots in central vision and eventual scarring or formation of a disciform that represents the end-stage of AMD and associated vision loss. (*Id.*).

48. AMD “affects > 1.75 million individuals in the US and it is estimated that by 2020 this number will increase to almost 3 million” and “[w]orldwide, AMD is estimated to affect 14 million people.” (Ex.1006, Dixon, 1573).

49. Early treatments for wet AMD were focused on laser and photodynamic therapy, in which portions of the eye were cauterized to prevent the spread of new blood vessels. However, while this therapy could be effective at controlling vision loss in some patients, the therapy itself could result in vision loss in some portions

of the eye. (See Ex.1043, Brown, 627; Ex.1006, Dixon, 1573 (“[Patients treated with photodynamic therapy] continued to experience a decline in visual acuity and the treatment was of questionable cost and effectiveness.”)).

## **2. Diabetic retinopathy (DR).**

50. DR “occurs when diabetes damages the tiny blood vessels in the retina, which is the light-sensitive tissue at the back of the eye.” (Ex.1044, NIH DR, 1). DR “can cause blood vessels in the retina to leak fluid or hemorrhage (bleed), distorting vision.” (*Id.*, 1-2). Further, “[i]n its most advanced stage, new abnormal blood vessels proliferate (increase in number) on the surface of the retina which can lead to scarring and cell loss in the retina.” (*Id.*, 2). DR is the “leading cause of vision impairment and blindness among working-age adults.” (*Id.*, 1).

## **3. Diabetic macular edema (DME).**

51. DME is a consequence of DR. “DME is the build-up of fluid (edema) in a region of the retina called the macula.” (Ex.1044, NIH DR, 3). “DME is the most common cause of vision loss among people with diabetic retinopathy.” (*Id.*).

## **4. Retinal vein occlusion (RVO).**

52. RVO is a disorder characterized by obstruction of the retinal veins, which leads to the leaking and accumulation of blood and fluid in the retina. Central RVO (CRVO) results from the blockage of the central retinal vein while branch

RVO (BRVO) results from the blockage of one of the smaller branch veins. VEGF signaling is associated with both conditions and anti-VEGF therapy is a critical tool in its treatment.

**B. Angiogenesis and Vascular Endothelial Growth Factor (VEGF).**

53. Angiogenesis is a key process necessary for embryonic development of the vascular system; early gene knockout studies revealed that loss of one or more genes responsible for angiogenesis results in embryonic lethality. (*See* Ex.1045, Ferrara-1999, 1359). However, aberrant angiogenesis has also been identified as a contributor to the development of many tumors and disorders associated with increased vascularization. (*See id.*, 1360). Early on, researchers recognized the potential promise of targeting angiogenesis as a therapeutic strategy for treating diseases and disorders characterized by increased vascularity. (*See id.*, 1359-60).

**C. VEGF Antagonists.**

54. While Vascular Endothelial Growth Factor (VEGF) may be “a naturally occurring protein in the body whose normal role is to trigger formation of new blood vessels (angiogenesis) to support the growth of the body’s tissues and organs,” (Ex.1012, Regeneron (28-April-2008), 2), additional research also identified a role for VEGF in tumor angiogenesis, with studies showing an upregulation of VEGF in various tumor types, (Ex.1046, Ferrara-2005, 968). As a

result, anti-angiogenic VEGF inhibitors were identified as potential therapies, and were soon developed and entered clinical testing. (*Id.*, 971).

55. One of the first of these was bevacizumab, a humanized monoclonal antibody approved for the treatment of metastatic colon cancer in combination with 5-fluoruracil (5FU). (*Id.*, 967, 971).

56. VEGF has also been identified as a factor in the abnormal growth and fragility of new blood vessels in the eye, a condition associated with wet AMD. (Ex.1012, Regeneron (28-April-2008), 2 (“Blockade of VEGF, which can prevent abnormal blood vessel formation and vascular leak, has proven beneficial in the treatment of wet AMD and a VEGF inhibitor, ranibizumab, has been approved for treatment of patients with this condition.”)). This led some physicians to speculate that bevacizumab and other anti-VEGF factors could be used to treat vitreoretinal diseases. Indeed, since the initial approval of bevacizumab for use in treating cancer, some ophthalmic physicians have used it off-label for the treatment of AMD (via intravitreal injection) with promising results. (*See, e.g.*, Ex.1047, Bashshur, 1).

57. In addition, based on the recognition that neovascularization and vascular leakage are a major cause of vision loss in wet AMD, anti-VEGF agents were also developed for the specific purpose of treating AMD.

58. One of these, ranibizumab, is a humanized monoclonal Fab fragment capable of blocking the activity of VEGF-A, and marketed under the name LUCENTIS®. Approved in 2006, it was originally indicated for the treatment of wet AMD via monthly intravitreal administration of 0.5mg. The prescribing information available in 2006 also suggested a regimen of three monthly intravitreal injections followed by less frequent dosing. (Ex.1048, Lucentis, 1). Indeed, using a regimen that involved less frequent dosing was a preferred option over monthly dosing at the time, due to the nature of intravitreal injections.

59. Intravitreal treatment involves administering an injection directly into the vitreous of the eye. Because of this, patients can experience significant pain and discomfort. Soreness in the injected eye is a frequent side effect. In addition, potential complications that can occur include subconjunctival hemorrhage, infection, and inflammation. While the risk of infection is small, the consequences can be devastating. Lastly, the cost and inconvenience of monthly visits and injections can be a major drawback for patients, many of whom are elderly, cannot drive due to their deteriorating vision, and must rely on family, friends, or public transportation to get to their appointments—which can sometimes take 2-5 hours because of the assessments (optical coherence tomography (OCT) scan and visual acuity (VA)) that must be done, followed by the actual treatment, if necessary.



60. These drawbacks and risks were a recognized concern in the mid- and late-2000's. As a result, the frequency of injections was the subject of investigation for those of ordinary skill in the art at the time, as well as in the patient community, and provided with this strong motivation to move from monthly dosing to less frequent dosing, the trend in place before the '069 patent's priority date was already moving away from monthly dosing. This is evident from the Lucentis (ranibizumab) 2006 prescribing information ("treatment may be reduced to one injection every three months after the first four injections"), as well as the ranibizumab trials initiated by Genentech after the early ANCHOR and MARINA monthly dosing trials, almost all of which were exploring ways to reduce injection frequency, including through PRN dosing regimens. (*See, e.g.*, SUSTAIN (PRN dosing after 3 monthly loading doses); EXCITE (quarterly dosing after 3 monthly loading doses); PrONTO (PRN dosing after three monthly loading doses); SAILOR (PRN dosing after 3 monthly loading doses); and PIER (quarterly dosing after 3 monthly loading doses); Ex.1030, Mitchell, 6-7).

61. Also, in my experience, by 2010/2011 very few physicians were engaging in straight monthly dosing of VEGF antagonists. The typical practice was to either (1) treat with 2 or 3 monthly loading doses, followed by as-needed dosing thereafter, based on OCT and visual acuity assessments; or (2) engage in what has

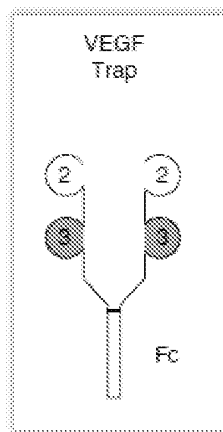
been termed “treat-and-extend,” which involves 2 or 3 loading doses, followed by increased spacing between visits, so long as the patient is maintaining gains in visual acuity. (*See, e.g.,* Ex.1027, Spaide, 305; Ex.1049, Spielberg, 24 (“Our modified ‘evaluate-and-extend’ approach utilized the same evaluation strategy [as treat-and-extend], allowing for frequent evaluation of the fundus, but only treated as-needed, in case of recurrence.”)).

62. Thus, because of the strong motivation to move away from monthly dosing, those in the medical and research communities had already proposed and tested extended regimens for intravitreally-administered anti-VEGF biologics, including PRN regimens, to reduce the time, expense, and patient discomfort associated with monthly intravitreal injections, and medical practitioners were already incorporating such regimens into their practice. (Ex.1027, Spaide, 305; Ex.1049, Spielberg, 24; *see also, e.g.,* Ex.1006, Dixon, 1574; Ex.1012, Regeneron (28-April-2008), 1 (noting that the long residence time of VEGF Trap-Eye in the eye means that the drug may be able to be dosed less frequently than once-monthly); Ex.1050, Schmidt-Erfurth, 1153 (“[The ranibizumab PrONTO study] suggested that flexible OCT-guided retreatment could sustain visual gain with fewer injections, a concept which has since become a popular model in clinical practice, particularly in Europe.”); Ex.1051, Keane, 592 (“[M]uch effort has focused on the development of

alternative treatment regimens, which would reduce the number of injections required . . . .”).

**D. VEGF Trap-Eye/Aflibercept.**

63. VEGF Trap-Eye is a VEGF blocker developed by Regeneron. Unlike the VEGF blocker ranibizumab, which is a humanized monoclonal antibody, VEGF Trap-Eye is a fusion protein of Ig domain 2 of human VEGFR1 and Ig domain 3 of human VEGFR2, combined with a human IgG Fc fragment, as depicted below:



(Ex.1006, Dixon, 1575-76, Fig.1; *see also* Ex.1012, Regeneron (28-April-2008), 2 (“VEGF Trap-Eye is a fully human, soluble VEGF receptor fusion protein that binds all forms of VEGF-A along with the related Placental Growth Factor (PlGF).”)).

64. In 2002, Regeneron published an article detailing its development of VEGF Trap-Eye, a high-affinity VEGF blocker “that has prolonged *in vivo* pharmacokinetics and pharmacodynamics, lacks nonspecific toxicities, and can

effectively suppress the growth and vascularization of a number of different types of tumors *in vivo*,” and was intended to treat disorders associated with increased angiogenesis. (Ex.1004, Holash, 11393).

65. From this, the authors concluded that “although the parental VEGF-Trap and its VEGF-Trap<sub>R1R2</sub> derivative are quite comparable *in vitro* (see above), the VEGF-Trap<sub>R1R2</sub> performs much better *in vivo*, presumably because of its dramatically enhanced pharmacokinetic profile.” (*Id.*, 11395-96). The authors closed with a report of studies comparing VEGF-Trap<sub>R1R2</sub> with anti-VEGF monoclonal antibodies, and concluded that efficacy was equal to or better than anti-VEGF antibodies. This led the authors to conclude that given the comparable half-lives of fusion proteins in humans, the efficacious dose of the VEGF Trap may be much lower than that of a monoclonal anti-VEGF antibody. (*See id.*, 11397).

66. The Holash authors also concluded that VEGF-Trap may be useful in the treatment of retinopathies, given the contribution of pathological angiogenesis to such disorders. (*See id.*).

67. This is consistent with the understanding of physicians at the time that VEGF Trap-Eye was known to have a high binding affinity to VEGF, which the medical community believed could translate to good clinical efficacy outcomes.

68. Subsequent work by Regeneron reinforced VEGF Trap's potential as a possible antiangiogenic therapy for vascular eye diseases. For example, Rudge noted that blocking VEGF-A exhibited impressive results in the treatment of wet AMD, suggesting that a VEGF blockade like VEGF Trap could be useful in treating eye disorders characterized by leaky and proliferating vasculature. (Ex.1052, Rudge, 411).

69. Rudge also includes experimental work which indicated a role for VEGF in the pathology of other vascular eye disorders, including diabetic edema, DR, and AMD. (*Id.*, 414). Preclinical studies with VEGF Trap showed that it was able to inhibit choroidal and corneal neovascularization, suppress vascular leak in the retina, and promote the survival of corneal transplants by inhibiting neovascularization. (*Id.*). Following the promising preclinical trials, VEGF Trap entered clinical trials assessing its effectiveness in treating AMD and diabetic edema and retinopathy. The preliminary results showed that "VEGF Trap can rapidly and impressively decrease retinal swelling, and that these changes can be associated with improvement in visual acuity." (*Id.*, 414-15). The authors also noted that the VEGF Trap was in the process of entering even more clinical trials related to vascular eye diseases. (Ex.1052, Rudge, 415).

**E. Regeneron's Press Releases and Clinical Trials.**

70. In the mid-2000's, Regeneron began reporting on its clinical trials on VEGF Trap-Eye in AMD patients, and in or around 2009, began clinical trials in RVO and DME patients. Provided below is a table summarizing the trials, their nomenclature, exemplary dosing regimens involved, and some of the references that refer to and describe those studies, which will be discussed in greater detail later in my declaration.

| <b>Trial</b>  | <b>Name</b>  | <b>Reference(s)</b>            | <b>Dosing regimen</b>   |
|---------------|--------------|--------------------------------|---|
| Phase 1 (AMD) | CLEAR-IT-1   | Dixon; Nguyen-2009             | Single intravitreal injection (incl. 0.5, 2, and 4 mg doses)                        |
| Phase 2 (AMD) | CLEAR-IT-2   | Heier-2009; Dixon; Adis        | Monthly or quarterly through week 12 followed by PRN (incl. 0.5, 2, and 4 mg doses) |
| Phase 3 (AMD) | VIEW1; VIEW2 | Dixon; Adis; NCT-795; NCT-377; | Monthly through week 8, followed by   |

|               |                        |                                       |   |
|---------------|------------------------|---------------------------------------|---|
|               |                        | Regeneron (8-May-2008) <sup>3</sup>   | every 8 weeks (0.5 and 2 mg doses)  |
| Phase 3 (RVO) | GALILEO;<br>COPERNICUS | Regeneron (30-April-2009);<br>NCT-973 | Monthly for six months, PRN thereafter  |
| Phase 2 (DME) | DA VINCI               | Regeneron (18-February-2010)          | Monthly (0.5 or 2 mg doses) or bimonthly/PRN following three monthly (2 mg doses) |

71. In addition, because some of the AMD clinical trials involving ranibizumab (LUCENTIS<sup>®</sup>) are discussed throughout my declaration, and the dosing regimens used in those studies are relevant to the dosing regimen used in

---

<sup>3</sup> The VIEW1 and VIEW2 trials were discussed in numerous Regeneron press releases between August 2007 and the time the '069 patent priority applications were filed in 2011. Regeneron (8-May-2008) is provided here as an illustrative example.

Regeneron's Phase 3 VIEW1/2 studies of VEGF Trap-Eye, a table summarizing those studies is also provided.

| Trial <sup>4</sup><br>(Disease) | Dosing regimen                               |
|---------------------------------|--|
| MARINA (AMD)                    | Monthly                                      |
| ANCHOR (AMD)                    | Monthly                                      |
| PIER (AMD)                      | Quarterly after 3 initial monthly injections |
| EXCITE (AMD)                    | Quarterly after 3 initial monthly injections |
| PrONTO (AMD)                    | PRN after 3 initial monthly injections       |
| SAILOR (AMD)                    | PRN after 3 initial monthly injections       |
| SUSTAIN (AMD)                   | PRN after 3 initial monthly injections       |
| RESOLVE (DME)                   | PRN after 3 initial monthly injections       |

---

<sup>4</sup> A summary of these trials also can be found in Mitchell (Ex.1030) and Massin (Ex.1031).



72. In connection with Regeneron’s VEGF Trap clinical program, Regeneron issued a series of press releases, beginning around March 2007 and disclosing at least the following information regarding its clinical trials to persons of ordinary skill in the art:

| Press Release | Representative Disclosure   |
|---------------|---|
| 27 Mar. 2007  | <p><b><u>Phase 2 trial:</u></b> 4-week (i.e., monthly) dosing of AMD patients with 0.5 or 2.0 mg of VEGF Trap-Eye yields “a statistically significant reduction in retinal thickness after 12 weeks.” (Ex.1053, Regeneron (27-March-2007), 1).</p>  |
| 2 Aug. 2007   | <p><b><u>Phase 2 trial:</u></b> Results show monthly (i.e., every 4 week) VEGF Trap-Eye dosing in AMD patients yields “a statistically significant reduction in retinal thickness and improvement in visual acuity after 12 weeks.” (Ex.1054, Regeneron (2-August-2007), 1).</p> <p><b><u>Phase 3 trial:</u></b> VIEW1 trial initiated, testing the safety and efficacy of VEGF Trap-Eye dosed in AMD patients at either <u>4-week intervals</u> (0.5 and 2.0 mg) or <u>8-week intervals</u> (2.0 mg). (Id.).</p> |

28 Apr. 2008

**Phase 2 trial:** Previously reported gains in visual acuity and decreases in retinal thickness for week 12 were maintained out to week 32 when using a PRN (i.e., *pro re nata* or as-needed) dosing schedule after week 12. PRN dosing was “determined by the physician’s assessment of pre-specified criteria,” including “safety, retinal thickness, and visual acuity.” Further, during the PRN dosing period after the initial loading doses, “patients from all dose groups combined required, on average, only one additional injection over the following 20 weeks to maintain the visual acuity gain established during the fixed-dosing period. Notably, 55 percent of the patients who received 2.0 mg monthly for 12 weeks did not require any additional treatment throughout the next 20-week PRN dosing period.” (Ex.1012, Regeneron (28-April-2008), 1).

**Phase 3 trials (VIEW1 & 2):** Testing “a monthly loading dose of 0.5 mg or 2.0 mg for 12 weeks, followed by a nine-month fixed-dosing regimen of 0.5 mg monthly, 2.0 mg monthly, or 2.0 mg every eight weeks.” (*Id.*, 2).

|               |   |
|---------------|---|
| 8 May 2008    | <p><b><u>Phase 2 trial:</u></b> “[P]atients on the PRN dosing schedule maintained the gain in visual acuity and decrease in retinal thickness achieved at week 12 through week 32 of the study.” (Ex.1013, Regeneron (8-May-2008), 1).</p> <p><b><u>Phase 3 trials (VIEW1 &amp; 2):</u></b> Evaluating “2.0 mg [VEGF Trap-Eye] at an 8-week dosing interval, including one additional 2.0 mg dose at week four,” for up to one year—i.e., doses at weeks 0, 4, 8, 16, 24, 32, 40, and 48. (<i>Id.</i>).</p> |
| 28 Sept. 2008 | <p><b><u>Phase 2 trial:</u></b> Patients receiving monthly doses of either 2.0 or 0.5 mg VEGF Trap-Eye for 12 weeks followed by PRN dosing achieved improved visual acuity and decreased retinal thickness after one year.<sup>5</sup> Specifically, “[p]atients receiving monthly doses of VEGF Trap-Eye of either 2.0 or 0.5 milligrams (mg) for 12 weeks followed by PRN dosing achieved mean</p>  |

<sup>5</sup> The September 28, 2008 Press Release also reported that the Phase 2 results were presented earlier that day at the 2008 annual meeting of the Retina Society in Scottsdale, AZ, and that slides, including data reported at the meeting, were available at the Regeneron website. (*See, e.g.,* Ex.1055, Retina Society Meeting Presentation).

|              |  |
|--------------|--|
|              | <p>improvements in visual acuity versus baseline of 9.0 letters (p&lt;0.0001 versus baseline) and 5.4 letters (p&lt;0.085 versus baseline), respectively, at the end of one year. . . . During the week 12 to week 52 PRN dosing period, <i>patients initially dosed on a 2.0 mg monthly schedule received, on average, only 1.6 additional injections . . . .</i>” (Ex.1056, Regeneron (28-September-2008), 1 (emphasis added)).</p> <p><b><u>Phase 3 trials (VIEW1 &amp; 2):</u></b> Studies involve “2.0 mg [VEGF Trap-Eye] every 8 weeks (following three monthly doses)”— i.e., doses at weeks 0, 4, and 8, followed by doses at weeks 16, 24, 32, 40, and 48.<sup>6</sup> (<i>Id.</i>, 2).</p> |
| 30 Apr. 2009 | <p><b><u>Phase 3 trials (COPERNICUS &amp; GALILEO):</u></b> Evaluating the safety and efficacy of 2 mg VEGF Trap-Eye administered</p>  |

<sup>6</sup> The Phase 3 VIEW1 and VIEW2 studies reported in the above disclosures appear to correspond to the Phase 3 study reported in the '069 patent at Example 4. (*Compare* Ex.1056, Regeneron (28-September-2008), 2, *with* Ex.1001, '069 patent, 9:11 – 13:49).

|              |   |
|--------------|---|
|              | monthly for 6 months, followed by PRN dosing for an additional six months to treat CRVO? <sup>7</sup> (Ex.1028, Regeneron (30-April-2009), 1).  |
| 14 Sep. 2009 | <b><u>Phase 3 trials (VIEW1 &amp; 2)</u></b> : Treatment arms for the first year of the VIEW studies to be (i) 0.5 mg every four weeks; (ii) 2.0 mg every four weeks; and (iii) 2.0 mg every eight weeks following three monthly doses—i.e., doses at weeks 0, 4, and 8, followed by doses at weeks 16, 24, 32, 40, and 48. PRN dosing to be used for the second year of the programs. (Ex.1068, Regeneron (14-September-2009), 1). |
| 18 Feb. 2010 | <b><u>Phase 2 trial (DME)</u></b> : Results for several treatment arms presented, including for 2 mg monthly and 2 mg monthly for three months, followed by PRN dosing. (Ex.1057, Regeneron (18-February-2010), 1).   |

<sup>7</sup> The Phase 3 CRVO study described in the April 2009 Regeneron press release appears to be the same CRVO Phase 3 study described in the '069 patent at Example 6. (See, e.g., Ex.1001, '069 patent, 14:35 – 15:11).

73. In sum, the above press releases set forth disclosures between 2007 and 2010 of several VEGF Trap-Eye (aflibercept) clinical studies that included evaluation of the following dosing regimens:

| Study                                     | Disclosed Dosage Regimen   |
|---|--|
| Phase 2 AMD<br>(CLEAR-IT-2)               | 4 monthly doses of 2 mg; PRN dosing thereafter   |
| Phase 3 AMD<br>(VIEW1 & VIEW2)            | 3 monthly doses of 2 mg followed by dosing every eight weeks (i.e., bimonthly); the second year reverted to PRN dosing |
| Phase 3 CRVO<br>(COPERNICUS &<br>GALILEO) | 6 monthly doses of 2 mg; PRN dosing thereafter   |
| Phase 2 DME<br>(DA VINCI)                 | 3 monthly doses of 2 mg; PRN dosing thereafter   |

## VII. SCOPE AND CONTENT OF THE PRIOR ART REFERENCES.

### A. Dixon (Ex.1006).

74. Dixon was published in August 2009. I understand that because the Dixon reference published before the earliest priority date of the '069 patent,<sup>8</sup> it is prior art. I have reviewed Dixon, which is an article summarizing the current state of AMD therapies as of 2009, and profiling in particular, and the development and clinical testing of Regeneron's VEGF Trap-Eye, including Regeneron's Phase 2 and Phase 3 studies.

75. The following paragraphs represent examples of the disclosures in Dixon that, in my opinion, are relevant to the method(s) of treatment claimed in the '069 patent:

76. As an initial matter, Dixon makes note of the anti-VEGF therapeutics that were on the market before VEGF Trap-Eye's approval—ranibizumab (Lucentis)

---

<sup>8</sup> I have been asked by counsel for Petitioner to use January 13, 2011, as the priority date of the '069 patent for purposes of my declaration. I understand that counsel for Petitioner reserves the right to challenge whether there is sufficient support in the priority document for Regeneron to properly rely on this date.

and bevacizumab (Avastin).<sup>9</sup> (Ex.1006, Dixon, 1573 (“In addition to two anti-VEGF drugs currently in widespread use, ranibizumab and bevacizumab, a number of medications that interrupt angiogenesis are currently under investigation.”)).

77. Dixon reports on several ranibizumab studies, including the PIER and PrONTO studies initiated by Genentech in 2004, which, according to Dixon, were initiated to study alternative dosing schedules that might reduce the “time and financial burden of monthly injections.” (*Id.*, 1574).

- The PIER study assessed patients after receiving 3 monthly (i.e., every 4 week) injections, followed by quarterly (i.e., every 12 week) dosing.
- The PrONTO study assessed patients after receiving 3 monthly (i.e., every 4 week) injections, followed by as-needed (p.r.n.) dosing. The PrONTO study reported that “78% of patients had maintained vision and vision had improved by > 3 lines in 43% of patients with an average of five injections a year.” (*Id.*).

---

<sup>9</sup> Although bevacizumab was only approved as a cancer treatment, because of its well-known anti-VEGF mode of action, it was commonly used off-label for the treatment of vitreoretinal disorders. (*See, e.g.*, Ex.1006, Dixon, 1574).



78. While acknowledging the efficacious outcomes achieved with ranibizumab and bevacizumab, Dixon states that in the development of new drugs for treating AMD, the focus at that time was on improving efficacy and extending the duration of action. (*Id.*). Regeneron’s VEGF Trap-Eye—which, at the time, was well known and in commercial development for the treatment of AMD—was identified by Dixon as “[o]ne promising new drug” that “blocks all isoforms of VEGF-A and placental growth factors-1 and -2.” (*Id.*, 1573).

79. Among other VEGF-Trap related disclosures,<sup>10</sup> Dixon discusses Regeneron’s Phase II AMD trial, named CLEAR-IT-2. (*Id.*, 1576). The CLEAR-IT-2 trial included 5 dose groups:

- 0.5 mg monthly for 12 weeks (i.e., doses at weeks 0, 4, 8, and 12);
- 2.0 mg monthly for 12 weeks (i.e., doses at weeks 0, 4, 8, and 12);
- 0.5 mg quarterly for 12 weeks (i.e., doses at weeks 0 and 12);
- 2.0 mg quarterly for 12 weeks (i.e., doses at weeks 0 and 12); and

---

<sup>10</sup> For example, Dixon discusses (i) Regeneron’s CLEAR-IT-1 trial, a two-part, Phase I study of intravitreal aflibercept in patients with AMD; and (ii) “a small open-label safety study for the treatment of diabetic macular edema” with a single dose of 4 mg VEGF Trap.

- 4.0 mg quarterly for 12 weeks (i.e., doses at weeks 0 and 12). (*Id.*).

Following each of the above 12-week fixed dosage regimens, “patients were treated with the same dose of VEGF Trap-Eye on a p.r.n. [i.e., as needed]<sup>11</sup> basis.” (*Id.*). This is consistent with the ’069 patent’s description of the same trial, described in the specification of the ’069 patent at Example 2, where the patentees stated that after the 12 weeks of fixed interval dosing, subjects “were evaluated every 4 weeks for 9 months, during which additional doses were administered based on pre-specified criteria.” (Ex.1001, ’069 patent, 8:19-49).

80. Dixon states that in the Phase 2 CLEAR-IT-2 trial “[p]atients initially treated with 2.0 or 0.5 mg of VEGF Trap-Eye monthly achieved mean improvements of 9.0 ( $p < 0.0001$ ) and 5.4 ( $p < 0.085$ ) ETDRS letters with 29 and 19% gaining, respectively,  $\geq 15$  ETDRS letters at 52 weeks.” (Ex.1006, Dixon, 1576). Dixon also states that “[d]uring the p.r.n. dosing period, patients initially dosed on a 2.0 mg

---

<sup>11</sup> In my experience, PRN dosing at this stage in any such dosing regimen involves monthly visits wherein each patient is evaluated and a determination is made (on a monthly basis) whether another injection is required. Consequently, in my opinion, the most frequent dosing that would typically occur under such a “p.r.n. basis” is monthly (or every 4 weeks).

monthly schedule received an average of 1.6 more injections and those initially dosed on a 0.5 mg monthly schedule received an average of 2.5 injections.” (*Id.*).

81. Dixon also reported on Regeneron’s Phase 3 AMD studies, named VIEW1 and VIEW2, which were intended to “evaluate the safety and efficacy of intravitreal VEGF Trap-Eye.” (*Id.*). The planned dosage regimens included:

- 0.5 mg every 4 weeks (i.e., doses at weeks 0, 4, 8, 12, . . .);
- 2.0 mg every 4 weeks (i.e., doses at weeks 0, 4, 8, 12, . . .);
- 2.0 mg every 8 weeks *after 3 initial, monthly doses* (i.e., doses at weeks 0, 4 and 8, followed by doses at weeks 16, 24, 32, 40, 48, . . .).<sup>12</sup> (*Id.*).

Also included as a comparator was 0.5 mg of ranibizumab administered every 4 weeks. (*Id.*). Furthermore, “[a]fter the first year of the study, patients will enter a second year of p.r.n. dosing evaluation.” (*Id.*).

---

<sup>12</sup> The choice of every-eight-week, or bimonthly dosing, is consistent with Dixon’s stated concerns among physicians about the time and financial burdens of monthly administration required for existing therapies, like ranibizumab, and the suggestion that “desirable attributes for emerging therapies for neovascular AMD include higher visual improvement rates and *decreased dosing intervals*.” (Ex.1006, Dixon, 1577 (emphasis added)).

82. The Dixon authors also note that “VEGF Trap-Eye is under Phase II investigation in DME and Phase III investigation in central retinal vein occlusion” and suggest that “FDA approval of VEGF Trap-Eye for these indications would significantly add to the ophthalmologists’ armamentarium for treatment of retinal vascular disease.” (*Id.*, 1577-78).

**B. Adis (Ex.1007).**

83. The Adis reference was published in 2008. I understand because the Adis reference published before the earliest priority date of the ’069 patent, it is prior art.

84. Adis discloses VEGF Trap-Eye clinical trials, including the VIEW1/2 Phase 3 trials and the CLEAR-IT-2 Phase 2 trial, and the dosing regimens used in each.

85. Adis discloses that “[a]flibercept is a fully human recombinant fusion protein composed of the second Ig domain of VEGFR1 and the third Ig domain of VEGFR2, fused to the Fc region of human IgG<sub>1</sub>,” and that while Regeneron and Sanofi were developing it for the treatment of cancer, Regeneron and Bayer were developing it for eye disorders. (Ex.1007, Adis, 261). Throughout Adis, including in the title, the authors use the terms aflibercept and VEGF Trap-Eye interchangeably. (*See, e.g., id.* at Title).

86. Adis states that “Regeneron and Bayer initiated a phase III trial of aflibercept in approximately 1200 patients with the neovascular form of wet AMD in August 2007.” (*Id.*, 263).

87. According to Adis the VIEW1 and VIEW2 trials were initiated to evaluate the safety and efficacy of (1) 0.5 and 2.0 mg doses administered monthly (i.e., at weeks 0, 4, 8, 12, 16 . . .); or (2) 2.0 mg doses administered every 8 weeks following three monthly doses (i.e., at weeks 0, 4, 8, 16, 24, 32, 40, and 48). (*Id.* (“2.0 mg at an 8-week dosing interval, including one additional 2.0 mg dose at week 4.”)).<sup>13</sup>

88. Adis also discusses Regeneron disclosures indicating that “Regeneron has completed a 12-week, phase II trial in patients with wet AMD, to evaluate the safety and efficacy of intravitreal aflibercept using different doses and dose regimens.” (*Id.*, 263). Adis states that these dosage regimens were:

- 0.5 mg monthly for 12 weeks (i.e., doses at weeks 0, 4, 8, and 12);

---

<sup>13</sup> Notably, Adis cites Regeneron and Bayer Press Releases retrieved online from the companies’ respective websites. (*See, e.g., id.*, 263, 268 (ref. nos. 10-13)). In my opinion, this confirms that such press releases were well known and widely available to persons of ordinary skill in the art prior to January 2011.

- 2.0 mg monthly for 12 weeks (i.e., doses at weeks 0, 4, 8, and 12);
- 0.5 mg quarterly for 12 weeks (i.e., doses at weeks 0 and 12);
- 2.0 mg quarterly for 12 weeks (i.e., doses at weeks 0 and 12); and
- 4.0 mg quarterly for 12 weeks (i.e., doses at weeks 0 and 12). (*Id.*)

Adis further discloses that the patients from the Phase 2 trial received “as-needed (PRN)” dosing after the 12-week fixed dose period. (*Id.*, 267-68).

89. Adis further reports that in the Phase 2 study “157 patients receiving either 0.5 or 2.0 mg followed by as-needed (PRN) dosing achieved mean improvements in visual acuity of 8.0 and 10.1 letters, respectively, and mean decreases in retinal thickness of 141 and 162 microns, respectively.” (*Id.*, 267). The authors continue, observing that while PRN dosing following fixed quarterly dosing maintained improvements, it was not as robust as those results achieved with initial fixed monthly dosing. (*Id.*, 268). However, patients from all dose groups only required, on average, one additional injection between weeks 12 and 32, and fifty-five percent of patients in the 2 mg monthly fixed dose group did not require any additional injections between weeks 12 and 32. (*Id.*). They also report that phase I AMD preliminary results “have shown rapid, substantial and prolonged ( $\geq 4$  weeks) reductions in retinal thickness with single-dose intravitreal injections of VEGF Trap.” (*Id.*).

**C. Regeneron (28-April-2008) (Ex.1012).**

90. According to Regeneron (28-April-2008), it was made available to the public by Regeneron on April 28, 2008. Because this falls before the earliest priority date of the '069 patent, it is my understanding that this makes Regeneron (28-April-2008) prior art to the '069 patent.

91. Regeneron (28-April-2008) reports on the results of the Phase 2 study in AMD (also discussed above in Dixon and Adis) in which patients were assessed at 32 weeks after receiving fixed dosing of VEGF Trap-Eye for the first 12 weeks, followed by PRN dosing. The treatment arms were the same as those disclosed above in Dixon and Adis and included a regimen of 4 fixed monthly doses followed by a PRN schedule based upon physician assessment of pre-specified criteria. (Ex.1012, Regeneron (28-April-2008), 1). The investigators concluded that all dosing groups exhibited mean gains in visual acuity and a decrease in retinal thickness, but also noted that patients that initially received the fixed monthly dosing exhibited greater improvements than those that received fixed quarterly dosing. (*Id.*). One of the lead investigators, Dr. Quan Dong Nguyen, noted that the long residence time of VEGF Trap-Eye in the eye means that the drug may be able to be dosed less frequently than once monthly. (*Id.*).

92. Regeneron (28-April-2008) also contains a statement from the sole inventor listed on the '069 patent, Dr. George Yancopoulos: “[t]hese study results further increase our confidence in the design of our Phase 3 clinical program for VEGF Trap-Eye in wet AMD,” including PRN dosing in the second year of the studies. (*Id.*, 2).

93. Regeneron also stated that the 32-week results would be disclosed and discussed “today” (i.e., April 28, 2008) at the 2008 Association for Research in Vision and Ophthalmology (ARVO) annual meeting in Fort Lauderdale, a meeting targeted to basic and clinical eye and vision researchers.<sup>14</sup> (*Id.*, 1). Regeneron (28-April-2008) also states that the Phase 2 study data being reported at the meeting were being made available on Regeneron’s website at the Investor Relations page. (*Id.*).

**D. Heier-2009 (Ex.1020).**

94. Heier-2009, published in 2009, describes the CLEAR-IT-2 Phase 2 trial assessing the safety and efficacy of VEGF Trap-Eye in the treatment of AMD—this is the same Phase 2 trial described above in Dixon, Adis, and Regeneron (28-April-

---

<sup>14</sup> Contemporaneous references disclose that the ARVO Conference was held April 27 – May 1, 2008 in Fort Lauderdale, FL. (*See, e.g.*, Ex.1058, ARVONews, Winter/Spring 2008, 19; Ex.1059, ARVONews Summer 2007, 11).



2008). Because Heier-2009 was published well before the earliest priority date of the '069 patent, it is my understanding that this makes Heier-2009 prior art to the '069 patent.

95. Heier-2009 discloses that the CLEAR-IT-2 trial involved two treatment arms: (1) patients received either monthly intravitreal injections; or (2) quarterly intravitreal injections through three months. Both of these arms included PRN/as-needed doses at monthly visits for the remainder of the year, and both treatment arms explored different doses (0.5 or 2.0 mg for the monthly arm; 0.5, 2.0, or 4.0 mg for the quarterly arm). (Ex.1020, Heier-2009, 45).

96. Heier-2009 reports that after one year, patients receiving the monthly loading dose regimen followed by as-needed dosing “achieved mean improvements in BCVA [best-corrected visual acuity] of 9.0 letters from baseline” and “mean decreases in retinal thickness vs. baseline.”<sup>15</sup> (*Id.*).

---

<sup>15</sup> While Heier-2009 states that patients received “three monthly doses,” it is my opinion that patients received four doses at weeks 0, 4, 8, and 12, as indicated by Heier-2009’s disclosure that patients received injections “for an initial 3-month fixed-dose period,” and confirmed by Dixon, and that one of ordinary skill in the art reading Heier-2009 would have understood “three monthly doses” to be in addition

97. Heier-2009 also notes that there was a six-month extension stage of the CLEAR-IT-2 trial, in which patients continued to receive 2.0 mg of VEGF Trap-Eye on an as-needed basis. (*Id.*) The 117 patients who entered the extension phase achieved BCVA improvement of 7.1 letters compared to baseline. (*Id.*) Over the 15-month as-needed phase of the CLEAR-IT-2 trial, patients received a mean of 3.5 injections. (*Id.*)

98. Heier-2009 further reports that the treatment was well-tolerated and no serious adverse events were observed, and concludes that patients with AMD “achieved and maintained significant improvement in BCVA for 18 months with initial fixed dosing followed by 15 months of as-needed administration.” (*Id.*)

99. Heier-2009 also notes that the results of the CLEAR-IT-2 trial were presented at the 2008 Retina Society annual meeting in Scottsdale, Arizona, and the six-month extension results were presented at the 2009 ARVO annual meeting in Fort Lauderdale. (*Id.*, 44-45). Heier-2009 also cites the presented papers, indicating

---

to the initial dose. (See Ex.1020, Heier-2009, 45; Ex.1006, Dixon, 1576 (“Two groups received monthly doses of either 0.5 or 2.0 mg for 12 weeks (at weeks 0, 4, 8 and 12) . . . .”)).

the public availability of these presentations to those of ordinary skill in the art. (*Id.*, 45).

**E. Regeneron (30-April-2009) (Ex.1028).**

100. According to Regeneron (30-April-2009), it was made available by Regeneron on April 30, 2009. Because this falls before the earliest priority date of the '069 patent, it is my understanding that this makes Regeneron (30-April-2009) prior art to the '069 patent.

101. Regeneron (30-April-2009) represents Regeneron's efforts to expand beyond AMD and assess VEGF Trap-Eye in other vitreoretinal disorders, including RVO and DME. Regeneron (30-April-2009) discloses aspects of Regeneron's clinical program for central retinal vein occlusion (CRVO). (Ex.1028, Regeneron (30-April-2009), 1). The Phase 3 program was described as consisting of two multinational, one-year studies in which patients were to receive six monthly injections, followed by six months of PRN (as needed) dosing. (*Id.*). The first of these studies was to be led by Regeneron and was termed COPERNICUS (Controlled Phase 3 Evaluation of Repeated intravitreal administration of VEGF Trap-Eye In Central retinal vein occlusion: Utility and Safety) and the second was to be led by Bayer and was named GALILEO (General Assessment Limiting

Infiltration of Exudates in central retinal vein Occlusion with VEGF Trap-Eye).  
(*Id.*).

102. Regeneron (30-April-2009) also states that “[a]dditional information about Regeneron and recent news releases are available on Regeneron’s web site at [www.regeneron.com](http://www.regeneron.com)” and in Regeneron’s filings with the United States Securities and Exchange Commission (SEC), including its Form 10-K. (*Id.*, 2). Finally, Regeneron (30-April-2009) ends with a date and time stamp:

```
PR
-- NY08289 --
8289 04/30/2009 02:00 EDT http://www.prnewswire.com
```

(*Id.*, 3).

**F. Mitchell (Ex.1030).**

103. Mitchell, published online in 2009, analyzes data from several ranibizumab clinical trials in an assessment of various dosing schedules. Because Mitchell was available online well before the earliest priority date of the '069 patent, it is my understanding that this makes Mitchell prior art to the '069 patent. As discussed above, ranibizumab (Lucentis®) is a monoclonal anti-VEGF antibody approved in 2006 for AMD and marketed and sold by Genentech. Because of the large overlap in mode of action and approved indications between ranibizumab and

the indications being pursued by Regeneron for VEGF Trap-Eye, the dosing regimens used and explored for ranibizumab were highly informative and, in some cases identical, to those being considered for VEGF Trap-Eye.

104. The Mitchell authors note that the regimen involving three monthly doses followed by monthly injections has provided the best outcomes, but also state that a more flexible approach is viable where monthly monitoring is coupled with flexible re-treatment. (Ex.1030, Mitchell, 2). The authors also note that “[i]nitiation regimens of fewer than three injections have not been assessed.” (*Id.*).

105. Mitchell begins by describing the ranibizumab clinical trials utilizing monthly dosing—MARINA and ANCHOR. Mitchell notes that “[r]anibizumab initiation with three consecutive monthly injections appears optimal as this is when the majority of patients experienced most VA gain in all studies” and “[i]mprovements occurred rapidly, and the largest VA gain occurred after the first injection.” (*Id.*, 4; *see also id.*, 5 (Fig.1)).

106. Mitchell also discloses that “[m]ost VA improvement was seen during the initial 3-month phase with subsequent injections appearing to maintain the achieved benefit” and suggests that “[p]rospective clinical trials would be valuable for investigating fewer injections in the initiation phase.” (*Id.*).

107. After the monthly dosing MARINA and ANCHOR studies yielded positive results, researchers turned to investigating less frequent dosing schedules of ranibizumab. For example, the PrONTO and SUSTAIN studies were designed to deliver three initial monthly doses, followed by monthly monitoring, with injections administered when needed to maintain the visual acuity gains from the first three months. (Mitchell, 6-7). Mitchell reports that these regimens were able to deliver outcomes similar to the monthly dosing regimens in MARINA and ANCHOR. (*Id.*, 6). Mitchell concludes that appropriate dosing intervals may include monthly dosing, but that when monthly dosing is not feasible, a flexible approach that includes monthly monitoring may be used. (*Id.*, 7). Mitchell further explains that during the monthly monitoring, “[i]f active disease is present or recurs, additional treatment should be initiated quickly to improve functional outcomes,” and “[i]f the disease is inactive, retreatment can be deferred”—in other words, as-needed (PRN) dosing. (*Id.*, 11).

**G. Lalwani (Ex.1035).**

108. Lalwani, published in 2009, sets forth the 2-year data from the PrONTO study also described in Fung. Because Lalwani was published well before the earliest priority date of the '069 patent, it is my understanding that this makes Lalwani prior art to the '069 patent. The focus of the PrONTO study described in

Lalwani was the same: a loading dose phase with injections at day 0 (baseline), month 1 and month 2, followed by as-needed injections (i.e., PRN dosing). (Ex.1035, Lalwani, 43). The difference is that the second-year retreatment criteria were amended to include “any qualitative increase in the amount of fluid detected using OCT.” (*Id.*). Lalwani notes the uncertainty about whether monthly dosing is ideal, and discusses the observations from earlier studies that OCT-guided treatment might provide a way to determine the appropriate dosing intervals for each individual patient. (*Id.*). According to Lalwani, these observations led to testing whether an OCT-guided regimen “could result in fewer injections and similar clinical outcomes.” (*Id.*, 44).

109. At the conclusion of the 24-month study, Lalwani reports visual acuity mean improvement of 11.1 letters and a mean decrease in retinal thickness of 212  $\mu\text{m}$ . (*Id.*, 47-48). Moreover, these improvements were seen with a mean number of injections of 9.9 over two years. (*Id.*, 48-49). This compares to 24 injections received by patients in the two-year MARINA and ANCHOR studies that utilized straight monthly dosing. (*Id.*, 56). Thus, with fewer than half the number of injections with PRN dosing, researchers were able to achieve comparable outcomes to that observed for monthly dosing. (*Id.*). This was an important development and

suggested that the overall goal of decreasing the number of injections could be met by an as-needed dosing scheme.

#### H. '758 Patent (Ex.1010).

110. U.S. Patent No. 7,374,758 issued May 20, 2008, from Application No. 11/016,503, filed on December 17, 2004, and is assigned, on its face, to Regeneron Pharmaceuticals, Inc. I understand that the '758 patent qualifies as prior art to the '338 patent because it issued prior to January 13, 2011, the earliest priority date of the '338 patent.

111. The '758 patent is drawn to “[m]odified chimeric polypeptides with improved pharmacokinetics” and methods of “using the modified polypeptides to decrease or inhibit plasma leakage and/or vascular permeability in a mammal.” (Ex.1010, '758 patent, Abstract). The '758 patent discloses the VEGF fusion polypeptide disclosed as preferred embodiments in the '664 patent discussed above. Specifically, the '758 patent sets forth in Figure 24A-C the annotated sequence of VEGFR1R2-Fc $\Delta$ C1(a), which includes the signal sequence (aa 1-26); the Flt-1 Ig domain 2 (aa 27-129); the Flk-1 Ig domain 3 (aa 130-231); and the Fc domain (aa 232-458). (*Id.*, Fig.24A-C; *see also id.*, 10:15-17 (“Nucleotide (SEQ ID NO:15) and deduced amino acid sequence (SEQ ID NO:16) of the modified Flt1 receptor termed VEGFR1R2-Fc $\Delta$ C1(a).”)).



**I. Dix (Ex.1033).**

112. U.S. Publication No. 2006/0217311 (“Dix”) was published September 28, 2006, from Application No. 11/387,256, filed March 22, 2006. Because Dix published before January 13, 2011, the earliest priority date of the ’338 patent, it is my understanding that Dix qualifies as prior art to the ’338 patent.

113. Dix is drawn to “[f]ormulations of a vascular endothelial growth factor (VEGF)-specific fusion protein antagonist” wherein “[p]referably, the fusion protein has the sequence of SEQ ID NO:4.” (Ex.1033, Dix, Abstract). I note that SEQ ID NO:4 of Dix is the same as that of SEQ ID NO:2 of the ’338 patent.

114. Dix discloses that “[a] soluble VEGF-specific fusion protein antagonist, termed a ‘VEGF trap’ has been described [in Holash (Ex.1004)], which applications are specifically incorporated by reference in their entirety.” (*Id.*, [0005]). Dix describes the fusion protein as containing the second Ig domain of Flt1, the third Ig domain of Flk1, and a multimerizing component, and more specifically, where the fusion protein has the amino acid sequence of SEQ ID NO:2 or SEQ ID NO:4. (*Id.*, [0008]). More preferred embodiments consist of formulations containing the fusion protein with the amino acid sequence of SEQ ID NO:4. (*Id.*, [0013]-[0014]). Furthermore, a specific embodiment includes a fusion protein comprising amino acids 27-457 of SEQ ID NO:4. (*Id.*, [0030]).

## VIII. UNPATENTABILITY OF THE '069 PATENT.

### A. Claims 1 and 9-12 of the '069 Patent Are Anticipated by the CLEAR-IT-2 Disclosures in Either Heier-2009 (Ex.1020) or Dixon (Ex.1006).

#### 1. Claim 1 is anticipated by Heier-2009 and Dixon.

115. I was asked to review claim 1 of the '069 patent (set forth above), as well as the disclosures of Regeneron's CLEAR-IT-2 trial, including the discussion in Heier-2009 and Dixon, and was then asked to consider whether each and every element of Claim 1 is present in the CLEAR-IT-2 disclosures, found for example in the Heier-2009 and Dixon references. It is my opinion that each of Heier-2009 and Dixon, as well as the other references disclosing Regeneron's Phase 2 trial, disclose every element of the claimed method(s) and thus anticipate each of the challenged claims 1 and 9-12 of the '069 patent.

116. Based on the movement away from monthly dosing, it came as no surprise when Regeneron disclosed the dosing regimen structure of its Phase 2 program (CLEAR-IT-2), which involved the administration of VEGF Trap-Eye to patients with AMD, through a regimen of PRN dosing following four monthly doses. (Ex.1020, Heier-2009, 45 (disclosing "monthly intravitreal injections . . . for an initial 3-month fixed-dose period, after which they received the same doses on an as needed basis"); Ex.1006, Dixon, 1576 ("Two groups received monthly doses of

either 0.5 or 2.0 mg for 12 weeks (at weeks 0, 4, 8 and 12) . . . Following this fixed dosing period, patients were treated with the same dose of VEGF Trap-Eye on a p.r.n. basis.”)).

117. Indeed, dosing regimens including less frequent dosing were becoming the norm due to the concerns over the inconvenience and discomfort of receiving monthly intravitreal injections. (*See* Ex.1006, Dixon, 1574 (“The time and financial burden of monthly injections has led to the initiation of studies to examine the efficacy of alternative dosing schedules.”)). For example, the Dixon authors note that the ranibizumab PrONTO AMD study, was designed to study as-needed/prn dosing after three monthly injections. (*Id.*). The study employed ocular coherence tomography and fluorescein angiogram analyses to determine the need for further injections. (*Id.*). The authors indicate that the PrONTO study showed that it may be possible to extend the time between injections when patients are closely monitored. (*Id.*). This is consistent with my experience in the industry, where, at that time, increasing the time between injections was the primary approach of ophthalmological researchers and medical providers.

118. Thus, the dosage regimens being tested in Regeneron’s Phase 2 VEGF Trap-Eye study (PRN following 4 monthly doses) fell right in with the prevailing trend at the time. (*See id.*).

119. The Phase 2 PRN dosing was to be based on “visual and/or anatomical outcomes as assessed by a physician.” For example, Heier-2009 notes that the as-needed dosing was to be administered at “monthly visits out to 1 year.” (Ex.1020, Heier-2009, 45). A person of ordinary skill in the art would recognize that the monthly visits in a PRN dosing scheme would necessarily include an assessment “based on visual and/or anatomical outcomes” prior to making a determination about whether an injection was needed at that visit. Likewise, Dixon discloses that the criteria used to assess the need for administering doses during this PRN period included “an increase in central retinal thickness of  $\geq 100 \mu\text{m}$  by OCT, a loss of  $\geq 5$  ETDRS letters in conjunction with recurrent fluid by OCT, persistent fluid as indicated by OCT, new onset classic neovascularization, new or persistent leak on FA or new macular subretinal hemorrhage.” (Ex.1006, Dixon, 1576).

120. Further, while I understand that a claim preamble is presumed not to be a claim limitation, in the event that the Board decides that it is a limitation, a person of ordinary skill in the art would have concluded that the dosage regimens disclosed in Heier-2009 and Dixon, and later claimed in the '069 patent, were capable of “treating an angiogenic eye disorder,” based upon the references’ disclosures of the successful treatment of AMD in the Phase 2 CLEAR-IT-2 trial. (Ex.1020, Heier-2009, 45 (disclosing that “[p]atients who received three monthly doses of 2.0 mg

followed by as-needed dosing achieved mean improvements in BCVA of 9.0 letters from baseline” and “mean decreases in retinal thickness vs baseline at 1 year”); Ex.1006, Dixon, 1576).

121. In view of these disclosures of the dosing regimen and the monthly assessments, *first*, one of ordinary skill in the art readily would have recognized that the claimed “initial dose” would have been the first dose given in the CLEAR-IT-2 regimen—in this case the “baseline” dose, i.e., the first of the four monthly doses disclosed in Heier-2009 and Dixon. *Second*, one of ordinary skill in the art would have recognized that the “secondary doses . . . wherein each secondary dose is administered 2 to 4 weeks after the immediately preceding dose,” could be found in Heier-2009 and Dixon’s disclosure of the next three of the four monthly doses disclosed for the fixed dose period (i.e., the doses at weeks 4, 8, and 12). *Third*, one of ordinary skill in the art would have recognized that the “tertiary dose . . . administered on an as-needed/pro re nata (PRN) basis” could be found in the references’ disclosures that following the twelve-week fixed-dosing period, patients were to be treated on an “as needed,” or “p.r.n. basis.” *Finally*, one of ordinary skill in the art would have recognized that the claim element requiring that the PRN dosing be “based on visual and/or anatomical outcomes as assessed by a physician or other qualified medical professional” could be found in the reference to “as

needed” and “p.r.n.” dosing. By definition, to determine the need for an injection at each visit during the trial, a physician or other qualified medical professional would have to make an assessment, and that would have been well understood by persons of ordinary skill in the art to include visual and/or anatomical outcomes, such as visual acuity and retinal swelling measurements. Indeed, both Heier-2009 and Dixon disclose several measures that physicians were to use in assessing patients for PRN dosing. (See, e.g., Ex.1020, Heier-2009, 45 (assessing BCVA and retinal thickness); Ex.1006, Dixon, 1576).<sup>16</sup>

122. At my direction, the following graphic was compiled to help visualize how each of Heier-2009’s and Dixon’s disclosures of Regeneron’s CLEAR-IT-2 Phase 2 AMD study align with the dosage regimen elements of claim 1 of the ’069 patent:

| Week                  | 0                     | 4   | 8 | 12 | 16                | 24  | 28 | 32 | 36 | 52 |
|-----------------------|-----------------------|---|---|----|-------------------|---|----|----|----|----|
| '069 Patent (Claim 1) | “single initial dose” | “one or more secondary doses [administered 2 to 4 weeks after the immediately preceding dose]...” |   |    |                   | followed by one or more tertiary doses [administered on an as-needed/pro re nata (PRN) basis...]” |    |    |    |    |
| Phase 2 (AMD)         | +                     | +   | + | +  | PRN dosing period |   |    |    |    |    |

<sup>16</sup> I note that claim 1 does not indicate which “visual and/or anatomical outcomes” one should rely upon.

123. Thus, it is my opinion that both Heier-2009 and Dixon, in their disclosures and discussion of the CLEAR-IT-2 study, set forth each and every dosing element of claim 1 of the '069 patent.

124. I also note that for the purposes of my analysis, I have assumed, and as the '069 patent states, that “‘monthly’ dosing is equivalent to dosing once every four weeks.” (Ex.1001, '069 patent, 7:58-59; *see also* Ex.1006, Dixon, 1576 (“Two groups received monthly doses . . . (at weeks 0, 4, 8 and 12) . . .”).

125. Finally, the last element of claim 1—“wherein the VEGF antagonist is a receptor-based chimeric molecule comprising (1) a VEGFR1 component comprising amino acids 27 to 129 of SEQ ID NO:2; (2) a VEGFR2 component comprising amino acids 130-231 of SEQ ID NO:2; and (3) a multimerization component comprising amino acids 232-457 of SEQ ID NO:2”—was disclosed well before January 2011. (*See, e.g.*, Ex.1020, Heier-2009, 44-45; Ex.1006, Dixon, 1575, 1576 (Fig.1); Ex.1010, '758 patent, Fig.24A-C (disclosing the nucleotide sequence and deduced amino acid sequence, as well as a description of each molecular component therein (i.e., the signal sequence, the FLT1 Ig domain 2, the FLK1 Ig domain 3, and the FcΔC1 domain), 10:15-17 (specifying that this molecule is termed “VEGFR1R2-FcΔC1(a).”)); Ex.1033, Dix, SEQ ID NO:4; Ex.1083; Ex.1039, '095 patent, 1:45-54; Ex.1040, WHO Drug Info, 118-19; Ex.1021, 2009 10-Q, 20;

Ex.1041, Regeneron (26-February-2009), 1-2 (using VEGF Trap and aflibercept interchangeably and explaining that “VEGF Trap-Eye is a specially purified and formulated form of VEGF Trap for use in intraocular applications.”); Ex.1007, Adis, 261 (indicating in the title that aflibercept, VEGF Trap (R1R2), and VEGF Trap-Eye, among other terms, were understood by a person of ordinary skill in the art to refer, interchangeably, to the same drug)).

126. Thus, for these reasons, it is my opinion that claim 1 of the '069 patent is anticipated by each of Heier-2009 and Dixon.

**2. Dependent claims 9 and 10 are anticipated by Heier-2009 and Dixon.**

127. I have been informed that claim 9 can be described as “dependent” from claim 1. It is my understanding that a dependent claim incorporates the elements from the independent claim from which it depends.

128. Claim 9 claims the method of claim 1, “wherein the angiogenic eye disorder is selected from the group consisting of: age related macular degeneration, diabetic retinopathy, diabetic macular edema, central retinal vein occlusion, branch retinal vein occlusion, and corneal neovascularization.”

129. Claim 10 claims the method of claim 9, “wherein the angiogenic eye disorder is age related macular degeneration.”



130. The Heier-2009 and Dixon references both indicate in their titles that VEGF Trap-Eye was being studied for the treatment of AMD. Likewise, the bulk of the references' disclosures are devoted to discussing VEGF Trap-Eye as it relates to the treatment of AMD, including disclosure of the regimens and results from the CLEAR-IT-2 AMD clinical trial.

131. Thus, for these reasons, as well as for the reasons discussed above for claim 1, it is my opinion that claims 9 and 10 of the '069 patent are anticipated by each of Heier-2009 and Dixon and their disclosures of the Phase 2 CLEAR-IT-2 trial.

**3. Dependent claim 11 is anticipated by Heier-2009 and Dixon.**

132. Dependent claim 11 depends from claim 1 and recites "wherein all doses of the VEGF antagonist are administered to the patient by topical administration or by intraocular administration."

133. To a person of ordinary skill in the art, it is well-understood that intravitreal administration is a form of intraocular administration. Intraocular administration refers to administration to the eye generally, while intravitreal administration, a subset of intraocular administration, refers to administration directly into the vitreous of the eye.

134. Heier-2009 discloses that CLEAR-IT-2 patients were to receive “intravitreal injections.” (Ex.1020, Heier-2009, 45). In Dixon’s disclosure of the CLEAR-IT-2 studies, Dixon stated that the study will assess patients “treated with VEGF Trap-Eye in one eye” and repeatedly referred to administered “injections.” (Ex.1006, Dixon, 1576). In my opinion, the only way to interpret Dixon’s disclosure is that VEGF Trap-Eye was being administered by intravitreal injection. This is supported by the fact that skilled artisans and authors, such as Heier-2009, understood that to be the case, and the fact that the CLEAR-IT-2 study followed on the CLEAR-IT-1 study, which was a Phase 1 study, also described in Dixon, in which the “safety, tolerability and biological activity of *intravitreal* VEGF Trap-Eye” was evaluated. (*Id.*, 1575 (emphasis added)). Likewise, I have reviewed the slide presentation cited and relied upon by Dixon. (*Id.*, 1576, 1579 (ref. no. 45)). Therein, the presenters expressly state that CLEAR-IT-2 was a “Phase 2, Randomized, Controlled Dose- and Interval-Ranging Study of *Intravitreal* VEGF Trap-Eye in Patients With Neovascular Age-Related Macular Degeneration.” (Ex.1055, Retina Society Meeting Presentation, 1 (emphasis added); *see also* Ex.1007, Adis, 263 (“Regeneron has completed a 12-week, phase II trial in patients with wet AMD, to evaluate the safety and efficacy of *intravitreal* aflibercept . . .” (emphasis added)); Ex.1056, Regeneron (28-September-2008), 1 (“The most

common adverse events [in the Phase 2 trial] were those typically associated with *intravitreal* injections.” (emphasis added))). Further, Dixon’s disclosure of monthly doses of 0.5 or 2.0 mg, and patients being “treated with VEGF Trap-Eye in one eye” in CLEAR-IT-2 would have indicated intravitreal administration to a person of ordinary skill in the art. Intravenous administration is not capable of treating “in one eye,” and intravenous doses would have been denoted in mg/kg.

135. Thus, for these reasons, as well as for the reasons discussed above for claim 1, it is my opinion that claim 11 of the ’069 patent is anticipated by each of Heier-2009 and Dixon and their disclosures of the Phase 2 CLEAR-IT-2 trial.

**4. Dependent claim 12 is anticipated by Heier-2009 and Dixon.**

136. Claim 12 of the ’069 patent claims the method of claim 1, “wherein the VEGF antagonist is VEGFR1R2-Fc $\Delta$ C1(a) encoded by the nucleic acid sequence of SEQ ID NO:1.”

137. The nucleotide sequence for VEGF Trap-Eye/aflibercept was disclosed in prior art references disclosing the amino acid sequence. (*See, e.g.*, Ex.1010, ’758 patent, Fig.24A-C (disclosing the nucleotide sequence and deduced amino acid sequence, as well as a description of each molecular component therein (i.e., the signal sequence, the FLT1 Ig domain 2, the FLK1 Ig domain 3, and the Fc $\Delta$ C1 domain), 10:15-17 (specifying that this molecule is termed “VEGFR1R2-

FcΔC1(a).”); Ex.1033, Dix, SEQ ID NO:3; Ex.1083). Thus, for these reasons, as well as for the reasons discussed above for claim 1, it is my opinion that claim 12 of the '069 patent is anticipated by each of Heier-2009 and Dixon and their disclosures of the Phase 2 CLEAR-IT-2 trial.

**B. Claims 1 and 9-12 of the '069 Patent Are Anticipated by Regeneron (30-April-2009) (Ex.1028).**

**1. Claim 1 of the '069 patent is anticipated by Regeneron (30-April-2009).**

138. I was asked to review claim 1 of the '069 patent (set forth above), as well as the disclosures of Regeneron (30-April-2009), and was then asked to consider whether each and every element of claim 1 is present in Regeneron (30-April-2009). It is my opinion that Regeneron (30-April-2009) discloses every element of the claimed method(s) and thus anticipates each of the challenged claims 1 and 9-12 of the '069 patent.

139. In Regeneron (30-April-2009), Regeneron discloses that Regeneron and Bayer were to extend their development program of VEGF Trap-Eye to include Central Retinal Vein Occlusion (“CRVO”). (Ex.1028, Regeneron (30-April-2009), 1). Regeneron publicly announced that the companies were initiating a Phase 3 study in the second half of that year (2009), and that the studies were to be referred to as COPERNICUS and GALILEO. (*Id.*) They further announced that the studies

will involve treatment arms in which patients will receive 6 monthly intravitreal injections of 2 mg, followed by PRN dosing for an additional six months. (*Id.*)

140. *First*, in view of these disclosures, one of ordinary skill in the art readily would have recognized that the “initial dose” would have been the first dose given—in this case the first of the six monthly doses to be administered. (*See id.*) *Second*, one of ordinary skill in the art would have recognized that the “secondary doses . . . wherein each secondary dose is administered 2 to 4 weeks after the immediately preceding dose,” could be found in Regeneron (30-April-2009)’s disclosure of the next five of the six monthly doses. *Third*, one of ordinary skill in the art would have recognized that the “tertiary dose . . . administered on an as-needed/pro re nata (PRN) basis” could be found in Regeneron (30-April-2009)’s disclosure that following the six-month fixed-dosing period, “all patients will be dosed on a PRN (as needed) basis for another 6 months.” (*Id.*) *Finally*, one of ordinary skill in the art would have recognized that the claim element requiring that the PRN dosing be “based on visual and/or anatomical outcomes as assessed by a physician or other qualified medical professional” could be found in Regeneron (30-April-2009)’s disclosure of the primary endpoint (improvement in visual acuity) as well as a description of the morphology of CRVO (abnormal new blood vessel growth)—characteristics that a physician could use to assess whether a patient requires additional PRN dosing. (*See*

*id.*)<sup>17</sup> As discussed above, it is my understanding that there is a presumption that the preamble is not a claim limitation. However, if it is, one of ordinary skill in the art would have recognized VEGF Trap-Eye's ability to treat VEGF-mediated eye disorders based on the visual acuity and retinal thickness results observed with the AMD CLEAR-IT-2 trial. Although AMD and RVO are different disorders, a person of ordinary skill in the art would have been aware of the success observed with ranibizumab in treating both RVO and AMD. (*See, e.g.,* Ex.1030, Mitchell; Ex.1036, Campochiaro). As a result, "treating" RVO would have been an inherent feature of the regimen outlined in Regeneron (30-April-2009), especially in light of the VEGF Trap-Eye AMD Phase 2 trial visual acuity and retinal thickness results. Indeed, this is confirmed by subsequent reports of the results of the VEGF Trap-Eye RVO clinical trials using monthly loading doses followed by PRN dosing. (*See, e.g.,* Ex.1060, Korobelnik, 202 (reporting that, with a regimen of 6 monthly VEGF Trap-Eye injections followed by as-needed dosing, "[a]t week 52, the mean percentage of

---

<sup>17</sup> I note that claim 1 does not indicate which "visual and/or anatomical outcomes" one should rely upon. I also have reviewed the '069 patent and have concluded that the specification of the '069 patent does not specify which criteria one should rely upon in the assessment.

patients gaining 15 letters or more was 60.2% in the aflibercept group and 32.4% in the sham group”).

141. At my direction, the following graphic was compiled to help visualize how the disclosures of Regeneron’s GALILEO and COPERNICUS studies in Regeneron (30-April-2009) align with the elements of claim 1 of the ’069 patent.

| Week                  | 0                     | 4  | 8 | 12 | 16 | 24 | 28  | 32 | 36 | 52 |  |
|-----------------------|-----------------------|--|---|----|----|----|---|----|----|----|--|
| '069 Patent (Claim 1) | “single initial dose” | “one or more secondary doses [administered 2 to 4 weeks after the immediately preceding dose]... |   |    |    |    | followed by one or more tertiary doses [administered on an as-needed/pro re nata (PRN) basis...”] |    |    |    |  |
| Phase 3 (CRVO)        | +                     | +  | + | +  | +  | +  | PRN dosing period   |    |    |    |  |

142. Thus, it is my opinion that Regeneron (30-April-2009), in its disclosure and discussion of the CRVO Phase 3 studies, sets forth each and every dosing element of claim 1 of the ’069 patent.

143. Finally, the last element of claim 1— “wherein the VEGF antagonist is a receptor-based chimeric molecule comprising (1) a VEGFR1 component comprising amino acids 27 to 129 of SEQ ID NO:2; (2) a VEGFR2 component comprising amino acids 130-231 of SEQ ID NO:2; and (3) a multimerization component comprising amino acids 232-457 of SEQ ID NO:2”—was disclosed well before January 2011. (*See, e.g.*, Ex.1020, Heier-2009, 44-45; Ex.1006, Dixon, 1575, 1576 (Fig.1); Ex.1010, ’758 patent, Fig.24A-C (disclosing the nucleotide sequence

and deduced amino acid sequence, as well as a description of each molecular component therein (i.e., the signal sequence, the FLT1 Ig domain 2, the FLK1 Ig domain 3, and the FcΔC1 domain), 10:15-17 (specifying that this molecule is termed “VEGFR1R2-FcΔC1(a).”)); Ex.1033, Dix, SEQ ID NO:4; Ex.1082; Ex.1039, '095 patent, 1:45-54; Ex.1040, WHO Drug Info, 118-19; Ex.1021, 2009 10-Q, 20; Ex.1041, Regeneron (26-February-2009), 1-2 (using VEGF Trap and aflibercept interchangeably and explaining that “VEGF Trap-Eye is a specially purified and formulated form of VEGF Trap for use in intraocular applications.”); Ex.1007, Adis, 261 (indicating in the title that aflibercept, VEGF Trap (R1R2), and VEGF Trap-Eye, among other terms, were understood by a person of ordinary skill in the art to refer, interchangeably, to the same drug)).

144. Thus, for these reasons, it is my opinion that claim 1 is anticipated by Regeneron (30-April-2009).

**2. Dependent claims 9 and 10 are anticipated by Regeneron (30-April-2009).**

145. Claim 9 is dependent on claim 1 and recites the method of claim 1, “wherein the angiogenic eye disorder is selected from the group consisting of” several well-known eye disorders, including CRVO and AMD.

146. Claim 10 requires that the “angiogenic eye disorder is age related macular degeneration.”



147. Regeneron (30-April-2009) indicates in the title that Bayer and Regeneron were extending their VEGF Trap-Eye development program to include CRVO. The remainder of the press release is spent discussing CRVO and the Phase 3 clinical trials (COPERNICUS and GALILEO) designed to assess VEGF Trap-Eye in the treatment of CRVO, as well as recounting VEGF Trap-Eye's usefulness in treating AMD and other angiogenic eye disorders.

148. While the dosing regimen discussed in Regeneron (30-April-2009) was discussed in the context of the CRVO trials, Regeneron (30-April-2009) also disclosed that VEGF Trap-Eye was being used for the treatment of AMD. In my opinion, there is no reason to believe that the CRVO dosing regimen of 6 monthly doses followed by PRN dosing would not have been successful at treating AMD, especially in light of the promising data that had emerged from the CLEAR-IT-2 AMD trial discussed above, which incorporated a very similar PRN regimen. As a result, Regeneron (30-April-2009) clearly discloses that AMD was one of the disorders that VEGF Trap-Eye was intended to treat and clearly discloses a dosing regimen (six monthly doses followed by PRN dosing) that would have been suitable for treating AMD.

149. Thus, for these reasons, as well as for the reasons discussed above for claim 1, it is my opinion that claims 9 and 10 of the '069 patent are anticipated by Regeneron (30-April-2009).

**3. Dependent claim 11 is anticipated by Regeneron (30-April-2009).**

150. Dependent claim 11 depends from claim 1 and recites “wherein all doses of the VEGF antagonist are administered to the patient by topical administration or by intraocular administration.”

151. As I discussed above, to a person of ordinary skill in the art, it is well understood that intravitreal administration is a form of intraocular administration. Intraocular administration refers to administration to the eye generally, while intravitreal administration, a subset of intraocular administration, refers to administration directly into the vitreous of the eye.

152. In the disclosure of the CRVO Phase 3 studies in Regeneron (30-April-2009), the press release states that “[p]atients in both studies will receive 6 monthly intravitreal injections of either VEGF Trap-Eye at a dose of 2 milligrams (mg) or sham control injections.” (Ex.1028, Regeneron (30-April-2009), 1).

153. Therefore, it is my opinion that claim 11 of the '069 patent is anticipated by Regeneron (30-April-2009).

**4. Dependent claim 12 is anticipated by Regeneron (30-April-2009).**

154. Claim 12 of the '069 patent depends from claim 1 and recites "wherein the VEGF antagonist is VEGFR1R2-FcΔC1(a) encoded by the nucleic acid sequence of SEQ ID NO:1."

155. The nucleotide sequence for VEGF Trap-Eye/aflibercept was disclosed in prior art references disclosing the amino acid sequence. (*See, e.g.*, Ex.1010, '758 patent, Fig.24A-C (disclosing the nucleotide sequence and deduced amino acid sequence, as well as a description of each molecular component therein (i.e., the signal sequence, the FLT1 Ig domain 2, the FLK1 Ig domain 3, and the FcΔC1 domain), 10:15-17 (specifying that this molecule is termed "VEGFR1R2-FcΔC1(a)."); Ex.1033, Dix, SEQ ID NO:3; Ex.1083). Therefore, it is my opinion that claim 12 of the '069 patent is anticipated by Regeneron (30-April-2009).

**C. Claims 1 and 8-12 of the '069 Patent Are Anticipated and Made Obvious by the VIEW1/VIEW2 Disclosures in Dixon.**

**1. Claim 1 of the '069 patent is anticipated by the VIEW1/VIEW2 disclosures.**

156. I was asked to review claim 1 of the '069 patent, as well as the disclosures of Regeneron's VIEW1 and VIEW2 trials, including that which was disclosed in Dixon. I was also asked to review statements made by Regeneron to the USPTO regarding the dosing regimens claimed in the '069 patent. I was then

asked to consider whether, after applying Regeneron's statements in the '069 patent prosecution history, each and every element of claim 1 is present in those VIEW1/VIEW2 disclosures. It is my opinion that Dixon's VIEW1/VIEW2 disclosures disclose every element of the claimed method(s) under Regeneron's interpretation and thus anticipate each of the challenged claims.

157. Dixon discloses the Phase 3 VIEW1/VIEW2 studies of VEGF Trap-Eye/aflibercept in patients with AMD. In addition to monthly dosing arms, the VIEW1/VIEW2 studies also included treatment arms using 2 mg every eight weeks after 3 initial monthly doses. (Ex.1006, Dixon, 1576). This choice was entirely consistent with the trend that had emerged in the treatment of patients with intravitreal VEGF blockers, and, indeed, consistent with Dixon's disclosure that "[t]he time and financial burden of monthly injections has led to the initiation of studies to examine the efficacy of alternative dosing schedules." (*Id.*, 1574).

158. This is also consistent with Dixon's report of the treatment landscape at the time, which included regimens of intravitreal VEGF blockers that included monthly loading doses, followed by less frequent dosing. For example:

- Regeneron's Phase 2 CLEAR-IT-2 study of VEGF Trap-Eye in AMD (4 monthly loading doses, followed by PRN dosing);

- Genentech’s PIER study of ranibizumab in AMD (3 monthly loading doses followed by quarterly dosing);
- Genentech’s PrONTO study of ranibizumab in AMD (3 monthly loading doses followed by PRN dosing). (*Id.*, 1574, 1576).

159. Indeed, the VIEW1/VIEW2 regimen emerged onto the scene at a time when monthly dosing was increasingly being called into question due to the cost and discomfort to patients, and dosing regimens based on lengthening the dosing intervals (such as those bullet-pointed above) already were becoming the norm.

160. I have reviewed the prosecution history of the ’069 patent. During prosecution, I understand that Regeneron argued for the patentability of the ’069 patent claims to PRN dosing by relying on data from the VIEW1/VIEW2 every-8-week regimen. (Ex.1017, ’069 FH, 1/30/17 Remarks, 5-9). Regeneron presented the Patent Office with the Heier-2012 paper that reported results from the VIEW1/VIEW2 trials, and stated that the “Heier et al. paper shows results of a treatment protocol *of the type claimed*” and that the “results clearly show that by administering the VEGF antagonist in accordance with a dosage regimen as claimed in independent claim 1, it is possible to treat angiogenic eye disorders such as AMD while administering doses on a less frequent basis.” (*Id.*, 6 (emphasis added)). Regeneron continues, noting that the clinical trial included the following regimens:

“Patients were randomized in a 1:1:1:1 ratio to the following regimens: 0.5 mg aflibercept every 4 weeks (0.5q4); 2 mg aflibercept every 4 weeks (2q4); 2mg aflibercept every 8 weeks (2q8) after 3 injections at week 0, 4 and 8 (to maintain masking, sham injections were given at the interim 4-week visits after week 8); or 0.5mg ranibizumab every 4 weeks (Rq4). Consecutively enrolled patients were assigned to treatment groups on the basis of predetermined central randomization scheme with balanced allocation, managed by an interactive voice response system. “

(*Id.*, 7). In the selection above, and as disclosed in the VIEW1/VIEW2 art generally, of the four treatment arms, only one employed dosing that was less frequent than monthly, and that was the every-8-week scheme. Regeneron concludes that “the results show that the treatment groups which were compared with the monthly treatment groups surprisingly did not obtain an inferior result. *As such, the PRN treatment protocol as encompassed by the presently pending independent claim 1 achieves results which are as good or better than the results obtained with monthly treatment.*” (*Id.* (emphasis added)). Regeneron continues:

Within the “Discussion” section of the Heier et al. paper, it is noted that the treatment group treated every two months achieved a visual acuity score within 0.3 letters of the group treated on a monthly basis. See also the results summarized in Table 1, page 15, of the present application. Thus, it is indicated that the treatment group which received the drug far less frequently than the monthly dosing arm achieved remarkably similar improvements without requiring the monthly monitoring and visits to the health care provider.

(*Id.*).

161. In making these arguments, Regeneron also quotes a portion of their specification, which reads “the administration of VEGFT to patients suffering from angiogenic eye disorders (*e.g.*, AMD and DME) at a frequency of once every 8 weeks, following a single initial dose and two secondary doses administered four weeks apart, resulted in significant prevention of moderate or severe vision loss or improvements in visual acuity,” (*id.*, 7-8), and states that the Heier-2012 results echo this conclusion, (*id.*, 8). Regeneron concludes their discussion of Heier-2012 by stating that based on the outcomes observed for the every-2-month (*i.e.*, every 8 weeks) VIEW1/VIEW2 regimen, “it is clear that the *claimed* treatment protocol provides enormous advantages to patients.” (*Id.* (emphasis added)).

162. Based on the above, it is my opinion that Regeneron was presenting the VIEW1/VIEW2 dosing regimen (every 8 weeks following 3 monthly doses) to the Examiner as an example of a regimen that falls within the claim 1 PRN dosing scheme. Upon that representation, Regeneron presented data from that every-8-week dosing regimen to the Examiner in order to, as I understand it, secure allowance of the '069 patent claims directed to the claimed PRN dosing regimens.

163. Because the dosing regimen set forth in Heier-2012 is the same VIEW1/VIEW2 dosing regimen expressly set forth in Dixon and each of the

VIEW1/VIEW2 prior art disclosures<sup>18</sup> from the time period before the '069 patent application was filed, it is my opinion that the VIEW1/VIEW2 disclosures set forth each and every element of claim 1 under Regeneron's interpretation.

164. Below I have constructed a chart for the purpose of showing where each and every claim element from claim 1 is found in Dixon's VIEW1/VIEW2 disclosures,:

| Claim 1:   | Dixon   |
|--|---|
| A method for treating <sup>19</sup> an angiogenic eye disorder in a patient, said method | "Phase III trial of VEGF Trap-Eye" in patients "with neovascular AMD" |

<sup>18</sup> See, e.g., Ex.1014, NCT-795, 8; Ex.1015, NCT-377, 6; Ex.1013, Regeneron (8-May-2008), 1; Ex.1056, Regeneron (28-September-2008), 2; Ex.1006, Dixon, 1576; Ex.1007, Adis, 263.

<sup>19</sup> In my opinion, claim 1 does not specify any particular level of treating, in terms of efficacy measures. In my experience, and as I discuss above, any patient involved in a clinical study is, by definition, being treated. However, in the event that the Board decides that the preamble is a claim limitation, a person of ordinary skill in the art would have concluded that the dosage regimens disclosed in Dixon were capable of "treating an angiogenic eye disorder," based upon Dixon's disclosures of the successful treatment of AMD in the Phase 2 CLEAR-IT-2 trial (Ex.1006, Dixon, 1576), as well as the VIEW results later disclosed in Heier-2012.



|  |   |
|--|---|
| <p>comprising sequentially administering to the patient a single initial dose of a VEGF antagonist, followed by one or more secondary doses of the VEGF antagonist, followed by one or more tertiary doses of the VEGF antagonist;</p> | <p>where VEGF Trap-Eye is administered at “2.0 mg at an 8 week dosing interval (following three monthly doses).” (Ex.1006, Dixon, 1576). AMD is well known to be an angiogenic eye disorder, and the dosing sequence disclosed for the VIEW1/VIEW2 trials would have involved sequential administration. (See Ex.1007, Adis, 263; Ex.1056, Regeneron (28-September-2008), 2; Ex.103, Regeneron (8-May-2008), 1; Ex.1014, NCT-795, 8; Ex.1015, NCT-377, 6).</p>  |
| <p>wherein each secondary dose is administered 2 to 4 weeks after the immediately preceding dose; and</p>  | <p>“2.0 mg at an 8 week dosing interval (following three monthly doses).” (Ex.1006, Dixon, 1576 (emphasis added)). As I explain above, “three monthly doses” involves a dose at baseline, i.e., day 0, as well as a “secondary dose” one month later (i.e., “4 weeks after the immediately preceding dose”), and another “secondary dose” one month after that (i.e., “4 weeks after the immediately preceding dose”). (See Ex.1007, Adis, 263; Ex.1056, Regeneron (28-September-2008), 2; Ex.1013, Regeneron (8-May-2008), 1; Ex.1014, NCT-795, 8; Ex.1015, NCT-377, 6).</p> |
| <p>wherein each tertiary dose is administered on an as-needed/pro re nata (PRN) basis, based on visual and/or anatomical outcomes as assessed by a physician or other qualified medical professional;</p>                              | <p>“2.0 mg at an 8 week dosing interval (following three monthly doses).” (Ex.1006, Dixon, 1576 (emphasis added)). As discussed above, Regeneron held out the every-8-week VIEW regimen as a regimen “of the type claimed” in the ’069 patent’s PRN dosing claims. The assessments of</p>   |

|  |  |
|--|--|
|  | visual or anatomical outcomes are a typical practice in clinical trials when evaluating treated patients. ( <i>See, e.g., id.</i> , 1576 (indicating that PRN dosing criteria “included an increase in retinal thickness of $\geq 100 \mu\text{m}$ by OCT, a loss of $\geq 5$ ETDRS letters in conjunction with recurrent fluid by OCT, persistent fluid as indicated by OCT, new onset classic neovascularization, new or persistent leak on FA or new macular subretinal hemorrhage”). |
| Wherein the VEGF antagonist is a VEGF receptor-based chimeric molecule comprising (1) a VEGFR1 component comprising amino acids 27 to 129 of SEQ ID NO:2; (2) a VEGFR2 component comprising amino acids 130-231 of SEQ ID NO:2; and (3) a multimerization component comprising amino acids 232-457 of SEQ ID NO:2. | “One promising new drug is aflibercept (VEGF Trap-Eye).” (Ex.1006, Dixon, 1573). “VEGF Trap-Eye is a fusion protein of key binding domains of human VEGFR-1 and -2 combined with a human IgG Fc fragment.”; “VEGF Trap-Eye and aflibercept . . . have the same molecular structure.” ( <i>Id.</i> , 1575). <sup>20</sup>   |

165. Consequently, in my opinion, based upon the arguments that Regeneron made to the USPTO during prosecution, the VIEW1/VIEW2 disclosures, including those found in Dixon, include all the dosing elements of claim 1, and thus anticipate claim 1.

---

<sup>20</sup> As discussed above, the structure and sequence of VEGF Trap-Eye/aflibercept was well known to those of ordinary skill in the art. (*See, e.g., Sec. VIII(A)(1) above*).

166. The last element of claim 1—“wherein the VEGF antagonist is a receptor-based chimeric molecule comprising (1) a VEGFR1 component comprising amino acids 27 to 129 of SEQ ID NO:2; (2) a VEGFR2 component comprising amino acids 130-231 of SEQ ID NO:2; and (3) a multimerization component comprising amino acids 232-457 of SEQ ID NO:2”—was disclosed well before January 2011. (*See, e.g.*, Ex.1020, Heier-2009, 44-45; Ex.1006, Dixon, 1575, 1576 (Fig.1); Ex.1010, '758 patent, Fig.24A-C (disclosing the nucleotide sequence and deduced amino acid sequence, as well as a description of each molecular component therein (i.e., the signal sequence, the FLT1 Ig domain 2, the FLK1 Ig domain 3, and the Fc $\Delta$ C1 domain), 10:15-17 (specifying that this molecule is termed “VEGFR1R2-Fc $\Delta$ C1(a).”)); Ex.1039, '095 patent, 1:45-54; Ex.1040, WHO Drug Info, 118-19; Ex.1021, 2009 10-Q, 20; Ex.1041, Regeneron (26-February-2009), 1-2 (using VEGF Trap and aflibercept interchangeably and explaining that “VEGF Trap-Eye is a specially purified and formulated form of VEGF Trap for use in intraocular applications.”); Ex.1007, Adis, 261 (indicating in the title that aflibercept, VEGF Trap (R1R2), and VEGF Trap-Eye, among other terms, were understood by a person of ordinary skill in the art to refer, interchangeably, to the same drug)).

167. Therefore, in my opinion, and in view of Regeneron's arguments to the USPTO during prosecution, the VIEW1/VIEW2 disclosures, including those in Dixon, anticipate claim 1 of the '069 patent.

**2. Claim 1 of the '069 patent is made obvious by the VIEW1/VIEW2 disclosures in Dixon.**

168. In my opinion, in view of Regeneron's arguments to the USPTO during prosecution regarding the VIEW1/VIEW2 disclosures, claim 1 is obvious over Dixon. My element-by-element claim analysis presented above for anticipation is incorporated here, and for the reasons I discuss above, Dixon also makes obvious claim 1 of the '069 patent. Motivation came from the Dixon reference through its disclosures of the burdens of monthly intravitreal dosing and the already-implemented PRN regimens of VEGF antagonists (including VEGF Trap-Eye) in which dosing was carried out less frequently than monthly. (Ex.1006, Dixon, 1574, 1576). Further, a person of ordinary skill in the art would have had a reasonable expectation of success in light of the positive results reported in Dixon for Regeneron's Phase 2 CLEAR-IT-2 trial with monthly loading doses and a PRN dosing scheme. (*Id.*, 1576).

169. However, if a decision is made by the Board in this case that Dixon or the other VIEW references do not disclose the dosing regimen in claim 1, claim 1 nevertheless is drawn to an obvious variation of well-known dosing schemes being

used by practicing ophthalmologists for years prior to the filing of the '069 patent application, including those dosing regimens disclosed for the VIEW studies. For example, it was well known in the art to begin anti-VEGF therapy with a loading dose scheme, which the VIEW studies did. (Ex.1006, Dixon, 1576 (“8 week dosing interval (*following three monthly doses*)” (emphasis added)); *see also, e.g., id.*, 1574 (“The PrONTO study looked at an needed (p.r.n.) dosing of ranibizumab after three consecutive monthly doses”); Ex.1026, Engelbert-2009, 1429 (“The PrONTO study explored three monthly injections followed by dosing on an as-needed or PRN basis”); Ex.1025, Engelbert-2010, 1369 (“PrONTO-style dosing has become popular.”)). It was also a well-accepted and routinely-applied practice when administering VEGF antagonist therapy to assess patients “based on visual and/or anatomical outcomes” at periodic intervals. These intervals were often monthly but may have been less often if the doctor decided monthly visits were not required. It was also routine to administer injections of the VEGF antagonists on those visits where the assessment of “visual and/or anatomical outcomes” dictated such treatment.

170. Second, I note that the VIEW studies were designed to incorporate, after the first year of 8-week dosing, a year of PRN dosing. Thus, in my opinion, in view of Regeneron’s prosecution statements, claim 1 of the '069 patent is obvious

for this additional reason. A person of ordinary skill in the art would have been aware of the efforts to reduce dosing frequency, and would have been aware of the PRN dosing scheme tested by Regeneron in its Phase 2 VEGF Trap CLEAR-IT-2 trial, the second year of PRN dosing in its Phase 3 VIEW studies, as well as the PRN dosing schemes being tested by Genentech with its Lucentis® (ranibizumab) product with promising results.

171. For example, Dixon disclosed that PRN dosing in the Phase 2 trial (CLEAR-IT-2) had led to mean increases in visual acuity and mean decreases in retinal thickness. The one-year results discussed in Dixon show that in the randomized 157 patient trial, patients that were treated with 2.0 mg monthly doses at weeks 0, 4, 8, and 12, followed by PRN dosing, exhibited mean improvements of 9.0 letters in visual acuity and a mean decrease in retinal thickness of 143  $\mu\text{m}$ . Further, the study showed that the median time to first reinjection after the loading dose phase was 110 days, and that patients that received monthly loading doses of 2.0 mg required on average only 1.6 more injections between weeks 12 and 52.

172. Further, the Genentech ranibizumab trials had implemented PRN dosing regimens to address the community's need for extended dosage regimens and shown these regimens to be effective. (*See, e.g.*, Ex.1006, Dixon, 1574 (noting that in the PrONTO study, “[a]t 2 years of follow up, 78% of patients had maintained

vision and vision had improved by > 3 lines in 43% of patients”); SUSTAIN trial (PRN dosing after 3 monthly loading doses)).

173. As a result, it would have been obvious to incorporate the three monthly loading doses of the first year of the VIEW trials (the same loading dose scheme used in the PrONTO and SUSTAIN trials), and combine that with the PRN dosing disclosed for year 2 of the VEGF Trap-Eye VIEW trials (and also used with success in the Phase 2 VEGF Trap-Eye trial). Moreover, because of the promising results already observed in the Phase 2 VEGF Trap-Eye trials and the promising results from the PRN dosing PrONTO ranibizumab trial, a person of ordinary skill in the art would have had a reasonable expectation of success that one could treat an angiogenic eye disorder with such a scheme.

174. Thus, for these reasons, it is my opinion that claim 1 of the '069 patent is anticipated and made obvious by the VIEW1/VIEW2 disclosures in Dixon in view of Regeneron's prosecution statements to the Examiner.

**3. Dependent claim 8 is anticipated and made obvious by the VIEW1/VIEW2 disclosures.**

175. Claim 8 claims the method of claim 1, “wherein only two secondary doses are administered to the patient, and wherein each secondary dose is administered 4 weeks after the immediately preceding dose.”

176. Thus, claim 8 merely dictates that there be three monthly loading doses (i.e., “a single initial dose” and “two secondary doses” 4 weeks apart; in other words, doses at weeks 0, 4, and 8).

177. As discussed above, the VIEW1/VIEW2 regimens, as disclosed in Dixon and other sources as early as 2009, included this exact loading dose scheme. (See, e.g., Ex.1006, Dixon, 1576 (“8 week dosing interval (*following three monthly doses*)” (emphasis added)).

178. Thus, for this reason, as well as the reasons set forth for claim 1 above, it is my opinion that claim 8 of the ‘069 patent is anticipated and made obvious by the VIEW1/VIEW2 disclosures in Dixon in view of Regeneron’s prosecution statements to the Examiner.

**4. Dependent claims 9 and 10 of the ‘069 patent are anticipated and made obvious by the VIEW1/VIEW2 disclosures.**

179. Claim 9 claims the method of claim 1, “wherein the angiogenic eye disorder is selected from the group consisting of: age related macular degeneration, diabetic retinopathy, diabetic macular edema, central retinal vein occlusion, branch retinal vein occlusion, and corneal neovascularization.”

180. Claim 10 claims the method of claim 9, “wherein the angiogenic eye disorder is age related macular degeneration.”



181. It was well known among those of ordinary skill in the art that the VIEW1/VIEW2 studies were directed to treating patients with AMD. The Dixon reference indicates in the title that VEGF Trap-Eye was being studied for the treatment of AMD and the bulk of the reference is devoted to discussing VEGF Trap-Eye as it relates to the treatment of AMD, including the discussion of the Phase 1 CLEAR-IT-1 clinical trial in patients with neovascular AMD; the Phase 2 CLEAR-IT-2 clinical trials in wet AMD; and the Phase 3 VIEW1 and VIEW2 clinical trials.

182. Thus, for these reasons, as well as for the reasons discussed above for claim 1, it is my opinion that claims 9 and 10 of the '069 patent are anticipated and made obvious by the VIEW1/VIEW2 disclosures in Dixon in view of Regeneron's prosecution statements to the Examiner.

**5. Dependent claim 11 is anticipated and made obvious by the VIEW1/VIEW2 disclosures.**

183. Dependent claim 11 depends from claim 1 and recites "wherein all doses of the VEGF antagonist are administered to the patient by topical administration or by intraocular administration."

184. To a person of ordinary skill in the art, it is well understood that intravitreal administration is a form of intraocular administration. Intraocular administration refers to administration to the eye generally, while intravitreal

administration, a subset of intraocular administration, refers to administration directly into the vitreous of the eye.

185. It was well known among those of ordinary skill in the art that the VIEW1/VIEW2 studies were utilizing intravitreal injection. (Ex.1006, Dixon, 1576 (“[VIEW1] will evaluate the safety and efficacy of intravitreal VEGF Trap-Eye . . . .”)).

186. Thus, for these reasons, as well as for the reasons discussed above for claim 1, it is my opinion that claim 11 of the ‘069 patent is anticipated and made obvious by the VIEW1/VIEW2 disclosures in Dixon in view of Regeneron’s prosecution statements to the Examiner.

**6. Dependent claim 12 is anticipated and made obvious by the VIEW1/VIEW2 disclosures.**

187. Claim 12 of the ‘069 patent claims the method of claim 1, “wherein the VEGF antagonist is VEGFR1R2-FcΔC1(a) encoded by the nucleic acid sequence of SEQ ID NO:1.”

188. The nucleotide sequence for VEGF Trap-Eye/afibercept was disclosed in prior art references disclosing the amino acid sequence. (*See, e.g.*, Ex.1010, ‘758 patent, Fig.24A-C (disclosing the nucleotide sequence and deduced amino acid sequence, as well as a description of each molecular component therein (i.e., the signal sequence, the FLT1 Ig domain 2, the FLK1 Ig domain 3, and the FcΔC1

domain), 10:15-17 (specifying that this molecule is termed “VEGFR1R2-FcΔC1(a).”); Ex.1033, Dix, SEQ ID NO:3; Ex.1083).

189. Thus, for these reasons, as well as for the reasons discussed above for claim 1, it is my opinion that claim 12 of the '069 patent is anticipated and made obvious by the VIEW1/VIEW2 disclosures, including Dixon.

**D. Claims 1 and 8-12 of the '069 Patent Are Made Obvious by Heier-2009 (Ex.1020) in View of Mitchell (Ex.1030), or Alternatively in View of Dixon (Ex.1006), and if Necessary, in View of the '758 Patent (Ex.1010) or Dix (Ex.1033).**

**1. Claim 1 of the '069 patent is obvious.**

190. As discussed above, the trend among physicians treating AMD in the mid to late 2000's was to minimize the financial burdens, time commitment, and risks associated with monthly dosing of intravitreal anti-VEGF agents. As a result, physicians were turning to regimens that included monthly monitoring with injections given as-needed, or a treat-and-extend approach, in which time between office visits (and thus injections), was increased, so long as gains in visual acuity and/or retinal thickness were being maintained.

191. With the concept of minimizing the frequency of injections in mind, a person of ordinary skill in the art would have viewed with interest Regeneron's Phase 2 studies of VEGF Trap-Eye in treating AMD, the results of which were reported in Heier-2009 and Dixon. In the Phase 2 study, patients were treated with

a regimen that included four monthly loading doses, followed by as-needed (i.e., PRN) dosing. (Ex.1020, Heier-2009, 45; Ex.1006, Dixon, 1576). This regimen resulted in patients achieving mean improvements in BCVA of 9.0 letters and mean decreases in retinal thickness. (Ex.1020, Heier-2009, 45; Ex.1006, Dixon, 1576). In the nine-months following the loading doses, plus the six-month extension stage of the study (i.e., 15 total months of PRN dosing), patients received a mean of only 3.5 injections. (Ex.1020, Heier-2009, 45).

192. In addition, Heier-2009 and Dixon clearly set forth the specific “VEGF antagonist” claimed in claim 1, through their disclosure of VEGF Trap-Eye, which was widely published in the prior art. (*See, e.g., id.*, 44-45; Ex.1006, Dixon, 1575, 1576 (Fig.1); Ex.1010, ’758 patent, Fig.24A-C (disclosing the nucleotide sequence and deduced amino acid sequence, as well as a description of each molecular component therein (i.e., the signal sequence, the FLT1 Ig domain 2, the FLK1 Ig domain 3, and the Fc $\Delta$ C1 domain), 10:15-17 (specifying that this molecule is termed “VEGFR1R2-Fc $\Delta$ C1(a).”)); Ex.1039, ’095 patent, 1:45-54; Ex.1040, WHO Drug Info, 118-19; Ex.1021, 2009 10-Q, 20; Ex.1041, Regeneron (26-February-2009), 1-2 (using VEGF Trap and aflibercept interchangeably and explaining that “VEGF Trap-Eye is a specially purified and formulated form of VEGF Trap for use in intraocular applications.”); Ex.1007, Adis, 261 (indicating in the title that aflibercept,

VEGF Trap (R1R2), and VEGF Trap-Eye, among other terms, were understood by a person of ordinary skill in the art to refer, interchangeably, to the same drug); Ex.1033, Dix, SEQ ID NO:4; Ex.1082). Moreover, Heier-2009 and Dixon make clear that the studies were investigating VEGF Trap-Eye for the treatment of AMD, which was well-understood at the time to be “an angiogenic eye disorder.”

193. In addition, in my opinion, with the Phase 2 results in hand, one of ordinary skill in the art also would have been following with interest, and thus been motivated to consult the ranibizumab literature, given that ranibizumab was the only approved anti-angiogenic protein-based VEGF antagonist approved for AMD at the time, for guidance and confirmation as to potential longer-term dosing regimens.

194. For example, Mitchell discloses extended ranibizumab dosing regimens involving individualized dosing, including those used in the PrONTO and SUSTAIN trials.<sup>21</sup> (Ex.1030, Mitchell, 9 (Table 3)). Mitchell describes the PrONTO study as

---

<sup>21</sup> The PrONTO regimen and results were widely disclosed in other references, including in Lalwani (reporting the 2-year results of the PrONTO study). Lalwani expressed skepticism that monthly dosing was the best option, reflecting the prevailing opinion at the time, and described the study’s objective as “investigating

involving “three consecutive monthly injections followed by OCT-guided variable dosing,” with several retreatment criteria set forth (in other words, as-needed, or PRN, dosing). (*Id.*, 6). Tabulated data in Mitchell reveal that after 24 months, the PrONTO patients showed a mean VA change of +10.7 letters, compared to +6.6 and +10.7 in the ranibizumab MARINA and ANCHOR studies using monthly dosing. (*Id.* (Table 2), 9 (Table 3)). The authors note that the VA outcomes in PrONTO required fewer intravitreal injections to get to similar results described for MARINA/ANCHOR. (*Id.*, 6; *see also id.* (Table 2), 9 (Table 3) (noting 9 injections following the loading doses in MARINA/ANCHOR versus a mean of 2.6 in

---

whether a variable-dosing OCT-guided regimen with ranibizumab could result in fewer injections and similar clinical outcomes.” (Ex.1035, Lalwani, 43-44). Lalwani reported that after two years, mean visual acuity scores improved by 11.1 letters and retinal thickness decreased by a mean of 212  $\mu\text{m}$ . (*Id.*, 47-48). The two-year PrONTO results showed that mean outcomes were comparable to monthly dosing, but with far fewer injections—9.9 injections in the two-year PrONTO study compared to 24 injections in two years of monthly dosing. (*Id.*, 56). Therefore, in my opinion, the Lalwani reference could be interchanged with Mitchell in this ground and, in combination with Heier-2009, would make the claims obvious.

PrONTO)). The authors noted that differences in the trial designs limit comparison, but despite PrONTO being a small and open-label study, it still “suggests that flexible OCT-guided retreatment could sustain visual gain with fewer injections.” (*Id.*, 6). In my experience, PrONTO initiated a major change in the way that ophthalmologists were administering anti-VEGF agents, and, by showing that these regimens were safe and effective, opened the door to more ophthalmologists making use of individualized, PRN treatment regimens for intravitreally-administered anti-VEGF agents.

195. Mitchell also discusses the results of the SUSTAIN study, in which ranibizumab was administered in three monthly injections, followed by a period of as-needed dosing based on visual acuity and retinal thickness criteria. (*Id.*, 7). The authors conclude that the gains from the three-month initiation phase were largely maintained which suggested that “flexible, guided dosing with fewer ranibizumab injections and monthly monitoring can maintain efficacy outcomes.” (*Id.*).

196. From this, the authors concluded that while monthly dosing is recommended, “when a monthly regimen is not possible, a flexible strategy with monthly monitoring is feasible.” (*Id.*). Mitchell also observed that “[m]ost VA improvement was seen during the initial 3-month phase with subsequent injections appearing to maintain the achieved benefit.” (*Id.*, 4).

197. With these disclosures in mind, including the success at using VEGF Trap-Eye in treating AMD on a regimen that included administering doses less frequently than monthly, a person of ordinary skill in the art would have been motivated to consult the above ranibizumab literature and implement regimens that incorporated extended or individualized dosing after three monthly loading doses. The person of ordinary skill in the art would have observed the successes of the regimens being used to treat AMD with ranibizumab involving three monthly loading doses (i.e., “a single initial dose” and “one or more secondary doses” in which “each secondary dose is administered 2 to 4 weeks after the immediately preceding dose”), followed by individualized dosing (i.e., “one or more tertiary doses . . . administered on an as-needed/pro re nata (PRN) basis, based on visual and/or anatomical outcomes as assessed by a physician”), and would have been motivated to combine the teachings of those references with those of Heier-2009 disclosing successful PRN treatment of AMD with VEGF Trap-Eye. In other words, it would have been obvious to combine the three monthly loading doses widely used in the ranibizumab studies, disclosed in Mitchell, with the PRN dosing shown to work with VEGF Trap-Eye. Moreover, one of ordinary skill in the art would have been motivated to combine these teachings to reduce the intravitreal dosing frequency (i.e., drop from the four loading doses used in CLEAR-IT-2 to the three



loading doses being used in numerous ranibizumab studies). Consequently, it is my opinion that the claim 1 dosing regimen is made obvious by Heier-2009 in combination with Mitchell.

198. In addition, as discussed above, in my opinion the differences in molecular architecture between ranibizumab and aflibercept, both of which are anti-VEGF biologic agents, would not have dissuaded a person of ordinary skill in the art from relying on teachings from the ranibizumab clinical trials. Despite the differences in molecular structure, clinical trials revealed similar efficacy. For example, in the ranibizumab AMD PrONTO trial, a mean change in visual acuity of 9.3 letters after one year was observed. (Ex.1034, Fung, 566, 577; Ex.1035, Lalwani, 47). In the VEGF Trap-Eye CLEAR-IT-2 trial, the patients in the monthly loading dose arms receiving 2.0 or 0.5 mg doses experienced mean improvements of 9.0 and 5.4 letters, respectively, at the one-year mark. (Ex.1006, Dixon, 1576). This also is consistent with the final results of Regeneron's Phase 3 trials, where "[a]ll aflibercept groups were noninferior and clinically equivalent to monthly ranibizumab for the primary end point." (Ex.1018, Heier-2012, 2537). This included monthly VEGF Trap-Eye patients, compared to monthly ranibizumab patients. (*Id.*).

199. In addition, with the success of the VEGF Trap-Eye Phase 2 trial, one of ordinary skill in the art also would have been motivated to consult the literature disclosing the VEGF Trap-Eye Phase 3 regimens. For example, Dixon discloses the Phase 3 VIEW trials that would follow the successful Phase 2 trial, reporting that the VIEW trials will incorporate regimens of three monthly loading doses, followed by dosing every 8 weeks. (Ex.1006, Dixon, 1576). After the first year, patients will continue to be dosed on a PRN basis. (*Id.*). Given the valid concerns over dosing frequency and the motivation to reduce the number of doses patients received, a person of ordinary skill in the art would have been motivated to reduce the four monthly loading doses of the Phase 2 CLEAR-IT-2 trial to the three monthly loading doses planned for the Phase 3 VIEW regimens.

200. A person of ordinary skill in the art also would have observed that Regeneron planned to incorporate PRN dosing in the second year of the VIEW trials. Given these disclosures, a person of ordinary skill in the art would have been motivated to combine the PRN dosing regimens already used with success in the Phase 2 CLEAR-IT-2 trial disclosed in Heier-2009 and Dixon and proposed in Dixon for the second year of the Phase 3 trial (i.e., “one or more tertiary doses . . . administered on an as-needed/pro re nata (PRN) basis, based on visual and/or anatomical outcomes as assessed by a physician”), and combine it with the three

monthly loading doses (i.e., “a single initial dose” and “one or more secondary doses” in which “each secondary dose is administered 2 to 4 weeks after the immediately preceding dose”), disclosed in Dixon. Consequently, it is my opinion that the claim 1 dosing regimen is made obvious by Heier-2009 in combination with Dixon.

201. Further, based on the success of Regeneron’s Phase 2 trial, a person of ordinary skill in the art would have had a reasonable expectation of success in treating AMD with such regimens. (Ex.1020, Heier-2009, 45 (disclosing that patients receiving monthly loading doses and PRN dosing “achieved mean improvements in BCVA of 9.0 letters . . . [and] mean decreases in retinal thickness.”); Ex.1006, Dixon, 1576). Indeed, decreases in retinal thickness were even observed with just a single dose of VEGF Trap-Eye in the Phase I CLEAR-IT-1 AMD trial. (Ex.1006, Dixon, 1575 (“[T]he mean decrease in retinal thickness in the low dose group was 63.7  $\mu$ m compared to 175  $\mu$ m for the high dose group.”)).

202. As for the last wherein clause, this is simply a recitation of the molecular architecture of the “aflibercept” / “VEGF Trap-Eye” disclosed in Heier-2009 and Dixon. As discussed above, the background knowledge of a person of ordinary skill in the art would have included familiarity with the sequence and molecular structure disclosures of VEGF Trap-Eye/aflibercept, which were widely

available in the art at the time. (See, e.g., Ex.1010, Regeneron's '758 patent, Fig.24A-C; Ex.1033, Dix, [0013]-[0014], [0030], SEQ ID NO:4; Ex.1082; Ex.1039, '095 patent, 1:45-54; Ex.1040, WHO Drug Info, 118-19; Ex.1021, 2009 10-Q, 20; Ex.1041, Regeneron (26-February-2009), 1-2 (using VEGF Trap and aflibercept interchangeably and explaining that "VEGF Trap-Eye is a specially purified and formulated form of VEGF Trap for use in intraocular applications"); Ex.1007, Adis, 261 (indicating in the title that aflibercept, VEGF Trap (R1R2), and VEGF Trap-Eye, among other terms, were understood by a person of ordinary skill in the art to refer, interchangeably, to the same drug)).

203. For these reasons, in my opinion, the dosing regimen claimed in claim 1 of the '069 is made obvious by Heier-2009, in light of the disclosures of Mitchell, or alternatively in light of the disclosures of Dixon, and if necessary, the '758 patent or Dix.

**2. Dependent claim 8 is obvious.**

204. Claim 8 depends from claim 1 and specifies that "only two secondary doses are administered to the patient, and wherein each secondary dose is administered 4 weeks after the immediately preceding dose." In other words, loading doses at weeks 0 (initial dose), 4, and 8 (two secondary doses).

205. A person of ordinary skill in the art would have immediately recognized this as the regimen that Genentech used in its ranibizumab PrONTO trial employing three monthly loading doses (i.e., “one initial dose” and “two secondary doses . . . administered 4 weeks after the immediately preceding dose”), and as-needed doses (i.e., “one or more tertiary doses . . . administered on an as-needed/pro re nata (PRN) basis, based on visual and/or anatomical outcomes as assessed by a physician”). (See Ex.1030, Mitchell, 6). A person of ordinary skill in the art would have been motivated to adopt such a regimen for VEGF Trap-Eye based on the success of the regimen with ranibizumab. Moreover, a person of ordinary skill in the art would have been motivated to make the slight adjustment from the CLEAR-IT-2 regimen (4 monthly loading/PRN) to the PrONTO regimen (3 monthly loading/PRN) in order to minimize the number and frequency of injections.

206. A person of ordinary skill in the art also would have recognized the claim 8 regimen as a combination of the three monthly loading doses from the Phase 3 VEGF Trap-Eye AMD VIEW trials and the PRN dosing regimen of the successful Phase 2 VEGF Trap-Eye trial. A person of ordinary skill in the art would have viewed the PRN dosing of the Phase 2 regimen as a success and would have looked to combine it with the three loading doses from the Phase 3 trials in order to reduce the number of loading doses to minimize the frequency of intravitreal injections.

207. Thus, for these reasons, as well as for the reasons discussed above for claim 1, it is my opinion that claim 8 of the '069 patent is obvious.

**3. Dependent claims 9 and 10 are obvious.**

208. Claim 9 depends from claim 1 and specifies that the angiogenic eye disorder is selected from a group of well-known angiogenic eye disorders. Claim 10 specifies that the disorder is AMD.

209. As I discussed above with regard to claim 1, the Phase 2 and Phase 3 VEGF Trap-Eye studies were AMD trials. (Ex.1020, Heier-2009; Ex.1006, Dixon). Likewise, Mitchell is a review focused on the ranibizumab AMD trials and the regimens used therein to treat AMD.

210. Thus, for these reasons, as well as for the reasons discussed above for claim 1, it is my opinion that claims 9 and 10 of the '069 patent are obvious.

**4. Dependent claim 11 is obvious.**

211. Claim 11 depends from claim 1 and specifies that “all doses of the VEGF antagonist are administered to the patient by topical administration or by intraocular administration.”

212. The Phase 2 VEGF Trap-Eye studies were AMD trials involving intravitreal administration. (Ex.1020, Heier-2009; Ex.1006, Dixon). Likewise, Mitchell is a review focused on the ranibizumab AMD trials involving intravitreal

administration. It was well known among those of ordinary skill in the art that intravitreal administration, which involves injection directly into the vitreous, is a sub-category of intraocular administration (administration to the eye, generally). (*See, e.g.*, Ex.1001, '069 patent, 2:41-42).

213. Thus, for these reasons, as well as for the reasons discussed above for claim 1, it is my opinion that claim 11 of the '069 patent is obvious.

**5. Dependent claim 12 is obvious.**

214. Claim 12 depends from claim 1 and specifies that “the VEGF antagonist is VEGFR1R2-Fc $\Delta$ C1(a) encoded by the nucleic acid sequence of SEQ ID NO:1.”

215. As I discussed previously the prior art disclosed the nucleotide sequence for VEGF Trap-Eye/aflibercept. (*See, e.g.*, Ex.1010, '758 patent, Fig.24A-C (disclosing the nucleotide sequence and deduced amino acid sequence, as well as a description of each molecular component therein (i.e., the signal sequence, the FLT1 Ig domain 2, the FLK1 Ig domain 3, and the Fc $\Delta$ C1 domain), 10:15-17 (specifying that this molecule is termed “VEGFR1R2-Fc $\Delta$ C1(a).”); Ex.1033, Dix, SEQ ID NO:3; Ex.1083).

216. Thus, for these reasons, as well as for the reasons discussed above for claim 1, it is my opinion that claim 12 of the '069 patent is obvious.

## IX. SECONDARY CONSIDERATIONS.

217. I understand that a patent owner may rely on “secondary considerations of obviousness” to refute a finding of obviousness of a claim. However, I understand that secondary considerations of obviousness are not relevant to anticipation, and thus are not relevant in refuting any of the anticipation grounds that have been presented above. I also understand that there are several categories of secondary considerations, which might include evidence of commercial success, unexpected results, or a “long-felt but unmet need.” Notwithstanding that the unpatentability of the challenged claims is supported by strong evidence, including the numerous Regeneron disclosures and public announcements of its dosage regimens for VEGF Trap-Eye/aflibercept, as well as the teachings and suggestions from the ranibizumab literature, well prior to the filing date of the ’069 patent, it is my opinion that there are no unexpected results or a “long-felt but unmet need” that would refute the strong case of obviousness against the challenged claims.

218. I was asked to review arguments that I understand Regeneron made to the USPTO dated January 30, 2017, asserting that the patentability of the ’069 patent claims were supported by so-called “improved unexpected results,” based on a 2012 publication reporting on the results of the VIEW studies (Ex.1018, Heier-2012). (See Ex.1017, ’069 patent FH, 1/30/17 Remarks). Regeneron characterizes the



standard of care prior to the filing of the '069 patent as once-per-month dosing. (*Id.*, 6). They further characterize the results reported in Heier-2012 as surprising, dramatic, and unexpected since the every-eight-week dosing group exhibited outcomes similar to those receiving monthly injections. (*Id.*, 7-9).

219. First, the applicants have taken the position that an every-8-week dosing regimen, exemplified by the VIEW1/VIEW2 trials, is a treatment regimen “of the type claimed” in the '069 patent. (*Id.*, 6). However, this VIEW1/VIEW2 treatment regimen was disclosed and disseminated before the filing date of the '069 patent, as I discuss above. (*See, e.g.*, Ex.1006, Dixon, and the detailed discussion therein of the disclosures of the VIEW1 and/or VIEW2 studies).

220. Second, in my experience and that of the skilled person, as of 2010, monthly dosing was not the regimen typically used in standard clinical practice. By 2010, as I discuss above, the discomfort, inconvenience, and risks experienced by patients<sup>22</sup> receiving intravitreal injections, and the reports of the PrONTO study, led

---

<sup>22</sup> This is a point on which I agree with Regeneron. (*See, e.g.*, Ex.1017, '069 patent FH, 5-6 (once-per-month injections are “(1) expensive; (2) painful to the patient; (3) inconvenient for the patient as well as the patient’s family; (4) psychologically

most in the ophthalmology community to reduce the frequency of administration whenever possible. For example, my typical practice, together with the typical practice of the skilled person, when administering intravitreal anti-VEGF agents involved the administration of a few loading dose injections, typically spaced a month apart. Thereafter, we would usually bring back patients for monthly visits to assess visual acuity and retinal edema and only administer injections on those monthly visits where there appeared to be loss in visual acuity or increase in retinal edema (in other words, PRN dosing).

221. Third, in addition to that approach being common practice among practicing ophthalmologists and skilled persons, it was the trend among industry leaders at the time as well. For example, after Genentech's monthly dosing studies of ranibizumab (MARINA and ANCHOR), they embarked on a clinical trial campaign directed to investigating dosing regimens with less frequent injections. For example, Genentech began, as early as 2007, to assess dosing regimens that included three monthly loading doses, followed by a period of individualized (i.e., as-needed/PRN) dosing, or fixed quarterly dosing. (*See, e.g., SUSTAIN (PRN*

---

and physically traumatic to the patient; and (5) subjects the patient to potential adverse effects such as infection with each treatment event.”)).

dosing after 3 monthly loading doses); EXCITE (quarterly dosing after 3 monthly loading doses); PrONTO (PRN dosing after three monthly loading doses); SAILOR (PRN dosing after 3 monthly loading doses); and PIER (quarterly dosing after 3 monthly loading doses); Ex.1030, Mitchell, 6-7 (providing a summary of each of the above studies). From these studies, the authors concluded that while fixed quarterly dosing may be inferior to monthly dosing (though still more effective than placebo), the individualized regimens (i.e., PRN) could achieve outcomes similar to that observed for monthly dosing. (*See, e.g., id.*, 6-7). All of this work was published, and the groundwork laid for these extended regimens, before the filing date of Regeneron's '069 patent.

222. Fourth, in my opinion, the results reported in Heier-2012, and which Regeneron relies upon in their remarks to the Patent Office, were not unexpected in light of the positive results reported for Regeneron's Phase 2 studies of VEGF Trap-Eye in AMD. In that study, Regeneron used two treatment arms: (1) quarterly dosing for 12 weeks followed by PRN dosing; and (2) fixed monthly dosing for 12 weeks followed by PRN dosing. The latter group, when dosed with 2 mg, achieved on average a gain in visual acuity of 9 letters and a mean decrease in retinal thickness of 143  $\mu\text{m}$ . (Ex.1006, Dixon, 1576). The results of the VIEW studies as reported in Heier-2012 included a mean gain in visual acuity of 7.9 letters and a mean decrease

in retinal thickness of 128.5  $\mu\text{m}$ . (Ex.1018, Heier-2012, 2542). In my opinion, these results from the VIEW studies would not have been surprising or unexpected in light of the results reported for the Phase 2 CLEAR-IT-2 study. This is confirmed by Regeneron itself, which stated that the Phase 2 study results “indicat[e] that an 8-week dosing schedule may be feasible.” (Ex.1012, Regeneron (28-April-2008), 1); *see also id.* (“Due to its high affinity for all isoforms of VEGF-A and PlGF . . . as well as its long residence time in the eye, it is anticipated that VEGF Trap-Eye may be able to be dosed at a frequency less than once monthly . . . . These emerging Phase 2 clinical data seem to support the concept of durability of VEGF Trap-Eye.”)).

223. Lastly, I disagree that there were “an infinite number of different treatment protocols” when deciding on dosing regimens to investigate. Given the concern (shared by Regeneron) over the frequency of monthly dosing, monthly injections would have been avoided if possible, and anything more frequent than monthly would not have been reasonably considered by skilled artisans. However, the VEGF Trap-Eye CLEAR-IT-2 study and the ranibizumab PRN studies (PrONTO, SUSTAIN) were showing that it was possible to maintain gains with such regimens. As a result, given that monthly was disfavored, and that PRN regimens were being employed with success, a person of ordinary skill in the art naturally would have considered PRN dosing, just as Regeneron did in its Phase 2 and year

two of its Phase 3 studies, or every-8-week dosing, as Regeneron did in year one of its Phase 3 studies. Regarding the number of loading doses, the trend in the industry was that three monthly loading doses could achieve substantial gains in visual acuity and decreases in retinal thickness. (*See, e.g.*, Ex.1030, Mitchell, 6-7). Therefore, in my opinion, there was nothing new or nonobvious about the regimen Regeneron settled upon, and its claims to the Patent Office that there were “an infinite number of different treatment protocols” was not true given the state of the art and the practical realities of treating AMD patients with intravitreal injections.

224. In sum, one of ordinary skill in the art would have expected the claimed dosing regimen to work based on the positive Phase 1 and Phase 2 trial results, particularly since the claims do not require a particular level of effectiveness or particular degrees of “treating.” Thus, it would have been expected that following the dosing regimen set forth in the ’069 patent would have led to at least some level of “treating” an angiogenic eye disorder. The dosing regimens claimed in the ’069 patent were not unexpected in my opinion, and the arguments presented by the patentees to the Patent Office do not support their claims of unexpected results.

225. Moreover, in my opinion, any unmet and long-felt need claimed by Regeneron was not met by the ’069 patent claims. While I agree that there may have been a long-felt but unmet need for VEGF antagonists prior to their development, in

my opinion, once those antagonists were developed, and especially after the knowledge gained from the extended dosing regimens being tested for ranibizumab and the early trials of VEGF Trap-Eye, arriving at a dosage regimen that extended the administration beyond once-monthly was obvious, was already noted in the literature, and served no “unmet” need. This is particularly so given that the VIEW dosage regimen on which Regeneron relies in its arguments to the USPTO was already publicly disclosed as early as 2009, meaning that any “unmet” need had already been met by Regeneron’s own public disclosures, as well as the ranibizumab literature and the disclosures of Regeneron’s Phase 2 trial, well before the ’069 patent was filed.

226. I further understand that there may be commercial products that the patent owner may attempt to assert are encompassed by the claims, one potential example being Eylea®. However, in my opinion, none of the claimed dosage regimens covered by the ’069 patent that I have discussed above are responsible for any commercial success of Eylea® and I have seen no evidence that any commercial success of Eylea® has been due to anything outside of the molecule itself, or other factors, such as marketing, promotional activities, or regulatory exclusivity.

I hereby declare that all statements made herein of my own knowledge are true and that all statements made on information and belief are believed to be true. I further declare that all of my statements are made with the knowledge that willful false statements are punishable by fine or imprisonment, or both, under Section 1001 of Title 18 of the United States Code.

Dated: 5/4/21

By:   
Dr. Thomas A. Albini

UNITED STATES PATENT AND TRADEMARK OFFICE

---

BEFORE THE PATENT TRIAL AND APPEAL BOARD

---

MYLAN PHARMACEUTICALS INC.,  
Petitioner

v.

REGENERON PHARMACEUTICALS, INC.,  
Patent Owner

---

*Inter Partes* Review No.: IPR2021-00880

---

U.S. Patent No. 9,669,069 B2  
Filed: December 17, 2015  
Issued: June 6, 2017  
Inventor: George D. Yancopoulos

Title: USE OF A VEGF ANTAGONIST TO TREAT  
ANGIOGENIC EYE DISORDERS

---

**EXPERT DECLARATION OF MARY GERRITSEN, PH.D.  
IN SUPPORT OF PETITION FOR *INTER PARTES* REVIEW OF  
U.S. PATENT NO. 9,669,069 B2**



## TABLE OF CONTENTS

|       |  |    |
|-------|--|----|
| I.    | INTRODUCTION.....  | 1  |
| II.   | QUALIFICATIONS.....  | 1  |
| III.  | SCOPE OF ENGAGEMENT.....   | 4  |
| IV.   | THE PERSON OF ORDINARY SKILL IN THE ART.....   | 7  |
| V.    | LEGAL STANDARDS.....   | 9  |
| VI.   | U.S. PATENT NO. 9,669,069.....   | 9  |
| VII.  | PROSECUTION HISTORIES OF THE '069 PATENT AND ITS<br>EUROPEAN EQUIVALENT, EP-325.....       | 10 |
| VIII. | DISCLOSURES, KNOWLEDGE, & INFORMATION AVAILABLE<br>IN THE ART BEFORE JANUARY 13, 2011..... | 23 |
|       | A. JOURNAL ARTICLES.....   | 23 |
|       | B. REGENERON PRESS RELEASES.....   | 25 |
|       | 1. May 2008 Press Release.....   | 27 |
|       | 2. September 2008 Press Release.....   | 30 |
|       | 3. April 2009 Press Release.....   | 33 |
|       | 4. February 2010 Press Release.....  | 35 |
|       | 5. Additional Regeneron Press Releases.....  | 37 |
|       | C. CLINICALTRIALS.GOV.....   | 42 |
|       | D. SEC FILINGS.....  | 53 |
| IX.   | CONCLUDING STATEMENTS.....   | 56 |

I, Mary Gerritsen, Ph.D., declare as follows:

## **I. INTRODUCTION.**

1. I submit this declaration on behalf of Mylan Pharmaceuticals Inc. (“Petitioner”). I understand that Petitioner is filing a petition with the United States Patent and Trademark Office (“USPTO”) for *inter partes* review of U.S. Patent No. 9,669,069 B2 (the “’069 patent”) (Ex.1001).

2. This Declaration contains my qualifications; my opinions based on my expertise and my review of the ’069 patent and other documents cited within this Declaration; the factual basis for those opinions; and data or other information I considered in forming my opinions. The opinions and facts set forth in this Declaration are based upon information and my analysis of documents related to the ’069 patent, as well as my knowledge and experience in the pharmaceutical and biotechnology industries.

## **II. QUALIFICATIONS.**

3. I am a pharmacologist with over thirty years of experience in the pharmaceutical and biotechnology industries.

4. In 2010, I founded Gerritsen Consulting, and I have been a consultant for the biotechnology industry on topics related to biotherapeutics and drug discovery in the therapeutic areas of oncology, immuno-oncology, ophthalmology, autoimmune diseases/inflammation, cardiovascular disease, and angiogenesis-

related diseases. Specifically, I have collaborated with companies in numerous areas of product development, including research strategy, target selection and assessment, preclinical pharmacology and mechanism of action studies, preparation of Investigational New Drug applications, procedures for clinical trials, and evaluation of pipeline portfolio strategies.

5. Prior to my consulting work, I was the Vice President of Molecular and Cellular Pharmacology at Exelixis, Inc. from 2004-2010. Exelixis is a biotechnology company focused on the development of small molecular therapeutics for the treatment of oncology and metabolic disease. I supervised many of the processes involved in preclinical to early clinical development, including target identification and validation, early lead discovery and validation, lead optimization, cellular and molecular pharmacology studies, pharmacodynamic assays, and early translational medicine studies. I also collaborated with the clinical groups in the early stages of Phase I clinical trials.

6. From 2003-2004, I was a consultant with Frazier Health Care Ventures in which I was involved in the founding of MacuSight, Inc., a pharmaceutical company focused on angiogenesis disorders, specifically focused on age-related macular degeneration and diabetic macular edema. I was an inventor on several of the patents that were the basis for the foundation of the company which included U.S. Patent Nos. 8,222,271, 8,486,960, and 9,452,156.

7. From 2002-2003, I was the Senior Director, Vascular Biology with Millennium Pharmaceuticals (formerly COR Therapeutics) where I was responsible for development of the strategic plan for vascular biology and oversaw numerous small molecule development programs in the therapeutic indications of atherosclerosis, peripheral vascular disease, and fibrosis.

8. Prior to the above, I was Associate Director of the Department of Cardiovascular Research at Genentech, Inc. from 1997-2001. Separately, I was a senior investigator in the angiogenesis group whose focus was the identification of novel targets for protein-based therapeutics. Throughout my time at Genentech, I was involved in the drafting and filing of over 1000 patent applications in which over forty such applications issued as patents.

9. Before joining Genentech, I was a Principal Staff Scientist and Group Leader, Institute for Inflammation and Autoimmunity at Bayer Pharmaceuticals (formerly Miles Pharmaceuticals) from 1990-1997. During this time, I led the screening efforts for small molecule inhibitors of leukocyte adhesion, cyclooxygenase, and cytokine release/action while also supervising six laboratories within the Institute. Additionally, I developed collaborations with other industrial development laboratories as well as academic laboratories in order to promote advances in target discovery and assay development.

10. Prior to my roles in the pharmaceutical and biotechnology industry, I received a Bachelor of Science degree in Zoology and a Ph.D. in Endocrinology and Pharmacology from the University of Calgary. I completed my post-doctoral studies in Pharmacology at the University of California, San Diego. Following my post-doctoral work, I was an Assistant and later an Associate Professor of Physiology at New York Medical College from 1980-1989. During this time, I conducted research in therapeutic areas including stroke, inflammation, ophthalmology and diabetic vascular disease.

11. Throughout my career, I have more than 100 publications in peer-reviewed journals, written numerous book chapters, and authored three books. I am currently, or have been, a member of numerous professional organizations, and I have been presented with numerous awards and honors throughout my career.

12. Additional information about my professional and educational experience, and other background information, is described in my *curriculum vitae* (Ex.1061).

### **III. SCOPE OF ENGAGEMENT.**

13. I have been retained by Petitioner as a technical expert to offer my analysis and opinions regarding various issues related to certain prior art references as they relate to the '069 patent, discussed in more detail below.

14. My time spent on this project is compensated at \$350 per hour. My compensation does not depend in any way on the outcome of Petitioner's petition for *inter partes* review of the '069 patent. Furthermore, I have no financial interest in this matter.

15. My opinions and views set forth in this Declaration are based on my education and training, my experience in academia and the pharmaceutical and biotechnology industries, and on the materials I have reviewed for this case.

16. I have reviewed the '069 patent and relevant sections of its prosecution history before the USPTO, (*see* Ex.1017, '069 FH). I have also reviewed and considered various other documents in arriving at my opinions, and cite them in this Declaration.

17. I have been asked to consider the level of education, skill set and training possessed by persons of ordinary skill in the field relevant to the '069 patent as of at least January 13, 2011.<sup>1,2</sup>

18. I have also been asked to consider, from the perspective of the person of ordinary skill in the art as of at least January 13, 2011, whether certain references or documents were available as printed publications, or in other words, whether certain references or documents would have been publicly accessible to persons interested and ordinarily skilled in the subject matter or art, exercising reasonable diligence, before Jan. 13, 2011.

19. I have formed certain opinions on these issues, which I set forth in greater detail below. In sum, it is my opinion that each of the references I discuss in

---

<sup>1</sup> I have been asked to assume that the priority date of the '069 patent is January 13, 2011, the date of the earliest filed provisional application that appears on the '069 patent cover page. However, I note that the Applicant of the application that issued as the '069 patent argued that the priority date of the '069 patent was November 2011. (*See* Ex.1017, '069 FH, 1/20/17 Amendment, 6). I have formed no opinion regarding the merit of the '069 patent's claim to any priority date.

<sup>2</sup> I provide my understanding of the qualifications for a person of ordinary skill in the art relevant to the '069 patent in ¶¶ 22-24, below.

this declaration are printed publications in that they were publicly accessible to persons interested and ordinarily skilled in the subject matter or art of the '069 patent, exercising reasonable diligence, before Jan. 13, 2011. Moreover, my opinions in this regard are repeatedly confirmed by other contemporaneous prior art documents, which expressly cite the references I have been asked to evaluate. (*See* ¶¶ 50, 58, 64, 70, 81, 88-93, 103, below).

#### **IV. THE PERSON OF ORDINARY SKILL IN THE ART.**

20. As I mentioned above, it is my understanding that my analysis is to be conducted from the perspective of a person of ordinary skill in the art at the time of the invention.

21. I also understand that in defining a person of ordinary skill in the art the following factors may be considered: (1) the educational level of the inventor; (2) the type of problems encountered in the art; (3) prior art solutions to those problems; (4) rapidity with which innovations are made; and (5) sophistication of the technology and educational level of active workers in the field.

22. I understand that a person of ordinary skill in the art is a hypothetical person who is presumed to be aware of all pertinent art, thinks along conventional wisdom in the art, and is a person of ordinary creativity at the time of the invention. I further understand that the relevant timeframe for assessing the '069 patent's



claims from the perspective of a person of ordinary skill in the art is assumed to be January 13, 2011 (the earliest possible priority date for the '069 patent).

23. With respect to the '069 patent, a person of ordinary skill in the art would have: (1) knowledge regarding the diagnosis and treatment of angiogenic eye disorders, including the administration of therapies to treat said disorders; and (2) the ability to understand results and findings presented or published by others in the field, including the publications discussed herein. Typically, such a person would have an advanced degree, such as an M.D. or Ph.D. (or equivalent, or less education but considerable professional experience in the medical, biotechnological, or pharmaceutical field), with practical academic or medical experience in: (i) developing treatments for angiogenic eye disorders, such as age-related macular degeneration ("AMD"), including through the use of VEGF antagonists, or (ii) treating of same, including through the use of VEGF antagonists.

24. A person of ordinary skill in the art would have been aware of the references and teachings described below, as well as other important information and references relating to angiogenic eye disorders, the causes of said disorders, and useful treatments for said disorders.

## V. LEGAL STANDARDS.

25. I am not a lawyer and do not purport to offer any legal opinions. In forming my opinions set forth herein, I have been asked to apply certain standards regarding printed publications.

26. I understand that a reference, publication, document, etc. is a “printed publication” if the document is “publicly accessible.” I also understand that a reference is considered “publicly accessible” if it was disseminated or otherwise made available to the extent that persons interested and ordinarily skilled in the subject matter or art, exercising reasonable diligence, can locate it.

27. Thus, a reference that could be classified as a “printed publication” before the priority date of the ’069 patent would be considered prior art to the ’069 patent.

## VI. U.S. PATENT NO. 9,669,069.

28. I understand that the ’069 patent issued on June 6, 2017 to Regeneron Pharmaceuticals, Inc. and is titled “USE OF A VEGF ANTAGONIST TO TREAT ANGIOGENIC EYE DISORDERS” with George D. Yancopoulos listed as the sole inventor. (Ex.1001, ’069 patent, cover). I also understand that the ’069 patent issued from U.S. Application No. 14/972,560 (“the ’560 Application”), a continuation of U.S. Application No. 13/940,370, filed on July 12, 2013, which issued as U.S. Patent No. 9,254,338 (“the ’338 patent”), which is a continuation-in-part of International

Application No. PCT/US2012/020855, filed January 11, 2012, and claims priority to U.S. Provisional Application No. 61/432,245, filed on January 13, 2011, U.S. Provisional Application No. 61/434,836, filed on January 21, 2011, and U.S. Provisional Application No. 61/561,957, filed on November 21, 2011. (*Id.*).

29. I understand that the '069 patent contains one independent claim and eleven dependent claims. The independent claim is listed below:

1. A method for treating an angiogenic eye disorder in a patient, said method comprising sequentially administering to the patient a single initial dose of a VEGF antagonist, followed by one or more secondary doses of the VEGF antagonist, followed by one or more tertiary doses of the VEGF antagonist;  
wherein each secondary dose is administered 2 to 4 weeks after the immediately preceding dose; and  
wherein each tertiary dose is administered on an as-needed/pro re nata (PRN) basis, based on visual and/or anatomical outcomes as assessed by a physician or other qualified medical professional;  
wherein the VEGF antagonist is a receptor-based chimeric molecule comprising (1) a VEGFR1 component comprising amino acids 27 to 129 of SEQ ID NO:2; (2) a VEGFR2 component comprising amino acids 130-231 of SEQ ID NO:2; and (3) a multimerization component comprising amino acids 232-457 of SEQ ID NO:2.

(Ex.1001, '069 patent, 21:42-60). I also understand that claims 2-12 depend from claim 1, directly or indirectly. (*Id.*, 21:61-22:66).

#### **VII. PROSECUTION HISTORIES OF THE '069 PATENT AND ITS EUROPEAN EQUIVALENT, EP-325.**

30. I have reviewed the prosecution history for the '069 patent, which I understand appears at Ex.1001. It is my understanding that the '560 Application

was filed on December 17, 2015 (*see* Ex.1017, '069 FH, 12/17/2015 Preliminary Amendment, 2) and originally included twelve claims directed towards a method of treating “an angiogenic eye disorder” with a “VEGF antagonist,” (*id.*, 2-3).

31. I have also reviewed EP 2 663 325 (Ex.1062, EP-325), which appears to be the European equivalent to the '370 Application, that issued as the '338 patent. (*Id.*, cover). EP-325 claims the same priority chain as the '370 Application—specifically, EP-325 claims priority to International Application No. PCT/US2012/020855, filed January 11, 2012, which claims priority to U.S. Provisional Application No. 61/432,245, filed on January 13, 2011, U.S. Provisional Application No. 61/434,836, filed on January 21, 2011, and U.S. Provisional Application No. 61/561,957, filed on November 21, 2011. (*Id.*).

32. As originally filed, it is my understanding that EP-325 included claims similar to those prosecuted in the '370 Application that issued as the '338 patent and those prosecuted in the '560 Application that issued as the '069 patent. (Ex.1062, EP-325, [0020]-[0024]; Ex.1063, EP-325-FH, 7/5/2013 Amendments, 19-20; Ex.1017, '069 FH, 12/17/2015 '370 Application Original Claims, 22-23). I have prepared the following chart to illustrate the similarities between the '560 Application claims, the '370 Application claims, and the EP-325 claims:

| '560 Application<br>Original Claims <sup>3,4</sup>  | '370 Application<br>Original Claims   | EP-325<br>Original Claims   |
|---|---|---|
| <p>1. <b>(Currently Amended)</b><br/>A method for treating an angiogenic eye disorder in a patient, said method comprising sequentially administering to the patient a single initial dose of a VEGF antagonist, followed by one or more secondary doses of the VEGF antagonist, followed by one or more tertiary doses of the VEGF antagonist;</p> <p>wherein each secondary dose is administered 2 to 4 weeks after the immediately preceding dose; and</p> <p>wherein each tertiary dose is administered <del>at least 8 weeks after the immediately preceding dose</del> <u>on an as-</u></p> | <p>1. A method for treating an angiogenic eye disorder in a patient, said method comprising sequentially administering to the patient a single initial dose of a VEGF antagonist, followed by one or more secondary doses of the VEGF antagonist, followed by one or more tertiary doses of the VEGF antagonist;</p> <p>wherein each secondary dose is administered 2 to 4 weeks after the immediately preceding dose; and</p> <p>wherein each tertiary dose is administered at least 8 weeks after the</p> | <p>1. A method for treating an angiogenic eye disorder in a patient, said method comprising sequentially administering to the patient a single initial dose of a VEGF antagonist, followed by one or more secondary doses of the VEGF antagonist, followed by one or more tertiary doses of the VEGF antagonist;</p> <p>wherein each secondary dose is administered 2 to 4 weeks after the immediately preceding dose; and</p> <p>wherein each tertiary dose is administered at least 8 weeks after the</p> |

<sup>3</sup> It is my understanding that the language to Claims 1, 8, 13, and 18 of the '560 Application was initially amended as noted in the chart.

<sup>4</sup> Based on my review of the '560 Application's original claims, it appears that Claims 4-5, 9-12, and 15-17 were cancelled during prosecution.

| '560 Application<br>Original Claims <sup>3, 4</sup>  | '370 Application<br>Original Claims  | EP-325<br>Original Claims  |
|--|--|--|
| <p><u>needed/pro re nata (PRN) basis, based on visual and/or anatomical outcomes as assessed by a physician or other qualified medical professional;</u></p> <p><u>wherein the VEGF antagonist is a receptor-based chimeric molecule comprising (1) a VEGFR1 component comprising amino acids 27 to 129 of SEQ ID NO:2; (2) a VEGFR2 component comprising amino acids 130-231 of SEQ ID NO:2; and (3) a multimerization component comprising amino acids 232-457 of SEQ ID NO:2.</u></p> | <p>immediately preceding dose.</p>   | <p>immediately preceding dose.</p>   |
| <p>2. (Original) The method of claim 1, wherein only a single secondary dose is administered to the patient, and wherein the single secondary dose is administered 4 weeks after the initial dose of the VEGF antagonist.</p>  | <p>2. The method of claim 1, wherein only a single secondary dose is administered to the patient, and wherein the single secondary dose is administered 4 weeks after the initial dose of the VEGF antagonist.</p> | <p>2. The method of claim 1, wherein only a single secondary dose is administered to the patient, and wherein the single secondary dose is administered 4 weeks after the initial dose of the VEGF antagonist.</p> |
| <p>3. (Original) The method of claim 1, wherein only</p>   | <p>3. The method of claim 1, wherein only two</p>  | <p>3. The method of claim 1, wherein only two</p>  |

| <b>'560 Application<br/>Original Claims<sup>3, 4</sup></b>   | <b>'370 Application<br/>Original Claims</b>  | <b>EP-325<br/>Original Claims</b>  |
|--|--|--|
| two secondary doses are administered to the patient, and wherein each secondary dose is administered 4 weeks after the immediately preceding dose.                       | secondary doses are administered to the patient, and wherein each secondary dose is administered 4 weeks after the immediately preceding dose.   | secondary doses are administered to the patient, and wherein each secondary dose is administered 4 weeks after the immediately preceding dose.   |
| 4. <b>(Canceled)</b><br><br>5. <b>(Canceled)</b>   | 4. The method of claim 3, wherein each tertiary dose is administered 8 weeks after the immediately preceding dose.<br><br>5. The method of claim 1, wherein at least 5 tertiary doses of the VEGF antagonist are administered to the patient, and wherein the first four tertiary doses are administered 8 weeks after the immediately preceding dose, and wherein each subsequent tertiary dose is administered 8 or 12 weeks after the immediately preceding dose. | 4. The method of claim 3, wherein each tertiary dose is administered 8 weeks after the immediately preceding dose.<br><br>5. The method of claim 1, wherein at least 5 tertiary doses of the VEGF antagonist are administered to the patient, and wherein the first four tertiary doses are administered 8 weeks after the immediately preceding dose, and wherein each subsequent tertiary dose is administered 8 or 12 weeks after the immediately preceding dose. |
| 6. The method of claim 1, wherein the angiogenic eye disorder is selected from the group consisting of: age related macular degeneration, diabetic retinopathy, diabetic | 6. The method of claim 1, wherein the angiogenic eye disorder is selected from the group consisting of: age related macular degeneration, diabetic retinopathy, diabetic   | 6. The method of claim 1, wherein the angiogenic eye disorder is selected from the group consisting of: age related macular degeneration, diabetic retinopathy, diabetic   |

| '560 Application<br>Original Claims <sup>3, 4</sup>   | '370 Application<br>Original Claims  | EP-325<br>Original Claims  |
|---|--|--|
| <p>macular edema, central retinal vein occlusion, branch retinal vein occlusion, and corneal neovascularization.</p> <p>7. (Original) The method of claim 6, wherein the angiogenic eye disorder is age related macular degeneration.</p>   | <p>macular edema, central retinal vein occlusion, branch retinal vein occlusion, and corneal neovascularization.</p> <p>7. The method of claim 6, wherein the angiogenic eye disorder is age related macular degeneration.</p> | <p>macular edema, central retinal vein occlusion and corneal neovascularization.</p> <p>7. The method of claim 6, wherein the angiogenic eye disorder is age related macular degeneration.</p>             |
| <p>8. (Currently Amended) The method of claim 1, wherein <u>all doses of the VEGF antagonist</u> <del>is an anti-VEGF antibody or fragment thereof, an anti-VEGF receptor antibody or fragment thereof, or a VEGF receptor-based chimeric molecule</del> <u>are administered to the patient by topical administration or by intraocular administration.</u></p> | <p>8. The method of claim 1, wherein the VEGF antagonist is an anti-VEGF antibody or fragment thereof, an anti-VEGF receptor antibody or fragment thereof, or a VEGF receptor-based chimeric molecule.</p>                     | <p>8. The method of claim 1, wherein the VEGF antagonist is an anti-VEGF antibody or fragment thereof, an anti-VEGF receptor antibody or fragment thereof, or a VEGF receptor based chimeric molecule.</p> |
| <p>9. (Canceled)</p>  | <p>9. The method of claim 8, wherein the VEGF antagonist is a VEGF receptor-based chimeric molecule.</p>   | <p>9. The method of claim 8, wherein the VEGF antagonist is a VEGF receptor-based chimeric molecule.</p>   |



| <b>'560 Application<br/>Original Claims<sup>3, 4</sup></b> | <b>'370 Application<br/>Original Claims</b>   | <b>EP-325<br/>Original Claims</b>   |
|--|---|---|
| 10. <b>(Canceled)</b>                                      | 10. The method of claim 9, wherein the VEGF receptor-based chimeric molecule comprises VEGFR1R2-FcΔC1(a) encoded by the nucleic acid sequence of SEQ ID NO:1.   | 10. The method of claim 9, wherein the VEGF receptor-based chimeric molecule comprises VEGFR1R2-FcΔC1(a) encoded by the nucleic acid sequence of SEQ ID NO:1.   |
| 11. <b>(Canceled)</b>                                      | 11. The method of claim 9, wherein the VEGF receptor-based chimeric molecule comprises (1) a VEGFR1 component comprising amino acids 27 to 129 of SEQ ID NO:2; (2) a VEGFR2 component comprising amino acids 130-231 of SEQ ID NO:2; and (3) a multimerization component comprising amino acids 232-457 of SEQ ID NO:2. | 11. The method of claim 9, wherein the VEGF receptor-based chimeric molecule comprises (1) a VEGFR1 component comprising amino acids 27 to 129 of SEQ ID NO:2; (2) a VEGFR2 component comprising amino acids 130-231 of SEQ ID NO:2; and (3) a multimerization component comprising amino acids 232-457 of SEQ ID NO:2. |
| 12. <b>(Canceled)</b>                                      | 12. The method of claim 1, wherein all doses of the VEGF antagonist are administered to the patient by topical administration or by intraocular administration.   | 12. The method of claim 1, wherein all doses of the VEGF antagonist are administered to the patient by topical administration or by intraocular administration.   |

| <b>'560 Application<br/>Original Claims<sup>3, 4</sup></b>  | <b>'370 Application<br/>Original Claims</b>   | <b>EP-325<br/>Original Claims</b>   |
|---|---|---|
| <p>13. <b>(Currently Amended)</b> The method of claim <del>2</del> <del>12</del>, wherein all doses of the VEGF antagonist are administered to the patient by intraocular administration.</p> <p>14. <b>(Original)</b> The method of claim 13, wherein the intraocular administration is intravitreal administration.</p> | <p>13. The method of claim 12, wherein all doses of the VEGF antagonist are administered to the patient by intraocular administration.</p> <p>14. The method of claim 13, wherein the intraocular administration is intravitreal administration.</p>  | <p>13. The method of claim 12, wherein all doses of the VEGF antagonist are administered to the patient by intraocular administration.</p> <p>14. The method of claim 13, wherein the intraocular administration is intravitreal administration.</p>  |
| <p>15. <b>(Canceled)</b></p> <p>16. <b>(Canceled)</b></p> <p>17. <b>(Canceled)</b></p>  | <p>15. The method of claim 11, wherein all doses of the VEGF antagonist are administered to the patient by topical administration or by intraocular administration.</p> <p>16. The method of claim 15, wherein all doses of the VEGF antagonist are administered to the patient by intraocular administration.</p> <p>17. The method of claim 16, wherein the</p> | <p>15. The method of claim 11, wherein all doses of the VEGF antagonist are administered to the patient by topical administration or by intraocular administration.</p> <p>16. The method of claim 15, wherein all doses of the VEGF antagonist are administered to the patient by intraocular administration.</p> <p>17. The method of claim 16, wherein the</p> |

| '560 Application<br>Original Claims <sup>3, 4</sup>   | '370 Application<br>Original Claims  | EP-325<br>Original Claims  |
|---|--|--|
|   | intraocular administration<br>is intravitreal<br>administration.   | intraocular administration<br>is intravitreal<br>administration.   |
| <p>18. <b>(Currently Amended)</b> The method of claim <del>13</del> 17, wherein all doses of the VEGF antagonist comprise from about 0.5 mg to about 2 mg of the VEGF antagonist.</p> <p>19. (Original) The method of claim 18, wherein all doses of the VEGF antagonist comprise 0.5 mg of the VEGF antagonist.</p> <p>20. (Original) The method of claim 18, wherein all doses of the VEGF antagonist comprise 2 mg of the VEGF antagonist.</p> | <p>18. The method of claim 17, wherein all doses of the VEGF antagonist comprise from about 0.5 mg to about 2 mg of the VEGF antagonist.</p> <p>19. The method of claim 18, wherein all doses of the VEGF antagonist comprise 0.5 mg of the VEGF antagonist.</p> <p>20. The method of claim 18, wherein all doses of the VEGF antagonist comprise 2 mg of the VEGF antagonist.</p> | <p>18. The method of claim 17, wherein all doses of the VEGF antagonist comprise from about 0.5 mg to about 2 mg of the VEGF antagonist.</p> <p>19. The method of claim 18, wherein all doses of the VEGF antagonist comprise 0.5 mg of the VEGF antagonist.</p> <p>20. The method of claim 18, wherein all doses of the VEGF antagonist comprise 2 mg of the VEGF antagonist.</p> |
| <p>21. <b>(New)</b> The method of claim 1, wherein the VEGF antagonist is VEGFR1R2-FcΔC1(a) encoded by the nucleic</p>  | <p>10. The method of claim 9, wherein the VEGF receptor-based chimeric molecule comprises VEGFR1R2-FcΔC1(a) encoded by the nucleic acid sequence of SEQ ID NO:1.</p>   | <p>10. The method of claim 9, wherein the VEGF receptor-based chimeric molecule comprises VEGFR1R2-FcΔC1(a) encoded by the nucleic acid sequence of SEQ ID NO:1.</p>   |

| '560 Application<br>Original Claims <sup>3,4</sup> | '370 Application<br>Original Claims | EP-325<br>Original Claims |
|--|-------------------------------------|---------------------------|
| acid sequence of SEQ ID<br>NO:1. <sup>5</sup>      |                                     |                           |

(Ex.1017, '069 FH, 12/17/2015 Preliminary Amendment, 2-3; *id.*, 12/17/2015 '370 Application Original Claims, 22-23; Ex.1063, EP-325-FH, 1/23/2012 Claims, 19-20). As noted above, the original claims of the '560 Application are very similar, if not the same but for a few amendments to the claims, to the original claims of the '370 Application, and the original claims of EP-325. (*Id.*)

33. As I describe in more detail in the following paragraphs, several references were cited as prior art against EP-325, confirming, in my opinion their public availability and relevance to the '069 patent.

34. According to the prosecution history of EP-325, the International Searching Authority identified a September 28, 2008 Regeneron Press Release as a

---

<sup>5</sup> Based on my review of the '560 Application's Original Claims, the '370 Application's Original Claims, and EP-325's Original Claims, Claim 21 of the '560 Application appears to add the same claim limitation that was present in Claim 10 of the '370 Application and EP-325; however, the '560 Application's applicants cancelled Claim 10 during prosecution.

“prior art document” that it “considered” in its May 22, 2012 written opinion (referencing the document as “D13”):

D13: XP002674126

Thomson Reuters Integrity: "VEGF Trap-Eye final phase II results in age-related macular degeneration presented at 2008 Retina Society Meeting",

28 September 2008 (2008-09-28), pages 1-1, XP002674126.

D13 (phase II study) describes the improvement of visual acuity in age-related macular degeneration patients after VEGF Trap-Eye monthly or quarterly administration for 12 weeks followed by an 40 additional weeks-treatment on a PNR (as needed) dosing schedule.

(Ex.1063, EP-325-FH, 5/14/2012 International Searching Authority Written Opinion, 3-4; *id.*, 7/19/2012 International Search Report, 1; *see also id.*, 9/5/2016 Third Party Observations, 2 (D13)). The International Search Authority then continued to discuss “D13” as the “closest prior art”:

7.1 **The closest prior art, D13** (phase II study summary), describes the improvement of visual acuity in age-related macular degeneration patients after VEGF Trap-Eye monthly or quarterly administration for 12 weeks followed by 40 additional weeks treatment on a PNR (as needed) dosing schedule.

(*Id.*, 5/14/2012 International Searching Authority Written Opinion, 5).

35. The European Patent Office cited to this same Regeneron Press Release (as “D13”) in reaching its conclusions in its August 21, 2014 Communication:

7.6 **The problem to be solved** "provision of improved protocols to treat age related macular degeneration, diabetic retinopathy, diabetic macular edema, central retinal vein occlusion and corneal neovascularization" has not been shown to be solved by the claimed solutions in the present application. The objective technical problem needs to be reformulated to the less ambitious one "provision of alternative protocols to treat age related macular degeneration, diabetic retinopathy, diabetic macular edema, central retinal vein occlusion and corneal neovascularization" for which the claimed solutions are obvious in view of D13.

(*Id.*, 8/21/2014 Communication, 8; *see also id.*, 3-5).

36. Indeed, multiple Third-Party Observations were submitted during prosecution of EP 325. The first Third Party Observation included reference to, *inter alia*, Regeneron Press Releases, a ClinicalTrials.gov record from the VIEW2 study, and Regeneron's Form 10-Q from November 2007—all submitted as "prior art":

|       |   |
|-------|---|
| D13:  | XP002674126   |
| OBS1: | Slides for the 2008 Retina Society Meeting "VEGF Trap-Eye in Wet AMD CLEAR-IT 2: Summary of One-Year Key Results", September 28, 2008 |
| OBS2: | Information from ClinicalTrials.gov archive on the VIEW 2 study (NCT00637377) version available on 17 March 2008                      |
| OBS3: | Regeneron Pharmaceuticals, Inc. FORM 10-Q, published on 7 November 2007 for the period ending 30 September 2007                       |
| OBS4: | WHO Drug Information, Vol.20, No. 2, 2006, pages 115-119  |
| OBS5: | Dixon et al., Expert Opin. Investig. Drugs (2009) 18 (10): 1-8  |
| OBS6: | Símó and Hernández, Diabetes Care, Volume 32, Number 8, August 2009   |
| OBS7: | Mousa and Mousa, Biodrugs 2010; 24(3); 183-194  |
| OBS8: | Regeneron, Press release "Regeneron Reports First Quarter 2008 Financial and Operating Results", May 1, 2008                          |

(*Id.*, 9/5/2016 Third Party Observations, 2; *see also id.*, 3-4). The second Third Party Observation additionally identified the following:

|         |   |
|---------|---|
| Annex 1 | Press Release of Regeneron dated 22 November 2010 |
| Annex 2 | Press Release of Regeneron dated 20 December 2010 |
| Annex 3 | Article in Retinal Physician (March 2010)         |

(*Id.*, 9/7/2016 Third Party Observations, 2).

37. The European Patent Office's reliance on the above-mentioned documents confirms, in my opinion, that each was publicly accessible to persons interested and ordinarily skilled in the subject matter or art of the '069 patent, exercising reasonable diligence, before 2011. I further note that, as far as I can tell from reviewing the EP-325 file history, Regeneron never contested the public availability of those documents.

38. Separately, I find it important to note that, while prosecuting the '069 patent, the Applicants relied extensively on Heier-2012, a reference that, in my opinion, further confirms the public accessibility of Petitioner's asserted ClinicalTrials.gov reports, e.g., NCT-795 and NCT-377:

### Study Design

The “VEGF Trap-Eye: Investigation of Efficacy and Safety in Wet AMD” studies (VIEW 1 and VIEW 2) were similarly designed, prospective, double-masked, multinational, parallel-group, active-controlled, randomized clinical trials. The investigators from the VIEW 1 and VIEW 2 studies are listed in Appendix 1, available at <http://aaojournal.org>. Patients in VIEW 1 (registered at [www.clinicaltrials.gov](http://www.clinicaltrials.gov) on July 31, 2007; NCT00509795. Accessed August 8, 2012) were randomized at 154 sites in the United States and Canada. Patients in VIEW 2 (registered at [www.clinicaltrials.gov](http://www.clinicaltrials.gov) on March 12, 2008; NCT00637377. Accessed August 8, 2012) were randomized at 172 sites in Europe, the Middle East, Asia-Pacific, and Latin America; the last patient in both studies completed 52 weeks in September 2010. The study protocols were

(Ex.1018, Heier-2012, 2539; *see also* Ex.1017, ’069 FH, 1/30/2017 Applicant Arguments, 7 (“[t]he attached Heier et al. article is a peer reviewed article published in ‘Ophthalmology’”)).

## VIII. DISCLOSURES, KNOWLEDGE, & INFORMATION AVAILABLE IN THE ART BEFORE JANUARY 13, 2011.

### A. JOURNAL ARTICLES.

39. Journal articles are routinely provided online prior to being made available in the printed journal, and their public availability and dissemination online would have allowed persons interested and ordinarily skilled in the art exercising reasonable diligence to locate them. Not only would a person of ordinary skill in the art have been interested in, and sought out, the information contained in printed journals, but this person would have been able to easily obtain these articles from the journal’s website on the date of, or earlier than, the date of printed publication. In fact, journals routinely publish articles on their website earlier than the printed



journal in order to disseminate them to the public quicker and in an easily accessible manner. Additionally, these articles typically appear in web search results when a person of ordinary skill in the art conducts a search using various search engines (e.g., via Google Scholar, Google, PubMed, etc.).

40. For example, the Mitchell article analyzes data from several ranibizumab clinical trials in an assessment of various dosing schedules. (See Ex.1030, Mitchell, 5-7). Mitchell published in print in the British Journal of Ophthalmology (“BJO”) in January 2010, but the article states that it was first published online on May 20, 2009. (*Id.*, 2 (“Published Online First 20 May 2009”). “Online First” was the BJO’s advanced online publication of manuscripts in PDF form. (Ex.1064, Wayback-BJO-Online First, 1 (Wayback Machine record from February 12, 2009 describing the BJO’s “Online First” advanced publication procedure)). According to the BJO’s website from February 12, 2009, the articles published through “Online First” were “indexed by PubMed,” and would appear, at least, in PubMed search results. (*Id.*). Furthermore, the BJO retains online download statistics for all their articles and shows that in the first month that Mitchell was available online, May 2009, the PDF was downloaded 299 times. (Ex.1065, BJO-Article Metrics, 1). As such, as of May 20, 2009, a person of ordinary skill in the art exercising reasonable diligence would have been able to locate the article on,

among other things, the BJO's website or PubMed, and easily download an electronic copy.

**B. REGENERON PRESS RELEASES.**

41. In my experience in the pharmaceutical and biotechnology industries, companies like Regeneron and Bayer routinely issue press releases that include, e.g., information on product development and/or clinical trials. These press releases can include information regarding, among other things, the specific product in development, the study design of a clinical trial, and/or preliminary or final results from a specific clinical trial(s). A person of ordinary skill in the art would be interested in this type of information regarding ongoing product development within the industry, including information regarding the development of products of a direct competitor. For example, this type of information continually updates the competitive landscape for a particular market and would assist the person of ordinary skill in the art in evaluating the same. As these press releases are a rich source of information about the ongoing development for a particular treatment, persons of ordinary skill in the art routinely review such press releases, whether as a result of exercising diligence, received from email alerts (e.g., via Google Alerts), or website updates (e.g., Seeking Alpha, Evaluate Pharma, and FiercePharma). Indeed, I myself have searched for, reviewed and relied upon such press releases throughout my professional career.

42. Regeneron's and Bayer's press releases regarding VEGF Trap-Eye were no different, and, in my opinion, a person of ordinary skill in the art would have sought out this information. As specifically noted below, the Regeneron and Bayer press releases regarding VEGF Trap-Eye disclosed the ongoing development of VEGF Trap-Eye as a therapy for angiogenic eye disorders, including different treatment regimens using VEGF Trap-Eye.

43. Not only would a person of ordinary skill in the art have been interested in, and sought out, the information contained in the Regeneron and Bayer press releases, but this person would have been able to easily obtain these press releases directly from Regeneron's website on the date of each release. In fact, companies routinely publish press releases and other information on the company website under a "News" menu or something similar (e.g., "Media" menu or "Investors & Media" menu) in order to disseminate them to the public in an easily accessible manner, and press releases are well-known to the community interested in the subject matter of the reference as a source of useful information. Additionally, documents such as press releases typically appear in web search results (e.g., via Google) when a person of ordinary skill in the art conducts a search using various search engines.

44. Thus, as of the date of each press release, a person of ordinary skill in the art would have been able to locate the specific press release on, among other

things, Regeneron's website exercising reasonable diligence, easily access each press release via Regeneron's website, and easily download an electronic copy.

**1. May 2008 Press Release.**

45. Regeneron and Bayer HealthCare AG issued a press release dated May 8, 2008 (Ex.1013, Regeneron (8-May-2008)), which described the Phase 3 age-related macular degeneration VIEW 2 clinical trial as well as results of a Phase 2 clinical trial. (*Id.*, 1; *see also* Ex.1032, Bayer (8-May-2008), 1).

46. Specifically, Regeneron (8-May-2008) stated that both the complete VIEW 1 trial and the VIEW 2 trial were "designed to evaluate the efficacy and safety of VEGF Trap-Eye administered by intravitreal injection, at dosing intervals of 4 and 8 weeks." (Ex.1013, Regeneron (8-May-2008), 1; Ex.1032, Bayer (8-May-2008), 1). Moreover, the Phase 2 clinical trial described "met both primary and secondary key endpoints" and that "[f]ollowing the initial 12-week fixed-dosing phase of the trial, patients continued to receive therapy at the same dose on a PRN (as needed) dosing schedule based upon the physician assessment of the need for re-treatment." (Ex.1013, Regeneron (8-May-2008), 1).

47. Regeneron (8-May-2008) also described the dosing regimens used in the VIEW 2 clinical trial, including "2.0 mg at an 8-week dosing interval, including one additional 2.0 mg dose at week four," in which one of the dosing arms included

a regimen of 2 mg every 8 weeks, with an additional injection at week 4. (Ex.1013, Regeneron (8-May-2008), 1).

48. Regeneron (8-May-2008) concluded that in the Phase 2 clinical trial, “on average, patients on the PRN dosing schedule maintained the gain in visual acuity and decrease in retinal thickness achieved at week 12 through week 32 of the study.” (Ex.1013, Regeneron (8-May-2008), 1).

49. A person of ordinary skill in the art would have understood that the dosing regimens disclosed in Regeneron (8-May-2008) included the experimental group that received VEGF Trap-Eye 2 mg every other month or on a PRN dosing schedule following the initial monthly injections over the first twelve weeks. (Ex.1013, Regeneron (8-May-2008), 1).

50. A person of ordinary skill in the art would have been interested in, and sought out, the information disclosed in Regeneron (8-May-2008) because it pertains to ongoing product development within the industry, including dosing regimens of a known therapy (VEGF Trap-Eye or aflibercept) in patients with age-related macular degeneration. (Ex.1013, Regeneron (8-May-2008), 1). Again, my opinion in this regard is, in fact, confirmed by other contemporaneous prior art to the '069 patent that expressly refer to similar Regeneron and Bayer press releases. For example, Adis (Ex.1007, Adis) provides the following among twenty separate references to online “Media Releases”:

12. Bayer HealthCare AG. Bayer and Regeneron start additional Phase 3 Study for VEGF Trap-Eye in Wet Age-related Macular Degeneration. Media Release: 8 May 2008. Available from URL: <http://www.bayerscheringpharma.de>
13. Bayer HealthCare AG, Regeneron Pharmaceuticals Inc. Bayer and Regeneron Dose First Patient in Second Phase 3 Study for VEGF Trap-Eye in Wet Age-Related Macular Degeneration. Media Release: 8 May 2008. Available from URL: <http://www.bayerhealthcare.com>

(*Id.*, 268 (emphasis added); *see also* Ex.1032, Bayer (8-May-2008), 1). Indeed, press releases such as Regeneron (8-May-2008) were well-known—and widely available—to the community interested in the subject matter of the '069 patent. (*See, e.g.*, Ex.1007, Adis, 262-63, 268-69).

51. In my opinion (and as confirmed by, e.g., Adis), a person of ordinary skill in the art would have also been able to locate Regeneron (8-May-2008) exercising reasonable diligence, which would have at least led the person of ordinary skill in the art to Regeneron's website where the document was easily accessible, and recognize and comprehend therefrom the essentials of the subject matter contained therein without further research or experimentation.<sup>6</sup> Thus, a person of ordinary skill in the art could have easily accessed Regeneron (8-May-2008) via Regeneron's website and easily downloaded an electronic copy.

---

<sup>6</sup> Ex.1013, Regeneron (8-May-2008), 1.

52. For at least these reasons, it is my opinion that Regeneron (8-May-2008) was a well-known, printed publication that was publicly accessible to persons interested and ordinarily skilled in the subject matter or art of the '069 patent, exercising reasonable diligence, before 2011.

**2. September 2008 Press Release.**

53. Regeneron and Bayer HealthCare AG issued a press release dated September 28, 2008 (Ex.1056, Regeneron (28-September-2008)), which described the final results for the same “double-masked, prospective, randomized, multi-center Phase 2 trial” in patients with wet age-related macular degeneration, treated with VEGF Trap-Eye that was described in Regeneron (8-May-2008). (*Id.*, 1).

54. As noted above, the patients in the study were “randomized to five dose groups” as follows:

- (1) monthly dose of 0.5 milligrams (mg) of VEGF Trap-Eye for twelve weeks followed by therapy at the same dose on a PRN dosing schedule;
- (2) monthly dose of 2.0 mg of VEGF Trap-Eye for twelve weeks followed by therapy at the same dose on a PRN dosing schedule;
- (3) quarterly dose of 0.5 mg of VEGF Trap-Eye (at baseline and week 12) followed by therapy at the same dose on a PRN dosing schedule;
- (4) quarterly dose of 2.0 mg of VEGF Trap-Eye (at baseline and week 12) followed by therapy at the same dose on a PRN dosing schedule; or

- (5) quarterly dose of 4.0 mg of VEGF Trap-Eye (at baseline and week 12) followed by therapy at the same dose on a PRN dosing schedule.

*(Id.*, 1).

55. Regeneron (28-September-2008) stated that “[p]atients receiving monthly doses of VEGF Trap-Eye of either 2.0 or 0.5 milligrams (mg) for 12 weeks followed by PRN dosing achieved mean improvements in visual acuity versus baseline” and “mean decreases in retinal thickness versus baseline.” *(Id.*, 1).

56. Regeneron (28-September-2008) also described the dosing regimens used in the two Phase 3 trials, VIEW1 and VIEW2, including “VEGF Trap-Eye dosed . . . 2 mg every 8 weeks (following three monthly doses).” *(Id.*, 1-2).

57. A person of ordinary skill in the art would have understood the dosing regimens disclosed in Regeneron (28-September-2008) included the experimental groups that were to receive VEGF Trap-Eye 2 mg every eight weeks (following three monthly doses) or “monthly doses of 0.5 or 2.0 milligrams (mg) of VEGF Trap-Eye” followed by “a PRN dosing schedule based upon the physician assessment of the need for re-treatment.” *(Id.*, 1-2).

58. A person of ordinary skill in the art would have been interested in, and sought out, the information disclosed in Regeneron (28-September-2008) because it pertains to ongoing product development within the industry, including dosing regimens of a known therapy (VEGF Trap-Eye or aflibercept) in patients with wet