



(19) **United States**

(12) **Patent Application Publication** (10) **Pub. No.: US 2006/0116818 A1**

Chao et al. (43) **Pub. Date: Jun. 1, 2006**

(54) **METHOD AND SYSTEM FOR MULTIPLE ROUTE NAVIGATION**

(52) **U.S. Cl. 701/211; 701/208; 455/456.1; 455/457; 340/990**

(75) **Inventors: Yi-Chung Chao, Fremont, CA (US); Robert Rennard, Gilroy, CA (US); Salman Dhanani, Redmond, WA (US)**

(57) **ABSTRACT**

Correspondence Address:
IRENE HU
2033 RALSTON AVE., PMB 146
BELMONT, CA 94002 (US)

Method and system for providing multiple route navigation guidance. The system comprises a client integrated with a mobile communication device (e.g. PDA, cellular telephone, etc.) and a server communicating via wireless carriers and networks. The server obtains a user's initial position, a user-designated destination, and calculates multiple routes from the user's initial position to the destination. The client displays turn-by-turn navigation instructions to the user using the multiple routes sent by the server. If the client detects a deviation from the multiple routes, the client sends a request for new multiple routes to the server. Then, the server recalculates new multiple routes from the user's current position to the destination and sends navigation information related to the new multiple routes to the client.

(73) **Assignee: Televigation, Inc., Sunnyvale, CA**

(21) **Appl. No.: 11/004,198**

(22) **Filed: Dec. 1, 2004**

Publication Classification

(51) **Int. Cl. G01C 21/30 (2006.01)**

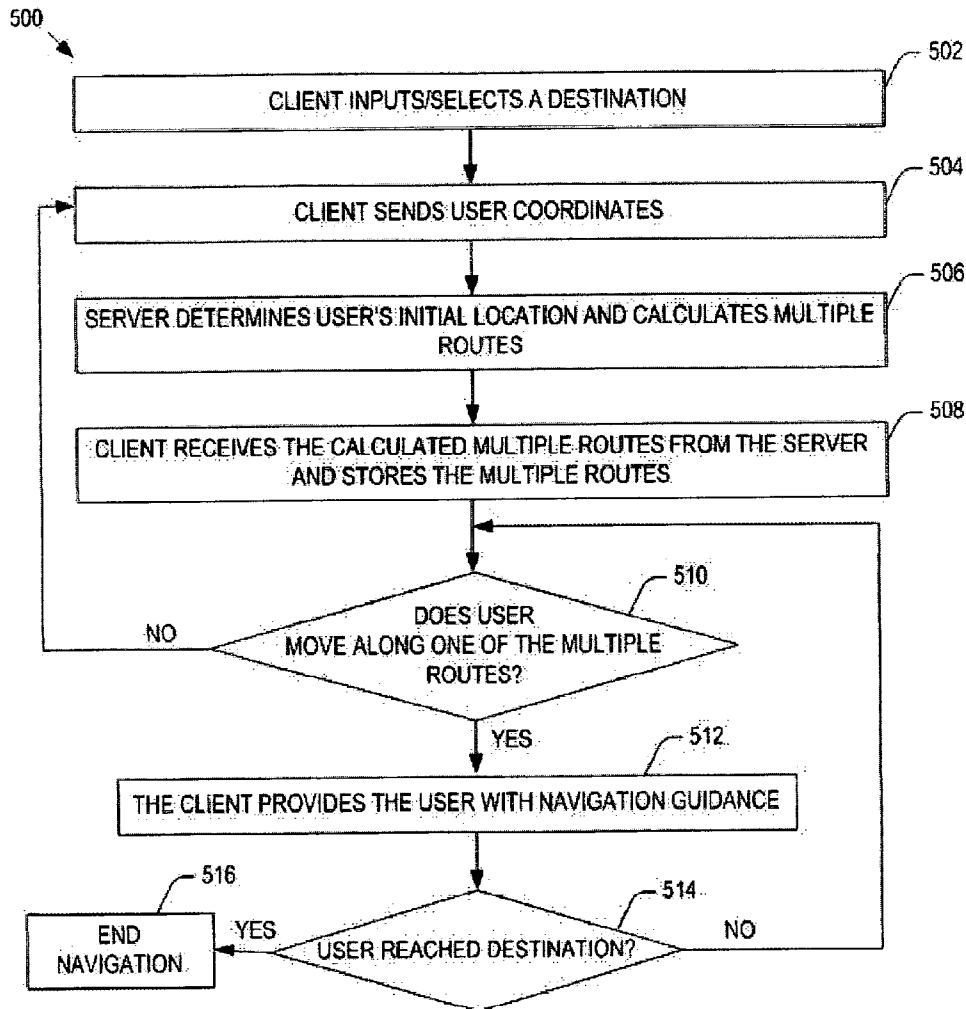

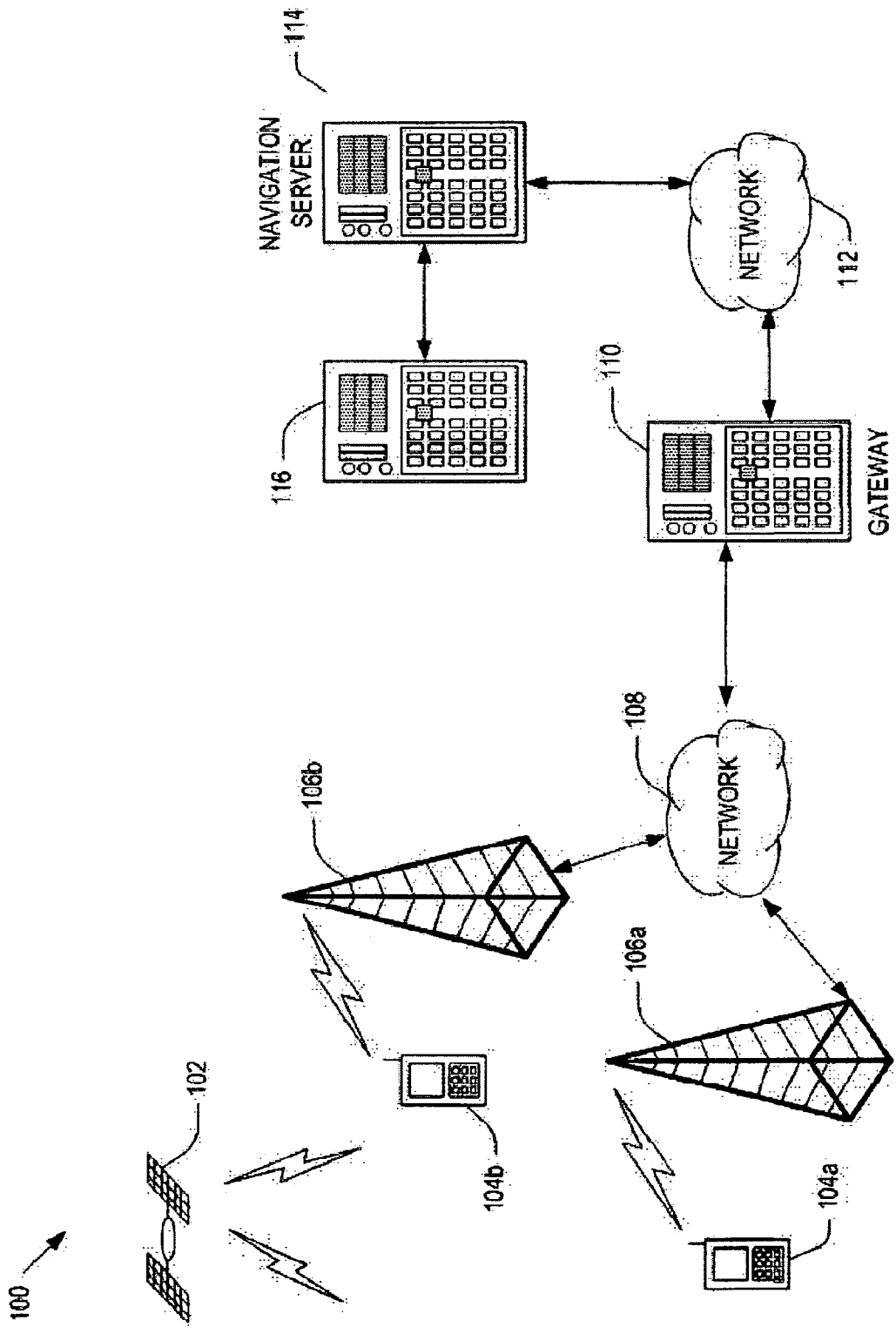

FIG. 1A

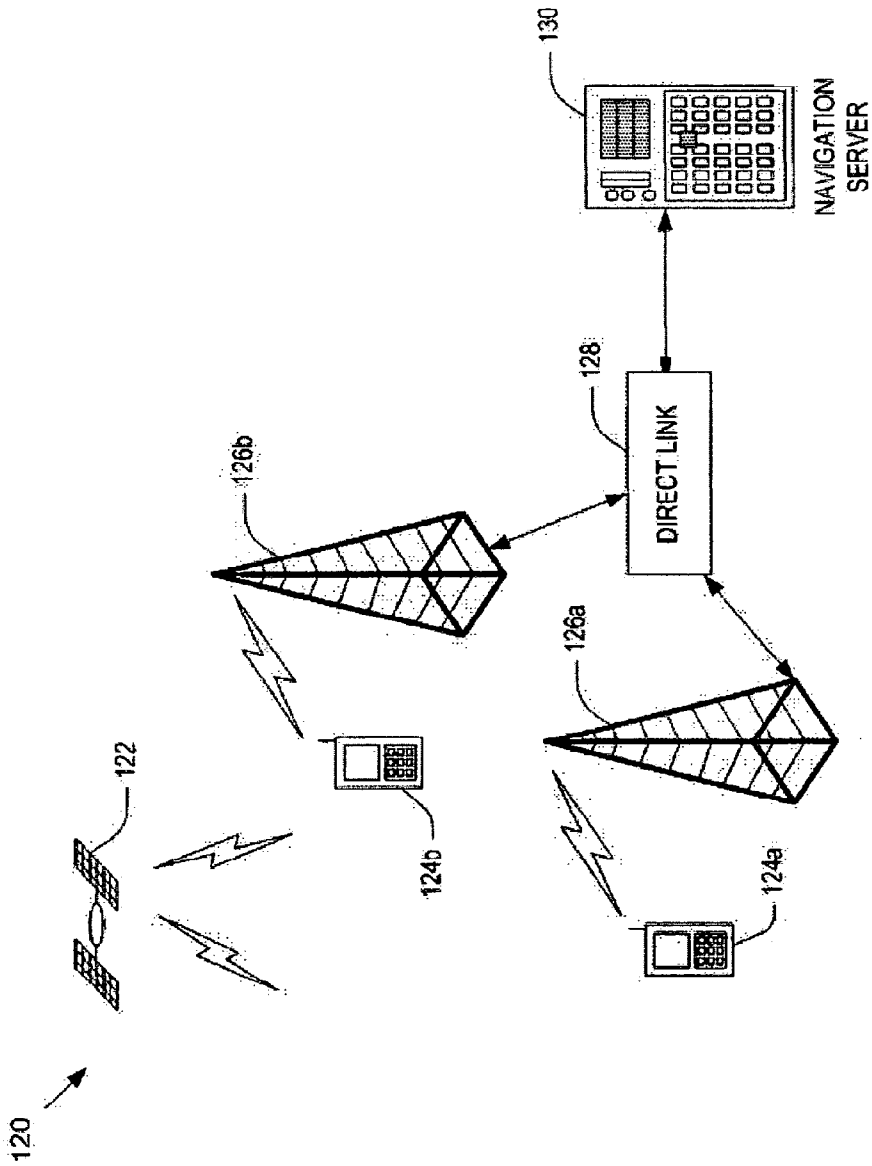

FIG. 1B

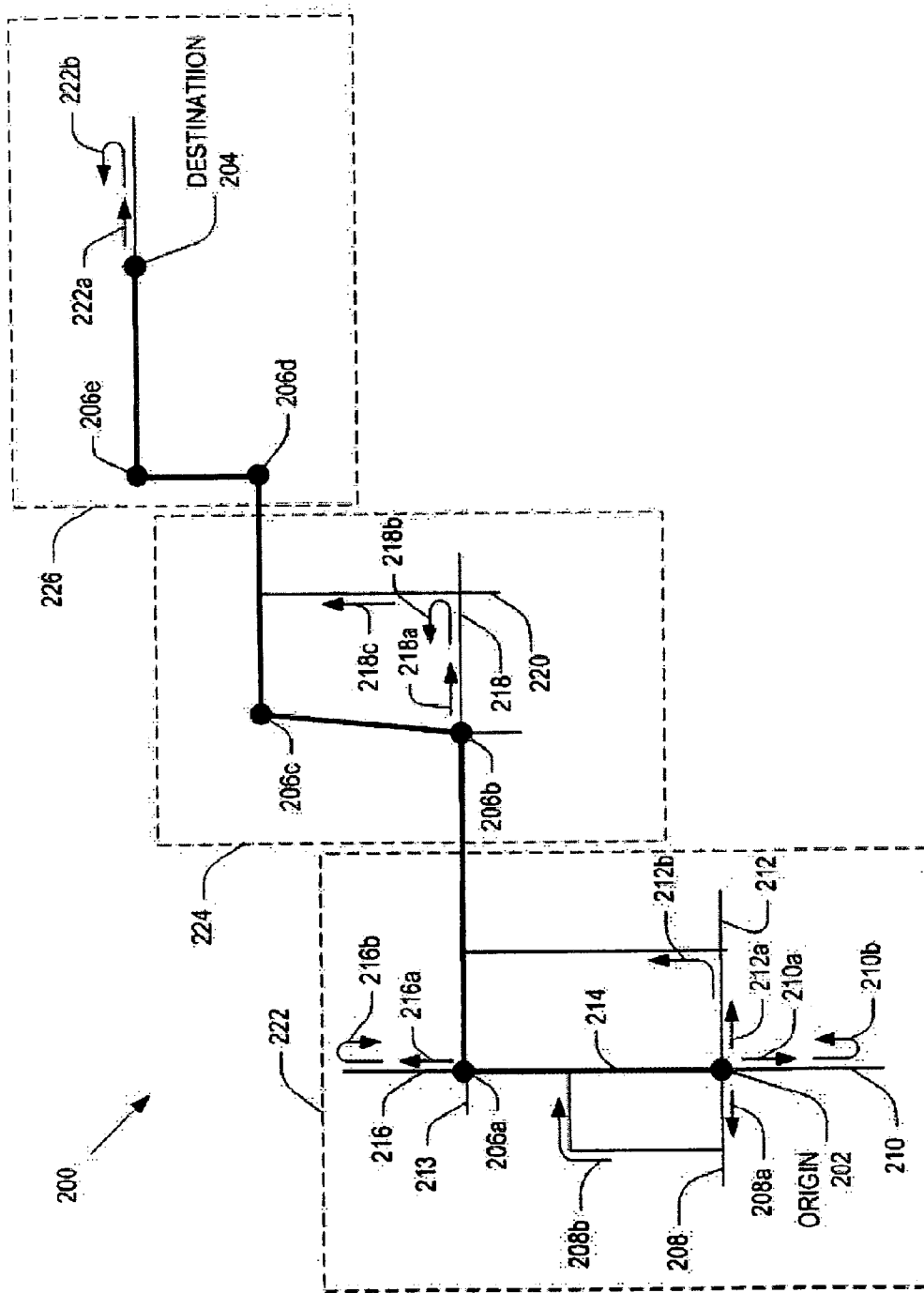

FIG. 2

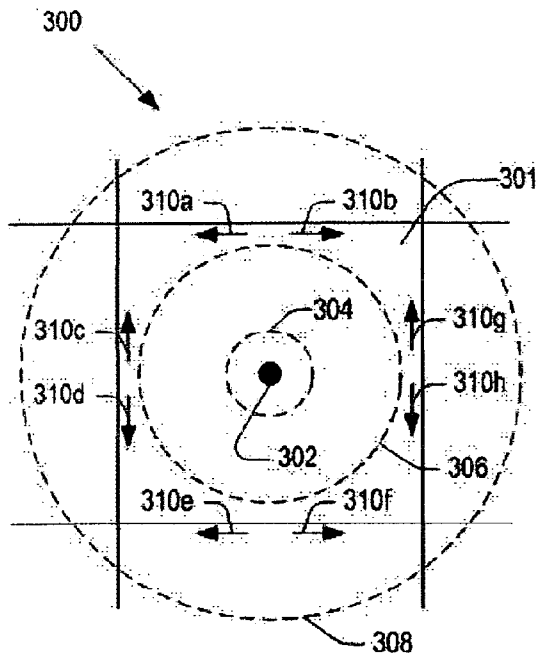

FIG. 3A

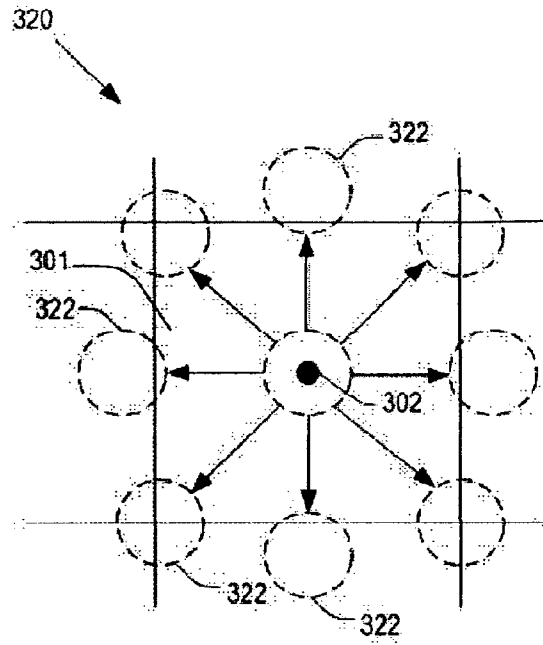

FIG. 3B

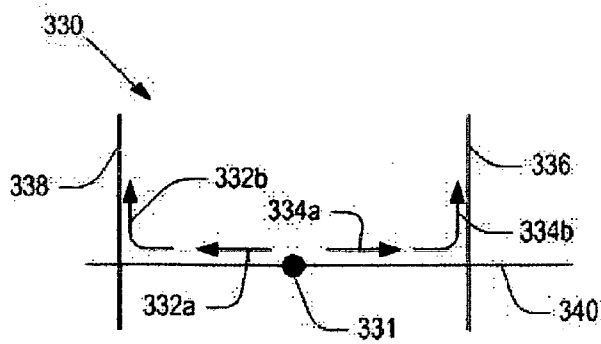

FIG. 3C

Explore Litigation Insights

Docket Alarm provides insights to develop a more informed litigation strategy and the peace of mind of knowing you're on top of things.

Real-Time Litigation Alerts



Keep your litigation team up-to-date with **real-time alerts** and advanced team management tools built for the enterprise, all while greatly reducing PACER spend.

Our comprehensive service means we can handle Federal, State, and Administrative courts across the country.

Advanced Docket Research



With over 230 million records, Docket Alarm's cloud-native docket research platform finds what other services can't. Coverage includes Federal, State, plus PTAB, TTAB, ITC and NLRB decisions, all in one place.

Identify arguments that have been successful in the past with full text, pinpoint searching. Link to case law cited within any court document via Fastcase.

Analytics At Your Fingertips



Learn what happened the last time a particular judge, opposing counsel or company faced cases similar to yours.

Advanced out-of-the-box PTAB and TTAB analytics are always at your fingertips.

API

Docket Alarm offers a powerful API (application programming interface) to developers that want to integrate case filings into their apps.

LAW FIRMS

Build custom dashboards for your attorneys and clients with live data direct from the court.

Automate many repetitive legal tasks like conflict checks, document management, and marketing.

FINANCIAL INSTITUTIONS

Litigation and bankruptcy checks for companies and debtors.

E-DISCOVERY AND LEGAL VENDORS

Sync your system to PACER to automate legal marketing.