



US 20110248817A1

(19) **United States**

(12) **Patent Application Publication**
Houston et al.

(10) **Pub. No.: US 2011/0248817 A1**

(43) **Pub. Date: Oct. 13, 2011**

(54) **SYNCHRONIZED VIBRATION DEVICE FOR HAPTIC FEEDBACK**

Publication Classification

(75) Inventors: **John Houston**, New York, NY (US); **Nathan Delson**, San Diego, CA (US)

(51) **Int. Cl.**
G08B 6/00 (2006.01)

(52) **U.S. Cl.** **340/4.2**

(73) Assignee: **Coactive Drive Corporation**, New York, NY (US)

(57) **ABSTRACT**

(21) Appl. No.: **13/030,663**

(22) Filed: **Feb. 18, 2011**

The present invention relates to synchronized vibration devices that can provide haptic feedback to a user. A wide variety of actuator types may be employed to provide synchronized vibration, including linear actuators, rotary actuators, rotating eccentric mass actuators, and rocking mass actuators. A controller may send signals to one or more driver circuits for directing operation of the actuators. The controller may provide direction and amplitude control, vibration control, and frequency control to direct the haptic experience. Parameters such as frequency, phase, amplitude, duration, and direction can be programmed or input as different patterns suitable for use in gaming, virtual reality and real-world situations.

Related U.S. Application Data

(63) Continuation of application No. 11/476,436, filed on Jun. 27, 2006, now Pat. No. 7,919,945.

(60) Provisional application No. 60/694,468, filed on Jun. 27, 2005.

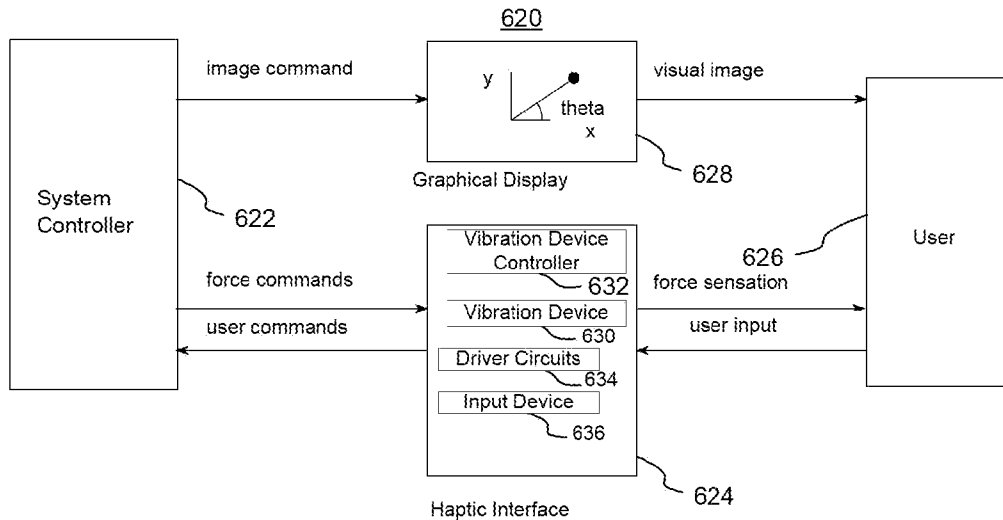

FIG. 1 10

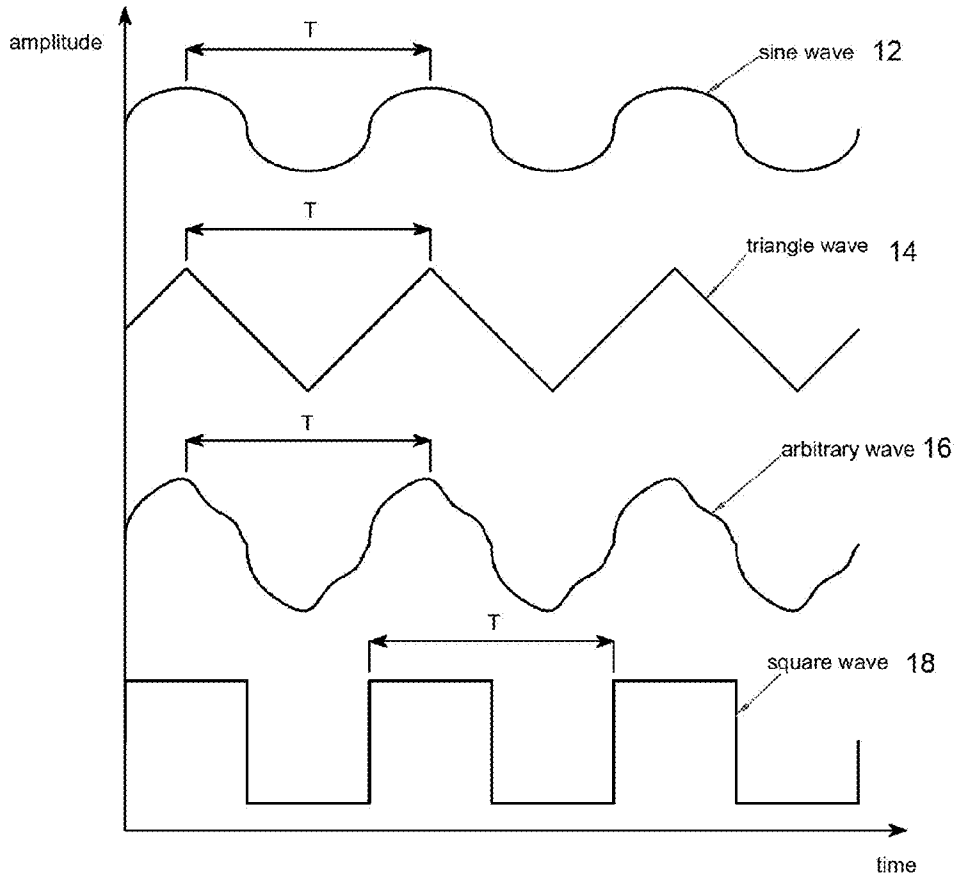
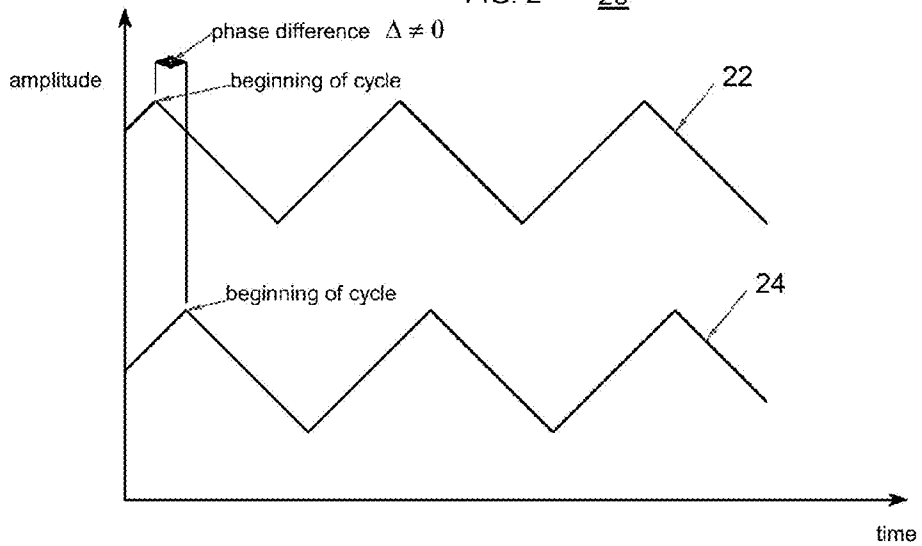

FIG. 2 20



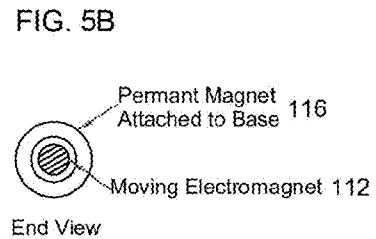
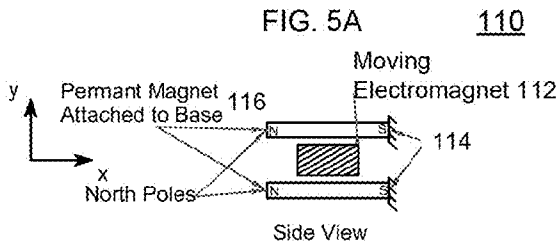
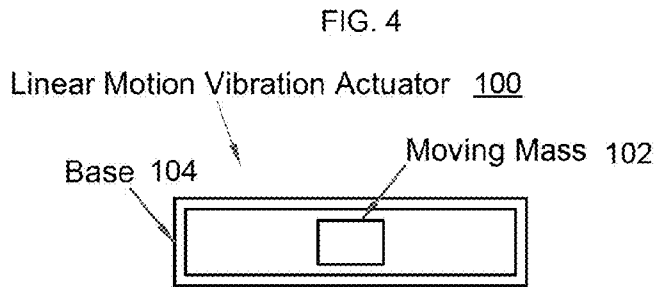
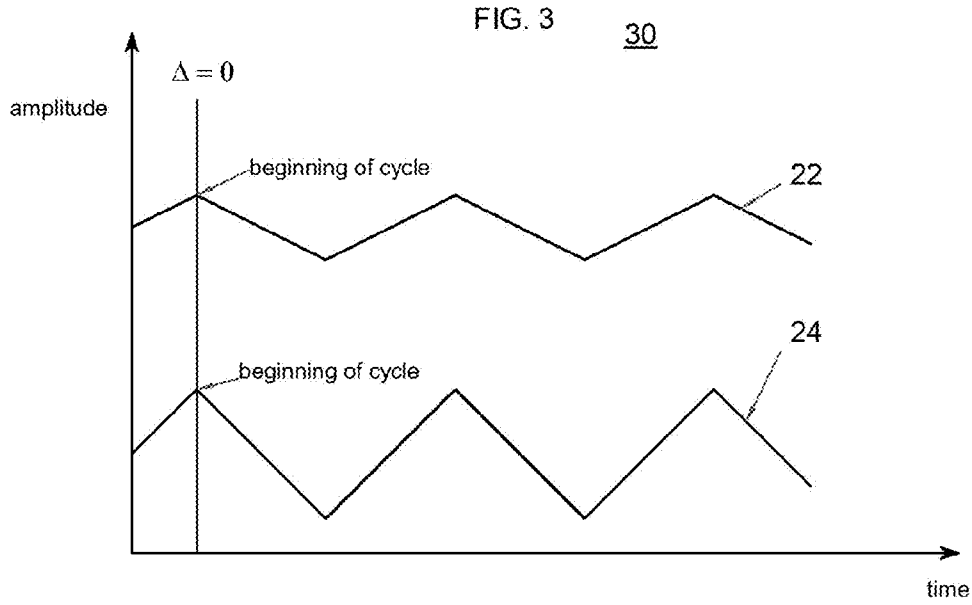

FIG. 6A 120

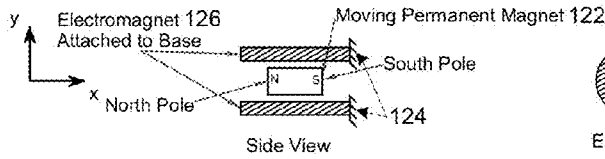

FIG. 6B

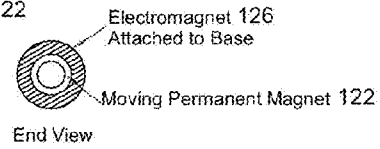

FIG. 7A 130

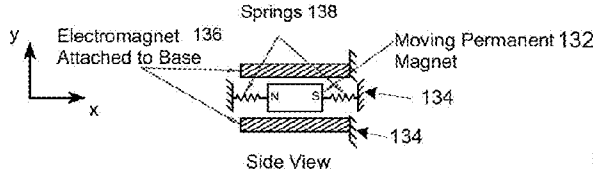

FIG. 7B

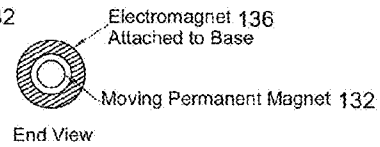

FIG. 8A 140

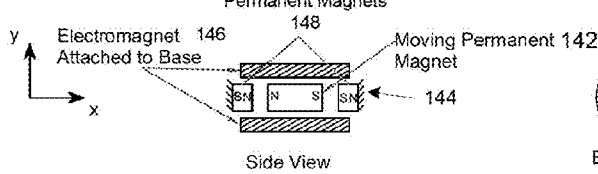

FIG. 8B

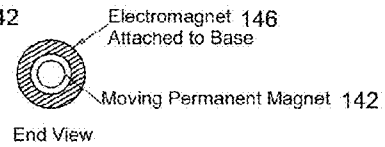

FIG. 9 150

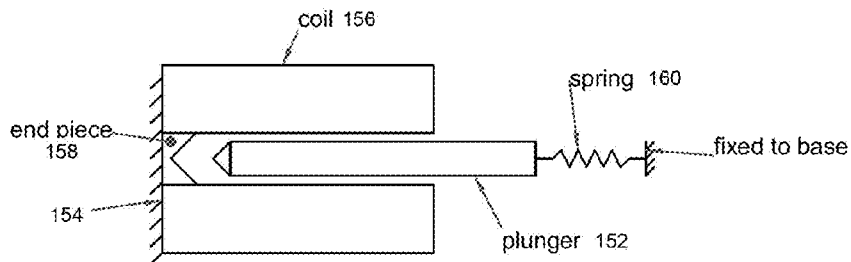

FIG. 10

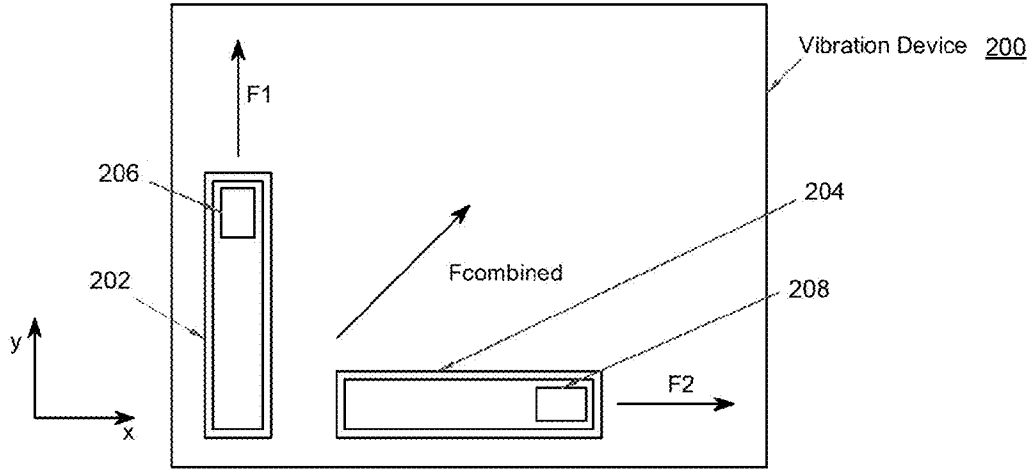
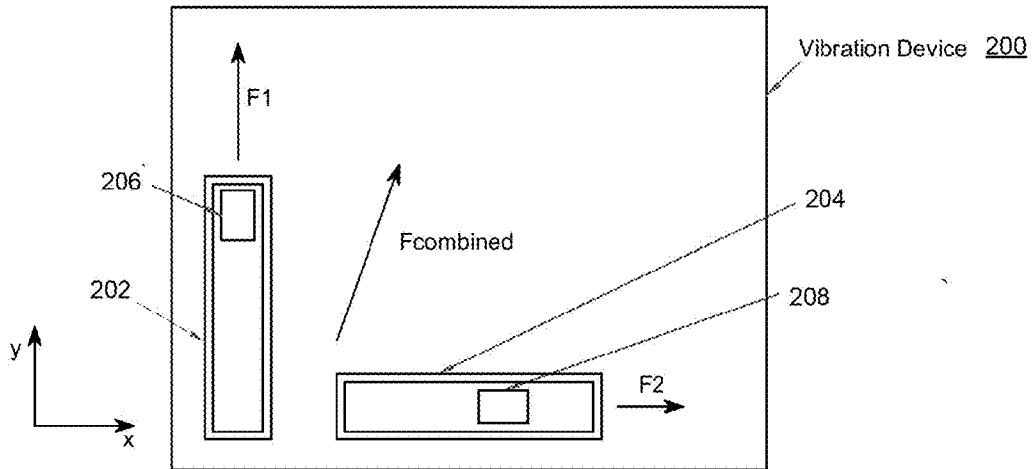

FIG. 11



Explore Litigation Insights

Docket Alarm provides insights to develop a more informed litigation strategy and the peace of mind of knowing you're on top of things.

Real-Time Litigation Alerts



Keep your litigation team up-to-date with **real-time alerts** and advanced team management tools built for the enterprise, all while greatly reducing PACER spend.

Our comprehensive service means we can handle Federal, State, and Administrative courts across the country.

Advanced Docket Research



With over 230 million records, Docket Alarm's cloud-native docket research platform finds what other services can't. Coverage includes Federal, State, plus PTAB, TTAB, ITC and NLRB decisions, all in one place.

Identify arguments that have been successful in the past with full text, pinpoint searching. Link to case law cited within any court document via Fastcase.

Analytics At Your Fingertips



Learn what happened the last time a particular judge, opposing counsel or company faced cases similar to yours.

Advanced out-of-the-box PTAB and TTAB analytics are always at your fingertips.

API

Docket Alarm offers a powerful API (application programming interface) to developers that want to integrate case filings into their apps.

LAW FIRMS

Build custom dashboards for your attorneys and clients with live data direct from the court.

Automate many repetitive legal tasks like conflict checks, document management, and marketing.

FINANCIAL INSTITUTIONS

Litigation and bankruptcy checks for companies and debtors.

E-DISCOVERY AND LEGAL VENDORS

Sync your system to PACER to automate legal marketing.