



(12) **United States Patent**  
**Liao**

(10) **Patent No.:** **US 10,505,803 B2**  
(45) **Date of Patent:** **Dec. 10, 2019**

(54) **POWER-EFFICIENT OPERATION FOR WIDER BANDWIDTH**

(71) Applicant: **MEDIATEK INC.**, Hsinchu (TW)

(72) Inventor: **Pei-Kai Liao**, Hsinchu (TW)

(73) Assignee: **MEDIATEK INC.**, Hsin-Chu (TW)

(\* ) Notice: Subject to any disclaimer, the term of this patent is extended or adjusted under 35 U.S.C. 154(b) by 0 days.

(21) Appl. No.: **16/008,024**

(22) Filed: **Jun. 14, 2018**

(65) **Prior Publication Data**

US 2018/0367386 A1 Dec. 20, 2018

**Related U.S. Application Data**

(60) Provisional application No. 62/519,923, filed on Jun. 15, 2017, provisional application No. 62/544,118, filed on Aug. 11, 2017.

(51) **Int. Cl.**

**H04L 12/24** (2006.01)

**H04W 52/14** (2009.01)

(Continued)

(52) **U.S. Cl.**

CPC ..... **H04L 41/0833** (2013.01); **H04L 5/001** (2013.01); **H04L 5/0048** (2013.01); **H04L 5/0053** (2013.01); **H04L 5/0092** (2013.01); **H04W 48/00** (2013.01); **H04W 52/146** (2013.01); **H04W 48/12** (2013.01); **H04W 72/042** (2013.01)

(58) **Field of Classification Search**

None

See application file for complete search history.

(56) **References Cited**

U.S. PATENT DOCUMENTS

2015/0131563 A1 5/2015 Guo et al. .... 370/329  
2018/0063865 A1\* 3/2018 Islam ..... H04W 76/27  
(Continued)

FOREIGN PATENT DOCUMENTS

CN 103580819 A 2/2014

OTHER PUBLICATIONS

International Search Report and Written Opinion of International Search Authority for PCT/CN2018/091476 dated Sep. 10, 2018 (9 pages).

(Continued)

*Primary Examiner* — Eunsook Choi

(74) *Attorney, Agent, or Firm* — Imperium Patent Works; Helen Mao; Zheng Jin

(57) **ABSTRACT**

Apparatus and methods are provided for power-efficient operation for wide bandwidth. In one novel aspect, the configuration of the CORESET with CSS includes at least one of the time duration of the CORESET within a slot and the periodicity of the CORESET burst. In another embodiment, each configured BWP includes at least one CORESET with UE-specific search space and one CORESET with CSS. In another embodiment, at least one of the configured BWPs includes one CORESET with type-1 CSS for PCell. Each configured BWPs includes one CORESET with type-2 CSS for both PCell and SCell and at least one CORESET with UE-specific search space for PCell and SCell. In another novel aspect, a timer-triggered transmission of activating DL BWP indication in all DL BWP configured is used when the UE mis-detects or false-alarms the explicit signaling for BWP switch.

**28 Claims, 7 Drawing Sheets**

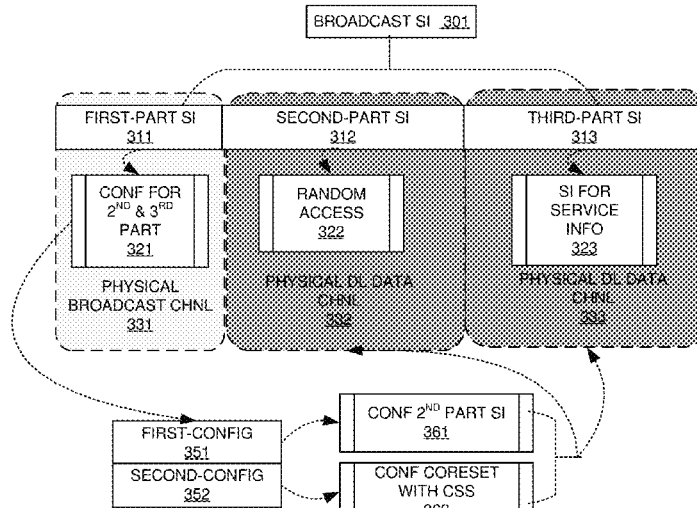

- (51) **Int. Cl.**  
*H04L 5/00* (2006.01)  
*H04W 48/00* (2009.01)  
*H04W 72/04* (2009.01)  
*H04W 48/12* (2009.01)

(56) **References Cited**

U.S. PATENT DOCUMENTS

2018/0279218 A1\* 9/2018 Park ..... H04W 48/20  
2018/0279229 A1\* 9/2018 Dinan ..... H04W 52/146  
2018/0279289 A1\* 9/2018 Islam ..... H04W 72/048  
2018/0324770 A1\* 11/2018 Nogami ..... H04L 5/0053

OTHER PUBLICATIONS

R1-1707626 3GPP TSG RAN WG1 Meeting #89, LG Electronics,  
“Discussion on CORESET Configuration”, Hangzhou, P.R. China,  
May 15-19, 2017 (5 pages).

R1-1709265 3GPP TSG RAN WG1 Meeting #89, Oppo et al., “WF  
on band width part configuration”, Hangzhou, P.R. China, May  
15-19, 2017 (5 pages).

R1-1706900 3GPP TSG RAN WG1 Meeting #89, Huawei et al.,  
“On bandwidth part and bandwidth adaptation”, Hangzhou, P.R.  
China, May 15-19, 2017 (9 pages).

\* cited by examiner

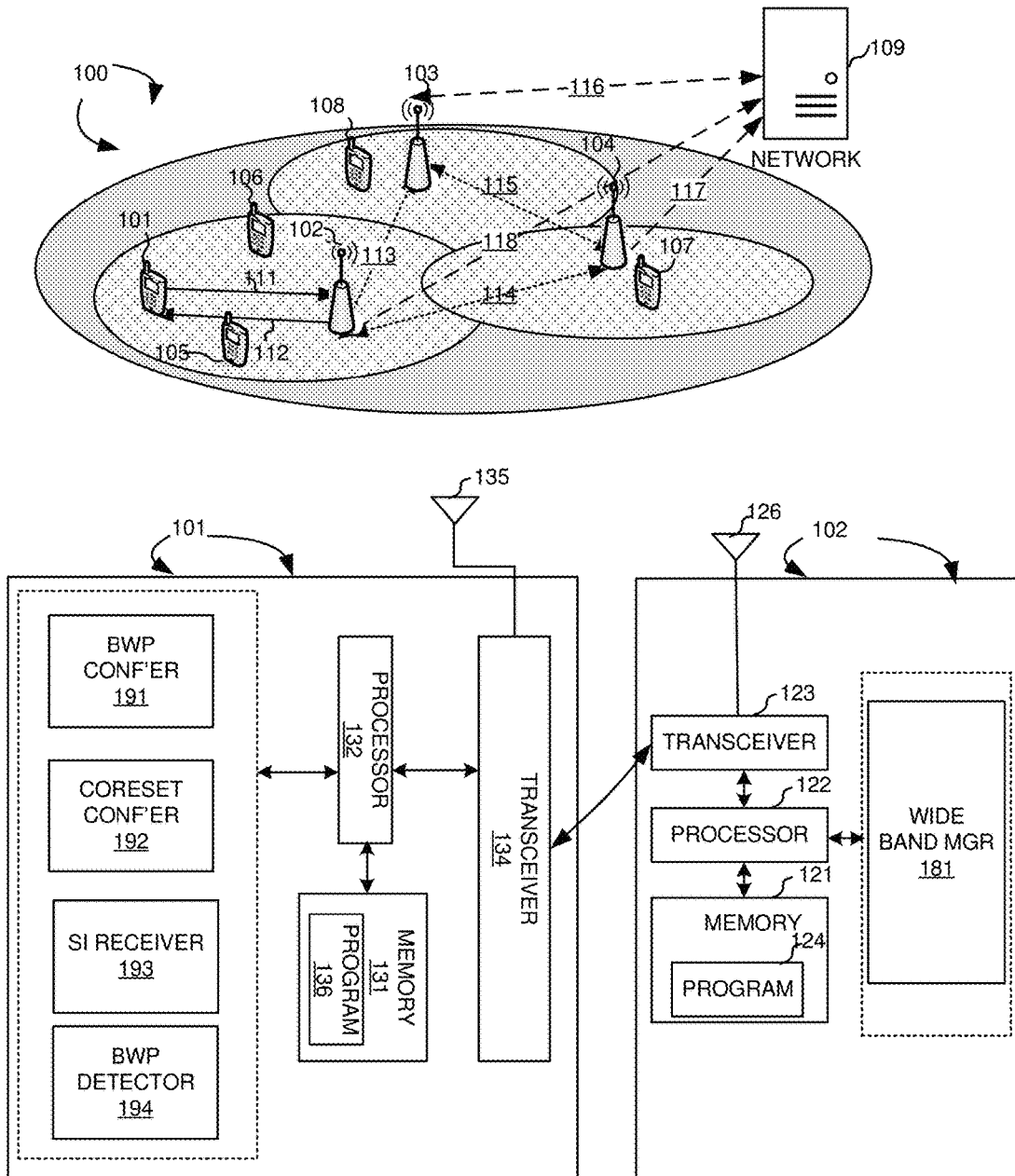

FIG. 1

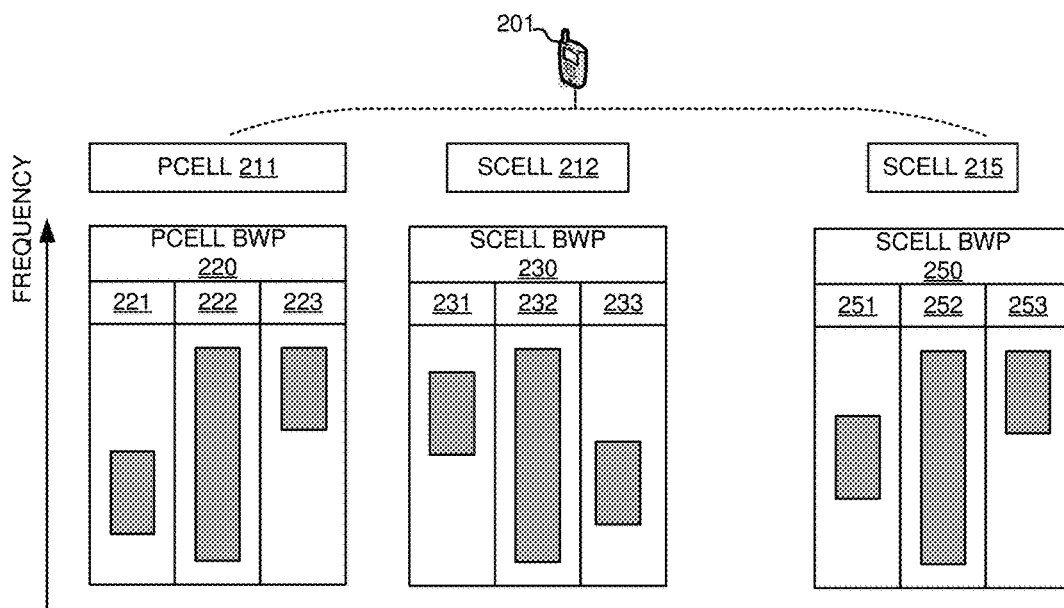

FIG. 2

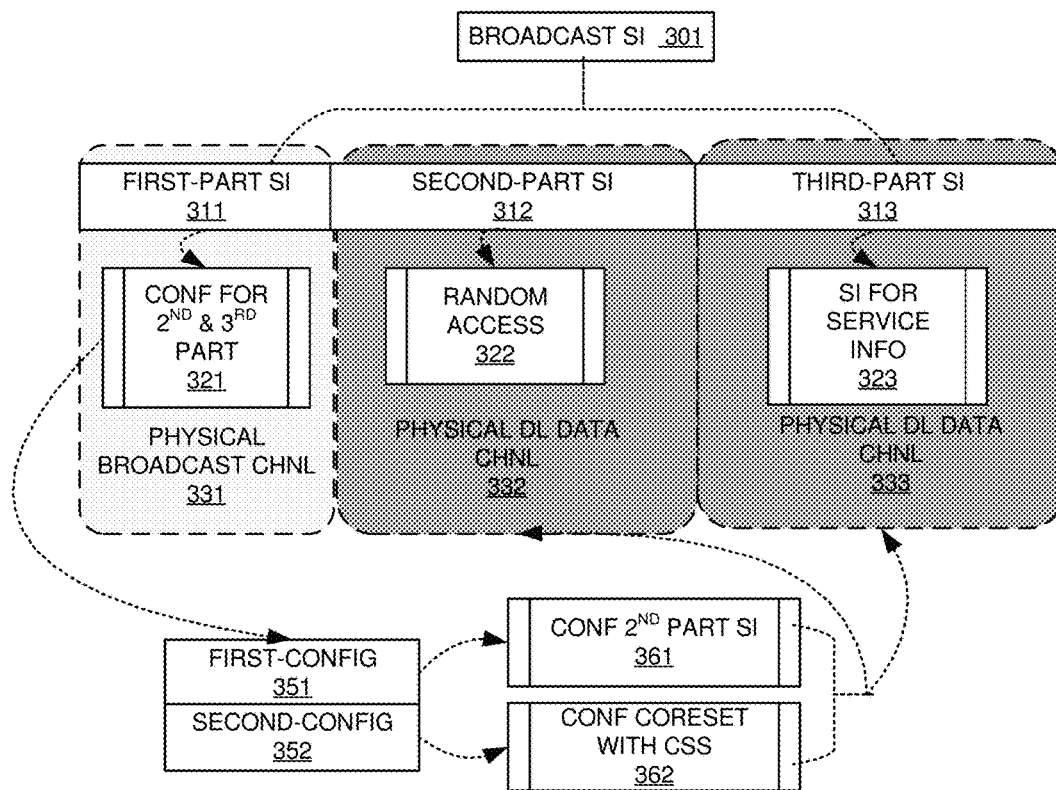

FIG. 3

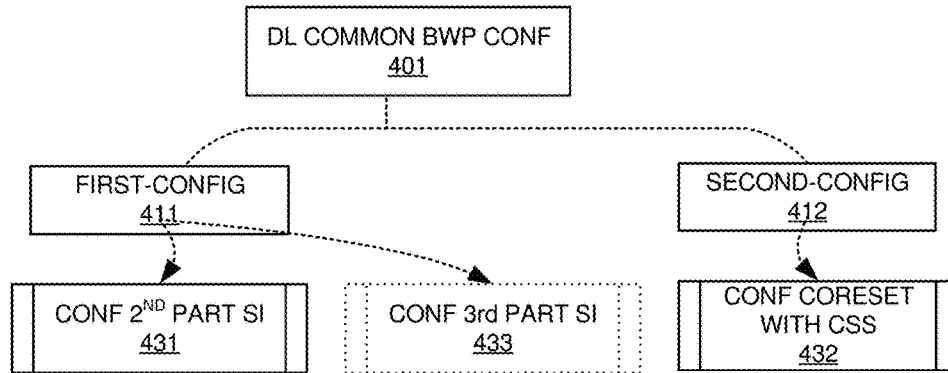

FIG. 4

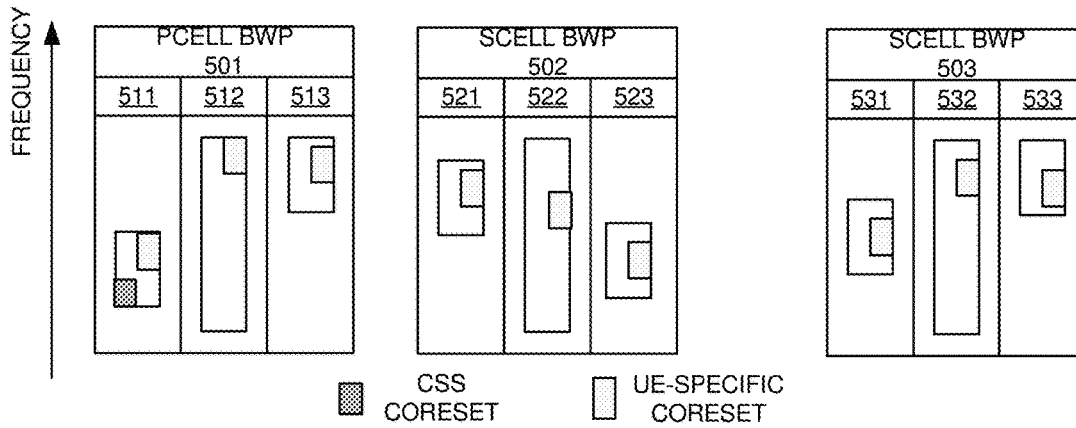

FIG. 5A

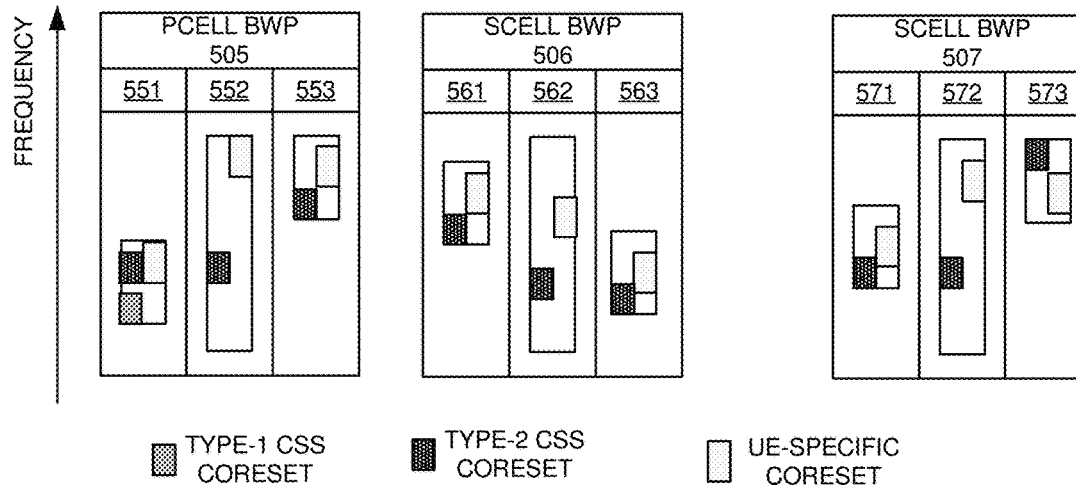

FIG. 5B

# Explore Litigation Insights

Docket Alarm provides insights to develop a more informed litigation strategy and the peace of mind of knowing you're on top of things.

## Real-Time Litigation Alerts



Keep your litigation team up-to-date with **real-time alerts** and advanced team management tools built for the enterprise, all while greatly reducing PACER spend.

Our comprehensive service means we can handle Federal, State, and Administrative courts across the country.

## Advanced Docket Research



With over 230 million records, Docket Alarm's cloud-native docket research platform finds what other services can't. Coverage includes Federal, State, plus PTAB, TTAB, ITC and NLRB decisions, all in one place.

Identify arguments that have been successful in the past with full text, pinpoint searching. Link to case law cited within any court document via Fastcase.

## Analytics At Your Fingertips



Learn what happened the last time a particular judge, opposing counsel or company faced cases similar to yours.

Advanced out-of-the-box PTAB and TTAB analytics are always at your fingertips.

## API

Docket Alarm offers a powerful API (application programming interface) to developers that want to integrate case filings into their apps.

## LAW FIRMS

Build custom dashboards for your attorneys and clients with live data direct from the court.

Automate many repetitive legal tasks like conflict checks, document management, and marketing.

## FINANCIAL INSTITUTIONS

Litigation and bankruptcy checks for companies and debtors.

## E-DISCOVERY AND LEGAL VENDORS

Sync your system to PACER to automate legal marketing.