



[54] **SYSTEM AND METHOD FOR ERROR CORRECTING A RECEIVED DATA STREAM IN A CONCATENATED SYSTEM**

[75] Inventors: **Hisashi Kobayashi; Jan Bajcsy**, both of Princeton, N.J.

[73] Assignee: **The Trustees of Princeton University**, Princeton, N.J.

[21] Appl. No.: **08/840,383**

[22] Filed: **Apr. 28, 1997**

[51] **Int. Cl.⁷** **H03M 13/00**

[52] **U.S. Cl.** **714/755**

[58] **Field of Search** **714/755, 752; 371/37.4, 43.7**

[56] **References Cited**

U.S. PATENT DOCUMENTS

3,622,986 11/1971 Tang et al. 340/146.1
5,721,745 2/1998 Hladik et al. 371/37.4

OTHER PUBLICATIONS

Error-Correcting Codes, Second Ed., Peterson et al., pp. 2-3-8.
Prentice-Hall Series in Computer Applications in Electrical Engineering, Shu Lin et al., pp. 274-280, "Error Control Coding: Fundamentals and Applications".
IBM Journal of Research and Development, Jan. 1971, vol. 15 H. Kobayashi, pp. 64-74, "Application of Probabilistic Decoding to Digital Magnetic Recording Systems".
Kluwer Academic Publishers, Jan W. M. Bergmans, pp. 316-323, "Digital Baseband Transmission and Recording".
IEEE Communications Magazine, Apr. 1986-vol. 24, No. 4, Carl-Erik Sundberg, pp. 26-38, "Continuous Phase Modulation".

IEEE Transactions on Communication Technology, vol. COM-19, No. 4 Aug. 1971, H. Kobayashi et al., pp. 467-477, "On Decoding of Correlative Level Coding Systems with Ambiguity Zone Detection".

IEEE Transactions on Communication Technology, vol. COM-19, No. 6 Dec. 1971, H. Kobayashi, pp. 1087-1100, "A Survey of Coding Schemes for Transmission or Recording of Digital Data".

IEEE Transactions on Information Theory, vol. IT-17, No. 5, Sep. 1971, H. Kobayashi, pp. 586-594, "Correlative Level Coding and Maximum-Likelihood Decoding".

IEEE Transactions on Communications, vol. 44-No. 10, Oct. 1996, C. Berrou et al., pp. 1261-1270, "Near Optimum Error Correcting Coding and Decoding: Turbo-Codes".

Xiao-an Wang, Stephen B. Wicker, A Soft-Output Decoding Algorithm for concatenated System, IEEE, pp. 543-553, Feb. 3, 1996.

Primary Examiner—Albert De Cady
Assistant Examiner—Shelly A Chase

[57] **ABSTRACT**

A received signal is first converted into a digital sequence that may contain "erasures" (or ambiguity symbols) as well as errors. Then iterative decoding is applied in order to eliminate or reduce the erasures. This decoding procedure works effectively with the associated transmitter that adopts a concatenation of an outer coder, a permutation and an inner coder. The principal of the invention is also applicable to a system in which the inner coder is replaced by a "digital modulator" that introduces some constraint, or a channel that introduces some memory such as partial response signaling, intersymbol interference or multipath propagation. The invention can be applied to many existing systems while maintaining "backward compatibility" in the sense that the transmitter side need not be modified.

12 Claims, 14 Drawing Sheets

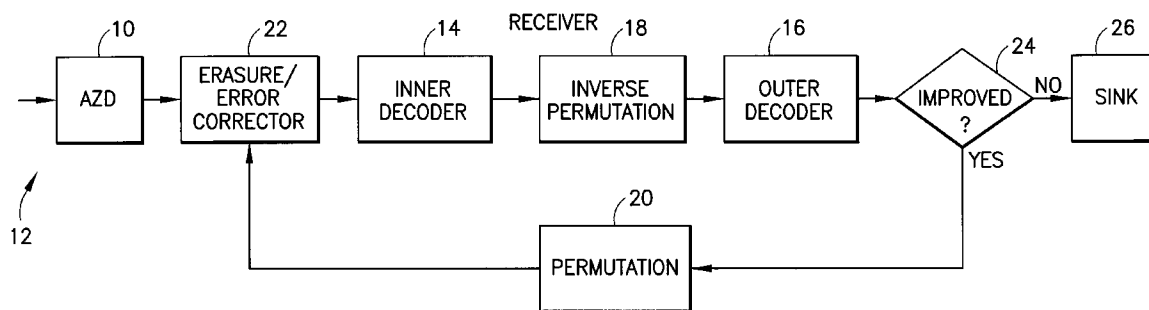

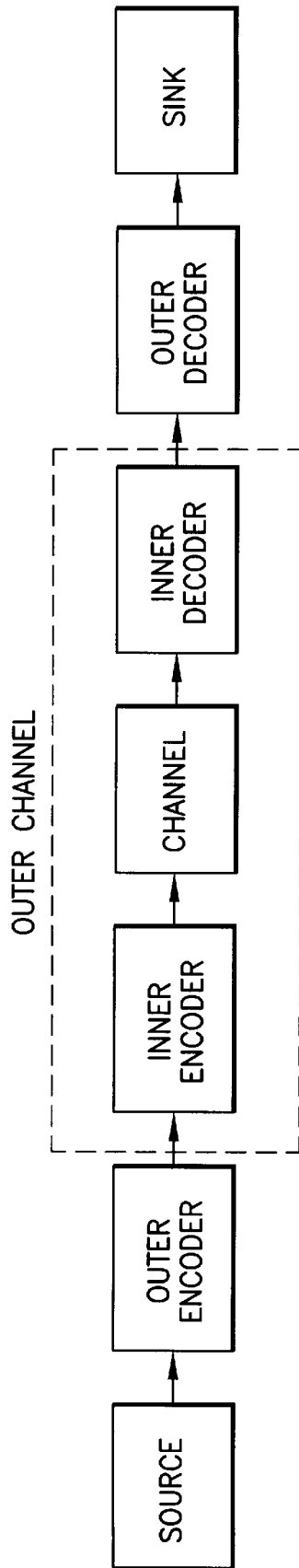

FIG. 1
PRIOR ART

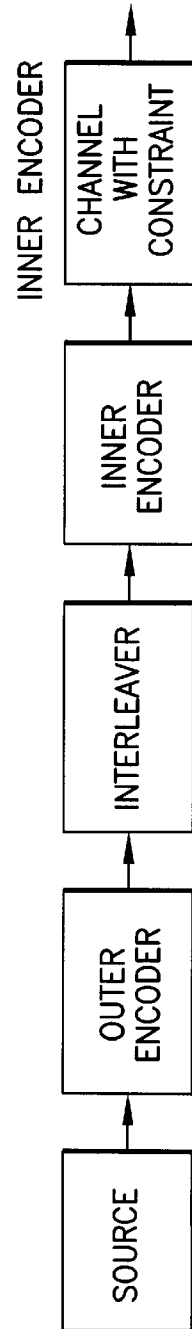

FIG. 3

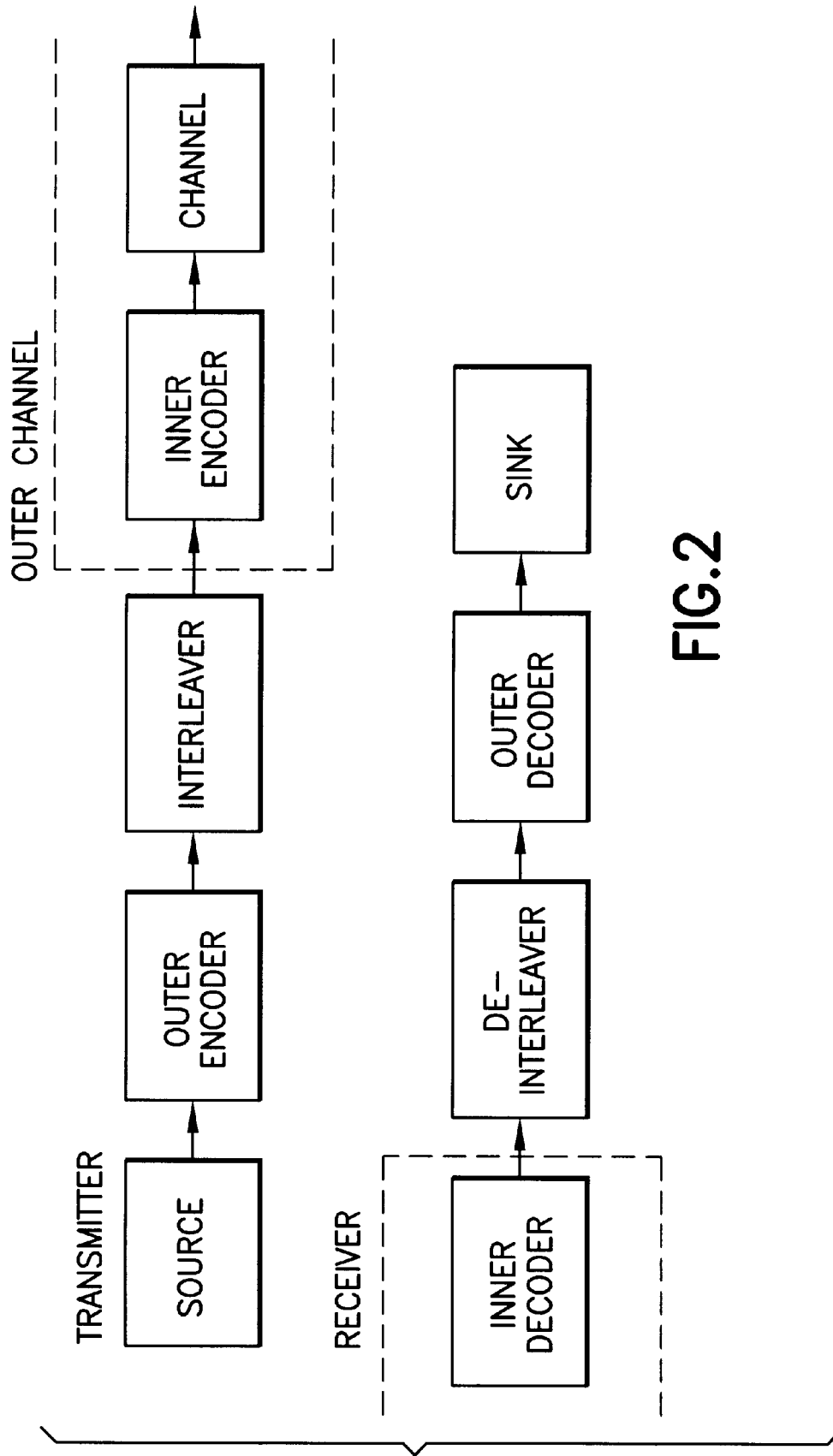

FIG.2

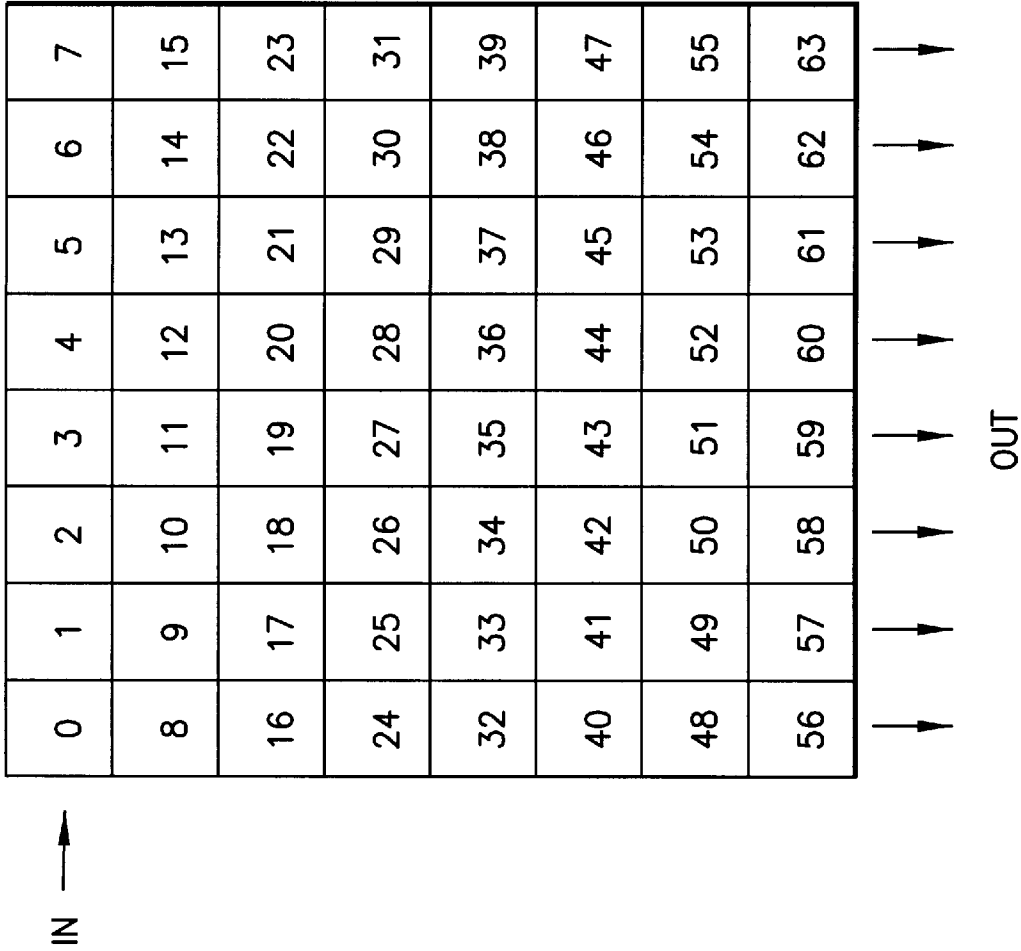

FIG.2A

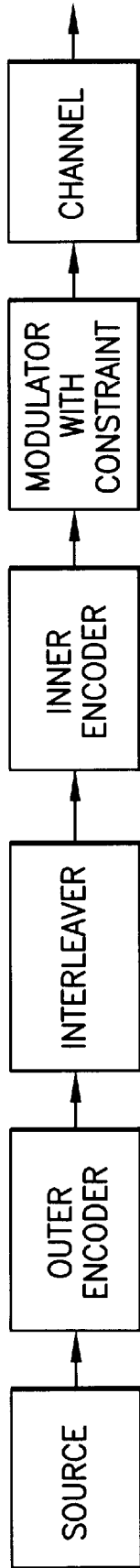

FIG. 4

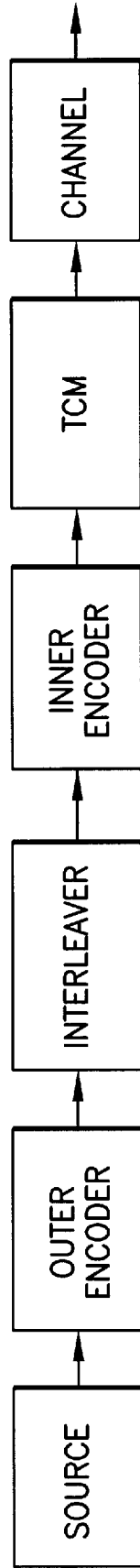

FIG. 5

Explore Litigation Insights

Docket Alarm provides insights to develop a more informed litigation strategy and the peace of mind of knowing you're on top of things.

Real-Time Litigation Alerts



Keep your litigation team up-to-date with **real-time alerts** and advanced team management tools built for the enterprise, all while greatly reducing PACER spend.

Our comprehensive service means we can handle Federal, State, and Administrative courts across the country.

Advanced Docket Research



With over 230 million records, Docket Alarm's cloud-native docket research platform finds what other services can't. Coverage includes Federal, State, plus PTAB, TTAB, ITC and NLRB decisions, all in one place.

Identify arguments that have been successful in the past with full text, pinpoint searching. Link to case law cited within any court document via Fastcase.

Analytics At Your Fingertips



Learn what happened the last time a particular judge, opposing counsel or company faced cases similar to yours.

Advanced out-of-the-box PTAB and TTAB analytics are always at your fingertips.

API

Docket Alarm offers a powerful API (application programming interface) to developers that want to integrate case filings into their apps.

LAW FIRMS

Build custom dashboards for your attorneys and clients with live data direct from the court.

Automate many repetitive legal tasks like conflict checks, document management, and marketing.

FINANCIAL INSTITUTIONS

Litigation and bankruptcy checks for companies and debtors.

E-DISCOVERY AND LEGAL VENDORS

Sync your system to PACER to automate legal marketing.