



US007826471B2

(12) **United States Patent**  
**Wilson et al.**

(10) **Patent No.:** **US 7,826,471 B2**  
(45) **Date of Patent:** **Nov. 2, 2010**

(54) **MULTI-BEAM CELLULAR COMMUNICATION SYSTEM**

(75) Inventors: **Fiona Wilson**, Spellbrook (GB); **Simon Gale**, Bishops Stortford (GB)

(73) Assignee: **Nortel Networks Limited** (CA)

(\*) Notice: Subject to any disclaimer, the term of this patent is extended or adjusted under 35 U.S.C. 154(b) by 1322 days.

(21) Appl. No.: **10/385,792**

(22) Filed: **Mar. 11, 2003**

(65) **Prior Publication Data**

US 2004/0179544 A1 Sep. 16, 2004

(51) **Int. Cl.**  
**H04B 7/212** (2006.01)

(52) **U.S. Cl.** ..... **370/442**

(58) **Field of Classification Search** ..... None  
See application file for complete search history.

(56) **References Cited**

U.S. PATENT DOCUMENTS

5,029,183	A *	7/1991	Tymes	375/141
5,565,873	A *	10/1996	Dean	342/372
6,005,854	A *	12/1999	Xu et al.	370/335
6,356,767	B2 *	3/2002	Froula	455/512
6,377,559	B1 *	4/2002	Haardt	370/326
6,477,158	B1 *	11/2002	Take	370/335
6,542,485	B1 *	4/2003	Mujtaba	370/335

(Continued)

FOREIGN PATENT DOCUMENTS

GB 2378857 2/2003

OTHER PUBLICATIONS

Giuliano R, Mazzenga F, Vatalaro F: "Smart cell sectorization for third generation CDMA systems"—Wireless Communications and Mobile Computing 2002 pp. 253-267, XP002401304.

(Continued)

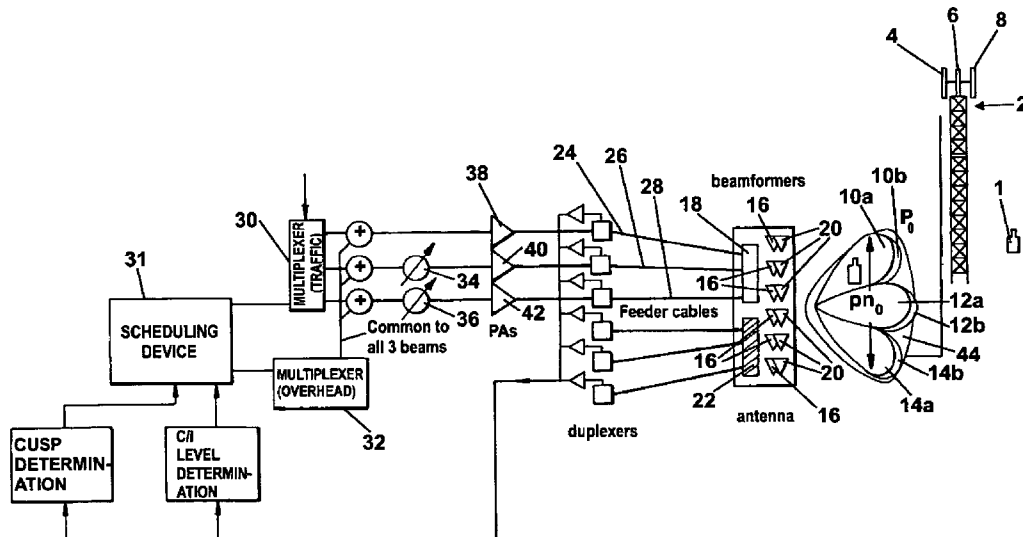
Primary Examiner—Robert W Wilson

(74) Attorney, Agent, or Firm—Barnes & Thornburg LLP

(57) **ABSTRACT**

A cellular communication system comprising a plurality of geographically spaced base stations (2) each of which comprises an antenna arrangement (4, 6, 8) per base station sector, each of which antenna arrangements has an antenna element for generating an array of narrow beams (10, 12, 14) covering the sector. Timeslots are simultaneously transmitted over each of the beams so as to generate successive sets of simultaneously transmitted timeslots per sector. The timeslots are each split into multiple orthogonal codes, for example Walsh codes. The communication system additionally comprising a scheduling device (31) for allocating for successive sets of timeslots common overhead channels, including a common pilot channel, which are allocated to the same sub-set of codes of each timeslot in the set. For successive sets of timeslots different data traffic is allocated to the same sub-set of codes of each timeslot in the set. This effectively generates a sector wide antenna beam carrying the common overhead channels and a plurality of narrow beams each of which carry different data traffic. Inter-beam interference is addressed by the application of Adaptive Modulation and Coding and by an inter-beam handoff scheme. The handoff scheme ensures that when an end user equipment is located in a cusp region between adjacent beams the antenna arrangement simultaneously transmits data traffic to that mobile station on at least both of the adjacent beams.

41 Claims, 4 Drawing Sheets



U.S. PATENT DOCUMENTS

6,891,813 B2\* 5/2005 Feria et al. .... 370/329  
6,907,272 B2\* 6/2005 Roy ..... 455/562.1  
7,095,987 B2\* 8/2006 Brothers et al. .... 455/101  
7,133,379 B2\* 11/2006 Yoshii et al. .... 370/328  
2002/0072393 A1\* 6/2002 McGowan et al. .... 455/562  
2002/0105929 A1 8/2002 Chen et al.

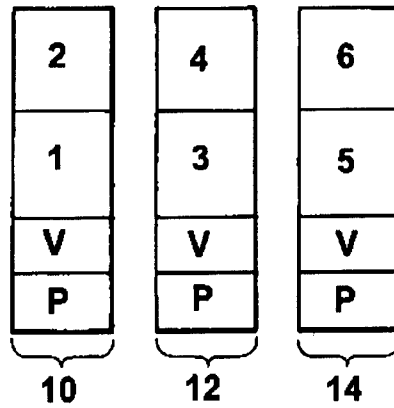
OTHER PUBLICATIONS

Motorola Inc. "Technical Overview of 1xEV-DV" —Global Telecom  
Solution Sector, Sep. 6, 2002, XP002427030.

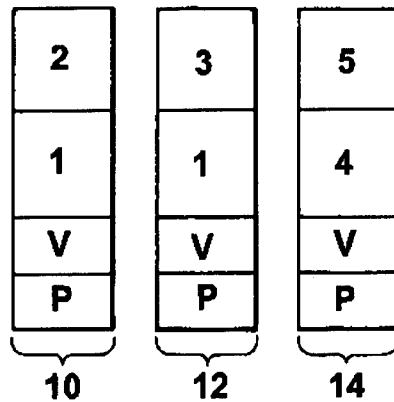
Dennet S. "The cdma2000 ITU-R RTT Candidate Submission" Jul.  
27, 1998, XP002427031.

\* cited by examiner

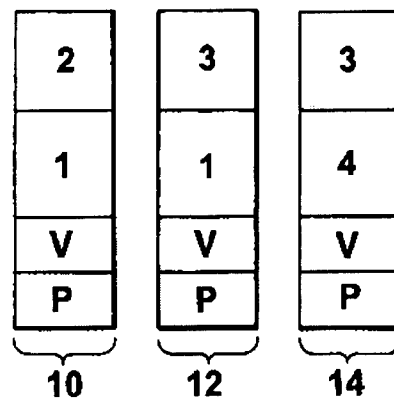




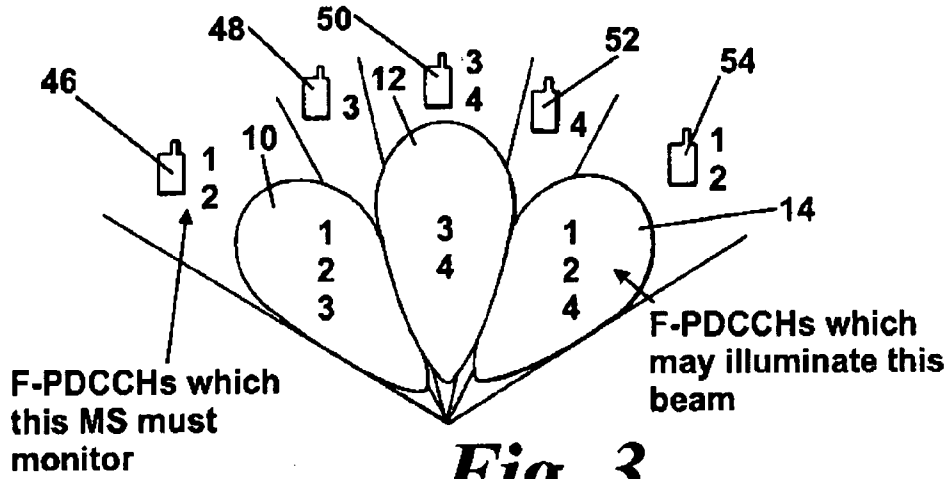
*Fig. 2A*



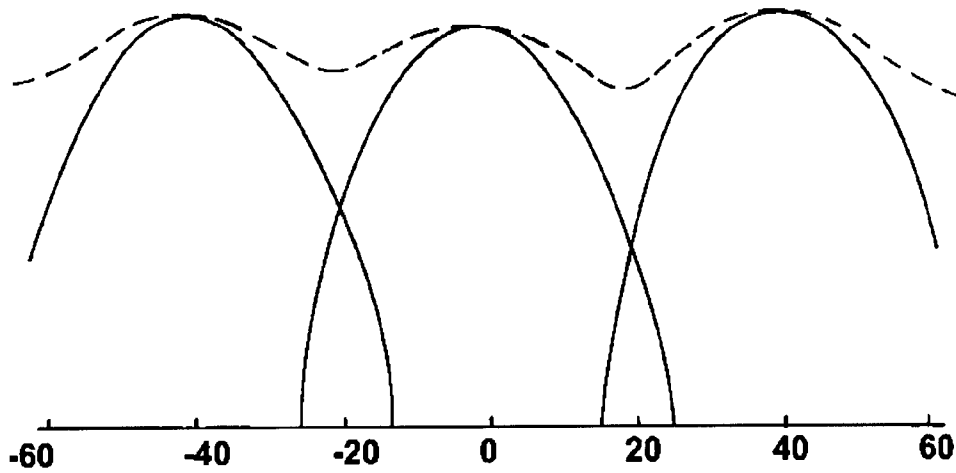
*Fig. 2B*



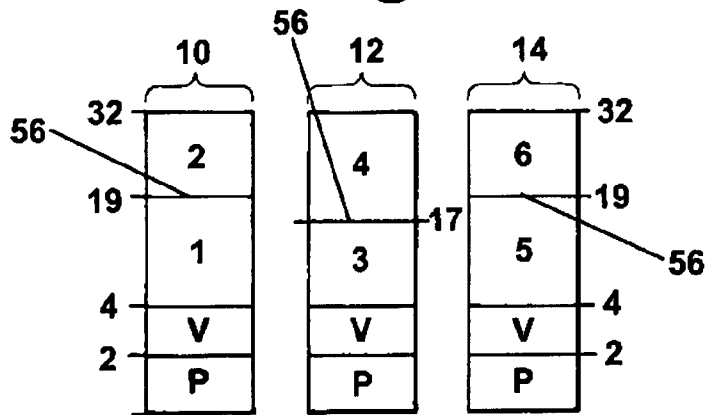
*Fig. 2C*



*Fig. 3*



*Fig. 4*



*Fig. 5*

# Explore Litigation Insights

Docket Alarm provides insights to develop a more informed litigation strategy and the peace of mind of knowing you're on top of things.

## Real-Time Litigation Alerts



Keep your litigation team up-to-date with **real-time alerts** and advanced team management tools built for the enterprise, all while greatly reducing PACER spend.

Our comprehensive service means we can handle Federal, State, and Administrative courts across the country.

## Advanced Docket Research



With over 230 million records, Docket Alarm's cloud-native docket research platform finds what other services can't. Coverage includes Federal, State, plus PTAB, TTAB, ITC and NLRB decisions, all in one place.

Identify arguments that have been successful in the past with full text, pinpoint searching. Link to case law cited within any court document via Fastcase.

## Analytics At Your Fingertips



Learn what happened the last time a particular judge, opposing counsel or company faced cases similar to yours.

Advanced out-of-the-box PTAB and TTAB analytics are always at your fingertips.

## API

Docket Alarm offers a powerful API (application programming interface) to developers that want to integrate case filings into their apps.

## LAW FIRMS

Build custom dashboards for your attorneys and clients with live data direct from the court.

Automate many repetitive legal tasks like conflict checks, document management, and marketing.

## FINANCIAL INSTITUTIONS

Litigation and bankruptcy checks for companies and debtors.

## E-DISCOVERY AND LEGAL VENDORS

Sync your system to PACER to automate legal marketing.