



US007248559B2

(12) **United States Patent**  
**Ma et al.**

(10) **Patent No.:** **US 7,248,559 B2**  
(45) **Date of Patent:** **Jul. 24, 2007**

(54) **SCATTERED PILOT PATTERN AND CHANNEL ESTIMATION METHOD FOR MIMO-OFDM SYSTEMS**

(75) Inventors: **Jianglei Ma**, Kanata (CA); **Ming Jia**, Ottawa (CA); **Peiying Zhu**, Kanata (CA); **Wen Tong**, Ottawa (CA)

(73) Assignee: **Nortel Networks Limited**, St. Laurent, Quebec (CA)

(\* ) Notice: Subject to any disclaimer, the term of this patent is extended or adjusted under 35 U.S.C. 154(b) by 898 days.

(21) Appl. No.: **10/038,883**

(22) Filed: **Jan. 8, 2002**

(65) **Prior Publication Data**

US 2003/0072254 A1 Apr. 17, 2003

**Related U.S. Application Data**

(60) Provisional application No. 60/329,509, filed on Oct. 17, 2001.

(51) **Int. Cl.**

**H04J 11/00** (2006.01)  
**H04Q 7/00** (2006.01)  
**H04B 7/216** (2006.01)  
**H04B 7/02** (2006.01)  
**H04L 27/00** (2006.01)

(52) **U.S. Cl.** ..... **370/208**; 370/328; 370/335; 370/342; 370/441; 375/299; 375/316; 455/101

(58) **Field of Classification Search** ..... 370/208, 370/203, 334, 435, 437, 465, 491, 500  
See application file for complete search history.

(56) **References Cited**

**U.S. PATENT DOCUMENTS**

5,867,478 A \* 2/1999 Baum et al. .... 370/203  
6,298,035 B1 \* 10/2001 Heiskala ..... 370/206  
6,359,938 B1 \* 3/2002 Keevill et al. .... 375/316

6,473,393 B1 \* 10/2002 Ariyavisitakul et al. .... 370/203  
6,654,429 B1 \* 11/2003 Li ..... 375/316  
2002/0003774 A1 \* 1/2002 Wang et al. .... 370/208  
2002/0034213 A1 \* 3/2002 Wang et al. .... 375/132  
2002/0080887 A1 \* 6/2002 Jeong et al. .... 375/295  
2002/0122383 A1 \* 9/2002 Wu et al. .... 370/210  
2002/0144294 A1 \* 10/2002 Rabinowitz et al. .... 725/139  
2002/0181390 A1 \* 12/2002 Mody et al. .... 370/208  
2003/0016621 A1 \* 1/2003 Li ..... 370/203

**OTHER PUBLICATIONS**

Fernández-Getino Garcia, M<sup>a</sup> Julia et al; Efficient Pilot Patterns for Channel Estimation in OFDM Systems Over HF Channels; pp. 2193-2197.

Jones, V.K.; Raleigh, Gregory G.; Channel Estimation for Wireless OFDM Systems; pp. 980-985.

\* cited by examiner

*Primary Examiner*—Chi Pham

*Assistant Examiner*—Melanie Jagannathan

(57) **ABSTRACT**

A method and apparatus are provided for reducing the number of pilot symbols within a MIMO-OFDM communication system, and for improving channel estimation within such a system. For each transmitting antenna in an OFDM transmitter, pilot symbols are encoded so as to be unique to the transmitting antenna. The encoded pilot symbols are then inserted into an OFDM frame to form a diamond lattice, the diamond lattices for the different transmitting antennae using the same frequencies but being offset from each other by a single symbol in the time domain. At the OFDM receiver, a channel response is estimated for a symbol central to each diamond of the diamond lattice using a two-dimensional interpolation. The estimated channel responses are smoothed in the frequency domain. The channel responses of remaining symbols are then estimated by interpolation in the frequency domain.

**44 Claims, 7 Drawing Sheets**

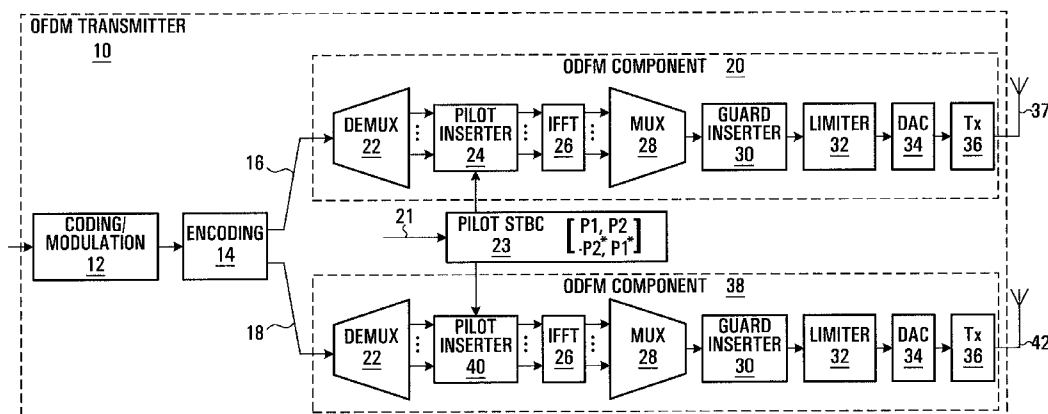

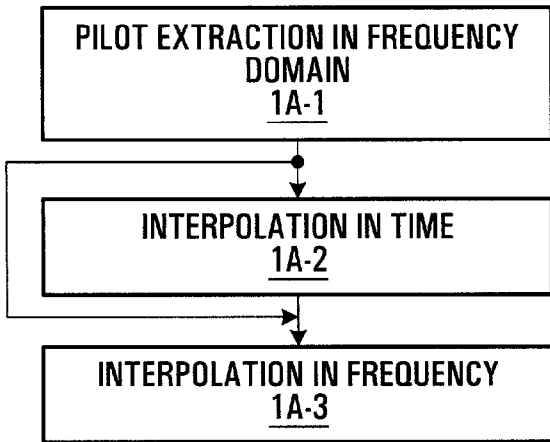

FIG. 1A  
(PRIOR ART)

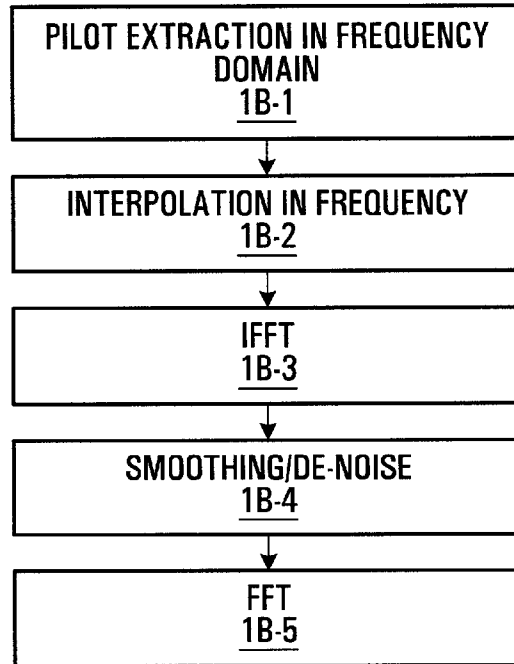

FIG. 1B  
(PRIOR ART)

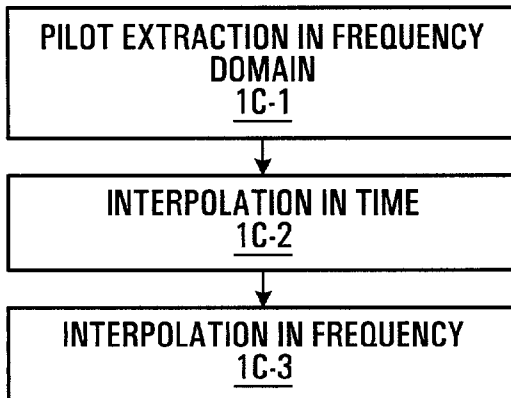

FIG. 1C  
(PRIOR ART)

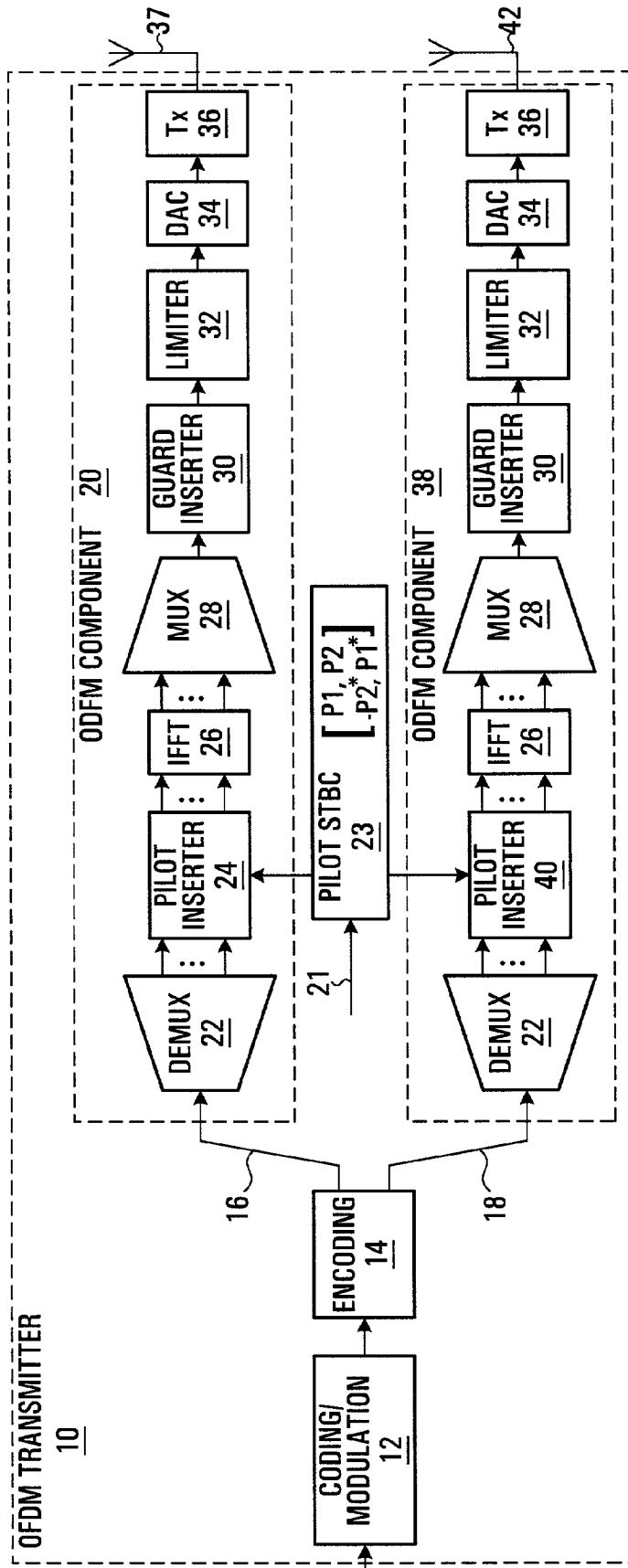

FIG. 2

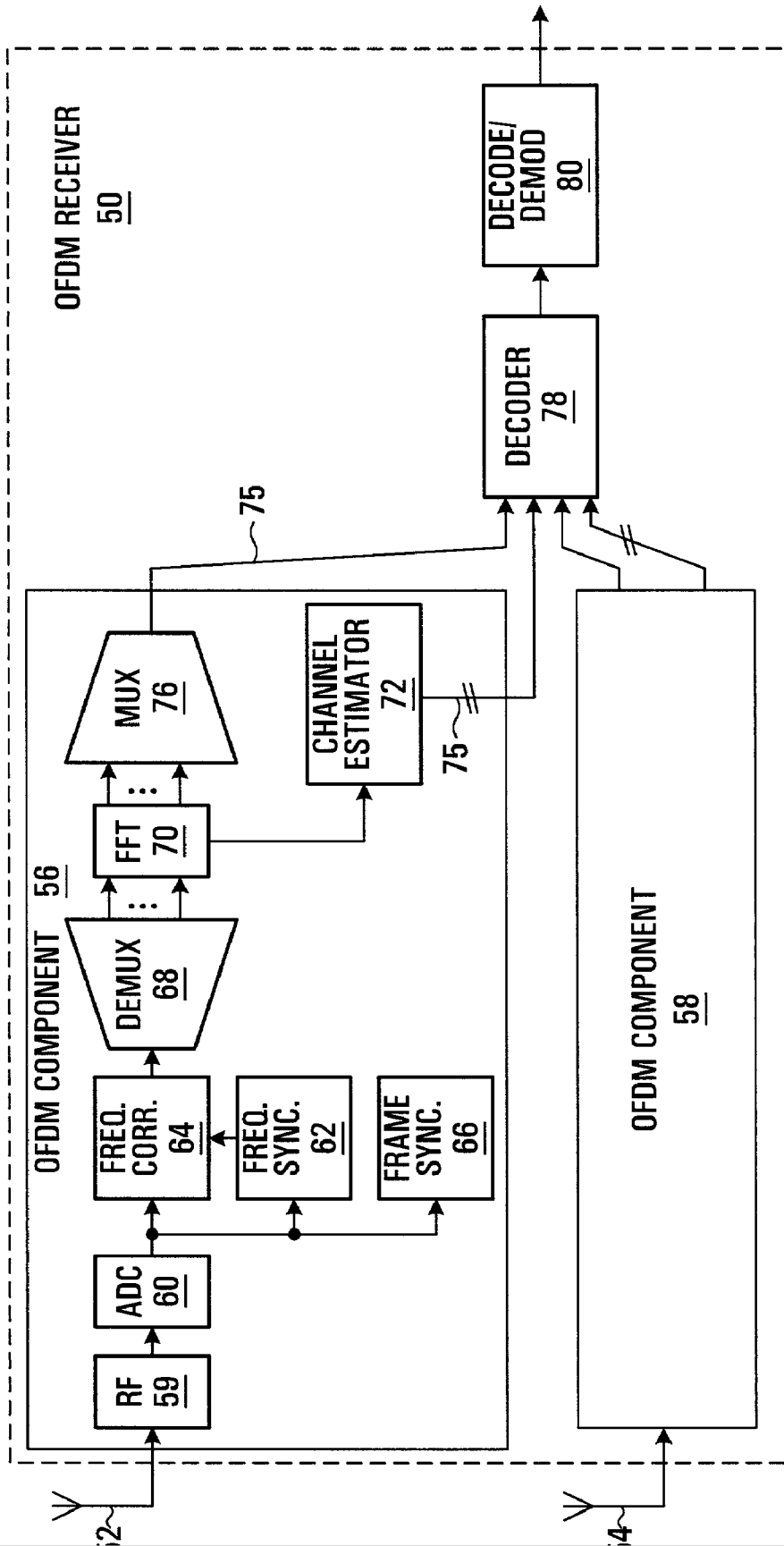

FIG. 3

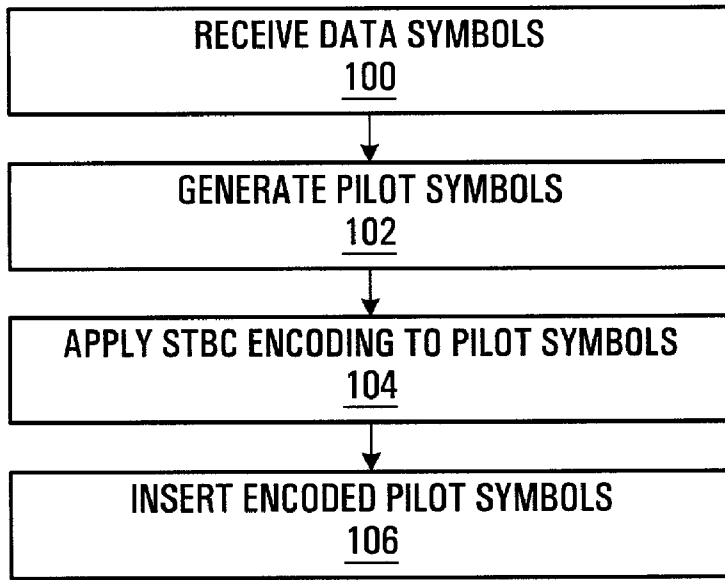

FIG. 4

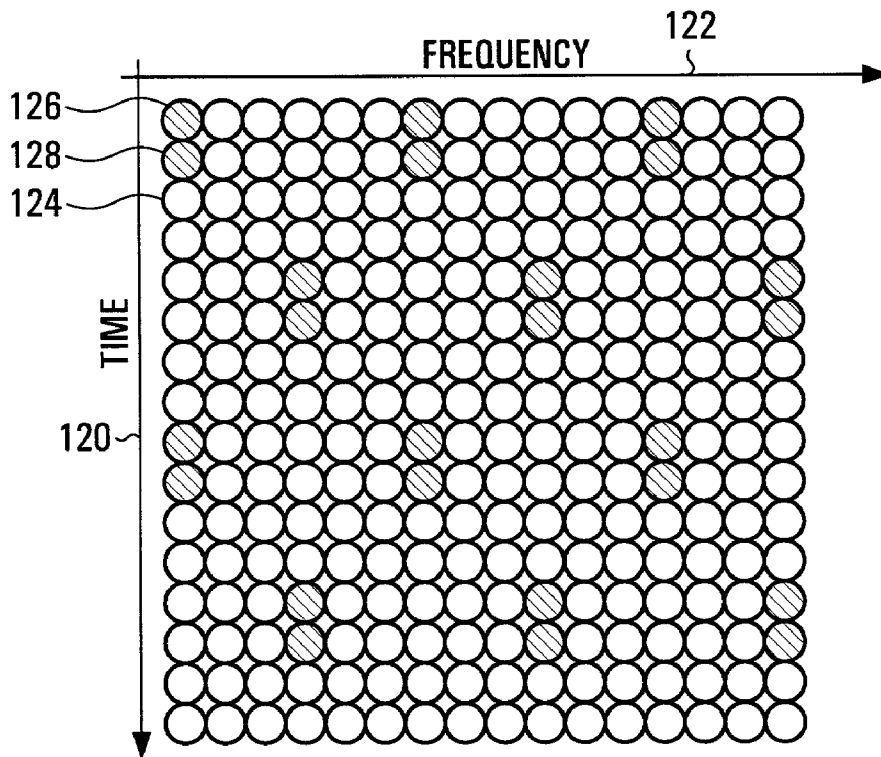

FIG. 5

# Explore Litigation Insights

Docket Alarm provides insights to develop a more informed litigation strategy and the peace of mind of knowing you're on top of things.

## Real-Time Litigation Alerts



Keep your litigation team up-to-date with **real-time alerts** and advanced team management tools built for the enterprise, all while greatly reducing PACER spend.

Our comprehensive service means we can handle Federal, State, and Administrative courts across the country.

## Advanced Docket Research



With over 230 million records, Docket Alarm's cloud-native docket research platform finds what other services can't. Coverage includes Federal, State, plus PTAB, TTAB, ITC and NLRB decisions, all in one place.

Identify arguments that have been successful in the past with full text, pinpoint searching. Link to case law cited within any court document via Fastcase.

## Analytics At Your Fingertips



Learn what happened the last time a particular judge, opposing counsel or company faced cases similar to yours.

Advanced out-of-the-box PTAB and TTAB analytics are always at your fingertips.

## API

Docket Alarm offers a powerful API (application programming interface) to developers that want to integrate case filings into their apps.

## LAW FIRMS

Build custom dashboards for your attorneys and clients with live data direct from the court.

Automate many repetitive legal tasks like conflict checks, document management, and marketing.

## FINANCIAL INSTITUTIONS

Litigation and bankruptcy checks for companies and debtors.

## E-DISCOVERY AND LEGAL VENDORS

Sync your system to PACER to automate legal marketing.