

SCORE Placeholder Sheet for IFW Content

Application Number: 17012813

Document Date: 09/04/2020

The presence of this form in the IFW record indicates that the following document type was received in electronic format on the date identified above. This content is stored in the SCORE database.

Since this was an electronic submission, there is no physical artifact folder, no artifact folder is recorded in PALM, and no paper documents or physical media exist. The TIFF images in the IFW record were created from the original documents that are stored in SCORE.

- Drawing

At the time of document entry (noted above):

- USPTO employees may access SCORE content via DAV or via the SCORE web page.
- External customers may access SCORE content via PAIR using the Supplemental Content tab.

Under the Paperwork Reduction Act of 1995, no persons are required to respond to a collection of information unless it displays a valid OMB control number.

TRANSMITTAL FOR POWER OF ATTORNEY TO ONE OR MORE REGISTERED PRACTITIONERS

NOTE: This form is to be submitted with the Power of Attorney by Applicant form (PTO/AIA/82B) to identify the application to which the Power of Attorney is directed, in accordance with 37 CFR 1.5, unless the application number and filing date are identified in the Power of Attorney by Applicant form. If neither form PTO/AIA/82A nor form PTO/AIA82B identifies the application to which the Power of Attorney is directed, the Power of Attorney will not be recognized in the application.

Application Number	Not Yet Known
Filing Date	September 4, 2020
First Named Inventor	Li et al.
Title	METHOD AND APPARATUS USING CELL-SPECIFIC AND COMMON PILOT SUBCARRIERS IN MULTI-CARRIER, MULTI-CELL WIRELESS COMMUNICATION NETWORKS
Art Unit	Not Yet Known
Examiner Name	Not Yet Known
Attorney Docket Number	NEO-PT008.8

SIGNATURE of Applicant or Patent Practitioner

Signature	/Andrew D. Buschmeier/	Date (Optional)	September 4, 2020
Name	Andrew D. Buschmeier	Registration Number	73179
Title (if Applicant is a juristic entity)			
Applicant Name (if Applicant is a juristic entity)	Neo Wireless LLC		

NOTE: This form must be signed in accordance with 37 CFR 1.33. See 37 CFR 1.4(d) for signature requirements and certifications. If more than one applicant, use multiple forms.

*Total of 1 forms are submitted.

This collection of information is required by 37 CFR 1.131, 1.32, and 1.33. The information is required to obtain or retain a benefit by the public which is to file (and by the USPTO to process) an application. Confidentiality is governed by 35 U.S.C. 122 and 37 CFR 1.11 and 1.14. This collection is estimated to take 3 minutes to complete, including gathering, preparing, and submitting the completed application form to the USPTO. Time will vary depending upon the individual case. Any comments on the amount of time you require to complete this form and/or suggestions for reducing this burden, should be sent to the Chief Information Officer, U.S. Patent and Trademark Office, U.S. Department of Commerce, P.O. Box 1450, Alexandria, VA 22313-1450. **DO NOT SEND FEES OR COMPLETED FORMS TO THIS ADDRESS. SEND TO: Commissioner for Patents, P.O. Box 1450, Alexandria, VA 22313-1450.**

If you need assistance in completing the form, call 1-800-PTO-9199 and select option 2.

Under the Paperwork Reduction Act of 1995, no persons are required to respond to a collection of information unless it displays a valid OMB control number

POWER OF ATTORNEY BY APPLICANT

I hereby revoke all previous powers of attorney given in the application identified in either the attached transmittal letter or the boxes below.

Table with 2 columns: Application Number, Filing Date

(Note: The boxes above may be left blank if information is provided on form PTO/AIA/82A.)

I hereby appoint the Patent Practitioner(s) associated with the following Customer Number as my/our attorney(s) or agent(s), and to transact all business in the United States Patent and Trademark Office connected therewith for the application referenced in the attached transmittal letter (form PTO/AIA/82A) or identified above:

03624

OR

I hereby appoint Practitioner(s) named in the attached list (form PTO/AIA/82C) as my/our attorney(s) or agent(s), and to transact all business in the United States Patent and Trademark Office connected therewith for the patent application referenced in the attached transmittal letter (form PTO/AIA/82A) or identified above. (Note: Complete form PTO/AIA/82C.)

Please recognize or change the correspondence address for the application identified in the attached transmittal letter or the boxes above to:

The address associated with the above-mentioned Customer Number

OR

The address associated with Customer Number:

OR

Firm or Individual Name

Address

City State Zip

Country

Telephone Email

I am the Applicant (if the Applicant is a juristic entity, list the Applicant name in the box):

Neo Wireless LLC

- Inventor or Joint Inventor (title not required below)
Legal Representative of a Deceased or Legally Incapacitated Inventor (title not required below)
Assignee or Person to Whom the Inventor is Under an Obligation to Assign (provide signer's title if applicant is a juristic entity)
Person Who Otherwise Shows Sufficient Proprietary Interest (e.g., a petition under 37 CFR 1.46(b)(2) was granted in the application or is concurrently being filed with this document) (provide signer's title if applicant is a juristic entity)

SIGNATURE of Applicant for Patent

The undersigned (whose title is supplied below) is authorized to act on behalf of the applicant (e.g., where the applicant is a juristic entity).

Signature Date (Optional)

Name David Loo

Title C.E.O., Neo Wireless LLC

NOTE: Signature - This form must be signed by the applicant in accordance with 37 CFR 1.33. See 37 CFR 1.4 for signature requirements and certifications. If more than one applicant, use multiple forms.

Total of 1 forms are submitted.

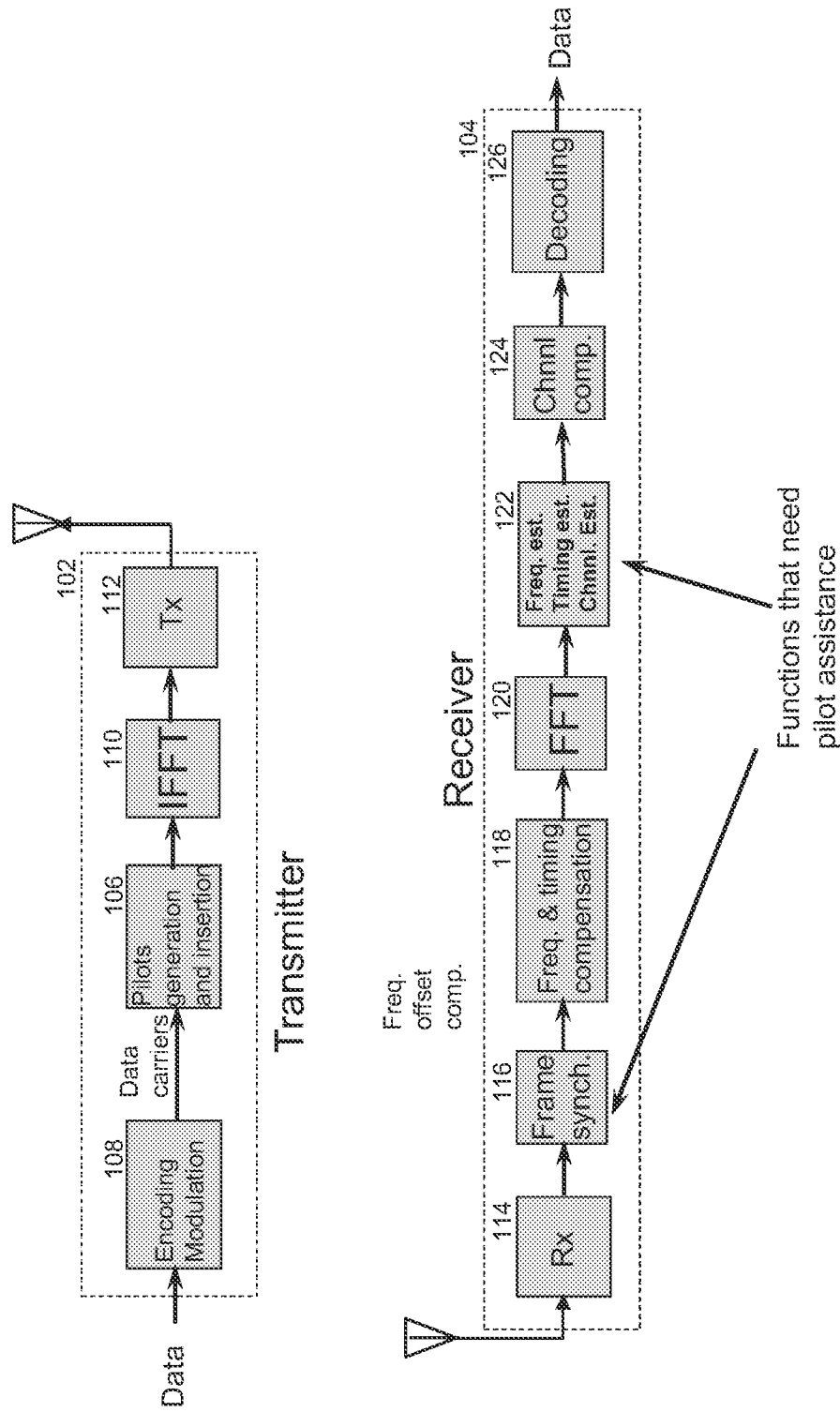

FIG. 1

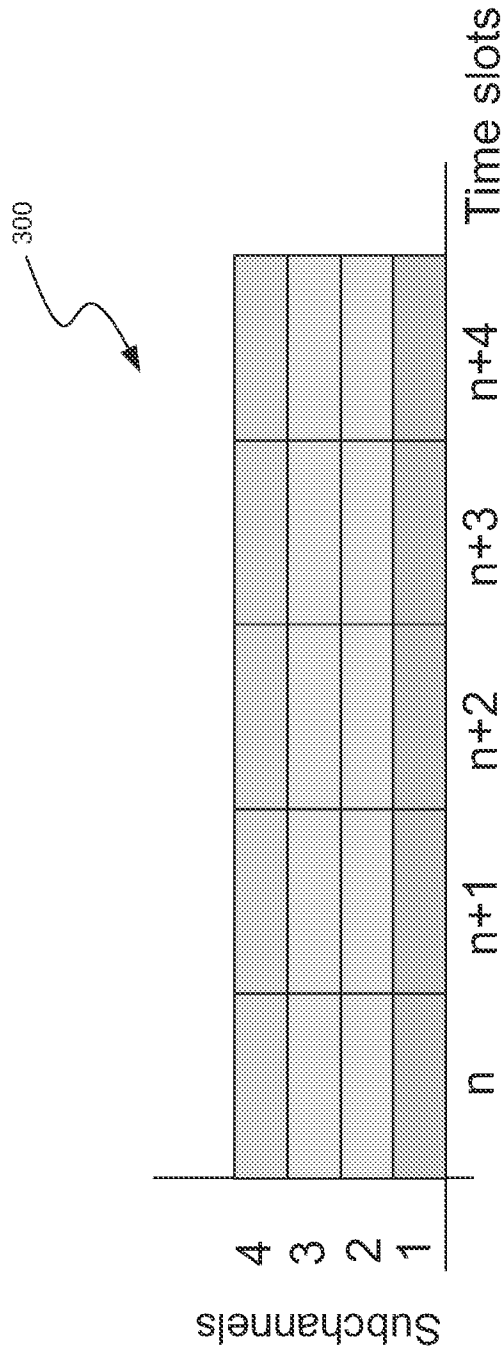

FIG. 3

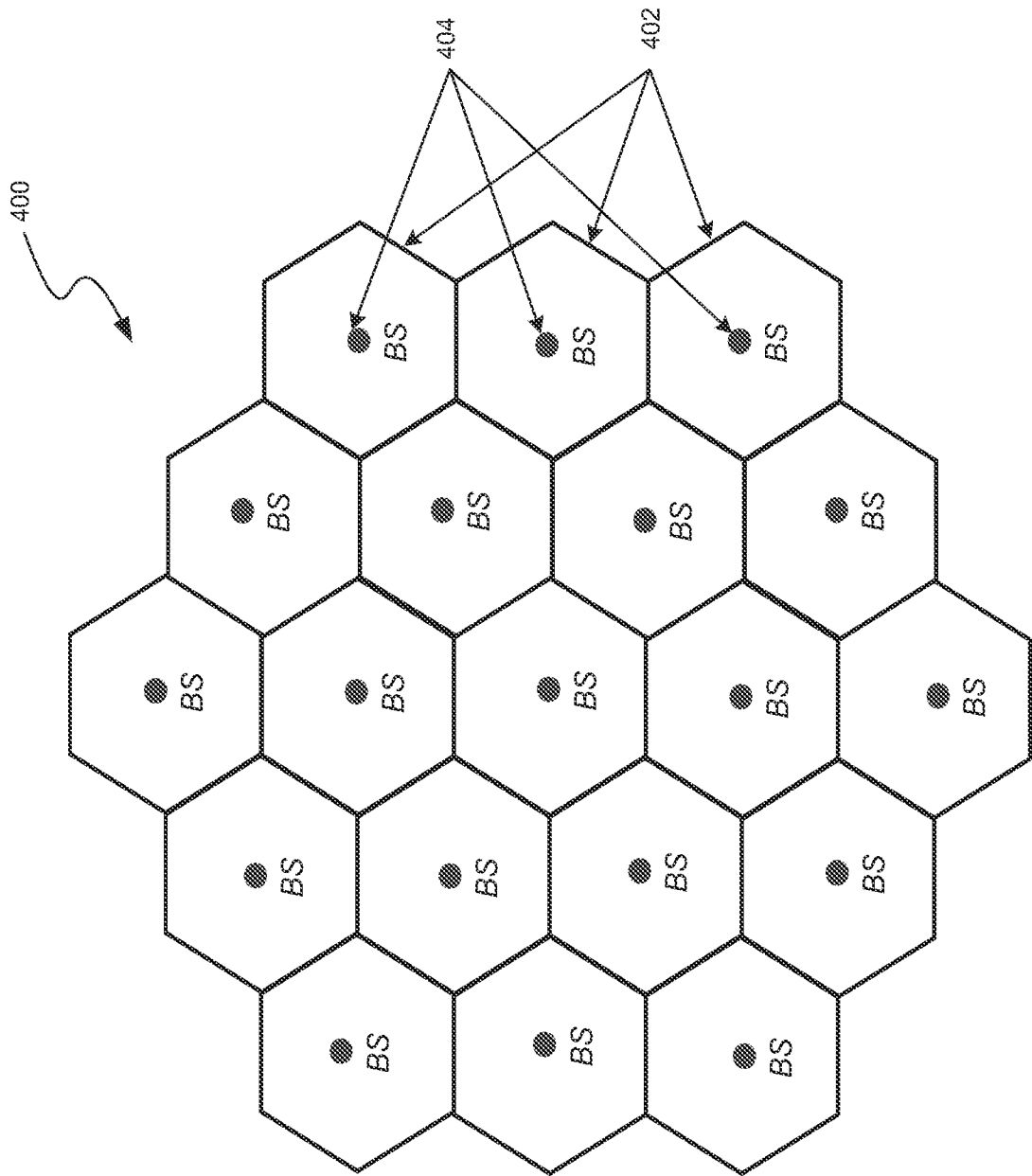

FIG. 4

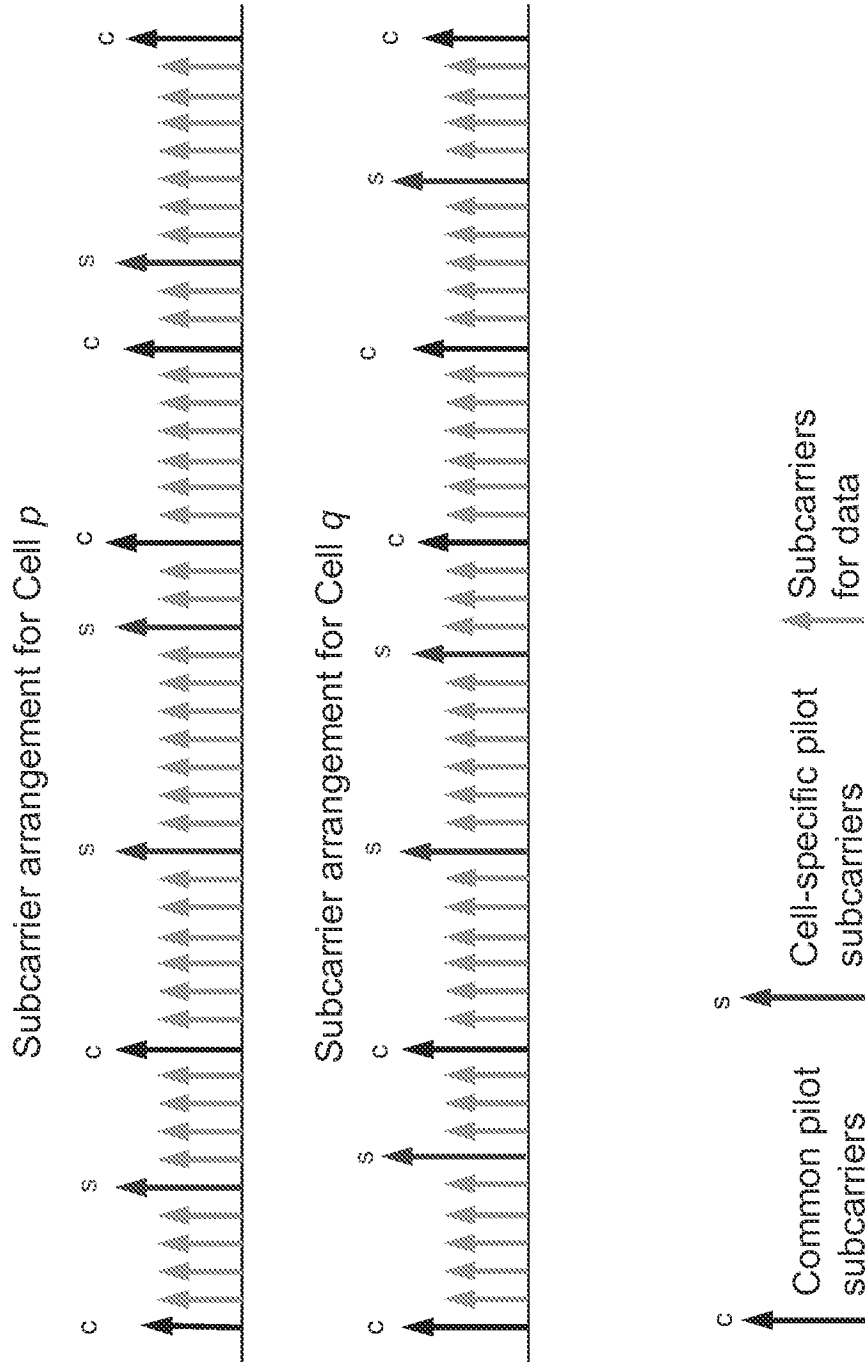

FIG. 5

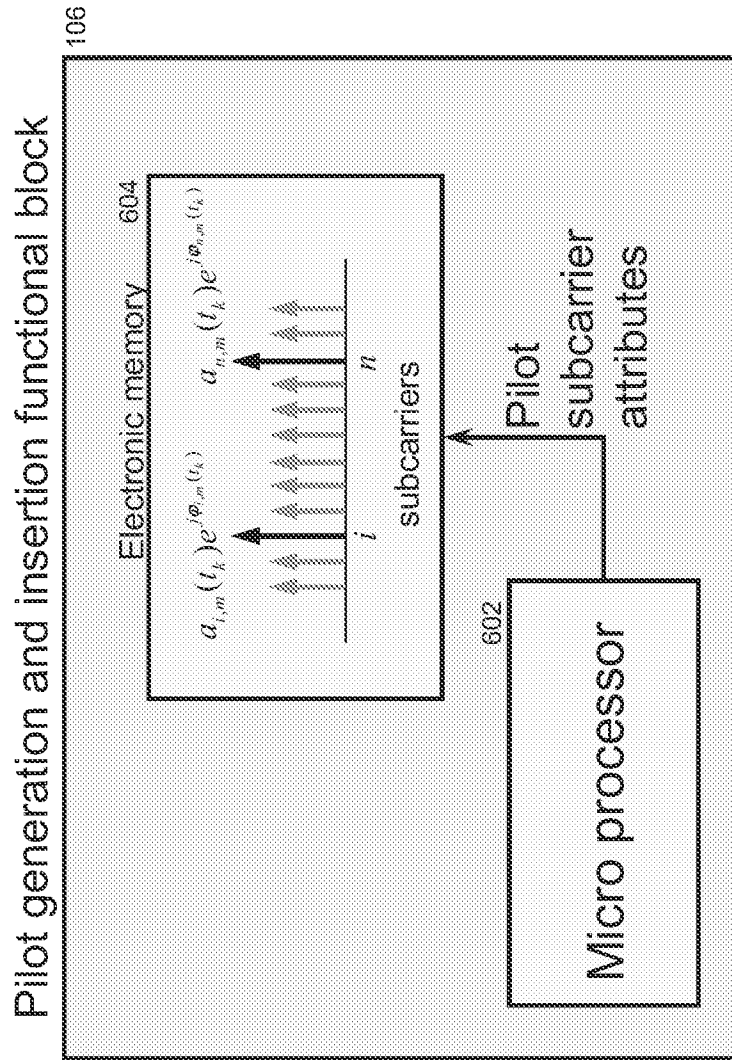

FIG. 6

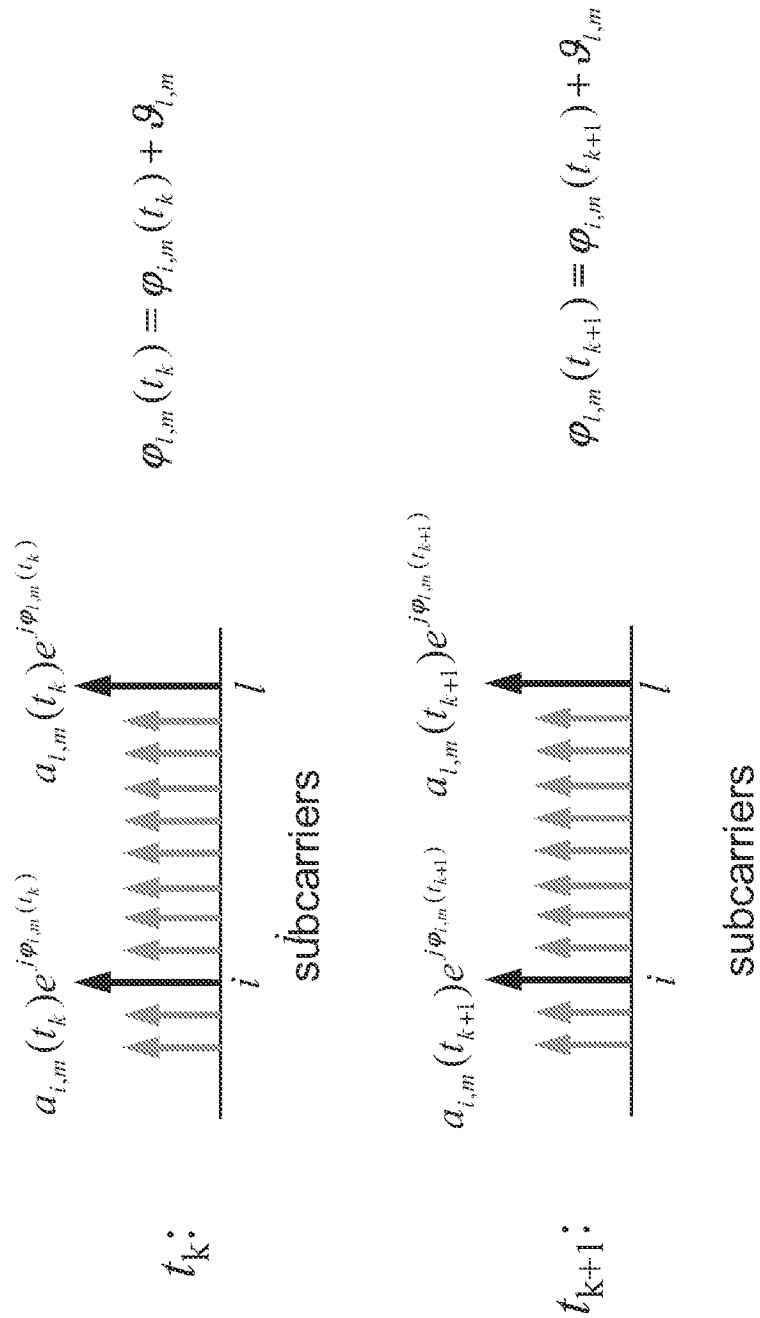

FIG. 7

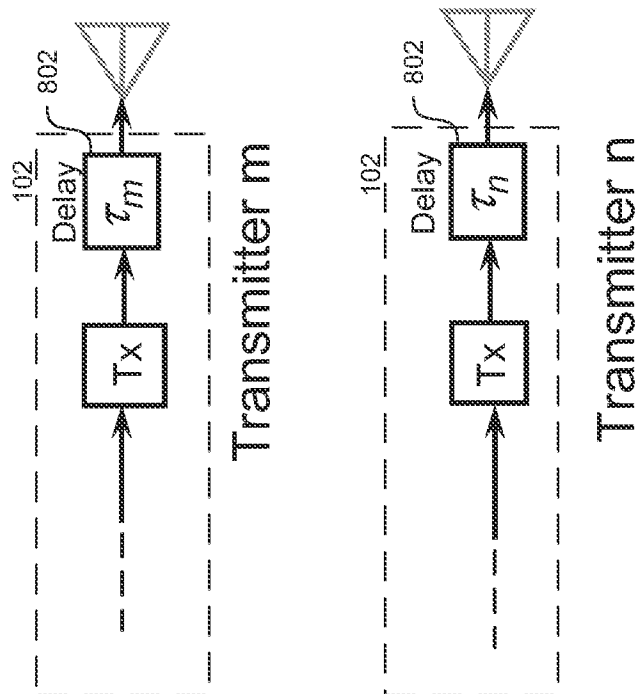
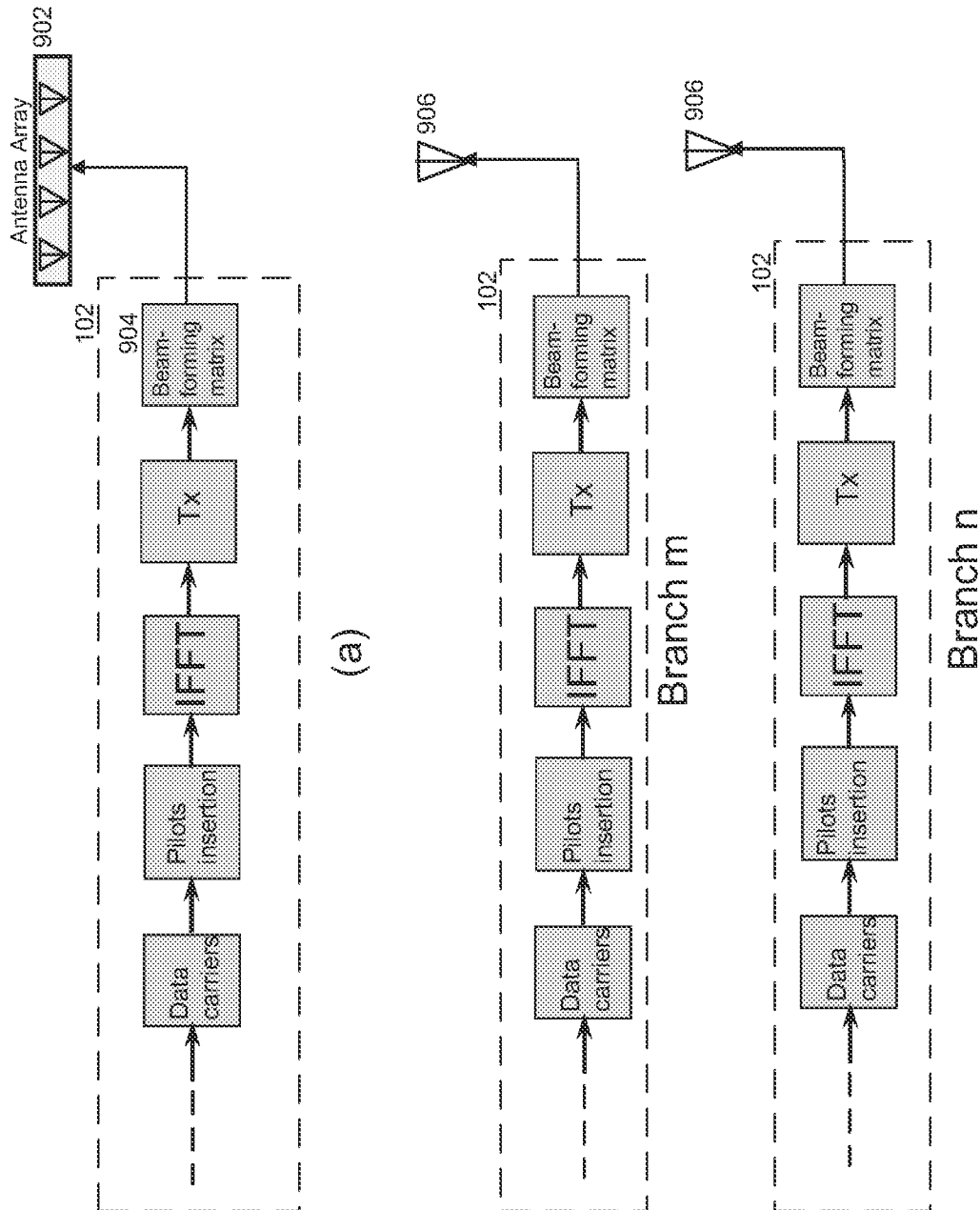

FIG. 8



(b) FIG. 9

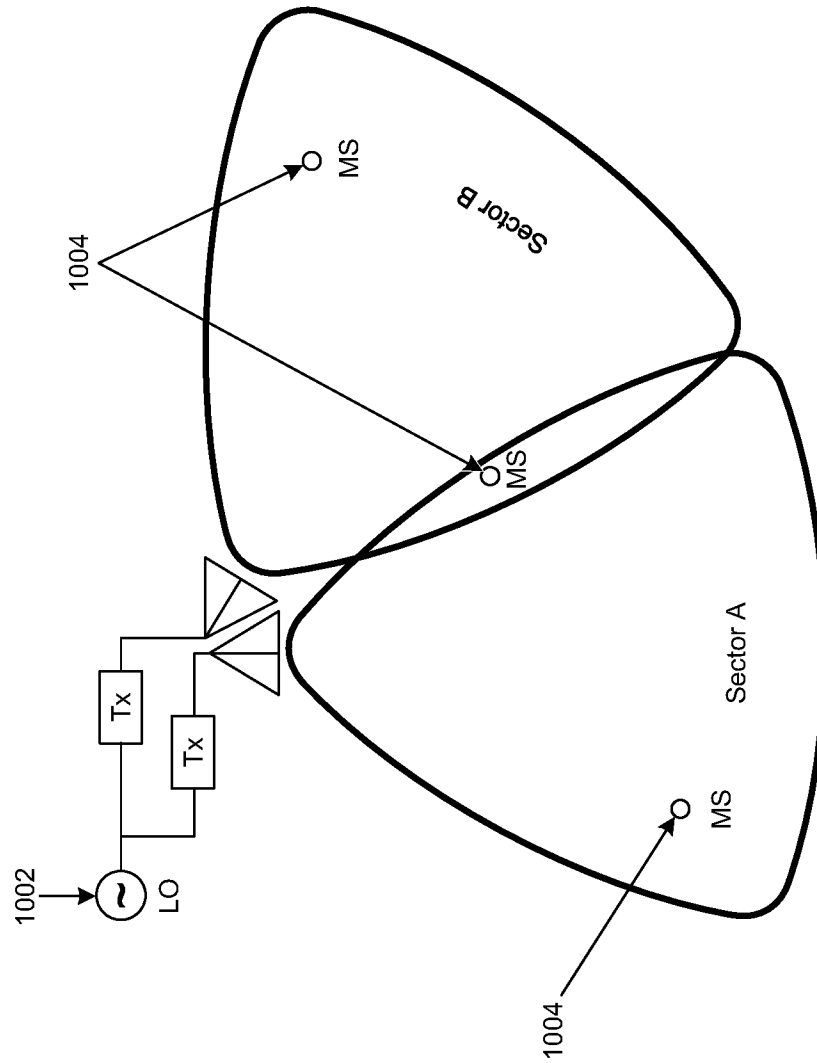

FIG. 10

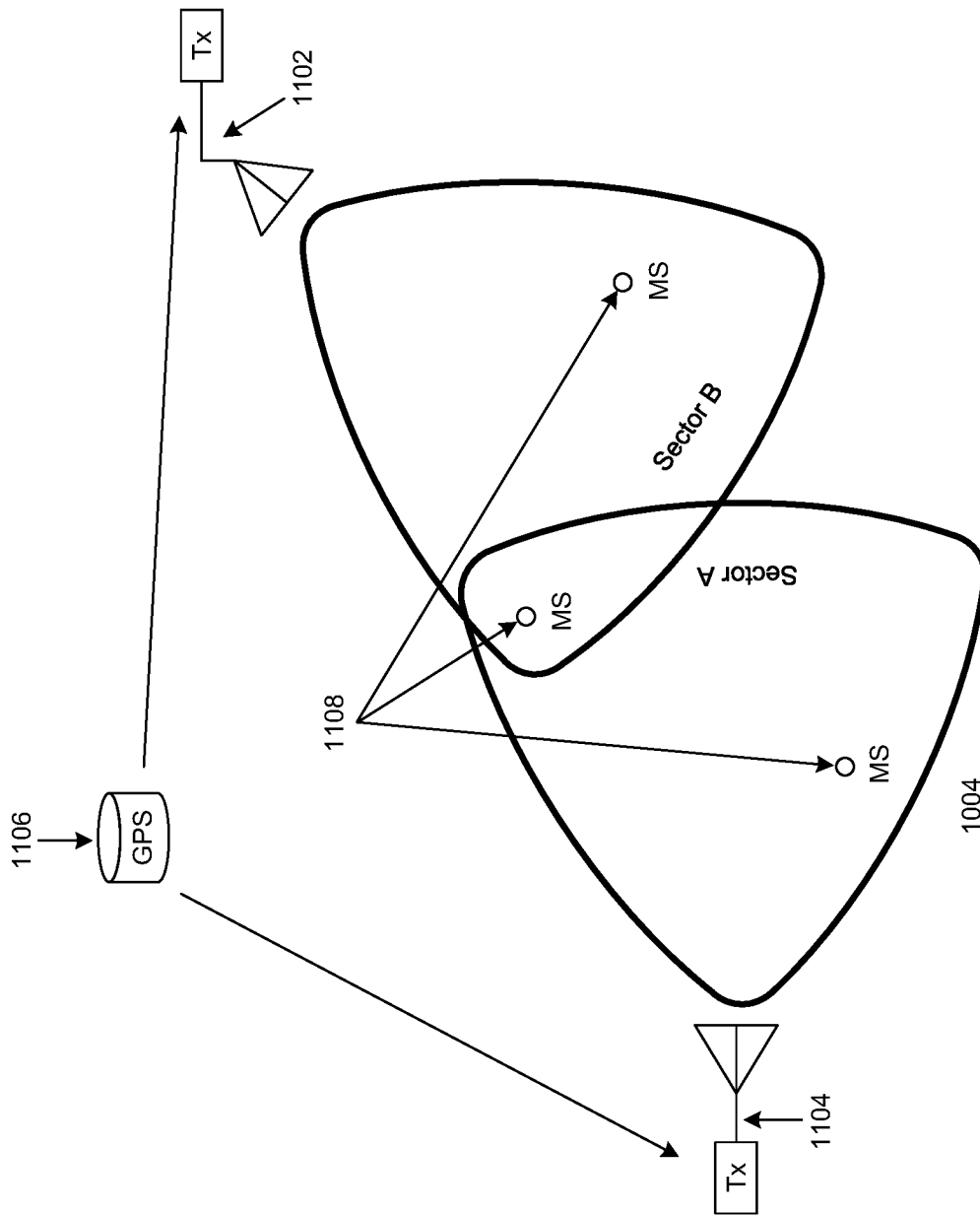

FIG. 11

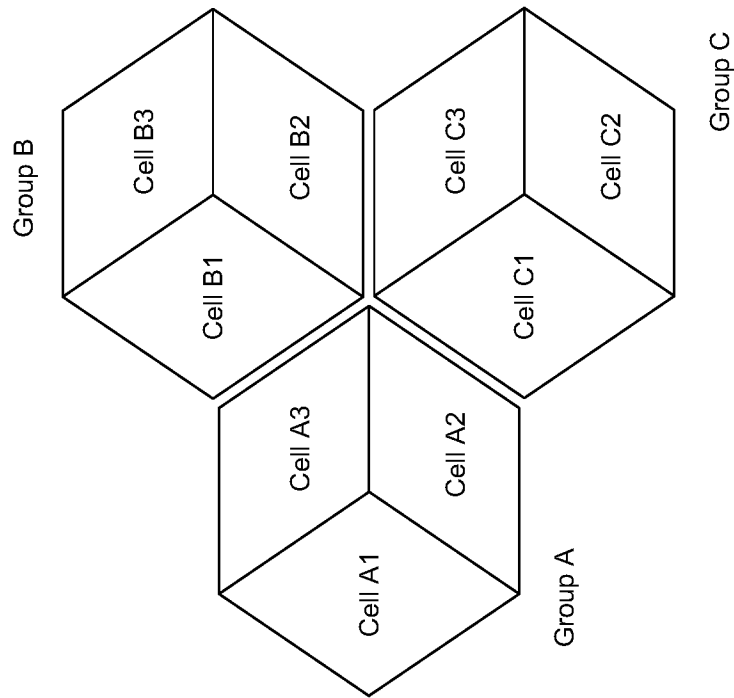

FIG. 12

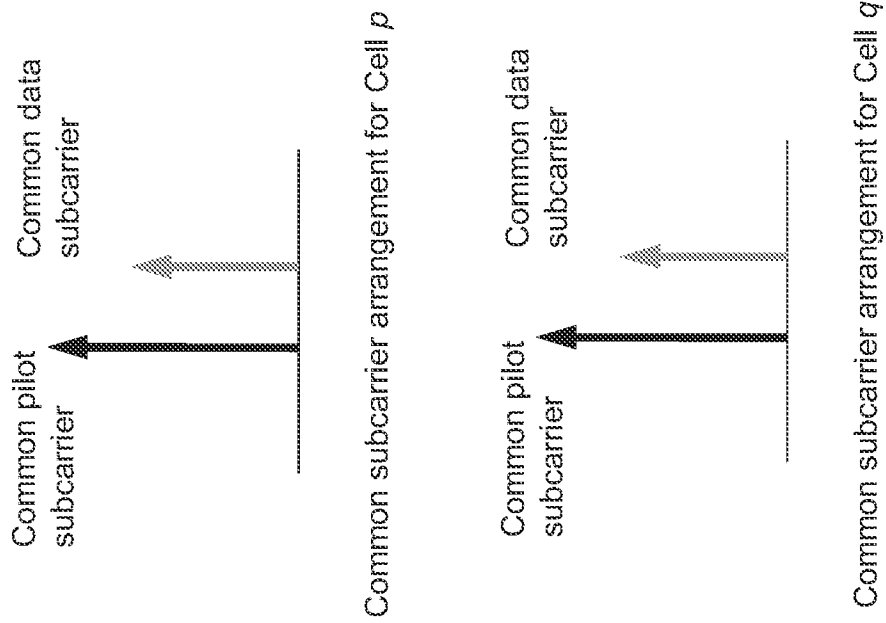

FIG. 13

**DECLARATION (37 CFR 1.63) FOR UTILITY OR DESIGN APPLICATION USING AN
APPLICATION DATA SHEET (37 CFR 1.76)**

Title of Invention	METHOD AND APPARATUS USING CELL-SPECIFIC AND COMMON PILOT SUBCARRIERS IN MULTI-CARRIER, MULTI-CELL WIRELESS COMMUNICATION NETWORKS
-------------------------------	---

As the below named inventor, I hereby declare that:

This declaration The attached application, or
is directed to:
 United States application or PCT international application number 13/874,278
filed on 04/30/2013

The above-identified application was made or authorized to be made by me.

I believe that I am the original inventor or an original joint inventor of a claimed invention in the application.

I hereby acknowledge that any willful false statement made in this declaration is punishable under 18 U.S.C. 1001 by fine or imprisonment of not more than five (5) years, or both.

I hereby state that I have reviewed and understand the contents of the above identified application, including the claims, as amended by any amendment.

I acknowledge the duty to disclose information material to patentability as defined in 37 C.F.R. 1.56 including for continuation-in-part applications, material information which became available between the filing date of the prior application and the national or PCT international filing date of the continuation-in-part application.

WARNING:

Petitioner/applicant is cautioned to avoid submitting personal information in documents filed in a patent application that may contribute to identity theft. Personal information such as social security numbers, bank account numbers, or credit card numbers (other than a check or credit card authorization form PTO-2038 submitted for payment purposes) is never required by the USPTO to support a petition or an application. If this type of personal information is included in documents submitted to the USPTO, petitioners/applicants should consider redacting such personal information from the documents before submitting them to the USPTO. Petitioner/applicant is advised that the record of a patent application is available to the public after publication of the application (unless a non-publication request in compliance with 37 CFR 1.213(a) is made in the application) or issuance of a patent. Furthermore, the record from an abandoned application may also be available to the public if the application is referenced in a published application or an issued patent (see 37 CFR 1.14). Checks and credit card authorization forms PTO-2038 submitted for payment purposes are not retained in the application file and therefore are not publicly available.

LEGAL NAME OF INVENTOR

Inventor: Xiaodong Li

Date: 6/5/2013

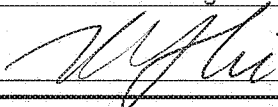
Signature: 

Note: An application data sheet (PTO/SB/14 or equivalent), including naming the entire inventive entity, must accompany this form or must have been previously filed. Use an additional PTO/AIA/01 form for each additional inventor.

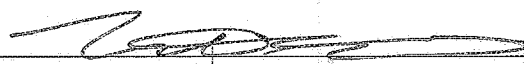
DECLARATION (37 CFR 1.63) FOR UTILITY OR DESIGN APPLICATION USING AN APPLICATION DATA SHEET (37 CFR 1.76)	
Title of Invention	METHOD AND APPARATUS USING CELL-SPECIFIC AND COMMON PILOT SUBCARRIERS IN MULTI-CARRIER, MULTI-CELL WIRELESS COMMUNICATION NETWORKS
As the below named inventor, I hereby declare that:	
This declaration <input type="checkbox"/> The attached application, or is directed to:	
<input checked="" type="checkbox"/> United States application or PCT international application number <u>13/874,278</u> filed on <u>04/30/2013</u>	
The above-identified application was made or authorized to be made by me.	
I believe that I am the original inventor or an original joint inventor of a claimed invention in the application.	
I hereby acknowledge that any willful false statement made in this declaration is punishable under 18 U.S.C. 1001 by fine or imprisonment of not more than five (5) years, or both.	
I hereby state that I have reviewed and understand the contents of the above identified application, including the claims, as amended by any amendment.	
I acknowledge the duty to disclose information material to patentability as defined in 37 C.F.R. 1.56 including for continuation-in-part applications, material information which became available between the filing date of the prior application and the national or PCT international filing date of the continuation-in-part application.	
WARNING:	
Petitioner/applicant is cautioned to avoid submitting personal information in documents filed in a patent application that may contribute to identity theft. Personal information such as social security numbers, bank account numbers, or credit card numbers (other than a check or credit card authorization form PTO-2038 submitted for payment purposes) is never required by the USPTO to support a petition or an application. If this type of personal information is included in documents submitted to the USPTO, petitioners/applicants should consider redacting such personal information from the documents before submitting them to the USPTO. Petitioner/applicant is advised that the record of a patent application is available to the public after publication of the application (unless a non-publication request in compliance with 37 CFR 1.213(a) is made in the application) or issuance of a patent. Furthermore, the record from an abandoned application may also be available to the public if the application is referenced in a published application or an issued patent (see 37 CFR 1.14). Checks and credit card authorization forms PTO-2038 submitted for payment purposes are not retained in the application file and therefore are not publicly available.	
LEGAL NAME OF INVENTOR	
Inventor: <u>Titus Lo</u>	Date: <u>6/5/2013</u>
Signature: 	
Note: An application data sheet (PTO/SB/14 or equivalent), including naming the entire inventive entity, must accompany this form or must have been previously filed. Use an additional PTO/AIA/01 form for each additional inventor.	

DECLARATION (37 CFR 1.63) FOR UTILITY OR DESIGN APPLICATION USING AN APPLICATION DATA SHEET (37 CFR 1.76)	
Title of Invention	METHOD AND APPARATUS USING CELL-SPECIFIC AND COMMON PILOT SUBCARRIERS IN MULTI-CARRIER, MULTI-CELL WIRELESS COMMUNICATION NETWORKS
<p>As the below named inventor, I hereby declare that</p> <p>This declaration <input type="checkbox"/> The attached application, or is directed to:</p> <p style="margin-left: 40px;"><input checked="" type="checkbox"/> United States application or PCT international application number <u>13/874,278</u> filed on <u>04/30/2013</u></p> <p>The above-identified application was made or authorized to be made by me.</p> <p>I believe that I am the original inventor or an original joint inventor of a claimed invention in the application.</p> <p>I hereby acknowledge that any willful false statement made in this declaration is punishable under 18 U.S.C. 1001 by fine or imprisonment of not more than five (5) years, or both.</p> <p>I hereby state that I have reviewed and understand the contents of the above identified application, including the claims, as amended by any amendment.</p> <p>I acknowledge the duty to disclose information material to patentability as defined in 37 C.F.R. 1.56 including for continuation-in-part applications, material information which became available between the filing date of the prior application and the national or PCT international filing date of the continuation-in-part application.</p> <p style="text-align: center;">WARNING:</p> <p>Petitioner/applicant is cautioned to avoid submitting personal information in documents filed in a patent application that may contribute to identity theft. Personal information such as social security numbers, bank account numbers, or credit card numbers (other than a check or credit card authorization form PTO-2038 submitted for payment purposes) is never required by the USPTO to support a petition or an application. If this type of personal information is included in documents submitted to the USPTO, petitioners/applicants should consider redacting such personal information from the documents before submitting them to the USPTO. Petitioner/applicant is advised that the record of a patent application is available to the public after publication of the application (unless a non-publication request in compliance with 37 CFR 1.213(a) is made in the application) or issuance of a patent. Furthermore, the record from an abandoned application may also be available to the public if the application is referenced in a published application or an issued patent (see 37 CFR 1.14). Checks and credit card authorization forms PTO-2038 submitted for payment purposes are not retained in the application file and therefore are not publicly available.</p>	
LEGAL NAME OF INVENTOR	
Inventor: _____	Date: <u>06/05/2013</u>
Signature: <u></u>	
<p>Note: An application data sheet (PTO/SB/14 or equivalent), including naming the entire inventive entity, must accompany this form or must have been previously filed. Use an additional PTO/AIA/01 form for each additional inventor.</p>	

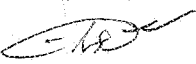
DECLARATION (37 CFR 1.63) FOR UTILITY OR DESIGN APPLICATION USING AN APPLICATION DATA SHEET (37 CFR 1.76)	
Title of Invention	METHOD AND APPARATUS USING CELL-SPECIFIC AND COMMON PILOT SUBCARRIERS IN MULTI-CARRIER, MULTI-CELL WIRELESS COMMUNICATION NETWORKS
As the below named inventor, I hereby declare that:	
This declaration is directed to: <input type="checkbox"/> The attached application, or	
<input checked="" type="checkbox"/> United States application or PCT international application number <u>13/874,278</u>	
filed on <u>04/30/2013</u>	
The above-identified application was made or authorized to be made by me.	
I believe that I am the original inventor or an original joint inventor of a claimed invention in the application.	
I hereby acknowledge that any willful false statement made in this declaration is punishable under 18 U.S.C. 1001 by fine or imprisonment of not more than five (5) years, or both.	
I hereby state that I have reviewed and understand the contents of the above identified application, including the claims, as amended by any amendment.	
I acknowledge the duty to disclose information material to patentability as defined in 37 C.F.R. 1.56 including for continuation-in-part applications, material information which became available between the filing date of the prior application and the national or PCT international filing date of the continuation-in-part application.	
WARNING:	
Petitioner/applicant is cautioned to avoid submitting personal information in documents filed in a patent application that may contribute to identity theft. Personal information such as social security numbers, bank account numbers, or credit card numbers (other than a check or credit card authorization form PTO-2038 submitted for payment purposes) is never required by the USPTO to support a petition or an application. If this type of personal information is included in documents submitted to the USPTO, petitioners/applicants should consider redacting such personal information from the documents before submitting them to the USPTO. Petitioner/applicant is advised that the record of a patent application is available to the public after publication of the application (unless a non-publication request in compliance with 37 CFR 1.213(a) is made in the application) or issuance of a patent. Furthermore, the record from an abandoned application may also be available to the public if the application is referenced in a published application or an issued patent (see 37 CFR 1.14). Checks and credit card authorization forms PTO-2038 submitted for payment purposes are not retained in the application file and therefore are not publicly available.	
LEGAL NAME OF INVENTOR	
Inventor: <u>Haiming Huang</u>	Date: <u>6/5/2013</u>
Signature: 	
Note: An application data sheet (PTO/SB/14 or equivalent), including naming the entire inventive entity, must accompany this form or must have been previously filed. Use an additional PTO/AIA/01 form for each additional inventor.	

**CERTIFICATION AND REQUEST FOR PRIORITIZED EXAMINATION
 UNDER 37 CFR 1.102(e)** (Page 1 of 1)

First Named Inventor:	Xiaodong Li	Nonprovisional Application Number (if known):	
Title of Invention:	METHOD AND APPARATUS USING CELL-SPECIFIC AND COMMON PILOT SUBCARRIERS IN MULTI-CARRIER, MULTI-CELL WIRELESS COMMUNICATION NETWORKS		

APPLICANT HEREBY CERTIFIES THE FOLLOWING AND REQUESTS PRIORITIZED EXAMINATION FOR THE ABOVE-IDENTIFIED APPLICATION.

1. The processing fee set forth in 37 CFR 1.17(i)(1) and the prioritized examination fee set forth in 37 CFR 1.17(c) have been filed with the request. The publication fee requirement is met because that fee, set forth in 37 CFR 1.18(d), is currently \$0. The basic filing fee, search fee, and examination fee are filed with the request or have been already been paid. I understand that any required excess claims fees or application size fee must be paid for the application.
2. I understand that the application may not contain, or be amended to contain, more than four independent claims, more than thirty total claims, or any multiple dependent claims, and that any request for an extension of time will cause an outstanding Track I request to be dismissed.
3. The applicable box is checked below:

I. Original Application (Track One) - Prioritized Examination under § 1.102(e)(1)

- i. (a) The application is an original nonprovisional utility application filed under 35 U.S.C. 111(a). This certification and request is being filed with the utility application via EFS-Web.
 ---OR---
 (b) The application is an original nonprovisional plant application filed under 35 U.S.C. 111(a). This certification and request is being filed with the plant application in paper.
- ii. An executed inventor's oath or declaration under 37 CFR 1.63 or 37 CFR 1.64 for each inventor, or the application data sheet meeting the conditions specified in 37 CFR 1.53(f)(3)(i) is filed with the application.

II. Request for Continued Examination - Prioritized Examination under § 1.102(e)(2)

- i. A request for continued examination has been filed with, or prior to, this form.
- ii. If the application is a utility application, this certification and request is being filed via EFS-Web.
- iii. The application is an original nonprovisional utility application filed under 35 U.S.C. 111(a), or is a national stage entry under 35 U.S.C. 371.
- iv. This certification and request is being filed prior to the mailing of a first Office action responsive to the request for continued examination.
- v. No prior request for continued examination has been granted prioritized examination status under 37 CFR 1.102(e)(2).

Signature /Andrew D. Buschmeier/	Date September 4, 2020
Name (Print/Typed) Andrew D. Buschmeier	Practitioner Registration Number 73179

Note: This form must be signed in accordance with 37 CFR 1.33. See 37 CFR 1.4(d) for signature requirements and certifications. Submit multiple forms if more than one signature is required.*

*Total of 1 forms are submitted.

Privacy Act Statement

The **Privacy Act of 1974 (P.L. 93-579)** requires that you be given certain information in connection with your submission of the attached form related to a patent application or patent. Accordingly, pursuant to the requirements of the Act, please be advised that: (1) the general authority for the collection of this information is 35 U.S.C. 2(b)(2); (2) furnishing of the information solicited is voluntary; and (3) the principal purpose for which the information is used by the U.S. Patent and Trademark Office is to process and/or examine your submission related to a patent application or patent. If you do not furnish the requested information, the U.S. Patent and Trademark Office may not be able to process and/or examine your submission, which may result in termination of proceedings or abandonment of the application or expiration of the patent.

The information provided by you in this form will be subject to the following routine uses:

1. The information on this form will be treated confidentially to the extent allowed under the Freedom of Information Act (5 U.S.C. 552) and the Privacy Act (5 U.S.C. 552a). Records from this system of records may be disclosed to the Department of Justice to determine whether disclosure of these records is required by the Freedom of Information Act.
2. A record from this system of records may be disclosed, as a routine use, in the course of presenting evidence to a court, magistrate, or administrative tribunal, including disclosures to opposing counsel in the course of settlement negotiations.
3. A record in this system of records may be disclosed, as a routine use, to a Member of Congress submitting a request involving an individual, to whom the record pertains, when the individual has requested assistance from the Member with respect to the subject matter of the record.
4. A record in this system of records may be disclosed, as a routine use, to a contractor of the Agency having need for the information in order to perform a contract. Recipients of information shall be required to comply with the requirements of the Privacy Act of 1974, as amended, pursuant to 5 U.S.C. 552a(m).
5. A record related to an International Application filed under the Patent Cooperation Treaty in this system of records may be disclosed, as a routine use, to the International Bureau of the World Intellectual Property Organization, pursuant to the Patent Cooperation Treaty.
6. A record in this system of records may be disclosed, as a routine use, to another federal agency for purposes of National Security review (35 U.S.C. 181) and for review pursuant to the Atomic Energy Act (42 U.S.C. 218(c)).
7. A record from this system of records may be disclosed, as a routine use, to the Administrator, General Services, or his/her designee, during an inspection of records conducted by GSA as part of that agency's responsibility to recommend improvements in records management practices and programs, under authority of 44 U.S.C. 2904 and 2906. Such disclosure shall be made in accordance with the GSA regulations governing inspection of records for this purpose, and any other relevant (*i.e.*, GSA or Commerce) directive. Such disclosure shall not be used to make determinations about individuals.
8. A record from this system of records may be disclosed, as a routine use, to the public after either publication of the application pursuant to 35 U.S.C. 122(b) or issuance of a patent pursuant to 35 U.S.C. 151. Further, a record may be disclosed, subject to the limitations of 37 CFR 1.14, as a routine use, to the public if the record was filed in an application which became abandoned or in which the proceedings were terminated and which application is referenced by either a published application, an application open to public inspection or an issued patent.
9. A record from this system of records may be disclosed, as a routine use, to a Federal, State, or local law enforcement agency, if the USPTO becomes aware of a violation or potential violation of law or regulation.

Under the Paperwork Reduction Act of 1995, no persons are required to respond to a collection of information unless it contains a valid OMB control number.

Application Data Sheet 37 CFR 1.76		Attorney Docket Number	NEO-PT008.8
		Application Number	
Title of Invention	METHOD AND APPARATUS USING CELL-SPECIFIC AND COMMON PILOT SUBCARRIERS IN MULTI-CARRIER, MULTI-CELL WIRELESS COMMUNICATION NETWORKS		
The application data sheet is part of the provisional or nonprovisional application for which it is being submitted. The following form contains the bibliographic data arranged in a format specified by the United States Patent and Trademark Office as outlined in 37 CFR 1.76. This document may be completed electronically and submitted to the Office in electronic format using the Electronic Filing System (EFS) or the document may be printed and included in a paper filed application.			

Secrecy Order 37 CFR 5.2:

Portions or all of the application associated with this Application Data Sheet may fall under a Secrecy Order pursuant to 37 CFR 5.2 (Paper filers only. Applications that fall under Secrecy Order may not be filed electronically.)

Inventor Information:

Inventor	1				Remove
Legal Name					
Prefix	Given Name	Middle Name	Family Name	Suffix	
	Xiaodong		Li		
Residence Information (Select One) <input checked="" type="radio"/> US Residency <input type="radio"/> Non US Residency <input type="radio"/> Active US Military Service					
City	Kirkland	State/Province	WA	Country of Residence	US

Mailing Address of Inventor:

Address 1	1750 112th Ave. NE				
Address 2	Suite D159				
City	Bellevue	State/Province	WA		
Postal Code	98004	Country	US		

Inventor	2				Remove
Legal Name					
Prefix	Given Name	Middle Name	Family Name	Suffix	
	Titus		o		
Residence Information (Select One) <input checked="" type="radio"/> US Residency <input type="radio"/> Non US Residency <input type="radio"/> Active US Military Service					
City	Bellevue	State/Province	WA	Country of Residence	US

Mailing Address of Inventor:

Address 1	1750 112th Ave. NE				
Address 2	Suite D159				
City	Bellevue	State/Province	WA		
Postal Code	98004	Country	US		

Inventor	3				Remove
Legal Name					
Prefix	Given Name	Middle Name	Family Name	Suffix	
	Kemin		Li		
Residence Information (Select One) <input checked="" type="radio"/> US Residency <input type="radio"/> Non US Residency <input type="radio"/> Active US Military Service					

Application Data Sheet 37 CFR 1.76	Attorney Docket Number	NEO-PT008.8
	Application Number	
Title of Invention	METHOD AND APPARATUS USING CELL-SPECIFIC AND COMMON PILOT SUBCARRIERS IN MULTI-CARRIER, MULTI-CELL WIRELESS COMMUNICATION NETWORKS	

City	Bellevue	State/Province	WA	Country of Residence	US
------	----------	----------------	----	----------------------	----

Mailing Address of Inventor:

Address 1	1750 112th Ave. NE				
Address 2	Suite D159				
City	Bellevue	State/Province	WA		
Postal Code	98004	Country	US		

Inventor	4	<input type="button" value="Remove"/>
----------	---	---------------------------------------

Legal Name					
------------	--	--	--	--	--

Prefix	Given Name	Middle Name	Family Name	Suffix
	Haiming		Huang	

Residence Information (Select One)	<input checked="" type="radio"/> US Residency	<input type="radio"/> Non US Residency	<input type="radio"/> Active US Military Service
------------------------------------	---	--	--

City	Bellevue	State/Province	WA	Country of Residence	US
------	----------	----------------	----	----------------------	----

Mailing Address of Inventor:

Address 1	1750 112th Ave. NE				
Address 2	Suite D159				
City	Bellevue	State/Province	WA		
Postal Code	98004	Country	US		

All Inventors Must Be Listed - Additional Inventor Information blocks may be generated within this form by selecting the Add button.	<input type="button" value="Add"/>
---	------------------------------------

Correspondence Information:

Enter either Customer Number or complete the Correspondence Information section below. For further information see 37 CFR 1.33(a).

<input type="checkbox"/> An Address is being provided for the correspondence information of this application.

Customer Number	03624		
Email Address	eooffice@vklaw.com	<input type="button" value="Add Email"/>	<input type="button" value="Remove Email"/>

Application Information:

Title of the Invention	METHOD AND APPARATUS USING CELL-SPECIFIC AND COMMON PILOT SUBCARRIERS IN MULTI-CARRIER, MULTI-CELL WIRELESS COMMUNICATION NETWORKS				
Attorney Docket Number	NEO-PT008.8	Small Entity Status Claimed	<input type="checkbox"/>		
Application Type	Nonprovisional				
Subject Matter	Utility				
Total Number of Drawing Sheets (if any)	13	Suggested Figure for Publication (if any)	5		

Under the Paperwork Reduction Act of 1995, no persons are required to respond to a collection of information unless it contains a valid OMB control number.

Application Data Sheet 37 CFR 1.76	Attorney Docket Number	NEO-PT008.8
	Application Number	
Title of Invention	METHOD AND APPARATUS USING CELL-SPECIFIC AND COMMON PILOT SUBCARRIERS IN MULTI-CARRIER, MULTI-CELL WIRELESS COMMUNICATION NETWORKS	

Filing By Reference:

Only complete this section when filing an application by reference under 35 U.S.C. 111(c) and 37 CFR 1.57(a). Do not complete this section if application papers including a specification and any drawings are being filed. Any domestic benefit or foreign priority information must be provided in the appropriate section(s) below (i.e., "Domestic Benefit/National Stage Information" and "Foreign Priority Information").

For the purposes of a filing date under 37 CFR 1.53(b), the description and any drawings of the present application are replaced by this reference to the previously filed application, subject to conditions and requirements of 37 CFR 1.57(a).

Application number of the previously filed application	Filing date (YYYY-MM-DD)	Intellectual Property Authority or Country

Publication Information:

Request Early Publication (Fee required at time of Request 37 CFR 1.219)

Request Not to Publish. I hereby request that the attached application not be published under 35 U.S.C. 122(b) and certify that the invention disclosed in the attached application **has not and will not** be the subject of an application filed in another country, or under a multilateral international agreement, that requires publication at eighteen months after filing.

Representative Information:

Representative information should be provided for all practitioners having a power of attorney in the application. Providing this information in the Application Data Sheet does not constitute a power of attorney in the application (see 37 CFR 1.32). Either enter Customer Number or complete the Representative Name section below. If both sections are completed the customer number will be used for the Representative Information during processing.

Please Select One:	<input checked="" type="radio"/> Customer Number	US Patent Practitioner	<input type="radio"/> Limited Recognition (37 CFR 11.9)
Customer Number	03624		

Domestic Benefit/National Stage Information:

This section allows for the applicant to either claim benefit under 35 U.S.C. 119(e), 120, 121, 365(c), or 386(c) or indicate National Stage entry from a PCT application. Providing benefit claim information in the Application Data Sheet constitutes the specific reference required by 35 U.S.C. 119(e) or 120, and 37 CFR 1.78.

When referring to the current application, please leave the "Application Number" field blank.

Prior Application Status	Pending		Remove
Application Number	Continuity Type	Prior Application Number	Filing or 371(c) Date (YYYY-MM-DD)
	Continuation of	16440754	2019-06-13

Under the Paperwork Reduction Act of 1995, no persons are required to respond to a collection of information unless it contains a valid OMB control number.

Application Data Sheet 37 CFR 1.76		Attorney Docket Number	NEO-PT008.8		
		Application Number			
Title of Invention	METHOD AND APPARATUS USING CELL-SPECIFIC AND COMMON PILOT SUBCARRIERS IN MULTI-CARRIER, MULTI-CELL WIRELESS COMMUNICATION NETWORKS				
Prior Application Status	Patented			Remove	
Application Number	Continuity Type	Prior Application Number	Filing Date (YYYY-MM-DD)	Patent Number	Issue Date (YYYY-MM-DD)
16440754	Continuation of	15688441	2017-08-28	10326631	2019-06-18
Prior Application Status	Patented			Remove	
Application Number	Continuity Type	Prior Application Number	Filing Date (YYYY-MM-DD)	Patent Number	Issue Date (YYYY-MM-DD)
15688441	Continuation of	14746676	2015-06-22	9749168	2017-08-29
Prior Application Status	Patented			Remove	
Application Number	Continuity Type	Prior Application Number	Filing Date (YYYY-MM-DD)	Patent Number	Issue Date (YYYY-MM-DD)
14746676	Continuation of	14595132	2015-01-12	9065614	2015-06-23
Prior Application Status	Patented			Remove	
Application Number	Continuity Type	Prior Application Number	Filing Date (YYYY-MM-DD)	Patent Number	Issue Date (YYYY-MM-DD)
14595132	Continuation of	13874278	2013-04-30	8934473	2015-01-13
Prior Application Status	Patented			Remove	
Application Number	Continuity Type	Prior Application Number	Filing Date (YYYY-MM-DD)	Patent Number	Issue Date (YYYY-MM-DD)
13874278	Continuation of	13212116	2011-08-17	8432891	2013-04-30
Prior Application Status	Patented			Remove	
Application Number	Continuity Type	Prior Application Number	Filing Date (YYYY-MM-DD)	Patent Number	Issue Date (YYYY-MM-DD)
13212116	Continuation of	10583530	2007-05-30	8009660	2011-08-30
Prior Application Status	Expired			Remove	
Application Number	Continuity Type	Prior Application Number	Filing or 371(c) Date (YYYY-MM-DD)		
10583530	a 371 of international	PCT/US05/01939	2005-01-20		
Prior Application Status	Expired			Remove	
Application Number	Continuity Type	Prior Application Number	Filing or 371(c) Date (YYYY-MM-DD)		
PCT/US05/01939	Claims benefit of provisional	60540032	2004-01-29		
Additional Domestic Benefit/National Stage Data may be generated within this form by selecting the Add button.					Add

Foreign Priority Information:

Under the Paperwork Reduction Act of 1995, no persons are required to respond to a collection of information unless it contains a valid OMB control number.

Application Data Sheet 37 CFR 1.76	Attorney Docket Number	NEO-PT008.8
	Application Number	
Title of Invention	METHOD AND APPARATUS USING CELL-SPECIFIC AND COMMON PILOT SUBCARRIERS IN MULTI-CARRIER, MULTI-CELL WIRELESS COMMUNICATION NETWORKS	

This section allows for the applicant to claim priority to a foreign application. Providing this information in the application data sheet constitutes the claim for priority as required by 35 U.S.C. 119(b) and 37 CFR 1.55. When priority is claimed to a foreign application that is eligible for retrieval under the priority document exchange program (PDX)ⁱ the information will be used by the Office to automatically attempt retrieval pursuant to 37 CFR 1.55(i)(1) and (2). Under the PDX program, applicant bears the ultimate responsibility for ensuring that a copy of the foreign application is received by the Office from the participating foreign intellectual property office, or a certified copy of the foreign priority application is filed, within the time period specified in 37 CFR 1.55(g)(1).

Application Number	Country ⁱ	Filing Date (YYYY-MM-DD)	Access Code ⁱ (if applicable)

Additional Foreign Priority Data may be generated within this form by selecting the **Add** button.

Statement under 37 CFR 1.55 or 1.78 for AIA (First Inventor to File) Transition Applications

This application (1) claims priority to or the benefit of an application filed before March 16, 2013 and (2) also contains, or contained at any time, a claim to a claimed invention that has an effective filing date on or after March 16, 2013.

NOTE: By providing this statement under 37 CFR 1.55 or 1.78, this application, with a filing date on or after March 16, 2013, will be examined under the first inventor to file provisions of the AIA.

Application Data Sheet 37 CFR 1.76	Attorney Docket Number	NEO-PT008.8
	Application Number	
Title of Invention	METHOD AND APPARATUS USING CELL-SPECIFIC AND COMMON PILOT SUBCARRIERS IN MULTI-CARRIER, MULTI-CELL WIRELESS COMMUNICATION NETWORKS	

Authorization or Opt-Out of Authorization to Permit Access:

When this Application Data Sheet is properly signed and filed with the application, applicant has provided written authority to permit a participating foreign intellectual property (IP) office access to the instant application-as-filed (see paragraph A in subsection 1 below) and the European Patent Office (EPO) access to any search results from the instant application (see paragraph B in subsection 1 below).

Should applicant choose not to provide an authorization identified in subsection 1 below, applicant **must opt-out** of the authorization by checking the corresponding box A or B or both in subsection 2 below.

NOTE: This section of the Application Data Sheet is **ONLY** reviewed and processed with the **INITIAL** filing of an application. After the initial filing of an application, an Application Data Sheet cannot be used to provide or rescind authorization for access by a foreign IP office(s). Instead, Form PTO/SB/39 or PTO/SB/69 must be used as appropriate.

1. Authorization to Permit Access by a Foreign Intellectual Property Office(s)

A. Priority Document Exchange (PDX) - Unless box A in subsection 2 (opt-out of authorization) is checked, the undersigned hereby **grants the USPTO authority** to provide the European Patent Office (EPO), the Japan Patent Office (JPO), the Korean Intellectual Property Office (KIPO), the State Intellectual Property Office of the People's Republic of China (SIPO), the World Intellectual Property Organization (WIPO), and any other foreign intellectual property office participating with the USPTO in a bilateral or multilateral priority document exchange agreement in which a foreign application claiming priority to the instant patent application is filed, access to: (1) the instant patent application-as-filed and its related bibliographic data, (2) any foreign or domestic application to which priority or benefit is claimed by the instant application and its related bibliographic data, and (3) the date of filing of this Authorization. See 37 CFR 1.14(h)(1).

B. Search Results from U.S. Application to EPO - Unless box B in subsection 2 (opt-out of authorization) is checked, the undersigned hereby **grants the USPTO authority** to provide the EPO access to the bibliographic data and search results from the instant patent application when a European patent application claiming priority to the instant patent application is filed. See 37 CFR 1.14(h)(2).

The applicant is reminded that the EPO's Rule 141(1) EPC (European Patent Convention) requires applicants to submit a copy of search results from the instant application without delay in a European patent application that claims priority to the instant application.

2. Opt-Out of Authorizations to Permit Access by a Foreign Intellectual Property Office(s)

A. Applicant **DOES NOT** authorize the USPTO to permit a participating foreign IP office access to the instant application-as-filed. If this box is checked, the USPTO will not be providing a participating foreign IP office with any documents and information identified in subsection 1A above.

B. Applicant **DOES NOT** authorize the USPTO to transmit to the EPO any search results from the instant patent application. If this box is checked, the USPTO will not be providing the EPO with search results from the instant application.

NOTE: Once the application has published or is otherwise publicly available, the USPTO may provide access to the application in accordance with 37 CFR 1.14.

Under the Paperwork Reduction Act of 1995, no persons are required to respond to a collection of information unless it contains a valid OMB control number.

Application Data Sheet 37 CFR 1.76	Attorney Docket Number	NEO-PT008.8
	Application Number	
Title of Invention	METHOD AND APPARATUS USING CELL-SPECIFIC AND COMMON PILOT SUBCARRIERS IN MULTI-CARRIER, MULTI-CELL WIRELESS COMMUNICATION NETWORKS	

Applicant Information:

Providing assignment information in this section does not substitute for compliance with any requirement of part 3 of Title 37 of CFR to have an assignment recorded by the Office.

Applicant	1	<input type="button" value="Remove"/>
<p>If the applicant is the inventor (or the remaining joint inventor or inventors under 37 CFR 1.45), this section should not be completed. The information to be provided in this section is the name and address of the legal representative who is the applicant under 37 CFR 1.43; or the name and address of the assignee, person to whom the inventor is under an obligation to assign the invention, or person who otherwise shows sufficient proprietary interest in the matter who is the applicant under 37 CFR 1.46. If the applicant is an applicant under 37 CFR 1.46 (assignee, person to whom the inventor is obligated to assign, or person who otherwise shows sufficient proprietary interest) together with one or more joint inventors, then the joint inventor or inventors who are also the applicant should be identified in this section.</p>		
<input type="button" value="Clear"/>		
<input checked="" type="radio"/> Assignee	Legal Representative under 35 U.S.C. 117	Joint Inventor
Person to whom the inventor is obligated to assign.		Person who shows sufficient proprietary interest
If applicant is the legal representative, indicate the authority to file the patent application, the inventor is:		
<div style="border: 1px solid black; height: 20px; width: 100%;"></div>		
Name of the Deceased or Legally Incapacitated Inventor: <input type="text"/>		
If the Applicant is an Organization check here. <input checked="" type="checkbox"/>		
Organization Name	Neo Wireless LLC	
Mailing Address Information For Applicant:		
Address 1	123 West Wayne Avenue, Floor 1	
Address 2		
City	Wayne	State/Province PA
Country	US	Postal Code 19087
Phone Number		Fax Number
Email Address		
Additional Applicant Data may be generated within this form by selecting the Add button. <input type="button" value="Add"/>		

Assignee Information including Non-Applicant Assignee Information:

Providing assignment information in this section does not substitute for compliance with any requirement of part 3 of Title 37 of CFR to have an assignment recorded by the Office.

Under the Paperwork Reduction Act of 1995, no persons are required to respond to a collection of information unless it contains a valid OMB control number.

Application Data Sheet 37 CFR 1.76	Attorney Docket Number	NEO-PT008.8
	Application Number	
Title of Invention	METHOD AND APPARATUS USING CELL-SPECIFIC AND COMMON PILOT SUBCARRIERS IN MULTI-CARRIER, MULTI-CELL WIRELESS COMMUNICATION NETWORKS	

Assignee	1		
Complete this section if assignee information, including non-applicant assignee information, is desired to be included on the patent application publication. An assignee-applicant identified in the "Applicant Information" section will appear on the patent application publication as an applicant. For an assignee-applicant, complete this section only if identification as an assignee is also desired on the patent application publication.			
<input type="button" value="Remove"/>			
If the Assignee or Non-Applicant Assignee is an Organization check here. <input checked="" type="checkbox"/>			
Organization Name	Neo Wireless LLC		
Mailing Address Information For Assignee including Non-Applicant Assignee:			
Address 1	123 West Wayne Avenue, Floor 1		
Address 2			
City	Wayne	State/Province	PA
Country ⁱ	US	Postal Code	19087
Phone Number		Fax Number	
Email Address			
Additional Assignee or Non-Applicant Assignee Data may be generated within this form by selecting the Add button. <input type="button" value="Add"/>			

Signature:

NOTE: This Application Data Sheet must be signed in accordance with 37 CFR 1.33(b). However, if this Application Data Sheet is submitted with the **INITIAL** filing of the application and either box A or B is **not** checked in subsection 2 of the "Authorization or Opt-Out of Authorization to Permit Access" section, then this form must also be signed in accordance with 37 CFR 1.14(c).

This Application Data Sheet **must** be signed by a patent practitioner if one or more of the applicants is a **juristic entity** (e.g., corporation or association). If the applicant is two or more joint inventors, this form must be signed by a patent practitioner, **all** joint inventors who are the applicant, or one or more joint inventor-applicants who have been given power of attorney (e.g., see USPTO Form PTO/AIA/81) on behalf of **all** joint inventor-applicants.

See 37 CFR 1.4(d) for the manner of making signatures and certifications.

Signature	/Andrew D. Buschmeier/		Date (YYYY-MM-DD)	2020-09-04	
First Name	Andrew D.	Last Name	Buschmeier	Registration Number	73179
Additional Signature may be generated within this form by selecting the Add button. <input type="button" value="Add"/>					

Under the Paperwork Reduction Act of 1995, no persons are required to respond to a collection of information unless it contains a valid OMB control number.

Application Data Sheet 37 CFR 1.76	Attorney Docket Number	NEO-PT008.8
	Application Number	
Title of Invention	METHOD AND APPARATUS USING CELL-SPECIFIC AND COMMON PILOT SUBCARRIERS IN MULTI-CARRIER, MULTI-CELL WIRELESS COMMUNICATION NETWORKS	

This collection of information is required by 37 CFR 1.76. The information is required to obtain or retain a benefit by the public which is to file (and by the USPTO to process) an application. Confidentiality is governed by 35 U.S.C. 122 and 37 CFR 1.14. This collection is estimated to take 23 minutes to complete, including gathering, preparing, and submitting the completed application data sheet form to the USPTO. Time will vary depending upon the individual case. Any comments on the amount of time you require to complete this form and/or suggestions for reducing this burden, should be sent to the Chief Information Officer, U.S. Patent and Trademark Office, U.S. Department of Commerce, P.O. Box 1450, Alexandria, VA 22313-1450. DO NOT SEND FEES OR COMPLETED FORMS TO THIS ADDRESS. **SEND TO: Commissioner for Patents, P.O. Box 1450, Alexandria, VA 22313-1450.**

Privacy Act Statement

The Privacy Act of 1974 (P.L. 93-579) requires that you be given certain information in connection with your submission of the attached form related to a patent application or patent. Accordingly, pursuant to the requirements of the Act, please be advised that: (1) the general authority for the collection of this information is 35 U.S.C. 2(b)(2); (2) furnishing of the information solicited is voluntary; and (3) the principal purpose for which the information is used by the U.S. Patent and Trademark Office is to process and/or examine your submission related to a patent application or patent. If you do not furnish the requested information, the U.S. Patent and Trademark Office may not be able to process and/or examine your submission, which may result in termination of proceedings or abandonment of the application or expiration of the patent.

The information provided by you in this form will be subject to the following routine uses:

1. The information on this form will be treated confidentially to the extent allowed under the Freedom of Information Act (5 U.S.C. 552) and the Privacy Act (5 U.S.C. 552a). Records from this system of records may be disclosed to the Department of Justice to determine whether the Freedom of Information Act requires disclosure of these records.
2. A record from this system of records may be disclosed, as a routine use, in the course of presenting evidence to a court, magistrate, or administrative tribunal, including disclosures to opposing counsel in the course of settlement negotiations.
3. A record in this system of records may be disclosed, as a routine use, to a Member of Congress submitting a request involving an individual, to whom the record pertains, when the individual has requested assistance from the Member with respect to the subject matter of the record.
4. A record in this system of records may be disclosed, as a routine use, to a contractor of the Agency having need for the information in order to perform a contract. Recipients of information shall be required to comply with the requirements of the Privacy Act of 1974, as amended, pursuant to 5 U.S.C. 552a(m).
5. A record related to an International Application filed under the Patent Cooperation Treaty in this system of records may be disclosed, as a routine use, to the International Bureau of the World Intellectual Property Organization, pursuant to the Patent Cooperation Treaty.
6. A record in this system of records may be disclosed, as a routine use, to another federal agency for purposes of National Security review (35 U.S.C. 181) and for review pursuant to the Atomic Energy Act (42 U.S.C. 218(c)).
7. A record from this system of records may be disclosed, as a routine use, to the Administrator, General Services, or his/her designee, during an inspection of records conducted by GSA as part of that agency's responsibility to recommend improvements in records management practices and programs, under authority of 44 U.S.C. 2904 and 2906. Such disclosure shall be made in accordance with the GSA regulations governing inspection of records for this purpose, and any other relevant (i.e., GSA or Commerce) directive. Such disclosure shall not be used to make determinations about individuals.
8. A record from this system of records may be disclosed, as a routine use, to the public after either publication of the application pursuant to 35 U.S.C. 122(b) or issuance of a patent pursuant to 35 U.S.C. 151. Further, a record may be disclosed, subject to the limitations of 37 CFR 1.14, as a routine use, to the public if the record was filed in an application which became abandoned or in which the proceedings were terminated and which application is referenced by either a published application, an application open to public inspections or an issued patent.
9. A record from this system of records may be disclosed, as a routine use, to a Federal, State, or local law enforcement agency, if the USPTO becomes aware of a violation or potential violation of law or regulation.

ABSTRACT

A multi-carrier cellular wireless network (400) employs base stations (404) that transmit two different groups of pilot subcarriers: (1) cell-specific pilot subcarriers, which are used by a receiver to extract information unique to each individual cell (402), and (2) common pilots subcarriers, which are designed to possess a set of characteristics common to all the base stations (404) of the system. The design criteria and transmission formats of the cell-specific and common pilot subcarriers are specified to enable a receiver to perform different system functions. The methods and processes can be extended to other systems, such as those with multiple antennas in an individual sector and those where some subcarriers bear common network/system information.

CLAIMS

What is claimed is:

1. An orthogonal frequency division multiple access (OFDMA)-compatible base station that uses subcarriers in a frequency domain and time slots in a time domain, the OFDMA-compatible base station comprising:
 - a plurality of antennas; and
 - a transmitter operably coupled to the plurality of antennas;
 - the transmitter configured to:
 - insert cell-specific pilots onto a first plurality of subcarriers; and
 - insert data and second pilots onto a second plurality of subcarriers;
 - wherein at least some subcarriers of the first plurality of subcarriers or the second plurality of subcarriers are beam-formed; and
 - the plurality of antennas configured to transmit the first plurality of subcarriers and the second plurality of subcarriers in at least one of the time slots.
2. The OFDMA-compatible base station of claim 1 wherein all subcarriers of the first plurality of subcarriers are different than all subcarriers of the second plurality of subcarriers.
3. The OFDMA-compatible base station of claim 1 wherein the second plurality of subcarriers includes an n^{th} subcarrier and an $n+18$ subcarrier spaced apart from the n^{th} subcarrier by 17 subcarriers and the first plurality of subcarriers includes an m^{th} subcarrier and an $m+20$ subcarrier spaced apart from the m^{th} subcarrier by 19 subcarriers.
4. The OFDMA-compatible base station of claim 1 wherein each cell-specific pilot of the cell-specific pilots is unique to a respective cell.
5. The OFDMA-compatible base station of claim 1 wherein the first plurality of subcarriers are not aligned in frequency with subcarriers of at least another cell onto which respective cell-specific pilots are inserted.

6. The OFDMA-compatible base station of claim 1 wherein the second plurality of subcarriers are beam-formed.

7. The OFDMA-compatible base station of claim 1 wherein the cell-specific pilots are used to convey cell-specific information.

8. A method performed by an orthogonal frequency division multiple access (OFDMA)-compatible base station that uses subcarriers in a frequency domain and time slots in a time domain, the method comprising:

inserting, by the OFDMA-compatible base station, cell-specific pilots onto a first plurality of subcarriers;

inserting, by the OFDMA-compatible base station, data and second pilots onto a second plurality of subcarriers;

wherein at least some subcarriers of the first plurality of subcarriers or the second plurality of subcarriers are beam-formed; and

transmitting, by the OFDMA-compatible base station, the first plurality of subcarriers and the second plurality of subcarriers in at least one of the time slots using a plurality of antennas.

9. The method of claim 8 wherein all subcarriers of the first plurality of subcarriers are different than all subcarriers of the second plurality of subcarriers.

10. The method of claim 8 wherein the second plurality of subcarriers includes an n^{th} subcarrier and an $n+18$ subcarrier spaced apart from the n^{th} subcarrier by 17 subcarriers and the first plurality of subcarriers includes an m^{th} subcarrier and an $m+20$ subcarrier spaced apart from the m^{th} subcarrier by 19 subcarriers.

11. The method of claim 8 wherein each cell-specific pilot of the cell-specific pilots is unique to a respective cell.

12. The method of claim 8 wherein the first plurality of subcarriers are not aligned in frequency with subcarriers of at least another cell onto which respective cell-specific pilots are inserted.

13. The method of claim 8 wherein the second plurality of subcarriers are beam-formed.

14. The method of claim 8 wherein the cell-specific pilots are used to convey cell-specific information.

15. An orthogonal frequency division multiple access (OFDMA)-compatible mobile station that uses subcarriers in a frequency domain and time slots in a time domain, the OFDMA-compatible mobile station comprising:

at least one antenna; and

a receiver; and

the at least one antenna and the receiver are configured to:

receive cell-specific pilots on a first plurality of subcarriers; and

receive second pilots and data on a second plurality of subcarriers,

wherein the first plurality of subcarriers and the second plurality of subcarriers are received in at least one of the time slots;

wherein at least some subcarriers of the first plurality of subcarriers or the second plurality of subcarriers are beam-formed; and

the receiver is further configured to:

recover the data using channel estimates from at least the second pilots;

and

recover cell-specific information using the cell-specific pilots.

16. The OFDMA-compatible mobile station of claim 15 wherein all subcarriers of the first plurality of subcarriers are different than all subcarriers of the second plurality of subcarriers.

17. The OFDMA-compatible mobile station of claim 15 wherein the second plurality of subcarriers includes an n^{th} subcarrier and an $n+18$ subcarrier spaced apart from the n^{th} subcarrier by 17 subcarriers and the first plurality of subcarriers includes an m^{th} subcarrier and an $m+20$ subcarrier spaced apart from the m^{th} subcarrier by 19 subcarriers.

18. The OFDMA-compatible mobile station of claim 15 wherein each cell-specific pilot of the cell-specific pilots is unique to a respective cell.

19. The OFDMA-compatible mobile station of claim 15 wherein the first plurality of subcarriers are transmitted at a same time as the second plurality of subcarriers.

20. The OFDMA-compatible mobile station of claim 15 wherein the second plurality of subcarriers are beam-formed.

21. The OFDMA-compatible mobile station of claim 15 wherein the first plurality of subcarriers are not aligned in frequency with subcarriers of at least another cell onto which respective cell-specific pilots are inserted.

22. The OFDMA-compatible mobile station of claim 15 wherein the receiver is further configured to extract cell-specific information from the cell-specific pilots.

23. A method performed by an orthogonal frequency division multiple access (OFDMA)-compatible mobile station that uses subcarriers in a frequency domain and time slots in a time domain, the method comprising:
receiving cell-specific pilots on a first plurality of subcarriers;
receiving second pilots and data on a second plurality of subcarriers, wherein the first plurality of subcarriers and the second plurality of subcarriers are received in at least one of the time slots;

wherein at least some subcarriers of the first plurality of subcarriers or the second plurality of subcarriers are beam-formed;
recovering the data using channel estimates from at least the second pilots; and
recovering cell-specific information using the cell-specific pilots.

24. The method of claim 23 wherein all subcarriers of the first plurality of subcarriers are different than all subcarriers of the second plurality of subcarriers.

25. The method of claim 23 wherein the second plurality of subcarriers includes an n^{th} subcarrier and an $n+18$ subcarrier spaced apart from the n^{th} subcarrier by 17 subcarriers and the first plurality of subcarriers includes an m^{th} subcarrier and an $m+20$ subcarrier spaced apart from the m^{th} subcarrier by 19 subcarriers.

26. The method of claim 23 wherein each cell-specific pilot of the cell-specific pilots is unique to a respective cell.

27. The method of claim 23 wherein the first plurality of subcarriers are transmitted at a same time as the second plurality of subcarriers.

28. The method of claim 23 wherein the second plurality of subcarriers are beam-formed.

29. The method of claim 23 wherein the first plurality of subcarriers are not aligned in frequency with subcarriers of at least another cell onto which respective cell-specific pilots are inserted.

30. The method of claim 23 further comprising extracting cell-specific information from the cell-specific pilots.

METHOD AND APPARATUS USING CELL-SPECIFIC AND COMMON
PILOT SUBCARRIERS IN MULTI-CARRIER, MULTI-CELL WIRELESS
COMMUNICATION NETWORKS

CROSS-REFERENCE TO RELATED APPLICATION(S)

[0001] This application is a continuation of U.S. Patent Application No. 16/440,754, filed June 13, 2019, which is a continuation of U.S. Patent Application No. 15/688,441, filed August 28, 2017, which issued as U.S. Patent No. 10,326,631 on June 18, 2019, which is a continuation of U.S. Patent Application No. 14/746,676, filed June 22, 2015, which issued as U.S. Patent No. 9,749,168 on August 29, 2017, which is a continuation of U.S. Patent Application No. 14/595,132, filed January 12, 2015, which issued as U.S. Patent No. 9,065,614 on June 23, 2015, which is a continuation of U.S. Patent Application No. 13/874,278, filed April 30, 2013, which issued as U.S. Patent No. 8,934,473 on January 13, 2015, which is a continuation of U.S. Patent Application No. 13/212,116, filed August 17, 2011, which issued as U.S. Patent No. 8,432,891 on April 30, 2013, which is a continuation of U.S. Patent Application No. 10/583,530, filed May 30, 2007, which issued as U.S. Patent No. 8,009,660 on August 30, 2011, which is a U.S. National Stage of PCT Application No. PCT/US05/01939, filed January 20, 2005, which claims the benefit of and priority to U.S. Provisional Patent Application No. 60/540,032, filed on January 29, 2004, the entire contents of all of which are hereby incorporated by reference herein.

BACKGROUND

[0002] In multi-carrier wireless communications, many important system functions such as frequency synchronization and channel estimation, depicted in Figure 1, are facilitated by using the network information provided by a portion of total subcarriers such as pilot subcarriers. The fidelity level of the received subcarriers dictates how well these functions can be achieved, which in turn affect the efficiency and capacity of the entire network.

[0003] In a wireless network, there are a number of base stations, each of which provides coverage to designated areas, normally called a cell. If a cell is divided into

sectors, from a system engineering point of view each sector can be considered a cell. In this context, the terms "cell" and "sector" are interchangeable. The network information can be categorized into two types: the cell-specific information that is unique to a particular cell, and the common information that is common to the entire network or to a portion of the entire networks such as a group of cells.

[0004] In a multi-cell environment, for example, the base station transmitter of each cell transmits its own pilot subcarriers, in addition to data carriers, to be used by the receivers within the cell. In such an environment, carrying out the pilot-dependent functions becomes a challenging task in that, in addition to the degradation due to multipath propagation channels, signals originated from the base stations at different cells interfere with each other.

[0005] One approach to deal with the interference problem has been to have each cell transmit a particular pattern of pilot subcarriers based on a certain type of cell-dependent random process. This approach, to a certain degree, has mitigated the impact of the mutual interference between the pilot subcarriers from adjacent cells; however, it has not provided for a careful and systematic consideration of the unique requirements of the pilot subcarriers.

BRIEF DESCRIPTION OF THE DRAWINGS

[0006] Figure 1 depicts a basic multi-carrier wireless communication system consisting of a transmitter and a receiver.

[0007] Figure 2 shows basic structure of a multi-carrier signal in the frequency domain, which is made up of subcarriers.

[0008] Figure 3 shows a radio resource divided into small units in both the frequency and time domains: subchannels and time slots.

[0009] Figure 4 depicts a cellular wireless network comprised of multiple cells, in each of which coverage is provided by a base station (BS).

[0010] Figure 5 shows pilot subcarriers divided into two groups: cell-specific pilot subcarriers and common pilot subcarriers.

[0011] Figure 6 is an embodiment of pilot-generation-and-insertion functional block shown in Figure 1, which employs a microprocessor to generate pilot subcarriers and insert them into a frequency sequence contained in the electronic memory.

[0012] Figure 7 shows that common pilot subcarriers are generated by a microprocessor of Figure 6 to realize phase diversity.

[0013] Figure 8 is an embodiment of delay diversity, which effectively creates phase diversity by adding a random delay time duration, either in baseband or RF, to the time-domain signals.

[0014] Figure 9 shows two examples for extension to multiple antenna applications.

[0015] Figure 10 is an embodiment of synchronization in frequency and time domains of two collocated base stations sharing a common frequency oscillator.

[0016] Figure 11 is an embodiment of synchronization in frequency and time domains with base stations at different locations sharing a common frequency reference signal generated from the GPS signals.

[0017] Figure 12 is an embodiment depicting a wireless network consisting of three groups of cells (or sectors) and base stations in each group that share their own set of common pilot subcarriers.

[0018] Figure 13 shows all base stations within a network transmit, along with a common pilot subcarrier, a data subcarrier carrying data information common to all cells in the network.

DETAILED DESCRIPTION

[0019] In the following description the invention is explained with respect to some of its various embodiments, providing specific details for a thorough understanding and enablement. However, one skilled in the art will understand that the invention may be practiced without such details. In other instances, well-known structures and functions have not been shown or described in detail to avoid obscuring the depiction of the embodiments.

[0020] Unless the context clearly requires otherwise, throughout the description and the claims, the words "comprise," "comprising," and the like are to be construed in an inclusive sense as opposed to an exclusive or exhaustive sense; that is to say, in the sense of "including, but not limited to." Words using the singular or plural number also include the plural or singular number respectively. Additionally, the words "herein," "above," "below" and words of similar import, when used in this application, shall refer to this application as a whole and not to any particular portions of this application. When the claims use the word "or" in reference to a list of two or more items, that word covers all of the following interpretations of the word: any of the items in the list, all of the items in the list and any combination of the items in the list.

[0021] Figure 1 depicts a basic multi-carrier wireless communication system consisting of a transmitter 102 and a receiver 104. A functional block 106 at the transmitter, called Pilot generation and insertion, generates pilot subcarriers and inserts them into predetermined frequency locations. These pilot subcarriers are used by the receiver to carry out certain functions. In aspects of this invention, pilot subcarriers are divided into two different groups according to their functionalities, and hence their distinct requirements. The transmission format of each group of pilot subcarriers will be designed so that it optimizes the performance of the system functions such as frequency synchronization and channel estimation.

[0022] The first group is called "cell-specific pilot subcarriers," and will be used by the receiver 104 to extract information unique to each individual cell. For example, these cell-specific pilot subcarriers can be used in channel estimation where it is necessary for a particular receiver to be able to differentiate the pilot subcarriers that are intended for its use from those of other cells. For these pilot subcarriers, counter-interference methods are necessary.

[0023] The second group is termed "common pilot sub-carriers," and are designed to possess a set of characteristics common to all base stations of the system. Thus, every receiver 104 within the system is able to exploit these common pilot subcarriers to perform necessary functions without interference problem. For instance, these common pilot subcarriers can be used in the frequency synchronization process, where it is not

necessary to discriminate pilot subcarriers of different cells, but it is desirable for the receiver to combine coherently the energy of common pilot subcarriers with the same carrier index from different cells, so as to achieve relatively accurate frequency estimation.

[0024] Aspects of this invention provide methods to define the transmission formats of the cell-specific and common pilot subcarriers that enable a receiver to perform different system functions. In particular, a set of design criteria are provided for pilot subcarriers. Other features of this invention further provide apparatus or means to implement the above design processes and methods. In particular, signal reception can be improved by manipulating phase values of the pilot subcarriers and by using power control.

[0025] The methods and processes can also be extended to other cases, such as where multiple antennas are used within an individual sector and where some subcarriers are used to carry common network/system information. Base stations can be synchronized in frequency and time by sharing a common frequency oscillator or a common frequency reference signal, such as the one generated from the signals provided by the Global Positioning System (GPS).

Multi-Carrier Communication System

[0026] In a multi-carrier communication system such as multi-carrier code division multiple access (MC-CDMA) and orthogonal frequency division multiple access (OFDMA), information data are multiplexed on subcarriers that are mutually orthogonal in the frequency domain. In effect, a frequency selective channel is broken into a number of parallel but small segments in frequency that can be treated as flat fading channels and hence can be easily dealt with using simple one-tap equalizers. The modulation/demodulation can be performed using the fast Fourier transform (FFT).

[0027] In a multi-carrier communication system the physical media resource (e.g., radio or cable) can be divided in both the frequency and the time domains. This canonical division provides a high flexibility and fine granularity for resource sharing. The basic structure of a multi-carrier signal in the frequency domain is made up of subcarriers, and

within a particular spectral band or channel there are a fixed number of subcarriers. There are three types of subcarriers:

[0028] 1. Data subcarriers, which carry information data;

[0029] 2. Pilot subcarriers, whose phases and amplitudes are predetermined and made known to all receivers and which are used for assisting system functions such as estimation of system parameters; and

[0030] 3. Silent subcarriers, which have no energy and are used for guard bands and DC carriers.

[0031] The data subcarriers can be arranged into groups called subchannels to support multiple access and scalability. The subcarriers forming one subchannel are not necessarily adjacent to each other. This concept is illustrated in Figure 2, showing a basic structure of a multi-carrier signal 200 in the frequency domain, which is made up of subcarriers. Data subcarriers can be grouped into subchannels in a particular way. The pilot subcarriers are also distributed over the entire channel in a particular way.

[0032] The basic structure of a multi-carrier signal in the time domain is made up of time slots to support multiple-access. The resource division in both the frequency and time domains is depicted in Figure 3 which shows a radio resource divided into small units in both the frequency and time domains: subchannels and time slots, 300. The basic structure of a multi-carrier signal in the time domain is made up of time slots.

[0033] As depicted in Figure 1, in a multi-carrier communication system, a generic transmitter may consist of the following functional blocks:

1. Encoding and modulation 108
2. Pilot generation and insertion 106
3. Inverse fast Fourier transform (IFFT) 110
4. Transmission 112

And a generic receiver may consist of the following functional blocks:

1. Reception 114

2. Frame synchronization 116
3. Frequency and timing compensation 118
4. Fast Fourier transform (FFT) 120
5. Frequency, timing, and channel estimation 122
6. Channel compensation 124
7. Decoding 126

Cellular Wireless Networks

[0034] In a cellular wireless network, the geographical region to be serviced by the network is normally divided into smaller areas called cells. In each cell the coverage is provided by a base station. Thus, this type of structure is normally referred to as the cellular structure depicted in Figure 4, which illustrates a cellular wireless network 400 comprised of multiple cells 402, in each of which coverage is provided by a base station (BS) 404. Mobile stations are distributed within each coverage area.

[0035] A base station 404 is connected to the backbone of the network via a dedicated link and also provides radio links to mobile stations within its coverage. A base station 404 also serves as a focal point to distribute information to and collect information from its mobile stations by radio signals. The mobile stations within each coverage area are used as the interface between the users and the network.

[0036] In an M-cell wireless network arrangement, with one-way or two-way communication and time division or frequency division duplexing, the transmitters at all the cells are synchronized via a particular means and are transmitting simultaneously. In a specific cell 402 of this arrangement, the pth cell, a receiver receives a signal at a specific subcarrier, the ith subcarrier, at the time t_k , which can be described as:

$$s_i(t_k) = a_{i,p}(t_k)e^{j\varphi_{i,p}(t_k)} + \sum_{\substack{m=1 \\ m \neq p}}^M a_{i,m}(t_k)e^{j\varphi_{i,m}(t_k)} \quad (1)$$

where $a_{i,m}(t_k)$ and $\varphi_{i,m}(t_k)$ denote the signal amplitude and phase, respectively, associated with the i^{th} subcarrier from the base station of the m^{th} cell.

Cell-Specific Pilot Subcarriers

[0037] If the i th subcarrier is used as a pilot subcarrier at the p th cell for the cell-specific purposes, the cell-specific information carried by $a_{i,p}(t_k)$ and $\varphi_{i,p}(t_k)$ will be of interest to the receiver at the p th cell and other signals described by the second term on the right hand side of equation (1) will be interference, which is an incoherent sum of signals from other cells. In this case, a sufficient level of the carrier-to-interference ratio (CIR) is required to obtain the estimates of $a_{i,p}(t_k)$ and $\varphi_{i,p}(t_k)$ with desirable accuracy.

[0038] There are many ways to boost the CIR. For examples, the amplitude of a pilot subcarrier can be set larger than that of a data subcarrier; power control can be applied to the pilot subcarriers; and cells adjacent to the p th cell may avoid using the i th subcarrier as pilot subcarrier. All these can be achieved with coordination between the cells based on certain processes, described below.

Common Pilot Subcarriers

[0039] The common pilot subcarriers for different cells are normally aligned in the frequency index at the time of transmission, as depicted in Figure 5, which shows pilot subcarriers divided into two groups: cell-specific pilot sub-carriers and common pilot subcarriers. The cell-specific pilot subcarriers for different cells are not necessarily aligned in frequency. They can be used by the receiver to extract cell-specific information. The common pilot subcarriers for different cells may be aligned in frequency, and possess a set of attributes common to all base stations within the network. Thus, every receiver within the system is able to exploit these common pilot subcarriers without interference problem. The power of the pilot subcarriers can be varied through a particular power control scheme and based on a specific application.

[0040] If the i th subcarrier is used as a pilot subcarrier at the p th cell for the common purposes, it is not necessary to consider the second term on the right hand side of equation (1) to be interference. Instead, this term can be turned into a coherent component of the desirable signal by designing the common pilot carriers to meet the criteria specified in the aspects of this invention, provided that base stations at all cells

are synchronized in frequency and time. In such a case the cell in which the receiver is located becomes irrelevant and, consequently, the received signal can be rewritten as:

$$s_i(t_k) = \sum_{m=1}^M a_{i,m}(t_k) e^{j\varphi_{i,m}(t_k)} \quad (2)$$

The common pilot subcarriers can be used for a number of functionalities, such as frequency offset estimation and timing estimation.

[0041] To estimate the frequency, normally signals at different times are utilized. In an example with two common pilot subcarriers of the same frequency index, the received signal at time t_{k+1} , with respect to the received signal at time t_k , is given by

$$s_i(t_{k+1}) = e^{j2\pi f_i \Delta t} \sum_{m=1}^M a_{i,m}(t_{k+1}) e^{j\varphi_{i,m}(t_{k+1})} \quad (3)$$

where $\Delta t = t_{k+1} - t_k$. If Δt is much less than the coherence period of the channel and

$$\alpha_{i,m}(t_k) = c_i \alpha_{i,m}(t_{k+1}) \quad (4)$$

and

$$\phi_{i,m}(t_k) = \phi_{i,m}(t_{k+1}) + \beta_i \quad (5)$$

then the frequency can be determined by

$$2\pi f_i \Delta t = \arg \{s_i(k) s_i(k+1)\} - \beta_i \quad (6)$$

where $c_i > 0$ and $-\pi \leq \beta_i \leq \pi$ or are predetermined constants for all values of m . And from all the frequency estimates $\{f_i\}$, a frequency offset can be derived based on a certain criterion.

[0042] For timing estimation, normally multiple common pilot carriers are required. In an example of two common pilot subcarriers, the received signal at f_n , is given by

$$s_n(t_k) = e^{j2\pi \Delta f T_s(t_k)} \sum_{m=1}^M a_{n,m}(t_k) e^{j\varphi_{n,m}(t_k)} \quad (7)$$

where $\Delta f = f_n - f_i$ and T_s denotes the sampling period. If Δf is much less than the coherence bandwidth of the channel and

$$\alpha_{i,m}(t_k) = c(t_k) \alpha_{n,m}(t_k) \quad (8)$$

and

$$\phi_{i,m}(t_k) = \phi_{n,m}(t_k) + \gamma(t_k) \quad (9)$$

then T_s can be determined by

$$2\pi\Delta f T_s(t_k) = \arg \{s_i^*(t_k) s_n(t_k)\} - \gamma(t_k) \quad (10)$$

where $c(t_k) > 0$ and $-\pi \leq \gamma(t_k) \leq \pi$ are predetermined constants for all values of m .

[0043] Figure 6 is an embodiment of pilot-generation-and-insertion functional block 106 shown in Figure 1, which employs a microprocessor 602 to generate pilot subcarriers and insert them into a frequency sequence contained in electronic memory 604. In one embodiment of the invention illustrated in Figure 6, a microprocessor 602 embedded in the pilot-generation-and-insertion functional block 106 computes the attributes of the pilot subcarriers such as their frequency indices and complex values specified by their requirements, and insert them into the frequency sequence contained in the electronic memory 604, such as a RAM, ready for the application of IFFT.

Diversity for Common Pilot Subcarriers

[0044] Considering equation (2), which is the sum of a number of complex signals, it is possible for these signals to be destructively superimposed on each other and cause the amplitude of the receiver signal at this particular subcarrier to be so small that the signal itself becomes unreliable. Phase diversity can help this adverse effect. In the example of frequency estimation, a random phase $\mathcal{G}_{l,m}$ can be added to another pilot subcarrier, say the l th subcarrier, which results in

$$\phi_{l,m}(t_k) = \phi_{i,m}(t_k) + \mathcal{G}_{l,m} \quad (11)$$

and

$$\phi_{l,m}(t_{k+1}) = \phi_{i,m}(t_{k+1}) + \mathcal{G}_{l,m} \quad (12)$$

where $\mathcal{G}_{l,m}$ should be set differently for each cell, and provided that the following condition is met,

$$\phi_{l,m}(t_k) = \phi_{l,m}(t_{k+1}) + \beta_l, \text{ for all values of } m \quad (13)$$

[0045] With the phase diversity, it is expected that the probability of both $|s_i(t_k)|$ and $|s_i(t_k)|$ diminishing at the same time is relatively small. The embodiment of phase diversity is depicted in Figure 7, which shows common pilot subcarriers generated by a microprocessor of Figure 6 to realize phase diversity. It should be noted that time delay will achieve the equivalent diversity effect.

[0046] Another embodiment is illustrated in Figure 8, which effectively creates phase diversity by adding a random delay time duration 802, either in baseband or RF, to the time-domain signals.

Power Control for Pilot Subcarriers

[0047] In one embodiment of the invention, power control can be applied to the pilot subcarriers. The power of the pilot subcarriers can be adjusted individually or as a subgroup to

- [0048]** 1. meet the needs of their functionalities;
- [0049]** 2. adapt to the operation environments (e.g., propagation channels); and
- [0050]** 3. reduce interference between cells or groups of cells.

In another embodiment power control is implemented differently for cell-specific pilot subcarriers and common pilot subcarriers. For example, stronger power is applied to common pilot subcarriers than to the cell-specific subcarriers.

Application to Multiple Antennas

[0051] The methods and processes provided by this invention can also be implemented in applications where multiple antennas are used within an individual sector, provided that the criteria specified either by equations (4) and (5) for frequency estimation or by equations (8) and (9) for timing estimation are satisfied.

[0052] Figure 9 shows two examples for extension to multiple antenna applications. In case (a) where there is only one transmission branch that is connected to an array of antennas 902 through a transformer 904 (e.g., a beam-forming matrix), the implementation is exactly the same as in the case of single antenna. In case (b) of multiple transmission branches connected to different antennas 906 (e.g., in a transmission

diversity scheme or a multiple-input multiple-output scheme), the cell-specific pilot subcarriers for transmission branches are usually defined by a multiple-antenna scheme whereas the common pilot subcarriers for each transmission branch are generated to meet the requirements of (4) and (5) for frequency estimation or (8) and (9) for timing estimation.

Joint-Use of Cell-Specific and Common Pilot Subcarriers

[0053] In one embodiment the cell-specific and common pilot subcarriers can be used jointly in the same process based on certain information theoretic criteria, such as the optimization of the signal-to-noise ratio. For example, in the estimation of a system parameter (e.g. frequency), some or all cell-specific subcarriers, if they satisfy a certain criterion, such as to exceed a CIR threshold, may be selected to be used together with the common pilot subcarriers to improve estimation accuracy. Furthermore, the common pilot sub-carriers can be used along with the cell-specific subcarriers to determine the cell-specific information in some scenarios, one of which is the operation at the edge of the network.

Base Transmitters Synchronization

[0054] Base stations at all cells are required to be synchronized in frequency and time. In one embodiment of the invention the collocated base station transmitters are locked to a single frequency oscillator, as in the case where a cell is divided into sectors and the base stations of these sectors are physically placed at the same location.

[0055] Figure 10 is an embodiment of synchronization in frequency and time domains of two collocated base stations sharing a common frequency oscillator 1002. Mobile stations 1004 covered by these two base stations do not experience interference when receiving the common pilot subcarriers. The base station transmitters that are located at different areas are locked to a common reference frequency source, such as the GPS signal. Figure 11 depicts an embodiment of synchronization in frequency and time domains with base stations 1102 and 1104 at different locations sharing a common frequency reference signal generated from the GPS 1106 signals. Mobile stations 1108 covered by these two base stations 1102 and 1104 do not experience interference when receiving the common pilot subcarriers.

[0056] In some applications, the entire wireless network may consist of multiple groups of cells (or sectors) and each group may have its own set of common pilot subcarriers. In such scenarios, only those base stations within their group are required to synchronize to a common reference. While the common pilot subcarriers within each group are designed to meet the criteria defined by equations (4) and (5) or by (8) and (9) for the use by its base stations, a particular counter-interference process (e.g., randomization in frequency or power control) will be applied to different sets of common pilot subcarriers. This will cause the signals from the cells within the same group to add coherently while the signals from the cells in other groups are treated as randomized interference.

[0057] One embodiment of such implementation is illustrated in Figure 12, where a wireless network consists of three groups (A, B, and C) of cells (or sectors). The base stations within their own group share the same set of common pilot subcarriers. In this scenario, only those base stations within their group are required to synchronize to a common reference. While the common pilot subcarriers within each group are designed to meet the criteria defined in this invention, a particular counter-interference process (e.g., randomization in frequency) will be applied to different sets of common pilot subcarriers. For example, the base stations at Cells A1, A2, and A3 in Group A synchronize to their own common reference source and transmit the same set of common pilot subcarriers; and the base stations at Cells B1, B2, and B3 in Group B synchronize to their own reference source and transmit another set of common pilot subcarriers that are located at different places in the frequency domain.

Extension to Transmission of Data Information

[0058] All design processes, criteria, and methods described in the embodiments of this invention can be extended to applications where common network information is required to be distributed to all receivers within the network. In one example, all the base stations within the network transmit, along with some common pilot subcarriers, an identical set of data subcarriers in which the data information common to all the cells in the network is imbedded.

[0059] Figure 13 shows all base stations within a network transmit, along with a common pilot subcarrier, a data subcarrier carrying data information common to all cells in the network. A receiver within the network can determine the composite channel coefficient based on the common pilot subcarrier and apply it to the data subcarrier to compensate for the channel effect, thereby recovering the data information.

[0060] The above detailed descriptions of embodiments of the invention are not intended to be exhaustive or to limit the invention to the precise form disclosed above. While specific embodiments of, and examples for, the invention are described above for illustrative purposes, various equivalent modifications are possible within the scope of the invention, as those skilled in the relevant art will recognize. For example, while steps are presented in a given order, alternative embodiments may perform routines having steps in a different order. The teachings of the invention provided herein can be applied to other systems, not necessarily the system described herein. These and other changes can be made to the invention in light of the detailed description.

[0061] The elements and acts of the various embodiments described above can be combined to provide further embodiments.

[0062] These and other All of the above U.S. patents and applications and other references are incorporated herein by reference. Aspects of the invention can be modified, if necessary, to employ the systems, functions and concepts of the various references described above to provide yet further embodiments of the invention.

[0063] Changes can be made to the invention in light of the above detailed description. In general, the terms used in the following claims should not be construed to limit the invention to the specific embodiments disclosed in the specification, unless the above detailed description explicitly defines such terms. Accordingly, the actual scope of the invention encompasses the disclosed embodiments and all equivalent ways of practicing or implementing the invention under the claims.

[0064] While certain aspects of the invention are presented below in certain claim forms, the inventors contemplate the various aspects of the invention in any number of claim forms. For example, while only one aspect of the invention is recited as embodied in a computer-readable medium, other aspects may likewise be embodied in a computer-

NEO-PT008.8

readable medium. Accordingly, the inventors reserve the right to add additional claims after filing the application to pursue such additional claim forms for other aspects of the invention.

IN THE UNITED STATES PATENT AND TRADEMARK OFFICE

In the **PATENT APPLICATION** of:

Neo Wireless LLC

Application No.: Not Yet Known

Confirmation No.: Not Yet Known

Filed: September 4, 2020

For: METHOD AND
APPARATUS USING CELL-SPECIFIC AND
COMMON PILOT SUBCARRIERS IN MULTI-
CARRIER, MULTI-CELL WIRELESS
COMMUNICATION NETWORKS

Group: Not Yet Known

Examiner: Not Yet Known

Our File: NEO-PT008.8

Date: September 4, 2020

INFORMATION DISCLOSURE STATEMENT

Mail Stop Amendment (via EFS)
Commissioner for Patents
P.O. Box 1450
Alexandria, VA 22313-1450

Further to Applicant's Duty of Disclosure pursuant to 37 C.F.R. §1.56,
Applicant wishes to bring to the Examiner's attention the material cited on the
enclosed Information Disclosure Statement Form.

Pursuant to 37 C.F.R. §1.98(d) copies of documents cited in the parent
application are not enclosed, but copies will be provided upon request.

This application is a continuation of U.S. Patent Application No. 16/440,754,
filed June 13, 2019, which is a continuation of U.S. Patent Application No.
15/688,441, filed August 28, 2017, which issued as U.S. Patent No. 10,326,631 on
June 18, 2019, which is a continuation of U.S. Patent Application No. 14/746,676,
filed June 22, 2015, which issued as U.S. Patent No. 9,749,168 on August 29, 2017,

which is a continuation of U.S. Patent Application No. 14/595,132, filed January 12, 2015, which issued as U.S. Patent No. 9,065,614 on June 23, 2015, which is a continuation of U.S. Patent Application No. 13/874,278, filed April 30, 2013, which issued as U.S. Patent No. 8,934,473 on January 13, 2015, which is a continuation of U.S. Patent Application No. 13/212,116, filed August 17, 2011, which issued as U.S. Patent No. 8,432,891 on April 30, 2013, which is a continuation of U.S. Patent Application No. 10/583,530, filed May 30, 2007, which issued as U.S. Patent No. 8,009,660 on August 30, 2011, which is a U.S. National Stage of PCT Application No. PCT/US05/01939, filed January 20, 2005, which claims the benefit of and priority to U.S. Provisional Patent Application No. 60/540,032, filed on January 29, 2004.

Applicant: Neo Wireless LLC
Application No.: Not Yet Known

It is respectfully requested that the Examiner consider these documents and return an initialed copy of the Information Disclosure Statement Form indicating consideration of the cited materials.

Respectfully submitted,

Neo Wireless LLC

By /Andrew D. Buschmeier/
Andrew D. Buschmeier
Registration No. 73,179

Volpe and Koenig, P.C.
30 South 17th Street
Philadelphia, PA 19103
Telephone: (215) 568-6400
Facsimile: (215) 568-6499

AB/jrrs
Enclosure

**INFORMATION DISCLOSURE
STATEMENT BY APPLICANT**
(Not for submission under 37 CFR 1.99)

Application Number	Not Yet Known
Filing Date	2020-09-04
First Named Inventor	Li et al.
Art Unit	Not Yet Known
Examiner Name	Not Yet Known
Attorney Docket Number	NEO-PT008.8

U.S. PATENT DOCUMENTS

EXAMINER INITIAL	DOCUMENT NUMBER	DATE	NAME	CLASS	SUBCLASS	FILING DATE IF APPROPRIATE
	5,825,807	10/1998	Kumar			
	5,867,478	02/1999	Baum et al.			
*	5,909,436	06/1999	Engstrom et al.			
*	6,141,546	10/2000	Thomas			
*	6,434,364	08/2002	O'Riordain			
	6,480,558	11/2002	Ottosson et al.			
	6,515,960	02/2003	Usui et al.			
	6,567,383	05/2003	Bohnke			
	6,643,281	11/2003	Ryan			
	6,731,673	05/2004	Kotov et al.			
	6,741,578	05/2004	Moon et al.			
*	6,771,706	08/2004	Ling et al. ¹			
	6,847,678	01/2005	Berezdivin et al.			
	6,922,388	07/2005	Larocia et al.			
	6,940,827	09/2005	Li et al. ²			
	7,035,663	04/2006	Linebarger et al.			
	7,039,001	05/2006	Krishnan et al.			
	7,062,002	06/2006	Michel et al.			
	7,123,934	10/2006	Linebarger et al.			
*	7,149,239	12/2006	Hudson			
	7,161,985	01/2007	Dostert et al.			
	7,161,987	01/2007	Webster et al.			
	7,218,666	05/2007	Baum et al.			
	7,260,054	08/2007	Olszewski			
*	7,274,652	09/2007	Webster et al. ³			
*	7,317,931	01/2008	Guo			

1 Corresponds to KR 2003-0085040

2 Corresponds to WO 02/073831

3 Corresponds to CN 1432245

**INFORMATION DISCLOSURE
STATEMENT BY APPLICANT**
(Not for submission under 37 CFR 1.99)

Application Number	Not Yet Known
Filing Date	2020-09-04
First Named Inventor	Li et al.
Art Unit	Not Yet Known
Examiner Name	Not Yet Known
Attorney Docket Number	NEO-PT008.8

EXAMINER INITIAL	DOCUMENT NUMBER	DATE	NAME	CLASS	SUBCLASS	FILING DATE IF APPROPRIATE
	7,342,974	03/2008	Chiou			
	7,386,055	06/2008	Morita et al.			
	7,403,556	07/2008	Kao et al.			
	7,418,042	08/2008	Choi et al. ⁴			
	7,443,829	10/2008	Rizvi et al.			
	7,548,506	06/2009	Ma et al.			
	7,555,268	06/2009	Trachewsky et al.			
	7,567,624	07/2009	Schmidl et al.			
	7,646,747	01/2010	Atarashi et al. ⁵			
	7,693,032	04/2010	Li et al.			
	7,724,720	05/2010	Korpela et al.			
	7,738,437	06/2010	Ma			
	7,864,725	01/2011	Li et al.			
	7,907,592	03/2011	Han et al.			
	8,009,660	08/2011	Li et al.			
*	8,089,887	01/2012	Lippman et al.			
*	8,094,611	01/2012	Li et al.			
*	8,428,009	04/2013	Li et al.			
*	8,432,891	04/2013	Li et al.			
*	8,767,522	07/2014	Li et al.			
*	2001/0021182	09/2001	Wakutsu			
*	2001/0242937	09/2013	Li et al.			
*	2002/0141483	10/2002	Doetsch et al.			
	2002/0159422	10/2002	Li et al.			
*	2003/0072255	04/2003	Ma et al.			
	2003/0081538	05/2003	Walton et al.			
*	2003/0179776	09/2003	Sumasu et al. ⁶			
	2004/0085946	05/2004	Morita et al.			

4 Corresponds to US 2005/0243774

5 Corresponds to US 2002/0159430

6 Corresponds to CN 1465150

**INFORMATION DISCLOSURE
STATEMENT BY APPLICANT**
(Not for submission under 37 CFR 1.99)

Application Number	Not Yet Known
Filing Date	2020-09-04
First Named Inventor	Li et al.
Art Unit	Not Yet Known
Examiner Name	Not Yet Known
Attorney Docket Number	NEO-PT008.8

EXAMINER INITIAL		DOCUMENT NUMBER	DATE	NAME	CLASS	SUBCLASS	FILING DATE IF APPROPRIATE
		2004/0171357	09/2004	Lobinger			
	*	2004/0264600	12/2004	Kao et al.			
		2005/0111397	05/2005	Attar et al.			
	*	2006/0114815	06/2006	Hasegawa			
		2006/0245409	11/2006	Korpela			
	*	2008/0304551	12/2008	Li et al.			
		2011/0211617	09/2011	Li et al.			
	*	2011/0299474	12/2011	Li et al.			
	*	2012/0106513	05/2012	Li et al.			
	*	2013/0242937	09/2013	Li et al.			

FOREIGN PATENT DOCUMENTS

EXAMINER INITIAL		DOCUMENT NUMBER	DATE	COUNTRY	CLASS	SUBCLASS	TRANSLATION	
							YES	NO
	*	1407745	04/2003	CN				
	*	1445949	10/2003	CN				
	*	1452326	10/2003	CN				
		1 650 891	04/2006	EP				
		09-233047	09/1997	JP				
		10-210002	08/1998	JP				
		2001-0083789	09/2001	KR				
		2003-0060892	07/2003	KR				
		2009-0040929	04/2009	KR				
	*	2003/058881	07/2003	WO ⁷				

OTHER DOCUMENTS

**INFORMATION DISCLOSURE
STATEMENT BY APPLICANT**
(Not for submission under 37 CFR 1.99)

Application Number	Not Yet Known
Filing Date	2020-09-04
First Named Inventor	Li et al.
Art Unit	Not Yet Known
Examiner Name	Not Yet Known
Attorney Docket Number	NEO-PT008.8

EXAMINER INITIAL	DESCRIPTION (Including Author, Title, Date, Pertinent Pages, Etc.)
*	EUROPEAN TELECOMMUNICATIONS STANDARDS INSTITUTE, Digital Video Broadcasting (DVB); Framing structure, channel coding and modulation for digital terrestrial television, ETSI EN 300 744 V1.5.1 (June 2004).
	Examination Report, European Application No. 05711777.2, Mail Date October 29, 2012, 6 pages.
	Examination Report, European Application No. 05712825.8, Mail Date August 16, 2012, 6 pages.
*	IEEE Standard for Local and metropolitan area networks; Part 16: Air Interface for Fixed Broadband Wireless Access Systems — Amendment 2: Medium Access Control Modifications and Additional Physical Layer Specifications for 2–11 GHz, IEEE Std. 802.16a-2003 (April 1, 2003).
	International Search Report and Written Opinion for International Application No. PCT/US05/01939, Mail Date 4/26/2005, 7 pages.
	International Search Report and Written Opinion; International Patent Application No. PCT/US05/03518; Filed Jan. 27, 2005; Applicant: WalticalSolutions, Inc.; Mailed: May 23, 2005; 8 pages.
	Supplementary European Search Report, European Application No. 05711777, May 7, 2012, 6 pages.
	Supplementary European Search Report, European Application No. 05712825, March 26, 2012, 4 pages
	Tufvesson, F., et al. "OFDM Time and Frequency Synchronization by Spread Spectrum Pilot Technique," Communication Theory Mini-Conference, Vancouver, B.C., Canada, June 6-10, 1999, pages 115-119.

Electronic Patent Application Fee Transmittal

Application Number:	
Filing Date:	
Title of Invention:	METHOD AND APPARATUS USING CELL-SPECIFIC AND COMMON PILOT SUBCARRIERS IN MULTI-CARRIER, MULTI-CELL WIRELESS COMMUNICATION NETWORKS
First Named Inventor/Applicant Name:	Xiaodong Li
Filer:	Andrew D. Buschmeier/Justin Slater
Attorney Docket Number:	NEO-PT008.8

Filed as Large Entity

Filing Fees for Track I Prioritized Examination - Nonprovisional Application under 35 USC 111(a)

Description	Fee Code	Quantity	Amount	Sub-Total in USD(\$)
Basic Filing:				
UTILITY APPLICATION FILING	1011	1	300	300
UTILITY SEARCH FEE	1111	1	660	660
UTILITY EXAMINATION FEE	1311	1	760	760
REQUEST FOR PRIORITIZED EXAMINATION	1817	1	4000	4000
Pages:				
Claims:				
CLAIMS IN EXCESS OF 20	1202	10	100	1000
INDEPENDENT CLAIMS IN EXCESS OF 3	1201	1	460	460

Description	Fee Code	Quantity	Amount	Sub-Total in USD(\$)
Miscellaneous-Filing:				
PUBL. FEE- EARLY, VOLUNTARY, OR NORMAL	1504	1	0	0
PROCESSING FEE, EXCEPT PROV. APPLS.	1830	1	140	140
Petition:				
Patent-Appeals-and-Interference:				
Post-Allowance-and-Post-Issuance:				
Extension-of-Time:				
Miscellaneous:				
Total in USD (\$)				7320

Electronic Acknowledgement Receipt

EFS ID:	40476235
Application Number:	17012813
International Application Number:	
Confirmation Number:	8746
Title of Invention:	METHOD AND APPARATUS USING CELL-SPECIFIC AND COMMON PILOT SUBCARRIERS IN MULTI-CARRIER, MULTI-CELL WIRELESS COMMUNICATION NETWORKS
First Named Inventor/Applicant Name:	Xiaodong Li
Customer Number:	3624
Filer:	Andrew D. Buschmeier/Justin Slater
Filer Authorized By:	Andrew D. Buschmeier
Attorney Docket Number:	NEO-PT008.8
Receipt Date:	04-SEP-2020
Filing Date:	
Time Stamp:	15:27:31
Application Type:	Utility under 35 USC 111(a)

Payment information:

Submitted with Payment	yes
Payment Type	CARD
Payment was successfully received in RAM	\$7320
RAM confirmation Number	E202094F27566747
Deposit Account	220493
Authorized User	Justin Slater

The Director of the USPTO is hereby authorized to charge indicated fees and credit any overpayment as follows:

37 CFR 1.17 (Patent application and reexamination processing fees)

37 CFR 1.19 (Document supply fees)

File Listing:

Document Number	Document Description	File Name	File Size(Bytes)/ Message Digest	Multi Part /.zip	Pages (if appl.)
1	Power of Attorney	NEO-PT008_8- Executed_POA_ByApplicant_aia0082_EFS-20200904.pdf	376001 cb7411d1dde804b805e75e5d929da100c509ad29	no	2
Warnings:					
Information:					
2	Drawings-only black and white line drawings	NEO-PT008_8- Drawings_EFS-20200904.pdf	132779 1aac775672332926551d840de7229cd168544cf	no	13
Warnings:					
Information:					
3	Oath or Declaration filed	NEO-PT008_8- Executed_Declarations_EFS-20200904.pdf	438489 05a97e41b3c2e5270cc817ae947c9b3227fb1465	no	4
Warnings:					
Information:					
4	TrackOne Request	NEO-PT008_8- TrackOneRequest_aia0424_EFS-20200904.pdf	125642 d6a09d61fa921e7fd306367f3d5ae929dd14bbc5	no	2
Warnings:					
Information:					
5	Application Data Sheet	NEO-PT008_8- ADS_aia0014_EFS-20200904.pdf	1332463 f964c2ca27e357acd6696c1ce807c3ee10fef5e2	no	10
Warnings:					
Information:					
6		NEO-PT008_8- Application_EFS-20200904.pdf	314776 17ec41cc20dc2a2fe4d3fae3f9439ccad66ff7d7	yes	21
	Multipart Description/PDF files in .zip description				
	Document Description	Start	End		

	Abstract	21	21
	Claims	16	20
	Specification	1	15

Warnings:

Information:

7	Transmittal Letter	NEO-PT008_8-IDS_TransmittalLtr_EFS-20200904.pdf	86640	no	3
			zff56332c2f30ad25d3c29a2f615fe3cb7a9aa72		

Warnings:

Information:

8	Information Disclosure Statement (IDS) Form (SB08)	NEO-PT008_8-IDS_EFS-20200904.pdf	134647	no	4
			0e04bb7067efda144d9b12967b7aaa653bd5073		

Warnings:

Information:

This is not an USPTO supplied IDS fillable form

9	Fee Worksheet (SB06)	fee-info.pdf	43330	no	2
			c8c0e8eccbbb501b97e0a4f5ff344ab2cc41cc84		

Warnings:

Information:

Total Files Size (in bytes): 2984767

This Acknowledgement Receipt evidences receipt on the noted date by the USPTO of the indicated documents, characterized by the applicant, and including page counts, where applicable. It serves as evidence of receipt similar to a Post Card, as described in MPEP 503.

New Applications Under 35 U.S.C. 111

If a new application is being filed and the application includes the necessary components for a filing date (see 37 CFR 1.53(b)-(d) and MPEP 506), a Filing Receipt (37 CFR 1.54) will be issued in due course and the date shown on this Acknowledgement Receipt will establish the filing date of the application.

National Stage of an International Application under 35 U.S.C. 371

If a timely submission to enter the national stage of an international application is compliant with the conditions of 35 U.S.C. 371 and other applicable requirements a Form PCT/DO/EO/903 indicating acceptance of the application as a national stage submission under 35 U.S.C. 371 will be issued in addition to the Filing Receipt, in due course.

New International Application Filed with the USPTO as a Receiving Office

If a new international application is being filed and the international application includes the necessary components for an international filing date (see PCT Article 11 and MPEP 1810), a Notification of the International Application Number and of the International Filing Date (Form PCT/RO/105) will be issued in due course, subject to prescriptions concerning national security, and the date shown on this Acknowledgement Receipt will establish the international filing date of the application.

PATENT APPLICATION FEE DETERMINATION RECORD
Substitute for Form PTO-875

Application or Docket Number
17/012,813

APPLICATION AS FILED - PART I

(Column 1)		(Column 2)	SMALL ENTITY		OR	OTHER THAN SMALL ENTITY	
FOR	NUMBER FILED	NUMBER EXTRA	RATE(\$)	FEE(\$)		RATE(\$)	FEE(\$)
BASIC FEE (37 CFR 1.16(a), (b), or (c))	N/A	N/A	N/A			N/A	300
SEARCH FEE (37 CFR 1.16(k), (l), or (m))	N/A	N/A	N/A			N/A	660
EXAMINATION FEE (37 CFR 1.16(o), (p), or (q))	N/A	N/A	N/A			N/A	760
TOTAL CLAIMS (37 CFR 1.16(j))	30 minus 20 = *	10			OR	x 100 =	1000
INDEPENDENT CLAIMS (37 CFR 1.16(h))	4 minus 3 = *	1				x 460 =	460
APPLICATION SIZE FEE (37 CFR 1.16(s))	If the specification and drawings exceed 100 sheets of paper, the application size fee due is \$310 (\$155 for small entity) for each additional 50 sheets or fraction thereof. See 35 U.S.C. 41(a)(1)(G) and 37 CFR 1.16(s).						0.00
MULTIPLE DEPENDENT CLAIM PRESENT (37 CFR 1.16(j))							0.00
* If the difference in column 1 is less than zero, enter "0" in column 2.			TOTAL			TOTAL	3180

APPLICATION AS AMENDED - PART II

(Column 1)		(Column 2)	(Column 3)	SMALL ENTITY		OR	OTHER THAN SMALL ENTITY	
AMENDMENT A		CLAIMS REMAINING AFTER AMENDMENT	HIGHEST NUMBER PREVIOUSLY PAID FOR	PRESENT EXTRA	RATE(\$)	ADDITIONAL FEE(\$)	RATE(\$)	ADDITIONAL FEE(\$)
	Total (37 CFR 1.16(j))	*	Minus	**	=	x =	OR	x =
	Independent (37 CFR 1.16(h))	*	Minus	***	=	x =	OR	x =
	Application Size Fee (37 CFR 1.16(s))						OR	
	FIRST PRESENTATION OF MULTIPLE DEPENDENT CLAIM (37 CFR 1.16(j))						OR	
					TOTAL ADD'L FEE		TOTAL ADD'L FEE	
(Column 1)		(Column 2)	(Column 3)	SMALL ENTITY		OR	OTHER THAN SMALL ENTITY	
AMENDMENT B		CLAIMS REMAINING AFTER AMENDMENT	HIGHEST NUMBER PREVIOUSLY PAID FOR	PRESENT EXTRA	RATE(\$)	ADDITIONAL FEE(\$)	RATE(\$)	ADDITIONAL FEE(\$)
	Total (37 CFR 1.16(j))	*	Minus	**	=	x =	OR	x =
	Independent (37 CFR 1.16(h))	*	Minus	***	=	x =	OR	x =
	Application Size Fee (37 CFR 1.16(s))						OR	
	FIRST PRESENTATION OF MULTIPLE DEPENDENT CLAIM (37 CFR 1.16(j))						OR	
					TOTAL ADD'L FEE		TOTAL ADD'L FEE	

* If the entry in column 1 is less than the entry in column 2, write "0" in column 3.
 ** If the "Highest Number Previously Paid For" IN THIS SPACE is less than 20, enter "20".
 *** If the "Highest Number Previously Paid For" IN THIS SPACE is less than 3, enter "3".
 The "Highest Number Previously Paid For" (Total or Independent) is the highest found in the appropriate box in column 1.



UNITED STATES PATENT AND TRADEMARK OFFICE

UNITED STATES DEPARTMENT OF COMMERCE
United States Patent and Trademark Office
Address: COMMISSIONER FOR PATENTS
P.O. Box 1450
Alexandria, Virginia 22313-1450
www.uspto.gov

Table with 7 columns: APPLICATION NUMBER, FILING or 371(c) DATE, GRP ART UNIT, FIL FEE REC'D, ATTY. DOCKET NO, TOT CLAIMS, IND CLAIMS. Row 1: 17/012,813, 09/04/2020, 2631, 3180, NEO-PT008.8, 30, 4

CONFIRMATION NO. 8746

FILING RECEIPT

3624
Volpe Koenig
30 SOUTH 17TH STREET, 18TH FLOOR
PHILADELPHIA, PA 19103



Date Mailed: 09/16/2020

Receipt is acknowledged of this non-provisional utility patent application. The application will be taken up for examination in due course. Applicant will be notified as to the results of the examination. Any correspondence concerning the application must include the following identification information: the U.S. APPLICATION NUMBER, FILING DATE, NAME OF FIRST INVENTOR, and TITLE OF INVENTION. Fees transmitted by check or draft are subject to collection.

Please verify the accuracy of the data presented on this receipt. If an error is noted on this Filing Receipt, please submit a written request for a corrected Filing Receipt, including a properly marked-up ADS showing the changes with strike-through for deletions and underlining for additions. If you received a "Notice to File Missing Parts" or other Notice requiring a response for this application, please submit any request for correction to this Filing Receipt with your reply to the Notice. When the USPTO processes the reply to the Notice, the USPTO will generate another Filing Receipt incorporating the requested corrections provided that the request is grantable.

Inventor(s)

Xiaodong Li, Kirkland, WA;
Titus Lo, Bellevue, WA;
Kemin Li, Bellevue, WA;
Haiming Huang, Bellevue, WA;

Applicant(s)

Neo Wireless LLC, Wayne, PA;

Assignment For Published Patent Application

Neo Wireless LLC, Wayne, PA

Power of Attorney: The patent practitioners associated with Customer Number 03624

Domestic Priority data as claimed by applicant

This application is a CON of 16/440,754 06/13/2019
which is a CON of 15/688,441 08/28/2017 PAT 10326631
which is a CON of 14/746,676 06/22/2015 PAT 9749168
which is a CON of 14/595,132 01/12/2015 PAT 9065614
which is a CON of 13/874,278 04/30/2013 PAT 8934473
which is a CON of 13/212,116 08/17/2011 PAT 8432891
which is a CON of 10/583,530 05/30/2007 PAT 8009660
which is a 371 of PCT/US05/01939 01/20/2005
which claims benefit of 60/540,032 01/29/2004

Foreign Applications for which priority is claimed (You may be eligible to benefit from the **Patent Prosecution Highway** program at the USPTO. Please see <http://www.uspto.gov> for more information.) - None.

Foreign application information must be provided in an Application Data Sheet in order to constitute a claim to foreign priority. See 37 CFR 1.55 and 1.76.

Permission to Access Application via Priority Document Exchange: Yes

Permission to Access Search Results: Yes

Applicant may provide or rescind an authorization for access using Form PTO/SB/39 or Form PTO/SB/69 as appropriate.

If Required, Foreign Filing License Granted: 09/15/2020

The country code and number of your priority application, to be used for filing abroad under the Paris Convention, is **US 17/012,813**

Projected Publication Date: 12/24/2020

Non-Publication Request: No

Early Publication Request: No

Title

METHOD AND APPARATUS USING CELL-SPECIFIC AND COMMON PILOT SUBCARRIERS IN MULTI-CARRIER, MULTI-CELL WIRELESS COMMUNICATION NETWORKS

Preliminary Class

375

Statement under 37 CFR 1.55 or 1.78 for AIA (First Inventor to File) Transition Applications: No

PROTECTING YOUR INVENTION OUTSIDE THE UNITED STATES

Since the rights granted by a U.S. patent extend only throughout the territory of the United States and have no effect in a foreign country, an inventor who wishes patent protection in another country must apply for a patent in a specific country or in regional patent offices. Applicants may wish to consider the filing of an international application under the Patent Cooperation Treaty (PCT). An international (PCT) application generally has the same effect as a regular national patent application in each PCT-member country. The PCT process **simplifies** the filing of patent applications on the same invention in member countries, but **does not result** in a grant of "an international patent" and does not eliminate the need of applicants to file additional documents and fees in countries where patent protection is desired.

Almost every country has its own patent law, and a person desiring a patent in a particular country must make an application for patent in that country in accordance with its particular laws. Since the laws of many countries differ in various respects from the patent law of the United States, applicants are advised to seek guidance from specific foreign countries to ensure that patent rights are not lost prematurely.

Applicants also are advised that in the case of inventions made in the United States, the Director of the USPTO must issue a license before applicants can apply for a patent in a foreign country. The filing of a U.S. patent application serves as a request for a foreign filing license. The application's filing receipt contains further information and guidance as to the status of applicant's license for foreign filing.

Applicants may wish to consult the USPTO booklet, "General Information Concerning Patents" (specifically, the section entitled "Treaties and Foreign Patents") for more information on timeframes and deadlines for filing foreign patent applications. The guide is available either by contacting the USPTO Contact Center at 800-786-9199, or it can be viewed on the USPTO website at <http://www.uspto.gov/web/offices/pac/doc/general/index.html>.

For information on preventing theft of your intellectual property (patents, trademarks and copyrights), you may wish to consult the U.S. Government website, <http://www.stopfakes.gov>. Part of a Department of Commerce initiative, this website includes self-help "toolkits" giving innovators guidance on how to protect intellectual property in specific countries such as China, Korea and Mexico. For questions regarding patent enforcement issues, applicants may call the U.S. Government hotline at 1-866-999-HALT (1-866-999-4258).

LICENSE FOR FOREIGN FILING UNDER
Title 35, United States Code, Section 184
Title 37, Code of Federal Regulations, 5.11 & 5.15

GRANTED

The applicant has been granted a license under 35 U.S.C. 184, if the phrase "IF REQUIRED, FOREIGN FILING LICENSE GRANTED" followed by a date appears on this form. Such licenses are issued in all applications where the conditions for issuance of a license have been met, regardless of whether or not a license may be required as set forth in 37 CFR 5.15. The scope and limitations of this license are set forth in 37 CFR 5.15(a) unless an earlier license has been issued under 37 CFR 5.15(b). The license is subject to revocation upon written notification. The date indicated is the effective date of the license, unless an earlier license of similar scope has been granted under 37 CFR 5.13 or 5.14.

This license is to be retained by the licensee and may be used at any time on or after the effective date thereof unless it is revoked. This license is automatically transferred to any related applications(s) filed under 37 CFR 1.53(d). This license is not retroactive.

The grant of a license does not in any way lessen the responsibility of a licensee for the security of the subject matter as imposed by any Government contract or the provisions of existing laws relating to espionage and the national security or the export of technical data. Licensees should apprise themselves of current regulations especially with respect to certain countries, of other agencies, particularly the Office of Defense Trade Controls, Department of State (with respect to Arms, Munitions and Implements of War (22 CFR 121-128)); the Bureau of Industry and Security, Department of Commerce (15 CFR parts 730-774); the Office of Foreign Assets Control, Department of Treasury (31 CFR Parts 500+) and the Department of Energy.

NOT GRANTED

No license under 35 U.S.C. 184 has been granted at this time, if the phrase "IF REQUIRED, FOREIGN FILING LICENSE GRANTED" DOES NOT appear on this form. Applicant may still petition for a license under 37 CFR 5.12, if a license is desired before the expiration of 6 months from the filing date of the application. If 6 months has lapsed from the filing date of this application and the licensee has not received any indication of a secrecy order under 35 U.S.C. 181, the licensee may foreign file the application pursuant to 37 CFR 5.15(b).

SelectUSA

The United States represents the largest, most dynamic marketplace in the world and is an unparalleled location for business investment, innovation, and commercialization of new technologies. The U.S. offers tremendous resources and advantages for those who invest and manufacture goods here. Through SelectUSA, our nation works to promote and facilitate business investment. SelectUSA provides information assistance to the international investor community; serves as an ombudsman for existing and potential investors; advocates on behalf of U.S. cities, states, and regions competing for global investment; and counsels U.S. economic development organizations on investment attraction best practices. To learn more about why the United States is the best country in the world to develop technology, manufacture products, deliver services, and grow your business, visit <http://www.SelectUSA.gov> or call +1-202-482-6800.

INFORMATION DISCLOSURE STATEMENT BY APPLICANT (Not for submission under 37 CFR 1.99)	Application Number	17012813
	Filing Date	2020-09-04
	First Named Inventor	Li et al.
	Art Unit	2645
	Examiner Name	Omoniyi Obayanju
	Attorney Docket Number	NEO-PT008.8

U.S.PATENTS						Remove
Examiner Initial*	Cite No	Patent Number	Kind Code ¹	Issue Date	Name of Patentee or Applicant of cited Document	Pages,Columns,Lines where Relevant Passages or Relevant Figures Appear
	1	5828650	A	1998-10-27	Malkamaki et al.	
	2	6175550	B1	2001-01-16	van Nee	
	3	7411897	B2	2008-08-12	Yoo et al.	
	4	7471667	B2	2008-12-30	Hirsch et al.	
	5	7873009	B2	2011-01-18	Larsson et al.	
	6	8102832	B2	2012-01-24	Agrawal et al.	
	7	8363691	B2	2013-01-29	Hasegawa et al.	
If you wish to add additional U.S. Patent citation information please click the Add button.						Add
U.S.PATENT APPLICATION PUBLICATIONS						Remove

**INFORMATION DISCLOSURE
STATEMENT BY APPLICANT**
(Not for submission under 37 CFR 1.99)

Application Number	17012813
Filing Date	2020-09-04
First Named Inventor	Li et al.
Art Unit	2645
Examiner Name	Omoniyi Obayanju
Attorney Docket Number	NEO-PT008.8

Examiner Initial*	Cite No	Publication Number	Kind Code ¹	Publication Date	Name of Patentee or Applicant of cited Document	Pages, Columns, Lines where Relevant Passages or Relevant Figures Appear
	1					

If you wish to add additional U.S. Published Application citation information please click the Add button.

FOREIGN PATENT DOCUMENTS

Examiner Initial*	Cite No	Foreign Document Number ³	Country Code ² i	Kind Code ⁴	Publication Date	Name of Patentee or Applicant of cited Document	Pages, Columns, Lines where Relevant Passages or Relevant Figures Appear	T ⁵
	1							

If you wish to add additional Foreign Patent Document citation information please click the Add button

NON-PATENT LITERATURE DOCUMENTS

Examiner Initials*	Cite No	Include name of the author (in CAPITAL LETTERS), title of the article (when appropriate), title of the item (book, magazine, journal, serial, symposium, catalog, etc), date, pages(s), volume-issue number(s), publisher, city and/or country where published.	T ⁵
	1		

If you wish to add additional non-patent literature document citation information please click the Add button

EXAMINER SIGNATURE

Examiner Signature		Date Considered	
--------------------	--	-----------------	--

*EXAMINER: Initial if reference considered, whether or not citation is in conformance with MPEP 609. Draw line through a citation if not in conformance and not considered. Include copy of this form with next communication to applicant.

¹ See Kind Codes of USPTO Patent Documents at www.USPTO.GOV or MPEP 901.04. ² Enter office that issued the document, by the two-letter code (WIPO Standard ST.3). ³ For Japanese patent documents, the indication of the year of the reign of the Emperor must precede the serial number of the patent document. ⁴ Kind of document by the appropriate symbols as indicated on the document under WIPO Standard ST.16 if possible. ⁵ Applicant is to place a check mark here if English language translation is attached.

INFORMATION DISCLOSURE STATEMENT BY APPLICANT (Not for submission under 37 CFR 1.99)	Application Number	17012813
	Filing Date	2020-09-04
	First Named Inventor	Li et al.
	Art Unit	2645
	Examiner Name	Omoniyi Obayanju
	Attorney Docket Number	NEO-PT008.8

CERTIFICATION STATEMENT

Please see 37 CFR 1.97 and 1.98 to make the appropriate selection(s):

That each item of information contained in the information disclosure statement was first cited in any communication from a foreign patent office in a counterpart foreign application not more than three months prior to the filing of the information disclosure statement. See 37 CFR 1.97(e)(1).

OR

That no item of information contained in the information disclosure statement was cited in a communication from a foreign patent office in a counterpart foreign application, and, to the knowledge of the person signing the certification after making reasonable inquiry, no item of information contained in the information disclosure statement was known to any individual designated in 37 CFR 1.56(c) more than three months prior to the filing of the information disclosure statement. See 37 CFR 1.97(e)(2).

See attached certification statement.

The fee set forth in 37 CFR 1.17 (p) has been submitted herewith.

A certification statement is not submitted herewith.

SIGNATURE

A signature of the applicant or representative is required in accordance with CFR 1.33, 10.18. Please see CFR 1.4(d) for the form of the signature.

Signature	/Andrew D. Buschmeier/	Date (YYYY-MM-DD)	2020-10-01
Name/Print	Andrew D. Buschmeier	Registration Number	73,179

This collection of information is required by 37 CFR 1.97 and 1.98. The information is required to obtain or retain a benefit by the public which is to file (and by the USPTO to process) an application. Confidentiality is governed by 35 U.S.C. 122 and 37 CFR 1.14. This collection is estimated to take 1 hour to complete, including gathering, preparing and submitting the completed application form to the USPTO. Time will vary depending upon the individual case. Any comments on the amount of time you require to complete this form and/or suggestions for reducing this burden, should be sent to the Chief Information Officer, U.S. Patent and Trademark Office, U.S. Department of Commerce, P.O. Box 1450, Alexandria, VA 22313-1450. **DO NOT SEND FEES OR COMPLETED FORMS TO THIS ADDRESS. SEND TO: Commissioner for Patents, P.O. Box 1450, Alexandria, VA 22313-1450.**

Privacy Act Statement

The Privacy Act of 1974 (P.L. 93-579) requires that you be given certain information in connection with your submission of the attached form related to a patent application or patent. Accordingly, pursuant to the requirements of the Act, please be advised that: (1) the general authority for the collection of this information is 35 U.S.C. 2(b)(2); (2) furnishing of the information solicited is voluntary; and (3) the principal purpose for which the information is used by the U.S. Patent and Trademark Office is to process and/or examine your submission related to a patent application or patent. If you do not furnish the requested information, the U.S. Patent and Trademark Office may not be able to process and/or examine your submission, which may result in termination of proceedings or abandonment of the application or expiration of the patent.

The information provided by you in this form will be subject to the following routine uses:

1. The information on this form will be treated confidentially to the extent allowed under the Freedom of Information Act (5 U.S.C. 552) and the Privacy Act (5 U.S.C. 552a). Records from this system of records may be disclosed to the Department of Justice to determine whether the Freedom of Information Act requires disclosure of these records.
2. A record from this system of records may be disclosed, as a routine use, in the course of presenting evidence to a court, magistrate, or administrative tribunal, including disclosures to opposing counsel in the course of settlement negotiations.
3. A record in this system of records may be disclosed, as a routine use, to a Member of Congress submitting a request involving an individual, to whom the record pertains, when the individual has requested assistance from the Member with respect to the subject matter of the record.
4. A record in this system of records may be disclosed, as a routine use, to a contractor of the Agency having need for the information in order to perform a contract. Recipients of information shall be required to comply with the requirements of the Privacy Act of 1974, as amended, pursuant to 5 U.S.C. 552a(m).
5. A record related to an International Application filed under the Patent Cooperation Treaty in this system of records may be disclosed, as a routine use, to the International Bureau of the World Intellectual Property Organization, pursuant to the Patent Cooperation Treaty.
6. A record in this system of records may be disclosed, as a routine use, to another federal agency for purposes of National Security review (35 U.S.C. 181) and for review pursuant to the Atomic Energy Act (42 U.S.C. 218(c)).
7. A record from this system of records may be disclosed, as a routine use, to the Administrator, General Services, or his/her designee, during an inspection of records conducted by GSA as part of that agency's responsibility to recommend improvements in records management practices and programs, under authority of 44 U.S.C. 2904 and 2906. Such disclosure shall be made in accordance with the GSA regulations governing inspection of records for this purpose, and any other relevant (i.e., GSA or Commerce) directive. Such disclosure shall not be used to make determinations about individuals.
8. A record from this system of records may be disclosed, as a routine use, to the public after either publication of the application pursuant to 35 U.S.C. 122(b) or issuance of a patent pursuant to 35 U.S.C. 151. Further, a record may be disclosed, subject to the limitations of 37 CFR 1.14, as a routine use, to the public if the record was filed in an application which became abandoned or in which the proceedings were terminated and which application is referenced by either a published application, an application open to public inspections or an issued patent.
9. A record from this system of records may be disclosed, as a routine use, to a Federal, State, or local law enforcement agency, if the USPTO becomes aware of a violation or potential violation of law or regulation.

Electronic Acknowledgement Receipt

EFS ID:	40736053
Application Number:	17012813
International Application Number:	
Confirmation Number:	8746
Title of Invention:	METHOD AND APPARATUS USING CELL-SPECIFIC AND COMMON PILOT SUBCARRIERS IN MULTI-CARRIER, MULTI-CELL WIRELESS COMMUNICATION NETWORKS
First Named Inventor/Applicant Name:	Xiaodong Li
Customer Number:	3624
Filer:	Andrew D. Buschmeier/Justin Slater
Filer Authorized By:	Andrew D. Buschmeier
Attorney Docket Number:	NEO-PT008.8
Receipt Date:	01-OCT-2020
Filing Date:	04-SEP-2020
Time Stamp:	15:31:47
Application Type:	Utility under 35 USC 111(a)

Payment information:

Submitted with Payment	no
------------------------	----

File Listing:

Document Number	Document Description	File Name	File Size(Bytes)/ Message Digest	Multi Part /.zip	Pages (if appl.)
1	Transmittal Letter	NEO-PT008_8- IDS_TransmittalLtr_EFS-202010 01.pdf	87900 <small>92a4823636984dccc195f85dd5702c7c7a2ca6147</small>	no	3

Warnings:

Information:					
2	Information Disclosure Statement (IDS) Form (SB08)	NEO-PT008_8-SB08_EFS-20201001.pdf	1064918	no	4
			4af22181bb0e01bade796081f7d5a2b725466264		
Warnings:					
Information:					
Total Files Size (in bytes):				1152818	
<p>This Acknowledgement Receipt evidences receipt on the noted date by the USPTO of the indicated documents, characterized by the applicant, and including page counts, where applicable. It serves as evidence of receipt similar to a Post Card, as described in MPEP 503.</p> <p><u>New Applications Under 35 U.S.C. 111</u> If a new application is being filed and the application includes the necessary components for a filing date (see 37 CFR 1.53(b)-(d) and MPEP 506), a Filing Receipt (37 CFR 1.54) will be issued in due course and the date shown on this Acknowledgement Receipt will establish the filing date of the application.</p> <p><u>National Stage of an International Application under 35 U.S.C. 371</u> If a timely submission to enter the national stage of an international application is compliant with the conditions of 35 U.S.C. 371 and other applicable requirements a Form PCT/DO/EO/903 indicating acceptance of the application as a national stage submission under 35 U.S.C. 371 will be issued in addition to the Filing Receipt, in due course.</p> <p><u>New International Application Filed with the USPTO as a Receiving Office</u> If a new international application is being filed and the international application includes the necessary components for an international filing date (see PCT Article 11 and MPEP 1810), a Notification of the International Application Number and of the International Filing Date (Form PCT/RO/105) will be issued in due course, subject to prescriptions concerning national security, and the date shown on this Acknowledgement Receipt will establish the international filing date of the application.</p>					

IN THE UNITED STATES PATENT AND TRADEMARK OFFICE

In the PATENT APPLICATION of:

Li et al.

Application No.: 17/012,813

Confirmation No.: 8746

Filed: September 4, 2020

**For: METHOD AND APPARATUS USING
CELL-SPECIFIC AND COMMON PILOT
SUBCARRIERS IN MULTI-CARRIER,
MULTI-CELL WIRELESS
COMMUNICATION NETWORKS**

Group: 2645

Examiner: Omoniyi Obayanju

Our File: NEO-PT008.8

Date: October 1, 2020

INFORMATION DISCLOSURE STATEMENT

Mail Stop Amendment (via EFS)
Commissioner for Patents
P.O. Box 1450
Alexandria, VA 22313-1450

Further to Applicant's Duty of Disclosure pursuant to 37 C.F.R. §1.56,
Applicant wishes to bring to the Examiner's attention the material cited on the
enclosed PTO Form SB-08. Pursuant to 37 C.F.R. §1.98(a)(2)(ii), copies of the cited
U.S. publications and/or patent documents have not been included.

This Application is a continuation of U.S. Patent Application No. 16/440,754,
filed June 13, 2019, which is a continuation of U.S. Patent Application No.
15/688,441, filed August 28, 2017, which issued as U.S. Patent No. 10,326,631 on
June 18, 2019, which is a continuation of U.S. Patent Application No. 14/746,676,
filed June 22, 2015, which issued as U.S. Patent No. 9,749,168 on August 29, 2017,

which is a continuation of U.S. Patent Application No. 14/595,132, filed January 12, 2015, which issued as U.S. Patent No. 9,065,614 on June 23, 2015, which is a continuation of U.S. Patent Application No. 13/874,278, filed April 30, 2013, which issued as U.S. Patent No. 8,934,473 on January 13, 2015, which is a continuation of U.S. Patent Application No. 13/212,116, filed August 17, 2011, which issued as U.S. Patent No. 8,432,891 on April 30, 2013, which is a continuation of U.S. Patent Application No. 10/583,530, filed May 30, 2007, which issued as U.S. Patent No. 8,009,660 on August 30, 2011, which is a U.S. National Stage of PCT Application No. PCT/US05/01939, filed January 20, 2005, which claims the benefit of and priority to U.S. Provisional Patent Application No. 60/540,032, filed on January 29, 2004.

Applicant would like to bring the following Applications to the Examiner's attention: U.S. Patent Application No. 16/908,067, filed June 22, 2020; U.S. Patent Application No. 16/902,740, filed June 16, 2020; U.S. Patent Application No. 15/953,950, filed April 16, 2018, which issued September 8, 2020 as U.S. Patent No. 10,771,302; U.S. Patent Application No. 14/321,615, filed July 1, 2014, which issued April 17, 2018 as U.S. Patent No. 9,948,488; U.S. Patent Application No. 13/861,942, filed April 12, 2013, which issued July 1, 2014 as U.S. Patent No. 8,767,522; U.S. Patent Application No. 13/347,644, filed January 10, 2012, which issued April 23, 2013 as U.S. Patent No. 8,428,009; U.S. Patent Application No. 12/975,226, filed December 21, 2010, which issued January 10, 2012 as U.S. Patent No. 8,094,611; U.S. Patent Application No. 10/583,229, filed August 27, 2008, which

issued January 4, 2011 as U.S. Patent No. 7,864,725; U.S. Provisional Patent Application No. 60/540,586, filed January 30, 2004; and PCT Application No. PCT/US2005/003518, filed January 27, 2005.

It is respectfully requested that the Examiner consider these documents and return an initialed copy of the PTO Form SB-08 indicating consideration of the cited materials.

Respectfully submitted,

Neo Wireless LLC

By /Andrew D. Buschmeier/
Andrew D. Buschmeier
Registration No. 73,179
(215) 568-6400

Volpe Koenig
United Plaza, Suite 1800
30 South 17th Street
Philadelphia, PA 19103

AB/PCK
Enclosure



UNITED STATES PATENT AND TRADEMARK OFFICE

UNITED STATES DEPARTMENT OF COMMERCE
United States Patent and Trademark Office
Address: COMMISSIONER FOR PATENTS
P.O. Box 1450
Alexandria, Virginia 22313-1450
www.uspto.gov

Table with 5 columns: APPLICATION NO., FILING DATE, FIRST NAMED INVENTOR, ATTORNEY DOCKET NO., CONFIRMATION NO. Includes application details for Xiaodong Li and examiner information for OBAYANJU, OMONIYI.

Please find below and/or attached an Office communication concerning this application or proceeding.

The time period for reply, if any, is set in the attached communication.

Notice of the Office communication was sent electronically on above-indicated "Notification Date" to the following e-mail address(es):

eoffice@volpe-koenig.com

<i>Decision Granting Request for Prioritized Examination (Track I)</i>	Application No. 17/012,813	Applicant(s) Li et al.	
	Examiner CHERYL P GIBSON BAYLOR	Art Unit OPET	AIA (FITF) Status No

1. THE REQUEST FILED 04 September 2020 IS **GRANTED** .

The above-identified application has met the requirements for prioritized examination

- A. for an original nonprovisional application (Track I).
- B. for an application undergoing continued examination (RCE).

2. **The above-identified application will undergo prioritized examination.** The application will be accorded special status throughout its entire course of prosecution until one of the following occurs:

- A. filing a **petition for extension of time** to extend the time period for filing a reply;
- B. filing an **amendment to amend the application to contain more than four independent claims, more than thirty total claims**, or a multiple dependent claim;
- C. filing a **request for continued examination** ;
- D. filing a notice of appeal;
- E. filing a request for suspension of action;
- F. mailing of a notice of allowance;
- G. mailing of a final Office action;
- H. completion of examination as defined in 37 CFR 41.102; or
- I. abandonment of the application.

Telephone inquiries with regard to this decision should be directed to CHERYL GIBSON BAYLOR at (571)272-3213. In his/her absence, calls may be directed to Petition Help Desk at (571) 272-3282.

/CHERYL GIBSON BAYLOR/
Paralegal Specialist, OPET



UNITED STATES DEPARTMENT OF COMMERCE
United States Patent and Trademark Office
Address: COMMISSIONER FOR PATENTS
P.O. Box 1450
Alexandria, Virginia 22313-1450
www.uspto.gov

NOTICE OF ALLOWANCE AND FEE(S) DUE

3624 7590 10/27/2020
Volpe Koenig
30 SOUTH 17TH STREET, 18TH FLOOR
PHILADELPHIA, PA 19103

Table with 2 columns: EXAMINER (OBAYANJU, OMONIYI), ART UNIT (2645), PAPER NUMBER (8746)

DATE MAILED: 10/27/2020

Table with 5 columns: APPLICATION NO. (17/012,813), FILING DATE (09/04/2020), FIRST NAMED INVENTOR (Xiaodong Li), ATTORNEY DOCKET NO. (NEO-PT008.8), CONFIRMATION NO. (8746)

TITLE OF INVENTION: METHOD AND APPARATUS USING CELL-SPECIFIC AND COMMON PILOT SUBCARRIERS IN MULTI-CARRIER, MULTI-CELL WIRELESS COMMUNICATION NETWORKS

Table with 7 columns: APPLN. TYPE (nonprovisional), ENTITY STATUS (UNDISCOUNTED), ISSUE FEE DUE (\$1200), PUBLICATION FEE DUE (\$0.00), PREV. PAID ISSUE FEE (\$0.00), TOTAL FEE(S) DUE (\$1200), DATE DUE (01/27/2021)

THE APPLICATION IDENTIFIED ABOVE HAS BEEN EXAMINED AND IS ALLOWED FOR ISSUANCE AS A PATENT. PROSECUTION ON THE MERITS IS CLOSED. THIS NOTICE OF ALLOWANCE IS NOT A GRANT OF PATENT RIGHTS. THIS APPLICATION IS SUBJECT TO WITHDRAWAL FROM ISSUE AT THE INITIATIVE OF THE OFFICE OR UPON PETITION BY THE APPLICANT. SEE 37 CFR 1.313 AND MPEP 1308.

THE ISSUE FEE AND PUBLICATION FEE (IF REQUIRED) MUST BE PAID WITHIN THREE MONTHS FROM THE MAILING DATE OF THIS NOTICE OR THIS APPLICATION SHALL BE REGARDED AS ABANDONED. THIS STATUTORY PERIOD CANNOT BE EXTENDED. SEE 35 U.S.C. 151. THE ISSUE FEE DUE INDICATED ABOVE DOES NOT REFLECT A CREDIT FOR ANY PREVIOUSLY PAID ISSUE FEE IN THIS APPLICATION. IF AN ISSUE FEE HAS PREVIOUSLY BEEN PAID IN THIS APPLICATION (AS SHOWN ABOVE), THE RETURN OF PART B OF THIS FORM WILL BE CONSIDERED A REQUEST TO REAPPLY THE PREVIOUSLY PAID ISSUE FEE TOWARD THE ISSUE FEE NOW DUE.

HOW TO REPLY TO THIS NOTICE:

I. Review the ENTITY STATUS shown above. If the ENTITY STATUS is shown as SMALL or MICRO, verify whether entitlement to that entity status still applies. If the ENTITY STATUS is the same as shown above, pay the TOTAL FEE(S) DUE shown above. If the ENTITY STATUS is changed from that shown above, on PART B - FEE(S) TRANSMITTAL, complete section number 5 titled "Change in Entity Status (from status indicated above)". For purposes of this notice, small entity fees are 1/2 the amount of undiscounted fees, and micro entity fees are 1/2 the amount of small entity fees.

II. PART B - FEE(S) TRANSMITTAL, or its equivalent, must be completed and returned to the United States Patent and Trademark Office (USPTO) with your ISSUE FEE and PUBLICATION FEE (if required). If you are charging the fee(s) to your deposit account, section "4b" of Part B - Fee(s) Transmittal should be completed and an extra copy of the form should be submitted. If an equivalent of Part B is filed, a request to reapply a previously paid issue fee must be clearly made, and delays in processing may occur due to the difficulty in recognizing the paper as an equivalent of Part B.

III. All communications regarding this application must give the application number. Please direct all communications prior to issuance to Mail Stop ISSUE FEE unless advised to the contrary.

IMPORTANT REMINDER: Maintenance fees are due in utility patents issuing on applications filed on or after Dec. 12, 1980. It is patentee's responsibility to ensure timely payment of maintenance fees when due. More information is available at www.uspto.gov/PatentMaintenanceFees.

PART B - FEE(S) TRANSMITTAL

Complete and send this form, together with applicable fee(s), by mail or fax, or via EFS-Web.

By mail, send to: Mail Stop ISSUE FEE
 Commissioner for Patents
 P.O. Box 1450
 Alexandria, Virginia 22313-1450

By fax, send to: (571)-273-2885

INSTRUCTIONS: This form should be used for transmitting the ISSUE FEE and PUBLICATION FEE (if required). Blocks 1 through 5 should be completed where appropriate. All further correspondence including the Patent, advance orders and notification of maintenance fees will be mailed to the current correspondence address as indicated unless corrected below or directed otherwise in Block 1, by (a) specifying a new correspondence address; and/or (b) indicating a separate "FEE ADDRESS" for maintenance fee notifications.

CURRENT CORRESPONDENCE ADDRESS (Note: Use Block 1 for any change of address)

3624 7590 10/27/2020
Volpe Koenig
 30 SOUTH 17TH STREET, 18TH FLOOR
 PHILADELPHIA, PA 19103

Note: A certificate of mailing can only be used for domestic mailings of the Fee(s) Transmittal. This certificate cannot be used for any other accompanying papers. Each additional paper, such as an assignment or formal drawing, must have its own certificate of mailing or transmission.

Certificate of Mailing or Transmission

I hereby certify that this Fee(s) Transmittal is being deposited with the United States Postal Service with sufficient postage for first class mail in an envelope addressed to the Mail Stop ISSUE FEE address above, or being transmitted to the USPTO via EFS-Web or by facsimile to (571) 273-2885, on the date below.

(Typed or printed name)
(Signature)
(Date)

APPLICATION NO.	FILING DATE	FIRST NAMED INVENTOR	ATTORNEY DOCKET NO.	CONFIRMATION NO.
17/012,813	09/04/2020	Xiaodong Li	NEO-PT008.8	8746

TITLE OF INVENTION: METHOD AND APPARATUS USING CELL-SPECIFIC AND COMMON PILOT SUBCARRIERS IN MULTI-CARRIER, MULTI-CELL WIRELESS COMMUNICATION NETWORKS

APPLN. TYPE	ENTITY STATUS	ISSUE FEE DUE	PUBLICATION FEE DUE	PREV. PAID ISSUE FEE	TOTAL FEE(S) DUE	DATE DUE
nonprovisional	UNDISCOUNTED	\$1200	\$0.00	\$0.00	\$1200	01/27/2021

EXAMINER	ART UNIT	CLASS-SUBCLASS
OBAYANJU, OMONIYI	2645	370-330000

<p>1. Change of correspondence address or indication of "Fee Address" (37 CFR 1.363).</p> <p><input type="checkbox"/> Change of correspondence address (or Change of Correspondence Address form PTO/SB/122) attached.</p> <p><input type="checkbox"/> "Fee Address" indication (or "Fee Address" Indication form PTO/SB/47; Rev 03-09 or more recent) attached. Use of a Customer Number is required.</p>	<p>2. For printing on the patent front page, list</p> <p>(1) The names of up to 3 registered patent attorneys or agents OR, alternatively, _____ 1</p> <p>(2) The name of a single firm (having as a member a registered attorney or agent) and the names of up to 2 registered patent attorneys or agents. If no name is listed, no name will be printed. _____ 2</p> <p>_____ 3</p>
---	---

3. ASSIGNEE NAME AND RESIDENCE DATA TO BE PRINTED ON THE PATENT (print or type)

PLEASE NOTE: Unless an assignee is identified below, no assignee data will appear on the patent. If an assignee is identified below, the document must have been previously recorded, or filed for recordation, as set forth in 37 CFR 3.11 and 37 CFR 3.81(a). Completion of this form is NOT a substitute for filing an assignment.

(A) NAME OF ASSIGNEE _____ (B) RESIDENCE: (CITY and STATE OR COUNTRY) _____

Please check the appropriate assignee category or categories (will not be printed on the patent) : Individual Corporation or other private group entity Government

4a. Fees submitted: Issue Fee Publication Fee (if required) Advance Order - # of Copies _____

4b. Method of Payment: (Please first reapply any previously paid fee shown above)

Electronic Payment via EFS-Web Enclosed check Non-electronic payment by credit card (Attach form PTO-2038)

The Director is hereby authorized to charge the required fee(s), any deficiency, or credit any overpayment to Deposit Account No. _____

5. Change in Entity Status (from status indicated above)

Applicant certifying micro entity status. See 37 CFR 1.29

Applicant asserting small entity status. See 37 CFR 1.27

Applicant changing to regular undiscounted fee status.

NOTE: Absent a valid certification of Micro Entity Status (see forms PTO/SB/15A and 15B), issue fee payment in the micro entity amount will not be accepted at the risk of application abandonment.

NOTE: If the application was previously under micro entity status, checking this box will be taken to be a notification of loss of entitlement to micro entity status.

NOTE: Checking this box will be taken to be a notification of loss of entitlement to small or micro entity status, as applicable.

NOTE: This form must be signed in accordance with 37 CFR 1.31 and 1.33. See 37 CFR 1.4 for signature requirements and certifications.

Authorized Signature _____ Date _____

Typed or printed name _____ Registration No. _____



UNITED STATES PATENT AND TRADEMARK OFFICE

UNITED STATES DEPARTMENT OF COMMERCE
United States Patent and Trademark Office
Address: COMMISSIONER FOR PATENTS
P.O. Box 1450
Alexandria, Virginia 22313-1450
www.uspto.gov

Table with columns: APPLICATION NO., FILING DATE, FIRST NAMED INVENTOR, ATTORNEY DOCKET NO., CONFIRMATION NO., EXAMINER, ART UNIT, PAPER NUMBER. Includes application details for Xiaodong Li and examiner OBAYANJU, OMONIYI.

Determination of Patent Term Adjustment under 35 U.S.C. 154 (b)
(Applications filed on or after May 29, 2000)

The Office has discontinued providing a Patent Term Adjustment (PTA) calculation with the Notice of Allowance.

Section 1(h)(2) of the AIA Technical Corrections Act amended 35 U.S.C. 154(b)(3)(B)(i) to eliminate the requirement that the Office provide a patent term adjustment determination with the notice of allowance. See Revisions to Patent Term Adjustment, 78 Fed. Reg. 19416, 19417 (Apr. 1, 2013). Therefore, the Office is no longer providing an initial patent term adjustment determination with the notice of allowance. The Office will continue to provide a patent term adjustment determination with the Issue Notification Letter that is mailed to applicant approximately three weeks prior to the issue date of the patent, and will include the patent term adjustment on the patent. Any request for reconsideration of the patent term adjustment determination (or reinstatement of patent term adjustment) should follow the process outlined in 37 CFR 1.705.

Any questions regarding the Patent Term Extension or Adjustment determination should be directed to the Office of Patent Legal Administration at (571)-272-7702. Questions relating to issue and publication fee payments should be directed to the Customer Service Center of the Office of Patent Publication at 1-(888)-786-0101 or (571)-272-4200.

OMB Clearance and PRA Burden Statement for PTOL-85 Part B

The Paperwork Reduction Act (PRA) of 1995 requires Federal agencies to obtain Office of Management and Budget approval before requesting most types of information from the public. When OMB approves an agency request to collect information from the public, OMB (i) provides a valid OMB Control Number and expiration date for the agency to display on the instrument that will be used to collect the information and (ii) requires the agency to inform the public about the OMB Control Number's legal significance in accordance with 5 CFR 1320.5(b).

The information collected by PTOL-85 Part B is required by 37 CFR 1.311. The information is required to obtain or retain a benefit by the public which is to file (and by the USPTO to process) an application. Confidentiality is governed by 35 U.S.C. 122 and 37 CFR 1.14. This collection is estimated to take 30 minutes to complete, including gathering, preparing, and submitting the completed application form to the USPTO. Time will vary depending upon the individual case. Any comments on the amount of time you require to complete this form and/or suggestions for reducing this burden, should be sent to the Chief Information Officer, U.S. Patent and Trademark Office, U.S. Department of Commerce, P.O. Box 1450, Alexandria, Virginia 22313-1450. DO NOT SEND FEES OR COMPLETED FORMS TO THIS ADDRESS. SEND TO: Commissioner for Patents, P.O. Box 1450, Alexandria, Virginia 22313-1450. Under the Paperwork Reduction Act of 1995, no persons are required to respond to a collection of information unless it displays a valid OMB control number.

Privacy Act Statement

The Privacy Act of 1974 (P.L. 93-579) requires that you be given certain information in connection with your submission of the attached form related to a patent application or patent. Accordingly, pursuant to the requirements of the Act, please be advised that: (1) the general authority for the collection of this information is 35 U.S.C. 2(b)(2); (2) furnishing of the information solicited is voluntary; and (3) the principal purpose for which the information is used by the U.S. Patent and Trademark Office is to process and/or examine your submission related to a patent application or patent. If you do not furnish the requested information, the U.S. Patent and Trademark Office may not be able to process and/or examine your submission, which may result in termination of proceedings or abandonment of the application or expiration of the patent.

The information provided by you in this form will be subject to the following routine uses:

1. The information on this form will be treated confidentially to the extent allowed under the Freedom of Information Act (5 U.S.C. 552) and the Privacy Act (5 U.S.C. 552a). Records from this system of records may be disclosed to the Department of Justice to determine whether disclosure of these records is required by the Freedom of Information Act.
2. A record from this system of records may be disclosed, as a routine use, in the course of presenting evidence to a court, magistrate, or administrative tribunal, including disclosures to opposing counsel in the course of settlement negotiations.
3. A record in this system of records may be disclosed, as a routine use, to a Member of Congress submitting a request involving an individual, to whom the record pertains, when the individual has requested assistance from the Member with respect to the subject matter of the record.
4. A record in this system of records may be disclosed, as a routine use, to a contractor of the Agency having need for the information in order to perform a contract. Recipients of information shall be required to comply with the requirements of the Privacy Act of 1974, as amended, pursuant to 5 U.S.C. 552a(m).
5. A record related to an International Application filed under the Patent Cooperation Treaty in this system of records may be disclosed, as a routine use, to the International Bureau of the World Intellectual Property Organization, pursuant to the Patent Cooperation Treaty.
6. A record in this system of records may be disclosed, as a routine use, to another federal agency for purposes of National Security review (35 U.S.C. 181) and for review pursuant to the Atomic Energy Act (42 U.S.C. 218(c)).
7. A record from this system of records may be disclosed, as a routine use, to the Administrator, General Services, or his/her designee, during an inspection of records conducted by GSA as part of that agency's responsibility to recommend improvements in records management practices and programs, under authority of 44 U.S.C. 2904 and 2906. Such disclosure shall be made in accordance with the GSA regulations governing inspection of records for this purpose, and any other relevant (i.e., GSA or Commerce) directive. Such disclosure shall not be used to make determinations about individuals.
8. A record from this system of records may be disclosed, as a routine use, to the public after either publication of the application pursuant to 35 U.S.C. 122(b) or issuance of a patent pursuant to 35 U.S.C. 151. Further, a record may be disclosed, subject to the limitations of 37 CFR 1.14, as a routine use, to the public if the record was filed in an application which became abandoned or in which the proceedings were terminated and which application is referenced by either a published application, an application open to public inspection or an issued patent.
9. A record from this system of records may be disclosed, as a routine use, to a Federal, State, or local law enforcement agency, if the USPTO becomes aware of a violation or potential violation of law or regulation.

Notice of Allowability	Application No. 17/012,813	Applicant(s) Li et al.	
	Examiner OMONIYI OBAYANJU	Art Unit 2645	AIA (FITF) Status No

-- The MAILING DATE of this communication appears on the cover sheet with the correspondence address--

All claims being allowable, PROSECUTION ON THE MERITS IS (OR REMAINS) CLOSED in this application. If not included herewith (or previously mailed), a Notice of Allowance (PTOL-85) or other appropriate communication will be mailed in due course. **THIS NOTICE OF ALLOWABILITY IS NOT A GRANT OF PATENT RIGHTS.** This application is subject to withdrawal from issue at the initiative of the Office or upon petition by the applicant. See 37 CFR 1.313 and MPEP 1308.

1. This communication is responsive to 10/01/2020.
 A declaration(s)/affidavit(s) under **37 CFR 1.130(b)** was/were filed on _____.
2. An election was made by the applicant in response to a restriction requirement set forth during the interview on _____; the restriction requirement and election have been incorporated into this action.
3. The allowed claim(s) is/are 1-30. As a result of the allowed claim(s), you may be eligible to benefit from the **Patent Prosecution Highway** program at a participating intellectual property office for the corresponding application. For more information, please see http://www.uspto.gov/patents/init_events/pph/index.jsp or send an inquiry to PPHfeedback@uspto.gov.
4. Acknowledgment is made of a claim for foreign priority under 35 U.S.C. § 119(a)-(d) or (f).

Certified copies:

- a) All b) Some *c) None of the:
1. Certified copies of the priority documents have been received.
 2. Certified copies of the priority documents have been received in Application No. _____.
 3. Copies of the certified copies of the priority documents have been received in this national stage application from the International Bureau (PCT Rule 17.2(a)).

* Certified copies not received: _____.

Applicant has THREE MONTHS FROM THE "MAILING DATE" of this communication to file a reply complying with the requirements noted below. Failure to timely comply will result in ABANDONMENT of this application.

THIS THREE-MONTH PERIOD IS NOT EXTENDABLE.

5. CORRECTED DRAWINGS (as "replacement sheets") must be submitted.
 including changes required by the attached Examiner's Amendment / Comment or in the Office action of Paper No./Mail Date _____.
- Identifying indicia such as the application number (see 37 CFR 1.84(c)) should be written on the drawings in the front (not the back) of each sheet. Replacement sheet(s) should be labeled as such in the header according to 37 CFR 1.121(d).**
6. DEPOSIT OF and/or INFORMATION about the deposit of BIOLOGICAL MATERIAL must be submitted. Note the attached Examiner's comment regarding REQUIREMENT FOR THE DEPOSIT OF BIOLOGICAL MATERIAL.

Attachment(s)

- | | |
|---|--|
| 1. <input checked="" type="checkbox"/> Notice of References Cited (PTO-892) | 5. <input checked="" type="checkbox"/> Examiner's Amendment/Comment |
| 2. <input checked="" type="checkbox"/> Information Disclosure Statements (PTO/SB/08),
Paper No./Mail Date _____. | 6. <input checked="" type="checkbox"/> Examiner's Statement of Reasons for Allowance |
| 3. <input type="checkbox"/> Examiner's Comment Regarding Requirement for Deposit
of Biological Material _____. | 7. <input type="checkbox"/> Other _____. |
| 4. <input checked="" type="checkbox"/> Interview Summary (PTO-413),
Paper No./Mail Date. _____. | |

/OMONIYI OBAYANJU/
Primary Examiner, Art Unit 2645

DETAILED ACTION

Notice of Pre-AIA or AIA Status

The present application is being examined under the pre-AIA first to invent provisions.

EXAMINER'S AMENDMENT

An examiner's amendment to the record appears below. Should the changes and/or additions be unacceptable to applicant, an amendment may be filed as provided by 37 CFR 1.312. To ensure consideration of such an amendment, it **MUST** be submitted no later than the payment of the issue fee.

Authorization for this examiner's amendment was given in an interview with **Mr. Andrew Buschmeier** on **10/20/2020**.

The application has been amended as follows:

CLAIMS:

1. (Currently Amended) An orthogonal frequency division multiple access (OFDMA)-compatible base station that uses subcarriers in a frequency domain and time slots in a time domain, the OFDMA-compatible base station comprising:
 - a plurality of antennas; and
 - a transmitter operably coupled to the plurality of antennas;
 - the transmitter configured to:

insert first pilots of a first type ~~cell-specific pilots~~ onto a first plurality of subcarriers, wherein the first pilots are cell-specific pilots; and

insert data and second pilots of a second type onto a second plurality of subcarriers;

wherein at least some subcarriers of the first plurality of subcarriers or the second plurality of subcarriers are beam-formed; and

the plurality of antennas configured to transmit the first plurality of subcarriers and the second plurality of subcarriers in at least one of the time slots;

wherein the second type is different than the first type and wherein the first pilots do not interfere with the second pilots.

8. (Currently Amended) An orthogonal frequency division multiple access (OFDMA)-compatible base station that uses subcarriers in a frequency domain and time slots in a time domain, the OFDMA-compatible base station comprising:

a plurality of antennas; and

a transmitter operably coupled to the plurality of antennas;

the transmitter configured to:

insert first pilots of a first type ~~cell-specific pilots~~ onto a first plurality of subcarriers, wherein the first pilots are cell-specific pilots; and

insert data and second pilots of a second type onto a second plurality of subcarriers;

wherein at least some subcarriers of the first plurality of subcarriers or the second plurality of subcarriers are beam-formed; and

the plurality of antennas configured to transmit the first plurality of subcarriers and the second plurality of subcarriers in at least one of the time slots;

wherein the second type is different than the first type and wherein the first pilots do not interfere with the second pilots.

15. (Currently Amended) An orthogonal frequency division multiple access (OFDMA)-compatible mobile station that uses subcarriers in a frequency domain and time slots in a time domain, the OFDMA-compatible mobile station comprising:

at least one antenna; and

a receiver; and

the at least one antenna and the receiver are configured to:

receive first pilots of a first type ~~cell-specific pilots~~ on a first plurality of subcarriers, wherein the first pilots are cell-specific pilots; and

receive second pilots of a second type and data on a second plurality of subcarriers, wherein the first plurality of subcarriers and the second plurality of subcarriers are received in at least one of the time slots;

wherein at least some subcarriers of the first plurality of subcarriers or the second plurality of subcarriers are beam-formed; and

the receiver is further configured to:

recover the data using channel estimates from at least the second pilots;

and

recover cell-specific information using the cell-specific pilots;

wherein the second type is different than the first type and wherein the first pilots do not interfere with the second pilots.

23. (Currently Amended) A method performed by an orthogonal frequency division multiple access (OFDMA)-compatible mobile station that uses subcarriers in a frequency domain and time slots in a time domain, the method comprising:

receiving first pilots of a first type ~~cell-specific pilots~~ on a first plurality of subcarriers, wherein the first pilots are cell-specific pilots;

receiving second pilots of a second type and data on a second plurality of subcarriers, wherein the first plurality of subcarriers and the second plurality of subcarriers are received in at least one of the time slots;

wherein at least some subcarriers of the first plurality of subcarriers or the second plurality of subcarriers are beam-formed;

recovering the data using channel estimates from at least the second pilots; and
recovering cell-specific information using the cell-specific pilots;

wherein the second type is different than the first type and wherein the first pilots do not interfere with the second pilots.

Allowable Subject Matter

Claims 1-30 are allowed.

The following is an examiner's statement of reasons for allowance:

The closest prior art of record **Li et al. (US Patent No. 7650152)** discussed the concept of allocating subcarriers in an orthogonal frequency division multiple access (OFDMA), which comprises allocating at least one diversity cluster of subcarriers to a first subscriber and allocating at least one coherence cluster to a second subscriber (**see fig. 1 and abs**). **Li** further discussed the concept that each base station transmits pilot symbols simultaneously, and each pilot symbol occupies the entire OFDM frequency bandwidth (**see fig. 2A-C**).

Another close prior art reference **Seki et al. (US Publication No. 20040190598)** discussed the concept of a multicarrier CDMA transmission system, wherein time multiplexer 52 time-multiplexes the pilot of the plurality of symbols to the front of the transmit data. The subcarrier signals S_1 to S_N are multicode multiplexed signals obtained by multiplexing results of spreading the two symbols by respective ones of the orthogonal codes (**see fig. 24, and pp0071**).

However, singly and/or in combination the prior art references does not teach the at least portion of the claim of **an orthogonal frequency division multiple access (OFDMA)-compatible base station** that uses subcarriers in a frequency domain and time slots in a time domain, the OFDMA-compatible base station comprising: a plurality of antennas; and a transmitter operably coupled to the plurality of antennas; the transmitter configured to: **insert first pilots of a first type onto a first plurality of subcarriers, wherein the first pilots are cell-specific pilots; and insert data and second pilots of a second type onto a second plurality of subcarriers; wherein at least some subcarriers of the first plurality of subcarriers or the second plurality of subcarriers are beam-formed; and the plurality of antennas configured to**

transmit the first plurality of subcarriers and the second plurality of subcarriers in at least one of the time slots; wherein the second type is different than the first type and wherein the first pilots do not interfere with the second pilots.

Any comments considered necessary by applicant must be submitted no later than the payment of the issue fee and, to avoid processing delays, should preferably accompany the issue fee. Such submissions should be clearly labeled "Comments on Statement of Reasons for Allowance."

Conclusion

Any inquiry concerning this communication or earlier communications from the examiner should be directed to OMONIYI OBAYANJU whose telephone number is (571)270-5885. The examiner can normally be reached on M-Thur 10:30-7pm.

Examiner interviews are available via telephone, in-person, and video conferencing using a USPTO supplied web-based collaboration tool. To schedule an interview, applicant is encouraged to use the USPTO Automated Interview Request (AIR) at <http://www.uspto.gov/interviewpractice>.

If attempts to reach the examiner by telephone are unsuccessful, the examiner's supervisor, ANTHONY S ADDY can be reached on (571) 272-7795. The fax phone number for the organization where this application or proceeding is assigned is 571-273-8300.

Information regarding the status of an application may be obtained from the Patent Application Information Retrieval (PAIR) system. Status information for published applications may be obtained from either Private PAIR or Public PAIR. Status information for unpublished applications is available through Private PAIR only. For more information about the PAIR system, see <https://ppair-my.uspto.gov/pair/PrivatePair>. Should you have questions on access to the Private PAIR system, contact the Electronic Business Center (EBC) at 866-217-9197 (toll-free). If you would like assistance from a USPTO Customer Service Representative or access to the automated information system, call 800-786-9199 (IN USA OR CANADA) or 571-272-1000.

/OMONIYI OBAYANJU/
Primary Examiner, Art Unit 2645

Examiner-Initiated Interview Summary	Application No. 17/012,813	Applicant(s) Li et al.		
	Examiner OMONIYI OBAYANJU	Art Unit 2645	AIA (First Inventor to File) Status No	Page 1 of 1

All Participants (applicant, applicants representative, PTO personnel)	Title	Type
OMONIYI OBAYANJU	Primary Examiner	Telephonic
Andrew Buschmeier (73,179)	Attorney	

Date of Interview: 20 October 2020

Issues Discussed:

35 U.S.C. 112

The Examiner discussed potential clarity 112 issues in the independent claim because the claims mentioned a second pilots without clearly specifying what is the first pilots.

Proposed Amendment(s)

The Examiner also discussed and/or suggest some amendments. The Applicant made alternative amendments and agreed to enter the amendments with an Examiner's amendments, after further search and/or consideration by the Examiner.

/OMONIYI OBAYANJU/ Primary Examiner, Art Unit 2645	
<p>Applicant is reminded that a complete written statement as to the substance of the interview must be made of record in the application file. It is the applicants responsibility to provide the written statement, unless the interview was initiated by the Examiner and the Examiner has indicated that a written summary will be provided. See MPEP 713.04</p> <p>Please further see: MPEP 713.04 Title 37 Code of Federal Regulations (CFR) § 1.133 Interviews, paragraph (b) 37 CFR § 1.2 Business to be transacted in writing</p>	

Applicant recordation instructions: It is not necessary for applicant to provide a separate record of the substance of interview.

Examiner recordation instructions: Examiners must summarize the substance of any interview of record. A complete and proper recordation of the substance of an interview should include the items listed in MPEP 713.04 for complete and proper recordation including the identification of the general thrust of each argument or issue discussed, a general indication of any other pertinent matters discussed regarding patentability and the general results or outcome of the interview, to include an indication as to whether or not agreement was reached on the issues raised.

Notice of References Cited

Application/Control No. 17/012,813	Applicant(s)/Patent Under Reexamination Li et al.	
Examiner OMONIYI OBAYANJU	Art Unit 2645	Page 1 of 1

U.S. PATENT DOCUMENTS

*		Document Number Country Code-Number-Kind Code	Date MM-YYYY	Name	CPC Classification	US Classification
*	A	US-7650152-B2	01-2010	Li; Xiaodong	H04L25/0228	455/452.1
*	B	US-20040190598-A1	09-2004	Seki, Hiroyuki	H04B7/0669	375/141
	C					
	D					
	E					
	F					
	G					
	H					
	I					
	J					
	K					
	L					
	M					

FOREIGN PATENT DOCUMENTS

*		Document Number Country Code-Number-Kind Code	Date MM-YYYY	Country	Name	CPC Classification
	N					
	O					
	P					
	Q					
	R					
	S					
	T					

NON-PATENT DOCUMENTS

*		Include as applicable: Author, Title Date, Publisher, Edition or Volume, Pertinent Pages)
	U	
	V	
	W	
	X	

*A copy of this reference is not being furnished with this Office action. (See MPEP § 707.05(a).)
 Dates in MM-YYYY format are publication dates. Classifications may be US or foreign.

<i>Search Notes</i> 	Application/Control No. 17/012,813	Applicant(s)/Patent Under Reexamination Li et al.
	Examiner OMONIYI OBAYANJU	Art Unit 2645

CPC - Searched*		
Symbol	Date	Examiner
H04L5/0053	10/21/2020	OO
H04L5/0007	10/21/2020	OO
H04L5/0048	10/21/2020	OO

CPC Combination Sets - Searched*		
Symbol	Date	Examiner

US Classification - Searched*			
Class	Subclass	Date	Examiner

* See search history printout included with this form or the SEARCH NOTES box below to determine the scope of the search.

Search Notes		
Search Notes	Date	Examiner
See Attached East Search History	10/21/2020	OO

Interference Search			
US Class/CPC Symbol	US Subclass/CPC Group	Date	Examiner
Same As Above	Same As Above	10/21/2020	OO
Interference Search	East Patent Claim Search	10/21/2020	OO

--	--

Issue Classification 	Application/Control No. 17/012,813	Applicant(s)/Patent Under Reexamination Li et al.
	Examiner OMONIYI OBAYANJU	Art Unit 2645

CPC					Type	Version
Symbol						
H04L	/	27	/	2637	F	2013-01-01
H04L	/	27	/	2613	I	2013-01-01
H04B	/	1	/	707	I	2013-01-01
H04L	/	5	/	0007	I	2013-01-01
H04L	/	5	/	0028	I	2013-01-01
H04L	/	25	/	03834	I	2013-01-01
H04L	/	27	/	0008	I	2013-01-01
H04L	/	27	/	0012	I	2013-01-01
H04L	/	27	/	2602	I	2013-01-01
H04W	/	72	/	0446	I	2013-01-01
H04B	/	7	/	0413	I	2013-01-01
H04L	/	5	/	0048	I	2013-01-01
H04L	/	27	/	2626	I	2013-01-01
H04J	/	11	/	005	I	2013-01-01
H04L	/	27	/	2646	I	2013-01-01
H04W	/	72	/	044	I	2013-01-01
H04W	/	16	/	02	I	2013-01-01
H04L	/	27	/	2655	A	2013-01-01
H04L	/	27	/	2657	A	2013-01-01
H04L	/	5	/	0016	A	2013-01-01
H04L	/	25	/	0228	A	2013-01-01
H04L	/	27	/	2607	A	2013-01-01

CPC Combination Sets				
Symbol	Type	Set	Ranking	Version
/	/			

NONE	Total Claims Allowed:	
(Assistant Examiner)	(Date)	30
/OMONIYI OBAYANJU/ Primary Examiner, Art Unit 2645	21 October 2020	O.G. Print Claim(s)
(Primary Examiner)	(Date)	1
		O.G. Print Figure
		5

Issue Classification 	Application/Control No. 17/012,813	Applicant(s)/Patent Under Reexamination Li et al.
	Examiner OMONIYI OBAYANJU	Art Unit 2645

INTERNATIONAL CLASSIFICATION			
CLAIMED			
H04W	/	4	/ 00

NON-CLAIMED			
/	/	/	/

US ORIGINAL CLASSIFICATION	
CLASS	SUBCLASS

CROSS REFERENCES(S)						
CLASS	SUBCLASS (ONE SUBCLASS PER BLOCK)					

NONE		Total Claims Allowed:	
(Assistant Examiner)	(Date)	30	
/OMONIYI OBAYANJU/ Primary Examiner, Art Unit 2645	21 October 2020	O.G. Print Claim(s)	O.G. Print Figure
(Primary Examiner)	(Date)	1	5

Issue Classification 	Application/Control No. 17/012,813	Applicant(s)/Patent Under Reexamination Li et al.
	Examiner OMONIYI OBAYANJU	Art Unit 2645

Claims renumbered in the same order as presented by applicant
 CPA
 T.D.
 R.1.47

CLAIMS															
Final	Original	Final	Original	Final	Original	Final	Original	Final	Original	Final	Original	Final	Original	Final	Original
	1		10		19		28								
	2		11		20		29								
	3		12		21		30								
	4		13		22										
	5		14		23										
	6		15		24										
	7		16		25										
	8		17		26										
	9		18		27										

NONE	Total Claims Allowed:	
(Assistant Examiner)	(Date)	30
/OMONIYI OBAYANJU/ Primary Examiner, Art Unit 2645	21 October 2020	O.G. Print Claim(s) O.G. Print Figure
(Primary Examiner)	(Date)	1 5

EAST Search History

EAST Search History (Prior Art)

Ref #	Hits	Search Query	DBs	Default Operator	Plurals	Time Stamp
L1	264	((orthogonal near2 frequency near2 division near2 multiple near2 access) or ofdma) and ((sub\$1carrier or sub adj carrier or sub\$1band or sub adj band or carrier or band or sub\$1channel or sub adj channel or channel or frequency) with (cell\$1specific or cell adj specific) with pilot) and (beam\$1form\$3 or beam adj form\$3)	US-PGPUB; USPAT; EPO; JPO; DERWENT; IBM_TDB	OR	ON	2020/10/21 15:27
L2	0	1 and (@ad<"20040129" or @pd<"20040129" or @rlad<"20040129")	US-PGPUB; USPAT; EPO; JPO; DERWENT; IBM_TDB	OR	ON	2020/10/21 15:28
L3	962	((orthogonal near2 frequency near2 division near2 multiple near2 access) or ofdma) and ((sub\$1carrier or sub adj carrier or sub\$1band or sub adj band or carrier or band or sub\$1channel or sub adj channel or channel or frequency) with (cell) with pilot) and (beam\$1form\$3 or beam adj form\$3)	US-PGPUB; USPAT; EPO; JPO; DERWENT; IBM_TDB	OR	ON	2020/10/21 15:28
L4	18	3 and (@ad<"20040129" or @pd<"20040129" or @rlad<"20040129")	US-PGPUB; USPAT; EPO; JPO; DERWENT; IBM_TDB	OR	ON	2020/10/21 15:29
L18	6,036	370/330.ccls.	US-PGPUB; USPAT; EPO; JPO; DERWENT; IBM_TDB	OR	ON	2020/10/21 17:17
L19	70,889	((H04L5/0053 OR H04L5/0007 OR H04L5/0048).CPC.)	US-PGPUB; USPAT; EPO; JPO; DERWENT; IBM_TDB	OR	ON	2020/10/21 17:18
L20	74,982	18 or 19	US-PGPUB; USPAT; EPO; JPO; DERWENT; IBM_TDB	OR	ON	2020/10/21 17:18

L21	6,724	20 and (cell\$1specific or cell adj specific) and (beam\$1form\$3 or beam adj form\$3)	US-PGPUB; USPAT; EPO; JPO; DERWENT; IBM_TDB	OR	ON	2020/10/21 17:23
L22	4	21 and (@ad<"20040129" or @pd<"20040129" or @rlad<"20040129")	US-PGPUB; USPAT; EPO; JPO; DERWENT; IBM_TDB	OR	ON	2020/10/21 17:23
S1	0	"16440754"	US-PGPUB; USPAT; EPO; JPO; DERWENT; IBM_TDB	OR	ON	2020/03/17 01:05
S2	0	(Neo near2 Wireless).as.	US-PGPUB; USPAT; EPO; JPO; DERWENT; IBM_TDB	OR	ON	2020/03/17 01:05
S3	144	NEOCIFIC.as.	US-PGPUB; USPAT; EPO; JPO; DERWENT; IBM_TDB	OR	ON	2020/03/17 01:08
S4	0	(CFIP near2 NCF).as.	US-PGPUB; USPAT; EPO; JPO; DERWENT; IBM_TDB	OR	ON	2020/03/17 01:08
S5	16	(WALTICAL near2 SOLUTIONS).as.	US-PGPUB; USPAT; EPO; JPO; DERWENT; IBM_TDB	OR	ON	2020/03/17 01:09
S6	684	((Li near2 Xiaodong) or (Lo near2 Titus) or (Li near2 Kemin) or (Huang near2 Haiming)).inv.	US-PGPUB; USPAT; EPO; JPO; DERWENT; IBM_TDB	OR	ON	2020/03/17 01:11
S7	21	"10583530"	US-PGPUB; USPAT; EPO; JPO; DERWENT; IBM_TDB	OR	ON	2020/03/17 09:07
S8	684	((Li near2 Xiaodong) or (Lo near2 Titus) or (Li near2 Kemin) or (Huang near2 Haiming)).inv.	US-PGPUB; USPAT; EPO; JPO;	OR	ON	2020/03/18 16:52

			DERWENT; IBM_TDB			
S9	16	(WALTICAL near2 SOLUTIONS).as.	US-PGPUB; USPAT; EPO; JPO; DERWENT; IBM_TDB	OR	ON	2020/03/18 16:53
S10	144	NEOCIFIC.as.	US-PGPUB; USPAT; EPO; JPO; DERWENT; IBM_TDB	OR	ON	2020/03/18 16:53
S11	711	(S8 or S9 or S10)	US-PGPUB; USPAT; EPO; JPO; DERWENT; IBM_TDB	OR	ON	2020/03/18 16:53
S12	4	S11 and (pilot and common and (carrier or band or sub\$1band or sub\$1carrier) and ratio and amplitude and phase and power and (cell\$1specific or cell adj specific)).clm.	US-PGPUB; USPAT; EPO; JPO; DERWENT; IBM_TDB	OR	ON	2020/03/18 16:57
S13	4	(transmi\$10 near2 power) and (((common or "same" or similar or identical or equal) near2 pilot) same (ratio near2 amplitude)) and (phase near2 differen\$3) and ((sync\$15 or align\$8 or calibrat\$3 or correct\$3) near3 (carrier or band or sub\$1band or sub\$1carrier))	US-PGPUB; USPAT; EPO; JPO; DERWENT; IBM_TDB	OR	ON	2020/03/18 17:36
S14	5	(transmi\$10 near2 power) and ((pilot) same (ratio near2 amplitude)) and (phase near2 differen\$3) and ((sync\$15 or align\$8 or calibrat\$3 or correct\$3) near3 (carrier or band or sub\$1band or sub\$1carrier))	US-PGPUB; USPAT; EPO; JPO; DERWENT; IBM_TDB	OR	ON	2020/03/18 17:38
S15	1	S14 not S13	US-PGPUB; USPAT; EPO; JPO; DERWENT; IBM_TDB	OR	ON	2020/03/18 17:39
S16	12,669	455/522.ccls.	US-PGPUB; USPAT; EPO; JPO; DERWENT; IBM_TDB	OR	ON	2020/03/18 17:42
S17	18,128	((H04W52/146 OR H04W52/34 OR H04W52/04 OR H04W52/143 OR H04W52/38).CPC.)	US-PGPUB; USPAT; EPO; JPO;	OR	ON	2020/03/18 17:44

			DERWENT; IBM_TDB			
S18	27,434	(S16 or S17)	US-PGPUB; USPAT; EPO; JPO; DERWENT; IBM_TDB	OR	ON	2020/03/18 17:44
S19	0	S18 and ((common near2 pilot) same (amplitude near2 ratio))	US-PGPUB; USPAT; EPO; JPO; DERWENT; IBM_TDB	OR	ON	2020/03/18 17:45
S20	8	((common near2 pilot) same (amplitude near2 ratio))	US-PGPUB; USPAT; EPO; JPO; DERWENT; IBM_TDB	OR	ON	2020/03/18 17:46
S21	4	S20 not S14	US-PGPUB; USPAT; EPO; JPO; DERWENT; IBM_TDB	OR	ON	2020/03/18 17:46
S22	485	((common near2 pilot) same (cell\$1specific or cell adj specific))	US-PGPUB; USPAT; EPO; JPO; DERWENT; IBM_TDB	OR	ON	2020/03/18 17:51
S23	22	S22 and S18	US-PGPUB; USPAT; EPO; JPO; DERWENT; IBM_TDB	OR	ON	2020/03/18 17:52
S24	4	((transmi\$10 near2 power) and (((common or "same" or similar or identical or equal) near2 pilot) same (ratio near2 amplitude)) and (phase near2 differen\$3) and ((sync\$15 or align\$8 or calibrat\$3 or correct\$3) near3 (carrier or band or sub\$1band or sub\$1carrier))).clm.	US-PGPUB; USPAT; EPO; JPO; DERWENT; IBM_TDB	OR	ON	2020/03/18 17:56
S32	9	"8934473"	US-PGPUB; USPAT; EPO; JPO; DERWENT; IBM_TDB	OR	ON	2020/03/23 21:27
S33	1	"16440754"	US-PGPUB; USPAT; EPO; JPO;	OR	ON	2020/10/16 22:15

			DERWENT; IBM_TDB			
S34	145	(Neocific).as.	US-PGPUB; USPAT; EPO; JPO; DERWENT; IBM_TDB	OR	ON	2020/10/19 08:28
S35	73	((insert\$3 or add\$3 or combin\$8 or include or attach\$9 or embed\$8 or append\$9 or together or incorporat\$3) near4 pilot near4 (sub\$1carrier or sub adj carrier or sub\$1band or sub adj band or carrier or band)) and ((orthogonal near2 frequency near2 division) or ofdma) and ((sub\$1carrier or sub adj carrier or sub\$1band or sub adj band or carrier or band) near2 (beam\$1form\$3 or beam adj form\$3))	US-PGPUB; USPAT; EPO; JPO; DERWENT; IBM_TDB	OR	ON	2020/10/19 11:56
S36	0	S35 and (@ad<"20040129" or @pd<"20040129" or @rlad<"20040129")	US-PGPUB; USPAT; EPO; JPO; DERWENT; IBM_TDB	OR	ON	2020/10/19 11:59
S37	86	(pilot near5 (sub\$1carrier or sub adj carrier or sub\$1band or sub adj band or carrier or band) near5 data) and ((orthogonal near2 frequency near2 division) or ofdma) and ((sub\$1carrier or sub adj carrier or sub\$1band or sub adj band or carrier or band) near2 (beam\$1form\$3 or beam adj form\$3))	US-PGPUB; USPAT; EPO; JPO; DERWENT; IBM_TDB	OR	ON	2020/10/19 12:01
S38	0	S37 and (@ad<"20040129" or @pd<"20040129" or @rlad<"20040129")	US-PGPUB; USPAT; EPO; JPO; DERWENT; IBM_TDB	OR	ON	2020/10/19 12:02
S39	40	S37 not S35	US-PGPUB; USPAT; EPO; JPO; DERWENT; IBM_TDB	OR	ON	2020/10/19 12:06
S40	245	(pilot near5 (sub\$1carrier or sub adj carrier or sub\$1band or sub adj band or carrier or band)) and ((orthogonal near2 frequency near2 division) or ofdma) and ((sub\$1carrier or sub adj carrier or sub\$1band or sub adj band or carrier or band) near2 (beam\$1form\$3 or beam adj form\$3))	US-PGPUB; USPAT; EPO; JPO; DERWENT; IBM_TDB	OR	ON	2020/10/19 12:09

S41	14	S40 and (@ad<"20040129" or @pd<"20040129" or @rlad<"20040129")	US-PGPUB; USPAT; EPO; JPO; DERWENT; IBM_TDB	OR	ON	2020/10/19 12:10
S42	14	S41 not S37	US-PGPUB; USPAT; EPO; JPO; DERWENT; IBM_TDB	OR	ON	2020/10/19 12:10
S43	82	((insert\$3 or add\$3 or combin\$8 or include or attach\$9 or embed\$8 or append\$9 or together or incorporat\$3) near4 (pilot or sounding) near4 (sub\$1carrier or sub adj carrier or sub\$1band or sub adj band or carrier or band)) and ((orthogonal near2 frequency near2 division) or ofdma) and ((sub\$1carrier or sub adj carrier or sub\$1band or sub adj band or carrier or band) near2 (beam\$1form\$3 or beam adj form\$3))	US-PGPUB; USPAT; EPO; JPO; DERWENT; IBM_TDB	OR	ON	2020/10/19 12:23
S44	0	S43 and (@ad<"20040129" or @pd<"20040129" or @rlad<"20040129")	US-PGPUB; USPAT; EPO; JPO; DERWENT; IBM_TDB	OR	ON	2020/10/19 12:25
S45	246	(pilot near5 (sub\$1carrier or sub adj carrier or sub\$1band or sub adj band or carrier or band or sub\$1channel or sub adj channel)) and ((orthogonal near2 frequency near2 division) or ofdma) and ((sub\$1carrier or sub adj carrier or sub\$1band or sub adj band or carrier or band) near2 (beam\$1form\$3 or beam adj form\$3))	US-PGPUB; USPAT; EPO; JPO; DERWENT; IBM_TDB	OR	ON	2020/10/19 12:33
S46	1	S45 not S40	US-PGPUB; USPAT; EPO; JPO; DERWENT; IBM_TDB	OR	ON	2020/10/19 12:34
S47	128	((insert\$3 or add\$3 or combin\$8 or include or attach\$9 or embed\$8 or append\$9 or together or incorporat\$3) near4 data near4 (sub\$1carrier or sub adj carrier or sub\$1band or sub adj band or carrier or band or sub\$1channel or sub adj channel)) and ((orthogonal near2 frequency near2 division) or ofdma) and ((sub\$1carrier or sub adj	US-PGPUB; USPAT; EPO; JPO; DERWENT; IBM_TDB	OR	ON	2020/10/19 12:52

		carrier or sub\$1band or sub adj band or carrier or band) near2 (beam\$1form\$3 or beam adj form\$3))				
S48	24	S47 and (@ad<"20040129" or @pd<"20040129" or @rlad<"20040129")	US-PGPUB; USPAT; EPO; JPO; DERWENT; IBM_TDB	OR	ON	2020/10/19 12:54
S49	25	("5828650" "6175550" "7411897" "7471667" "7873009" "8102832" "8363691").PN.	US-PGPUB; USPAT; EPO; JPO; DERWENT; IBM_TDB	OR	ON	2020/10/19 13:00
S50	22	S49 and (@ad<"20040129" or @pd<"20040129" or @rlad<"20040129")	US-PGPUB; USPAT; EPO; JPO; DERWENT; IBM_TDB	OR	ON	2020/10/19 13:00
S51	0	((sub\$1carrier or sub adj carrier or sub\$1band or sub adj band or sub\$1channel or sub adj channel) same pilot same (beam\$1form\$3 or beam adj form\$3)) and (ofdma) and (time\$1slot or time adj slot)).clm.	US-PGPUB; USPAT; EPO; JPO; DERWENT; IBM_TDB	OR	ON	2020/10/19 13:16
S52	218	((pilot) same (data) same (sub\$1carrier or sub adj carrier or sub\$1band or sub adj band or carrier or band or sub\$1channel or sub adj channel)) and ((orthogonal near2 frequency near2 division near2 multiple near2 access) or ofdma) and ((sub\$1carrier or sub adj carrier or sub\$1band or sub adj band or carrier or band) near4 (beam\$1form\$3 or beam adj form\$3))	US-PGPUB; USPAT; EPO; JPO; DERWENT; IBM_TDB	OR	ON	2020/10/19 13:36
S53	20	S52 and (@ad<"20040129" or @pd<"20040129" or @rlad<"20040129")	US-PGPUB; USPAT; EPO; JPO; DERWENT; IBM_TDB	OR	ON	2020/10/19 13:37
S54	20	S53 not S48	US-PGPUB; USPAT; EPO; JPO; DERWENT; IBM_TDB	OR	ON	2020/10/19 13:38
S55	151	(US-20030085040-\$ US-0021182-\$ US-0040929-\$ US-0060892-\$ US-0072255-\$ US-0081538-\$ US-0083789-\$ US-0085040-\$ US-0085946-\$ US-0106513-\$ US-	US-PGPUB; USPAT; EPO; JPO; DERWENT; IBM_TDB	OR	ON	2020/10/19 14:00

		0111397-\$ US-0114815-\$ US-0141483-\$ US-0159422-\$ US-0159430-\$ US-0171357-\$ US-0179776-\$ US-0211617-\$ US-0242937-\$ US-0243774-\$ US-0245409-\$ US-0264600-\$ US-0299474-\$ US-0304551-\$ US-05711777-\$ US-05712825-\$ US-1407745-\$ US-1432245-\$ US-1445949-\$ US-1452326-\$ US-1465150-\$ US-20010083789-\$ US-20010021182-\$ US-20010242937-\$ US-20020141483-\$ US-20020159422-\$ US-20030060892-\$ US-20030072255-\$ US-20030081538-\$ US-20030179776-\$ US-20040085946-\$ US-20040171357-\$ US-20040264600-\$ US-20050111397-\$ US-20060114815-\$ US-20060245409-\$ US-20080304551-\$ US-20090040929-\$ US-20110211617-\$ US-20110299474-\$ US-20120106513-\$ US-20130242937-\$ US-5825807-\$ US-5867478-\$ US-5909436-\$ US-6141546-\$ US-6434364-\$ US-6480558-\$ US-6515960-\$ US-6567383-\$ US-6643281-\$ US-6731673-\$ US-6741578-\$ US-6771706-\$ US-6847678-\$ US-6922388-\$ US-6940827-\$ US-6440372-\$ US-7035663-\$ US-7039001-\$ US-7062002-\$ US-7123934-\$ US-7149239-\$ US-7161985-\$ US-7161987-\$ US-7218666-\$ US-7260054-\$ US-7274652-\$ US-7317931-\$ US-7342974-\$ US-7386055-\$ US-7403556-\$ US-7418042-\$ US-7443829-\$ US-7548506-\$ US-7555268-\$ US-7567624-\$ US-7646747-\$ US-7693032-\$ US-7724720-\$ US-7738437-\$ US-7864725-\$ US-7907592-\$ US-8009660-\$ US-8089887-\$ US-8094611-\$ US-8428009-\$ US-8432891-\$ US-8767522-\$ US-20020159430-\$ US-20050243774-\$).DID.				
S56	128	S55 and (@ad<"20040129" or @pd<"20040129" or @riad<"20040129")	US-PGPUB; USPAT; EPO; JPO;	OR	ON	2020/10/19 14:01

			DERWENT; IBM_TDB			
S57	0	S56 and ((orthogonal near2 frequency near2 division near2 multiple near2 access) or ofdma) and ((sub\$1carrier or sub adj carrier or sub\$1band or sub adj band or carrier or band) near4 (beam\$1form\$3 or beam adj form\$3))	US-PGPUB; USPAT; EPO; JPO; DERWENT; IBM_TDB	OR	ON	2020/10/19 14:05
S66	33	((orthogonal near2 frequency near2 division near2 multiple near2 access) or ofdma) and ((sub\$1carrier or sub adj carrier or sub\$1band or sub adj band or carrier or band or sub\$1channel or sub adj channel) with (cell\$1specific or cell adj specific) with pilot) and (beam\$1form\$3 or beam adj form\$3)	US-PGPUB; USPAT; EPO; JPO; DERWENT; IBM_TDB	OR	ON	2020/10/21 10:51
S67	0	S66 and (@ad<"20040129" or @pd<"20040129" or @rlad<"20040129")	US-PGPUB; USPAT; EPO; JPO; DERWENT; IBM_TDB	OR	ON	2020/10/21 10:52
S68	259	((orthogonal near2 frequency near2 division near2 multiple near2 access) or ofdma) and ((sub\$1carrier or sub adj carrier or sub\$1band or sub adj band or carrier or band or sub\$1channel or sub adj channel) same (cell\$1specific or cell adj specific) same pilot) and (beam\$1form\$3 or beam adj form\$3)	US-PGPUB; USPAT; EPO; JPO; DERWENT; IBM_TDB	OR	ON	2020/10/21 10:52
S69	0	S68 and (@ad<"20040129" or @pd<"20040129" or @rlad<"20040129")	US-PGPUB; USPAT; EPO; JPO; DERWENT; IBM_TDB	OR	ON	2020/10/21 10:53
S70	48	((orthogonal near2 frequency near2 division near2 multiple near2 access) or ofdma) and ((sub\$1carrier or sub adj carrier or sub\$1band or sub adj band or carrier or band or sub\$1channel or sub adj channel) with ((cell) near2 pilot)) and (beam\$1form\$3 or beam adj form\$3)	US-PGPUB; USPAT; EPO; JPO; DERWENT; IBM_TDB	OR	ON	2020/10/21 10:54
S71	16	S70 and (@ad<"20040129" or @pd<"20040129" or @rlad<"20040129")	US-PGPUB; USPAT; EPO; JPO; DERWENT; IBM_TDB	OR	ON	2020/10/21 10:55
S72	32	((orthogonal near2 frequency near2 division near2 multiple near2 access) or	US-PGPUB; USPAT; EPO;	OR	ON	2020/10/21 11:15

		ofdma) and ((sub\$1carrier or sub adj carrier or sub\$1band or sub adj band or carrier or band or sub\$1channel or sub adj channel) with (beam\$1form\$3 or beam adj form\$3)) and ((cell\$1specific or cell adj specific) near2 pilot)	JPO; DERWENT; IBM_TDB			
S73	0	S72 and (@ad<"20040129" or @pd<"20040129" or @rlad<"20040129")	US-PGPUB; USPAT; EPO; JPO; DERWENT; IBM_TDB	OR	ON	2020/10/21 11:16

10/21/2020 5:31:45 PM

C:\Users\oobayanju\Documents\EAST\Workspaces\17012813.wsp

INFORMATION DISCLOSURE STATEMENT BY APPLICANT (Not for submission under 37 CFR 1.99)	Application Number	Not Yet Known
	Filing Date	2020-09-04
	First Named Inventor	Li et al.
	Art Unit	Not Yet Known
	Examiner Name	Not Yet Known
	Attorney Docket Number	NEO-PT008.8

U.S. PATENT DOCUMENTS

EXAMINER INITIAL	DOCUMENT NUMBER	DATE	NAME	CLASS	SUBCLASS	FILING DATE IF APPROPRIATE
	5,825,807	10/1998	Kumar			
	5,867,478	02/1999	Baum et al.			
*	5,909,436	06/1999	Engstrom et al.			
*	6,141,546	10/2000	Thomas			
*	6,434,364	08/2002	O'Riordain			
	6,480,558	11/2002	Ottosson et al.			
	6,515,960	02/2003	Usui et al.			
	6,567,383	05/2003	Bohnke			
	6,643,281	11/2003	Ryan			
	6,731,673	05/2004	Kotov et al.			
	6,741,578	05/2004	Moon et al.			
*	6,771,706	08/2004	Ling et al. ¹			
	6,847,678	01/2005	Berezdivin et al.			
	6,922,388	07/2005	Larota et al.			
	6,940,827	09/2005	Li et al. ²			
	7,035,663	04/2006	Linebarger et al.			
	7,039,001	05/2006	Krishnan et al.			
	7,062,002	06/2006	Michel et al.			
	7,123,934	10/2006	Linebarger et al.			
*	7,149,239	12/2006	Hudson			
	7,161,985	01/2007	Dostert et al.			
	7,161,987	01/2007	Webster et al.			
	7,218,666	05/2007	Baum et al.			
	7,260,054	08/2007	Olszewski			
*	7,274,652	09/2007	Webster et al. ³			
*	7,317,931	01/2008	Guo			

/OMONIYI OBAYANJU/ 10/21/2020

1 Corresponds to KR 2003-0085040

2 Corresponds to WO 02/073831

3 Corresponds to CN 1432245

INFORMATION DISCLOSURE STATEMENT BY APPLICANT (Not for submission under 37 CFR 1.99)	Application Number	Not Yet Known
	Filing Date	2020-09-04
	First Named Inventor	Li et al.
	Art Unit	Not Yet Known
	Examiner Name	Not Yet Known
	Attorney Docket Number	NEO-PT008.8

EXAMINER INITIAL	DOCUMENT NUMBER	DATE	NAME	CLASS	SUBCLASS	FILING DATE IF APPROPRIATE
	7,342,974	03/2008	Chiou			
	7,386,055	06/2008	Morita et al.			
	7,403,556	07/2008	Kao et al.			
	7,418,042	08/2008	Choi et al.4			
	7,443,829	10/2008	Rizvi et al.			
	7,548,506	06/2009	Ma et al.			
	7,555,268	06/2009	Trachewsky et al.			
	7,567,624	07/2009	Schmidl et al.			
	7,646,747	01/2010	Atarashi et al. ⁵			
	7,693,032	04/2010	Li et al.			
	7,724,720	05/2010	Korpela et al.			
	7,738,437	06/2010	Ma			
	7,864,725	01/2011	Li et al.			
	7,907,592	03/2011	Han et al.			
	8,009,660	08/2011	Li et al.			
*	8,089,887	01/2012	Lippman et al.			
*	8,094,611	01/2012	Li et al.			
*	8,428,009	04/2013	Li et al.			
*	8,432,891	04/2013	Li et al.			
*	8,767,522	07/2014	Li et al.			
*	2001/0021182	09/2001	Wakutsu			
*	2001/0242937	09/2013	Li et al.			
*	2002/0141483	10/2002	Doetsch et al.			
	2002/0159422	10/2002	Li et al.			
*	2003/0072255	04/2003	Ma et al.			
	2003/0081538	05/2003	Walton et al.			
*	2003/0179776	09/2003	Sumasu et al. ⁶			
	2004/0085946	05/2004	Morita et al.			

4 Corresponds to US 2005/0243774

/OMONIYI OBAYANJU/

10/21/2020

5 Corresponds to US 2002/0159430

6 Corresponds to CN 1465150

INFORMATION DISCLOSURE STATEMENT BY APPLICANT (Not for submission under 37 CFR 1.99)	Application Number	Not Yet Known
	Filing Date	2020-09-04
	First Named Inventor	Li et al.
	Art Unit	Not Yet Known
	Examiner Name	Not Yet Known
	Attorney Docket Number	NEO-PT008.8

EXAMINER INITIAL	DOCUMENT NUMBER	DATE	NAME	CLASS	SUBCLASS	FILING DATE IF APPROPRIATE
	2004/0171357	09/2004	Lobinger			
*	2004/0264600	12/2004	Kao et al.			
	2005/0111397	05/2005	Attar et al.			
*	2006/0114815	06/2006	Hasegawa			
	2006/0245409	11/2006	Korpela			
*	2008/0304551	12/2008	Li et al.			
	2011/0211617	09/2011	Li et al.			
*	2011/0299474	12/2011	Li et al.			
*	2012/0106513	05/2012	Li et al.			
*	2013/0242937	09/2013	Li et al.			

FOREIGN PATENT DOCUMENTS

EXAMINER INITIAL	DOCUMENT NUMBER	DATE	COUNTRY	CLASS	SUBCLASS	TRANSLATION	
						YES	NO
*	1407745	04/2003	CN				
*	1445949	10/2003	CN				
*	1452326	10/2003	CN				
	1 650 891	04/2006	EP				
	09-233047	09/1997	JP				
	10-210002	08/1998	JP				
	2001-0083789	09/2001	KR				
	2003-0060892	07/2003	KR				
	2009-0040929	04/2009	KR				
*	2003/058881	07/2003	WO ⁷				

OTHER DOCUMENTS

/OMONIYI OBAYANJU/

10/21/2020

7 Corresponds to WO 2003/058887

INFORMATION DISCLOSURE STATEMENT BY APPLICANT (Not for submission under 37 CFR 1.99)	Application Number	Not Yet Known
	Filing Date	2020-09-04
	First Named Inventor	Li et al.
	Art Unit	Not Yet Known
	Examiner Name	Not Yet Known
	Attorney Docket Number	NEO-PT008.8

EXAMINER INITIAL	DESCRIPTION (Including Author, Title, Date, Pertinent Pages, Etc.)
*	EUROPEAN TELECOMMUNICATIONS STANDARDS INSTITUTE, Digital Video Broadcasting (DVB); Framing structure, channel coding and modulation for digital terrestrial television, ETSI EN 300 744 V1.5.1 (June 2004).
	Examination Report, European Application No. 05711777.2, Mail Date October 29, 2012, 6 pages.
	Examination Report, European Application No. 05712825.8, Mail Date August 16, 2012, 6 pages.
*	IEEE Standard for Local and metropolitan area networks; Part 16: Air Interface for Fixed Broadband Wireless Access Systems — Amendment 2: Medium Access Control Modifications and Additional Physical Layer Specifications for 2–11 GHz, IEEE Std. 802.16a-2003 (April 1, 2003).
	International Search Report and Written Opinion for International Application No. PCT/US05/01939, Mail Date 4/26/2005, 7 pages.
	International Search Report and Written Opinion; International Patent Application No. PCT/US05/03518; Filed Jan. 27, 2005; Applicant: WalticalSolutions, Inc.; Mailed: May 23, 2005; 8 pages.
	Supplementary European Search Report, European Application No. 05711777, May 7, 2012, 6 pages.
	Supplementary European Search Report, European Application No. 05712825, March 26, 2012, 4 pages
	Tufvesson, F., et al. "OFDM Time and Frequency Synchronization by Spread Spectrum Pilot Technique," Communication Theory Mini-Conference, Vancouver, B.C., Canada, June 6-10, 1999, pages 115-119.

/OMONIYI OBAYANJU/

10/21/2020

Bibliographic Data

Application No: 17/012,813

Foreign Priority claimed: Yes No

35 USC 119 (a-d) conditions met: Yes No Met After Allowance

Verified and Acknowledged:

/OMONIYI OBAYANJU/

Examiner's Signature

Initials

Title:

METHOD AND APPARATUS USING CELL-SPECIFIC AND COMMON PILOT SUBCARRIERS IN MULTI-CARRIER, MULTI-CELL WIRELESS COMMUNICATION NETWORKS

FILING or 371(c) DATE	CLASS	GROUP ART UNIT	ATTORNEY DOCKET NO.
09/04/2020	370	2645	NEO-PT008.8
RULE			

APPLICANTS

Neo Wireless LLC, Wayne, PA, UNITED STATES

INVENTORS

Xiaodong Li, Kirkland, WA, UNITED STATES

Titus Lo, Bellevue, WA, UNITED STATES

Kemin Li, Bellevue, WA, UNITED STATES

Haiming Huang, Bellevue, WA, UNITED STATES

CONTINUING DATA

This application is a CON of 16440754 06/13/2019

16440754 is a CON of 15688441 08/28/2017 PAT 10326631

15688441 is a CON of 14746676 06/22/2015 PAT 9749168

14746676 is a CON of 14595132 01/12/2015 PAT 9065614

14595132 is a CON of 13874278 04/30/2013 PAT 8934473

13874278 is a CON of 13212116 08/17/2011 PAT 8432891

13212116 is a CON of 10583530 05/30/2007 PAT 8009660

10583530 is a 371 of PCT/US05/01939 01/20/2005

PCT/US05/01939 has PRO of 60540032 01/29/2004

FOREIGN APPLICATIONS

IF REQUIRED, FOREIGN LICENSE GRANTED**

09/15/2020

STATE OR COUNTRY

UNITED STATES

ADDRESS

Volpe Koenig

30 SOUTH 17TH STREET, 18TH FLOOR

PHILADELPHIA, PA 19103

UNITED STATES

FILING FEE RECEIVED

\$7,320

Doc code: IDS
 Doc description: Information Disclosure Statement (IDS) Filed

PTO/SB/08a (02-18)
 Approved for use through 11/30/2020. OMB 0651-0031
 U.S. Patent and Trademark Office; U.S. DEPARTMENT OF COMMERCE
 Under the Paperwork Reduction Act of 1995, no persons are required to respond to a collection of information unless it contains a valid OMB control number.

INFORMATION DISCLOSURE STATEMENT BY APPLICANT (Not for submission under 37 CFR 1.99)	Application Number	17012813
	Filing Date	2020-09-04
	First Named Inventor	Li et al.
	Art Unit	2645
	Examiner Name	Omoniyi Obayanju
	Attorney Docket Number	NEO-PT008.8

U.S.PATENTS						Remove
Examiner Initial*	Cite No	Patent Number	Kind Code ¹	Issue Date	Name of Patentee or Applicant of cited Document	Pages,Columns,Lines where Relevant Passages or Relevant Figures Appear
	1	5828650	A	1998-10-27	Malkamaki et al.	
	2	6175550	B1	2001-01-16	van Nee	
	3	7411897	B2	2008-08-12	Yoo et al.	
	4	7471667	B2	2008-12-30	Hirsch et al.	
	5	7873009	B2	2011-01-18	Larsson et al.	
	6	8102832	B2	2012-01-24	Agrawal et al.	
	7	8363691	B2	2013-01-29	Hasegawa et al.	
If you wish to add additional U.S. Patent citation information please click the Add button.						Add
U.S.PATENT APPLICATION PUBLICATIONS						Remove

**INFORMATION DISCLOSURE
STATEMENT BY APPLICANT**
(Not for submission under 37 CFR 1.99)

Application Number	17012813
Filing Date	2020-09-04
First Named Inventor	Li et al.
Art Unit	2645
Examiner Name	Omoniyi Obayanju
Attorney Docket Number	NEO-PT008.8

Examiner Initial*	Cite No	Publication Number	Kind Code ¹	Publication Date	Name of Patentee or Applicant of cited Document	Pages, Columns, Lines where Relevant Passages or Relevant Figures Appear
	1					

If you wish to add additional U.S. Published Application citation information please click the Add button.

FOREIGN PATENT DOCUMENTS

Examiner Initial*	Cite No	Foreign Document Number ³	Country Code ²	Kind Code ⁴	Publication Date	Name of Patentee or Applicant of cited Document	Pages, Columns, Lines where Relevant Passages or Relevant Figures Appear	T ⁵
	1							

If you wish to add additional Foreign Patent Document citation information please click the Add button.

NON-PATENT LITERATURE DOCUMENTS

Examiner Initials*	Cite No	Include name of the author (in CAPITAL LETTERS), title of the article (when appropriate), title of the item (book, magazine, journal, serial, symposium, catalog, etc), date, pages(s), volume-issue number(s), publisher, city and/or country where published.	T ⁵
	1		

If you wish to add additional non-patent literature document citation information please click the Add button.

EXAMINER SIGNATURE

Examiner Signature	/OMONIYI OBAYANJU/	Date Considered	10/21/2020
--------------------	--------------------	-----------------	------------

*EXAMINER: Initial if reference considered, whether or not citation is in conformance with MPEP 609. Draw line through a citation if not in conformance and not considered. Include copy of this form with next communication to applicant.

¹ See Kind Codes of USPTO Patent Documents at www.USPTO.GOV or MPEP 901.04. ² Enter office that issued the document, by the two-letter code (WIPO Standard ST.3). ³ For Japanese patent documents, the indication of the year of the reign of the Emperor must precede the serial number of the patent document. ⁴ Kind of document by the appropriate symbols as indicated on the document under WIPO Standard ST.16 if possible. ⁵ Applicant is to place a check mark here if English language translation is attached.

INFORMATION DISCLOSURE STATEMENT BY APPLICANT (Not for submission under 37 CFR 1.99)	Application Number		17012813
	Filing Date		2020-09-04
	First Named Inventor	Li et al.	
	Art Unit		2645
	Examiner Name	Omoniyi Obayanju	
	Attorney Docket Number		NEO-PT008.8

CERTIFICATION STATEMENT

Please see 37 CFR 1.97 and 1.98 to make the appropriate selection(s):

That each item of information contained in the information disclosure statement was first cited in any communication from a foreign patent office in a counterpart foreign application not more than three months prior to the filing of the information disclosure statement. See 37 CFR 1.97(e)(1).

OR

That no item of information contained in the information disclosure statement was cited in a communication from a foreign patent office in a counterpart foreign application, and, to the knowledge of the person signing the certification after making reasonable inquiry, no item of information contained in the information disclosure statement was known to any individual designated in 37 CFR 1.56(c) more than three months prior to the filing of the information disclosure statement. See 37 CFR 1.97(e)(2).

See attached certification statement.

The fee set forth in 37 CFR 1.17 (p) has been submitted herewith.

A certification statement is not submitted herewith.

SIGNATURE

A signature of the applicant or representative is required in accordance with CFR 1.33, 10.18. Please see CFR 1.4(d) for the form of the signature.

Signature	/Andrew D. Buschmeier/	Date (YYYY-MM-DD)	2020-10-01
Name/Print	Andrew D. Buschmeier	Registration Number	73,179

This collection of information is required by 37 CFR 1.97 and 1.98. The information is required to obtain or retain a benefit by the public which is to file (and by the USPTO to process) an application. Confidentiality is governed by 35 U.S.C. 122 and 37 CFR 1.14. This collection is estimated to take 1 hour to complete, including gathering, preparing and submitting the completed application form to the USPTO. Time will vary depending upon the individual case. Any comments on the amount of time you require to complete this form and/or suggestions for reducing this burden, should be sent to the Chief Information Officer, U.S. Patent and Trademark Office, U.S. Department of Commerce, P.O. Box 1450, Alexandria, VA 22313-1450. **DO NOT SEND FEES OR COMPLETED FORMS TO THIS ADDRESS. SEND TO: Commissioner for Patents, P.O. Box 1450, Alexandria, VA 22313-1450.**

Privacy Act Statement

The Privacy Act of 1974 (P.L. 93-579) requires that you be given certain information in connection with your submission of the attached form related to a patent application or patent. Accordingly, pursuant to the requirements of the Act, please be advised that: (1) the general authority for the collection of this information is 35 U.S.C. 2(b)(2); (2) furnishing of the information solicited is voluntary; and (3) the principal purpose for which the information is used by the U.S. Patent and Trademark Office is to process and/or examine your submission related to a patent application or patent. If you do not furnish the requested information, the U.S. Patent and Trademark Office may not be able to process and/or examine your submission, which may result in termination of proceedings or abandonment of the application or expiration of the patent.

The information provided by you in this form will be subject to the following routine uses:

1. The information on this form will be treated confidentially to the extent allowed under the Freedom of Information Act (5 U.S.C. 552) and the Privacy Act (5 U.S.C. 552a). Records from this system of records may be disclosed to the Department of Justice to determine whether the Freedom of Information Act requires disclosure of these records.
2. A record from this system of records may be disclosed, as a routine use, in the course of presenting evidence to a court, magistrate, or administrative tribunal, including disclosures to opposing counsel in the course of settlement negotiations.
3. A record in this system of records may be disclosed, as a routine use, to a Member of Congress submitting a request involving an individual, to whom the record pertains, when the individual has requested assistance from the Member with respect to the subject matter of the record.
4. A record in this system of records may be disclosed, as a routine use, to a contractor of the Agency having need for the information in order to perform a contract. Recipients of information shall be required to comply with the requirements of the Privacy Act of 1974, as amended, pursuant to 5 U.S.C. 552a(m).
5. A record related to an International Application filed under the Patent Cooperation Treaty in this system of records may be disclosed, as a routine use, to the International Bureau of the World Intellectual Property Organization, pursuant to the Patent Cooperation Treaty.
6. A record in this system of records may be disclosed, as a routine use, to another federal agency for purposes of National Security review (35 U.S.C. 181) and for review pursuant to the Atomic Energy Act (42 U.S.C. 218(c)).
7. A record from this system of records may be disclosed, as a routine use, to the Administrator, General Services, or his/her designee, during an inspection of records conducted by GSA as part of that agency's responsibility to recommend improvements in records management practices and programs, under authority of 44 U.S.C. 2904 and 2906. Such disclosure shall be made in accordance with the GSA regulations governing inspection of records for this purpose, and any other relevant (i.e., GSA or Commerce) directive. Such disclosure shall not be used to make determinations about individuals.
8. A record from this system of records may be disclosed, as a routine use, to the public after either publication of the application pursuant to 35 U.S.C. 122(b) or issuance of a patent pursuant to 35 U.S.C. 151. Further, a record may be disclosed, subject to the limitations of 37 CFR 1.14, as a routine use, to the public if the record was filed in an application which became abandoned or in which the proceedings were terminated and which application is referenced by either a published application, an application open to public inspections or an issued patent.
9. A record from this system of records may be disclosed, as a routine use, to a Federal, State, or local law enforcement agency, if the USPTO becomes aware of a violation or potential violation of law or regulation.

EAST Search History

EAST Search History (Interference)

Ref #	Hits	Search Query	DBs	Default Operator	Plurals	Time Stamp
L16	1	((((sub\$1carrier or sub adj carrier or sub\$1band or sub adj band or sub\$1channel or sub adj channel)) and pilot and (beam\$1form\$3 or beam adj form\$3)) and (ofdma or (orthogonal near2 frequency near2 division near2 multiple near2 access)) and (time\$1slot or time adj slot) and (data or traffic or user adj plane) and (interfere or interference)).clm.	USPAT	OR	ON	2020/10/21 17:00
L17	0	((((sub\$1carrier or sub adj carrier or sub\$1band or sub adj band or sub\$1channel or sub adj channel)) and pilot and (beam\$1form\$3 or beam adj form\$3)) and (ofdma or (orthogonal near2 frequency near2 division near2 multiple near2 access)) and (time\$1slot or time adj slot) and (data or traffic or user adj plane) and (interfere or interference) and (cell\$1specific or cell adj specific)).clm.	USPAT	OR	ON	2020/10/21 17:02
S58	0	((((sub\$1carrier or sub adj carrier or sub\$1band or sub adj band or sub\$1channel or sub adj channel) same pilot same (beam\$1form\$3 or beam adj form\$3)) and (ofdma) and (time\$1slot or time adj slot)).clm.	USPAT	OR	ON	2020/10/19 13:17
S59	0	((((sub\$1carrier or sub adj carrier or sub\$1band or sub adj band or sub\$1channel or sub adj channel) same pilot and (beam\$1form\$3 or beam adj form\$3)) and (ofdma) and (time\$1slot or time adj slot)).clm.	USPAT	OR	ON	2020/10/19 13:26
S60	0	((((sub\$1carrier or sub adj carrier or sub\$1band or sub adj band or sub\$1channel or sub adj channel) same pilot and (beam\$1form\$3 or beam adj form\$3)) and (ofdma or (orthogonal near2 frequency near2 division near2 multiple near2 access)) and (time\$1slot or time adj slot)).clm.	USPAT	OR	ON	2020/10/19 13:28
S61	1	((((sub\$1carrier or sub adj carrier or sub\$1band or sub adj band or sub\$1channel or sub adj channel) and pilot and (beam\$1form\$3 or beam adj form\$3)) and (ofdma or (orthogonal near2 frequency near2 division near2 multiple near2 access)) and (time\$1slot or time adj slot)).clm.	USPAT	OR	ON	2020/10/19 13:28
S62	1	((((sub\$1carrier or sub adj carrier or sub\$1band or sub adj band or sub\$1channel or sub adj channel) and pilot and (beam\$1form\$3 or beam adj form\$3)) and (ofdma or (orthogonal near2	USPAT	OR	ON	2020/10/19 13:31

		frequency near2 division near2 multiple near2 access)) and (time\$1slot or time adj slot) and (data or traffic or user adj plane)).clm.				
S63	0	((((sub\$1carrier or sub adj carrier or sub\$1band or sub adj band or sub\$1channel or sub adj channel) near2 different) and pilot and (beam\$1form\$3 or beam adj form\$3)) and (ofdma or (orthogonal near2 frequency near2 division near2 multiple near2 access)) and (time\$1slot or time adj slot) and (data or traffic or user adj plane)).clm.	USPAT	OR	ON	2020/10/19 13:51
S64	0	((((sub\$1carrier or sub adj carrier or sub\$1band or sub adj band or sub\$1channel or sub adj channel) near5 different) and pilot and (beam\$1form\$3 or beam adj form\$3)) and (ofdma or (orthogonal near2 frequency near2 division near2 multiple near2 access)) and (time\$1slot or time adj slot) and (data or traffic or user adj plane)).clm.	USPAT	OR	ON	2020/10/19 13:51

10/21/2020 5:32:52 PM

C:\Users\oobayanju\Documents\EAST\Workspaces\17012813.wsp

PATENT

IN THE UNITED STATES PATENT AND TRADEMARK OFFICE

In the **PATENT APPLICATION** of:

Neo Wireless LLC

Application No.: 17/012,813

Confirmation No.: 8746

Filed: September 4, 2020

For: METHOD AND
APPARATUS USING CELL-SPECIFIC AND
COMMON PILOT SUBCARRIERS IN MULTI-
CARRIER, MULTI-CELL WIRELESS
COMMUNICATION NETWORKS

Group: 2645

Examiner: OBAYANJU, OMONIYI

Our File: NEO-PT008.8

Date: November 10, 2020

**AMENDMENT AFTER ALLOWANCE
PURSUANT TO 37 C.F.R. §1.312**

Mail Stop Amendment (via EFS)
Commissioner for Patents
P.O. Box 1450
Alexandria, VA 22313-1450

This amendment is submitted further to the Notice of Allowance dated October 27, 2020 to correct a minor non-substantive formality.

Please amend the application without prejudice or disclaimer as follows:

Electronic Acknowledgement Receipt

EFS ID:	41078970
Application Number:	17012813
International Application Number:	
Confirmation Number:	8746
Title of Invention:	METHOD AND APPARATUS USING CELL-SPECIFIC AND COMMON PILOT SUBCARRIERS IN MULTI-CARRIER, MULTI-CELL WIRELESS COMMUNICATION NETWORKS
First Named Inventor/Applicant Name:	Xiaodong Li
Customer Number:	3624
Filer:	Andrew D. Buschmeier/Justin Slater
Filer Authorized By:	Andrew D. Buschmeier
Attorney Docket Number:	NEO-PT008.8
Receipt Date:	10-NOV-2020
Filing Date:	04-SEP-2020
Time Stamp:	12:24:20
Application Type:	Utility under 35 USC 111(a)

Payment information:

Submitted with Payment	no
------------------------	----

File Listing:

Document Number	Document Description	File Name	File Size(Bytes)/ Message Digest	Multi Part /.zip	Pages (if appl.)
1		NEO-PT008_8-1_312Amendment_EFS-20201110.pdf	130050 f0d6133e9b4aef30c0da2529e7e4d907e8d76128	yes	11

Multipart Description/PDF files in .zip description			
Document Description		Start	End
Applicant Arguments/Remarks Made in an Amendment		10	11
Claims		2	9
Amendment after Notice of Allowance (Rule 312)		1	1

Warnings:

Information:

Total Files Size (in bytes):	130050
-------------------------------------	--------

This Acknowledgement Receipt evidences receipt on the noted date by the USPTO of the indicated documents, characterized by the applicant, and including page counts, where applicable. It serves as evidence of receipt similar to a Post Card, as described in MPEP 503.

New Applications Under 35 U.S.C. 111

If a new application is being filed and the application includes the necessary components for a filing date (see 37 CFR 1.53(b)-(d) and MPEP 506), a Filing Receipt (37 CFR 1.54) will be issued in due course and the date shown on this Acknowledgement Receipt will establish the filing date of the application.

National Stage of an International Application under 35 U.S.C. 371

If a timely submission to enter the national stage of an international application is compliant with the conditions of 35 U.S.C. 371 and other applicable requirements a Form PCT/DO/EO/903 indicating acceptance of the application as a national stage submission under 35 U.S.C. 371 will be issued in addition to the Filing Receipt, in due course.

New International Application Filed with the USPTO as a Receiving Office

If a new international application is being filed and the international application includes the necessary components for an international filing date (see PCT Article 11 and MPEP 1810), a Notification of the International Application Number and of the International Filing Date (Form PCT/RO/105) will be issued in due course, subject to prescriptions concerning national security, and the date shown on this Acknowledgement Receipt will establish the international filing date of the application.

REMARKS

After the foregoing Amendment, claims 1-30 are currently pending in this application. Claim 8 is amended with respect to claim 8 as included in the Examiner's Amendment. Claim 8 as included in the Examiner's amendment did not accurately reflect changes to claim 8 as filed, rather the language of claim 8 as listed in the Examiner's Amendment was actually the language of claim 1. The amendments to claim 8 herein are to correctly fix claim 8 to reflect the method claim as originally filed along with the incorporation of similar changes as were made to the other independent claims in the Examiner's Amendment.

Examiner Interview

Applicant thanks the Examiner for the telephonic interview with the Applicant's representative on October 20, 2020. During the telephonic interview, amendments to the independent claims were discussed. Claim 8 was unintentionally overlooked as a reproduction of claim 1. The Applicant has corrected the claim via the foregoing Amendment.

Conclusion

Applicant submits that no new matter has been introduced into the application by this Amendment, and respectfully requests that this Amendment be entered pursuant to 37 C.F.R. §1.312 and that the application continues to grant.

If the Examiner believes that any additional minor formal matters need to be addressed, the Examiner is invited to contact the undersigned by telephone at the Examiner's convenience.

Respectfully submitted,

Neo Wireless LLC

By /Andrew D. Buschmeier/
Andrew D. Buschmeier
Registration No. 73,179

Volpe Koenig
30 South 17th Street
Philadelphia, PA 19103-4009
Telephone: (215) 568-6400
Facsimile: (215) 568-6499

AB/jrrs

Amendments to the Claims:

This listing of the claims will replace all prior versions of the claims in the application:

1. (previously presented) An orthogonal frequency division multiple access (OFDMA)-compatible base station that uses subcarriers in a frequency domain and time slots in a time domain, the OFDMA-compatible base station comprising:

a plurality of antennas; and

a transmitter operably coupled to the plurality of antennas;

the transmitter configured to:

insert first pilots of a first type onto a first plurality of subcarriers, wherein the first pilots are cell-specific pilots; and

insert data and second pilots of a second type onto a second plurality of subcarriers;

wherein at least some subcarriers of the first plurality of subcarriers or the second plurality of subcarriers are beam-formed; and

the plurality of antennas configured to transmit the first plurality of subcarriers and the second plurality of subcarriers in at least one of the time slots;

wherein the second type is different than the first type and wherein the first pilots do not interfere with the second pilots.

2. (original) The OFDMA-compatible base station of claim 1 wherein all subcarriers of the first plurality of subcarriers are different than all subcarriers of the second plurality of subcarriers.

3. (original) The OFDMA-compatible base station of claim 1 wherein the second plurality of subcarriers includes an n th subcarrier and an $n+18$ subcarrier

spaced apart from the n th subcarrier by 17 subcarriers and the first plurality of subcarriers includes an m th subcarrier and an $m+20$ subcarrier spaced apart from the m th subcarrier by 19 subcarriers.

4. (original) The OFDMA-compatible base station of claim 1 wherein each cell-specific pilot of the cell-specific pilots is unique to a respective cell.

5. (original) The OFDMA-compatible base station of claim 1 wherein the first plurality of subcarriers are not aligned in frequency with subcarriers of at least another cell onto which respective cell-specific pilots are inserted.

6. (original) The OFDMA-compatible base station of claim 1 wherein the second plurality of subcarriers are beam-formed.

7. (original) The OFDMA-compatible base station of claim 1 wherein the cell-specific pilots are used to convey cell-specific information.

8. (currently amended) ~~An orthogonal frequency division multiple access (OFDMA) compatible base station that uses subcarriers in a frequency domain and time slots in a time domain, the OFDMA compatible base station comprising:~~
a plurality of antennas; and
a transmitter operably coupled to the plurality of antennas;
~~the transmitter configured to:~~
—— insert first pilots of a first type onto a first plurality of subcarriers,
~~wherein the first pilots are cell specific pilots; and~~
—— insert data and second pilots of a second type onto a second plurality of subcarriers;

~~wherein at least some subcarriers of the first plurality of subcarriers or the second plurality of subcarriers are beam formed; and~~

~~the plurality of antennas configured to transmit the first plurality of subcarriers and the second plurality of subcarriers in at least one of the time slots;~~

A method performed by an orthogonal frequency division multiple access (OFDMA)-compatible base station that uses subcarriers in a frequency domain and time slots in a time domain, the method comprising:

inserting, by the OFDMA-compatible base station, first pilots of a first type onto a first plurality of subcarriers, wherein the first pilots are cell-specific pilots;

inserting, by the OFDMA-compatible base station, data and second pilots of a second type onto a second plurality of subcarriers;

wherein at least some subcarriers of the first plurality of subcarriers or the second plurality of subcarriers are beam-formed; and

transmitting, by the OFDMA-compatible base station, the first plurality of subcarriers and the second plurality of subcarriers in at least one of the time slots using a plurality of antennas;

wherein the second type is different than the first type and wherein the first pilots do not interfere with the second pilots.

9. (original) The method of claim 8 wherein all subcarriers of the first plurality of subcarriers are different than all subcarriers of the second plurality of subcarriers.

10. (original) The method of claim 8 wherein the second plurality of subcarriers includes an n th subcarrier and an $n+18$ subcarrier spaced apart from the n th subcarrier by 17 subcarriers and the first plurality of subcarriers includes an m th subcarrier and an $m+20$ subcarrier spaced apart from the m th subcarrier by 19 subcarriers.

11. (original) The method of claim 8 wherein each cell-specific pilot of the cell-specific pilots is unique to a respective cell.

12. (original) The method of claim 8 wherein the first plurality of subcarriers are not aligned in frequency with subcarriers of at least another cell onto which respective cell-specific pilots are inserted.

13. (original) The method of claim 8 wherein the second plurality of subcarriers are beam-formed.

14. (original) The method of claim 8 wherein the cell-specific pilots are used to convey cell-specific information.

15. (previously presented) An orthogonal frequency division multiple access (OFDMA)-compatible mobile station that uses subcarriers in a frequency domain and time slots in a time domain, the OFDMA-compatible mobile station comprising:

at least one antenna; and

a receiver; and

the at least one antenna and the receiver are configured to:

receive first pilots of a first type on a first plurality of subcarriers, wherein the first pilots are cell-specific pilots; and

receive second pilots of a second type and data on a second plurality of subcarriers, wherein the first plurality of subcarriers and the second plurality of subcarriers are received in at least one of the time slots;

wherein at least some subcarriers of the first plurality of subcarriers or the second plurality of subcarriers are beam-formed; and

the receiver is further configured to:

recover the data using channel estimates from at least the second pilots; and

recover cell-specific information using the cell-specific pilots;

wherein the second type is different than the first type and wherein the first pilots do not interfere with the second pilots.

16. (original) The OFDMA-compatible mobile station of claim 15 wherein all subcarriers of the first plurality of subcarriers are different than all subcarriers of the second plurality of subcarriers.

17. (original) The OFDMA-compatible mobile station of claim 15 wherein the second plurality of subcarriers includes an n th subcarrier and an $n+18$ subcarrier spaced apart from the n th subcarrier by 17 subcarriers and the first plurality of subcarriers includes an m th subcarrier and an $m+20$ subcarrier spaced apart from the m th subcarrier by 19 subcarriers.

18. (original) The OFDMA-compatible mobile station of claim 15 wherein each cell-specific pilot of the cell-specific pilots is unique to a respective cell.

19. (original) The OFDMA-compatible mobile station of claim 15 wherein the first plurality of subcarriers are transmitted at a same time as the second plurality of subcarriers.

20. (original) The OFDMA-compatible mobile station of claim 15 wherein the second plurality of subcarriers are beam-formed.

21. (original) The OFDMA-compatible mobile station of claim 15 wherein the first plurality of subcarriers are not aligned in frequency with subcarriers of at least another cell onto which respective cell-specific pilots are inserted.

22. (original) The OFDMA-compatible mobile station of claim 15 wherein the receiver is further configured to extract cell-specific information from the cell-specific pilots.

23. (previously presented) A method performed by an orthogonal frequency division multiple access (OFDMA)-compatible mobile station that uses subcarriers in a frequency domain and time slots in a time domain, the method comprising:

receiving first pilots of a first type on a first plurality of subcarriers, wherein the first pilots are cell-specific pilots;

receiving second pilots of a second type and data on a second plurality of subcarriers, wherein the first plurality of subcarriers and the second plurality of subcarriers are received in at least one of the time slots;

wherein at least some subcarriers of the first plurality of subcarriers or the second plurality of subcarriers are beam-formed;

recovering the data using channel estimates from at least the second pilots;
and

recovering cell-specific information using the cell-specific pilots;

wherein the second type is different than the first type and wherein the first pilots do not interfere with the second pilots.

24. (original) The method of claim 23 wherein all subcarriers of the first plurality of subcarriers are different than all subcarriers of the second plurality of subcarriers.

25. (original) The method of claim 23 wherein the second plurality of subcarriers includes an n th subcarrier and an $n+18$ subcarrier spaced apart from the n th subcarrier by 17 subcarriers and the first plurality of subcarriers includes an m th subcarrier and an $m+20$ subcarrier spaced apart from the m th subcarrier by 19 subcarriers.

26. (original) The method of claim 23 wherein each cell-specific pilot of the cell-specific pilots is unique to a respective cell.

27. (original) The method of claim 23 wherein the first plurality of subcarriers are transmitted at a same time as the second plurality of subcarriers.

28. (original) The method of claim 23 wherein the second plurality of subcarriers are beam-formed.

29. (original) The method of claim 23 wherein the first plurality of subcarriers are not aligned in frequency with subcarriers of at least another cell onto which respective cell-specific pilots are inserted.

30. (original) The method of claim 23 further comprising extracting cell-specific information from the cell-specific pilots.



UNITED STATES PATENT AND TRADEMARK OFFICE

UNITED STATES DEPARTMENT OF COMMERCE
United States Patent and Trademark Office
Address: COMMISSIONER FOR PATENTS
P.O. Box 1450
Alexandria, Virginia 22313-1450
www.uspto.gov

Table with 5 columns: APPLICATION NO., FILING DATE, FIRST NAMED INVENTOR, ATTORNEY DOCKET NO., CONFIRMATION NO. Includes details for application 17/012,813 and 3624 7590, listing inventor Xiaodong Li, attorney NEO-PT008.8, examiner OBAYANJU, OMONIYI, art unit 2645, and notification date 12/11/2020.

Please find below and/or attached an Office communication concerning this application or proceeding.

The time period for reply, if any, is set in the attached communication.

Notice of the Office communication was sent electronically on above-indicated "Notification Date" to the following e-mail address(es):

eoffice@volpe-koenig.com

Response to Rule 312 Communication	Application No. 17/012,813	Applicant(s) Li et al.	
	Examiner OMONIYI OBAYANJU	Art Unit 2645	AIA (FITF) Status No

-- The MAILING DATE of this communication appears on the cover sheet with the correspondence address --

1. The amendment filed on 10 November 2020 under 37 CFR 1.312 has been considered, and has been:
- a) entered.
 - b) entered as directed to matters of form not affecting the scope of the invention.
 - c) disapproved because the amendment was filed after the payment of the issue fee.
Any amendment filed after the date the issue fee is paid must be accompanied by a petition under 37 CFR 1.313(c)(1) and the required fee to withdraw the application from issue.
 - d) disapproved. See explanation below.
 - e) entered in part. See explanation below.

/OMONIYI OBAYANJU/
Primary Examiner, Art Unit 2645

PATENT

IN THE UNITED STATES PATENT AND TRADEMARK OFFICE

In the **PATENT APPLICATION** of:

Neo Wireless LLC

Application No.: 17/012,813

Confirmation No.: 8746

Filed: September 4, 2020

For: METHOD AND
APPARATUS USING CELL-SPECIFIC AND
COMMON PILOT SUBCARRIERS IN MULTI-
CARRIER, MULTI-CELL WIRELESS
COMMUNICATION NETWORKS

Group: 2645

Examiner: OBAYANJU, OMONIYI

Our File: NEO-PT008.8

Date: November 10, 2020

**AMENDMENT AFTER ALLOWANCE
PURSUANT TO 37 C.F.R. §1.312**

Mail Stop Amendment (via EFS)
Commissioner for Patents
P.O. Box 1450
Alexandria, VA 22313-1450

This amendment is submitted further to the Notice of Allowance dated October 27, 2020 to correct a minor non-substantive formality.

Please amend the application without prejudice or disclaimer as follows:



UNITED STATES PATENT AND TRADEMARK OFFICE

UNITED STATES DEPARTMENT OF COMMERCE
United States Patent and Trademark Office
Address: COMMISSIONER FOR PATENTS
P.O. Box 1450
Alexandria, Virginia 22313-1450
www.uspto.gov

Table with 4 columns: APPLICATION NUMBER (17/012,813), FILING OR 371(C) DATE (09/04/2020), FIRST NAMED APPLICANT (Xiaodong Li), ATTY. DOCKET NO./TITLE (NEO-PT008.8)

CONFIRMATION NO. 8746

PUBLICATION NOTICE

3624
Volpe Koenig
30 SOUTH 17TH STREET, 18TH FLOOR
PHILADELPHIA, PA 19103



Title:METHOD AND APPARATUS USING CELL-SPECIFIC AND COMMON PILOT SUBCARRIERS IN MULTI-CARRIER, MULTI-CELL WIRELESS COMMUNICATION NETWORKS

Publication No.US-2020-0403838-A1

Publication Date:12/24/2020

NOTICE OF PUBLICATION OF APPLICATION

The above-identified application will be electronically published as a patent application publication pursuant to 37 CFR 1.211, et seq. The patent application publication number and publication date are set forth above.

The publication may be accessed through the USPTO's publically available Searchable Databases via the Internet at www.uspto.gov. The direct link to access the publication is currently http://www.uspto.gov/patft/.

The publication process established by the Office does not provide for mailing a copy of the publication to applicant. A copy of the publication may be obtained from the Office upon payment of the appropriate fee set forth in 37 CFR 1.19(a)(1). Orders for copies of patent application publications are handled by the USPTO's Public Records Division. The Public Records Division can be reached by telephone at (571) 272-3150 or (800) 972-6382, by facsimile at (571) 273-3250, by mail addressed to the United States Patent and Trademark Office, Public Records Division, Alexandria, VA 22313-1450 or via the Internet.

In addition, information on the status of the application, including the mailing date of Office actions and the dates of receipt of correspondence filed in the Office, may also be accessed via the Internet through the Patent Electronic Business Center at www.uspto.gov using the public side of the Patent Application Information and Retrieval (PAIR) system. The direct link to access this status information is currently https://portal.uspto.gov/pair/PublicPair. Prior to publication, such status information is confidential and may only be obtained by applicant using the private side of PAIR.

Further assistance in electronically accessing the publication, or about PAIR, is available by calling the Patent Electronic Business Center at 1-866-217-9197.

Office of Data Management, Application Assistance Unit (571) 272-4000, or (571) 272-4200, or 1-888-786-0101

PART B - FEE(S) TRANSMITTAL

Complete and send this form, together with applicable fee(s), by mail or fax, or via EFS-Web.

By mail, send to: Mail Stop ISSUE FEE
 Commissioner for Patents
 P.O. Box 1450
 Alexandria, Virginia 22313-1450

By fax, send to: (571)-273-2885

INSTRUCTIONS: This form should be used for transmitting the ISSUE FEE and PUBLICATION FEE (if required). Blocks 1 through 5 should be completed where appropriate. All further correspondence including the Patent, advance orders and notification of maintenance fees will be mailed to the current correspondence address as indicated unless corrected below or directed otherwise in Block 1, by (a) specifying a new correspondence address; and/or (b) indicating a separate "FEE ADDRESS" for maintenance fee notifications.

CURRENT CORRESPONDENCE ADDRESS (Note: Use Block 1 for any change of address)

Note: A certificate of mailing can only be used for domestic mailings of the Fee(s) Transmittal. This certificate cannot be used for any other accompanying papers. Each additional paper, such as an assignment or formal drawing, must have its own certificate of mailing or transmission.

3624 7590 10/27/2020
 Volpe Koenig
 30 SOUTH 17TH STREET, 18TH FLOOR
 PHILADELPHIA, PA 19103

Electronically filed on January 27, 2021

APPLICATION NO.	FILING DATE	FIRST NAMED INVENTOR	ATTORNEY DOCKET NO.	CONFIRMATION NO.
17/012,813	09/04/2020	Xiaodong Li	NEO-PT008.8	8746

TITLE OF INVENTION: METHOD AND APPARATUS USING CELL-SPECIFIC AND COMMON PILOT SUBCARRIERS IN MULTI-CARRIER, MULTI-CELL WIRELESS COMMUNICATION NETWORKS

APPLN. TYPE	ENTITY STATUS	ISSUE FEE DUE	PUBLICATION FEE DUE	PREV. PAID ISSUE FEE	TOTAL FEE(S) DUE	DATE DUE
nonprovisional	UNDISCOUNTED	\$1200	\$0.00	\$0.00	\$1200	01/27/2021

EXAMINER	ART UNIT	CLASS-SUBCLASS
OBAYANJU, OMONIYI	2645	370-330000

1. Change of correspondence address or indication of "Fee Address" (37 CFR 1.363).

Change of correspondence address (or Change of Correspondence Address form PTO/SB/122) attached.

"Fee Address" indication (or "Fee Address" Indication form PTO/SB/47; Rev 03-09 or more recent) attached. **Use of a Customer Number is required.**

2. For printing on the patent front page, list

- (1) The names of up to 3 registered patent attorneys or agents OR, alternatively,
- (2) The name of a single firm (having as a member a registered attorney or agent) and the names of up to 2 registered patent attorneys or agents. If no name is listed, no name will be printed.

1 Volpe Koenig
 2 _____
 3 _____

3. ASSIGNEE NAME AND RESIDENCE DATA TO BE PRINTED ON THE PATENT (print or type)

PLEASE NOTE: Unless an assignee is identified below, no assignee data will appear on the patent. If an assignee is identified below, the document must have been previously recorded, or filed for recordation, as set forth in 37 CFR 3.11 and 37 CFR 3.81(a). Completion of this form is NOT a substitute for filing an assignment.

(A) NAME OF ASSIGNEE

(B) RESIDENCE: (CITY and STATE OR COUNTRY)

Neo Wireless LLC

Wayne, PA

Please check the appropriate assignee category or categories (will not be printed on the patent) : Individual Corporation or other private group entity Government

4a. Fees submitted: Issue Fee Publication Fee (if required) Advance Order - # of Copies _____

4b. Method of Payment: (Please first reapply any previously paid fee shown above)

Electronic Payment via EFS-Web Enclosed check Non-electronic payment by credit card (Attach form PTO-2038)

The Director is hereby authorized to charge the required fee(s), any deficiency, or credit any overpayment to Deposit Account No. 22-0493

5. Change in Entity Status (from status indicated above)

- Applicant certifying micro entity status. See 37 CFR 1.29
- Applicant asserting small entity status. See 37 CFR 1.27
- Applicant changing to regular undiscounted fee status.

NOTE: Absent a valid certification of Micro Entity Status (see forms PTO/SB/15A and 15B), issue fee payment in the micro entity amount will not be accepted at the risk of application abandonment.
 NOTE: If the application was previously under micro entity status, checking this box will be taken to be a notification of loss of entitlement to micro entity status.
 NOTE: Checking this box will be taken to be a notification of loss of entitlement to small or micro entity status, as applicable.

NOTE: This form must be signed in accordance with 37 CFR 1.31 and 1.33. See 37 CFR 1.4 for signature requirements and certifications.

Authorized Signature /Andrew D. Buschmeier/
 Typed or printed name Andrew D. Buschmeier

Date January 27, 2021
 Registration No. 73,179

Electronic Patent Application Fee Transmittal

Application Number:	17012813
Filing Date:	04-Sep-2020
Title of Invention:	METHOD AND APPARATUS USING CELL-SPECIFIC AND COMMON PILOT SUBCARRIERS IN MULTI-CARRIER, MULTI-CELL WIRELESS COMMUNICATION NETWORKS
First Named Inventor/Applicant Name:	Xiaodong Li
Filer:	Andrew D. Buschmeier/Margaret Ferello
Attorney Docket Number:	NEO-PT008.8

Filed as Large Entity

Filing Fees for Utility under 35 USC 111(a)

Description	Fee Code	Quantity	Amount	Sub-Total in USD(\$)
Basic Filing:				
Pages:				
Claims:				
Miscellaneous-Filing:				
Petition:				
Patent-Appeals-and-Interference:				
Post-Allowance-and-Post-Issuance:				
UTILITY APPL ISSUE FEE	1501	1	1200	1200

Description	Fee Code	Quantity	Amount	Sub-Total in USD(\$)
Extension-of-Time:				
Miscellaneous:				
Total in USD (\$)				1200

Electronic Acknowledgement Receipt

EFS ID:	41761229
Application Number:	17012813
International Application Number:	
Confirmation Number:	8746
Title of Invention:	METHOD AND APPARATUS USING CELL-SPECIFIC AND COMMON PILOT SUBCARRIERS IN MULTI-CARRIER, MULTI-CELL WIRELESS COMMUNICATION NETWORKS
First Named Inventor/Applicant Name:	Xiaodong Li
Customer Number:	3624
Filer:	Andrew D. Buschmeier/Margaret Ferello
Filer Authorized By:	Andrew D. Buschmeier
Attorney Docket Number:	NEO-PT008.8
Receipt Date:	27-JAN-2021
Filing Date:	04-SEP-2020
Time Stamp:	17:29:33
Application Type:	Utility under 35 USC 111(a)

Payment information:

Submitted with Payment	yes
Payment Type	CARD
Payment was successfully received in RAM	\$1200
RAM confirmation Number	E20211QH30047410
Deposit Account	220493
Authorized User	Margaret Ferello

The Director of the USPTO is hereby authorized to charge indicated fees and credit any overpayment as follows:
37 CFR 1.17 (Patent application and reexamination processing fees)

--	--	--	--	--	--

File Listing:

Document Number	Document Description	File Name	File Size(Bytes)/ Message Digest	Multi Part /.zip	Pages (if appl.)
1	Issue Fee Payment (PTO-85B)	NEO_PT008_8_Issue_Fee_Form_PTOL_85.pdf	153631 5661da3a9b6fa42057b06d3cb26aa2d7a82a6874	no	1

Warnings:

Information:

2	Fee Worksheet (SB06)	fee-info.pdf	30774 96bbaee98a14b1b37964e03a2e88b375de8dac34	no	2
---	----------------------	--------------	---	----	---

Warnings:

Information:

Total Files Size (in bytes):			184405		
-------------------------------------	--	--	--------	--	--

This Acknowledgement Receipt evidences receipt on the noted date by the USPTO of the indicated documents, characterized by the applicant, and including page counts, where applicable. It serves as evidence of receipt similar to a Post Card, as described in MPEP 503.

New Applications Under 35 U.S.C. 111

If a new application is being filed and the application includes the necessary components for a filing date (see 37 CFR 1.53(b)-(d) and MPEP 506), a Filing Receipt (37 CFR 1.54) will be issued in due course and the date shown on this Acknowledgement Receipt will establish the filing date of the application.

National Stage of an International Application under 35 U.S.C. 371

If a timely submission to enter the national stage of an international application is compliant with the conditions of 35 U.S.C. 371 and other applicable requirements a Form PCT/DO/EO/903 indicating acceptance of the application as a national stage submission under 35 U.S.C. 371 will be issued in addition to the Filing Receipt, in due course.

New International Application Filed with the USPTO as a Receiving Office

If a new international application is being filed and the international application includes the necessary components for an international filing date (see PCT Article 11 and MPEP 1810), a Notification of the International Application Number and of the International Filing Date (Form PCT/RO/105) will be issued in due course, subject to prescriptions concerning national security, and the date shown on this Acknowledgement Receipt will establish the international filing date of the application.

REQUEST FOR CONTINUED EXAMINATION(RCE)TRANSMITTAL (Submitted Only via EFS-Web)

Application Number	17012813	Filing Date	2020-09-04	Docket Number (if applicable)	NEO-PT008.8	Art Unit	2645
First Named Inventor	Li et al.			Examiner Name	Omoniyi Obayanju		

This is a Request for Continued Examination (RCE) under 37 CFR 1.114 of the above-identified application.
Request for Continued Examination (RCE) practice under 37 CFR 1.114 does not apply to any utility or plant application filed prior to June 8, 1995, or to any design application. The Instruction Sheet for this form is located at WWW.USPTO.GOV

SUBMISSION REQUIRED UNDER 37 CFR 1.114

Note: If the RCE is proper, any previously filed unentered amendments and amendments enclosed with the RCE will be entered in the order in which they were filed unless applicant instructs otherwise. If applicant does not wish to have any previously filed unentered amendment(s) entered, applicant must request non-entry of such amendment(s).

Previously submitted. If a final Office action is outstanding, any amendments filed after the final Office action may be considered as a submission even if this box is not checked.

Consider the arguments in the Appeal Brief or Reply Brief previously filed on _____

Other _____

Enclosed

Amendment/Reply

Information Disclosure Statement (IDS)

Affidavit(s)/ Declaration(s)

Other

_____ Petition under 37 CFR 1.313(c)(2) to Withdraw from Issue after Payment of the Issue Fee and Petition Fee

MISCELLANEOUS

Suspension of action on the above-identified application is requested under 37 CFR 1.103(c) for a period of months _____
(Period of suspension shall not exceed 3 months; Fee under 37 CFR 1.17(i) required)

Other _____

FEES

The RCE fee under 37 CFR 1.17(e) is required by 37 CFR 1.114 when the RCE is filed.

The Director is hereby authorized to charge any underpayment of fees, or credit any overpayments, to
Deposit Account No 220493

SIGNATURE OF APPLICANT, ATTORNEY, OR AGENT REQUIRED

Patent Practitioner Signature

Applicant Signature

Signature of Registered U.S. Patent Practitioner

Signature	/Andrew D. Buschmeier/	Date (YYYY-MM-DD)	2021-02-08
Name	Andrew D. Buschmeier	Registration Number	73179

This collection of information is required by 37 CFR 1.114. The information is required to obtain or retain a benefit by the public which is to file (and by the USPTO to process) an application. Confidentiality is governed by 35 U.S.C. 122 and 37 CFR 1.11 and 1.14. This collection is estimated to take 12 minutes to complete, including gathering, preparing, and submitting the completed application form to the USPTO. Time will vary depending upon the individual case. Any comments on the amount of time you require to complete this form and/or suggestions for reducing this burden, should be sent to the Chief Information Officer, U.S. Patent and Trademark Office, U.S. Department of Commerce, P.O. Box 1450, Alexandria, VA 22313-1450.

If you need assistance in completing the form, call 1-800-PTO-9199 and select option 2.

Privacy Act Statement

The Privacy Act of 1974 (P.L. 93-579) requires that you be given certain information in connection with your submission of the attached form related to a patent application or patent. Accordingly, pursuant to the requirements of the Act, please be advised that: (1) the general authority for the collection of this information is 35 U.S.C. 2(b)(2); (2) furnishing of the information solicited is voluntary; and (3) the principal purpose for which the information is used by the U.S. Patent and Trademark Office is to process and/or examine your submission related to a patent application or patent. If you do not furnish the requested information, the U.S. Patent and Trademark Office may not be able to process and/or examine your submission, which may result in termination of proceedings or abandonment of the application or expiration of the patent.

The information provided by you in this form will be subject to the following routine uses:

1. The information on this form will be treated confidentially to the extent allowed under the Freedom of Information Act (5 U.S.C. 552) and the Privacy Act (5 U.S.C. 552a). Records from this system of records may be disclosed to the Department of Justice to determine whether the Freedom of Information Act requires disclosure of these records.
2. A record from this system of records may be disclosed, as a routine use, in the course of presenting evidence to a court, magistrate, or administrative tribunal, including disclosures to opposing counsel in the course of settlement negotiations.
3. A record in this system of records may be disclosed, as a routine use, to a Member of Congress submitting a request involving an individual, to whom the record pertains, when the individual has requested assistance from the Member with respect to the subject matter of the record.
4. A record in this system of records may be disclosed, as a routine use, to a contractor of the Agency having need for the information in order to perform a contract. Recipients of information shall be required to comply with the requirements of the Privacy Act of 1974, as amended, pursuant to 5 U.S.C. 552a(m).
5. A record related to an International Application filed under the Patent Cooperation Treaty in this system of records may be disclosed, as a routine use, to the International Bureau of the World Intellectual Property Organization, pursuant to the Patent Cooperation Treaty.
6. A record in this system of records may be disclosed, as a routine use, to another federal agency for purposes of National Security review (35 U.S.C. 181) and for review pursuant to the Atomic Energy Act (42 U.S.C. 218(c)).
7. A record from this system of records may be disclosed, as a routine use, to the Administrator, General Services, or his/her designee, during an inspection of records conducted by GSA as part of that agency's responsibility to recommend improvements in records management practices and programs, under authority of 44 U.S.C. 2904 and 2906. Such disclosure shall be made in accordance with the GSA regulations governing inspection of records for this purpose, and any other relevant (i.e., GSA or Commerce) directive. Such disclosure shall not be used to make determinations about individuals.
8. A record from this system of records may be disclosed, as a routine use, to the public after either publication of the application pursuant to 35 U.S.C. 122(b) or issuance of a patent pursuant to 35 U.S.C. 151. Further, a record may be disclosed, subject to the limitations of 37 CFR 1.14, as a routine use, to the public if the record was filed in an application which became abandoned or in which the proceedings were terminated and which application is referenced by either a published application, an application open to public inspections or an issued patent.
9. A record from this system of records may be disclosed, as a routine use, to a Federal, State, or local law enforcement agency, if the USPTO becomes aware of a violation or potential violation of law or regulation.

IN THE UNITED STATES PATENT AND TRADEMARK OFFICE

In the PATENT APPLICATION of:

Li et al.

Application No.: 17/012,813

Confirmation No.: 8746

Filed: September 4, 2020

**For: METHOD AND APPARATUS USING
CELL-SPECIFIC AND COMMON PILOT
SUBCARRIERS IN MULTI-CARRIER,
MULTI-CELL WIRELESS
COMMUNICATION NETWORKS**

Group: 2645

Examiner: Omoniyi Obayanju

Our File: NEO-PT008.8

Date: February 8, 2021

INFORMATION DISCLOSURE STATEMENT (IDS)

Mail Stop Amendment (via EFS)
Commissioner for Patents
P.O. Box 1450
Alexandria, VA 22313-1450

Sir:

Further to Applicant's Duty of Disclosure pursuant to 37 C.F.R. §1.56, Applicant wishes to bring to the Examiner's attention the material cited on the enclosed PTO Form SB-08. Pursuant to 37 C.F.R. §1.98(a)(2)(ii), copies of the cited U.S. publications and/or patent documents have not been included.

This Application is a continuation of U.S. Patent Application No. 16/440,754, filed June 13, 2019, which is a continuation of U.S. Patent Application No. 15/688,441, filed August 28, 2017, which issued as U.S. Patent No. 10,326,631 on June 18, 2019, which is a continuation of U.S. Patent Application No. 14/746,676, filed June 22, 2015, which issued as U.S. Patent No. 9,749,168 on August 29, 2017, which is a

continuation of U.S. Patent Application No. 14/595,132, filed January 12, 2015, which issued as U.S. Patent No. 9,065,614 on June 23, 2015, which is a continuation of U.S. Patent Application No. 13/874,278, filed April 30, 2013, which issued as U.S. Patent No. 8,934,473 on January 13, 2015, which is a continuation of U.S. Patent Application No. 13/212,116, filed August 17, 2011, which issued as U.S. Patent No. 8,432,891 on April 30, 2013, which is a continuation of U.S. Patent Application No. 10/583,530, filed May 30, 2007, which issued as U.S. Patent No. 8,009,660 on August 30, 2011, which is a U.S. National Stage of PCT Application No. PCT/US05/01939, filed January 20, 2005, which claims the benefit of and priority to U.S. Provisional Patent Application No. 60/540,032, filed on January 29, 2004.

Applicant would like to bring the following Applications to the Examiner's attention: U.S. Patent Application No. 16/908,067, filed June 22, 2020; U.S. Patent Application No. 16/902,740, filed June 16, 2020; U.S. Patent Application No. 15/953,950, filed April 16, 2018, which issued September 8, 2020 as U.S. Patent No. 10,771,302; U.S. Patent Application No. 14/321,615, filed July 1, 2014, which issued April 17, 2018 as U.S. Patent No. 9,948,488; U.S. Patent Application No. 13/861,942, filed April 12, 2013, which issued July 1, 2014 as U.S. Patent No. 8,767,522; U.S. Patent Application No. 13/347,644, filed January 10, 2012, which issued April 23, 2013 as U.S. Patent No. 8,428,009; U.S. Patent Application No. 12/975,226, filed December 21, 2010, which issued January 10, 2012 as U.S. Patent No. 8,094,611; U.S. Patent Application No. 10/583,229, filed August 27, 2008, which issued January 4,

Applicant: Neo Wireless LLC
Application No.: 17/012,813

2011 as U.S. Patent No. 7,864,725; U.S. Provisional Patent Application No. 60/540,586, filed January 30, 2004; and PCT Application No. PCT/US2005/003518, filed January 27, 2005.

It is respectfully requested that the Examiner consider these documents and return an initialed copy of the PTO Form SB-08 indicating consideration of the cited materials.

Respectfully submitted,

Neo Wireless LLC

By /Andrew D. Buschmeier/
Andrew D. Buschmeier
Registration No. 73,179
(215) 568-6400

Volpe Koenig
United Plaza, Suite 1800
30 South 17th Street
Philadelphia, PA 19103

AB/PCK/pf
Enclosure

INFORMATION DISCLOSURE STATEMENT BY APPLICANT (Not for submission under 37 CFR 1.99)	Application Number	17012813
	Filing Date	2020-09-04
	First Named Inventor	Li et al.
	Art Unit	2645
	Examiner Name	Omoniyi Obayanju
	Attorney Docket Number	NEO-PT008.8

U.S.PATENTS						Remove
Examiner Initial*	Cite No	Patent Number	Kind Code ¹	Issue Date	Name of Patentee or Applicant of cited Document	Pages,Columns,Lines where Relevant Passages or Relevant Figures Appear
	1	6188717	B1	2001-02-13	Kaiser et al.	
	2	6882619	B1	2005-04-19	Gerakoulis	
	3	7133352	B1	2006-11-07	Hadad	
	4	7639660	B2	2009-12-29	Kim et al.	
	5	7876716	B2	2011-01-25	Sudo	

If you wish to add additional U.S. Patent citation information please click the Add button. Add

U.S.PATENT APPLICATION PUBLICATIONS						Remove
Examiner Initial*	Cite No	Publication Number	Kind Code ¹	Publication Date	Name of Patentee or Applicant of cited Document	Pages,Columns,Lines where Relevant Passages or Relevant Figures Appear
	1					

If you wish to add additional U.S. Published Application citation information please click the Add button. Add

FOREIGN PATENT DOCUMENTS Remove

INFORMATION DISCLOSURE STATEMENT BY APPLICANT (Not for submission under 37 CFR 1.99)	Application Number		17012813	
	Filing Date		2020-09-04	
	First Named Inventor	Li et al.		
	Art Unit	2645		
	Examiner Name	Omoniyi Obayanju		
	Attorney Docket Number	NEO-PT008.8		

Examiner Initial*	Cite No	Foreign Document Number ³	Country Code ² i	Kind Code ⁴	Publication Date	Name of Patentee or Applicant of cited Document	Pages, Columns, Lines where Relevant Passages or Relevant Figures Appear	T ⁵
	1							

If you wish to add additional Foreign Patent Document citation information please click the Add button

NON-PATENT LITERATURE DOCUMENTS

Examiner Initials*	Cite No	Include name of the author (in CAPITAL LETTERS), title of the article (when appropriate), title of the item (book, magazine, journal, serial, symposium, catalog, etc), date, pages(s), volume-issue number(s), publisher, city and/or country where published.	T ⁵
	1		

If you wish to add additional non-patent literature document citation information please click the Add button

EXAMINER SIGNATURE

Examiner Signature		Date Considered	
--------------------	--	-----------------	--

*EXAMINER: Initial if reference considered, whether or not citation is in conformance with MPEP 609. Draw line through a citation if not in conformance and not considered. Include copy of this form with next communication to applicant.

¹ See Kind Codes of USPTO Patent Documents at www.USPTO.GOV or MPEP 901.04. ² Enter office that issued the document, by the two-letter code (WIPO Standard ST.3). ³ For Japanese patent documents, the indication of the year of the reign of the Emperor must precede the serial number of the patent document. ⁴ Kind of document by the appropriate symbols as indicated on the document under WIPO Standard ST.16 if possible. ⁵ Applicant is to place a check mark here if English language translation is attached.

INFORMATION DISCLOSURE STATEMENT BY APPLICANT (Not for submission under 37 CFR 1.99)	Application Number	17012813
	Filing Date	2020-09-04
	First Named Inventor	Li et al.
	Art Unit	2645
	Examiner Name	Omoniyi Obayanju
	Attorney Docket Number	NEO-PT008.8

CERTIFICATION STATEMENT

Please see 37 CFR 1.97 and 1.98 to make the appropriate selection(s):

That each item of information contained in the information disclosure statement was first cited in any communication from a foreign patent office in a counterpart foreign application not more than three months prior to the filing of the information disclosure statement. See 37 CFR 1.97(e)(1).

OR

That no item of information contained in the information disclosure statement was cited in a communication from a foreign patent office in a counterpart foreign application, and, to the knowledge of the person signing the certification after making reasonable inquiry, no item of information contained in the information disclosure statement was known to any individual designated in 37 CFR 1.56(c) more than three months prior to the filing of the information disclosure statement. See 37 CFR 1.97(e)(2).

See attached certification statement.

The fee set forth in 37 CFR 1.17 (p) has been submitted herewith.

A certification statement is not submitted herewith.

SIGNATURE

A signature of the applicant or representative is required in accordance with CFR 1.33, 10.18. Please see CFR 1.4(d) for the form of the signature.

Signature	/Andrew D. Buschmeier/	Date (YYYY-MM-DD)	2021-02-08
Name/Print	Andrew D. Buschmeier	Registration Number	73,179

This collection of information is required by 37 CFR 1.97 and 1.98. The information is required to obtain or retain a benefit by the public which is to file (and by the USPTO to process) an application. Confidentiality is governed by 35 U.S.C. 122 and 37 CFR 1.14. This collection is estimated to take 1 hour to complete, including gathering, preparing and submitting the completed application form to the USPTO. Time will vary depending upon the individual case. Any comments on the amount of time you require to complete this form and/or suggestions for reducing this burden, should be sent to the Chief Information Officer, U.S. Patent and Trademark Office, U.S. Department of Commerce, P.O. Box 1450, Alexandria, VA 22313-1450. **DO NOT SEND FEES OR COMPLETED FORMS TO THIS ADDRESS. SEND TO: Commissioner for Patents, P.O. Box 1450, Alexandria, VA 22313-1450.**

Privacy Act Statement

The Privacy Act of 1974 (P.L. 93-579) requires that you be given certain information in connection with your submission of the attached form related to a patent application or patent. Accordingly, pursuant to the requirements of the Act, please be advised that: (1) the general authority for the collection of this information is 35 U.S.C. 2(b)(2); (2) furnishing of the information solicited is voluntary; and (3) the principal purpose for which the information is used by the U.S. Patent and Trademark Office is to process and/or examine your submission related to a patent application or patent. If you do not furnish the requested information, the U.S. Patent and Trademark Office may not be able to process and/or examine your submission, which may result in termination of proceedings or abandonment of the application or expiration of the patent.

The information provided by you in this form will be subject to the following routine uses:

1. The information on this form will be treated confidentially to the extent allowed under the Freedom of Information Act (5 U.S.C. 552) and the Privacy Act (5 U.S.C. 552a). Records from this system of records may be disclosed to the Department of Justice to determine whether the Freedom of Information Act requires disclosure of these records.
2. A record from this system of records may be disclosed, as a routine use, in the course of presenting evidence to a court, magistrate, or administrative tribunal, including disclosures to opposing counsel in the course of settlement negotiations.
3. A record in this system of records may be disclosed, as a routine use, to a Member of Congress submitting a request involving an individual, to whom the record pertains, when the individual has requested assistance from the Member with respect to the subject matter of the record.
4. A record in this system of records may be disclosed, as a routine use, to a contractor of the Agency having need for the information in order to perform a contract. Recipients of information shall be required to comply with the requirements of the Privacy Act of 1974, as amended, pursuant to 5 U.S.C. 552a(m).
5. A record related to an International Application filed under the Patent Cooperation Treaty in this system of records may be disclosed, as a routine use, to the International Bureau of the World Intellectual Property Organization, pursuant to the Patent Cooperation Treaty.
6. A record in this system of records may be disclosed, as a routine use, to another federal agency for purposes of National Security review (35 U.S.C. 181) and for review pursuant to the Atomic Energy Act (42 U.S.C. 218(c)).
7. A record from this system of records may be disclosed, as a routine use, to the Administrator, General Services, or his/her designee, during an inspection of records conducted by GSA as part of that agency's responsibility to recommend improvements in records management practices and programs, under authority of 44 U.S.C. 2904 and 2906. Such disclosure shall be made in accordance with the GSA regulations governing inspection of records for this purpose, and any other relevant (i.e., GSA or Commerce) directive. Such disclosure shall not be used to make determinations about individuals.
8. A record from this system of records may be disclosed, as a routine use, to the public after either publication of the application pursuant to 35 U.S.C. 122(b) or issuance of a patent pursuant to 35 U.S.C. 151. Further, a record may be disclosed, subject to the limitations of 37 CFR 1.14, as a routine use, to the public if the record was filed in an application which became abandoned or in which the proceedings were terminated and which application is referenced by either a published application, an application open to public inspections or an issued patent.
9. A record from this system of records may be disclosed, as a routine use, to a Federal, State, or local law enforcement agency, if the USPTO becomes aware of a violation or potential violation of law or regulation.

Electronic Petition Request	PETITION TO WITHDRAW AN APPLICATION FROM ISSUE AFTER PAYMENT OF THE ISSUE FEE UNDER 37 CFR 1.313(c)
Application Number	17012813
Filing Date	04-Sep-2020
First Named Inventor	Xiaodong Li
Art Unit	2645
Examiner Name	OMONIYI OBAYANJU
Attorney Docket Number	NEO-PT008.8
Title	METHOD AND APPARATUS USING CELL-SPECIFIC AND COMMON PILOT SUBCARRIERS IN MULTI-CARRIER, MULTI-CELL WIRELESS COMMUNICATION NETWORKS

An application may be withdrawn from issue for further action upon petition by the applicant. To request that the Office withdraw an application from issue, applicant must file a petition under this section including the fee set forth in § 1.17(h) and a showing of good and sufficient reasons why withdrawal of the application from issue is necessary.

APPLICANT HEREBY PETITIONS TO WITHDRAW THIS APPLICATION FROM ISSUE UNDER 37 CFR 1.313(c).

A grantable petition requires the following items:

- (1) Petition fee; and
- (2) One of the following reasons:
 - (a) Unpatentability of one or more claims, which must be accompanied by an unequivocal statement that one or more claims are unpatentable, an amendment to such claim or claims, and an explanation as to how the amendment causes such claim or claims to be patentable;
 - (b) Consideration of a request for continued examination in compliance with § 1.114 (for a utility or plant application only); or
 - (c) Express abandonment of the application. Such express abandonment may be in favor of a continuing application, but not a CPA under 37 CFR 1.53(d).

Petition Fee

<input type="radio"/> Small Entity
<input type="radio"/> Micro Entity
<input checked="" type="radio"/> Regular Undiscounted

Reason for withdrawal from issue

- One or more claims are unpatentable
- Consideration of a request for continued examination (RCE) (List of Required Documents and Fees)
- Applicant hereby expressly abandons the instant application (any attorney/agent signing for this reason must have power of attorney pursuant to 37 CFR 1.32(b)).

RCE request, submission, and fee.

- I certify, in accordance with 37 CFR 1.4(d)(4) that :
- The RCE request ,submission, and fee have already been filed in the above-identified application on
 - Are attached.

THIS PORTION MUST BE COMPLETED BY THE SIGNATORY OR SIGNATORIES

I certify, in accordance with 37 CFR 1.4(d)(4) that I am:

- An attorney or agent registered to practice before the Patent and Trademark Office who has been given power of attorney in this application.
- An attorney or agent registered to practice before the Patent and Trademark Office, acting in a representative capacity.
- A sole inventor
- A joint inventor; I certify that I am authorized to sign this submission on behalf of all of the inventors as evidenced by the power of attorney in the application
- A joint inventor; all of whom are signing this e-petition

Signature	/Andrew D. Buschmeier/
Name	Andrew D. Buschmeier
Registration Number	73179

Electronic Patent Application Fee Transmittal

Application Number:	17012813			
Filing Date:	04-Sep-2020			
Title of Invention:	METHOD AND APPARATUS USING CELL-SPECIFIC AND COMMON PILOT SUBCARRIERS IN MULTI-CARRIER, MULTI-CELL WIRELESS COMMUNICATION NETWORKS			
First Named Inventor/Applicant Name:	Xiaodong Li			
Filer:	Andrew D. Buschmeier/Margaret Ferello			
Attorney Docket Number:	NEO-PT008.8			
Filed as Large Entity				
Filing Fees for Utility under 35 USC 111(a)				
Description	Fee Code	Quantity	Amount	Sub-Total in USD(\$)
Basic Filing:				
PETITION FEE- 37 CFR 1.17(H) (GROUP III)	1464	1	140	140
RCE- 1ST REQUEST	1801	1	1360	1360
Pages:				
Claims:				
Miscellaneous-Filing:				
Petition:				
Patent-Appeals-and-Interference:				

Description	Fee Code	Quantity	Amount	Sub-Total in USD(\$)
Post-Allowance-and-Post-Issuance:				
Extension-of-Time:				
Miscellaneous:				
Total in USD (\$)			1500	



UNITED STATES PATENT AND TRADEMARK OFFICE

Commissioner for Patents
United States Patent and Trademark Office
P.O. Box 1450
Alexandria, VA 22313-1450
www.uspto.gov

Decision Date : February 8, 2021

In re Application of :

Xiaodong Li

DECISION ON PETITION

UNDER CFR 1.313(c)(2)

Application No : 17012813

Filed : 04-Sep-2020

Attorney Docket No : NEO-PT008.8

This is an electronic decision on the petition under 37 CFR 1.313(c)(2), filed February 8, 2021 , to withdraw the above-identified application from issue after payment of the issue fee.

The petition is **GRANTED**.

The above-identified application is withdrawn from issue for consideration of a submission under 37 CFR 1.114 (request for continued examination). See 37 CFR 1.313(c)(2).

Petitioner is advised that the issue fee paid in this application cannot be refunded. If, however, this application is again allowed, petitioner may request that it be applied towards the issue fee required by the new Notice of Allowance.

Telephone inquiries concerning this decision should be directed to the Patent Electronic Business Center (EBC) at 866-217-9197.

This application file is being referred to Technology Center AU 2645 for processing of the request for continuing examination under 37 CFR 1.114 .

Office of Petitions

Electronic Acknowledgement Receipt

EFS ID:	41866777
Application Number:	17012813
International Application Number:	
Confirmation Number:	8746
Title of Invention:	METHOD AND APPARATUS USING CELL-SPECIFIC AND COMMON PILOT SUBCARRIERS IN MULTI-CARRIER, MULTI-CELL WIRELESS COMMUNICATION NETWORKS
First Named Inventor/Applicant Name:	Xiaodong Li
Customer Number:	3624
Filer:	Andrew D. Buschmeier/Margaret Ferello
Filer Authorized By:	Andrew D. Buschmeier
Attorney Docket Number:	NEO-PT008.8
Receipt Date:	08-FEB-2021
Filing Date:	04-SEP-2020
Time Stamp:	17:31:47
Application Type:	Utility under 35 USC 111(a)

Payment information:

Submitted with Payment	yes
Payment Type	CARD
Payment was successfully received in RAM	\$ 1500
RAM confirmation Number	E202128H31424785
Deposit Account	220493
Authorized User	Margaret Ferello

The Director of the USPTO is hereby authorized to charge indicated fees and credit any overpayment as follows:
37 CFR 1.17 (Patent application and reexamination processing fees)

File Listing:					
Document Number	Document Description	File Name	File Size(Bytes)/ Message Digest	Multi Part /.zip	Pages (if appl.)
1	Request for Continued Examination (RCE)	NEO_PT008_8_RCE.pdf	46195	no	3
			3d6f0518552d55db613bca1f63fca223b1cf0de		
Warnings:					
This is not a USPTO supplied RCE SB30 form.					
Information:					
2	Transmittal Letter	NEO_PT008_8_IDS_Transmittal_Letter.pdf	87635	no	3
			c8a7be0b373d94e5752aece8d58461d0dcfadd67		
Warnings:					
Information:					
3	Information Disclosure Statement (IDS) Form (SB08)	NEO_PT008_8_IDS_Form_SB_08_efs.pdf	1092072	no	4
			2c0bb2f8ab0e49d5aec8bf92dc13af475379502f		
Warnings:					
Information:					
4	Petition automatically granted by EFS	petition-request.pdf	31700	no	2
			467c1f92043de553f127fc1023de3021e379cb16		
Warnings:					
Information:					
5	Fee Worksheet (SB06)	fee-info.pdf	32368	no	2
			e73376179353cdf8236f2438848ddaa6d4191340		
Warnings:					
Information:					
Total Files Size (in bytes):			1289970		

This Acknowledgement Receipt evidences receipt on the noted date by the USPTO of the indicated documents, characterized by the applicant, and including page counts, where applicable. It serves as evidence of receipt similar to a Post Card, as described in MPEP 503.

New Applications Under 35 U.S.C. 111

If a new application is being filed and the application includes the necessary components for a filing date (see 37 CFR 1.53(b)-(d) and MPEP 506), a Filing Receipt (37 CFR 1.54) will be issued in due course and the date shown on this Acknowledgement Receipt will establish the filing date of the application.

National Stage of an International Application under 35 U.S.C. 371

If a timely submission to enter the national stage of an international application is compliant with the conditions of 35 U.S.C. 371 and other applicable requirements a Form PCT/DO/EO/903 indicating acceptance of the application as a national stage submission under 35 U.S.C. 371 will be issued in addition to the Filing Receipt, in due course.

New International Application Filed with the USPTO as a Receiving Office

If a new international application is being filed and the international application includes the necessary components for an international filing date (see PCT Article 11 and MPEP 1810), a Notification of the International Application Number and of the International Filing Date (Form PCT/RO/105) will be issued in due course, subject to prescriptions concerning national security, and the date shown on this Acknowledgement Receipt will establish the international filing date of the application.



UNITED STATES DEPARTMENT OF COMMERCE
United States Patent and Trademark Office
Address: COMMISSIONER FOR PATENTS
P.O. Box 1450
Alexandria, Virginia 22313-1450
www.uspto.gov

NOTICE OF ALLOWANCE AND FEE(S) DUE

3624 7590 02/19/2021
Volpe Koenig
30 SOUTH 17TH STREET, 18TH FLOOR
PHILADELPHIA, PA 19103

Table with 2 columns: EXAMINER (OBAYANJU, OMONIYI), ART UNIT (2645), PAPER NUMBER

DATE MAILED: 02/19/2021

Table with 5 columns: APPLICATION NO. (17/012,813), FILING DATE (09/04/2020), FIRST NAMED INVENTOR (Xiaodong Li), ATTORNEY DOCKET NO. (NEO-PT008.8), CONFIRMATION NO. (8746)

TITLE OF INVENTION: METHOD AND APPARATUS USING CELL-SPECIFIC AND COMMON PILOT SUBCARRIERS IN MULTI-CARRIER, MULTI-CELL WIRELESS COMMUNICATION NETWORKS

Table with 7 columns: APPLN. TYPE (nonprovisional), ENTITY STATUS (UNDISCOUNTED), ISSUE FEE DUE (\$1200), PUBLICATION FEE DUE (\$0.00), PREV. PAID ISSUE FEE (\$1200.00), TOTAL FEE(S) DUE (\$0), DATE DUE (05/19/2021)

THE APPLICATION IDENTIFIED ABOVE HAS BEEN EXAMINED AND IS ALLOWED FOR ISSUANCE AS A PATENT. PROSECUTION ON THE MERITS IS CLOSED. THIS NOTICE OF ALLOWANCE IS NOT A GRANT OF PATENT RIGHTS. THIS APPLICATION IS SUBJECT TO WITHDRAWAL FROM ISSUE AT THE INITIATIVE OF THE OFFICE OR UPON PETITION BY THE APPLICANT. SEE 37 CFR 1.313 AND MPEP 1308.

THE ISSUE FEE AND PUBLICATION FEE (IF REQUIRED) MUST BE PAID WITHIN THREE MONTHS FROM THE MAILING DATE OF THIS NOTICE OR THIS APPLICATION SHALL BE REGARDED AS ABANDONED. THIS STATUTORY PERIOD CANNOT BE EXTENDED. SEE 35 U.S.C. 151. THE ISSUE FEE DUE INDICATED ABOVE DOES NOT REFLECT A CREDIT FOR ANY PREVIOUSLY PAID ISSUE FEE IN THIS APPLICATION. IF AN ISSUE FEE HAS PREVIOUSLY BEEN PAID IN THIS APPLICATION (AS SHOWN ABOVE), THE RETURN OF PART B OF THIS FORM WILL BE CONSIDERED A REQUEST TO REAPPLY THE PREVIOUSLY PAID ISSUE FEE TOWARD THE ISSUE FEE NOW DUE.

HOW TO REPLY TO THIS NOTICE:

I. Review the ENTITY STATUS shown above. If the ENTITY STATUS is shown as SMALL or MICRO, verify whether entitlement to that entity status still applies.

If the ENTITY STATUS is the same as shown above, pay the TOTAL FEE(S) DUE shown above.

If the ENTITY STATUS is changed from that shown above, on PART B - FEE(S) TRANSMITTAL, complete section number 5 titled "Change in Entity Status (from status indicated above)".

For purposes of this notice, small entity fees are 1/2 the amount of undiscounted fees, and micro entity fees are 1/2 the amount of small entity fees.

II. PART B - FEE(S) TRANSMITTAL, or its equivalent, must be completed and returned to the United States Patent and Trademark Office (USPTO) with your ISSUE FEE and PUBLICATION FEE (if required). If you are charging the fee(s) to your deposit account, section "4b" of Part B - Fee(s) Transmittal should be completed and an extra copy of the form should be submitted. If an equivalent of Part B is filed, a request to reapply a previously paid issue fee must be clearly made, and delays in processing may occur due to the difficulty in recognizing the paper as an equivalent of Part B.

III. All communications regarding this application must give the application number. Please direct all communications prior to issuance to Mail Stop ISSUE FEE unless advised to the contrary.

IMPORTANT REMINDER: Maintenance fees are due in utility patents issuing on applications filed on or after Dec. 12, 1980. It is patentee's responsibility to ensure timely payment of maintenance fees when due. More information is available at www.uspto.gov/PatentMaintenanceFees.

PART B - FEE(S) TRANSMITTAL

Complete and send this form, together with applicable fee(s), by mail or fax, or via EFS-Web.

By mail, send to: **Mail Stop ISSUE FEE**
Commissioner for Patents
P.O. Box 1450
Alexandria, Virginia 22313-1450

By fax, send to: **(571)-273-2885**

INSTRUCTIONS: This form should be used for transmitting the **ISSUE FEE** and **PUBLICATION FEE** (if required). Blocks 1 through 5 should be completed where appropriate. All further correspondence including the Patent, advance orders and notification of maintenance fees will be mailed to the current correspondence address as indicated unless corrected below or directed otherwise in Block 1, by (a) specifying a new correspondence address; and/or (b) indicating a separate "FEE ADDRESS" for maintenance fee notifications.

CURRENT CORRESPONDENCE ADDRESS (Note: Use Block 1 for any change of address)

Note: A certificate of mailing can only be used for domestic mailings of the Fee(s) Transmittal. This certificate cannot be used for any other accompanying papers. Each additional paper, such as an assignment or formal drawing, must have its own certificate of mailing or transmission.

3624 7590 02/19/2021
Volpe Koenig
30 SOUTH 17TH STREET, 18TH FLOOR
PHILADELPHIA, PA 19103

Certificate of Mailing or Transmission

I hereby certify that this Fee(s) Transmittal is being deposited with the United States Postal Service with sufficient postage for first class mail in an envelope addressed to the Mail Stop ISSUE FEE address above, or being transmitted to the USPTO via EFS-Web or by facsimile to (571) 273-2885, on the date below.

(Typed or printed name)
(Signature)
(Date)

APPLICATION NO.	FILING DATE	FIRST NAMED INVENTOR	ATTORNEY DOCKET NO.	CONFIRMATION NO.
17/012,813	09/04/2020	Xiaodong Li	NEO-PT008.8	8746

TITLE OF INVENTION: METHOD AND APPARATUS USING CELL-SPECIFIC AND COMMON PILOT SUBCARRIERS IN MULTI-CARRIER, MULTI-CELL WIRELESS COMMUNICATION NETWORKS

APPLN. TYPE	ENTITY STATUS	ISSUE FEE DUE	PUBLICATION FEE DUE	PREV. PAID ISSUE FEE	TOTAL FEE(S) DUE	DATE DUE
nonprovisional	UNDISCOUNTED	\$1200	\$0.00	\$1200.00	\$0	05/19/2021

EXAMINER	ART UNIT	CLASS-SUBCLASS
OBAYANJU, OMONIYI	2645	370-330000

1. Change of correspondence address or indication of "Fee Address" (37 CFR 1.363).

- Change of correspondence address (or Change of Correspondence Address form PTO/SB/122) attached.
- "Fee Address" indication (or "Fee Address" Indication form PTO/SB/47; Rev 03-09 or more recent) attached. **Use of a Customer Number is required.**

2. For printing on the patent front page, list

- (1) The names of up to 3 registered patent attorneys or agents OR, alternatively, 1 _____
- (2) The name of a single firm (having as a member a registered attorney or agent) and the names of up to 2 registered patent attorneys or agents. If no name is listed, no name will be printed. 2 _____
- 3 _____

3. ASSIGNEE NAME AND RESIDENCE DATA TO BE PRINTED ON THE PATENT (print or type)

PLEASE NOTE: Unless an assignee is identified below, no assignee data will appear on the patent. If an assignee is identified below, the document must have been previously recorded, or filed for recordation, as set forth in 37 CFR 3.11 and 37 CFR 3.81(a). Completion of this form is NOT a substitute for filing an assignment.

(A) NAME OF ASSIGNEE _____ (B) RESIDENCE: (CITY and STATE OR COUNTRY) _____

Please check the appropriate assignee category or categories (will not be printed on the patent) : Individual Corporation or other private group entity Government

4a. Fees submitted: Issue Fee Publication Fee (if required) Advance Order - # of Copies _____

4b. Method of Payment: (Please first reapply any previously paid fee shown above)

- Electronic Payment via EFS-Web Enclosed check Non-electronic payment by credit card (Attach form PTO-2038)
- The Director is hereby authorized to charge the required fee(s), any deficiency, or credit any overpayment to Deposit Account No. _____

5. Change in Entity Status (from status indicated above)

- Applicant certifying micro entity status. See 37 CFR 1.29
- Applicant asserting small entity status. See 37 CFR 1.27
- Applicant changing to regular undiscounted fee status.

NOTE: Absent a valid certification of Micro Entity Status (see forms PTO/SB/15A and 15B), issue fee payment in the micro entity amount will not be accepted at the risk of application abandonment.

NOTE: If the application was previously under micro entity status, checking this box will be taken to be a notification of loss of entitlement to micro entity status.

NOTE: Checking this box will be taken to be a notification of loss of entitlement to small or micro entity status, as applicable.

NOTE: This form must be signed in accordance with 37 CFR 1.31 and 1.33. See 37 CFR 1.4 for signature requirements and certifications.

Authorized Signature _____ Date _____

Typed or printed name _____ Registration No. _____



UNITED STATES PATENT AND TRADEMARK OFFICE

UNITED STATES DEPARTMENT OF COMMERCE
United States Patent and Trademark Office
Address: COMMISSIONER FOR PATENTS
P.O. Box 1450
Alexandria, Virginia 22313-1450
www.uspto.gov

Table with columns: APPLICATION NO., FILING DATE, FIRST NAMED INVENTOR, ATTORNEY DOCKET NO., CONFIRMATION NO., EXAMINER, ART UNIT, PAPER NUMBER. Includes application details for Xiaodong Li and examiner OBAYANJU, OMONIYI.

Determination of Patent Term Adjustment under 35 U.S.C. 154 (b)
(Applications filed on or after May 29, 2000)

The Office has discontinued providing a Patent Term Adjustment (PTA) calculation with the Notice of Allowance.

Section 1(h)(2) of the AIA Technical Corrections Act amended 35 U.S.C. 154(b)(3)(B)(i) to eliminate the requirement that the Office provide a patent term adjustment determination with the notice of allowance. See Revisions to Patent Term Adjustment, 78 Fed. Reg. 19416, 19417 (Apr. 1, 2013). Therefore, the Office is no longer providing an initial patent term adjustment determination with the notice of allowance. The Office will continue to provide a patent term adjustment determination with the Issue Notification Letter that is mailed to applicant approximately three weeks prior to the issue date of the patent, and will include the patent term adjustment on the patent. Any request for reconsideration of the patent term adjustment determination (or reinstatement of patent term adjustment) should follow the process outlined in 37 CFR 1.705.

Any questions regarding the Patent Term Extension or Adjustment determination should be directed to the Office of Patent Legal Administration at (571)-272-7702. Questions relating to issue and publication fee payments should be directed to the Customer Service Center of the Office of Patent Publication at 1-(888)-786-0101 or (571)-272-4200.

OMB Clearance and PRA Burden Statement for PTOL-85 Part B

The Paperwork Reduction Act (PRA) of 1995 requires Federal agencies to obtain Office of Management and Budget approval before requesting most types of information from the public. When OMB approves an agency request to collect information from the public, OMB (i) provides a valid OMB Control Number and expiration date for the agency to display on the instrument that will be used to collect the information and (ii) requires the agency to inform the public about the OMB Control Number's legal significance in accordance with 5 CFR 1320.5(b).

The information collected by PTOL-85 Part B is required by 37 CFR 1.311. The information is required to obtain or retain a benefit by the public which is to file (and by the USPTO to process) an application. Confidentiality is governed by 35 U.S.C. 122 and 37 CFR 1.14. This collection is estimated to take 30 minutes to complete, including gathering, preparing, and submitting the completed application form to the USPTO. Time will vary depending upon the individual case. Any comments on the amount of time you require to complete this form and/or suggestions for reducing this burden, should be sent to the Chief Information Officer, U.S. Patent and Trademark Office, U.S. Department of Commerce, P.O. Box 1450, Alexandria, Virginia 22313-1450. DO NOT SEND FEES OR COMPLETED FORMS TO THIS ADDRESS. SEND TO: Commissioner for Patents, P.O. Box 1450, Alexandria, Virginia 22313-1450. Under the Paperwork Reduction Act of 1995, no persons are required to respond to a collection of information unless it displays a valid OMB control number.

Privacy Act Statement

The Privacy Act of 1974 (P.L. 93-579) requires that you be given certain information in connection with your submission of the attached form related to a patent application or patent. Accordingly, pursuant to the requirements of the Act, please be advised that: (1) the general authority for the collection of this information is 35 U.S.C. 2(b)(2); (2) furnishing of the information solicited is voluntary; and (3) the principal purpose for which the information is used by the U.S. Patent and Trademark Office is to process and/or examine your submission related to a patent application or patent. If you do not furnish the requested information, the U.S. Patent and Trademark Office may not be able to process and/or examine your submission, which may result in termination of proceedings or abandonment of the application or expiration of the patent.

The information provided by you in this form will be subject to the following routine uses:

1. The information on this form will be treated confidentially to the extent allowed under the Freedom of Information Act (5 U.S.C. 552) and the Privacy Act (5 U.S.C. 552a). Records from this system of records may be disclosed to the Department of Justice to determine whether disclosure of these records is required by the Freedom of Information Act.
2. A record from this system of records may be disclosed, as a routine use, in the course of presenting evidence to a court, magistrate, or administrative tribunal, including disclosures to opposing counsel in the course of settlement negotiations.
3. A record in this system of records may be disclosed, as a routine use, to a Member of Congress submitting a request involving an individual, to whom the record pertains, when the individual has requested assistance from the Member with respect to the subject matter of the record.
4. A record in this system of records may be disclosed, as a routine use, to a contractor of the Agency having need for the information in order to perform a contract. Recipients of information shall be required to comply with the requirements of the Privacy Act of 1974, as amended, pursuant to 5 U.S.C. 552a(m).
5. A record related to an International Application filed under the Patent Cooperation Treaty in this system of records may be disclosed, as a routine use, to the International Bureau of the World Intellectual Property Organization, pursuant to the Patent Cooperation Treaty.
6. A record in this system of records may be disclosed, as a routine use, to another federal agency for purposes of National Security review (35 U.S.C. 181) and for review pursuant to the Atomic Energy Act (42 U.S.C. 218(c)).
7. A record from this system of records may be disclosed, as a routine use, to the Administrator, General Services, or his/her designee, during an inspection of records conducted by GSA as part of that agency's responsibility to recommend improvements in records management practices and programs, under authority of 44 U.S.C. 2904 and 2906. Such disclosure shall be made in accordance with the GSA regulations governing inspection of records for this purpose, and any other relevant (i.e., GSA or Commerce) directive. Such disclosure shall not be used to make determinations about individuals.
8. A record from this system of records may be disclosed, as a routine use, to the public after either publication of the application pursuant to 35 U.S.C. 122(b) or issuance of a patent pursuant to 35 U.S.C. 151. Further, a record may be disclosed, subject to the limitations of 37 CFR 1.14, as a routine use, to the public if the record was filed in an application which became abandoned or in which the proceedings were terminated and which application is referenced by either a published application, an application open to public inspection or an issued patent.
9. A record from this system of records may be disclosed, as a routine use, to a Federal, State, or local law enforcement agency, if the USPTO becomes aware of a violation or potential violation of law or regulation.

Notice of Allowability	Application No. 17/012,813	Applicant(s) Li et al.	
	Examiner OMONIYI OBAYANJU	Art Unit 2645	AIA (FITF) Status No

-- The MAILING DATE of this communication appears on the cover sheet with the correspondence address--

All claims being allowable, PROSECUTION ON THE MERITS IS (OR REMAINS) CLOSED in this application. If not included herewith (or previously mailed), a Notice of Allowance (PTOL-85) or other appropriate communication will be mailed in due course. **THIS NOTICE OF ALLOWABILITY IS NOT A GRANT OF PATENT RIGHTS.** This application is subject to withdrawal from issue at the initiative of the Office or upon petition by the applicant. See 37 CFR 1.313 and MPEP 1308.

1. This communication is responsive to 02/08/2021.
 A declaration(s)/affidavit(s) under **37 CFR 1.130(b)** was/were filed on _____.
2. An election was made by the applicant in response to a restriction requirement set forth during the interview on _____; the restriction requirement and election have been incorporated into this action.
3. The allowed claim(s) is/are 1-30. As a result of the allowed claim(s), you may be eligible to benefit from the **Patent Prosecution Highway** program at a participating intellectual property office for the corresponding application. For more information, please see http://www.uspto.gov/patents/init_events/pph/index.jsp or send an inquiry to PPHfeedback@uspto.gov.
4. Acknowledgment is made of a claim for foreign priority under 35 U.S.C. § 119(a)-(d) or (f).

Certified copies:

- a) All b) Some *c) None of the:
1. Certified copies of the priority documents have been received.
 2. Certified copies of the priority documents have been received in Application No. _____.
 3. Copies of the certified copies of the priority documents have been received in this national stage application from the International Bureau (PCT Rule 17.2(a)).

* Certified copies not received: _____.

Applicant has THREE MONTHS FROM THE "MAILING DATE" of this communication to file a reply complying with the requirements noted below. Failure to timely comply will result in ABANDONMENT of this application.

THIS THREE-MONTH PERIOD IS NOT EXTENDABLE.

5. CORRECTED DRAWINGS (as "replacement sheets") must be submitted.
 including changes required by the attached Examiner's Amendment / Comment or in the Office action of Paper No./Mail Date _____.
- Identifying indicia such as the application number (see 37 CFR 1.84(c)) should be written on the drawings in the front (not the back) of each sheet. Replacement sheet(s) should be labeled as such in the header according to 37 CFR 1.121(d).**
6. DEPOSIT OF and/or INFORMATION about the deposit of BIOLOGICAL MATERIAL must be submitted. Note the attached Examiner's comment regarding REQUIREMENT FOR THE DEPOSIT OF BIOLOGICAL MATERIAL.

Attachment(s)

- | | |
|---|--|
| 1. <input checked="" type="checkbox"/> Notice of References Cited (PTO-892) | 5. <input type="checkbox"/> Examiner's Amendment/Comment |
| 2. <input checked="" type="checkbox"/> Information Disclosure Statements (PTO/SB/08),
Paper No./Mail Date _____. | 6. <input checked="" type="checkbox"/> Examiner's Statement of Reasons for Allowance |
| 3. <input type="checkbox"/> Examiner's Comment Regarding Requirement for Deposit
of Biological Material _____. | 7. <input type="checkbox"/> Other _____. |
| 4. <input type="checkbox"/> Interview Summary (PTO-413),
Paper No./Mail Date. _____. | |

/OMONIYI OBAYANJU/
Primary Examiner, Art Unit 2645

DETAILED ACTION

Notice of Pre-AIA or AIA Status

The present application is being examined under the pre-AIA first to invent provisions.

Continued Examination Under 37 CFR 1.114

A request for continued examination under 37 CFR 1.114, including the fee set forth in 37 CFR 1.17(e), was filed in this application after allowance or after an Office action under *Ex Parte Quayle*, 25 USPQ 74, 453 O.G. 213 (Comm'r Pat. 1935). Since this application is eligible for continued examination under 37 CFR 1.114, and the fee set forth in 37 CFR 1.17(e) has been timely paid, prosecution in this application has been reopened pursuant to 37 CFR 1.114. Applicant's submission filed on 02/08/2021 has been entered.

Allowable Subject Matter

Claims 1-30 are allowed.

The following is an examiner's statement of reasons for allowance:

The closest prior art of record **Li et al. (US Patent No. 7650152)** discussed the concept of allocating subcarriers in an orthogonal frequency division multiple access (OFDMA), which comprises allocating at least one diversity cluster of subcarriers to a first subscriber and allocating at least one coherence cluster to a second subscriber (**see fig. 1 and abs**). **Li** further discussed the concept that each base station transmits

Art Unit: 2645

pilot symbols simultaneously, and each pilot symbol occupies the entire OFDM frequency bandwidth (**see fig. 2A-C**).

Another close prior art reference **Seki et al. (US Publication No. 20040190598)** discussed the concept of a multicarrier CDMA transmission system, wherein time multiplexer 52 time-multiplexes the pilot of the plurality of symbols to the front of the transmit data. The subcarrier signals S_1 to S_N are multicode multiplexed signals obtained by multiplexing results of spreading the two symbols by respective ones of the orthogonal codes (**see fig. 24, and pp0071**).

However, singly and/or in combination the prior art references does not teach the at least portion of the claim of **an orthogonal frequency division multiple access (OFDMA)-compatible base station** that uses subcarriers in a frequency domain and time slots in a time domain, the OFDMA-compatible base station comprising: a plurality of antennas; and a transmitter operably coupled to the plurality of antennas; the transmitter configured to: **insert first pilots of a first type onto a first plurality of subcarriers, wherein the first pilots are cell-specific pilots; and insert data and second pilots of a second type onto a second plurality of subcarriers; wherein at least some subcarriers of the first plurality of subcarriers or the second plurality of subcarriers are beam-formed; and the plurality of antennas configured to transmit the first plurality of subcarriers and the second plurality of subcarriers in at least one of the time slots; wherein the second type is different than the first type and wherein the first pilots do not interfere with the second pilots.**

Any comments considered necessary by applicant must be submitted no later than the payment of the issue fee and, to avoid processing delays, should preferably accompany the issue fee. Such submissions should be clearly labeled "Comments on Statement of Reasons for Allowance."

Conclusion

Any inquiry concerning this communication or earlier communications from the examiner should be directed to OMONIYI OBAYANJU whose telephone number is (571)270-5885. The examiner can normally be reached on M-Thur 10:30-7pm.

Examiner interviews are available via telephone, in-person, and video conferencing using a USPTO supplied web-based collaboration tool. To schedule an interview, applicant is encouraged to use the USPTO Automated Interview Request (AIR) at <http://www.uspto.gov/interviewpractice>.

If attempts to reach the examiner by telephone are unsuccessful, the examiner's supervisor, ANTHONY S ADDY can be reached on (571) 272-7795. The fax phone number for the organization where this application or proceeding is assigned is 571-273-8300.

Information regarding the status of an application may be obtained from the Patent Application Information Retrieval (PAIR) system. Status information for published applications may be obtained from either Private PAIR or Public PAIR. Status information for unpublished applications is available through Private PAIR only. For more information about the PAIR system, see <https://ppair->

Art Unit: 2645

my.uspto.gov/pair/PrivatePair. Should you have questions on access to the Private PAIR system, contact the Electronic Business Center (EBC) at 866-217-9197 (toll-free). If you would like assistance from a USPTO Customer Service Representative or access to the automated information system, call 800-786-9199 (IN USA OR CANADA) or 571-272-1000.

/OMONIYI OBAYANJU/
Primary Examiner, Art Unit 2645

Notice of References Cited

Application/Control No. 17/012,813	Applicant(s)/Patent Under Reexamination Li et al.	
Examiner OMONIYI OBAYANJU	Art Unit 2645	Page 1 of 1

U.S. PATENT DOCUMENTS

*		Document Number Country Code-Number-Kind Code	Date MM-YYYY	Name	CPC Classification	US Classification
*	A	US-7650152-B2	01-2010	Li; Xiaodong	H04L25/0228	455/452.1
*	B	US-20040190598-A1	09-2004	Seki, Hiroyuki	H04B7/0669	375/141
	C					
	D					
	E					
	F					
	G					
	H					
	I					
	J					
	K					
	L					
	M					

FOREIGN PATENT DOCUMENTS

*		Document Number Country Code-Number-Kind Code	Date MM-YYYY	Country	Name	CPC Classification
	N					
	O					
	P					
	Q					
	R					
	S					
	T					

NON-PATENT DOCUMENTS

*		Include as applicable: Author, Title Date, Publisher, Edition or Volume, Pertinent Pages)
	U	
	V	
	W	
	X	

*A copy of this reference is not being furnished with this Office action. (See MPEP § 707.05(a).)
 Dates in MM-YYYY format are publication dates. Classifications may be US or foreign.

Issue Classification 	Application/Control No. 17/012,813	Applicant(s)/Patent Under Reexamination Li et al.
	Examiner OMONIYI OBAYANJU	Art Unit 2645

CPC					Type	Version
Symbol						
H04L	/	27	/	2637	F	2013-01-01
H04W	/	16	/	02	I	2013-01-01
H04L	/	27	/	2613	I	2013-01-01
H04B	/	1	/	707	I	2013-01-01
H04L	/	5	/	0007	I	2013-01-01
H04L	/	5	/	0028	I	2013-01-01
H04L	/	25	/	03834	I	2013-01-01
H04L	/	27	/	0008	I	2013-01-01
H04L	/	27	/	0012	I	2013-01-01
H04L	/	27	/	2602	I	2013-01-01
H04W	/	72	/	0446	I	2013-01-01
H04B	/	7	/	0413	I	2013-01-01
H04L	/	5	/	0048	I	2013-01-01
H04L	/	27	/	2626	I	2013-01-01
H04J	/	11	/	005	I	2013-01-01
H04L	/	27	/	2646	I	2013-01-01
H04W	/	72	/	044	I	2013-01-01
H04L	/	27	/	2657	A	2013-01-01
H04L	/	5	/	0016	A	2013-01-01
H04L	/	25	/	0228	A	2013-01-01
H04L	/	27	/	2607	A	2013-01-01
H04L	/	27	/	2655	A	2013-01-01

CPC Combination Sets				
Symbol	Type	Set	Ranking	Version
/	/			

NONE	Total Claims Allowed:	
(Assistant Examiner)	(Date)	30
/OMONIYI OBAYANJU/ Primary Examiner, Art Unit 2645	11 February 2021	O.G. Print Claim(s) O.G. Print Figure
(Primary Examiner)	(Date)	1 5

Issue Classification 	Application/Control No. 17/012,813	Applicant(s)/Patent Under Reexamination Li et al.
	Examiner OMONIYI OBAYANJU	Art Unit 2645

INTERNATIONAL CLASSIFICATION			
CLAIMED			
H04W	/	4	/ 00

NON-CLAIMED			
/	/	/	/

US ORIGINAL CLASSIFICATION	
CLASS	SUBCLASS

CROSS REFERENCES(S)						
CLASS	SUBCLASS (ONE SUBCLASS PER BLOCK)					

NONE		Total Claims Allowed:	
(Assistant Examiner)	(Date)	30	
/OMONIYI OBAYANJU/ Primary Examiner, Art Unit 2645	11 February 2021	O.G. Print Claim(s)	O.G. Print Figure
(Primary Examiner)	(Date)	1	5

Issue Classification 	Application/Control No. 17/012,813	Applicant(s)/Patent Under Reexamination Li et al.
	Examiner OMONIYI OBAYANJU	Art Unit 2645

Claims renumbered in the same order as presented by applicant
 CPA
 T.D.
 R.1.47

CLAIMS															
Final	Original	Final	Original	Final	Original	Final	Original	Final	Original	Final	Original	Final	Original	Final	Original
	1		10		19		28								
	2		11		20		29								
	3		12		21		30								
	4		13		22										
	5		14		23										
	6		15		24										
	7		16		25										
	8		17		26										
	9		18		27										

NONE	Total Claims Allowed:	
(Assistant Examiner)	(Date)	30
/OMONIYI OBAYANJU/ Primary Examiner, Art Unit 2645	11 February 2021	O.G. Print Claim(s) O.G. Print Figure
(Primary Examiner)	(Date)	1 5

<i>Search Notes</i> 	Application/Control No. 17/012,813	Applicant(s)/Patent Under Reexamination Li et al.
	Examiner OMONIYI OBAYANJU	Art Unit 2645

CPC - Searched*		
Symbol	Date	Examiner
H04L5/0053	10/21/2020	OO
H04L5/0007	10/21/2020	OO
H04L5/0048	10/21/2020	OO

CPC Combination Sets - Searched*		
Symbol	Date	Examiner

US Classification - Searched*			
Class	Subclass	Date	Examiner

* See search history printout included with this form or the SEARCH NOTES box below to determine the scope of the search.

Search Notes		
Search Notes	Date	Examiner
See Attached East Search History	10/21/2020	OO
See Attached East Search History (Updated)	02/11/2021	OO
Google NPL Search	02/11/2021	OO

--	--

<i>Search Notes</i> 	Application/Control No. 17/012,813	Applicant(s)/Patent Under Reexamination Li et al.
	Examiner OMONIYI OBAYANJU	Art Unit 2645

Interference Search			
US Class/CPC Symbol	US Subclass/CPC Group	Date	Examiner
Same As Above	Same As Above	10/21/2020	OO
Interference Search	East Patent Claim Search	10/21/2020	OO
Interference Search (Updated)	East Patent Claim Search (Updated)	02/11/2021	OO

--	--

EAST Search History

EAST Search History (Prior Art)

Ref #	Hits	Search Query	DBs	Default Operator	Plurals	Time Stamp
L1	11	("6188717" "6882619" "7133352" "7639660" "7876716").PN.	US-PGPUB; USPAT; EPO; JPO; DERWENT; IBM_TDB	OR	ON	2021/02/11 11:21
L2	0	1 and (cell\$1specific or cell adj specific) and (beam\$1form\$3 or beam adj form\$3)	US-PGPUB; USPAT; EPO; JPO; DERWENT; IBM_TDB	OR	ON	2021/02/11 11:21
L3	74,340	((H04L5/0053 OR H04L5/0007 OR H04L5/0048).CPC.)	US-PGPUB; USPAT; EPO; JPO; DERWENT; IBM_TDB	OR	ON	2021/02/11 11:23
L4	106	3 and (((cell\$1specific or cell adj specific) near2 pilot) and (beam\$1form\$3 or beam adj form\$3))	US-PGPUB; USPAT; EPO; JPO; DERWENT; IBM_TDB	OR	ON	2021/02/11 11:24
L10	735	((Li near2 Xiaodong) or (Lo near2 Titus) or (Li near2 Kemin) or (Huang near2 Haiming)).inv.	US-PGPUB; USPAT; EPO; JPO; DERWENT; IBM_TDB	OR	ON	2021/02/11 11:26
L11	4	10 and (((cell\$1specific or cell adj specific) near2 pilot) and (beam\$1form\$3 or beam adj form\$3)).clm.	US-PGPUB; USPAT; EPO; JPO; DERWENT; IBM_TDB	OR	ON	2021/02/11 11:27
L12	145	NEOCIFIC.as.	US-PGPUB; USPAT; EPO; JPO; DERWENT; IBM_TDB	OR	ON	2021/02/11 11:28
L13	16	(WALTICAL near2 SOLUTIONS).as.	US-PGPUB; USPAT; EPO; JPO; DERWENT; IBM_TDB	OR	ON	2021/02/11 11:28
L14	3	12 and (((cell\$1specific or cell adj specific) near2 pilot) and (beam\$1form\$3 or beam adj form\$3)).clm.	US-PGPUB; USPAT; EPO; JPO; DERWENT; IBM_TDB	OR	ON	2021/02/11 11:29
L15	0	13 and (((cell\$1specific or cell adj specific) near2 pilot) and (beam\$1form\$3 or beam adj form\$3)).clm.	US-PGPUB; USPAT; EPO; JPO; DERWENT; IBM_TDB	OR	ON	2021/02/11 11:30

2/11/2021 11:31:06 AM

C:\Users\oobayanju\Documents\EAST\Workspaces\17012813.wsp

Doc code: IDS
 Doc description: Information Disclosure Statement (IDS) Filed

PTO/SB/08a (02-18)
 Approved for use through 11/30/2020. OMB 0651-0031
 U.S. Patent and Trademark Office; U.S. DEPARTMENT OF COMMERCE
 Under the Paperwork Reduction Act of 1995, no persons are required to respond to a collection of information unless it contains a valid OMB control number.

INFORMATION DISCLOSURE STATEMENT BY APPLICANT (Not for submission under 37 CFR 1.99)	Application Number	17012813
	Filing Date	2020-09-04
	First Named Inventor	Li et al.
	Art Unit	2645
	Examiner Name	Omoniyi Obayanju
	Attorney Docket Number	NEO-PT008.8

U.S.PATENTS						Remove
Examiner Initial*	Cite No	Patent Number	Kind Code ¹	Issue Date	Name of Patentee or Applicant of cited Document	Pages,Columns,Lines where Relevant Passages or Relevant Figures Appear
	1	6188717	B1	2001-02-13	Kaiser et al.	
	2	6882619	B1	2005-04-19	Gerakoulis	
	3	7133352	B1	2006-11-07	Hadad	
	4	7639660	B2	2009-12-29	Kim et al.	
	5	7876716	B2	2011-01-25	Sudo	

If you wish to add additional U.S. Patent citation information please click the Add button. Add

U.S.PATENT APPLICATION PUBLICATIONS						Remove
Examiner Initial*	Cite No	Publication Number	Kind Code ¹	Publication Date	Name of Patentee or Applicant of cited Document	Pages,Columns,Lines where Relevant Passages or Relevant Figures Appear
	1					

If you wish to add additional U.S. Published Application citation information please click the Add button. Add

FOREIGN PATENT DOCUMENTS						Remove
--------------------------	--	--	--	--	--	--------

INFORMATION DISCLOSURE STATEMENT BY APPLICANT (Not for submission under 37 CFR 1.99)	Application Number		17012813	
	Filing Date		2020-09-04	
	First Named Inventor	Li et al.		
	Art Unit	2645		
	Examiner Name	Omoniyi Obayanju		
	Attorney Docket Number	NEO-PT008.8		

Examiner Initial*	Cite No	Foreign Document Number ³	Country Code ² i	Kind Code ⁴	Publication Date	Name of Patentee or Applicant of cited Document	Pages, Columns, Lines where Relevant Passages or Relevant Figures Appear	T ⁵
	1							

If you wish to add additional Foreign Patent Document citation information please click the Add button

NON-PATENT LITERATURE DOCUMENTS

Examiner Initials*	Cite No	Include name of the author (in CAPITAL LETTERS), title of the article (when appropriate), title of the item (book, magazine, journal, serial, symposium, catalog, etc), date, pages(s), volume-issue number(s), publisher, city and/or country where published.	T ⁵
	1		

If you wish to add additional non-patent literature document citation information please click the Add button

EXAMINER SIGNATURE

Examiner Signature	/OMONIYI OBAYANJU/	Date Considered	02/11/2021
--------------------	--------------------	-----------------	------------

*EXAMINER: Initial if reference considered, whether or not citation is in conformance with MPEP 609. Draw line through a citation if not in conformance and not considered. Include copy of this form with next communication to applicant.

¹ See Kind Codes of USPTO Patent Documents at www.USPTO.GOV or MPEP 901.04. ² Enter office that issued the document, by the two-letter code (WIPO Standard ST.3). ³ For Japanese patent documents, the indication of the year of the reign of the Emperor must precede the serial number of the patent document. ⁴ Kind of document by the appropriate symbols as indicated on the document under WIPO Standard ST.16 if possible. ⁵ Applicant is to place a check mark here if English language translation is attached.

INFORMATION DISCLOSURE STATEMENT BY APPLICANT (Not for submission under 37 CFR 1.99)	Application Number		17012813
	Filing Date		2020-09-04
	First Named Inventor	Li et al.	
	Art Unit		2645
	Examiner Name	Omoniyi Obayanju	
	Attorney Docket Number		NEO-PT008.8

CERTIFICATION STATEMENT

Please see 37 CFR 1.97 and 1.98 to make the appropriate selection(s):

That each item of information contained in the information disclosure statement was first cited in any communication from a foreign patent office in a counterpart foreign application not more than three months prior to the filing of the information disclosure statement. See 37 CFR 1.97(e)(1).

OR

That no item of information contained in the information disclosure statement was cited in a communication from a foreign patent office in a counterpart foreign application, and, to the knowledge of the person signing the certification after making reasonable inquiry, no item of information contained in the information disclosure statement was known to any individual designated in 37 CFR 1.56(c) more than three months prior to the filing of the information disclosure statement. See 37 CFR 1.97(e)(2).

See attached certification statement.

The fee set forth in 37 CFR 1.17 (p) has been submitted herewith.

A certification statement is not submitted herewith.

SIGNATURE

A signature of the applicant or representative is required in accordance with CFR 1.33, 10.18. Please see CFR 1.4(d) for the form of the signature.

Signature	/Andrew D. Buschmeier/	Date (YYYY-MM-DD)	2021-02-08
Name/Print	Andrew D. Buschmeier	Registration Number	73,179

This collection of information is required by 37 CFR 1.97 and 1.98. The information is required to obtain or retain a benefit by the public which is to file (and by the USPTO to process) an application. Confidentiality is governed by 35 U.S.C. 122 and 37 CFR 1.14. This collection is estimated to take 1 hour to complete, including gathering, preparing and submitting the completed application form to the USPTO. Time will vary depending upon the individual case. Any comments on the amount of time you require to complete this form and/or suggestions for reducing this burden, should be sent to the Chief Information Officer, U.S. Patent and Trademark Office, U.S. Department of Commerce, P.O. Box 1450, Alexandria, VA 22313-1450. **DO NOT SEND FEES OR COMPLETED FORMS TO THIS ADDRESS. SEND TO: Commissioner for Patents, P.O. Box 1450, Alexandria, VA 22313-1450.**

Privacy Act Statement

The Privacy Act of 1974 (P.L. 93-579) requires that you be given certain information in connection with your submission of the attached form related to a patent application or patent. Accordingly, pursuant to the requirements of the Act, please be advised that: (1) the general authority for the collection of this information is 35 U.S.C. 2(b)(2); (2) furnishing of the information solicited is voluntary; and (3) the principal purpose for which the information is used by the U.S. Patent and Trademark Office is to process and/or examine your submission related to a patent application or patent. If you do not furnish the requested information, the U.S. Patent and Trademark Office may not be able to process and/or examine your submission, which may result in termination of proceedings or abandonment of the application or expiration of the patent.

The information provided by you in this form will be subject to the following routine uses:

1. The information on this form will be treated confidentially to the extent allowed under the Freedom of Information Act (5 U.S.C. 552) and the Privacy Act (5 U.S.C. 552a). Records from this system of records may be disclosed to the Department of Justice to determine whether the Freedom of Information Act requires disclosure of these records.
2. A record from this system of records may be disclosed, as a routine use, in the course of presenting evidence to a court, magistrate, or administrative tribunal, including disclosures to opposing counsel in the course of settlement negotiations.
3. A record in this system of records may be disclosed, as a routine use, to a Member of Congress submitting a request involving an individual, to whom the record pertains, when the individual has requested assistance from the Member with respect to the subject matter of the record.
4. A record in this system of records may be disclosed, as a routine use, to a contractor of the Agency having need for the information in order to perform a contract. Recipients of information shall be required to comply with the requirements of the Privacy Act of 1974, as amended, pursuant to 5 U.S.C. 552a(m).
5. A record related to an International Application filed under the Patent Cooperation Treaty in this system of records may be disclosed, as a routine use, to the International Bureau of the World Intellectual Property Organization, pursuant to the Patent Cooperation Treaty.
6. A record in this system of records may be disclosed, as a routine use, to another federal agency for purposes of National Security review (35 U.S.C. 181) and for review pursuant to the Atomic Energy Act (42 U.S.C. 218(c)).
7. A record from this system of records may be disclosed, as a routine use, to the Administrator, General Services, or his/her designee, during an inspection of records conducted by GSA as part of that agency's responsibility to recommend improvements in records management practices and programs, under authority of 44 U.S.C. 2904 and 2906. Such disclosure shall be made in accordance with the GSA regulations governing inspection of records for this purpose, and any other relevant (i.e., GSA or Commerce) directive. Such disclosure shall not be used to make determinations about individuals.
8. A record from this system of records may be disclosed, as a routine use, to the public after either publication of the application pursuant to 35 U.S.C. 122(b) or issuance of a patent pursuant to 35 U.S.C. 151. Further, a record may be disclosed, subject to the limitations of 37 CFR 1.14, as a routine use, to the public if the record was filed in an application which became abandoned or in which the proceedings were terminated and which application is referenced by either a published application, an application open to public inspections or an issued patent.
9. A record from this system of records may be disclosed, as a routine use, to a Federal, State, or local law enforcement agency, if the USPTO becomes aware of a violation or potential violation of law or regulation.



About 373 results

Download with Concepts Slide-by-side

Sort by · Relevance Group by · None Deduplicate by · Family Results / page · 10

Multiple-antenna system for cell-specific and user-specific transmission



WO US CN · US1014917382 · Titus L · Neeffic, Inc
Priority 2005-11-14 · Filed 2016-05-16 · Granted 2018-12-04 · Published 2018-12-04
selecting a plurality of user-specific OFDM subcarriers in the time slot for transmission to a specific mobile device within the cell, wherein a second weight is applied to a user-specific OFDM subcarrier, transmitting control information on the plurality of cell-specific OFDM subcarriers through a ...

Methods and apparatus for multi-carrier, multi-cell wireless communication ...



WO EP US CN KR · EP1712082B1 · Xiaodong Li · Neeffic, Inc.
Priority 2004-01-29 · Filed 2005-01-20 · Granted 2014-11-19 · Published 2014-11-19
where $s_i(t, k)$ denotes a received common pilot subcarrier signal at subcarrier index i and at time index t, k , and $a_{i,m}(t, k)$ and $\phi_{i,m}(t, k)$ denote the signal amplitude and phase, respectively, associated with a common pilot subcarrier at subcarrier index i and at time index t, k transmitted from a ...

Fronthaul evolution: from CPRI to Ethernet

Google Scholar · kar.kent.ac.uk · Gomes N · Optical Fiber Technology
Published 2015

... However, these antennas are used to form beams partly carrying the same data towards an ... The scheduling information has to include additional information about the assigned beam, which is ... 7. The beamforming operation for massive MIMO can be shifted from the BBU/CO to ...

A method for uplink interference coordination on demand basis with cell ...



EP US CN JP KR SF DE ES · KR101223798B1 · 크리스티안 게요프크 게를라흐 · 일파텔 루슨트
Priority 2005-06-15 · Filed 2006-06-05 · Granted 2013-01-17 · Published 2013-01-17
In the case of receive diversity, for example beamforming, interference can only be seen or rarely seen by one interfering mobile terminal, and the base station can also try to avoid the interference. One may attempt to schedule to a less disturbed subset that is in principle the same as the ...

Method for transmitting data in multiple antenna system



WO US KR · KR2009071314A · 곽영수 · 엘지전자 주식회사
Priority 2007-12-16 · Filed 2008-04-29 · Published 2009-07-01
The subcarrier allocated to the terminal and the subcarrier allocated to the terminal are adjacently mapped to at least one of the first pilot pattern region and the second pilot pattern region. A data transmission method in a multiple antenna system, characterized in that a pilot for local ...

Apparatus, method and computer program product providing common pilot channel ...



WO EP US CN KR HK · KR2008023443A · 이카피 광대 · 노키아 코포레이션
Priority 2005-10-07 · Filed 2006-10-06 · Published 2008-06-17
And the pilot power of any one of said first and second frequency bands is different between a first symbol and a second symbol forming a pilot resource. The method of claim 1, At least one pilot resource is allocated at least every eighth sub-carrier The method of claim 1, And the sum of the high ...

Dynamic downlink frequency and power allocation in OFDMA cellular networks

Google Scholar · IEEE Xplore · Lopez Perez D · IEEE Transactions on Communications
Published 2012

... Multiple Input Multiple Output (MIMO) Orthogonal Frequency Division Multiplexing (OFDM) beamforming cellular network ... is not a convex problem, and does not have a closed-form solution ... or coupling among cells) using standardized MRs on cell-specific pilot signals, which ...

A method for uplink interference coordination in single frequency networks, a ...



EP US CN JP KR FR · KR20060120423A · 크리스티안 게요프크 게를라흐 · 일파텔
Priority 2005-06-14 · Filed 2006-06-05 · Published 2006-12-19
In the case of receive diversity, i.e., beamforming, if only interference from one or a small amount of interfering mobile terminals is seen, the base station may also attempt to escape this interference and the adaptive subcarrier You can try to schedule your mobile terminal with a subset that is ...

How to Enable Downlink Transparent Relay in Wireless Communication Networks



WO EP US CN JP KR BR · KR20110044501A · 지영태이 다 · 노요텔 테크놀로지 리미티드
Priority 2008-08-12 · Filed 2009-08-12 · Published 2011-05-02
FIG. 7A shows an SC-FDMA transmitter 700 that includes a DFT logic 702, a subcarrier mapping logic 704, an OFDMA transmit circuit 706, an RF circuit 708, and a transmit antenna 710. 7B illustrates an SC-FDMA receiver 780 that includes an IDFT logic 758, a subcarrier mapping logic 756, an OFDMA ...

A kind of filtering method and relevant apparatus of signal interference

CN · CN103887423B · 任海峰 · 华为技术有限公司

Priority 2014-05-13 • Filed 2014-05-13 • Granted 2017-10-17 • Published 2017-10-17

Methods described is applied to the non-pilot money in the selected region on the symbol comprising cell-specific pilot signal CRS Source unit, according to formula To described When being modified, Off diagonal element keep it is constant, the p be p A p B , the p A With the p B Obtained by base station by ...

Next > About 373 results

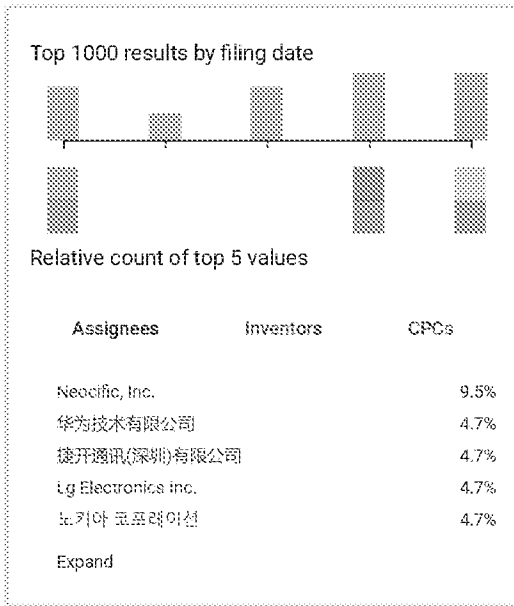

EAST Search History

EAST Search History (Interference)

Ref #	Hits	Search Query	DBs	Default Operator	Plurals	Time Stamp
L5	0	(((sub\$1carrier or sub adj carrier or sub\$1band or sub adj band or sub\$1channel or sub adj channel) same pilot same (beam\$1form\$3 or beam adj form\$3)) and (ofdma) and (time\$1slot or time adj slot)).clm.	USPAT	OR	ON	2021/02/11 11:24
L6	0	(((sub\$1carrier or sub adj carrier or sub\$1band or sub adj band or sub\$1channel or sub adj channel) same pilot and (beam\$1form\$3 or beam adj form\$3)) and (ofdma) and (time\$1slot or time adj slot)).clm.	USPAT	OR	ON	2021/02/11 11:25
L7	0	(((sub\$1carrier or sub adj carrier or sub\$1band or sub adj band or sub\$1channel or sub adj channel) same pilot and (beam\$1form\$3 or beam adj form\$3)) and (ofdma or (orthogonal near2 frequency near2 division near2 multiple near2 access)) and (time\$1slot or time adj slot)).clm.	USPAT	OR	ON	2021/02/11 11:25
L8	0	(((sub\$1carrier or sub adj carrier or sub\$1band or sub adj band or sub\$1channel or sub adj channel) near2 different) and pilot and (beam\$1form\$3 or beam adj form\$3)) and (ofdma or (orthogonal near2 frequency near2 division near2 multiple near2 access)) and (time\$1slot or time adj slot) and (data or traffic or user adj plane)).clm.	USPAT	OR	ON	2021/02/11 11:25
L9	0	(((sub\$1carrier or sub adj carrier or sub\$1band or sub adj band or sub\$1channel or sub adj channel)) and pilot and (beam\$1form\$3 or beam adj form\$3)) and (ofdma or (orthogonal near2 frequency near2 division near2 multiple near2 access)) and (time\$1slot or time adj slot) and (data or traffic or user adj plane) and (interfere or interference) and (cell\$1specific or cell adj specific)).clm.	USPAT	OR	ON	2021/02/11 11:25

2/11/2021 11:31:24 AM

C:\Users\oobayanju\Documents\EAST\Workspaces\17012813.wsp

ILW

Complete and send this form, together with applicable fee(s), by mail or fax, or via EFS-Web.

By mail, send to: Mail Stop ISSUE FEE
Commissioner for Patents
P.O. Box 1450
Alexandria, Virginia 22313-1450

By fax, send to: (571)-273-2885

INSTRUCTIONS: This form should be used for transmitting the ISSUE FEE and PUBLICATION FEE (if required). Blocks 1 through 5 should be completed where appropriate. All further correspondence including the Patent, advance orders and notification of maintenance fees will be mailed to the current correspondence address as indicated unless corrected below or directed otherwise in Block 1, by (a) specifying a new correspondence address; and/or (b) indicating a separate "FEE ADDRESS" for maintenance fee notifications.

CURRENT CORRESPONDENCE ADDRESS (Note: Use Block 1 for any change of address)

3624 7590 02/19/2021
Volpe Koenig
30 SOUTH 17TH STREET, 18TH FLOOR
PHILADELPHIA, PA 19103

Note: A certificate of mailing can only be used for domestic mailings of the Fee(s) Transmittal. This certificate cannot be used for any other accompanying papers. Each additional paper, such as an assignment or formal drawing, must have its own certificate of mailing or transmission.

Certificate of Mailing or Transmission

I hereby certify that this Fee(s) Transmittal is being deposited with the United States Postal Service with sufficient postage for first class mail in an envelope addressed to the Mail Stop ISSUE FEE address above, or being transmitted to the USPTO via EFS-Web or by facsimile to (571) 273-2885, on the date below.

_____	(Typed or printed name)
_____	(Signature)
_____	(Date)

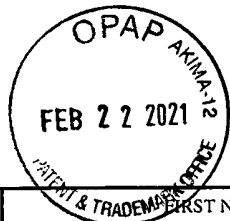

APPLICATION NO.	FILING DATE	FIRST NAMED INVENTOR	ATTORNEY DOCKET NO.	CONFIRMATION NO.
17/012,813	09/04/2020	Xiaodong Li	NEO-PT008.8	8746

TITLE OF INVENTION: METHOD AND APPARATUS USING CELL-SPECIFIC AND COMMON PILOT SUBCARRIERS IN MULTI-CARRIER, MULTI-CELL WIRELESS COMMUNICATION NETWORKS

APPLN. TYPE	ENTITY STATUS	ISSUE FEE DUE	PUBLICATION FEE DUE	PREV. PAID ISSUE FEE	TOTAL FEE(S) DUE	DATE DUE
nonprovisional	UNDISCOUNTED	\$1200	\$0.00	\$1200.00	\$0	05/19/2021

EXAMINER	ART UNIT	CLASS-SUBCLASS
OBAYANJU, OMONIYI	2645	370-330000

1. Change of correspondence address or indication of "Fee Address" (37 CFR 1.363).
 Change of correspondence address (or Change of Correspondence Address form PTO/SB/122) attached.
 "Fee Address" indication (or "Fee Address" Indication form PTO/SB/47; Rev 03-09 or more recent) attached. **Use of a Customer Number is required.**

2. For printing on the patent front page, list
(1) The names of up to 3 registered patent attorneys or agents OR, alternatively, 1 Volpe Koenig
(2) The name of a single firm (having as a member a registered attorney or agent) and the names of up to 2 registered patent attorneys or agents. If no name is listed, no name will be printed. 2 _____
3 _____

3. ASSIGNEE NAME AND RESIDENCE DATA TO BE PRINTED ON THE PATENT (print or type)
PLEASE NOTE: Unless an assignee is identified below, no assignee data will appear on the patent. If an assignee is identified below, the document must have been previously recorded, or filed for recordation, as set forth in 37 CFR 3.11 and 37 CFR 3.81(a). Completion of this form is NOT a substitute for filing an assignment.

(A) NAME OF ASSIGNEE: NEO WIRELESS LLC
(B) RESIDENCE: (CITY and STATE OR COUNTRY): WAYNE, PENNSYLVANIA

Please check the appropriate assignee category or categories (will not be printed on the patent): Individual Corporation or other private group entity Government

4a. Fees submitted: Issue Fee Publication Fee (if required) Advance Order - # of Copies _____
4b. Method of Payment: (Please first reapply any previously paid fee shown above)
 Electronic Payment via EFS-Web Enclosed check Non-electronic payment by credit card (Attach form PTO-2038)
 The Director is hereby authorized to charge the required fee(s), any deficiency, or credit any overpayment to Deposit Account No. 22-0493

5. Change in Entity Status (from status indicated above)
 Applicant certifying micro entity status. See 37 CFR 1.29
 Applicant asserting small entity status. See 37 CFR 1.27
 Applicant changing to regular undiscounted fee status.
NOTE: Absent a valid certification of Micro Entity Status (see forms PTO/SB/15A and 15B), issue fee payment in the micro entity amount will not be accepted at the risk of application abandonment.
NOTE: If the application was previously under micro entity status, checking this box will be taken to be a notification of loss of entitlement to micro entity status.
NOTE: Checking this box will be taken to be a notification of loss of entitlement to small or micro entity status, as applicable.

NOTE: This form must be signed in accordance with 37 CFR 1.31 and 1.33. See 37 CFR 1.4 for signature requirements and certifications.
Authorized Signature /Andrew D. Buschmeier/ Date February 22, 2021
Typed or printed name Andrew D. Buschmeier Registration No. 73,179

PATENT

IN THE UNITED STATES PATENT AND TRADEMARK OFFICE

In the **PATENT APPLICATION** of:

Neo Wireless LLC

Application No.: 17/012,813

Confirmation No.: 8746

Filed: September 4, 2020

For: METHOD AND
APPARATUS USING CELL-SPECIFIC AND
COMMON PILOT SUBCARRIERS IN MULTI-
CARRIER, MULTI-CELL WIRELESS
COMMUNICATION NETWORKS

Group: 2645

Examiner: OBAYANJU, OMONIYI

Our File: NEO-PT008.8

Date: February 22, 2021

TRANSMITTAL REGARDING ISSUE FEE PAYMENT

Mail Stop Amendment (via EFS)
Commissioner for Patents
P.O. Box 1450
Alexandria, VA 22313-1450

Applicant submits that the Issue Fee Payment in this matter was paid on January 27, 2021 (EFS ID: 41761229). On February 8, 2021 an RCE was filed for submission of additional IDS references. The submission of this Issue Fee Payment is after consideration of those references by the Examiner.

Applicant: Neo Wireless LLC
Application No.: 17/012,813

If the Examiner believes that any additional information is needed, the Examiner is invited to contact the undersigned by telephone at the Examiner's convenience.

Respectfully submitted,

Neo Wireless LLC

By /Andrew D. Buschmeier/
Andrew D. Buschmeier
Registration No. 73,179

Volpe Koenig
30 South 17th Street
Philadelphia, PA 19103-4009
Telephone: (215) 568-6400
Facsimile: (215) 568-6499

AB/jmm

Electronic Acknowledgement Receipt

EFS ID:	41981826
Application Number:	17012813
International Application Number:	
Confirmation Number:	8746
Title of Invention:	METHOD AND APPARATUS USING CELL-SPECIFIC AND COMMON PILOT SUBCARRIERS IN MULTI-CARRIER, MULTI-CELL WIRELESS COMMUNICATION NETWORKS
First Named Inventor/Applicant Name:	Xiaodong Li
Customer Number:	3624
Filer:	Andrew D. Buschmeier/Joann Miceli
Filer Authorized By:	Andrew D. Buschmeier
Attorney Docket Number:	NEO-PT008.8
Receipt Date:	22-FEB-2021
Filing Date:	04-SEP-2020
Time Stamp:	15:48:29
Application Type:	Utility under 35 USC 111(a)

Payment information:

Submitted with Payment	no
------------------------	----

File Listing:

Document Number	Document Description	File Name	File Size(Bytes)/ Message Digest	Multi Part /.zip	Pages (if appl.)
1	Issue Fee Payment (PTO-85B)	NEO_PT008_8_Issue_Fee_EFS.pdf	197119 6325dd33cad511fc1bd8924f24623eb9390f2737	no	1

Warnings:

Information:					
2	Miscellaneous Incoming Letter	NEO_PT008_8_Misc_Transmittal_EFS.pdf	82884	no	2
			db3937034352d65cc8236699d64404824721b9ab		
Warnings:					
Information:					
Total Files Size (in bytes):				280003	
<p>This Acknowledgement Receipt evidences receipt on the noted date by the USPTO of the indicated documents, characterized by the applicant, and including page counts, where applicable. It serves as evidence of receipt similar to a Post Card, as described in MPEP 503.</p> <p><u>New Applications Under 35 U.S.C. 111</u> If a new application is being filed and the application includes the necessary components for a filing date (see 37 CFR 1.53(b)-(d) and MPEP 506), a Filing Receipt (37 CFR 1.54) will be issued in due course and the date shown on this Acknowledgement Receipt will establish the filing date of the application.</p> <p><u>National Stage of an International Application under 35 U.S.C. 371</u> If a timely submission to enter the national stage of an international application is compliant with the conditions of 35 U.S.C. 371 and other applicable requirements a Form PCT/DO/EO/903 indicating acceptance of the application as a national stage submission under 35 U.S.C. 371 will be issued in addition to the Filing Receipt, in due course.</p> <p><u>New International Application Filed with the USPTO as a Receiving Office</u> If a new international application is being filed and the international application includes the necessary components for an international filing date (see PCT Article 11 and MPEP 1810), a Notification of the International Application Number and of the International Filing Date (Form PCT/RO/105) will be issued in due course, subject to prescriptions concerning national security, and the date shown on this Acknowledgement Receipt will establish the international filing date of the application.</p>					

PART B - FEE(S) TRANSMITTAL

Complete and send this form, together with applicable fee(s), by mail or fax, or via EFS-Web.

By mail, send to: **Mail Stop ISSUE FEE**
Commissioner for Patents
P.O. Box 1450
Alexandria, Virginia 22313-1450

By fax, send to: **(571)-273-2885**

INSTRUCTIONS: This form should be used for transmitting the **ISSUE FEE** and **PUBLICATION FEE** (if required). Blocks 1 through 5 should be completed where appropriate. All further correspondence including the Patent, advance orders and notification of maintenance fees will be mailed to the current correspondence address as indicated unless corrected below or directed otherwise in Block 1, by (a) specifying a new correspondence address; and/or (b) indicating a separate "FEE ADDRESS" for maintenance fee notifications.

CURRENT CORRESPONDENCE ADDRESS (Note: Use Block 1 for any change of address)

Note: A certificate of mailing can only be used for domestic mailings of the Fee(s) Transmittal. This certificate cannot be used for any other accompanying papers. Each additional paper, such as an assignment or formal drawing, must have its own certificate of mailing or transmission.

3624 7590 02/19/2021
Volpe Koenig
30 SOUTH 17TH STREET, 18TH FLOOR
PHILADELPHIA, PA 19103

Certificate of Mailing or Transmission

I hereby certify that this Fee(s) Transmittal is being deposited with the United States Postal Service with sufficient postage for first class mail in an envelope addressed to the Mail Stop ISSUE FEE address above, or being transmitted to the USPTO via EFS-Web or by facsimile to (571) 273-2885, on the date below.

_____ (Typed or printed name)
_____ (Signature)
_____ (Date)

APPLICATION NO.	FILING DATE	FIRST NAMED INVENTOR	ATTORNEY DOCKET NO.	CONFIRMATION NO.
17/012,813	09/04/2020	Xiaodong Li	NEO-PT008.8	8746

TITLE OF INVENTION: METHOD AND APPARATUS USING CELL-SPECIFIC AND COMMON PILOT SUBCARRIERS IN MULTI-CARRIER, MULTI-CELL WIRELESS COMMUNICATION NETWORKS

APPLN. TYPE	ENTITY STATUS	ISSUE FEE DUE	PUBLICATION FEE DUE	PREV. PAID ISSUE FEE	TOTAL FEE(S) DUE	DATE DUE
nonprovisional	UNDISCOUNTED	\$1200	\$0.00	\$1200.00	\$0	05/19/2021

EXAMINER	ART UNIT	CLASS-SUBCLASS
OBAYANJU, OMONIYI	2645	370-330000

1. Change of correspondence address or indication of "Fee Address" (37 CFR 1.363).

- Change of correspondence address (or Change of Correspondence Address form PTO/SB/122) attached.
- "Fee Address" indication (or "Fee Address" Indication form PTO/SB/47; Rev 03-09 or more recent) attached. **Use of a Customer Number is required.**

2. For printing on the patent front page, list

- (1) The names of up to 3 registered patent attorneys or agents OR, alternatively, _____ 1 **Volpe Koenig**
- (2) The name of a single firm (having as a member a registered attorney or agent) and the names of up to 2 registered patent attorneys or agents. If no name is listed, no name will be printed. _____ 2
- _____ 3

3. ASSIGNEE NAME AND RESIDENCE DATA TO BE PRINTED ON THE PATENT (print or type)

PLEASE NOTE: Unless an assignee is identified below, no assignee data will appear on the patent. If an assignee is identified below, the document must have been previously recorded, or filed for recordation, as set forth in 37 CFR 3.11 and 37 CFR 3.81(a). Completion of this form is NOT a substitute for filing an assignment.

(A) NAME OF ASSIGNEE **NEO WIRELESS LLC**

(B) RESIDENCE: (CITY and STATE OR COUNTRY) **WAYNE, PENNSYLVANIA**

Please check the appropriate assignee category or categories (will not be printed on the patent) : Individual Corporation or other private group entity Government

4a. Fees submitted: Issue Fee Publication Fee (if required) Advance Order - # of Copies _____

4b. Method of Payment: (Please first reapply any previously paid fee shown above)

- Electronic Payment via EFS-Web Enclosed check Non-electronic payment by credit card (Attach form PTO-2038)
- The Director is hereby authorized to charge the required fee(s), any deficiency, or credit any overpayment to Deposit Account No. **22-0493**

5. Change in Entity Status (from status indicated above)

- Applicant certifying micro entity status. See 37 CFR 1.29
- Applicant asserting small entity status. See 37 CFR 1.27
- Applicant changing to regular undiscounted fee status.

NOTE: Absent a valid certification of Micro Entity Status (see forms PTO/SB/15A and 15B), issue fee payment in the micro entity amount will not be accepted at the risk of application abandonment.

NOTE: If the application was previously under micro entity status, checking this box will be taken to be a notification of loss of entitlement to micro entity status.

NOTE: Checking this box will be taken to be a notification of loss of entitlement to small or micro entity status, as applicable.

NOTE: This form must be signed in accordance with 37 CFR 1.31 and 1.33. See 37 CFR 1.4 for signature requirements and certifications.

Authorized Signature /Andrew D. Buschmeier/ Date February 22, 2021

Typed or printed name Andrew D. Buschmeier Registration No. 73,179



United States Patent and Trademark Office

Office of the Chief Financial Officer

Document Code:WFEE

User :C46472

Sale Accounting Date:02/23/2021

Sale Item Reference Number	Effective Date
17012813	02/22/2021

Document Number	Fee Code	Fee Code Description	Amount Paid	Payment Method
I20212M036483694	1501	UTILITY APPL ISSUE FEE	\$1,200.00	Salea



APPLICATION NO.	ISSUE DATE	PATENT NO.	ATTORNEY DOCKET NO.	CONFIRMATION NO.
17/012,813	03/30/2021	10965512	NEO-PT008.8	8746

3624 7590 03/10/2021
Volpe Koenig
30 SOUTH 17TH STREET, 18TH FLOOR
PHILADELPHIA, PA 19103

ISSUE NOTIFICATION

The projected patent number and issue date are specified above.

Determination of Patent Term Adjustment under 35 U.S.C. 154 (b)
(application filed on or after May 29, 2000)

The Patent Term Adjustment is 0 day(s). Any patent to issue from the above-identified application will include an indication of the adjustment on the front page.

If a Continued Prosecution Application (CPA) was filed in the above-identified application, the filing date that determines Patent Term Adjustment is the filing date of the most recent CPA.

Applicant will be able to obtain more detailed information by accessing the Patent Application Information Retrieval (PAIR) WEB site (<http://pair.uspto.gov>).

Any questions regarding the Patent Term Extension or Adjustment determination should be directed to the Office of Patent Legal Administration at (571)-272-7702. Questions relating to issue and publication fee payments should be directed to the Application Assistance Unit (AAU) of the Office of Data Management (ODM) at (571)-272-4200.

APPLICANT(s) (Please see PAIR WEB site <http://pair.uspto.gov> for additional applicants):

Xiaodong Li, Kirkland, WA;
Neo Wireless LLC, Wayne, PA;
Titus Lo, Bellevue, WA;
Kemin Li, Bellevue, WA;
Haiming Huang, Bellevue, WA;

The United States represents the largest, most dynamic marketplace in the world and is an unparalleled location for business investment, innovation, and commercialization of new technologies. The USA offers tremendous resources and advantages for those who invest and manufacture goods here. Through SelectUSA, our nation works to encourage and facilitate business investment. To learn more about why the USA is the best country in the world to develop technology, manufacture products, and grow your business, visit SelectUSA.gov.

TO: Mail Stop 8 Director of the U.S. Patent and Trademark Office P.O. Box 1450 Alexandria, VA 22313-1450	REPORT ON THE FILING OR DETERMINATION OF AN ACTION REGARDING A PATENT OR TRADEMARK
--	--

In Compliance with 35 U.S.C. § 290 and/or 15 U.S.C. § 1116 you are hereby advised that a court action has been filed in the U.S. District Court _____ for the Middle District of Tennessee _____ on the following

Trademarks or Patents. (the patent action involves 35 U.S.C. § 292.);

DOCKET NO. 3:22-cv-00220	DATE FILED 3/29/2022	U.S. DISTRICT COURT for the Middle District of Tennessee
PLAINTIFF NEO Wireless, LLC		DEFENDANT Nissan North America Inc.
PATENT OR TRADEMARK NO.	DATE OF PATENT OR TRADEMARK	HOLDER OF PATENT OR TRADEMARK
1 8467366		See attached complaint
2 10833908		
3 10075941		
4 10447450		
5 10965512		

In the above—entitled case, the following patent(s)/ trademark(s) have been included:

DATE INCLUDED	INCLUDED BY <input type="checkbox"/> Amendment <input type="checkbox"/> Answer <input type="checkbox"/> Cross Bill <input checked="" type="checkbox"/> Other Pleading	
PATENT OR TRADEMARK NO.	DATE OF PATENT OR TRADEMARK	HOLDER OF PATENT OR TRADEMARK
1 10771302		
2		
3		
4		
5		

In the above—entitled case, the following decision has been rendered or judgement issued:

DECISION/JUDGEMENT

CLERK LYNDA M. HILL	(BY) DEPUTY CLERK VANESSA HAINES	DATE 4/4/2022
------------------------	-------------------------------------	------------------

Copy 1—Upon initiation of action, mail this copy to Director Copy 3—Upon termination of action, mail this copy to Director
 Copy 2—Upon filing document adding patent(s), mail this copy to Director Copy 4—Case file copy

AO 120 (Rev. 08/10)

TO: Mail Stop 8 Director of the U.S. Patent and Trademark Office P.O. Box 1450 Alexandria, VA 22313-1450	REPORT ON THE FILING OR DETERMINATION OF AN ACTION REGARDING A PATENT OR TRADEMARK
---	---

In Compliance with 35 U.S.C. § 290 and/or 15 U.S.C. § 1116 you are hereby advised that a court action has been filed in the U.S. District Court Northern District of Ohio on the following

Trademarks or Patents. (the patent action involves 35 U.S.C. § 292.):

DOCKET NO. 3:22-cv-01252	DATE FILED 7/15/2022	U.S. DISTRICT COURT Northern District of Ohio
PLAINTIFF Neo Wireless LLC		DEFENDANT FCA US, LLC
PATENT OR TRADEMARK NO.	DATE OF PATENT OR TRADEMARK	HOLDER OF PATENT OR TRADEMARK
1 8,467,366	6/18/2013	Neo Wireless LLC
2 10,075,941	9/11/2018	Neo Wireless LLC
3 10,447,450	10/15/2019	Neo Wireless LLC
4 10,771,302	9/8/2020	Neo Wireless LLC
5 10,833,908	4/17/2018	Neo Wireless LLC

In the above—entitled case, the following patent(s)/ trademark(s) have been included:

DATE INCLUDED	INCLUDED BY <input type="checkbox"/> Amendment <input type="checkbox"/> Answer <input type="checkbox"/> Cross Bill <input type="checkbox"/> Other Pleading	
PATENT OR TRADEMARK NO.	DATE OF PATENT OR TRADEMARK	HOLDER OF PATENT OR TRADEMARK
1		
2		
3		
4		
5		

In the above—entitled case, the following decision has been rendered or judgement issued:

DECISION/JUDGEMENT

CLERK	(BY) DEPUTY CLERK	DATE
-------	-------------------	------

Copy 1—Upon initiation of action, mail this copy to Director Copy 3—Upon termination of action, mail this copy to Director
 Copy 2—Upon filing document adding patent(s), mail this copy to Director Copy 4—Case file copy

REPORT ON THE FILING OR DETERMINATION OF AN ACTION REGARDING A
PATENT OR TRADEMARK

Page 2 of 2

PATENT OR TRADEMARK NO.	DATE OF PATENT OR TRADEMARK	HOLDER OF PATENT OR TRADEMARK
6 10,965,512	3/30/2021	Neo Wireless LLC

AO 120 (Rev. 08/10)

Mail Stop 8 Director of the U.S. Patent and Trademark Office P.O. Box 1450 Alexandria, VA 22313-1450	REPORT ON THE FILING OR DETERMINATION OF AN ACTION REGARDING A PATENT OR TRADEMARK
---	---

In Compliance with 35 U.S.C. § 290 and/or 15 U.S.C. § 1116 you are hereby advised that a court action has been filed in the U.S. District Court Middle District of Florida on the following

Trademarks or Patents. (the patent action involves 35 U.S.C. § 292.):

DOCKET NO.	DATE FILED	U.S. DISTRICT COURT	
3:22-cv-780-J-MMHJBT	July 15, 2022	Middle District of Florida	
PLAINTIFF		DEFENDANT	
NEO WIRELESS, LLC		MERCEDES-BENZ USA, LLC	
PATENT OR TRADEMARK NO.	DATE OF PATENT OR TRADEMARK	HOLDER OF PATENT OR TRADEMARK	
1 8,467,366	January 23, 2020	Neo Wireless LLC	
2 10,833,908	June 16, 2020	Neo Wireless LLC	
3 10,075,941	January 23, 2020	Neo Wireless LLC	
4 10,447,450	January 23, 2020	Neo Wireless LLC	
5 10,965,512	September 4, 2020	Neo Wireless	
6 10,771,302	January 23, 2020	Neo Wireless LLC	

CLERK	(BY) DEPUTY CLERK	DATE
ELIZABETH M. WARREN	Amy Thomas	July 20, 2022

Copy 1—Upon initiation of action, mail this copy to Director **Copy 3—Upon termination of action, mail this copy to Director**
Copy 2—Upon filing document adding patent(s), mail this copy to Director **Copy 4—Case file copy**

AO 120 (Rev. 08/10)

TO: Mail Stop 8 Director of the U.S. Patent and Trademark Office P.O. Box 1450 Alexandria, VA 22313-1450	REPORT ON THE FILING OR DETERMINATION OF AN ACTION REGARDING A PATENT OR TRADEMARK
---	---

In Compliance with 35 U.S.C. § 290 and/or 15 U.S.C. § 1116 you are hereby advised that a court action has been filed in the U.S. District Court Northern District of Ohio on the following

Trademarks or Patents. (the patent action involves 35 U.S.C. § 292.):

DOCKET NO. 3:22-cv-01252	DATE FILED 7/15/2022	U.S. DISTRICT COURT Northern District of Ohio
PLAINTIFF Neo Wireless LLC		DEFENDANT FCA US, LLC
PATENT OR TRADEMARK NO.	DATE OF PATENT OR TRADEMARK	HOLDER OF PATENT OR TRADEMARK
1 8,467,366	6/18/2013	Neo Wireless LLC
2 10,075,941	9/11/2018	Neo Wireless LLC
3 10,447,450	10/15/2019	Neo Wireless LLC
4 10,771,302	9/8/2020	Neo Wireless LLC
5 10,833,908	4/17/2018	Neo Wireless LLC

In the above—entitled case, the following patent(s)/ trademark(s) have been included:

DATE INCLUDED	INCLUDED BY <input type="checkbox"/> Amendment <input type="checkbox"/> Answer <input type="checkbox"/> Cross Bill <input type="checkbox"/> Other Pleading	
PATENT OR TRADEMARK NO.	DATE OF PATENT OR TRADEMARK	HOLDER OF PATENT OR TRADEMARK
1		
2		
3		
4		
5		

In the above—entitled case, the following decision has been rendered or judgement issued:

DECISION/JUDGEMENT Conditional Transfer Order (CTO 1) by the Judicial Panel on Multidistrict Litigation. In re: MDL 3034 Neo Wireless, LLC, Patent Litigation. Case Transferred to Eastern District of Michigan and assigned to the Honorable Terrence G. Berg.

CLERK Sandy Opacich	(BY) DEPUTY CLERK /s/Natalie Wlotzko	DATE 8/15/2022
------------------------	---	-------------------

Copy 1—Upon initiation of action, mail this copy to Director Copy 3—Upon termination of action, mail this copy to Director
 Copy 2—Upon filing document adding patent(s), mail this copy to Director Copy 4—Case file copy

REPORT ON THE FILING OR DETERMINATION OF AN ACTION REGARDING A
PATENT OR TRADEMARK

Page 2 of 2

PATENT OR TRADEMARK NO.	DATE OF PATENT OR TRADEMARK	HOLDER OF PATENT OR TRADEMARK
6 10,965,512	3/30/2021	Neo Wireless LLC