



(12) **United States Patent**
Burke et al.

(10) **Patent No.:** **US 7,155,231 B2**
(45) **Date of Patent:** ***Dec. 26, 2006**

(54) **TRANSMIT PRE-CORRECTION IN A WIRELESS COMMUNICATION SYSTEM**

(75) Inventors: **Joseph P. Burke**, Carlsbad, CA (US); **Michael J. Wengler**, Carlsbad, CA (US); **Bhaskar D. Rao**, San Diego, CA (US); **Harris S. Simon**, Poway, CA (US)

(73) Assignee: **Qualcomm, Incorporated**, San Diego, CA (US)

(*) Notice: Subject to any disclaimer, the term of this patent is extended or adjusted under 35 U.S.C. 154(b) by 390 days.

This patent is subject to a terminal disclaimer.

(21) Appl. No.: **10/271,934**

(22) Filed: **Oct. 15, 2002**

(65) **Prior Publication Data**

US 2003/0153322 A1 Aug. 14, 2003

Related U.S. Application Data

(60) Provisional application No. 60/355,296, filed on Feb. 8, 2002.

(51) **Int. Cl.**
H04Q 7/20 (2006.01)

(52) **U.S. Cl.** **455/450; 455/67.14; 342/423; 375/357**

(58) **Field of Classification Search** **455/450, 455/67.11, 67.14, 423, 424, 425; 342/111, 342/129, 423, 430, 432, 444, 463; 375/296, 375/355, 356, 357**

See application file for complete search history.

(56) **References Cited**

U.S. PATENT DOCUMENTS

4,780,721 A * 10/1988 Dobson 342/178

5,483,676 A *	1/1996	Mahany et al.	455/67.14
5,828,658 A *	10/1998	Ottersten et al.	370/310
5,930,288 A *	7/1999	Eberhardt	375/148
5,982,327 A *	11/1999	Vook et al.	342/380
6,041,227 A *	3/2000	Sumner	455/412.2
6,118,983 A *	9/2000	Egusa et al.	455/69
6,426,960 B1	7/2002	Antonio	
6,434,366 B1 *	8/2002	Harrison et al.	455/69
6,615,024 B1 *	9/2003	Boros et al.	455/67.14
6,665,545 B1 *	12/2003	Raleigh et al.	455/562.1
6,711,412 B1 *	3/2004	Tellado et al.	455/506
6,747,594 B1 *	6/2004	Lindskog et al.	342/174

* cited by examiner

Primary Examiner—Charles N Appiah

Assistant Examiner—Nghì H. Ly

(74) *Attorney, Agent, or Firm*—Philip Wadsworth; Sandra L. Godsey

(57) **ABSTRACT**

Techniques for pre-correction of transmit signals are disclosed. In one aspect, a transmit antenna array configurable to generate multiple transmit beams is deployed. The parameters for configuring the antenna array are computed in response to channel estimates and a noise floor estimate made at the receiver. Information is transmitted in accordance with the multiple transmit beams, delayed as necessary, such that the multipaths may arrive time-aligned an in-phase at the receiver. In another aspect, pre-RAKE pre-correction is deployed by calculating Wiener weights. In yet another aspect, space-time diversity is deployed for calculating tap values for FIR filters used in transmission on the transmit antenna array. In yet another aspect, space only pre-correction is deployed. Various other aspects are also disclosed. These aspects have the benefit of reducing the interference experienced at a receiver, resulting in increased capacity, increased data throughput, and other system benefits.

44 Claims, 17 Drawing Sheets

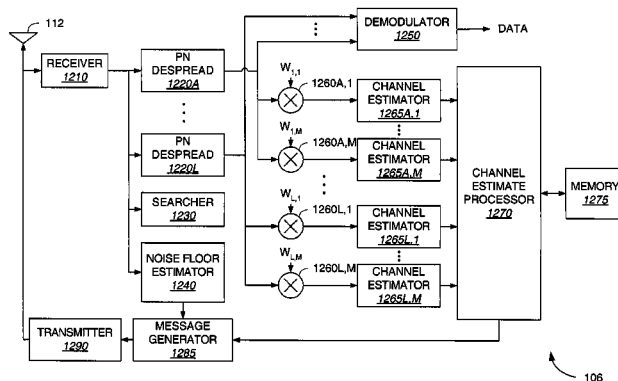

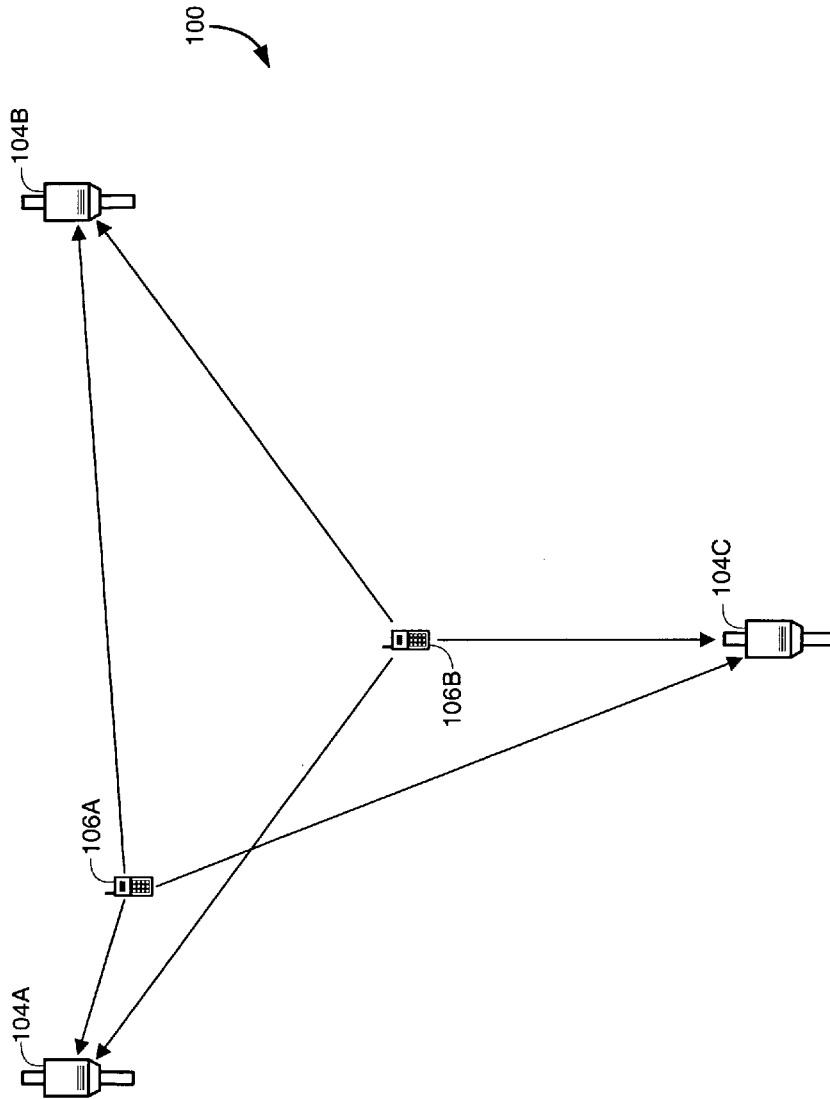

FIG. 1

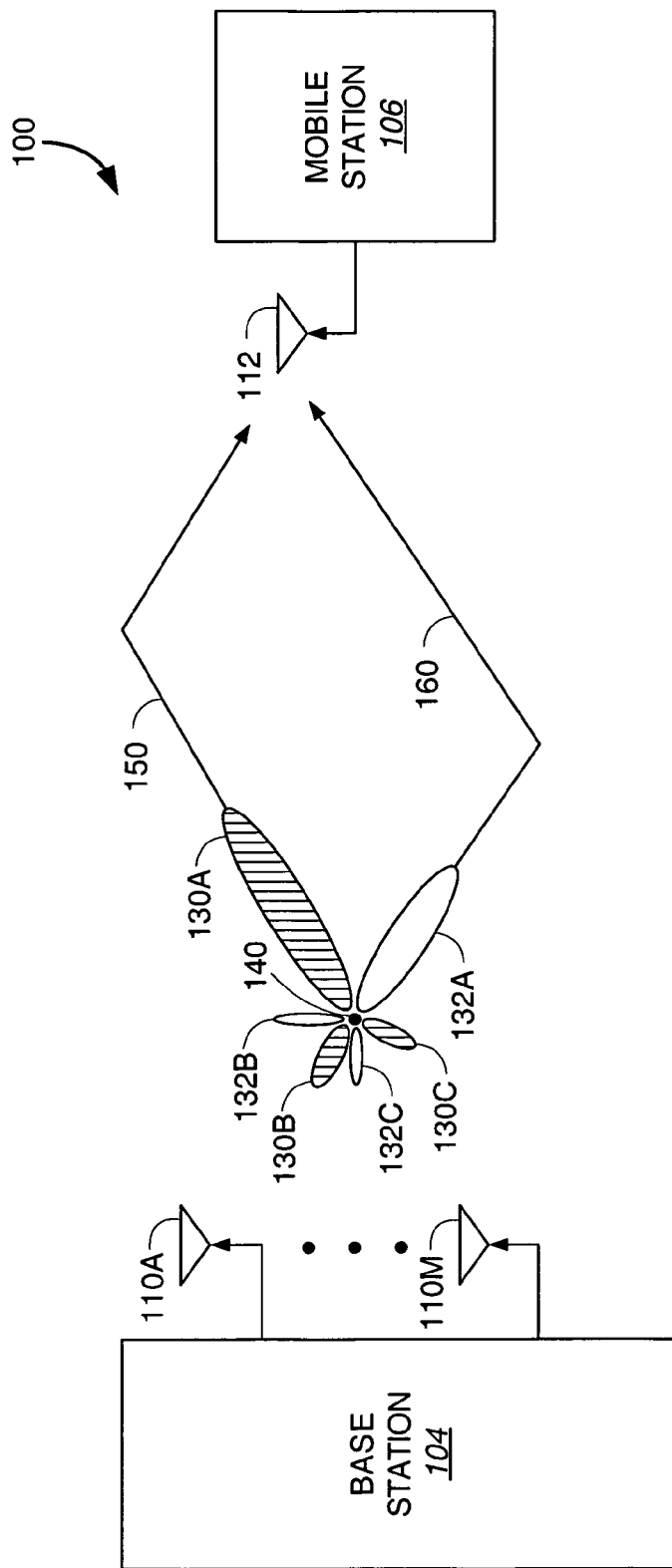

FIG. 2

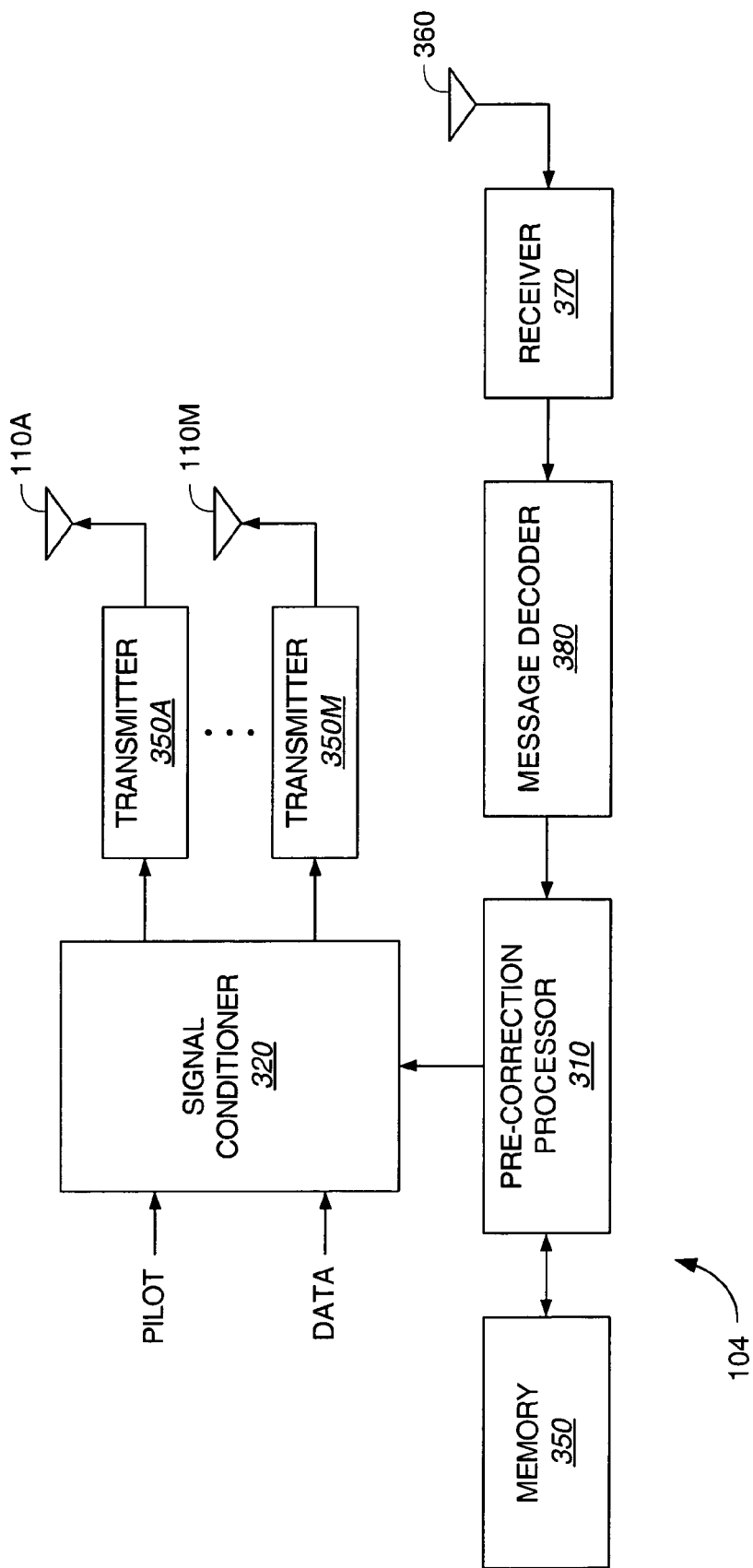

FIG. 3

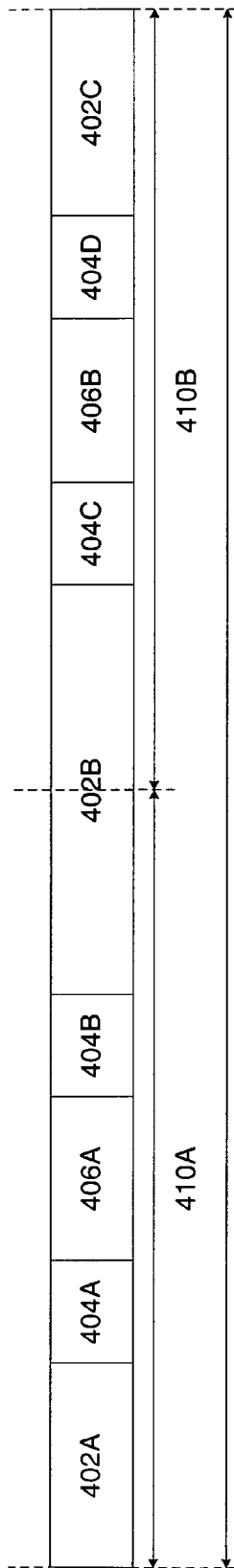

FIG. 4A

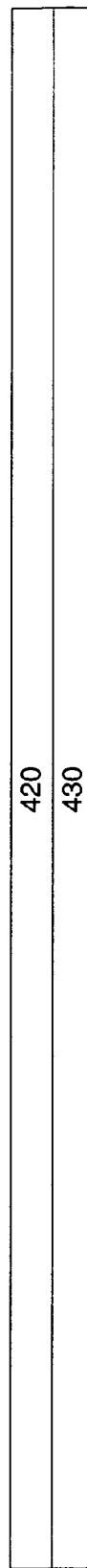

FIG. 4B

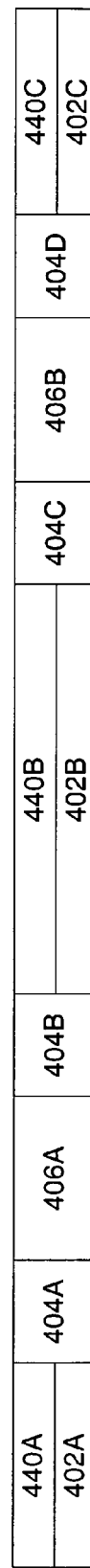

FIG. 4C

Explore Litigation Insights

Docket Alarm provides insights to develop a more informed litigation strategy and the peace of mind of knowing you're on top of things.

Real-Time Litigation Alerts



Keep your litigation team up-to-date with **real-time alerts** and advanced team management tools built for the enterprise, all while greatly reducing PACER spend.

Our comprehensive service means we can handle Federal, State, and Administrative courts across the country.

Advanced Docket Research



With over 230 million records, Docket Alarm's cloud-native docket research platform finds what other services can't. Coverage includes Federal, State, plus PTAB, TTAB, ITC and NLRB decisions, all in one place.

Identify arguments that have been successful in the past with full text, pinpoint searching. Link to case law cited within any court document via Fastcase.

Analytics At Your Fingertips



Learn what happened the last time a particular judge, opposing counsel or company faced cases similar to yours.

Advanced out-of-the-box PTAB and TTAB analytics are always at your fingertips.

API

Docket Alarm offers a powerful API (application programming interface) to developers that want to integrate case filings into their apps.

LAW FIRMS

Build custom dashboards for your attorneys and clients with live data direct from the court.

Automate many repetitive legal tasks like conflict checks, document management, and marketing.

FINANCIAL INSTITUTIONS

Litigation and bankruptcy checks for companies and debtors.

E-DISCOVERY AND LEGAL VENDORS

Sync your system to PACER to automate legal marketing.