

**UNITED STATES INTERNATIONAL TRADE COMMISSION  
WASHINGTON, D.C.**

**Before the Honorable Monica Bhattacharyya  
Administrative Law Judge**

**In the Matter of**

**CERTAIN LIGHT-BASED PHYSIOLOGICAL  
MEASUREMENT DEVICES AND  
COMPONENTS THEREOF**

Inv. No. 337-TA-1276

**COMPLAINANTS' REPLY POST-HEARING BRIEF**

## TABLE OF CONTENTS

	Page No.
I. INTRODUCTION .....	1
A. Procedural History .....	4
B. The Parties .....	4
1. Masimo & Cercacor .....	4
2. Apple.....	5
C. Overview of the Technology .....	5
D. The Asserted Patents.....	5
1. U.S. Patent Nos. 10,912,501, 10,912,502, and 10,945,648 .....	5
2. U.S. Patent No. 10,687,745.....	6
3. U.S. Patent No. 7,761,127.....	6
E. The Products at Issue .....	6
1. Masimo’s Domestic Industry Products.....	6
a. Masimo Watch.....	6
b. rainbow® Sensors.....	9
2. Accused Products.....	10
II. JURISDICTION .....	10
III. RESPONSE TO APPLE’S LEGAL STANDARD FOR DOMESTIC INDUSTRY REQUIREMENT.....	11
IV. ’501, ’502 AND ’648 PATENTS .....	13
A. Level of Ordinary Skill in the Art.....	13
B. Claim Construction.....	13
1. “arranged over”/“positioned over”/“above” .....	14

**TABLE OF CONTENTS**  
*(cont'd)*

	<b>Page No.</b>
2. “openings”/“through the protrusion”/“through holes” .....	17
C. Infringement.....	19
1. Protrusions, Openings, or Through Holes “arranged over”/“positioned over”/“above” Interior Surface or Photodiodes.....	20
2. “Openings”/“Through Holes” that are “Through the Protrusion” .....	25
D. Domestic Industry – “Technical Prong” .....	27
1. Domestic Industry Articles [REDACTED] .....	30
2. Masimo Watch Products Practice the Multi-Detector Patent Claims .....	32
a. [REDACTED] and [REDACTED] are “User-Worn Devices” as required by ’501 [1PRE] and [12].....	32
b. W1, [REDACTED] measure oxygen saturation and include “one or more processors configured” to calculate oxygen saturation as required by ’501 [1PRE], [1F] .....	33
c. W1, [REDACTED] include “at least three photodiodes arranged on an interior surface” and “opaque lateral surfaces configured to avoid light piping” as required by ’501 [1B], [1E].....	35
d. [REDACTED] is a “user worn device” with “a strap configured to position the user-worn device on the user” as required by ’502 [28PRE] and [28M].....	36
e. W1, [REDACTED] measure oxygen saturation and include “one or more processors configured” to calculate oxygen saturation as required by ’502 [28PRE] and [28I].....	36
f. W1, [REDACTED] include the LEDs required by ’502 [28A] and [28B], the photodiodes required by	

**TABLE OF CONTENTS**  
*(cont'd)*

	<b>Page No.</b>
'502 [28C], the thermistor required by '502 [28D], and the storage device required by [28L] .....	36
g. [REDACTED] are “user worn devices” with “a strap configured to position the housing proximate the tissue of the user when the device is worn” as required by '648 [8PRE], [20PRE] and [8I] .....	37
h. W1, [REDACTED] are configured to non-invasively determine oxygen saturation, have “processors configured to “output measurements of a physiological parameter,” and “determine measurements of oxygen saturation” as required by '648 [8PRE], [20PRE], [8G] and [20E].....	37
i. W1, [REDACTED] include the LEDs and photodiodes required by '648 [8A], [8B], [8C] and 20[B] .....	37
E. Validity .....	37
1. Apple’s Hindsight “State of the Art” Arguments Cannot Prove Invalidity .....	38
2. Anticipation/Obviousness .....	39
a. Ground 1: Lumidigm Does Not Anticipate or Render Obvious Any Asserted Claim .....	39
i. Lumidigm Fails to Disclose All the Elements as Arranged in the Claim.....	40
ii. Lumidigm Does Not Disclose or Suggest Many Claim Elements or Render Obvious Any Asserted Claim.....	43
(a) User-Worn Device Configured to Calculate, Determine, or Output Measurements of Physiological Parameters/SpO <sub>2</sub> .....	44
(b) Three or More Photodiodes .....	46

**TABLE OF CONTENTS**  
*(cont'd)*

	<b>Page No.</b>
(c) “Protrusion Comprising a Convex Surface”.....	46
(d) Protrusion Over/Above an “Interior Surface”.....	47
(e) Protrusion “Openings”/“Through Holes” or “Windows”/“Optically Transparent Material” Therein.....	48
(f) Opaque Lateral Surface or Opaque Material Configured to Avoid or Reduce Light Piping .....	49
(g) Processor(s) Configured to Make Measurements of Physiological Parameters/SpO <sub>2</sub> .....	49
(h) Thermistor or Adjusting Device Operation Responsive to Temperature.....	50
(i) Cavities Formed by the Protrusion, Opaque Wall, and Interior Surface .....	50
(j) Network Interface or Storage Device Configured As Claimed .....	51
(k) User Interface Comprising Touch-Screen, Configured As Claimed .....	51
(l) Protrusion Further Comprising One or More Chamfered Edges .....	51
iii. No Motivation to Combine or Reasonable Expectation of Success .....	52
(a) No Motivation to Combine Lumidigm Embodiments .....	52
(b) No Reasonable Expectation of Success in Combining Lumidigm Embodiments .....	54

**TABLE OF CONTENTS**  
*(cont'd)*

	<b>Page No.</b>
iv. Apple’s Failure to Treat the Asserted Claims as an Integrated Whole (Applies To: Grounds 1-6) .....	55
b. Ground 2: Lumidigm + Seiko 131 + Cramer Does Not Render Obvious Any Asserted Claim.....	55
i. The Combination Fails to Disclose or Suggest Numerous Elements .....	55
(a) Protrusion Comprising a Convex Surface .....	57
(b) “Openings”/“Through Holes” In or Through the Protrusion, or “Windows” Therein .....	60
(c) Opaque Lateral Surface/Opaque Material Configured to Avoid or Reduce Light Piping .....	61
(d) “Windows”/“Optically Transparent Material” Therein.....	65
(e) One or More Chamfered Edges .....	68
ii. No Motivation to Combine or Reasonable Expectation of Success .....	69
(a) Apple Fails to Address Every Element.....	69
(b) Lumidigm Does Not “Expressly Suggest” Adding All of Its Features to a Wristwatch .....	70
(c) There Is Nothing “Natural” About the Ground 2 Combination .....	70
(d) No Motivation to Combine Features of Seiko 131 or Cramer with Lumidigm’s Wristwatch .....	71
(e) No Reasonable Expectation of Success .....	77

**TABLE OF CONTENTS**  
*(cont'd)*

	<b>Page No.</b>
c.	Ground 3: Lumidigm + Webster Would Not Have Rendered Obvious '502 Patent Claim 22..... 78
i.	The Combination Fails to Disclose or Suggest Numerous Elements ..... 78
ii.	No Motivation to Combine or Reasonable Expectation of Success ..... 80
(a)	No Motivation to Combine Thermistor from Webster's Invasive Sensor with Lumidigm's Wristwatch ..... 80
(b)	No Reasonable Expectation of Success ..... 81
d.	Ground 4: Lumidigm + Seiko 131 + Cramer + Webster Does Not Render Obvious '502 Patent Claim 22..... 82
e.	Ground 5: Lumidigm + Webster + Apple 047 Does Not Render Obvious '502 Patent Claim 28 ..... 82
i.	The Combination Fails to Disclose or Suggest Numerous Elements ..... 82
ii.	No Motivation to Combine or Reasonable Expectation of Success ..... 84
(a)	No Motivation To Combine Apple 047's iPad-like Touch-Screen with Lumidigm's Wristwatch ..... 84
(b)	No Reasonable Expectation of Success ..... 85
f.	Ground 6: Lumidigm + Seiko 131 + Cramer + Webster + Apple 047 Does Not Render Obvious '502 Patent Claim 28..... 85
g.	Objective Indicia of Nonobviousness ..... 85
i.	Apple's Skepticism and Failures Demonstrate the Nonobviousness of the Asserted Claims..... 85

**TABLE OF CONTENTS**  
*(cont'd)*

	<b>Page No.</b>
ii. The Protrusions of the Multi-Detector Patents Achieved Unexpected Results .....	91
iii. Apple Fails to Rebut the Evidence of Copying or Commercial Success.....	94
h. Apple’s Improper IPR Arguments .....	96
i. Different Claims.....	98
ii. Different Prior Art.....	99
iii. Different Standard.....	99
iv. Objective Evidence of Nonobviousness .....	100
3. 35 U.S.C. § 112 (pre-AIA).....	100
a. Written Description.....	100
i. Claimed Combinations of LEDs, Photodiodes, and Openings with Opaque Surfaces (’501 Patent Claim 12; ’502 Patent Claims 22, 28; ’648 Patent Claim 12).....	100
ii. Sets of LEDs Each Emitting at a First Wavelength and a Second Wavelength (’502 Patent Claim 28) .....	103
iii. “At Least Four Emitters ... Wherein Each of the Plurality of Emitters Comprises a Respective Set of at Least Three LEDs” (’502 Patent Claim 22) .....	103
b. Enablement .....	104
i. “Touch-Screen Display” and “Indicia of Measurements” (’502 Patent Claim 28).....	104
ii. Reducing/Avoiding “Light Piping” (’501 Patent Claim 12; ’502 Patent Claim 28; ’648 Patent Claim 24).....	104



**TABLE OF CONTENTS**  
*(cont'd)*

	<b>Page No.</b>
F. Enforceability.....	105
1. Prosecution Laches .....	105
2. Unclean Hands .....	108
V. '745 PATENT.....	109
A. Level of Ordinary Skill in the Art.....	109
B. Claim Construction .....	109
C. Infringement.....	112
1. MLA Receives Light Having the First Shape [1B]/[20B] .....	112
2. The MLA Changes the Shape of Light into a Second Shape [1B]/[20B].....	113
3. Apple Indirectly Infringes Claim 27 .....	118
D. Domestic Industry – “Technical Prong” .....	119
1. Domestic Industry Articles <span style="background-color: black; color: black;">[REDACTED]</span> .....	119
2. Masimo Watch Products Practice '745 Patent Claim 18 .....	120
a. Masimo Satisfies [15B].....	120
b. Masimo Satisfies [15H] .....	121
E. Validity .....	121
1. Obviousness .....	121
a. Response to State of the Art.....	121
b. Ground 1: Apple Has Not Established Claims 9 and 27 Would Have Been Obvious in View of Series 0.....	122
i. Apple Has Not Established that the Series 0 Is Prior Art to the '745 Patent.....	123

**TABLE OF CONTENTS**  
*(cont'd)*

	<b>Page No.</b>
ii. Apple Has Not Established the Structure and Function of the Series 0 as of the Priority date.....	123
iii. The Series 0 Does Not Render Obvious Claims 9 and 27.....	124
c. Grounds 2 and 3: Apple Has Not Established that Iwamiya and Sarantos Render Claim 9 Obvious or that Iwamiya, Sarantos, and Venkatraman Render Claims 18 and 27 Obvious .....	127
i. No measurement of “oxygen saturation” as required by [9] and [18], no motivation to combine, and no reasonable expectation of success.....	128
ii. No “second wavelength” as required by [27], no motivation to combine, and no reasonable expectation of success.....	129
iii. No “surface comprising a dark-colored coating” as required by [1D] and [20D] .....	130
iv. No “plurality of photodiodes” arranged in the “array” as required in [15D] .....	130
v. No “touch-screen display configured to present visual feedback responsive to the physiological parameter data” as required by [20G].....	132
d. Objective Indicia of Nonobviousness .....	132
2. 35 U.S.C. § 112 (pre-AIA).....	133
a. Claims 9 and 27 Have Written-Description Support .....	133
b. Claim 18 Is Definite.....	134
F. Enforceability (Prosecution Laches).....	134
VI. '127 PATENT.....	135

**TABLE OF CONTENTS**  
*(cont'd)*

	<b>Page No.</b>
A. Level of Ordinary Skill in the Art.....	135
B. Claim Construction .....	135
1. “thermal mass” .....	136
2. “bulk temperature” .....	138
C. Infringement.....	141
1. The Accused Products have the claimed “Thermal Mass” [7A], [7B], [7D], [7F] .....	141
2. The Accused Apple Watches Determine a “Bulk Temperature” [7F] .....	149
D. Domestic Industry – “Technical Prong” .....	154
1. Current rainbow® Sensors Practice Claim 9 .....	155
a. “Thermal Mass” [7A] .....	155
b. “Bulk Temperature” [7F].....	157
2. Early rainbow® sensors Practice Claim 9 .....	159
a. “Thermal Mass” ([7A]).....	159
b. “Bulk Temperature” [7F].....	160
E. Validity .....	160
1. Obviousness .....	161
a. Mendelson in view of Webster would not Render Claim 9 Obvious [No disclosure of [7A], [7D], [7E], [7F], or [9]]. .....	161
b. Yamada in View of Noguchi Would Not Render Claim 9 Obvious [No disclosure of [7A], [7D], [7E], or [7F]]. .....	164
2. Objective Indicia of Nonobviousness .....	167

**TABLE OF CONTENTS**  
*(cont'd)*

	<b>Page No.</b>
VII. ECONOMIC PRONG .....	167
A.    Apple’s Argument of Five Supposed “Major Shortcomings” Fails .....	170
B.    Masimo’s Corroborated Evidence Refutes Apple’s Unsupported Arguments.....	172
C.    Masimo’s Watch Activities Have [REDACTED], Confirming That its Domestic Industry is At Least In The Process of Being Further Established .....	176
D.    Masimo’s [REDACTED] are Relevant .....	177
E.    Masimo’s Prior Investments Are Properly Included .....	178
F.    The Masimo Watch Benefitted From The Full Scope of Masimo’s [REDACTED] .....	179
G.    Masimo Domestic Expenditures are Highly Significant .....	180
VIII. REMEDY AND BONDING.....	181
IX.    CONCLUSION.....	183

**TABLE OF AUTHORITIES**

	<b>Page No(s).</b>
<i>O1 Communique Labs., Inc. v. Citrix Sys., Inc.</i> , 889 F.3d 735 (Fed. Cir. 2018).....	135
<i>ActiveVideo Networks, Inc. v. Verizon Commc'ns, Inc.</i> , 694 F.3d 1312 .....	77, 78
<i>Adidas AG v. Nike, Inc.</i> , 963 F.3d 1355 (Fed. Cir. 2020).....	<i>passim</i>
<i>Albrechtsen v. Bd. of Regents of Univ. of Wisconsin System</i> , 309 F.3d 433 (7th Cir. 2002) .....	14, 135
<i>Apple Inc. v. Masimo Corp.</i> , IPR2020-01520 .....	98
<i>Apple Inc. v. Masimo Corp.</i> , IPR2020-01521 .....	98
<i>Apple Inc. v. Motorola, Inc.</i> , 757 F.3d 1286 (Fed. Cir. 2014).....	<i>passim</i>
<i>Ashland Oil, Inc. v. Delta Resins &amp; Refractories, Inc.</i> , 776 F.2d 281 .....	126
<i>Atlantic Thermoplastics Co. v. Faytex Corp.</i> , 970 F.2d 834 (Fed. Cir. 1992).....	144
<i>Belden Inc. v. Berk-Tek LLC</i> , 805 F.3d 1064 (Fed. Cir. 2015).....	165
<i>In re Bogese</i> , 303 F.3d 1362 (Fed. Cir. 2002).....	108
<i>Cancer Research Tech. Ltd. v. Barr Labs., Inc.</i> , 625 F.3d 724 (Fed. Cir. 2010).....	108
<i>Certain Batteries &amp; Electrochemical Devices Containing Composite Separators, Components Thereof, &amp; Prod. Containing Same</i> , Inv. No. 337-TA-1087, Comm'n Op., 2018 WL 4331965 (Sept. 7, 2018) .....	173
<i>Certain Battery-Powered Ride-On Toy Vehicles</i> , Inv. No. 337-TA-314 .....	169

**TABLE OF AUTHORITIES**  
(*cont'd*)

	<b>Page No(s).</b>
<i>Certain Beverage Dispensing Sys. &amp; Components Thereof,</i> Inv. No. 337-TA-1130 (June 1, 2020) .....	174
<i>Certain Carburetors and Products Containing Such Carburetors,</i> Inv. No. 337-TA-1123, Comm'n Op. at 28 (Oct. 28, 2019).....	180
<i>Certain Chem. Mech. Planarization Slurries,</i> Inv. No. 337-TA-1204, Doc. ID 748910 .....	71
<i>Certain Concealed Cabinet Hinges,</i> 337-TA-289, Comm'n Op., 1990 WL 10608981 (1990) .....	12
<i>Certain Digital Video Receivers &amp; Related Hardware and Software Components,</i> Inv. No. 337-TA-1103, 2019 WL 2953269 (June 4, 2019) .....	174
<i>Certain Elec. Devices, Including Mobile Phones, Portable Music Players, &amp; Computers,</i> Inv. No. 337-TA-701, 2010 WL 5621540 (Nov. 18, 2010).....	174
<i>Certain Electronic Devices, Including Mobile Phones, Portable Music Players, and Computers,</i> Inv. No. 337-TA-701, Order No. 58, at 6 (Nov. 18, 2010).....	11, 168
<i>Certain Electronic Imaging Devices,</i> Inv. No. 337-TA-726, Order No. 18 (Feb. 7, 2011) .....	11
<i>Certain Laser Imageable Lithographic Printing Plates,</i> Inv. No. 337-TA-636 .....	11
<i>Certain Magnetic Data Storage Tapes &amp; Cartridges Containing the Same,</i> Inv. No. 337-TA-1076, Comm'n Op., 2019 WL 2635512 (June 20, 2019).....	181
<i>Certain Mobile Devices with Multifunction Emulators,</i> Inv. No. 337-TA-1170, Order No. 19, 2020 WL 3819518 (June 9, 2020).....	177
<i>Certain Mobile Electronic Devices and Radio Frequency and Processing Components Thereof,</i> Inv. No. 337-TA-1065 .....	180
<i>Certain Non-Volatile Memory Devices and Products Containing the Same,</i> 337-TA-1046, 2018 WL 6012622 (October 26, 2018).....	177

**TABLE OF AUTHORITIES**  
**(cont'd)**

	<b>Page No(s).</b>
<i>Certain Non-Volatile Memory Devices,</i> Inv. No. 337-TA-1046, Comm'n Op. ....	<i>passim</i>
<i>Certain Semiconductor Chips and Products,</i> Inv. No. 337-TA-753, ID at 248 (Mar. 2, 2012) (Doc. ID 474876) .....	107
<i>Certain Solid State Storage Drives, Stacked Elecs. Components, &amp; Prod. Containing Same,</i> Inv. No. 337-TA-1097, Comm'n Opinion, 2018 WL 4300500 (June 29, 2018) .....	174
<i>Certain Thermoplastic-Encapsulated Electric Motors,</i> Inv. No. 337-TA-1073, Comm'n Op. at 7 (Aug. 12, 2019).....	12
<i>Certain Two-Way Radio Equipment,</i> Inv. No. 337-TA-1053, Doc. ID 664543, Comm'n Op. at 19-22 (Dec. 18, 2018) .....	95
<i>Certain Variable Speed Wind Turbines &amp; Components,</i> Inv. No. 337-TA-641, ID, 2009 WL 1070796 (Apr. 2, 2009).....	179
<i>Crocs, Inc. v. Int'l Trade Comm'n,</i> 598 F.3d 1294 (Fed. Cir. 2010).....	167
<i>Cuozzo Speed Techs., LLC v. Lee,</i> 579 U.S. 261 (2016).....	100
<i>Demaco Corp. v. F. Von Langsdorff Licensing Ltd.,</i> 851 F.2d 1387 (Fed. Cir. 1988).....	167
<i>Dynamic Drinkware, LLC v. Nat'l Graphics, Inc.,</i> 800 F.3d 1375 (Fed. Cir. 2015).....	99
<i>Eko Brands, LLC v. Adrian Rivera Maynez Enterprises, Inc.,</i> 946 F.3d 1367 (Fed. Cir. 2020).....	138
<i>Flash-Control, LLC v. Intel Corp.,</i> No. 2020-2141, 2021 WL 2944592 (Fed. Cir. 2021) .....	101, 102, 133
<i>Golden Blount, Inc. v. Robert H. Peterson Co.,</i> 438 F.3d 1354 (Fed. Cir. 2006).....	118

**TABLE OF AUTHORITIES**  
(*cont'd*)

	<b>Page No(s).</b>
<i>Guangdong Alison Hi-Tech Co. v. Int'l Trade Comm'n</i> , 936 F.3d 1353 (Fed. Cir. 2019).....	40, 63
<i>Henny Penny Corp. v. Frymaster LLC</i> , 938 F.3d 1324 (Fed. Cir. 2019).....	73
<i>Hyatt v. Hirshfield</i> , 998 F.3d 1347 (Fed. Cir. 2021).....	106
<i>Hynix Semiconductor, Inc. v. Rambus, Inc.</i> , 2007 WL 4209386 (N.D. Cal. Nov. 26, 2007) .....	108
<i>Hynix Semiconductor Inc. v. Rambus Inc.</i> , 645 F.3d 1336 (Fed. Cir. 2011).....	101
<i>Hyosung TNS Inc. v. Int'l Trade Comm'n</i> , 926 F.3d 1353 (Fed. Cir. 2019).....	178
<i>InTouch Techs., Inc. v. VGO Commc'ns, Inc.</i> , 751 F.3d 1327 (Fed. Cir. 2014).....	74, 84
<i>Juicy Whip Inc. v. Orange Bang, Inc.</i> 292 F.3d 728 (Fed. Cir. 2002).....	126
<i>Kim v. ConAgra Foods, Inc.</i> , 465 F.3d 1312 (Fed. Cir. 2006).....	147
<i>Kinetic Concepts, Inc. v. Smith &amp; Nephew, Inc.</i> , 688 F.3d 1342 (Fed. Cir. 2012).....	54
<i>Kingsdown Medical Consultants, Ltd. v. Hollister, Inc.</i> , 863 F.2d 867 (Fed. Cir. 1988).....	107
<i>In re Klopfinstein</i> , 380 F.3d 1345 (Fed. Cir. 2004).....	75
<i>Knorr-Bremse Systeme Fuer Nutzfahrzeuge GmbH v. Dana Corp.</i> , 383 F.3d 1337 (Fed. Cir. 2004) (en banc).....	107, 108
<i>Koito Mfg. Co. v. Turn-Key-Tech, LLC</i> , 381 F.3d 1142 (Fed. Cir. 2004).....	<i>passim</i>



**TABLE OF AUTHORITIES**  
(*cont'd*)

	<b>Page No(s).</b>
<i>In re Lister</i> , 583 F.3d 1307 (Fed. Cir. 2009).....	75
<i>Martek Biosciences Corp. v. Nutrinova, Inc.</i> , 579 F.3d 1363 (Fed. Cir. 2009).....	147
<i>Metalcraft of Mayville, Inc. v. The Toro Co.</i> , 848 F.3d 1358 (Fed. Cir. 2017).....	54
<i>Microsoft Corp. v. i4i Ltd. Partnership</i> , 564 U.S. 91 (2011).....	99
<i>In re Mihalich</i> , 980 F.2d 744 (Fed. Cir. 1992) .....	149
<i>Monsanto Co. v. David</i> , 516 F.3d 1009 (Fed. Cir. 2008).....	157
<i>Net MoneyIN, Inc. v. VeriSign, Inc.</i> , 545 F.3d 1359 (Fed. Cir. 2008).....	40
<i>Novozymes A/S v. DuPont Nutrition Biosciences APS</i> , 723 F.3d 1336 (Fed. Cir. 2013).....	133, 134
<i>In re NTP, Inc.</i> , 654 F.3d 1279 (Fed. Cir. 2011).....	38
<i>Otsuka v. Pharm. Co. v. Sandoz, Inc.</i> , 678 F.3d 1280 (Fed. Cir. 2012).....	50, 72
<i>Par Pharm., Inc. v. TWI Pharms., Inc.</i> , 773 F.3d 1186 (Fed. Cir. 2014).....	<i>passim</i>
<i>Personal Web Techs., LLC v. Apple, Inc.</i> , 917 F.3d 1376 (Fed. Cir. 2019).....	39, 80
<i>Personalized Media Commc'ns, LLC v. Apple, Inc.</i> , 552 F. Supp. 3d 664 (E.D. Tex. 2021).....	106
<i>Princeton Biochemicals, Inc. v. Beckman Coulter, Inc.</i> , 411 F.3d 1332 (Fed. Cir. 2005).....	52, 55

**TABLE OF AUTHORITIES**  
**(cont'd)**

	<b>Page No(s).</b>
<i>Randolph v. Collectramatic, Inc.</i> , 590 F.2d 844 (10th Cir. 1979) .....	143
<i>Ricoh Co., Ltd. v. Quanta Computer Inc.</i> , 550 F.3d 1325 (Fed. Cir. 2008).....	118
<i>Rohm &amp; Haas Co. v. Brotech Corp.</i> , 127 F.3d 1089 (Fed. Cir. 1997).....	115
<i>Sandt Tech., Ltd. v. Resco Metal &amp; Plastics Corp.</i> , 264 F.3d 1344 (Fed. Cir. 2001).....	148
<i>Scripps Clinic &amp; Research Found. v. Genentech, Inc.</i> , 927 F.2d 1565 (Fed. Cir. 1991).....	40, 64
<i>Seaboard Int'l, Inc. v. Cameron Int'l Corp.</i> , 2013 WL 3936889 (E.D. Cal. July 30, 2013).....	108
<i>Securus Techs., Inc. v. Global Tel*Link Corp.</i> , 701 Fed. Appx. 971 (2017).....	71
<i>SRI Int'l v. Matsushita Elec. Corp. of Am.</i> , 775 F.2d 1107 (Fed. Cir. 1985) (en banc).....	14
<i>In re Stepan Co.</i> , 868 F.3d 1342 (Fed. Cir. 2017).....	54
<i>Stringed Musical Instruments &amp; Components Thereof</i> , Inv. No. 337-TA-586, Comm'n Op., 2009 WL 5134139 (Dec. 2009).....	172, 173
<i>Symbol Technologies, Inc. v. Lemelson Med., Educ. &amp; Research Found.</i> , 422 F.3d 1378 (Fed. Cir. 2005).....	106, 134
<i>Trading Techs. Int'l, Inc. v. eSpeed, Inc.</i> , 595 F.3d 1340 (Fed. Cir. 2010).....	16
<i>Transocean Offshore Deepwater Drilling, Inc. v. Maersk Drilling USA, Inc.</i> , 699 F.3d 1340 (Fed. Cir. 2012).....	<i>passim</i>
<i>Velander v. Garner</i> , 348 F.3d 1359 (Fed. Cir. 2003).....	52

**TABLE OF AUTHORITIES**  
*(cont'd)*

	<b>Page No(s).</b>
<i>Vitronics Corp. v. Conceptoronic, Inc.</i> , 90 F.3d 1576 (Fed. Cir. 1996).....	111, 141
<i>Vivid Techs., Inc. v. Am. Sci. &amp; Eng'g, Inc.</i> , 200 F.3d 795 (Fed. Cir. 1999).....	18
<i>W.L. Gore &amp; Assocs., Inc. v. Garlock, Inc.</i> , 721 F.2d 1540 (Fed. Cir. 1983).....	40, 122
<i>Wasica Fin. GmbH v. Cont'l Auto. Sys., Inc.</i> , 853 F.3d 1272 (Fed. Cir. 2017).....	43
<i>WBIP, LLC v. Kohler Co.</i> , 829 F.3d 1317 (Fed. Cir. 2016).....	69, 100, 167
<i>Zenith Labs., Inc. v. Bristol-Myers Squibb Co.</i> , 19 F.3d 1418 (Fed. Cir. 1994).....	144

**OTHER AUTHORITIES**

35 U.S.C. § 102.....	75
35 U.S.C. § 112.....	100, 105, 133
35 U.S.C. § 282.....	99
35 U.S.C. § 316.....	100

**TABLE OF ACRONYMS AND ABBREVIATIONS**

<b>Abbreviation</b>	<b>Description</b>
<b>'127 Patent</b>	U.S. Patent No. 7,761,127
<b>'501 Patent</b>	U.S. Patent No. 10,912,501
<b>'502 Patent</b>	U.S. Patent No. 10,912,502
<b>'648 Patent</b>	U.S. Patent No. 10,945,648
<b>'745 Patent</b>	U.S. Patent No. 10,687,745
<b>127 DI Products</b>	'127 Patent Domestic Industry Products (Current rainbow® sensors and Early rainbow® sensors)
<b>745 DI Products</b>	'745 Patent Domestic Industry Products (██████████, WI)
<b>Accused Products</b>	Apple Watch Series 6 (model nos. A2291-A2294, “Series 6”), Apple Watch Series 7 (model nos. A2473-A2475 and A2477, “Series 7”), and Next-Generation Apple Watches
<b>AP</b>	Application processor
<b>Apple</b>	Respondent Apple Inc.
<b>AppleIPHB</b>	Apple’s Initial Post-Hearing Brief
<b>Apple 047</b>	U.S. Patent No. 9,001,047 (RX-0673)
<b>Cercacor</b>	Complainant Cercacor Laboratories, Inc.
<b>Cheung</b>	U.S. Patent No. 5,259,381 (RX-0406)
<b>██████████</b>	Masimo Watches with ██████████ (example: CPX-0021C with CPX-0014)
<b>Compl.</b>	First Amended Complaint
<b>Cramer</b>	U.S. Patent No. 4,224,948 (RX-0670)
<b>ERS</b>	Engineering Requirements Specification
<b>IPHB</b>	Initial Post-Hearing Brief
<b>Iwamiya</b>	U.S. Patent No. 8,670,819 (RX-0130)
<b>Lumidigm</b>	U.S. Patent No. 7,620,212 (RX-0411)
<b>Masimo</b>	Complainants Masimo Corporation and Cercacor Laboratories, Inc.
<b>MasimoIPHB</b>	Masimo’s Initial Post-Hearing Brief
<b>Masimo Corp.</b>	Complainant Masimo Corporation
<b>Mendelson</b>	Invasive and Non-invasive Blood Gas Monitoring by Y. Mendelson (RX-0370 & RX-0458)
<b>Mendelson '799</b>	U.S. Patent No. 6,801,799
<b>MLA</b>	Microlens array
<b>MPEP</b>	Manual of Patent Examining Procedure
<b>Multi-Detector Patents</b>	The '501, '502, and '648 Patents
<b>Noguchi</b>	U.S. Patent No. 5,334,916 (RX-0353)
<b>PHB</b>	Pre-hearing brief
<b>POSITA</b>	Person of Ordinary Skill in the Art

<b>Abbreviation</b>	<b>Description</b>
<b>PVD</b>	Physical vapor deposition
<b>Resp.</b>	Response
█	Masimo Watches with █ (examples: CPX-0052C, CPX-0012C (laptop), CPX-0013C (Bluetooth dongle))
█	Masimo Watches with █ (example: CPX-0058C)
█	Masimo Watches with █ (examples: CPX-0019C, CPX-0020C, CPX-0065C)
<b>RTP</b>	Real-time processor
<b>Sarantos</b>	U.S. Patent No. 9,392,946 (RX-0366)
<b>Scarlett</b>	The Multilayer Printed Circuit Board Handbook by J.A. Scarlett (RX-0397)
<b>Seiko 131</b>	U.S. Patent No. 5,776,131 (RX-0666)
<b>SiP</b>	System-in-package
<b>SpO<sub>2</sub></b>	Oxygen saturation
<b>Venkatraman</b>	U.S. Patent No. 8,998,815 (RX-0368)
<b>W1</b>	Masimo Watch W1 (examples: CPX-0146C, CPX-0157C)
<b>Webster</b>	Design of Pulse Oximeters by J.G. Webster (RX-0035)
█	Masimo Watches with █ (example: CPX-0029C with CPX-0014)
<b>Yamada</b>	Japanese Unexamined Patent Application Publication No. 2004-337605 (RX-0381)

**TABLES OF CLAIM ELEMENT IDENTIFIERS**

<b>U.S. Patent No. 10,912,501</b>	
<b>Identifier</b>	<b>Claim/Element</b>
<b>Claim 12</b>	
<b>[1PRE]</b>	A user-worn device configured to noninvasively measure a physiological parameter of a user, the user-worn device comprising:
<b>[1A]</b>	at least three light emitting diodes (LEDs);
<b>[1B]</b>	at least three photodiodes arranged on an interior surface of the user-worn device and configured to receive light attenuated by tissue of the user;
<b>[1C]</b>	a protrusion arranged over the interior surface, the protrusion comprising a convex surface and
<b>[1D]</b>	a plurality of openings extending through the protrusion and positioned over the three photodiodes,
<b>[1E]</b>	the openings each comprising an opaque lateral surface, the plurality of openings configured to allow light to reach the photodiodes, the opaque lateral surface configured to avoid light piping through the protrusion; and
<b>[1F]</b>	one or more processors configured to receive one or more signals from the photodiodes and calculate a measurement of the physiological parameter of the user.
<b>[12]</b>	The user-worn device of Claim 1, wherein the convex surface of the protrusion is an outermost surface configured to contact the tissue of the user and conform the tissue into a concave shape.

**U.S. Patent No. 10,912,502**

<b>Identifier</b>	<b>Claim/Element</b>
<b>Claim 22</b>	
<b>[19PRE]</b>	A user-worn device configured to non-invasively measure an oxygen saturation of a user, the user worn device comprising:
<b>[19A]</b>	a plurality of emitters configured to emit light, each of the emitters comprising at least two light emitting diodes (LEDs);
<b>[19B]</b>	four photodiodes arranged within the user-worn device and configured to receive light after at least a portion of the light has been attenuated by tissue of the user;
<b>[19C]</b>	a protrusion comprising a convex surface including separate openings extending through the protrusion and lined with opaque material, each opening positioned over a different one of the four photodiodes, the opaque material configured to reduce an amount of light reaching the photodiodes without being attenuated by the tissue;
<b>[19D]</b>	optically transparent material within each of the openings; and
<b>[19E]</b>	one or more processors configured to receive one or more signals from at least one of the four photodiodes and output measurements responsive to the one or more signals, the measurements indicative of the oxygen saturation of the user.
<b>[20]</b>	The user-worn device of claim 19 further comprising a thermistor.
<b>[21]</b>	The user-worn device of claim 20, wherein the one or more processors are further configured to receive a temperature signal from the thermistor and adjust operation of the user-worn device responsive to the temperature signal.
<b>[22]</b>	The user-worn device of claim 21, wherein the plurality of emitters comprise at least four emitters, and wherein each of the plurality of emitters comprises a respective set of at least three LEDs.

**U.S. Patent No. 10,912,502**

<b>Identifier</b>	<b>Claim/Element</b>
<b>Claim 28</b>	
<b>[28PRE]</b>	A user-worn device configured to non-invasively measure an oxygen saturation of a user, the user worn device comprising:
<b>[28A]</b>	a first set of light emitting diodes (LEDs), the first set of LEDs comprising at least an LED configured to emit light at a first wavelength and an LED configured to emit light at a second wavelength;
<b>[28B]</b>	a second set of LEDs spaced apart from the first set of LEDs, the second set of LEDs comprising at least an LED configured to emit light at the first wavelength and an LED configured to emit light at the second wavelength;
<b>[28C]</b>	four photodiodes arranged in a quadrant configuration on an interior surface of the user-worn device and configured to receive light after at least a portion of the light has been attenuated by tissue of the user;
<b>[28D]</b>	a thermistor configured to provide a temperature signal;
<b>[28E]</b>	a protrusion arranged above the interior surface, the protrusion comprising: a convex surface;
<b>[28F]</b>	a plurality of openings in the convex surface, extending through the protrusion, and aligned with the four photodiodes, each opening defined by an opaque surface configured to reduce light piping; and
<b>[28G]</b>	a plurality of transmissive windows, each of the transmissive windows extending across a different one of the openings;
<b>[28H]</b>	at least one opaque wall extending between the interior surface and the protrusion, wherein at least the interior surface, the opaque wall and the protrusion form cavities, wherein the photodiodes are arranged on the interior surface within the cavities;
<b>[28I]</b>	one or more processors configured to receive one or more signals from at least one of the photodiodes and calculate an oxygen saturation measurement of the user, the one or more processors further configured to receive the temperature signal;
<b>[28J]</b>	a network interface configured to wirelessly communicate the oxygen saturation measurement to at least one of a mobile phone or an electronic network;
<b>[28K]</b>	a user interface comprising a touch-screen display, wherein the user interface is configured to display indicia responsive to the oxygen saturation measurement of the user;
<b>[28L]</b>	a storage device configured to at least temporarily store at least the measurement; and
<b>[28M]</b>	a strap configured to position the user-worn device on the user.



**U.S. Patent No. 10,945,648**

<b>Identifier</b>	<b>Claim/Element</b>
<b>Claim 12</b>	
<b>[8PRE]</b>	A user-worn device configured to non-invasively determine measurements of a physiological parameter of a user, the user-worn device comprising:
<b>[8A]</b>	a first set of light emitting diodes (LEDs), the first set comprising at least an LED configured to emit light at a first wavelength and at least an LED configured to emit light at a second wavelength;
<b>[8B]</b>	a second set of LEDs spaced apart from the first set of LEDs, the second set of LEDs comprising an LED configured to emit light at the first wavelength and an LED configured to emit light at the second wavelength;
<b>[8C]</b>	four photodiodes;
<b>[8D]</b>	a protrusion comprising a convex surface, at least a portion of the protrusion comprising an opaque material;
<b>[8E]</b>	a plurality of openings provided through the protrusion and the convex surface, the openings aligned with the photodiodes;
<b>[8F]</b>	a separate optically transparent window extending across each of the openings;
<b>[8G]</b>	one or more processors configured to receive one or more signals from at least one of the photodiodes and output measurements of a physiological parameter of a user;
<b>[8H]</b>	a housing; and
<b>[8I]</b>	a strap configured to position the housing proximate tissue of the user when the device is worn.
<b>[12]</b>	The user-worn device of Claim 8, wherein the physiological parameter comprises oxygen or oxygen saturation.
<b>Claim 24</b>	
<b>[20PRE]</b>	A user-worn device configured to non-invasively determine measurements of a user's tissue, the user-worn device comprising:
<b>[20A]</b>	a plurality of light emitting diodes (LEDs);
<b>[20B]</b>	at least four photodiodes configured to receive light emitted by the LEDs, the four photodiodes being arranged to capture light at different quadrants of tissue of a user;
<b>[20C]</b>	a protrusion comprising a convex surface and
<b>[20D]</b>	a plurality of through holes, each through hole including a window and arranged over a different one of the at least four photodiodes; and
<b>[20E]</b>	one or more processors configured to receive one or more signals from at least one of the photodiodes and determine measurements of oxygen saturation of the user.
<b>[24]</b>	The user-worn device of Claim 20, wherein the protrusion comprises opaque material configured to substantially prevent light piping.

**U.S. Patent No. 10,945,648**

<b>Identifier</b>	<b>Claim/Element</b>
<b>Claim 30</b>	
<b>[20PRE]</b>	A user-worn device configured to non-invasively determine measurements of a user's tissue, the user-worn device comprising:
<b>[20A]</b>	a plurality of light emitting diodes (LEDs);
<b>[20B]</b>	at least four photodiodes configured to receive light emitted by the LEDs, the four photodiodes being arranged to capture light at different quadrants of tissue of a user;
<b>[20C]</b>	a protrusion comprising a convex surface and
<b>[20D]</b>	a plurality of through holes, each through hole including a window and arranged over a different one of the at least four photodiodes; and
<b>[20E]</b>	one or more processors configured to receive one or more signals from at least one of the photodiodes and determine measurements of oxygen saturation of the user.
<b>[30]</b>	The user-worn device of Claim 20, wherein the protrusion further comprises one or more chamfered edges.

**U.S. Patent No. 10,687,745**

<b>Identifier</b>	<b>Claim/Element</b>
<b>Claim 9</b>	
<b>[1PRE]</b>	A physiological monitoring device comprising:
<b>[1A]</b>	a plurality of light-emitting diodes configured to emit light in a first shape;
<b>[1B]</b>	a material configured to be positioned between the plurality of light-emitting diodes and tissue on a wrist of a user when the physiological monitoring device is in use, the material configured to change the first shape into a second shape by which the light emitted from one or more of the plurality of light-emitting diodes is projected towards the tissue;
<b>[1C]</b>	a plurality of photodiodes configured to detect at least a portion of the light after the at least the portion of the light passes through the tissue, the plurality of photodiodes further configured to output at least one signal responsive to the detected light;
<b>[1D]</b>	a surface comprising a dark-colored coating, the surface configured to be positioned between the plurality of photodiodes and the tissue when the physiological monitoring device is in use, wherein an opening defined in the dark-colored coating is configured to allow at least a portion of light reflected from the tissue to pass through the surface;
<b>[1E]</b>	a light block configured to prevent at least a portion of the light emitted from the plurality of light-emitting diodes from reaching the plurality of photodiodes without first reaching the tissue;
<b>[1F]</b>	and a processor configured to receive and process the outputted at least one signal and determine a physiological parameter of the user responsive to the outputted at least one signal.
<b>[9]</b>	The physiological monitoring device of claim 1, wherein the physiological parameter comprises oxygen saturation.

<b>U.S. Patent No. 10,687,745</b>	
<b>Identifier</b>	<b>Claim/Element</b>
<b>Claim 18</b>	
<b>[15PRE]</b>	A physiological monitoring device comprising:
<b>[15A]</b>	a plurality of light-emitting diodes configured to emit light proximate a wrist of a user;
<b>[15B]</b>	a light diffusing material configured to be positioned between the plurality of light-emitting diodes and a tissue measurement site on the wrist of the user when the physiological monitoring device is in use;
<b>[15C]</b>	a light block having a circular shape;
<b>[15D]</b>	a plurality of photodiodes configured to detect at least a portion of the light emitted from the plurality of light-emitting diodes after the light passes through the light diffusing material and a portion of the tissue measurement site encircled by the light block, wherein the plurality of photodiodes are arranged in an array having a spatial configuration corresponding to a shape of the portion of the tissue measurement site encircled by the light block,
<b>[15E]</b>	wherein the plurality of photodiodes are further configured to output at least one signal responsive to the detected light, and
<b>[15F]</b>	wherein the plurality of light-emitting diodes and the plurality of photodiodes are arranged in a reflectance measurement configuration;
<b>[15G]</b>	wherein the light block is configured to optically isolate the plurality of light-emitting diodes from the plurality of photodiodes by preventing at least a portion of light emitted from the plurality of light-emitting diodes from reaching the plurality of photodiodes without first reaching the portion of the tissue measurement site;
<b>[15H]</b>	a processor configured to receive and process the outputted at least one signal and determine a physiological parameter of the user responsive to the outputted at least one signal; and
<b>[15I]</b>	wherein the physiological monitoring device is configured to transmit physiological parameter data to a separate processor.
<b>[18]</b>	The physiological monitoring device of claim 15, wherein the physiological parameter comprises oxygen saturation.

**U.S. Patent No. 10,687,745**

<b>Identifier</b>	<b>Claim/Element</b>
<b>Claim 27</b>	
<b>[20PRE]</b>	A system configured to measure one or more physiological parameters of a user, the system comprising: a physiological monitoring device comprising:
<b>[20A]</b>	a plurality of light-emitting diodes configured to emit light in a first shape;
<b>[20B]</b>	a material configured to be positioned between the plurality of light-emitting diodes and tissue of the user when the physiological monitoring device is in use, the material configured to change the first shape into a second shape by which the light emitted from one or more of the plurality of light-emitting diodes is projected towards the tissue;
<b>[20C]</b>	a plurality of photodiodes configured to detect at least a portion of the light after the at least the portion of the light passes through the tissue, the plurality of photodiodes further configured to output at least one signal responsive to the detected light;
<b>[20D]</b>	a surface comprising a dark-colored coating, the surface configured to be positioned between the plurality of photodiodes and the tissue when the physiological monitoring device is in use, wherein an opening defined in the dark-colored coating is configured to allow at least a portion of light reflected from the tissue to pass through the surface;
<b>[20E]</b>	a light block configured to prevent at least a portion of light from the plurality of light-emitting diodes from reaching the plurality of photodiodes without first reaching the tissue; and
<b>[20F]</b>	a processor configured to receive and process the outputted at least one signal and determine a physiological parameter of the user responsive to the outputted at least one signal; and
<b>[20G]</b>	a processing device configured to wirelessly receive physiological parameter data from the physiological monitoring device, wherein the processing device comprises a user interface, a storage device, and a network interface configured to wirelessly communicate with the physiological monitoring device, and wherein the user interface includes a touch-screen display configured to present visual feedback responsive to the physiological parameter data.
<b>[27]</b>	The system of claim 20, wherein at least one of the plurality of light-emitting diodes is configured to emit light of a first wavelength and at least one of the plurality of light-emitting diodes is configured to emit light of a second wavelength, the second wavelength being different than the first wavelength.

**U.S. Patent No. 7,761,127**

<b>Identifier</b>	<b>Claim/Element</b>
<b>Claim 9</b>	
<b>[7PRE]</b>	A physiological sensor capable of emitting light into tissue and producing an output signal usable to determine one or more physiological parameters of a patient, the physiological sensor comprising:
<b>[7A]</b>	a thermal mass;
<b>[7B]</b>	a plurality of light emitting sources, including a substrate of the plurality of light emitting sources, thermally coupled to the thermal mass,
<b>[7C]</b>	the sources having a corresponding plurality of operating wavelengths,
<b>[7D]</b>	the thermal mass disposed within the substrate;
<b>[7E]</b>	a temperature sensor thermally coupled to the thermal mass and
<b>[7F]</b>	[the temperature sensor] capable of determining a bulk temperature for the thermal mass, the operating wavelengths dependent on the bulk temperature; and
<b>[7G]</b>	a detector capable of detecting light emitted by the light emitting sources after tissue attenuation,
<b>[7H]</b>	wherein the detector is capable of outputting a signal usable to determine one or more physiological parameters of a patient based upon the operating wavelengths.
<b>[9]</b>	The physiological sensor according to claim 7 wherein the temperature sensor comprises a thermistor.

[REDACTED]

Pursuant to G.R. 13.1 (Order No. 4), Complainants Masimo Corporation and Cercacor Laboratories, Inc. (collectively, “Masimo”) submit this reply post-hearing brief.

### **I. INTRODUCTION**

The full evidentiary record confirms Apple’s Section 337 violation. Apple attempts to avoid infringement with strained constructions that are inconsistent with the intrinsic and extrinsic evidence. Apple attempts to challenge domestic industry by asserting that sworn testimony, corroborated by extensive contemporaneous documentation, is insufficient. Apple cannot succeed by ignoring the evidence presented. The record establishes Apple’s infringement and Masimo’s domestic industry. Apple has not credibly disputed either.

After ignoring the evidence on these issues, Apple shifts to a different approach for validity. Here, Apple invites error by relying on (1) documentary evidence that fails to show the claimed elements, (2) conclusory expert testimony and fact witness opinions that contradict the evidentiary record, and (3) uncorroborated fact testimony. Apple’s approach to validity comes nowhere close to clear and convincing evidence.

For the Multi-Detector Patents, in an attempt to avoid infringement, Apple advocates for narrow claim constructions of “over” and “openings” that contradict the intrinsic and extrinsic evidence. Apple does not apply those constructions for validity or domestic industry. Apple cannot reconcile its constructions with its own advertising, patents, and internal documents, so it ignores them.

For validity, Apple hid its positions during this Investigation with countless permutations of combinations and dozens of so-called “background” references. Now, Apple rests all of its prior art defenses for the Multi-Detector Patents on Lumidigm. Apple’s reliance on Lumidigm is from a wish list of extended functionality features that arose from a “brainstorming session” of the

[REDACTED]

inventors, and in no way anticipates any claim. For obviousness, Apple relies on hindsight for generic motivations to combine Lumidigm with as many as four other references. But Apple ignores the [REDACTED] about a convex protrusion, the [REDACTED] to develop a device that could measure oxygen saturation, [REDACTED] the contemporaneous evidence confirming Apple's view that a convex protrusion with holes coated with opaque coating to block light piping was inventive, and the increased commercial success the inventions delivered to Apple. Even after hiring engineers from Masimo and Nellcor, [REDACTED]

[REDACTED]

[REDACTED]

For the '745 Patent, Apple again takes inconsistent positions on infringement and validity. For infringement, Apple argues that [REDACTED] between the LED emission surface and the [REDACTED] changes the shape of the light before the [REDACTED] but ignores the change in shape by the [REDACTED]. Apple also ignores the similar [REDACTED] in the Series 0, when attempting to show it as prior art.

Apple also again ignores its own [REDACTED] in obtaining oxygen saturation on the wrist in its conclusory assertions of obviousness. Apple's attempt to argue obviousness based on the Series 0 is hypocritical: after faulting Masimo for not having enough evidence of its Masimo Watch to meet a preponderance standard, Apple seeks to present a Series 0 invalidity defense lacking any details or documentary evidence from the relevant time period, and argues this meets a clear and convincing standard. Apple failed to have its expert even analyze a physical sample of Series 0 or any of its internal documents showing the design of the Series 0. Apple relied on testimony and documents that did not match the physical it alleged to be the Series 0.



[REDACTED]

Apple again takes contradictory claim construction positions for the '127 Patent. The infringing Apple Watches use the exact features described and claimed in the '127 Patent to estimate the operating wavelengths of their LEDs based on temperature. Apple hopes to avoid infringement and to challenge domestic industry by importing numerous requirements into Claim 9, such as requiring the bulk temperature to be constant, uniform throughout, and precisely an average of the PCB temperature. Claim 9 is not so limited. For validity, Apple shifts its position and ignores the requirements it imports into Claim 9 for noninfringement, and moves to an overbroad construction ignoring the express claim limitations in a manner that would encompass the very prior art over which the Examiner allowed the claims. Apple fails to show any prior art that estimates the operating wavelengths of LEDs based on a temperature of a thermal mass in accordance with the claims. Apple also ignores and does not rebut the awards and industry praise for, and commercial success of, Masimo's rainbow® sensors.

Masimo showed a domestic industry exists or is in the process of being established with its extensive investments and activities in designing, developing, and manufacturing Masimo Watches and rainbow® sensors in the United States. Masimo has and will continue to invest in its patented technology through [REDACTED], and acquiring the consumer electronics company Sound United for \$1 billion [REDACTED]. [REDACTED]. Masimo's pre-complaint investments, as well as the significant and unusual developments occurring after the Complaint, satisfy the domestic industry showing.

Perhaps because of its own failures, Apple continues to question that Masimo, the world leader in pulse oximetry, implemented Masimo SET® technology into the Masimo Watch. Apple's supposed disbelief does not change Masimo's domestic industry showing. The evidentiary record

[REDACTED]

showed Masimo’s development history, documentation of its design and testing, and multiple physical examples of the Masimo Watch that practice the claimed inventions.

The appropriate remedies for Apple’s Section 337 violation are a limited exclusion order and a cease-and-desist order against the infringing Series 6, 7, and Next-Generation Apple Watches.

**A. Procedural History**

Apple claims that Masimo filed its First Amended Complaint on July 7, 2021. AppleIPHB 6. However, the Commission afforded the First Amended Complaint a date of July 12, 2021. Doc. ID 747137 (Notice of Receipt of Amended Complaint).<sup>1</sup>

**B. The Parties**

**1. Masimo & Cercacor**

Apple’s description of Masimo ignores Masimo’s history of consumer products and Kiani’s testimony regarding them. *See* MasimoIPHB 9-12 (summarizing testimony and exhibits).



CDX-0017C.002 (excerpt).

Apple’s attempts to rewrite history ignore the contemporaneous documents and evidence that it [REDACTED]

[REDACTED]

<sup>1</sup> Masimo’s IPHB included a parenthetical inadvertently listing the filing date as July 7, 2021. MasimoIPHB 200. Masimo referenced the July 12 filing date accorded by the ITC elsewhere throughout its brief. *See id.* at 7.

[REDACTED]

[REDACTED]

[REDACTED]

[REDACTED]

[REDACTED] (7) hired Masimo’s Chief Medical Officer, (8) welcomed an offer from Lamego (a named inventor), to solve the “deceptive patient equation” for Apple based on his 10 years of experience at Masimo and Cercacor, [REDACTED]

[REDACTED] See MasimoIPHB 13-16. Apple’s view of Masimo over the years contradicts its current arguments.

**2. Apple**

In the 1266 Investigation, the ALJ recently found a Section 337 violation based on Apple’s importation of the Apple Watch Series 6 and Series 7, because they infringe multiple patents related to wearable devices with ECG functionality. Doc. ID 773989.

**C. Overview of the Technology**

See MasimoIPHB 16-17.

**D. The Asserted Patents**

**1. U.S. Patent Nos. 10,912,501, 10,912,502, and 10,945,648**

Apple faults the Multi-Detector Patents as lacking the specific word “wrist,” but ignores that this word is not in the claims. Apple also ignores that its expert admitted he was being “very, very specific” in his testimony about the word “wrist,” and knew when he so testified that the specification describes the sensor as being “located somewhere along a non-dominant arm or a non-dominant hand, e.g., a right-handed person’s left arm or a left hand.” Tr. (Warren) 1277:25-178:8; JX-0001 at 11:45-48. Thus, these patents expressly encompass non-invasive measurement at the wrist.

[REDACTED]

2. **U.S. Patent No. 10,687,745**

Apple’s description of the ’745 Patent uses a legally erroneous “point of novelty” approach, rather than addressing the claims as a whole. *See infra* Section V.E.1.a.

3. **U.S. Patent No. 7,761,127**

Apple makes the irrelevant point that Masimo has not sold products practicing the ’127 Patent to measure blood oxygen saturation. It is undisputed that Claim 9 is not limited to a specific physiological parameter and that the specification discloses that its sensor “allows the measurement of oxygen saturation and pulse rate with increased accuracy or robustness.” JX-0007 at 5:13-15. The evidence showed that Masimo uses the patented technology to more accurately measure difficult parameters, such as carbon monoxide and methemoglobin.

E. **The Products at Issue**

1. **Masimo’s Domestic Industry Products**

a. **Masimo Watch**

There is nothing “purported” about the Masimo Watch. Masimo presented extensive contemporaneous documentation, physical exhibits, and fact testimony explaining the evidence of the domestic development and investments in the Masimo Watch. Masimo [REDACTED]

[REDACTED] Masimo also presented expert testimony regarding its Masimo Watches, and its domestic activities regarding them, including tours by its expert of Masimo’s facilities that Apple’s experts declined to visit. Masimo’s witnesses explained the origins of the Masimo Watch project, [REDACTED]

[REDACTED] Tr. (Kiani) 115:5-7, 116:8-9; Tr. (Al-Ali) 248:24-250:2, 328:8-16. Contrary to Apple’s argument, the testimony was not “inconsistent” as to when the project began. Kiani and Al-Ali described [REDACTED] *id.*, and Al-Ali explained [REDACTED]

[REDACTED]

Tr. (Al-Ali) 328:8-16. Consistent with this testimony, Muhsin explained that [REDACTED]

[REDACTED]

[REDACTED] Tr. (Muhsin) 342:16-343:7. Apple's hope to find an inconsistency was delusional.

Apple also seeks to confine Masimo's W1 evidence to a single physical exhibit and to ignore other physical examples of W1 admitted into evidence. *See* AppleIPHB 11 n.1, 42 n.14. But the undisputed evidence confirmed U.S. production of many W1 Watches. Tr. (Muhsin) 352:21-353:2, 393:4-8, Tr. (Scruggs) 398:24-400:2, RX-1209C (Scruggs) 44:2-6, 44:10-12, 44:14-45:6, 45:9-13, CX-0680C. Apple acknowledges Masimo's pre-hearing brief identified multiple examples of W1. AppleIPHB 11 n.1. Apple did not object to other physical examples of W1 when Masimo's witnesses introduced them. Tr. (Scruggs) 398:4-400:2; Tr. (Muhsin) 348:5-13, 349:10-352:4. Also, the ALJ overruled Apple's objection to CPX-0157C when counsel objected during Madisetti's testimony. Tr. (Madisetti) 704:2-708:12. Apple presents no basis to confine the evidence of W1 to a single physical watch. Masimo's witnesses consistently confirmed the W1 watches presented at the hearing [REDACTED]

[REDACTED] Tr. (Muhsin) 351:17-352:16; Tr. (Scruggs) 393:17-394:3 (testifying all Masimo Watches [REDACTED]); Tr. (Al-Ali) 315:16-19. Apple had [REDACTED] but presented no contrary evidence.

Apple distracted from the merits of Masimo's DI evidence by asking each Masimo witness whether the Masimo Watch is currently available for purchase in a physical "store." That was not in dispute, and no Masimo witness had claimed otherwise. Kiani and Muhsin explained the status of the Masimo Watch, and Masimo's careful approach to releasing effective products. Tr. (Kiani) 124:12-24; Tr. (Muhsin) 352:17-353:11. Despite the repeated distractions, Apple cites no case

[REDACTED]

finding a lack of domestic industry where a product undergoes a phased release. Instead, the ITC has found domestic industry in the absence of any commercialization. *See Certain Non-Volatile Memory Devices*, Inv. No. 337-TA-1046, Comm’n Op., at 40-43 (finding statutory term “article” in Section 337 does not require commercial production).

Regardless of in-physical-store status, Masimo’s witnesses explained that the Masimo W1 is currently available [REDACTED] Tr. (Al-Ali) 317:14-318:22. Kiani explained how the Masimo W1 accurately and continuously monitors SpO<sub>2</sub>, which sets it apart from other products like the Apple Watch. Tr. (Kiani) 125:12-24; *see also* Tr. (Muhsin) 354:10-19 (explaining his demonstration of continuous monitoring feature of W1 for SpO<sub>2</sub> and pulse rate). Masimo provides a physiologically relevant product to users, rather than a “gimmick” that misleads users about the accuracy of its measurements. Tr. (Waydo) 950:21-951:7; CX-1606 at 2 (describing Apple’s blood oxygen monitoring as “more of a gimmick than anything else.”).

Finally, the evidence contradicts Apple’s argument that “[n]one of these articles is the ‘Masimo Watch’ described in the Complaint.” AppleIPHB 11. Al-Ali and other Masimo witnesses confirmed Masimo [REDACTED]

[REDACTED]

[REDACTED] Tr. (Al-Ali) 313:14-317:20; *see also* RX-1209C (Scruggs) 239:19-240:4, 240:6-10, 240:12-13; Tr. (Muhsin) 376:25-377:2; Tr. (Scruggs) 454:8-455:3. Scruggs also confirmed that [REDACTED]

[REDACTED]

[REDACTED] Tr. (Scruggs) 477:9-478:8.

[REDACTED]

Apple identified [REDACTED]

[REDACTED] As Scruggs testified at the hearing [REDACTED]

[REDACTED] Tr. (Scruggs) 467:2-7; 477:9-478:8.

Apple also identifies no claim element that is impacted by [REDACTED]

[REDACTED] Masimo's witnesses explained that W1: [REDACTED] (Tr. (Scruggs) 410:5-24); [REDACTED] (id.); (3) [REDACTED] (Tr. (Al-Ali) 319:20-320:14); and (4) [REDACTED] (Tr. (Muhsin) 346:20-347:1). [REDACTED] W1 practice any Asserted DI Claim. Apple presented no evidence to support its attempts to argue otherwise.

**b. rainbow® Sensors**

Apple argues Masimo did not list each product by any particular part number. AppleIPHB 224-225. But Apple cites no requirement, and there is none, for Masimo to do so. And Masimo identified the rainbow® sensors by model number in a sales spreadsheet. CX-0649C ("Rainbow Revenue" tab listing names and part IDs of rainbow® sensors). Apple further complains that Masimo did not identify which articles are early or current rainbow® sensors. AppleIPHB 224;

---

<sup>2</sup> For one [REDACTED] (CPX-0019C), Scruggs testified [REDACTED]

[REDACTED] RX-1209C (Scruggs) 91:18-92:17.

[REDACTED] *Id.* at 92:22-24. Al-Ali explained [REDACTED]

[REDACTED] Tr. (Al-Ali) 319:20-320:14.

[REDACTED]

*see also id.* at 207. This is also not required. Masimo’s sales spreadsheet identifies both pre-2009 and later sales of rainbow® sensors (CX-0649C), and Diab established that pre-2009 sales are for early rainbow® sensors and later sales are for current rainbow® sensors. Tr. (Diab) 216:15-218:1, 220:4-221:10. Apple also argues that Masimo did not “prove that any particular article is representative of the so-called” early and current rainbow® sensors. AppleIPHB 207, 225. But Diab and Goldberg explained the technical documents are representative of, and describe the relevant details about, all rainbow® sensors. *See, e.g.*, CX-0430C; CX-0590C; CX-1635C; CX-0589C; CX-0419C; CX-0597C; CX-0588C; CX-0584C; CX-0397C; CX-0454C; CX-0782C; CX-0797C; CX-0596C; CX-0816C; CX-0426C; CPX-0152C; CX-0440C; CX-0388C; CX-0678; Tr. (Diab) 210:13-212:20 (all rainbow® sensors use Claim 9’s wavelength-correction); CDX-0013C.021; Tr. (Goldberg) 627:3-13.

## 2. Accused Products

When defining the “Accused Apple Watches,” Apple only identifies the Series 6 and 7. AppleIPHB 13. Apple does not dispute that the Next-Generation Apple Watches are also “Accused Apple Watches.” MasimoIPHB 39-41.

## II. JURISDICTION

Apple does not dispute standing, subject matter jurisdiction, or personal jurisdiction. *See* AppleIPHB 18. Apple also “does not dispute that the Commission has jurisdiction over the accused Apple Watch Series 6 and Series 7 products.” *Id.* (citing Doc. ID 770046). Apple presents no challenge to the ITC’s jurisdiction over its Next-Generation Apple Watches. Masimo explained why *in rem* jurisdiction is proper over these watches [REDACTED]

[REDACTED] MasimoIPHB 40-41 (citing CX-1259C, CX-1257C).



[REDACTED]

Apple has also admitted that a finding of infringement of the Series 7 Watch [REDACTED]

[REDACTED] CX-1259C at 2-3. Therefore, the Commission can adjudicate these as well.

### **III. RESPONSE TO APPLE'S LEGAL STANDARD FOR DOMESTIC INDUSTRY REQUIREMENT**

The ALJ should reject Apple's request to disregard all evidence of Masimo's post-complaint activities and development as unsupported by the case law. Apple has repeatedly but unsuccessfully pressed that incorrect argument in this Investigation. The Commission considers post-complaint evidence, at least when there is domestic manufacturing, which undisputedly exists here. MasimoIPHB 289-290. Apple's argument relies instead on investigations addressing licensing rather than manufacturing.

The Commission has repeatedly recognized the appropriateness of considering post-complaint activities and evidence. See *Certain Electronic Devices, Including Mobile Phones, Portable Music Players, and Computers*, Inv. No. 337-TA-701, Order No. 58, at 6 (Nov. 18, 2010) (unreviewed) ("there have been a number of instances when it has been acceptable to look later in the investigation, either because of the development of new, relevant and timely disclosed evidence ..."); *Certain Electronic Imaging Devices*, Inv. No. 337-TA-726, Order No. 18 (Feb. 7, 2011) (unreviewed) ("The Commission ... has examined the existence of a domestic industry at various points in the investigation timeline, depending on the circumstances of the case" and explaining that "a domestic industry that exists after the filing of the initial complaint but before the close of discovery may be relevant"); *Certain Laser Imageable Lithographic Printing Plates*, Inv. No. 337-TA-636, Final I.D. at 93-94 (July 24, 2009) (examining technical evidence prepared after the filing of the complaint when evaluating domestic industry and noting the Commission's use of the end of discovery as the cutoff point for satisfaction of the domestic industry requirement) (unreviewed

[REDACTED]

in relevant part); *Certain Concealed Cabinet Hinges*, 337-TA-289, Comm’n Op., 1990 WL 10608981 at \*11 (1990) (noting that “we assess the existence of the domestic industry as of the discovery cutoff date prior to the evidentiary hearing” and “therefore do not adopt the ALJ’s finding that the date of the last supplement to the complaint is significant in determining what evidence of domestic industry may be adduced to prove the existence of a domestic industry”).

Apple relies on footnote 17 from *Certain Coaxial Cable Connectors*. AppleIPHB 18 (citing Inv. No. 337-TA-650, Comm’n Op. at 51 n.17 (Apr. 14, 2010) (Doc. ID 422832)). But that footnote related to the requirement that *licensing* efforts under subprong (c) include the asserted patents. *Certain Coaxial Cable Connectors*, Inv. No. 337-TA-650, Comm’n Op. at 51 (Apr. 14, 2010) (Doc. ID 422832) (n.17 to sentence “A complainant must clearly link each activity to licensing efforts concerning the asserted patent.”).

Apple also relies on *Thermoplastic-Encapsulated Electric Motors*, where complainant Intellectual Ventures relied on *licensing* activities for a third party’s product. The Commission issued a Notice of Review addressing (1) the post-complaint status of the commercial product of Intellectual Ventures’ licensee, (2) whether post-complaint facts supported pre-complaint growth projections, and (3) “whether there are any other ‘significant and unusual’ circumstances in the record.” AppleIPHB 19; *Certain Thermoplastic-Encapsulated Electric Motors*, Inv. No. 337-TA-1073, Comm’n Op. at 7 (Aug. 12, 2019) (Doc. ID 684974). Because Intellectual Ventures failed to show that its licensee’s post-complaint commercial product satisfied the technical prong, the Commission declined to consider its post-complaint evidence. *Id.* By comparison, Masimo has shown that W1 satisfies the technical prong. MasimoIPHB 83-117, 203-211. Moreover, Masimo [REDACTED] Tr. (Young) 504:14-22. And, Masimo

[REDACTED]

has other significant and unusual developments. MasimoIPHB 289-290, 308; CX-1637 at 19-20; Tr. (Young) 483:1-18.

Because Masimo is relying on subprongs (a) and (b) of the economic prong, Apple's licensing-based cases are inapposite. Moreover, even if it were proper to apply Apple's proposed standard, that would still support including post-Complaint evidence. Examples of Masimo's significant and unusual developments include [REDACTED] [REDACTED] and its recent \$1 billion acquisition of Sound United [REDACTED] [REDACTED]. Masimo has also shown that it satisfied the domestic industry requirement as of the Complaint.

#### **IV. '501, '502 AND '648 PATENTS**

##### **A. Level of Ordinary Skill in the Art**

The parties do not dispute the level of ordinary skill in the art for the purposes of this Investigation. MasimoIPHB 41-42; AppleIPHB 26.

##### **B. Claim Construction**

Apple applies a heads-we-win/tails-you-lose approach to claim construction, alternating between an unsupported narrow claim construction for noninfringement and a broad construction for invalidity. Apple never provides a specific and consistent construction for its invalidity, domestic industry, and noninfringement arguments.

For invalidity, Apple evaluated references without referring to any device orientation for the "over" elements (AppleIPHB 74-75, 83, 92, 101) or whether the art allegedly disclosed material in the "openings" (AppleIPHB 111-113, 134, 136). For domestic industry, Apple also did not refer to device orientation or whether the articles had material in the openings. *See* AppleIPHB 45-56 (not contesting either term). Yet, Apple rested its entire noninfringement

[REDACTED]

argument on its narrow view of the terms: (1) “arranged over”/“positioned over”/“above” and (2) “openings”/“through the protrusion”/“through holes.” AppleIPHB 26-40. But Apple never provided its narrowing constructions in its IPHB or anywhere else.

By failing to specify or apply consistent constructions, one is forced to deduce them from Apple’s arguments. See *Albrechtsen v. Bd. of Regents of Univ. of Wisconsin System*, 309 F.3d 433, 436 (7th Cir. 2002) (“Courts are entitled to assistance from counsel...”). Apple’s strategy was to cast its legal construction arguments into factual disputes. But claim construction is a question of law.

Apple also blames Madisetti for not applying Apple’s unstated constructions, alleging that he “ignored the additional requirements” (AppleIPHB 32) and “effectively ignored the requirement.” AppleIPHB 34. Madisetti did not ignore anything. He applied the plain meaning of these terms in view of the intrinsic evidence, properly applied those constructions, analyzed the evidence, and rendered his opinions.

**1. “arranged over”/“positioned over”/“above”**

Apple argues “arranged over”/“positioned over”/“above” in the claims refer to the position of the components relative to gravity. AppleIPHB 26-33. Apple relies on the design and operation of the Accused Products to interpret the claims. But construing claims in light of the accused devices is error. *SRI Int’l v. Matsushita Elec. Corp. of Am.*, 775 F.2d 1107, 1118 (Fed. Cir. 1985) (en banc). Apple’s overly narrow construction also ignores the intrinsic evidence. The Multi-Detector Patents’ disclosure describes devices that work in any orientation. JX-0001 at 8:21-23, 10:15-27, 10:62-11:3, 11:45-55. Thus, the term “over” is not tied to gravity.

[REDACTED]

Masimo explained in detail the reasons why “arranged over”/“positioned over”/“above” in the claims, specification, and extrinsic evidence refer to the configuration of features of the device relative to each other, not the position of the device relative to the Earth. MasimoIPHB 42-49.

Apple argues that “over” is vertically above relative to gravity. AppleIPHB 28 (contrasting face-down Apple Watch orientation to MDP’s transmissive, finger-worn embodiment). But the specification imposes no such requirement. Indeed, the specification describes different measurement sites including “a finger, toe, hand, foot, ear, forehead, or the like.” JX-0001 at 8:21-23, 10:64-66 (“any location on a patient’s body”), 11:45-48. And as Warren conceded, the patents’ specification expressly teaches that “[i]n some embodiments, the measurement site 102 is located somewhere along a non-dominant arm or a non-dominant hand, e.g., a right-handed person’s left arm or left hand.” Tr. (Warren) 1277:21-1278:8. These different measurement sites involve different positions and orientations. The specification places no requirement on device orientation when taking a measurement. Thus, its use of the term “over” is never restricted to Earth’s gravitational center.

Further, the concept of “over” for a pulse oximeter sensor being based on gravity makes no sense at the time of filing. Pulse oximeter sensors, like Masimo’s devices, take measurements regardless of the orientation, as shown below.



CX-1371 at 56; CX-0691 at 3. Apple identifies no evidence that a POSITA *at the time of filing* would consider the term “over” in describing a pulse oximetry sensor as having any gravitational position requirement. *Trading Techs. Int’l, Inc. v. eSpeed, Inc.*, 595 F.3d 1340, 1351 (Fed. Cir. 2010) (claims are interpreted from perspective of POSITA as of the priority date). Nor has Apple identified any pulse oximeters from the “time of filing” that restricted operation based on gravity. That Apple now claims some vague gravitational requirement for the Apple Watch does nothing to inform what a POSITA would have understood the term “over” to mean for a pulse oximeter sensor in the Multi-Detector patents in 2008.

Not surprisingly, Apple’s patents on its Watches also use the term “over” unrelated to gravity. MasimoIPHB 46-48. The intrinsic and extrinsic evidence, Apple’s own patents, and the

[REDACTED]

case law makes clear that the terms recite the configuration of features of the device relative to each other. *See* MasimoIPHB 42-49.

2. “openings”/“through the protrusion”/“through holes”

Apple narrowly construes “openings”/“through the protrusion”/“through holes” to require an “absence of material.” AppleIPHB 34-39. Apple points to nothing in the claim, specification or any extrinsic evidence to support Apple’s narrowing construction. To the contrary, the evidence contradicts Apple’s arguments.

The Multi-Detector Patents’ disclosure teaches the openings can be made from glass or other transparent material. *See, e.g.*, JX-0001 at 8:26-29, 27:22-26, FIG. 7B. Glass or other transparent material is not an “absence of material.” Masimo also presented extensive evidence explaining that the “openings”/“through the protrusion”/“through holes” in the patents refer to the passage of light, and not physical or tangible objects. MasimoIPHB 49-53 (citing JX-0001 at 8:26-29, 19:38-53, 27:22-26; Tr. (Madisetti) 702:8-703:10).

Apple alleges “Madisetti’s interpretation appears to conflate the meaning of ‘opening’ or ‘through hole’ with the separate term ‘window’ ....” AppleIPHB 37-38. Apple relies on its own fact witness, Block’s deposition testimony, to provide “opening” with an alleged plain and ordinary meaning of “the fact that light can pass through something does not mean that it’s an opening.” AppleIPHB 37 (citing CX-0281C (Block) 272:10-17). But Block’s self-serving opinion does not inform what a POSITA would have thought in 2008, and was made with respect to “windows” in the Series 6. CX-0281C (Block) 271:21-272:17.

Madisetti supported his opinion on a POSITA’s understanding by explaining the specification teaches “[t]he *openings* can be *made from glass* to allow attenuated light from a

[REDACTED]

measurement site, such as a finger, to pass through to one or more detectors.”<sup>3</sup> Tr. (Madisetti) 702:8-703:10 (citing JX-0001 at 8:25-29). He also referred to the patent specifications explanation that “[t]he conductive *glass 730b can be used for* some or all of the *openings 703b.*” *Id.* (citing JX-0001 at 27:22-26 and FIG. 7B). Both quotes use the word “openings” and do not contain the “separate term ‘window’” as Apple imagines. Apple, not Madisetti, conflated the meaning of opening with windows.<sup>4</sup>

Apple next alleges “Madisetti’s view of how a POSITA would understand the term ‘opening’ is not correct,” citing only Warren for support. AppleIPHB 38 (citing Tr. (Warren) 1252:7-25). Apple misleadingly suggests this Warren excerpt includes an opinion on how a POSITA would interpret the claim language. It does not. Warren merely gave the conclusory opinion that the Accused Products “don’t have openings that extend through the protrusion” (Tr. (Warren) 1252:7-14) and explained that [REDACTED]

[REDACTED] (*id.* at 1252:15-24). Warren’s testimony addressed the Accused Products, *not* how a POSITA would interpret the claim language at the time in view of the contemporaneous evidence. Apple again invites legal error by using that testimony regarding the Accused Products as a proxy for claim construction. “[C]laims are construed objectively and without reference to the accused device.” *Vivid Techs., Inc. v. Am. Sci. & Eng’g, Inc.*, 200 F.3d 795, 803 (Fed. Cir. 1999).

---

<sup>3</sup> Emphasis added unless indicated otherwise.

<sup>4</sup> Apple alleges that Masimo’s argument is somehow “new” and “offered for the first time at trial.” AppleIPHB 37. But Masimo’s Pre-Hearing Brief explained that “Apple presents two arguments, both of which rest on claim construction,” that Apple’s proposed construction “contradicts the specification . . .,” and “the Accused Products’ [REDACTED] allow light to reach the photodiodes and form part of the ‘openings extending through the protrusion.’” Masimo PHB at 41-43. Madisetti also explained the same in his expert report. *See, e.g.*, CX-0307 at 561-562.



[REDACTED]

In other testimony, Warren agreed with Madisetti as to how a POSITA would understand the term “opening” *in 2008*. Warren testified, “I would say in 2008 and many decades prior, *openings are a way for light or to allow light to get to a detector.*” Tr. (Warren) 1192:23-1193:6. He later confirmed, “I noted earlier that *you need an opening to allow light to reach a detector.*” *Id.* at 1193:23-1194:7. This is consistent with Madisetti’s testimony. Tr. (Madisetti) 702:8-703:10.

Apple now provides yet another “plain and ordinary meaning” of “opening” or “hole” as “a void into which other material can be placed.” AppleIPHB 38. That does not match Apple’s prior proposed construction of “absence of material” or Apple’s reference to Block’s supposed “plain and ordinary meaning.” Regardless, this additional newly-proposed construction would also establish infringement. *See* MasimoIPHB 57-59. Apple itself describes the back crystal of the Accused Products [REDACTED] As Dr. Block explained at the hearing, [REDACTED]

[REDACTED]

AppleIPHB 36. The new proposal, however, is wrong, because it still ignores the specifications’ teaching that “[t]he *openings can be made from glass*” rather than merely accepting another material. Tr. (Madisetti) 702:8-703:5 (citing JX-0001 at 8:25-29). Being made from glass is not an “absence of material” or a “void into which other material can be placed.”

**C. Infringement**

The parties do not dispute the structure and operation of the Accused Products with respect to the Multi-Detector Patents. Despite requiring Masimo to devote significant time setting forth detailed infringement evidence for every element of each Asserted Claim at the hearing, Apple



disputes only two elements. To dispute those elements, Apple relies on the two improper constructions described above.

Notably, '648 Claim 12 does not recite “arranged over”/“positioned over”/“above,” and instead recites “aligned with.” Thus, Apple’s “arranged over”/“positioned over”/“above” construction and noninfringement arguments do not apply to this claim. If the ALJ were to adopt Apple’s construction of “openings” as meaning a “void into which other material can be placed,” Apple would infringe '648 Claim 12.

**1. Protrusions, Openings, or Through Holes “arranged over”/“positioned over”/“above” Interior Surface or Photodiodes**

**(Applies to:** '501 Claim 12 ([1C]); '502 Claims 22 ([19C]) and 28 ([28E]); '648 Claims 24 and 30 ([20C])

Masimo established that the Accused Products satisfy these elements. MasimoIPHB 54-57. They include a protrusion “arranged over the interior surface,” comprising a convex surface, as shown below.

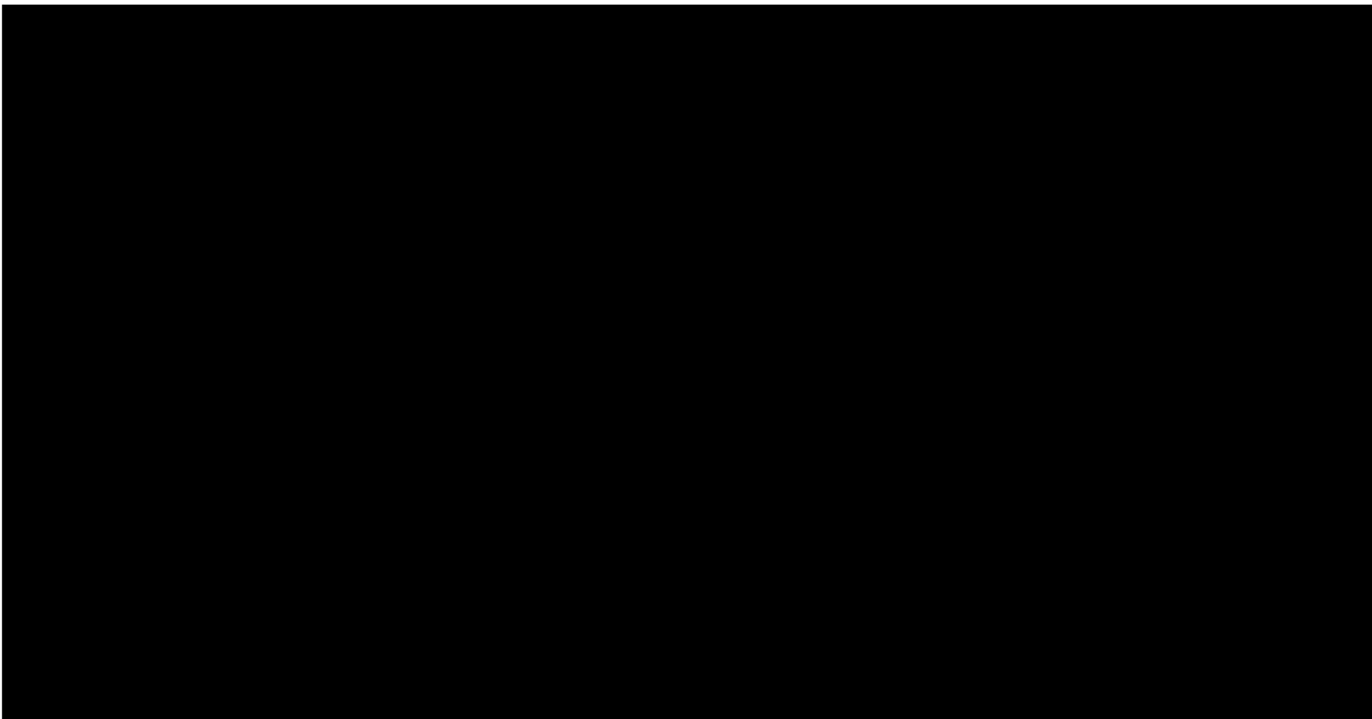



CDX-0011C.016 (citing CX-1646C at 4; CX-1548C at 3; CX-0063C at 1). Madisetti identified the protrusion with a red arrow and its convex surface with a dashed line. Tr. (Madisetti) 681:12-683:17. The Accused Products’ protrusion, openings, and through holes are “over” or “above” the interior surface or photodiodes. *Id.*

Apple argues the Accused Products measure oxygen saturation only when in a “face up” orientation with respect to Earth’s center. AppleIPHB 27-31. In the “face up” orientation, Apple argues the protrusion, openings, or through holes are *under*, not “over” or “above,” the interior surface or photodiodes. *Id.*

Apple’s claim that Masimo has not identified any evidence of measurement in a non-“face up” orientation (*Id.* at 31), ignores the first piece of evidence (CX-1451 (below)) cited in **every** infringement chart throughout this Investigation and identified by Madisetti at the hearing.

*'501 Patent Claim 12*  
**The Accused Products Satisfy [1 Preamble] – Undisputed**

**[1 Preamble]** 1. A user-worn device configured to non-invasively measure a physiological parameter of a user, the user-worn device comprising:



**Supporting Evidence:**

- CX-1451 (Series 6 Ad.) at 1:49 (left)
- CX-1406 (Apple webpage showing how to take oxygen saturation measurements with Accused Products)
- CPX-159 (Series 7)
- CX-1726 (Series 7 Technical Specifications) at 1 (confirming inclusion of Blood Oxygen feature)
- CX-0100C (Scandium ERS) at 3-8 (Accused Products calculate SpO2)
- CX-0281C (Block Depo.) at 71-72, 87, 177-178, 251 (confirming Accused Products are user-worn devices configured to non-invasively measure oxygen saturation)

CDX-0011C.013

CDX-0011C.013 (citing CX-1451).



The image on CDX-0011C.013 is merely one screenshot from the underlying evidence – Apple’s release video for the Series 6. CX-1451. The final scene asks consumers to imagine a future with a device using red and infrared light to measure your blood-oxygen level. CX-1451 at 1:28-2:06. As the video zooms to a spacecraft, it reveals astronauts wearing the Series 6:



*Id.* at 1:44. The video continues by showing the astronauts using the Series 6 to take a blood oxygen measurement:



*Id.* at 1:48. The video cuts back to astronauts holding up their wrists to show the results of this blood oxygen feature:



*Id.* at 1:50. The camera then twirls to show the astronauts as if they are in zero gravity:



*Id.* at 1:52. Neither Apple nor its engineers explained which direction would be “face up” in this context, conceivably because the notion is nonsensical. The relative relationship of the protrusion remains “over” the interior surface and photodiodes because, on a small, portable, wearable device, the relative positions of components are described with respect to one another, and not to the Earth.

Apple never argued this advertisement was inaccurate in its depiction of the Apple Watch. Apple clearly advertised users’ arms in multiple positions when measuring oxygen saturation. One is upside down relative to the other, and at least two of them are holding their wrists up.

Apple’s reliance on Waydo’s testimony in support of its strict “face up” orientation requirement is misplaced. AppleIPHB 29. Waydo testified “we restrict our measurements to when

[REDACTED]

the watch is *more or less* face up ....” Tr. (Waydo) 926:23-927:5. Apple also characterizes “face up” as a requirement based on the [REDACTED] (RX-0307C.004). AppleIPHB 29-30. But Waydo testified that document, like his earlier testimony, “really boils down to the watch being *more or less* level and face up, like so.” Tr. (Waydo) 929:5-11.

Regardless, whether the Accused Products can take blood oxygen measurements in other positions is of *no consequence* because, the terms “over”/“above” in the patent have no relationship with gravity. The Accused Products measure oxygen saturation with the protrusion “over”/“above” the interior surface or photodiodes when in a “face up” orientation. MasimoIPHB 54-57. They are configured as claimed irrespective of orientation when in use. *Id.* Under the proper construction, Apple has no noninfringement position.

Because Apple’s technical documents show the protrusion above the interior surface or photodiodes, Apple resorted to having Venugopal sketch the “relative layout” of Apple Watch components using Microsoft Paint. Tr. (Venugopal) 825:8-827:25; RDX-0004. Venugopal’s sketch is the only depiction of the Accused Products’ components offered to support Apple’s orientation-based argument. AppleIPHB 27-34. Resorting to this sketch confirms Apple’s construction of “over”/“above” is a manufactured noninfringement position inconsistent with the Multi-Detector Patents and Apple’s own descriptions of these components.

Apple also now criticizes Madisetti for allegedly treating the terms “over”/“above” indistinguishably. AppleIPHB 31-34. But because the Multi-Detector Patent claims and intrinsic record make no reference to gravity, the terms are indistinguishable.

Apple also contends “the words ‘over’ and ‘above’ played no role in [Madisetti’s] analysis.” *Id.* Apple’s incorrect contention is based on applying its erroneous construction to

[REDACTED]

Madisetti's testimony. Madisetti applied the meaning of the 'over' and 'above' terms precisely as they are used in the patents. MasimoIPHB 54-56. He also relied on Apple's own documents and testimony to support his opinion. *Id.* at 56-57.

Apple next argues Madisetti was unable to answer basic questions about the Accused Products' posture requirement. AppleIPHB 32. But Apple's "face up" orientation requirement is irrelevant to whether the Accused Products infringe Masimo's Multi-Detector Patents. Madisetti repeatedly explained the protrusion (which is part of the back crystal) of the Accused Products is "over the photodiodes" regardless of orientation. *See, e.g.*, Tr. (Madisetti) 700:9-23. The protrusion remains in that position when measuring oxygen saturation "face up." Thus, Apple is wrong about Madisetti offering "no opinion that Apple Watch at any time can satisfy all the limitations as necessary to show infringement." AppleIPHB 32.

In sum, Apple relies on an inferred, incorrect assumption that "over"/"above" somehow means "above" relative to gravity. Apple's argument is baseless.

**2. "Openings"/"Through Holes" that are "Through the Protrusion"**

**(Applies to: '501 Claim 12; '502 Claims 22 and 28; '648 Claims 12, 24, and 30)**

Masimo established the Accused Products satisfy these elements. MasimoIPHB 57-59. They include "a plurality of openings extending through the protrusion and positioned over the three photodiodes," as shown below.

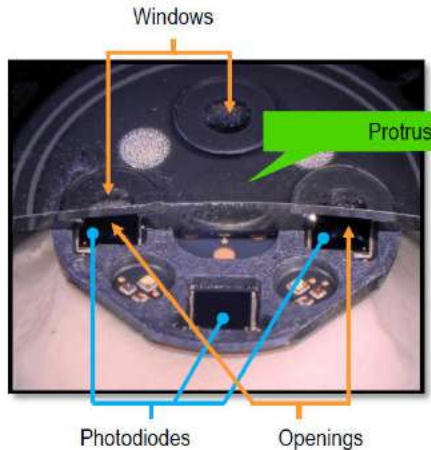

Series 6  
CX-1646C

Series 7  
CX-1548C

Series 7  
CX-26C

CDX-0011C.017 (citing CX-1646C at 4; CX-1548C at 3; CX-0026C at 8, 31; CX-0063C; CX-0189C); CX-0190C–CX-0192C.

Apple now misleadingly argues that Madisetti identified “a gap between the photodiodes and the alleged protrusion ... as the openings.” AppleIPHB 34. Masimo does not contend such gaps are openings as claimed. Rather, the openings are the holes extending through the protrusion to allow light to reach the photodiodes. MasimoIPHB 57-59. As Madisetti explained, the openings “*extend through*” the protrusion. Tr. (Madisetti) 682:12-683:9. Madisetti even quoted Block’s testimony explaining [REDACTED] and unambiguously stated [REDACTED]

[REDACTED] *Id.* at 683:7-9.

According to Apple, the Accused Products do not infringe because Apple [REDACTED] [REDACTED] AppleIPHB 36.<sup>5</sup> But, the patents describe “openings” as allowing the passage of *light*. MasimoIPHB 49-53. Thus, the presence of [REDACTED]

<sup>5</sup> Apple improperly relies on undesignated Block deposition testimony to argue the Accused Products’ protrusion has openings until the [REDACTED] are added. AppleIPHB 35-36 (relying on 246:13-23 and 255:3-11, which are not in evidence). Regardless, the Accused Products have openings as claimed, as explained herein.



[REDACTED]

[REDACTED] does not remove the openings. The Accused Products include “openings” because, as Warren admitted, photodiodes “can’t detect *light* without some sort of *opening* above it.” Tr. (Warren) 1193:5-6. There is no dispute the detectors within the Accused Products detect light received after attenuation by a user’s tissue. AppleIPHB 34-39. That light passes through the [REDACTED] in the Accused Apple Watches. MasimoIPHB 57-59.

In sum, under Masimo’s construction or Apple’s “new construction,” the Accused Products include “openings”/“through holes” extending through the protrusion allowing light to reach each photodiode.

**D. Domestic Industry – “Technical Prong”**

Apple’s technical prong challenge to Masimo Watch relies on two errors. First, Apple mischaracterizes the evidence to present a false narrative that [REDACTED]. Second, Apple and its expert ignore the actual evidence, such as the testimony of Masimo’s witnesses and contemporaneous documents that contradict Apple’s false narrative.

Contrary to Apple’s argument, AppleIPHB 41, the undisputed evidence established [REDACTED] Apple erroneously states the date of the First Amended Complaint throughout its brief as July 7, 2021. AppleIPHB 6, 21, 42, 174, 249, 266. The ITC accorded the First Amended Complaint a filing date of July 12, 2021. Doc. ID 747137 at 1 (“The Commission has received an amended complaint ... filed on behalf of Masimo Corporation and Cercacor Laboratories, Inc. on July 12, 2021.”). At the hearing, Apple’s counsel falsely represented the filing date to a witness in an attempt to “prove” [REDACTED]

[REDACTED]

Q. And the question to you at your deposition was: Masimo has indicated that

[REDACTED]

Q. And I'll represent to you the complaint in this case was filed on July 7<sup>th</sup>, and you would agree with me that July 9<sup>th</sup> is later than July 7<sup>th</sup>, right?

A. Yes, July 9<sup>th</sup> is later than July 7<sup>th</sup>.

Tr. (Scruggs) 457:16-25; *id.* at 460:23-461:16 (Apple's counsel again "establishing" July 9, 2021 is after July 7, 2021). But, Apple's representation to the witness was incorrect.

Scruggs confirmed Masimo [REDACTED]

[REDACTED] Tr. (Scruggs) 396:10-11 ([REDACTED]), 397:24 ([REDACTED]), 398:20-23 ([REDACTED]). Al-Ali testified similarly. Tr. (Al-Ali) 315:16-19 (testifying [REDACTED]). Thus,

[REDACTED] And the evidence showed that the W1 had [REDACTED] related to the Asserted Patent Claims. *Supra* Section I.E.1.a.

Masimo's witnesses also testified regarding the design, development and manufacturing efforts in the U.S. leading to the W1. Tr. (Muhsin) 342:25-343:7, 344:14-19, 345:2-7; Tr. (Scruggs) 393:12-20, 402:2-12. And as noted repeatedly throughout this Investigation, Apple ignores that Masimo has pled both that a domestic industry exists and/or is in the process of being established. Compl. ¶86.

Apple deepens its error by ignoring the evidence regarding the Masimo Watches. For example, Apple argues there is insufficient evidence the Masimo Watches calculate oxygen saturation. But, Apple and its experts ignore Masimo's evidence showing medically accurate measurements, including [REDACTED]

[REDACTED]

[REDACTED]

[REDACTED] Tr. (Al-Ali) 262:7-263:10, 264:6-264:13, 268:22-271:18, 272:16-278:13, 313:14-318:22; CX-0378C; CX-0433C; CX-0370C; CX-0494C.<sup>6</sup>

The undisputed evidence showed that the Masimo Watches indeed calculate oxygen saturation, very accurately. MasimoIPHB 86-87, 99-101. Apple falsely represents that the only demonstrations of record were those done for or by Apple’s experts, but CX-0836C contains the results of Scruggs’ demonstrations for Madisetti confirming the devices were still calculating oxygen saturation. Notably, Apple’s experts never affirmatively opine that [REDACTED]

[REDACTED]

[REDACTED]

[REDACTED] Apple continues to ignore [REDACTED]

[REDACTED]

---

<sup>6</sup> Apple apparently claims it is implausible that Masimo—the world’s best-in-class pulse oximetry provider whose products are used on over 200 million patients a year and whom Apple wanted to mine for its technology—could successfully measure oxygen saturation continuously at the wrist. Perhaps that is because Apple failed to achieve reasonable accuracy despite (1) hiring many engineers from Masimo, (2) hiring a 20-year veteran of pulse oximetry design from Nellcor to replace Dr. Lamego, (3) having an army of “Ph.D.s” dedicated to the project, and (4) employing a team who spent [REDACTED]



CX-0378C at 32; *see also* CX-0494C; Tr. (Al-Ali) 272:16-277:13, 315:16-317:20.

Thus, Apple presents no evidence to rebut Masimo’s showing on the functionality and operation of the Masimo Watches. Apple also challenges several claim features because its experts could not “visually” confirm the presence of the elements inside the watch. But, this ignores the testimony and extensive corroborating documents exhibiting these features.

**1. Domestic Industry Articles** [redacted]

Masimo relies on [redacted] and W1 for the Multi-Detector Patent claims. The un rebutted evidence shows that [redacted] (CPX-0052C), [redacted] (CPX-0019C), [redacted] (CPX-0058C), and [redacted] (CPX-0065C) [redacted], and that [redacted] (CPX-0020C) and the W1 [redacted]

Apple attempts to challenge Masimo’s evidence of [redacted] (CPX-0052C) due to a [redacted] [redacted] AppleIPHB 174. But Scruggs explained [redacted]



[redacted] Tr. (Scruggs) 476:10-477:1. Al-Ali testified watches with [redacted]

[redacted] Tr. (Al-Ali) 261:20-262:25, 263:6-13. This evidence confirms [redacted]

[redacted] Moreover, [redacted]

[REDACTED]

[REDACTED]. [REDACTED]

[REDACTED]

[REDACTED] Tr. (Al-Ali) 264:10-265:14; Tr. (Scruggs) 396:2-13

( [REDACTED] ). Apple

cites no authority for its opinion that testimony from witnesses with firsthand knowledge of the

Masimo Watches needs to be “corroborated” to show the Masimo Watches [REDACTED]

[REDACTED] AppleIPHB 43. Regardless, Al-Ali not only testified [REDACTED]

[REDACTED] CX-0378C; CX-0494C. Apple

simply ignores this contemporaneous documentary evidence.

Apple also attempts to challenge [REDACTED] and [REDACTED] based on [REDACTED]

[REDACTED] But Apple cites no authority for its argument that [REDACTED]

[REDACTED] And Apple ignores the testimony from

Masimo’s witnesses that [REDACTED]

[REDACTED] Tr. (Muhsin) 346:6-16; (Scruggs) 476:1-4.

[REDACTED]

[REDACTED] Tr. (Scruggs) 475:16-25 (testifying [REDACTED]

[REDACTED]

[REDACTED]. The particular sample

of [REDACTED]

[REDACTED] Tr. (Scruggs) 476:1-4 ([REDACTED]

[REDACTED]

[REDACTED]). Apple had full access to [REDACTED]

[REDACTED]

[REDACTED]

[REDACTED] Apple's own brief acknowledges the "known date" [REDACTED] AppleIPHB 42. In view of this record, Apple cannot rebut this evidence by ignoring these watches in the technical prong analysis.

Apple relies on Madisetti's testimony as acknowledging that [REDACTED] [REDACTED] to argue that CPX-0146C is not representative of CPX-0157C and CPX-0155C. AppleIPHB 42 n.14. Masimo addressed this issue at the hearing, where the ALJ overruled Apple's objection to reliance on W1 watches other than CPX-0146C. Tr. (Madisetti) 704:2-708:12. Masimo's engineers confirmed that all W1 watches calculate oxygen saturation. Tr. (Muhsin) 346:6-347:1; Tr. (Scruggs) 393:9:20.

**2. Masimo Watch Products Practice the Multi-Detector Patent Claims**

**a. [REDACTED] are "User-Worn Devices" as required by '501 [1PRE] and [12]**

Apple argues [REDACTED] (CPX-0052C) and [REDACTED] (CPX-0058C) are not "user worn device[s]" [REDACTED] AppleIPHB 45. But again, this argument ignores the evidence. Both [REDACTED] and [REDACTED] [REDACTED] MasimoIPHB 89. Apple's criticism of Madisetti's request to view CPX-0052C prior to answering a cross-examination question regarding that specific physical exhibit in no way calls "into question the totality of his opinions." AppleIPHB 46. Rather, this request reflects a reasonable request from a sincere expert attempting to understand a very specific question from counsel about one specific physical among the many on which he provided opinions.

Apple cites no support for its theory that [REDACTED] [REDACTED] Undisputed testimony

[REDACTED]

confirms [REDACTED]

[REDACTED] Tr. (Scruggs) 405:8-406:3, 406:23-407:18.

- b. W1, [REDACTED] measure oxygen saturation and include “one or more processors configured” to calculate oxygen saturation as required by ’501 [1PRE], [1F]

Masimo’s fact witnesses repeatedly testified regarding the ability of the W1, [REDACTED]

[REDACTED] to calculate oxygen saturation [REDACTED] MasimoIPHB 86-87.

This included: (1) testimony from Scruggs regarding [REDACTED]

[REDACTED] (2) testimony from Muhsin regarding [REDACTED]

[REDACTED] and (3) Al-Ali’s testimony regarding the ability of the devices to calculate oxygen saturation, which was confirmed by [REDACTED]

[REDACTED] *Id.* Masimo witnesses also provided testimony corroborated by documents regarding [REDACTED] *Id.*

at 100-101. Neither Apple nor its expert addressed any of this evidence at the hearing, and Apple continues to ignore it in briefing.

Instead, Apple argues Masimo [REDACTED] AppleIPHB

47. But [REDACTED]

[REDACTED] Apple’s experts also do not contend [REDACTED]

[REDACTED] Instead, they merely criticize [REDACTED]

[REDACTED] *Id.* But, Apple ignores [REDACTED]

---

<sup>7</sup> Apple relies on Sarrafzadeh to argue [REDACTED] AppleIPHB 47-48, 176 n.28. But Sarrafzadeh’s criticism at best points out a typo in Madisetti’s report, which Madisetti explained during his deposition and Masimo corrected. *See* Doc. ID 769464 at 4, 15. Regardless, as explained in Section I.E.1, Masimo’s witnesses explained [REDACTED]

[REDACTED]

[REDACTED] Tr. (Muhsin) 345:21-346:2 [REDACTED]

[REDACTED]

[REDACTED] *see also* Tr.

(Al-Ali) 315:16-23 [REDACTED] The evidence

shows the Masimo Watches calculate the oxygen saturation of the user.<sup>8</sup>

Apple erroneously states only Apple’s experts observed demonstrations of these Masimo Watches. AppleIPHB 48. But Madisetti also observed demonstrations of the devices, as did Apple’s counsel. *See, e.g.*, MasimoIPHB 86-87. Apple’s criticism that Madisetti did not review the Masimo Watches in person, AppleIPHB 48, is misplaced. Madisetti attended the demonstrations remotely—similar to most depositions and all hearings in this Investigation—and the demonstrations were photographed and presented as evidence. Although Apple raises [REDACTED]

[REDACTED], such testimony at best relates to accuracy, which Apple’s counsel represented is not at issue in this proceeding.<sup>9</sup> Tr. at 295:9-14.

Moreover, the results [REDACTED]

[REDACTED]

[REDACTED] MasimoIPHB 85.

<sup>8</sup> Apple criticizes Madisetti for not reviewing [REDACTED], AppleIPHB 48, [REDACTED]

[REDACTED] Tr. (Al-Ali) 264:10-265:14; Tr. (Scruggs) 396:2-13, 405:8-406:22, 462:11-15

[REDACTED] Apple also criticizes Madisetti because AppleIPHB 47 n.17. But Muhsin [REDACTED]

[REDACTED] Tr. (Muhsin) 351:17-352:16.

<sup>9</sup> Apple’s reliance on observations of CPX-0021C and CPX-0029C, which were not analyzed under the asserted claims of the Multi-Detector Patents, are irrelevant to whether W1, [REDACTED] calculate oxygen saturation.



- [REDACTED]
- c. W1, [REDACTED] include “at least three photodiodes arranged on an interior surface” and “opaque lateral surfaces configured to avoid light piping” as required by ’501 [1B], [1E]

For numerous claim elements, Apple contends the Masimo Watches fail to meet these elements because Warren was “unable to confirm from a visual inspection” that the articles practiced the elements. *See, e.g.*, AppleIPHB 53. Apple ignores the substantial evidence presented by Masimo regarding these claim elements in the form of testimony and corroborating contemporaneous documents. MasimoIPHB 91-92, 96-99.

Apple’s contention that [REDACTED], AppleIPHB 52-53,<sup>10</sup> ignores Scruggs’ and Al-Ali’s sworn testimony that [REDACTED]. As Scruggs testified at the hearing [REDACTED]. Tr. (Scruggs) 467:2-7; 477:9-478:8. As Al-Ali testified, [REDACTED]. Tr. (Al-Ali) 313:14-314:7; CX-1634C. The testimony and supporting documents prove well beyond a preponderance of the evidence that the Masimo Watches meet these elements. Apple ignoring this evidence does not make it go away.

Apple also ignores [REDACTED] CX-0680C. Muhsin testified this video showed the [REDACTED]. Tr. (Muhsin) 358:14-23.

---

<sup>10</sup> In illustrating the [REDACTED] Apple cites testimony that is not part of the record. *Compare* AppleIPHB 53 (citing RX-1209C [Scruggs Jan. 6 Dep. Tr.] at 130:10-132:2; *id.* at 143:1-23 with RX-1209C).

[REDACTED]

CX-0680C at 0:01:46. This shows the “at least three photodiodes” recited in the claim [REDACTED]

[REDACTED] Yet, Warren still incredibly testified there was no evidence supporting such elements. Tr. (Warren) 1259:9-20.

d. [REDACTED] is a “user worn device” with “a strap configured to position the user-worn device on the user” as required by ’502 [28PRE] and [28M]

[REDACTED] meets elements ’502 [28PRE] and [28M] for the reasons stated in Section IV.D.2.a, *supra*, and for the reasons stated in Masimo’s Initial Brief. MasimoIPHB 102, 112.

e. W1, [REDACTED] measure oxygen saturation and include “one or more processors configured” to calculate oxygen saturation as required by ’502 [28PRE] and [28I]

W1, [REDACTED] meet elements ’502 [28PRE] and [28I] for the reasons stated in Section IV.D.2.b, *supra*.

f. W1, [REDACTED] include the LEDs required by ’502 [28A] and [28B], the photodiodes required by ’502 [28C], the thermistor required by ’502 [28D], and the storage device required by [28L]

Apple again challenges elements on the basis that its expert could not visually confirm them. This challenge falls short for the reasons set forth in Section IV.D.2.c, *supra*, and for the reasons stated in Masimo’s Initial Brief. MasimoIPHB 103-106, 111.

- [REDACTED]
- [REDACTED]
- g. [REDACTED] are “user worn devices” with “a strap configured to position the housing proximate the tissue of the user when the device is worn” as required by ’648 [8PRE], [20PRE] and [8I]

[REDACTED] meet elements ’648 [8PRE], [20PRE], and [8I] for the reasons stated in Section IV.D.2.b, *supra*. Although [REDACTED] [REDACTED] Tr. (Scruggs) 405:8-406:3, 406:23-407:18.

- h. W1, [REDACTED] are configured to non-invasively determine oxygen saturation, have “processors configured to “output measurements of a physiological parameter,” and “determine measurements of oxygen saturation” as required by ’648 [8PRE], [20PRE], [8G] and [20E]

W1, [REDACTED] meet elements ’648 [8PRE], [20PRE], [8G], and [20E] for the reasons stated in Section IV.D.2.b, *supra*.

- i. W1, [REDACTED] include the LEDs and photodiodes required by ’648 [8A], [8B], [8C] and 20[B]

Apple again challenges elements on the basis that its expert could not visually confirm them. This challenge falls short for the reasons set forth in Section IV.D.2.c, *supra*, and for the reasons stated in Masimo’s Initial Brief. MasimoIPHB 112-113, 115-116.

#### **E. Validity**

Apple’s validity analysis improperly treats the features of the Multi-Detector Patent claims as isolated pieces that could be plucked and reassembled from the prior art. Masimo’s IPHB explained that Apple failed to not only find all the pieces despite its extensive prior art searching, but also to find any reason or motivation to combine what it found. Apple’s own contemporaneous documents, testimony from its witness, and the Apple Watch development timeline contradict any reasonable expectation of success in the proposed hindsight combinations. Apple’s IPHB exposed those deficiencies and revealed additional flaws.

[REDACTED]

Apple relied on Lumidigm for all its prior art grounds. But Lumidigm lacks many claimed elements. As Masimo explained in its IPHB, Apple called Lumidigm’s self-described “key”/“primary inventor,” Robert Rowe, as a witness. But Apple promptly excused Rowe when he did not supplement the specification in the manner Apple apparently hoped.

After attempting to rewrite Lumidigm, Apple turned to its expert, Warren. He alleges that a POSITA would have known about many claim elements missing from Lumidigm. But Warren failed to support his allegations with contemporaneous evidence. He supplied no reason to piece together the elements he asserted would have been obvious. Warren’s approach is improper hindsight. *In re NTP, Inc.*, 654 F.3d 1279, 1298-99 (Fed. Cir. 2011). Warren also set forth inconsistent opinions when it comes to specification support in the Multi-Detector Patents: he claimed various features were well-known to a POSITA for purposes of his prior art analysis, yet contended the Multi-Detector Patents’ specification should have provided more details about these same features when he opined on written description and enablement.

**1. Apple’s Hindsight “State of the Art” Arguments Cannot Prove Invalidity**

Apple’s “State of the Art” arguments contradict its representations to the ALJ regarding background references. Before the hearing, Apple represented to the ALJ “that the additional prior art references identified in its prehearing brief will not be relied upon as grounds for anticipation or obviousness ....” Doc. ID 772058 (Order No. 40) at 1-2. Yet, Apple reneged on that promise.

Apple relies on its “State of the Art” references as supposedly showing specific elements of the claims, as part of its “Anticipation/Obviousness” section. AppleIPHB 56-67. For example, Apple compares McCarthy, Smart, and other “State of the Art” references to specific claimed features as the first argument in Apple’s Post-Hearing Brief. *Id.* at 22 (“It would have been obvious to a POSITA that these elements *could be combined* into a single device in the manner claimed

[REDACTED]

...”); *see, e.g., id.* at 104 (citing Warren testimony referring to Smart as teaching a protrusion comprising a convex surface). And for the “background” references that were mentioned at the hearing, Warren provided only conclusory testimony. Tr. (Warren) 1190:5-1195:22. The ALJ should reject Apple’s attempt to use these references to show elements of the claims.

Apple’s “State of the Art” arguments also theorize what a device “could include” if multiple references were combined. AppleIPHB 57-67. But Apple invites error, because it cannot establish obviousness based on a field of prior art devices that could be hypothetically combined. *See, e.g., Personal Web Techs., LLC v. Apple, Inc.*, 917 F.3d 1376, 1380 (Fed. Cir. 2019) (remanding obviousness finding where Apple “said nothing more than that the two references could be combined”); *Adidas AG v. Nike, Inc.*, 963 F.3d 1355, 1359 (Fed. Cir. 2020) (obviousness analysis asks what a POSITA would have been motivated to do, not what “could” be done). Regardless, these “State of the Art” references, alone or in combination, fail to show the claimed features.

## **2. Anticipation/Obviousness**

Apple’s significant mischaracterizations, omissions, and flaws in its IPHB confirm it failed to establish clear and convincing evidence of invalidity.

### **a. Ground 1: Lumidigm Does Not Anticipate or Render Obvious Any Asserted Claim**

Apple cannot reasonably dispute that Lumidigm fails to explicitly disclose many elements for the reasons Masimo has shown. MasimoIPHB 123-143. Apple nevertheless continues to argue anticipation, presumably to evade the significant objective evidence of nonobviousness. AppleIPHB 67-103. But Apple failed to show that Lumidigm anticipates or renders obvious any Asserted Claim.

[REDACTED]

[REDACTED]

**i. Lumidigm Fails to Disclose All the Elements as Arranged in the Claim**

To anticipate, prior art “must not only disclose all elements of the claim within the four corners of the document, but also must teach those elements ‘as arranged in the claim.’” *Net MoneyIN, Inc. v. VeriSign, Inc.*, 545 F.3d 1359, 1369 (Fed. Cir. 2008) (quoting *Connell v. Sears, Roebuck & Co.*, 722 F.2d 1542, 1548 (Fed. Cir. 1983)). Apple strays well beyond Lumidigm’s four corners.<sup>11</sup> In *over forty instances*, Apple relies on Warren to improperly fill the gaps in Lumidigm based on what a POSITA allegedly “would have understood.” See e.g., AppleIPHB 67-103; see, e.g., *Scripps Clinic & Research Found. v. Genentech, Inc.*, 927 F.2d 1565, 1576 (Fed. Cir. 1991) (using extrinsic evidence “to fill gaps in the reference” is impermissible (cleaned up)); *W.L. Gore & Assocs., Inc. v. Garlock, Inc.*, 721 F.2d 1540, 1554 (Fed. Cir. 1983) (finding expert testimony cannot overcome reference’s shortcomings). Warren’s repeated references to what a POSITA would have understood for missing elements, rather than what Lumidigm actually discloses within its four corners, confirms Lumidigm’s failure to anticipate.

For anticipation, features not explicitly disclosed must be “‘necessarily present,’ not merely probably or possibly present,” such that they are inherently disclosed. *Guangdong Alison Hi-Tech Co. v. Int’l Trade Comm’n*, 936 F.3d 1353, 1364 (Fed. Cir. 2019) (internal citations omitted). Apple repeatedly argues Lumidigm “can” or “could” or “should” include various features, which fails to show inherent disclosure. AppleIPHB 67-103. And Apple does not contend—much less provide any testimony—that the features not expressly disclosed in Lumidigm are necessarily

---

<sup>11</sup> When Apple asserted Lumidigm expressly disclosed a feature, it used “explains” (AppleIPHB 70, 75, 80, 84), “teaches” (*id.* at 71), “discloses” (*id.* at 72-74, 78-80, 82-83, 85-86) “expressly states” (*id.* at 76), or “expressly confirms” (*id.* at 77, 83).



present. *Id.* at 70-103. Instead, Apple invites error by ignoring the inherency requirement. Lumidigm fails to expressly or inherently disclose numerous elements, and thus fails to anticipate.

Lumidigm does not disclose or suggest at least the following features:

**Lumidigm Does Not Disclose or Suggest At Least the Following Claim Features/Elements**

- ✘ NO protrusion comprising a convex surface
- ✘ NO protrusion over/above an interior surface
- ✘ NO photodiodes disclosed
- ✘ NO "openings" or "through holes" in protrusion, or windows in openings
- ✘ NO disclosure of SpO<sub>2</sub> calculations or measurements
- ✘ NO cavities as claimed
- ✘ NO opaque lateral surface or opaque material configured to avoid or reduce light piping
- ✘ NO thermistor, adjustment responsive to temp.
- ✘ References hemoglobin or "oxygen levels in the blood" as "extended functionality"

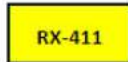
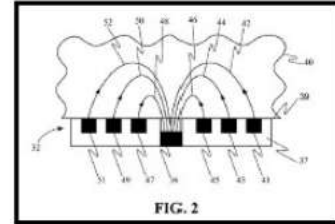

Tr. (Madisetti) 1329:14-1332:24; CDX-0012C.009; MasimoIPHB 123-143. Rather than trying to show where Lumidigm allegedly discloses these missing elements, Apple focuses on what a POSITA allegedly would have understood, or speculated about what the sensor “can” include, for features in every Asserted Claim:

<b>Claimed Feature Not Taught By Lumidigm</b>	<b>Applies to:</b>	<b>Apple’s Argument that “a POSITA would have understood”:</b>	<b>Apple IPHB</b>
protrusion comprising a convex surface	’501 [1C], [12] ’502 [19C], [28E] ’648 [8D], [20C]	that when the sensor has a “compound curvature on the optical surface” (i.e., the surface directly in contact with the user’s tissue), it has a protrusion; the benefits of including a convex protrusion to improve signal quality	75



Claimed Feature Not Taught By Lumidigm	Applies to:	Apple's Argument that "a POSITA <i>would have understood</i> ":	Apple IPHB
protrusion over/above an interior surface	'501 [1C] '502 [28E]	that when the sensor has a "compound curvature on the optical surface" ... it has a protrusion, with a convex surface, arranged over the interior surface holding the detectors	75
photodiodes	'501 [1C] '502 [28E]	a detector made of InGaAs or silicon <i>would be</i> a photodiode	72
"openings" or "through holes" in protrusion, or windows in openings	'501 [1D] '502 [19C+19D], [28F+28G] '648 [8E], [20D+20E]	the sensor <i>can include</i> a plurality of detectors, such as shown in Figure 6, and that for the embodiments with three or more photodiodes, the protrusion <i>would include</i> an opening positioned over each photodiode	76
SpO <sub>2</sub> or physiological parameter calculations or measurements	'501 [1PRE], [1F] '502 [19PRE], [19E], [28PRE], [28I] '648 [8G], [12], [20E]	Lumidigm's "computational devices" include one or more processors configured to use signals to output measurements of physiological parameters and that the processors <i>could be</i> implemented in a separate reader or integrated onto the same device	86
cavities as claimed	'502 [28H]	there <i>would be</i> opaque walls between the interior surface of the sensor and the protrusion, thereby forming cavities or recesses where the respective photodiodes are located	93-94
opaque lateral surface or opaque material configured to avoid or reduce light piping	'501 [1E] '502 [28F] '648 [24]	openings made of opaque material over each detector avoid light piping through the protrusion ( <i>i.e.</i> , light traveling from the LEDs to the photodiodes without first passing through the user's tissue)	77
thermistor; adjustment responsive to temperature	'502 [20]-[21], [28D], [28I]	adjusting operations based on temperature requires, in addition to the thermistor, one or more processors to receive the temperature signal from the thermistor and to adjust operation of the sensor responsive to the temperature signal	87





Further, “anticipation requires that a single reference ‘describe the claimed invention with sufficient precision and detail to establish that the subject matter *existed* in the prior art.’” *Wasica Fin. GmbH v. Cont’l Auto. Sys., Inc.*, 853 F.3d 1272, 1284 (Fed. Cir. 2017) (quoting *Verve, LLC v. Crane Cams, Inc.*, 311 F.3d 1116, 1120 (Fed. Cir. 2002)). If a reference is “ambiguous as to whether it discloses the pertinent features,” it does not anticipate. *Id.*

Lumidigm fails to describe the features listed in the chart above, or render obvious any asserted Multi-Detector Patent claim for the reasons set forth below.

**ii. Lumidigm Does Not Disclose or Suggest Many Claim Elements or Render Obvious Any Asserted Claim**

Ground 1 fails because Lumidigm does not disclose or suggest any of the following claim elements:

<b>Element</b>	<b>Applies to:</b>	<b>MasimoIPHB (Explaining Lumidigm’s Deficiencies)</b>
User-Worn Device Configured to Calculate, Determine, or Output Measurements of Physiological Parameters/SpO <sub>2</sub>	’501 [1PRE] ’502 [19PRE], [28PRE] ’648 [12]	124-129
Three or More Photodiodes	’501 [1B] ’502 [19B], [28C] ’648 [8C], [20B]	129-130
Protrusion Comprising a Convex Surface	’501 [1C], [12] ’502 [19C], [28E] ’648 [8D], [20C]	130-136
Protrusion Over or Above an Interior Surface	’501 [1B], [1C] ’502 [28C], [28E]	136-138
Protrusion “Openings”/“Through Holes” or “Windows”/“Optically Transparent Material” Therein	’501 [1D] ’502 [19C+19D], [28F+28G] ’648 [8E], [20D+20E]	138-139
Opaque Lateral Surface or Opaque Material Configured to Avoid or Reduce Light Piping	’501 [1E] ’502 [28F] ’648 [24]	139-140



<b>Element</b>	<b>Applies to:</b>	<b>MasimoIPHB (Explaining Lumidigm’s Deficiencies)</b>
“One or More Processors” Configured to Make Measurements of Physiological Parameters/SpO <sub>2</sub>	’501 [1F] ’502 [19E], [28I] ’648 [8G], [20E]	124-129
Thermistor or Adjusting Device Operation Responsive to Temperature	’502 [20]-[21], [28D], [28I]	140
Cavities	’502 [28H]	141
Network Interface or Storage Device Configured As Claimed	’502 [28J], [28L]	141-142
User Interface Comprising Touch-Screen, Configured As Claimed	’502 [28K]	141-142
Protrusion Further Comprising One or More Chamfered Edges	’648 [30]	142-143

Accordingly, Lumidigm fails to anticipate any Asserted Claim. Apple also fails to establish obviousness based on Lumidigm alone. Because Lumidigm does not disclose or suggest the above elements, Apple failed to meet its “burden to prove that all claimed limitations are disclosed in the prior art” and thus failed to establish obviousness based on Ground 1. *Par Pharm., Inc. v. TWI Pharms., Inc.*, 773 F.3d 1186, 1194 (Fed. Cir. 2014).

Ground 1 also fails to anticipate or render obvious any claim for the reasons discussed below.

(a) **User-Worn Device Configured to Calculate, Determine, or Output Measurements of Physiological Parameters/SpO<sub>2</sub>**

**(Applies to: ’501 [1PRE]; ’502 [19PRE], [28PRE]; ’648 [12])**

Apple relies on a combination of Lumidigm’s FIG. 8B wristwatch and a separate embodiment in its “extended functionality” section mentioning a “hemoglobin monitor” for these elements. *See, e.g.*, AppleIPHB 70-71, 79-80. But Lumidigm fails to explicitly or inherently

[REDACTED]

disclose or suggest a user-worn device as claimed for several reasons, including because nothing links these disparate embodiments. MasimoIPHB 124-129. Apple now misleadingly cites Warren’s testimony to argue that “Lumidigm’s sensor” uses signals to measure oxygenation and/or hemoglobin levels. AppleIPHB 70 (citing Tr. (Warren) 1208:1-13, 1214:12-1215:4). But Warren said nothing about oxygenation or hemoglobin in the cited testimony. Rather, he addressed “sensor geometries.” Apple also acknowledges that Lumidigm refers to the watch embodiment and extended functionality as separate embodiments. AppleIPHB 70, 79-80. Apple resorts to inserting the key language “pulse oximetry functionality” in brackets in its quote from Warren because neither Warren nor Lumidigm used that phrase. *Id.*

Apple’s challenge to Masimo’s domestic industry technical prong evidence further exposes the deficiency in Lumidigm’s passing mention of oxygenation or hemoglobin. As explained above, Apple argues Masimo failed to show the W1 measures oxygen saturation at the wrist and criticized Masimo’s evidence. AppleIPHB 46-54. That evidence includes the repeated [REDACTED] [REDACTED] *Supra* Sections IV.D-IV.D.1. Apple and Warren claim that is not enough when it came to evidence for the domestic industry products.

Yet when it comes to claim coverage for Lumidigm, Apple and Warren’s demands disappeared. For invalidity, Apple argues “receiving and processing signals from the photodiodes and calculating physiological measurements” would have been known to a POSITA. AppleIPHB 78. Warren did not rely on any oxygen saturation measurements for his Lumidigm analysis because there was none. As Rowe explained, [REDACTED] [REDACTED] Despite these shortcomings, Apple and Warren contend

[REDACTED]

Lumidigm anticipated or rendered obvious the Asserted Claims. Apple's and Warren's inconsistent positions on domestic industry and validity expose their lack of credibility.

(b) **Three or More Photodiodes**

**(Applies to: '501 [1B]; '502 [19B], [28C]; '648 [8C], [20B])**

Apple relies on a combination of the FIG. 8B wristwatch, the detectors of the FIGS. 6-7 embodiments, and the recessed detector embodiment of FIG. 2 for the claimed "photodiodes." *See, e.g.,* AppleIPHB 72-74. But Lumidigm fails to disclose three or more photodiodes in a wristwatch. MasimoIPHB 129-130. Apple now also relies on Warren's testimony to argue that "[a] POSITA would have understood that" different embodiments with multiple detectors "would be similarly arranged" to FIG. 2. AppleIPHB 74 (citing Tr. (Warren) 1209:19-1210:11). But Apple overstates Warren's testimony, which merely reiterated the claim language and discussed FIG. 2. It is undisputed that FIG. 2 shows only a single detector. Warren described the "center photodiode" and "the detector," but said nothing about three or more photodiodes. Tr. (Warren) 1209:19-1210:11.

(c) **"Protrusion Comprising a Convex Surface"**

**(Applies to: '501 [1C], [12]; '502 [19C], [28E]; '648 [8D], [20C])**

Lumidigm fails to disclose or suggest a protrusion comprising a convex surface. MasimoIPHB 130-132. Apple relies on a combination of the FIG. 8B wristwatch, the "flat sensor head" of the FIG. 2 embodiment, an optional "compound curvature on the optical surface" of the FIG. 2 embodiment, and the "optical relay (not shown)" of yet another embodiment for protrusion comprising a convex surface. AppleIPHB 69, 74-75. But nothing links those separate embodiments. MasimoIPHB 125, 132.

[REDACTED]

Furthermore, and without the support of its expert, Apple simply presumes a “compound curvature” that is ergonomic and “allow[s] for good ... coupling” would be convex and applied to the sensor surface 39 of the FIG. 2 sensor head. AppleIPHB 74-75. But Apple failed to establish either point. MasimoIPHB 130-134.

Madisetti explained the compound curvature in Lumidigm describes what is more likely a *concave* surface. Tr. (Madisetti) 1331:20-1332:8, 1339:5-7. Rowe confirmed the “compound curvature” referred to a concave surface. CX-0279C (Rowe) 69:8-21. Apple’s attorney argument contradicts the record, and Warren contradicts Lumidigm’s inventor Rowe. Tr. (Warren) 1211:6-8. At best, these contradictions would only establish an ambiguity in Lumidigm’s specification, and show that Lumidigm fails to anticipate. *See, e.g., Wasica*, 853 F.3d at 1284 (“[A]mbiguous references do not, as a matter of law, anticipate a claim.”).

Moreover, Lumidigm discloses the reason for a compound curvature is to match the profile of the device, to incorporate ergonomic features allowing for good optical and mechanical coupling with the tissue being measured, or for other technical or stylistic reasons. RX-0411 at 7:57-63. Nowhere does Lumidigm disclose that the compound curvature is any protrusion, much less a convex protrusion. Warren’s testimony contradicts Lumidigm and its inventor’s explanation.

**(d) Protrusion Over/Above an “Interior Surface”**

**(Applies to: ’501 [1B], [1C]; ’502 [28C], [28E])**

Apple’s arguments regarding an “interior surface” in Lumidigm (AppleIPHB 73-74) were not included in its Pre-Hearing Brief (*see* Apple PHB 47-49) and thus are waived per G.R. 9.2.

The arguments are also wrong. Apple relies on a combination of the FIG. 8B wristwatch with an Apple-modified version of FIG. 2 for an “interior surface.” *Id.* at 69, 73-74. However,

[REDACTED]

Apple still does not identify what it or Warren contends is the interior surface of Lumidigm. At the hearing, Warren failed to identify any “interior surface” in Lumidigm at all, much less an interior surface on which three or more photodiodes are arranged. Tr. (Warren) 1209:19-1210:11; AppleIPHB 74 (relying on same). Apple therefore fails to show an “interior surface” in Lumidigm.

Apple’s protrusion arguments fail for the reason discussed in the previous section. And because Lumidigm fails to disclose or suggest either a protrusion or an interior surface, it cannot disclose a protrusion over/above an interior surface. MasimoIPHB 136-138.

(e) **Protrusion “Openings”/“Through Holes” or “Windows”/“Optically Transparent Material” Therein**

**(Applies to: ’501 [1D]; ’502 [19C+19D], [28F+28G]; ’648 [8E], [20D+20E])**

Apple relies on a combination of the FIG. 8B, FIG. 2, and FIG. 6 embodiments for the “openings”/“through holes” elements. *See, e.g.*, AppleIPHB 69, 75-76. But Lumidigm fails to disclose or suggest openings or through holes. MasimoIPHB 138-139. Apple also relies on Warren’s testimony that “when you read the spec, the cross-section in FIG. 6 would be similar to FIG. 2.” Tr. (Warren) 1211:9-1212:10; AppleIPHB 76 (citing same). But Warren did not identify any disclosure in Lumidigm linking FIG. 6 to FIG. 2, because there is none. MasimoIPHB 138-139.

For the “windows”/“optically transparent material” elements, Apple relies on a combination of the FIG. 8B and FIG. 2 embodiments and the “optical relay (not shown)” of yet another embodiment. AppleIPHB 69, 84-85. Apple also relies on a Warren demonstrative concerning the untimely contention that Lumidigm’s optical relay includes a “lens.” *Id.* at 84. That contention was not in Apple’s PHB (at 55-56) and is waived per G.R. 9.2. MasimoIPHB 138-139. Regardless, Lumidigm does not disclose or suggest a protrusion or “windows”/“optically transparent material” in protrusion openings. *Id.*

[REDACTED]

(f) **Opaque Lateral Surface or Opaque Material Configured to Avoid or Reduce Light Piping**

**(Applies to: '501 [1E]; '502 [28F]; '648 [24])**

Apple relies on a combination of the FIG. 8B wristwatch and FIG. 2 sensor head embodiments for these elements. *See, e.g.*, AppleIPHB 69, 76-77. Apple also relies on Warren's testimony regarding a different element ('501 [1D]). *Id.* (citing Tr. (Warren) 1211:10-1212:3). But Lumidigm fails to disclose or suggest the protrusion or its openings comprise opaque lateral surfaces or opaque material configured to avoid or reduce light piping. MasimoIPHB 139-140. Apple relies on "shunted light" (AppleIPHB 118), but that refers only to light reflecting from the skin—not light bypassing the measurement site—and fails to recognize light piping as a problem or motivate a solution to address it. MasimoIPHB 139-140; *infra* Section IV.E.2.b.i.(c).

(g) **Processor(s) Configured to Make Measurements of Physiological Parameters/SpO<sub>2</sub>**

**(Applies to: '501 [1F]; '502 [19E], [28I]; '648 [8G], [20E])**

Apple relies on a combination of the FIG. 8B wristwatch, FIG. 9 computer system, and "extended functionality" hemoglobin monitor embodiments for these elements. *See, e.g.*, AppleIPHB 69, 77-79. But Lumidigm fails to disclose or suggest one or more processors configured to calculate, determine, or output measurements of SpO<sub>2</sub> or another physiological parameter. MasimoIPHB 124-129. Further, Apple relies on Warren's response to a single question for these elements. AppleIPHB 77-79 (citing Tr. (Warren) 1213:4-1214:1). But Warren did not testify, and Apple does not even contend, that Lumidigm's wristwatch included or could include a processor. *Id.* Instead, Apple argues Lumidigm "refers to the processors in its devices." AppleIPHB 77-79. But that says nothing about combining the processors into the FIG. 8B wristwatch.

[REDACTED]

(h) **Thermistor or Adjusting Device Operation Responsive to Temperature**

**(Applies to: '502 [20]-[21], [28D], [28I])**

Apple relies on a combination of the FIG. 8B wristwatch embodiment with a biometric “enrollment function” embodiment mentioned in two sentences. *See, e.g.*, AppleIPHB 86-87. But Lumidigm fails to disclose or suggest a thermistor or adjusting user-worn device operation responsive to a temperature signal. MasimoIPHB 140. And Apple’s hindsight argument that it would have been “obvious to include a thermistor” (AppleIPHB 87) impermissibly uses the claim language (’502 [21]) to reconstruct the claims. *Otsuka v. Pharm. Co. v. Sandoz, Inc.*, 678 F.3d 1280, 1296 (Fed. Cir. 2012). Neither Apple nor Warren even allege Lumidigm discloses a thermistor. AppleIPHB 86-87.

(i) **Cavities Formed by the Protrusion, Opaque Wall, and Interior Surface**

**(Applies to: '648 [28H])**

Apple relies on a combination of the FIG. 8B wristwatch and FIG. 2 embodiments, and, based on its analysis for ’501 [1B], also relies on the FIGS. 6-7 embodiments. *See, e.g.*, AppleIPHB 93-94, 72-74. But Lumidigm fails to disclose or suggest the claimed cavities. MasimoIPHB 141, 130-132, 136-138. Apple now relies on Warren’s testimony to argue a POSITA would have understood Lumidigm included cavities. AppleIPHB 93-94 (citing Tr. (Warren) 1226:2-8). But Warren described an alleged opaque wall in FIG. 2, not cavities as claimed.



[REDACTED]

(j) **Network Interface or Storage Device Configured As Claimed**

**(Applies to: '502 [28J], [28L])**

Apple relies on a combination of the FIG. 8B wristwatch and the FIG. 9 computer system for both of these elements, and additionally relies on the FIG. 8A keyfob and “hemoglobin monitor” embodiments for a “network interface.” *See, e.g.*, AppleIPHB 94-95, 96-97. But Lumidigm fails to disclose or suggest either element. MasimoIPHB 141-142.

(k) **User Interface Comprising Touch-Screen, Configured As Claimed**

**(Applies to: '502 [28K])**

Apple argues a POSITA would have understood the claimed user interface “could be incorporated” into Lumidigm’s wristwatch. AppleIPHB 96. Apple relies on a combination of the FIG. 8B wristwatch, FIG. 8D, and FIG. 8E embodiments for this element. *Id.* at 95-96. Apple also relies on an unrelated passage of Lumidigm discussing scanning a bar code and displaying information retrieved from the Internet on an unidentified device. *Id.* (citing RX-0411 at 21:29-33). But Lumidigm fails to disclose or suggest a user interface comprising a touch-screen display at all, much less one as claimed. MasimoIPHB 141-142.

(l) **Protrusion Further Comprising One or More Chamfered Edges**

**(Applies to: '648 [30])**

Apple relies on a combination of the FIG. 8B wristwatch and Lumidigm’s discussion of possible “shapes” for the FIG. 2 sensor head embodiment. *See, e.g.*, AppleIPHB 102-103. But Lumidigm fails to disclose or suggest the claimed chamfered edge(s). MasimoIPHB 142-143.

[REDACTED]

**iii. No Motivation to Combine or Reasonable Expectation of Success**

Lumidigm does not disclose or suggest any of the claim elements discussed above. And the obviousness analysis “consider[s] motivation to combine and reasonable expectation of success ***only if*** all the elements of an invention are found in [the prior art].” *Par Pharm.*, 773 F.3d at 1194 (internal citation and quotation marks omitted); *see, e.g., Velandar v. Garner*, 348 F.3d 1359, 1363 (Fed. Cir. 2003) (***if*** all the elements of an invention are found in the prior art, motivation to combine or expectation of success are considered). Accordingly, the ALJ need not even reach Apple’s arguments about motivations to combine or reasonable expectations of success in combining Lumidigm’s embodiments. *Id.*

**(a) No Motivation to Combine Lumidigm Embodiments**

Apple’s arguments regarding motivations or expectations invite legal error because they rely upon hindsight and conclusory expert testimony, mischaracterize and selectively pick and choose from the references, and treat the claims as interchangeable building blocks rather than an integrated whole. MasimoIPHB 123-143. *Princeton Biochemicals, Inc. v. Beckman Coulter, Inc.*, 411 F.3d 1332, 1337 (Fed. Cir. 2005). Apple’s IPHB reveals further deficiencies.

First, Apple argues Lumidigm alone renders obvious every asserted claim. AppleIPHB 67-103. To do so, Apple argues for combining many different embodiments of Lumidigm. *Id.* Specifically, Apple’s Lumidigm-only obviousness arguments require combining the FIG. 8B embodiment with the following embodiments:

1. The “extended functionality” section’s “hemoglobin monitor” embodiment from the inventors’ “brainstorming” list. (AppleIPHB 70-71, 77-80, 85-86, 88, 94-95, 98, 100-101);

- 
2. Multiple emitters or sets of LEDs from the FIGS. 3, 5, 7 embodiments and the FIG. 6 embodiment of an incorporated-by-reference application (AppleIPHB 71-72, 80-82, 88-90, 98, 100);
  3. Detectors from the FIGS. 2, 6-7 embodiments (AppleIPHB 72-74, 82-83, 90-91, 98, 100);
  4. The optional “compound curvature” for the FIG. 2 sensor head (32) (AppleIPHB 70-71, 74-75, 79, 83-85, 92, 98, 101-103);
  5. The FIG. 2 sensor head “optically opaque material” (AppleIPHB 76-77, 83-84, 92-94, 98-99, 101-102);
  6. The alleged processor from the FIG. 9 “computer system” embodiment (AppleIPHB 77-79, 85-87, 94, 99, 101);
  7. The alleged network interface from the FIG. 8A and FIG. 9 embodiments (AppleIPHB 94-95);
  8. The alleged touch-screen of the FIG. 8D-8E embodiments (AppleIPHB 95-96);
  9. The alleged storage device from the FIG. 8A and FIG. 9 embodiments (AppleIPHB 96-97);
  10. The optical relay “not shown” and mentioned only for a different “embodiment of the sensor” (AppleIPHB 74-75, 84-85, 92, 99, 101);
  11. A “thermistor” not in Lumidigm (AppleIPHB 86-87, 92);
  12. A processor configuration to receive a temperature signal from the thermistor (not in Lumidigm) and adjust operation of the user-worn device (also not in Lumidigm) (AppleIPHB 87, 94); and
  13. Chamfered edge(s) not in Lumidigm (AppleIPHB 102-103).

[REDACTED]

Apple fails to provide reasons that would have motivated a POSITA to combine all of these embodiments. AppleIPHB 70-103. Rather, Apple relies on Warren’s opinion that various features were well-known. *Id.* But Apple still needed to establish a motivation to combine particular embodiments. *See, e.g., Metalcraft of Mayville, Inc. v. The Toro Co.*, 848 F.3d 1358, 1367 (Fed. Cir. 2017) (demonstrating elements were independently known fails to supply a motivation to combine them); *Kinetic Concepts, Inc. v. Smith & Nephew, Inc.*, 688 F.3d 1342, 1369 (Fed. Cir. 2012) (“a patent composed of several elements is not proved obvious merely by demonstrating that each of its elements was, independently, known in the prior art.”).

Indeed, for Ground 1 Apple failed to address what a POSITA allegedly “would have been motivated to do.” *Id.* But the law requires more:

Whether ... combining disclosures from multiple references, combining multiple embodiments from a single reference, or selecting from large lists of elements in a single reference, *there must be a motivation to make the combination* ... otherwise a skilled artisan would not arrive at the claimed combination.

*In re Stepan Co.*, 868 F.3d 1342, 1346 (Fed. Cir. 2017). Accordingly, because Apple set forth no motivation to the numerous Lumidigm embodiments listed above, Apple’s Lumidigm-based obviousness arguments fail.

(b) **No Reasonable Expectation of Success in Combining Lumidigm Embodiments**

Apple also failed to provide reasons a POSITA would have reasonably expected success in combining the numerous Lumidigm embodiments above. AppleIPHB 70-103. Obviousness based on a combination of embodiments from a single reference requires clear and convincing evidence of “a reasonable expectation that such a combination would be successful.” *In re Stepan*, 868 F.3d at 1346. Rather than attempt to establish why a POSITA would expect success in combining the numerous embodiments, Apple relies on Warren’s testimony that various features

[REDACTED]

were well-known. AppleIPHB 70-103. But that fails to establish a POSITA would have made any such combinations with a reasonable expectation of success.

Warren’s failure to analyze expectation of success for this ground—or address it at all—confirms Apple’s failure to provide clear and convincing evidence of obviousness based on Lumidigm alone.

iv. **Apple’s Failure to Treat the Asserted Claims as an Integrated Whole (Applies To: Grounds 1-6)**

Apple’s analysis treats the Asserted Claims as mere catalogs of separate parts, in disregard of the part-to-part relationships that give the claims their meaning. MasimoIPHB 143. Apple’s approach to obviousness improperly “break[s] [each] invention into its component parts, then find[s] a prior art reference corresponding to each component.” *Princeton Biochemicals, Inc. v. Beckman Coulter, Inc.*, 411 F.3d 1332, 1337 (Fed. Cir. 2005). But the Federal Circuit has cautioned against Apple’s use of hindsight in the obviousness determination by “using the invention as a roadmap to find its prior art components.” *Id.* Indeed, Apple’s approach improperly bypasses the statutory requirement to consider the claimed invention “as a whole”—a requirement that “prevents evaluation of the invention part by part.” *Id.* Accordingly, Apple’s disjointed approach fails to establish obviousness.

b. **Ground 2: Lumidigm + Seiko 131 + Cramer Does Not Render Obvious Any Asserted Claim**

The combination of Lumidigm with Seiko 131 and Cramer fails to render obvious any Asserted Claim.

i. **The Combination Fails to Disclose or Suggest Numerous Elements**

The purported combination of Lumidigm with Seiko 131 and Cramer fails to render any claim obvious, at least because it fails to disclose or suggest the following claim elements.



Element	Applies to:	MasimoIPHB (Explaining Deficiencies of References Relied On For Element)
“Openings”/“Through Holes” in Protrusion Comprising a Convex Surface that are “Over”/“Above”/“Aligned With” the Photodiodes	’501 [1C]-[1D], [12] ’502 [19C], [28E]-[28F] ’648 [8D]-[8E], [20C]- [20D]	130-132, 138-139 (Lumidigm) 144-146 (Cramer) 148-149 (Seiko 131)
Protrusion or Protrusion Openings Comprising an Opaque Lateral Surface or Opaque Material Configured to Avoid or Reduce Light Piping	’501 [1E] ’502 [28F] ’648 [24]	139-140 (Lumidigm) 147 (Cramer) 149-150 (Seiko 131)
“Windows”/“Optically Transparent Material” in Protrusion Openings	’501 [1D] ’502 [19D], [28G] ’648 [8F], [20D]	138-139 (Lumidigm) 145-147 (Cramer) 148-149 (Seiko 131)
Protrusion Further Comprising One or More Chamfered Edges	’648 [30]	142-143 (Lumidigm) 147-148 (Cramer) 150 (Seiko 131)
User-Worn Device Configured to Calculate, Determine, or Output Measurements of Physiological Parameters/SpO <sub>2</sub>	’501 [1PRE] ’502 [19PRE], [28PRE] ’648 [12]	124-129 (Lumidigm)
Three or More Photodiodes	’501 [1B] ’502 [19B], [28C] ’648 [8C], [20B]	129-130 (Lumidigm)
“One or More Processors” Configured to Make Measurements of Physiological Parameters/SpO <sub>2</sub>	’501 [1F] ’502 [19E], [28I] ’648 [8G], [20E]	124-129 (Lumidigm)
Protrusion Arranged Over/Above the Interior Surface or Photodiodes	’501 [1C] ’502 [19C], [28E] ’648 [20C]	136-138 (Lumidigm) 144-145 (Cramer)
Cavities	’648 [28H]	141 (Lumidigm)
Network Interface or Storage Device Configured As Claimed	’502 [28J], [28L]	141-142 (Lumidigm)

Accordingly, Apple failed to meet its burden to prove by clear and convincing evidence that “all claimed limitations are disclosed in the prior art.” *Par Pharm.*, 773 F.3d at 1194.

The prior art in Ground 2 would not have rendered obvious any claim for the reasons addressed below.

(a) Protrusion Comprising a Convex Surface

(Applies to: '501 [1C], [12]; '502 [19C], [28E]; '648 [8D], [20C])

Apple argues the “use of a protrusion with a convex surface” was “well-known” in the art and disclosed by Lumidigm, Seiko 131, and Cramer. AppleIPH 104-107. Apple relies on Warren’s testimony about the “State of the Art,” *id.* at 104, where Warren identified Smart, Cramer, Seiko 131, and Lumidigm. Tr. (Warren) 1194:17-1195:5, 1195:20-22, 1210:13-1211:18. Warren testified these four references include “structures protruding into the tissue in optical sensors.” *Id.* at 1194:17-1195:5.

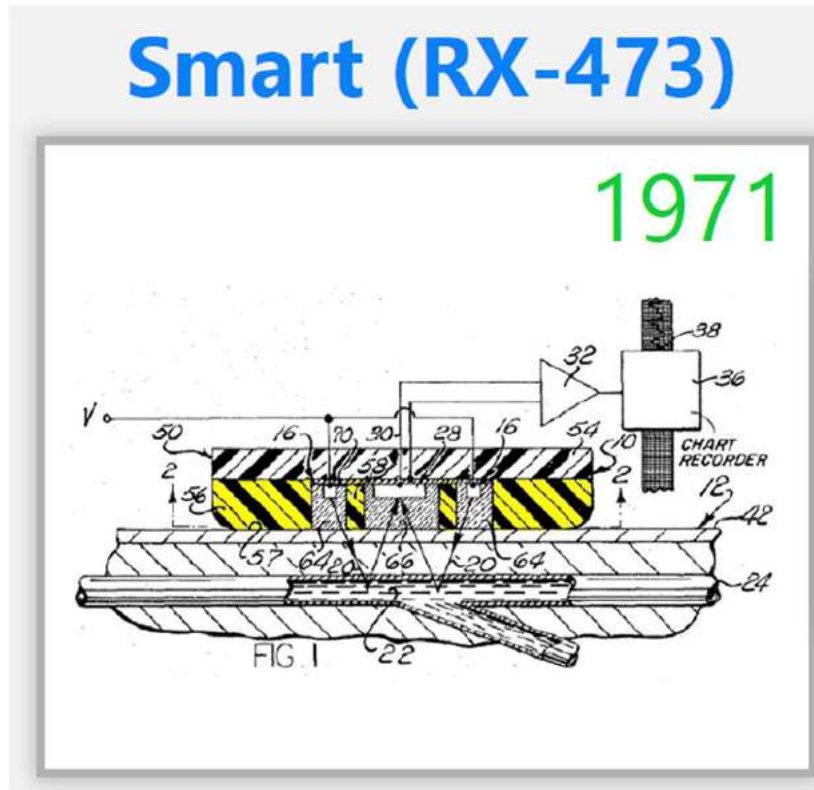

Regarding Smart (above, RDX-0008.12 (excerpt showing RX-0473 at FIG. 1)), Warren testified it had a “convex protrusion[] to conform to a measurement site.” *Id.* at 1195:20-22. Warren did not explain how Smart’s alleged convex protrusion would conform to a measurement site. *Id.* And the evidence shows that to conform to or approximate the measurement site, a convex

[REDACTED]

protrusion would not be used. MasimoIPHB 133-134. Regardless, Smart (RX-0473), like Lumidigm, merely shows a *flat sensor head with no protrusion* and is not configured to conform tissue into a concave shape. RX-0473 at FIG. 1. Warren even showed Smart’s flat sensor head on his above demonstrative. FIG. 1 of Smart (above) shows the transducer housing identified by Warren has a flat surface lying flat on the skin (42). Smart thus fails to disclose a protrusion comprising a convex surface, much less a protrusion where the convex surface is an outermost surface configured to conform the user’s tissue into a concave shape.

Lumidigm, Seiko 131, and Cramer also fail to disclose the claimed protrusion. Masimo explained Lumidigm does not disclose a protrusion as claimed. MasimoIPHB 130-132. Cramer fails to disclose a protrusion comprising a convex surface because the alleged protrusions (bosses 22, 22a) in Cramer are discrete annular rings. *Id.* at 144-147. They are not a convex surface arranged *over or above* the detectors (23) or an interior surface on which the detectors are arranged. *Id.* Cramer and Seiko 131 also lack openings (or through holes) extending through a protrusion comprising a convex surface. *Id.* at 144-150.

Apple’s IPHB arguments expose that the prior art does not disclose a protrusion comprising a convex surface as claimed. First, Apple relies on Warren’s testimony. AppleIPHB 104 (citing Tr. (Warren) 1210:13-1211:8). But Warren’s sole testimony for this element was “it was already well-known that a convex curvature could be a useful element in increasing signal quality,” without citing any evidence. Such “[g]eneral and conclusory testimony” about what was allegedly known cannot establish invalidity. *Koito Mfg. Co. v. Turn-Key-Tech, LLC*, 381 F.3d 1142, 1151-52 (Fed. Cir. 2004). Warren did not relate that alleged knowledge to any disclosure of a convex protrusion in Lumidigm, Seiko 131, or Cramer.





Second, Apple falsely describes Seiko 131 as disclosing a protrusion comprising a convex surface “in a watch” or “on a wrist-based sensor.” AppleIPHB 105-107. But Apple relies on a finger-based sensor (30), not a wrist-based sensor, as shown below.

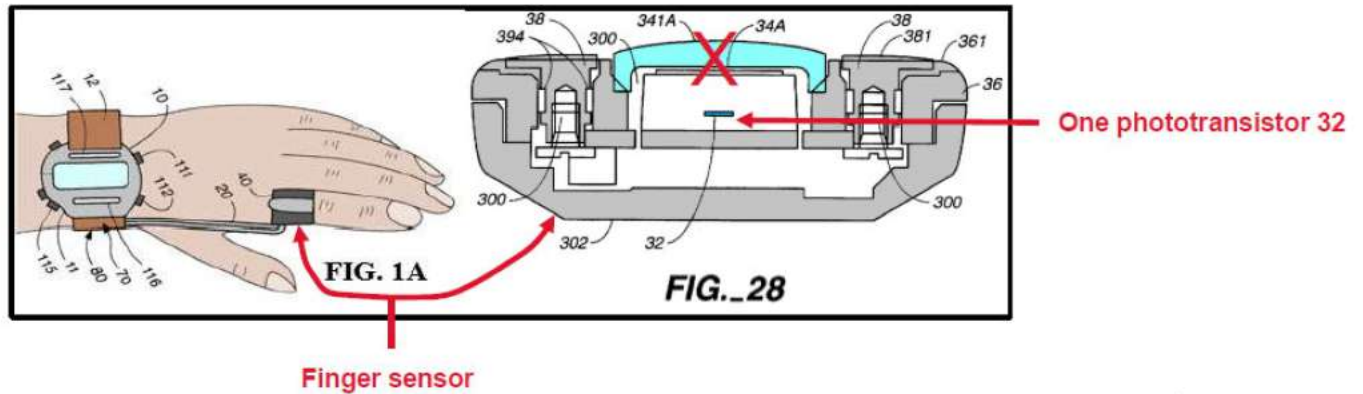

CDX-0012C.023; RX-0666 at FIGS. 1B, 28, 8:10-12, 19:5-13; MasimoIPHB 148-149. The alleged protrusion of Seiko 131 is not over multiple photodetectors. RX-0666 at FIG. 28.

Third, Apple argues Cramer’s “bosses” (22/22a) disclose “a protrusion comprising a convex surface.” AppleIPHB 105-106 (citing Tr. (Warren) 1232:21-25). But Warren’s testimony says nothing about those bosses comprising a convex surface. Instead, Warren stated merely that Cramer’s bosses allow “measurement with minimum discomfort to the user.” Tr. (Warren) 1232:21-25.

Fourth, Apple vaguely refers to Cramer as having a “protrusion.” AppleIPHB 106. But Cramer explains its bosses are physically separate, “concentric” rings with distinct functions and different identifiers (22/22a). RX-0670 at FIGS. 2, 6, 2:46-51, 3:15-18, 5:36-51. Cramer does not disclose these two distinct rings as a singular protrusion. And even if Apple were to interpret those two rings as a single protrusion, it would not have the claimed features associated with the protrusion such as openings or windows. Thus, Cramer’s bosses (22/22a), individually or together, fail to disclose a protrusion as claimed. MasimoIPHB 144-148.

[REDACTED]

Finally, Apple also argues, based on Warren’s testimony, that Seiko 131 and Cramer suggest including a protrusion comprising a convex surface in a watch. AppleIPHB 106 (citing Tr. (Warren) 1233:1-14, 1245:17-1246:3). Yet again, Warren’s conclusory testimony provides no support for Apple’s argument. Warren’s testimony about Seiko 131’s finger sensor includes no suggestion of incorporating a protrusion as claimed (or any feature) into a watch. Tr. (Warren) 1245:17-1246:3. And Warren stated merely that a POSITA “would know that they *could* go to a reference like Seiko or Cramer to teach different ways that you *might* incorporate a convex protrusion into one of these reflectance sensors.” *Id.* at 1233:1-14. Warren’s testimony about what a POSITA “might” or “could” do does not establish what a POSITA *would have been motivated to do*. *Adidas*, 963 F.3d at 1359. Such testimony cannot establish obviousness by clear and convincing evidence.

(b) **“Openings”/“Through Holes” In or Through the Protrusion, or “Windows” Therein**

**(Applies to: ’501 [1D]; ’502 [19C]-[19D], [28F]-[28G]; ’648 [8E]-[8F], [20D])**

Apple argues openings were “well-known” in the art and disclosed by Lumidigm, Seiko 131, and Cramer. AppleIPHB 107-111. Apple refers to Warren’s testimony about the “State of the Art” and Lumidigm. *Id.* at 107 (citing Tr. (Warren) 1192:25-1193:6, 1211:10-1212:3). However, Warren did not identify any art in that testimony beyond Lumidigm. Tr. (Warren) 1192:25-1193:6, 1211:10-1212:3. Furthermore, Lumidigm does not disclose openings (or through holes) at all because Lumidigm does not disclose a protrusion as claimed. MasimoIPHB 138-139. Seiko 131 does not include the claimed openings over multiple detectors because Seiko 131 only has a single detector. *Id.* at 148-149. Cramer also fails to disclose the claimed openings because its photodiodes are located in the flat space between the annular rings or “bosses” rather than in or

extending through any protrusion. *Id.* at 145-147. Masimo has already explained why Lumidigm, Seiko 131, and Cramer fail to disclose the claimed openings.

Apple now raises one additional argument further confirming the prior art does not disclose the claimed openings. Specifically, Apple argues the space between the phototransistor (32) and alleged protrusion (341A) of Seiko 131 is an opening (shown in yellow below):

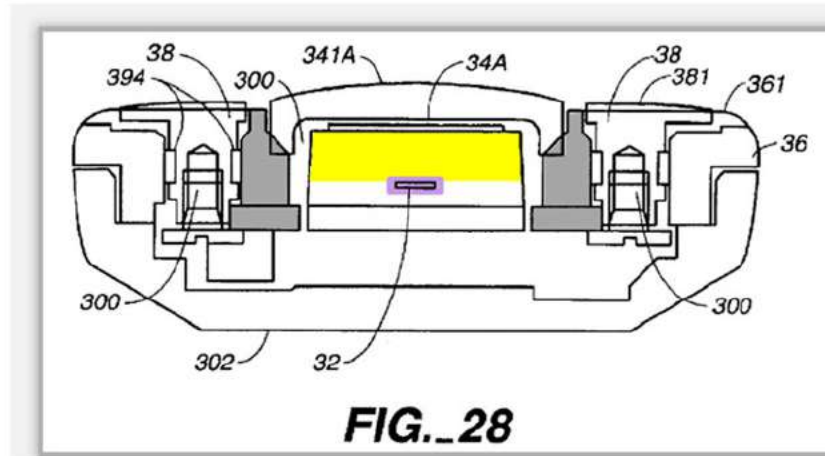

RDX-0008.70 (annotating RX-0666 at FIG. 28); AppleIPHB 108. However, the claims require (in '501 [1D]; '502 [19C], [28F]; '648 [8E]) both (a) multiple openings and (b) that the openings are in or extend through the protrusion. Seiko 131 discloses neither requirement. Apple does not explain how Seiko 131 could satisfy either, or contend Seiko 131 has more than “an opening.” AppleIPHB 108. *Id.* And, as shown in FIG. 28 above, the alleged “opening” does not extend through the protrusion. Apple’s failure to consider the elements as arranged in the claims is fatal to its attempt to prove invalidity.

(c) **Opaque Lateral Surface/Opaque Material Configured to Avoid or Reduce Light Piping**

**(Applies to: '501 [1E]; '502 [28F]; '648 [24])**

The Asserted Claims require the claimed protrusion or protrusion openings further comprise an opaque lateral surface or opaque material configured to avoid or reduce light piping.

[REDACTED]

The Multi-Detector Patents explain that light piping is “light that bypasses the measurement site.” JX-0001 at 22:48-50. Kiani explained that light piping refers to “light that goes from the LED directly to the photodetector, without going through the tissue.” Tr. (Kiani) 100:14-24.

Apple argues openings with opaque lateral surfaces or lined with opaque material configured to reduce or avoid light piping were “well-known” in the art, and disclosed by Lumidigm, Seiko 131, and Cramer. AppleIPHB 107-111. Apple refers to Warren’s testimony about the “State of the Art” and Lumidigm. *Id.* at 107 (citing Tr. (Warren) 1192:25-1193:6, 1211:10-1212:3). But Warren did not identify *any* art whatsoever. Rather, his testimony was wholly conclusory: “Well, I would say in 2008 and many decades prior, openings are a way for light or to allow light to get to a detector. A detector can’t detect light without some sort of opening above it.” Tr. (Warren) 1192:25-1193:6. This testimony contradicts Apple’s noninfringement arguments. And simply saying a feature is well-known, without more, is not clear and convincing evidence.

None of the art in Ground 2 discloses this feature. Lumidigm fails to disclose the claimed protrusion or openings that comprise opaque lateral surfaces or opaque material. MasimoIPHB 130-132, 138-139. Moreover, Lumidigm does not recognize light piping as a problem or provide a motivation to address it. Apple asserts Lumidigm’s mention of “shunted light” refers to light piping. AppleIPHB 118. But Lumidigm expressly refers to “reflections from the top surface of tissue” as “shunted light.” RX-0411 at 7:64-67. Reflections from the skin *are not light piping*. MasimoIPHB 139-140.

Seiko 131 does not disclose the claimed protrusion or openings with an opaque lateral surface. *Id.* at 148-150. Seiko 131’s alleged protrusion (341A) is made of transparent glass, and does not disclose an opaque lateral surface or opaque material. *Id.* at 149-150. Seiko 131 fails to

[REDACTED]

recognize light piping as a problem or provide a solution to address it. *Id.* Further, Cramer does not disclose the claimed protrusion or openings. *Id.* at 144-147. Accordingly, Lumidigm, Seiko 131, and Cramer fail to disclose these claim elements.

Apple's additional arguments further expose the prior art does not disclose these elements. First, Apple raises an improper and untimely new argument about opaque lateral surfaces in Seiko 131. AppleIPHB 108. In Apple's Pre-Hearing Brief, Apple did not identify that alleged opaque lateral surface in Seiko 131. Per G.R. 9.2, Apple waived such a contention. Apple PHB at 75. Regardless, Seiko 131, including the disclosure that Apple now relies on, does not teach the claimed protrusion or protrusion openings with opaque lateral surfaces or opaque material. MasimoIPHB 149-150.

Second, Apple argues Cramer's discrete bosses (22/22a) "isolate the photo detector from direct view from the light source" and prevent "direct transmission of light between source 24 and detectors 23." AppleIPHB 118; *id.* at 110. Apple also relies on Warren, who testified that "Cramer teaches the *similar notion of openings* with opaque surfaces with regard to the opaque region that comprises, not only the sensor head, but the boss regions, all of which help prevent light piping because of the fact that they are indeed opaque material." Tr. (Warren) 1233:23-1234:2; AppleIPHB 110 (citing same). But Warren does not say that Cramer explicitly discloses any "opaque region," much less an opening comprising an opaque lateral surface. RX-0670. If Warren is relying on inherency, then he has failed to show that it is necessarily present. *Guangdong Alison Hi-Tech Co. v. Int'l Trade Comm'n*, 936 F.3d 1353, 1364 (Fed. Cir. 2019).

Third, Apple relies on what a POSITA allegedly would have understood from "the data sheet for the CLT 2160 referenced in Cramer's specification." AppleIPHB 109 (citing RX-0670 at 5:33-35). But the data sheet is undated, and Apple made no attempt to show it was available at



the time of Cramer in 1980. RX-1221. No witness authenticated the data sheet or explained anything about it. Apple presented no evidence of any “opaque material” in the CLT 2160 “can.” Apple cannot rely on an undated, uncorroborated data sheet to “fill the gaps” in Cramer. *Scripps*, 927 F.2d at 1576.

More importantly, Apple deceptively presents an image on the bottom of page 109 of its IPHB as “Cramer” and cited as “RX-0670 at Fig. 6.” But this image (below) is not from Cramer.

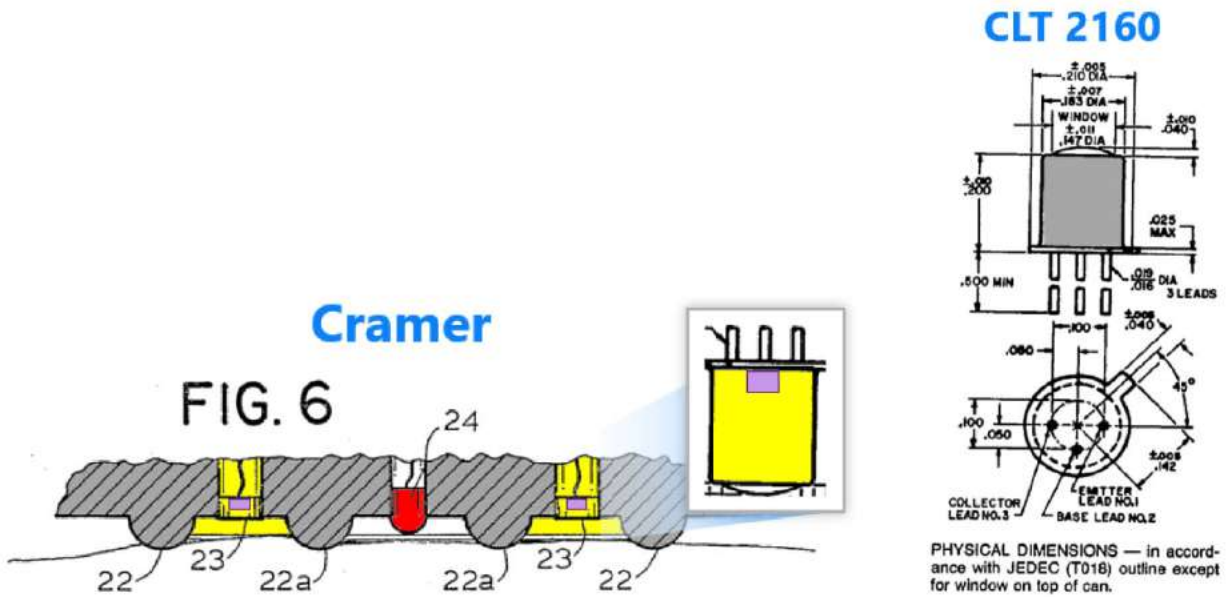

AppleIPHB 109. It includes figures from a datasheet (RX-1221) and drawn-in purple rectangles purporting to be photodiodes. AppleIPHB 109. Even worse, the modification is not the same modification that was in Warren’s hearing demonstratives. *See* RDX-0008.65. Yet, Apple’s IPHB includes no notation in the cite or the text to convey that it embellished FIG. 6 in this manner. Apple cannot satisfy its burden by modifying a figure in Cramer, citing and labelling that figure as FIG. 6 of Cramer, and claiming that this is somehow prior art.

[REDACTED]

(d) **“Windows”/“Optically Transparent Material” Therein**

**(Applies to: ’502 [19D], [28G]; ’648 [8F], [20D])**

Apple argues “optically transparent material” or “transmissive windows” in openings over photodiodes were “well-known” and disclosed by Lumidigm, Seiko 131, and Cramer. AppleIPHB 111-113. Apple also refers to Warren’s testimony about “State of the Art” examples and Lumidigm. *Id.* at 111. Warren testified “I really like” Cramer, Nippon, Seiko 131, Haar, and a rudimentary Kansas State device (RX-0648). Tr. (Warren) 1193:24-1194:14, 1221:16-1222:9. But he did not identify where any of those “disclosed” a window (or any other feature). *Id.* Such conclusory testimony does not establish the claimed windows were “well-known.” *Koito*, 381 F.3d at 1152. Furthermore, Apple represented to the ALJ “that the additional prior art references identified in its prehearing brief will not be relied upon as grounds for anticipation or obviousness ....” Doc. ID 772058 (Order No. 40) at 1-2. Thus, the ALJ need not consider them in evaluating any ground.

Regardless, none of these references disclose windows as claimed. For example, Nippon, Haar, and Kansas State do not teach a protrusion comprising a convex surface. RX-0665 at FIG. 3b; RX-0667 at Fig. 2; RX-0648. Nippon, Haar, and Kansas State thus do not have openings in the claimed protrusion, much less any windows in protrusion openings. *Id.*

Lumidigm, Seiko 131, and Cramer also fail to disclose the claimed windows for the reasons discussed below. Lumidigm does not disclose windows in a convex protrusion at all because Lumidigm does not disclose a protrusion or openings as claimed. MasimoIPHB 138-139. Furthermore, a POSITA would not have understood Lumidigm’s vaguely mentioned “optical relays,”—including a “fiber optic face plate,” “fiber bundle,” or “optical relay units”—to be windows for inclusion in openings over detectors. *Id.* Cramer and Seiko 131 do not disclose the



claimed windows because neither reference discloses a protrusion or openings as claimed. *Id.* at 144-150. Masimo, therefore, has already explained why Lumidigm, Seiko 131, and Cramer fail to disclose the claimed windows.

Apple raises two additional arguments that further reveal the prior art does not disclose the claimed windows. First, like its analysis for the light-piping-related claim elements (discussed above), Apple’s analysis of Cramer for these claim elements relies on what a POSITA allegedly would have understood from “the data sheet for the CLT 2160 referenced in Cramer’s specification.” AppleIPHB 112 (citing RX-0670 at 5:33-35). The ALJ should reject that argument for the reasons explained above.

Second, Apple now relies on another doctored image (below) to argue Cramer “has a further layer of clear transparent windows between the cans and the tissue”:

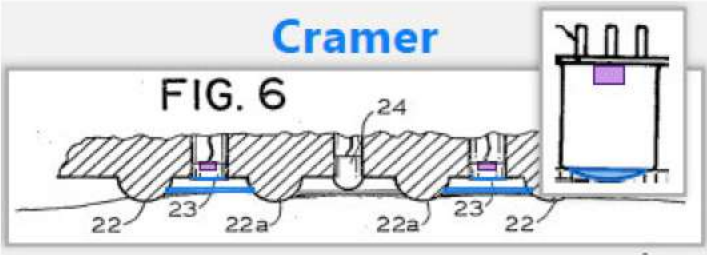

RDX-0008.74 (annotating RX-0670 at FIG. 6 and RX-1221 at 1, including by drawing in alleged windows in blue and alleged photodiodes in purple which are shown nowhere, and adding a “callout” from a different source)<sup>12</sup>; AppleIPHB 113.

The bottommost blue lines Warren added are particularly misleading. Those lines correspond to the portion of the annular rings or bosses, not to any separate structure over the detectors of Cramer. Those blue lines are actually the rings (22/22a) behind the cross section.

<sup>12</sup> The above figure is yet another example of an edited figure taken from Warren’s demonstratives for which Apple deceptively cited to the reference only without conveying it had been modified. AppleIPHB 113.





Comparing Apple’s demonstrative (below, top) of FIG. 6 of Cramer with FIG. 3 of Cramer (below, bottom), which are figures showing the same sensor from the same perspective, shows that the “further layer” of windows identified by Apple does not exist.

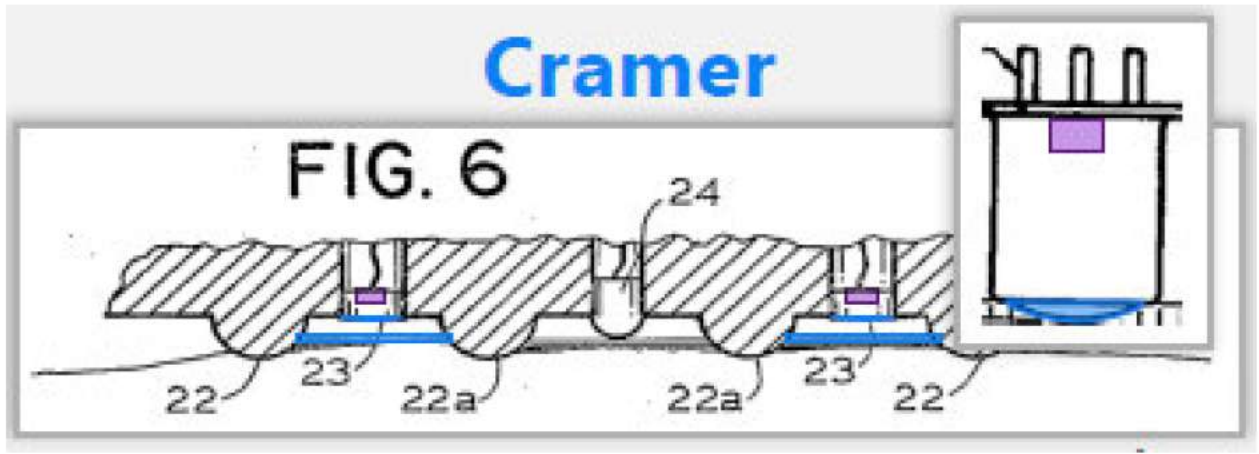
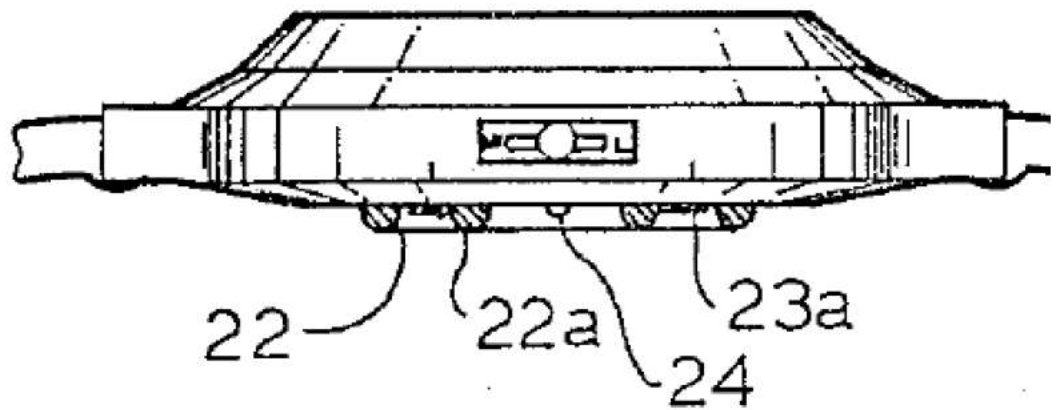

FIG. 3



And even if the ALJ credits Warren’s artistic license, the blue lines, as drawn, would be a single window in an annular shape in the space between the two annular bosses (22/22a). That imaginary structure fails to disclose *multiple* “windows” or transparent material in *multiple* “openings.”

(e) One or More Chamfered Edges

(Applies to: '648 [30])

Apple asserts that chamfered edges were “well-known” in the art and disclosed by Lumidigm, Seiko 131, and Cramer. AppleIPHB 114-115. Apple again relies on Warren’s testimony. *Id.* (citing Tr. (Warren) 1228:24-1229:10, 1236:17-1237:3).

The claim language requires that the claimed protrusion “further compris[es] one or more chamfered edges.” Lumidigm does not disclose one or more chamfered edges, including, because (1) Lumidigm does not disclose the claimed protrusion, and (2) Apple relies the *front face* of wristwatch of FIG. 8B, but that is the opposite side of the watch from the alleged protrusion. MasimoIPHB 142-143.

Seiko 131 does not disclose this claim element because (1) Seiko 131 does not disclose the claimed protrusion, and (2) the alleged protrusion (341A—shaded yellow below) of Seiko 131 does not comprise the chamfered edge identified by Apple (shaded blue below), which Warren admitted at the hearing. *Id.* at 150 (citing Tr. (Warren) 1279:24-1280:2).

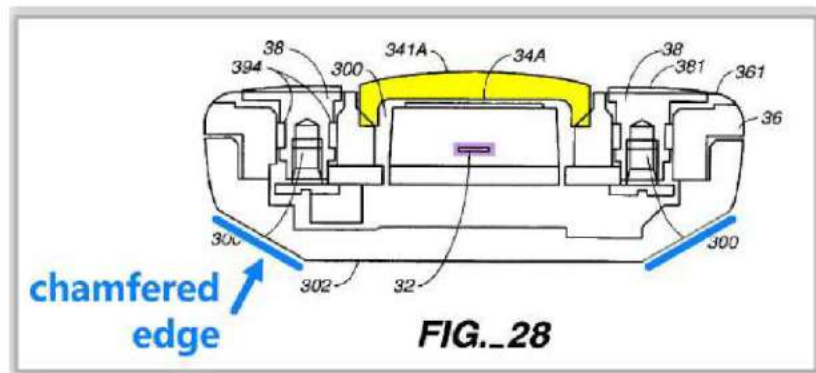

RDX-0008.75. Apple no longer contends that FIG. 28 of Seiko 131 discloses this claim element. AppleIPHB 114. Instead, Apple now argues that FIG. 5 of Seiko 131 discloses a chamfered edge. *Id.* But the FIG. 5 embodiment does not include the alleged protrusion (341A), which appears only in the FIG. 28 embodiment. RX-0666 at FIGS. 5, 28. FIG. 5 of Seiko 131 thus fails to

[REDACTED]

disclose the claimed protrusion further comprising one or more chamfered edges. Apple provided no reason to select a chamfered edge from FIG. 5 and apply it to a different structure. AppleIPHB 114-115.

Cramer does not disclose this claim element because (1) Cramer does not disclose the claimed protrusion, and (2) the alleged protrusion(s) (bosses 22, 22a) of Cramer do not comprise the chamfered edge identified by Apple. *Id.* at 147-148. Lumidigm, Seiko 131, and Cramer therefore fail to disclose the claimed one or more chamfered edges.

ii. **No Motivation to Combine or Reasonable Expectation of Success**

The combination of Lumidigm, Seiko 131, and Cramer does not disclose or suggest numerous claim elements. Thus, the ALJ need not even reach Apple's arguments about motivations to combine or reasonable expectations of success. *Par Pharm.*, 773 F.3d at 1194. Masimo already explained that Apple failed to show a motivation to combine or reasonable expectation of success for the combinations of features it relies on. MasimoIPHB 144-153. But Apple's IPHB provides additional reasons exposing why Apple failed to establish obviousness based on this combination. AppleIPHB 115-120.

(a) **Apple Fails to Address Every Element**

Apple's "Motivation to Combine" does not address the proposed combination as a whole. AppleIPHB 115-120. For example, Apple fails to show any motivation to configure Lumidigm's wristwatch to measure a physiological parameter/SpO<sub>2</sub>, or to include a processor configured to calculate such measurements. *Id.* Apple also fails to address the "cavities," "network interface," and "storage device" claim elements. *Id.* Accordingly, Apple fails to show motivations to combine sufficient to establish any "*claimed invention as a whole* would have been obvious." *WBIP, LLC v. Kohler Co.*, 829 F.3d 1317, 1328 (Fed. Cir. 2016); *see* MasimoIPHB 123-143.

[REDACTED]

(b) **Lumidigm Does Not “Expressly Suggest” Adding All of Its Features to a Wristwatch**

Apple incorrectly contends Lumidigm “expressly suggests” using *some* claim elements while ignoring many others. AppleIPHB 115-120. Specifically, Apple contends “Lumidigm expressly suggests using” the following generalized categories of elements: (1) “the recited protrusion with a convex surface”; (2) “the recited openings over the photodiodes with opaque lateral surfaces and opaque materials to provide optical blocking”; (3) “the recited transparent materials and windows across the openings”; and (4) “the recited chamfered edges.” *Id.* at 115. Masimo has already explained Lumidigm neither teaches nor suggests combining the above-identified features with the FIG. 8B wristwatch. MasimoIPHB 123-143.

Apple’s reliance on Warren’s testimony shows Lumidigm does not suggest these features. Warren’s testimony fails to address windows, opaque lateral surfaces/material, or chamfered edges *at all*, much less show any combinations of features expressly suggested in Lumidigm. Tr. (Warren) 1204:18-1206:7, 1207:23-1208:13, 1214:12-1215:4.

(c) **There Is Nothing “Natural” About the Ground 2 Combination**

Apple relies on Warren’s testimony to argue “a POSITA would have known that the elements would form a ‘natural combination’ and yield predictable results.” AppleIPHB 116 (citing Tr. (Warren) 1237:4-1238:14). Warren testified that because each of Lumidigm, Seiko 131, and Cramer is a “watch embodiment,” the references “would then form a natural combination for teaching purposes.” Tr. (Warren) 1237:4-1238:14. But Seiko 131 describes *finger sensors*. CDX-0012C.023; RX-0666 at FIGS. 1A-1B, 28, 8:10-12, 19:5-13; MasimoIPHB 148-149. Warren’s explanation therefore does not provide a reason to combine Seiko 131 with Lumidigm

[REDACTED]

and Cramer. Warren also failed to explain any reason why a POSITA would have combined any particular features. Tr. (Warren) 1237:4-1238:14.

Apple also argues a POSITA would have been “motivated to look at Cramer and Seiko 131, as each are analogous art ...” AppleIPHB 116. But the mere existence of two references in the same field provides no motivation to combine them. *See, e.g., Securus Techs., Inc. v. Global Tel\*Link Corp.*, 701 Fed. Appx. 971, 977 (2017) (affirming nonobviousness finding). Apple also relies on Warren to argue a POSITA would look to light-based physiological measurement devices because “all make use of the same general components and techniques.” AppleIPHB 117. But Warren did not address the “components and techniques” at all. Tr. (Warren) 1193:7-22, 1237:4-1238:6. Rather, he stated the same “light management features” are used for *any* spectroscopic measurements. *Id.* But the art cited in this case demonstrates otherwise. *See, e.g., RX-0366* at 18:35-51 (explaining “aspect ratios and dimensional values” that are tailored for light of one spectrum (e.g., green) “are not tailored for use in other spectrums, such as the red or infrared spectra”). Merely being light-based measurement devices fails to provide a motivation to combine the specific references. *See, e.g., Certain Chem. Mech. Planarization Shurries*, Inv. No. 337-TA-1204, Doc. ID 748910, I.D. at 188-189 (July 8, 2021), *aff’d*, Comm’n Op., Doc. ID759875 (Jan. 6, 2022).

(d) **No Motivation to Combine Features of Seiko 131 or Cramer with Lumidigm’s Wristwatch**

Apple also fails to establish any motivation to combine specific features with Lumidigm’s FIG. 8B wristwatch.

**Protrusion Comprising a Convex Surface:** Apple argues improving (a) sensor coupling/contact with tissue and (b) user comfort, would motivate a POSITA to add “pressure on the measurement site and yield a more accurate measurement.” AppleIPHB 117. But Apple points

[REDACTED]

to no teaching that pressure on the measurement site would yield a more accurate measurement. *Id.* Indeed, as explained in Masimo’s IPHB, the prior art taught that pressure induced errors. MasimoIPHB 133. The only teaching regarding the benefit of a protrusion comprising a convex surface comes from the Multi-Detector Patents; that is hindsight. *Otsuka*, 678 F.3d at 1296.

Moreover, as Masimo already explained, a POSITA would not have been motivated to combine Lumidigm’s FIG. 8B wristwatch with a protrusion comprising a convex surface for each of the reasons explained above for Ground 1. MasimoIPHB 13-136. Additionally, the combination would make the FIG. 8B wristwatch less comfortable. Tr. (Madisetti) 1339:18-1340:3. Also, Seiko 131 does not disclose that such a combination would increase signal quality. MasimoIPHB 151-152. Cramer attributes minimizing discomfort to its coaxial arrangement of ring-shaped bosses 22/22a, which is not a protrusion as claimed. *Id.* Further, Warren’s testimony about what a POSITA allegedly “could” do fails to establish what a POSITA would have been motivated to do. MasimoIPHB 133-136, 151-153. Masimo has already explained why a POSITA would not have been motivated to combine a protrusion comprising a convex surface with the FIG. 8B wristwatch.

Apple raises four arguments further exposing the lack of motivation to combine a protrusion comprising a convex surface with Lumidigm’s wristwatch. First, Nippon lacks a protrusion comprising a convex surface—rather, it is flat. RX-0665 at FIG. 3b. Indeed, the Patent Office considered Nippon (calling it “Jaeb” for its first-named inventor) during prosecution and found it did not teach or suggest a protrusion as claimed. *See, e.g.*, JX-0004 at 385-386; JX-0005 at 385-387; JX-0006 at 383-386. Apple provides no reason to add such a feature.

Second, Apple argues Seiko 131’s alleged protrusion (341A) would improve “contact”/“pressure” on skin. AppleIPHB 117. But Apple ignores that Seiko 131 teaches finger

[REDACTED]

sensors. RX-0666 at 21:16-29. Seiko fails to discuss anything about a sensor at the wrist. Apple fails to consider the prior art “as a whole” for what it teaches. *Henny Penny Corp. v. Frymaster LLC*, 938 F.3d 1324, 1332 (Fed. Cir. 2019).

Third, Apple argues Cramer’s alleged protrusion(s) (22/22a) would improve comfort. AppleIPHB 117. But Apple ignores Cramer’s recognition that a protrusion would be “forced into the flesh of the wrist” and thus “*be uncomfortable* over a prolonged period of time.” MasimoIPHB 151; RX-0670 at 5:26-29; Tr. (Madisetti) 1339:18-1340:3. Apple cannot establish a motivation to combine by “selectively” relying on parts of a reference. *Henny*, 938 F.3d at 1332.

Fourth, Apple relies on Warren’s testimony to argue a POSITA would have added the claimed protrusion to FIG. 8B. AppleIPHB 117. But Warren merely speculated about what a POSITA *could have done* with a protrusion or that a protrusion “*could be*” useful. Tr. (Warren) 1194:17-1195:5, 1211:2-8. Such testimony about what a POSITA “could” do fails to show obviousness. *Adidas*, 963 F.3d at 1359.

**“Openings”/“Through Holes”/“Windows”/“Optically Transparent Material”**: Apple argues a POSITA would have been motivated to incorporate openings or windows because “the protrusion would need to have openings [ ] so light can travel ... to the photodiodes placed on the interior surface of the sensor.” AppleIPHB 117-118. Apple also argues “a POSITA would further have recognized that the use of” the claimed windows (or optically transparent material) had the benefit of “transferring and directing light” and “protecting the photodiodes from damage” or contaminants. AppleIPHB 119.

These arguments presume a device already having the claimed protrusion, which Apple fails to show. MasimoIPHB 138-139, 144-150. Moreover, a POSITA would not have been motivated to combine Lumidigm’s FIG. 8B wristwatch with a protrusion comprising a convex

[REDACTED]

surface. MasimoIPHB 133-136, 151-153. For the same reasons, a POSITA would not have been motivated to add the claimed protrusion openings to Lumidigm's wristwatch or incorporate windows in those openings. *Id.* at 138-139, 145-149. Accordingly, Masimo has already explained why a POSITA would not have been motivated to combine openings or windows as claimed with the FIG. 8B wristwatch.

Apple now raises other arguments further revealing the lack of motivation to add a protrusion comprising a convex surface to Lumidigm's wristwatch.

First, Warren's generic discussion of the alleged "State of the Art" provides no motivation to combine windows in openings in a convex protrusion with FIG. 8B. Tr. (Warren) 1193:24-1194:7. And Warren's testimony that "you could use" a "lens," "fiber-optic faceplate," "fiber bundle, or other "optical relay" from Lumidigm as a window does not address what a POSITA would have been motivated to do and is thus not evidence of obviousness. *Id.* at 1221:16-1222:16; *InTouch Techs., Inc. v. VGO Commc'ns, Inc.*, 751 F.3d 1327, 1351-52 (Fed. Cir. 2014) (rejecting testimony "primarily consist[ing] of conclusory references to [expert's] belief that [a POSITA] could combine" art) (emphasis in original). Moreover, Masimo has explained Apple's reliance on a "lens" as an optical relay is waived per G.R. 9.2 and a POSITA would not have used an optical relay as a window. MasimoIPHB 138-139.

Second, Apple relies on Webster and Haar to argue a motivation to incorporate the claimed windows. AppleIPHB 119. Apple did not rely on the cited pages of Webster for this point in its Pre-Hearing Brief and such contentions are waived per G.R. 9.2. Apple PHB at 79-84. Webster provides no motivation for this combination. MasimoIPHB 154-155. As for Haar, it states using "light-conducting elements" such as "fiber optic plates" between the sensor and skin "*in many cases cause signal variations* which are far higher than the desired measuring accuracy ...." RX-



[REDACTED]

0667 at 3:1-15. Haar thus confirms that a POSITA would not have been motivated to use optical relays, such as fiber optical plates, as windows in Lumidigm’s wristwatch. *Id.*; MasimoIPHB 138-139.

**“Opaque Lateral Surfaces”/“Opaque Material” Configured to Reduce/Avoid Light**

**Piping**: Apple relies on Lumidigm, Seiko 131, and Cramer to argue a POSITA would have understood the benefits of using openings with opaque lateral surfaces or opaque material, including that such features could reduce or avoid light piping. AppleIPHB 118-119. A POSITA would not have been motivated to combine Lumidigm’s FIG. 8B wristwatch with a protrusion comprising a convex surface. MasimoIPHB 133-136, 151-153. A POSITA also would not have been motivated to combine the claimed protrusion or protrusion openings with opaque lateral surfaces or opaque material and Lumidigm’s wristwatch. *Id.* at 147, 149. None of the references recognize light piping or provide a solution to address it. *Id.* at 138-140, 149-150. Thus, a POSITA would not have been motivated to combine these elements with the FIG. 8B wristwatch.

Apple now raises two arguments that further expose the lack of motivation to combine these features with Lumidigm’s wristwatch. First, Apple argues a rudimentary Kansas State sensor heads include opaque material “to reduce light mixing.” AppleIPHB 118 (citing RX-0515 and RX-0504). Apple did not establish the public availability or accessibility of RX-0504 or RX-0515. *See, e.g., In re Lister*, 583 F.3d 1307, 1311 (Fed. Cir. 2009) (“In order to qualify as a printed publication within the meaning of § 102, a reference ‘must have been sufficiently accessible to the public interested in the art.’”) (internal citation omitted). Indeed, Warren conceded he pulled the Kansas State 6D, the photo of which is RX-515, out of storage. Tr. (Warren) 1262:18-24. Warren’s testimony claiming that a presentation was given publicly fails to establish that presentation as prior art. *In re Klopfinstein*, 380 F.3d 1345, 1350-52 (Fed. Cir. 2004) (considering

[REDACTED]

copies distributed, indexing or cataloging in a library, length of time display was exhibited, expertise of target audience, whether audience members could copy the presentation, the ease with which the presentation could be copied). Warren testified about none of the relevant factors. Kansas State (RX-0515 and RX-0504) is not prior art.

Apple does not contend that the Kansas State document teaches reducing light piping. Nor could it, as the Kansas State document merely states at least the 6D sensor head was “less susceptible to ambient noise due to opaque material and flexible design.” RX-0504 at 1. Ambient noise (i.e., ambient light) *is not light piping*. See, e.g., JX-0001 at 22:48-50; Tr. (Kiani) 100:14-102:1; CDX-0001.002; CX-0067C at 11. The Kansas State documents provide no detail about the structure around the sensor heads, including adhesives or other materials between the LEDs and photodetector and foam.

Second, Apple again ignores that ambient light is not light piping in arguing that Webster teaches using “opaque materials to minimize ambient light” on the detector(s). AppleIPHB 119. Apple also relies on pages 96, 111, 201-202 of Webster, none of which were relied in its Pre-Hearing Brief, and per G.R. 9.2 such contentions are waived. Compare *id. with* Apple PHB at 79-84. Even if considered, Apple ignores the actual teachings of Webster. AppleIPHB 119. Webster teaches “to cover the probe site with some opaque material, such as a surgical towel ... [which] frequently becomes displaced and exposes the oximeter probe.” RX-0035.201-202. Webster also mentions shunting through skin yet discloses no solution. *Id.*

**Chamfered Edges:** A POSITA would not have been motivated to combine a chamfered edge as claimed with Lumidigm’s wristwatch because: (1) the combination lacks the claimed protrusion or reason to add such a feature to FIG. 8B; (2) Apple ignores the protrusion must comprise the chamfered edge(s); (3) Lumidigm’s “other shapes” for sensor head 32 provides no

[REDACTED]

reason to include chamfered edges as claimed; and (4) Lumidigm’s mention of a “compound curvature” would not have motivated this feature, which concerns “edges,” not curves. MasimoIPHB 142-143, 147-148, 150.

Apple now raises another argument exposing a lack of motivation to combine. Specifically, it relies on Warren’s testimony in arguing “[a] POSITA would have understood that a convex protrusion *could* have a beveled edge.” AppleIPHB 120. That argument fails because: (1) the alleged understanding of what “could” be done fails to show a POSITA would have been motivated to combine, *Adidas*, 963 F.3d at 1359; and (2) a “beveled edge” is not claimed.

**(e) No Reasonable Expectation of Success**

Apple argues: (1) all elements could be combined; (2) the combination “amounted to nothing more than the use of known techniques,” “according to known methods,” to “yield predictable results”; (3) certain claim elements were “known and had been used in the field”; and (4) “A POSITA would have been able to mix and match these elements in any number of permutations” while expecting success because “similar combinations ‘had already been done in various forms’.” AppleIPHB 119-120, 116. Such boilerplate assertions are not clear and convincing evidence of a reasonable expectation of success. *ActiveVideo Networks, Inc. v. Verizon Commc’ns, Inc.*, 694 F.3d 1312, 1327. A POSITA would not have reasonably expected success in the specific combinations of features Apple asserts. MasimoIPHB 129, 133-136, 151-153.

Apple now relies on Warren’s testimony to argue a POSITA would have had an expectation of success. AppleIPHB 120. Warren offered only generalized testimony about the alleged “State of the Art,” the use of black foam in his student’s sensor head, the alleged use of openings with opaque materials in Herczfeld, and then concluded that the combination of a “convex surface, the openings, the windows, and the chamfered edges” had “already been done in various forms as I

[REDACTED]

illustrated with my combination slide earlier.” Tr. (Warren) 1237:4-1238:6, 1189:12-1195:22, 1200:2-15, 1203:6-9. But Warren did not actually identify any evidence that such combination had been done. His general, conclusory testimony is not “clear and convincing evidence that [a POSITA] would have had a reasonable expectation of success” in combining the specific features Apple relies on. *ActiveVideo Networks*, 694 F.3d at 1327.

c. **Ground 3: Lumidigm + Webster Would Not Have Rendered Obvious '502 Patent Claim 22**

The combination of Lumidigm and Webster would not have rendered obvious '502 Patent Claim 22.

i. **The Combination Fails to Disclose or Suggest Numerous Elements**

**(Applies to: '502 [20]-[21], [28D], [28I])**

Apple’s purported combination of Lumidigm with Webster fails to render any claim obvious. MasimoIPHB 153-155. Specifically, Apple and Warren relied on two different chapters of Webster written by different authors, passing them off as if each section described the same device. That is not true. Webster discloses a thermistor in Chapter 3 on page 42, discussing an invasive, transcutaneous PO<sub>2</sub> electrode. The thermistor is used to measure and control the amount of heat applied to the skin to avoid burning infants. RX-0035 at 42-43. The second reference appears forty pages later in Chapter 5. That chapter does not disclose a thermistor. It talks about using a temperature sensor built into a probe to measure wavelength shift based on ambient temperature. RX-0035 at 85-86. Warren’s demonstrative deceptively left off the page number for “Fig. 3.4” suggesting the two passages were related. Worse, Warren, after having Webster for 20 years, testified that the unrelated temperature probe of page 85 was somehow “illustrated explicitly



in Figure, I believe it's 3.4." Tr. (Warren) 1239:10-17. A brief review of the actual evidence exposes the lack of any connection.

Lumidigm also does not disclose or suggest these and other elements, as discussed above regarding Ground 1. *Id.* at 140. Apple relies only on Lumidigm for several elements that Lumidigm fails to disclose, including the following elements:

<b>Element</b>	<b>Applies to:</b>	<b>MasimoIPHB</b> (Explaining Deficiencies of Lumidigm)
User-Worn Device Configured to Calculate, Determine, or Output Measurements of Physiological Parameters/SpO <sub>2</sub>	'501 [1PRE] '502 [19PRE], [28PRE] '648 [12]	124-129 (Lumidigm)
Three or More Photodiodes	'501 [1B] '502 [19B], [28C] '648 [8C], [20B]	129-130 (Lumidigm)
"One or More Processors" Configured to Make Measurements of Physiological Parameters/SpO <sub>2</sub>	'501 [1F] '502 [19E], [28I] '648 [8G], [20E]	124-129 (Lumidigm)
Cavities	'648 [28H]	141 (Lumidigm)
Network Interface or Storage Device Configured As Claimed	'502 [28J], [28L]	141-142 (Lumidigm)

Because neither Lumidigm nor Webster discloses or suggests these elements, Apple fails to meet its burden to prove that the combination of Ground 3 discloses all claim elements. *Par Pharm.*, 773 F.3d at 1194.

Apple points to a statement in Lumidigm that "these and other techniques are *well known in the art*," as if that somehow refers specifically to thermistor claim elements. AppleIPHB 122. But Lumidigm does not describe any thermistor or adjusting device operation based on the temperature signal from the thermistor.

[REDACTED]

ii. **No Motivation to Combine or Reasonable Expectation of Success**

The combination of Lumidigm and Webster does not disclose or suggest numerous claim elements. Therefore, the ALJ need not reach Apple’s arguments regarding motivation to combine or expectation of success. *Par Pharm.*, 773 F.3d at 1194. Even if Apple had shown all of the elements in the combination, Apple failed to show a motivation to combine or reasonable expectation of success. MasimoIPHB 153-155.

(a) **No Motivation to Combine Thermistor from Webster’s Invasive Sensor with Lumidigm’s Wristwatch**

Apple argues it would be obvious to combine a thermistor and the use of processors to adjust device operation based on temperature signals with Lumidigm’s wristwatch. AppleIPHB 123. But a POSITA would not have been motivated to combine such features with Lumidigm, including because Webster’s thermistor is part of an invasive PO<sub>2</sub> electrode/sensor and serves a purpose of not burning the infant. MasimoIPHB 154.

Apple argues “a POSITA would have known that the[se] elements *could have been combined* with Lumidigm to yield predictable results.” AppleIPHB 123. Critically, Apple does not contend a POSITA *would have been motivated* to do so. *Id.* This failure is dispositive of Ground 3. *See, e.g., Personal Web*, 917 F.3d at 1380; *Adidas*, 963 F.3d at 1359.

Apple argues a POSITA would have known a thermistor would be used to measure temperature and to compensate for temperature variations in LEDs because it was supposedly taught in many prior art references. AppleIPHB 123. But Apple failed to identify any commercial pulse oximeter that uses this or the “many prior art references.” *See, e.g., In re NTP*, 654 F.3d at 1298-99. Apple relies on Warren to argue “[a] POSITA would have been motivated to use Webster,” a 262-page textbook. AppleIPHB 123. But Warren merely stated he “kept a copy for

[REDACTED]

20 years.” Tr. (Warren) 1238:24-1239:8. Apple provides no explanation of why Warren’s possession of a book for 20 years provides a motivation to combine. Apple relies on other alleged art not in the grounds, such as McCarthy (RX-0489), for the thermistor and use of processors to adjust device operation based on temperature. But Apple represented to the ALJ that additional prior art references, like McCarthy, would not be relied upon as grounds for anticipation or obviousness. Doc. ID 772058 (Order No. 40) at 1-2.

**(b) No Reasonable Expectation of Success**

Apple raises additional arguments exposing its failure to show any reasonable expectation of success in the asserted combination. AppleIPHB 123-124.

First, Apple relies solely on Warren’s testimony in asserting “[t]he combination of Lumidigm’s wristwatch and Webster’s teachings is nothing more than the use of a known technique to improve a similar device in the same way and this combination would yield predictable results.” *Id.* at 124. Warren did not testify about similarity between devices, nor did he discuss predictable results. Tr. (Warren) 1238:15-1240:3. The devices in Webster and Lumidigm’s wristwatch are not “similar” because the transcutaneous PO<sub>2</sub> sensor in Webster is invasive. MasimoIPHB 153-154. It also serves a different purpose of simply measuring the heat level to avoid burning infants. RX-0035 at 42-43.

Second, Apple relies on the same Warren testimony to assert Lumidigm and Webster “are in the same field of endeavor and the combination would be used together based on sound engineering principles.” AppleIPHB 124. But Warren did not discuss field of endeavor or using anything according to “sound engineering principles,” or indicate what such “principles” might be. Tr. (Warren) 1238:15-1240:3.

[REDACTED]

[REDACTED]

d. **Ground 4: Lumidigm + Seiko 131 + Cramer + Webster Does Not Render Obvious '502 Patent Claim 22**

Apple's addition of Seiko 131 and Cramer to the Lumidigm + Webster combination of Ground 3 does not remedy the deficiencies in Apple's obviousness defense. AppleIPHB 124-128. Apple merely combined the art from Grounds 2-3, which fails to teach elements '502 [19PRE], [19B], [19C], [19D], [19E], [20]-[22] for the reasons explained above for those grounds. *See also* MasimoIPHB 123-143, 144-153, 153-155.

Apple identifies no shortcoming in its previous combinations that would motivate this particular combination of references. Instead, Apple provides generic motivations to add more references to its patchwork analysis based on a POSITA allegedly "recogniz[ing] the benefits of the claimed features" and argues that the combination is merely the use of a known technique to improve similar devices in the same way. AppleIPHB 126-128. Apple cites Warren testimony about the combination being a "three plus one plus plus one." Tr. (Warren) 1241:25-1242:1; AppleIPHB 103, 127. That testimony fails to inform why anything in the combination would have been obvious. Apple's lack of support for Ground 4 confirms it relied on improper hindsight, using the claims as a guide. Apple has not met its burden of showing obviousness by clear and convincing evidence.

e. **Ground 5: Lumidigm + Webster + Apple 047 Does Not Render Obvious '502 Patent Claim 28**

i. **The Combination Fails to Disclose or Suggest Numerous Elements**

Webster fails to disclose or suggest the thermistor-related claim elements ('502 [20]-[21], [28D], [28I]) as discussed above. MasimoIPHB 153-157; *supra* Section IV.E.2.c. Apple 047 fails to disclose or suggest the claimed user interface ('502 [28K]). MasimoIPHB 155-157. And Lumidigm does not disclose or suggest these and numerous other claim elements, as discussed





above regarding Ground 1. *Id.* at 140-142; *supra* Section IV.E.2.a.ii. Apple relies only on Lumidigm for several elements that Lumidigm fails to disclose, including the following elements:

Element	Applies to:	MasimoIPHB (Explaining Deficiencies of Lumidigm)
User-Worn Device Configured to Calculate, Determine, or Output Measurements of Physiological Parameters/SpO <sub>2</sub>	'501 [1PRE] '502 [19PRE], [28PRE] '648 [12]	124-129 (Lumidigm)
Three or More Photodiodes	'501 [1B] '502 [19B], [28C] '648 [8C], [20B]	129-130 (Lumidigm)
“One or More Processors” Configured to Make Measurements of Physiological Parameters/SpO <sub>2</sub>	'501 [1F] '502 [19E], [28I] '648 [8G], [20E]	124-129 (Lumidigm)
Cavities	'648 [28H]	141 (Lumidigm)
Network Interface or Storage Device Configured As Claimed	'502 [28J], [28L]	141-142 (Lumidigm)

Because none of Lumidigm, Webster, or Apple 047 discloses or suggests these elements, Apple has not met its “burden to prove that all claimed limitations are disclosed in the prior art” and thus fails to establish obviousness based on Ground 5. *Par Pharm.*, 773 F.3d at 1194.

For '502 [28K], Apple argues that the “use of user interfaces with touch screen displays also was well known in the art,” was suggested by Lumidigm, and disclosed by Apple 047. AppleIPHB 129-132. Lumidigm does not disclose the claimed user interface because it lacks a touch-screen on its wristwatch. MasimoIPHB 141-142. Apple 047 does not disclose this element because Apple 047 does not disclose a user-worn touch-screen or a touch-screen display configured to display a measurement of oxygen saturation or any physiological parameter. *Id.* at 156-157.

Apple now also relies on Land, but his testimony provides no support for combining a touch-screen with a wristwatch in the 2008 time period. Tr. (Land) 955:10-956:4.

[REDACTED]

**ii. No Motivation to Combine or Reasonable Expectation of Success**

The combination of Lumidigm, Webster, and Apple 047 does not disclose or suggest numerous claim elements. Accordingly, the ALJ need not even reach Apple’s arguments about motivations to combine or reasonable expectations of success. *Par Pharm.*, 773 F.3d at 1194. Apple also failed to show a motivation to combine or reasonable expectation of success for the combinations of features it relies on. MasimoIPHB 123-143, 153-157. A POSITA would not have been motivated to combine Lumidigm and Webster as explained above for Ground 3 and in Masimo’s IPHB. *Id.* at 153-157. And Apple’s IPHB reveals additional reasons why Ground 5 fails. AppleIPHB 128-134.

**(a) No Motivation To Combine Apple 047’s iPad-like Touch-Screen with Lumidigm’s Wristwatch**

Warren’s testimony does not support that a POSITA would have “found it obvious” to use Apple 047’s touch-screen with Lumidigm’s “device.” MasimoIPHB 157; *see also InTouch Techs.*, 751 F.3d at 1351-52. At best, he testified a POSITA “could” look to Apple 047, saying nothing of what a POSITA would have been motivated to do. *Adidas*, 963 F.3d at 1359.

Apple also presents new contentions that were not in its PHB and per G.R. 9.2 are waived. AppleIPHB 133 relies on pages 114, 137, 220-223 of Webster (RX-0035), which were not relied on at page 94 of its PHB for the same point. And AppleIPHB 131 argues Apple 047 suggests this combination, which is not a contention in on pages 92-95 of its PHB for the same combination.

Apple also relies on FIGS. 8B-8E of Lumidigm to incorrectly argue “Lumidigm expressly discloses touch screen displays ....” AppleIPHB 131. FIG. 8B shows an analog watch without a touch-screen, because Lumidigm does not disclose a touch-screen at all, as explained above. MasimoIPHB 141-142. The remainder of Apple’s arguments rely on irrelevant citations in an

[REDACTED]

attempt to show touch-screens were well-known. AppleIPHB 132-134. Even if true, Apple fails to show a motivation to combine Apple 047’s iPad-sized touch screen with Lumidigm’s wristwatch to display a measurement Lumidigm does not take. *Id.*; MasimoIPHB 156-157.

**(b) No Reasonable Expectation of Success**

Apple presents its expectation-of-success arguments in the same conclusory format used for all of its grounds. AppleIPHB 132-134. Apple and Warren never explained how a POSITA would have incorporated Apple 047’s large-format touch-screen in Lumidigm’s wristwatch, or how the combination was supposed to work (if it would even work at all). MasimoIPHB 156-157.

**f. Ground 6: Lumidigm + Seiko 131 + Cramer + Webster + Apple 047 Does Not Render Obvious ’502 Patent Claim 28**

Apple’s five-reference combination of Ground 6 uses art from Grounds 2 and 5 with no additional analysis. AppleIPHB 134-140. Apple does not even explain whether a POSITA would begin with the Ground 2 combination or the separate combination in Ground 5. *Id.* Apple identified no shortcoming in either combination, no reason to look to any other art, and no motivation for this combination. *Id.* at 103-120, 128-134.

**g. Objective Indicia of Nonobviousness**

Apple invites error by disregarding the significant objective evidence of nonobviousness. Such evidence “*must* always when present be considered.” *Transocean Offshore Deepwater Drilling, Inc. v. Maersk Drilling USA, Inc.*, 699 F.3d 1340, 1349 (Fed. Cir. 2012) (citation omitted).

**i. Apple’s Skepticism and Failures Demonstrate the Nonobviousness of the Asserted Claims**

Apple relies on Lumidigm’s FIG. 8B wristwatch as the “user-worn device” for its obviousness arguments. AppleIPHB 67-140. According to Apple, it would have been obvious in 2008 to add pulse oximetry and a protrusion (from, for example, Seiko 131 or Cramer) to that

[REDACTED]

wristwatch. *Id.* Madisetti disagreed and explained the industry skepticism of measuring oxygen saturation at the wrist. MasimoIPHB 160-172; Tr. (Madisetti) 1371:12-1372:12. Masimo detailed Apple’s skepticism and failures in developing its blood-oxygen feature. *Id.*

Apple’s Post-Hearing Brief identifies additional supporting evidence. As Apple explained,

[REDACTED]

[REDACTED] AppleIPHB 14. For example, Waydo—Apple’s Human Interface Devices group director [REDACTED]

[REDACTED]—testified the engineers on his team, which was [REDACTED] spent [REDACTED]

[REDACTED] *Id.* at 14, 145, 157 n.25.

[REDACTED] is Apple’s internal code name for the blood-oxygen-sensing feature in the Apple Watch. *Id.* at 14 n.2 (citing Tr. (Land) 965:9-11).

Apple’s claim to arduous development demonstrates adding pulse oximetry to a wristwatch, like Lumidigm, would have been no obvious task. Apple now tries to explain its lengthy development efforts by referring to the many other features of Apple Watch. But the timeline itself is not the extent of the evidence. Rather, the actual evidence contradicts Apple’s revisionist history. Waydo testified that the [REDACTED]

[REDACTED] which refers specifically to development of the oxygen-saturation algorithm alone. Apple turns to Warren’s testimony as showing the alleged capability of a POSITA. AppleIPHB 144-146. But Warren failed to acknowledge Apple’s [REDACTED]

[REDACTED] or the testimony of Mannheimer, who despite over 20 years of experience had great skepticism about whether pulse oximetry at the wrist was even possible. Tr. (Mannheimer) 1012:12-25 (Mannheimer had an eye

[REDACTED]

roll reaction upon being assigned to measure oxygen saturation at the wrist). Apple also attempts to explain away the development timeline by describing its market focus on consumer devices rather than clinical devices. AppleIPHB 145. But Lumidigm, too, was a consumer device. CX-0279C (Rowe) 1145:7-20.

Apple also now argues, “[t]o draft claims to try to cover Apple Watch, Masimo was forced to use *claim language* directed to *rudimentary technology* common to both the clinical setting (from which the patents originated) and the consumer wearable setting (in which Apple Watch is sold). That *rudimentary technology was disclosed in the prior art* many times over, and in some instances many decades earlier.” AppleIPHB 4. But contrary to that revisionist history argument from counsel, the contemporaneous evidence showed that Apple’s engineers Mannheim and Block thought otherwise. Mannheim and others recognized that [REDACTED] CX-0177C at 13; Tr. (Land) 982:3-983:12. They then described some of what they perceived to be inventive in their patent filed in July 2016. CX-1569. That patent described and claimed a convex surface with openings extending from an interior surface to an exterior surface with an opaque light block separating the openings. CX-1569 at 2:31-39; 4:18-19; 5:25-33. Claim 1 (below) provides an example of what Apple presented as inventive (*id.* at Claim 1):

- A portable electronic device comprising:
  - a housing having an *opening extending from an interior surface of the housing to an exterior surface of the housing*;
  - a photosensor *window positioned within the opening*, the photosensor window including:
    - a first transparent region that allows light from a photoemitter positioned within the housing to pass through the opening, and wherein the first transparent region forms a first portion of a perimeter of the photosensor window;
    - a second transparent region that allows light to pass through the opening and be received by a photodetector that is positioned within the housing, and wherein the second transparent region forms a second portion of the perimeter of the photosensor window; and

[REDACTED]

an *opaque region positioned between and optically isolating the first transparent region from the second transparent region*;

wherein the first transparent region, the second transparent region and the opaque region are *arranged to form a convex surface that forms a portion of an exterior surface* of the electronic device.

Apple's pursuit of this particular claim contradicts its litigation-driven argument that Masimo's claim features are "rudimentary technology" "disclosed in the prior art many times over" (*cf.* AppleIPHB 4). In Claim 1 of CX-1569, Apple engineers claimed "a convex surface that forms a portion of an exterior surface." But Warren and Apple now argue "that protrusions in a variety of shapes (including convex surfaces) have been used, since at least the 1970s." AppleIPHB 63-64. Apple's Claim 1 also recites "an opening ...." CX-1569 at Claim 1. But Warren and Apple now argue that prior art teaches "photodiodes ... and the openings all in one bundle, 50 years old." AppleIPHB 62-64. In Claim 1, Mannheimer and Block also claimed a "window positioned within the opening" that Apple and Warren now contend "goes back more than 40 years." *Compare id. with* CX-1569 at Claim 1. Finally, Mannheimer and Block claimed "an opaque region positioned between and optically isolating the first transparent region from the second transparent region." CX-1569 at Claim 1. But Apple now argues that "Professor Warren explained that the use of openings over photodiodes, with opaque surfaces, has been known for the past 40 years." AppleIPHB 61.

Apple cannot reasonably contend Masimo's claims cover *rudimentary technology* from the clinical setting after Apple itself, and its veteran of pulse oximetry design of over 20 years, that was skeptical of the task, and knew [REDACTED] sought patent protection for the same features. CX-0177C at 13; Tr. (Land) 982:3-983:12. This evidence contradicts Apple's hindsight approach in this litigation, directly contradicting its own contemporaneous documents.

[REDACTED]

Apple's expert Warren was apparently unaware of Apple's efforts to patent these features and Apple's lengthy development work. Apple failed to share its internal development documents with Warren. He confirmed Apple did not provide CX-1789C and CX-1790C for him to consider. Tr. (Warren) 1269:11-1271:20. Apple objected to Masimo even showing Apple documents to Warren on the grounds that these Apple documents were "later introduced into the case." *Id.* at 1270:24-1271:3. The timing of introduction was because Apple withheld them and did not give them to Warren or Masimo, and repeatedly objected to their use in this Investigation.

In any event, those documents show [REDACTED]

[REDACTED] At that time Apple's engineers working on the pulse oximetry sensor explained that [REDACTED] CX-1789C at 2. The second document Apple withheld from Warren explained a [REDACTED]

[REDACTED]

[REDACTED]

[REDACTED] CX-

1790C at 1. [REDACTED]

[REDACTED]

[REDACTED]

[REDACTED]  
[REDACTED]  
CX-1790C at 1 (explanation), 5 (illustration). Tr. (Block) 906:14-25. [REDACTED]

[REDACTED] CX-  
1790C at 3 [REDACTED] Apple  
chose not to address this evidence in its IPHB.

Apple relies solely on Warren to contradict the Apple engineers and contemporaneous Apple documents, by arguing “[a] POSITA would have understood the benefits of including a convex protrusion, including to improve signal quality.” AppleIPHB 75. But Apple’s internal documents, which it withheld, show that Apple engineers thought the convex protrusion alone does not “improve signal quality.”

Apple also failed to provide any evidence to support Warren’s opinion that “[a] POSITA would have understood the benefits of including a convex protrusion, including to improve signal quality.” *Id.* at 75. Rather, it is a conclusory statement that the evidence contradicts. Apple engineer Land testified the “back crystal” in the Series 0 Watch was “dome-shaped.” Tr. (Land) 959:14-16. He explained “the primary reason” for the dome shape was to provide wireless charging. *Id.* at 959:17-960:2. Land also testified after the initial design of the Series 0 [REDACTED] Apple turned to improving the heart-rate feature and to adding “a blood oxygen sensor.” *Id.* at 965:15-24. But despite that dome-shaped protrusion, Apple still faced “challenges” including what Waydo described as the [REDACTED]

[REDACTED] Tr. (Waydo) 923:24-924:16; AppleIPHB 145. That evidence suggests Apple thought the opposite, that using a convex protrusion would not “improve signal quality” on its own. Rather, the innovative combination of features claimed in the Multi-Detector Patents provides the advance and should be protected. This confirms Apple’s skepticism as to the claimed features.



[REDACTED]

ii. **The Protrusions of the Multi-Detector Patents Achieved Unexpected Results**

Apple criticizes Madisetti for allegedly relying “on a single prior art reference,” Mendelson ’799, to show skepticism regarding the convex protrusion. AppleIPHB 146. There are several problems with Apple’s argument.

First, in response to Mendelson ’799, Apple relies on Warren’s testimony regarding a few words Warren highlighted in his demonstrative (RDX-0008.127). AppleIPHB 146. But Mendelson ’799 actually discloses the following:

[V]ariations in contact pressure between the sensor and the skin can cause larger errors in reflection pulse oximetry (as compared to transmission pulse oximetry) since some of the blood near the superficial layers of the skin may be normally displaced away from the sensor housing towards deeper subcutaneous structures. Consequently, the highly reflective bloodless tissue compartment near the surface of the skin can cause large errors even at body locations where the bone is located too far away to influence the incident light generated by the sensor.

Tr. (Warren) 1267:19-1268:11; RDX-0008.127; CX-1733 at 2:47-57. Apple now argues that “[t]he Mendelson patent does not disclose a ‘convex protrusion’ at all.” AppleIPHB 146. But this is exactly the point. Apple fails to address Mendelson ’799 teaches the undesirability of displacing blood away from the sensor. MasimoIPHB 133, 151-153, 161. Mendelson ’799 taught to *avoid* displacing blood. Thus, of course Mendelson ’799 does not disclose or teach a convex protrusion, because it taught that introducing pressure would displace blood, and cause errors. CX-1733 at 2:47-57.

Second, after criticizing Mendelson ’799, Apple contends Nippon (RX-0665) is “one of many articles that conveys that, if the detector protrudes slightly into the tissue, not only can you get more repeatable coupling, but you can increase the sensitivity of the sensor thereby improving the sensor.” AppleIPHB 146. But the Patent Office considered Nippon during prosecution of the Multi-Detector Patents because Masimo cited it. JX-0004 at 430; JX-0005 at 402; JX-0006 at 481.

[REDACTED]

The Examiner referred to it as Jaeb—the first-named inventor—and cited it in the reasons for allowance for all three Multi-Detector Patents. JX-0004 at 385-386; JX-0005 at 385-387; JX-0006 at 383-386. Apple refers to this same art by a different name, but that does not change that the Patent Office already considered it. The Examiner correctly explained that Nippon/Jaeb does not teach or suggest “a protrusion arranged over the interior surface, the protrusion comprising a convex surface ....” *Id.* Rather, Nippon/Jaeb is flat. RX-0665 at FIG. 3b. Again, the evidence contradicts Apple’s argument.

Third, Apple and Warren ignored the relevant Kiani and Rowe testimony and additional Apple evidence. Apple’s third-party witness, Rowe, conceded that, if anything, the *concave* compound curvature of the Lumidigm patent would better [REDACTED] and thus provide better coupling. CX-0279C (Rowe) 69:8-21. This is consistent with Mendelson ’799, and the opposite of adding a pressure-inducing convex protrusion.

Kiani testified about the inventors’ own surprise in development work leading to the claimed inventions. Before the claimed inventions, Masimo believed sensors with a well or cavity were advantageous because they would avoid pressure to the measurement site. Tr. (Kiani) 99:2-4, 99:8-16. Then, when Masimo and Cercacor were developing technology to noninvasively measure hemoglobin and glucose, “[j]ust getting to the signal is really challenging.” *Id.* at 98:13-16. Kiani explained how he was surprised to discover the benefit of a pressure-inducing convex protrusion that was later disclosed in his patents. *Id.* at 98:9-99:16.

Apple also fails to address its own patents. Apple recognized the benefit of the claimed protrusion comprising a convex surface years after Masimo. And, in 2015, Block expressed his surprise that [REDACTED] CX-0114C at 3. Block explained that [REDACTED]

[REDACTED]

[REDACTED] *Id.* at 2. He described, [REDACTED]

[REDACTED] *Id.* [REDACTED]

[REDACTED]

*Id.* Therefore, Apple’s own engineers were surprised by the benefit of the claimed feature. Those in the field understood what was espoused by Mendelson ’799 and others, that pressure should not be applied to the tissue.

As explained in Masimo’s IPHB, in 2016, Apple’s engineers followed up on their surprise discovery by filing a series of patents describing the benefits of a pressure-inducing convex protrusion. CX-1569; CX-1806. Figures 3A and 3B from CX-1806 illustrate a “protrusion 302” applying “pressure 320.”

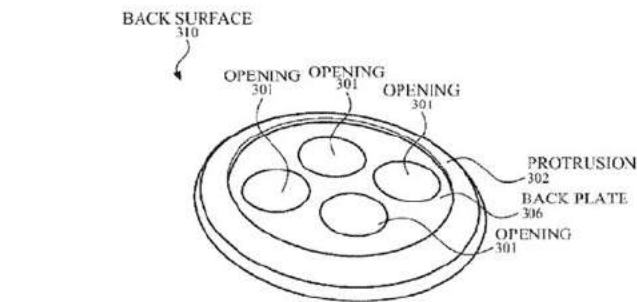

FIG. 3A

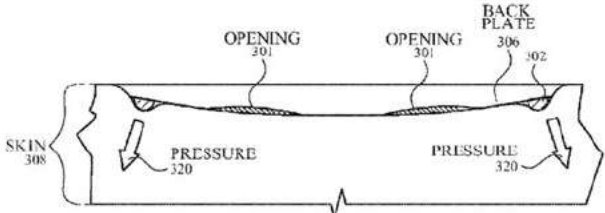

FIG. 3B

CX-1806 at FIGS. 3A, 3B. Just as Block expressed to the team about [REDACTED]

[REDACTED] the specification describes “[b]y applying localized pressure to the individual’s skin, the pressure gradient across arterial walls can be reduced, which can lead to an

[REDACTED]

*increase in pulsatile (AC) signal.”* *Id.* ¶[0032]. Thus, the Apple engineers were surprised by, and then touted in their patents, the benefits of a convex protrusion long after the Multi-Detector Patents.

This evidence contradicts Warren’s unsupported conclusory opinion that a protrusion would have been known to “increase your AC-to-DC signal ratio, meaning that you would see the tissue perfusion in a better way.” Tr. (Warren) 1194:15-24. As explained above, the contemporaneous documents, and Apple’s patents filed years later, contradict Apple’s hindsight arguments. Certainly, Apple’s evidence contradicts counsel’s claims about rudimentary-decades-old technology.

iii. **Apple Fails to Rebut the Evidence of Copying or Commercial Success**

Apple ignores its copying of Masimo’s technology by focusing on the development of the Series 6 without addressing the earlier watches. AppleIPHB 140-143. Apple contends that “Apple Watch Series 6 with the Blood Oxygen feature accused in this case was released *before* Complainants filed for the [Multi-Detector] Patents; Apple therefore could not have copied the features recited in the claims themselves.” *Id.* at 140. Apple then relies on responses to leading questions to its own engineers about the development of that Series 6. *Id.* at 141. But as Masimo explained, copying of “the claim themselves” is not a limitation on evidence of copying technology. *See* MasimoIPHB 172-173.

Masimo presented evidence of copying starting much earlier in 2012. MasimoIPHB 172-173. Apple alleges a lack of nexus. But Apple fails to address [REDACTED] or why Apple provided and introduced no documents about its watch development from the time period when Apple

[REDACTED]

employed Michael O'Reilly (Masimo's former CMO) and Marcelo Lamego (Cercacor's former CTO). Lamego is a named inventor of the Multi-Detector Patents.

Apple came forward with no documentary evidence regarding the genesis of the supposed convex curve on the back crystal on the Series 0 Apple Watch. Apple hired Mannheimer [REDACTED] [REDACTED] CX-0175C (identifying Mannheimer [REDACTED] [REDACTED] Mannheimer worked on adding pulse oximetry, but only after the Series 0 had already been designed with a curved back crystal. Tr. (Mannheimer) 1013:1-6, 1015:9-19. And, the [REDACTED] [REDACTED] RX-0396C at 17-18. Thus, the origins of the supposed curve in Apple's back crystal design for the Series 0 remains a mystery due to Apple's deliberate choice to withhold documents regarding the Series 0 design during the relevant time. The failure to provide documentation that clearly exists justifies an inference that these documents would show connection to Masimo employees. *See, e.g., Certain Two-Way Radio Equipment*, Inv. No. 337-TA-1053, Doc. ID 664543, Comm'n Op. at 19-22 (Dec. 18, 2018) (inferring copying where, *inter alia*, respondent's employees were formerly employed by complainant, former employees of complainant actively recruited and hired additional employees from complainant to work for respondent, former employees had access to complainants' confidential information and refused to answer questions at deposition regarding whether the accused products were developed using complainants' confidential information).

Regarding commercial success, Apple points to "numerous features" of the Apple Watch and "the accused Blood Oxygen feature is only one." AppleIPHB 144. But Apple fails to address its decision to emphasize that feature in launching the Series 6 and the evidence showing the products' success is significantly attributable to that infringing feature. MasimoIPHB 173-174.

[REDACTED]

Apple also ignores that its market share soared, with the only material change being the addition of pulse oximetry. MasimoIPHB 173-175.

**h. Apple's Improper IPR Arguments**<sup>13</sup>

Apple relies on IPR final written decisions to misleadingly allege the PTAB “rejected similar arguments from [Madisetti].” AppleIPHB 67, n.20.<sup>14</sup> Apple (1) failed to make any IPR arguments or reference any plan to introduce IPR evidence in its Pre-Hearing Brief, (2) failed to introduce evidence during the hearing, and (3) ignores the evidence that did come in when Apple’s counsel tried to argue about the IPRs through witnesses. Thus, such arguments are waived under G.R. 9.2. See Doc. ID 774416 at 7-8. The only actual evidence was Madisetti responding to Apple’s repeated attempts to draw improper inferences without evidence, through Apple’s attorney arguments. Specifically, Madisetti explained that Apple’s IPRs involved “different claims, different prior art, and all the prior art, all these patents, the prior art and other IPR material was disclosed to the Patent Office and considered by the Patent Office before the issuance of the claims that are asserted in this litigation matter.” Tr. (Madisetti) 1388:17-22.

Procedurally, Apple’s assertions that the PTAB rejected Madisetti’s arguments is simply impossible. During the IPRs, Apple submitted new expert opinions on Reply that directly

---

<sup>13</sup> Masimo has moved to strike Apple’s inclusion of sixteen non-admitted exhibits from the IPRs with its IPHB. Doc. ID 774416.

<sup>14</sup> Apple also attacks Madisetti’s opinions for other reasons. But these attacks repeat Apple’s failed attempt to challenge Madisetti’s expertise at the hearing. Tr. (Madisetti) 665:1-674:12. The ALJ admitted Madisetti “as an expert in the field of *physiological monitoring technologies*.” *Id.* Apple again argues Madisetti has worked “[a]gainst Apple” and made money doing so. AppleIPHB 25. Every expert renders opinions adverse to at least one party and receives compensation for doing so. Apple also ignores the frequency of litigation involving Apple—a company regularly accused of patent infringement in many forums. Indeed, on June 27, 2022, ALJ Elliot issued an initial determination in Inv. No. 337-TA-1266, finding a Section 337 violation based on patent infringement by Apple Watch Series 6 and 7 for another medical parameter measurement Apple heavily touted as its own innovation. Doc. ID 773989.

[REDACTED]

contradicted Apple's and its expert's original position regarding the impact of a convex surface. Specifically, Apple's Petitions, expert declarations, and deposition testimony from its expert took the position that a convex cover would be beneficial because it would condense light *to the center*. However, the problem was that the combination Apple presented moved the detectors away from the center and to the periphery. Once Masimo exposed this flaw in its Patent Owner Response, Apple pivoted, much like it does here, and presented a brand new expert declaration in Reply claiming that the lens would instead direct light *to the periphery*. *Apple Inc. v. Masimo Corp.*, IPR2020-01520, Exhibit 1047 ¶¶18-22 (Aug. 20, 2021); *Apple Inc. v. Masimo Corp.*, IPR2020-01521, Exhibit 1047 ¶¶18-22 (Oct. 1, 2021).

Madisetti never presented any opinions in response to this pivot by Apple because Apple presented this theory on Reply only. As Madisetti explained in the brief testimony about this topic when Apple attempted to argue with him about the IPRs, Madisetti never had the opportunity to provide rebuttal opinions. Tr. (Madisetti) 1388:6-22. Thus, Apple implicitly asks the ALJ to infer that the PTAB somehow rejected something Madisetti never said.

Notably, Apple did not confront Madisetti on any of his actual opinions during the IPRs. Apple failed to present any evidence about those opinions during the hearing, and failed to relate any opinions from the IPRs to the Asserted Patents or prior art grounds. Apple knows it did not rely on Lumidigm in any IPR. Apple knows the Asserted Claims differ from those at issue in the IPRs. Apple also knows the Patent Office considered all of its IPR arguments and all of its IPR prior art when examining and issuing the Asserted Claims.

Apple's (1) silence on the IPRs in its pre-hearing brief, (2) failure to present any evidence of the IPRs in its pre-hearing brief or during the hearing, and (3) belated attempt to argue IPRs and selectively present select evidence in its initial post-hearing brief all strongly suggest that Apple

[REDACTED]

chose to avoid the actual evidence and is trying to influence the Initial Determination through improper inferences. Had Apple made such arguments in its pre-hearing brief Masimo would have presented evidence rebutting Apple's IPR arguments. The ALJ should reject Apple's procedurally improper tactics.

**i. Different Claims**

Apple argues the Asserted Claims are "related" to those found unpatentable in IPRs. AppleIPHB 1. But that analysis is intentionally superficial. This likely explains why Apple did not include the argument in its pre-hearing brief. Only now—after the hearing—has Apple attempted to make this argument without a developed record. Indeed, as explained in Masimo's motion to strike, Apple waited until the due date of its IPHB to mention for the first time its plan to try to admit selected IPR materials.

Apple fails to candidly present the claims challenged in the IPRs, which as Madisetti explained, are different. Tr. (Madisetti) 1388:6-22. The Asserted Claims have elements not present in any of the claims challenged during the IPRs. For example, the Multi-Detector Patents include an opaque material configured to reduce light reaching the photodiodes without being attenuated by the tissue ('502 [19C], '648 [8D]), or opaque lateral surfaces or opaque material configured to avoid light piping through the protrusion ('501 [1E], '502 [28F], '648 [24]). Those features were not in any claims in any of the IPRs and were not considered by the PTAB, nor did Apple argue that the prior art disclosed any such elements.

As another example, the Multi-Detector Patent claims ('502 [20]-[21], [28D], [28I]) recite a thermistor and describe features such as adjusting operation of the user-worn device responsive to the temperature signal. Those features were not in any claims in any of the IPRs, were not considered by the PTAB during the previous IPRs, were considered by the Patent Office when



[REDACTED]

granting the Asserted Claims, and Apple did not present any argument that any such elements were disclosed by the art.

The PTAB did not consider the Asserted Claims in the IPRs. But, when issuing the Asserted Claims, the Examiner did have Apple's PTAB arguments, evidence, and prior art from the IPRs. *See, e.g.*, JX-0004 at 410-422, 529-539. Apple cannot exploit the IPR decisions to end-run Apple's burden to prove invalidity by clear and convincing evidence.

**ii. Different Prior Art**

Apple also fails to address the different prior art. Again, Madisetti provided the only hearing evidence on the record regarding the content of the IPRs. He identified that the prior art was different. Tr. (Madisetti) 1388:6-22, 1386:11-1387:3. Here, Apple relies on Lumidigm for all its prior art challenges to the Multi-Detector Patents. But Apple provides no evidence connecting Lumidigm to any Apple IPR. And as Madisetti explained, during prosecution of the Multi-Detector Patents, Masimo disclosed the prior art and other IPR materials to the Patent Office, including Apple's arguments and expert testimony. *See, e.g.*, JX-0004 at 410-422, 529-539; Tr. (Madisetti) 1388:6-22. The Patent Office considered that art, Apple's IPR arguments, and Apple's IPR expert testimony before issuing the Asserted Claims. *Id.*

**iii. Different Standard**

Apple also conveniently disregards the different burdens of proof. In the ITC, as in district courts, patents enjoy a statutory presumption of validity, and challengers must prove each patent claim invalid by clear and convincing evidence—the highest burden of proof in U.S. civil litigation. 35 U.S.C. § 282; *Microsoft Corp. v. i4i Ltd. Partnership*, 564 U.S. 91, 95 (2011). But no such presumption of validity applies in PTAB proceedings. *See, e.g.*, *Dynamic Drinkware, LLC v. Nat'l Graphics, Inc.*, 800 F.3d 1375, 1379 (Fed. Cir. 2015). Petitioners need only establish

[REDACTED]

unpatentability by a preponderance of the evidence—i.e., that the claims are more likely than not unpatentable. *Id.*; 35 U.S.C. § 316; see *Cuozzo Speed Techs., LLC v. Lee*, 579 U.S. 261, 279 (2016). This is a very significantly reduced burden of proof compared to that which Apple had to—but failed—to meet in this Investigation. Apple’s post-hearing attempt to rescue its failed obviousness arguments through innuendo regarding other IPRs fails to meet that standard.

**iv. Objective Evidence of Nonobviousness**

The PTAB also did not have and could not consider the significant objective evidence of nonobviousness presented here. Indeed, much of that evidence stems from Apple’s own internal contemporaneous documents and testimony from its witnesses in this Investigation contradicting the arguments Apple presented both here and at the PTAB. Apple certainly never disclosed any of that information to the PTAB. Such “evidence of secondary considerations *may often be the most probative and cogent evidence in the record.*” *WBIP*, 829 F.3d at 1328 (internal citation and quotation marks omitted) (“objective indicia of non-obviousness play an important role as a guard against the statutorily proscribed hindsight reasoning in the obviousness analysis”). Apple fails to address this distinction at all.

**3. 35 U.S.C. § 112 (pre-AIA)**

Apple presents validity positions under 35 U.S.C. § 112 that contradict its anticipation and obviousness defenses.

**a. Written Description**

**i. Claimed Combinations of LEDs, Photodiodes, and Openings with Opaque Surfaces ('501 Patent Claim 12; '502 Patent Claims 22, 28; '648 Patent Claim 12)**

Apple concedes the specification discloses the claimed features, but disputes whether it describes them in a single embodiment. AppleIPHB 147-151. But Apple cites no legal authority

[REDACTED]

requiring a claim be directed to a single embodiment. *Id.* To the contrary, the legal authority it cites acknowledges that written description support may be provided by specification embodiments “linked together in the specification.” *Flash-Control, LLC v. Intel Corp.*, No. 2020-2141, 2021 WL 2944592, at \*4 (Fed. Cir. 2021). Nevertheless, as Masimo explained, FIG. 3 discloses these features in a single embodiment. MasimoIPHB 176-177.

At the hearing, Apple only asked Warren a single question on Apple’s written description theory. AppleIPHB 148 (citing Tr. (Warren) 1246:24-1247:7)). Warren responded merely that: “I can’t find a single embodiment.” Tr. (Warren) 1246:24-1247:7. Based on that testimony alone, Apple now labels the specification a “mix-and-match approach to the embodiments.” *Id.* Warren never explained which embodiments are supposedly mixed and matched. But Masimo explained how the specification links the claim elements together. MasimoIPHB 176-179. Warren gave no opinion on that linkage in the specification. Tr. (Warren) 1247:3-7. Thus, Warren’s inability to find a single embodiment provides no evidence on the question of written description.

Apple now argues Madisetti’s testimony is somehow “insufficient to show” satisfaction of the written description requirement. AppleIPHB 151 n.24. Apple again invites legal error by attempting to place an affirmative burden on Masimo to prove written description support for the claims. Masimo has no such burden, and issued claims have the presumption of written description support. *See, e.g., Hynix Semiconductor Inc. v. Rambus Inc.*, 645 F.3d 1336, 1351 (Fed. Cir. 2011) (“To overcome the presumption of validity of patents, the accused must show that the claims lack a written description by clear and convincing evidence.”).

In addition, Masimo did much more than rely on Madisetti’s testimony to rebut Warren’s single answer to a single Apple question. Masimo identified how the patent specification itself expressly states the features of the sensors shown or described in various embodiments, including

[REDACTED]

at least FIGS. 1-2, 7A-7B, 13, and 14F-14I, apply to the sensor of FIG. 3. MasimoIPHB 178-179 (citing JX-0001 at 6:45-47, 6:65-7:8, 7:13-14, 21:51-54, 26:21-29, 38:3-36, and 44:22-29). Madisetti also pointed out where the *specification* links the embodiments together. Tr. (Madisetti) 1347:18-1349:6; CDX-0012C.044. Apple relies on *Flash-Control, LLC v. Intel Corp.*, No. 2020-2141, 2021 WL 2944592, at \*3-4 (Fed. Cir. July 14, 2021). But Masimo’s IPHB already explained that *Flash-Control* addressed embodiments that are “*never linked together in the specification.*” MasimoIPHB 179. That is not the case here. Kiani also testified that Figure 3C showed the LEDs, photodiodes, and openings with optical barriers “to make sure only the light through the tissue gets to that photodetector that’s sitting at the bottom of that hole.” Tr. (Kiani) 99:17-100:3, 101:6-12. Without explanation, Apple fails to address Kiani’s testimony regarding those optical barriers or their function to suggest that Fig. 3C does not show the claimed integrated whole. AppleIPHB 149. Apple cannot show a lack of written description support by ignoring the full scope of the specification or all of Kiani’s testimony about it.

In contrast to its written description position, Apple alleged “Lumidigm itself expressly suggests” implementing the claimed features. AppleIPHB 151 n.24. Apple never explains how Lumidigm “expressly suggests” such features, much less what would be “express” about a “suggestion.” Nor could it. Lumidigm’s key inventor, Rowe, explained the specification was a “brainstorming session” rather than the result of any actual work attempted or done. Tr. (Rowe) 1146:18-1147:3 Apple failed to carry its burden to prove invalidity by clear and convincing evidence with its reliance on the single Warren answer that he “can’t find” a single embodiment.

[REDACTED]

ii. **Sets of LEDs Each Emitting at a First Wavelength and a Second Wavelength**  
**(’502 Patent Claim 28)**

Apple again relies on Warren’s hearing testimony for its written description defense. Apple asked Warren if he had identified a discussion of this element in the specification, but all he said was: “I have not found one, no.” AppleIPHB 151 (citing Tr. (Warren) 1247:13-17). Masimo’s IPHB addressed the specification support and Madisetti’s explanation of it. MasimoIPHB 180-181 (citing JX-0001 at FIGS. 7A-7B, 13, 14I, 9:60-63, 12:9-12 (“In an embodiment, the emitter 104 includes *sets of optical sources* that are capable of *emitting visible and near-infrared optical radiation.*”), 12:13-25, 13:16-21, 33:30-38, 21:51-54, 38:8-22). Apple presented no evidence of how a POSITA would interpret that specification support. Apple cannot meet its burden by having its expert say “I couldn’t find one,” much less by ignoring the evidence provided and criticizing rebuttal to non-existent opinions.

iii. **“At Least Four Emitters ... Wherein Each of the Plurality of Emitters Comprises a Respective Set of at Least Three LEDs”**  
**(’502 Patent Claim 22)**

For the “at least four emitters” element, Apple again relies on Warren’s testimony. AppleIPHB 151. Warren had a one-word answer on Apple’s written-description question at the hearing: “No.” Tr. (Warren) 1247:8-12. Masimo and Madisetti more than adequately rebutted Warren’s testimony and addressed the specification support. MasimoIPHB 180. Neither Apple nor Warren addressed that support. Apple utterly failed to carry its burden to prove invalidity with Warren’s “no.”

[REDACTED]

**b. Enablement**

**i. “Touch-Screen Display” and “Indicia of Measurements”  
(’502 Patent Claim 28)**

Apple pretends as though Warren thoroughly addressed this issue at the hearing. AppleIPHB 152. But Warren merely said in response to a leading question: “I have only found two brief references to touchscreens, so no.” *Id.* (citing Tr. (Warren) 1247:18-23)). And for this same element, when analyzing the prior art, Apple relied on Warren’s conclusory testimony to argue that the use and implementation of user interfaces with touch screens was also “well known.” AppleIPHB 95-96.

Apple now criticizes Madisetti’s rebuttal testimony as if he had something from Warren to rebut. AppleIPHB 152. He did not. Apple failed to present clear and convincing evidence of lack of enablement. Madisetti, not Warren, provided the only testimony about what a POSITA would have known about these features based on the specification. MasimoIPHB 181-182.

**ii. Reducing/Avoiding “Light Piping”  
(’501 Patent Claim 12; ’502 Patent Claim 28; ’648 Patent  
Claim 24)**

For the reducing/avoiding light piping elements, Apple again relies on Warren’s testimony in response to a single question to argue “light piping” elements in three claims lack written description or lack enablement. AppleIPHB 152-153. Warren testified, “No. I’ve just seen a vague correlation between the two, that’s it.” Tr. (Warren) 1247:24-1248:4. Warren provided no explanation for his summary conclusion. Masimo explained, with extensive supporting evidence, the multiple ways the specification teaches to reduce or avoid light piping, and Madisetti’s explanation of them. MasimoIPHB 182-183.

Apple now argues, without evidentiary support, about what a “POSITA can determine” from the specification. AppleIPHB 153. But Apple elicited no testimony to support that attorney

[REDACTED]

argument, and cannot carry its burden based on it. Even though Apple’s deficient hearing presentation required no rebuttal, Madisetti still explained, with citations to evidence, that the specification teaches how to reduce or avoid light piping. Tr. (Madisetti) 1350:4-21, 1352:25-1353:11; CDX-0012C.046. Indeed, Warren acknowledged that the specification describes not only light piping, but also hard opaque plastics that reduce or avoid it. Tr. (Warren) 1247:24-1248:4.

Warren’s conclusory testimony about what he could not find or could not see fails to support Apple’s validity challenges under 35 U.S.C. § 112. Apple’s decision to devote minimal hearing time to these defenses confirms their lack of merit. Yet, Apple continues to press these defenses despite the lack of supporting evidence.

**F. Enforceability**

**1. Prosecution Laches**

Apple identifies no evidence of unreasonable or unexplained delay. Apple first presents an attorney-drafted “timeline” from its opening to falsely assert “Masimo put a hold on filing any new applications in this family for nearly five years....” AppleIPHB 154. But Apple cites no evidence of any “hold” or “gap.” Cromar provided unrebutted testimony to the contrary, explaining Apple’s opening slide omitted many filings spread throughout the time period such that the timeline was a “misrepresentation.” Tr. (Cromar) 1038:10-19.<sup>15</sup>

Apple then relies on the time period between the earliest filing in the family and the filing of the specific applications that led to the Poeze patents to argue delay. AppleIPHB 155. But Apple never shows any delay or improper conduct *during the prosecution* of any of Masimo’s

---

<sup>15</sup> For example, Apple’s alleged five-year “gap” (from 2010 to 2015) omits the filing of App. 14/069,974, App. 13/888,266, App. 14/153,895, App. 13/525,166, App. 14/064055, and the active prosecution of many more applications.

[REDACTED]

patent applications. Apple instead argues “[i]t is irrelevant whether ‘there was active prosecution; through that time period; of other patents in the family.’” *Id.* at 156. Under Apple’s theory, “prosecution activities with respect to other applications cannot justify the unreasonable delay for the asserted patents.” *Id.* at 155.

Apple invites legal error. Apple’s own brief quotes *Symbol Techs., Inc. v. Lemelson Med., Educ. & Research Found.*, 422 F.3d 1378, 1385-86 (Fed. Cir. 2005), to explain that prosecution laches may apply “*only* after an unreasonable and unexplained delay in *prosecution*,” which requires examining the “prosecution history of *all* of a series of related patents....” AppleIPHB 157 (quoting *Symbol Techs.*, 422 F.3d at 1386).

Apple cites *Hyatt* and *Personalized Media*, both dealing with pre-GATT filings, but neither case relied solely on the timing of the applications. Both cases focused on clear prosecution tactics that made it virtually “impossible” for the PTO to reasonably examine the patents. See *Hyatt v. Hirshfield*, 998 F.3d 1347, 1366-38 (Fed. Cir. 20210) (“Hyatt adopted an approach to prosecution that all but guaranteed indefinite prosecution delay,” addressing pre-GATT patents that eventually included “at least 115,000” claims); *Personalized Media Commc’ns, LLC v. Apple, Inc.*, 552 F. Supp. 3d 664, 686 (E.D. Tex. 2021) (“prosecution conduct” made it “virtually impossible for the PTO” to engage in reasonable examination, where patentee asserted 20,000 pre-GATT claims in a “deliberate strategy of delay” that included “effort[s] to keep its patent portfolio hidden”).

Apple asserts that “by *apparently* tying its filings and prosecution of its continuation applications to Apple’s product releases,” Masimo “intentionally and methodically delayed prosecution ....” AppleIPHB 156-157. Obviously, arguing that Masimo “apparently” engaged in conduct cannot satisfy Apple’s burden of clear and convincing evidence. See *Personalized Media*, 552 F. Supp. 3d at 684-85. Regardless, Apple cites nothing to support its speculation. Apple



[REDACTED]

asserts that Masimo’s delays “tracked the releases of Apple Watch products,” *id.* at 157, but Apple again cites no supporting evidence. *Id.* Apple’s demonstrative attorney-created timeline—which Masimo’s responsible prosecution attorney rightly explained is a “misrepresentation” and incomplete—is not evidence. Tr. (Cromar) 1038:10-19. Regardless, at best, Apple’s timeline shows (1) Apple released a version of the Apple Watch in 2015 and in each year from 2018 to 2020 and (2) Masimo filed some applications in those (and other) years. That shows no correlation. Indeed, Apple nowhere showed that any of those filings have claims that Apple contends cover its products. Apple did not even present the claims. Apple’s timeline also deceptively groups Masimo applications eight months apart into a single entry in an attempt to imply a correlation. AppleIPHB 154. Cromar presented un rebutted testimony rejecting Apple’s “correlation.” Tr. (Cromar) 1034:11-1035:19; 1040:1-9.

Even if Apple could show a purported correlation between Apple’s watches and Masimo’s patent filings, that would be woefully insufficient. There is nothing improper about drafting claims to cover competitors’ products. *See Kingsdown Med. Consultants, Ltd. v. Hollister, Inc.*, 863 F.2d 867, 874 (Fed. Cir. 1988). Accordingly, “the mere passage of time and/or intent to cover after-arising technology is insufficient to demonstrate prosecution laches[.]” *Certain Semiconductor Chips and Products*, Inv. No. 337-TA-753, I.D. at 248 (Mar. 2, 2012) (Doc. ID 474876), *aff’d* Comm’n Op. (Aug. 17, 2012). Apple also improperly asks the ALJ to draw an adverse inference from Masimo’s invocation of privilege, AppleIPHB 158 & n.26, citing Masimo’s privilege claims while arguing Masimo engaged in “bad-faith actions.” *Id.*; *see Knorr-Bremse Systeme Fuer Nutzfahrzeuge GmbH v. Dana Corp.*, 383 F.3d 1337, 1345 (Fed. Cir. 2004) (en banc) (“[C]ourts

[REDACTED]

have declined to impose adverse inferences on invocation of the attorney-client privilege....[T]his rule applies to the same extent in patent cases”).<sup>16</sup>

Apple also fails to show any prejudice. Instead, Apple dumps an unexplained string cite of evidence into a footnote. AppleIPHB 157 n.25. Apple’s string cite apparently shows Apple’s general development of the Apple Watch with no reference to any particular time period. *Id.* That is insufficient: laches requires a showing that others developed intervening rights “during the period of delay.” *Cancer Research Tech. Ltd. v. Barr Labs., Inc.*, 625 F.3d 724, 729 (Fed. Cir. 2010). Here, the earliest watch at issue—Apple’s Series 6—was released in 2020. That is five years *after* Masimo’s alleged (though non-existent) five year “gap” in prosecution from 2010 to 2015. Apple released its Series 6 watch approximately ten years *after* the Poeze patent specification was published in 2010. Tr. (Stoll) 1412:7-16. As Stoll explained, as of 2010, the public could “look at the specification and the prosecution of the applications after that.” *Id.*

Finally, Apple cites *Seaboard Int’l, Inc. v. Cameron Int’l Corp.*, No. 1:13-cv-00281-MLH-SKO, 2013 WL 3936889 (E.D. Cal. Jul. 30, 2013), but that case addressed whether certain allegations were “above the speculative level” on a motion to dismiss. *Id.* at 2. *Seaboard* does not excuse Apple’s failures here.

## 2. Unclean Hands

Because Apple’s laches defense fails, it has not established unclean hands either.

---

<sup>16</sup> None of Apple’s cases suggest that drafting claims to cover a competitor can establish laches. Those cases address other conduct not at issue here. See *Hynix Semiconductor, Inc. v. Rambus, Inc.*, 2007 WL 4209386 at \*4-5 (N.D. Cal. Nov. 26, 2007) (denying summary judgment because there was evidence patentee “repeatedly delayed issuing its patents or informing others about them”); *In re Bogese*, 303 F.3d 1362, 1369 (Fed. Cir. 2002) (holding that a desire to cover competitive products does not excuse unreasonable delay). *In Re Bogese*, 303 F.3d at 1369, indicates the opposite, finding a “legitimate desire to obtain claims fully disclosed and supported in an earlier application” is “*easily distinguishable* from appellant’s failure to further the prosecution of his application toward the issuance of any claims.”

[REDACTED]

**V. '745 PATENT**

**A. Level of Ordinary Skill in the Art**

The parties stipulated to the level of ordinary skill. Doc. ID 770692 ¶10; MasimoIPHB 185; AppleIPHB 163.

**B. Claim Construction**

Apple again applies its heads-we-win, tails-you-lose approach to the claim construction of “first shape.” Apple never articulates a specific and consistent construction of the term for its invalidity and noninfringement arguments, arguing under different constructions at each point.

The parties have competing constructions for the term “second shape.” AppleIPHB 163. But the parties agree this construction dispute does not affect the issues presented. MasimoIPHB 186; AppleIPHB 164.

Apple now rests its noninfringement defense on a new shape “requirement” that directly contradicts Apple’s opening statement and Sarrafzadeh’s position. Apple explained during opening as follows: “But if Your Honor looks at the claim language, the requirement is to change the first shape into a second shape at the material, at the material. So *the relevant comparison is between the shape of light when it reaches the [REDACTED] and the shape of light when it emerges from the [REDACTED]*” Tr. (Apple Opening) 65:18-23.

Sarrafzadeh similarly talked about the shape entering the [REDACTED] on the Apple watch versus the shape exiting the [REDACTED] *see also* Tr. (Sarrafzadeh) 1118:1-11 (comparing the shapes “input to [REDACTED]” and “exit from [REDACTED]”).

Now, Apple shifts, contending the first shape is the shape at the immediate surface of the light-emitting diodes only, not the LED-emitted light entering the material of the diffuser. AppleIPHB 165. With this construction, Apple argued noninfringement based on Sarrafzadeh’s

[REDACTED]

claim that air between the LED surface and the material supposedly changes the shape before the light ever reaches the [REDACTED] *Id.* at 160, 165-67. Masimo previously explained the problems with this narrow interpretation of the claims. MasimoIPHB 186-187.

Apple now tries to support its new construction by arguing that “light-emitting diodes configured to emit light in a first shape” in [1A] and [20A] provides antecedent basis for “the first shape” changed by the material in [1B] and [20B]. AppleIPHB 164 (citing *Bicon, Inc. v. Straumann Co.*, 441 F.3d 945, 954 (Fed. Cir. 2006) and *Process Control Corp. v. HydReclaim Corp.*, 190 F.3d 1350, 1356 (Fed. Cir. 1999)). Apple’s attempt to confine the “first shape” to the LED emission surface contradicts the specification.

The specification explains that the light diffuser receives “optical radiation emitted from the emitter” or “the input light beam from the emitter” JX-0009 at 7:42-49. “The light from the emitter is directed in the tissue.” *Id.* at 7:18-22. “The sensor ... detects the emitted light.” *Id.* at 7:6-9. “[T]he diffuser is further configured to define a surface area shape by which the emitted spread light is distributed onto a surface of the tissue measurement site.” *Id.* at 3:8-11. “[E]mitting the spread light from the diffuser to the tissue measurement site includes spreading the emitted light so as to define a surface area shape ....” *Id.* at 4:23-28. These disclosures confirm that the specification’s references to light emitted from the LEDs encompasses light from emission to detection. In the claims, the “first shape” refers to any shape of light emitted by the LEDs before the claimed “material” changes it into a second shape. MasimoIPHB 186-187.

Apple relies on FIGS. 7A&B to support its view that the specification limits the first shape to the light emitted at the LED surface because the diffuser and LED abut each other. AppleIPHB 164-165. That is merely one embodiment. Apple identified no unequivocal disavowal of claim scope or lexicography to limit the claim scope to a single embodiment.



FIG. 3 (below) contradicts Apple’s argument. Fig. 3 shows a gap between the light emitter 302 and the diffuser 304.

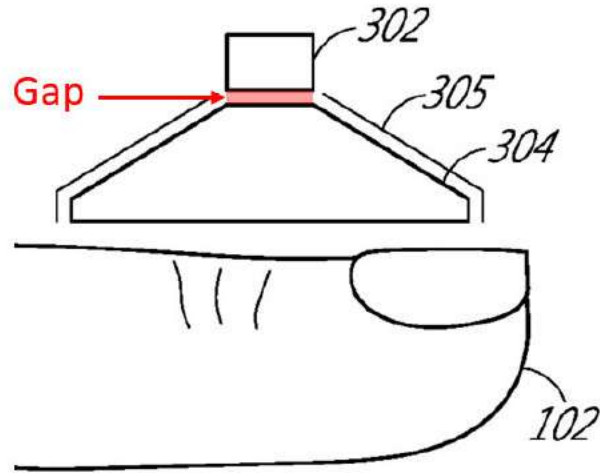

JX-0009 at Fig. 3. Under Apple’s view, the gap would change the shape of light before it reaches the diffuser, and thus the light reaching the diffuser would no longer be a first shape. *See, e.g.,* AppleIPHB 165-67. Thus, adopting Apple’s view would improperly exclude this FIG. 3 embodiment. *See Vitronics Corp. v. Conceptronic, Inc.*, 90 F.3d 1576, 1583 (Fed. Cir. 1996).

Apple attempts to explain away FIG. 3 by arguing the specification’s failure to explicitly mention the words “spacing” or “air gap” suggests that none exists, and implies this would necessarily limit the claim scope. AppleIPHB 170. *Id.* But, the only testimony is from Madisetti who confirmed “there is a separation” in FIG. 3 and “the light emitter is not in contact with the light diffuser.” Tr. (Madisetti) 746:13-747:2. Certainly, there is no express limitation of the “first shape” or “unequivocal disavowal” of claim scope to so limit the claim.

Apple applies its new “first shape” construction for noninfringement only. AppleIPHB 169-70. For validity, Apple does not require that the first shape be the shape at the “immediate surface of the light-emitting diodes.” *See id.* at 179-80. Indeed, Apple ignores the

in the Series 0. *See* Tr. (Venugopal) 835:5-836:2. Apple’s

[REDACTED]

failure to consistently apply the same construction confirms that Apple contrived the construction for noninfringement.

C. **Infringement**

1. **[REDACTED] Receives Light Having the First Shape [1B]/[20B]**

Apple relies on its new improper construction to argue the [REDACTED] does not receive the first shape that was emitted by the LEDs. AppleIPHB 165-167. Apple points to a combination of three demonstratives (RDX-0007.140C-142C) with annotated photographs from Madisetti's tests and labels them "Light at LED Emission Plane" and "Light at [REDACTED] Entry Plane."

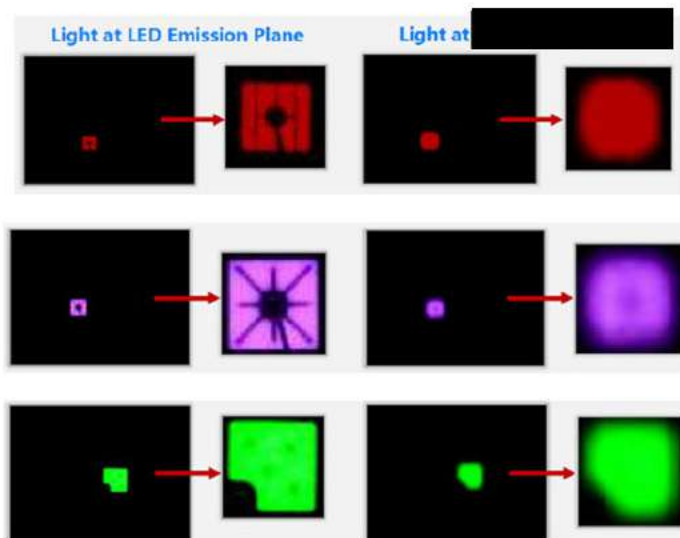

AppleIPHB 167-68 (citing RDX-7.140C-142C) (annotating CX-0307iC). Apple alleges that Madisetti agreed that the first set of images on the left are the "first shape." *Id.* (citing Tr. (Madisetti) 789:4-12). Apple then alleges that shape changes before it reaches the [REDACTED] AppleIPHB 167-68. Apple also relies on testimony from Venugopal and Sarrafzadeh about the light received by the [REDACTED]. See AppleIPHB 169.

But, as discussed above regarding claim construction, the "first shape" is not limited to the shape immediately at the LED emission surface. Thus, Apple's discussion of the "first shape" changing before reaching the [REDACTED] is irrelevant. See MasimoIPHB 193.

[REDACTED]

2. The [REDACTED] Changes the Shape of Light into a Second Shape [1B]/[20B]

Apple accuses Madisetti of “omitting entirely any analysis of the shape of light received and acted on by the [REDACTED]” AppleIPHB 169, 172-173. The record shows otherwise. Madisetti compared: (1) the shapes at the surface of the LED with the shapes after the [REDACTED] and also (2) the shapes before (received by) the [REDACTED] and the shapes after the [REDACTED]. He testified that the shapes were different before and after the [REDACTED] for both comparisons. Tr. (Madisetti) 732:25-733:18, 747:3-12. The demonstrative below and Madisetti’s testimony regarding it confirms that he performed the first comparison.

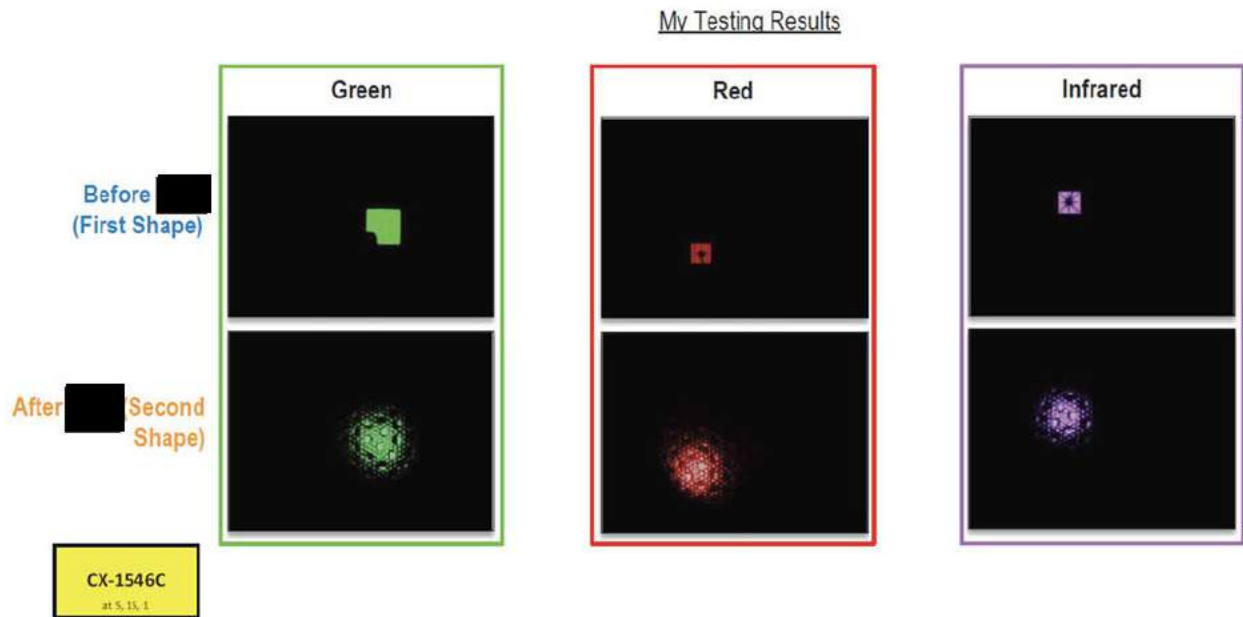







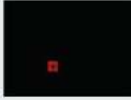

CDX-0011C.077 (excerpt) (citing CX-1546C); Tr. (Madisetti) 732:25-733:18. The demonstrative below and Madisetti’s testimony regarding it confirms that he performed the second comparison. This is the “relevant comparison” that Apple’s counsel described in opening: “So the relevant comparison is between the shape of light when it reaches the [REDACTED] and the shape of light when it emerges from the [REDACTED].” Tr. (Apple Opening) 65:20-23.

[REDACTED]

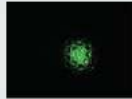
3. Apple incorrectly interprets the results of my tests

- My results show that the [REDACTED] changes the shape

	Surface	Before [REDACTED]	After [REDACTED]
Red			
Green			
IR			

• Shapes in columns 2 and 3 are different.

CDX-0011C.091

CX-1546C

CDX-0011C.091 (citing CX-1546C); Tr. (Madisetti) 747:3-12.

Apple admits that the [REDACTED] between red and IR light, but argues that it does not change the shape of light. AppleIPHB 171. Madisetti explained that the [REDACTED] changed the shape in addition to creating an [REDACTED] Tr. (Madisetti) 808:11-19. Venugopal testified to his opinion that the [REDACTED] [REDACTED] but provided no contemporaneous evidence in support. Tr. (Venugopal) 830:19-831:9. Apple’s documents and Madisetti’s testing show otherwise. MasimoIPHB 195-96; RX-0895C at 317 (Apple simulations of final and prototype [REDACTED], depicted as the [REDACTED] CX-1546C (Madisetti testing); CX-0307iC (same).

In a footnote, Apple misleadingly states that “Dr. Madisetti *agreed* that two circles may overlap, or not overlap, *while remaining ‘circles.’*” AppleIPHB 171 n.27 (citing Tr. (Madisetti) 779:20-780:11). But Madisetti disagreed: “Q. And we can agree they are all still circles, right? A. I disagree.” Tr. (Madisetti) 780:12-14.



[REDACTED]

Apple criticizes Madisetti's photographs as having "camera artifacts," pointing to dark spots in the "After [REDACTED] images. AppleIPHB 171. Sarrafzadeh asserted, without evidence, that "we know there is light, so the dark spots in the middle and kind of on the boundary should actually be in the corresponding color." Tr. (Sarrafzadeh) 1119:24-1120:4. But Sarrafzadeh provided no testing or explanation of why there should be light at the dark spots, or otherwise explain any reason for supposed "artifacts," other than because he says so. MasimoIPHB 195; *Rohm & Haas Co. v. Brotech Corp.*, 127 F.3d 1089, 1092 (Fed. Cir. 1997) (factfinder not required to credit "unsupported assertions of an expert witness"). Regardless, both the color and black and white images (which filled in the dark spots due to image post-processing) show a change in shape. *See* CDX-0011C.088; CX-1546C; Tr. (Madisetti) 745:5-746:5 (confirming black and white images also show shape change from before [REDACTED] to after [REDACTED]).

Apple seeks to characterize the dark spots as "intensity variations [which] are not a change in shape." AppleIPHB 172. Sarrafzadeh provided no support for that conclusion. *Id.* (citing Tr. (Sarrafzadeh) 1120:5-6 ("Q. Are intensity variations a change in shape? A. They are not.")). Apple's argument is inconsistent with the '745 Patent, which identifies various shapes, such as, rectangle, circle, annular, oval, and donut. JX-0009 3:8-14, 8:9-12, 10:65-11:2; *see also* Apple PHB 142. The perimeter does not distinguish between these shapes. For example, a circle and donut have the same outer perimeter. If the intensity variations were ignored, the circle and donut would be the same shape.

Apple also cites two passages from the '745 Patent to suggest that the specification distinguishes between light intensity and shape. AppleIPHB 172 (citing JX-0009 at 4:22-23, 8:1-14). Neither passage supports that distinction. The first passage merely states that "[i]n some embodiments the emitted spread light is emitted with a substantially uniform intensity profile."



JX-0009 4:22-23. The second passage describes various embodiments where the diffuser can emit light in a “Lambertian pattern” or it can distribute light in a predefined geometry (e.g., a rectangle, square, or circle).” *Id.* at 8:1-14.

Apple also attempted to attack Madisetti’s infringement analysis by asking him to compare various hypothetical shapes. AppleIPHB 160-62, 169; RDX-0012.3-12.5, Tr. (Madisetti) 783:1-4, 1384:23-1385:10. But Madisetti based his infringement analysis on the actual light before and after the MLA, as captured during his testing.

The hypothetical shapes presented to Madisetti are below:

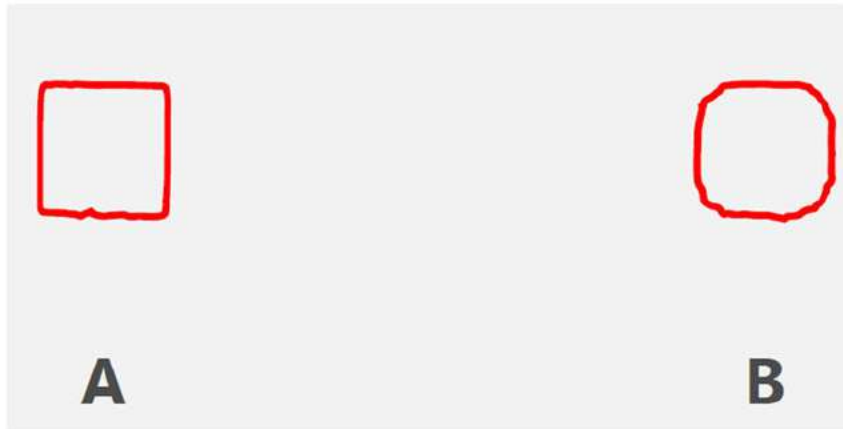

RDX-0012.5.

Madisetti repeatedly informed counsel that the red outlines did not provide context for an on-the-spot opinion related to the ’745 Patent. Tr. (Madisetti) 782:10-11 (“I don’t have an opinion.”), 782:15-16 (“Again, if these are figures from a testing, I’m not sure what you are showing here.”), 782:24-25 (“As I said, I need more information for this. I can’t say.”). Instead of providing Madisetti the requested information, counsel waited until Madisetti’s rebuttal testimony two days later to reveal that the outlines were supposedly based on images from Madisetti’s testing:



RDX-0012.5 (after animation) (citing CX-0307iC at 17); Tr. (Madisetti) 1384:23-1385:10. But, the red outlines were not images of the light, just outlines created by counsel.

Apple argues that because Madisetti did not answer the red outline questions without asking for more information, that this is somehow “fatal to Complainants’ infringement case.” AppleIPHB 162. But both the shapes above are based on Madisetti’s photos of light before the [redacted]. As explained above, a comparison of those particular shapes is irrelevant to infringement. Apple omits that Madisetti answered that the shapes shown in the prior slide, RDX-0012.4, were different. Tr. (Madisetti) 782:12-20; RDX-0012.4 (below).

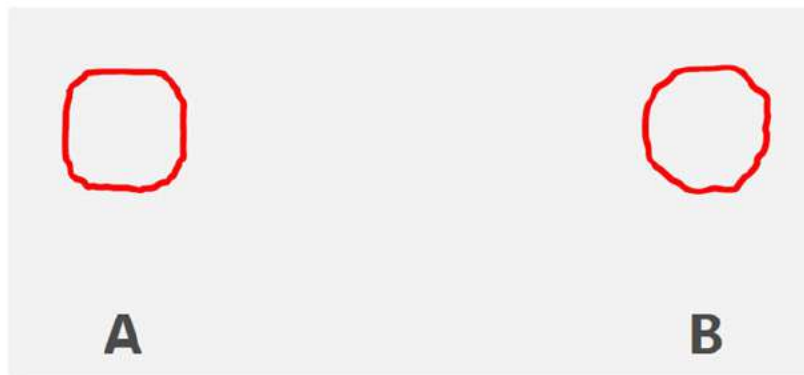

RDX-0012.4. Counsel asked Madisetti, “Why were you able to tell me with respect to the last slide but not this one?” Tr. (Madisetti) 783:5-8. When Madisetti began to explain, and asked counsel to go back to the previous slide, counsel decided she did not want an answer. *Id.* Counsel’s

[REDACTED]

red outlines were merely another attempt to distract from actual testing of the light and Apple's own contemporaneous documents, showing a change of shape readily apparent to everyone but Sarrafzadeh.

**3. Apple Indirectly Infringes Claim 27**

Apple argues Masimo failed to show induced infringement because Madisetti did not give opinions on specific intent to encourage users to directly infringe. AppleIPHB 173. Madisetti is a technical expert who need not opine on intent. *Certain Two-Way Radio Equip.*, Inv. No. 337-TA-1053, Order No. 33 at 3-4 (Jan. 16, 2018) (precluding experts from offering opinions on intent to induce infringement; citing cases). Regardless, Madisetti explained at the hearing that Apple knew of the '745 Patent since the initiation of this Investigation and that Apple directed and instructed end-users to use the Accused Products with iPhones in an infringing manner. Tr. (Madisetti) 739:2-740:5. Moreover, Apple admitted its knowledge of the patent. MasimoIPHB 199-200 (citing CX-1254C).

Additionally, Apple knew that its acts caused direct infringement by end-users. MasimoIPHB 199-200. Masimo showed that Apple knew of the '745 Patent, and instructs end-users to use the Accused Products with iPhones in a manner that would infringe Claim 27. *Id.*; see also *Ricoh Co., Ltd. v. Quanta Computer Inc.*, 550 F.3d 1325, 1342-43 (Fed. Cir. 2008) ("specific intent may be inferred from circumstantial evidence where a defendant has both knowledge of the patent and specific intent to cause the acts constituting infringement."); *Golden Blount, Inc. v. Robert H. Peterson Co.*, 438 F.3d 1354, 1364 n.4 (Fed. Cir. 2006) (knowledge of patent and provision of instructions to customers directing them to perform specific acts that lead to the assembly of infringing devices is sufficient to show intent).

[REDACTED]

Accordingly, Masimo has demonstrated that Apple directly infringes Claim 9 and indirectly infringes Claim 27. Apple’s reliance on irrelevant comparisons and misrepresentations of the record fail to rebut Masimo’s showing.

**D. Domestic Industry – “Technical Prong”**

**1. Domestic Industry Articles** [REDACTED]

Scruggs confirmed that Masimo Watches identified as [REDACTED] and [REDACTED] Tr. (Scruggs) 394:12-18 ([REDACTED]), 395:13-15 ([REDACTED]), 396:4-11 ([REDACTED]), 397:24 ([REDACTED] 398:20-23 ([REDACTED])). Al-Ali’s testimony regarding [REDACTED] and capable of calculating oxygen saturation. Tr. (Al-Ali) 262:7-263:10, 264:6-264:13, 268:22-271:18, 272:16-278:13, 313:14-318:22; CX-0378C; CX-0433C; CX-1634C; CX-0494C. Masimo previously addressed Apple’s allegations with respect to W1, [REDACTED] for the Multi-Detector Patents. Masimo responds here to Apple’s arguments regarding [REDACTED].

Apple speculates that Masimo [REDACTED] (CPX-0021C) [REDACTED] AppleIPHB 174. No evidence supports Apple’s accusation. Instead, Scruggs explained at [REDACTED] [REDACTED] Tr. (Scruggs) 474:20-475:4. Scruggs also confirmed CPX-0021C [REDACTED] [REDACTED] Tr. (Scruggs) 475:8-15; *see also id.* at 475:5-7 (confirming demonstration to Apple’s experts).

Apple argues [REDACTED] (CPX-0029C) fails the technical prong [REDACTED] But Masimo explained this watch operates the same as [REDACTED] [REDACTED] CX-0836C at 5 (showing operation of [REDACTED]

[REDACTED]

[REDACTED] during demonstration); Tr. (Scruggs) 404:3-405:7 (explaining operation of [REDACTED] same as operation of [REDACTED]), 403:11-404:2 (explaining operation of [REDACTED] 414:25-415:15 (same).

**2. Masimo Watch Products Practice '745 Patent Claim 18**

Apple required Masimo to waste extensive hearing time and briefing to present all claim elements. Apple's IPHB finally concedes that it disputes [15B] and [15H] only. AppleIPHB 175.

**a. Masimo Satisfies [15B]**

Apple cites no case law supporting its view that Masimo's fact testimony, contemporaneous corroborating documents, expert testimony, photographic evidence, and inspection-based evidence fail to confirm the presence of light diffusing material in the 745 DI Products. AppleIPHB 175-176. Nor can it. Masimo demonstrated beyond a preponderance of the evidence that each of the 745 DI Products includes [REDACTED]

[REDACTED] See MasimoIPHB 205-207. Masimo also introduced photographs and documents confirming this point. See *id.* at 205-206 (screenshots from Scruggs' demonstration videos).

Rather than offering contrary evidence, Apple points to Sarrafzadeh's conclusory statements that photographs and inspections are "unscientific" and "unreliable" for small components. AppleIPHB 175. But Sarrafzadeh had no problem relying on alleged photographs of small components to opine on invalidity. See, e.g., RDX-0007.90C; Tr. (Sarrafzadeh) 1130:6-1131:9 (image of Series 1 Watch he claimed was a Series 0). And Apple never explains why the ALJ should disregard Scruggs' sworn testimony [REDACTED]

[REDACTED]

[REDACTED]  
[REDACTED]  
[REDACTED] Tr. (Scruggs) 429:17-23 (pointing to rows 62-64 in CX-1185C as showing [REDACTED]).

**b. Masimo Satisfies [15H]**

As explained above for the Multi-Detector Patents at Section IV.D.2.b, the [REDACTED] and W1 all satisfy [15H] by including a processor that receives and processes signals from the photodiodes and determines a physiological parameter. [REDACTED]

[REDACTED] Tr. (Madisetti) 756:21-23 (citing CX-0679); MasimoIPHB 209-211.

Apple expresses disbelief that these watches measure physiological parameters, but the record confirms otherwise. AppleIPHB 176-177. Sarrafzadeh’s claimed concern (Tr. (Sarrafzadeh) 1124:4-23) over [REDACTED]

[REDACTED]

[REDACTED]

[REDACTED]

[REDACTED] MasimoIPHB 210.

**E. Validity**

**1. Obviousness**

**a. Response to State of the Art**

Apple attempts to improperly limit the ’745 Patent to Apple’s “purported point of novelty,” “changing the shape of the light emitted from the LEDs from a ‘first shape’ to a ‘second shape.’” AppleIPHB 159-160; *see also id.* at 8-9, 178. Apple dismisses the other claim limitations as simply “a collection of long known, prior art components.” *Id.* at 178. Apple’s mistreatment of the claimed features as merely isolated pieces that could be plucked and reassembled from various references runs afoul of settled law that the claims must be considered as a whole. *Lindemann,*

[REDACTED]

730 F.2d at 1462 (“The claimed invention must be considered as a whole[.]”); *W.L. Gore*, 721 F.2d at 1548 (same); *Princeton*, 411 F.3d at 1337 (same).

Apple misrepresents Al-Ali’s testimony as saying that “the ’745 Patent’s invention is shaping the light *into a ring*.” AppleIPHB 178; *see also id.* at 8-9, 159-160. Al-Ali testified that “one configuration” described in the ’745 Patent is to have a “second shape as a ring or a doughnut.” Tr. (Al-Ali) 335:19-22. When asked if that configuration was what he invented, he instead identified “reshaping the light” as the invention. *Id.* at 335:23-24.

Al-Ali also explained that [REDACTED]

[REDACTED] Tr. (Al-Ali) 326:11-327:12; MasimoIPHB 20-22. The ’745 Patent discloses using light blocks to inhibit LED light from reaching the detectors before attenuation by the tissue to improve accuracy. *See, e.g.*, JX-0009 at 10:49-51, 11:10-20, FIGS. 7A-7B. The patent also describes using a dark-colored coating to address the multiple scattering problem described in the patent, thereby improving accuracy. *Id.* at 8:54-9:7; MasimoIPHB 21-22.

The novel combination of these features allows improved measurement of a user’s physiological parameters, such as oxygen saturation, at the user’s wrist. MasimoIPHB 20-22. As explained below, Apple’s invalidity arguments fail to recognize the claimed inventions as a whole and ignore its own documents and witness testimony regarding skepticism, copying, and commercial success.

**b. Ground 1: Apple Has Not Established Claims 9 and 27 Would Have Been Obvious in View of Series 0**

Apple relies on tenuous and unsupported arguments regarding the Series 0. Apple failed to demonstrate clear and convincing evidence of (1) the availability of the Series 0 before the



[REDACTED]

priority date; and (2) the actual structure and function of the Series 0 before the priority date. MasimoIPHB 212-224.

i. **Apple Has Not Established that the Series 0 Is Prior Art to the '745 Patent**

Apple does not establish that the Series 0 is prior art. The only document Apple relies upon to establish the alleged commercial launch of the Series 0 is a press release, RX-0023, which announces a future event, does not include a picture of a Series 0, or establish any features as of that time. AppleIPHB 178-179; MasimoIPHB 212-213. Apple also points to uncorroborated testimony from its expert, Sarrafzadeh, and several Apple employees in an attempt to establish availability before the priority date. AppleIPHB 13, 178-179. Finally, Apple attempts to bootstrap Kiani's statement that he did not know the date, but would accept counsel's representation, as if it were evidence of the actual date.<sup>17</sup> *Id.* at 13, 179. But uncorroborated testimony cannot provide clear and convincing evidence of availability before the priority date. MasimoIPHB 212-213. Apple failed to present contemporaneous documents establishing the Series 0 as prior art. MasimoIPHB 213-214.

ii. **Apple Has Not Established the Structure and Function of the Series 0 as of the Priority date**

Apple also failed to provide evidence of the structure and function of Series 0, much less before July 2015. Apple relies on only one document dated before the July 2015 priority date, a "pre-release" engineering requirements specification, RX-0396C, dated 2013. Yet, Apple

---

<sup>17</sup> Apple's reliance on Kiani testimony as evidence of the Series 0 launch date exposes Apple's failure of proof. AppleIPHB 13. Apple's counsel asked "And you understand the very first watch, the Series 0, was released in April of 2015[?]" Kiani answered, "Yes. I don't remember the exact timing, but I'm sure those dates are correct." Tr. (Kiani) 138:1-4. Kiani obviously trusted Apple's counsel to accurately represent the facts. His qualified response in no manner establishes the launch date by clear and convincing evidence.

[REDACTED]

contends the design of the Series 0 was not ready until the summer of 2014. Tr. (Land) 962:15-19. Apple uses this document to show only some claimed features. But, as explained in Masimo’s IPHB, this document does not match any Series 0 watch. MasimoIPHB 216-218.

Apple’s remaining “evidence” regarding the structure and function of Series 0 is either too late or undated: RX-0392C (dated 2016), RPX-0005 (undated), Google images of a Series 1 (undated). AppleIPHB 178-185; MasimoIPHB 212-218. Apple’s uncorroborated testimony does not cure its failure of proof. Apple has no clear and convincing evidence of the structure and function of the Series 0 before July 2015. *See, e.g.*, MasimoIPHB 212-224.

After Masimo exposed that the Google image was a Series 1 rather than a Series 0, Apple raised a new argument that the image is “representative of the Series 0.” AppleIPHB 182 n.29. But, that is not what Sarrafzadeh previously said, and Apple made no such argument in its Pre-Hearing Brief. Apple PHB at 159. Whether the use of a Series 1 image by Sarrafzadeh and Apple was simply a mistake, or intentional, Apple’s last-minute pivot confirms its failure to establish the structure of the Series 0 before the priority date.

**iii. The Series 0 Does Not Render Obvious Claims 9 and 27**

Apple has also failed to show that the Series 0 disclosed or suggests at least elements [9], [1B]/[20B], [1D]/[20D], [1E]/[20E] and [20G]; and has therefore failed to demonstrate that Claim 9 and 27 would have been obvious over the Series 0. MasimoIPHB 218-224.

**Element [9]**: Apple argues it would have been obvious to modify the Series 0 to measure oxygen saturation, but Apple ignores the record evidence that contradicts its position. AppleIPHB 183-184. Apple argues “pulse oximeters have been known and commercially available since the 1970s, and pulse oximetry is the same as heart rate sensing, with the addition of comparing the amplitude of the heart rate signal at two different wavelengths of light.” *Id.* at 184 (citations

[REDACTED]

omitted). But this “addition” is not a simple tweak to the Series 0. As Waydo acknowledged, measurement of oxygen saturation is “very different” than heart rate measurement. Tr. (Waydo) 937:9-16. It took Apple nearly [REDACTED] including a pulse oximetry designer having over 20 years of experience, and [REDACTED] [REDACTED] to develop the blood oxygen feature for the wrist. MasimoIPHB 165-172, 233-34.

To distract from its own skepticism and failures, Apple now tries to rewrite history, arguing that “wrist-based pulse oximeters were known in the 1990s, and it would have been within the skill of a POSITA to make a wrist-based oximeter by 1991, even if making a commercial product would have been difficult.” AppleIPHB 183-184 (citing Sarrafzadeh). Apple did not support such arguments. And the contemporaneous documents and Apple testimony contradict this story. Land testified that Apple “had to work [] at the wrist, which was *unprecedented* - - [REDACTED]

[REDACTED]

[REDACTED] Tr. (Land) 963:19-964:11. Mannheimer testified that when they began developing the blood oxygen feature [REDACTED]

[REDACTED]

[REDACTED] Apple’s own testimony, contemporaneous documents and development history directly contradict its hindsight arguments that it would have been obvious to modify the Series 0 to measure oxygen saturation at the wrist. *See also* MasimoIPHB 218-220.

[REDACTED]

**Element [1B]/[20B]:** Regarding the “material configured to change the first shape into a second shape,” Apple relies solely upon uncorroborated opinions that the Fresnel lens supposedly in the Series 0 would change the infrared light into a crescent shape.<sup>18</sup> AppleIPHB 179-181.

Apple argues the off-center alignment of the infrared LEDs and the grooves in the Fresnel lens change the shape of light received from the infrared LEDs into a crescent shape. AppleIPHB 180. But Apple failed to establish the structure of the “grooves” or the “optical center” upon which it relies. Thus, Apple’s unsupported opinion from its expert and opinion from its fact witness, without any supporting evidence, fail to establish that the Series 0 changes the shape of the infrared LED light into a crescent. MasimoIPHB 220-222; *see Ashland Oil, Inc. v. Delta Resins & Refractories, Inc.*, 776 F.2d 281, 294 (Fed. Cir. 1985 (lack of factual support for expert opinion “may render the testimony of little probative value in a validity determination”). Venugopal, a fact witness, provided no facts establishing any personal knowledge of any shape change. *Finnigan*, 180 F.3d at 1370 (witness testimony alone is “insufficient as a matter of law to establish invalidity”); *Juicy Whip Inc. v. Orange Bang, Inc.* 292 F.3d 728, 740-43 (Fed. Cir. 2002) (uncorroborated witness testimony failed to provide clear and convincing evidence necessary to invalidate a patent).

**Element [1D]/[20D]:** Apple relies upon Sarrafzadeh’s Google image of a Series 1 to support its argument that the Series 0 discloses the dark-colored coating. AppleIPHB 181-182. But as explained above, that image is not of Series 0 and not before the July 2015 priority date. *See also* MasimoIPHB 222-223. Moreover, Masimo explained why Sarrafzadeh’s testimony about the first layer being a dark-colored coating is unsupported. *Id.*

---

<sup>18</sup> Sarrafzadeh’s invalidity analysis is inconsistent with his noninfringement analysis. For noninfringement, Sarrafzadeh relied on an [REDACTED] between the LED and the [REDACTED] to argue a change in shape occurs before the [REDACTED]. For invalidity, he fails to mind the [REDACTED].

[REDACTED]

Apple now relies on testimony from Venugopal and Mannheimer, and RPX-0005 to equate

[REDACTED] AppleIPHB 182. But Apple failed to establish the structure of the back surface of any of these watches.

**Element [1E]/[20E]**: Apple also failed to establish that the Series 0 discloses the claimed light block. MasimoIPHB 216-217, 223. Apple relies on Land testimony to establish RX-0396C discloses a light block. AppleIPHB 182-183. Land's testimony failed to address Masimo's criticisms of RX-0396C, MasimoIPHB 216-218, despite having advance notice of such criticisms. Masimo PHB 162. The [REDACTED] document Land relies upon does not reflect the Series 0, [REDACTED] and LEDs that do not match the supposed Series 0 physical exhibit. It is therefore not relevant for any purpose. MasimoIPHB 216-217.

**Element [20G]**: Apple also fails to establish the obviousness of the claimed touch-screen display as configured to present visual feedback. *See* MasimoIPHB 223.

c. **Grounds 2 and 3: Apple Has Not Established that Iwamiya and Sarantos Render Claim 9 Obvious or that Iwamiya, Sarantos, and Venkatraman Render Claims 18 and 27 Obvious**<sup>19</sup>

Apple failed to demonstrate that Claim 9 would have been obvious over Iwamiya and Sarantos or that Claims 18 and 27 would have been obvious over Iwamiya, Sarantos, and Venkatraman. MasimoIPHB 224-33.

---

<sup>19</sup> Masimo addresses Grounds 2 and 3 together because the arguments are applicable to both. *See* MasimoIPHB 224-25.

[REDACTED]

[REDACTED]

[REDACTED]

i. **No measurement of “oxygen saturation” as required by [9] and [18], no motivation to combine, and no reasonable expectation of success**

Iwamiya and Sarantos do not disclose devices that measure oxygen saturation. MasimoIPHB 225-230. Both Iwamiya and Sarantos describe the use of one wavelength only, not the red and infrared LEDs needed for oxygen saturation. MasimoIPHB 225-230. Masimo also explained that a POSITA would not have been motivated to combine the references for several reasons. *Id.* Apple ignores these deficiencies. AppleIPHB 191-92, 197.

Apple now argues that a POSITA would have been motivated to combine Iwamiya and Sarantos to measure oxygen saturation because both “are physiological wrist-worn devices in the same field as the ’745 patent.” AppleIPHB 192. But two references being in the same field is insufficient to demonstrate a motivation to combine, especially here where the references teach away from the use of two wavelengths. *See* MasimoIPHB 228 (citing *Certain Chem. Mech. Planarization Slurries*, Doc. ID 748910 at 188-189).

Apple also incorrectly alleges that a POSITA would have had a reasonable expectation of success because “wrist-worn pulse oximeters, for measuring blood oxygen were known by the time of the application for the ’745 patent, as shown by Sarantos and other literature.” AppleIPHB 192 (citing Tr. (Sarrafzadeh) 1101:20-1102:1, RX-0366 (Sarantos) 13:44-47). But, as explained above, Sarantos’ invention was “not tailored for use in other spectrums, such as red or infrared spectra,” confirming that its reference to oxygen saturation was merely aspirational. MasimoIPHB 227-28; RX-0366 at 18:48-51. And neither Apple nor Sarrafzadeh identified any wrist-based pulse oximeter in existence before the July 2015 priority date for the ’745 Patent.

Moreover, Apple dismisses the testimony of its own engineers who developed the blood oxygen feature. Mannheimer testified that in 2014, he did not know if measuring oxygen

[REDACTED]

saturation at the wrist could be done. Tr. (Mannheimer) 1012:12-25. Mannheimer’s boss, Land, further testified that measuring oxygen saturation at the wrist was [REDACTED]

[REDACTED]

[REDACTED] Tr. (Land) 963:19-964:11; *see also* MasimoIPHB 170-71.

Apple also wrongly suggests a POSITA would have had a reasonable expectation of success by oversimplifying pulse oximetry as just “taking a heart rate measurement at different wavelengths.” AppleIPHB 192. But that is inconsistent with Apple’s own engineers’ testimony that pulse oximetry at the wrist was “very different” and “a more difficult measurement than [] heart rate measurement” (Tr. (Waydo) 937:9-16, 938:3-15), “extremely challenging to develop,” (*id.* at 938:21-24), and [REDACTED] (Tr. (Land) 963:19-964:11). The full record confirms that not even highly educated and experienced engineers dedicated to pulse oximetry would have had a reasonable expectation of success in measuring oxygen saturation at the wrist, let alone a person of ordinary skill. *See also* MasimoIPHB 165-72 and 233-34 (objective indicia of nonobviousness).

ii. **No “second wavelength” as required by [27], no motivation to combine, and no reasonable expectation of success**

Iwamiya uses only a single wavelength of light—940 nm. MasimoIPHB 230; RX-0130 10:34-38. A POSITA would not have been motivated to combine Iwamiya with Sarantos to add another wavelength because Sarantos focuses on green light (under 600 nm) while Iwamiya taught away from using light under 600 nm due to skin absorption issues affecting signal strength. MasimoIPHB 226-29. Further, Iwamiya uses an optical filter that blocks light below 900 nm, which includes the red light needed for pulse oximetry. *Id.* at 227-30.

Apple relies on hindsight as the reason to combine Sarantos with Iwamiya. Apple identifies no reason to enhance Iwamiya to add a second wavelength other than to measure oxygen saturation. But, as explained above for [9], a POSITA would not have a reasonable expectation of

[REDACTED]

success given the challenges in measuring oxygen saturation in wrist-worn devices like Sarantos and Iwamiya.

iii. **No “surface comprising a dark-colored coating” as required by [1D] and [20D]**

Apple argues it would have been obvious to implement a dark-colored coating from Sarantos with Iwamiya’s “light shielding frame 18.” AppleIPHB 188<sup>20</sup>. Apple also argues that the “in-mold label or other black or opaque coating” in Sarantos is “used to prevent stray light from reaching photodiodes.” AppleIPHB 188. A POSITA would not have been motivated to combine Iwamiya’s light shielding frame with a dark coating, whether from Sarantos or elsewhere, because the light shielding frame already blocks light and because Iwamiya taught the use of reflective metals for “light shielding.” MasimoIPHB 230-232; Tr. (Madisetti) 1361:9-14; RX-0130 at 8:38-47, 18:61-65.

iv. **No “plurality of photodiodes” arranged in the “array” as required in [15D]**

Apple’s expert failed to identify any specific passage of Iwamiya in his testimony to explain how Iwamiya discloses the claimed array corresponding to a shape of the portion of the measurement site encircled by the light block. *See* MasimoIPHB 232; Tr. (Sarrafzadeh) 1103:23-1104:5. Apple now identifies Iwamiya at 14:39-41 as allegedly disclosing that feature “[u]nder Complainants’ interpretation.” AppleIPHB 195. The passage states: “plural light receiving units 9 are preferably disposed on the same circumference centered on an optical axis of the scattered light taking unit 8.” RX-0130 at 14:39-41. Neither Apple nor Sarrafzadeh explain what they mean by “Complainants’ interpretation.”

---

<sup>20</sup> Apple also misleadingly annotated Figure 4 of Iwamiya to include a ring, drawn with an outline as though it were part of the original figure. AppleIPHB 187. Figure 4 of Iwamiya does not include that yellow ring. *See* RX-0130 at Fig. 4.



[REDACTED]

Masimo interpreted [15D] consistent with the plain language of the claims and the intrinsic record for the '745 Patent—both of which Apple ignored in its indefiniteness argument. *See* MasimoIPHB 236-38; AppleIPHB 202-204. [15D] requires that the plurality of photodiodes are “arranged in an array having a spatial configuration corresponding to a shape of the portion of the tissue measurement site *encircled* by the light block.” That light block has a “circular shape,” as recited in [15C]. MasimoIPHB 237. Thus, in order to meet [15D], a plurality of photodiodes would need to be arranged in a circular-shaped array.

Masimo also referred to an office action response providing further guidance. *Id.* at 237-38; Tr. (Madisetti) 1366:13-1367:19. That response explained that “[i]n order for the claimed ‘plurality of detectors’ to ‘match’ or ‘represent’ an ‘at least partially circular shape’ or an ‘annular shape,’ the ‘plurality of detectors’ must include sufficient detectors to represent such shapes.” CX-1760 at 322. “For example, six or more detectors could be arranged in an annular shape and meet the recited limitation.” *Id.*

The cited Iwamiya passage does not teach or disclose that photodiodes are “arranged in an array having a spatial configuration corresponding to a shape of the portion of the tissue measurement site encircled by the light block.” Sarrafzadeh did not provide any opinion as to how a POSITA would interpret this passage from Iwamiya or whether a POSITA would interpret it in such a way that satisfies [15D]. Instead, he merely quoted back the claim element:

[T]here are a number of photodiodes shown, and they would have, according to Masimo’s interpretation, they would be arranged in a shape that corresponds to the shape of the portion of the tissue measurement that is encircled by the light block.

Tr. (Sarrafzadeh) 1103:23-1104:5; AppleIPHB 194-95. Accordingly, Apple fails to show by clear and convincing evidence that Iwamiya discloses [15D].

[REDACTED]

v. **No “touch-screen display configured to present visual feedback responsive to the physiological parameter data” as required by [20G]**

Contrary to Apple’s assertion, Masimo does dispute whether Iwamiya and Venkatraman disclose [20G]. AppleIPHB 197-98. Masimo’s pre-hearing brief explained that “Apple fails to address the actual claim language for [20G].” Masimo PHB 172. Specifically, Apple never addressed whether Venkatraman discloses a touch screen “configured to present visual feedback responsive to the physiological parameter data.” Tr. (Sarrafzadeh) 1108:1-23; AppleIPHB 198.

Thus, Apple fails to meet its burden to demonstrate by clear and convincing evidence that Claim 9 would have been obvious based on Iwamiya and Sarantos and that Claims 18 and 27 would have been obvious based on Iwamiya, Sarantos, and Venkatraman.

d. **Objective Indicia of Nonobviousness**

Apple argues “the ’745 Patent disclosed well-known devices and components.” AppleIPHB 199-201. But none of Apple’s prior art disclosed measuring oxygen saturation at the wrist. MasimoIPHB 233-234; *see* RDX-7131C. Apple now relies on Mannheim’s explanation that “simply adding more LEDs to Series 0 would have enabled the heart rate sensor to measure blood oxygen.” AppleIPHB 201 (citing Tr. (Mannheimer) 1015:9-19). But Masimo explained Apple’s own development history, starting with the Series 0, showing that measuring oxygen saturation at the wrist is not as simple as retrofitting a device with red and infrared LEDs. MasimoIPHB 233-234.

As detailed above regarding the Multi-Detector Patents, Apple’s Post-Hearing Brief identifies additional evidence of nonobviousness. *Supra* Section IV.E.2.g. For example, Waydo testified that the engineers on his team, which was [REDACTED]

[REDACTED]

[REDACTED]  
[REDACTED]  
[REDACTED] AppleIPHB 14, 145, 157 n.25. Measuring oxygen saturation at the wrist was not as simple as “simply adding more LEDs” as Apple now argues.

Moreover, as explained above in Section IV.E.2.g, Apple’s commercial success with the Accused Products and copying of Masimo further support the nonobviousness of the ’745 Patent claims. Apple argues “there is no evidence the accused blood oxygen feature drives commercial success.” AppleIPHB 200-201. But Apple ignores its decision to emphasize that feature in launching the Series 6 and the evidence showing the products’ success is significantly attributable to that infringing feature. MasimoIPHB 173-174. Apple also ignores the evidence showing its market share soared, with the only significant new feature being the addition of pulse oximetry. MasimoIPHB 173-175.

Finally, regarding copying, Apple alleges that “Complainants have shown no evidence of copying.” AppleIPHB 201. But, as explained above in Section IV.E.2.g, Apple ignores its copying of Masimo’s technology by isolating the development of the Series 6 oxygen saturation without addressing its earlier watches. *See also* MasimoIPHB 172-173; Tr. (Waydo) 923:12-18.

**2. 35 U.S.C. § 112 (pre-AIA)**

**a. Claims 9 and 27 Have Written-Description Support**

Apple argues the specification does not associate transmittance oximeters with wrist-based monitoring. AppleIPHB 201-202. But Apple never acknowledges the actual evidence in the patent itself at 7:4-14, which discloses that the 3D sensor 300 of Figure 3 can be used in other examples, such as Figures 7A and 7B, in reflectance mode. *See* MasimoIPHB 235-236.

Apple relies on *Flash-Control, LLC v. Intel Corp.*, No. 2020-2141, 2021 WL 2944592, at \*3-4 (Fed. Cir. July 14, 2021) and *Novozymes A/S v. DuPont Nutrition Biosciences APS*, 723 F.3d 1336, 1349 (Fed. Cir. 2013). AppleIPHB 202. In both those cases, the specification did not link

[REDACTED]

the claimed features. MasimoIPHB 178. But here, the specification expressly links together the claimed embodiments, as shown above.

**b. Claim 18 Is Definite**

Apple argues the specification provides insufficient guidance for how to determine the spatial configuration of an array of detectors or when a specific spatial configuration of the array corresponds with the portion of the irradiated tissue. AppleIPHB 203. But Apple fails to fully consider the specification and ignores the prosecution history. MasimoIPHB 236-238. The surrounding claim language and file history provides context for understanding this element. *Id.*

**F. Enforceability (Prosecution Laches)**

Apple cites no evidence of unreasonable or unexplained delay. AppleIPHB 204. Instead, Apple simply lists six applications that Masimo filed over five years. *Id.* If anything, that demonstrates active prosecution—not unreasonable delay. Apple nonetheless asserts with zero evidence that Masimo purportedly: (1) “spaced out its submissions”; (2) with a “strategy” that “allowed Masimo to wait” and (3) “enabled Masimo to draft its claims” in view of the Apple Watches. *Id.* at 204. Apple further asserts with no evidence that Masimo “apparently” tied its prosecution to “Apple’s product releases....” *Id.* at 205. Such speculation cannot constitute clear and convincing evidence of unreasonable and unexplained delay.

Apple cites *Symbol Techs.*, 422 F.3d at 1385-86, but that case supports Masimo, observing that “one might refile an application” for many proper reasons, “including in order to attempt to support broader claims as the development of an invention progresses.” *Id.* *Symbol Techs.* further explains that laches only applies in “*egregious cases* of misuse of the statutory patent system.” *Id.* Here, Apple cites nothing but ordinary prosecution activities. Indeed, Apple called no witnesses responsible for the prosecution of the ’745 patent. Apple makes no attempt to address Stoll’s

[REDACTED]

testimony that there was a “continuous unbroken chain of patent prosecution. There was no delay.” Tr. (Stoll) 1415:2-10. Apple argues prejudice in a single sentence, but cites no supporting evidence. AppleIPHB 205. The ALJ should reject Apple’s defense.

## **VI. ’127 PATENT**

### **A. Level of Ordinary Skill in the Art**

The parties do not dispute the level of ordinary skill in the art for the purposes of this Investigation. MasimoIPHB 239; AppleIPHB 209.

### **B. Claim Construction**

Apple never provides a specific and consistent construction for its invalidity and noninfringement arguments. For invalidity, Apple argues any circuit board connected to a temperature sensor and LEDs is a “thermal mass,” regardless of the board’s thermal properties. Yet, for infringement, Apple argues its circuit board with numerous thermally coupled metallized layers is not the claimed “thermal mass.”

By not offering specific and consistent constructions, Apple leaves the ALJ to search through Apple’s arguments to find its changing constructions. *See Albrechtsen v. Bd. of Regents of Univ. of Wisconsin System*, 309 F.3d 433, 436 (7th Cir. 2002) (“Courts are entitled to assistance from counsel ....”) (cleaned up).

Masimo provided specific constructions, which follow the intrinsic evidence and are the same for infringement, DI, and validity. Apple argues: (1) Masimo construed the claims too broadly and conducted a conclusory analysis for infringement and (2) ’127 Patent Claim 9 would be invalid if that broad construction and conclusory analysis were allowed. AppleIPHB 208, 211.

Apple cites *01 Communique Labs., Inc. v. Citrix Sys., Inc.*, 889 F.3d 735, 743 (Fed. Cir. 2018) for support. AppleIPHB 208, 211. There, the Federal Circuit reiterated that claim terms

[REDACTED]

must be “construed the same way for both invalidity and infringement.” *Id.* at 743. Masimo agrees that the ALJ should construe claim terms consistently for validity and infringement. As indicated above, Masimo’s constructions are the same for infringement, DI, and validity.

**1. “thermal mass”**

Masimo has consistently argued that “thermal mass” is a mass that provides a bulk temperature that can be used to reliably estimate the operating wavelengths of the LEDs. MasimoIPHB 240-42. When a thermal mass within the substrate provides thermal conductivity between the LEDs and a thermistor, the resistance of the thermistor can then be used to determine a meaningful bulk temperature for LEDs mounted on the substrate. JX-0007 at 10:62-11:4.

Rather than articulate a specific construction of “thermal mass,” Apple cites the specification and testimony in an attempt to construe the word “stabilize” from the specification. AppleIPHB 213. Specifically, for infringement, by “stabilization,” Apple seeks to limit “thermal mass” to something that: (1) has some minimum thickness, (2) has the same temperature throughout (no temperature gradient), and (3) never changes its temperature. AppleIPHB 206-207, 213-218. Apple identifies no claim construction principles, such as lexicography or unequivocal disavowal, supporting such a restrictive construction.

Apple tries to support these limitations by selecting testimony without context. For example, Apple cites to Diab simply agreeing the Summary of the Invention states that the thermal mass stabilizes the bulk temperature. AppleIPHB 213 (citing Tr. (Diab) 237:10-15). But nowhere does that define “stabilize” to impose Apple’s numerous requirements on the claims. And Diab’s full testimony regarding stabilization contradicts Apple’s argument:

[REDACTED]

[REDACTED]

Tr. (Diab) 239:2-10. Apple ignored this testimony, which is consistent with the patent's disclosure. JX-0007 at 10:22-39, 10:62-11:4 (thermal mass thermally coupled to LEDs and thermistor provides bulk temperature that has a meaningful relationship to the LED wavelengths).

For validity, Apple eliminates the limitations it tries to insert for noninfringement, arguing that Masimo's construction of "thermal mass" covers *any* circuit board. AppleIPHB 234-235. Not so. Masimo has consistently argued that "thermal mass" is a mass that provides a bulk temperature that can be used to reliably estimate the operating wavelengths of the LEDs. MasimoIPHB 240-42. The patent supports this consistent construction. JX-0007 at 10:62-11:4.

As explained in Masimo's IPHB, the file history also contradicts Apple's argument that Masimo's construction covers *any* circuit board. MasimoIPHB 242, 275. The Examiner allowed the claims over Cheung, which has a temperature sensor and LEDs mounted on the same circuit board. *Id.*

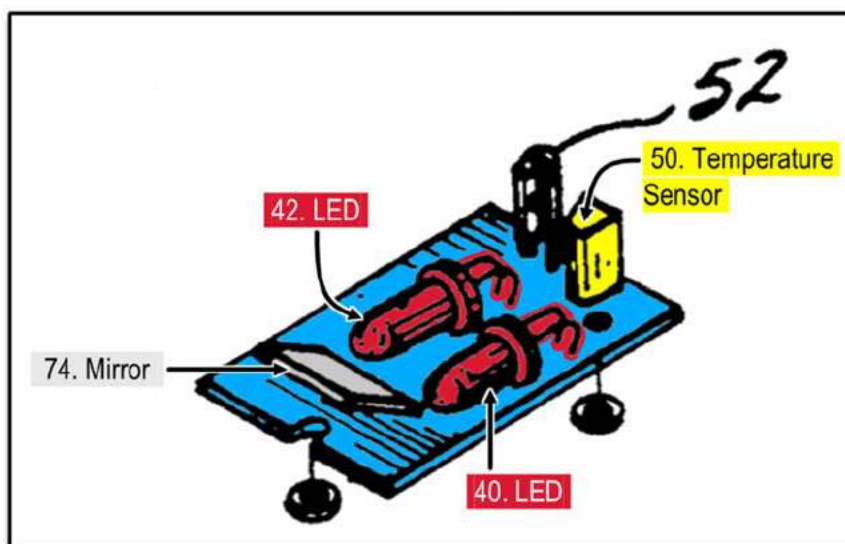

[REDACTED]

Tr. (Goldberg) 1394:23-1396:3; CDX-0014C.003 (citing RX-0406). Claim 9 requires measuring a “bulk temperature for the thermal mass,” and Masimo does not contend it covers *any* circuit board, as argued by Apple.

**2. “bulk temperature”**

Masimo has consistently maintained “bulk temperature” is a single temperature of the thermal mass used to estimate the operating wavelengths of all the LEDs. MasimoIPHB 244-247. Apple never provides a specific and consistent construction for “bulk temperature.”

Instead, it makes a variety of inconsistent arguments under the heading “Bulk Temperature for the Thermal Mass.” AppleIPHB 214-215. Specifically, Apple argues “bulk temperature for the thermal mass” (1) *requires* “measuring a *certain* temperature *of* the thermal mass,” (2) is “*different from* a regular temperature measurement by a temperature sensor, which is a local temperature,” (3) “*is* the majority or greater part,” and (4) *should be* an “average temperature.” AppleIPHB 214-215. Apple does not attempt to unify these disparate arguments into a consistent claim construction for either its noninfringement or invalidity arguments.

With respect to its “*certain* temperature” argument, Apple does *not*: (1) explain what it means, (2) provide any support for it, or (3) rely on it for infringement, DI, or validity. AppleIPHB 214. Any “certain temperature” construction should be rejected as unsupported and not meaningful to any issue.

Apple argues “bulk temperature” is “*different from* a regular temperature measurement by a temperature sensor.” AppleIPHB 215. This argument improperly attempts to insert a negative limitation in the claim. *See Eko Brands, LLC v. Adrian Rivera Maynez Enterprises, Inc.*, 946 F.3d 1367, 1381 (Fed. Cir. 2020) (addition of negative limitations during claim construction must be supported by express disclaimer or lexicography in the specification or file history). Specifically,



[REDACTED]

Apple hopes to exclude a *single* temperature sensor as measuring a “bulk temperature” to support its noninfringement argument. AppleIPHB 222-24.

The '127 Patent contradicts Apple's negative limitation. The specification teaches exactly what Apple argues is excluded: “the resistance of the thermistor ... can be measured ... to determine the bulk temperature.” JX-0007 at 10:62-67. That description is the normal way a thermistor works, as numerous Apple and Masimo witnesses agreed. Tr. (Mehra) 887:12-15; Tr. (Sarrafzadeh) 1055:19-1056:1; Tr. (Diab) 207:18-22; Tr. (Goldberg) 626:10-16. Further, there is no dispute a thermistor measures a temperature where it is located. Tr. (Goldberg) 647:17-20; Tr. (Sarrafzadeh) 1073:11-16; Tr. (Mehra) 889:25-890:6. The thermistor's temperature provides a “bulk temperature” because the thermal mass thermally couples the LEDs to the thermistor so that the single temperature measurement can be used to estimate the operating wavelengths of all the LEDs. Tr. (Goldberg) 624:7-25; JX-0007 at 10:21-48, 10:62-11:4. As explained by Diab, this provides the necessary relationship between temperature and wavelength. Tr. (Diab) 239:2-10.

Apple twists Abdul-Hafiz's testimony to try to support its negative limitation. AppleIPHB 215. But, immediately after testifying that “local temperature is where you put the thermostat,” Abdul-Hafiz testified [REDACTED]

[REDACTED]

[REDACTED]

RX-1195C (Abdul-Hafiz) 99:1-19. His testimony is consistent with the specification's disclosure that a single thermistor, which measures temperature of one spot only, measures the bulk temperature for the thermal mass. MasimoIPHB 246; JX-0007 at 10:62-67. It also matches Diab's

[REDACTED]

testimony regarding the relationship established between the LEDs and the temperature of the thermal mass. Tr. (Diab) 239:2-10.

Apple offers no evidence showing that the ordinary meaning of “bulk” in “bulk temperature” is the majority or greater part. AppleIPHB 215. Apple ignores Abdul-Hafiz’s and Diab’s complete testimony and plucks out the terms “average” and “a representative temperature of the whole bulk.” *Id.* Neither the inventors’ testimony nor any other evidence establishes that those terms mean the majority or greater part. *See* RX-1195C (Abdul-Hafiz) 99:1-19; RX-1200C (Diab) 137:12-138:8. As explained in Masimo’s IPHB, “bulk temperature” does not require an “average” temperature. MasimoIPHB 247.

Apple also misuses Masimo counsel’s unrelated statement at the *Markman* hearing: “But I think it is understood ... that people understand bulk is the vast majority.” *Id.* (citing Markman Hr’g Tr. at 42:6-9). Masimo’s counsel was discussing “bulk *measurement*” in unrelated patents, and not “bulk *temperature*.” Doc. ID 763489, Markman Hr’g Tr. at 42:6-9. Masimo’s arguments relate to an entirely different technical issue—taking a “bulk measurement” of a detector signal divisible into a non-pulsatile portion making up 99.9% and a pulsatile portion making up the tiny remaining 0.1%. Masimo’s statement had nothing to do with the ’127 Patent’s different “bulk temperature” term. No such relationship exists in the context of the claimed bulk temperature, which is not divided into portions.

Apple’s noninfringement arguments also attempt to require that the “bulk temperature” be uniform throughout the PCB. AppleIPHB 220-222 (arguing Accused Products do not measure “bulk temperature” because [REDACTED]); 223 (arguing Goldberg tests did not show temperature throughout the PCB). But, as previously

[REDACTED]

explained, the '127 Patent contradicts any uniform-temperature requirement. MasimoIPHB 245-247.

In sum, Apple's arguments are incorrect because they would exclude the single-thermistor embodiment disclosed in the specification. MasimoIPHB 246-247; *Vitronics*, 90 F.3d at 1583. Apple's arguments ignore that the patent describes precisely what Apple's Accused Products have and the prior art lacks: a thermal mass thermally coupled to the LEDs and to a temperature sensor, where the thermal mass provides sufficient thermal conductivity such that a single temperature measurement of that thermal mass provides a relationship to the LED wavelengths. The claimed "bulk temperature" is a temperature of the thermal mass used to estimate the operating wavelengths of all the LEDs, due to the relationship provided by the thermal mass.

**C. Infringement**

**1. The Accused Products have the claimed "Thermal Mass" [7A], [7B], [7D], [7F]**

Apple spent years improving the accuracy of pulse oximetry for the Apple Watch. CX-0291C (Mehra) 244:7-245:9. While researching improvements, Apple learned that its blood-oxygen-saturation [REDACTED]

[REDACTED] RX-0307C at 11. It found that its LED temperature changes would [REDACTED]

[REDACTED] CX-0206C at 11. To solve this problem, Apple [REDACTED]

[REDACTED]

[REDACTED] CX-0206C at 3. Apple recognized that the [REDACTED]

[REDACTED] *Id.* at 11. The LED junction is

within the LED itself. Tr. (Diab) 198:21-199:11. Measuring LED junction temperature is

difficult. In fact, at Masimo, Diab, [REDACTED]

[REDACTED]

[REDACTED]

[REDACTED] Tr. (Diab) 199:9-11. Indeed, [REDACTED]

[REDACTED] Instead, Apple placed a single thermistor in thermal communication with a multilayer board (the “PCB”) and LEDs. Apple’s temperature sensor measures all [REDACTED]

[REDACTED]

[REDACTED] CX-0206C at 11.

During its research, Apple also learned that [REDACTED]

[REDACTED]

[REDACTED]

[REDACTED]

[REDACTED]

[REDACTED]

[REDACTED] It provides a bulk temperature that can be used to reliably estimate the operating wavelengths of the LEDs. MasimoIPHB 251; Tr. (Goldberg) 622:15-18.

Apple’s own contemporaneous documents acknowledge the PCB substrate includes a thermal mass that [REDACTED]

[REDACTED]

[REDACTED]

CDX-0013C.016 (citing CX-0011C at 23 (annotated)); Tr. (Goldberg) 622:22-623:7; RX-0294C at 7 (listing [REDACTED] Apple’s engineer Mehra attempted to explain away Apple’s use of the term “thermal mass.” CX-0291C (Mehra) 176:10-182:17. But the above-cited documents and other evidence in Masimo’s IPHB show that Apple designed the PCB with [REDACTED] to sufficiently stabilize a bulk temperature, which is then used to reliably estimate the operating wavelengths of the LEDs. MasimoIPHB 248-52, 254-58; *see also* CX-0206C at 11 (“package-level T measurement”).

Apple ignores the above evidence. Instead, Apple relies on conclusory opinion testimony from a fact witness, Mehra. He claimed that the PCB’s [REDACTED]

[REDACTED]

[REDACTED] AppleIPHB 206, 216 (citing Tr. (Mehra) 883:2-12; 885:18-25). Mehra’s testimony is not credible for several reasons. First, Mehra’s testimony contradicts the contemporaneous documents, which identify the [REDACTED]

[REDACTED] CX-0011C at 23 [REDACTED] RX-0294C at 7 [REDACTED]; CX-0206C at 11 [REDACTED]

[REDACTED] RX-0307C at 11 [REDACTED] CX-0012C at 22 [REDACTED]

Second, Apple never offered Mehra as an expert regarding bulk-temperature stabilization. Tr. (Mehra) 883:25-884:5 (sustaining multiple objections to opinions offered by Mehra); *Randolph v. Collectramatic, Inc.*, 590 F.2d 844, 846 (10th Cir. 1979) (fact witness generally may not express opinions “as to matters which are beyond the realm of common experience and which require the special skill and knowledge of an expert witness”). Third, Apple laid no foundation, and Mehra did not explain, how Mehra could conclude the [REDACTED]

[REDACTED]

[REDACTED] Fourth, Mehra did not testify about what he meant by stabilization. Mehra's improper opinion testimony appears to parrot Apple's noninfringement arguments limiting "stabilize." AppleIPHB 206-207, 213-218.

Mehra's opinion cannot show noninfringement. Mehra never disputed, nor could he, that the [REDACTED] of the [REDACTED] are thermally coupled to each other and to the LEDs and thermistor, and provide a bulk temperature that is used to reliably estimate the operating wavelengths. MasimoIPHB 248-58, 262-265.

Apple also had Sarrafzadeh opine that the [REDACTED] are "too thin" to be a thermal mass because they do not "stabilize" the bulk temperature. AppleIPHB 206, 216-218. Apple's "too thin" and lack-of-temperature-stabilization arguments fail to overcome Masimo's showing and are contradicted by Apple's own documents. MasimoIPHB 243-244, 256-258.

Apple's "too thin" argument also improperly compares the relative thickness of the [REDACTED] of the early Masimo rainbow® sensors with the Accused Products. AppleIPHB 206, 216-217. This comparison is legal error. MasimoIPHB 243, 256-257; *Zenith Labs., Inc. v. Bristol-Myers Squibb Co.*, 19 F.3d 1418, 1423 (Fed. Cir. 1994); *Atlantic Thermoplastics Co. v. Faytex Corp.*, 970 F.2d 834, 846 (Fed. Cir. 1992). Further, Claim 9 does not specify a minimum thickness for the thermal mass. MasimoIPHB 243.

Apple's lack-of-temperature-stabilization argument relies on Sarrafzadeh's thermal-imaging tests that actually show the opposite— [REDACTED]

[REDACTED] See CX-0012C at 22. Below are the thermal images:

[REDACTED]

[REDACTED]

AppleIPHB 221; CX-0322bC ¶304.

The thermal-imaging camera took images of the PCB, which has components mounted on it. The images show some of the PCB, but the components (such as photodiodes, the LEDs, and thermistor) cover the underlying PCB in multiple locations. The thermal images were taken at four points in time: (1) before turning on any LED (first column); (2) after a red LED has been turned on for five seconds (second column); (3) after the red LED has been turned on for 15 seconds (third column); and (4) two minutes after the red LED has been turned off (fourth column).

CX-0322bC ¶¶300-303. The imaging was repeated in three separate trials.

[REDACTED]

[REDACTED] See CX-0012C at 22. The light-

[REDACTED]

green portions are the components on top of the PCB, not the PCB itself. The first two columns illustrate that once the red LED is first activated, heat from it [REDACTED]

[REDACTED] CX-0322bC ¶303.

The visible PCB underlying the components illustrates [REDACTED]

[REDACTED]

[REDACTED]

[REDACTED] These images show that the PCB has [REDACTED] stabilizes a single bulk temperature that can be used to reliably estimate the operating wavelengths of the LEDs. *See* JX-0007 at 10:62-11:4. Notably, this effect occurs with only activating the red LED, rather than activating multiple LEDs as would happen in operation. Tr. (Sarrafzadeh) 1075:5-9; CX-0322bC ¶¶298, 300.

Apple incorrectly interprets these images, arguing they show the PCB temperature [REDACTED] AppleIPHB 217-18. In support, Sarrafzadeh points to the difference in temperature between the LED and thermistor. Tr. (Sarrafzadeh) 1078:10-19. As Diab explained, the temperature of the thermistor is different from, but tracks, the LED temperatures over time. Tr. (Diab) 198:21-204:11; JX-0007 at 10:26-31. Apple also uses these images to argue the temperature is not stabilized, and, thus, the PCB cannot have a thermal mass. AppleIPHB 217-18. But, as just explained, the images actually show the PCB temperature is very stable. Moreover, Claim 9 does not require the temperature of the thermal mass to be uniform or remain constant. MasimoIPHB 243-44, 257-58.

Apple next argues Goldberg's infringement opinion is conclusory because he did not test the Accused Products to verify their [REDACTED] stabilize a bulk temperature. AppleIPHB 207-208, 214, 218. Apple relies on Diab's testimony [REDACTED]. *Id.*



[REDACTED]

at 218 (citing Tr. (Diab) 238:15-19). Apple also relies on *Kim v. ConAgra Foods, Inc.*, 465 F.3d 1312, 1320 (Fed. Cir. 2006), to suggest that expert tests are required to prove infringement. Even accepting these arguments, Goldberg *tested* the Accused Products and relied on *Apple's tests* to confirm infringement. Further, *Kim* does not require an expert to conduct tests to prove infringement. See *Martek Biosciences Corp. v. Nutrinova, Inc.*, 579 F.3d 1363, 1374 (Fed. Cir. 2009).

Goldberg's tests show that both the LEDs and thermistor are thermally coupled to the [REDACTED] of the PCB. Tr. (Goldberg) 620:17-621:15; CX-0839 (test results); CX-0840 (test setup). Apple argues that Goldberg applies these tests to [7E] only. AppleIPHB 218, n.30. But both [7E] and [7B] address thermal coupling of the LEDs and the thermistor to the thermal mass, which Goldberg's tests show. Tr. (Goldberg) 620:21-621:15. The thermal coupling of the [REDACTED] to the LEDs and thermistor allows the [REDACTED] to function as a thermal mass to provide a bulk temperature that can be used to reliably estimate the operating wavelengths of the LEDs. See JX-0007 at 10:62-11:4.

In addition to his tests, Goldberg also relied on Apple's tests and studies. These tests and studies confirmed that the thermistor's temperature measurement is related to the LED temperature and can be used to accurately estimate the LEDs' operating wavelengths. See MasimoIPHB 248-258 (collecting Apple witness testimony and documents and describing Goldberg's reliance on them).

Further, Mehra's testimony established Apple's thorough testing to prove correlation between the thermistor temperature and LED operating wavelengths. He testified, [REDACTED]

[REDACTED]

[REDACTED] CX-0291C

[REDACTED]

(Mehra) at 141:9-14. He also testified, [REDACTED]

[REDACTED] *Id.* at 163:15-

17. The Federal Circuit has recognized contemporaneous evidence is generally more reliable than that created for litigation. *Sandt Tech., Ltd. v. Resco Metal & Plastics Corp.*, 264 F.3d 1344, 1351 (Fed. Cir. 2001). Apple does not dispute the reliability of these contemporaneous tests.

Goldberg also relied on his examination of the structure and thermal properties of the Apple PCB. Tr. (Goldberg) 617:9-25, 619:18-620:3. Apple argues Goldberg did not explain which materials and thermal properties of the PCB show it contains a thermal mass. AppleIPHB 219. But, Goldberg explained that the [REDACTED] shown below are thermally coupled by [REDACTED] and function as the thermal mass.

[REDACTED]

Tr. (Goldberg) 617:9-25, 619:18-620:3; CDX-0013C.008 (excerpted, annotated, citing CX-0193C); *see also* CX-0105C ([REDACTED] of Series 7); CX-1230C at 8. Apple's expert did not dispute that the [REDACTED] are thermally coupled to each other, and to the LEDs and thermistor.

Goldberg also presented evidence that the [REDACTED] have thermal conductivity and specific heat capacity consistent with their function as a thermal mass. Tr. (Goldberg) 617:9-21 (citing CX-0845 to CX-0853), 622:22-623:13 (proper balance of thermal properties of [REDACTED] [REDACTED] is maintained), 660:14-661:2 (balance of thermal properties in PCB). Apple does not dispute

[REDACTED]

that the thermal properties of the PCB are consistent with a thermal mass. And the unpublished *Mihalich* case Apple cites (AppleIPHB 219) does not undermine Goldberg’s analysis. Here, unlike *Mihalich*, where the expert merely referred to “metal,” Goldberg specifically identifies the [REDACTED] and other specific materials of the PCB and their thermal properties. *See In re Mihalich*, 980 F.2d 744 (Fed. Cir. 1992) (unpublished).

In sum, Apple does not deny: (1) the Accused Products’ thermistor measures a single temperature of the PCB [REDACTED] (2) that single temperature correlates with the LED operating wavelengths such that they can be reliably estimated; and (3) [REDACTED]

[REDACTED] These undisputed facts show that the Accused Products have a “thermal mass,” which provides a bulk temperature that can be used to reliably estimate the operating wavelengths of the LEDs.

## **2. The Accused Apple Watches Determine a “Bulk Temperature” [7F]**

Apple makes seven noninfringement arguments for [7F]. Each rely on the multiple limitations Apple adds to “bulk temperature.” Namely, Apple’s argues the “bulk temperature:” (1) *requires* “measuring a *certain* temperature *of* the thermal mass,” (2) *cannot be* “a regular temperature measurement by a temperature sensor, which is a local temperature,” (3) “*is* the majority or greater part, and (4) *should be* an “average temperature.” AppleIPHB 214-215. Regardless, Masimo addressed most of Apple’s arguments in its IPHB.

*First*, Apple argues that the thermistor measurement is not a “bulk temperature” because the thermistor measures temperature in a [REDACTED] AppleIPHB 207, 220 (citing Tr. (Mehra) 888:20-24, 892:5-10 [REDACTED])

[REDACTED] However, as Masimo explained, that the single thermistor measures a local area, and the size of the measurement area, are not relevant to whether the thermistor is

[REDACTED]

measuring a bulk temperature. MasimoIPHB 263. The evidence demonstrates, Apple’s single thermistor measures the board temperature, which is a “bulk temperature.” MasimoIPHB 252-53, 262-65.

Apple misuses Mehra’s testimony to suggest he opined Apple’s single thermistor cannot “measure the temperature of the [REDACTED] of the PCB as a whole” because “the [REDACTED] [REDACTED] AppleIPHB 220 (citing Tr. (Mehra) 890:18-23). Mehra never gave that opinion, and, in fact, the ALJ struck his opinion testimony. *Id.*; see also Tr. (Mehra) 890:18-892:2 (testimony and granting of motion to strike). The full context of Mehra’s testimony, including the stricken portion, follows:

[REDACTED]

*Second*, Apple argues the thermistor does not measure a “bulk temperature” because [REDACTED] AppleIPHB 206-207, 222. With respect to [REDACTED] Apple argues the temperature of the [REDACTED] [REDACTED] *See id.* [REDACTED] [REDACTED] But Claim 9 does not require the bulk temperature to remain constant at all times. MasimoIPHB 243-44, 264-65. The bulk temperature changes with the temperature of the LEDs.

[REDACTED]

With respect to [REDACTED]

[REDACTED] *See id.* at 206-207, 220-222. But again, Claim 9 does not require the bulk temperature to be precisely uniform across the entire substrate. MasimoIPHB 246-247, 263-264. For the reasons mentioned above, Apple’s PCB board does not have any relevant [REDACTED]

Apple additionally argues “the thermistor [REDACTED]

[REDACTED] AppleIPHB 222. [REDACTED]

[REDACTED]

MasimoIPHB 245; Tr. (Diab) 208:18-25. Claim 9 does not require the bulk temperature to match the LED junction temperature. MasimoIPHB 243-44; Tr. (Diab) 202:19-203:6, 209:3-210:12; Tr. (Goldberg) 646:19-25, 618:14-20, 614:19-25.

Sarrafzadeh’s tests confirm Masimo’s arguments. Apple claims those tests confirm

[REDACTED] AppleIPHB

206-207, 221-22. As explained above, Sarrafzadeh’s testing actually shows [REDACTED]

[REDACTED] Further, as explained above, Claim 9 does not require the “bulk temperature” to be constant or uniform.

*Third*, Apple asserts that Goldberg never identified “(1) any ‘temperature values [measured by the thermistor] as being the measured bulk temperature for the [REDACTED] in the [REDACTED] [REDACTED]’ or (2) ‘a bulk temperature for the [REDACTED] at any point.’” AppleIPHB 222. To the contrary, Goldberg expressly identified the [REDACTED] measured by the thermistor, also called [REDACTED] in Apple’s documents, as the claimed bulk temperature. MasimoIPHB 263 (citing Tr. (Goldberg) 621:18-622:1).

[REDACTED]

*Fourth*, Apple argues that Goldberg “could not have shown that the thermistor measures a ‘bulk temperature’ because he *never conducted any thermal simulations or temperature measurements of the accused thermal mass.*” AppleIPHB 207, 222-223 (emphasis in original). But Goldberg did perform testing and relied on Apple’s tests, documents, and testimony indicating [REDACTED] is closely correlated to LED operating wavelengths due to thermal coupling of the [REDACTED] to the LEDs and thermistor. MasimoIPHB 252-253, 262-265.

Apple argues that Goldberg needed to do different tests to show the thermistor temperature is the claimed “bulk temperature,” including: (1) measuring the temperature of multiple locations on the PCB, (2) showing the temperature throughout the PCB, (3) showing the average temperature of the PCB, and (4) showing stabilization and normalization of the bulk temperature. AppleIPHB 222. These tests are irrelevant because “bulk temperature” does not require them. Regardless, as explained above, Goldberg identified and explained ample evidence to show the thermistor that is thermally coupled to the [REDACTED] measures a bulk temperature, just as described and claimed in the ’127 Patent.

*Fifth*, Apple argues that Goldberg did not show that the [REDACTED] measurement shown in the excerpted figure below is a bulk temperature. AppleIPHB 206-207, 223.

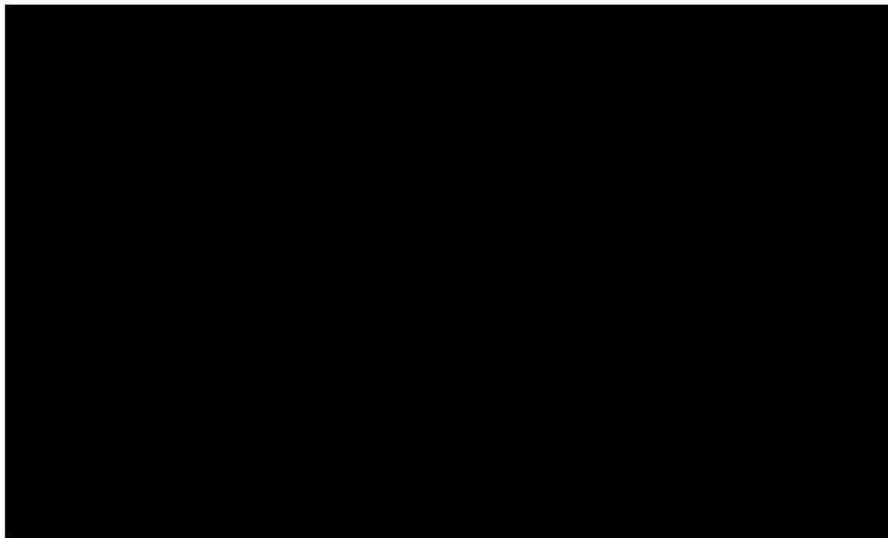

[REDACTED]

CDX-0013C.014 (citing CX-0100C at 12 (excerpted, annotated)). But Apple’s argument that [REDACTED] is not a bulk temperature is merely a repeat of its first argument above, namely, that Apple argues that the thermistor measures a local temperature. That argument fails for the reasons explained above.

*Sixth*, Apple argues that showing that the operating wavelengths depend on the thermistor measurement is irrelevant to show that the thermistor measurement is a “bulk temperature” and relates to a different claim element. AppleIPHB 224. But Goldberg’s opinion tracks the proper construction of “bulk temperature”—a single temperature of the thermal mass used to estimate the operating wavelengths of all the LEDs. MasimoIPHB 245-46; JX-0007 at 10:22-48.

*Seventh*, Apple argues that Goldberg’s opinion that the “thermistor’s measurement is a single temperature used to estimate the operating wavelengths of all the LEDs” has no factual support. AppleIPHB 224. This is a new argument not included in Apple’s pre-hearing brief, and is thus waived per G.R. 9.2. Apple argues the thermistor [REDACTED]

[REDACTED]

[REDACTED]

AppleIPHB 224. But Goldberg cited evidence showing that a [REDACTED]

[REDACTED] CX-0012C at 21-22; CX-

0111C at 7-11; CX-0206C at 3, 11 [REDACTED]

[REDACTED] Further, Mehra testified [REDACTED]

[REDACTED] CX-0291C

(Mehra) 39:19-21; *see also id.* at 38:14-39:3; CX-0281C (Block) 185:21-186:10; CX-0299C

(Waydo) 56:3-11, 84:2-85:2; CX-0283C (Lefort) 77:7-81:1, 123:6-12; CX-0289C (Mannheimer)

[REDACTED]

159:5-163:17. Goldberg also cited Apple’s source code as support for his opinion. Tr. (Goldberg) 621:18-622:3; CDX-0013C.014 (citing CPX-0154C (source code)).

The evidence is overwhelming that the temperature measured by the Accused Products’ thermistor is a [REDACTED]

[REDACTED] Masimo established, by more than a preponderance of the evidence, that the Accused Products satisfy [7F].

**D. Domestic Industry – “Technical Prong”**

Apple argues Masimo did not (1) list each product by any particular part number, (2) identify which articles are early or current rainbow® sensors, or (3) prove any particular article is representative. These arguments are meritless, as explained above. *See supra*, Section I.E.1.b.

Apple also misleads by quoting Al-Ali’s testimony that Masimo does not sell a product “claimed in the ’127 patent *for measuring SpO<sub>2</sub>*.” AppleIPHB 225 (citing Tr. (Al-Ali) 331:17-21). This is unremarkable, because Masimo’s rainbow® sensors use the claimed invention to measure other “physiological parameters,” such as carboxyhemoglobin. Apple’s argument is irrelevant to the DI technical prong because Masimo need only show the rainbow® sensors practice Claim 9, which nowhere requires measuring only SpO<sub>2</sub>.

Apple also quibbles the Rad-57 monitor, which Diab testified is a rainbow® “product” (Tr. (Diab) 211:7-12), is not a rainbow® sensor. AppleIPHB 225, n.31. Masimo does not rely on the Rad-57 as a DI rainbow® sensor, and Apple nowhere identifies any such contention. But the Rad-57 is evidence of rainbow®-sensor functionality because it is one of the monitors that connects to the rainbow® sensors and displays measurements based on signals received from the rainbow® sensors. CX-0678 at 15, 20, 23, 62.



[REDACTED]

1. **Current rainbow® Sensors Practice Claim 9**

a. **“Thermal Mass” [7A]**

Apple argues Goldberg’s testimony was “ cursory” and “conclusory” and did not address whether or how [REDACTED] of the current rainbow® sensors perform a thermal function or stabilize a bulk temperature. AppleIPHB 207-208, 226-27. But Goldberg explained how [REDACTED] of the current rainbow® sensors are a thermal mass.

[REDACTED]

CDX-0013C.023 (showing CX-0590C and CX-1635C, annotated); Tr. (Goldberg) 628:1-24.

Goldberg presented evidence showing the [REDACTED]

[REDACTED]

[REDACTED] Tr. (Diab) 221:11-222:1, 224:15-

21, 225:16-23; Tr. (Goldberg) 628:8-11; CX-0589C; CX-0597C at 1, 4, 19; CX-0590C; CX-

0419C at 1; CX-0845; CX-0846. The structure and thermal properties of [REDACTED]

[REDACTED] Tr. (Diab) 221:11-222:1, 224:15-21, 225:16-23; Tr. (Goldberg)

628:8-11; CX-0589C; CX-0597C at 1, 4, 19; CX-0590C; CX-0419C at 1; CX-0845; CX-0846.

[REDACTED]

And CX-0597C and CX-0845 include d [REDACTED]

[REDACTED] respectively.

Apple attempts to minimize the importance of [REDACTED]

[REDACTED] by pointing to Sarrafzadeh’s dismissive conclusion that [REDACTED]

[REDACTED] AppleIPHB

227 (citing Tr. (Sarrafzadeh) 1085:3-11). But that is not relevant to whether [REDACTED]

[REDACTED]. Indeed, as shown below, [REDACTED]

[REDACTED]

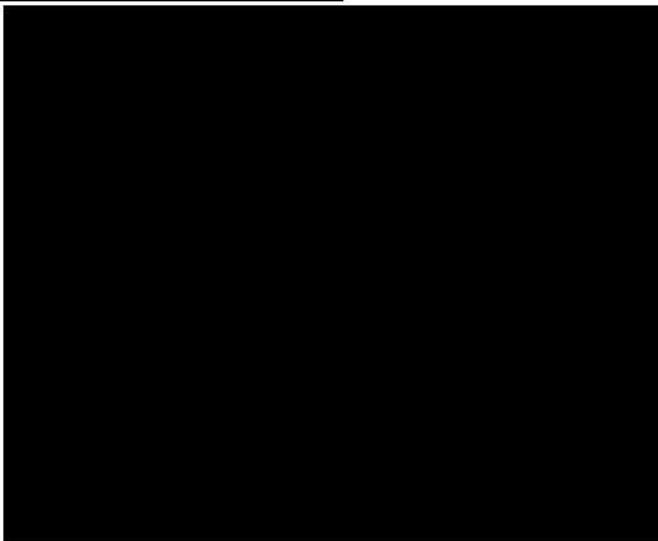

CX-1635C at 98. Apple challenges the sufficiency of Masimo’s showing, but presents no affirmative evidence rebutting it.

Goldberg also relies on Masimo’s tests showing that “every single” rainbow® sensor uses the temperature measured by the thermistor of the thermal mass [REDACTED]

[REDACTED] Tr. (Diab) 201:21-204:1, 246:4-19; Tr. (Goldberg) 627:23-628:24 (Diab’s testimony supports Goldberg’s analysis that the current rainbow® sensors meet [7A]). Thus,

Apple’s arguments that Goldberg [REDACTED]

[REDACTED] simply ignores the evidence.

[REDACTED]

Apple does not challenge any of Masimo’s tests and simulations. Indeed, it does quite the opposite. Apple embraces the thoroughness of Masimo’s tests and simulations to [REDACTED] [REDACTED] AppleIPHB 207-208, 227 (citing Tr. (Diab) 200:14-201:20 [REDACTED]); see also *id.* at 228 (citing Tr. (Diab) 201:10-14, 201:21-203:6 [REDACTED] [REDACTED] [REDACTED] [REDACTED])). Apple does so in hopes of denigrating Goldberg’s testing. AppleIPHB 207-208, 214, 227-28. Apple suggests Goldberg cannot rely on [REDACTED] [REDACTED], and Diab’s un rebutted testimony (and CX-0342C reflecting the simulations). Apple cites no authority requiring an expert to repeat contemporaneous tests conducted by others. See, e.g., *Monsanto Co. v. David*, 516 F.3d 1009, 1015-16 (Fed. Cir. 2008) (expert can rely on tests conducted by others); *Apple Inc. v. Motorola, Inc.*, 757 F.3d 1286, 1322 (Fed. Cir. 2014) (reasonable and common for expert to rely on party’s technical information (cleaned up)).

The evidence for [7F] further supports that the current rainbow® sensors meet [7A].

**b. “Bulk Temperature” [7F]**

Apple argues that Goldberg “did nothing to show that the thermistor reads a *‘bulk temperature for the thermal mass,*’ or that it takes anything other than a run-of-the-mill, local temperature measurement.” AppleIPHB 207-208, 229. But Apple relies on its improper negative limitation that would exclude a local temperature from “bulk temperature.” As discussed above, this construction is wrong. The rainbow® sensor’s thermistor measurement satisfies [7F] under the correct construction. MasimoIPHB 271-73; Tr. (Goldberg) 632:17-633:12; CDX-0013C.033 (referencing CX-0430C, CX-0816C, CX-0426C).

[REDACTED]

Apple also repeats the argument Goldberg needed to conduct more tests to verify the current rainbow® sensors measure a bulk temperature. AppleIPHB 207-208, 214, 229. But, as explained above, Apple’s specific testing demands are premised on its newly added limitations, not the correct construction of “bulk temperature.”

Apple also argues that Goldberg’s [REDACTED]

[REDACTED]

[REDACTED] AppleIPHB 229-30. Apple never made this argument in its pre-hearing brief, and it is therefore waived per G.R. 9.2. Regardless, Apple’s argument erroneously [REDACTED]

[REDACTED] Tr. (Goldberg)

633:18-24; *see also* MasimoIPHB 272. Sarrafzadeh did not rebut Goldberg’s [REDACTED]

[REDACTED] And Apple’s argument that [REDACTED]

[REDACTED]

[REDACTED]

Apple also cites Sarrafzadeh as supporting its “local,” “average,” and “vast majority” temperature arguments. AppleIPHB 230. But Sarrafzadeh’s opinion relies on an incorrect construction of “bulk temperature.” It does not *exclude* a “local temperature” and does not *require* an “average” or a “vast majority” temperature.

Apple also labels Goldberg’s analysis “inadequate” and “conclusory,” and alleges that Goldberg [REDACTED]

[REDACTED] AppleIPHB 230. This allegation is baseless, as demonstrated by substantial evidence Goldberg explained, as set forth herein and in Masimo’s IPHB. MasimoIPHB 271-73.

[REDACTED]

Apple argues that Goldberg did not prove the documents he relied on apply to both the early and current rainbow® sensors. AppleIPHB 230. But he did not have to. Diab explained which exhibits apply to all rainbow® sensors and which apply to just the early or current rainbow® sensors. Tr. (Diab) 212:21-213:6, 222:16-223:25, 224:1-14. CX-0430C [REDACTED]

[REDACTED]

Tr. (Diab) 222:16-223:25; CX-0430 at 1. CX-0426C and CX-0816C are [REDACTED]

[REDACTED] Tr. (Diab) 224:1-14; CX-0426C at 1; CX-0816C at 1. [REDACTED]

[REDACTED] Tr. (Diab) 212:21-213:6. Thus, Masimo has shown its rainbow® sensors use a “bulk temperature” as claimed.

**2. Early rainbow® sensors Practice Claim 9**

**a. “Thermal Mass” (I7A)**

For the early rainbow® sensors, Apple repeats the same arguments it made for the current rainbow® sensors, claiming Goldberg’s analysis was cursory and conclusory, he conducted no tests, and he did not explain how [REDACTED] AppleIPHB 230-232. But the same [REDACTED] discussed above also apply to the early rainbow® sensors and provide ample support for Goldberg’s analysis. Tr. (Goldberg) 627:3-629:18.

Apple also argues that [REDACTED] are not representative of the early rainbow® sensors because [REDACTED] AppleIPHB 232, n.32. This criticism is inconsistent with (1) Apple’s reliance on Sarrafzadeh’s tests of turning on just one LED to attempt to show lack of temperature stabilization (Tr. (Sarrafzadeh) 1075:5-9; CX-0322bC ¶¶298,

[REDACTED]

300) and (2) Apple embracing [REDACTED] as the type of tests Goldberg allegedly should have done (AppleIPHB 227-28). Masimo verified the results of the simulations [REDACTED] [REDACTED] Tr. (Diab) 201:21-204:1, 246:4-19.

Apple also asserts [REDACTED] to ‘bulk temperature’ stabilization.” AppleIPHB 232, n.32. [REDACTED]

[REDACTED] Tr. (Diab) 201:21-203:6.

In addition, Goldberg’s [REDACTED] [REDACTED] of the early rainbow® sensors supports that [REDACTED] [REDACTED] See MasimoIPHB 268-69. Apple repeats its attempt to minimize Goldberg’s thermal-properties analysis by arguing even a speck of dust has “some thermal properties.” AppleIPHB 231. [REDACTED]

**b. “Bulk Temperature” [7F]**

For the early rainbow® sensors, Apple relies on its analysis for the current rainbow® sensors. AppleIPHB 232. For the reasons given above, the early rainbow® sensors satisfy [7F]. See *supra*, Section VI.D.1.b.

**E. Validity**

Apple’s invalidity analysis contradicts its noninfringement arguments. Apple abandons every noninfringement argument upon which it relies when it turns to invalidity. Apple presents no evidence of testing or simulations to establish the presence of a “thermal mass” or “bulk temperature” of the prior art. Apple argues that general concepts such as using a temperature sensor on an LED substrate to compensate for wavelength changes due to temperature were well-

[REDACTED]

known. AppleIPHB 210. However, none of Apple’s prior art would render the specific elements of Claim 9 (including the “thermal mass” and “bulk temperature” elements) obvious under Masimo’s constructions or Apple’s reading of the claim for noninfringement. Rather, for validity, Apple pivots to an overly broad construction that ignores the prosecution history.

**1. Obviousness**

**a. Mendelson in view of Webster would not Render Claim 9 Obvious [No disclosure of [7A], [7D], [7E], [7F], or [9]].**

**Element [7A]**: Apple does not assert Mendelson’s ceramic substrate has a “thermal mass.” AppleIPHB 234. Instead, Apple argues it would have been “obvious to implement Mendelson’s ceramic substrate as a multilayered printed circuit board with a thermal core,” as shown in Scarlett. *Id.* (citing Tr. (Sarrafzadeh) 1050:7-10, 1050:25-1051:12; RX-0397); *see also* AppleIPHB 205-206, 208. But that presumes the point Apple must prove, that a POSITA would have been looking to create a thermal mass.

The ALJ should reject Apple’s reliance on Scarlett because Apple did not disclose any grounds based on Scarlett. MasimoIPHB 283-84, Appendix A at 12. Apple’s reliance on Scarlett contradicts Apple’s prior representation to the ALJ that Scarlett is “background,” because Apple now argues Scarlett shows a claim element. *See* Doc. ID 772058 at 2.

Regardless, Scarlett does not rescue Apple. Scarlett is a book about circuit boards, not about physiological monitoring. It discloses a metal core for removing heat to alleviate overheating. RX-0397 at 122. Scarlett does not suggest its heat-removal components would provide a temperature that could track the temperature of a component on the board. MasimoIPHB 283-84; Tr. (Goldberg) 1398:9-1399:8. Apple identifies no motivation to add a thermal mass to Mendelson, except hindsight, and does not establish a reasonable expectation of

[REDACTED]

success. MasimoIPHB 283-84. The prior art also teaches away, as shown in the objective indicia section below.

Apple also stretches Goldberg’s infringement analysis to argue that *any* metallized layers in a PCB can be a thermal mass. AppleIPHB 234-35 (citing Tr. (Sarrafzadeh) 1050:25-1052:2); *see also* AppleIPHB 208. Neither Masimo nor Goldberg made that argument. MasimoIPHB 277-78. Apple’s broad construction for purposes of validity ignores that the Examiner considered Cheung, which has a circuit board with electronic components attached, and found the claim patentable. *Id.* at 275-76.

**Element [7D]**: Apple does not assert Mendelson has a “thermal mass disposed within the substrate” of [7D]. Instead, Apple argues it would have been obvious to add this feature to Mendelson. AppleIPHB 236. But Apple provides no motivation, other than hindsight, to make that modification. MasimoIPHB 284-85.

**Elements [7E]-[7F]**: Apple admits Mendelson does not disclose [7E] and [7F], and relies on Webster to fill the gap. AppleIPHB 205-206, 236-37. But Webster cites to and merely rehashes Cheung in stating that “[t]he temperature sensor will read at best an average of the two LED temperatures, and at worst an average of the two LED temperatures along with the skin and ambient temperatures.” RX-0035 at 85-86; *cf.* RX-0406 at 19:32-33, Abstract, 13:25-27 (Cheung’s disclosure that its temperature sensor measures the “ambient temperature” of the “sensor” or “sensor assembly 48”). For the reasons discussed above, that disclosure is insufficient to teach measuring a “bulk temperature” as claimed. *See supra* VI.B.1. The Examiner considered Cheung and allowed the claims over it. MasimoIPHB 275-76. So, adding Webster to Mendelson would not render the claim obvious. *Id.*



[REDACTED]

Apple argues [7F] is present by mischaracterizing Goldberg’s opinion. AppleIPHB 237. Apple argues that Goldberg pointed merely to a thermistor measuring a local temperature to satisfy this limitation [7F] for infringement. AppleIPHB 237-38. But Goldberg did much more. He explained that a thermal mass thermally couples the LEDs to the thermistor so that the thermistor measures a “bulk temperature” to estimate the operating wavelengths of all the LEDs. MasimoIPHB 244-47, 252-53, 262-65. Neither Mendelson nor Webster discloses [7F] because Webster’s temperature sensor is not “thermally coupled to the thermal mass and capable of determining a bulk temperature for the thermal mass.” MasimoIPHB 280.

Apple relies on Sarrafzadeh’s opinion that Webster’s discussion of the temperature dependency of LED wavelengths somehow discloses “a bulk temperature for the thermal mass.” AppleIPHB 237-38. According to Sarrafzadeh, this is merely a “property of physics.” *Id.* But the temperature dependency of an LED based on its junction temperature is different from the use of a single “bulk temperature for the thermal mass” to estimate the operating wavelengths of multiple LEDs. Tr. (Diab) 198:5-199:16; CX-0206C at 11. Claim 9 does not claim any property of physics. Further, because Apple’s reliance on Scarlett for the “thermal mass” implicitly admits that Webster and Mendelson do not disclose a thermal mass, those references cannot disclose measuring the “bulk temperature for the thermal mass.”

The combination also does not meet [9] because Webster does not disclose that its temperature sensor comprises a thermistor. MasimoIPHB 280. Apple relies on Yamada and a dictionary for disclosure of a thermistor. AppleIPHB 239 (citing RX-0381 (Yamada), RX-0419 (dictionary)). However, again, Apple cannot rely on either for particular claim elements, because it did not identify either as part of the Mendelson ground. MasimoIPHB, Appendix A at 12.

[REDACTED]

Though Masimo does not dispute that Mendelson discloses [7H] *for a device other than a pulse oximeter*, Sarrafzadeh’s demonstrative regarding that limitation exposes Sarrafzadeh’s complete unfamiliarity with pulse oximetry. MasimoIPHB 278-79. Goldberg made this criticism at the hearing. Tr. (Goldberg) 1393:10-22. Apple did not address this in its IPHB.

Mendelson was not a pulse oximeter. MasimoIPHB 279. It discloses an ear oximeter requiring compressing the ear using a transparent pressure capsule to render the ear pinna almost bloodless to take a first reading, and then allowing blood back to fill the ear before taking a second reading. RX-0458 at 19. It did not measure the flow of blood over time. So, it could not measure pulse rate or pulse-oximetry-based oxygen saturation (SpO<sub>2</sub>). MasimoIPHB 279. Also, the next section in Mendelson after Ear Oximetry is Pulse Oximeters. RX-0458 at 20. Mendelson explains that pulse oximetry is a “*different* optical approach.” *Id.*

Webster also explains the difference between an ear oximeter and a pulse oximeter. It even has a section entitled “Pulse oximeter *versus in vivo* eight-wavelength ear oximeter.” RX-0035 at 13. Webster goes on to explain in detail the problems with the ear oximeter and the introduction of pulse oximetry. *Id.* at 29-37. Thus, no expert in pulse oximetry would think the ear oximeter was a pulse oximeter.

**b. Yamada in View of Noguchi Would Not Render Claim 9 Obvious [No disclosure of [7A], [7D], [7E], or [7F]].**

**Elements [7A] and [7D]:** Apple argues that Yamada’s substrate 15 is a “thermal mass.” AppleIPHB 239-40. But Yamada does not disclose the structure or thermal properties of the substrate 15. MasimoIPHB 281. So, Apple improperly turns to Scarlett to fill the gap, as it did with Mendelson. AppleIPHB 240; MasimoIPHB, Appendix A at 12 (Scarlett not listed). Also, as explained above, Scarlett does not disclose a “thermal mass.”

[REDACTED]

**Element [7E]:** Apple relies on Yamada’s temperature sensor “attached to the light probe 1.” AppleIPHB 241 (citing Tr. (Sarrafzadeh) 1060:1-7). The probe 1 comprises a light-emitting component 11, a light-receiving component 12, a main structure 13, a light channel 14, a substrate 15, and a protective component 16. RX-0381 ¶42. Yamada further proposes many locations for the temperature sensor: the surface of the substrate 15 facing the user, the top surface of the substrate, near the center, the inner surface, or the outer surface of main structure 13. *Id.* ¶¶109-110. Yamada does not disclose that its temperature sensor is thermally coupled to a thermal mass. MasimoIPHB 281-82.

**Element [7F]:** Apple relies on Yamada’s temperature sensor and Noguchi’s teaching that LED wavelength is a function of temperature to argue that a POSITA would have found it obvious to use multiple temperature sensors to measure a bulk temperature. AppleIPHB 241-243. There are numerous flaws in this argument.

First, Sarrafzadeh asserted that Yamada’s temperature sensor “*could* be attached to the surface” and that a POSITA could use multiple temperature sensors to do some sort of a bulk temperature of the thermal mass. Tr. (Sarrafzadeh) 1060:8-17. But what someone “could” do with Yamada says nothing about what a POSITA “would” have been motivated to do. *Belden Inc. v. Berk-Tek LLC*, 805 F.3d 1064, 1073 (Fed. Cir. 2015). Second, Yamada explains that by “using the temperature sensor to monitor the temperature of the light probe 1, it is possible to take action when the temperature gets too high, for example by *sounding an alarm or halting light emission* from the light-emitting component 11.” RX-0381 ¶111. Thus, Yamada says nothing about using a temperature sensor to measure a temperature of a thermal mass for estimating LED operating wavelengths. MasimoIPHB 282; Tr. (Goldberg) 1397:2-8.



Third, Yamada also describes a thermal conductor extending from the LED out of the “main structure,” as shown below:

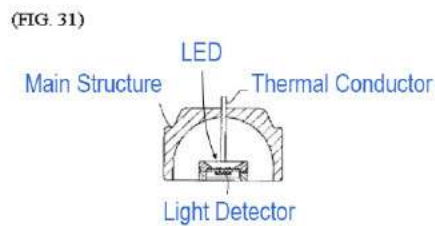
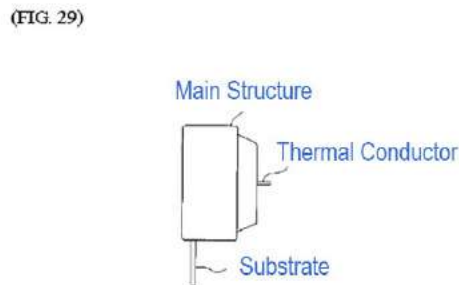
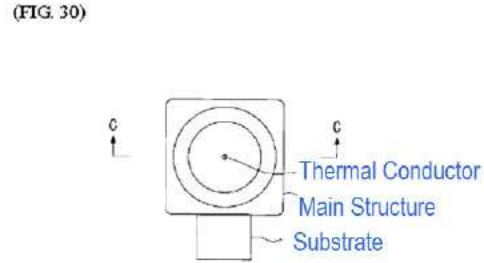
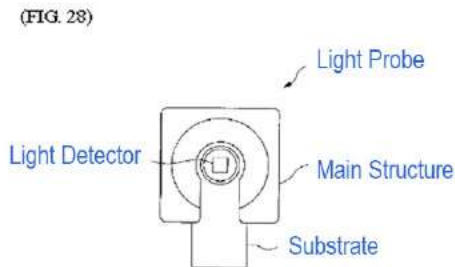

RX-0381 at FIGS. 28-31(annotated), ¶¶101-102. Yamada teaches the thermal conductor “is able to adequately disperse heat” from the LED. *Id.* Yamada’s concern of removing heat from the probe is different from Claim 9’s use of a thermal mass to provide a bulk temperature for measurement. Tr. (Goldberg) 1398:9-1399:8 (discussing difference of heat removal and thermal mass for providing a bulk temperature in connection with Scarlett).

Apple then turns to Noguchi for its disclosure of “a temperature measurement means or a plurality of temperature measurement means.” AppleIPHB 242. Noguchi discloses measuring the “temperature of *an LED* or for measuring the temperature in the environment in which *the LED* is disposed.” RX-0353 at 1:40-43; MasimoIPHB 283. This does not disclose a “bulk temperature” of the thermal mass used for estimating all LED operating wavelengths. MasimoIPHB 283.

[REDACTED]

Noguchi does not use its temperature measurement to estimate LED operating wavelengths for physiological measurements. MasimoIPHB 283; Tr. (Goldberg) 1397:9-21.

Further, Apple has not shown a motivation to combine Yamada and Noguchi, or a reasonable expectation of success. MasimoIPHB 284-85. The prior art also teaches away, as shown in the objective indicia section below.

## **2. Objective Indicia of Nonobviousness**

Apple argues that there is no nexus between any commercial success or industry praise and the '127 Patent. AppleIPHB 244. Masimo need only present evidence that commercial success and industry praise are connected to the invention recited in Claim 9. *WBIP*, 829 F.3d at 1329 (citing *J.T. Eaton & Co. v. Atl. Paste & Glue Co.*, 106 F.3d 1563, 1571 (Fed. Cir. 1997)); *Crocs, Inc. v. Int'l Trade Comm'n*, 598 F.3d 1294, 1310-11 (Fed. Cir. 2010). Objective evidence shows that the rainbow® sensors which enjoyed commercial success and received praise are connected to “the invention disclosed and claimed in the patent.” MasimoIPHB 286-87.

Apple could have attempted to rebut nexus by presenting evidence the objective indicia were “due to extraneous factors other than the patented invention.” *Demaco Corp. v. F. Von Langsdorff Licensing Ltd.*, 851 F.2d 1387, 1392-93 (Fed. Cir. 1988). But Apple presented no such evidence. AppleIPHB 244.

Apple also did not address Masimo’s teaching-away evidence (*see* MasimoIPHB 287), and Sarrafzadeh did not testify on the teaching away by Huiki and Webster. AppleIPHB 244-45.

## **VII. ECONOMIC PRONG**

Apple spent most of this Investigation denying the existence of any Masimo Watch, with insatiable requests for more and more evidence that Masimo promptly provided. Apple belabored its false narrative in conferences and unsuccessfully sought sanctions against Masimo for its sw [REDACTED]

[REDACTED]

declarations and corroborating testimony confirming the Masimo Watch's existence. Now, faced with the evidence refuting its case-long rhetoric, Apple seeks to deny that developing and manufacturing the Masimo Watch in the United States entailed significant domestic expenditures.

Apple bases its latest denial on attorney argument unsupported by evidence or authority. Apple's core argument is that the ALJ should discredit the sworn and unrefuted testimony of Masimo's witnesses. Because Masimo [REDACTED]

[REDACTED] Tr. (Young) 486:22-25. Apple urges the ALJ to ignore that evidence. Tr. (Young) 486:1-25. But Apple and its expert lost that same argument in other Investigations. *Certain Electronic Devices*, Inv. 337-TA-701, I.D. (Order No. 58) at 13 n.25 (Nov. 18, 2010); *Certain Mobile Electronic Devices*, Inv. 337-TA-1065, I.D. at 113 (Sept. 28, 2018).

Moreover, Apple's argument that Masimo lacks supporting evidence is false. Apple chose for its expert not to inspect Masimo's facilities and then tried to block evidence of any inspection by seeking (unsuccessfully) to exclude the photographs from the inspection conducted by Masimo's expert. Tr. (Thomas) 1321:6-1323:7. Masimo introduced over 160 photographs and video evidence showing its domestic activities, consistent with its documentary evidence and testimony. CX-0680C; CX-0835C.

Apple also continues to deny that Masimo's post-Complaint expenditures are relevant, despite the fact that Masimo pled that a domestic industry both exists *and* is in the process of being further established, and despite the existence of significant and unusual developments, and ongoing activities occurring after the Complaint was filed. MasimoIPHB 288-89. Apple denies that [REDACTED] are significant amounts of money, and that [REDACTED] are

[REDACTED]

significant labor. Apple's latest denials are as implausible as its earlier denial of the Masimo Watch's existence.

Apple is familiar with the costs and complexities of developing and manufacturing consumer electronics such as the Masimo Watch. Tr. (Waydo) 925:23-926:6. The undisputed fact that Masimo [REDACTED] [REDACTED] is sufficient to satisfy the economic prong by a preponderance of the evidence. Tr. (Young) 504:3-25. See e.g., *Certain Battery-Powered Ride-On Toy Vehicles*, Inv. No. 337-TA-314, I.D. at 21 (Aug. 1991) ("The purpose of the domestic industry requirement is to prevent the ITC from becoming a forum for resolving disputes brought by foreign complainants whose only connection with the United States is ownership of a U.S. patent."). Apple does not contend that it is possible to design and manufacture such a device with insignificant expenditures. Indeed, Apple's documents and witnesses claim that Apple expended over 20,000 hours over more than five years trying to develop infrequent spot measurements of SpO<sub>2</sub> for its watch. Tr. (Waydo) 925:23-926:6. Meanwhile Masimo's watch, [REDACTED], provides continuous measurement of that parameter at medical grade accuracy. Tr. (Kiani) 122:2-21.

Masimo far exceeded the requirements for showing that a domestic industry exists and is in the process of being further established, both at the time of the Complaint and as of the hearing. MasimoIPHB 288-310. Apple does not appear to argue that a domestic industry does *not* exist—it merely argues that there is supposedly insufficient evidence to determine by a preponderance of the evidence whether Masimo's domestic expenditures in the Masimo Watch were significant.

Apple repeats many of its arguments regarding Masimo Watch expenditures when attempting to challenge Masimo's expenditures for its rainbow® domestic industry products. But

[REDACTED]

as with the Masimo Watch, the uncontroverted evidence confirms that Masimo’s domestic expenditures for rainbow® sensors cannot reasonably be called insignificant. Masimo

[REDACTED]

[REDACTED]

[REDACTED] Tr. (Young) 505:1-16; CX-0649C. Masimo has spent

[REDACTED]

[REDACTED] MasimoIPHB 309-310.

**A. Apple’s Argument of Five Supposed “Major Shortcomings” Fails**

Apple categorizes its criticism of Masimo’s employment of labor or capital and its investment in plant and equipment into what it calls five “major shortcomings.” AppleIPHB 247-48. Comparing those criticisms to Masimo’s actual employment of labor or capital (MasimoIPHB 303-310) demonstrates that Apple’s criticisms, in addition to being inaccurate, are also inconsequential. Those five supposed “major shortcomings” compared to Masimo’s employment of labor or capital are:

1. [REDACTED]  
[REDACTED]

2. [REDACTED]  
[REDACTED]  
[REDACTED]

3. [REDACTED]

4. [REDACTED]  
[REDACTED]



[REDACTED]

5. [REDACTED]

Apple's criticisms are limited to Masimo's dollar-based expenditures. Masimo also demonstrated the significance of its domestic industry based on [REDACTED]

[REDACTED] MasimoIPHB 307, 310.

Apple does not dispute that Masimo [REDACTED]

[REDACTED] Apple also does not dispute that Masimo [REDACTED]

[REDACTED] Masimo [REDACTED]

[REDACTED] shown in CX-0635C's [REDACTED] tab,

which contains [REDACTED]

[REDACTED] an excerpt of which is shown here:

[REDACTED]

CX-0635C. Masimo [REDACTED]

[REDACTED] CX-0635C [REDACTED]

Apple ignores Masimo's [REDACTED] for the Masimo

Watch, and only addresses the [REDACTED]

AppleIPHB 278. Masimo's [REDACTED] is thus

undisputed, as is the significance of [REDACTED]

[REDACTED]

[REDACTED]

[REDACTED]

Moreover, Masimo’s documentary and testimonial evidence regarding its [REDACTED]

[REDACTED]

[REDACTED]

**B. Masimo’s Corroborated Evidence Refutes Apple’s Unsupported Arguments**

Apple begins its economic-prong argument with the false claim that “Complainants’ entire economic-prong claim for the Masimo Watch rests on [REDACTED]

[REDACTED] AppleIPHB 245. But Masimo relies on more than spreadsheets.

The [REDACTED]

[REDACTED]. Masimo presented un rebutted evidence of its domestic industry expenditures through Masimo Corp. CFO Micah Young and Cercacor CFO Gerry Hammarth, both of whom carefully relied on inputs from the appropriate executives and groups at Masimo. Tr. (Young) 485:10-486:21; Tr. (Hammarth) 523:22-524:13; Tr. (Scruggs) 435:21-436:12; Tr. (Al-Ali) 322:6-324:3; Tr. (Mushin) 359:22-360:20. Masimo also presented evidence from its financial expert, Daniel McGavock, who inspected Masimo’s facilities and considered financial appendices, other documents, and witness testimony. Tr. (McGavock) 535:15-538:15.

Apple incorrectly claims that McGavock did not review relevant deposition testimony. AppleIPHB 246. In fact, McGavock reviewed relevant depositions, and Apple’s attempt to cross-examine him with an outdated, incomplete list of materials considered was exposed on redirect. Tr. (McGavock) 573:14-25. Rather than attempt to rebut the evidence, Apple urges the ALJ to ignore it by seeking to impose audit and corroboration requirements unsupported by Commission authority. AppleIPHB 245-248, 265-66. However, “a precise accounting [of domestic investments] is not necessary, as most people do not document their daily affairs in contemplation

[REDACTED]

of possible litigation.” *Stringed Musical Instruments & Components Thereof*, Inv. No. 337-TA-586, Comm’n Op., 2009 WL 5134139, at \*17 (Dec. 2009). The ITC has a long-standing principle that domestic industry is not determined by a rigid formula, but by an examination of the facts in each investigation, the article of commerce, and realities of the marketplace. *See Certain Batteries & Electrochemical Devices*, Inv. No. 337-TA-1087, Comm’n Op., 2018 WL 4331965, at \*2 (Sept. 7, 2018).

Young confirmed that the financial information he presented from the analysis is consistent with his personal experience at Masimo, including his close daily work with Masimo’s executive team and with the leaders of its functional groups. Tr. (Young) 509:5-21. He confirmed that he has toured the area where Masimo [REDACTED]

[REDACTED] *Id.* He further confirmed that, as Masimo Corp.’s CFO, he is responsible for overseeing the company’s financials and working closely with each of the team members to understand those financials. *Id.* Young confirmed that the information in Masimo’s financial appendices are consistent with his years of extensive firsthand knowledge of Masimo’s activities and expenditures. *Id.* at 509:22-25. Apple’s suggestion that the spreadsheets were created [REDACTED] (AppleIPHB 245) ignores the evidence showing that the spreadsheets were a careful, collaborative effort with input from [REDACTED]. Apple’s claim that Masimo [REDACTED] [REDACTED] is also false. MasimoIPHB 299-300.

Apple also faults Masimo for a “failure to proffer corroborating documents.” AppleIPHB 247. But no such obligation exists for economic evidence of domestic industry. “[T]here is no Commission requirement that sworn witness testimony directed to the domestic industry

[REDACTED]

requirement cannot be credited without further corroboration by underlying documentation.” *Certain Solid State Storage Drives*, Inv. No. 337-TA-1097, Comm’n Op., 2018 WL 4300500, at \* 13 (June 29, 2018) (crediting the testimony of a fact witness on economic prong); *accord Certain Beverage Dispensing Sys.*, Inv. No. 337-TA-1130 (June 1, 2020) (nothing more than unrebutted testimony required to support allocation approach). Instead, all that is required is the use of reasonable allocations for the purposes of establishing the economic prong. *See Solid State*, at \*13.

Apple and its expert Thomas tried and failed on this same argument in the 701 Investigation. *See Certain Elec. Devices*, Inv. No. 337-TA-701, 2010 WL 5621540, at \*3 (Nov. 18, 2010) (rejecting “Apple’s pro forma objections that Nokia has failed to give a precise accounting or failed to provide underlying documentation for sworn witness testimony”); *id.* at \*13 n.25 (“Apple’s argument that a sworn affidavit by a witness should be discredited because Nokia does not cite to any documentation lacks merit as a matter of law. It is further noted that Apple presents no evidence of disputed fact, merely unsupported attorney argument.”) (internal citations omitted).

Apple next argues that Masimo needed to independently verify its domestic industry evidence. AppleIPHB 264, 272, 278. In *Certain Digital Video Receivers*, Inv. No. 337-TA-1103, 2019 WL 2953269, at \*156 (June 4, 2019), the ALJ rejected a similar argument, finding that an outside audit or SEC reporting was unnecessary in view of the testimony of Complainants’ Vice President of Finance and its expert witness. Apple identifies no basis for its insinuation that Masimo’s estimates are unreliable. Young provided sworn testimony that the financial appendices were consistent with his experiences at Masimo. Tr. (Young) 509:5-25. Masimo’s [REDACTED]

[REDACTED]

[REDACTED]

[REDACTED] Tr. (Young) 486:16-25; Tr. (Scruggs) 435:21-436:12; Tr. (Al-Ali) 322:6-324:3; Tr. (Mushin) 359:22-360:20. Apple did not present any evidence to call into question the reliability of the estimates.

Apple criticizes certain Masimo domestic expenditures. In addition to Apple's criticisms being misplaced, Apple's argument is unhelpful because it does not present any opinion or evidence as to whether subtracting any particular expenditures from the domestic industry analysis could somehow change the totality of Masimo's expenditures so that they are no longer significant.

Apple also makes assorted attorney arguments about various Masimo expenditures that are unsupported by the record. Apple argues Masimo failed to present evidence of [REDACTED] [REDACTED] AppleIPHB 250-52. But Masimo [REDACTED]

[REDACTED] Tr. (Mushin) 364:5-8; Tr. (Young) 489:2-16; Tr. (Al-Ali) 321:23-322:2.

Apple also argues that Masimo lacks sufficient evidence supporting its [REDACTED] [REDACTED] AppleIPHB 252-53, 268-69. But Apple does not dispute Masimo's [REDACTED]

[REDACTED] Tr. (Scruggs) 434:11-17. Apple also argues that Masimo's R&D expenditures are [REDACTED] AppleIPHB 271, 276-277. But the evidence shows that the Masimo Watch has been [REDACTED]

[REDACTED] Tr. (Al-Ali) 328:8-24; Tr. (Scruggs) 393:2-394:18; CDX-005C; Tr. (Kiani) 179:23-180:7.

[REDACTED]

Apple criticizes Masimo's collaboration with [REDACTED]

[REDACTED] AppleIPHB 271. However, Masimo [REDACTED]

[REDACTED] CX-0617 at 1

[REDACTED] and CX-0618 at 4 ([REDACTED]

[REDACTED]; CX-0620C at 23 ([REDACTED]); Tr.

496:12-14. Apple's criticisms of Masimo's [REDACTED]

[REDACTED] (AppleIPHB 269-272) also offers mere argument against sworn testimony and

cannot refute that Masimo [REDACTED] Apple also

questions to the extent certain [REDACTED]

[REDACTED] (AppleIPHB 277-78) but cannot overcome that

[REDACTED] CX-0642C, CX-0627C, CX-0635C.

Apple also criticizes Masimo for supposedly including [REDACTED] in its domestic industry analysis. AppleIPHB 266-67. However, Masimo mentioned [REDACTED] to corroborate the significance of the Masimo Watch project, but did not include those expenditures in its domestic industry analysis. Tr. (Kiani) 123:7-16, 496:20-25. *See, e.g., Solid State*, 2018 WL 4300500 at \*13 (recognizing that marketing and sales activities "may be considered as part of the overall evaluation of whether or not a Complainant meets the economic prong").

**C. Masimo's Watch Activities Have [REDACTED], Confirming That its Domestic Industry is At Least In The Process of Being Further Established**

Apple argues Masimo failed to satisfy the domestic industry requirement under the "process of being established" standard. AppleIPHB 249, 258-60. The record shows that Masimo

[REDACTED]

has [REDACTED]

[REDACTED] and that Masimo launched a production version of the Masimo Watch a few months after the First Amended Complaint was filed. Tr. (Kiani) 124:5-125:5, 173:16-175:19; *see Certain Non-Volatile Memory Devices*, Inv. No. 337-TA-1046, 2018 WL 6012622 (October 26, 2018) (“article” includes “pre-commercial or non-commercial items”); *Certain Mobile Devices with Multifunction Emulators*, Inv. No. 337-TA-1170, Order No. 19, 2020 WL 3819518 at \*6-7 (June 9, 2020) (commercialization not required for domestic industry). Apple’s expert admitted that domestic industry does not require that a product is commercially available. Tr. (Thomas) 1318:9-21. But here, the Masimo Watch is commercially available. Tr. (Kiani) 124:17-21. Masimo has [REDACTED]

[REDACTED] Tr. (McGavock) 542:14-20, 563:8-13, 574:25-575:2.

**D. Masimo’s Post-Complaint Expenditures are Relevant**

Masimo has demonstrated that it is appropriate to consider post-Complaint evidence of its domestic industry. MasimoIPHB 289-290. Evidence of domestic manufacturing is one example of a significant and unusual activity that supports analysis of post-complaint evidence. *See Certain Electronic Devices*, 2010 WL 5621540. Masimo [REDACTED]

[REDACTED] Tr. (Scruggs) 432:22-435:10; Tr. (McGavock) 537:3-538:10. Masimo also acquired Sound United post-Complaint for over \$1 billion [REDACTED]. Tr. (Young) 483:3-18; CX-1637; Tr. (McGavock) 544:9-20.

[REDACTED]

Masimo also has [REDACTED] for its Masimo Watch project. Tr. (Young)

504:9-25. For the rainbow® sensors, Masimo's [REDACTED]

[REDACTED]

[REDACTED]

[REDACTED]

[REDACTED] Tr. (Young) 505:12-

16. Apple continues its incorrect and already unsuccessful argument seeking to exclude post-Complaint evidence. AppleIPHB 266. In particular, Masimo's very recent acquisition of Sound United for over \$1 billion, even if the [REDACTED] were ignored, alone confirms that Masimo's post-Complaint activities related to further establishing a domestic industry have been significant and unusual.

**E. Masimo's Prior Investments Are Properly Included**

Although Thomas testified Masimo's domestic expenditures [REDACTED] should not be included in the domestic industry analysis, Apple did not include that argument in its IPHB. That may be due to Thomas's admission in cross-examination that he has included older expenditures in other Investigations. Tr. (Thomas) 1313:22-1314:24. Indeed, the Federal Circuit has confirmed that "past expenditures may be considered to support a domestic industry claim so long as those investments pertain to the complainant's industry with respect to the articles protected by the asserted [intellectual property] rights and the complainant is continuing to make qualifying investments at the time the complaint is filed." *Hyosung TNS Inc. v. Int'l Trade Comm'n*, 926 F.3d 1353, 1361-2 (Fed. Cir. 2019) (citing *Television Sets*, Inv. No. 337-TA-910, 2015 WL 6755093, at \*36 (Oct. 30, 2015)).



[REDACTED]

Apple also disputes whether Masimo's identified expenditures are for the Domestic Industry products. AppleIPHB 256-57, 261-62, 274. Masimo has shown that they are. MasimoIPHB 288-311.

**F. The Masimo Watch Benefitted From The Full Scope of Masimo's [REDACTED]**

Witnesses confirmed that Masimo's Watch project was built on [REDACTED]

[REDACTED] Tr. (Kiani) 114:3-115:22, 118:20-119:8, 112:22-123:6; Tr. (Al-Ali) 248:20-250-14. Monitoring parameters on the wrist is significantly more complex than transmissive-based monitoring, resulting in Masimo investing [REDACTED] Tr. (Young) 497:1-6; CX-0640C. Apple's own engineers confirmed this. Tr. (Block) 902:13-903:2. Apple also misrepresents the testimony of Al-Ali, claiming that he [REDACTED]

[REDACTED] AppleIPHB 250. This ignores the testimony from Kiani and Al-Ali about [REDACTED]. Tr. (Kiani) 115:5-7, 116:8-9; Tr. (Al-Ali) 248:24-250:2, 328:8-16; MasimoIPHB 27-30; CPX-0139C; CPX-0140C.

Apple argues the ALJ and Commission should ignore that employment of domestic R&D labor because Masimo Watch [REDACTED]

[REDACTED] AppleIPHB 250-51, 267-68. However, the R&D labor was not a tangible asset where allocation was necessary because [REDACTED]

[REDACTED] Instead, the [REDACTED] used for the Masimo Watch. Tr. (Kiani) 115:1-122:21; Tr. (Young) 497:1-20. Moreover, even when certain expenditures cannot be allocated amongst DI-products and non-DI products, those expenditures may nonetheless be relevant to the domestic industry analysis. *Certain Variable Speed Wind Turbines & Components*, Inv. No. 337-TA-641, ID, 2009 WL 1070796, at \*4-6 (Apr. 2, 2009).

[REDACTED]

**G. Masimo Domestic Expenditures are Highly Significant**

Masimo has identified several examples demonstrating the significance of its domestic employment of labor or capital, and its domestic investment in plant and equipment, for both the Masimo Watch and the rainbow® sensors. MasimoIPHB 307-310.

In the 1065 investigation, Apple and Thomas argued that complainant Qualcomm’s DI-specific expenditures should be compared to its corporate-wide revenue. *Certain Mobile Electronic Devices*, Inv. No. 337-TA-1065, I.D., at \*113 (Sept. 28, 2018). The ALJ rejected that argument, holding that “this type of comparison [is] not required for an economic prong analysis (as it would disproportionately prejudice large, diversified companies like Qualcomm), it does nothing to show that the [] of domestically invested dollars in the DI Products are insignificant.” *Id.* Here, Apple attempts to similarly disproportionately prejudice Masimo based on its size and the fact that most of its revenues and expenditures have historically been for hospital-focused life-saving products. Apple’s argument for using such an overly-broad, inappropriate context for the significance analysis should be rejected here just as it was in the 1065 Investigation.

In rejecting Apple’s argument, the ALJ quoted the Commission’s Opinion from the 1094 Investigation, where it held that “[t]he fact that Samsung’s total sales revenues in 2010 and 2011 were much greater than its domestic engineering and R&D expenses, as Apple argues, does not negate the fact that Samsung has invested millions of dollars domestically relating to protected articles.” *Mobile Electronic Devices*, at \*113 (quoting *Certain Mobile Electronic Devices*, Inv. No. 337-TA-794, Comm’n Op. at 104 (July 5, 2013)); see *Certain Carburetors*, Inv. No. 337-TA-1123, Comm’n Op. at 28 (Oct. 28, 2019) (complainant’s sales of non-domestic industry articles irrelevant to significance).

[REDACTED]

**VIII. REMEDY AND BONDING**

Apple seeks an ongoing warranty exception to any limited exclusion order, AppleIPHB 279, but fails to disclose Apple limits its warranty to a 1-year period from purchase. *See* RX-0925.001 (warranty lasts “ONE (1) YEAR from the date of original retail purchase”); RX-0929.0002 (same); RX-0930.0003 (same). More importantly, this limited warranty gives Apple the option to *refund*, rather than replace, the product under warranty. *See* RX-0925.003 at (iii) (giving Apple the option to “exchange the Apple Product for a refund of your purchase price”); RX-0929.003 (same); RX-0930.33 (same). In similar circumstances where a refund option was available, the ITC rejected a warranty exception. *See Certain Magnetic Data Storage Tapes*, Inv. No. 337-TA-1076, Comm’n Op., 2019 WL 2635512, at \*42-43 (June 20, 2019) (noting that Respondent was “less than forthcoming by failing to explain that its warranties give it the option to provide a refund rather than replace or repair the subject product”).

Apple argues [REDACTED] consumers have made use of Apple’s service and repair programs, citing RX-0928C and Land testimony. AppleIPHB 279. But Land’s testimony does not support this. He merely explained that this exhibit listed [REDACTED]

[REDACTED]

[REDACTED]

[REDACTED] Tr. (Land) 968:20-969:1. He did not explain the service events, their categorization, or provide any context from which one could draw any conclusions from Apple’s attorney argument about [REDACTED] *Id.* Moreover, Apple’s attorney argument does not identify those

that purchased infringing watches that are now outside of Apple’s limited one-year warranty. Nor does Apple acknowledge that even [REDACTED]

[REDACTED] For example, Apple’s verified Response to the Complaint

[REDACTED]

confirms that it sold [REDACTED] of the Series 6 watch from Q42020 to Q32021, Doc. ID 751134 at Exhibit A; *see also* CX-0129C [REDACTED] CX-0134C (Series 7 sales).

Apple also seeks a certification provision for any limited exclusion order, but fails to explain why a certification would be necessary. Apple stipulated that “[a] determination in this Investigation that the Apple Watch Series 7 infringes any asserted claim of any of the patents at issue in this Investigation [REDACTED] [REDACTED] CX-1259C at ¶8.

In view of that stipulation, Apple must be [REDACTED] Apple Watch that was not disclosed in this Investigation. As Masimo pointed out in its IPHB, it is reasonable to assume that Apple has [REDACTED] [REDACTED] Tr. (Mannheimer) 1014:3-5 [REDACTED] [REDACTED] But Apple has kept the details of [REDACTED] [REDACTED] [REDACTED] as part of this Investigation and issue a determination as to whether each of them infringe. Apple has thus not provided any basis upon which to justify a certification provision. Apple should bear the risk [REDACTED] [REDACTED]

Finally, Apple suggests that Masimo cannot argue against a warranty exception under G.R. 9.2. Masimo contends the ALJ should issue an exclusion order for all infringing Watches, and its responses to Apple’s arguments are in support of that contention.

On the issue of bonding, Apple’s argument regarding lack of competition is inconsistent with its prior positions in this Investigation. In other filings, Apple argued that “Cercacor, like

[REDACTED]

Apple, sells direct-to consumer devices that measure wellness parameters (including blood oxygen)” and noted that “Masimo plans to launch a product that competes directly with the Apple Watch later this year.” Doc. ID 750872 at 4, 11.

The record also contains evidence regarding the unreliability of the Accused Products in obtaining oxygen saturation measurements. CX-1606 at 1 (“the Series 6’s blood oxygen monitor is not medically accurate”), 2 (“Someday Apple’s blood oxygen monitoring could be accurate enough to actually detect medical conditions. But right now it’s more of a gimmick than anything else.”); CX-1608 (review of Series 6 identifying “BAD STUFF” as “Blood oxygen monitoring is unreliable”).

Apple’s internal documents also reveal user concerns regarding accuracy. [REDACTED]

[REDACTED]

[REDACTED]

[REDACTED] CX-1805C at 1.

This record supports the entry of a bond to protect Masimo from injury due to any continued importation of infringing Apple Watches during the Presidential review period.

#### **IX. CONCLUSION**

The evidentiary record supports a finding that Apple violates Section 337 through its importation and sale after importation of infringing Apple Watches. Apple’s efforts to avoid a finding of infringement rest on the strained addition of multiple limitations to the claims that Apple does not apply to its invalidity defenses. Apple has not credibly challenged Masimo’s domestic industry showing in light of the investments required to develop and manufacture devices that measure oxygen saturation on the wrist.

[REDACTED]

Apple contorts the prior art in the hopes of challenging validity, but its arguments fall flat, just like Lumidigm. Apple's attempt to establish the structure and function of the Series 0 expose an evidentiary void that uncorroborated testimony cannot fill.

Apple's validity defense to the '127 Patent rests on a broad interpretation of Claim 9 that Apple does not apply for noninfringement and is inconsistent with the Patent Office's allowance over Cheung.

Masimo's engineers invented multiple features in the area of light-based physiological monitoring, and Masimo has invested heavily in those innovations in the United States. An exclusion order and cease and desist order will protect those innovations and investments from Apple's infringement.

**CERTIFICATE OF WORD COUNT**

The undersigned certifies that this brief complies with the word count requirements of Order No. 49. Specifically, this brief contains no more than 49,857 words, including footnotes and any image containing more than 20 words, but not including any image containing 20 or fewer words, the caption, the tables of contents, authorities, acronyms and abbreviations, and claim element identifiers, this word count certificate, the signature block, or the certificate of service. Masimo's initial and reply post-hearing briefs combined contain fewer than 125,000 words and, thus, comply with the word count requirements of Order No. 49.

Dated: July 11, 2022

By: /s/ Sheila N. Swaroop

Stephen C. Jensen  
Joseph R. Re  
Irfan A. Lateef  
Sheila N. Swaroop  
Ted M. Cannon  
Brian C. Claassen  
Alan G. Laquer

[REDACTED]

Kendall M. Loebbaka  
Daniel C. Kiang  
Douglas B. Wentzel  
**KNOBBE, MARTENS, OLSON & BEAR, LLP**  
2040 Main Street, Fourteenth Floor  
Irvine, CA 92614  
Telephone: (949) 760-0404  
Facsimile: (949) 760-9502

William R. Zimmerman  
Jonathan E. Bachand  
**KNOBBE, MARTENS, OLSON & BEAR, LLP**  
1717 Pennsylvania Avenue N.W., Suite 900  
Washington, DC 20006  
Telephone: (202) 640-6400  
Facsimile: (202) 640-6401

Carol Pitzel Cruz  
**KNOBBE, MARTENS, OLSON & BEAR, LLP**  
925 4th Ave., #2500  
Seattle, WA 98104  
Telephone: (206) 405-2000  
Facsimile: (206) 405 2001

Karl W. Kowallis  
Matthew S. Friedrichs  
**KNOBBE, MARTENS, OLSON & BEAR, LLP**  
1155 Avenue of the Americas  
24th Floor  
New York, NY 10036  
Telephone: (212) 849-3000  
Facsimile: (212) 849-3001

*Counsel for Complainants  
Masimo Corporation and  
Cercacor Laboratories, Inc.*

**In the Matter of Certain Light-Based Physiological Measurement Devices  
and Components Thereof  
Inv. No. 337-TA-1276**

**CERTIFICATE OF SERVICE**

The undersigned hereby certifies that on July 25, 2022, I caused copies of the foregoing document to be filed and served as indicated below:

Secretary – U.S. International Trade Commission	
The Honorable Lisa R. Barton Secretary to the Commission U.S. International Trade Commission 500 E Street, SW, Room 112 Washington, DC 20436	<input checked="" type="checkbox"/> Via Electronic Filing [EDIS]
Administrative Law Judge – U.S. International Trade Commission	
The Honorable Monica Bhattacharyya U.S. International Trade Commission 500 E Street, S.W., Room 317 Washington, D.C. 20436	<input checked="" type="checkbox"/> Via E-mail to <a href="mailto:edward.jou@usitc.gov">edward.jou@usitc.gov</a> ; <a href="mailto:michael.maas@usitc.gov">michael.maas@usitc.gov</a> ; and <a href="mailto:Bhattacharyya337@usitc.gov">Bhattacharyya337@usitc.gov</a>
Counsel for Respondent Apple, Inc.	
Michael Esch David Cavanaugh <b>WILMER CUTLER PICKERING HALE AND DORR LLP</b> 1875 Pennsylvania Avenue, NW Washington, DC 20006	<input checked="" type="checkbox"/> Via E-mail to WApple- <a href="mailto:Masimo1276ServiceList@wilmerhale.com">Masimo1276ServiceList@wilmerhale.com</a>
Mark Selwyn <b>WILMER CUTLER PICKERING HALE AND DORR LLP</b> 2600 El Camino Real Suite 400 Palo Alto, California 94306	
Joseph Mueller Richard Goldenberg Sarah Frazier <b>WILMER CUTLER PICKERING HALE AND DORR LLP</b> 60 State Street Boston, Massachusetts 02109	



July 25, 2022

/s/ Claire A. Stoneman  
Claire A. Stoneman  
Litigation Paralegal  
Knobbe, Martens, Olson & Bear, LLP