



US006477164B1

(12) **United States Patent**  
**Vargo et al.**

(10) **Patent No.:** **US 6,477,164 B1**  
(45) **Date of Patent:** **Nov. 5, 2002**

(54) **SYSTEM AND METHOD FOR REAL-TIME DATA AND VOICE TRANSMISSION OVER AN INTERNET NETWORK**

5,774,469 A \* 6/1998 Wirkestrand ..... 370/473  
5,930,265 A \* 7/1999 Duault et al. .... 370/473  
6,304,550 B1 \* 10/2001 Fox ..... 370/393

(75) Inventors: **Michael F. Vargo**, San Carlos, CA (US); **Maxim Ladonnikov**, Sunnyvale, CA (US)

\* cited by examiner

(73) Assignee: **Clarent Corporation**, Redwood City, CA (US)

*Primary Examiner*—Huy D. Vu  
*Assistant Examiner*—Steven Nguyen  
(74) *Attorney, Agent, or Firm*—Carr & Ferrell LLP

(\*) Notice: Subject to any disclaimer, the term of this patent is extended or adjusted under 35 U.S.C. 154(b) by 0 days.

(57) **ABSTRACT**

A system and method is disclosed for real-time data and voice transmission over an internet network. A PSTN voice packet is received and digitized at a network gateway. A destination gateway and destination transmux is identified and a destination gateway address and a destination transmux address are appended to the digitized voice packet. The voice packet is received at an originating transmux and broken into gateway subpackets. The gateway subpackets are aggregated and the destination transmux address is removed from the gateway subpackets. The transmux voice packets are then transmitted over the network to a destination transmux, where they are broken into transmux subpackets. The subpackets are sorted and aggregated by a destination gateway address, and the destination gateway addresses are then removed. Voice packets are received from the destination transmux by a destination gateway and converted to analog voice packets and transmitted to a destination PSTN.

(21) Appl. No.: **09/130,896**

(22) Filed: **Aug. 7, 1998**

**Related U.S. Application Data**

(60) Provisional application No. 60/079,659, filed on Mar. 27, 1998.

(51) **Int. Cl.**<sup>7</sup> ..... **H04L 12/66**; H04L 12/28; H04J 3/24

(52) **U.S. Cl.** ..... **370/356**; 370/474; 370/401; 370/389

(58) **Field of Search** ..... 370/352, 353, 370/354, 355, 356, 473, 474, 475, 476, 477, 401, 402, 400, 389, 428, 429, 471, 393

(56) **References Cited**

**U.S. PATENT DOCUMENTS**

5,748,613 A \* 5/1998 Kilk et al. .... 370/473

**18 Claims, 7 Drawing Sheets**

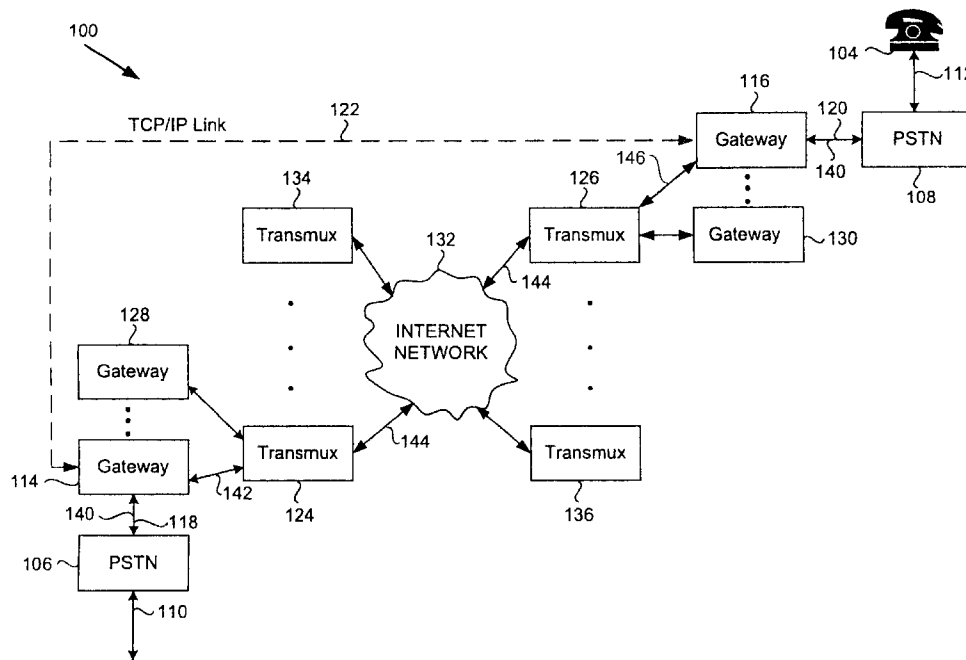

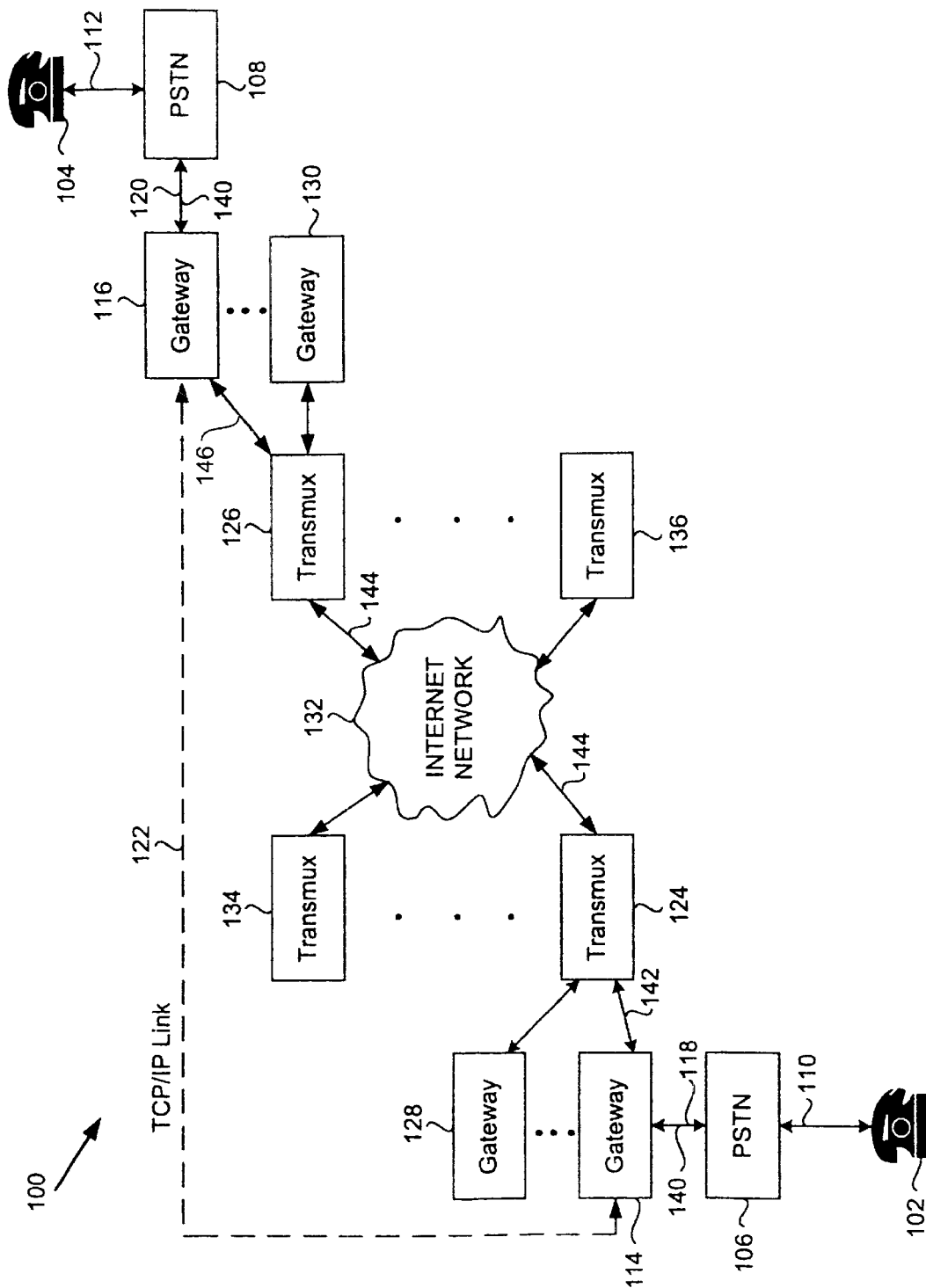

FIG. 1

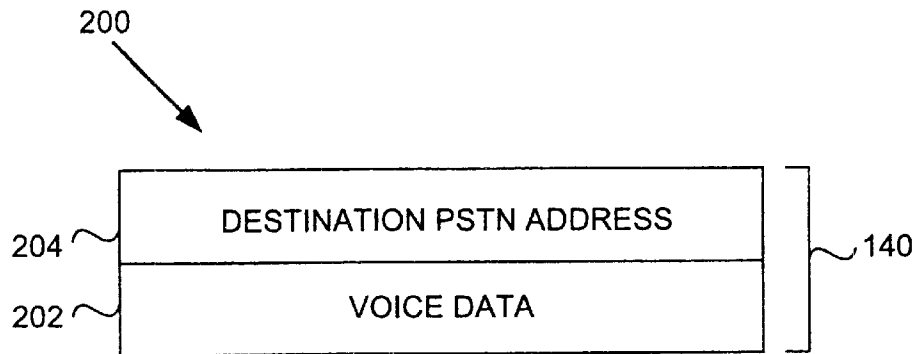

FIG. 2

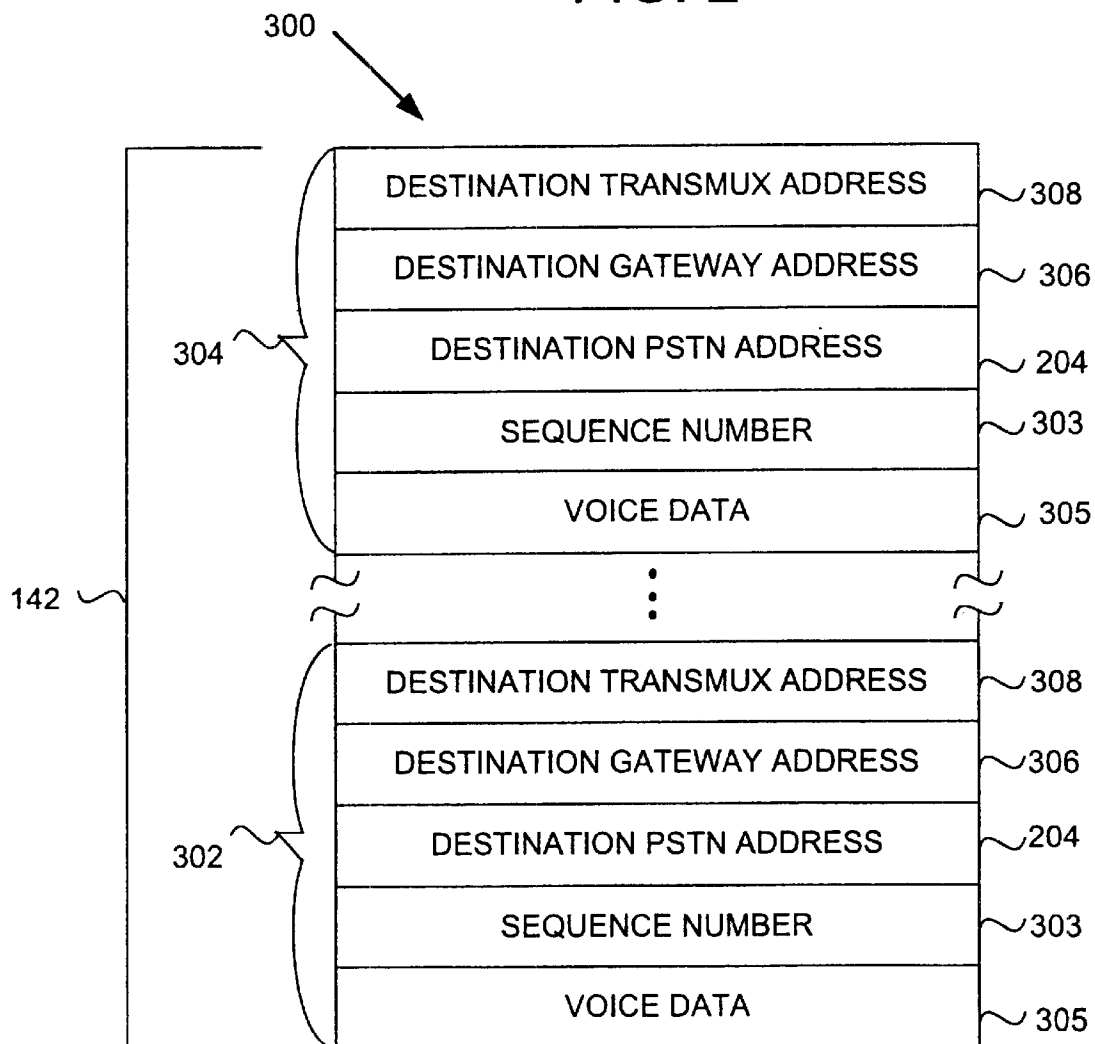

FIG. 3

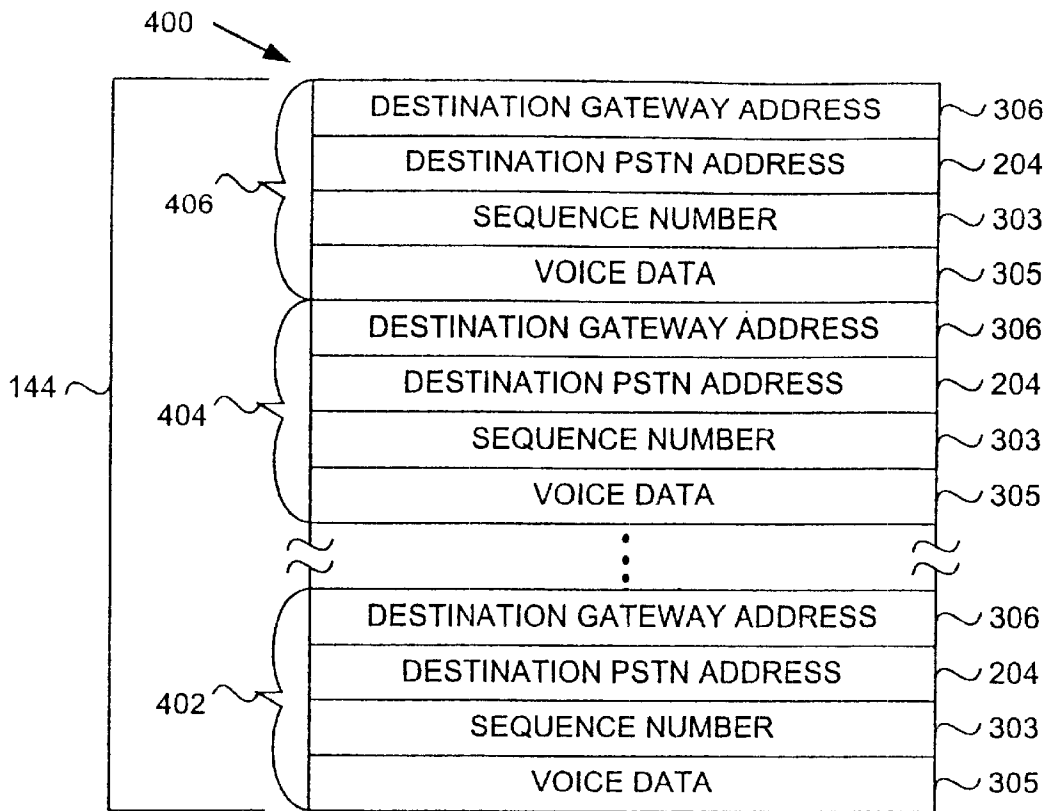

FIG. 4

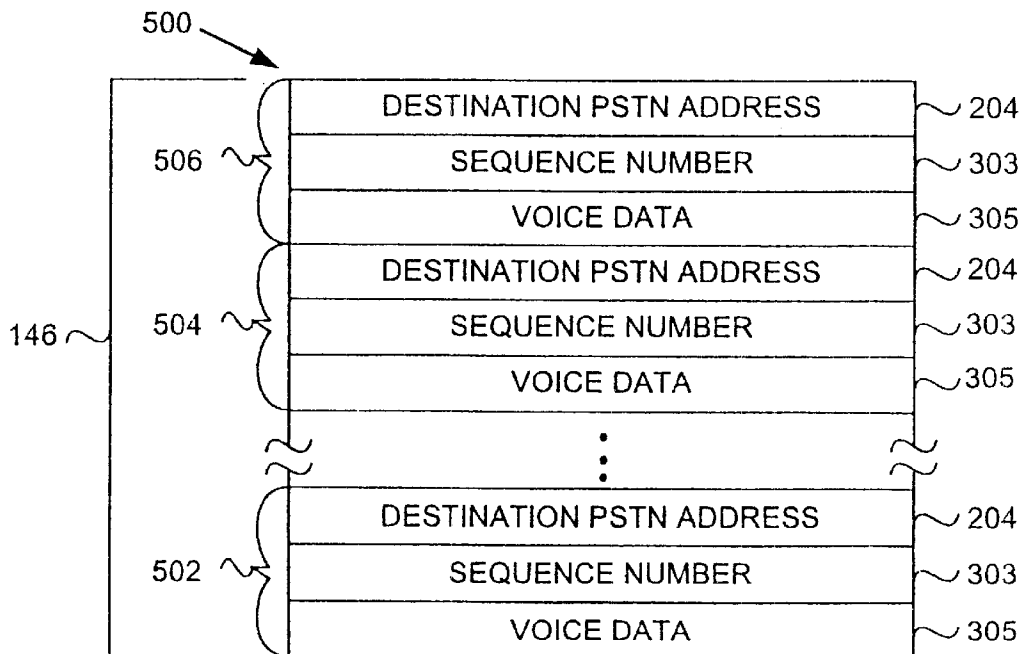

FIG. 5

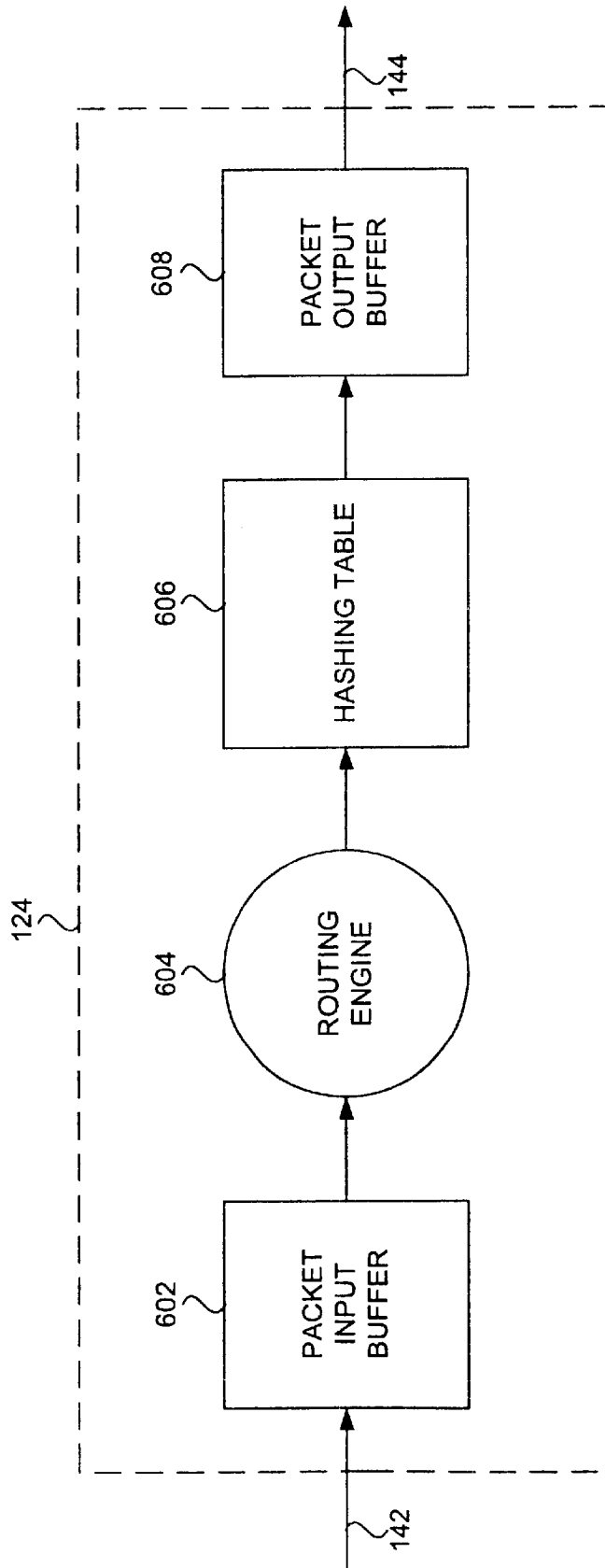

FIG. 6

# Explore Litigation Insights

Docket Alarm provides insights to develop a more informed litigation strategy and the peace of mind of knowing you're on top of things.

## Real-Time Litigation Alerts



Keep your litigation team up-to-date with **real-time alerts** and advanced team management tools built for the enterprise, all while greatly reducing PACER spend.

Our comprehensive service means we can handle Federal, State, and Administrative courts across the country.

## Advanced Docket Research



With over 230 million records, Docket Alarm's cloud-native docket research platform finds what other services can't. Coverage includes Federal, State, plus PTAB, TTAB, ITC and NLRB decisions, all in one place.

Identify arguments that have been successful in the past with full text, pinpoint searching. Link to case law cited within any court document via Fastcase.

## Analytics At Your Fingertips



Learn what happened the last time a particular judge, opposing counsel or company faced cases similar to yours.

Advanced out-of-the-box PTAB and TTAB analytics are always at your fingertips.

## API

Docket Alarm offers a powerful API (application programming interface) to developers that want to integrate case filings into their apps.

## LAW FIRMS

Build custom dashboards for your attorneys and clients with live data direct from the court.

Automate many repetitive legal tasks like conflict checks, document management, and marketing.

## FINANCIAL INSTITUTIONS

Litigation and bankruptcy checks for companies and debtors.

## E-DISCOVERY AND LEGAL VENDORS

Sync your system to PACER to automate legal marketing.