



US 20110208659A1

(19) **United States**

(12) **Patent Application Publication**
Easterly et al.

(10) **Pub. No.: US 2011/0208659 A1**

(43) **Pub. Date: Aug. 25, 2011**

(54) **METHOD AND APPARATUS FOR MAKING SECURE TRANSACTIONS USING AN INTERNET ACCESSIBLE DEVICE AND APPLICATION**

(60) Provisional application No. 61/331,469, filed on May 5, 2010, provisional application No. 60/913,964, filed on Apr. 25, 2007, provisional application No. 60/915,139, filed on May 1, 2007.

(75) Inventors: **Frank Easterly**, Midlothian, VA (US); **Clifford Mason**, Columbus, GA (US)

Publication Classification

(51) **Int. Cl.**
G06Q 20/00 (2006.01)

(73) Assignee: **Last Mile Technologies, LLC**, Richmond, VA (US)

(52) **U.S. Cl.** **705/79**

(21) Appl. No.: **13/101,317**

(57) **ABSTRACT**

(22) Filed: **May 5, 2011**

A method for making financial transactions uses a proprietary server and network in communication with a merchant's point of sale (POS) terminal and a customer's smart phone. The smart phone runs an application that generates or downloads from the server a two dimensional barcode containing encrypted information. The barcode display is scanned at the POS, and transaction information is returned to the proprietary server for processing as an ACH or a conventional transaction.

Related U.S. Application Data

(63) Continuation-in-part of application No. 12/109,960, filed on Apr. 25, 2008, which is a continuation-in-part of application No. 11/464,694, filed on Aug. 15, 2006, now abandoned.

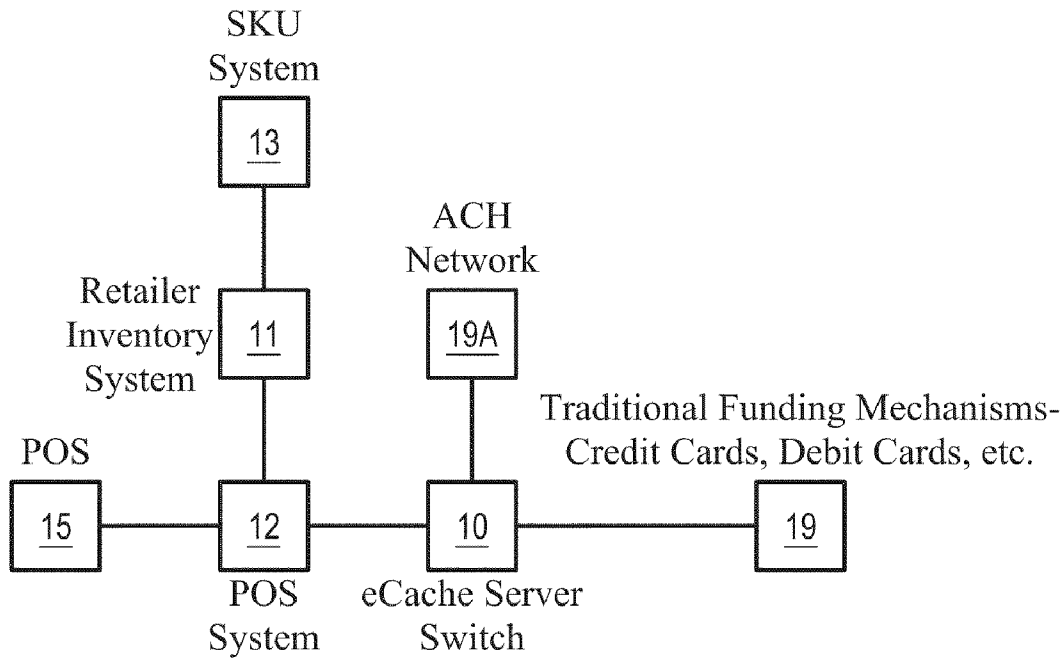

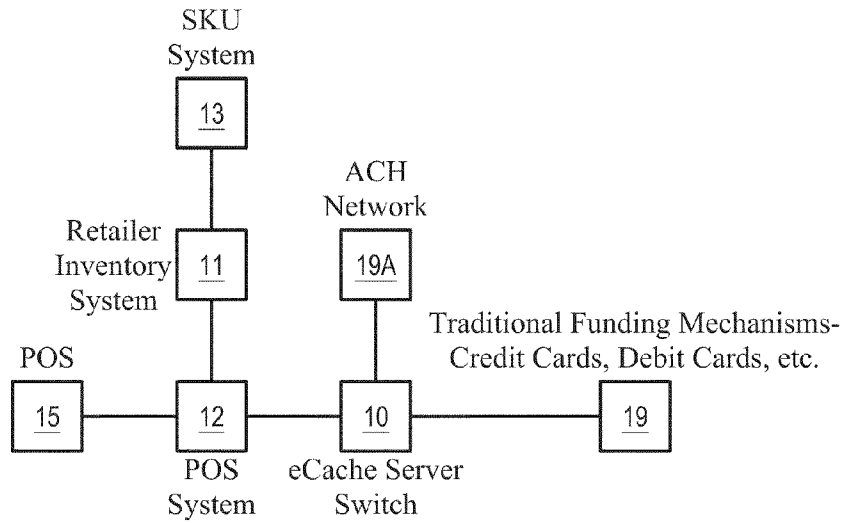
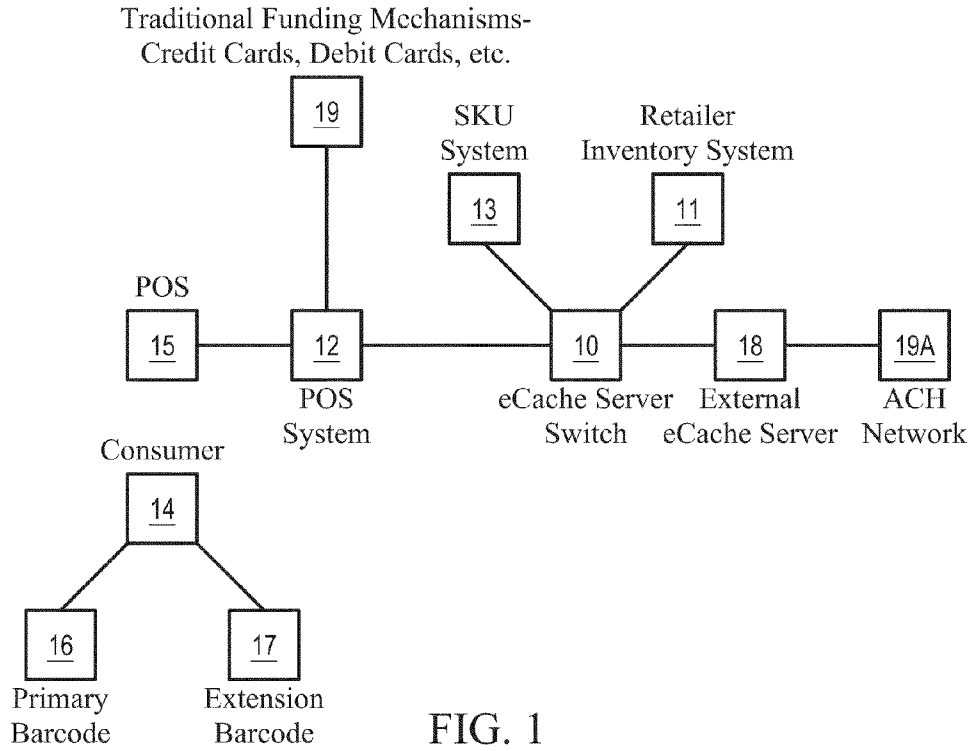

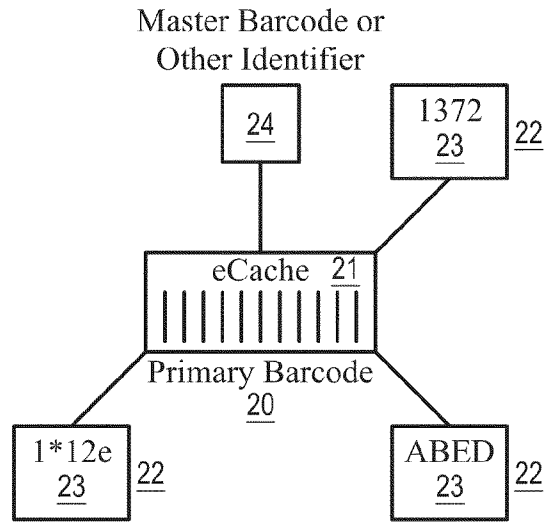

FIG. 2

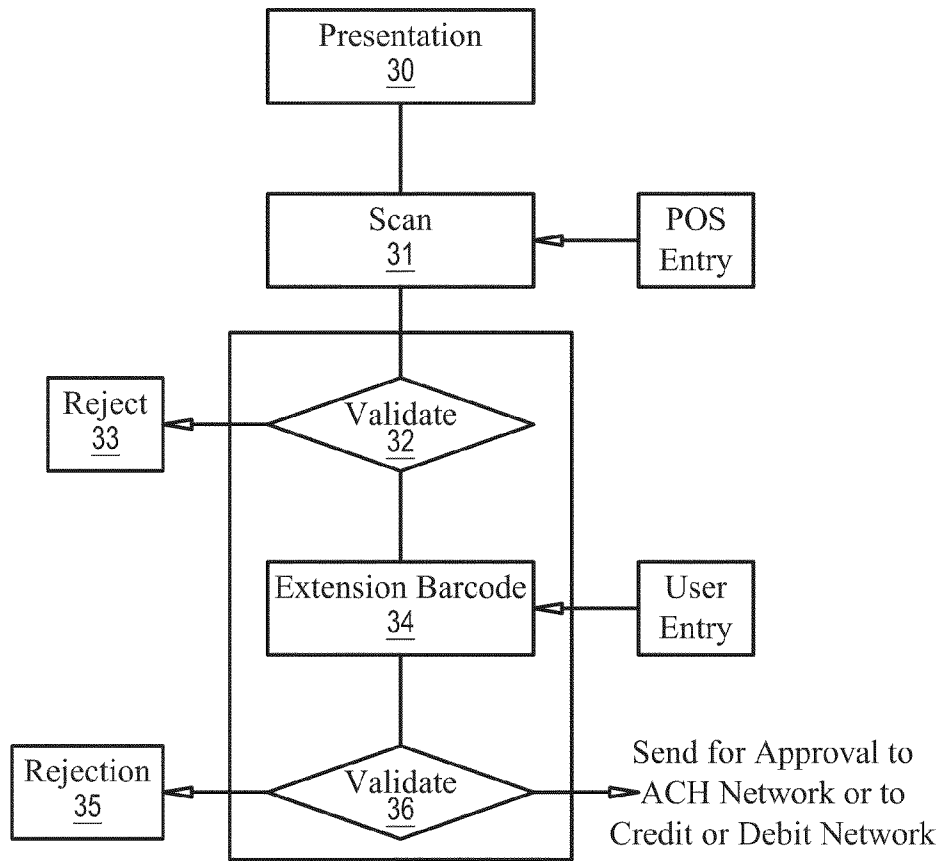

FIG. 3

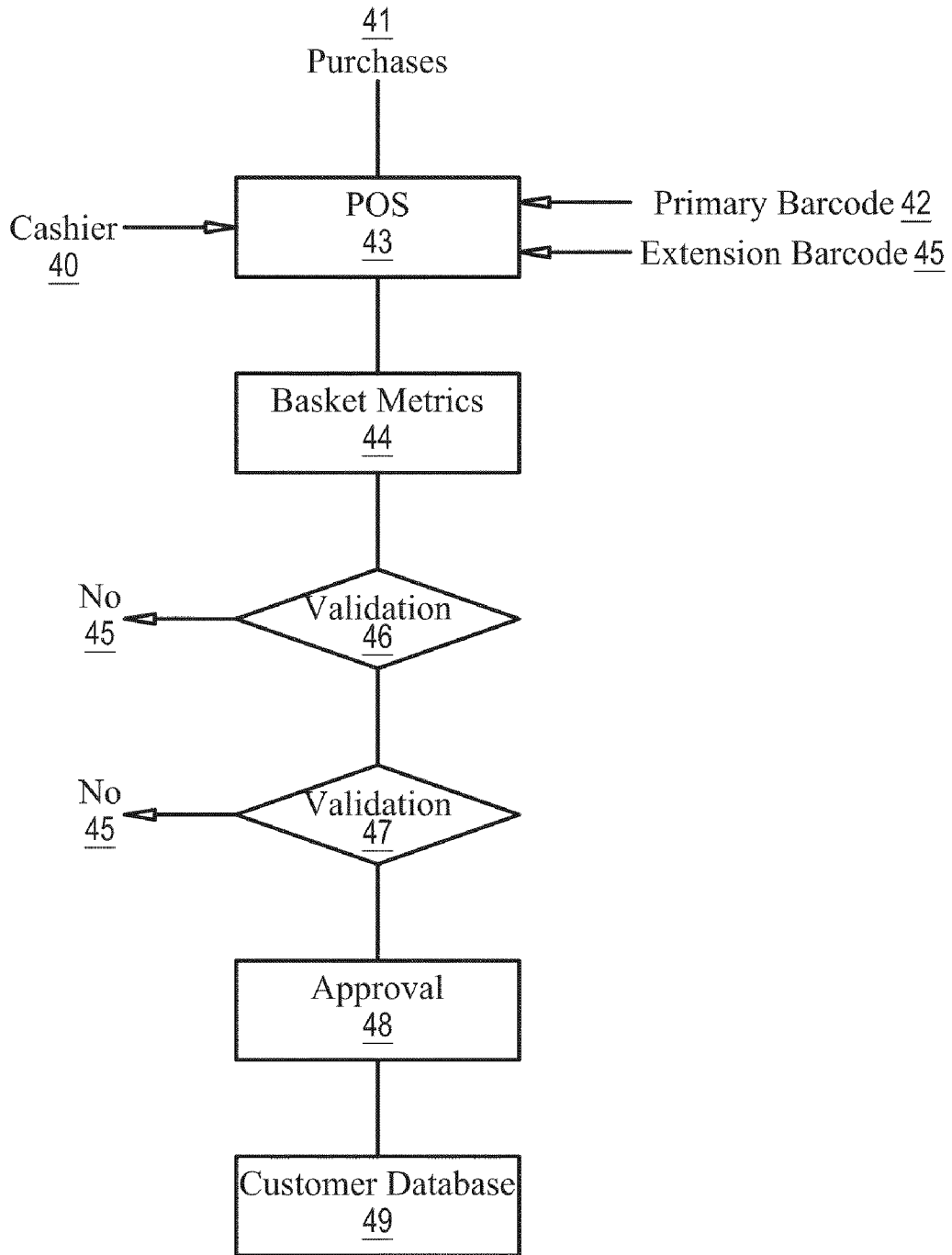

FIG. 4

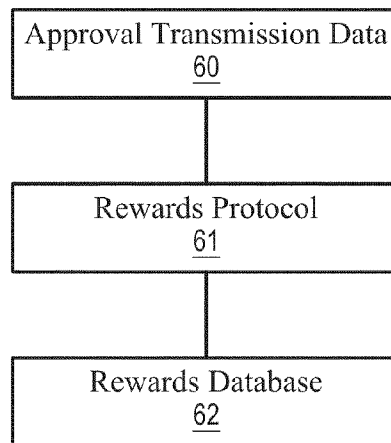
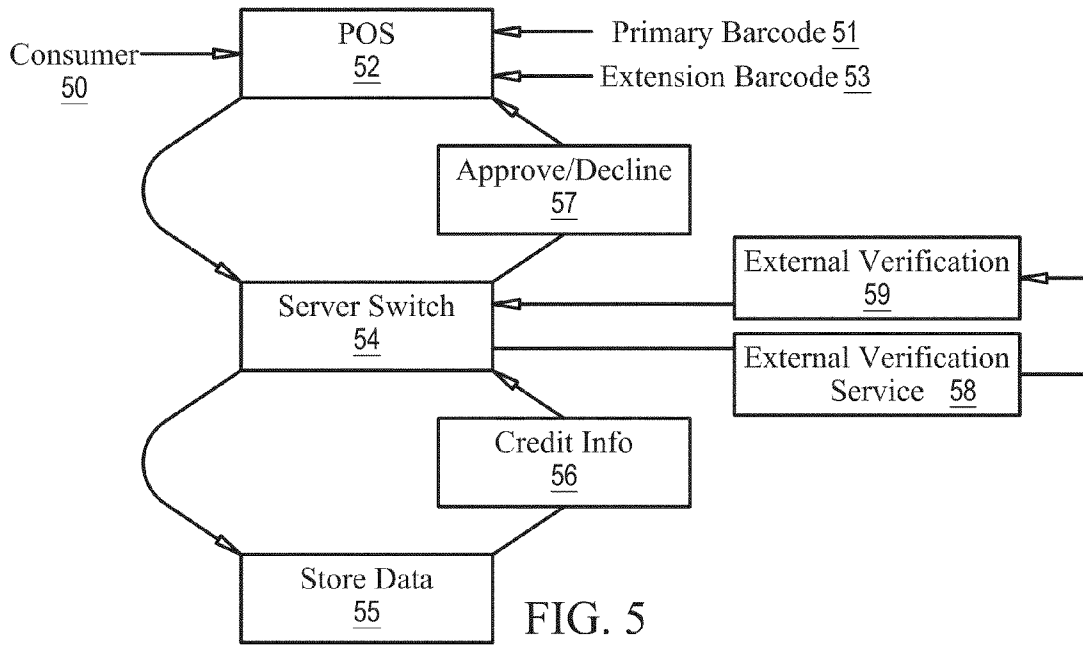

FIG. 6

Explore Litigation Insights

Docket Alarm provides insights to develop a more informed litigation strategy and the peace of mind of knowing you're on top of things.

Real-Time Litigation Alerts



Keep your litigation team up-to-date with **real-time alerts** and advanced team management tools built for the enterprise, all while greatly reducing PACER spend.

Our comprehensive service means we can handle Federal, State, and Administrative courts across the country.

Advanced Docket Research



With over 230 million records, Docket Alarm's cloud-native docket research platform finds what other services can't. Coverage includes Federal, State, plus PTAB, TTAB, ITC and NLRB decisions, all in one place.

Identify arguments that have been successful in the past with full text, pinpoint searching. Link to case law cited within any court document via Fastcase.

Analytics At Your Fingertips



Learn what happened the last time a particular judge, opposing counsel or company faced cases similar to yours.

Advanced out-of-the-box PTAB and TTAB analytics are always at your fingertips.

API

Docket Alarm offers a powerful API (application programming interface) to developers that want to integrate case filings into their apps.

LAW FIRMS

Build custom dashboards for your attorneys and clients with live data direct from the court.

Automate many repetitive legal tasks like conflict checks, document management, and marketing.

FINANCIAL INSTITUTIONS

Litigation and bankruptcy checks for companies and debtors.

E-DISCOVERY AND LEGAL VENDORS

Sync your system to PACER to automate legal marketing.