

are inhibitors of neprilysin are useful analgesic agents which can be administered with the GCC agonists described herein or covalently linked to a GCC agonist to form a therapeutic conjugate. Sialorphin and related polypeptides are described in U.S. Patent 6,589,750; U.S. 20030078200 A1; and WO 02/051435 A2.

[197] In another embodiment, a GCC agonist formulation of the invention is administered as part of a regimen of combination therapy with an opioid receptor antagonist or agonist. In one embodiment, the GCC agonist and the opioid receptor antagonist or agonist are linked via a covalent bond. Non-limiting examples of opioid receptor antagonists include naloxone, naltrexone, methyl naloxone, nalmefene, cypridime, beta funaltrexamine, naloxonazine, naltrindole, nor-binaltorphimine, enkephalin pentapeptide (HOE825; Tyr-D-Lys-Gly-Phe-L-homoserine; SEQ ID NO:258), trimebutine, vasoactive intestinal polypeptide, gastrin, glucagons. Non-limiting examples of opioid receptor agonists include fedotozine, asimadoline, and ketocyclazocine, the compounds described in WO03/097051 and WO05/007626, morphine, diphenyloxylate, frakefamide (H-Tyr-D-Ala-Phe(F)-Phe-NH₂; SEQ ID NO:259; WO 01/019849 A1), and loperamide.

[198] Further non-limiting examples of analgesic agents that can be used in a regimen of combination therapy along with the GCC agonist formulations of the invention include the dipeptide Tyr-Arg (kyotorphin); the chromogranin-derived polypeptide (CgA 47-66; *See, e.g.*, Ghia et al. 2004 Regulatory polypeptides 119:199); CCK receptor agonists such as caerulein; conotoxin polypeptides; peptide analogs of thymulin (FR Application 2830451); CCK (CCKa or CCKb) receptor antagonists, including loxiglumide and dexloxiglumide (the R- isomer of loxiglumide) (WO 88/05774); 5-HT₄ agonists such as tegaserod (Zelnorm®), mosapride, metoclopramide, zacopride, cisapride, renzapride, benzimidazolone derivatives such as BIMU 1 and BIMU 8, and lorexapride; calcium channel blockers such as ziconotide and related compounds described in, for example, EP625162B1, US 5,364,842, US 5,587,454, US 5,824,645, US 5,859,186, US 5,994,305, US 6,087,091, US 6,136,786, WO 93/13128 A1,

EP 1336409 A1, EP 835126 A1, EP 835126 B1, US 5,795,864, US 5,891,849, US 6,054,429, WO 97/01351 A1; NK-1, receptor antagonists such as aprepitant (Merck & Co Inc), vofopitant, ezlopitant (Pfizer, Inc.), R-673 (Hoffmann-La Roche Ltd), SR-48968 (Sanofi Synthelabo), CP-122,721 (Pfizer, Inc.), GW679769 (Glaxo Smith Kline), TAK-637 (Takeda/Abbot), SR-14033,

and related compounds described in, for example, EP 873753 A1, US 20010006972 A1, US 20030109417 A1, WO 01/52844 A1 (for a review see Giardina et al. 2003. *Drugs* 6:758); NK-2 receptor antagonists such as nepadutant (Menarini Ricerche SpA), saredutant (Sanofi-Synthelabo), GW597599 (Glaxo Smith Kline), SR-144190 (Sanofi-Synthelabo) and UK-290795 (Pfizer Inc); NK3 receptor antagonists such as osanetant (SR-142801; Sanofi-Synthelabo), SSR-241586, talnetant and related compounds described in, for example, WO 02/094187 A2, EP 876347 A1, WO 97/21680 A1, US 6,277,862, WO 98/1 1090, WO 95/28418, WO 97/19927, and Boden et al. (*J Med Chem.* 39:1664-75, 1996); norepinephrine-serotonin reuptake inhibitors (NSRI) such as milnacipran and related compounds described in WO 03/077897; and vanilloid receptor antagonists such as arvanil and related compounds described in WO 01/64212 A1.

[199] In addition to sialorphin-related polypeptides, analgesic polypeptides include: AspPhe, endomorphin-1, endomorphin-2, nocistatin, dalargin, lupron, ziconotide, and substance P.

EXAMPLES

Example 1: Synthesis and Purification of GCC Agonist Peptides

[200] The GCC agonist peptides were synthesized using standard methods for solid-phase peptide synthesis. Either a Boc/Bzl or Fmoc/tBu protecting group strategy was selected depending upon the scale of the peptide to be produced. In the case of smaller quantities, it is possible to get the desired product using an Fmoc/tBu protocol, but for larger quantities (1 g or more), Boc/Bzl is superior.

[201] In each case the GCC agonist peptide was started by either using a pre-loaded Wang (Fmoc) or Merrifield (Boc) or Pam (Boc) resin. For products with C-terminal Leu, Fmoc-Leu-Wang (D-1115) or Boc-Leu-Pam resin (D-1230) or Boc-Leu-Merrifield (D-1030) Thus, for peptides containing the C-terminal d-Leu, the resin was Fmoc-dLeu-Wang Resin (D-2535) and Boc-dLeu-Merrifield, Boc-dLeu-Pam-Resin (Bachem Product D-1230 and D-1590, respectively) (SP-332 and related analogs). For peptides produced as C-terminal amides, a resin with Ramage

linker (Bachem Product D-2200) (Fmoc) or mBHA (Boc) (Bachem Product D-1210) was used and loaded with the C-terminal residue as the first synthetic step.

Fmoc-tBu Overview

[202] Each synthetic cycle consisted of deprotection with 20% piperidine in DMF. Resin washes were accomplished with alternating DMF and IpOH to swell and shrink the resin, respectively. Peptide synthesis elongated the chain from the C-terminus to the N-terminus. Activation chemistry for each amino acid was with HBTU/DIEA in a 4 fold excess for 45 minutes. In automated chemistries, each amino acid was double coupled to maximize the coupling efficiency. To insure the correct position of disulfide bonds, the Cys residues were introduced as Cys (Acm) at positions 15 and 7. Cys (Trt) was positioned at Cys4 and Cys12. This protecting group strategy yields the correct topoisomer as the dominant product (75:25). (For enterotoxin analogs, a third disulfide bond protecting group (Mob) was utilized).

[203] For peptides containing C-terminal Aeea (aminoethoxyethoxyacetyl) groups, these were coupled to a Ramage amide linker using the same activation chemistry above by using an Fmoc-protected Aeea derivative. The Cys numbering in these cases remains the same and the positioning of the protecting groups as well. For the peptides containing the N-terminal extension of Aeea, the Cys residue numbering will be increased by three: Cys4 becomes Cys7, Cys12 becomes Cys15; Cys7 becomes Cys10 and Cys 15 becomes Cys18. The latter pair is protected with Acm and the former pair keeps the Trt groups.

[204] For analogs containing D-amino acid substitutions, these were introduced directly by incorporating the correctly protected derivative at the desired position using the same activation chemistry described in this document. For Fmoc strategies, Fmoc-dAsn(Trt)-OH, Fmoc-dAsn(Xan)-OH, Fmoc-dAsp(tBu)-OH, Fmoc-dGlu(tBu)-OH and for Boc strategies, Boc-dAsn(Xan)-OH, Boc-dAsn(Trt)-OH, Boc-dAsp(Chx), Boc-dAsp(Bzl)-OH, Boc-dGlu(Chx)-OH and Boc-dGlu(Bzl)-OH would be utilized.

[205] Each peptide is cleaved from the solid-phase support using a cleavage cocktail of TFA:H₂O:Tris(isopropyl)silane (8.5:0.75:0.75) ml/g of resin for 2 hr at RT. The crude deprotected peptide is filtered to remove the spent resin beads and precipitated into ice-cold diethylether.

[206] Each disulfide bonds was introduced orthogonally. Briefly, the crude synthetic product was dissolved in water containing NH_4OH to increase the pH to 9. Following complete solubilization of the product, the disulfide bond was made between the Trt deprotected Cys residues by titration with H_2O_2 . The monocyclic product was purified by RP-HPLC. The purified mono-cyclic product was subsequently treated with a solution of iodine to simultaneously remove the Acn protecting groups and introduce the second disulfide bond.

[207] For enterotoxin analogs, the Mob group was removed via treatment of the dicyclic product with TFA 85% containing 10% DMSO and 5% thioanisole for 2 hr at RT.

[208] Each product was then purified by RP-HPLC using a combination buffer system of TEAP in H_2O versus MeCN, followed by TFA in H_2O versus MeCN. Highly pure fractions were combined and lyophilized. The final product was converted to an Acetate salt using either ion exchange with Acetate loaded Dow-Ex resin or using RP-HPLC using a base-wash step with NH_4OAc followed by 1% AcOH in water versus MeCN.

[209] It is also possible to prepare enterotoxin analogs using a random oxidation methodology using Cys(Trt) in Fmoc or Cys(MeB) in Boc. Following cleavage, the disulfide bonds can be formed using disulfide interchange redox pairs such as glutathione (red/ox) and/or cysteine/cystine. This process will yield a folded product that the disulfide pairs must be determined as there would be no way of knowing their position directly.

Boc-Bzl Process

[210] Peptide synthesis is initiated on a Merrifield or Pam pre-loaded resin or with mBHA for peptides produced as C-terminal amides. Each synthetic cycle consists of a deprotection step with 50% TFA in MeCl_2 . The resin is washed repetitively with MeCl_2 and MeOH. The TFA salt formed is neutralized with a base wash of 10% TEA in MeCl_2 . The resin is washed with MeCl_2 and MeOH and lastly with DMF prior to coupling steps. A colorimetric test is conducted to ensure deprotection. Each coupling is mediated with diisopropyl carbodiimide with HOBT to form the active ester. Each coupling is allowed to continue for 2 hr at RT or overnight on difficult couplings. Recouplings are conducted with either Uronium or Phosphonium reagents until a negative colorimetric test is obtained for free primary amines. The

resin is then washed with DMF, MeCl₂ and MeOH and prepared for the next solid-phase step. Cys protection utilizes Cys(Acm) at positions 7 and 15, and Cys(MeB) at Cys 4 and Cys12.

[211] Cleavage and simultaneous deprotection is accomplished by treatment with HF using anisole as a scavenger (9:1:1) ml:ml:g (resin) at 0°C for 60 min. The peptide is subsequently extracted from the resin and precipitated in ice cold ether. The introduction of disulfide bonds and purification follows the exact same protocol described above for the *Fmoc-produced* product.

Example 2: *In vitro* Biological and Chemical Stability of SP-304 after Incubation in Simulated Gastric Fluid (SGF)

[212] The stability of SP-304 in the presence of simulated gastric fluid (SGF) was determined by biological activity measurements and HPLC analyses (Figs. 1A & 1B). SP-304 (final concentration of 8.5 mg/ml) was incubated in SGF (Proteose peptone (8.3 g/liter; Difco), D-Glucose (3.5 g/liter; Sigma), NaCl (2.05 g/liter; Sigma), KH₂PO₄ (0.6 g/liter; Sigma), CaCl₂ (0.11 g/liter), KCl (0.37 g/liter; Sigma), Porcine bile (final 1 X concentration 0.05 g/liter; Sigma) in PBS, Lysozyme (final 1 X concentration 0.10 g/liter; Sigma) in PBS, Pepsin (final 1 X concentration 0.0133 g/liter; Sigma) in PBS). SGF was made on the day of the experiment and the pH was adjusted to 2.0 ± 0.1 using HCl or NaOH as necessary. After the pH adjustment, SGF is filter sterilized with 0.22 µm membrane filters. SP-304 (final concentration of 8.5 mg/ml) was incubated in SGF at 37°C for 0, 15, 30, 45, 60 and 120 min, respectively, in triplicate aliquots. Following incubations, samples were snap frozen in dry ice then stored in a -80°C freezer until assayed in duplicate.

[213] Figure 1A shows a bar chart showing the biological activity of SP-304 after incubation with SGF for times as indicated. The activity at 0 min was taken as 100%. The data are an average of triplicates ± SD for each data point. The data demonstrate that SP-304 is resistant to breakdown in SGF for incubations lasting as long as two hours. In addition, the data also suggest that the activity of SP-304 is unaltered by exposure to the acidic pH of the SGF.

[214] The HPLC chromatograms of samples of SP-304 incubated in SGF for 0 and 120 min are shown in Fig. 1B. Here, aliquots of the two samples were analyzed by HPLC using a

previously developed method for analyzing SP-304 peptide. Samples from the SGF incubations were diluted to give a final concentration 0.17 mg/mL of SP-304. The major peak of SP-304 did not change following incubation with SGF, indicating that the peptide was resistant to SGF treatment.

Example 3: *In vitro* Biological and Chemical Stability of SP-304 after Incubation in Simulated Intestinal Fluid (SIF)

[215] The stability of SP-304 was also evaluated after incubation with simulated intestinal fluid (SIF) by measuring its biological activity and by HPLC analyses (Figs. 2A & 2B). SIF solution was prepared by the method as described in the United States Pharmacopoeia, 24th edition, p2236. The recipe to prepare SIF solution was as described below. The SIF solution contained NaCl (2.05 g/liter; Sigma), KH_2PO_4 (0.6 g/liter; Sigma), CaCl_2 (0.11 g/liter), KCl (0.37 g/liter; Sigma), and Pancreatin 10 mg/ml. The pH was adjusted to 6 and the solution was filter sterilized. A solution of SP-304 (8.5 mg/ml) was incubated in SGF at 37°C for 0, 30, 60, 90, 120, 150 and 300 min respectively, in triplicate aliquots. Following incubations, samples were removed and snap frozen with dry ice and stored in a -80°C freezer until assayed in duplicate. Figure 2A is a bar chart showing the ability of SP-304, after incubation in SIF for times as indicated, to stimulate cGMP synthesis in T84 cells. The cGMP stimulation activity at 0 min was taken as 100%. The data are an average of 3 triplicates \pm SD. The data indicated that the biological activity of SP-304 is reduced by about 30% following incubation in SIF for 300 min.

[216] The physical stability of SP-304 peptide exposed to SIF was evaluated by HPLC using the method described for SGF digestion. Figure 2B shows HPLC chromatograms for SP-304 after incubation with heat-inactivated SIF for 300 min, and SIF for 120 min, respectively. SP-304 treated with heat-inactivated SIF remained intact (Note: the major peak of SP-304 eluting at 16.2 min), whereas SP-304 treated with SIF for 120 min was completely converted into another peak eluting at 9.4 min plus a few minor additional peaks.

[217] Figure 3 is a schematic representation of the possible metabolites of SP-304. The major degradation products involve Asn and Asp clipped from the N-terminus and Leu from the

C-terminus of SP304. The fact that only 30% reduction in biological activity was observed even after 2 hours incubation in SIF implies that one or more of the degradation products observed in Fig. 2B are also biologically active. To address this possibility, several truncated peptides were synthesized and evaluated for their abilities to stimulate cGMP synthesis in T84 cells (Figure 4).

[218] Figure 4 shows data from the analyses of various peptides in the T84 cell cGMP stimulation assay (essentially as described in Shailubhai, *et al.*, *Cancer Research* 60, 5151-5157 (2000) . Briefly, confluent monolayers of T-84 cells in 24-well plates were washed twice with 250 μ l of DMEM containing 50 mM HEPES (pH 7.4) and pre-incubated at 37°C for 10 minutes with 250 μ l of DMEM containing 50 mM HEPES (pH 7.4) and 1 mM isobutyl methylxanthine (IBMX). Monolayers of T84 cells were then incubated with 250 μ l of DMEM containing 50 mM HEPES (pH 7.4) containing one of the peptides shown in the Figure 4 at a concentration of 1.0 μ M for 30 min. After the 30 min incubation, the medium was aspirated and the reaction was terminated by the addition of 3% perchloric acid. Following centrifugation and the addition of NaOH (0.1 N) to neutralize the pH, intracellular cGMP levels were determined in lysates using a cGMP ELISA kit (Cat. No. 581021 ; Cayman Chemical, Ann Arbor, MI). Peptide incubations were run in duplicate, and samples taken from each incubation were run as duplicates in the ELISA test.

[219] The data indicate that SP-338, the 15-mer peptide missing the leucine (L) residue at the C-terminus of SP-304, retains about 80% of the biological activity of the full length 16-mer SP-304 peptide. Thus, the C-terminal Leu clearly does make some contribution to the biological potency of the peptide. Similarly, peptides SP-327, SP-329 and SP-331, which are all missing their C-terminal Leu, also showed a 20-25% reduction in biological potency relative to their counterpart parent peptides SP-326, SP-328 and SP-330, respectively. In addition, the data also suggest that amino acid residues at the N-terminus may also contribute to the stability and/or potency of the peptides. Several additional peptides were synthesized with D-forms of amino acids replacing the corresponding L-forms at the C- and N-termini of the peptides. These peptides were evaluated for their abilities to stimulate cGMP synthesis in T84 cells as shown in Figure 5.

[220] The results presented in Figure 5 indicate that substitution of L-amino acids with D-amino acids at the C- and N-termini did not significantly alter their potency relative to SP-304. Peptides SP-332, SP-333 and SP-335 all showed comparable ability to stimulate cGMP synthesis in T84 cells. These results suggest that the amino acid residues Asn, Asp and Glu at the N-terminus and Leu at the C-terminus can be replaced with their respective D-amino acid forms. On the other hand, substitution of L-leucine with D-leucine at the 6th position (SP-337) resulted in virtually complete loss of biological activity.

[221] Figure 7 (A-F) shows the stabilities of peptides SP-332, SP-333 and SP-304 when incubated in SIF for two hours. The results demonstrate that SP-333, which has D-Asn at the N-terminus and D-Leu at the C-terminus, remained virtually 100% biologically active after a two hour incubation in SIF (Figure 7A), and remained virtually intact to digestion with SIF after two hours (Figs. 7F-1 & 7F-2). Subsequent incubation studies with SP-333 performed in SIF for up to 24 hours indicate that there is very little degradation even after 24 hours in SIF (Fig. 7G). The data indicated that SP-333 is stable against digestion with SIF for up to 24 hours. Peptide SP-332 with D-Leu at the C-terminus showed a minor reduction in potency following the 120 min incubation with SIF (Figure 7B). Interestingly, the HPLC analyses of SP-332 did not reveal any clear-cut degradation of the peptide (Figure 7E-1 & 7E2), also suggesting that this peptide is also almost completely resistant to proteolysis by SIF during the 2-hr incubation. On the other hand, peptide SP-304 lost about 30% of its potency following digestion with SIF for just one hour (Figure 7C). The HPLC analysis of SP-304 following SIF incubation confirmed its degradation (Figure 7D-1 & 7D-2). These results suggest that SP-304 undergoes substantial proteolysis following incubation with SIF within one hour.

Example 4: Cyclic GMP Stimulation Assays

[222] The ability of the GCC agonist peptide to bind to and activate the intestinal GC-C receptor was tested using T84 human colon carcinoma cell line. Human T84 colon carcinoma cells were obtained from the American Type Culture Collection. Cells were grown in a 1:1 mixture of Ham's F-12 medium and Dulbecco's modified Eagle's medium (DMEM) supplemented with 10% fetal bovine serum, 100 U penicillin/ml, and 100 µg/ml streptomycin. The cells were fed fresh medium every third day and split at a confluence of approximately 80%.

[223] Biological activity of the GCC agonist peptides was assayed as previously reported (Shailubhai, *et al.*, Cancer Research 60, 5151-5157 (2000)). Briefly, the confluent monolayers of T-84 cells in 24-well plates were washed twice with 250 μ l of DMEM containing 50 mM HEPES (pH 7.4), pre-incubated at 37°C for 10 min with 250 μ l of DMEM containing 50 mM HEPES (pH 7.4) and 1 mM isobutylmethylxanthine (IBMX), followed by incubation with GCC agonist peptides (0.1 nM to 10 μ M) for 30 min. The medium was aspirated, and the reaction was terminated by the addition of 3% perchloric acid. Following centrifugation, and neutralization with 0.1 N NaOH, the supernatant was used directly for measurements of cGMP using an ELISA kit (Caymen Chemical, Ann Arbor, Mich.).

[224] Figure 6 shows results from experiments evaluating the potency of peptides (*via* cGMP stimulation assay) having structures similar to the 14-mer peptide SP-339, also referred to as linaclotide. SP-339 is a truncated analog of the *E. coli* enterotoxin ST peptide. SP-354 was found to be virtually identical to SP-339 in biological activity. Notably, peptide SP-353, which has a Ser residue at the 6th position, was found to be more potent than SP-339, and was the most potent of all the peptides tested. Peptide SP-355 which has a D-Tyr at the C-terminus showed considerably less potency than the other peptides tested.

Example 5: Peggylated Peptides

[225] An additional strategy to render peptides more resistant towards digestion by digestive proteases is to peggylate them at the N- and C-terminus. The peptide SP-333 was peggylated with the aminoethoxy-ethoxy-acetic acid (Aeea) group at the C-terminus (SP-347) or at the N-terminus (SP-350) or at both termini (SP-343). Cyclic GMP synthesis in T84 cells was measured by the method as described above.

[226] The peptides SP-347 and SP-350 showed potencies comparable to SP-333 in their abilities to stimulate cGMP synthesis in T84 cells. However, peptide SP-343 was considerably less potent as compared to the other peptides tested. The poor activity of SP-343 might be due to the considerable steric hindrance afforded by the large Aeea groups at both termini.

Example 6: Combination of Guanylate Cyclase Receptor Agonists with Phosphodiesterase Inhibitors

[227] Regulation of intracellular concentrations of cyclic nucleotides (*i.e.*, cAMP and cGMP) and thus, signaling via these second messengers, has been generally considered to be governed by their rates of production versus their rates of destruction within cells. Thus, levels of cGMP in tissues and organs can also be regulated by the levels of expression of cGMP-specific phosphodiesterases (cGMP-PDE), which are generally overexpressed in cancer and inflammatory diseases. Therefore, a combination consisting of an agonist of GC-C with an inhibitor of cGMP-PDE might produce synergistic effect on levels of cGMP in the target tissues and organs.

[228] Sulindac Sulfone (SS) and Zaprinast (ZAP) are two of the known inhibitors of cGMP-PDE and have been shown to induce apoptosis in cancer cells via a cGMP-dependent mechanism. SS and ZAP in combination with SP-304 or SP-333 were evaluated to see if these PDE inhibitors had any synergistic effects on intracellular accumulation of cGMP (Fig. 9-12). As the data show, SS at a concentration of 100 μM did not enhance intracellular accumulation of cGMP. However, the combination of SS with SP-304 stimulated cGMP production several-fold more than stimulation by SP-304 alone. This synergistic effect on cGMP levels was more pronounced when SP-304 were used at a 0.1 μM concentration (Fig 10). Similar observations were made when SP-304 or SP-333 were used in combination with ZAP (Fig 10, Fig 11 and Fig 12). These results suggest that the intracellular levels of cGMP are stabilized because SS inhibits cGMP-PDE that might be responsible for depletion of intracellular cGMP. Thus, the approach to use a combination of GCC agonist with a cGMP-PDE inhibitor is attractive.

[229] For the results shown in Figure 9, cyclic GMP synthesis in T84 cells was assessed essentially as described in Shailubhai et al., Cancer Research 60, 5151-5157 (2000). Briefly, confluent monolayers of T-84 cells in 24-well plates were washed twice with 250 μl of DMEM containing 50 mM HEPES (pH 7.4) and pre-incubated at 37°C for 10 minutes with 250 μl of DMEM containing 50 mM HEPES (pH 7.4) and 1 mM isobutyl methylxanthine (IBMX). Monolayers of T84 cells were then incubated with 250 μl of DMEM containing 50 mM HEPES (pH 7.4) containing SP-304 or PDE inhibitors either alone or in combinations, as indicated below in the following experimental sets: 1) Control; 2) SP-304 (0.1 μM); 3) Sulindac Sulfone (100

μM); 4) Zaprinast (100 μM); 5) SP-304 (0.1 μM) + Sulindac Sulfone (100 μM); and 6) SP-304 (0.1 μM) + Zaprinast (100 μM). After the 30 min incubation, the medium was aspirated and the reaction was terminated by the addition of 3% perchloric acid. Following centrifugation and the addition of NaOH (0.1 N) to neutralize the pH, intracellular cGMP levels were determined in lysates using a cGMP ELISA kit (Cat. No. 581021 ; Cayman Chemical, Ann Arbor, MI). Incubations were performed in duplicate, and each sample was run in duplicate using the ELISA test.

[230] For the results shown in Figure 10, the method used was same as the one used for Fig. 9 except that the monolayers of T84 cells were incubated with 500 μl of DMEM containing 50 mM HEPES (pH 7.4) containing SP-304 (0.1 or 1.0 μM) or increasing concentrations of PDE inhibitors (0 to 750 μM) either alone or in combination with SP-304. After the 30 min incubation, the medium was aspirated and the reaction was terminated by the addition of 3% perchloric acid. Following centrifugation and the addition of NaOH (0.1 N) to neutralize the pH, intracellular cGMP levels were determined in lysates using a cGMP ELISA kit (Cat. No. 581021; Cayman Chemical, Ann Arbor, MI). Samples were run in triplicate using the ELISA test.

[231] For the results shown in Figure 11, the method used was same as the one used for Fig. 10 except that the monolayers of T84 cells were incubated with 500 μl of DMEM containing 50 mM HEPES (pH 7.4) containing SP-3333 (0.1 or 1.0 μM) or increasing concentrations of ZAP (0 to 500 μM) either alone or in combination with SP-333. After the 30 min incubation, the medium was aspirated and the reaction was terminated by the addition of 3% perchloric acid. Following centrifugation and the addition of NaOH (0.1 N) to neutralize the pH, intracellular cGMP levels were determined in lysates using a cGMP ELISA kit (Cat. No. 581021 ; Cayman Chemical, Ann Arbor, MI). Samples were run in triplicate using the ELISA test.

[232] For the results shown in Figure 12, the method used was same as the one used for Fig. 10 except that the monolayers of T84 cells were incubated with 500 μl of DMEM containing 50 mM HEPES (pH 7.4) containing SP-333 (0.1 μM) or increasing concentrations of Sulindac Sulfone (0 to 500 μM) either alone or in combination with SP-333. After the 30 min incubation, the medium was aspirated and the reaction was terminated by the addition of 3% perchloric acid.

Following centrifugation and the addition of NaOH (0.1 N) to neutralize the pH, intracellular cGMP levels were determined in lysates using a cGMP ELISA kit (Cat. No. 581021 ; Cayman Chemical, Ann Arbor, MI). Samples were run in triplicate using the ELISA test.

Example 7: A Repeated Oral Dose Toxicity Study of SP-304 in Cynomolgus Monkeys.

[233] The primary purpose of this experiment was to evaluate the toxicity and pharmacokinetics of a repeated oral dose of SP-304 in cynomolgus monkeys. Treatment with a daily dose of 250 mg of SP-304 for 14 consecutive days was well tolerated by all of the monkeys, however the treatment consistently produced liquid feces and watery diarrhea (Figure 14). Monkeys returned to normal stool consistency within 24-48 hours following the last dose of SP-304.

Example 8: SP-304 Treatment Improves Stool Consistency and Clears TNBS-induced Intestinal Blockage in a TNBS-induced Murine Model of Colitis.

[234] SP-304 is a superior analog of uroguanylin and an agonist of GC-C. The anal administration of trinitrobenzene sulphonic acid (TNBS) is typically used to produce intestinal blockage, resulting in poor stool consistency. As shown in Figure 13, oral administration of SP-304 considerably improved stool consistency in mice treated with TNBS. Treatment with SP-304 at a dose between 0.05 to 0.5 mg/kg body weight was sufficient to completely restore the consistency score to the level observed in mice treated with phosphate buffer instead of TNBS (minus TNBS control). Sulfasalazine, a FDA approved drug used as a positive control, also restored normal stool consistency.

Example 9: A Randomized, Double-blind, Placebo-Controlled, Single-, Ascending-, Oral-Dose Safety, Tolerability, and Pharmacokinetic Study of SP-304 in Healthy Adult Human Male and Female Volunteers

[235] The objectives of this study were to assess the safety and pharmacokinetics of a single oral dose of SP-304 in healthy subjects. This was a phase 1, single-site, randomized, double-blind, placebo-controlled, single-, ascending-, oral-dose, sequential dose escalation study of SP-304 in fasted, healthy male and female subjects. A total of 9 cohorts utilizing 8 subjects per cohort (6 SP-304; 2 placebo) were utilized, totaling 71 volunteers administered drug (one

volunteer dropping out). Each cohort was administered a single, oral dose or matching placebo administered in 10-fold diluted phosphate buffered saline (PBS) (240 mL). Subjects were only administered one dose of study treatment and could not be enrolled in subsequent cohorts. The nine cohort doses included 0.1, 0.3, 0.9, 2.7, 5.4, 8.1, 16.2, 24.3 mg and 48.6 mg SP-304.

Doses of SP-304

0.1 mg (6 active, 2 placebo)
0.3 mg (6 active, 2 placebo)
0.9 mg (6 active, 2 placebo)
2.7 mg (6 active, 2 placebo)
5.4 mg (6 active, 2 placebo)
8.1 mg (6 active, 2 placebo)
16.2 mg (5 active, 2 placebo)
24.3 mg (6 active, 2 placebo)
48.6 mg (6 active, 2 placebo)

[236] The decision to proceed to the next cohort was made by the study sponsor and principal investigator after reviewing the preliminary blinded, safety information from the cohort. All safety data collected through the 48 hours after dosing were reviewed to assess tolerability of the dose level. A minimum of 3 evaluable subjects were required for the determination of safety and tolerability at each dose level.

[237] The stopping criteria were: 1) clinically significant adverse events [including clinically significant changes in laboratory or electrocardiogram (ECG) parameters] in ≥ 4 subjects (collectively within a cohort), or 2) 1 drug related, serious adverse event (SAE). No higher doses were to be administered if one of these criteria was met. Otherwise, the study could proceed to the next higher dose cohort.

[238] Safety was monitored by physical examinations, vital signs, clinical laboratory tests (hematology, chemistry, urinalysis, fecal occult blood), ECG, and adverse experience assessments). Serial blood samples were collected 0, 0.5, 1, 1.5, 2, 3, 4, 6, 8, 16, 24, 36, and 48 hours after dosing. Plasma samples were assayed by a validated method for SP-304, and pharmacokinetic parameters calculated. Pharmacodynamic endpoints that were evaluated included time to first stool, stool frequency (48-hour period), and stool consistency (48-hour period) using the Bristol Stool Form Scale (BSFS).

[239] The phase 1 study (Protocol No. SP-SP304101-08) used an oral solution prepared by a registered licensed pharmacist at the investigation site not more than one hour before administration of dose.

[240] The primary objectives of this clinical evaluation were to determine safety, toxicity and systemic absorption of a single oral dose of SP-304. The data indicated that SP-304 was well-tolerated at all dosage levels and there were no severe adverse events (SAEs). The most prevalent adverse event (AE) observed during this study was grade I diarrhea (12.7%), as defined using the Common Terminology Criteria for Adverse Events (CTCAE), which is an increase in the number of bowel movements from 1 and <4 in a 24-hour period. Notably, SP-304 was expected to promote bowel movement, thus the increase in number of bowel movements was considered to be related to the pharmacodynamic (PD) action of SP-304.

[241] The effect of a single oral dose of SP-304 on stool consistency, as judged by the Bristol form stool scale (BSFS), was also examined in volunteers. The BSFS score for the seven types of stool are:

- Type 1: Separate hard lumps, like nuts (hard to pass)
- Type 2: Sausage-shaped, but lumpy
- Type 3: Like a sausage but with cracks on its surface
- Type 4: Like a sausage or snake, smooth and soft
- Type 5: Soft blobs with clear cut edges (passed easily)
- Type 6: Fluffy pieces with ragged edges, a mushy stool
- Type 7: Entirely liquid

[242] Types 1 and 2 indicate constipation, with 3 and 4 being the "ideal stools" especially the latter, as they are the easiest to pass, and 5-7 score indicate further tending towards diarrhea or urgency.

[243] Figure 15A-B shows the effect of a single dose of SP-304 or placebo on BSFS score in volunteers treated with SP-304 ranging from 0.1 mg up to a maximum of 48.6 mg dose. The data indicate that treatment with SP-304 produced an increase in BSFS score in volunteers, relative to placebo-treated volunteers, reflecting a change in stool consistency towards a looser bowel movement in SP-304 treated volunteers. These results indicate that SP-304 has the

potential to normalize bowel movement and to relieve the discomfort due to chronic constipation.

[244] Figure 16 shows the effect of a single dose of SP-304 or placebo on the time to first stool in the 24 hours period following dosing. The data indicate that SP-304 treatment significantly decreased the time to first bowel movement from 10.6 hours in volunteers treated with placebo to about 3 to 6 hours, following SP-304 treatment at doses ranging from 2.7 to 48.6 mg.

Example 10: SP-304 Ameliorates Inflammation in DSS-induced Colitis in BDF-1 Mice.

[245] The cGMP pathway mediates the anti-inflammatory effects of cellular molecules such as nitric oxide and heme oxygenase-1. Therapies that induce cGMP (phosphodiesterase-4 inhibitors) have demonstrated efficacy in murine models of IBD. The anti-inflammatory effects of the GCC agonist SP-304 were evaluated in a murine model of ulcerative colitis, the DSS-induced colitis model.

[246] Forty eight BDF1 mice were divided into 8 treatment groups (6 mice / group). One group was not exposed to DSS (untreated control) and groups 2-10 were treated with 5% DSS in the drinking water. DSS was refreshed daily. All mice were weighed on day -1, and treated with the test materials beginning on day -1. 4hrs post dosing on Day 0, DSS was placed in the drinking water of groups 2-8 and DSS remained in the water until the end of the study. The test agents were administered at 9 AM daily until day 7. Animals were treated with a single dose of test agents and the groups were as follows:

1. No DSS exposure – PBS gavage (No DSS control)
2. 5% DSS + PBS (Vehicle control)
3. 5% DSS + 80 mg/kg Sulfasalazine (positive control)
4. 5% DSS + 0.005 mg/kg SP-304
5. 5% DSS + 0.05 mg/kg SP-304
6. 5% DSS + 0.5 mg/kg SP-304
7. 5% DSS + 2.5 mg/kg SP-304
8. 5% DSS + 50 mg/kg SP-304

[247] All doses were administered by oral gavage using a 0.1ml dose per 10g body weight. To avoid cage-to-cage variation, different treatment groups were housed in the same

cage and animals were ear punched for identification purposes. Mice were sacrificed on day 7, 4-6 hrs post last dosing. The animals were also subjected to internal examination of the major organs for any gross abnormalities. The distal section of the large intestine (sufficient for histopathological examination) was removed and fixed in Carnoy's solution and embedded in paraffin. Two non-serial sections per slide were cut and H&E stained for visual severity score analysis. All slides were scored in a blinded manner.

Histopathology scoring

0	normal
1	all crypts remaining but look abnormal, all muscle intact
2	less than 90% crypts remaining, all muscle intact
3	less than 75% crypts remaining, majority muscle intact
4	less than 10% crypts remaining, most of muscle degraded
5	no crypts left, muscle degraded

[248] Five different sections of the tissue were examined for histopathological scoring and the scores were averaged for each mouse. The histopathology scores in Fig. 17 are expressed as an average of 6 mice. As shown in Fig. 17, the data indicate that treatment of mice with DSS produced mild inflammation in the large intestine. As expected, the severity of the inflammation was considerably reduced in mice treated with sulfasalazine. Similarly, mice treated with SP-304 doses ranging from 0.005 to 5 mg/kg/body weight also showed reduced inflammation in the colon tissue. These results indicate that oral administration with SP-304 ameliorated DSS-induced inflammation in the colon tissue. The treatment with SP-304 did not change the colon weight considerably.

Example 11: SP-304 Ameliorates Inflammation in TNBS-induced Colitis in BDF-1 Mice

[249] Anal administration of TNBS is widely used to induce inflammation in the colon of mice and rats. The TNBS-induced ulcerative colitis is commonly used model for experimental colitis in mice for evaluation of drugs to be used for treatment of IBD in humans. To evaluate the anti-inflammatory effects of the GCC agonist SP-304, ninety BDF-1 mice were randomly divided into 9 groups of 10 each as follows:

1. No TNBS exposure – PBS gavage (No TNBS control)
2. TNBS + PBS (Vehicle control)

3. TNBS + 80 mg/kg Sulfasalazine (positive control)
4. TNBS + 0.0005 mg/kg SP-304
5. TNBS + 0.005 mg/kg SP-304
6. TNBS + 0.05 mg/kg SP-304
7. TNBS + 0.5 mg/kg SP-304
8. TNBS + 2.5 mg/kg SP-304
9. TNBS + 50 mg/kg SP-304

[250] Groups 2-9 were given 2.5 mg of TNBS in 50% ethanol through anal route using a rubber catheter on day 0. Mice were given a single dose of SP-304 at 9 am everyday for seven days. At the end of the study mice were sacrificed by cervical dislocation. The distal large intestine was removed and fixed in Carnoy's fixative. Samples were paraffin embedded and 2 non-serial sections per sample were cut & mounted on one slide before staining with H&E. Slides of intestinal tissues was scored. Blinded histological sections were observed microscopically and assigned a severity score of 0 to 5, as per the scoring system described in Fig 8. For every mouse 5 cross sectional areas of the large intestine were assessed. Results are expressed as an average. As shown in Fig 18, treatment with SP-304 at a dose as low as 0.05 mg/kg body weight significantly reduced colonic inflammation. Interestingly, the potency of SP-304 even at concentrations as low as 0.05 mg/kg was comparable to sulfasalazine given at a dose of 80 mg/kg body weight.

Example 12: Repeated daily dose of SP-304 produced severe diarrhea in cynomolgus monkeys

[251] Male (n=4) and female (n=4) monkeys were given a daily dose (1 or 10 or 75 mg/kg body weight) of SP-304 repeatedly for 28 days. Effect of treatment on stool consistency was recorded three times a day. As shown in Figure 19, oral treatment with SP-304 produced diarrhea/watery stools in both sexes. However, female monkeys showed a more pronounced effect. In females, a dose of 10 mg/kg body weight produced severe diarrhea consistently. Therefore, SP-304 was used at 10 mg/kg body weight in the subsequent experiments. Similar results were obtained with SP-333.

Example 13: Repeated dose of SP-304 produced severe bloating in the proximal intestines in mice

[252] The objective of this experiment was to determine the primary site of action for orally administered SP-304 with respect to its ability to stimulate water secretion in the gastrointestinal tract. Under normal physiological circumstances, water secretion occurs primarily in the duodenum and the secreted water is then reabsorbed in the ileum. Mice (females, n=6; males, n=6) were given a single dose of SP-304 by oral gavage and sacrificed 30 minutes later. The gastrointestinal tract was examined for signs of bloating which indicates excessive secretion of water. As shown in Table VIII, SP-304 produced bloating only in the stomach and in the proximal intestine (duodenum and jejunum) but not in cecum or distal intestine (ileum and colon). These results demonstrate that orally administered SP-304 caused water secretion in the duodenum/jejunum. Thus, the site of action of SP-304 is primarily in the duodenum and jejunum portions of the gastrointestinal tract.

GI Tract Segment	Male Mice Number of Animals with Bloating (% of total) n=6	Female Mice Number of Animals with Bloating (% of total) n=6
Stomach	3 (50%)	2 (33%)
Duodenum	2 (33%)	2 (33%)
Jejunum	6 (100%)	6 (100%)
Cecum	1 (2%)	0 (0%)

Table VIII: SP-304 oral administration produced severe bloating in proximal intestine of mice. Mice (6 males and 6 females) were orally administered with SP-304 (1200 mg/kg body weight). After 30 minutes, mice were sacrificed and immediately opened to determine if SP-304 administration had caused bloating, due to excessive secretion of fluid, in different segments of the GI tract. Results are expressed as % number of mice showing bloating in various parts of the GI tract.

Example 14: Formulations of SP-304 for different GI diseases

[253] As indicated by the data in Table VIII, orally administered SP-304 acts in the proximal portions of the GI tract (duodenum, jejunum) to stimulate water secretion. Thus, a formulation for delivery of SP-304 to this region should demonstrate improved efficacy for the treatment of chronic constipation, IBS-C and other diseases of the proximal intestine. This is because such a

formulation would more effectively stimulate the secretion of water and promote the normalization of bowel movement in patients suffering from these conditions. In addition, aggregation of SP-304, which occurs beginning at 1.0 mg/ml and is promoted by acidic conditions, would be minimized in a pH dependent release formulation designed to release at higher pH. Thus, a pH dependent release formulation of SP-304 comprising the Eudragit polymer was tested for efficacy of release at pH greater than 5.5, which would target release to the duodenum. As shown in Figure 20, gelatin capsules coated with Eudragit polymer for dissolution at pH greater than 5.5 did not disintegrate and SP-304 was not released under acidic conditions at pH 1 or 2.5. As expected, incubation of the capsule at pH 5.7 released SP-304 within 20 minutes and within 60 minutes most of the peptide was released. The released SP-304 was biologically active as determined in the T84 cells bioassay (see Figure 21).

[254] For the treatment of IBD and other diseases or disorders of the distal GI tract, it is advantageous to develop a formulation which targets GCC agonists to the distal GI tract, particularly the terminal ileum. This is particularly the case for the treatment of IBD which is often complicated by diarrhea. Thus, oral administration of a GCC agonist would likely be counterproductive for IBD due to the stimulation of water secretion in the duodenum. This problem would be circumvented by a formulation that targeted delivery to the terminal ileum. A pH dependent release formulation of SP-304 was therefore tested for efficacy of release at pH greater than 7, which would target release to the terminal ileum. As shown in Figures 20 and 21, the Eudragit polymer formulation released the SP-304 at pH 7.2 and the released SP-304 was biologically active.

Example 15: SP-304 and SP-333 formulated in Eudragit polymer coating for delivery at or above pH 7 minimized diarrhea in cynomolgus monkeys

[255] As shown in Figure 22, SP-304 formulated in gelatin capsules coated with Eudragit polymer (for dissolution at pH above 7) produced considerably less incidences of diarrhea as compared to the uncoated capsules containing the same dose of SP-304 (10 mg/kg body weight). These results demonstrate that the delivery of a GCC agonist to the distal intestine reduces the incidence of diarrhea which would otherwise be expected from oral administration of the agonist.

Thus, such a formulation would be preferred for the treatment of IBD, colon cancer and other diseases of the distal intestine.

[256] SP-333 is a GCC agonist which was designed for increased stability against the proteolysis which would normally occur in the intestinal fluid. Thus, this peptide would also be useful for the treatment of IBD, colon cancer and other diseases of the distal intestine. SP-333 was formulated in gelatin capsules coated with Eudragit polymer for dissolution at pH above 7. As shown in Figure 23, the coated capsules produced a considerably lower incidence of diarrhea compared to the uncoated capsules.

We claim:

1. A GCC agonist formulation comprising (1) a core, which contains at least one GCC agonist peptide, and (2) one or more targeting materials selected from the group consisting of a pH-dependent polymer, a swellable polymer, and a degradable composition, wherein the GCC agonist peptide is selected from the group consisting of SEQ ID NOs: 1-249.
2. The GCC agonist formulation of claim 1, wherein the GCC agonist peptide is selected from the group consisting of SEQ ID NOs: 1, 8, 9, 55 or 56.
3. The GCC agonist formulation of claim 2, wherein the GCC agonist peptide is selected from the group consisting of SEQ ID NOs: 1 and 9.
4. The GCC agonist formulation of claim 1, wherein the formulation is for an oral route of administration.
5. The GCC agonist formulation of claim 1, wherein the formulation is optimized for delivery of a GCC agonist to the duodenum or jejunum.
6. The GCC agonist formulation of claim 5, wherein the formulation comprises one or more pH dependent polymers which degrade in a pH range of 4.5 to 5.5 or in a pH range of 5.5 to 6.5.
7. The GCC agonist formulation of claim 1, wherein the formulation is optimized for delivery of a GCC agonist to the ileum, terminal ileum, or ascending colon.
8. The GCC agonist formulation of claim 7, wherein the formulation comprises one or more pH dependent polymers which degrade in a pH range of 5.5 to 6.5 or in a pH range of 6.5 to 7.5.
9. The GCC agonist formulation of claim 6 or 8, wherein the pH dependent polymer is selected from the group consisting of a methacrylic acid copolymer, a polyvinyl acetate

- phthalate, a hydroxypropylmethylcellulose phthalate, a cellulose acetate trimellitate, a cellulose acetate phthalate, or a hydroxypropyl methyl cellulose acetate succinate.
10. The GCC agonist formulation of claim 9, wherein at least one of the pH dependent polymers is a methacrylic acid copolymer.
 11. The GCC agonist formulation of claim 10, wherein the methacrylic acid copolymer is selected from among the EUDRAGIT polymers.
 12. The GCC agonist formulation of claim 11, wherein the EUDRAGIT polymer is selected from among the group consisting of EUDRAGIT L100, EUDRAGIT L-30D, EUDRAGIT S100, EUDRAGIT FS 30D, and EUDRAGIT L100-55, and combinations thereof.
 13. The GCC agonist formulation of claim 7, wherein the formulation comprises one or more pH dependent polymers and a swellable polymer.
 14. The GCC agonist formulation of claim 13, wherein the formulation comprises two pH dependent polymers which degrade in a pH range of 6.5 to 7.5 and wherein the swellable polymer forms a layer between the two pH dependent polymers.
 15. The GCC agonist formulation of claim 13, wherein the swellable polymer is selected from the group consisting of an acrylic copolymer, polyvinylacetate, and cellulose derivatives.
 16. The GCC agonist formulation of claim 15, wherein the swellable polymer is an acrylic copolymer selected from the group consisting of EUDRAGIT RL, EUDRAGIT RS, and EUDRAGIT NE.
 17. The GCC agonist formulation of claim 13, further comprising a pore forming agent.
 18. The GCC agonist formulation of claim 17, wherein the pore forming agent is selected from the group consisting of saccharose, sodium chloride, potassium chloride, polyvinylpyrrolidone, polyethyleneglycol, water soluble organic acids, sugars and sugar alcohol.

19. The GCC agonist formulation of claim 1, wherein the formulation comprises a degradable composition.
20. The GCC agonist formulation of claim 19, wherein the degradable composition is selected from the group consisting of amylase, chitosan, chondroitin sulfate, cyclodextrin, dextran, guar gum, pectin, and xylan.
21. The GCC agonist formulation of claim 20, further comprising a material selected from the group consisting of cellulose acetate phthalate, hydroxy propyl methyl cellulose acetate succinate, EUDRAGIT L100 and EUDRAGIT L30D-55, wherein the material forms an outer coating over the degradable composition.
22. The GCC agonist formulation of claim 19, wherein the degradable composition is a carrier molecule linked to the GCC agonist by a covalent bond, wherein the covalent bond is stable in the stomach and small intestines but labile in the lower gastrointestinal tract, especially the colon.
23. The GCC agonist formulation of claim 22, wherein the covalent bond is an azo bond or a glycosidic bond.
24. The GCC agonist formulation of claim 22, wherein the carrier molecule is selected from the group consisting of a glucuronide, a cyclodextrin, a dextran ester, or a polar amino acid.
25. A method for treating or preventing a gastrointestinal disease or disorder in a subject in need thereof, comprising administering to the subject a GCC agonist formulation comprising (1) a core, which contains at least one GCC agonist peptide, and (2) one or more targeting materials selected from the group consisting of a pH-dependent polymer, a swellable polymer, and a degradable composition, wherein the GCC agonist peptide is selected from the group consisting of SEQ ID NOs: 1-249.
26. The method of claim 25, wherein the formulation comprises one or more pH dependent polymers which degrade in a pH range of 4.5 to 5.5 or in a pH range of 5.5 to 6.5.

27. The method of claim 26, wherein the gastrointestinal disease or disorder is selected from the group consisting of irritable bowel syndrome, non-ulcer dyspepsia, chronic intestinal pseudo-obstruction, functional dyspepsia, colonic pseudo-obstruction, duodenogastric reflux, gastro esophageal reflux disease, chronic idiopathic constipation, gastroparesis, heartburn, gastric cancer, and H. pylori infection.
28. The method of claim 27, wherein the gastrointestinal disease or disorder is selected from the group consisting of chronic idiopathic constipation and irritable bowel syndrome.
29. The method of claim 25, wherein the formulation comprises one or more pH dependent polymers which degrade in a pH range of 5.5 to 6.5 or in a pH range of 6.5 to 7.5.
30. The method of claim 29, wherein the gastrointestinal disease or disorder is selected from the group consisting of ileitis (post-operative ileitis), Crohn's disease, ulcerative colitis, terminal ileitis, and colon cancer.
31. The method of claim 30, wherein the gastrointestinal disease or disorder is selected from the group consisting of ulcerative colitis and Crohn's disease.
32. The method of claim 26 or 29, wherein the GCC agonist peptide is selected from the group consisting of SEQ ID NOs: 1, 8, 9, 55 or 56.
33. The method of claim 32, wherein the GCC agonist peptide is selected from the group consisting of SEQ ID NOs: 1 and 9.
34. The method of claim 26 or 29, further comprising administering to the subject an effective amount of an inhibitor of a cGMP-specific phosphodiesterase.
35. The method of claim 34, wherein the cGMP-dependent phosphodiesterase inhibitor is selected from the group consisting of suldinac sulfone, zaprinast, and motapizone, vardenafil, and sildenafil.
36. The method of claim 26, further comprising administering to the subject an effective amount of at least one laxative.

37. The method of claim 36, wherein the at least one laxative is selected from the group consisting of SENNA, MIRALAX, PEG, or calcium polycarbophil.
38. The method of claim 26 or 29, further comprising administering to the subject an effective amount of at least one anti-inflammatory agent.
39. The method of claim 26 or 29, wherein the subject is a human.

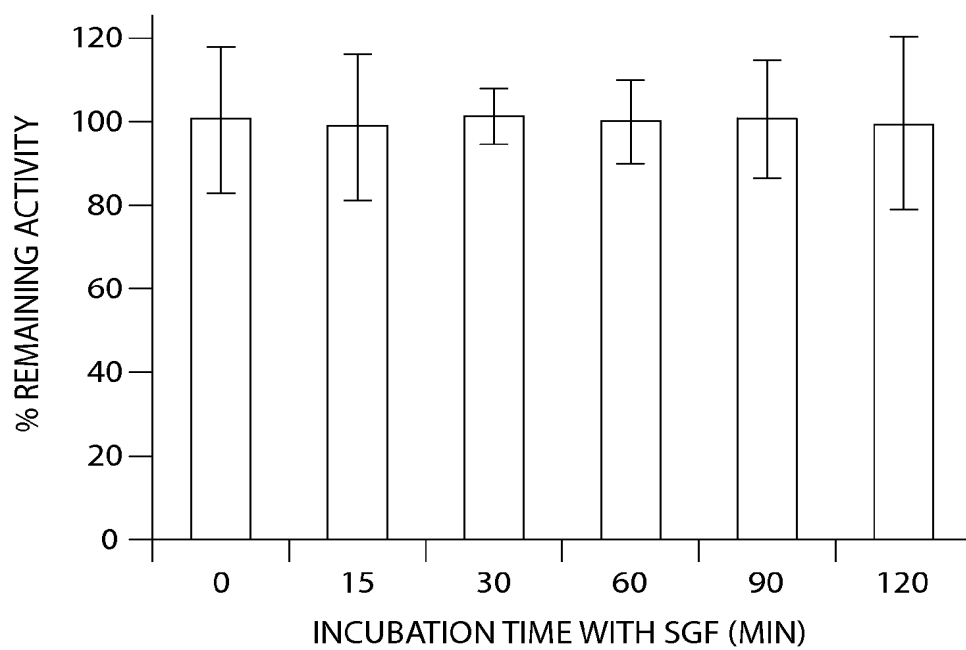

Fig. 1A

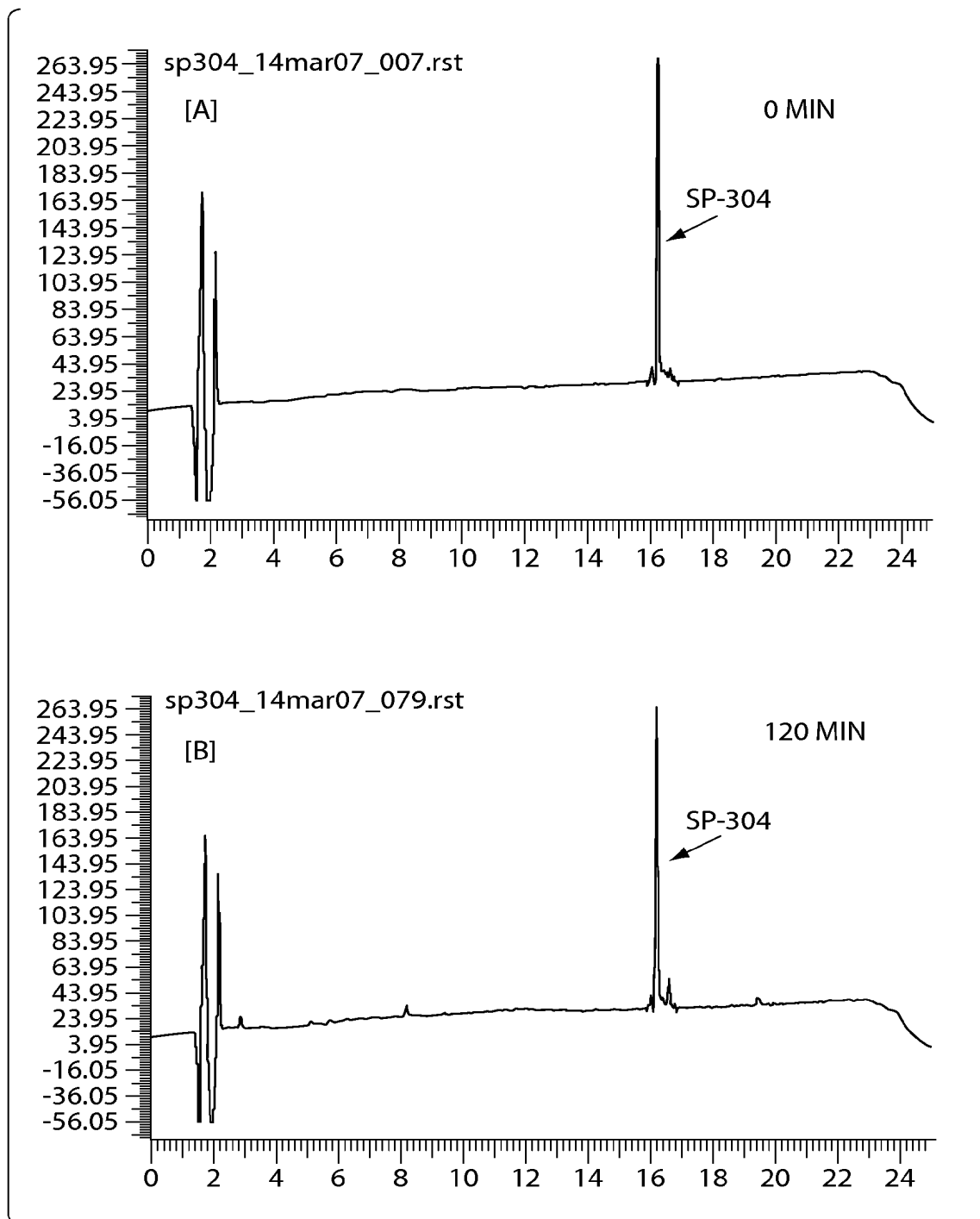

Fig. 1B

3/28

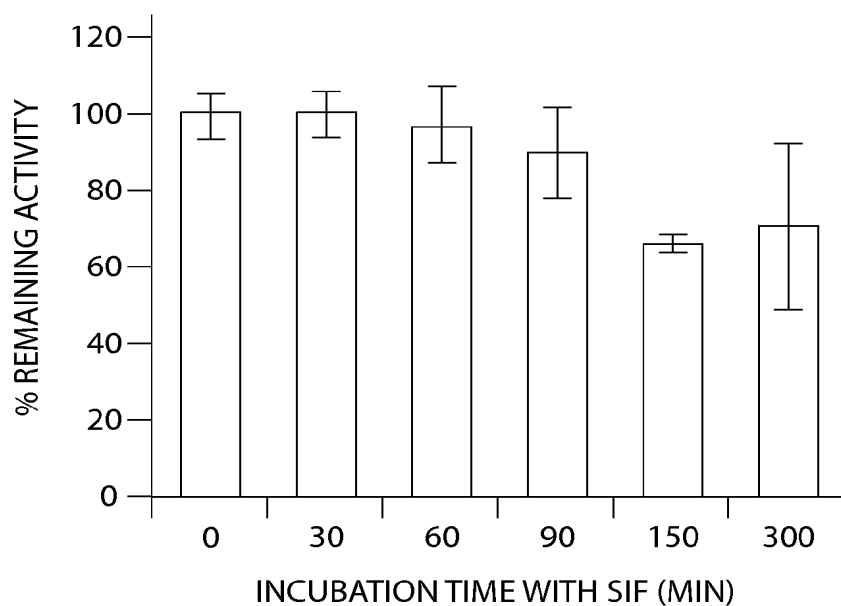

Fig. 2A

4/28

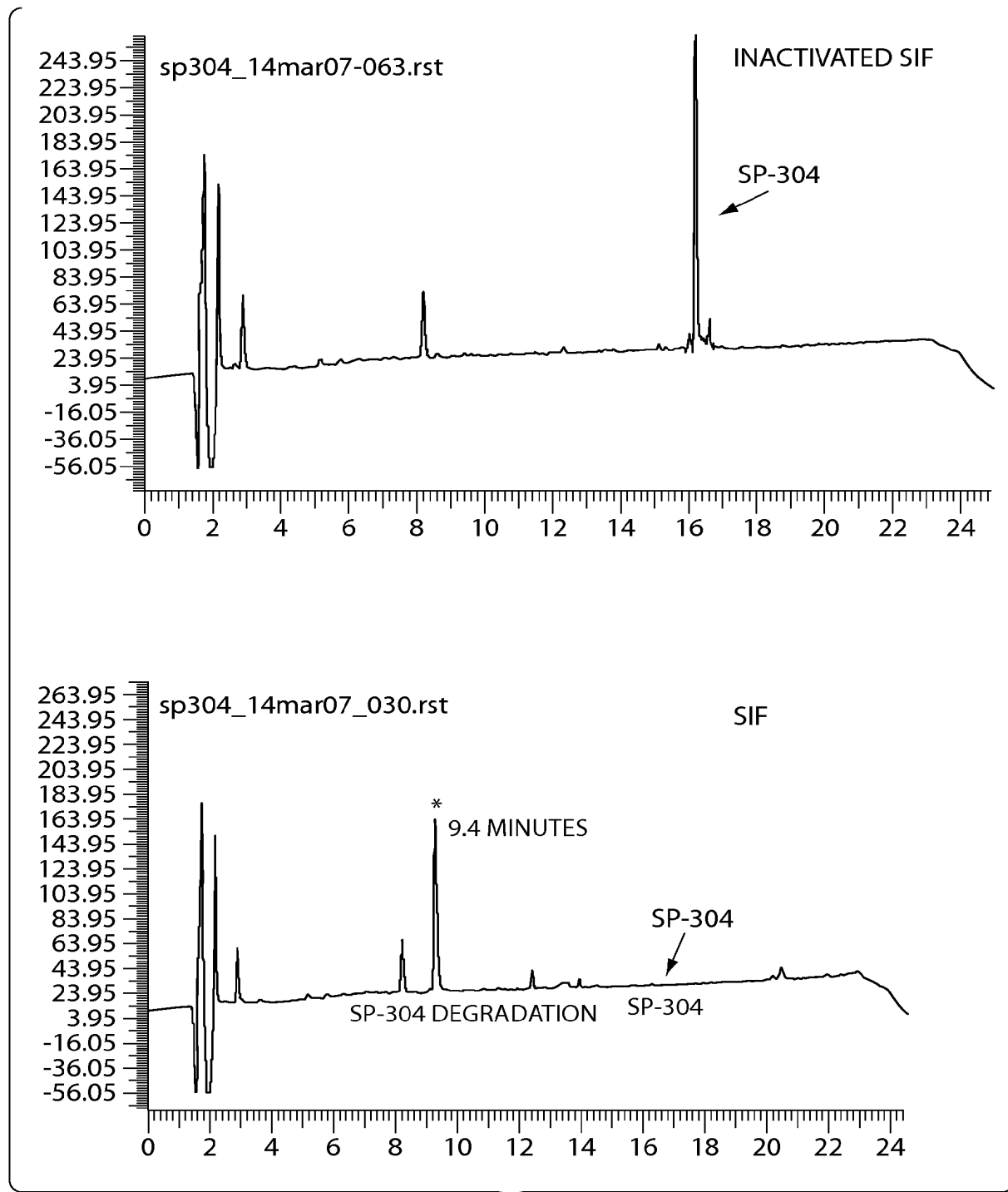

Fig. 2B

5/28

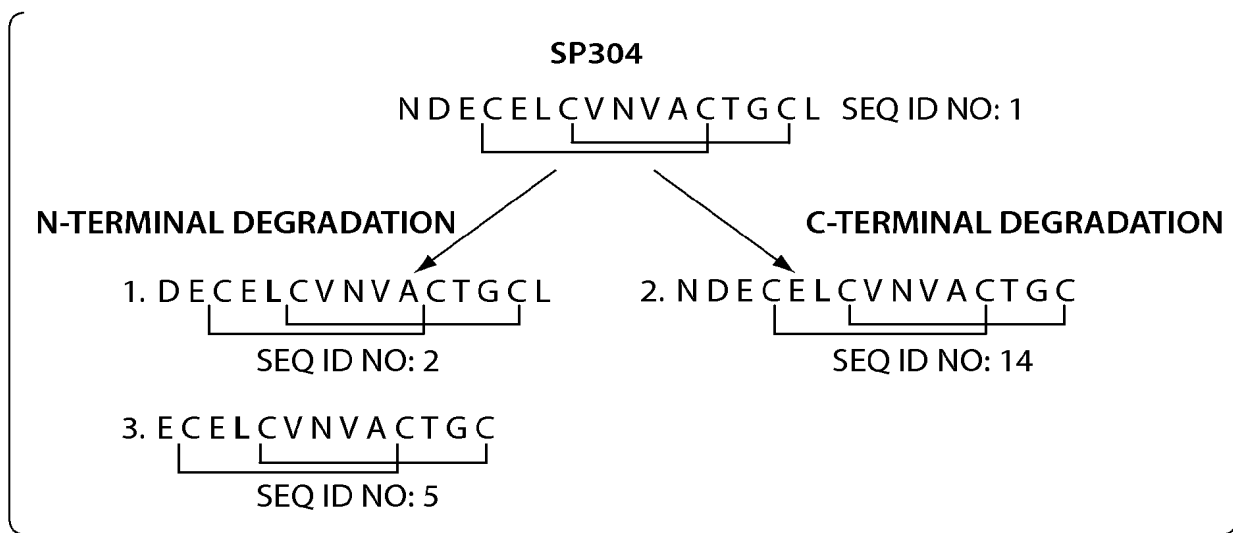

Fig. 3

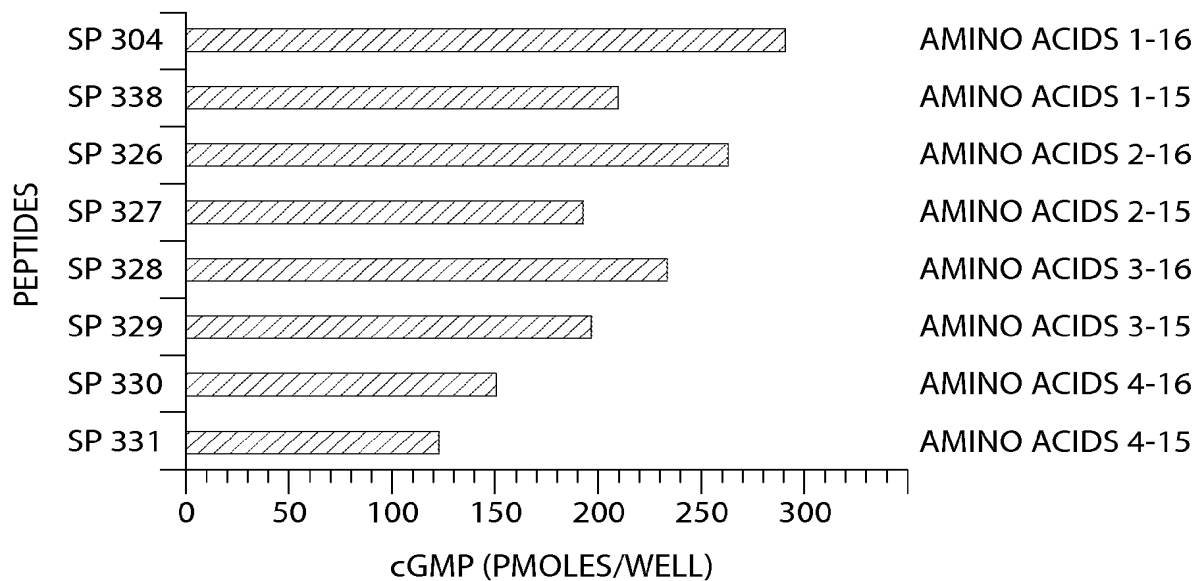

Fig. 4

6/28

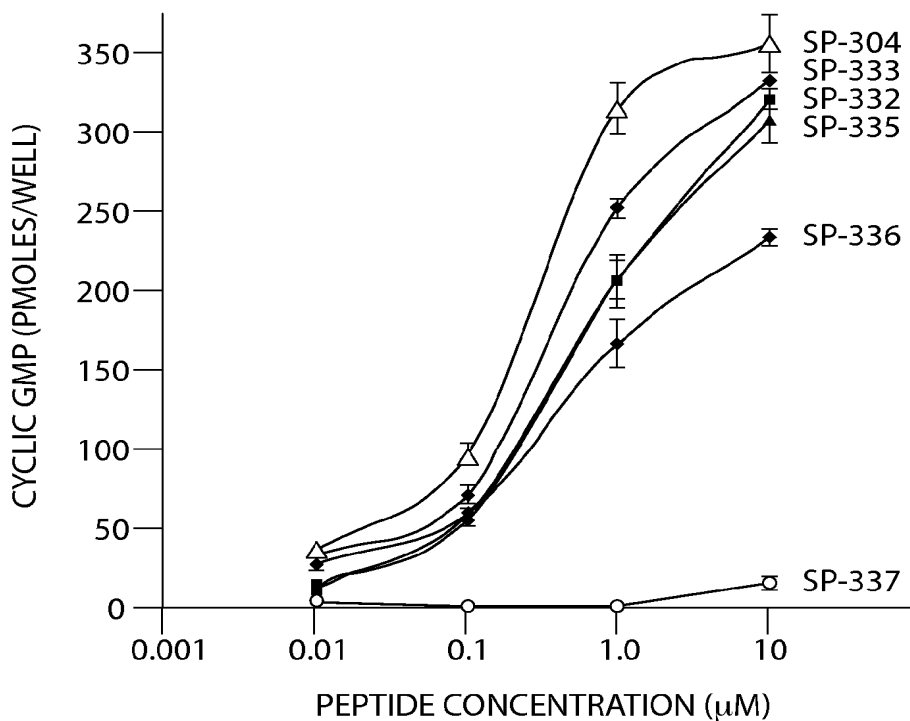

Fig. 5

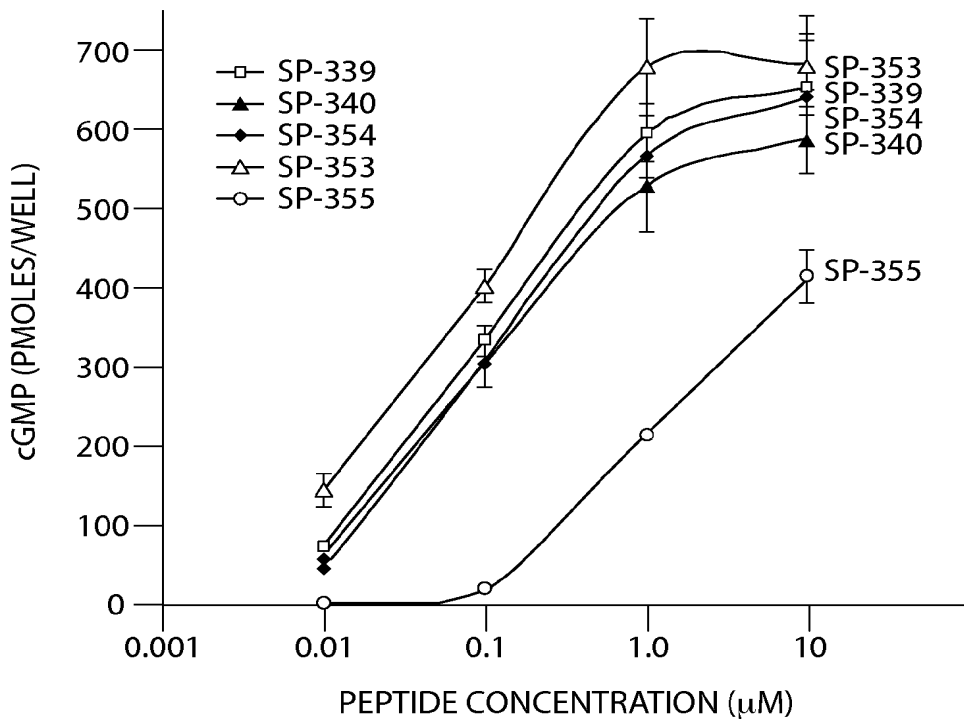

Fig. 6

SUBSTITUTE SHEET (RULE 26)

7/28

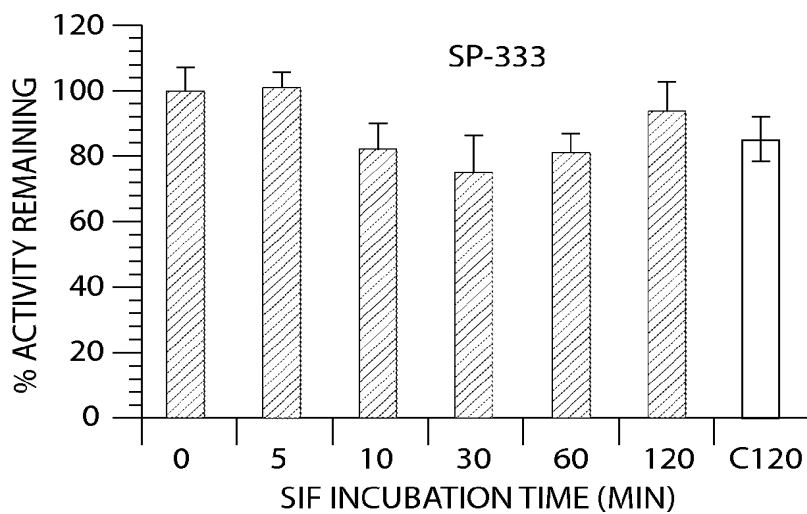

Fig. 7A

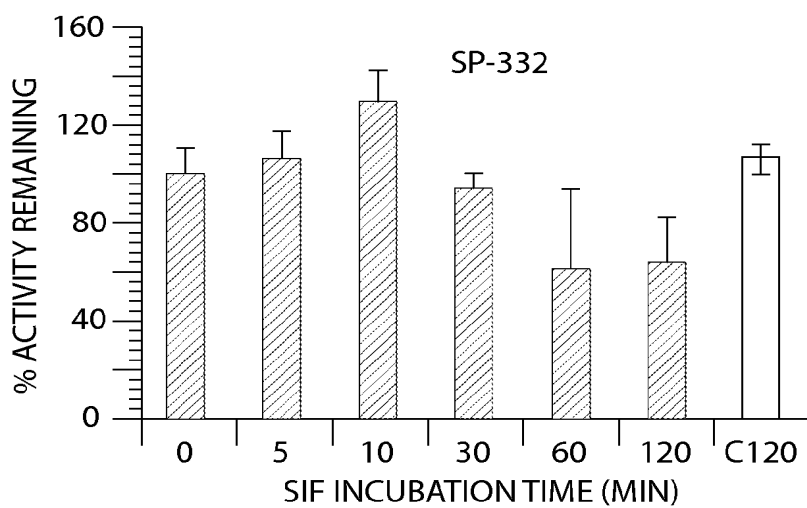

Fig. 7B

8/28

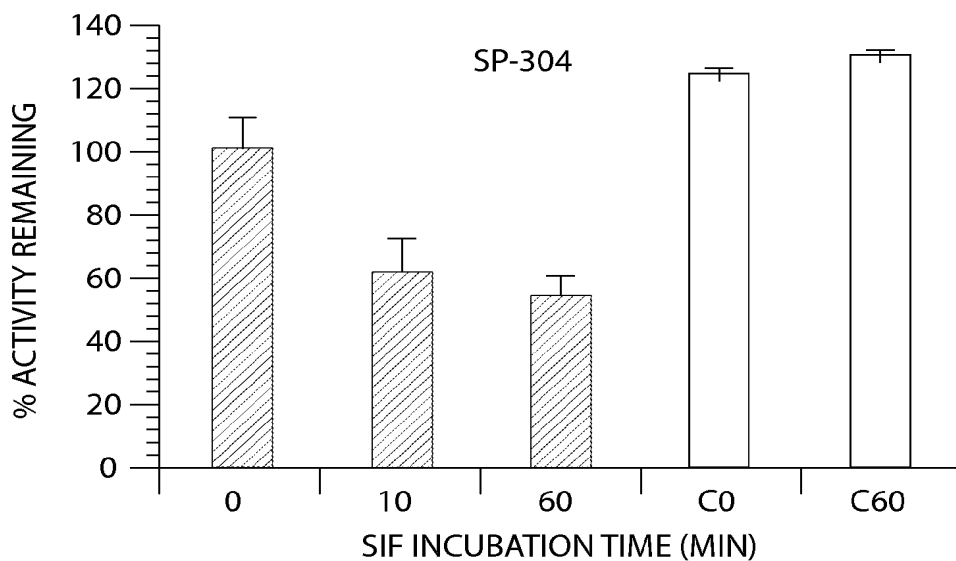

Fig. 7C

XWC OF DAD SPECTRAL DATA: 218.0 TO 220.0 nm
FROM SAMPLE 1 (M-SCAN #89950 DIGEST 0 MIN) OF 64.wiff

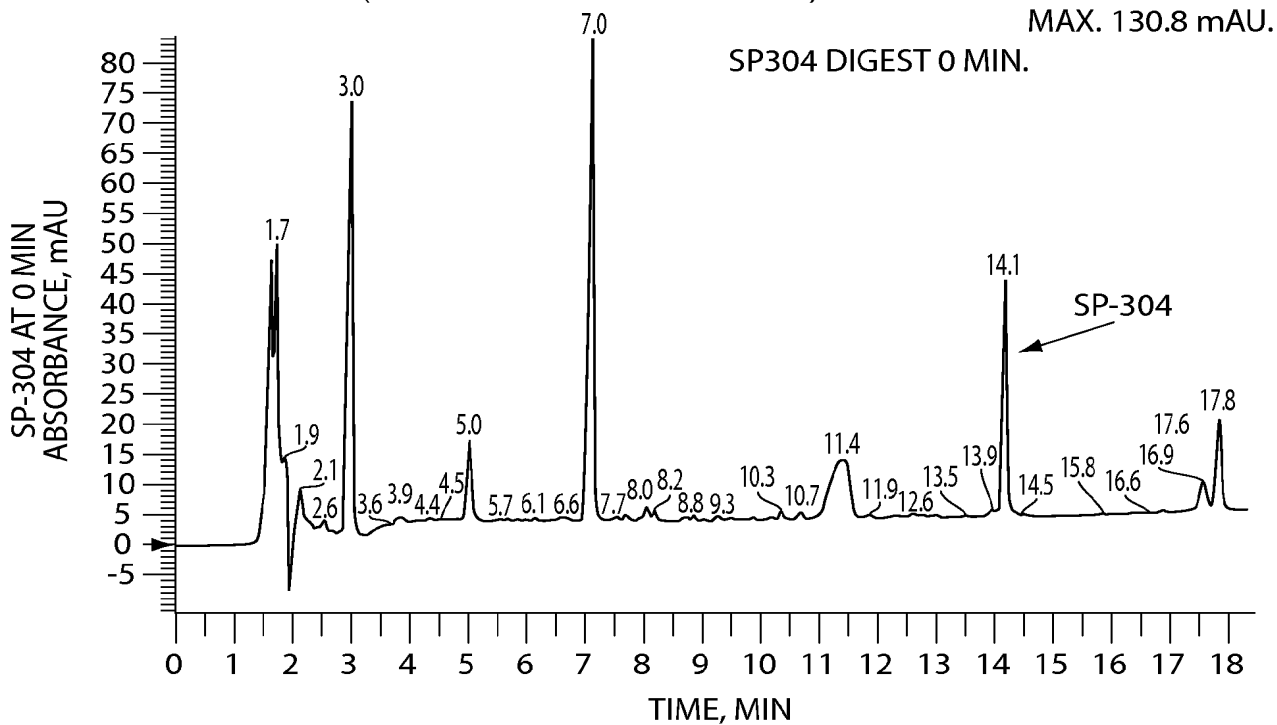

Fig. 7D-1

SUBSTITUTE SHEET (RULE 26)

XWC OF DAD SPECTRAL DATA: 218.0 TO 220.0 nm
FROM SAMPLE 1 (M-SCAN #89950 DIGEST 60 MIN) OF 67.wiff

MAX. 130.5 mAU.

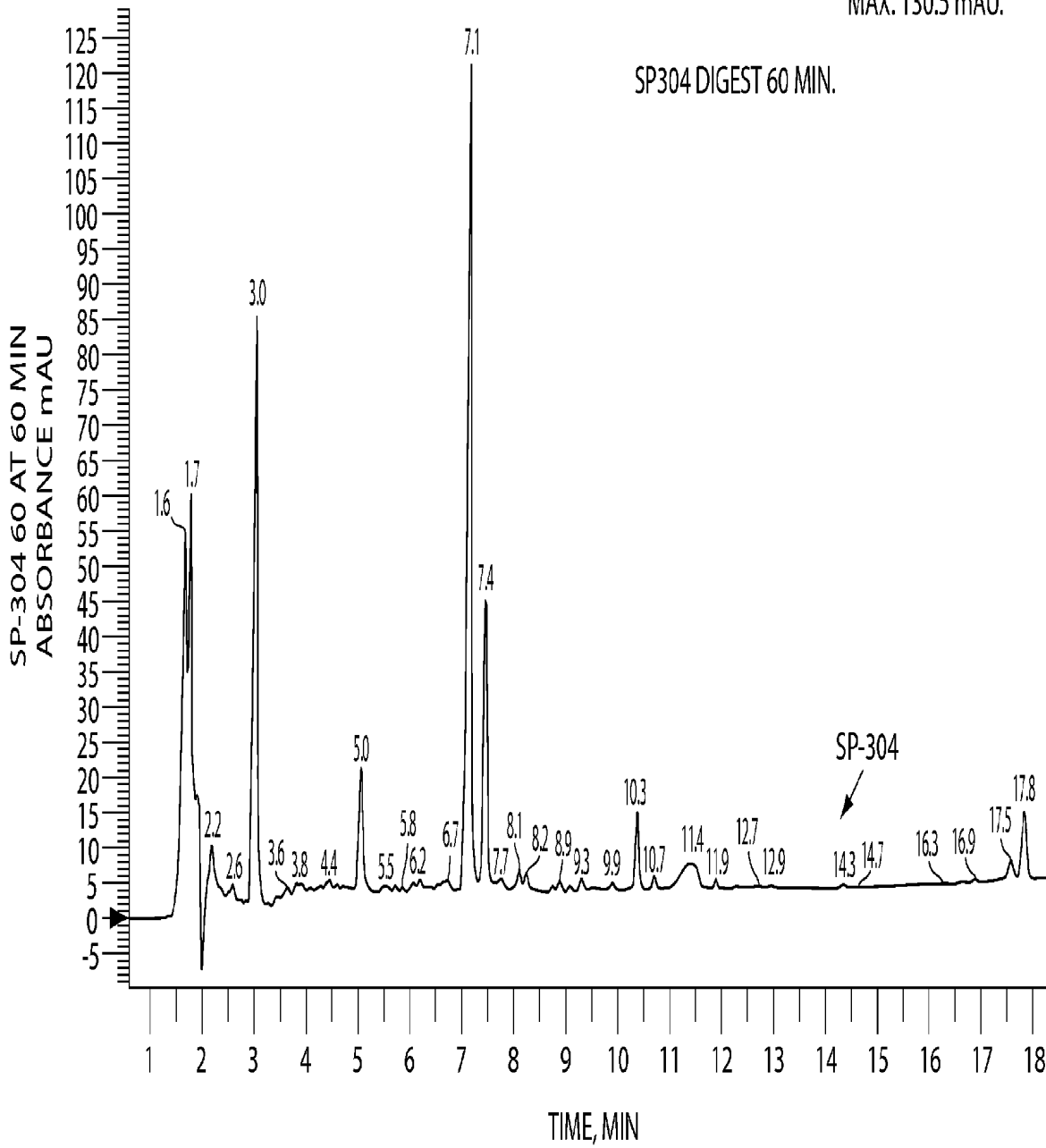

Fig. 7D-2

XWC OF DAD SPECTRAL DATA: 218.0 TO 220.0 nm
FROM SAMPLE 1 (M-SCAN #89608 CONTROL 0 MIN) OF 54.wiff

MAX. 130.6 mAU.

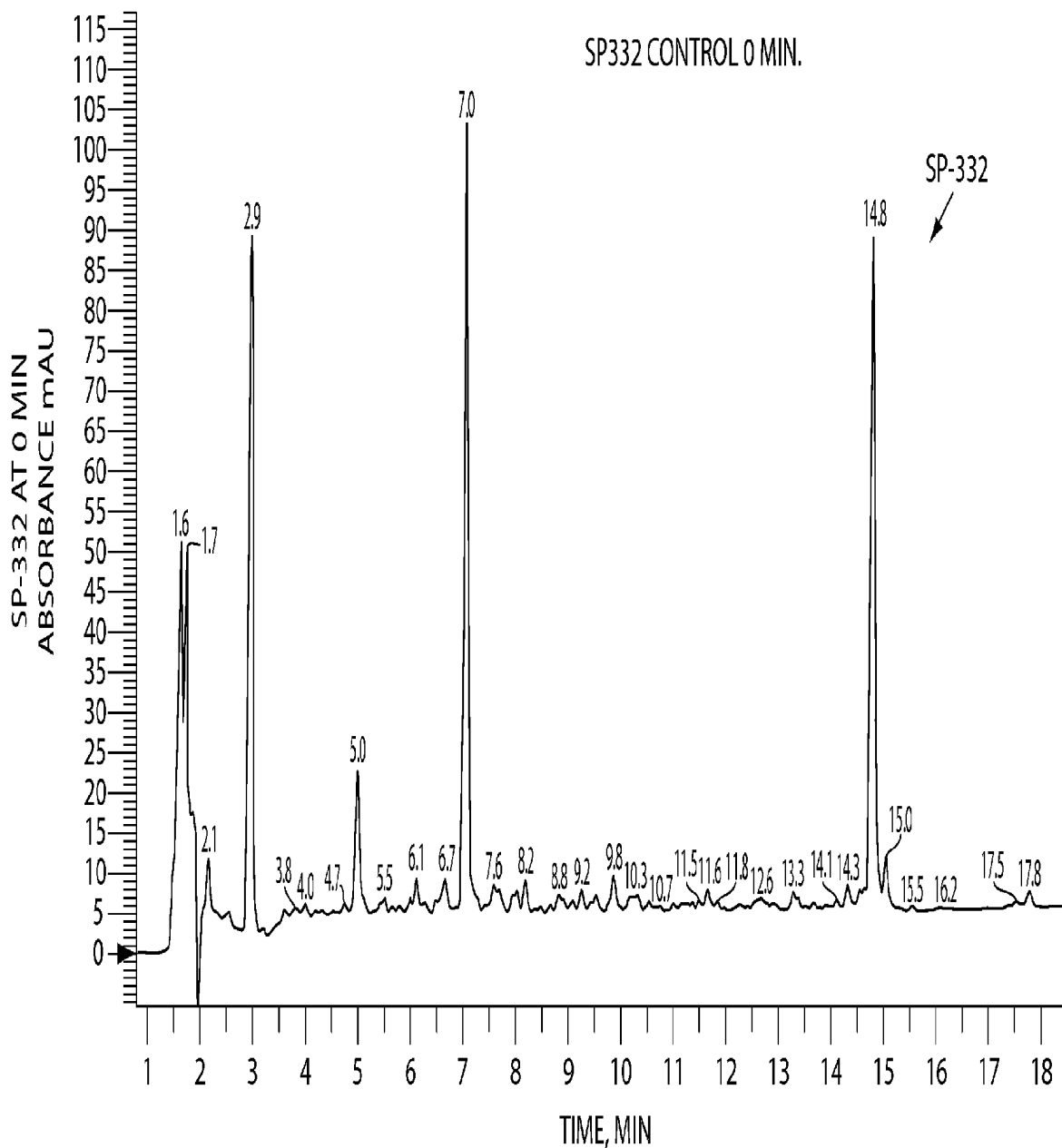

Fig. 7E-1

XWC OF DAD SPECTRAL DATA: 218.0 TO 220.0 nm
FROM SAMPLE 1 (M-SCAN #89608 CONTROL 120 MIN) OF 61.wiff

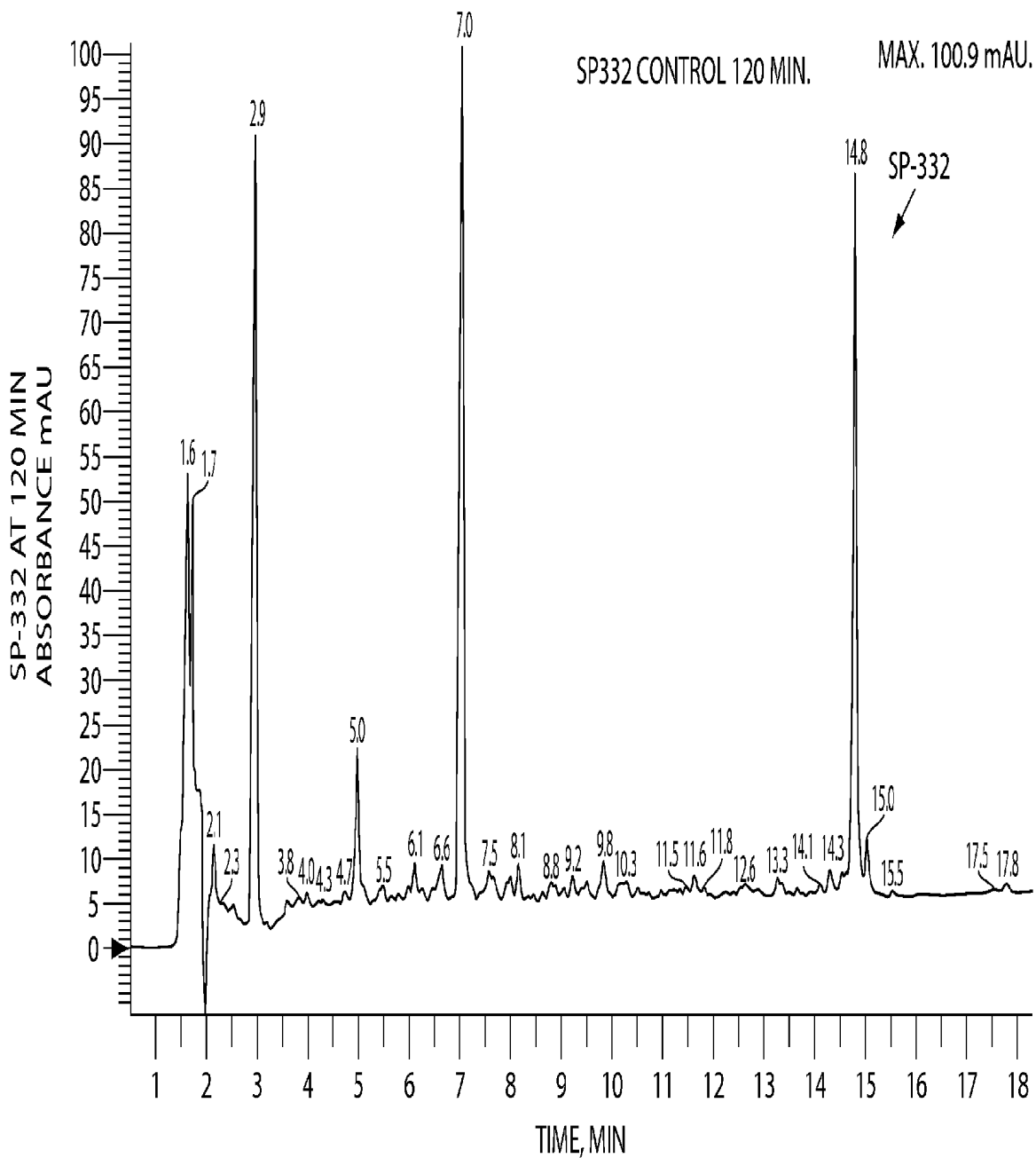

Fig. 7E-2

XWC OF DAD SPECTRAL DATA: 218.0 TO 220.0 nm
FROM SAMPLE 1 (M-SCAN #89609 CONTROL 0 MIN) OF 76.wiff

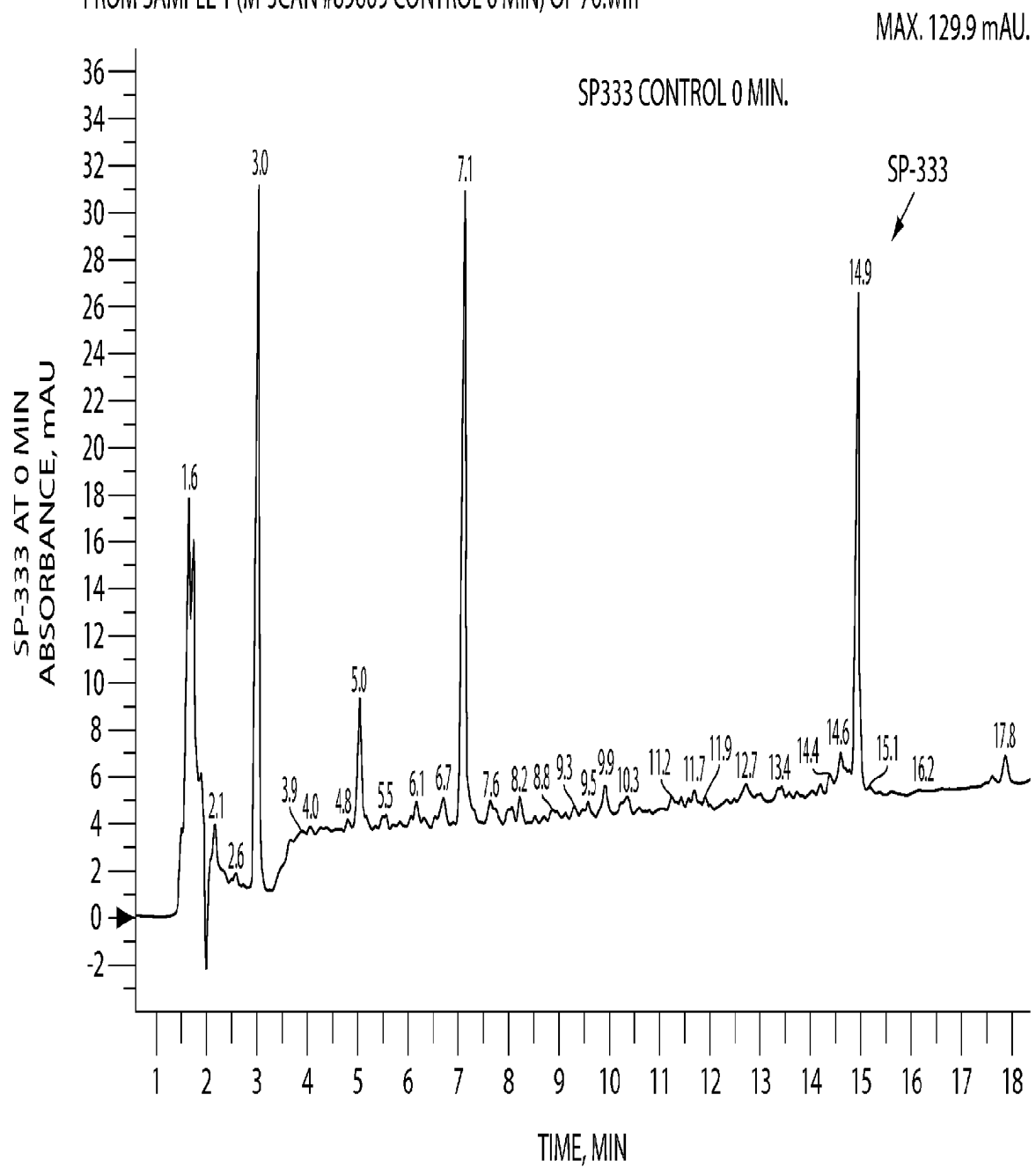

Fig. 7F-1

XWC OF DAD SPECTRAL DATA: 218.0 TO 220.0 nm
FROM SAMPLE 1 (M-SCAN #89609 CONTROL 120 MIN) OF 83.wiff

MAX. 131.9 mAU.

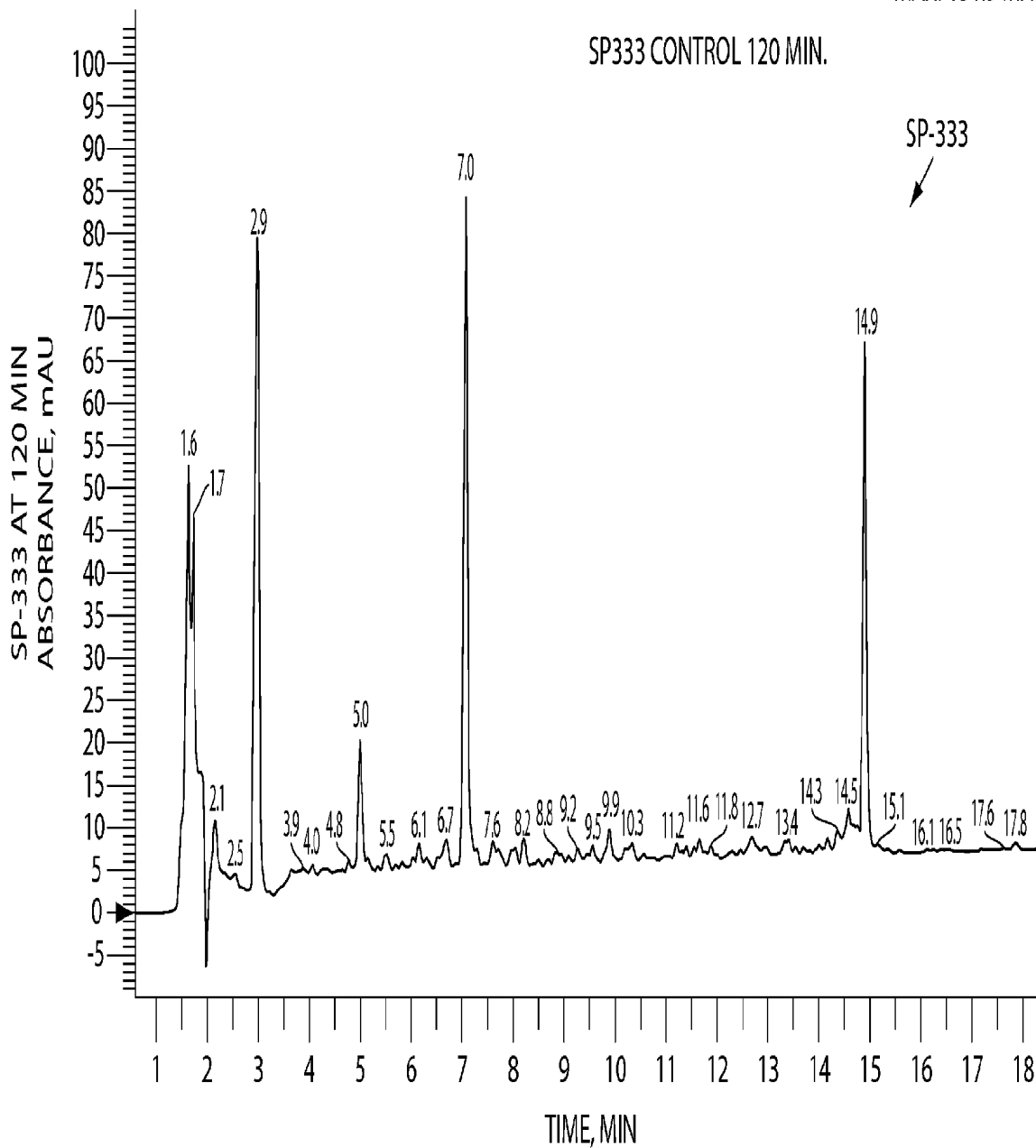

Fig. 7F-2

14/28

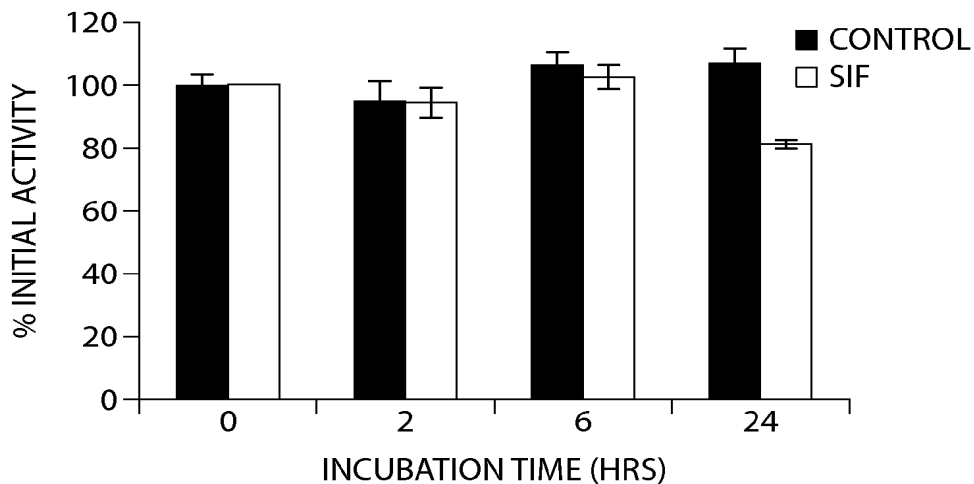

Fig. 7G-1

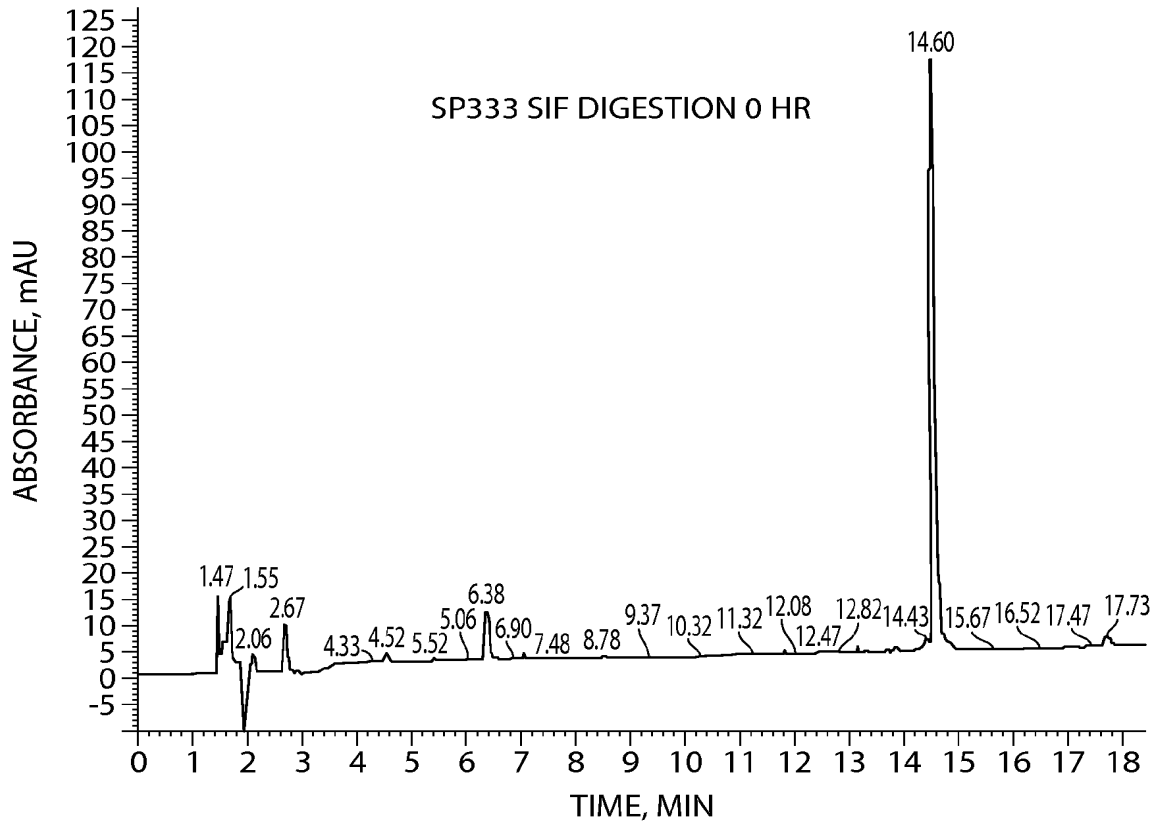

Fig. 7G-2

SUBSTITUTE SHEET (RULE 26)

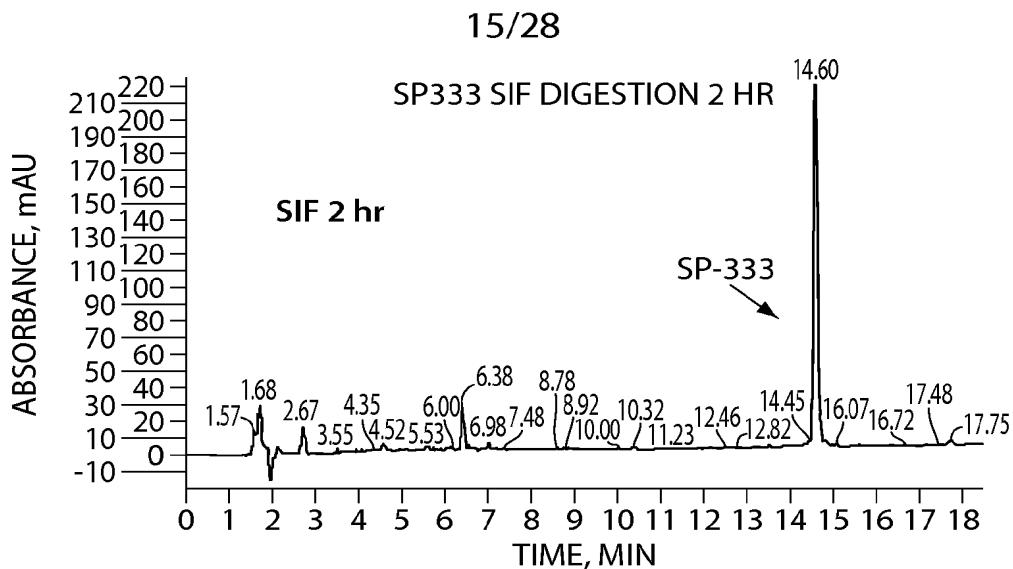

Fig. 7G-3

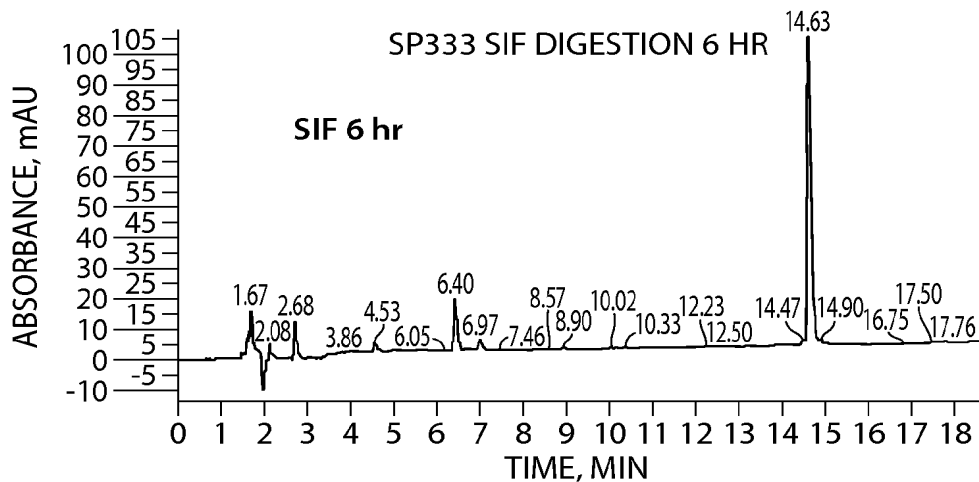

Fig. 7G-4

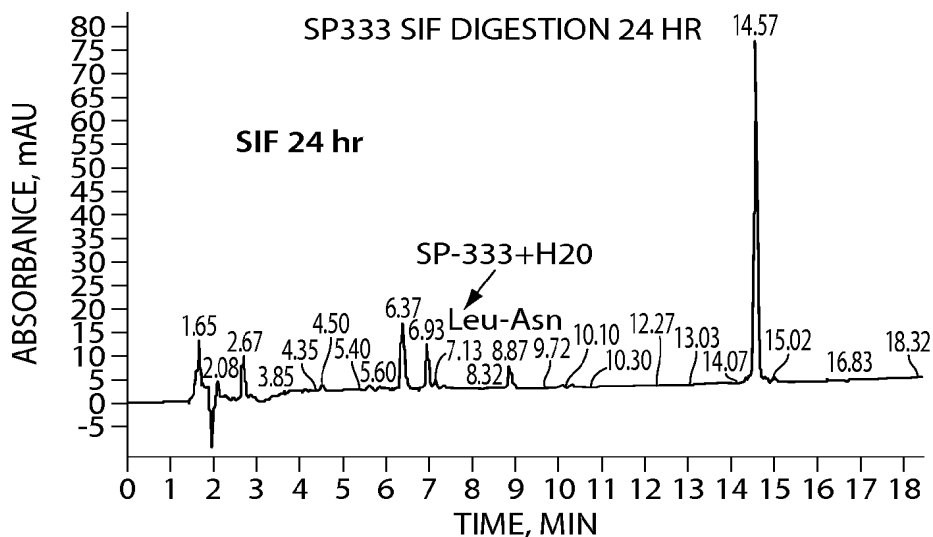

Fig. 7G-5

SUBSTITUTE SHEET (RULE 26)

16/28

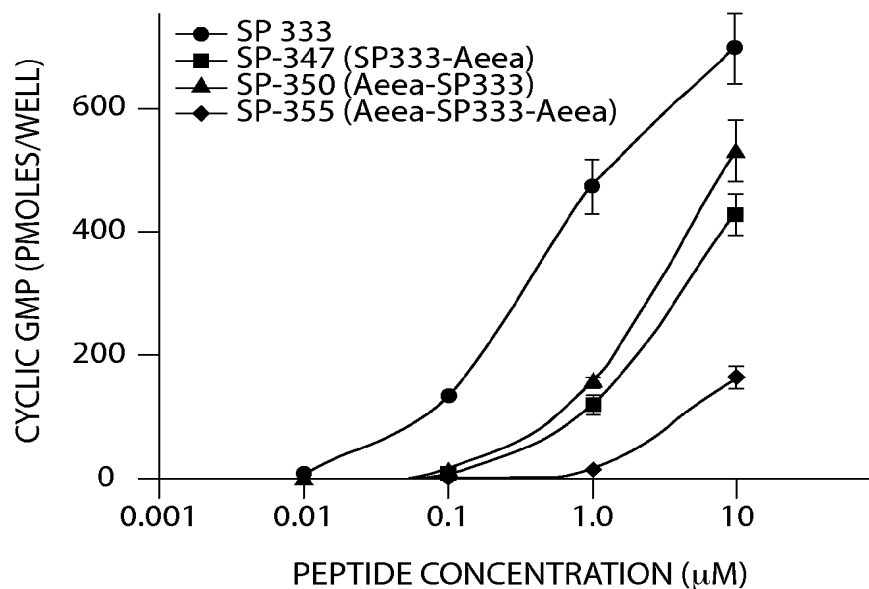

Fig. 8

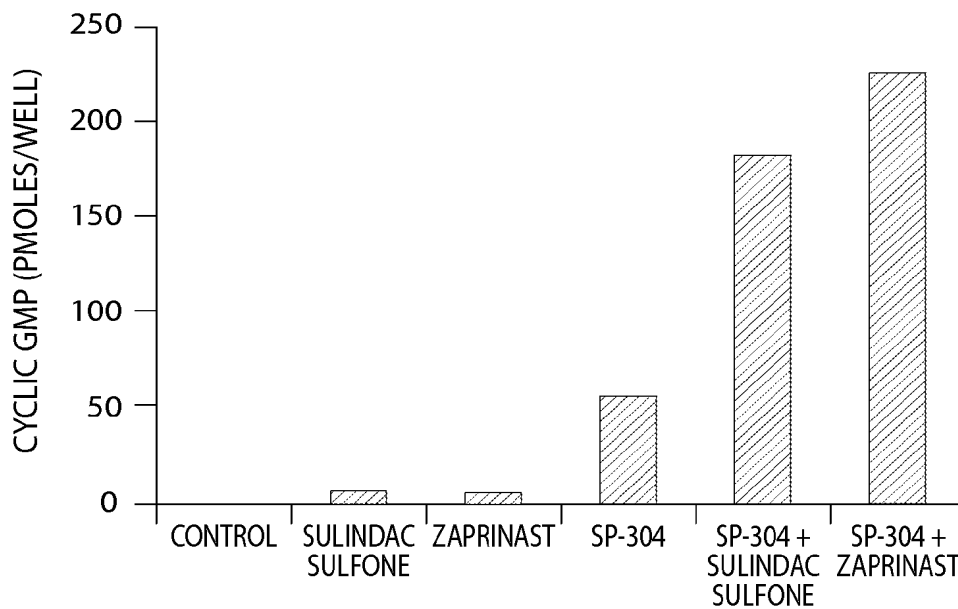

Fig. 9

17/28

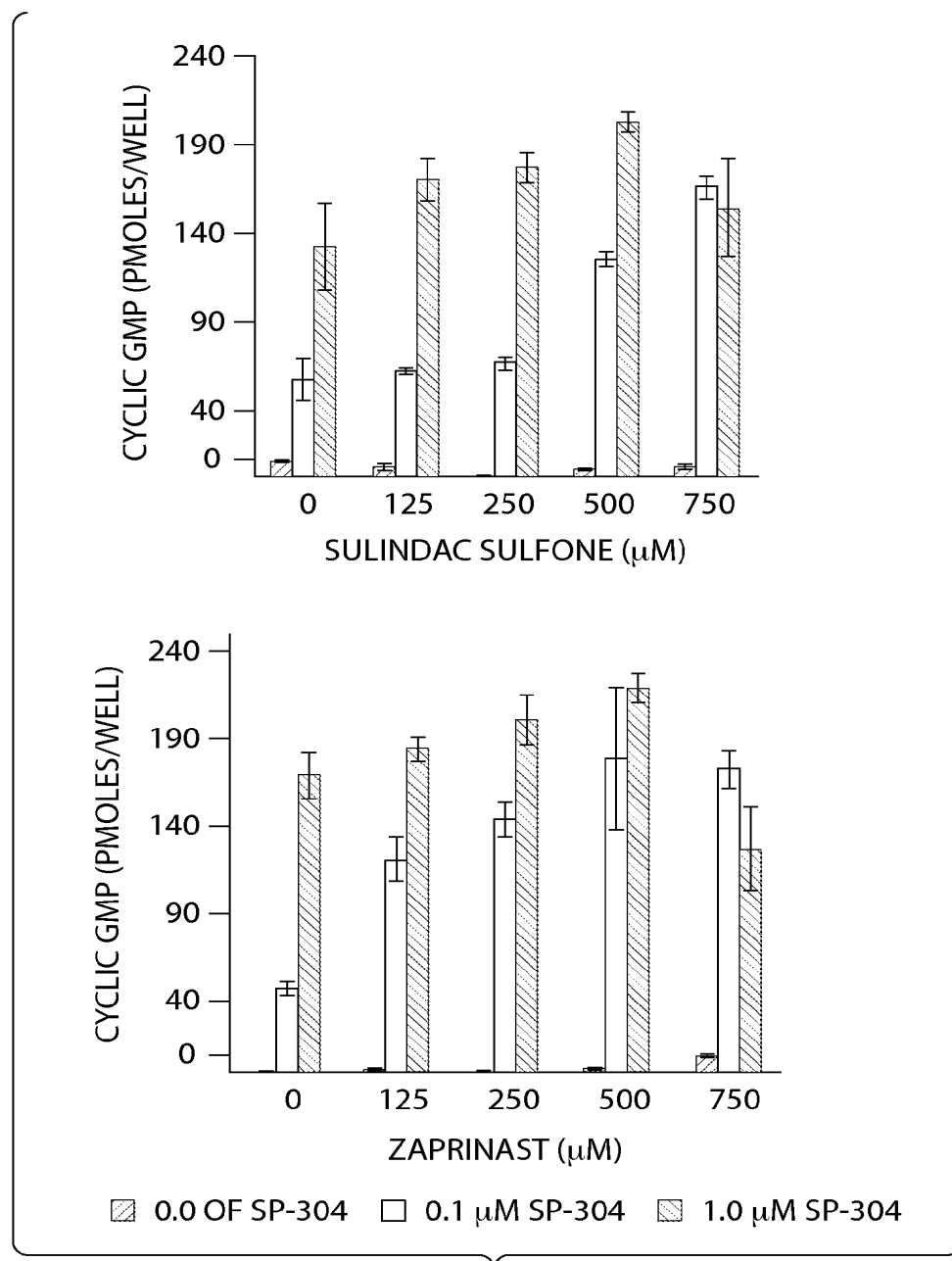

Fig. 10

18/28

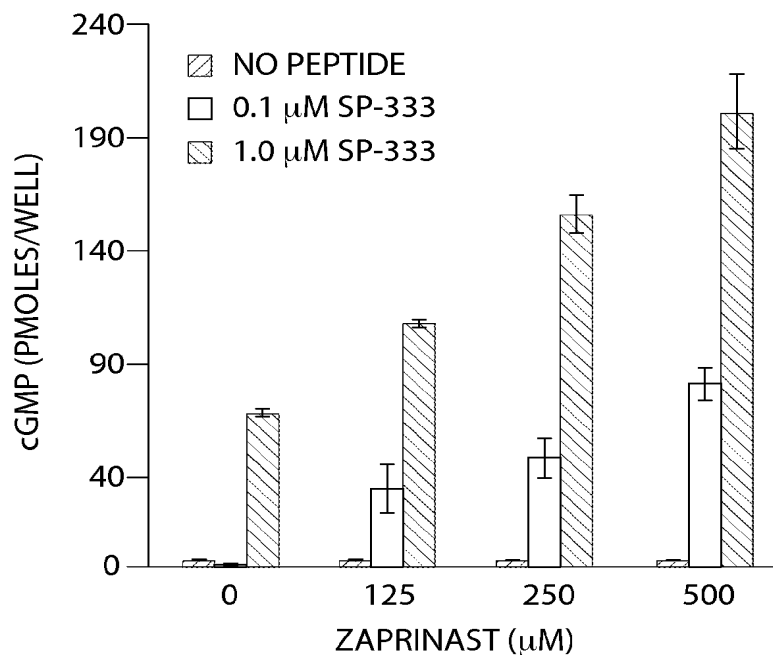

Fig. 11

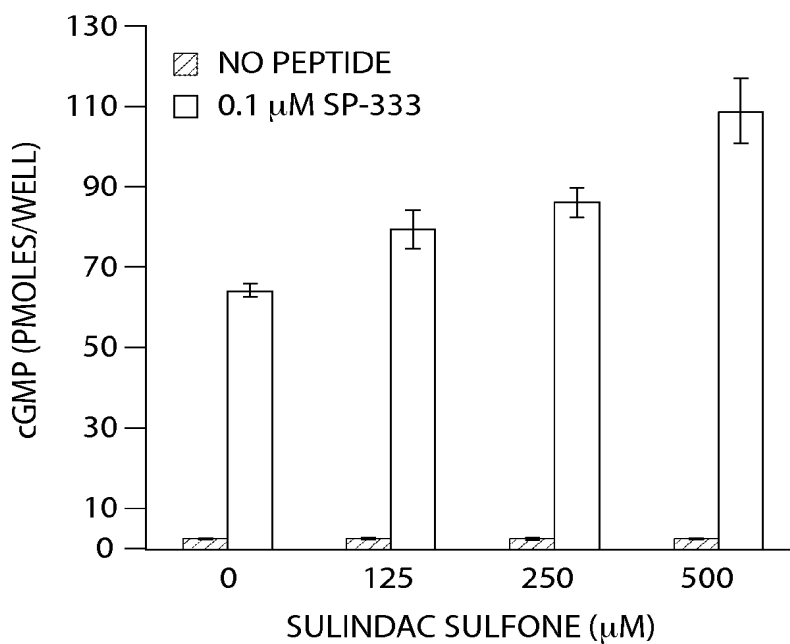

Fig. 12

19/28

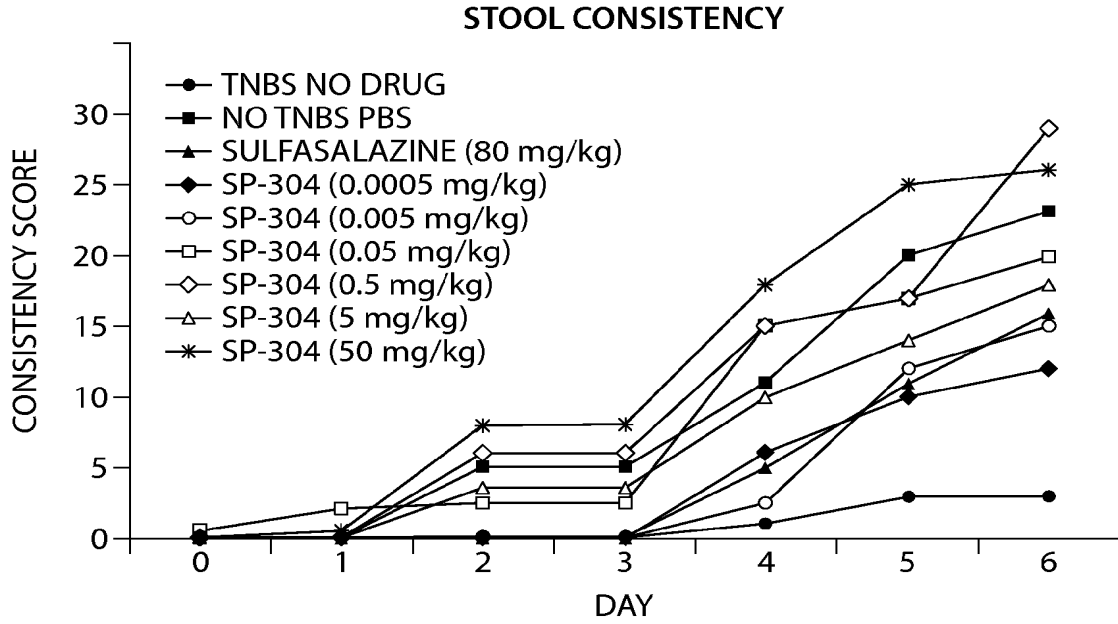

Fig. 13

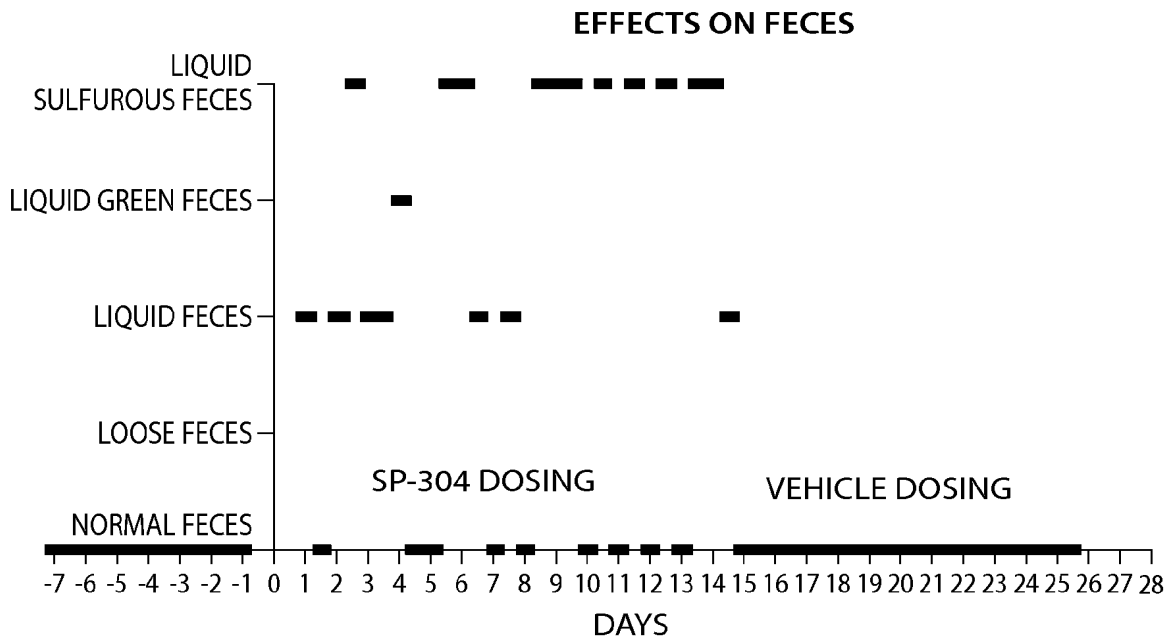
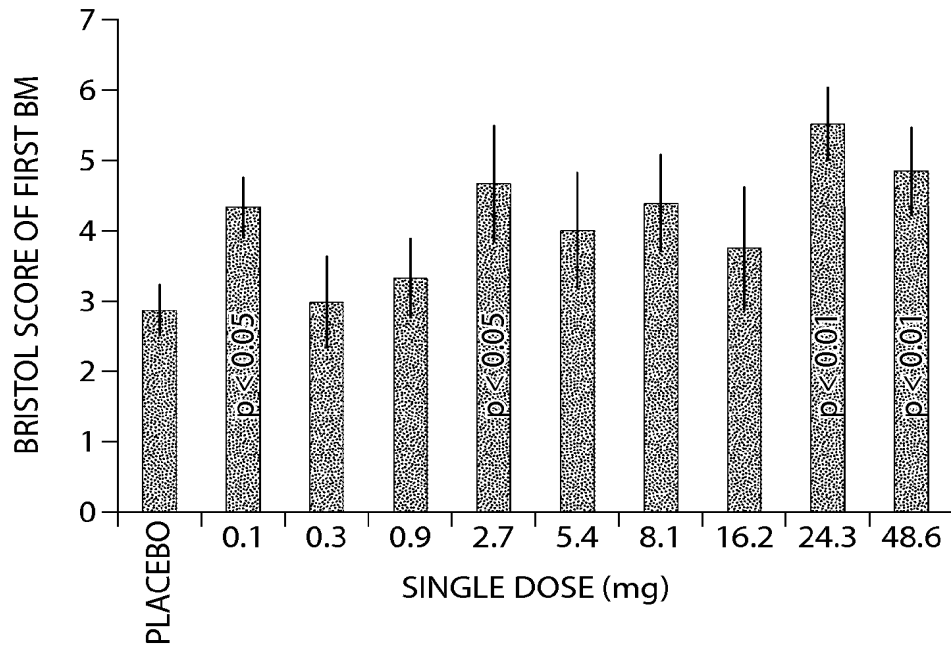

Fig. 14

20/28



* WILCOXON TWO-SAMPLE TEST TREATMENT VS PLACEBO ONE-SIDED

Fig. 15A

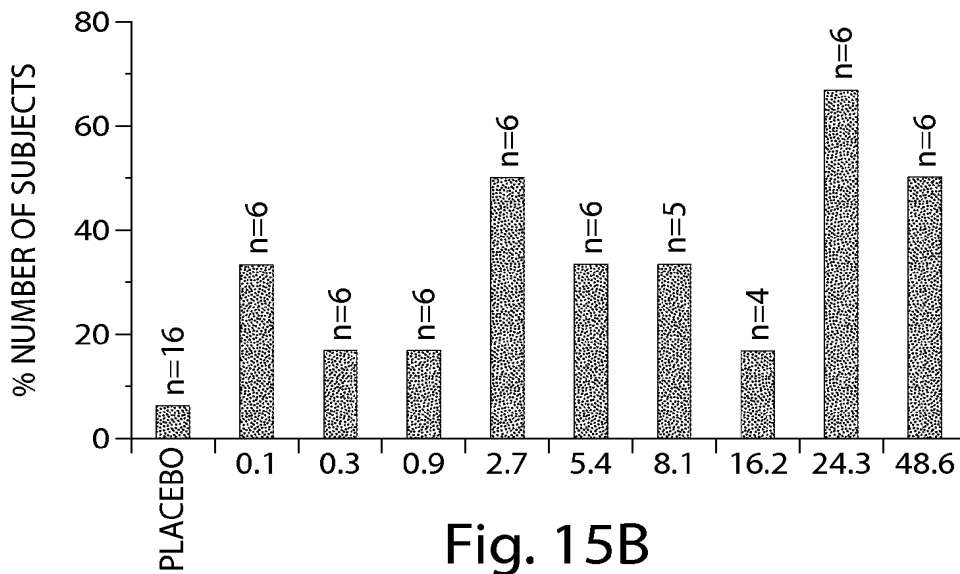

Fig. 15B

21/28

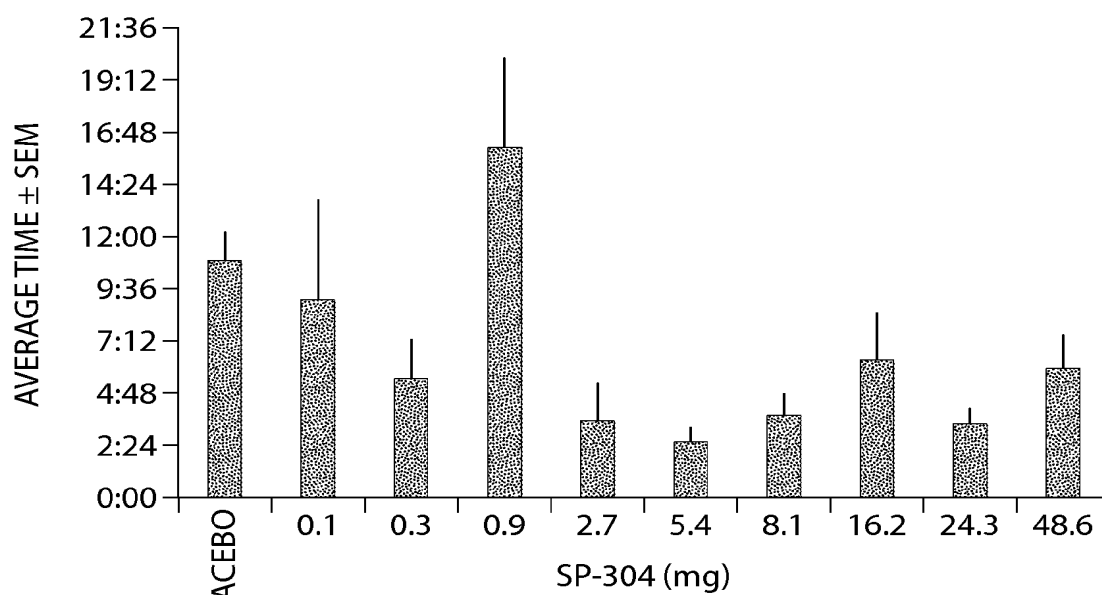

Fig. 16

22/28

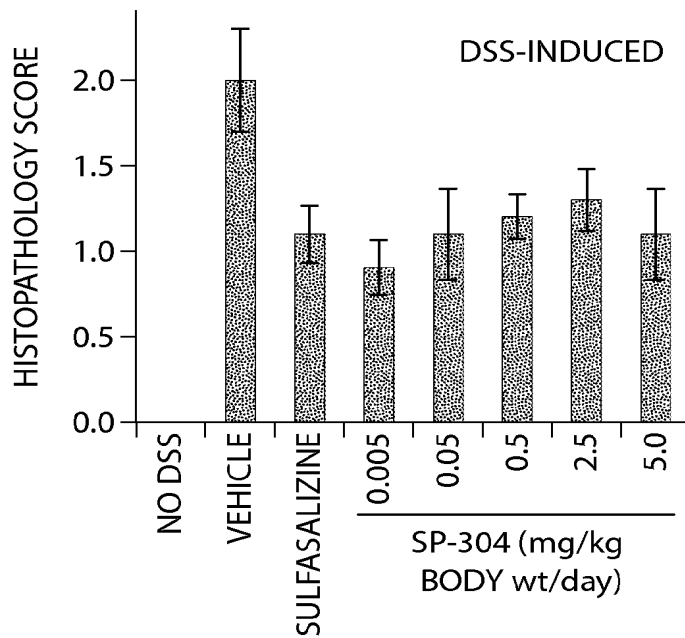

Fig. 17A

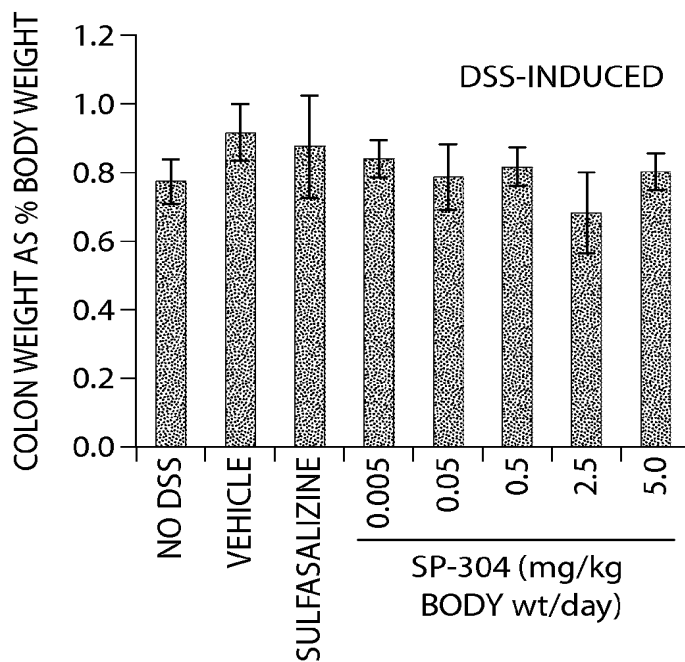

Fig. 17B

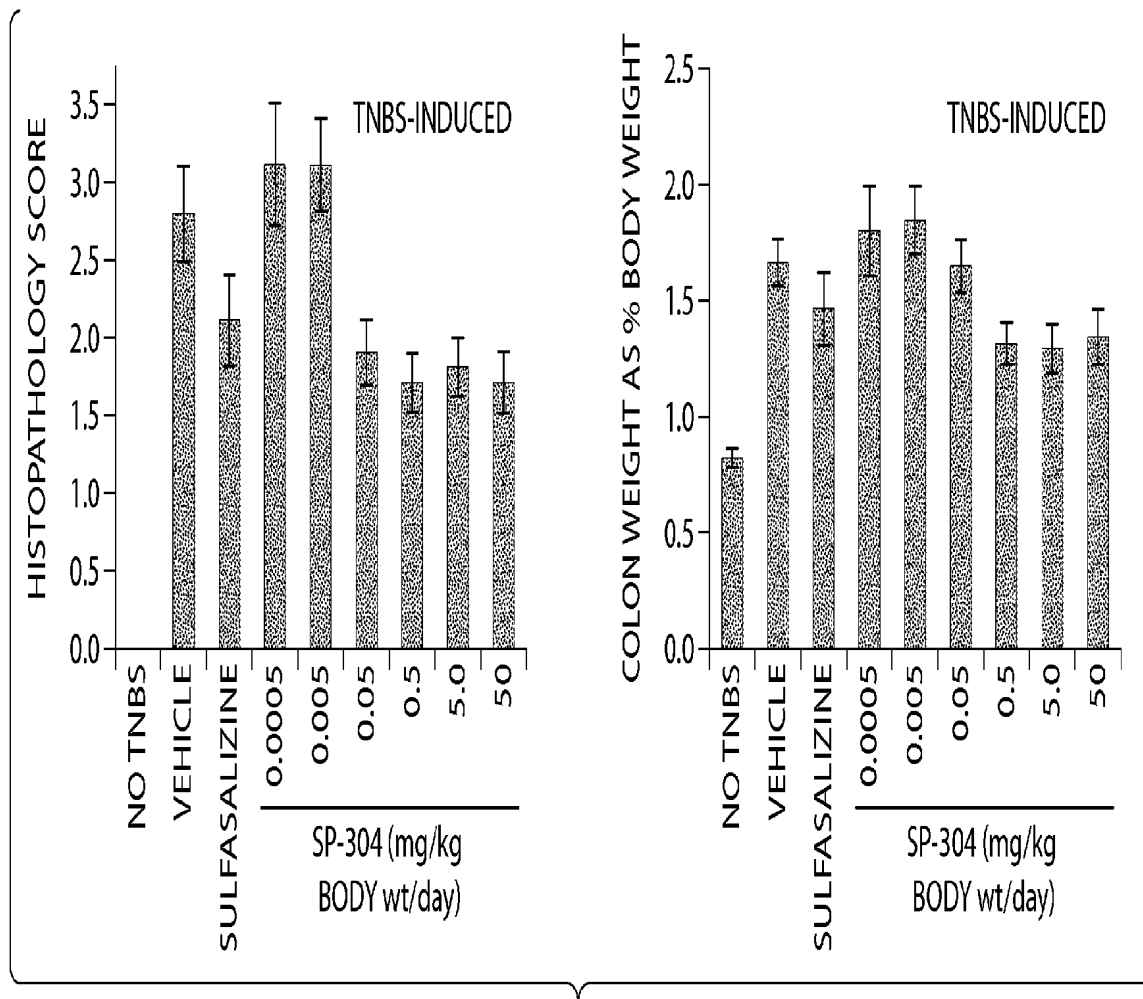

Fig. 18

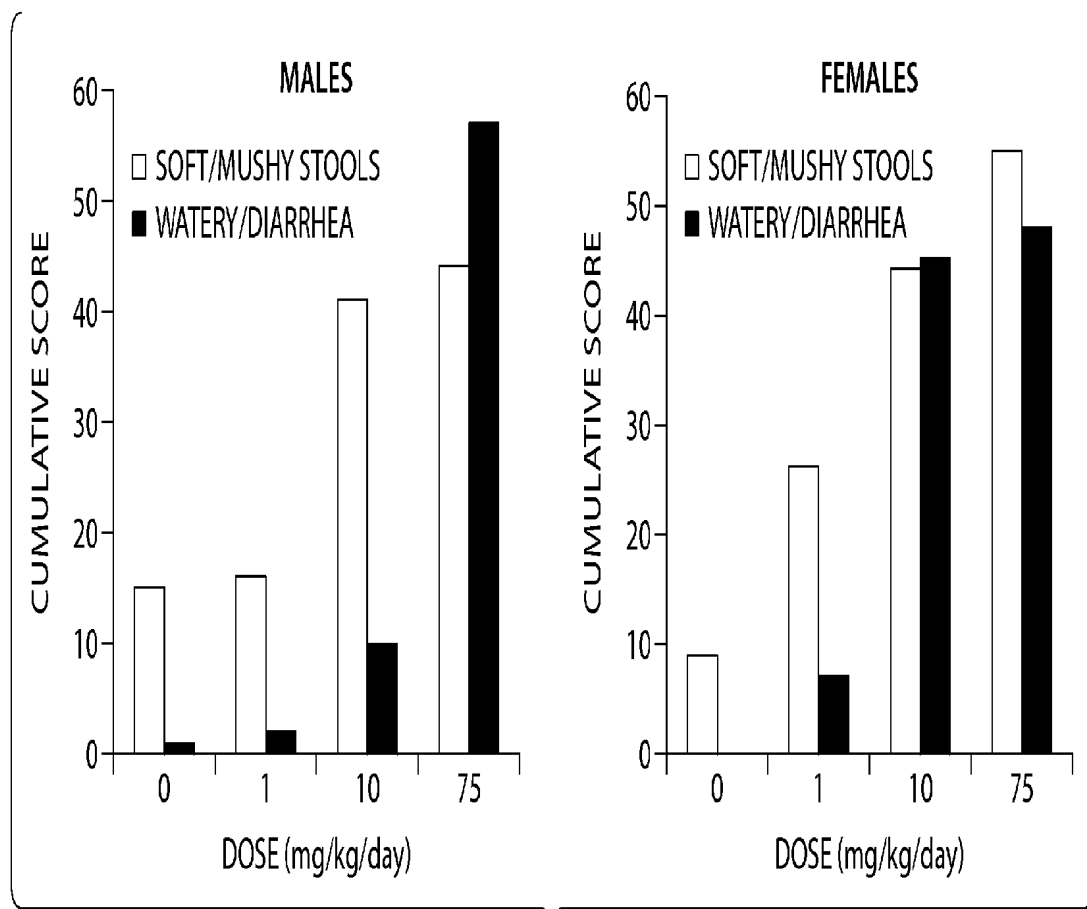

Fig. 19

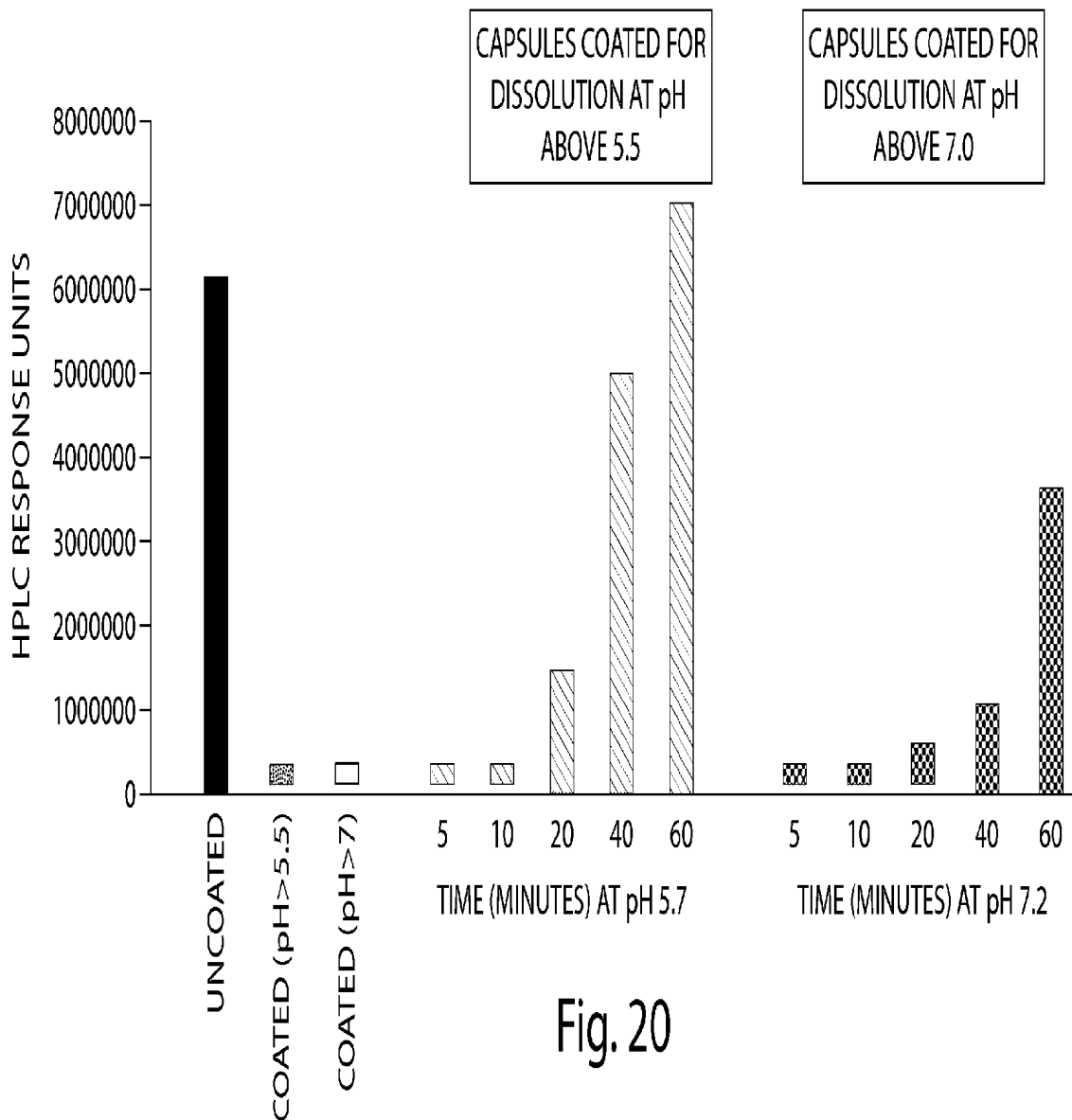

Fig. 20

26/28

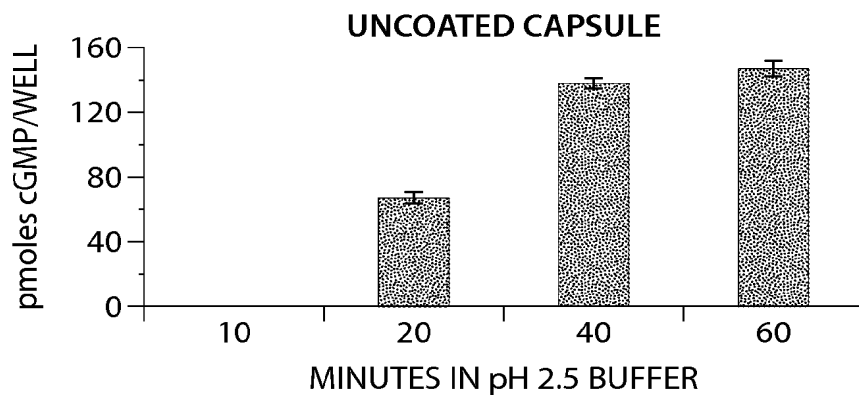

Fig. 21A

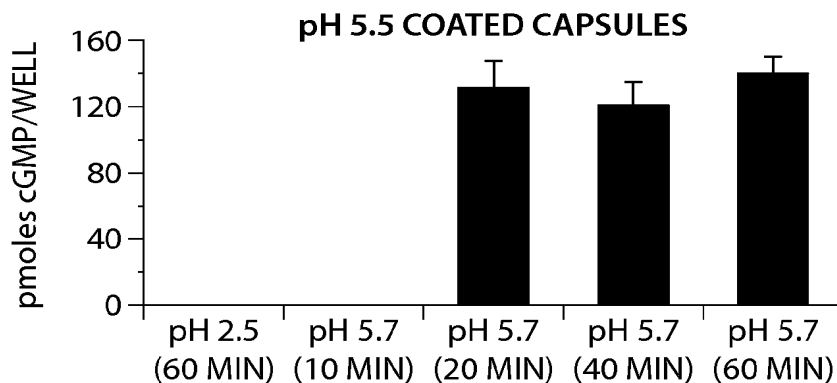

Fig. 21B

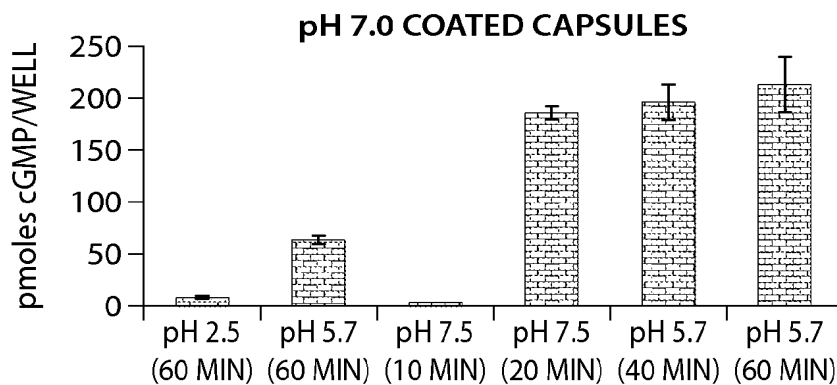

Fig. 21C

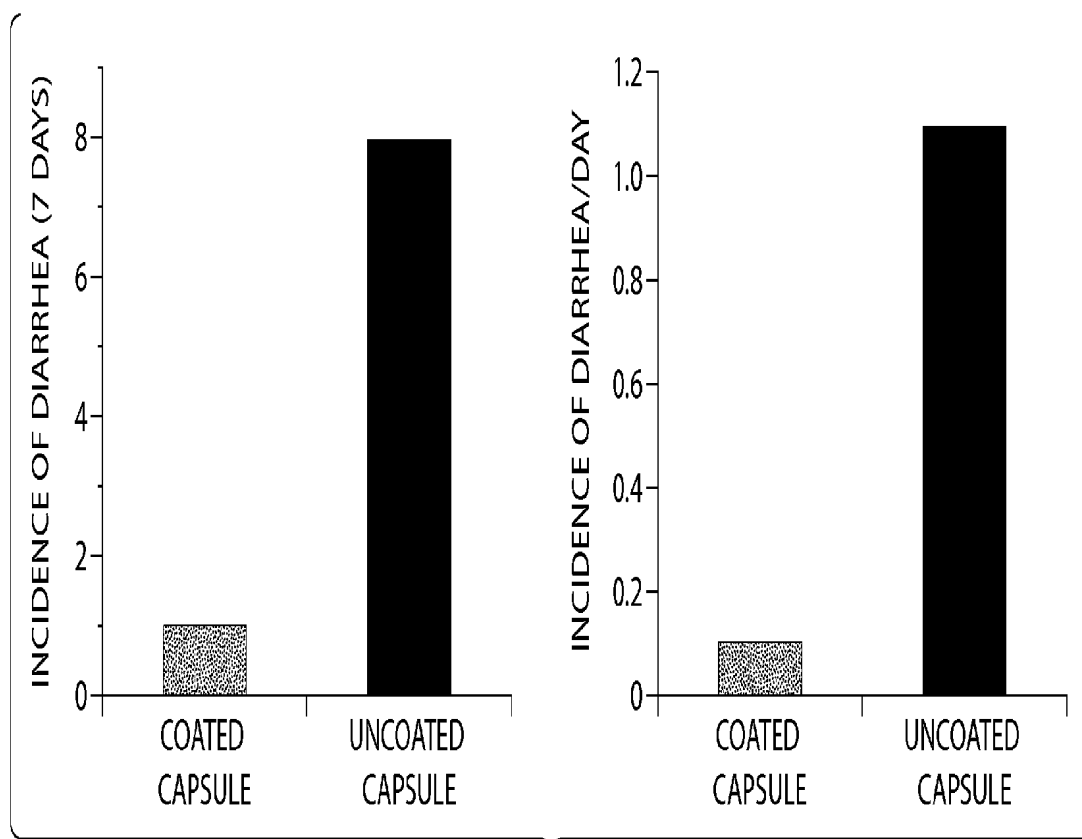

Fig. 22

28/28

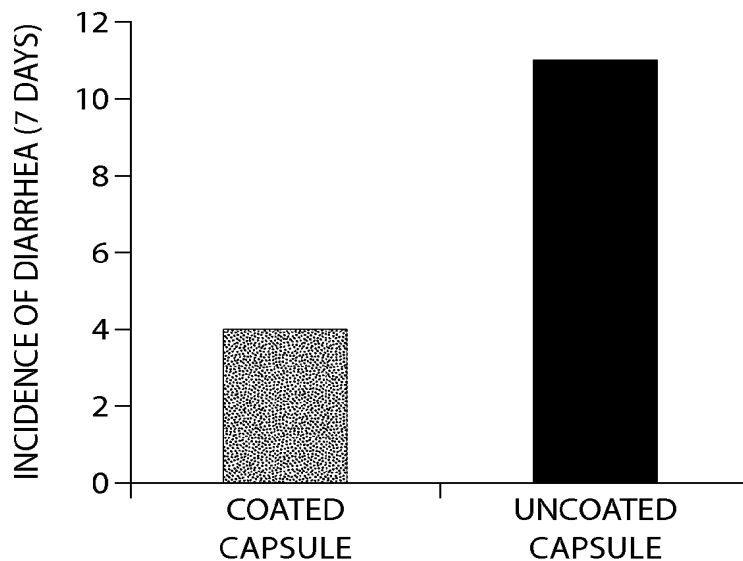

Fig. 23A

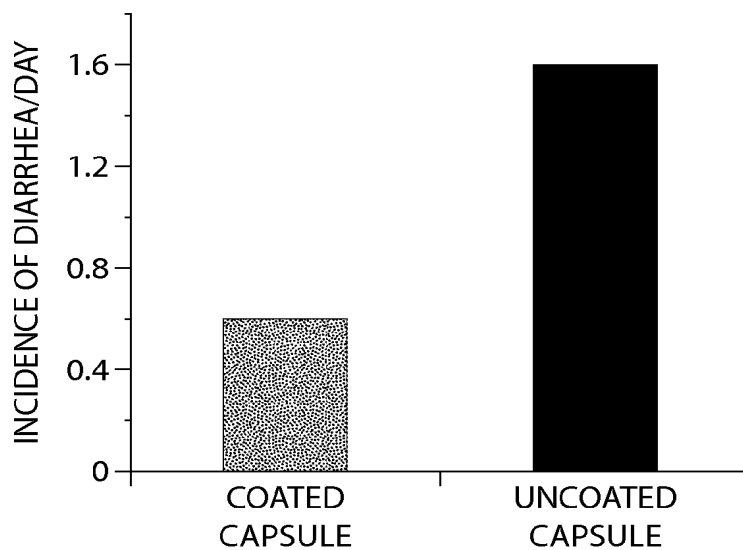

Fig. 23B

(19) World Intellectual Property Organization
International Bureau



(43) International Publication Date
17 February 2011 (17.02.2011)

(10) International Publication Number
WO 2011/020054 A1

- (51) **International Patent Classification:**
A61K 38/10 (2006.01) *A61P 1/00* (2006.01)
A61K 9/00 (2006.01) *A61P 1/10* (2006.01)
A61K 47/00 (2006.01)
- (21) **International Application Number:** PCT/US2010/045518
- (22) **International Filing Date:** 13 August 2010 (13.08.2010)
- (25) **Filing Language:** English
- (26) **Publication Language:** English
- (30) **Priority Data:** 61/233,740 13 August 2009 (13.08.2009) US
- (71) **Applicant** (for all designated States except US): **IRONWOOD PHARMACEUTICALS INC.** [US/US]; 301 Binney Street, Cambridge, MA 02142 (US).
- (72) **Inventors; and**
- (75) **Inventors/Applicants** (for US only): **JOHNSTON, Jeffrey** [US/US]; 26 Hanson Street, Unit #2, Boston, MA 02118 (US). **KURTZ, Caroline** [US/US]; 40 Stone Road, Sudbury, MA 01776 (US).
- (74) **Agent:** **MURPHY, Kelly, T.**; Honilgman Miller Schwartz And Cohn LLP, 350 East Michigan Avenue, Suite 300, Kalamazoo, MI 49007 (US).
- (81) **Designated States** (unless otherwise indicated, for every kind of national protection available): AE, AG, AL, AM, AO, AT, AU, AZ, BA, BB, BG, BH, BR, BW, BY, BZ, CA, CH, CL, CN, CO, CR, CU, CZ, DE, DK, DM, DO, DZ, EC, EE, EG, ES, FI, GB, GD, GE, GH, GM, GT, HN, HR, HU, ID, IL, IN, IS, JP, KE, KG, KM, KN, KP, KR, KZ, LA, LC, LK, LR, LS, LT, LU, LY, MA, MD, ME, MG, MK, MN, MW, MX, MY, MZ, NA, NG, NI, NO, NZ, OM, PE, PG, PH, PL, PT, RO, RS, RU, SC, SD, SE, SG, SK, SL, SM, ST, SV, SY, TH, TJ, TM, TN, TR, TT, TZ, UA, UG, US, UZ, VC, VN, ZA, ZM, ZW.
- (84) **Designated States** (unless otherwise indicated, for every kind of regional protection available): ARIPO (BW, GH, GM, KE, LR, LS, MW, MZ, NA, SD, SL, SZ, TZ, UG, ZM, ZW), Eurasian (AM, AZ, BY, KG, KZ, MD, RU, TJ, TM), European (AL, AT, BE, BG, CH, CY, CZ, DE, DK, EE, ES, FI, FR, GB, GR, HR, HU, IE, IS, IT, LT, LU, LV, MC, MK, MT, NL, NO, PL, PT, RO, SE, SI, SK, SM, TR), OAPI (BF, BJ, CF, CG, CI, CM, GA, GN, GQ, GW, ML, MR, NE, SN, TD, TG).
- Published:**
- with international search report (Art. 21(3))
 - before the expiration of the time limit for amending the claims and to be republished in the event of receipt of amendments (Rule 48.2(h))
 - with sequence listing part of description (Rule 5.2(a))



WO 2011/020054 A1

(54) **Title:** METHOD FOR MODULATING THE PHARMACODYNAMIC EFFECT OF ORALLY ADMINISTERED GUANYLATE CYCLASE RECEPTOR AGONISTS

(57) **Abstract:** A method of modulating the pharmacodynamic effect of a GC-C receptor agonist polypeptide formulation in a subject in need of such treatment is disclosed, The method comprises administering the GC-C receptor agonist polypeptide formulation to the subject before the ingestion of food.

METHOD FOR MODULATING THE PHARMACODYNAMIC EFFECT OF ORALLY ADMINISTERED GUANYLATE CYCLASE RECEPTOR AGONISTS

FIELD

This disclosure concerns methods of modulating the pharmacodynamic effect of a GC-C receptor agonist polypeptide formulations in a subject in need of such treatment.

PRIORITY CLAIM

This application claims priority to United States Application Serial No. 61/233,740, filed August 13, 2009. The entire contents of the aforementioned application are incorporated herein by reference.

SEQUENCE LISTING

This application incorporates by reference in its entirety the Sequence Listing entitled "mod_effect_app_ST25.txt" (4 kilobytes) which was created August 13, 2010 and filed electronically herewith.

BACKGROUND OF THE INVENTION

Linaclotide, a polypeptide having the amino acid sequence Cys Cys Glu Tyr Cys Cys Asn Pro Ala Cys Thr Gly Cys Tyr (SEQ ID NO: 1), activates the guanylate cyclase-C (GC-C) receptor (See, e.g., US 7,304,036 and US 7,371,727).

Linaclotide and other GC-C receptor agonists (such as those disclosed in any of US 7,304,036, US 7,371,727, WO 02/78683, WO 2004/069165, WO2005/087797, WO 2007/022531, WO2005/016244, WO2005/074575, WO2006/102069, WO2008/002971, WO2008/106429, WO 2008/137318, WO2002/078683, WO 2006/086653, WO 2007/101158, WO 2008/151257, US7041786, and WO 2007/101161) may be administered orally for the treatment of gastrointestinal disorders and conditions including irritable bowel syndrome (IBS) and chronic constipation (CC). Solid formulations comprising linaclotide have been developed for oral administration.

Methods are needed for modulating the pharmacodynamic effect of these linaclotide formulations as well as other GC-C receptor agonist polypeptide formulations.

SUMMARY OF THE INVENTION

These and other needs are met by the present invention, which provides a method for decreasing the pharmacodynamic effect of a GC-C receptor agonist polypeptide formulation

which is administered to a subject in need of such treatment, comprising administering the GC-C receptor agonist polypeptide to the subject before the ingestion of food.

In some embodiments, the GC-C receptor agonist polypeptide is administered to the subject as a formulation which comprising the GC-C receptor agonist polypeptide, a pharmaceutically acceptable carrier, and one or more agents selected from a cation selected from Mg^{2+} , Ca^{2+} , Zn^{2+} , Mn^{2+} , K^+ , Na^+ and Al^{3+} and a sterically hindered primary amine.

In another embodiment, the invention also provides a method of decreasing the pharmacodynamic effect of linaclotide which is administered to a subject in need of such treatment, comprising administering linaclotide to the subject before the ingestion of food.

The invention also provides a method of decreasing the pharmacodynamic effect of a linaclotide formulation which is administered to a subject in need of such treatment, comprising administering the GC-C receptor agonist polypeptide formulation to the subject before the ingestion of food, wherein the GC-C receptor agonist formulation comprises linaclotide, a pharmaceutically acceptable carrier, and one or more agents selected from a cation selected from Mg^{2+} , Ca^{2+} , Zn^{2+} , Mn^{2+} , K^+ , Na^+ and Al^{3+} and a sterically hindered primary amine.

The invention also provides a method of decreasing the pharmacodynamic effect of a GC-C receptor agonist polypeptide formulation which is administered to a subject suffering from irritable bowel syndrome or constipation, comprising administering the GC-C receptor agonist polypeptide formulation to the subject before the ingestion of food, wherein the GC-C receptor agonist formulation comprises a GC-C receptor agonist polypeptide, a pharmaceutically acceptable carrier, Ca^{+2} , and leucine.

The invention also provides a method of decreasing the pharmacodynamic effect of a linaclotide formulation which is administered to a subject suffering from irritable bowel syndrome (e.g., constipation-predominant irritable bowel syndrome) or constipation (e.g., chronic constipation), comprising administering the linaclotide formulation to the subject before the ingestion of food, wherein the GC-C receptor agonist formulation comprises linaclotide or a pharmaceutically acceptable salt of linaclotide, a pharmaceutically acceptable carrier, Ca^{+2} , and leucine.

The invention also provides a method of decreasing the pharmacodynamic effect of a linaclotide formulation which is administered to a subject suffering from irritable bowel syndrome or constipation, comprising administering the linaclotide formulation to the subject before the ingestion of food, wherein the linaclotide agonist formulation is in the form of a tablet or capsule that comprises:

- (a) Linaclotide;
- (b) $\text{CaCl}_2 \cdot 2\text{H}_2\text{O}$;
- (c) L-Leucine; and
- (d) Hydroxypropyl Methylcellulose

wherein linaclotide is present in the pharmaceutical composition in an amount between $100\mu\text{g}$ to $600\mu\text{g}$ and the molar ratio of Ca^{2+} :leucine:linaclotide is between 5-100:5-50:1.

In some embodiments, linaclotide is present in the tablet or capsule in an amount of 133 or $266\mu\text{g}$. In some embodiments, CaCl_2 is present in the tablet or capsule in an amount of $1541\mu\text{g}$. In some embodiments, leucine is present in the tablet or capsule in an amount of $687\mu\text{g}$. In some embodiments, hydroxypropyl methylcellulose is present in the tablet or capsule in an amount of $700\mu\text{g}$.

The invention also provides a method of decreasing the pharmacodynamic effect of a linaclotide formulation which is administered to a subject suffering from irritable bowel syndrome or constipation, comprising administering the linaclotide formulation to the subject before the ingestion of food, wherein the linaclotide agonist formulation is in the form of a tablet or capsule that comprises:

- (a) Linaclotide;
- (b) $\text{CaCl}_2 \cdot 2\text{H}_2\text{O}$;
- (c) L-Leucine; and
- (d) Hydroxypropyl Methylcellulose

wherein linaclotide is present in the pharmaceutical composition in an amount between $100\mu\text{g}$ to $600\mu\text{g}$ and the molar ratio of Ca^{2+} :leucine:linaclotide is between 5-100:5-50:1.

More particularly, linaclotide is present in the tablet or capsule in an amount of 133 or $266\mu\text{g}$.

More particularly, CaCl_2 is present in the tablet or capsule in an amount of $1541\mu\text{g}$.

More particularly, leucine is present in the tablet or capsule in an amount of $687\mu\text{g}$.

More particularly, hydroxypropyl methylcellulose is present in the tablet or capsule in an amount of $700\mu\text{g}$.

The invention also provides a method of treating irritable bowel syndrome or constipation in a subject in need of such treatment, comprising: administering a GC-C receptor agonist polypeptide to the subject before the ingestion of food.

DETAILED DESCRIPTION OF THE INVENTION

Definitions

As used herein, the term “binder” refers to any pharmaceutically acceptable binder that may be used in the practice of the invention. Examples of pharmaceutically acceptable binders include, without limitation, a starch (e.g., corn starch, potato starch and pre-gelatinized starch (e.g., STARCH 1500® and STARCH 1500 LM®, sold by Colorcon, Ltd.) and other starches), maltodextrin, gelatin, natural and synthetic gums such as acacia, powdered tragacanth, guar gum, cellulose and its derivatives (e.g., methylcellulose, hydroxyethyl cellulose, hydroxyethyl methylcellulose, hydroxypropyl cellulose and hydroxypropyl methylcellulose (hypromellose), ethyl cellulose, cellulose acetate, carboxymethyl cellulose calcium, sodium carboxymethyl cellulose, carboxymethylcellulose, microcrystalline cellulose (e.g. AVICEL™, such as, AVICEL-PH-101™, -103™ and -105™, sold by FMC Corporation, Marcus Hook, PA, USA)), polyvinyl alcohol, polyvinyl pyrrolidone (e.g., polyvinyl pyrrolidone K30), and mixtures thereof.

As used herein, the term “filler” refers to any pharmaceutically acceptable filler that may be used in the practice of the invention. Examples of pharmaceutically acceptable fillers include, without limitation, talc, calcium carbonate (e.g., granules or powder), dibasic calcium phosphate, tribasic calcium phosphate, calcium sulfate (e.g., granules or powder), microcrystalline cellulose (e.g., Avicel PH101 or Celphere CP-305), powdered cellulose, dextrates, kaolin, mannitol, silicic acid, sorbitol, starch (e.g., Starch 1500), pre-gelatinized starch, lactose, glucose, fructose, galactose, trehalose, sucrose, maltose, isomalt, raffinose, maltitol, melezitose, stachyose, lactitol, palatinite, xylitol, myoinositol, and mixtures thereof.

Examples of pharmaceutically acceptable fillers that may be particularly used for coating with linaclotide include, without limitation, talc, microcrystalline cellulose (e.g., Avicel PH101 or Celphere CP-305), powdered cellulose, dextrates, kaolin, mannitol, silicic acid, sorbitol, starch, pre-gelatinized starch, lactose, glucose, fructose, galactose, trehalose, sucrose, maltose, isomalt, dibasic calcium phosphate, raffinose, maltitol, melezitose, stachyose, lactitol, palatinite, xylitol, mannitol, myoinositol, and mixtures thereof.

As used herein, the term “additives” refers to any pharmaceutically acceptable additive. Pharmaceutically acceptable additives include, without limitation, disintegrants, dispersing additives, lubricants, glidants, antioxidants, coating additives, diluents, surfactants, flavoring additives, humectants, absorption promoting additives, controlled release additives, anti-caking additives, anti-microbial agents (e.g., preservatives), colorants, desiccants, plasticizers and dyes.

As used herein, an “excipient” is any pharmaceutically acceptable additive, filler, binder or agent.

As used herein, the term “alkyl”, as used herein, refers to a saturated linear or branched-chain monovalent hydrocarbon radical. Unless otherwise specified, an alkyl group contains 1-20 carbon atoms (e.g., 1-20 carbon atoms, 1-10 carbon atoms, 1-8 carbon atoms, 1-6 carbon atoms, 1-4 carbon atoms or 1-3 carbon atoms). Examples of alkyl groups include, but are not limited to, methyl, ethyl, n-propyl, isopropyl, n-butyl, isobutyl, s-butyl, t-butyl, pentyl, hexyl, heptyl, octyl and the like.

As used herein, the terms C_{n-m} “alkoxyalkyl” and C_{n-m} “thioalkoxyalkyl” mean alkyl, substituted with one or more alkoxy or thioalkoxy groups, as the case may be, wherein the combined total number of carbons of the alkyl and alkoxy groups, or alkyl and thioalkoxy groups, combined, as the case may be, is between the values of n and m. For example, a C_{4-6} alkoxyalkyl has a total of 4-6 carbons divided between the alkyl and alkoxy portion; e.g. it can be $-CH_2OCH_2CH_2CH_3$, $-CH_2CH_2OCH_2CH_3$ or $-CH_2CH_2CH_2OCH_3$.

As used herein, the term “aryl” (as in “aryl ring” or “aryl group”), used alone or as part of a larger moiety, refers to a carbocyclic ring system wherein at least one ring in the system is aromatic and has a single point of attachment to the rest of the molecule. Unless otherwise specified, an aryl group may be monocyclic, bicyclic or tricyclic and contain 6-18 ring members. Examples of aryl rings include, but are not limited to, phenyl, naphthyl, indanyl, indenyl, tetralin, fluorenyl, and anthracenyl.

As used herein, the term “heteroaryl” (or “heteroaromatic” or “heteroaryl group” or “aromatic heterocycle”) used alone or as part of a larger moiety as in “heteroaralkyl” or “heteroarylalkoxy” refers to a ring system wherein at least one ring in the system is aromatic and contains one or more heteroatoms, wherein each ring in the system contains 3 to 7 ring members and which has a single point of attachment to the rest of the molecule. Unless otherwise specified, a heteroaryl ring system may be monocyclic, bicyclic or tricyclic and have a total of five to fourteen ring members. In one embodiment, all rings in a heteroaryl system are aromatic. Also included in this definition are heteroaryl radicals where the heteroaryl ring is fused with one or more aromatic or non-aromatic carbocyclic or heterocyclic rings, or combinations thereof, as long as the radical or point of attachment is in the heteroaryl ring. Bicyclic 6,5 heteroaromatic system, as used herein, for example, is a six membered heteroaromatic ring fused to a second five membered ring wherein the radical or point of attachment is on the six membered ring.

Heteroaryl rings include, but are not limited to the following monocycles: 2-furanyl, 3-furanyl, N-imidazolyl, 2-imidazolyl, 4-imidazolyl, 5-imidazolyl, 3-isoxazolyl, 4-isoxazolyl, 5-isoxazolyl, 2-oxazolyl, 4-oxazolyl, 5-oxazolyl, N-pyrrolyl, 2-pyrrolyl, 3-pyrrolyl, 2-pyridyl, 3-pyridyl, 4-pyridyl, 2-pyrimidinyl, 4-pyrimidinyl, 5-pyrimidinyl, pyridazinyl (e.g., 3-pyridazinyl), 2-thiazolyl, 4-thiazolyl, 5-thiazolyl, tetrazolyl (e.g., 5-tetrazolyl), triazolyl (e.g., 2-triazolyl and 5-triazolyl), 2-thienyl, 3-thienyl, pyrazolyl (e.g., 2-pyrazolyl), isothiazolyl, 1,2,3-oxadiazolyl, 1,2,5-oxadiazolyl, 1,2,4-oxadiazolyl, 1,2,3-triazolyl, 1,2,3-thiadiazolyl, 1,3,4-thiadiazolyl, 1,2,5-thiadiazolyl, pyrazinyl, 1,3,5-triazinyl, and the following bicycles: benzimidazolyl, benzofuryl, benzothiophenyl, benzopyrazinyl, benzopyranonyl, indolyl (e.g., 2-indolyl), purinyl, quinolinyl (e.g., 2-quinolinyl, 3-quinolinyl, 4-quinolinyl), and isoquinolinyl (e.g., 1-isoquinolinyl, 3-isoquinolinyl, or 4-isoquinolinyl).

Stable GC-C Receptor Agonist Polypeptide Formulations

The formulations used in the method contain a GC-C receptor agonist polypeptide such as linaclotide, a pharmaceutically acceptable salt thereof, or a polypeptide as disclosed in any of US 7,304,036, US 7,371,727, WO 02/78683, WO 2004/069165, WO2005/087797, WO 2007/022531, WO2005/016244, WO2005/074575, WO2006/102069, WO2008/002971, WO2008/106429, WO 2008/137318, WO2002/078683, WO 2006/086653, WO 2007/101158, WO 2008/151257, US7041786, and WO 2007/101161.

The solid, stable formulations used in the invention contain a GC-C receptor agonist polypeptide as described in any of the above documents or linaclotide or a pharmaceutically acceptable salt of linaclotide. The formulations are stable and have a sufficient shelf life for manufacturing, storing and distributing the drug. For example, the formulations have an expected shelf life of at least 12 months at room temperature storage conditions (e.g., 25°C/60 percent relative humidity (RH)) and up to at least 18 months or 24 months at room temperature storage conditions (e.g., 25°C/60 percent RH). In the formulations, greater than or equal to 95 percent of the original amount of linaclotide in the composition remains after three months when packaged samples are stored at accelerated conditions (40°C/75 percent RH) when assessed in an assay on a weight/weight basis as determined by high pressure liquid chromatography (HPLC) against a linaclotide reference standard.

The GC-C receptor agonist polypeptide formulations are prepared from a solution, e.g., an aqueous solution ("the coating solution"), comprising: (i) a GC-C receptor agonist polypeptide such as linaclotide or a pharmaceutically acceptable salt thereof; (ii) a cation selected from Mg²⁺, Ca²⁺, Zn²⁺, Mn²⁺, K⁺, Na⁺ and Al³⁺ and/or a sterically hindered primary

amine (e.g., leucine); and optionally (iii) a pharmaceutically acceptable binder. The GC-C receptor agonist polypeptide formulations can optionally include one or more of: a pharmaceutically acceptable glidant, a pharmaceutically acceptable lubricant or a pharmaceutically acceptable additive that acts as both a glidant and lubricant.

It has been found that a cation selected from Mg^{2+} , Ca^{2+} , Zn^{2+} , Mn^{2+} , K^+ , Na^+ and Al^{3+} is useful for suppressing the formation of an oxidation product of the GC-C receptor agonist polypeptide linaclotide during storage. It has also been found that a sterically hindered primary amine is useful for suppressing the formation of a formaldehyde imine adduct of the GC-C receptor agonist polypeptide linaclotide ("formaldehyde imine product") during storage. Thus, the GC-C receptor agonist polypeptide formulations comprising a cation selected from Mg^{2+} , Ca^{2+} , Zn^{2+} , Mn^{2+} , K^+ , Na^+ or Al^{3+} --that is, a divalent cation selected from Zn^{2+} , Mg^{2+} and Ca^{2+} --and/or a sterically hindered primary amine, such as an amino acid, have a sufficient shelf life (as measured by chromatographic purity and/or by a weight/weight assay) for manufacturing, storing and distributing the drug. Further, while the presence of a sterically hindered amine alone can increase the formation of a hydrolysis product of linaclotide during storage, the combination of a sterically hindered primary amine and a cation, e.g., the combination of leucine and Ca^{2+} , suppresses the formation of the hydrolysis product of the GC-C receptor agonist polypeptide as well as the oxidation product of GC-C receptor agonist polypeptide during storage, leading to an even greater overall stability as determined by a weight/weight assay and/or by chromatographic purity.

GC-C receptor agonist polypeptide formulations are typically produced as follows.

Preparation of the Coating Solution: Approximately 32 g to 42 g of purified water is mixed with hydrochloric acid to create a solution with a pH between 1.5 and 2.0. The cation, if used, is added to the solution in a quantity to provide the desired concentration, and the solution is mixed for sufficient time to produce a clear solution. The sterically hindered primary amine, if used, is added to the solution in a quantity to provide the desired concentration, and the solution is mixed for sufficient time to produce a clear solution. Other additives, such as antioxidants, are then added, if desired. The pH of the solution is tested, and hydrochloric acid is added, if necessary, to produce a solution having a pH between 1.5 and 2.0. The binder is then added to the solution and the mixture is then stirred for sufficient time to achieve a clear solution. The desired amount of linaclotide is added to the solution and mixed for 30-100 minutes to provide the coating solution.

Preparation of the Active Beads: Approximately 30-36 g of dried microcrystalline cellulose beads are added to a Mini Column Fluid Bed Coater. The microcrystalline cellulose

beads are fluidized and heated prior to layering. Next, the coating solution is layered to the beads. The spraying temperature is controlled between 24°C and 55°C by controlling inlet temperature, spray rate, atomization pressure, and air volume. After the entire coating solution is layered to the beads, the beads are dried. The product of this process is referred to as active beads.

Preparation of Active Beads with Protective Coating (Optional): Approximately 35 g of Active Beads are added to a Mini Column Fluid Bed Coater. The Active Beads are fluidized and heated prior to coating with Aquacoat (e.g. Aquacoat Ethylcellulose Aqueous Dispersion, 15% w/w, FMC Biopolymer, ECD-30), Eudragit (e.g. Eudragit E PO PE-EL, Roehm Pharma Polymers) or Opadry (e.g. Opadry AMB dispersion, 20% w/w, Colorcon). Next, the coating solution is layered to the beads. The spraying temperature is controlled between 24°C and 55°C by controlling inlet temperature, spray rate, atomization pressure, and air volume. After the entire coating solution is layered to the beads, the beads are dried.

Formulation Scheme B

Preparation of the Coating Solution: Approximately 8.3 kg of purified water is mixed with hydrochloric acid to create a solution with a pH between 1.5 and 2.0. The cation, if used, is added to the solution in a quantity to provide the desired concentration, and the solution is mixed for sufficient time to produce a clear solution. The sterically hindered primary amine, if used, is added to the solution in a quantity to provide the desired concentration, and the solution is mixed for sufficient time to produce a clear solution. Other additives, such as antioxidants, are then added, if desired. The binder is then added to the solution and the solution is mixed for sufficient time to achieve a clear solution. The pH of the solution is tested, and hydrochloric acid is added if necessary to produce a solution having a pH between 1.5 and 2.0. This is Solution 1. Approximately 8.3 kg of purified water is mixed with hydrochloric acid to create a solution with a pH between 1.5 and 2.0. The desired amount of linaclotide is added to the solution and mixed for 10 to 30 minutes. The pH of the solution is tested, and hydrochloric acid is added if necessary to produce a solution having a pH between 1.5 and 2.0. This is Solution 2. Solution 1 and Solution 2 are then mixed together. The pH of the solution is tested, and hydrochloric acid is added if necessary to produce a solution having a pH between 1.5 and 2.0. This is the coating solution.

Preparation of the Active Beads: Approximately 24.19 kg of microcrystalline cellulose beads are added to a Wurster Column of a Glatt GPCG-30 Fluid Bed. The microcrystalline cellulose beads are fluidized and heated to product temperature of 45-47°C. Next, the coating solution is layered to the beads. The product spraying temperature is

controlled between 37°C and 47°C by controlling inlet temperature, spray rate, atomization pressure, and air volume. After the entire coating solution is layered to the beads, the beads are dried with a product drying temperature of 37°C to 47°C. The product of this process is referred to as active beads.

Indications

The GC-C receptor agonist polypeptide formulations can be used to treat a variety of disorders in patients. Typically, the patient is suffering from: a disorder selected from the group consisting of gastrointestinal motility disorders, chronic intestinal pseudo-obstruction, colonic pseudo-obstruction, duodenogastric reflux, dyspepsia, functional dyspepsia, nonulcer dyspepsia, a functional gastrointestinal disorder, functional heartburn, gastroesophageal reflux disease (GERD), gastroparesis, irritable bowel syndrome (e.g., constipation-predominant irritable bowel syndrome (c-IBS) and/or alternating irritable bowel syndrome (a-IBS)), post-operative ileus, chronic constipation, constipation, pain associated with constipation, and disorders and conditions associated with constipation (e.g., constipation associated with use of opiate pain killers, post-surgical constipation, and constipation associated with neuropathic disorders as well as other conditions and disorders described herein); and colonic pseudo-obstruction. In a further embodiment, the patient has been diagnosed with irritable bowel syndrome (e.g. (e.g. diarrhea predominant-IBS, constipation predominant-IBS, and/or alternating-IBS), according to the Rome Criteria (e.g. Rome II).

The dose range of the GC-C receptor agonist polypeptide (specifically linaclotide) for adult humans is generally from 25 µg to 6 mg per day orally. In one embodiment, the dose range is 25 µg to 2 mg per day orally of linaclotide. In a further embodiment, the dose range for adult humans is 50 µg to 1 mg per day orally of linaclotide (e.g., 50 µg, 67.5 µg, 100 µg, 133 µg, 150 µg, 200 µg, 250 µg, 266 µg, 300 µg, 350 µg, 400 µg, 450 µg, 500 µg, 550 µg, 600 µg, 650 µg, 700 µg, 750 µg, 800 µg, 850 µg, 900 µg, 950 µg or 1 mg). In yet a further embodiment, the dose range is 100 µg to 600 µg per day orally of linaclotide. In other embodiments, the dose is 50 µg, 67.5 µg, 100 µg, 133 µg, 150 µg, 200 µg, 266 µg, 300 µg, 400 µg, 500 µg or 600 µg linaclotide per day orally.

Methods

In one embodiment, the invention provides a method of decreasing the pharmacodynamic effect of a GC-C receptor agonist polypeptide formulation which is administered to a subject in need of such treatment, comprising administering the GC-C

receptor agonist polypeptide formulation to the subject before the ingestion of food. In a further embodiment, the GC-C receptor agonist formulation comprises a GC-C receptor agonist polypeptide, a pharmaceutically acceptable carrier, and one or more agents selected from a cation selected from Mg^{2+} , Ca^{2+} , Zn^{2+} , Mn^{2+} , K^+ , Na^+ and Al^{3+} and a sterically hindered primary amine. In yet a further embodiment, the GC-C receptor agonist polypeptide is linaclotide.

It has been found that the pharmacodynamic effect of a GC-C receptor agonist polypeptide (e.g., linaclotide) may be modulated by administering the polypeptide either before the ingestion of food or with food (e.g., with a meal or soon after ingesting a meal). Thus, the pharmacodynamic effect of the GC-C receptor agonist polypeptide (e.g., linaclotide) may be adjusted according the therapeutic needs of the subject in a beneficial manner, e.g., the pharmacodynamic effect may be modulated to improve one or more therapeutic indices or outcomes or, to decrease one or more undesired outcomes in a subject. Specifically, it has been found that administering a GC-C receptor agonist polypeptide (e.g., linaclotide) before the ingestion of food decreases the pharmacodynamic effect of the polypeptide, thus decreasing the risk of potential side effects (e.g., loose stools or diarrhea). Conversely, one may administer a GC-C receptor agonist polypeptide to increase the pharmacodynamic effect of the polypeptide if a greater therapeutic effect is desired

“Before the ingestion of food” means prior to eating; that is, 15 minutes, 30 minutes, 45 minutes, 60 minutes, 2 hours, 4 hours, 6 hours, 8 hours, 10 hours, 12 hours, and up to 24 hours before the ingestion of food. Administration of the formulation prior to the consumption of food decreases the pharmacodynamic effect of the GC-C receptor agonist polypeptide while minimizing potential adverse events. These adverse events may include, for example, loose stools. “Before the ingestion of food” also means the GC-C receptor agonist polypeptide formulation is administered on an empty stomach.

Thus, in one aspect, the GC-C receptor agonist polypeptide formulation is administered 15 minutes to 4 hours before the ingestion of food.

In another aspect, the GC-C receptor agonist polypeptide formulation is administered to the subject from 15 minutes to 24 hours before the ingestion of food.

In another aspect, the GC-C receptor agonist polypeptide formulation is administered at least 15 minutes before the ingestion of food.

In another aspect, the GC-C receptor agonist polypeptide formulation is administered to the subject 30 minutes to 8 hours before the ingestion of food.

In another aspect, the GC-C receptor agonist polypeptide formulation is administered to the subject 30 minutes before the ingestion of food.

In another aspect, the GC-C receptor agonist polypeptide formulation is administered to the subject at least 30 minutes before the ingestion of food.

Thus, in another aspect, the GC-C receptor agonist polypeptide formulation is administered to the subject 45 minutes before the ingestion of food.

Thus, in another aspect, the GC-C receptor agonist polypeptide formulation is administered to the subject 60 minutes before the ingestion of food.

In another aspect, the GC-C receptor agonist polypeptide formulation is administered to the subject 30 minutes to 8 hours before the ingestion of food.

In another aspect, the GC-C receptor agonist polypeptide formulation is administered to the subject 1 hour to 18 hours before the ingestion of food.

In another aspect, the GC-C receptor agonist polypeptide formulation is administered to the subject 4 to 12 hours before the ingestion of food.

In another aspect, the GC-C receptor agonist polypeptide formulation is administered to the subject 1 to 8 hours before the ingestion of food.

In another aspect, the GC-C receptor agonist polypeptide formulation is administered to a subject having an empty stomach.

In a further embodiment of the above aspects, the GC-C receptor agonist polypeptide is linaclotide or a pharmaceutically acceptable salt thereof.

In a further aspect, the pharmacodynamic effect is measured by the Bristol Stool Form Scale (BSFS), the number of spontaneous bowel movements (SBM) in a given time period and/or the number of complete SBM (CSBM) in a given time period. A decrease in the pharmacodynamic effect may be measured by a decrease in the BSFS, SBM or CSBM when the GC-C receptor agonist polypeptide formulation is administered to a subject before the ingestion of food (e.g., at least 15 minutes, at least 30 minutes, at least 45 minutes, at least one hour or at least two hours before the ingestion of food or at least four hours, at least eight hours, at least ten hours or at least 12 hours after a prior ingestion of food) compared to the pharmacodynamic effect of the GC-C receptor agonist polypeptide formulation when it is administered to a subject with food (e.g., a meal) or shortly after ingestion of food (e.g., within 15 minutes, within 30 minutes, within 90 minutes or within two hours after ingestion of food).

In another aspect, the pharmacodynamic effect results in a lower score on the Bristol Stool Form Scale (BSFS) when the formulation is administered to the subject before

ingestion of food as compared to when the formulation is administered to the subject with food or shortly after ingestion of food.

In another aspect, the pharmacodynamic effect results in fewer spontaneous bowel movements (SBM) in a time period (e.g., a 24 hour period, three day time period, seven day time period, two week time period or four week time period) when the formulation is administered to the subject before ingestion of food as compared to when the formulation is administered to the subject with food or shortly after ingestion of food.

In another aspect, the pharmacodynamic effect results in fewer spontaneous bowel movements in a time period (e.g., a 24 hour period) when the formulation is administered to a subject before ingestion of food as compared to when the formulation is administered to the subject with food or shortly after ingestion of food.

In another aspect, the pharmacodynamic effect results in fewer complete spontaneous bowel movements (CSBM) in a time period (e.g., a 24 hour period, three day time period, seven day time period, two week time period or four week time period) when the formulation is administered to the subject before ingestion of food as compared to when the formulation is administered to the subject with food or shortly after ingestion of food.

In another aspect, the pharmacodynamic effect results in a lower score on the Bristol Stool Form Scale (BSFS), fewer spontaneous bowel movements (SBM) in a time period (e.g., a 24 hour period, three day time period, seven day time period, two week time period or four week time period), and fewer complete spontaneous bowel movements (CSBM) in a time period (e.g., a 24 hour period, three day time period, seven day time period, two week time period or four week time period) when the formulation is administered to the subject before ingestion of food as compared to when the formulation is administered to the subject with food or shortly after ingestion of food.

In another aspect, the pharmacodynamic effect results in a lower score on the Bristol Stool Form Scale (BSFS) and fewer spontaneous bowel movements (SBM) in a time period (e.g., a 24 hour period, three day time period, seven day time period, two week time period or four week time period), when the formulation is administered to a subject who has not eaten as compared to said subject before ingestion of food as compared to when the formulation is administered to the subject with food or shortly after ingestion of food.

In another aspect, the pharmacodynamic effect results in a lower score on the Bristol Stool Form Scale (BSFS) and fewer complete spontaneous bowel movements (CSBM) in a time period (e.g., a 24 hour period, three day time period, seven day time period, two week time period or four week time period), when the formulation is administered to a subject

before ingestion of food as compared to when the formulation is administered to the subject with food or shortly after ingestion of food.

In another aspect, the pharmacodynamic effect results in fewer SBM in a time period (e.g., a 24 hour period, three day time period, seven day time period, two week time period or four week time period) and fewer CSBM in a time period (e.g., a 24 hour period, three day time period, seven day time period, two week time period or four week time period) when the formulation is administered to a subject before ingestion of food as compared to when the formulation is administered to the subject with food or shortly after ingestion of food.

As indicated previously, the GC-C receptor agonist polypeptide formulation of the invention method comprises a GC-C receptor agonist polypeptide, a pharmaceutically acceptable carrier, and one or more agents selected from a cation and a sterically hindered primary amine.

In one aspect, the GC-C receptor agonist polypeptide is selected from linaclotide and any of the polypeptides disclosed in any of US 7,304,036, US 7,371,727, WO 02/78683, WO 2004/069165, WO2005/087797, WO 2007/022531, WO2005/016244, WO2005/074575, WO2006/102069, WO2008/002971, WO2008/106429, WO 2008/137318, WO2002/078683, WO 2006/086653, WO 2007/101158, WO 2008/151257, US7041786, and WO 2007/101161.

More particularly, the polypeptide is selected from the group consisting of: CCEFCCNPACTGCY (SEQ ID NO: 2), CCEFCCNPACTGC (SEQ ID NO: 3), CCEICCNPACTGCY (SEQ ID NO: 4), CCEICCNPACTGC (SEQ ID NO: 5), CCELCCNPACTGCY (SEQ ID NO: 6), CCELCCNPACTGC (SEQ ID NO: 7), CCEWCCNPACTGCY (SEQ ID NO: 8), CCEWCCNPACTGC (SEQ ID NO: 9), CCEYCCNPACTGC (SEQ ID NO: 10), PGTCEICAYAACTGC (SEQ ID NO: 11), NDDCELCVNVACTGCL (SEQ ID NO: 12), NDECELCVNVACTGCL (SEQ ID NO: 13), and CCEYCCNPACTGCY (SEQ ID NO: 14).

More particularly, the GC-C receptor agonist polypeptide is linaclotide.

In another aspect, the agent is cation selected from the group consisting of Mg^{2+} , Ca^{2+} , Zn^{2+} , Mn^{2+} , K^+ , Na^+ and Al^{3+} .

In another aspect, the Mg^{2+} , Ca^{2+} , Zn^{2+} , Mn^{2+} , K^+ , Na^+ or Al^{3+} is provided as magnesium acetate, magnesium chloride, magnesium phosphate, magnesium sulfate, calcium acetate, calcium chloride, calcium phosphate, calcium sulfate, zinc acetate, zinc chloride, zinc phosphate, zinc sulfate, manganese acetate, manganese chloride, manganese phosphate, manganese sulfate, potassium acetate, potassium chloride, potassium phosphate, potassium

sulfate, sodium acetate, sodium chloride, sodium phosphate, sodium sulfate, aluminum acetate, aluminum chloride, aluminum phosphate or aluminum sulfate.

More particularly, the Mg^{2+} , Ca^{2+} , Zn^{2+} , Mn^{2+} , K^+ , Na^+ or Al^{3+} is provided as magnesium chloride, calcium chloride, calcium phosphate, calcium sulfate, zinc acetate, manganese chloride, potassium chloride, sodium chloride or aluminum chloride.

In another aspect, the agent is Mg^{2+} , Ca^{2+} or Zn^{2+} .

More particularly, the Mg^{2+} , Ca^{2+} or Zn^{2+} is provided as magnesium chloride, calcium chloride or zinc acetate.

More particularly, the agent is Ca^{2+} .

More particularly, the Ca^{2+} is provided as calcium chloride.

In another aspect, the agent is a sterically hindered primary amine.

More particularly, the sterically hindered primary amine is an amino acid.

More particularly, the amino acid is a naturally-occurring amino acid.

More particularly, the naturally-occurring amino acid is histidine, phenylalanine, alanine, glutamic acid, aspartic acid, glutamine, leucine, methionine, asparagine, tyrosine, threonine, isoleucine, tryptophan, glycine or valine.

More particularly, the naturally-occurring amino acid is leucine, isoleucine, alanine or methionine.

More particularly, the naturally-occurring amino acid is leucine or methionine.

More particularly, the naturally-occurring amino acid is leucine.

Alternatively, the sterically hindered primary amine is a non-naturally occurring amino acid.

More particularly, the non-naturally occurring amino acid is 1-aminocyclohexane carboxylic acid.

Alternatively, the sterically hindered primary amine has the formula: $\text{R}_1\text{R}_2\text{R}_3\text{N}$, wherein R_1 , R_2 and R_3 are independently selected from: H; $-C(O)OH$; C_1-C_6 alkyl, optionally substituted by $-CO_2H$, $-CONH_2$, or a 5-10 membered aryl or heteroaryl; C_1-C_6 alkoxyalkyl; or C_1-C_6 thioalkoxyalkyl, wherein any of the alkyl or aryl groups above can be singly or multiply substituted with halogen or $-NH_2$, and provided that no more than two of R_1 , R_2 and R_3 are H. In a further embodiment, no more than one of R_1 , R_2 and R_3 is H.

More particularly, the sterically hindered primary amine has the formula:

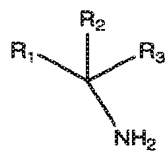

, wherein R_1 , R_2 and R_3 are independently selected from: H; $-C(O)OH$; C_1 - C_6 alkyl; C_1 - C_6 alkoxyalkyl; or C_1 - C_6 thioalkoxyalkyl, wherein any of the alkyl or aryl groups above can be singly or multiply substituted with halogen or $-NH_2$, and provided that no more than two of R_1 , R_2 and R_3 are H. In a further embodiment, no more than one of R_1 , R_2 and R_3 is H.

More particularly, the sterically hindered primary amine has the formula:

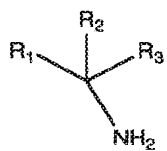

, wherein R_1 , R_2 and R_3 are independently selected from: H; $-C(O)OH$; C_1 - C_6 alkyl; C_1 - C_6 alkoxyalkyl; or C_1 - C_6 thioalkoxyalkyl, and provided that no more than two of R_1 , R_2 and R_3 are H. In a further embodiment, no more than one of R_1 , R_2 and R_3 is H.

In another embodiment, the sterically hindered primary amine is cyclohexylamine or 2-methylbutylamine.

In another embodiment, the sterically hindered primary amine is chitosan.

In any of these aspects and embodiments, the GC-C receptor agonist polypeptide may be linacotide.

In another aspect, the GC-C receptor agonist polypeptide formulation used in the method comprises a cation selected from Mg^{2+} , Ca^{2+} , Zn^{2+} , Mn^{2+} , K^+ , Na^+ and Al^{3+} and a sterically hindered primary amine.

More particularly, the Mg^{2+} , Ca^{2+} , Zn^{2+} , Mn^{2+} , K^+ , Na^+ or Al^{3+} is provided as magnesium acetate, magnesium chloride, magnesium phosphate, magnesium sulfate, calcium acetate, calcium chloride, calcium phosphate, calcium sulfate, zinc acetate, zinc chloride, zinc phosphate, zinc sulfate, manganese acetate, manganese chloride, manganese phosphate, manganese sulfate, potassium acetate, potassium chloride, potassium phosphate, potassium sulfate, sodium acetate, sodium chloride, sodium phosphate, sodium sulfate, aluminum acetate, aluminum chloride, aluminum phosphate or aluminum sulfate.

More particularly, the Mg^{2+} , Ca^{2+} , Zn^{2+} , Mn^{2+} , K^+ , Na^+ or Al^{3+} is provided as magnesium chloride, calcium chloride, calcium phosphate, calcium sulfate, zinc acetate, manganese chloride, potassium chloride, sodium chloride or aluminum chloride.

More particularly, the cation is selected from Mg^{2+} , Ca^{2+} or Zn^{2+} .

More particularly, the Mg^{2+} , Ca^{2+} or Zn^{2+} is provided as magnesium chloride, calcium chloride or zinc acetate.

More particularly, the cation is Ca^{2+} .

More particularly, the Ca^{2+} is provided as calcium chloride.

More particularly, the sterically hindered primary amine is an amino acid.

More particularly, the amino acid is a naturally-occurring amino acid.

More particularly, the naturally-occurring amino acid is histidine, phenylalanine, alanine, glutamic acid, aspartic acid, glutamine, leucine, methionine, asparagine, tyrosine, threonine, isoleucine, tryptophan, glycine or valine.

More particularly, the naturally-occurring amino acid is leucine, isoleucine, alanine or methionine.

More particularly, the naturally-occurring amino acid is leucine or methionine.

More particularly, the naturally-occurring amino acid is leucine.

Alternatively, the sterically hindered primary amine is a non-naturally occurring amino acid.

More particularly, the non-naturally occurring amino acid is 1-aminocyclohexane carboxylic acid.

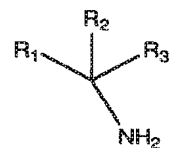
Alternatively, the sterically hindered primary amine has the formula: , wherein R_1 , R_2 and R_3 are independently selected from: H; $-C(O)OH$; C_1-C_6 alkyl, optionally substituted by $-CO_2H$, $-CONH_2$, or a 5-10 membered aryl or heteroaryl; C_1-C_6 alkoxyalkyl; or C_1-C_6 thioalkoxyalkyl, wherein any of the alkyl or aryl groups above can be singly or multiply substituted with halogen or $-NH_2$, and provided that no more than two of R_1 , R_2 and R_3 are H. In a further embodiment, no more than one of R_1 , R_2 and R_3 is H.

More particularly, the sterically hindered primary amine has the formula:

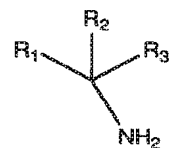

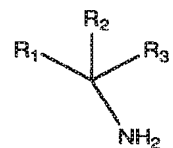
, wherein R_1 , R_2 and R_3 are independently selected from: H; $-C(O)OH$; C_1-C_6 alkyl; C_1-C_6 alkoxyalkyl; or C_1-C_6 thioalkoxyalkyl, wherein any of the alkyl or aryl groups above can be singly or multiply substituted with halogen or $-NH_2$, and provided that no more than two of R_1 , R_2 and R_3 are H. In a further embodiment, no more than one of R_1 , R_2 and R_3 is H.

More particularly, the sterically hindered primary amine has the formula:

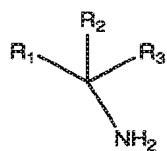

, wherein R₁, R₂ and R₃ are independently selected from: H; -C(O)OH; C₁-C₆ alkyl; C₁-C₆ alkoxyalkyl; or C₁-C₆ thioalkoxyalkyl, and provided that no more than two of R₁, R₂ and R₃ are H. In a further embodiment, no more than one of R₁, R₂ and R₃ is H.

In another embodiment, the sterically hindered primary amine is cyclohexylamine or 2-methylbutylamine.

In another embodiment, the sterically hindered primary amine is chitosan.

In any of these aspects or embodiments, the GC-C receptor agonist polypeptide may be linaclotide.

In these aspects, the GC-C receptor agonist polypeptide formulation additionally comprises a pharmaceutically acceptable binder. In particular, the pharmaceutically acceptable binder is selected from polyvinyl alcohol, polyvinylpyrrolidone (povidone), a starch, maltodextrin or a cellulose ether. More particularly, the pharmaceutically acceptable binder is a cellulose ether which may be selected from: methylcellulose, ethylcellulose, carboxymethylcellulose, hydroxyethyl cellulose, hydroxyethyl methylcellulose, hydroxypropyl cellulose and hydroxypropyl methylcellulose.

In these aspects, the GC-C receptor agonist polypeptide formulation additionally comprises a pharmaceutically acceptable glidant, lubricant or additive that acts as both a glidant and lubricant.

In these aspects, the GC-C receptor agonist polypeptide formulation additionally comprises an antioxidant. In particular, the antioxidant is BHA, vitamin E or propyl gallate.

In these aspects, the GC-C receptor agonist polypeptide formulation additionally comprises a pharmaceutically acceptable filler. In particular, the pharmaceutically acceptable filler is cellulose, isomalt, mannitol or dibasic calcium phosphate.

More particularly, the cellulose used in the filler is selected from microfine cellulose and microcrystalline cellulose. More particularly, the pharmaceutically acceptable filler comprises particles having an average diameter between 150 μm and 1000 μm .

In another aspect, the sterically hindered primary amine is leucine and the cation is Ca²⁺.

In another aspect, the molar ratio of Ca²⁺ to leucine is at least 1:1.

More particularly, the molar ratio of Ca²⁺ to leucine is at least 1.5:1.

More particularly, the molar ratio of Ca^{2+} to leucine is at least 2:1.

In this aspect, the sterically hindered amine is leucine and the molar ratio of leucine to GC-C receptor agonist polypeptide is at least 10:1.

More particularly, the molar ratio of leucine to GC-C receptor agonist polypeptide is at least 20:1.

More particularly, the molar ratio of leucine to GC-C receptor agonist polypeptide in the pharmaceutical composition is at least 30:1.

In the GC-C receptor agonist polypeptide formulations comprising a filler, the weight ratio of GC-C receptor agonist polypeptide to pharmaceutically acceptable filler is between 1:25 and 1:2,500.

More particularly, the weight ratio of GC-C receptor agonist polypeptide to pharmaceutically acceptable filler is between 1:100 and 1:2000.

More particularly, the weight ratio of GC-C receptor agonist polypeptide to pharmaceutically acceptable filler is between 1:100 and 1:1000.

In the GC-C receptor agonist polypeptide formulations, comprising a cation and a sterically hindered primary amine, the molar ratio of cation:sterically hindered primary amine:GC-C receptor agonist polypeptide is 40-100:20-50:1.

More particularly, when the cation is Ca^{2+} and the sterically hindered primary amine is leucine, the molar ratio of Ca^{2+} :leucine:GC-C receptor agonist polypeptide is 100:30:1, 80:40:1, 80:30:1, 80:20:1, 60:30:1, 60:20:1, 50:30:1, 50:20:1, 40:20:1, 20:20:1, 10:10:1, 10:5:1, 5:10:1 or 5:5:1.

More particularly, the molar ratio of Ca^{2+} :leucine:GC-C receptor agonist polypeptide is 60:30:1.

More particularly, the cation is provided as CaCl_2 .

In any of these aspects or embodiments, the GC-C receptor agonist polypeptide may be linacotide.

In another aspect, the GC-C receptor antagonist formulation is in the form of a capsule or tablet.

In particular, each capsule or tablet comprises 50 μg to 1 mg GC-C receptor agonist polypeptide.

More particularly, each capsule or tablet comprises 100 μg , 150 μg , 200 μg , 300 μg , 400 μg , 500 μg or 600 μg GC-C receptor agonist polypeptide.

In some embodiments, each capsule or tablet comprises 50 µg to 1 mg linaclotide. In some embodiments, each capsule or tablet comprises 100 µg, 133 µg, 150 µg, 200 µg, 266 µg, 300 µg, 400 µg, 500 µg or 600 µg linaclotide.

In another aspect, the subject in need of such treatment is suffering from a disorder selected from the group consisting of gastrointestinal motility disorder, chronic intestinal pseudo-obstruction, colonic pseudo-obstruction, duodenogastric reflux, dyspepsia, functional dyspepsia, nonulcer dyspepsia, functional gastrointestinal disorder, functional heartburn, gastroesophageal reflux disease (GERD), gastroparesis, irritable bowel syndrome, post-operative ileus, and constipation.

In another aspect, the subject in need of treatment is suffering from irritable bowel syndrome with constipation (IBS-c) or alternating IBS (IBS-a).

In another aspect, the subject in need of treatment is suffering from irritable bowel syndrome with constipation (IBS-c). In this aspect, a once daily effective amount of the pharmaceutical formulation described herein is administered to the patient. In various aspects, the pharmaceutical formulation comprises 50 µg to 1 mg linaclotide (more particularly, 100 µg, 133 µg, 150 µg, 200 µg, 266 µg, 300 µg, 400 µg, 500 µg or 600 µg linaclotide; even more particularly 133 µg or 266 µg linaclotide) or another GC-C receptor agonist polypeptide per unit dose per day. In other aspects, the pharmaceutical composition is administered for a period of at least one day, two days, three days, four days, five days, six days, one week, two weeks, three weeks, four weeks, twelve weeks or longer. In some aspects, treatment with the linaclotide composition improves at least one symptom selected from reduced abdominal pain, an increase in the number of complete spontaneous bowel movements (CSBM) in a week, an increase in the number of spontaneous bowel movements (SBM) in a week, improved stool consistency, reduced straining, reduced abdominal discomfort, reduced bloating or reduced IBS-c symptom severity.

In another aspect, the subject in need of such treatment is suffering from constipation (e.g., chronic constipation). In this aspect, a once daily effective amount of the pharmaceutical formulation described herein is administered to the patient. In various aspects, the pharmaceutical formulation comprises 50 µg to 1 mg linaclotide (more particularly, 100 µg, 133 µg, 150 µg, 200 µg, 266 µg, 300 µg, 400 µg, 500 µg or 600 µg linaclotide; even more particularly 133 µg or 266 µg linaclotide) or another GC-C receptor agonist polypeptide per unit dose per day. In other aspects, the pharmaceutical composition is administered for a period of at least one day, two days, three days, four days, five days, six days, one week, two weeks, three weeks, four weeks, twelve weeks or longer. In some

embodiments, treatment with the linaclotide composition improves at least one symptom selected from an increase in the number of complete spontaneous bowel movements (CSBM) in a week, an increase in the number of spontaneous bowel movements (SBM) in a week, improved stool consistency, reduced straining, reduced abdominal discomfort, reduced bloating or reduced severity of constipation.

Stool consistency of each bowel movement (BM) may be monitored by the 7-point Bristol Stool Form Scale (BSFS) (1 = hard lumps, 2 = lumpy sausage, 3 = cracked sausage, 4 = smooth sausage, 5 = soft lumps, 6 = mushy, 7 = watery). Straining may be monitored by the 7-point Ease of Passage Scale (1 = manual disimpaction/enema needed, 2 = severe straining, 3 = moderate straining, 4 = mild straining, 5 = no straining, 6 = urgency, 7 = incontinent). CSBM may be measured by the sensation of complete emptying after an SBM (yes/no). Abdominal discomfort, bloating and severity of constipation may be measured using, e.g., a 5-point ordinal scale (1 = none, 2 = mild, 3 = moderate, 4 = severe, 5 = very severe).

In another embodiment, the invention provides a method of decreasing the pharmacodynamic effect of a GC-C receptor agonist polypeptide which is administered to a subject in need of such treatment, comprising administering the GC-C receptor agonist polypeptide to the subject before the ingestion of food.

In one aspect of this embodiment, the GC-C receptor agonist polypeptide is administered to the subject 15 minutes to 4 hours before the ingestion of food.

In another aspect of this embodiment, the GC-C receptor agonist polypeptide is administered to the subject 1 to 18 hours before the ingestion of food.

In another aspect of this embodiment, the GC-C receptor agonist polypeptide is administered to the subject 4 to 12 hours before the ingestion of food.

In another aspect of this embodiment, the GC-C receptor agonist polypeptide is administered to the subject 30 minutes to 8 hours before the ingestion of food.

In another aspect of this embodiment, the GC-C receptor agonist polypeptide is administered to a subject having an empty stomach.

In another aspect of this embodiment, the GC-C receptor agonist polypeptide formulation is administered to the subject at least 15 minutes before the ingestion of food.

In another aspect of this embodiment, the GC-C receptor agonist polypeptide formulation is administered to the subject at least 30 minutes before the ingestion of food.

In another aspect of this embodiment, the GC-C receptor agonist polypeptide formulation is administered to the subject at least 1 hour before the ingestion of food.

In another aspect of this embodiment, the GC-C receptor agonist polypeptide formulation is administered to the subject at least 2 hours before the ingestion of food.

In another embodiment, the invention provides a method of increasing the pharmacodynamic effect of a GC-C receptor agonist polypeptide which is administered to a subject in need of such treatment, comprising administering the GC-C receptor agonist polypeptide to the subject after a prior ingestion of food. In one embodiment, the GC-C receptor agonist polypeptide is administered at least four hours, at least eight hours, at least ten hours or at least 12 hours after a prior ingestion of food. In a further embodiment, the GC-C receptor agonist polypeptide is administered on an empty stomach.

In any of these aspects or embodiments, the GC-C receptor agonist polypeptide may be linaclotide.

In another aspect of this embodiment, the GC-C receptor agonist polypeptide is administered as a formulation comprising the GC-C receptor agonist polypeptide and a pharmaceutically acceptable excipient. In some embodiments, the GC-C receptor agonist polypeptide is linaclotide.

In another aspect of this embodiment, the subject in need of such treatment is suffering from a disorder selected from the group consisting of irritable bowel syndrome (IBS) and constipation. In one aspect, the disorder is IBS, which is constipation-predominant IBS (IBS-c) or alternating IBS (IBS-a). More particularly, the disorder is IBS-c. In another aspect, the subject in need of such treatment is suffering from constipation. More particularly, the disorder is constipation which is chronic constipation, idiopathic constipation, post-operative ileus, or constipation caused by opiate use.

In another aspect of this embodiment, the formulation further comprises one or more agents selected from a cation selected from Mg^{2+} , Ca^{2+} , Zn^{2+} , Mn^{2+} , K^+ , Na^+ and Al^{3+} or a sterically hindered primary amine.

In particular, the Mg^{2+} , Ca^{2+} , Zn^{2+} , Mn^{2+} , K^+ , Na^+ or Al^{3+} is provided as magnesium acetate, magnesium chloride, magnesium phosphate, magnesium sulfate, calcium acetate, calcium chloride, calcium phosphate, calcium sulfate, zinc acetate, zinc chloride, zinc phosphate, zinc sulfate, manganese acetate, manganese chloride, manganese phosphate, manganese sulfate, potassium acetate, potassium chloride, potassium phosphate, potassium sulfate, sodium acetate, sodium chloride, sodium phosphate, sodium sulfate, aluminum acetate, aluminum chloride, aluminum phosphate or aluminum sulfate.

More particularly, the Mg^{2+} , Ca^{2+} , Zn^{2+} , Mn^{2+} , K^+ , Na^+ or Al^{3+} is provided as magnesium chloride, calcium chloride, calcium phosphate, calcium sulfate, zinc acetate, manganese chloride, potassium chloride, sodium chloride or aluminum chloride.

More particularly, the cation is Mg^{2+} , Ca^{2+} or Zn^{2+} .

More particularly, the Mg^{2+} , Ca^{2+} or Zn^{2+} is provided as magnesium chloride, calcium chloride or zinc acetate.

More particularly, the agent is Ca^{2+} .

More particularly, the Ca^{2+} is provided as calcium chloride.

Alternatively, the agent is a sterically hindered primary amine.

More particularly, the sterically hindered primary amine is an amino acid.

More particularly, the amino acid is a naturally-occurring amino acid.

More particularly, the naturally-occurring amino acid is histidine, phenylalanine, alanine, glutamic acid, aspartic acid, glutamine, leucine, methionine, asparagine, tyrosine, threonine, isoleucine, tryptophan, glycine or valine.

More particularly, the naturally-occurring amino acid is leucine, isoleucine, alanine or methionine.

More particularly, the naturally-occurring amino acid is leucine or methionine.

More particularly, the naturally-occurring amino acid is leucine.

Alternatively, the sterically hindered primary amine is a non-naturally occurring amino acid.

Alternatively, the sterically hindered primary amine has the formula: $\begin{matrix} R_2 \\ | \\ R_1-C-R_3 \\ | \\ NH_2 \end{matrix}$, wherein R_1 , R_2 and R_3 are independently selected from: H; $-C(O)OH$; C_1-C_6 alkyl, optionally substituted by $-CO_2H$, $-CONH_2$, or a 5-10 membered aryl or heteroaryl; C_1-C_6 alkoxyalkyl; or C_1-C_6 thioalkoxyalkyl, wherein any of the alkyl or aryl groups above can be singly or multiply substituted with halogen or $-NH_2$, and provided that no more than two of R_1 , R_2 and R_3 are H. In a further embodiment, no more than one of R_1 , R_2 and R_3 is H.

More particularly, the sterically hindered primary amine has the formula:

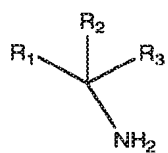

, wherein R_1 , R_2 and R_3 are independently selected from: H; $-C(O)OH$; C_1-C_6 alkyl; C_1-C_6 alkoxyalkyl; or C_1-C_6 thioalkoxyalkyl, wherein any of the alkyl or aryl groups above can be singly or multiply substituted with halogen or $-NH_2$, and provided that no more

than two of R_1 , R_2 and R_3 are H. In a further embodiment, no more than one of R_1 , R_2 and R_3 is H.

More particularly, the sterically hindered primary amine has the formula:

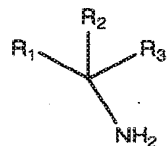

, wherein R_1 , R_2 and R_3 are independently selected from: H; $-C(O)OH$; C_1 - C_6 alkyl; C_1 - C_6 alkoxyalkyl; or C_1 - C_6 thioalkoxyalkyl, and provided that no more than two of R_1 , R_2 and R_3 are H. In a further embodiment, no more than one of R_1 , R_2 and R_3 is H.

In one aspect, the sterically hindered primary amine is cyclohexylamine or 2-methylbutylamine.

In one aspect, the sterically hindered primary amine is chitosan.

In any of these aspects or embodiments, the GC-C receptor agonist polypeptide may be linaclotide.

In another aspect, the GC-C receptor agonist polypeptide formulation used in the method comprises a cation selected from Mg^{2+} , Ca^{2+} , Zn^{2+} , Mn^{2+} , K^+ , Na^+ and Al^{3+} and a sterically hindered primary amine.

More particularly, the cation Mg^{2+} , Ca^{2+} , Zn^{2+} , Mn^{2+} , K^+ , Na^+ or Al^{3+} is provided as magnesium acetate, magnesium chloride, magnesium phosphate, magnesium sulfate, calcium acetate, calcium chloride, calcium phosphate, calcium sulfate, zinc acetate, zinc chloride, zinc phosphate, zinc sulfate, manganese acetate, manganese chloride, manganese phosphate, manganese sulfate, potassium acetate, potassium chloride, potassium phosphate, potassium sulfate, sodium acetate, sodium chloride, sodium phosphate, sodium sulfate, aluminum acetate, aluminum chloride, aluminum phosphate or aluminum sulfate.

More particularly, the cation Mg^{2+} , Ca^{2+} , Zn^{2+} , Mn^{2+} , K^+ , Na^+ or Al^{3+} is provided as magnesium chloride, calcium chloride, calcium phosphate, calcium sulfate, zinc acetate, manganese chloride, potassium chloride, sodium chloride or aluminum chloride.

More particularly, the cation is selected from Mg^{2+} , Ca^{2+} and Zn^{2+} and a sterically hindered primary amine.

More particularly, the Mg^{2+} , Ca^{2+} or Zn^{2+} is provided as magnesium chloride, calcium chloride or zinc acetate.

More particularly, the cation is Ca^{2+} .

More particularly, the Ca^{2+} is provided as calcium chloride.

More particularly, the sterically hindered primary amine is an amino acid.

More particularly, the amino acid is a naturally-occurring amino acid.

More particularly, the naturally-occurring amino acid is histidine, phenylalanine, alanine, glutamic acid, aspartic acid, glutamine, leucine, methionine, asparagine, tyrosine, threonine, isoleucine, tryptophan, glycine or valine.

More particularly, the naturally-occurring amino acid is leucine, isoleucine, alanine or methionine.

More particularly, the naturally-occurring amino acid is leucine or methionine.

More particularly, the naturally-occurring amino acid is leucine.

Alternatively, the sterically hindered primary amine is a non-naturally occurring amino acid.

More particularly, the non-naturally occurring amino acid is 1-aminocyclohexane carboxylic acid.

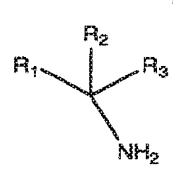
Alternatively, the sterically hindered primary amine has the formula: , wherein R₁, R₂ and R₃ are independently selected from: H; -C(O)OH; C₁-C₆ alkyl, optionally substituted by -CO₂H, -CONH₂, or a 5-10 membered aryl or heteroaryl; C₁-C₆ alkoxyalkyl; or C₁-C₆ thioalkoxyalkyl, wherein any of the alkyl or aryl groups above can be singly or multiply substituted with halogen or -NH₂, and provided that no more than two of R₁, R₂ and R₃ are H. In a further embodiment, no more than one of R₁, R₂ and R₃ is H.

More particularly, the sterically hindered primary amine has the formula:

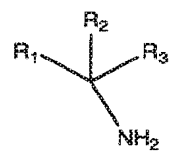
, wherein R₁, R₂ and R₃ are independently selected from: H; -C(O)OH; C₁-C₆ alkyl; C₁-C₆ alkoxyalkyl; or C₁-C₆ thioalkoxyalkyl, wherein any of the alkyl or aryl groups above can be singly or multiply substituted with halogen or -NH₂, and provided that no more than two of R₁, R₂ and R₃ are H. In a further embodiment, no more than one of R₁, R₂ and R₃ is H.

More particularly, the sterically hindered primary amine has the formula:

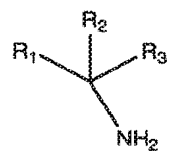
, wherein R₁, R₂ and R₃ are independently selected from: H; -C(O)OH; C₁-C₆ alkyl; C₁-C₆ alkoxyalkyl; or C₁-C₆ thioalkoxyalkyl, and provided that no more than two of R₁, R₂ and R₃ are H. In a further embodiment, no more than one of R₁, R₂ and R₃ is H.

In one aspect, the sterically hindered primary amine is cyclohexylamine or 2-methylbutylamine.

In one aspect, the sterically hindered primary amine is chitosan.

In any of these aspects or embodiments, the GC-C receptor agonist polypeptide may be linacotide.

In these aspects, the GC-C receptor agonist polypeptide formulation additionally comprises a pharmaceutically acceptable binder. In particular, the pharmaceutically acceptable binder is selected from polyvinyl alcohol, polyvinylpyrrolidone (povidone), a starch, maltodextrin or a cellulose ether. More particularly, the pharmaceutically acceptable binder is a cellulose ether which may be selected from: methylcellulose, ethylcellulose, carboxymethylcellulose, hydroxyethyl cellulose, hydroxyethyl methylcellulose, hydroxypropyl cellulose and hydroxypropyl methylcellulose..

In these aspects, the GC-C receptor agonist polypeptide formulation additionally comprises a pharmaceutically acceptable glidant, lubricant or additive that acts as both a glidant and lubricant.

In these aspects, the GC-C receptor agonist polypeptide formulation additionally comprises an antioxidant. In particular, the antioxidant is BHA, vitamin E or propyl gallate.

In these aspects, the GC-C receptor agonist polypeptide formulation additionally comprises a pharmaceutically acceptable filler. In particular, the pharmaceutically acceptable filler is cellulose, isomalt, mannitol or dibasic calcium phosphate.

More particularly, the cellulose used in the filler is selected from microfine cellulose and microcrystalline cellulose. More particularly, the pharmaceutically acceptable filler comprises particles having an average diameter between 150 μm and 1000 μm .

In another aspect, when the sterically hindered primary amine is leucine and the cation is Ca^{2+} .

In another aspect, the molar ratio of Ca^{2+} to leucine is at least 1:1.

More particularly, the molar ratio of Ca^{2+} to leucine is at least 1.5:1.

More particularly, the molar ratio of Ca^{2+} to leucine is at least 2:1.

In this aspect, the sterically hindered amine is leucine and the molar ratio of leucine to GC-C receptor agonist polypeptide is at least 10:1.

More particularly, the molar ratio of leucine to GC-C receptor agonist polypeptide is at least 20:1.

More particularly, the molar ratio of leucine to GC-C receptor agonist polypeptide in the pharmaceutical formulation is at least 30:1.

In the GC-C receptor agonist polypeptide formulations comprising a filler, the weight ratio of GC-C receptor agonist polypeptide to pharmaceutically acceptable filler is between 1:25 and 1:2,500.

More particularly, the weight ratio of GC-C receptor agonist polypeptide to pharmaceutically acceptable filler is between 1:100 and 1:2000.

More particularly, the weight ratio of GC-C receptor agonist polypeptide to pharmaceutically acceptable filler is between 1:100 and 1:1000.

In the GC-C receptor agonist polypeptide formulations, comprising a cation and a sterically hindered primary amine, the molar ratio of cation:sterically hindered primary amine:GC-C receptor agonist polypeptide is 40-100:20-50:1.

More particularly, when the cation is Ca^{2+} and the sterically hindered primary amine is leucine, the molar ratio of Ca^{2+} :leucine:GC-C receptor agonist polypeptide is 100:30:1, 80:40:1, 80:30:1, 80:20:1, 60:30:1, 60:20:1, 50:30:1, 50:20:1, 40:20:1, 20:20:1, 10:10:1, 10:5:1, 5:10:1 or 5:5:1.

More particularly, the molar ratio of Ca^{2+} :leucine:GC-C receptor agonist polypeptide is 60:30:1.

More particularly, the cation is provided as CaCl_2 .

In any of these aspects or embodiments, the GC-C receptor agonist polypeptide may be linaclotide.

In another aspect, the GC-C receptor antagonist formulation is in the form of a capsule or tablet.

In particular, each capsule or tablet comprises 50 μg to 1 mg GC-C receptor agonist polypeptide. In some embodiments, each capsule or tablet comprises 50 μg to 1 mg linaclotide.

More particularly, each capsule or tablet comprises 100 μg , 133 μg , 150 μg , 200 μg , 266 μg , 300 μg , 400 μg , 500 μg or 600 μg GC-C receptor agonist polypeptide. In some embodiments, each capsule or tablet comprises 100 μg , 133 μg , 150 μg , 200 μg , 266 μg , 300 μg , 400 μg , 500 μg or 600 μg linaclotide.

More particularly, each tablet or capsule comprises:

- (a) Linaclotide;
- (b) $\text{CaCl}_2 \cdot 2\text{H}_2\text{O}$;
- (c) L-Leucine; and
- (d) Hydroxypropyl Methylcellulose

wherein linaclotide is present in the pharmaceutical composition in an amount between $100\mu\text{g}$ to $600\mu\text{g}$ and the molar ratio of Ca^{2+} :leucine:linaclotide is between 5-100:5-50:1.

More particularly, linaclotide is present in the tablet or capsule in an amount of 133 or $266\mu\text{g}$.

More particularly, CaCl_2 is present in the tablet or capsule in an amount of $1541\mu\text{g}$.

More particularly, leucine is present in the tablet or capsule in an amount of $687\mu\text{g}$.

More particularly, hydroxypropyl methylcellulose is present in the tablet or capsule in an amount of $700\mu\text{g}$.

In another embodiment, the invention provides a method of decreasing the pharmacodynamic effect of a GC-C receptor agonist polypeptide which is administered to a subject in need of such treatment, comprising administering the GC-C receptor agonist polypeptide to the subject a sufficient time period after an ingestion of food

In one aspect of this embodiment, the GC-C receptor agonist polypeptide formulation is administered to the subject at least 6 hours after the ingestion of food.

In another aspect of this embodiment, the GC-C receptor agonist polypeptide formulation is administered to the subject at least 8 hours after the ingestion of food.

In another aspect of this embodiment, the GC-C receptor agonist polypeptide formulation is administered to the subject at least 10 hours after the ingestion of food.

In another aspect of this embodiment, the GC-C receptor agonist polypeptide formulation is administered to the subject at least 15 minutes before the ingestion of more food.

In another aspect of this embodiment, the GC-C receptor agonist polypeptide formulation is administered to the subject at least 30 minutes before the ingestion of more food.

In another aspect of this embodiment, the GC-C receptor agonist polypeptide formulation is administered to the subject at least 1 hour before the ingestion of more food.

In another aspect of this embodiment, the GC-C receptor agonist polypeptide formulation is administered to the subject at least 2 hours before the ingestion of more food.

In these aspects, the GC-C receptor agonist polypeptide may be linaclotide.

In another aspect of this embodiment, the subject in need of such treatment is suffering from irritable bowel syndrome (IBS). More particularly the disorder is IBS, which is constipation-predominant IBS (IBS-c) or alternating IBS (IBS-a). More particularly, the disorder is IBS-c. In some embodiments, the GC-C receptor agonist polypeptide is linaclotide.

In another aspect of this embodiment, the subject in need of such treatment is suffering from constipation. More particularly, the disorder is constipation which is chronic constipation, idiopathic constipation, post-operative ileus, or constipation caused by opiate use. In some embodiments, the GC-C receptor agonist polypeptide is linaclotide.

In these aspects, the GC-C receptor agonist polypeptide is administered as a formulation comprising the GC-C receptor agonist polypeptide and a pharmaceutically acceptable excipient.

In another embodiment, the invention provides a method of increasing the pharmacodynamic effect of a GC-C receptor agonist polypeptide which is administered to a subject in need of such treatment, comprising administering the GC-C receptor agonist polypeptide to the subject with the ingestion of food or within two hours after the ingestion of food.

In one aspect of this embodiment, the GC-C receptor agonist polypeptide is administered with the ingestion of food.

In another aspect of this embodiment, the GC-C receptor agonist polypeptide is administered with a meal.

In another aspect of this embodiment, the GC-C receptor agonist polypeptide is administered within two hours after the ingestion of food.

In another aspect of this embodiment, the GC-C receptor agonist polypeptide is administered within one hour after the ingestion of food.

In another aspect of this embodiment, the GC-C receptor agonist polypeptide is administered within 30 minutes after the ingestion of food.

In another aspect of this embodiment, the GC-C receptor agonist polypeptide is administered within 15 minutes after the ingestion of food.

In another aspect of this embodiment, the GC-C receptor agonist polypeptide is linaclotide.

In another aspect of this embodiment, the subject in need of such treatment is suffering from irritable bowel syndrome (IBS). More particularly the disorder is IBS, which

is constipation-predominant IBS (IBS-c) or alternating IBS (IBS-a). More particularly, the disorder is IBS-c.

In another aspect of this embodiment, the subject in need of such treatment is suffering from constipation. More particularly, the disorder is constipation which is chronic constipation, idiopathic constipation, post-operative ileus, or constipation caused by opiate use.

In another aspect of this embodiment, the GC-C receptor agonist polypeptide is administered as a formulation comprising the GC-C receptor agonist polypeptide and a pharmaceutically acceptable excipient.

In another aspect of this embodiment, the formulation further comprises one or more agents selected from a cation selected from Mg^{2+} , Ca^{2+} , Zn^{2+} , Mn^{2+} , K^+ , Na^+ and Al^{3+} or a sterically hindered primary amine.

In particular, the Mg^{2+} , Ca^{2+} , Zn^{2+} , Mn^{2+} , K^+ , Na^+ or Al^{3+} is provided as magnesium acetate, magnesium chloride, magnesium phosphate, magnesium sulfate, calcium acetate, calcium chloride, calcium phosphate, calcium sulfate, zinc acetate, zinc chloride, zinc phosphate, zinc sulfate, manganese acetate, manganese chloride, manganese phosphate, manganese sulfate, potassium acetate, potassium chloride, potassium phosphate, potassium sulfate, sodium acetate, sodium chloride, sodium phosphate, sodium sulfate, aluminum acetate, aluminum chloride, aluminum phosphate or aluminum sulfate.

More particularly, the Mg^{2+} , Ca^{2+} , Zn^{2+} , Mn^{2+} , K^+ , Na^+ or Al^{3+} is provided as magnesium chloride, calcium chloride, calcium phosphate, calcium sulfate, zinc acetate, manganese chloride, potassium chloride, sodium chloride or aluminum chloride.

More particularly, the cation is Mg^{2+} , Ca^{2+} , Zn^{2+} .

More particularly, the Mg^{2+} , Ca^{2+} or Zn^{2+} is provided as magnesium chloride, calcium chloride or zinc acetate.

More particularly, the agent is Ca^{2+} .

More particularly, the Ca^{2+} is provided as calcium chloride.

Alternatively, the agent is a sterically hindered primary amine.

More particularly, the sterically hindered primary amine is an amino acid.

More particularly, the amino acid is a naturally-occurring amino acid.

More particularly, the naturally-occurring amino acid is histidine, phenylalanine, alanine, glutamic acid, aspartic acid, glutamine, leucine, methionine, asparagine, tyrosine, threonine, isoleucine, tryptophan, glycine or valine.

More particularly, the naturally-occurring amino acid is leucine, isoleucine, alanine or methionine.

More particularly, the naturally-occurring amino acid is leucine or methionine.

More particularly, the naturally-occurring amino acid is leucine.

Alternatively, the sterically hindered primary amine is a non-naturally occurring amino acid.

More particularly, the non-naturally occurring amino acid is 1-aminocyclohexane carboxylic acid.

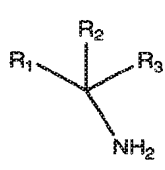
Alternatively, the sterically hindered primary amine has the formula: , wherein R₁, R₂ and R₃ are independently selected from: H; -C(O)OH; C₁-C₆ alkyl, optionally substituted by -CO₂H, -CONH₂, or a 5-10 membered aryl or heteroaryl; C₁-C₆ alkoxyalkyl; or C₁-C₆ thioalkoxyalkyl, wherein any of the alkyl or aryl groups above can be singly or multiply substituted with halogen or -NH₂, and provided that no more than two of R₁, R₂ and R₃ are H. In a further embodiment, no more than one of R₁, R₂ and R₃ is H.

More particularly, the sterically hindered primary amine has the formula:

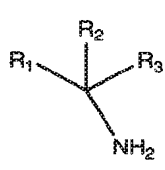
, wherein R₁, R₂ and R₃ are independently selected from: H; -C(O)OH; C₁-C₆ alkyl; C₁-C₆ alkoxyalkyl; or C₁-C₆ thioalkoxyalkyl, wherein any of the alkyl or aryl groups above can be singly or multiply substituted with halogen or -NH₂, and provided that no more than two of R₁, R₂ and R₃ are H. In a further embodiment, no more than one of R₁, R₂ and R₃ is H.

More particularly, the sterically hindered primary amine has the formula:

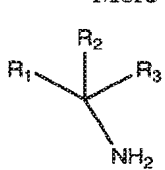
, wherein R₁, R₂ and R₃ are independently selected from: H; -C(O)OH; C₁-C₆ alkyl; C₁-C₆ alkoxyalkyl; or C₁-C₆ thioalkoxyalkyl, and provided that no more than two of R₁, R₂ and R₃ are H. In a further embodiment, no more than one of R₁, R₂ and R₃ is H.

In some embodiments, the sterically hindered primary amine is cyclohexylamine or 2-methylbutylamine.

In some embodiments, the sterically hindered primary amine is chitosan.

In some embodiments, the GC-C receptor agonist polypeptide is linaclotide.

In another aspect, the GC-C receptor agonist polypeptide formulation used in the method comprises a cation selected from Mg^{2+} , Ca^{2+} , Zn^{2+} , Mn^{2+} , K^+ , Na^+ and Al^{3+} and a sterically hindered primary amine.

More particularly, the Mg^{2+} , Ca^{2+} , Zn^{2+} , Mn^{2+} , K^+ , Na^+ or Al^{3+} is provided as magnesium acetate, magnesium chloride, magnesium phosphate, magnesium sulfate, calcium acetate, calcium chloride, calcium phosphate, calcium sulfate, zinc acetate, zinc chloride, zinc phosphate, zinc sulfate, manganese acetate, manganese chloride, manganese phosphate, manganese sulfate, potassium acetate, potassium chloride, potassium phosphate, potassium sulfate, sodium acetate, sodium chloride, sodium phosphate, sodium sulfate, aluminum acetate, aluminum chloride, aluminum phosphate or aluminum sulfate.

More particularly, the Mg^{2+} , Ca^{2+} , Zn^{2+} , Mn^{2+} , K^+ , Na^+ or Al^{3+} is provided as magnesium chloride, calcium chloride, calcium phosphate, calcium sulfate, zinc acetate, manganese chloride, potassium chloride, sodium chloride or aluminum chloride.

More particularly, the cation is Mg^{2+} , Ca^{2+} or Zn^{2+} .

More particularly, the Mg^{2+} , Ca^{2+} or Zn^{2+} is provided as magnesium chloride, calcium chloride or zinc acetate.

More particularly, the cation is Ca^{2+} .

More particularly, the Ca^{2+} is provided as calcium chloride.

More particularly, the sterically hindered primary amine is an amino acid.

More particularly, the amino acid is a naturally-occurring amino acid.

More particularly, the naturally-occurring amino acid is histidine, phenylalanine, alanine, glutamic acid, aspartic acid, glutamine, leucine, methionine, asparagine, tyrosine, threonine, isoleucine, tryptophan, glycine or valine.

More particularly, the naturally-occurring amino acid is leucine, isoleucine, alanine or methionine.

More particularly, the naturally-occurring amino acid is leucine or methionine.

More particularly, the naturally-occurring amino acid is leucine.

Alternatively, the sterically hindered primary amine is a non-naturally occurring amino acid.

More particularly, the non-naturally occurring amino acid is 1-aminocyclohexane carboxylic acid.

Alternatively, the sterically hindered primary amine has the formula: $R_1-CH_2-CH_2-NH-R_2$, wherein R_1 , R_2 and R_3 are independently selected from: H; $-C(O)OH$; C_1-C_6 alkyl, optionally substituted by $-CO_2H$, $-CONH_2$, or a 5-10 membered aryl or heteroaryl; C_1-C_6 alkoxyalkyl; or C_1-C_6

thioalkoxyalkyl, wherein any of the alkyl or aryl groups above can be singly or multiply substituted with halogen or $-NH_2$, and provided that no more than two of R_1 , R_2 and R_3 are H. In a further embodiment, no more than one of R_1 , R_2 and R_3 is H.

More particularly, the sterically hindered primary amine has the formula:

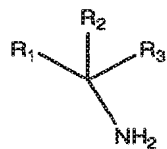

, wherein R_1 , R_2 and R_3 are independently selected from: H; $-C(O)OH$; C_1-C_6 alkyl; C_1-C_6 alkoxyalkyl; or C_1-C_6 thioalkoxyalkyl, wherein any of the alkyl or aryl groups above can be singly or multiply substituted with halogen or $-NH_2$, and provided that no more than two of R_1 , R_2 and R_3 are H. In a further embodiment, no more than one of R_1 , R_2 and R_3 is H.

More particularly, the sterically hindered primary amine has the formula:

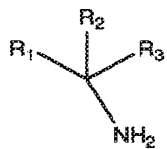

, wherein R_1 , R_2 and R_3 are independently selected from: H; $-C(O)OH$; C_1-C_6 alkyl; C_1-C_6 alkoxyalkyl; or C_1-C_6 thioalkoxyalkyl, and provided that no more than two of R_1 , R_2 and R_3 are H. In a further embodiment, no more than one of R_1 , R_2 and R_3 is H.

In some embodiments, the sterically hindered primary amine is cyclohexylamine or 2-methylbutylamine.

In some embodiments, the sterically hindered primary amine is chitosan.

In some embodiments, the GC-C receptor agonist polypeptide is linaclootide.

In these aspects, the GC-C receptor agonist polypeptide formulation additionally comprises a pharmaceutically acceptable binder. In particular, the pharmaceutically acceptable binder is selected from polyvinyl alcohol, polyvinylpyrrolidone (povidone), a starch, maltodextrin or a cellulose ether. More particularly, the pharmaceutically acceptable binder is a cellulose ether which may be selected from: methylcellulose, ethylcellulose, carboxymethylcellulose, hydroxyethyl cellulose, hydroxyethyl methylcellulose, hydroxypropyl cellulose and hydroxypropyl methylcellulose..

In these aspects, the GC-C receptor agonist polypeptide formulation additionally comprises a pharmaceutically acceptable glidant, lubricant or additive that acts as both a glidant and lubricant.

In these aspects, the GC-C receptor agonist polypeptide formulation additionally comprises an antioxidant. In particular, the antioxidant is BHA, vitamin E or propyl gallate.

In these aspects, the GC-C receptor agonist polypeptide formulation additionally comprises a pharmaceutically acceptable filler. In particular, the pharmaceutically acceptable filler is cellulose, isomalt, mannitol or dibasic calcium phosphate. More particularly, the cellulose used in the filler is selected from microfine cellulose and microcrystalline cellulose. More particularly, the pharmaceutically acceptable filler comprises particles having an average diameter between 150 μm and 1000 μm .

In another aspect, when the sterically hindered primary amine is leucine and the cation is Ca^{2+} .

In another aspect, the molar ratio of Ca^{2+} to leucine is at least 1:1.

More particularly, the molar ratio of Ca^{2+} to leucine is at least 1.5:1.

More particularly, the molar ratio of Ca^{2+} to leucine is at least 2:1.

In this aspect, the sterically hindered amine is leucine and the molar ratio of leucine to GC-C receptor agonist polypeptide is at least 10:1.

More particularly, the molar ratio of leucine to GC-C receptor agonist polypeptide is at least 20:1.

More particularly, the molar ratio of leucine to GC-C receptor agonist polypeptide in the pharmaceutical formulation is at least 30:1.

In the GC-C receptor agonist polypeptide formulations comprising a filler, the weight ratio of GC-C receptor agonist polypeptide to pharmaceutically acceptable filler is between 1:25 and 1:2,500.

More particularly, the weight ratio of GC-C receptor agonist polypeptide to pharmaceutically acceptable filler is between 1:100 and 1:2000.

More particularly, the weight ratio of GC-C receptor agonist polypeptide to pharmaceutically acceptable filler is between 1:100 and 1:1000.

In the GC-C receptor agonist polypeptide formulations, comprising a cation and a sterically hindered primary amine, the molar ratio of cation:sterically hindered primary amine:GC-C receptor agonist polypeptide is 40-100:20-50:1.

More particularly, when the cation is Ca^{2+} and the sterically hindered primary amine is leucine, the molar ratio of Ca^{2+} :leucine:GC-C receptor agonist polypeptide is 100:30:1, 80:40:1, 80:30:1, 80:20:1, 60:30:1, 60:20:1, 50:30:1, 50:20:1, 40:20:1, 20:20:1, 10:10:1, 10:5:1, 5:10:1 or 5:5:1.

More particularly, the molar ratio of Ca^{2+} :leucine:GC-C receptor agonist polypeptide is 60:30:1.

More particularly, the cation is provided as CaCl_2 .

In some embodiments, the GC-C receptor agonist polypeptide is linaclotide.

In another aspect of the invention method, the GC-C receptor antagonist formulation is in the form of a capsule or tablet.

In particular, each capsule or tablet comprises 50 μg to 1 mg GC-C receptor agonist polypeptide. In some embodiments, each capsule or tablet comprises 50 μg to 1 mg linaclotide.

More particularly, each capsule or tablet comprises 100 μg , 150 μg , 200 μg , 300 μg , 400 μg , 500 μg or 600 μg GC-C receptor agonist polypeptide. In some embodiments, each capsule or tablet comprises 100 μg , 133 μg , 150 μg , 200 μg , 266 μg , 300 μg , 400 μg , 500 μg or 600 μg linaclotide.

More particularly, each tablet or capsule comprises:

- (a) Linaclotide;
- (b) $\text{CaCl}_2 \cdot 2\text{H}_2\text{O}$;
- (c) L-Leucine; and
- (d) Hydroxypropyl Methylcellulose

wherein linaclotide is present in the pharmaceutical composition in an amount between 100 μg to 600 μg and the molar ratio of Ca^{2+} :leucine:linaclotide is between 5-100:5-50:1.

More particularly, linaclotide is present in the tablet or capsule in an amount of 133 or 266 μg .

More particularly, CaCl_2 is present in the tablet or capsule in an amount of 1541 μg .

More particularly, leucine is present in the tablet or capsule in an amount of 687 μg .

More particularly, hydroxypropyl methylcellulose is present in the tablet or capsule in an amount of 700 μg .

In another embodiment, the invention provides a method of treating irritable bowel syndrome (e.g., IBS-c) or constipation (e.g., chronic constipation) in a subject in need of such treatment, comprising: administering a GC-C receptor agonist polypeptide to the subject before the ingestion of food.

In one aspect of this embodiment, the GC-C receptor agonist polypeptide formulation is administered to the subject at least 6 hours after the ingestion of food.

In another aspect of this embodiment, the GC-C receptor agonist polypeptide formulation is administered to the subject at least 8 hours after the ingestion of food.

In another aspect of this embodiment, the GC-C receptor agonist polypeptide formulation is administered to the subject at least 10 hours after the ingestion of food.

In another aspect of this embodiment, the GC-C receptor agonist polypeptide formulation is administered to the subject at least 15 minutes before the ingestion of more food.

In another aspect of this embodiment, the GC-C receptor agonist polypeptide formulation is administered to the subject at least 30 minutes before the ingestion of more food.

In another aspect of this embodiment, the GC-C receptor agonist polypeptide formulation is administered to the subject at least 1 hour before the ingestion of more food.

In another aspect of this embodiment, the GC-C receptor agonist polypeptide formulation is administered to the subject at least 2 hours before the ingestion of more food.

In these aspects, the GC-C receptor agonist polypeptide may be linaclotide.

In another aspect of this embodiment, the subject in need of such treatment is suffering from irritable bowel syndrome (IBS). More particularly the disorder is IBS, which is constipation-predominant IBS (IBS-c) or alternating IBS (IBS-a). More particularly, the disorder is IBS-c.

In another aspect of this embodiment, the subject in need of such treatment is suffering from constipation. More particularly, the disorder is constipation which is chronic constipation, idiopathic constipation, post-operative ileus, or constipation caused by opiate use.

In these aspects, the GC-C receptor agonist polypeptide is administered as a formulation comprising the GC-C receptor agonist polypeptide and a pharmaceutically acceptable excipient.

In another embodiment, the invention provides a method of increasing the pharmacodynamic effect of a GC-C receptor agonist polypeptide which is administered to a subject in need of such treatment, comprising administering the GC-C receptor agonist polypeptide to the subject with the ingestion of food or within two hours after the ingestion of food.

In one aspect of this embodiment, the GC-C receptor agonist polypeptide is administered with the ingestion of food.

In another aspect of this embodiment, the GC-C receptor agonist polypeptide is administered with a meal.

In another aspect of this embodiment, the GC-C receptor agonist polypeptide is administered within two hours after the ingestion of food.

In another aspect of this embodiment, the GC-C receptor agonist polypeptide is administered within one hour after the ingestion of food.

In another aspect of this embodiment, the GC-C receptor agonist polypeptide is administered within 30 minutes after the ingestion of food.

In another aspect of this embodiment, the GC-C receptor agonist polypeptide is administered within 15 minutes after the ingestion of food.

In another aspect of this embodiment, the GC-C receptor agonist polypeptide is linaclotide.

In another aspect of this embodiment, the subject in need of such treatment is suffering from irritable bowel syndrome (IBS). More particularly the disorder is IBS, which is constipation-predominant IBS (IBS-c) or alternating IBS (IBS-a). More particularly, the disorder is IBS-c.

In another aspect of this embodiment, the subject in need of such treatment is suffering from constipation. More particularly, the disorder is constipation which is chronic constipation, idiopathic constipation, post-operative ileus, or constipation caused by opiate use.

In another aspect of this embodiment, the GC-C receptor agonist polypeptide is administered as a formulation comprising the GC-C receptor agonist polypeptide and a pharmaceutically acceptable excipient.

In another aspect of this embodiment, the formulation further comprises one or more agents selected from a cation selected from Mg^{2+} , Ca^{2+} , Zn^{2+} , Mn^{2+} , K^+ , Na^+ and Al^{3+} or a sterically hindered primary amine.

In particular, the Mg^{2+} , Ca^{2+} , Zn^{2+} , Mn^{2+} , K^+ , Na^+ or Al^{3+} is provided as magnesium acetate, magnesium chloride, magnesium phosphate, magnesium sulfate, calcium acetate, calcium chloride, calcium phosphate, calcium sulfate, zinc acetate, zinc chloride, zinc phosphate, zinc sulfate, manganese acetate, manganese chloride, manganese phosphate, manganese sulfate, potassium acetate, potassium chloride, potassium phosphate, potassium sulfate, sodium acetate, sodium chloride, sodium phosphate, sodium sulfate, aluminum acetate, aluminum chloride, aluminum phosphate or aluminum sulfate.

More particularly, the Mg^{2+} , Ca^{2+} , Zn^{2+} , Mn^{2+} , K^+ , Na^+ or Al^{3+} is provided as magnesium chloride, calcium chloride, calcium phosphate, calcium sulfate, zinc acetate, manganese chloride, potassium chloride, sodium chloride or aluminum chloride.

More particularly, the cation is Mg^{2+} , Ca^{2+} , Zn^{2+} .

More particularly, the Mg^{2+} , Ca^{2+} or Zn^{2+} is provided as magnesium chloride, calcium chloride or zinc acetate.

More particularly, the agent is Ca^{2+} .

More particularly, the Ca^{2+} is provided as calcium chloride.

Alternatively, the agent is a sterically hindered primary amine.

More particularly, the sterically hindered primary amine is an amino acid.

More particularly, the amino acid is a naturally-occurring amino acid.

More particularly, the naturally-occurring amino acid is histidine, phenylalanine, alanine, glutamic acid, aspartic acid, glutamine, leucine, methionine, asparagine, tyrosine, threonine, isoleucine, tryptophan, glycine or valine.

More particularly, the naturally-occurring amino acid is leucine, isoleucine, alanine or methionine.

More particularly, the naturally-occurring amino acid is leucine or methionine.

More particularly, the naturally-occurring amino acid is leucine.

Alternatively, the sterically hindered primary amine is a non-naturally occurring amino acid.

More particularly, the non-naturally occurring amino acid is 1-aminocyclohexane carboxylic acid.

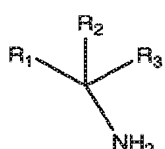
Alternatively, the sterically hindered primary amine has the formula: , wherein R_1 , R_2 and R_3 are independently selected from: H; $-C(O)OH$; C_1-C_6 alkyl, optionally substituted by $-CO_2H$, $-CONH_2$, or a 5-10 membered aryl or heteroaryl; C_1-C_6 alkoxyalkyl; or C_1-C_6 thioalkoxyalkyl, wherein any of the alkyl or aryl groups above can be singly or multiply substituted with halogen or $-NH_2$, and provided that no more than two of R_1 , R_2 and R_3 are H. In a further embodiment, no more than one of R_1 , R_2 and R_3 is H.

More particularly, the sterically hindered primary amine has the formula:

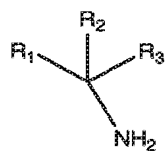

, wherein R_1 , R_2 and R_3 are independently selected from: H; $-C(O)OH$; C_1-C_6

alkyl; C₁-C₆ alkoxyalkyl; or C₁-C₆ thioalkoxyalkyl, wherein any of the alkyl or aryl groups above can be singly or multiply substituted with halogen or -NH₂, and provided that no more than two of R₁, R₂ and R₃ are H. In a further embodiment, no more than one of R₁, R₂ and R₃ is H.

More particularly, the sterically hindered primary amine has the formula:

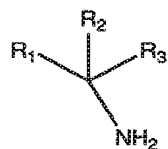

, wherein R₁, R₂ and R₃ are independently selected from: H; -C(O)OH; C₁-C₆ alkyl; C₁-C₆ alkoxyalkyl; or C₁-C₆ thioalkoxyalkyl, and provided that no more than two of R₁, R₂ and R₃ are H. In a further embodiment, no more than one of R₁, R₂ and R₃ is H.

In some embodiments, the sterically hindered primary amine is cyclohexylamine or 2-methylbutylamine.

In some embodiments, the sterically hindered primary amine is chitosan.

In some embodiments, the GC-C receptor agonist polypeptide is linacotide.

In another aspect, the GC-C receptor agonist polypeptide formulation used in the method comprises a cation selected from Mg²⁺, Ca²⁺, Zn²⁺, Mn²⁺, K⁺, Na⁺ and Al³⁺ and a sterically hindered primary amine.

More particularly, the Mg²⁺, Ca²⁺, Zn²⁺, Mn²⁺, K⁺, Na⁺ or Al³⁺ is provided as magnesium acetate, magnesium chloride, magnesium phosphate, magnesium sulfate, calcium acetate, calcium chloride, calcium phosphate, calcium sulfate, zinc acetate, zinc chloride, zinc phosphate, zinc sulfate, manganese acetate, manganese chloride, manganese phosphate, manganese sulfate, potassium acetate, potassium chloride, potassium phosphate, potassium sulfate, sodium acetate, sodium chloride, sodium phosphate, sodium sulfate, aluminum acetate, aluminum chloride, aluminum phosphate or aluminum sulfate.

More particularly, the Mg²⁺, Ca²⁺, Zn²⁺, Mn²⁺, K⁺, Na⁺ or Al³⁺ is provided as magnesium chloride, calcium chloride, calcium phosphate, calcium sulfate, zinc acetate, manganese chloride, potassium chloride, sodium chloride or aluminum chloride.

More particularly, the cation is Mg²⁺, Ca²⁺ or Zn²⁺.

More particularly, the Mg²⁺, Ca²⁺ or Zn²⁺ is provided as magnesium chloride, calcium chloride or zinc acetate.

More particularly, the cation is Ca²⁺.

More particularly, the Ca²⁺ is provided as calcium chloride.

More particularly, the sterically hindered primary amine is an amino acid.

More particularly, the amino acid is a naturally-occurring amino acid.

More particularly, the naturally-occurring amino acid is histidine, phenylalanine, alanine, glutamic acid, aspartic acid, glutamine, leucine, methionine, asparagine, tyrosine, threonine, isoleucine, tryptophan, glycine or valine.

More particularly, the naturally-occurring amino acid is leucine, isoleucine, alanine or methionine.

More particularly, the naturally-occurring amino acid is leucine or methionine.

More particularly, the naturally-occurring amino acid is leucine.

Alternatively, the sterically hindered primary amine is a non-naturally occurring amino acid.

More particularly, the non-naturally occurring amino acid is l-aminocyclohexane carboxylic acid.

Alternatively, the sterically hindered primary amine has the formula: $\text{C}(\text{R}_1)(\text{R}_2)(\text{R}_3)\text{NH}_2$, wherein R_1 , R_2 and R_3 are independently selected from: H; $-\text{C}(\text{O})\text{OH}$; $\text{C}_1\text{-C}_6$ alkyl, optionally substituted by $-\text{CO}_2\text{H}$, $-\text{CONH}_2$, or a 5-10 membered aryl or heteroaryl; $\text{C}_1\text{-C}_6$ alkoxyalkyl; or $\text{C}_1\text{-C}_6$ thioalkoxyalkyl, wherein any of the alkyl or aryl groups above can be singly or multiply substituted with halogen or $-\text{NH}_2$, and provided that no more than two of R_1 , R_2 and R_3 are H. In a further embodiment, no more than one of R_1 , R_2 and R_3 is H.

More particularly, the sterically hindered primary amine has the formula:

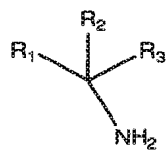

, wherein R_1 , R_2 and R_3 are independently selected from: H; $-\text{C}(\text{O})\text{OH}$; $\text{C}_1\text{-C}_6$ alkyl; $\text{C}_1\text{-C}_6$ alkoxyalkyl; or $\text{C}_1\text{-C}_6$ thioalkoxyalkyl, wherein any of the alkyl or aryl groups above can be singly or multiply substituted with halogen or $-\text{NH}_2$, and provided that no more than two of R_1 , R_2 and R_3 are H. In a further embodiment, no more than one of R_1 , R_2 and R_3 is H.

More particularly, the sterically hindered primary amine has the formula:

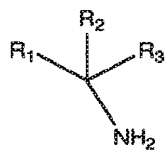

, wherein R_1 , R_2 and R_3 are independently selected from: H; $-\text{C}(\text{O})\text{OH}$; $\text{C}_1\text{-C}_6$ alkyl; $\text{C}_1\text{-C}_6$ alkoxyalkyl; or $\text{C}_1\text{-C}_6$ thioalkoxyalkyl, and provided that no more than two of R_1 , R_2 and R_3 are H. In a further embodiment, no more than one of R_1 , R_2 and R_3 is H.

More particularly, the sterically hindered primary amine is cyclohexylamine or 2-methylbutylamine.

More particularly, the sterically hindered primary amine is chitosan.

In some embodiments, the GC-C receptor agonist polypeptide is linaclotide.

In these aspects, the GC-C receptor agonist polypeptide formulation additionally comprises a pharmaceutically acceptable binder. In particular, the pharmaceutically acceptable binder is selected from polyvinyl alcohol, polyvinylpyrrolidone (povidone), a starch, maltodextrin or a cellulose ether. More particularly, the pharmaceutically acceptable binder is a cellulose ether which may be selected from: methylcellulose, ethylcellulose, carboxymethylcellulose, hydroxyethyl cellulose, hydroxyethyl methylcellulose, hydroxypropyl cellulose and hydroxypropyl methylcellulose..

In these aspects, the GC-C receptor agonist polypeptide formulation additionally comprises a pharmaceutically acceptable glidant, lubricant or additive that acts as both a glidant and lubricant.

In these aspects, the GC-C receptor agonist polypeptide formulation additionally comprises an antioxidant. In particular, the antioxidant is BHA, vitamin E or propyl gallate.

In these aspects, the GC-C receptor agonist polypeptide formulation additionally comprises a pharmaceutically acceptable filler. In particular, the pharmaceutically acceptable filler is cellulose, isomalt, mannitol or dibasic calcium phosphate. More particularly, the cellulose used in the filler is selected from microfine cellulose and microcrystalline cellulose. More particularly, the pharmaceutically acceptable filler comprises particles having an average diameter between 150 μm and 1000 μm .

In another aspect, when the sterically hindered primary amine is leucine and the cation is Ca^{2+} .

In another aspect, the molar ratio of Ca^{2+} to leucine is at least 1:1.

More particularly, the molar ratio of Ca^{2+} to leucine is at least 1.5:1.

More particularly, the molar ratio of Ca^{2+} to leucine is at least 2:1.

In this aspect, the sterically hindered amine is leucine and the molar ratio of leucine to GC-C receptor agonist polypeptide is at least 10:1.

More particularly, the molar ratio of leucine to GC-C receptor agonist polypeptide is at least 20:1.

More particularly, the molar ratio of leucine to GC-C receptor agonist polypeptide in the pharmaceutical formulation is at least 30:1.

In the GC-C receptor agonist polypeptide formulations comprising a filler, the weight ratio of GC-C receptor agonist polypeptide to pharmaceutically acceptable filler is between 1:25 and 1:2,500.

More particularly, the weight ratio of GC-C receptor agonist polypeptide to pharmaceutically acceptable filler is between 1:100 and 1:2000.

More particularly, the weight ratio of GC-C receptor agonist polypeptide to pharmaceutically acceptable filler is between 1:100 and 1:1000.

In the GC-C receptor agonist polypeptide formulations, comprising a cation and a sterically hindered primary amine, the molar ratio of cation:sterically hindered primary amine:GC-C receptor agonist polypeptide is 40-100:20-50:1.

More particularly, when the cation is Ca^{2+} and the sterically hindered primary amine is leucine, the molar ratio of Ca^{2+} :leucine:GC-C receptor agonist polypeptide is 100:30:1, 80:40:1, 80:30:1, 80:20:1, 60:30:1, 60:20:1, 50:30:1, 50:20:1, 40:20:1, 20:20:1, 10:10:1, 10:5:1, 5:10:1 or 5:5:1.

More particularly, the molar ratio of Ca^{2+} :leucine:GC-C receptor agonist polypeptide is 60:30:1.

More particularly, the cation is provided as CaCl_2 .

In another aspect of the invention method, the GC-C receptor antagonist formulation is in the form of a capsule or tablet.

In particular, each capsule or tablet comprises 50 μg to 1 mg GC-C receptor agonist polypeptide. In some embodiments, each capsule or tablet comprises 50 μg to 1 mg linaclotide.

More particularly, each capsule or tablet comprises 100 μg , 150 μg , 200 μg , 300 μg , 400 μg , 500 μg or 600 μg GC-C receptor agonist polypeptide. In some embodiments, each capsule or tablet comprises 100 μg , 150 μg , 200 μg , 300 μg , 400 μg , 500 μg or 600 μg linaclotide.

More particularly, each tablet or capsule comprises:

- (a) Linaclotide;
- (b) $\text{CaCl}_2 \cdot 2\text{H}_2\text{O}$;
- (c) L-Leucine; and
- (d) Hydroxypropyl Methylcellulose

wherein linaclotide is present in the pharmaceutical composition in an amount between 100 μg to 600 μg and the molar ratio of Ca^{2+} :leucine:linaclotide is between 5-100:5-50:1.

More particularly, linaclotide is present in the tablet or capsule in an amount of 133 or 266 μ g.

More particularly, CaCl₂ is present in the tablet or capsule in an amount of 1541 μ g.

More particularly, leucine is present in the tablet or capsule in an amount of 687 μ g.

More particularly, hydroxypropyl methylcellulose is present in the tablet or capsule in an amount of 700 μ g.

EXAMPLES

Linaclotide Food Effect Study

Linaclotide is a 14 amino acid polypeptide that binds to and activates the guanylate cyclase receptor subtype C (GC-C) receptor on the luminal surface of intestinal enterocytes, resulting in an increase in fluid secretion into the lumen of the intestine and acceleration of colonic transit. Linaclotide has also demonstrated mitigating effects on visceral hypersensitivity in animal models. Linaclotide is being developed as an orally administered therapeutic for the treatment of chronic constipation (CC), irritable bowel syndrome with constipation (IBS-C), and other gastrointestinal (GI) disorders.

The randomized, open-label, two-period, two-sequence, crossover trial of oral linaclotide in healthy volunteers tested under fasted or fed conditions summarized herein was undertaken to determine if linaclotide is susceptible to a food effect. The study consisted of 4 stages: an 8-day to 15-day Screening Stage, two 15- to 16-day Crossover Periods (1 and 2), and a 21-day Washout Stage which was to occur between Crossover Periods 1 and 2. The doses tested in this study were 300 ug and a 1-day dose of 3000 ug at the end of Crossover Periods 1 and 2.

Objectives

The objective of this study was to compare the pharmacodynamic (PD) effect on stool consistency of linaclotide administered under fed and fasting conditions.

Methodology

The study consisted of 4 stages: an 8-day to 15-day Screening Stage which was to take place at home and determine eligibility, two 15- to 16-day stages (Crossover Periods 1 and 2) which were to take place in a Phase 1 unit, and a 21-day Washout Stage which was to take place at home and occur between Crossover Periods 1 and 2. The individual study Stages are detailed below.

Screening Stage: The Screening Stage was to start with the signature of the informed consent form (ICF) at Visit 1 and lasted for 8 to 15 days. During this Stage, eligible healthy volunteers were to be instructed to follow a specific diet (similar to the diet subjects received during Crossover Periods 1 and 2) and to keep a paper based daily diary of their bowel habits (the Bowel Habit Diary, BHD). In this diary, subjects were to record their bowel movements (BMs) during a particular day and provide the date, time, and consistency of each BM. They were also to assess the degree of straining associated with each BM and whether each BM was associated with a sense of complete evacuation. Subjects were not allowed to use laxatives, enemas, and suppositories during the Screening Stage. At the end of the Screening Stage, which was the start of Crossover Period 1, subjects were to report to the Phase 1 unit to have their eligibility for randomization determined.

Crossover Periods 1 and 2: Eligible subjects were entered into the Phase 1 unit and were randomized to 1 of 2 Treatment Sequences. Sequence 1 (Fed-Fasted): During Crossover Period 1, linaclotide was to be administered immediately after a high-fat breakfast (the fed condition); during Crossover Period 2, linaclotide was to be administered after a 10-hour fast (the fasted condition). Sequence 2 (Fasted-Fed): During Crossover Period 1, linaclotide was to be administered under the fasted condition; during Crossover Period 2, linaclotide was to be administered under the fed condition.

Crossover Period 1 lasted for 15 days and Crossover Period 2 started on Day 35, immediately after the 21-day Washout Stage, and lasted for 16 days. Subjects were to record their bowel habits in their BHD and ingest their meals at the time determined by their randomization sequence. At a specified time on each day, the information in the BHD was to be reviewed by the site staff to insure appropriate completion.

During the Pretreatment Phase of each Crossover Period, subjects were not to receive study drug. On Day 8 of Crossover Period 1 and Day 43 of Crossover Period 2, subjects started the Treatment Phase and were to receive 300 ug linaclotide once daily for a total of 7 days. On Day 14 and 15 of Crossover Period 1, blood was to be drawn to assay for linaclotide and its active metabolite. After the study procedures were completed on Day 15, subjects were discharged home with instructions to follow the same outpatient diet that they followed during the Screening Stage and to return to the Phase 1 unit on Day 35 for Crossover Period 2. On Day 50 of Crossover Period 2, subjects were to receive a single oral dose of 3000 ug linaclotide and were discharged from the Phase 1 unit on Day 51. After subjects received the 3000 ug dose, blood was to be drawn on Day 50 and 51 to assay for linaclotide and linaclotide metabolites.

Linaclootide was to be administered at the same time each morning with 240 cc (8 oz) of water; food was to be withheld for approximately 4 hr after dosing, and additional water was to be withheld from 1 hour before linaclootide administration until 1 hour after dosing. Under the fed condition, subjects were required to start and complete a high-fat breakfast during the 30 minutes before linaclootide administration. Under the fasted condition, linaclootide was to be administered following an overnight fast.

All meals and meal times were standardized during Crossover Periods 1 and 2 with the total daily calorie, fat, and fiber intake the same for each diet condition (fed and fasted). The daily quantity of these nutrients was based on the "United States Department of Agriculture (USDA) Dietary Recommendations for Americans." Each subject received approximately 2000 total calories per day.

Number of Subjects (Planned and Analyzed): 20 subjects were planned so that at least 16 subjects completed both Crossover Periods; 20 subjects were enrolled and 18 completed both Crossover Periods. Subjects withdrawing from the study were not replaced.

Diagnosis and Main Criteria for Inclusion: Males and females (non pregnant and non breast feeding) aged 18 to 65 years; Body Mass Index score was ≥ 18.5 and < 35 at the Screening Visit; in good health as determined by medical history, physical examination, 12-lead electrocardiogram (ECG), and vital signs; subject had 4 to 14 BMs and a Bristol Stool Form Scale (BSFS) Score for stool consistency of 2 to 5 for each bowel movement during the last 7 days of the 8-day to 15-day Screening Stage.

Test Product, Dose and Mode of Administration: Linaclootide, 300 ug, oral gelatin capsule. Linaclootide, 3000 ug (5 oral gelatin capsules of 600 ug linaclootide each), single dose.

Duration of Treatment: The 300 ug dose of linaclootide was to be administered for a total of 14 days. Since this was a crossover study, each subject was to receive two 7-day courses of the 300 ug doses with each course being separated by 28 days (a 21-day Washout Stage and a 7-day Pretreatment Phase). The 3000 ug dose of linaclootide was to be administered as a single oral dose on Day 50 only. Total subject participation lasted for 66 days.

Criteria for Evaluation:

Pharmacodynamic (PD): The primary endpoint was the change from Pretreatment Phase to Treatment Phase for each Crossover Period in stool consistency on the BSFS scale. For each of the Pretreatment and Treatment Phases, a subject's BSFS Score was the average of the BSFS Scores for each spontaneous bowel movement (SBM) occurring during that week. The secondary endpoints were SBM frequency, complete spontaneous bowel

movement (CSBM) frequency, and degree of straining. An additional analysis of the primary and secondary endpoints was completed based on the last 4 days of treatment (Sensitivity Analysis).

Pharmacokinetic (PK): Blood samples were to be collected at 0 hour (prior to dosing) and 0.5, 1, 2, 3, 4, 6 and 24 hours post dose on Day 14 of Crossover Period 1 and on Day 50 of Crossover Period 2, for determination of the following PK parameters for linaclotide and a metabolite of linaclotide (CCEYCCNPACTGC (SEQ ID NO: 10)) (if systemic levels of linaclotide and or the metabolite are detected): maximum observed plasma concentration (C_{max}), time to maximum concentration (T_{max}), area under the plasma concentration time curve (AUC_{0-t}), area under the plasma concentration time curve extrapolated to infinity ($AUC_{0-\infty}$), clearance relative to bioavailability (CL/F), apparent volume of distribution (Vd/F), apparent terminal half life ($t_{1/2}$).

Statistical Methods:

Primary Endpoint Analysis:

The primary endpoint analysis was a 90 percent confidence interval of the difference in the effect of linaclotide administered in a fasting versus fed condition on the change from Pretreatment BSFS Scores. Equivalence margins of ± 0.6125 were used such that if the 90 percent confidence interval was contained within the equivalence margins, the study would have demonstrated equivalence between the fasting and fed conditions relative to stool consistency.

Sample Size Determination:

For this cross-over design study, a sample size of 20 randomized subjects provided 80 percent power to reject the non-equivalence null hypothesis based upon the primary endpoint analysis under the following set of assumptions: 16 of the 20 subjects completed the study and were included in the Per-Protocol population, the standard deviation of the within subject change from Pretreatment to Treatment in BSFS Scores was 0.75, and the expected difference between the fed and fasting conditions was 0.

The primary analysis population for the analysis was the Per-protocol Population. All subjects who completed the study with no major protocol violations were included in the Per-protocol Population.

Summary of Results

For the Pre-protocol Population, the mean subject age for all subjects was 34.6 years. The mean age for the Fed-Fasted Treatment Sequence was higher (37.3 years) when

compared with the Fasted-Fed Treatment Sequence (31.9 years). The difference appeared to be driven by the enrollment of a 62-year-old subject into the Fed-Fasted Treatment Sequence. The majority of subjects were male (83.3 percent) and white (72.2 percent). The percentage of male subjects was higher in the Fasted-Fed Treatment Sequence when compared with the Fed-Fasted Treatment Sequence. African American subjects comprised 27.8 percent of the study population; 11.1 percent of subjects reported Hispanic/Latino ethnicity.

PD Results: The primary endpoint analysis, the 90 percent confidence interval of the difference between linaclotide in the fasted versus fed condition on the change from pretreatment BSFS Scores, did not demonstrate equivalence, as the confidence interval (0.25, 0.98) was not within the equivalence margins of ± 0.6125 . This result indicates that taking linaclotide in the fed condition results in looser stools (higher BSFS scores) compared with taking it in the fasted condition. The statistically significantly higher number of SBMs and CSBMs in the fed condition versus the fasted condition also indicates that the fed condition enhances the PD effects of linaclotide. Table 6 provides a summary of bowel habits data for the fed and fasted conditions.

Table 6
Summary of Bowel Habits Data for the Fed and Fasted Conditions
(Over 7 days of Treatment)

PD Score	Change from Pretreatment Mean (SEM)		Difference Mean and 90 % CI	P-Value
	Linaclotide (300 ug) Fed	Linaclotide (300 ug) Fasted	Fed-Fasted Difference	Fed vs Fasted
BSFS Score	2.45 (0.159)	1.84 (0.177)	0.61 (0.25, 0.98) ^c	0.0092
SBM	5.94 (1.503)	1.50 (0.487)	4.44 (2.22, 6.67)	0.0031
CSBM	4.06 (1.181)	1.00 (0.443)	3.06 (0.90, 5.21)	0.0251
Straining Score	-0.16 (0.064)	-0.17 (0.057)	0.01 (-0.12, 0.14)	0.9387

CI = Confidence interval

^c Did not demonstrate equivalence between the fed and fasted conditions because the 90 percent confidence interval was not within the equivalence margins of ± 0.6125 .

For the last 4 days of treatment (Sensitivity Analysis), the mean Fed-Fasted difference in BSFS Score was lower than it was for the entire 7 days of treatment, but the 90 percent CI (-0.09, 0.86) still did not fall within the equivalence margins (± 0.6125) defined for the primary efficacy endpoint. This result indicates that the enhanced PD effects during the fed condition are present during the last 4 days of treatment but are somewhat less than the results over the 7 days of treatment. Table 7 provides a summary of bowel habits data for the fed and fasted conditions over the last 4 days of treatment for BSFS; and SBM and CSBM Frequency.

Table 7
Summary of Bowel Habits Data for the Fed and Fasted Conditions
(Last 4 Days of Treatment)

PD Score	Change from Pretreatment Mean (SEM)		Difference Mean and 90 percent CI	P-Value
	Linaclootide (300 ug) Fed	Linaclootide (300 ug) Fasted	Fed-Fasted Difference	Fed vs Fasted
BSFS Score	2.36 (0.230)	1.97 (0.174)	0.38 (-0.09, 0.86)	0.1754
SBM	2.28 (0.704)	0.72 (0.419)	1.56 (0.60, 2.51)	0.0118
CSBM	1.00 (0.647)	0.39 (0.293)	0.61 (-0.49, 1.71)	0.3454

CI = Confidence interval

PK Results: Plasma from all subjects who were administered 300 ug of linaclootide for 7 days of treatment showed no quantifiable levels of linaclootide (limit of detection = 0.2 ng/ml) or linaclootide metabolite (limit of detection = 2.0 ng/ml). The resulting bioanalysis of the 18 subjects who received 10 times this dose (3000 ug), yielded only 2 individuals (subject numbers 001012 and 001019, both in the fasted condition) with detectable levels of linaclootide with C_{max} (T_{max}) being 0.735ng/ml (2h) and 0.212ng/ml (0.5 h), respectively in the plasma. Subject 001019 had only a single sample with a measurable level (0.212 ng/mL), right at the lower limit of quantification (LLOQ) of the assay. No metabolite (SEQ ID NO: 10) was detected in the plasma from any subject. No PK parameters (apart from the observed C_{max} and T_{max}) could be calculated in the 2 subjects due to limited data points.

As for the 24-hour stool results, approximately 3 percent of a single dose of linaclootide was recovered on average following 7 days of dosing at 300 ug per day under both fed and fasted conditions. The recovery was predominately in the form of a major linaclootide metabolite.

Conclusions of Study

In this study of healthy subjects, the PD effects of linaclootide after 7 days of dosing were not demonstrated to be equivalent following dosing in the presence of a high-fat meal versus dosing in the fasted condition. Thus, taking linaclootide with food appears to increase the PD effects of linaclootide.

Without further description, it is believed that one of ordinary skill in the art can, using the preceding description and the illustrative examples, make and utilize the present invention and practice the claimed methods. It should be understood that the foregoing discussion and examples merely present a detailed description of certain preferred embodiments. It will be apparent to those of ordinary skill in the art that various

modifications and equivalents can be made without departing from the spirit and scope of the invention. All the patents and patent publications discussed or cited above are herein incorporated by reference.

What is claimed is:

1. A method of decreasing the pharmacodynamic effect of a GC-C receptor agonist polypeptide formulation which is administered to a subject in need of such treatment, comprising administering the GC-C receptor agonist polypeptide formulation to the subject before the ingestion of food, wherein the GC-C receptor agonist formulation comprises a GC-C receptor agonist polypeptide, a pharmaceutically acceptable carrier, and one or more agents selected from a cation selected from Mg^{2+} , Ca^{2+} , Zn^{2+} , Mn^{2+} , K^+ , Na^+ and Al^{3+} and a sterically hindered primary amine.
2. The method of claim 1, wherein the GC-C receptor agonist polypeptide formulation is administered to the subject 15 minutes to 4 hours before the ingestion of food.
3. The method of claim 1, wherein GC-C receptor agonist polypeptide formulation is administered to the subject 1 to 18 hours before the ingestion of food.
4. The method of claim 1, wherein GC-C receptor agonist polypeptide formulation is administered to the subject 4 to 12 hours before the ingestion of food.
5. The method of claim 1, wherein GC-C receptor agonist polypeptide formulation is administered to the subject 30 minutes to 8 hours before the ingestion of food.
6. The method of claim 1, wherein the GC-C receptor agonist polypeptide formulation is administered to a subject having an empty stomach.
7. The method of claim 1, wherein the subject in need of such treatment is suffering from a disorder selected from the group consisting of gastrointestinal motility disorder, chronic intestinal pseudo-obstruction, colonic pseudo-obstruction, duodenogastric reflux, dyspepsia, functional dyspepsia, nonulcer dyspepsia, functional gastrointestinal disorder, functional heartburn, gastroesophageal reflux disease (GERD), gastroparesis, irritable bowel syndrome, post-operative ileus, and constipation.

8. The method of claim 1, wherein the subject in need of such treatment is suffering from a disorder selected from the group consisting of irritable bowel syndrome (IBS) and constipation.
9. The method of claim 8, wherein said disorder is IBS, and said IBS is constipation-predominant IBS (IBS-c) or alternating IBS (IBS-a).
10. The method of claim 9, wherein said IBS is IBS-c.
11. The method of claim 8, wherein said disorder is constipation, and said constipation is chronic constipation, idiopathic constipation, post-operative ileus, or constipation caused by opiate use.
12. The method of claim 1, wherein the pharmacodynamic effect is measured by the Bristol Stool Form Scale (BSFS), the number of spontaneous bowel movements (SBM) in a given time period and/or the number of complete SBM (CSBM) in a given time period.
13. The method of claim 1, wherein the pharmacodynamic effect results in a lower score on the Bristol Stool Form Scale (BSFS) when the formulation is administered to the subject before ingestion of food as compared to when the formulation is administered to the subject with food or shortly after ingestion of food.
14. The method of claim 1, wherein the pharmacodynamic effect results in fewer spontaneous bowel movements (SBM) in a time period (e.g., a 24 hour period, three day time period, seven day time period, two week time period or four week time period) when the formulation is administered to the subject before ingestion of food as compared to when the formulation is administered to the subject with food or shortly after ingestion of food.
15. The method of claim 1, wherein the pharmacodynamic effect results in fewer spontaneous bowel movements (SBM) in a time period (e.g., a 24 hour period) when the formulation is administered to the subject before ingestion of food as compared to

when the formulation is administered to the subject with food or shortly after ingestion of food.

16. The method of claim 1, wherein the pharmacodynamic effect results in fewer complete spontaneous bowel movements (CSBM) in a time period (e.g., a 24 hour period, three day time period, seven day time period, two week time period or four week time period) when the formulation is administered to the subject before ingestion of food as compared to when the formulation is administered to the subject with food or shortly after ingestion of food
17. The method of claim 1, wherein the pharmacodynamic effect results in fewer complete spontaneous bowel movements (CSBM) in a time period (e.g., a 24 hour period, three day time period, seven day time period, two week time period or four week time period) when the formulation is administered to a subject before ingestion of food as compared to when the formulation is administered to the subject with food or shortly after ingestion of food.
18. The method of claim 1, wherein the GC-C receptor agonist polypeptide of the GC-C receptor agonist polypeptide formulation is selected from linaclotide and any of the polypeptides disclosed in any of US 7,304,036, US 7,371,727, WO 02/78683, WO 2004/069165, WO2005/087797, WO 2007/022531, WO2005/016244, WO2005/074575, WO2006/102069, WO2008/002971, WO2008/106429, WO 2008/137318, WO2002/078683, WO 2006/086653, WO 2007/101158, WO 2008/151257, US7041786, and WO 2007/101161.
19. The method of claim 18, wherein said polypeptide is selected from the group consisting of CCEFCCNPACTGCY (SEQ ID NO: 2), CCEFCCNPACTGC (SEQ ID NO: 3), CCEICCNPACTGCY (SEQ ID NO: 4), CCEICCNPACTGC (SEQ ID NO: 5), CCELCCNPACTGCY (SEQ ID NO: 6), CCELCCNPACTGC (SEQ ID NO: 7), CCEWCCNPACTGCY (SEQ ID NO: 8), CCEWCCNPACTGC (SEQ ID NO: 9), CCEYCCNPACTGC (SEQ ID NO: 10), PGTCEICAYA ACTGC (SEQ ID NO: 11), NDDCEL CVNVACTGCL (SEQ ID NO: 12), NDECEL CVNVACTGCL (SEQ ID NO: 13), and CCEYCCNPACTGCY (SEQ ID NO: 14).

20. The method of claim 1-18, wherein the GC-C receptor agonist polypeptide is linaclotide.
21. The method of claim 1, wherein the agent is a cation selected from the group consisting of Mg^{2+} , Ca^{2+} , Zn^{2+} , Mn^{2+} , K^+ , Na^+ and Al^{3+} .
22. The method of claim 21, wherein the Mg^{2+} , Ca^{2+} , Zn^{2+} , Mn^{2+} , K^+ , Na^+ or Al^{3+} is provided as magnesium acetate, magnesium chloride, magnesium phosphate, magnesium sulfate, calcium acetate, calcium chloride, calcium phosphate, calcium sulfate, zinc acetate, zinc chloride, zinc phosphate, zinc sulfate, manganese acetate, manganese chloride, manganese phosphate, manganese sulfate, potassium acetate, potassium chloride, potassium phosphate, potassium sulfate, sodium acetate, sodium chloride, sodium phosphate, sodium sulfate, aluminum acetate, aluminum chloride, aluminum phosphate or aluminum sulfate.
23. The method of claim 22, wherein the agent is a cation selected from Mg^{2+} , Ca^{2+} or Zn^{2+} , provided as magnesium chloride, calcium chloride or zinc acetate.
24. The method of claim 23, wherein the cation is Ca^{2+} provided as calcium chloride.
25. The method of claim 1, wherein the agent is a sterically hindered primary amine.
26. The method of claim 25, wherein the sterically hindered primary amine is selected from a naturally-occurring amino acid, a non-naturally occurring amino acid, and a sterically hindered primary amine has the formula: $R_1R_2R_3N$, wherein R_1 , R_2 and R_3 are independently selected from: H; $-C(O)OH$; C_1-C_6 alkyl, optionally substituted by $-CO_2H$, $-CONH_2$, or a 5-10 membered aryl or heteroaryl; C_1-C_6 alkoxyalkyl; or C_1-C_6 thioalkoxyalkyl, wherein any of the alkyl or aryl groups above can be singly or multiply substituted with halogen or $-NH_2$, and provided that no more than two of R_1 , R_2 and R_3 are H. In a further embodiment, no more than one of R_1 , R_2 and R_3 is H.

27. The method of claim 27, wherein the naturally-occurring amino acid is histidine, phenylalanine, alanine, glutamic acid, aspartic acid, glutamine, leucine, methionine, asparagine, tyrosine, threonine, isoleucine, tryptophan, glycine or valine.
28. The method of claim 27, wherein the naturally-occurring amino acid is leucine or methionine.
29. The method of claim 27, wherein the naturally-occurring amino acid is leucine.
30. The method of claim 27, wherein the sterically hindered primary amine is a non-naturally occurring amino acid which is 1-aminocyclohexane carboxylic acid.
31. The method of claim 27, wherein the sterically hindered primary amine is cyclohexylamine, 2-methylbutylamine, or chitosan.
32. The method of claim 1, wherein the GC-C receptor agonist polypeptide formulation comprises a cation selected from Mg^{2+} , Ca^{2+} , Zn^{2+} , Mn^{2+} , K^+ , Na^+ and Al^{3+} , and a sterically hindered primary amine selected from a naturally-occurring amino acid, a non-naturally occurring amino acid, and a sterically hindered primary amine has the formula: , wherein R_1 , R_2 and R_3 are independently selected from: H; $-C(O)OH$; C_1 - C_6 alkyl, optionally substituted by $-CO_2H$, $-CONH_2$, or a 5-10 membered aryl or heteroaryl; C_1 - C_6 alkoxyalkyl; or C_1 - C_6 thioalkoxyalkyl, wherein any of the alkyl or aryl groups above can be singly or multiply substituted with halogen or $-NH_2$, and provided that no more than two of R_1 , R_2 and R_3 are H. In a further embodiment, no more than one of R_1 , R_2 and R_3 is H.
33. The method of claim 32, wherein the GC-C receptor agonist polypeptide formulation comprises a cation selected from Mg^{2+} , Ca^{2+} and Zn^{2+} provided as magnesium chloride, calcium chloride, calcium phosphate, calcium sulfate, zinc acetate, manganese chloride, potassium chloride, sodium chloride or aluminum chloride and a sterically hindered primary amine selected from histidine, phenylalanine, alanine, glutamic acid, aspartic acid, glutamine, leucine, methionine, asparagine, tyrosine, threonine, isoleucine, tryptophan, glycine, valine, 1-aminocyclohexane carboxylic acid, cyclohexylamine 2-methylbutylamine, and chitosan.

34. The method of claims 1-33, wherein the cation is Ca^{2+} provided as calcium chloride and the sterically hindered primary amine is leucine.
35. The method of claim 34, wherein the molar ratio of Ca^{2+} to leucine is at least 1:1.
36. The method of claim 34, wherein the molar ratio of Ca^{2+} to leucine is at least 1.5:1.
37. The method of claim 34, wherein the molar ratio of Ca^{2+} to leucine is at least 2:1.
38. The method of claim 1-37, wherein the sterically hindered amine is leucine and the molar ratio of leucine to GC-C receptor agonist polypeptide is at least 10:1.
39. The method of claim 38, wherein the molar ratio of leucine to GC-C receptor agonist polypeptide is at least 20:1.
40. The method of claim 38, wherein the molar ratio of leucine to GC-C receptor agonist polypeptide is at least 30:1.
41. The method of claims 1-40, wherein the GC-C receptor agonist polypeptide formulation further comprises a pharmaceutically acceptable binder.
42. The method of claim 41, wherein the pharmaceutically acceptable binder is selected from polyvinyl alcohol, polyvinylpyrrolidone (povidone), a starch, maltodextrin or a cellulose ether selected from methylcellulose, ethylcellulose, carboxymethylcellulose, hydroxyethyl cellulose, hydroxyethyl methylcellulose, hydroxypropyl cellulose and hydroxypropyl methylcellulose..
43. The method of claims 1-42, wherein the GC-C receptor agonist polypeptide formulation further comprises a pharmaceutically acceptable glidant or lubricant or an additive that acts as both a glidant and lubricant.

44. The method of claims 1-43, wherein the GC-C receptor agonist polypeptide formulation additionally comprises an antioxidant selected from BHA, vitamin E, and propyl gallate.
45. The method of claims 1-44, wherein the GC-C receptor agonist polypeptide formulation further comprises a pharmaceutically acceptable filler particles having an average diameter between 150 μm and 1000 μm , wherein the pharmaceutically acceptable filler is selected from microfine cellulose, microcrystalline cellulose, isomalt, mannitol, and dibasic calcium phosphate.
46. The method of claim 45, wherein the weight ratio of GC-C receptor agonist polypeptide to pharmaceutically acceptable filler is between 1:25 and 1:2,500.
47. The method of claim 46, wherein the weight ratio of GC-C receptor agonist polypeptide to pharmaceutically acceptable filler is between 1:100 and 1:2000.
48. The method of claim 47, wherein the weight ratio of GC-C receptor agonist polypeptide to pharmaceutically acceptable filler is between 1:100 and 1:1000.
49. The method of claims 1-48, wherein the molar ratio of cation:sterically hindered primary amine:GC-C receptor agonist polypeptide is 40-100:20-50:1.
50. The method of claim 49, wherein the molar ratio of Ca^{2+} :leucine:GC-C receptor agonist polypeptide is 100:30:1, 80:40:1, 80:30:1, 80:20:1, 60:30:1, 60:20:1, 50:30:1, 50:20:1, 40:20:1, 20:20:1, 10:10:1, 10:5:1, 5:10:1 or 5:5:1.
51. The method of claim 50, wherein the molar ratio of Ca^{2+} :leucine:GC-C receptor agonist polypeptide is 60:30:1.
52. The method of claims 1-51, wherein the GC-C receptor antagonist formulation is in the form of a capsule or tablet.
53. The method of claim 52, wherein the capsule or tablet comprises 50 μg to 1 mg GC-C receptor agonist polypeptide.

54. The method of claim 52, wherein the capsule or tablet comprises 100 μg , 150 μg , 200 μg , 300 μg , 400 μg , 500 μg or 600 μg GC-C receptor agonist polypeptide.
55. A method of decreasing the pharmacodynamic effect of a GC-C receptor agonist polypeptide formulation which is administered to a subject suffering from irritable bowel syndrome or constipation, comprising administering the GC-C receptor agonist polypeptide formulation to the subject before the ingestion of food, wherein the GC-C receptor agonist formulation comprises a GC-C receptor agonist polypeptide, a pharmaceutically acceptable carrier, Ca^{+2} provided as calcium chloride, and leucine.
56. The method of any one of claims 21-55, wherein the GC-C receptor agonist polypeptide is linaclotide.
57. A method of decreasing the pharmacodynamic effect of a linaclotide formulation which is administered to a subject suffering from irritable bowel syndrome or constipation, comprising administering the GC-C receptor agonist polypeptide formulation to the subject before the ingestion of food, wherein the GC-C receptor agonist formulation comprises linaclotide or a pharmaceutically acceptable salt of linaclotide, a pharmaceutically acceptable carrier, Ca^{+2} provided as calcium chloride, and leucine.
58. A method of decreasing the pharmacodynamic effect of a linaclotide formulation which is administered to a subject suffering from irritable bowel syndrome or constipation, comprising administering the GC-C receptor agonist polypeptide formulation to the subject before the ingestion of food, wherein the GC-C receptor agonist formulation in a comprises:
- (a) Linaclotide;
 - (b) $\text{CaCl}_2 \cdot 2\text{H}_2\text{O}$;
 - (c) L-Leucine; and
 - (d) Hydroxypropyl Methylcellulose

wherein linaclotide is present in the pharmaceutical composition in an amount between 100 μg to 600 μg and the molar ratio of Ca^{2+} :leucine:linaclotide is between 5-100:5-50:1.

59. The method of claim 58, in the formulation is in the form of a tablet or capsule that comprises:
- 133 or 266 μ g of linaclotide;
 - 1541 μ g of CaCl₂;
 - 687 μ g of leucine; and
 - 700 μ g hydroxypropyl methylcellulose.
60. The method of claim 1, wherein the pharmacodynamic effect results in a lower score on the Bristol Stool Form Scale (BSFS), fewer spontaneous bowel movements (SBM) in a time period (e.g., a 24 hour period, three day time period, seven day time period, two week time period or four week time period), and fewer complete spontaneous bowel movements (CSBM) in a time period (e.g., a 24 hour period, three day time period, seven day time period, two week time period or four week time period) when the formulation is administered to the subject before ingestion of food as compared to when the formulation is administered to the subject with food or shortly after ingestion of food.
61. The method of claim 1, wherein the pharmacodynamic effect results in a lower score on the Bristol Stool Form Scale (BSFS) and fewer spontaneous bowel movements (SBM) in a time period (e.g., a 24 hour period, three day time period, seven day time period, two week time period or four week time period), when the formulation is administered to a subject who has not eaten as compared to said subject before ingestion of food as compared to when the formulation is administered to the subject with food or shortly after ingestion of food.
62. The method of claim 1, wherein the pharmacodynamic effect results in a lower score on the Bristol Stool Form Scale (BSFS) and fewer complete spontaneous bowel movements (CSBM) in a time period (e.g., a 24 hour period, three day time period, seven day time period, two week time period or four week time period), when the formulation is administered to a subject before ingestion of food as compared to when the formulation is administered to the subject with food or shortly after ingestion of food.

63. A method of decreasing the pharmacodynamic effect of a GC-C receptor agonist polypeptide which is administered to a subject in need of such treatment, comprising administering the GC-C receptor agonist polypeptide to the subject before the ingestion of food.
64. The method of claim 59, wherein the GC-C receptor agonist polypeptide is administered to the subject 15 minutes to 24 hours before the ingestion of food.
65. The method of claim 59, wherein GC-C receptor agonist polypeptide is administered to the subject 1 to 18 hours before the ingestion of food.
66. The method of claim 59, wherein GC-C receptor agonist polypeptide is administered to the subject 4 to 12 hours before the ingestion of food.
67. The method of claim 59, wherein GC-C receptor agonist polypeptide is administered to the subject 30 minutes to 8 hours before the ingestion of food.
68. The method of claim 59, wherein the GC-C receptor agonist polypeptide is administered to a subject having an empty stomach.
69. The method of claims 59-64, wherein the GC-C receptor agonist polypeptide is linaclotide.
70. The method of claim 1, wherein the GC-C receptor agonist polypeptide formulation is administered to the subject at least 15 minutes before the ingestion of food.
71. The method of claim 66, wherein the GC-C receptor agonist polypeptide formulation is administered to the subject at least 30 minutes before the ingestion of food.
72. The method of claim 67, wherein the GC-C receptor agonist polypeptide formulation is administered to the subject at least 1 hour before the ingestion of food.
73. The method of claim 68, wherein the GC-C receptor agonist polypeptide formulation is administered to the subject at least 2 hours before the ingestion of food.

74. The method according to any one of claims 66-69, wherein the GC-C receptor agonist polypeptide is linaclotide.
75. The method according to claim 63, wherein the GC-C receptor agonist polypeptide is administered to the subject at least 15 minutes before the ingestion of food.
76. The method of claim 75, wherein the GC-C receptor agonist polypeptide is administered to the subject at least 30 minutes before the ingestion of food.
77. The method of claim 76, wherein the GC-C receptor agonist polypeptide is administered to the subject at least 1 hour before the ingestion of food.
78. The method of claim 77, wherein the GC-C receptor agonist polypeptide is administered to the subject at least 2 hours before the ingestion of food.
79. The method according to any one of claims 75-78, wherein the GC-C receptor agonist polypeptide is linaclotide.
80. The method according to any one of claims 63 or 75-79, wherein said GC-C receptor agonist polypeptide is administered as a formulation comprising the GC-C receptor agonist polypeptide and a pharmaceutically acceptable excipient.
81. The method according to any one of claims 63-80, wherein the subject in need of such treatment is suffering from a disorder selected from the group consisting of irritable bowel syndrome (IBS) and constipation.
82. The method of claim 81, wherein said disorder is IBS, and said IBS is constipation-predominant IBS (IBS-c) or alternating IBS (IBS-a).
83. The method of claim 82, wherein said IBS is IBS-c.

84. The method of claim 81, wherein said disorder is constipation, and said constipation is chronic constipation, idiopathic constipation, post-operative ileus, or constipation caused by opiate use.
85. The method of claim 1, wherein the GC-C receptor agonist polypeptide formulation is administered to the subject at least 4 hours after the ingestion of food.
86. The method of claim 85, wherein the GC-C receptor agonist polypeptide formulation is administered to the subject at least 6 hours after the ingestion of food.
87. The method of claim 86, wherein the GC-C receptor agonist polypeptide formulation is administered to the subject at least 8 hours after the ingestion of food.
88. The method of claim 87, wherein the GC-C receptor agonist polypeptide formulation is administered to the subject at least 10 hours after the ingestion of food.
89. The method of any one of claims 85-88, wherein the GC-C receptor agonist polypeptide formulation is administered to the subject at least 15 minutes before the ingestion of more food.
90. The method of claim 89, wherein the GC-C receptor agonist polypeptide formulation is administered to the subject at least 30 minutes before the ingestion of more food.
91. The method of claim 90, wherein the GC-C receptor agonist polypeptide formulation is administered to the subject at least 1 hour before the ingestion of more food.
92. The method of claim 91, wherein the GC-C receptor agonist polypeptide formulation is administered to the subject at least 2 hours before the ingestion of more food.
93. The method of any one of claims 85-92, wherein the GC-C receptor agonist polypeptide is linaclotide.

94. The method of any one of claims 85-93, wherein the subject in need of such treatment is suffering from a disorder selected from the group consisting of irritable bowel syndrome (IBS) and constipation.
95. The method of claim 94, wherein said disorder is IBS, and said IBS is constipation-predominant IBS (IBS-c) or alternating IBS (IBS-a).
96. The method of claim 95, wherein said IBS is IBS-c.
97. The method of claim 94, wherein said disorder is constipation, and said constipation is chronic constipation, idiopathic constipation, post-operative ileus, or constipation caused by opiate use.
98. The method of claim 63, wherein the GC-C receptor agonist is administered to the subject at least 4 hours after the ingestion of food.
99. The method of claim 98, wherein the GC-C receptor agonist polypeptide is administered to the subject at least 6 hours after the ingestion of food.
100. The method of claim 99, wherein the GC-C receptor agonist polypeptide is administered to the subject at least 8 hours after the ingestion of food.
101. The method of claim 101, wherein the GC-C receptor agonist polypeptide is administered to the subject at least 10 hours after the ingestion of food.
102. The method of any one of claims 98-101, wherein the GC-C receptor agonist polypeptide is administered to the subject at least 15 minutes before the ingestion of more food.
103. The method of claim 102, wherein the GC-C receptor agonist polypeptide is administered to the subject at least 30 minutes before the ingestion of more food.
104. The method of claim 103, wherein the GC-C receptor agonist polypeptide is administered to the subject at least 1 hour before the ingestion of more food.

105. The method of claim 104, wherein the GC-C receptor agonist polypeptide is administered to the subject at least 2 hours before the ingestion of more food.
106. The method of any one of claims 98-105, wherein the GC-C receptor agonist polypeptide is linaclotide.
107. The method according to any one of claims 98-106, wherein said GC-C receptor agonist polypeptide is administered as a formulation comprising the GC-C receptor agonist polypeptide and a pharmaceutically acceptable excipient.
108. The method of any one of claims 98-107, wherein the subject in need of such treatment is suffering from a disorder selected from the group consisting of irritable bowel syndrome (IBS) and constipation.
109. The method of claim 108, wherein said disorder is IBS, and said IBS is constipation-predominant IBS (IBS-c) or alternating IBS (IBS-a).
110. The method of claim 109, wherein said IBS is IBS-c.
111. The method of claim 108, wherein said disorder is constipation, and said constipation is chronic constipation, idiopathic constipation, post-operative ileus, or constipation caused by opiate use.
112. The method of claim 111, wherein said constipation is chronic constipation.
113. A method of increasing the pharmacodynamic effect of a GC-C receptor agonist polypeptide which is administered to a subject in need of such treatment, comprising administering the GC-C receptor agonist polypeptide to the subject with the ingestion of food or within two hours after the ingestion of food.
114. The method according to claim 113, wherein the GC-C receptor agonist polypeptide is administered with the ingestion of food.

115. The method according to claim 114, wherein the GC-C receptor agonist polypeptide is administered with a meal.
116. The method according to claim 113, wherein the GC-C receptor agonist polypeptide is administered within two hours after the ingestion of food.
117. The method according to claim 116, wherein the GC-C receptor agonist polypeptide is administered within one hour after the ingestion of food.
118. The method according to claim 117, wherein the GC-C receptor agonist polypeptide is administered within 30 minutes after the ingestion of food.
119. The method according to claim 118, wherein the GC-C receptor agonist polypeptide is administered within 15 minutes after the ingestion of food.
120. The method of any one of claims 113-119, wherein the GC-C receptor agonist polypeptide is linaclotide.
121. The method according to any one of claims 113-120, wherein said GC-C receptor agonist polypeptide is administered as a formulation comprising the GC-C receptor agonist polypeptide and a pharmaceutically acceptable excipient.
122. The method of any one of claims 113-121, wherein the subject in need of such treatment is suffering from a disorder selected from the group consisting of irritable bowel syndrome (IBS) and constipation.
123. The method of claim 122, wherein said disorder is IBS, and said IBS is constipation-predominant IBS (IBS-c) or alternating IBS (IBS-a).
124. The method of claim 123, wherein said IBS is IBS-c.
125. The method of claim 124, wherein said disorder is constipation, and said constipation is chronic constipation, idiopathic constipation, post-operative ileus, or constipation caused by opiate use.

126. The method according to claim 121, wherein the formulation further comprises one or more agents selected from a cation selected from Mg^{2+} , Ca^{2+} , Zn^{2+} , Mn^{2+} , K^+ , Na^+ and Al^{3+} or a sterically hindered primary amine.
127. The method of claim 126, wherein the Mg^{2+} , Ca^{2+} , Zn^{2+} , Mn^{2+} , K^+ , Na^+ or Al^{3+} is provided as magnesium acetate, magnesium chloride, magnesium phosphate, magnesium sulfate, calcium acetate, calcium chloride, calcium phosphate, calcium sulfate, zinc acetate, zinc chloride, zinc phosphate, zinc sulfate, manganese acetate, manganese chloride, manganese phosphate, manganese sulfate, potassium acetate, potassium chloride, potassium phosphate, potassium sulfate, sodium acetate, sodium chloride, sodium phosphate, sodium sulfate, aluminum acetate, aluminum chloride, aluminum phosphate or aluminum sulfate.
128. The method of claim 127, wherein the agent is a cation selected from Mg^{2+} , Ca^{2+} and Zn^{2+} , provided as magnesium chloride, calcium chloride or zinc acetate.
129. The method of claim 128, wherein the cation is Ca^{2+} provided as calcium chloride.
130. The method of claim 126, wherein the agent is a sterically hindered primary amine.
131. The method of claim 130, wherein the sterically hindered primary amine is selected from a naturally-occurring amino acid, a non-naturally occurring amino acid, and a sterically hindered primary amine has the formula: , wherein R_1 , R_2 and R_3 are independently selected from: H; $-C(O)OH$; C_1 - C_6 alkyl, optionally substituted by $-CO_2H$, $-CONH_2$, or a 5-10 membered aryl or heteroaryl; C_1 - C_6 alkoxyalkyl; or C_1 - C_6 thioalkoxyalkyl, wherein any of the alkyl or aryl groups above can be singly or multiply substituted with halogen or $-NH_2$, and provided that no more than two of R_1 , R_2 and R_3 are H. In a further embodiment, no more than one of R_1 , R_2 and R_3 is H.
132. The method of claim 131, wherein the naturally-occurring amino acid is histidine, phenylalanine, alanine, glutamic acid, aspartic acid, glutamine, leucine, methionine, asparagine, tyrosine, threonine, isoleucine, tryptophan, glycine or valine.

133. The method of claim 132, wherein the naturally-occurring amino acid is leucine or methionine.
134. The method of claim 133, wherein the naturally-occurring amino acid is leucine.
135. The method of claim 131, wherein the sterically hindered primary amine is a non-naturally occurring amino acid which is 1-aminocyclohexane carboxylic acid.
136. The method of claim 135, wherein the sterically hindered primary amine is cyclohexylamine, 2-methylbutylamine, or chitosan.
137. The method of claims 113-136, wherein the GC-C receptor agonist polypeptide formulation comprises a cation selected from Mg^{2+} , Ca^{2+} , Zn^{2+} , Mn^{2+} , K^+ , Na^+ and Al^{3+} , and a sterically hindered primary amine selected from a naturally-occurring amino acid, a non-naturally occurring amino acid, and a sterically hindered primary amine has the formula: $R_1R_2R_3N$, wherein R_1 , R_2 and R_3 are independently selected from: H; $-C(O)OH$; C_1-C_6 alkyl, optionally substituted by $-CO_2H$, $-CONH_2$, or a 5-10 membered aryl or heteroaryl; C_1-C_6 alkoxyalkyl; or C_1-C_6 thioalkoxyalkyl, wherein any of the alkyl or aryl groups above can be singly or multiply substituted with halogen or $-NH_2$, and provided that no more than two of R_1 , R_2 and R_3 are H. In a further embodiment, no more than one of R_1 , R_2 and R_3 is H.
138. The method of claim 137, wherein the GC-C receptor agonist polypeptide formulation comprises a cation selected from Mg^{2+} , Ca^{2+} and Zn^{2+} provided as magnesium chloride, calcium chloride, calcium phosphate, calcium sulfate, zinc acetate, manganese chloride, potassium chloride, sodium chloride or aluminum chloride and a sterically hindered primary amine selected from histidine, phenylalanine, alanine, glutamic acid, aspartic acid, glutamine, leucine, methionine, asparagine, tyrosine, threonine, isoleucine, tryptophan, glycine, valine, 1-aminocyclohexane carboxylic acid, cyclohexylamine 2-methylbutylamine, and chitosan.
139. The method of claims 137, wherein the cation is Ca^{2+} provided as calcium chloride and the sterically hindered primary amine is leucine.

140. The method of claim 139 wherein the molar ratio of Ca^{2+} to leucine is at least 1:1.
141. The method of claim 139, wherein the molar ratio of Ca^{2+} to leucine is at least 1.5:1.
142. The method of claim 139, wherein the molar ratio of Ca^{2+} to leucine is at least 2:1.
143. The method of claim 137, wherein the sterically hindered amine is leucine and the molar ratio of leucine to GC-C receptor agonist polypeptide is at least 10:1.
144. The method of claim 137, wherein the molar ratio of leucine to GC-C receptor agonist polypeptide is at least 20:1.
145. The method of claim 137, wherein the molar ratio of leucine to GC-C receptor agonist polypeptide is at least 30:1.
146. The method of claims 137, wherein the GC-C receptor agonist polypeptide formulation further comprises a pharmaceutically acceptable binder.
147. The method of claim 146, wherein the pharmaceutically acceptable binder is selected from polyvinyl alcohol, polyvinylpyrrolidone (povidone), a starch, maltodextrin or a cellulose ether selected from methylcellulose, ethylcellulose, carboxymethylcellulose, hydroxyethyl cellulose, hydroxyethyl methylcellulose, hydroxypropyl cellulose and hydroxypropyl methylcellulose..
148. The method of claims 113-147, wherein the GC-C receptor agonist polypeptide formulation further comprises a pharmaceutically acceptable glidant or lubricant or an additive that acts as both a glidant and lubricant.
149. The method of claims 113-148, wherein the GC-C receptor agonist polypeptide formulation additionally comprises an antioxidant selected from BHA, vitamin E, and propyl gallate.
150. The method of claims 113-149, wherein the GC-C receptor agonist polypeptide formulation additionally comprises a pharmaceutically acceptable filler particles

- having an average diameter between 150 μm and 1000 μm , wherein the pharmaceutically acceptable filler is selected from microfine cellulose, microcrystalline cellulose, isomalt, mannitol, and dibasic calcium phosphate.
151. The method of claim 150, wherein the weight ratio of GC-C receptor agonist polypeptide to pharmaceutically acceptable filler is between 1:25 and 1:2,500.
 152. The method of claim 151, wherein the weight ratio of GC-C receptor agonist polypeptide to pharmaceutically acceptable filler is between 1:100 and 1:2000.
 153. The method of claim 152, wherein the weight ratio of GC-C receptor agonist polypeptide to pharmaceutically acceptable filler is between 1:100 and 1:1000.
 154. The method of claims 113-153, wherein the molar ratio of cation:sterically hindered primary amine:GC-C receptor agonist polypeptide is 40-100:20-50:1.
 155. The method of claim 154, wherein the molar ratio of Ca^{2+} :leucine:GC-C receptor agonist polypeptide is 100:30:1, 80:40:1, 80:30:1, 80:20:1, 60:30:1, 60:20:1, 50:30:1, 50:20:1, 40:20:1, 20:20:1, 10:10:1, 10:5:1, 5:10:1 or 5:5:1.
 156. The method of claim 155, wherein the molar ratio of Ca^{2+} :leucine:GC-C receptor agonist polypeptide is 60:30:1.
 157. The method of claims 113-156, wherein the GC-C receptor antagonist formulation is in the form of a capsule or tablet.
 158. The method of claim 157, wherein the capsule or tablet comprises 50 μg to 1 mg GC-C receptor agonist polypeptide.
 159. The method of claim 157, wherein the capsule or tablet comprises 100 μg , 133 μg , 150 μg , 200 μg , 266 μg , 300 μg , 400 μg , 500 μg or 600 μg GC-C receptor agonist polypeptide.
 160. The method of claim 157, wherein the capsule or tablet comprises:

- (a) Linaclotide;
- (b) $\text{CaCl}_2 \cdot 2\text{H}_2\text{O}$;
- (c) L-Leucine; and
- (d) Hydroxypropyl Methylcellulose

wherein linaclotide is present in the pharmaceutical composition in an amount between $100\mu\text{g}$ to $600\mu\text{g}$ and the molar ratio of Ca^{2+} :leucine:linaclotide is between 5-100:5-50:1.

161. The method of claim 160, wherein the capsule or tablet comprises:
133 or $266\mu\text{g}$ of linaclotide;
1541 μg of CaCl_2 ;
687 μg of leucine; and
700 μg hydroxypropyl methylcellulose.
162. A method of treating irritable bowel syndrome or constipation in a subject in need of such treatment, comprising: administering a GC-C receptor agonist polypeptide to the subject before the ingestion of food.
163. The method of claim 162, wherein GC-C receptor agonist polypeptide formulation is administered to the subject at least 15 minutes before the ingestion of food.
164. The method of claim 162 wherein GC-C receptor agonist polypeptide formulation is administered to the subject at least 30 minutes before the ingestion of food.
165. The method of claim 162, wherein the GC-C receptor agonist polypeptide is administered to a subject having an empty stomach.
166. The method of claim 162, wherein said disorder is IBS, and said IBS is constipation-predominant IBS (IBS-c) or alternating IBS (IBS-a).
167. The method of claim 162, wherein said IBS is IBS-c.
168. The method of claim 162, wherein said disorder is constipation, and said constipation is chronic constipation, idiopathic constipation, post-operative ileus, or constipation caused by opiate use.

169. The method of claim 162, wherein the GC-C receptor agonist polypeptide of the GC-C receptor agonist polypeptide formulation is selected from linaclotide and any of the polypeptides disclosed in any of US 7,304,036, US 7,371,727, WO 02/78683, WO 2004/069165, WO2005/087797, WO 2007/022531, WO2005/016244, WO2005/074575, WO2006/102069, WO2008/002971, WO2008/106429, WO 2008/137318, WO2002/078683, WO 2006/086653, WO 2007/101158, WO 2008/151257, US7041786, and WO 2007/101161.
170. The method of claim 169, wherein said polypeptide is selected from the group consisting CCEFCCNPACTGCY (SEQ ID NO: 2), CCEFCCNPACTGC (SEQ ID NO: 3), CCEICCNPACTGCY (SEQ ID NO: 4), CCEICCNPACTGC (SEQ ID NO: 5), CCELCCNPACTGCY (SEQ ID NO: 6), CCELCCNPACTGC (SEQ ID NO: 7), CCEWCCNPACTGCY (SEQ ID NO: 8), CCEWCCNPACTGC (SEQ ID NO: 9), CCEYCCNPACTGC (SEQ ID NO: 10), PGTCEICAYAACTGC (SEQ ID NO: 11), NDDCELCVNVACTGCL (SEQ ID NO: 12), NDECELCVNVACTGCL (SEQ ID NO: 13), and CCEYCCNPACTGCY (SEQ ID NO: 14).
171. The method of claim 162-170, wherein the GC-C receptor agonist polypeptide is linaclotide.
172. The method of claims 169-171, wherein the GC-C receptor agonist is administered as a formulation comprising the GC-C receptor agonist polypeptide, a pharmaceutically acceptable carrier, and one or more agents selected from a cation selected from the group consisting of Mg^{2+} , Ca^{2+} , Zn^{2+} , Mn^{2+} , K^+ , Na^+ and Al^{3+} and a sterically hindered primary amine
173. The method of claim 172, wherein the agent is a cation selected from the group consisting of Mg^{2+} , Ca^{2+} , Zn^{2+} , Mn^{2+} , K^+ , Na^+ and Al^{3+} .
174. The method of claim 173, wherein the Mg^{2+} , Ca^{2+} , Zn^{2+} , Mn^{2+} , K^+ , Na^+ or Al^{3+} is provided as magnesium acetate, magnesium chloride, magnesium phosphate, magnesium sulfate, calcium acetate, calcium chloride, calcium phosphate, calcium sulfate, zinc acetate, zinc chloride, zinc phosphate, zinc sulfate, manganese acetate, manganese chloride, manganese phosphate, manganese sulfate, potassium acetate,

potassium chloride, potassium phosphate, potassium sulfate, sodium acetate, sodium chloride, sodium phosphate, sodium sulfate, aluminum acetate, aluminum chloride, aluminum phosphate or aluminum sulfate.

175. The method of claim 174, wherein the agent is a cation selected from Mg^{2+} , Ca^{2+} or Zn^{2+} , provided as magnesium chloride, calcium chloride or zinc acetate.
176. The method of claim 175, wherein the cation is Ca^{2+} provided as calcium chloride.
177. The method of claim 172, wherein the agent is a sterically hindered primary amine.
178. The method of claim 177, wherein the sterically hindered primary amine is selected from a naturally-occurring amino acid, a non-naturally occurring amino acid, and a sterically hindered primary amine has the formula: $R_1-CH(R_2)-CH_2-NH-R_3$, wherein R_1 , R_2 and R_3 are independently selected from: H; $-C(O)OH$; C_1-C_6 alkyl, optionally substituted by $-CO_2H$, $-CONH_2$, or a 5-10 membered aryl or heteroaryl; C_1-C_6 alkoxyalkyl; or C_1-C_6 thioalkoxyalkyl, wherein any of the alkyl or aryl groups above can be singly or multiply substituted with halogen or $-NH_2$, and provided that no more than two of R_1 , R_2 and R_3 are H. In a further embodiment, no more than one of R_1 , R_2 and R_3 is H.
179. The method of claim 177, wherein the naturally-occurring amino acid is histidine, phenylalanine, alanine, glutamic acid, aspartic acid, glutamine, leucine, methionine, asparagine, tyrosine, threonine, isoleucine, tryptophan, glycine or valine.
180. The method of claim 177, wherein the naturally-occurring amino acid is leucine or methionine.
181. The method of claim 177, wherein the naturally-occurring amino acid is leucine.
182. The method of claim 177, wherein the sterically hindered primary amine is a non-naturally occurring amino acid which is 1-aminocyclohexane carboxylic acid.
183. The method of claim 177, wherein the sterically hindered primary amine is cyclohexylamine, 2-methylbutylamine, or chitosan.

184. The method of claim 172 wherein the GC-C receptor agonist polypeptide formulation comprises a cation selected from Mg^{2+} , Ca^{2+} , Zn^{2+} , Mn^{2+} , K^+ , Na^+ and Al^{3+} , and a sterically hindered primary amine selected from a naturally-occurring amino acid, a non-naturally occurring amino acid, and sterically hindered primary amine has the formula: $R_1-CH_2-CH_2-NH-R_2-CH_2-CH_2-NH-R_3$, wherein R_1 , R_2 and R_3 are independently selected from: H; $-C(O)OH$; C_1 - C_6 alkyl, optionally substituted by $-CO_2H$, $-CONH_2$, or a 5-10 membered aryl or heteroaryl; C_1 - C_6 alkoxyalkyl; or C_1 - C_6 thioalkoxyalkyl, wherein any of the alkyl or aryl groups above can be singly or multiply substituted with halogen or $-NH_2$, and provided that no more than two of R_1 , R_2 and R_3 are H. In a further embodiment, no more than one of R_1 , R_2 and R_3 is H.
185. The method of claim 184, wherein the GC-C receptor agonist polypeptide formulation comprises a cation selected from Mg^{2+} , Ca^{2+} and Zn^{2+} provided as magnesium chloride, calcium chloride, calcium phosphate, calcium sulfate, zinc acetate, manganese chloride, potassium chloride, sodium chloride or aluminum chloride and a sterically hindered primary amine selected from histidine, phenylalanine, alanine, glutamic acid, aspartic acid, glutamine, leucine, methionine, asparagine, tyrosine, threonine, isoleucine, tryptophan, glycine, valine, l-aminocyclohexane carboxylic acid, cyclohexylamine 2-methylbutylamine, and chitosan.
186. The method of claims 184, wherein the cation is Ca^{2+} provided as calcium chloride and the sterically hindered primary amine is leucine.
187. The method of claim 184, wherein the molar ratio of Ca^{2+} to leucine is at least 1:1.
188. The method of claim 184, wherein the molar ratio of Ca^{2+} to leucine is at least 1.5:1.
189. The method of claim 184, wherein the molar ratio of Ca^{2+} to leucine is at least 2:1.
190. The method of claim 184, wherein the sterically hindered amine is leucine and the molar ratio of leucine to GC-C receptor agonist polypeptide is at least 10:1.

191. The method of claim 172, wherein the molar ratio of leucine to GC-C receptor agonist polypeptide is at least 20:1.
192. The method of claim 172, wherein the molar ratio of leucine to GC-C receptor agonist polypeptide is at least 30:1.
193. The method of claims 172, wherein the GC-C receptor agonist polypeptide formulation further comprises a pharmaceutically acceptable binder.
194. The method of claim 172, wherein the pharmaceutically acceptable binder is selected from polyvinyl alcohol, polyvinylpyrrolidone (povidone), a starch, maltodextrin or a cellulose ether selected from methylcellulose, ethylcellulose, carboxymethylcellulose, hydroxyethyl cellulose, hydroxyethyl methylcellulose, hydroxypropyl cellulose and hydroxypropyl methylcellulose..
195. The method of claims 172, wherein the GC-C receptor agonist polypeptide formulation further comprises a pharmaceutically acceptable glidant or lubricant or an additive that acts as both a glidant and lubricant.
196. The method of claims 195, wherein the GC-C receptor agonist polypeptide formulation additionally comprises an antioxidant selected from BHA, vitamin E, and propyl gallate.
197. The method of claims 172, wherein the GC-C receptor agonist polypeptide formulation further comprises pharmaceutically acceptable filler particles having an average diameter between 150 μm and 1000 μm , wherein the pharmaceutically acceptable filler is selected from microfine cellulose, microcrystalline cellulose, isomalt, mannitol, and dibasic calcium phosphate.
198. The method of claim 197, wherein the weight ratio of GC-C receptor agonist polypeptide to pharmaceutically acceptable filler is between 1:25 and 1:2,500.
199. The method of claim 198, wherein the weight ratio of GC-C receptor agonist polypeptide to pharmaceutically acceptable filler is between 1:100 and 1:2000.

200. The method of claim 198, wherein the weight ratio of GC-C receptor agonist polypeptide to pharmaceutically acceptable filler is between 1:100 and 1:1000.
201. The method of claims 185, wherein the molar ratio of cation:sterically hindered primary amine:GC-C receptor agonist polypeptide is 40-100:20-50:1.
202. The method of claim 185, wherein the molar ratio of Ca^{2+} :leucine:GC-C receptor agonist polypeptide is 100:30:1, 80:40:1, 80:30:1, 80:20:1, 60:30:1, 60:20:1, 50:30:1, 50:20:1, 40:20:1, 20:20:1, 10:10:1, 10:5:1, 5:10:1 or 5:5:1.
203. The method of claim 185, wherein the molar ratio of Ca^{2+} :leucine:GC-C receptor agonist polypeptide is 60:30:1.
204. The method of claims 185, wherein the GC-C receptor antagonist formulation is in the form of a capsule or tablet.
205. The method of claim 204, wherein the capsule or tablet comprises 50 μg to 1 mg GC-C receptor agonist polypeptide.
206. The method of claim 204, wherein the capsule or tablet comprises 100 μg , 133 μg , 150 μg , 200 μg , 266 μg , 300 μg , 400 μg , 500 μg or 600 μg GC-C receptor agonist polypeptide.
207. The method of claim 204, wherein the capsule or tablet comprises:
- (a) Linaclotide;
 - (b) $\text{CaCl}_2 \cdot 2\text{H}_2\text{O}$;
 - (c) L-Leucine; and
 - (d) Hydroxypropyl Methylcellulose

wherein linaclotide is present in the pharmaceutical composition in an amount between 100 μg to 600 μg and the molar ratio of Ca^{2+} :leucine:linaclotide is between 5-100:5-50:1.

208. The method of claim 207, wherein the linaclotide is present in an amount of 133 or 266 μg .

209. The method of claims 207-208, wherein the CaCl_2 is present in an amount of 1541 μg .
210. The method of claims 207-209 wherein the leucine is present in an amount of 687 μg .
211. The method of claims 207-210 wherein the hydroxypropyl methylcellulose is present in an amount of 700 μg .

INTERNATIONAL SEARCH REPORT

International application No
PCT/US2010/045518

A. CLASSIFICATION OF SUBJECT MATTER
 INV. A61K38/10 A61K9/00 A61K47/00 A61P1/00 A61P1/10
 ADD.

According to International Patent Classification (IPC) or to both national classification and IPC

B. FIELDS SEARCHED
 Minimum documentation searched (classification system followed by classification symbols)
 A61K A61P

Documentation searched other than minimum documentation to the extent that such documents are included in the fields searched

Electronic data base consulted during the international search (name of data base and, where practical, search terms used)
 EPO-Internal, WPI Data

C. DOCUMENTS CONSIDERED TO BE RELEVANT

Category*	Citation of document, with indication, where appropriate, of the relevant passages	Relevant to claim No.
A,P	WO 2010/019266 A2 (IRONWOOD PHARMACEUTICALS INC [US]; FOREST LABORATORIES [US]; FRETZEN A) 18 February 2010 (2010-02-18) see claims 21-42, 71-90, 171, example 56	1-211
X	WO 2007/022531 A2 (MICROBIA INC [US]; CURRIE MARK G [US]; MAHAJAN-MIKLOS SHALINA [US]; FR) 22 February 2007 (2007-02-22)	63,68, 69,74, 80-84, 165-171
Y	see claims 1-41, 102, 122, pages 36-55, examples 8-10	1-119, 121-211

Further documents are listed in the continuation of Box C. See patent family annex.

* Special categories of cited documents :

A document defining the general state of the art which is not considered to be of particular relevance	*T* later document published after the international filing date or priority date and not in conflict with the application but cited to understand the principle or theory underlying the invention
E earlier document but published on or after the international filing date	*X* document of particular relevance; the claimed invention cannot be considered novel or cannot be considered to involve an inventive step when the document is taken alone
L document which may throw doubts on priority claim(s) or which is cited to establish the publication date of another citation or other special reason (as specified)	*Y* document of particular relevance; the claimed invention cannot be considered to involve an inventive step when the document is combined with one or more other such documents, such combination being obvious to a person skilled in the art.
O document referring to an oral disclosure, use, exhibition or other means	*&* document member of the same patent family
P document published prior to the international filing date but later than the priority date claimed	

Date of the actual completion of the international search 3 January 2011	Date of mailing of the international search report 13/01/2011
--	---

Name and mailing address of the ISA/ European Patent Office, P.B. 5818 Patentlaan 2 NL - 2280 HV Rijswijk Tel. (+31-70) 340-2040, Fax: (+31-70) 340-3016	Authorized officer Merckling-Ruiz, V
--	--

INTERNATIONAL SEARCH REPORT

International application No
PCT/US2010/045518

C(Continuation). DOCUMENTS CONSIDERED TO BE RELEVANT		
Category*	Citation of document, with indication, where appropriate, of the relevant passages	Relevant to claim No.
Y	<p>BRADY S ET AL: "Microbia and Forst Laboratories Announce Preliminary Results of Linaclotide Phase 2B Studies", COMMUNICATIONS OF MICROBIA, CAMBRIDGE, 4 March 2008 (2008-03-04), pages 1-4, XP002576432, the whole document</p> <p>-----</p>	<p>1-119, 121-211</p>
Y	<p>Forest Research Institute: "Phase III randomized double-blind placebo-controlled trial of linaclotide administered to patients with chronic constipation.", ClinicalTrials.gov, identifier NCT00765882</p> <p>1 October 2008 (2008-10-01), XP002613766, Retrieved from the Internet: URL:http://www.clinicaltrials.gov/ct2/show/NCT00765882?term=linaclotide&rank=3 [retrieved on 2010-12-09] the whole document</p> <p>-----</p>	<p>1-119, 121-211</p>

INTERNATIONAL SEARCH REPORT

Information on patent family members

International application No
PCT/US2010/045518

Patent document cited in search report	Publication date	Patent family member(s)	Publication date
WO 2010019266	A2	18-02-2010 US 2010048489 A1	25-02-2010
WO 2007022531	A2	22-02-2007 CA 2619650 A1	22-02-2007
		EP 1940441 A2	09-07-2008
		US 2009253634 A1	08-10-2009



(51) International Patent Classification:

A61K 38/16 (2006.01) A61K 9/48 (2006.01)
A61K 38/10 (2006.01) A61K 47/48 (2006.01)
A61K 9/16 (2006.01) A61P 35/00 (2006.01)
A61K 9/20 (2006.01) A61P 3/00 (2006.01)

(21) International Application Number:

PCT/US2011/051805

(22) International Filing Date:

15 September 2011 (15.09.2011)

(25) Filing Language:

English

(26) Publication Language:

English

(30) Priority Data:

61/383,156 15 September 2010 (15.09.2010) US
61/387,636 29 September 2010 (29.09.2010) US
61/392,186 12 October 2010 (12.10.2010) US

(63) Related by continuation (CON) or continuation-in-part (CIP) to earlier applications:

US 61/392,186 (CIP)
Filed on 12 October 2010 (12.10.2010)
US 61/383,156 (CIP)
Filed on 15 September 2010 (15.09.2010)
US 61/387,636 (CIP)
Filed on 29 September 2010 (29.09.2010)

(71) Applicant (for all designated States except US): **SYNERGY PHARMACEUTICALS INC.** [US/US]; 420 Lexington Avenue, Suite 1609, New York, NY 10170 (US).

(72) Inventors; and

(75) Inventors/Applicants (for US only): **COMISKEY, Stephen** [US/US]; 105 Steeplechase Drive, Doylestown, PA 18902 (US). **FENG, Rong** [CA/US]; 74 Pine Glen Road, Langhorne, PA 19047 (US). **FOSS, John** [US/US]; 525 Linden Avenue, Doylestown, PA 18901-4435 (US). **SHAILUBHAI, Kunwar** [US/US]; 2707 Bald Eagle Circle, Audubon, PA 19403 (US).

(74) Agents: **ELRIFI, Ivor, R.** et al.; Mintz Levin Cohn Ferris Glovsky And Popeo, P.C., One Financial Center, Boston, MA 02111 (US).

(81) Designated States (unless otherwise indicated, for every kind of national protection available): AE, AG, AL, AM, AO, AT, AU, AZ, BA, BB, BG, BH, BR, BW, BY, BZ, CA, CH, CL, CN, CO, CR, CU, CZ, DE, DK, DM, DO, DZ, EC, EE, EG, ES, FI, GB, GD, GE, GH, GM, GT, HN, HR, HU, ID, IL, IN, IS, JP, KE, KG, KM, KN, KP, KR, KZ, LA, LC, LK, LR, LS, LT, LU, LY, MA, MD, ME, MG, MK, MN, MW, MX, MY, MZ, NA, NG, NI, NO, NZ, OM, PE, PG, PH, PL, PT, QA, RO, RS, RU, RW, SC, SD, SE, SG, SK, SL, SM, ST, SV, SY, TH, TJ, TM, TN, TR, TT, TZ, UA, UG, US, UZ, VC, VN, ZA, ZM, ZW.

[Continued on next page]

(54) Title: FORMULATIONS OF GUANYLATE CYCLASE C AGONISTS AND METHODS OF USE

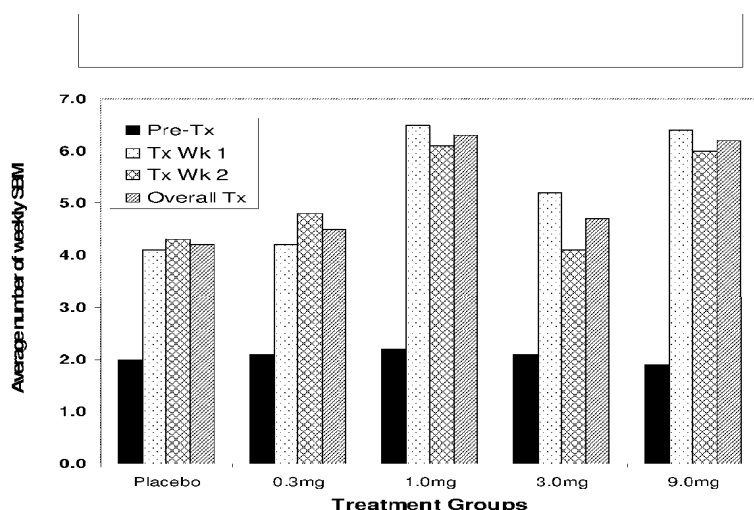

Fig. 2

(57) Abstract: The invention provides low-dose formulations of guanylate cyclase-C ("GCC") agonist peptides and methods for their use. The formulations of the invention can be administered either alone or in combination with one or more additional therapeutic agents, preferably an inhibitor of cGMP-dependent phosphodiesterase or a laxative.

WO 2012/037380 A2



(84) Designated States (*unless otherwise indicated, for every kind of regional protection available*): ARIPO (BW, GH, GM, KE, LR, LS, MW, MZ, NA, SD, SL, SZ, TZ, UG, ZM, ZW), Eurasian (AM, AZ, BY, KG, KZ, MD, RU, TJ, TM), European (AL, AT, BE, BG, CH, CY, CZ, DE, DK, EE, ES, FI, FR, GB, GR, HR, HU, IE, IS, IT, LT, LU, LV, MC, MK, MT, NL, NO, PL, PT, RO, RS, SE, SI, SK,

SM, TR), OAPI (BF, BJ, CF, CG, CI, CM, GA, GN, GQ, GW, ML, MR, NE, SN, TD, TG).

Published:

— *without international search report and to be republished upon receipt of that report (Rule 48.2(g))*

FORMULATIONS OF GUANYLATE CYCLASE C AGONISTS AND METHODS OF USE

RELATED APPLICATIONS

[01] This application claims the benefit of priority to U.S. Provisional Application No. 61/383,156 filed on September 15, 2010, U.S. Provisional Application No. 61/387,636 filed on September 29, 2010, and U.S. Provisional Application No. 61/392,186 filed on October 12, 2010, the contents of which are incorporated by reference in their entireties.

FIELD OF THE INVENTION

[02] The present invention relates to low-dose formulations of guanylate cyclase C peptide agonists useful for the treatment and prevention of various diseases and disorders.

BACKGROUND OF THE INVENTION

[03] Guanylate cyclase C is a transmembrane form of guanylate cyclase that is expressed on various cells, including gastrointestinal epithelial cells (reviewed in Vaandrager 2002 *Mol. Cell. Biochem.* 230:73-83). It was originally discovered as the intestinal receptor for the heat-stable toxin (ST) peptides secreted by enteric bacteria and which cause diarrhea. The ST peptides share a similar primary amino acid structure with two peptides isolated from intestinal mucosa and urine, guanylin and uroguanylin (Currie, *et al.*, *Proc. Nat'l Acad. Sci. USA* 89:947-951 (1992); Hamra, *et al.*, *Proc. Nat'l Acad. Sci. USA* 90:10464-10468 (1993); Forte, L., *Reg. Pept.* 81:25-39 (1999); Schulz, *et al.*, *Cell* 63:941-948 (1990); Guba, *et al.*, *Gastroenterology* 111:1558-1568 (1996); Joo, *et al.*, *Am. J. Physiol.* 274:G633-G644 (1998)).

[04] In the intestines, guanylin and uroguanylin act as regulators of fluid and electrolyte balance. In response to high oral salt intake, these peptides are released into the intestinal lumen where they bind to guanylate cyclase C localized on the luminal membrane of enterocytes (simple columnar epithelial cells of the small intestines and colon). The binding of the guanylin peptides to guanylate cyclase C induces electrolyte and water excretion into

the intestinal lumen via a complex intracellular signaling cascade that is initiated by an increase in cyclic guanosine monophosphate (cGMP).

[05] The cGMP-mediated signaling that is initiated by the guanylin peptides is critical for the normal functioning of the gut. Any abnormality in this process could lead to gastrointestinal disorders such as irritable bowel syndrome (IBS) and inflammatory bowel diseases. Inflammatory bowel disease is a general name given to a group of disorders that cause the intestines to become inflamed, characterized by red and swollen tissue. Examples include ulcerative colitis and Crohn's disease. Crohn's disease is a serious inflammatory disease that predominantly affects the ileum and colon, but can also occur in other sections of the gastrointestinal tract. Ulcerative colitis is exclusively an inflammatory disease of the colon, the large intestine. Unlike Crohn's disease, in which all layers of the intestine are involved, and in which there can be normal healthy bowel in between patches of diseased bowel, ulcerative colitis affects only the innermost lining (mucosa) of the colon in a continuous manner. Depending on which portion of the gastrointestinal tract is involved, Crohn's disease may be referred to as ileitis, regional enteritis, colitis, etc. Crohn's disease and ulcerative colitis differ from spastic colon or irritable bowel syndrome, which are motility disorders of the gastrointestinal tract. Gastrointestinal inflammation can be a chronic condition. It is estimated that as many as 1,000,000 Americans are afflicted with inflammatory bowel disease, with male and female patients appearing to be equally affected. Most cases are diagnosed before age 30, but the disease can occur in the sixth, seventh, and later decades of life.

[06] IBS and chronic idiopathic constipation are pathological conditions that can cause a great deal of intestinal discomfort and distress but unlike the inflammatory bowel diseases, IBS does not cause the serious inflammation or changes in bowel tissue and it is not thought to increase the risk of colorectal cancer. In the past, inflammatory bowel disease, celiac disease and IBS were regarded as completely separate disorders. Now, with the description of inflammation, albeit low-grade, in IBS, and of symptom overlap between IBS and celiac disease, this contention has come under question. Acute bacterial gastroenteritis is the strongest risk factor identified to date for the subsequent development of postinfective irritable bowel syndrome. Clinical risk factors include prolonged acute illness and the absence of vomiting. A genetically determined susceptibility to inflammatory stimuli may also be a risk factor for irritable bowel syndrome. The underlying pathophysiology indicates

increased intestinal permeability and low-grade inflammation, as well as altered motility and visceral sensitivity. Serotonin (5-hydroxytryptamine [5-HT]) is a key modulator of gut function and is known to play a major role in pathophysiology of IBS. The activity of 5-HT is regulated by cGMP.

[07] While the precise causes of IBS and inflammatory bowel diseases (IBD) are not known, a disruption in the process of continual renewal of the gastrointestinal mucosa may contribute to disease pathology in IBD and aggravate IBS. The renewal process of the gastrointestinal lining is an efficient and dynamic process involving the continual proliferation and replenishment of unwanted damaged cells. Proliferation rates of cells lining the gastrointestinal mucosa are very high, second only to the hematopoietic system. Gastrointestinal homeostasis depends on both the proliferation and programmed cellular death (apoptosis) of epithelial cells lining the gut mucosa. Cells are continually lost from the villus into the lumen of the gut and are replenished at a substantially equal rate by the proliferation of cells in the crypts, followed by their upward movement to the villus. The rates of cell proliferation and apoptosis in the gut epithelium can be increased or decreased in a variety of circumstances, *e.g.*, in response to physiological stimuli such as aging, inflammatory signals, hormones, peptides, growth factors, chemicals and dietary habits. In addition, an enhanced proliferation rate is frequently associated with a reduction in turnover time and an expansion of the proliferative zone. The proliferation index is much higher in pathological states such as ulcerative colitis and other gastrointestinal disorders. Intestinal hyperplasia is a major promoter of gastrointestinal inflammation. Apoptosis and cell proliferation together regulate cell number and determine the proliferation index. Reduced rates of apoptosis are often associated with abnormal growth, inflammation, and neoplastic transformation. Thus, both increased proliferation and/or reduced cell death may increase the proliferation index of intestinal tissue, which may in turn lead to gastrointestinal inflammatory diseases.

[08] In addition to a role for uroguanylin and guanylin as modulators of intestinal fluid and ion secretion, these peptides may also be involved in the continual renewal of gastrointestinal mucosa by maintaining the balance between proliferation and apoptosis. For example, uroguanylin and guanylin peptides appear to promote apoptosis by controlling cellular ion flux. Given the prevalence of inflammatory conditions in Western societies a need exists to

improve the treatment options for inflammatory conditions, particularly of the gastrointestinal tract.

[09] Peptide agonists of guanylate cyclase C agonists (“GCC agonists”) are described in U.S. Patent Nos. 7,041,786, 7,799,897, and U.S. Patent Application Publication Nos. US2009/0048175, US 2010/0069306, US 2010/0120694, US 2010/0093635, and US 2010/0221329. However, the formulation of peptides for pharmaceutical delivery presents a number of special problems. For example, peptides are subject to structural modifications by a variety of degradation mechanisms resulting in problems of chemical and physical instability of the formulation.

SUMMARY OF THE INVENTION

[10] The present invention provides low-dose formulations of peptide agonists of guanylate cyclase C (“GCC”) and methods for their use in the treatment and prevention of human diseases and disorders, such as a gastrointestinal motility disorder, irritable bowel syndrome, a functional gastrointestinal disorder, gastroesophageal reflux disease, functional heartburn, dyspepsia, functional dyspepsia, nonulcer dyspepsia, gastroparesis, chronic intestinal pseudo-obstruction, colonic pseudo-obstruction; Crohn's disease, ulcerative colitis, inflammatory bowel disease, colonic pseudo-obstruction, obesity, congestive heart failure, and benign prostatic hyperplasia. In certain embodiments, the formulations are stabilized against chemical degradation of the peptide. The low-dose formulations of the invention have unexpected efficacy in humans in a dosage range that was not predicted based on studies in primates. The formulations of the invention are particularly useful for the treatment or prevention of chronic idiopathic constipation. In certain embodiments, the GCC agonists are analogs of uroguanylin and bacterial ST peptides. In preferred embodiments, the analogs have superior properties compared to the naturally occurring or “wild-type” peptides. Examples of such superior properties include a high resistance to degradation at the N-terminus and C-terminus from carboxypeptidases, aminopeptidases, and/or by other proteolytic enzymes present in the stimulated human intestinal juices and human gastric juices. Examples of GCC agonists that can be used in the formulations and methods of the invention are described in more detail below and in U.S. Patent Nos. 7,041,786, 7,799,897, and U.S. Patent Application Publication Nos. US2009/0048175, US 2010/0069306, US

2010/0120694, US 2010/0093635, and US 2010/0221329, each of which is incorporated herein by reference in its entirety.

[11] The invention provides an oral dosage formulation comprising one or more pharmaceutically acceptable excipients and at least one GCC agonist peptide, wherein the amount of GCC agonist peptide per unit dose is from 0.01 mg to 10 mg, and wherein the GCC agonist peptide is selected from the group consisting of SEQ ID NOs: 1-54 and 56-249. In one embodiment, the GCC agonist peptide has a chromatographic purity of no less than 90%, no less than 90.5%, no less than 91%, no less than 92%, no less than 93%, no less than 94%, no less than 95%, no less than 96%, no less than 97%, no less than 98%, or no less than 99%. The chromatographic purity of the GCC agonist peptide is determined as area percent by HPLC. In one embodiment, the GCC agonist peptide is selected from the group consisting of SEQ ID NOs: 1, 8, 9, or 56. In one embodiment, the GCC agonist peptide is selected from the group consisting of SEQ ID NOs: 1 and 9. In one embodiment, the GCC agonist peptide is selected from the group consisting of SEQ ID NOs: 8 and 9. In one embodiment, the amount of GCC agonist peptide per unit dose is 0.1 mg, 0.3 mg, 0.6 mg, 1.0 mg, 3.0 mg, 6.0 mg, 9.0 mg or 9.5 mg.

[12] In one embodiment, the GCC agonist peptide has a total impurity content of no greater than 10%, no greater than 9.5%, no greater than 9%, no greater than 8%, no greater than 7%, no greater than 6%, no greater than 5%, no greater than 4%, no greater than 3%, no greater than 2%, or no greater than 1%. The total impurity content is determined as total area percentages of impurities by HPLC. The impurities do not include any pharmaceutically acceptable excipient used for the formulation. In one embodiment, the formulation is substantially free of inorganic acids and carboxylic acids, e.g., HCl, phosphoric acid, or acetic acid. In this context, carboxylic acids do not include amino acids or peptides. In this context “substantially” free of acids means that the acid content of the formulation at the time of packaging is preferably less than 0.2%, less than 0.1%, less than 0.05%, less than 0.01%, less than 0.005%, or less than 0.001% of the total weight of the formulation. In one embodiment, the formulation is free of HCl.

[13] In one embodiment, the formulation is a solid formulation. In one embodiment, the formulation is in the form of a powder, granule, sachet, troche, tablet, or capsule. In another embodiment, the formulation is a liquid formulation and the GCC agonist peptide is in

solution or suspension in a lipophilic liquid. In one embodiment, the liquid is a refined specialty oil or a medium chain triglyceride or related ester. In one embodiment, the refined specialty oil is selected from Arachis oil, Castor oil, cottonseed oil, maize (corn) oil, olive oil, sesame oil, soybean oil, and sunflower oil. In one embodiment, the medium chain triglyceride or related ester is AKOMED E, AKOMED R, CAPTEX 355, LABRAFAC CC, LABRAFAC PG, LAUROGLYCOL FCC, MIGLYOL 810, MIGLYOL 812, MIGLYOL 829, MIGLYOL 840, and SOFTISAN 645. In one embodiment, the liquid is selected from the group consisting of medium chain triglycerides, propylene glycol dicaprylocaprate, vitamin E, and soybean oil. In one embodiment, the unit dose is a powder, tablet, or capsule. In one embodiment, the unit dose is a liquid-filled capsule. In one embodiment, the capsule or tablet is in a blister pack or strip. Preferably, the blister pack or strip is made of a material that is impermeable to water vapor and oxygen. In one embodiment the blister pack is comprised of a metal foil. In one embodiment, the container of the blister pack is flushed with an inert gas such as nitrogen or argon. In one embodiment, the container further includes a desiccant. In a preferred embodiment the desiccant is a molecular sieve. In one embodiment, the unit dose is in a high density polyethylene bottle having a seal. In one embodiment, the bottle further comprises a desiccant. In one embodiment, the bottle further comprises an oxygen scavenger or molecular sieve. In one embodiment, the bottle is nearly impermeable to oxygen and water vapor (e.g., much more impermeable than a HDPE bottle), such as an OxyGuard bottle.

[14] In one embodiment, the one or more pharmaceutically acceptable excipients include an inert carrier. In one embodiment, the inert carrier is selected from mannitol, lactose, a microcrystalline cellulose, or starch. In one embodiment, the inert carrier has a particle size of from 50 to 900 microns, from 50 to 800 microns, from 50 to 300 microns, from 50 to 200 microns, from 75 to 150 microns, from 75 to 200 microns, or from 75 to 300 microns.

[15] In one embodiment, the GCC agonist peptide is stabilized against chemical or physical degradation for a period of at least 18 months at 30 °C and 65% relative humidity, or at least 18 months at 25 °C and 60% relative humidity, or at least 18 months at 2-8 °C.

[16] In one embodiment, the one or more pharmaceutically acceptable excipients include a divalent cation salt such as calcium chloride. In one embodiment, the one or more pharmaceutically acceptable excipients comprise an amino acid, such as leucine.

[17] In one embodiment, the oral dosage formulation consists of the GCC agonist peptide described herein, an inert carrier, and a lubricant (e.g., magnesium stearate). In one embodiment, the formulation consists of the GCC agonist peptide, an inert carrier, a divalent cation salt (e.g., CaCl_2), an amino acid (e.g., leucine), a coating agent (e.g., hypromellose) and optionally a lubricant (e.g., magnesium stearate).

[18] The invention also provides a process for making the oral dosage formulations described herein, wherein the process comprises a step of dry granulation, wet granulation, or spray coating followed by drying. In another embodiment, the process comprises a step of dry mixing. In a preferred embodiment the step of dry mixing includes geometric blending. In one embodiment, the process comprises a step of direct compression. In one embodiment, the process for making the oral dosage formulations described herein is a spray coating-drying process which includes (a) providing an aqueous solution comprising: a GCC agonist peptide selected from the group consisting of SEQ ID NOs: 1-54 and 56-249, and one or more pharmaceutically acceptable excipients, wherein the concentration of the GCC agonist peptide ranges from 10 to 60 mg/mL; and (b) applying the aqueous solution to a pharmaceutically acceptable carrier to generate a GCC agonist peptide-coated carrier.

[19] In one embodiment of the spray coating-drying process above, the one or more pharmaceutically acceptable excipients comprise a divalent cation salt wherein the divalent cation is selected from Ca^{2+} , Mg^{2+} , Zn^{2+} , and Mn^{2+} . In one embodiment, the one or more pharmaceutically acceptable excipients comprise an amino acid selected from leucine, isoleucine, and valine. In one embodiment, the one or more pharmaceutically acceptable excipients comprise a coating agent (such as hypromellose). In one embodiment, the aqueous solution has a pH greater than 4 (e.g., 4.5-5.5, 5-6, or about 5). In one embodiment, the aqueous solution is substantially free of inorganic acids and carboxylic acids. In one embodiment, the GCC agonist peptide is selected from the group consisting of SEQ ID NOs: 1, 8, 9, and 56. In one embodiment, the process further includes drying the GCC agonist peptide-coated carrier.

[20] The invention further provides an oral dosage formulation made by the process described herein. Preferably, the GCC agonist peptide as made is stabilized against chemical or physical degradation for a period of at least 18 months at 30 °C and 65% relative humidity, or at least 18 months at 25 °C and 60% relative humidity, or at least 18 months at 2-8 °C.

[21] The invention also provides a method for treating or preventing a disease or disorder in a subject in need thereof, comprising administering to the subject an oral dosage formulation comprising at least one GCC agonist peptide, wherein the amount of GCC agonist peptide per unit dose is from 0.01 mg to 10 mg, and wherein the GCC agonist peptide is selected from the group consisting of SEQ ID NOs: 1-54 and 56-249. Preferably, the subject is a human subject. In one embodiment, the GCC agonist peptide is selected from the group consisting of SEQ ID NOs: 1, 8, 9, or 56. In one embodiment, the GCC agonist peptide is selected from the group consisting of SEQ ID NOs: 1 and 9. In one embodiment, the amount of GCC agonist peptide per unit dose is 0.1 mg, 0.3 mg, 0.6 mg, 1.0 mg, 3.0 mg, 6.0 mg, 9.0 mg, 9.5 mg, or 10 mg.

[22] In one embodiment, the disease or disorder is a gastrointestinal disease or disorder selected from the group consisting of irritable bowel syndrome, non-ulcer dyspepsia, chronic intestinal pseudo-obstruction, functional dyspepsia, colonic pseudo-obstruction, duodenogastric reflux, gastro esophageal reflux disease, constipation, gastroparesis, heartburn, gastric cancer, and *H. pylori* infection. In a preferred embodiment, the gastrointestinal disease or disorder is chronic idiopathic constipation.

[23] In one embodiment, the method further comprises administering to the subject an effective amount of an inhibitor of a cGMP-specific phosphodiesterase. In one embodiment, the cGMP-dependent phosphodiesterase inhibitor is selected from the group consisting of suldinac sulfone, zaprinast, and motapizone, vardenafil, and sildenafil.

[24] In one embodiment, the method further comprises administering to the subject an effective amount of at least one laxative. In one embodiment, the at least one laxative is selected from the group consisting of SENNA, MIRALAX, PEG, or calcium polycarbophil.

[25] In one embodiment, the method further comprises administering to the subject an effective amount of at least one anti-inflammatory agent.

[26] The invention also provides pharmaceutical compositions comprising the formulations described herein.

[27] Other features and advantages of the invention will be apparent from and are encompassed by the following detailed description and claims.

BRIEF DESCRIPTION OF THE DRAWINGS

- [28] Figure 1: Plecanatide (SP-304) treatment reduced time to first BM following daily dose.
- [29] Figure 2: Effect of daily treatment with plecanatide on spontaneous bowel movements (SBM) in chronic constipation patients.
- [30] Figure 3: Effect of daily treatment with plecanatide on complete spontaneous bowel movements (CSBM) in chronic constipation patients.
- [31] Figure 4: Effect of daily treatment with plecanatide on Bristol Stool Form Scores (BSFS) in chronic constipation patients.
- [32] Figure 5: Effect of daily treatment with plecanatide on straining scores in chronic constipation patients
- [33] Figure 6: Percentage of subjects reporting improvements in abdominal discomfort scores after 14-days of daily treatment with plecanatide.

DETAILED DESCRIPTION

[34] The invention provides pharmaceutical formulations of peptide GCC agonists. It is intended that the formulations of the invention are “pharmaceutical” formulations, meaning that they are suitable for pharmaceutical use. Accordingly, the term “formulations” as used herein is meant to encompass pharmaceutical formulations even if “pharmaceutical” is not expressly stated. Pharmaceutical compositions comprising the formulations described herein are also provided by the invention. The formulations of the invention preferably provide stability against chemical and physical degradation of the peptide, e.g., plecanatide (i.e., SEQ ID #1).

[35] The invention is based in part upon the discovery that mannitol mixes very effectively with the GCC agonist peptides described herein and provides stability against degradation, allowing the peptides to be formulated at very low doses. The invention is also based in part on the discovery that very low doses of the GCC agonist peptides described herein are effective for the treatment of diseases and disorders in humans. The dosage range found to

be effective was not predicted based on animal studies. The invention is also based in part upon the discovery that a divalent cation (e.g., Ca^{2+}) and/or an amino acid (e.g., leucine) stabilize the GCC agonist peptides described herein during a process (e.g., spray coating-drying process) of manufacturing a formulation of the GCC agonist peptides and provides stability against degradation both during the manufacturing process and storage of the formulation.

[36] Plecanatide is a charged peptide due to the presence of four carboxylic acids and single amine group with a calculated pKa of approximately 3.5. Therefore plecanatide is likely to interact with ions in solution or in the solid state. Plecanatide is a hygroscopic peptide requiring the control of water during manufacture and storage to promote long term stability. Plecanatide is prone to degradation by oxidation in the presence of residual peroxides or formaldehyde contaminants that are formed from peroxide reaction with polymeric excipients. The present invention discloses a manufacturing process and dry solid formulation compositions that minimizes water content. The formulations are comprised of components to minimize levels of residual formaldehyde and peroxides commonly found in many pharmaceutical excipients. The invention also discloses additives (i.e. CaCl_2) that may function as local desiccants in the formulation. Divalent cation salts such as MgCl_2 , ZnCl_2 , MnCl_2 and CaCl_2 bind plecanatide and sterically hinder reactive species such as water or oxygen from causing plecanatide degradation by molecular displacement. The invention further includes scavengers of residual formaldehyde (amino acids such as leucine, isoleucine and valine), and discloses packaging confirmations to minimize oxygen exposure and water vapor during storage. The invention also discloses a stable manufacturing process comprised of initially dissolving plecanatide in cold water to minimize solution degradation, followed by spray coating the peptide solution on particles and drying to remove moisture.

[37] The formulations of the invention are particularly useful for the treatment or prevention of a gastrointestinal disease or disorder selected from the group consisting of irritable bowel syndrome, non-ulcer dyspepsia, chronic intestinal pseudo-obstruction, functional dyspepsia, colonic pseudo-obstruction, duodenogastric reflux, gastro esophageal reflux disease, chronic idiopathic constipation, gastroparesis, heartburn, gastric cancer, and *H. pylori* infection.

[38] In one embodiment, the formulations of the invention are used in a method for the treatment of constipation. Clinically accepted criteria that define constipation range from the frequency of bowel movements, the consistency of feces and the ease of bowel movement. One common definition of constipation is less than three bowel movements per week. Other definitions include abnormally hard stools or defecation that requires excessive straining. Constipation may be idiopathic (functional constipation or slow transit constipation) or secondary to other causes including neurologic, metabolic or endocrine disorders. These disorders include diabetes mellitus, hypothyroidism, hyperthyroidism, hypocalcaemia, Multiple sclerosis, Parkinson's disease, spinal cord lesions, Neurofibromatosis, autonomic neuropathy, Chagas disease, Hirschsprung disease and cystic fibrosis. Constipation may also be the result of surgery or due to the use of drugs such as analgesics (like opioids), antihypertensives, anticonvulsants, antidepressants, antispasmodics and antipsychotics. In a preferred embodiment, the constipation is chronic idiopathic constipation.

[39] The stabilized formulations of the invention comprise at least one GCC agonist peptide formulated with one or more excipients such that the peptide is stabilized against chemical degradation. Chemical degradation of peptides results from a number of mechanisms including oxidation, water-mediated degradation, and reaction with aldehydes or reducing sugars. The ideal excipient or combination of excipients will be non-hygroscopic, have few or no reducing sugars, and be substantially free of contaminants such as iron, peroxide, and formaldehyde. The formulations of the invention are preferably substantially free of water. In this context "substantially" free of water means that the water content of the formulation at the time of packaging is preferably less than 7%, less than 5%, less than 1%, or less than 0.5% of the total weight of the formulation. In one embodiment the amount of water is between 0.1 to 5% of the total weight of the formulation. In one embodiment, the amount of water in the formulation of the invention manufactured through a spray-coating process is less than 0.5% (e.g., about 0.47%).

[40] In the context of the present formulations, the term "stable" or "stabilized" refers to the resistance of the peptide to chemical or physical degradation over time. Preferably, a stable formulation of the invention retains an amount of the peptide in the formulation over a period of time that is at least 90%, preferably at least 95%, and most preferably at least 99% the amount of peptide initially present in the formulation. In one embodiment, a stable formulation of the invention, over a period of time (e.g., 18 month), has an increase in the

total impurity content not greater than 8%, not greater than 7%, not greater than 6%, not greater than 5%, not greater than 4%, not greater than 3%, not greater than 2%, or not greater than 1%. In one embodiment, the peptide is chemically stable in the formulation for a period of time that is at least 18 months, at least 20 months, or at least 24 months when stored at 25 degrees Celsius (25C) and 60 % relative humidity. In one embodiment, the peptide is chemically stable in the formulation for a period of time that is at least 18 months, at least 20 months, or at least 24 months when stored at 2-8 degrees Celsius (2-8C). In one embodiment, the peptide is chemically stable in the formulation for a period of time that is at least 3 months, 12 months, 18 months and preferably 24 months when stored at 25 degrees Celsius (25C) and 60 % relative humidity. In one embodiment, the peptide is chemically stable in the formulation for a period of time that is at least 3 months, 18 months and preferably 24 months when stored at 30 degrees Celsius (30C).

[41] The low-dose formulations of the invention comprise an amount of at least one GCC agonist peptide per unit dose that is less than 10 mg. It is especially advantageous to formulate oral compositions in unit dosage form for ease of administration and uniformity of dosage. The term "unit dosage form" as used herein refers to physically discrete units suited as unitary dosages for the subject to be treated; each unit containing a predetermined quantity of active compound calculated to produce the desired therapeutic effect in association with the required pharmaceutical carrier. The specification for the dosage unit forms of the invention are dictated by and directly dependent on the unique characteristics of the active compound and the particular therapeutic effect to be achieved. In one embodiment, the unit dosage form is a tablet or a capsule.

[42] In one embodiment of the low-dose formulations of the invention, the amount of GCC agonist peptide per unit dose is from 0.01 mg to 10 mg. In one embodiment, the amount of GCC agonist peptide per unit dose is 0.1 mg, 0.3 mg, 0.6 mg, 1.0 mg, 3.0 mg, 6.0 mg, 9.0 mg, 9.5 mg, or 10 mg.

[43] In one embodiment, the low-dose formulation contains a carrier that is non-hygroscopic. In one embodiment, the carrier is selected from mannitol and maltose (e.g., ADVANTOSE 100).

[44] In one embodiment, the carrier is cellulose, preferably microcrystalline cellulose (e.g., Avicel PH 102 or Celphere SCP-100). In one embodiment, the carrier is calcium phosphate or calcium sulphate. In another embodiment, the carrier is a saccharide. The term “saccharide” as used herein also refers to polysaccharides. Thus, the term saccharide is meant to include polysaccharides. In one embodiment, the saccharide is selected from mannitol, trehalose, lactose, sucrose, sorbitol, and maltose. In a preferred embodiment, the saccharide is mannitol. Preferably the saccharide has a low water content, a small particle size and a narrow particle-size distribution.

[45] Carriers having small particle sizes, and/or spherical shape, and narrow size distribution are preferred. Particles of less than 20 microns have a relatively high surface area to volume ratio causing inter-particle attractive forces to dominate and resist bulk flow. Larger particles (greater than 100 microns) tend to roll or slide over one another and exhibit superior bulk flow properties compared with small particles. A narrow particle-size distribution reduces particle packing and increases flow. In one embodiment, the particles are between 20 and 500 microns in size (as measured across the largest diameter of the particle, on average). In one embodiment, a small particle size and a narrow particle size range refers to particles having a size range of from 20-300 microns, 50-200 microns, or 75-150 microns. In certain embodiments, the carrier has a substantially spherical shape such as can be obtained with a spray drying process.

[46] In one embodiment, the low-dose formulation is a solid formulation and the unit dose is in the form of a tablet or capsule. In one embodiment, the low-dose formulation is a liquid formulation and the unit dosage form is a liquid-filled capsule. In one embodiment, the liquid formulation in the form of a solution or suspension of the GCC agonist peptide in an lipophilic liquid. Examples of suitable liquids include medium chain triglycerides (e.g., LABRAFAC Lipophile), propylene glycol dicaprylocaprate (e.g., LABRAFAC PG), vitamin E (e.g., α tocopherol), PEG 400 (e.g., Polyethylene glycol low M.W. (liquid)), propylene glycol, soybean oil, and Castor oil. In one embodiment, the liquid is selected from the group consisting of medium chain triglycerides, propylene glycol dicaprylocaprate, vitamin E, and soybean oil. In one embodiment, the refined specialty oil is selected from Arachis oil, Castor oil, cottonseed oil, maize (corn) oil, olive oil, sesame oil, soybean oil, and sunflower oil. In one embodiment, the medium chain triglyceride or related ester is AKOMED E, AKOMED

R, CAPTEX 355, LABRAFAC CC, LABRAFAC PG, LAUROGLYCOL FCC, MIGLYOL 810, MIGLYOL 812, MIGLYOL 829, MIGLYOL 840, and SOFTISAN 645.

[47] A formulation according to the invention may be contained in a blister pack. In a particular embodiment, the powder, tablet, or capsule comprising the formulation is contained in a blister pack. Preferably, the blister pack is made of a material that allows only minimal permeation by water vapor and oxygen. In one embodiment the blister pack is comprised of a metal foil. In one embodiment, the blister pack is comprised of ACLAR. In one embodiment, the container of the blister pack is flushed with an inert gas such as nitrogen or argon. In one embodiment, the container further includes a desiccant. In one embodiment, the desiccant is calcium chloride. In one embodiment the desiccant is a molecular sieve.

[48] While any GCC agonist known in the art can be formulated according to the present invention, analogs of uroguanylin and bacterial ST peptides are preferred. In certain embodiments, the uroguanylin and bacterial ST peptide analogs have superior properties compared to naturally occurring, or "wild-type" peptides. For example, the uroguanylin and bacterial ST peptides for use in the present invention are preferably modified to increase their resistance to degradation at the N-terminus and C-terminus from carboxypeptidases, aminopeptidases, and/or by other proteolytic enzymes present in the stimulated human intestinal juices and human gastric juices. In certain embodiments, the GCC agonist formulation comprises a peptide consisting essentially of an amino acid sequence selected from SEQ ID NOs: 1-249. In a preferred embodiment, the peptide consists essentially of an amino acid sequence selected from SEQ ID NOs: 1, 8, 9, 55 and 56. The term "consists essentially of" refers to a peptide that is identical to the reference peptide in its amino acid sequence or to a peptide that does not differ substantially in terms of either structure or function from the reference peptide. A peptide differs substantially from the reference peptide if its primary amino acid sequence varies by more than three amino acids from the reference peptide or if its activation of cellular cGMP production is reduced by more than 50% compared to the reference peptide. Preferably, substantially similar peptides differ by no more than two amino acids and not by more than about 25% with respect to activating cGMP production. In preferred embodiments, the GCC agonist is a peptide comprising at least 12 amino acid residues, and most preferably comprising between 12 and 26 amino acids. Non-limiting examples of such analogs of uroguanylin and bacterial ST peptides are described in Section 1.2 below.

[49] The invention provides methods for treating or preventing certain diseases and disorders and methods for increasing gastrointestinal motility in a subject in need thereof by administering an effective amount of a GCC agonist formulation to the subject. The term "treating" as used herein refers to a reduction, a partial improvement, amelioration, or a mitigation of at least one clinical symptom associated with the gastrointestinal disorders being treated. The term "preventing" refers to an inhibition or delay in the onset or progression of at least one clinical symptom associated with the gastrointestinal disorders to be prevented. The term "effective amount" as used herein refers to an amount that provides some improvement or benefit to the subject. In certain embodiments, an effective amount is an amount that provides some alleviation, mitigation, and/or decrease in at least one clinical symptom of the gastrointestinal disorder to be treated. In other embodiments, the effective amount is the amount that provides some inhibition or delay in the onset or progression of at least one clinical symptom associated with the gastrointestinal disorder to be prevented. The therapeutic effects need not be complete or curative, as long as some benefit is provided to the subject. The term "subject" preferably refers to a human subject but may also refer to a non-human primate or other mammal preferably selected from among a mouse, a rat, a dog, a cat, a cow, a horse, or a pig.

[50] In accordance with the methods of the present invention, the GCC agonist formulation can be administered alone or in combination with one or more additional therapeutic agents to prevent or treat inflammation, cancer and other disorders, particularly of the gastrointestinal tract. In a preferred embodiment, the GCC agonist formulation is administered for the treatment of chronic constipation. In one embodiment, the GCC agonist formulation is administered in combination with one or more additional therapeutic agents selected from the group consisting of phosphodiesterase inhibitors, cyclic nucleotides (such as cGMP and cAMP), a laxative (such as SENNA, METAMUCIL, MIRALAX, PEG, or calcium polycarbophil), a stool softener, an anti-tumor necrosis factor alpha therapy for IBD (such as REMICADE, ENBREL, or HUMAIRA), and anti-inflammatory drugs (such as COX-2 inhibitors, sulfasalazine, 5-ASA derivatives and NSAIDS). In certain embodiments, the GCC agonist formulation is administered in combination with an effective dose of an inhibitor of cGMP-specific phosphodiesterase (cGMP-PDE) either concurrently or sequentially with said GCC agonist. cGMP-PDE inhibitors include, for example, sildinac sulfone, zaprinast, motapizone, vardenafil, and sildenafil. In another embodiment, the GCC

agonist formulation is administered in combination with inhibitors of cyclic nucleotide transporters.

1.1 Formulations

[51] The formulations of the invention contain one or more GCC agonist peptides described herein, in combination with one or more pharmaceutically acceptable carriers (also referred to as diluents) and/or excipients. In a preferred embodiment, the formulations of the invention include an inert carrier. The inert carrier is preferably non-hygroscopic. In one embodiment, the carrier in the formulation contains few or no reducing sugars and is substantially free of contaminants including, but not limited to, iron, peroxide, and formaldehyde. In one embodiment, the carrier is selected from the group consisting of sorbitol, mannitol, EMDEX, and starch. In one embodiment, the carrier is mannitol (e.g., MANNOGEM) or microcrystalline cellulose (e.g. PROSOLV, CELPHERE, CELPHERE beads).

[52] The low-dose formulations of the invention contain no greater than 10 mg per unit dose of a GCC agonist peptide. The remainder of the formulation is comprised of the carrier and one or more optional excipients. In one embodiment, the amount of carrier is at least 90% of the total weight of the formulation. In another embodiment, the amount of carrier is at least 95% or at least 98% of the total weight of the formulation. In one embodiment, the amount of carrier is between 90 and 99.9% of the total weight of the formulation. In one embodiment, the one or more optional excipients comprise a disintegrant which is present at 1 to 5% of the total weight of the formulation. In one embodiment, the one or more optional excipients comprise a lubricant which is present at 0.02 to 5% of the total weight of the formulation. In one embodiment, the one or more optional excipients comprise an amino acid such as leucine, isoleucine, valine, histidine, phenylalanine, alanine, glutamic acid, aspartic acid, glutamine, methionine, asparagine, tyrosine, threonine, tryptophan, or glycine, which is present at 0.1 to 4% (e.g., 0.1-1%) of the total weight of the formulation. In one embodiment, the molar ratio between the amino acid and the GCC agonist peptide is from about 2:1 to about 20:1 (e.g., 5:1). In one embodiment, the one or more optional excipients comprise a stabilizer such as a divalent cation salt, more specifically, a water-soluble divalent cation salt (e.g., calcium chloride, magnesium chloride, zinc chloride, manganese chloride),

which is present at 0.1 to 12% (e.g., 0.1-4%) of the total weight of the formulation. In one embodiment, the molar ratio between the salt and the GCC agonist peptide is from about 5:1 to about 20:1 (e.g., 10:1).

[53] The formulations may contain other additives as needed, including for example lactose, glucose, fructose, galactose, trehalose, sucrose, maltose, raffinose, maltitol, melezitose, stachyose, lactitol, palatinite, starch, xylitol, mannitol, myoinositol, and the like, and hydrates thereof, and amino acids, for example alanine, glycine and betaine, and polypeptides and proteins, for example albumen.

[54] Further examples of pharmaceutically acceptable carriers and excipients include, but are not limited to binders, fillers, disintegrants, lubricants, anti-microbial agents, and coating agents such as: BINDERS: corn starch, potato starch, other starches, gelatin, natural and synthetic gums such as acacia, xanthan, sodium alginate, alginic acid, other alginates, powdered tragacanth, guar gum, cellulose and its derivatives (e.g., ethyl cellulose, cellulose acetate, carboxymethyl cellulose calcium, sodium carboxymethyl cellulose), polyvinyl pyrrolidone (e.g., povidone, crospovidone, copovidone, etc), methyl cellulose, Methocel, pre-gelatinized starch (e.g., STARCH 1500® and STARCH 1500 LM®, sold by Colorcon, Ltd.), hydroxypropyl methyl cellulose, microcrystalline cellulose (FMC Corporation, Marcus Hook, PA, USA), or mixtures thereof, FILLERS: talc, calcium carbonate (e.g., granules or powder), dibasic calcium phosphate, tribasic calcium phosphate, calcium sulfate (e.g., granules or powder), microcrystalline cellulose, powdered cellulose, dextrates, kaolin, mannitol, silicic acid, sorbitol, starch, pre-gelatinized starch, dextrose, fructose, honey, lactose anhydrate, lactose monohydrate, lactose and aspartame, lactose and cellulose, lactose and microcrystalline cellulose, maltodextrin, maltose, mannitol, microcrystalline cellulose & guar gum, molasses, sucrose, or mixtures thereof, DISINTEGRANTS: agar-agar, alginic acid, calcium carbonate, microcrystalline cellulose, croscarmellose sodium, crospovidone, polacrillin potassium, sodium starch glycolate, potato or tapioca starch, other starches, pre-gelatinized starch, clays, other algins, other celluloses, gums (like gellan), low-substituted hydroxypropyl cellulose, or mixtures thereof, LUBRICANTS: calcium stearate, magnesium stearate, mineral oil, light mineral oil, glycerin, sorbitol, mannitol, polyethylene glycol, other glycols, stearic acid, sodium lauryl sulfate, sodium stearyl fumarate, vegetable based fatty acids lubricant, talc, hydrogenated vegetable oil (e.g., peanut oil, cottonseed oil, sunflower oil, sesame oil, olive oil, corn oil and soybean oil), zinc stearate, ethyl oleate, ethyl laurate,

agar, syloid silica gel (AEROSIL 200, W.R. Grace Co., Baltimore, MD USA), a coagulated aerosol of synthetic silica (Deaussa Co., Piano, TX USA), a pyrogenic silicon dioxide (CAB-O-SIL, Cabot Co., Boston, MA USA), or mixtures thereof, ANTI-CAKING AGENTS: calcium silicate, magnesium silicate, silicon dioxide, colloidal silicon dioxide, talc, or mixtures thereof, ANTIMICROBIAL AGENTS: benzalkonium chloride, benzethonium chloride, benzoic acid, benzyl alcohol, butyl paraben, cetylpyridinium chloride, cresol, chlorobutanol, dehydroacetic acid, ethylparaben, methylparaben, phenol, phenylethyl alcohol, phenoxyethanol, phenylmercuric acetate, phenylmercuric nitrate, potassium sorbate, propylparaben, sodium benzoate, sodium dehydroacetate, sodium propionate, sorbic acid, thimersol, thymo, or mixtures thereof, and COATING AGENTS: sodium carboxymethyl cellulose, cellulose acetate phthalate, ethylcellulose, gelatin, pharmaceutical glaze, hydroxypropyl cellulose, hydroxypropyl methylcellulose (hypromellose), hydroxypropyl methyl cellulose phthalate, methylcellulose, polyethylene glycol, polyvinyl acetate phthalate, shellac, sucrose, titanium dioxide, carnauba wax, microcrystalline wax, gellan gum, maltodextrin, methacrylates, microcrystalline cellulose and carrageenan or mixtures thereof.

[55] The formulation can also include other excipients and categories thereof including but not limited to Pluronic®, Poloxamers (such as Lutrol® and Poloxamer 188), ascorbic acid, glutathione, protease inhibitors (e.g. soybean trypsin inhibitor, organic acids), pH lowering agents, creams and lotions (like maltodextrin and carrageenans); materials for chewable tablets (like dextrose, fructose, lactose monohydrate, lactose and aspartame, lactose and cellulose, maltodextrin, maltose, mannitol, microcrystalline cellulose and guar gum, sorbitol crystalline); parenterals (like mannitol and povidone); plasticizers (like dibutyl sebacate, plasticizers for coatings, polyvinylacetate phthalate); powder lubricants (like glyceryl behenate); soft gelatin capsules (like sorbitol special solution); spheres for coating (like sugar spheres); spherization agents (like glyceryl behenate and microcrystalline cellulose); suspending/gelling agents (like carrageenan, gellan gum, mannitol, microcrystalline cellulose, povidone, sodium starch glycolate, xanthan gum); sweeteners (like aspartame, aspartame and lactose, dextrose, fructose, honey, maltodextrin, maltose, mannitol, molasses, sorbitol crystalline, sorbitol special solution, sucrose); wet granulation agents (like calcium carbonate, lactose anhydrous, lactose monohydrate, maltodextrin, mannitol, microcrystalline cellulose, povidone, starch), caramel, carboxymethylcellulose sodium, cherry cream flavor and cherry flavor, citric acid anhydrous, citric acid, confectioner's sugar, D&C Red No. 33, D&C Yellow

#10 Aluminum Lake, disodium edetate, ethyl alcohol 15%, FD&C Yellow No. 6 aluminum lake, FD&C Blue # 1 Aluminum Lake, FD&C Blue No. 1, FD&C blue no. 2 aluminum lake, FD&C Green No.3, FD&C Red No. 40, FD&C Yellow No. 6 Aluminum Lake, FD&C Yellow No. 6, FD&C Yellow No.10, glycerol palmitostearate, glyceryl monostearate, indigo carmine, lecithin, manitol, methyl and propyl parabens, mono ammonium glycyrrhizinate, natural and artificial orange flavor, pharmaceutical glaze, poloxamer 188, Polydextrose, polysorbate 20, polysorbate 80, polyvidone, pregelatinized corn starch, pregelatinized starch, red iron oxide, saccharin sodium, sodium carboxymethyl ether, sodium chloride, sodium citrate, sodium phosphate, strawberry flavor, synthetic black iron oxide, synthetic red iron oxide, titanium dioxide, and white wax.

[56] Solid oral dosage forms may optionally be treated with coating systems (e.g. Opadry® fx film coating system, for example Opadry® blue (OY-LS-20921), Opadry® white (YS-2-7063), Opadry® white (YS- 1-7040), and black ink (S- 1-8 106).

[57] The agents either in their free form or as a salt can be combined with a polymer such as polylactic-glycolic acid (PLGA), poly-(D)-lactic-glycolic-tartaric acid (P(D)LGT) (WO 01/12233), polyglycolic acid (U.S. 3,773,919), polylactic acid (U.S. 4,767,628), poly(ε-caprolactone) and poly(alkylene oxide) (U.S. 20030068384) to create a sustained release formulation. Other sustained release formulations and polymers for use in the compositions and methods of the invention are described in EP 0 467 389 A2, WO 93/24150, U.S. 5,612,052, WO 97/40085, WO 03/075887, WO 01/01964A2, U.S. 5,922,356, WO 94/155587, WO 02/074247A2, WO 98/25642, U.S. 5,968,895, U.S. 6,180,608, U.S. 20030171296, U.S. 20020176841, U.S. 5,672,659, U.S. 5,893,985, U.S. 5,134,122, U.S. 5,192,741, U.S. 5,192,741, U.S. 4,668,506, U.S. 4,713,244, U.S. 5,445,832 U.S. 4,931,279, U.S. 5,980,945, WO 02/058672, WO 97/26015, WO 97/04744, and US20020019446. In such sustained release formulations microparticles (Delie and Blanco-Prieto 2005 Molecule 10:65-80) of polypeptide are combined with microparticles of polymer. U.S. 6,011,0 1 and WO 94/06452 describe a sustained release formulation providing either polyethylene glycols (i.e. PEG 300 and PEG 400) or triacetin. WO 03/053401 describes a formulation which may both enhance bioavailability and provide controlled release of the agent within the GI tract. Additional controlled release formulations are described in WO 02/38129, EP 326151, U.S. 5,236,704, WO 02/30398, WO 98/13029; U.S. 20030064105, U.S. 20030138488A1, U.S. 20030216307A1, U.S. 6,667,060, WO 01/49249, WO 01/49311, WO 01/49249, WO

01/49311, and U.S. 5,877,224 materials which may include those described in WO04041195 (including the seal and enteric coating described therein) and pH-sensitive coatings that achieve delivery in the colon including those described in US4,910,021 and WO9001329. US4910021 describes using a pH-sensitive material to coat a capsule. WO9001329 describes using pH-sensitive coatings on beads containing acid, where the acid in the bead core prolongs dissolution of the pH-sensitive coating. U. S. Patent No. 5,175,003 discloses a dual mechanism polymer mixture composed of pH-sensitive enteric materials and film-forming plasticizers capable of conferring permeability to the enteric material, for use in drug-delivery systems; a matrix pellet composed of a dual mechanism polymer mixture permeated with a drug and sometimes covering a pharmaceutically neutral nucleus; a membrane-coated pellet comprising a matrix pellet coated with a dual mechanism polymer mixture envelope of the same or different composition; and a pharmaceutical dosage form containing matrix pellets. The matrix pellet releases acid-soluble drugs by diffusion in acid pH and by disintegration at pH levels of nominally about 5.0 or higher.

[58] The GCC peptides described herein may be formulated in the pH triggered targeted control release systems described in WO04052339. The agents described herein may be formulated according to the methodology described in any of WO03105812 (extruded hydratable polymers); WO0243767 (enzyme cleavable membrane translocators); WO03007913 and WO03086297 (mucoadhesive systems); WO02072075 (bilayer laminated formulation comprising pH lowering agent and absorption enhancer); WO04064769 (amidated polypeptides); WO05063156 (solid lipid suspension with pseudotropic and/or thixotropic properties upon melting); WO03035029 and WO03035041 (erodible, gastric retentive dosage forms); US5007790 and US5972389 (sustained release dosage forms); WO041 1271 1 (oral extended release compositions); WO05027878, WO02072033, and WO02072034 (delayed release compositions with natural or synthetic gum); WO05030182 (controlled release formulations with an ascending rate of release); WO05048998 (microencapsulation system); US Patent 5,952,314 (biopolymer); US5,108,758 (glassy amylose matrix delivery); US 5,840,860 (modified starch based delivery). JP10324642 (delivery system comprising chitosan and gastric resistant material such as wheat gliadin or zein); US 5,866,619 and US 6,368,629 (saccharide containing polymer); US 6,531,152 (describes a drug delivery system containing a water soluble core (Ca pectinate or other water-insoluble polymers) and outer coat which bursts (e.g. hydrophobic polymer-

Eudragit)); US 6,234,464; US 6,403,130 (coating with polymer containing casein and high methoxy pectin; WO0174 175 (Maillard reaction product); WO05063206 (solubility increasing formulation); WO040 19872 (transferring fusion proteins).

[59] The GCC peptides described herein may be formulated using gastrointestinal retention system technology (GIRES; Merrion Pharmaceuticals). GIRES comprises a controlled-release dosage form inside an inflatable pouch, which is placed in a drug capsule for oral administration. Upon dissolution of the capsule, a gas-generating system inflates the pouch in the stomach where it is retained for 16-24 hours, all the time releasing agents described herein.

[60] The GCC peptides described herein can also be formulated using the multi matrix system technology (MMX).

[61] The GCC peptides described herein can be formulated in an osmotic device including the ones disclosed in US 4,503,030, US 5,609,590 and US 5,358,502. US 4,503,030 discloses an osmotic device for dispensing a drug to certain pH regions of the gastrointestinal tract. More particularly, the invention relates to an osmotic device comprising a wall formed of a semi-permeable pH sensitive composition that surrounds a compartment containing a drug, with a passageway through the wall connecting the exterior of the device with the compartment. The device delivers the drug at a controlled rate in the region of the gastrointestinal tract having a pH of less than 3.5, and the device self- destructs and releases all its drug in the region of the gastrointestinal tract having a pH greater than 3.5, thereby providing total availability for drug absorption. U.S. Patent Nos. 5,609,590 and 5, 358,502 disclose an osmotic bursting device for dispensing a beneficial agent to an aqueous environment. The device comprises a beneficial agent and osmagent surrounded at least in part by a semi-permeable membrane. The beneficial agent may also function as the osmagent. The semi-permeable membrane is permeable to water and substantially impermeable to the beneficial agent and osmagent. A trigger means is attached to the semi-permeable membrane (e.g., joins two capsule halves). The trigger means is activated by a pH of from 3 to 9 and triggers the eventual, but sudden, delivery of the beneficial agent. These devices enable the pH-triggered release of the beneficial agent core as a bolus by osmotic bursting.

1.2 GCC Agonists

[62] The GCC agonists for use in the formulations and methods of the invention bind to guanylate cyclase C and stimulate intracellular production of cGMP. Optionally, the GCC agonists induce apoptosis and inhibit proliferation of epithelial cells. The term, “guanylate cyclase C” refers to a transmembrane form of guanylate cyclase that acts as the intestinal receptor for the heat-stable toxin (ST) peptides secreted by enteric bacteria. Guanylate cyclase C is also the receptor for the naturally occurring peptides guanylin and uroguanylin. The possibility that there may be different receptors for each of these peptides has not been excluded. Hence, the term “guanylate cyclase C” may also encompass a class of transmembrane guanylate cyclase receptors expressed on epithelial cells lining the gastrointestinal mucosa.

[63] The term “GCC agonist” refers to both peptides and non-peptide compounds such as that bind to an intestinal guanylate cyclase C and stimulate the intracellular production of cGMP. Where the GCC agonist is a peptide, the term encompasses biologically active fragments of such peptides and pro-peptides that bind to guanylate cyclase C and stimulate the intracellular production of cGMP.

[64] Preferably, the GCC agonists for use in the formulations and methods of the invention stimulate intracellular cGMP production at higher levels than naturally occurring GCC agonists such as uroguanylin, guanylin, and ST peptides. In some embodiments, the GCC agonists stimulate intracellular cGMP production at higher levels than the peptide designated SP-304 (SEQ ID NO:1). In specific embodiments, a GCC agonist for use in the formulations and methods of the invention stimulates 5%, 10%, 20%, 30%, 40%, 50%, 75%, 90% or more intracellular cGMP compared to uroguanylin, guanylin, lymphoguanylin, linaclotide, ST peptides, or SP-304. The terms “induce” and “stimulate” are used interchangeably throughout the specification.

[65] Preferably, the GCC agonists for use in the formulations and methods of the invention are more stable than naturally occurring GCC agonists such as uroguanylin, guanylin, and ST peptides. In some embodiments, the GCC agonists are more stable than the peptide designated SP-304. “Stability” in this context refers to resistance to degradation in gastrointestinal fluid and/or intestinal fluid (or simulated gastrointestinal or intestinal fluids)

compared to the reference peptide. For example, the GCC agonists for use in the formulations and methods of the invention preferably degrade 2%, 3%, 5%, 10%, 15%, 20%, 30%, 40%, 50%, 75%, 90% or less compared to naturally occurring GCC agonists and/or SP-304.

[66] The GCC agonists for use in the formulations and methods of the invention are preferably peptides. In some embodiments, the GCC agonist peptide is less than 30 amino acids in length. In particular embodiments, the GCC agonist peptide is less than or equal to 30, 25, 20, 15, 14, 13, 12, 11, 10, or 5 amino acids in length. Examples of GCC agonist peptides for use in the formulations and methods of the invention include those described in U.S. Serial Nos.: 12/133,344, filed June 4, 2008, 12/478505, filed June 4, 2009; 12/478511, filed June 4, 2009; 12/504288, filed July 16, 2009; and U.S. Provisional Application Serial Nos.: 60/933194, filed June 4, 2007; 61/058,888, filed June 4, 2008; 61/058,892, filed June 4, 2008; and 61/081,289, filed July 16, 2008, each of which is incorporated by reference herein in its entirety.

[67] Specific examples of GCC agonist peptides for use in the formulations and methods of the invention include those described in Tables I-VII below. As used Tables I-VII, the terms "PEG3" or "3PEG" refer to a polyethylene glycol such as aminoethoxy-ethoxy-acetic acid (AeeA), and polymers thereof. The term "X_{aa}" refers to any natural or unnatural amino acid or amino acid analogue. The term "M_{aa}" refers to a cysteine (Cys), penicillamine (Pen) homocysteine, or 3-mercaptoproline. The term "Xaa_{n1}" is meant to denote an amino acid sequence of any natural or unnatural amino acid or amino acid analogue that is one, two or three residues in length; Xaa_{n2} is meant to denote an amino acid sequence that is zero or one residue in length; and Xaa_{n3} is meant to denote an amino acid sequence zero, one, two, three, four, five or six residues in length. Additionally, any amino acid represented by Xaa, Xaa_{n1}, Xaa_{n2}, or Xaa_{n3} may be an L-amino acid, a D-amino acid, a methylated amino acid or any combination of thereof. Optionally, any GCC agonist peptide represented by Formulas I to XX in the tables may contain on or more polyethylene glycol residues at the the N-terminus, C-terminus or both.

[68] In certain embodiments, a GCC agonist formulation of the invention comprises a peptide selected from SEQ ID NOs: 1-249, the sequences of which are set forth below in

Tables I to VII below. In one embodiment, a GCC agonist formulation comprises the peptide designated by SEQ ID NOs:1, 8, 9, 55, or 56.

[69] In certain embodiments, a GCC agonist formulation of the invention comprises a peptide that is substantially equivalent to a peptide selected from SEQ ID NOs: 1-249. The term “substantially equivalent” refers to a peptide that has an amino acid sequence equivalent to that of the binding domain where certain residues may be deleted or replaced with other amino acids without impairing the peptide’s ability to bind to an intestinal guanylate cyclase receptor and stimulate fluid and electrolyte transport.

1.2.1 GCC Agonist Peptides

[70] In a preferred embodiment, the GCC agonists for use in the formulations and methods of the invention are GCC agonist peptides. In certain embodiments, the GCC agonist peptides are analogues of uroguanylin or a bacterial ST peptide. Uroguanylin is a circulating peptide hormone with natriuretic activity. An ST peptide is a member of a family of heat stable enterotoxins (ST peptides) secreted by pathogenic strains of *E. coli* and other enteric bacteria that activate guanylate cyclase receptor and cause secretory diarrhea. Unlike bacterial ST peptides, the binding of uroguanylin to guanylate cyclase receptor is dependent on the physiological pH of the gut. Therefore, uroguanylin is expected to regulate fluid and electrolyte transport in a pH dependent manner and without causing severe diarrhea.

[71] The GCC agonist peptides for use in the formulations and methods of the invention can be polymers of L-amino acids, D-amino acids, or a combination of both. For example, in various embodiments, the peptides are D retro-inverso peptides. The term “retro-inverso isomer” refers to an isomer of a linear peptide in which the direction of the sequence is reversed and the chirality of each amino acid residue is inverted. *See, e.g., Jameson et al., Nature, 368, 744-746 (1994); Brady et al., Nature, 368, 692-693 (1994).* The net result of combining D-enantiomers and reverse synthesis is that the positions of carbonyl and amino groups in each amide bond are exchanged, while the position of the side-chain groups at each alpha carbon is preserved. Unless specifically stated otherwise, it is presumed that any given L-amino acid sequence of the invention may be made into a D retro-inverso peptide by synthesizing a reverse of the sequence for the corresponding native L-amino acid sequence.

[72] The GCC agonist peptides for use in the formulations and methods of the invention are able to induce intracellular cGMP production in cells and tissues expressing guanylate cyclase C. In certain embodiments, the GCC agonist peptide stimulates 5%, 10%, 20%, 30%, 40%, 50%, 75%, 90% or more intracellular cGMP compared to naturally occurring GCC agonists such as uroguanylin, guanylin, or ST peptides. Optionally, the GCC agonist peptide stimulates 5%, 10%, 20%, 30%, 40%, 50%, 75%, 90% or more intracellular cGMP compared SP-304 (SEQ ID NO:1). In further embodiments, the GCC agonist peptide stimulates apoptosis, *e.g.*, programmed cell death, or activate the cystic fibrosis transmembrane conductance regulator (CFTR).

[73] In some embodiments, the GCC agonist peptides for use in the formulations and methods of the invention are more stable than naturally occurring GCC agonists and/or SP-304 (SEQ ID NO:1), SP-339 (linaclotide) (SEQ ID NO: 55) or SP-340 (SEQ ID NO: 56). For example, the GCC agonist peptide degrades 2%, 3%, 5%, 10%, 15%, 20%, 30%, 40%, 50%, 75%, 90% or less compared to naturally occurring GCC agonists and/or SP-304, SP-339 (linaclotide) or SP-340. In certain embodiments, the GCC agonist peptides for use in the formulations and methods of the invention are more stable to proteolytic digestion than naturally occurring GCC agonists and/or SP-304 (SEQ ID NO:1), SP-339 (linaclotide) (SEQ ID NO: 55) or SP-340 (SEQ ID NO: 56). In one embodiment, a GCC agonist peptide is pegylated in order to render the peptides more resistant towards proteolysis by enzymes of the gastrointestinal tract. In a preferred embodiment, the GCC agonist peptide is pegylated with the aminoethoxy-ethoxy-acetic acid (Aeea) group at its C-terminal end, at its N-terminal end, or at both termini.

[74] Specific examples of GCC agonist peptides that can be used in the methods and formulations of the invention include a peptide selected from the group designated by SEQ ID NOs: 1-249.

[75] In one embodiment, the GCC agonist peptide is a peptide having the amino acid sequence of any one of Formulas X- XVII (*e.g.* SEQ ID NO:87-98).

[76] In some embodiments, GCC agonist peptides include peptides having the amino acid sequence of Formula I, wherein at least one amino acid of Formula I is a D-amino acid or a methylated amino acid and/or the amino acid at position 16 is a serine. Preferably, the amino

acid at position 16 of Formula I is a D-amino acid or a methylated amino acid. For example, the amino acid at position 16 of Formula I is a d-leucine or a d-serine. Optionally, one or more of the amino acids at positions 1-3 of Formula I are D-amino acids or methylated amino acids or a combination of D-amino acids or methylated amino acids. For example, Asn¹, Asp² or Glu³ (or a combination thereof) of Formula I is a D-amino acid or a methylated amino acid. Preferably, the amino acid at position Xaa⁶ of Formula I is a leucine, serine or tyrosine.

[77] In alternative embodiments, GCC agonist peptides include peptides having the amino acid sequence of Formula II, wherein at least one amino acid of Formula II is a D-amino acid or a methylated amino acid. Preferably, the amino acid denoted by Xaa_{n2} of Formula II is a D-amino acid or a methylated amino acid. In some embodiments, the amino acid denoted by Xaa_{n2} of Formula II is a leucine, a d-leucine, a serine, or a d-serine. Preferably, the one or more amino acids denoted by Xaa_{n1} of Formula II is a D-amino acid or a methylated amino acid. Preferably, the amino acid at position Xaa⁶ of Formula II is a leucine, a serine, or a tyrosine.

[78] In some embodiments, GCC agonist peptides include peptides having the amino acid sequence of Formula III, wherein at least one amino acid of Formula III is a D-amino acid or a methylated amino acid and/or Maa is not a cysteine. Preferably, the amino acid denoted by Xaa_{n2} of Formula III is a D-amino acid or a methylated amino acid. In some embodiments the amino acid denoted by Xaa_{n2} of Formula III is a leucine, a d-leucine, a serine, or a d-serine. Preferably, the one or more amino acids denoted by Xaa_{n1} of Formula III is a D-amino acid or a methylated amino acid. Preferably, the amino acid at position Xaa⁶ of Formula III is a leucine, a serine, or a tyrosine.

[79] In other embodiments, GCC agonist peptides include peptides having the amino acid sequence of Formula IV, wherein at least one amino acid of Formula IV is a D-amino acid or a methylated amino acid, and/or Maa is not a cysteine. Preferably, the Xaa_{n2} of Formula IV is a D-amino acid or a methylated amino acid. In some embodiments, the amino acid denoted by Xaa_{n2} of Formula IV is a leucine, a d-leucine, a serine, or a d-serine. Preferably, the one or more of the amino acids denoted by Xaa_{n1} of Formula IV is a D-amino acid or a methylated amino acid. Preferably, the amino acid denoted Xaa⁶ of Formula IV is a leucine, a serine, or a tyrosine.

[80] In further embodiments, GCC agonist peptides include peptides having the amino acid sequence of Formula V, wherein at least one amino acid of Formula V is a D-amino acid or a methylated amino acid. Preferably, the amino acid at position 16 of Formula V is a D-amino acid or a methylated amino acid. For example, the amino acid at position 16 (i.e., Xaa¹⁶) of Formula V is a d-leucine or a d-serine. Optionally, one or more of the amino acids at position 1-3 of Formula V are D-amino acids or methylated amino acids or a combination of D-amino acids or methylated amino acids. For example, Asn¹, Asp² or Glu³ (or a combination thereof) of Formula V is a D-amino acids or a methylated amino acid. Preferably, the amino acid denoted at Xaa⁶ of Formula V is a leucine, a serine, or a tyrosine.

[81] In additional embodiments, GCC agonist peptides include peptides having the amino acid sequence of Formula VI, VII, VIII, or IX. Preferably, the amino acid at position 6 of Formula VI, VII, VIII, or IX is a leucine, a serine, or a tyrosine. In some aspects the amino acid at position 16 of Formula VI, VII, VIII, or IX is a leucine or a serine. Preferably, the amino acid at position 16 of Formula V is a D-amino acid or a methylated amino acid.

[82] In additional embodiments, GCC agonist peptides include peptides having the amino acid sequence of Formula X, XI, XII, XIII, XIV, XV, XVI or XVII. Optionally, one or more amino acids of Formulas X, XI, XII, XIII, XIV, XV, XVI or XVII is a D-amino acid or a methylated amino acid. Preferably, the amino acid at the carboxy terminus of the peptides according to Formulas X, XI, XII, XIII, XIV, XV, XVI or XVII is a D-amino acid or a methylated amino acid. For example the the amino acid at the carboxy terminus of the peptides according to Formulas X, XI, XII, XIII, XIV, XV, XVI or XVII is a D-tyrosine.

[83] Preferably, the amino acid denoted by Xaa⁶ of Formula XIV is a tyrosine, phenylalanine or a serine. Most preferably the amino acid denoted by Xaa⁶ of Formula XIV is a phenylalanine or a serine. Preferably, the amino acid denoted by Xaa⁴ of Formula XV, XVI or XVII is a tyrosine, a phenylalanine, or a serine. Most preferably, the amino acid position Xaa⁴ of Formula V, XVI or XVII is a phenylalanine or a serine.

[84] In some embodiments, GCRA peptides include peptides containing the amino acid sequence of Formula XVIII. Preferably, the amino acid at position 1 of Formula XVIII is a glutamic acid, aspartic acid, glutamine or lysine. Preferably, the amino acid at position 2 and 3 of Formula XVIII is a glutamic acid, or an aspartic acid. Preferably, the amino acid at

position 5 a glutamic acid. Preferably, the amino acid at position 6 of Formula XVIII is an isoleucine, valine, serine, threonine or tyrosine. Preferably, the amino acid at position 8 of Formula XVIII is a valine or isoleucine. Preferably, the amino acid at position 9 of Formula XVIII is an asparagine. Preferably, the amino acid at position 10 of Formula XVIII is a valine or a methionine. Preferably, the amino acid at position 11 of Formula XVIII is an alanine. Preferably, the amino acid at position 13 of Formula XVIII is a threonine. Preferably, the amino acid at position 14 of Formula XVIII is a glycine. Preferably, the amino acid at position 16 of Formula XVIII is a leucine, serine or threonine

[85] In alternative embodiments, GCRA peptides include peptides containing the amino acid sequence of Formula XIX. Preferably, the amino acid at position 1 of Formula XIX is a serine or asparagine. Preferably, the amino acid at position 2 of Formula XIX is a histidine or an aspartic acid. Preferably, the amino acid at position 3 of Formula XIX is a threonine or a glutamic acid. Preferably, the amino acid at position 5 of Formula XIX is a glutamic acid. Preferably, the amino acid at position 6 of Formula XIX is an isoleucine, leucine, valine or tyrosine. Preferably, the amino acid at position 8, 10, 11, or 13 of Formula XIX is an alanine. Preferably, the amino acid at position 9 of Formula XIX is an asparagine or a phenylalanine. Preferably, the amino acid at position 14 of Formula XIX is a glycine.

[86] In further embodiments, GCRA peptides include peptides containing the amino acid sequence of Formula XX. Preferably, the amino acid at position 1 of Formula XX is a glutamine. Preferably, the amino acid at position 2 or 3 of Formula XX is a glutamic acid or a aspartic acid. Preferably, the amino acid at position 5 of Formula XX is a glutamic acid. Preferably, the amino acid at position 6 of Formula XX is threonine, glutamine, tyrosine, isoleucine, or leucine. Preferably, the amino acid at position 8 of Formula XX is isoleucine or valine. Preferably, the amino acid at position 9 of Formula XX is asparagine. Preferably, the amino acid at position 10 of Formula XX is methionine or valine. Preferably, the amino acid at position 11 of Formula XX is alanine. Preferably, the amino acid at position 13 of Formula XX is a threonine. Preferably, the amino acid at position 14 of Formula XX is a glycine. Preferably, the amino acid at position 15 of Formula XX is a tyrosine. Optionally, the amino acid at position 15 of Formula XX is two amino acid in length and is Cysteine (Cys), Penicillamine (Pen) homocysteine, or 3-mercaptoproline and serine, leucine or threonine.

[87] In certain embodiments, one or more amino acids of the GCC agonist peptides are replaced by a non-naturally occurring amino acid or a naturally or non-naturally occurring amino acid analog. Such amino acids and amino acid analogs are known in the art. See, for example, Hunt, "The Non-Protein Amino Acids," in *Chemistry and Biochemistry of the Amino Acids*, Barrett, Chapman and Hall, 1985. In some embodiments, an amino acid is replaced by a naturally-occurring, non-essential amino acid, e.g., taurine. Non-limiting examples of naturally occurring amino acids that can be replaced by non-protein amino acids include the following: (1) an aromatic amino acid can be replaced by 3,4-dihydroxy-L-phenylalanine, 3-iodo-L-tyrosine, triiodothyronine, L-thyroxine, phenylglycine (Phg) or nor-tyrosine (norTyr); (2) Phg and norTyr and other amino acids including Phe and Tyr can be substituted by, e.g., a halogen, -CH₃, -OH, -CH₂NH₃, -C(O)H, -CH₂CH₃, -CN, -CH₂CH₂CH₃, -SH, or another group; (3) glutamine residues can be substituted with gamma-Hydroxy-Glu or gamma-Carboxy-Glu; (4) tyrosine residues can be substituted with an alpha substituted amino acid such as L-alpha-methylphenylalanine or by analogues such as: 3-Amino-Tyr; Tyr(CH₃); Tyr(PO₃(CH₃)₂); Tyr(SO₃H); beta-Cyclohexyl-Ala; beta-(1-Cyclopentenyl)-Ala; beta-Cyclopentyl-Ala; beta-Cyclopropyl-Ala; beta-Quinolyl-Ala; beta-(2-Thiazolyl)-Ala; beta-(Triazole-1-yl)-Ala; beta-(2-Pyridyl)-Ala; beta-(3-Pyridyl)-Ala; Amino-Phe; Fluoro-Phe; Cyclohexyl-Gly; tBu-Gly; beta-(3-benzothienyl)-Ala; beta-(2-thienyl)-Ala; 5-Methyl-Trp; and A-Methyl-Trp; (5) proline residues can be substituted with homopro (L-pipecolic acid); hydroxy-Pro; 3,4-Dehydro-Pro; 4-fluoro-Pro; or alpha-methyl-Pro or an N(alpha)-C(alpha) cyclized amino acid analogues with the structure: n = 0, 1, 2, 3; and (6) alanine residues can be substituted with alpha-substituted or N-methylated amino acid such as alpha-amino isobutyric acid (aib), L/D-alpha-ethylalanine (L/D-isovaline), L/D-methylvaline, or L/D-alpha-methylleucine or a non-natural amino acid such as beta-fluoro-Ala. Alanine can also be substituted with: n = 0, 1, 2, 3 Glycine residues can be substituted with alpha-amino isobutyric acid (aib) or L/D-alpha-ethylalanine (L/D-isovaline).

[88] Further examples of non-natural amino acids include: an unnatural analog of tyrosine; an unnatural analogue of glutamine; an unnatural analogue of phenylalanine; an unnatural analogue of serine; an unnatural analogue of threonine; an alkyl, aryl, acyl, azido, cyano, halo, hydrazine, hydrazide, hydroxyl, alkenyl, alkynyl, ether, thiol, sulfonyl, seleno, ester, thioacid, borate, boronate, phospho, phosphono, phosphine, heterocyclic, enone, imine, aldehyde, hydroxylamine, keto, or amino substituted amino acid, or any combination thereof;

an amino acid with a photoactivatable cross-linker; a spin-labeled amino acid; a fluorescent amino acid; an amino acid with a novel functional group; an amino acid that covalently or noncovalently interacts with another molecule; a metal binding amino acid; an amino acid that is amidated at a site that is not naturally amidated, a metal-containing amino acid; a radioactive amino acid; a photocaged and/or photoisomerizable amino acid; a biotin or biotin-analogue containing amino acid; a glycosylated or carbohydrate modified amino acid; a keto containing amino acid; amino acids comprising polyethylene glycol or polyether; a heavy atom substituted amino acid (*e.g.*, an amino acid containing deuterium, tritium, ^{13}C , ^{15}N , or ^{18}O); a chemically cleavable or photocleavable amino acid; an amino acid with an elongated side chain; an amino acid containing a toxic group; a sugar substituted amino acid, *e.g.*, a sugar substituted serine or the like; a carbon-linked sugar-containing amino acid; a redox-active amino acid; an α -hydroxy containing acid; an amino thio acid containing amino acid; an α , α disubstituted amino acid; a β - amino acid; a cyclic amino acid other than proline; an O-methyl-L-tyrosine; an L-3-(2- naphthyl)alanine; a 3-methyl-phenylalanine; a p-acetyl-L-phenylalanine; an O-4-allyl-L-tyrosine; a 4-propyl-L-tyrosine; a tri-O-acetyl-GlcNAc β -serine; an L-Dopa; a fluorinated phenylalanine; an isopropyl-L-phenylalanine; a p-azido-L-phenylalanine; a p-acyl-L-phenylalanine; a p- benzoyl-L-phenylalanine; an L-phosphoserine; a phosphoserine; a phosphotyrosine; a p- iodo-phenylalanine; a 4-fluorophenylglycine; a p-bromophenylalanine; a p-amino-L- phenylalanine; an isopropyl-L-phenylalanine; L-3-(2-naphthyl)alanine; D- 3-(2-naphthyl)alanine (dNal); an amino-, isopropyl-, or O-allyl-containing phenylalanine analogue; a dopa, 0-methyl-L-tyrosine; a glycosylated amino acid; a p-(propargyloxy)phenylalanine; dimethyl-Lysine; hydroxy-proline; mercaptopropionic acid; methyl-lysine; 3-nitro-tyrosine; norleucine; pyro-glutamic acid; Z (Carbobenzoxyl); ϵ -Acetyl-Lysine; β -alanine; aminobenzoyl derivative; aminobutyric acid (Abu); citrulline; aminohexanoic acid; aminoisobutyric acid (AIB); cyclohexylalanine; d-cyclohexylalanine; hydroxyproline; nitro-arginine; nitro-phenylalanine; nitro-tyrosine; norvaline; octahydroindole carboxylate; ornithine (Orn); penicillamine (PEN); tetrahydroisoquinoline; acetamidomethyl protected amino acids and pegylated amino acids. Further examples of unnatural amino acids and amino acid analogs can be found in U.S. 20030108885, U.S. 20030082575, US20060019347 (paragraphs 410-418) and the references cited therein. The polypeptides of the invention can include further modifications including those described in US20060019347, paragraph 589. Exemplary GCC agonist peptides which include a non-naturally occurring amino acid include for example SP-368 and SP-369.

[89] In some embodiments, the GCC agonist peptides are cyclic peptides. GCC agonist cyclic peptides can be prepared by methods known in the art. For example, macrocyclization is often accomplished by forming an amide bond between the peptide N- and C-termini, between a side chain and the N- or C-terminus [*e.g.*, with $K_3Fe(CN)_6$ at pH 8.5] (Samson *et al.*, *Endocrinology*, 137: 5182-5185 (1996)), or between two amino acid side chains, such as cysteine. See, *e.g.*, DeGrado, *Adv Protein Chem*, 39: 51-124 (1988). In various embodiments, the GCC agonist peptides are [4,12; 7,15] bicycles.

[90] In certain embodiments, one or both Cys residues which normally form a disulfide bond in a GCC agonist peptide are replaced with homocysteine, penicillamine, 3-mercaptoproline (Kolodziej *et al.* 1996 *Int. J. Pept. Protein Res.* 48:274), β , β dimethylcysteine (Hunt *et al.* 1993 *Int. J. Pept. Protein Res.* 42:249), or diaminopropionic acid (Smith *et al.* 1978 *J. Med. Chem.* 21:117) to form alternative internal cross-links at the positions of the normal disulfide bonds.

[91] In certain embodiments, one or more disulfide bonds in a GCC agonist peptide are replaced by alternative covalent cross-links, *e.g.*, an amide linkage (-CH₂CH(O)NHCH₂- or -CH₂NHCH(O)CH₂-), an ester linkage, a thioester linkage, a lactam bridge, a carbamoyl linkage, a urea linkage, a thiourea linkage, a phosphonate ester linkage, an alkyl linkage (-CH₂CH₂CH₂CH₂-), an alkenyl linkage (-CH₂CH=CHCH₂-), an ether linkage (-CH₂CH₂OCH₂- or -CH₂OCH₂CH₂-), a thioether linkage (-CH₂CH₂SCH₂- or -CH₂SCH₂CH₂-), an amine linkage (-CH₂CH₂NHCH₂- or -CH₂NHCH₂CH₂-) or a thioamide linkage (-CH₂CH(S)HNHCH₂- or -CH₂NHCH(S)CH₂-). For example, Ledu *et al.* (*Proc. Natl. Acad. Sci.* 100:11263-78, 2003) describe methods for preparing lactam and amide cross-links. Exemplary GCC agonist peptides which include a lactam bridge include, for example, SP-370.

[92] In certain embodiments, the GCC agonist peptides have one or more conventional polypeptide bonds replaced by an alternative bond. Such replacements can increase the stability of the polypeptide. For example, replacement of the polypeptide bond between a residue amino terminal to an aromatic residue (*e.g.* Tyr, Phe, Trp) with an alternative bond can reduce cleavage by carboxy peptidases and may increase half-life in the digestive tract. Bonds that can replace polypeptide bonds include: a retro-inverso bond (C(O)-NH instead of NH-C(O)); a reduced amide bond (NH-CH₂); a thiomethylene bond (S-CH₂ or CH₂-S); an

oxomethylene bond (O-CH₂ or CH₂-O); an ethylene bond (CH₂-CH₂); a thioamide bond (C(S)-NH); a trans-olefine bond (CH=CH); a fluoro substituted trans-olefine bond (CF=CH); a ketomethylene bond (C(O)-CHR or CHR-C(O) wherein R is H or CH₃); and a fluoro-ketomethylene bond (C(O)-CFR or CFR-C(O) wherein R is H or F or CH₃).

[93] In certain embodiments, the GCC agonist peptides are modified using standard modifications. Modifications may occur at the amino (N-), carboxy (C-) terminus, internally or a combination of any of the preceding. In one aspect described herein, there may be more than one type of modification on the polypeptide. Modifications include but are not limited to: acetylation, amidation, biotinylation, cinnamoylation, farnesylation, formylation, myristoylation, palmitoylation, phosphorylation (Ser, Tyr or Thr), stearoylation, succinylation, sulfurylation and cyclisation (via disulfide bridges or amide cyclisation), and modification by Cys3 or Cys5. The GCC agonist peptides described herein may also be modified by 2, 4-dinitrophenyl (DNP), DNP-lysine, modification by 7-Amino-4-methyl-coumarin (AMC), fluorescein, NBD (7-Nitrobenz-2-Oxa-1,3-Diazole), p-nitro-anilide, rhodamine B, EDANS (5-((2-aminoethyl)amino)naphthalene-1- sulfonic acid), dabeyl, dabsyl, dansyl, texas red, Fmoc, and Tamra (Tetramethylrhodamine). The GCC agonist peptides described herein may also be conjugated to, for example, polyethylene glycol (PEG); alkyl groups (e.g., C1-C20 straight or branched alkyl groups); fatty acid radicals; combinations of PEG, alkyl groups and fatty acid radicals (*See*, U.S. Patent 6,309,633; Soltero et al., 2001 *Innovations in Pharmaceutical Technology* 106-110); BSA and KLH (Keyhole Limpet Hemocyanin). The addition of PEG and other polymers which can be used to modify polypeptides of the invention is described in US20060 19347 section IX.

[94] A GCC agonist peptide can also be a derivatives of a GCC agonist peptide described herein. For example, a derivative includes hybrid and modified forms of GCC agonist peptides in which certain amino acids have been deleted or replaced. A modification may also include glycosylation. Preferably, where the modification is an amino acid substitution, it is a conservative substitution at one or more positions that are predicted to be non-essential amino acid residues for the biological activity of the peptide. A "conservative substitution" is one in which the amino acid residue is replaced with an amino acid residue having a similar side chain. Families of amino acid residues having similar side chains have been defined in the art. These families include amino acids with basic side chains (*e.g.*, lysine, arginine, histidine), acidic side chains (*e.g.*, aspartic acid, glutamic acid), uncharged polar side chains

(*e.g.*, glycine, asparagine, glutamine, serine, threonine, tyrosine, cysteine), nonpolar side chains (*e.g.*, alanine, valine, leucine, isoleucine, proline, phenylalanine, methionine, tryptophan), beta-branched side chains (*e.g.*, threonine, valine, isoleucine) and aromatic side chains (*e.g.*, tyrosine, phenylalanine, tryptophan, histidine).

[95] In one embodiment, a GCC agonist peptide described herein is subjected to random mutagenesis in order to identify mutants having biological activity.

[96] In one embodiment, the GCC agonist peptide is substantially homologous to a GCC agonist peptide described herein. Such substantially homologous peptides can be isolated by virtue of cross-reactivity with antibodies to a GCC agonist peptide described herein.

[97] Further examples of GCC agonist peptides that can be used in the methods and formulations of the invention are found in Tables I - VII below.

1.2.2 Preparation of GCC agonist peptides

[98] GCC agonist peptides can be prepared using art recognized techniques such as molecular cloning, peptide synthesis, or site-directed mutagenesis.

[99] Peptide synthesis can be performed using standard solution phase or solid phase peptide synthesis techniques or a combination of both processes where segments are synthesized by solid phase and condensed in solution phase, in which a peptide linkage occurs through the direct condensation of the amino group of one amino acid with the carboxy group of the other amino acid with the elimination of a water molecule. Peptide bond synthesis by direct condensation, as formulated above, requires suppression of the reactive character of the amino group of the first and of the carboxyl group of the second amino acid. The masking substituents must permit their ready removal, without inducing breakdown of the labile peptide molecule.

[100] In solution phase synthesis, a wide variety of coupling methods and protecting groups may be used (*See*, Gross and Meienhofer, eds., "The Peptides: Analysis, Synthesis, Biology," Vol. 1-4 (Academic Press, 1979); Bodansky and Bodansky, "The Practice of Peptide Synthesis," 2d ed. (Springer Verlag, 1994)). In addition, intermediate purification and linear scale up are possible. Those of ordinary skill in the art will appreciate that solution synthesis

requires consideration of main chain and side chain protecting groups and activation method. In addition, careful segment selection is necessary to minimize racemization during segment condensation. Solubility considerations are also a factor. Solid phase peptide synthesis uses an insoluble polymer for support during organic synthesis. The polymer-supported peptide chain permits the use of simple washing and filtration steps instead of laborious purifications at intermediate steps. Solid-phase peptide synthesis may generally be performed according to the method of Merrifield et al., J. Am. Chem. Soc., 1963, 85:2149, which involves assembling a linear peptide chain on a resin support using protected amino acids. Solid phase peptide synthesis typically utilizes either the Boc or Fmoc strategy, which are well known in the art.

[101] Those of ordinary skill in the art will recognize that, in solid phase synthesis, deprotection and coupling reactions must go to completion and the side-chain blocking groups must be stable throughout the synthesis. In addition, solid phase synthesis is generally most suitable when peptides are to be made on a small scale.

[102] Acetylation of the N-terminal can be accomplished by reacting the final peptide with acetic anhydride before cleavage from the resin. C-amidation is accomplished using an appropriate resin such as methylbenzhydrylamine resin using the Boc technology.

[103] Alternatively the GCC agonist peptides are produced by modern cloning techniques. For example, the GCC agonist peptides are produced either in bacteria including, without limitation, *E. coli*, or in other existing systems for polypeptide or protein production (*e.g.*, *Bacillus subtilis*, baculovirus expression systems using *Drosophila Sf9* cells, yeast or filamentous fungal expression systems, mammalian cell expression systems), or they can be chemically synthesized. If the GCC agonist peptide or variant peptide is to be produced in bacteria, *e.g.*, *E. coli*, the nucleic acid molecule encoding the polypeptide may also encode a leader sequence that permits the secretion of the mature polypeptide from the cell. Thus, the sequence encoding the polypeptide can include the pre sequence and the pro sequence of, for example, a naturally-occurring bacterial ST polypeptide. The secreted, mature polypeptide can be purified from the culture medium.

[104] The sequence encoding a GCC agonist peptide described herein can be inserted into a vector capable of delivering and maintaining the nucleic acid molecule in a bacterial cell.

The DNA molecule may be inserted into an autonomously replicating vector (suitable vectors include, for example, pGEM3Z and pcDNA3, and derivatives thereof). The vector nucleic acid may be a bacterial or bacteriophage DNA such as bacteriophage lambda or M13 and derivatives thereof. Construction of a vector containing a nucleic acid described herein can be followed by transformation of a host cell such as a bacterium. Suitable bacterial hosts include but are not limited to, *E. coli*, *B. subtilis*, *Pseudomonas*, *Salmonella*. The genetic construct also includes, in addition to the encoding nucleic acid molecule, elements that allow expression, such as a promoter and regulatory sequences. The expression vectors may contain transcriptional control sequences that control transcriptional initiation, such as promoter, enhancer, operator, and repressor sequences.

[105] A variety of transcriptional control sequences are well known to those in the art. The expression vector can also include a translation regulatory sequence (*e.g.*, an untranslated 5' sequence, an untranslated 3' sequence, or an internal ribosome entry site). The vector can be capable of autonomous replication or it can integrate into host DNA to ensure stability during polypeptide production.

[106] The protein coding sequence that includes a GCC agonist peptide described herein can also be fused to a nucleic acid encoding a polypeptide affinity tag, *e.g.*, glutathione S-transferase (GST), maltose E binding protein, protein A, FLAG tag, hexa-histidine, myc tag or the influenza HA tag, in order to facilitate purification. The affinity tag or reporter fusion joins the reading frame of the polypeptide of interest to the reading frame of the gene encoding the affinity tag such that a translational fusion is generated. Expression of the fusion gene results in translation of a single polypeptide that includes both the polypeptide of interest and the affinity tag. In some instances where affinity tags are utilized, DNA sequence encoding a protease recognition site will be fused between the reading frames for the affinity tag and the polypeptide of interest.

[107] Genetic constructs and methods suitable for production of immature and mature forms of the GCC agonist peptides and variants described herein in protein expression systems other than bacteria, and well known to those skilled in the art, can also be used to produce polypeptides in a biological system.

[108] The peptides disclosed herein may be modified by attachment of a second molecule that confers a desired property upon the peptide, such as increased half-life in the body, for example, pegylation. Such modifications also fall within the scope of the term "variant" as used herein.

Table I. GCRA Peptides (SP-304 and Derivatives)

Name	Position of Disulfide bonds	Structure	SEQ ID NO
SP-304	C4:C12, C7:C15	Asn ¹ -Asp ² -Glu ³ -Cys ⁴ -Glu ⁵ -Leu ⁶ -Cys ⁷ -Val ⁸ -Asn ⁹ -Val ¹⁰ -Ala ¹¹ -Cys ¹² -Thr ¹³ -Gly ¹⁴ -Cys ¹⁵ -Leu ¹⁶	1
SP-326	C3:C11, C6:C14	Asp ¹ -Glu ² -Cys ³ -Glu ⁴ -Leu ⁵ -Cys ⁶ -Val ⁷ -Asn ⁸ -Val ⁹ -Ala ¹⁰ -Cys ¹¹ -Thr ¹² -Gly ¹³ -Cys ¹⁴ -Leu ¹⁵	2
SP-327	C2:C10, C5:C13	Asp ¹ -Glu ² -Cys ³ -Glu ⁴ -Leu ⁵ -Cys ⁶ -Val ⁷ -Asn ⁸ -Val ⁹ -Ala ¹⁰ -Cys ¹¹ -Thr ¹² -Gly ¹³ -Cys ¹⁴	3
SP-328	C2:C10, C5:C13	Glu ¹ -Cys ² -Glu ³ -Leu ⁴ -Cys ⁵ -Val ⁶ -Asn ⁷ -Val ⁸ -Ala ⁹ -Cys ¹⁰ -Thr ¹¹ -Gly ¹² -Cys ¹³ -Leu ¹⁴	4
SP-329	C2:C10, C5:C13	Glu ¹ -Cys ² -Glu ³ -Leu ⁴ -Cys ⁵ -Val ⁶ -Asn ⁷ -Val ⁸ -Ala ⁹ -Cys ¹⁰ -Thr ¹¹ -Gly ¹² -Cys ¹³	5
SP-330	C1:C9, C4:C12	Cys ¹ -Glu ² -Leu ³ -Cys ⁴ -Val ⁵ -Asn ⁶ -Val ⁷ -Ala ⁸ -Cys ⁹ -Thr ¹⁰ -Gly ¹¹ -Cys ¹² -Leu ¹³	6
SP-331	C1:C9, C4:C12	Cys ¹ -Glu ² -Leu ³ -Cys ⁴ -Val ⁵ -Asn ⁶ -Val ⁷ -Ala ⁸ -Cys ⁹ -Thr ¹⁰ -Gly ¹¹ -Cys ¹²	7
SP332	C4:C12, C7:C15	Asn ¹ -Asp ² -Glu ³ -Cys ⁴ -Glu ⁵ -Leu ⁶ -Cys ⁷ -Val ⁸ -Asn ⁹ -Val ¹⁰ -Ala ¹¹ -Cys ¹² -Thr ¹³ -Gly ¹⁴ -Cys ¹⁵ -dl eu ¹⁶	8
SP-333	C4:C12, C7:C15	dAsn ¹ -Asp ² -Glu ³ -Cys ⁴ -Glu ⁵ -Leu ⁶ -Cys ⁷ -Val ⁸ -Asn ⁹ -Val ¹⁰ -Ala ¹¹ -Cys ¹² -Thr ¹³ -Gly ¹⁴ -Cys ¹⁵ -dl eu ¹⁶	9
SP-334	C4:C12, C7:C15	dAsn ¹ -dAsp ² -Glu ³ -Cys ⁴ -Glu ⁵ -Leu ⁶ -Cys ⁷ -Val ⁸ -Asn ⁹ -Val ¹⁰ -Ala ¹¹ -Cys ¹² -Thr ¹³ -Gly ¹⁴ -Cys ¹⁵ -dl eu ¹⁶	10
SP-335	C4:C12, C7:C15	dAsn ¹ -dAsp ² -dGlu ³ -Cys ⁴ -Glu ⁵ -Leu ⁶ -Cys ⁷ -Val ⁸ -Asn ⁹ -Val ¹⁰ -Ala ¹¹ -Cys ¹² -Thr ¹³ -Gly ¹⁴ -Cys ¹⁵ -dl eu ¹⁶	11
SP-336	C4:C12, C7:C15	dAsn ¹ -Asp ² -Glu ³ -Cys ⁴ -Glu ⁵ -Leu ⁶ -Cys ⁷ -Val ⁸ -Asn ⁹ -Val ¹⁰ -Ala ¹¹ -Cys ¹² -Thr ¹³ -Gly ¹⁴ -Cys ¹⁵ -Leu ¹⁶	12
SP-337	C4:C12, C7:C15	dAsn ¹ -Asp ² -Glu ³ -Cys ⁴ -Glu ⁵ -dl eu ⁶ -Cys ⁷ -Val ⁸ -Asn ⁹ -Val ¹⁰ -Ala ¹¹ -Cys ¹² -Thr ¹³ -Gly ¹⁴ -Cys ¹⁵ -dl eu ¹⁶	13
SP-338	C4:C12, C7:C15	Asn ¹ -Asp ² -Glu ³ -Cys ⁴ -Glu ⁵ -Leu ⁶ -Cys ⁷ -Val ⁸ -Asn ⁹ -Val ¹⁰ -Ala ¹¹ -Cys ¹² -Thr ¹³ -Gly ¹⁴ -Cys ¹⁵	14
SP-342	C4:C12, C7:C15	PEG3-Asn ¹ -Asp ² -Glu ³ -Cys ⁴ -Glu ⁵ -Leu ⁶ -Cys ⁷ -Val ⁸ -Asn ⁹ -Val ¹⁰ -Ala ¹¹ -Cys ¹² -Thr ¹³ -Gly ¹⁴ -Cys ¹⁵ -dl eu ¹⁶ -PEG3	15
SP-343	C4:C12, C7:C15	PEG3-dAsn ¹ -Asp ² -Glu ³ -Cys ⁴ -Glu ⁵ -Leu ⁶ -Cys ⁷ -Val ⁸ -Asn ⁹ -Val ¹⁰ -Ala ¹¹ -Cys ¹² -Thr ¹³ -Gly ¹⁴ -Cys ¹⁵ -dl eu ¹⁶ -PEG3	16
SP-344	C4:C12, C7:C15	PEG3-dAsn ¹ -dAsp ² -Glu ³ -Cys ⁴ -Glu ⁵ -Leu ⁶ -Cys ⁷ -Val ⁸ -Asn ⁹ -Val ¹⁰ -Ala ¹¹ -Cys ¹² -Thr ¹³ -Gly ¹⁴ -Cys ¹⁵ -dl eu ¹⁶ -PEG3	17
SP-347	C4:C12, C7:C15	dAsn ¹ -Asp ² -Glu ³ -Cys ⁴ -Glu ⁵ -Leu ⁶ -Cys ⁷ -Val ⁸ -Asn ⁹ -Val ¹⁰ -Ala ¹¹ -Cys ¹² -Thr ¹³ -Gly ¹⁴ -Cys ¹⁵ -dl eu ¹⁶ -PEG3	18
SP-348	C4:C12, C7:C15	PEG3-Asn ¹ -Asp ² -Glu ³ -Cys ⁴ -Glu ⁵ -Leu ⁶ -Cys ⁷ -Val ⁸ -Asn ⁹ -Val ¹⁰ -Ala ¹¹ -Cys ¹² -Thr ¹³ -Gly ¹⁴ -Cys ¹⁵ -dl eu ¹⁶	19

SP-350	C4:C12, C7:C15	PEG3-dAsn ¹ -Asp ² -Glu ³ -Cys ⁴ -Glu ⁵ -Leu ⁶ -Cys ⁷ -Val ⁸ -Asn ⁹ -Val ¹⁰ -Ala ¹¹ -Cys ¹² -Thr ¹³ -Gly ¹⁴ -Cys ¹⁵ -dLeu ¹⁶	20
SP-352	C4:C12, C7:C15	Asn ¹ -Asp ² -Glu ³ -Cys ⁴ -Glu ⁵ -Leu ⁶ -Cys ⁷ -Val ⁸ -Asn ⁹ -Val ¹⁰ -Ala ¹¹ -Cys ¹² -Thr ¹³ -Gly ¹⁴ -Cys ¹⁵ -dLeu ¹⁶ -PEG3	21
SP-358	C4:C12,C7:C15	PEG3-dAsn ¹ -dAsp ² -dGlu ³ -Cys ⁴ -Glu ⁵ -Leu ⁶ -Cys ⁷ -Val ⁸ -Asn ⁹ -Val ¹⁰ -Ala ¹¹ -Cys ¹² -Thr ¹³ -Gly ¹⁴ -Cys ¹⁵ -dLeu ¹⁶ -PEG3	22
SP-359	C4:C12,C7:C15	PEG3-dAsn ¹ -dAsp ² -dGlu ³ -Cys ⁴ -Glu ⁵ -Leu ⁶ -Cys ⁷ -Val ⁸ -Asn ⁹ -Val ¹⁰ -Ala ¹¹ -Cys ¹² -Thr ¹³ -Gly ¹⁴ -Cys ¹⁵ -dLeu ¹⁶	23
SP-360	C4:C12, C7:C15	dAsn ¹ -dAsp ² -dGlu ³ -Cys ⁴ -Glu ⁵ -Leu ⁶ -Cys ⁷ -Val ⁸ -Asn ⁹ -Val ¹⁰ -Ala ¹¹ -Cys ¹² -Thr ¹³ -Gly ¹⁴ -Cys ¹⁵ -dLeu ¹⁶ -PEG3	24
SP-361	C4:C12, C7:C15	dAsn ¹ -dAsp ² -Glu ³ -Cys ⁴ -Glu ⁵ -Leu ⁶ -Cys ⁷ -Val ⁸ -Asn ⁹ -Val ¹⁰ -Ala ¹¹ -Cys ¹² -Thr ¹³ -Gly ¹⁴ -Cys ¹⁵ -dLeu ¹⁶ -PEG3	25
SP-362	C4:C12, C7:C15	PEG3-dAsn ¹ -dAsp ² -Glu ³ -Cys ⁴ -Glu ⁵ -Leu ⁶ -Cys ⁷ -Val ⁸ -Asn ⁹ -Val ¹⁰ -Ala ¹¹ -Cys ¹² -Thr ¹³ -Gly ¹⁴ -Cys ¹⁵ -dLeu ¹⁶	26
SP-368	C4:C12, C7:C15	dAsn ¹ -Asp ² -Glu ³ -Cys ⁴ -Glu ⁵ -Leu ⁶ -Cys ⁷ -Val ⁸ -Asn ⁹ -Val ¹⁰ -Ala ¹¹ -Cys ¹² -Thr ¹³ -Gly ¹⁴ -Cys ¹⁵ -dIleu ¹⁶	27
SP-369	C4:C12, C7:C15	dAsn ¹ -Asp ² -Glu ³ -Cys ⁴ -Glu ⁵ -Leu ⁶ -Cys ⁷ -AIB ⁸ -Asn ⁹ -AIB ¹⁰ -Ala ¹¹ -Cys ¹² -Thr ¹³ -Gly ¹⁴ -Cys ¹⁵ -dIleu ¹⁶	28
SP-370	C4:C12, C7:C15	dAsn ¹ -Asp ² -Glu ³ -Cys ⁴ -Glu ⁵ -Leu ⁶ -Asp[actam] ⁷ -Val ⁸ -Asn ⁹ -Val ¹⁰ -Ala ¹¹ -Cys ¹² -Thr ¹³ -Gly ¹⁴ -Orn ¹⁵ -dLeu ¹⁶	29
SP-371	C4:C12,C7:C15	dAsn ¹ -Asp ² -Glu ³ -Cys ⁴ -Glu ⁵ -Tyr ⁶ -Cys ⁷ -Val ⁸ -Asn ⁹ -Val ¹⁰ -Ala ¹¹ -Cys ¹² -Thr ¹³ -Gly ¹⁴ -Cys ¹⁵ -dLeu ¹⁶	30
SP-372	C4:C12,C7:C15	dAsn ¹ -Asp ² -Glu ³ -Cys ⁴ -Glu ⁵ -Ser ⁶ -Cys ⁷ -Val ⁸ -Asn ⁹ -Val ¹⁰ -Ala ¹¹ -Cys ¹² -Thr ¹³ -Gly ¹⁴ -Cys ¹⁵ -dIleu ¹⁶	31
N1	C4:C12,C7:C15	PEG3-dAsn ¹ -Asp ² -Glu ³ -Cys ⁴ -Glu ⁵ -Tyr ⁶ -Cys ⁷ -Val ⁸ -Asn ⁹ -Val ¹⁰ -Ala ¹¹ -Cys ¹² -Thr ¹³ -Gly ¹⁴ -Cys ¹⁵ -dLeu ¹⁶ -PEG3	32
N2	C4:C12,C7:C15	PEG3-dAsn ¹ -Asp ² -Glu ³ -Cys ⁴ -Glu ⁵ -Tyr ⁶ -Cys ⁷ -Val ⁸ -Asn ⁹ -Val ¹⁰ -Ala ¹¹ -Cys ¹² -Thr ¹³ -Gly ¹⁴ -Cys ¹⁵ -dIleu ¹⁶	33
N3	C4:C12,C7:C15	dAsn ¹ -Asp ² -Glu ³ -Cys ⁴ -Glu ⁵ -Tyr ⁶ -Cys ⁷ -Val ⁸ -Asn ⁹ -Val ¹⁰ -Ala ¹¹ -Cys ¹² -Thr ¹³ -Gly ¹⁴ -Cys ¹⁵ -dLeu ¹⁶ -PEG3	34
N4	C4:C12,C7:C15	PEG3-dAsn ¹ -Asp ² -Glu ³ -Cys ⁴ -Glu ⁵ -Ser ⁶ -Cys ⁷ -Val ⁸ -Asn ⁹ -Val ¹⁰ -Ala ¹¹ -Cys ¹² -Thr ¹³ -Gly ¹⁴ -Cys ¹⁵ -dLeu ¹⁶ -PEG3	35
N5	C4:C12,C7:C15	PEG3-dAsn ¹ -Asp ² -Glu ³ -Cys ⁴ -Glu ⁵ -Ser ⁶ -Cys ⁷ -Val ⁸ -Asn ⁹ -Val ¹⁰ -Ala ¹¹ -Cys ¹² -Thr ¹³ -Gly ¹⁴ -Cys ¹⁵ -dLeu ¹⁶	36
N6	C4:C12,C7:C15	dAsn ¹ -Asp ² -Glu ³ -Cys ⁴ -Glu ⁵ -Ser ⁶ -Cys ⁷ -Val ⁸ -Asn ⁹ -Val ¹⁰ -Ala ¹¹ -Cys ¹² -Thr ¹³ -Gly ¹⁴ -Cys ¹⁵ -dIleu ¹⁶ -PEG3	37
N7	C4:C12,C7:C15	Asn ¹ -Asp ² -Glu ³ -Cys ⁴ -Glu ⁵ -Leu ⁶ -Cys ⁷ -Val ⁸ -Asn ⁹ -Val ¹⁰ -Ala ¹¹ -Cys ¹² -Thr ¹³ -Gly ¹⁴ -Cys ¹⁵ -Ser ¹⁶	38
N8	C4:C12,C7:C15	PEG3-Asn ¹ -Asp ² -Glu ³ -Cys ⁴ -Glu ⁵ -Leu ⁶ -Cys ⁷ -Val ⁸ -Asn ⁹ -Val ¹⁰ -Ala ¹¹ -Cys ¹² -Thr ¹³ -Gly ¹⁴ -Cys ¹⁵ -Ser ¹⁶ -PEG3	39
N9	C4:C12,C7:C15	PEG3-Asn ¹ -Asp ² -Glu ³ -Cys ⁴ -Glu ⁵ -Leu ⁶ -Cys ⁷ -Val ⁸ -Asn ⁹ -Val ¹⁰ -Ala ¹¹ -Cys ¹² -Thr ¹³ -Gly ¹⁴ -Cys ¹⁵ -Ser ¹⁶	40
N10	C4:C12,C7:C15	Asn ¹ -Asp ² -Glu ³ -Cys ⁴ -Glu ⁵ -Leu ⁶ -Cys ⁷ -Val ⁸ -Asn ⁹ -Val ¹⁰ -Ala ¹¹ -Cys ¹² -Thr ¹³ -Gly ¹⁴ -Cys ¹⁵ -Ser ¹⁶ -PEG3	41

N11	C4:C12,C7:C15	PEG3-Asn ¹ -Asp ² -Glu ³ -Cys ⁴ -Glu ⁵ -Leu ⁶ -Cys ⁷ -Val ⁸ -Asn ⁹ -Val ¹⁰ -Ala ¹¹ -Cys ¹² -Thr ¹³ -Gly ¹⁴ -Cys ¹⁵ -dSer ¹⁶ -PEG3	42
N12	C4:C12,C7:C15	PEG3-Asn ¹ -Asp ² -Glu ³ -Cys ⁴ -Glu ⁵ -Leu ⁶ -Cys ⁷ -Val ⁸ -Asn ⁹ -Val ¹⁰ -Ala ¹¹ -Cys ¹² -Thr ¹³ -Gly ¹⁴ -Cys ¹⁵ -dSer ¹⁶	43
N13	C4:C12,C7:C15	Asn ¹ -Asp ² -Glu ³ -Cys ⁴ -Glu ⁵ -Leu ⁶ -Cys ⁷ -Val ⁸ -Asn ⁹ -Val ¹⁰ -Ala ¹¹ -Cys ¹² -Thr ¹³ -Gly ¹⁴ -Cys ¹⁵ -dSer ¹⁶ -PEG3	44
Formula I	C4:C12,C7:C15	Asn ¹ -Asp ² -Glu ³ -Cys ⁴ -Xaa ⁵ -Xaa ⁶ -Cys ⁷ -Xaa ⁸ -Xaa ⁹ -Xaa ¹⁰ -Xaa ¹¹ -Cys ¹² -Xaa ¹³ -Xaa ¹⁴ -Cys ¹⁵ -Xaa ¹⁶	45
Formula II	C4:C12,C7:C15	Xaa _{n1} -Cys ⁴ -Xaa ⁵ -Xaa ⁶ -Cys ⁷ -Xaa ⁸ -Xaa ⁹ -Xaa ¹⁰ -Xaa ¹¹ -Cys ¹² -Xaa ¹³ -Xaa ¹⁴ -Cys ¹⁵ -Xaa ¹⁶	46
Formula	4:12,7:15	Xaa _{n1} -Maa ⁴ -Glu ⁵ -Xaa ⁶ -Maa ⁷ -Val ⁸ -Asn ⁹ -Val ¹⁰ -Ala ¹¹ -Maa ¹² -Thr ¹³ -Gly ¹⁴ -Maa ¹⁵ -Xaa _{n2}	47
Formula III			
Formula IV	4:12,7:15	Xaa _{n1} - Maa ⁴ -Xaa ⁵ -Xaa ⁶ -Maa ⁷ -Xaa ⁸ -Xaa ⁹ -Xaa ¹⁰ -Xaa ¹¹ -Maa ¹² -Xaa ¹³ -Xaa ¹⁴ -Maa ¹⁵ -Xaa _{n2}	48
Formula V	C4:C12,C7:C15	Asn ¹ -Asp ² -Asp ³ -Cys ⁴ -Xaa ⁵ -Xaa ⁶ -Cys ⁷ -Xaa ⁸ -Asn ⁹ -Xaa ¹⁰ -Xaa ¹¹ -Cys ¹² -Xaa ¹³ -Xaa ¹⁴ -Cys ¹⁵ -Xaa ¹⁶	49
Formula VI	C4:C12,C7:C15	dAsn ¹ -Glu ² -Glu ³ -Cys ⁴ -Xaa ⁵ -Xaa ⁶ -Cys ⁷ -X3 ⁸ -Asn ⁹ -Xaa ¹⁰ -Xaa ¹¹ -Cys ¹² -Xaa ¹³ -Xaa ¹⁴ -Cys ¹⁵ -d-Xaa ¹⁶	50
Formula VII	C4:C12,C7:C15	dAsn ¹ -dGlu ² -Asp ³ -Cys ⁴ -Xaa ⁵ -Xaa ⁶ -Cys ⁷ -Xaa ⁸ -Asn ⁹ -Xaa ¹⁰ -Xaa ¹¹ -Cys ¹² -Xaa ¹³ -Xaa ¹⁴ -Cys ¹⁵ -d-Xaa ¹⁶	51
Formula VIII	C4:C12,C7:C15	dAsn ¹ -dAsp ² -Glu ³ -Cys ⁴ -Xaa ⁵ -Xaa ⁶ -Cys ⁷ -Xaa ⁸ -Asn ⁹ -Xaa ¹⁰ -Xaa ¹¹ -Cys ¹² -Xaa ¹³ -Xaa ¹⁴ -Cys ¹⁵ -d-Xaa ¹⁶	52
Formula IX	C4:C12,C7:C15	dAsn ¹ -dAsp ² -dGlu ³ -Cys ⁴ -Xaa ⁵ -Xaa ⁶ -Cys ⁷ -Xaa ⁸ -Tyr ⁹ -Xaa ¹⁰ -Xaa ¹¹ -Cys ¹² -Xaa ¹³ -Xaa ¹⁴ -Cys ¹⁵ -d-Xaa ¹⁶	53
Formula X	C4:C12,C7:C15	dAsn ¹ -dGlu ² -dGlu ³ -Cys ⁴ -Xaa ⁵ -Xaa ⁶ -Cys ⁷ -Xaa ⁸ -Tyr ⁹ -Xaa ¹⁰ -Xaa ¹¹ -Cys ¹² -Xaa ¹³ -Xaa ¹⁴ -Cys ¹⁵ -d-Xaa ¹⁶	54

Table II. Linaclotide and Derivatives

Name	Position of Disulfide bonds	Structure	SEQ ID NO:
SP-339 (linaclotide)	C1:C6, C2:C10, C5:13	Cys ¹ -Cys ² -Glu ³ -Tyr ⁴ -Cys ⁵ -Cys ⁶ -Asn ⁷ -Pro ⁸ -Ala ⁹ -Cys ¹⁰ -Thr ¹¹ -Gly ¹² -Cys ¹³ -Tyr ¹⁴	55
SP-340	C1:C6, C2:C10, C5:13	Cys ¹ -Cys ² -Glu ³ -Tyr ⁴ -Cys ⁵ -Cys ⁶ -Asn ⁷ -Pro ⁸ -Ala ⁹ -Cys ¹⁰ -Thr ¹¹ -Gly ¹² -Cys ¹³	56
SP-349	C1:C6, C2:C10, C5:13	PEG3-Cys ¹ -Cys ² -Glu ³ -Tyr ⁴ -Cys ⁵ -Cys ⁶ -Asn ⁷ -Pro ⁸ -Ala ⁹ -Cys ¹⁰ -Thr ¹¹ -Gly ¹² -Cys ¹³ -Tyr ¹⁴ -PEG3	57
SP-353	C3:C8, C4:C12, C7:15	Asn ¹ -Phe ² -Cys ³ -Cys ⁴ -Glu ⁵ -Ser ⁶ -Cys ⁷ -Cys ⁸ -Asn ⁹ -Pro ¹⁰ -Ala ¹¹ -Cys ¹² -Thr ¹³ -Gly ¹⁴ -Cys ¹⁵ -Tyr ¹⁶	58
SP-354	C3:C8, C4:C12, C7:15	Asn ¹ -Phe ² -Cys ³ -Cys ⁴ -Glu ⁵ -Phe ⁶ -Cys ⁷ -Cys ⁸ -Asn ⁹ -Pro ¹⁰ -Ala ¹¹ -Cys ¹² -Thr ¹³ -Gly ¹⁴ -Cys ¹⁵ -Tyr ¹⁶	59
SP-355	C1:C6, C2:C10, C5:13	Cys ¹ -Cys ² -Glu ³ -Tyr ⁴ -Cys ⁵ -Cys ⁶ -Asn ⁷ -Pro ⁸ -Ala ⁹ -Cys ¹⁰ -Thr ¹¹ -Gly ¹² -Cys ¹³ -dTyr ¹⁴	60
SP-357	C1:C6, C2:C10, C5:13	PEG3-Cys ¹ -Cys ² -Glu ³ -Tyr ⁴ -Cys ⁵ -Cys ⁶ -Asn ⁷ -Pro ⁸ -Ala ⁹ -Cys ¹⁰ -Thr ¹¹ -Gly ¹² -Cys ¹³ -Tyr ¹⁴	61
SP-374	C3:C8, C4:C12, C7:15	Asn ¹ -Phe ² -Cys ³ -Cys ⁴ -Thr ⁵ -Cys ⁶ -Cys ⁷ -Cys ⁸ -Asn ⁹ -Pro ¹⁰ -Ala ¹¹ -Cys ¹² -Thr ¹³ -Gly ¹⁴ -Cys ¹⁵ -Tyr ¹⁶	62
SP-375	C3:C8, C4:C12, C7:15	Asn ¹ -Phe ² -Cys ³ -Cys ⁴ -Glu ⁵ -Ser ⁶ -Cys ⁷ -Cys ⁸ -Asn ⁹ -Pro ¹⁰ -Ala ¹¹ -Cys ¹² -Thr ¹³ -Gly ¹⁴ -Cys ¹⁵ -dTyr ¹⁶	63
SP-376	C3:C8, C4:C12, C7:15	dAsn ¹ -Phe ² -Cys ³ -Cys ⁴ -Glu ⁵ -Ser ⁶ -Cys ⁷ -Cys ⁸ -Asn ⁹ -Pro ¹⁰ -Ala ¹¹ -Cys ¹² -Thr ¹³ -Gly ¹⁴ -Cys ¹⁵ -Tyr ¹⁶	64
SP-377	C3:C8, C4:C12, C7:15	dAsn ¹ -Phe ² -Cys ³ -Cys ⁴ -Glu ⁵ -Ser ⁶ -Cys ⁷ -Cys ⁸ -Asn ⁹ -Pro ¹⁰ -Ala ¹¹ -Cys ¹² -Thr ¹³ -Gly ¹⁴ -Cys ¹⁵ -dTyr ¹⁶	65
SP-378	C3:C8, C4:C12, C7:15	Asn ¹ -Phe ² -Cys ³ -Cys ⁴ -Glu ⁵ -Thr ⁶ -Cys ⁷ -Cys ⁸ -Asn ⁹ -Pro ¹⁰ -Ala ¹¹ -Cys ¹² -Thr ¹³ -Gly ¹⁴ -Cys ¹⁵ -dTyr ¹⁶	66
SP-379	C3:C8, C4:C12, C7:15	dAsn ¹ -Phe ² -Cys ³ -Cys ⁴ -Glu ⁵ -Thr ⁶ -Cys ⁷ -Cys ⁸ -Asn ⁹ -Pro ¹⁰ -Ala ¹¹ -Cys ¹² -Thr ¹³ -Gly ¹⁴ -Cys ¹⁵ -Tyr ¹⁶	67
SP-380	C3:C8, C4:C12, C7:15	dAsn ¹ -Phe ² -Cys ³ -Cys ⁴ -Glu ⁵ -Thr ⁶ -Cys ⁷ -Cys ⁸ -Asn ⁹ -Pro ¹⁰ -Ala ¹¹ -Cys ¹² -Thr ¹³ -Gly ¹⁴ -Cys ¹⁵ -dTyr ¹⁶	68
SP-381	C3:C8, C4:C12, C7:15	Asn ¹ -Phe ² -Cys ³ -Cys ⁴ -Glu ⁵ -Phe ⁶ -Cys ⁷ -Cys ⁸ -Asn ⁹ -Pro ¹⁰ -Ala ¹¹ -Cys ¹² -Thr ¹³ -Gly ¹⁴ -Cys ¹⁵ -dTyr ¹⁶	69

SP-382	C3:C8, C4:C12, C7:15	dAsn ¹ -Phe ² -Cys ³ -Cys ⁴ -Glu ⁵ -Phe ⁶ -Cys ⁷ -Cys ⁸ -Asn ⁹ -Pro ¹⁰ -Ala ¹¹ -Cys ¹² -Thr ¹³ -Gly ¹⁴ -Cys ¹⁵ -Tyr ¹⁶	70
SP-383	C3:C8, C4:C12, C7:15	dAsn ¹ -Phe ² -Cys ³ -Cys ⁴ -Glu ⁵ -Phe ⁶ -Cys ⁷ -Cys ⁸ -Asn ⁹ -Pro ¹⁰ -Ala ¹¹ -Cys ¹² -Thr ¹³ -Gly ¹⁴ -Cys ¹⁵ -dTyr ¹⁶	71
SP384	C1:C6, C2:C10, C5:13	Cys ¹ -Cys ² -Glu ³ -Tyr ⁴ -Cys ⁵ -Cys ⁶ -Asn ⁷ -Pro ⁸ -Ala ⁹ -Cys ¹⁰ -Thr ¹¹ -Gly ¹² -Cys ¹³ -Tyr ¹⁴ -PEG3	72
N14	C1:C6, C2:C10, C5:13	PEG3-Cys ¹ -Cys ² -Glu ³ -Tyr ⁴ -Cys ⁵ -Cys ⁶ -Asn ⁷ -Pro ⁸ -Ala ⁹ -Cys ¹⁰ -Thr ¹¹ -Gly ¹² -Cys ¹³ -PEG3	73
N15	C1:C6, C2:C10, C5:13	PEG3-Cys ¹ -Cys ² -Glu ³ -Tyr ⁴ -Cys ⁵ -Cys ⁶ -Asn ⁷ -Pro ⁸ -Ala ⁹ -Cys ¹⁰ -Thr ¹¹ -Gly ¹² -Cys ¹³	74
N16	C1:C6, C2:C10, C5:13	Cys ¹ -Cys ² -Glu ³ -Tyr ⁴ -Cys ⁵ -Cys ⁶ -Asn ⁷ -Pro ⁸ -Ala ⁹ -Cys ¹⁰ -Thr ¹¹ -Gly ¹² -Cys ¹³ -PEG3	75
N17	C3:C8, C4:C12, C7:15	PEG3-Asn ¹ -Phe ² -Cys ³ -Cys ⁴ -Glu ⁵ -Ser ⁶ -Cys ⁷ -Cys ⁸ -Asn ⁹ -Pro ¹⁰ -Ala ¹¹ -Cys ¹² -Thr ¹³ -Gly ¹⁴ -Cys ¹⁵ -Tyr ¹⁶ -PEG3	76
N18	C3:C8, C4:C12, C7:15	PEG3-Asn ¹ -Phe ² -Cys ³ -Cys ⁴ -Glu ⁵ -Ser ⁶ -Cys ⁷ -Cys ⁸ -Asn ⁹ -Pro ¹⁰ -Ala ¹¹ -Cys ¹² -Thr ¹³ -Gly ¹⁴ -Cys ¹⁵ -Tyr ¹⁶	77
N19	C3:C8, C4:C12, C7:15	Asn ¹ -Phe ² -Cys ³ -Cys ⁴ -Glu ⁵ -Ser ⁶ -Cys ⁷ -Cys ⁸ -Asn ⁹ -Pro ¹⁰ -Ala ¹¹ -Cys ¹² -Thr ¹³ -Gly ¹⁴ -Cys ¹⁵ -Tyr ¹⁶ -PEG3	78
N20	C3:C8, C4:C12, C7:15	PEG3-Asn ¹ -Phe ² -Cys ³ -Cys ⁴ -Glu ⁵ -Phe ⁶ -Cys ⁷ -Cys ⁸ -Asn ⁹ -Pro ¹⁰ -Ala ¹¹ -Cys ¹² -Thr ¹³ -Gly ¹⁴ -Cys ¹⁵ -Tyr ¹⁶ -PEG3	79
N21	C3:C8, C4:C12, C7:15	PEG3-Asn ¹ -Phe ² -Cys ³ -Cys ⁴ -Glu ⁵ -Phe ⁶ -Cys ⁷ -Cys ⁸ -Asn ⁹ -Pro ¹⁰ -Ala ¹¹ -Cys ¹² -Thr ¹³ -Gly ¹⁴ -Cys ¹⁵ -Tyr ¹⁶	80
N22	C3:C8, C4:C12, C7:15	Asn ¹ -Phe ² -Cys ³ -Cys ⁴ -Glu ⁵ -Phe ⁶ -Cys ⁷ -Cys ⁸ -Asn ⁹ -Pro ¹⁰ -Ala ¹¹ -Cys ¹² -Thr ¹³ -Gly ¹⁴ -Cys ¹⁵ -Tyr ¹⁶ -PEG3	81
N23	C3:C8, C4:C12, C7:15	PEG3-Asn ¹ -Phe ² -Cys ³ -Cys ⁴ -Glu ⁵ -Tyr ⁶ -Cys ⁷ -Cys ⁸ -Asn ⁹ -Pro ¹⁰ -Ala ¹¹ -Cys ¹² -Thr ¹³ -Gly ¹⁴ -Cys ¹⁵ -Tyr ¹⁶ -PEG3	82

N24	C3:C8, C4:C12, C7:15	PEG3-Asn ¹ -Phe ² -Cys ³ -Cys ⁴ -Glu ⁵ -Tyr ⁶ -Cys ⁷ -Cys ⁸ -Asn ⁹ -Pro ¹⁰ -Ala ¹¹ -Cys ¹² -Thr ¹³ -Gly ¹⁴ -Cys ¹⁵ -Tyr ¹⁶	83
N25	C3:C8, C4:C12, C7:15	Asn ¹ -Phe ² -Cys ³ -Cys ⁴ -Glu ⁵ -Tyr ⁶ -Cys ⁷ -Cys ⁸ -Asn ⁹ -Pro ¹⁰ -Ala ¹¹ -Cys ¹² -Thr ¹³ -Gly ¹⁴ -Cys ¹⁵ -Tyr ¹⁶ -PEG3	84
N26	C1:C6, C2:C10, C5:13	Cys ¹ -Cys ² -Glu ³ -Ser ⁴ -Cys ⁵ -Cys ⁶ -Asn ⁷ -Pro ⁸ -Ala ⁹ -Cys ¹⁰ -Thr ¹¹ -Gly ¹² -Cys ¹³ -Tyr ¹⁴	85
N27	C1:C6, C2:C10, C5:13	Cys ¹ -Cys ² -Glu ³ -Phe ⁴ -Cys ⁵ -Cys ⁶ -Asn ⁷ -Pro ⁸ -Ala ⁹ -Cys ¹⁰ -Thr ¹¹ -Gly ¹² -Cys ¹³ -Tyr ¹⁴	86
N28	C1:C6, C2:C10, C5:13	Cys ¹ -Cys ² -Glu ³ -Ser ⁴ -Cys ⁵ -Cys ⁶ -Asn ⁷ -Pro ⁸ -Ala ⁹ -Cys ¹⁰ -Thr ¹¹ -Gly ¹² -Cys ¹³ -	87
N29	C1:C6, C2:C10, C5:13	Cys ¹ -Cys ² -Glu ³ -Phe ⁴ -Cys ⁵ -Cys ⁶ -Asn ⁷ -Pro ⁸ -Ala ⁹ -Cys ¹⁰ -Thr ¹¹ -Gly ¹² -Cys ¹³	88
N30	1:6, 2:10, 5:13	Pen ¹ -Pen ² -Glu ³ -Tyr ⁴ -Pen ⁵ -Pen ⁶ -Asn ⁷ -Pro ⁸ -Ala ⁹ -Pen ¹⁰ -Thr ¹¹ -Gly ¹² -Pen ¹³ -Tyr ¹⁴	89
N31	1:6, 2:10, 5:13	Pen ¹ -Pen ² -Glu ³ -Tyr ⁴ -Pen ⁵ -Pen ⁶ -Asn ⁷ -Pro ⁸ -Ala ⁹ -Pen ¹⁰ -Thr ¹¹ -Gly ¹² -Pen ¹³	90
Formula X	C9:C14, C10:C18, C13:21	Xaa ¹ -Xaa ² -Xaa ³ -Xaa ⁴ -Xaa ⁵ -Xaa ⁶ -Asn ⁷ -Tyr ⁸ -Cys ⁹ -Cys ¹⁰ -Xaa ¹¹ -Tyr ¹² -Cys ¹³ -Cys ¹⁴ -Xaa ¹⁵ -Xaa ¹⁶ -Xaa ¹⁷ -Cys ¹⁸ -Xaa ¹⁹ -Xaa ²⁰ -Cys ²¹ -Xaa ²²	91
Formula XI	C9:C14, C10:C18, C13:21	Xaa ¹ -Xaa ² -Xaa ³ -Xaa ⁴ -Xaa ⁵ -Xaa ⁶ -Asn ⁷ -Phe ⁸ -Cys ⁹ -Cys ¹⁰ -Xaa ¹¹ -Phe ¹² -Cys ¹³ -Cys ¹⁴ -Xaa ¹⁵ -Xaa ¹⁶ -Xaa ¹⁷ -Cys ¹⁸ -Xaa ¹⁹ -Xaa ²⁰ -Cys ²¹ -Xaa ²²	92
Formula XII	C3:C8, C4:C12, C7:15	Asn ¹ -Phe ² -Cys ³ -Cys ⁴ -Xaa ⁵ -Phe ⁶ -Cys ⁷ -Cys ⁸ -Xaa ⁹ -Xaa ¹⁰ -Xaa ¹¹ -Cys ¹² -Xaa ¹³ -Xaa ¹⁴ -Cys ¹⁵ -Xaa ¹⁶	93
Formula XIII	3:8, 4:12, C:15	Asn ¹ -Phe ² -Pen ³ -Cys ⁴ -Xaa ⁵ -Phe ⁶ -Cys ⁷ -Pen ⁸ -Xaa ⁹ -Xaa ¹⁰ -Xaa ¹¹ -Cys ¹² -Xaa ¹³ -Xaa ¹⁴ -Cys ¹⁵ -Xaa ¹⁶	94
Formula XIV	3:8, 4:12, 7:15	Asn ¹ -Phe ² -Maa ³ -Maa ⁴ -Xaa ⁵ -Xaa ⁶ -Maa ⁷ -Maa ⁸ -Xaa ⁹ -Xaa ¹⁰ -Xaa ¹¹ -Maa ¹² -Xaa ¹³ -Xaa ¹⁴ -Maa ¹⁵ -Xaa ¹⁶	95
Formula XV	1:6, 2:10, 5:13	Maa ¹ -Maa ² -Glu ³ -Xaa ⁴ -Maa ⁵ -Maa ⁶ -Asn ⁷ -Pro ⁸ -Ala ⁹ -Maa ¹⁰ -Thr ¹¹ -Gly ¹² -Maa ¹³ -Tyr ¹⁴	96
Formula XVI	1:6, 2:10, 5:13	Maa ¹ -Maa ² -Glu ³ -Xaa ⁴ -Maa ⁵ -Maa ⁶ -Asn ⁷ -Pro ⁸ -Ala ⁹ -Maa ¹⁰ -Thr ¹¹ -Gly ¹² -Maa ¹³ -	97
Formula XVII	1:6, 2:10, 5:13	Xaa _{a3} -Maa ¹ -Maa ² -Xaa ³ -Xaa ⁴ -Maa ⁵ -Maa ⁶ -Xaa ⁷ -Xaa ⁸ -Xaa ⁹ -Maa ¹⁰ -Xaa ¹¹ -Xaa ¹² -Maa ¹³ -Xaa _{a2}	98

Table III. GCRA Peptides

Name	Position of Disulfide bonds	Structure	SEQ ID NO:
SP-363	C4:C12;C7:C15	dAsn ¹ -Asp ² -Glu ³ -Cys ⁴ -Glu ⁵ -Leu ⁶ -Cys ⁷ -Val ⁸ -Asn ⁹ -Val ¹⁰ -Ala ¹¹ -Cys ¹² -Thr ¹³ -Gly ¹⁴ -Cys ¹⁵ -dLeu-AMIDE ¹⁶	99
SP-364	C4:C12; C7:C15	dAsn ¹ -Asp ² -Glu ³ -Cys ⁴ -Glu ⁵ -Leu ⁶ -Cys ⁷ -Val ⁸ -Asn ⁹ -Val ¹⁰ -Ala ¹¹ -Cys ¹² -Thr ¹³ -Gly ¹⁴ -Cys ¹⁵ -dSer ¹⁶	100
SP-365	C4:C12; C7:C15	dAsn ¹ -Asp ² -Glu ³ -Cys ⁴ -Glu ⁵ -Leu ⁶ -Cys ⁷ -Val ⁸ -Asn ⁹ -Val ¹⁰ -Ala ¹¹ -Cys ¹² -Thr ¹³ -Gly ¹⁴ -Cys ¹⁵ -dSer ¹⁶ -AMIDE ¹⁶	101
SP-366	C4:C12; C7:C15	dAsn ¹ -Asp ² -Glu ³ -Cys ⁴ -Glu ⁵ -Leu ⁶ -Cys ⁷ -Val ⁸ -Asn ⁹ -Val ¹⁰ -Ala ¹¹ -Cys ¹² -Thr ¹³ -Gly ¹⁴ -Cys ¹⁵ -dIYr ¹⁶	102
SP-367	C4:C12; C7:C15	dAsn ¹ -Asp ² -Glu ³ -Cys ⁴ -Glu ⁵ -Leu ⁶ -Cys ⁷ -Val ⁸ -Asn ⁹ -Val ¹⁰ -Ala ¹¹ -Cys ¹² -Thr ¹³ -Gly ¹⁴ -Cys ¹⁵ -dIYr ¹⁶ -AMIDE ¹⁶	103
SP-373	C4:C12; C7:C15	Pyglu ¹ -Asp ² -Glu ³ -Cys ⁴ -Glu ⁵ -Leu ⁶ -Cys ⁷ -Val ⁸ -Asn ⁹ -Val ¹⁰ -Ala ¹¹ -Cys ¹² -Thr ¹³ -Gly ¹⁴ -Cys ¹⁵ -dLeu-AMIDE ¹⁶	104
SP-304 di PEG	C4:C12; C7:C15	PEG3-Asn ¹ -Asp ² -Glu ³ -Cys ⁴ -Glu ⁵ -Leu ⁶ -Cys ⁷ -Val ⁸ -Asn ⁹ -Val ¹⁰ -Ala ¹¹ -Cys ¹² -Thr ¹³ -Gly ¹⁴ -Cys ¹⁵ -Leu ¹⁶ -PEG3	105
SP-304 N-PEG	C4:C12; C7:C15	PEG3-Asn ¹ -Asp ² -Glu ³ -Cys ⁴ -Glu ⁵ -Leu ⁶ -Cys ⁷ -Val ⁸ -Asn ⁹ -Val ¹⁰ -Ala ¹¹ -Cys ¹² -Thr ¹³ -Gly ¹⁴ -Cys ¹⁵ -Leu ¹⁶	106
SP-304 C-PEG	C4:C12; C7:C15	Asn ¹ -Asp ² -Glu ³ -Cys ⁴ -Glu ⁵ -Leu ⁶ -Cys ⁷ -Val ⁸ -Asn ⁹ -Val ¹⁰ -Ala ¹¹ -Cys ¹² -Thr ¹³ -Gly ¹⁴ -Cys ¹⁵ -Leu ¹⁶ -PEG3	107

Table IV. SP-304 Analogs, Uroguanylin, and Uroguanylin Analogs

Name	Position of Disulfide bonds	Structure	SEQ ID NO
Formula XVIII	C4:C12, C7:C15	Xaa ¹ -Xaa ² -Xaa ³ -Maa ⁴ -Xaa ⁵ -Xaa ⁶ -Maa ⁷ -Xaa ⁸ -Xaa ⁹ -Xaa ¹⁰ -Xaa ¹¹ -Maa ¹² -Xaa ¹³ -Xaa ¹⁴ -Maa ¹⁵ -Xaa ¹⁶	108
Uroguanylin	C4:C12, C7:C15	Asn ¹ -Asp ² -Asp ³ -Cys ⁴ -Glu ⁵ -Leu ⁶ -Cys ⁷ -Val ⁸ -Asn ⁹ -Val ¹⁰ -Ala ¹¹ -Cys ¹² -Thr ¹³ -Gly ¹⁴ -Cys ¹⁵ -Leu ¹⁶	109
N32	C4:C12, C7:C15	Glu ¹ -Asp ² -Asp ³ -Cys ⁴ -Glu ⁵ -Ileu ⁶ -Cys ⁷ -Val ⁸ -Asn ⁹ -Val ¹⁰ -Ala ¹¹ -Cys ¹² -Thr ¹³ -Gly ¹⁴ -Cys ¹⁵ -Ileu ¹⁶	110
N33	C4:C12, C7:C15	Glu ¹ -Asp ² -Glu ³ -Cys ⁴ -Glu ⁵ -Ileu ⁶ -Cys ⁷ -Val ⁸ -Asn ⁹ -Val ¹⁰ -Ala ¹¹ -Cys ¹² -Thr ¹³ -Gly ¹⁴ -Cys ¹⁵ -Ileu ¹⁶	111
N34	C4:C12, C7:C15	Glu ¹ -Glu ² -Asp ³ -Cys ⁴ -Glu ⁵ -Ileu ⁶ -Cys ⁷ -Val ⁸ -Asn ⁹ -Val ¹⁰ -Ala ¹¹ -Cys ¹² -Thr ¹³ -Gly ¹⁴ -Cys ¹⁵ -Ileu ¹⁶	112
N35	C4:C12, C7:C15	Glu ¹ -Glu ² -Glu ³ -Cys ⁴ -Glu ⁵ -Ileu ⁶ -Cys ⁷ -Val ⁸ -Asn ⁹ -Val ¹⁰ -Ala ¹¹ -Cys ¹² -Thr ¹³ -Gly ¹⁴ -Cys ¹⁵ -Ileu ¹⁶	113
N36	C4:C12, C7:C15	Asp ¹ -Asp ² -Asp ³ -Cys ⁴ -Glu ⁵ -Ileu ⁶ -Cys ⁷ -Val ⁸ -Asn ⁹ -Val ¹⁰ -Ala ¹¹ -Cys ¹² -Thr ¹³ -Gly ¹⁴ -Cys ¹⁵ -Ileu ¹⁶	114
N37	C4:C12, C7:C15	Asp ¹ -Asp ² -Glu ³ -Cys ⁴ -Glu ⁵ -Ileu ⁶ -Cys ⁷ -Val ⁸ -Asn ⁹ -Val ¹⁰ -Ala ¹¹ -Cys ¹² -Thr ¹³ -Gly ¹⁴ -Cys ¹⁵ -Ileu ¹⁶	115
N38	C4:C12,	Asp ¹ -Glu ² -Asp ³ -Cys ⁴ -Glu ⁵ -Ileu ⁶ -Cys ⁷ -Val ⁸ -Asn ⁹ -Val ¹⁰ -Ala ¹¹ -Cys ¹² -Thr ¹³ -Gly ¹⁴ -Cys ¹⁵ -Ileu ¹⁶	116

	C7:C15		
N39	C4:C12, C7:C15	Asp ¹ -Glu ² -Glu ³ -Cys ⁴ -Glu ⁵ -Leu ⁶ -Cys ⁷ -Val ⁸ -Asn ⁹ -Val ¹⁰ -Ala ¹¹ -Cys ¹² -Thr ¹³ -Gly ¹⁴ -Cys ¹⁵ -Leu ¹⁶	117
N40	C4:C12, C7:C15	Gln ¹ -Asp ² -Asp ³ -Cys ⁴ -Glu ⁵ -Leu ⁶ -Cys ⁷ -Val ⁸ -Asn ⁹ -Val ¹⁰ -Ala ¹¹ -Cys ¹² -Thr ¹³ -Gly ¹⁴ -Cys ¹⁵ -Leu ¹⁶	118
N41	C4:C12, C7:C15	Gln ¹ -Asp ² -Glu ³ -Cys ⁴ -Glu ⁵ -Leu ⁶ -Cys ⁷ -Val ⁸ -Asn ⁹ -Val ¹⁰ -Ala ¹¹ -Cys ¹² -Thr ¹³ -Gly ¹⁴ -Cys ¹⁵ -Leu ¹⁶	119
N42	C4:C12, C7:C15	Gln ¹ -Glu ² -Asp ³ -Cys ⁴ -Glu ⁵ -Leu ⁶ -Cys ⁷ -Val ⁸ -Asn ⁹ -Val ¹⁰ -Ala ¹¹ -Cys ¹² -Thr ¹³ -Gly ¹⁴ -Cys ¹⁵ -Leu ¹⁶	120
N43	C4:C12, C7:C15	Gln ¹ -Glu ² -Glu ³ -Cys ⁴ -Glu ⁵ -Leu ⁶ -Cys ⁷ -Val ⁸ -Asn ⁹ -Val ¹⁰ -Ala ¹¹ -Cys ¹² -Thr ¹³ -Gly ¹⁴ -Cys ¹⁵ -Leu ¹⁶	121
N44	C4:C12, C7:C15	Lys ¹ -Asp ² -Asp ³ -Cys ⁴ -Glu ⁵ -Leu ⁶ -Cys ⁷ -Val ⁸ -Asn ⁹ -Val ¹⁰ -Ala ¹¹ -Cys ¹² -Thr ¹³ -Gly ¹⁴ -Cys ¹⁵ -Leu ¹⁶	122
N45	C4:C12, C7:C15	Lys ¹ -Asp ² -Glu ³ -Cys ⁴ -Glu ⁵ -Leu ⁶ -Cys ⁷ -Val ⁸ -Asn ⁹ -Val ¹⁰ -Ala ¹¹ -Cys ¹² -Thr ¹³ -Gly ¹⁴ -Cys ¹⁵ -Leu ¹⁶	123
N46	C4:C12, C7:C15	Lys ¹ -Glu ² -Asp ³ -Cys ⁴ -Glu ⁵ -Leu ⁶ -Cys ⁷ -Val ⁸ -Asn ⁹ -Val ¹⁰ -Ala ¹¹ -Cys ¹² -Thr ¹³ -Gly ¹⁴ -Cys ¹⁵ -Leu ¹⁶	124
N47	C4:C12, C7:C15	Lys ¹ -Glu ² -Glu ³ -Cys ⁴ -Glu ⁵ -Leu ⁶ -Cys ⁷ -Val ⁸ -Asn ⁹ -Val ¹⁰ -Ala ¹¹ -Cys ¹² -Thr ¹³ -Gly ¹⁴ -Cys ¹⁵ -Leu ¹⁶	125
N48	C4:C12, C7:C15	Gln ¹ -Asp ² -Asp ³ -Cys ⁴ -Glu ⁵ -Leu ⁶ -Cys ⁷ -Val ⁸ -Asn ⁹ -Val ¹⁰ -Ala ¹¹ -Cys ¹² -Thr ¹³ -Gly ¹⁴ -Cys ¹⁵ -Ser ¹⁶	126
N49	C4:C12, C7:C15	Glu ¹ -Asp ² -Glu ³ -Cys ⁴ -Glu ⁵ -Leu ⁶ -Cys ⁷ -Val ⁸ -Asn ⁹ -Val ¹⁰ -Ala ¹¹ -Cys ¹² -Thr ¹³ -Gly ¹⁴ -Cys ¹⁵ -Ser ¹⁶	127

N50	C4:C12, C7:C15	Glu ¹ -Glu ² -Asp ³ -Cys ⁴ -Glu ⁵ -Ileu ⁶ -Cys ⁷ -Val ⁸ -Asn ⁹ -Val ¹⁰ -Ala ¹¹ -Cys ¹² -Thr ¹³ -Gly ¹⁴ -Cys ¹⁵ -Ser ¹⁶	128
N51	C4:C12, C7:C15	Glu ¹ -Glu ² -Glu ³ -Cys ⁴ -Glu ⁵ -Ileu ⁶ -Cys ⁷ -Val ⁸ -Asn ⁹ -Val ¹⁰ -Ala ¹¹ -Cys ¹² -Thr ¹³ -Gly ¹⁴ -Cys ¹⁵ -Ser ¹⁶	129
N52	C4:C12, C7:C15	Asp ¹ -Asp ² -Asp ³ -Cys ⁴ -Glu ⁵ -Ileu ⁶ -Cys ⁷ -Val ⁸ -Asn ⁹ -Val ¹⁰ -Ala ¹¹ -Cys ¹² -Thr ¹³ -Gly ¹⁴ -Cys ¹⁵ -Ser ¹⁶	130
N53	C4:C12, C7:C15	Asp ¹ -Asp ² -Glu ³ -Cys ⁴ -Glu ⁵ -Ileu ⁶ -Cys ⁷ -Val ⁸ -Asn ⁹ -Val ¹⁰ -Ala ¹¹ -Cys ¹² -Thr ¹³ -Gly ¹⁴ -Cys ¹⁵ -Ser ¹⁶	131
N54	C4:C12, C7:C15	Asp ¹ -Glu ² -Asp ³ -Cys ⁴ -Glu ⁵ -Ileu ⁶ -Cys ⁷ -Val ⁸ -Asn ⁹ -Val ¹⁰ -Ala ¹¹ -Cys ¹² -Thr ¹³ -Gly ¹⁴ -Cys ¹⁵ -Ser ¹⁶	132
N55	C4:C12, C7:C15	Asp ¹ -Glu ² -Glu ³ -Cys ⁴ -Glu ⁵ -Ileu ⁶ -Cys ⁷ -Val ⁸ -Asn ⁹ -Val ¹⁰ -Ala ¹¹ -Cys ¹² -Thr ¹³ -Gly ¹⁴ -Cys ¹⁵ -Ser ¹⁶	133
N56	C4:C12, C7:C15	Gln ¹ -Asp ² -Asp ³ -Cys ⁴ -Glu ⁵ -Ileu ⁶ -Cys ⁷ -Val ⁸ -Asn ⁹ -Val ¹⁰ -Ala ¹¹ -Cys ¹² -Thr ¹³ -Gly ¹⁴ -Cys ¹⁵ -Ser ¹⁶	134
N57	C4:C12, C7:C15	Gln ¹ -Asp ² -Glu ³ -Cys ⁴ -Glu ⁵ -Ileu ⁶ -Cys ⁷ -Val ⁸ -Asn ⁹ -Val ¹⁰ -Ala ¹¹ -Cys ¹² -Thr ¹³ -Gly ¹⁴ -Cys ¹⁵ -Ser ¹⁶	135
N58	C4:C12, C7:C15	Gln ¹ -Glu ² -Asp ³ -Cys ⁴ -Glu ⁵ -Ileu ⁶ -Cys ⁷ -Val ⁸ -Asn ⁹ -Val ¹⁰ -Ala ¹¹ -Cys ¹² -Thr ¹³ -Gly ¹⁴ -Cys ¹⁵ -Ser ¹⁶	136
N59	C4:C12, C7:C15	Gln ¹ -Glu ² -Glu ³ -Cys ⁴ -Glu ⁵ -Ileu ⁶ -Cys ⁷ -Val ⁸ -Asn ⁹ -Val ¹⁰ -Ala ¹¹ -Cys ¹² -Thr ¹³ -Gly ¹⁴ -Cys ¹⁵ -Ser ¹⁶	137
N60	C4:C12, C7:C15	Lys ¹ -Asp ² -Asp ³ -Cys ⁴ -Glu ⁵ -Ileu ⁶ -Cys ⁷ -Val ⁸ -Asn ⁹ -Val ¹⁰ -Ala ¹¹ -Cys ¹² -Thr ¹³ -Gly ¹⁴ -Cys ¹⁵ -Ser ¹⁶	138
N61	C4:C12,	Lys ¹ -Asp ² -Glu ³ -Cys ⁴ -Glu ⁵ -Ileu ⁶ -Cys ⁷ -Val ⁸ -Asn ⁹ -Val ¹⁰ -Ala ¹¹ -Cys ¹² -Thr ¹³ -Gly ¹⁴ -Cys ¹⁵ -Ser ¹⁶	139

	C7:C15		
N62	C4:C12, C7:C15	Lys ¹ -Glu ² -Asp ³ -Cys ⁴ -Glu ⁵ -Leu ⁶ -Cys ⁷ -Val ⁸ -Asn ⁹ -Val ¹⁰ -Ala ¹¹ -Cys ¹² -Thr ¹³ -Gly ¹⁴ -Cys ¹⁵ -Ser ¹⁶	140
N63	C4:C12, C7:C15	Lys ¹ -Glu ² -Glu ³ -Cys ⁴ -Glu ⁵ -Leu ⁶ -Cys ⁷ -Val ⁸ -Asn ⁹ -Val ¹⁰ -Ala ¹¹ -Cys ¹² -Thr ¹³ -Gly ¹⁴ -Cys ¹⁵ -Ser ¹⁶	141
N65	C4:C12, C7:C15	Glu ¹ -Asp ² -Asp ³ -Cys ⁴ -Glu ⁵ -Leu ⁶ -Cys ⁷ -Ile ⁸ -Asn ⁹ -Met ¹⁰ -Ala ¹¹ -Cys ¹² -Thr ¹³ -Gly ¹⁴ -Cys ¹⁵ -Leu ¹⁶	142
N66	C4:C12, C7:C15	Glu ¹ -Asp ² -Glu ³ -Cys ⁴ -Glu ⁵ -Leu ⁶ -Cys ⁷ -Ile ⁸ -Asn ⁹ -Met ¹⁰ -Ala ¹¹ -Cys ¹² -Thr ¹³ -Gly ¹⁴ -Cys ¹⁵ -Leu ¹⁶	143
N67	C4:C12, C7:C15	Glu ¹ -Glu ² -Asp ³ -Cys ⁴ -Glu ⁵ -Leu ⁶ -Cys ⁷ -Ile ⁸ -Asn ⁹ -Met ¹⁰ -Ala ¹¹ -Cys ¹² -Thr ¹³ -Gly ¹⁴ -Cys ¹⁵ -Leu ¹⁶	144
N68	C4:C12, C7:C15	Glu ¹ -Glu ² -Glu ³ -Cys ⁴ -Glu ⁵ -Leu ⁶ -Cys ⁷ -Ile ⁸ -Asn ⁹ -Met ¹⁰ -Ala ¹¹ -Cys ¹² -Thr ¹³ -Gly ¹⁴ -Cys ¹⁵ -Leu ¹⁶	145
N69	C4:C12, C7:C15	Asp ¹ -Asp ² -Asp ³ -Cys ⁴ -Glu ⁵ -Leu ⁶ -Cys ⁷ -Ile ⁸ -Asn ⁹ -Met ¹⁰ -Ala ¹¹ -Cys ¹² -Thr ¹³ -Gly ¹⁴ -Cys ¹⁵ -Leu ¹⁶	146
N70	C4:C12, C7:C15	Asp ¹ -Asp ² -Glu ³ -Cys ⁴ -Glu ⁵ -Leu ⁶ -Cys ⁷ -Ile ⁸ -Asn ⁹ -Met ¹⁰ -Ala ¹¹ -Cys ¹² -Thr ¹³ -Gly ¹⁴ -Cys ¹⁵ -Leu ¹⁶	147
N71	C4:C12, C7:C15	Asp ¹ -Glu ² -Asp ³ -Cys ⁴ -Glu ⁵ -Leu ⁶ -Cys ⁷ -Ile ⁸ -Asn ⁹ -Met ¹⁰ -Ala ¹¹ -Cys ¹² -Thr ¹³ -Gly ¹⁴ -Cys ¹⁵ -Leu ¹⁶	148
N72	C4:C12, C7:C15	Asp ¹ -Glu ² -Glu ³ -Cys ⁴ -Glu ⁵ -Leu ⁶ -Cys ⁷ -Ile ⁸ -Asn ⁹ -Met ¹⁰ -Ala ¹¹ -Cys ¹² -Thr ¹³ -Gly ¹⁴ -Cys ¹⁵ -Leu ¹⁶	149
N73	C4:C12, C7:C15	Gln ¹ -Asp ² -Asp ³ -Cys ⁴ -Glu ⁵ -Leu ⁶ -Cys ⁷ -Ile ⁸ -Asn ⁹ -Met ¹⁰ -Ala ¹¹ -Cys ¹² -Thr ¹³ -Gly ¹⁴ -Cys ¹⁵ -Leu ¹⁶	150

N74	C4:C12, C7:C15	Gln ¹ -Asp ² -Glu ³ -Cys ⁴ -Glu ⁵ -Ileu ⁶ -Cys ⁷ -Ile ⁸ -Asn ⁹ -Met ¹⁰ -Ala ¹¹ -Cys ¹² -Thr ¹³ -Gly ¹⁴ -Cys ¹⁵ -Ileu ¹⁶	151
N75	C4:C12, C7:C15	Gln ¹ -Glu ² -Asp ³ -Cys ⁴ -Glu ⁵ -Ileu ⁶ -Cys ⁷ -Ile ⁸ -Asn ⁹ -Met ¹⁰ -Ala ¹¹ -Cys ¹² -Thr ¹³ -Gly ¹⁴ -Cys ¹⁵ -Ileu ¹⁶	152
N76	C4:C12, C7:C15	Gln ¹ -Glu ² -Glu ³ -Cys ⁴ -Glu ⁵ -Ileu ⁶ -Cys ⁷ -Ile ⁸ -Asn ⁹ -Met ¹⁰ -Ala ¹¹ -Cys ¹² -Thr ¹³ -Gly ¹⁴ -Cys ¹⁵ -Ileu ¹⁶	153
N77	C4:C12, C7:C15	Lys ¹ -Asp ² -Asp ³ -Cys ⁴ -Glu ⁵ -Ileu ⁶ -Cys ⁷ -Ile ⁸ -Asn ⁹ -Met ¹⁰ -Ala ¹¹ -Cys ¹² -Thr ¹³ -Gly ¹⁴ -Cys ¹⁵ -Ileu ¹⁶	154
N78	C4:C12, C7:C15	Lys ¹ -Asp ² -Glu ³ -Cys ⁴ -Glu ⁵ -Ileu ⁶ -Cys ⁷ -Ile ⁸ -Asn ⁹ -Met ¹⁰ -Ala ¹¹ -Cys ¹² -Thr ¹³ -Gly ¹⁴ -Cys ¹⁵ -Ileu ¹⁶	155
N79	C4:C12, C7:C15	Lys ¹ -Glu ² -Asp ³ -Cys ⁴ -Glu ⁵ -Ileu ⁶ -Cys ⁷ -Ile ⁸ -Asn ⁹ -Met ¹⁰ -Ala ¹¹ -Cys ¹² -Thr ¹³ -Gly ¹⁴ -Cys ¹⁵ -Ileu ¹⁶	156
N80	C4:C12, C7:C15	Lys ¹ -Glu ² -Glu ³ -Cys ⁴ -Glu ⁵ -Ileu ⁶ -Cys ⁷ -Ile ⁸ -Asn ⁹ -Met ¹⁰ -Ala ¹¹ -Cys ¹² -Thr ¹³ -Gly ¹⁴ -Cys ¹⁵ -Ileu ¹⁶	157
N81	C4:C12, C7:C15	Glu ¹ -Asp ² -Asp ³ -Cys ⁴ -Glu ⁵ -Ileu ⁶ -Cys ⁷ -Ile ⁸ -Asn ⁹ -Met ¹⁰ -Ala ¹¹ -Cys ¹² -Thr ¹³ -Gly ¹⁴ -Cys ¹⁵ -Ser ¹⁶	158
N82	C4:C12, C7:C15	Glu ¹ -Asp ² -Glu ³ -Cys ⁴ -Glu ⁵ -Ileu ⁶ -Cys ⁷ -Ile ⁸ -Asn ⁹ -Met ¹⁰ -Ala ¹¹ -Cys ¹² -Thr ¹³ -Gly ¹⁴ -Cys ¹⁵ -Ser ¹⁶	159
N83	C4:C12, C7:C15	Glu ¹ -Glu ² -Asp ³ -Cys ⁴ -Glu ⁵ -Ileu ⁶ -Cys ⁷ -Ile ⁸ -Asn ⁹ -Met ¹⁰ -Ala ¹¹ -Cys ¹² -Thr ¹³ -Gly ¹⁴ -Cys ¹⁵ -Ser ¹⁶	160
N84	C4:C12, C7:C15	Glu ¹ -Glu ² -Glu ³ -Cys ⁴ -Glu ⁵ -Ileu ⁶ -Cys ⁷ -Ile ⁸ -Asn ⁹ -Met ¹⁰ -Ala ¹¹ -Cys ¹² -Thr ¹³ -Gly ¹⁴ -Cys ¹⁵ -Ser ¹⁶	161
N85	C4:C12,	Asp ¹ -Asp ² -Asp ³ -Cys ⁴ -Glu ⁵ -Ileu ⁶ -Cys ⁷ -Ile ⁸ -Asn ⁹ -Met ¹⁰ -Ala ¹¹ -Cys ¹² -Thr ¹³ -Gly ¹⁴ -Cys ¹⁵ -Ser ¹⁶	162

	C7:C15		
N86	C4:C12, C7:C15	Asp ¹ -Asp ² -Glu ³ -Cys ⁴ -Glu ⁵ -Leu ⁶ -Cys ⁷ -Ile ⁸ -Asn ⁹ -Met ¹⁰ -Ala ¹¹ -Cys ¹² -Thr ¹³ -Gly ¹⁴ -Cys ¹⁵ -Ser ¹⁶	163
N87	C4:C12, C7:C15	Asp ¹ -Glu ² -Asp ³ -Cys ⁴ -Glu ⁵ -Leu ⁶ -Cys ⁷ -Ile ⁸ -Asn ⁹ -Met ¹⁰ -Ala ¹¹ -Cys ¹² -Thr ¹³ -Gly ¹⁴ -Cys ¹⁵ -Ser ¹⁶	164
N88	C4:C12, C7:C15	Asp ¹ -Glu ² -Glu ³ -Cys ⁴ -Glu ⁵ -Leu ⁶ -Cys ⁷ -Ile ⁸ -Asn ⁹ -Met ¹⁰ -Ala ¹¹ -Cys ¹² -Thr ¹³ -Gly ¹⁴ -Cys ¹⁵ -Ser ¹⁶	165
N89	C4:C12, C7:C15	Gln ¹ -Asp ² -Asp ³ -Cys ⁴ -Glu ⁵ -Leu ⁶ -Cys ⁷ -Ile ⁸ -Asn ⁹ -Met ¹⁰ -Ala ¹¹ -Cys ¹² -Thr ¹³ -Gly ¹⁴ -Cys ¹⁵ -Ser ¹⁶	166
N90	C4:C12, C7:C15	Gln ¹ -Asp ² -Glu ³ -Cys ⁴ -Glu ⁵ -Leu ⁶ -Cys ⁷ -Ile ⁸ -Asn ⁹ -Met ¹⁰ -Ala ¹¹ -Cys ¹² -Thr ¹³ -Gly ¹⁴ -Cys ¹⁵ -Ser ¹⁶	167
N91	C4:C12, C7:C15	Gln ¹ -Glu ² -Asp ³ -Cys ⁴ -Glu ⁵ -Leu ⁶ -Cys ⁷ -Ile ⁸ -Asn ⁹ -Met ¹⁰ -Ala ¹¹ -Cys ¹² -Thr ¹³ -Gly ¹⁴ -Cys ¹⁵ -Ser ¹⁶	168
N92	C4:C12, C7:C15	Gln ¹ -Glu ² -Glu ³ -Cys ⁴ -Glu ⁵ -Leu ⁶ -Cys ⁷ -Ile ⁸ -Asn ⁹ -Met ¹⁰ -Ala ¹¹ -Cys ¹² -Thr ¹³ -Gly ¹⁴ -Cys ¹⁵ -Ser ¹⁶	169
N93	C4:C12, C7:C15	Lys ¹ -Asp ² -Asp ³ -Cys ⁴ -Glu ⁵ -Leu ⁶ -Cys ⁷ -Ile ⁸ -Asn ⁹ -Met ¹⁰ -Ala ¹¹ -Cys ¹² -Thr ¹³ -Gly ¹⁴ -Cys ¹⁵ -Ser ¹⁶	170
N94	C4:C12, C7:C15	Lys ¹ -Asp ² -Glu ³ -Cys ⁴ -Glu ⁵ -Leu ⁶ -Cys ⁷ -Ile ⁸ -Asn ⁹ -Met ¹⁰ -Ala ¹¹ -Cys ¹² -Thr ¹³ -Gly ¹⁴ -Cys ¹⁵ -Ser ¹⁶	171
N95	C4:C12, C7:C15	Lys ¹ -Glu ² -Asp ³ -Cys ⁴ -Glu ⁵ -Leu ⁶ -Cys ⁷ -Ile ⁸ -Asn ⁹ -Met ¹⁰ -Ala ¹¹ -Cys ¹² -Thr ¹³ -Gly ¹⁴ -Cys ¹⁵ -Ser ¹⁶	172
N96	C4:C12, C7:C15	Lys ¹ -Glu ² -Glu ³ -Cys ⁴ -Glu ⁵ -Leu ⁶ -Cys ⁷ -Ile ⁸ -Asn ⁹ -Met ¹⁰ -Ala ¹¹ -Cys ¹² -Thr ¹³ -Gly ¹⁴ -Cys ¹⁵ -Ser ¹⁶	173

Table V. Guanylin and Analogs

Name	Position of Disulfide bonds	Structure	SEQ ID NO
Formula XIX	4:12,7:15	Xaa ¹ -Xaa ² -Xaa ³ -Maa ⁴ -Xaa ⁵ -Xaa ⁶ -Maa ⁷ -Xaa ⁸ -Xaa ⁹ -Xaa ¹⁰ -Xaa ¹¹ -Maa ¹² -Xaa ¹³ -Xaa ¹⁴ -Maa ¹⁵	174
Guanylin	C4:C12, C7:C15	Ser ¹ -His ² -Thr ³ -Cys ⁴ -Glu ⁵ -Ile ⁶ -Cys ⁷ -Ala ⁸ -Phe ⁹ -Ala ¹⁰ -Ala ¹¹ -Cys ¹² -Ala ¹³ -Gly ¹⁴ -Cys ¹⁵	175
N97	C4:C12, C7:C15	Ser ¹ -His ² -Thr ³ -Cys ⁴ -Glu ⁵ -Ile ⁶ -Cys ⁷ -Ala ⁸ -Asn ⁹ -Ala ¹⁰ -Ala ¹¹ -Cys ¹² -Ala ¹³ -Gly ¹⁴ -Cys ¹⁵	176
N98	C4:C12, C7:C15	Ser ¹ -His ² -Thr ³ -Cys ⁴ -Glu ⁵ -Leu ⁶ -Cys ⁷ -Ala ⁸ -Asn ⁹ -Ala ¹⁰ -Ala ¹¹ -Cys ¹² -Ala ¹³ -Gly ¹⁴ -Cys ¹⁵	177
N99	C4:C12, C7:C15	Ser ¹ -His ² -Thr ³ -Cys ⁴ -Glu ⁵ -Val ⁶ -Cys ⁷ -Ala ⁸ -Asn ⁹ -Ala ¹⁰ -Ala ¹¹ -Cys ¹² -Ala ¹³ -Gly ¹⁴ -Cys ¹⁵	178
N100	C4:C12, C7:C15	Ser ¹ -His ² -Thr ³ -Cys ⁴ -Glu ⁵ -Tyr ⁶ -Cys ⁷ -Ala ⁸ -Asn ⁹ -Ala ¹⁰ -Ala ¹¹ -Cys ¹² -Ala ¹³ -Gly ¹⁴ -Cys ¹⁵	179
N101	C4:C12, C7:C15	Ser ¹ -His ² -Thr ³ -Cys ⁴ -Glu ⁵ -Ile ⁶ -Cys ⁷ -Ala ⁸ -Asn ⁹ -Ala ¹⁰ -Ala ¹¹ -Cys ¹² -Ala ¹³ -Gly ¹⁴ -Cys ¹⁵	180
N102	C4:C12, C7:C15	Ser ¹ -His ² -Thr ³ -Cys ⁴ -Glu ⁵ -Leu ⁶ -Cys ⁷ -Ala ⁸ -Asn ⁹ -Ala ¹⁰ -Ala ¹¹ -Cys ¹² -Ala ¹³ -Gly ¹⁴ -Cys ¹⁵	181
N103	C4:C12, C7:C15	Ser ¹ -His ² -Thr ³ -Cys ⁴ -Glu ⁵ -Val ⁶ -Cys ⁷ -Ala ⁸ -Asn ⁹ -Ala ¹⁰ -Ala ¹¹ -Cys ¹² -Ala ¹³ -Gly ¹⁴ -Cys ¹⁵	182
N104	C4:C12, C7:C15	Ser ¹ -His ² -Thr ³ -Cys ⁴ -Glu ⁵ -Tyr ⁶ -Cys ⁷ -Ala ⁸ -Asn ⁹ -Ala ¹⁰ -Ala ¹¹ -Cys ¹² -Ala ¹³ -Gly ¹⁴ -Cys ¹⁵	183
N105	C4:C12, C7:C15	Ser ¹ -His ² -Thr ³ -Cys ⁴ -Glu ⁵ -Ile ⁶ -Cys ⁷ -Ala ⁸ -Asn ⁹ -Ala ¹⁰ -Ala ¹¹ -Cys ¹² -Ala ¹³ -Gly ¹⁴ -Cys ¹⁵	184
N106	C4:C12, C7:C15	Ser ¹ -His ² -Thr ³ -Cys ⁴ -Glu ⁵ -Leu ⁶ -Cys ⁷ -Ala ⁸ -Asn ⁹ -Ala ¹⁰ -Ala ¹¹ -Cys ¹² -Ala ¹³ -Gly ¹⁴ -Cys ¹⁵	185
N107	C4:C12, C7:C15	Ser ¹ -His ² -Thr ³ -Cys ⁴ -Glu ⁵ -Val ⁶ -Cys ⁷ -Ala ⁸ -Asn ⁹ -Ala ¹⁰ -Ala ¹¹ -Cys ¹² -Ala ¹³ -Gly ¹⁴ -Cys ¹⁵	186

N108	C4:C12, C7:C15	Ser ¹ -His ² -Thr ³ -Cys ⁴ -Glu ⁵ -Tyr ⁶ -Cys ⁷ -Ala ⁸ -Asn ⁹ -Ala ¹⁰ -Ala ¹¹ -Cys ¹² -Ala ¹³ -Gly ¹⁴ -Cys ¹⁵	187
N109	C4:C12, C7:C15	Ser ¹ -His ² -Thr ³ -Cys ⁴ -Glu ⁵ -Ile ⁶ -Cys ⁷ -Ala ⁸ -Asn ⁹ -Ala ¹⁰ -Ala ¹¹ -Cys ¹² -Ala ¹³ -Gly ¹⁴ -Cys ¹⁵	188
N110	C4:C12, C7:C15	Ser ¹ -His ² -Thr ³ -Cys ⁴ -Glu ⁵ -Leu ⁶ -Cys ⁷ -Ala ⁸ -Asn ⁹ -Ala ¹⁰ -Ala ¹¹ -Cys ¹² -Ala ¹³ -Gly ¹⁴ -Cys ¹⁵	189
N111	C4:C12, C7:C15	Ser ¹ -His ² -Thr ³ -Cys ⁴ -Glu ⁵ -Val ⁶ -Cys ⁷ -Ala ⁸ -Asn ⁹ -Ala ¹⁰ -Ala ¹¹ -Cys ¹² -Ala ¹³ -Gly ¹⁴ -Cys ¹⁵	190
N112	C4:C12, C7:C15	Ser ¹ -His ² -Thr ³ -Cys ⁴ -Glu ⁵ -Tyr ⁶ -Cys ⁷ -Ala ⁸ -Asn ⁹ -Ala ¹⁰ -Ala ¹¹ -Cys ¹² -Ala ¹³ -Gly ¹⁴ -Cys ¹⁵	191
N113	C4:C12, C7:C15	Asn ¹ -Asp ² -Glu ³ -Cys ⁴ -Glu ⁵ -Ile ⁶ -Cys ⁷ -Ala ⁸ -Asn ⁹ -Ala ¹⁰ -Ala ¹¹ -Cys ¹² -Ala ¹³ -Gly ¹⁴ -Cys ¹⁵	192
N114	C4:C12, C7:C15	Asn ¹ -Asp ² -Glu ³ -Cys ⁴ -Glu ⁵ -Leu ⁶ -Cys ⁷ -Ala ⁸ -Asn ⁹ -Ala ¹⁰ -Ala ¹¹ -Cys ¹² -Ala ¹³ -Gly ¹⁴ -Cys ¹⁵	193
N115	C4:C12, C7:C15	Asn ¹ -Asp ² -Glu ³ -Cys ⁴ -Glu ⁵ -Val ⁶ -Cys ⁷ -Ala ⁸ -Asn ⁹ -Ala ¹⁰ -Ala ¹¹ -Cys ¹² -Ala ¹³ -Gly ¹⁴ -Cys ¹⁵	194
N116	C4:C12, C7:C15	Asn ¹ -Asp ² -Glu ³ -Cys ⁴ -Glu ⁵ -Tyr ⁶ -Cys ⁷ -Ala ⁸ -Asn ⁹ -Ala ¹⁰ -Ala ¹¹ -Cys ¹² -Ala ¹³ -Gly ¹⁴ -Cys ¹⁵	195
N117	C4:C12, C7:C15	Asn ¹ -Asp ² -Glu ³ -Cys ⁴ -Glu ⁵ -Ile ⁶ -Cys ⁷ -Ala ⁸ -Asn ⁹ -Ala ¹⁰ -Ala ¹¹ -Cys ¹² -Ala ¹³ -Gly ¹⁴ -Cys ¹⁵	196
N118	C4:C12, C7:C15	Asn ¹ -Asp ² -Glu ³ -Cys ⁴ -Glu ⁵ -Leu ⁶ -Cys ⁷ -Ala ⁸ -Asn ⁹ -Ala ¹⁰ -Ala ¹¹ -Cys ¹² -Ala ¹³ -Gly ¹⁴ -Cys ¹⁵	197
N119	C4:C12, C7:C15	Asn ¹ -Asp ² -Glu ³ -Cys ⁴ -Glu ⁵ -Val ⁶ -Cys ⁷ -Ala ⁸ -Asn ⁹ -Ala ¹⁰ -Ala ¹¹ -Cys ¹² -Ala ¹³ -Gly ¹⁴ -Cys ¹⁵	198
N120	C4:C12, C7:C15	Asn ¹ -Asp ² -Glu ³ -Cys ⁴ -Glu ⁵ -Tyr ⁶ -Cys ⁷ -Ala ⁸ -Asn ⁹ -Ala ¹⁰ -Ala ¹¹ -Cys ¹² -Ala ¹³ -Gly ¹⁴ -Cys ¹⁵	199
N121	C4:C12, C7:C15	Asn ¹ -Asp ² -Glu ³ -Cys ⁴ -Glu ⁵ -Ile ⁶ -Cys ⁷ -Ala ⁸ -Asn ⁹ -Ala ¹⁰ -Ala ¹¹ -Cys ¹² -Ala ¹³ -Gly ¹⁴ -Cys ¹⁵	200
N122	C4:C12, C7:C15	Asn ¹ -Asp ² -Glu ³ -Cys ⁴ -Glu ⁵ -Leu ⁶ -Cys ⁷ -Ala ⁸ -Asn ⁹ -Ala ¹⁰ -Ala ¹¹ -Cys ¹² -Ala ¹³ -Gly ¹⁴ -Cys ¹⁵	201
N123	C4:C12, C7:C15	Asn ¹ -Asp ² -Glu ³ -Cys ⁴ -Glu ⁵ -Val ⁶ -Cys ⁷ -Ala ⁸ -Asn ⁹ -Ala ¹⁰ -Ala ¹¹ -Cys ¹² -Ala ¹³ -Gly ¹⁴ -Cys ¹⁵	202
N124	C4:C12, C7:C15	Asn ¹ -Asp ² -Glu ³ -Cys ⁴ -Glu ⁵ -Tyr ⁶ -Cys ⁷ -Ala ⁸ -Asn ⁹ -Ala ¹⁰ -Ala ¹¹ -Cys ¹² -Ala ¹³ -Gly ¹⁴ -Cys ¹⁵	203

N125	C4:C12, C7:C15	Asn ¹ -Asp ² -Glu ³ -Cys ⁴ -Glu ⁵ -Ile ⁶ -Cys ⁷ -Ala ⁸ -Asn ⁹ -Ala ¹⁰ -Ala ¹¹ -Cys ¹² -Ala ¹³ -Gly ¹⁴ -Cys ¹⁵	204
N126	C4:C12, C7:C15	Asn ¹ -Asp ² -Glu ³ -Cys ⁴ -Glu ⁵ -Leu ⁶ -Cys ⁷ -Ala ⁸ -Asn ⁹ -Ala ¹⁰ -Ala ¹¹ -Cys ¹² -Ala ¹³ -Gly ¹⁴ -Cys ¹⁵	205
N127	C4:C12, C7:C15	Asn ¹ -Asp ² -Glu ³ -Cys ⁴ -Glu ⁵ -Val ⁶ -Cys ⁷ -Ala ⁸ -Asn ⁹ -Ala ¹⁰ -Ala ¹¹ -Cys ¹² -Ala ¹³ -Gly ¹⁴ -Cys ¹⁵	206
N128	C4:C12, C7:C15	Asn ¹ -Asp ² -Glu ³ -Cys ⁴ -Glu ⁵ -Tyr ⁶ -Cys ⁷ -Ala ⁸ -Asn ⁹ -Ala ¹⁰ -Ala ¹¹ -Cys ¹² -Ala ¹³ -Gly ¹⁴ -Cys ¹⁵	207

Table VI. Lymphoguanaylin and Analogs

Name	Position of Disulfide bonds	Structure	SEQ ID NO
Formula XX	4:12,7:15	Xaa ¹ -Xaa ² -Xaa ³ -Maa ⁴ -Xaa ⁵ -Xaa ⁶ -Maa ⁷ -Xaa ⁸ -Xaa ⁹ -Xaa ¹⁰ -Xaa ¹¹ -Maa ¹² -Xaa ¹³ -Xaa ¹⁴ -Xaa ¹⁵	208
<u>Lymphoguanaylin</u>	C4:C12	Gln ¹ -Glu ² -Glu ³ -Cys ⁴ -Glu ⁵ -Leu ⁶ -Cys ⁷ -Ile ⁸ -Asn ⁹ -Met ¹⁰ -Ala ¹¹ -Cys ¹² -Thr ¹³ -Gly ¹⁴ -Tyr ¹⁵	209
N129	C4:C12	Gln ¹ -Glu ² -Glu ³ -Cys ⁴ -Glu ⁵ -Thr ⁶ -Cys ⁷ -Ile ⁸ -Asn ⁹ -Met ¹⁰ -Ala ¹¹ -Cys ¹² -Thr ¹³ -Gly ¹⁴ -Tyr ¹⁵	210
N130	C4:C12	Gln ¹ -Asp ² -Glu ³ -Cys ⁴ -Glu ⁵ -Thr ⁶ -Cys ⁷ -Ile ⁸ -Asn ⁹ -Met ¹⁰ -Ala ¹¹ -Cys ¹² -Thr ¹³ -Gly ¹⁴ -Tyr ¹⁵	211
N131	C4:C12	Gln ¹ -Asp ² -Asp ³ -Cys ⁴ -Glu ⁵ -Thr ⁶ -Cys ⁷ -Ile ⁸ -Asn ⁹ -Met ¹⁰ -Ala ¹¹ -Cys ¹² -Thr ¹³ -Gly ¹⁴ -Tyr ¹⁵	212
N132	C4:C12	Gln ¹ -Glu ² -Asp ³ -Cys ⁴ -Glu ⁵ -Thr ⁶ -Cys ⁷ -Ile ⁸ -Asn ⁹ -Met ¹⁰ -Ala ¹¹ -Cys ¹² -Thr ¹³ -Gly ¹⁴ -Tyr ¹⁵	213
N133	C4:C12	Gln ¹ -Glu ² -Glu ³ -Cys ⁴ -Glu ⁵ -Glu ⁶ -Cys ⁷ -Ile ⁸ -Asn ⁹ -Met ¹⁰ -Ala ¹¹ -Cys ¹² -Thr ¹³ -Gly ¹⁴ -Tyr ¹⁵	214

N134	C4:C12	Gln ¹ -Asp ² -Glu ³ -Cys ⁴ -Glu ⁵ -Glu ⁶ -Cys ⁷ -Ile ⁸ -Asn ⁹ -Met ¹⁰ -Ala ¹¹ -Cys ¹² -Thr ¹³ -Gly ¹⁴ -Tyr ¹⁵	215
N135	C4:C12	Gln ¹ -Asp ² -Asp ³ -Cys ⁴ -Glu ⁵ -Glu ⁶ -Cys ⁷ -Ile ⁸ -Asn ⁹ -Met ¹⁰ -Ala ¹¹ -Cys ¹² -Thr ¹³ -Gly ¹⁴ -Tyr ¹⁵	216
N136	C4:C12	Gln ¹ -Glu ² -Asp ³ -Cys ⁴ -Glu ⁵ -Glu ⁶ -Cys ⁷ -Ile ⁸ -Asn ⁹ -Met ¹⁰ -Ala ¹¹ -Cys ¹² -Thr ¹³ -Gly ¹⁴ -Tyr ¹⁵	217
N137	C4:C12	Gln ¹ -Glu ² -Glu ³ -Cys ⁴ -Glu ⁵ -Tyr ⁶ -Cys ⁷ -Ile ⁸ -Asn ⁹ -Met ¹⁰ -Ala ¹¹ -Cys ¹² -Thr ¹³ -Gly ¹⁴ -Tyr ¹⁵	218
N138	C4:C12	Gln ¹ -Asp ² -Glu ³ -Cys ⁴ -Glu ⁵ -Tyr ⁶ -Cys ⁷ -Ile ⁸ -Asn ⁹ -Met ¹⁰ -Ala ¹¹ -Cys ¹² -Thr ¹³ -Gly ¹⁴ -Tyr ¹⁵	219
N139	C4:C12	Gln ¹ -Asp ² -Asp ³ -Cys ⁴ -Glu ⁵ -Tyr ⁶ -Cys ⁷ -Ile ⁸ -Asn ⁹ -Met ¹⁰ -Ala ¹¹ -Cys ¹² -Thr ¹³ -Gly ¹⁴ -Tyr ¹⁵	220
N140	C4:C12	Gln ¹ -Glu ² -Asp ³ -Cys ⁴ -Glu ⁵ -Ile ⁶ -Cys ⁷ -Ile ⁸ -Asn ⁹ -Met ¹⁰ -Ala ¹¹ -Cys ¹² -Thr ¹³ -Gly ¹⁴ -Tyr ¹⁵	221
N141	C4:C12	Gln ¹ -Glu ² -Glu ³ -Cys ⁴ -Glu ⁵ -Ile ⁶ -Cys ⁷ -Ile ⁸ -Asn ⁹ -Met ¹⁰ -Ala ¹¹ -Cys ¹² -Thr ¹³ -Gly ¹⁴ -Tyr ¹⁵	222
N142	C4:C12	Gln ¹ -Asp ² -Glu ³ -Cys ⁴ -Glu ⁵ -Ile ⁶ -Cys ⁷ -Ile ⁸ -Asn ⁹ -Met ¹⁰ -Ala ¹¹ -Cys ¹² -Thr ¹³ -Gly ¹⁴ -Tyr ¹⁵	223
N143	C4:C12	Gln ¹ -Asp ² -Asp ³ -Cys ⁴ -Glu ⁵ -Ile ⁶ -Cys ⁷ -Ile ⁸ -Asn ⁹ -Met ¹⁰ -Ala ¹¹ -Cys ¹² -Thr ¹³ -Gly ¹⁴ -Tyr ¹⁵	224
N144	C4:C12	Gln ¹ -Glu ² -Asp ³ -Cys ⁴ -Glu ⁵ -Ile ⁶ -Cys ⁷ -Ile ⁸ -Asn ⁹ -Met ¹⁰ -Ala ¹¹ -Cys ¹² -Thr ¹³ -Gly ¹⁴ -Tyr ¹⁵	225
N145	C4:C12, C7:C15	Gln ¹ -Glu ² -Glu ³ -Cys ⁴ -Glu ⁵ -Thr ⁶ -Cys ⁷ -Ile ⁸ -Asn ⁹ -Met ¹⁰ -Ala ¹¹ -Cys ¹² -Thr ¹³ -Gly ¹⁴ -Cys ¹⁵ -Ser ¹⁶	226
N146	C4:C12, C7:C15	Gln ¹ -Asp ² -Glu ³ -Cys ⁴ -Glu ⁵ -Thr ⁶ -Cys ⁷ -Ile ⁸ -Asn ⁹ -Met ¹⁰ -Ala ¹¹ -Cys ¹² -Thr ¹³ -Gly ¹⁴ -Cys ¹⁵ -Ser ¹⁶	227
N147	C4:C12, C7:C15	Gln ¹ -Asp ² -Asp ³ -Cys ⁴ -Glu ⁵ -Thr ⁶ -Cys ⁷ -Ile ⁸ -Asn ⁹ -Met ¹⁰ -Ala ¹¹ -Cys ¹² -Thr ¹³ -Gly ¹⁴ -Cys ¹⁵ -Ser ¹⁶	228
N148	C4:C12,	Gln ¹ -Glu ² -Asp ³ -Cys ⁴ -Glu ⁵ -Thr ⁶ -Cys ⁷ -Ile ⁸ -Asn ⁹ -Met ¹⁰ -Ala ¹¹ -Cys ¹² -Thr ¹³ -Gly ¹⁴ -Cys ¹⁵ -Ser ¹⁶	229

	C7:C15		
N149	C4:C12, C7:C15	Gln ¹ -Glu ² -Glu ³ -Cys ⁴ -Glu ⁵ -Glu ⁶ -Cys ⁷ -Ile ⁸ -Asn ⁹ -Met ¹⁰ -Ala ¹¹ -Cys ¹² -Thr ¹³ -Gly ¹⁴ -Cys ¹⁵ -Ser ¹⁶	230
N150	C4:C12, C7:C15	Gln ¹ -Asp ² -Glu ³ -Cys ⁴ -Glu ⁵ -Glu ⁶ -Cys ⁷ -Ile ⁸ -Asn ⁹ -Met ¹⁰ -Ala ¹¹ -Cys ¹² -Thr ¹³ -Gly ¹⁴ -Cys ¹⁵ -Ser ¹⁶	231
N151	C4:C12, C7:C15	Gln ¹ -Asp ² -Asp ³ -Cys ⁴ -Glu ⁵ -Glu ⁶ -Cys ⁷ -Ile ⁸ -Asn ⁹ -Met ¹⁰ -Ala ¹¹ -Cys ¹² -Thr ¹³ -Gly ¹⁴ -Cys ¹⁵ -Ser ¹⁶	232
N152	C4:C12, C7:C15	Gln ¹ -Glu ² -Asp ³ -Cys ⁴ -Glu ⁵ -Glu ⁶ -Cys ⁷ -Ile ⁸ -Asn ⁹ -Met ¹⁰ -Ala ¹¹ -Cys ¹² -Thr ¹³ -Gly ¹⁴ -Cys ¹⁵ -Ser ¹⁶	233
N153	C4:C12, C7:C15	Gln ¹ -Glu ² -Glu ³ -Cys ⁴ -Glu ⁵ -Tyr ⁶ -Cys ⁷ -Ile ⁸ -Asn ⁹ -Met ¹⁰ -Ala ¹¹ -Cys ¹² -Thr ¹³ -Gly ¹⁴ -Cys ¹⁵ -Ser ¹⁶	234
N154	C4:C12, C7:C15	Gln ¹ -Asp ² -Glu ³ -Cys ⁴ -Glu ⁵ -Tyr ⁶ -Cys ⁷ -Ile ⁸ -Asn ⁹ -Met ¹⁰ -Ala ¹¹ -Cys ¹² -Thr ¹³ -Gly ¹⁴ -Cys ¹⁵ -Ser ¹⁶	235
N155	C4:C12, C7:C15	Gln ¹ -Asp ² -Asp ³ -Cys ⁴ -Glu ⁵ -Tyr ⁶ -Cys ⁷ -Ile ⁸ -Asn ⁹ -Met ¹⁰ -Ala ¹¹ -Cys ¹² -Thr ¹³ -Gly ¹⁴ -Cys ¹⁵ -Ser ¹⁶	236
N156	C4:C12, C7:C15	Gln ¹ -Glu ² -Asp ³ -Cys ⁴ -Glu ⁵ -Tyr ⁶ -Cys ⁷ -Ile ⁸ -Asn ⁹ -Met ¹⁰ -Ala ¹¹ -Cys ¹² -Thr ¹³ -Gly ¹⁴ -Cys ¹⁵ -Ser ¹⁶	237
N157	C4:C12, C7:C15	Gln ¹ -Glu ² -Glu ³ -Cys ⁴ -Glu ⁵ -Ile ⁶ -Cys ⁷ -Ile ⁸ -Asn ⁹ -Met ¹⁰ -Ala ¹¹ -Cys ¹² -Thr ¹³ -Gly ¹⁴ -Cys ¹⁵ -Ser ¹⁶	238

N158	C4:C12, C7:C15	Gln ¹ -Asp ² -Glu ³ -Cys ⁴ -Glu ⁵ -Ile ⁶ -Cys ⁷ -Ile ⁸ -Asn ⁹ -Met ¹⁰ -Ala ¹¹ -Cys ¹² -Thr ¹³ -Gly ¹⁴ -Cys ¹⁵ -Ser ¹⁶	239
N159	C4:C12, C7:C15	Gln ¹ -Asp ² -Asp ³ -Cys ⁴ -Glu ⁵ -Ile ⁶ -Cys ⁷ -Ile ⁸ -Asn ⁹ -Met ¹⁰ -Ala ¹¹ -Cys ¹² -Thr ¹³ -Gly ¹⁴ -Cys ¹⁵ -Ser ¹⁶	240
N160	C4:C12, C7:C15	Gln ¹ -Glu ² -Asp ³ -Cys ⁴ -Glu ⁵ -Ile ⁶ -Cys ⁷ -Ile ⁸ -Asn ⁹ -Met ¹⁰ -Ala ¹¹ -Cys ¹² -Thr ¹³ -Gly ¹⁴ -Cys ¹⁵ -Ser ¹⁶	241

Table VII. ST Peptide and Analogues

Name	Position of Disulfide bonds	Structure	SEQ ID NO
SI Peptide	C3:C8, C4:C12, C7:15	Asn ¹ -Ser ² -Ser ³ -Asn ⁴ -Ser ⁵ -Ser ⁶ -Asn ⁷ -IYr ⁸ -Cys ⁹ -Glu ¹⁰ -Glu ¹¹ -Lys ¹² -Cys ¹³ -Cys ¹⁴ -Asn ¹⁵ -Pro ¹⁶ -Ala ¹⁷ -Cys ¹⁸ -Thr ¹⁹ -Gly ²⁰ -Cys ²¹ -IYr ²²	242
N161	C3:C8, C4:C12, C7:15	PEG3-Asn ¹ -Phe ² -Cys ³ -Cys ⁴ -Glu ⁵ -Thr ⁶ -Cys ⁷ -Cys ⁸ -Asn ⁹ -Pro ¹⁰ -Ala ¹¹ -Cys ¹² -Thr ¹³ -Gly ¹⁴ -Cys ¹⁵ -IYr ¹⁶ -PEG3	243
N162	C3:C8, C4:C12, C7:15	PEG3-Asn ¹ -Phe ² -Cys ³ -Cys ⁴ -Glu ⁵ -Thr ⁶ -Cys ⁷ -Cys ⁸ -Asn ⁹ -Pro ¹⁰ -Ala ¹¹ -Cys ¹² -Thr ¹³ -Gly ¹⁴ -Cys ¹⁵ -IYr ¹⁶	244
N163	C3:C8, C4:C12, C7:15	Asn ¹ -Phe ² -Cys ³ -Cys ⁴ -Glu ⁵ -Thr ⁶ -Cys ⁷ -Cys ⁸ -Asn ⁹ -Pro ¹⁰ -Ala ¹¹ -Cys ¹² -Thr ¹³ -Gly ¹⁴ -Cys ¹⁵ -IYr ¹⁶ -PEG3	245
N164	C3:C8, C4:C12, C7:15	Asn ¹ -Phe ² -Cys ³ -Cys ⁴ -Glu ⁵ -IYr ⁶ -Cys ⁷ -Cys ⁸ -Asn ⁹ -Pro ¹⁰ -Ala ¹¹ -Cys ¹² -Thr ¹³ -Gly ¹⁴ -Cys ¹⁵ -IYr ¹⁶	246

N165	C3:C8, C4:C12, C7:15	dAsn ¹ -Phe ² -Cys ³ -Cys ⁴ -Glu ⁵ -Tyr ⁶ -Cys ⁷ -Cys ⁸ -Asn ⁹ -Pro ¹⁰ -Ala ¹¹ -Cys ¹² -Thr ¹³ -Gly ¹⁴ -Cys ¹⁵ -dTyr ¹⁶	247
N166	C3:C8, C4:C12, C7:15	Asn ¹ -Phe ² -Cys ³ -Cys ⁴ -Glu ⁵ -Tyr ⁶ -Cys ⁷ -Cys ⁸ -Asn ⁹ -Pro ¹⁰ -Ala ¹¹ -Cys ¹² -Thr ¹³ -Gly ¹⁴ -Cys ¹⁵ -dTyr ¹⁶	248
N167	C3:C8, C4:C12, C7:15	dAsn ¹ -Phe ² -Cys ³ -Cys ⁴ -Glu ⁵ -Tyr ⁶ -Cys ⁷ -Cys ⁸ -Asn ⁹ -Pro ¹⁰ -Ala ¹¹ -Cys ¹² -Thr ¹³ -Gly ¹⁴ -Cys ¹⁵ -Tyr ¹⁶	249

1.3 Methods of Use

[109] The invention provides methods for treating or preventing gastrointestinal disorders and increasing gastrointestinal motility in a subject in need thereof by administering an effective amount of a GCC agonist formulation to the subject. Non-limiting examples of gastrointestinal disorders that can be treated or prevented according to the methods of the invention include irritable bowel syndrome (IBS), non-ulcer dyspepsia, chronic intestinal pseudo-obstruction, functional dyspepsia, colonic pseudo-obstruction, duodenogastric reflux, gastroesophageal reflux disease (GERD), ileus (*e.g.*, post-operative ileus), gastroparesis, heartburn (high acidity in the GI tract), constipation (*e.g.*, constipation associated with use of medications such as opioids, osteoarthritis drugs, or osteoporosis drugs); post surgical constipation, constipation associated with neuropathic disorders, Crohn's disease, and ulcerative colitis.

[110] In one embodiment, the invention provides methods for treating or preventing gastrointestinal motility disorder, irritable bowel syndrome, a functional gastrointestinal disorder, gastroesophageal reflux disease, duodenogastric reflux, functional heartburn, dyspepsia, functional dyspepsia, nonulcer dyspepsia, gastroparesis, chronic intestinal pseudo-obstruction, colonic pseudo-obstruction, obesity, congestive heart failure, or benign prostatic hyperplasia.

[111] In one embodiment, the invention provides methods for treating or preventing constipation and/or increasing gastrointestinal motility in a subject in need thereof by administering an effective amount of a GCC agonist formulation to the subject. Clinically accepted criteria that define constipation range from the frequency of bowel movements, the consistency of feces and the ease of bowel movement. One common definition of constipation is less than three bowel movements per week. Other definitions include abnormally hard stools or defecation that requires excessive straining (Schiller 2001 *Aliment Pharmacol Ther* 15:749-763). Constipation may be idiopathic (functional constipation or slow transit constipation) or secondary to other causes including neurologic, metabolic or endocrine disorders. These disorders include diabetes mellitus, hypothyroidism, hyperthyroidism, hypocalcaemia, Multiple sclerosis, Parkinson's disease, spinal cord lesions, Neurofibromatosis, autonomic neuropathy, Chagas disease, Hirschsprung disease and cystic fibrosis. Constipation may also be the result of

surgery or due to the use of drugs such as analgesics (like opioids), antihypertensives, anticonvulsants, antidepressants, antispasmodics and antipsychotics.

[112] In various embodiments, the constipation is associated with use of a therapeutic agent; the constipation is associated with a neuropathic disorder; the constipation is postsurgical constipation; the constipation is associated with a gastrointestinal disorder; the constipation is idiopathic (functional constipation or slow transit constipation); the constipation is associated with neuropathic, metabolic or endocrine disorder (e.g., diabetes mellitus, hypothyroidism, hyperthyroidism, hypocalcaemia, Multiple Sclerosis, Parkinson's disease, spinal cord lesions, neurofibromatosis, autonomic neuropathy, Chagas disease, Hirschsprung disease or cystic fibrosis). Constipation may also be the result of surgery or due to the use of drugs such as analgesics (e.g., opioids), antihypertensives, anticonvulsants, antidepressants, antispasmodics and antipsychotics.

[113] In one embodiment, the invention provides methods for treating or preventing chronic idiopathic constipation and increasing gastrointestinal motility in a subject in need thereof by administering an effective amount of a GCC agonist formulation to the subject.

[114] The term "treating" as used herein refers to a reduction, a partial improvement, amelioration, or a mitigation of at least one clinical symptom associated with the gastrointestinal disorders being treated. The term "preventing" refers to an inhibition or delay in the onset or progression of at least one clinical symptom associated with the gastrointestinal disorders to be prevented. The term "effective amount" as used herein refers to an amount that provides some improvement or benefit to the subject. In certain embodiments, an effective amount is an amount that provides some alleviation, mitigation, and/or decrease in at least one clinical symptom of the gastrointestinal disorder to be treated. In other embodiments, the effective amount is the amount that provides some inhibition or delay in the onset or progression of at least one clinical symptom associated with the gastrointestinal disorder to be prevented. The therapeutic effects need not be complete or curative, as long as some benefit is provided to the subject. The term "subject" preferably refers to a human subject but may also refer to a non-human primate or other mammal preferably selected from among a mouse, a rat, a dog, a cat, a cow, a horse, or a pig.

[115] The invention also provides methods for treating gastrointestinal cancer in a subject in need thereof by administering an effective amount of a GCC agonist formulation to the subject. Non-limiting examples of gastrointestinal cancers that can be treated according to the methods of the invention include gastric cancer, esophageal cancer, pancreatic cancer, colorectal cancer, intestinal cancer, anal cancer, liver cancer, gallbladder cancer, or colon cancer.

[116] The invention also provides methods for treating lipid metabolism disorders, biliary disorders, inflammatory disorders, lung disorders, cancer, cardiac disorders including cardiovascular disorders, eye disorders, oral disorders, blood disorders, liver disorders, skin disorders, prostate disorders, endocrine disorders, and obesity.

[117] Lipid metabolism disorders include, but are not limited to, dyslipidemia, hyperlipidemia, hypercholesterolemia, hypertriglyceridemia, sitosterolemia, familial hypercholesterolemia, xanthoma, combined hyperlipidemia, lecithin cholesterol acyltransferase deficiency, tangier disease, abetalipoproteinemia, erectile dysfunction, fatty liver disease, and hepatitis.

[118] Biliary disorders include gallbladder disorders such as for example, gallstones, gall bladder cancer cholangitis, or primary sclerosing cholangitis; or bile duct disorders such as for example, cholecystitis, bile duct cancer or fascioliasis.

[119] Inflammatory disorders include tissue and organ inflammation such as kidney inflammation (e.g., nephritis), gastrointestinal system inflammation (e.g., Crohn's disease and ulcerative colitis); necrotizing enterocolitis (NEC); pancreatic inflammation (e.g., pancreatitis), lung inflammation (e.g., bronchitis or asthma) or skin inflammation (e.g., psoriasis, eczema).

[120] Lung Disorders include for example chronic obstructive pulmonary disease (COPD), and fibrosis.

[121] Cancer includes tissue and organ carcinogenesis including metastases such as for example gastrointestinal cancer, (e.g., gastric cancer, esophageal cancer, pancreatic cancer colorectal cancer, intestinal cancer, anal cancer, liver cancer, gallbladder cancer, or colon cancer; lung cancer; thyroid cancer; skin cancer (e.g., melanoma); oral cancer; urinary tract cancer (e.g. bladder cancer or kidney cancer); blood cancer (e.g. myeloma or leukemia) or prostate cancer.

[122] Cardiac disorders include for example, congestive heart failure, trachea cardia hypertension, high cholesterol, or high triglycerides. Cardiovascular disorders include for example aneurysm, angina, atherosclerosis, cerebrovascular accident (stroke), cerebrovascular disease, congestive heart failure, coronary artery disease, myocardial infarction (heart attack), or peripheral vascular disease.

[123] Liver disorders include for example cirrhosis and fibrosis. In addition, GC-C agonist may also be useful to facilitate liver regeneration in liver transplant patients. Eye disorders include for example increased intra-ocular pressure, glaucoma, dry eyes retinal degeneration, disorders of tear glands or eye inflammation. Skin disorders include for example xerosis. Oral disorders include for example dry mouth (xerostomia), Sjögren's syndrome, gum diseases (e.g., periodontal disease), or salivary gland duct blockage or malfunction. Prostate disorders include for example benign prostatic hyperplasia (BPH). Endocrine disorders include for example diabetes mellitus, hyperthyroidism, hypothyroidism, and cystic fibrosis.

1.3.1 Therapeutically Effective Dosages

[124] Disorders are treated, prevented or alleviated by administering to a subject, *e.g.*, a mammal such as a human in need thereof, a therapeutically effective dose of a GCC agonist peptide. The present invention is based in part on the unexpected results of clinical trials in humans which demonstrated that the formulations of the invention are therapeutically effective at much lower doses than predicted based on animal studies. In accordance with one aspect of the invention, the therapeutically effective dose is between 0.01 milligrams (mg) and 10 mg per unit dose. The term "unit dose" refers to a single drug delivery entity, *e.g.*, a tablet, capsule, solution or inhalation formulation. In one embodiment, the effective dose is between 0.01 mg and 9 mg. In another embodiment, the effective dose is between 0.01 mg and 5 mg. In another embodiment, the effective dose is between 0.01 mg and 3 mg. In another embodiment, the effective dose is between 0.10 mg and 5 mg. In another embodiment, the effective dose is between 0.10 mg and 3 mg. In one embodiment, the unit dose is .01 mg, .05 mg, 0.1 mg, 0.2 mg, 0.3 mg, 0.5 mg, 1.0 mg, 1.5 mg, 2.0 mg, 2.5 mg, 3.0 mg, 5 mg, or 10 mg. In one embodiment, the unit dose is 0.3 mg, 1.0 mg, 3.0 mg, 9.0 mg, or 9.5 mg.

[125] The GCC agonist peptides may be in a pharmaceutical composition in unit dose form, together with one or more pharmaceutically acceptable excipients. The amount of peptide present should be sufficient to have a positive therapeutic effect when administered to a patient. What constitutes a “positive therapeutic effect” will depend upon the particular condition being treated and will include any significant improvement in a condition readily recognized by one of skill in the art.

[126] The GCC agonists for use in the methods described above are preferably administered orally. Dosage forms include solutions, suspensions, emulsions, tablets, and capsules.

[127] The total daily dose can be administered to the patient in a single dose, or in multiple sub-doses. Typically, sub-doses can be administered two to six times per day, preferably two to four times per day, and even more preferably two to three times per day. Preferably, a single daily dose is administered.

[128] The GCC agonists may be administered as either the sole active agent or in combination with one or more additional active agents. In all cases, additional active agents should be administered at a dosage that is therapeutically effective using the existing art as a guide. The GCC agonists may be administered in a single composition or sequentially with the one or more additional active agents. In one embodiment, the GCC agonist is administered in combination with one or more inhibitors of cGMP dependent phosphodiesterase such as suldinac sulfone, zaprinast, motapizone, vardenafil, or sildenafil. In another embodiment, the GCC agonist is administered in combination with one or more chemotherapeutic agents. In another embodiment, the GCC agonist is administered in combination with one or more anti-inflammatory drugs such as steroids or non-steroidal anti-inflammatory drugs (NSAIDS), such as aspirin.

[129] Combination therapy can be achieved by administering two or more agents, *e.g.*, a GCC agonist peptide described herein and another compound, each of which is formulated and administered separately, or by administering two or more agents in a single formulation. Other combinations are also encompassed by combination therapy. For example, two agents can be formulated together and administered in conjunction with a separate formulation containing a

third agent. While the two or more agents in the combination therapy can be administered simultaneously, they need not be. For example, administration of a first agent (or combination of agents) can precede administration of a second agent (or combination of agents) by minutes, hours, days, or weeks. Thus, the two or more agents can be administered within minutes of each other or within 1, 2, 3, 6, 9, 12, 15, 18, or 24 hours of each other or within 1, 2, 3, 4, 5, 6, 7, 8, 9, 10, 12, 14 days of each other or within 2, 3, 4, 5, 6, 7, 8, 9, or 10 weeks of each other. In some cases even longer intervals are possible. While in many cases it is desirable that the two or more agents used in a combination therapy be present in within the patient's body at the same time, this need not be so.

[130] The GCC agonist peptides described herein may be combined with phosphodiesterase inhibitors, *e.g.*, sulindae sulfone, Zaprinast, sildenafil, vardenafil or tadalafil to further enhance levels of cGMP in the target tissues or organs.

[131] Combination therapy can also include two or more administrations of one or more of the agents used in the combination. For example, if agent X and agent Y are used in a combination, one could administer them sequentially in any combination one or more times, *e.g.*, in the order X-Y- X, X-X-Y, Y-X-Y, Y-Y-X, X-X-Y-Y, etc.

1.3.2 Exemplary Agents for Combination Therapy

[132] The GCC agonist formulations of the invention may be administered alone or in combination with one or more additional therapeutic agents as part of a therapeutic regimen for the treatment or prevention of a gastrointestinal disease or disorder. In some embodiments, the GCC agonist formulation comprises one or more additional therapeutic agents. In other embodiments, the GCC agonist is formulated separately from the one or more additional therapeutic agents. In accordance with this embodiment, the GCC agonist is administered either simultaneously, sequentially, or at a different time than the one or more additional therapeutic agents. In one embodiment, the GCC agonist formulation is administered in combination with one or more additional therapeutic agents selected from the group consisting of phosphodiesterase inhibitors, cyclic nucleotides (such as cGMP and cAMP), a laxative (such as SENNA or METAMUCIL), a stool softner, an anti-tumor necrosis factor alpha therapy for IBD

(such as REMICADE, ENBREL, or HUMIRA), and anti-inflammatory drugs (such as COX-2 inhibitors, sulfasalazine, 5-ASA derivatives and NSAIDS). In certain embodiments, the GCC agonist formulation is administered in combination with an effective dose of an inhibitor of cGMP-specific phosphodiesterase (cGMP-PDE) either concurrently or sequentially with said GCC agonist. cGMP-PDE inhibitors include, for example, suldinac sulfone, zaprinast, motapizone, vardenafil, and sildenafil. In another embodiment, the GCC agonist formulation is administered in combination with inhibitors of cyclic nucleotide transporters. Further examples of therapeutic agents that may be administered in combination with the GCC agonist formulations of the invention are given in the following sections.

1.3.2.1 Agents to Treat Gastrointestinal Cancers

[133] The GCC agonist formulations described herein can be used in combination with one or more antitumor agents including but not limited to alkylating agents, epipodophyllotoxins, nitrosoureas, anti-metabolites, vinca alkaloids, anthracycline antibiotics, nitrogen mustard agents, and the like. Particular antitumor agents include tamoxifen, taxol, etoposide, and 5-fluorouracil. In one embodiment, the GCC agonist formulations are used in combination with an antiviral agent or a monoclonal antibody.

[134] Non-limiting examples of antitumor agents that can be used in combination with the GCC agonist formulations of the invention for the treatment of colon cancer include anti-proliferative agents, agents for DNA modification or repair, DNA synthesis inhibitors, DNA/RNA transcription regulators, RNA processing inhibitors, agents that affect protein expression, synthesis and stability, agents that affect protein localization or their ability to exert their physiological action, agents that interfere with protein-protein or protein-nucleic acid interactions, agents that act by RNA interference, receptor binding molecules of any chemical nature (including small molecules and antibodies), targeted toxins, enzyme activators, enzyme inhibitors, gene regulators, HSP-90 inhibitors, molecules interfering with microtubules or other cytoskeletal components or cell adhesion and motility, agents for phototherapy, and therapy adjuncts.

[135] Representative anti-proliferative agents include N-acetyl-D-sphingosine (C.sub.2 ceramide), apigenin, berberine chloride, dichloromethylenediphosphonic acid disodium salt, loe-emodine, emodin, HA 14-1, N-hexanoyl-D-sphingosine (C.sub.6 ceramide), 7 β -hydroxycholesterol, 25-hydroxycholesterol, hyperforin, parthenolide, and rapamycin.

Representative agents for DNA modification and repair include aphidicolin, bleomycin sulfate, carboplatin, carmustine, chlorambucil, cyclophosphamide monohydrate, cyclophosphamide monohydrate ISOPAC.RTM., cis-diammineplatinum(II) dichloride (Cisplatin), esculetin, melphalan, methoxyamine hydrochloride, mitomycin C, mitoxantrone dihydrochloride, oxaliplatin, and streptozocin.

[136] Representative DNA synthesis inhibitors include (.+-.).amethopterin (methotrexate), 3-amino-1,2,4-benzotriazine 1,4-dioxide, aminopterin, cytosine b-D-arabinofurdnoside (Ara-C), cytosine b-D-arabinofuranoside (Ara-C) hydrochloride, 2-fluoroadenine-9-b-D-arabinofuranoside (Fludarabine des-phosphate; F-ara-A), 5-fluoro-5'-deoxyuridinc, 5-fluorouracil, ganciclovir, hydroxyurea, 6-mercaptopurine, and 6-thioguanine.

[137] Representative DNA/RNA transcription regulators include actinomycin D, daunorubicin hydrochloride, 5,6-dichlorobenzimidazole 1-b-D-ribofuranoside, doxorubicin hydrochloride, homoharringtonine, and idarubicin hydrochloride.

[138] Representative enzyme activators and inhibitors include forskolin, DL-aminoglutethimide, apicidin, Bowman-Birk Inhibitor, butein, (S)-(+)-camptothecin, curcumin, (-)-deguelin, (-)-depudecin, doxycycline hyclate, etoposide, formestane, fostriecin sodium salt, hispidin, 2-imino-1-imidazolidineacetic acid (Cyclocreatine), oxamflatin, 4-phenylbutyric acid, roscovitine, sodium valproate, trichostatin A, tyrphostin AG 34, tyrphostin AG 879, urinary trypsin inhibitor fragment, valproic acid (2-propylpentanoic acid), and XK469.

[139] Representative gene regulators include 5-aza-2'-deoxycytidine, 5-azacytidine, cholecalciferol (Vitamin D3), ciglitizone, cyproterone acetate, 15-deoxy-D.sup.12,14-prostaglandin J.sub.2, epitestosterone, flutamide, glycyrrhizic acid ammonium salt (glycyrrhizin), 4-hydroxytamoxifen, mifepristone, procainamide hydrochloride, raloxifene hydrochloride, all trans-retinal (vitamin A aldehyde), retinoic acid (vitamin A acid), 9-cis-

retinoic acid, 13-cis-retinoic acid, retinoic acid p-hydroxyanilide, retinol (Vitamin A), tamoxifen, tamoxifen citrate salt, tetradecylthioacetic acid, and troglitazone.

[140] Representative HSP-90 inhibitors include 17-(allylamino)-17-demethoxygeldanamycin and geldanamycin.

[141] Representative microtubule inhibitors include colchicines, dolastatin 15, nocodazole, taxanes and in particular paclitaxel, podophyllotoxin, rhizoxin, vinblastine sulfate salt, vincristine sulfate salt, and vindesine sulfate salt and vinorelbine (Navelbine) ditartrate salt.

[142] Representative agents for performing phototherapy include photoactive porphyrin rings, hypericin, 5-methoxypsoralen, 8-methoxypsoralen, psoralen and ursodeoxycholic acid.

[143] Representative agents used as therapy adjuncts include amifostine, 4-amino-1,8-naphthalimide, brefeldin A, cimetidine, phosphomycin disodium salt, leuprolide (leuprorelin) acetate salt, luteinizing hormone-releasing hormone (LH-RH) acetate salt, lectin, papaverine hydrochloride, pifithrin-a, (-)-scopolamine hydrobromide, and thapsigargin.

[144] The agents can also be anti-VEGF (vascular endothelial growth factor) agents, as such are known in the art. Several antibodies and small molecules are currently in clinical trials or have been approved that function by inhibiting VEGF, such as Avastin (Bevacizumab), SU5416, SU11248 and BAY 43-9006. The agents can also be directed against growth factor receptors such as those of the EGF/Erb-B family such as EGF Receptor (Iressa or Gefitinib, and Tarceva or Erlotinib), Erb-B2, receptor (Herceptin or Trastuzumab), other receptors (such as Rituximab or Rituxan/MabThera), tyrosine kinases, non-receptor tyrosine kinases, cellular serine/threonine kinases (including MAP kinases), and various other proteins whose deregulation contribute to oncogenesis (such as small/Ras family and large/heterotrimeric G proteins). Several antibodies and small molecules targeting those molecules are currently at various stages of development (including approved for treatment or in clinical trials).

[145] In a preferred embodiment, the invention provides a method for treating colon cancer in a subject in need thereof by administering to the subject a GCC agonist formulation in combination with one or more antitumor agent selected from the group consisting of paclitaxel,

docetaxel, tamoxifen, vinorelbine, gemcitabine, cisplatin, etoposide, topotecan, irinotecan, anastrozole, rituximab, trastuzumab, fludarabine, cyclophosphamide, gentuzumab, carboplatin, interferons, and doxorubicin. In a particular embodiment the antitumor agent is paclitaxel. In a further embodiment, the method further comprises an antitumor agent selected from the group consisting of 5-FU, doxorubicin, vinorelbine, cytoxan, and cisplatin.

1.3.2.2 Agents that Treat Crohn's Disease

[146] In one embodiment, a GCC agonist formulation of the invention is administered as part of a combination therapy with one or more additional therapeutic agents for the treatment of Crohn's disease. Non-limiting examples of the one or more additional therapeutic agents include sulfasalazine and other mesalamine-containing drugs, generally known as 5-ASA agents, such as Asacol, Dipentum, or Pentasa, or infliximab (REMICADE). In certain embodiments, the one or more additional agents is a corticosteroid or an immunosuppressive agent such as 6-mercaptopurine or azathioprine. In another embodiment, the one or more additional agents is an antidiarrheal agent such as diphenoxylate, loperamide, or codeine.

1.3.2.3 Agents that Treat Ulcerative Colitis

[147] In one embodiment, a GCC agonist formulation of the invention is administered as part of a combination therapy with one or more additional therapeutic agents for the treatment of ulcerative colitis. The agents that are used to treat ulcerative colitis overlap with those used to treat Crohn's Disease. Non-limiting examples of the one or more additional therapeutic agents that can be used in combination with a GCC agonist formulation of the invention include aminosalicylates (drugs that contain 5-aminosalicylic acid (5-ASA)) such as sulfasalazine, olsalazine, mesalamine, and balsalazide. Other therapeutic agents that can be used include corticosteroids, such as prednisone and hydrocortisone, immunomodulators, such as azathioprine, 6-mercapto-purine (6-MP), cytokines, interleukins, and lymphokines, and anti-TNF-alpha agents, including the thiazolidinediones or glitazones such as rosiglitazone and pioglitazone. In one embodiment, the one or more additional therapeutic agents includes both cyclosporine A and 6-MP or azathioprine for the treatment of active, severe ulcerative colitis.

1.3.2.4 Agents that Treat Constipation/Irritable Bowel Syndrome

[148] In one embodiment, a GCC agonist formulation of the invention is administered as part of a combination therapy with one or more additional therapeutic agents for the treatment of constipation, such as that associated with irritable bowel syndrome. Non-limiting examples of the one or more additional therapeutic agents include laxatives such as SENNA, MIRALAX, LACTULOSE, PEG, or calcium polycarbophil), stool softeners (such as mineral oil or COLACE), bulking agents (such as METAMUCIL or bran), agents such as ZELNORM (also called tegaserod), and anticholinergic medications such as BENTYL and LEVSIN.

1.3.2.5 Agents for the Treatment of Postoperative Ileus

[149] In one embodiment, a GCC agonist formulation of the invention is administered as part of a combination therapy with one or more additional therapeutic agents for the treatment of postoperative ileus. Non-limiting examples of the one or more additional therapeutic agents include ENTEREG (alvimopan; formerly called ado lor/ ADL 8-2698), conivaptan, and related agents describes in US 6,645,959.

1.3.2.6 Anti-obesity agents

[150] In one embodiment, a GCC agonist formulation of the invention is administered as part of a combination therapy with one or more additional therapeutic agents for the treatment of obesity. Non-limiting examples of the one or more additional therapeutic agents include 1 β HSD-I (11-beta hydroxy steroid dehydrogenase type 1) inhibitors, such as BVT 3498, BVT 2733, 3-(1-adamantyl)-4-ethyl-5-(ethylthio)-4H-1,2,4-triazole, 3-(1-adamantyl)-5-(3,4,5-trimethoxyphenyl)-4-methyl-4H-1,2,4-triazole, 3-adamantany-4,5,6,7,8,9,10,11,12,3a-decahydro-1,2,4-triazolo[4,3-a][1,1]annulene, and those compounds disclosed in WO01/90091, WOO 1/90090, WOO 1/90092 and WO02/072084; 5HT antagonists such as those in WO03/037871, WO03/037887, and the like; 5HT1a modulators such as carbidopa, benserazide and those disclosed in US6207699, WO03/031439, and the like; 5HT2c (serotonin receptor 2c) agonists, such as BVT933, DPCA37215, IK264, PNU 22394, WAY161503, R-1065, SB 243213 (Glaxo Smith Kline) and YM 348 and those disclosed in US3914250, WO00/77010,

WO02/36596, WO02/48124, WO02/10169, WO01/66548, WO02/44152, WO02/51844, WO02/40456, and WO02/40457; 5HT6 receptor modulators, such as those in WO03/030901, WO03/035061, WO03/039547, and the like; acyl-estrogens, such as oleoyl-estrone, disclosed in del Mar-Grasa, M. et al, Obesity Research, 9:202-9 (2001) and Japanese Patent Application No. JP 2000256190; anorectic bicyclic compounds such as 1426 (Aventis) and 1954 (Aventis), and the compounds disclosed in WO00/18749, WO01/32638, WO01/62746, WO01/62747, and WO03/015769; CB 1 (cannabinoid-1 receptor) antagonist/inverse agonists such as rimonabant (Acomplia; Sanofi), SR-147778 (Sanofi), SR-141716 (Sanofi), BAY 65-2520 (Bayer), and SLV 319 (Solvay), and those disclosed in patent publications US4973587, US5013837, US5081122, US5112820, US5292736, US5532237, US5624941, US6028084, US6509367, US6509367, WO96/33159, WO97/29079, WO98/31227, WO98/33765, WO98/37061, WO98/41519, WO98/43635, WO98/43636, WO99/02499, WO00/10967, WO00/10968, WO01/09120, WO01/58869, WO01/64632, WO01/64633, WO01/64634, WO01/70700, WO01/96330, WO02/076949, WO03/006007, WO03/007887, WO03/020217, WO03/026647, WO03/026648, WO03/027069, WO03/027076, WO03/027114, WO03/037332, WO03/040107, WO03/086940, WO03/084943 and EP658546; CCK-A (cholecystokinin-A) agonists, such as AR-R 15849, GI 181771 (GSK), JMV-180, A- 71378, A-71623 and SR146131 (Sanofi), and those described in US5739106; CNTF (Ciliary neurotrophic factors), such as GI- 181771 (Glaxo-SmithKline), SRI 46131 (Sanofi Synthelabo), butabindide, PD 170,292, and PD 149164 (Pfizer); CNTF derivatives, such as Axokine® (Regeneron), and those disclosed in WO94/09134, WO98/22128, and WO99/43813; dipeptidyl peptidase IV (DP-IV) inhibitors, such as isoleucine thiazolidide, valine pyrrolidide, NVP-DPP728, LAF237, P93/01, P 3298, TSL 225 (tryptophyl-1,2,3,4-tetrahydroisoquinoline-3- carboxylic acid; disclosed by Yamada et al, Bioorg. & Med. Chem. Lett. 8 (1998) 1537-1540), TMC-2A/2B/2C, CD26 inhibitors, FE 999011, P9310/K364, VIP 0177, SDZ 274-444, 2- cyanopyrrolidides and 4-cyanopyrrolidides as disclosed by Ashworth et al, Bioorg. & Med. Chem. Lett., Vol. 6, No. 22, pp 1163-1166 and 2745-2748 (1996) and the compounds disclosed patent publications. WO99/38501, WO99/46272, WO99/67279 (Probiodrug), WO99/67278 (Probiodrug), WO99/61431 (Probiodrug), WO02/083128, WO02/062764, WO03/000180, WO03/000181, WO03/000250, WO03/002530, WO03/002531, WO03/002553, WO03/002593, WO03/004498, WO03/004496, WO03/017936, WO03/024942,

WO03/024965, WO03/033524, WO03/037327 and EP1258476; growth hormone secretagogue receptor agonists/antagonists, such as NN703, hexarelin, MK- 0677 (Merck), SM-130686, CP-424391 (Pfizer), LY 444,711 (Eli Lilly), L-692,429 and L- 163,255, and such as those disclosed in USSN 09/662448, US provisional application 60/203335, US6358951, US2002049196, US2002/022637, WO01/56592 and WO02/32888; H3 (histamine H3) antagonist/inverse agonists, such as thioperamide, 3-(1H-imidazol-4- yl)propyl N-(4-pentenyl)carbamate), clobenpropit, iodophenpropit, imoproxifan, GT2394 (Gliatech), and A331440, O-[3-(1H-imidazol-4-yl)propanol]carbamates (Kiec-Kononowicz, K. et al., *Pharmazie*, 55:349-55 (2000)), piperidine-containing histamine H3-receptor antagonists (Lazewska, D. et al., *Pharmazie*, 56:927-32 (2001), benzophenone derivatives and related compounds (Sasse, A. et al., *Arch. Pharm.(Weinheim)* 334:45-52 (2001)), substituted N- phenylcarbamates (Reidemeister, S. et al., *Pharmazie*, 55:83-6 (2000)), and proxifan derivatives (Sasse, A. et al., *J. Med. Chem.* 43:3335-43 (2000)) and histamine H3 receptor modulators such as those disclosed in WO02/15905, WO03/024928 and WO03/024929; leptin derivatives, such as those disclosed in US5552524, US5552523, US5552522, US5521283, WO96/23513, WO96/23514, WO96/23515, WO96/23516, WO96/23517, WO96/23518, WO96/23519, and WO96/23520; leptin, including recombinant human leptin (PEG-OB, Hoffman La Roche) and recombinant methionyl human leptin (Amgen); lipase inhibitors, such as tetrahydrolipstatin (orlistat/Xenical®), Triton WR1 339, RHC80267, lipstatin, teasaponin, diethylumbelliferyl phosphate, FL-386, WAY-121898, Bay-N-3176, valilactone, esteracin, ebelactone A, ebelactone B, and RHC 80267, and those disclosed in patent publications WO01/77094, US4598089, US4452813, USUS5512565, US5391571, US5602151, US4405644, US4189438, and US4242453; lipid metabolism modulators such as maslinic acid, erythrodiol, ursolic acid uvaol, betulinic acid, betulin, and the like and compounds disclosed in WO03/011267; Mc4r (melanocortin 4 receptor) agonists, such as CHIR86036 (Chiron), ME- 10142, ME-10145, and HS-131 (Melacure), and those disclosed in PCT publication Nos. WO99/64002, WO00/74679, WOO 1/991752, WOO 1/25192, WOO 1/52880, WOO 1/74844, WOO 1/70708, WO01/70337, WO01/91752, WO02/059095, WO02/059107, WO02/059108, WO02/059117, WO02/06276, WO02/12166, WO02/11715, WO02/12178, WO02/15909, WO02/38544, WO02/068387, WO02/068388, WO02/067869, WO02/081430, WO03/06604, WO03/007949, WO03/009847, WO03/009850, WO03/013509,

and WO03/031410; Mc5r (melanocortin 5 receptor) modulators, such as those disclosed in WO97/19952, WO00/15826, WO00/15790, US20030092041; melanin-concentrating hormone 1 receptor (MCHR) antagonists, such as T-226296 (Takeda), SB 568849, SNP-7941 (Synaptic), and those disclosed in patent publications WOO 1/21169, WO01/82925, WO01/87834, WO02/051809, WO02/06245, WO02/076929, WO02/076947, WO02/04433, WO02/51809, WO02/083134, WO02/094799, WO03/004027, WO03/13574, WO03/15769, WO03/028641, WO03/035624, WO03/033476, WO03/033480, JP13226269, and JP1437059; mGluR5 modulators such as those disclosed in WO03/029210, WO03/047581, WO03/048137, WO03/051315, WO03/051833, WO03/053922, WO03/059904, and the like; serotonergic agents, such as fenfluramine (such as Pondimin® (Benzeneethanamine, N-ethyl- alpha-methyl-3-(trifluoromethyl)-, hydrochloride), Robbins), dexfenfluramine (such as Redux® (Benzeneethanamine, N-ethyl-alpha-methyl-3-(trifluoromethyl)-, hydrochloride), Interneuron) and sibutramine ((Meridia®, Knoll/Reductil™) including racemic mixtures, as optically pure isomers (+) and (-), and pharmaceutically acceptable salts, solvents, hydrates, clathrates and prodrugs thereof including sibutramine hydrochloride monohydrate salts thereof, and those compounds disclosed in US4746680, US4806570, and US5436272, US20020006964, WOO 1/27068, and WOO 1/62341; NE (norepinephrine) transport inhibitors, such as GW 320659, despiramine, talsupram, and nomifensine; NPY 1 antagonists, such as BIBP3226, J-115814, BIBO 3304, LY-357897, CP-671906, GI- 264879A, and those disclosed in US6001836, WO96/14307, WO01/23387, WO99/51600, WO01/85690, WO01/85098, WO01/85173, and WO01/89528; NPY5 (neuropeptide Y Y5) antagonists, such as 152,804, GW-569180A, GW-594884A, GW- 587081X, GW-548118X, FR235208, FR226928, FR240662, FR252384, 1229U91, GI-264879A, CGP71683A, LY-377897, LY-366377, PD-160170, SR- 120562A, SR-120819A, JCF-104, and H409/22 and those compounds disclosed in patent publications US6140354, US6191160, US6218408, US6258837, US6313298, US6326375, US6329395, US6335345, US6337332, US6329395, US6340683, EP01010691, EP-01044970, WO97/19682, WO97/20820, WO97/20821, WO97/20822, WO97/20823, WO98/27063, WO00/107409, WO00/185714, WO00/185730, WO00/64880, WO00/68197, WO00/69849, WO/0113917, WO01/09120, WO01/14376, WO01/85714, WO01/85730, WO01/07409, WO01/02379, WO01/23388, WO01/23389, WOO 1/44201, WO01/62737, WO01/62738, WO01/09120,

WO02/20488, WO02/22592, WO02/48152, WO02/49648, WO02/051806, WO02/094789, WO03/009845, WO03/014083, WO03/022849, WO03/028726 and Norman et al, J. Med. Chem. 43:4288-4312 (2000); opioid antagonists, such as nalmefene (REVEX ®), 3-methoxynaltrexone, methylnaltrexone, naloxone, and naltrexone (e.g. PT901; Pain Therapeutics, Inc.) and those disclosed in US20050004155 and WO00/21509; orexin antagonists, such as SB-334867-A and those disclosed in patent publications WO01/96302, WO01/68609, WO02/44172, WO02/51232, WO02/51838, WO02/089800, WO02/090355, WO03/023561, WO03/032991, and WO03/037847; PDE inhibitors (e.g. compounds which slow the degradation of cyclic AMP (cAMP) and/or cyclic GMP (cGMP) by inhibition of the phosphodiesterases, which can lead to a relative increase in the intracellular concentration of cAMP and cGMP; possible PDE inhibitors are primarily those substances which are to be numbered among the class consisting of the PDE3 inhibitors, the class consisting of the PDE4 inhibitors and/or the class consisting of the PDE5 inhibitors, in particular those substances which can be designated as mixed types of PDE3/4 inhibitors or as mixed types of PDE3/4/5 inhibitors) such as those disclosed in patent publications DE1470341, DE2108438, DE2123328, DE2305339, DE2305575, DE2315801, DE2402908, DE2413935, DE2451417, DE2459090, DE2646469, DE2727481, DE2825048, DE2837161, DE2845220, DE2847621, DE2934747, DE3021792, DE3038166, DE3044568, EP000718, EP0008408, EP0010759, EP0059948, EP0075436, EP0096517, EPO1 12987, EPO1 16948, EP0150937, EP0158380, EP0161632, EP0161918, EP0167121, EP0199127, EP0220044, EP0247725, EP0258191, EP0272910, EP0272914, EP0294647, EP0300726, EP0335386, EP0357788, EP0389282, EP0406958, EP0426180, EP0428302, EP0435811, EP0470805, EP0482208, EP0490823, EP0506194, EP0511865, EP0527117, EP0626939, EP0664289, EP0671389, EP0685474, EP0685475, EP0685479, JP92234389, JP94329652, JP95010875, US4963561, US5141931, WO9117991, WO9200968, WO9212961, WO9307146, WO9315044, WO9315045, WO9318024, WO9319068, WO9319720, WO9319747, WO9319749, WO9319751, WO9325517, WO9402465, WO9406423, WO9412461, WO9420455, WO9422852, WO9425437, WO9427947, WO9500516, WO9501980, WO9503794, WO9504045, WO9504046, WO9505386, WO9508534, WO9509623, WO9509624, WO9509627, WO9509836, WO9514667, WO9514680, WO9514681, WO9517392, WO9517399, WO9519362, WO9522520, WO9524381, WO9527692, WO9528926,

WO9535281, WO9535282, WO9600218, WO9601825, WO9602541, WO9611917, DE3142982, DE1 116676, DE2162096, EP0293063, EP0463756, EP0482208, EP0579496, EP0667345 US6331543, US20050004222 (including those disclosed in formulas I- XIII and paragraphs 37-39, 85-0545 and 557-577), WO9307124, EP0163965, EP0393500, EP0510562, EP0553174, WO9501338 and WO9603399, as well as PDE5 inhibitors (such as RX-RA-69, SCH-51866, KT-734, vesnarinone, zaprinast, SKF-96231, ER-21355, BF/GP-385, NM-702 and sildenafil (Viagra™)), PDE4 inhibitors (such as etazolate, ICI63197, RP73401, imazolidinone (RO-20-1724), MEM 1414 (R1533/R1500; Pharmacia Roche), denbufylline, rolipram, oxagrelate, nitraquazone, Y-590, DH-6471, SKF-94120, motapizone, lixazinone, indolidan, olprinone, atizoram, KS-506-G, dipamfylline, BMY-43351, atizoram, arofylline, filaminast, PDB-093, UCB-29646, CDP-840, SKF-107806, piclamilast, RS-17597, RS-25344- 000, SB-207499, TIBENELAST, SB-210667, SB-211572, SB-211600, SB-212066, SB-212179, GW-3600, CDP-840, mopidamol, anagrelide, ibudilast, amrinone, pimobendan, cilostazol, quazinone and N-(3,5-dichloropyrid-4-yl)-3-cyclopropylmethoxy-4-difluoromethoxybenzamide, PDE3 inhibitors (such as ICI153, 100, bemorandane (RWJ 22867), MCI-154, UD-CG 212, sulmazole, ampizone, cilostamide, carbazeran, piroximone, imazodan, CI-930, siguazodan, adibendan, saterinone, SKF-95654, SDZ-MKS-492, 349-U-85, emoradan, EMD-53998, EMD- 57033, NSP-306, NSP-307, revizinone, NM-702, WIN-62582 and WIN-63291, enoximone and milrinone, PDE3/4 inhibitors (such as benafentrine, trequinsin, ORG-30029, zardaverine, L- 686398, SDZ-ISQ-844, ORG-20241, EMD-54622, and tolafentrine) and other PDE inhibitors (such as vinpocetin, papaverine, enprofylline, cilomilast, fenoximone, pentoxifylline, roflumilast, tadalafil(Cialis®), theophylline, and vardenafil(Levitra®); Neuropeptide Y2 (NPY2) agonists include but are not limited to: polypeptide YY and fragments and variants thereof (e.g. YY3-36 (PYY3-36)(N. Engl. J. Med. 349:941, 2003; IKPEAPGE DASPEELNRY YASLRHYLNL VTRQRY (SEQ ID NO:XXX)) and PYY agonists such as those disclosed in WO02/47712, WO03/026591, WO03/057235, and WO03/027637; serotonin reuptake inhibitors, such as, paroxetine, fluoxetine (Prozac™), fluvoxamine, sertraline, citalopram, and imipramine, and those disclosed in US6162805, US6365633, WO03/00663, WOO 1/27060, and WOO 1/162341; thyroid hormone β agonists, such as KB-2611 (KaroBioBMS), and those disclosed in WO02/15845, WO97/21993, WO99/00353, GB98/284425, U.S. Provisional Application No.

60/183,223, and Japanese Patent Application No. JP 2000256190; UCP-I (uncoupling protein-1), 2, or 3 activators, such as phytanic acid, 4-[(E)-2-(5, 6,7,8- tetrahydro-5,5,8,8-tetramethyl-2-naphthalenyl)-1-propenyl]benzoic acid (TTNPB), retinoic acid, and those disclosed in WO99/00123; β 3 (beta adrenergic receptor 3) agonists, such as AJ9677/TAK677 (Dainippon/Takeda), L750355 (Merck), CP331648 (Pfizer), CL-316,243, SB 418790, BRL-37344, L-796568, BMS-196085, BRL-35135A, CGP12177A, BTA-243, GW 427353, Trecadrine, Zeneca D7114, N-5984 (Nisshin Kyorin), LY-377604 (Lilly), SR 59119A, and those disclosed in US5541204, US5770615, US5491134, US5776983, US488064, US5705515, US5451677, WO94/18161, WO95/29159, WO97/46556, WO98/04526 and WO98/32753, WO01/74782, WO02/32897, WO03/014113, WO03/016276, WO03/016307, WO03/024948, WO03/024953 and WO03/037881; noradrenergic agents including, but not limited to, diethylpropion (such as Tenuate® (1- propanone, 2-(diethylamino)-1 -phenyl-, hydrochloride), Merrell), dextroamphetamine (also known as dextroamphetamine sulfate, dexamphetamine, dexedrine, Dexampex, Ferndex, Oxydess II, Robese, Spancap #1), mazindol ((or 5-(p-chlorophenyl)-2,5-dihydro-3H- imidazo[2,1-a]isoindol-5-ol) such as Sanorex®, Novartis or Mazanor®, Wyeth Ayerst), phenylpropanolamine (or Benzenemethanol, alpha-(1-aminoethyl)-, hydrochloride), phentermine ((or Phenol, 3-[[4,5-duhydro-1H-imidazol-2-yl)ethyl](4-methylphenyl)amino], monohydrochloride) such as Adipex-P®, Lemmon, FASTIN®, Smith-Kline Beecham and Ionamin®, Medeva), phendimetrazine ((or (2S,3S)-3,4-Dimethyl-2phenylmorpholine L-(+)- tartrate (1 :1)) such as Metra® (Forest) , Plegine® (Wyeth- Ay erst), Prelu-2® (Boehringer Ingelheim), and Statobex® (Lemmon), phendamine tartrate (such as Thephorin® (2,3,4,9- Tetrahydro-2-methyl-9-phenyl-1H-indenol[2,1-c]pyridine L-(+)-tartrate (1 :1)), Hoffmann- LaRoche), methamphetamine (such as Desoxyn®, Abbot ((S)-N, (alpha)-dimethylbenzeneethanamine hydrochloride)), and phendimetrazine tartrate (such as Bontril® Slow-Release Capsules, Amarin (-3,4-Dimethyl-2-phenylmorpholine Tartrate); fatty acid oxidation upregulator/inducers such as Famoxin® (Genset); monamine oxidase inhibitors including but not limited to befloxatone, moclobemide, brofaromine, phenoxathine, esuprone, befol, toloxatone, pirlindol, amiflamine, sercloremine, bazinaprine, lazabemide, milacemide, caroxazone and other certain compounds as disclosed by WO01/12176; and other anti-obesity agents such as 5HT-2 agonists, ACC (acetyl-CoA carboxylase) inhibitors such as those described

in WO03/072197, alpha-lipoic acid (alpha-LA), AOD9604, appetite suppressants such as those in WO03/40107, ATL-962 (Alizyme PLC), benzocaine, benzphetamine hydrochloride (Didrex), bladderwrack (*focus vesiculosus*), BRS3 (bombesin receptor subtype 3) agonists, bupropion, caffeine, CCK agonists, chitosan, chromium, conjugated linoleic acid, corticotropin-releasing hormone agonists, dehydroepiandrosterone, DGAT1 (diacylglycerol acyltransferase 1) inhibitors, DGAT2 (diacylglycerol acyltransferase 2) inhibitors, dicarboxylate transporter inhibitors, ephedra, exendin-4 (an inhibitor of glp-1) FAS (fatty acid synthase) inhibitors (such as Cerulenin and C75), fat resorption inhibitors (such as those in WO03/053451, and the like), fatty acid transporter inhibitors, natural water soluble fibers (such as psyllium, plantago, guar, oat, pectin), galanin antagonists, galega (Goat's Rue, French Lilac), garcinia cambogia, germander (*teucrium chamaedrys*), ghrelin antibodies and ghrelin antagonists (such as those disclosed in WO01/87335, and WO02/08250), polypeptide hormones and variants thereof which affect the islet cell secretion, such as the hormones of the secretin/gastric inhibitory polypeptide (GIP)/vasoactive intestinal polypeptide (VIP)/pituitary adenylate cyclase activating polypeptide (PACAP)/glucagon-like polypeptide II (GLP- II)/glicentin/glucagon gene family and/or those of the adrenomedullin/amylin/calcitonin gene related polypeptide (CGRP) gene family including GLP-1 (glucagon-like polypeptide 1) agonists (e.g. (1) exendin-4, (2) those GLP-I molecules described in US20050130891 including GLP- 1(7-34), GLP-I(7-35), GLP-I(7-36) or GLP-I(7-37) in its C-terminally carboxylated or amidated form or as modified GLP-I polypeptides and modifications thereof including those described in paragraphs 17-44 of US20050130891, and derivatives derived from GLP-I-(7- 34)COOH and the corresponding acid amide are employed which have the following general formula: R-NH-HAEGTFTSDVSYLEGQAAKEFIAWLVK-CONH₂ wherein R=H or an organic compound having from 1 to 10 carbon atoms. Preferably, R is the residue of a carboxylic acid. Particularly preferred are the following carboxylic acid residues: formyl, acetyl, propionyl, isopropionyl, methyl, ethyl, propyl, isopropyl, n-butyl, sec-butyl, tert- butyl.) and glp-1 (glucagon-like polypeptide- 1), glucocorticoid antagonists, glucose transporter inhibitors, growth hormone secretagogues (such as those disclosed and specifically described in US5536716), interleukin-6 (IL-6) and modulators thereof (as in WO03/057237, and the like), L- carnitine, Mc3r (melanocortin 3 receptor) agonists, MCH2R (melanin concentrating hormone 2R)

agonist/antagonists, melanin concentrating hormone antagonists, melanocortin agonists (such as Melanotan II or those described in WO 99/64002 and WO 00/74679), nomame herba, phosphate transporter inhibitors, phytopharm compound 57 (CP 644,673), pyruvate, SCD-I (stearoyl-CoA desaturase-1) inhibitors, T71 (Tularik, Inc., Boulder CO), Topiramate (Topimax®, indicated as an anti-convulsant which has been shown to increase weight loss), transcription factor modulators (such as those disclosed in WO03/026576), β -hydroxy steroid dehydrogenase-1 inhibitors (β -HSD-I), β -hydroxy- β -methylbutyrate, p57 (Pfizer), Zonisamide (Zonegran™, indicated as an anti-epileptic which has been shown to lead to weight loss), and the agents disclosed in US20030119428 paragraphs 20-26.

1.3.2.7 Phosphodiesterase inhibitors

[151] In certain embodiments, the regimen of combination therapy includes the administration of one or more phosphodiesterase (“PDE”) inhibitors. PDE inhibitors slow the degradation of cyclic AMP (cAMP) and/or cyclic GMP (cGMP) by inhibiting phosphodiesterases, which can lead to a relative increase in the intracellular concentration of cAMP and/or cGMP. Non-limiting examples of PDE inhibitors that can be used in combination with the GCC agonists of the invention include PDE3 inhibitors, PDE4 inhibitors and/or PDE5 inhibitors, in particular those substances which can be designated as mixed types of PDE3/4 inhibitors or as mixed types of PDE3/4/5 inhibitors. Non-limiting examples of such PDE inhibitors are described in the following patent applications and patents: DE1470341, DE2108438, DE2123328, DE2305339, DE2305575, DE2315801, DE2402908, DE2413935, DE2451417, DE2459090, DE2646469, DE2727481, DE2825048, DE2837161, DE2845220, DE2847621, DE2934747, DE3021792, DE3038166, DE3044568, EP000718, EP0008408, EP0010759, EP0059948, EP0075436, EP0096517, EPO1 12987, EPO1 16948, EP0150937, EP0158380, EP0161632, EP0161918, EP0167121, EP0199127, EP0220044, EP0247725, EP0258191, EP0272910, EP0272914, EP0294647, EP0300726, EP0335386, EP0357788, EP0389282, EP0406958, EP0426180, EP0428302, EP0435811, EP0470805, EP0482208, EP0490823, EP0506194, EP0511865, EP0527117, EP0626939, EP0664289, EP0671389, EP0685474, EP0685475, EP0685479, JP92234389, JP94329652, JP95010875, U.S. Pat. Nos. 4,963,561, 5,141,931, WO9117991, WO9200968, WO9212961, WO9307146, WO9315044, WO9315045, WO9318024,

WO9319068, WO9319720, WO9319747, WO9319749, WO9319751, WO9325517, WO9402465, WO9406423, WO9412461, WO9420455, WO9422852, WO9425437, WO9427947, WO9500516, WO9501980, WO9503794, WO9504045, WO9504046, WO9505386, WO9508534, WO9509623, WO9509624, WO9509627, WO9509836, WO9514667, WO9514680, WO9514681, WO9517392, WO9517399, WO9519362, WO9522520, WO9524381, WO9527692, WO9528926, WO9535281, WO9535282, WO9600218, WO9601825, WO9602541, WO9611917, DE3142982, DE1 116676, DE2162096, EP0293063, EP0463756, EP0482208, EP0579496, EP0667345 US6,331,543, US20050004222 (including those disclosed in formulas I-XIII and paragraphs 37-39, 85-0545 and 557-577) and WO9307124, EP0163965, EP0393500, EP0510562, EP0553174, WO9501338 and WO9603399. PDE5 inhibitors which may be mentioned by way of example are RX-RA-69, SCH-51866, KT-734, vesnarinone, zaprinast, SKF-96231, ER-21355, BF/GP-385, NM-702 and sildenafil (Viagra®). PDE4 inhibitors which may be mentioned by way of example are RO-20-1724, MEM 1414 (R1533/R1500; Pharmacia Roche), DENBUFYLLINE, ROLIPRAM, OXAGRELATE, NITRAQUAZONE, Y-590, DH-6471, SKF-94120, MOTAPIZONE, LIXAZINONE, INDOLIDAN, OLPRINONE, ATIZORAM, KS-506-G, DIPAMFYLLINE, BMY-43351, ATIZORAM, AROFYLLINE, FILAMINAST, PDB-093, UCB-29646, CDP-840, SKF-107806, PICLAMILAST, RS-17597, RS-25344-000, SB-207499, TIBENELAST, SB-210667, SB-211572, SB-211600, SB-212066, SB-212179, GW-3600, CDP-840, MOPIDAMOL, ANAGRELIDE, IBUDILAST, AMRINONE, PIMOBENDAN, CILOSTAZOL, QUAZINONE and N-(3,5-dichloropyrid-4-yl)-3-cyclopropylmethoxy-4-difluoromethoxybenzamide. PDE3 inhibitors which may be mentioned by way of example are SULMAZOLE, AMPIZONE, CILOSTAMIDE, CARBAZERAN, PIROXIMONE, IMAZODAN, CI-930, SIGUAZODAN, ADIBENDAN, SATERINONE, SKF-95654, SDZ-MKS-492, 349-U-85, EMORADAN, EMD-53998, EMD-57033, NSP-306, NSP-307, REVIZINONE, NM-702, WIN-62582 and WIN-63291, ENOXIMONE and MILRINONE. PDE3/4 inhibitors which may be mentioned by way of example are BENAFENTRINE, TREQUINSIN, ORG-30029, ZARDAVERINE, L-686398, SDZ-ISQ-844, ORG-20241, EMD-54622, and TOLAFENTRINE. Other PDE inhibitors include: cilomilast, pentoxifylline, roflumilast, tadalafil (Cialis®), theophylline, and vardenafil (Levitra®), zaprinast (PDE5 specific). GCC AGONIST

1.3.2.8 Analgesic Agents

[152] In certain embodiments, the regimen of combination therapy includes the administration of one or more analgesic agents, *e.g.*, an analgesic compound or an analgesic polypeptide. In some embodiments, the GCC agonist formulation is administered simultaneously or sequentially with one or more analgesic agents. In other embodiments, the GCC agonist is covalently linked or attached to an analgesic agent to create a therapeutic conjugate. Non-limiting examples of analgesic agents that can be used include calcium channel blockers, 5HT receptor antagonists (for example 5HT₃, 5HT₄ and 5HT₁ receptor antagonists), opioid receptor agonists (loperamide, fedotozine, and fentanyl), NK₁ receptor antagonists, CCK receptor agonists (*e.g.*, loxiglumide), NK₁ receptor antagonists, NK₃ receptor antagonists, norepinephrine-serotonin reuptake inhibitors (NSRI), vanilloid and cannabinoic receptor agonists, and sialorphin. Further examples of analgesic agents in the various classes are known in the art.

[153] In one embodiment, the analgesic agent is an analgesic polypeptide selected from the group consisting of sialorphin-related polypeptides, including those comprising the amino acid sequence QHNPR (SEQ ID NO: 239), including: VQHNPR (SEQ ID NO: 240); VRQHNPR (SEQ ID NO: 241); VRGQHNPR (SEQ ID NO: 242); VRGPQHNPR (SEQ ID NO: 243); VRGPRQHNPR (SEQ ID NO: 244); VRGPRRQHNPR (SEQ ID NO: 245); and RQHNPR (SEQ ID NO: 246). Sialorphin-related polypeptides bind to neprilysin and inhibit neprilysin-mediated breakdown of substance P and Met-enkephalin. Thus, compounds or polypeptides that are inhibitors of neprilysin are useful analgesic agents which can be administered with the GCC agonists described herein or covalently linked to a GCC agonist to form a therapeutic conjugate. Sialorphin and related polypeptides are described in U.S. Patent 6,589,750; U.S. 20030078200 A1; and WO 02/051435 A2.

[154] In another embodiment, a GCC agonist formulation of the invention is administered as part of a regimen of combination therapy with an opioid receptor antagonist or agonist. In one embodiment, the GCC agonist and the opioid receptor antagonist or agonist are linked via a covalent bond. Non-limiting examples of opioid receptor antagonists include naloxone, naltrexone, methyl naloxone, nalmefene, cypridime, beta funaltrexamine, naloxonazine, naltrindole, nor-binaltorphimine, enkephalin pentapeptide (HOE825; Tyr-D-Lys-Gly-Phe-L-

homoserine), trimebutine, vasoactive intestinal polypeptide, gastrin, glucagons. Non-limiting examples of opioid receptor agonists include fedotozine, asimadoline, and ketocyclazocine, the compounds described in WO03/097051 and WO05/007626, morphine, diphenyloxyate, frakefamide (H-Tyr-D-Ala-Phe(F)-Phe-NH₂; WO 01/019849 A1), and loperamide.

[155] Further non-limiting examples of analgesic agents that can be used in a regimen of combination therapy along with the GCC agonist formulations of the invention include the dipeptide Tyr-Arg (kyotorphin); the chromogranin-derived polypeptide (CgA 47-66; *See, e.g.,* Ghia et al. 2004 Regulatory polypeptides 119:199); CCK receptor agonists such as caerulein; conotoxin polypeptides; peptide analogs of thymulin (FR Application 2830451); CCK (CCKa or CCKb) receptor antagonists, including loxiglumide and dexloxiglumide (the R- isomer of loxiglumide) (WO 88/05774); 5-HT₄ agonists such as tegaserod (Zelnorm®), mosapride, metoclopramide, zacopride, cisapride, renzapride, benzimidazolone derivatives such as BIMU 1 and BIMU 8, and lorexapride; calcium channel blockers such as ziconotide and related compounds described in, for example, EP625162B1, US 5,364,842, US 5,587,454, US 5,824,645, US 5,859,186, US 5,994,305, US 6,087,091, US 6,136,786, WO 93/13128 A1, EP 1336409 A1, EP 835126 A1, EP 835126 B1, US 5,795,864, US 5,891,849, US 6,054,429, WO 97/01351 A1; NK-1, receptor antagonists such as aprepitant (Merck & Co Inc), vofopitant, ezlopitant (Pfizer, Inc.), R-673 (Hoffmann-La Roche Ltd), SR-48968 (Sanofi Synthelabo), CP-122,721 (Pfizer, Inc.), GW679769 (Glaxo Smith Kline), TAK-637 (Takeda/Abbot), SR-14033, and related compounds described in, for example, EP 873753 A1, US 20010006972 A1, US 20030109417 A1, WO 01/52844 A1 (for a review see Giardina et al. 2003. *Drugs* 6:758); NK-2 receptor antagonists such as nepadutant (Menarini Ricerche SpA), saredutant (Sanofi-Synthelabo), GW597599 (Glaxo Smith Kline), SR-144190 (Sanofi-Synthelabo) and UK-290795 (Pfizer Inc); NK3 receptor antagonists such as osanetant (SR-142801; Sanofi-Synthelabo), SSR-241586, talnetant and related compounds described in, for example, WO 02/094187 A2, EP 876347 A1, WO 97/21680 A1, US 6,277,862, WO 98/1 1090, WO 95/28418, WO 97/19927, and Boden et al. (*J Med Chem.* 39:1664-75, 1996); norepinephrine-serotonin reuptake inhibitors (NSRI) such as milnacipran and related compounds described in WO 03/077897; and vanilloid receptor antagonists such as arvanil and related compounds described in WO 01/64212 A1.

[156] In addition to sialorphin-related polypeptides, analgesic polypeptides include: AspPhe, endomorphin-1, endomorphin-2, nocistatin, dalargin, lupron, ziconotide, and substance P.

1.3.2.9 Insulin and Insulin Modulating Agents

[157] The GCC agonist peptides described herein can be used in combination therapy with insulin and related compounds including primate, rodent, or rabbit insulin including biologically active variants thereof including allelic variants, more preferably human insulin available in recombinant form. Sources of human insulin include pharmaceutically acceptable and sterile formulations such as those available from Eli Lilly (Indianapolis, Ind. 46285) as Humulin™ (human insulin rDNA origin). See, the THE PHYSICIAN'S DESK REFERENCE, 55.sup.th Ed. (2001) Medical Economics, Thomson Healthcare (disclosing other suitable human insulins).

[158] The GCC peptides described herein can also be used in combination therapy with agents that can boost insulin effects or levels of a subject upon administration, e.g. glipizide and/or rosiglitazone. The polypeptides and agonists described herein can be used in combination therapy with SYMLIN® (pramlintide acetate) and Exenatide® (synthetic exendin-4; a 39 aa polypeptide).

1.3.2.10 Anti-Hypertensive Agents

[159] The GCC agonist peptides described herein can be used in combination therapy with an anti-hypertensive agent including but not limited to: (1) diuretics, such as thiazides, including chlorthalidone, chlorthiazide, dichlorophenamide, hydroflumethiazide, indapamide, polythiazide, and hydrochlorothiazide; loop diuretics, such as bumetanide, ethacrynic acid, furosemide, and torsemide; potassium sparing agents, such as amiloride, and triamterene; carbonic anhydrase inhibitors, osmotics (such as glycerin) and aldosterone antagonists, such as spironolactone, eplerenone, and the like; (2) beta-adrenergic blockers such as acebutolol, atenolol, betaxolol, bevantolol, bisoprolol, bopindolol, carteolol, carvedilol, celiprolol, esmolol, indenolol, metoprolol, nadolol, nebivolol, penbutolol, pindolol, propranolol, sotalol, tertatolol, tilisolol, and timolol, and the like; (3) calcium channel blockers such as amlodipine, amlodipine, azelnidipine, barnidipine, benidipine, bepridil, cinaldipine, clevidipine, diltiazem, efonidipine, felodipine, gallopamil, isradipine, lacidipine, lemdipine, lercanidipine, nicardipine, nifedipine, nilvadipine,

nimodipine, nisoldipine, nitrendipine, manidipine, pranidipine, and verapamil, and the like; (4) angiotensin converting enzyme (ACE) inhibitors such as benazepril; captopril; ceranapril; cilazapril; delapril; enalapril; enalapril; fosinopril; imidapril; lisinopril; losinopril; moexipril; quinapril; quinaprilat; ramipril; perindopril; perindopril; quanipril; spirapril; tenocapril;trandolapril, and zofenopril, and the like; (5) neutral endopeptidase inhibitors such as omapatrilat, cadoxatril and ecadotril, fosidotril, sampatrilat, AVE7688, ER4030, and the like; (6) endothelin antagonists such as tezosentan, A308165, and YM62899, and the like; (7) vasodilators such as hydralazine, clonidine, minoxidil, and nicotiny alcohol, and the like; (8) angiotensin II receptor antagonists such as aprosartan, candesartan, eprosartan, irbesartan, losartan, olmesartan, prazosartan, tasosartan, telmisartan, valsartan, and EXP-3137, FI6828K, and RNH6270, and the like; (9) α/β adrenergic blockers such as nipradilol, arotinolol and amosulalol, and the like; (10) alpha 1 blockers, such as terazosin, urapidil, prazosin, tamsulosin, bunazosin, trimazosin, doxazosin, naftopidil, indoramin, WHP 164, and XENOIO, and the like; (11) alpha 2 agonists such as lofexidine, tiamenidine, moxonidine, rilmenidine and guanobenz, and the like; (12) aldosterone inhibitors, and the like; and (13) angiotensin-2 -binding agents such as those disclosed in WO03/030833. Specific anti-hypertensive agents that can be used in combination with polypeptides and agonists described herein include, but are not limited to: diuretics, such as thiazides (e.g., chlorthalidone, cyclothiazide (CAS RN 2259-96-3), chlorothiazide (CAS RN 72956-09-3, which may be prepared as disclosed in US2809194), dichlorophenamide, hydroflumethiazide, indapamide, polythiazide, bendroflumethazide, methyclothazide, polythiazide, trichlormethazide, chlorthalidone, indapamide, metolazone, quinethazone, althiazide (CAS RN 5588-16-9, which may be prepared as disclosed in British Patent No. 902,658), benzthiazide (CAS RN 91-33-8, which may be prepared as disclosed in US3108097), buthiazide (which may be prepared as disclosed in British Patent Nos. 861 ,367), and hydrochlorothiazide), loop diuretics (e.g. bumetanide, ethacrynic acid, furosemide, and torasemide), potassium sparing agents (e.g. amiloride, and triamterene (CAS Number 396-01-O)), and aldosterone antagonists (e.g. spironolactone (CAS Number 52-01-7), epi renone, and the like); β -adrenergic blockers such as Amiodarone (Cordarone, Pacerone), bunolol hydrochloride (CAS RN 31969-05-8, Parke-Davis), acebutolol (\pm N-[3-Acetyl-4-[2-hydroxy-3-[(1-methylethyl)amino]propoxy]phenyl]-butanamide, or (\pm)-3'-Acetyl-4'-[2-hydroxy -3-

(isopropylamino) propoxy] butyranilide), acebutolol hydrochloride (e.g. Sectral®, Wyeth-Ayerst), alprenolol hydrochloride (CAS RN 13707-88-5 see Netherlands Patent Application No. 6,605,692), atenolol (e.g. Tenormin®, AstraZeneca), carteolol hydrochloride (e.g. Cartrol® Filmtab®, Abbott), Celiprolol hydrochloride (CAS RN 57470-78-7, also see in US4034009), cetamolol hydrochloride (CAS RN 77590-95-5, see also US4059622), labetalol hydrochloride (e.g. Normodyne®, Schering), esmolol hydrochloride (e.g. Brevibloc®, Baxter), levobetaxolol hydrochloride (e.g. Betaxon™ Ophthalmic Suspension, Alcon), levobunolol hydrochloride (e.g. Betagan® Liquifilm® with C CAP® Compliance Cap, Allergan), nadolol (e.g. Nadolol, Mylan), practolol (CAS RN 6673-35-4, see also US3408387), propranolol hydrochloride (CAS RN 318-98-9), sotalol hydrochloride (e.g. Betapace AF™, Berlex), timolol (2-Propanol, 1-[(1,1-dimethylethyl)amino]-3-[[4-(4-morpholinyl)-1,2,5-thiadiazol-3-yl]oxy]-, hemihydrate, (S)-, CAS RN 91524-16-2), timolol maleate (S)-I-[(1,1-dimethylethyl) amino]-3-[[4-(4-morpholinyl)-1,2,5-thiadiazol-3-yl]oxy]-2-propanol (Z)-2-butenedioate (1 :1) salt, CAS RN 26921-17-5), bisoprolol (2-Propanol, 1-[4-[[2-(1-methylethoxy)ethoxy]-methyl]phenoxy]-3-[(1-methylethyl)amino]-, (±), CAS RN 66722-44-9), bisoprolol fumarate (such as (±)-1-[4-[[2-(1-Methylethoxy) ethoxy]methyl]phenoxy]-3-[(1-methylethyl)amino]-2-propanol (E) -2-butenedioate (2:1) (salt), e.g., Zebeta™, Lederle Consumer), nebivalol (2H-1-Benzopyran-2-methanol, $\alpha\alpha'$ -[iminobis(methylene)]bis[6-fluoro-3,4-dihydro-, CAS RN 99200-09-6 see also U.S. Pat. No. 4,654,362), cicloprolol hydrochloride, such 2-Propanol, 1-[4-[2-(cyclopropylmethoxy)ethoxy]phenoxy]-3-[1-methylethyl)amino]-, hydrochloride, A.A.S. RN 63686-79-3), dexpropranolol hydrochloride (2-Propanol, 1-[1-methylethyl)-amino]-3-(1-naphthalenyloxy)-hydrochloride (CAS RN 13071-11-9), diacetolol hydrochloride (Acetamide, N-[3-acetyl-4-[2-hydroxy-3-[(1-methyl-ethyl)amino]propoxy] [phenyl]-, monohydrochloride CAS RN 69796-04-9), dilevalol hydrochloride (Benzamide, 2-hydroxy-5-[1-hydroxy-2-[1-methyl-3-phenylpropyl)amino]ethyl]-, monohydrochloride, CAS RN 75659-08-4), exaprolol hydrochloride (2-Propanol, 1-(2-cyclohexylphenoxy)-3 - [(1-methylethyl)amino] -, hydrochloride CAS RN 59333-90-3), flestolol sulfate (Benzoic acid, 2-fluoro-, 3-[[2-[aminocarbonyl)amino]- - dimethylethyl]amino]-2-hydroxypropyl ester, (+)- sulfate (1 :1) (salt), CAS RN 88844-73-9; metalol hydrochloride (Methanesulfonamide, N-[4-[1-hydroxy-2-(methylamino)propyl]phenyl]-, monohydrochloride CAS RN 7701-65-7), metoprolol 2-

Propanolol, 1-[4-(2-methoxyethyl)phenoxy]-3-[(1-methylethyl)amino]-; CAS RN 37350-58-6), metoprolol tartrate (such as 2-Propanolol, 1-[4-(2-methoxyethyl)phenoxy]-3-[(1-methylethyl)amino]-, e.g., Lopressor®, Novartis), pamtolol sulfate (Carbamic acid, [2-[4-[2-hydroxy-3-[(1-methylethyl)amino]propoxy]phenyl]-ethyl]-, methyl ester, (±) sulfate (salt) (2:1), CAS RN 59954-01-7), penbutolol sulfate (2-Propanolol, 1-(2-cyclopentylphenoxy)-3-[(1,1-dimethyl-ethyl)amino] 1, (S)-, sulfate (2:1) (salt), CAS RN 38363-32-5), practolol (Acetamide, N-[4-[2-hydroxy-3-[(1-methylethyl)amino]-propoxy]phenyl]-, CAS RN 6673-35-4; tiprenolol hydrochloride (Propanolol, 1-[(1-methylethyl)amino]-3-[2-(methylthio)-phenoxy]-, hydrochloride, (±), CAS RN 39832-43-4), tolamolol (Benzamide, 4-[2-[[2-hydroxy-3-(2-methylphenoxy)-propyl] amino] ethoxy]-, CAS RN 38103-61-6), bopindolol, indenolol, pindolol, propanolol, tertatolol, and tilisolol, and the like; calcium channel blockers such as besylate salt of amlodipine (such as 3-ethyl-5-methyl-2-(2-aminoethoxymethyl)-4-(2-chlorophenyl)-1,4-dihydro-6-methyl-3,5-pyridinedicarboxylate benzenesulphonate, e.g., Norvasc®, Pfizer), clentiazem maleate (1,5-Benzothiazepin-4(5H)-one, 3-(acetyloxy)-8-chloro-5-[2-(dimethylamino)ethyl]-2,3-dihydro-2-(4-methoxyphenyl)-(2S-cis)-, (Z)-2-butenedioate (1:1), see also US4567195), isradipine (3,5-Pyridinedicarboxylic acid, 4-(4-benzofurazanyl)-1,4-dihydro-2,6-dimethyl-, methyl 1-methylethyl ester, (±)-4-(4-benzofurazanyl)-1,4-dihydro-2,6-dimethyl-3,5-pyridinedicarboxylate, see also US4466972); nimodipine (such as isopropyl (2-methoxyethyl) 1,4-dihydro-2,6-dimethyl-4-(3-nitrophenyl)-3,5-pyridine-dicarboxylate, e.g. Nimotop®, Bayer), felodipine (such as ethyl methyl 4-(2,3-dichlorophenyl)-1,4-dihydro-2,6-dimethyl-3,5-pyridinedicarboxylate-, e.g. Plendil® Extended-Release, AstraZeneca LP), nilvadipine (3,5-Pyridinedicarboxylic acid, 2-cyano-1,4-dihydro-6-methyl-4-(3-nitrophenyl)-,3-methyl 5-(1-methylethyl) ester, also see US3799934), nifedipine (such as 3,5-pyridinedicarboxylic acid,1,4-dihydro-2,6-dimethyl-4-(2-nitrophenyl)-, dimethyl ester, e.g., Procardia XL® Extended Release Tablets, Pfizer), diltiazem hydrochloride (such as 1,5-Benzothiazepin-4(5H)-one,3-(acetyloxy)-5[2-(dimethylamino)ethyl]-2,3-dihydro-2(4-methoxyphenyl)-, monohydrochloride, (+)-cis., e.g., Tiazac®, Forest), verapamil hydrochloride (such as benzeneacetonitrile, (alpha)-[[3-[[2-(3,4-dimethoxyphenyl) ethyl]methylamino]propyl] -3,4-dimethoxy-(alpha)-(1-methylethyl) hydrochloride, e.g., Isoptin® SR, Knoll Labs), teludipine hydrochloride (3,5-Pyridinedicarboxylic acid, 2-[(dimethylamino)methyl]4-[2-[(1E)-3-(1,1-dimethylethoxy)-3-oxo-1-

propenyl]phenyl]-1,4-dihydro-6-methyl-, diethyl ester, monohydrochloride) CAS RN 108700-03-4), belfosdil (Phosphonic acid, [2-(2-phenoxy ethyl)- 1,3 -propane- diyl]bis-, tetrabutyl ester CAS RN 103486-79-9), fostedil (Phosphonic acid, [[4-(2-benzothiazolyl)phenyl]methyl]-, diethyl ester CAS RN 75889-62-2), aranidipine, azelnidipine, barnidipine, benidipine, bepridil, cinaldipine, clevidipine, efonidipine, gallopamil, lacidipine, lemildipine, lercanidipine, monatepil maleate (1-Piperazinebutanamide, N-(6, 11 -dihydrodibenzo(b,e)thiepin- 11 -yl)4-(4-fluorophenyl)-, (+)-, (Z)-2-butenedioate (1 :1) (\pm)-N-(6,11-Dihydrodibenzo(b,e)thiepin-11-yl)-4-(p- fluorophenyl)-1-piperazinebutyramide maleate (1 :1) CAS RN 132046-06-1), nicardipine, nisoldipine, nitrendipine, manidipine, pranidipine, and the like; T-channel calcium antagonists such as mibefradil; angiotensin converting enzyme (ACE) inhibitors such as benazepril, benazepril hydrochloride (such as 3-[[1-(ethoxycarbonyl)-3- phenyl-(1 S)-propyl]amino]-2,3 ,4,5-tetrahydro-2-oxo- 1 H - 1 -(3 S)-benzazepine- 1 -acetic acid monohydrochloride, e.g., Lotrel®, Novartis), captopril (such as 1-[(2S)-3-mercapto-2- methylpropionyl]-L-proline, e.g., Captopril, Mylan, CAS RN 62571-86-2 and others disclosed in US4046889), ceranapril (and others disclosed in US4452790), cetapril (alacepril, Dainippon disclosed in Eur. Therap. Res. 39:671 (1986); 40:543 (1986)), cilazapril (Hoffman-LaRoche) disclosed in J. Cardiovasc. Pharmacol. 9:39 (1987), indalapril (delapril hydrochloride (2H-1,2,4- Benzothiadiazine-7-sulfonamide, 3-bicyclo[2.2.1]hept-5-en-2-yl-6-chloro-3,4-dihydro-, 1,1- dioxide CAS RN 2259-96-3); disclosed in US4385051), enalapril (and others disclosed in US4374829), enalapril, enalaprilat, fosinopril, ((such as L-proline, 4-cyclohexyl-1-[[[2-methyl- 1-(1-oxopropoxy) propoxy](4-phenylbutyl) phosphinyl]acetyl]-, sodium salt, e.g., Monopril, Bristol-Myers Squibb and others disclosed in US4168267), fosinopril sodium (L- Proline, 4-cyclohexyl-1-[[R)-[(1S)-2-methyl-1-(1-ox- opropoxy)propox), imidapril, indolapril (Schering, disclosed in J. Cardiovasc. Pharmacol. 5:643, 655 (1983)), lisinopril (Merck), losinopril, moexipril, moexipril hydrochloride (3-Isoquinolinecarboxylic acid, 2-[(2S)-2-[[[(1S)- 1 -(ethoxycarbonyl)-3-phenylpropyl]amino]- 1 -oxopropyl]- 1 -, 2,3,4-tetrahydro-6,7-dimethoxy-, monohydrochloride, (3S)- CAS RN 82586-52-5), quinapril, quinaprilat, ramipril (Hoechst) disclosed in EP 79022 and Curr. Ther. Res. 40:74 (1986), perindopril erbumine (such as 2S,3aS,7aS- 1 -[(S)-N-[(S)- 1 - Carboxybutyl]alanyl]hexahydro^indolinecarboxylic acid, 1 -ethyl ester, compound with tert-butylamine (1 :1), e.g., Aceon®, Solvay), perindopril (Servier, disclosed in Eur. J. clin.

Pharmacol. 31 :519 (1987)), quanipril (disclosed in US4344949), spirapril (Schering, disclosed in Acta. Pharmacol. Toxicol. 59 (Supp. 5): 173 (1986)), tenocapril, trandolapril, zofenopril (and others disclosed in US4316906), rentiapril (fentiapril, disclosed in Clin. Exp. Pharmacol. Physiol. 10:131 (1983)), pivopril, YS980, teprotide (Bradykinin potentiator BPP9a CAS RN 35115-60-7), BRL 36,378 (Smith Kline Beecham, see EP80822 and EP60668), MC-838 (Chugai, see CA. 102:72588v and Jap. J. Pharmacol. 40:373 (1986)), CGS 14824 (Ciba-Geigy, 3-[[l-ethoxycarbonyl-3-phenyl-(1S)-propyl]amino)-2,3,4,5-tetrahydro-2-oxo-1-(3S)-benzazepine-1-acetic acid HCl, see U.K. Patent No. 2103614), CGS 16,617 (Ciba-Geigy, 3(S)-[[[(1S)-5-amino-1-carboxypentyl]amino]-2,3,4,5-tetrahydro-2-oxo-1H-1-benzazepine-1-ethanoic acid, see US4473575), Ru 44570 (Hoechst, see Arzneimittelforschung 34:1254 (1985)), R 31-2201 (Hoffman-LaRoche see FEBS Lett. 165:201 (1984)), CI925 (Pharmacologist 26:243, 266 (1984)), WY-44221 (Wyeth, see J. Med. Chem. 26:394 (1983)), and those disclosed in US2003006922 (paragraph 28), US4337201, US4432971 (phosphoramidates); neutral endopeptidase inhibitors such as omapatrilat (Vanlev®), CGS 30440, cadoxatril and ecadotril, fasidotril (also known as aladotril or alatriopril), sampatrilat, mixanpril, and gemopatrilat, AVE7688, ER4030, and those disclosed in US5362727, US5366973, US5225401, US4722810, US5223516, US4749688, US5552397, US5504080, US5612359, US5525723, EP0599444, EP0481522, EP0599444, EP0595610, EP0534363, EP534396, EP534492, EP0629627; endothelin antagonists such as tezosentan, A308165, and YM62899, and the like; vasodilators such as hydralazine (apresoline), clonidine (clonidine hydrochloride (1H-Imidazol-2-amine, N-(2,6-dichlorophenyl)4,5-dihydro-, monohydrochloride CAS RN 4205-91-8), catapres, minoxidil (loniten), nicotiny alcohol (roniacol), diltiazem hydrochloride (such as 1,5-Benzothiazepin-4(5H)-one,3-(acetyloxy)-5[2-(dimethylamino)ethyl]-2,3-dihydro-2(4-methoxyphenyl)-, monohydrochloride, (+)-cis, e.g., Tiazac®, Forest), isosorbide dinitrate (such as 1,4:3,6-dianhydro-D-glucitol 2,5-dinitrate e.g., Isordil® Titradose®, Wyeth-Ayerst), sororbide mononitrate (such as 1,4:3,6-dianhydro-D-glucitol-1,5-nitrate, an organic nitrate, e.g., Ismo®, Wyeth-Ayerst), nitroglycerin (such as 2,3 propanetriol trinitrate, e.g., Nitrostat® Parke-Davis), verapamil hydrochloride (such as benzeneacetonitrile, (±)-(alpha)[3-[[2-(3,4 dimethoxyphenyl)ethyl]methylamino]propyl]-3,4-dimethoxy-(alpha)-(1-methylethyl) hydrochloride, e.g., Covera HS® Extended-Release, Searle), chromonar (which may be prepared as disclosed in

US3282938), clonitate (Annalen 1870 155), droprenilamine (which may be prepared as disclosed in DE2521113), lidoflazine (which may be prepared as disclosed in US3267104); prenylamine (which may be prepared as disclosed in US3152173), propatyl nitrate (which may be prepared as disclosed in French Patent No. 1,103,113), mioflazine hydrochloride (1 -Piperazineacetamide, 3-(aminocarbonyl)4-[4,4-bis(4-fluorophenyl)butyl]-N-(2,6-dichlorophenyl)-, dihydrochloride CAS RN 83898-67-3), mixidine (Benzeneethanamine, 3,4-dimethoxy-N-(1-methyl-2-pyrrolidinylidene)-Pyrrolidine, 2-[(3,4-dimethoxyphenethyl)imino]-1-methyl-1-Methyl-2-[(3,4-dimethoxyphenethyl)imino]pyrrolidine CAS RN 27737-38-8), molsidomine (1,2,3-Oxadiazolium, 5-[(ethoxycarbonyl)amino]-3-(4-morpholinyl)-, inner salt CAS RN 25717-80-0), isosorbide mononitrate (D-Glucitol, 1,4:3,6-dianhydro-, 5-nitrate CAS RN 16051-77-7), erythrityl tetranitrate (1,2,3,4-Butanetetrol, tetranitrate, (2R,3S)-rel-CAS RN 7297-25-8), clonitate(1,2-Propanediol, 3-chloro-, dinitrate (7CI, 8CI, 9CI) CAS RN 2612-33-1), dipyridamole Ethanol, 2,2',2'',2'''-[(4,8-di-1-piperidinylpyrimido[5,4-d]pyrimidine-2,6-diy)l]dinitrilo]tetrakis- CAS RN 58-32-2), nicorandil (CAS RN 65141-46-0 3-), pyridinecarboxamide (N-[2-(nitrooxy)ethyl]-Nisoldipine3,5-Pyridinedicarboxylic acid, 1,4-dihydro-2,6-dimethyl-4-(2-nitrophenyl)-, methyl 2-methylpropyl ester CAS RN 63675-72-9), nifedipine3,5-Pyridinedicarboxylic acid, 1,4-dihydro-2,6-dimethyl-4-(2-nitrophenyl)-, dimethyl ester CAS RN 21829-25-4), perhexiline maleate (Piperidine, 2-(2,2-dicyclohexylethyl)-, (2Z)-2-butenedioate (1 :1) CAS RN 6724-53-4), oxprenolol hydrochloride (2-Propanol, 1-[(1-methylethyl)amino]-3-[2-(2-propenyloxy)phenoxy]-, hydrochloride CAS RN 6452-73-9), pentrinitrol (1,3-Propanediol, 2,2-bis[(nitrooxy)methyl]-, mononitrate (ester) CAS RN 1607-17-6), verapamil (Benzeneacetonitrile, α -[3-[[2-(3,4-dimethoxyphenyl)ethyl]-methylamino]propyl]-3,4-dimethoxy- α -(1-methylethyl)- CAS RN 52-53-9) and the like; angiotensin II receptor antagonists such as, aprosartan, zolasartan, olmesartan, prazosartan, FI6828K, RNH6270, candesartan (1 H-Benzimidazole-7-carboxylic acid, 2-ethoxy-1-[[2'-(1H-tetrazol-5-yl)[1,1'-biphenyl]4-yl]methyl]- CAS RN 139481-59-7), candesartan cilexetil ((+/-)-1-(cyclohexylcarbonyloxy)ethyl-2-ethoxy-1-[[2'-(1H-tetrazol-5-yl)biphenyl-4-yl]-1H-benzimidazole carboxylate, CAS RN 145040-37-5, US5703110 and US5196444), eprosartan (3-[1-4-carboxyphenylmethyl]-2-n-butyl-imidazol-5-yl)-(2-thienylmethyl) propenoic acid, US5185351 and US5650650), irbesartan (2-n-butyl-3-[[2'-(1h-tetrazol-5-yl)biphenyl-4-yl]methyl] 1,3-

diazazspiro[4,4]non-1-en-4-one, US5270317 and US5352788), losartan (2-N-butyl-4-chloro-5-hydroxymethyl-1-[(2'-(1H-tetrazol-5-yl)biphenyl-4-yl)-methyl]imidazole, potassium salt, US5138069, US5153197 and US5128355), tasosartan (5,8-dihydro-2,4-dimethyl-8-[(2'-(1H-tetrazol-5-yl)[1,1'-biphenyl]-4-yl)methyl]-pyrido[2,3-d]pyrimidin-7(6H)-one, US5149699), telmisartan (4'-[(1,4-dimethyl-2'-propyl-(2,6'-bi-1H-benzimidazol)-r-yl)]-[1,1'-biphenyl]-2-carboxylic acid, CAS RN 144701-48-4, US5591762), milfasartan, abitesartan, valsartan (Diovan® (Novartis), (S)-N-valeryl-N-[[2'-(1H-tetrazol-5-yl)biphenyl-4-yl)methyl]valine, US5399578), EXP-3137 (2-N-butyl-4-chloro-1-[(2'-(1H-tetrazol-5-yl)biphenyl-4-yl)-methyl]imidazole-5-carboxylic acid, US5138069, US5153197 and US5128355), 3-(2'-(tetrazol-5-yl)-1,1'-biphenyl-4-yl)methyl-5,7-dimethyl-2-ethyl-3H-imidazo[4,5-b]pyridine, 4'[2-ethyl-4-methyl-6-(5,6,7,8-tetrahydroimidazo[1,2-a]pyridin-2-yl)-benzimidazol-1-yl]-methyl]-1,1'-biphenyl]-2-carboxylic acid, 2-butyl-6-(1-methoxy-1-methylethyl)-2-[2'-(1H-tetrazol-5-yl)biphenyl-4-yl)methyl]guinazolin-4(3H)-one, 3-[2'-carboxybiphenyl-4-yl)methyl]-2-cyclopropyl-7-methyl-3H-imidazo[4,5-b]pyridine, 2-butyl-4-chloro-1-[(2'-tetrazol-5-yl)biphenyl-4-yl)methyl]imidazole-carboxylic acid, 2-butyl-4-chloro-1-[[2'-(1H-tetrazol-5-yl)[1,1'-biphenyl]-4-yl)methyl]-1H-imidazole-5-carboxylic acid-1-(ethoxycarbonyloxy)ethyl ester potassium salt, dipotassium 2-butyl-4-(methylthio)-1-[[2-[[[(propylamino)carbonyl]amino]sulfonyl](1,1'-biphenyl)-4-yl)methyl]-1H-imidazole-5-carboxylate, methyl-2-[[4-butyl-2-methyl-6-oxo-5-[[2'-(1H-tetrazol-5-yl)-[1,1'-biphenyl]-4-yl)methyl]-1-(6H)-pyrimidinyl]methyl]-3-thiophencarboxylate, 5-[(3,5-dibutyl-1H-1,2,4-triazol-1-yl)methyl]-2-[2-(1H-tetrazol-5-ylphenyl)]pyridine, 6-butyl-2-(2-phenylethyl)-5[[2'-(1H-tetrazol-5-yl)[1,1'-biphenyl]-4-methyl]pyrimidin-4-(3H)-one D,L lysine salt, 5-methyl-7-n-propyl-8-[[2'-(1H-tetrazol-5-yl)biphenyl-4-yl)methyl]-[1,2,4]-triazolo[1,5-c]pyrimidin-2(3H)-one, 2,7-diethyl-5-[[2'-(5-tetrazolyl)biphenyl-4-yl)methyl]-5H-pyrazolo[1,5-b][1,2,4]triazole potassium salt, 2-[2-butyl-4,5-dihydro-4-oxo-3-[2'-(1H-tetrazol-5-yl)-4-biphenylmethyl]-3H-imidazol[4,5-c]pyridine-5-ylmethyl]benzoic acid, ethyl ester, potassium salt, 3-methoxy-2,6-dimethyl-4-[[2'-(1H-tetrazol-5-yl)-1,1'-biphenyl-4-yl]methoxy]pyridine, 2-ethoxy-1-[[2'-(5-oxo-2,5-dihydro-1,2,4-oxadiazol-3-yl)biphenyl-4-yl)methyl]-1H-benzimidazole-7-carboxylic acid, 1-[N-(2'-(1H-tetrazol-5-yl)biphenyl-4-yl)-methyl]-N-valerolylaminomethylcyclopentane-1-carboxylic acid, 7-methyl-2-n-propyl-3-[[2'-(1H-tetrazol-5-yl)biphenyl-4-yl)methyl]-3H-imidazo[4,5-b]pyridine, 2-[5-[(2-

ethyl-5,7-dimethyl-3H-imidazo[4,5-b]pyridine-3-yl)methyl]-2-quinoliny]sodium benzoate, 2-butyl-6-chloro-4-hydroxymethyl-5-methyl-3-[[2'-(1H-tetrazol-5-yl)biphenyl-4-yl]methyl]pyridine, 2-[[2-butyl-1-[(4-carboxyphenyl)methyl]-1H-imidazol-5-yl]methyl]amino]benzoic acid tetrazol-5-yl)biphenyl-4-yl]methyl]pyrimidin-6-one, 4(S)-[4-(carboxymethyl)phenoxy]-N-[2(R)-[4-(2-sulfobenzamido)imidazol-1-yl]octanoyl]-L-proline, 1-(2,6-dimethylphenyl)-4-butyl-1,3-dihydro-3-[[6-[2-(1H-tetrazol-5-yl)phenyl]-3-pyridinyl]methyl]-2H-imidazol-2-one, 5,8-ethano-5,8-dimethyl-2-n-propyl-5,6,7,8-tetrahydro-1-[[2'-(1H-tetrazol-5-yl)biphenyl-4-yl]methyl]-1H,4H-1,3,4a,8a-tetraazacyclopentanaphthalene-9-one, 4-[1-[2'-(1,2,3,4-tetrazol-5-yl)biphen-4-yl)methylamino]-5,6,7,8-tetrahydro-2-triflylquinazoline, 2-(2-chlorobenzoyl)imino-5-ethyl-3-[2'-(1H-tetrazole-5-yl)biphenyl-4-yl]methyl-1,3,4-thiadiazoline, 2-[5-ethyl-3-[2-(1H-tetrazole-5-yl)biphenyl-4-yl]methyl-1,3,4-thiazoline-2-ylidene]aminocarbonyl-1-cyclopentencarboxylic acid dipotassium salt, and 2-butyl-4-[N-methyl-N-(3-methylcrotonoyl)amino]-1-[[2'-(1H-tetrazol-5-yl)biphenyl-4-yl]methyl]-1H-imidazole-5-carboxylic acid 1-ethoxycarbonyloxyethyl ester, those disclosed in patent publications EP475206, EP497150, EP539086, EP539713, EP535463, EP535465, EP542059, EP497121, EP535420, EP407342, EP415886, EP424317, EP435827, EP433983, EP475898, EP490820, EP528762, EP324377, EP323841, EP420237, EP500297, EP426021, EP480204, EP429257, EP430709, EP434249, EP446062, EP505954, EP524217, EP514197, EP514198, EP514193, EP514192, EP450566, EP468372, EP485929, EP503162, EP533058, EP467207 EP399731, EP399732, EP412848, EP453210, EP456442, EP470794, EP470795, EP495626, EP495627, EP499414, EP499416, EP499415, EP511791, EP516392, EP520723, EP520724, EP539066, EP438869, EP505893, EP530702, EP400835, EP400974, EP401030, EP407102, EP411766, EP409332, EP412594, EP419048, EP480659, EP481614, EP490587, EP467715, EP479479, EP502725, EP503838, EP505098, EP505111 EP513,979 EP507594, EP510812, EP511767, EP512675, EP512676, EP512870, EP517357, EP537937, EP534706, EP527534, EP540356, EP461040, EP540039, EP465368, EP498723, EP498722, EP498721, EP515265, EP503785, EP501892, EP519831, EP532410, EP498361, EP432737, EP504888, EP508393, EP508445, EP403159, EP403158, EP425211, EP427463, EP437103, EP481448, EP488532, EP501269, EP500409, EP540400, EP005528, EP028834, EP028833, EP411507, EP425921, EP430300, EP434038, EP442473, EP443568, EP445811, EP459136, EP483683,

EP518033, EP520423, EP531876, EP531874, EP392317, EP468470, EP470543, EP502314, EP529253, EP543263, EP540209, EP449699, EP465323, EP521768, EP415594, WO92/14468, WO93/08171, WO93/08169, WO91/00277, WO91/00281, WO91/14367, WO92/00067, WO92/00977, WO92/20342, WO93/04045, WO93/04046, WO91/15206, WO92/14714, WO92/09600, WO92/16552, WO93/05025, WO93/03018, WO91/07404, WO92/02508, WO92/13853, WO91/19697, WO91/11909, WO91/12001, WO91/11999, WO91/15209, WO91/15479, WO92/20687, WO92/20662, WO92/20661, WO93/01177, WO91/14679, WO91/13063, WO92/13564, WO91/17148, WO91/18888, WO91/19715, WO92/02257, WO92/04335, WO92/05161, WO92/07852, WO92/15577, WO93/03033, WO91/16313, WO92/00068, WO92/02510, WO92/09278, WO9210179, WO92/10180, WO92/10186, WO92/10181, WO92/10097, WO92/10183, WO92/10182, WO92/10187, WO92/10184, WO92/10188, WO92/10180, WO92/10185, WO92/20651, WO93/03722, WO93/06828, WO93/03040, WO92/19211, WO92/22533, WO92/06081, WO92/05784, WO93/00341, WO92/04343, WO92/04059, US5104877, US5187168, US5149699, US5185340, US4880804, US5138069, US4916129, US5153197, US5173494, US5137906, US5155126, US5140037, US5137902, US5157026, US5053329, US5132216, US5057522, US5066586, US5089626, US5049565, US5087702, US5124335, US5102880, US5128327, US5151435, US5202322, US5187159, US5198438, US5182288, US5036048, US5140036, US5087634, US5196537, US5153347, US5191086, US5190942, US5177097, US5212177, US5208234, US5208235, US5212195, US5130439, US5045540, US5041152, and US5210204, and pharmaceutically acceptable salts and esters thereof; α/β adrenergic blockers such as nipradilol, arotinolol, amosulalol, bretylium tosylate (CAS RN: 61-75-6), dihydroergtamine mesylate (such as ergotaman-3', 6',18-trione,9,-10-dihydro-12'-hydroxy-2'-methyl-5'-(phenylmethyl)-,(5'(α))-, monomethanesulfonate, e.g., DHE 45® Injection, Novartis), carvedilol (such as (\pm)-1-(Carbazol-4-yloxy)-3-[[2-(o-methoxyphenoxy)ethyl] amino] -2-propanol, e.g., Coreg®, SmithKline Beecham), labetalol (such as 5-[1-hydroxy-2-[(1-methyl-3-phenylpropyl) amino] ethyl]salicylamide monohydrochloride, e.g., Normodyne®, Schering), bretylium tosylate (Benzenemethanaminium, 2-bromo-N-ethyl-N,N-dimethyl-, salt with 4-methylbenzenesulfonic acid (1 :1) CAS RN 61-75-6), phentolamine mesylate (Phenol, 3-[[[(4,5-dihydro-1H-imidazol-2-yl)methyl](4-methylphenyl)amino]-, monomethanesulfonate (salt) CAS RN 65-28-1),

solypertine tartrate (5H-1,3-Dioxolo[4,5-f]indole, 7-[2-[4-(2-methoxyphenyl)-1-piperazinyl]ethyl]-, (2R,3R)-2,3-dihydroxybutanedioate (1 :1) CAS RN 5591-43-5), zolertine hydrochloride (Piperazine, 1-phenyl4-[2-(1H-tetrazol-5-yl)ethyl]-, monohydrochloride (8Cl, 9Cl) CAS RN 7241-94-3) and the like; α adrenergic receptor blockers, such as alfuzosin (CAS RN: 81403-68-1), terazosin, urapidil, prazosin (Minipress®), tamsulosin, bunazosin, trimazosin, doxazosin, naftopidil, indoramin, WHP 164, XENOIO, fenspiride hydrochloride (which may be prepared as disclosed in US3399192), proroxan (CAS RN 33743-96-3), and labetalol hydrochloride and combinations thereof; α 2 agonists such as methyldopa, methyldopa HCL, lofexidine, tiamenidine, moxonidine, rilmenidine, guanobenz, and the like; aldosterone inhibitors, and the like; renin inhibitors including Aliskiren (SPPIOO; Novartis/Speedel); angiopoietin-2-binding agents such as those disclosed in WO03/030833; anti-angina agents such as ranolazine (hydrochloride 1-Piperazineacetamide, N-(2,6- dimethylphenyl)-4-[2-hydroxy-3-(2-methoxyphenoxy)propyl]-, dihydrochloride CAS RN 95635- 56-6), betaxolol hydrochloride (2-Propanol, 1-[4-[2 (cyclopropylmethoxy)ethyl]phenoxy]-3-[(1- methylethyl)amino]-, hydrochloride CAS RN 63659-19-8), butoprozine hydrochloride (Methanone, [4-[3(dibutylamino)propoxy]phenyl](2-ethyl-3-indoliziny)-, monohydrochloride CAS RN 62134-34-3), cinepazet maleate-Piperazineacetic acid, 4-[1-oxo-3-(3,4,5- trimethoxyphenyl)-2-propenyl]-, ethyl ester, (2Z)-2-butenedioate (1 :1) CAS RN 50679-07-7), tosifen (Benzenesulfonamide, 4-methyl-N-[[[(1S)-1-methyl-2-phenylethyl]amino]carbonyl]- CAS RN 32295-184), verapamilhydrochloride (Benzeneacetonitrile, α -[3-[[2-(3,4-dimethoxyphenyl)ethyl]methylamino]propyl]-3 ,4-dimethoxy- α -(1 -methylethyl)-, monohydrochloride CAS RN 152-114), molsidomine (1,2,3-Oxadiazolium, 5-[(ethoxycarbonyl)amino]-3-(4-morpholinyl)-, inner salt CAS RN 25717-80-0), and ranolazine hydrochloride (1 -Piperazineacetamide, N-(2,6-dimethylphenyl)4-[2-hydroxy-3-(2-methoxyphenoxy)propyl]-, dihydrochloride CAS RN 95635-56-6); tosifen (Benzenesulfonamide, 4-methyl-N-[[[(1S)-1-methyl-2-phenylethyl]amino]carbonyl]- CAS RN 32295-184); adrenergic stimulants such as guanfacine hydrochloride (such as N-amidino-2-(2,6-dichlorophenyl)acetamide hydrochloride, e.g., Tenex® Tablets available from Robins); methyldopa-hydrochlorothiazide (such as levo-3-(3,4-dihydroxyphenyl)-2-methylalanine) combined with Hydrochlorothiazide (such as 6-chloro-3,4-dihydro-2H -1,2,4-benzothiadiazine-7- sulfonamide

1,1-dioxide, e.g., the combination as, e.g., Aldoril® Tablets available from Merck), methyl dopa-chlorothiazide (such as 6-chloro-2H-1, 2,4-benzothiadiazine-7-sulfonamide 1,1-dioxide and methyl dopa as described above, e.g., Aldoclor®, Merck), clonidine hydrochloride (such as 2-(2,6-dichlorophenylamino)-2-imidazoline hydrochloride and chlorthalidone (such as 2-chloro-5-(1-hydroxy-3-oxo-1-isoindolinyl) benzenesulfonamide), e.g., Combipres®, Boehringer Ingelheim), clonidine hydrochloride (such as 2-(2,6-dichlorophenylamino)-2-imidazoline hydrochloride, e.g., Catapres®, Boehringer Ingelheim), clonidine (1H-Imidazol-2-amine, N-(2,6-dichlorophenyl)4,5-dihydro-CAS RN 4205-90-7), Hyzaar (Merck; a combination of losartan and hydrochlorothiazide), Co-Diovan (Novartis; a combination of valsartan and hydrochlorothiazide), Lotrel (Novartis; a combination of benazepril and amlodipine) and Caduet (Pfizer; a combination of amlodipine and atorvastatin), and those agents disclosed in US20030069221.

1.3.2.11 Agents for the Treatment of Respiratory Disorders

[160] The GCC agonist peptides described herein can be used in combination therapy with one or more of the following agents useful in the treatment of respiratory and other disorders including but not limited to: (1) β -agonists including but not limited to : albuterol (PRO VENTIL® , S ALBUT AMOI® , VENTOLIN®), bambuterol, bitoterol, clenbuterol, fenoterol, formoterol, isoetharine (BRONKOSOL®, BRONKOMETER®), metaproterenol (ALUPENT®, METAPREL®), pirbuterol (MAXAIR®), reproterol, rimiterol, salmeterol, terbutaline (BRETHAIRE®, BRETHINE®, BRICANYL®), adrenalin, isoproterenol (ISUPREL®), epinephrine bitartrate (PRIMATENE®), ephedrine, orciprenline, fenoterol and isoetharine; (2) steroids, including but not limited to beclomethasone, beclomethasone dipropionate, betamethasone, budesonide, budesonide, butixocort, dexamethasone, flunisolide, fluocortin, fluticasone, hydrocortisone, methyl prednisone, mometasone, predonisolone, predonisone, tipredane, tixocortal, triamcinolone, and triamcinolone acetonide; (3) β 2-agonist-corticosteroid combinations [e.g., salmeterol-fluticasone (AD V AIR®), formoterol-budesonid (S YMBICORT®)] ; (4) leukotriene D4 receptor antagonists/leukotriene antagonists/LTD4 antagonists (i.e., any compound that is capable of blocking, inhibiting, reducing or otherwise interrupting the interaction between leukotrienes and the Cys LTI receptor) including but not limited to: zafhiukast, montelukast, montelukast sodium (SINGULAIR®), pranlukast, iralukast,

pobilukast, SKB-106,203 and compounds described as having LTD₄ antagonizing activity described in U.S. Patent No. 5,565,473; (5) 5 -lipoxygenase inhibitors and/or leukotriene biosynthesis inhibitors [e.g., zileuton and BAY1005 (CA registry 128253-31-6)]; (6) histamine H₁ receptor antagonists/antihistamines (i.e., any compound that is capable of blocking, inhibiting, reducing or otherwise interrupting the interaction between histamine and its receptor) including but not limited to: astemizole, acrivastine, antazoline, azatadine, azelastine, astemizole, bromopheniramine, bromopheniramine maleate, carbinoxamine, carebastine, cetirizine, chlorpheniramine, chlorpheniramine maleate, cimetidine clemastine, cyclizine, cyproheptadine, descarboethoxy loratadine, dexchlorpheniramine, dimethindene, diphenhydramine, diphenylpyraline, doxylamine succinate, doxylamine, ebastine, efletirizine, epinastine, famotidine, fexofenadine, hydroxyzine, hydroxyzine, ketotifen, levocabastine, levocetirizine, levocetirizine, loratadine, meclizine, mepyramine, mequitazine, methdilazine, mianserin, mizolastine, noberastine, norastemizole, noraztemizole, phenindamine, pheniramine, picumast, promethazine, pynlamine, pyrillamine, ranitidine, temelastine, terfenadine, trimeprazine, tripelenamine, and triprolidine; (7) an anticholinergic including but not limited to: atropine, benztropine, biperiden, flutropium, hyoscyamine (e.g. Levsin®; Levbid®; Levsin/SL®, Anaspaz®, Levsinex timecaps®, NuLev®), ilutropium, ipratropium, ipratropium bromide, methscopolamine, oxybutinin, rispenzepine, scopolamine, and tiotropium; (8) an anti-tussive including but not limited to: dextromethorphan, codeine, and hydromorphone; (9) a decongestant including but not limited to: pseudoephedrine and phenylpropanolamine; (10) an expectorant including but not limited to: guaifenesin, guaicol sulfate, terpin, ammonium chloride, glycerol guaicolate, and iodinated glycerol; (11) a bronchodilator including but not limited to: theophylline and aminophylline; (12) an anti-inflammatory including but not limited to: fluribiprofen, diclophenac, indomethacin, ketoprofen, S-ketoprophen, tenoxicam; (13) a PDE (phosphodiesterase) inhibitor including but not limited to those disclosed herein; (14) a recombinant humanized monoclonal antibody [e.g. xolair (also called omalizumab), rhuMab, and talizumab]; (15) a humanized lung surfactant including recombinant forms of surfactant proteins SP-B, SP-C or SP-D [e.g. SURFAXIN®, formerly known as dsc-104 (Discovery Laboratories)], (16) agents that inhibit epithelial sodium channels (ENaC) such as amiloride and related compounds; (17) antimicrobial agents used to treat pulmonary infections such as acyclovir,

amikacin, amoxicillin, doxycycline, trimethoprin sulfamethoxazole, amphotericin B, azithromycin, clarithromycin, roxithromycin, clarithromycin, cephalosporins(ceffoxitin, cefmetazole etc), ciprofloxacin, ethambutol, gentimycin, ganciclovir, imipenem, isoniazid, itraconazole, penicillin, ribavirin, rifampin, rifabutin, amantadine, rimantidine, streptomycin, tobramycin, and vancomycin; (18) agents that activate chloride secretion through Ca⁺⁺ dependent chloride channels (such as purinergic receptor (P2Y(2) agonists); (19) agents that decrease sputum viscosity, such as human recombinant DNase 1, (Pulmozyme®); (20) nonsteroidal anti-inflammatory agents (acemetacin, acetaminophen, acetyl salicylic acid, alclofenac, alminoprofen, apazone, aspirin, benoxaprofen, bezpiperylon, bucloxic acid, carprofen, clidanac, diclofenac, diclofenac, diflunisal, diflusinal, etodolac, fenbufen, fenbufen, fenclofenac, fenclozic acid, fenoprofen, fentiazac, feprazone, flufenamic acid, flufenisal, flufenisal, fluprofen, flurbiprofen, flurbiprofen, furofenac, ibufenac, ibuprofen, indomethacin, indomethacin, indoprofen, isoxepac, isoxicam, ketoprofen, ketoprofen, ketorolac, meclofenamic acid, meclofenamic acid, mefenamic acid, mefenamic acid, miroprofen, mofebutazone, nabumetone oxaprozin, naproxen, naproxen, niflumic acid , oxaprozin, oxpinac, oxyphenbutazone, phenacetin, phenylbutazone, phenylbutazone, piroxicam, piroxicam, pirprofen, pranoprofen, sudoxicam, tenoxicam, sulfasalazine, sulindac, sulindac, suprofen, tiaprofenic acid, tiopinac, tioxaprofen, tolfenamic acid, tolmetin, tolmetin, zidometacin, zomepirac, and zomepirac); and (21) aerosolized antioxidant therapeutics such as S-Nitrosoglutathione.

1.3.2.12 Anti-Diabetic Agents

[161] The GCC agonist peptides described herein can be used in therapeutic combination with one or more anti-diabetic agents, including but not limited to: PPAR γ agonists such as glitazones (e.g., WAY-120,744, AD 5075, balaglitazone, ciglitazone, darglitazone (CP-86325, Pfizer), englitazone (CP-68722, Pfizer), isaglitazone (MIT/J&J), MCC- 555 (Mitsubishi disclosed in 5 US5594016), pioglitazone (such as such as Actos™ pioglitazone; Takeda), rosiglitazone (Avandia™;Smith Kline Beecham), rosiglitazone maleate, troglitazone (Rezulin®, disclosed in US4572912), rivoglitazone (CS-Ol 1, Sankyo), GL-262570 (Glaxo Welcome), BRL49653 (disclosed in WO98/05331), CLX-0921, 5-BTZD, GW-0207, LG- 100641, JJT-501

(JPNT/P&U), L-895645 (Merck), R-119702 (Sankyo/Pfizer), NN-2344 (Dr. Reddy/NN), YM-440 (Yamanouchi), LY-300512, LY-519818, R483 (Roche), T131 (Tularik), and the like and compounds disclosed in US4687777, US5002953, US5741803, US5965584, US6150383, US6150384, US6166042, US6166043, US6172090, US6211205, US6271243, US6288095, 5 US6303640, US6329404, US5994554, W097/10813, W097/27857, W097/28115, W097/28137, W097/27847, W000/76488, W003/000685, W003/027112, W003/035602, W003/048130, W003/055867, and pharmaceutically acceptable salts thereof; biguanides such as metformin hydrochloride (N,N-dimethylimidodicarbonimidic diamide hydrochloride, such as Glucophage™, Bristol-Myers Squibb); metformin hydrochloride with glyburide, such as 10 Glucovance™, Bristol-Myers Squibb); buformin (Imidodicarbonimidic diamide, N-butyl-); etoformine (l-Butyl-2-ethylbiguanide, Schering A. G.); other metformin salt forms (including where the salt is chosen from the group of, acetate, benzoate, citrate, fumarate, embonate, chlorophenoxyacetate, glycolate, palmoate, aspartate, methanesulphonate, maleate, parachlorophenoxyisobutyrate, formate, lactate, succinate, sulphate, tartrate, 15 cyclohexanecarboxylate, hexanoate, octanoate, decanoate, hexadecanoate, octodecanoate, benzenesulphonate, trimethoxybenzoate, paratoluenesulphonate, adamantanecarboxylate, glycoxylate, glutarnate, pyrrolidonecarboxylate, naphthalenesulphonate, 1-glucosephosphate, nitrate, sulphite, dithionate and phosphate), and phenformin; protein tyrosine phosphatase- IB (PTP-IB) inhibitors, such as A-401,674, KR 61639, OC- 060062, OC-83839, OC-297962, 20 MC52445, MC52453, ISIS 113715, and those disclosed in WO99/585521, WO99/58518, WO99/58522, WO99/61435, WO03/032916, WO03/032982, WO03/041729, WO03/055883, WO02/26707, WO02/26743, JP2002114768, and pharmaceutically acceptable salts and esters thereof; sulfonylureas such as acetoexamide (e.g. Dymelor, Eli Lilly), carbutamide, chlorpropamide (e.g. Diabinese®, Pfizer), gliamilide (Pfizer), gliclazide (e.g. Diamcron, Servier 25 Canada Inc), glimepiride (e.g. disclosed in US4379785, such as Amaryl , Aventis), glipentide, glipizide (e.g. Glucotrol or Glucotrol XL Extended Release, Pfizer), gliquidone, glisolamide, glyburide/glibenclamide (e.g. Micronase or Glynase Prestab, Pharmacia & Upjohn and Diabeta, Aventis), tolazamide (e.g. Tolinase), and tolbutamide (e.g. Orinase), and pharmaceutically acceptable salts and esters thereof; meglitinides such as repaglinide (e.g. Prandin®, Novo 30 Nordisk), KAD1229 (PF/Kissei), and nateglinide (e.g. Starlix®, Novartis), and pharmaceutically

acceptable salts and esters thereof; α glucoside hydrolase inhibitors (or glucoside inhibitors) such as acarbose (e.g. Precose™, Bayer disclosed in US4904769), miglitol (such as GLYSET™, Pharmacia & Upjohn disclosed in US4639436), camiglibose (Methyl 6-deoxy-6-[(2R,3R,4R,5S)-3,4,5-trihydroxy-2-(hydroxymethyl)piperidino]- α -D-glucopyranoside, Marion Merrell Dow), voglibose (Takeda), adiposine, emigliate, pradimicin-Q, salbostatin, CKD-711, MDL-25,637, MDL- 73,945, and MOR 14, and the compounds disclosed in US4062950, US4174439, US4254256, US4701559, US4639436, US5192772, US4634765, US5157116, US5504078, US5091418, US5217877, US51091 and WOO 1/47528 (polyamines); α -amylase inhibitors such as tendamistat, trestatin, and AI -3688, and the compounds disclosed in US4451455, US4623714, and US4273765; SGLT2 inhibitors including those disclosed in US6414126 and US6515117; an α 2 inhibitor such as disclosed in US6548529; insulin secretagogues such as linoglriride, A-4166, forskilin, dibutyl cAMP, isobutylmethylxanthine (IBMX), and pharmaceutically acceptable salts and esters thereof; fatty acid oxidation inhibitors, such as clomoxir, and etomoxir, and pharmaceutically acceptable salts and esters thereof; A2 antagonists, such as midaglizole, isaglidole, derigidole, idazoxan, earoxan, and fluparoxan, and pharmaceutically acceptable salts and esters thereof; insulin and related compounds (e.g. insulin mimetics) such as biota, LP-100, novarapid, insulin detemir, insulin lispro, insulin glargine, insulin zinc suspension (lente and ultralente), Lys-Pro insulin, GLP-I (1-36) amide, GLP-I (73-7) (insulintropin, disclosed in US5614492), LY-315902 (Lilly), GLP-I (7-36)-NH₂, AL-401 (Autoimmune), certain compositions as disclosed in US4579730, US4849405, US4963526, US5642868, US5763396, US5824638, US5843866, US6153632, US6191105, and WO 85/05029, and primate, rodent, or rabbit insulin including biologically active variants thereof including allelic variants, more preferably human insulin available in recombinant form (sources of human insulin include pharmaceutically acceptable and sterile formulations such as those available from Eli Lilly (Indianapolis, Ind. 46285) as Humulin™ (human insulin rDNA origin), also see the THE PHYSICIAN'S DESK REFERENCE, 55.sup.th Ed. (2001) Medical Economics, Thomson Healthcare (disclosing other suitable human insulins); non-thiazolidinediones such as JT-501 and farglitazar (GW-2570/GI- 262579), and pharmaceutically acceptable salts and esters thereof; PPAR α / γ dual agonists such as AR-HO39242 (Aztazeneca), GW-409544 (Glaxo-Wellcome), BVT-142, CLX-0940, GW-1536, GW-1929, GW-2433, KRP-

297 (Kyorin Merck; 5-[(2,4-Dioxo thiazolidinyl)methyl] methoxy-N-[[4-(trifluoromethyl)phenyl] methyl]benzamide), L-796449, LR-90, MK-0767 (Merck/Kyorin/Banyu), SB 219994, muraglitazar (BMS), tesaglitazar (Astrazeneca), reglitazar (JTT-501) and those disclosed in WO99/16758, WO99/19313, WO99/20614, WO99/38850, 5 WO00/23415, WO00/23417, WO00/23445, WO00/50414, WO01/00579, WO01/79150, WO02/062799, WO03/004458, WO03/016265, WO03/018010, WO03/033481, WO03/033450, WO03/033453, WO03/043985, WO 031053976, U.S. application Ser. No. 09/664,598, filed Sep. 18, 2000, Murakami et al. Diabetes 47, 1841-1847 (1998), and pharmaceutically acceptable salts and esters thereof; other insulin sensitizing drugs; VPAC2 receptor agonists; GLK modulators, 10 such as those disclosed in WO03/015774; retinoid modulators such as those disclosed in WO03/000249; GSK 3 β /GSK 3 inhibitors such as 4-[2-(2-bromophenyl)-4-(4-fluorophenyl)-1H-imidazol-5-yl]pyridine and those compounds disclosed in WO03/024447, WO03/037869, WO03/037877, WO03/037891, WO03/068773, EP1295884, EP1295885, and the like; glycogen phosphorylase (HGLPa) inhibitors such as CP-368,296, CP-316,819, BAYR3401, and 15 compounds disclosed in WOO 1/94300, WO02/20530, WO03/037864, and pharmaceutically acceptable salts or esters thereof; ATP consumption promoters such as those disclosed in WO03/007990; TRB3 inhibitors; vanilloid receptor ligands such as those disclosed in WO03/049702; hypoglycemic agents such as those disclosed in WO03/015781 and WO03/040114; glycogen synthase kinase 3 inhibitors such as those disclosed in WO03/035663 20 agents such as those disclosed in WO99/51225, US20030134890, WO01/24786, and WO03/059870; insulin-responsive DNA binding protein-1 (IRDBP-I) as disclosed in WO03/057827, and the like; adenosine A2 antagonists such as those disclosed in WO03/035639, WO03/035640, and the like; PPAR δ agonists such as GW 501516, GW 590735, and compounds disclosed in JP10237049 and WO02/14291; dipeptidyl peptidase IV (DP-IV) inhibitors, such as 25 isoleucine thiazolidide, NVP-DPP728A (1- [[2-[(5-cyanopyridin-2-yl)amino]ethyl]amino]acetyl]-2-cyano-(S)-pyrrolidine, disclosed by Hughes et al, Biochemistry, 38(36), 11597-11603, 1999), P32/98, NVP-LAF-237, P3298, TSL225 (tryptophyl-1,2,3,4-tetrahydro-isoquinoline-3-carboxylic acid, disclosed by Yamada et al, Bioorg. & Med. Chem. Lett. 8 (1998) 1537-1540), valine pyrrolidide, TMC-2A/2B/2C, CD- 26 inhibitors, FE999011, 30 P9310/K364, VIP 0177, DPP4, SDZ 274-444, 2-cyanopyrrolidides and 4-cyanopyrrolidides as

disclosed by Ashworth et al, Bioorg. & Med. Chem. Lett., Vol. 6, No. 22, pp 1163-1166 and 2745-2748 (1996), and the compounds disclosed in US6395767, US6573287, US6395767 (compounds disclosed include BMS-477118, BMS-471211 and BMS 538,305), WO99/38501, WO99/46272, WO99/67279, WO99/67278, WO99/61431WO03/004498, WO03/004496, 5 EP1258476, WO02/083128, WO02/062764, WO03/000250, WO03/002530, WO03/002531, WO03/002553, WO03/002593, WO03/000180, and WO03/000181; GLP-I agonists such as exendin-3 and exendin-4 (including the 39 aa polypeptide synthetic exendin-4 called Exenatide®), and compounds disclosed in US2003087821 and NZ 504256, and pharmaceutically acceptable salts and esters thereof; peptides including amlintide and Symlin® 10 (pramlintide acetate); and glyco kinase activators such as those disclosed in US2002103199 (fused heteroaromatic compounds) and WO02/48106 (isoindolin-1-one-substituted propionamide compounds).

EXAMPLES

Example 1: Clinical Study for safety and efficacy in humans for the treatment of chronic idiopathic constipation

[162] A randomized, double-blind, placebo-controlled, 14-day repeat oral, dose ranging study was conducted in patients with chronic idiopathic constipation (CIC). The primary objective of this study was to evaluate the safety of SP-304 (1.0 mg, 3.0 mg, 9.0 mg and 0.3 mg) for 14 days in patients with CIC. One secondary objective was to assess the pharmacokinetic profile of SP-304 in plasma. Other secondary objectives included evaluations of pharmacodynamic effects (efficacy) on parameters such as the time to first bowel movement after daily dosing with SP-304, bowel habits over time – for example, spontaneous bowel movements (SBMs), complete spontaneous bowel movements (CSBMs), and stool consistency [using Bristol Stool Form Scale (BSFS)] – and other patient reported outcomes such as abdominal discomfort.

[163] The study included five arms with assigned interventions as indicated in the table below.

Arms	Interventions
SP-304 1.0 mg: Experimental	Subjects receiving SP-304 1.0 mg for 14 consecutive days
SP-304 3.0 mg: Experimental	Subjects receiving SP-304 3.0 mg for 14 consecutive days
SP-304 9.0 mg: Experimental	Subjects receiving SP-304 9.0 mg for 14 consecutive days
Placebo: Placebo Comparator	Subjects receiving Placebo for 14 consecutive days
SP-304 0.3 mg: Experimental	Subjects receiving SP-304 0.3 mg for 14 consecutive days

[164] Subjects diagnosed with CIC were screened for the anticipated 4 cohorts to yield 80 randomized subjects for enrollment. There were four dose cohorts (1.0 mg, 3.0mg, 9.0 mg and 0.3 mg) with 20 subjects per dose cohort [randomization ratio 3:1 (15 receive SP-304:5 receive placebo)]. Subjects who continued to meet all the entry criteria and complete the pre-treatment bowel movement (BM) diary received, in a double-blind, randomized fashion, SP-304 or matching placebo. The entry criteria included (1) meeting modified ROME III criteria for chronic constipation (CC); (2) no significant finding in colonoscopy within past 5 years; (3) good health as determined by physical examination, medical history, vital signs, ECG, clinical chemistry, hematology, urinalysis, drug screen and serology assessments; and (4) during 14-day pre-treatment period, subjects reporting < 6 SBM and < 3 CSBM in each pre-treatment week. All subjects receiving at least one dose of SP-304 or matching placebo were considered evaluable for the safety endpoints (78 total). If a subject did not have a major protocol deviation, had at least 5 days of study treatment each week and corresponding entries for bowel habits, he/she was considered evaluable for efficacy parameters (54-55 total).

[165] The demographics of the subjects in the study are summarized in the table below.

	Placebo	0.3 mg	1.0 mg	3.0 mg	9.0 mg
Age					
	47.7 (14.6)	51.1 (12.0)	50.5 (10.6)	48.5 (16.1)	47.3 (12.7)
Gender					
Female	18 (90.0%)	12 (85.7%)	14 (100%)	13 (86.7)	12 (80%)
Male	2 (10.0%)	2 (14.3%)	0	2 (13.3%)	3 (20%)
Race					
White	17 (85.0%)	13 (92.9%)	12 (85.7%)	14 (93.3%)	12 (80.0%)

African American	1 (5.0%)	0	1 (7.1%)	0	2 (13.3%)
Asian	1 (5.0%)	1 (7.1%)	1 (7.1%)	0	1 (6.7%)
American Indian	1 (5.0%)	0	0	0	0
Other	0	0	0	1 (6.7%)	0

Values for age are the mean (standard deviation); values for gender and race are the number (percentage of experimental arm).

Results

[166] Pharmacokinetics and Safety:

[167] There was no detectable systemic absorption of plecanatide (assay sensitivity ≥ 10 ng/mL). No serious adverse events (SAE) were reported in subjects receiving plecanatide and no deaths reported in this study. 10% (2/20) subjects who received placebo and 17.2% (10/58) subjects who received SP-304 reported adverse events considered as related to the treatment. The majority of adverse events were mild / moderate and transient in nature. 10% (2/20) subjects who received placebo and 5.2% (3/58) subjects who received SP-304 reported GI-related adverse events considered as related to treatment. There was no diarrhea reported for any subject receiving SP-304. The table below is a GI-related adverse event (AE) summary.

	Placebo n=20	0.3 mg n=14	1.0 mg n=14	3.0 mg n=15	9.0 mg n=15
Abdominal Cramping	1 (5.0%)	0	0	0	0
Abdominal Pain	1 (5.0%)	0	0	0	0
Bloating	0	0	0	0	1 (6.7%)
Diarrhea	1 (5.0%)	0	0	0	0
Flatulence	2 (10.0%)	0	0	0	0
Nausea	0	1 (7.1%)		0	0
Upset Stomach	0	0	0	1 (6.7%)	0

Values are the number (percentage of experimental arm).

[168] Efficacy:

[169] SP-304 (plecanatide) treatment decreased the time to first bowel movement, increased stool frequency (SBM and CSBM), improved stool consistency, and reduced straining and abdominal discomfort. See Figures 1-6.

Example 2: Composition of Wet Granulation batch 10005

Item No.	Ingredient	Use	Concentration % w/w
1	SP304		0.23
2	Mannogem EZ, USP/EP (Mannitol)	Diluent	79.77
3	PROSOLV SMCC 90 LM (silicified microcrystalline cellulose)	Binder	15.0
4	Purified Water (chilled to 5°C), USP	vehicle	n/a
5	Purified Water (chilled to 5°C), USP		n/a
6	Explotab (Sodium Starch Glycolate)	Disintegrant	4.0
7	Pruv (sodium stearyl fumarate)	Lubricant	1.0
	Total		100

Example 3: Composition of Wet Granulation batch 10007

Item No.	Ingredient	Use	Concentration % w/w
1	SP304		0.3
3	PROSOLV SMCC 90 HD (silicified microcrystalline cellulose)	Binder	95.7
4	Purified Water (chilled to 5°C), USP	vehicle	n/a
5	Purified Water (chilled to 5°C), USP		n/a

6	Explotab (Sodium Starch Glycolate)	Disintregant	4.0
	Total		100

Example 4: EXCIPIENT COMPATIBILITY

[170] Binary mixtures of SP-304 were prepared and stored in glass vials. For solid excipients the binary mixtures were comprised of 9.1% or 50% excipient. Glass vials were stored at 40C/75RH open or closed. The percent purity (measured by HPLC) of the GCC agonist peptide (SP-304) after storage for the time indicated in each column (i.e., 1, 2, or 3 months for the closed vial and 0.5, 1, 2, or 3 months for the open vials) is indicated by numerical values.

PURPOSE	EXCIPIENT	Closed			Open			
		1M	2M	3M	0.5M	1M	2M	3M
None	None	91.4	88.2	84.1	93.7	91.2	88.2	84.8
Diluent	Sorbitol	92.4	90.1	87.2	92.2	90.8	87.1	80.9
	Mannitol	91.9	88.4	85.1	92.6	90.5	87.9	83.8
	Prosolv	92.2	89.6	86.3	93	90.5	87.8	83.7
	Starch	91.4	88.7	85.4	92.5	90.5	87.9	83.7
Binder	Emdex	91.3	88.7	85.2	91.8	90.7	87.9	81.9
	Plasdone	92.8	90.6	85.6	93.1	90.4	87.3	83
Disintregant	Explotab	91.9	89.4	87.1	92.2	90.3	84.7	78.3
	Polyplasdone	92	89	85.6	93.5	90.3	87.4	83.1
Glidant	Cabosil	92.1	88.3	85.6	92.6	90.5	87.3	84
Lubricant	Mg stearte	91.5	87.7	84.6	92.6	90.6	87.6	83.8
	PRUV	92	88.3	85.7	92.2	90.5	87.5	83.8
	compritol	90.8	87.1	84.4	92	90.5	86.7	84.1
Excipient	PEG 3350	90.9	87	83.3	91.5	89.4	84.4	77.5
Antioxidant	Ascorbic acid	91.3	86.9	83	92.8	90	85.7	83.8
	BHA	91.9	88.9	85.9	93.5	90.8	87.4	85.8
	BHT	90.8	87.2	84.6	92.4	90.3	86.6	83.6
	EDTA	90.9	87.5	84.1	92.3	90.4	86.7	84.6
Capsule	HPMC capsule	92.2	89	85.2	92.3	90.2	86.4	83.5
	Gelatin capsule	91.5	88.3	84.3	84.3	90.5	86.7	83.6

Liquid for liquid filled capsule	Medium chain trig		90.4					
	PG dicaprylocaprate		89.3					
	Vit E		90					
	Soybean oil		89.6					
	Cremaphor		79.7					
	PG		3.4					
	PG 400		0.7					

Example 5: Geometric dry mix for 0.3mg capsule

[171] Place 12g mannitol in mortar. Add 4g SP-304 and gently mix until a visually uniform powder is obtained. Transfer to Turbula mixer. Rinse mortar with mannitol and transfer to Turbula mixer and mix at high speed for 10 minutes. Add about 150g of mannitol to 4 quart V-shell mixer. Transfer the contents of the Turbula mixer to the V-shell and add 150g of mannitol mix. Discharge v-shell contents and screen through 40 mesh and return to mixer. Add 586g of mannitol to mixer and mix for 20 minutes.

Example 6: Wet granulation process:

[172] Batch 017-10005 comprised of mannitol and low-moisture (2.4%) PROSOLV LM90 (0.33 g/mL) was sprayed with SP-304 solution and fluid bed dried resulted in granulation water content of 0.35%. The final blend contained 1% water, flowed well, and filled capsules well. The 2nd prototype 017-1006 comprised of the same components was adjusted to obtain a target capsule fill weight of 100 mg based on the results of the 1st batch. Water was sprayed onto powder blend with SP-304. The inlet temperature was 50C and the granulation was dried for 1.5 hours and stopped when the product temperature reached 36C. The 3rd (batch017-10006) and 4th (batch 017-10007) capsule prototypes will use PROSOLV HD90, which is a higher density material with superior flow properties and higher moisture content of 5.5% than the PROSOLV LM90. The moisture content of the PROSOLV HD90 is readily removed by fluid bed drying.

The density of PROSOLV HD90 is about 0.55 g/mL. The PRUV lubricant will be removed for these batches.

Example 7: Wet granulation stability

[173] SP-304 was extracted from the capsules by sonication at either at room temperature (RT) or cold temperature and the amount of peptide was determined by HPLC. Initial percentages are based on the amount stated on the label.

Batch	% peptide (initial)	% peptide (1 mos at RT)
017-10006	101.1 (sonicated RT)	97.6 (sonicated cold)
017-10008	97.5 (sonicated RT)	108.2 (sonicated cold)

Example 8: 1M capsule stability in HDPE Bottles

[174] Capsules contained 0.3 mg SP-304 with the remainder of the fill weight (up to 5 mg) made up by mannitol (Perlitol 300 DC). Each capsule contained 1.5% by weight SP-304 and 98.5% mannitol. The capsule shell was composed of HPMC. Amounts are relative to the amount specified on the label (i.e., 0.30 mg peptide). The indicated number of capsules was placed in a high density polyethylene bottle with an induction seal and molecular sieve desiccant for 1 month at either 2-8C (first two columns) or 25C and 60% relative humidity (last two columns). The initial amount of peptide present was 101% of the label claim. The last row gives the amount of peptide remaining after 1 month storage at the indicated temperature as determined by HPLC.

2-8C	2-8C	25C/60RH	25C/60RH
1-capsule per bottle	6-capsules per bottle	1-capsule per bottle	6-capsules per bottle
100%	92%	92%	98%

Example 9: Composition of batch 1528-2855-RD (capsules) and spray coating and drying process

Item No.	Ingredient	Amount per unit (mg)	Concentration % w/w
1	SP-304	0.3246	0.3246
2	Microcrystalline cellulose (Cephene SCP-100)	99.10	99.10
3	Calcium chloride dihydrate	0.2622	0.2622
4	Leucine USP	0.1171	0.1171
5	Hypromellose (Methocel E5 PremLV)	0.2000	0.2000
6	Purified Water, USP	7.2 mL*	n/a
	Total	100	100

*: The amount of water is calculated based on use of 119.0 mL purified water for the whole batch containing 5.356 g SP-304.

[175] The spray drying process of making the batch 2855-RD is described below.

Preparation of Coating Dispersion:

[176] Purified water was added to a glass container and stirred such that a liquid vortex was produced without introducing air. Then calcium chloride dihydrate was slowly added into the water. The mixture was stirred until the salt was dissolved or well dispersed. Next, leucine was slowly added and the resulting mixture was stirred until the amino acid was dissolved or well dispersed. Afterward, methocel was slowly added and the mixture was stirred until methocel was completely dissolved. The solution could be warmed up to dissolve methocel, if necessary. The resulting excipient solution was allowed to cool to room temperature and pass through 80 mesh screen. Then, 127.9g of screened excipient solution was added to a glass container and placed in an ice bath for 0.5 to 1 hour until the solution reached 0 °C. Next, SP-304 was added

into the cold excipient solution. The mixture was stirred vigorously to allow the peptide to dissolve in the cold solution. The resulting peptide solution was kept cold in the ice bath as a spraying/coating solution.

Drug Layering

[177] A Glatt GPCG-2 fluid bed processor (with top spray tower) with a Wurster insert was set up for drug layering onto Celphere SCP-100 beads. After loading the Wurster column with Celphere SCP-100 beads, bed temperature was raised to 35 °C and maintained for 30 minutes with minimum fluidization of the beads. The bed temperature was reduced until an exhaust temperature of 35 °C was achieved. The pump tubing of the peristaltic pump used was primed by circulating the spraying solution mentioned above. After the spraying apparatus was adjusted to obtain a satisfactory spray pattern, the coating solution was sprayed onto Celphere SCP-100 beads until all coating solution was sprayed. Operating parameters were recorded. The bed temperature and fluidization were maintained until the beads were sufficiently dry. The fluidization was then reduced while the bed temperature was maintained at 35 °C for 10 minutes. 2g of beads were sampled for moisture analysis when the bed temperature was kept at 35 °C. When the moisture of the sampled beads reached < 5% moisture, the coated beads were discharged and loaded into a dry container. LOD (loss on drying) 2.399%.

Example 10: Composition of batch 1528-2851-RD (tablets) and spray coating and drying process

Item No.	Ingredient	Amount per unit (mg)	Concentration % w/w
1	SP-304	0.3246	0.3607
2	Microcrystalline cellulose (Avicel PH 102)	88.88	98.75
3	Calcium chloride dihydrate	0.2622	0.2913
4	Leucine USP	0.1171	0.1301
5	Hypromellose	0.2000	0.2222

	(Methocel E5 PremLV)		
6	Magnesium stearate	0.225	0.2500
7	Purified Water, USP	7.2 mL*	n/a
	Total	90.0	100

*: The amount of water is calculated based on use of 119.0 mL purified water for the whole batch containing 5.356 g SP-304.

[178] The spray coating and drying process of making the batch 2851-RD is described below.

Preparation of Coating Dispersion:

[179] Purified water was added to a glass container and stirred such that a liquid vortex was produced without introducing air. Then calcium chloride dihydrate was slowly added into the water. The mixture was stirred until the salt was dissolved or well dispersed. Next, leucine was slowly added and the resulting mixture was stirred until the amino acid was dissolved or well dispersed. Afterward, methocel was slowly added and the mixture was stirred until methocel was completely dissolved. The solution could be warmed up to dissolve methocel, if necessary. The resulting excipient solution was allowed to cool to room temperature and pass through 80 mesh screen. Then, 127.9g of screened excipient solution was added to a glass container and placed in an ice bath for 0.5 to 1 hour until the solution reached 0 °C. Next, SP-304 was added into the cold excipient solution. The mixture was stir vigorously to allow the peptide to dissolve in the cold solution. The resulting peptide solution was kept cold in the ice bath as a spraying/coating solution.

Drug Layering

[180] A Glatt GPCG-2 fluid bed processor (with top spray tower) with a Wurster insert was set up for drug layering onto Avicel PH 102 beads. After loading the Wurster column with Avicel PH 102 beads, temperature was raised to 35 °C and maintained for 30 minutes with minimum fluidization of the beads. The bed temperature was reduced until an exhaust temperature of 35 °C was achieved. The pump tubing of the peristaltic pump used was primed by circulating the spraying solution mentioned above. After the spraying apparatus was adjusted to obtain a

satisfactory spray pattern, the coating solution was sprayed onto Avicel PH 102 beads until all coating solution was sprayed. Operating parameters were recorded. The bed temperature and fluidization were maintained until the beads were sufficiently dry. The fluidization was then reduced while the bed temperature was maintained at 35 °C for 10 minutes. 2g of beads were sampled for moisture analysis when the bed temperature was kept at 35 °C. When the moisture of the sampled beads reached < 5% moisture, the coated beads were discharged and loaded into a dry container. LOD (loss on drying) <5%.

[181] The net weight of the coated blend was determined for calculation of the amount of magnesium stearate needed to lubricate the blend. Then the magnesium stearate was added to the coated blend and the mixture was blended for 1 minute.

Compression

[182] A Fette tablet press was set up. Then the blend mixture was loaded into the powder hopper and tooling was installed. The weight of each tablet was set to be 90 mg±5% and hardness to be 4-6 Kp. The weight, hardness and thickness of tablets were measured and recorded every 5 to 10 minutes. Friability measurement was also performed to ensure satisfactory product.

Example 11: Composition of batch 1528-2850-RD (capsules) and process

Item No.	Ingredient	Concentration % w/w
1	SP-304	0.3246
2	Microcrystalline cellulose (Avicel PH 102)	99.43
3	Magnesium stearate	0.2500
4	HPMC capsule shells	n/a
	Total	100

[183] The dry blend process of making the batch 2850-RD is described below.

Blending:

[184] Avicel PH 102 was screened through a 60 mesh screen. V-blenders (1 Qt, 4Qt, and 16 Qt) were then dusted by the screened Avicel PH 102. SP-304 was screened through a 200 mesh screen and loaded into the 1-Qt V-blender. Then, about 80 g Avicel PH 102 was added into the 1-Qt blender and the mixture was blended for 10 minutes at 25 rpm. The mixture was then transferred to the 4-Qt V-blender which was pre-dusted by the screened Avicel PH 102. The 1-Qt blender was rinsed with Avicel and the rinse material was transferred to the 4-Qt blender. The rinsing was repeated until all SP-304 was transferred to the 4-Qt blender. About 200g Avicel was added to the 4-Qt V-blender and the mixture was blended for 10 minutes. The resulting blend was then screened through a 60 mesh screen and then transferred into the pre-dusted 16-Qt blender (dusted with 1500g Avicel). The 4-Qt blender was rinsed with Avicel and the rinse material was transferred to the 16-Qt blender. The remaining Avicel was added to the 16-Qt blender and the mixture was blended for 10 minutes. The resulting blend was passed through Comil and then returned to the 16-Qt blender and was further blended for 5 minutes. Proper amount of magnesium stearate was weighed, screened through a 60 mesh screen, and added into the 16-Qt blender. The resulting mixture was blended for 2 minutes.

Encapsulation

[185] A MG2 Planeta capsule filler was set up. Average weight of the empty capsule shells was determined and target capsule fill weight was calculated ($\pm 5\%$). The blend from the above process was added into the hopper of the capsule filler and encapsulation was started. Run weight parameters were manually adjusted. Resulting capsules were then sorted according to the target fill weight.

Example 12: Composition of batch 1528-2850B-RD (tablets) and process

Item No.	Ingredient	Concentration % w/w
1	SP-304	0.3246
2	Microcrystalline cellulose (Avicel PH	99.43

	102)	
3	Magnesium stearate	0.2500
	Total	100

[186] The dry blend process of making the batch 2850B-RD is described below.

Blending:

[187] Avicel PH 102 was screened through a 60 mesh screen. V-blenders (1 Qt, 4Qt, and 16 Qt) were then dusted by the screened Avicel PH 102. SP-304 was screened through a 200 mesh screen and loaded into the 1-Qt V-blender. Then, about 80 g Avicel PH 102 was added into the 1-Qt blender and the mixture was blended for 10 minutes at 25 rpm. The mixture was then transferred to the 4-Qt V-blender which was pre-dusted by the screened Avicel PH 102. The 1-Qt blender was rinsed with Avicel and the rinse material was transferred to the 4-Qt blender. The rinsing was repeated until all SP-304 was transferred to the 4-Qt blender. About 200g Avicel was added to 4-Qt V-blender and the mixture was blended for 10 minutes. The resulting blend was then screened through a 60 mesh screen and then transferred into the pre-dusted 16-Qt blender (dusted with 1500g Avicel). The 4-Qt blender was rinsed with Avicel and the rinse material was transferred to the 16-Qt blender. The remaining Avicel was added to the 16-Qt blender and the mixture was blended for 10 minutes. The resulting blend was passed through Comil and then returned to the 16-Qt blender and was further blended for 5 minutes. Proper amount of magnesium stearate was weighed, screened through a 60 mesh screen, and added into the 16-Qt blender. The resulting mixture was blended for 2 minutes.

Compression

[188] A Fette tablet press was set up. Then the blend mixture was loaded into the powder hopper and tooling was installed. The weight of each tablet was set to be 90 mg±5% and hardness to be 4-6 Kp. The weight, hardness, and thickness of tablets were measured and recorded every 5 to 10 minutes. Friability measurement was also performed to ensure satisfactory product.

[189] Other batches were prepared by the processes similar to those described in Examples 9-12. Their compositions are listed below.

[190] Batch 500-55: 0.33% plecanatide, 95.17% microcrystalline cellulose, 4.0% sodium starch glycolate, and 0.5% magnesium stearate.

[191] Batches 1528-2907-RD and 2010F100A: 3.318% plecanatide, 96.43% Avicel, and 0.25% Mg stearate.

[192] Batches 1528-2906-RD and 2010F099A: 1.106% plecanatide, 98.65% Avicel, and 0.25% Mg stearate.

[193] Batches 1528-2890-RD and 2010F101A: 0.3246% plecanatide, 99.43% Avicel, and 0.25% Mg stearate.

Example 13: Plecanatide tablet and capsule stability

[194] Capsules and tablets of different batches were tested for their stability and the results were provided. Unless otherwise specified, 1M, 2M, 3M, or 4M in the tables below denotes that the measurements were carried out at the end of 1, 2, 3, or 4 month(s) of the storage period.

[195] Potency Summary: This test was performed by taking a composite sample of about 5 units to determine the average potency of the sample. The table below shows the stability of capsules or tablets in terms of potency (% of label claim).

Lot (description)	HPLC Potency (% Label Claim)							
	Bulk**	Package	Initial	40C/75RH		30C/65RH	25C/60RH	5C
				1M	3M	3M	3M	4M
1528-2850-RD (0.3mg dry blend capsules)	89	HDPE bottle		89	87	89	91	89.3
		Oxyguard bottle		91	91	92	91	88.9
		Blister strip	90	90	85	88	91	
1528-2855-RD (0.3mg coated bead capsule)	94	HDPE bottle		101	100	96	102	
		Oxyguard bottle		101	96	99	104	
		Blister strip		97	103	99	98	

500-55 (0.3mg dry blend capsule)	97	HDPE bottle		97	94	95	96	
		Oxyguard bottle		98	96	96	102	
		Blister strip	93	97	93	95	106	
1528- 2850B-RD (0.3mg dry blend tablet)	78	HDPE bottle		85	88	94	83	
		Oxyguard bottle		84	84	88	74	
1528-2851- RD (0.3mg coated particle tablet)	96	HDPE bottle		115	72	90	99	
		Oxyguard bottle		81	88	83	111	
2010F100A (3mg dry blend capsule)	101							
2010F101A (0.3mg dry blend capsule)	97							
2010F099A (1mg dry blend capsule)	98							
1528-2907- RD (3mg dry blend capsule)	98							
1528-2906- RD (1mg dry blend capsule)	98							
1528-2890- RD (0.3mg dry blend capsule)	93							

**Bulk means before packaging.

[196] As demonstrated by the table above, there was little or no appreciable loss in potency after storage under accelerated conditions (40C/75RH or 30C/65RH), which suggests that these

capsules or tablets could be stable at room temperature for 18 months or for longer times if refrigerated or stored at 25C.

[197] Water content summary: The table below shows that the water content was stable over the testing period in the packages evaluated for various capsule/tablet compositions. This further demonstrated that products were stable.

Lot	Water (in-process)	Packaging	Initial	Water packaged product				
				1M	3M			4M
				40C /75RH	40C /75RH	30C /65RH	25C /60RH	5C
1528-2850-RD 0.3mg dry blend capsule		32-count, HDPE bottle, 60cc, N2, 2g mol. sieve		5.03	5.64	3.00	2.22	5.48
		32-count, Oxyguard bottle, 40cc, PharmaKeep KD-20		5.07	5.24	4.28	5.33	5.31
		Blister, N2	4.21	4.87	5.80	4.76	4.31	
1528-2855-RD 0.3mg coated bead capsule	2.40	32-count, HDPE bottle, 60cc, N2, 2g mol. sieve		0.57	0.47	1.63	0.68	
		32-count, Oxyguard bottle, 40cc, PharmaKeep KD-20		2.10	1.05	1.29	2.07	
		Blister strip		0.73	2.11	0.54	0.58	
500-55 0.3mg dry blend capsule		HDPE bottle		5.63	4.19	5.51	5.79	
		Oxyguard bottle		5.78	4.69	5.90	5.66	
		Blister strip	4.09	5.78	4.17	5.53	6.16	
1528-2850B-RD 0.3mg dry blend tablet		32-count, HDPE bottle, 60cc, N2, 2g mol. sieve		4.09	4.03	6.28	6.10	
		32-count, Oxyguard bottle, 40cc, PharmaKeep KD-20		4.81	4.91	6.15	6.30	
1528-2851-RD 0.3mg coated particle tablet	3.32	32-count, HDPE bottle, 60cc, N2, 2g mol. sieve		4.33	4.50	5.09	5.90	
		32-count, Oxyguard bottle, 40cc, PharmaKeep KD-20		5.15	4.88	5.82	6.02	

1528-2907-RD 3mg dry blend capsule		Bulk capsule	4.78					
1528-2906-RD 1m dry blend capsule		Bulk capsule	4.84					
1528-2890-RD		Bulk capsule	4.8					

Impurity summary: The table below shows the product stability in terms of HPLC or UPLC of total impurities as a function of time and storage condition. The data in the table suggest that the increase in total impurities in tested batches except batch 500-55 be no greater than 7% at room temperature after 18 months. It also suggest that the increase in total impurities in all tested 5 1528-2855-RD batche in different packages be no greater than 7% at 30 °C for 18 months. It was also observed that the 1528-2855-RD batch had less impurity increase than the 1528- 2850-RD batch or was more stable than the 1528-2850-RD batch.

Batch	Package	Total impurities $\geq 0.05\%$ area						
		Initial	40C/75RH			30C/65RH	25C/60RH	5C
			1M	2M	3M	3M	3M	4M
1528-2850-RD	HDPE bottle	3.3	5.5		5.9	4.4	3.8	3.1
	Oxyguard bottle		5.7		7.4	5.3	4.3	3.1
	Blister strip		5.1		7.0	5.0	4.3	
1528-2855-RD	HDPE bottle	3.6	3.6		5.1	3.8	3.4	
	Oxyguard bottle		3.9		4.4	4.1	3.7	
	Blister strip		4.0		5.2	4.0	3.6	
500-55	HDPE bottle	3.3	5.7		8.4	5.4	4.4	
	Oxyguard bottle		5.6		7.0	5.1	4.3	
	Blister strip		6.5		8.0	5.7	4.8	
1528-2850B-RD	HDPE bottle	3.7	5.0		6.5	4.5	3.9	
	Oxyguard bottle		5.6		7.3	4.7	4.1	
1528-2851-RD	HDPE bottle	3.8	4.2		5.1	4.0	3.8	
	Oxyguard bottle		4.9		6.8	4.7	4.4	
1528-	HDPE bottle	1.83		5.18				

2906-RD								
1528-2907-RD	HDPE bottle	1.85		4.58				
1528-2890-RD	Bulk	1.9						

[198] Content uniformity: This test was performed by placing 10 individual capsule/tablet units in 10 individual bottles and potency of each unit was measured to show whether individual capsules or tablets have uniform potency (% label claim or %LC).

0.3mg Dry blend tablet 1528-2850B-RD	
Sample	%LC
	1528-2850B-RD (dry tabs)
1	78.62
2	91.43
3	86.52
4	90.9
5	84.83
6	95.29
7	75.69
8	76.87
9	84.92
10	86.9
Mean	85.2
std. dev	6.51
% RSD	7.64

0.3mg Coated particle tablet 1528-2851-RD		
Sample	Weight	% Label

	(mg)	Claim
1	88.86	69.55
2	89	94.41
3	88.89	94.34
4	88.6	72.18
5	88.37	142.52
6	88.76	149.44
7	89.42	78.8
8	88.56	131.08
9	89.08	102.55
10	88.78	99.13
Mean		103.4
St. Dev		28.53
%RSD		27.59

0.3mg Dry blend capsule 1528-2890		3mg Dry blend capsule 1528-2907-RD		1mg Dry blend capsule 1528-2906-RD	
Sample	%LC	Sample	%LC	Sample	%LC
1	87.2	1	94.5	1	98.1
2	94.6	2	101.2	2	101.8
3	92.6	3	97.9	3	93.1
4	94.2	4	94.5	4	97.5
5	93.5	5	95.9	5	97.9
6	91.7	6	95.2	6	97.1
7	91.6	7	96.1	7	94.5
8	99	8	99	8	100.1
9	91.8	9	93.8	9	98.1
10	92.1	10	93.4	10	97.9
Mean	92.8	Mean	96.2	Mean	97.6
RSD	3.20%	RSD	2.60%	RSD	2.50%
AV(10)***	12.8	AV(10)	8.4	AV(10)	6.8

***AV = acceptance value used for UPS <905> content uniformity. Ideally AV should be less than 15 to pass USP <905> content uniformity.

0.3mg dry blend capsule 1528-2850-RD		
Sample	Original %LC	Re -preparation %LC
1	82.73	85.87
2	84.57	89.45
3	80.29	91.39
4	84.88	88.45
5	85.2	86.96
6	82.9	84.84
7	84.75	86.21
8	86.58	91.37
9	84.34	88.79
10	88.82	84.75
Mean	84.51	87.81
std. dev	2.288445	2.467121
% RSD	2.7	2.8

Conte1528-2855-RD Sample	%LC	1528-2850B-RD Sample	%LC
1	88.82	1	78.62
2	93.73	2	91.43
3	89.06	3	86.52
4	84.94	4	90.9
5	89.93	5	84.83
6	88.7	6	95.29
7	88.71	7	75.69
8	86.85	8	76.87
9	86.92	9	84.92
10	91.33	10	86.9
Mean	88.9	Mean	85.2
std. dev	2.45	std. dev	6.51
% RSD	2.76	% RSD	7.64

500-55	
Sample	% label claim
1	96.90%
2	99.40%
3	103.20%
4	96.90%
5	100.00%
6	99.60%
7	96.90%
8	102.80%
9	96.80%
10	93.90%
Mean	98.60%
SD	2.91
RSD	3.00%
AV	7.1 (PASS)

[199] The data in the tables above show that all of the batches yield very good content uniformity acceptable for commercial product.

[200] Dissolution 50-rpm summary: The tables below are summaries of the dissolution of drug from capsules or tablets in an unconventional small-volume apparatus needed to measure the small amount of drug in the units using slow stirring to look for changes in dissolution over time. The test was performed by placing one unit into a very small volume of water at 37C with a paddle stirring at 50-rpm (which is slow) and data were collected at 15, 30 45, and 60 minutes to show the drug release rate over time. These tested products are “immediate release” oral solid dosage forms and a conventional requirement is to have about 75% released in about 45 minutes. The tables summarize the results at 45 minutes and indicate that dissolution was stable over time.

		Dissolution (% label claim at 45 minutes)						
Lot (description)		Initial		40C/75RH	30C/65RH		25C	5C
		bulk	0M	1M	2M	3M	3M	4M
1528-2850-RD (dry blend V- Cap capsule HDPE bottle)	Vessel 1	85		78	84	81	86	83
	Vessel 2	87		73	90	82	84	85
	Vessel 3	88		79	85	79	91	87
	Vessel 4	84		86	87	78	83	85
	Vessel 5	89		72	89	80	79	90
	Vessel 6	88		81	85	82	88	83
	Average	87		78	87	80	85	85
	RSD	2		6.4	2.7	2.1	5.0	2.9
1528-2850-RD (dry blend Vcap capsule OxyGuard bottle)	Vessel 1	85		69	89	79	88	82
	Vessel 2	87		75	89	87	81	85
	Vessel 3	88		77	87	86	84	86
	Vessel 4	84		80	87	83	83	80
	Vessel 5	89		71	88	89	84	84
	Vessel 6	88		76	88	79	86	89
	Average	87		75	88	84	84	84
	RSD	2		5.3	1.2	5.2	3.1	3.6
1528-2850-RD (dry blend V- cap capsule blister strip)	Vessel 1	85	75	59	86	73	83	
	Vessel 2	87	89	77	79	81	81	
	Vessel 3	88	88	83	87	74	84	
	Vessel 4	84	89	67	93	85	83	
	Vessel 5	89	93	75	82	82	84	
	Vessel 6	88	90	82	90	67	87	
	Average	87	87	74	86	77	84	
	RSD	2	7	12.5	6.3	8.6	2.4	

		Dissolution (% label claim at 45 minutes)				
Lot (description)		Initial	40C/75RH	30C/65RH		25C
		bulk	1M	2M	3M	3M
1528-2855-RD (coated bead V-Cap capsule HDPE bottle)	Vessel 1	104	85	100	79	83
	Vessel 2	89	90	97	83	88
	Vessel 3	91	84	71	91	50

	Vessel 4	88	64	73	94	88
	Vessel 5	94	75	72	75	92
	Vessel 6	93	80	39	96	94
	Average	93	80	75	86	83
	RSD	6	12	29	9.7	20
1528-2855RD (coated bead V-cap capsule OxyGuard bottle)	Vessel 1	104	88	80	87	78
	Vessel 2	89	79	91	86	94
	Vessel 3	91	84	63	92	74
	Vessel 4	88	92	98	90	98
	Vessel 5	94	89	81	81	93
	Vessel 6	93	44	99	81	78
	Average	93	79	85	86	86
	RSD	6	23	16	5.3	12.1
	1528-2855-RD (coated bead V-cap capsule blister strip)	Vessel 1	104	85	98	100
Vessel 2		89	84	94	63	80
Vessel 3		91	97	96	82	87
Vessel 4		88	94	96	55	74
Vessel 5		94	64	75	95	66
Vessel 6		93	96	102	89	82
Average		93	87	93	81	78
RSD		6	14	10	22.4	9.2

Dissolution (% label claim at 45 minutes)					
Lot (description)		Initial	40C/75RH	30C/65RH	
		bulk	1M	2M	3M

1528-2851- RD (coated particle tablet HDPE bottle)	Vessel 1	58%	67	68	89
	Vessel 2	77%	84	78	124
	Vessel 3	57%	62	68	70
	Vessel 4	96%	110	84	105
	Vessel 5	95%	65	107	61
	Vessel 6	64%	103	76	51
	Average	74%	82	80	83
	RSD	24%	26	18	33
1528-2851- RD (coated particle tablet OxyGuard bottle)	Vessel 1	58%	89	54	118
	Vessel 2	77%	73	101	69
	Vessel 3	57%	75	82	80
	Vessel 4	96%	68	67	73
	Vessel 5	95%	76	162	96
	Vessel 6	64%	97	82	95
	Average	74%	80	91	89
	RSD	24%	14	42	21

Lot (description)	Dissolution (% label claim at 45 minutes)				
		Initial	40C/75RH	30C/65RH	
		bulk	1M	2M	3M
1528-2850B- RD (dry blend tablet HDPE bottle)	Vessel 1	90%	88	96	92
	Vessel 2	69%	79	82	92
	Vessel 3	83%	76	100	85
	Vessel 4	94%	96	86	94
	Vessel 5	88%	89	89	83
	Vessel 6	92%	83	97	83
	Average	86%	85	92	88
	RSD	11%	8.2	8	5.6
1528-2850B- RD (dry blend tablet OxyGuard bottle)	Vessel 1	90%	74	80	91
	Vessel 2	69%	97	87	95
	Vessel 3	83%	91	86	90
	Vessel 4	94%	94	91	90
	Vessel 5	88%	83	91	89
	Vessel 6	92%	91	76	84
	Average	86%	88	85	90

	RSD	11%	9.6	7	4.0
--	-----	-----	------------	---	------------

Lot (description)	Dissolution (% label claim at 45 minutes)						
		Initial		40C/75RH	30C/65RH		25C
		bulk	0M	1M	2M	3M	3M
500-55 (dry blend V-Cap Plus capsule HDPE bottle)	Vessel 1	95		90	92	91	89
	Vessel 2	98		85	98	97	98
	Vessel 3	69		85	96	94	76
	Vessel 4	94		89	95	100	97
	Vessel 5	99		89	97	98	86
	Vessel 6	104		100	99	94	92
	Average	93		89	96	96	90
	RSD	13.1		6.2	2.4	3.6	9.1
500-55 (dry blend V-Cap Plus capsule OxyGuard bottle)	Vessel 1	95		84	103	99	94
	Vessel 2	98		97	101	95	103
	Vessel 3	69		97	99	98	97
	Vessel 4	94		92	97	92	96
	Vessel 5	99		91	100	95	101
	Vessel 6	104		96	95	93	91
	Average	93		93	99	95	97
	RSD	13.1		5.3	2.7	2.7	4.3
500-55 (dry blend V-Cap Plus capsule foil blister)	Vessel 1	95	98	99		89	98
	Vessel 2	98	101	88		94	87
	Vessel 3	69	107	90		89	96
	Vessel 4	94	96	90		86	87
	Vessel 5	99	99	68		89	94
	Vessel 6	104	99	90		82	89
	Average	93	100	87		88	92
	RSD	13.1	3.8	11.8		4.3	5.5

Dry blend 3mg lot 1528-2907-RD 500-mL				
	15 min	30 min	45 min	60 min
Vessel 1	91	96	97	96
Vessel 2	96	95	97	96

Vessel 3	96	97	97	97
Vessel 4	95	102	100	100
Vessel 5	97	96	96	97
Vessel 6	92	99	98	98
Average	94	97	98	97
RSD	2.7	2.5	1.1	1.4

Dry blend 1mg lot 1528-2906-RD 150-mL				
	15 min	30 min	45 min	60 min
Vessel 1	65	92	96	99
Vessel 2	49	91	95	96
Vessel 3	46	88	96	97
Vessel 4	44	96	101	102
Vessel 5	39	78	93	99
Vessel 6	57	90	95	96
Average	50	89	96	98
RSD	18.8	7	2.8	2.4

Dry blend 0.3mg lot 1528-2890-RD 50-mL				
	15 min	30 min	45 min	60 min
Vessel 1	57	94	100	105
Vessel 2	60	96	100	105
Vessel 3	86	93	94	95
Vessel 4	76	90	91	101
Vessel 5	69	90	97	106
Vessel 6	68	95	97	97
Average	69	93	97	102
RSD	15.6	2.8	3.4	4.5

[201] Dissolution 75-rpm: The tables below show a few examples where the stirring rate was increased slightly to 75-rpm to give more consistent results and indicates stable dissolution after accelerated storage of 1 or 2 months at 40C 75% relative humidity.

Dry blend 0.3mg lot 1528-2850-RD 1M 40C/75RH 75-rpm 50-mL				
	15 min	30 min	45 min	60 min
Vessel 1	75	80	80	81

Vessel 2	61	75	80	82
Vessel 3	65	81	83	84
Vessel 4	78	86	84	85
Vessel 5	66	79	83	84
Vessel 6	62	79	84	86
Average	68	80	82	84
RSD	10.3	4.5	2.3	2.2

Dry blend 1mg lot 1528-2906A-RD 2M 40C/75RH 75-rpm 50-mL				
	15 min	30 min	45 min	60 min
Vessel 1	69	84	88	88
Vessel 2	62	82	84	85
Vessel 3	65	82	85	85
Vessel 4	58	70	80	79
Vessel 5	59	77	82	81
Vessel 6	68	80	83	84
Average	64	79	84	84
RSD	7.2	6.4	3.3	3.8

[202] 2855-RD dissolution: The tables below are all the dissolution profiles of batch 1528-2850-RD and indicate stable drug release over time.

Vessel	Initial Percent Dissolved			
	15	30	45	60
1	84%	99%	104%	104%
2	28%	80%	89%	92%
3	68%	83%	91%	95%
4	56%	79%	88%	98%
5	29%	83%	94%	98%
6	74%	85%	93%	96%
Mean	57%	85%	93%	97%
RSD	41.20%	8.50%	6.00%	4.20%

1M 40C/75RH OxyGuard Packaging						2M 30C/65RH OxyGuard						3M 30C/65RH OxyGuard						3M 25C/60RH OxyGuard					
Vessel	15 min	30 min	45 min	60 min	60 min	15 min	30 min	45 min	60 min	60 min	15 min	30 min	45 min	60 min	60 min	15 min	30 min	45 min	60 min	60 min			
1	35	74	88	93	93	47	67	80	90	90	76	83	87	88	88	44	62	78	85	85			
2	46	74	79	85	85	57	80	91	95	95	65	79	86	91	91	70	89	94	97	97			
3	39	78	84	88	88	43	55	63	71	71	64	84	92	97	97	48	62	74	79	79			
4	59	82	92	94	94	753	92	98	101	101	71	85	90	94	94	65	92	98	103	103			
5	22	82	89	92	92	38	64	81	92	92	60	75	81	87	87	72	86	93	96	96			
6	4	20	44	61	61	54	94	99	101	101	55	74	81	87	87	53	74	78	84	84			
Average	34	68	79	86	86	52	75	85	92	92	65	80	86	91	91	59	78	86	91	91			
RSD	57	35	23	14	14	25	21	16	12	12	11.7	5.7	5.3	4.6	4.6	20.1	17.4	12.1	10.4	10.4			

1M 40C/75RH HDPE Bottle						2M 30C/65RH HDPE						3M 30C/65RH HDPE						3M 25C/60RH HDPE					
Vessel	15 min	30 min	45 min	60 min	60 min	15 min	30 min	45 min	60 min	60 min	15 min	30 min	45 min	60 min	60 min	15 min	30 min	45 min	60 min	60 min			
1	61	78	85	89	89	78	97	100	103	103	58	72	79	85	85	54	70	83	92	92			
2	63	83	90	92	92	77	93	97	98	98	51	72	83	90	90	66	81	88	92	92			
3	66	79	84	91	91	41	59	71	78	78	53	84	91	94	94	10	29	50	66	66			
4	25	44	64	77	77	50	65	73	78	78	66	89	94	95	95	69	81	88	92	92			
5	47	67	75	80	80	37	59	72	83	83	48	66	75	81	81	68	83	92	97	97			
6	57	71	80	85	85	6	21	39	52	52	85	94	96	99	99	82	91	94	97	97			
Average	53	70	80	86	86	48	66	75	82	82	60	80	86	91	91	58	73	83	89	89			
RSD	28	20	12	7	7	56	42	29	22	22	22.6	14	9.7	7.3	7.3	43	30.6	19.6	13.3	13.3			

1M 40C/75RH Blister Packaging						2M 30C/65RH Blister						3M 30C/65RH Blister						3M 25C/60RH Blister					
Vessel	15 min	30 min	45 min	60 min	60 min	15 min	30 min	45 min	60 min	60 min	15 min	30 min	45 min	60 min	60 min	15 min	30 min	45 min	60 min	60 min			
1	36	69	85	90	90	61	91	98	100	100	82	95	100	102	102	53	71	81	90	90			
2	41	69	84	88	88	57	82	94	100	100	31	48	63	74	74	27	57	80	87	87			

3	67	96	97	98		63	87	96	100		69	77	82	85		70	78	87	92
4	54	83	94	104		36	80	96	100		29	41	55	69		52	66	74	87
5	10	46	64	79		45	61	75	83		84	94	95	97		25	48	66	80
6	70	91	96	100		87	100	102	104		74	84	89	82		50	74	82	84
Average	47	76	87	93		58	83	93	98		62	73	81	85		46	66	78	87
RSD	48	25	14	10		30	16	10	8		40.5	32.1	22.4	14.9		37.0	17.0	9.2	5.3

[203] Bathes 2850-RD, 2850B-RD, 2851-RD, and 500-55 were also tested in the similar fashion and all showed stable drug release over time.

We claim:

1. An oral dosage formulation comprising at least one GCC agonist peptide and one or more pharmaceutically acceptable excipients, wherein the amount of GCC agonist peptide per unit dose is from 0.01 mg to 10 mg, and the GCC agonist peptide is selected from the group consisting of SEQ ID NOs: 9 and 8.
2. An oral dosage formulation comprising at least one GCC agonist peptide and one or more pharmaceutically acceptable excipients, wherein the amount of GCC agonist peptide per unit dose is from 0.01 mg to 10 mg, the GCC agonist peptide is selected from the group consisting of SEQ ID NOs: 1-54 and 56-249, and the GCC agonist peptide has a chromatographic purity of no less than 91%.
3. The oral dosage formulation of claim 1 or 2, wherein the GCC agonist peptide has a chromatographic purity of no less than 92%.
4. The oral dosage formulation of claim 1 or 2, wherein the GCC agonist peptide has a chromatographic purity of no less than 95%.
5. The oral dosage formulation of claim 1 or 2, wherein the GCC agonist peptide has a total impurity content of no greater than 9%.
6. The oral dosage formulation of claim 1 or 2, wherein the GCC agonist peptide has a total impurity content of no greater than 7%.
7. The oral dosage formulation of claim 1 or 2, wherein the GCC agonist peptide has a total impurity content of no greater than 6%.
8. The oral dosage formulation of claim 1 or 2, wherein the GCC agonist peptide has a total impurity content of no greater than 5%.
9. The oral dosage formulation of claim 1 or 2, wherein the formulation is substantially free of inorganic acids and carboxylic acids.

10. The oral dosage formulation of claim 2, wherein the GCC agonist peptide is selected from the group consisting of SEQ ID NOs: 1, 8, 9, or 56.
11. The oral dosage formulation of claim 2, wherein the GCC agonist peptide is selected from the group consisting of SEQ ID NOs: 1 and 9.
12. The oral dosage formulation of any of claims 1-11, wherein the amount of GCC agonist peptide per unit dose is 0.1 mg, 0.3 mg, 1.0 mg, 3.0 mg, 6.0 mg, 9.0 mg or 9.5 mg.
13. The oral dosage formulation of any of claims 1-12, wherein the formulation is a solid formulation and the unit dose is a powder, granule, sachet, troche, tablet, or capsule.
14. The oral dosage formulation of any of claims 1-13, wherein the one or more pharmaceutically acceptable excipients comprise an inert carrier.
15. The oral dosage formulation of claim 14, wherein the inert carrier is selected from mannitol, lactose, a microcrystalline cellulose, or starch.
16. The oral dosage formulation of claim 15, wherein the inert carrier has a particle size of from 50 to 900 microns.
17. The oral dosage formulation of any of claims 1-16, wherein the one or more pharmaceutically acceptable excipients comprise a divalent cation salt.
18. The oral dosage formulation of claim 17, wherein the salt is calcium chloride.
19. The oral dosage formulation of any of claims 1-18, wherein the one or more pharmaceutically acceptable excipients comprise an amino acid.
20. The oral dosage formulation of claim 19, wherein the amino acid is leucine.
21. The oral dosage formulation of any of claims 1-13, wherein the formulation consists of the GCC agonist peptide, an inert carrier, and a lubricant.

22. The oral dosage formulation of any of claims 1-13, wherein the formulation consists of the GCC agonist peptide, an inert carrier, a divalent cation salt, an amino acid, a coating agent and optionally a lubricant.
23. The oral dosage of formulation of claim 21 or 22, wherein the inert carrier is microcrystalline cellulose and the lubricant is magnesium stearate.
24. The oral dosage of formulation of claim 22, wherein the divalent cation salt is CaCl_2 , the amino acid is leucine, and the coating agent is hypromellose.
25. The oral dosage formulation of any of claims 1-24, wherein the GCC agonist peptide is stabilized against degradation for a period of at least 18 months at 30 °C and 65% relative humidity, or at least 18 months at 25 °C and 60% relative humidity, or at least 18 months at 2-8 °C.
26. The oral dosage formulation of any of claims 1-25, wherein the formulation is in the form of a capsule or tablet.
27. The oral dosage formulation of claim 26, wherein the capsule or tablet is in a blister pack or strip.
28. The oral dosage formulation of any of claims 1-25, wherein the GCC agonist peptide is in solution or suspension in a lipophilic liquid.
29. The oral dosage formulation of claim 28, wherein the unit dosage form is a liquid-filled capsule.
30. The oral dosage formulation of claim 29, wherein the liquid is a refined specialty oil or a medium chain triglyceride or related ester.
31. A process for making an oral dosage formulation comprising at least one GCC agonist peptide, the method comprising:
 - a) providing an aqueous solution comprising: a GCC agonist peptide selected from the group consisting of SEQ ID NOs: 1-54 and 56-249, and one or more pharmaceutically

- acceptable excipients, wherein the concentration of the GCC agonist peptide ranges from 10 to 60 mg/mL; and
- b) applying the aqueous solution to a pharmaceutically acceptable carrier to generate a GCC agonist peptide-coated carrier.
32. The process of claim 31, wherein the one or more pharmaceutically acceptable excipients comprise a divalent cation salt wherein the divalent cation is selected from Ca^{2+} , Mg^{2+} , Zn^{2+} , and Mn^{2+}
33. The process of claim 31 or 32, wherein the one or more pharmaceutically acceptable excipients comprise an amino acid selected from leucine, isoleucine, and valine.
34. The process of any of claims 31-33, wherein the one or more pharmaceutically acceptable excipients comprise a coating agent.
35. The process of claim 34, wherein the coating agent is hypromellose.
36. The process of any of claims 31-35, wherein the aqueous solution has a pH greater than 4.
37. The process of any of claims 31-36, wherein the aqueous solution has a pH about 5.
38. The process of any of claims 31-37, wherein the GCC agonist peptide is selected from the group consisting of SEQ ID NOs: 1, 8, 9, and 56.
39. The process of any of claims 31-38, wherein the aqueous solution is substantially free of inorganic acids and carboxylic acids.
40. The process of any of claims 31-39, further comprising drying the GCC agonist peptide-coated carrier.
41. An oral dosage formulation made by the process of any of claims 31-40, wherein the GCC agonist peptide is stabilized against degradation for a period of at least 18 months at 30 °C and 65% relative humidity, or at least 18 months at 25 °C and 60% relative humidity, or at least 18 months at 2-8 °C.

42. A method for treating or preventing a disease or disorder in a subject in need thereof, comprising administering to the subject an oral dosage formulation of any of claims 1-30.
43. The method of claim 42, wherein the disease or disorder is a gastrointestinal disease or disorder selected from the group consisting of irritable bowel syndrome, non-ulcer dyspepsia, chronic intestinal pseudo-obstruction, functional dyspepsia, colonic pseudo-obstruction, duodenogastric reflux, gastro esophageal reflux disease, constipation, gastroparesis, heartburn, gastric cancer, and H. pylori infection.
44. The method of claim 43, wherein the gastrointestinal disease or disorder is chronic idiopathic constipation.
45. The method of claim 42, wherein the GCC agonist peptide is selected from the group consisting of SEQ ID NOs: 1, 8, 9, or 56.
46. The method of claim 42, wherein the GCC agonist peptide is selected from the group consisting of SEQ ID NOs: 1 and 9.
47. The method of claim 42, further comprising administering to the subject an effective amount of an inhibitor of a cGMP-specific phosphodiesterase.
48. The method of claim 47, wherein the cGMP-dependent phosphodiesterase inhibitor is selected from the group consisting of suldinac sulfone, zaprinast, and motapizone, vardenafil, and sildenafil.
49. The method of claim 42, further comprising administering to the subject an effective amount of at least one laxative.
50. The method of claim 49, wherein the at least one laxative is selected from the group consisting of SENNA, MIRALAX, PEG, or calcium polycarbophil.
51. The method of claim 42, further comprising administering to the subject an effective amount of at least one anti-inflammatory agent.
52. The method of claim 42, wherein the subject is a human.

53. A pharmaceutical composition comprising the oral dosage formulation of any of claims 1-30.

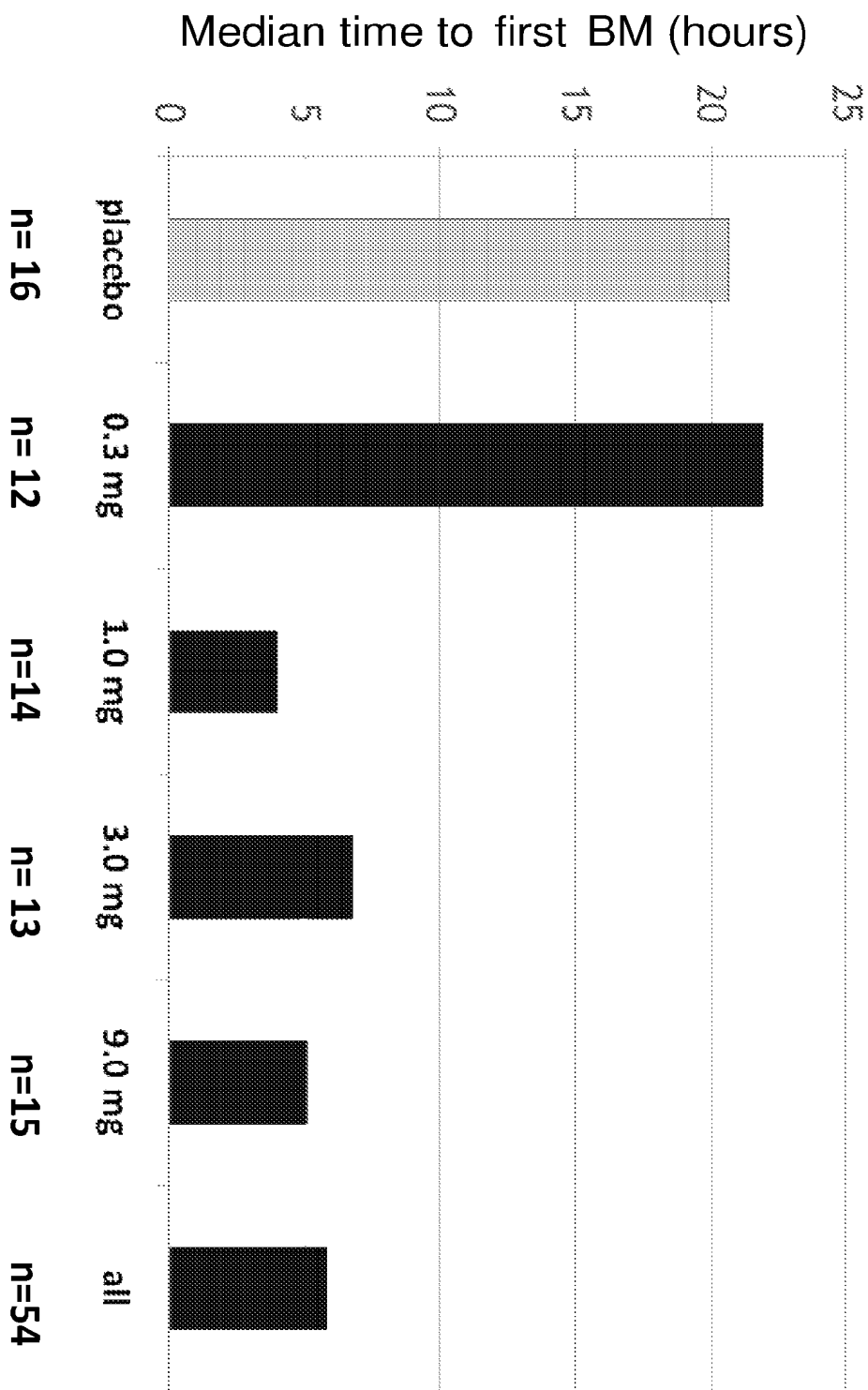

Fig. 1

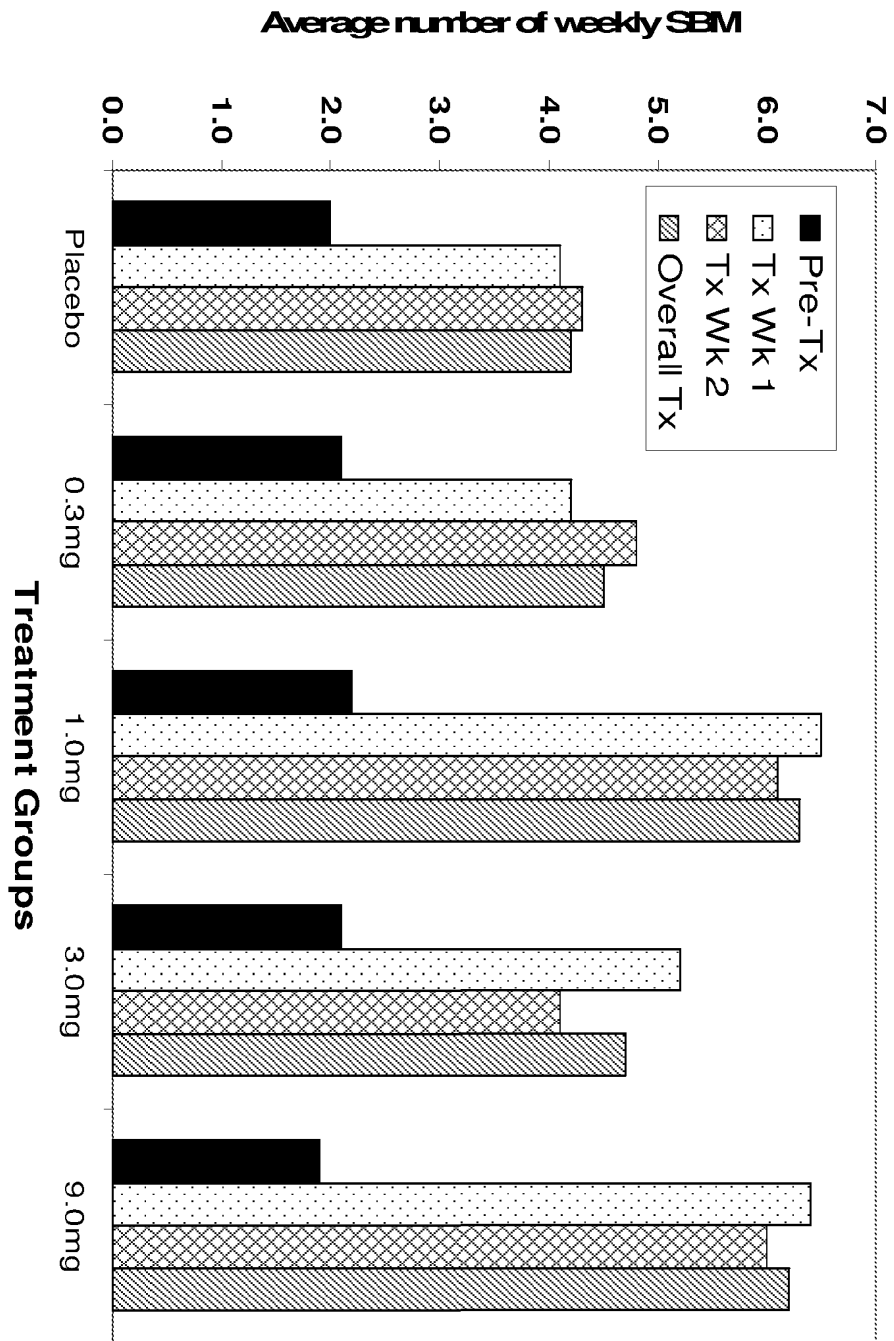

Fig. 2



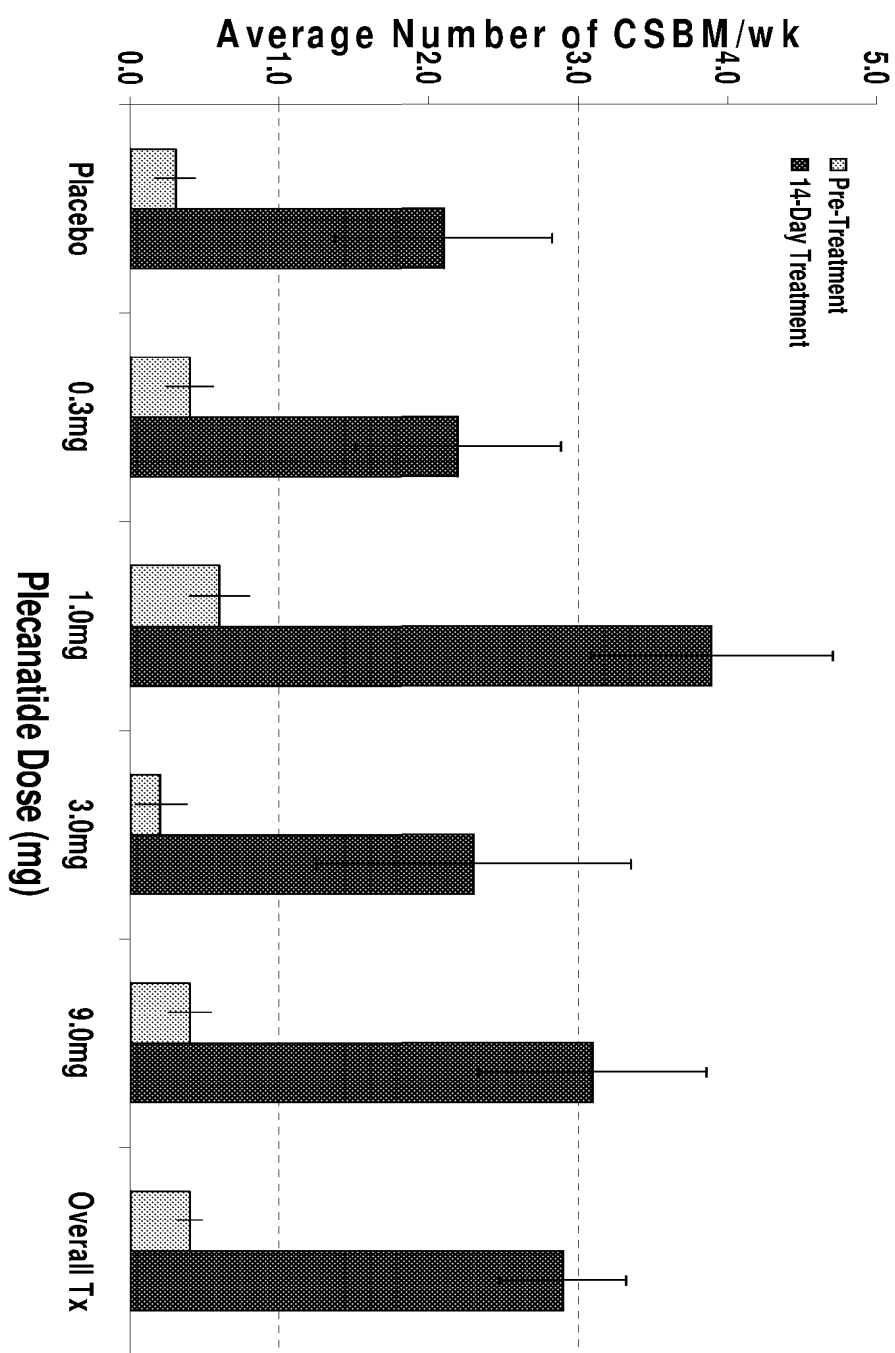

Fig. 3

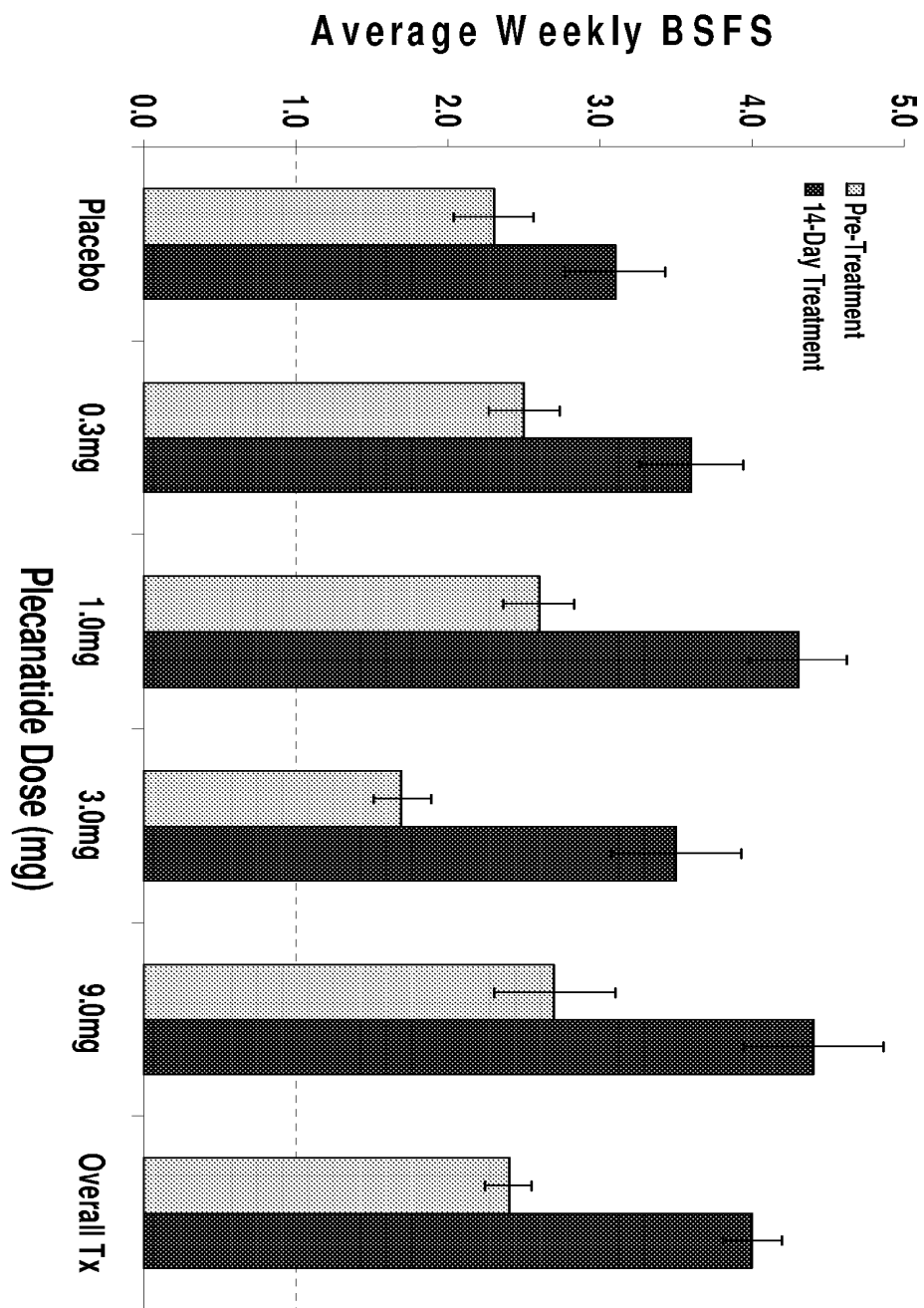

Fig. 4

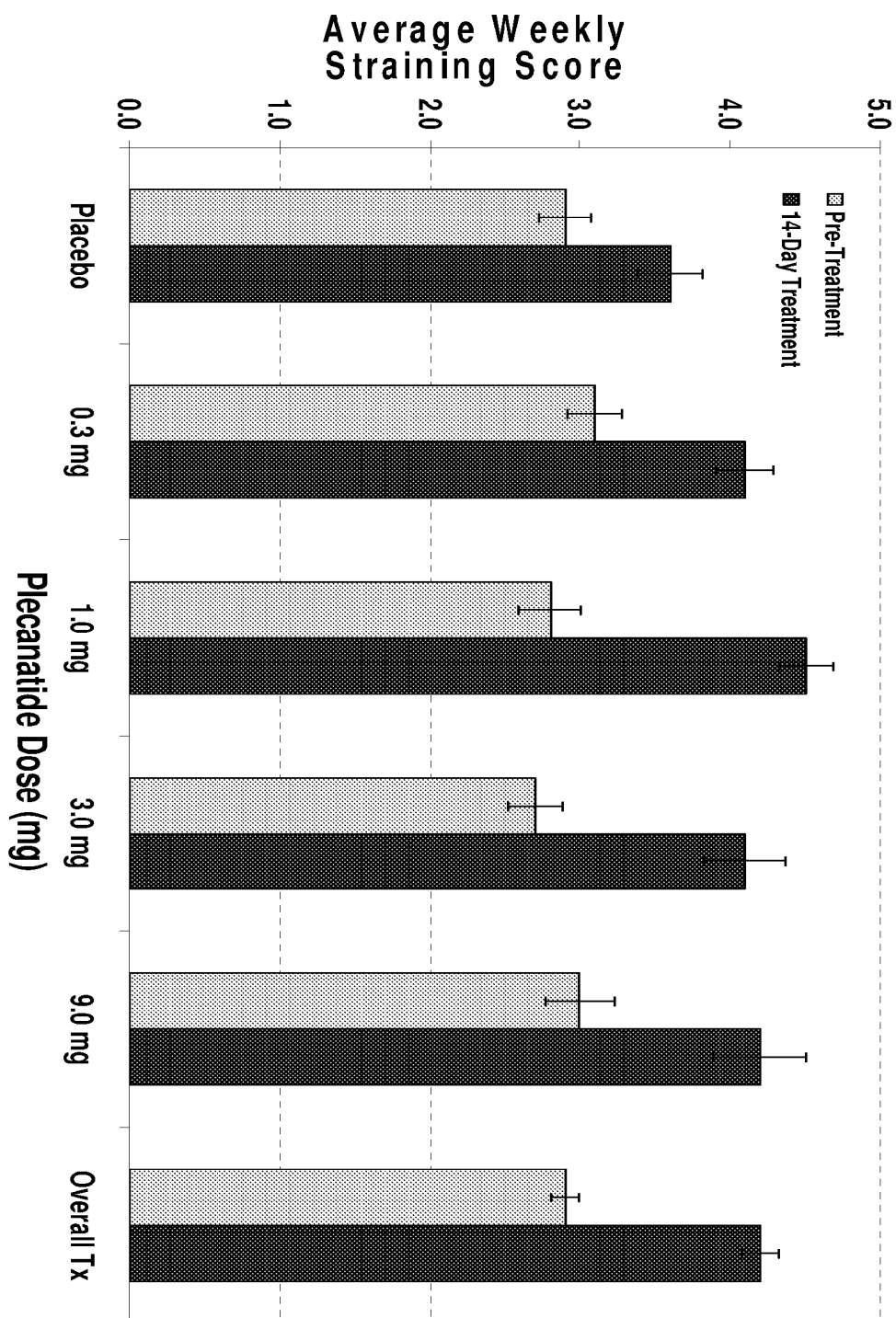

Fig. 5

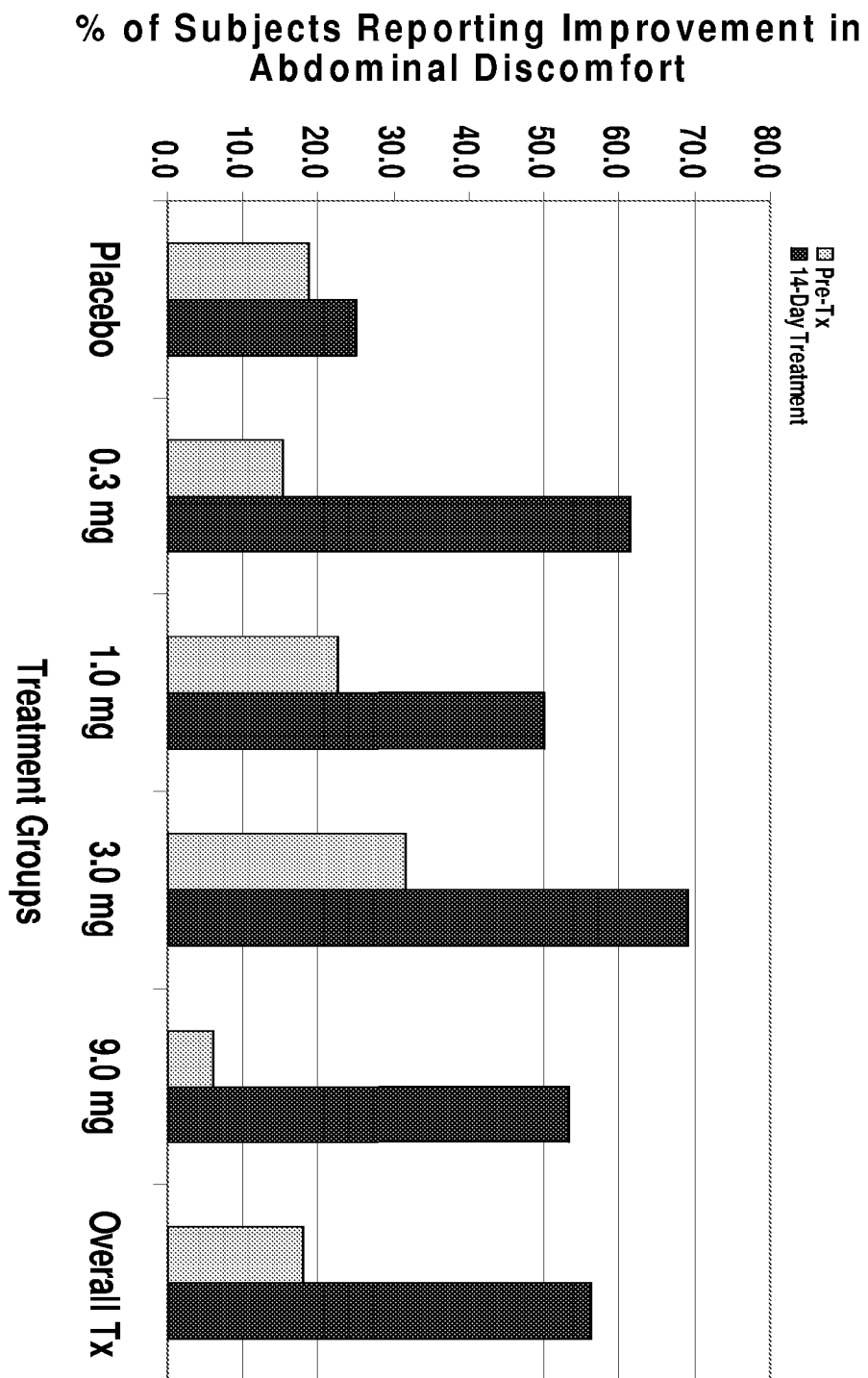

Fig. 6

Electronic Acknowledgement Receipt

EFS ID:	21543620
Application Number:	13421769
International Application Number:	
Confirmation Number:	3135
Title of Invention:	Formulations of Guanylate Cyclase C Agonists and Methods of Use
First Named Inventor/Applicant Name:	Stephen Comiskey
Customer Number:	58249
Filer:	Anne Elizabeth Fleckenstein
Filer Authorized By:	
Attorney Docket Number:	40737-509001US
Receipt Date:	19-FEB-2015
Filing Date:	15-MAR-2012
Time Stamp:	19:05:45
Application Type:	Utility under 35 USC 111(a)

Payment information:

Submitted with Payment	no
------------------------	----

File Listing:

Document Number	Document Description	File Name	File Size(Bytes)/ Message Digest	Multi Part /.zip	Pages (if appl.)
1	Foreign Reference	DE19744027.pdf	23796196 <small>c3cd3160c41c7c21244192dd6af5de01e194129a</small>	no	29

Warnings:

Information:

2	Foreign Reference	WO198805306.pdf	24507181	no	75
			1d0f155ac51e97c6123a4d3ecb9b8dfce0033b7b		
Warnings:					
Information:					
3	Foreign Reference	WO_93_12068_A1.pdf	2468028	no	74
			e9abec32db007847006eea92a7ac73c7f85276e		
Warnings:					
Information:					
4	Foreign Reference	WO1999026567.pdf	1992640	no	60
			a6b137697de3d86b93bdf7fa29155a7486237695		
Warnings:					
Information:					
5	Foreign Reference	WO200125266.pdf	2460609	no	55
			09a0fa80e61ea877af8bd83d08f0ab30d1e34da1		
Warnings:					
Information:					
6	Foreign Reference	WO2002062369.pdf	3125223	no	82
			51d9c7a91b86a9d902f7026201329ae5a85eea51		
Warnings:					
Information:					
7	Foreign Reference	WO_02_078683_A1.pdf	2009301	no	47
			d556f5f6f2bffe7160cc273911c3c12dc7e84ef6		
Warnings:					
Information:					
8	Foreign Reference	WO02098912.pdf	16495781	no	18
			d8f01c9ef96e2e494dae83ab809ed008b03a1cb2		
Warnings:					
Information:					
9	Foreign Reference	WO2004069165.pdf	5725690	no	93
			091141719f5f6182907884f4a38b168f424a8ea9		
Warnings:					
Information:					
10	Foreign Reference	WO_2005_016244_A2.pdf	16549157	no	247
			f7b31e29c7d2f4290d167fa8878f081d76c5d6e3		
Warnings:					
Information:					

11	Foreign Reference	WO2005087797.pdf	9475980	no	171
			e7417bfc306b64b5504c6d6f64d9e146d70caa6		
Warnings:					
Information:					
12	Foreign Reference	WO2006086653_A2.pdf	25930827	no	409
			b48029b0df31059396fe972ba5d94372264417fe		
Warnings:					
Information:					
13	Foreign Reference	WO2008106429.pdf	13031698	no	253
			81f664d868b2d8241a4660c1ed8b7758c94663d3		
Warnings:					
Information:					
14	Foreign Reference	WO_2008_137318_A1.pdf	16065928	no	172
			34af12edafc9f4abca51bc54d4fd95ed9ba3fb4c		
Warnings:					
Information:					
15	Foreign Reference	WO_2008_151257_A2.pdf	6721230	no	120
			cea2151ba4517a68a85381c671bf8f9a63f0aedc		
Warnings:					
Information:					
16	Foreign Reference	WO_2009_149278_A1.pdf	5403275	no	89
			2c834feb68b70e34166079de7e89d19c896aa7e4		
Warnings:					
Information:					
17	Foreign Reference	WO_2009_149279_A2.pdf	5299411	no	86
			9e42f6bc3fd40b8ed846a47f109d8a7701f79589		
Warnings:					
Information:					
18	Foreign Reference	WO2010009319.pdf	5742085	no	99
			5a6e454ed8d7a5bcc0ed2924a0c4a8d4d8065e46		
Warnings:					
Information:					
19	Foreign Reference	WO_2010_027404_A2.pdf	2000836	no	39
			2e1719958c833955561858de0614c8eb8fa70bb0		
Warnings:					
Information:					

20	Foreign Reference	WO_2010_065751_A2.pdf	6317154	no	143
			887289fe235736995d661557bc6c45908913d2c4		
Warnings:					
Information:					
21	Foreign Reference	WO_2011_020054_A1.pdf	6592591	no	78
			95002b0ea0234d6fcd6998f5defec4322f37898e		
Warnings:					
Information:					
22	Foreign Reference	WO_2012_037380_A2.pdf	6731174	no	139
			41af6e5fa3c927b9ac2a3186d7e6efe92a93a121		
Warnings:					
Information:					
Total Files Size (in bytes):				208441995	

This Acknowledgement Receipt evidences receipt on the noted date by the USPTO of the indicated documents, characterized by the applicant, and including page counts, where applicable. It serves as evidence of receipt similar to a Post Card, as described in MPEP 503.

New Applications Under 35 U.S.C. 111

If a new application is being filed and the application includes the necessary components for a filing date (see 37 CFR 1.53(b)-(d) and MPEP 506), a Filing Receipt (37 CFR 1.54) will be issued in due course and the date shown on this Acknowledgement Receipt will establish the filing date of the application.

National Stage of an International Application under 35 U.S.C. 371

If a timely submission to enter the national stage of an international application is compliant with the conditions of 35 U.S.C. 371 and other applicable requirements a Form PCT/DO/EO/903 indicating acceptance of the application as a national stage submission under 35 U.S.C. 371 will be issued in addition to the Filing Receipt, in due course.

New International Application Filed with the USPTO as a Receiving Office

If a new international application is being filed and the international application includes the necessary components for an international filing date (see PCT Article 11 and MPEP 1810), a Notification of the International Application Number and of the International Filing Date (Form PCT/RO/105) will be issued in due course, subject to prescriptions concerning national security, and the date shown on this Acknowledgement Receipt will establish the international filing date of the application.

Electronic Acknowledgement Receipt

EFS ID:	21540129
Application Number:	13421769
International Application Number:	
Confirmation Number:	3135
Title of Invention:	Formulations of Guanylate Cyclase C Agonists and Methods of Use
First Named Inventor/Applicant Name:	Stephen Comiskey
Customer Number:	58249
Filer:	Anne Elizabeth Fleckenstein
Filer Authorized By:	
Attorney Docket Number:	40737-509001US
Receipt Date:	19-FEB-2015
Filing Date:	15-MAR-2012
Time Stamp:	19:10:04
Application Type:	Utility under 35 USC 111(a)

Payment information:

Submitted with Payment	no
------------------------	----

File Listing:

Document Number	Document Description	File Name	File Size(Bytes)/ Message Digest	Multi Part /.zip	Pages (if appl.)
1	Non Patent Literature	Genbank_AAD09215.pdf	1941116 <small>9a4c41b59dbe3aa84a100990c88a5a82b9217439</small>	no	2

Warnings:

Information:

2	Non Patent Literature	Genbank_CAA98994.pdf	1934263	no	2
			4effb1e0382b8c7bb1d62911d71e050050cc cd605		
Warnings:					
Information:					
3	Non Patent Literature	Genbank_CAB06042pdf.pdf	2182156	no	2
			e2a053ac033dde084e46631f5b2856bbf0d c013a		
Warnings:					
Information:					
4	Non Patent Literature	Genbank_738946.pdf	1553709	no	1
			b92a400ac8e6af59f30c3038e3196d5bd826 43f1		
Warnings:					
Information:					
5	Non Patent Literature	Guba_et_al_Gastroenterol_111 _1558_1996.pdf	3632755	no	13
			50c6ebbd5aebded1e2ff4a89eb79bdd4297 f4fbc		
Warnings:					
Information:					
Total Files Size (in bytes):				11243999	

This Acknowledgement Receipt evidences receipt on the noted date by the USPTO of the indicated documents, characterized by the applicant, and including page counts, where applicable. It serves as evidence of receipt similar to a Post Card, as described in MPEP 503.

New Applications Under 35 U.S.C. 111

If a new application is being filed and the application includes the necessary components for a filing date (see 37 CFR 1.53(b)-(d) and MPEP 506), a Filing Receipt (37 CFR 1.54) will be issued in due course and the date shown on this Acknowledgement Receipt will establish the filing date of the application.

National Stage of an International Application under 35 U.S.C. 371

If a timely submission to enter the national stage of an international application is compliant with the conditions of 35 U.S.C. 371 and other applicable requirements a Form PCT/DO/EO/903 indicating acceptance of the application as a national stage submission under 35 U.S.C. 371 will be issued in addition to the Filing Receipt, in due course.

New International Application Filed with the USPTO as a Receiving Office

If a new international application is being filed and the international application includes the necessary components for an international filing date (see PCT Article 11 and MPEP 1810), a Notification of the International Application Number and of the International Filing Date (Form PCT/RO/105) will be issued in due course, subject to prescriptions concerning national security, and the date shown on this Acknowledgement Receipt will establish the international filing date of the application.

PATENT COOPERATION TREATY

PCT

INTERNATIONAL PRELIMINARY REPORT ON PATENTABILITY
(Chapter II of the Patent Cooperation Treaty)

(PCT Article 36 and Rule 70)

Applicant's or agent's file reference 40737-500001WQ	FOR FURTHER ACTION		See Form PCT/IPEA/416
International application No. PCT/US11/01805	International filing date (day/month/year) 15 September 2011 (15.09.2011)	Priority date (day/month/year) 15 September 2010 (15.09.2010)	
International Patent Classification (IPC) or national classification and IPC IPC: Please See Continuation Sheet USPC: 514/1			
Applicant SYNERGY PHARMACEUTICALS INC.			
<p>1. This report is the international preliminary examination report, established by this International Preliminary Examining Authority under Article 35 and transmitted to the applicant according to Article 36.</p> <p>2. This REPORT consists of a total of <u>62</u> sheets, including this cover sheet.</p> <p>3. This report is also accompanied by ANNEXES, comprising:</p> <p>a. <input checked="" type="checkbox"/> (sent to the applicant and to the International Bureau) a total of <u>11</u> sheets, as follows:</p> <p><input checked="" type="checkbox"/> sheets of the description, claims and/or drawings which have been amended and/or sheets containing rectifications authorized by this Authority, unless those sheets were superseded or cancelled, and any accompanying letters (see Rules 46.5, 66.8, 70.16, 91.2, and Section 607 of the Administrative Instructions).</p> <p><input type="checkbox"/> sheets containing rectifications, where the decision was made by this Authority not to take them into account because they were not authorized by or notified to this Authority at the time when this Authority began to draw up this report, and any accompanying letters (Rules 66.4bis, 70.2(e), 70.16 and 91.2).</p> <p><input type="checkbox"/> superseded sheets and any accompanying letters, where this Authority either considers that the superseding sheets contain an amendment that goes beyond the disclosure in the international application as filed, or the superseding sheets were not accompanied by a letter indicating the basis for the amendments in the application as filed, as indicated in item 4 of Box No.I and the Supplemental Box (see Rule 70.16(b)).</p> <p>b. <input type="checkbox"/> (sent to the International Bureau only) a total of (indicate type and number of electronic carrier(s)) containing a sequence listing, in electronic form only, as indicated in the Supplemental Box Relating to Sequence Listing (see paragraph 3bis of Annex C of the Administrative Instructions).</p>			
<p>4. This report contains indications relating to the following items:</p> <p><input checked="" type="checkbox"/> Box No. I Basis of the report</p> <p><input type="checkbox"/> Box No. II Priority</p> <p><input checked="" type="checkbox"/> Box No. III Non-establishment of opinion with regard to novelty, inventive step and industrial applicability</p> <p><input type="checkbox"/> Box No. IV Lack of unity of invention</p> <p><input checked="" type="checkbox"/> Box No. V Reasoned statement under Article 35(2) with regard to novelty, inventive step and industrial applicability; citations and explanations supporting such statement</p> <p><input type="checkbox"/> Box No. VI Certain documents cited</p> <p><input type="checkbox"/> Box No. VII Certain defects in the international application</p> <p><input type="checkbox"/> Box No. VIII Certain observations on the international application</p>			
Date of submission of the demand 20 September 2012 (20.09.2012)		Date of completion of this report 15 December 2012 (15.12.2012)	
Name and mailing address of the IPEA/ US Mail Stop PCT, Ann: IPEA/US Commissioner for Patents P.O. Box 1450 Alexandria, Virginia 22313-1450 Facsimile No. (571) 273-3201		Authorized officer CHRISTINA BRADLEY Telephone No. (571)272-0700	

Form PCT/IPEA/409 (cover sheet) (July 2011)

INTERNATIONAL PRELIMINARY REPORT ON PATENTABILITY

International application No.

PCT/US11/51805

Box No. I Basis of the report

1. With regard to the language, this report is based on:
 - the international application in the language in which it was filed.
 - a translation of the international application into English which is the language of a translation furnished for the purposes of:
 - international search (Rules 12.3(a) and 23.1(b)).
 - publication of the international application (Rule 12.4(a)).
 - international preliminary examination (Rules 55.2(a) and/or 55.3(a) and (b)).
2. With regard to the elements of the international application, this report is based on (replacement sheets which have been furnished to the receiving Office in response to an invitation under Article 14 are referred to in this report as "originally filed" and are not annexed to this report):
 - the international application as originally filed/furnished
 - the description:
 - pages 1-71, 73, 75, 76 and 79-125 as originally filed/furnished
 - pages* NONE received by this Authority on _____
 - pages* 72, 74, 77 and 78 received by this Authority on 26 November 2012 (26.11.2012)
 - the claims:
 - pages 126-131 as originally filed/furnished
 - pages* NONE as amended (together with any statement) under Article 19
 - pages* NONE received by this Authority on _____
 - pages* NONE received by this Authority on _____
 - the drawings:
 - pages 1/6-6/6 as originally filed/furnished
 - pages* NONE received by this Authority on _____
 - pages* NONE received by this Authority on _____
 - a sequence listing - see Supplemental Box Relating to Sequence Listing.
3. The amendments have resulted in the cancellation of:
 - the description, pages _____
 - the claims, Nos. _____
 - the drawings, sheets/figs _____
 - the sequence listing (specify): _____
4. This report has been established as if (some of) the amendments annexed to this report and listed below had not been made, since either they are considered to go beyond the disclosure as filed, or they were not accompanied by a letter indicating the basis for the amendments in the application as filed, as indicated in the Supplemental Box (Rules 70.2(c) and (c-bis)):
 - the description, pages _____
 - the claims, Nos. _____
 - the drawings, sheets/figs _____
 - the sequence listing (specify): _____
5. This report has been established:
 - taking into account the rectification of an obvious mistake authorized by or notified to this Authority under Rule 91 (Rules 66.1(d-bis) and 70.2(e)).
 - without taking into account the rectification of an obvious mistake authorized by or notified to this Authority under Rule 91 (Rules 66.4bis) and 70.2(e)).
6. Supplementary international search report(s) from Authority(ies) _____ has/have been received and taken into account in establishing this report (Rule 45bis 3(b) and (c)).

* If item 4 applies, some or all of those sheets may be marked "superseded."

INTERNATIONAL PRELIMINARY REPORT ON PATENTABILITY

International application No.

PCT/US11/51805

Box No. III Non-establishment of opinion with regard to novelty, inventive step and industrial applicability

The questions whether the claimed invention appears to be novel, to involve an inventive step (to be non obvious), or to be industrially applicable have not been examined in respect of:

- the entire international application.
- claims Nos. 12-30 and 34-53

because:

- the said international application, or the said claim Nos. _____ relate to the following subject matter which does not require an international preliminary examination (*specify*):
- the description, claims or drawings (*indicate particular elements below*) or said claims Nos. 12-30 and 34-53 are so unclear that no meaningful opinion could be formed (*specify*):

The claims are improper multiple dependent claims under PCT Rule 6.4(a).

- the claims, or said claims Nos. _____ are so inadequately supported by the description that no meaningful opinion could be formed (*specify*):
- no international search report has been established for said claims Nos. _____
- a meaningful opinion could not be formed without the sequence listing; the applicant did not, within the prescribed time limit:
- furnish a sequence listing on paper complying with the standard provided for in Annex C of the Administrative Instructions, and such listing was not available to the International Preliminary Examining Authority in a form and manner acceptable to it.
- furnish a sequence listing in electronic form complying with the standard provided for in Annex C of the Administrative Instructions, and such listing was not available to the International Preliminary Examining Authority in a form and manner acceptable to it.
- pay the required late furnishing fee for the furnishing of a sequence listing in response to an invitation under Rules 13ter.1(a) or (b) and 13ter.2.
- See Supplemental Box for further details

INTERNATIONAL PRELIMINARY REPORT ON PATENTABILITY

International application No.
PCT/US11/51805

Box No. V Reasoned statement under Article 35(2) with regard to novelty, inventive step or industrial applicability; citations and explanations supporting such statement

1. Statement

Novelty (N)	Claims <u>NONE</u>	YES
	Claims <u>1-11, 31-33</u>	NO
Inventive Step (IS)	Claims <u>NONE</u>	YES
	Claims <u>1-11, 31-33</u>	NO
Industrial Applicability (IA)	Claims <u>1-11, 31-33</u>	YES
	Claims <u>NONE</u>	NO

2. Citations and Explanations (Rule 70.7)

Reference is made to the following documents:

D1: US 2010-0221329 A1 (KUNWAB SHAH, LIBHAI et al.) 02 September 2010

1. Novelty and Inventive Step

D1 provides novel formulations of guanylate cyclase-C agonists (L6CC agonists) which are optimized for the targeted delivery of the agonist to a specific portion of the gastrointestinal tract, for example, to the small intestines, preferably to the duodenum or jejunum, or to the distal small intestines or the large intestines, preferably the ileum, terminal ileum, or ascending colon.

The subject matter of claims 1, 10, 11, 31-33 consisting of the sequence NDECELCVNVACTGCL (SEQ ID NO: 1, SP-304), NDECELCVNVACTGCL (SEQ ID NO: 8 or 9, partially D-amino acids), or CCEYCCNPACTGC (SEQ ID NO: 56, SP-340) is substantially the same as the known polypeptides in 91. D1 also relates to an oral dosage formulation (or process) of 6CC agonists which are optimized for delivery to specific regions of the gastrointestinal tract and are useful for the treatment and prevention of gastrointestinal diseases and disorders (abstract; Tables 1-2; paragraphs [0079], [0120], [0135], [0138], [0156]; Example 3; claims). Therefore, the subject-matter of claims 1, 10, 11, 31-33 is not considered to be novel under PCT Article 33(2).

Since the novelty of claims 1, 10, 11, 31-33 cannot be acknowledged over D1, the inventive step of them cannot be acknowledged, either (PCT Article 33(3)).

The subject matter of claims 2-9 differs from that of the prior art documents in the chromatographic purity of GCC agonist peptides. The control of chromatographic purity is part of standard laboratory technique generally known to the skilled person, who would perform such a control without the use of inventive skill. Therefore, the subject-matter of claims 2-9 meets the requirements of PCT Article 33(2) but lacks an inventive step under PCT Article 33(3).

2. Industrial Applicability

The subject-matter of claims 1-11, 31-33 is considered to be industrially applicable under PCT Article 33(4).

----- NEW CITATIONS -----

INTERNATIONAL PRELIMINARY REPORT ON PATENTABILITY

International application No.
PCT/US11/51805

Supplemental Box

In case the space in any of the preceding boxes is not sufficient.
Continuation of:

Continuation of IPC:
A61K 38/16(2006.01);C07K 7/08(2006.01);A61K 9/00(2006.01);A61K 38/00(2006.01);A61K 9/48;C07K 7/00(2006.01);A61K 38/10

INTERNATIONAL PRELIMINARY REPORT ON PATENTABILITY

International application No.
PCT/US11/51805

Supplemental Box

In case the space in any of the preceding boxes is not sufficient.

Continuation of:

Continuation of IPC:

A61K 38/16(2006.01);C07K 7/08(2006.01);A61K 9/00(2006.01);A61K 38/00(2006.01);A61K 9/48;C07K 7/00(2006.01);A61K 38/10

WO9535281, WO9535282, WO9600218, WO9601825, WO9602541, WO9611917, DE3142982, DE116676, DE2162096, EP0293063, EP0463756, EP0482208, EP0579496, EP0667345 US6331543, US20050004222 (including those disclosed in formulas I- XIII and paragraphs 37-39, 85-0545 and 557-577), WO9307124, EP0163965, EP0393500, EP0510562, EP0553174, WO9501338 and WO9603399, as well as PDE5 inhibitors (such as RX-RA-69, SCH-51866, KT-734, vesnarinone, zaprinast, SKF-96231, ER-21355, BF/GP-385, NM-702 and sildenafil (ViagraTM)), PDE4 inhibitors (such as etazolate, ICI63197, RP73401, imazolidinone (RO-20-1724), MEM 1414 (R1533/R1500; Pharmacia Roche), deabufylline, rolipram, oxagrelate, nitraquazone, Y-590, DH-6471, SKF-94120, motapizone, lixazinone, indolidan, olprinone, atizoram, KS-506-G, dipamfylline, BMY-43351, atizoram, arofylline, flaminast, PDB-093, UCB-29646, CDP-840, SKF-107806, piclamilast, RS-17597, RS-25344-000, SB-207499, TIBENELAST, SB-210667, SB-211572, SB-211600, SB-212066, SB-212179, GW-3600, CDP-840, mopidamol, anagrelide, ibudilast, amrinone, pimobendan, cilostazol, quazinone and N-(3,5-dichloropyrid-4-yl)-3-cyclopropylmethoxy-4-difluoromethoxybenzamide, PDE3 inhibitors (such as ICI153, 100, bemorandane (RWJ 22867), MCI-154, UD-CG 212, sulmazole, ampizone, cilostamide, carbazeran, piroximone, imazodan, CI-930, siguazodan, adibendan, saterinone, SKF-95654, SDZ-MKS-492, 349-U-85, emoradan, EMD-53998, EMD-57033, NSP-306, NSP-307, revizinone, NM-702, WIN-62582 and WIN-63291, enoximone and milrinone, PDE3/4 inhibitors (such as benafentrine, trequinsin, ORG-30029, zardaverine, L-686398, SDZ-ISQ-844, ORG-20241, EMD-54622, and tolafentrine) and other PDE inhibitors (such as vinpocetin, papaverine, enprofylline, cilomilast, fenoximone, pentoxifylline, roflumilast, tadalafil(Cialis[®]), theophylline, and vardenafil(Levitra[®]); Neuropeptide Y2 (NPY2) agonists include but are not limited to: polypeptide YY and fragments and variants thereof (e.g. YY3-36 (PYY3-36) (N. Engl. J. Med. 349:941, 2003; IKPEAPGE DASPEELNRY YASLRHYLNL VTRQRY (SEQ ID NO: 250)) and PYY agonists such as those disclosed in WO02/47712, WO03/026591, WO03/057235, and WO03/027637; serotonin reuptake inhibitors, such as, paroxetine, fluoxetine (ProzacTM), fluvoxamine, sertraline, citalopram, and imipramine, and those disclosed in US6162805, US6365633, WO03/00663, WOO 1/27060, and WOO 1/162341; thyroid hormone β agonists, such as KB-2611 (KaroBioBMS), and those disclosed in WO02/15845, WO97/21993, WO99/00353, GB98/284425, U.S. Provisional Application No.

in WO03/072197, alpha-lipoic acid (alpha-LA), ACD9604, appetite suppressants such as those in WO03/40107, ATL-962 (Alizyme PLC), benzocaine, benzphetamine hydrochloride (Didrex), bladderwrack (*focus vesiculosus*), BRS3 (bombesin receptor subtype 3) agonists, bupropion, caffeine, CCK agonists, chitosan, chromium, conjugated linoleic acid, corticotropin-releasing hormone agonists, dehydroepiandrosterone, DGAT1 (diacylglycerol acyltransferase 1) inhibitors, DGAT2 (diacylglycerol acyltransferase 2) inhibitors, dicarboxylate transporter inhibitors, ephedra, exendin-4 (an inhibitor of glp-1) FAS (fatty acid synthase) inhibitors (such as Cerulenin and C75), fat resorption inhibitors (such as those in WO03/053451, and the like), fatty acid transporter inhibitors, natural water soluble fibers (such as psyllium, plantago, guar, oat, pectin), galanin antagonists, galega (Goat's Rue, French Lilac), garcinia cambogia, germander (*teucrium chamaedrys*), ghrelin antibodies and ghrelin antagonists (such as those disclosed in WO01/87335, and WO02/08250), polypeptide hormones and variants thereof which affect the islet cell secretion, such as the hormones of the secretin/gastric inhibitory polypeptide (GIP)/vasoactive intestinal polypeptide (VIP)/pituitary adenylate cyclase activating polypeptide (PACAP)/glucagon-like polypeptide II (GLP- II)/glicentin/glucagon gene family and/or those of the adrenomedullin/amylin/calcitonin gene related polypeptide (CGRP) gene family including GLP-1 (glucagon-like polypeptide 1) agonists (e.g. (1) exendin-4, (2) those GLP-1 molecules described in US20050130891 including GLP-1(7-34), GLP-1(7-35), GLP-1(7-36) or GLP-1(7-37) in its C-terminally carboxylated or amidated form or as modified GLP-1 polypeptides and modifications thereof including those described in paragraphs 17-44 of US20050130891, and derivatives derived from GLP-1-(7-34)COOH and the corresponding acid amide are employed which have the following general formula: R-NH-HAEGTFTSDVSYLEGQAAKEFIAWLVK-CONH₂ (SEQ ID NO: 251) wherein R=H or an organic compound having from 1 to 10 carbon atoms. Preferably, R is the residue of a carboxylic acid. Particularly preferred are the following carboxylic acid residues: formyl, acetyl, propionyl, isopropionyl, methyl, ethyl, propyl, isopropyl, n-butyl, sec-butyl, tert-butyl) and glp-1 (glucagon-like polypeptide- 1), glucocorticoid antagonists, glucose transporter inhibitors, growth hormone secretagogues (such as those disclosed and specifically described in US5536716), interleukin-6 (IL-6) and modulators thereof (as in WO03/057237, and the like), L-carnitine, Mc3r (melanocortin 3 receptor) agonists, MCH2R (melanin concentrating hormone 2R)

1.3.2.8 Analgesic Agents

[152] In certain embodiments, the regimen of combination therapy includes the administration of one or more analgesic agents, e.g., an analgesic compound or an analgesic polypeptide. In some embodiments, the GCC agonist formulation is administered simultaneously or sequentially with one or more analgesic agents. In other embodiments, the GCC agonist is covalently linked or attached to an analgesic agent to create a therapeutic conjugate. Non-limiting examples of analgesic agents that can be used include calcium channel blockers, 5HT receptor antagonists (for example 5HT₃, 5HT₄ and 5HT₁ receptor antagonists), opioid receptor agonists (loperamide, fedotozine, and fentanyl), NK₁ receptor antagonists, CCK receptor agonists (e.g., loxiglumide), NK₁ receptor antagonists, NK₃ receptor antagonists, norepinephrine-serotonin reuptake inhibitors (NSRI), vanilloid and cannabinoid receptor agonists, and sialorphin. Further examples of analgesic agents in the various classes are known in the art.

[153] In one embodiment, the analgesic agent is an analgesic polypeptide selected from the group consisting of sialorphin-related polypeptides, including those comprising the amino acid sequence QHNPR (SEQ ID NO: 252), including: VQHNPR (SEQ ID NO: 253); VRQHNPR (SEQ ID NO: 254); VRGQHNPR (SEQ ID NO: 255); VRGPQHNPR (SEQ ID NO: 256); VRGFRQHNPR (SEQ ID NO: 257); VRGPRRQHNPR (SEQ ID NO: 258); and RQHNPR (SEQ ID NO: 259). Sialorphin-related polypeptides bind to neprilysin and inhibit neprilysin-mediated breakdown of substance P and Met-enkephalin. Thus, compounds or polypeptides that are inhibitors of neprilysin are useful analgesic agents which can be administered with the GCC agonists described herein or covalently linked to a GCC agonist to form a therapeutic conjugate. Sialorphin and related polypeptides are described in U.S. Patent 6,589,750; U.S. 20030078200 A1; and WO 02/051435 A2.

[154] In another embodiment, a GCC agonist formulation of the invention is administered as part of a regimen of combination therapy with an opioid receptor antagonist or agonist. In one embodiment, the GCC agonist and the opioid receptor antagonist or agonist are linked via a covalent bond. Non-limiting examples of opioid receptor antagonists include naloxone, naltrexone, methyl naloxone, nalmefene, cypridime, beta funaltrexamine, naloxonazine, naltrindole, nor-binaltorphimine, enkephalin pentapeptide (HOE825; Tyr-D-Lys-Gly-Phe-L-

homoserine (SEQ ID NO: 260)), trimebutine, vasoactive intestinal polypeptide, gastrin, glucagons. Non-limiting examples of opioid receptor agonists include fedotozine, asimadoline, and ketocyclazocine, the compounds described in WO03/097051 and WO05/007626, morphine, diphenyloxylate, fraxefamide (H-Tyr-D-Ala-Phe(F)-Phe-NH₂ (SEQ ID NO: 261); WO 01/019849 A1), and loperamide.

[155] Further non-limiting examples of analgesic agents that can be used in a regimen of combination therapy along with the GCC agonist formulations of the invention include the dipeptide Tyr-Arg (kyotorphin); the chromogranin-derived polypeptide (CgA 47-66; *See, e.g.*, Ghia et al. 2004 Regulatory polypeptides 119:199); CCK receptor agonists such as caerulein; conotoxin polypeptides; peptide analogs of thymulin (FR Application 2830451); CCK (CCKa or CCKb) receptor antagonists, including loxiglumide and dexloxiglumide (the R- isomer of loxiglumide) (WO 88/05774); 5-HT₄ agonists such as tegaserod (Zelnorm®), mosapride, metoclopramide, zacopride, cisapride, renzapride, benzimidazolone derivatives such as BIMU 1 and BIMU 8, and lorexapride; calcium channel blockers such as ziconotide and related compounds described in, for example, EP625162B1, US 5,364,842, US 5,587,454, US 5,824,645, US 5,859,186, US 5,994,305, US 6,087,091, US 6,136,786, WO 93/13128 A1, EP 1336409 A1, EP 835126 A1, EP 835126 B1, US 5,795,864, US 5,891,849, US 6,054,429, WO 97/01351 A1; NK-1 receptor antagonists such as aprepitant (Merck & Co Inc), vofopitant, ezlopitant (Pfizer, Inc.), R-673 (Hoffmann-La Roche Ltd), SR-48968 (Sanofi Synthelabo), CP-122,721 (Pfizer, Inc.), GW679769 (Glaxo Smith Kline), TAK-637 (Takeda/Abbot), SR-14033, and related compounds described in, for example, EP 873753 A1, US 20010006972 A1, US 20030109417 A1, WO 01/52844 A1 (for a review see Giardina et al. 2003.Drugs 6:758); NK-2 receptor antagonists such as nepadutant (Menarini Ricerche SpA), saredutant (Sanofi-Synthelabo), GW597599 (Glaxo Smith Kline), SR-144190 (Sanofi-Synthelabo) and UK-290795 (Pfizer Inc); NK3 receptor antagonists such as osanetant (SR-142801; Sanofi-Synthelabo), SSR-241586, talnetant and related compounds described in, for example, WO 02/094187 A2, EP 876347 A1, WO 97/21680 A1, US 6,277,862, WO 98/1 1090, WO 95/28418, WO 97/19927, and Boden et al. (J Med Chem. 39:1664-75, 1996); norepinephrine-serotonin reuptake inhibitors (NSRI) such as milnacipran and related compounds described in WO 03/077897; and vanilloid receptor antagonists such as arvanil and related compounds described in WO 01/64212 A1.

Via EFS
Date of Deposit: 20 September 2012

Docket No.: 40737-509001WO

IN THE UNITED STATES PATENT OFFICE
AS INTERNATIONAL PRELIMINARY EXAMINING AUTHORITY

International Application No. : PCT/US2011/051805
International Filing Date : 15 September 2011 (15.09.2011)
Earliest Priority Date : 15 September 2010 (15.09.2010)
Applicant : Synergy Pharmaceuticals Inc., et al.
Title : Formulations of Guanylate Cyclase C Agonists and
Methods of Use

AMENDMENTS UNDER PCT ARTICLE 34

The Applicant hereby submits Amendments made Under Article 34 with a Demand for Preliminary Examination in the specification of the International application.

Amendments to the Specification begin on page 2 of this paper and include the attached replacement sheets.

Remarks/Arguments begin on page 3 of this paper.

Amendments to the Specification

Please amend the specification as indicated below:

Page 72, line 25 has been amended to provide the appropriate SEQ ID NO identifier.

Page 74, line 23 has been amended to provide the appropriate SEQ ID NO identifier.

Page 77, lines 15-18 have been amended to include the appropriate SEQ ID NO identifiers.

Page 78, line 1 has been amended to include the appropriate SEQ ID NO identifier.

Page 78, line 4 has been amended to correct a typographical error and to include the appropriate SEQ ID NO identifier.

REMARKS

Amendments are made to the specification to insert the required SEQ ID NO identifiers associated with various listed sequences and to correct a typographical error.

No new matter has been added by these amendments.

Applicant respectfully requests entry of these replacement sheets. The Authorized Officer is invited to contact the undersigned if further information is required.

Dated: 20 September 2012

Respectfully submitted,

/Cynthia Kozakiewicz/

Cynthia A. Kozakiewicz, J.D., Ph.D.

Registration No.: 42,764

Linyu Mitra, Ph.D.

MINTZ LEVIN COHN FERRIS GLOVSKY

AND POPEO, P.C.

One Financial Center

Boston, Massachusetts 02111

(617) 542-6000

WO9535281, WO9535282, WO9600218, WO9601825, WO9602541, WO9611917, DE3142982, DE1 116676, DE2162096, EP0293063, EP0463756, EP0482208, EP0579496, EP0667345 US6331543, US20050004222 (including those disclosed in formulas I- XIII and paragraphs 37-39, 85-0545 and 557-577), WO9307124, EP0163965, EP0393500, EP0510562, EP0553174, WO9501338 and WO9603399, as well as PDE5 inhibitors (such as RX-RA-69, SCH-51866, KT-734, vesnarinone, zaprinast, SKF-96231, ER-21355, BF/GP-385, NM-702 and sildenafil (Viagra™)), PDE4 inhibitors (such as etazolate, ICI63197, RP73401, imazolidinone (RO-20-1724), MEM 1414 (R1533/R1500; Pharmacia Roche), denbufylline, rolipram, oxagrelate, nitraquazone, Y-590, DH-6471, SKF-94120, motapizone, lixazinone, indolidan, olprinone, atizoram, KS-506-G, dipamfylline, BMY-43351, atizoram, arofylline, filaminast, PDB-093, UCB-29646, CDP-840, SKF-107806, piclamilast, RS-17597, RS-25344-000, SB-207499, TIBENELAST, SB-210667, SB-211572, SB-211600, SB-212066, SB-212179, GW-3600, CDP-840, mopidamol, anagrelide, ibudilast, amrinone, pimobendan, cilostazol, quazinone and N-(3,5-dichloropyrid-4-yl)-3-cyclopropylmethoxy-4-difluoromethoxybenzamide, PDE3 inhibitors (such as ICI153, 100, bemorandane (RWJ 22867), MCI-154, UD-CG 212, sulmazole, ampizone, cilostamide, carbazeran, piroximone, imazodan, CI-930, siguazodan, adibendan, saterinone, SKF-95654, SDZ-MKS-492, 349-U-85, emoradan, EMD-53998, EMD- 57033, NSP-306, NSP-307, revizinone, NM-702, WIN-62582 and WIN-63291, enoximone and milrinone, PDE3/4 inhibitors (such as benafentrine, trequinsin, ORG-30029, zardaverine, L- 686398, SDZ-ISQ-844, ORG-20241, EMD-54622, and tolafentrine) and other PDE inhibitors (such as vinpocetin, papaverine, enprofylline, cilomilast, fenoximone, pentoxifylline, roflumilast, tadalafil(Cialis®), theophylline, and vardenafil(Levitra®); Neuropeptide Y2 (NPY2) agonists include but are not limited to: polypeptide YY and fragments and variants thereof (e.g. YY3-36 (PYY3-36)(N. Engl. J. Med. 349:941, 2003; IKPEAPGE DASPEELNRY YASLRHYLNL VTRQRY (SEQ ID NO:XXX 250)) and PYY agonists such as those disclosed in WO02/47712, WO03/026591, WO03/057235, and WO03/027637; serotonin reuptake inhibitors, such as, paroxetine, fluoxetine (Prozac™), fluvoxamine, sertraline, citalopram, and imipramine, and those disclosed in US6162805, US6365633, WO03/00663, WOO 1/27060, and WOO 1/162341; thyroid hormone β agonists, such as KB-2611 (KaroBioBMS), and those disclosed in WO02/15845, WO97/21993, WO99/00353, GB98/284425, U.S. Provisional Application No.

in WO03/072197, alpha-lipoic acid (alpha-LA), AOD9604, appetite suppressants such as those in WO03/40107, ATL-962 (Alizyme PLC), benzocaine, benzphetamine hydrochloride (Didrex), bladderwrack (*focus vesiculosus*), BRS3 (bombesin receptor subtype 3) agonists, bupropion, caffeine, CCK agonists, chitosan, chromium, conjugated linoleic acid, corticotropin-releasing hormone agonists, dehydroepiandrosterone, DGAT1 (diacylglycerol acyltransferase 1) inhibitors, DGAT2 (diacylglycerol acyltransferase 2) inhibitors, dicarboxylate transporter inhibitors, ephedra, exendin-4 (an inhibitor of glp-1) FAS (fatty acid synthase) inhibitors (such as Cerulenin and C75), fat resorption inhibitors (such as those in WO03/053451, and the like), fatty acid transporter inhibitors, natural water soluble fibers (such as psyllium, plantago, guar, oat, pectin), galanin antagonists, galega (Goat's Rue, French Lilac), garcinia cambogia, germander (*teucrium chamaedrys*), ghrelin antibodies and ghrelin antagonists (such as those disclosed in WO01/87335, and WO02/08250), polypeptide hormones and variants thereof which affect the islet cell secretion, such as the hormones of the secretin/gastric inhibitory polypeptide (GIP)/vasoactive intestinal polypeptide (VIP)/pituitary adenylate cyclase activating polypeptide (PACAP)/glucagon-like polypeptide II (GLP- II)/glucagon gene family and/or those of the adrenomedullin/amylin/calcitonin gene related polypeptide (CGRP) gene family including GLP-1 (glucagon-like polypeptide 1) agonists (e.g. (1) exendin-4, (2) those GLP-I molecules described in US20050130891 including GLP- 1(7-34), GLP-I(7-35), GLP-I(7-36) or GLP-I(7-37) in its C-terminally carboxylated or amidated form or as modified GLP-I polypeptides and modifications thereof including those described in paragraphs 17-44 of US20050130891, and derivatives derived from GLP-1-(7- 34)COOH and the corresponding acid amide are employed which have the following general formula: R-NH-
| HAEGTFTSDVSYLEGQAAKEFIAWLVK-CONH₂ (SEQ ID NO: 251) wherein R=H or an organic compound having from 1 to 10 carbon atoms. Preferably, R is the residue of a carboxylic acid. Particularly preferred are the following carboxylic acid residues: formyl, acetyl, propionyl, isopropionyl, methyl, ethyl, propyl, isopropyl, n-butyl, sec-butyl, tert-butyl.) and glp-1 (glucagon-like polypeptide- 1), glucocorticoid antagonists, glucose transporter inhibitors, growth hormone secretagogues (such as those disclosed and specifically described in US5536716), interleukin-6 (IL-6) and modulators thereof (as in WO03/057237, and the like), L-carnitine, Mc3r (melanocortin 3 receptor) agonists, MCH2R (melanin concentrating hormone 2R)

1.3.2.8 Analgesic Agents

[152] In certain embodiments, the regimen of combination therapy includes the administration of one or more analgesic agents, e.g., an analgesic compound or an analgesic polypeptide. In some embodiments, the GCC agonist formulation is administered simultaneously or sequentially with one or more analgesic agents. In other embodiments, the GCC agonist is covalently linked or attached to an analgesic agent to create a therapeutic conjugate. Non-limiting examples of analgesic agents that can be used include calcium channel blockers, 5HT receptor antagonists (for example 5HT₃, 5HT₄ and 5HT₁ receptor antagonists), opioid receptor agonists (loperamide, fedotozine, and fentanyl), NK₁ receptor antagonists, CCK receptor agonists (e.g., loxiglumide), NK₁ receptor antagonists, NK₃ receptor antagonists, norepinephrine-serotonin reuptake inhibitors (NSRI), vanilloid and cannabinoid receptor agonists, and sialorphin. Further examples of analgesic agents in the various classes are known in the art.

[153] In one embodiment, the analgesic agent is an analgesic polypeptide selected from the group consisting of sialorphin-related polypeptides, including those comprising the amino acid sequence QHNPR (SEQ ID NO: ~~239~~ 252), including: VQHNPR (SEQ ID NO: 246253); VRQHNPR (SEQ ID NO: 244254); VRGQHNPR (SEQ ID NO: 242255); VRGPQHNPR (SEQ ID NO: 243256); VRGPRQHNPR (SEQ ID NO: 244257); VRGPRRQHNPR (SEQ ID NO: 245258); and RQHNPR (SEQ ID NO: 246259). Sialorphin-related polypeptides bind to neprilysin and inhibit neprilysin-mediated breakdown of substance P and Met-enkephalin. Thus, compounds or polypeptides that are inhibitors of neprilysin are useful analgesic agents which can be administered with the GCC agonists described herein or covalently linked to a GCC agonist to form a therapeutic conjugate. Sialorphin and related polypeptides are described in U.S. Patent 6,589,750; U.S. 20030078200 A1; and WO 02/051435 A2.

[154] In another embodiment, a GCC agonist formulation of the invention is administered as part of a regimen of combination therapy with an opioid receptor antagonist or agonist. In one embodiment, the GCC agonist and the opioid receptor antagonist or agonist are linked via a covalent bond. Non-limiting examples of opioid receptor antagonists include naloxone, naltrexone, methyl naloxone, nalmefene, cypridime, beta funaltrexamine, naloxonazine, naltrindole, nor-binaltorphimine, enkephalin pentapeptide (HOE825; Tyr-D-Lys-Gly-Phe-L-

homoserine (SEQ ID NO: 260)), trimebutine, vasoactive intestinal polypeptide, gastrin, glucagons. Non-limiting examples of opioid receptor agonists include fedotozine, asimadoline, and ketocyclazocine, the compounds described in WO03/097051 and WO05/007626, morphine, diphenyloxylate, frakefamide (H-Tyr-D-Ala-Phe(F)-Phe-NH-2, (SEQ ID NO: 261); WO 01/019849 A1), and loperamide.

[155] Further non-limiting examples of analgesic agents that can be used in a regimen of combination therapy along with the GCC agonist formulations of the invention include the dipeptide Tyr-Arg (kyotorphin); the chromogranin-derived polypeptide (CgA 47-66; See, e.g., Ghia et al. 2004 Regulatory polypeptides 119:199); CCK receptor agonists such as caerulein; conotoxin polypeptides; peptide analogs of thymulin (FR Application 2830451); CCK (CCKa or CCKb) receptor antagonists, including loxiglumide and dexloxiglumide (the R- isomer of loxiglumide) (WO 88/05774); 5-HT₄ agonists such as tegaserod (Zelnorm®), mosapride, metoclopramide, zacopride, cisapride, renzapride, benzimidazolone derivatives such as BIMU 1 and BIMU 8, and lorexapride; calcium channel blockers such as ziconotide and related compounds described in, for example, EP625162B1, US 5,364,842, US 5,587,454, US 5,824,645, US 5,859,186, US 5,994,305, US 6,087,091, US 6,136,786, WO 93/13128 A1, EP 1336409 A1, EP 835126 A1, EP 835126 B1, US 5,795,864, US 5,891,849, US 6,054,429, WO 97/01351 A1; NK-1 receptor antagonists such as aprepitant (Merck & Co Inc), vofopitant, ezlopitant (Pfizer, Inc.), R-673 (Hoffmann-La Roche Ltd), SR-48968 (Sanofi-Synthelabo), CP-122,721 (Pfizer, Inc.), GW679769 (Glaxo Smith Kline), TAK-637 (Takeda/Abbot), SR-14033, and related compounds described in, for example, EP 873753 A1, US 20010006972 A1, US 20030109417 A1, WO 01/52844 A1 (for a review see Giardina et al. 2003.Drugs 6:758); NK-2 receptor antagonists such as nepadutant (Menarini Ricerche SpA), saredutant (Sanofi-Synthelabo), GW597599 (Glaxo Smith Kline), SR-144190 (Sanofi-Synthelabo) and UK-290795 (Pfizer Inc); NK3 receptor antagonists such as osanetant (SR-142801; Sanofi-Synthelabo), SSR-241586, talnetant and related compounds described in, for example, WO 02/094187 A2, EP 876347 A1, WO 97/21680 A1, US 6,277,862, WO 98/1 1090, WO 95/28418, WO 97/19927, and Boden et al. (J Med Chem. 39:1664-75, 1996); norepinephrine-serotonin reuptake inhibitors (NSRI) such as milnacipran and related compounds described in WO 03/077897; and vanilloid receptor antagonists such as arvanil and related compounds described in WO 01/64212 A1.

PATENT COOPERATION TREATY

PCT

INTERNATIONAL PRELIMINARY REPORT ON PATENTABILITY

(Chapter I of the Patent Cooperation Treaty)

(PCT Rule 44bis)

Applicant's or agent's file reference SYPA-009/002WO	FOR FURTHER ACTION		See item 4 below
International application No. PCT/US2013/030561	International filing date (day/month/year) 12 March 2013 (12.03.2013)	Priority date (day/month/year) 15 March 2012 (15.03.2012)	
International Patent Classification (5th edition unless older edition indicated) See relevant information in Form PCT/ISA/237			
Applicant SYNERGY PHARMACEUTICALS INC.			

1. This international preliminary report on patentability (Chapter I) is issued by the International Bureau on behalf of the International Searching Authority under Rule 44 bis.1(a).

2. This REPORT consists of a total of 7 sheets, including this cover sheet.

In the attached sheets, any reference to the written opinion of the International Searching Authority should be read as a reference to the international preliminary report on patentability (Chapter I) instead.

3. This report contains indications relating to the following items:

<input checked="" type="checkbox"/>	Box No. I	Basis of the report
<input checked="" type="checkbox"/>	Box No. II	Priority
<input type="checkbox"/>	Box No. III	Non-establishment of opinion with regard to novelty, inventive step and industrial applicability
<input type="checkbox"/>	Box No. IV	Lack of unity of invention
<input checked="" type="checkbox"/>	Box No. V	Reasoned statement under Article 35(2) with regard to novelty, inventive step or industrial applicability; citations and explanations supporting such statement
<input checked="" type="checkbox"/>	Box No. VI	Certain documents cited
<input type="checkbox"/>	Box No. VII	Certain defects in the international application
<input type="checkbox"/>	Box No. VIII	Certain observations on the international application

4. The International Bureau will communicate this report to designated Offices in accordance with Rules 44bis.3(c) and 50bis.1 but not, except where the applicant makes an express request under Article 23(2), before the expiration of 30 months from the priority date (Rule 44bis.2).

The International Bureau of WIPO 34, chemin des Colombettes 1211 Geneva 20, Switzerland	Date of issuance of this report 16 September 2014 (16.09.2014)
	Authorized officer Yukari Nakamura
Facsimile No. +41 22 338 92 70	e-mail: pt07.pct@wipo.int

PATENT COOPERATION TREATY

From the
INTERNATIONAL SEARCHING AUTHORITY

PCT

**WRITTEN OPINION OF THE
INTERNATIONAL SEARCHING AUTHORITY
(PCT Rule 43bis.1)**

To:

see form PCT/ISA/220

Date of mailing
(day/month/year) see form PCT/ISA/210 (second sheet)

Applicant's or agent's file reference
see form PCT/ISA/220

FOR FURTHER ACTION
See paragraph 2 below

International application No.
PCT/US2013/030551

International filing date (day/month/year)
12.03.2013

Priority date (day/month/year)
15.03.2012

International Patent Classification (IPC) or both national classification and IPC
INV. A61K38/10 A61P1/00 A61P1/10

Applicant
SYNERGY PHARMACEUTICALS INC.

1. This opinion contains indications relating to the following items:

- Box No. I Basis of the opinion
- Box No. II Priority
- Box No. III Non-establishment of opinion with regard to novelty, inventive step and industrial applicability
- Box No. IV Lack of unity of invention
- Box No. V Reasoned statement under Rule 43bis.1(a)(i) with regard to novelty, inventive step and industrial applicability; citations and explanations supporting such statement
- Box No. VI Certain documents cited
- Box No. VII Certain defects in the international application
- Box No. VIII Certain observations on the international application

2. FURTHER ACTION

If a demand for international preliminary examination is made, this opinion will usually be considered to be a written opinion of the International Preliminary Examining Authority ("IPEA") except that this does not apply where the applicant chooses an Authority other than this one to be the IPEA and the chosen IPEA has notified the International Bureau under Rule 66.1bis(b) that written opinions of this International Searching Authority will not be so considered.

If this opinion is, as provided above, considered to be a written opinion of the IPEA, the applicant is invited to submit to the IPEA a written reply together, where appropriate, with amendments, before the expiration of 3 months from the date of mailing of Form PCT/ISA/220 or before the expiration of 22 months from the priority date, whichever expires later.

For further options, see Form PCT/ISA/220.

Name and mailing address of the ISA:

 European Patent Office
D-80296 Munich
Tel. +49 89 2399 - 0
Fax: +49 89 2399 - 4465

Date of completion of this opinion

see form PCT/ISA/210

Authorized Officer

Vandenbogaerde, Ann

Telephone No. +49 89 2399-7374



Box No. I Basis of the opinion

1. With regard to the **language**, this opinion has been established on the basis of:
 - the international application in the language in which it was filed
 - a translation of the international application into , which is the language of a translation furnished for the purposes of international search (Rules 12.3(a) and 23.1 (b)).
2. This opinion has been established taking into account the **rectification of an obvious mistake** authorized by or notified to this Authority under Rule 91 (Rule 43bis.1(a))
3. With regard to any **nucleotide and/or amino acid sequence** disclosed in the international application, this opinion has been established on the basis of a sequence listing filed or furnished:
 - a. (means)
 - on paper
 - in electronic form
 - b. (time)
 - in the international application as filed
 - together with the international application in electronic form
 - subsequently to this Authority for the purposes of search
4. In addition, in the case that more than one version or copy of a sequence listing has been filed or furnished, the required statements that the information in the subsequent or additional copies is identical to that in the application as filed or does not go beyond the application as filed, as appropriate, were furnished.
5. Additional comments:

Box No. II Priority

1. The validity of the priority claim has not been considered because the International Searching Authority does not have in its possession a copy of the earlier application whose priority has been claimed or, where required, a translation of that earlier application. This opinion has nevertheless been established on the assumption that the relevant date (Rules 43bis.1 and 64.1) is the claimed priority date.
2. This opinion has been established as if no priority had been claimed due to the fact that the priority claim has been found invalid (Rules 43bis.1 and 64.1). Thus for the purposes of this opinion, the international filing date indicated above is considered to be the relevant date.
3. Additional observations, if necessary:

Box No. V Reasoned statement under Rule 43bis.1(a)(i) with regard to novelty, inventive step or industrial applicability; citations and explanations supporting such statement

1. Statement

Novelty (N)	Yes: Claims	<u>1</u>
	No: Claims	<u>2-42</u>
Inventive step (IS)	Yes: Claims	
	No: Claims	<u>1-42</u>
Industrial applicability (IA)	Yes: Claims	<u>1-42</u>
	No: Claims	

2. Citations and explanations

see separate sheet

Box No. VI Certain documents cited

1. Certain published documents (Rules 43bis.1 and 70.10)

and /or

2. Non-written disclosures (Rules 43bis.1 and 70.9)

see form 210

Re Item V

Reasoned statement with regard to novelty, inventive step or industrial applicability; citations and explanations supporting such statement

Reference is made to the following documents:

- D1 WO 2011/020054 A1 (IRONWOOD PHARMACEUTICALS INC [US]; JOHNSTON JEFFREY [US]; KURTZ CAROLI) 17 February 2011 (2011-02-17)
- D2 WO 2010/065751 A2 (SYNERGY PHARMACEUTICALS INC [US]; SHAILUBHAI KUNWAR [US]; COMISKEY STE) 10 June 2010 (2010-06-10)
- D3 SHAILUBHAI KUNWAR ET AL: "Phase II Clinical Evaluation of SP-304, a Guanylate Cyclase-C Agonist, for Treatment of Chronic Constipation", AMERICAN JOURNAL OF GASTROENTEROLOGY, ELSEVIER SCIENCE INC, US, vol. 105, no. Suppl. 1, 1 October 2010 (2010-10-01), pages S487-S488, XP009152336, ISSN: 0002-9270
- D4 WO 2012/037380 A2 (SYNERGY PHARMACEUTICALS INC [US]; COMISKEY STEPHEN [US]; FENG RONG [US) 22 March 2012 (2012-03-22)

- D1 discloses (cf. claims 162, 168, 170, 186, 204, 205) the treatment of irritable bowel syndrome of constipation using an oral dosage formulation (tablet or capsule) comprising 0.05 mg to 1 mg GCC agonist peptide of SEQ ID No: 10 (identical to SEQ ID No: 56 of the present application) or SEQ ID No: 13 (identical to SEQ ID No: 1 of the present application) together with calcium chloride as cation and leucine as primary amino acid; the formulation is further comprising a binder such as hypromellose (claim 194), a lubricant (claim 195) and/or a filler such as microcrystalline cellulose (claim 197). D1 also discloses (cf. claim 207) said formulation wherein the GCC agonist peptide is linaclotide (SEQ ID No: 14), which is identical to SEQ ID No: 55 of the present application but not claimed by the present application.
- D2 describes (cf. [221], Fig. 7 (A-F)) that SP-332 (SEQ ID No: 8 corresponding to SEQ ID No: 8 of the present application) and SP-333 (SEQ ID No: 8 corresponding to SEQ ID No: 8 of the present application) are completely or

almost completely resistant to proteolysis after 2h incubation in simulated intestinal fluid (SIF), whereas SP-304 ((SEQ ID No: 1 corresponding to SEQ ID No: 1 of the present application) lost 30% of its potency after 1 h SIF incubation.

- D3 discloses (cf. abstract) that some chronic constipation patients in each cohort receiving oral treatment of 0.3, 1, 3 and 9 mg SP-304 (identical to SEQ ID No: 1 of the present application, = plecanatide) as repeated daily dose during 14 days are experiencing improvement in bowel function.

1 Method of treatment

Claims 36-41 relate to subject-matter considered by this Authority to be covered by the provisions of Rule 39.1(iv) / 67.1(iv) PCT. The patentability can be dependent upon the formulation of the claims. The EPO, for example, does not recognise as patentable claims to the use of a compound in medical treatment, but may allow claims to a product, in particular substances or compositions for use in a further medical treatment.

2 Claim 1: Novelty - Inventive step

- 2.1 The subject-matter of claim 1 relates to an oral dosage formulation comprising 0.01 mg to 10 mg of the GCC agonist peptide of SEQ ID No: 8 or 9 per unit dose.
- 2.2 The subject-matter of claim 1 is novel according to Article 33(2) PCT over the teaching of the cited prior art. However, the subject-matter of claims cannot be considered as involving an inventive step in the sense of Article 33(3) PCT in view of closest prior art document D1 taking into account the alternative GCC agonist peptides of SEQ ID Nos: 8-9 disclosed in D2.

3 Claims 2-25, 26-34, 35, 36-41 and 42: Novelty - Inventive step

- 3.1 The subject-matter of claims 2-25, 26-34, 35, 36-41 and 42 relates to an oral dosage formulation comprising 0.01 mg to 10 mg GCC agonist peptide of SEQ ID Nos: 1-54 or 56-249 per unit dose (claims 2-25, 35, 42), a process of preparing said formulation (claims 26-34), and its medical use in general (claim 36) and in the treatment of gastrointestinal diseases, in particular chronic idiopathic constipation (claims 37-41). The preferred excipients in said formulation are microcrystalline cellulose as inert carrier, magnesium stearate as lubricant, calcium chloride or calcium ascorbate as divalent cation salt, leucine, histidine or arginine as amino acid and hypromellose as coating agent (claims 18-19).
- 3.2 The subject-matter of independent claims 2, 26, 35, 36 and 42 is not novel according to Article 33(2) PCT over the teaching of D1 or D3.

Document D1 discloses (cf. claims 162, 168, 170, 186) the treatment of irritable bowel syndrome of constipation using an oral dosage formulation comprising 0.05 mg to 1 mg of a GCC agonist peptide of SEQ ID No: 10 (identical to SEQ ID No: 56 of application) or SEQ ID No: 13 (identical to SEQ ID No: 1 of application) together with calcium chloride as cation and leucine as primary amino acid; the formulation is further comprising a binder such as hypromellose (claim 194), a lubricant (claim 195) and/or a filler such as microcrystalline cellulose (claim 197).

D3 discloses (cf. abstract) that some chronic constipation patients in each cohort receiving oral treatment of 0.3, 1, 3 and 9 mg SP-304 (identical to SEQ ID No: 1 of the present application, = plecanatide) as repeated daily dose during 14 days are experiencing improvement in bowel function.

- 3.3 Dependent claims 3-25, 37-34, 37-41 do not contain any features which, in combination with the features of any claim to which they refer, meet the requirements of the PCT in respect of novelty and/or inventive step in view of closest prior art document D1. No surprising technical effect can be seen in the use of the excipients.

Re Item VI

Certain documents cited

Application No Patent No	Publication date (day/month/year)	Filing date (day/month/year)	Priority date (valid claim) (day/month/year)
WO2012/037380	22.03.2012	15.09.2011	15.09.2010

PATENT COOPERATION TREATY

PCT

INTERNATIONAL SEARCH REPORT

(PCT Article 18 and Rules 43 and 44)

Applicant's or agent's file reference 33357-517001WO	FOR FURTHER ACTION		see Form PCT/ISA/230 as well as, where applicable, Item 5 below.
International application No. PCT/US2009/046287	International filing date (day/month/year) 04/06/2009	(Earliest) Priority Date (day/month/year) 04/06/2008	
Applicant SYNERGY PHARMACEUTICALS INC.			

This international search report has been prepared by this International Searching Authority and is transmitted to the applicant according to Article 18. A copy is being transmitted to the International Bureau.

This international search report consists of a total of 5 sheets.

It is also accompanied by a copy of each prior art document cited in this report.

1. Basis of the report

a. With regard to the language, the international search was carried out on the basis of:

- the international application in the language in which it was filed
- a translation of the international application into _____, which is the language of a translation furnished for the purposes of international search (Rules 12.3(a) and 23.1(b))

b. This international search report has been established taking into account the rectification of an obvious mistake authorized by or notified to this Authority under Rule 91 (Rule 43.5bis(a)).

c. With regard to any nucleotide and/or amino acid sequence disclosed in the international application, see Box No. I.

2. Certain claims were found unsearchable (See Box No. II)

3. Unity of invention is lacking (see Box No. III)

4. With regard to the title,

- the text is approved as submitted by the applicant
- the text has been established by this Authority to read as follows:

5. With regard to the abstract,

- the text is approved as submitted by the applicant
- the text has been established, according to Rule 36.2(b), by this Authority as it appears in Box No. IV. The applicant may, within one month from the date of mailing of this international search report, submit comments to this Authority

6. With regard to the drawings,

- a. the figure of the drawings to be published with the abstract is Figure No. _____
 - as suggested by the applicant
 - as selected by this Authority, because the applicant failed to suggest a figure
 - as selected by this Authority, because this figure better characterizes the invention
- b. none of the figures is to be published with the abstract

INTERNATIONAL SEARCH REPORT

International application No.
PCT/US2009/046287

Box No. 1 Nucleotide and/or amino acid sequence(s) (Continuation of item 1.b of the first sheet)

1. With regard to any nucleotide and/or amino acid sequence disclosed in the international application and necessary to the claimed invention, the international search was carried out on the basis of:
 - a. type of material
 - a sequence listing
 - table(s) related to the sequence listing
 - b. format of material
 - on paper
 - in electronic form
 - c. time of filing/furnishing
 - contained in the international application as filed
 - filed together with the international application in electronic form
 - furnished subsequently to this Authority for the purpose of search
2. In addition, in the case that more than one version or copy of a sequence listing and/or table relating thereto has been filed or furnished, the required statements that the information in the subsequent or additional copies is identical to that in the application as filed or does not go beyond the application as filed, as appropriate, were furnished.
3. Additional comments.

INTERNATIONAL SEARCH REPORT

International application No
PCT/US2009/046287

A. CLASSIFICATION OF SUBJECT MATTER
INV. A61K38/10 C07K7/08

According to International Patent Classification (IPC) or to both national classification and IPC

B. FIELDS SEARCHED

Minimum documentation searched (classification system followed by classification symbols)
A61K C07K

Documentation searched other than minimum documentation to the extent that such documents are included in the fields searched

Electronic data base consulted during the international search (name of data base and, where practical, search terms used)

EPO-Internal, WPI Data, BIOSIS, Sequence Search, CHEM ABS Data, EMBASE

C. DOCUMENTS CONSIDERED TO BE RELEVANT

Category	Citation of document, with indication, where appropriate, of the relevant passages	Relevant to claim No.
X	WO 2007/101158 A (MICROBIA INC [US]; CURRIE MARK G [US]) 7 September 2007 (2007-09-07) page 45 - page 63; claims 10,63; sequences 21,27,40,42,49,70,85,98,10,128 page 213, line 13 - line 23 page 206, line 26 - line 27 page 190, line 1 - line 15	1-13
X	US 2003/073628 A1 (SHAILUBHAI KUNWAR [US] ET AL) 17 April 2003 (2003-04-17) claims; sequence 20	1-13
X	WO 2005/016244 A (MICROBIA INC [US]; CURRIE MARK G [US]; MAHAJAN-MIKLOS SHALINA [US]; LI) 24 February 2005 (2005-02-24) the whole document	1-13

Further documents are listed in the continuation of Box C.

See patent family annex.

* Special categories of cited documents:

- *A* document defining the general state of the art which is not considered to be of particular relevance
- *E* earlier document but published on or after the international filing date
- *L* document which may throw doubts on priority claim(s) or which is cited to establish the publication date of another citation or other special reason (as specified)
- *O* document referring to an oral disclosure, use, exhibition or other means
- *P* document published prior to the international filing date but later than the priority date claimed

- *T* later document published after the international filing date or priority date and not in conflict with the application but cited to understand the principle or theory underlying the invention
- *X* document of particular relevance: the claimed invention cannot be considered novel or cannot be considered to involve an inventive step when the document is taken alone
- *Y* document of particular relevance: the claimed invention cannot be considered to involve an inventive step when the document is combined with one or more other such documents, such combination being obvious to a person skilled in the art
- *Z* document member of the same patent family

Date of the actual completion of the international search

Date of mailing of the international search report

28 October 2009

10/11/2009

Name and mailing address of the ISA/

European Patent Office, P.B. 5516 Patentlaan 2
NL - 2260 HW Rijswijk
Tel: (+31-70) 340-2040
Fax: (+31-70) 340-2016

Authorized officer

Armandola, Elena

INTERNATIONAL SEARCH REPORT

International application No

PCT/US2009/046287

C(Continuation). DOCUMENTS CONSIDERED TO BE RELEVANT

Category*	Citation of document, with indication, where appropriate, of the relevant passages	Relevant to claim No.
X	WO 02/078683 A (SYNERGY PHARMACEUTICALS INC [US]) 10 October 2002 (2002-10-10) claims; sequence 20	1-13
X	WO 2006/086653 A (MICROBIA INC [US]; CURRIE MARK G [US]; MAHAJAN-MIKLOS SHALINA [US]; SU) 17 August 2006 (2006-08-17) the whole document	1-13
P,X	WO 2008/137318 A (IRONWOOD PHARMACEUTICALS INC [US]; CURRIE MARK G [US]; ZIMMER DANIEL P) 13 November 2008 (2008-11-13) claims; sequence 10	1-13
P,X	WO 2008/151257 A (SYNERGY PHARMACEUTICALS INC [US]; SHAILUBHAI KUNWAR [US]; JACOB GARY S) 11 December 2008 (2008-12-11) claims; sequences 1, 8-13, 15-26, 38-44	1-13

INTERNATIONAL SEARCH REPORT

Information on patent family members

International application No.

PCT/US2009/046287

Patent document cited in search report		Publication date	Patent family member(s)	Publication date
WO 2007101158	A	07-09-2007	US 2009192083 A1	30-07-2009
US 2003073628	A1	17-04-2003	US 2006154868 A1	13-07-2006
WO 2005016244	A	24-02-2005	CA 2529307 A1	24-02-2005
			EP 1644021 A2	12-04-2006
			JP 2007501866 T	01-02-2007
			US 2006094658 A1	04-05-2006
WO 02078583	A	10-10-2002	CA 2441970 A1	10-10-2002
			CN 1551760 A	01-12-2004
			EP 1379224 A1	14-01-2004
			EP 2103624 A1	23-09-2009
			JP 4206272 B2	07-01-2009
			JP 2004532208 T	21-10-2004
			JP 2009001582 A	08-01-2009
WO 2006086653	A	17-08-2006	CA 2596505 A1	17-08-2006
			EP 1853295 A2	14-11-2007
WO 2008137318	A	13-11-2008	NONE	
WO 2008151257	A	11-12-2008	US 2009048175 A1	19-02-2009

PATENT COOPERATION TREATY

PCT

INTERNATIONAL SEARCH REPORT

(PCT Article 18 and Rules 43 and 44)

Applicant's or agent's file reference 33357-518001WO	FOR FURTHER ACTION		see Form PCT/ISA/220 as well as, where applicable, item 5 below.
International application No. PCT/US2009/046288	International filing date (day/month/year) 04/06/2009	(Earliest) Priority Date (day/month/year) 04/06/2008	
Applicant SYNERGY PHARMACEUTICALS INC.			

This international search report has been prepared by this International Searching Authority and is transmitted to the applicant according to Article 18. A copy is being transmitted to the International Bureau.

This international search report consists of a total of 9 sheets.

It is also accompanied by a copy of each prior art document cited in this report.

1. Basis of the report

a. With regard to the language, the international search was carried out on the basis of:

- the international application in the language in which it was filed
 a translation of the international application into _____, which is the language of a translation furnished for the purposes of international search (Rules 12.3(a) and 23.1(b))

b. This international search report has been established taking into account the rectification of an obvious mistake authorized by or notified to this Authority under Rule 91 (Rule 43.6bis(a)).

c. With regard to any nucleotide and/or amino acid sequence disclosed in the international application, see Box No. I.

2. Certain claims were found unsearchable (See Box No. II)

3. Unity of invention is lacking (see Box No. III)

4. With regard to the title,

- the text is approved as submitted by the applicant
 the text has been established by this Authority to read as follows:

5. With regard to the abstract,

- the text is approved as submitted by the applicant
 the text has been established, according to Rule 38.2(b), by this Authority as it appears in Box No. IV. The applicant may, within one month from the date of mailing of this international search report, submit comments to this Authority

6. With regard to the drawings,

- a. the figure of the drawings to be published with the abstract is Figure No. _____
 as suggested by the applicant
 as selected by this Authority, because the applicant failed to suggest a figure
 as selected by this Authority, because this figure better characterizes the invention
- b. none of the figures is to be published with the abstract.

INTERNATIONAL SEARCH REPORT

International application No.

PCT/US2009/046288

Box No. I Nucleotide and/or amino acid sequence(s) (Continuation of item 1.b of the first sheet)

1. With regard to any nucleotide and/or amino acid sequence disclosed in the international application and necessary to the claimed invention, the international search was carried out on the basis of:
 - a. type of material
 - a sequence listing
 - table(s) related to the sequence listing
 - b. format of material
 - on paper
 - in electronic form
 - c. time of filing/furnishing
 - contained in the international application as filed
 - filed together with the international application in electronic form
 - furnished subsequently to this Authority for the purpose of search
2. In addition, in the case that more than one version or copy of a sequence listing and/or table relating thereto has been filed or furnished, the required statements that the information in the subsequent or additional copies is identical to that in the application as filed or does not go beyond the application as filed, as appropriate, were furnished.
3. Additional comments:

INTERNATIONAL SEARCH REPORT

International application No
PCT/US2009/046288

A. CLASSIFICATION OF SUBJECT MATTER
INV. C07K7/08 A61K38/04 A61P1/04 A61P29/00 A61P35/00

According to International Patent Classification (IPC) or to both national classification and IPC

B. FIELDS SEARCHED

Minimum documentation searched (classification system followed by classification symbols)
C07K

Documentation searched other than minimum documentation to the extent that such documents are included in the fields searched

Electronic data base consulted during the international search (name of data base and, where practical, search terms used)
EPO-Internal, Sequence Search, WPI Data, EMBASE, BIOSIS

C. DOCUMENTS CONSIDERED TO BE RELEVANT

Category*	Citation of document, with indication, where appropriate, of the relevant passages	Relevant to claim No.
X	US 2003/073628 A1 (SHAILUBHAI KUNWAR [US] ET AL) 17 April 2003 (2003-04-17) abstract sequence 20 paragraphs [0011] - [0017] paragraph [0018]	1-7, 10-13
X	WO 2005/016244 A (MICROBIA INC [US]; CURRIE MARK G [US]; MAHAJAN-MIKLOS SHALINA [US]; LI) 24 February 2005 (2005-02-24) abstract page 2, lines 12-21 sequence 17 page 3, lines 7-25 page 27, line 17 page 34, lines 24-27 page 35, lines 21-26 page 60, lines 1-6	1-7, 10, 11

Further documents are listed in the continuation of Box C. See patent family annex.

* Special categories of cited documents:

- *A* document defining the general state of the art which is not considered to be of particular relevance
- *E* earlier document but published on or after the international filing date
- *L* document which may throw doubts on priority claim(s) or which is cited to establish the publication date of another citation or other special reason (as specified)
- *O* document referring to an oral disclosure, use, exhibition or other means
- *P* document published prior to the international filing date but later than the priority date claimed
- *T* later document published after the international filing date or priority date and not in conflict with the application but cited to understand the principle or theory underlying the invention
- *X* document of particular relevance; the claimed invention cannot be considered novel or cannot be considered to involve an inventive step when the document is taken alone
- *Y* document of particular relevance; the claimed invention cannot be considered to involve an inventive step when the document is combined with one or more other such documents, such combination being obvious to a person skilled in the art
- *Z* document member of the same patent family

Date of the actual completion of the international search: 26 August 2009
Date of mailing of the international search report: 09/12/2009

Name and mailing address of the ISA/
European Patent Office, P.O. Box 5818 Patentlaan 2
NL - 6200 HV Rijswijk
Tel. (+31-70) 340-2040
Fax (+31-70) 340-3016
Authorized officer: Montrone, Marco

INTERNATIONAL SEARCH REPORT

International application No.

PCT/US2009/046288

(Continuation) DOCUMENTS CONSIDERED TO BE RELEVANT

Category*	Citation of document, with indication, where appropriate, of the relevant passages	Relevant to claim No.
P, X	WO 2008/151257 A (SYNERGY PHARMACEUTICALS INC [US]; SHAILUBHAI KUNWAR [US]; JACOB GARY S) 11 December 2008 (2008-12-11) abstract; sequences 10-13, 15-19 page 1, lines 11-16 page 5, line 1 - page 6, line 34	1-7, 10-13

INTERNATIONAL SEARCH REPORT

International application No.
PCT/US2009/046288

Box No. II Observations where certain claims were found unsearchable (Continuation of item 2 of first sheet)

This international search report has not been established in respect of certain claims under Article 17(2)(a) for the following reasons:

1. Claims Nos.: see annex
because they relate to subject matter not required to be searched by this Authority, namely:
Although claims 4 to 7 and 11 to 13 are directed to a method of treatment of the human/animal body, the search has been carried out and based on the alleged effects of the compound/.
2. Claims Nos.:
because they relate to parts of the international application that do not comply with the prescribed requirements to such an extent that no meaningful international search can be carried out, specifically:
3. Claims Nos.:
because they are dependent claims and are not drafted in accordance with the second and third sentences of Rule 6.4(a).

Box No. III Observations where unity of invention is lacking (Continuation of item 3 of first sheet)

This International Searching Authority found multiple inventions in this international application, as follows:

see additional sheet

1. As all required additional search fees were timely paid by the applicant, this international search report covers all searchable claims.
2. As all searchable claims could be searched without effort justifying an additional fees, this Authority did not invite payment of additional fees.
3. As only some of the required additional search fees were timely paid by the applicant, this international search report covers only those claims for which fees were paid, specifically claims Nos.:
4. No required additional search fees were timely paid by the applicant. Consequently, this international search report is restricted to the invention first mentioned in the claims; it is covered by claims Nos.:

see annex

Remark on Protest

- The additional search fees were accompanied by the applicant's protest and, where applicable, the payment of a protest fee.
- The additional search fees were accompanied by the applicant's protest but the applicable protest fee was not paid within the time limit specified in the invitation.
- No protest accompanied the payment of additional search fees.

FURTHER INFORMATION CONTINUED FROM PCT/ISA/ 210

This International Searching Authority found multiple (groups of) inventions in this international application, as follows:

Invention 1 claims 1-7,10(all partially),11-13(complete)

A method for preventing or treating a condition selected from the group consisting of Ulcerative Colitis comprising administering to a patient in need thereof, an effective dosage of a guanylate cyclase receptor agonist having the sequence of any one of SEQIDNO:2-4 or

A method for preventing or treating a condition selected from the group consisting of Ulcerative Colitis comprising administering to a patient in need thereof, an effective dosage of a guanylate cyclase receptor agonist having the sequence of any one of SEQIDNO:2-4 further comprising administering an effective dose of inhibitor of a cGMP-specific phosphodiesterase or

A method of increasing cGMP production in a cell comprising contacting said cell with a peptide selected from the group consisting of the amino acid sequence of SEQ ID NO:2-4.

Invention 2 claims 1-4,8-10(all partially)

A method for preventing or treating a condition selected from the group consisting of Ulcerative Colitis comprising administering to a patient in need thereof, an effective dosage of a guanylate cyclase receptor agonist having the sequence of any one of SEQIDNO:2-4 further comprising administering an effective dose of at least one anti-inflammatory agent.

Invention 3-30 claims 1-7,10(all partially)

FURTHER INFORMATION CONTINUED FROM PCT/ISA/ 210

A method for preventing or treating a condition selected from the group consisting of Irritable bowel syndrome (IBS), necrotizing enterocolitis (NEC), non-ulcer dyspepsia chronic intestinal pseudo-obstruction, functional dyspepsia, colonic pseudo-obstruction, duodenogastric reflux, constipation associated with use of opiate pain killers, gastroesophageal reflux disease (GERD), post surgical constipation, gastroparesis, constipation associated with neuropathic disorders, heartburn, poor gastrointestinal motility, congestive heart failure, hypertension, benign prostatic hyperplasia (BPH), colon cancer, lung cancer, bladder cancer, liver cancer, salivary gland cancer or skin cancer, bronchitis, tissue inflammation, organ inflammation, respiratory inflammation, asthma, COPD comprising administering to a patient in need thereof, an effective dosage of a guanylate cyclase receptor agonist having the sequence of any one of SEQIDNO:2-4 or

A method for preventing or treating a condition selected from the group consisting of Irritable bowel syndrome (IBS), necrotizing enterocolitis (NEC), non-ulcer dyspepsia chronic intestinal pseudo-obstruction, functional dyspepsia, colonic pseudo-obstruction, duodenogastric reflux, constipation associated with use of opiate pain killers, gastroesophageal reflux disease (GERD), post surgical constipation, gastroparesis, constipation associated with neuropathic disorders, heartburn, poor gastrointestinal motility, congestive heart failure, hypertension, benign prostatic hyperplasia (BPH), colon cancer, lung cancer, bladder cancer, liver cancer, salivary gland cancer or skin cancer, bronchitis, tissue inflammation, organ inflammation, respiratory inflammation, asthma, COPD comprising administering to a patient in need thereof, an effective dosage of a guanylate cyclase receptor agonist having the sequence of any one of SEQIDNO:2-4 further comprising administering an effective dose of inhibitor of a cGMP-specific phosphodiesterase.

Invention 31-59 claims 1-4,8-10(all partially)

FURTHER INFORMATION CONTINUED FROM PCT/ISA/ 210

A method for preventing or treating a condition selected from the group consisting of Irritable bowel syndrome (IBS), necrotizing enterocolitis (NEC), non-ulcer dyspepsia chronic intestinal pseudo-obstruction, functional dyspepsia, colonic pseudo-obstruction, duodenogastric reflux, constipation associated with use of opiate pain killers, gastroesophageal reflux disease (GERD), post surgical constipation, gastroparesis, constipation associated with neuropathic disorders, heartburn, poor gastrointestinal motility, congestive heart failure, hypertension, benign prostatic hyperplasia (BPH), colon cancer, lung cancer, bladder cancer, liver cancer, salivary gland cancer or skin cancer, bronchitis, tissue inflammation, organ inflammation, respiratory inflammation, asthma, COPD comprising administering to a patient in need thereof, an effective dosage of a guanylate cyclase receptor agonist having the sequence of any one of SEQIDNO:2-4 further comprising administering an effective dose of at least one anti-inflammatory agent.

INTERNATIONAL SEARCH REPORT

Information on patent family members

International application No
PCT/US2009/046288

Patent document cited in search report	Publication date	Patent family member(s)	Publication date
US 2003073628 A1	17-04-2003	US 2006154868 A1	13-07-2006
WO 2005016244 A	24-02-2005	CA 2529307 A1	24-02-2005
		EP 1644021 A2	12-04-2006
		JP 2007501866 T	01-02-2007
		US 2006094658 A1	04-05-2006
WO 2008151257 A	11-12-2008	US 2009048175 A1	19-02-2009

PATENT COOPERATION TREATY

PCT

INTERNATIONAL SEARCH REPORT

(PCT Article 18 and Rules 43 and 44)

Applicant's or agent's file reference 40737-509001	FOR FURTHER ACTION	see Form PCT/ISA/220 as well as, where applicable, Item 5 below.
International application No. PCT/US2011/051805	International filing date (<i>day/month/year</i>) 15 SEPTEMBER 2011 (15.09.2011)	(Earliest) Priority Date (<i>day/month/year</i>) 15 SEPTEMBER 2010 (15.09.2010)
Applicant SYNERGY PHARMACEUTICALS INC. et al		

This International search report has been prepared by this International Searching Authority and is transmitted to the applicant according to Article 18. A copy is being transmitted to the International Bureau.

This international search report consists of a total of 6 sheets.

It is also accompanied by a copy of each prior art document cited in this report.

1. Basis of the report

a. With regard to the language, the international search was carried out on the basis of:

- the international application in the language in which it was filed
 a translation of the international application into _____, which is the language of a translation furnished for the purposes of international search (Rules 12.3(a) and 23.1(b))

b. This international search report has been established taking into account the rectification of an obvious mistake authorized by or notified to this Authority under Rule 91 (Rule 43.6bis(a)).

c. With regard to any nucleotide and/or amino acid sequence disclosed in the international application, see Box No. I.

2. Certain claims were found unsearchable (See Box No. II)

3. Unity of invention is lacking (See Box No. III)

4. With regard to the title,

- the text is approved as submitted by the applicant.
 the text has been established by this Authority to read as follows:

5. With regard to the abstract,

- the text is approved as submitted by the applicant.
 the text has been established, according to Rule 38.2, by this Authority as it appears in Box No. IV. The applicant may, within one month from the date of mailing of this international search report, submit comments to this Authority.

6. With regard to the drawings,

- a. the figure of the drawings to be published with the abstract is Figure No. 2
 as suggested by the applicant.
 as selected by this Authority, because the applicant failed to suggest a figure.
 as selected by this Authority, because this figure better characterizes the invention.
- b. none of the figure is to be published with the abstract.

INTERNATIONAL SEARCH REPORT

International application No.

PCT/US2011/051805

Box No. 1 Nucleotide and/or amino acid sequence(s) (Continuation of item I.c of the first sheet)

1. With regard to any nucleotide and/or amino acid sequence disclosed in the international application, the international search was carried out on the basis of:

a. a sequence listing filed or furnished

- on paper
 in electronic form

b. time of filing or furnishing

- contained in the international application as filed
 filed together with the international application in electronic form
 furnished subsequently to this Authority for the purposes of search

2. In addition, in the case that more than one version or copy of a sequence listing has been filed or furnished, the required statements that the information in the subsequent or additional copies is identical to that in the application as filed or does not go beyond the application as filed, as appropriate, were furnished.

3. Additional comments:

Box No. II Observations where certain claims were found unsearchable (Continuation of item 2 of first sheet)

This international search report has not been established in respect of certain claims under Article 17(2)(a) for the following reasons:

1. Claims Nos.: 42-52
because they relate to subject matter not required to be searched by this Authority, namely:
Claims 42-52 pertain to methods for treatment of the human by therapy and thus relate to a subject matter which this International Searching Authority is not required, under Article 17(2)(a)(i) of the PCT and Rule 39.1(iv) of the Regulations under the PCT, to search.
2. Claims Nos.: 15,16,18,20,24,27,29,30,35,43-52
because they relate to parts of the international application that do not comply with the prescribed requirements to such an extent that no meaningful international search can be carried out, specifically:
Claims 15,16,18,20,24,27,29,30,35,43-52 are unclear, since they refer to claims which are not searchable due to not being drafted in accordance with the third sentences of PCT Rule 6.4(a).
3. Claims Nos.: 12,14,17,19,21-23,25,26,28,34,36-42,53
because they are dependent claims and are not drafted in accordance with the second and third sentences of Rule 6.4(a).

Box No. III Observations where unity of invention is lacking (Continuation of item 3 of first sheet)

This International Searching Authority found multiple inventions in this international application, as follows:

1. As all required additional search fees were timely paid by the applicant, this international search report covers all searchable claims.
2. As all searchable claims could be searched without effort justifying an additional fee, this Authority did not invite payment of any additional fee.
3. As only some of the required additional search fees were timely paid by the applicant, this international search report covers only those claims for which fees were paid, specifically claims Nos.:
4. No required additional search fees were timely paid by the applicant. Consequently, this international search report is restricted to the invention first mentioned in the claims; it is covered by claims Nos.:

Remark on Protest

- The additional search fees were accompanied by the applicant's protest and, where applicable, the payment of a protest fee.
- The additional search fees were accompanied by the applicant's protest but the applicable protest fee was not paid within the time limit specified in the invitation.
- No protest accompanied the payment of additional search fees.

A. CLASSIFICATION OF SUBJECT MATTER

A61K 38/16(2006.01), *A61K 38/10(2006.01)*, *A61K 9/16(2006.01)*, *A61K 9/20(2006.01)*, *A61K 9/48(2006.01)*, *A61K 47/48(2006.01)*, *A61P 35/00(2006.01)*, *A61P 3/00(2006.01)*

According to International Patent Classification (IPC) or to both national classification and IPC

B. FIELDS SEARCHED

Minimum documentation searched (classification system followed by classification symbols)

A61K 38/16; *C07K 7/08*; *A61K 9/00*; *A61K 38/00*; *A61K 9/48*; *C07K 7/00*; *A61K 38/10*

Documentation searched other than minimum documentation to the extent that such documents are included in the fields searched

Korean utility models and applications for utility models
Japanese utility models and applications for utility models

Electronic data base consulted during the international search (name of data base and, where practicable, search terms used)

eKOMPASS(KIPO internal), Pubmed, Google

C. DOCUMENTS CONSIDERED TO BE RELEVANT

Category*	Citation of document, with indication, where appropriate, of the relevant passages	Relevant to claim No.
X	US 2010-0221529 A1 (KUNWAR SHAHLESHA et al.) 02 September 2010 See abstract; Tables 1-2; paragraphs [0073], [0120], [0135], [0138], [0136]; Example 2; claims.	1-11, 31-33
X	US 2010-0120604 A1 (KUNWAR SHAHLESHA et al.) 13 May 2010 See abstract; Table 1; claims.	1-11, 31-33
A	US 2000-0102093 A1 (MARK G. CHERIE) 20 July 2000 See abstract; paragraphs [0272], [0275]; claims.	1-11, 31-33
A	WO 02-062069 A2 (PHARMACIA CORPORATION) 15 August 2002 See abstract; claims.	1-11, 31-33

Further documents are listed in the continuation of Box C.

See patent family annex.

* Special categories of cited documents:

"X" document defining the general state of the art which is not considered to be of particular relevance

"E" earlier application or patent but published on or after the international filing date

"L" document which may throw doubts on priority claim(s) or which is cited to establish the publication date of citation or other special reason (as specified)

"O" document referring to an oral disclosure, use, exhibition or other means

"P" document published prior to the international filing date but later than the priority date claimed

"T" later document published after the international filing date or priority date and not in conflict with the application but cited to understand the principle or theory underlying the invention

"N" document of particular relevance; the claimed invention cannot be considered novel or cannot be considered to involve an inventive step when the document is taken alone

"Y" document of particular relevance; the claimed invention cannot be considered to involve an inventive step when the document is combined with one or more other such documents, such combination being obvious to a person skilled in the art

"&" document member of the same patent family

Date of the actual completion of the international search

19 JUNE 2012 (19.06.2012)

Date of mailing of the international search report

21 JUNE 2012 (21.06.2012)

Name and mailing address of the ISA/ER



Korean Intellectual Property Office
189 Cheongsa-ro, Seo-gu, Daejeon Metropolitan
City, 302-701, Republic of Korea

Facsimile No. 82-42-472-7140

Authorized officer

PARK, JEONG UNG

Telephone No. 82-42-481-8131



INTERNATIONAL SEARCH REPORT

Information on patent family members

International application No.

PCT/US2011/051805

Patent document cited in search report	Publication date	Patent family member(s)	Publication date
US 2010-0221329 A1	02.09.2010	AU 2009-322285 A1 CA 2745694 A1 EP 2373296 A2 WO 2010-065751 A2 WO 2010-065751 A3	10.06.2010 10.06.2010 12.10.2011 10.06.2010 10.06.2010
US 2010-0120694 A1	13.05.2010	AU 2008-261102 A1 AU 2009-256156 A1 AU 2009-256157 A1 AU 2009-270833 A1 CA 2668161 A1 CA 2726913 A1 CA 2726917 A1 CA 2730603 A1 CN 101772513 A EP 2170930 A2 EP 2296685 A1 EP 2321341 A2 EP 2328910 A2 JP 2010-530849 A JP 2011-522828 A JP 2011-523062 A JP 2011-528375 A US 2009-0048175 A1 US 2010-0069306 A1 US 2010-0093635 A1 US 2010-0152118 A1 US 2011-0160120 A1 US 7879802 B2 US 8034782 B2 WO 2008-151257 A2 WO 2008-151257 A3 WO 2009-149278 A1 WO 2009-149278 A8 WO 2009-149279 A2 WO 2009-149279 A3 WO 2009-149279 A3 WO 2009-149279 A3 WO 2010-009319 A2 WO 2010-009319 A3 WO 2011-068038 A2 WO 2011-068038 A3	11.12.2008 10.12.2009 10.12.2009 21.01.2010 11.12.2008 10.12.2009 10.12.2009 21.01.2010 07.07.2010 07.04.2010 23.03.2011 18.05.2011 08.06.2011 16.09.2010 04.08.2011 18.08.2011 17.11.2011 19.02.2009 18.03.2010 15.04.2010 17.06.2010 30.06.2011 01.02.2011 11.10.2011 11.12.2008 11.12.2008 10.12.2009 10.12.2009 10.12.2009 10.12.2009 21.01.2010 21.01.2010 21.01.2010 09.06.2011 09.06.2011
US 2009-0192083 A1	30.07.2009	WO 2007-101158 A2 WO 2007-101158 A3	07.09.2007 02.05.2008
WO 02-062369 A2	15.08.2002	AU 2002-235520 A1 AU 2002-235520 A8 CA 2435835 A1 EP 1365753 A2	19.08.2002 19.08.2002 15.08.2002 03.12.2003

INTERNATIONAL SEARCH REPORT

Information on patent family members

International application No.

PCT/US2011/051805

Patent document cited in search report	Publication date	Patent family member(s)	Publication date
		JP 2004-521123 A	15.07.2004
		JP 2004-521123 T	15.07.2004
		US 2004-0121961 A1	24.06.2004
		WO 02-062389 A3	15.08.2002

PATENT COOPERATION TREATY

PCT

INTERNATIONAL SEARCH REPORT

(PCT Article 18 and Rules 43 and 44)

Applicant's or agent's file reference 40737-509002WO	FOR FURTHER ACTION		<i>see Form PCT/ISA/220 as well as, where applicable, item 5 below.</i>
International application No. PCT/US2013/030551	International filing date (day/month/year) 12/03/2013	(Earliest) Priority Date (day/month/year) 15/03/2012	
Applicant SYNERGY PHARMACEUTICALS INC.			

This international search report has been prepared by this International Searching Authority and is transmitted to the applicant according to Article 18. A copy is being transmitted to the International Bureau.

This international search report consists of a total of 5 sheets.

It is also accompanied by a copy of each prior art document cited in this report.

1. Basis of the report

a. With regard to the language, the international search was carried out on the basis of:

- the international application in the language in which it was filed
 a translation of the international application into _____, which is the language of a translation furnished for the purposes of international search (Rules 12.3(a) and 23.1(b))

b. This international search report has been established taking into account the rectification of an obvious mistake authorized by or notified to this Authority under Rule 91 (Rule 43.6bis(a)).

c. With regard to any nucleotide and/or amino acid sequence disclosed in the international application, see Box No. I.

2. Certain claims were found unsearchable (See Box No. II)

3. Unity of invention is lacking (see Box No. III)

4. With regard to the title,

- the text is approved as submitted by the applicant
 the text has been established by this Authority to read as follows:

5. With regard to the abstract,

- the text is approved as submitted by the applicant
 the text has been established, according to Rule 38.2, by this Authority as it appears in Box No. IV. The applicant may, within one month from the date of mailing of this international search report, submit comments to this Authority

6. With regard to the drawings,

- a. the figure of the drawings to be published with the abstract is Figure No. _____
 as suggested by the applicant
 as selected by this Authority, because the applicant failed to suggest a figure
 as selected by this Authority, because this figure better characterizes the invention
- b. none of the figures is to be published with the abstract

INTERNATIONAL SEARCH REPORT

International application No.

PCT/US2013/039551

Box No. 1 Nucleotide and/or amino acid sequence(s) (Continuation of item 1.c of the first sheet)

1. With regard to any nucleotide and/or amino acid sequence disclosed in the international application and necessary to the claimed invention, the international search was carried out on the basis of:
- a. (means)
- on paper
- in electronic form
- b. (time)
- in the international application as filed
- together with the international application in electronic form
- subsequently to this Authority for the purpose of search
2. In addition, in the case that more than one version or copy of a sequence listing and/or table relating thereto has been filed or furnished, the required statements that the information in the subsequent or additional copies is identical to that in the application as filed or does not go beyond the application as filed, as appropriate, were furnished.
3. Additional comments:

INTERNATIONAL SEARCH REPORT

International application No

PCT/US2013/030551

A. CLASSIFICATION OF SUBJECT MATTER

INV. A61K38/10 A61P1/00 A61P1/10
ADD.

According to International Patent Classification (IPC) or to both national classification and IPC

B. FIELDS SEARCHED

Minimum documentation searched (classification system followed by classification symbols)

A61K A61P

Documentation searched other than minimum documentation to the extent that such documents are included in the fields searched

Electronic data base consulted during the international search (name of data base and, where practicable, search terms used)

EPO-Internal, WPI Data, BIOSIS, CHEM ABS Data, Sequence Search, EMBASE

C. DOCUMENTS CONSIDERED TO BE RELEVANT

Category	Citation of document, with indication, where appropriate, of the relevant passages	Relevant to claim No.
X	WO 2011/020054 A1 (IRONWOOD PHARMACEUTICALS INC [US]; JOHNSTON JEFFREY [US]; KURTZ CAROLI) 17 February 2011 (2011-02-17)	2-42
Y	claims 162,168,170,186,194,195,197,207; sequences 10,13,14	1
Y	WO 2010/065751 A2 (SYNERGY PHARMACEUTICALS INC [US]; SHAILUBHAI KUNWAR [US]; COMISKEY STE) 10 June 2010 (2010-06-10) paragraph [0221]; figure 7; sequences 1,8,9	1
	----- -/--	

Further documents are listed in the continuation of Box C.

See patent family annex.

* Special categories of cited documents:

A document defining the general state of the art which is not considered to be of particular relevance

E earlier application or patent but published on or after the international filing date

L document which may throw doubts on priority claim(s) or which is cited to establish the publication date of another citation or other special reason (as specified)

O document referring to an oral disclosure, use, exhibition or other means

P document published prior to the international filing date but later than the priority date claimed

T later document published after the international filing date or priority date and not in conflict with the application but cited to understand the principle or theory underlying the invention

X document of particular relevance; the claimed invention cannot be considered novel or cannot be considered to involve an inventive step when the document is taken alone

Y document of particular relevance; the claimed invention cannot be considered to involve an inventive step when the document is combined with one or more other such documents, such combination being obvious to a person skilled in the art

S document member of the same patent family

Date of the actual completion of the international search

11 June 2013

Date of mailing of the international search report

18/06/2013

Name and mailing address of the ISA/

European Patent Office, P.B. 5818 Patentbox 2
NL - 2200 HV Rijswijk
Tel. (+31-70) 340-2040,
Fax: (+31-70) 340-3016

Authorized officer

Vandenbogaerde, Ann

INTERNATIONAL SEARCH REPORT

International application No

PCT/US2013/030551

C(Continuation). DOCUMENTS CONSIDERED TO BE RELEVANT

Category	Citation of document, with indication, where appropriate, of the relevant passages	Relevant to claim No.
X	SHAILUBHAI KUNWAR ET AL: "Phase II Clinical Evaluation of SP-304, a Guanylate Cyclase-C Agonist, for Treatment of Chronic Constipation", AMERICAN JOURNAL OF GASTROENTEROLOGY, ELSEVIER SCIENCE INC, US, vol. 105, no. Suppl. 1, 1 October 2010 (2010-10-01), pages S487-S488, XP009152336, ISSN: 0002-9270 abstract	2-42
X,P	----- WO 2012/037380 A2 (SYNERGY PHARMACEUTICALS INC [US]; COMISKEY STEPHEN [US]; FENG RONG [US] 22 March 2012 (2012-03-22) the whole document -----	1-42

INTERNATIONAL SEARCH REPORT

Information on patent family members

International application No

PCT/US2013/030551

Patent document cited in search report	Publication date	Patent family member(s)	Publication date
WO 2011020054 A1	17-02-2011	EP 2464373 A1	20-06-2012
		US 2013045239 A1	21-02-2013
		WO 2011020054 A1	17-02-2011
WO 2010065751 A2	10-06-2010	AU 2009322285 A1	30-06-2011
		CA 2745694 A1	10-06-2010
		EP 2373296 A2	12-10-2011
		JP 2012510527 A	10-05-2012
		US 2010221329 A1	02-09-2010
		WO 2010065751 A2	10-06-2010
WO 2012037380 A2	22-03-2012	AU 2011302006 A1	07-03-2013
		CA 2810243 A1	22-03-2012
		US 2012237593 A1	20-09-2012
		WO 2012037380 A2	22-03-2012

Electronic Acknowledgement Receipt

EFS ID:	21541674
Application Number:	13421769
International Application Number:	
Confirmation Number:	3135
Title of Invention:	Formulations of Guanylate Cyclase C Agonists and Methods of Use
First Named Inventor/Applicant Name:	Stephen Comiskey
Customer Number:	58249
Filer:	Anne Elizabeth Fleckenstein
Filer Authorized By:	
Attorney Docket Number:	40737-509001US
Receipt Date:	19-FEB-2015
Filing Date:	15-MAR-2012
Time Stamp:	19:07:01
Application Type:	Utility under 35 USC 111(a)

Payment information:

Submitted with Payment	no
------------------------	----

File Listing:

Document Number	Document Description	File Name	File Size(Bytes)/ Message Digest	Multi Part /.zip	Pages (if appl.)
1	Non Patent Literature	Gulcan-2007.pdf	2111738 <small>3666c0d0c3fcb4feb7365a2bb12c74e9d04d4ace</small>	no	8

Warnings:

Information:

2	Non Patent Literature	Gulcan-2009.pdf	1152243	no	4
			3600182be841bee27d34201a2787b6c880f6ec98		
Warnings:					
Information:					
3	Non Patent Literature	Gura-et-al-1997.pdf	669286	no	2
			1747250d87ca4ad454be05403f9cd841f1624c63		
Warnings:					
Information:					
4	Non Patent Literature	Hamman-2005.pdf	4467593	no	13
			237313f25e004e7debe1388f8a1e444e7b3058fe		
Warnings:					
Information:					
5	Non Patent Literature	Hamra-et-al-1993.pdf	1530377	no	5
			8ef2ec6e3628d72e7200fc734820619b3e195206		
Warnings:					
Information:					
6	Non Patent Literature	Harris-2007.pdf	2390955	no	8
			165fe80d3e7f663dcf0d5b71515f045e7115b2f7		
Warnings:					
Information:					
7	Non Patent Literature	Hess-et-al-1995.pdf	1506951	no	7
			0ddccdfbae8ad44a7d35c76f96fa6f7eb0c24b76		
Warnings:					
Information:					
8	Non Patent Literature	Hidaka-et-al-1998.pdf	2707820	no	10
			18c2b5d01251ec7a37bb8bc7b029284a74961258		
Warnings:					
Information:					
9	Non Patent Literature	Hidaka-et-al-2000.pdf	3319377	no	9
			9f6f0e1dae9fa5682b743ce33c19b276f309a607		
Warnings:					
Information:					
10	Non Patent Literature	Hill-et-al-1995b.pdf	1071875	no	4
			f0a5614ddf148a67e1d2fa13b4ec7392e3d30c3		
Warnings:					
Information:					

11	Non Patent Literature	Hill-etal-Analysis-1995.pdf	618947 ffa088c5c44ee78faf3678d100018cecfce3287e	no	5
Warnings:					
Information:					
12	Non Patent Literature	Hinds-etal-2000.pdf	2045819 0a3cb0c9bc930223ca55e858f9be9d2ab2522f5c	no	7
Warnings:					
Information:					
13	Non Patent Literature	Howard-2003.pdf	5595392 05672fdb530b4a1a5b87cd34106ffb3b50a8ea25	no	13
Warnings:					
Information:					
14	Non Patent Literature	Huff-etal-2002.pdf	1096918 e01dfa0eb7a4ef1edbee674ed4981966735404ef	no	9
Warnings:					
Information:					
15	Non Patent Literature	Hudson-2001.pdf	5713232 cc/b2631abcb3a787443c9efabf5194c5262bb48	no	22
Warnings:					
Information:					
16	Non Patent Literature	Hui-etal-2008.pdf	951939 8a750c5ca2761b5c952c07f25fab6ed1e51761af	no	7
Warnings:					
Information:					
17	Non Patent Literature	Hughes-1997.pdf	2405859 69a2ed5c1b5aff21cf79d36438660b01da5f033c	no	10
Warnings:					
Information:					
18	Non Patent Literature	IPRP-PCTUS2011051805-Dec-2012.pdf	2234157 15747e372b44143a178cc943feb06daf4d84c45	no	17
Warnings:					
Information:					
19	Non Patent Literature	IPRP-PCTUS2013030551-Sep-2014.pdf	937842 7a6681fc287eba98495a67de5e1d074ae3bb736	no	7
Warnings:					
Information:					

20	Non Patent Literature	ISR-PCTUS2009046287- Nov-2009.pdf	600379 470ef7626be80ea0e6f6fc4557020979ce4c80f3	no	5
Warnings:					
Information:					
21	Non Patent Literature	ISR-PCTUS2009046288- Dec-2009.pdf	1031435 68cd1f4d22a7865c3bc12fb885a044deb83790e8	no	9
Warnings:					
Information:					
22	Non Patent Literature	ISR-PCTUS2011051805- Jun-2012.pdf	677439 2394f70eb396694571c5c5edf7f1d93b1252a871	no	6
Warnings:					
Information:					
23	Non Patent Literature	ISR-PCTUS2013030551- Jun-2013.pdf	527149 20c22f76029f8e5cb17a322295869c7aa889aeb0	no	5
Warnings:					
Information:					
24	Non Patent Literature	Joo-etal-Physiol-1988.pdf	3521464 f7e58a50235db2067c7a21b9d28ad4419b5c1e82	no	14
Warnings:					
Information:					
25	Non Patent Literature	Kelland-2004.pdf	2535567 6a7c4d9256e8b78f75c93d9919779b6620c7c8fd	no	10
Warnings:					
Information:					
26	Non Patent Literature	Kita-1994.pdf	1843723 9dd6dce0918de460682cb95f985dc0ca80bcb87	no	7
Warnings:					
Information:					
27	Non Patent Literature	Klodt-etal-1997.pdf	3038315 651c5df4ebf90ff7e5f8ba5b7ce40764b5511239	no	11
Warnings:					
Information:					
28	Non Patent Literature	Krause-1977.pdf	5085889 ef41e86e0d097a0577f25663aa204fabfe7c6fd4	no	19
Warnings:					
Information:					

29	Non Patent Literature	Lam-2007.pdf	6195635	no	24
			c11f837b66c3a34e78f8be25ed7cde553fa3a55de		
Warnings:					
Information:					
30	Non Patent Literature	Leister-1990.pdf	1139797	no	4
			b9f521aac9939c4268ab2cd7ccdf252544438dd		
Warnings:					
Information:					
31	Non Patent Literature	Li-1997.pdf	2304703	no	12
			0743868e3f4c54bb79223f1a8133eeea82a9b33		
Warnings:					
Information:					
32	Non Patent Literature	Lipkin-1972.pdf	504143	no	3
			a88495af968d12fd887cda765ec44f841971baa9		
Warnings:					
Information:					
33	Non Patent Literature	Lorenz-2003.pdf	2838726	no	12
			1b855535f971e4e9802781526704ecab476020da		
Warnings:					
Information:					
34	Non Patent Literature	MacFarlane-and-MacFarlane-1993.pdf	1853311	no	9
			2c61237346340676757b5775b6ca54fe3f4d1499		
Warnings:					
Information:					
35	Non Patent Literature	Magert-1999.pdf	2281408	no	8
			7b5bafb84be8f470dd6f1edefb9a51edc0b37		
Warnings:					
Information:					
36	Non Patent Literature	Mahato-2003.pdf	14673934	no	62
			6d1ea41cc1c0edfe2c66d5adbab69e48bba6723d		
Warnings:					
Information:					
37	Non Patent Literature	Marx-1998.pdf	2479939	no	12
			876a1c6ffb69da7df43e1a68dde9f3273f6db4b4		
Warnings:					
Information:					

38	Non Patent Literature	Miyazato-1996.pdf	1094005	no	5
			b94c1eb0b1226ab3df7cee2c42bfe3d72fc4f265		
Warnings:					
Information:					
39	Non Patent Literature	Miyazato-etal-1996.pdf	1125421	no	5
			dd47f660d41f39f969765ef3920bcb708a889ac0		
Warnings:					
Information:					
40	Non Patent Literature	Moon-1979.pdf	1404341	no	6
			756b5f43517e40707ace8c94755b54344951b63a		
Warnings:					
Information:					
41	Non Patent Literature	Muller-Lissner-2006.pdf	2904081	no	12
			e9ba162519558fe81ca0b944b181ec20d227932f		
Warnings:					
Information:					
42	Non Patent Literature	Nakazuto-1998.pdf	2216735	no	8
			cab15e65fdb58fd55d202f1c5c6c3547a93f0590		
Warnings:					
Information:					
43	Non Patent Literature	Nathan-1993.pdf	2285752	no	9
			05311f18d7e451b141bfc13bcc6b92e02eb e7e3a		
Warnings:					
Information:					
44	Non Patent Literature	Nemethy-1983.pdf	1863398	no	5
			c1ea195d002f2addb10fb89a62e528f095a59ddc		
Warnings:					
Information:					
45	Non Patent Literature	Nikiforovich-1991.pdf	3312501	no	15
			9f4bedbd74238158b8ca0c4129fcf00405126264		
Warnings:					
Information:					
46	Non Patent Literature	Nikiforovich-1994.pdf	7232380	no	19
			477d5672fab4dd26dd9894d061229de7939d8256		
Warnings:					
Information:					

47	Non Patent Literature	Nyburg-1974.pdf	1051690	no	4
			8855c6c2f938a562353a1690494db7fe0e206017		
Warnings:					
Information:					
48	Non Patent Literature	Ohbayashi-1998.pdf	2003641	no	12
			87e03e27d56b6ea3fadf0c00837f3a3ec569992c		
Warnings:					
Information:					
49	Non Patent Literature	Perkins-1997.pdf	2175395	no	8
			8fecfe474b0d25e1a7a484475749db3d21f5791a		
Warnings:					
Information:					
50	Non Patent Literature	Peterson-2004.pdf	1921851	no	8
			e1c02b29f0561bcf065bf5bca3012d24885eed96		
Warnings:					
Information:					
51	Non Patent Literature	Pitari-etal-PNAS-2001.pdf	2408594	no	6
			0984ede2d78f3f649db67e9bbdb1097fe3c3458d		
Warnings:					
Information:					
52	Non Patent Literature	Potten-1997.pdf	2851530	no	12
			1f25e5398c66a565371fe4d2ae5c12e7759c277f		
Warnings:					
Information:					
53	Non Patent Literature	Provenzale-2001.pdf	1919265	no	7
			6e0c8d597bead3400d4afb56a56a5488245e9143		
Warnings:					
Information:					
54	Non Patent Literature	PubChem-CID-469.pdf	375349	no	19
			4a25564bd34eb0db137050441d93b77ed230957c		
Warnings:					
Information:					
55	Non Patent Literature	Ramamoorthy-2007.pdf	2670833	no	9
			340429b4d372813ec41cd69ef8642d560d3ea296		
Warnings:					
Information:					

56	Non Patent Literature	Reddy-and-Rao-2006.pdf	2471132	no	8
			f1faedbda5ad93a5a2d4da3fb3bec5383fc38cc3		
Warnings:					
Information:					
57	Non Patent Literature	Remington-1980.pdf	1494118	no	7
			4d7a1cbe93fbf131a4b1cbf67d60c78b0a54fd4		
Warnings:					
Information:					
58	Non Patent Literature	Roberts-2002.pdf	3246695	no	18
			0463ccc53d119b764eef6a29293faeaabd20884b		
Warnings:					
Information:					
59	Non Patent Literature	Rolfe-and-Milla-1999.pdf	1901854	no	8
			b5d824e9d0f4e7b6758bc081c7975bab6cc22f23		
Warnings:					
Information:					
Total Files Size (in bytes):				145591837	

This Acknowledgement Receipt evidences receipt on the noted date by the USPTO of the indicated documents, characterized by the applicant, and including page counts, where applicable. It serves as evidence of receipt similar to a Post Card, as described in MPEP 503.

New Applications Under 35 U.S.C. 111

If a new application is being filed and the application includes the necessary components for a filing date (see 37 CFR 1.53(b)-(d) and MPEP 506), a Filing Receipt (37 CFR 1.54) will be issued in due course and the date shown on this Acknowledgement Receipt will establish the filing date of the application.

National Stage of an International Application under 35 U.S.C. 371

If a timely submission to enter the national stage of an international application is compliant with the conditions of 35 U.S.C. 371 and other applicable requirements a Form PCT/DO/EO/903 indicating acceptance of the application as a national stage submission under 35 U.S.C. 371 will be issued in addition to the Filing Receipt, in due course.

New International Application Filed with the USPTO as a Receiving Office

If a new international application is being filed and the international application includes the necessary components for an international filing date (see PCT Article 11 and MPEP 1810), a Notification of the International Application Number and of the International Filing Date (Form PCT/RO/105) will be issued in due course, subject to prescriptions concerning national security, and the date shown on this Acknowledgement Receipt will establish the international filing date of the application.

PATENT COOPERATION TREATY

From the
INTERNATIONAL SEARCHING AUTHORITY

PCT

**WRITTEN OPINION OF THE
INTERNATIONAL SEARCHING AUTHORITY**

(PCT Rule 43bis.1)

To: ELRIEI IVOR R. MINTZ LEVIN COHN FERRIS GLOVSKY AND POPEO, P.C. ONE FINANCIAL CENTER BOSTON MA 02111 USA
--

Date of mailing (day/month/year) 21 JUNE 2012 (21.06.2012)
--

Applicant's or agent's file reference 40737-509001	FOR FURTHER ACTION See paragraph 2 below
---	--

International application No. PCT/US2011/051805	International filing date (day/month/year) 15 SEPTEMBER 2011 (15.09.2011)	Priority date(day/month/year) 15 SEPTEMBER 2010 (15.09.2010)
---	---	---

International Patent Classification (IPC) or both national classification and IPC <i>A61K 38/16(2006.01)i, A61K 38/10(2006.01)i, A61K 9/16(2006.01)i, A61K 9/20(2006.01)i, A61K 9/48(2006.01)i, A61K 47/48(2006.01)i, A61P 35/00(2006.01)i, A61P 3/00(2006.01)i</i>
--

Applicant SYNERGY PHARMACEUTICALS INC. et al
--



1. This opinion contains indications relating to the following items:
- Box No. I Basis of the opinion
 - Box No. II Priority
 - Box No. III Non-establishment of opinion with regard to novelty, inventive step and industrial applicability
 - Box No. IV Lack of unity of invention
 - Box No. V Reasoned statement under Rule 43bis.1(a)(i) with regard to novelty, inventive step or industrial applicability; citations and explanations supporting such statement
 - Box No. VI Certain documents cited
 - Box No. VII Certain defects in the international application
 - Box No. VIII Certain observations on the international application

2. **FURTHER ACTION**

If a demand for international preliminary examination is made, this opinion will be considered to be a written opinion of the International Preliminary Examining Authority ("IPEA") except that this does not apply where the applicant chooses an Authority other than this one to be the IPEA and the chosen IPEA has notified the International Bureau under Rule 66.1bis(b) that written opinions of this International Searching Authority will not be so considered.

If this opinion is, as provided above, considered to be a written opinion of the IPEA, the applicant is invited to submit to the IPEA a written reply together, where appropriate, with amendments, before the expiration of 3 months from the date of mailing of Form PCT/ISA/220 or before the expiration of 22 months from the priority date, whichever expires later.

For further options, see Form PCT/ISA/220.

 Name and mailing address of the ISA/KR Korean Intellectual Property Office 189 Cheongsu-ro, Seo-gu, Daejeon Metropolitan City, 302-701, Republic of Korea Facsimile No. 82-42-472-7140	Date of completion of this opinion 19 JUNE 2012 (19.06.2012)	Authorized officer PARK, JEONG UNG Telephone No.82-42-481-8131	
---	---	--	---

**WRITTEN OPINION OF THE
INTERNATIONAL SEARCHING AUTHORITY**

International application No.

PCT/US2011/051805

Box No. I Basis of this opinion

1. With regard to the **language**, this opinion has been established on the basis of :
 - the international application in the language in which it was filed
 - a translation of the international application into _____, which is the language of a translation furnished for the purposes of international search (Rules 12.3(a) and 23.1(b))
2. This opinion has been established taking into account the **rectification of an obvious mistake** authorized by or notified to this Authority under Rule 91 (Rule 43*bis*.1(a))
3. With regard to any **nucleotide and/or amino acid sequence** disclosed in the international application, this opinion has been established on the basis of:
 - a. a sequence listing filed or furnished
 - on paper
 - in electronic form
 - b. time of filing or furnishing
 - contained in the international application as filed.
 - filed together with the international application in electronic form.
 - furnished subsequently to this Authority for the purposes of search.
4. In addition, in the case that more than one version or copy of a sequence listing has been filed or furnished, the required statements that the information in the subsequent or additional copies is identical to that in the application as filed or does not go beyond the application as filed, as appropriate, were furnished.
5. Additional comments:

WRITTEN OPINION OF THE
INTERNATIONAL SEARCHING AUTHORITY

International application No.
PCT/US2011/051805

Box No. III Non-establishment of opinion with regard to novelty, inventive step and industrial applicability

The questions whether the claimed invention appears to be novel, to involve an inventive step (to be non obvious), or to be industrially applicable have not been examined in respect of:

the entire international application

claims Nos. 12-30,34-53

because:

the said international application, or the said claims Nos. 42-52

relate to the following subject matter which does not require an international search (*specify*):

The subject-matter of claims 42-52 does not require an opinion with respect to industrial applicability, as it is substantially directed to a method for treatment of the human by therapy (Rule 43 bis.1(b), Rule 67.1(iv)).

the description, claims or drawings (*indicate particular elements below*) or said claims Nos. See below are so unclear that no meaningful opinion could be formed (*specify*):

Claims 15,16,18,20,24,27,29-30,35,43-52 are unclear, since they refer to claims which are not searchable due to not being drafted in accordance with the third sentences of PCT Rule 6.4(a).

the claims, or said claims Nos. _____ are so inadequately supported by the description that no meaningful opinion could be formed (*specify*):

no international search report has been established for said claims Nos. 12-30,34-53

a meaningful opinion could not be formed without the sequence listing; the applicant did not, within the prescribed time limit:

furnish a sequence listing on paper complying with the standard provided for in Annex C of the Administrative Instructions, and such listing was not available to the International Searching Authority in a form and manner acceptable to it.

furnish a sequence listing in electronic form complying with the standard provided for in Annex C of the Administrative Instructions, and such listing was not available to the International Searching Authority in a form and manner acceptable to it.

pay the required late furnishing fee for the furnishing of a sequence listing in response to an invitation under Rule 13ter.1(a) or (b).

See Supplemental Box for further details.

**WRITTEN OPINION OF THE
INTERNATIONAL SEARCHING AUTHORITY**

International application No.

PCT/US2011/051805

Box No. V Reasoned statement under Rule 43bis.1(a)(i) with regard to novelty, inventive step or industrial applicability; citations and explanations supporting such statement

1. Statement

Novelty (N)	Claims	2-9	YES
	Claims	1,10,11,31-33	NO
Inventive step (IS)	Claims	NONE	YES
	Claims	1-11,31-33	NO
Industrial applicability (IA)	Claims	1-11,31-33	YES
	Claims	NONE	NO

2. Citations and explanations :

Reference is made to the following documents:

D1: US 2010-0221329 A1 (KUNWAR SHAILUBHAI et al.) 02 September 2010

1. Novelty and Inventive Step

D1 provides novel formulations of guanylate cyclase-C agonists (LGCC agonists) which are optimized for the targeted delivery of the agonist to a specific portion of the gastrointestinal tract, for example, to the small intestines, preferably to the duodenum or jejunum, or to the distal small intestines or the large intestines, preferably the ileum, terminal ileum, or ascending colon.

The subject matter of claims 1, 10, 11, 31-33 consisting of the sequence NDECELCVNVACTGCL (SEQ ID NO: 1, SP-304), NDECELCVNVACTGCL (SEQ ID NO: 8 or 9, partially D-amino acids), or CCEYCCNPACTGC (SEQ ID NO: 56, SP-340) is substantially the same as the known polypeptides in D1. D1 also relates to an oral dosage formulation (or process) of GCC agonists which are optimized for delivery to specific regions of the gastrointestinal tract and are useful for the treatment and prevention of gastrointestinal diseases and disorders (abstract; Tables 1-2; paragraphs [0079], [0120], [0135], [0138], [0156]; Example 3; claims). Therefore, the subject-matter of claims 1, 10, 11, 31-33 is not considered to be novel under PCT Article 33(2).

Since the novelty of claims 1, 10, 11, 31-33 cannot be acknowledged over D1, the inventive step of them cannot be acknowledged, either (PCT Article 33(3)).

The subject matter of claims 2-9 differs from that of the prior art documents in the chromatographic purity of GCC agonist peptides. The control of chromatographic purity is part of standard laboratory technique generally known to the skilled person, who would perform such a control without the use of inventive skill. Therefore, the subject-matter of claims 2-9 meets the requirements of PCT Article 33(2) but lacks an inventive step under PCT Article 33(3).

2. Industrial Applicability

The subject-matter of claims 1-11,31-33 is considered to be industrially applicable under PCT Article 33(4).

**WRITTEN OPINION OF THE
INTERNATIONAL SEARCHING AUTHORITY**

International application No.
PCT/US2011/051805

Box No. VII Certain defects in the international application

The following defects in the form or contents of the international application have been noted:

The scope of claims 12-14,17,19,21-23,25,26,28,34,36-42,53 do not comply with the third sentence of PCT Rule 6.4(a) because multiple dependent claims should not serve as a basis for any other multiple dependent claim.

PATENT COOPERATION TREATY

From the
INTERNATIONAL SEARCHING AUTHORITY

PCT

WRITTEN OPINION OF THE
INTERNATIONAL SEARCHING AUTHORITY
(PCT Rule 43*bis*.1)

To:

see form PCT/ISA/220

Date of mailing
(day/month/year) see form PCT/ISA/210 (second sheet)

Applicant's or agent's file reference
see form PCT/ISA/220

FOR FURTHER ACTION
See paragraph 2 below

International application No.
PCT/US2013/030551

International filing date (day/month/year)
12.03.2013

Priority date (day/month/year)
15.03.2012

International Patent Classification (IPC) or both national classification and IPC
INV. A61K38/10 A61P1/00 A61P1/10

Applicant
SYNERGY PHARMACEUTICALS INC.

1. This opinion contains indications relating to the following items:

- Box No. I Basis of the opinion
- Box No. II Priority
- Box No. III Non-establishment of opinion with regard to novelty, inventive step and industrial applicability
- Box No. IV Lack of unity of invention
- Box No. V Reasoned statement under Rule 43*bis*.1(a)(i) with regard to novelty, inventive step and industrial applicability; citations and explanations supporting such statement
- Box No. VI Certain documents cited
- Box No. VII Certain defects in the international application
- Box No. VIII Certain observations on the international application

2. **FURTHER ACTION**

If a demand for international preliminary examination is made, this opinion will usually be considered to be a written opinion of the International Preliminary Examining Authority ("IPEA") except that this does not apply where the applicant chooses an Authority other than this one to be the IPEA and the chosen IPEA has notified the International Bureau under Rule 66.1*bis*(b) that written opinions of this International Searching Authority will not be so considered.

If this opinion is, as provided above, considered to be a written opinion of the IPEA, the applicant is invited to submit to the IPEA a written reply together, where appropriate, with amendments, before the expiration of 3 months from the date of mailing of Form PCT/ISA/220 or before the expiration of 22 months from the priority date, whichever expires later.

For further options, see Form PCT/ISA/220.

Name and mailing address of the ISA:



European Patent Office
D-80298 Munich
Tel. +49 89 2399 - 0
Fax: +49 89 2399 - 4465

Date of completion of this opinion

see form
PCT/ISA/210

Authorized Officer

Vandenbogaerde, Ann

Telephone No. +49 89 2399-7874



Box No. I Basis of the opinion

1. With regard to the **language**, this opinion has been established on the basis of:
 - the international application in the language in which it was filed
 - a translation of the international application into , which is the language of a translation furnished for the purposes of international search (Rules 12.3(a) and 23.1 (b)).
2. This opinion has been established taking into account the **rectification of an obvious mistake** authorized by or notified to this Authority under Rule 91 (Rule 43bis.1(a))
3. With regard to any **nucleotide and/or amino acid sequence** disclosed in the international application, this opinion has been established on the basis of a sequence listing filed or furnished:
 - a. (means)
 - on paper
 - in electronic form
 - b. (time)
 - in the international application as filed
 - together with the international application in electronic form
 - subsequently to this Authority for the purposes of search
4. In addition, in the case that more than one version or copy of a sequence listing has been filed or furnished, the required statements that the information in the subsequent or additional copies is identical to that in the application as filed or does not go beyond the application as filed, as appropriate, were furnished.
5. Additional comments:

Box No. II Priority

1. The validity of the priority claim has not been considered because the International Searching Authority does not have in its possession a copy of the earlier application whose priority has been claimed or, where required, a translation of that earlier application. This opinion has nevertheless been established on the assumption that the relevant date (Rules 43bis.1 and 64.1) is the claimed priority date.
2. This opinion has been established as if no priority had been claimed due to the fact that the priority claim has been found invalid (Rules 43bis.1 and 64.1). Thus for the purposes of this opinion, the international filing date indicated above is considered to be the relevant date.
3. Additional observations, if necessary:

Box No. V Reasoned statement under Rule 43bis.1(a)(i) with regard to novelty, inventive step or industrial applicability; citations and explanations supporting such statement

1. Statement

Novelty (N)	Yes: Claims	<u>1</u>
	No: Claims	<u>2-42</u>
Inventive step (IS)	Yes: Claims	
	No: Claims	<u>1-42</u>
Industrial applicability (IA)	Yes: Claims	<u>1-42</u>
	No: Claims	

2. Citations and explanations

see separate sheet

Box No. VI Certain documents cited

1. Certain published documents (Rules 43bis.1 and 70.10)

and / or

2. Non-written disclosures (Rules 43bis.1 and 70.9)

see form 210

Re Item V

Reasoned statement with regard to novelty, inventive step or industrial applicability; citations and explanations supporting such statement

Reference is made to the following documents:

- D1 WO 2011/020054 A1 (IRONWOOD PHARMACEUTICALS INC [US]; JOHNSTON JEFFREY [US]; KURTZ CAROLI) 17 February 2011 (2011-02-17)
- D2 WO 2010/065751 A2 (SYNERGY PHARMACEUTICALS INC [US]; SHAILUBHAI KUNWAR [US]; COMISKEY STE) 10 June 2010 (2010-06-10)
- D3 SHAILUBHAI KUNWAR ET AL: "Phase II Clinical Evaluation of SP-304, a Guanylate Cyclase-C Agonist, for Treatment of Chronic Constipation", AMERICAN JOURNAL OF GASTROENTEROLOGY, ELSEVIER SCIENCE INC, US, vol. 105, no. Suppl. 1, 1 October 2010 (2010-10-01), pages S487-S488, XP009152336, ISSN: 0002-9270
- D4 WO 2012/037380 A2 (SYNERGY PHARMACEUTICALS INC [US]; COMISKEY STEPHEN [US]; FENG RONG [US) 22 March 2012 (2012-03-22)
- D1 discloses (cf. claims 162, 168, 170, 186, 204, 205) the treatment of irritable bowel syndrome of constipation using an oral dosage formulation (tablet or capsule) comprising 0.05 mg to 1 mg GCC agonist peptide of SEQ ID No: 10 (identical to SEQ ID No: 56 of the present application) or SEQ ID No: 13 (identical to SEQ ID No: 1 of the present application) together with calcium chloride as cation and leucine as primary amino acid; the formulation is further comprising a binder such as hypromellose (claim 194), a lubricant (claim 195) and/or a filler such as microcrystalline cellulose (claim 197). D1 also discloses (cf. claim 207) said formulation wherein the GCC agonist peptide is linaclotide (SEQ ID No: 14), which is identical to SEQ ID No: 55 of the present application but not claimed by the present application.
 - D2 describes (cf. [221], Fig. 7 (A-F)) that SP-332 (SEQ ID No: 8 corresponding to SEQ ID No: 8 of the present application) and SP-333 (SEQ ID No: 8 corresponding to SEQ ID No: 8 of the present application) are completely or

almost completely resistant to proteolysis after 2h incubation in simulated intestinal fluid (SIF), whereas SP-304 ((SEQ ID No: 1 corresponding to SEQ ID No: 1 of the present application) lost 30% of its potency after 1 h SIF incubation.

- D3 discloses (cf. abstract) that some chronic constipation patients in each cohort receiving oral treatment of 0.3, 1, 3 and 9 mg SP-304 (identical to SEQ ID No: 1 of the present application, = plecanatide) as repeated daily dose during 14 days are experiencing improvement in bowel function.

1 Method of treatment

Claims 36-41 relate to subject-matter considered by this Authority to be covered by the provisions of Rule 39.1(iv) / 67.1(iv) PCT. The patentability can be dependent upon the formulation of the claims. The EPO, for example, does not recognise as patentable claims to the use of a compound in medical treatment, but may allow claims to a product, in particular substances or compositions for use in a further medical treatment.

2 Claim 1: Novelty - Inventive step

- 2.1 The subject-matter of claim 1 relates to an oral dosage formulation comprising 0.01 mg to 10 mg of the GCC agonist peptide of SEQ ID No: 8 or 9 per unit dose.
- 2.2 The subject-matter of claim 1 is novel according to Article 33(2) PCT over the teaching of the cited prior art. However, the subject-matter of claims cannot be considered as involving an inventive step in the sense of Article 33(3) PCT in view of closest prior art document D1 taking into account the alternative GCC agonist peptides of SEQ ID Nos: 8-9 disclosed in D2.

3 Claims 2-25, 26-34, 35, 36-41 and 42: Novelty - Inventive step

- 3.1 The subject-matter of claims 2-25, 26-34, 35, 36-41 and 42 relates to an oral dosage formulation comprising 0.01 mg to 10 mg GCC agonist peptide of SEQ ID Nos: 1-54 or 56-249 per unit dose (claims 2-25, 35, 42), a process of preparing said formulation (claims 26-34), and its medical use in general (claim 36) and in the treatment of gastrointestinal diseases, in particular chronic idiopathic constipation (claims 37-41). The preferred excipients in said formulation are microcrystalline cellulose as inert carrier, magnesium stearate as lubricant, calcium chloride or calcium ascorbate as divalent cation salt, leucine, histidine or arginine as amino acid and hypromellose as coating agent (claims 18-19).
- 3.2 The subject-matter of independent claims 2, 26, 35, 36 and 42 is not novel according to Article 33(2) PCT over the teaching of D1 or D3.

Document D1 discloses (cf. claims 162, 168, 170, 186) the treatment of irritable bowel syndrome of constipation using an oral dosage formulation comprising 0.05 mg to 1 mg of a GCC agonist peptide of SEQ ID No: 10 (identical to SEQ ID No: 56 of application) or SEQ ID No: 13 (identical to SEQ ID No: 1 of application) together with calcium chloride as cation and leucine as primary amino acid; the formulation is further comprising a binder such as hypromellose (claim 194), a lubricant (claim 195) and/or a filler such as microcrystalline cellulose (claim 197).

D3 discloses (cf. abstract) that some chronic constipation patients in each cohort receiving oral treatment of 0.3, 1, 3 and 9 mg SP-304 (identical to SEQ ID No: 1 of the present application, = plecanatide) as repeated daily dose during 14 days are experiencing improvement in bowel function.

- 3.3 Dependent claims 3-25, 37-34, 37-41 do not contain any features which, in combination with the features of any claim to which they refer, meet the requirements of the PCT in respect of novelty and/or inventive step in view of closest prior art document D1. No surprising technical effect can be seen in the use of the excipients.

Re Item VI

Certain documents cited

Application No	Publication date	Filing date	Priority date (<i>valid claim</i>)
Patent No	(<i>day/month/year</i>)	(<i>day/month/year</i>)	(<i>day/month/year</i>)
WO2012/037380	22.03.2012	15.09.2011	15.09.2010

Electronic Acknowledgement Receipt

EFS ID:	21541182
Application Number:	13421769
International Application Number:	
Confirmation Number:	3135
Title of Invention:	Formulations of Guanylate Cyclase C Agonists and Methods of Use
First Named Inventor/Applicant Name:	Stephen Comiskey
Customer Number:	58249
Filer:	Anne Elizabeth Fleckenstein
Filer Authorized By:	
Attorney Docket Number:	40737-509001US
Receipt Date:	19-FEB-2015
Filing Date:	15-MAR-2012
Time Stamp:	19:08:28
Application Type:	Utility under 35 USC 111(a)

Payment information:

Submitted with Payment	no
------------------------	----

File Listing:

Document Number	Document Description	File Name	File Size(Bytes)/ Message Digest	Multi Part /.zip	Pages (if appl.)
1	Non Patent Literature	Samuel_1968.pdf	13633336 <small>13031802a723b3fa1d4b333b66e59728b8b4ff75</small>	no	9

Warnings:

Information:

2	Non Patent Literature	Schulz2005.pdf	19769361	no	12
			6bda5e428c4d42c0697aadeaab2529e50dfeffd3		
Warnings:					
Information:					
3	Non Patent Literature	Sciaky_1995.pdf	5695182	no	3
			66637fc0e531502ee7ea1a30aaaade52cbcc77fd		
Warnings:					
Information:					
4	Non Patent Literature	Sellers-2005.pdf	18776492	no	12
			b0a289a1569307b4233712026986c9f1f5ddcc7e		
Warnings:					
Information:					
5	Non Patent Literature	Shailubhai_2002.pdf	16325246	no	8
			93f93fdc5a7201bf26ca50ae8862661a639f4997		
Warnings:					
Information:					
6	Non Patent Literature	Shailubhai_2007.pdf	1567858	no	1
			a19a2979cf19c3ecfd6977eea5ff89fd951f7d7		
Warnings:					
Information:					
7	Non Patent Literature	Shailubhai_2007b.pdf	370065	no	1
			3ae299e9fa86e534fd2f073137d49a57d4d65842		
Warnings:					
Information:					
8	Non Patent Literature	Shailubhai_2008.pdf	115656	no	1
			110b1d730372846bfb2583d8f0af8b17e624d08		
Warnings:					
Information:					
9	Non Patent Literature	Shailubhai_2008a.pdf	706879	no	2
			bfb3b50c33db7ca4ee31e8ee69cfc0c62adff86cd		
Warnings:					
Information:					
10	Non Patent Literature	Shailubhai_2009.pdf	1776607	no	1
			4f60f1cf73bca291102006233ceaaa12f53a27e5		
Warnings:					
Information:					

11	Non Patent Literature	Shailubhai_2009b.pdf	1266796 90232d457a69f956ea5aecfb63debcc8b5176eae	no	1
Warnings:					
Information:					
12	Non Patent Literature	Shinozaki_2000.pdf	11935907 f3a023688763724426977f9d75271c5803c94ef4	no	6
Warnings:					
Information:					
13	Non Patent Literature	Sindice_2002.pdf	4223857 679ae03de6728a4891ec405fcb2fa7542682eda2	no	8
Warnings:					
Information:					
14	Non Patent Literature	Spranger_2003.pdf	12524468 2cf57e441d7610edd020d13b2e8b9908d3b6015c	no	6
Warnings:					
Information:					
15	Non Patent Literature	St_Johns_Providence_Health_Center.pdf	164775 6c03a9878827f99a82e5141671eb05b0c24ab901	no	2
Warnings:					
Information:					
16	Non Patent Literature	Takada_2000.pdf	2005026 5f4a090b95ab7911895e27fce8ea31b56ed1e308	no	8
Warnings:					
Information:					
17	Non Patent Literature	Talley_1995.pdf	10608554 d8053b396a3960c15a592853212cb1712fd eabf8	no	6
Warnings:					
Information:					
18	Non Patent Literature	Tian_2008.pdf	1550375 f3cbe0d4c96af55eefc799ef29717b0bf5281005	no	12
Warnings:					
Information:					
19	Non Patent Literature	Venkatkrishnan_2000.pdf	3986680 db7936ef5fc47114d7cdd864bac4f854e9637607	no	8
Warnings:					
Information:					

20	Non Patent Literature	Tilg_2008.pdf	19478820	no	10
			ee1f6fb94081903e420dbc4dde4eace0f10167dd		
Warnings:					
Information:					
21	Non Patent Literature	Veronese_2001.pdf	18935774	no	14
			222f193841535a3b1a462ec5ec16f2a51ef794be		
Warnings:					
Information:					
22	Non Patent Literature	Veronese_2005.pdf	16437305	no	8
			1d2d6251b2b8da8a52917f9345a0b4995ffb16b7		
Warnings:					
Information:					
23	Non Patent Literature	Waldman_1998.pdf	15687365	no	10
			c727a30e9cdcd5eaff4497efed257bbad2e48950		
Warnings:					
Information:					
24	Non Patent Literature	Weber_2001.pdf	19540558	no	9
			18a4a28ffbbe6aaf2063542de95e7360aaef8e80		
Warnings:					
Information:					
25	Non Patent Literature	Welsh_1993.pdf	2418237	no	4
			092325a2b25663d64d32a376b8f7540bbcf048de		
Warnings:					
Information:					
26	Non Patent Literature	Whitaker-1997.pdf	10819077	no	7
			8cf759451977154ed70b27ae7fd2effabbe702a2		
Warnings:					
Information:					
27	Non Patent Literature	Wong_1999.pdf	25495652	no	13
			9d502a5f3949252e348aac878331ef925875c4d4		
Warnings:					
Information:					
28	Non Patent Literature	Wong_2002.pdf	11777195	no	6
			b3e1596006fbb835575e152d046609aff2017271		
Warnings:					
Information:					

29	Non Patent Literature	Wu_1997.pdf	4273853 354089935574b371197676a6806fdd15d364e281	no	8
Warnings:					
Information:					
30	Non Patent Literature	Zhang_1997.pdf	12918548 ac2e4a81564c1a7a2e3c72da9e44ac3977430a71	no	6
Warnings:					
Information:					
31	Non Patent Literature	Zimmerman_1977.pdf	24894989 d8a9bd843ca194128871c3524e86937a6372d8f5	no	33
Warnings:					
Information:					
32	Non Patent Literature	Schulz_et_al_Cell_63_941_1990.pdf	2682908 860dfc994cd36a67bc8b9fa68de33f48e3d0116c	no	10
Warnings:					
Information:					
33	Non Patent Literature	Shailubhai_et_al_Am_J_Gastroenterol_105_S487_2010.pdf	3086817 750f9de7f71ff5e83927f64203b9d3a876bd8963	no	4
Warnings:					
Information:					
34	Non Patent Literature	Thomas_et_al_GUT_55_1321_2006.pdf	1807521 ca303db5dd017bd443c14a75d3f656083acfd02d	no	13
Warnings:					
Information:					
35	Non Patent Literature	Vaandrager_Mol_Cell_Biochem_230_73_2002.pdf	2018007 791409654a7d20d9c7fb77564fb797b7d541bcfd	no	13
Warnings:					
Information:					
36	Non Patent Literature	Variyam_GUT_39_521_1996.pdf	6778061 dd8fc25a395049c7f7026a90d0c270eedb922ec8	no	8
Warnings:					
The page size in the PDF is too large. The pages should be 8.5 x 11 or A4. If this PDF is submitted, the pages will be resized upon entry into the Image File Wrapper and may affect subsequent processing					
Information:					
37	Foreign Reference	Written_Opinion_PCT_US2011_051805_Jun_21_2012.pdf	191349 3f02ee92793eb831e21e6034ef0edb327af0ef6c	no	5

Warnings:					
Information:					
38	Foreign Reference	Written_Opinion_PCT_US2013_030551_Jun_18_2013.pdf	245245 c76507919934561c5c39216241295a026db2445c	no	6
Warnings:					
Information:					
39	Non Patent Literature	Veronese_et_a_1999.pdf	9059534 4c27a380c72fd5b827d947dcf9e321118a21a8ab	no	20
Warnings:					
Information:					
Total Files Size (in bytes):			335549935		
<p>This Acknowledgement Receipt evidences receipt on the noted date by the USPTO of the indicated documents, characterized by the applicant, and including page counts, where applicable. It serves as evidence of receipt similar to a Post Card, as described in MPEP 503.</p> <p><u>New Applications Under 35 U.S.C. 111</u> If a new application is being filed and the application includes the necessary components for a filing date (see 37 CFR 1.53(b)-(d) and MPEP 506), a Filing Receipt (37 CFR 1.54) will be issued in due course and the date shown on this Acknowledgement Receipt will establish the filing date of the application.</p> <p><u>National Stage of an International Application under 35 U.S.C. 371</u> If a timely submission to enter the national stage of an international application is compliant with the conditions of 35 U.S.C. 371 and other applicable requirements a Form PCT/DO/EO/903 indicating acceptance of the application as a national stage submission under 35 U.S.C. 371 will be issued in addition to the Filing Receipt, in due course.</p> <p><u>New International Application Filed with the USPTO as a Receiving Office</u> If a new international application is being filed and the international application includes the necessary components for an international filing date (see PCT Article 11 and MPEP 1810), a Notification of the International Application Number and of the International Filing Date (Form PCT/RO/105) will be issued in due course, subject to prescriptions concerning national security, and the date shown on this Acknowledgement Receipt will establish the international filing date of the application.</p>					