

Xaa<sub>16</sub> Gly<sub>17</sub> Cys<sub>18</sub> Xaa<sub>19</sub> Xaa<sub>20</sub> Xaa<sub>21</sub> (II) or Cys Cys Glu Xaa<sub>4</sub> Cys Cys Asn Pro Ala Cys Thr Gly Cys Xaa<sub>14</sub> (SEQ ID NO:XXX) as described herein.

The peptide can be administered in combination with one or more agents for treatment of congestive heart failure, for example, a natriuretic peptide such as atrial natriuretic peptide, brain natriuretic peptide or C-type natriuretic peptide), a diuretic, or an inhibitor of angiotensin converting enzyme.

In a fifteenth aspect, the invention features a method for treating benign prostatic hyperplasia, the method comprising administering to a patient a pharmaceutical composition comprising a purified peptide comprising, consisting of or consisting essentially of the amino acid sequence: Xaa<sub>1</sub> Xaa<sub>2</sub> Xaa<sub>3</sub> Xaa<sub>4</sub> Xaa<sub>5</sub> Cys<sub>6</sub> Cys<sub>7</sub> Xaa<sub>8</sub> Xaa<sub>9</sub> Cys<sub>10</sub> Cys<sub>11</sub> Xaa<sub>12</sub> Xaa<sub>13</sub> Xaa<sub>14</sub> Cys<sub>15</sub> Xaa<sub>16</sub> Xaa<sub>17</sub> Cys<sub>18</sub> Xaa<sub>19</sub> Xaa<sub>20</sub> Xaa<sub>21</sub> (I) or Xaa<sub>1</sub> Xaa<sub>2</sub> Xaa<sub>3</sub> Xaa<sub>4</sub> Xaa<sub>5</sub> Cys<sub>6</sub> Cys<sub>7</sub> Xaa<sub>8</sub> Xaa<sub>9</sub> Cys<sub>10</sub> Cys<sub>11</sub> Asn<sub>12</sub> Pro<sub>13</sub> Ala<sub>14</sub> Cys<sub>15</sub> Xaa<sub>16</sub> Gly<sub>17</sub> Cys<sub>18</sub> Xaa<sub>19</sub> Xaa<sub>20</sub> Xaa<sub>21</sub> (II) or Cys Cys Glu Xaa<sub>4</sub> Cys Cys Asn Pro Ala Cys Thr Gly Cys Xaa<sub>14</sub> (SEQ ID NO:XXX) as described herein. The peptide can be administered alone or in combination with another agent for treatment of BPH, for example, a 5-alpha reductase inhibitor (e.g., finasteride) or an alpha adrenergic inhibitor (e.g., doxazosine).

In a sixteenth aspect, the invention features a method for treating or reducing pain, including visceral pain, pain associated with a gastrointestinal disorder or pain associated with some other disorder, the method comprising administering to a patient a pharmaceutical composition comprising or consisting essentially of a purified peptide comprising, consisting of or consisting essentially of the amino acid sequence: Xaa<sub>1</sub> Xaa<sub>2</sub> Xaa<sub>3</sub> Xaa<sub>4</sub> Xaa<sub>5</sub> Cys<sub>6</sub> Cys<sub>7</sub> Xaa<sub>8</sub> Xaa<sub>9</sub> Cys<sub>10</sub> Cys<sub>11</sub> Xaa<sub>12</sub> Xaa<sub>13</sub> Xaa<sub>14</sub> Cys<sub>15</sub> Xaa<sub>16</sub> Xaa<sub>17</sub> Cys<sub>18</sub> Xaa<sub>19</sub> Xaa<sub>20</sub> Xaa<sub>21</sub> (I) or Xaa<sub>1</sub> Xaa<sub>2</sub> Xaa<sub>3</sub> Xaa<sub>4</sub> Xaa<sub>5</sub> Cys<sub>6</sub> Cys<sub>7</sub> Xaa<sub>8</sub> Xaa<sub>9</sub> Cys<sub>10</sub> Cys<sub>11</sub> Asn<sub>12</sub> Pro<sub>13</sub> Ala<sub>14</sub> Cys<sub>15</sub> Xaa<sub>16</sub> Gly<sub>17</sub> Cys<sub>18</sub> Xaa<sub>19</sub> Xaa<sub>20</sub> Xaa<sub>21</sub> (II) or Cys Cys Glu Xaa<sub>4</sub> Cys Cys Asn Pro Ala Cys Thr Gly Cys Xaa<sub>14</sub> (SEQ ID NO:XXX) as described herein.

In a seventeenth aspect, the invention features a method for treating inflammation, including inflammation of the gastrointestinal tract, e.g., inflammation associated with a gastrointestinal disorder or infection or some other disorder, the method comprising

5 administering to a patient a pharmaceutical composition comprising a purified peptide comprising, consisting of or consisting essentially of the amino acid sequence: Xaa<sub>1</sub> Xaa<sub>2</sub> Xaa<sub>3</sub> Xaa<sub>4</sub> Xaa<sub>5</sub> Cys<sub>6</sub> Cys<sub>7</sub> Xaa<sub>8</sub> Xaa<sub>9</sub> Cys<sub>10</sub> Cys<sub>11</sub> Xaa<sub>12</sub> Xaa<sub>13</sub> Xaa<sub>14</sub> Cys<sub>15</sub> Xaa<sub>16</sub> Xaa<sub>17</sub> Cys<sub>18</sub> Xaa<sub>19</sub> Xaa<sub>20</sub> Xaa<sub>21</sub> (I) or Xaa<sub>1</sub> Xaa<sub>2</sub> Xaa<sub>3</sub> Xaa<sub>4</sub> Xaa<sub>5</sub> Cys<sub>6</sub> Cys<sub>7</sub> Xaa<sub>8</sub> Xaa<sub>9</sub> Cys<sub>10</sub> Cys<sub>11</sub> Asn<sub>12</sub> Pro<sub>13</sub> Ala<sub>14</sub> Cys<sub>15</sub> Xaa<sub>16</sub> Gly<sub>17</sub> Cys<sub>18</sub> Xaa<sub>19</sub> Xaa<sub>20</sub> Xaa<sub>21</sub> (II) or Cys Cys Glu

10 Xaa<sub>4</sub> Cys Cys Asn Pro Ala Cys Thr Gly Cys Xaa<sub>14</sub> (SEQ ID NO:XXX) as described herein.

In an eighteenth aspect, the invention features a method for treating congestive heart failure, the method comprising administering a complete or partial agonist of the

15 intestinal guanylate cyclase (GC-C) receptor. Thus, the invention features a method for treating congestive heart failure, the method comprising administering to a patient a pharmaceutical composition comprising a purified peptide comprising, consisting of or consisting essentially of the amino acid sequence: Xaa<sub>1</sub> Xaa<sub>2</sub> Xaa<sub>3</sub> Xaa<sub>4</sub> Xaa<sub>5</sub> Cys<sub>6</sub> Cys<sub>7</sub> Xaa<sub>8</sub> Xaa<sub>9</sub> Cys<sub>10</sub> Cys<sub>11</sub> Xaa<sub>12</sub> Xaa<sub>13</sub> Xaa<sub>14</sub> Cys<sub>15</sub> Xaa<sub>16</sub> Xaa<sub>17</sub> Cys<sub>18</sub> Xaa<sub>19</sub> Xaa<sub>20</sub> Xaa<sub>21</sub> (I)

20 or Xaa<sub>1</sub> Xaa<sub>2</sub> Xaa<sub>3</sub> Xaa<sub>4</sub> Xaa<sub>5</sub> Cys<sub>6</sub> Cys<sub>7</sub> Xaa<sub>8</sub> Xaa<sub>9</sub> Cys<sub>10</sub> Cys<sub>11</sub> Asn<sub>12</sub> Pro<sub>13</sub> Ala<sub>14</sub> Cys<sub>15</sub> Xaa<sub>16</sub> Gly<sub>17</sub> Cys<sub>18</sub> Xaa<sub>19</sub> Xaa<sub>20</sub> Xaa<sub>21</sub> (II) or Cys Cys Glu Xaa<sub>4</sub> Cys Cys Asn Pro Ala Cys Thr Gly Cys Xaa<sub>14</sub> (SEQ ID NO:XXX) as described herein. The agonist/peptide can be administered alone or in combination with another agent for treatment of congestive heart failure, for example, a natriuretic peptide such as atrial natriuretic peptide, brain

25 natriuretic peptide or C-type natriuretic peptide, a diuretic, or an inhibitor of angiotensin converting enzyme. In various embodiments the congestive heart failure is categorized as Class II congestive heart failure; the congestive heart failure is categorized as Class III congestive heart failure; and the congestive heart failure is categorized as Class IV congestive heart failure. The New York Heart Association (NYHA) functional



classification system relates congestive heart failure symptoms to everyday activities and the patient's quality of life. The NYHA defines the classes of patient symptoms relating to congestive heart failure as: Class II-slight limitation of physical activity, comfortable at rest, but ordinary physical activity results in fatigue, palpitation, or dyspnea; Class III-  
5 marked limitation of physical activity, comfortable at rest, but less than ordinary activity causes fatigue, palpitation, or dyspnea and Class IV- unable to carry out any physical activity without discomfort, symptoms of cardiac insufficiency at rest, if any physical activity is undertaken, discomfort is increased. Heart failure treatment using the polypeptides and methods described herein can also be classified according to the  
10 ACC/AHA guidelines (Stage A: At risk for developing heart failure without evidence of cardiac dysfunction; Stage B: Evidence of cardiac dysfunction without symptoms; Stage C: Evidence of cardiac dysfunction with symptoms; and Stage D: Symptoms of heart failure despite maximal therapy).

15 In a nineteenth aspect, the invention features a method for treating BPH, the method comprising administering a complete or partial agonist of the intestinal guanylate cyclase (GC-C) receptor. The agonist can be administered alone or in combination with another agent for treatment of BPH, for example, a 5-alpha reductase inhibitor (e.g., finasteride) or an alpha adrenergic inhibitor (e.g., doxazosine).

20 In a twentieth aspect, the invention features isolated nucleic acid molecules comprising a sequence encoding a peptide described herein. Also within the invention are vectors, e.g., expression vectors that include such nucleic acid molecules and can be used to express a peptide described herein in a cultured cell (e.g., a eukaryotic cell or a  
25 prokaryotic cell). The vector can further include one or more regulatory elements, e.g., a heterologous promoter or elements required for translation operably linked to the sequence encoding the peptide. In some cases the nucleic acid molecule will encode an amino acid sequence that includes the amino acid sequence of a peptide described herein. For example, the nucleic acid molecule can encode a preprotein or a preproprotein that

can be processed to produce a peptide described herein. In cases where unnatural amino acids are present in the polypeptides described herein, selector codons can be utilized in the synthesis of such polypeptides similar to that described in US20060019347 (for example, paragraphs 398-408, 457-499, and 576-588) herein incorporated by reference.

5

A vector that includes a nucleotide sequence encoding a peptide described herein or a peptide or polypeptide comprising a peptide described herein may be either RNA or DNA, single- or double-stranded, prokaryotic, eukaryotic, or viral. Vectors can include transposons, viral vectors, episomes, (e.g., plasmids), chromosomes inserts, and artificial  
10 chromosomes (e.g. BACs or YACs). Suitable bacterial hosts for expression of the encode peptide or polypeptide include, but are not limited to, *E. coli*. Suitable eukaryotic hosts include yeast such as *S. cerevisiae*, other fungi, vertebrate cells, invertebrate cells (e.g., insect cells), plant cells, human cells, human tissue cells, and whole eukaryotic organisms. (e.g., a transgenic plant or a transgenic animal). Further, the vector nucleic  
15 acid can be used to transfect a virus such as vaccinia or baculovirus (for example using the Bac-to-Bac® Baculovirus expression system (Invitrogen Life Technologies, Carlsbad, CA)).

As noted above the invention includes vectors and genetic constructs suitable for  
20 production of a peptide described herein or a peptide or polypeptide comprising such a peptide. Generally, the genetic construct also includes, in addition to the encoding nucleic acid molecule, elements that allow expression, such as a promoter and regulatory sequences. The expression vectors may contain transcriptional control sequences that control transcriptional initiation, such as promoter, enhancer, operator, and repressor  
25 sequences. A variety of transcriptional control sequences are well known to those in the art and may be functional in, but are not limited to, a bacterium, yeast, plant, or animal cell. The expression vector can also include a translation regulatory sequence (e.g., an untranslated 5' sequence, an untranslated 3' sequence, a poly A addition site, or an internal ribosome entry site), a splicing sequence or splicing regulatory sequence, and a

transcription termination sequence. The vector can be capable of autonomous replication or it can integrate into host DNA.

The invention also includes isolated host cells harboring one of the forgoing nucleic acid molecules and methods for producing a peptide by culturing such a cell and recovering the peptide or a precursor of the peptide. Recovery of the peptide or precursor may refer to collecting the growth solution and need not involve additional steps of purification. Proteins of the present invention, however, can be purified using standard purification techniques, such as, but not limited to, affinity chromatography, thermoprecipitation, immunoaffinity chromatography, ammonium sulfate precipitation, ion exchange chromatography, filtration, electrophoresis and hydrophobic interaction chromatography.

The peptides can be purified. Purified peptides are peptides separated from other proteins, lipids, and nucleic acids or from the compounds from which is it synthesized. The polypeptide can constitute at least 10, 20, 50 70, 80 or 95% by dry weight of the purified preparation.

In a twenty-first aspect, the invention features a method of increasing the level of cyclic guanosine 3'-monophosphate (cGMP) in an organ, tissue (e.g, the intestinal mucosa), or cell (e.g., a cell bearing GC-A receptor) by administering to a patient a composition comprising or consisting essentially of a purified peptide comprising, consisting of or consisting essentially of the amino acid sequence: Xaa<sub>1</sub> Xaa<sub>2</sub> Xaa<sub>3</sub> Xaa<sub>4</sub> Xaa<sub>5</sub> Cys<sub>6</sub> Cys<sub>7</sub> Xaa<sub>8</sub> Xaa<sub>9</sub> Cys<sub>10</sub> Cys<sub>11</sub> Xaa<sub>12</sub> Xaa<sub>13</sub> Xaa<sub>14</sub> Cys<sub>15</sub> Xaa<sub>16</sub> Xaa<sub>17</sub> Cys<sub>18</sub> Xaa<sub>19</sub> Xaa<sub>20</sub> Xaa<sub>21</sub> (I) or Xaa<sub>1</sub> Xaa<sub>2</sub> Xaa<sub>3</sub> Xaa<sub>4</sub> Xaa<sub>5</sub> Cys<sub>6</sub> Cys<sub>7</sub> Xaa<sub>8</sub> Xaa<sub>9</sub> Cys<sub>10</sub> Cys<sub>11</sub> Asn<sub>12</sub> Pro<sub>13</sub> Ala<sub>14</sub> Cys<sub>15</sub> Xaa<sub>16</sub> Gly<sub>17</sub> Cys<sub>18</sub> Xaa<sub>19</sub> Xaa<sub>20</sub> Xaa<sub>21</sub> (II) or Cys Cys Glu Xaa<sub>4</sub> Cys Cys Asn Pro Ala Cys Thr Gly Cys Xaa<sub>14</sub> (SEQ ID NO:XXX) as described herein.

In a twenty-second aspect, the invention features polypeptides comprising, consisting or consisting essentially of the amino acid sequence Xaa<sub>1</sub> Xaa<sub>2</sub> Xaa<sub>3</sub> Xaa<sub>4</sub> Xaa<sub>5</sub> Cys<sub>6</sub> Cys<sub>7</sub>

Xaa<sub>8</sub> Xaa<sub>9</sub> Cys<sub>10</sub> Cys<sub>11</sub> Xaa<sub>12</sub> Xaa<sub>13</sub> Xaa<sub>14</sub> Cys<sub>15</sub> Xaa<sub>16</sub> Xaa<sub>17</sub> Cys<sub>18</sub> Xaa<sub>19</sub> Xaa<sub>20</sub> Xaa<sub>21</sub>  
wherein: a) Xaa<sub>8</sub> or Xaa<sub>9</sub> is not present; b) neither Xaa<sub>8</sub> or Xaa<sub>9</sub> is present; c) one of  
Xaa<sub>12</sub>, Xaa<sub>13</sub> and Xaa<sub>14</sub> is not present; d) two of Xaa<sub>12</sub>, Xaa<sub>13</sub> and Xaa<sub>14</sub> are not present; e)  
three of Xaa<sub>12</sub>, Xaa<sub>13</sub> and Xaa<sub>14</sub> are not present; f) one of Xaa<sub>16</sub> and Xaa<sub>17</sub> is not present;  
5 g) neither Xaa<sub>16</sub> or Xaa<sub>17</sub> is present and combinations thereof. In various embodiments,  
one, two, three, four or five of Xaa<sub>1</sub> Xaa<sub>2</sub> Xaa<sub>3</sub> Xaa<sub>4</sub> and Xaa<sub>5</sub> are not present. In other  
embodiments, one, two or three of Xaa<sub>19</sub> Xaa<sub>20</sub> and Xaa<sub>21</sub> are missing.

In twenty third aspect, the invention features a method for treating a disorder ameliorated  
10 by increasing cGMP levels, the method comprising administering a pharmaceutical  
composition comprising, consisting essentially of or consisting of a peptide or agonist  
described herein and a pharmaceutically acceptable carrier.

In a twenty-fourth aspect, the invention features a method for treating hypertension. The  
15 method comprises: administering to the patient a pharmaceutical composition  
comprising, consisting essentially of, or consisting of a peptide or agonist described  
herein and a pharmaceutically acceptable carrier. The composition can be administered  
in combination with another agent for treatment of hypertension, for example, a diuretic,  
an ACE inhibitor, an angiotensin receptor blocker, a beta-blocker, or a calcium channel  
20 blocker.

In a twenty-fifth aspect, the invention features a method for treating secondary  
hyperglycemias in connection with pancreatic diseases (chronic pancreatitis,  
pancreasectomy, hemochromatosis) or endocrine diseases (acromegaly, Cushing's  
25 syndrome, pheochromocytoma or hyperthyreosis), drug-induced hyperglycemias  
(benzothiadiazine saluretics, diazoxide or glucocorticoids), pathologic glucose tolerance,  
hyperglycemias, dyslipoproteinemias, adiposity, hyperlipoproteinemias and/or  
hypotensions is described. The method comprises: administering to the patient a

pharmaceutical composition comprising, consisting essentially of, or consisting of a peptide or agonist described herein and a pharmaceutically acceptable carrier.

In a twenty-sixth aspect, the invention features a method for decreasing  
 5 gastrointestinal pain or visceral pain in a patient, the method comprising: administering to the patient a pharmaceutical composition comprising, consisting essentially of, or consisting of SEQ ID NO. 3 (or another peptide described herein) and a pharmaceutically acceptable carrier

10 Among the useful peptides are peptides comprising, consisting of or consisting essentially of the amino acid sequence Xaa<sub>1</sub> Xaa<sub>2</sub> Xaa<sub>3</sub> Xaa<sub>4</sub> Xaa<sub>5</sub> Cys Cys Glu Xaa<sub>9</sub> Cys Cys Asn Pro Ala Cys Thr Gly Cys Tyr Xaa<sub>20</sub> Xaa<sub>21</sub> (II) (SEQ ID NO:---) are the following peptides:

Gln Ser Ser Asn Tyr Cys Cys Glu Tyr Cys Cys Asn Pro Ala Cys Thr Gly Cys Tyr (SEQ ID NO:---)

15 Asn Thr Ser Asn Tyr Cys Cys Glu Tyr Cys Cys Asn Pro Ala Cys Thr Gly Cys Tyr (SEQ ID NO:---)  
 )

Asn Leu Ser Asn Tyr Cys Cys Glu Tyr Cys Cys Asn Pro Ala Cys Thr Gly Cys Tyr (SEQ ID NO:---)  
 )

Asn Ile Ser Asn Tyr Cys Cys Glu Tyr Cys Cys Asn Pro Ala Cys Thr Gly Cys Tyr (SEQ ID NO:---)

20 Asn Ser Ser Gln Tyr Cys Cys Glu Tyr Cys Cys Asn Pro Ala Cys Thr Gly Cys Tyr (SEQ ID NO:---)  
 Ser Ser Asn Tyr Cys Cys Glu Tyr Cys Cys Asn Pro Ala Cys Thr Gly Cys Tyr (SEQ ID NO:---)

Gln Ser Ser Gln Tyr Cys Cys Glu Tyr Cys Cys Asn Pro Ala Cys Thr Gly Cys Tyr (SEQ ID NO:---)

Ser Ser Gln Tyr Cys Cys Glu Tyr Cys Cys Asn Pro Ala Cys Thr Gly Cys Tyr (SEQ ID NO:---).

Asn Ser Ser Asn Tyr Cys Cys Glu Ala Cys Cys Asn Pro Ala Cys Thr Gly Cys Tyr (SEQ ID NO:

25 )

Asn Ser Ser Asn Tyr Cys Cys Glu Arg Cys Cys Asn Pro Ala Cys Thr Gly Cys Tyr (SEQ ID NO: )

Asn Ser Ser Asn Tyr Cys Cys Glu Asn Cys Cys Asn Pro Ala Cys Thr Gly Cys Tyr (SEQ ID NO: )

Asn Ser Ser Asn Tyr Cys Cys Glu Asp Cys Cys Asn Pro Ala Cys Thr Gly Cys Tyr (SEQ ID NO: )

Asn Ser Ser Asn Tyr Cys Cys Glu Cys Cys Cys Asn Pro Ala Cys Thr Gly Cys Tyr (SEQ ID NO: )

Asn Ser Ser Asn Tyr Cys Cys Glu Gln Cys Cys Asn Pro Ala Cys Thr Gly Cys Tyr (SEQ ID NO: )  
 Asn Ser Ser Asn Tyr Cys Cys Glu Glu Cys Cys Asn Pro Ala Cys Thr Gly Cys Tyr (SEQ ID NO: )  
 Asn Ser Ser Asn Tyr Cys Cys Glu Gly Cys Cys Asn Pro Ala Cys Thr Gly Cys Tyr (SEQ ID NO: )  
 Asn Ser Ser Asn Tyr Cys Cys Glu His Cys Cys Asn Pro Ala Cys Thr Gly Cys Tyr (SEQ ID NO: )  
 5 Asn Ser Ser Asn Tyr Cys Cys Glu Ile Cys Cys Asn Pro Ala Cys Thr Gly Cys Tyr (SEQ ID NO: )  
 Asn Ser Ser Asn Tyr Cys Cys Glu Lys Cys Cys Asn Pro Ala Cys Thr Gly Cys Tyr (SEQ ID NO: )  
 Asn Ser Ser Asn Tyr Cys Cys Glu Met Cys Cys Asn Pro Ala Cys Thr Gly Cys Tyr (SEQ ID NO: )  
 Asn Ser Ser Asn Tyr Cys Cys Glu Phe Cys Cys Asn Pro Ala Cys Thr Gly Cys Tyr (SEQ ID NO: )  
 Asn Ser Ser Asn Tyr Cys Cys Glu Pro Cys Cys Asn Pro Ala Cys Thr Gly Cys Tyr (SEQ ID NO: )  
 10 Asn Ser Ser Asn Tyr Cys Cys Glu Ser Cys Cys Asn Pro Ala Cys Thr Gly Cys Tyr (SEQ ID NO: )  
 Asn Ser Ser Asn Tyr Cys Cys Glu Thr Cys Cys Asn Pro Ala Cys Thr Gly Cys Tyr (SEQ ID NO: )  
 Asn Ser Ser Asn Tyr Cys Cys Glu Trp Cys Cys Asn Pro Ala Cys Thr Gly Cys Tyr (SEQ ID NO: )  
 Asn Ser Ser Asn Tyr Cys Cys Glu Val Cys Cys Asn Pro Ala Cys Thr Gly Cys Tyr (SEQ ID NO: )  
 Cys Cys Glu Ala Cys Cys Asn Pro Ala Cys Thr Gly Cys Tyr (SEQ ID NO: )  
 15 Cys Cys Glu Arg Cys Cys Asn Pro Ala Cys Thr Gly Cys Tyr (SEQ ID NO: )  
 Cys Cys Glu Asn Cys Cys Asn Pro Ala Cys Thr Gly Cys Tyr (SEQ ID NO: )  
 Cys Cys Glu Asp Cys Cys Asn Pro Ala Cys Thr Gly Cys Tyr (SEQ ID NO: )  
 Cys Cys Glu Cys Cys Cys Asn Pro Ala Cys Thr Gly Cys Tyr (SEQ ID NO: )  
 Cys Cys Glu Gln Cys Cys Asn Pro Ala Cys Thr Gly Cys Tyr (SEQ ID NO: )  
 20 Cys Cys Glu Glu Cys Cys Asn Pro Ala Cys Thr Gly Cys Tyr (SEQ ID NO: )  
 Cys Cys Glu Gly Cys Cys Asn Pro Ala Cys Thr Gly Cys Tyr (SEQ ID NO: )  
 Cys Cys Glu His Cys Cys Asn Pro Ala Cys Thr Gly Cys Tyr (SEQ ID NO: )  
 Cys Cys Glu Ile Cys Cys Asn Pro Ala Cys Thr Gly Cys Tyr (SEQ ID NO: )  
 Cys Cys Glu Lys Cys Cys Asn Pro Ala Cys Thr Gly Cys Tyr (SEQ ID NO: )  
 25 Cys Cys Glu Met Cys Cys Asn Pro Ala Cys Thr Gly Cys Tyr (SEQ ID NO: )  
 Cys Cys Glu Phe Cys Cys Asn Pro Ala Cys Thr Gly Cys Tyr (SEQ ID NO: )  
 Cys Cys Glu Pro Cys Cys Asn Pro Ala Cys Thr Gly Cys Tyr (SEQ ID NO: )  
 Cys Cys Glu Ser Cys Cys Asn Pro Ala Cys Thr Gly Cys Tyr (SEQ ID NO: )  
 Cys Cys Glu Thr Cys Cys Asn Pro Ala Cys Thr Gly Cys Tyr (SEQ ID NO: )

- Cys Cys Glu Trp Cys Cys Asn Pro Ala Cys Thr Gly Cys Tyr (SEQ ID NO: )
- Cys Cys Glu Val Cys Cys Asn Pro Ala Cys Thr Gly Cys Tyr (SEQ ID NO: )
- Cys Cys Glu Tyr Cys Cys Asn Pro Ala Cys Thr Gly Cys (SEQ ID NO:6 )
- Cys Cys Glu Ala Cys Cys Asn Pro Ala Cys Thr Gly Cys (SEQ ID NO: )
- 5 Cys Cys Glu Arg Cys Cys Asn Pro Ala Cys Thr Gly Cys (SEQ ID NO: )
- Cys Cys Glu Asn Cys Cys Asn Pro Ala Cys Thr Gly Cys (SEQ ID NO: )
- Cys Cys Glu Asp Cys Cys Asn Pro Ala Cys Thr Gly Cys (SEQ ID NO: )
- Cys Cys Glu Cys Cys Cys Asn Pro Ala Cys Thr Gly Cys (SEQ ID NO: )
- Cys Cys Glu Gln Cys Cys Asn Pro Ala Cys Thr Gly Cys (SEQ ID NO: )
- 10 Cys Cys Glu Glu Cys Cys Asn Pro Ala Cys Thr Gly Cys (SEQ ID NO: )
- Cys Cys Glu Gly Cys Cys Asn Pro Ala Cys Thr Gly Cys (SEQ ID NO: )
- Cys Cys Glu His Cys Cys Asn Pro Ala Cys Thr Gly Cys (SEQ ID NO: )
- Cys Cys Glu Ile Cys Cys Asn Pro Ala Cys Thr Gly Cys (SEQ ID NO: )
- Cys Cys Glu Lys Cys Cys Asn Pro Ala Cys Thr Gly Cys (SEQ ID NO: )
- 15 Cys Cys Glu Met Cys Cys Asn Pro Ala Cys Thr Gly Cys (SEQ ID NO: )
- Cys Cys Glu Phe Cys Cys Asn Pro Ala Cys Thr Gly Cys (SEQ ID NO: )
- Cys Cys Glu Pro Cys Cys Asn Pro Ala Cys Thr Gly Cys (SEQ ID NO: )
- Cys Cys Glu Ser Cys Cys Asn Pro Ala Cys Thr Gly Cys (SEQ ID NO: )
- Cys Cys Glu Thr Cys Cys Asn Pro Ala Cys Thr Gly Cys; (SEQ ID NO: )
- 20 Cys Cys Glu Trp Cys Cys Asn Pro Ala Cys Thr Gly Cys (SEQ ID NO: )
- Cys Cys Glu Val Cys Cys Asn Pro Ala Cys Thr Gly Cys (SEQ ID NO: ).

Also useful are peptides comprising, consisting of or consisting essentially of any of the following sequences:

- 25 Cys Cys Glu Leu Cys Cys Ala Pro Ala Cys Thr Gly Cys Tyr
- Cys Cys Glu Leu Cys Cys Val Pro Ala Cys Thr Gly Cys Tyr
- Cys Cys Glu Leu Cys Cys Leu Pro Ala Cys Thr Gly Cys Tyr
- Cys Cys Glu Leu Cys Cys Ile Pro Ala Cys Thr Gly Cys Tyr
- Cys Cys Glu Leu Cys Cys Pro Pro Ala Cys Thr Gly Cys Tyr

Cys Cys Glu Leu Cys Cys Met Pro Ala Cys Thr Gly Cys Tyr  
Cys Cys Glu Leu Cys Cys Phe Pro Ala Cys Thr Gly Cys Tyr  
Cys Cys Glu Leu Cys Cys Trp Pro Ala Cys Thr Gly Cys Tyr  
Cys Cys Glu Leu Cys Cys Gly Pro Ala Cys Thr Gly Cys Tyr  
5 Cys Cys Glu Leu Cys Cys Ser Pro Ala Cys Thr Gly Cys Tyr  
Cys Cys Glu Leu Cys Cys Thr Pro Ala Cys Thr Gly Cys Tyr  
Cys Cys Glu Leu Cys Cys Cys Pro Ala Cys Thr Gly Cys Tyr  
Cys Cys Glu Leu Cys Cys Gln Pro Ala Cys Thr Gly Cys Tyr  
Cys Cys Glu Leu Cys Cys Tyr Pro Ala Cys Thr Gly Cys Tyr  
10 Cys Cys Glu Leu Cys Cys Asp Pro Ala Cys Thr Gly Cys Tyr  
Cys Cys Glu Leu Cys Cys Glu Pro Ala Cys Thr Gly Cys Tyr  
Cys Cys Glu Leu Cys Cys Lys Pro Ala Cys Thr Gly Cys Tyr  
Cys Cys Glu Leu Cys Cys Arg Pro Ala Cys Thr Gly Cys Tyr  
Cys Cys Glu Leu Cys Cys His Pro Ala Cys Thr Gly Cys Tyr  
15 Cys Cys Glu Tyr Cys Cys Ala Pro Ala Cys Thr Gly Cys Tyr  
Cys Cys Glu Tyr Cys Cys Val Pro Ala Cys Thr Gly Cys Tyr  
Cys Cys Glu Tyr Cys Cys Leu Pro Ala Cys Thr Gly Cys Tyr  
Cys Cys Glu Tyr Cys Cys Ile Pro Ala Cys Thr Gly Cys Tyr  
Cys Cys Glu Tyr Cys Cys Pro Pro Ala Cys Thr Gly Cys Tyr  
20 Cys Cys Glu Tyr Cys Cys Met Pro Ala Cys Thr Gly Cys Tyr  
Cys Cys Glu Tyr Cys Cys Phe Pro Ala Cys Thr Gly Cys Tyr  
Cys Cys Glu Tyr Cys Cys Trp Pro Ala Cys Thr Gly Cys Tyr  
Cys Cys Glu Tyr Cys Cys Gly Pro Ala Cys Thr Gly Cys Tyr  
Cys Cys Glu Tyr Cys Cys Ser Pro Ala Cys Thr Gly Cys Tyr  
25 Cys Cys Glu Tyr Cys Cys Thr Pro Ala Cys Thr Gly Cys Tyr  
Cys Cys Glu Tyr Cys Cys Cys Pro Ala Cys Thr Gly Cys Tyr  
Cys Cys Glu Tyr Cys Cys Gln Pro Ala Cys Thr Gly Cys Tyr  
Cys Cys Glu Tyr Cys Cys Tyr Pro Ala Cys Thr Gly Cys Tyr  
Cys Cys Glu Tyr Cys Cys Asp Pro Ala Cys Thr Gly Cys Tyr



Cys Cys Glu Tyr Cys Cys Glu Pro Ala Cys Thr Gly Cys Tyr  
Cys Cys Glu Tyr Cys Cys Lys Pro Ala Cys Thr Gly Cys Tyr  
Cys Cys Glu Tyr Cys Cys Arg Pro Ala Cys Thr Gly Cys Tyr  
Cys Cys Glu Tyr Cys Cys His Pro Ala Cys Thr Gly Cys Tyr  
5 Cys Cys Glu Leu Cys Cys Ala Pro Ala Cys Thr Gly Cys  
Cys Cys Glu Leu Cys Cys Val Pro Ala Cys Thr Gly Cys  
Cys Cys Glu Leu Cys Cys Leu Pro Ala Cys Thr Gly Cys  
Cys Cys Glu Leu Cys Cys Ile Pro Ala Cys Thr Gly Cys  
Cys Cys Glu Leu Cys Cys Pro Pro Ala Cys Thr Gly Cys  
10 Cys Cys Glu Leu Cys Cys Met Pro Ala Cys Thr Gly Cys  
Cys Cys Glu Leu Cys Cys Phe Pro Ala Cys Thr Gly Cys  
Cys Cys Glu Leu Cys Cys Trp Pro Ala Cys Thr Gly Cys  
Cys Cys Glu Leu Cys Cys Gly Pro Ala Cys Thr Gly Cys  
Cys Cys Glu Leu Cys Cys Ser Pro Ala Cys Thr Gly Cys  
15 Cys Cys Glu Leu Cys Cys Thr Pro Ala Cys Thr Gly Cys  
Cys Cys Glu Leu Cys Cys Cys Pro Ala Cys Thr Gly Cys  
Cys Cys Glu Leu Cys Cys Gln Pro Ala Cys Thr Gly Cys  
Cys Cys Glu Leu Cys Cys Tyr Pro Ala Cys Thr Gly Cys  
Cys Cys Glu Leu Cys Cys Asp Pro Ala Cys Thr Gly Cys  
20 Cys Cys Glu Leu Cys Cys Glu Pro Ala Cys Thr Gly Cys  
Cys Cys Glu Leu Cys Cys Lys Pro Ala Cys Thr Gly Cys  
Cys Cys Glu Leu Cys Cys Arg Pro Ala Cys Thr Gly Cys  
Cys Cys Glu Leu Cys Cys His Pro Ala Cys Thr Gly Cys  
Cys Cys Glu Tyr Cys Cys Ala Pro Ala Cys Thr Gly Cys  
25 Cys Cys Glu Tyr Cys Cys Val Pro Ala Cys Thr Gly Cys  
Cys Cys Glu Tyr Cys Cys Leu Pro Ala Cys Thr Gly Cys  
Cys Cys Glu Tyr Cys Cys Ile Pro Ala Cys Thr Gly Cys  
Cys Cys Glu Tyr Cys Cys Pro Pro Ala Cys Thr Gly Cys  
Cys Cys Glu Tyr Cys Cys Met Pro Ala Cys Thr Gly Cys

Cys Cys Glu Tyr Cys Cys Phe Pro Ala Cys Thr Gly Cys  
Cys Cys Glu Tyr Cys Cys Trp Pro Ala Cys Thr Gly Cys  
Cys Cys Glu Tyr Cys Cys Gly Pro Ala Cys Thr Gly Cys  
Cys Cys Glu Tyr Cys Cys Ser Pro Ala Cys Thr Gly Cys  
5 Cys Cys Glu Tyr Cys Cys Thr Pro Ala Cys Thr Gly Cys  
Cys Cys Glu Tyr Cys Cys Cys Pro Ala Cys Thr Gly Cys  
Cys Cys Glu Tyr Cys Cys Gln Pro Ala Cys Thr Gly Cys  
Cys Cys Glu Tyr Cys Cys Tyr Pro Ala Cys Thr Gly Cys  
Cys Cys Glu Tyr Cys Cys Asp Pro Ala Cys Thr Gly Cys  
10 Cys Cys Glu Tyr Cys Cys Glu Pro Ala Cys Thr Gly Cys  
Cys Cys Glu Tyr Cys Cys Lys Pro Ala Cys Thr Gly Cys  
Cys Cys Glu Tyr Cys Cys Arg Pro Ala Cys Thr Gly Cys  
Cys Cys Glu Tyr Cys Cys His Pro Ala Cys Thr Gly Cys  
Cys Cys Glu Leu Cys Cys Asn Pro Thr Cys Thr Gly Cys Tyr  
15 Cys Cys Glu Tyr Cys Cys Asn Pro Thr Cys Thr Gly Cys Tyr  
Cys Cys Glu Leu Cys Cys Asn Pro Thr Cys Thr Gly Cys  
Cys Cys Glu Tyr Cys Cys Asn Pro Thr Cys Thr Gly Cys  
Cys Cys Glu Phe Cys Cys Asn Pro Thr Cys Thr Gly Cys Tyr  
Cys Cys Glu Phe Cys Cys Asn Pro Thr Cys Thr Gly Cys  
20 Cys Cys Glu Trp Cys Cys Asn Pro Thr Cys Thr Gly Cys Tyr  
Cys Cys Glu Trp Cys Cys Asn Pro Thr Cys Thr Gly Cys  
Cys Cys Glu Leu Cys Cys Asn Gly Ala Cys Thr Gly Cys Tyr  
Cys Cys Glu Tyr Cys Cys Asn Gly Ala Cys Thr Gly Cys Tyr  
Cys Cys Glu Leu Cys Cys Asn Gly Ala Cys Thr Gly Cys  
25 Cys Cys Glu Tyr Cys Cys Asn Gly Ala Cys Thr Gly Cys  
Cys Cys Glu Phe Cys Cys Asn Gly Ala Cys Thr Gly Cys Tyr  
Cys Cys Glu Phe Cys Cys Asn Gly Ala Cys Thr Gly Cys  
Cys Cys Glu Trp Cys Cys Asn Gly Ala Cys Thr Gly Cys Tyr  
Cys Cys Glu Trp Cys Cys Asn Gly Ala Cys Thr Gly Cys

Cys Cys Glu Leu Cys Cys Asn Pro Ala Cys Val Gly Cys Tyr  
Cys Cys Glu Tyr Cys Cys Asn Pro Ala Cys Val Gly Cys Tyr  
Cys Cys Glu Leu Cys Cys Asn Pro Ala Cys Val Gly Cys  
Cys Cys Glu Tyr Cys Cys Asn Pro Ala Cys Val Gly Cys  
5 Cys Cys Glu Phe Cys Cys Asn Pro Ala Cys Val Gly Cys Tyr  
Cys Cys Glu Phe Cys Cys Asn Pro Ala Cys Val Gly Cys  
Cys Cys Glu Trp Cys Cys Asn Pro Ala Cys Val Gly Cys Tyr  
Cys Cys Glu Trp Cys Cys Asn Pro Ala Cys Val Gly Cys  
Cys Cys Glu Leu Cys Cys Asn Pro Ala Cys Gly Gly Cys Tyr  
10 Cys Cys Glu Tyr Cys Cys Asn Pro Ala Cys Gly Gly Cys Tyr  
Cys Cys Glu Leu Cys Cys Asn Pro Ala Cys Gly Gly Cys  
Cys Cys Glu Tyr Cys Cys Asn Pro Ala Cys Gly Gly Cys  
Cys Cys Glu Phe Cys Cys Asn Pro Ala Cys Gly Gly Cys Tyr  
Cys Cys Glu Phe Cys Cys Asn Pro Ala Cys Gly Gly Cys  
15 Cys Cys Glu Trp Cys Cys Asn Pro Ala Cys Gly Gly Cys Tyr  
Cys Cys Glu Trp Cys Cys Asn Pro Ala Cys Gly Gly Cys  
Cys Cys Glu Leu Cys Cys Asn Pro Ala Cys Thr Ala Cys Tyr  
Cys Cys Glu Tyr Cys Cys Asn Pro Ala Cys Thr Ala Cys Tyr  
Cys Cys Glu Leu Cys Cys Asn Pro Ala Cys Thr Ala Cys  
20 Cys Cys Glu Tyr Cys Cys Asn Pro Ala Cys Thr Ala Cys  
Cys Cys Glu Trp Cys Cys Asn Pro Ala Cys Thr Ala Cys Tyr  
Cys Cys Glu Trp Cys Cys Asn Pro Ala Cys Thr Ala Cys  
Cys Cys Glu Phe Cys Cys Asn Pro Ala Cys Thr Ala Cys Tyr  
Cys Cys Glu Phe Cys Cys Asn Pro Ala Cys Thr Ala Cys  
25 Cys Cys Glu Leu Cys Cys Asn Pro Ala Cys Thr Gly Cys Ala  
Cys Cys Glu Leu Cys Cys Asn Pro Ala Cys Thr Gly Cys Val  
Cys Cys Glu Leu Cys Cys Asn Pro Ala Cys Thr Gly Cys Leu  
Cys Cys Glu Leu Cys Cys Asn Pro Ala Cys Thr Gly Cys Ile  
Cys Cys Glu Leu Cys Cys Asn Pro Ala Cys Thr Gly Cys Pro

Cys Cys Glu Leu Cys Cys Asn Pro Ala Cys Thr Gly Cys Met  
 Cys Cys Glu Leu Cys Cys Asn Pro Ala Cys Thr Gly Cys Phe  
 Cys Cys Glu Leu Cys Cys Asn Pro Ala Cys Thr Gly Cys Trp  
 Cys Cys Glu Leu Cys Cys Asn Pro Ala Cys Thr Gly Cys Gly  
 5 Cys Cys Glu Leu Cys Cys Asn Pro Ala Cys Thr Gly Cys Ser  
 Cys Cys Glu Leu Cys Cys Asn Pro Ala Cys Thr Gly Cys Thr  
 Cys Cys Glu Leu Cys Cys Asn Pro Ala Cys Thr Gly Cys Cys  
 Cys Cys Glu Leu Cys Cys Asn Pro Ala Cys Thr Gly Cys Asn  
 Cys Cys Glu Leu Cys Cys Asn Pro Ala Cys Thr Gly Cys Gln  
 10 Cys Cys Glu Leu Cys Cys Asn Pro Ala Cys Thr Gly Cys Asp  
 Cys Cys Glu Leu Cys Cys Asn Pro Ala Cys Thr Gly Cys Glu  
 Cys Cys Glu Leu Cys Cys Asn Pro Ala Cys Thr Gly Cys Lys  
 Cys Cys Glu Leu Cys Cys Asn Pro Ala Cys Thr Gly Cys Arg  
 Cys Cys Glu Leu Cys Cys Asn Pro Ala Cys Thr Gly Cys His  
 15 Cys Cys Glu Tyr Cys Cys Asn Pro Ala Cys Thr Gly Cys Ala  
 Cys Cys Glu Tyr Cys Cys Asn Pro Ala Cys Thr Gly Cys Val  
 Cys Cys Glu Tyr Cys Cys Asn Pro Ala Cys Thr Gly Cys Leu  
 Cys Cys Glu Tyr Cys Cys Asn Pro Ala Cys Thr Gly Cys Ile  
 Cys Cys Glu Tyr Cys Cys Asn Pro Ala Cys Thr Gly Cys Pro  
 20 Cys Cys Glu Tyr Cys Cys Asn Pro Ala Cys Thr Gly Cys Met  
 Cys Cys Glu Tyr Cys Cys Asn Pro Ala Cys Thr Gly Cys Phe  
 Cys Cys Glu Tyr Cys Cys Asn Pro Ala Cys Thr Gly Cys Trp  
 Cys Cys Glu Tyr Cys Cys Asn Pro Ala Cys Thr Gly Cys Gly  
 Cys Cys Glu Tyr Cys Cys Asn Pro Ala Cys Thr Gly Cys Ser  
 25 Cys Cys Glu Tyr Cys Cys Asn Pro Ala Cys Thr Gly Cys Thr  
 Cys Cys Glu Tyr Cys Cys Asn Pro Ala Cys Thr Gly Cys Cys  
 Cys Cys Glu Tyr Cys Cys Asn Pro Ala Cys Thr Gly Cys Asn  
 Cys Cys Glu Tyr Cys Cys Asn Pro Ala Cys Thr Gly Cys Gln  
 Cys Cys Glu Tyr Cys Cys Asn Pro Ala Cys Thr Gly Cys Asp

Cys Cys Glu Tyr Cys Cys Asn Pro Ala Cys Thr Gly Cys Glu  
Cys Cys Glu Tyr Cys Cys Asn Pro Ala Cys Thr Gly Cys Lys  
Cys Cys Glu Tyr Cys Cys Asn Pro Ala Cys Thr Gly Cys Arg  
Cys Cys Glu Tyr Cys Cys Asn Pro Ala Cys Thr Gly Cys His  
5 Cys Cys Ala Leu Cys Cys Asn Pro Ala Cys Thr Gly Cys Tyr  
Cys Cys Val Leu Cys Cys Asn Pro Ala Cys Thr Gly Cys Tyr  
Cys Cys Leu Leu Cys Cys Asn Pro Ala Cys Thr Gly Cys Tyr  
Cys Cys Ile Leu Cys Cys Asn Pro Ala Cys Thr Gly Cys Tyr  
Cys Cys Met Leu Cys Cys Asn Pro Ala Cys Thr Gly Cys Tyr  
10 Cys Cys Phe Leu Cys Cys Asn Pro Ala Cys Thr Gly Cys Tyr  
Cys Cys Trp Leu Cys Cys Asn Pro Ala Cys Thr Gly Cys Tyr  
Cys Cys Gly Leu Cys Cys Asn Pro Ala Cys Thr Gly Cys Tyr  
Cys Cys Ser Leu Cys Cys Asn Pro Ala Cys Thr Gly Cys Tyr  
Cys Cys Thr Leu Cys Cys Asn Pro Ala Cys Thr Gly Cys Tyr  
15 Cys Cys Cys Leu Cys Cys Asn Pro Ala Cys Thr Gly Cys Tyr  
Cys Cys Asn Leu Cys Cys Asn Pro Ala Cys Thr Gly Cys Tyr  
Cys Cys Gln Leu Cys Cys Asn Pro Ala Cys Thr Gly Cys Tyr  
Cys Cys Tyr Leu Cys Cys Asn Pro Ala Cys Thr Gly Cys Tyr  
Cys Cys Asp Leu Cys Cys Asn Pro Ala Cys Thr Gly Cys Tyr  
20 Cys Cys Lys Leu Cys Cys Asn Pro Ala Cys Thr Gly Cys Tyr  
Cys Cys Arg Leu Cys Cys Asn Pro Ala Cys Thr Gly Cys Tyr  
Cys Cys His Leu Cys Cys Asn Pro Ala Cys Thr Gly Cys Tyr  
Cys Cys Ala Leu Cys Cys Asn Pro Ala Cys Thr Gly Cys  
Cys Cys Val Leu Cys Cys Asn Pro Ala Cys Thr Gly Cys  
25 Cys Cys Leu Leu Cys Cys Asn Pro Ala Cys Thr Gly Cys  
Cys Cys Ile Leu Cys Cys Asn Pro Ala Cys Thr Gly Cys  
Cys Cys Met Leu Cys Cys Asn Pro Ala Cys Thr Gly Cys  
Cys Cys Phe Leu Cys Cys Asn Pro Ala Cys Thr Gly Cys  
Cys Cys Trp Leu Cys Cys Asn Pro Ala Cys Thr Gly Cys

Cys Cys Gly Leu Cys Cys Asn Pro Ala Cys Thr Gly Cys  
Cys Cys Ser Leu Cys Cys Asn Pro Ala Cys Thr Gly Cys  
Cys Cys Thr Leu Cys Cys Asn Pro Ala Cys Thr Gly Cys  
Cys Cys Cys Leu Cys Cys Asn Pro Ala Cys Thr Gly Cys  
5 Cys Cys Asn Leu Cys Cys Asn Pro Ala Cys Thr Gly Cys  
Cys Cys Gln Leu Cys Cys Asn Pro Ala Cys Thr Gly Cys  
Cys Cys Tyr Leu Cys Cys Asn Pro Ala Cys Thr Gly Cys  
Cys Cys Asp Leu Cys Cys Asn Pro Ala Cys Thr Gly Cys  
Cys Cys Lys Leu Cys Cys Asn Pro Ala Cys Thr Gly Cys  
10 Cys Cys Arg Leu Cys Cys Asn Pro Ala Cys Thr Gly Cys  
Cys Cys His Leu Cys Cys Asn Pro Ala Cys Thr Gly Cys  
Cys Cys Ala Tyr Cys Cys Asn Pro Ala Cys Thr Gly Cys Tyr  
Cys Cys Val Tyr Cys Cys Asn Pro Ala Cys Thr Gly Cys Tyr  
Cys Cys Leu Tyr Cys Cys Asn Pro Ala Cys Thr Gly Cys Tyr  
15 Cys Cys Ile Tyr Cys Cys Asn Pro Ala Cys Thr Gly Cys Tyr  
Cys Cys Met Tyr Cys Cys Asn Pro Ala Cys Thr Gly Cys Tyr  
Cys Cys Phe Tyr Cys Cys Asn Pro Ala Cys Thr Gly Cys Tyr  
Cys Cys Trp Tyr Cys Cys Asn Pro Ala Cys Thr Gly Cys Tyr  
Cys Cys Gly Tyr Cys Cys Asn Pro Ala Cys Thr Gly Cys Tyr  
20 Cys Cys Ser Tyr Cys Cys Asn Pro Ala Cys Thr Gly Cys Tyr  
Cys Cys Thr Tyr Cys Cys Asn Pro Ala Cys Thr Gly Cys Tyr  
Cys Cys Cys Tyr Cys Cys Asn Pro Ala Cys Thr Gly Cys Tyr  
Cys Cys Asn Tyr Cys Cys Asn Pro Ala Cys Thr Gly Cys Tyr  
Cys Cys Gln Tyr Cys Cys Asn Pro Ala Cys Thr Gly Cys Tyr  
25 Cys Cys Tyr Tyr Cys Cys Asn Pro Ala Cys Thr Gly Cys Tyr  
Cys Cys Asp Tyr Cys Cys Asn Pro Ala Cys Thr Gly Cys Tyr  
Cys Cys Lys Tyr Cys Cys Asn Pro Ala Cys Thr Gly Cys Tyr  
Cys Cys Arg Tyr Cys Cys Asn Pro Ala Cys Thr Gly Cys Tyr  
Cys Cys His Tyr Cys Cys Asn Pro Ala Cys Thr Gly Cys Tyr

Cys Cys Ala Tyr Cys Cys Asn Pro Ala Cys Thr Gly Cys  
 Cys Cys Val Tyr Cys Cys Asn Pro Ala Cys Thr Gly Cys  
 Cys Cys Leu Tyr Cys Cys Asn Pro Ala Cys Thr Gly Cys  
 Cys Cys Ile Tyr Cys Cys Asn Pro Ala Cys Thr Gly Cys  
 5 Cys Cys Met Tyr Cys Cys Asn Pro Ala Cys Thr Gly Cys  
 Cys Cys Phe Tyr Cys Cys Asn Pro Ala Cys Thr Gly Cys  
 Cys Cys Trp Tyr Cys Cys Asn Pro Ala Cys Thr Gly Cys  
 Cys Cys Gly Tyr Cys Cys Asn Pro Ala Cys Thr Gly Cys  
 Cys Cys Ser Tyr Cys Cys Asn Pro Ala Cys Thr Gly Cys  
 10 Cys Cys Thr Tyr Cys Cys Asn Pro Ala Cys Thr Gly Cys  
 Cys Cys Cys Tyr Cys Cys Asn Pro Ala Cys Thr Gly Cys  
 Cys Cys Asn Tyr Cys Cys Asn Pro Ala Cys Thr Gly Cys  
 Cys Cys Gln Tyr Cys Cys Asn Pro Ala Cys Thr Gly Cys  
 Cys Cys Tyr Tyr Cys Cys Asn Pro Ala Cys Thr Gly Cys  
 15 Cys Cys Asp Tyr Cys Cys Asn Pro Ala Cys Thr Gly Cys  
 Cys Cys Lys Tyr Cys Cys Asn Pro Ala Cys Thr Gly Cys  
 Cys Cys Arg Tyr Cys Cys Asn Pro Ala Cys Thr Gly Cys  
 Cys Cys His Tyr Cys Cys Asn Pro Ala Cys Thr Gly Cys  
 Cys Cys Glu Phe Cys Cys Ala Pro Ala Cys Thr Gly Cys Tyr  
 20 Cys Cys Glu Phe Cys Cys Val Pro Ala Cys Thr Gly Cys Tyr  
 Cys Cys Glu Phe Cys Cys Leu Pro Ala Cys Thr Gly Cys Tyr  
 Cys Cys Glu Phe Cys Cys Ile Pro Ala Cys Thr Gly Cys Tyr  
 Cys Cys Glu Phe Cys Cys Pro Pro Ala Cys Thr Gly Cys Tyr  
 Cys Cys Glu Phe Cys Cys Met Pro Ala Cys Thr Gly Cys Tyr  
 25 Cys Cys Glu Phe Cys Cys Phe Pro Ala Cys Thr Gly Cys Tyr  
 Cys Cys Glu Phe Cys Cys Trp Pro Ala Cys Thr Gly Cys Tyr  
 Cys Cys Glu Phe Cys Cys Gly Pro Ala Cys Thr Gly Cys Tyr  
 Cys Cys Glu Phe Cys Cys Ser Pro Ala Cys Thr Gly Cys Tyr  
 Cys Cys Glu Phe Cys Cys Thr Pro Ala Cys Thr Gly Cys Tyr

Cys Cys Glu Phe Cys Cys Cys Pro Ala Cys Thr Gly Cys Tyr  
Cys Cys Glu Phe Cys Cys Gln Pro Ala Cys Thr Gly Cys Tyr  
Cys Cys Glu Phe Cys Cys Tyr Pro Ala Cys Thr Gly Cys Tyr  
Cys Cys Glu Phe Cys Cys Asp Pro Ala Cys Thr Gly Cys Tyr  
5 Cys Cys Glu Phe Cys Cys Glu Pro Ala Cys Thr Gly Cys Tyr  
Cys Cys Glu Phe Cys Cys Lys Pro Ala Cys Thr Gly Cys Tyr  
Cys Cys Glu Phe Cys Cys Arg Pro Ala Cys Thr Gly Cys Tyr  
Cys Cys Glu Phe Cys Cys His Pro Ala Cys Thr Gly Cys Tyr  
Cys Cys Glu Phe Cys Cys Ala Pro Ala Cys Thr Gly Cys  
10 Cys Cys Glu Phe Cys Cys Val Pro Ala Cys Thr Gly Cys  
Cys Cys Glu Phe Cys Cys Leu Pro Ala Cys Thr Gly Cys  
Cys Cys Glu Phe Cys Cys Ile Pro Ala Cys Thr Gly Cys  
Cys Cys Glu Phe Cys Cys Pro Pro Ala Cys Thr Gly Cys  
Cys Cys Glu Phe Cys Cys Met Pro Ala Cys Thr Gly Cys  
15 Cys Cys Glu Phe Cys Cys Phe Pro Ala Cys Thr Gly Cys  
Cys Cys Glu Phe Cys Cys Trp Pro Ala Cys Thr Gly Cys  
Cys Cys Glu Phe Cys Cys Gly Pro Ala Cys Thr Gly Cys  
Cys Cys Glu Phe Cys Cys Ser Pro Ala Cys Thr Gly Cys  
Cys Cys Glu Phe Cys Cys Thr Pro Ala Cys Thr Gly Cys  
20 Cys Cys Glu Phe Cys Cys Cys Pro Ala Cys Thr Gly Cys  
Cys Cys Glu Phe Cys Cys Gln Pro Ala Cys Thr Gly Cys  
Cys Cys Glu Phe Cys Cys Tyr Pro Ala Cys Thr Gly Cys  
Cys Cys Glu Phe Cys Cys Asp Pro Ala Cys Thr Gly Cys  
Cys Cys Glu Phe Cys Cys Glu Pro Ala Cys Thr Gly Cys  
25 Cys Cys Glu Phe Cys Cys Lys Pro Ala Cys Thr Gly Cys  
Cys Cys Glu Phe Cys Cys Arg Pro Ala Cys Thr Gly Cys  
Cys Cys Glu Phe Cys Cys His Pro Ala Cys Thr Gly Cys  
Cys Cys Glu Trp Cys Cys Ala Pro Ala Cys Thr Gly Cys Tyr  
Cys Cys Glu Trp Cys Cys Val Pro Ala Cys Thr Gly Cys Tyr



Cys Cys Glu Trp Cys Cys Leu Pro Ala Cys Thr Gly Cys Tyr  
Cys Cys Glu Trp Cys Cys Ile Pro Ala Cys Thr Gly Cys Tyr  
Cys Cys Glu Trp Cys Cys Pro Pro Ala Cys Thr Gly Cys Tyr  
Cys Cys Glu Trp Cys Cys Met Pro Ala Cys Thr Gly Cys Tyr  
6 Cys Cys Glu Trp Cys Cys Phe Pro Ala Cys Thr Gly Cys Tyr  
Cys Cys Glu Trp Cys Cys Trp Pro Ala Cys Thr Gly Cys Tyr  
Cys Cys Glu Trp Cys Cys Gly Pro Ala Cys Thr Gly Cys Tyr  
Cys Cys Glu Trp Cys Cys Ser Pro Ala Cys Thr Gly Cys Tyr  
Cys Cys Glu Trp Cys Cys Thr Pro Ala Cys Thr Gly Cys Tyr  
10 Cys Cys Glu Trp Cys Cys Cys Pro Ala Cys Thr Gly Cys Tyr  
Cys Cys Glu Trp Cys Cys Gln Pro Ala Cys Thr Gly Cys Tyr  
Cys Cys Glu Trp Cys Cys Tyr Pro Ala Cys Thr Gly Cys Tyr  
Cys Cys Glu Trp Cys Cys Asp Pro Ala Cys Thr Gly Cys Tyr  
Cys Cys Glu Trp Cys Cys Glu Pro Ala Cys Thr Gly Cys Tyr  
15 Cys Cys Glu Trp Cys Cys Lys Pro Ala Cys Thr Gly Cys Tyr  
Cys Cys Glu Trp Cys Cys Arg Pro Ala Cys Thr Gly Cys Tyr  
Cys Cys Glu Trp Cys Cys His Pro Ala Cys Thr Gly Cys Tyr  
Cys Cys Glu Trp Cys Cys Ala Pro Ala Cys Thr Gly Cys  
Cys Cys Glu Trp Cys Cys Val Pro Ala Cys Thr Gly Cys  
20 Cys Cys Glu Trp Cys Cys Leu Pro Ala Cys Thr Gly Cys  
Cys Cys Glu Trp Cys Cys Ile Pro Ala Cys Thr Gly Cys  
Cys Cys Glu Trp Cys Cys Pro Pro Ala Cys Thr Gly Cys  
Cys Cys Glu Trp Cys Cys Met Pro Ala Cys Thr Gly Cys  
Cys Cys Glu Trp Cys Cys Phe Pro Ala Cys Thr Gly Cys  
25 Cys Cys Glu Trp Cys Cys Trp Pro Ala Cys Thr Gly Cys  
Cys Cys Glu Trp Cys Cys Gly Pro Ala Cys Thr Gly Cys  
Cys Cys Glu Trp Cys Cys Ser Pro Ala Cys Thr Gly Cys  
Cys Cys Glu Trp Cys Cys Thr Pro Ala Cys Thr Gly Cys  
Cys Cys Glu Trp Cys Cys Cys Pro Ala Cys Thr Gly Cys

Cys Cys Glu Trp Cys Cys Gln Pro Ala Cys Thr Gly Cys  
Cys Cys Glu Trp Cys Cys Tyr Pro Ala Cys Thr Gly Cys  
Cys Cys Glu Trp Cys Cys Asp Pro Ala Cys Thr Gly Cys  
Cys Cys Glu Trp Cys Cys Glu Pro Ala Cys Thr Gly Cys  
5 Cys Cys Glu Trp Cys Cys Lys Pro Ala Cys Thr Gly Cys  
Cys Cys Glu Trp Cys Cys Arg Pro Ala Cys Thr Gly Cys  
Cys Cys Glu Trp Cys Cys His Pro Ala Cys Thr Gly Cys  
Cys Cys Glu Trp Cys Cys Asn Pro Ala Cys Thr Gly Cys Ala  
Cys Cys Glu Trp Cys Cys Asn Pro Ala Cys Thr Gly Cys Val  
10 Cys Cys Glu Trp Cys Cys Asn Pro Ala Cys Thr Gly Cys Leu  
Cys Cys Glu Trp Cys Cys Asn Pro Ala Cys Thr Gly Cys Ile  
Cys Cys Glu Trp Cys Cys Asn Pro Ala Cys Thr Gly Cys Pro  
Cys Cys Glu Trp Cys Cys Asn Pro Ala Cys Thr Gly Cys Met  
Cys Cys Glu Trp Cys Cys Asn Pro Ala Cys Thr Gly Cys Phe  
15 Cys Cys Glu Trp Cys Cys Asn Pro Ala Cys Thr Gly Cys Trp  
Cys Cys Glu Trp Cys Cys Asn Pro Ala Cys Thr Gly Cys Gly  
Cys Cys Glu Trp Cys Cys Asn Pro Ala Cys Thr Gly Cys Ser  
Cys Cys Glu Trp Cys Cys Asn Pro Ala Cys Thr Gly Cys Thr  
Cys Cys Glu Trp Cys Cys Asn Pro Ala Cys Thr Gly Cys Cys  
20 Cys Cys Glu Trp Cys Cys Asn Pro Ala Cys Thr Gly Cys Asn  
Cys Cys Glu Trp Cys Cys Asn Pro Ala Cys Thr Gly Cys Gln  
Cys Cys Glu Trp Cys Cys Asn Pro Ala Cys Thr Gly Cys Asp  
Cys Cys Glu Trp Cys Cys Asn Pro Ala Cys Thr Gly Cys Glu  
Cys Cys Glu Trp Cys Cys Asn Pro Ala Cys Thr Gly Cys Lys  
25 Cys Cys Glu Trp Cys Cys Asn Pro Ala Cys Thr Gly Cys Arg  
Cys Cys Glu Trp Cys Cys Asn Pro Ala Cys Thr Gly Cys His  
Cys Cys Glu Phe Cys Cys Asn Pro Ala Cys Thr Gly Cys Ala  
Cys Cys Glu Phe Cys Cys Asn Pro Ala Cys Thr Gly Cys Val  
Cys Cys Glu Phe Cys Cys Asn Pro Ala Cys Thr Gly Cys Leu

Cys Cys Glu Phe Cys Cys Asn Pro Ala Cys Thr Gly Cys Ile  
Cys Cys Glu Phe Cys Cys Asn Pro Ala Cys Thr Gly Cys Pro  
Cys Cys Glu Phe Cys Cys Asn Pro Ala Cys Thr Gly Cys Met  
Cys Cys Glu Phe Cys Cys Asn Pro Ala Cys Thr Gly Cys Phe  
5 Cys Cys Glu Phe Cys Cys Asn Pro Ala Cys Thr Gly Cys Trp  
Cys Cys Glu Phe Cys Cys Asn Pro Ala Cys Thr Gly Cys Gly  
Cys Cys Glu Phe Cys Cys Asn Pro Ala Cys Thr Gly Cys Ser  
Cys Cys Glu Phe Cys Cys Asn Pro Ala Cys Thr Gly Cys Thr  
Cys Cys Glu Phe Cys Cys Asn Pro Ala Cys Thr Gly Cys Cys  
10 Cys Cys Glu Phe Cys Cys Asn Pro Ala Cys Thr Gly Cys Asn  
Cys Cys Glu Phe Cys Cys Asn Pro Ala Cys Thr Gly Cys Gln  
Cys Cys Glu Phe Cys Cys Asn Pro Ala Cys Thr Gly Cys Asp  
Cys Cys Glu Phe Cys Cys Asn Pro Ala Cys Thr Gly Cys Glu  
Cys Cys Glu Phe Cys Cys Asn Pro Ala Cys Thr Gly Cys Lys  
15 Cys Cys Glu Phe Cys Cys Asn Pro Ala Cys Thr Gly Cys Arg  
Cys Cys Glu Phe Cys Cys Asn Pro Ala Cys Thr Gly Cys His  
Cys Cys Ala Phe Cys Cys Asn Pro Ala Cys Thr Gly Cys Tyr  
Cys Cys Val Phe Cys Cys Asn Pro Ala Cys Thr Gly Cys Tyr  
Cys Cys Leu Phe Cys Cys Asn Pro Ala Cys Thr Gly Cys Tyr  
20 Cys Cys Ile Phe Cys Cys Asn Pro Ala Cys Thr Gly Cys Tyr  
Cys Cys Met Phe Cys Cys Asn Pro Ala Cys Thr Gly Cys Tyr  
Cys Cys Phe Phe Cys Cys Asn Pro Ala Cys Thr Gly Cys Tyr  
Cys Cys Trp Phe Cys Cys Asn Pro Ala Cys Thr Gly Cys Tyr  
Cys Cys Gly Phe Cys Cys Asn Pro Ala Cys Thr Gly Cys Tyr  
25 Cys Cys Ser Phe Cys Cys Asn Pro Ala Cys Thr Gly Cys Tyr  
Cys Cys Thr Phe Cys Cys Asn Pro Ala Cys Thr Gly Cys Tyr  
Cys Cys Cys Phe Cys Cys Asn Pro Ala Cys Thr Gly Cys Tyr  
Cys Cys Asn Phe Cys Cys Asn Pro Ala Cys Thr Gly Cys Tyr  
Cys Cys Gln Phe Cys Cys Asn Pro Ala Cys Thr Gly Cys Tyr

Cys Cys Tyr Phe Cys Cys Asn Pro Ala Cys Thr Gly Cys Tyr  
Cys Cys Asp Phe Cys Cys Asn Pro Ala Cys Thr Gly Cys Tyr  
Cys Cys Lys Phe Cys Cys Asn Pro Ala Cys Thr Gly Cys Tyr  
Cys Cys Arg Phe Cys Cys Asn Pro Ala Cys Thr Gly Cys Tyr  
5 Cys Cys His Phe Cys Cys Asn Pro Ala Cys Thr Gly Cys Tyr  
Cys Cys Ala Phe Cys Cys Asn Pro Ala Cys Thr Gly Cys  
Cys Cys Val Phe Cys Cys Asn Pro Ala Cys Thr Gly Cys  
Cys Cys Leu Phe Cys Cys Asn Pro Ala Cys Thr Gly Cys  
Cys Cys Ile Phe Cys Cys Asn Pro Ala Cys Thr Gly Cys  
10 Cys Cys Met Phe Cys Cys Asn Pro Ala Cys Thr Gly Cys  
Cys Cys Phe Phe Cys Cys Asn Pro Ala Cys Thr Gly Cys  
Cys Cys Trp Phe Cys Cys Asn Pro Ala Cys Thr Gly Cys  
Cys Cys Gly Phe Cys Cys Asn Pro Ala Cys Thr Gly Cys  
Cys Cys Ser Phe Cys Cys Asn Pro Ala Cys Thr Gly Cys  
15 Cys Cys Thr Phe Cys Cys Asn Pro Ala Cys Thr Gly Cys  
Cys Cys Cys Phe Cys Cys Asn Pro Ala Cys Thr Gly Cys  
Cys Cys Asn Phe Cys Cys Asn Pro Ala Cys Thr Gly Cys  
Cys Cys Gln Phe Cys Cys Asn Pro Ala Cys Thr Gly Cys  
Cys Cys Tyr Phe Cys Cys Asn Pro Ala Cys Thr Gly Cys  
20 Cys Cys Asp Phe Cys Cys Asn Pro Ala Cys Thr Gly Cys  
Cys Cys Lys Phe Cys Cys Asn Pro Ala Cys Thr Gly Cys  
Cys Cys Arg Phe Cys Cys Asn Pro Ala Cys Thr Gly Cys  
Cys Cys His Phe Cys Cys Asn Pro Ala Cys Thr Gly Cys  
Cys Cys Ala Trp Cys Cys Asn Pro Ala Cys Thr Gly Cys Tyr  
25 Cys Cys Val Trp Cys Cys Asn Pro Ala Cys Thr Gly Cys Tyr  
Cys Cys Leu Trp Cys Cys Asn Pro Ala Cys Thr Gly Cys Tyr  
Cys Cys Ile Trp Cys Cys Asn Pro Ala Cys Thr Gly Cys Tyr  
Cys Cys Met Trp Cys Cys Asn Pro Ala Cys Thr Gly Cys Tyr  
Cys Cys Phe Trp Cys Cys Asn Pro Ala Cys Thr Gly Cys Tyr

Cys Cys Trp Trp Cys Cys Asn Pro Ala Cys Thr Gly Cys Tyr  
Cys Cys Gly Trp Cys Cys Asn Pro Ala Cys Thr Gly Cys Tyr  
Cys Cys Ser Trp Cys Cys Asn Pro Ala Cys Thr Gly Cys Tyr  
Cys Cys Thr Trp Cys Cys Asn Pro Ala Cys Thr Gly Cys Tyr  
5 Cys Cys Cys Trp Cys Cys Asn Pro Ala Cys Thr Gly Cys Tyr  
Cys Cys Asn Trp Cys Cys Asn Pro Ala Cys Thr Gly Cys Tyr  
Cys Cys Gln Trp Cys Cys Asn Pro Ala Cys Thr Gly Cys Tyr  
Cys Cys Tyr Trp Cys Cys Asn Pro Ala Cys Thr Gly Cys Tyr  
Cys Cys Asp Trp Cys Cys Asn Pro Ala Cys Thr Gly Cys Tyr  
10 Cys Cys Lys Trp Cys Cys Asn Pro Ala Cys Thr Gly Cys Tyr  
Cys Cys Arg Trp Cys Cys Asn Pro Ala Cys Thr Gly Cys Tyr  
Cys Cys His Trp Cys Cys Asn Pro Ala Cys Thr Gly Cys Tyr  
Cys Cys Ala Trp Cys Cys Asn Pro Ala Cys Thr Gly Cys  
Cys Cys Val Trp Cys Cys Asn Pro Ala Cys Thr Gly Cys  
15 Cys Cys Leu Trp Cys Cys Asn Pro Ala Cys Thr Gly Cys  
Cys Cys Ile Trp Cys Cys Asn Pro Ala Cys Thr Gly Cys  
Cys Cys Met Trp Cys Cys Asn Pro Ala Cys Thr Gly Cys  
Cys Cys Phe Trp Cys Cys Asn Pro Ala Cys Thr Gly Cys  
Cys Cys Trp Trp Cys Cys Asn Pro Ala Cys Thr Gly Cys  
20 Cys Cys Gly Trp Cys Cys Asn Pro Ala Cys Thr Gly Cys  
Cys Cys Ser Trp Cys Cys Asn Pro Ala Cys Thr Gly Cys  
Cys Cys Thr Trp Cys Cys Asn Pro Ala Cys Thr Gly Cys  
Cys Cys Cys Trp Cys Cys Asn Pro Ala Cys Thr Gly Cys  
Cys Cys Asn Trp Cys Cys Asn Pro Ala Cys Thr Gly Cys  
25 Cys Cys Gln Trp Cys Cys Asn Pro Ala Cys Thr Gly Cys  
Cys Cys Tyr Trp Cys Cys Asn Pro Ala Cys Thr Gly Cys  
Cys Cys Asp Trp Cys Cys Asn Pro Ala Cys Thr Gly Cys  
Cys Cys Lys Trp Cys Cys Asn Pro Ala Cys Thr Gly Cys  
Cys Cys Arg Trp Cys Cys Asn Pro Ala Cys Thr Gly Cys

Cys Cys His Trp Cys Cys Asn Pro Ala Cys Thr Gly Cys

Additional useful peptides include:

- 5 Cys Glu Leu Cys Ile Asn Val Ala Cys Thr Gly Cys  
 Cys Glu Leu Cys Val Asn Val Ala Cys Thr Gly Cys  
 Cys Ala Glu Leu Cys Cys Asn Pro Ala Cys  
 Cys Cys Gly Leu Cys Cys Asn Pro Ala Cys Ala Gly Cys  
 Cys Cys Gly Leu Cys Cys Tyr Pro Ala Cys Ala Gly Cys
- 10 Cys Glu Leu Cys Cys Asn Pro Ala Cys Ala Gly Cys  
 Cys Cys Asp Val Cys Cys Tyr Pro Ala Cys Thr Gly Cys  
 Cys Cys Glu Leu Cys Cys Asn Pro Ala Cys Ala Gly Cys  
 Cys Cys Glu Leu Cys Cys Tyr Pro Ala Cys Ala Gly Cys  
 Cys Cys Glu Leu Cys Cys Asn Pro Ala Cys Thr Gly Cys
- 15 Cys Cys Glu Leu Cys Cys Tyr Pro Ala Cys Thr Gly Cys  
 Cys Cys Glu Leu Cys Cys Asn Pro Gly Cys Thr Gly Cys  
 Cys Cys Glu Ala Cys Cys Asn Pro Ala Cys Thr Gly Cys  
 Cys Cys Glu Lys Cys Cys Asn Pro Ala Cys Thr Gly Cys  
 Cys Cys Glu Leu Cys Cys Asn Pro Ala Cys Thr Ala Cys
- 20 Cys Cys Pro Leu Cys Cys Asn Pro Ala Cys Thr Gly Cys  
 Ala Cys Glu Leu Cys Ala Asn Pro Ala Cys Thr Gly Cys  
 Cys Cys Glu Leu Ala Cys Asn Pro Ala Cys Thr Gly Ala  
 Cys Glu Leu Cys Ala Asn Pro Ala Cys Thr Gly Cys  
 Cys Cys Glu Leu Ala Cys Asn Pro Ala Cys
- 25 Cys Cys Asp Val Cys Cys Asn Pro Ala Cys Ala Gly Cys  
 Cys Cys Asp Val Cys Cys Asn Pro Ala Cys Thr Gly Cys  
 Cys Cys Asp Val Cys Cys Asn Pro Ala Cys Ala Gly Cys Tyr  
 Cys Cys Asp Val Cys Cys Asn Pro Ala Cys Thr Gly Cys Tyr  
 Cys Cys Glu Leu Cys Cys Tyr Pro Ala Cys Ala Gly Cys

Cys Cys Ile Cys Cys Asn Pro Ala Cys Phe Gly Cys  
 Cys Cys Asn Tyr Cys Cys Ser Pro Cys Gly Cys

Also useful are the following peptides wherein Xaa represents any of the 20 naturally  
 5 occurring amino acids

Cys Cys Xaa Xaa Cys Cys Xaa Pro Ala Cys Xaa Gly Cys  
 Cys Cys Ile Xaa Cys Cys Asn Pro Ala Cys Phe Gly Cys  
 Cys Cys Asn Tyr Cys Cys Ser Pro Xaa Cys Xaa Gly Cys

10 The invention also features deletion variants of any of the peptides described herein in  
 which one, two, three or four amino acids (or non-natural amino acids or natural or non-  
 natural amino acid analogs), other than a Cys (or an amino acid substituted for Cys, e.g,  
 an amino acid capable of forming a covalent bond to another amino acid), are deleted.  
 Where two (or more) amino acids are deleted and the peptide comprises the sequence:  
 15 Cys<sub>a</sub> Cys<sub>b</sub> Xaa Xaa Cys<sub>c</sub> Cys<sub>d</sub> Xaa Xaa Xaa Cys<sub>e</sub> Xaa Xaa Cys<sub>f</sub>, in some embodiments  
 two or more deletions can be located between Cys<sub>b</sub> and Cys<sub>c</sub> and/or between Cys<sub>d</sub> and  
 Cys<sub>e</sub> and/or between Cys<sub>e</sub> and Cys<sub>f</sub>. However, in other embodiments there is at most one  
 deletion between each of Cys<sub>b</sub> and Cys<sub>c</sub> or between Cys<sub>d</sub> and Cys<sub>e</sub> or between Cys<sub>e</sub> and  
 Cys<sub>f</sub>. Thus, the invention includes any of the peptides described herein comprising the  
 20 sequence Cys<sub>a</sub> Cys<sub>b</sub> Xaa Xaa Cys<sub>c</sub> Cys<sub>d</sub> Xaa Xaa Xaa Cys<sub>e</sub> Xaa Xaa Cys<sub>f</sub> wherein: a) one  
 amino acid between Cys<sub>b</sub> and Cys<sub>c</sub> is deleted; b) one amino acid between Cys<sub>d</sub> and Cys<sub>e</sub>  
 is deleted; c) one amino acid between Cys<sub>e</sub> and Cys<sub>f</sub> is deleted; d) one amino acid  
 between Cys<sub>b</sub> and Cys<sub>c</sub> is deleted and one amino acid between Cys<sub>d</sub> and Cys<sub>e</sub> is deleted;  
 e) one amino acid between Cys<sub>d</sub> and Cys<sub>e</sub> is deleted and one amino acid between Cys<sub>e</sub>  
 25 and Cys<sub>f</sub> is deleted; f) one amino acid between Cys<sub>b</sub> and Cys<sub>c</sub> is deleted and one amino  
 acid between Cys<sub>e</sub> and Cys<sub>f</sub> is deleted or g) one amino acid between Cys<sub>b</sub> and Cys<sub>c</sub> is  
 deleted, one amino acid between Cys<sub>d</sub> and Cys<sub>e</sub> is deleted and one amino acid between  
 Cys<sub>e</sub> and Cys<sub>f</sub> is deleted. In certain embodiments, the various deletion variants are

peptides that bind to and/or activate the GC-C receptor. In various embodiments, the various deletion variants are peptides that increase cGMP levels.

Deletion variants of Cys Cys Glu Tyr Cys Cys Asn Pro Ala Cys Thr Gly Cys Tyr (SEQ  
5 ID NO:3) include the peptides listed in FIG. 11. In these deletion variants, any of the amino acids can be deleted and there can be one, two, three or four amino acids deleted other than Cys.

The invention also features insertion variants of any of the peptides described herein in  
10 which one, two, three or four amino acids (e.g., Gly or Ala) are inserted before or after any amino acid in the peptide. In some embodiments no more than one amino acid is inserted between two Cys. For example, where two or more amino acids are inserted and the peptide comprises the sequence Cys<sub>a</sub> Cys<sub>b</sub> Xaa Xaa Cys<sub>c</sub> Cys<sub>d</sub> Xaa Xaa Xaa Cys<sub>e</sub> Xaa Xaa Cys<sub>f</sub>, in some embodiments two or more insertions can be located between Cys<sub>b</sub> and  
15 Cys<sub>c</sub> or between Cys<sub>d</sub> and Cys<sub>e</sub> or between Cys<sub>e</sub> and Cys<sub>f</sub>. However, in other embodiments no more than one insertion is located between Cys<sub>b</sub> and Cys<sub>c</sub> or between Cys<sub>d</sub> and Cys<sub>e</sub> or between Cys<sub>e</sub> and Cys<sub>f</sub>. Thus, the invention features any of the peptides described herein comprising the sequence Cys<sub>a</sub> Cys<sub>b</sub> Xaa Xaa Cys<sub>c</sub> Cys<sub>d</sub> Xaa Xaa Xaa Cys<sub>e</sub> Xaa Xaa Cys<sub>f</sub> wherein: a) one amino acid is inserted between Cys<sub>b</sub> and Cys<sub>c</sub>; b) one  
20 amino acid is inserted between Cys<sub>d</sub> and Cys<sub>e</sub>; c) one amino acid is inserted between Cys<sub>e</sub> and Cys<sub>f</sub>; d) one amino acid is inserted between Cys<sub>b</sub> and Cys<sub>c</sub> and one amino acid is inserted between Cys<sub>d</sub> and Cys<sub>e</sub>; e) one amino acid is inserted between Cys<sub>d</sub> and Cys<sub>e</sub> and one amino acid is inserted between Cys<sub>e</sub> and Cys<sub>f</sub>; f) one amino acid is inserted between Cys<sub>b</sub> and Cys<sub>c</sub> and one amino acid is inserted between Cys<sub>e</sub> and Cys<sub>f</sub>; or g) one amino  
25 acid is inserted between Cys<sub>b</sub> and Cys<sub>c</sub>, one amino acid is inserted between Cys<sub>d</sub> and Cys<sub>e</sub> and one amino acid is inserted between Cys<sub>e</sub> and Cys<sub>f</sub>. In addition, one or more amino acids can be inserted preceding Cys<sub>a</sub> and/or one or more amino acids can be inserted following Cys<sub>f</sub>.



In various embodiments, the various insertion variants are peptides that bind to and/or activate the GC-C receptor. In various embodiments, the various insertion variants are peptides that increase cGMP levels.

5 Insertion variants of Cys Cys Glu Tyr Cys Cys Asn Pro Ala Cys Thr Gly Cys Tyr (SEQ ID NO:3) include those in which up to four amino acids (i.e., 0, 1, 2, 3 or 4) can be inserted after each amino acid. Thus, the invention includes peptides having the sequence: Cys Xaa<sub>(0-4)</sub> Cys Xaa<sub>(0-4)</sub> Glu Xaa<sub>(0-4)</sub> Tyr Xaa<sub>(0-4)</sub> Cys Xaa<sub>(0-4)</sub> Cys Xaa<sub>(0-4)</sub> Asn Xaa<sub>(0-4)</sub> Pro Xaa<sub>(0-4)</sub> Ala Xaa<sub>(0-4)</sub> Cys Xaa<sub>(0-4)</sub> Thr Xaa<sub>(0-4)</sub> Gly Xaa<sub>(0-4)</sub> Cys Xaa<sub>(0-4)</sub> Tyr  
 10 Xaa<sub>(0-4)</sub> (SEQ ID NO: ). The inserted amino acids can be any amino acid or amino acid analog (natural or non-natural) and can be the same or different. In certain embodiments the inserted amino acids are all Gly or all Ala or a combination of Gly and Ala.

FIG. 12 depicts insertion variants of the peptide having the sequence: Cys Cys Glu Tyr  
 15 Cys Cys Asn Pro Ala Cys Thr Gly Cys Tyr (SEQ ID NO:3).

The invention also features variants of peptides having the sequence Xaa<sub>1</sub> Xaa<sub>2</sub> Xaa<sub>3</sub> Xaa<sub>4</sub> Xaa<sub>5</sub> Cys<sub>6</sub> Cys<sub>7</sub> Xaa<sub>8</sub> Xaa<sub>9</sub> Cys<sub>10</sub> Cys<sub>11</sub> Xaa<sub>12</sub> Xaa<sub>13</sub> Xaa<sub>14</sub> Cys<sub>15</sub> Xaa<sub>16</sub> Xaa<sub>17</sub> Cys<sub>18</sub> Xaa<sub>19</sub> Xaa<sub>20</sub> Xaa<sub>21</sub> (SEQ ID NO:1), e.g., variants of Cys Cys Glu Tyr Cys Cys Asn Pro Ala Cys  
 20 Thr Gly Cys Tyr (SEQ ID NO:3), in which up to four amino acids are deleted and/or up to four amino acids are inserted. The insertions and deletions can be between Cys<sub>6</sub> and Cys<sub>18</sub> in SEQ ID NO:1 or they can be amino terminal to Cys<sub>6</sub> and/or carboxy terminal to Cys<sub>18</sub> in SEQ ID NO:1.

25 The invention also features peptides which may include one or more of the peptide modifications, one or more non-natural amino acid or amino acid analogs, one or more of the disulfide bond alternatives or one more of the alternative peptide bonds described herein.

The peptides described herein can be present with a counterion. Useful counterions include salts of: acetate, benzenesulfonate, benzoate, calcium edetate, camsylate, carbonate, citrate, edetate (EDTA), edisylate, embonate, esylate, fumarate, gluceptate, gluconate, glutamate, glycolylarsanilate, hexylresorcinate, iodide, bromide, chloride, 5 hydroxynaphthoate, isethionate, lactate, lactobionate, estolate, maleate, malate, mandelate, mesylate, mucate, napsylate, nitrate, pantothenate, phosphate, salicylate, stearate, succinate, sulfate, tartarate, tartrate, hydrochlorate, theoclate, acetamidobenzoate, adipate, alginate, aminosalicylate, anhydromethylenecitrate, ascorbate, aspartate, camphorate, caprate, caproate, caprylate, cinnamate, cyclamate, 10 dichloroacetate, formate, gentisate, glucuronate, glycerophosphate, glycolate, hippurate, fluoride, malonate, napadisylate, nicotinate, oleate, orotate, oxalate, oxoglutarate, palmitate, pectinate, pectinate polymer, phenylethylbarbiturate, picrate, propionate, pidolate, sebacate, rhodanide, tosylate, and tannate.

15 The peptides and agonist of the intestinal guanylate cyclase (GC-C) receptor can be used to treat constipation or decreased intestinal motility, slow digestion or slow stomach emptying. The peptides can be used to relieve one or more symptoms of IBS (bloating, pain, constipation), GERD (acid reflux into the esophagus), duodenogastric reflux, functional dyspepsia, or gastroparesis (nausea, vomiting, bloating, delayed gastric 20 emptying) and other disorders described herein.

Also described herein is a purified polypeptide comprising (consisting essentially of or consisting of) the amino acid sequence:

$X_1$  Cys Glu  $X_2$   $X_3$   $X_4$  Asn Pro Ala Cys Thr Gly  $X_5$   $X_6$

25 wherein:

$X_1$ ,  $X_3$ ,  $X_4$  and  $X_5$  are independently selected from: Ala, Arg, Asn, Asp, Cys, Gln, Glu, Gly, His, Ile, Leu, Lys, Met, Phe, Pro, Ser, Thr, Trp, Tyr and Val;

$X_2$  is selected from: Ala, Arg, Asn, Asp, Cys, Gln, Glu, Gly, His, Ile, Leu, Lys, Met, Phe, Pro, Ser, Thr, Trp, Tyr and Val; and

$X_6$  is selected from Phe, Trp and Tyr or is missing, provided that when both  $X_1$  and  $X_4$  are Ala and both  $X_3$  and  $X_5$  are Cys or when both  $X_3$  and  $X_5$  are Ala and both  $X_1$  and  $X_4$  are Cys or when  $X_1$ ,  $X_3$ ,  $X_4$  and  $X_5$  are all Cys, then either  $X_6$  is selected from Phe and Trp or  $X_2$  is not Leu.

5

In various embodiments: at least one of  $X_1$ ,  $X_3$ ,  $X_4$  and  $X_5$  is Cys; at least two of  $X_1$ ,  $X_3$ ,  $X_4$  and  $X_5$  are Cys; at least three of  $X_1$ ,  $X_3$ ,  $X_4$  and  $X_5$  is Cys;  $X_1$ ,  $X_3$ ,  $X_4$  and  $X_5$  are Cys;  $X_1$  and  $X_4$  are Cys;  $X_3$  and  $X_5$  are Gly or Ala;  $X_3$  and  $X_5$  are Cys;  $X_1$  and  $X_4$  are Gly or Ala;  $X_1$ ,  $X_3$ ,  $X_4$  and  $X_5$  are Cys;  $X_2$  is selected from: Ala, Arg, Asn, Asp, Cys, Gln, Glu,  
 10 Gly, His, Ile, Lys, Met, Phe, Pro, Ser, Thr, Val, Trp and Tyr; one of  $X_1$ ,  $X_3$ ,  $X_4$  and  $X_5$  is Gly or Ala and the rest are Cys; two of  $X_1$ ,  $X_3$ ,  $X_4$  and  $X_5$  are Gly or Ala and the rest are Cys; three of  $X_1$ ,  $X_3$ ,  $X_4$  and  $X_5$  are Gly or Ala and the rest are Cys;  $X_1$  and  $X_4$  are independently Gly or Ala and  $X_3$  and  $X_5$  are Cys;  $X_3$  and  $X_5$  are independent Gly or Ala and  $X_1$  and  $X_4$  are Cys;  $X_2$  is Phe, Tyr or Trp;  $X_2$  is Phe;  $X_2$  is Tyr;  $X_2$  is Trp;  $X_6$  is Tyr;  
 15  $X_6$  is missing;  $X_1$  is Gly or Ala;  $X_3$  is Gly or Ala;  $X_4$  is Gly or Ala;  $X_5$  is Gly or Ala;  $X_1$  and  $X_4$  are Ala and  $X_3$  and  $X_5$  are Cys;  $X_3$  and  $X_5$  are Ala and  $X_1$  and  $X_4$  are Cys;  $X_1$  and  $X_4$  are Gly and  $X_3$  and  $X_5$  are Cys;  $X_3$  and  $X_5$  are Gly and  $X_1$  and  $X_4$  are Cys; one of  $X_1$  and  $X_4$  is Ala and the other is Gly and  $X_3$  and  $X_5$  are Cys; an one  $X_3$  and  $X_5$  is Ala and the other is Gly and  $X_1$  and  $X_4$  are Cys; the polypeptide comprises 100 or fewer amino  
 20 acids; the polypeptide comprises 20 or fewer amino acids; the polypeptide comprises 15 or fewer amino acids. Additional embodiments are shown in Figure 18.

The variants of the forgoing polypeptides can be created by insertion or deletion of amino acids. For example, one or two amino acids within the sequence  $X_1$  Cys Glu  $X_2$   $X_3$   $X_4$   
 25 Asn Pro Ala Cys Thr Gly  $X_5$   $X_6$  can be deleted. The deleted amino acids can be selected from Glu,  $X_2$ , Asn, Pro, Ala, Thr and Gly in the sequence  $X_1$  Cys Glu  $X_2$   $X_3$   $X_4$  Asn Pro Ala Cys Thr Gly  $X_5$   $X_6$ . In addition, insertions of 1, 2, 3, or 4 contiguous amino acids into a peptide having the sequence  $X_1$  Cys Glu  $X_2$   $X_3$   $X_4$  Asn Pro Ala Cys Thr Gly  $X_5$   $X_6$  can be made. Preferably the insertions are not between  $X_1$  and Cys or between  $X_5$   $X_6$  in a

peptide having the sequence X<sub>1</sub> Cys Glu X<sub>2</sub> X<sub>3</sub> X<sub>4</sub> Asn Pro Ala Cys Thr Gly X<sub>5</sub> X<sub>6</sub>. Various insertion and deletion variants are depicted in Figures 19 and 20 (X<sub>aa</sub> represents any amino acid, e.g., any of the amino acids listed in Table II.

5 Also described are therapeutic methods employing any of the forgoing polypeptides (both with and without the proviso. The therapeutic methods include treating a disorder selected from the group consisting of: a gastrointestinal disorder, cystic fibrosis, congestive heart failure, benign prostatic hyperplasia, the method comprising administering a composition comprising any of the forgoing polypeptides (both with and  
10 without the proviso). The disorders that can be treated include: a gastrointestinal motility disorder, irritable bowel syndrome, chronic constipation, a functional gastrointestinal disorder, gastroesophageal reflux disease, functional heartburn, dyspepsia, functional dyspepsia, nonulcer dyspepsia, gastroparesis, chronic intestinal pseudo-obstruction, colonic pseudo-obstruction, Crohn's disease, ulcerative colitis, and inflammatory bowel  
15 disease as well as other diseases and disorders described herein.

Also described are methods for producing any of the forgoing polypeptides comprising providing a cell harboring a nucleic acid molecule encoding the polypeptide, culturing the cell under conditions in which the peptide is expressed, and isolating the expressed  
20 peptide.

Also described are methods for producing any of the forgoing polypeptides comprising chemically synthesizing the peptide and then purifying the synthesized peptide. Also described are pharmaceutical compositions comprising the forgoing polypeptides. Also described are nucleic acid molecules encoding any of the forgoing polypeptides,  
25 vectors (e.g., expression vectors) containing such nucleic acid molecules and host cells harboring the nucleic acid molecules or vectors.

The details of one or more embodiments described herein are set forth in the accompanying description. All of the publications, patents and patent applications are hereby incorporated by reference.

5

### FIGURES

Figure 1a depicts the results of LCMS analysis of recombinant SEQ ID NO:4 peptide and SEQ ID NO:5 peptide.

10 Figures 1b and 1c depict the results of LCMS analysis of synthetic SEQ ID NO:3 peptide and the blank.

Figures 2a and b depict the results of the intestinal GC-C receptor activity assay of synthetic SEQ ID NO:4 peptide, SEQ ID NO:5 peptide, two different SEQ ID NO:3  
15 peptides and SEQ ID NO:6 peptide.

Figure 3a depicts the effect of recombinant SEQ ID NO:4 peptide and Zelnorm® in an acute murine gastrointestinal transit model.

20 Figure 3b depicts the effect of synthetic SEQ ID NO:3 peptide and Zelnorm® in an acute murine gastrointestinal transit model.

Figures 4a and 4b depict the effect of peptides SEQ ID NO:5, SEQ ID NO:3, and SEQ ID NO:4 in an acute murine gastrointestinal transit model.

25

Figure 4c depicts the effect of SEQ ID NO:3 peptide in a chronic murine gastrointestinal transit model.

Figures 4d and 4e depict the effect of Zelnorm®, and peptides SEQ ID NO:3, SEQ ID NO:6 in an acute rat gastrointestinal transit model.

5 Figure 4f depicts the effect of SEQ ID NO:3 peptide on a gastrointestinal transit model in wild-type mice and mice lacking the guanylate cyclase C receptor.

Figure 5a depicts the effect of SEQ ID NO:4 peptide and Zelnorm® in a suckling mouse intestinal secretion model.

10 Figure 5b depicts the effects of SEQ ID NO:3 and Zelnorm® in a mouse intestinal secretion model.

Figures 6a, 6b, and 6c depict the effects of SEQ ID NO:4, SEQ ID NO:3, SEQ ID NO:5 and SEQ ID NO:6 peptides in a mouse intestinal secretion model.

15

Figures 7a and 7b show the results of experiments in which SEQ ID NO:3 activity was analyzed in either the TNBS colonic distension model or the PRS colonic distension model.

20 Figures 7c and 7d show the results of colonic distension experiments in wild-type and GC-C KO mice under basal and TNBS-inducing conditions in the presence and absence of SEQ ID NO:3.

25 Figures 7e and 7f show the results of baseline and water avoidance stress induced visceral nociception in the presence and absence of SEQ ID NO:3.

Figures 8a and 8b show the effects of differing doses of SEQ ID NO:5 and SEQ ID NO:3 in the PBQ writhing assay.

Figure 9a shows the results of Kd determination analysis using SEQ ID NO:3 in a competitive radioligand binding assay.

Figure 9b shows the results of SEQ ID NO:3 binding experiments in wild-type and GC-C  
5 KO mice.

Figures 10a and 10b show bioavailability data for IV and orally administered SEQ ID NO:3 as detected by an ELISA assay and LCMS.

Figure 11 depicts deletion variants of a peptide having the sequence of SEQ ID NO:3.  
10

Figure 12 depicts insertion variants of a peptide having the sequence of SEQ ID NO:3.

Figure 13a depicts the carboxypeptidase A digestion of a Z-Gly-Gly-Leu control peptide.

15 Figure 13b depicts the carboxypeptidase digestion of SEQ ID NO:3.

Figure 13c depicts the total ion current chromatography of carboxypeptidase A digested samples.

Figure 13d depicts the spectrum view of the 3.3 min peak of T240 sample of SEQ ID  
20 NO:3.

Figure 13e depicts the rate of formation of SEQ ID NO:3 product in the presence of Carboxypeptidase A.

25 Figure 13f depicts the disappearance of SEQ ID NO:3 and the formation of SEQ ID NO:6.

Figure 14a is an explanation of The Bristol Stool Form Scale (BSFS).

Figure 14b shows the stool consistency scored by the subjects using the Bristol Stool Form Scale after a single dose of SEQ ID NO:3.

5 Figure 14c shows the percent of subjects with at least a 2-point increase in BSFS consistency score (mean pre-dose compared to peak post-dose) after a single dose of SEQ ID NO:3.

10 Figure 15a shows The Bristol Stool Form Scale scores for the different dosing groups of SEQ ID NO:3 the seven days prior to and the seven days during dosing.

Figure 15b shows the Mean Stool Frequency (stools per week) for the subjects over 7 days treatment with varying doses of SEQ ID NO:3 or placebo.

15 Figure 15c shows the Mean Stool Weight (g) over 7 days treatment with varying doses of SEQ ID NO:3 or placebo.

Figure 15d presents the Mean Ease of Passage Scale.

20 Figure 15e shows the Mean Ease of Passage Scores for subjects treated over 7 days treatment with varying doses of SEQ ID NO: 3 or placebo.

Figure 15f shows the mean time to first bowel movement for subjects treated over 7 days treatment with varying doses of SEQ ID NO: 3 or placebo.

Figure 16 shows the effects of SEQ ID NO:3 in an in vivo model of post operative ileus.

25 Figures 17a-d show the effects of SEQ ID NO:3 and SEQ ID NO: 6 on cGMP activity and secretion in rodent ligated loop experiments .

Figures 18 – 20 depict variants of SEQ ID NO:3.



Figure 21 shows the effect of SEQ ID NO:3 on opioid induced constipation.

Figure 22 shows mass spectrometry characterization of SEQ ID NO:3 fragments.

5

### DETAILED DESCRIPTION

The peptides described herein bind to the intestinal guanylate cyclase (GC-C) receptor, a key regulator of fluid and electrolyte balance in the intestine. When stimulated, this  
10 receptor, which is located on the apical membrane of the intestinal epithelial surface, causes an increase in intestinal epithelial cyclic GMP (cGMP). This increase in cGMP is believed to cause a decrease in water and sodium absorption and an increase in chloride and potassium ion secretion, leading to changes in intestinal fluid and electrolyte transport and increased intestinal motility. The intestinal GC-C receptor possesses an  
15 extracellular ligand binding region, a transmembrane region, an intracellular protein kinase-like region and a cyclase catalytic domain. Proposed functions for the GC-C receptor are fluid and electrolyte homeostasis, the regulation of epithelial cell proliferation and the induction of apoptosis (Shalubhai 2002 *Curr Opin Drug Dis Devel* 5:261-268).

20

In addition to being expressed in the intestine by gastrointestinal epithelial cells, GC-C is expressed in extra-intestinal tissues including kidney, lung, pancreas, pituitary, adrenal, developing liver and gall bladder (reviewed in Vaandrager 2002 *Mol Cell Biochem* 230:73-83, Kulaksiz et al. 2004, *Gastroenterology* 126:732-740) and male and female  
25 reproductive tissues (reviewed in Vaandrager 2002 *Mol Cell Biochem* 230:73-83). This suggests that the GC-C receptor agonists can be used in the treatment of disorders outside the GI tract, for example, congestive heart failure and benign prostatic hyperplasia.

Ghrelin, a peptide hormone secreted by the stomach, is a key regulator of appetite in humans. Ghrelin expression levels are regulated by fasting and by gastric emptying (Kim et al. 2003 *Neuroreprt* 14:1317-20; Gualillo et al. 2003 *FEBS Letts* 552: 105-9). Thus, by increasing gastrointestinal motility, GC-C receptor agonists may also be used to regulate  
5 obesity.

In humans, the GC-C receptor is activated by guanylin (Gn) (U.S. 5,96,097), uroguanylin (Ugn) (U.S. 5,140,102) and lymphoguanylin (Forte et al. 1999 *Endocrinology* 140:1800-1806). Interestingly, these agents are 10-100 fold less potent than a class of bacterially  
10 derived peptides, termed ST (reviewed in Gianella 1995 *J Lab Clin Med* 125:173-181). ST peptides are considered super agonists of GC-C and are very resistant to proteolytic degradation.

ST peptide is capable of stimulating the enteric nervous system (Rolfe et al., 1994, *J*  
15 *Physiol* 475: 531-537; Rolfe et al. 1999 *Gut* 44: 615-619; Nzegwu et al. 1996 *Exp Physiol* 81: 313-315). Also, cGMP has been reported to have antinociceptive effects in multiple animal models of pain (Lazaro Ibanez et al. 2001 *Eur J Pharmacol* 426: 39-44; Soares et al. 2001 *British J Pharmacol* 134: 127-131; Jain et al. 2001 *Brain Res* 909:170-178; Amarante et al. 2002 *Eur J Pharmacol* 454:19-23). Thus, GC-C agonists may have  
20 both an analgesic as well an anti-inflammatory effect.

In bacteria, ST peptides are derived from a preproprotein that generally has at least 70 amino acids. The pre and pro regions are cleaved as part of the secretion process, and the resulting mature protein, which generally includes fewer than 20 amino acids, is  
25 biologically active.

Among the known bacterial ST peptides are: *E. coli* ST Ib (Moseley et al. 1983 *Infect. Immun.* 39:1167) having the mature amino acid sequence Asn Ser Ser Asn Tyr Cys Cys Glu Leu Cys Cys Asn Pro Ala Cys Thr Gly Cys Tyr (SEQ ID NO:\_\_); *E. coli* ST Ia (So

and McCarthy 1980 Proc. Natl. Acad. Sci. USA 77:4011) having the mature amino acid sequence Asn Thr Phe Tyr Cys Cys Glu Leu Cys Cys Asn Pro Ala Cys Ala Gly Cys Tyr (SEQ ID NO:7). *E. coli* ST I\* (Chan and Giannella 1981 J. Biol. Chem. 256:7744) having the mature amino acid sequence Asn Thr Phe Tyr Cys Cys Glu Leu Cys Cys Tyr  
 5 Pro Ala Cys Ala Gly Cys Asn (SEQ ID NO:\_\_); *C. freundii* ST peptide (Guarino et al. 1989b *Infect. Immun.* 57:649) having the mature amino acid sequence Asn Thr Phe Tyr Cys Cys Glu Leu Cys Cys Asn Pro Ala Cys Ala Gly Cys Tyr (SEQ ID NO:\_\_); *Y. enterocolitica* ST peptides, Y-ST(Y-STa), Y-STb, and Y-STc (reviewed in Huang et al. 1997 *Microb. Pathog.* 22:89) having the following pro-form amino acid sequences: Gln  
 10 Ala Cys Asp Pro Pro Ser Pro Pro Ala Glu Val Ser Ser Asp Trp Asp Cys Cys Asp Val Cys Cys Asn Pro Ala Cys Ala Gly Cys (SEQ ID NO:\_\_) (as well as a Ser-7 to Leu-7 variant of Y-STa (SEQ ID NO:\_\_), (Takao et al. 1985 *Eur. J. Biochem.* 152:199)); Lys Ala Cys Asp Thr Gln Thr Pro Ser Pro Ser Glu Glu Asn Asp Asp Trp Cys Cys Glu Val Cys Cys Asn Pro Ala Cys Ala Gly Cys (SEQ ID NO:\_\_); Gln Glu Thr Ala Ser Gly Gln Val Gly  
 15 Asp Val Ser Ser Ser Thr Ile Ala Thr Glu Val Ser Glu Ala Glu Cys Gly Thr Gln Ser Ala Thr Thr Gln Gly Glu Asn Asp Trp Asp Trp Cys Cys Glu Leu Cys Cys Asn Pro Ala Cys Phe Gly Cys (SEQ ID NO:\_\_), respectively; *Y. kristensenii* ST peptide having the mature amino acid sequence Ser Asp Trp Cys Cys Glu Val Cys Cys Asn Pro Ala Cys Ala Gly Cys (SEQ ID NO:\_\_); *V. cholerae* non-01 ST peptide (Takao et al. (1985) *FEBS Lett.* 193:250) having the mature amino acid sequence Ile Asp Cys Cys Glu Ile Cys Cys Asn Pro Ala Cys Phe Gly Cys Leu Asn (SEQ ID NO:\_\_); and *V. mimicus* ST peptide (Arita et al. 1991 *FEMS Microbiol. Lett.* 79:105) having the mature amino acid sequence Ile Asp Cys Cys Glu Ile Cys Cys Asn Pro Ala Cys Phe Gly Cys Leu Asn (SEQ ID NO:\_\_). Table I below provides sequences of all or a portion of a number of mature ST  
 25 peptides and analogs thereof. Such peptides and peptides comprising these peptides are useful GCC agonists.

Table I

GenBank®	GenBank®	Sequence
----------	----------	----------

Accession No.	GI No.	
QHECIB	69638	NSSNYCCELCCNPACTGICY(SEQ ID NO: )
P01559	123711	NTFYCCELCCNPACAGCY(SEQ ID NO: )
AAA24653	147878	NTFYCCELCCNPACAPCY(SEQ ID NO: )
P01560	123707	NTFYCCELCCYPACAGCN(SEQ ID NO: )
AAA27561	295439	IDCCEICCNPAFCGCLN(SEQ ID NO: )
P04429	123712	IDCCEICCNPAFCGCLN(SEQ ID NO: )
S34671	421286	IDCCEICCNPAFC(SEQ ID NO: )
CAA52209	395161	IDCCEICCNPAFCG(SEQ ID NO: )
A54534	628844	IDCCEICCNPAFCGCLN(SEQ ID NO: )
AAL02159	15592919	IDRCEICCNPAFCGCLN(SEQ ID NO: )
AAA18472	487395	DWDCCDVCCNPACAGC(SEQ ID NO: )
S25659	282047	DWDCCDVCCNPACAGC(SEQ ID NO: )
P74977	3913874	NDDWCCEVCCNPACAGC(SEQ ID NO: )
BAA23656	2662339	WDWCCELCCNPACFGC(SEQ ID NO: )
P31518	399947	SDWCCEVCCNPACAGC(SEQ ID NO: )
		QACDPPSPPAEVSSDWDCCDVCCDPAC AGC
		QACDPPSPPAEVSSDWDCCDVCCNPACAG C
		KACDTQTPSPSEENDDTCCEVCCNPACAG C
		QETASGQVGDVSSSTIATEVSEABCQTQSATTQGE NDWDWCCELCCNPACFGC
		MKKLMLAIFISVLSFSPFSQSTESLDS SKEKITLETKKCDVVKNNSEKksen MNNTFYCCELCCNPACAGCY
		MKKSILFIFLSVLSFSPFAQDAKPVES SKEKITLESKKCNIAKSNKSGPESM NSSNYCCELCCNPACTGICY
		MKKIVFVLVLMSSFGAFGQETVSG QFSDALSTPITAEVYKQACDPPLPPA EVSSDWDCCDVCCNPACAGC

		GNLIDCCBICCNPAFCGLN
		GNLIDRCEICCNPAFCGLN
		PPAEVSSDWDCCDVCCNPACAGC
		NYCCELCCNPACTGCF

The immature (including pre and pro regions) form of *E. coli* ST-1A (ST-P) protein has the sequence:

mkkmlaifisvlfspsfsqstesldsskekitletkkedvkvknsekksenmnnfyccelccnpacagcy (SEQ ID  
 5 NO: \_\_\_; see GenBank<sup>®</sup> Accession No. P01559 (gi:123711)). The pre sequence extends from aa 1-19. The pro sequence extends from aa 20-54. The mature protein extends from 55-72. The immature (including pre and pro regions) form of *E. coli* ST-1B (ST-H) protein has the sequence:

mkkksilfilsvlfsfpfaqdakpvesskekitletkkoniakksnksgpesmnsnyccelccnpactgcy (SEQ ID  
 10 NO: \_\_\_; see GenBank<sup>®</sup> Accession No. P07965 (gi:3915589)). The immature (including pre and pro regions) form of *Y. enterocolitica* ST protein has the sequence:  
 mlckivfylvmlssfgafgqetvsgqfsdalstptaevykqacdpplppaevssdwdccdvccnpacagc  
 (SEQ ID NO: \_\_\_; see GenBank<sup>®</sup> Accession No. S25659 (gi:282047)).

15 The peptides described herein, like the bacterial ST peptides, have six Cys residues. These six Cys residues form three disulfide bonds in the mature and active form of the peptide. If the six Cys residues are identified, from the amino to carboxy terminus of the peptide, as A, B, C, D, E, and F, then the disulfide bonds form as follows: A-D, B-E, and C-F. The formation of these bonds is thought to be important for GC-C receptor binding.  
 20 Certain of the peptides described herein include a potentially functional chymotrypsin cleavage site, e.g., a Trp, Tyr or Phe located between either Cys B and Cys D or between Cys E and Cys F. Cleavage at either chymotrypsin cleavage site may reduce or eliminates the ability of the peptide to bind to the GC-C receptor.

In the human body an inactive form of chymotrypsin, chymotrypsinogen is produced in the pancreas. When this inactive enzyme reaches the small intestine it is converted to active chymotrypsin by the excision of two di-peptides. Active chymotrypsin can potentially cleave peptides at the peptide bond on the carboxy-terminal side of Trp, Tyr or Phe. The presence of active chymotrypsin in the intestinal tract can potentially lead to cleavage of certain of the peptides described herein having an appropriately positioned functional chymotrypsin cleavage site. It is expected that chymotrypsin cleavage will moderate the action of a peptide described herein having an appropriately positioned chymotrypsin cleavage site as the peptide passes through the intestinal tract.

10

Trypsinogen, like chymotrypsin, is a serine protease that is produced in the pancreas and is present in the digestive tract. The active form, trypsin, will cleave peptides having a Lys or Arg. The presence of active trypsin in the intestinal tract can lead to cleavage of certain of the peptides described herein having an appropriately positioned functional trypsin cleavage site. It is expected that chymotrypsin cleavage will moderate the action of a peptide described herein having an appropriately positioned trypsin cleavage site as the peptide passes through the intestinal tract.

15

Many gastrointestinal disorders, including IBS, are associated with abdominal or visceral pain. Certain of the peptides described herein include analgesic or antinociceptive tags such as the carboxy-terminal sequence AspPhe immediately following a Trp, Tyr or Phe that creates a functional chymotrypsin cleavage site or following Lys or Arg that creates a functional trypsin cleavage site. Chymotrypsin in the intestinal tract can potentially cleave such peptides immediately carboxy terminal to the Trp, Phe or Tyr residue, releasing the dipeptide, AspPhe. This dipeptide has been shown to have analgesic activity in animal models (Abdikkahi et al. 2001 *Fundam Clin Pharmacol* 15:117-23; Nikfar et al 1997, 29:583-6; Edmundson et al 1998 *Clin Pharmacol Ther* 63:580-93). In this manner such peptides can treat both pain and inflammation. Other analgesic peptides can be present at the amino or carboxy terminus of the peptide (e.g., following a

20  
25

functional cleavage site) including: endomorphin-1, endomorphin-2, nocistatin, dalargin, lupron, and substance P.

A number of the useful peptides are based on the core sequence: Cys Cys Glu Leu Cys  
 5 Cys Asn Pro Ala Cys Thr Gly Cys Tyr. To create a variant having a potentially functional  
 chymotrypsin cleavage site capable of inactivating the peptide, either the Leu  
 (underlined) or the Thr (underlined) can be replaced by Trp, Phe or Tyr or both the Leu  
 and the Thr can be replaced by (independently) Trp, Phe or Tyr. To create a variant  
 having an analgesic di-peptide, the core sequence is followed by Asp Phe. The carboxy  
 10 terminal Tyr in the core sequence can allow the Asp Phe dipeptide to be released by  
 chymotrypsin in the digestive tract. The core sequence can be optionally be preceded by  
 Asn Ser Ser Asn Tyr or Asn.

Thus, useful variants based on the core sequence include:

15 Asn Ser Ser Asn Tyr Cys Cys Glu Leu Cys Cys Asn Pro Ala Cys Thr Gly Cys Tyr  
 (SEQ ID NO:4)  
 Asn Ser Ser Asn Tyr Cys Cys Glu Leu Cys Cys Asn Pro Ala Cys Trp Gly Cys Tyr  
 (SEQ ID NO:---)  
 Asn Ser Ser Asn Tyr Cys Cys Glu Tyr Cys Cys Asn Pro Ala Cys Thr Gly Cys Tyr  
 20 (SEQ ID NO:5)  
 Cys Cys Glu Leu Cys Cys Asn Pro Ala Cys Thr Gly Cys Tyr (SEQ ID NO:8)  
 Cys Cys Glu Leu Cys Cys Asn Pro Ala Cys Trp Gly Cys Tyr (SEQ ID NO:---)  
 Cys Cys Glu Tyr Cys Cys Asn Pro Ala Cys Thr Gly Cys Tyr (SEQ ID NO:3)  
 Asn Cys Cys Glu Leu Cys Cys Asn Pro Ala Cys Thr Gly Cys Tyr (SEQ ID NO:---)  
 25 Asn Cys Cys Glu Leu Cys Cys Asn Pro Ala Cys Trp Gly Cys Tyr (SEQ ID NO:---)  
 Asn Cys Cys Glu Phe Cys Cys Asn Pro Ala Cys Thr Gly Cys Tyr (SEQ ID NO:---)  
 Asn Cys Cys Glu Tyr Cys Cys Asn Pro Ala Cys Thr Gly Cys Tyr (SEQ ID NO:---)  
 Asn Cys Cys Glu Trp Cys Cys Asn Pro Ala Cys Thr Gly Cys Tyr (SEQ ID NO:---)  
 Asn Cys Cys Glu Arg Cys Cys Asn Pro Ala Cys Thr Gly Cys Tyr (SEQ ID NO:---)

Asn Cys Cys Glu Lys Cys Cys Asn Pro Ala Cys Thr Gly Cys Tyr (SEQ ID NO:---)  
Asn Ser Ser Asn Tyr Cys Cys Glu Leu Cys Cys Asn Pro Ala Cys Thr Gly Cys Tyr Asp  
Phe

(SEQ ID NO:---)

5 Asn Ser Ser Asn Tyr Cys Cys Glu Leu Cys Cys Asn Pro Ala Cys Trp Gly Cys Tyr Asp  
Phe

(SEQ ID NO:---)

Asn Ser Ser Asn Tyr Cys Cys Glu Phe Cys Cys Asn Pro Ala Cys Thr Gly Cys Tyr Asp  
Phe

10 (SEQ ID NO:---)

Asn Ser Ser Asn Tyr Cys Cys Glu Tyr Cys Cys Asn Pro Ala Cys Thr Gly Cys Tyr Asp  
Phe

(SEQ ID NO:---)

Asn Ser Ser Asn Tyr Cys Cys Glu Trp Cys Cys Asn Pro Ala Cys Thr Gly Cys Tyr Asp  
15 Phe

(SEQ ID NO:---)

Asn Ser Ser Asn Tyr Cys Cys Glu Arg Cys Cys Asn Pro Ala Cys Thr Gly Cys Tyr Asp  
Phe

(SEQ ID NO:---)

20 Asn Ser Ser Asn Tyr Cys Cys Glu Lys Cys Cys Asn Pro Ala Cys Thr Gly Cys Tyr Asp  
Phe

(SEQ ID NO:---)

Cys Cys Glu Leu Cys Cys Asn Pro Ala Cys Thr Gly Cys Tyr Asp Phe (SEQ ID NO:---)

Cys Cys Glu Leu Cys Cys Asn Pro Ala Cys Trp Gly Cys Tyr Asp Phe (SEQ ID NO:---)

25 Cys Cys Glu Phe Cys Cys Asn Pro Ala Cys Thr Gly Cys Tyr Asp Phe (SEQ ID NO:---)

Cys Cys Glu Tyr Cys Cys Asn Pro Ala Cys Thr Gly Cys Tyr Asp Phe (SEQ ID NO:---)

Cys Cys Glu Trp Cys Cys Asn Pro Ala Cys Thr Gly Cys Tyr Asp Phe (SEQ ID NO:---)

Cys Cys Glu Arg Cys Cys Asn Pro Ala Cys Thr Gly Cys Tyr Asp Phe (SEQ ID NO:---)

Cys Cys Glu Lys Cys Cys Asn Pro Ala Cys Thr Gly Cys Tyr Asp Phe (SEQ ID NO:---)



Asn Cys Cys Glu Leu Cys Cys Asn Pro Ala Cys Thr Gly Cys Tyr Asp Phe (SEQ ID NO:--  
 --)

Asn Cys Cys Glu Leu Cys Cys Asn Pro Ala Cys Trp Gly Cys Tyr Asp Phe (SEQ ID NO:--  
 --)

5 Asn Cys Cys Glu Phe Cys Cys Asn Pro Ala Cys Thr Gly Cys Tyr Asp Phe (SEQ ID NO:--  
 --)

Asn Cys Cys Glu Tyr Cys Cys Asn Pro Ala Cys Thr Gly Cys Tyr Asp Phe (SEQ ID NO:--  
 --)

10 Asn Cys Cys Glu Trp Cys Cys Asn Pro Ala Cys Thr Gly Cys Tyr Asp Phe (SEQ ID NO:--  
 --)

Asn Cys Cys Glu Arg Cys Cys Asn Pro Ala Cys Thr Gly Cys Tyr Asp Phe (SEQ ID NO:--  
 --)

Asn Cys Cys Glu Lys Cys Cys Asn Pro Ala Cys Thr Gly Cys Tyr Asp Phe (SEQ ID NO:--  
 --)

15

In some cases, the peptides described herein are produced as a prepro protein that includes the amino terminal leader sequence:

mkksilfilsvlsfspfaqdakpvesskekitleskkcniakksnksqpsmn. Where the peptide is

20 produced by a bacterial cell, e.g., *E. coli*, the forgoing leader sequence will be cleaved and the mature peptide will be efficiently secreted from the bacterial cell. U.S. Patent No. 5,395,490 describes vectors, expression systems and methods for the efficient production of ST peptides in bacterial cells and methods for achieving efficient secretion of mature ST peptides. The vectors, expression systems and methods described in U.S. Patent No. 5,395,490 can be used to produce the ST peptides and variant ST peptides of  
 25 the present invention

#### Variant Peptides

The invention includes variant peptides which can include one, two, three, four, five, six, seven, eight, nine, or ten (in some embodiments fewer than 5 or fewer than 3 or 2 or

fewer) amino acid substitutions and/or deletions compared to SEQ ID NOs: \_\_\_\_ to \_\_\_\_.

The substitution(s) can be conservative or non-conservative. The naturally-occurring amino acids can be substituted by D-isomers of any amino acid, non-natural amino acids, natural and natural amino acid analogs and other groups. A conservative amino acid

5 substitution results in the alteration of an amino acid for a similar acting amino acid, or amino acid of like charge, polarity, or hydrophobicity. At some positions, even conservative amino acid substitutions can alter the activity of the peptide. A conservative substitution can substitute a naturally-occurring amino acid for a non-naturally-occurring amino acid. The amino acid substitutions among naturally-occurring amino acids are

10 listed in Table II.

Table II

For Amino Acid	Code	Replace with any of
Alanine	Ala	Gly, Cys, Ser
Arginine	Arg	Lys, His
Asparagine	Asn	Asp, Glu, Gln,
Aspartic Acid	Asp	Asn, Glu, Gln
Cysteine	Cys	Met, Thr, Ser
Glutamine	Gln	Asn, Glu, Asp
Glutamic Acid	Glu	Asp, Asn, Gln
Glycine	Gly	Ala
Histidine	His	Lys, Arg
Isoleucine	Ile	Val, Leu, Met
Leucine	Leu	Val, Ile, Met
Lysine	Lys	Arg, His
Methionine	Met	Ile, Leu, Val
Phenylalanine	Phe	Tyr, His, Trp
Proline	Pro	
Serine	Ser	Thr, Cys, Ala
Threonine	Thr	Ser, Met, Val
Tryptophan	Trp	Phe, Tyr
Tyrosine	Tyr	Phe, His
Valine	Val	Leu, Ile, Met

In some circumstances it can be desirable to treat patients with a variant peptide that binds to and activates intestinal GC-C receptor, but is less active than the non-variant form the peptide. This reduced activity can arise from reduced affinity for the receptor or a reduced ability to activate the receptor once bound or reduced stability of the peptide.

6.

#### Production of peptides

Useful peptides can be produced either in bacteria including, without limitation, *E. coli*, or in other existing systems for peptide or protein production (e.g., *Bacillus subtilis*,  
10 baculovirus expression systems using *Drosophila* Sf9 cells, yeast or filamentous fungal expression systems, mammalian cell expression systems), or they can be chemically synthesized.

If the peptide or variant peptide is to be produced in bacteria, e.g., *E. coli*, the nucleic acid molecule encoding the peptide will preferably also encode a leader sequence that  
15 permits the secretion of the mature peptide from the cell. Thus, the sequence encoding the peptide can include the pre sequence and the pro sequence of, for example, a naturally-occurring bacterial ST peptide. The secreted, mature peptide can be purified from the culture medium.

20

The sequence encoding a peptide described herein is preferably inserted into a vector capable of delivering and maintaining the nucleic acid molecule in a bacterial cell. The DNA molecule may be inserted into an autonomously replicating vector (suitable vectors include, for example, pGEM3Z and pcDNA3, and derivatives thereof). The vector  
25 nucleic acid may be a bacterial or bacteriophage DNA such as bacteriophage lambda or M13 and derivatives thereof. Construction of a vector containing a nucleic acid described herein can be followed by transformation of a host cell such as a bacterium. Suitable bacterial hosts include but are not limited to, *E. coli*, *B. subtilis*, *Pseudomonas*, *Salmonella*. The genetic construct also includes, in addition to the encoding nucleic acid

molecule, elements that allow expression, such as a promoter and regulatory sequences. The expression vectors may contain transcriptional control sequences that control transcriptional initiation, such as promoter, enhancer, operator, and repressor sequences. A variety of transcriptional control sequences are well known to those in the art. The  
5 expression vector can also include a translation regulatory sequence (e.g., an untranslated 5' sequence, an untranslated 3' sequence, or an internal ribosome entry site). The vector can be capable of autonomous replication or it can integrate into host DNA to ensure stability during peptide production.

10 The protein coding sequence that includes a peptide described herein can also be fused to a nucleic acid encoding a polypeptide affinity tag, e.g., glutathione S-transferase (GST), maltose E binding protein, protein A, FLAG tag, hexa-histidine, myc tag or the influenza HA tag, in order to facilitate purification. The affinity tag or reporter fusion joins the reading frame of the peptide of interest to the reading frame of the gene encoding the  
15 affinity tag such that a translational fusion is generated. Expression of the fusion gene results in translation of a single polypeptide that includes both the peptide of interest and the affinity tag. In some instances where affinity tags are utilized, DNA sequence encoding a protease recognition site will be fused between the reading frames for the affinity tag and the peptide of interest.

20 Genetic constructs and methods suitable for production of immature and mature forms of the peptides and variants described herein in protein expression systems other than bacteria, and well known to those skilled in the art, can also be used to produce peptides in a biological system.

25 Mature peptides and variants thereof can be synthesized by the solid-phase chemical synthesis. For example, the peptide can be synthesized on Cyc(4-CH<sub>2</sub> Bxl)-OCH<sub>2</sub>-4-(oxymethyl)-phenylacetamidomethyl resin using a double coupling program. Protecting groups must be used appropriately to create the correct disulfide bond pattern. For

example, the following protecting groups can be used: t-butyloxycarbonyl (alpha-amino groups); acetamidomethyl (thiol groups of Cys residues B and E); 4-methylbenzyl (thiol groups of Cys residues C and F); benzyl (gamma-carboxyl of glutamic acid and the hydroxyl group of threonine, if present); and bromobenzyl (phenolic group of tyrosine, if present).

5 Coupling is effected with symmetrical anhydride of t-butoxycarbonylamino acids or hydroxybenzotriazole ester (for asparagine or glutamine residues), and the peptide is deprotected and cleaved from the solid support in hydrogen fluoride, dimethyl sulfide, anisole, and p-thiocresol using 8/1/1/0.5 ratio (v/v/v/w) at 0°C for 60 min. After removal of hydrogen fluoride and dimethyl sulfide by reduced pressure and anisole and p-  
10 thiocresol by extraction with ethyl ether and ethyl acetate sequentially, crude peptides are extracted with a mixture of 0.5M sodium phosphate buffer, pH 8.0 and N, N-dimethylformamide using 1/1 ratio, v/v. The disulfide bond for Cys residues B and E is the formed using dimethyl sulfoxide (Tam et al. (1991) *J. Am. Chem. Soc.* 113:6657-62). The resulting peptide is the purified by reverse-phase chromatography. The disulfide  
15 bond between Cys residues C and F is formed by first dissolving the peptide in 50% acetic acid in water. Saturated iodine solution in glacial acetic acid is added (1 ml iodine solution per 100 ml solution). After incubation at room temperature for 2 days in an enclosed glass container, the solution is diluted five-fold with deionized water and extracted with ethyl ether four times for removal of unreacted iodine. After removal of  
20 the residual amount of ethyl ether by rotary evaporation the solution of crude product is lyophilized and purified by successive reverse-phase chromatography.

Peptides can also be synthesized by many other methods including solid phase synthesis using traditional Fmoc protection (i.e., coupling with DCC-HOBt and deprotection with  
25 piperidine in DMF). Cys thiol groups can be trityl protected. Treatment with TFA can be used for final deprotection of the peptide and release of the peptide from the solid-state resin. In many cases air oxidation is sufficient to achieve proper disulfide bond formation.

**Example 1: Preparation of variant ST peptides and wild-type ST peptide****1a: Preparation of recombinant variant ST peptides and wild-type ST peptide**

5

A variant ST peptide having the sequence Asn Ser Ser Asn Tyr Cys Cys Glu Tyr Cys Cys Asn Pro Ala Cys Thr Gly Cys Tyr (SEQ ID NO:5) was produced recombinantly and tested in an animal model. A peptide having the sequence of the wild-type ST peptide was also created (SEQ ID NO:4).

10

SEQ ID NO:5 and SEQ ID NO:4 peptides were produced as preproteins using vectors produced as follows. A sequence encoding a heat-stable enterotoxin pre-pro sequence was amplified from pGK51/pGSK51 (ATCC 67728) using oligonucleotide MO3514 (5' CACACCATATGAAGAAATCAATATTATTTATTTTCTTCTG 3' (SEQ ID NO: )) and oligonucleotide MO3515 (5'

15

CACACCTCGAGTTAGGTCTCCATGCTTTCAGGACCACTTTTATTAC 3' (SEQ ID NO: \_\_)). The amplification product fragment was digested with NdeI/XhoI and ligated to the T7 expression vector, pET26b(+) (Novagen) digested with NdeI/XhoI thereby creating plasmid MB3976. The region encoding the pre-pro protein was sequenced and found to encode the amino acid sequence:

20

mkksilfilsvlsfspfaqdakpagsskekitleskkcnivkkssnksgpesm (SEQ ID NO: \_\_) which differs from the amino acid sequence of heat-stable enterotoxin a2 precursor (sta2; mkksilfilsvlsfspfaqdakpagsskekitleskkcnivkknnesspesm (SEQ ID NO: \_\_); GenBank<sup>®</sup> Accession No. Q47185, GI: 3913876) at three positions (indicated by underlining and bold text) near the C-terminus. To create expression vectors with the pre-pro sequence, complementary oligos encoding each ST peptide variant or wild-type ST peptide were

25  
annealed and cloned into the MB3976 expression vector. To create MB3984 (encoding SEQ ID NO:4 peptide (wild-type ST peptide) as a prepro protein), containing the amino acid sequence, NSSNYCCELCCNPACTGCGY (SEQ ID NO: \_\_) fused downstream of

the pre-pro sequence, MB 3976 was digested with BsaI/XhoI and ligated to annealed oligos MO3621 (5'

GCATGAATAGTAGCAATTACTGCTGTGAATTGTGTTGTAATCCTGCTTGTACCG  
GGTGCTATTAATAAC 3' (SEQ ID NO: \_\_)) and MO3622 (5'

5 TCGAGTTATTAATAGCACCCGGTACAAGCAGGATTACAACACAATTCACAGCA  
GTAATTGCTACTATTC 3' (SEQ ID NO: \_\_)). To create MB3985 (encoding SEQ ID  
NO:5 as a prepro protein) containing the following amino acid sequence,

NSSNYCCEYCCNPACTGCY fused downstream of the pre-pro sequence, MB 3976 was  
digested with BsaI/XhoI and ligated to annealed oligos MO3529 (5'

10 GCATGAATAGTAGCAATTACTGCTGTGAATATTGTTGTAATCCTGCTTGTACCGG  
GTGCTATTAATAAC 3' (SEQ ID NO: \_\_)) and MO3530 (5'

TCGAGTTATTAATAGCACCCGGTACAAGCAGGATTACAACAATATTCACAGCAG  
TAATTGCTACTATTC 3' (SEQ ID NO: \_\_)).

15 The SEQ ID NO:5 peptide and the SEQ ID NO:4 peptide were produced as follows. The  
expression vectors were transformed into *E. coli* bacterial host BL21  $\lambda$  DE3 (Invitrogen).  
A single colony was inoculated and grown shaking overnight at 30°C in L broth + 25  
mg/l kanamycin. The overnight culture was added to 3.2 L of batch medium (Glucose 25  
g/l, Caseamino Acids 5 g/l, Yeast Extract 5 g/l,  $\text{KH}_2\text{PO}_4$  13.3 g/l,  $(\text{NH}_4)_2\text{HPO}_4$  4 g/l,  
20  $\text{MgSO}_4 \cdot 7\text{H}_2\text{O}$  1.2 g/l, Citric Acid 1.7 g/l, EDTA 8.4 mg/l,  $\text{CoCl}_2 \cdot 6\text{H}_2\text{O}$  2.5 mg/l,  $\text{MnCl}_2 \cdot$   
 $4\text{H}_2\text{O}$  15 mg/l,  $\text{CuCl}_2 \cdot 4\text{H}_2\text{O}$  1.5 mg/l,  $\text{H}_3\text{BO}_3$  3 mg/l,  $\text{Na}_2\text{MoO}_4 \cdot 2\text{H}_2\text{O}$  2.5 mg/l, Zn  
Acetate- $2\text{H}_2\text{O}$  13 mg/l, Ferric Citrate 100 mg/l, Kanamycin 25 mg/l, Antifoam DF $_2\text{O}_4$  1  
ml/l) and fermented using the following process parameters : pH 6.7 - control with base  
only (28%  $\text{NH}_4\text{OH}$ ), 30°C, aeration : 5 liters per minute. After the initial consumption of  
25 batch glucose (based on monitoring dissolved oxygen (DO) levels), 1.5 L of feed medium  
(Glucose 700 g/l, Caseamino Acids 10 g/l, Yeast Extract 10 g/l,  $\text{MgSO}_4 \cdot 7\text{H}_2\text{O}$  4 g/l,  
EDTA 13 mg/l,  $\text{CoCl}_2 \cdot 6\text{H}_2\text{O}$  4 mg/l,  $\text{MnCl}_2 \cdot 4\text{H}_2\text{O}$  23.5 mg/l,  $\text{CuCl}_2 \cdot 4\text{H}_2\text{O}$  2.5 mg/l,  
 $\text{H}_3\text{BO}_3$  5 mg/l,  $\text{Na}_2\text{MoO}_4 \cdot 2\text{H}_2\text{O}$  4 mg/l, Zn Acetate- $2\text{H}_2\text{O}$  16 mg/l, Ferric Citrate 40 mg/l,  
Antifoam DF $_2\text{O}_4$  1 ml/l) was added at a feed rate controlled to maintain 20% DO. IPTG

was added to 0.2 mM 2 hours post feed start. The total run time was approximately 40-45 hours (until feed exhaustion).

5 Cells were collected by centrifugation at 5,000 g for 10 minutes. The cell pellet was discarded and the supernatant was passed through a 50 Kd ultrafiltration unit. The 50 Kd filtrate (0.6 liters) was loaded onto a 110 ml Q-Sepharose fast Flow column (Amersham Pharmacia, equilibrated with 20 mM Tris-HCl pH 7.5) at a flow rate of 400 ml/hour. The column was washed with six volumes of 20 mM Tris-HCl pH 7.5 and proteins were eluted with 50 mM acetic acid collecting 50 ml fractions. Fractions containing ST  
10 peptide variant or wild-type ST peptide were pooled and the solvent was removed by rotary evaporation. The dried proteins were resuspended in 10 ml of 8% acetic acid, 0.1% trifluoroacetic acid (TFA) and loaded onto a Varian Polaris C18-A column (250 X 21.2 mm 10 µm, equilibrated in the same buffer) at a flow rate of 20 ml/min. The column was washed with 100 ml of 8% methanol, 0.1% TFA and developed with a  
15 gradient (300 ml) of 24 to 48% methanol, 0.1% TFA, collecting 5-ml fractions. Fractions containing peptide were pooled and the solvent was removed by rotary evaporation. The peptides were dissolved in 0.1%TFA and lyophilized.

The SEQ ID NO:5 peptide and SEQ ID NO:4 peptide fractions were analyzed by  
20 standard LCMS and HPLC. LCMS analysis revealed that SEQ ID NO:5 peptide is more homogeneous than SEQ ID NO: 4 peptide (see Figure 1a; note that SEQ ID NO:5 peptide exhibits fewer peaks (Panel B) than SEQ ID NO:4 peptide (Panel A)).

#### 1b: Preparation of synthetic variant ST peptides and wild-type ST peptide

25

Peptides were chemically synthesized by a commercial peptide synthesis company. Varying yields of peptides were obtained depending on the efficiency of chemical synthesis. Thus, the four peptides, in decreasing order of yield were: Cys Cys Glu Tyr Cys Cys Asn Pro Ala Cys Thr Gly Cys Tyr (SEQ ID NO:3), 10-20% yield; Cys Cys Glu



Leu Cys Cys Asn Pro Ala Cys Thr Gly Cys Tyr (SEQ ID NO:8); Asn Ser Ser Asn Tyr  
Cys Cys Glu Tyr Cys Cys Asn Pro Ala Cys Thr Gly Cys Tyr (SEQ ID NO:5); Asn Ser  
Ser Asn Tyr Cys Cys Glu Leu Cys Cys Asn Pro Ala Cys Thr Gly Cys Tyr (SEQ ID  
NO:SEQ ID NO:4), <5% yield. Thus the specific amino acid changes introduced into  
5 the peptides can create improved manufacturing properties.

Figure 1b shows the total ion chromatograph profile of synthetically manufactured SEQ  
ID NO:3 peptide. Figure 1c shows the total ion chromatograph profile of the control  
blank sample. There is one major peak present in the SEQ ID NO:3 peptide sample that  
10 is not also present in the control sample. Quantitative analysis suggests the SEQ ID  
NO:3 peptide is >98% pure.

#### **Example 2: Activation of the intestinal GC-C receptor by a variant ST peptide and ST peptide**

15 The ability of SEQ ID NO:5, SEQ ID NO:4, SEQ ID NO:3, and SEQ ID NO:6 to  
activate the intestinal GC-C receptor was assessed in an assay employing the T84 human  
colon carcinoma cell line (American Type Culture Collection (Bethesda, Md)). For the  
assays cells were grown to confluency in 24-well culture plates with a 1:1 mixture of  
20 Ham's F12 medium and Dulbecco's modified Eagle's medium (DMEM), supplemented  
with 5% fetal calf serum and were used at between passages 54 and 60.

Briefly, monolayers of T84 cells in 24-well plates were washed twice with 1 ml/well  
DMEM, then incubated at 37°C for 10 min with 0.45 ml DMEM containing 1 mM  
25 isobutylmethylxanthine (IBMX), a cyclic nucleotide phosphodiesterase inhibitor. Test  
peptides (50µl) were then added and incubated for 30 minutes at 37°C. The media was  
aspirated and the reaction was then terminated by the addition of ice cold 0.5 ml of 0.1N  
HCl. The samples were held on ice for 20 minutes and then evaporated to dryness using  
a heat gun or vacuum centrifugation. The dried samples were resuspended in 0.5ml of

phosphate buffer provided in the Cayman Chemical Cyclic GMP EIA kit (Cayman Chemical, Ann Arbor, MI). Cyclic GMP was measured by EIA according to procedures outlined in the Cayman Chemical Cyclic GMP EIA kit.

- 5 Figures 2a and 2b show the activity of chemically synthesized peptide variants in this GC-C receptor activity assay. In this assay, SEQ ID NO:4 and two different SEQ ID NO:3 peptides (SEQ ID NO:3(a) and SEQ ID NO:3(b), synthesized by two different methods) had activity comparable to SEQ ID NO:4. SEQ ID NO:5 and SEQ ID NO:4 peptide were chemically synthesized in a manner identical to that of SEQ ID NO:3(b).  
10 SEQ ID NO:6 was chemically synthesized in a manner identical to that of SEQ ID NO:3(a).

**Example 3: Intestinal transit in rodents can be increased by administering certain peptides**

- 15 In order to determine whether the peptides increase the rate of gastrointestinal transit, the peptides and controls were tested using a murine gastrointestinal transit (GIT) assay (Moon et al. *Infection and Immunity* 25:127, 1979). In this assay, charcoal, which can be readily visualized in the gastrointestinal tract is administered to mice after the administration of a test compound. The distance traveled by the charcoal is measured  
20 and expressed as a percentage of the total length of the colon.

- Mice were fasted with free access to water for 12 to 16 hours before the treatment with peptide or control buffer. The peptides were orally administered at 1 $\mu$ g/kg – 1mg/kg of peptide in buffer (20mM Tris pH 7.5) 7 minutes before being given an oral dose of 5%  
25 Activated Carbon (Aldrich 242276-250G). Control mice were administered buffer only before being given a dose of Activated Carbon. After 15 minutes, the mice were sacrificed and their intestines from the stomach to the cecum were dissected. The total length of the intestine as well as the distance traveled from the stomach to the charcoal

front was measured for each animal and the results are expressed as the percent of the total length of the intestine traveled by the charcoal front. All results are reported as the average of 10 mice  $\pm$  standard deviation. A comparison of the distance traveled by the charcoal between the mice treated with peptide versus the mice treated with vehicle alone  
5 was performed using a Student's t test and a statistically significant difference was considered for  $P < 0.05$ . P-values are calculated using a two-sided T-Test assuming unequal variances.

As can be seen in Figure 3a and Figure 3b, wild-type ST peptide SEQ ID NO:4, (Sigma-  
10 Aldrich, St Louis, MO); 0.1 mg/kg), synthetically manufactured SEQ ID NO:3 and Zelnorm® (0.1 mg/kg), a drug approved for IBS that is an agonist for the serotonin receptor 5HT<sub>4</sub>, increase gastrointestinal transit rate in this model. Figure 4a shows the result of a study demonstrating that intestinal transit rate increases with an increasing dosage of either recombinantly synthesized SEQ ID NO:4 or SEQ ID NO:5. Figure 4b  
15 shows the results of a study demonstrating both chemically synthesized SEQ ID NO:4 or SEQ ID NO:3 peptide increase intestinal transit rates more than either Tris buffer alone or an equivalent dose of Zelnorm®.

The identical experiment was performed to determine if SEQ ID NO:3 is effective in a  
20 chronic dosing treatment regimen. Briefly, 8 week old CD1 female mice are dosed orally once a day for 5 days with either SEQ ID NO:3 (0.06mg/kg or 0.25mg/kg in 20mM Tris pH 7.5) or vehicle alone (20mM Tris pH 7.5). On the 5<sup>th</sup> day, a GIT assay is performed identical to that above except 200 $\mu$ l of a 10% charcoal solution is administered. Figure 4c shows the results of a study demonstrating both chemically synthesized SEQ ID NO:3  
25 or Zelnorm® are effective in a mouse gastrointestinal motility assay upon chronic dosing (daily for 5 days). The results are shown side by side with acute dosing (1 day).

The gastrointestinal transit assay was also performed in male and female CD rats (Charles River; Wilmington, MA) weighing between 136–191 g with an average weight

of 167.6 g. The assay was performed as described above for mice except an average of 5-8 animals were used for each test group and test peptide and 5% activated carbon were administered simultaneously (versus 7 minutes apart). In addition, the animals were sacrificed 10 minutes after the administration of peptide and test compound. Figure 4d shows the results of a study demonstrating that intestinal transit increases following the administration of SEQ ID NO:3, but not Zelnorm® in the rat GIT assay. Figure 4e shows the results of a study demonstrating that intestinal transit increases in a dose dependent manner with the administration of either SEQ ID NO:3 or SEQ ID NO:6 in female rats. Similar effects were seen in male rats.

10

The gastrointestinal transit assay was also performed in wild-type mice and mice lacking the guanylate cyclase C receptor (GC-C KO; Mann et al 1997 Biochem and Biophysical Research Communications 239:463). Wild type and GC-C KO mice were fasted overnight and SEQ ID NO:3 or vehicle alone were orally administered 10 minutes prior to an oral dose of a 10% Activated Carbon/10% Gum Arabic suspension. Animals were sacrificed 5 minutes after peptide or vehicle administration. Figure 4F shows the results of the gastrointestinal transit assay in 14 wild-type and 14 GC-C KO female mice. In vehicle treated animals, no difference was observed in transit rate between wild-type and GC-C KO animals. When compared to vehicle (20mM Tris pH 7.5) alone, an increase ( $p < 0.001$ ) in gastrointestinal transit rate was observed upon oral treatment with 100µg/kg of SEQ ID NO:3 in wild-type but not GC-C KO mice. Similar effects were observed in male mice.

**Example 4: Certain peptides increase intestinal secretion in suckling mice (SuMi assay)**

25

SEQ ID NO:4 peptide and SEQ ID NO:3 were tested for their ability to increase intestinal secretion using a suckling mouse model of intestinal secretion. In this model a test compound is administered to suckling mice that are between 7 and 9 days old. After

the mice are sacrificed, the gastrointestinal tract from the stomach to the cecum is dissected ("guts"). The remains ("carcass") as well as the guts are weighed and the ratio of guts to carcass weight is calculated. If the ratio is above 0.09, one can conclude that the test compound increases intestinal secretion. Figure 5a shows a dose response curve for wild-type ST peptide (SEQ ID NO:4) in this model. Figure 5b shows dose response curve for the SEQ ID NO:3 peptide in this model. These data show that wild-type ST peptide (purchased from TDT, Inc. West Chester, PA) and the SEQ ID NO:3 peptide increase intestinal secretion. The effect of Zelnorm® was also studied. As can be seen from Figure 5, Zelnorm® at 0.2 mg/kg does not increase intestinal secretion in this model. Figure 6a shows a dose response curve for the recombinant SEQ ID NO:4 peptide described above and the recombinant SEQ ID NO:5 peptide described above. As can be seen from Figure 6a, both peptides increase intestinal secretion in this model. Similarly figure 6b shows a dose response curve for chemically synthesized SEQ ID NO:5, SEQ ID NO:3 and SEQ ID NO:4 as well as wild-type ST peptide (purchased from Sigma-Aldrich, St Louis, MO). Figure 6c shows a dose response curve for chemically synthesized SEQ ID NO:3 and SEQ ID NO:6.

#### Colonic hyperalgesia animal models

Hypersensitivity to colorectal distension is common in patients with IBS and may be responsible for the major symptom of pain. Both inflammatory and non-inflammatory animal models of visceral hyperalgesia to distension have been developed to investigate the effect of compounds on visceral pain in IBS.

#### I. Trinitrobenzenesulphonic acid (TNBS)-induced rectal allodynia in two rodent models

##### TNBS visceral hypersensitivity rat model

Male Wistar rats (220-250 g) were premedicated with 0.5 mg/kg of acepromazine injected intraperitoneally (IP) and anesthetized by intramuscular administration of 100

mg/kg of ketamine. Pairs of nichrome wire electrodes (60 cm in length and 80  $\mu$ m in diameter) were implanted in the striated muscle of the abdomen, 2 cm laterally from the white line. The free ends of electrodes were exteriorized on the back of the neck and protected by a plastic tube attached to the skin. Electromyographic (EMG) recordings were started 5 days after surgery. Electrical activity of abdominal striated muscle was recorded with an electroencephalograph machine (Mini VIII, Alvar, Paris, France) using a short time constant (0.03 sec.) to remove low-frequency signals (<3 Hz).

Ten days post surgical implantation, trinitrobenzenesulphonic acid (TNBS) was administered to induce rectal inflammation. TNBS (80 mg kg<sup>-1</sup> in 0.3 ml 50 % ethanol) was administered intrarectally through a silicone rubber catheter introduced at 3 cm from the anus under light diethyl-ether anesthesia, as described (Morteau et al. 1994 *Dig Dis Sci* 39:1239). Following TNBS administration, rats were placed in plastic tunnels where they were severely limited in mobility for several days before colorectal distension (CRD). Experimental compound was administered one hour before CRD which was performed by insertion into the rectum, at 1 cm of the anus, a 4 cm long balloon made from a latex condom (Gue et al, 1997 *Neurogastroenterol. Motil.* 9:271). The balloon was fixed on a rigid catheter taken from an embolectomy probe (Fogarty). The catheter attached balloon was fixed at the base of the tail. The balloon, connected to a barostat, was inflated progressively by step of 15 mmHg, from 0 to 60 mmHg, each step of inflation lasting 5 min. Evaluation of rectal sensitivity, as measured by EMG, was performed before (1-2 days) and 3 days following rectal instillation of TNBS.

The number of spike bursts that corresponds to abdominal contractions was determined per 5 min periods. Statistical analysis of the number of abdominal contractions and evaluation of the dose-effects relationships was performed by a one way analysis of variance (ANOVA) followed by a post-hoc (Student or Dunnett tests) and regression analysis for ED50 if appropriate.

Figure 7a shows the results of experiment in which SEQ ID NO:3 activity was analyzed in the TNBS colorectal model. Significant decreases in abdominal response are observed at 0.3  $\mu\text{g}/\text{kg}$  and 3  $\mu\text{g}/\text{kg}$  SEQ ID NO:3. These results demonstrate that SEQ ID NO:3 reduces pain associated with colorectal distension in this animal model.

5

TNBS visceral hypersensitivity model in wild-type (WT) mice and mice lacking the guanylate-cyclase C receptor (GC-C KO)

TNBS induced visceral hypersensitivity was assessed in WT and GC-C KO mice. Two groups (WT and GC-C KO) of male mice (22-25g) were surgically prepared for  
10 electromyographic (EMG) recordings. Three electrodes were implanted in the striated muscles of the abdomen for EMG recording of abdominal contractions. Colorectal distension (CRD) was performed with a balloon inflated by 10s steps of 0.02 ml from 0 to 0.12ml. Under basal conditions mice were submitted to control CRD (time 0) followed by oral administration of SEQ ID NO:3 (0.01 and 0.3  $\mu\text{g}/\text{kg}$ ) or vehicle only  
15 (distilled water, 1 ml) at 3 hours. One hour post dosing the CRD procedure was repeated. Abdominal EMG contractile response to colorectal distension in basal conditions in both WT and GC-C KO mice (12-14 mice per group) was determined in the absence of vehicle and SEQ ID NO:3, and the mean  $\pm$  standard error of the mean (SEM) is graphically depicted in Figure 7c. GC-C KO mice exhibited a decreased EMG  
20 contractile response to CRD when compared to wild-type mice. SEQ ID NO:3 dosing of WT and GC-C KO mice under basal conditions decreased the EMG response to colorectal distension in WT but not GC-C KO mice.

For TNBS induced visceral hypersensitivity conditions, mice were submitted to control CRD (time 0) and TNBS (20 mg/kg) was administered at 3 days. Three days post  
25 intracolonic TNBS-induction animals were orally administered SEQ ID NO:3 (0.01 and 0.3  $\mu\text{g}/\text{kg}$ ) or vehicle (distilled water, 1ml) 1 hour before CRD. The effect of SEQ ID NO:3 (0.01  $\mu\text{g}/\text{kg}$ ) on abdominal response to colorectal distension after TNBS in WT and GC-C KO mice (12-14 per group) at a volume distension of 0.8 ml was determined and the mean  $\pm$  standard error of the mean (SEM) is graphically depicted in Figure 7d. SEQ

ID NO:3 reduces the TNBS induced hypersensitivity to CRD in WT mice at 0.01 $\mu$ g/kg. A similar effect was not observed in GC-C KO mice.

5           II. Partial restraint stress-induced hyperalgesia model

Five groups of female Wistar rats (weighing 200-250g each), were surgically prepared for electromyography as described (Morteau et al. 1994 Dig Dis Sci 39:1239-48) and were used to evaluate the effects of SEQ ID NO:3 on colorectal sensitivity and  
10 compliance after a 2 hour partial restraint stress session. Partial restraint stress (PRS), a relatively mild stress, was induced as previously described (Morteau et al. 1994 Dig Dis Sci 39:1239-48). Female rats were lightly anesthetized with diethyl ether and their shoulders, upper forelimbs and thoracic trunk were wrapped in a confining harness of paper tape to restrict, but not prevent body movements. Control sham-stress animals  
15 were anesthetized but not wrapped. Animals received isobaric colorectal distensions (CRD) directly prior to (control CRD) and 15 minutes after two hours of partial restraint induced stress. Rats were treated orally with SEQ ID NO:3 (0.3, 3, 30  $\mu$ g/kg) or vehicle only (distilled water 1 mL) one hour before the CRD procedure. For the CRD procedure, rats were acclimatized to restraint in polypropylene tunnels (diameter: 7 cm; length: 20  
20 cm) periodically for several days before CRD in order to minimize recording artifacts. The balloon used for distension was 4 cm long and made from a latex condom. It was fixed on a rigid catheter taken from an embolectomy probe (Fogarty). CRD was performed by insertion of the balloon in the rectum at 1 cm from the anus. The tube was fixed at the base of the tail. Isobaric distensions were performed from 0 to 60 mmHg,  
25 with each distension step lasting 5 minutes. The first distension was performed at a pressure of 15 mmHg and an increment of 15 mmHg was added at each following step, until a maximal pressure of 60 mmHg was attained. Electromyographic recordings commenced 5 days after surgery. Electrical activity was recorded with an electroencephalograph (Mini VIII, Alvar, Paris, France) using a short time constant (0.03



sec.) to remove low-frequency signals (<3 Hz) and a paper speed of 3.6 cm/minute. Isobaric distensions of the colon were performed by connecting the balloon to a computerized barostat. Colonic pressure and balloon volume were continuously monitored on a potentiometric recorder (L6514, Linseis, Selb, Germany) with a paper speed of 1.0 cm/minute. The number of spike bursts, corresponding to abdominal contractions, was evaluated per 5-minute period. Colorectal volumes were determined as the maximal volume obtained for each stage of distension using the potentiometric recorder. Statistical analysis of these two parameters was performed using a one way analysis of variance (ANOVA) followed by an unpaired two-tailed Student's *t* test using GraphPad Prism 4.0. *p* values <0.05 were considered significantly different. The values were expressed as mean ± SEM. Figure 7b shows the results of an experiment in which SEQ ID NO:3 activity was analysed in the Stress-Induced Hyperalgesia model. SEQ ID NO:3 reduced the response to CRD after PRS (*p*<0.0001) at a distending pressure of 15 mm Hg when administered at doses of 0.3 and 3.0 µg/kg.

### 15 III. Water avoidance stress-induced hyperalgesia model

The effect of SEQ ID NO:3 on basal visceral nociception in a model of water avoidance stress-induced visceral hyperalgesia in adult male Wistar rats was tested. The stress involved confining rats to a platform surrounded by water for a period of 1 hour and then measuring their visceromotor response to colonic distension using electromyography (EMG).

At least 7 days prior to stress measurements, animals were deeply anesthetized with pentobarbital sodium (45 mg/kg) and equipped with electrodes implanted into the external oblique musculature, just superior to the inguinal ligament. Electrode leads were then tunneled subcutaneously and externalized laterally for future access. Following surgery, rats were housed in pairs and allowed to recover for at least 7 days. On the day of the experiment, animals were lightly anesthetized with halothane, and a lubricated latex balloon (6 cm) was inserted intra-anally into the descending colon. Animals were allowed to recover for 30 minutes, and colorectal distension (CRD) was initiated. The

CRD procedure consisted of graded intensities of phasic CRD (10, 20, 40, 60 mmHg; 20 s duration; 4 min inter-stimulus interval). Visceromotor response (VMR) to CRD was quantified by measuring EMG activity. To determine the effects of SEQ ID NO:3 on basal visceral nociception, a baseline CRD was recorded. Animals were allowed 1 hour recovery and then SEQ ID NO:3 or vehicle was orally administered. At 1 hour following administration of SEQ ID NO:3 or vehicle CRD was repeated. Administration of 30  $\mu\text{g}/\text{kg}$  of SEQ ID NO:3 increased basal visceral nociception as compared to vehicle only. The mean value ( $\pm$  SEM) of in vehicle and SEQ ID NO:3 treated groups ( $n=7$  for each group) is graphically depicted in Figure 7e. Oral administration of SEQ ID NO:3 at a lower dose ( $3 \mu\text{g}/\text{kg}$ ) had no effects on basal visceral.

To determine the effect of SEQ ID NO:3 in a model of water avoidance stress-induced visceral hyperalgesia, a baseline CRD was recorded and then the animals were subjected to 1 hour of water avoidance stress. For water avoidance stress, the test apparatus consisted of a Plexiglas tank with a block affixed to the center of the floor. The tank was filled with fresh room temperature water ( $25^\circ\text{C}$ ) to within 1 cm of the top of the block. The animals were placed on the block for a period of 1 h. The sham water avoidance stress consisted in placing the rats on the same platform in a waterless container. A second CRD was performed at 24 hours post water avoidance stress. Following the second CRD, animals were allowed 1 hour recovery and then SEQ ID NO:3 or vehicle was orally administered. At 1 hour following administration of SEQ ID NO:3 or vehicle CRD was repeated. Following water avoidance stress,  $3 \mu\text{g}/\text{kg}$  of SEQ ID NO:3 exhibited anti-hyperalgesic properties, by reducing the increased visceromotor response to colorectal distension (CRD) 24 hours after stress. This effect is graphically depicted (mean  $\pm$  SEM;  $n=7$ ) in Figure 7f.

#### Phenylbenzoquinone-induced writhing model

The PBQ-induced writhing model can be used to assess pain control activity of the peptides and GC-C receptor agonists described herein. This model is described by Siegmund et al. (1957 Proc. Soc. Exp. Bio. Med. 95:729-731). Briefly, one hour after

oral dosing with a test compound, e.g., a peptide, morphine or vehicle, 0.02% phenylbenzoquinone (PBQ) solution (12.5 mL/kg) is injected by intraperitoneal route into the mouse. The number of stretches and writhings are recorded from the 5<sup>th</sup> to the 10<sup>th</sup> minute after PBQ injection, and can also be counted between the 35<sup>th</sup> and 40<sup>th</sup> minute  
5 and between the 60<sup>th</sup> and 65<sup>th</sup> minute to provide a kinetic assessment. The results are expressed as the number of stretches and writhings (mean  $\pm$  SEM) and the percentage of variation of the nociceptive threshold calculated from the mean value of the vehicle-treated group. The statistical significance of any differences between the treated groups and the control group is determined by a Dunnett's test using the residual variance after a  
10 one-way analysis of variance ( $P < 0.05$ ) using SigmaStat Software.

Figures 8a and 8b show the effect of different doses of SEQ ID NO:5 and SEQ ID NO:3 in the PBQ writhing assay. Indomethacin, an NSAID (nonsteroidal anti-inflammatory drug) with known pain control activity, was used as the positive control in the assay.  
15 Significant reductions in writhings were observed for SEQ ID NO:5 (1 mg/kg dose) and SEQ ID NO:3 (2.5 mg/kg dose) compared to the vehicle control. Loss of efficacy at the highest dose tested has also been observed for multiple other compounds (such as 5HT-3 antagonists) tested in similar assays. The results of this study suggest that both SEQ ID NO:5 and SEQ ID NO:3 have antinociceptive effects in this visceral pain model  
20 comparable to the intermediate doses of indomethacin.

#### **Example 5: SEQ ID NO:3 Kd determination and binding assays**

To determine the affinity of SEQ ID NO:3 for GC-C receptors found in rat intestinal  
25 mucosa, a competition binding assay was performed using rat intestinal epithelial cells. Epithelial cells from the small intestine of rats were obtained as described by Kessler et al. (*J. Biol. Chem.* 245: 5281-5288 (1970)). Briefly, animals were sacrificed and their abdominal cavities exposed. The small intestine was rinsed with 300 ml ice cold saline or PBS. 10 cm of the small intestine measured at 10 cm from the pylorus was removed

and cut into 1 inch segments. Intestinal mucosa was extruded from the intestine by gentle pressure between a piece of parafilm and a P-1000 pipette tip. Intestinal epithelial cells were placed in 2 ml PBS and pipetted up and down with a 5 ml pipette to make a suspension of cells. Protein concentration in the suspension was measured using the  
5 Bradford method (*Anal. Biochem.* 72: 248-254 (1976)).

A competition binding assay was performed based on the method of Giannella et al. (*Am. J. Physiol.* 245: G492-G498) between [<sup>125</sup>I] labeled SEQ ID NO:4 and SEQ ID NO:3. The assay mixture contained: 0.5 ml of DME with 20 mM HEPES-KOH pH 7.0, 0.9 mg  
10 of the cell suspension listed above, 21.4 fmol [<sup>125</sup>I]-SEQ ID NO:4 (42.8 pM), and different concentrations of competitor SEQ ID NO:3 (0.01 to 1000 nM). The mixture was incubated at room temperature for 1 hour, and the reaction stopped by applying the mixture to GF/B glass-fiber filters (Whatman). The filters were washed with 5 ml ice-cold PBS and radioactivity was measured. Figure 9a shows that the K<sub>d</sub> for SEQ ID NO:3  
15 in this assay is 4.5 nM. %B/B<sub>0</sub> is the percentage of the ratio of radioactivity trapped in each sample (B) compared to the radioactivity retained in a control sample with no cold competitor (B<sub>0</sub>). Giannella et al. (*Am. J. Physiol.* 245: G492-G498) observed that the K<sub>d</sub> for wild-type ST peptide in this same assay was ~13 nM.

20 Similar competition binding assays were performed in intestinal epithelial cells from wild-type and guanylate cyclase C knockout (GC-C KO; Mann et al. 1997 *Biochem and Biophysical Research Communications* 239:463) mice. Mouse intestinal epithelial cells were prepared identical to that above as for rat intestinal epithelial cells except the cells were homogenized with an Omni homogenizer for 20 seconds on the maximum setting to  
25 make a suspension of cells. A competition binding assay was performed identical to that described above between <sup>125</sup>I labeled SEQ ID NO:3 and unlabeled SEQ ID NO:3 (competitor). Figure 9b shows the results of an assay in which <sup>125</sup>I-SEQ ID NO:3 was prepared and incubated alone or with an excess of unlabeled SEQ ID NO:3 with isolated intestinal epithelial cells from two female wild-type and two female GC-C KO mice.

There is a reduction in SEQ ID NO:3 binding to intestinal epithelial cells from GC-C KO mice when compared to wild-type mice.

The binding of SEQ ID NO:3 and SEQ ID NO:6 to GC-C receptors on the cell surface of human colonic cells (T84 cells ATCC Catalog No. CCL-248) was characterized in a competitive radioligand-binding assay at pH conditions of 5, 7 and 8. The radiolabeled tracer used in these experiments was  $^{125}\text{I}$ - SEQ ID NO:7. To determine binding constants, competitive inhibition of binding was used. T84 cells were cultured in T-150 plastic flasks in DMEM and Ham's F-12 medium containing 5% fetal bovine serum. Monolayers at 60-70% confluency (approximately  $10^7$  cells) were collected by gentle scraping followed by centrifugation, and washed twice in 50 mL of phosphate-buffered saline (PBS). The cells were resuspended in 1 mL DMEM containing 20 mM *N*-(2-hydroxymethyl)piperazine-*N'*-(2-ethanesulfonic acid) (Hepes), pH 7.0 and 0.5% bovine serum albumin (BSA). T84 cells were incubated with a constant amount of  $^{125}\text{I}$ - SEQ ID NO:7 containing various concentrations of cold competitor. Free  $^{125}\text{I}$ - SEQ ID NO:7 was separated from bound tracer by rapid suction filtration. The binding reactions were carried out in 1.5 mL microfuge tubes in 0.24 mL of DMEM/20 mM Hepes pH 7.0/0.5% BSA containing:  $2.5 \times 10^5$  T84 cells (0.25 mg protein), 200,000 cpm  $^{125}\text{I}$ - SEQ ID NO:7 (41 fmol, 170 pM), and 0.01 to 1,000 nM competitor. Binding assays at pH 5.0 were done in DMEM/20 mM 2-(*N*-morpholino) ethanesulfonic acid (Mes), pH 5.0. Binding assays in pH 8.0 were done in DMEM/20 mM Hepes/50 mM sodium bicarbonate pH 8.0. One sample contained no competitor ( $B_0$ ) and another contained no cells. After incubation at 37 °C for 1 h, the reaction mixtures were applied to Whatman GF/B glass-fiber filters by suction filtration. The filters were then rinsed with 10 mL ice-cold PBS buffer, inserted into plastic tubes, and added to 2 mL scintillation fluid. Radioactivity was measured in a LS 6500 liquid scintillation counter (Beckman-Coulter). The percent bound in each sample is calculated by the equation:

$$\% B/B_0 = \frac{(\text{sample cpm} - \text{no cells cpm}) \times 100}{(B_0 \text{ cpm} - \text{no cells cpm})}$$

Competitive radioligand-binding curves were generated using the Graphpad PRISM™ computer program. Nonlinear regression analysis of the binding data was used to calculate the concentration of competitor that resulted in 50% radioligand bound ( $IC_{50}$ ).

6 The apparent dissociation equilibrium constant ( $K_i$ ) for each competitor was obtained from the  $IC_{50}$  values and the previously reported estimate of the dissociation constant for the radioligand,  $K_d \approx 15$  nM (Hamra et al. 1997 PNAS 2705-10) and the method of Cheng and Prusoff 1973 Biochem Pharmacol 22:3099-108. Using a two site model, high and low affinity-binding sites were identified on T84 cells ( $K_{i1}$  and  $K_{i2}$ ) for all the test

10 agents. At pH 7.0, for SEQ ID NO:3  $K_{i1}$  ranged from 0.89-1.23 nM and  $K_{i2}$  ranged from 88.9-156 nM. The SEQ ID NO:6 binding affinities at pH 7.0 were  $K_{i1} = 1.57$  nM and  $K_{i2} = 446$  nM. The SEQ ID NO:3 binding affinities at pH 5.0 were  $K_{i1} = 1.38$  nM and  $K_{i2} = 17$  nM. At pH 8.0 the high and low affinity binding sites were  $K_{i1} = 0.6$  and  $K_{i2} = 94.4$  nM respectively. Thus, binding of SEQ ID NO:3 to the high affinity site,  $K_{i1}$ , was not

15 affected by pH.

#### Example 6: Pharmacokinetic properties of SEQ ID NO:3

To study the pharmacokinetics of SEQ ID NO:3, absorbability studies in mice were

20 performed by administering SEQ ID NO:3 intravenously via tail vein injection or orally by gavage to 8-week-old CD1 mice. Serum was collected from the animals at various time points and tested for the presence of SEQ ID NO:3 using a competitive enzyme-linked immunoabsorbent assay (Oxoid, ST ELA kit, Cat#TD0700). The assay utilized monoclonal antibodies against ST peptide (antibodies are provided in the Oxoid kit) and

25 synthetically manufactured SEQ ID NO:3. Figure 10a shows absorption data for intravenously and orally administered SEQ ID NO:3 as detected by the ELISA assay. SEQ ID NO:3 appears to be minimally systemically absorbed and is < 2.2% bioavailable.

A similar bioavailability study was performed in which LCMS rather than ELISA was used to detect SEQ ID NO:3. Initially, serum samples were extracted from the whole blood of exposed and control mice, then injected directly (10mL) onto an in-line solid phase extraction (SPE) column (Waters Oasis HLB 25µm column, 2.0 x 15mm direct connect) without further processing. The sample on the SPE column was washed with a 5% methanol, 95% dH<sub>2</sub>O solution (2.1 mL/min, 1.0 minute), then loaded onto an analytical column using a valve switch that places the SPE column in an inverted flow path onto the analytical column (Waters Xterra MS C8 5µm IS column, 2.1 x 20mm). The sample was eluted from the analytical column with a reverse phase gradient (Mobile Phase A: 10 mM ammonium hydroxide in dH<sub>2</sub>O, Mobile Phase B: 10 mM ammonium hydroxide in 80% acetonitrile and 20% methanol; 20% B for the first 3 minutes then ramping to 95% B over 4 min. and holding for 2 min., all at a flow rate of 0.4 mL/min.). At 9.1 minutes, the gradient returns to the initial conditions of 20%B for 1 min. SEQ ID NO:3 eluted from the analytical column at 1.45 minutes, and was detected by triple-quadrupole mass spectrometry (MRM, 764 (+2 charge state)>182 (+1 charge state) Da; cone voltage = 30V; collision = 20 eV; parent resolution = 2 Da at base peak; daughter resolution = 2 Da at base peak). Instrument response was converted into concentration units by comparison with a standard curve using known amounts of chemically synthesized SEQ ID NO:3 prepared and injected in mouse serum using the same procedure.

Figure 10b shows absorption data for IV and orally administered SEQ ID NO:3 as detected by LCMS. In this assay, SEQ ID NO:3 appears similarly minimally systemically absorbed and is < 0.11 % bioavailable.

Similarly, oral bioavailability was determined in rats using LCMS methodology. Rat plasma samples containing SEQ ID NO:3 and/or SEQ ID NO:6 were extracted using a Waters Oasis MAX 96 well solid phase extraction (SPE) plate. A 200 µL volume of rat plasma was mixed with 200 µL of <sup>13</sup>C<sub>9</sub>, <sup>15</sup>N - SEQ ID NO:3 in the well of a prepared SPE

plate. The samples were drawn through the stationary phase with 15 mm Hg vacuum. All samples were rinsed with 200  $\mu$ L of 2% ammonium hydroxide in water followed by 200  $\mu$ L of 20% methanol in water. The samples were eluted with consecutive 100  $\mu$ L volumes of 5/20/75 formic acid/water/methanol and 100  $\mu$ L 5/15/80 formic acid/water/methanol. The samples were dried under nitrogen and resuspended in 100  $\mu$ L of 20% methanol in water. Samples were analyzed by a Waters Quattro Micro mass spectrometer coupled to a Waters 1525 binary pump with a Waters 2777 autosampler. A 40  $\mu$ L volume of each sample was injected onto a Thermo Hypersil GOLD C18 column (2.1x50 mm, 5  $\mu$ m). SEQ ID NO:3 and SEQ ID NO:6 were eluted by a gradient over 3 minutes with acetonitrile and water containing 0.05% trifluoroacetic acid. The Quattro Micro mass spectrometer was run in multiple reaction monitoring (MRM) mode using the mass transitions of 764>182 and 682>136 for SEQ ID NO:3 and SEQ ID NO:6 respectively. Using this methodology, SEQ ID NO:3 was dosed orally and by IV to rats at 10 mg/kg. The area under the curve (AUC) for orally dosed SEQ ID NO:3 was 776.6 nM-min, while the AUC for intravenously administered SEQ ID NO:3 was 738,855 nM-min. In addition, SEQ ID NO:6 was detected in the plasma of rats dosed with SEQ ID NO:3, showing that this is a metabolite in rats. The AUC for SEQ ID NO:6 in rats dosed orally with SEQ ID NO:3 was 216 nM-min and the AUC for SEQ ID NO:6 in SEQ ID NO:3 intravenously dosed rats was 3580 nM-min. From the AUC values, the 6 h bioavailability of SEQ ID NO:3 determined by circulating plasma levels is 0.11%. When AUC values for SEQ ID NO:6 are included in the calculation, the 6 h bioavailability increases to 0.13%. To determine the oral bioavailability of SEQ ID NO:6, this peptide was dosed to rats at 10 mg/kg. In this experiment, the limit of detection (LOD) for SEQ ID NO:6 was 0.78 nM. SEQ ID NO:6 was detected at all time points for the intravenous dose and was not detected beyond 240 min for the oral dose. For non-detected values, the LOD was used as an upper estimate of the concentration of SEQ ID NO:6. The calculated value for AUC<sub>p.o.</sub>(0-6h) was < 1308 nM-min and AUC<sub>i.v.</sub>(0-6h) was 1,590,000 nM-min. The 6 h bioavailability of SEQ ID NO:6 determined by circulating plasma levels was 0.08%



Oral bioavailability was also determined using a radioimmunoassay (RIA) detection method. Female CD-1 mice (Charles River, Wilmington, MA) weighing approximately 25 g (7-8 weeks old) or female CD rats (Charles River, Wilmington, MA) weighing approximately 153 g were included in this study. Monoclonal antibody, 20C1 (Brandwein et al. 1985 *Infect Immun.* 47:242-246), which recognizes SEQ ID NO:7 and <sup>125</sup>I labeled- SEQ ID NO:7, a labeled tracer, were used in these experiments. The labeled tracer was purified by HPLC using a Waters C-18u Bondapak<sup>®</sup> column (25 cm) previously equilibrated with 10 mM ammonium acetate pH 5.8. A gradient from 0 to 25% acetonitrile was applied to the column in 60 min, followed by isocratic elution at 25% acetonitrile for another 20 min. This method separated two monoiodinated forms from each other and from unlabeled precursor (Thompson et al. 1985 *Anal Biochem.* 148:26-36). The first monoiodinated peak (Peak 1) had a retention time of 60 min and corresponded to iodination of the C-terminal tyrosine, and was used as the labeled tracer in this study. The labeled tracer had a specific activity of 2200 Ci/mmol. The tracer was stored in aliquots at -20 °C. Animals were fasted overnight before administration of compounds. Animals received SEQ ID NO:3 (rats-10 mg/kg; mice 8 mg/kg) or vehicle alone (20 mM Tris-HCl, pH 7.5) intravenously or orally. Blood was drawn from all dosed animals by retro-orbital eye bleeding at specific intervals and test compound levels were analyzed by radioimmunoassay (RIA). SEQ ID NO:3 was extracted from the serum or plasma using Amersham Biosciences Amprep C18 columns (100 mg). Samples (80 µL) were first diluted to 0.5 mL with start buffer (8% methanol, 0.095% TFA in water) and applied to C18 columns previously conditioned with 1 mL methanol and equilibrated with 2 mL of start buffer. After washing with 1 mL start buffer, SEQ ID NO:3 was eluted with 0.8 mL of 80% methanol, 0.05% TFA and dried down in a centrifugal evaporator. Samples were reconstituted in 0.194 mL assay buffer (PBS buffer, pH 7.4, containing 10% fetal bovine serum). Standard dilutions of SEQ ID NO:3 (0 to 256 nM) were made in rat plasma. To perform RIA analysis, samples from dosed animal and standards were mixed with 5 µL diluted antibody (in RIA wash buffer; phosphate-

buffered saline (PBS) containing 0.1% bovine serum albumin (BSA), 1:40,000 final dilution, 0.0022  $\mu\text{g}$ ), and incubated 1 to 4 h at 4 °C. One tube contained the zero standard ( $B_0$ ) and another no standard and no antibody (non-specific binding, NSB). Labeled tracer (0.018  $\mu\text{Ci}$ , diluted in RIA wash buffer) was then added and incubated at 4 °C for  
 5 12 to 18 h. The antibody bound fraction containing SEQ ID NO:3 was collected by magnetic separation using 10  $\mu\text{L}$  of sheep anti-mouse IgG beads previously washed twice in 10 volumes RIA assay buffer. The beads were then washed twice with 1 mL of RIA wash buffer, collected by magnetic separation, resuspended in 0.1 mL of RIA wash buffer, and added to 2 mL scintillation fluid. Radioactivity was measured in a LS 6500  
 10 scintillation counter (Beckman-Coulter). The binding efficiency is defined as the percent radioactivity in the  $B_0$  sample compared to the input counts. The percent bound in each sample was calculated by the equation:

$$\% B/B_0 = (\text{sample cpm} - \text{NSB cpm}) \times 100 / (B_0 \text{ cpm} - \text{NSB cpm})$$

15

A standard curve was prepared by plotting % B/ $B_0$  as a function of the log SEQ ID NO:3 concentration. A concentration vs. time plot was generated from the data in GraphPad Prism or Summit Software PK Solutions 2.0 to generate oral and i.v. PK curves. The area under the curve from T = 0 to 4 hours ( $\text{AUC}_{0-4\text{h}}$ ) was calculated by the software for  
 20 both p.o. and i.v. dosed animals. If the values were below the lower limit of detection (LOD) than the LOD was used to estimate the value (in this experiment 2 nM). Oral Bioavailability (F) is calculated using the equation:

$$F = (\text{AUC}_{\text{p.o.},(0-4\text{h})} * D_{\text{i.v.}}) / (\text{AUC}_{\text{i.v.},(0-4\text{h})} * D_{\text{p.o.}})$$

25 where  $D_{\text{i.v.}}$  and  $D_{\text{p.o.}}$  equal the intravenous and oral dose, respectively. For SEQ ID NO:3 administered to mice, the calculated  $\text{AUC}_{\text{p.o.},(0-4\text{h})}$  was  $\leq 0.69 \text{ ug-min/mL}$ , the  $\text{AUC}_{\text{i.v.},(0-4\text{h})}$  was 1660.98  $\text{ug-min/mL}$  and the bioavailability (F) was  $\leq 0.04\%$ . The estimated bioavailability of 8 mg/kg SEQ ID NO:3 in mice using the RIA method is not more than

0.04% over 4 hours. For SEQ ID NO:3 administered to rats, the calculated value of  $AUC_{p.o.,(0-6h)}$  was 2.90 ug-min/mL, the  $AUC_{i.v.,(0-6h)}$  was 1422.64 ug-min/mL and the bioavailability was 0.20%. The estimated bioavailability of 10 mg/kg SEQ ID NO:3 in rats using the RIA method is not more than 0.20% over 6 hours.

5

#### EXAMPLE 7: *In vitro* proteolytic stability of SEQ ID NO:3

The stability of SEQ ID NO:3 in the presence of several mammalian digestive enzymes was determined. SEQ ID NO:3 was exposed to a variety of *in vitro* conditions including digestive enzymes and low pH environments designed to simulate gastric fluid. SEQ ID NO:3 was incubated with chymotrypsin, trypsin, pepsin, aminopeptidase, carboxypeptidase A, and simulated gastric fluid (sgf) at pH 1.0. Samples were collected at 0, 3, and 24 h for all conditions except pepsin digestion and the SGF. For the latter two conditions, samples were obtained at 0, 1, and 3 h. Negative control samples were prepared for initial and final time points. A separate, positive activity control was run in parallel to SEQ ID NO:3. All samples were analyzed by LC/MS

Chymotrypsin

20 500  $\mu$ l samples of 0.01 mg/mL SEQ ID NO:3 and guanylin (Sigma-Aldrich, G116; positive control) were prepared in the chymotrypsin reaction buffer (100 mM Tris-HCl, 10 mM  $CaCl_2$ , pH 7.5) in 2 mL eppendorf tubes. Zero and 24 h control samples were prepared by adding 5  $\mu$ L of a 10 mM chymostatin (Sigma-Aldrich, C7268; a chymotrypsin inhibitor) stock for a final concentration of 100  $\mu$ M. All samples were incubated at 37 °C

25 for 5 min. 20  $\mu$ L of a 0.01 mg/mL chymotrypsin stock ( $\alpha$ -chymotrypsin from bovine pancreas; Sigma-Aldrich, C6423) were added to each sample for a 0.0004 mg/mL final concentration. Samples were returned to the 37° C water bath. The reaction was quenched with 5  $\mu$ L of a 10 mM chymostatin stock at each time point for a final concentration of 100  $\mu$ M. No extra chymostatin was added to the control samples as they

already had inhibitor. Samples were subsequently flash frozen in liquid nitrogen, and stored at  $-80^{\circ}\text{C}$  until analysis. Upon analysis, samples were thawed and transferred to a 1 mL 96-well plate. Standards of SEQ ID NO:3 and guanylin were prepared in chymotrypsin reaction buffer at 0.625, 1.25, 2.50, 5.00, and 10.00  $\mu\text{g}/\text{mL}$  concentrations.

5 These standards were used to generate a standard curve for quantification of samples. When necessary, the standard curves were also used to calculate the concentration of the corresponding digestion product. 10  $\mu\text{L}$  injections were made of each sample and standard.

#### 10 Trypsin

500  $\mu\text{L}$  samples of 0.01 mg/mL SEQ ID NO:3 and BAEE ( $\text{N}_{\alpha}$  Benzoyl-L-arginine ethyl ester hydrochloride; Sigma-Aldrich, B4500; positive control) were prepared with trypsin reaction buffer (100 mM Tris-HCl, pH 7.5) in 2 mL eppendorf tubes. Zero and 24 h time point control samples were prepared were prepared ( $N = 1$ ) with 5  $\mu\text{L}$  of a 100  
15 mg/mL AEBSF (4-(2-Aminoethyl)benzenesulfonyl fluoride hydrochloride; a trypsin inhibitor) stock for a final concentration of 1 mg/mL. All control and test samples (0, 3, and 24 h) were incubated at  $37^{\circ}\text{C}$  for 5 min. Twenty (20)  $\mu\text{L}$  of a 0.01 mg/mL trypsin (Sigma-Aldrich, T6467) stock were added to each sample for a final concentration of 0.0004 mg/mL. Samples were returned to the  $37^{\circ}\text{C}$  water bath. The reaction was  
20 quenched with 5  $\mu\text{L}$  of a 100 mg/mL AEBSF stock, which was added to each sample at the indicated timepoint, for a final concentration of 1 mg/mL. No extra AEBSF was added to the control samples as they already had inhibitor. Samples were subsequently flash frozen in liquid nitrogen, and stored at  $-80^{\circ}\text{C}$  until analysis. Upon analysis, samples were thawed and transferred to a 1 mL 96-well plate. Standards of SEQ ID  
25 NO:3 and BAEE were prepared in trypsin reaction buffer at 0.625, 1.25, 2.50, 5.00, and 10.00  $\mu\text{g}/\text{mL}$  concentrations. These standards were used to generate a standard curve for quantification of samples. When necessary, the standard curves were also used to calculate the concentration of the corresponding digestion product. Ten (10)  $\mu\text{L}$  injections were made of each sample and standard.

### Pepsin

500  $\mu$ L samples of 100 U/mL pepsin (Pepsin porcine gastric mucosa; Sigma-Aldrich, P68871; U = release of 0.01 absorbance at 280 nM (A280) as TCA soluble hydrolysis products per min at 37 °C of hemoglobin) were prepared in the pepsin reaction buffer (100 mM HCl-KCl, pH 2.0) in 5 mL polystyrene round bottom tubes. To the control samples (0 and 24 h), 500  $\mu$ L of a 1 M ammonium acetate (pepsin inhibitor) stock were added, for a final concentration of 0.5 M. All control and test samples (0, 1, and 3 h) were incubated at 37 °C for 5 min, while shaking. Fifty (50)  $\mu$ L of 0.1 mg/mL SEQ ID NO:3 and Insulin B chain, oxidized (Sigma-Aldrich, I6383; positive control), stocks were added to the respective tubes. Samples were returned to the 37 °C shaking water bath. Reactions were quenched by the addition of 500  $\mu$ L of 1 M ammonium acetate for a final concentration of 0.5 M (except to the control samples, which already contained 0.5 M ammonium acetate). Samples were cooled on ice and stored at 4 °C until analysis. Upon analysis, samples were transferred to a 1 mL 96-well plate. Standards of SEQ ID NO:3 and Insulin B chain, oxidized, were prepared in 25 mM Tris-hydrochloric acid, 500 mM sodium chloride, pH 7.5 buffer at 0.625, 1.25, 2.50, 5.00, and 10.00  $\mu$ g/mL concentrations. These standards were used to generate a standard curve for quantification of samples. Ten (10)  $\mu$ L injections were made of each sample and standard.

### Aminopeptidase

500  $\mu$ L samples of 0.01 mg/mL SEQ ID NO:3 and chemically synthesized SEQ ID NO:4 (wild type ST; positive control) were prepared in the aminopeptidase reaction buffer (5 mM Tris-HCl, 5 mM MgCl<sub>2</sub>, pH 7.5) in 2 mL eppendorf tubes. 5  $\mu$ L of a 5 mg/mL Bestatin hydrochloride (BioChemika, 08170; an aminopeptidase inhibitor) stock was added to each control sample (0 and 24 h), for a final concentration of 0.05 mg/mL. All control and test samples (0, 3, and 24 h) were incubated at 37 °C for 5 min. 0.02 U aminopeptidase (Aminopeptidase M, amino acid aryl amidase (Roche, 102768; U = hydrolysis of 1.0  $\mu$ mol of L-leucinamide to leucine and NH<sub>3</sub> per min at pH 8.5 at 25 °C)

were added to each sample. Samples were returned to the 37 °C water bath. The reaction was quenched with 5 µL of a 5 mg/mL Bestatin hydrochloride stock at the proper time point. No extra Bestatin hydrochloride was added to the control samples since they already had inhibitor present. Samples were subsequently flash frozen in liquid nitrogen, and stored at -80 °C until analysis. Upon analysis, samples were thawed and transferred to a 1 mL 96-well plate. Standards of SEQ ID NO:3 and SEQ ID NO:4 were prepared in aminopeptidase reaction buffer at 0.625, 1.25, 2.50, 5.00, and 10.00 µg/mL concentrations. These standards were used to generate a standard curve for quantification of samples. When necessary, the standard curves were also used to calculate the concentration of the corresponding digestion product. Ten (10) µL injections were made of each sample and standard.

#### Carboxypeptidase A

500 µL samples of 0.01 mg/mL SEQ ID NO:3 and N-CBZ-Glycine-Glycine-Leucine (Z-Gly-Gly-Leu; Sigma-Aldrich, C8501; positive control) were prepared in the carboxypeptidase A reaction buffer (25 mM Tris-HCl, 500 mM NaCl, pH 7.5) in 2 mL eppendorf tubes. Five (5) µL of a 40 µg/mL carboxypeptidase inhibitor (carboxypeptidase inhibitor from potato tuber (Sigma-Aldrich, C0279) stock was added to each control sample (0 and 24 h), for a final concentration of 0.4 µg/mL. All control and test (0, 3 and 24 h) samples were incubated at 37 °C for 5 min. Twenty (20) µL of a 0.01 mg/mL carboxypeptidase A (Carboxypeptidase A from human pancreas; Sigma-Aldrich, C5358) stock was added to each sample. The samples were returned to the 37 °C water bath. The reaction was quenched with 5 µL of a 40 µg/mL carboxypeptidase inhibitor at the proper time point. No extra carboxypeptidase inhibitor was added to the control samples since there was already inhibitor present. Samples were subsequently flash frozen in liquid nitrogen, and stored at -80 °C until analysis. Upon analysis, samples were thawed and transferred to a 1 mL 96-well deep microtiter plate. Standards of SEQ ID NO:3 and Z-Gly-Gly-Leu were prepared in carboxypeptidase A reaction buffer at 0.625, 1.25, 2.50, 5.00, and 10.00 µg/mL concentrations. These standards were

used to generate a standard curve for quantification of samples. When necessary, the standard curves were also used to calculate the concentration of the corresponding digestion product. Ten (10)  $\mu\text{L}$  injections were made of each sample and standard. As shown in Figure 13a, Z-Gly-Gly-Leu, was proteolyzed by carboxypeptidase A. The Z-Gly-Gly-Leu T0 control and T0 samples had average calculated concentrations of 7.1 (+/- 0.30)  $\mu\text{g}/\text{mL}$ . No precursor mass was detected in T3 h and T24 h samples. The calculated concentrations of the Z-Gly-Gly-Leu products for T3 h and T24 h samples were 2.2 (+/- 0.10)  $\mu\text{g}/\text{mL}$ . As shown in Figure 13b, some proteolysis of SEQ ID NO:3 was observed upon treatment with carboxypeptidase A. The SEQ ID NO:3 calculated concentrations of all samples were 8.4 (+/- 1.2)  $\mu\text{g}/\text{mL}$ . For the SEQ ID NO:3 time 0 control and time 0 samples the calculated concentrations for the SEQ ID NO:3 products were 0.8 (+/- 0.02)  $\mu\text{g}/\text{mL}$  and 0.8 (+/- 0.01)  $\mu\text{g}/\text{mL}$ , respectively. The T3 h and T24 h samples had average calculated SEQ ID NO:3 product concentrations of 1.3 (+/- 0.06)  $\mu\text{g}/\text{mL}$  and 1.3 (+/- 0.04)  $\mu\text{g}/\text{mL}$ , respectively.

15

#### Carboxypeptidase A - Identification of Proteolysis Product

To further study the SEQ ID NO:3 carboxypeptidase A digestion product, samples of 0.01 mg/mL SEQ ID NO:3 were prepared in the carboxypeptidase A reaction buffer at a total volume of 500  $\mu\text{L}$  in 2 mL eppendorf tubes. Triplicate samples were prepared for the following time points: 0, 15, 30, 60, 120, 180 and 240 min. The samples were incubated at 37 °C for 5 min. Twenty (20)  $\mu\text{L}$  of a 0.01 mg/mL carboxypeptidase A stock were added to each sample and returned to the 37 °C water bath. The reactions were quenched with 5  $\mu\text{L}$  of a 40  $\mu\text{g}/\text{mL}$  carboxypeptidase inhibitor at the proper time points. Samples were subsequently flash frozen in liquid nitrogen, and stored at -80 °C until analysis. Upon analysis, samples were thawed and transferred to a 1 mL 96-well plate. Standards of SEQ ID NO:3 were prepared in carboxypeptidase A reaction buffer at 0.625, 1.25, 2.50, 5.00, and 10.00  $\mu\text{g}/\text{mL}$  concentrations. These standards were used to generate a standard curve for quantification of samples. When necessary, the standard curves were also used to calculate the concentration of the corresponding digestion

25

product. Ten (10)  $\mu\text{L}$  injections were made of each sample and standard. If the formation of a digestion product was evident, then a spectral analysis was used to determine the mass of the digestion product, and predict its possible identity. Direct comparison between the total ion current (TIC) chromatograms from digestion at time 0 min (T0) and 240 min (T240) revealed a peak at 3.3 min in the T240 chromatogram (upper panel, Figure 13c) that was not present in the T0 chromatogram (lower panel, Figure 13c). The retention time of SEQ ID NO:3 was 3.51 min. A spectral view of the 3.3 min peak indicates the mass of the digestion product is 1362 Da. The spectrum shows 3 singly charged species representing protonated, ammoniated, and sodiated ions with mass/charge ( $m/z$ ) ratio of 1363 ( $[\text{M}+\text{H}]^+$ ), 1380 ( $[\text{M}+\text{NH}_4]^+$ ), 1385 ( $[\text{M}+\text{Na}]^+$ ) (Figure 13d). The sum of the areas of all 3 adducts increased over time (Figure 13e). A digestion product mass of 1362 Da corresponds to the loss of the carboxy-terminal tyrosine residue of (SEQ ID NO:6), the first expected product of carboxypeptidase A proteolysis. SEQ ID NO:6 is a peptide that corresponds to the proposed SEQ ID NO:3 carboxypeptidase A cleavage product (it is sequentially identical to SEQ ID NO:3 minus the carboxy-terminal tyrosine residue). This peptide was used as a standard to quantify digestion product formation. The increase in concentration of SEQ ID NO:6 was proportional to the disappearance of SEQ ID NO:3. Based on these findings, SEQ ID NO:6 appears to be the sole digestion product of SEQ ID NO:3 under these *in vitro* conditions. The SEQ ID NO:3 average concentration at T0 was 5115 ( $\pm$  121) nM. The concentration decreased with time, with the T240 average concentration calculated to be 4438 ( $\pm$  188) nM. The average concentration of SEQ ID NO:6 at T0 was 108 ( $\pm$  2) nM. The concentration increased with time, with the T240 average concentration calculated to be 726 ( $\pm$  138) nM. When comparing the rate of disappearance of SEQ ID NO:3 with the rate of formation of SEQ ID NO:6, both rates decreased at 60 min and leveled off at 120 min. In addition, the sum of the concentration of SEQ ID NO:3 and SEQ ID NO:6 remains essentially constant over the 4 h incubation. A graphical representation of the data is shown in Figure 13f. The initial SEQ ID NO:3 concentration used was 5113 nM.



Simulated Gastric Fluid (SGF)

Samples of 153 µg/mL SEQ ID NO:3 were prepared in the simulated gastric fluid buffer (0.2% NaCl (w/v), 0.7% HCl (v/v), pH 1) to a total volume of 500 µL in 2 mL eppendorf tubes. The reference control and test samples (0, 1 and 3 h) were incubated at 37 °C for the time point indicated. The reference control sample was diluted 10-fold (1000 µL volume) in distilled water for a final concentration of 10 µM and chilled on ice. At each time point, samples were diluted 10-fold (1000 µL volume) in distilled water for an expected concentration of 10 µM, and chilled on ice, until analysis. Upon analysis, samples were transferred to a 1 mL 96-well plate. Standards of SEQ ID NO:3 were prepared in distilled water at 0.625, 1.25, 2.50, 5.00, and 10.00 µM concentrations. These standards were used to generate a standard curve for quantification of samples. Ten (10) µL injections were made of each sample and standard.

15. Table III summarizes the results of SEQ ID NO:3 in vitro proteolytic stability experiments

Proteolytic substance	Cleavage of SEQ ID NO:3 by proteolytic substance
Chymotrypsin	not detectable
Pepsin	not detectable
Aminopeptidase	not detectable
Carboxypeptidase A	Yes
Simulated gastric fluid	not detectable

**Example 8: SEQ ID NO:3 results in an increase in Bristol Stool Form Scale scores for consistency of bowel movements in humans after a single dose**

20

Single doses of 30, 100, 300, 1000 or 3000 µg of chemically synthesized SEQ ID NO:3 were given to 30 healthy males and postmenopausal females. At each dose level (100 µg

was done twice) SEQ ID NO:3 or placebo (vehicle) was administered orally in 5.0 mL 50 mM phosphate buffer (pH 6.0) plus 3x20mL water rinses and 175 mL water after at least a 10-hour fast. In each dosing group, subjects were randomized to receive either placebo (1 subject) or SEQ ID NO:3 (3-4 subjects). Bowel habits (including Bristol Stool Form Scale score (BSFS; Figure 14a), stool frequency, and stool weight) were evaluated for each collected bowel movement 48 hours prior to dose and up to approximately 48 hours postdose.

Administration of a single dose of SEQ ID NO:3 resulted in an increase in maximum BSFS score (Figure 14b). Higher BSFS post-dose scores correlated with a higher dose of the SEQ ID NO:3. Figure 14c shows the percent of subjects with at least a 2-point increase in BSFS consistency score (mean pre-dose compared to peak 48 hours post-dose). The highest percent of subjects with a 2-point or greater increase in BSFS score are found in the 1000 µg dose group.

15

**Example 9: SEQ ID NO:3 alters the consistency and timing of bowel movements in humans after a seven-day dosing period.**

Seven daily doses of 30, 100, 300, or 1000 µg of chemically synthesized SEQ ID NO:3 were given to 48 healthy subjects. SEQ ID NO:3 or placebo (vehicle) was administered orally in 5.0 mL 50 mM phosphate buffer (pH 6.0) plus 3x20mL water rinses and 175 mL water after at least a 10-hour fast. In each dosing group, 8 subjects were randomized to receive SEQ ID NO:3 and 4 subjects were randomized to receive placebo. Figure 15a shows the daily mean BSFS scores for the different dosing groups the seven days prior to and the seven days during dosing with SEQ ID NO:3. Figure 15b shows the Mean Stool Frequency (stools per week) for the subjects over the seven-day treatment period. An increase in Mean Stool Frequency score was observed with higher doses of SEQ ID NO:3. Figure 15C shows the Mean Stool Weight (in grams) of the subjects' stools over the seven-day SEQ ID NO:3 dosing period. An increase in Mean Stool Weight was

25

observed with higher doses of SEQ ID NO:3. The Mean Ease of Passage (Figure 15d) of stools was tested for subjects treated with 30-1000 $\mu$ g SEQ ID NO:3. In Figure 15e, the 1000  $\mu$ g dose group shows the greatest difference in baseline versus treatment values between placebo and SEQ ID NO:3 for Mean Ease of Passage of stools. Figure 15F  
5 shows the mean time to first bowel movement for each of the different doses.

Example 10: SEQ ID NO:3 effects in a rat model of postoperative ileus.

Female CD rats were used to test the effect of SEQ ID NO:3 on delayed transit  
10 induced by abdominal surgery and manual manipulation of the small intestine. Groups of at least nine rats underwent abdominal surgery under isoflurane anesthesia. Surgery consisted of laparotomy and 5 minutes of gentle manual intestinal massage. Following recovery from anesthesia, rats were dosed orally with either 10  $\mu$ g/kg SEQ ID NO:3 or vehicle (20mM Tris) in a volume of 300 $\mu$ l. 1 hour after dosing, intestinal transit rate was  
15 measured. Animals were again dosed with 300 $\mu$ l of the test article followed immediately by 500 $\mu$ l of a charcoal meal (10% charcoal, 10% gum arabic in water). To calculate the distance of the small intestine traveled by the charcoal front, after 20 minutes, the total length of the intestine as well as the distance traveled from the stomach to the charcoal front were measured for each animal. Animals dosed with 10 $\mu$ g/kg SEQ ID NO:3  
20 experienced an increase in transit following abdominal surgery compared to animals dosed with vehicle alone (Figure 16). Charcoal transit in SEQ ID NO:3 dosed animals was measured at 37.3  $\pm$  3.0% (mean  $\pm$  SEM) of the small intestine compared with vehicle at 24.7  $\pm$  1.4% (mean  $\pm$  SEM) of the small intestine .

25 Example 11: SEQ ID NO:3 effect on cGMP levels and secretion in ligated loops rodent models

The effect of SEQ ID NO:3 on cGMP levels and secretion were studied by injecting SEQ ID NO:3 directly into an isolated loop in either wild-type or GC-C KO mice. This was done by surgically ligating a loop in the small intestine of the mouse.

The methodology for ligated loop formation was a similar to that described in London et al. 1997 Am J Physiol p.G93-105. The loop was roughly centered and was a length of 1-3 cm. The loops were injected with 100µl of either SEQ ID NO:3 (5µg) or vehicle (20 mM Tris, pH 7.5 or Krebs Ringer, 10mM Glucose, HEPES buffer (KRGH)). Following a recovery time of 90 minutes the loops were excised. Weights were recorded for each loop before and after removal of the fluid contained therein. The length of each loop was also recorded. A weight to length ratio (W/L) for each loop was calculated to determine the effects of SEQ ID NO:3 on secretion.

To determine the effect of SEQ ID NO:3 on cGMP activity, fluid from the loop was collected in ice-cold trichloroacetic acid (TCA) and stored at -80°C for use in an assay to measure cGMP levels in the fluid. Intestinal fluid samples were TCA extracted, and cyclic GMP was measured by EIA according to procedures outlined in the Cayman Chemical Cyclic GMP EIA kit (Cayman Chemical, Ann Arbor, MI) to determine cyclic GMP levels in the intestinal fluid of the mouse in the presence of either SEQ ID NO:3 or vehicle. Figure 17a depicts the effects of SEQ ID NO:3 in wild-type and GC-C KO mice ligated loops with regards to cGMP activity and secretion (n=5-7 animal/group for secretion assays; n=4-7 animals/group for cGMP assays). In contrast to wild-type mice, SEQ ID NO:3 has no effect on cGMP activity or secretion in GC-C KO mice.

The effects of SEQ ID NO:3 on cGMP levels and secretion in ligated loops in female CD rats was also determined using protocols similar to those described above. In the case of the rat, however four loops of intestine were surgically ligated. The first three loops were distributed equally in the small intestine and the fourth loop was located in colon. Loops were 1 to 3 centimeters, and were injected with 200µL of either SEQ ID NO:3 (5µg) or vehicle (Krebs Ringer, 10mM glucose, HEPES buffer (KRGH)). SEQ ID NO:3 increases cGMP levels and secretion in the center loop of the rat small intestine as shown in figure 17b (n=9-10 animal per group for secretion assays; n=7-8 animals for cGMP assays). Similar experiments were performed to determine the effect of SEQ ID NO:6 on cGMP levels and secretion in ligated loops in female CD rats. Experimental

results comparing the effects of SEQ ID NO:3, SEQ ID NO:6 and vehicle only on secretion and cGMP production are shown in figures 17c and 17d.

**Example 11. SEQ ID NO:3 effects on opioid induced constipation**

5       The effect of SEQ ID NO:3 on opioid induced constipation was studied by dosing female rats (~160g each) with 300µl of the opiate, morphine (2.5mg/kg) via intraperitoneal injection. Thirty minutes post dosing, animals were treated with 300 µl of SEQ ID NO:3 or vehicle only. Ten minutes later, the animals were orally dosed with 500µl 10% charcoal, 10% gum arabic meal. After ten minutes, the animals were  
10       sacrificed and gastrointestinal transit was measured as in Example 3 above. Experimental results are shown in Figure 21.

**Example 13. Mass Spectrometry Characterization of Disulfide Bonds in SEQ ID NO:3**

15       The position of disulfide bonds in SEQ ID NO:3 was determined. To identify the optimal conditions required to partially reduce SEQ ID NO:3, chemically synthesized peptide was alkylated with iodoacetamide after TCEP (tris(2-carboxyethyl) phosphine) treatment (0.1 to 10 mM for 20 minutes at room temperature). After TCEP reduction, the reaction was adjusted to pH 8.0 with Tris and iodoacetamide was added to 50 mM. The  
20       reaction products were analyzed by LC-MS. 0.1 mM TCEP did not reduce SEQ ID NO:3 while 10 mM reduced all three disulfide bonds in the molecule. 1mM TCEP resulted in a mixture of molecules containing native SEQ ID NO:3, one reduced disulfide bond (3 species), two reduced disulfide bonds (3 species) and three reduced bonds (one species).

25       Partially reduced SEQ ID NO:3 was then cyanylated, cleaved with base and completely reduced to separate fragments. After partial reduction, cyanylation, and cleavage of SEQ ID NO:3 were performed either in a test tube or in an HPLC column, a modified method of Wu and Watson ((2002) *Methods Mol. Biol.* 194: 1-22) was used to determine the position of the disulfide bonds. The steps were carried out manually, with isolation of the alkylation products by solid phase extraction (SPE), or in-line

(automated), with reactions occurring in an SPE column. Briefly, the manual procedure comprised the following. Chemically synthesized SEQ ID NO:3 (162  $\mu$ g) was partially reduced with 1 mM tris(2-carboxyethyl) phosphine (TCEP) at pH 3. The sulfhydryl groups of partially reduced SEQ ID NO:3 were cyanylated with 2.1  $\mu$ moles 1-cyano-4-dimethylamino-pyridinium tetrafluoroborate (CDAP) for 15 minutes. The reaction mixture was then diluted to 0.5 mL with 10 mM ammonium acetate pH 5.8 and applied to an Amprep octadecyl C18 minicolumn (100 mg, GE HealthTech). The minicolumn was washed with 1 mL of 10 mM ammonium acetate pH 5.8 and peptides eluted with 0.6 mL methanol. After drying, the peptides were cleaved in 1 M NH<sub>4</sub>OH and fully reduced with 0.1 M TCEP. After drying, the peptide fragments were reconstituted in 0.1% formic acid and analyzed by LC-MS. Briefly, the automated procedure comprised the following. SEQ ID NO:3 (16.2 mg, 0.01 mmole) was loaded onto an Oasis HLB 2 X 15 mm column (Waters). Reactions were carried out by filling a 5 mL sample loop with 1.2 mM TCEP, 2.4 mM CDAP, 2 M NH<sub>4</sub>OH or 6 mM TCEP and pushing each reagent through the column with 0.1% formic acid in 5% methanol at a flow rate of 0.3 mL/min. The column was then back-flushed and the cleaved peptides analyzed by LC-MS.

LC-MS procedures comprised the following. An Atlantis dC18 2.1 X 50 mm column (Waters) equilibrated in 98% buffer A (0.1 % formic acid), 2% buffer B (0.1% formic acid: 85% methanol, 15% CH<sub>3</sub>CN) at a flow rate of 0.3 mL/min. After a 4 min wash with the same buffers, peptides were eluted with a linear gradient of 2% buffer B to 40% buffer B over 38 min with a constant flow rate of 0.3 mL/min. Cleaved peptide masses were determined using a Micromass Q-ToF II instrument equipped with an electrospray ionization (ESI) source operating in positive ion mode. The instrument was programmed to scan in the mass range of *m/z* 100 to 1000. Molecular weight predictions and data analysis were carried out with MassLynx version 4.0 software. NMR analysis of SEQ ID NO:3 was performed. Briefly, SEQ ID NO:3 was dissolved at 7.5 mg/mL in D<sub>2</sub>O (pD of 5 adjusted with NaOD). Nuclear Overhauser Enhancement Spectroscopy (NOESY) spectrum was acquired at 500 MHz. NOE-based distance restraints were collected from the NOESY spectra. The peptide structure was determined using the

programs. Based on the method of Wu and Watson (supra), a list of possible fragments resulting from CN-induced cleavage of singly reduced and cyanylated species of SEQ ID NO:3 with all possible disulfide linkage combinations was generated. The list included the signature fragments for each possible structure. Figure 22 is a table which presents a list of the observed fragments of SEQ ID NO:3 after partial reduction, cyanylation, and cleavage. These results indicate that the disulfide structure of SEQ ID NO:3 is Cys1-Cy6, Cys2-Cys10, and Cys5-Cys13.

#### Example 14. Diuresis and Natriuresis Assays

##### Effect on Diuresis and Natriuresis

The effect of polypeptides/GC-agonists described herein on diuresis and natriuresis can be determined using methodology similar to that described in WO06/001931 (examples 6 (p. 42) and 8 (p.45)). Briefly, the polypeptide/agonist described herein (180-pmol) is infused for 60 min into a group of 5 anesthetized rats. Given an estimated rat plasma volume of 10 mL, the infusion rate is approximately 3 pmol/mL/min. Blood pressure, urine production, and sodium excretion are monitored for approximately 40 minutes prior to the infusion, during the infusion, and for approximately 50 minutes after the infusion to measure the effect of the polypeptide/GC-C agonist on diuresis and natriuresis. For comparison, a control group of five rats is infused with regular saline. Urine and sodium excretion can be assessed. Dose response can also be determined. polypeptide/GC-C agonist described herein is infused intravenously into rats over 60 minutes. Urine is collected at 30 minute intervals up to 180 minutes after termination of polypeptide/GC-C agonist infusion, and urine volume, sodium excretion, and potassium excretion are determined for each collection interval. Blood pressure is monitored continuously. For each dose a dose-response relationship for urine volume, sodium and potassium excretion can be determined. Plasma concentration of the polypeptide/GC-agonist is also determined before and after iv infusion.

### Rat Diuresis Experiment:

Female Sprague-Dawley rats (> 170 g, 2-8 per group) are given 3.0mL of isotonic saline perorally, and then anesthetized with isoflurane /oxygen. Once an appropriate level of anesthesia has been achieved, a sterile polyurethane catheter (~16 cm, 0.6mm ID, 0.9mm OD) is inserted 1.5-2.0 cm into the urethra and secured using 1 – 2 drops of veterinary bond adhesive applied to urethra/catheter junction. Rats are then dosed with either vehicle or test article via the intravenous or intraperitoneal route. Rats are then placed in appropriately sized rat restraint tubes, with the catheter protruding out of the restraint tube into a 10 mL graduated cylinder. Rats are allowed to regain consciousness, and the volume of urine excreted over a 1-5 hour duration is recorded periodically for each rat.

---

### 15 Administration of peptides and GC-C receptor agonists

For treatment of gastrointestinal disorders, the peptides and agonists described herein are preferably administered orally, e.g., as a tablet or cachet containing a predetermined amount of the active ingredient, pellet, gel, paste, syrup, bolus, electuary, slurry, sachet; capsule; powder; lyophilized powder; granules; as a solution or a suspension in an aqueous liquid or a non-aqueous liquid; as an oil-in-water liquid emulsion or a water-in-oil liquid emulsion, via a liposomal formulation (see, e.g., EP 736299) or in some other form. Orally administered compositions can include binders, lubricants, inert diluents, lubricating, surface active or dispersing agents, flavoring agents, and humectants. Orally administered formulations such as tablets may optionally be coated or scored and may be formulated so as to provide sustained, delayed or controlled release of the active ingredient therein. The peptides and agonists can be co-administered with other agents used to treat gastrointestinal disorders including but not limited to the agents described herein. The peptides and agonists can also be administered by rectal suppository. For the treatment of disorders outside the gastrointestinal tract such as congestive heart failure



and benign prostatic hypertrophy, peptides and agonists are preferably administered parenterally or orally.

5 The peptides described herein can be administered alone or in combination with other agents. For example, the peptides can be administered together with an analgesic peptide or compound. The analgesic peptide or compound can be covalently attached to a peptide described herein or it can be a separate agent that is administered together with or sequentially with a peptide described herein in a combination therapy.

10 Combination therapy can be achieved by administering two or more agents, e.g., a peptide described herein and an analgesic peptide or compound, each of which is formulated and administered separately, or by administering two or more agents in a single formulation. Other combinations are also encompassed by combination therapy. For example, two agents can be formulated together and administered in conjunction with a separate formulation containing a third agent. While the two or more agents in the  
15 combination therapy can be administered simultaneously, they need not be. For example, administration of a first agent (or combination of agents) can precede administration of a second agent (or combination of agents) by minutes, hours, days, or weeks. Thus, the two or more agents can be administered within minutes of each other or within 1, 2, 3, 6, 9, 12, 15, 18, or 24 hours of each other or within 1, 2, 3, 4, 5, 6, 7, 8, 9, 10, 12, 14 days of  
20 each other or within 2, 3, 4, 5, 6, 7, 8, 9, or 10 weeks of each other. In some cases even longer intervals are possible. While in many cases it is desirable that the two or more agents used in a combination therapy be present in within the patient's body at the same time, this need not be so.

25 Combination therapy can also include two or more administrations of one or more of the agents used in the combination. For example, if agent X and agent Y are used in a combination, one could administer them sequentially in any combination one or more times, e.g., in the order X-Y-X, X-X-Y, Y-X-Y, Y-Y-X, X-X-Y-Y, etc.

Combination therapy can also include the administration of two or more agents via different routes or locations. For example, (a) one agent is administered orally and another agent is administered intravenously or (b) one agent is administered orally and another is administered locally. In each case, the agents can either simultaneously or sequentially. Approximated dosages for some of the combination therapy agents  
5 described herein are found in the "BNF Recommended Dose" column of tables on pages 11-17 of WO01/76632 (the data in the tables being attributed to the March 2000 British National Formulary) and can also be found in other standard formularies and other drug prescribing directories. For some drugs, the customary prescribed dose for an indication  
10 will vary somewhat from country to country.

The agents, alone or in combination, can be combined with any pharmaceutically acceptable carrier or medium. Thus, they can be combined with materials that do not produce an adverse, allergic or otherwise unwanted reaction when administered to a patient. The carriers or mediums used can include solvents, dispersants, coatings,  
15 absorption promoting agents, controlled release agents, and one or more inert excipients (which include starches, polyols, granulating agents, microcrystalline cellulose (e.g. celphere, Celphere beads®), diluents, lubricants, binders, disintegrating agents, and the like), etc. If desired, tablet dosages of the disclosed compositions may be coated by  
20 standard aqueous or nonaqueous techniques.

Compositions of the present invention may also optionally include other therapeutic ingredients, anti-caking agents, preservatives, sweetening agents, colorants, flavors, desiccants, plasticizers, dyes, glidants, anti-adherents, anti-static agents, surfactants (wetting agents), anti-oxidants, film-coating agents, and the like. Any such optional  
25 ingredient must be compatible with the compound described herein to insure the stability of the formulation.

The composition may contain other additives as needed, including for example lactose, glucose, fructose, galactose, trehalose, sucrose, maltose, raffinose, maltitol, melezitose,

stachyose, lactitol, palatinite, starch, xylitol, mannitol, myoinositol, and the like, and hydrates thereof, and amino acids, for example alanine, glycine and betaine, and peptides and proteins, for example albumen.

- 5 Examples of excipients for use as the pharmaceutically acceptable carriers and the pharmaceutically acceptable inert carriers and the aforementioned additional ingredients include, but are not limited to binders, fillers, disintegrants, lubricants, anti-microbial agents, and coating agents such as:
- 10 BINDERS: corn starch, potato starch, other starches, gelatin, natural and synthetic gums such as acacia, xanthan, sodium alginate, alginic acid, other alginates, powdered tragacanth, guar gum, cellulose and its derivatives (*e.g.*, ethyl cellulose, cellulose acetate, carboxymethyl cellulose calcium, sodium carboxymethyl cellulose), polyvinyl pyrrolidone (*e.g.*, povidone, crospovidone, copovidone, etc), methyl cellulose, Methocel, pre-gelatinized starch (*e.g.*, STARCH 1500® and STARCH 1500 LM®, sold by
- 15 Colorcon, Ltd.), hydroxypropyl methyl cellulose, microcrystalline cellulose (*e.g.* AVICEL™, such as, AVICEL-PH-101™, -103™ and -105™, sold by FMC Corporation, Marcus Hook, PA, USA), or mixtures thereof,
- 20 FILLERS: talc, calcium carbonate (*e.g.*, granules or powder), dibasic calcium phosphate, tribasic calcium phosphate, calcium sulfate (*e.g.*, granules or powder), microcrystalline cellulose, powdered cellulose, dextrates, kaolin, mannitol, silicic acid, sorbitol, starch, pre-gelatinized starch, dextrose, fructose, honey, lactose anhydrate, lactose monohydrate, lactose and aspartame, lactose and cellulose, lactose and microcrystalline cellulose,
- 25 maltodextrin, maltose, mannitol, microcrystalline cellulose & guar gum, molasses, sucrose, or mixtures thereof,

DISINTEGRANTS: agar-agar, alginic acid, calcium carbonate, microcrystalline cellulose, croscarmellose sodium, crospovidone, polacrillin potassium, sodium starch

glycolate, potato or tapioca starch, other starches, pre-gelatinized starch, clays, other algin, other celluloses, gums (like gellan), low-substituted hydroxypropyl cellulose, or mixtures thereof,

- 5 LUBRICANTS: calcium stearate, magnesium stearate, mineral oil, light mineral oil, glycerin, sorbitol, mannitol, polyethylene glycol, other glycols, stearic acid, sodium lauryl sulfate, sodium stearyl fumarate, vegetable based fatty acids lubricant, talc, hydrogenated vegetable oil (*e.g.*, peanut oil, cottonseed oil, sunflower oil, sesame oil, olive oil, corn oil and soybean oil), zinc stearate, ethyl oleate, ethyl laurate, agar, syloid
- 10 silica gel (AEROSIL 200, W.R. Grace Co., Baltimore, MD USA), a coagulated aerosol of synthetic silica (Deaussa Co., Plano, TX USA), a pyrogenic silicon dioxide (CAB-O-SIL, Cabot Co., Boston, MA USA), or mixtures thereof,

- ANTI-CAKING AGENTS: calcium silicate, magnesium silicate, silicon dioxide,
- 15 colloidal silicon dioxide, talc, or mixtures thereof,

- ANTIMICROBIAL AGENTS: benzalkonium chloride, benzethonium chloride, benzoic acid, benzyl alcohol, butyl paraben, cetylpyridinium chloride, cresol, chlorobutanol, dehydroacetic acid, ethylparaben, methylparaben, phenol, phenylethyl alcohol,
- 20 phenoxyethanol, phenylmercuric acetate, phenylmercuric nitrate, potassium sorbate, propylparaben, sodium benzoate, sodium dehydroacetate, sodium propionate, sorbic acid, thimersol, thymo, or mixtures thereof, and

- COATING AGENTS: sodium carboxymethyl cellulose, cellulose acetate phthalate,
- 25 ethylcellulose, gelatin, pharmaceutical glaze, hydroxypropyl cellulose, hydroxypropyl methylcellulose (hypromellose), hydroxypropyl methyl cellulose phthalate, methylcellulose, polyethylene glycol, polyvinyl acetate phthalate, shellac, sucrose, titanium dioxide, carnauba wax, microcrystalline wax, gellan gum, maltodextrin, methacrylates, microcrystalline cellulose and carrageenan or mixtures thereof.

The formulation can also include other excipients and categories thereof including but not limited to L-histidine, Pluronic®, Poloxamers (such as Lutrol® and Poloxamer 188), ascorbic acid, glutathione, permeability enhancers (e.g. lipids, sodium cholate, acylcarnitine, salicylates, mixed bile salts, fatty acid micelles, chelators, fatty acid, surfactants, medium chain glycerides), protease inhibitors (e.g. soybean trypsin inhibitor, organic acids), pH lowering agents and absorption enhancers effective to promote bioavailability (including but not limited to those described in US6086918 and US5912014), creams and lotions (like maltodextrin and carrageenans); materials for chewable tablets (like dextrose, fructose, lactose monohydrate, lactose and aspartame, lactose and cellulose, maltodextrin, maltose, mannitol, microcrystalline cellulose and guar gum, sorbitol crystalline); parenterals (like mannitol and povidone); plasticizers (like dibutyl sebacate, plasticizers for coatings, polyvinylacetate phthalate); powder lubricants (like glyceryl behenate); soft gelatin capsules (like sorbitol special solution); spheres for coating (like sugar spheres); spherization agents (like glyceryl behenate and microcrystalline cellulose); suspending/gelling agents (like carrageenan, gellan gum, mannitol, microcrystalline cellulose, povidone, sodium starch glycolate, xanthan gum); sweeteners (like aspartame, aspartame and lactose, dextrose, fructose, honey, maltodextrin, maltose, mannitol, molasses, sorbitol crystalline, sorbitol special solution, sucrose); wet granulation agents (like calcium carbonate, lactose anhydrous, lactose monohydrate, maltodextrin, mannitol, microcrystalline cellulose, povidone, starch), caramel, carboxymethylcellulose sodium, cherry cream flavor and cherry flavor, citric acid anhydrous, citric acid, confectioner's sugar, D&C Red No. 33, D&C Yellow #10 Aluminum Lake, disodium edetate, ethyl alcohol 15%, FD& C Yellow No. 6 aluminum lake, FD&C Blue #1 Aluminum Lake, FD&C Blue No. 1, FD&C blue no. 2 aluminum lake, FD&C Green No.3, FD&C Red No. 40, FD&C Yellow No. 6 Aluminum Lake, FD&C Yellow No. 6, FD&C Yellow No.10, glycerol palmitostearate, glyceryl monostearate, indigo carmine, lecithin, manitol, methyl and propyl parabens, mono ammonium glycyrrhizinate, natural and artificial orange flavor, pharmaceutical glaze,

poloxamer 188, Polydextrose, polysorbate 20, polysorbate 80, polyvidone, pregelatinized  
corn starch, pregelatinized starch, red iron oxide, saccharin sodium, sodium  
carboxymethyl ether, sodium chloride, sodium citrate, sodium phosphate, strawberry  
flavor, synthetic black iron oxide, synthetic red iron oxide, titanium dioxide, and white  
5 wax.

Solid oral dosage forms may optionally be treated with coating systems (e.g. Opadry® fx  
film coating system, for example Opadry® blue (OY-LS-20921), Opadry® white (YS-2-  
7063), Opadry® white (YS-1-7040), and black ink (S-1-8106).

10

The agents either in their free form or as a salt can be combined with a polymer such as  
polylactic-glycolic acid (PLGA), poly-(D)-lactic-glycolic-tartaric acid (P(D)LGT) (WO  
01/12233), polyglycolic acid (U.S. 3,773,919), polylactic acid (U.S. 4,767,628), poly( $\epsilon$ -  
caprolactone) and poly(alkylene oxide) (U.S. 20030068384) to create a sustained release  
15 formulation. Such formulations can be used to implants that release a peptide or another  
agent over a period of a few days, a few weeks or several months depending on the  
polymer, the particle size of the polymer, and the size of the implant (see, e.g., U.S.  
6,620,422). Other sustained release formulations and polymers for use in are described in  
EP 0 467 389 A2, WO 93/24150, U.S. 5,612,052, WO 97/40085, WO 03/075887, WO  
20 01/01964A2, U.S. 5,922,356, WO 94/155587, WO 02/074247A2, WO 98/25642, U.S.  
5,968,895, U.S. 6,180,608, U.S. 20030171296, U.S. 20020176841, U.S. 5,672,659, U.S.  
5,893,985, U.S. 5,134,122, U.S. 5,192,741, U.S. 5,192,741, U.S. 4,668,506, U.S.  
4,713,244, U.S. 5,445,832 U.S. 4,931,279, U.S. 5,980,945, WO 02/058672, WO  
9726015, WO 97/04744, and US20020019446. In such sustained release formulations  
25 microparticles (Delie and Blanco-Prieto 2005 Molecule 10:65-80) of peptide are  
combined with microparticles of polymer. One or more sustained release implants can be  
placed in the large intestine, the small intestine or both. U.S. 6,011,011 and WO  
94/06452 describe a sustained release formulation providing either polyethylene glycols  
(i.e. PEG 300 and PEG 400) or triacetin. WO 03/053401 describes a formulation which

may both enhance bioavailability and provide controlled release of the agent within the GI tract. Additional controlled release formulations are described in U.S. 6,734,188, WO 02/38129, EP 326 151, U.S. 5,236,704, WO 02/30398, WO 98/13029; U.S. 20030064105, U.S. 20030138488A1, U.S. 20030216307A1, U.S. 6,667,060, WO 5 01/49249, WO 01/49311, WO 01/49249, WO 01/49311, and U.S. 5,877,224.

The agents can be administered, e.g., by intravenous injection, intramuscular injection, subcutaneous injection, intraperitoneal injection, topical, sublingual, intraarticular (in the joints), intradermal, buccal, ophthalmic (including intraocular), intranasal (including 10 using a cannula), intraspinally, intrathecally, or by other routes. The agents can be administered orally, e.g., as a tablet or cachet containing a predetermined amount of the active ingredient, gel, pellet, paste, syrup, bolus, electuary, slurry, capsule, powder, lyophilized powder, granules, sachet, as a solution or a suspension in an aqueous liquid or a non-aqueous liquid, as an oil-in-water liquid emulsion or a water-in-oil liquid emulsion, 15 via a micellar formulation (see, e.g. WO 97/11682) via a liposomal formulation (see, e.g., EP 736299, WO 99/59550 and WO 97/13500), via formulations described in WO 03/094886, via bilosome (bile-salt based vesicular system), via a dendrimer, or in some other form. Orally administered compositions can include binders, lubricants, inert diluents, lubricating, surface active or dispersing agents, flavoring agents, and 20 humectants. Orally administered formulations such as tablets may optionally be coated or scored and may be formulated so as to provide sustained, delayed or controlled release of the active ingredient therein. The agents can also be administered transdermally (i.e. via reservoir-type or matrix-type patches, microneedles, thermal poration, hypodermic needles, iontophoresis, electroporation, ultrasound or other forms of sonophoresis, jet 25 injection, or a combination of any of the preceding methods (Prausnitz et al. 2004, Nature Reviews Drug Discovery 3:115-124)). The agents can be administered using high-velocity transdermal particle injection techniques using the hydrogel particle formulation described in U.S. 20020061336. Additional particle formulations are described in WO 00/45792, WO 00/53160, and WO 02/19989. An example of a transdermal formulation

containing plaster and the absorption promoter dimethylisorbide can be found in WO 89/04179. WO 96/11705 provides formulations suitable for transdermal administration. The agents can be administered in the form a suppository or by other vaginal or rectal means. The agents can be administered in a transmembrane formulation as described in  
5 WO 90/07923. The agents can be administered non-invasively via the dehydrated particules described in U.S. 6,485,706. The agent can be administered in an enteric-coated drug formulation as described in WO 02/49621. The agents can be administered intranasally using the formulation described in U.S. 5,179,079. Formulations suitable for parenteral injection are described in WO 00/62759. The agents can be administered  
10 using the casein formulation described in U. S. 20030206939 and WO 00/06108. The agents can be administered using the particulate formulations described in U.S. 20020034536.

The agents, alone or in combination with other suitable components, can be administered  
15 by pulmonary route utilizing several techniques including but not limited to intratracheal instillation (delivery of solution into the lungs by syringe), intratracheal delivery of liposomes, insufflation (administration of powder formulation by syringe or any other similar device into the lungs) and aerosol inhalation. Aerosols (e.g., jet or ultrasonic nebulizers, metered-dose inhalers (MDIs), and dry-powder inhalers (DPIs)) can also be  
20 used in intranasal applications. Aerosol formulations are stable dispersions or suspensions of solid material and liquid droplets in a gaseous medium and can be placed into pressurized acceptable propellants, such as hydrofluoroalkanes (HFAs, i.e. HFA-134a and HFA-227, or a mixture thereof), dichlorodifluoromethane (or other chlorofluocarbon propellants such as a mixture of Propellants 11, 12, and/or 114), propane, nitrogen, and  
25 the like. Pulmonary formulations may include permeation enhancers such as fatty acids, saccharides, chelating agents, enzyme inhibitors (e.g., protease inhibitors), adjuvants (e.g., glycocholate, surfactin, span 85, and nafamostat), preservatives (e.g., benzalkonium chloride or chlorobutanol), and ethanol (normally up to 5% but possibly up to 20%, by weight). Ethanol is commonly included in aerosol compositions as it can improve the



function of the metering valve and in some cases also improve the stability of the dispersion. Pulmonary formulations may also include surfactants which include but are not limited to bile salts and those described in U.S. 6,524,557 and references therein. The surfactants described in U.S. 6,524,557, e.g., a C8-C16 fatty acid salt, a bile salt, a phospholipid, or alkyl saccharide are advantageous in that some of them also reportedly enhance absorption of the peptide in the formulation. Also suitable in the invention are dry powder formulations comprising a therapeutically effective amount of active compound blended with an appropriate carrier and adapted for use in connection with a dry-powder inhaler. Absorption enhancers which can be added to dry powder formulations of the present invention include those described in U.S. 6,632,456. WO 02/080884 describes new methods for the surface modification of powders. Aerosol formulations may include U.S. 5,230,884, U.S. 5,292,499, WO 01/78694, WO 01/78696, U.S. 2003019437, U. S. 20030165436, and WO 96/40089 (which includes vegetable oil). Sustained release formulations suitable for inhalation are described in U.S. 20010036481A1, 20030232019A1, and U.S. 20040018243A1 as well as in WO 01/13891, WO 02/067902, WO 03/072080, and WO 03/079885. Pulmonary formulations containing microparticles are described in WO 03/015750, U.S. 20030008013, and WO 00/00176. Pulmonary formulations containing stable glassy state powder are described in U.S. 20020141945 and U.S. 6,309,671. Other aerosol formulations are described in EP 1338272A1 WO 90/09781, U. S. 5,348,730, U.S. 6,436,367, WO 91/04011, and U.S. 6,294,153 and U.S. 6,290,987 describes a liposomal based formulation that can be administered via aerosol or other means. Powder formulations for inhalation are described in U.S. 20030053960 and WO 01/60341. The agents can be administered intranasally as described in U.S. 20010038824.

The agents can be incorporated into microemulsions, which generally are thermodynamically stable, isotropically clear dispersions of two immiscible liquids, such as oil and water, stabilized by an interfacial film of surfactant molecules (Encyclopedia of Pharmaceutical Technology (New York: Marcel Dekker, 1992), volume 9). For the preparation of microemulsions, surfactant (emulsifier), co-surfactant (co-emulsifier), an

- oil phase and a water phase are necessary. Suitable surfactants include any surfactants that are useful in the preparation of emulsions, e.g., emulsifiers that are typically used in the preparation of creams. The co-surfactant (or "co-emulsifier") is generally selected from the group of polyglycerol derivatives, glycerol derivatives and fatty alcohols.
- 5 Preferred emulsifier/co-emulsifier combinations are generally although not necessarily selected from the group consisting of: glyceryl monostearate and polyoxyethylene stearate; polyethylene glycol and ethylene glycol palmitostearate; and caprylic and capric triglycerides and oleoyl macroglycerides. The water phase includes not only water but also, typically, buffers, glucose, propylene glycol, polyethylene glycols, preferably lower
- 10 molecular weight polyethylene glycols (e.g., PEG 300 and PEG 400), and/or glycerol, and the like, while the oil phase will generally comprise, for example, fatty acid esters, modified vegetable oils, silicone oils, mixtures of mono- di- and triglycerides, mono- and di-esters of PEG (e.g., oleoyl macrogol glycerides), etc.
- 15 The agents described herein can be incorporated into pharmaceutically-acceptable nanoparticle, nanosphere, and nanocapsule formulations (Delie and Blanco-Prieto 2005 Molecule 10:65-80). Nanocapsules can generally entrap compounds in a stable and reproducible way (Henry-Michelland et al., 1987; Quintanar-Guerrero et al., 1998; Douglas et al., 1987). To avoid side effects due to intracellular polymeric overloading,
- 20 ultrafine particles (sized around 0.1  $\mu\text{m}$ ) can be designed using polymers able to be degraded in vivo (e.g. biodegradable polyalkyl-cyanoacrylate nanoparticles). Such particles are described in the prior art (Couvreur et al, 1980; 1988; zur Muhlen et al., 1998; Zambaux et al. 1998; Pinto-Alphandry et al., 1995 and U.S. Pat. No. 5,145,684).
- 25 The agents described herein can be formulated with pH sensitive materials which may include those described in WO04041195 (including the seal and enteric coating described therein) and pH-sensitive coatings that achieve delivery in the colon including those described in US4910021 and WO9001329. US4910021 describes using a pH-sensitive material to coat a capsule. WO9001329 describes using pH-sensitive coatings on beads

containing acid, where the acid in the bead core prolongs dissolution of the pH-sensitive coating. U. S. Patent No. 5,175, 003 discloses a dual mechanism polymer mixture composed of pH-sensitive enteric materials and film-forming plasticizers capable of conferring permeability to the enteric material, for use in drug-delivery systems; a matrix pellet composed of a dual mechanism polymer mixture permeated with a drug and sometimes covering a pharmaceutically neutral nucleus; a membrane-coated pellet comprising a matrix pellet coated with a dual mechanism polymer mixture envelope of the same or different composition; and a pharmaceutical dosage form containing matrix pellets. The matrix pellet releases acid-soluble drugs by diffusion in acid pH and by disintegration at pH levels of nominally about 5.0 or higher. The agents described herein may be formulated in the pH triggered targeted control release systems described in WO04052339. The agents described herein may be formulated according to the methodology described in any of WO03105812 (extruded hydratable polymers); WO0243767 (enzyme cleavable membrane translocators); WO03007913 and WO03086297 (mucoadhesive systems); WO02072075 (bilayer laminated formulation comprising pH lowering agent and absorption enhancer); WO04064769 (amidated peptides); WO05063156 (solid lipid suspension with pseudotropic and/or thixotropic properties upon melting); WO03035029 and WO03035041 (erodible, gastric retentive dosage forms); US5007790 and US5972389 (sustained release dosage forms); WO04112711 (oral extended release compositions); WO05027878, WO02072033, and WO02072034 (delayed release compositions with natural or synthetic gum); WO05030182 (controlled release formulations with an ascending rate of release); WO05048998 (microencapsulation system); US Patent 5,952, 314 (biopolymer); US5108758 (glassy amylose matrix delivery); US 5840860 (modified starch based delivery). JP10324642 (delivery system comprising chitosan and gastric resistant material such as wheat gliadin or zein); US5866619 and US6368629 (saccharide containing polymer); US 6531152 (describes a drug delivery system containing a water soluble core (Ca pectinate or other water-insoluble polymers) and outer coat which bursts (eg hydrophobic polymer-Eudragit)); US 6234464; US 6403130 (coating with polymer

containing casein and high methoxy pectin; WO0174175 (Maillard reaction product); WO05063206 (solubility increasing formulation); WO04019872 (transferring fusion proteins). The agents described herein may be formulated using gastrointestinal retention system technology (GIRES; Merrion Pharmaceuticals). GIRES comprises a controlled-  
5 release dosage form inside an inflatable pouch, which is placed in a drug capsule for oral administration. Upon dissolution of the capsule, a gas-generating system inflates the pouch in the stomach where it is retained for 16-24 hours, all the time releasing agents described herein.

10 The agents described herein can be formulated in an osmotic device including the ones disclosed in US4503030, US5609590 and US5358502. US4503030 discloses an osmotic device for dispensing a drug to certain pH regions of the gastrointestinal tract. More particularly, the invention relates to an osmotic device comprising a wall formed of a  
15 semi-permeable pH sensitive composition that surrounds a compartment containing a drug, with a passageway through the wall connecting the exterior of the device with the compartment. The device delivers the drug at a controlled rate in the region of the gastrointestinal tract having a pH of less than 3.5, and the device self- destructs and releases all its drug in the region of the gastrointestinal tract having a pH greater than 3.5, thereby providing total availability for drug absorption. U. S. Patent Nos. 5,609, 590 and  
20 5, 358,502 disclose an osmotic bursting device for dispensing a beneficial agent to an aqueous environment. The device comprises a beneficial agent and osmagent surrounded at least in part by a semi-permeable membrane. The beneficial agent may also function as the osmagent. The semi-permeable membrane is permeable to water and substantially impermeable to the beneficial agent and osmagent. A trigger means is attached to the  
25 semi-permeable membrane (e. g. , joins two capsule halves). The trigger means is activated by a pH of from 3 to 9 and triggers the eventual, but sudden, delivery of the beneficial agent. These devices enable the pH-triggered release of the beneficial agent core as a bolus by osmotic bursting.

The agents described herein may be formulated based on the invention described in U. S. Patent No. 5,316, 774 which discloses a composition for the controlled release of an active substance comprising a polymeric particle matrix, where each particle defines a network of internal pores. The active substance is entrapped within the pore network together with a blocking agent having physical and chemical characteristics selected to modify the release rate of the active substance from the internal pore network. In one embodiment, drugs may be selectively delivered to the intestines using an enteric material as the blocking agent. The enteric material remains intact in the stomach but degrades under the pH conditions of the intestines. In another embodiment, the sustained release formulation employs a blocking agent, which remains stable under the expected conditions of the environment to which the active substance is to be released. The use of pH-sensitive materials alone to achieve site-specific delivery is difficult because of leaking of the beneficial agent prior to the release site or desired delivery time and it is difficult to achieve long time lags before release of the active ingredient after exposure to high pH (because of rapid dissolution or degradation of the pH-sensitive materials).

The agents may also be formulated in a hybrid system which combines pH-sensitive materials and osmotic delivery systems. These hybrid devices provide delayed initiation of sustained-release of the beneficial agent. In one device a pH-sensitive matrix or coating dissolves releasing osmotic devices that provide sustained release of the beneficial agent see U. S. Patent Nos. 4,578, 075, 4,681, 583, and 4,851, 231. A second device consists of a semipermeable coating made of a polymer blend of an insoluble and a pH-sensitive material. As the pH increases, the permeability of the coating increases, increasing the rate of release of beneficial agent see U. S. Patent Nos. 4,096, 238,4, 503,030, 4, 522, 625, and 4,587, 117.

The agents described herein may be formulated in terpolymers according to U. S. Patent No. 5,484, 610 which discloses terpolymers which are sensitive to pH and temperature which are useful carriers for conducting bioactive agents through the gastric juices of the

stomach in a protected form. The terpolymers swell at the higher physiologic pH of the intestinal tract causing release of the bioactive agents into the intestine. The terpolymers are linear and are made up of 35 to 99 wt % of a temperature sensitive component, which imparts to the terpolymer LCST (lower critical solution temperature) properties below  
5 body temperatures, 1 to 30 wt % of a pH sensitive component having a pKa in the range of from 2 to 8 which functions through ionization or deionization of carboxylic acid groups to prevent the bioactive agent from being lost at low pH but allows bioactive agent release at physiological pH of about 7.4 and a hydrophobic component which stabilizes the LCST below body temperatures and compensates for bioactive agent effects  
10 on the terpolymers. The terpolymers provide for safe bioactive agent loading, a simple procedure for dosage form fabrication and the terpolymer functions as a protective carrier in the acidic environment of the stomach and also protects the bioactive agents from digestive enzymes until the bioactive agent is released in the intestinal tract.

15 The agents described herein may be formulated in pH sensitive polymers according to those described in U. S. Patent No. 6,103, 865. U. S. Patent No. 6,103, 865 discloses pH-sensitive polymers containing sulfonamide groups, which can be changed in physical properties, such as swellability and solubility, depending on pH and which can be applied for a drug-delivery system, bio-material, sensor, and the like, and a preparation method  
20 therefore. The pH-sensitive polymers are prepared by introduction of sulfonamide groups, various in pKa, to hydrophilic groups of polymers either through coupling to the hydrophilic groups of polymers, such as acrylamide, N, N- dimethylacrylamide, acrylic acid, N-isopropylacrylamide and the like or copolymerization with other polymerizable monomers. These pH-sensitive polymers may have a structure of linear polymer, grafted  
25 copolymer, hydrogel or interpenetrating network polymer.

The agents described herein may be formulated according U. S. Patent No. 5, 656, 292 which discloses a composition for pH dependent or pH regulated controlled release of active ingredients especially drugs. The composition consists of a compactable mixture of

the active ingredient and starch molecules substituted with acetate and dicarboxylate residues. The preferred dicarboxylate acid is succinate. The average substitution degree of the acetate residue is at least 1 and 0.2-1.2 for the dicarboxylate residue. The starch molecules can have the acetate and dicarboxylate residues attached to the same starch molecule backbone or attached to separate starch molecule backbones. The present invention also discloses methods for preparing said starch acetate dicarboxylates by transesterification or mixing of starch acetates and starch dicarboxylates respectively.

The agents described herein may be formulated according to the methods described in U.S. Patent Nos. 5,554, 147,5, 788, 687, and 6,306, 422 which disclose a method for the controlled release of a biologically active agent wherein the agent is released from a hydrophobic, pH-sensitive polymer matrix. The polymer matrix swells when the environment reaches pH 8.5, releasing the active agent. A polymer of hydrophobic and weakly acidic comonomers is disclosed for use in the controlled release system. Also disclosed is a specific embodiment in which the controlled release system may be used. The pH-sensitive polymer is coated onto a latex catheter used in ureteral catheterization. A ureteral catheter coated with a pH-sensitive polymer having an antibiotic or urease inhibitor trapped within its matrix will release the active agent when exposed to high pH urine.

The agents described herein may be formulated in/with bioadhesive polymers according to US Patent No. 6,365, 187. Bioadhesive polymers in the form of, or as a coating on, microcapsules containing drugs or bioactive substances which may serve for therapeutic, or diagnostic purposes in diseases of the gastrointestinal tract, are described in US6365187. The polymeric microspheres all have a bioadhesive force of at least 11 mN/cm<sup>2</sup> (110 N/m<sup>2</sup>) Techniques for the fabrication of bioadhesive microspheres, as well as a method for measuring bioadhesive forces between microspheres and selected segments of the gastrointestinal tract in vitro are also described. This quantitative method provides a means to establish a correlation between the chemical nature, the surface

morphology and the dimensions of drug-loaded microspheres on one hand and bioadhesive forces on the other, allowing the screening of the most promising materials from a relatively large group of natural and synthetic polymers which, from theoretical consideration, should be used for making bioadhesive microspheres. Solutions of  
5 medicament in buffered saline and similar vehicles are commonly employed to generate an aerosol in a nebulizer. Simple nebulizers operate on Bernoulli's principle and employ a stream of air or oxygen to generate the spray particles. More complex nebulizers employ ultrasound to create the spray particles. Both types are well known in the art and are described in standard textbooks of pharmacy such as Sprowls' American Pharmacy  
10 and Remington's The Science and Practice of Pharmacy. Other devices for generating aerosols employ compressed gases, usually hydrofluorocarbons and chlorofluorocarbons, which are mixed with the medicament and any necessary excipients in a pressurized container, these devices are likewise described in standard textbooks such as Sprowls and Remington.

15

The agents can be a free acid or base, or a pharmacologically acceptable salt thereof. Solids can be dissolved or dispersed immediately prior to administration or earlier. In some circumstances the preparations include a preservative to prevent the growth of microorganisms. The pharmaceutical forms suitable for injection can include sterile  
20 aqueous or organic solutions or dispersions which include, e.g., water, an alcohol, an organic solvent, an oil or other solvent or dispersant (e.g., glycerol, propylene glycol, polyethylene glycol, and vegetable oils). The formulations may contain antioxidants, buffers, bacteriostats, and solutes that render the formulation isotonic with the blood of the intended recipient, and aqueous and non-aqueous sterile suspensions that can include  
25 suspending agents, solubilizers, thickening agents, stabilizers, and preservatives. Pharmaceutical agents can be sterilized by filter sterilization or by other suitable means. The agent can be fused to immunoglobulins or albumin, albumin variants or fragments thereof, or incorporated into a liposome to improve half-life. Thus the peptides described herein may be fused directly or via a peptide linker, water soluble polymer, or prodrug



linker to albumin or an analog, fragment, or derivative thereof. Generally, the albumin proteins that are part of the fusion proteins of the present invention may be derived from albumin cloned from any species, including human. Human serum albumin (HSA) consists of a single non-glycosylated polypeptide chain of 585 amino acids with a  
5 formula molecular weight of 66,500. The amino acid sequence of human HSA is known [See Meloun, et al. (1975) FEBS Letters 58:136; Behrens, et al. (1975) Fed. Proc. 34:591; Lawn, et al. (1981) Nucleic Acids Research 9:6102-6114; Minghetti, et al. (1986) J. Biol. Chem. 261:6747, each of which are incorporated by reference herein]. A variety of polymorphic variants as well as analogs and fragments of albumin have been described.  
10 [See Weitkamp, et al., (1973) Ann. Hum. Genet. 37:219]. For example, in EP 322,094, various shorter forms of HSA. Some of these fragments of HSA are disclosed, including HSA(1-373), HSA(1-388), HSA(1-389), HSA(1-369), and HSA(1-419) and fragments between 1-369 and 1-419. EP 399,666 discloses albumin fragments that include HSA(1-177) and HSA(1-200) and fragments between HSA(1-177) and HSA(1-200). Methods  
15 related to albumin fusion proteins can be found in US 7,056,701, US 6,994,857, US 6,946,134, US 6,926,898, and US 6,905,688 and the related priority documents and references cited therein. The agent can also be conjugated to polyethylene glycol (PEG) chains. Methods for pegylation and additional formulations containing PEG-conjugates (i.e. PEG-based hydrogels, PEG modified liposomes) can be found in Harris and Chess,  
20 Nature Reviews Drug Discovery 2: 214-221 and the references therein. Peptides can also be modified with alkyl groups (e.g., C1-C20 straight or branched alkyl groups); fatty acid radicals; and combinations of PEG, alkyl groups and fatty acid radicals (see U.S. Patent 6,309,633; Soltero et al., 2001 Innovations in Pharmaceutical Technology 106-110).  
The agent can be administered via a nanocochleate or cochleate delivery vehicle  
25 (BioDelivery Sciences International). The agents can be delivered transmucosally (i.e. across a mucosal surface such as the vagina, eye or nose) using formulations such as that described in U.S. 5,204,108. The agents can be formulated in microcapsules as described in WO 88/01165. The agent can be administered intra-orally using the formulations

described in U.S. 20020055496, WO 00/47203, and U.S. 6,495,120. The agent can be delivered using nanoemulsion formulations described in WO 01/91728A2.

#### Controlled release formulations

- 5 In general, one can provide for controlled release of the agents described herein through the use of a wide variety of polymeric carriers and controlled release systems including erodible and non-erodible matrices, osmotic control devices, various reservoir devices, enteric coatings and multiparticulate control devices.
- 10 Matrix devices are a common device for controlling the release of various agents. In such devices, the agents described herein are generally present as a dispersion within the polymer matrix, and are typically formed by the compression of a polymer/drug mixture or by dissolution or melting. The dosage release properties of these devices may be dependent upon the solubility of the agent in the polymer matrix or, in the case of porous
- 15 matrices, the solubility in the sink solution within the pore network, and the tortuosity of the network. In one instance, when utilizing an erodible polymeric matrix, the matrix imbibes water and forms an aqueous-swollen gel that entraps the agent. The matrix then gradually erodes, swells, disintegrates or dissolves in the GI tract, thereby controlling release of one or more of the agents described herein. In non-erodible devices, the agent
- 20 is released by diffusion through an inert matrix.

Agents described herein can be incorporated into an erodible or non-erodible polymeric matrix controlled release device. By an erodible matrix is meant aqueous-erodible or water-swellaible or aqueous-soluble in the sense of being either erodible or swellaible or

25 dissolvable in pure water or requiring the presence of an acid or base to ionize the polymeric matrix sufficiently to cause erosion or dissolution. When contacted with the aqueous environment of use, the erodible polymeric matrix imbibes water and forms an aqueous-swollen gel or matrix that entraps the agent described herein. The aqueous-swollen matrix gradually erodes, swells, disintegrates or dissolves in the environment of

use, thereby controlling the release of a compound described herein to the environment of use.

The erodible polymeric matrix into which an agent described herein can be incorporated may generally be described as a set of excipients that are mixed with the agent following its formation that, when contacted with the aqueous environment of use imbibes water and forms a water-swollen gel or matrix that entraps the drug form. Drug release may occur by a variety of mechanisms, for example, the matrix may disintegrate or dissolve from around particles or granules of the agent or the agent may dissolve in the imbibed aqueous solution and diffuse from the tablet, beads or granules of the device. One ingredient of this water-swollen matrix is the water-swallowable, erodible, or soluble polymer, which may generally be described as an osmopolymer, hydrogel or water-swallowable polymer. Such polymers may be linear, branched, or crosslinked. The polymers may be homopolymers or copolymers. In certain embodiments, they may be synthetic polymers derived from vinyl, acrylate, methacrylate, urethane, ester and oxide monomers. In other embodiments, they can be derivatives of naturally occurring polymers such as polysaccharides (e.g. chitin, chitosan, dextran and pullulan; gum agar, gum arabic, gum karaya, locust bean gum, gum tragacanth, carrageenans, gum ghatti, guar gum, xanthan gum and scleroglucan), starches (e.g. dextrin and maltodextrin), hydrophilic colloids (e.g. pectin), phosphatides (e.g. lecithin), alginates (e.g. ammonium alginate, sodium, potassium or calcium alginate, propylene glycol alginate), gelatin, collagen, and cellulosics. Cellulosics are cellulose polymer that has been modified by reaction of at least a portion of the hydroxyl groups on the saccharide repeat units with a compound to form an ester-linked or an ether-linked substituent. For example, the cellulose ethyl cellulose has an ether linked ethyl substituent attached to the saccharide repeat unit, while the cellulose cellulose acetate has an ester linked acetate substituent. In certain embodiments, the cellulosics for the erodible matrix comprises aqueous-soluble and aqueous-erodible cellulosics can include, for example, ethyl cellulose (EC), methylethyl cellulose (MEC), carboxymethyl cellulose (CMC), CMEC, hydroxyethyl

cellulose (HEC), hydroxypropyl cellulose (HPC), cellulose acetate (CA), cellulose propionate (CP), cellulose butyrate (CB), cellulose acetate butyrate (CAB), CAP, CAT, hydroxypropyl methyl cellulose (HPMC), HPMCP, HPMCAS, hydroxypropyl methyl cellulose acetate trimellitate (HPMCAT), and ethylhydroxy ethylcellulose (EHEC). In certain embodiments, the cellulose comprises various grades of low viscosity (MW less than or equal to 50,000 daltons, for example, the Dow Methocel™ series E5, E15LV, E50LV and K100LY) and high viscosity (MW greater than 50,000 daltons, for example, E4MCR, E10MCR, K4M, K15M and K100M and the Methocel™ K series) HPMC. Other commercially available types of HPMC include the Shin Etsu Metolose 90SH series.

10 The choice of matrix material can have a large effect on the maximum drug concentration attained by the device as well as the maintenance of a high drug concentration. The matrix material can be a concentration-enhancing polymer, for example, as described in WO05/011634.

15 Other materials useful as the erodible matrix material include, but are not limited to, pullulan, polyvinyl pyrrolidone, polyvinyl alcohol, polyvinyl acetate, glycerol fatty acid esters, polyacrylamide, polyacrylic acid, copolymers of ethacrylic acid or methacrylic acid (EUDRAGIT, Rohm America, Inc., Piscataway, New Jersey) and other acrylic acid derivatives such as homopolymers and copolymers of butylmethacrylate, methylmethacrylate, ethylmethacrylate, ethylacrylate, (2-dimethylaminoethyl) methacrylate, and (trimethylaminoethyl) methacrylate chloride.

20

The erodible matrix polymer may contain a wide variety of the same types of additives and excipients known in the pharmaceutical arts, including osmopolymers, osmagens, solubility-enhancing or-retarding agents and excipients that promote stability or processing of the device.

25

Alternatively, the agents of the present invention may be administered by or incorporated into a non-erodible matrix device. In such devices, an agent described herein is distributed in an inert matrix. The agent is released by diffusion through the inert matrix.

Examples of materials suitable for the inert matrix include insoluble plastics (e.g. methyl acrylate-methyl methacrylate copolymers, polyvinyl chloride, polyethylene), hydrophilic polymers (e.g. ethyl cellulose, cellulose acetate, crosslinked polyvinylpyrrolidone (also known as crospovidone)), and fatty compounds (e.g. carnauba wax, microcrystalline wax, and triglycerides). Such devices are described further in Remington: The Science and Practice of Pharmacy, 20th edition (2000).

Matrix controlled release devices may be prepared by blending an agent described herein and other excipients together, and then forming the blend into a tablet, caplet, pill, or other device formed by compressive forces. Such compressed devices may be formed using any of a wide variety of presses used in the fabrication of pharmaceutical devices. Examples include single-punch presses, rotary tablet presses, and multilayer rotary tablet presses, all well known in the art. See for example, Remington: The Science and Practice of Pharmacy, 20th Edition, 2000. The compressed device may be of any shape, including round, oval, oblong, cylindrical, or triangular. The upper and lower surfaces of the compressed device may be flat, round, concave, or convex.

In certain embodiments, when formed by compression, the device has a strength of at least 5 Kiloponds (Kp)/cm<sup>2</sup> (for example, at least 7 Kp/cm<sup>2</sup>). Strength is the fracture force, also known as the tablet hardness required to fracture a tablet formed from the materials, divided by the maximum cross-sectional area of the tablet normal to that force. The fracture force may be measured using a Schleuniger Tablet Hardness Tester, Model 6D. The compression force required to achieve this strength will depend on the size of the tablet, but generally will be greater than about 5 kP/cm<sup>2</sup>. Friability is a well-known measure of a device's resistance to surface abrasion that measures weight loss in percentage after subjecting the device to a standardized agitation procedure. Friability values of from 0.8 to 1.0% are regarded as constituting the upper limit of acceptability. Devices having a strength of greater than 5 kP/cm<sup>2</sup> generally are very robust, having a friability of less than 0.5%. Other methods for forming matrix controlled-release devices

are well known in the pharmaceutical arts. See for example, Remington: The Science and Practice of Pharmacy, 20th Edition, 2000.

As noted above, the agents described herein may also be incorporated into an osmotic control device. Such devices generally include a core containing one or more agents as described herein and a water permeable, non-dissolving and non-eroding coating surrounding the core which controls the influx of water into the core from an aqueous environment of use so as to cause drug release by extrusion of some or all of the core to the environment of use. In certain embodiments, the coating is polymeric, aqueous-permeable, and has at least one delivery port. The core of the osmotic device optionally includes an osmotic agent which acts to imbibe water from the surrounding environment via such a semi-permeable membrane. The osmotic agent contained in the core of this device may be an aqueous-swelling hydrophilic polymer or it may be an osmogen, also known as an osmagent. Pressure is generated within the device which forces the agent(s) out of the device via an orifice (of a size designed to minimize solute diffusion while preventing the build-up of a hydrostatic pressure head).

Osmotic agents create a driving force for transport of water from the environment of use into the core of the device. Osmotic agents include but are not limited to water-swelling hydrophilic polymers, and osmogens (or osmagens). Thus, the core may include water-swelling hydrophilic polymers, both ionic and nonionic, often referred to as osmopolymers and hydrogels. The amount of water-swelling hydrophilic polymers present in the core may range from about 5 to about 80 wt% (including for example, 10 to 50 wt%). Nonlimiting examples of core materials include hydrophilic vinyl and acrylic polymers, polysaccharides such as calcium alginate, polyethylene oxide (PEO), polyethylene glycol (PEG), polypropylene glycol (PPG), poly (2-hydroxyethyl methacrylate), poly (acrylic) acid, poly (methacrylic) acid, polyvinylpyrrolidone (PVP) and crosslinked PVP, polyvinyl alcohol (PVA), PVA/PVP copolymers and PVA/PVP copolymers with hydrophobic monomers such as methyl methacrylate, vinyl acetate, and the like, hydrophilic polyurethanes containing large PEO blocks, sodium croscarmellose,

carrageenan, hydroxyethyl cellulose (HEC), hydroxypropyl cellulose (HPC), hydroxypropyl methyl cellulose (HPMC), carboxymethyl cellulose (CMC) and carboxyethyl cellulose (CEC), sodium alginate, polycarbophil, gelatin, xanthan gum, and sodium starch glycolat. Other materials include hydrogels comprising interpenetrating  
5 networks of polymers that may be formed by addition or by condensation polymerization, the components of which may comprise hydrophilic and hydrophobic monomers such as those just mentioned. Water-swellaible hydrophilic polymers include but are not limited to PEO, PEG, PVP, sodium croscarmellose, HPMC, sodium starch glycolate, polyacrylic acid and crosslinked versions or mixtures thereof.

10

The core may also include an osmogen (or osmagent). The amount of osmogen present in the core may range from about 2 to about 70 wt% (including, for example, from 10 to 50 wt%). Typical classes of suitable osmogens are water-soluble organic acids, salts and sugars that are capable of imbibing water to thereby effect an osmotic pressure gradient  
15 across the barrier of the surrounding coating. Typical useful osmogens include but are not limited to magnesium sulfate, magnesium chloride, calcium chloride, sodium chloride, lithium chloride, potassium sulfate, sodium carbonate, sodium sulfite, lithium sulfate, potassium chloride, sodium sulfate, mannitol, xylitol, urea, sorbitol, inositol, raffinose, sucrose, glucose, fructose, lactose, citric acid, succinic acid, tartaric acid, and mixtures  
20 thereof. In certain embodiments, the osmogen is glucose, lactose, sucrose, mannitol, xylitol, sodium chloride, including combinations thereof.

The core may include a wide variety of additives and excipients that enhance the performance of the dosage form or that promote stability, tableting or processing. Such additives and excipients include tableting aids, surfactants, water-soluble polymers, pH  
25 modifiers, fillers, binders, pigments, disintegrants, antioxidants, lubricants and flavorants. Nonlimiting examples of additives and excipients include but are not limited to those described elsewhere herein as well as microcrystalline cellulose, metallic salts of acids (e.g. aluminum stearate, calcium stearate, magnesium stearate, sodium stearate, zinc stearate), pH control agents (e.g. buffers, organic acids, organic acid salts, organic and

inorganic bases), fatty acids, hydrocarbons and fatty alcohols (e.g. stearic acid, palmitic acid, liquid paraffin, stearyl alcohol, and palmitol), fatty acid esters (e.g. glyceryl (mono- and di-) stearates, triglycerides, glyceryl (palmiticstearic) ester, sorbitan esters (e.g. sorbitan monostearate, saccharose monostearate, saccharose monopalmitate, sodium stearyl fumarate), polyoxyethylene sorbitan esters), surfactants (e.g. alkyl sulfates (e.g. sodium lauryl sulfate, magnesium lauryl sulfate), polymers (e.g. polyethylene glycols, polyoxyethylene glycols, polyoxyethylene, polyoxypropylene ethers, including copolymers thereof), polytetrafluoroethylene), and inorganic materials (e.g. talc, calcium phosphate), cyclodextrins, sugars (e.g. lactose, xylitol), sodium starch glycolate).

5

10 Nonlimiting examples of disintegrants are sodium starch glycolate (e. g., Explotab™ CLV, (microcrystalline cellulose (e. g., Avicel™), microcrystalline silicified cellulose (e.g., ProSolv™), croscarmellose sodium (e. g., Ac-Di-Sol™). When the agent described herein is a solid amorphous dispersion formed by a solvent process, such additives may be added directly to the spray-drying solution when forming an agent described

15 herein/concentration-enhancing polymer dispersion such that the additive is dissolved or suspended in the solution as a slurry, Alternatively, such additives may be added following the spray-drying process to aid in forming the final controlled release device.

A nonlimiting example of an osmotic device consists of one or more drug layers

20 containing an agent described herein, such as a solid amorphous drug/polymer dispersion, and a sweller layer that comprises a water-swellaable polymer, with a coating surrounding the drug layer and sweller layer. Each layer may contain other excipients such as tableting aids, osmagents, surfactants, water-soluble polymers and water-swellaable polymers.

25

Such osmotic delivery devices may be fabricated in various geometries including bilayer (wherein the core comprises a drug layer and a sweller layer adjacent to each other), trilayer (wherein the core comprises a sweller layer sandwiched between two drug layers) and concentric (wherein the core comprises a central sweller agent surrounded by the



drug layer). The coating of such a tablet comprises a membrane permeable to water but substantially impermeable to drug and excipients contained within. The coating contains one or more exit passageways or ports in communication with the drug-containing layer(s) for delivering the drug agent. The drug-containing layer(s) of the core contains  
5 the drug agent (including optional osmagents and hydrophilic water-soluble polymers), while the sweller layer consists of an expandable hydrogel, with or without additional osmotic agents.

When placed in an aqueous medium, the tablet imbibes water through the membrane,  
10 causing the agent to form a dispensable aqueous agent, and causing the hydrogel layer to expand and push against the drug-containing agent, forcing the agent out of the exit passageway. The agent can swell, aiding in forcing the drug out of the passageway. Drug can be delivered from this type of delivery system either dissolved or dispersed in the agent that is expelled from the exit passageway.

15 The rate of drug delivery is controlled by such factors as the permeability and thickness of the coating, the osmotic pressure of the drug-containing layer, the degree of hydrophilicity of the hydrogel layer, and the surface area of the device. Those skilled in the art will appreciate that increasing the thickness of the coating will reduce the release  
20 rate, while any of the following will increase the release rate: increasing the permeability of the coating; increasing the hydrophilicity of the hydrogel layer; increasing the osmotic pressure of the drug-containing layer; or increasing the device's surface area.

Other materials useful in forming the drug-containing agent, in addition to the agent  
25 described herein itself, include HPMC, PEO and PVP and other pharmaceutically acceptable carriers. In addition, osmagents such as sugars or salts, including but not limited to sucrose, lactose, xylitol, mannitol, or sodium chloride, may be added. Materials which are useful for forming the hydrogel layer include sodium CMC, PEO (e.g. polymers having an average molecular weight from about 5,000,000 to about 7,500,000

daltons), poly (acrylic acid), sodium (polyacrylate), sodium croscarmellose, sodium starch glycolat, PVP, crosslinked PVP, and other high molecular weight hydrophilic materials.

5 In the case of a bilayer geometry, the delivery port(s) or exit passageway(s) may be located on the side of the tablet containing the drug agent or may be on both sides of the tablet or even on the edge of the tablet so as to connect both the drug layer and the sweller layer with the exterior of the device. The exit passageway(s) may be produced by mechanical means or by laser drilling, or by creating a difficult-to-coat region on the  
10 tablet by use of special tooling during tablet compression or by other means.

The osmotic device can also be made with a homogeneous core surrounded by a semipermeable membrane coating, as in US3845770. The agent described herein can be incorporated into a tablet core and a semipermeable membrane coating can be applied via  
15 conventional tablet-coating techniques such as using a pan coater. A drug delivery passageway can then be formed in this coating by drilling a hole in the coating, either by use of a laser or mechanical means. Alternatively, the passageway may be formed by rupturing a portion of the coating or by creating a region on the tablet that is difficult to coat, as described above. In one embodiment, an osmotic device comprises: (a) a single-  
20 layer compressed core comprising: (i) an agent described herein, (ii) a hydroxyethylcellulose, and (iii) an osmagent, wherein the hydroxyethylcellulose is present in the core from about 2.0% to about 35% by weight and the osmagent is present from about 15% to about 70% by weight; (b) a water-permeable layer surrounding the core; and (c) at least one passageway within the water-permeable layer (b) for delivering  
25 the drug to a fluid environment surrounding the tablet. In certain embodiments, the device is shaped such that the surface area to volume ratio (of a water-swollen tablet) is greater than  $0.6 \text{ mm}^{-1}$  (including, for example, greater than  $1.0 \text{ mm}^{-1}$ ). The passageway connecting the core with the fluid environment can be situated along the tablet band area. In certain embodiments, the shape is an oblong shape where the ratio of the tablet tooling

axes, i.e., the major and minor axes which define the shape of the tablet, are between 1.3 and 3 (including, for example, between 1.5 and 2.5). In one embodiment, the combination of the agent described herein and the osmagent have an average ductility from about 100 to about 200 Mpa, an average tensile strength from about 0.8 to about 2.0 Mpa, and an average brittle fracture index less than about 0.2. The single-layer core may optionally include a disintegrant, a bioavailability enhancing additive, and/or a pharmaceutically acceptable excipient, carrier or diluent.

In certain embodiments, entrainment of particles of agents described herein in the extruding fluid during operation of such osmotic device is desirable. For the particles to be well entrained, the agent drug form is dispersed in the fluid before the particles have an opportunity to settle in the tablet core. One means of accomplishing this is by adding a disintegrant that serves to break up the compressed core into its particulate components. Nonlimiting examples of standard disintegrants include materials such as sodium starch glycolate (e. g., Explotab™ CLV), microcrystalline cellulose (e. g., Avicel™), microcrystalline silicified cellulose (e. g., ProSolV™) and croscarmellose sodium (e. g., Ac-Di-Sol™), and other disintegrants known to those skilled in the art. Depending upon the particular formulation, some disintegrants work better than others. Several disintegrants tend to form gels as they swell with water, thus hindering drug delivery from the device. Non-gelling, non-swelling disintegrants provide a more rapid dispersion of the drug particles within the core as water enters the core. In certain embodiments, non-gelling, non-swelling disintegrants are resins, for example, ion-exchange resins. In one embodiment, the resin is Amberlite™ IRP 88 (available from Rohm and Haas, Philadelphia, PA). When used, the disintegrant is present in amounts ranging from about 50-74% of the core agent.

Water-soluble polymers are added to keep particles of the agent suspended inside the device before they can be delivered through the passageway(s) (e.g., an orifice). High viscosity polymers are useful in preventing settling. However, the polymer in

combination with the agent is extruded through the passageway(s) under relatively low pressures. At a given extrusion pressure, the extrusion rate typically slows with increased viscosity. Certain polymers in combination with particles of the agent described herein form high viscosity solutions with water but are still capable of being extruded from the tablets with a relatively low force. In contrast, polymers having a low weight-average, 5 molecular weight (< about 300,000) do not form sufficiently viscous solutions inside the tablet core to allow complete delivery due to particle settling. Settling of the particles is a problem when such devices are prepared with no polymer added, which leads to poor drug delivery unless the tablet is constantly agitated to keep the particles from settling 10 inside the core. Settling is also problematic when the particles are large and/or of high density such that the rate of settling increases.

In certain embodiments, the water-soluble polymers for such osmotic devices do not interact with the drug. In certain embodiments the water-soluble polymer is a non-ionic 15 polymer. A nonlimiting example of a non-ionic polymer forming solutions having a high viscosity yet still extrudable at low pressures is Natrosol™ 250H (high molecular weight hydroxyethylcellulose, available from Hercules Incorporated, Aqualon Division, Wilmington, DE; MW equal to about 1 million daltons and a degree of polymerization equal to about 3,700). Natrosol 250H™ provides effective drug delivery at concentrations 20 as low as about 3% by weight of the core when combined with an osmagent. Natrosol 250H™ NF is a high-viscosity grade nonionic cellulose ether that is soluble in hot or cold water. The viscosity of a 1% solution of Natrosol 250H using a Brookfield LVT (30 rpm) at 25°C is between about 1,500 and about 2,500 cps.

In certain embodiments, hydroxyethylcellulose polymers for use in these monolayer 25 osmotic tablets have a weight-average, molecular weight from about 300,000 to about 1.5 million. The hydroxyethylcellulose polymer is typically present in the core in an amount from about 2.0% to about 35% by weight.

Another example of an osmotic device is an osmotic capsule. The capsule shell or portion of the capsule shell can be semipermeable. The capsule can be filled either by a powder or liquid consisting of an agent described herein, excipients that imbibe water to provide osmotic potential, and/or a water-swellaible polymer, or optionally solubilizing excipients.

5 The capsule core can also be made such that it has a bilayer or multilayer agent analogous to the bilayer, trilayer or concentric geometries described above.

Another class of osmotic device useful in this invention comprises coated swellaible tablets, for example, as described in EP378404. Coated swellaible tablets comprise a

10 tablet core comprising an agent described herein and a swelling material, preferably a hydrophilic polymer, coated with a membrane, which contains holes, or pores through which, in the aqueous use environment, the hydrophilic polymer can extrude and carry out the agent. Alternatively, the membrane may contain polymeric or low molecular weight water-soluble porosigens. Porosigens dissolve in the aqueous use environment,

15 providing pores through which the hydrophilic polymer and agent may extrude. Examples of porosigens are water-soluble polymers such as HPMC, PEG, and low molecular weight compounds such as glycerol, sucrose, glucose, and sodium chloride. In addition, pores may be formed in the coating by drilling holes in the coating using a laser or other mechanical means. In this class of osmotic devices, the membrane material may

20 comprise any film-forming polymer, including polymers which are water permeable or impermeable, providing that the membrane deposited on the tablet core is porous or contains water-soluble porosigens or possesses a macroscopic hole for water ingress and drug release. Embodiments of this class of sustained release devices may also be

multilayered, as described, for example, in EP378404.

25

When an agent described herein is a liquid or oil, such as a lipid vehicle formulation, for example as described in WO05/011634, the osmotic controlled-release device may comprise a soft-gel or gelatin capsule formed with a composite wall and comprising the liquid formulation where the wall comprises a barrier layer formed over the external

surface of the capsule, an expandable layer formed over the barrier layer, and a semipermeable layer formed over the expandable layer. A delivery port connects the liquid formulation with the aqueous use environment. Such devices are described, for example, in US6419952, US6342249, US5324280, US4672850, US4627850, 5 US4203440, and US3995631.

The osmotic controlled release devices of the present invention can also comprise a coating. In certain embodiments, the osmotic controlled release device coating exhibits one or more of the following features: is water-permeable, has at least one port for the delivery of drug, and is non-dissolving and non-eroding during release of the drug 10 formulation, such that drug is substantially entirely delivered through the delivery port(s) or pores as opposed to delivery primarily via permeation through the coating material itself. Delivery ports include any passageway, opening or pore whether made mechanically, by laser drilling, by pore formation either during the coating process or *in situ* during use or by rupture during use. In certain embodiments, the coating is present in 15 an amount ranging from about 5 to 30 wt% (including, for example, 10 to 20 wt%) relative to the core weight.

One form of coating is a semipermeable polymeric membrane that has the port(s) formed therein either prior to or during use. Thickness of such a polymeric membrane may vary 20 between about 20 and 800  $\mu\text{m}$  (including, for example, between about 100 to 500  $\mu\text{m}$ ). The diameter of the delivery port (s) may generally range in size from 0.1 to 3000  $\mu\text{m}$  or greater (including, for example, from about 50 to 3000  $\mu\text{m}$  in diameter). Such port(s) may be formed post-coating by mechanical or laser drilling or may be formed *in situ* by rupture of the coatings; such rupture may be controlled by intentionally incorporating a 25 relatively small weak portion into the coating. Delivery ports may also be formed *in situ* by erosion of a plug of water-soluble material or by rupture of a thinner portion of the coating over an indentation in the core. In addition, delivery ports may be formed during coating, as in the case of asymmetric membrane coatings of the type disclosed in US5612059 and US5698220. The delivery port may be formed *in situ* by rupture of the

coating, for example, when a collection of beads that may be of essentially identical or of a variable agent are used. Drug is primarily released from such beads following rupture of the coating and, following rupture, such release may be gradual or relatively sudden. When the collection of beads has a variable agent, the agent may be chosen such that the beads rupture at various times following administration, resulting in the overall release of drug being sustained for a desired duration.

Coatings may be dense, microporous or asymmetric, having a denser region supported by a thick porous region such as those disclosed in US5612059 and US5698220. When the coating is dense the coating can be composed of a water-permeable material. When the coating is porous, it may be composed of either a water-permeable or a water-impermeable material. When the coating is composed of a porous water-impermeable material, water permeates through the pores of the coating as either a liquid or a vapor. Nonlimiting examples of osmotic devices that utilize dense coatings include US3995631 and US3845770. Such dense coatings are permeable to the external fluid such as water and may be composed of any of the materials mentioned in these patents as well as other water-permeable polymers known in the art.

The membranes may also be porous as disclosed, for example, in US5654005 and US5458887 or even be formed from water-resistant polymers. US5120548 describes another suitable process for forming coatings from a mixture of a water-insoluble polymer and a leachable water-soluble additive. The porous membranes may also be formed by the addition of pore-formers as disclosed in US4612008. In addition, vapor-permeable coatings may even be formed from extremely hydrophobic materials such as polyethylene or polyvinylidene difluorid that, when dense, are essentially water-impermeable, as long as such coatings are porous. Materials useful in forming the coating include but are not limited to various grades of acrylic, vinyls, ethers, polyamides, polyesters and cellulosic derivatives that are water-permeable and water-insoluble at physiologically relevant pHs, or are susceptible to being rendered water-insoluble by chemical alteration such as by crosslinking. Nonlimiting examples of

suitable polymers (or crosslinked versions) useful in forming the coating include plasticized, unplasticized and reinforced cellulose acetate (CA), cellulose diacetate, cellulose triacetate, CA propionate, cellulose nitrate, cellulose acetate butyrate (CAB), CA ethyl carbamate, CAP, CA methyl carbamate, CA succinate, cellulose acetate  
5 trimellitate (CAT), CA dimethylaminoacetate, CA ethyl carbonate, CA chloroacetate, CA ethyl oxalate, CA methyl sulfonate, CA butyl sulfonate, CA p-toluene sulfonate, agar acetate, amylose triacetate, beta glucan acetate, beta glucan triacetate, acetaldehyde dimethyl acetate, triacetate of locust bean gum, hydroxiated ethylene-vinylacetate, EC, PEG, PPG, PEG/PPG copolymers, PVP, HEC, HPC, CMC, CMEC, HPMC, HPMCP,  
10 HPMCAS, HPMCAT, poly (acrylic) acids and esters and poly- (methacrylic) acids and esters and copolymers thereof, starch, dextran, dextrin, chitosan, collagen, gelatin, polyalkenes, polyethers, polysulfones, polyethersulfones, polystyrenes, polyvinyl halides, polyvinyl esters and ethers, natural waxes and synthetic waxes. In various embodiments, the coating agent comprises a cellulosic polymer, in particular cellulose ethers, cellulose  
15 esters and cellulose ester-ethers, i.e., cellulosic derivatives having a mixture of ester and ether substituents, the coating materials are made or derived from poly (acrylic) acids and esters, poly (methacrylic) acids and esters, and copolymers thereof, the coating agent comprises cellulose acetate, the coating comprises a cellulosic polymer and PEG, the coating comprises cellulose acetate and PEG.

20

Coating is conducted in conventional fashion, typically by dissolving or suspending the coating material in a solvent and then coating by dipping, spray coating or by pan-coating. In certain embodiments, the coating solution contains 5 to 15 wt% polymer. Typical solvents useful with the cellulosic polymers mentioned above include but are not  
25 limited to acetone, methyl acetate, ethyl acetate, isopropyl acetate, n-butyl acetate, methyl isobutyl ketone, methyl propyl ketone, ethylene glycol monoethyl ether, ethylene glycol monoethyl acetate, methylene dichloride, ethylene dichloride, propylene dichloride, nitroethane, nitropropane, tetrachloroethane, 1,4-dioxane, tetrahydrofuran, diglyme, water, and mixtures thereof. Pore-formers and non-solvents (such as water, glycerol and



ethanol) or plasticizers (such as diethyl phthalate) may also be added in any amount as long as the polymer remains soluble at the spray temperature. Pore-formers and their use in fabricating coatings are described, for example, in US5612059. Coatings may also be hydrophobic microporous layers wherein the pores are substantially filled with a gas and are not wetted by the aqueous medium but are permeable to water vapor, as disclosed, for example, in US5798119. Such hydrophobic but water-vapor permeable coatings are typically composed of hydrophobic polymers such as polyalkenes, polyacrylic acid derivatives, polyethers, polysulfones, polyethersulfones, polystyrenes, polyvinyl halides, polyvinyl esters and ethers, natural waxes and synthetic waxes. Hydrophobic microporous coating materials include but are not limited to polystyrene, polysulfones, polyethersulfones, polyethylene, polypropylene, polyvinyl chloride, polyvinylidene fluoride and polytetrafluoroethylene. Such hydrophobic coatings can be made by known phase inversion methods using any of vapor-quench, liquid quench, thermal processes, leaching soluble material from the coating or by sintering coating particles. In thermal processes, a solution of polymer in a latent solvent is brought to liquid-liquid phase separation in a cooling step. When evaporation of the solvent is not prevented, the resulting membrane will typically be porous. Such coating processes may be conducted by the processes disclosed, for example, in US4247498, US4490431 and US4744906. Osmotic controlled-release devices may be prepared using procedures known in the pharmaceutical arts. See for example, Remington: The Science and Practice of Pharmacy, 20th Edition, 2000.

As further noted above, the agents described herein may be provided in the form of microparticulates, generally ranging in size from about 10 $\mu$ m to about 2mm (including, for example, from about 100 $\mu$ m to 1mm in diameter). Such microparticulates may be packaged, for example, in a capsule such as a gelatin capsule or a capsule formed from an aqueous-soluble polymer such as HPMCAS, HPMC or starch; dosed as a suspension or slurry in a liquid; or they may be formed into a tablet, caplet, or pill by compression or other processes known in the art. Such microparticulates may be made by any known

process, such as wet- and dry-granulation processes, extrusion/spheronization, roller-compaction, melt-congealing, or by spray-coating seed cores. For example, in wet-and dry- granulation processes, the agent described herein and optional excipients may be granulated to form multiparticulates of the desired size. Other excipients, such as a binder (e. g., microcrystalline cellulose), may be blended with the agent to aid in processing and forming the multiparticulates. In the case of wet granulation, a binder such as microcrystalline cellulose may be included in the granulation fluid to aid in forming a suitable multiparticulate. See, for example, Remington : The Science and Practice of Pharmacy, 20<sup>th</sup> Edition, 2000. In any case, the resulting particles may themselves constitute the therapeutic composition or they may be coated by various film-forming materials such as enteric polymers or water-swellaible or water-soluble polymers, or they may be combined with other excipients or vehicles to aid in dosing to patients. Suitable pharmaceutical compositions in accordance with the invention will generally include an amount of the active compound(s) with an acceptable pharmaceutical diluent or excipient, such as a sterile aqueous solution, to give a range of final concentrations, depending on the intended use. The techniques of preparation are generally well known in the art, as exemplified by Remington's Pharmaceutical Sciences (18<sup>th</sup> Edition, Mack Publishing Company, 1995).

#### 20 Kits

The agents described herein and combination therapy agents can be packaged as a kit that includes single or multiple doses of two or more agents, each packaged or formulated individually, or single or multiple doses of two or more agents packaged or formulated in combination. Thus, one or more agents can be present in first container, and the kit can optionally include one or more agents in a second container. The container or containers are placed within a package, and the package can optionally include administration or dosage instructions. A kit can include additional components such as syringes or other means for administering the agents as well as diluents or other means for formulation.

Thus, the kits can comprise: a) a pharmaceutical composition comprising a compound described herein and a pharmaceutically acceptable carrier, vehicle or diluent; and b) a container or packaging. The kits may optionally comprise instructions describing a method of using the pharmaceutical compositions in one or more of the methods

5 described herein (e.g. gastrointestinal motility disorders, chronic intestinal pseudo-obstruction, colonic pseudo-obstruction, Crohn's disease, duodenogastric reflux, dyspepsia, functional dyspepsia, nonulcer dyspepsia, a functional gastrointestinal disorder, functional heartburn, gastroesophageal reflux disease (GERD), gastroparesis, irritable bowel syndrome, post-operative ileus, ulcerative colitis, chronic constipation,

10 and disorders and conditions associated with constipation (e.g. constipation associated with use of opiate pain killers, post-surgical constipation, and constipation associated with neuropathic disorders as well as other conditions and disorders described herein). The kit may optionally comprise a second pharmaceutical composition comprising one or more additional agents including but not limited to those including analgesic peptides and

15 compounds, a phosphodiesterase inhibitor, an agent used to treat gastrointestinal and other disorders (including those described herein), an agent used to treat constipation, an antidiarrheal agent, an insulin or related compound (including those described herein), an anti-hypertensive agent, an agent useful in the treatment of respiratory and other disorders, an anti-obesity agent, an anti-diabetic agents, an agent that activates soluble

20 guanylate cyclase and a pharmaceutically acceptable carrier, vehicle or diluent. The pharmaceutical composition comprising the compound described herein and the second pharmaceutical composition contained in the kit may be optionally combined in the same pharmaceutical composition.

25 A kit includes a container or packaging for containing the pharmaceutical compositions and may also include divided containers such as a divided bottle or a divided foil packet. The container can be, for example a paper or cardboard box, a glass or plastic bottle or jar, a re-sealable bag (for example, to hold a "refill" of tablets for placement into a different container), or a blister pack with individual doses for pressing out of the pack

according to a therapeutic schedule. It is feasible that more than one container can be used together in a single package to market a single dosage form. For example, tablets may be contained in a bottle which is in turn contained within a box.

5 An example of a kit is a so-called blister pack. Blister packs are well known in the packaging industry and are being widely used for the packaging of pharmaceutical unit dosage forms (tablets, capsules, and the like). Blister packs generally consist of a sheet of relatively stiff material covered with a foil of a preferably transparent plastic material. During the packaging process, recesses are formed in the plastic foil. The recesses have  
10 the size and shape of individual tablets or capsules to be packed or may have the size and shape to accommodate multiple tablets and/or capsules to be packed. Next, the tablets or capsules are placed in the recesses accordingly and the sheet of relatively stiff material is sealed against the plastic foil at the face of the foil which is opposite from the direction in which the recesses were formed. As a result, the tablets or capsules are individually  
15 sealed or collectively sealed, as desired, in the recesses between the plastic foil and the sheet. Preferably the strength of the sheet is such that the tablets or capsules can be removed from the blister pack by manually applying pressure on the recesses whereby an opening is formed in the sheet at the place of the recess. The tablet or capsule can then be removed via said opening.

20 It maybe desirable to provide a written memory aid containing information and/or instructions for the physician, pharmacist or subject regarding when the medication is to be taken. A "daily dose" can be a single tablet or capsule or several tablets or capsules to be taken on a given day. When the kit contains separate compositions, a daily dose of one  
25 or more compositions of the kit can consist of one tablet or capsule while a daily dose of another one or more compositions of the kit can consist of several tablets or capsules. A kit can take the form of a dispenser designed to dispense the daily doses one at a time in the order of their intended use. The dispenser can be equipped with a memory-aid, so as to further facilitate compliance with the regimen. An example of such a memory-aid is a

mechanical counter which indicates the number of daily doses that have been dispensed. Another example of such a memory-aid is a battery-powered micro-chip memory coupled with a liquid crystal readout, or audible reminder signal which, for example, reads out the date that the last daily dose has been taken and/or reminds one when the next dose is to  
5 be taken.

Methods to increase chemical and/or physical stability of the agents the described herein are found in U.S. 6,541,606, U.S. 6,068,850, U.S. 6,124,261, U.S. 5,904,935, and WO 00/15224, U.S. 20030069182 (via the additon of nicotinamide), U.S. 20030175230A1,  
10 U.S. 20030175230A1, U.S. 20030175239A1, U.S. 20020045582, U.S. 20010031726, WO 02/26248, WO 03/014304, WO 98/00152A1, WO 98/00157A1, WO 90/12029, WO 00/04880, and WO 91/04743, WO 97/04796 and the references cited therein.

Methods to increase bioavailability of the agents described herein are found in U.S.  
15 6,008,187, U.S. 5,424,289, U.S. 20030198619, WO 90/01329, WO 01/49268, WO 00/32172, and WO 02/064166. Glycyrrhizinate can also be used as an absorption enhancer (see, e.g., EP397447). WO 03/004062 discusses Ulex europaeus I (UEAI) and UEAI mimetics which may be used to target the agents described herein to the GI tract. The bioavailability of the agents described herein can also be increased by addition of oral  
20 bioavailability-enhancing agents such as those described in U.S. 6,818,615 including but not limited to: cyclosporins (including cyclosporins A through Z as defined in Table 1 of U.S. 6,818,615), for example, cyclosporin A (cyclosporin), cyclosporin F, cyclosporin D, dihydro cyclosporin A, dihydro cyclosporin C, acetyl cyclosporin A, PSC-833, (Me-Ile-4)-cyclosporin (SDZ-NIM 811) (both from Sandoz Pharmaceutical Corp.), and related  
25 oligopeptides produced by species in the genus Topycladium); antifungals including but not limited to ketoconazole; cardiovascular drug including but not limited to MS-209 (BASF), amiodarone, nifedipine, reserpine, quinidine, nicardipine, ethacrynic acid, propafenone, reserpine, amiloride; anti-migraine natural products including but not limited to ergot alkaloids; antibiotics including but not limited to cefoperazone,

tetracycline, chloroquine, fosfomycin; antiparasitics including but not limited to ivermectin; multi-drug resistance reversers including but not limited to VX-710 and VX-853 (Vertex Pharmaceutical Incorporated); tyrosine kinase inhibitors including but not limited to genistein and related isoflavonoids, quercetin; protein kinase C inhibitors including but not limited to calphostin; apoptosis inducers including but not limited to ceramides; and agents active against endorphin receptors including but not limited to morphine, morphine congeners, other opioids and opioid antagonists including (but not limited to) naloxone, naltrexone and nalmefene).

10 The agents described herein can be fused to a modified version of the blood serum protein transferrin. U.S. 20030221201, U.S. 20040023334, U.S. 20030226155, WO 04/020454, and WO 04/019872 discuss the manufacture and use of transferrin fusion proteins. Transferrin fusion proteins may improve circulatory half life and efficacy, decrease undesirable side effects and allow reduced dosage.

15

The peptides and agonists described herein can be recombinantly expressed in bacteria. Bacteria expressing the peptide or agonists can be administered orally, rectally, mucosally or in via some other mode of administration including but not limited to those described herein. Bacterial hosts suitable for such administration include but are not limited to certain *Lactobacteria* (e.g. *Lactococcus lactis*, *Lactobacillus plantarum*, *Lact. rhamnosus* and *Lact. paracasei ssp. Paracasei* and other species found in normal human flora (Ahrne et al. Journal of Applied Microbiology 1998 85:88)), certain *Streptococcus sp.* (e.g. *S. gordonii*), and certain *B. subtilis* strains (including pSM539 described in Porzio et al. BMC Biotechnology 2004 4:27). The polypeptides and agonists described herein can be administered using the *Helicobacter* based preparation methods described in WO06/015445.

#### Dosage

The dose range for adult humans is generally from 0.005 mg to 10 g/day orally. Tablets or other forms of presentation provided in discrete units may conveniently contain an amount of compound described herein which is effective at such dosage or as a multiple of the same, for instance, units containing 5 mg to 500 mg, usually around 10 mg to 200 mg. The precise amount of compound administered to a patient will be the responsibility of the attendant physician. However, the dose employed will depend on a number of factors, including the age and sex of the patient, the precise disorder being treated, and its severity.

10 A dosage unit (e.g. an oral dosage unit) can include from, for example, 1 to 30  $\mu\text{g}$ , 1 to 40  $\mu\text{g}$ , 1 to 50  $\mu\text{g}$ , 1 to 100  $\mu\text{g}$ , 1 to 200  $\mu\text{g}$ , 1 to 300  $\mu\text{g}$ , 1 to 400  $\mu\text{g}$ , 1 to 500  $\mu\text{g}$ , 1 to 600  $\mu\text{g}$ , 1 to 700  $\mu\text{g}$ , 1 to 800  $\mu\text{g}$ , 1 to 900  $\mu\text{g}$ , 1 to 1000  $\mu\text{g}$ , 10 to 30  $\mu\text{g}$ , 10 to 40  $\mu\text{g}$ , 10 to 50  $\mu\text{g}$ , 10 to 100  $\mu\text{g}$ , 10 to 200  $\mu\text{g}$ , 10 to 300  $\mu\text{g}$ , 10 to 400  $\mu\text{g}$ , 10 to 500  $\mu\text{g}$ , 10 to 600  $\mu\text{g}$ , 10 to 700  $\mu\text{g}$ , 10 to 800  $\mu\text{g}$ , 10 to 900  $\mu\text{g}$ , 10 to 1000  $\mu\text{g}$ , 100 to 200  $\mu\text{g}$ , 100 to 300  $\mu\text{g}$ , 100 to 400  $\mu\text{g}$ , 100 to 500  $\mu\text{g}$ , 100 to 600  $\mu\text{g}$ , 100 to 700  $\mu\text{g}$ , 100 to 800  $\mu\text{g}$ , 100 to 900  $\mu\text{g}$ , 100 to 1000  $\mu\text{g}$ , 100 to 1250  $\mu\text{g}$ , 100 to 1500  $\mu\text{g}$ , 100 to 1750  $\mu\text{g}$ , 100 to 2000  $\mu\text{g}$ , 100 to 2250  $\mu\text{g}$ , 100 to 2500  $\mu\text{g}$ , 100 to 2750  $\mu\text{g}$ , 100 to 3000  $\mu\text{g}$ , 200 to 300  $\mu\text{g}$ , 200 to 400  $\mu\text{g}$ , 200 to 500  $\mu\text{g}$ , 200 to 600  $\mu\text{g}$ , 200 to 700  $\mu\text{g}$ , 200 to 800  $\mu\text{g}$ , 200 to 900  $\mu\text{g}$ , 200 to 1000  $\mu\text{g}$ , 200 to 1250  $\mu\text{g}$ , 200 to 1500  $\mu\text{g}$ , 200 to 1750  $\mu\text{g}$ , 200 to 2000  $\mu\text{g}$ , 200 to 2250  $\mu\text{g}$ , 200 to 2500  $\mu\text{g}$ , 200 to 2750  $\mu\text{g}$ , 200 to 3000  $\mu\text{g}$ , 300 to 400  $\mu\text{g}$ , 300 to 500  $\mu\text{g}$ , 300 to 600  $\mu\text{g}$ , 300 to 700  $\mu\text{g}$ , 300 to 800  $\mu\text{g}$ , 300 to 900  $\mu\text{g}$ , 300 to 1000  $\mu\text{g}$ , 300 to 1250  $\mu\text{g}$ , 300 to 1500  $\mu\text{g}$ , 300 to 1750  $\mu\text{g}$ , 300 to 2000  $\mu\text{g}$ , 300 to 2250  $\mu\text{g}$ , 300 to 2500  $\mu\text{g}$ , 300 to 2750  $\mu\text{g}$ , 300 to 3000  $\mu\text{g}$ , 400 to 500  $\mu\text{g}$ , 400 to 600  $\mu\text{g}$ , 400 to 700  $\mu\text{g}$ , 400 to 800  $\mu\text{g}$ , 400 to 900  $\mu\text{g}$ , 400 to 1000  $\mu\text{g}$ , 400 to 1250  $\mu\text{g}$ , 400 to 1500  $\mu\text{g}$ , 400 to 1750  $\mu\text{g}$ , 400 to 2000  $\mu\text{g}$ , 400 to 2250  $\mu\text{g}$ , 400 to 2500  $\mu\text{g}$ , 400 to 2750  $\mu\text{g}$ , 400 to 3000  $\mu\text{g}$ , 500 to 600  $\mu\text{g}$ , 500 to 700  $\mu\text{g}$ , 500 to 800  $\mu\text{g}$ , 500 to 900  $\mu\text{g}$ , 500 to 1000  $\mu\text{g}$ , 500 to 1250  $\mu\text{g}$ , 500 to 1500  $\mu\text{g}$ , 500 to 1750  $\mu\text{g}$ , 500 to 2000  $\mu\text{g}$ , 500 to 2250  $\mu\text{g}$ , 500 to 2500  $\mu\text{g}$ , 500 to 2750  $\mu\text{g}$ , 500 to 3000  $\mu\text{g}$ , 600 to 700  $\mu\text{g}$ , 600 to 800  $\mu\text{g}$ , 600 to 900  $\mu\text{g}$ , 600 to 1000  $\mu\text{g}$ , 600 to 1250  $\mu\text{g}$ , 600 to 1500  $\mu\text{g}$ , 600 to 1750  $\mu\text{g}$ , 600 to 2000  $\mu\text{g}$ , 600 to 2250  $\mu\text{g}$ , 600 to 2500

5  $\mu\text{g}$ , 600 to 2750  $\mu\text{g}$ , 600 to 3000  $\mu\text{g}$ , 700 to 800  $\mu\text{g}$ , 700 to 900  $\mu\text{g}$ , 700 to 1000  $\mu\text{g}$ , 700 to 1250  $\mu\text{g}$ , 700 to 1500  $\mu\text{g}$ , 700 to 1750  $\mu\text{g}$ , 700 to 2000  $\mu\text{g}$ , 700 to 2250  $\mu\text{g}$ , 700 to 2500  $\mu\text{g}$ , 700 to 2750  $\mu\text{g}$ , 700 to 3000  $\mu\text{g}$ , 800 to 900  $\mu\text{g}$ , 800 to 1000  $\mu\text{g}$ , 800 to 1250  $\mu\text{g}$ , 800 to 1500  $\mu\text{g}$ , 800 to 1750  $\mu\text{g}$ , 800 to 2000  $\mu\text{g}$ , 800 to 2250  $\mu\text{g}$ , 800 to 2500  $\mu\text{g}$ , 800 to 2750  $\mu\text{g}$ , 800 to 3000  $\mu\text{g}$ , 900 to 1000  $\mu\text{g}$ , 900 to 1250  $\mu\text{g}$ , 900 to 1500  $\mu\text{g}$ , 900 to 1750  $\mu\text{g}$ , 900 to 2000  $\mu\text{g}$ , 900 to 2250  $\mu\text{g}$ , 900 to 2500  $\mu\text{g}$ , 900 to 2750  $\mu\text{g}$ , 900 to 3000  $\mu\text{g}$ , 1000 to 1250  $\mu\text{g}$ , 1000 to 1500  $\mu\text{g}$ , 1000 to 1750  $\mu\text{g}$ , 1000 to 2000  $\mu\text{g}$ , 1000 to 2250  $\mu\text{g}$ , 1000 to 2500  $\mu\text{g}$ , 1000 to 2750  $\mu\text{g}$ , 1000 to 3000  $\mu\text{g}$ , 2 to 500  $\mu\text{g}$ , 50 to 500  $\mu\text{g}$ , 3 to 100  $\mu\text{g}$ , 5 to 20  $\mu\text{g}$ , 5 to 100  $\mu\text{g}$ , 10  $\mu\text{g}$ , 20  $\mu\text{g}$ , 30  $\mu\text{g}$ , 40  $\mu\text{g}$ , 50  $\mu\text{g}$ , 60  $\mu\text{g}$ , 70  $\mu\text{g}$ , 75  $\mu\text{g}$ , 80  $\mu\text{g}$ , 90  $\mu\text{g}$ , 100  $\mu\text{g}$ , 150  $\mu\text{g}$ , 200  $\mu\text{g}$ , 250  $\mu\text{g}$ , 300  $\mu\text{g}$ , 350  $\mu\text{g}$ , 400  $\mu\text{g}$ , 450  $\mu\text{g}$ , 500  $\mu\text{g}$ , 550  $\mu\text{g}$ , 600  $\mu\text{g}$ , 650  $\mu\text{g}$ , 700  $\mu\text{g}$ , 750  $\mu\text{g}$ , 800  $\mu\text{g}$ , 850  $\mu\text{g}$ , 900  $\mu\text{g}$ , 950  $\mu\text{g}$ , 1000  $\mu\text{g}$ , 1050  $\mu\text{g}$ , 1100  $\mu\text{g}$ , 1150  $\mu\text{g}$ , 1200  $\mu\text{g}$ , 1250  $\mu\text{g}$ , 1300  $\mu\text{g}$ , 1350  $\mu\text{g}$ , 1400  $\mu\text{g}$ , 1450  $\mu\text{g}$ , 1500  $\mu\text{g}$ , 1550  $\mu\text{g}$ , 1600  $\mu\text{g}$ , 1650  $\mu\text{g}$ , 1700  $\mu\text{g}$ , 1750  $\mu\text{g}$ , 1800  $\mu\text{g}$ , 1850  $\mu\text{g}$ , 1900  $\mu\text{g}$ , 1950  $\mu\text{g}$ , 2000  $\mu\text{g}$ , 2050  $\mu\text{g}$ , 2100  $\mu\text{g}$ , 2150  $\mu\text{g}$ , 2200  $\mu\text{g}$ , 2250  $\mu\text{g}$ , 2300  $\mu\text{g}$ , 2350  $\mu\text{g}$ , 2400  $\mu\text{g}$ , 2450  $\mu\text{g}$ , 2500  $\mu\text{g}$ , 2550  $\mu\text{g}$ , 2600  $\mu\text{g}$ , 2650  $\mu\text{g}$ , 2700  $\mu\text{g}$ , 2750  $\mu\text{g}$ , 2800  $\mu\text{g}$ , 2850  $\mu\text{g}$ , 2900  $\mu\text{g}$ , 2950  $\mu\text{g}$ , 3000  $\mu\text{g}$ , 3250  $\mu\text{g}$ , 3500  $\mu\text{g}$ , 3750  $\mu\text{g}$ , 4000  $\mu\text{g}$ , 4250  $\mu\text{g}$ , 4500  $\mu\text{g}$ , 4750  $\mu\text{g}$ , 5000  $\mu\text{g}$  of a peptide or agonist described herein. Thus it may be desirable to administer 30, 75, 100, 150, 300, 600, 1000, or 3000  $\mu\text{g}$  of a peptide or agonist described herein (e.g. SEQ ID NO:3, SEQ ID NO:6) to prevent and/or treat constipation (e.g. opioid induced constipation, idiopathic constipation). Thus it may be desirable to administer 30, 75, 100, 150, 300, 600, 1000, or 3000  $\mu\text{g}$  of a peptide or agonist described herein (e.g. SEQ ID NO:3, SEQ ID NO:6) to prevent and/or treat irritable bowel syndrome (e.g. c-IBS, d-IBS, and/or a-IBS) and it may be desirable to administer these dosages as the total daily dose. In certain embodiments the dosage unit and daily dose are equivalent. In various 25 embodiments, the dosage unit is administered with food at anytime of the day, without food at anytime of the day, with food after an overnight fast (e.g. with breakfast), at bedtime after a low fat snack. In various embodiments, the dosage unit is administered once a day, twice a day, three times a day, four times a day, five times a day, six times a day. The dosage unit can optionally comprise other agents.



A dosage unit (e.g. an oral dosage unit) can include, for example, from 1 to 30  $\mu\text{g}$ , 1 to 40  $\mu\text{g}$ , 1 to 50  $\mu\text{g}$ , 1 to 100  $\mu\text{g}$ , 1 to 200  $\mu\text{g}$ , 1 to 300  $\mu\text{g}$ , 1 to 400  $\mu\text{g}$ , 1 to 500  $\mu\text{g}$ , 1 to 600  $\mu\text{g}$ , 1 to 700  $\mu\text{g}$ , 1 to 800  $\mu\text{g}$ , 1 to 900  $\mu\text{g}$ , 1 to 1000  $\mu\text{g}$ , 10 to 30  $\mu\text{g}$ , 10 to 40  $\mu\text{g}$ , 10 to 50  $\mu\text{g}$ , 10 to 100  $\mu\text{g}$ , 10 to 200  $\mu\text{g}$ , 10 to 300  $\mu\text{g}$ , 10 to 400  $\mu\text{g}$ , 10 to 500  $\mu\text{g}$ , 10 to 600  $\mu\text{g}$ , 10 to 700  $\mu\text{g}$ , 10 to 800  $\mu\text{g}$ , 10 to 900  $\mu\text{g}$ , 10 to 1000  $\mu\text{g}$ , 100 to 200  $\mu\text{g}$ , 100 to 300  $\mu\text{g}$ , 100 to 400  $\mu\text{g}$ , 100 to 500  $\mu\text{g}$ , 100 to 600  $\mu\text{g}$ , 100 to 700  $\mu\text{g}$ , 100 to 800  $\mu\text{g}$ , 100 to 900  $\mu\text{g}$ , 100 to 1000  $\mu\text{g}$ , 100 to 1250  $\mu\text{g}$ , 100 to 1500  $\mu\text{g}$ , 100 to 1750  $\mu\text{g}$ , 100 to 2000  $\mu\text{g}$ , 100 to 2250  $\mu\text{g}$ , 100 to 2500  $\mu\text{g}$ , 100 to 2750  $\mu\text{g}$ , 100 to 3000  $\mu\text{g}$ , 200 to 300  $\mu\text{g}$ , 200 to 400  $\mu\text{g}$ , 200 to 500  $\mu\text{g}$ , 200 to 600  $\mu\text{g}$ , 200 to 700  $\mu\text{g}$ , 200 to 800  $\mu\text{g}$ , 200 to 900  $\mu\text{g}$ , 200 to 1000  $\mu\text{g}$ , 200 to 1250  $\mu\text{g}$ , 200 to 1500  $\mu\text{g}$ , 200 to 1750  $\mu\text{g}$ , 200 to 2000  $\mu\text{g}$ , 200 to 2250  $\mu\text{g}$ , 200 to 2500  $\mu\text{g}$ , 200 to 2750  $\mu\text{g}$ , 200 to 3000  $\mu\text{g}$ , 300 to 400  $\mu\text{g}$ , 300 to 500  $\mu\text{g}$ , 300 to 600  $\mu\text{g}$ , 300 to 700  $\mu\text{g}$ , 300 to 800  $\mu\text{g}$ , 300 to 900  $\mu\text{g}$ , 300 to 1000  $\mu\text{g}$ , 300 to 1250  $\mu\text{g}$ , 300 to 1500  $\mu\text{g}$ , 300 to 1750  $\mu\text{g}$ , 300 to 2000  $\mu\text{g}$ , 300 to 2250  $\mu\text{g}$ , 300 to 2500  $\mu\text{g}$ , 300 to 2750  $\mu\text{g}$ , 300 to 3000  $\mu\text{g}$ , 400 to 500  $\mu\text{g}$ , 400 to 600  $\mu\text{g}$ , 400 to 700  $\mu\text{g}$ , 400 to 800  $\mu\text{g}$ , 400 to 900  $\mu\text{g}$ , 400 to 1000  $\mu\text{g}$ , 400 to 1250  $\mu\text{g}$ , 400 to 1500  $\mu\text{g}$ , 400 to 1750  $\mu\text{g}$ , 400 to 2000  $\mu\text{g}$ , 400 to 2250  $\mu\text{g}$ , 400 to 2500  $\mu\text{g}$ , 400 to 2750  $\mu\text{g}$ , 400 to 3000  $\mu\text{g}$ , 500 to 600  $\mu\text{g}$ , 500 to 700  $\mu\text{g}$ , 500 to 800  $\mu\text{g}$ , 500 to 900  $\mu\text{g}$ , 500 to 1000  $\mu\text{g}$ , 500 to 1250  $\mu\text{g}$ , 500 to 1500  $\mu\text{g}$ , 500 to 1750  $\mu\text{g}$ , 500 to 2000  $\mu\text{g}$ , 500 to 2250  $\mu\text{g}$ , 500 to 2500  $\mu\text{g}$ , 500 to 2750  $\mu\text{g}$ , 500 to 3000  $\mu\text{g}$ , 600 to 700  $\mu\text{g}$ , 600 to 800  $\mu\text{g}$ , 600 to 900  $\mu\text{g}$ , 600 to 1000  $\mu\text{g}$ , 600 to 1250  $\mu\text{g}$ , 600 to 1500  $\mu\text{g}$ , 600 to 1750  $\mu\text{g}$ , 600 to 2000  $\mu\text{g}$ , 600 to 2250  $\mu\text{g}$ , 600 to 2500  $\mu\text{g}$ , 600 to 2750  $\mu\text{g}$ , 600 to 3000  $\mu\text{g}$ , 700 to 800  $\mu\text{g}$ , 700 to 900  $\mu\text{g}$ , 700 to 1000  $\mu\text{g}$ , 700 to 1250  $\mu\text{g}$ , 700 to 1500  $\mu\text{g}$ , 700 to 1750  $\mu\text{g}$ , 700 to 2000  $\mu\text{g}$ , 700 to 2250  $\mu\text{g}$ , 700 to 2500  $\mu\text{g}$ , 700 to 2750  $\mu\text{g}$ , 700 to 3000  $\mu\text{g}$ , 800 to 900  $\mu\text{g}$ , 800 to 1000  $\mu\text{g}$ , 800 to 1250  $\mu\text{g}$ , 800 to 1500  $\mu\text{g}$ , 800 to 1750  $\mu\text{g}$ , 800 to 2000  $\mu\text{g}$ , 800 to 2250  $\mu\text{g}$ , 800 to 2500  $\mu\text{g}$ , 800 to 2750  $\mu\text{g}$ , 800 to 3000  $\mu\text{g}$ , 900 to 1000  $\mu\text{g}$ , 900 to 1250  $\mu\text{g}$ , 900 to 1500  $\mu\text{g}$ , 900 to 1750  $\mu\text{g}$ , 900 to 2000  $\mu\text{g}$ , 900 to 2250  $\mu\text{g}$ , 900 to 2500  $\mu\text{g}$ , 900 to 2750  $\mu\text{g}$ , 900 to 3000  $\mu\text{g}$ , 1000 to 1250  $\mu\text{g}$ , 1000 to 1500  $\mu\text{g}$ , 1000 to 1750  $\mu\text{g}$ , 1000 to 2000  $\mu\text{g}$ , 1000 to 2250  $\mu\text{g}$ , 1000 to 2500  $\mu\text{g}$ , 1000 to 2750  $\mu\text{g}$ , 1000 to 3000  $\mu\text{g}$ , 2 to 500  $\mu\text{g}$ , 50 to 500  $\mu\text{g}$ , 3 to 100  $\mu\text{g}$ , 5 to 20  $\mu\text{g}$ , 5 to

100 µg, 10 µg, 20 µg, 30 µg, 40 µg, 50 µg, 60 µg, 70 µg, 75 µg, 80 µg, 90 µg, 100 µg, 150  
µg, 200 µg, 250 µg, 300 µg, 350 µg, 400 µg, 450 µg, 500 µg, 550 µg, 600 µg, 650 µg, 700  
µg, 750 µg, 800 µg, 850 µg, 900 µg, 950 µg, 1000 µg, 1050 µg, 1100 µg, 1150 µg, 1200  
µg, 1250 µg, 1300 µg, 1350 µg, 1400 µg, 1450 µg, 1500 µg, 1550 µg, 1600 µg, 1650 µg,  
5 1700 µg, 1750 µg, 1800 µg, 1850 µg, 1900 µg, 1950 µg, 2000 µg, 2050 µg, 2100 µg,  
2150 µg, 2200 µg, 2250 µg, 2300 µg, 2350 µg, 2400 µg, 2450 µg, 2500 µg, 2550 µg,  
2600 µg, 2650 µg, 2700 µg, 2750 µg, 2800 µg, 2850 µg, 2900 µg, 2950 µg, 3000 µg,  
3250 µg, 3500 µg, 3750 µg, 4000 µg, 4250 µg, 4500 µg, 4750 µg, 5000 µg of a peptide  
or agonist described herein and from 50 mg to 650 mg (e.g. 50 mg, 100 mg, 150 mg, 200  
10 mg, 250 mg, 300 mg, 350 mg, 400 mg, 450 mg, 500 mg, 550 mg, 600 mg) of Modulon®  
(trimebutine maleate).

A dosage unit (e.g. an oral dosage unit) can include, for example, from 1 to 30 µg, 1 to 40  
µg, 1 to 50 µg, 1 to 100 µg, 1 to 200 µg, 1 to 300 µg, 1 to 400 µg, 1 to 500 µg, 1 to 600  
15 µg, 1 to 700 µg, 1 to 800 µg, 1 to 900 µg, 1 to 1000 µg, 10 to 30 µg, 10 to 40 µg, 10 to 50  
µg, 10 to 100 µg, 10 to 200 µg, 10 to 300 µg, 10 to 400 µg, 10 to 500 µg, 10 to 600 µg, 10  
to 700 µg, 10 to 800 µg, 10 to 900 µg, 10 to 1000 µg, 100 to 200 µg, 100 to 300 µg, 100  
to 400 µg, 100 to 500 µg, 100 to 600 µg, 100 to 700 µg, 100 to 800 µg, 100 to 900 µg,  
100 to 1000 µg, 100 to 1250 µg, 100 to 1500 µg, 100 to 1750 µg, 100 to 2000 µg, 100 to  
20 2250 µg, 100 to 2500 µg, 100 to 2750 µg, 100 to 3000 µg, 200 to 300 µg, 200 to 400 µg,  
200 to 500 µg, 200 to 600 µg, 200 to 700 µg, 200 to 800 µg, 200 to 900 µg, 200 to 1000  
µg, 200 to 1250 µg, 200 to 1500 µg, 200 to 1750 µg, 200 to 2000 µg, 200 to 2250 µg, 200  
to 2500 µg, 200 to 2750 µg, 200 to 3000 µg, 300 to 400 µg, 300 to 500 µg, 300 to 600 µg,  
300 to 700 µg, 300 to 800 µg, 300 to 900 µg, 300 to 1000 µg, 300 to 1250 µg, 300 to  
25 1500 µg, 300 to 1750 µg, 300 to 2000 µg, 300 to 2250 µg, 300 to 2500 µg, 300 to 2750  
µg, 300 to 3000 µg, 400 to 500 µg, 400 to 600 µg, 400 to 700 µg, 400 to 800 µg, 400 to  
900 µg, 400 to 1000 µg, 400 to 1250 µg, 400 to 1500 µg, 400 to 1750 µg, 400 to 2000 µg,  
400 to 2250 µg, 400 to 2500 µg, 400 to 2750 µg, 400 to 3000 µg, 500 to 600 µg, 500 to  
700 µg, 500 to 800 µg, 500 to 900 µg, 500 to 1000 µg, 500 to 1250 µg, 500 to 1500 µg,

500 to 1750 µg, 500 to 2000 µg, 500 to 2250 µg, 500 to 2500 µg, 500 to 2750 µg, 500 to 3000 µg, 600 to 700 µg, 600 to 800 µg, 600 to 900 µg, 600 to 1000 µg, 600 to 1250 µg, 600 to 1500 µg, 600 to 1750 µg, 600 to 2000 µg, 600 to 2250 µg, 600 to 2500 µg, 600 to 2750 µg, 600 to 3000 µg, 700 to 800 µg, 700 to 900 µg, 700 to 1000 µg, 700 to 1250 µg, 700 to 1500 µg, 700 to 1750 µg, 700 to 2000 µg, 700 to 2250 µg, 700 to 2500 µg, 700 to 2750 µg, 700 to 3000 µg, 800 to 900 µg, 800 to 1000 µg, 800 to 1250 µg, 800 to 1500 µg, 800 to 1750 µg, 800 to 2000 µg, 800 to 2250 µg, 800 to 2500 µg, 800 to 2750 µg, 800 to 3000 µg, 900 to 1000 µg, 900 to 1250 µg, 900 to 1500 µg, 900 to 1750 µg, 900 to 2000 µg, 900 to 2250 µg, 900 to 2500 µg, 900 to 2750 µg, 900 to 3000 µg, 1000 to 1250 µg, 1000 to 1500 µg, 1000 to 1750 µg, 1000 to 2000 µg, 1000 to 2250 µg, 1000 to 2500 µg, 1000 to 2750 µg, 1000 to 3000 µg, 2 to 500 µg, 50 to 500 µg, 3 to 100 µg, 5 to 20 µg, 5 to 100 µg, 10 µg, 20 µg, 30 µg, 40 µg, 50 µg, 60 µg, 70 µg, 75 µg, 80 µg, 90 µg, 100 µg, 150 µg, 200 µg, 250 µg, 300 µg, 350 µg, 400 µg, 450 µg, 500 µg, 550 µg, 600 µg, 650 µg, 700 µg, 750 µg, 800 µg, 850 µg, 900 µg, 950 µg, 1000 µg, 1050 µg, 1100 µg, 1150 µg, 1200 µg, 1250 µg, 1300 µg, 1350 µg, 1400 µg, 1450 µg, 1500 µg, 1550 µg, 1600 µg, 1650 µg, 1700 µg, 1750 µg, 1800 µg, 1850 µg, 1900 µg, 1950 µg, 2000 µg, 2050 µg, 2100 µg, 2150 µg, 2200 µg, 2250 µg, 2300 µg, 2350 µg, 2400 µg, 2450 µg, 2500 µg, 2550 µg, 2600 µg, 2650 µg, 2700 µg, 2750 µg, 2800 µg, 2850 µg, 2900 µg, 2950 µg, 3000 µg, 3250 µg, 3500 µg, 3750 µg, 4000 µg, 4250 µg, 4500 µg, 4750 µg, 5000 µg of a peptide or agonist described herein and from 1 mg to 80 mg (e.g. 1 mg, 5 mg, 10 mg, 15 mg, 20 mg, 25 mg, 30 mg, 35 mg, 40 mg, 45 mg, 50 mg, 55 mg, 60 mg, 65 mg, 70 mg, 75 mg, 80 mg) of Propulsid® (cisapride).

A dosage unit (e.g. an oral dosage unit) can include, for example, from 1 to 30 µg, 1 to 40 µg, 1 to 50 µg, 1 to 100 µg, 1 to 200 µg, 1 to 300 µg, 1 to 400 µg, 1 to 500 µg, 1 to 600 µg, 1 to 700 µg, 1 to 800 µg, 1 to 900 µg, 1 to 1000 µg, 10 to 30 µg, 10 to 40 µg, 10 to 50 µg, 10 to 100 µg, 10 to 200 µg, 10 to 300 µg, 10 to 400 µg, 10 to 500 µg, 10 to 600 µg, 10 to 700 µg, 10 to 800 µg, 10 to 900 µg, 10 to 1000 µg, 100 to 200 µg, 100 to 300 µg, 100 to 400 µg, 100 to 500 µg, 100 to 600 µg, 100 to 700 µg, 100 to 800 µg, 100 to 900 µg,

100 to 1000 µg, 100 to 1250 µg, 100 to 1500 µg, 100 to 1750 µg, 100 to 2000 µg, 100 to  
2250 µg, 100 to 2500 µg, 100 to 2750 µg, 100 to 3000 µg, 200 to 300 µg, 200 to 400 µg,  
200 to 500 µg, 200 to 600 µg, 200 to 700 µg, 200 to 800 µg, 200 to 900 µg, 200 to 1000  
µg, 200 to 1250 µg, 200 to 1500 µg, 200 to 1750 µg, 200 to 2000 µg, 200 to 2250 µg, 200  
5 to 2500 µg, 200 to 2750 µg, 200 to 3000 µg, 300 to 400 µg, 300 to 500 µg, 300 to 600 µg,  
300 to 700 µg, 300 to 800 µg, 300 to 900 µg, 300 to 1000 µg, 300 to 1250 µg, 300 to  
1500 µg, 300 to 1750 µg, 300 to 2000 µg, 300 to 2250 µg, 300 to 2500 µg, 300 to 2750  
µg, 300 to 3000 µg, 400 to 500 µg, 400 to 600 µg, 400 to 700 µg, 400 to 800 µg, 400 to  
900 µg, 400 to 1000 µg, 400 to 1250 µg, 400 to 1500 µg, 400 to 1750 µg, 400 to 2000 µg,  
10 400 to 2250 µg, 400 to 2500 µg, 400 to 2750 µg, 400 to 3000 µg, 500 to 600 µg, 500 to  
700 µg, 500 to 800 µg, 500 to 900 µg, 500 to 1000 µg, 500 to 1250 µg, 500 to 1500 µg,  
500 to 1750 µg, 500 to 2000 µg, 500 to 2250 µg, 500 to 2500 µg, 500 to 2750 µg, 500 to  
3000 µg, 600 to 700 µg, 600 to 800 µg, 600 to 900 µg, 600 to 1000 µg, 600 to 1250 µg,  
600 to 1500 µg, 600 to 1750 µg, 600 to 2000 µg, 600 to 2250 µg, 600 to 2500 µg, 600 to  
15 2750 µg, 600 to 3000 µg, 700 to 800 µg, 700 to 900 µg, 700 to 1000 µg, 700 to 1250 µg,  
700 to 1500 µg, 700 to 1750 µg, 700 to 2000 µg, 700 to 2250 µg, 700 to 2500 µg, 700 to  
2750 µg, 700 to 3000 µg, 800 to 900 µg, 800 to 1000 µg, 800 to 1250 µg, 800 to 1500 µg,  
800 to 1750 µg, 800 to 2000 µg, 800 to 2250 µg, 800 to 2500 µg, 800 to 2750 µg, 800 to  
3000 µg, 900 to 1000 µg, 900 to 1250 µg, 900 to 1500 µg, 900 to 1750 µg, 900 to 2000  
20 µg, 900 to 2250 µg, 900 to 2500 µg, 900 to 2750 µg, 900 to 3000 µg, 1000 to 1250 µg,  
1000 to 1500 µg, 1000 to 1750 µg, 1000 to 2000 µg, 1000 to 2250 µg, 1000 to 2500 µg,  
1000 to 2750 µg, 1000 to 3000 µg, 2 to 500 µg, 50 to 500 µg, 3 to 100 µg, 5 to 20 µg, 5 to  
100 µg, 10 µg, 20 µg, 30 µg, 40 µg, 50 µg, 60 µg, 70 µg, 75 µg, 80 µg, 90 µg, 100 µg, 150  
µg, 200 µg, 250 µg, 300 µg, 350 µg, 400 µg, 450 µg, 500 µg, 550 µg, 600 µg, 650 µg, 700  
25 µg, 750 µg, 800 µg, 850 µg, 900 µg, 950 µg, 1000 µg, 1050 µg, 1100 µg, 1150 µg, 1200  
µg, 1250 µg, 1300 µg, 1350 µg, 1400 µg, 1450 µg, 1500 µg, 1550 µg, 1600 µg, 1650 µg,  
1700 µg, 1750 µg, 1800 µg, 1850 µg, 1900 µg, 1950 µg, 2000 µg, 2050 µg, 2100 µg,  
2150 µg, 2200 µg, 2250 µg, 2300 µg, 2350 µg, 2400 µg, 2450 µg, 2500 µg, 2550 µg,  
2600 µg, 2650 µg, 2700 µg, 2750 µg, 2800 µg, 2850 µg, 2900 µg, 2950 µg, 3000 µg,

3250 µg, 3500 µg, 3750 µg, 4000 µg, 4250 µg, 4500 µg, 4750 µg, 5000 µg of a peptide or agonist described herein and from 10 mg to 600 mg (e.g. 10 mg, 20 mg, 30 mg, 40 mg, 50 mg, 60 mg, 70 mg, 80 mg, 90 mg, 100 mg, 110 mg, 120 mg, 130 mg, 140 mg, 150 mg, 160 mg, 200 mg, 250 mg, 300 mg, 350mg, 400 mg, 450 mg, 500 mg, 550 mg, 600 mg) of Bentlyl®/Bentylol® (dicyclomine).

A dosage unit (e.g. an oral dosage unit) can include, for example, from 1 to 30 µg, 1 to 40 µg, 1 to 50 µg, 1 to 100 µg, 1 to 200 µg, 1 to 300 µg, 1 to 400 µg, 1 to 500 µg, 1 to 600 µg, 1 to 700 µg, 1 to 800 µg, 1 to 900 µg, 1 to 1000 µg, 10 to 30 µg, 10 to 40 µg, 10 to 50 µg, 10 to 100 µg, 10 to 200 µg, 10 to 300 µg, 10 to 400 µg, 10 to 500 µg, 10 to 600 µg, 10 to 700 µg, 10 to 800 µg, 10 to 900 µg, 10 to 1000 µg, 100 to 200 µg, 100 to 300 µg, 100 to 400 µg, 100 to 500 µg, 100 to 600 µg, 100 to 700 µg, 100 to 800 µg, 100 to 900 µg, 100 to 1000 µg, 100 to 1250 µg, 100 to 1500 µg, 100 to 1750 µg, 100 to 2000 µg, 100 to 2250 µg, 100 to 2500 µg, 100 to 2750 µg, 100 to 3000 µg, 200 to 300 µg, 200 to 400 µg, 200 to 500 µg, 200 to 600 µg, 200 to 700 µg, 200 to 800 µg, 200 to 900 µg, 200 to 1000 µg, 200 to 1250 µg, 200 to 1500 µg, 200 to 1750 µg, 200 to 2000 µg, 200 to 2250 µg, 200 to 2500 µg, 200 to 2750 µg, 200 to 3000 µg, 300 to 400 µg, 300 to 500 µg, 300 to 600 µg, 300 to 700 µg, 300 to 800 µg, 300 to 900 µg, 300 to 1000 µg, 300 to 1250 µg, 300 to 1500 µg, 300 to 1750 µg, 300 to 2000 µg, 300 to 2250 µg, 300 to 2500 µg, 300 to 2750 µg, 300 to 3000 µg, 400 to 500 µg, 400 to 600 µg, 400 to 700 µg, 400 to 800 µg, 400 to 900 µg, 400 to 1000 µg, 400 to 1250 µg, 400 to 1500 µg, 400 to 1750 µg, 400 to 2000 µg, 400 to 2250 µg, 400 to 2500 µg, 400 to 2750 µg, 400 to 3000 µg, 500 to 600 µg, 500 to 700 µg, 500 to 800 µg, 500 to 900 µg, 500 to 1000 µg, 500 to 1250 µg, 500 to 1500 µg, 500 to 1750 µg, 500 to 2000 µg, 500 to 2250 µg, 500 to 2500 µg, 500 to 2750 µg, 500 to 3000 µg, 600 to 700 µg, 600 to 800 µg, 600 to 900 µg, 600 to 1000 µg, 600 to 1250 µg, 600 to 1500 µg, 600 to 1750 µg, 600 to 2000 µg, 600 to 2250 µg, 600 to 2500 µg, 600 to 2750 µg, 600 to 3000 µg, 700 to 800 µg, 700 to 900 µg, 700 to 1000 µg, 700 to 1250 µg, 700 to 1500 µg, 700 to 1750 µg, 700 to 2000 µg, 700 to 2250 µg, 700 to 2500 µg, 700 to 2750 µg, 700 to 3000 µg, 800 to 900 µg, 800 to 1000 µg, 800 to 1250 µg, 800 to 1500 µg,

800 to 1750  $\mu\text{g}$ , 800 to 2000  $\mu\text{g}$ , 800 to 2250  $\mu\text{g}$ , 800 to 2500  $\mu\text{g}$ , 800 to 2750  $\mu\text{g}$ , 800 to 3000  $\mu\text{g}$ , 900 to 1000  $\mu\text{g}$ , 900 to 1250  $\mu\text{g}$ , 900 to 1500  $\mu\text{g}$ , 900 to 1750  $\mu\text{g}$ , 900 to 2000  $\mu\text{g}$ , 900 to 2250  $\mu\text{g}$ , 900 to 2500  $\mu\text{g}$ , 900 to 2750  $\mu\text{g}$ , 900 to 3000  $\mu\text{g}$ , 1000 to 1250  $\mu\text{g}$ , 1000 to 1500  $\mu\text{g}$ , 1000 to 1750  $\mu\text{g}$ , 1000 to 2000  $\mu\text{g}$ , 1000 to 2250  $\mu\text{g}$ , 1000 to 2500  $\mu\text{g}$ , 1000 to 2750  $\mu\text{g}$ , 1000 to 3000  $\mu\text{g}$ , 2 to 500  $\mu\text{g}$ , 50 to 500  $\mu\text{g}$ , 3 to 100  $\mu\text{g}$ , 5 to 20  $\mu\text{g}$ , 5 to 100  $\mu\text{g}$ , 10  $\mu\text{g}$ , 20  $\mu\text{g}$ , 30  $\mu\text{g}$ , 40  $\mu\text{g}$ , 50  $\mu\text{g}$ , 60  $\mu\text{g}$ , 70  $\mu\text{g}$ , 75  $\mu\text{g}$ , 80  $\mu\text{g}$ , 90  $\mu\text{g}$ , 100  $\mu\text{g}$ , 150  $\mu\text{g}$ , 200  $\mu\text{g}$ , 250  $\mu\text{g}$ , 300  $\mu\text{g}$ , 350  $\mu\text{g}$ , 400  $\mu\text{g}$ , 450  $\mu\text{g}$ , 500  $\mu\text{g}$ , 550  $\mu\text{g}$ , 600  $\mu\text{g}$ , 650  $\mu\text{g}$ , 700  $\mu\text{g}$ , 750  $\mu\text{g}$ , 800  $\mu\text{g}$ , 850  $\mu\text{g}$ , 900  $\mu\text{g}$ , 950  $\mu\text{g}$ , 1000  $\mu\text{g}$ , 1050  $\mu\text{g}$ , 1100  $\mu\text{g}$ , 1150  $\mu\text{g}$ , 1200  $\mu\text{g}$ , 1250  $\mu\text{g}$ , 1300  $\mu\text{g}$ , 1350  $\mu\text{g}$ , 1400  $\mu\text{g}$ , 1450  $\mu\text{g}$ , 1500  $\mu\text{g}$ , 1550  $\mu\text{g}$ , 1600  $\mu\text{g}$ , 1650  $\mu\text{g}$ , 1700  $\mu\text{g}$ , 1750  $\mu\text{g}$ , 1800  $\mu\text{g}$ , 1850  $\mu\text{g}$ , 1900  $\mu\text{g}$ , 1950  $\mu\text{g}$ , 2000  $\mu\text{g}$ , 2050  $\mu\text{g}$ , 2100  $\mu\text{g}$ , 2150  $\mu\text{g}$ , 2200  $\mu\text{g}$ , 2250  $\mu\text{g}$ , 2300  $\mu\text{g}$ , 2350  $\mu\text{g}$ , 2400  $\mu\text{g}$ , 2450  $\mu\text{g}$ , 2500  $\mu\text{g}$ , 2550  $\mu\text{g}$ , 2600  $\mu\text{g}$ , 2650  $\mu\text{g}$ , 2700  $\mu\text{g}$ , 2750  $\mu\text{g}$ , 2800  $\mu\text{g}$ , 2850  $\mu\text{g}$ , 2900  $\mu\text{g}$ , 2950  $\mu\text{g}$ , 3000  $\mu\text{g}$ , 3250  $\mu\text{g}$ , 3500  $\mu\text{g}$ , 3750  $\mu\text{g}$ , 4000  $\mu\text{g}$ , 4250  $\mu\text{g}$ , 4500  $\mu\text{g}$ , 4750  $\mu\text{g}$ , 5000  $\mu\text{g}$  of a peptide or agonist described herein and from 1 mg to 25 mg (e.g. 1 mg, 2 mg, 3 mg, 4 mg, 5 mg, 6 mg, 7 mg, 8 mg, 9 mg, 10 mg, 11 mg, 12 mg, 13 mg, 14 mg, 15 mg, 16 mg, 17 mg, 18 mg, 19 mg, 20 mg, 21 mg, 22 mg, 23 mg, 24 mg, 25 mg) of Questran® (cholestyramine).

A dosage unit (e.g. an oral dosage unit) can include, for example, from 1 to 30  $\mu\text{g}$ , 1 to 40  $\mu\text{g}$ , 1 to 50  $\mu\text{g}$ , 1 to 100  $\mu\text{g}$ , 1 to 200  $\mu\text{g}$ , 1 to 300  $\mu\text{g}$ , 1 to 400  $\mu\text{g}$ , 1 to 500  $\mu\text{g}$ , 1 to 600  $\mu\text{g}$ , 1 to 700  $\mu\text{g}$ , 1 to 800  $\mu\text{g}$ , 1 to 900  $\mu\text{g}$ , 1 to 1000  $\mu\text{g}$ ; 10 to 30  $\mu\text{g}$ , 10 to 40  $\mu\text{g}$ , 10 to 50  $\mu\text{g}$ , 10 to 100  $\mu\text{g}$ , 10 to 200  $\mu\text{g}$ , 10 to 300  $\mu\text{g}$ , 10 to 400  $\mu\text{g}$ , 10 to 500  $\mu\text{g}$ , 10 to 600  $\mu\text{g}$ , 10 to 700  $\mu\text{g}$ , 10 to 800  $\mu\text{g}$ , 10 to 900  $\mu\text{g}$ , 10 to 1000  $\mu\text{g}$ , 100 to 200  $\mu\text{g}$ , 100 to 300  $\mu\text{g}$ , 100 to 400  $\mu\text{g}$ , 100 to 500  $\mu\text{g}$ , 100 to 600  $\mu\text{g}$ , 100 to 700  $\mu\text{g}$ , 100 to 800  $\mu\text{g}$ , 100 to 900  $\mu\text{g}$ , 100 to 1000  $\mu\text{g}$ , 100 to 1250  $\mu\text{g}$ , 100 to 1500  $\mu\text{g}$ , 100 to 1750  $\mu\text{g}$ , 100 to 2000  $\mu\text{g}$ , 100 to 2250  $\mu\text{g}$ , 100 to 2500  $\mu\text{g}$ , 100 to 2750  $\mu\text{g}$ , 100 to 3000  $\mu\text{g}$ , 200 to 300  $\mu\text{g}$ , 200 to 400  $\mu\text{g}$ , 200 to 500  $\mu\text{g}$ , 200 to 600  $\mu\text{g}$ , 200 to 700  $\mu\text{g}$ , 200 to 800  $\mu\text{g}$ , 200 to 900  $\mu\text{g}$ , 200 to 1000  $\mu\text{g}$ , 200 to 1250  $\mu\text{g}$ , 200 to 1500  $\mu\text{g}$ , 200 to 1750  $\mu\text{g}$ , 200 to 2000  $\mu\text{g}$ , 200 to 2250  $\mu\text{g}$ , 200 to 2500  $\mu\text{g}$ , 200 to 2750  $\mu\text{g}$ , 200 to 3000  $\mu\text{g}$ , 300 to 400  $\mu\text{g}$ , 300 to 500  $\mu\text{g}$ , 300 to 600  $\mu\text{g}$ , 300 to 700  $\mu\text{g}$ , 300 to 800  $\mu\text{g}$ , 300 to 900  $\mu\text{g}$ , 300 to 1000  $\mu\text{g}$ , 300 to 1250  $\mu\text{g}$ , 300 to

1500 µg, 300 to 1750 µg, 300 to 2000 µg, 300 to 2250 µg, 300 to 2500 µg, 300 to 2750  
µg, 300 to 3000 µg, 400 to 500 µg, 400 to 600 µg, 400 to 700 µg, 400 to 800 µg, 400 to  
900 µg, 400 to 1000 µg, 400 to 1250 µg, 400 to 1500 µg, 400 to 1750 µg, 400 to 2000 µg,  
400 to 2250 µg, 400 to 2500 µg, 400 to 2750 µg, 400 to 3000 µg, 500 to 600 µg, 500 to  
5 700 µg, 500 to 800 µg, 500 to 900 µg, 500 to 1000 µg, 500 to 1250 µg, 500 to 1500 µg,  
500 to 1750 µg, 500 to 2000 µg, 500 to 2250 µg, 500 to 2500 µg, 500 to 2750 µg, 500 to  
3000 µg, 600 to 700 µg, 600 to 800 µg, 600 to 900 µg, 600 to 1000 µg, 600 to 1250 µg,  
600 to 1500 µg, 600 to 1750 µg, 600 to 2000 µg, 600 to 2250 µg, 600 to 2500 µg, 600 to  
2750 µg, 600 to 3000 µg, 700 to 800 µg, 700 to 900 µg, 700 to 1000 µg, 700 to 1250 µg,  
10 700 to 1500 µg, 700 to 1750 µg, 700 to 2000 µg, 700 to 2250 µg, 700 to 2500 µg, 700 to  
2750 µg, 700 to 3000 µg, 800 to 900 µg, 800 to 1000 µg, 800 to 1250 µg, 800 to 1500 µg,  
800 to 1750 µg, 800 to 2000 µg, 800 to 2250 µg, 800 to 2500 µg, 800 to 2750 µg, 800 to  
3000 µg, 900 to 1000 µg, 900 to 1250 µg, 900 to 1500 µg, 900 to 1750 µg, 900 to 2000  
µg, 900 to 2250 µg, 900 to 2500 µg, 900 to 2750 µg, 900 to 3000 µg, 1000 to 1250 µg,  
15 1000 to 1500 µg, 1000 to 1750 µg, 1000 to 2000 µg, 1000 to 2250 µg, 1000 to 2500 µg,  
1000 to 2750 µg, 1000 to 3000 µg, 2 to 500 µg, 50 to 500 µg, 3 to 100 µg, 5 to 20 µg, 5 to  
100 µg, 10 µg, 20 µg, 30 µg, 40 µg, 50 µg, 60 µg, 70 µg, 75 µg, 80 µg, 90 µg, 100 µg, 150  
µg, 200 µg, 250 µg, 300 µg, 350 µg, 400 µg, 450 µg, 500 µg, 550 µg, 600 µg, 650 µg, 700  
µg, 750 µg, 800 µg, 850 µg, 900 µg, 950 µg, 1000 µg, 1050 µg, 1100 µg, 1150 µg, 1200  
20 µg, 1250 µg, 1300 µg, 1350 µg, 1400 µg, 1450 µg, 1500 µg, 1550 µg, 1600 µg, 1650 µg,  
1700 µg, 1750 µg, 1800 µg, 1850 µg, 1900 µg, 1950 µg, 2000 µg, 2050 µg, 2100 µg,  
2150 µg, 2200 µg, 2250 µg, 2300 µg, 2350 µg, 2400 µg, 2450 µg, 2500 µg, 2550 µg,  
2600 µg, 2650 µg, 2700 µg, 2750 µg, 2800 µg, 2850 µg, 2900 µg, 2950 µg, 3000 µg,  
3250 µg, 3500 µg, 3750 µg, 4000 µg, 4250 µg, 4500 µg, 4750 µg, 5000 µg of a peptide  
25 or agonist described herein and from 100 mg to 3000 mg (e.g. 100 mg, 200 mg, 300 mg,  
400 mg, 500 mg, 600 mg, 625 mg, 700 mg, 800 mg, 900 mg, 1000 mg, 1250 mg, 1300  
mg, 1400 mg, 1500 mg, 1600 mg, 1700 mg, 1800 mg, 1875 mg, 1900 mg, 2000 mg,  
2100 mg, 2200 mg, 2300 mg, 2400 mg, 2500 mg,) of Equalactin®/Fibercon® (Calcium  
Polycarbophil).

A dosage unit (e.g. an oral dosage unit) can include, for example, from 1 to 30  $\mu\text{g}$ , 1 to 40  $\mu\text{g}$ , 1 to 50  $\mu\text{g}$ , 1 to 100  $\mu\text{g}$ , 1 to 200  $\mu\text{g}$ , 1 to 300  $\mu\text{g}$ , 1 to 400  $\mu\text{g}$ , 1 to 500  $\mu\text{g}$ , 1 to 600  $\mu\text{g}$ , 1 to 700  $\mu\text{g}$ , 1 to 800  $\mu\text{g}$ , 1 to 900  $\mu\text{g}$ , 1 to 1000  $\mu\text{g}$ , 10 to 30  $\mu\text{g}$ , 10 to 40  $\mu\text{g}$ , 10 to 50  $\mu\text{g}$ , 10 to 100  $\mu\text{g}$ , 10 to 200  $\mu\text{g}$ , 10 to 300  $\mu\text{g}$ , 10 to 400  $\mu\text{g}$ , 10 to 500  $\mu\text{g}$ , 10 to 600  $\mu\text{g}$ , 10 to 700  $\mu\text{g}$ , 10 to 800  $\mu\text{g}$ , 10 to 900  $\mu\text{g}$ , 10 to 1000  $\mu\text{g}$ , 100 to 200  $\mu\text{g}$ , 100 to 300  $\mu\text{g}$ , 100 to 400  $\mu\text{g}$ , 100 to 500  $\mu\text{g}$ , 100 to 600  $\mu\text{g}$ , 100 to 700  $\mu\text{g}$ , 100 to 800  $\mu\text{g}$ , 100 to 900  $\mu\text{g}$ , 100 to 1000  $\mu\text{g}$ , 100 to 1250  $\mu\text{g}$ , 100 to 1500  $\mu\text{g}$ , 100 to 1750  $\mu\text{g}$ , 100 to 2000  $\mu\text{g}$ , 100 to 2250  $\mu\text{g}$ , 100 to 2500  $\mu\text{g}$ , 100 to 2750  $\mu\text{g}$ , 100 to 3000  $\mu\text{g}$ , 200 to 300  $\mu\text{g}$ , 200 to 400  $\mu\text{g}$ , 200 to 500  $\mu\text{g}$ , 200 to 600  $\mu\text{g}$ , 200 to 700  $\mu\text{g}$ , 200 to 800  $\mu\text{g}$ , 200 to 900  $\mu\text{g}$ , 200 to 1000  $\mu\text{g}$ , 200 to 1250  $\mu\text{g}$ , 200 to 1500  $\mu\text{g}$ , 200 to 1750  $\mu\text{g}$ , 200 to 2000  $\mu\text{g}$ , 200 to 2250  $\mu\text{g}$ , 200 to 2500  $\mu\text{g}$ , 200 to 2750  $\mu\text{g}$ , 200 to 3000  $\mu\text{g}$ , 300 to 400  $\mu\text{g}$ , 300 to 500  $\mu\text{g}$ , 300 to 600  $\mu\text{g}$ , 300 to 700  $\mu\text{g}$ , 300 to 800  $\mu\text{g}$ , 300 to 900  $\mu\text{g}$ , 300 to 1000  $\mu\text{g}$ , 300 to 1250  $\mu\text{g}$ , 300 to 1500  $\mu\text{g}$ , 300 to 1750  $\mu\text{g}$ , 300 to 2000  $\mu\text{g}$ , 300 to 2250  $\mu\text{g}$ , 300 to 2500  $\mu\text{g}$ , 300 to 2750  $\mu\text{g}$ , 300 to 3000  $\mu\text{g}$ , 400 to 500  $\mu\text{g}$ , 400 to 600  $\mu\text{g}$ , 400 to 700  $\mu\text{g}$ , 400 to 800  $\mu\text{g}$ , 400 to 900  $\mu\text{g}$ , 400 to 1000  $\mu\text{g}$ , 400 to 1250  $\mu\text{g}$ , 400 to 1500  $\mu\text{g}$ , 400 to 1750  $\mu\text{g}$ , 400 to 2000  $\mu\text{g}$ , 400 to 2250  $\mu\text{g}$ , 400 to 2500  $\mu\text{g}$ , 400 to 2750  $\mu\text{g}$ , 400 to 3000  $\mu\text{g}$ , 500 to 600  $\mu\text{g}$ , 500 to 700  $\mu\text{g}$ , 500 to 800  $\mu\text{g}$ , 500 to 900  $\mu\text{g}$ , 500 to 1000  $\mu\text{g}$ , 500 to 1250  $\mu\text{g}$ , 500 to 1500  $\mu\text{g}$ , 500 to 1750  $\mu\text{g}$ , 500 to 2000  $\mu\text{g}$ , 500 to 2250  $\mu\text{g}$ , 500 to 2500  $\mu\text{g}$ , 500 to 2750  $\mu\text{g}$ , 500 to 3000  $\mu\text{g}$ , 600 to 700  $\mu\text{g}$ , 600 to 800  $\mu\text{g}$ , 600 to 900  $\mu\text{g}$ , 600 to 1000  $\mu\text{g}$ , 600 to 1250  $\mu\text{g}$ , 600 to 1500  $\mu\text{g}$ , 600 to 1750  $\mu\text{g}$ , 600 to 2000  $\mu\text{g}$ , 600 to 2250  $\mu\text{g}$ , 600 to 2500  $\mu\text{g}$ , 600 to 2750  $\mu\text{g}$ , 600 to 3000  $\mu\text{g}$ , 700 to 800  $\mu\text{g}$ , 700 to 900  $\mu\text{g}$ , 700 to 1000  $\mu\text{g}$ , 700 to 1250  $\mu\text{g}$ , 700 to 1500  $\mu\text{g}$ , 700 to 1750  $\mu\text{g}$ , 700 to 2000  $\mu\text{g}$ , 700 to 2250  $\mu\text{g}$ , 700 to 2500  $\mu\text{g}$ , 700 to 2750  $\mu\text{g}$ , 700 to 3000  $\mu\text{g}$ , 800 to 900  $\mu\text{g}$ , 800 to 1000  $\mu\text{g}$ , 800 to 1250  $\mu\text{g}$ , 800 to 1500  $\mu\text{g}$ , 800 to 1750  $\mu\text{g}$ , 800 to 2000  $\mu\text{g}$ , 800 to 2250  $\mu\text{g}$ , 800 to 2500  $\mu\text{g}$ , 800 to 2750  $\mu\text{g}$ , 800 to 3000  $\mu\text{g}$ , 900 to 1000  $\mu\text{g}$ , 900 to 1250  $\mu\text{g}$ , 900 to 1500  $\mu\text{g}$ , 900 to 1750  $\mu\text{g}$ , 900 to 2000  $\mu\text{g}$ , 900 to 2250  $\mu\text{g}$ , 900 to 2500  $\mu\text{g}$ , 900 to 2750  $\mu\text{g}$ , 900 to 3000  $\mu\text{g}$ , 1000 to 1250  $\mu\text{g}$ , 1000 to 1500  $\mu\text{g}$ , 1000 to 1750  $\mu\text{g}$ , 1000 to 2000  $\mu\text{g}$ , 1000 to 2250  $\mu\text{g}$ , 1000 to 2500  $\mu\text{g}$ , 1000 to 2750  $\mu\text{g}$ , 1000 to 3000  $\mu\text{g}$ , 2 to 500  $\mu\text{g}$ , 50 to 500  $\mu\text{g}$ , 3 to 100  $\mu\text{g}$ , 5 to 20  $\mu\text{g}$ , 5 to



100 µg, 10 µg, 20 µg, 30 µg, 40 µg, 50 µg, 60 µg, 70 µg, 75 µg, 80 µg, 90 µg, 100 µg, 150  
µg, 200 µg, 250 µg, 300 µg, 350 µg, 400 µg, 450 µg, 500 µg, 550 µg, 600 µg, 650 µg, 700  
µg, 750 µg, 800 µg, 850 µg, 900 µg, 950 µg, 1000 µg, 1050 µg, 1100 µg, 1150 µg, 1200  
µg, 1250 µg, 1300 µg, 1350 µg, 1400 µg, 1450 µg, 1500 µg, 1550 µg, 1600 µg, 1650 µg,  
5 1700 µg, 1750 µg, 1800 µg, 1850 µg, 1900 µg, 1950 µg, 2000 µg, 2050 µg, 2100 µg,  
2150 µg, 2200 µg, 2250 µg, 2300 µg, 2350 µg, 2400 µg, 2450 µg, 2500 µg, 2550 µg,  
2600 µg, 2650 µg, 2700 µg, 2750 µg, 2800 µg, 2850 µg, 2900 µg, 2950 µg, 3000 µg,  
3250 µg, 3500 µg, 3750 µg, 4000 µg, 4250 µg, 4500 µg, 4750 µg, 5000 µg of a peptide  
or agonist described herein and from 1 mg to 20 mg (e.g. 1 mg, 2 mg, 2.5 mg, 3 mg, 4  
10 mg, 5 mg, 6 mg, 7 mg, 7.5 mg, 8 mg, 9 mg, 10 mg, 11 mg, 12 mg, 12.5 mg, 13 mg, 14  
mg, 15 mg, 16 mg, 17.5 mg, 18 mg, 19 mg, 20 mg) of darifenacin (Enablex®).

A dosage unit (e.g. an oral dosage unit) can include, for example, from 1 to 30 µg, 1 to 40  
µg, 1 to 50 µg, 1 to 100 µg, 1 to 200 µg, 1 to 300 µg, 1 to 400 µg, 1 to 500 µg, 1 to 600  
15 µg, 1 to 700 µg, 1 to 800 µg, 1 to 900 µg, 1 to 1000 µg, 10 to 30 µg, 10 to 40 µg, 10 to 50  
µg, 10 to 100 µg, 10 to 200 µg, 10 to 300 µg, 10 to 400 µg, 10 to 500 µg, 10 to 600 µg, 10  
to 700 µg, 10 to 800 µg, 10 to 900 µg, 10 to 1000 µg, 100 to 200 µg, 100 to 300 µg, 100  
to 400 µg, 100 to 500 µg, 100 to 600 µg, 100 to 700 µg, 100 to 800 µg, 100 to 900 µg,  
100 to 1000 µg, 100 to 1250 µg, 100 to 1500 µg, 100 to 1750 µg, 100 to 2000 µg, 100 to  
20 2250 µg, 100 to 2500 µg, 100 to 2750 µg, 100 to 3000 µg, 200 to 300 µg, 200 to 400 µg,  
200 to 500 µg, 200 to 600 µg, 200 to 700 µg, 200 to 800 µg, 200 to 900 µg, 200 to 1000  
µg, 200 to 1250 µg, 200 to 1500 µg, 200 to 1750 µg, 200 to 2000 µg, 200 to 2250 µg, 200  
to 2500 µg, 200 to 2750 µg, 200 to 3000 µg, 300 to 400 µg, 300 to 500 µg, 300 to 600 µg,  
300 to 700 µg, 300 to 800 µg, 300 to 900 µg, 300 to 1000 µg, 300 to 1250 µg, 300 to  
25 1500 µg, 300 to 1750 µg, 300 to 2000 µg, 300 to 2250 µg, 300 to 2500 µg, 300 to 2750  
µg, 300 to 3000 µg, 400 to 500 µg, 400 to 600 µg, 400 to 700 µg, 400 to 800 µg, 400 to  
900 µg, 400 to 1000 µg, 400 to 1250 µg, 400 to 1500 µg, 400 to 1750 µg, 400 to 2000 µg,  
400 to 2250 µg, 400 to 2500 µg, 400 to 2750 µg, 400 to 3000 µg, 500 to 600 µg, 500 to  
700 µg, 500 to 800 µg, 500 to 900 µg, 500 to 1000 µg, 500 to 1250 µg, 500 to 1500 µg,

500 to 1750 µg, 500 to 2000 µg, 500 to 2250 µg, 500 to 2500 µg, 500 to 2750 µg, 500 to 3000 µg, 600 to 700 µg, 600 to 800 µg, 600 to 900 µg, 600 to 1000 µg, 600 to 1250 µg, 600 to 1500 µg, 600 to 1750 µg, 600 to 2000 µg, 600 to 2250 µg, 600 to 2500 µg, 600 to 2750 µg, 600 to 3000 µg, 700 to 800 µg, 700 to 900 µg, 700 to 1000 µg, 700 to 1250 µg, 700 to 1500 µg, 700 to 1750 µg, 700 to 2000 µg, 700 to 2250 µg, 700 to 2500 µg, 700 to 2750 µg, 700 to 3000 µg, 800 to 900 µg, 800 to 1000 µg, 800 to 1250 µg, 800 to 1500 µg, 800 to 1750 µg, 800 to 2000 µg, 800 to 2250 µg, 800 to 2500 µg, 800 to 2750 µg, 800 to 3000 µg, 900 to 1000 µg, 900 to 1250 µg, 900 to 1500 µg, 900 to 1750 µg, 900 to 2000 µg, 900 to 2250 µg, 900 to 2500 µg, 900 to 2750 µg, 900 to 3000 µg, 1000 to 1250 µg, 1000 to 1500 µg, 1000 to 1750 µg, 1000 to 2000 µg, 1000 to 2250 µg, 1000 to 2500 µg, 1000 to 2750 µg, 1000 to 3000 µg, 2 to 500 µg, 50 to 500 µg, 3 to 100 µg, 5 to 20 µg, 5 to 100 µg, 10 µg, 20 µg, 30 µg, 40 µg, 50 µg, 60 µg, 70 µg, 75 µg, 80 µg, 90 µg, 100 µg, 150 µg, 200 µg, 250 µg, 300 µg, 350 µg, 400 µg, 450 µg, 500 µg, 550 µg, 600 µg, 650 µg, 700 µg, 750 µg, 800 µg, 850 µg, 900 µg, 950 µg, 1000 µg, 1050 µg, 1100 µg, 1150 µg, 1200 µg, 1250 µg, 1300 µg, 1350 µg, 1400 µg, 1450 µg, 1500 µg, 1550 µg, 1600 µg, 1650 µg, 1700 µg, 1750 µg, 1800 µg, 1850 µg, 1900 µg, 1950 µg, 2000 µg, 2050 µg, 2100 µg, 2150 µg, 2200 µg, 2250 µg, 2300 µg, 2350 µg, 2400 µg, 2450 µg, 2500 µg, 2550 µg, 2600 µg, 2650 µg, 2700 µg, 2750 µg, 2800 µg, 2850 µg, 2900 µg, 2950 µg, 3000 µg, 3250 µg, 3500 µg, 3750 µg, 4000 µg, 4250 µg, 4500 µg, 4750 µg, 5000 µg of a peptide or agonist described herein and from 1 mg to 250 mg (e.g. 1 mg, 2 mg, 3 mg, 4 mg, 5 mg, 6 mg, 7 mg, 8 mg, 9 mg, 10 mg, 20 mg, 30 mg, 40 mg, 50 mg, 60 mg, 70 mg, 80 mg, 90 mg, 100 mg, 110 mg, 120 mg, 130 mg, 140 mg, 150 mg, 160 mg, 170 mg, 180 mg, 190 mg, 200 mg, 210 mg, 220 mg, 230 mg, 240 mg, 250 mg) of Ondansetron HCl (Zofran®).

25 A dosage unit (e.g. an oral dosage unit) can include, for example, from 1 to 30 µg, 1 to 40 µg, 1 to 50 µg, 1 to 100 µg, 1 to 200 µg, 1 to 300 µg, 1 to 400 µg, 1 to 500 µg, 1 to 600 µg, 1 to 700 µg, 1 to 800 µg, 1 to 900 µg, 1 to 1000 µg, 10 to 30 µg, 10 to 40 µg, 10 to 50 µg, 10 to 100 µg, 10 to 200 µg, 10 to 300 µg, 10 to 400 µg, 10 to 500 µg, 10 to 600 µg, 10 to 700 µg, 10 to 800 µg, 10 to 900 µg, 10 to 1000 µg, 100 to 200 µg, 100 to 300 µg, 100

to 400 µg, 100 to 500 µg, 100 to 600 µg, 100 to 700 µg, 100 to 800 µg, 100 to 900 µg,  
100 to 1000 µg, 100 to 1250 µg, 100 to 1500 µg, 100 to 1750 µg, 100 to 2000 µg, 100 to  
2250 µg, 100 to 2500 µg, 100 to 2750 µg, 100 to 3000 µg, 200 to 300 µg, 200 to 400 µg,  
200 to 500 µg, 200 to 600 µg, 200 to 700 µg, 200 to 800 µg, 200 to 900 µg, 200 to 1000  
5 µg, 200 to 1250 µg, 200 to 1500 µg, 200 to 1750 µg, 200 to 2000 µg, 200 to 2250 µg, 200  
to 2500 µg, 200 to 2750 µg, 200 to 3000 µg, 300 to 400 µg, 300 to 500 µg, 300 to 600 µg,  
300 to 700 µg, 300 to 800 µg, 300 to 900 µg, 300 to 1000 µg, 300 to 1250 µg, 300 to  
1500 µg, 300 to 1750 µg, 300 to 2000 µg, 300 to 2250 µg, 300 to 2500 µg, 300 to 2750  
µg, 300 to 3000 µg, 400 to 500 µg, 400 to 600 µg, 400 to 700 µg, 400 to 800 µg, 400 to  
10 900 µg, 400 to 1000 µg, 400 to 1250 µg, 400 to 1500 µg, 400 to 1750 µg, 400 to 2000 µg,  
400 to 2250 µg, 400 to 2500 µg, 400 to 2750 µg, 400 to 3000 µg, 500 to 600 µg, 500 to  
700 µg, 500 to 800 µg, 500 to 900 µg, 500 to 1000 µg, 500 to 1250 µg, 500 to 1500 µg,  
500 to 1750 µg, 500 to 2000 µg, 500 to 2250 µg, 500 to 2500 µg, 500 to 2750 µg, 500 to  
3000 µg, 600 to 700 µg, 600 to 800 µg, 600 to 900 µg, 600 to 1000 µg, 600 to 1250 µg,  
15 600 to 1500 µg, 600 to 1750 µg, 600 to 2000 µg, 600 to 2250 µg, 600 to 2500 µg, 600 to  
2750 µg, 600 to 3000 µg, 700 to 800 µg, 700 to 900 µg, 700 to 1000 µg, 700 to 1250 µg,  
700 to 1500 µg, 700 to 1750 µg, 700 to 2000 µg, 700 to 2250 µg, 700 to 2500 µg, 700 to  
2750 µg, 700 to 3000 µg, 800 to 900 µg, 800 to 1000 µg, 800 to 1250 µg, 800 to 1500 µg,  
800 to 1750 µg, 800 to 2000 µg, 800 to 2250 µg, 800 to 2500 µg, 800 to 2750 µg, 800 to  
20 3000 µg, 900 to 1000 µg, 900 to 1250 µg, 900 to 1500 µg, 900 to 1750 µg, 900 to 2000  
µg, 900 to 2250 µg, 900 to 2500 µg, 900 to 2750 µg, 900 to 3000 µg, 1000 to 1250 µg,  
1000 to 1500 µg, 1000 to 1750 µg, 1000 to 2000 µg, 1000 to 2250 µg, 1000 to 2500 µg,  
1000 to 2750 µg, 1000 to 3000 µg, 2 to 500 µg, 50 to 500 µg, 3 to 100 µg, 5 to 20 µg, 5 to  
100 µg, 10 µg, 20 µg, 30 µg, 40 µg, 50 µg, 60 µg, 70 µg, 75 µg, 80 µg, 90 µg, 100 µg, 150  
25 µg, 200 µg, 250 µg, 300 µg, 350 µg, 400 µg, 450 µg, 500 µg, 550 µg, 600 µg, 650 µg, 700  
µg, 750 µg, 800 µg, 850 µg, 900 µg, 950 µg, 1000 µg, 1050 µg, 1100 µg, 1150 µg, 1200  
µg, 1250 µg, 1300 µg, 1350 µg, 1400 µg, 1450 µg, 1500 µg, 1550 µg, 1600 µg, 1650 µg,  
1700 µg, 1750 µg, 1800 µg, 1850 µg, 1900 µg, 1950 µg, 2000 µg, 2050 µg, 2100 µg,  
2150 µg, 2200 µg, 2250 µg, 2300 µg, 2350 µg, 2400 µg, 2450 µg, 2500 µg, 2550 µg,

2600 µg, 2650 µg, 2700 µg, 2750 µg, 2800 µg, 2850 µg, 2900 µg, 2950 µg, 3000 µg,  
3250 µg, 3500 µg, 3750 µg, 4000 µg, 4250 µg, 4500 µg, 4750 µg, 5000 µg of a peptide  
or agonist described herein and from 1 mg to 3000 mg (e.g. 1 mg, 2 mg, 3 mg, 4 mg, 5  
mg, 6 mg, 7 mg, 8 mg, 9 mg, 10 mg, 20 mg, 30 mg, 40 mg, 50 mg, 60 mg, 70 mg, 80 mg,  
5 90 mg, 100 mg, 200 mg, 250 mg, 300 mg, 350 mg, 400 mg, 450 mg, 500 mg, 750 mg,  
1000 mg, 1250 mg, 1500 mg, 1750 mg, 2000 mg, 2250 mg, 2500 mg, 2750 mg, 3000  
mg) of Cimetropium (Alginor®).

A dosage unit (e.g. an oral dosage unit) can include, for example, from 1 to 30 µg, 1 to 40  
10 µg, 1 to 50 µg, 1 to 100 µg, 1 to 200 µg, 1 to 300 µg, 1 to 400 µg, 1 to 500 µg, 1 to 600  
µg, 1 to 700 µg, 1 to 800 µg, 1 to 900 µg, 1 to 1000 µg, 10 to 30 µg, 10 to 40 µg, 10 to 50  
µg, 10 to 100 µg, 10 to 200 µg, 10 to 300 µg, 10 to 400 µg, 10 to 500 µg, 10 to 600 µg, 10  
to 700 µg, 10 to 800 µg, 10 to 900 µg, 10 to 1000 µg, 100 to 200 µg, 100 to 300 µg, 100  
to 400 µg, 100 to 500 µg, 100 to 600 µg, 100 to 700 µg, 100 to 800 µg, 100 to 900 µg,  
15 100 to 1000 µg, 100 to 1250 µg, 100 to 1500 µg, 100 to 1750 µg, 100 to 2000 µg, 100 to  
2250 µg, 100 to 2500 µg, 100 to 2750 µg, 100 to 3000 µg, 200 to 300 µg, 200 to 400 µg,  
200 to 500 µg, 200 to 600 µg, 200 to 700 µg, 200 to 800 µg, 200 to 900 µg, 200 to 1000  
µg, 200 to 1250 µg, 200 to 1500 µg, 200 to 1750 µg, 200 to 2000 µg, 200 to 2250 µg, 200  
to 2500 µg, 200 to 2750 µg, 200 to 3000 µg, 300 to 400 µg, 300 to 500 µg, 300 to 600 µg,  
20 300 to 700 µg, 300 to 800 µg, 300 to 900 µg, 300 to 1000 µg, 300 to 1250 µg, 300 to  
1500 µg, 300 to 1750 µg, 300 to 2000 µg, 300 to 2250 µg, 300 to 2500 µg, 300 to 2750  
µg, 300 to 3000 µg, 400 to 500 µg, 400 to 600 µg, 400 to 700 µg, 400 to 800 µg, 400 to  
900 µg, 400 to 1000 µg, 400 to 1250 µg, 400 to 1500 µg, 400 to 1750 µg, 400 to 2000 µg,  
400 to 2250 µg, 400 to 2500 µg, 400 to 2750 µg, 400 to 3000 µg, 500 to 600 µg, 500 to  
25 700 µg, 500 to 800 µg, 500 to 900 µg, 500 to 1000 µg, 500 to 1250 µg, 500 to 1500 µg,  
500 to 1750 µg, 500 to 2000 µg, 500 to 2250 µg, 500 to 2500 µg, 500 to 2750 µg, 500 to  
3000 µg, 600 to 700 µg, 600 to 800 µg, 600 to 900 µg, 600 to 1000 µg, 600 to 1250 µg,  
600 to 1500 µg, 600 to 1750 µg, 600 to 2000 µg, 600 to 2250 µg, 600 to 2500 µg, 600 to  
2750 µg, 600 to 3000 µg, 700 to 800 µg, 700 to 900 µg, 700 to 1000 µg, 700 to 1250 µg.

700 to 1500 µg, 700 to 1750 µg, 700 to 2000 µg, 700 to 2250 µg, 700 to 2500 µg, 700 to  
 2750 µg, 700 to 3000 µg, 800 to 900 µg, 800 to 1000 µg, 800 to 1250 µg, 800 to 1500 µg,  
 800 to 1750 µg, 800 to 2000 µg, 800 to 2250 µg, 800 to 2500 µg, 800 to 2750 µg, 800 to  
 3000 µg, 900 to 1000 µg, 900 to 1250 µg, 900 to 1500 µg, 900 to 1750 µg, 900 to 2000  
 5 µg, 900 to 2250 µg, 900 to 2500 µg, 900 to 2750 µg, 900 to 3000 µg, 1000 to 1250 µg,  
 1000 to 1500 µg, 1000 to 1750 µg, 1000 to 2000 µg, 1000 to 2250 µg, 1000 to 2500 µg,  
 1000 to 2750 µg, 1000 to 3000 µg, 2 to 500 µg, 50 to 500 µg, 3 to 100 µg, 5 to 20 µg, 5 to  
 100 µg, 10 µg, 20 µg, 30 µg, 40 µg, 50 µg, 60 µg, 70 µg, 75 µg, 80 µg, 90 µg, 100 µg, 150  
 µg, 200 µg, 250 µg, 300 µg, 350 µg, 400 µg, 450 µg, 500 µg, 550 µg, 600 µg, 650 µg, 700  
 10 µg, 750 µg, 800 µg, 850 µg, 900 µg, 950 µg, 1000 µg, 1050 µg, 1100 µg, 1150 µg, 1200  
 µg, 1250 µg, 1300 µg, 1350 µg, 1400 µg, 1450 µg, 1500 µg, 1550 µg, 1600 µg, 1650 µg,  
 1700 µg, 1750 µg, 1800 µg, 1850 µg, 1900 µg, 1950 µg, 2000 µg, 2050 µg, 2100 µg,  
 2150 µg, 2200 µg, 2250 µg, 2300 µg, 2350 µg, 2400 µg, 2450 µg, 2500 µg, 2550 µg,  
 2600 µg, 2650 µg, 2700 µg, 2750 µg, 2800 µg, 2850 µg, 2900 µg, 2950 µg, 3000 µg,  
 15 3250 µg, 3500 µg, 3750 µg, 4000 µg, 4250 µg, 4500 µg, 4750 µg, 5000 µg of a peptide  
 or agonist described herein and from 1 mg to 1000 mg (e.g. 1 mg, 5 mg, 10 mg, 15 mg,  
 20 mg, 25 mg, 30 mg, 35 mg, 40 mg, 45 mg, 50 mg, 75 mg, 100 mg, 150 mg, 200 mg,  
 250 mg, 300 mg, 350 mg, 400 mg, 450 mg, 500 mg, 550 mg, 600 mg, 650 mg, 700 mg,  
 750 mg, 800 mg, 850 mg, 900 mg, 950 mg, 1000 mg) of Dolasetron (Anzemet®).

20

A dosage unit (e.g. an oral dosage unit) can include, for example, from 1 to 30 µg, 1 to 40  
 µg, 1 to 50 µg, 1 to 100 µg, 1 to 200 µg, 1 to 300 µg, 1 to 400 µg, 1 to 500 µg, 1 to 600  
 µg, 1 to 700 µg, 1 to 800 µg, 1 to 900 µg, 1 to 1000 µg, 10 to 30 µg, 10 to 40 µg, 10 to 50  
 µg, 10 to 100 µg, 10 to 200 µg, 10 to 300 µg, 10 to 400 µg, 10 to 500 µg, 10 to 600 µg, 10  
 25 to 700 µg, 10 to 800 µg, 10 to 900 µg, 10 to 1000 µg, 100 to 200 µg, 100 to 300 µg, 100  
 to 400 µg, 100 to 500 µg, 100 to 600 µg, 100 to 700 µg, 100 to 800 µg, 100 to 900 µg,  
 100 to 1000 µg, 100 to 1250 µg, 100 to 1500 µg, 100 to 1750 µg, 100 to 2000 µg, 100 to  
 2250 µg, 100 to 2500 µg, 100 to 2750 µg, 100 to 3000 µg, 200 to 300 µg, 200 to 400 µg,  
 200 to 500 µg, 200 to 600 µg, 200 to 700 µg, 200 to 800 µg, 200 to 900 µg, 200 to 1000

μg, 200 to 1250 μg, 200 to 1500 μg, 200 to 1750 μg, 200 to 2000 μg, 200 to 2250 μg, 200 to 2500 μg, 200 to 2750 μg, 200 to 3000 μg, 300 to 400 μg, 300 to 500 μg, 300 to 600 μg, 300 to 700 μg, 300 to 800 μg, 300 to 900 μg, 300 to 1000 μg, 300 to 1250 μg, 300 to 1500 μg, 300 to 1750 μg, 300 to 2000 μg, 300 to 2250 μg, 300 to 2500 μg, 300 to 2750 μg, 300 to 3000 μg, 400 to 500 μg, 400 to 600 μg, 400 to 700 μg, 400 to 800 μg, 400 to 900 μg, 400 to 1000 μg, 400 to 1250 μg, 400 to 1500 μg, 400 to 1750 μg, 400 to 2000 μg, 400 to 2250 μg, 400 to 2500 μg, 400 to 2750 μg, 400 to 3000 μg, 500 to 600 μg, 500 to 700 μg, 500 to 800 μg, 500 to 900 μg, 500 to 1000 μg, 500 to 1250 μg, 500 to 1500 μg, 500 to 1750 μg, 500 to 2000 μg, 500 to 2250 μg, 500 to 2500 μg, 500 to 2750 μg, 500 to 3000 μg, 600 to 700 μg, 600 to 800 μg, 600 to 900 μg, 600 to 1000 μg, 600 to 1250 μg, 600 to 1500 μg, 600 to 1750 μg, 600 to 2000 μg, 600 to 2250 μg, 600 to 2500 μg, 600 to 2750 μg, 600 to 3000 μg, 700 to 800 μg, 700 to 900 μg, 700 to 1000 μg, 700 to 1250 μg, 700 to 1500 μg, 700 to 1750 μg, 700 to 2000 μg, 700 to 2250 μg, 700 to 2500 μg, 700 to 2750 μg, 700 to 3000 μg, 800 to 900 μg, 800 to 1000 μg, 800 to 1250 μg, 800 to 1500 μg, 800 to 1750 μg, 800 to 2000 μg, 800 to 2250 μg, 800 to 2500 μg, 800 to 2750 μg, 800 to 3000 μg, 900 to 1000 μg, 900 to 1250 μg, 900 to 1500 μg, 900 to 1750 μg, 900 to 2000 μg, 900 to 2250 μg, 900 to 2500 μg, 900 to 2750 μg, 900 to 3000 μg, 1000 to 1250 μg, 1000 to 1500 μg, 1000 to 1750 μg, 1000 to 2000 μg, 1000 to 2250 μg, 1000 to 2500 μg, 1000 to 2750 μg, 1000 to 3000 μg, 2 to 500 μg, 50 to 500 μg, 3 to 100 μg, 5 to 20 μg, 5 to 100 μg, 10 μg, 20 μg, 30 μg, 40 μg, 50 μg, 60 μg, 70 μg, 75 μg, 80 μg, 90 μg, 100 μg, 150 μg, 200 μg, 250 μg, 300 μg, 350 μg, 400 μg, 450 μg, 500 μg, 550 μg, 600 μg, 650 μg, 700 μg, 750 μg, 800 μg, 850 μg, 900 μg, 950 μg, 1000 μg, 1050 μg, 1100 μg, 1150 μg, 1200 μg, 1250 μg, 1300 μg, 1350 μg, 1400 μg, 1450 μg, 1500 μg, 1550 μg, 1600 μg, 1650 μg, 1700 μg, 1750 μg, 1800 μg, 1850 μg, 1900 μg, 1950 μg, 2000 μg, 2050 μg, 2100 μg, 2150 μg, 2200 μg, 2250 μg, 2300 μg, 2350 μg, 2400 μg, 2450 μg, 2500 μg, 2550 μg, 2600 μg, 2650 μg, 2700 μg, 2750 μg, 2800 μg, 2850 μg, 2900 μg, 2950 μg, 3000 μg, 3250 μg, 3500 μg, 3750 μg, 4000 μg, 4250 μg, 4500 μg, 4750 μg, 5000 μg of a peptide or agonist described herein and from 1 mg to 180 mg (e.g. 1 mg, 2 mg, 3 mg, 4 mg, 5 mg, 6 mg, 7 mg, 8 mg, 9 mg, 10 mg, 20 mg, 30 mg, 40 mg, 50 mg, 60 mg, 70 mg, 80 mg, 90

mg, 100 mg, 110 mg, 120 mg, 130 mg, 140 mg, 150 mg, 160 mg, 170 mg, 180 mg) of Zelnorm® (tegaserod).

A dosage unit (e.g. an oral dosage unit) can include, for example, from 1 to 30 µg, 1 to 40  
5 µg, 1 to 50 µg, 1 to 100 µg, 1 to 200 µg, 1 to 300 µg, 1 to 400 µg, 1 to 500 µg, 1 to 600  
µg, 1 to 700 µg, 1 to 800 µg, 1 to 900 µg, 1 to 1000 µg, 10 to 30 µg, 10 to 40 µg, 10 to 50  
µg, 10 to 100 µg, 10 to 200 µg, 10 to 300 µg, 10 to 400 µg, 10 to 500 µg, 10 to 600 µg, 10  
to 700 µg, 10 to 800 µg, 10 to 900 µg, 10 to 1000 µg, 100 to 200 µg, 100 to 300 µg, 100  
to 400 µg, 100 to 500 µg, 100 to 600 µg, 100 to 700 µg, 100 to 800 µg, 100 to 900 µg,  
10 100 to 1000 µg, 100 to 1250 µg, 100 to 1500 µg, 100 to 1750 µg, 100 to 2000 µg, 100 to  
2250 µg, 100 to 2500 µg, 100 to 2750 µg, 100 to 3000 µg, 200 to 300 µg, 200 to 400 µg,  
200 to 500 µg, 200 to 600 µg, 200 to 700 µg, 200 to 800 µg, 200 to 900 µg, 200 to 1000  
µg, 200 to 1250 µg, 200 to 1500 µg, 200 to 1750 µg, 200 to 2000 µg, 200 to 2250 µg, 200  
to 2500 µg, 200 to 2750 µg, 200 to 3000 µg, 300 to 400 µg, 300 to 500 µg, 300 to 600 µg,  
15 300 to 700 µg, 300 to 800 µg, 300 to 900 µg, 300 to 1000 µg, 300 to 1250 µg, 300 to  
1500 µg, 300 to 1750 µg, 300 to 2000 µg, 300 to 2250 µg, 300 to 2500 µg, 300 to 2750  
µg, 300 to 3000 µg, 400 to 500 µg, 400 to 600 µg, 400 to 700 µg, 400 to 800 µg, 400 to  
900 µg, 400 to 1000 µg, 400 to 1250 µg, 400 to 1500 µg, 400 to 1750 µg, 400 to 2000 µg,  
400 to 2250 µg, 400 to 2500 µg, 400 to 2750 µg, 400 to 3000 µg, 500 to 600 µg, 500 to  
20 700 µg, 500 to 800 µg, 500 to 900 µg, 500 to 1000 µg, 500 to 1250 µg, 500 to 1500 µg,  
500 to 1750 µg, 500 to 2000 µg, 500 to 2250 µg, 500 to 2500 µg, 500 to 2750 µg, 500 to  
3000 µg, 600 to 700 µg, 600 to 800 µg, 600 to 900 µg, 600 to 1000 µg, 600 to 1250 µg,  
600 to 1500 µg, 600 to 1750 µg, 600 to 2000 µg, 600 to 2250 µg, 600 to 2500 µg, 600 to  
2750 µg, 600 to 3000 µg, 700 to 800 µg, 700 to 900 µg, 700 to 1000 µg, 700 to 1250 µg,  
25 700 to 1500 µg, 700 to 1750 µg, 700 to 2000 µg, 700 to 2250 µg, 700 to 2500 µg, 700 to  
2750 µg, 700 to 3000 µg, 800 to 900 µg, 800 to 1000 µg, 800 to 1250 µg, 800 to 1500 µg,  
800 to 1750 µg, 800 to 2000 µg, 800 to 2250 µg, 800 to 2500 µg, 800 to 2750 µg, 800 to  
3000 µg, 900 to 1000 µg, 900 to 1250 µg, 900 to 1500 µg, 900 to 1750 µg, 900 to 2000  
µg, 900 to 2250 µg, 900 to 2500 µg, 900 to 2750 µg, 900 to 3000 µg, 1000 to 1250 µg,

- 1000 to 1500 µg, 1000 to 1750 µg, 1000 to 2000 µg, 1000 to 2250 µg, 1000 to 2500 µg,  
1000 to 2750 µg, 1000 to 3000 µg, 2 to 500 µg, 50 to 500 µg, 3 to 100 µg, 5 to 20 µg, 5 to  
100 µg, 10 µg, 20 µg, 30 µg, 40 µg, 50 µg, 60 µg, 70 µg, 75 µg, 80 µg, 90 µg, 100 µg, 150  
µg, 200 µg, 250 µg, 300 µg, 350 µg, 400 µg, 450 µg, 500 µg, 550 µg, 600 µg, 650 µg, 700  
5 µg, 750 µg, 800 µg, 850 µg, 900 µg, 950 µg, 1000 µg, 1050 µg, 1100 µg, 1150 µg, 1200  
µg, 1250 µg, 1300 µg, 1350 µg, 1400 µg, 1450 µg, 1500 µg, 1550 µg, 1600 µg, 1650 µg,  
1700 µg, 1750 µg, 1800 µg, 1850 µg, 1900 µg, 1950 µg, 2000 µg, 2050 µg, 2100 µg,  
2150 µg, 2200 µg, 2250 µg, 2300 µg, 2350 µg, 2400 µg, 2450 µg, 2500 µg, 2550 µg,  
2600 µg, 2650 µg, 2700 µg, 2750 µg, 2800 µg, 2850 µg, 2900 µg, 2950 µg, 3000 µg,  
10 3250 µg, 3500 µg, 3750 µg, 4000 µg, 4250 µg, 4500 µg, 4750 µg, 5000 µg of a peptide  
or agonist described herein and from 1 µg to 500 µg (e.g. 1 µg, 5 µg, 10 µg, 50 µg, 75 µg,  
100 µg, 125 µg, 150 µg, 175 µg, 200 µg, 225 µg, 250 µg, 275 µg, 300 µg, 325 µg, 350 µg,  
375 µg, 400 µg, 425 µg, 450 µg, 475 µg, 500 µg) of Levsin® (hyoscyamine sulfate).
- 15 A dosage unit (e.g. an oral dosage unit) can include, for example, from 1 to 30 µg, 1 to 40  
µg, 1 to 50 µg, 1 to 100 µg, 1 to 200 µg, 1 to 300 µg, 1 to 400 µg, 1 to 500 µg, 1 to 600  
µg, 1 to 700 µg, 1 to 800 µg, 1 to 900 µg, 1 to 1000 µg, 10 to 30 µg, 10 to 40 µg, 10 to 50  
µg, 10 to 100 µg, 10 to 200 µg, 10 to 300 µg, 10 to 400 µg, 10 to 500 µg, 10 to 600 µg, 10  
to 700 µg, 10 to 800 µg, 10 to 900 µg, 10 to 1000 µg, 100 to 200 µg, 100 to 300 µg, 100  
20 to 400 µg, 100 to 500 µg, 100 to 600 µg, 100 to 700 µg, 100 to 800 µg, 100 to 900 µg,  
100 to 1000 µg, 100 to 1250 µg, 100 to 1500 µg, 100 to 1750 µg, 100 to 2000 µg, 100 to  
2250 µg, 100 to 2500 µg, 100 to 2750 µg, 100 to 3000 µg, 200 to 300 µg, 200 to 400 µg,  
200 to 500 µg, 200 to 600 µg, 200 to 700 µg, 200 to 800 µg, 200 to 900 µg, 200 to 1000  
µg, 200 to 1250 µg, 200 to 1500 µg, 200 to 1750 µg, 200 to 2000 µg, 200 to 2250 µg, 200  
25 to 2500 µg, 200 to 2750 µg, 200 to 3000 µg, 300 to 400 µg, 300 to 500 µg, 300 to 600 µg,  
300 to 700 µg, 300 to 800 µg, 300 to 900 µg, 300 to 1000 µg, 300 to 1250 µg, 300 to  
1500 µg, 300 to 1750 µg, 300 to 2000 µg, 300 to 2250 µg, 300 to 2500 µg, 300 to 2750  
µg, 300 to 3000 µg, 400 to 500 µg, 400 to 600 µg, 400 to 700 µg, 400 to 800 µg, 400 to  
900 µg, 400 to 1000 µg, 400 to 1250 µg, 400 to 1500 µg, 400 to 1750 µg, 400 to 2000 µg,



400 to 2250 µg, 400 to 2500 µg, 400 to 2750 µg, 400 to 3000 µg, 500 to 600 µg, 500 to 700 µg, 500 to 800 µg, 500 to 900 µg, 500 to 1000 µg, 500 to 1250 µg, 500 to 1500 µg, 500 to 1750 µg, 500 to 2000 µg, 500 to 2250 µg, 500 to 2500 µg, 500 to 2750 µg, 500 to 3000 µg, 600 to 700 µg, 600 to 800 µg, 600 to 900 µg, 600 to 1000 µg, 600 to 1250 µg, 600 to 1500 µg, 600 to 1750 µg, 600 to 2000 µg, 600 to 2250 µg, 600 to 2500 µg, 600 to 2750 µg, 600 to 3000 µg, 700 to 800 µg, 700 to 900 µg, 700 to 1000 µg, 700 to 1250 µg, 700 to 1500 µg, 700 to 1750 µg, 700 to 2000 µg, 700 to 2250 µg, 700 to 2500 µg, 700 to 2750 µg, 700 to 3000 µg, 800 to 900 µg, 800 to 1000 µg, 800 to 1250 µg, 800 to 1500 µg, 800 to 1750 µg, 800 to 2000 µg, 800 to 2250 µg, 800 to 2500 µg, 800 to 2750 µg, 800 to 3000 µg, 900 to 1000 µg, 900 to 1250 µg, 900 to 1500 µg, 900 to 1750 µg, 900 to 2000 µg, 900 to 2250 µg, 900 to 2500 µg, 900 to 2750 µg, 900 to 3000 µg, 1000 to 1250 µg, 1000 to 1500 µg, 1000 to 1750 µg, 1000 to 2000 µg, 1000 to 2250 µg, 1000 to 2500 µg, 1000 to 2750 µg, 1000 to 3000 µg, 2 to 500 µg, 50 to 500 µg, 3 to 100 µg, 5 to 20 µg, 5 to 100 µg, 10 µg, 20 µg, 30 µg, 40 µg, 50 µg, 60 µg, 70 µg, 75 µg, 80 µg, 90 µg, 100 µg, 150 µg, 200 µg, 250 µg, 300 µg, 350 µg, 400 µg, 450 µg, 500 µg, 550 µg, 600 µg, 650 µg, 700 µg, 750 µg, 800 µg, 850 µg, 900 µg, 950 µg, 1000 µg, 1050 µg, 1100 µg, 1150 µg, 1200 µg, 1250 µg, 1300 µg, 1350 µg, 1400 µg, 1450 µg, 1500 µg, 1550 µg, 1600 µg, 1650 µg, 1700 µg, 1750 µg, 1800 µg, 1850 µg, 1900 µg, 1950 µg, 2000 µg, 2050 µg, 2100 µg, 2150 µg, 2200 µg, 2250 µg, 2300 µg, 2350 µg, 2400 µg, 2450 µg, 2500 µg, 2550 µg, 2600 µg, 2650 µg, 2700 µg, 2750 µg, 2800 µg, 2850 µg, 2900 µg, 2950 µg, 3000 µg, 3250 µg, 3500 µg, 3750 µg, 4000 µg, 4250 µg, 4500 µg, 4750 µg, 5000 µg of a peptide or agonist described herein and from 50 mg to 500 mg (e.g. 50 mg, 60 mg, 70 mg, 80 mg, 90 mg, 100 mg, 125 mg, 150 mg, 175 mg, 200 mg, 225 mg, 250 mg, 275 mg, 300 mg, 325 mg, 350 mg, 375 mg, 400 mg, 425 mg, 450 mg, 500 mg) of Dicetel® (pinaverium bromide).

A dosage unit (e.g. an oral dosage unit) can include, for example, from 1 to 30 µg, 1 to 40 µg, 1 to 50 µg, 1 to 100 µg, 1 to 200 µg, 1 to 300 µg, 1 to 400 µg, 1 to 500 µg, 1 to 600 µg, 1 to 700 µg, 1 to 800 µg, 1 to 900 µg, 1 to 1000 µg, 10 to 30 µg, 10 to 40 µg, 10 to 50

5     μg, 10 to 100 μg, 10 to 200 μg, 10 to 300 μg, 10 to 400 μg, 10 to 500 μg, 10 to 600 μg, 10 to 700 μg, 10 to 800 μg, 10 to 900 μg, 10 to 1000 μg, 100 to 200 μg, 100 to 300 μg, 100 to 400 μg, 100 to 500 μg, 100 to 600 μg, 100 to 700 μg, 100 to 800 μg, 100 to 900 μg, 100 to 1000 μg, 100 to 1250 μg, 100 to 1500 μg, 100 to 1750 μg, 100 to 2000 μg, 100 to 2250 μg, 100 to 2500 μg, 100 to 2750 μg, 100 to 3000 μg, 200 to 300 μg, 200 to 400 μg, 200 to 500 μg, 200 to 600 μg, 200 to 700 μg, 200 to 800 μg, 200 to 900 μg, 200 to 1000 μg, 200 to 1250 μg, 200 to 1500 μg, 200 to 1750 μg, 200 to 2000 μg, 200 to 2250 μg, 200 to 2500 μg, 200 to 2750 μg, 200 to 3000 μg, 300 to 400 μg, 300 to 500 μg, 300 to 600 μg, 300 to 700 μg, 300 to 800 μg, 300 to 900 μg, 300 to 1000 μg, 300 to 1250 μg, 300 to 1500 μg, 300 to 1750 μg, 300 to 2000 μg, 300 to 2250 μg, 300 to 2500 μg, 300 to 2750 μg, 300 to 3000 μg, 400 to 500 μg, 400 to 600 μg, 400 to 700 μg, 400 to 800 μg, 400 to 900 μg, 400 to 1000 μg, 400 to 1250 μg, 400 to 1500 μg, 400 to 1750 μg, 400 to 2000 μg, 400 to 2250 μg, 400 to 2500 μg, 400 to 2750 μg, 400 to 3000 μg, 500 to 600 μg, 500 to 700 μg, 500 to 800 μg, 500 to 900 μg, 500 to 1000 μg, 500 to 1250 μg, 500 to 1500 μg, 500 to 1750 μg, 500 to 2000 μg, 500 to 2250 μg, 500 to 2500 μg, 500 to 2750 μg, 500 to 3000 μg, 600 to 700 μg, 600 to 800 μg, 600 to 900 μg, 600 to 1000 μg, 600 to 1250 μg, 600 to 1500 μg, 600 to 1750 μg, 600 to 2000 μg, 600 to 2250 μg, 600 to 2500 μg, 600 to 2750 μg, 600 to 3000 μg, 700 to 800 μg, 700 to 900 μg, 700 to 1000 μg, 700 to 1250 μg, 700 to 1500 μg, 700 to 1750 μg, 700 to 2000 μg, 700 to 2250 μg, 700 to 2500 μg, 700 to 2750 μg, 700 to 3000 μg, 800 to 900 μg, 800 to 1000 μg, 800 to 1250 μg, 800 to 1500 μg, 800 to 1750 μg, 800 to 2000 μg, 800 to 2250 μg, 800 to 2500 μg, 800 to 2750 μg, 800 to 3000 μg, 900 to 1000 μg, 900 to 1250 μg, 900 to 1500 μg, 900 to 1750 μg, 900 to 2000 μg, 900 to 2250 μg, 900 to 2500 μg, 900 to 2750 μg, 900 to 3000 μg, 1000 to 1250 μg, 1000 to 1500 μg, 1000 to 1750 μg, 1000 to 2000 μg, 1000 to 2250 μg, 1000 to 2500 μg, 1000 to 2750 μg, 1000 to 3000 μg, 2 to 500 μg, 50 to 500 μg, 3 to 100 μg, 5 to 20 μg, 5 to 100 μg, 10 μg, 20 μg, 30 μg, 40 μg, 50 μg, 60 μg, 70 μg, 75 μg, 80 μg, 90 μg, 100 μg, 150 μg, 200 μg, 250 μg, 300 μg, 350 μg, 400 μg, 450 μg, 500 μg, 550 μg, 600 μg, 650 μg, 700 μg, 750 μg, 800 μg, 850 μg, 900 μg, 950 μg, 1000 μg, 1050 μg, 1100 μg, 1150 μg, 1200 μg, 1250 μg, 1300 μg, 1350 μg, 1400 μg, 1450 μg, 1500 μg, 1550 μg, 1600 μg, 1650 μg,

1700 µg, 1750 µg, 1800 µg, 1850 µg, 1900 µg, 1950 µg, 2000 µg, 2050 µg, 2100 µg,  
2150 µg, 2200 µg, 2250 µg, 2300 µg, 2350 µg, 2400 µg, 2450 µg, 2500 µg, 2550 µg,  
2600 µg, 2650 µg, 2700 µg, 2750 µg, 2800 µg, 2850 µg, 2900 µg, 2950 µg, 3000 µg,  
3250 µg, 3500 µg, 3750 µg, 4000 µg, 4250 µg, 4500 µg, 4750 µg, 5000 µg of a peptide  
5 or agonist described herein and from 50 mg to 500 mg (e.g. 50 mg, 75 mg, 100 mg, 125  
mg, 135 mg, 150 mg, 175 mg, 200 mg, 225 mg, 250 mg, 275 mg, 300 mg, 325 mg, 350  
mg, 375 mg, 400 mg, 425 mg, 450 mg, 475 mg, 500 mg) of mebeverine (DUSPATAL®,  
DUSPATALIN®, COLOFAC MR®, COLOTAL®).

10 A dosage unit (e.g. an oral dosage unit) can include, for example, from 1 to 30 µg, 1 to 40  
µg, 1 to 50 µg, 1 to 100 µg, 1 to 200 µg, 1 to 300 µg, 1 to 400 µg, 1 to 500 µg, 1 to 600  
µg, 1 to 700 µg, 1 to 800 µg, 1 to 900 µg, 1 to 1000 µg, 10 to 30 µg, 10 to 40 µg, 10 to 50  
µg, 10 to 100 µg, 10 to 200 µg, 10 to 300 µg, 10 to 400 µg, 10 to 500 µg, 10 to 600 µg, 10  
15 to 700 µg, 10 to 800 µg, 10 to 900 µg, 10 to 1000 µg, 100 to 200 µg, 100 to 300 µg, 100  
to 400 µg, 100 to 500 µg, 100 to 600 µg, 100 to 700 µg, 100 to 800 µg, 100 to 900 µg,  
100 to 1000 µg, 100 to 1250 µg, 100 to 1500 µg, 100 to 1750 µg, 100 to 2000 µg, 100 to  
2250 µg, 100 to 2500 µg, 100 to 2750 µg, 100 to 3000 µg, 200 to 300 µg, 200 to 400 µg,  
200 to 500 µg, 200 to 600 µg, 200 to 700 µg, 200 to 800 µg, 200 to 900 µg, 200 to 1000  
µg, 200 to 1250 µg, 200 to 1500 µg, 200 to 1750 µg, 200 to 2000 µg, 200 to 2250 µg, 200  
20 to 2500 µg, 200 to 2750 µg, 200 to 3000 µg, 300 to 400 µg, 300 to 500 µg, 300 to 600 µg,  
300 to 700 µg, 300 to 800 µg, 300 to 900 µg, 300 to 1000 µg, 300 to 1250 µg, 300 to  
1500 µg, 300 to 1750 µg, 300 to 2000 µg, 300 to 2250 µg, 300 to 2500 µg, 300 to 2750  
µg, 300 to 3000 µg, 400 to 500 µg, 400 to 600 µg, 400 to 700 µg, 400 to 800 µg, 400 to  
900 µg, 400 to 1000 µg, 400 to 1250 µg, 400 to 1500 µg, 400 to 1750 µg, 400 to 2000 µg,  
25 400 to 2250 µg, 400 to 2500 µg, 400 to 2750 µg, 400 to 3000 µg, 500 to 600 µg, 500 to  
700 µg, 500 to 800 µg, 500 to 900 µg, 500 to 1000 µg, 500 to 1250 µg, 500 to 1500 µg,  
500 to 1750 µg, 500 to 2000 µg, 500 to 2250 µg, 500 to 2500 µg, 500 to 2750 µg, 500 to  
3000 µg, 600 to 700 µg, 600 to 800 µg, 600 to 900 µg, 600 to 1000 µg, 600 to 1250 µg,  
600 to 1500 µg, 600 to 1750 µg, 600 to 2000 µg, 600 to 2250 µg, 600 to 2500 µg, 600 to

2750 µg, 600 to 3000 µg, 700 to 800 µg, 700 to 900 µg, 700 to 1000 µg, 700 to 1250 µg,  
700 to 1500 µg, 700 to 1750 µg, 700 to 2000 µg, 700 to 2250 µg, 700 to 2500 µg, 700 to  
2750 µg, 700 to 3000 µg, 800 to 900 µg, 800 to 1000 µg, 800 to 1250 µg, 800 to 1500 µg,  
800 to 1750 µg, 800 to 2000 µg, 800 to 2250 µg, 800 to 2500 µg, 800 to 2750 µg, 800 to  
5 3000 µg, 900 to 1000 µg, 900 to 1250 µg, 900 to 1500 µg, 900 to 1750 µg, 900 to 2000  
µg, 900 to 2250 µg, 900 to 2500 µg, 900 to 2750 µg, 900 to 3000 µg, 1000 to 1250 µg,  
1000 to 1500 µg, 1000 to 1750 µg, 1000 to 2000 µg, 1000 to 2250 µg, 1000 to 2500 µg,  
1000 to 2750 µg, 1000 to 3000 µg, 2 to 500 µg, 50 to 500 µg, 3 to 100 µg, 5 to 20 µg, 5 to  
100 µg, 10 µg, 20 µg, 30 µg, 40 µg, 50 µg, 60 µg, 70 µg, 75 µg, 80 µg, 90 µg, 100 µg, 150  
10 µg, 200 µg, 250 µg, 300 µg, 350 µg, 400 µg, 450 µg, 500 µg, 550 µg, 600 µg, 650 µg, 700  
µg, 750 µg, 800 µg, 850 µg, 900 µg, 950 µg, 1000 µg, 1050 µg, 1100 µg, 1150 µg, 1200  
µg, 1250 µg, 1300 µg, 1350 µg, 1400 µg, 1450 µg, 1500 µg, 1550 µg, 1600 µg, 1650 µg,  
1700 µg, 1750 µg, 1800 µg, 1850 µg, 1900 µg, 1950 µg, 2000 µg, 2050 µg, 2100 µg,  
2150 µg, 2200 µg, 2250 µg, 2300 µg, 2350 µg, 2400 µg, 2450 µg, 2500 µg, 2550 µg,  
15 2600 µg, 2650 µg, 2700 µg, 2750 µg, 2800 µg, 2850 µg, 2900 µg, 2950 µg, 3000 µg,  
3250 µg, 3500 µg, 3750 µg, 4000 µg, 4250 µg, 4500 µg, 4750 µg, 5000 µg of a peptide  
or agonist described herein and from 1 mg to 120 mg (e.g. 1 mg, 2.5 mg, 5 mg, 7.5 mg,  
10 mg, 12.5 mg, 15 mg, 20 mg, 25 mg, 30 mg, 40 mg, 50 mg, 60 mg, 70 mg, 80 mg, 90  
mg, 100 mg, 110 mg, 120 mg) of Propanthiline bromide (Pro-Banthine®).

20

A dosage unit (e.g. an oral dosage unit) can include, for example, from 1 to 30 µg, 1 to 40  
µg, 1 to 50 µg, 1 to 100 µg, 1 to 200 µg, 1 to 300 µg, 1 to 400 µg, 1 to 500 µg, 1 to 600  
µg, 1 to 700 µg, 1 to 800 µg, 1 to 900 µg, 1 to 1000 µg, 10 to 30 µg, 10 to 40 µg, 10 to 50  
µg, 10 to 100 µg, 10 to 200 µg, 10 to 300 µg, 10 to 400 µg, 10 to 500 µg, 10 to 600 µg, 10  
25 to 700 µg, 10 to 800 µg, 10 to 900 µg, 10 to 1000 µg, 100 to 200 µg, 100 to 300 µg, 100  
to 400 µg, 100 to 500 µg, 100 to 600 µg, 100 to 700 µg, 100 to 800 µg, 100 to 900 µg,  
100 to 1000 µg, 100 to 1250 µg, 100 to 1500 µg, 100 to 1750 µg, 100 to 2000 µg, 100 to  
2250 µg, 100 to 2500 µg, 100 to 2750 µg, 100 to 3000 µg, 200 to 300 µg, 200 to 400 µg,  
200 to 500 µg, 200 to 600 µg, 200 to 700 µg, 200 to 800 µg, 200 to 900 µg, 200 to 1000

μg, 200 to 1250 μg, 200 to 1500 μg, 200 to 1750 μg, 200 to 2000 μg, 200 to 2250 μg, 200 to 2500 μg, 200 to 2750 μg, 200 to 3000 μg, 300 to 400 μg, 300 to 500 μg, 300 to 600 μg, 300 to 700 μg, 300 to 800 μg, 300 to 900 μg, 300 to 1000 μg, 300 to 1250 μg, 300 to 1500 μg, 300 to 1750 μg, 300 to 2000 μg, 300 to 2250 μg, 300 to 2500 μg, 300 to 2750 μg, 300 to 3000 μg, 400 to 500 μg, 400 to 600 μg, 400 to 700 μg, 400 to 800 μg, 400 to 900 μg, 400 to 1000 μg, 400 to 1250 μg, 400 to 1500 μg, 400 to 1750 μg, 400 to 2000 μg, 400 to 2250 μg, 400 to 2500 μg, 400 to 2750 μg, 400 to 3000 μg, 500 to 600 μg, 500 to 700 μg, 500 to 800 μg, 500 to 900 μg, 500 to 1000 μg, 500 to 1250 μg, 500 to 1500 μg, 500 to 1750 μg, 500 to 2000 μg, 500 to 2250 μg, 500 to 2500 μg, 500 to 2750 μg, 500 to 3000 μg, 600 to 700 μg, 600 to 800 μg, 600 to 900 μg, 600 to 1000 μg, 600 to 1250 μg, 600 to 1500 μg, 600 to 1750 μg, 600 to 2000 μg, 600 to 2250 μg, 600 to 2500 μg, 600 to 2750 μg, 600 to 3000 μg, 700 to 800 μg, 700 to 900 μg, 700 to 1000 μg, 700 to 1250 μg, 700 to 1500 μg, 700 to 1750 μg, 700 to 2000 μg, 700 to 2250 μg, 700 to 2500 μg, 700 to 2750 μg, 700 to 3000 μg, 800 to 900 μg, 800 to 1000 μg, 800 to 1250 μg, 800 to 1500 μg, 800 to 1750 μg, 800 to 2000 μg, 800 to 2250 μg, 800 to 2500 μg, 800 to 2750 μg, 800 to 3000 μg, 900 to 1000 μg, 900 to 1250 μg, 900 to 1500 μg, 900 to 1750 μg, 900 to 2000 μg, 900 to 2250 μg, 900 to 2500 μg, 900 to 2750 μg, 900 to 3000 μg, 1000 to 1250 μg, 1000 to 1500 μg, 1000 to 1750 μg, 1000 to 2000 μg, 1000 to 2250 μg, 1000 to 2500 μg, 1000 to 2750 μg, 1000 to 3000 μg, 2 to 500 μg, 50 to 500 μg, 3 to 100 μg, 5 to 20 μg, 5 to 100 μg, 10 μg, 20 μg, 30 μg, 40 μg, 50 μg, 60 μg, 70 μg, 75 μg, 80 μg, 90 μg, 100 μg, 150 μg, 200 μg, 250 μg, 300 μg, 350 μg, 400 μg, 450 μg, 500 μg, 550 μg, 600 μg, 650 μg, 700 μg, 750 μg, 800 μg, 850 μg, 900 μg, 950 μg, 1000 μg, 1050 μg, 1100 μg, 1150 μg, 1200 μg, 1250 μg, 1300 μg, 1350 μg, 1400 μg, 1450 μg, 1500 μg, 1550 μg, 1600 μg, 1650 μg, 1700 μg, 1750 μg, 1800 μg, 1850 μg, 1900 μg, 1950 μg, 2000 μg, 2050 μg, 2100 μg, 2150 μg, 2200 μg, 2250 μg, 2300 μg, 2350 μg, 2400 μg, 2450 μg, 2500 μg, 2550 μg, 2600 μg, 2650 μg, 2700 μg, 2750 μg, 2800 μg, 2850 μg, 2900 μg, 2950 μg, 3000 μg, 3250 μg, 3500 μg, 3750 μg, 4000 μg, 4250 μg, 4500 μg, 4750 μg, 5000 μg of a peptide or agonist described herein and from 100 μg to 5000 μg (e.g. 100 μg, 200 μg, 300 μg, 400 μg, 500 μg, 600 μg, 700 μg, 800 μg, 900 μg, 1000 μg, 1250 μg, 1500 μg, 1750 μg, 2000

μg, 2250 μg, 2500 μg, 2750 μg, 3000 μg, 3500 μg, 4000 μg, 4500 μg, 5000 μg) of  
Granisetron (Kytril®).

A dosage unit (e.g. an oral dosage unit) can include, for example, from 1 to 30 μg, 1 to 40  
5 μg, 1 to 50 μg, 1 to 100 μg, 1 to 200 μg, 1 to 300 μg, 1 to 400 μg, 1 to 500 μg, 1 to 600  
μg, 1 to 700 μg, 1 to 800 μg, 1 to 900 μg, 1 to 1000 μg, 10 to 30 μg, 10 to 40 μg, 10 to 50  
μg, 10 to 100 μg, 10 to 200 μg, 10 to 300 μg, 10 to 400 μg, 10 to 500 μg, 10 to 600 μg, 10  
to 700 μg, 10 to 800 μg, 10 to 900 μg, 10 to 1000 μg, 100 to 200 μg, 100 to 300 μg, 100  
to 400 μg, 100 to 500 μg, 100 to 600 μg, 100 to 700 μg, 100 to 800 μg, 100 to 900 μg,  
10 100 to 1000 μg, 100 to 1250 μg, 100 to 1500 μg, 100 to 1750 μg, 100 to 2000 μg, 100 to  
2250 μg, 100 to 2500 μg, 100 to 2750 μg, 100 to 3000 μg, 200 to 300 μg, 200 to 400 μg,  
200 to 500 μg, 200 to 600 μg, 200 to 700 μg, 200 to 800 μg, 200 to 900 μg, 200 to 1000  
μg, 200 to 1250 μg, 200 to 1500 μg, 200 to 1750 μg, 200 to 2000 μg, 200 to 2250 μg, 200  
to 2500 μg, 200 to 2750 μg, 200 to 3000 μg, 300 to 400 μg, 300 to 500 μg, 300 to 600 μg,  
15 300 to 700 μg, 300 to 800 μg, 300 to 900 μg, 300 to 1000 μg, 300 to 1250 μg, 300 to  
1500 μg, 300 to 1750 μg, 300 to 2000 μg, 300 to 2250 μg, 300 to 2500 μg, 300 to 2750  
μg, 300 to 3000 μg, 400 to 500 μg, 400 to 600 μg, 400 to 700 μg, 400 to 800 μg, 400 to  
900 μg, 400 to 1000 μg, 400 to 1250 μg, 400 to 1500 μg, 400 to 1750 μg, 400 to 2000 μg,  
400 to 2250 μg, 400 to 2500 μg, 400 to 2750 μg, 400 to 3000 μg, 500 to 600 μg, 500 to  
20 700 μg, 500 to 800 μg, 500 to 900 μg, 500 to 1000 μg, 500 to 1250 μg, 500 to 1500 μg,  
500 to 1750 μg, 500 to 2000 μg, 500 to 2250 μg, 500 to 2500 μg, 500 to 2750 μg, 500 to  
3000 μg, 600 to 700 μg, 600 to 800 μg, 600 to 900 μg, 600 to 1000 μg, 600 to 1250 μg,  
600 to 1500 μg, 600 to 1750 μg, 600 to 2000 μg, 600 to 2250 μg, 600 to 2500 μg, 600 to  
2750 μg, 600 to 3000 μg, 700 to 800 μg, 700 to 900 μg, 700 to 1000 μg, 700 to 1250 μg,  
25 700 to 1500 μg, 700 to 1750 μg, 700 to 2000 μg, 700 to 2250 μg, 700 to 2500 μg, 700 to  
2750 μg, 700 to 3000 μg, 800 to 900 μg, 800 to 1000 μg, 800 to 1250 μg, 800 to 1500 μg,  
800 to 1750 μg, 800 to 2000 μg, 800 to 2250 μg, 800 to 2500 μg, 800 to 2750 μg, 800 to  
3000 μg, 900 to 1000 μg, 900 to 1250 μg, 900 to 1500 μg, 900 to 1750 μg, 900 to 2000  
μg, 900 to 2250 μg, 900 to 2500 μg, 900 to 2750 μg, 900 to 3000 μg, 1000 to 1250 μg,

1000 to 1500  $\mu\text{g}$ , 1000 to 1750  $\mu\text{g}$ , 1000 to 2000  $\mu\text{g}$ , 1000 to 2250  $\mu\text{g}$ , 1000 to 2500  $\mu\text{g}$ ,  
 1000 to 2750  $\mu\text{g}$ , 1000 to 3000  $\mu\text{g}$ , 2 to 500  $\mu\text{g}$ , 50 to 500  $\mu\text{g}$ , 3 to 100  $\mu\text{g}$ , 5 to 20  $\mu\text{g}$ , 5 to  
 100  $\mu\text{g}$ , 10  $\mu\text{g}$ , 20  $\mu\text{g}$ , 30  $\mu\text{g}$ , 40  $\mu\text{g}$ , 50  $\mu\text{g}$ , 60  $\mu\text{g}$ , 70  $\mu\text{g}$ , 75  $\mu\text{g}$ , 80  $\mu\text{g}$ , 90  $\mu\text{g}$ , 100  $\mu\text{g}$ , 150  
 $\mu\text{g}$ , 200  $\mu\text{g}$ , 250  $\mu\text{g}$ , 300  $\mu\text{g}$ , 350  $\mu\text{g}$ , 400  $\mu\text{g}$ , 450  $\mu\text{g}$ , 500  $\mu\text{g}$ , 550  $\mu\text{g}$ , 600  $\mu\text{g}$ , 650  $\mu\text{g}$ , 700  
 5  $\mu\text{g}$ , 750  $\mu\text{g}$ , 800  $\mu\text{g}$ , 850  $\mu\text{g}$ , 900  $\mu\text{g}$ , 950  $\mu\text{g}$ , 1000  $\mu\text{g}$ , 1050  $\mu\text{g}$ , 1100  $\mu\text{g}$ , 1150  $\mu\text{g}$ , 1200  
 $\mu\text{g}$ , 1250  $\mu\text{g}$ , 1300  $\mu\text{g}$ , 1350  $\mu\text{g}$ , 1400  $\mu\text{g}$ , 1450  $\mu\text{g}$ , 1500  $\mu\text{g}$ , 1550  $\mu\text{g}$ , 1600  $\mu\text{g}$ , 1650  $\mu\text{g}$ ,  
 1700  $\mu\text{g}$ , 1750  $\mu\text{g}$ , 1800  $\mu\text{g}$ , 1850  $\mu\text{g}$ , 1900  $\mu\text{g}$ , 1950  $\mu\text{g}$ , 2000  $\mu\text{g}$ , 2050  $\mu\text{g}$ , 2100  $\mu\text{g}$ ,  
 2150  $\mu\text{g}$ , 2200  $\mu\text{g}$ , 2250  $\mu\text{g}$ , 2300  $\mu\text{g}$ , 2350  $\mu\text{g}$ , 2400  $\mu\text{g}$ , 2450  $\mu\text{g}$ , 2500  $\mu\text{g}$ , 2550  $\mu\text{g}$ ,  
 2600  $\mu\text{g}$ , 2650  $\mu\text{g}$ , 2700  $\mu\text{g}$ , 2750  $\mu\text{g}$ , 2800  $\mu\text{g}$ , 2850  $\mu\text{g}$ , 2900  $\mu\text{g}$ , 2950  $\mu\text{g}$ , 3000  $\mu\text{g}$ ,  
 10 3250  $\mu\text{g}$ , 3500  $\mu\text{g}$ , 3750  $\mu\text{g}$ , 4000  $\mu\text{g}$ , 4250  $\mu\text{g}$ , 4500  $\mu\text{g}$ , 4750  $\mu\text{g}$ , 5000  $\mu\text{g}$  of a peptide  
 or agonist described herein and from 50  $\mu\text{g}$  to 3000  $\mu\text{g}$  (e.g. 50  $\mu\text{g}$ , 100  $\mu\text{g}$ , 200  $\mu\text{g}$ , 300  
 $\mu\text{g}$ , 400  $\mu\text{g}$ , 500  $\mu\text{g}$ , 600  $\mu\text{g}$ , 700  $\mu\text{g}$ , 800  $\mu\text{g}$ , 900  $\mu\text{g}$ , 1000  $\mu\text{g}$ , 1250  $\mu\text{g}$ , 1500  $\mu\text{g}$ , 1750  
 $\mu\text{g}$ , 2000  $\mu\text{g}$ , 2250  $\mu\text{g}$ , 2500  $\mu\text{g}$ , 2750  $\mu\text{g}$ , 3000  $\mu\text{g}$ ) of Lotronex® (alosetron  
 hydrochloride).

15

A dosage unit (e.g. an oral dosage unit) can include, for example, from 1 to 30  $\mu\text{g}$ , 1 to 40  
 $\mu\text{g}$ , 1 to 50  $\mu\text{g}$ , 1 to 100  $\mu\text{g}$ , 1 to 200  $\mu\text{g}$ , 1 to 300  $\mu\text{g}$ , 1 to 400  $\mu\text{g}$ , 1 to 500  $\mu\text{g}$ , 1 to 600  
 $\mu\text{g}$ , 1 to 700  $\mu\text{g}$ , 1 to 800  $\mu\text{g}$ , 1 to 900  $\mu\text{g}$ , 1 to 1000  $\mu\text{g}$ , 10 to 30  $\mu\text{g}$ , 10 to 40  $\mu\text{g}$ , 10 to 50  
 $\mu\text{g}$ , 10 to 100  $\mu\text{g}$ , 10 to 200  $\mu\text{g}$ , 10 to 300  $\mu\text{g}$ , 10 to 400  $\mu\text{g}$ , 10 to 500  $\mu\text{g}$ , 10 to 600  $\mu\text{g}$ , 10  
 20 to 700  $\mu\text{g}$ , 10 to 800  $\mu\text{g}$ , 10 to 900  $\mu\text{g}$ , 10 to 1000  $\mu\text{g}$ , 100 to 200  $\mu\text{g}$ , 100 to 300  $\mu\text{g}$ , 100  
 to 400  $\mu\text{g}$ , 100 to 500  $\mu\text{g}$ , 100 to 600  $\mu\text{g}$ , 100 to 700  $\mu\text{g}$ , 100 to 800  $\mu\text{g}$ , 100 to 900  $\mu\text{g}$ ,  
 100 to 1000  $\mu\text{g}$ , 100 to 1250  $\mu\text{g}$ , 100 to 1500  $\mu\text{g}$ , 100 to 1750  $\mu\text{g}$ , 100 to 2000  $\mu\text{g}$ , 100 to  
 2250  $\mu\text{g}$ , 100 to 2500  $\mu\text{g}$ , 100 to 2750  $\mu\text{g}$ , 100 to 3000  $\mu\text{g}$ , 200 to 300  $\mu\text{g}$ , 200 to 400  $\mu\text{g}$ ,  
 200 to 500  $\mu\text{g}$ , 200 to 600  $\mu\text{g}$ , 200 to 700  $\mu\text{g}$ , 200 to 800  $\mu\text{g}$ , 200 to 900  $\mu\text{g}$ , 200 to 1000  
 25  $\mu\text{g}$ , 200 to 1250  $\mu\text{g}$ , 200 to 1500  $\mu\text{g}$ , 200 to 1750  $\mu\text{g}$ , 200 to 2000  $\mu\text{g}$ , 200 to 2250  $\mu\text{g}$ , 200  
 to 2500  $\mu\text{g}$ , 200 to 2750  $\mu\text{g}$ , 200 to 3000  $\mu\text{g}$ , 300 to 400  $\mu\text{g}$ , 300 to 500  $\mu\text{g}$ , 300 to 600  $\mu\text{g}$ ,  
 300 to 700  $\mu\text{g}$ , 300 to 800  $\mu\text{g}$ , 300 to 900  $\mu\text{g}$ , 300 to 1000  $\mu\text{g}$ , 300 to 1250  $\mu\text{g}$ , 300 to  
 1500  $\mu\text{g}$ , 300 to 1750  $\mu\text{g}$ , 300 to 2000  $\mu\text{g}$ , 300 to 2250  $\mu\text{g}$ , 300 to 2500  $\mu\text{g}$ , 300 to 2750  
 $\mu\text{g}$ , 300 to 3000  $\mu\text{g}$ , 400 to 500  $\mu\text{g}$ , 400 to 600  $\mu\text{g}$ , 400 to 700  $\mu\text{g}$ , 400 to 800  $\mu\text{g}$ , 400 to

900 µg, 400 to 1000 µg, 400 to 1250 µg, 400 to 1500 µg, 400 to 1750 µg, 400 to 2000 µg,  
400 to 2250 µg, 400 to 2500 µg, 400 to 2750 µg, 400 to 3000 µg, 500 to 600 µg, 500 to  
700 µg, 500 to 800 µg, 500 to 900 µg, 500 to 1000 µg, 500 to 1250 µg, 500 to 1500 µg,  
500 to 1750 µg, 500 to 2000 µg, 500 to 2250 µg, 500 to 2500 µg, 500 to 2750 µg, 500 to  
5 3000 µg, 600 to 700 µg, 600 to 800 µg, 600 to 900 µg, 600 to 1000 µg, 600 to 1250 µg,  
600 to 1500 µg, 600 to 1750 µg, 600 to 2000 µg, 600 to 2250 µg, 600 to 2500 µg, 600 to  
2750 µg, 600 to 3000 µg, 700 to 800 µg, 700 to 900 µg, 700 to 1000 µg, 700 to 1250 µg,  
700 to 1500 µg, 700 to 1750 µg, 700 to 2000 µg, 700 to 2250 µg, 700 to 2500 µg, 700 to  
2750 µg, 700 to 3000 µg, 800 to 900 µg, 800 to 1000 µg, 800 to 1250 µg, 800 to 1500 µg,  
10 800 to 1750 µg, 800 to 2000 µg, 800 to 2250 µg, 800 to 2500 µg, 800 to 2750 µg, 800 to  
3000 µg, 900 to 1000 µg, 900 to 1250 µg, 900 to 1500 µg, 900 to 1750 µg, 900 to 2000  
µg, 900 to 2250 µg, 900 to 2500 µg, 900 to 2750 µg, 900 to 3000 µg, 1000 to 1250 µg,  
1000 to 1500 µg, 1000 to 1750 µg, 1000 to 2000 µg, 1000 to 2250 µg, 1000 to 2500 µg,  
1000 to 2750 µg, 1000 to 3000 µg, 2 to 500 µg, 50 to 500 µg, 3 to 100 µg, 5 to 20 µg, 5 to  
15 100 µg, 10 µg, 20 µg, 30 µg, 40 µg, 50 µg, 60 µg, 70 µg, 75 µg, 80 µg, 90 µg, 100 µg, 150  
µg, 200 µg, 250 µg, 300 µg, 350 µg, 400 µg, 450 µg, 500 µg, 550 µg, 600 µg, 650 µg, 700  
µg, 750 µg, 800 µg, 850 µg, 900 µg, 950 µg, 1000 µg, 1050 µg, 1100 µg, 1150 µg, 1200  
µg, 1250 µg, 1300 µg, 1350 µg, 1400 µg, 1450 µg, 1500 µg, 1550 µg, 1600 µg, 1650 µg,  
1700 µg, 1750 µg, 1800 µg, 1850 µg, 1900 µg, 1950 µg, 2000 µg, 2050 µg, 2100 µg,  
20 2150 µg, 2200 µg, 2250 µg, 2300 µg, 2350 µg, 2400 µg, 2450 µg, 2500 µg, 2550 µg,  
2600 µg, 2650 µg, 2700 µg, 2750 µg, 2800 µg, 2850 µg, 2900 µg, 2950 µg, 3000 µg,  
3250 µg, 3500 µg, 3750 µg, 4000 µg, 4250 µg, 4500 µg, 4750 µg, 5000 µg of a peptide  
or agonist described herein and from 10 mg to 600 mg (e.g. 10 mg, 20 mg, 30 mg, 40 mg,  
50 mg, 60 mg, 70 mg, 80 mg, 90 mg, 100 mg, 125 mg, 150 mg, 175 mg, 200 mg, 250  
25 mg, 300 mg, 350 mg, 400 mg, 450 mg, 500 mg, 550 mg, 600 mg) of Xifaxan®  
(rifaximin).

A dosage unit (e.g. an oral dosage unit) can include, for example, from 1 to 30 µg, 1 to 40  
µg, 1 to 50 µg, 1 to 100 µg, 1 to 200 µg, 1 to 300 µg, 1 to 400 µg, 1 to 500 µg, 1 to 600



μg, 1 to 700 μg, 1 to 800 μg, 1 to 900 μg, 1 to 1000 μg, 10 to 30 μg, 10 to 40 μg, 10 to 50 μg, 10 to 100 μg, 10 to 200 μg, 10 to 300 μg, 10 to 400 μg, 10 to 500 μg, 10 to 600 μg, 10 to 700 μg, 10 to 800 μg, 10 to 900 μg, 10 to 1000 μg, 100 to 200 μg, 100 to 300 μg, 100 to 400 μg, 100 to 500 μg, 100 to 600 μg, 100 to 700 μg, 100 to 800 μg, 100 to 900 μg,

5 100 to 1000 μg, 100 to 1250 μg, 100 to 1500 μg, 100 to 1750 μg, 100 to 2000 μg, 100 to 2250 μg, 100 to 2500 μg, 100 to 2750 μg, 100 to 3000 μg, 200 to 300 μg, 200 to 400 μg, 200 to 500 μg, 200 to 600 μg, 200 to 700 μg, 200 to 800 μg, 200 to 900 μg, 200 to 1000 μg, 200 to 1250 μg, 200 to 1500 μg, 200 to 1750 μg, 200 to 2000 μg, 200 to 2250 μg, 200 to 2500 μg, 200 to 2750 μg, 200 to 3000 μg, 300 to 400 μg, 300 to 500 μg, 300 to 600 μg,

10 300 to 700 μg, 300 to 800 μg, 300 to 900 μg, 300 to 1000 μg, 300 to 1250 μg, 300 to 1500 μg, 300 to 1750 μg, 300 to 2000 μg, 300 to 2250 μg, 300 to 2500 μg, 300 to 2750 μg, 300 to 3000 μg, 400 to 500 μg, 400 to 600 μg, 400 to 700 μg, 400 to 800 μg, 400 to 900 μg, 400 to 1000 μg, 400 to 1250 μg, 400 to 1500 μg, 400 to 1750 μg, 400 to 2000 μg, 400 to 2250 μg, 400 to 2500 μg, 400 to 2750 μg, 400 to 3000 μg, 500 to 600 μg, 500 to

15 700 μg, 500 to 800 μg, 500 to 900 μg, 500 to 1000 μg, 500 to 1250 μg, 500 to 1500 μg, 500 to 1750 μg, 500 to 2000 μg, 500 to 2250 μg, 500 to 2500 μg, 500 to 2750 μg, 500 to 3000 μg, 600 to 700 μg, 600 to 800 μg, 600 to 900 μg, 600 to 1000 μg, 600 to 1250 μg, 600 to 1500 μg, 600 to 1750 μg, 600 to 2000 μg, 600 to 2250 μg, 600 to 2500 μg, 600 to 2750 μg, 600 to 3000 μg, 700 to 800 μg, 700 to 900 μg, 700 to 1000 μg, 700 to 1250 μg,

20 700 to 1500 μg, 700 to 1750 μg, 700 to 2000 μg, 700 to 2250 μg, 700 to 2500 μg, 700 to 2750 μg, 700 to 3000 μg, 800 to 900 μg, 800 to 1000 μg, 800 to 1250 μg, 800 to 1500 μg, 800 to 1750 μg, 800 to 2000 μg, 800 to 2250 μg, 800 to 2500 μg, 800 to 2750 μg, 800 to 3000 μg, 900 to 1000 μg, 900 to 1250 μg, 900 to 1500 μg, 900 to 1750 μg, 900 to 2000 μg, 900 to 2250 μg, 900 to 2500 μg, 900 to 2750 μg, 900 to 3000 μg, 1000 to 1250 μg,

25 1000 to 1500 μg, 1000 to 1750 μg, 1000 to 2000 μg, 1000 to 2250 μg, 1000 to 2500 μg, 1000 to 2750 μg, 1000 to 3000 μg, 2 to 500 μg, 50 to 500 μg, 3 to 100 μg, 5 to 20 μg, 5 to 100 μg, 10 μg, 20 μg, 30 μg, 40 μg, 50 μg, 60 μg, 70 μg, 75 μg, 80 μg, 90 μg, 100 μg, 150 μg, 200 μg, 250 μg, 300 μg, 350 μg, 400 μg, 450 μg, 500 μg, 550 μg, 600 μg, 650 μg, 700 μg, 750 μg, 800 μg, 850 μg, 900 μg, 950 μg, 1000 μg, 1050 μg, 1100 μg, 1150 μg, 1200

μg, 1250 μg, 1300 μg, 1350 μg, 1400 μg, 1450 μg, 1500 μg, 1550 μg, 1600 μg, 1650 μg,  
1700 μg, 1750 μg, 1800 μg, 1850 μg, 1900 μg, 1950 μg, 2000 μg, 2050 μg, 2100 μg,  
2150 μg, 2200 μg, 2250 μg, 2300 μg, 2350 μg, 2400 μg, 2450 μg, 2500 μg, 2550 μg,  
2600 μg, 2650 μg, 2700 μg, 2750 μg, 2800 μg, 2850 μg, 2900 μg, 2950 μg, 3000 μg,  
5 3250 μg, 3500 μg, 3750 μg, 4000 μg, 4250 μg, 4500 μg, 4750 μg, 5000 μg of a  
polypeptide or agonist described herein and from 10 mg to 600 mg (e.g. 10 mg, 20 mg,  
30 mg, 40 mg, 50 mg, 60 mg, 70 mg, 80 mg, 90 mg, 100 mg, 120 mg, 140 mg, 160 mg,  
180 mg, 200 mg, 220 mg, 240 mg, 260 mg, 280 mg, 300 mg, 320 mg, 340 mg, 360 mg,  
380 mg, 400 mg, 420 mg, 440 mg, 460 mg, 480 mg, 500 mg, 520 mg, 540 mg, 560 mg,  
10 580 mg, 600 mg) of furosemide (Lasix).

A dosage unit (e.g. an oral, intravenous or intramuscular dosage unit) can include,  
for example, from 1 to 30 μg, 1 to 40 μg, 1 to 50 μg, 1 to 100 μg, 1 to 200 μg, 1 to 300  
μg, 1 to 400 μg, 1 to 500 μg, 1 to 600 μg, 1 to 700 μg, 1 to 800 μg, 1 to 900 μg, 1 to 1000  
15 μg, 10 to 30 μg, 10 to 40 μg, 10 to 50 μg, 10 to 100 μg, 10 to 200 μg, 10 to 300 μg, 10 to  
400 μg, 10 to 500 μg, 10 to 600 μg, 10 to 700 μg, 10 to 800 μg, 10 to 900 μg, 10 to 1000  
μg, 100 to 200 μg, 100 to 300 μg, 100 to 400 μg, 100 to 500 μg, 100 to 600 μg, 100 to  
700 μg, 100 to 800 μg, 100 to 900 μg, 100 to 1000 μg, 100 to 1250 μg, 100 to 1500 μg,  
100 to 1750 μg, 100 to 2000 μg, 100 to 2250 μg, 100 to 2500 μg, 100 to 2750 μg, 100 to  
20 3000 μg, 200 to 300 μg, 200 to 400 μg, 200 to 500 μg, 200 to 600 μg, 200 to 700 μg, 200  
to 800 μg, 200 to 900 μg, 200 to 1000 μg, 200 to 1250 μg, 200 to 1500 μg, 200 to 1750  
μg, 200 to 2000 μg, 200 to 2250 μg, 200 to 2500 μg, 200 to 2750 μg, 200 to 3000 μg, 300  
to 400 μg, 300 to 500 μg, 300 to 600 μg, 300 to 700 μg, 300 to 800 μg, 300 to 900 μg,  
300 to 1000 μg, 300 to 1250 μg, 300 to 1500 μg, 300 to 1750 μg, 300 to 2000 μg, 300 to  
25 2250 μg, 300 to 2500 μg, 300 to 2750 μg, 300 to 3000 μg, 400 to 500 μg, 400 to 600 μg,  
400 to 700 μg, 400 to 800 μg, 400 to 900 μg, 400 to 1000 μg, 400 to 1250 μg, 400 to  
1500 μg, 400 to 1750 μg, 400 to 2000 μg, 400 to 2250 μg, 400 to 2500 μg, 400 to 2750  
μg, 400 to 3000 μg, 500 to 600 μg, 500 to 700 μg, 500 to 800 μg, 500 to 900 μg, 500 to  
1000 μg, 500 to 1250 μg, 500 to 1500 μg, 500 to 1750 μg, 500 to 2000 μg, 500 to 2250

5  $\mu\text{g}$ , 500 to 2500  $\mu\text{g}$ , 500 to 2750  $\mu\text{g}$ , 500 to 3000  $\mu\text{g}$ , 600 to 700  $\mu\text{g}$ , 600 to 800  $\mu\text{g}$ , 600 to 900  $\mu\text{g}$ , 600 to 1000  $\mu\text{g}$ , 600 to 1250  $\mu\text{g}$ , 600 to 1500  $\mu\text{g}$ , 600 to 1750  $\mu\text{g}$ , 600 to 2000  $\mu\text{g}$ , 600 to 2250  $\mu\text{g}$ , 600 to 2500  $\mu\text{g}$ , 600 to 2750  $\mu\text{g}$ , 600 to 3000  $\mu\text{g}$ , 700 to 800  $\mu\text{g}$ , 700 to 900  $\mu\text{g}$ , 700 to 1000  $\mu\text{g}$ , 700 to 1250  $\mu\text{g}$ , 700 to 1500  $\mu\text{g}$ , 700 to 1750  $\mu\text{g}$ , 700 to 2000  $\mu\text{g}$ , 700 to 2250  $\mu\text{g}$ , 700 to 2500  $\mu\text{g}$ , 700 to 2750  $\mu\text{g}$ , 700 to 3000  $\mu\text{g}$ , 800 to 900  $\mu\text{g}$ , 800 to 1000  $\mu\text{g}$ , 800 to 1250  $\mu\text{g}$ , 800 to 1500  $\mu\text{g}$ , 800 to 1750  $\mu\text{g}$ , 800 to 2000  $\mu\text{g}$ , 800 to 2250  $\mu\text{g}$ , 800 to 2500  $\mu\text{g}$ , 800 to 2750  $\mu\text{g}$ , 800 to 3000  $\mu\text{g}$ , 900 to 1000  $\mu\text{g}$ , 900 to 1250  $\mu\text{g}$ , 900 to 1500  $\mu\text{g}$ , 900 to 1750  $\mu\text{g}$ , 900 to 2000  $\mu\text{g}$ , 900 to 2250  $\mu\text{g}$ , 900 to 2500  $\mu\text{g}$ , 900 to 2750  $\mu\text{g}$ , 900 to 3000  $\mu\text{g}$ , 1000 to 1250  $\mu\text{g}$ , 1000 to 1500  $\mu\text{g}$ , 1000 to 1750  $\mu\text{g}$ , 1000 to 2000  $\mu\text{g}$ , 1000 to 2250  $\mu\text{g}$ , 1000 to 2500  $\mu\text{g}$ , 1000 to 2750  $\mu\text{g}$ , 1000 to 3000  $\mu\text{g}$ , 2 to 500  $\mu\text{g}$ , 50 to 500  $\mu\text{g}$ , 3 to 100  $\mu\text{g}$ , 5 to 20  $\mu\text{g}$ , 5 to 100  $\mu\text{g}$ , 10  $\mu\text{g}$ , 20  $\mu\text{g}$ , 30  $\mu\text{g}$ , 40  $\mu\text{g}$ , 50  $\mu\text{g}$ , 60  $\mu\text{g}$ , 70  $\mu\text{g}$ , 75  $\mu\text{g}$ , 80  $\mu\text{g}$ , 90  $\mu\text{g}$ , 100  $\mu\text{g}$ , 150  $\mu\text{g}$ , 200  $\mu\text{g}$ , 250  $\mu\text{g}$ , 300  $\mu\text{g}$ , 350  $\mu\text{g}$ , 400  $\mu\text{g}$ , 450  $\mu\text{g}$ , 500  $\mu\text{g}$ , 550  $\mu\text{g}$ , 600  $\mu\text{g}$ , 650  $\mu\text{g}$ , 700  $\mu\text{g}$ , 750  $\mu\text{g}$ , 800  $\mu\text{g}$ , 850  $\mu\text{g}$ , 900  $\mu\text{g}$ , 950  $\mu\text{g}$ , 1000  $\mu\text{g}$ , 1050  $\mu\text{g}$ , 1100  $\mu\text{g}$ , 1150  $\mu\text{g}$ , 1200  $\mu\text{g}$ , 1250  $\mu\text{g}$ , 1300  $\mu\text{g}$ , 1350  $\mu\text{g}$ , 1400  $\mu\text{g}$ , 1450  $\mu\text{g}$ , 1500  $\mu\text{g}$ , 1550  $\mu\text{g}$ , 1600  $\mu\text{g}$ , 1650  $\mu\text{g}$ , 1700  $\mu\text{g}$ , 1750  $\mu\text{g}$ , 1800  $\mu\text{g}$ , 1850  $\mu\text{g}$ , 1900  $\mu\text{g}$ , 1950  $\mu\text{g}$ , 2000  $\mu\text{g}$ , 2050  $\mu\text{g}$ , 2100  $\mu\text{g}$ , 2150  $\mu\text{g}$ , 2200  $\mu\text{g}$ , 2250  $\mu\text{g}$ , 2300  $\mu\text{g}$ , 2350  $\mu\text{g}$ , 2400  $\mu\text{g}$ , 2450  $\mu\text{g}$ , 2500  $\mu\text{g}$ , 2550  $\mu\text{g}$ , 2600  $\mu\text{g}$ , 2650  $\mu\text{g}$ , 2700  $\mu\text{g}$ , 2750  $\mu\text{g}$ , 2800  $\mu\text{g}$ , 2850  $\mu\text{g}$ , 2900  $\mu\text{g}$ , 2950  $\mu\text{g}$ , 3000  $\mu\text{g}$ , 3250  $\mu\text{g}$ , 3500  $\mu\text{g}$ , 3750  $\mu\text{g}$ , 4000  $\mu\text{g}$ , 4250  $\mu\text{g}$ , 4500  $\mu\text{g}$ , 4750  $\mu\text{g}$ , 5000  $\mu\text{g}$  of a polypeptide or agonist described herein and  
10  
15  
20 from 0.2 mg to 10 mg (e.g. 0.2 mg, 0.4 mg, 0.5 mg, 0.75 mg, 1 mg, 1.5 mg, 2 mg, 2.5 mg, 3 mg, 3.5 mg, 4 mg, 4.5 mg, 5 mg, 5.5 mg, 6 mg, 6.5 mg, 7 mg, 7.5 mg, 8 mg, 8.5 mg, 9 mg, 9.5 mg, 10 mg) of bumetanide (Bumex®).

25 The precise amount of each of the two or more active ingredients in a dosage unit will depend on the desired dosage of each component. Thus, it can be useful to create a dosage unit that will, when administered according to a particular dosage schedule (e.g., a dosage schedule specifying a certain number of units and a particular timing for administration), deliver the same dosage of each component as would be administered if

the patient was being treated with only a single component. In other circumstances, it might be desirable to create a dosage unit that will deliver a dosage of one or more components that is less than that which would be administered if the patient was being treated only with a single component. Finally, it might be desirable to create a dosage unit that will deliver a dosage of one or more components that is greater than that which would be administered if the patient was being treated only with a single component. The pharmaceutical composition can include additional ingredients including but not limited to the excipients described herein. In certain embodiments, one or more therapeutic agents of the dosage unit may exist in an extended or control release formulation and additional therapeutic agents may not exist in extended release formulation. For example, a peptide or agonist described herein may exist in a controlled release formulation or extended release formulation in the same dosage unit with another agent that may or may not be in either a controlled release or extended release formulation. Thus, in certain embodiments, it may be desirable to provide for the immediate release of one or more of the agents described herein, and the controlled release of one or more other agents.

In certain embodiments the dosage unit and daily dose are equivalent. In certain embodiments the dosage unit and the daily dose are not equivalent. In various embodiments, the dosage unit is administered twenty minutes prior to food consumption, twenty minutes after food consumption, with food at anytime of the day, without food at anytime of the day, with food after an overnight fast (e.g. with breakfast), at bedtime after a low fat snack. In various embodiments, the dosage unit is administered once a day, twice a day, three times a day, four times a day, five times a day, six times a day.

When two or more active ingredients are combined in single dosage form, chemical interactions between the active ingredients may occur. For example, acidic and basic active ingredients can react with each other and acidic active ingredients can facilitate the degradation of acid labile substances. Thus, in certain dosage forms, acidic and basic

substances can be physically separated as two distinct or isolated layers in a compressed tablet, or in the core and shell of a press-coated tablet. Additional agents that are compatible with acidic as well as basic substances, have the flexibility of being placed in either layer. In certain multiple layer compositions at least one active ingredient can be enteric-coated. In certain embodiments thereof at least one active ingredient can be presented in a controlled release form. In certain embodiments where a combination of three or more active substances are used, they can be presented as physically isolated segments of a compressed multilayer tablet, which can be optionally film coated.

10 The therapeutic combinations described herein can be formulated as a tablet or capsule comprising a plurality of beads, granules, or pellets. All active ingredients including the vitamins of the combination are formulated into granules or beads or pellets that are further coated with a protective coat, an enteric coat, or a film coat to avoid the possible chemical interactions. Granulation and coating of granules or beads is done using techniques well known to a person skilled in the art. At least one active ingredient can present in a controlled release form. Finally these coated granules or beads are filled into hard gelatin capsules or compressed to form tablets.

The therapeutic combinations described herein can be formulated as a capsule comprising microtablets or minitables of all active ingredients. Microtablets of the individual agents can be prepared using well known pharmaceutical procedures of tablet making like direct compression, dry granulation or wet granulation. Individual microtablets can be filled into hard gelatin capsules. A final dosage form may comprise one or more microtablets of each individual component. The microtablets may be film coated or enteric coated.

25 The therapeutic combinations described herein can be formulated as a capsule comprising one or more microtablets and powder, or one or more microtablets and granules or beads. In order to avoid interactions between drugs, some active ingredients of a said combination can be formulated as microtablets and the others filled into capsules as a

powder, granules, or beads. The microtablets may be film coated or enteric coated. At least one active ingredient can be presented in controlled release form.

5 The therapeutic combinations described herein can be formulated wherein the active ingredients are distributed in the inner and outer phase of tablets. In an attempt to divide chemically incompatible components of proposed combination, few interacting components are converted in granules or beads using well known pharmaceutical procedures in prior art. The prepared granules or beads (inner phase) are then mixed with outer phase comprising the remaining active ingredients and at least one  
10 pharmaceutically acceptable excipient. The mixture thus comprising inner and outer phase is compressed into tablets or molded into tablets. The granules or beads can be controlled release or immediate release beads or granules, and can further be coated using an enteric polymer in an aqueous or non-aqueous system, using methods and materials that are known in the art.

15 The therapeutic combinations described herein can be formulated as single dosage unit comprising suitable buffering agent. All powdered ingredients of said combination are mixed and a suitable quantity of one or more buffering agents is added to the blend to minimize possible interactions.

20 The agents described herein, alone or in combination, can be combined with any pharmaceutically acceptable carrier or medium. Thus, they can be combined with materials that do not produce an adverse, allergic or otherwise unwanted reaction when administered to a patient. The carriers or mediums used can include solvents,  
25 dispersants, coatings, absorption promoting agents, controlled release agents, and one or more inert excipients (which include starches, polyols, granulating agents, microcrystalline cellulose, diluents, lubricants, binders, disintegrating agents, and the like), etc. If desired, tablet dosages of the disclosed compositions may be coated by standard aqueous or nonaqueous techniques.

Analgesic Agents in combitherapy

The peptides and agonists described herein can be used in combination therapy with an analgesic agent, e.g., an analgesic compound or an analgesic peptide. These peptides and compounds can be administered with the peptides described herein (simultaneously or sequentially). They can also be optionally covalently linked or attached to an agent described herein to create therapeutic conjugates. Among the useful analgesic agents are: Ca channel blockers, 5HT receptor antagonists (for example 5HT<sub>3</sub>, 5HT<sub>4</sub> and 5HT<sub>1</sub> receptor antagonists), opioid receptor agonists (loperamide, fedotozine, and fentanyl), NK<sub>1</sub> receptor antagonists, CCK receptor agonists (e.g., loxiglumide), NK<sub>1</sub> receptor antagonists, NK<sub>3</sub> receptor antagonists, norepinephrine-serotonin reuptake inhibitors (NSRI), vanilloid and cannaboid receptor agonists, and sialorphin. Analgesics agents in the various classes are described in the literature.

Among the useful analgesic peptides are sialorphin-related peptides, including those comprising the amino acid sequence QHNPR (SEQ ID NO: ), including: VQHNPR (SEQ ID NO: ); VRQHNPR (SEQ ID NO: ); VRGQHNPR (SEQ ID NO: ); VRGPQHNPR (SEQ ID NO: ); VRGPRQHNPR (SEQ ID NO: ); VRGPRRQHNPR (SEQ ID NO: ); and RQHNPR (SEQ ID NO: ). Sialorphin-related peptides bind to neprilysin and inhibit neprilysin-mediated breakdown of substance P and Met-enkephalin. Thus, compounds or peptides that are inhibitors of neprilysin are useful analgesic agents which can be administered with the peptides described herein in a co-therapy or linked to the peptides described herein, e.g., by a covalent bond. Sialorphin and related peptides are described in U.S. Patent 6,589,750; U.S. 20030078200 A1; and WO 02/051435 A2.

Opioid receptor antagonists and agonists can be administered with the peptides described herein in co-therapy or linked to the agent described herein, e.g., by a covalent bond. For example, opioid receptor antagonists such as naloxone, naltrexone, methyl nalozone,

nalmefene, cypridime, beta funaltrexamine, naloxonazine, naltrindole, and nor-binaltorphimine are thought to be useful in the treatment of IBS. It can be useful to formulate opioid antagonists of this type is a delayed and sustained release formulation such that initial release of the antagonist is in the mid to distal small intestine and/or ascending colon. Such antagonists are described in WO 01/32180 A2. Enkephalin pentapeptide (HOE825; Tyr-D-Lys-Gly-Phe-L-homoserine) is an agonist of the mu and delta opioid receptors and is thought to be useful for increasing intestinal motility (*Eur. J. Pharm.* 219:445, 1992), and this peptide can be used in conjunction with the peptides described herein. Also useful is trimebutine which is thought to bind to mu/delta/kappa opioid receptors and activate release of motilin and modulate the release of gastrin, vasoactive intestinal peptide, gastrin and glucagons. Kappa opioid receptor agonists such as fedotozine, asimadoline, and ketocyclazocine, and compounds described in WO 03/097051 and WO05/007626 can be used with or linked to the peptides described herein. In addition, mu opioid receptor agonists such as morphine, diphenyloxylate, frakefamide (H-Tyr-D-Ala-Phe(F)-Phe-NH<sub>2</sub>; WO 01/019849 A1) and loperamide can be used.

Tyr-Arg (kyotorphin) is a dipeptide that acts by stimulating the release of met-enkephalins to elicit an analgesic effect (*J. Biol. Chem* 262:8165, 1987). Kyotorphin can be used with or linked to the peptides described herein.

Chromogranin-derived peptide (CgA 47-66; see, e.g., Ghia et al. 2004 *Regulatory Peptides* 119:199) can be used with or linked to the peptides described herein.

CCK receptor agonists such as caerulein from amphibians and other species are useful analgesic agents that can be used with or linked to the peptides described herein.



Conotoxin peptides represent a large class of analgesic peptides that act at voltage gated Ca channels, NMDA receptors or nicotinic receptors. These peptides can be used with or linked to the peptides described herein.

- 5 Peptide analogs of thymulin (FR Application 2830451) can have analgesic activity and can be used with or linked to the peptides described herein.

- CCK (CCKa or CCKb) receptor antagonists, including loxiglumide and dexloxiglumide (the R-isomer of loxiglumide) (WO 88/05774) can have analgesic activity and can be  
10 used with or linked to the peptides described herein.

- Other useful analgesic agents include 5-HT<sub>4</sub> agonists such as tegaserod (Zelnorm®), mosapride, metoclopramide, zacopride, cisapride, renzapride, benzimidazolone derivatives such as BIMU 1 and BIMU 8, and lorexapride. Such agonists are described in:  
15 EP1321142 A1, WO 03/053432A1, EP 505322 A1, EP 505322 B1, US 5,510,353, EP 507672 A1, EP 507672 B1, and US 5,273,983.

- Calcium channel blockers such as ziconotide and related compounds described in, for example, EP625162B1, US 5,364,842, US 5,587,454, US 5,824,645, US 5,859,186, US  
20 5,994,305, US 6,087,091, US 6,136,786, WO 93/13128 A1, EP 1336409 A1, EP 835126 A1, EP 835126 B1, US 5,795,864, US 5,891,849, US 6,054,429, WO 97/01351 A1, can be used with or linked to the peptides described herein.

- Various antagonists of the NK-1, NK-2, and NK-3 receptors (for a review see Giardina et  
25 al. 2003 *Drugs* 6:758) can be used with or linked to the peptides described herein.

NK1 receptor antagonists such as: aprepitant (Merck & Co Inc), vofopitant, ezlopitant (Pfizer, Inc.), R-673 (Hoffmann-La Roche Ltd), SR-48968 (Sanofi Synthelabo), CP-122,721 (Pfizer, Inc.), GW679769 (Glaxo Smith Kline), TAK-637 (Takeda/Abbot), SR-

14033, and related compounds described in, for example, EP 873753 A1, US 20010006972 A1, US 20030109417 A1, WO 01/52844 A1, can be used with or linked to the peptides described herein.

- 5 NK-2 receptor antagonists such as nepadutant (Menarini Ricerche SpA), saredutant (Sanofi-Synthelabo), GW597599 (Glaxo Smith Kline), SR-144190 (Sanofi-Synthelabo) and UK-290795 (Pfizer Inc) can be used with or linked to the peptides described herein.

- NK3 receptor antagonists such as osanetant (SR-142801; Sanofi-Synthelabo), SSR-  
10 241586, talnetant and related compounds described in, for example, WO 02/094187 A2, EP 876347 A1, WO 97/21680 A1, US 6,277,862, WO 98/11090, WO 95/28418, WO 97/19927, and Boden et al. (*J Med Chem.* 39:1664-75, 1996) can be used with or linked to the peptides described herein.

- 15 Norepinephrine-serotonin reuptake inhibitors (NSRI) such as milnacipran and related compounds described in WO 03/077897 A1 can be used with or linked to the peptides described herein.

- Vanilloid receptor antagonists such as arvanil and related compounds described in WO  
20 01/64212 A1 can be used with or linked to the peptides described herein.

The analgesic peptides and compounds can be administered with the peptides and agonists described herein (simultaneously or sequentially). The analgesic agents can also be covalently linked to the peptides and agonists described herein to create therapeutic  
25 conjugates. Where the analgesic is a peptide and is covalently linked to an agent described herein the resulting peptide may also include at least one trypsin cleavage site. When present within the peptide, the analgesic peptide may be preceded by (if it is at the carboxy terminus) or followed by (if it is at the amino terminus) a trypsin cleavage site that allows release of the analgesic peptide.

In addition to sialorphin-related peptides, analgesic peptides include: AspPhe, endomorphin-1, endomorphin-2, nocistatin, dalargin, lupron, ziconotide, and substance P.

5 Diabetes, Obesity and other disorders

Pharmaceutical compositions comprising at least two of: 1) an agent that stimulates the production of cAMP (e.g., glucagon-like peptide 1 (GLP-1)); 2) an agent that inhibits the degradation of a cyclic nucleotide (e.g., a phosphodiesterase inhibitor); and 3) a peptide or agonist described herein useful for treating diabetes and obesity. Such compositions  
10 may also be useful for treating secondary hyperglycemias in connection with pancreatic diseases (chronic pancreatitis, pancreatectomy, hemochromatosis) or endocrine diseases (acromegaly, Cushing's syndrome, pheochromocytoma or hyperthyreosis), drug-induced hyperglycemias (benzothiadiazine saluretics, diazoxide or glucocorticoids), pathologic glucose tolerance, hyperglycemias, dyslipoproteinemias, adiposity,  
15 hyperlipoproteinemias and/or hypotensions.

The phosphodiesterase inhibitor can be specific for a particular phosphodiesterase (e.g., Group III or Group IV) or a non-specific phosphodiesterase inhibitor, such as papaverine, theophylline, enprofyllines and/or IBMX. Specific phosphodiesterase inhibitors which  
20 inhibit group III phosphodiesterases (cGMP-inhibited phosphodiesterases), including indolidane (LY195115), cilostamide (OPC 3689), lixazinone (RS 82856), Y-590, imazodane (CI914), SKF 94120, quazinone, ICI 153,110, cilostazole, bemorandane (RWJ 22867), siguazodane (SK&F 94-836), adibendane (BM 14,478), milrinone (WIN 47203), enoximone (MDL 17043), pimobendane (UD-CG 115), MCI-154, saterinone  
25 (BDF 8634), sulmazole (ARL 115), UD-CG 212, motapizone, piroximone, and ICI 118233 can be useful. In addition, phosphodiesterase inhibitors which inhibit group IV phosphodiesterases (cAMP-specific phosphodiesterases), such as rolipram ZK 62711; pyrrolidone), imidazolidinone (RO 20-1724), etazolate (SQ 65442), denbufylline (BRL 30892), ICI63197, and RP73401 can be used.

#### Other Agents for Use in Combitherapy

Also within the invention are pharmaceutical compositions comprising a peptide or agonists described herein and a second therapeutic agent. The second therapeutic agent  
6 can be administered to treat any condition for which it is useful, including conditions that are not considered to be the primary indication for treatment with the second therapeutic agent. The second therapeutic agent can be administered simultaneously or sequentially. The second therapeutic agent can be covalently linked to the peptides and agonists described herein to create a therapeutic conjugate. When the second therapeutic agent is  
10 another peptide, a linker including those described herein may be used between the peptide described herein and the second therapeutic peptide.

Examples of additional therapeutic agents to treat gastrointestinal and other disorders include:

15 agents to treat constipation (e.g., a chloride channel activator such as the bicyclic fatty acid, Lubiprostone (formerly known as SPI-0211; Sucampo Pharmaceuticals, Inc.; Bethesda, MD), a laxative (eg. a bulk-forming laxative (e.g. nonstarch polysaccharides, Colonel Tablet (polycarbophil calcium), Plantago Ovata®, Equalactin® (Calcium Polycarbophil)), fiber (e.g. FIBERCON® (Calcium Polycarbophil), an osmotic laxative,  
20 a stimulant laxative (such as diphenylmethanes (e.g. bisacodyl), anthraquinones (e.g. cascara, senna), and surfactant laxatives (e.g. castor oil, docusates), an emollient/lubricating agent (such as mineral oil, glycerine, and docusates), MiraLax (Braintree Laboratories, Braintree MA), dexloxiglumide (Forest Laboratories, also known as CR 2017 Rottapharm (Rotta Research Laboratorium SpA)), saline laxatives,  
25 enemas, suppositories, and CR 3700 (Rottapharm (Rotta Research Laboratorium SpA));  
  
acid reducing agents such as proton pump inhibitors (e.g., omeprazole (Prilosec®), esomeprazole (Nexium®), lansoprazole (Prevacid®), pantoprazole (Protonix®) and

rabeprazole (Aciphex®) and Histamine H2-receptor antagonist (also known as H2 receptor blockers including cimetidine, ranitidine, famotidine and nizatidine);

5 prokinetic agents including itopride, octreotide, bethanechol, metoclopramide (Reglan®), domperidone (Motilium®), erythromycin (and derivatives thereof) or cisapride (propulsid®);

10 prokineticin polypeptides homologs, variants and chimeras thereof including those described in US 7,052,674 which can be used with or linked to the polypeptides described herein;

pro-motility agents such as the vasostatin-derived peptide, chromogranin A (4-16) (see, e.g., Ghia et al. 2004 Regulatory Peptides 121:31) or motilin agonists (e.g., GM-611 or mitemincinal fumarate) or nociceptin/Orphanin FQ receptor modulators (US20050169917);

15 other peptides which can bind to and/or activate GC-C including those described in US20050287067;

20 complete or partial 5HT (e.g. 5HT1, 5HT2, 5HT3, 5HT4) receptor agonists or antagonists (including 5HT1A antagonists (e.g. AGI-001 (AGI therapeutics), 5HT2B antagonists (e.g. PGN1091 and PGN1164 (Pharmagene Laboratories Limited), and 5HT4 receptor agonists (such as tegaserod (ZELNORM®), prucalopride, mosapride, metoclopramide, zacopride, cisapride, renzapride, benzimidazolone derivatives such as BIMU 1 and BIMU 8, and lorexapride). Such agonists/modulators are described in: EP1321142 A1, WO 03/053432A1, EP 505322 A1, EP 505322 B1, US 5,510,353, EP 507672 A1, EP 25 507672 B1, US 5,273,983, and US 6,951,867); 5HT3 receptor agonists such as MKC-733; and 5HT3 receptor antagonists such as DDP-225 (MCI-225; Dynogen Pharmaceuticals, Inc.), cilansetron (Calmactin®), alosetron (Lotronex®), Ondansetron HCl (Zofran®), Dolasetron (ANZEMET®), palonosetron (Aloxi®), Granisetron (Kytril®), YM060(ramosetron; Astellas Pharma Inc.; ramosetron may be given as a daily

dose of 0.002 to 0.02 mg as described in EP01588707) and ATI-7000 (Aryx Therapeutics, Santa Clara CA);

muscarinic receptor agonists;

5

anti-inflammatory agents;

antispasmodics including but not limited to anticholinergic drugs (like dicyclomine (e.g. Colimex®, Formulex®, Lomine®, Protylol®, Viscerol®, Spasmoban®, Bentyl®,

10

Bentylol®), hyoscyamine (e.g. IB-Stat®, Nulev®, Levsin®, Levbid®, Levsinex Timecaps®, Levsin/SL®, Anaspaz®, A-Spas S/L®, Cystospaz®, Cystospaz-M®, Donnamar®, Colidrops Liquid Pediatric®, Gastroed®, Hyco Elixir®, Hyosol®, Hyospaz®, Hyosyne®, Losamine®, Medispaz®, Neosol®, Spacol®, Spasdel®, Symax®, Symax SL®), Donnatal (e.g. Donnatal Extentabs®), clidinium (e.g. Quarzan, in

15

combination with Librium = Librax), methantheline (e.g. Banthine), Mepenzolate (e.g. Cantil), homatropine (e.g. hycodan, Homapin), Propantheline bromide (e.g. Pro-Banthine), Glycopyrrolate (e.g. Robinul®, Robinul Forte®), scopolamine (e.g. Transderm-Scop®, Transderm-V®), hyosine-N-butylbromide (e.g. Buscopan®),

20

Pirenzepine (e.g. Gastrozepin®) Propantheline Bromide (e.g. Propanthel®), dicycloverine (e.g. Merbentyl®), glycopyrronium bromide (e.g. Glycopyrrolate®), hyoscine hydrobromide, hyoscine methobromide, methanthelinium, and octatropine); peppermint oil; and direct smooth muscle relaxants like cimetropium bromide,

25

mebeverine (DUSPATAL®, DUSPATALIN®, COLOFAC MR®, COLOTAL®), otilonium bromide (otilonium), pinaverium (e.g. Dicitel® (pinaverium bromide; Solvay S.A.)), Spasfon® (hydrated phloroglucinol and trimethylphloroglucinol) and trimebutine (including trimebutine maleate (Modulon®);

antidepressants, including but not limited to those listed herein, as well as tricyclic antidepressants like amitriptyline (Elavil®), desipramine (Norpramin®), imipramine (Tofranil®), amoxapine (Asendin®), nortriptyline; the selective serotonin reuptake

30

inhibitors (SSRI's) like paroxetine (Paxil®), fluoxetine (Prozac®), sertraline (Zoloft®), and citalopram (Celexa®); and others like doxepin (Sinequan®) and trazodone (Desyrel®);

- 5 centrally-acting analgesic agents such as opioid receptor agonists, opioid receptor antagonists (e.g., naltrexone);

agents for the treatment of Inflammatory bowel disease;

- 10 agents for the treatment of Crohn's disease and/or ulcerative colitis (e.g., alequel (Enzo Biochem, Inc.; Farmingsale, NY), the anti-inflammatory peptide RDP58 (Genzyme, Inc.; Cambridge, MA), and TRAFICET-EN™ (ChemoCentryx, Inc.; San Carlos, CA);

agents that treat gastrointestinal or visceral pain;

15

agents that increase cGMP levels (as described in US20040121994) like adrenergic receptor antagonists, dopamine receptor agonists and PDE (phosphodiesterase) inhibitors including but not limited to those disclosed herein;

- 20 purgatives that draw fluids to the intestine (e.g., VISICOL®, a combination of sodium phosphate monobasic monohydrate and sodium phosphate dibasic anhydrate);

Corticotropin Releasing Factor (CRF) receptor antagonists (including NBI-34041 (Neurocrine Biosciences, San Diego, CA), CRH9-41, astressin, R121919 (Janssen

- 25 Pharmaceutica), CP154,526, NBI-27914, Antalarmin, DMP696 (Bristol-Myers Squibb) CP-316,311 (Pfizer, Inc.), SB723620 (GSK), GW876008 (Neurocrine/Glaxo Smith Kline), ONO-2333Ms (Ono Pharmaceuticals), TS-041 (Janssen), AAG561 (Novartis) and those disclosed in US 5,063,245, US 5,861,398, US20040224964, US20040198726,

US20040176400, US20040171607, US20040110815, US20040006066, and  
US20050209253);

glucagon-like peptides (glp-1) and analogues thereof (including exendin-4 and GTP-010  
5 (Gastrotech Pharma A)) and inhibitors of DPP-IV (DPP-IV mediates the inactivation of  
glp-1);

tofisopam, enantiomerically-pure R-tofisopam, and pharmaceutically-acceptable salts  
thereof (US 20040229867);

10

tricyclic anti-depressants of the dibenzothiazepine type including but not limited to  
Dextofisopam® (Vela Pharmaceuticals), tianeptine (Stablon®) and other agents  
described in US 6,683,072;

15 (E)-4 (1,3bis(cyclohexylmethyl)-1,2,3,4,-tetrahydro-2,6-diono-9H-purin-8-yl)cinnamic  
acid nonaethylene glycol methyl ether ester and related compounds described in WO  
02/067942;

the probiotic PROBACTRIX® (The BioBalance Corporation; New York, NY) which  
20 contains microorganisms useful in the treatment of gastrointestinal disorders;

antidiarrheal drugs including but not limited to loperamide (Imodium, Pepto Diarrhea),  
diphenoxylate with atropine (Lomotil, Lomocot), cholestyramine (Questran, Cholybar),  
atropine (Co-Phenotrope, Diarsed, Diphenoxylate, Lofene, Logen, Lonox, Vi-Atro,  
25 atropine sulfate injection) and Xifaxan® (rifaximin; Salix Pharmaceuticals Ltd), TZP-  
201 (Tranzyme Pharma Inc.), the neuronal acetylcholine receptor (nAChR) blocker AGI-  
004 (AGI therapeutics), and bismuth subsalicylate (Pepto-bismol);



anxiolytic drugs including but not limited to Ativan (lorazepam), alprazolam (Xanax®),  
chlordiazepoxide/clidinium (Librium®, Librax®), clonazepam (Klonopin®), clorazepate  
(Tranxene®), diazepam (Valium®), estazolam (ProSom®), flurazepam (Dalmane®),  
oxazepam (Serax®), prazepam (Centrax®), temazepam (Restoril®), triazolam  
5 (Halcion®);

Bedelix® (Montmorillonite beidellitic; Ipsen Ltd), Solvay SLV332 (AtrQule Inc), YKP  
(SK Pharma), Asimadoline (Tioga Pharmaceuticals/Merck), AGI-003 (AGI  
Therapeutics);

10 neurokinin antagonists including those described in US20060040950;

potassium channel modulators including those described in US7,002,015;

15 the serotonin modulator AZD7371 (AstraZeneca Plc);

M3 muscarinic receptor antagonists such as darifenacin (Enablex; Novartis AG and  
zamifenacin (Pfizer);

20 herbal and natural therapies including but not limited to acidophilus, chamomile tea,  
evening primrose oil, fennel seeds, wormwood, comfrey, and compounds of Bao-Ji-Wan  
(magnolol, honokiol, imperatorin, and isoimperatorin) as in US6923992; and

25 compositions comprising lysine and an anti-stress agent for the treatment of irritable  
bowel syndrome as described in EP01550443.

The peptides and agonists described herein can be used in combination therapy  
with insulin and related compounds including primate, rodent, or rabbit insulin including  
biologically active variants thereof including allelic variants, more preferably human

insulin available in recombinant form. Sources of human insulin include pharmaceutically acceptable and sterile formulations such as those available from Eli Lilly (Indianapolis, Ind. 46285) as Humulin<sup>TM</sup> (human insulin rDNA origin). See the THE PHYSICIAN'S DESK REFERENCE, 55<sup>sup.th</sup> Ed. (2001) Medical Economics, Thomson Healthcare (disclosing other suitable human insulins). The peptides and agonists described herein can also be used in combination therapy with agents that can boost insulin effects or levels of a subject upon administration, e.g. glipizide and/or rosiglitazone. The peptides and agonists described herein can be used in combination therapy with SYMLIN<sup>®</sup> (pramlintide acetate) and Exenatide<sup>®</sup> (synthetic exendin-4; a 39 aa peptide).

The peptides and agonists described herein can also be used in combination therapy with agents (e.g., Entereg<sup>TM</sup> (alvimopan; formerly called adolor/ ADL 8-2698), conivaptan and related agents describe in US 6,645,959) used for the treatment of postoperative ileus and other disorders.

The peptides and agonists described herein can be used in combination therapy with an anti-hypertensive agent including but not limited to:

(1) diuretics, such as thiazides, including chlorthalidone, chlorthiazide, dichlorophenamide, hydroflumethiazide, indapamide, polythiazide, and hydrochlorothiazide; loop diuretics, such as bumetanide, ethacrynic acid, furosemide, and torsemide; potassium sparing agents, such as amiloride, and triamterene; carbonic anhydrase inhibitors, osmotics (such as glycerin) and aldosterone antagonists, such as spironolactone, epi renone, and the like; (2) beta-adrenergic blockers such as acebutolol, atenolol, betaxolol, bevantolol, bisoprolol, bopindolol, carteolol, carvedilol, celiprolol, esmolol, indenolol, metaprolol, nadolol, nebivolol, penbutolol, pindolol, propanolol, sotalol, tertatolol, tilisolol, and timolol, and the like;

(3) calcium channel blockers such as amlodipine, aranidipine, azelnidipine, barnidipine, benidipine, bepridil, cinaldipine, clevidipine, diltiazem, efonidipine,

felodipine, gallopamil, isradipine, lacidipine, lemildipine, lercanidipine, nicardipine, nifedipine, nilvadipine, nimodipine, nisoldipine, nitrendipine, manidipine, pranidipine, and verapamil, and the like;

(4) angiotensin converting enzyme (ACE) inhibitors such as benazepril;  
5 captopril; ceranapril; cilazapril; delapril; enalapril; enalapril; fosinopril; imidapril; lisinopril; losinopril; moexipril; quinapril; quinaprilat; ramipril; perindopril; perindopril; quanipril; spirapril; tenocapril;trandolapril, and zofenopril, and the like;

(5) neutral endopeptidase inhibitors such as omapatrilat, cadoxatril and ecadotril, fosidotril, sampatrilat, AVE7688, ER4030, and the like;

10 (6) endothelin antagonists such as tezosentan, A308165, and YM62899, and the like;

(7) vasodilators such as hydralazine, clonidine, minoxidil, and nicotinyl alcohol, and the like;

(8) angiotensin II receptor antagonists such as aprosartan, candesartan,  
15 eprosartan, irbesartan, losartan, olmesartan, prazosartan, tasosartan, telmisartan, valsartan, and EXP-3137, FI6828K, and RNH6270, and the like;

(9)  $\alpha/\beta$  adrenergic blockers such as nipradilol, arotinolol and amosulalol, and the like;

(10) alpha 1 blockers, such as terazosin, urapidil, prazosin, tamsulosin,  
20 bunazosin, trimazosin, doxazosin, naftopidil, indoramin, WHP 164, and XEN010, and the like;

(11) alpha 2 agonists such as lofexidine, tiamenidine, moxonidine, rilmenidine and guanobenz, and the like;

(12) aldosterone inhibitors, and the like; and

25 (13) angiotensin-2-binding agents such as those disclosed in WO03/030833.

Specific anti-hypertensive agents that can be used in combination with peptides and agonists described herein include, but are not limited to:

diuretics, such as thiazides (e.g., chlorthalidone, cyclothiazide (CAS RN 2259-96-3), chlorothiazide (CAS RN 72956-09-3, which may be prepared as disclosed in US2809194), dichlorophenamide, hydroflumethiazide, indapamide, polythiazide, bendroflumethazide, methyclothazide, polythiazide, trichlormethazide, chlorthalidone, 5 indapamide, metolazone, quinethazone, althiazide (CAS RN 5588-16-9, which may be prepared as disclosed in British Patent No. 902,658), benzthiazide (CAS RN 91-33-8, which may be prepared as disclosed in US3108097), buthiazide (which may be prepared as disclosed in British Patent Nos. 861,367), and hydrochlorothiazide), loop diuretics (e.g. bumetanide, ethacrynic acid, furosemide, and torasemide), potassium sparing agents 10 (e.g. amiloride, and triamterene (CAS Number 396-01-0)), and aldosterone antagonists (e.g. spironolactone (CAS Number 52-01-7), epi renone, and the like);  $\beta$ -adrenergic blockers such as Amiodarone (Cordarone, Pacerone), bunolol hydrochloride (CAS RN 31969-05-8, Parke-Davis), acebutolol ( $\pm$ N-[3-Acetyl-4-[2-hydroxy-3-[(1 methylethyl)amino]propoxy]phenyl]-butanamide, or ( $\pm$ )-3'-Acetyl-4'-[2-hydroxy-3- 15 (isopropylamino) propoxy] butyranilide), acebutolol hydrochloride (e.g. Sectral®, Wyeth-Ayerst), alprenolol hydrochloride (CAS RN 13707-88-5 see Netherlands Patent Application No. 6,605,692), atenolol (e.g. Tenormin®, AstraZeneca), carteolol hydrochloride (e.g. Cartrol® Filmtab®, Abbott), Celiprolol hydrochloride (CAS RN 57470-78-7, also see in US4034009), cetamolol hydrochloride (CAS RN 77590-95-5, see 20 also US4059622), labetalol hydrochloride (e.g. Normodyne®, Schering), esmolol hydrochloride (e.g. Brevibloc®, Baxter), levobetaxolol hydrochloride (e.g. Betaxon™ Ophthalmic Suspension, Alcon), levobunolol hydrochloride (e.g. Betagan® Liquifilm® with C CAP® Compliance Cap, Allergan), nadolol (e.g. Nadolol, Mylan), practolol (CAS RN 6673-35-4, see also US3408387), propranolol hydrochloride (CAS RN 318-98-9), 25 sotalol hydrochloride (e.g. Betapace AF™, Berlex), timolol (2-Propanol, 1-[(1,1-dimethylethyl)amino]-3-[[4-(4-morpholinyl)-1,2,5-thiadiazol-3-yl]oxy]-, hemihydrate, (S)-, CAS RN 91524-16-2), timolol maleate (S)-1-[(1,1-dimethylethyl) amino]-3-[[4-(4-morpholinyl)-1,2,5-thiadiazol-3-yl]oxy]-2-propanol (Z)-2-butenedioate (1:1) salt, CAS

RN 26921-17-5), bisoprolol (2-Propanol, 1-[4-[[2-(1-methylethoxy)ethoxy]-methyl]phenoxy]-3-[(1-methylethyl)amino]-, ( $\pm$ ), CAS RN 66722-44-9), bisoprolol fumarate (such as ( $\pm$ )-1-[4-[[2-(1-Methylethoxy) ethoxy]methyl]phenoxy]-3-[(1-methylethyl)amino]-2-propanol (E) -2-butenedioate (2:1) (salt), e.g., Zebeta™, Lederle Consumer), nebivolol (2H-1-Benzopyran-2-methanol,  $\alpha\alpha'$ -[iminobis(methylene)]bis[6-fluoro-3,4-dihydro-, CAS RN 99200-09-6 see also U.S. Pat. No. 4,654,362), cicloprolol hydrochloride, such 2-Propanol, 1-[4-[2-(cyclopropylmethoxy)ethoxy]phenoxy]-3-[1-methylethyl)amino]-, hydrochloride, A.A.S. RN 63686-79-3), dexpropranolol hydrochloride (2-Propanol, 1-[1-methylethyl)-amino]-3-(1-naphthalenyloxy)-hydrochloride (CAS RN 13071-11-9), diacetolol hydrochloride (Acetamide, N-[3-acetyl-4-[2-hydroxy-3-[(1-methyl-ethyl)amino]propoxy][phenyl]-, monohydrochloride CAS RN 69796-04-9), dilevalol hydrochloride (Benzamide, 2-hydroxy-5-[1-hydroxy-2-[1-methyl-3-phenylpropyl)amino]ethyl]-, monohydrochloride, CAS RN 75659-08-4), exaprolol hydrochloride (2-Propanol, 1-(2-cyclohexylphenoxy)-3-[(1-methylethyl)amino]-, hydrochloride CAS RN 59333-90-3), fleistolol sulfate (Benzoic acid, 2-fluoro-3-[[2-[aminocarbonyl)amino]-dimethylethyl]amino]-2-hydroxypropyl ester, ( $\pm$ )- sulfate (1:1) (salt), CAS RN 88844-73-9; metalol hydrochloride (Methanesulfonamide, N-[4-[1-hydroxy-2-(methylamino)propyl]phenyl]-, monohydrochloride CAS RN 7701-65-7), metoprolol 2-Propanol, 1-[4-(2-methoxyethyl)phenoxy]-3-[1-methylethyl)amino]-; CAS RN 37350-58-6), metoprolol tartrate (such as 2-Propanol, 1-[4-(2-methoxyethyl)phenoxy]-3-[(1-methylethyl)amino]-, e.g., Lopressor®, Novartis), pamatolol sulfate (Carbamic acid, [2-[4-[2-hydroxy-3-[(1-methylethyl)amino]propoxyl]phenyl]-ethyl]-, methyl ester, ( $\pm$ ) sulfate (salt) (2:1), CAS RN 59954-01-7), penbutolol sulfate (2-Propanol, 1-(2-cyclopentylphenoxy)-3-[1,1-dimethylethyl)amino]1, (S)-, sulfate (2:1) (salt), CAS RN 38363-32-5), practolol (Acetamide, N-[4-[2-hydroxy-3-[(1-methylethyl)amino]-propoxy]phenyl]-, CAS RN 6673-35-4); tiprenolol hydrochloride (Propanol, 1-[(1-methylethyl)amino]-3-[2-(methylthio)-phenoxy]-, hydrochloride, ( $\pm$ ), CAS RN 39832-43-4), tolamolol

(Benzamide, 4-[2-[[2-hydroxy-3-(2-methylphenoxy)-propyl]amino]ethoxyl]-, CAS RN 38103-61-6), bopindolol, indenolol, pindolol, propanolol, tertatolol, and tilisolol, and the like; calcium channel blockers such as besylate salt of amlodipine (such as 3-ethyl-5-methyl-2-(2-aminoethoxymethyl)-4-(2-chlorophenyl)-1,4-dihydro-6-methyl-3,5-

5 pyridinedicarboxylate benzenesulphonate, e.g., Norvasc®, Pfizer), clentiazem maleate (1,5-Benzothiazepin-4(5H)-one, 3-(acetyloxy)-8-chloro-5-[2-(dimethylamino)ethyl]-2,3-dihydro-2-(4-methoxyphenyl)-(2S-cis)-, (Z)-2-butenedioate (1:1), see also US4567195), isradipine (3,5-Pyridinedicarboxylic acid, 4-(4-benzofurazanyl)-1,4-dihydro-2,6-dimethyl-, methyl 1-methylethyl ester, (±)-4(4-benzofurazanyl)-1,4-dihydro-2,6-

10 dimethyl-3,5-pyridinedicarboxylate, see also US4466972); nimodipine (such as isopropyl (2-methoxyethyl) 1,4-dihydro-2,6-dimethyl-4-(3-nitrophenyl)-3,5-pyridine-dicarboxylate, e.g. Nimotop®, Bayer), felodipine (such as ethyl methyl 4-(2,3-dichlorophenyl)-1,4-dihydro-2,6-dimethyl-3,5-pyridinedicarboxylate-, e.g. Plendil® Extended-Release, AstraZeneca LP), nilvadipine (3,5-Pyridinedicarboxylic acid, 2-

15 cyano-1,4-dihydro-6-methyl-4-(3-nitrophenyl)-,3-methyl 5-(1-methylethyl) ester, also see US3799934), nifedipine (such as 3,5-pyridinedicarboxylic acid,1,4-dihydro-2,6-dimethyl-4-(2-nitrophenyl)-, dimethyl ester, e.g., Procardia XL® Extended Release Tablets, Pfizer), diltiazem hydrochloride (such as 1,5-Benzothiazepin-4(5H)-one,3-(acetyloxy)-5[2-(dimethylamino)ethyl]-2,-3-dihydro-2(4-methoxyphenyl)-, monohydrochloride, (+)-

20 cis., e.g., Tiazac®, Forest), verapamil hydrochloride (such as benzeneacetonitrile, (alpha)-[[3-[[2-(3,4-dimethoxyphenyl) ethyl]methylamino]propyl]-3,4-dimethoxy-(alpha)-(1-methylethyl) hydrochloride, e.g., Isoptin® SR, Knoll Labs), teludipine hydrochloride (3,5-Pyridinedicarboxylic acid, 2-[(dimethylamino)methyl]4-[2-[(1E)-3-(1,1-dimethylethoxy)-3-oxo-1-propenyl]phenyl]-1,4-dihydro-6-methyl-, diethyl ester,

25 monohydrochloride) CAS RN 108700-03-4), belfosdil (Phosphonic acid, [2-(2-phenoxyethyl)-1,3-propane-diyl]bis-, tetrabutyl ester CAS RN 103486-79-9), fostedil (Phosphonic acid, [[4-(2-benzothiazolyl)phenyl]methyl]-, diethyl ester CAS RN 75889-62-2), aranidipine, azelnidipine, barnidipine, benidipine, bepridil, cinaldipine, clevidipine, efonidipine, gallopamil, lacidipine, lemildipine, lercanidipine, monatepil

- maleate (1-Piperazinebutanamide, N-(6,11-dihydrodibenzo(b,e)thiepin-11-yl)<sub>4</sub>-(4-fluorophenyl)-, (±)-, (Z)-2-butenedioate (1:1) (±)-N-(6,11-Dihydrodibenzo(b,e)thiepin-11-yl)-4-(p-fluorophenyl)-1-piperazinebutyramide maleate (1:1) CAS RN 132046-06-1), nicardipine, nisoldipine, nitrendipine, manidipine, pranidipine, and the like;
- 5 T-channel calcium antagonists such as mibefradil; angiotensin converting enzyme (ACE) inhibitors such as benazepril, benazepril hydrochloride (such as 3-[[1-(ethoxycarbonyl)-3-phenyl-(1S)-propyl]amino]-2,3,4,5-tetrahydro-2-oxo-1H-1-(3S)-benzazepine-1-acetic acid monohydrochloride, e.g., Lotrel®, Novartis), captopril (such as 1-[(2S)-3-mercapto-2-methylpropionyl]-L-proline, e.g., Captopril, Mylan, CAS RN 62571-86-2 and others
- 10 disclosed in US4046889), ceranapril (and others disclosed in US4452790), cetapril (alacepril, Dainippon disclosed in Eur. Therap. Res. 39:671 (1986); 40:543 (1986)), cilazapril (Hoffman-LaRoche) disclosed in J. Cardiovasc. Pharmacol. 9:39 (1987), indalapril (delapril hydrochloride (2H-1,2,4-Benzothiadiazine-7-sulfonamide, 3-bicyclo[2.2.1]hept-5-en-2-yl-6-chloro-3,4-dihydro-, 1,1-dioxide CAS RN 2259-96-3);
- 15 disclosed in US4385051), enalapril (and others disclosed in US4374829), enalapril, enalaprilat, fosinopril, ((such as L-proline, 4-cyclohexyl-1-[[[2-methyl-1-(1-oxopropoxy)propoxy](4-phenylbutyl) phosphinyl]acetyl]-, sodium salt, trans—, e.g., Monopril, Bristol-Myers Squibb and others disclosed in US4168267), fosinopril sodium (L-Proline, 4-cyclohexyl-1-[[[R)-[(1S)-2-methyl-1-(1-oxopropoxy)propoxy]propoxy], imidapril, indolapril
- 20 (Schering, disclosed in J. Cardiovasc. Pharmacol. 5:643, 655 (1983)), lisinopril (Merck), losinopril, moexipril, moexipril hydrochloride (3-Isoquinolinecarboxylic acid, 2-[(2S)-2-[[[(1S)-1-(ethoxycarbonyl)-3-phenylpropyl]amino]-1-oxopropyl]-1,2,3,4-tetrahydro-6,7-dimethoxy-, monohydrochloride, (3S)- CAS RN 82586-52-5), quinapril, quinaprilat, ramipril (Hoechst) disclosed in EP 79022 and Curr. Ther. Res. 40:74 (1986), perindopril
- 25 erbumine (such as 2S,3aS,7aS-1-[(S)-N-[(S)-1-Carboxybutyl]alanyl]hexahydro-2-indolinecarboxylic acid, 1-ethyl ester, compound with tert-butylamine (1:1), e.g., Aceon®, Solvay), perindopril (Servier, disclosed in Eur. J. clin. Pharmacol. 31:519 (1987)), quanipril (disclosed in US4344949), spirapril (Schering, disclosed in Acta. Pharmacol. Toxicol. 59 (Supp. 5):173 (1986)), tenocapril, trandolapril, zofenopril (and

others disclosed in US4316906), rentiapril (fentiapril, disclosed in Clin. Exp. Pharmacol. Physiol. 10:131 (1983)), pivopril, YS980, teprotide (Bradykinin potentiator BPP9a CAS RN 35115-60-7), BRL 36,378 (Smith Kline Beecham, see EP80822 and EP60668), MC-838 (Chugai, see C.A. 102:72588v and Jap. J. Pharmacol. 40:373 (1986), CGS 14824  
5 (Ciba-Geigy, 3-([1-ethoxycarbonyl-3-phenyl-(1S)-propyl]amino)-2,3,4,5-tetrahydro-2-oxo- o-1-(3S)-benzazepine-1 acetic acid HCl, see U.K. Patent No. 2103614), CGS 16,617 (Ciba-Geigy, 3(S)-[[[(1S)-5-amino-1-carboxypentyl]amino]-2,3,4,- 5-tetrahydro-2-oxo-1H-1-benzazepine-1-ethanoic acid, see US4473575), Ru 44570 (Hoechst, see Arzneimittelforschung 34:1254 (1985)), R 31-2201 (Hoffman-LaRoche see FEBS Lett.  
10 165:201 (1984)), CI925 (Pharmacologist 26:243, 266 (1984)), WY-44221 (Wyeth, see J. Med. Chem. 26:394 (1983)), and those disclosed in US2003006922 (paragraph 28), US4337201, US4432971 (phosphoramidates); neutral endopeptidase inhibitors such as omapatrilat (Vanlev®), CGS 30440, cadoxatril and ecadotril, fasidotril (also known as aladotril or alatriopril), sampatrilat, mixanpril, and gemopatrilat, AVE7688, ER4030, and  
15 those disclosed in US5362727, US5366973, US5225401, US4722810, US5223516, US4749688, US5552397, US5504080, US5612359, US5525723, EP0599444, EP0481522, EP0599444, EP0595610, EP0534363, EP534396, EP534492, EP0629627; endothelin antagonists such as tezosentan, A308165, and YM62899, and the like; vasodilators such as hydralazine (apresoline), clonidine (clonidine hydrochloride (1H-  
20 Imidazol-2-amine, N-(2,6-dichlorophenyl)4,5-dihydro-, monohydrochloride CAS RN 4205-91-8), catapres, minoxidil (loniten), nicotinyl alcohol (roniacol), diltiazem hydrochloride (such as 1,5-Benzothiazepin-4(5H)-one,3-(acetyloxy)-5[2-(dimethylamino)ethyl]-2,-3-dihydro-2(4-methoxyphenyl)-, monohydrochloride, (+)-cis, e.g., Tiazac®, Forest), isosorbide dinitrate (such as 1,4:3,6-dianhydro-D-glucitol 2,5-  
25 dinitrate e.g., Isordil® Titradose®, Wyeth-Ayerst), sosorbide mononitrate (such as 1,4:3,6-dianhydro-D-glucito- 1,5-nitrate, an organic nitrate, e.g., Ismo®, Wyeth-Ayerst), nitroglycerin (such as 2,3 propanetriol trinitrate, e.g., Nitrostat® Parke-Davis), verapamil hydrochloride (such as benzeneacetonitrile, (±)-(alpha)[3-[[2-(3,4 dimethoxyphenyl)ethyl]methylamino]propyl]-3,4-dimethoxy-(alpha)- (1-methylethyl)



hydrochloride, e.g., Covera HS® Extended-Release, Searle), chromonar (which may be prepared as disclosed in US3282938), clonitate (Annalen 1870 155), droprenilamine (which may be prepared as disclosed in DE2521113), lidoflazine (which may be prepared as disclosed in US3267104); prenylamine (which may be prepared as disclosed in  
5 US3152173), propatyl nitrate (which may be prepared as disclosed in French Patent No. 1,103,113), mioflazine hydrochloride (1-Piperazineacetamide, 3-(aminocarbonyl)<sub>4</sub>-[4,4-bis(4-fluorophenyl)butyl]-N-(2,6-dichlorophenyl)-, dihydrochloride CAS RN 83898-67-3), mixidine (Benzeneethanamine, 3,4-dimethoxy-N-(1-methyl-2-pyrrolidinylidene)-Pyrrolidine, 2-[(3,4-dimethoxyphenethyl)imino]-1-methyl-1-Methyl-2-[(3,4-  
10 dimethoxyphenethyl)imino]pyrrolidine CAS RN 27737-38-8), molsidomine (1,2,3-Oxadiazolium, 5-[(ethoxycarbonyl)amino]-3-(4-morpholinyl)-, inner salt CAS RN 25717-80-0), isosorbide mononitrate (D-Glucitol, 1,4:3,6-dianhydro-, 5-nitrate CAS RN 16051-77-7), erythryl tetranitrate (1,2,3,4-Butanetetrol, tetranitrate, (2R,3S)-rel-CAS RN 7297-25-8), clonitrate(1,2-Propanediol, 3-chloro-, dinitrate (7CI, 8CI, 9CI) CAS RN  
15 2612-33-1), dipyridamole Ethanol, 2,2',2'',2'''-[(4,8-di-1-piperidinylpyrimido[5,4-d]pyrimidine-2,6-diyl)dinitrilo]tetrakis- CAS RN 58-32-2), nicorandil (CAS RN 65141-46-0 3-), pyridinecarboxamide (N-[2-(nitrooxy)ethyl]-Nisoldipine3,5-Pyridinedicarboxylic acid, 1,4-dihydro-2,6-dimethyl-4-(2-nitrophenyl)-, methyl 2-methylpropyl ester CAS RN 63675-72-9), nifedipine3,5-Pyridinedicarboxylic acid, 1,4-  
20 dihydro-2,6-dimethyl-4-(2-nitrophenyl)-, dimethyl ester CAS RN 21829-25-4), perhexiline maleate (Piperidine, 2-(2,2-dicyclohexylethyl)-, (2Z)-2-butenedioate (1:1) CAS RN 6724-53-4), oxprenolol hydrochloride (2-Propanol, 1-[(1-methylethyl)amino]-3-[2-(2-propenyloxy)phenoxy]-, hydrochloride CAS RN 6452-73-9), pentrinitrol (1,3-Propanediol, 2,2-bis[(nitrooxy)methyl]-, mononitrate (ester) CAS RN 1607-17-6),  
25 verapamil (Benzeneacetonitrile,  $\alpha$ -[3-[[2-(3,4-dimethoxyphenyl)ethyl]-methylamino]propyl]-3,4-dimethoxy- $\alpha$ -(1-methylethyl)- CAS RN 52-53-9) and the like; angiotensin II receptor antagonists such as, aprosartan, zolasartan, olmesartan, prazosartan, FI6828K, RNH6270, candesartan (1 H-Benzimidazole-7-carboxylic acid, 2-ethoxy-1-[[2'-(1H-tetrazol-5-yl)[1,1'-biphenyl]4-yl]methyl]- CAS RN 139481-59-7),

candesartan cilexetil ((+/-)-1-(cyclohexylcarbonyloxy)ethyl-2-ethoxy-1-[[2'-(1H-tetrazol-5-yl)biphenyl-4-yl]-1H-benzimidazole carboxylate, CAS RN 145040-37-5, US5703110 and US5196444), eprosartan (3-[1-4-carboxyphenylmethyl]-2-n-butyl-imidazol-5-yl)-(2-thienylmethyl) propenoic acid, US5185351 and US5650650), irbesartan (2-n-butyl-3-  
6 [[2'-(1H-tetrazol-5-yl)biphenyl-4-yl]methyl]1,3-diazaspiro[4,4]non-1-en-4-one, US5270317 and US5352788), losartan (2-N-butyl-4-chloro-5-hydroxymethyl-1-[(2'-(1H-tetrazol-5-yl)biphenyl-4-yl)-methyl]imidazole, potassium salt, US5138069, US5153197 and US5128355), tasosartan (5,8-dihydro-2,4-dimethyl-8-[(2'-(1H-tetrazol-5-yl)[1,1'-biphenyl]4-yl)methyl]-pyrido[2,3-d]pyrimidin-7(6H)-one, US5149699), telmisartan (4'-  
10 [(1,4-dimethyl-2'-propyl-(2,6'-bi-1H-benzimidazol)-1'-yl)]-[1,1'-biphenyl]-2-carboxylic acid, CAS RN 144701-48-4, US5591762), milfasartan, abitesartan, valsartan (Diovan® (Novartis), (S)-N-valeryl-N-[[2'-(1H-tetrazol-5-yl)biphenyl-4-yl)methyl]valine, US5399578), EXP-3137 (2-N-butyl-4-chloro-1-[(2'-(1H-tetrazol-5-yl)biphenyl-4-yl)-methyl]imidazole-5-carboxylic acid, US5138069, US5153197 and US5128355), 3-(2'-  
15 (tetrazol-5-yl)-1,1'-biphen-4-yl)methyl-5,7-dimethyl-2-ethyl-3H-imidazo[4,5-b]pyridine, 4'[2-ethyl-4-methyl-6-(5,6,7,8-tetrahydroimidazo[1,2-a]pyridin-2-yl)-benzimidazol-1-yl]-methyl-1,1'-biphenyl]-2-carboxylic acid, 2-butyl-6-(1-methoxy-1-methylethyl)-2-  
[[2'-(1H-tetrazol-5-yl)biphenyl-4-ylmethyl]guinazolin-4(3H)-one, 3-[2'-carboxybiphenyl-4-yl)methyl]-2-cyclopropyl-7-methyl-3H-imidazo[4,5-b]pyridine, 2-butyl-4-chloro-1-  
20 [(2'-tetrazol-5-yl)biphenyl-4-yl)methyl]imidazole-carboxylic acid, 2-butyl-4-chloro-1-[[2'-(1H-tetrazol-5-yl)[1,1'-biphenyl]-4-yl)methyl]-1H-imidazole-5-carboxylic acid-1-(ethoxycarbonyloxy)ethyl ester potassium salt, dipotassium 2-butyl-4-(methylthio)-1-  
[[2-[[[(propylamino)carbonyl]amino]-sulfonyl](1,1'-biphenyl)-4-yl)methyl]-1H-imidazole-5-carboxylate, methyl-2-[[4-butyl-2-methyl-6-oxo-5-[[2'-(1H-tetrazol-5-yl)-  
25 [1,1'-biphenyl]-4-yl)methyl]-1-(6H)-pyrimidinyl]methyl]-3-thiophencarboxylate, 5-[(3,5-dibutyl-1H-1,2,4-triazol-1-yl)methyl]-2-[2-(1H-tetrazol-5-ylphenyl)]pyridine, 6-butyl-2-(2-phenylethyl)-5[[2'-(1H-tetrazol-5-yl)[1,1'-biphenyl]-4-methyl]pyrimidin-4-(3H)-one D,L lysine salt, 5-methyl-7-n-propyl-8-[[2'-(1H-tetrazol-5-yl)biphenyl-4-yl)methyl]-  
[1,2,4]-triazolo[1,5-c]pyrimidin-2(3H)-one, 2,7-diethyl-5-[[2'-(5-tetrazolyl)biphenyl-4-

yl)methyl]-5H-pyrazolo[1,5-b][1,2,4]triazole potassium salt, 2-[2-butyl-4,5-dihydro-4-oxo-3-[2'-(1H-tetrazol-5-yl)-4-biphenylmethyl]-3H-imidazol[4,5-c]pyridine-5-ylmethyl]benzoic acid, ethyl ester, potassium salt, 3-methoxy-2,6-dimethyl-4-[[2'-(1H-tetrazol-5-yl)-1,1'-biphenyl-4-yl]methoxy]pyridine, 2-ethoxy-1-[[2'-(5-oxo-2,5-dihydro-1,2,4-oxadiazol-3-yl)biphenyl-4-yl]methyl]-1H-benzimidazole-7-carboxylic acid, 1-[N-(2'-(1H-tetrazol-5-yl)biphenyl-4-yl-methyl)-N-valerolylaminomethyl]cyclopentane-1-carboxylic acid, 7-methyl-2n-propyl-3-[[2'-(1H-tetrazol-5-yl)biphenyl-4-yl]methyl]-3H-imidazo[4,5-6]pyridine, 2-[5-[(2-ethyl-5,7-dimethyl-3H-imidazo[4,5-b]pyridine-3-yl)methyl]-2-quinolinyl]sodium benzoate, 2-butyl-6-chloro-4-hydroxymethyl-5-methyl-3-[[2'-(1H-tetrazol-5-yl)biphenyl-4-yl]methyl]pyridine, 2-[[[2-butyl-1-(4-carboxyphenyl)methyl]-1H-imidazol-5-yl]methyl]amino]benzoic acid tetrazol-5-yl)biphenyl-4-yl]methyl]pyrimidin-6-one, 4(S)-[4-(carboxymethyl)phenoxy]-N-[2(R)-[4-(2-sulfobenzamido)imidazol-1-yl]octanoyl]-L-proline, 1-(2,6-dimethylphenyl)-4-butyl-1,3-dihydro-3-[[6-[2-(1H-tetrazol-5-yl)phenyl]-3-pyridinyl]methyl]-2H-imidazol-2-one, 5,8-ethano-5,8-dimethyl-2-n-propyl-5,6,7,8-tetrahydro-1-[[2'-(1H-tetrazol-5-yl)biphenyl-4-yl]methyl]-1H,4H-1,3,4a,8a-tetraazacyclopentanaphthalene-9-one, 4-[1-[2'-(1,2,3,4-tetrazol-5-yl)biphen-4-yl)methylamino]-5,6,7,8-tetrahydro-2-triflylquinazoline, 2-(2-chlorobenzoyl)imino-5-ethyl-3-[2'-(1H-tetrazole-5-yl)biphenyl-4-yl)methyl-1,3,4-thiadiazoline, 2-[5-ethyl-3-[2-(1H-tetrazole-5-yl)biphenyl-4-yl]methyl-1,3,4-thiazoline-2-ylidene]aminocarbonyl-1-cyclopentencarboxylic acid dipotassium salt, and 2-butyl-4-[N-methyl-N-(3-methylcrotonoyl)amino]-1-[[2'-(1H-tetrazol-5-yl)biphenyl-4-yl]methyl]-1H-imidazole-5-carboxylic acid 1-ethoxycarbonyloxyethyl ester, those disclosed in patent publications EP475206, EP497150, EP539086, EP539713, EP535463, EP535465, EP542059, EP497121, EP535420, EP407342, EP415886, EP424317, EP435827, EP433983, EP475898, EP490820, EP528762, EP324377, EP323841, EP420237, EP500297, EP426021, EP480204, EP429257, EP430709, EP434249, EP446062, EP505954, EP524217, EP514197, EP514198, EP514193, EP514192, EP450566, EP468372, EP485929, EP503162, EP533058, EP467207 EP399731, EP399732, EP412848, EP453210, EP456442, EP470794, EP470795, EP495626, EP495627,

EP499414, EP499416, EP499415, EP511791, EP516392, EP520723, EP520724,  
EP539066, EP438869, EP505893, EP530702, EP400835, EP400974, EP401030,  
EP407102, EP411766, EP409332, EP412594, EP419048, EP480659, EP481614,  
EP490587, EP467715, EP479479, EP502725, EP503838, EP505098, EP505111  
5 EP513,979 EP507594, EP510812, EP511767, EP512675, EP512676, EP512870,  
EP517357, EP537937, EP534706, EP527534, EP540356, EP461040, EP540039,  
EP465368, EP498723, EP498722, EP498721, EP515265, EP503785, EP501892,  
EP519831, EP532410, EP498361, EP432737, EP504888, EP508393, EP508445,  
EP403159, EP403158, EP425211, EP427463, EP437103, EP481448, EP488532,  
10 EP501269, EP500409, EP540400, EP005528, EP028834, EP028833, EP411507,  
EP425921, EP430300, EP434038, EP442473, EP443568, EP445811, EP459136,  
EP483683, EP518033, EP520423, EP531876, EP531874, EP392317, EP468470,  
EP470543, EP502314, EP529253, EP543263, EP540209, EP449699, EP465323,  
EP521768, EP415594, WO92/14468, WO93/08171, WO93/08169, WO91/00277,  
15 WO91/00281, WO91/14367, WO92/00067, WO92/00977, WO92/20342, WO93/04045,  
WO93/04046, WO91/15206, WO92/14714, WO92/09600, WO92/16552, WO93/05025,  
WO93/03018, WO91/07404, WO92/02508, WO92/13853, WO91/19697, WO91/11909,  
WO91/12001, WO91/11999, WO91/15209, WO91/15479, WO92/20687, WO92/20662,  
WO92/20661, WO93/01177, WO91/14679, WO91/13063, WO92/13564, WO91/17148,  
20 WO91/18888, WO91/19715, WO92/02257, WO92/04335, WO92/05161, WO92/07852,  
WO92/15577, WO93/03033, WO91/16313, WO92/00068, WO92/02510, WO92/09278,  
WO9210179, WO92/10180, WO92/10186, WO92/10181, WO92/10097, WO92/10183,  
WO92/10182, WO92/10187, WO92/10184, WO92/10188, WO92/10180, WO92/10185,  
WO92/20651, WO93/03722, WO93/06828, WO93/03040, WO92/19211, WO92/22533,  
25 WO92/06081, WO92/05784, WO93/00341, WO92/04343, WO92/04059, US5104877,  
US5187168, US5149699, US5185340, US4880804, US5138069, US4916129,  
US5153197, US5173494, US5137906, US5155126, US5140037, US5137902,  
US5157026, US5053329, US5132216, US5057522, US5066586, US5089626,  
US5049565, US5087702, US5124335, US5102880, US5128327, US5151435,

US5202322, US5187159, US5198438, US5182288, US5036048, US5140036,  
US5087634, US5196537, US5153347, US5191086, US5190942, US5177097,  
US5212177, US5208234, US5208235, US5212195, US5130439, US5045540,  
US5041152, and US5210204, and pharmaceutically acceptable salts and esters thereof;  
5  $\alpha/\beta$  adrenergic blockers such as nipradilol, arotinolol, amosulalol, bretylium tosylate  
(CAS RN: 61-75-6), dihydroergtamine mesylate (such as ergotaman-3', 6', 18-trione, 9,-  
10-dihydro-12'-hydroxy-2'-methyl-5'-(phenylmethyl)-, (5'( $\alpha$ ))-, monomethanesulfonate,  
e.g., DHE 45® Injection, Novartis), carvedilol (such as ( $\pm$ )-1-(Carbazol-4-yloxy)-3-[[2-  
(o-methoxyphenoxy)ethyl]amino]-2-propanol, e.g., Coreg®, SmithKline Beecham),  
10 labetalol (such as 5-[1-hydroxy-2-[(1-methyl-3-phenylpropyl) amino] ethyl]salicylamide  
monohydrochloride, e.g., Normodyne®, Schering), bretylium tosylate  
(Benzenemethanaminium, 2-bromo-N-ethyl-N,N-dimethyl-, salt with 4-  
methylbenzenesulfonic acid (1:1) CAS RN 61-75-6), phentolamine mesylate (Phenol, 3-  
[[[4,5-dihydro-1H-imidazol-2-yl)methyl](4-methylphenyl)amino]-,  
15 monomethanesulfonate (salt) CAS RN 65-28-1), solypertine tartrate (5H-1,3-  
Dioxolo[4,5-f]indole, 7-[2-[4-(2-methoxyphenyl)-1-piperazinyl]ethyl]-, (2R,3R)-2,3-  
dihydroxybutanedioate (1:1) CAS RN 5591-43-5), zolertine hydrochloride (Piperazine, 1-  
phenyl-4-[2-(1H-tetrazol-5-yl)ethyl]-, monohydrochloride (8Cl, 9Cl) CAS RN 7241-94-3)  
and the like;  
20  $\alpha$  adrenergic receptor blockers, such as alfuzosin (CAS RN: 81403-68-1), terazosin,  
urapidil, prazosin (Minipress®), tamsulosin, bunazosin, trimazosin, doxazosin, naftopidil,  
indoramin, WHP 164, XEN010, fenspiride hydrochloride (which may be prepared as  
disclosed in US3399192), proroxan (CAS RN 33743-96-3), and labetalol hydrochloride  
and combinations thereof;  $\alpha$  2 agonists such as methyl dopa, methyl dopa HCL, lofexidine,  
25 tiamenidine, moxonidine, rilmenidine, guanobenz, and the like;  
aldosterone inhibitors, and the like; renin inhibitors including Aliskiren (SPP100;  
Novartis/Speedel); angiopoietin-2-binding agents such as those disclosed in  
WO03/030833;  
anti-angina agents such as ranolazine (hydrochloride)-1-Piperazineacetamide, N-(2,6-

dimethylphenyl)-4-[2-hydroxy-3-(2-methoxyphenoxy)propyl]-, dihydrochloride CAS RN 95635-56-6), betaxolol hydrochloride (2-Propanol, 1-[4-[2 (cyclopropylmethoxy)ethyl]phenoxy]-3-[(1-methylethyl)amino]-, hydrochloride CAS RN 63659-19-8), butoprozine hydrochloride (Methanone, [4-  
5 [3(dibutylamino)propoxy]phenyl](2-ethyl-3-indoliziny)-, monohydrochloride CAS RN 62134-34-3), cinepazet maleate 1-Piperazineacetic acid, 4-[1-oxo-3-(3,4,5-trimethoxyphenyl)-2-propenyl]-, ethyl ester, (2Z)-2-butenedioate (1:1) CAS RN 50679-07-7), tosisfen (Benzenesulfonamide, 4-methyl-N-[[[(1S)-1-methyl-2-phenylethyl]amino]carbonyl]- CAS RN 32295-184), verapamil hydrochloride  
10 (Benzeneacetonitrile,  $\alpha$ -[3-[[2-(3,4-dimethoxyphenyl)ethyl]methylamino]propyl]-3,4-dimethoxy- $\alpha$ -(1-methylethyl)-, monohydrochloride CAS RN 152-114), molsidomine (1,2,3-Oxadiazolium, 5-[(ethoxycarbonyl)amino]-3-(4-morpholinyl)-, inner salt CAS RN 25717-80-0), and ranolazine hydrochloride (1-Piperazineacetamide, N-(2,6-dimethylphenyl)<sub>4</sub>-[2-hydroxy-3-(2-methoxyphenoxy)propyl]-, dihydrochloride CAS RN  
15 95635-56-6); tosisfen (Benzenesulfonamide, 4-methyl-N-[[[(1S)-1-methyl-2-phenylethyl]amino]carbonyl]- CAS RN 32295-184); adrenergic stimulants such as guanfacine hydrochloride (such as N-amidino-2-(2,6-dichlorophenyl) acetamide hydrochloride, e.g., Tenex® Tablets available from Robins); methyl dopa hydrochlorothiazide (such as levo-3-(3,4-dihydroxyphenyl)-2-methylalanine) combined  
20 with Hydrochlorothiazide (such as 6-chloro-3,4-dihydro-2H-1,2,4-benzothiadiazine-7-sulfonamide 1,1-dioxide, e.g., the combination as, e.g., Aldoril® Tablets available from Merck), methyl dopa-chlorothiazide (such as 6-chloro-2H-1,2,4-benzothiadiazine-7-sulfonamide 1,1-dioxide and methyl dopa as described above, e.g., Aldoclor®, Merck), clonidine hydrochloride (such as 2-(2,6-dichlorophenylamino)-2-imidazoline  
25 hydrochloride and chlorthalidone (such as 2-chloro-5-(1-hydroxy-3-oxo-1-isoindolinyl) benzenesulfonamide), e.g., Combipres®, Boehringer Ingelheim), clonidine hydrochloride (such as 2-(2,6-dichlorophenylamino)-2-imidazoline hydrochloride, e.g., Catapres®, Boehringer Ingelheim), clonidine (1H-Imidazol-2-amine, N-(2,6-dichlorophenyl)<sub>4</sub>,5-dihydro-CAS RN 4205-90-7), Hyzaar (Merck; a combination of losartan and

hydrochlorothiazide), Co-Diovan (Novartis; a combination of valsartan and hydrochlorothiazide, Lotrel (Novartis; a combination of benazepril and amlodipine) and Caduet (Pfizer; a combination of amlodipine and atorvastatin), and those agents disclosed in US20030069221.

5

The peptides and agonists described herein can be used in combination therapy with one or more of the following agents useful in the treatment of respiratory and other disorders including but not limited to:

- (1)  $\beta$ -agonists including but not limited to: albuterol (PROVENTIL®), SALBUTAMOL®, VENTOLIN®), bambuterol, bitoterol, clenbuterol, fenoterol, formoterol, isoetharine (BRONKOSOL®, BRONKOMETER®), metaproterenol (ALUPENT®, METAPREL®), pirbuterol (MAXAIR®), reproterol, rimiterol, salmeterol, terbutaline (BRETHAIRE®, BRETLINE®, BRICANYL®), adrenalin, isoproterenol (ISUPREL®), epinephrine bitartrate (PRIMATENE®), ephedrine, orciiprenline, fenoterol and isoetharine;
- (2) steroids, including but not limited to beclomethasone, beclomethasone dipropionate, betamethasone, budesonide, bunedoside, butixocort, dexamethasone, flunisolide, fluocortin, fluticasone, hydrocortisone, methyl prednisone, mometasone, predonisolone, predonisone, tipredane, tixocortal, triamcinolone, and triamcinolone acetonide;
- (3)  $\beta$ 2-agonist-corticosteroid combinations [e.g., salmeterol-fluticasone (ADVAIR®), formoterol-budesonid (SYMBICORT®)];
- (4) leukotriene D4 receptor antagonists/leukotriene antagonists/LTD4 antagonists (i.e., any compound that is capable of blocking, inhibiting, reducing or otherwise interrupting the interaction between leukotrienes and the Cys LTI receptor) including but not limited to: zafirlukast, montelukast, montelukast sodium (SINGULAIR®), pranlukast, iralukast, pobilukast, SKB-106,203 and compounds described as having LTD4 antagonizing activity described in U.S. Patent No. 5,565,473;

20

25

(5) 5-lipoxygenase inhibitors and/or leukotriene biosynthesis inhibitors [e.g., zileuton and BAY1005 (CA registry 128253-31-6)];

(6) histamine H1 receptor antagonists/antihistamines (i.e., any compound that is capable of blocking, inhibiting, reducing or otherwise interrupting the interaction  
5 between histamine and its receptor) including but not limited to: astemizole, acrivastine, antazoline, azatadine, azelastine, astemizole, bromopheniramine, bromopheniramine maleate, carbinoxamine, carebastine, cetirizine, chlorpheniramine, chlorpheniramine maleate, cimetidine, clemastine, cyclizine, cyproheptadine, descarboethoxyloratadine, dexchlorpheniramine, dimethindene, diphenhydramine, diphenylpyraline, doxylamine  
10 succinate, doxylamine, ebastine, efletirizine, epinastine, famotidine, fexofenadine, hydroxyzine, hydroxyzine, ketotifen, levocabastine, levocetirizine, levocetirizine, loratadine, meclizine, mepyramine, mequitazine, methdilazine, mianserin, mizolastine, noberastine, norastemizole, noraztemizole, phenindamine, pheniramine, picumast, promethazine, pynlamine, pyrilamine, ranitidine, temelastine, terfenadine, trimeprazine,  
15 tripelenamine, and triprolidine;

(7) an anticholinergic including but not limited to: atropine, benztropine, biperiden, flutropium, hyoscyamine (e.g. Levsin®; Levbid®; Levsin/SL®, Anaspaz®, Levsinex timecaps®, NuLev®), ilutropium, ipratropium, ipratropium bromide, methscopolamine, oxybutinin, rispenzepine, scopolamine, and tiotropium;

(8) an anti-tussive including but not limited to: dextromethorphan, codeine,  
20 and hydromorphone;

(9) a decongestant including but not limited to: pseudoephedrine and phenylpropanolamine;

(10) an expectorant including but not limited to: guaifenesin, guaicol sulfate,  
25 terpin, ammonium chloride, glycerol guaicolate, and iodinated glycerol;

(11) a bronchodilator including but not limited to: theophylline and aminophylline;

(12) an anti-inflammatory including but not limited to: fluribiprofen, diclophenac, indomethacin, ketoprofen, S-ketoprophen, tenoxicam;



(13) a PDE (phosphodiesterase) inhibitor including but not limited to those disclosed herein;

(14) a recombinant humanized monoclonal antibody [e.g. xolair (also called omalizumab), rhuMab, and talizumab];

5 (15) a humanized lung surfactant including recombinant forms of surfactant proteins SP-B, SP-C or SP-D [e.g. SURFAXIN®, formerly known as dsc-104 (Discovery Laboratories)],

(16) agents that inhibit epithelial sodium channels (ENaC) such as amiloride and related compounds;

10 (17) antimicrobial agents used to treat pulmonary infections such as acyclovir, amikacin, amoxicillin, doxycycline, trimethoprim sulfamethoxazole, amphotericin B, azithromycin, clarithromycin, roxithromycin, clarithromycin, cephalosporins( ceffoxitin, cefmetazole etc), ciprofloxacin, ethambutol, gentimycin, ganciclovir, imipenem, isoniazid, itraconazole, penicillin, ribavirin, rifampin, rifabutin, amantadine, rimantidine,  
15 streptomycin, tobramycin, and vancomycin;

(18) agents that activate chloride secretion through  $Ca^{++}$  dependent chloride channels (such as purinergic receptor (P2Y(2) agonists);

(19) agents that decrease sputum viscosity, such as human recombinant DNase I, (Pulmozyme®);

20 (20) nonsteroidal anti-inflammatory agents (acemetacin, acetaminophen, acetyl salicylic acid, alclofenac, alminoprofen, apazone, aspirin, benoxaprofen, bezpiperylon, bucloxic acid, carprofen, clidanac, diclofenac, diclofenac, diflumisal, diflusinal, etodolac, fenbufen, fenbufen, fenclofenac, fenclozic acid, fenoprofen, fentiazac, feprazone, flufenamic acid, flufenisal, flufenisal, fluprofen, flurbiprofen, flurbiprofen, furofenac,  
25 ibufenac, ibuprofen, indomethacin, indomethacin, indoprofen, isoxepac, isoxicam, ketoprofen, ketoprofen, ketorolac, meclofenamic acid, meclofenamic acid, mefenamic acid, mefenamic acid, miroprofen, mofebutazone, nabumetone oxaprozin, naproxen, naproxen, niflumic acid, oxaprozin, oxpinac, oxyphenbutazone, phenacetin, phenylbutazone, phenylbutazone, piroxicam, piroxicam, pirprofen, pranoprofen,

sudoxicam, tenoxicam, sulfasalazine, sulindac, sulindac, suprofen, tiaprofenic acid, tiopinac, tiroxaprofen, tolfenamic acid, tolmetin, tolmetin, zidometacin, zomepirac, and zomepirac); and

(21) aerosolized antioxidant therapeutics such as S-Nitrosoglutathione.

6

The peptides and agonists described herein can be used in combination therapy with an anti-obesity agent. Suitable such agents include, but are not limited to:

11 $\beta$  HSD-1 (11-beta hydroxy steroid dehydrogenase type 1) inhibitors, such as BVT 3498, BVT 2733, 3-(1-adamantyl)-4-ethyl-5-(ethylthio)-4H-1,2,4-triazole, 3-(1-adamantyl)-5-(3,4,5-trimethoxyphenyl)-4-methyl-4H-1,2,4-triazole, 3-adamantany-10 4,5,6,7,8,9,10,11,12,3a-decahydro-1,2,4-triazolo[4,3-a][11]annulene, and those compounds disclosed in WO01/90091, WO01/90090, WO01/90092 and WO02/072084;

5HT antagonists such as those in WO03/037871, WO03/037887, and the like;

5HT1a modulators such as carbidopa, benserazide and those disclosed in US6207699, 15 WO03/031439, and the like;

5HT2c (serotonin receptor 2c) agonists, such as BVT933, DPCA37215, IK264, PNU 22394, WAY161503, R-1065, SB 243213 (Glaxo Smith Kline) and YM 348 and those disclosed in US3914250, WO00/77010, WO02/36596, WO02/48124, WO02/10169, WO01/66548, WO02/44152, WO02/51844, WO02/40456, and WO02/40457;

20 5HT6 receptor modulators, such as those in WO03/030901, WO03/035061, WO03/039547, and the like;

acyl-estrogens, such as oleoyl-estrone, disclosed in del Mar-Grasa, M. et al., Obesity Research, 9:202-9 (2001) and Japanese Patent Application No. JP 2000256190;

anorectic bicyclic compounds such as 1426 (Aventis) and 1954 (Aventis), and the compounds disclosed in WO00/18749, WO01/32638, WO01/62746, WO01/62747, and WO03/015769;

CB 1 (cannabinoid-1 receptor) antagonist/inverse agonists such as rimonabant  
5 (Acomplia; Sanofi), SR-147778 (Sanofi), SR-141716 (Sanofi), BAY 65-2520 (Bayer),  
and SLV 319 (Solvay), and those disclosed in patent publications US4973587,  
US5013837, US5081122, US5112820, US5292736, US5532237, US5624941,  
US6028084, US6509367, US6509367, WO96/33159, WO97/29079, WO98/31227,  
WO98/33765, WO98/37061, WO98/41519, WO98/43635, WO98/43636, WO99/02499,  
10 WO00/10967, WO00/10968, WO01/09120, WO01/58869, WO01/64632, WO01/64633,  
WO01/64634, WO01/70700, WO01/96330, WO02/076949, WO03/006007,  
WO03/007887, WO03/020217, WO03/026647, WO03/026648, WO03/027069,  
WO03/027076, WO03/027114, WO03/037332, WO03/040107, WO03/086940,  
WO03/084943 and EP658546;

15 CCK-A (cholecystokinin-A) agonists, such as AR-R 15849, GI 181771 (GSK), JMV-  
180, A-71378, A-71623 and SR146131 (Sanofi), and those described in US5739106;

CNTF (Ciliary neurotrophic factors), such as GI-181771 (Glaxo-SmithKline), SR146131  
(Sanofi Synthelabo), butabindide, PD170,292, and PD 149164 (Pfizer);

CNTF derivatives, such as Axokine® (Regeneron), and those disclosed in WO94/09134,  
20 WO98/22128, and WO99/43813;

dipeptidyl peptidase IV (DP-IV) inhibitors, such as isoleucine thiazolidide, valine  
pyrrolidide, NVP-DPP728, LAF237, P93/01, P 3298, TSL 225 (tryptophyl-1,2,3,4-  
tetrahydroisoquinoline-3-carboxylic acid; disclosed by Yamada et al, Bioorg. & Med.  
Chem. Lett. 8 (1998) 1537-1540), TMC-2A/2B/2C, CD26 inhibitors, FE 999011,  
25 P9310/K364, VIP 0177, SDZ 274-444, 2-cyanopyrrolidides and 4-cyanopyrrolidides as  
disclosed by Ashworth et al, Bioorg. & Med. Chem. Lett., Vol. 6, No. 22, pp 1163-1166

and 2745-2748 (1996) and the compounds disclosed patent publications. WO99/38501, WO99/46272, WO99/67279 (Probiodrug), WO99/67278 (Probiodrug), WO99/61431 (Probiodrug), WO02/083128, WO02/062764, WO03/000180, WO03/000181, WO03/000250, WO03/002530, WO03/002531, WO03/002553, WO03/002593,  
5 WO03/004498, WO03/004496, WO03/017936, WO03/024942, WO03/024965, WO03/033524, WO03/037327 and EP1258476;

growth hormone secretagogue receptor agonists/antagonists, such as NN703, hexarelin, MK-0677 (Merck), SM-130686, CP-424391 (Pfizer), LY 444,711 (Eli Lilly), L-692,429 and L-163,255, and such as those disclosed in USSN 09/662448, US provisional  
10 application 60/203335, US6358951, US2002049196, US2002/022637, WO01/56592 and WO02/32888;

H3 (histamine H3) antagonist/inverse agonists, such as thioperamide, 3-(1H-imidazol-4-yl)propyl N-(4-pentenyl)carbamate, clobenpropit, iodophenpropit, imoproxifan, GT2394 (Gliatech), and A331440, O-[3-(1H-imidazol-4-yl)propanol]carbamates (Kiec-  
15 Kononowicz, K. et al., Pharmazie, 55:349-55 (2000)), piperidine-containing histamine H3-receptor antagonists (Lazewska, D. et al., Pharmazie, 56:927-32 (2001)), benzophenone derivatives and related compounds (Sasse, A. et al., Arch. Pharm.(Weinheim) 334:45-52 (2001)), substituted N-phenylcarbamates (Reidemeister, S. et al., Pharmazie, 55:83-6 (2000)), and proxifan derivatives (Sasse, A. et al., J. Med.  
20 Chem., 43:3335-43 (2000)) and histamine H3 receptor modulators such as those disclosed in WO02/15905, WO03/024928 and WO03/024929;

leptin derivatives, such as those disclosed in US5552524, US5552523, US5552522, US5521283, WO96/23513, WO96/23514, WO96/23515, WO96/23516, WO96/23517, WO96/23518, WO96/23519, and WO96/23520;

25 leptin, including recombinant human leptin (PEG-OB, Hoffman La Roche) and recombinant methionyl human leptin (Amgen);

lipase inhibitors, such as tetrahydrolipstatin (orlistat/Xenical®), Triton WR1339, RHC80267, lipstatin, teasaponin, diethylumbelliferyl phosphate, FL-386, WAY-121898, Bay-N-3176, valilactone, esteracin, ebelactone A, ebelactone B, and RHC 80267, and those disclosed in patent publications WO01/77094, US4598089, US4452813,  
5 USUS5512565, US5391571, US5602151, US4405644, US4189438, and US4242453;

lipid metabolism modulators such as maslinic acid, erythrodiol, ursolic acid uvaol, betulinic acid, betulin, and the like and compounds disclosed in WO03/011267;

Mc4r (melanocortin 4 receptor) agonists, such as CHIR86036 (Chiron), ME-10142, ME-10145, and HS-131 (Melacure), and those disclosed in PCT publication Nos.  
10 WO99/64002, WO00/74679, WO01/991752, WO01/25192, WO01/52880, WO01/74844, WO01/70708, WO01/70337, WO01/91752, WO02/059095, WO02/059107, WO02/059108, WO02/059117, WO02/06276, WO02/12166, WO02/11715, WO02/12178, WO02/15909, WO02/38544, WO02/068387, WO02/068388, WO02/067869, WO02/081430, WO03/06604, WO03/007949, WO03/009847,  
15 WO03/009850, WO03/013509, and WO03/031410; (

Mc5r (melanocortin 5 receptor) modulators, such as those disclosed in WO97/19952, WO00/15826, WO00/15790, US20030092041;

melanin-concentrating hormone 1 receptor (MCHR) antagonists, such as T-226296 (Takeda), SB 568849, SNP-7941 (Synaptic), and those disclosed in patent publications  
20 WO01/21169, WO01/82925, WO01/87834, WO02/051809, WO02/06245, WO02/076929, WO02/076947, WO02/04433, WO02/51809, WO02/083134, WO02/094799, WO03/004027, WO03/13574, WO03/15769, WO03/028641, WO03/035624, WO03/033476, WO03/033480, JP13226269, and JP1437059;

mGluR5 modulators such as those disclosed in WO03/029210, WO03/047581,  
25 WO03/048137, WO03/051315, WO03/051833, WO03/053922, WO03/059904, and the like;

serotonergic agents, such as fenfluramine (such as Pondimin® (Benzeneethanamine, N-ethyl-alpha-methyl-3-(trifluoromethyl)-, hydrochloride), Robbins), dexfenfluramine (such as Redux® (Benzeneethanamine, N-ethyl-alpha-methyl-3-(trifluoromethyl)-, hydrochloride), Interneuron) and sibutramine ((Meridia®, Knoll/Reductil™) including  
5 racemic mixtures, as optically pure isomers (+) and (-), and pharmaceutically acceptable salts, solvents, hydrates, clathrates and prodrugs thereof including sibutramine hydrochloride monohydrate salts thereof, and those compounds disclosed in US4746680, US4806570, and US5436272, US20020006964, WO01/27068, and WO01/62341;

NE (norepinephrine) transport inhibitors, such as GW 320659, despiramine, talsupram,  
10 and nomifensine;

NPY 1 antagonists, such as BIBP3226, J-115814, BIBO 3304, LY-357897, CP-671906, GI-264879A, and those disclosed in US6001836, WO96/14307, WO01/23387, WO99/51600, WO01/85690, WO01/85098, WO01/85173, and WO01/89528;

NPY5 (neuropeptide Y Y5) antagonists, such as 152,804, GW-569180A, GW-594884A,  
15 GW-587081X, GW-548118X, FR235208, FR226928, FR240662, FR252384, 1229U91, GI-264879A, CGP71683A, LY-377897, LY-366377, PD-160170, SR-120562A, SR-120819A, JCF-104, and H409/22 and those compounds disclosed in patent publications US6140354, US6191160, US6218408, US6258837, US6313298, US6326375, US6329395, US6335345, US6337332, US6329395, US6340683, EP01010691, EP-  
20 01044970, WO97/19682, WO97/20820, WO97/20821, WO97/20822, WO97/20823, WO98/27063, WO00/107409, WO00/185714, WO00/185730, WO00/64880, WO00/68197, WO00/69849, WO/0113917, WO01/09120, WO01/14376, WO01/85714, WO01/85730, WO01/07409, WO01/02379, WO01/23388, WO01/23389, WO01/44201, WO01/62737, WO01/62738, WO01/09120, WO02/20488, WO02/22592, WO02/48152,  
25 WO02/49648, WO02/051806, WO02/094789, WO03/009845, WO03/014083, WO03/022849, WO03/028726 and Norman et al., J. Med. Chem. 43:4288-4312 (2000);

opioid antagonists, such as nalmefene (REVEX ®), 3-methoxynaltrexone, methylnaltrexone, naloxone, and naltrexone (e.g. PT901; Pain Therapeutics, Inc.) and those disclosed in US6734188, US20050004155 and WO00/21509;

---

orexin antagonists, such as SB-334867-A and those disclosed in patent publications  
5 WO01/96302, WO01/68609, WO02/44172, WO02/51232, WO02/51838, WO02/089800,  
WO02/090355, WO03/023561, WO03/032991, and WO03/037847;

PDE inhibitors (e.g. compounds which slow the degradation of cyclic AMP (cAMP) and/or cyclic GMP (cGMP) by inhibition of the phosphodiesterases, which can lead to a relative increase in the intracellular concentration of cAMP and cGMP; possible PDE  
10 inhibitors are primarily those substances which are to be numbered among the class consisting of the PDE3 inhibitors, the class consisting of the PDE4 inhibitors and/or the class consisting of the PDE5 inhibitors, in particular those substances which can be designated as mixed types of PDE3/4 inhibitors or as mixed types of PDE3/4/5 inhibitors) such as those disclosed in patent publications DE1470341, DE2108438,  
15 DE2123328, DE2305339, DE2305575, DE2315801, DE2402908, DE2413935, DE2451417, DE2459090, DE2646469, DE2727481, DE2825048, DE2837161, DE2845220, DE2847621, DE2934747, DE3021792, DE3038166, DE3044568, EP000718, EP0008408, EP0010759, EP0059948, EP0075436, EP0096517, EP0112987, EP0116948, EP0150937, EP0158380, EP0161632, EP0161918, EP0167121, EP0199127,  
20 EP0220044, EP0247725, EP0258191, EP0272910, EP0272914, EP0294647, EP0300726, EP0335386, EP0357788, EP0389282, EP0406958, EP0426180, EP0428302, EP0435811, EP0470805, EP0482208, EP0490823, EP0506194, EP0511865, EP0527117, EP0626939, EP0664289, EP0671389, EP0685474, EP0685475, EP0685479, JP92234389, JP94329652, JP95010875, US4963561, US5141931, WO9117991, WO9200968,  
25 WO9212961, WO9307146, WO9315044, WO9315045, WO9318024, WO9319068, WO9319720, WO9319747, WO9319749, WO9319751, WO9325517, WO9402465, WO9406423, WO9412461, WO9420455, WO9422852, WO9425437, WO9427947, WO9500516, WO9501980, WO9503794, WO9504045, WO9504046, WO9505386,

WO9508534, WO9509623, WO9509624, WO9509627, WO9509836, WO9514667,  
WO9514680, WO9514681, WO9517392, WO9517399, WO9519362, WO9522520,  
WO9524381, WO9527692, WO9528926, WO9535281, WO9535282, WO9600218,  
WO9601825, WO9602541, WO9611917, DE3142982, DE1116676, DE2162096,  
5 EP0293063, EP0463756, EP0482208, EP0579496, EP0667345 US6331543,  
US20050004222 (including those disclosed in formulas I-XIII and paragraphs 37-39, 85-  
0545 and 557-577), WO9307124, EP0163965, EP0393500, EP0510562, EP0553174,  
WO9501338 and WO9603399, as well as PDE5 inhibitors (such as RX-RA-69, SCH-  
51866, KT-734, vesnarinone, zaprinast, SKF-96231, ER-21355, BF/GP-385, NM-702  
10 and sildenafil (Viagra<sup>TM</sup>)), PDE4 inhibitors (such as etazolate, ICI63197, RP73401,  
imazolidinone (RO-20-1724), MEM 1414 (R1533/R1500; Pharmacia Roche),  
denbufylline, rolipram, oxagrelate, nitraquazone, Y-590, DH-6471, SKF-94120,  
motapizone, lixazinone, indolidan, olprinone, atizoram, KS-506-G, dipamfylline, BMY-  
43351, atizoram, arofylline, filaminast, PDB-093, UCB-29646, CDP-840, SKF-107806,  
15 piclamilast, RS-17597, RS-25344-000, SB-207499, TIBENELAST, SB-210667, SB-  
211572, SB-211600, SB-212066, SB-212179, GW-3600, CDP-840, mopidamol,  
anagrelide, ibudilast, amrinone, pimobendan, cilostazol, quazinone and N-(3,5-  
dichloropyrid-4-yl)-3-cyclopropylmethoxy-4-difluoromethoxybenzamide, PDE3  
inhibitors (such as ICI153, 100, bemorandane (RWJ 22867), MCI-154, UD-CG 212,  
20 sulmazole, ampizone, cilostamide, carbazeran, piroximone, imazodan, CI-930,  
siguazodan, adibendan, saterinone, SKF-95654, SDZ-MKS-492, 349-U-85, emoradan,  
EMD-53998, EMD-57033, NSP-306, NSP-307, revizinone, NM-702, WIN-62582 and  
WIN-63291, enoximone and milrinone, PDE3/4 inhibitors (such as benafentrine,  
trequinsin, ORG-30029, zardaverine, L-686398, SDZ-ISQ-844, ORG-20241, EMD-  
25 54622, and tolafentrine) and other PDE inhibitors (such as vinpocetin, papaverine,  
enprofylline, cilomilast, fenoximone, pentoxifylline, roflumilast, tadalafil(Cialis®),  
theophylline, and vardenafil(Levitra®);



Neuropeptide Y2 (NPY2) agonists include but are not limited to: peptide YY and fragments and variants thereof (e.g. YY3-36 (PYY3-36) (N. Engl. J. Med. 349:941, 2003; IKPEAPGE DASPEELNRY YASLRHYLNL VTRQRY (SEQ ID NO:XXX)) and PYY agonists such as those disclosed in WO02/47712, WO03/026591, WO03/057235,  
5 and WO03/027637;

serotonin reuptake inhibitors, such as, paroxetine, fluoxetine (Prozac<sup>TM</sup>), fluvoxamine, sertraline, citalopram, and imipramine, and those disclosed in US6162805, US6365633, WO03/00663, WO01/27060, and WO01/162341;

thyroid hormone  $\beta$  agonists, such as KB-2611 (KaroBioBMS), and those disclosed in  
10 WO02/15845, WO97/21993, WO99/00353, GB98/284425, U.S. Provisional Application No. 60/183,223, and Japanese Patent Application No. JP 2000256190;

UCP-1 (uncoupling protein-1), 2, or 3 activators, such as phytanic acid, 4-[(E)-2-(5,6,7,8-tetrahydro-5,5,8,8-tetramethyl-2-naphthalenyl)-1-propenyl]benzoic acid (TTNPB), retinoic acid, and those disclosed in WO99/00123;

$\beta_3$  (beta adrenergic receptor 3) agonists, such as AJ9677/TAK677 (Dainippon/Takeda), L750355 (Merck), CP331648 (Pfizer), CL-316,243, SB 418790, BRL-37344, L-796568, BMS-196085, BRL-35135A, CGP12177A, BTA-243, GW 427353, Trecadrine, Zeneca D7114, N-5984 (Nisshin Kyorin), LY-377604 (Lilly), SR 59119A, and those disclosed in  
15 US5541204, US5770615, US5491134, US5776983, US488064, US5705515,  
20 US5451677, WO94/18161, WO95/29159, WO97/46556, WO98/04526 and  
WO98/32753, WO01/74782, WO02/32897, WO03/014113, WO03/016276,  
WO03/016307, WO03/024948, WO03/024953 and WO03/037881;

noradrenergic agents including, but not limited to, diethylpropion (such as Tenuate® (1-propanone, 2-(diethylamino)-1-phenyl-, hydrochloride), Merrell), dextroamphetamine (also known as dextroamphetamine sulfate, dexamphetamine, dexedrine, Dexampex,  
25 Ferndex, Oxydess II, Robese, Spancap #1), mazindol ((or 5-(p-chlorophenyl)-2,5-

dihydro-3H-imidazo[2,1-a]isoindol-5-ol) such as Sanorex®, Novartis or Mazanor®,  
Wyeth Ayerst), phenylpropanolamine (or Benzenemethanol, alpha-(1-aminoethyl)-,  
hydrochloride), phentermine ((or Phenol, 3-[[4,5-dihydro-1H-imidazol-2-yl)ethyl](4-  
methylphenyl)amino], monohydrochloride) such as Adipex-P®, Lemmon, FASTIN®,  
5 Smith-Kline Beecham and Ionamin®, Medeva), phendimetrazine ((or (2S,3S)-3,4-  
Dimethyl-2-phenylmorpholine L-(+)-tartrate (1:1)) such as Metra® (Forest), Plegine®  
(Wyeth-Ayerst), Prelu-2® (Boehringer Ingelheim), and Statobex® (Lemmon),  
phendamine tartrate (such as Thephorin® (2,3,4,9-Tetrahydro-2-methyl-9-phenyl-1H-  
indanol[2,1-c]pyridine L-(+)-tartrate (1:1)), Hoffmann-LaRoche), methamphetamine  
10 (such as Desoxyn®, Abbot ((S)-N, (alpha)-dimethylbenzeneethanamine  
hydrochloride)), and phendimetrazine tartrate (such as Bontril® Slow-Release Capsules,  
Amarin (-3,4-Dimethyl-2-phenylmorpholine Tartrate);

fatty acid oxidation upregulator/inducers such as Famoxin® (Genset);

monamine oxidase inhibitors including but not limited to befloxatone, moclobemide,  
15 brofaromine, phenoxathine, csuprone, befol, toloxatone, pirlindol, amiflamine,  
serclorephine, bazinaprime, lazabemide, milacemide, caroxazone and other certain  
compounds as disclosed by WO01/12176; and

other anti-obesity agents such as 5HT-2 agonists, ACC (acetyl-CoA carboxylase)  
inhibitors such as those described in WO03/072197, alpha-lipoic acid (alpha-LA),  
20 AOD9604, appetite suppressants such as those in WO03/40107, ATL-962 (Alizyme  
PLC), benzocaine, benzphetamine hydrochloride (Didrex), bladderwrack (focus  
vesiculosus), BRS3 (bombesin receptor subtype 3) agonists, bupropion, caffeine, CCK  
agonists, chitosan, chromium, conjugated linoleic acid, corticotropin-releasing hormone  
agonists, dehydroepiandrosterone, DGAT1 (diacylglycerol acyltransferase 1) inhibitors,  
25 DGAT2 (diacylglycerol acyltransferase 2) inhibitors, dicarboxylate transporter inhibitors,  
ephedra, exendin-4 (an inhibitor of glp-1) FAS (fatty acid synthase) inhibitors (such as  
Cerulein and C75), fat resorption inhibitors (such as those in WO03/053451, and the

like), fatty acid transporter inhibitors, natural water soluble fibers (such as psyllium, plantago, guar, oat, pectin), galanin antagonists, galega (Goat's Rue, French Lilac), garcinia cambogia, germander (teucrium chamaedrys), ghrelin antibodies and ghrelin antagonists (such as those disclosed in WO01/87335, and WO02/08250), peptide

5 hormones and variants thereof which affect the islet cell secretion, such as the hormones of the secretin/gastric inhibitory peptide (GIP)/vasoactive intestinal peptide (VIP)/pituitary adenylate cyclase activating peptide (PACAP)/glucagon-like peptide II (GLP-II)/glicentin/glucagon gene family and/or those of the adrenomedullin/amylin/calcitonin gene related peptide (CGRP) gene family

10 including GLP-1 (glucagon-like peptide 1) agonists (e.g. (1) exendin-4, (2) those GLP-1 molecules described in US20050130891 including GLP-1(7-34), GLP-1(7-35), GLP-1(7-36) or GLP-1(7-37) in its C-terminally carboxylated or amidated form or as modified GLP-1 peptides and modifications thereof including those described in paragraphs 17-44

of US20050130891, and derivatives derived from GLP-1-(7-34)COOH and the

15 corresponding acid amide are employed which have the following general formula:



wherein R=H or an organic compound having from 1 to 10 carbon atoms. Preferably, R is the residue of a carboxylic acid. Particularly preferred are the following carboxylic acid residues: formyl, acetyl, propionyl, isopropionyl, methyl, ethyl, propyl, isopropyl, n-

20 butyl, sec-butyl, tert-butyl.) and glp-1 (glucagon-like peptide-1), glucocorticoid antagonists, glucose transporter inhibitors, growth hormone secretagogues (such as those disclosed and specifically described in US5536716), interleukin-6 (IL-6) and modulators thereof (as in WO03/057237, and the like), L-carnitine, Mc3r (melanocortin 3 receptor) agonists, MCH2R (melanin concentrating hormone 2R) agonist/antagonists, melanin

25 concentrating hormone antagonists, melanocortin agonists (such as Melanotan II or those described in WO 99/64002 and WO 00/74679), nomame herba, phosphate transporter inhibitors, phytopharm compound 57 (CP 644,673), pyruvate, SCD-1 (stearoyl-CoA desaturase-1) inhibitors, T71 (Tularik, Inc., Boulder CO), Topiramate (Topimax®),

indicated as an anti-convulsant which has been shown to increase weight loss), transcription factor modulators (such as those disclosed in WO03/026576),  $\beta$ -hydroxy steroid dehydrogenase-1 inhibitors ( $\beta$ -HSD-1),  $\beta$ -hydroxy- $\beta$ -methylbutyrate, p57 (Pfizer), Zonisamide (Zonegran<sup>TM</sup>, indicated as an anti-epileptic which has been shown to lead to weight loss), and the agents disclosed in US20030119428 paragraphs 20-26.

The peptides and agonists described herein can be used in therapeutic combination with one or more anti-diabetic agents, including but not limited to:

PPAR $\gamma$  agonists such as glitazones (e.g., WAY-120,744, AD 5075, balaglitazone, ciglitazone, darglitazone (CP-86325, Pfizer), englitazone (CP-68722, Pfizer), isaglitazone (MIT/J&J), MCC-555 (Mitsubishi disclosed in US5594016), pioglitazone (such as such as Actos<sup>TM</sup> pioglitazone; Takeda), rosiglitazone (Avandia<sup>TM</sup>; Smith Kline Beecham), rosiglitazone maleate, troglitazone (Rezulin<sup>®</sup>, disclosed in US4572912), rivoglitazone (CS-011; Sankyo), GL-262570 (Glaxo Wellcome), BRL49653 (disclosed in WO98/05331), CLX-0921, 5-BTZD, GW-0207, LG-100641, JJT-501 (JPNT/P&U), L-895645 (Merck), R-119702 (Sankyo/Pfizer), NN-2344 (Dr. Reddy/NN), YM-440 (Yamanouchi), LY-300512, LY-519818, R483 (Roche), T131 (Tularik), and the like and compounds disclosed in US4687777, US5002953, US5741803, US5965584, US6150383, US6150384, US6166042, US6166043, US6172090, US6211205, US6271243, US6288095, US6303640, US6329404, US5994554, W097/10813, W097/27857, W097/28115, W097/28137, W097/27847, W000/76488, W003/000685, W003/027112, W003/035602, W003/048130, W003/055867, and pharmaceutically acceptable salts thereof;

biguanides such as metformin hydrochloride (N,N-dimethylimidodicarbonimidic diamide hydrochloride, such as Glucophage<sup>TM</sup>, Bristol-Myers Squibb); metformin hydrochloride with glyburide, such as Glucovance<sup>TM</sup>, Bristol-Myers Squibb); buformin (Imidodicarbonimidic diamide, N-butyl-); etoformine (1-Butyl-2-ethylbiguanide, Schering A. G.); other metformin salt forms (including where the salt is chosen from the group of, acetate, benzoate, citrate, fumarate, embonate, chlorophenoxyacetate, glycolate,

palmoate, aspartate, methanesulphonate, maleate, parachlorophenoxyisobutyrate, formate, lactate, succinate, sulphate, tartrate, cyclohexanecarboxylate, hexanoate, octanoate, decanoate, hexadecanoate, octodecanoate, benzenesulphonate, trimethoxybenzoate, paratoluenesulphonate, adamantanecarboxylate, glycoxylate, 5 glutarnate, pyrrolidonecarboxylate, naphthalenesulphonate, 1-glucosephosphate, nitrate, sulphite, dithionate and phosphate), and phenformin;

protein tyrosine phosphatase-1B (PTP-1B) inhibitors, such as A-401,674, KR 61639, OC-060062, OC-83839, OC-297962, MC52445, MC52453, ISIS 113715, and those disclosed in WO99/585521, WO99/58518, WO99/58522, WO99/61435, WO03/032916, 10 WO03/032982, WO03/041729, WO03/055883, WO02/26707, WO02/26743, JP2002114768, and pharmaceutically acceptable salts and esters thereof;

sulfonylureas such as acetohexamide (e.g. Dymelor, Eli Lilly), carbutamide, chlorpropamide (e.g. Diabinese®, Pfizer), gliamilide (Pfizer), gliclazide (e.g. Diamcron, Servier Canada Inc), glimepiride (e.g. disclosed in US4379785, such as Amaryl™, 15 Aventis), glipentide, glipizide (e.g. Glucotrol or Glucotrol XL Extended Release, Pfizer), gliquidone, glisolamide, glyburide/glibenclamide (e.g. Micronase or Glynase Prestab, Pharmacia & Upjohn and Diabeta, Aventis), tolazamide (e.g. Tolinase), and tolbutamide (e.g. Orinase), and pharmaceutically acceptable salts and esters thereof;

meglitinides such as repaglinide (e.g. Prandin®, Novo Nordisk), KAD1229 (PF/Kissei), 20 and nateglinide (e.g. Starlix®, Novartis), and pharmaceutically acceptable salts and esters thereof;

$\alpha$  glucoside hydrolase inhibitors (or glucoside inhibitors) such as acarbose (e.g. Precose™, Bayer disclosed in US4904769), miglitol (such as GLYSET™, Pharmacia & Upjohn disclosed in US4639436), camiglibose (Methyl 6-deoxy-6-[(2R,3R,4R,5S)-3,4,5- 25 trihydroxy-2-(hydroxymethyl)piperidino]- $\alpha$ -D-glucopyranoside, Marion Merrell Dow), voglibose (Takeda), adiposine, emiglitate, pradimicin-Q, salbostatin, CKD-711, MDL- 25,637, MDL-73,945, and MOR 14, and the compounds disclosed in US4062950, US4174439, US4254256, US4701559, US4639436, US5192772, US4634765, US5157116, US5504078, US5091418, US5217877, US51091 and WO01/47528

(polyamines);  
α-amylase inhibitors such as tendamistat, frestatin, and A1-3688, and the compounds disclosed in US4451455, US4623714, and US4273765;  
SGLT2 inhibitors including those disclosed in US6414126 and US6515117;  
5 an αP2 inhibitor such as disclosed in US6548529;  
insulin secretagogues such as linogiride, A-4166, forskilin, dibutyl cAMP, isobutylmethylxanthine (IBMX), and pharmaceutically acceptable salts and esters thereof;  
fatty acid oxidation inhibitors, such as clomoxir, and etomoxir, and pharmaceutically  
10 acceptable salts and esters thereof;  
A2 antagonists, such as midaglizole, isaglidole, deriglidole, idazoxan, earoxan, and fluparoxan, and pharmaceutically acceptable salts and esters thereof;  
insulin and related compounds (e.g. insulin mimetics) such as biota, LP-100, novarapid, insulin detemir, insulin lispro, insulin glargine, insulin zinc suspension (lente and  
15 ultralente), Lys-Pro insulin, GLP-1 (1-36) amide, GLP-1 (73-7) (insulintropin, disclosed in US5614492), LY-315902 (Lilly), GLP-1 (7-36)-NH<sub>2</sub>, AL-401 (AutoImmune), certain compositions as disclosed in US4579730, US4849405, US4963526, US5642868, US5763396, US5824638, US5843866, US6153632, US6191105, and WO 85/05029, and primate, rodent, or rabbit insulin including biologically active variants thereof including  
20 allelic variants, more preferably human insulin available in recombinant form (sources of human insulin include pharmaceutically acceptable and sterile formulations such as those available from Eli Lilly (Indianapolis, Ind. 46285) as Humulin™ (human insulin rDNA origin), also see the THE PHYSICIAN'S DESK REFERENCE, 55.sup.th Ed. (2001) Medical Economics, Thomson Healthcare (disclosing other suitable human insulins);  
25 non-thiazolidinediones such as JT-501 and farglitazar (GW-2570/GI- 262579), and pharmaceutically acceptable salts and esters thereof;  
PPARα/γ dual agonists such as AR-HO39242 (Aztazeneca), GW-409544 (Glaxo-Wellcome), BVT-142, CLX-0940, GW-1536, GW-1929, GW-2433, KRP-297 (Kyorin Merck; 5-[(2,4-Dioxo thiazolidinyl)methyl] methoxy-N-[[4-(trifluoromethyl)phenyl]

- methyl]benzamide), L-796449, LR-90, MK-0767 (Merck/Kyorin/Banyu), SB 219994, muraglitazar (BMS), tesaglitazar (Astrazeneca), reglitazar (JTT-501) and those disclosed in WO99/16758, WO99/19313, WO99/20614, WO99/38850, WO00/23415, WO00/23417, WO00/23445, WO00/50414, WO01/00579, WO01/79150,
- 5 WO02/062799, WO03/004458, WO03/016265, WO03/018010, WO03/033481, WO03/033450, WO03/033453, WO03/043985, WO 031053976, U.S. application Ser. No. 09/664,598, filed Sep. 18, 2000, Murakami et al. Diabetes 47, 1841-1847 (1998), and pharmaceutically acceptable salts and esters thereof;
- other insulin sensitizing drugs;
- 10 VPAC2 receptor agonists;
- GLK modulators, such as those disclosed in WO03/015774;
- retinoid modulators such as those disclosed in WO03/000249;
- GSK 3 $\beta$ /GSK 3 inhibitors such as 4-[2-(2-bromophenyl)-4-(4-fluorophenyl)-1H-imidazol-5-yl]pyridine and those compounds disclosed in WO03/024447, WO03/037869,
- 15 WO03/037877, WO03/037891, WO03/068773, EP1295884, EP1295885, and the like;
- glycogen phosphorylase (HGLPa) inhibitors such as CP-368,296, CP-316,819, BAYR3401, and compounds disclosed in WO01/94300, WO02/20530, WO03/037864, and pharmaceutically acceptable salts or esters thereof;
- ATP consumption promoters such as those disclosed in WO03/007990;
- 20 TRB3 inhibitors;
- vanilloid receptor ligands such as those disclosed in WO03/049702;
- hypoglycemic agents such as those disclosed in WO03/015781 and WO03/040114;
- glycogen synthase kinase 3 inhibitors such as those disclosed in WO03/035663
- agents such as those disclosed in WO99/51225, US20030134890, WO01/24786, and
- 25 WO03/059870;
- insulin-responsive DNA binding protein-1 (IRDBP-1) as disclosed in WO03/057827, and the like;
- adenosine A2 antagonists such as those disclosed in WO03/035639, WO03/035640, and the like;

PPAR $\delta$  agonists such as GW 501516, GW 590735, and compounds disclosed in JP10237049 and WO02/14291;

dipeptidyl peptidase IV (DP-IV) inhibitors, such as isoleucine thiazolidide, NVP-DPP728A (1-[[[2-[(5-cyanopyridin-2-yl)amino]ethyl]amino]acetyl]-2-cyano-(S)-

5 pyrrolidine, disclosed by Hughes et al, Biochemistry, 38(36), 11597-11603, 1999), P32/98, NVP-LAF-237, P3298, TSL225 (tryptophyl-1,2,3,4-tetrahydro-isoquinoline-3-carboxylic acid, disclosed by Yamada et al, Bioorg. & Med. Chem. Lett. 8 (1998) 1537-1540), valine pyrrolidide, TMC-2A/2B/2C, CD-26 inhibitors, FE999011, P9310/K364, VIP 0177, DPP4, SDZ 274-444, 2-cyanopyrrolidides and 4-cyanopyrrolidides as

10 disclosed by Ashworth et al, Bioorg. & Med. Chem. Lett., Vol. 6, No. 22, pp 1163-1166 and 2745-2748 (1996), and the compounds disclosed in US6395767, US6573287, US6395767 (compounds disclosed include BMS-477118, BMS-471211 and BMS 538,305), WO99/38501, WO99/46272, WO99/67279, WO99/67278, WO99/61431, WO03/004498, WO03/004496, EP1258476, WO02/083128,

15 WO02/062764, WO03/000250, WO03/002530, WO03/002531, WO03/002553, WO03/002593, WO03/000180, and WO03/000181;

GLP-1 agonists such as exendin-3 and exendin-4 (including the 39 aa peptide synthetic exendin-4 called Exenatide®), and compounds disclosed in US2003087821 and NZ 504256, and pharmaceutically acceptable salts and esters thereof;

20 peptides including amlintide and Symlin® (pramlintide acetate); and glyco kinase activators such as those disclosed in US2002103199 (fused heteroaromatic compounds) and WO02/48106 (isoindolin-1-one-substituted propionamide compounds).

The peptides and agonists described herein useful in the treatment of obesity can

25 be administered as a cotherapy with electrostimulation (US20040015201).

The peptides and agonists described herein can be used in combination therapy with agents that activate soluble guanylate cyclase, for example those described in US20040192680.



The peptides and agonists described herein can be used in combination therapy with a phosphodiesterase inhibitor. PDE inhibitors are those compounds which slow the degradation of cyclic AMP (cAMP) and/or cyclic GMP (cGMP) by inhibition of the phosphodiesterases, which can lead to a relative increase in the intracellular concentration of cAMP and/or cGMP. Possible PDE inhibitors are primarily those substances which are to be numbered among the class consisting of the PDE3 inhibitors, the class consisting of the PDE4 inhibitors and/or the class consisting of the PDE5 inhibitors, in particular those substances which can be designated as mixed types of PDE3/4 inhibitors or as mixed types of PDE3/4/5 inhibitors. By way of example, those PDE inhibitors may be mentioned such as are described and/or claimed in the following patent applications and patents: DE1470341, DE2108438, DE2123328, DE2305339, DE2305575, DE2315801, DE2402908, DE2413935, DE2451417, DE2459090, DE2646469, DE2727481, DE2825048, DE2837161, DE2845220, DE2847621, DE2934747, DE3021792, DE3038166, DE3044568, EP000718, EP0008408, EP0010759, EP0059948, EP0075436, EP0096517, EP0112987, EP0116948, EP0150937, EP0158380, EP0161632, EP0161918, EP0167121, EP0199127, EP0220044, EP0247725, EP0258191, EP0272910, EP0272914, EP0294647, EP0300726, EP0335386, EP0357788, EP0389282, EP0406958, EP0426180, EP0428302, EP0435811, EP0470805, EP0482208, EP0490823, EP0506194, EP0511865, EP0527117, EP0626939, EP0664289, EP0671389, EP0685474, EP0685475, EP0685479, JP92234389, JP94329652, JP95010875, U.S. Pat. Nos. 4,963,561, 5,141,931, WO9117991, WO9200968, WO9212961, WO9307146, WO9315044, WO9315045, WO9318024, WO9319068, WO9319720, WO9319747, WO9319749, WO9319751, WO9325517, WO9402465, WO9406423, WO9412461, WO9420455, WO9422852, WO9425437, WO9427947, WO9500516, WO9501980, WO9503794, WO9504045, WO9504046, WO9505386, WO9508534, WO9509623, WO9509624, WO9509627, WO9509836, WO9514667, WO9514680, WO9514681, WO9517392, WO9517399, WO9519362, WO9522520, WO9524381, WO9527692, WO9528926, WO9535281, WO9535282, WO9600218, WO9601825, WO9602541, WO9611917,

DE3142982, DE1116676, DE2162096, EP0293063, EP0463756, EP0482208,  
EP0579496, EP0667345 US6,331,543, US20050004222 (including those disclosed in  
formulas I-XIII and paragraphs 37-39, 85-0545 and 557-577) and WO9307124,  
EP0163965, EP0393500, EP0510562, EP0553174, WO9501338 and WO9603399. PDE5  
5 inhibitors which may be mentioned by way of example are RX-RA-69, SCH-51866, KT-  
734, vesnarinone, zaprinast, SKF-96231, ER-21355, BF/GP-385, NM-702 and sildenafil  
(Viagra®). PDE4 inhibitors which may be mentioned by way of example are RO-20-  
1724, MEM 1414 (R1533/R1500; Pharmacia Roche), DENBUFYLLINE, ROLIPRAM,  
OXAGRELATE, NITRAQUAZONE, Y-590, DH-6471, SKF-94120, MOTAPIZONE,  
10 LIXAZINONE, INDOLIDAN, OLPRINONE, ATIZORAM, KS-506-G,  
DIPAMFYLLINE, BMY-43351, ATIZORAM, AROFYLLINE, FILAMINAST, PDB-  
093, UCB-29646, CDP-840, SKF-107806, PICLAMILAST, RS-17597, RS-25344-000,  
SB-207499, TIBENELAST, SB-210667, SB-211572, SB-211600, SB-212066, SB-  
212179; GW-3600, CDP-840, MOPIDAMOL, ANAGRELIDE, IBUDILAST,  
15 AMRINONE, PIMOBENDAN, CILOSTAZOL, QUAZINONE and N-(3,5-  
dichloropyrid-4-yl)-3-cyclopropylmethoxy-4-difluoromethoxybenzamide. PDE3  
inhibitors which may be mentioned by way of example are SULMAZOLE, AMPIZONE,  
CILOSTAMIDE, CARBAZERAN, PIROXIMONE, IMAZODAN, CI-930,  
SIGUAZODAN, ADIBENDAN, SATERINONE, SKF-95654, SDZ-MKS-492, 349-U-  
20 85, EMORADAN, EMD-53998, EMD-57033, NSP-306, NSP-307, REVIZINONE, NM-  
702, WIN-62582 and WIN-63291, ENOXIMONE and MILRINONE. PDE3/4 inhibitors  
which may be mentioned by way of example are BENAFENTRINE, TREQUINSIN,  
ORG-30029, ZARDAVERINE, L-686398, SDZ-ISQ-844, ORG-20241, EMD-54622,  
and TOLAFENTRINE. Other PDE inhibitors include: cilomilast, pentoxifylline,  
25 roflumilast, tadalafil(Cialis®), theophylline, and vardenafil(Levitra®), zaprinast (PDE5  
specific).

The peptides and agonists described herein can be used in combination therapy  
(for example, in order to decrease or inhibit uterine contractions) with a tocolytic agent

including but not limited to beta-adrenergic agents, magnesium sulfate, prostaglandin inhibitors, and calcium channel blockers.

The peptides and agonists described herein can be used in combination therapy  
5 with an anti-neoplastic agents including but not limited to alkylating agents,  
epipodophyllotoxins, nitrosoureas, antimetabolites, vinca alkaloids, anthracycline  
antibiotics, nitrogen mustard agents, and the like. Particular anti-neoplastic agents may  
include tamoxifen, taxol, etoposide and 5-fluorouracil. The peptides and agonists  
described herein can be used in combination therapy (for example as in a  
10 chemotherapeutic composition) with an antiviral and monoclonal antibody therapies.

The peptides and agonists described herein can be used in combination therapy  
(for example, in prevention/treatment of congestive heart failure or another method  
described herein) with the partial agonist of the nociceptin receptor ORL1 described by  
15 Dooley et al. (The Journal of Pharmacology and Experimental Therapeutics, 283 (2):  
735-741, 1997). The agonist is a hexapeptide having the amino acid sequence Ac- RYY  
(RK) (WI) (RK)-NH<sub>2</sub> ("the Dooley peptide"), where the brackets show allowable  
variation of amino acid residue. Thus Dooley peptide can include but are not limited to  
KYYRWR, RYYRWR, KWRYYR, RYYRWK, RYYRWK (all-D amin acids),  
20 RYYRIK, RYYRIR, RYYKIK, RYYKIR, RYYKWR, RYYKWK, RYYRWR,  
RYYRWK, RYYRIK, RYYKWR, RYYKWK, RYYRWK and KYYRWK, wherein the  
amino acid residues are in the L-form unless otherwise specified. The peptides and  
agonists described herein can also be used in combination therapy with peptide conjugate  
modifications of the Dooley peptide described in WO0198324.

25

#### Methods of Treatment

A number of disorders might be prevented or treated with GC-C receptor agonists and  
agents that increase cGMP levels including the peptides and agonists described herein.

The peptides and agonists described herein can be used alone or in combination therapy for the treatment or prevention of congestive heart failure. Such agents can be used in combination with natriuretic peptides (e.g., atrial natriuretic peptide, brain natriuretic peptide or C-type natriuretic peptide), a diuretic, or an inhibitor of angiotensin converting enzyme.

The peptides and agonists described herein can be used alone or in combination therapy for the treatment or prevention of benign prostatic hyperplasia (BPH). Such agents can be used in combination with one or more agents for treatment of BPH, for example, a 5-alpha reductase inhibitor (e.g., finasteride) or an alpha adrenergic inhibitor (e.g., doxazosine).

The peptides and agonists described herein can be used alone or in combination therapy for the treatment, prevention or reduction of visceral pain associated with a gastrointestinal disorder or pain associated with another disorder.

The peptides and agonists described herein can be used alone or in combination therapy for the treatment or prevention of obesity-related disorders (e.g. disorders that are associated with, caused by, or result from obesity). Examples of obesity-related disorders include overeating and bulimia, hypertension, diabetes, elevated plasma insulin concentrations and insulin resistance, dyslipidemias, hyperlipidemia, endometrial, breast, prostate and colon cancer, osteoarthritis, obstructive sleep apnea, cholelithiasis, gallstones, heart disease, abnormal heart rhythms and arrhythmias, myocardial infarction, congestive heart failure, coronary heart disease, sudden death, stroke, polycystic ovarian disease, craniopharyngioma, the Prader-Willi Syndrome, Frohlich's syndrome, GH-deficient subjects, normal variant short stature, Turner's syndrome, and other pathological conditions showing reduced metabolic activity or a decrease in resting energy expenditure as a percentage of total fat-free mass, e.g., children with acute lymphoblastic

leukemia. The agents described herein may be used to reduce or control body weight (or fat) or to prevent and/or treat obesity or other appetite related disorders related to the excess consumption of food, ethanol and other appetizing substances. The agents may be used to modulate lipid metabolism, reduce body fat (e.g. via increasing fat utilization) or  
5 reduce (or suppress) appetite (e.g. via inducing satiety). Further examples of obesity-related disorders are metabolic syndrome, also known as syndrome X, insulin resistance syndrome, sexual and reproductive dysfunction, such as infertility, hypogonadism in males and hirsutism in females, gastrointestinal motility disorders, such as obesity-related gastroesophageal reflux, respiratory disorders, such as obesity-hypoventilation syndrome  
10 (Pickwickian syndrome), cardiovascular disorders, inflammation, such as systemic inflammation of the vasculature, arteriosclerosis, hypercholesterolemia, hyperuricaemia, lower back pain, gallbladder disease, gout, and kidney cancer. The agents of the present invention are also useful for reducing the risk of secondary outcomes of obesity, such as reducing the risk of left ventricular hypertrophy.

15

The peptides and agonists described herein can be used alone or in combination therapy for the treatment or prevention of gastrointestinal related disorders including: chronic intestinal pseudo-obstruction (Ogilvie's syndrome), colonic pseudoobstruction, Crohn's disease, dyspepsia (including functional dyspepsia or nonulcer dyspepsia),  
20 duodenogastric reflux, functional bowel disorder, functional gastrointestinal disorders, functional heartburn, gastroesophageal reflux disease (GERD), gastrointestinal motility disorders, gastroparesis (e.g. idiopathic gastroparesis), hypertrophic pyloric stenosis, Inflammatory bowel disease, irritable bowel syndrome (IBS), post-operative ileus, and ulcerative colitis. The peptides and agonists described herein can be used alone or in  
25 combination therapy to patient suffering from or susceptible to GI disorders relating to damage to the GI tract stemming from impact or surgical intervention. The peptides and agonists described herein can be used alone or in combination therapy to patients at risk for or having particular diseases associated with hypomotility (e.g. colonic inertia) or stasis in the GI tract. For example, diabetic neuropathy, anorexia nervosa, and

achlorhydria are frequently accompanied by gastric hypomotility. Damage to the GI tract following surgical intervention, for instance, can result in substantial gastric stasis. The peptides and agonists described herein can be administered alone or in combination therapy to patients susceptible to or having a GI disorder associated with diabetes (e.g. diabetic gastropathy). The peptides and agonists described herein can be used alone or in combination therapy to prevent and/or treat GI disorders characterized by at least one of nausea, vomiting, heartburn, postprandial discomfort, diarrhea, constipation, indigestion or related symptoms. The peptides and agonists described herein can be used alone or in combination therapy to prevent and/or treat GI disorders associated with at least one of diabetes, anorexia nervosa, bulimia, achlorhydria, achalasia, anal fissure, haemorrhoids, irritable bowel syndrome, intestinal pseudoobstruction, scleroderma and gastrointestinal damage.

The peptides and agonists described herein can be used to prevent and/or treat constipation. Constipation can be used to describe bowel patterns which include one or more of hard, small, infrequent stools; the sensation of difficulty in passing stool, specifically excessive or ineffectual straining; the sensation of incomplete evacuation. Constipation has also been described as the passage of stool less than a certain number (e.g. 3) of times per week. A number of conditions can be associated with constipation. Constipation can be associated with numerous disorders and conditions. For example, constipation can be (1) associated with the use of a therapeutic agent (e.g. antihypertensives, anticonvulsants, antispasmodics, analgesics, anticholinergics, antidepressants, antipsychotics, cation-containing agents, anticonvulsants, ganglion blockers, vinca alkaloids); (2) associated with a muscular, neuropathic, metabolic or endocrine disorder (including but not limited to myotonic dystrophy, dermatomyositis, systemic sclerosis, scleroderma, amyloidosis (neurologic or muscular), ischemia, tumor of the central nervous system, autonomic neuropathy, Chagas disease, cystic fibrosis, diabetes mellitus, Hirschsprung disease, hyperthyroidism, hypocalcaemia, hypothyroidism, Multiple Sclerosis, neurofibromatosis, Parkinson's disease, and spinal

cord lesions (for example, related to sacral nerve damage related to trauma or a tumor or the enteric nervous system)); (3) post-surgical constipation (postoperative ileus); (4) associated with a structural colon alteration (for example that associated with Neoplasm, stricture, volvulus, anorectal, inflammation, prolapse, rectocele, or fissure); (5) associated with the a gastrointestinal disorder; (6) associated with a systemic illness or disorder (for example, electrolyte abnormalities, thyroid disease, diabetes mellitus, panhypopituitarism, Addison's disease, pheochromocytoma, uremia, porphyria); (7) chronic constipation; (8) associated with the use of analgesic drugs (e.g. opioid induced constipation); (9) associated with megacolon; and (10) idiopathic constipation (functional constipation). Functional constipation can be associated with normal transit, slow transit (e.g. one or fewer bowel movements per week) and pelvic floor dyssynergia. Pelvic floor dyssynergia is considered a disorder of the rectum and anus although these patients also have abnormal contractions throughout the colon. Patients with pelvic floor dyssynergia have abnormal colonic pressure waves prior to defecation and present with symptoms that may include a sensation of incomplete evacuation, excessive straining, a need for digital disimpaction, perianal heaviness, and tenesmus. Constipation can be associated with bloating and abdominal pain. The peptides and agonists described herein can be used to prevent and/or treat low stool frequency or poor stool consistency.

The peptides and agonists described herein can be used to treat decreased intestinal motility, slow digestion or slow stomach emptying. The peptides and agonists can be used to relieve one or more symptoms of IBS (bloating, pain, constipation), GERD (acid reflux into the esophagus), duodenogastric reflux, functional dyspepsia, or gastroparesis (nausea, vomiting, bloating, delayed gastric emptying) and other disorders described herein. The peptides and agonists described herein can be used to treat flatulence.

The peptides and agonists described herein can be used to increase intestinal motility, slow colonic transit, and to prevent and/or treat gastrointestinal immotility and other conditions calling for laxative or stool softener therapy. Gastrointestinal immotility can

include constipation, and also includes delayed oral cecal transit time, irregular Taxation, and other related gastrointestinal motility dysfunction including impaction. Impaction is a condition where a large mass of dry, hard stool develops in the rectum, often due to chronic constipation. This mass may be so hard that it cannot be excreted. The subjects  
5 affected by constipation or gastrointestinal immotility can be refractory to laxative therapy and/or stool softener therapy.

The peptides and agonists described herein can be used for the treatment or prevention of cancer, pre-cancerous growths, or metastatic growths. For example, they can be used for  
10 the prevention or treatment of: colorectal/local metastasized colorectal cancer, intestinal polyps, gastrointestinal tract cancer, lung cancer, cancer or pre-cancerous growths or metastatic growths of epithelial cells, polyps, breast, colorectal, lung, ovarian, pancreatic, prostatic, renal, stomach, bladder, liver, esophageal and testicular carcinoma, carcinoma (e.g., basal cell, basosquamous, Brown-Pearce, ductal carcinoma, Ehrlich tumor, Krebs,  
15 Merkel cell, small or non-small cell lung, oat cell, papillary, bronchiolar, squamous cell, transitional cell, (Walker), leukemia (e.g., B-cell, T-cell, HTLV, acute or chronic lymphocytic, mast cell, myeloid), histiocytoma, histiocytosis, Hodgkin's disease, non-Hodgkin's lymphoma, plasmacytoma, reticuloendotheliosis, adenoma, adeno-carcinoma, adenofibroma, adenolymphoma, ameloblastoma, angiokeratoma, angiolymphoid  
20 hyperplasia with eosinophilia, sclerosing angioma, angiomatosis, apudoma, branchionia, malignant carcinoid syndrome, carcinoid heart disease, carcinosarcoma, cementoma, cholangioma, cholesteatoma, chondrosarcoma, chondroblastoma, chondrosarcoma, chordoma, choristoma, craniopharyngioma, chondroma, cylindroma, cystadenocarcinoma, cystadenoma, cystosarcoma phyllodes, dysgeninoma,  
25 ependymoma, Ewing sarcoma, fibroma, fibrosarcoma, giant cell tumor, ganglioneuroma, glioblastoma, glomangioma, granulosa cell tumor, gynandroblastoma, hamartoma, hemangioendothelioma, hemangioma, hemangio-pericytoma, hemangiosarcoma, hepatoma, islet cell tumor, Kaposi sarcoma, leiomyoma, leiomyosarcoma, leukosarcoma, Leydig cell tumor, lipoma, liposarcoma, lymphangioma, lymphangiomyoma,



lymphangiosarcoma, medulloblastoma, meningioma, mesenchymoma, mesonephroma, mesothelioma, myoblastoma, myoma, myosarcoma, myxoma, myxosarcoma, neurilemmoma, neuroma, neuroblastoma, neuroepithelioma, neurofibroma, neurofibromatosis, odontoma, osteoma, osteosarcoma, papilloma, paraganglioma, 5 paraganglionia, nonchromaffin, pinealoma, rhabdomyoma, rhabdomyosarcoma, Sertoli cell tumor, teratoma, theca cell tumor, and other diseases in which cells have become dysplastic, immortalized, or transformed.

The peptides and agonists described herein can be used for the treatment or prevention of: 10 Familial Adenomatous Polyposis (FAP) (autosomal dominant syndrome) that precedes colon cancer, hereditary nonpolyposis colorectal cancer (HNPCC), and inherited autosomal dominant syndrome.

For treatment or prevention of cancer, pre-cancerous growths and metastatic growths, the 15 peptides and agonists described herein can be used in combination therapy with radiation or chemotherapeutic agents, an inhibitor of a cGMP-dependent phosphodiesterase or a selective cyclooxygenase-2 inhibitor. A number of selective cyclooxygenase-2 inhibitors are described in US20010024664, U.S. Pat. No. 5,380,738, U.S. Pat. No. 5,344,991, U.S. Pat. No. 5,393,790, U.S. Pat. No. 5,434,178, U.S. Pat. No. 5,474,995, U.S. Pat. No. 20 5,510,368, WO02/062369, WO 96/06840, WO 96/03388, WO 96/03387, WO 96/19469, WO 96/25405, WO 95/15316, WO 94/15932, WO 94/27980, WO 95/00501, WO 94/13635, WO 94/20480, and WO 94/26731, the disclosures of which are herein incorporated by reference. [Pyrazol-1-yl]benzenesulfonamides have also been described as inhibitors of cyclooxygenase-2.

25

The peptides and agonists described herein can be used in the treatment or prevention of inflammation. Thus, they can be used alone or in combination with an inhibitor of cGMP-dependent phosphodiesterase or a selective cyclooxygenase-2 inhibitor for treatment of: organ inflammation, IBD (e.g, Crohn's disease, ulcerative colitis), asthma,

nephritis, hepatitis, pancreatitis, bronchitis, cystic fibrosis, ischemic bowel diseases, intestinal inflammations/allergies, coeliac disease, proctitis, eosinophilic gastroenteritis, mastocytosis, and other inflammatory disorders. The peptides and agonists described herein can be used alone or in combination therapy in the treatment or prevention of  
5 gastrointestinal tract inflammation (e.g. inflammation associated with a gastrointestinal disorder, gastrointestinal tract infection, or another disorder). They can be used alone or in combination therapy with phenoxyalkylcarboxylic acid derivatives for the treatment of interstitial cystitis, irritable bowel syndrome, ulcerative colitis, and other inflammatory conditions, as mentioned in US20050239902A1.

10

The peptides and agonists described herein can also be used to treat or prevent insulin-related disorders, for example: II diabetes mellitus, hyperglycemia, obesity, disorders associated with disturbances in glucose or electrolyte transport and insulin secretion in cells, or endocrine disorders. They can be also used in insulin resistance treatment and  
15 post-surgical and non-post surgery decrease in insulin responsiveness.

The peptides and agonists described herein can be used to prevent and/or treat pulmonary and respiratory related disorders, including, inhalation, ventilation and mucus secretion disorders, pulmonary hypertension, chronic obstruction of vessels and airways, acute  
20 respiratory failure, and irreversible obstructions of vessels and bronchi. One may administer an agent described herein for treating bronchospasm, for inducing bronchodilation, for treating chronic obstructive pulmonary disease (including chronic bronchitis with normal airflow), for treating asthma (including bronchial asthma, intrinsic asthma, extrinsic asthma, acute asthma, chronic or inveterate asthma (e.g. late asthma and  
25 airways hyper-responsiveness), dust-induced asthma, allergen-induced asthma, viral-induced asthma, cold-induced asthma, pollution-induced asthma and exercise-induced asthma) and for treating rhinitis (including acute-, allergic, atrophic rhinitis or chronic rhinitis (such as rhinitis caseosa, hypertrophic rhinitis, rhinitis purulenta, rhinitis sicca), rhinitis medicamentosa, membranous rhinitis (including croupous, fibrinous and

pseudomembranous rhinitis), scrofulous rhinitis, perennial allergic rhinitis, seasonal rhinitis (including rhinitis nervosa (hay fever) and vasomotor rhinitis). The peptides described herein may also be useful in the treatment of dry eye disease and chronic sinusitis. The peptides described herein may also be used to prevent and/or treat

5 disorders characterized by acute pulmonary vasoconstriction such as may result from pneumonia, traumatic injury, aspiration or inhalation injury, fat embolism in the lung, acidosis inflammation of the lung, adult respiratory distress syndrome, acute pulmonary edema, acute mountain sickness, post-cardiac surgery, acute pulmonary hypertension, persistent pulmonary hypertension of the newborn, perinatal aspiration syndrome, hyaline

10 membrane disease, acute pulmonary thromboembolism, herapin-protamine reactions, sepsis, status asthmaticus or hypoxia (including iatrogenic hypoxia) and other forms of reversible pulmonary vasoconstriction. Such pulmonary disorders also are also characterized by inflammation of the lung including those associated with the migration into the lung of nonresident cell types including the various leucocyte subclasses. Also

15 included in the respiratory disorders contemplated are: bullous disease, cough, chronic cough associated with inflammation or iatrogenic induced, airway constriction, pigeon fancier's disease, eosinophilic bronchitis, asthmatic bronchitis, chronic bronchitis with airway obstruction (chronic obstructive bronchitis), eosinophilic lung disease, emphysema, farmer's lung, allergic eye diseases (including allergic conjunctivitis, vernal

20 conjunctivitis, vernal keratoconjunctivitis, and giant papillary conjunctivitis), idiopathic pulmonary fibrosis, cystic fibrosis, diffuse pan bronchiolitis and other diseases which are characterized by inflammation of the lung and/or excess mucosal secretion. Other physiological events which are contemplated to be prevented, treated or controlled include platelet activation in the lung, chronic inflammatory diseases of the lung which

25 result in interstitial fibrosis, such as interstitial lung diseases (ILD) (e.g., idiopathic pulmonary fibrosis, or ILD associated with rheumatoid arthritis, or other autoimmune conditions), chronic obstructive pulmonary disease (COPD)(such as irreversible COPD), chronic sinusitis, fibroid lung, hypersensitivity lung diseases, hypersensitivity

pneumonitis, idiopathic interstitial pneumonia, nasal congestion, nasal polyposis, and otitis media.

The peptides and agonists described herein can be used alone or in combitherapy to prevent or treat: retinopathy, nephropathy, diabetic angiopathy, and edema formation

The peptides and agonists described herein can be used alone or in combitherapy to prevent or treat neurological disorders, for example, headache, tension-type headache, migraines, anxiety, stress, cognitive disorders, cerebral ischemia, brain trauma, movement disorders, aggression, psychosis, seizures, panic attacks, hysteria, sleep disorders, depression, schizoaffective disorders, sleep apnea, attention deficit syndromes, memory loss, dementia, memory and learning disorders as discussed in Moncada and Higgs 1995 FASEB J. 9:1319-1330; Severina 1998 Biochemistry 63:794; Lee et al. 2000 PNAS 97: 10763-10768; Hobbs 1997 TIPS 18:484-491; Murad 1994 Adv. Pharmacol. 26:1-335; and Denninger et al. 1999 Biochim. Biophys. Acta 1411:334-350 and narcolepsy. They may also be used as a sedative.

The peptides and detectably peptides and agonists described herein can be used as markers to identify, detect, stage, or diagnosis diseases and conditions of small intestine, including, without limitation: Crohn's disease, colitis, inflammatory bowel disease, tumors, benign tumors, such as benign stromal tumors, adenoma, angioma, adenomatous (pedunculated and sessile) polyps, malignant, carcinoid tumors, endocrine cell tumors, lymphoma, adenocarcinoma, foregut, midgut, and hindgut carcinoma, gastrointestinal stromal tumor (GIST), such as leiomyoma, cellular leiomyoma, leiomyoblastoma, and leiomyosarcoma, gastrointestinal autonomic nerve tumor, malabsorption syndromes, celiac diseases, diverticulosis, Meckel's diverticulum, colonic diverticula, megacolon, Hirschsprung's disease, irritable bowel syndrome, mesenteric ischemia, ischemic colitis, colorectal cancer, colonic polyposis, polyp syndrome, intestinal adenocarcinoma, Liddle syndrome, Brody myopathy, infantile convulsions, and choreoathetosis

The peptides and agonists described herein can be conjugated to another molecule (e.g., a diagnostic or therapeutic molecule) to target cells bearing the GC-C receptor, e.g., cystic fibrosis lesions and specific cells lining the intestinal tract. Thus, they can be used to

5 target radioactive moieties or therapeutic moieties (active moieties like a radionuclide, an enzyme, a fluorescent label, a metal chelating group, a chemiluminescent label, a bioluminescent label, a chemotherapeutic, a toxin, an inactive prodrug, a radiosensitizing agent, a photodynamic agent) to the intestine to aid in imaging and diagnosing or treating colorectal/metastasized or local colorectal cancer. In addition, they can be used to deliver

10 antisense molecules or nucleic acid molecules (like normal copies of the p53 tumor suppressor gene) to the intestinal tract. The peptides and agonists described herein can also be used to increase the number of GC-C molecules on the surface of a cell. In some embodiments the cell is a metastasized colorectal cancer cell. In one embodiment the peptide or agonist described herein is therapeutically conjugated to a second agent. In

15 certain embodiments, the second agent can be radioactive or radiostable. In certain embodiments the second agent can be selected from the group consisting of a compound that causes cell death, a compound that inhibits cell division, a compound that induces cell differentiation, a chemotherapeutic, a toxin and a radiosensitizing agent. In certain embodiments the second agent can be selected from the group consisting of:

20 methotrexate, doxorubicin, daunorubicin, cytosinarabioside, etoposide, 5-4 fluorouracil, melphalan, chlorambucil, cis-platin, vindesine, mitomycin, bleomycin, puromycin, macromomycin, 1,4-benzoquinone derivatives, trenimon, ricin, ricin A chain, Pseudomonas exotoxin, diphtheria toxin, Clostridium perfringens phospholipase C, bovine pancreatic ribonuclease, pokeweed antiviral protein, abrin, abrin A chain, cobra

25 venom factor, gelonin, saporin, modeccin, viscumin, volkensin, nitroimidazole, metronidazole and misonidazole. In certain embodiments the second agent can be a cytotoxic agent selected from the group consisting of cemadotin, a derivative of cemadotin, a derivative of hemiasterlin, esperamicin C, neocarzinostatin, maytansinoid DM1, 7-

chloromethyl-10,11 methylenedioxy-camptothecin, rhizoxin, and the halichondrin B analog, ER-086526.

The peptides and agonists described herein can be used alone or in combination therapy  
5 to prevent and/or treat inner ear disorders, e.g., to prevent and/or treat Meniere's disease  
(including symptoms thereof such as vertigo, hearing loss, tinnitus, sensation of fullness  
in the ear), Mal de débarquement syndrome, otitis externa, otitis media, otorrhea, acute  
mastoiditis, otosclerosis, otic pain, otic bleeding, otic inflammation, Lermoyez's  
10 syndrome, vestibular neuronitis, benign paroxysmal positional vertigo (BPPV), herpes  
zoster oticus, Ramsay Hunt's syndrome, herpes, labyrinthitis, purulent labyrinthitis,  
perilymph fistulas, presbycusis, ototoxicity (including drug-induced ototoxicity),  
neuromias (including acoustic neuromas), aerotitis media, infectious myringitis, bullous  
myringitis, squamous cell carcinoma, basal cell carcinoma, pre-cancerous otic conditions,  
15 nonchromaffin paragangliomas, chemodectomas, glomus jugulare tumors, glomus  
tympanicum tumors, perichondritis, aural eczematoid dermatitis, malignant external  
otitis, subperichondrial hematoma, ceruminomas, impacted cerumen, sebaceous cysts,  
osteomas, keloids, otalgia, tinnitus, tympanic membrane infection, tympanitis, otic  
furuncles, petrositis, conductive and sensorineural hearing loss, epidural abscess, lateral  
20 sinus thrombosis, subdural empyema, otitic hydrocephalus, Dandy's syndrome, bullous  
myringitis, diffuse external otitis, foreign bodies, keratosis obturans, otic neoplasm,  
otomycosis, trauma, acute barotitis media, acute eustachian tube obstruction, postsurgical  
otalgia, cholesteatoma, infections related to an otic surgical procedure, and complications  
associated with any of said disorders. The peptides and agonists described herein can be  
used alone or in combination therapy to maintain fluid homeostasis in the inner ear.  
25 neuronitis (including viral neuronitis), ganglionitis, geniculate

The peptides and agonists described herein can be used alone or in combination therapy  
to prevent and/or treat disorders associated with fluid and sodium retention, e.g., diseases  
of the electrolyte-water/electrolyte transport system within the kidney, gut and urogenital

system, congestive heart failure, hypertension, hypotension, salt dependent forms of high blood pressure, hepatic edema, and liver cirrhosis. In addition they can be used to facilitate diuresis or control intestinal fluid. The peptides and agonists described herein can also be used to treat disorders where there is abnormal proliferation of epithelial cells  
5 within the kidney (e.g. as in the case of renal cancer).

The peptides and agonists described herein can be used alone or in combination therapy to prevent and/or treat kidney disease. "Kidney disease" includes renal failure (including acute renal failure), renal insufficiency, nephrotic edema, glomerulonephritis,  
10 pyelonephritis, kidney failure, chronic renal failure, nephritis, nephrosis, azotemia, uremia, immune renal disease, acute nephritic syndrome, rapidly progressive nephritic syndrome, nephrotic syndrome, Berger's Disease, chronic nephritic/proteinuric syndrome, tubulointerstitial disease, nephrotoxic disorders, renal infarction, atheroembolic renal disease, renal cortical necrosis, malignant nephroangiosclerosis, renal vein thrombosis,  
15 renal tubular acidosis, renal glucosuria, nephrogenic diabetes insipidus, Bartter's Syndrome, Liddle's Syndrome, polycystic kidney disease, medullary cystic disease, medullary sponge kidney, hereditary nephritis, and nail-patella syndrome, along with any disease or disorder that relates to the renal system and related disorders, as well as symptoms indicative of, or related to, renal or kidney disease and related disorders.

20 The peptides and agonists described herein can be used alone or in combination therapy to prevent or treat polycystic kidney disease. Polycystic kidney disease "PKD" (also called "polycystic renal disease") refers to a group of disorders characterized by a large number of cysts distributed throughout dramatically enlarged kidneys. The resultant cyst  
25 development leads to impairment of kidney function and can eventually cause kidney failure. "PKD" specifically includes autosomal dominant polycystic kidney disease (ADPKD) and recessive autosomal recessive polycystic kidney disease (ARPKD), in all stages of development, regardless of the underlying cause.

The peptides and agonists described herein can be used alone or in combination therapy to prevent and/or treat disorders associated with bicarbonate secretion, e.g., Cystic Fibrosis.

- 5 The peptides and agonists described herein can be used alone or in combination therapy to prevent and/or treat disorders associated with bile secretion. In addition, they can be used to facilitate or control chloride and bile fluid secretion in the gall bladder.

10 The peptides and agonists described herein can be used alone or in combination therapy to prevent and/or treat disorders associated with liver cell regeneration. This may include administration of the peptides and agonists to liver transplant recipients and to patients with drug or alcohol induced-liver damage. Furthermore, the peptides and agonists may be useful to treat liver damage as in the case of viral mediated hepatitis. The peptides and agonists described herein may be used alone or in combination to prevent and/or treat  
15 liver abscess, liver cancer (either primary or metastatic), cirrhosis (such as cirrhosis caused by the alcohol consumption or primary biliary cirrhosis), amebic liver abscess, autoimmune hepatitis, biliary atresia, coccidioidomycosis disseminated,  $\delta$  agent (hepatitis  $\delta$ ), hemochromatosis, hepatitis a, hepatitis b, hepatitis c, or any other acute, subacute, fulminant or chronic hepatitis of viral, metabolic or toxic etiology, hepatocellular  
20 carcinoma, pyogenic liver abscess, Reye's syndrome, sclerosing cholangitis, Wilson's disease, drug induced hepatotoxicity, or fulminant or acute liver failure. The peptides and agonists may be used in stimulating hepatic regeneration after surgical hepatectomy.

- 25 The peptides and agonists described herein can be used alone or in combination therapy to prevent and/or treat myocardial infraction, coronary artery disease, nitrate-induced tolerance, nitrate tolerance, diastolic dysfunction, angina pectoris, stable, unstable and variant (Prinzmetal) angina, atherosclerosis, thrombosis, endothelial dysfunction, cardiac



edema, stroke, conditions of reduced blood vessel patency, e.g., postpercutaneous transluminal coronary angioplasty (post-PTCA), and peripheral vascular disease.

The peptides and agonists described herein can be used alone or in combination therapy to prevent and/or treat glaucoma.

- 5 The peptides and agonists described herein can be used alone or in combination therapy to prevent and/or treat immunodeficiency.

The peptides and agonists described herein can be used alone or in combination therapy to prevent and/or treat bladder outlet obstruction and incontinence.

- 10 The peptides and agonists described herein can be used alone or in combination therapy to prevent and/or treat male (e.g. erectile dysfunction) or female sexual dysfunction, dysmenorrhea, endometriosis, polycystic ovary syndrome, vaginal dryness, uterine pain, or pelvic pain. These peptides and agonists described herein can be utilized as tocolytic agents that decrease or arrest uterine contractions. The peptides and agonists described herein can be used to prevent/treat premature/preterm labor. Premature or preterm labor  
15 can be associated with, for example, an illness/disorder/condition of the mother (such as pre-eclampsia, high blood pressure or diabetes, abnormal shape or size of the uterus, weak or short cervix, hormone imbalance, vaginal infection that spreads to the uterus, abnormalities of the placenta, such as placenta previa, and excessive amniotic fluid), premature rupture of the amniotic membranes ("water breaks"), large fetus, and more  
20 than one fetus. The peptides or agonists described herein can be used to prevent uterine rupture. The peptides or agonists described herein can be used treat rapid uterine contractions (for example, associated with placental abruption wherein the placental abruption is associated with hypertension, diabetes, a multiply pregnancy, an unusually large amount of amniotic fluid, numerous previous deliveries, or advanced maternal age  
25 (e.g. >40 years old). In certain embodiments they can be used in combination with a

phosphodiesterase inhibitor. The peptides and agonists described herein can be used alone or in combination therapy to prevent and/or treat infertility, for example, male infertility due to poor sperm quality, decreased sperm motility or low sperm count.

- 5 The peptides and agonists described herein can be used alone or in combination therapy to prevent and/or treat osteopenia disorders (bone loss disorders). "Bone loss disorders" include conditions and diseases wherein the inhibition of bone loss and/or the promotion of bone formation is desirable. Among such conditions and diseases are osteoporosis, osteomyelitis, Paget's disease (osteitis deformans), periodontitis, hypercalcemia,
- 10 osteonecrosis, osteosarcoma, osteolytic metastases, familial expansile osteolysis, prosthetic loosening, periprosthetic osteolysis, bone loss attendant rheumatoid arthritis, and cleidocranial dysplasia (CCD). Osteoporosis includes primary osteoporosis, endocrine osteoporosis (hyperthyroidism, hyperparathyroidism, Cushing's syndrome, and acromegaly), hereditary and congenital forms of osteoporosis (osteogenesis imperfecta,
- 15 homocystinuria, Menkes' syndrome, and Rile-Day syndrome) and osteoporosis due to immobilization of extremities osteomyelitis, or an infectious lesion in bone leading to bone loss. The peptides and agonists can be used alone or in combination therapy to stimulating bone regeneration. The bone regeneration may be following reconstruction of bone defects in cranio-maxillofacial surgery, or following an implant into bone, for
- 20 example a dental implant, bone supporting implant, or prosthesis. The bone regeneration may also be following a bone fracture.

The peptides and agonists described herein may be used alone or in combination therapy (for example, with other agents that increase cGMP) to prevent or treat disorders related to an alteration in cGMP including, but not limited to Alzheimer's disease, psoriasis, skin

25 necrosis, scarring, fibrosis, baldness, Kawasaki's Disease, nutcracker oesophagus (US20050245544), septic shock, NSAID-induced gastric disease or disorder, ischemic renal disease or disorder, peptic ulcer, sickle cell anemia, epilepsy, and a neuroinflammatory disease or disorder (for example as described in WO05105765).

The peptides described herein can be used as immunogens to create antibodies for immunoassays. The peptides described herein that have homology to ST peptides can be used as immunogens to treat and/or prevent one or more disease symptoms associated with traveler's diarrhea and for vaccination against pathogens, including but not limited to enterotoxigenic *E. coli* (ETEC). They may also be used in vaccines which also comprise interleukin 18 and either saponin adjuvant or CpG adjuvant for example as described in 5 WO05039634 and WO05039630. The methods described in US20040146534, US4220584, US4285391, US5182109, US4603049, US4545931, US4886663, US4758655, WO08402700, FR2525592, and FR2532850 can be similarly used to create 10 immunogens comprising the peptides described herein. US6043057, US5834246, US5268276, and EP368819, specifically describe an expression system containing CTB (cholera toxin Beta subunit) fused to an ST-like peptide under a foreign promoter for use as a vaccine. The nucleic acids that encode the peptides described herein may be use as genetic vaccines as described in US20050260605 and WO0148018. The nucleic acid 15 molecules may also be used for the manufacture of a functional ribonucleic acid, wherein the functional ribonucleic acid is selected from the group comprising ribozymes, antisense nucleic acids and siRNA (as described in WO05103073).

What is claimed is:

1. A purified polypeptide comprising the amino acid sequence:

X<sub>1</sub> Cys Glu X<sub>2</sub> X<sub>3</sub> X<sub>4</sub> Asn Pro Ala Cys Thr Gly X<sub>5</sub> X<sub>6</sub>

5 wherein:

X<sub>1</sub>, X<sub>3</sub>, X<sub>4</sub> and X<sub>5</sub> are independently selected from: Ala, Arg, Asn, Asp, Cys, Gln, Glu, Gly, His, Ile, Leu, Lys, Met, Phe, Pro, Ser, Thr, Trp, Tyr and Val;

X<sub>2</sub> is selected from: Ala, Arg, Asn, Asp, Cys, Gln, Glu, Gly, His, Ile, Leu, Lys, Met, Phe, Pro, Ser, Thr, Trp, Tyr and Val; and

10 X<sub>6</sub> is selected from Phe, Trp and Tyr or is missing,

provided that when both X<sub>1</sub> and X<sub>4</sub> are Ala and both X<sub>3</sub> and X<sub>5</sub> are Cys or when both X<sub>3</sub> and X<sub>5</sub> are Ala and both X<sub>1</sub> and X<sub>4</sub> are Cys or when X<sub>1</sub>, X<sub>3</sub>, X<sub>4</sub> and X<sub>5</sub> are all Cys, then either X<sub>6</sub> is selected from Phe and Trp or X<sub>2</sub> is not Leu.

15 2. The purified polypeptide of claim 1 wherein at least one of X<sub>1</sub>, X<sub>3</sub>, X<sub>4</sub> and X<sub>5</sub> is Cys.

3. The purified polypeptide of claim 1 wherein at least two of X<sub>1</sub>, X<sub>3</sub>, X<sub>4</sub> and X<sub>5</sub> are Cys.

20

4. The purified polypeptide claim 1 wherein at least three of X<sub>1</sub>, X<sub>3</sub>, X<sub>4</sub> and X<sub>5</sub> is Cys.

5. The purified polypeptide of claim 1 wherein X<sub>1</sub>, X<sub>3</sub>, X<sub>4</sub> and X<sub>5</sub> are Cys.

25

6. The purified polypeptide of any of claims 1 – 5 wherein X<sub>1</sub> and X<sub>4</sub> are Cys.

7. The purified polypeptide of any of claims 1 to 3 and 6 wherein X<sub>3</sub> and X<sub>5</sub> are Gly or Ala.
8. The purified polypeptide of claim 1 wherein X<sub>3</sub> and X<sub>5</sub> are Cys.
9. The purified polypeptide of any of claims 1 to 3 and 8 wherein X<sub>1</sub> and X<sub>4</sub> are Gly or Ala.
10. The purified polypeptide of claim 1 wherein at least one intermolecular disulfide bond is present between two Cys.
11. The purified polypeptide of claim 1 wherein X<sub>2</sub> is selected from: Ala, Arg, Asn, Asp, Cys, Gln, Glu, Gly, His, Ile, Lys, Met, Phe, Pro, Ser, Thr, Trp, Tyr and Val.
12. The purified polypeptide of claim 1 wherein one of X<sub>1</sub>, X<sub>3</sub>, X<sub>4</sub> and X<sub>5</sub> is Gly or Ala and the rest are Cys.
13. The purified polypeptide of claim 1 wherein two of X<sub>1</sub>, X<sub>3</sub>, X<sub>4</sub> and X<sub>5</sub> are Gly or Ala and the rest are Cys.
14. The purified polypeptide of claim 1 wherein three of X<sub>1</sub>, X<sub>3</sub>, X<sub>4</sub> and X<sub>5</sub> are Gly or Ala and the rest are Cys.
15. The purified polypeptide of claim 1 wherein X<sub>1</sub> and X<sub>4</sub> are independently Gly or Ala and X<sub>3</sub> and X<sub>5</sub> are Cys.
16. The purified polypeptide of claim 1 wherein X<sub>3</sub> and X<sub>5</sub> are independent Gly or Ala and X<sub>1</sub> and X<sub>4</sub> are Cys.

17. The purified polypeptide of any of the forgoing claims wherein X<sub>2</sub> is Phe,  
Tyr or Trp.
18. The purified polypeptide of any of the forgoing claims wherein X<sub>2</sub> is Phe.
- 5 19. The purified polypeptide of any of the forgoing claims wherein X<sub>2</sub> is Tyr.
20. The purified polypeptide of any of the forgoing claims wherein X<sub>2</sub> is Trp.
- 10 21. The purified polypeptide of any of the forgoing claims wherein X<sub>6</sub> is Tyr.
22. The purified polypeptide of any of the forgoing claims wherein X<sub>6</sub> is  
missing.
- 15 23. The purified polypeptide of any of claims 1-4 and 7-12 wherein X<sub>1</sub> is Gly  
or Ala.
24. The purified polypeptide of any of claims 1-4 and 7-12 wherein X<sub>3</sub> is Gly  
or Ala.
- 20 25. The purified polypeptide of any of claims 1-4 wherein X<sub>4</sub> is Gly or Ala.
- 26 26. The purified polypeptide of any of claims 1-4 wherein X<sub>5</sub> is Gly or Ala.
27. The purified polypeptide of claim 1 wherein X<sub>1</sub> and X<sub>4</sub> are Ala and X<sub>3</sub> and  
X<sub>5</sub> are Cys.
28. The purified polypeptide of claim 1 wherein X<sub>3</sub> and X<sub>5</sub> are Ala and X<sub>1</sub> and  
X<sub>4</sub> are Cys.

29. The purified polypeptide of claim 1 wherein  $X_1$  and  $X_4$  are Gly and  $X_3$  and  $X_5$  are Cys.
- 5 30. The purified polypeptide of claim 1 wherein  $X_3$  and  $X_5$  are Gly and  $X_1$  and  $X_4$  are Cys.
31. The purified polypeptide of claim 1 wherein one of  $X_1$  and  $X_4$  is Ala and the other is Gly and  $X_3$  and  $X_5$  are Cys.
- 10 32. The purified polypeptide of claim 1 wherein one of  $X_3$  and  $X_5$  is Ala and the other is Gly and  $X_1$  and  $X_4$  are Cys.
33. The purified polypeptide of any of claims 1-32 consisting essentially of  
15 the amino acid sequence  $X_1$  Cys Glu  $X_2$   $X_3$   $X_4$  Asn Pro Ala Cys Thr Gly  $X_5$   $X_6$ .
34. The purified polypeptide of any of claims 1-32 consisting of the amino acid sequence  $X_1$  Cys Glu  $X_2$   $X_3$   $X_4$  Asn Pro Ala Cys Thr Gly  $X_5$   $X_6$ .
- 20 35. The purified polypeptide of any of claims 1 – 33 wherein the polypeptide comprises 100 or fewer amino acids.
36. The purified polypeptide of any of claims 1 – 35 wherein the polypeptide comprises 20 or fewer amino acids.
- 25 37. The purified polypeptide of any of claims 1 – 35 wherein the polypeptide comprises 15 or fewer amino acids.

38. A method for treating a disorder selected from the group consisting of: a gastrointestinal disorder, cystic fibrosis, congestive heart failure, benign prostatic hyperplasia, the method comprising administering a composition comprising the polypeptide of any of claims 1-37.

5

39. A method for treating a disorder selected from the group consisting of: a gastrointestinal disorder, cystic fibrosis, congestive heart failure, benign prostatic hyperplasia, the method comprising administering a composition comprising the polypeptide of any of claims 1-37 without the proviso.

10

40. The method of any of 38 or 39 wherein the gastrointestinal disorder is a gastrointestinal motility disorder.

41. The method of claim 38 or 39 wherein the gastrointestinal disorder is selected from the group consisting of a gastrointestinal motility disorder, irritable bowel syndrome, chronic constipation, a functional gastrointestinal disorder, gastroesophageal reflux disease, functional heartburn, dyspepsia, functional dyspepsia, nonulcer dyspepsia, gastroparesis, chronic intestinal pseudo-obstruction, colonic pseudo-obstruction, Crohn's disease, ulcerative colitis, and inflammatory bowel disease.

20

42. A method of producing the peptide of any of claims 1-37 comprising providing a cell harboring a nucleic acid molecule encoding the polypeptide, culturing the cell under conditions in which the peptide is expressed, and isolating the expressed peptide.

25

43. A method of producing the peptide of any of claims 1-37, comprising chemically synthesizing the peptide and then purifying the synthesized peptide.



44. A pharmaceutical composition comprising the polypeptide of any of claims 1-37 and a pharmaceutically acceptable carrier.
45. An isolated nucleic acid molecule encoding the polypeptide of any of  
5 claims 1-37.
46. A vector comprising the nucleic acid molecule of claim 45.
47. The vector of claim 46 wherein the vector is an expression vector.  
10
48. An isolated cell comprising the isolated nucleic acid molecule of claim 45.
49. An isolated cell comprising the vector of claim 46.
- 15 50. A purified protein comprising the amino acid sequence Cys Cys Glu Tyr Cys Cys Asn Pro Ala Cys Thr Gly Cys having at least one of the following substitutions and no other substitutions within the amino acid sequence Cys Cys Glu Tyr Cys Cys Asn Pro Ala Cys Thr Gly Cys:
- (a) residue 3 of the sequence Cys Cys Glu Tyr Cys Cys Asn Pro Ala Cys Thr  
20 Gly Cys is substituted by an amino other than Glu;
- (b) residue 4 of the sequence Cys Cys Glu Tyr Cys Cys Asn Pro Ala Cys Thr Gly Cys is substituted by an amino other than Tyr provided that the amino acid is not Leu, Ile, Val, Ala or Lys when residue 3 is Asp, Glu, Gln, or Gly;
- (c) residue 7 of the sequence Cys Cys Glu Tyr Cys Cys Asn Pro Ala Cys Thr  
25 Gly Cys is substituted by an amino other than Asn;
- (d) residue 8 of the sequence Cys Cys Glu Tyr Cys Cys Asn Pro Ala Cys Thr Gly Cys is substituted by an amino other than Pro;
- (e) residue 9 of the sequence Cys Cys Glu Tyr Cys Cys Asn Pro Ala Cys Thr Gly Cys is substituted by an amino other than Ala;

(f) residue 11 of the sequence Cys Cys Glu Tyr Cys Cys Asn Pro Ala Cys Thr Gly Cys is substituted by an amino other than Thr; and

(g) residue 9 of the sequence Cys Cys Glu Tyr Cys Cys Asn Pro Ala Cys Thr Gly Cys is substituted by an amino other than Gly.

5

51. The purified protein of claim 50 having at most six substitutions selected from (a) – (g).

52. The purified protein of claim 50 having at most five substitutions selected  
10 from (a) – (g).

53. The purified protein of claim 50 having at most five substitutions selected from (a) – (g).

15 54. The purified protein of claim 50 having at most four substitutions selected from (a) – (g).

55. The purified protein of claim 50 having at most three substitutions selected from (a) – (g).

20

56. The purified protein of claim 50 having at most two substitutions selected from (a) – (g).

57. The purified protein of claim 50 having one substitution selected from (a)  
25 – (g).

58. The purified protein of any of claims 50 to 57 having at least substitution (a).

60. The purified protein of any of claims 50 to 57 having at least substitution  
(b).
61. The purified protein of any of claims 50 to 57 having at least substitution  
5 (c).
62. The purified protein of any of claims 50 to 57 having at least substitution  
(d).
- 10 63. The purified protein of any of claims 50 to 57 having at least substitution  
(e).
64. The purified protein of any of claims 50 to 57 having at least substitution  
(f).
- 15 65. The purified protein of any of claims 50 to 57 having at least substitution  
(g).
66. The purified protein of claim 57 having only substitution (a).
- 20 67. The purified protein of claim 57 having only substitution (b).
68. The purified protein of claim 57 having only substitution (c).
- 25 69. The purified protein of claim 57 having only substitution (d).
70. The purified protein of claim 57 having only substitution (e).
71. The purified protein of claim 57 having only substitution (f).

72. The purified protein of claim 57 having only substitution (g).

72. The purified protein of any of claims 50-72 wherein the substituted amino  
5 acid is a naturally-occurring amino acid.

73. The purified protein of any of claims 50-72 wherein the substituted amino  
acid is not a naturally-occurring amino acid.

10 74. The purified protein of any of claims 50-72 wherein the substituted amino  
acid is selected from Ala, Arg, Asn, Asp, Cys, Gln, Glu, Gly, His, Ile, Leu, Lys, Met,  
Phe, Pro, Ser, Thr, Trp, Tyr, and Val.

75. The purified protein of any of claims 50-74 wherein the substitution is a  
15 conservative substitution.

76. The purified protein of any of claims 50-74 wherein the substituted amino  
acid is a D-amino acid.

20 77. The purified protein of any of claims 50-74 wherein the amino terminal  
amino acid of the protein is a D-amino acid.

78. The purified protein of any of claims 50-74 wherein the carboxy terminal  
amino acid of the protein is a D-amino acid.

25 79. The purified protein of any of claims 50-74 wherein the amino and  
carboxy terminal amino acids of the protein are D-amino acids.

80. The purified protein of any of claims 50-74 wherein substitution (b) is an aromatic amino acid.
- 5 Trp. 81. The purified protein of any of claims 50-74 wherein substitution (b) is
- Phe. 82. The purified protein of any of claims 50-74 wherein substitution (b) is
- 10 Ala. 83. The purified protein of any of claims 50-74 wherein substitution (a) is Ala.
- Ala. 84. The purified protein of any of claims 50-74 wherein substitution (b) is
- 15 Ala. 85. The purified protein of any of claims 50-74 wherein substitution (c) is Ala.
- Ala. 86. The purified protein of any of claims 50-74 wherein substitution (d) is
- 20 Ala. 87. The purified protein of any of claims 50-74 wherein substitution (e) is Ala.
88. The purified protein of any of claims 50-74 wherein substitution (f) is Ala.
- 25 Ala. 89. The purified protein of any of claims 50-74 wherein substitution (g) is
90. The purified polypeptide of any of claims 50-74 comprising no more than 20 amino acids.

33. 91. The purified protein of any of claims 50-74 wherein substitution (a) is  
Gly.
92. The purified protein of any of claims 50-74 wherein substitution (b) is  
5 Gly.
93. The purified protein of any of claims 50-74 wherein substitution (c) is  
Gly.
- 10 94. The purified protein of any of claims 50-74 wherein substitution (d) is  
Gly.
95. The purified protein of any of claims 50-74 wherein substitution (e) is  
Gly.
- 15 96. The purified protein of any of claims 50-74 wherein substitution (f) is Gly.
97. The purified protein of any of claims 50-74 wherein substitution (g) is  
Gly.
- 20 98. The purified protein of any of claims 50-97 wherein the protein forms  
three intramolecular disulfide bonds.
99. The purified protein of any of claims 50-74 having a Tyr at the carboxy  
25 terminus.
100. The purified protein of any of claims 50-97 wherein the protein binds to  
the GC-C receptor.

101. The purified protein of any of claims 50-97 wherein the protein modulates the activity of the GC-C receptor.

102. The purified protein of any of claims 50-97 wherein the protein increases  
5 the activity of the GC-C receptor.

103. The purified protein of any of claims 50-97 wherein the protein increases intestinal transit when administered to a subject.

104. The purified protein of any of claims 50-97 wherein the protein decreases  
10 intestinal transit when administered to a subject.

105. The purified protein of any of claims 50-97 wherein the protein decreases stool firmness when administered to a subject.

15

106. The purified protein of any of claims 50-97 wherein the protein increases stool frequency when administered to a subject.

107. The purified protein of any of claims 50-97 wherein the protein decreases  
20 visceral pain when administered to a subject.

108. The purified protein any of claims 50-97 wherein in the protein comprises fewer than 30, but more than 13 amino acids.

109. The purified protein any of claims 50-108 wherein in the protein  
25 comprises fewer than 30 amino acids.

110. The purified protein any of claims 50-108 wherein in the protein comprises fewer than 25 amino acids.

111. The purified protein any of claims 50-108 wherein in the protein comprises fewer than 20 amino acids.

5 112. The purified protein any of claims 50-018 wherein in the protein comprises fewer than 19 amino acids.

113. The purified protein any of claims 50-108 wherein in the protein comprises fewer than 18 amino acids.

10

114. The purified protein any of claims 50-108 wherein in the protein comprises fewer than 17 amino acids.

115. The purified protein any of claims 50-108 wherein in the protein comprises fewer than 16 amino acids.

15

116. The purified protein any of claims 50-108 wherein in the protein comprises fewer than 15 amino acids.

20 117. The purified protein any of claims 50-108 wherein in the protein comprises fewer than 14 amino acids.

118. The purified protein any of claims 50-108 wherein in the protein comprises 14 - 20 amino acids.

25

119. The purified protein any of claims 50-108 wherein in the protein comprises 13 - 25 amino acids.



120. The protein of claim 50 wherein residue 4 of the sequence Cys Cys Glu Tyr Cys Cys Asn Pro Ala Cys Thr Gly Cys is substituted by an amino other than Tyr, Leu, Ile, Val, Ala or Lys.

5 121. A method for increasing intestinal motility comprising administering a GC-C receptor agonist to a patient in need thereof.

122. A method treating a disorder associated with reduced gastrointestinal transit rates or reduced gastrointestinal motility comprising administering a GC-C  
10 receptor agonist to a patient in need thereof.

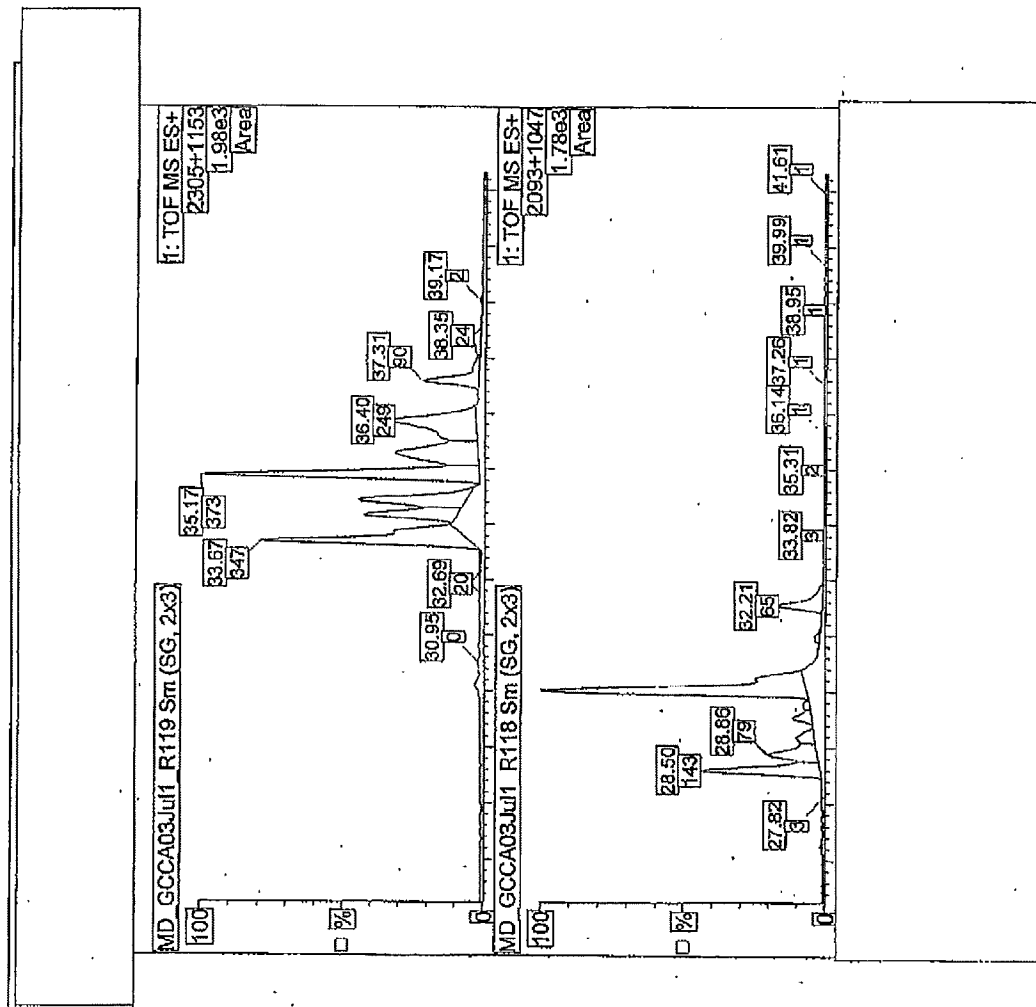
123. A method treating a gastrointestinal hypomotility disorder comprising administering a GC-C receptor agonist to a patient in need thereof.

15 124. The method of any of claims 121 to 123 wherein the disorder is selected from the group consisting of constipation, constipation dominant irritable bowel syndrome and pelvic floor dyssynergia.

124. A method treating a non-inflammatory gastrointestinal disorder  
20 comprising administering a GC-C receptor agonist to a patient in need thereof.

125. A method treating a gastrointestinal disorder other than Crohn's disease and ulcerative colitis comprising administering a GC-C receptor agonist to a patient in  
25 need thereof.

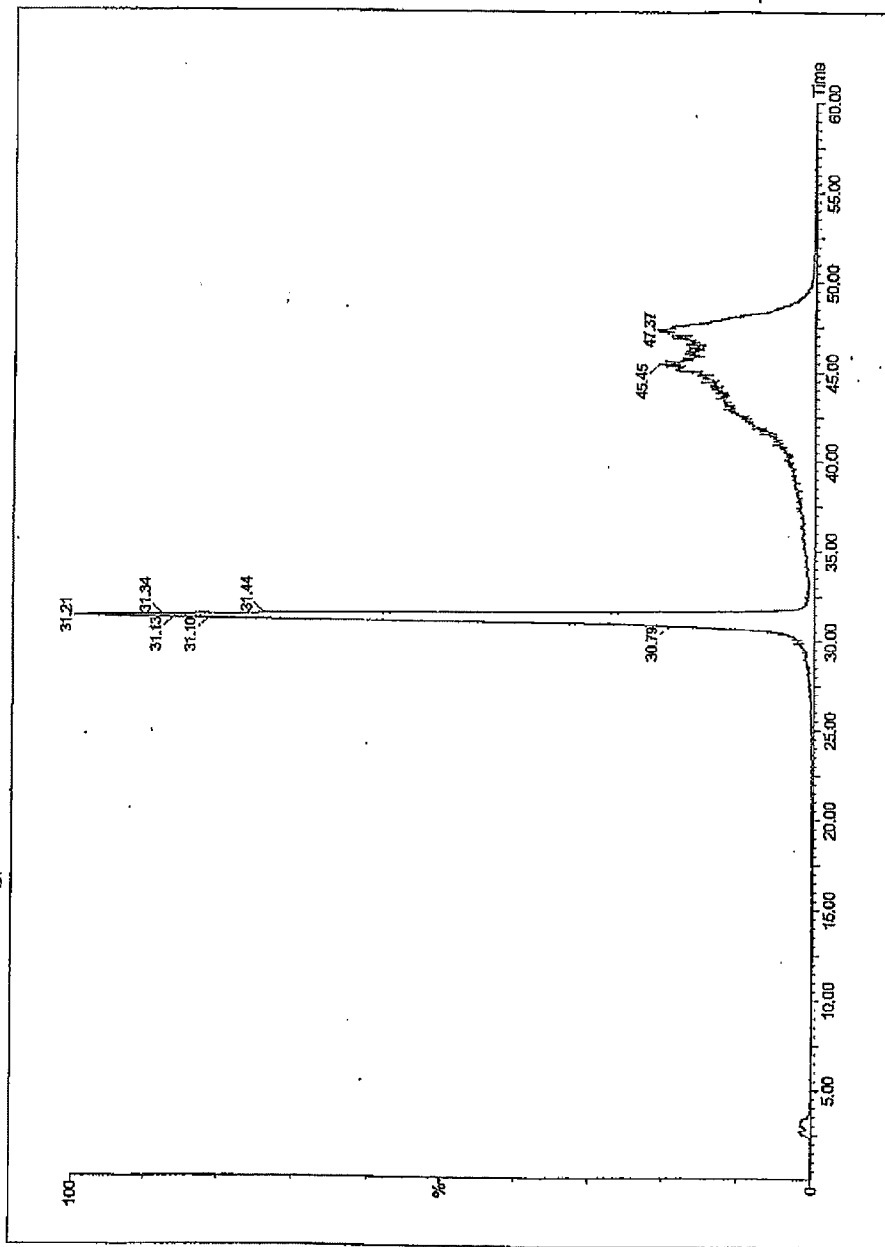
Figure 1a. LCMS analysis of recombinant peptide variants



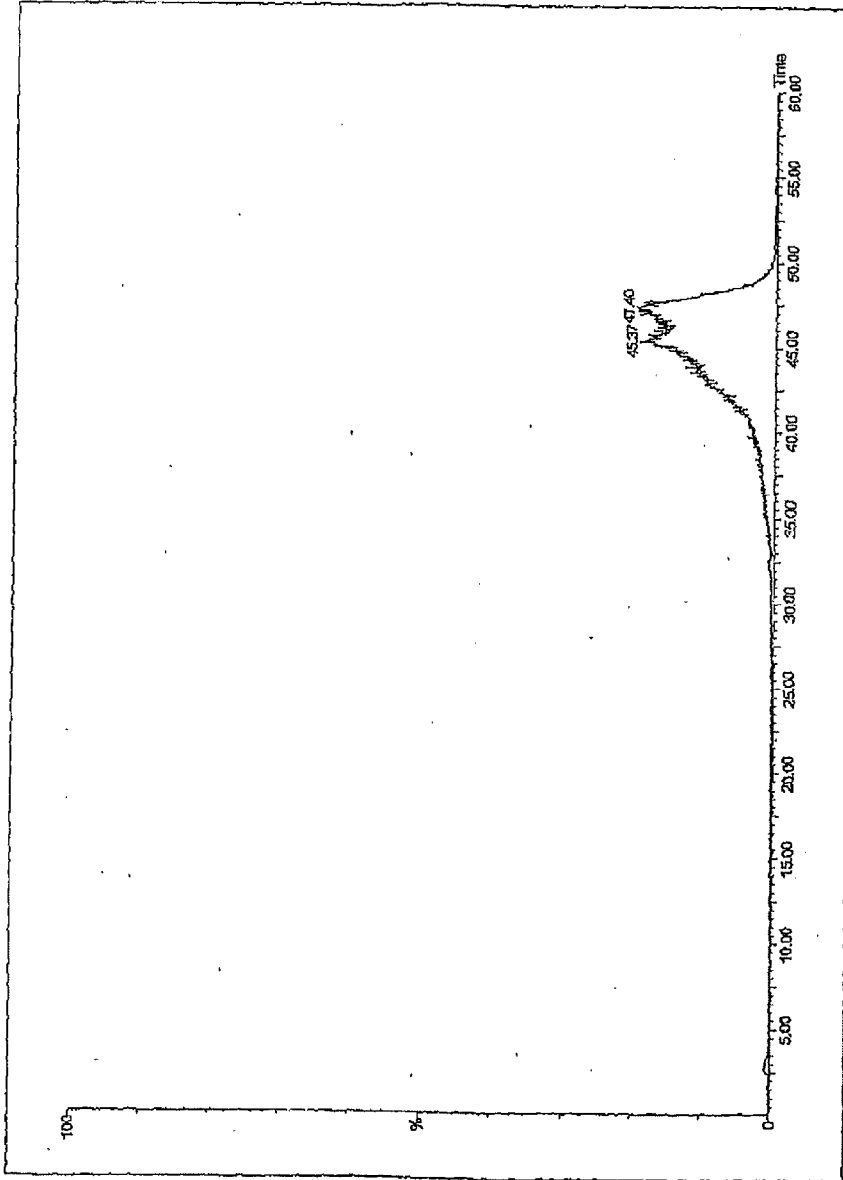
(A) SEQ ID NO:4

(B) SEQ ID NO:5

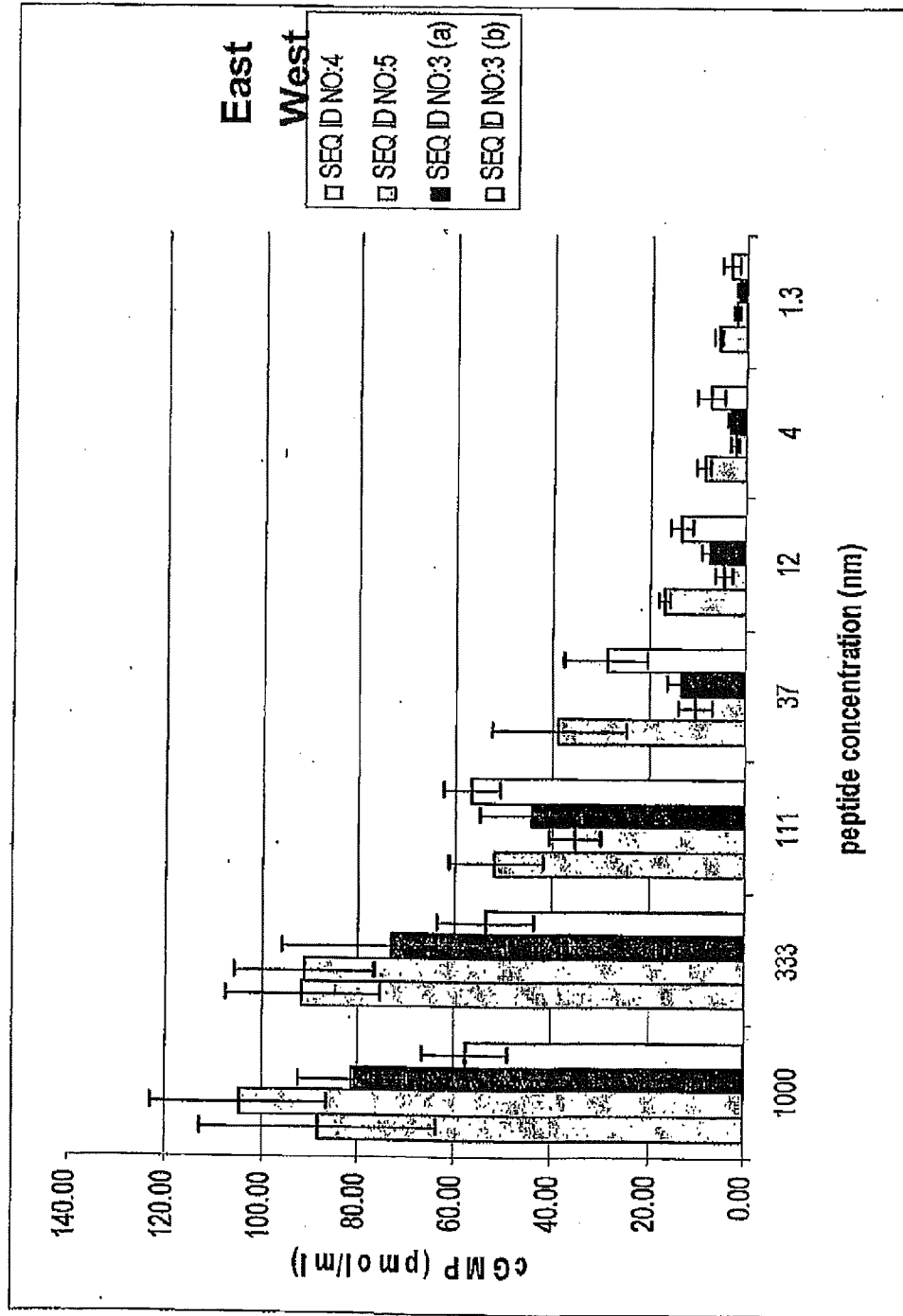
Figure 1b. LCMS analysis of synthetic SEQ ID NO:3 (Total Ion Chromatograph (TIC) )



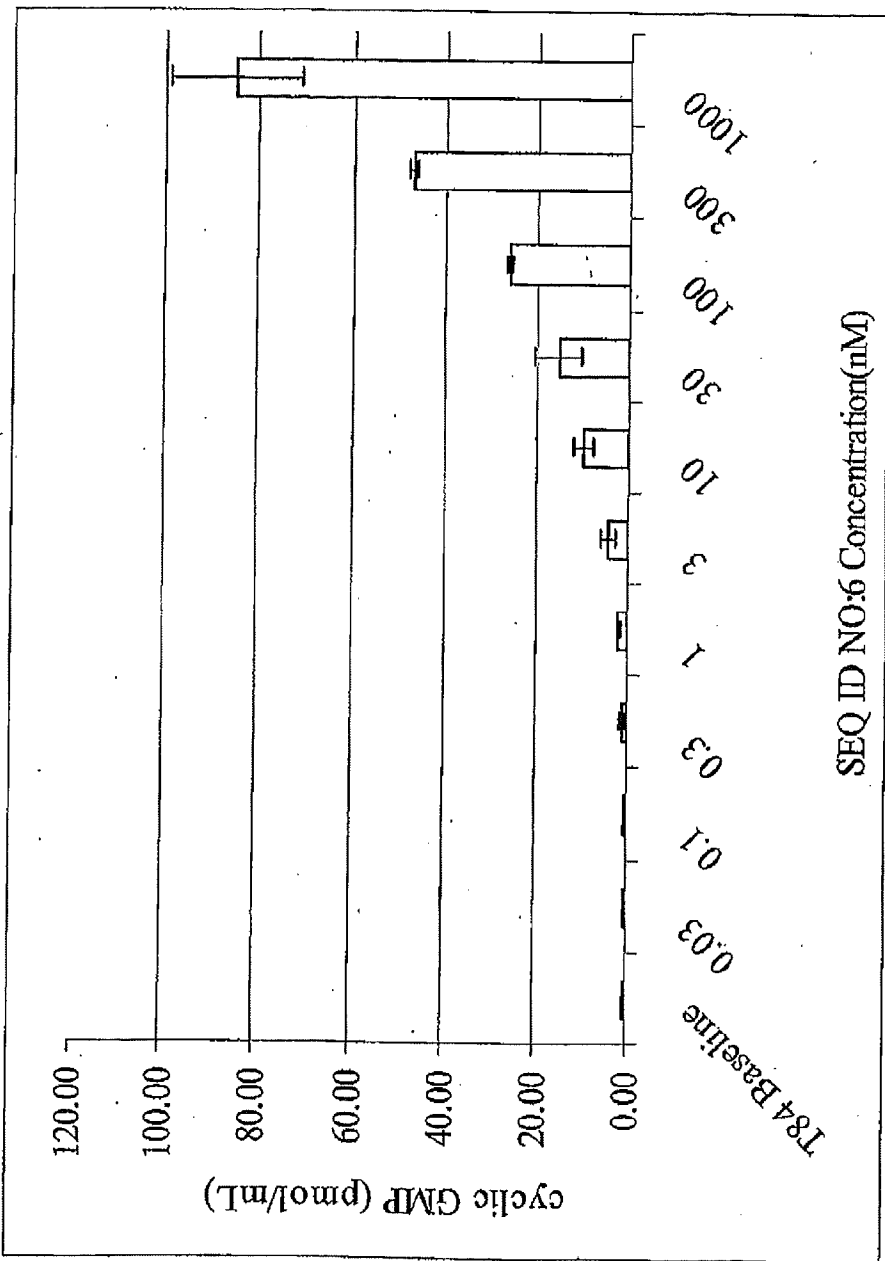
**Figure 1c. LCMS analysis (Total Ion Chromatograph of blank used in SEQ ID NO:3 analysis)**



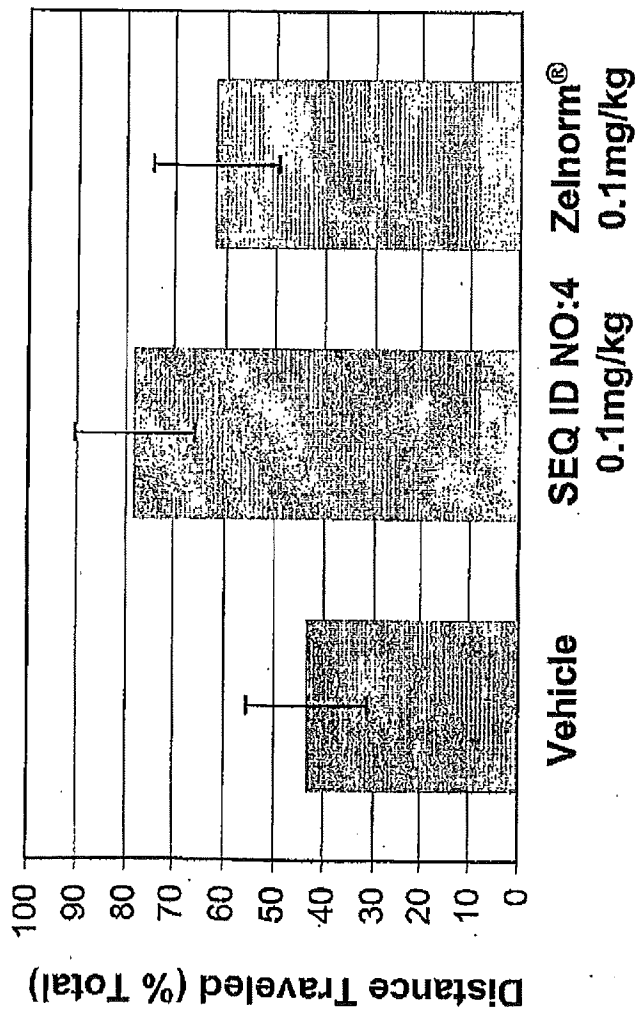
**Figure 2a. Chemically synthesized peptides in the Intestinal GC-C Receptor Activity Assay**



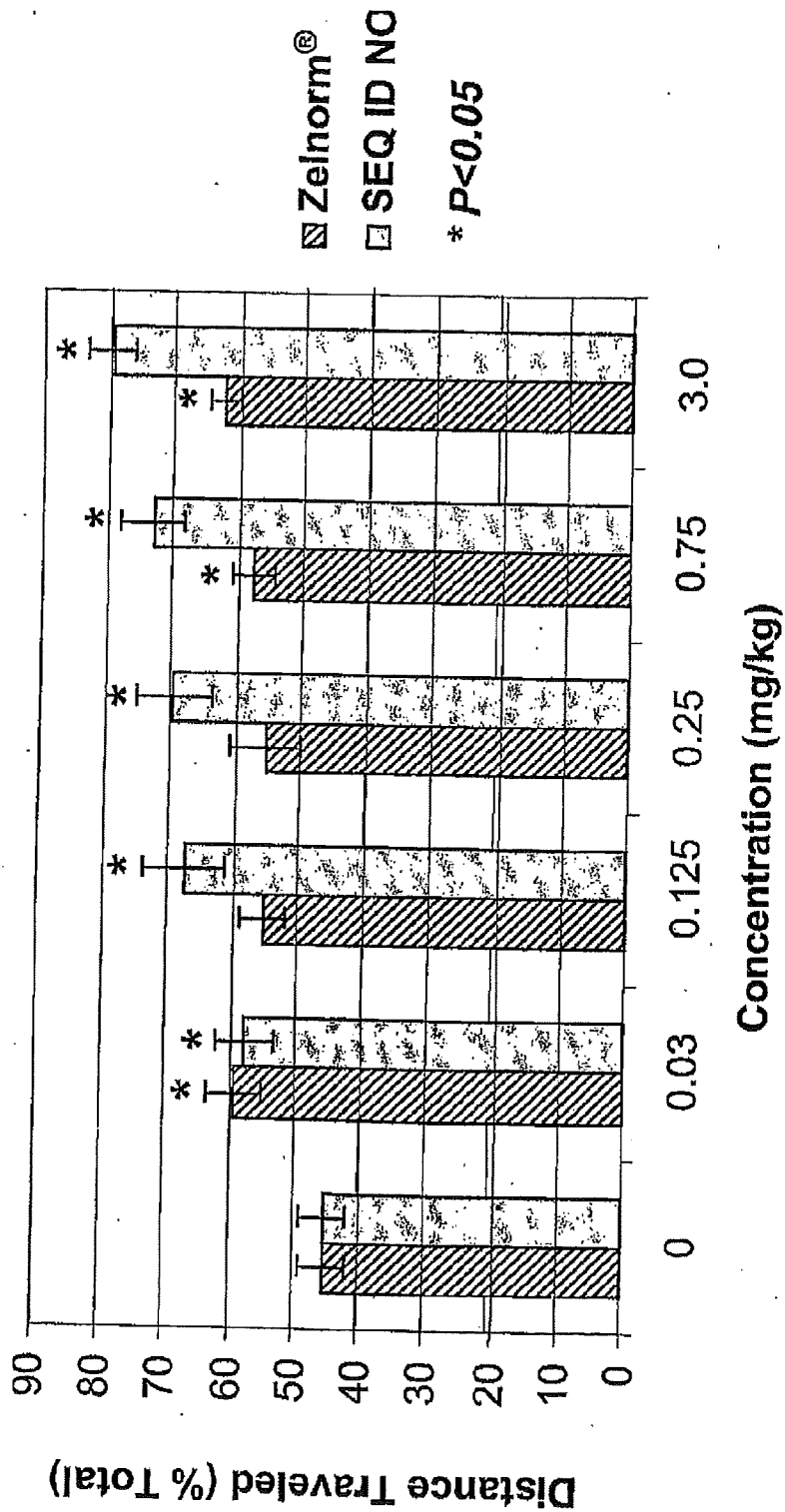
**Figure 2b: SEQ ID NO:6 in the intestinal GC-C Receptor Activity Assay**



**Figure 3a. SEQ ID NO:4 vs Zelnorm® in an acute Mouse Gastrointestinal Transit Model (GIT)**



**Figure 3b: SEQ ID NO:3 vs. Zelnorm® in an acute Mouse Gastrointestinal Transit Model**





**Figure 4a. Purified SEQ ID NO:5 and SEQ ID NO:4 in GIT Model**

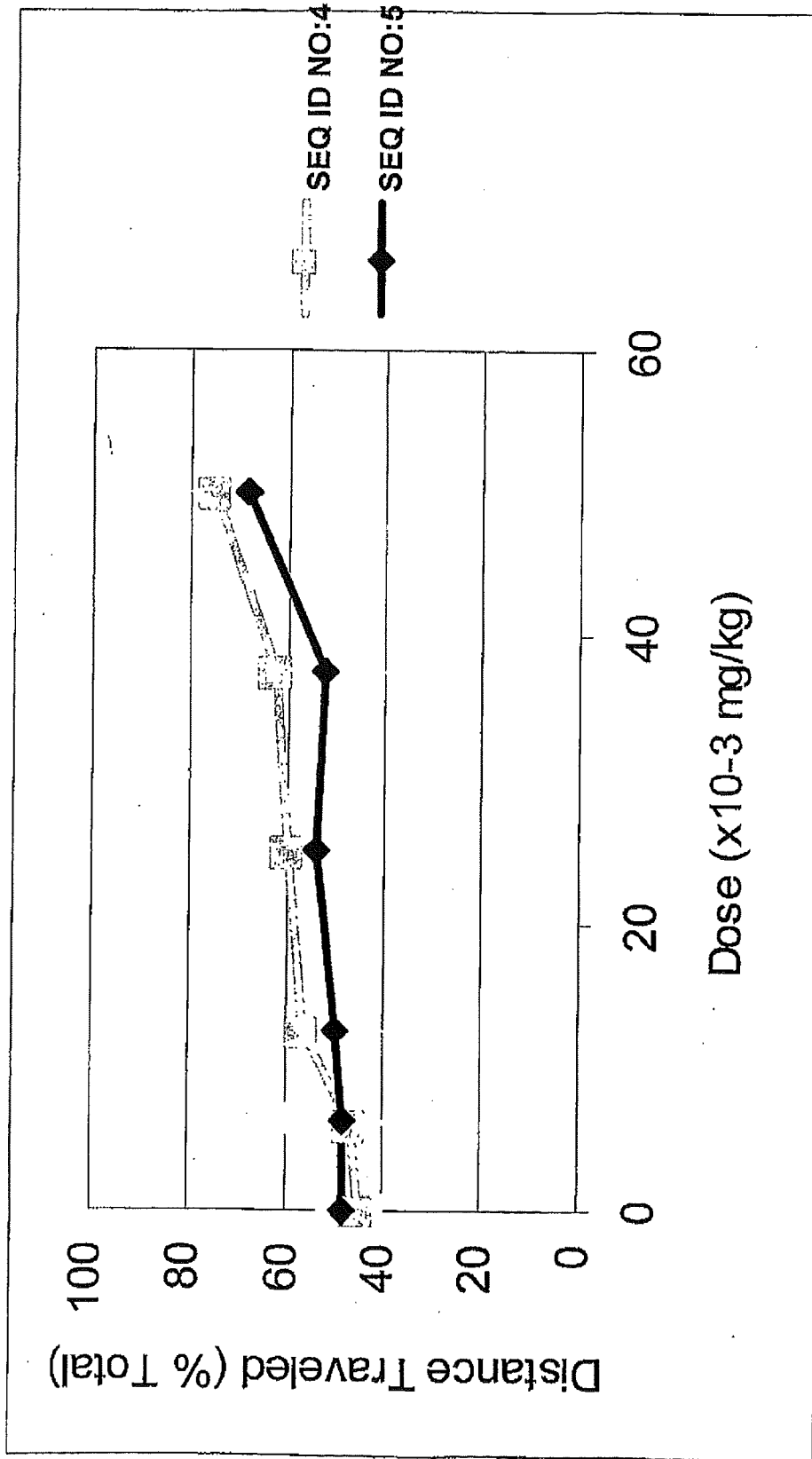


Figure 4b. Chemically Synthesized Peptides in GIT Mode

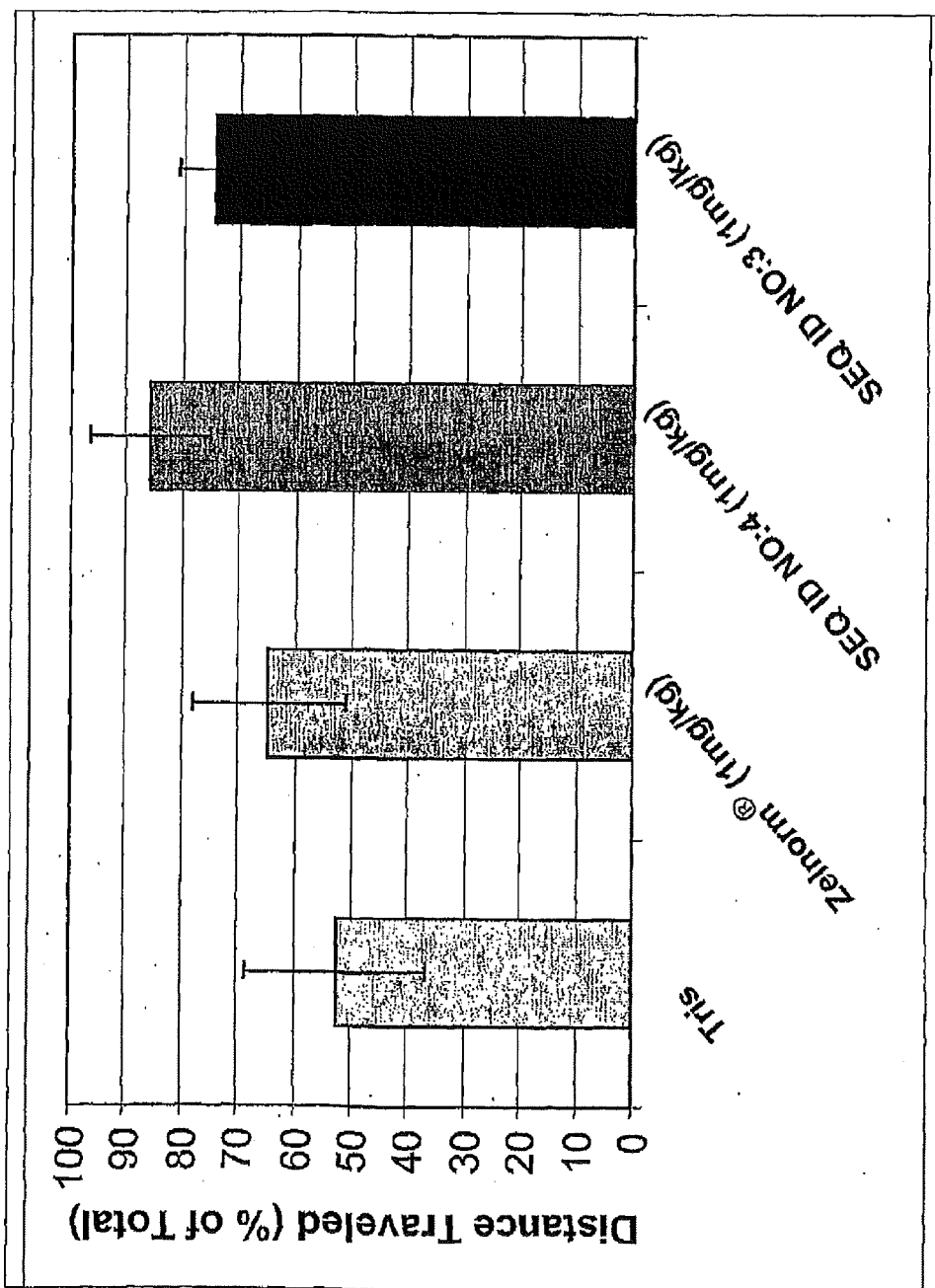
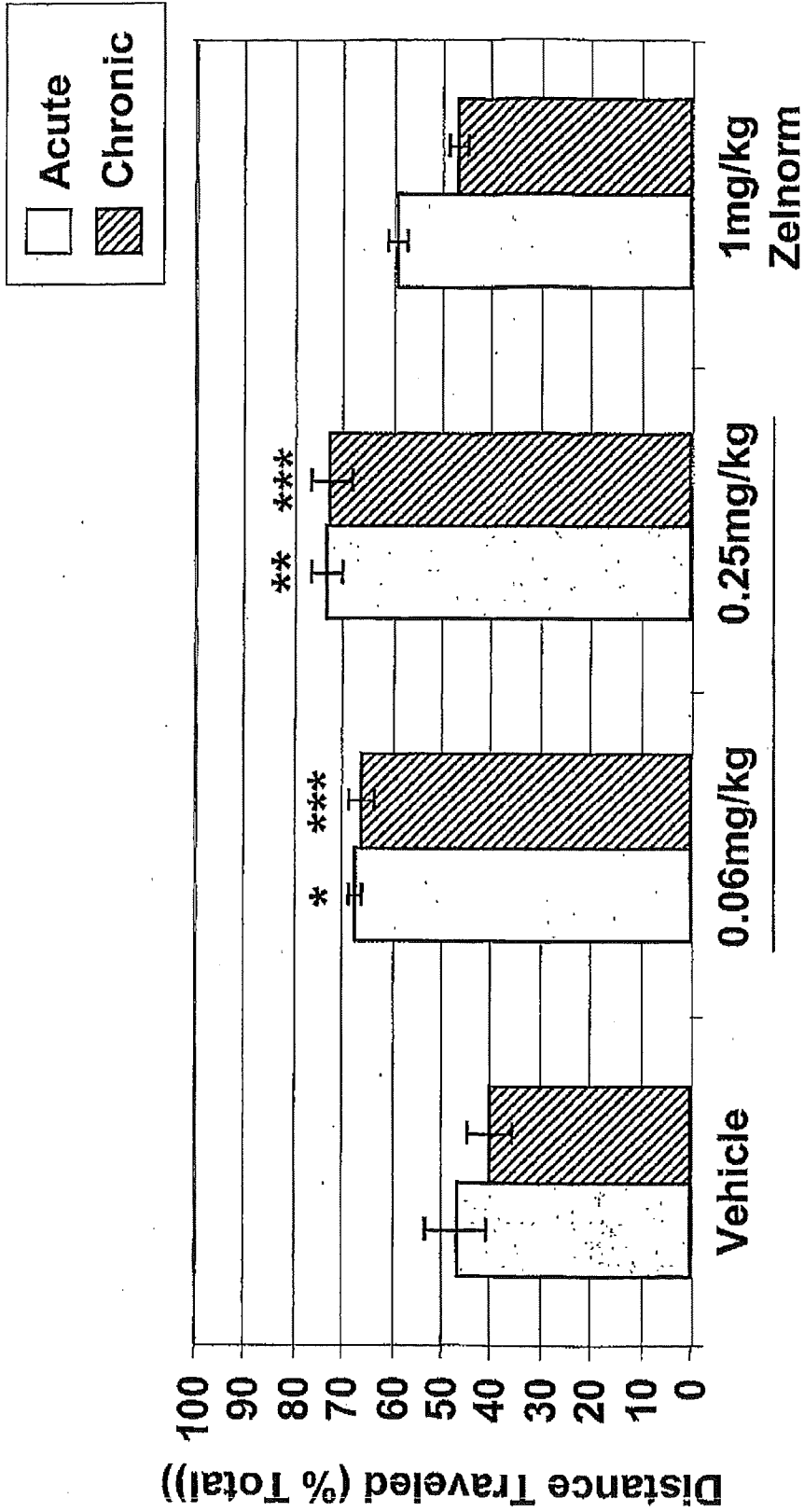


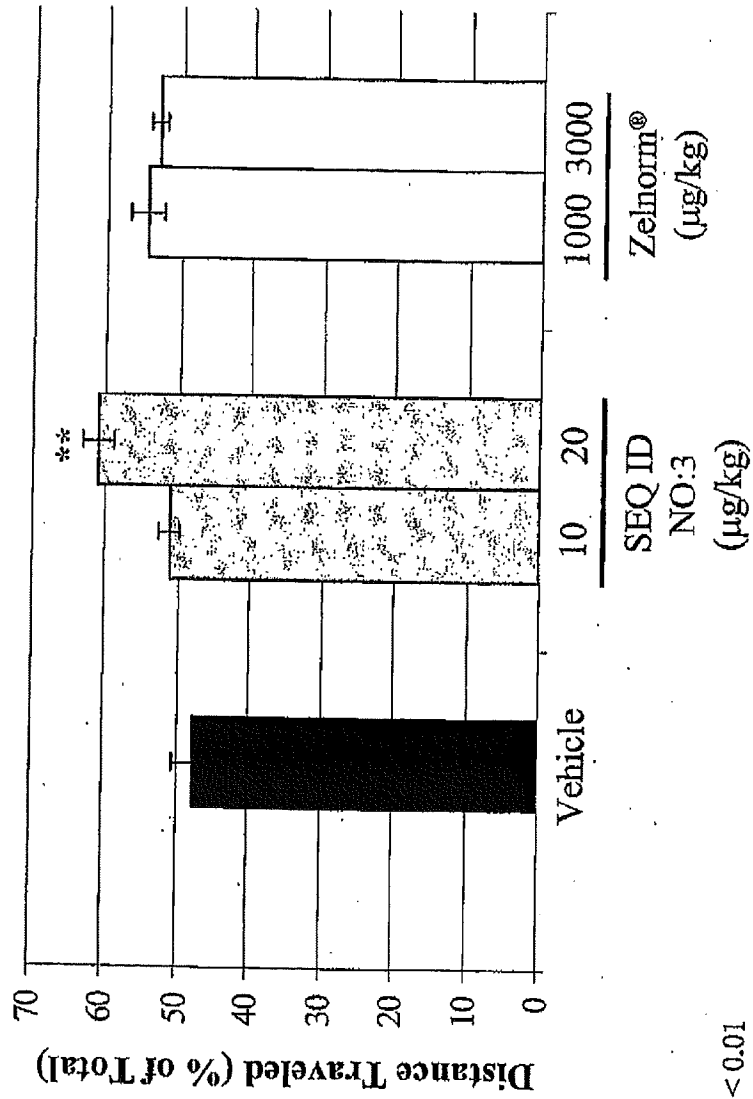
Figure 4c. Chronic vs. Acute Dosing in GIT Assay



SEQ ID NO:3

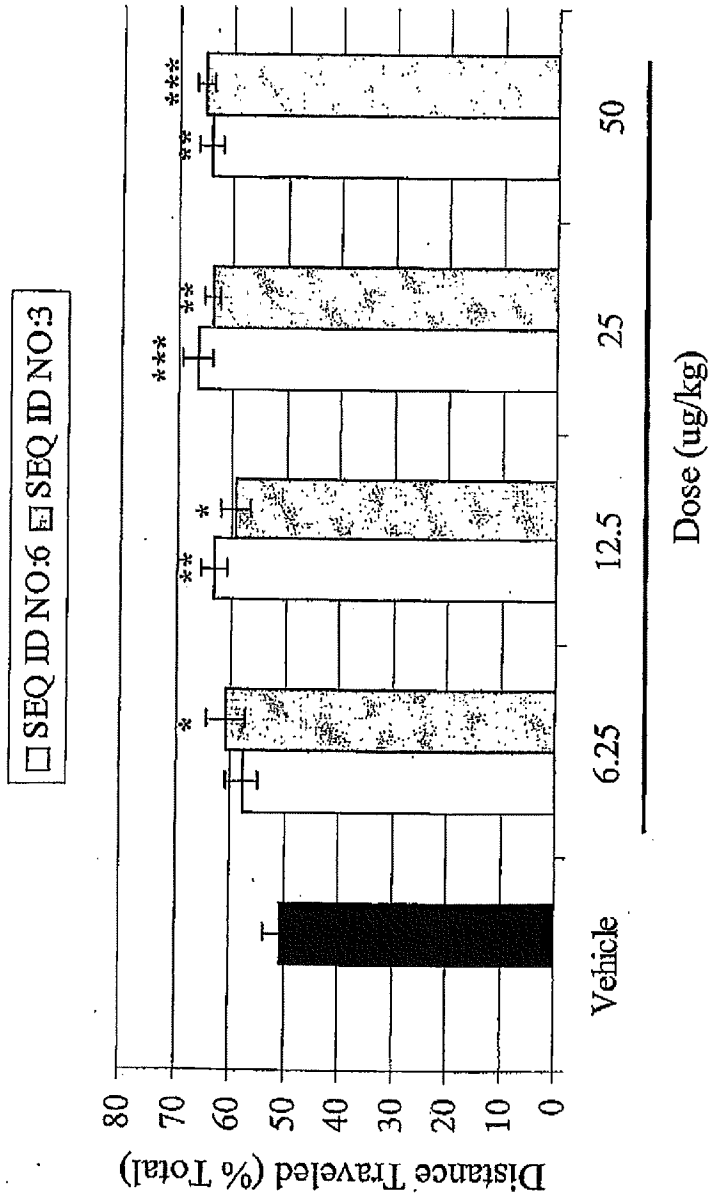
\* p < 0.01  
\*\* p < 0.005  
\*\*\* p < 0.0005

Figure 4d. SEQ ID NO:3 and Zelnorm® in the rat GIT Model



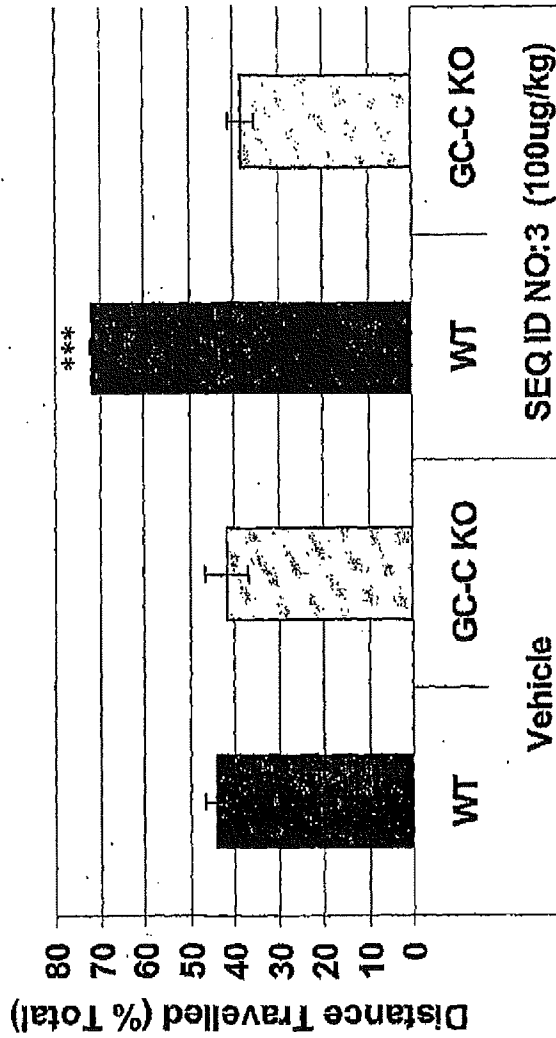
\*\* p < 0.01

Figure 4e. SEQ ID NO:3 and SEQ ID NO:6 in the Rat GIT model



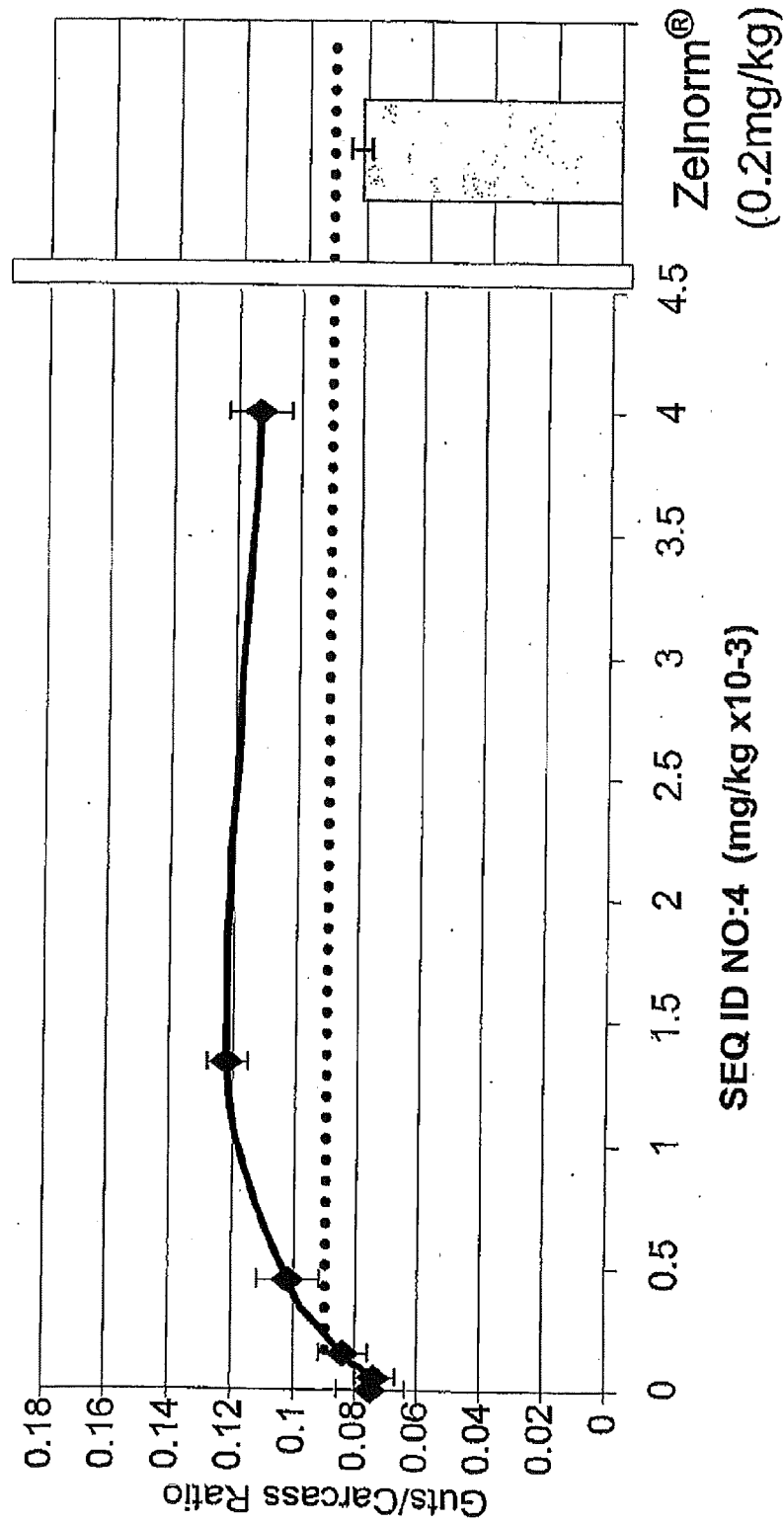
P values as compared to Vehicle Control: \* P<0.05 \*\* P<0.01 \*\*\* P<0.001

Figure 4f. Wild-type (WT) and GC-C KO mice in the mouse GIT model

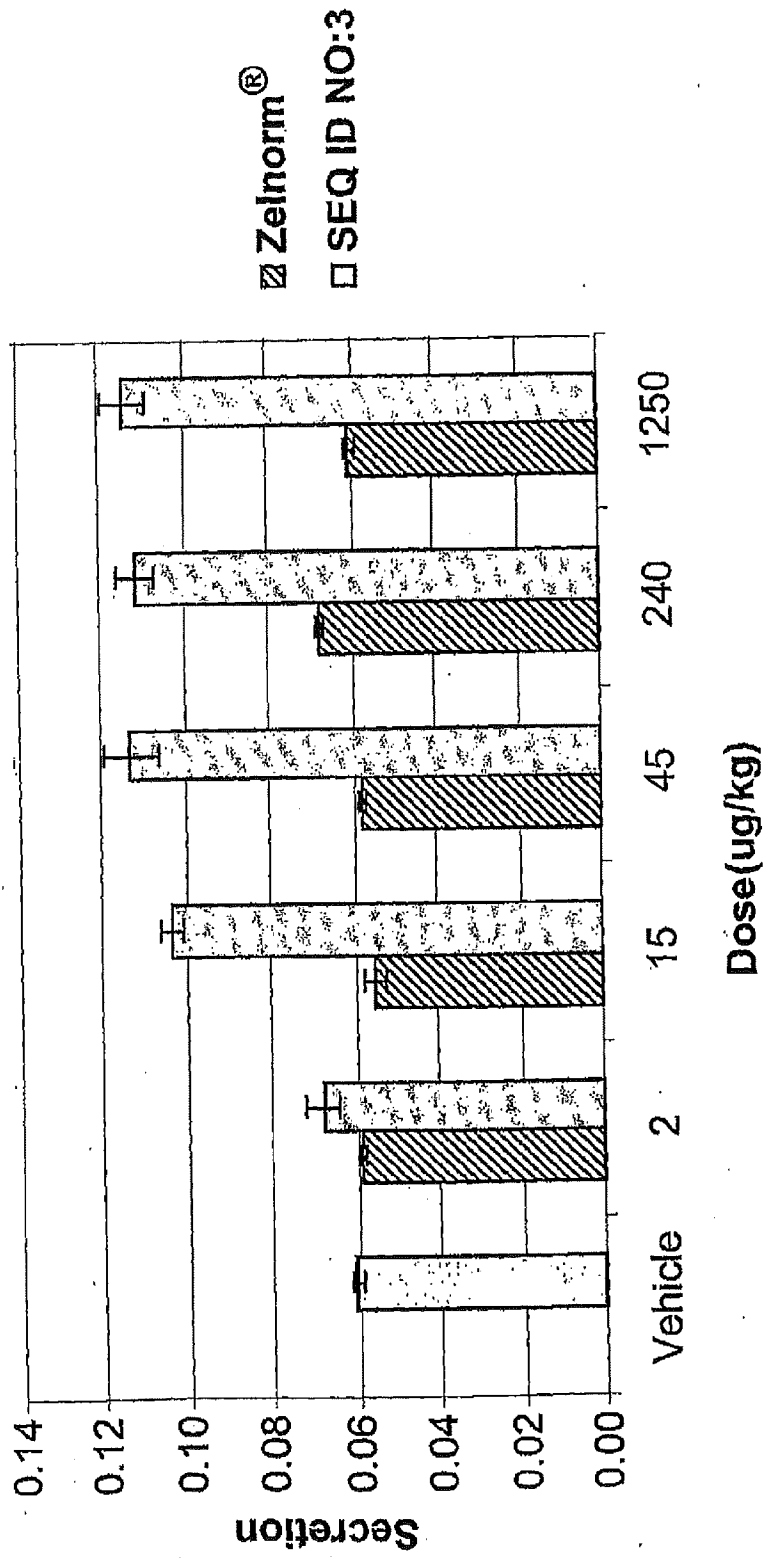


\*\*\*  $p < 0.001$

**Figure 5a. SEQ ID NO:4 vs Zelnorm® in a Mouse Intestinal Secretion Model**

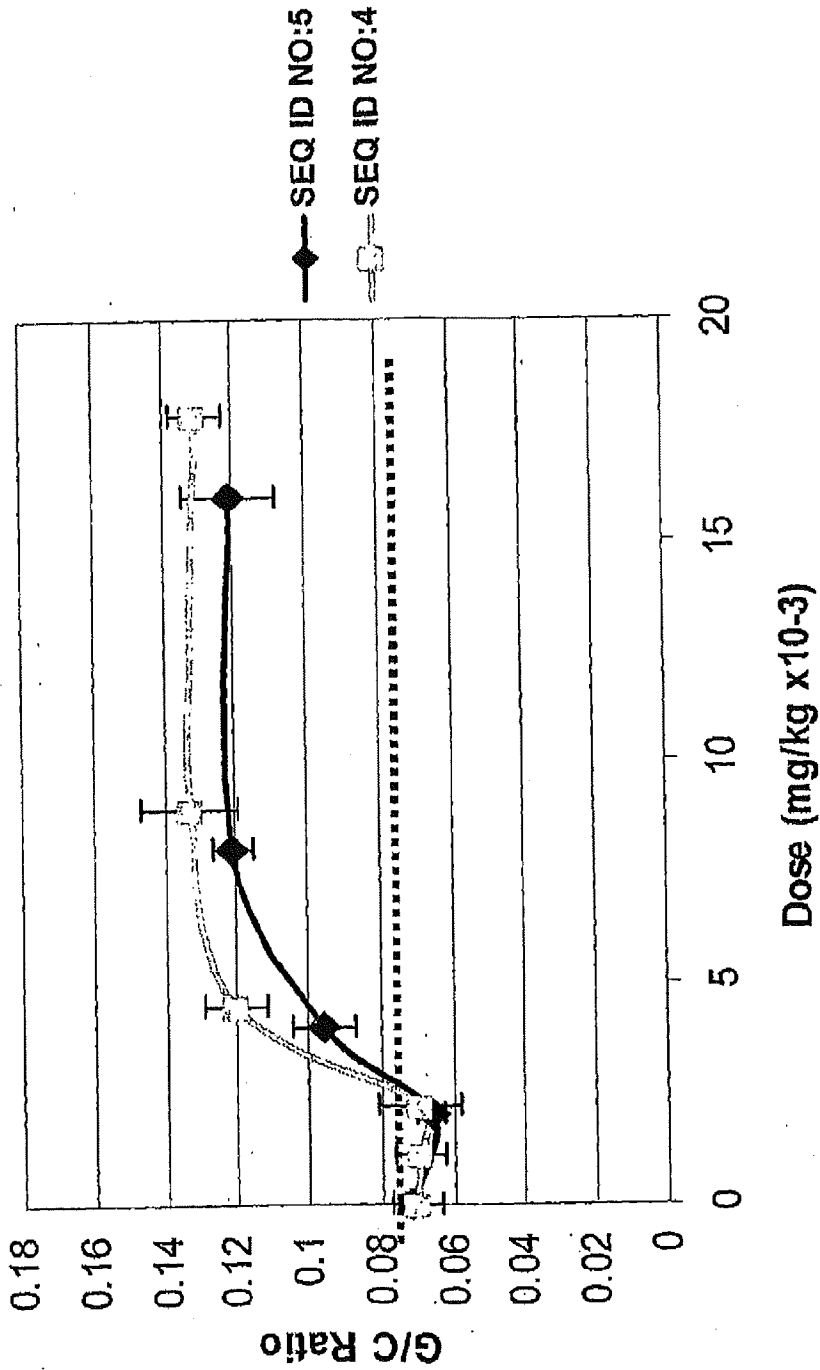


**Figure 5b: SEQ ID NO:3 vs Zelnorm® in Mouse Intestinal Secretion Model**

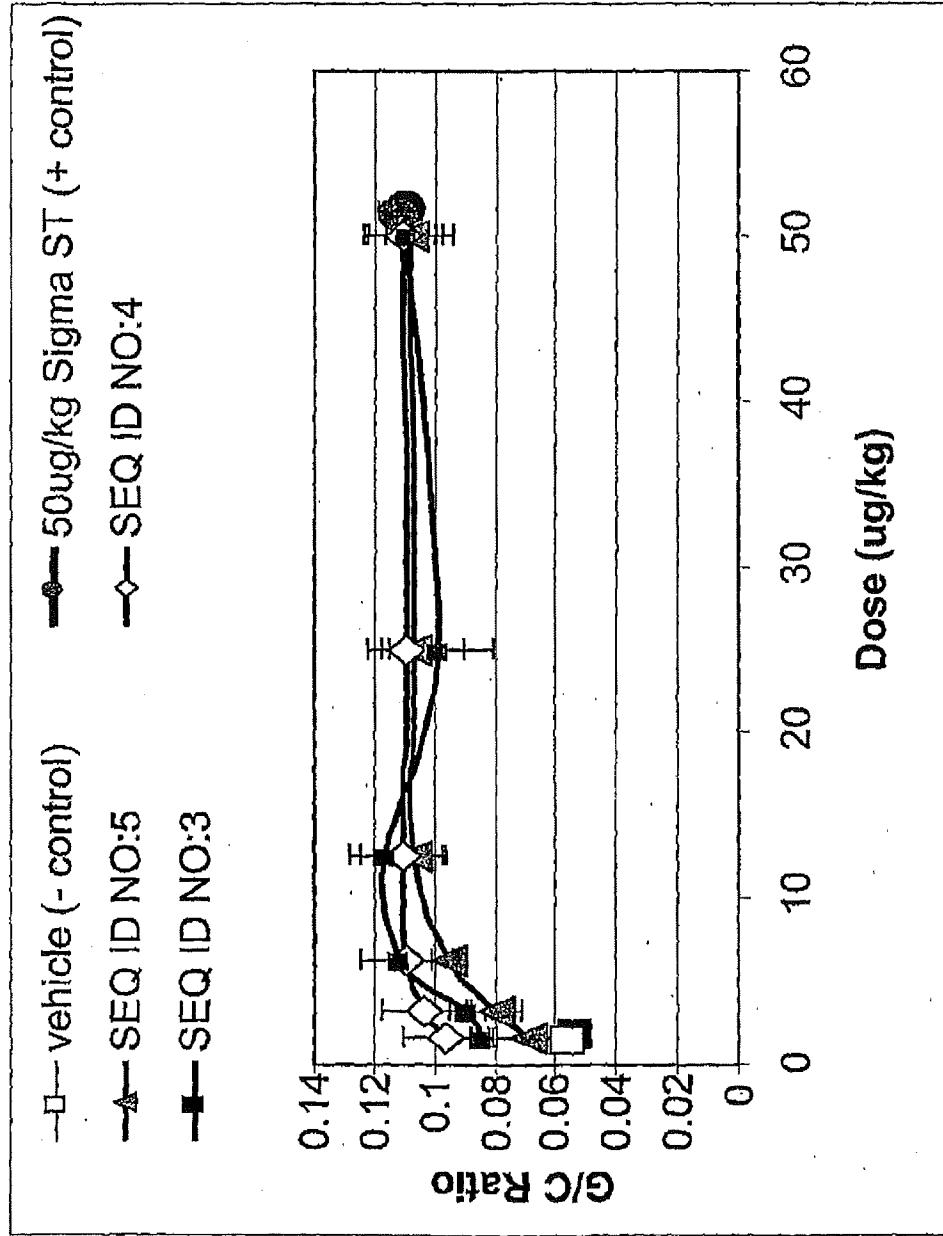




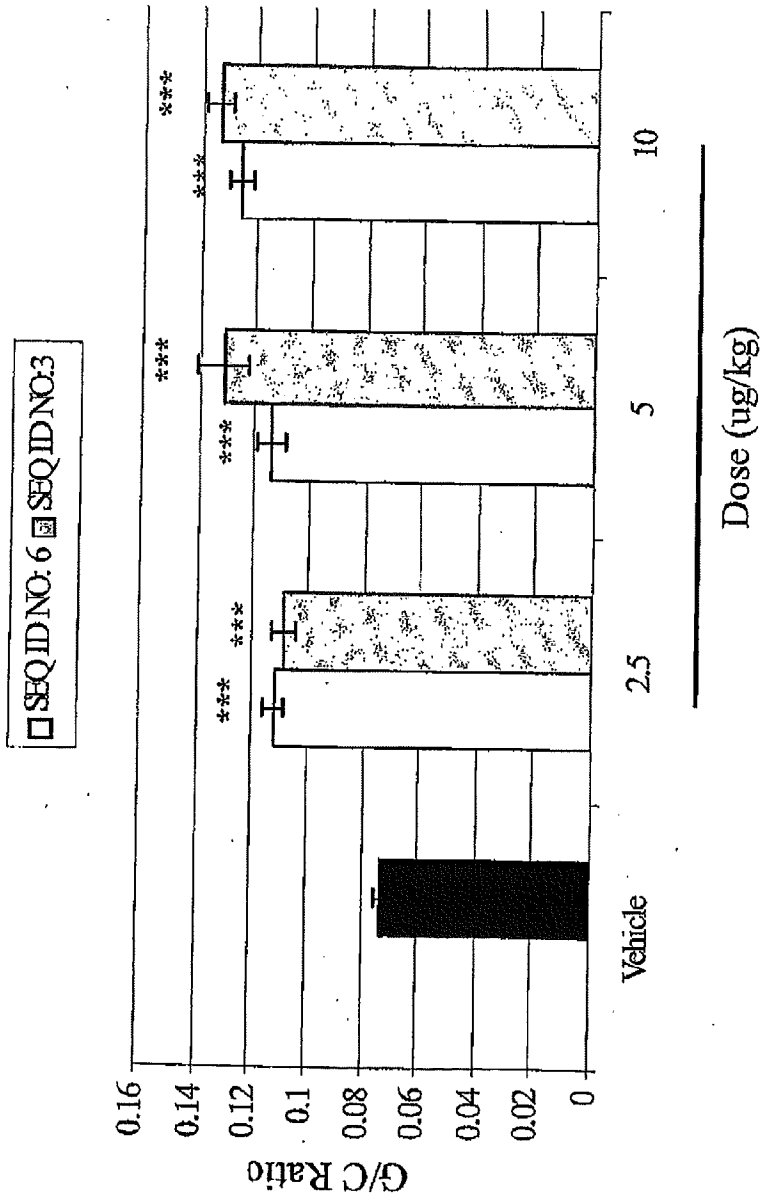
**Figure 6a. Recombinantly generated SEQ ID NO:5 and SEQ ID NO:4 in Mouse Intestinal Secretion Model**



**Figure 6b. Chemically synthesized peptides in Mouse Intestinal Secretion Model**

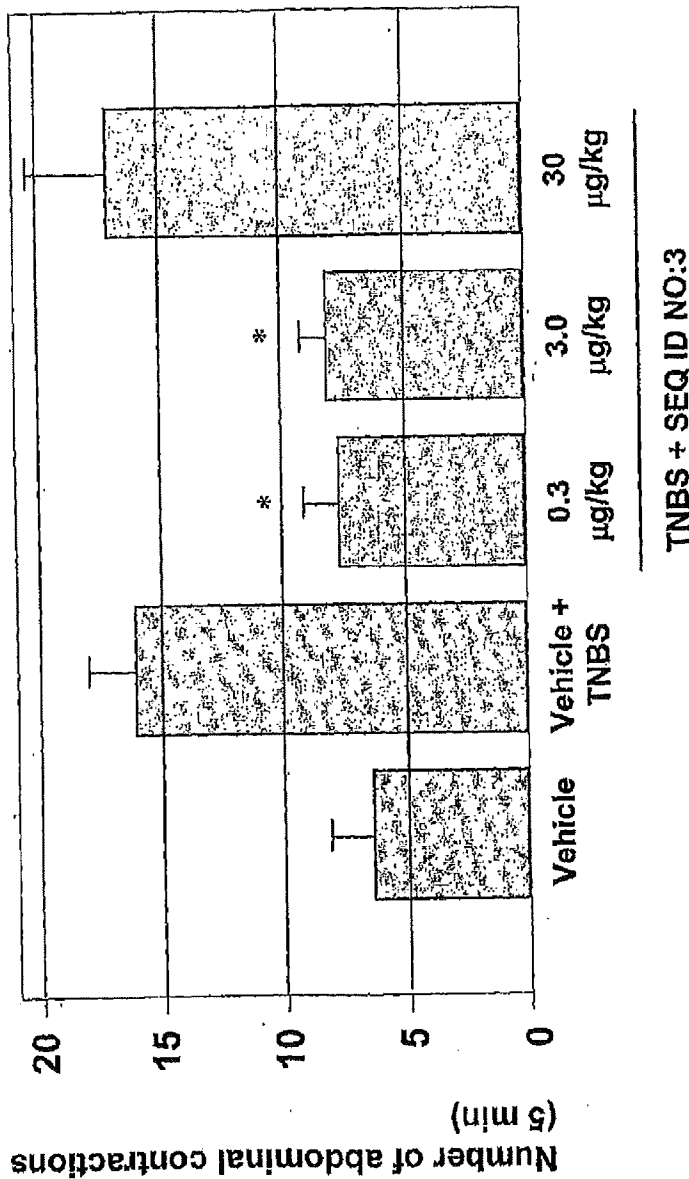


**Figure 6c. Chemically synthesized peptides in the mouse intestinal secretion model**



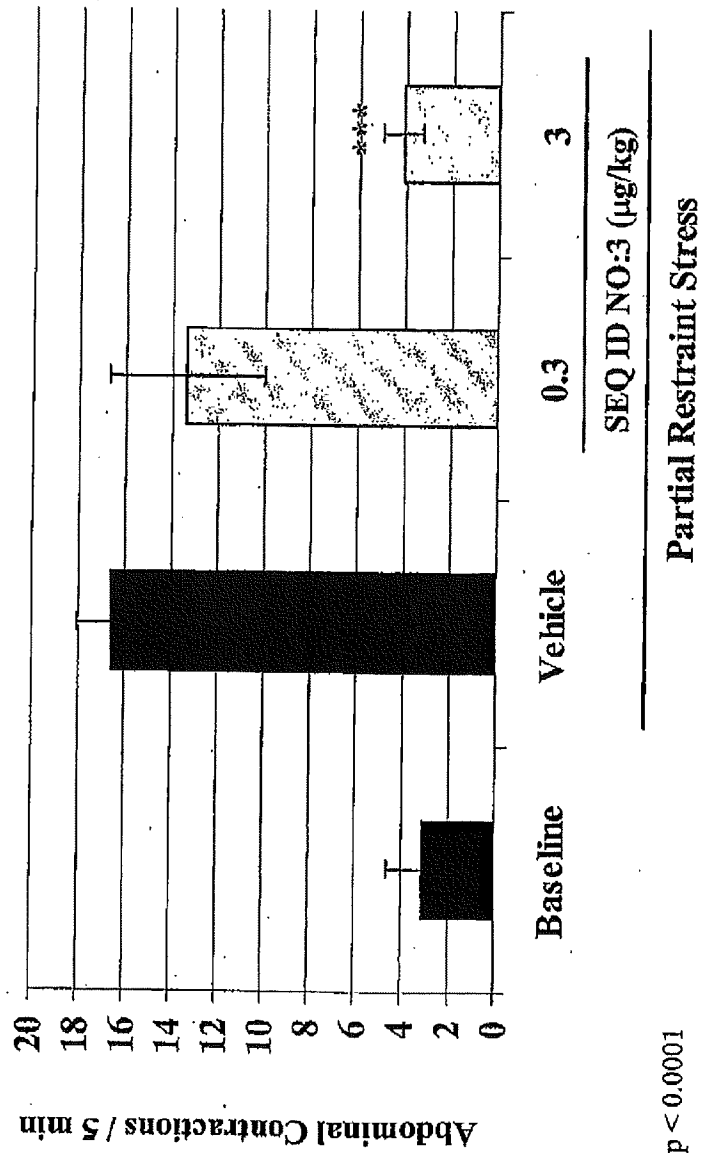
P values as compared to Vehicle Control: \*\*\* p<0.001

**Figure 7a. Effect of SEQ ID NO:3 on pain in a rat TNBS Colorectal Distension Assay**

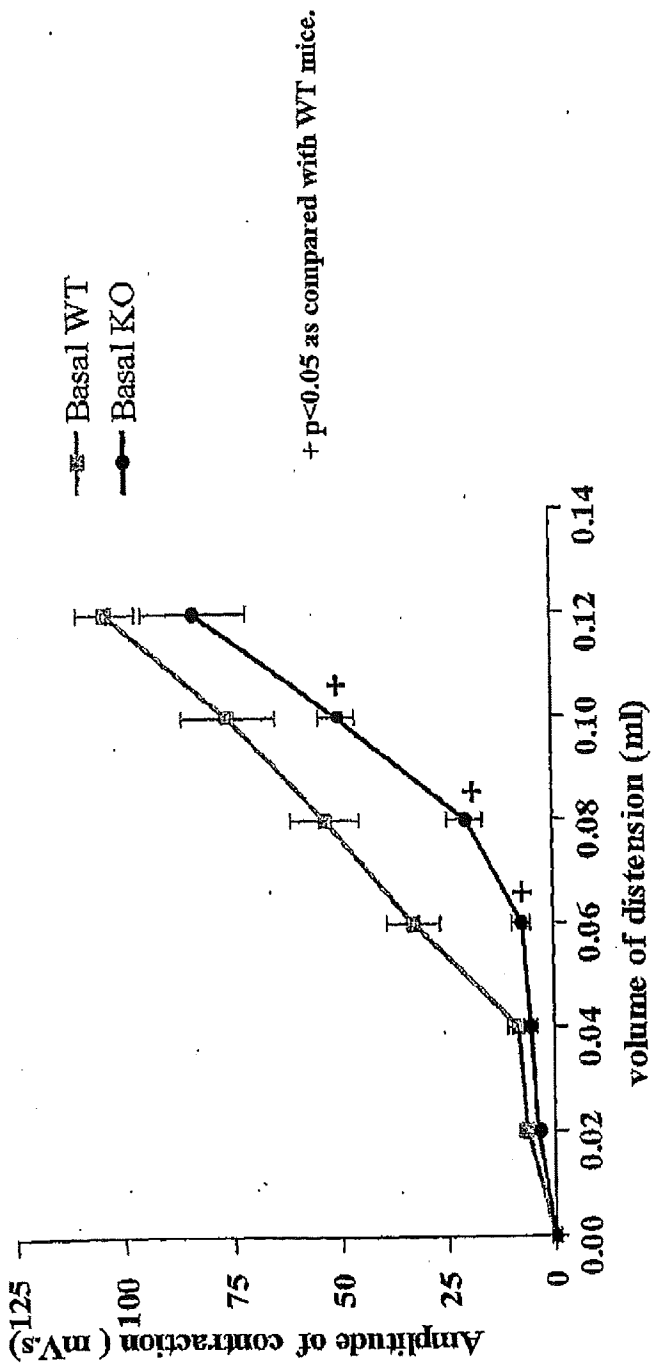


\* p<0.05 as compared to "vehicle" value

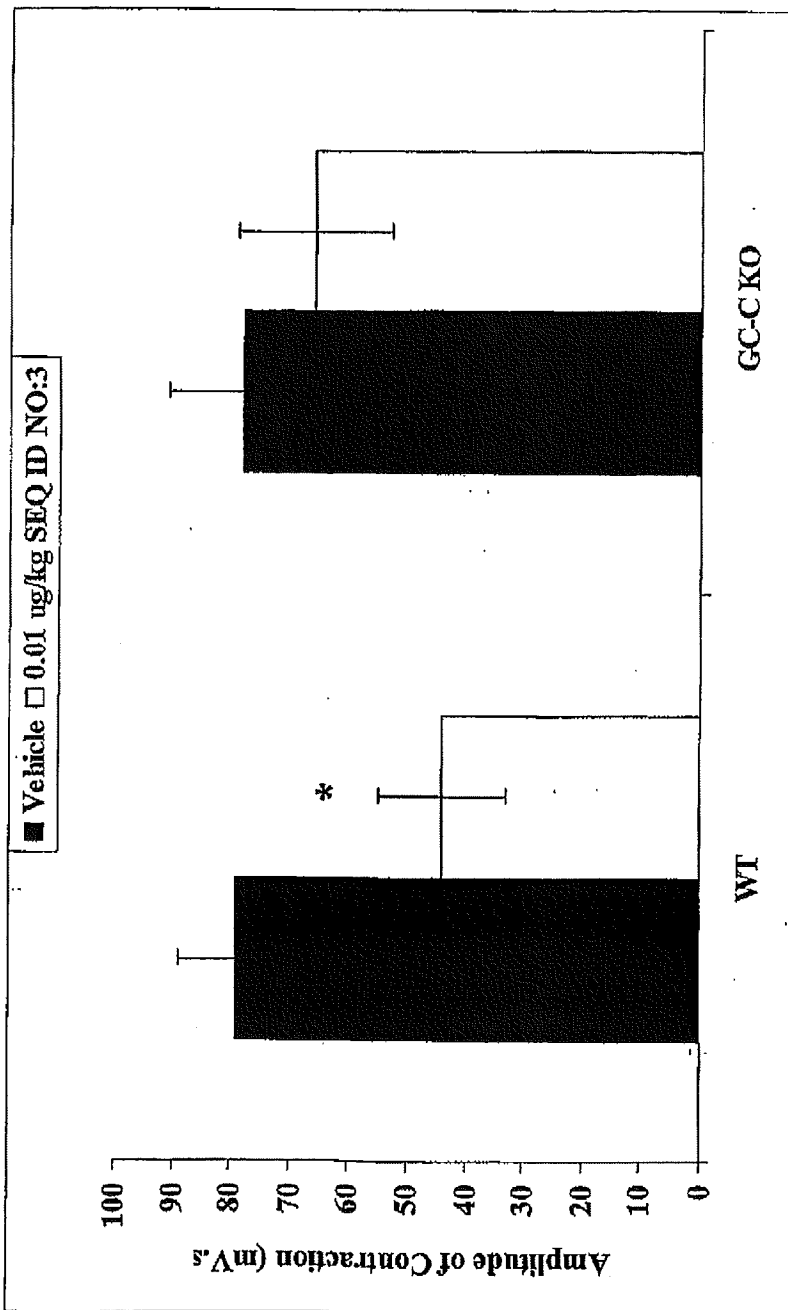
**Figure 7b. Effect of SEQ ID NO:3 in the Rat Partial Restraint Stress Colonic Distension Model**



**Figure 7c. Colorectal distension assay in wild-type (WT) and GC-C KO (KO) mice (basal conditions)**

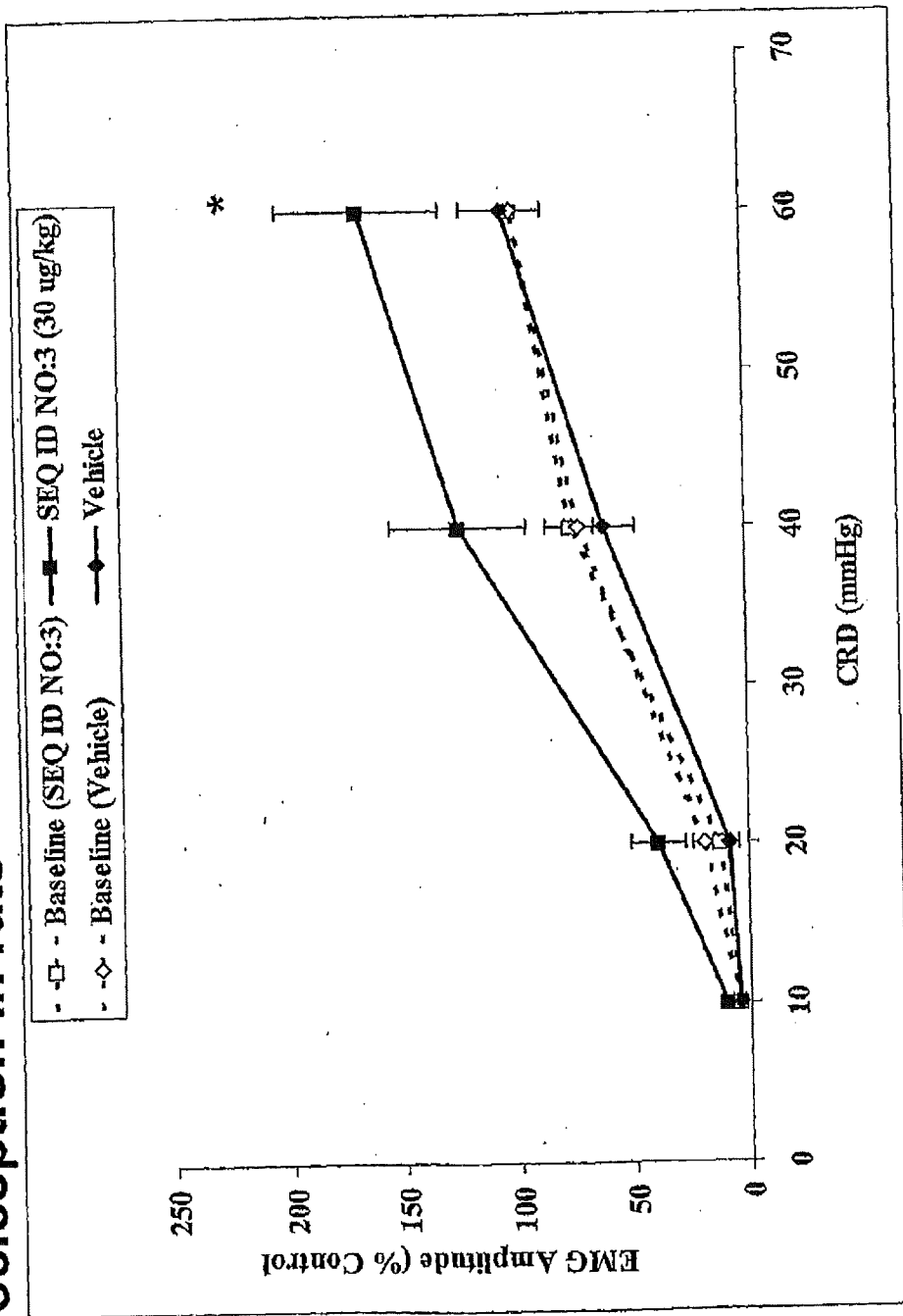


**Figure 7d. SEQ ID NO:3 effects in a TNBS colorectal distension assay in wild-type and GC-C KO mice**



\*p<0.05 as compared with TNBS+Vehicle

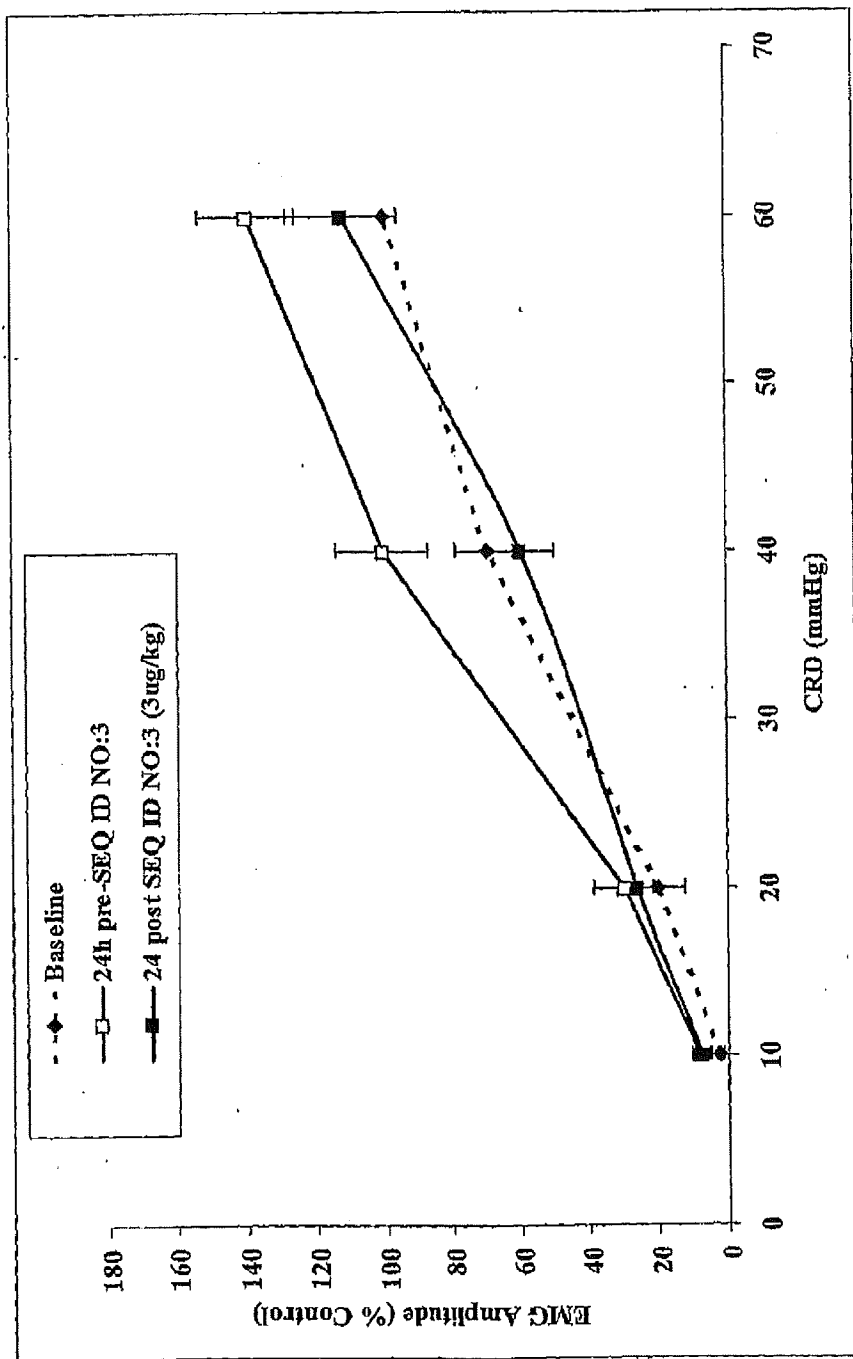
Figure 7e. Effects of SEQ ID NO:3 on baseline visceral nociception in rats



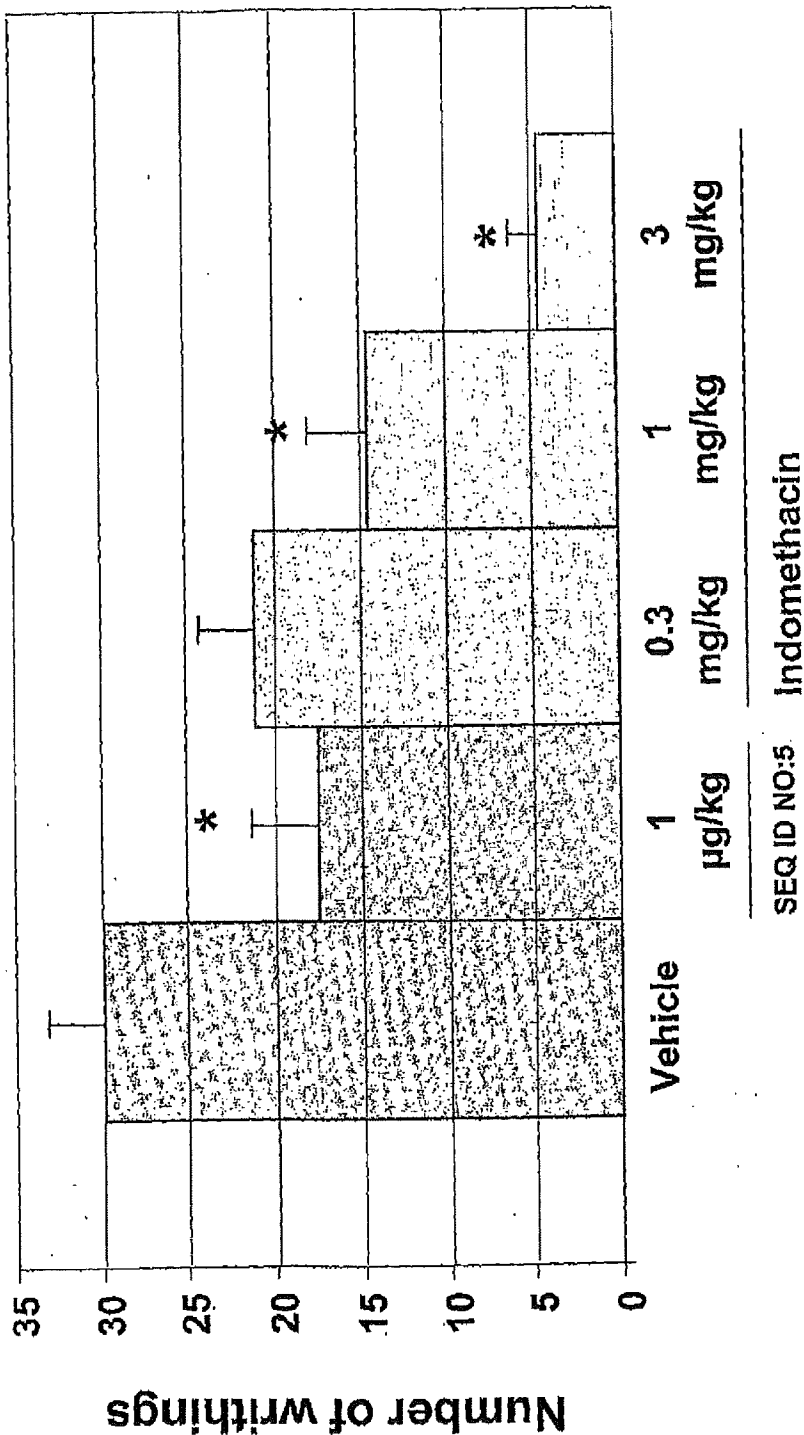
\*p<0.05 as compared to respective Baseline, two way ANOVA followed by Befferoni post-test.



**Figure 7f. Effect of SEQ ID NO:3 (3µg/kg) on water avoidance stress-induced delayed visceral hyperalgesia**



**Figure 8a. Visceral Antinociceptive Effects of SEQ ID NO: 5 in a Mouse Writhing Assay**



**Figure 8b. Visceral Antinociceptive Effects of SEQ ID NO:3 in a Mouse Writhing Assay**

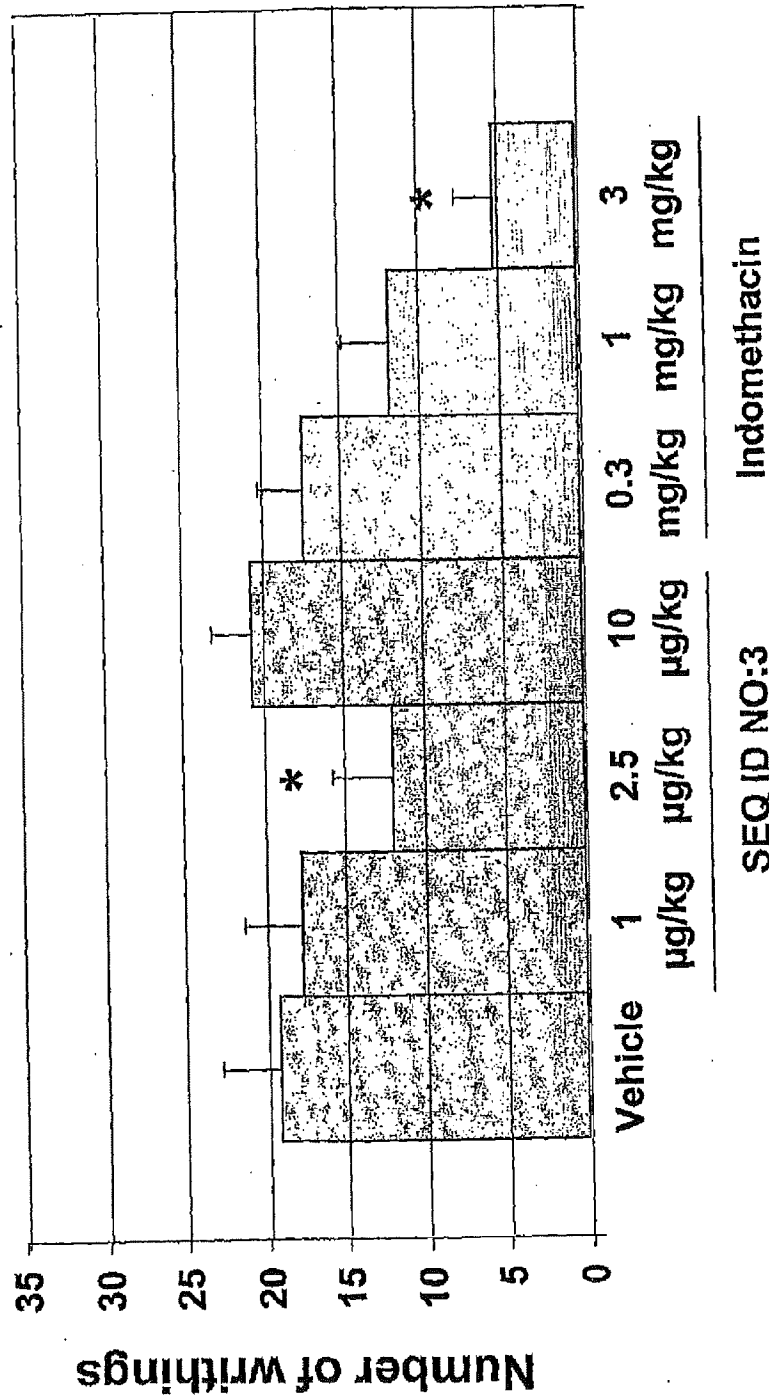
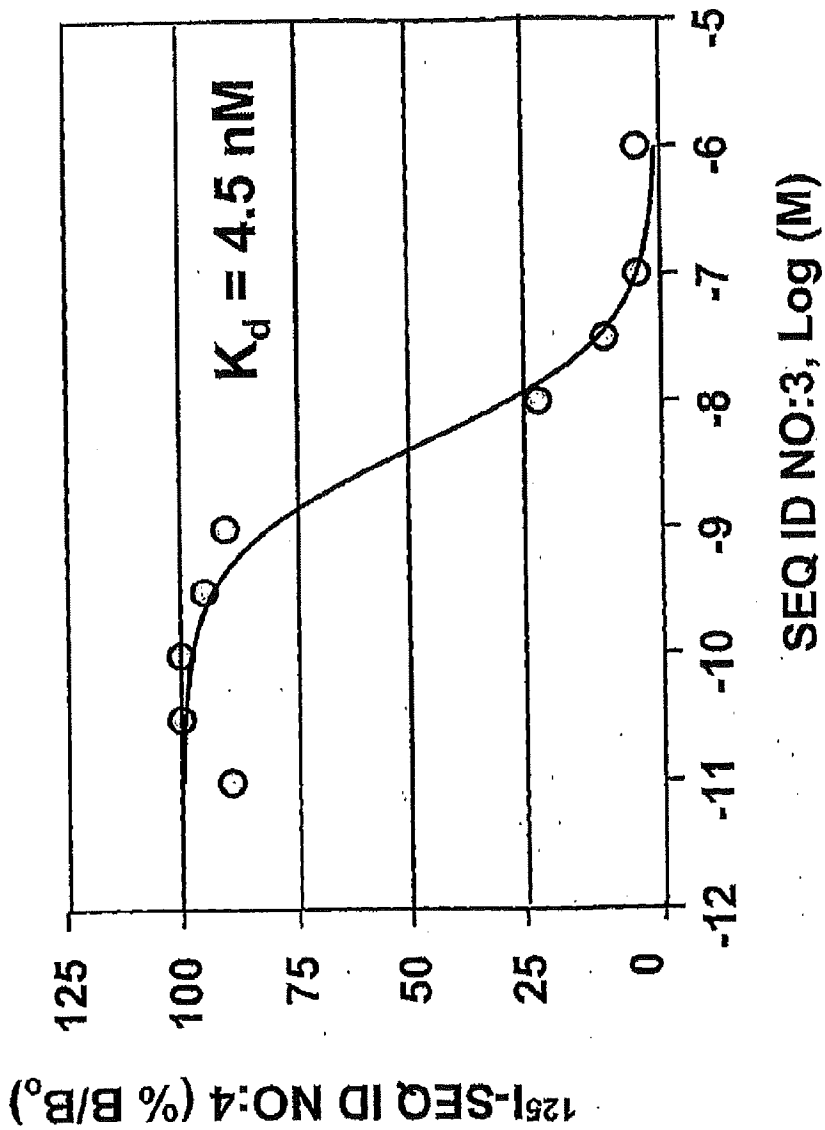
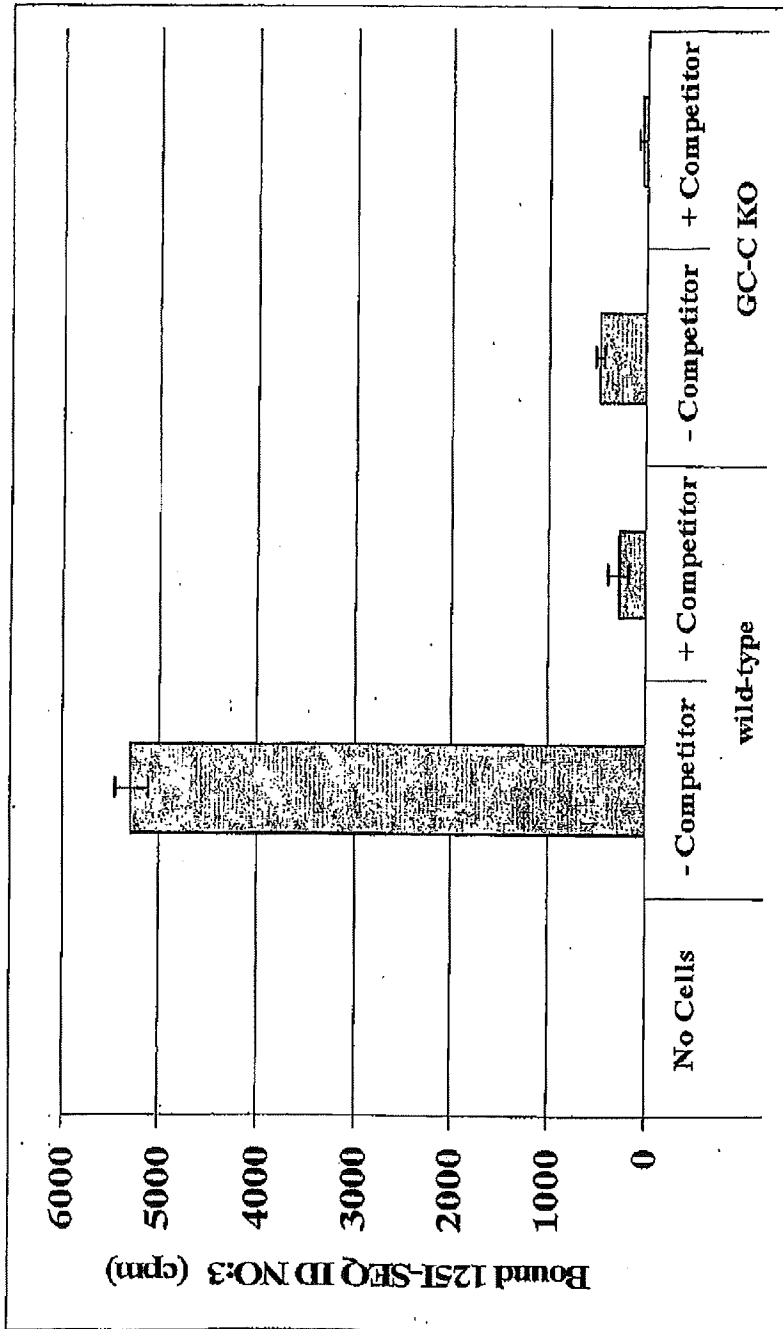


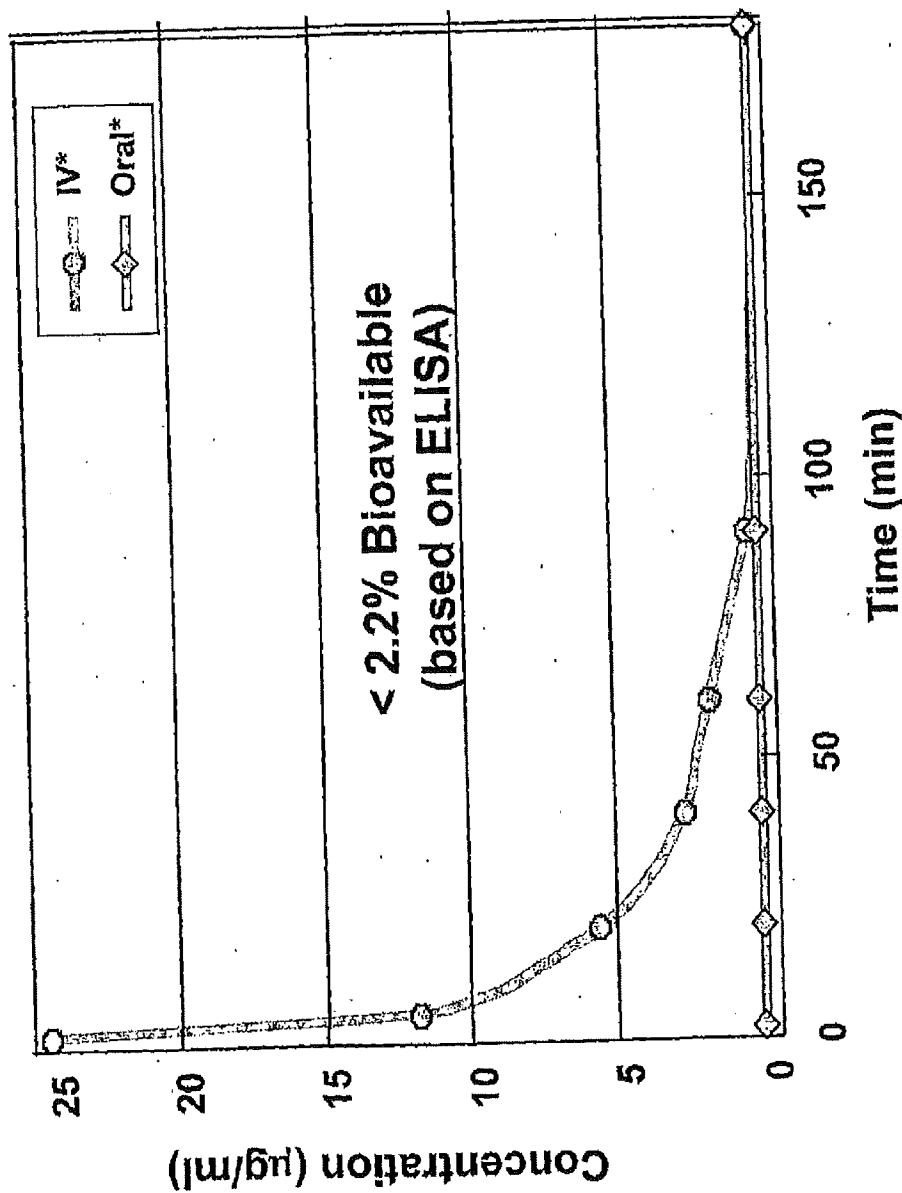
Figure 9a. Competitive Radioligand Binding of SEQ ID NO:3 in rat intestinal epithelial cells



**Figure 9b. SEQ ID NO:3 competitive binding assay in wild-type and GC-C KO mice**

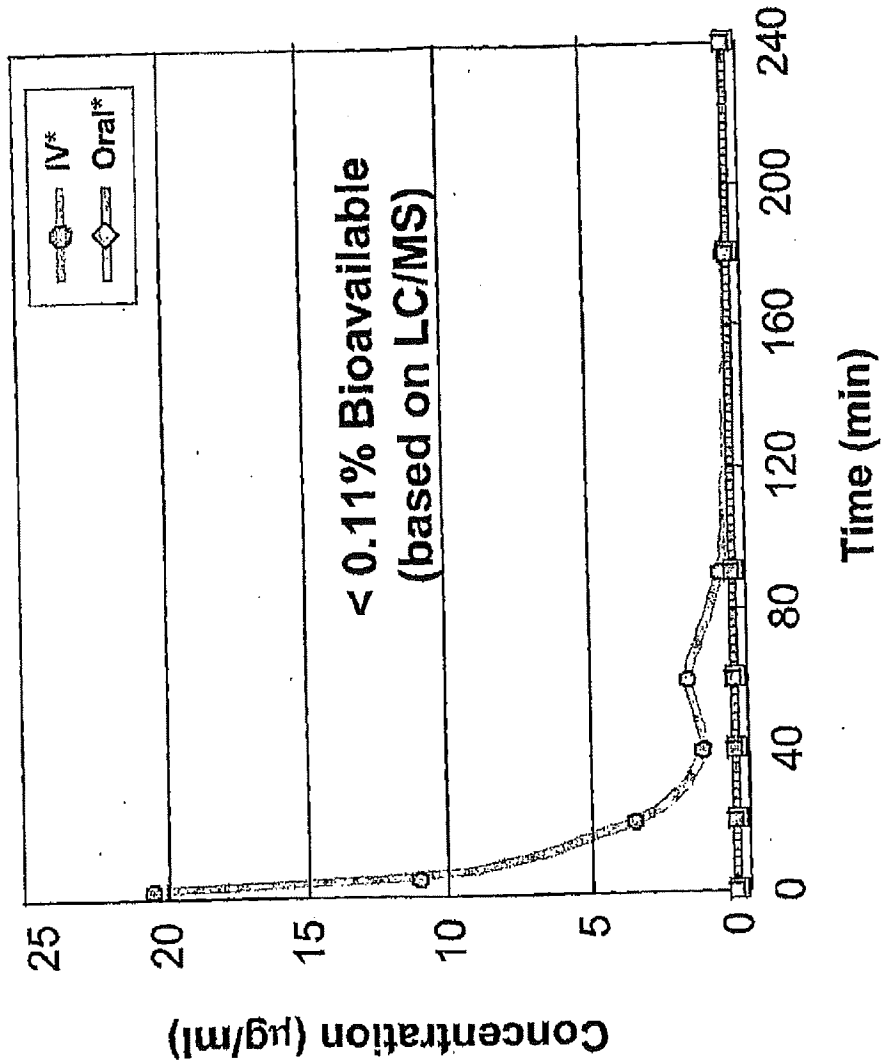


**Figure 10a. Minimum Systemic Absorption of SEQ ID NO:3 (based on ELISA)**



\* Limit of detection 0.061 µg/ml (40 nM)  
Dosing at 10 mg/kg

**Figure 10b. Minimum Systemic Absorption of SEQ ID NO:3 (based on LC/MS)**



- Limit of detection 0.00063 µg/mL (0.6 nM)
- Dosing at 10 mg/kg

FIG. 11 (sheet 1 of 5)

Cys	Cys	Glu	Tyr	Cys	Cys	Asn	Pro	Ala	Cys	Thr	Gly	Cys	Tyr	(SEQ ID NO:3)
Cys	Cys		Tyr	Cys	Cys	Asn	Pro	Ala	Cys	Thr	Gly	Cys	Tyr	(SEQ ID NO: )
Cys	Cys			Cys	Cys	Asn	Pro	Ala	Cys	Thr	Gly	Cys	Tyr	(SEQ ID NO: )
Cys	Cys			Cys	Cys		Pro	Ala	Cys	Thr	Gly	Cys	Tyr	(SEQ ID NO: )
Cys	Cys			Cys	Cys			Ala	Cys	Thr	Gly	Cys	Tyr	(SEQ ID NO: )
Cys	Cys			Cys	Cys		Pro		Cys	Thr	Gly	Cys	Tyr	(SEQ ID NO: )
Cys	Cys			Cys	Cys		Pro	Ala	Cys		Gly	Cys	Tyr	(SEQ ID NO: )
Cys	Cys			Cys	Cys		Pro	Ala	Cys	Thr		Cys	Tyr	(SEQ ID NO: )
Cys	Cys			Cys	Cys	Asn		Ala	Cys	Thr	Gly	Cys	Tyr	(SEQ ID NO: )
Cys	Cys			Cys	Cys	Asn			Cys	Thr	Gly	Cys	Tyr	(SEQ ID NO: )
Cys	Cys			Cys	Cys	Asn		Ala	Cys		Gly	Cys	Tyr	(SEQ ID NO: )
Cys	Cys			Cys	Cys	Asn		Ala	Cys	Thr		Cys	Tyr	(SEQ ID NO: )
Cys	Cys			Cys	Cys	Asn		Ala	Cys	Thr	Gly	Cys		(SEQ ID NO: )
Cys	Cys			Cys	Cys	Asn	Pro		Cys	Thr	Gly	Cys	Tyr	(SEQ ID NO: )
Cys	Cys			Cys	Cys	Asn	Pro		Cys		Gly	Cys	Tyr	(SEQ ID NO: )
Cys	Cys			Cys	Cys	Asn	Pro		Cys	Thr		Cys	Tyr	(SEQ ID NO: )
Cys	Cys			Cys	Cys	Asn	Pro		Cys	Thr	Gly	Cys		(SEQ ID NO: )
Cys	Cys			Cys	Cys	Asn	Pro	Ala	Cys		Gly	Cys	Tyr	(SEQ ID NO: )
Cys	Cys			Cys	Cys	Asn	Pro	Ala	Cys			Cys	Tyr	(SEQ ID NO: )
Cys	Cys			Cys	Cys	Asn	Pro	Ala	Cys		Gly	Cys		(SEQ ID NO: )
Cys	Cys			Cys	Cys	Asn	Pro	Ala	Cys	Thr		Cys	Tyr	(SEQ ID NO: )
Cys	Cys			Cys	Cys	Asn	Pro	Ala	Cys	Thr	Gly	Cys		(SEQ ID NO: )
Cys	Cys		Tyr	Cys	Cys		Pro	Ala	Cys	Thr	Gly	Cys	Tyr	(SEQ ID NO: )
Cys	Cys		Tyr	Cys	Cys			Ala	Cys	Thr	Gly	Cys	Tyr	(SEQ ID NO: )
Cys	Cys		Tyr	Cys	Cys				Cys	Thr	Gly	Cys	Tyr	(SEQ ID NO: )
Cys	Cys		Tyr	Cys	Cys			Ala	Cys		Gly	Cys	Tyr	(SEQ ID NO: )
Cys	Cys		Tyr	Cys	Cys			Ala	Cys	Thr		Cys	Tyr	(SEQ ID NO: )
Cys	Cys		Tyr	Cys	Cys		Pro		Cys	Thr	Gly	Cys	Tyr	(SEQ ID NO: )
Cys	Cys		Tyr	Cys	Cys		Pro		Cys	Thr		Cys	Tyr	(SEQ ID NO: )
Cys	Cys		Tyr	Cys	Cys		Pro		Cys	Thr	Gly	Cys		(SEQ ID NO: )
Cys	Cys		Tyr	Cys	Cys		Pro	Ala	Cys		Gly	Cys	Tyr	(SEQ ID NO: )
Cys	Cys		Tyr	Cys	Cys		Pro	Ala	Cys			Cys	Tyr	(SEQ ID NO: )
Cys	Cys		Tyr	Cys	Cys		Pro	Ala	Cys	Thr		Cys	Tyr	(SEQ ID NO: )
Cys	Cys		Tyr	Cys	Cys		Pro	Ala	Cys	Thr	Gly	Cys		(SEQ ID NO: )
Cys	Cys		Tyr	Cys	Cys	Asn		Ala	Cys	Thr	Gly	Cys	Tyr	(SEQ ID NO: )
Cys	Cys		Tyr	Cys	Cys	Asn			Cys	Thr	Gly	Cys	Tyr	(SEQ ID NO: )
Cys	Cys		Tyr	Cys	Cys	Asn			Cys	Thr		Cys	Tyr	(SEQ ID NO: )
Cys	Cys		Tyr	Cys	Cys	Asn		Ala	Cys		Gly	Cys	Tyr	(SEQ ID NO: )
Cys	Cys		Tyr	Cys	Cys	Asn		Ala	Cys			Cys	Tyr	(SEQ ID NO: )
Cys	Cys		Tyr	Cys	Cys	Asn		Ala	Cys	Thr		Cys	Tyr	(SEQ ID NO: )
Cys	Cys		Tyr	Cys	Cys	Asn		Ala	Cys	Thr	Gly	Cys		(SEQ ID NO: )
Cys	Cys		Tyr	Cys	Cys	Asn	Pro		Cys	Thr	Gly	Cys	Tyr	(SEQ ID NO: )
Cys	Cys		Tyr	Cys	Cys	Asn	Pro		Cys		Gly	Cys	Tyr	(SEQ ID NO: )
Cys	Cys		Tyr	Cys	Cys	Asn	Pro		Cys			Cys	Tyr	(SEQ ID NO: )
Cys	Cys		Tyr	Cys	Cys	Asn	Pro		Cys	Thr		Cys	Tyr	(SEQ ID NO: )
Cys	Cys		Tyr	Cys	Cys	Asn	Pro		Cys	Thr	Gly	Cys		(SEQ ID NO: )
Cys	Cys		Tyr	Cys	Cys	Asn	Pro	Ala	Cys		Gly	Cys	Tyr	(SEQ ID NO: )
Cys	Cys		Tyr	Cys	Cys	Asn	Pro	Ala	Cys			Cys	Tyr	(SEQ ID NO: )





FIG. 11 (sheet 3 of 3)

Cys	Cys	Glu	Tyr	Cys	Cys	---	Pro	---	Cys	Thr	---	Cys	Tyr	(SEQ ID NO: )
Cys	Cys	Glu	Tyr	Cys	Cys	---	Pro	---	Cys	Thr	---	Cys	---	(SEQ ID NO: )
Cys	Cys	Glu	Tyr	Cys	Cys	---	Pro	---	Cys	Thr	Gly	Cys	---	(SEQ ID NO: )
Cys	Cys	Glu	Tyr	Cys	Cys	---	Pro	Ala	Cys	---	Gly	Cys	Tyr	(SEQ ID NO: )
Cys	Cys	Glu	Tyr	Cys	Cys	---	Pro	Ala	Cys	---	---	Cys	Tyr	(SEQ ID NO: )
Cys	Cys	Glu	Tyr	Cys	Cys	---	Pro	Ala	Cys	---	---	Cys	---	(SEQ ID NO: )
Cys	Cys	Glu	Tyr	Cys	Cys	---	Pro	Ala	Cys	---	Gly	Cys	---	(SEQ ID NO: )
Cys	Cys	Glu	Tyr	Cys	Cys	---	Pro	Ala	Cys	Thr	---	Cys	Tyr	(SEQ ID NO: )
Cys	Cys	Glu	Tyr	Cys	Cys	---	Pro	Ala	Cys	Thr	---	Cys	---	(SEQ ID NO: )
Cys	Cys	Glu	Tyr	Cys	Cys	Asn	---	Ala	Cys	Thr	Gly	Cys	Tyr	(SEQ ID NO: )
Cys	Cys	Glu	Tyr	Cys	Cys	Asn	---	---	Cys	Thr	Gly	Cys	Tyr	(SEQ ID NO: )
Cys	Cys	Glu	Tyr	Cys	Cys	Asn	---	---	Cys	---	Gly	Cys	Tyr	(SEQ ID NO: )
Cys	Cys	Glu	Tyr	Cys	Cys	Asn	---	---	Cys	---	Gly	Cys	---	(SEQ ID NO: )
Cys	Cys	Glu	Tyr	Cys	Cys	Asn	---	---	Cys	---	Gly	Cys	---	(SEQ ID NO: )
Cys	Cys	Glu	Tyr	Cys	Cys	Asn	---	---	Cys	Thr	---	Cys	Tyr	(SEQ ID NO: )
Cys	Cys	Glu	Tyr	Cys	Cys	Asn	---	---	Cys	Thr	---	Cys	---	(SEQ ID NO: )
Cys	Cys	Glu	Tyr	Cys	Cys	Asn	---	Ala	Cys	---	Gly	Cys	Tyr	(SEQ ID NO: )
Cys	Cys	Glu	Tyr	Cys	Cys	Asn	---	Ala	Cys	---	---	Cys	Tyr	(SEQ ID NO: )
Cys	Cys	Glu	Tyr	Cys	Cys	Asn	---	Ala	Cys	---	Gly	Cys	---	(SEQ ID NO: )
Cys	Cys	Glu	Tyr	Cys	Cys	Asn	---	Ala	Cys	Thr	---	Cys	Tyr	(SEQ ID NO: )
Cys	Cys	Glu	Tyr	Cys	Cys	Asn	---	Ala	Cys	Thr	---	Cys	---	(SEQ ID NO: )
Cys	Cys	Glu	Tyr	Cys	Cys	Asn	Pro	---	Cys	Thr	Gly	Cys	Tyr	(SEQ ID NO: )
Cys	Cys	Glu	Tyr	Cys	Cys	Asn	Pro	---	Cys	---	Gly	Cys	Tyr	(SEQ ID NO: )
Cys	Cys	Glu	Tyr	Cys	Cys	Asn	Pro	---	Cys	---	---	Cys	Tyr	(SEQ ID NO: )
Cys	Cys	Glu	Tyr	Cys	Cys	Asn	Pro	---	Cys	---	Gly	Cys	---	(SEQ ID NO: )
Cys	Cys	Glu	Tyr	Cys	Cys	Asn	Pro	---	Cys	Thr	---	Cys	Tyr	(SEQ ID NO: )
Cys	Cys	Glu	Tyr	Cys	Cys	Asn	Pro	---	Cys	Thr	---	Cys	---	(SEQ ID NO: )
Cys	Cys	Glu	Tyr	Cys	Cys	Asn	Pro	Ala	Cys	---	Gly	Cys	Tyr	(SEQ ID NO: )
Cys	Cys	Glu	Tyr	Cys	Cys	Asn	Pro	Ala	Cys	---	---	Cys	Tyr	(SEQ ID NO: )
Cys	Cys	Glu	Tyr	Cys	Cys	Asn	Pro	Ala	Cys	---	---	Cys	---	(SEQ ID NO: )
Cys	Cys	Glu	Tyr	Cys	Cys	Asn	Pro	Ala	Cys	---	Gly	Cys	---	(SEQ ID NO: )
Cys	Cys	Glu	Tyr	Cys	Cys	Asn	Pro	Ala	Cys	Thr	---	Cys	Tyr	(SEQ ID NO: )
Cys	Cys	Glu	Tyr	Cys	Cys	Asn	Pro	Ala	Cys	Thr	---	Cys	---	(SEQ ID NO: )
Cys	Cys	Glu	Tyr	Cys	Cys	Asn	Pro	Ala	Cys	Thr	Gly	Cys	---	(SEQ ID NO: )











































































**Figure 13a. Carboxypeptidase A Digestion: Z-Gly-Gly-Leu**  
**Control**

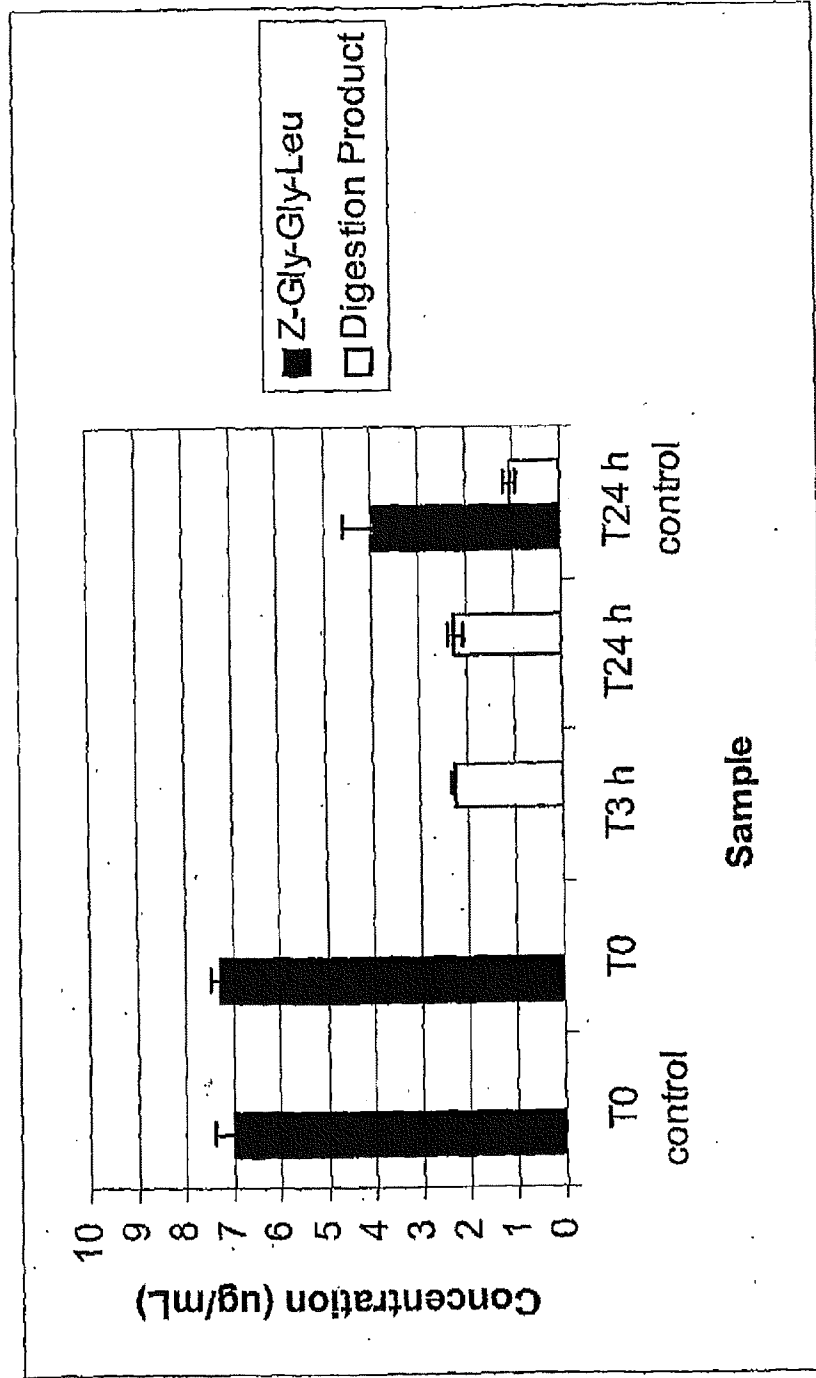
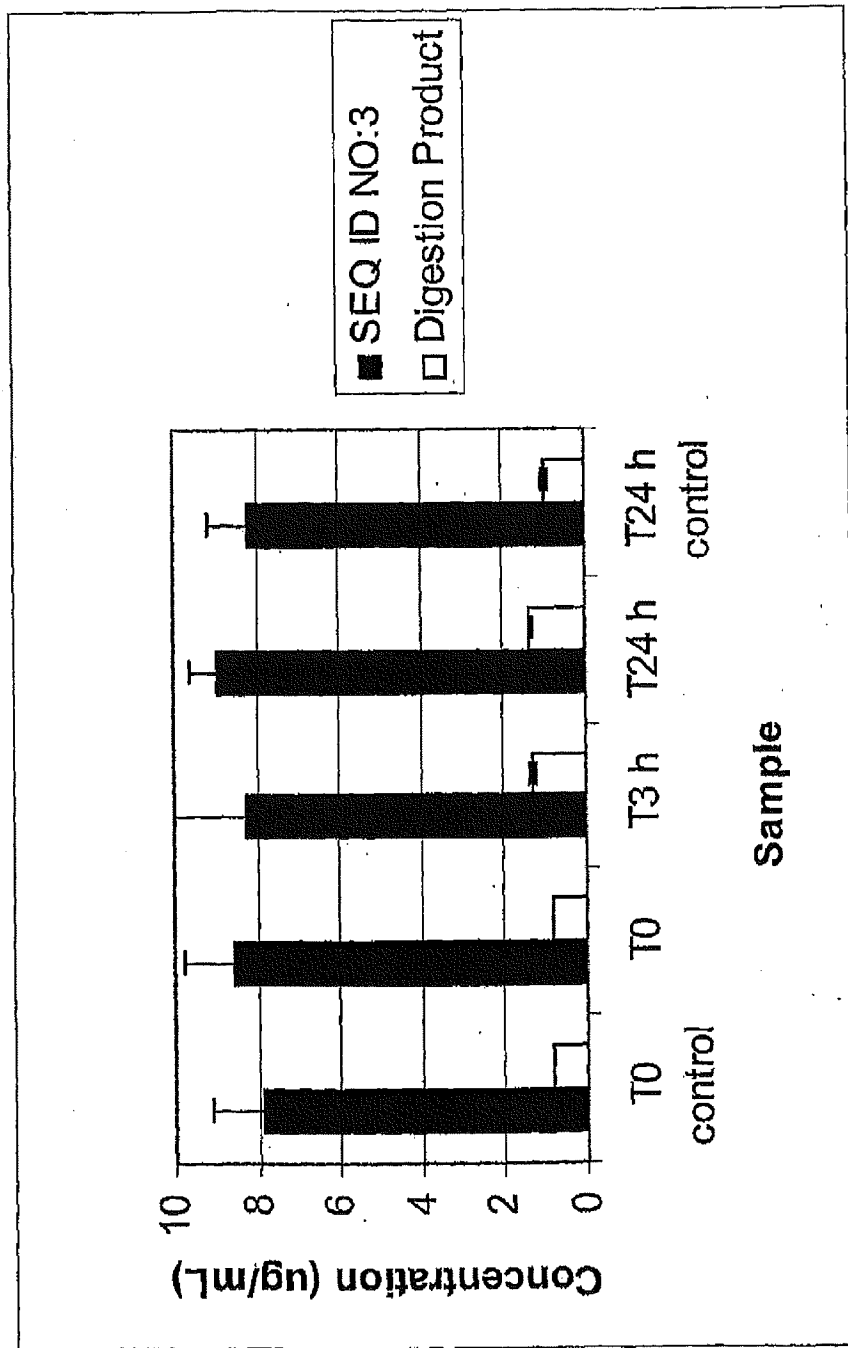


Figure 13b. SEQ ID NO:3 Carboxypeptidase digestion



**Figure 13c. Total ion current chromatography of carboxypeptidase A identification samples**

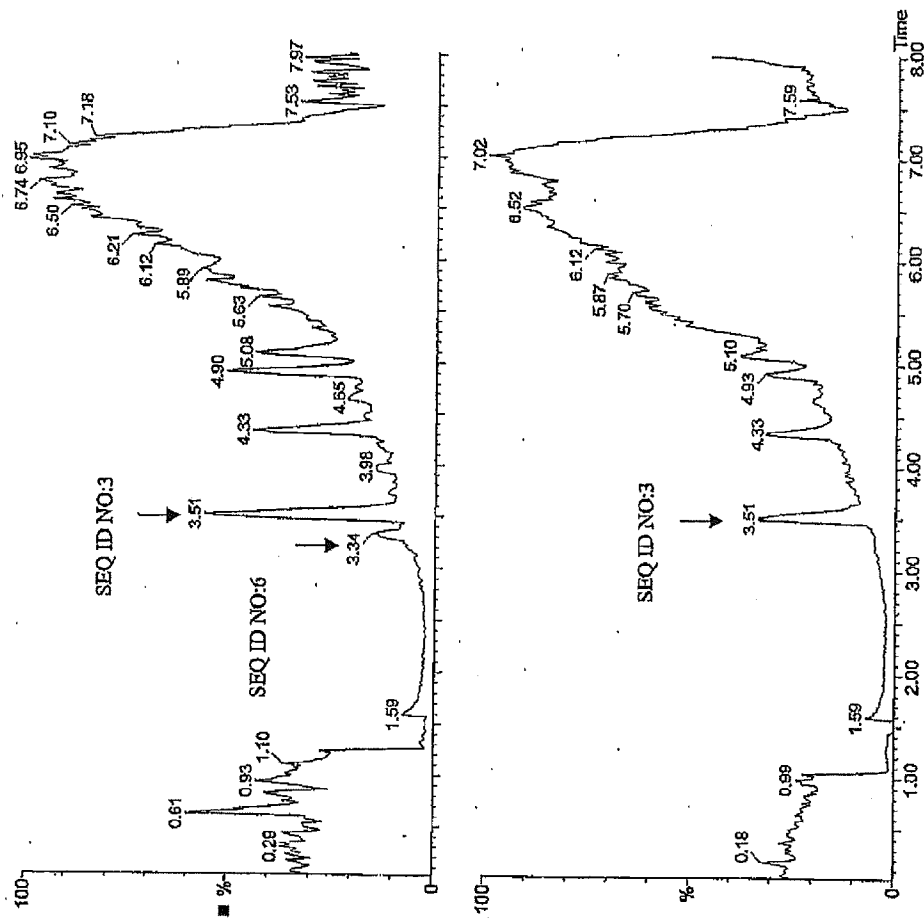
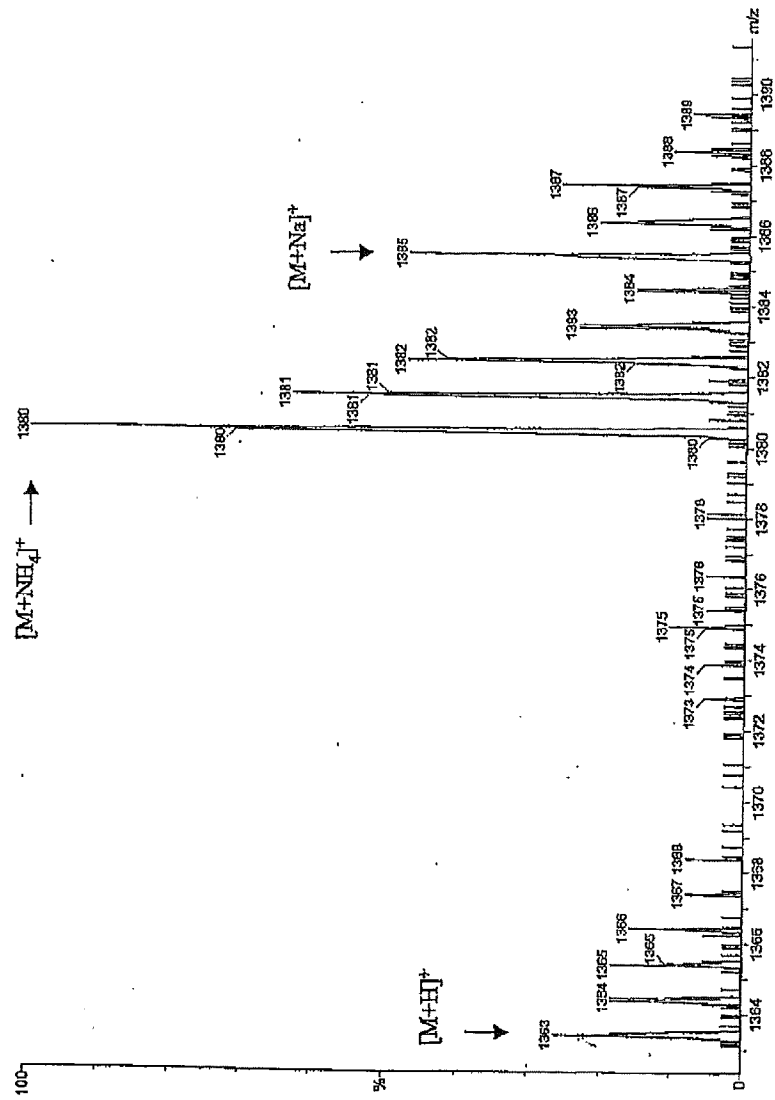
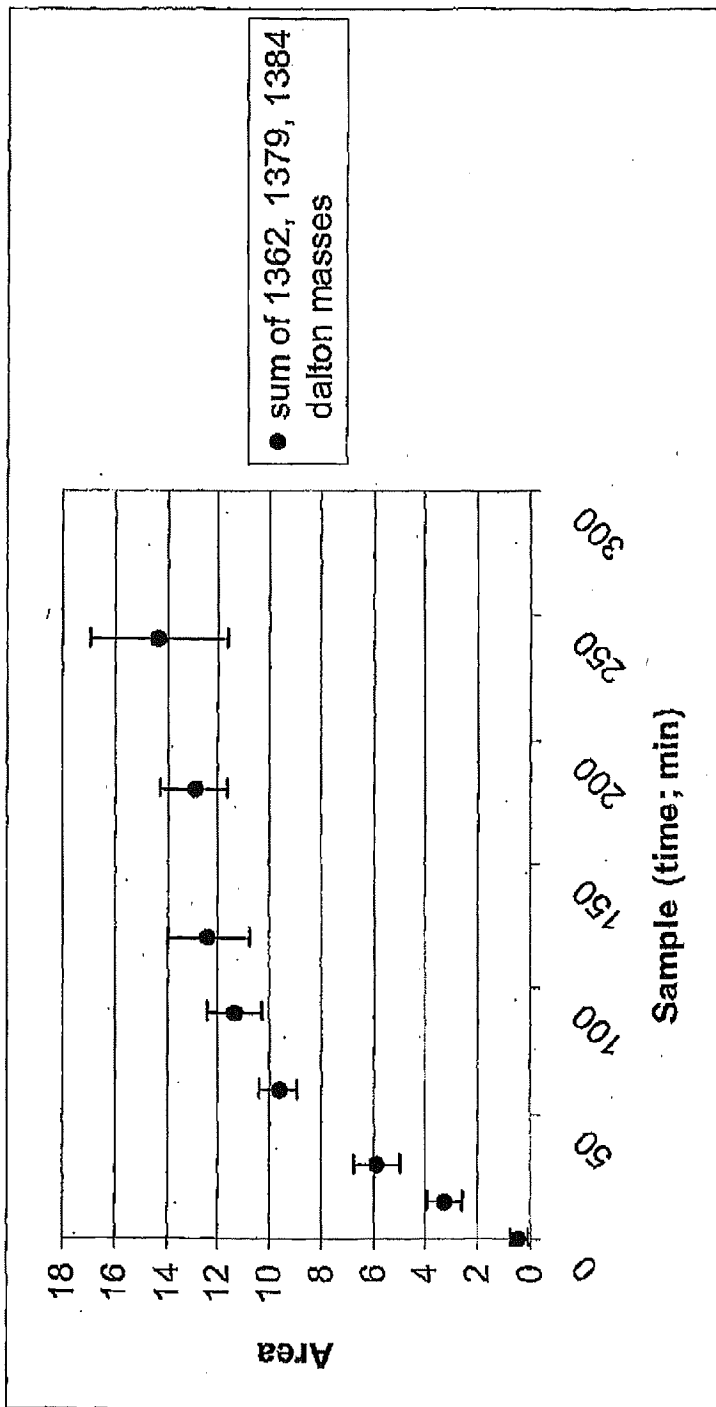


Figure 13d: Spectrum View of 3.3 min Peak of T240 Sample

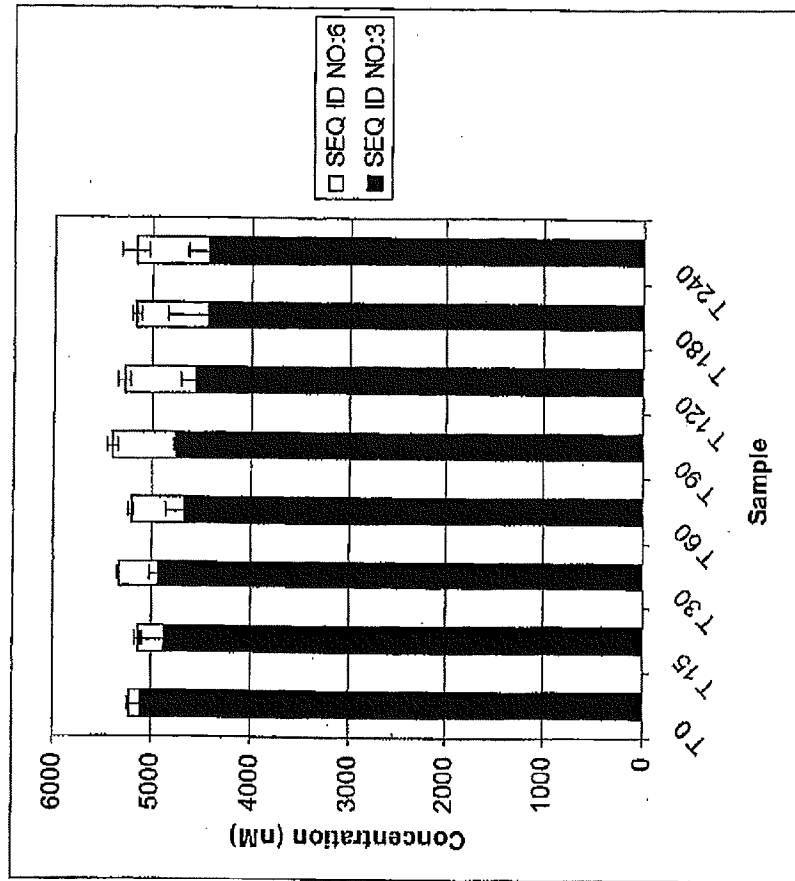


**Figure 13e: Rate of formation of SEQ ID NO:3 product in the presence of Carboxypeptidase A**





**Figure 13f: SEQ ID NO:3 disappearance and SEQ ID NO:6 formation**



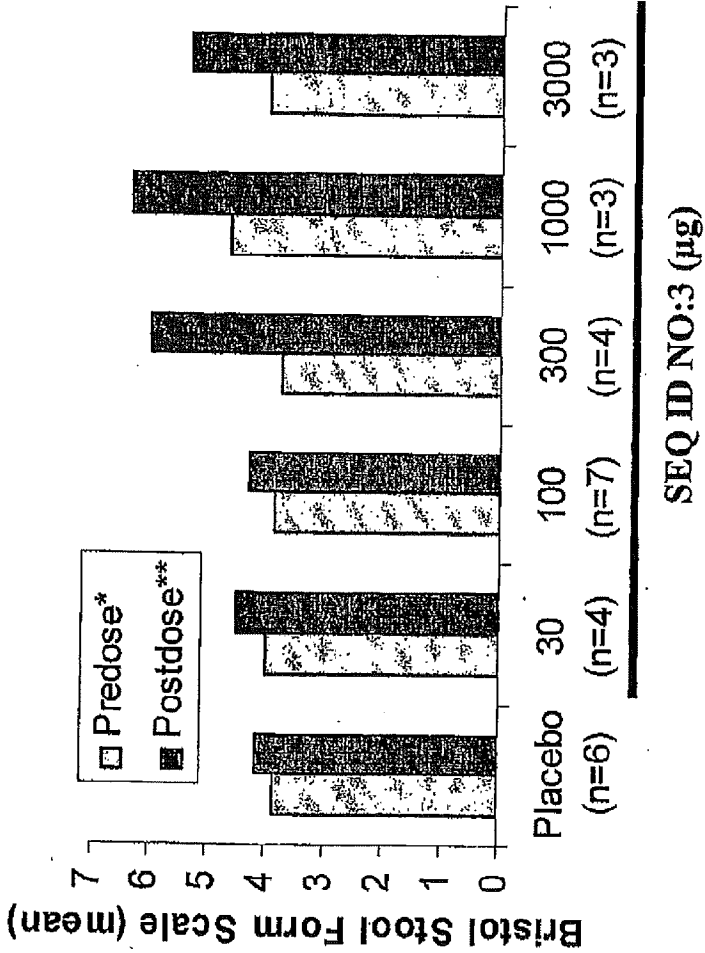
## Figure 14a. The Bristol Stool Form Scale (BSFS)

- 1: Separate hard lumps, like nuts
- 2: Sausage-shaped but lumpy
- 3: Like a sausage or snake but with cracks on its surface
- 4: Like a sausage or snake, smooth and soft
- 5: Soft blobs with clear-cut edges
- 6: Fluffy pieces with ragged edges, a mushy stool
- 7: Watery, no solid pieces

**Figure 14b. SEQ ID NO:3 Bristol Stool Form Scale score after single dose human studies**

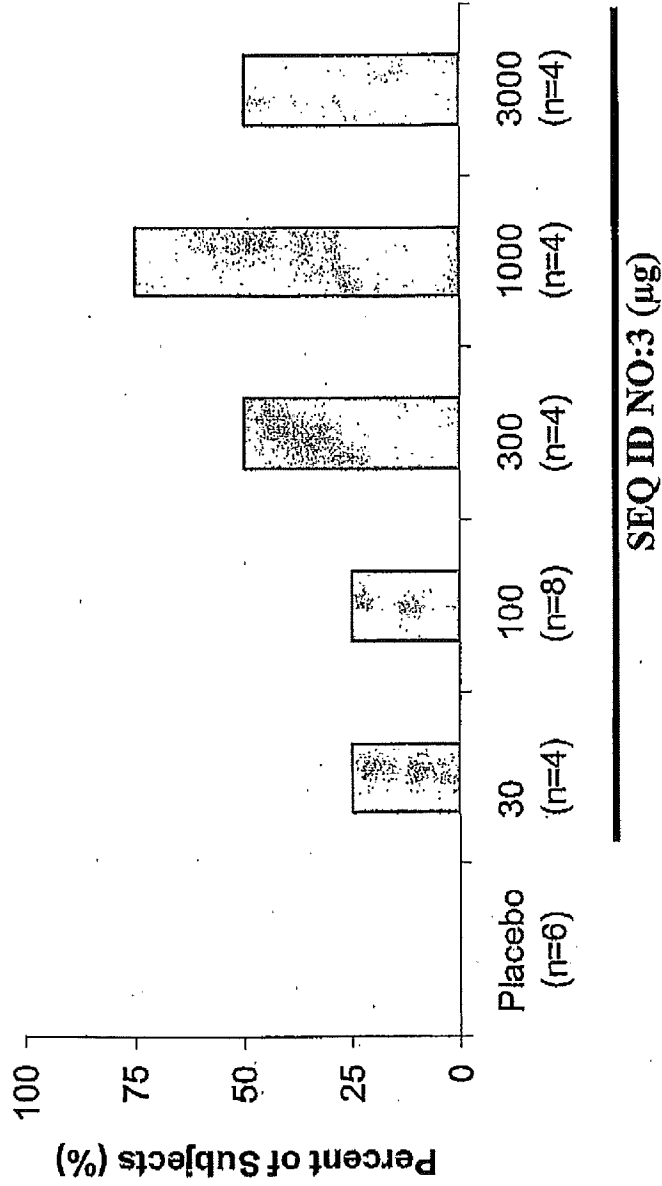
\*Maximum score 2 days predose.

\*\* Maximum score 2 days postdose.

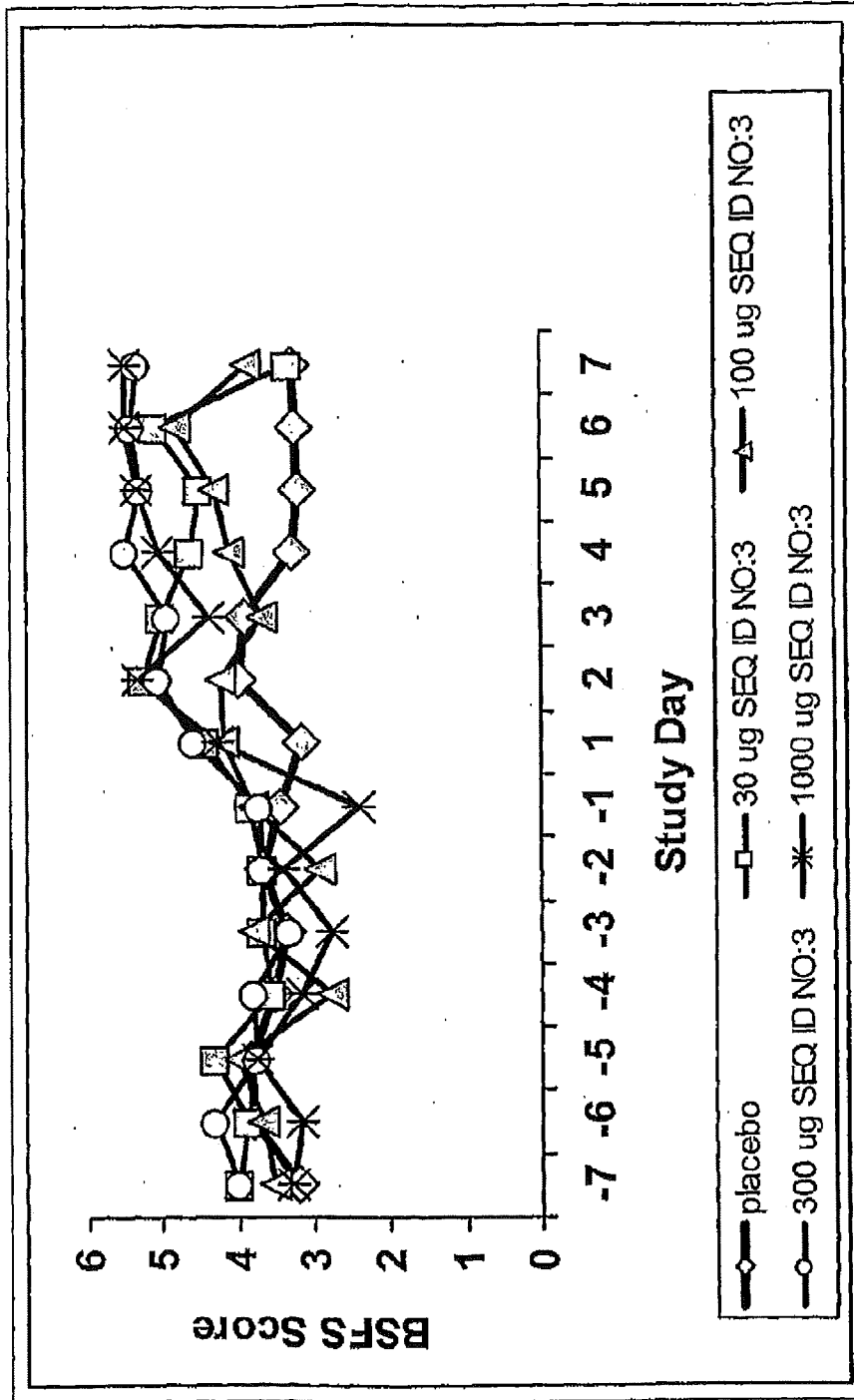


# Figure 14c. Percent of Subjects with 2-point Bristol Stool Form Scale Increase postdose after single dose studies

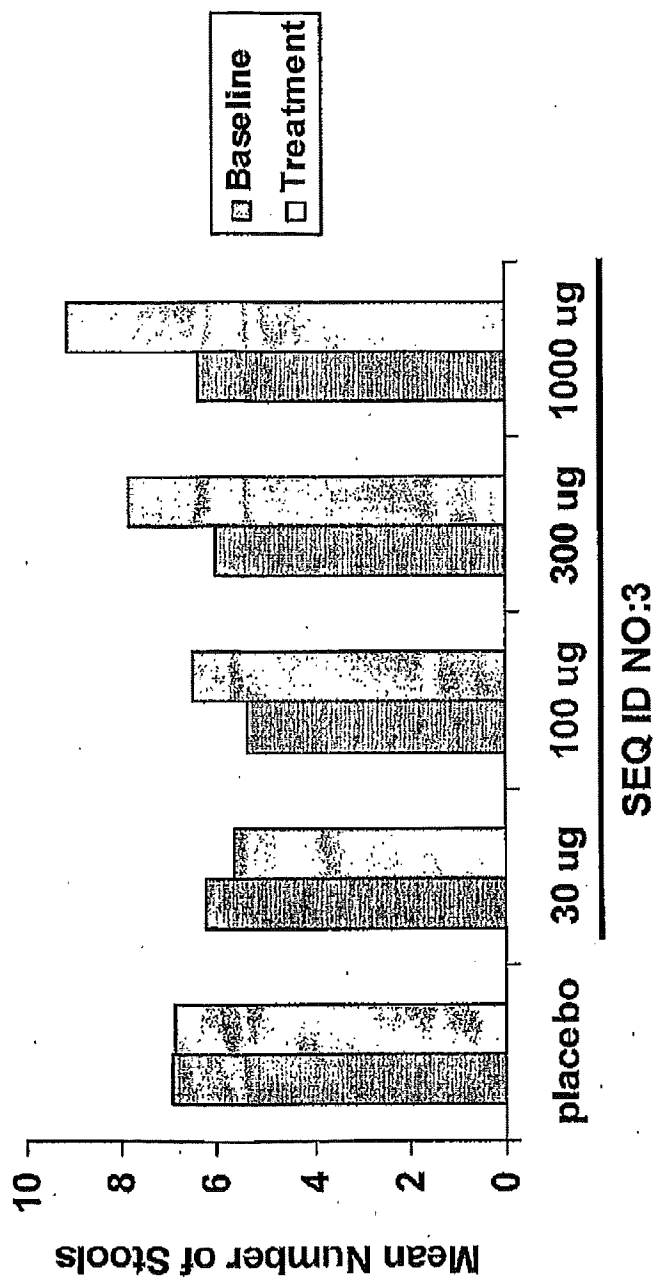
Includes subjects with a 2-point increase in Bristol Stool Form Scale score when comparing mean pre-dose score to maximum post-dose score for stool consistency



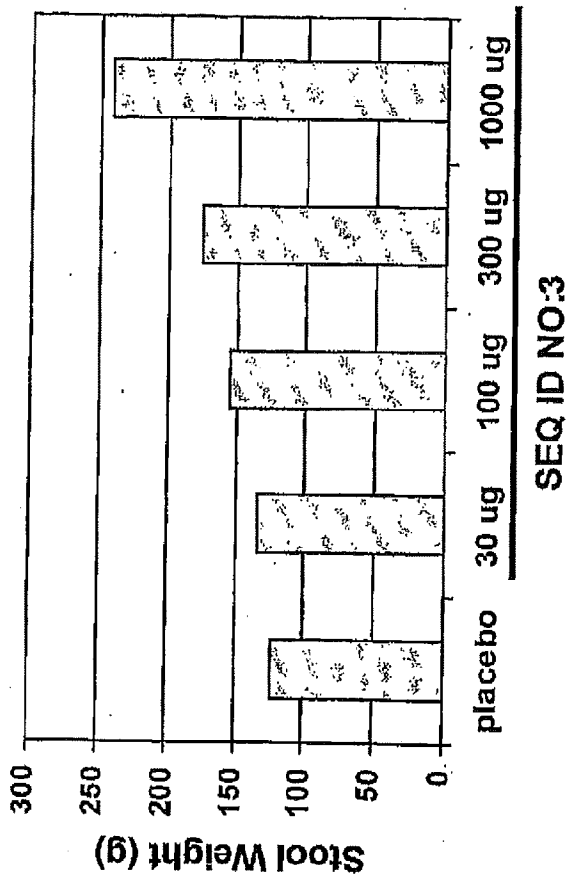
**Figure 15a. Bristol Stool Form Scale score for SEQ ID NO: 3 seven day dosing regimen**



**Figure 15b. Mean Stool Frequency (stools per week) during SEQ ID NO:3 seven day dosing regimen**



**Figure 15c. Mean Stool Weight during SEQ ID NO:3 seven day dosing regimen**



## Figure 15d. Mean Ease of Passage Scale

- 1: Manual disimpaction
- 2: Enema needed
- 3: Straining needed
- 4: Normal
- 5: Urgent without pain
- 6: Urgent with pain
- 7: Incontinent



**Figure 15e. Mean Ease of Passage during SEQ ID NO:3 seven day dosing regimen**

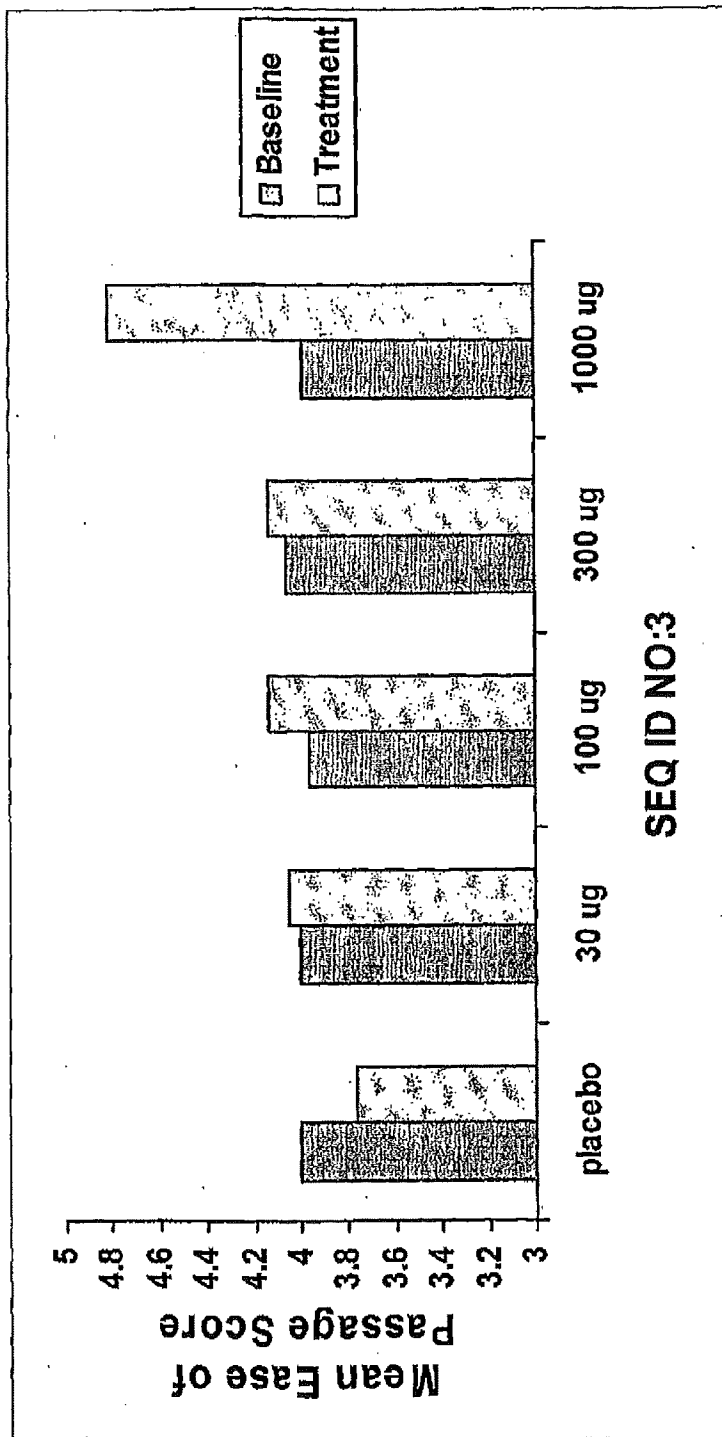
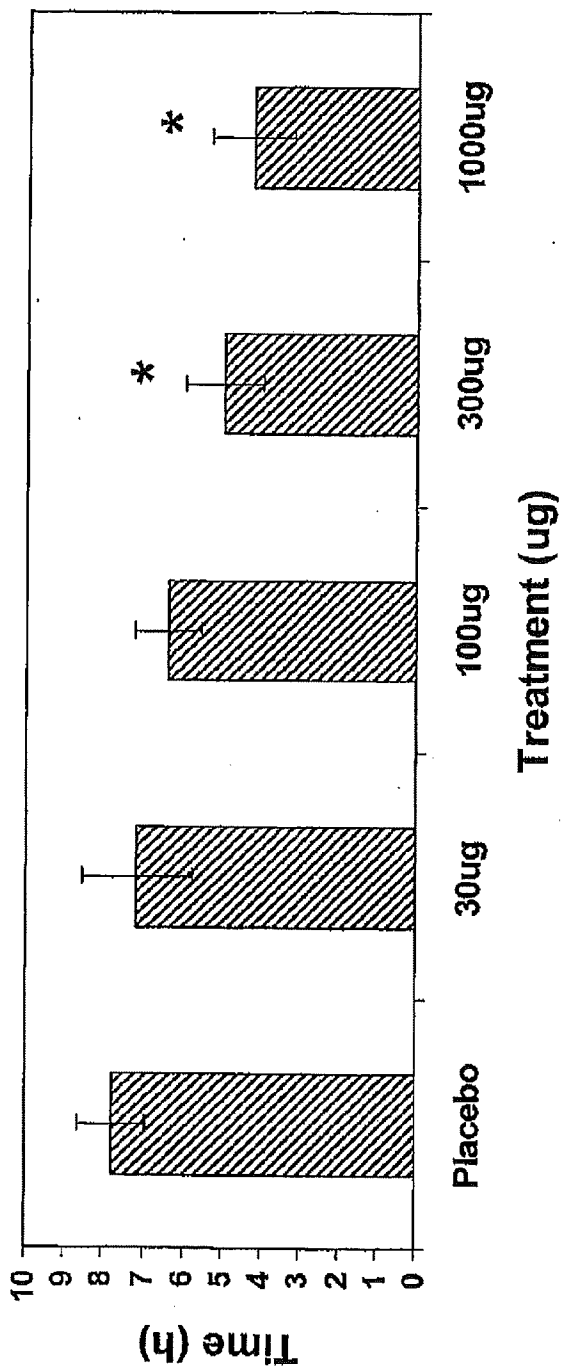


Figure 15F. Seq ID NO:3 effects on Mean Time to Bowel Movement<sup>1</sup>



\*  $p \leq 0.05$

1. Mean Time from study medication to bowel movement during the 7 day treatment period

**Figure 16. SEQ ID NO:3 in a rat model of postoperative ileus**

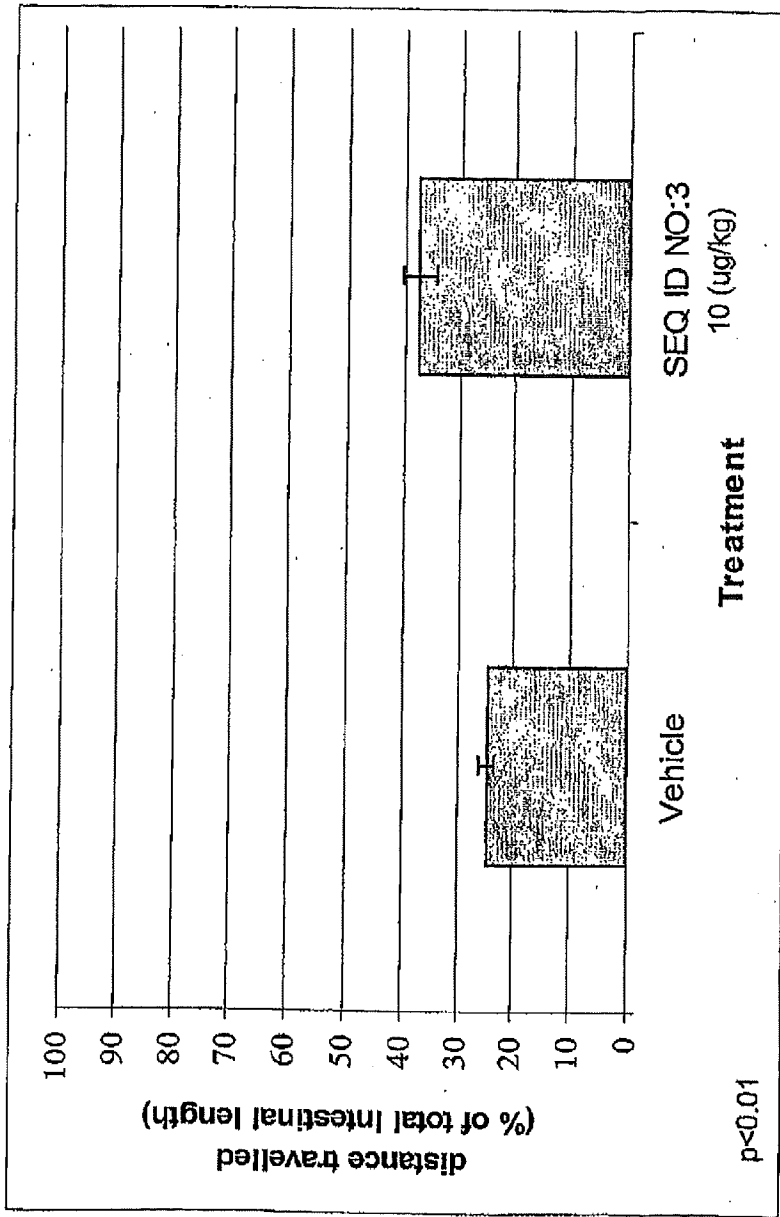


Figure 17a. Effect of SEQ ID NO:3 on cGMP activity and secretion in wild-type (WT) and GC-C KO (KO) mouse ligated loop experiments

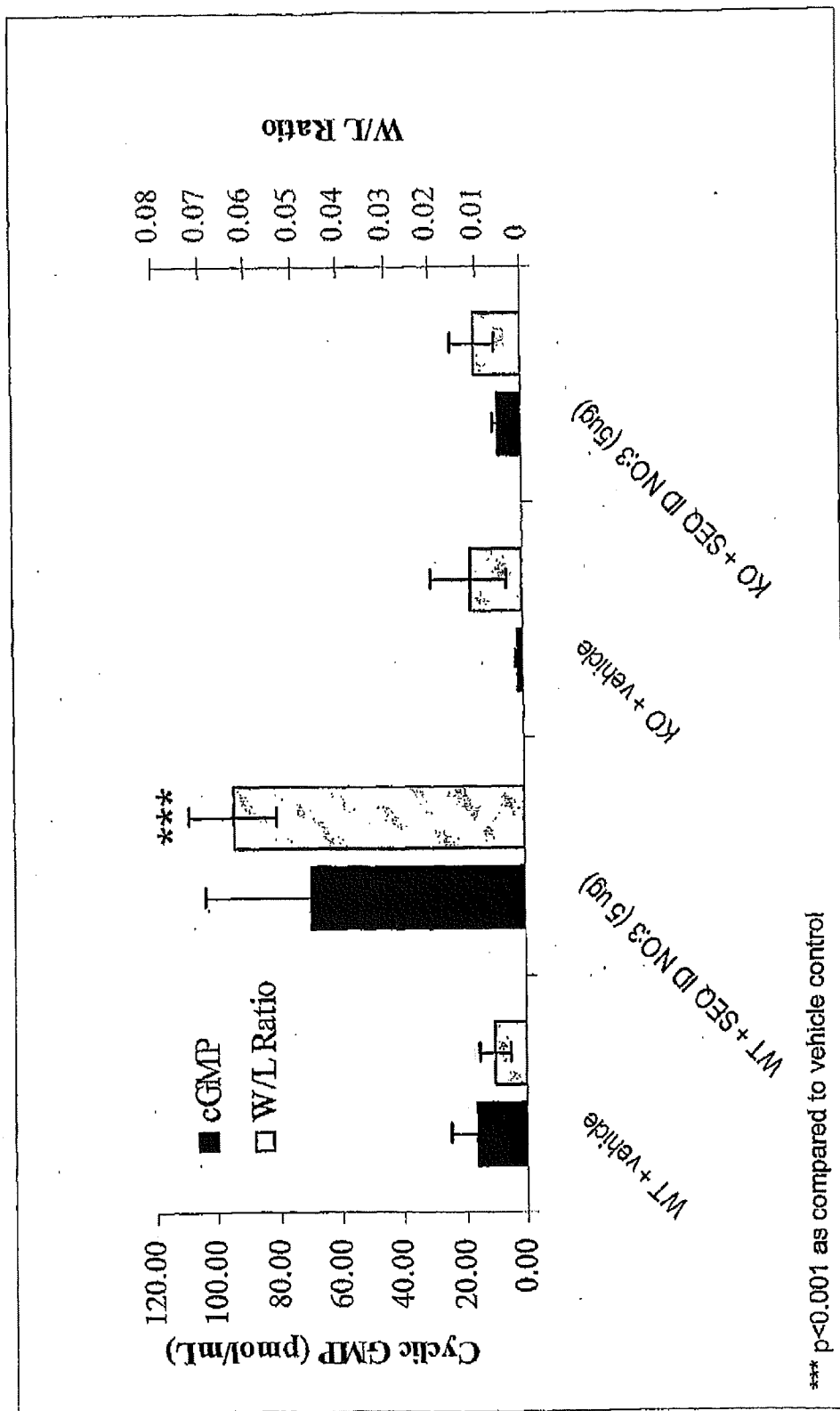
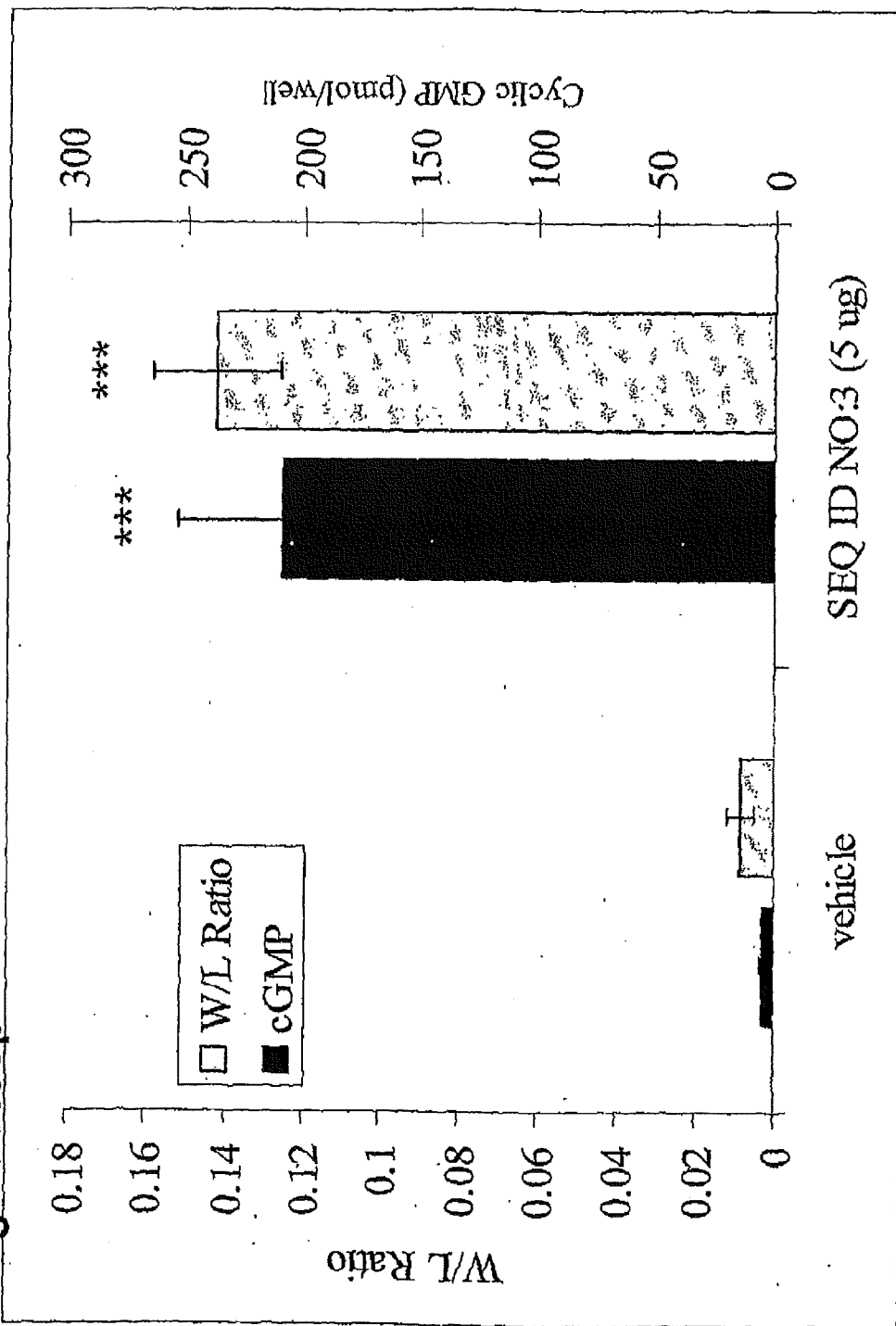
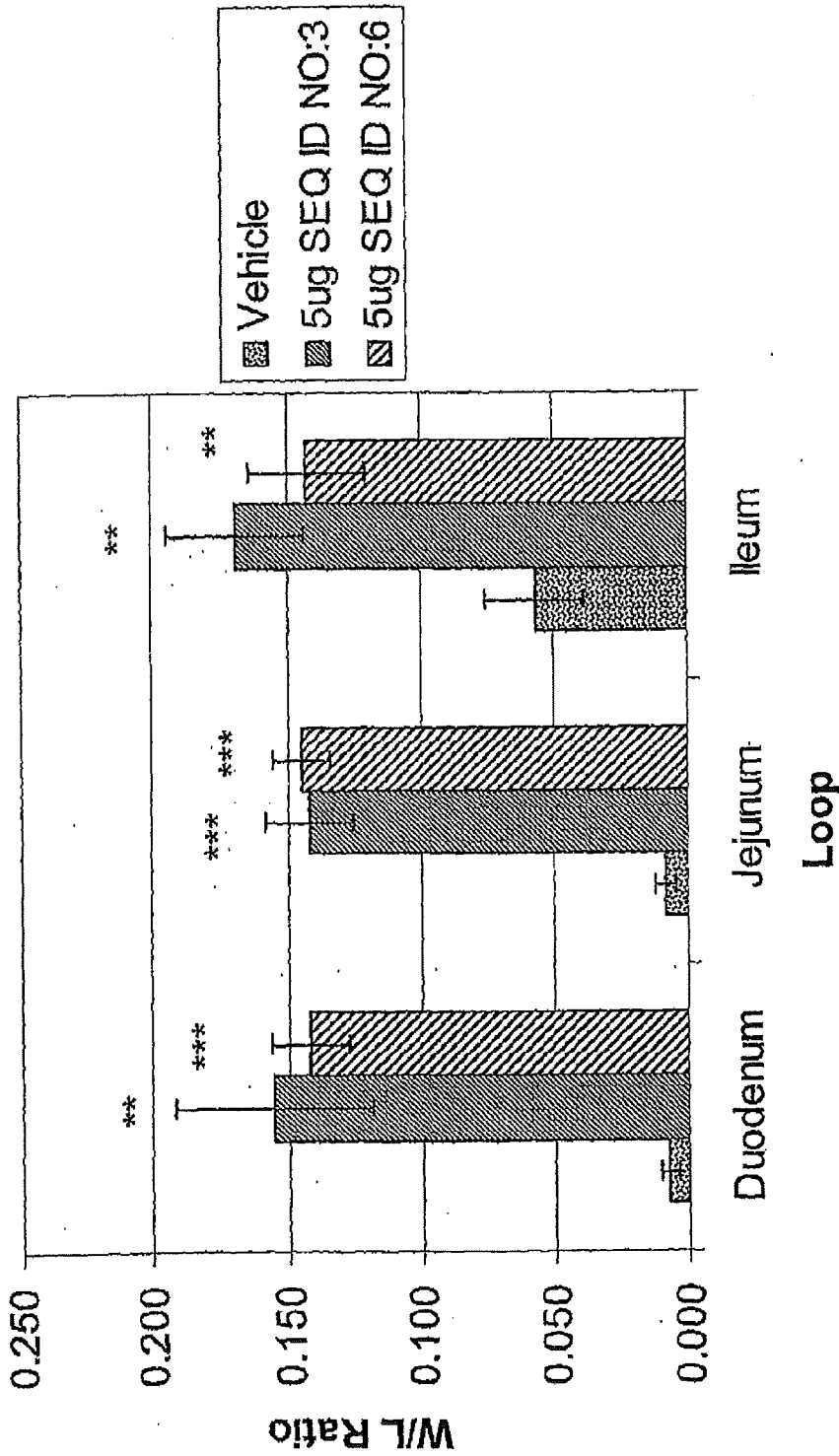


Figure 17b. Effect of SEQ ID NO:3 on cGMP activity and secretion in rat ligated loop



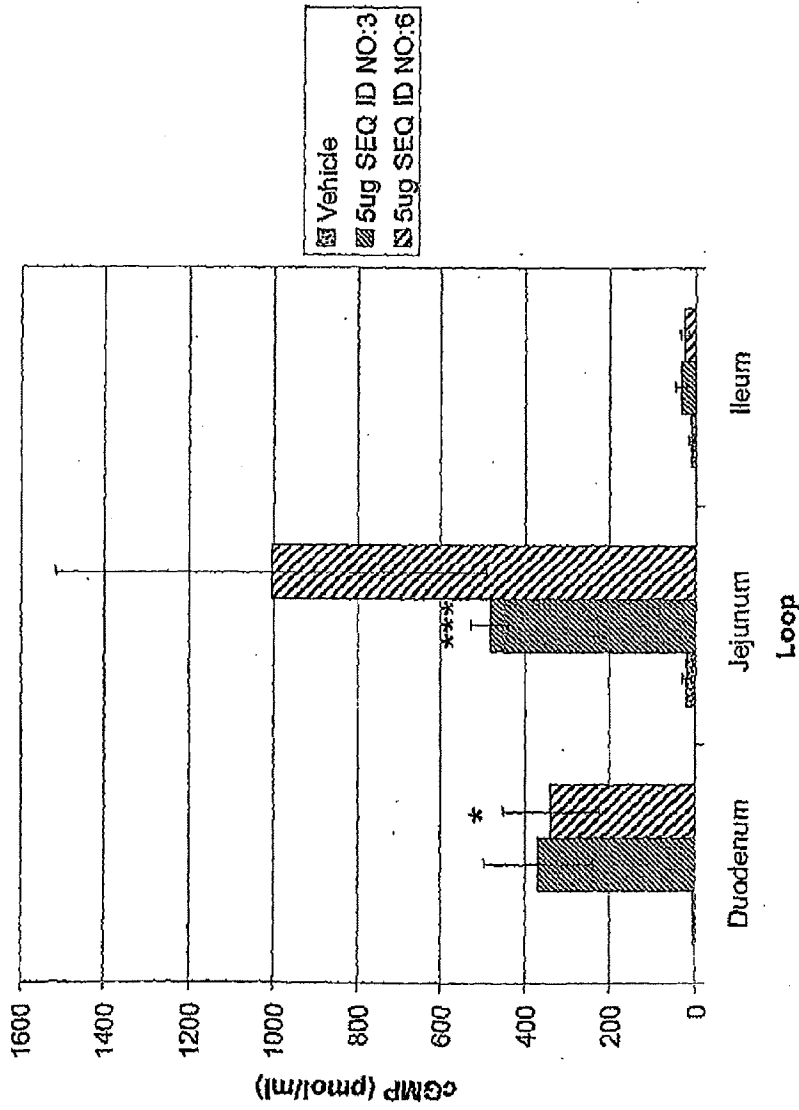
\*\*\* p<0.001

Figure 17c. SEQ ID NO:3 and SEQ ID NO:6 effects on secretion in ligated loops



\* $p \leq 0.05$ , \*\* $p \leq 0.01$ , \*\*\* $p \leq 0.001$  as compared to vehicle

Figure 17d. SEQ ID NO:3 and SEQ ID NO:6 effects on cGMP production in ligated loops



\* $p \leq 0.05$ , \*\* $p \leq 0.01$ , \*\*\* $p \leq 0.001$  as compared to vehicle

























Cys, Cys, Glu, Met, Gly, Cys, Asn, Pro, Ala, Cys, Thr, Gly, Ala  
 Cys, Cys, Glu, Phe, Gly, Cys, Asn, Pro, Ala, Cys, Thr, Gly, Ala  
 Cys, Cys, Glu, Pro, Gly, Cys, Asn, Pro, Ala, Cys, Thr, Gly, Ala  
 Cys, Cys, Glu, Ser, Gly, Cys, Asn, Pro, Ala, Cys, Thr, Gly, Ala  
 Cys, Cys, Glu, Thr, Gly, Cys, Asn, Pro, Ala, Cys, Thr, Gly, Ala  
 Cys, Cys, Glu, Trp, Gly, Cys, Asn, Pro, Ala, Cys, Thr, Gly, Ala  
 Cys, Cys, Glu, Tyr, Gly, Cys, Asn, Pro, Ala, Cys, Thr, Gly, Ala  
 Cys, Cys, Glu, Val, Gly, Cys, Asn, Pro, Ala, Cys, Thr, Gly, Ala  
 Cys, Cys, Glu, Leu, Ala, Cys, Asn, Pro, Ala, Cys, Thr, Gly, Ala, Tyr  
 Cys, Cys, Glu, Ala, Ala, Cys, Asn, Pro, Ala, Cys, Thr, Gly, Ala, Tyr  
 Cys, Cys, Glu, Arg, Ala, Cys, Asn, Pro, Ala, Cys, Thr, Gly, Ala, Tyr  
 Cys, Cys, Glu, Asn, Ala, Cys, Asn, Pro, Ala, Cys, Thr, Gly, Ala, Tyr  
 Cys, Cys, Glu, Asp, Ala, Cys, Asn, Pro, Ala, Cys, Thr, Gly, Ala, Tyr  
 Cys, Cys, Glu, Cys, Ala, Cys, Asn, Pro, Ala, Cys, Thr, Gly, Ala, Tyr  
 Cys, Cys, Glu, Gln, Ala, Cys, Asn, Pro, Ala, Cys, Thr, Gly, Ala, Tyr  
 Cys, Cys, Glu, Glu, Ala, Cys, Asn, Pro, Ala, Cys, Thr, Gly, Ala, Tyr  
 Cys, Cys, Glu, Gly, Ala, Cys, Asn, Pro, Ala, Cys, Thr, Gly, Ala, Tyr  
 Cys, Cys, Glu, His, Ala, Cys, Asn, Pro, Ala, Cys, Thr, Gly, Ala, Tyr  
 Cys, Cys, Glu, Ile, Ala, Cys, Asn, Pro, Ala, Cys, Thr, Gly, Ala, Tyr  
 Cys, Cys, Glu, Lys, Ala, Cys, Asn, Pro, Ala, Cys, Thr, Gly, Ala, Tyr  
 Cys, Cys, Glu, Met, Ala, Cys, Asn, Pro, Ala, Cys, Thr, Gly, Ala, Tyr  
 Cys, Cys, Glu, Phe, Ala, Cys, Asn, Pro, Ala, Cys, Thr, Gly, Ala, Tyr  
 Cys, Cys, Glu, Pro, Ala, Cys, Asn, Pro, Ala, Cys, Thr, Gly, Ala, Tyr  
 Cys, Cys, Glu, Ser, Ala, Cys, Asn, Pro, Ala, Cys, Thr, Gly, Ala, Tyr  
 Cys, Cys, Glu, Thr, Ala, Cys, Asn, Pro, Ala, Cys, Thr, Gly, Ala, Tyr  
 Cys, Cys, Glu, Trp, Ala, Cys, Asn, Pro, Ala, Cys, Thr, Gly, Ala, Tyr  
 Cys, Cys, Glu, Tyr, Ala, Cys, Asn, Pro, Ala, Cys, Thr, Gly, Ala, Tyr  
 Cys, Cys, Glu, Val, Ala, Cys, Asn, Pro, Ala, Cys, Thr, Gly, Ala, Tyr





























































