



US 20070279002A1

(19) **United States**

(12) **Patent Application Publication**  
**PARTOVI**

(10) **Pub. No.: US 2007/0279002 A1**

(43) **Pub. Date: Dec. 6, 2007**

(54) **POWER SOURCE, CHARGING SYSTEM,  
AND INDUCTIVE RECEIVER FOR MOBILE  
DEVICES**

**Publication Classification**

(51) **Int. Cl.**  
*H02J 7/00* (2006.01)

(76) **Inventor: AFSHIN PARTOVI,  
SUNNYVALE, CA (US)**

(52) **U.S. Cl. .... 320/115**

Correspondence Address:  
**FLIESLER MEYER LLP  
650 CALIFORNIA STREET, 14TH FLOOR  
SAN FRANCISCO, CA 94108**

(57) **ABSTRACT**

A power source, charging system, and inductive receiver for mobile devices. A pad or similar base unit comprises a primary, which creates a magnetic field by applying an alternating current to a winding, coil, or any type of current carrying wire. A receiver comprises a means for receiving the energy from the alternating magnetic field and transferring it to a mobile or other device. The receiver can also comprise electronic components or logic to set the voltage and current to the appropriate levels required by the mobile device, or to communicate information or data to and from the pad. The system may also incorporate efficiency measures that improve the efficiency of power transfer between the charger and receiver.

(21) **Appl. No.: 11/757,067**

(22) **Filed: Jun. 1, 2007**

**Related U.S. Application Data**

(60) **Provisional application No. 60/810,262, filed on Jun. 1, 2006, provisional application No. 60/810,298, filed on Jun. 1, 2006, provisional application No. 60/868,674, filed on Dec. 5, 2006.**

**100** →

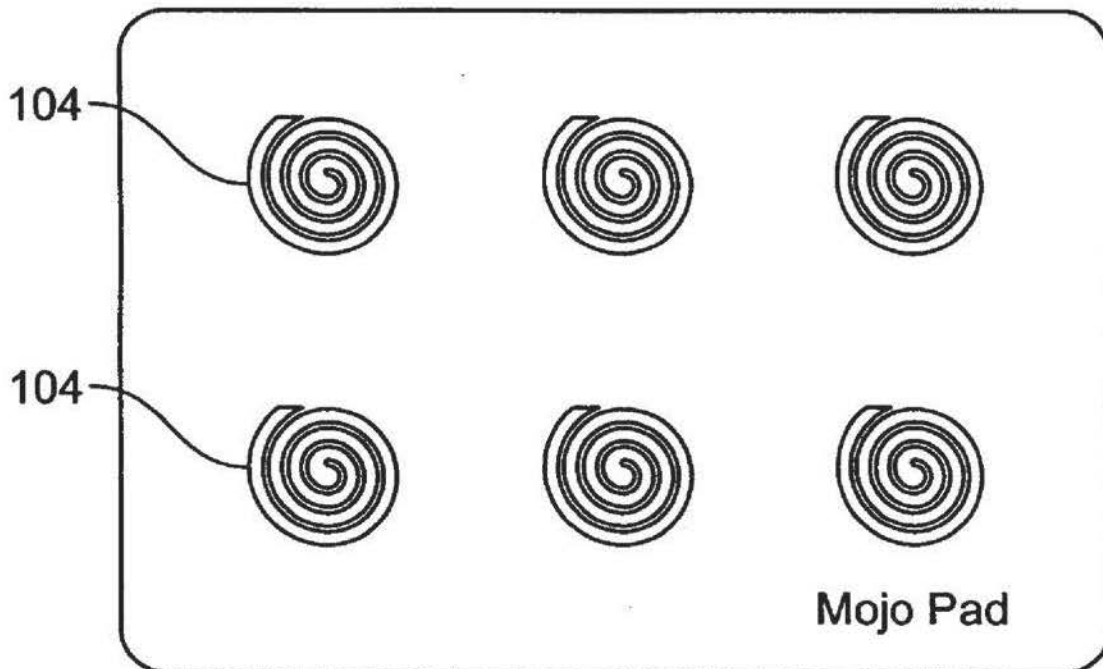

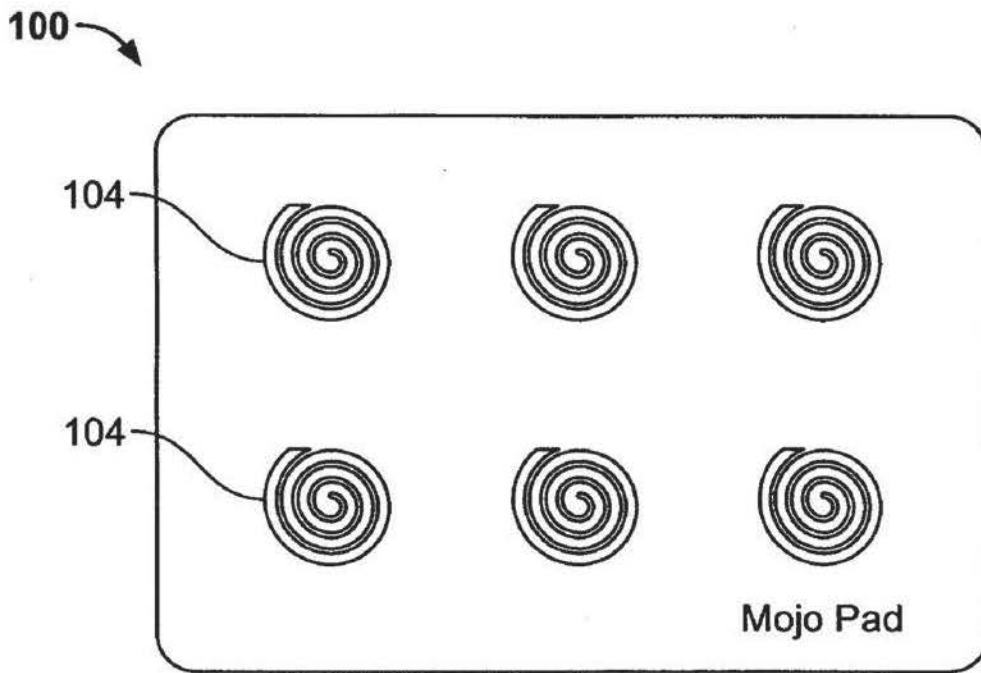

FIG. 1

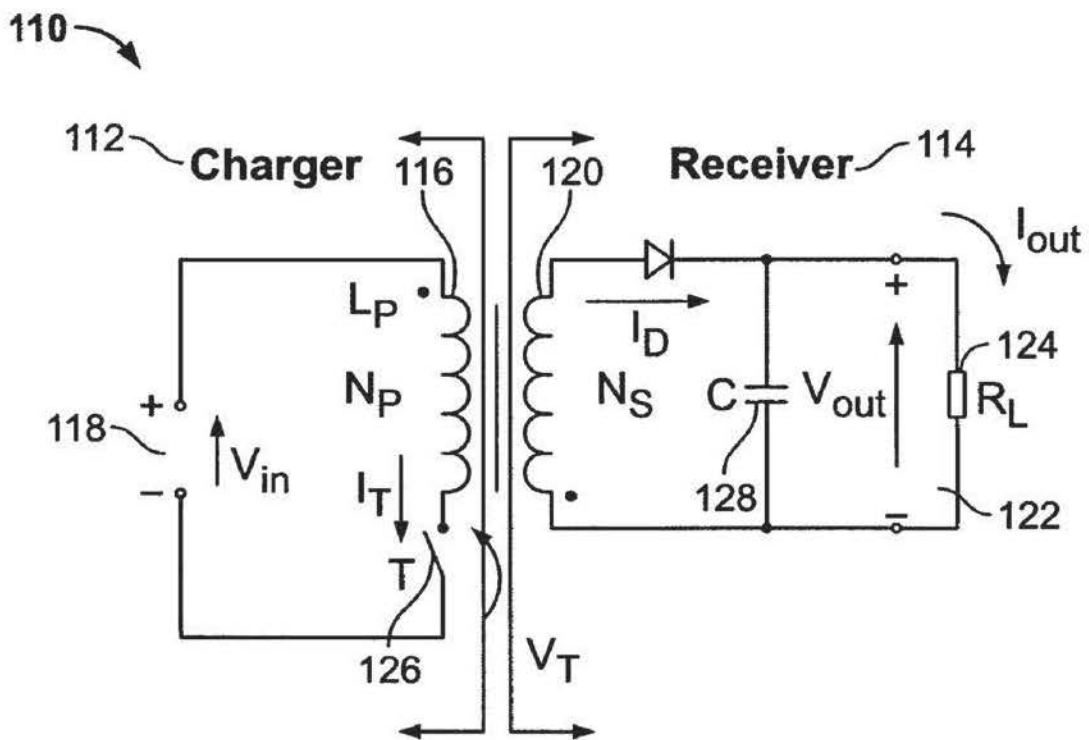

FIG. 2

140 →

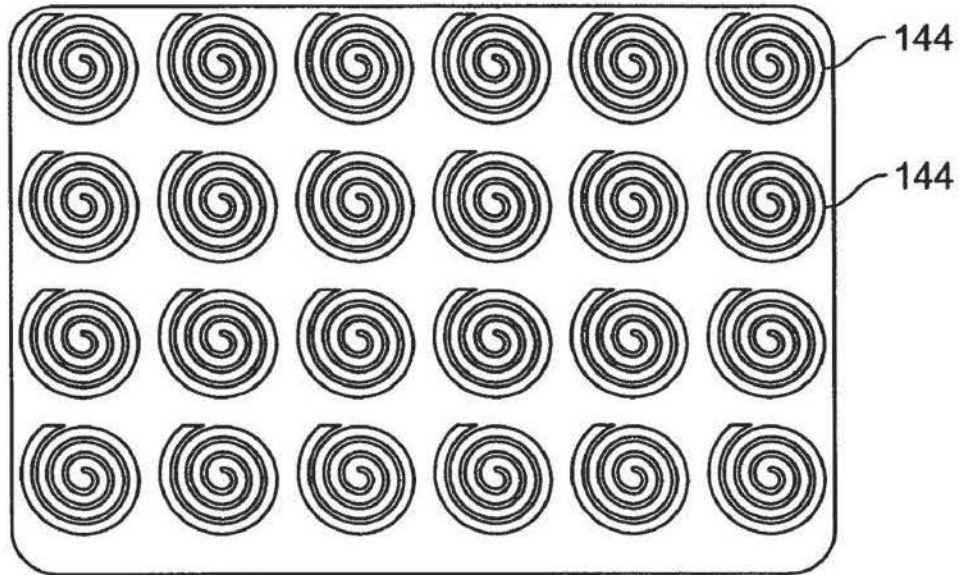

FIG. 3

150 →

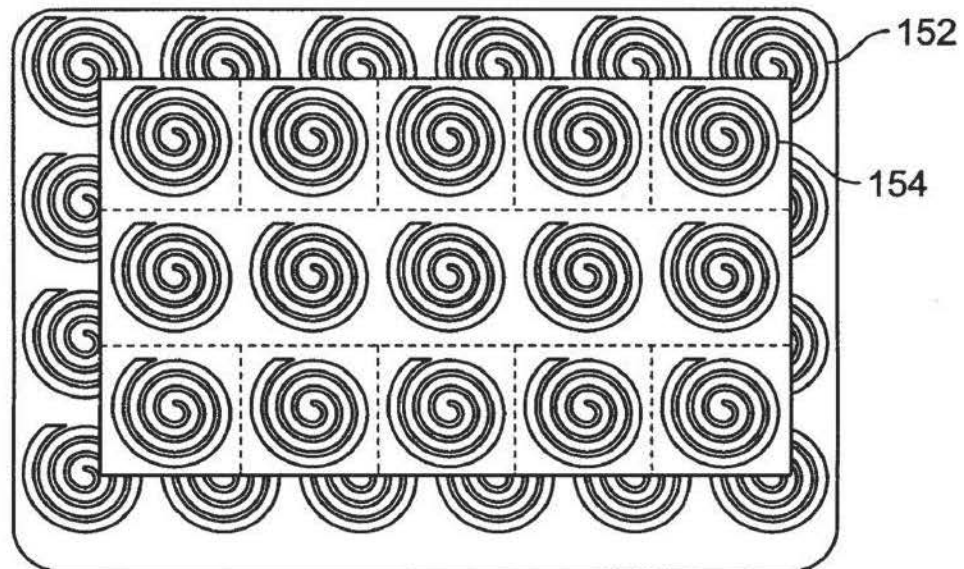

FIG. 4

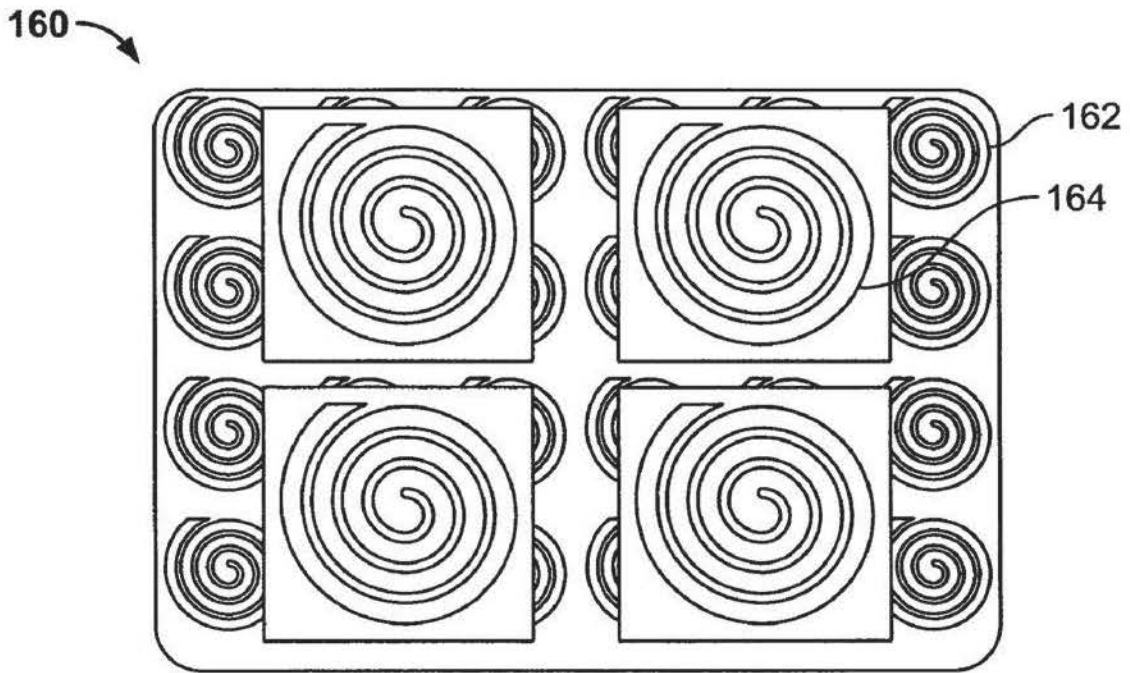

FIG. 5

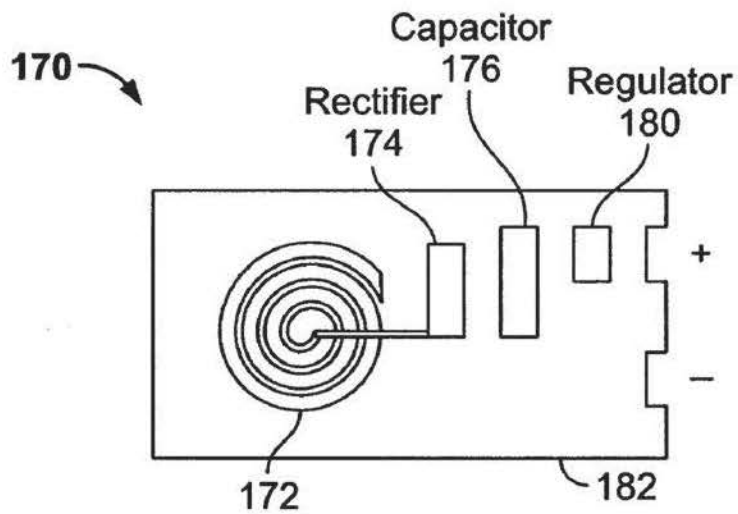

FIG. 6

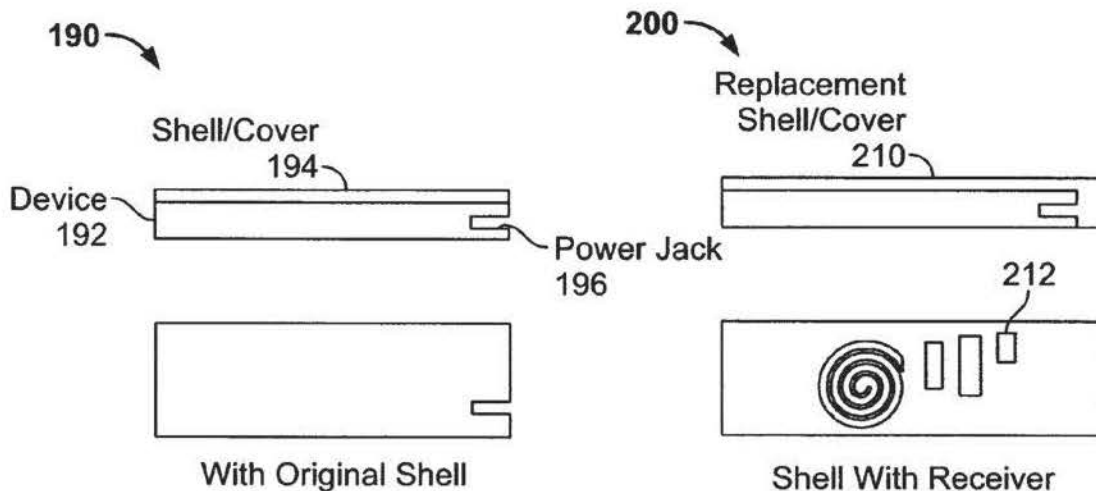

FIG. 7

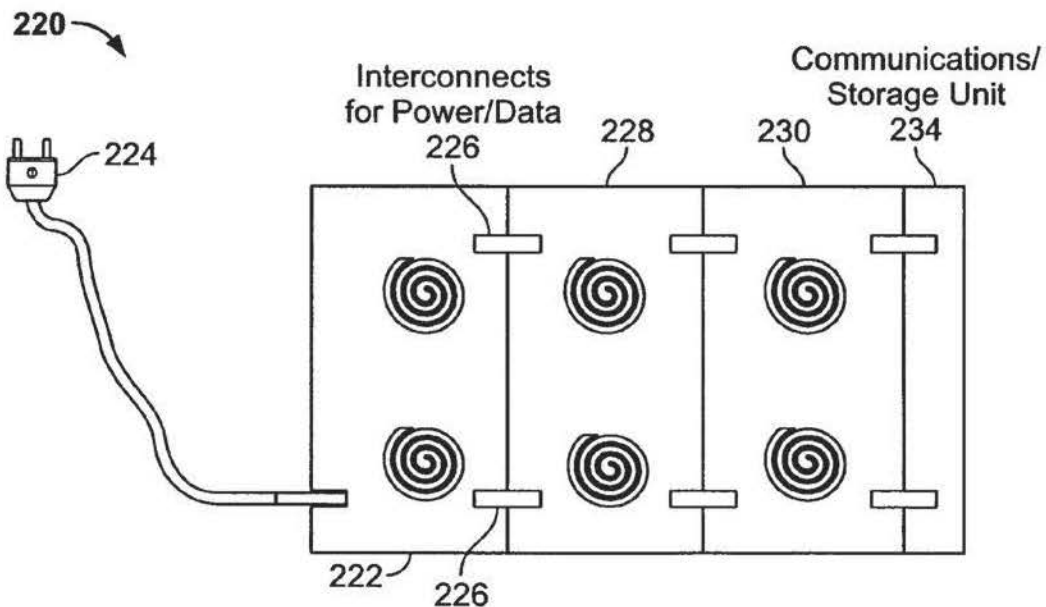

FIG. 8

# Explore Litigation Insights

Docket Alarm provides insights to develop a more informed litigation strategy and the peace of mind of knowing you're on top of things.

## Real-Time Litigation Alerts



Keep your litigation team up-to-date with **real-time alerts** and advanced team management tools built for the enterprise, all while greatly reducing PACER spend.

Our comprehensive service means we can handle Federal, State, and Administrative courts across the country.

## Advanced Docket Research



With over 230 million records, Docket Alarm's cloud-native docket research platform finds what other services can't. Coverage includes Federal, State, plus PTAB, TTAB, ITC and NLRB decisions, all in one place.

Identify arguments that have been successful in the past with full text, pinpoint searching. Link to case law cited within any court document via Fastcase.

## Analytics At Your Fingertips



Learn what happened the last time a particular judge, opposing counsel or company faced cases similar to yours.

Advanced out-of-the-box PTAB and TTAB analytics are always at your fingertips.

## API

Docket Alarm offers a powerful API (application programming interface) to developers that want to integrate case filings into their apps.

## LAW FIRMS

Build custom dashboards for your attorneys and clients with live data direct from the court.

Automate many repetitive legal tasks like conflict checks, document management, and marketing.

## FINANCIAL INSTITUTIONS

Litigation and bankruptcy checks for companies and debtors.

## E-DISCOVERY AND LEGAL VENDORS

Sync your system to PACER to automate legal marketing.