



US006427409B2

(12) **United States Patent**
Colson et al.

(10) **Patent No.:** **US 6,427,409 B2**
(45) **Date of Patent:** **Aug. 6, 2002**

(54) **CLADDING SYSTEM AND PANEL FOR USE IN SUCH SYSTEM**

3,300,926 A 1/1967 Heirich
3,315,727 A 4/1967 Clark
3,390,495 A 7/1968 Dalby

(75) Inventors: **Wendell B. Colson**, Boulder; **Lee A. Cole**, Evergreen; **Jason T. Throne**, Steamboat Spgs, all of CO (US)

(List continued on next page.)

FOREIGN PATENT DOCUMENTS

(73) Assignee: **Hunter Douglas Inc.**, Upper Saddle River, NJ (US)

CA 1287207 8/1991
CH 557938 1/1975

(List continued on next page.)

(*) Notice: Subject to any disclaimer, the term of this patent is extended or adjusted under 35 U.S.C. 154(b) by 0 days.

Primary Examiner—Robert Canfield

(74) *Attorney, Agent, or Firm*—Dorsey & Whitney LLP

(21) Appl. No.: **09/783,238**

(57) **ABSTRACT**

(22) Filed: **Feb. 14, 2001**

A cladding system for walls or ceilings of a building structure consisting of a panel or panels that are sectioned so as to provide a variety of aesthetics. The sections in the panel may be joined along articulated lines of joinder so that an entire panel comprised of a plurality of sections can be expanded or retracted to either cover or selectively expose the wall or ceiling across which the system is mounted. The sections in a panel may be cellular and may thereby form a honeycomb-type panel, and the materials from which the panels are made may vary between being rigid, flexible, hard, soft, flat, reflective, and the like. Panels can be supported with side rails extending along each side of the panel while not requiring cross rails so that, for example, when a panel is used in a ceiling system and retracted from its expanded condition beneath a ceiling structure, generous access is provided to the ceiling structure for repair or other work on utilities such as plumbing, electrical, and the like that are found embedded in the ceiling. Intermediate rails, parallel to the side rails, can also be provided, if necessary, to support a panel along intermediate portions thereof or between adjacent panels. The supporting rails for the panels can take on numerous configurations so as to support the panels in varied ways depending to some degree upon the particular panel construction being utilized.

Related U.S. Application Data

(62) Division of application No. 08/752,957, filed on Nov. 20, 1996, now Pat. No. 6,199,337.

(51) **Int. Cl.**⁷ **E04F 13/00**; E04B 9/00

(52) **U.S. Cl.** **52/506.08**; 52/506.07; 52/508; 160/84.05

(58) **Field of Search** 52/506.06, 506.07, 52/508, 511, 6, 63, 71, 222, 2.24, 2.22, 202, 203; 160/84.01, 84.03, 84.05, 84.08, 348

(56) **References Cited**

U.S. PATENT DOCUMENTS

912,849 A 2/1909 Hultgren
1,998,423 A 4/1935 Stubbs
2,073,036 A 3/1937 Voigt
2,271,929 A 2/1942 Venzie
2,497,912 A 2/1950 Rees
3,037,594 A 6/1962 Kaufman
3,139,958 A 7/1964 Dewitt
3,254,462 A 6/1966 Toler
3,264,792 A * 8/1966 Dradzdik et al.

10 Claims, 50 Drawing Sheets

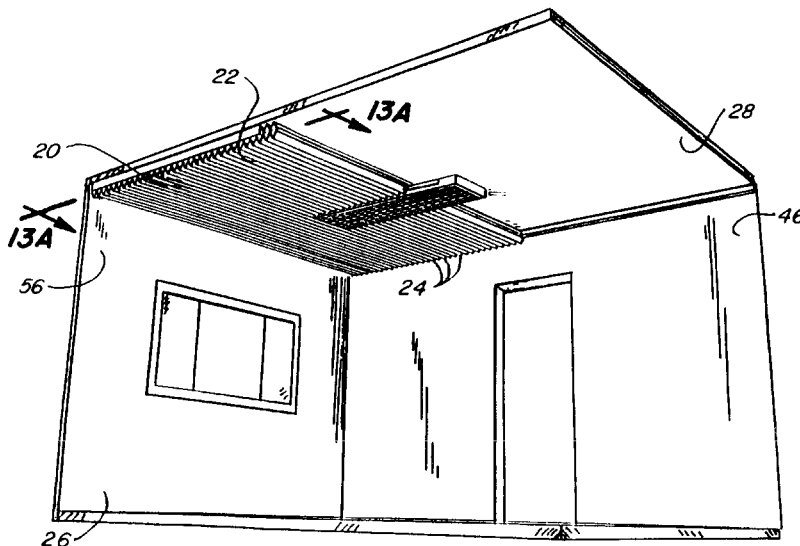

U.S. PATENT DOCUMENTS

3,418,766 A 12/1968 Jackson
 3,466,830 A 9/1969 Smith
 3,534,512 A 10/1970 Ballas
 3,741,843 A 6/1973 Louis
 3,762,108 A 10/1973 Pierson
 3,763,606 A 10/1973 Rindebong
 3,875,717 A 4/1975 Moeller
 3,934,387 A 1/1976 Moeller
 4,193,239 A 3/1980 Barto
 4,230,171 A 10/1980 Baker, Sr.
 4,374,536 A 2/1983 Becker
 4,450,027 A 5/1984 Colson
 4,461,232 A 7/1984 Berg
 4,463,537 A 8/1984 Rodriguez et al.
 4,550,545 A 11/1985 Schulz
 4,590,727 A 5/1986 Ghahremani et al.
 4,640,064 A 2/1987 Goodworth, II
 4,641,475 A 2/1987 Berridge
 4,647,488 A 3/1987 Schnebly et al.
 4,665,964 A 5/1987 Zommers
 4,677,012 A 6/1987 Andrson
 4,677,013 A 6/1987 Anderson
 4,696,142 A 9/1987 Mieyai et al.
 4,706,433 A 11/1987 Rijnders
 4,849,039 A * 7/1989 Colson et al.
 4,878,322 A 11/1989 Ikeda et al.
 4,880,044 A 11/1989 Judkins
 5,024,034 A 6/1991 Gailey
 5,106,444 A * 4/1992 Coery et al.
 5,182,893 A 2/1993 Goodworth
 5,184,659 A 2/1993 Alcocer
 5,205,334 A * 4/1993 Judkins
 5,251,415 A 10/1993 Van Auken et al.

5,253,463 A 10/1993 Witmyer
 5,273,096 A 12/1993 Thomsen et al.
 5,273,097 A * 12/1993 Siegler
 5,301,733 A * 4/1994 Toti
 5,417,025 A 5/1995 Nute et al.
 5,425,408 A 6/1995 Colson
 5,483,774 A 1/1996 Siemerink et al.
 5,503,210 A 4/1996 Colson et al.
 5,513,470 A 5/1996 Vollebregt
 5,649,583 A 7/1997 Hsu
 5,724,780 A 3/1998 Bolich
 6,006,476 A * 12/1999 Zarnick
 6,024,153 A * 2/2000 Goldman
 6,103,336 A * 8/2000 Swiszc
 6,192,642 B1 * 2/2001 Colson et al.
 6,199,337 B1 * 3/2001 Colson et al.

FOREIGN PATENT DOCUMENTS

| | | |
|----|---------|---------|
| CH | 657409 | 8/1986 |
| DE | 3245214 | 6/1984 |
| DE | 3631919 | 4/1988 |
| EP | 171116 | 2/1986 |
| EP | 305092 | 3/1989 |
| EP | 340815 | 11/1989 |
| EP | 451912 | 10/1991 |
| FR | 1286348 | 7/1962 |
| GB | 714595 | 9/1954 |
| GB | 1554159 | 10/1979 |
| GB | 2258257 | 1/1995 |
| NL | 7602204 | 9/1977 |
| NL | 9201396 | 3/1993 |
| WO | 9400663 | 1/1994 |

* cited by examiner

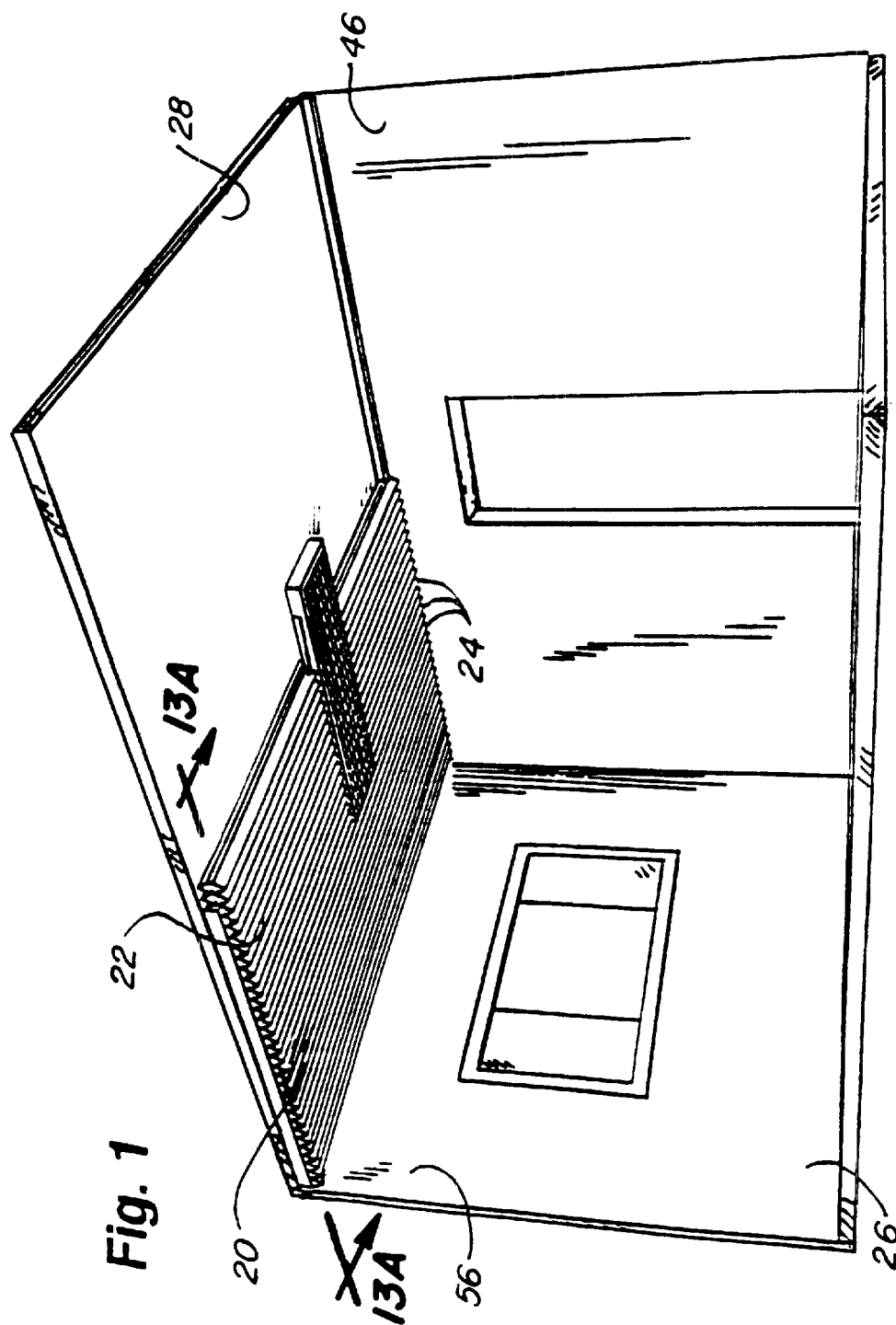

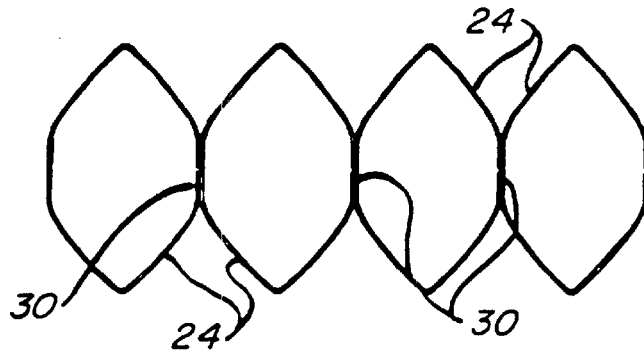

Fig-3

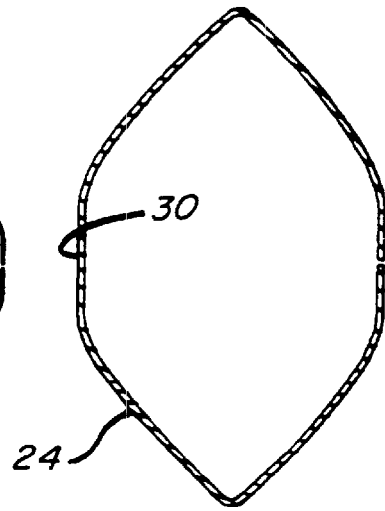

Fig-2

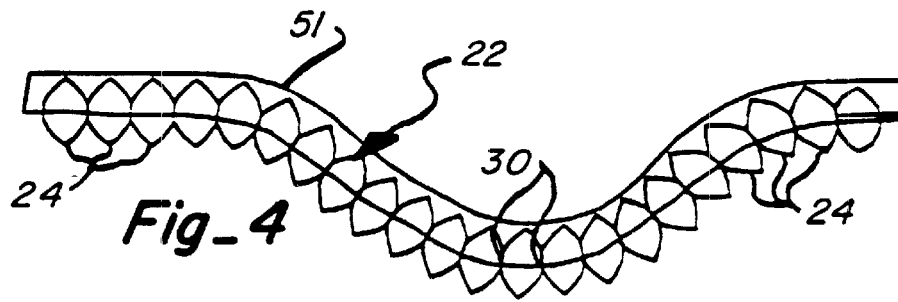

Fig-4

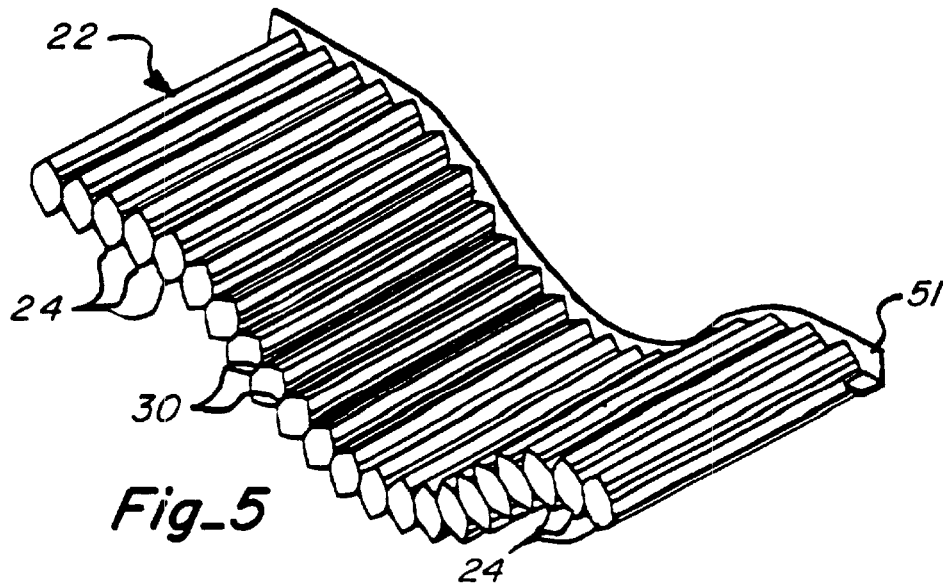
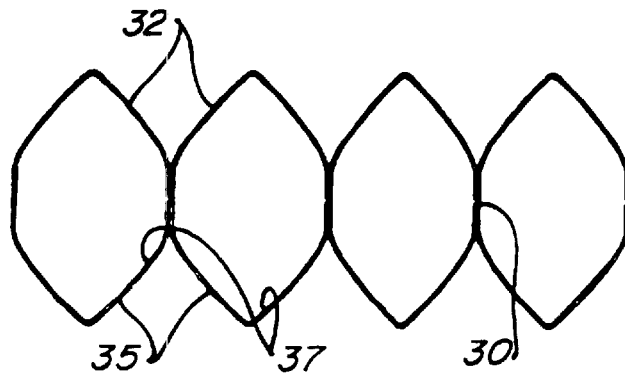
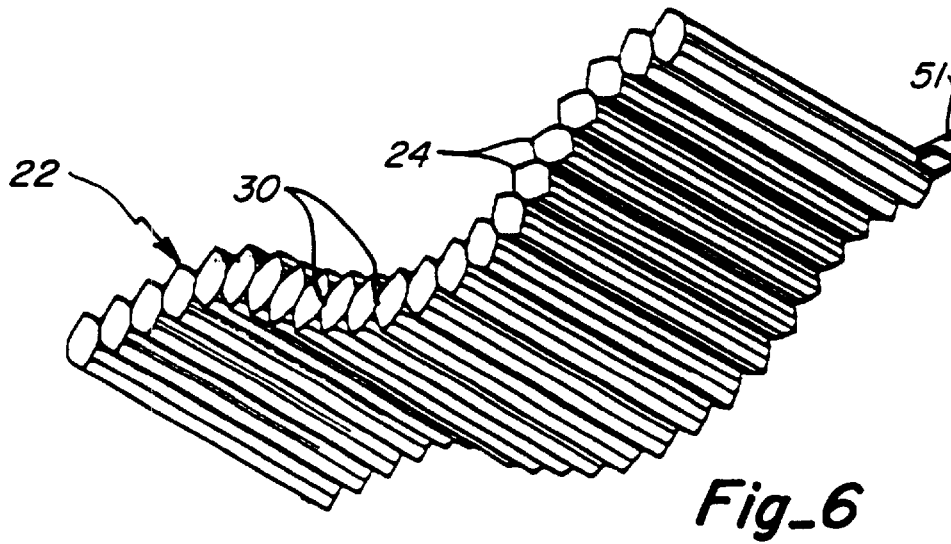
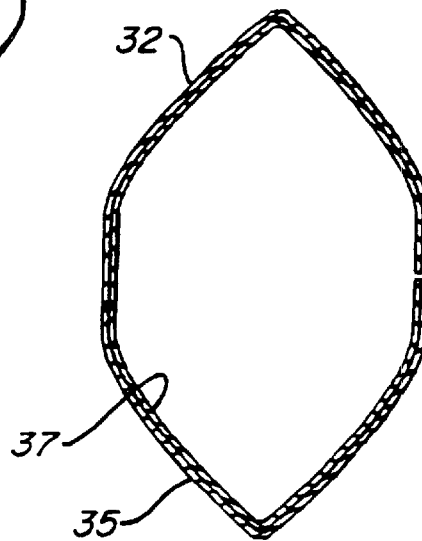

Fig-5



Fig_8



Fig_7

Explore Litigation Insights

Docket Alarm provides insights to develop a more informed litigation strategy and the peace of mind of knowing you're on top of things.

Real-Time Litigation Alerts



Keep your litigation team up-to-date with **real-time alerts** and advanced team management tools built for the enterprise, all while greatly reducing PACER spend.

Our comprehensive service means we can handle Federal, State, and Administrative courts across the country.

Advanced Docket Research



With over 230 million records, Docket Alarm's cloud-native docket research platform finds what other services can't. Coverage includes Federal, State, plus PTAB, TTAB, ITC and NLRB decisions, all in one place.

Identify arguments that have been successful in the past with full text, pinpoint searching. Link to case law cited within any court document via Fastcase.

Analytics At Your Fingertips



Learn what happened the last time a particular judge, opposing counsel or company faced cases similar to yours.

Advanced out-of-the-box PTAB and TTAB analytics are always at your fingertips.

API

Docket Alarm offers a powerful API (application programming interface) to developers that want to integrate case filings into their apps.

LAW FIRMS

Build custom dashboards for your attorneys and clients with live data direct from the court.

Automate many repetitive legal tasks like conflict checks, document management, and marketing.

FINANCIAL INSTITUTIONS

Litigation and bankruptcy checks for companies and debtors.

E-DISCOVERY AND LEGAL VENDORS

Sync your system to PACER to automate legal marketing.