

AO 120 (Rev. 08/10)

|  |   |
|--|---|
| <b>TO:</b> <b>Mail Stop 8</b><br><b>Director of the U.S. Patent and Trademark Office</b><br><b>P.O. Box 1450</b><br><b>Alexandria, VA 22313-1450</b> | <b>REPORT ON THE</b><br><b>FILING OR DETERMINATION OF AN</b><br><b>ACTION REGARDING A PATENT OR</b><br><b>TRADEMARK</b> |
|--|---|

In Compliance with 35 U.S.C. § 290 and/or 15 U.S.C. § 1116 you are hereby advised that a court action has been filed in the U.S. District Court Western District of Texas on the following

Trademarks or  Patents. (  the patent action involves 35 U.S.C. § 292.):

|                              |                             |  |
|------------------------------|-----------------------------|--|
| DOCKET NO.<br>6:21-cv-00428  | DATE FILED<br>4/28/2021     | U.S. DISTRICT COURT<br>Western District of Texas |
| PLAINTIFF<br>ECOFACTOR, INC. |                             | DEFENDANT<br>ECOBEE, INC.                        |
| PATENT OR TRADEMARK NO.      | DATE OF PATENT OR TRADEMARK | HOLDER OF PATENT OR TRADEMARK                    |
| 1 8,740,100                  | 6/3/2014                    | EcoFactor, Inc.                                  |
| 2 8,751,186                  | 6/10/2014                   | EcoFactor, Inc.                                  |
| 3 9,194,597                  | 11/24/2015                  | EcoFactor, Inc.                                  |
| 4 10,584,890                 | 3/10/2020                   | EcoFactor, Inc.                                  |
| 5                            |                             |  |

In the above—entitled case, the following patent(s)/ trademark(s) have been included:

|                         |   |                               |
|-------------------------|---|-------------------------------|
| DATE INCLUDED           | INCLUDED BY<br><input type="checkbox"/> Amendment <input type="checkbox"/> Answer <input type="checkbox"/> Cross Bill <input type="checkbox"/> Other Pleading |                               |
| PATENT OR TRADEMARK NO. | DATE OF PATENT OR TRADEMARK   | HOLDER OF PATENT OR TRADEMARK |
| 1                       |   |                               |
| 2                       |   |                               |
| 3                       |   |                               |
| 4                       |   |                               |
| 5                       |   |                               |

In the above—entitled case, the following decision has been rendered or judgement issued:

|                    |
|--------------------|
| DECISION/JUDGEMENT |
|--------------------|

|       |                   |      |
|-------|-------------------|------|
| CLERK | (BY) DEPUTY CLERK | DATE |
|-------|-------------------|------|

Copy 1—Upon initiation of action, mail this copy to Director    Copy 3—Upon termination of action, mail this copy to Director  
 Copy 2—Upon filing document adding patent(s), mail this copy to Director    Copy 4—Case file copy

GOOGLE 1009

001





UNITED STATES PATENT AND TRADEMARK OFFICE

UNITED STATES DEPARTMENT OF COMMERCE
United States Patent and Trademark Office
Address: COMMISSIONER FOR PATENTS
P.O. Box 1450
Alexandria, Virginia 22313-1450
www.uspto.gov

Table with 5 columns: APPLICATION NUMBER, FILING OR 371(C) DATE, FIRST NAMED APPLICANT, ATTY.DOCKET NO./TITLE, REQUEST ID. Values: 14/082,675, 11/18/2013, John Douglas Steinberg, EFACT.007C1, 99804

Acknowledgement of Loss of Entitlement to Entity Status Discount

The entity status change request below filed through Private PAIR on 11/14/2019 has been accepted.

CERTIFICATIONS:

Change of Entity Status:
X Applicant changing to regular undiscounted fee status.
NOTE: Checking this box will be taken to be notification of loss of entitlement to small or micro entity status, as applicable.

This portion must be completed by the signatory or signatories making the entity status change in accordance with 37 CFR 1.4(d)(4).

Table with 2 columns: Label, Value. Rows: Signature: /John R. King/, Name: John R. King, Registration Number: 34362



| APPLICATION NO. | ISSUE DATE | PATENT NO. | ATTORNEY DOCKET NO. | CONFIRMATION NO. |
|-----------------|------------|------------|---------------------|------------------|
| 14/082,675      | 11/24/2015 | 9194597    | EFACT.007C1         | 3336             |

20995                      7590                      11/04/2015  
**KNOBBE MARTENS OLSON & BEAR LLP**  
 2040 MAIN STREET  
 FOURTEENTH FLOOR  
 IRVINE, CA 92614

### ISSUE NOTIFICATION

The projected patent number and issue date are specified above.

**Determination of Patent Term Adjustment under 35 U.S.C. 154 (b)**  
 (application filed on or after May 29, 2000)

The Patent Term Adjustment is 57 day(s). Any patent to issue from the above-identified application will include an indication of the adjustment on the front page.

If a Continued Prosecution Application (CPA) was filed in the above-identified application, the filing date that determines Patent Term Adjustment is the filing date of the most recent CPA.

Applicant will be able to obtain more detailed information by accessing the Patent Application Information Retrieval (PAIR) WEB site (<http://pair.uspto.gov>).

Any questions regarding the Patent Term Extension or Adjustment determination should be directed to the Office of Patent Legal Administration at (571)-272-7702. Questions relating to issue and publication fee payments should be directed to the Application Assistance Unit (AAU) of the Office of Data Management (ODM) at (571)-272-4200.

APPLICANT(s) (Please see PAIR WEB site <http://pair.uspto.gov> for additional applicants):

EcoFactor, Inc., Millbrae, CA;  
 John Douglas Steinberg, Millbrae, CA;  
 Scott Douglas Hublou, Redwood City, CA;  
 Leo Cheung, Sunnyvale, CA;

The United States represents the largest, most dynamic marketplace in the world and is an unparalleled location for business investment, innovation, and commercialization of new technologies. The USA offers tremendous resources and advantages for those who invest and manufacture goods here. Through SelectUSA, our nation works to encourage and facilitate business investment. To learn more about why the USA is the best country in the world to develop technology, manufacture products, and grow your business, visit [SelectUSA.gov](http://SelectUSA.gov).



UNITED STATES PATENT AND TRADEMARK OFFICE

UNITED STATES DEPARTMENT OF COMMERCE
United States Patent and Trademark Office
Address: COMMISSIONER FOR PATENTS
P.O. Box 1450
Alexandria, Virginia 22313-1450
www.uspto.gov

Table with 5 columns: APPLICATION NO., FILING DATE, FIRST NAMED INVENTOR, ATTORNEY DOCKET NO., CONFIRMATION NO.
14/082,675 11/18/2013 John Douglas Steinberg EFACT.007C1 3336
7590 10/14/2015
KNOBBE MARTENS OLSON & BEAR LLP
2040 MAIN STREET
FOURTEENTH FLOOR
IRVINE, CA 92614
EXAMINER
NORMAN, MARC E
ART UNIT 3744 PAPER NUMBER
NOTIFICATION DATE 10/14/2015 DELIVERY MODE ELECTRONIC

NOTICE OF NON-COMPLIANT INFORMATION DISCLOSURE STATEMENT

An Information Disclosure Statement (IDS) filed 10/8/15 in the above-identified application fails to meet the requirements of 37 CFR 1.97(d) for the reason(s) specified below. Accordingly, the IDS will be placed in the file, but the information referred to therein has not been considered.

The IDS is not compliant with 37 CFR 1.97(d) because:

- [X] The IDS lacks a statement as specified in 37 CFR 1.97(e).
[ ] The IDS lacks the fee set forth in 37 CFR 1.17(p).
[ ] The IDS was filed after the issue fee was paid. Applicant may wish to consider filing a petition to withdraw the application from issue under 37 CFR 1.313(c) to have the IDS considered. See MPEP 1308.

Fe Ut
571-272-4200 or 1-888-786-0101
Application Assistance Unit
Office of Data Management



INFORMATION DISCLOSURE  
STATEMENT BY APPLICANT

Application No. 14/082675  
 Filing Date November 18, 2013  
 First Named Inventor John Douglas Steinberg  
 Art Unit 3744  
 Examiner Norman, Marc E.  
 Attorney Docket No. EFACT.007C1

(Multiple sheets used when necessary)

SHEET 1 OF 3

## U.S. PATENT DOCUMENTS

| Examiner Initials | Cite No. | Document Number<br>Number - Kind Code (if known)<br>Example: 1,234,567 B1 | Publication Date<br>MM-DD-YYYY | Name              | Pages, Columns, Lines Where Relevant Passages or Relevant Figures Appear |
|-------------------|----------|---|--------------------------------|-------------------|--|
|                   | 1        | 12/805705   | 06/10/2010                     | Crabtree          |  |
|                   | 2        | 13/470074   | 08/30/2012                     | Steinberg         |  |
|                   | 3        | 13/523697   | 06/14/2012                     | Hublou et al.     |  |
|                   | 4        | 13/725447   | 06/06/2013                     | Steinberg         |  |
|                   | 5        | 13/729401   | 12/28/2012                     | Sloop             |  |
|                   | 6        | 13/852577   | 03/28/2013                     | Steinberg et al.  |  |
|                   | 7        | 13/858710   | 09/05/2013                     | Steinberg et al.  |  |
|                   | 8        | 14/082,675<br>(EFACT.007C1)   | 11/18/2003                     | Steinberg et al.  |  |
|                   | 9        | 14/263,762  | 04/28/2014                     | Steinberg         |  |
|                   | 10       | 14/285,384  | 05/22/2014                     | Steinberg, et al. |  |
|                   | 11       | 14/292,377  | 05/30/2014                     | Steinberg         |  |
|                   | 12       | 14/491,554  | 09/19/2014                     | Steinberg         |  |
|                   | 13       | 14/527,433  | 10/29/2014                     | Steinberg, et al. |  |
|                   | 14       | 14/731,221  | 06/04/2015                     | Steinberg, et al. |  |
|                   | 15       | D 646,990   | 10/18/2011                     | Rhodes            |  |
|                   | 16       | D 659,560   | 05/15/2012                     | Rhodes            |  |
|                   | 17       | D 673,467   | 01/01/2013                     | Lee et al.        |  |
|                   | 18       | D 705,095<br>(EFACT.015DA)  | 05/20/2014                     | Steinberg et al.  |  |
|                   | 19       | 5,124,502   | 06/23/1992                     | Nelson et al.     |  |
|                   | 20       | 5,348,078   | 09/20/1994                     | Dushane et al.    |  |
|                   | 21       | 5,725,148   | 03/10/1998                     | Hartman           |  |
|                   | 22       | 5,729,474   | 03/17/1998                     | Hildebrand et al. |  |
|                   | 23       | 6,079,626   | 06/27/2000                     | Hartman           |  |
|                   | 24       | 6,241,156   | 06/05/2001                     | Kline et al.      |  |
|                   | 25       | 6,644,098   | 11/11/2003                     | Cardinale et al.  |  |
|                   | 26       | 6,700,224   | 03/02/2004                     | Biskup, Sr.,      |  |
|                   | 27       | 6,786,421   | 09/07/2004                     | Rosen             |  |
|                   | 28       | 7,206,670   | 04/17/2007                     | Pimputkar, et al. |  |

Change(s) applied  
to document,  
/D.H.P./  
9/1/2015

Examiner Signature /Marc Norman/ Date Considered 06/29/2015

\*Examiner: Initial if reference considered, whether or not citation is in conformance with MPEP 609. Draw line through citation if not in conformance and not considered. Include copy of this form with next communication to applicant.

T - Place a check mark in this area when an English language translation is attached. **ALL REFERENCES CONSIDERED EXCEPT WHERE LINED THROUGH. /MN/**

**PART B - FEE(S) TRANSMITTAL**

Complete and send this form, together with applicable fee(s), to: **Mail** **Mail Stop ISSUE FEE**  
**Commissioner for Patents**  
**P.O. Box 1450**  
**Alexandria, Virginia 22313-1450**  
**or Fax (571)-273-2885**

**INSTRUCTIONS:** This form should be used for transmitting the ISSUE FEE and PUBLICATION FEE (if required). Blocks 1 through 5 should be completed where appropriate. All further correspondence including the Patent, advance orders and notification of maintenance fees will be mailed to the current correspondence address as indicated unless corrected below or directed otherwise in Block 1, by (a) specifying a new correspondence address; and/or (b) indicating a separate "FEE ADDRESS" for maintenance fee notifications.

Note: A certificate of mailing can only be used for domestic mailings of the Fee(s) Transmittal. This certificate cannot be used for any other accompanying papers. Each additional paper, such as an assignment or formal drawing, must have its own certificate of mailing or transmission.

CURRENT CORRESPONDENCE ADDRESS (Note: Use Block 1 for any change of address)

20995 7590 07/13/2015  
**KNOBBE MARTENS OLSON & BEAR LLP**  
**2040 MAIN STREET**  
**FOURTEENTH FLOOR**  
**IRVINE, CA 92614**

**Certificate of Mailing or Transmission**

I hereby certify that this Fee(s) Transmittal is being deposited with the United States Postal Service with sufficient postage for first class mail in an envelope addressed to the Mail Stop ISSUE FEE address above, or being facsimile transmitted to the USPTO (571) 273-2885, on the date indicated below.

|                             |
|-----------------------------|
| _____<br>(Depositor's name) |
| _____<br>(Signature)        |
| _____<br>(Date)             |

| APPLICATION NO. | FILING DATE | FIRST NAMED INVENTOR   | ATTORNEY DOCKET NO. | CONFIRMATION NO. |
|-----------------|-------------|------------------------|---------------------|------------------|
| 14/082,675      | 11/18/2013  | John Douglas Steinberg | EFACT.007C1         | 3336             |

TITLE OF INVENTION: SYSTEM, METHOD AND APPARATUS FOR IDENTIFYING MANUAL INPUTS TO AND ADAPTIVE PROGRAMMING OF A THERMOSTAT

| APPLN. TYPE    | ENTITY STATUS | ISSUE FEE DUE | PUBLICATION FEE DUE | PREV. PAID ISSUE FEE | TOTAL FEE(S) DUE | DATE DUE   |
|----------------|---------------|---------------|---------------------|----------------------|------------------|------------|
| nonprovisional | SMALL         | \$480         | \$0                 | \$0                  | \$480            | 10/13/2015 |

| EXAMINER      | ART UNIT | CLASS-SUBCLASS |
|---------------|----------|----------------|
| NORMAN, MARCE | 3744     | 236-00100C     |

1. Change of correspondence address or indication of "Fee Address" (37 CFR 1.363).

- Change of correspondence address (or Change of Correspondence Address form PTO/SB/122) attached.
- "Fee Address" indication (or "Fee Address" Indication form PTO/SB/47; Rev 03-02 or more recent) attached. **Use of a Customer Number is required.**

2. For printing on the patent front page, list

- (1) The names of up to 3 registered patent attorneys or agents OR, alternatively,
- (2) The name of a single firm (having as a member a registered attorney or agent) and the names of up to 2 registered patent attorneys or agents. If no name is listed, no name will be printed.

- 1. Knobbe, Martens,
- 2. Olson & Bear, LLP
- 3. \_\_\_\_\_

3. ASSIGNEE NAME AND RESIDENCE DATA TO BE PRINTED ON THE PATENT (print or type)

PLEASE NOTE: Unless an assignee is identified below, no assignee data will appear on the patent. If an assignee is identified below, the document has been filed for recordation as set forth in 37 CFR 3.11. Completion of this form is NOT a substitute for filing an assignment.

(A) NAME OF ASSIGNEE

(B) RESIDENCE: (CITY and STATE OR COUNTRY)

EcoFactor, Inc.

Redwood City, CA

Please check the appropriate assignee category or categories (will not be printed on the patent):  Individual  Corporation or other private group entity  Government

4a. The following fee(s) are submitted:

- Issue Fee
- Publication Fee (No small entity discount permitted)
- Advance Order - # of Copies \_\_\_\_\_

4b. Payment of Fee(s): (Please first reapply any previously paid issue fee shown above)

- A check is enclosed.
- Payment by credit card. Form PTO-2038 is attached.
- The director is hereby authorized to charge the required fee(s), any deficiency, or credits any overpayment, to Deposit Account Number 11-1410 (enclose an extra copy of this form).

5. Change in Entity Status (from status indicated above)

- Applicant certifying micro entity status. See 37 CFR 1.29
- Applicant asserting small entity status. See 37 CFR 1.27
- Applicant changing to regular undiscounted fee status.

NOTE: Absent a valid certification of Micro Entity Status (see forms PTO/SB/15A and 15B), issue fee payment in the micro entity amount will not be accepted at the risk of application abandonment.

NOTE: If the application was previously under micro entity status, checking this box will be taken to be a notification of loss of entitlement to micro entity status.

NOTE: Checking this box will be taken to be a notification of loss of entitlement to small or micro entity status, as applicable.

NOTE: This form must be signed in accordance with 37 CFR 1.31 and 1.33. See 37 CFR 1.4 for signature requirements and certifications.

Authorized Signature John R. King Date 10-8-2015  
 Typed or printed name John R. King Registration No. 34,362

**IN THE UNITED STATES PATENT AND TRADEMARK OFFICE**

Inventor : Steinberg, et al.  
App. No. : 14/082,675  
Filed : November 18, 2013  
For : SYSTEM, METHOD AND APPARATUS FOR IDENTIFYING  
MANUAL INPUTS TO AND ADAPTIVE PROGRAMMING OF A  
THERMOSTAT  
Examiner : Marc E. Norman  
Art Unit : 3744  
Conf. No. : 3336

**COMMENTS ON STATEMENT OF REASONS FOR ALLOWANCE****Mail Stop Amendment**

Commissioner for Patents  
P.O. Box 1450  
Alexandria, VA 22313-1450

Dear Sir:

In response to the Statement of Reasons for Allowance in the Notice of Allowance mailed July 13, 2015, Applicants respectfully submit the following comments.

Applicant respectfully disagrees with the Examiner's statement of reasons for allowance to the extent that the limitations recited by the Examiner are not present in all of the claims. Also, to the extent that there is any implication that the patentability of the claims rests on the recitation of a single feature, Applicant respectfully disagrees with the Examiner's Statement because it is the combination of features that makes the claims patentable.

Application No.: 14/082,675  
Filing Date: November 18, 2013

Applicant submits that the claims of the present application are allowable because each of the claims recites a combination of features that are not taught or suggested by the prior art.

Respectfully submitted,  
KNOBBE, MARTENS, OLSON & BEAR, LLP

Dated: 10-8-2015

By: John R. King  
John R. King  
Registration No. 34,362  
Attorney of Record  
Customer No. 20,995  
(949) 760-0404

21742188:ad  
100215

**INFORMATION DISCLOSURE STATEMENT**

Inventor     : Steinberg, et al.

App. No.    : 14/082,675

Filed       : November 18, 2013

For         : SYSTEM, METHOD AND APPARATUS FOR IDENTIFYING MANUAL  
              INPUTS TO AND ADAPTIVE PROGRAMMING OF A THERMOSTAT

Examiner    : Norman, Marc E.

Art Unit    : 3744

Conf. No.   : 3336

Commissioner for Patents  
P.O. Box 1450  
Alexandria, VA 22313-1450

**References and Listing**

Pursuant to 37 CFR 1.56, an Information Disclosure Statement listing references is provided herewith. Copies of any listed foreign and non-patent literature references are being submitted.

**No Disclaimers**

To the extent that anything in the Information Disclosure Statement or the listed references could be construed as a disclaimer of any subject matter supported by the present application, Applicant hereby rescinds and retracts such disclaimer.

**Timing of Disclosure**

This Information Disclosure Statement is being filed after the mailing date of a final action or after the mailing date of a Notice of Allowance. Please place these references in the file in accordance with 37 CFR 1.97(i).

Respectfully submitted,  
KNOBBE, MARTENS, OLSON & BEAR, LLP

Dated: 10-8-2015

By: John R. King  
John R. King  
Registration No. 34,362  
Attorney of Record  
Customer No. 20995  
(949) 760-0404

|  |                      |                        |                 |
|--|----------------------|------------------------|-----------------|
| <b>INFORMATION DISCLOSURE<br/>STATEMENT BY APPLICANT</b> | Application No.      | 14/082675              |                 |
|  | Filing Date          | November 18, 2013      |                 |
|  | First Named Inventor | John Douglas Steinberg |                 |
|  | Art Unit             | 3744                   |                 |
| <i>(Multiple sheets used when necessary)</i>             |                      | Examiner               | Norman, Marc E. |
| SHEET 1 OF 1   |                      | Attorney Docket No.    | EFACT.007C1     |

**U.S. PATENT DOCUMENTS**

| Examiner Initials | Cite No. | Document Number<br><i>Number - Kind Code (if known)</i><br>Example: 1,234,567 B1 | Publication Date<br>MM-DD-YYYY | Name              | Pages, Columns, Lines Where Relevant Passages or Relevant Figures Appear |
|-------------------|----------|--|--------------------------------|-------------------|--|
|                   | 1        | 9,057,649<br>(EFACT.006C2)   | 06/16/2015                     | Steinberg, et al. |  |
|                   | 2        | 2013/0178985   | 07/11/2013                     | Lombard et al.    |  |
|                   | 3        | 2015/0168001<br>(EFACT.012C2)  | 06/18/2015                     | Steinberg         |  |

**FOREIGN PATENT DOCUMENTS**

| Examiner Initials | Cite No. | Foreign Patent Document<br><i>Country Code-Number-Kind Code</i><br>Example: JP 1234567 A1 | Publication Date<br>MM-DD-YYYY | Name                  | Pages, Columns, Lines Where Relevant Passages or Relevant Figures Appear | T <sup>1</sup> |
|-------------------|----------|---|--------------------------------|-----------------------|--|----------------|
|                   | 4        | WO 2005/098331 A1   | 10/20/2005                     | Zip Ind Aust Pty Ltd. |  |                |

**NON PATENT LITERATURE DOCUMENTS**

| Examiner Initials | Cite No. | Include name of the author (in CAPITAL LETTERS), title of the article (when appropriate), title of the item (book, magazine, journal, serial, symposium, catalog, etc.), date, page(s), volume-issue number(s), publisher, city and/or country where published. | T <sup>1</sup> |
|-------------------|----------|---|----------------|
|                   |          |   |                |

21742097:ad  
100215

|                    |                 |
|--------------------|-----------------|
| Examiner Signature | Date Considered |
|--------------------|-----------------|

\***Examiner:** Initial if reference considered, whether or not citation is in conformance with MPEP 609. Draw line through citation if not in conformance and not considered. Include copy of this form with next communication to applicant.

T<sup>1</sup> - Place a check mark in this area when an English language <sup>010</sup> translation is attached.

(19) World Intellectual Property Organization  
International Bureau



(43) International Publication Date  
20 October 2005 (20.10.2005)

PCT

(10) International Publication Number  
**WO 2005/098331 A1**

(51) International Patent Classification<sup>7</sup>: **F25B 49/02**,  
F25D 11/00, 13/00, 29/00

(74) Agent: **SPRUSON & FERGUSON**; GPO Box 3898, Sydney, NSW 2001 (AU).

(21) International Application Number:  
PCT/AU2005/000361

(81) Designated States (unless otherwise indicated, for every kind of national protection available): AE, AG, AL, AM, AT, AU, AZ, BA, BB, BG, BR, BW, BY, BZ, CA, CH, CN, CO, CR, CU, CZ, DE, DK, DM, DZ, EC, EE, EG, ES, FI, GB, GD, GE, GH, GM, HR, HU, ID, IL, IN, IS, JP, KE, KG, KP, KR, KZ, LC, LK, LR, LS, LT, LU, LV, MA, MD, MG, MK, MN, MW, MX, MZ, NA, NI, NO, NZ, OM, PG, PH, PL, PT, RO, RU, SC, SD, SE, SG, SK, SL, SM, SY, TJ, TM, TN, TR, TT, TZ, UA, UG, US, UZ, VC, VN, YU, ZA, ZM, ZW.

(22) International Filing Date: 15 March 2005 (15.03.2005)

(25) Filing Language: English

(26) Publication Language: English

(30) Priority Data:  
2004901850 6 April 2004 (06.04.2004) AU

(84) Designated States (unless otherwise indicated, for every kind of regional protection available): ARIPO (BW, GH, GM, KE, LS, MW, MZ, NA, SD, SL, SZ, TZ, UG, ZM, ZW), Eurasian (AM, AZ, BY, KG, KZ, MD, RU, TJ, TM), European (AT, BE, BG, CH, CY, CZ, DE, DK, EE, ES, FI, FR, GB, GR, HU, IE, IS, IT, LT, LU, MC, NL, PL, PT, RO, SE, SI, SK, TR), OAPI (BF, BJ, CF, CG, CI, CM, GA, GN, GQ, GW, ML, MR, NE, SN, TD, TG).

(71) Applicant (for all designated States except US): **ZIP INDUSTRIES (AUST) PTY LTD** [AU/AU]; 67 Allingham Street, Condell Park, NSW 2200 (AU).

(72) Inventors; and

(75) Inventors/Applicants (for US only): **CHERTKOW, Brian** [ZA/AU]; 67 Allingham Road, Condell Park, NSW 2200 (AU). **PEPPER, Philip, Ross** [AU/AU]; 57 Fifth Street, Ashbury, NSW 2193 (AU). **CURTH, Roger** [GB/AU]; 8 Laurina Avenue, Engadine, NSW 2233 (AU). **CHICK, Steve** [AU/AU]; 14/122 Todman Avenue, Kensington, NSW 2033 (AU).

Published:

— with international search report

For two-letter codes and other abbreviations, refer to the "Guidance Notes on Codes and Abbreviations" appearing at the beginning of each regular issue of the PCT Gazette.

(54) Title: A METHOD OF OPERATING A WATER CHILLER

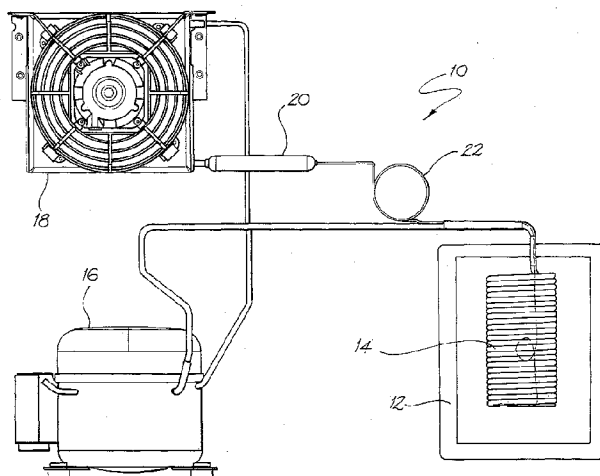

(57) Abstract: A method of operating a water chiller (10) having a water tank (12), a cold water tap, and a condenser and fan (18). The chiller avoids freezing of the water in the tank (12) by switching between 'normal' and 'protection' operating modes. The switching is initially triggered by checking the length of time since the cold water tap was last operated.

WO 2005/098331 A1

## A METHOD OF OPERATING A WATER CHILLER

### Field of the Invention

The present invention relates to a method of operating a water chiller.

The invention has been primarily developed in relation to a combined water  
5 chiller and boiling water heater unit and will be described hereinafter with reference to  
this application. However, it will be appreciated that the invention is not limited to this  
particular field of use and also suitable for use in a stand alone water chiller unit.

### Background of the Invention

A known combined water chiller and boiling water heater unit provides instant  
10 boiling and instant chilled water from a single tap. The tap is typically mounted on a  
bench top or on a sink and the heater and chiller are housed together in a module,  
commonly in a cupboard under the sink. The unit includes a boiling water storage tank as  
well as a chilled water storage tank. An electronic controller controls both the boiling and  
chiller units.

15 The chiller unit has a complete refrigeration circuit which includes a compressor,  
a condenser, a fan and an evaporator. The chiller unit also has a chilled water tank with  
the evaporator (ie. cooling coil) and level and temperature sensors therein.

As per any refrigeration plant, to achieve cooling, heat must be removed. The  
refrigeration process involves the refrigerant being compressed through the compressor.  
20 This compression also raises the temperature of the refrigerant. The refrigerant then  
passes through a heat exchanger, known as a condenser, which cools the refrigerant.  
Thereafter the refrigerant passes through an evaporator which allows the refrigerant to  
expand causing the refrigerant to cool rapidly. This evaporator is submerged in the  
chilled water tank. As the water is hotter than the refrigerant, heat is removed from the  
25 water and passed into the refrigerant through the evaporator coils. The refrigerant then  
passes through the compressor again and the cycle starts over.

The heat is removed through a heat exchanger condenser that is force air cooled  
via an electric fan. The air is thus the cooling medium and its temperature rises. The  
effect of all of this is that the ambient air temperature within the unit, and within the  
30 cupboard, rises. Cupboards are often not well ventilated and as such the temperature of  
ambient air in the cupboard can rise noticeably. It follows that the hotter the ambient air,  
the less efficient the cooling process.



It should also be noted that water contracts in size as it cools to a temperature of 4 °C. As the water cools from 4 to 0 °C it expands again until the water is completely frozen. As water freezes the temperature remains constant at 0 °C until all the water has frozen and thereafter the temperature will continue to drop.

5 It is important that the water in the unit's chilled water tank is not allowed to freeze, as this can cause the tank to rupture.

A known approach to this issue has involved shutting down the compressor and indicating a fault if the compressor has been running continuously for one hour with no water being drawn off from the unit. This is based on the assumptions that, under normal  
10 circumstances, a compressor will normally only run for 5 to 10 minutes at a time if no new water is being introduced to the tank and that one hour continuous running is insufficient to completely freeze all of the water in the tank.

Units of this type suffer from the problem that: if the cupboard is not sufficiently ventilated; the incoming ambient water temperature is high; and the unit is required to  
15 work continuously due to the demands of chilled water, then this can result in the ambient air temperature inside the cupboard becoming so high that the chiller is only able to reduce the water temperature to about 7 or 8°C. Accordingly, the rate at which the unit is attempting to dissipate heat is the same rate at which the unit is absorbing heat. A state of equilibrium is thus reached and no further cooling of the water occurs. As a result, even  
20 if water is not being drawn off, the compressor runs continuously and upon reaching an hour the unit indicates a fault and shuts down. This results in a service call being required, which is both a cost and a source of dissatisfaction to the user.

### **Object of the Invention**

It is the object of the present invention to substantially overcome at least  
25 ameliorate one or more of the above prior art deficiencies.

### **Summary of the Invention**

Accordingly, in a first aspect, the present invention provides a method of operating a water chiller having: a water tank, a cold water tap, a condenser and a fan, the method including the following steps:

30 (a) monitoring a first predetermined time period since the cold water tap has been activated and if the first time period has not been reached then the chiller is said to be operating in normal mode and the method includes returning to step (a) or if the first

time period has been reached then the chiller is said to be operating in protection mode and the method includes proceeding to step (b);

(b) determining if the compressor is on or off and if the compressor is off then proceeding to step (c) or if the compressor is on then proceeding to step (e);

5 (c) determining if a predetermined high set point temperature for the water in the tank has been reached and if the high set point has been reached then proceeding to step (d) or if the high set point has not been reached then returning to step (b);

(d) turning the compressor on then returning to step (b);

(e) determining if a predetermined low set point temperature for the water  
10 in the tank has been reached and if the low set point has been reached then proceeding to step (f) and if the low set point has not been reached then proceeding to step (g);

(f) turning the compressor off, turning the fan on for a second predetermined time period and then returning to step (b);

(g) determining if a third predetermined time period has elapsed since the  
15 chiller entered the protection mode and if the third time period has been reached then proceeding to step (h) and if the third time period has not been reached then returning to step (b);

(h) determining if a fourth predetermined time period has elapsed and if the  
20 fourth time period has been reached then proceeding to step (i) or if the fourth time period has not been reached then returning to step (b);

(i) measuring the temperature of the water in the chiller at least three times at intervals of a fifth predetermined time period and calculating an first average temperature then proceeding to step (j);

(j) waiting for a sixth predetermined time period another then measuring  
25 the temperature of the water in the chiller and calculating a second average temperature for the last at least three measurements;

(k) comparing the first and second average temperatures and if the first  
30 average temperature is less than the second average temperature then returning to step (b) or if the first temperature is equal to or more than the second average temperature then proceeding to step (l);

(l) turning the compressor off and keeping the fan on then proceeding to  
step (m); and

(m) waiting for a seventh predetermined period of time before returning to  
step (b)

wherein if the cold water tap is activated when the chiller is in the protection mode then the chiller is altered to the normal mode.

The first, second, third, fourth, fifth, sixth and seventh predetermined time periods are preferably approximately 30, 5, 30, 5, 5, 5 and 30 minutes respectively.

5 The low set point and the high set point temperatures are preferably approximately 4.7 °C and 10.0 °C respectively.

Step (i) preferably includes measuring the temperature of the water in the chiller three times before calculating an average.

### Brief Description of the Drawings

10 An embodiment of the invention will now be described, by way of an example only, with reference to the accompanying drawings in which:

Fig. 1 is a schematic diagram of the components of a water heater in accordance with an embodiment of the invention.

15 Fig. 2 is a logic diagram associated with an embodiment of a method for operating a heater according to the invention; and

Fig. 3 is a further logic diagram associated with the method set out in Fig. 2.

### Detailed Description of the Preferred Embodiments

Referring firstly to Fig. 1, there is shown an embodiment of a water chiller 10 in accordance with an embodiment of the present invention. The chiller 10 forms a part of a combined boiling water heater and instant chilled water unit but the components of the boiling water heater are not shown for the sake of clarity.

20 The chiller 10 includes an insulated water tank 12 which has chilling evaporator coils 14 and a temperature sensor (not shown) therein. The tank 12 also has a cold water tap (not shown) to enable users to draw water from the tank 12. The chiller 10 also includes a PCB controller (not shown), a compressor 16, a condenser and fan 18, a filter dryer 20 and a capillary tube 22. The components of the chiller 10 are arranged to operate as per a normal refrigeration cycle.

25 Turning now to Fig. 2, there is shown a logic diagram associated with the initial steps of operating the chiller 10 in a manner which avoids freezing of water in the tank 12. When the chiller 10 is operating and there is no potential risk of the water in the tank 12 freezing, it is said to be operating in a 'normal' mode, as indicated at Step 30 of Fig. 2. The controller continuously checks the length of time since the cold water tap was last

operated, as shown in Step 32. As shown in Step 30, if the cold tap has been operated within the preceding 30 minutes, the unit continues to operate in the normal mode.

As shown in Step 34, if the cold tap has not been operated for 30 minutes or more then the chiller 10 switches to a 'protection' mode that has safeguards against freezing the water in the tank 12, as will be described below. However, as indicated at Step 36, if during any time the chiller 10 is operating in the protection mode and the cold tap is operated, it reverts to the normal mode, at Step 32, and the controller again begins checking for periods where the cold tap has not operated for 30 minutes.

The logic steps associated with the protection mode will now be described in relation to Fig. 3. As indicated at Step 40, the protection mode initially involves checking whether or not the compressor 16 is on. If the compressor 16 is not on, then the controller, as per Step 42, checks whether the water high set point temperature of 10.0 °C of the water in the tank 12 has been reached. If the water temperature is at or above 10.0 °C the compressor 16 is turned on, as indicated by Step 44, and the controller returns to Step 40 and checks whether or not the compressor 16 is on.

If the temperature of the water in the tank 12 has not reached 10.0 °C then the compressor 16 remains off and the controller returns to checking whether or not the compressor is on at Step 40.

If the compressor 16 is on then, as indicated at Step 46, the controller checks as to whether or not the water in the tank 12 has reached the low set point temperature of 4.7°C. If this is the case then, as indicated at Step 48, the compressor 16 is turned off and the fan is operated for a further 5 minutes to remove the heat soak that occurs. The controller then returns to Step 40 and continues to check whether or not the compressor 16 is on.

If the temperature of the water in the tank 12 has not reached the low set point of 4.7°C then, as indicated in Step 50, the controller checks whether or not 30 minutes has elapsed since entering the protection mode. If not, the controller returns to Step 40. If yes, then the controller proceeds to Step 52 and waits for a further 5 minutes before, at Step 54, it measures the temperature of the water in the tank 12. A new reading of the water temperature is taken every subsequent 5 minutes and, after three readings, an average of those three readings is calculated. After a further five minutes another reading is taken and the new moving average is compared to the previous average, as indicated at Step 56.

If the new average is less than the previous average it means that the chiller 10 is still chilling down and the normal operation continues. However, if the new average is the same or higher than the previous average it means that no more cooling is occurring. There are two main reasons that could lead to this occurring. The first is that the ambient  
5 temperature of the air has reached a point in which the chiller 10 is operating at equilibrium and is to not to take any further heat out of the water. The second reason may be a failure of the controller or the temperature sensor probe.

Normally, as previously described in relation to Step 48, when the water is cooled to 4.7°C the compressor 16 is turned off. The cooling fan 18 then continues to run  
10 for a further 5 minutes to remove the heat soak that occurs. If however the controller or the temperature sensor probe fails, the water may be continued to be cooled down past the 4.7 °C set point. If this occurs then the water starts to freeze and 0 °C and remains at this temperature until all of the water is frozen. However, the chiller 10 will recognise that the temperature is not dropping and will shut down the compressor 16 and turn on the fan  
15 18, as indicated at Step 58.

As indicated at Step 60, prior to a complete freeze of the water in the tank 12, the fan 18 is kept running for 30 minutes after the compressor 16 has been shut down in order to clear any residual ambient heat in the chiller 10 and the cupboard. Thereafter, the chiller 10 returns to the normal mode of operation. Typically, the excess heat mode  
20 described above may occur after the chiller 10 has been operating continuously during the day and at the end of the day when the users have departed, the cupboard is too hot for the chilled water's lower set point temperature to be reached.

The method described above advantageously allows the heat in the cupboard to be dissipated in the evening and allows the chiller 10 to cool down to the point where the  
25 next day it is ready to function in the normal operating mode. Further, the controller also includes provision to supply a warning message if the overheating protection mode regularly occurs to indicate that the cupboard ventilation is inadequate and needs attention.

Although the invention has been described with reference to a preferred  
30 embodiment, it will be appreciated for those skilled in the art that the invention may be embodied in many other forms.

**Claims:**

1. A method of operating a water chiller having: a water tank, a cold water tap, a condenser and a fan, the method including the following steps:
  - 5 (b) monitoring a first predetermined time period since the cold water tap has been activated and if the first time period has not been reached then the chiller is said to be operating in normal mode and the method includes returning to step (a) or if the first time period has been reached then the chiller is said to be operating in protection mode and the method includes proceeding to step (b);
  - 10 (b) determining if the compressor is on or off and if the compressor is off then proceeding to step (c) or if the compressor is on then proceeding to step (e);
  - (c) determining if a predetermined high set point temperature for the water in the tank has been reached and if the high set point has been reached then proceeding to step (d) or if the high set point has not been reached then returning to step (b);
  - 15 (d) turning the compressor on then returning to step (b);
  - (e) determining if a predetermined low set point temperature for the water in the tank has been reached and if the low set point has been reached then proceeding to step (f) and if the low set point has not been reached then proceeding to step (g);
  - (f) turning the compressor off, turning the fan on for a second
  - 20 predetermined time period and then returning to step (b);
  - (g) determining if a third predetermined time period has elapsed since the chiller entered the protection mode and if the third time period has been reached then proceeding to step (h) and if the third time period has not been reached then returning to step (b);
  - 25 (h) determining if a fourth predetermined time period has elapsed and if the fourth time period has been reached then proceeding to step (i) or if the fourth time period has not been reached then returning to step (b);
  - (i) measuring the temperature of the water in the chiller at least three times at intervals of a fifth predetermined time period and calculating an first average
  - 30 temperature then proceeding to step (j);
  - (j) waiting for a sixth predetermined time period another then measuring the temperature of the water in the chiller and calculating a second average temperature for the last at least three measurements;

(k) comparing the first and second average temperatures and if the first average temperature is less than the second average temperature then returning to step (b) or if the first temperature is equal to or more than the second average temperature then proceeding to step (l);

5 (l) turning the compressor off and keeping the fan on then proceeding to step (m); and

(m) waiting for a seventh predetermined period of time before returning to step (b)

10 wherein if the cold water tap is activated when the chiller is in the protection mode then the chiller is altered to the normal mode.

2. The method as claimed in claim 1, wherein the first, second, third, fourth, fifth, sixth and seventh predetermined time periods are approximately 30, 5, 30, 5, 5, 5 and 30 minutes respectively.

3. The method as claimed in claim 1 or 2, wherein the low set point and the high set  
15 point temperatures are approximately 4.7 °C and 10.0 °C respectively.

4. The method as claimed in claim 1, 2 or 3, wherein step (i) includes measuring the temperature of the water in the chiller three times before calculating an average.

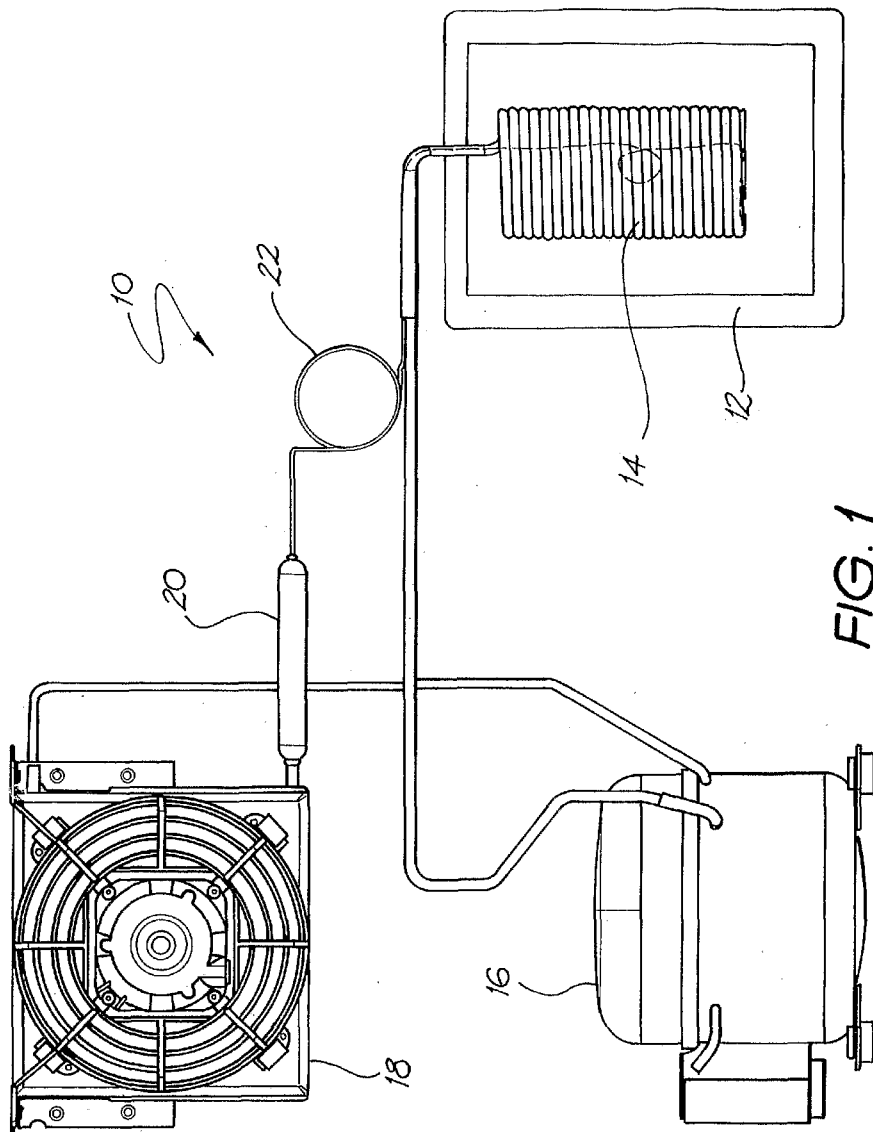
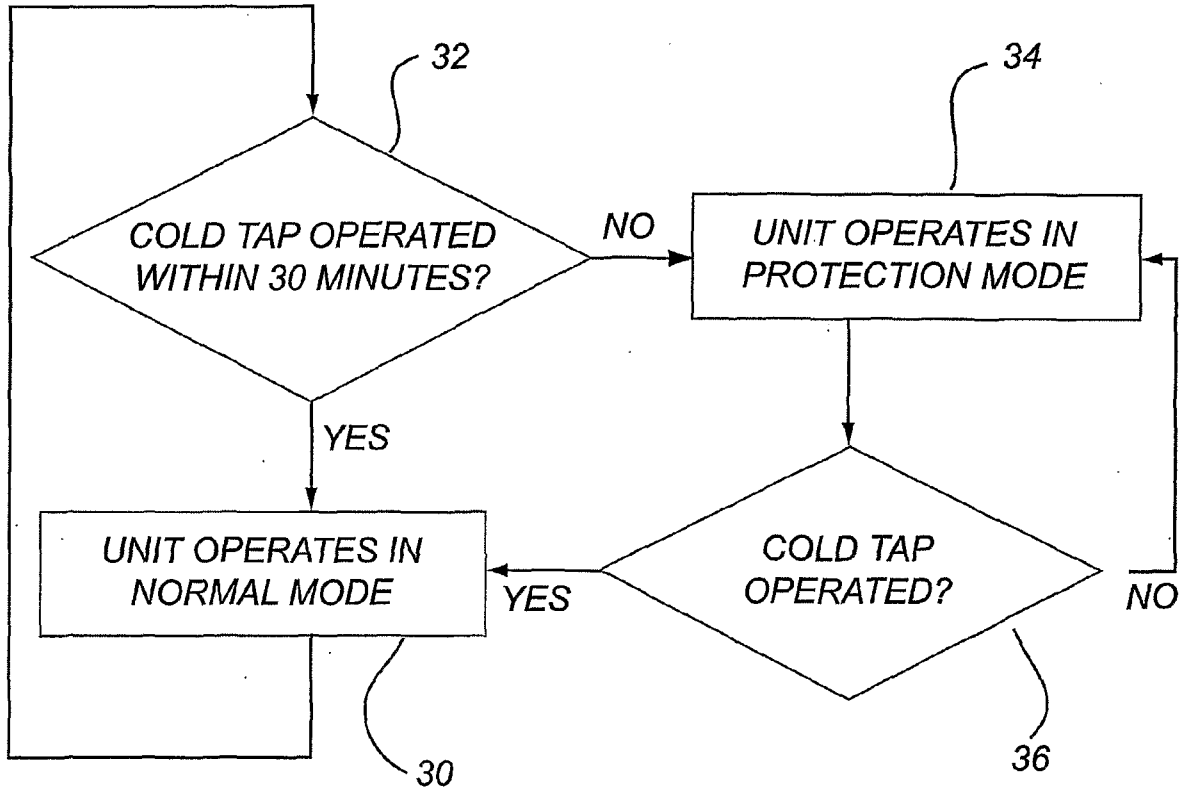

FIG. 1





**FIG. 2**

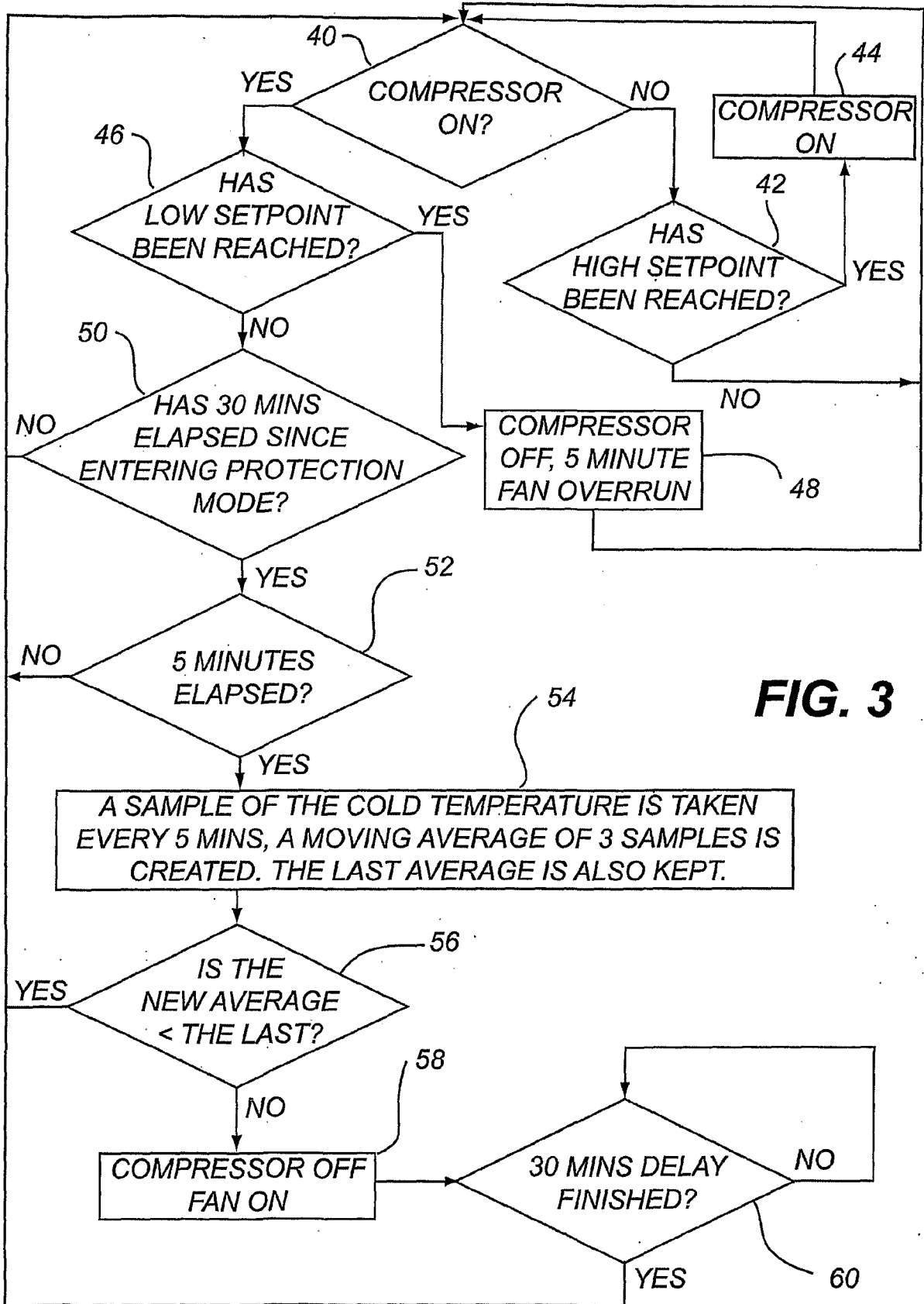

FIG. 3

## INTERNATIONAL SEARCH REPORT

International application No.  
PCT/AU2005/000361

| A. CLASSIFICATION OF SUBJECT MATTER   |  |                       |
|---|--|-----------------------|
| Int. Cl. <sup>7</sup> : F25B 49/02; F25D 11/00, 13/00, 29/00  |  |                       |
| According to International Patent Classification (IPC) or to both national classification and IPC   |  |                       |
| B. FIELDS SEARCHED  |  |                       |
| Minimum documentation searched (classification system followed by classification symbols)   |  |                       |
| Documentation searched other than minimum documentation to the extent that such documents are included in the fields searched   |  |                       |
| Electronic data base consulted during the international search (name of data base and, where practicable, search terms used)<br>DWPI: F25+/IC; F25B 49/02; F25D 11/00, 13/00, 29/00 & keywords - freez+, water chill+ |  |                       |
| C. DOCUMENTS CONSIDERED TO BE RELEVANT  |  |                       |
| Category*   | Citation of document, with indication, where appropriate, of the relevant passages   | Relevant to claim No. |
| A   | WO 2001/079733 A (ZIP HEATERS (AUSTRALIA) PTY LIMITED) 25 October 2001<br>Whole document   | 1-4                   |
| A   | EP 0967449 A (DANFOSS A/S) 29 December 1999<br>Whole document  | 1-4                   |
| A   | US 5224355 A (SO et al) 6 July 1993<br>Whole document  | 1-4                   |
| A   | Patent Abstracts of Japan, JP 2002-318050 A (MIURA CO LTD) 31 October 2002<br>Abstract   | 1-4                   |
| <input type="checkbox"/> Further documents are listed in the continuation of Box C <input checked="" type="checkbox"/> See patent family annex  |  |                       |
| * Special categories of cited documents:  |  |                       |
| "A" document defining the general state of the art which is not considered to be of particular relevance  | "T" later document published after the international filing date or priority date and not in conflict with the application but cited to understand the principle or theory underlying the invention  |                       |
| "E" earlier application or patent but published on or after the international filing date   | "X" document of particular relevance; the claimed invention cannot be considered novel or cannot be considered to involve an inventive step when the document is taken alone   |                       |
| "L" document which may throw doubts on priority claim(s) or which is cited to establish the publication date of another citation or other special reason (as specified)   | "Y" document of particular relevance; the claimed invention cannot be considered to involve an inventive step when the document is combined with one or more other such documents, such combination being obvious to a person skilled in the art |                       |
| "O" document referring to an oral disclosure, use, exhibition or other means  | "&" document member of the same patent family  |                       |
| "P" document published prior to the international filing date but later than the priority date claimed  |  |                       |
| Date of the actual completion of the international search<br>10 May 2005  | Date of mailing of the international search report<br>19 MAY 2005  |                       |
| Name and mailing address of the ISA/AU<br>AUSTRALIAN PATENT OFFICE<br>PO BOX 200, WODEN ACT 2606, AUSTRALIA<br>E-mail address: pct@ipaaustralia.gov.au<br>Facsimile No. (02) 6285 3929                                | Authorized officer<br><br><b>Tharu Fernando</b><br>Telephone No : (02) 6283 2486   |                       |

## INTERNATIONAL SEARCH REPORT

International application No.

Information on patent family members

**PCT/AU2005/000361**

This Annex lists the known "A" publication level patent family members relating to the patent documents cited in the above-mentioned international search report. The Australian Patent Office is in no way liable for these particulars which are merely given for the purpose of information.

| Patent Document Cited in Search Report |            | Patent Family Member |          |    |                    |
|--|------------|----------------------|----------|----|--------------------|
| WO                                     | 2001079733 | AU                   | 48148/01 |    |                    |
| EP                                     | 0967449    | BR                   | 9903275  | CN | 1240924 US 6138465 |
| US                                     | 5224355    | JP                   | 2539569  | KR | 9402232            |
| JP                                     | 2002318050 | NONE                 |          |    |                    |

Due to data integration issues this family listing may not include 10 digit Australian applications filed since May 2001.

END OF ANNEX

## Electronic Patent Application Fee Transmittal

|  |  |                 |               |                             |
|--|--|-----------------|---------------|-----------------------------|
| <b>Application Number:</b>                         | 14082675   |                 |               |                             |
| <b>Filing Date:</b>                                | 18-Nov-2013  |                 |               |                             |
| <b>Title of Invention:</b>                         | SYSTEM, METHOD AND APPARATUS FOR IDENTIFYING MANUAL INPUTS TO AND ADAPTIVE PROGRAMMING OF A THERMOSTAT |                 |               |                             |
| <b>First Named Inventor/Applicant Name:</b>        | John Douglas Steinberg   |                 |               |                             |
| <b>Filer:</b>                                      | John R. King/Amy Durrant   |                 |               |                             |
| <b>Attorney Docket Number:</b>                     | EFACT.007C1  |                 |               |                             |
| Filed as Small Entity                              |  |                 |               |                             |
| <b>Filing Fees for Utility under 35 USC 111(a)</b> |  |                 |               |                             |
| <b>Description</b>                                 | <b>Fee Code</b>  | <b>Quantity</b> | <b>Amount</b> | <b>Sub-Total in USD(\$)</b> |
| <b>Basic Filing:</b>                               |  |                 |               |                             |
| <b>Pages:</b>                                      |  |                 |               |                             |
| <b>Claims:</b>                                     |  |                 |               |                             |
| <b>Miscellaneous-Filing:</b>                       |  |                 |               |                             |
| <b>Petition:</b>                                   |  |                 |               |                             |
| <b>Patent-Appeals-and-Interference:</b>            |  |                 |               |                             |
| <b>Post-Allowance-and-Post-Issuance:</b>           |  |                 |               |                             |
| Utility Appl Issue Fee                             | 2501   | 1               | 480           | 480                         |

| Description               | Fee Code | Quantity | Amount | Sub-Total in USD(\$) |
|---------------------------|----------|----------|--------|----------------------|
| <b>Extension-of-Time:</b> |          |          |        |                      |
| <b>Miscellaneous:</b>     |          |          |        |                      |
| <b>Total in USD (\$)</b>  |          |          |        | <b>480</b>           |

## Electronic Acknowledgement Receipt

|   |  |
|---|--|
| <b>EFS ID:</b>                              | 23729243   |
| <b>Application Number:</b>                  | 14082675   |
| <b>International Application Number:</b>    |  |
| <b>Confirmation Number:</b>                 | 3336   |
| <b>Title of Invention:</b>                  | SYSTEM, METHOD AND APPARATUS FOR IDENTIFYING MANUAL INPUTS TO AND ADAPTIVE PROGRAMMING OF A THERMOSTAT |
| <b>First Named Inventor/Applicant Name:</b> | John Douglas Steinberg   |
| <b>Customer Number:</b>                     | 20995  |
| <b>Filer:</b>                               | John R. King/Christina Graul   |
| <b>Filer Authorized By:</b>                 | John R. King   |
| <b>Attorney Docket Number:</b>              | EFACT.007C1  |
| <b>Receipt Date:</b>                        | 08-OCT-2015  |
| <b>Filing Date:</b>                         | 18-NOV-2013  |
| <b>Time Stamp:</b>                          | 13:48:31   |
| <b>Application Type:</b>                    | Utility under 35 USC 111(a)  |

### Payment information:

|  |                               |
|--|-------------------------------|
| Submitted with Payment                   | yes                           |
| Payment Type                             | Credit Card                   |
| Payment was successfully received in RAM | \$480                         |
| RAM confirmation Number                  | 66                            |
| Deposit Account                          | 111410                        |
| Authorized User                          | KNOBBE MARTENS OLSON AND BEAR |

The Director of the USPTO is hereby authorized to charge indicated fees and credit any overpayment as follows:

Charge any Additional Fees required under 37 C.F.R. Section 1.16 (National application filing, search, and examination fees)

Charge any Additional Fees required under 37 C.F.R. Section 1.27 (Patent application and reexamination processing fees)

| <b>File Listing:</b>                |  |                          |   |                         |                         |
|-------------------------------------|--|--------------------------|---|-------------------------|-------------------------|
| <b>Document Number</b>              | <b>Document Description</b>                                | <b>File Name</b>         | <b>File Size(Bytes)/<br/>Message Digest</b> | <b>Multi Part /.zip</b> | <b>Pages (if appl.)</b> |
| 1                                   | Issue Fee Payment (PTO-85B)                                | EFACT-007C1_issuefee.pdf | 154421                                      | no                      | 1                       |
|                                     |  |                          | d72dcc0d8dc9b23d8903072d1f37d4a14a43f978    |                         |                         |
| <b>Warnings:</b>                    |  |                          |   |                         |                         |
| <b>Information:</b>                 |  |                          |   |                         |                         |
| 2                                   | Miscellaneous Incoming Letter                              | EFACT-007C1_comments.pdf | 88585                                       | no                      | 2                       |
|                                     |  |                          | f8ce889d0f13cf55649055a4c964d159733ed949    |                         |                         |
| <b>Warnings:</b>                    |  |                          |   |                         |                         |
| <b>Information:</b>                 |  |                          |   |                         |                         |
| 3                                   |  | EFACT-007C1_IDS.pdf      | 120987                                      | yes                     | 2                       |
|                                     |  |                          | 873dac4a7e86cb57f17b9c3ed48af0a24abb43c0    |                         |                         |
|                                     | <b>Multipart Description/PDF files in .zip description</b> |                          |   |                         |                         |
|                                     | <b>Document Description</b>                                |                          | <b>Start</b>                                | <b>End</b>              |                         |
|                                     | Transmittal Letter   |                          | 1   | 1                       |                         |
|                                     | Information Disclosure Statement (IDS) Form (SB08)         |                          | 2   | 2                       |                         |
| <b>Warnings:</b>                    |  |                          |   |                         |                         |
| <b>Information:</b>                 |  |                          |   |                         |                         |
| 4                                   | Foreign Reference  | EFACT-007C1_REF.pdf      | 608434                                      | no                      | 14                      |
|                                     |  |                          | d8c9ff97eaf30e5b13e0554fca420b8604e8665f    |                         |                         |
| <b>Warnings:</b>                    |  |                          |   |                         |                         |
| <b>Information:</b>                 |  |                          |   |                         |                         |
| 5                                   | Fee Worksheet (SB06)                                       | fee-info.pdf             | 30769                                       | no                      | 2                       |
|                                     |  |                          | bfc51aed662f22824c1af6ef95563a5985f8c8e     |                         |                         |
| <b>Warnings:</b>                    |  |                          |   |                         |                         |
| <b>Information:</b>                 |  |                          |   |                         |                         |
| <b>Total Files Size (in bytes):</b> |  |                          | 1003196                                     |                         |                         |



**This Acknowledgement Receipt evidences receipt on the noted date by the USPTO of the indicated documents, characterized by the applicant, and including page counts, where applicable. It serves as evidence of receipt similar to a Post Card, as described in MPEP 503.**

**New Applications Under 35 U.S.C. 111**

**If a new application is being filed and the application includes the necessary components for a filing date (see 37 CFR 1.53(b)-(d) and MPEP 506), a Filing Receipt (37 CFR 1.54) will be issued in due course and the date shown on this Acknowledgement Receipt will establish the filing date of the application.**

**National Stage of an International Application under 35 U.S.C. 371**

**If a timely submission to enter the national stage of an international application is compliant with the conditions of 35 U.S.C. 371 and other applicable requirements a Form PCT/DO/EO/903 indicating acceptance of the application as a national stage submission under 35 U.S.C. 371 will be issued in addition to the Filing Receipt, in due course.**

**New International Application Filed with the USPTO as a Receiving Office**

**If a new international application is being filed and the international application includes the necessary components for an international filing date (see PCT Article 11 and MPEP 1810), a Notification of the International Application Number and of the International Filing Date (Form PCT/RO/105) will be issued in due course, subject to prescriptions concerning national security, and the date shown on this Acknowledgement Receipt will establish the international filing date of the application.**

Please Direct All Correspondence to Customer Number 20995

**RESPONSE TO INFORMATIONAL NOTICE**

|          |  |
|----------|--|
| Inventor | : John Douglas Steinberg   |
| App. No. | : 14/082,675   |
| Filed    | : November 18, 2013  |
| For      | : SYSTEM, METHOD AND APPARATUS FOR IDENTIFYING MANUAL INPUTS TO AND ADAPTIVE PROGRAMMING OF A THERMOSTAT |
| Art Unit | : 3744   |
| Conf No. | : 3336   |

**Commissioner for Patents  
P.O. Box 1450  
Alexandria, VA 22313-1450**

Dear Sir:

The above-captioned application was filed without a Declaration and/or Substitute Statement. Enclosed in compliance with 37 CFR 1.53(f) are the following.

(X) Declarations for:

John Douglas Steinberg, Scott Douglas Hublou, and Leo Cheung

The Commissioner is hereby authorized to charge any additional fees which may be required, now or in the future, or credit any overpayment, to Account No. 11-1410.

Dated: 8-28-2015

By: John R. King  
John R. King  
Registration No. 34,362  
Attorney of Record  
Customer No. 20995  
(949) 760-0404

Under the Paperwork Reduction Act of 1995, no persons are required to respond to a collection of information unless it displays a valid OMB control number.

**DECLARATION (37 CFR 1.63) FOR UTILITY OR DESIGN APPLICATION USING AN APPLICATION DATA SHEET (37 CFR 1.76)**

|                           |   |
|---------------------------|---|
| <b>Title of Invention</b> | <b>SYSTEM, METHOD AND APPARATUS FOR IDENTIFYING MANUAL INPUTS TO AND ADAPTIVE PROGRAMMING OF A THERMOSTAT</b> |
|---------------------------|---|

As the below named inventor, I hereby declare that:

This declaration is directed to:  The attached application, or  
 United States application or PCT international application number 14/082675  
filed on November 18, 2013.

The above-identified application was made or authorized to be made by me.

I believe that I am the original inventor or an original joint inventor of a claimed invention in the application.

I hereby acknowledge that any willful false statement made in this declaration is punishable under 18 U.S.C. 1001 by fine or imprisonment of not more than five (5) years, or both.

**WARNING:**

Petitioner/applicant is cautioned to avoid submitting personal information in documents filed in a patent application that may contribute to identity theft. Personal information such as social security numbers, bank account numbers, or credit card numbers (other than a check or credit card authorization form PTO-2038 submitted for payment purposes) is never required by the USPTO to support a petition or an application. If this type of personal information is included in documents submitted to the USPTO, petitioners/applicants should consider redacting such personal information from the documents before submitting them to the USPTO. Petitioner/applicant is advised that the record of a patent application is available to the public after publication of the application (unless a non-publication request in compliance with 37 CFR 1.213(a) is made in the application) or issuance of a patent. Furthermore, the record from an abandoned application may also be available to the public if the application is referenced in a published application or an issued patent (see 37 CFR 1.14). Checks and credit card authorization forms PTO-2038 submitted for payment purposes are not retained in the application file and therefore are not publicly available.

**LEGAL NAME OF INVENTOR**

Inventor: John Douglas Steinberg Date (Optional): \_\_\_\_\_

Signature: \_\_\_\_\_

Note: An application data sheet (PTO/SB/14 or equivalent), including naming the entire inventive entity, must accompany this form or must have been previously filed. Use an additional PTO/AIA/01 form for each additional inventor.

This collection of information is required by 35 U.S.C. 115 and 37 CFR 1.63. The information is required to obtain or retain a benefit by the public which is to file (and by the USPTO to process) an application. Confidentiality is governed by 35 U.S.C. 122 and 37 CFR 1.11 and 1.14. This collection is estimated to take 1 minute to complete, including gathering, preparing, and submitting the completed application form to the USPTO. Time will vary depending upon the individual case. Any comments on the amount of time you require to complete this form and/or suggestions for reducing this burden, should be sent to the Chief Information Officer, U.S. Patent and Trademark Office, U.S. Department of Commerce, P.O. Box 1450, Alexandria, VA 22313-1450. DO NOT SEND FEES OR COMPLETED FORMS TO THIS ADDRESS. **SEND TO: Commissioner for Patents, P.O. Box 1450, Alexandria, VA 22313-1450.**

If you need assistance in completing the form, call 1-800-PTO-9199 and select option 2.

Under the Paperwork Reduction Act of 1995, no persons are required to respond to a collection of information unless it displays a valid OMB control number.

## DECLARATION (37 CFR 1.63) FOR UTILITY OR DESIGN APPLICATION USING AN APPLICATION DATA SHEET (37 CFR 1.76)

**Title of  
Invention**

**SYSTEM, METHOD AND APPARATUS FOR IDENTIFYING MANUAL INPUTS TO AND ADAPTIVE PROGRAMMING OF A THERMOSTAT**

As the below named inventor, I hereby declare that:

This declaration  
is directed to:

The attached application, or

United States application or PCT international application number 14/082675

filed on November 18, 2013

The above-identified application was made or authorized to be made by me.

I believe that I am the original inventor or an original joint inventor of a claimed invention in the application.

I hereby acknowledge that any willful false statement made in this declaration is punishable under 18 U.S.C. 1001 by fine or imprisonment of not more than five (5) years, or both.

### WARNING:

Petitioner/applicant is cautioned to avoid submitting personal information in documents filed in a patent application that may contribute to identity theft. Personal information such as social security numbers, bank account numbers, or credit card numbers (other than a check or credit card authorization form PTO-2038 submitted for payment purposes) is never required by the USPTO to support a petition or an application. If this type of personal information is included in documents submitted to the USPTO, petitioners/applicants should consider redacting such personal information from the documents before submitting them to the USPTO. Petitioner/applicant is advised that the record of a patent application is available to the public after publication of the application (unless a non-publication request in compliance with 37 CFR 1.213(a) is made in the application) or issuance of a patent. Furthermore, the record from an abandoned application may also be available to the public if the application is referenced in a published application or an issued patent (see 37 CFR 1.14). Checks and credit card authorization forms PTO-2038 submitted for payment purposes are not retained in the application file and therefore are not publicly available.

LEGAL NAME OF INVENTOR

Inventor: Scott Douglas Hublou

Date (Optional) : \_\_\_\_\_

Signature: \_\_\_\_\_

Note: An application data sheet (PTO/SB/14 or equivalent), including naming the entire inventive entity, must accompany this form or must have been previously filed. Use an additional PTO/AIA/01 form for each additional inventor.

This collection of information is required by 35 U.S.C. 115 and 37 CFR 1.63. The information is required to obtain or retain a benefit by the public which is to file (and by the USPTO to process) an application. Confidentiality is governed by 35 U.S.C. 122 and 37 CFR 1.11 and 1.14. This collection is estimated to take 1 minute to complete, including gathering, preparing, and submitting the completed application form to the USPTO. Time will vary depending upon the individual case. Any comments on the amount of time you require to complete this form and/or suggestions for reducing this burden, should be sent to the Chief Information Officer, U.S. Patent and Trademark Office, U.S. Department of Commerce, P.O. Box 1450, Alexandria, VA 22313-1450. DO NOT SEND FEES OR COMPLETED FORMS TO THIS ADDRESS. SEND TO: **Commissioner for Patents, P.O. Box 1450, Alexandria, VA 22313-1450.**

*If you need assistance in completing the form, call 1-800-PTO-9199 and select option 2.*

Under the Paperwork Reduction Act of 1995, no persons are required to respond to a collection of information unless it displays a valid OMB control number.

## DECLARATION (37 CFR 1.63) FOR UTILITY OR DESIGN APPLICATION USING AN APPLICATION DATA SHEET (37 CFR 1.76)

Title of  
Invention

SYSTEM, METHOD AND APPARATUS FOR IDENTIFYING MANUAL INPUTS TO AND ADAPTIVE PROGRAMMING OF A THERMOSTAT

As the below named inventor, I hereby declare that:

This declaration  
is directed to:

The attached application, or

United States application or PCT International application number 14/082675

filed on November 18, 2013

The above-identified application was made or authorized to be made by me.

I believe that I am the original inventor or an original joint inventor of a claimed invention in the application.

I hereby acknowledge that any willful false statement made in this declaration is punishable under 18 U.S.C. 1001 by fine or imprisonment of not more than five (5) years, or both.

### WARNING:

Petitioner/applicant is cautioned to avoid submitting personal information in documents filed in a patent application that may contribute to identity theft. Personal information such as social security numbers, bank account numbers, or credit card numbers (other than a check or credit card authorization form PTO-2038 submitted for payment purposes) is never required by the USPTO to support a petition or an application. If this type of personal information is included in documents submitted to the USPTO, petitioners/applicants should consider redacting such personal information from the documents before submitting them to the USPTO. Petitioner/applicant is advised that the record of a patent application is available to the public after publication of the application (unless a non-publication request in compliance with 37 CFR 1.213(a) is made in the application) or issuance of a patent. Furthermore, the record from an abandoned application may also be available to the public if the application is referenced in a published application or an issued patent (see 37 CFR 1.14). Checks and credit card authorization forms PTO-2038 submitted for payment purposes are not retained in the application file and therefore are not publicly available.

LEGAL NAME OF INVENTOR

Inventor: Leo Cheung

Date (Optional): \_\_\_\_\_

Signature: \_\_\_\_\_

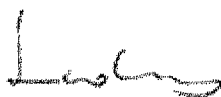

Note: An application data sheet (PTO/SB/14 or equivalent), including naming the entire inventive entity, must accompany this form or must have been previously filed. Use an additional PTO/AIA/01 form for each additional inventor.

This collection of information is required by 35 U.S.C. 115 and 37 CFR 1.63. The information is required to obtain or retain a benefit by the public which is to file (and by the USPTO to process) an application. Confidentiality is governed by 35 U.S.C. 122 and 37 CFR 1.11 and 1.14. This collection is estimated to take 1 minute to complete, including gathering, preparing, and submitting the completed application form to the USPTO. Time will vary depending upon the individual case. Any comments on the amount of time you require to complete this form and/or suggestions for reducing this burden, should be sent to the Chief Information Officer, U.S. Patent and Trademark Office, U.S. Department of Commerce, P.O. Box 1450, Alexandria, VA 22313-1450. DO NOT SEND FEES OR COMPLETED FORMS TO THIS ADDRESS. SEND TO: Commissioner for Patents, P.O. Box 1450, Alexandria, VA 22313-1450.

If you need assistance in completing the form, call 1-800-PTO-9199 and select option 2.

## Electronic Acknowledgement Receipt

|   |  |
|---|--|
| <b>EFS ID:</b>                              | 23343930   |
| <b>Application Number:</b>                  | 14082675   |
| <b>International Application Number:</b>    |  |
| <b>Confirmation Number:</b>                 | 3336   |
| <b>Title of Invention:</b>                  | SYSTEM, METHOD AND APPARATUS FOR IDENTIFYING MANUAL INPUTS TO AND ADAPTIVE PROGRAMMING OF A THERMOSTAT |
| <b>First Named Inventor/Applicant Name:</b> | John Douglas Steinberg   |
| <b>Customer Number:</b>                     | 20995  |
| <b>Filer:</b>                               | John R. King/Tony Do   |
| <b>Filer Authorized By:</b>                 | John R. King   |
| <b>Attorney Docket Number:</b>              | EFACT.007C1  |
| <b>Receipt Date:</b>                        | 28-AUG-2015  |
| <b>Filing Date:</b>                         | 18-NOV-2013  |
| <b>Time Stamp:</b>                          | 16:08:24   |
| <b>Application Type:</b>                    | Utility under 35 USC 111(a)  |

### Payment information:

|                        |    |
|------------------------|----|
| Submitted with Payment | no |
|------------------------|----|

### File Listing:

| Document Number | Document Description                              | File Name                   | File Size(Bytes)/<br>Message Digest               | Multi Part /.zip | Pages (if appl.) |
|-----------------|---|-----------------------------|---|------------------|------------------|
| 1               | Applicant Response to Pre-Exam Formalities Notice | EFACT-007C1_transmittal.pdf | 71632<br>b85add730343dd904d3dc9f73ba0980a510e1d13 | no               | 1                |

### Warnings:

### Information:

034

|   |                           |                              |  |    |   |
|---|---------------------------|------------------------------|--|----|---|
| 2 | Oath or Declaration filed | EFACT-007C1_declarations.pdf | 228562<br>d12cb0e7f39191a4450447a6b94d9789ea9fa5c3 | no | 3 |
|---|---------------------------|------------------------------|--|----|---|

**Warnings:**

**Information:**

|                                     |        |
|-------------------------------------|--------|
| <b>Total Files Size (in bytes):</b> | 300194 |
|-------------------------------------|--------|

**This Acknowledgement Receipt evidences receipt on the noted date by the USPTO of the indicated documents, characterized by the applicant, and including page counts, where applicable. It serves as evidence of receipt similar to a Post Card, as described in MPEP 503.**

**New Applications Under 35 U.S.C. 111**

**If a new application is being filed and the application includes the necessary components for a filing date (see 37 CFR 1.53(b)-(d) and MPEP 506), a Filing Receipt (37 CFR 1.54) will be issued in due course and the date shown on this Acknowledgement Receipt will establish the filing date of the application.**

**National Stage of an International Application under 35 U.S.C. 371**

**If a timely submission to enter the national stage of an international application is compliant with the conditions of 35 U.S.C. 371 and other applicable requirements a Form PCT/DO/EO/903 indicating acceptance of the application as a national stage submission under 35 U.S.C. 371 will be issued in addition to the Filing Receipt, in due course.**

**New International Application Filed with the USPTO as a Receiving Office**

**If a new international application is being filed and the international application includes the necessary components for an international filing date (see PCT Article 11 and MPEP 1810), a Notification of the International Application Number and of the International Filing Date (Form PCT/RO/105) will be issued in due course, subject to prescriptions concerning national security, and the date shown on this Acknowledgement Receipt will establish the international filing date of the application.**



NOTICE OF ALLOWANCE AND FEE(S) DUE

20995 7590 07/13/2015
KNOBBE MARTENS OLSON & BEAR LLP
2040 MAIN STREET
FOURTEENTH FLOOR
IRVINE, CA 92614

Table with 2 columns: EXAMINER (NORMAN, MARC E), ART UNIT (3744), PAPER NUMBER (3336)

DATE MAILED: 07/13/2015

Table with 5 columns: APPLICATION NO., FILING DATE, FIRST NAMED INVENTOR, ATTORNEY DOCKET NO., CONFIRMATION NO.

TITLE OF INVENTION: SYSTEM, METHOD AND APPARATUS FOR IDENTIFYING MANUAL INPUTS TO AND ADAPTIVE PROGRAMMING OF A THERMOSTAT

Table with 7 columns: APPLN. TYPE, ENTITY STATUS, ISSUE FEE DUE, PUBLICATION FEE DUE, PREV. PAID ISSUE FEE, TOTAL FEE(S) DUE, DATE DUE

THE APPLICATION IDENTIFIED ABOVE HAS BEEN EXAMINED AND IS ALLOWED FOR ISSUANCE AS A PATENT. PROSECUTION ON THE MERITS IS CLOSED. THIS NOTICE OF ALLOWANCE IS NOT A GRANT OF PATENT RIGHTS. THIS APPLICATION IS SUBJECT TO WITHDRAWAL FROM ISSUE AT THE INITIATIVE OF THE OFFICE OR UPON PETITION BY THE APPLICANT. SEE 37 CFR 1.313 AND MPEP 1308.

THE ISSUE FEE AND PUBLICATION FEE (IF REQUIRED) MUST BE PAID WITHIN THREE MONTHS FROM THE MAILING DATE OF THIS NOTICE OR THIS APPLICATION SHALL BE REGARDED AS ABANDONED. THIS STATUTORY PERIOD CANNOT BE EXTENDED. SEE 35 U.S.C. 151. THE ISSUE FEE DUE INDICATED ABOVE DOES NOT REFLECT A CREDIT FOR ANY PREVIOUSLY PAID ISSUE FEE IN THIS APPLICATION. IF AN ISSUE FEE HAS PREVIOUSLY BEEN PAID IN THIS APPLICATION (AS SHOWN ABOVE), THE RETURN OF PART B OF THIS FORM WILL BE CONSIDERED A REQUEST TO REAPPLY THE PREVIOUSLY PAID ISSUE FEE TOWARD THE ISSUE FEE NOW DUE.

HOW TO REPLY TO THIS NOTICE:

I. Review the ENTITY STATUS shown above. If the ENTITY STATUS is shown as SMALL or MICRO, verify whether entitlement to that entity status still applies.

If the ENTITY STATUS is the same as shown above, pay the TOTAL FEE(S) DUE shown above.

If the ENTITY STATUS is changed from that shown above, on PART B - FEE(S) TRANSMITTAL, complete section number 5 titled "Change in Entity Status (from status indicated above)".

For purposes of this notice, small entity fees are 1/2 the amount of undiscounted fees, and micro entity fees are 1/2 the amount of small entity fees.

II. PART B - FEE(S) TRANSMITTAL, or its equivalent, must be completed and returned to the United States Patent and Trademark Office (USPTO) with your ISSUE FEE and PUBLICATION FEE (if required). If you are charging the fee(s) to your deposit account, section "4b" of Part B - Fee(s) Transmittal should be completed and an extra copy of the form should be submitted. If an equivalent of Part B is filed, a request to reapply a previously paid issue fee must be clearly made, and delays in processing may occur due to the difficulty in recognizing the paper as an equivalent of Part B.

III. All communications regarding this application must give the application number. Please direct all communications prior to issuance to Mail Stop ISSUE FEE unless advised to the contrary.

IMPORTANT REMINDER: Utility patents issuing on applications filed on or after Dec. 12, 1980 may require payment of maintenance fees. It is patentee's responsibility to ensure timely payment of maintenance fees when due.



**PART B - FEE(S) TRANSMITTAL**

**Complete and send this form, together with applicable fee(s), to: Mail Mail Stop ISSUE FEE  
 Commissioner for Patents  
 P.O. Box 1450  
 Alexandria, Virginia 22313-1450  
 or Fax (571)-273-2885**

**INSTRUCTIONS:** This form should be used for transmitting the ISSUE FEE and PUBLICATION FEE (if required). Blocks 1 through 5 should be completed where appropriate. All further correspondence including the Patent, advance orders and notification of maintenance fees will be mailed to the current correspondence address as indicated unless corrected below or directed otherwise in Block 1, by (a) specifying a new correspondence address; and/or (b) indicating a separate "FEE ADDRESS" for maintenance fee notifications.

CURRENT CORRESPONDENCE ADDRESS (Note: Use Block 1 for any change of address)

20995 7590 07/13/2015  
**KNOBBE MARTENS OLSON & BEAR LLP**  
 2040 MAIN STREET  
 FOURTEENTH FLOOR  
 IRVINE, CA 92614

Note: A certificate of mailing can only be used for domestic mailings of the Fee(s) Transmittal. This certificate cannot be used for any other accompanying papers. Each additional paper, such as an assignment or formal drawing, must have its own certificate of mailing or transmission.

**Certificate of Mailing or Transmission**

I hereby certify that this Fee(s) Transmittal is being deposited with the United States Postal Service with sufficient postage for first class mail in an envelope addressed to the Mail Stop ISSUE FEE address above, or being facsimile transmitted to the USPTO (571) 273-2885, on the date indicated below.

|                    |
|--------------------|
| (Depositor's name) |
| (Signature)        |
| (Date)             |

| APPLICATION NO. | FILING DATE | FIRST NAMED INVENTOR   | ATTORNEY DOCKET NO. | CONFIRMATION NO. |
|-----------------|-------------|------------------------|---------------------|------------------|
| 14/082,675      | 11/18/2013  | John Douglas Steinberg | EFACT.007C1         | 3336             |

TITLE OF INVENTION: SYSTEM, METHOD AND APPARATUS FOR IDENTIFYING MANUAL INPUTS TO AND ADAPTIVE PROGRAMMING OF A THERMOSTAT

| APPLN. TYPE    | ENTITY STATUS | ISSUE FEE DUE | PUBLICATION FEE DUE | PREV. PAID ISSUE FEE | TOTAL FEE(S) DUE | DATE DUE   |
|----------------|---------------|---------------|---------------------|----------------------|------------------|------------|
| nonprovisional | SMALL         | \$480         | \$0                 | \$0                  | \$480            | 10/13/2015 |

| EXAMINER       | ART UNIT | CLASS-SUBCLASS |
|----------------|----------|----------------|
| NORMAN, MARC E | 3744     | 236-00100C     |

|   |   |
|---|---|
| <p>1. Change of correspondence address or indication of "Fee Address" (37 CFR 1.363).</p> <p><input type="checkbox"/> Change of correspondence address (or Change of Correspondence Address form PTO/SB/122) attached.</p> <p><input type="checkbox"/> "Fee Address" indication (or "Fee Address" Indication form PTO/SB/47; Rev 03-02 or more recent) attached. <b>Use of a Customer Number is required.</b></p> | <p>2. For printing on the patent front page, list</p> <p>(1) The names of up to 3 registered patent attorneys or agents OR, alternatively, _____ 1</p> <p>(2) The name of a single firm (having as a member a registered attorney or agent) and the names of up to 2 registered patent attorneys or agents. If no name is listed, no name will be printed. _____ 2</p> <p>_____ 3</p> |
|---|---|

3. ASSIGNEE NAME AND RESIDENCE DATA TO BE PRINTED ON THE PATENT (print or type)

PLEASE NOTE: Unless an assignee is identified below, no assignee data will appear on the patent. If an assignee is identified below, the document has been filed for recordation as set forth in 37 CFR 3.11. Completion of this form is NOT a substitute for filing an assignment.

(A) NAME OF ASSIGNEE \_\_\_\_\_ (B) RESIDENCE: (CITY and STATE OR COUNTRY) \_\_\_\_\_

Please check the appropriate assignee category or categories (will not be printed on the patent) :  Individual  Corporation or other private group entity  Government

|   |  |
|---|--|
| <p>4a. The following fee(s) are submitted:</p> <p><input type="checkbox"/> Issue Fee</p> <p><input type="checkbox"/> Publication Fee (No small entity discount permitted)</p> <p><input type="checkbox"/> Advance Order - # of Copies _____</p> | <p>4b. Payment of Fee(s): (<b>Please first reapply any previously paid issue fee shown above</b>)</p> <p><input type="checkbox"/> A check is enclosed.</p> <p><input type="checkbox"/> Payment by credit card. Form PTO-2038 is attached.</p> <p><input type="checkbox"/> The director is hereby authorized to charge the required fee(s), any deficiency, or credits any overpayment, to Deposit Account Number _____ (enclose an extra copy of this form).</p> |
|---|--|

5. **Change in Entity Status** (from status indicated above)

Applicant certifying micro entity status. See 37 CFR 1.29

Applicant asserting small entity status. See 37 CFR 1.27

Applicant changing to regular undiscounted fee status.

**NOTE:** Absent a valid certification of Micro Entity Status (see forms PTO/SB/15A and 15B), issue fee payment in the micro entity amount will not be accepted at the risk of application abandonment.

**NOTE:** If the application was previously under micro entity status, checking this box will be taken to be a notification of loss of entitlement to micro entity status.

**NOTE:** Checking this box will be taken to be a notification of loss of entitlement to small or micro entity status, as applicable.

**NOTE:** This form must be signed in accordance with 37 CFR 1.31 and 1.33. See 37 CFR 1.4 for signature requirements and certifications.

Authorized Signature \_\_\_\_\_ Date \_\_\_\_\_

Typed or printed name \_\_\_\_\_ Registration No. \_\_\_\_\_



UNITED STATES PATENT AND TRADEMARK OFFICE

UNITED STATES DEPARTMENT OF COMMERCE
United States Patent and Trademark Office
Address: COMMISSIONER FOR PATENTS
P.O. Box 1450
Alexandria, Virginia 22313-1450
www.uspto.gov

Table with 5 columns: APPLICATION NO., FILING DATE, FIRST NAMED INVENTOR, ATTORNEY DOCKET NO., CONFIRMATION NO.
14/082,675 11/18/2013 John Douglas Steinberg EFACT.007C1 3336

20995 7590 07/13/2015
KNOBBE MARTENS OLSON & BEAR LLP
2040 MAIN STREET
FOURTEENTH FLOOR
IRVINE, CA 92614

EXAMINER

NORMAN, MARC E

ART UNIT PAPER NUMBER

3744

DATE MAILED: 07/13/2015

Determination of Patent Term Adjustment under 35 U.S.C. 154 (b)
(Applications filed on or after May 29, 2000)

The Office has discontinued providing a Patent Term Adjustment (PTA) calculation with the Notice of Allowance.

Section 1(h)(2) of the AIA Technical Corrections Act amended 35 U.S.C. 154(b)(3)(B)(i) to eliminate the requirement that the Office provide a patent term adjustment determination with the notice of allowance. See Revisions to Patent Term Adjustment, 78 Fed. Reg. 19416, 19417 (Apr. 1, 2013). Therefore, the Office is no longer providing an initial patent term adjustment determination with the notice of allowance. The Office will continue to provide a patent term adjustment determination with the Issue Notification Letter that is mailed to applicant approximately three weeks prior to the issue date of the patent, and will include the patent term adjustment on the patent. Any request for reconsideration of the patent term adjustment determination (or reinstatement of patent term adjustment) should follow the process outlined in 37 CFR 1.705.

Any questions regarding the Patent Term Extension or Adjustment determination should be directed to the Office of Patent Legal Administration at (571)-272-7702. Questions relating to issue and publication fee payments should be directed to the Customer Service Center of the Office of Patent Publication at 1-(888)-786-0101 or (571)-272-4200.

|   |                               |  |  |
|---|-------------------------------|--|--|
| <b><i>Notice Requiring Inventor's Oath or Declaration</i></b> | Application No.<br>14/082,675 | Applicant(s)<br>John Douglas Steinberg |  |
|   | Examiner<br>NORMAN, MARC E    | Art Unit<br>3744                       |  |

This notice is an attachment to the Notice of Allowability (PTOL-37), or the Notice of Allowability For A Design Application (PTOL-37D).

An inventor's oath or declaration in compliance with 37 CFR 1.63 or 1.64 executed by or with respect to each inventor has not yet been submitted.

An oath or declaration in compliance with 37 CFR 1.63, or a substitute statement in compliance with 37 CFR 1.64, executed by or with respect to each inventor (for any inventor for which a compliant oath, declaration, or substitute statement has not yet been submitted) **MUST** be filed no later than the date on which the issue fee is paid. See 35 U.S.C. 115(f). Failure to timely comply will result in ABANDONMENT of this application.

A properly executed inventor's oath to declaration has not been received for the following inventor(s):

If applicant previously filed one or more oaths, declarations, or substitute statements, applicant may have received an informational notice regarding deficiencies therein.

The following deficiencies are noted:

**INFORMAL ACTION PROBLEMS**

- A properly executed inventor's oath or declaration has not been received for the following inventor(s): **John Douglas Steinberg, Scott Douglas Hublou, and Leo Cheung.**

Applicant may submit the inventor's oath or declaration at any time before the Notice of Allowance and Fee(s) Due, PTOL-85, is mailed.

Questions relating to this Notice should be directed to the Application Assistance Unit at 571-272-4200.

## OMB Clearance and PRA Burden Statement for PTOL-85 Part B

The Paperwork Reduction Act (PRA) of 1995 requires Federal agencies to obtain Office of Management and Budget approval before requesting most types of information from the public. When OMB approves an agency request to collect information from the public, OMB (i) provides a valid OMB Control Number and expiration date for the agency to display on the instrument that will be used to collect the information and (ii) requires the agency to inform the public about the OMB Control Number's legal significance in accordance with 5 CFR 1320.5(b).

The information collected by PTOL-85 Part B is required by 37 CFR 1.311. The information is required to obtain or retain a benefit by the public which is to file (and by the USPTO to process) an application. Confidentiality is governed by 35 U.S.C. 122 and 37 CFR 1.14. This collection is estimated to take 12 minutes to complete, including gathering, preparing, and submitting the completed application form to the USPTO. Time will vary depending upon the individual case. Any comments on the amount of time you require to complete this form and/or suggestions for reducing this burden, should be sent to the Chief Information Officer, U.S. Patent and Trademark Office, U.S. Department of Commerce, P.O. Box 1450, Alexandria, Virginia 22313-1450. DO NOT SEND FEES OR COMPLETED FORMS TO THIS ADDRESS. SEND TO: Commissioner for Patents, P.O. Box 1450, Alexandria, Virginia 22313-1450. Under the Paperwork Reduction Act of 1995, no persons are required to respond to a collection of information unless it displays a valid OMB control number.

### Privacy Act Statement

**The Privacy Act of 1974 (P.L. 93-579)** requires that you be given certain information in connection with your submission of the attached form related to a patent application or patent. Accordingly, pursuant to the requirements of the Act, please be advised that: (1) the general authority for the collection of this information is 35 U.S.C. 2(b)(2); (2) furnishing of the information solicited is voluntary; and (3) the principal purpose for which the information is used by the U.S. Patent and Trademark Office is to process and/or examine your submission related to a patent application or patent. If you do not furnish the requested information, the U.S. Patent and Trademark Office may not be able to process and/or examine your submission, which may result in termination of proceedings or abandonment of the application or expiration of the patent.

The information provided by you in this form will be subject to the following routine uses:

1. The information on this form will be treated confidentially to the extent allowed under the Freedom of Information Act (5 U.S.C. 552) and the Privacy Act (5 U.S.C. 552a). Records from this system of records may be disclosed to the Department of Justice to determine whether disclosure of these records is required by the Freedom of Information Act.
2. A record from this system of records may be disclosed, as a routine use, in the course of presenting evidence to a court, magistrate, or administrative tribunal, including disclosures to opposing counsel in the course of settlement negotiations.
3. A record in this system of records may be disclosed, as a routine use, to a Member of Congress submitting a request involving an individual, to whom the record pertains, when the individual has requested assistance from the Member with respect to the subject matter of the record.
4. A record in this system of records may be disclosed, as a routine use, to a contractor of the Agency having need for the information in order to perform a contract. Recipients of information shall be required to comply with the requirements of the Privacy Act of 1974, as amended, pursuant to 5 U.S.C. 552a(m).
5. A record related to an International Application filed under the Patent Cooperation Treaty in this system of records may be disclosed, as a routine use, to the International Bureau of the World Intellectual Property Organization, pursuant to the Patent Cooperation Treaty.
6. A record in this system of records may be disclosed, as a routine use, to another federal agency for purposes of National Security review (35 U.S.C. 181) and for review pursuant to the Atomic Energy Act (42 U.S.C. 218(c)).
7. A record from this system of records may be disclosed, as a routine use, to the Administrator, General Services, or his/her designee, during an inspection of records conducted by GSA as part of that agency's responsibility to recommend improvements in records management practices and programs, under authority of 44 U.S.C. 2904 and 2906. Such disclosure shall be made in accordance with the GSA regulations governing inspection of records for this purpose, and any other relevant (i.e., GSA or Commerce) directive. Such disclosure shall not be used to make determinations about individuals.
8. A record from this system of records may be disclosed, as a routine use, to the public after either publication of the application pursuant to 35 U.S.C. 122(b) or issuance of a patent pursuant to 35 U.S.C. 151. Further, a record may be disclosed, subject to the limitations of 37 CFR 1.14, as a routine use, to the public if the record was filed in an application which became abandoned or in which the proceedings were terminated and which application is referenced by either a published application, an application open to public inspection or an issued patent.
9. A record from this system of records may be disclosed, as a routine use, to a Federal, State, or local law enforcement agency, if the USPTO becomes aware of a violation or potential violation of law or regulation.

|                               |                                      |   |  |
|-------------------------------|--------------------------------------|---|--|
| <b>Notice of Allowability</b> | <b>Application No.</b><br>14/082,675 | <b>Applicant(s)</b><br>STEINBERG ET AL. |  |
|                               | <b>Examiner</b><br>MARC NORMAN       | <b>Art Unit</b><br>3744                 | <b>AIA (First Inventor to File) Status</b><br>No |

**-- The MAILING DATE of this communication appears on the cover sheet with the correspondence address--**

All claims being allowable, PROSECUTION ON THE MERITS IS (OR REMAINS) CLOSED in this application. If not included herewith (or previously mailed), a Notice of Allowance (PTOL-85) or other appropriate communication will be mailed in due course. **THIS NOTICE OF ALLOWABILITY IS NOT A GRANT OF PATENT RIGHTS.** This application is subject to withdrawal from issue at the initiative of the Office or upon petition by the applicant. See 37 CFR 1.313 and MPEP 1308.

1.  This communication is responsive to amendment filed 6/23/15.  
 A declaration(s)/affidavit(s) under 37 CFR 1.130(b) was/were filed on \_\_\_\_\_.
2.  An election was made by the applicant in response to a restriction requirement set forth during the interview on \_\_\_\_\_; the restriction requirement and election have been incorporated into this action.
3.  The allowed claim(s) is/are 1-24. As a result of the allowed claim(s), you may be eligible to benefit from the **Patent Prosecution Highway** program at a participating intellectual property office for the corresponding application. For more information, please see [http://www.uspto.gov/patents/init\\_events/pph/index.jsp](http://www.uspto.gov/patents/init_events/pph/index.jsp) or send an inquiry to [PPHfeedback@uspto.gov](mailto:PPHfeedback@uspto.gov).
4.  Acknowledgment is made of a claim for foreign priority under 35 U.S.C. § 119(a)-(d) or (f).

**Certified copies:**

- a)  All    b)  Some    \*c)  None of the:
1.  Certified copies of the priority documents have been received.
  2.  Certified copies of the priority documents have been received in Application No. \_\_\_\_\_.
  3.  Copies of the certified copies of the priority documents have been received in this national stage application from the International Bureau (PCT Rule 17.2(a)).

\* Certified copies not received: \_\_\_\_\_.

Applicant has THREE MONTHS FROM THE "MAILING DATE" of this communication to file a reply complying with the requirements noted below. Failure to timely comply will result in ABANDONMENT of this application.

**THIS THREE-MONTH PERIOD IS NOT EXTENDABLE.**

5.  CORRECTED DRAWINGS ( as "replacement sheets") must be submitted.  
 including changes required by the attached Examiner's Amendment / Comment or in the Office action of Paper No./Mail Date \_\_\_\_\_.  
**Identifying indicia such as the application number (see 37 CFR 1.84(c)) should be written on the drawings in the front (not the back) of each sheet. Replacement sheet(s) should be labeled as such in the header according to 37 CFR 1.121(d).**
6.  DEPOSIT OF and/or INFORMATION about the deposit of BIOLOGICAL MATERIAL must be submitted. Note the attached Examiner's comment regarding REQUIREMENT FOR THE DEPOSIT OF BIOLOGICAL MATERIAL.

**Attachment(s)**

- |  |  |
|--|--|
| <ol style="list-style-type: none"> <li>1. <input type="checkbox"/> Notice of References Cited (PTO-892)</li> <li>2. <input checked="" type="checkbox"/> Information Disclosure Statements (PTO/SB/08),<br/>Paper No./Mail Date _____</li> <li>3. <input type="checkbox"/> Examiner's Comment Regarding Requirement for Deposit of Biological Material</li> <li>4. <input checked="" type="checkbox"/> Interview Summary (PTO-413),<br/>Paper No./Mail Date _____.</li> </ol> | <ol style="list-style-type: none"> <li>5. <input type="checkbox"/> Examiner's Amendment/Comment</li> <li>6. <input checked="" type="checkbox"/> Examiner's Statement of Reasons for Allowance</li> <li>7. <input type="checkbox"/> Other _____.</li> </ol> |
|--|--|

/MARC NORMAN/  
Primary Examiner, Art Unit 3744

Art Unit: 3744

### REASONS FOR ALLOWANCE

Claims 1-24 are allowed.

The following is an examiner's statement of reasons for allowance:

Applicant's amendments overcome the previously applied rejections under 35 USC 101.

As per independent claims 1, 9, and 17, the prior art does not teach the method/apparatus combinations as recited, and in particular comprising the combined control steps of calculating with at least one computer, scheduled programming of the thermostatic controller for one or more times to control the heating ventilation and air conditioning system, the scheduled programming comprising at least a first automated setpoint at a first time; recording, with the thermostatic controller, actual setpoints of the heating ventilation and air condition system; communicating the actual setpoints from the one or more thermostatic controllers to the at least one computer; generating with the at least one computer, a difference value based on comparing at least one of the an actual setpoints at the first time for the thermostatic controller to the first automated setpoint for the thermostatic controller; detecting a manual change to the first automated setpoint by determining whether the at least one of the actual setpoints and the first automated setpoint are the same or different based on the difference value; and logging the manual change to a database.

Any comments considered necessary by applicant must be submitted no later than the payment of the issue fee and, to avoid processing delays, should preferably accompany the issue fee. Such submissions should be clearly labeled "Comments on Statement of Reasons for Allowance."

Art Unit: 3744

Any inquiry concerning this communication or earlier communications from the examiner should be directed to MARC NORMAN whose telephone number is (571)272-4812.

The examiner can normally be reached on Mon.-Fri., 8:30-5:00.

If attempts to reach the examiner by telephone are unsuccessful, the examiner's supervisor, Cheryl Tyler can be reached on 571-272-4834. The fax phone number for the organization where this application or proceeding is assigned is 571-273-8300.

Information regarding the status of an application may be obtained from the Patent Application Information Retrieval (PAIR) system. Status information for published applications may be obtained from either Private PAIR or Public PAIR. Status information for unpublished applications is available through Private PAIR only. For more information about the PAIR system, see <http://pair-direct.uspto.gov>. Should you have questions on access to the Private PAIR system, contact the Electronic Business Center (EBC) at 866-217-9197 (toll-free). If you would like assistance from a USPTO Customer Service Representative or access to the automated information system, call 800-786-9199 (IN USA OR CANADA) or 571-272-1000.

/MARC NORMAN/  
Primary Examiner, Art Unit 3744

|  |                                      |   |  |
|--|--------------------------------------|---|--|
| <b>Applicant-Initiated Interview Summary</b> | <b>Application No.</b><br>14/082,675 | <b>Applicant(s)</b><br>STEINBERG ET AL. |  |
|  | <b>Examiner</b><br>MARC NORMAN       | <b>Art Unit</b><br>3744                 |  |

All participants (applicant, applicant's representative, PTO personnel):

- (1) MARC NORMAN. (3) John Steinberg.  
(2) John King. (4) \_\_\_\_\_.

Date of Interview: 6/22/15.

Type:  Telephonic  Video Conference  
 Personal [copy given to:  applicant  applicant's representative]

Exhibit shown or demonstration conducted:  Yes  No.  
If Yes, brief description: \_\_\_\_\_.

Issues Discussed  101  112  102  103  Others  
(For each of the checked box(es) above, please describe below the issue and detailed description of the discussion)

Claim(s) discussed: 1.

Identification of prior art discussed: \_\_\_\_\_.

**Substance of Interview**

(For each issue discussed, provide a detailed description and indicate if agreement was reached. Some topics may include: identification or clarification of a reference or a portion thereof, claim interpretation, proposed amendments, arguments of any applied references etc...)

Possible ways to overcome the rejections under 35 USC 101 in order to render the claims statutory. Agreement was reached on the claim language as recited in the amendment submitted on 6/23/15.

**Applicant recordation instructions:** The formal written reply to the last Office action must include the substance of the interview. (See MPEP section 713.04). If a reply to the last Office action has already been filed, applicant is given a non-extendable period of the longer of one month or thirty days from this interview date, or the mailing date of this interview summary form, whichever is later, to file a statement of the substance of the interview

**Examiner recordation instructions:** Examiners must summarize the substance of any interview of record. A complete and proper recordation of the substance of an interview should include the items listed in MPEP 713.04 for complete and proper recordation including the identification of the general thrust of each argument or issue discussed, a general indication of any other pertinent matters discussed regarding patentability and the general results or outcome of the interview, to include an indication as to whether or not agreement was reached on the issues raised.

Attachment

/MARC NORMAN/  
Primary Examiner, Art Unit 3744



## Summary of Record of Interview Requirements

### Manual of Patent Examining Procedure (MPEP), Section 713.04, Substance of Interview Must be Made of Record

A complete written statement as to the substance of any face-to-face, video conference, or telephone interview with regard to an application must be made of record in the application whether or not an agreement with the examiner was reached at the interview.

### Title 37 Code of Federal Regulations (CFR) § 1.133 Interviews

Paragraph (b)

In every instance where reconsideration is requested in view of an interview with an examiner, a complete written statement of the reasons presented at the interview as warranting favorable action must be filed by the applicant. An interview does not remove the necessity for reply to Office action as specified in §§ 1.111, 1.135. (35 U.S.C. 132)

37 CFR §1.2 Business to be transacted in writing.

All business with the Patent or Trademark Office should be transacted in writing. The personal attendance of applicants or their attorneys or agents at the Patent and Trademark Office is unnecessary. The action of the Patent and Trademark Office will be based exclusively on the written record in the Office. No attention will be paid to any alleged oral promise, stipulation, or understanding in relation to which there is disagreement or doubt.

The action of the Patent and Trademark Office cannot be based exclusively on the written record in the Office if that record is itself incomplete through the failure to record the substance of interviews.

It is the responsibility of the applicant or the attorney or agent to make the substance of an interview of record in the application file, unless the examiner indicates he or she will do so. It is the examiner's responsibility to see that such a record is made and to correct material inaccuracies which bear directly on the question of patentability.

Examiners must complete an Interview Summary Form for each interview held where a matter of substance has been discussed during the interview by checking the appropriate boxes and filling in the blanks. Discussions regarding only procedural matters, directed solely to restriction requirements for which interview recordation is otherwise provided for in Section 812.01 of the Manual of Patent Examining Procedure, or pointing out typographical errors or unreadable script in Office actions or the like, are excluded from the interview recordation procedures below. Where the substance of an interview is completely recorded in an Examiners Amendment, no separate Interview Summary Record is required.

The Interview Summary Form shall be given an appropriate Paper No., placed in the right hand portion of the file, and listed on the "Contents" section of the file wrapper. In a personal interview, a duplicate of the Form is given to the applicant (or attorney or agent) at the conclusion of the interview. In the case of a telephone or video-conference interview, the copy is mailed to the applicant's correspondence address either with or prior to the next official communication. If additional correspondence from the examiner is not likely before an allowance or if other circumstances dictate, the Form should be mailed promptly after the interview rather than with the next official communication.

The Form provides for recordation of the following information:

- Application Number (Series Code and Serial Number)
- Name of applicant
- Name of examiner
- Date of interview
- Type of interview (telephonic, video-conference, or personal)
- Name of participant(s) (applicant, attorney or agent, examiner, other PTO personnel, etc.)
- An indication whether or not an exhibit was shown or a demonstration conducted
- An identification of the specific prior art discussed
- An indication whether an agreement was reached and if so, a description of the general nature of the agreement (may be by attachment of a copy of amendments or claims agreed as being allowable). Note: Agreement as to allowability is tentative and does not restrict further action by the examiner to the contrary.
- The signature of the examiner who conducted the interview (if Form is not an attachment to a signed Office action)

It is desirable that the examiner orally remind the applicant of his or her obligation to record the substance of the interview of each case. It should be noted, however, that the Interview Summary Form will not normally be considered a complete and proper recordation of the interview unless it includes, or is supplemented by the applicant or the examiner to include, all of the applicable items required below concerning the substance of the interview.

A complete and proper recordation of the substance of any interview should include at least the following applicable items:

- 1) A brief description of the nature of any exhibit shown or any demonstration conducted,
- 2) an identification of the claims discussed,
- 3) an identification of the specific prior art discussed,
- 4) an identification of the principal proposed amendments of a substantive nature discussed, unless these are already described on the Interview Summary Form completed by the Examiner,
- 5) a brief identification of the general thrust of the principal arguments presented to the examiner,  
(The identification of arguments need not be lengthy or elaborate. A verbatim or highly detailed description of the arguments is not required. The identification of the arguments is sufficient if the general nature or thrust of the principal arguments made to the examiner can be understood in the context of the application file. Of course, the applicant may desire to emphasize and fully describe those arguments which he or she feels were or might be persuasive to the examiner.)
- 6) a general indication of any other pertinent matters discussed, and
- 7) if appropriate, the general results or outcome of the interview unless already described in the Interview Summary Form completed by the examiner.

Examiners are expected to carefully review the applicant's record of the substance of an interview. If the record is not complete and accurate, the examiner will give the applicant an extendable one month time period to correct the record.

### Examiner to Check for Accuracy

If the claims are allowable for other reasons of record, the examiner should send a letter setting forth the examiner's version of the statement attributed to him or her. If the record is complete and accurate, the examiner should place the indication, "Interview Record OK" on the paper recording the substance of the interview along with the date and the examiner's initials.







**INFORMATION DISCLOSURE  
STATEMENT BY APPLICANT**

*(Multiple sheets used when necessary)*

SHEET 1 OF 3

|                      |                        |
|----------------------|------------------------|
| Application No.      | 14/082675              |
| Filing Date          | November 18, 2013      |
| First Named Inventor | John Douglas Steinberg |
| Art Unit             | 3744                   |
| Examiner             | Norman, Marc E.        |
| Attorney Docket No.  | EFACT.007C1            |

**U.S. PATENT DOCUMENTS**

| Examiner Initials | Cite No. | Document Number<br>Number - Kind Code (if known)<br>Example: 1,234,567 B1 | Publication Date<br>MM-DD-YYYY | Name              | Pages, Columns, Lines Where Relevant Passages or Relevant Figures Appear |
|-------------------|----------|---|--------------------------------|-------------------|--|
|                   | 1        | 12/805705   | 06/10/2010                     | Crabtree          |  |
|                   | 2        | 13/470074   | 08/30/2012                     | Steinberg         |  |
|                   | 3        | 13/523697   | 06/14/2012                     | Hublou et al.     |  |
|                   | 4        | 13/725447   | 06/06/2013                     | Steinberg         |  |
|                   | 5        | 13/729401   | 12/28/2012                     | Sloop             |  |
|                   | 6        | 13/852577   | 03/28/2013                     | Steinberg et al.  |  |
|                   | 7        | 13/858710   | 09/05/2013                     | Steinberg et al.  |  |
|                   | 8        | 14/082,675<br>(EFACT.007C1)   | 11/18/2003                     | Steinberg et al.  |  |
|                   | 9        | 14/263,762  | 04/28/2014                     | Steinberg         |  |
|                   | 10       | 14/285,384  | 05/22/2014                     | Steinberg, et al. |  |
|                   | 11       | 14/292,377  | 05/30/2014                     | Steinberg         |  |
|                   | 12       | 14/491,554  | 09/19/2014                     | Steinberg         |  |
|                   | 13       | 14/527,433  | 10/29/2014                     | Steinberg, et al. |  |
|                   | 14       | 14/731,2210   | 06/04/2015                     | Steinberg, et al. |  |
|                   | 15       | D 646,990   | 10/18/2011                     | Rhodes            |  |
|                   | 16       | D 659,560   | 05/15/2012                     | Rhodes            |  |
|                   | 17       | D 673,467   | 01/01/2013                     | Lee et al.        |  |
|                   | 18       | D 705,095<br>(EFACT.015DA)  | 05/20/2014                     | Steinberg et al.  |  |
|                   | 19       | 5,124,502   | 06/23/1992                     | Nelson et al.     |  |
|                   | 20       | 5,348,078   | 09/20/1994                     | Dushane et al.    |  |
|                   | 21       | 5,725,148   | 03/10/1998                     | Hartman           |  |
|                   | 22       | 5,729,474   | 03/17/1998                     | Hildebrand et al. |  |
|                   | 23       | 6,079,626   | 06/27/2000                     | Hartman           |  |
|                   | 24       | 6,241,156   | 06/05/2001                     | Kline et al.      |  |
|                   | 25       | 6,644,098   | 11/11/2003                     | Cardinale et al.  |  |
|                   | 26       | 6,700,224   | 03/02/2004                     | Biskup, Sr.,      |  |
|                   | 27       | 6,786,421   | 09/07/2004                     | Rosen             |  |
|                   | 28       | 7,206,670   | 04/17/2007                     | Pimputkar, et al. |  |

Examiner Signature /Marc Norman/ Date Considered 06/29/2015

\*Examiner: Initial if reference considered, whether or not citation is in conformance with MPEP 609. Draw line through citation if not in conformance and not considered. Include copy of this form with next communication to applicant.

T<sup>1</sup> - Place a check mark in this area when an English language translation is attached. **ALL REFERENCES CONSIDERED EXCEPT WHERE LINED THROUGH. /MN/**

|  |                      |                        |
|--|----------------------|------------------------|
| <b>INFORMATION DISCLOSURE<br/>STATEMENT BY APPLICANT</b><br><br><i>(Multiple sheets used when necessary)</i> | Application No.      | 14/082675              |
|  | Filing Date          | November 18, 2013      |
|  | First Named Inventor | John Douglas Steinberg |
|  | Art Unit             | 3744                   |
| SHEET 2 OF 3   | Examiner             | Norman, Marc E.        |
|  | Attorney Docket No.  | EFACT.007C1            |

| U.S. PATENT DOCUMENTS |          |  |                                |                   |  |
|-----------------------|----------|--|--------------------------------|-------------------|--|
| Examiner Initials     | Cite No. | Document Number<br><i>Number - Kind Code (if known)</i><br>Example: 1,234,567 B1 | Publication Date<br>MM-DD-YYYY | Name              | Pages, Columns, Lines Where Relevant Passages or Relevant Figures Appear |
|                       | 29       | 7,476,020  | 01/13/2009                     | Zufferey et al.   |  |
|                       | 30       | 7,702,424  | 04/20/2010                     | Cannon et al.     |  |
|                       | 31       | 7,758,729  | 07/20/2010                     | DeWhitt           |  |
|                       | 32       | 7,869,904  | 01/11/2011                     | Cannon et al.     |  |
|                       | 33       | 8,498,753<br>(EFACT.009A)  | 07/30/2013                     | Steinberg et al.  |  |
|                       | 34       | 8,556,188<br>(EFACT.012A)  | 10/15/2013                     | Steinberg         |  |
|                       | 35       | 8,596,550<br>(EFACT.007A)  | 12/03/2013                     | Steinberg et al.  |  |
|                       | 36       | 8,712,590<br>(EFACT.013C2)   | 04/29/2014                     | Steinberg         |  |
|                       | 37       | 8,738,327<br>(EFACT.004C3)   | 05/27/2014                     | Steinberg, et al. |  |
|                       | 38       | 8,740,100<br>(EFACT.008A)  | 06/03/2014                     | Steinberg         |  |
|                       | 39       | 8,751,186<br>(EFACT.005C3)   | 06/10/2014                     | Steinberg, et al. |  |
|                       | 40       | 8,840,033<br>(EFACT.012C1)   | 09/23/2014                     | Steinberg         |  |
|                       | 41       | 8,886,488<br>(EFACT.005C2)   | 11/11/2014                     | Steinberg, et al. |  |
|                       | 42       | 2011/0253796   | 10/20/2011                     | Posa et al.       |  |
|                       | 43       | 2013/0226502<br>EFACT.006C2  | 08/29/2013                     | Steinberg, et al. |  |
|                       | 44       | 2013/0310989<br>(EFACT.009C1)  | 11/21/2013                     | Steinberg et al.  |  |
|                       | 45       | 2014/0039690<br>(EFACT.012C1)  | 02/06/2014                     | Steinberg         |  |
|                       | 46       | 2014/0229018<br>(EFACT.013C3)  | 08/20/2014                     | Steinberg         |  |
|                       | 47       | 2015/0021405<br>(EFACT.008C1)  | 01/22/2015                     | Steinberg         |  |
|                       | 48       | 2015/0043615<br>(EFACT.004C4)  | 02/12/2015                     | Steinberg et al.  |  |
|                       | 49       | 2015/0120235<br>(EFACT.005C4)  | 04/30/2015                     | Steinberg et al.  |  |

| FOREIGN PATENT DOCUMENTS |          |   |                                |      |  |                |
|--------------------------|----------|---|--------------------------------|------|--|----------------|
| Examiner Initials        | Cite No. | Foreign Patent Document<br><i>Country Code-Number-Kind Code</i><br>Example: JP 1234567 A1 | Publication Date<br>MM-DD-YYYY | Name | Pages, Columns, Lines Where Relevant Passages or Relevant Figures Appear | T <sup>1</sup> |

|                    |               |                 |            |
|--------------------|---------------|-----------------|------------|
| Examiner Signature | /Marc Norman/ | Date Considered | 06/29/2015 |
|--------------------|---------------|-----------------|------------|

\*Examiner: Initial if reference considered, whether or not citation is in conformance with MPEP 609. Draw line through citation if not in conformance and not considered. Include copy of this form with next communication to applicant.

T<sup>1</sup> - Place a check mark in the area when an English language translation is attached. **ALL REFERENCES CONSIDERED EXCEPT WHERE LINED THROUGH. /MN/**

|  |                      |                                    |
|--|----------------------|------------------------------------|
| <b>INFORMATION DISCLOSURE<br/>STATEMENT BY APPLICANT</b><br><br><i>(Multiple sheets used when necessary)</i> | Application No.      | 14/082675                          |
|  | Filing Date          | November 18, 2013                  |
|  | First Named Inventor | John Douglas Steinberg             |
|  | Art Unit             | 3744                               |
| SHEET 3 OF 3   |                      | Examiner<br>Norman, Marc E.        |
|  |                      | Attorney Docket No.<br>EFACT.007C1 |

#### FOREIGN PATENT DOCUMENTS

| Examiner Initials | Cite No. | Foreign Patent Document<br>Country Code-Number-Kind<br>Code<br>Example: JP 1234567 A1 | Publication Date<br>MM-DD-YYYY | Name                              | Pages, Columns, Lines<br>Where Relevant Passages<br>or Relevant Figures<br>Appear | T <sup>1</sup> |
|-------------------|----------|---|--------------------------------|-----------------------------------|---|----------------|
|                   | 50       | JP 05-189659  | 07/30/1993                     | Hitachi Bill Shisetsu Eng.<br>KK. |   |                |
|                   | 51       | JP 2010-038377  | 02/18/2010                     | Mitsubishi Heavy Ind. Ltd.        |   |                |
|                   | 52       | JP 2010-286218  | 12/24/2010                     | Mitsubishi Heavy Ind. Ltd.        |   |                |
|                   | 53       | KR 10-1999-0070368  | 09/15/1999                     | Samsung Electronics Co.<br>Ltd.   |   |                |
|                   | 54       | WO 2011/149600<br>(EFACT.012WO)   | 12/01/2011                     | EcoFactor, Inc.                   |   |                |
|                   | 55       | WO 2012/024534<br>(EFACT.013WO)   | 02/23/2012                     | EcoFactor, Inc.                   |   |                |
|                   | 56       | WO 2013/187996  | 12/19/2013                     | EcoFactor, Inc.                   |   |                |

#### NON PATENT LITERATURE DOCUMENTS

| Examiner Initials | Cite No. | Include name of the author (in CAPITAL LETTERS), title of the article (when appropriate), title of the item (book, magazine, journal, serial, symposium, catalog, etc.), date, page(s), volume-issue number(s), publisher, city and/or country where published. | T <sup>1</sup> |
|-------------------|----------|---|----------------|
|                   | 57       | International Search Report and Written Opinion for PCT/US2013/035726 (EFACT.014WO), dated 8/6/13.  |                |
|                   | 58       | International Preliminary Report on Patentability in PCT/US2013/035726 dated 12/16/2014 (EFACT.014WO).  |                |

20900442:ad  
061215

|                                       |                                 |
|---------------------------------------|---------------------------------|
| Examiner Signature      /Marc Norman/ | Date Considered      06/29/2015 |
|---------------------------------------|---------------------------------|

\***Examiner:** Initial if reference considered, whether or not citation is in conformance with MPEP 609. Draw line through citation if not in conformance and not considered. Include copy of this form with next communication to applicant.

~~ALL REFERENCES CONSIDERED EXCEPT WHERE LINED THROUGH. /MN/~~

T<sup>1</sup> - Place a check mark in this area when an English language translation is attached.

|   |  |  |
|---|--|--|
| <b>Index of Claims</b><br><br> | <b>Application/Control No.</b><br><br>14082675 | <b>Applicant(s)/Patent Under Reexamination</b><br><br>STEINBERG ET AL. |
|   | <b>Examiner</b><br><br>MARC NORMAN             | <b>Art Unit</b><br><br>3744  |

|   |                 |
|---|-----------------|
| ✓ | <b>Rejected</b> |
| = | <b>Allowed</b>  |

|   |                   |
|---|-------------------|
| - | <b>Cancelled</b>  |
| ÷ | <b>Restricted</b> |

|   |                     |
|---|---------------------|
| N | <b>Non-Elected</b>  |
| I | <b>Interference</b> |

|   |                 |
|---|-----------------|
| A | <b>Appeal</b>   |
| O | <b>Objected</b> |

Claims renumbered in the same order as presented by applicant
  CPA
  T.D.
  R.1.47

| CLAIM |          | DATE       |            |  |  |  |  |  |  |
|-------|----------|------------|------------|--|--|--|--|--|--|
| Final | Original | 02/03/2015 | 06/29/2015 |  |  |  |  |  |  |
|       | 1        | ✓          | =          |  |  |  |  |  |  |
|       | 2        | ✓          | =          |  |  |  |  |  |  |
|       | 3        | ✓          | =          |  |  |  |  |  |  |
|       | 4        | ✓          | =          |  |  |  |  |  |  |
|       | 5        | ✓          | =          |  |  |  |  |  |  |
|       | 6        | ✓          | =          |  |  |  |  |  |  |
|       | 7        | ✓          | =          |  |  |  |  |  |  |
|       | 8        | ✓          | =          |  |  |  |  |  |  |
|       | 9        | ✓          | =          |  |  |  |  |  |  |
|       | 10       | ✓          | =          |  |  |  |  |  |  |
|       | 11       | ✓          | =          |  |  |  |  |  |  |
|       | 12       | ✓          | =          |  |  |  |  |  |  |
|       | 13       | ✓          | =          |  |  |  |  |  |  |
|       | 14       | ✓          | =          |  |  |  |  |  |  |
|       | 15       | ✓          | =          |  |  |  |  |  |  |
|       | 16       | ✓          | =          |  |  |  |  |  |  |
|       | 17       | ✓          | =          |  |  |  |  |  |  |
|       | 18       | ✓          | =          |  |  |  |  |  |  |
|       | 19       | ✓          | =          |  |  |  |  |  |  |
|       | 20       | ✓          | =          |  |  |  |  |  |  |
|       | 21       | ✓          | =          |  |  |  |  |  |  |
|       | 22       | ✓          | =          |  |  |  |  |  |  |
|       | 23       | ✓          | =          |  |  |  |  |  |  |
|       | 24       | ✓          | =          |  |  |  |  |  |  |



|  |  |  |
|--|--|--|
| <b>Search Notes</b><br><br> | <b>Application/Control No.</b><br><br>14082675 | <b>Applicant(s)/Patent Under Reexamination</b><br><br>STEINBERG ET AL. |
|  | <b>Examiner</b><br><br>MARC NORMAN             | <b>Art Unit</b><br><br>3744  |

| CPC- SEARCHED   |         |          |
|---|---------|----------|
| Symbol  | Date    | Examiner |
| F24F 11/0009, 001, 0012, 006; 2011/0009, 001, 0012, 0013, 006, 0061, 0063, 0075 | 2/3/15  | MN       |
| updated above   | 6/29/15 |          |

| CPC COMBINATION SETS - SEARCHED |      |          |
|---------------------------------|------|----------|
| Symbol                          | Date | Examiner |
|                                 |      |          |

| US CLASSIFICATION SEARCHED |               |         |          |
|----------------------------|---------------|---------|----------|
| Class                      | Subclass      | Date    | Examiner |
| 236                        | 1C, 51, 94    | 2/3/15  | MN       |
| 700                        | 276, 278      | 2/3/15  | MN       |
| 62                         | 161, 163      | 2/3/15  | MN       |
|                            | updated above | 6/29/15 |          |

| SEARCH NOTES  |        |          |
|---|--------|----------|
| Search Notes  | Date   | Examiner |
| consulted prosecution history of parent case 12/778,052 | 2/3/15 | MN       |

| INTERFERENCE SEARCH     |  |         |          |
|-------------------------|--|---------|----------|
| US Class/<br>CPC Symbol | US Subclass / CPC Group  | Date    | Examiner |
| F24F                    | 11/0009, 001, 0012, 006; 2011/0009, 001, 0012, 0013, 006, 0061, 0063, 0075 | 6/29/15 | MN       |
| 236                     | 1C, 51, 94   | 6/29/15 | MN       |
| 700                     | 276, 278   | 6/29/15 | MN       |
| 62                      | 161, 163   | 6/29/15 | MN       |

|  |  |
|--|--|
|  |  |
|--|--|

**IN THE UNITED STATES PATENT AND TRADEMARK OFFICE**

|           |   |  |
|-----------|---|--|
| Inventor  | : | Steinberg, et al.  |
| App. No.  | : | 14/082,675   |
| Filed     | : | November 18, 2013  |
| For       | : | SYSTEM, METHOD AND<br>APPARATUS FOR IDENTIFYING<br>MANUAL INPUTS TO AND<br>ADAPTIVE PROGRAMMING OF A<br>THERMOSTAT |
| Examiner  | : | Norman, Marc E.  |
| Art Unit  | : | 3744   |
| Conf. No. | : | 3336   |

**RESPONSE TO OFFICE ACTION DATED MARCH 23, 2015****Mail Stop Amendment**

Commissioner for Patents  
P.O. Box 1450  
Alexandria, VA 22313-1450

Dear Sir:

In response to the Office Action mailed March 23, 2015, Applicants respectfully submit the following amendments and comments.

**Amendments to the Claims** are reflected in the listing of claims which begins on page 2 of this paper.

**Summary of Interview** begins on page 8 of this paper.

**Remarks/Arguments** begin on page 9 of this paper.

### AMENDMENTS TO THE CLAIMS

Please amend Claims 1, 9, and 17 as indicated below.

1. (Currently Amended) A method for detecting manual changes to the setpoint for a thermostatic controller comprising:

providing a thermostatic controller operatively connected to a heating ventilation and air conditioning system, the temperature set point of the heating ventilation and air conditioning system being manually changeable;

accessing stored data comprising a plurality of internal temperature measurements taken within a structure and a plurality of outside temperature measurements;

using the stored data to predict changes in temperature inside the structure in response to at least changes in outside temperatures;

calculating with at least one computer, scheduled programming of the thermostatic controller for one or more times to control the heating ventilation and air conditioning system, the scheduled programming comprising at least a first automated setpoint at a first time;

recording, with the thermostatic controller, actual setpoints of the heating ventilation and air condition system;

communicating the actual setpoints from the one or more thermostatic controllers to the at least one computer;

generating with the at least one computer, a difference value based on comparing at least one of the an actual setpoint-setpoints at the first time for the thermostatic controller to the first automated setpoint for the thermostatic controller;

detecting a manual change to the first automated setpoint by determining whether the at least one of the actual setpoint setpoints and the first automated setpoint are the same or different based on the difference value; and

logging the manual change to a database.

2. (Original) A method as in Claim 1 where the thermostatic controller operates a system for changing the air temperature in a structure.

3. (Original) A method as in Claim 1 where the thermostatic controller operates a heating, ventilation and air conditioning system.

4. (Original) A method as in Claim 1 where the thermostatic controller operates a heating, ventilation and air conditioning system in a single family residence.

5. (Original) A method as in Claim 1 in which the at least one computer communicates with the thermostatic control device.

6. (Original) A method as in Claim 5 in which the at least one computer is not located in the same structure as the thermostatic controller.

7. (Original) A method as in Claim 5 in which the at least one computer sets programming for the thermostatic controller.

8. (Original) A method as in Claim 1 in which the thermostatic controller is programmable.

9. (Currently Amended) A method for incorporating manual changes to the setpoint for a thermostatic controller, the method comprising:

providing a thermostatic controller operatively connected to a heating ventilation and air conditioning system, the temperature set point of the heating ventilation and air conditioning system being manually changeable;

accessing stored data comprising a plurality of internal temperature measurements taken within a structure and a plurality of outside temperature measurements;

using the stored data to predict changes in temperatures inside the structure in response to at least changes in outside temperatures;

calculating scheduled programming of setpoints in the thermostatic controller based on the predicted rate of change, the scheduled programming comprising at least a first automated setpoint at a first time and a second automated setpoint at a second time to control the heating ventilation and air conditioning system;

recording, with the thermostatic controller, actual setpoints of the heating ventilation and air condition system;

communicating the actual setpoints from the thermostatic controller to the at least one computer;

comparing at least one of the actual setpoint-setpoints at the first time for the thermostatic controller to the first automated setpoint for the thermostatic controller;

detecting a manual change to the first automated setpoint by determining whether the at least one of the actual setpoint-setpoints and the first automated setpoint are the same or different; and

changing the operation of the heating ventilation and air conditioning system by changing the second automated setpoint at the second time based on at least one rule for the interpretation of the manual change.

10. (Original) A method as in Claim 9 where the thermostatic controller operates a system for changing the air temperature in a structure.

11. (Original) A method as in Claim 9 where the thermostatic controller operates a heating, ventilation and air conditioning system.

12. (Original) A method as in Claim 9 where the thermostatic controller operates a heating, ventilation and air conditioning system in a single family residence.

13. (Original) A method as in Claim 9 in which at least one computer is in communication with the thermostatic control device.

14. (Original) A method as in Claim 13 in which the at least one computer is not located in the same structure as the thermostatic controller.

15. (Original) A method as in Claim 13 in which the at least one computer sets programming for the thermostatic controller.

16. (Original) A system as in Claim 9 in which the thermostatic controller is programmable.

17. (Currently Amended) An apparatus for detecting manual changes to one or more setpoints for a thermostatic controller, the apparatus comprising:

a programmable communicating thermostat operatively connected to a heating ventilation and air conditioning system, the temperature set point of the heating ventilation and air conditioning system being manually changeable;

at least an electronic storage medium comprising stored data of a plurality of internal temperature measurements taken within a structure and a plurality of outside temperature measurements;

computer hardware configured to communicate with the electronic storage medium and with ~~a~~ the programmable communicating thermostat, the computer hardware configured to use the stored data to predict a rate of change of temperatures inside the structure in response to changes in outside temperatures;

the computer hardware further configured to calculate a scheduled setpoint programming of the programmable communicating thermostat for one or more times to control the heating ventilation and air conditioning system based on the predicted rate of change, the scheduled programming comprising one or more automated setpoints;

wherein the programmable communicating thermostat records actual setpoints of the heating ventilation and air condition system;

wherein the computer hardware is further configured to store in the electronic storage medium, the one or more automated setpoints associated with the scheduled programming for the programmable communicating thermostat;

wherein the programmable communicating thermostat records actual setpoints of the heating ventilation and air condition system;

wherein the computer hardware is further configured to obtain the actual setpoints from the setpoint programming of the programmable communicating thermostat and store the actual setpoints ~~setpoint programming~~ in the electronic storage medium; and

wherein the computer hardware is further configured to compare the one or more automated setpoints associated with the scheduled setpoint programming with at least one of the actual setpoints; and setpoint programming

wherein the computer hardware is further configured to detect a manual change to the one or more automated setpoints by determining whether the at least one of the actual setpoints and the one or more automated setpoints are the same or different based on the difference value.

18. (Original) An apparatus as in claim 17 where the programmable communicating thermostat operates a system for changing the air temperature in a structure.

19. (Original) An apparatus as in claim 17 where the programmable communicating thermostat operates a heating, ventilation and air conditioning system.

20. (Original) An apparatus as in claim 17 where the programmable communicating thermostat operates a heating, ventilation and air conditioning system in a single family residence.

**Application No.: 14/082,675**

**Filing Date: November 18, 2013**

21. (Original) An apparatus as in claim 17 further comprising the programmable communicating thermostat.

22. (Original) An apparatus as in claim 17 in which the computer hardware is not located in the same structure as the programmable communicating thermostat.

23. (Original) An apparatus as in claim 17 in which the computer hardware sets programming for the programmable communicating thermostat.

24. (Original) An apparatus as in claim 17 in which the electronic storage medium comprises one or more databases



**Application No.: 14/082,675**  
**Filing Date: November 18, 2013**

## **SUMMARY OF EXAMINER INTERVIEW**

### Attendees, Date and Type of Interview

Telephone interviews were conducted on June 15, 2015 and June 22, 2015. Both interviews were attended by Examiner Norman, John King and John Steinberg.

### Exhibits and/or Demonstrations

None

### Identification of Claims Discussed

Claim 1 was discussed.

### Identification of Prior Art Discussed

None

### Proposed Clarifications

Please see the amendments to Claim 1 as set forth above.

### Principal Arguments and Other Matters

Applicant discussed with Examiner Norman why the amendments set forth in amended Claim 1 were patentable in light of Section 101.

### Results of Interview

It was Applicant's understanding that the amendments to Claim 1 overcame the Section 101 rejection. Accordingly, Applicant has made similar amendments to Claims 9 and 17.

## **REMARKS**

The March 23, 2015 Office Action was based upon pending Claims 1-24. This Amendment amends Claims 1, 9 and 17. Thus, after entry of this Amendment, Claims 1-24 are pending and presented for further consideration.

### **INTERVIEW**

Applicant would like to thank Examiner Norman for the telephone interviews extended to Applicant's counsel of record, John R. King, on June 15, 2015 and June 22, 2015.

The interviews helped clarify the Section 101 rejection raised in the Office Action. Accordingly, Applicant has endeavored to revise the claims with the Examiner's comments in mind.

### **ISSUES RAISED IN THE OFFICE ACTION**

Claims 1-24 were rejected under obviousness-type double patenting.

In addition, Claims 1-24 were rejected under 35 U.S.C. § 101.

### **REJECTION OF CLAIMS FOR OBVIOUSNESS-TYPE DOUBLE PATENTING**

The Examiner rejected the pending claims under obviousness-type double patenting as being unpatentable over the claims of U.S. Patent No. 8,596,550.

In response, Applicant submits herewith a Terminal Disclaimer in compliance with 37 C.F.R. §1.321(b) and (c). Accordingly, Applicant respectfully requests that the obviousness-type double patenting rejection be withdrawn.

### **REJECTION OF CLAIMS 1-24 UNDER 35 U.S.C. § 101**

In addition, Claims 1-24 were rejected under 35 U.S.C. § 101 because the claimed invention is directed to a judicial exception (i.e., a law of nature, a natural phenomenon, or an abstract idea) without significantly more.

**Application No.: 14/082,675**  
**Filing Date: November 18, 2013**

Claims 1, 9, and 17

As discussed in the interview, Applicant has amended independent Claims 1, 9, and 17 to overcome the Section 101 rejection. Thus, Applicant respectfully requests allowance of amended Claims 1, 9 and 17.

Claims 2-8

Claims 2-8 depend from amended Claim 1 and are believed to be patentable for the same reasons articulated above with respect to amended Claim 1, and because of the additional features recited therein.

Claims 10-18

Claims 10-18 depend from amended Claim 9 and are believed to be patentable for the same reasons articulated above with respect to amended Claim 9, and because of the additional features recited therein.

Claims 18-24

Claims 18-24 depend from amended Claim 17 and are believed to be patentable for the same reasons articulated above with respect to amended Claim 17, and because of the additional features recited therein.

**OTHER APPLICATIONS OF ASSIGNEE**

Applicant wishes to draw the Examiner's attention to the following applications owned by of the present application's assignee:

| <b>Inventors</b> | <b>Appl. No.</b>          | <b>Filing Date</b> | <b>Attorney Docket No.</b> | <b>Title</b>   |
|------------------|---------------------------|--------------------|----------------------------|--|
| Steinberg et al. | 60/963,183<br>Now Expired | 08/03/07           | EFACT.003PR                | System And Method For Using A Network Of Thermostats As Tool To Verify Peak Demand Reduction |
| Steinberg et al. | 60/944,011<br>Now Expired | 09/17/07           | EFACT.005PR                | System And Method For Calculating The Thermal Mass Of A Building                             |

Application No.: 14/082,675

Filing Date: November 18, 2013

| Inventors        | Appl. No.                           | Filing Date | Attorney Docket No. | Title  |
|------------------|-------------------------------------|-------------|---------------------|--|
| Steinberg et al. | 12/183,949<br>Now Pat.<br>7,908,116 | 07/31/08    | EFACT.004A          | System And Method For Using A Network Of Thermostats As Tool To Verify Peak Demand Reduction                       |
| Steinberg et al. | 12/183,990<br>Now Pat.<br>7,908,117 | 07/31/08    | EFACT.003A          | System And Method For Using A Network Of Thermostats As Tool To Verify Peak Demand Reduction                       |
| Steinberg et al. | 12/211,690<br>Now Pat.<br>8,019,567 | 09/16/08    | EFACT.006A          | System And Method For Evaluating Changes In The Efficiency Of An HVAC System                                       |
| Steinberg et al. | 12/211,733<br>Now Pat.<br>7,848,900 | 09/16/08    | EFACT.005A          | System And Method For Calculating The Thermal Mass Of A Building   |
| Steinberg et al. | 61/215,657<br>Now Expired           | 05/08/09    | EFACT.009PR         | System, Method And Apparatus For Just-In-Time Conditioning Using A Thermostat                                      |
| Steinberg        | 61/215,816<br>Now Expired           | 05/11/09    | EFACT.008PR         | System, Method And Apparatus For Dynamically Variable Compressor Delay In Thermostat To Reduce Energy Consumption  |
| Steinberg et al. | 61/215,999<br>Now Expired           | 05/12/09    | EFACT.007PR         | System, Method And Apparatus For Identifying Manual Inputs To And Adaptive Programming Of A Thermostat             |
| Cheung et al.    | 12/498,142<br>Now Pat.<br>8,010,237 | 07/06/09    | EFACT.010A          | System And Method For Using Ramped Setpoint Temperature Variation With Networked Thermostats To Improve Efficiency |
| Steinberg        | 12/502,064<br>Now Pat.<br>8,180,492 | 07/13/09    | EFACT.011A          | System And Method For Using A Networked Electronic Device As An Occupancy Sensor For An Energy Management System   |
| Steinberg et al. | 12/773,690<br>Now Pat.<br>8,498,753 | 05/04/10    | EFACT.009A          | System, Method And Apparatus For Just-In-Time Conditioning Using A Thermostat                                      |
| Steinberg        | 12/774,580<br>Now Pat.<br>8,740,100 | 05/05/10    | EFACT.008A          | System, Method And Apparatus For Dynamically Variable Compressor Delay In Thermostat To Reduce Energy Consumption  |
| Steinberg et al. | 12/778,052<br>Now Pat.<br>8,596,550 | 05/11/10    | EFACT.007A          | System, Method And Apparatus For Identifying Manual Inputs To And Adaptive Programming Of A Thermostat             |

Application No.: 14/082,675

Filing Date: November 18, 2013

| Inventors        | Appl. No.                               | Filing Date | Attorney Docket No. | Title  |
|------------------|---|-------------|---------------------|--|
| Steinberg        | 12/788,246<br>Now Pat.<br>8,556,188     | 05/26/10    | EFACT.012A          | System And Method For Using A Mobile Electronic Device To Optimize An Energy Management System                     |
| Steinberg        | 12/860,821<br>Now Pat.<br>8,090,477     | 08/20/10    | EFACT.013A          | System And Method For Optimizing Use Of Plug-In Air Conditioners And Portable Heaters                              |
| Steinberg et al. | 12/959,225<br>Now Pat.<br>8,131,497     | 12/02/10    | EFACT.005C1         | System And Method For Calculating The Thermal Mass Of A Building   |
| Steinberg et al. | 13/037,162<br>Now Pat.<br>8,131,506     | 02/28/11    | EFACT.004C1         | System And Method For Using A Network Of Thermostats As Tool To Verify Peak Demand Reduction                       |
| Cheung et al.    | 13/219,381<br>Published<br>2011/0307103 | 08/26/11    | EFACT.010C1         | System And Method For Using Ramped Setpoint Temperature Variation With Networked Thermostats To Improve Efficiency |
| Steinberg et al. | 13/230,610<br>Now Pat.<br>8,423,322     | 09/12/11    | EFACT.006C1         | System And Method For Evaluating Changes In The Efficiency Of An HVAC System                                       |
| Steinberg        | 13/329,117<br>Now Pat.<br>8,340,826     | 12/16/11    | EFACT.013C1         | System And Method For Optimizing Use Of Plug-In Air Conditioners And Portable Heaters                              |
| Steinberg et al. | 13/409,697<br>Now Pat.<br>8,412,488     | 03/01/12    | EFACT.004C2         | System And Method For Using A Network Of Thermostats As Tool To Verify Peak Demand Reduction                       |
| Steinberg et al. | 13/409,729<br>Now Pat.<br>8,886,488     | 03/01/12    | EFACT.005C2         | System And Method For Calculating The Thermal Mass Of A Building   |
| Steinberg        | 13/470,074<br>Published<br>2012/0221151 | 05/11/12    | EFACT.011C1         | System And Method For Using A Wireless Device As A Sensor For An Energy Management System                          |
| Hublou et al.    | 13/523,697<br>Published<br>2013/0338837 | 06/14/12    | EFACT.014A          | System And Method For Optimizing Use Of Individual Hvac Units In Multi-Unit Chiller-Based Systems                  |
| Steinberg        | 13/725,447<br>Now Pat.<br>8,712,590     | 12/21/12    | EFACT.013C2         | System And Method For Optimizing Use Of Plug-In Air Conditioners And Portable Heaters                              |

Application No.: 14/082,675

Filing Date: November 18, 2013

| Inventors        | Appl. No.                               | Filing Date | Attorney Docket No. | Title   |
|------------------|---|-------------|---------------------|---|
| Steinberg et al. | 13/852,577<br>Now Pat.<br>8,738,327     | 03/28/13    | EFACT.004C3         | System And Method For Using A Network Of Thermostats As Tool To Verify Peak Demand Reduction                      |
| Steinberg et al. | 13/858,710<br>Now Pat.<br>8,751,186     | 04/08/13    | EFACT.005C3         | System And Method For Calculating The Thermal Mass Of A Building  |
| Steinberg et al. | 13/861,189<br>Published<br>2013/0226502 | 04/11/13    | EFACT.006C2         | System And Method For Evaluating Changes In The Efficiency Of An HVAC System                                      |
| Steinberg et al. | 13/952,253<br>Published<br>2013/0310989 | 07/26/13    | EFACT.009C1         | System, Method And Apparatus For Just-In-Time Conditioning Using A Thermostat                                     |
| Steinberg        | 14/048,932<br>Now Pat.<br>8,840,033     | 10/08/13    | EFACT.012C1         | System And Method For Using A Mobile Electronic Device To Optimize An Energy Management System                    |
| Steinberg et al. | 14/082,675<br>Published<br>2014/0188290 | 11/18/13    | EFACT.007C1         | System, Method And Apparatus For Identifying Manual Inputs To And Adaptive Programming Of A Thermostat            |
| Steinberg        | 14/263,762<br>Published<br>2014/0229018 | 04/28/14    | EFACT.013C3         | System And Method For Optimizing Use Of Plug-In Air Conditioners And Portable Heaters                             |
| Steinberg et al. | 14/285,384<br>Published<br>2015/0043615 | 05/22/14    | EFACT.004C4         | System And Method For Using A Network Of Thermostats As Tool To Verify Peak Demand Reduction                      |
| Steinberg        | 14/292,377<br>Published<br>2015/0021405 | 05/30/14    | EFACT.008C1         | System, Method And Apparatus For Dynamically Variable Compressor Delay In Thermostat To Reduce Energy Consumption |
| Steinberg        | 14/491,554                              | 09/19/14    | EFACT.012C2         | System And Method For Using A Mobile Electronic Device To Optimize An Energy Management System                    |
| Steinberg et al. | 14/527,433<br>Published<br>2015/0120235 | 10/29/14    | EFACT.005C4         | System And Method For Calculating The Thermal Mass Of A Building  |
| Steinberg et al. | 14/731,221                              | 06/04/15    | EFACT.006C3         | System And Method For Evaluating Changes In The Efficiency Of An HVAC System                                      |

**Application No.: 14/082,675**  
**Filing Date: November 18, 2013**

Applicant notes that cited references, office actions, responses and notices of allowance currently exist or will exist for the above-referenced matters. Applicant also understands that the Examiner has access to sophisticated online Patent Office computing systems that provide ready access to the full file histories of these matters including, for example, specifications, drawings, pending claims, cited art, office actions, responses, declarations, and notices of allowance.

Rather than submit copies these file histories, Applicant respectfully requests that the Examiner continue to review these file histories online for past, current, and future information about these matters. Also, if the Examiner cannot readily access these file histories, the Applicant would be pleased to provide any portion of any of the file histories at any time upon specific Examiner request.

#### **SUPPLEMENTAL INFORMATION DISCLOSURE STATEMENT**

Submitted concurrently herewith is a Supplemental Information Disclosure Statement citing references for consideration. Applicant respectfully requests the Examiner to consider the pending claims in connection with these references in order to make the references of record.

#### **NO DISCLAIMERS OR DISAVOWALS**

Although the present communication may include alterations to the application or claims, or characterizations of claim scope or referenced art, Applicant is not conceding in this application that previously pending claims are not patentable over the cited references. Rather, any alterations or characterizations are being made to facilitate expeditious prosecution of this application.

Applicant reserves the right to pursue at a later date any previously pending or other broader or narrower claims that capture any subject matter supported by the present disclosure, including subject matter found to be specifically disclaimed herein or by any prior prosecution.

**Application No.: 14/082,675**  
**Filing Date: November 18, 2013**

Accordingly, reviewers of this or any parent, child or related prosecution history shall not reasonably infer that Applicant has made any disclaimers or disavowals of any subject matter supported by the present application.

**CONCLUSION**

Applicants have endeavored to address all of the Examiner's concerns as expressed in the outstanding Office Action. In light of the above remarks, reconsideration and withdrawal of the outstanding rejections is specifically requested.

Please charge any additional fees, including any fees for additional extension of time, or credit overpayment to Deposit Account No. 11-1410.

Respectfully submitted,

KNOBBE, MARTENS, OLSON & BEAR, LLP

Dated: June 23, 2015

By: John R. King  
John R. King  
Registration No. 34,362  
Attorney of Record  
Customer No. 20,995  
(949) 760-0404

20430575:ad  
062315



**INFORMATION DISCLOSURE STATEMENT**

Inventor : John Douglas Steinberg  
App. No. : 14/082,675  
Filed : November 18, 2013  
For : SYSTEM, METHOD AND  
APPARATUS FOR IDENTIFYING  
MANUAL INPUTS TO AND  
ADAPTIVE PROGRAMMING OF A  
THERMOSTAT  
Examiner : Norman, Marc E.  
Art Unit : 3744  
Conf. No. : 3336

Mail Stop Amendment  
Commissioner for Patents  
P.O. Box 1450  
Alexandria, VA 22313-1450

**References and Listing**

Pursuant to 37 CFR 1.56, an Information Disclosure Statement listing references is provided herewith. Copies of any listed foreign and non-patent literature references are being submitted.

**No Disclaimers**

To the extent that anything in the Information Disclosure Statement or the listed references could be construed as a disclaimer of any subject matter supported by the present application, Applicant hereby rescinds and retracts such disclaimer.

**Timing of Disclosure**

This Information Disclosure Statement is being filed after receipt of a First Office Action, but before the mailing date of a Final Action and before the mailing date of a Notice of Allowance. This Statement is accompanied by the fees set forth in 37 CFR 1.17(p).

**Application No.: 14/082675**  
**Filing Date: November 18, 2013**

The Commissioner is hereby authorized to charge any additional fees which may be required or to credit any overpayment to Account No. 11-1410.

Respectfully submitted,  
KNOBBE, MARTENS, OLSON & BEAR, LLP

Dated: June 23, 2015

By: John R. King  
John R. King  
Registration No. 34,362  
Attorney of Record  
Customer No. 20995  
(949) 760-0404

20995755.ad  
061215

INFORMATION DISCLOSURE  
STATEMENT BY APPLICANT

(Multiple sheets used when necessary)

SHEET 1 OF 3

|                      |                        |
|----------------------|------------------------|
| Application No.      | 14/082675              |
| Filing Date          | November 18, 2013      |
| First Named Inventor | John Douglas Steinberg |
| Art Unit             | 3744                   |
| Examiner             | Norman, Marc E.        |
| Attorney Docket No.  | EFACT.007C1            |

U.S. PATENT DOCUMENTS

| Examiner Initials | Cite No. | Document Number<br>Number - Kind Code (if known)<br>Example: 1,234,567 B1 | Publication Date<br>MM-DD-YYYY | Name              | Pages, Columns, Lines Where<br>Relevant Passages or<br>Relevant Figures Appear |
|-------------------|----------|---|--------------------------------|-------------------|--|
|                   | 1        | 12/805705   | 06/10/2010                     | Crabtree          |  |
|                   | 2        | 13/470074   | 08/30/2012                     | Steinberg         |  |
|                   | 3        | 13/523697   | 06/14/2012                     | Hublou et al.     |  |
|                   | 4        | 13/725447   | 06/06/2013                     | Steinberg         |  |
|                   | 5        | 13/729401   | 12/28/2012                     | Sloop             |  |
|                   | 6        | 13/852577   | 03/28/2013                     | Steinberg et al.  |  |
|                   | 7        | 13/858710   | 09/05/2013                     | Steinberg et al.  |  |
|                   | 8        | 14/082,675<br>(EFACT.007C1)   | 11/18/2003                     | Steinberg et al.  |  |
|                   | 9        | 14/263,762  | 04/28/2014                     | Steinberg         |  |
|                   | 10       | 14/285,384  | 05/22/2014                     | Steinberg, et al. |  |
|                   | 11       | 14/292,377  | 05/30/2014                     | Steinberg         |  |
|                   | 12       | 14/491,554  | 09/19/2014                     | Steinberg         |  |
|                   | 13       | 14/527,433  | 10/29/2014                     | Steinberg, et al. |  |
|                   | 14       | 14/731,2210   | 06/04/2015                     | Steinberg, et al. |  |
|                   | 15       | D 646,990   | 10/18/2011                     | Rhodes            |  |
|                   | 16       | D 659,560   | 05/15/2012                     | Rhodes            |  |
|                   | 17       | D 673,467   | 01/01/2013                     | Lee et al.        |  |
|                   | 18       | D 705,095<br>(EFACT.015DA)  | 05/20/2014                     | Steinberg et al.  |  |
|                   | 19       | 5,124,502   | 06/23/1992                     | Nelson et al.     |  |
|                   | 20       | 5,348,078   | 09/20/1994                     | Dushane et al.    |  |
|                   | 21       | 5,725,148   | 03/10/1998                     | Hartman           |  |
|                   | 22       | 5,729,474   | 03/17/1998                     | Hildebrand et al. |  |
|                   | 23       | 6,079,626   | 06/27/2000                     | Hartman           |  |
|                   | 24       | 6,241,156   | 06/05/2001                     | Kline et al.      |  |
|                   | 25       | 6,644,098   | 11/11/2003                     | Cardinale et al.  |  |
|                   | 26       | 6,700,224   | 03/02/2004                     | Biskup, Sr.,      |  |
|                   | 27       | 6,786,421   | 09/07/2004                     | Rosen             |  |
|                   | 28       | 7,206,670   | 04/17/2007                     | Pimputkar, et al. |  |

Examiner Signature

Date Considered

\*Examiner: Initial if reference considered, whether or not citation is in conformance with MPEP 609. Draw line through citation if not in conformance and not considered. Include copy of this form with next communication to applicant.

T<sup>1</sup> - Place a check mark in this area when an English language Translation is attached.

**INFORMATION DISCLOSURE  
STATEMENT BY APPLICANT**

(Multiple sheets used when necessary)

SHEET 2 OF 3

|                      |                        |
|----------------------|------------------------|
| Application No.      | 14/082675              |
| Filing Date          | November 18, 2013      |
| First Named Inventor | John Douglas Steinberg |
| Art Unit             | 3744                   |
| Examiner             | Norman, Marc E.        |
| Attorney Docket No.  | EFACT.007C1            |

**U.S. PATENT DOCUMENTS**

| Examiner Initials | Cite No. | Document Number<br>Number - Kind Code (if known)<br>Example: 1,234,567 B1 | Publication Date<br>MM-DD-YYYY | Name              | Pages, Columns, Lines Where Relevant Passages or Relevant Figures Appear |
|-------------------|----------|---|--------------------------------|-------------------|--|
|                   | 29       | 7,476,020   | 01/13/2009                     | Zufferey et al.   |  |
|                   | 30       | 7,702,424   | 04/20/2010                     | Cannon et al.     |  |
|                   | 31       | 7,758,729   | 07/20/2010                     | DeWhitt           |  |
|                   | 32       | 7,869,904   | 01/11/2011                     | Cannon et al.     |  |
|                   | 33       | 8,498,753<br>{EFACT.009A}   | 07/30/2013                     | Steinberg et al.  |  |
|                   | 34       | 8,556,188<br>{EFACT.012A}   | 10/15/2013                     | Steinberg         |  |
|                   | 35       | 8,596,550<br>{EFACT.007A}   | 12/03/2013                     | Steinberg et al.  |  |
|                   | 36       | 8,712,590<br>{EFACT.013C2}  | 04/29/2014                     | Steinberg         |  |
|                   | 37       | 8,738,327<br>{EFACT.004C3}  | 05/27/2014                     | Steinberg, et al. |  |
|                   | 38       | 8,740,100<br>{EFACT.008A}   | 06/03/2014                     | Steinberg         |  |
|                   | 39       | 8,751,186<br>{EFACT.005C3}  | 06/10/2014                     | Steinberg, et al. |  |
|                   | 40       | 8,840,033<br>{EFACT.012C1}  | 09/23/2014                     | Steinberg         |  |
|                   | 41       | 8,886,488<br>{EFACT.005C2}  | 11/11/2014                     | Steinberg, et al. |  |
|                   | 42       | 2011/0253796  | 10/20/2011                     | Posa et al.       |  |
|                   | 43       | 2013/0226502<br>EFACT.006C2   | 08/29/2013                     | Steinberg, et al. |  |
|                   | 44       | 2013/0310989<br>{EFACT.009C1}   | 11/21/2013                     | Steinberg et al.  |  |
|                   | 45       | 2014/0039690<br>{EFACT.012C1}   | 02/06/2014                     | Steinberg         |  |
|                   | 46       | 2014/0229018<br>{EFACT.013C3}   | 08/20/2014                     | Steinberg         |  |
|                   | 47       | 2015/0021405<br>{EFACT.008C1}   | 01/22/2015                     | Steinberg         |  |
|                   | 48       | 2015/0043615<br>{EFACT.004C4}   | 02/12/2015                     | Steinberg et al.  |  |
|                   | 49       | 2015/0120235<br>{EFACT.005C4}   | 04/30/2015                     | Steinberg et al.  |  |

**FOREIGN PATENT DOCUMENTS**

| Examiner Initials | Cite No. | Foreign Patent Document<br>Country Code-Number-Kind<br>Code<br>Example: JP 1234567 A1 | Publication Date<br>MM-DD-YYYY | Name | Pages, Columns, Lines Where Relevant Passages or Relevant Figures Appear | T <sup>1</sup> |
|-------------------|----------|---|--------------------------------|------|--|----------------|
|-------------------|----------|---|--------------------------------|------|--|----------------|

|                    |                 |
|--------------------|-----------------|
| Examiner Signature | Date Considered |
|--------------------|-----------------|

\***Examiner:** Initial if reference considered, whether or not citation is in conformance with MPEP 609. Draw line through citation if not in conformance and not considered. Include copy of this form with next communication to applicant.

T<sup>1</sup> - Place a check mark in this area when an English language Translation is attached.

|  |                      |                        |
|--|----------------------|------------------------|
| <b>INFORMATION DISCLOSURE<br/>STATEMENT BY APPLICANT</b><br><br><i>(Multiple sheets used when necessary)</i> | Application No.      | 14/082675              |
|  | Filing Date          | November 18, 2013      |
|  | First Named Inventor | John Douglas Steinberg |
|  | Art Unit             | 3744                   |
| SHEET 3 OF 3   | Examiner             | Norman, Marc E.        |
|  | Attorney Docket No.  | EFACT.007C1            |

#### FOREIGN PATENT DOCUMENTS

| Examiner Initials | Cite No. | Foreign Patent Document<br>Country Code-Number-Kind<br>Code<br>Example: JP 1234567 A1 | Publication Date<br>MM-DD-YYYY | Name                              | Pages, Columns, Lines<br>Where Relevant Passages<br>or Relevant Figures<br>Appear | T <sup>1</sup> |
|-------------------|----------|---|--------------------------------|-----------------------------------|---|----------------|
|                   | 50       | JP 05-189659  | 07/30/1993                     | Hitachi Bill Shisetsu Eng.<br>KK. |   |                |
|                   | 51       | JP 2010-038377  | 02/18/2010                     | Mitsubishi Heavy Ind. Ltd.        |   |                |
|                   | 52       | JP 2010-286218  | 12/24/2010                     | Mitsubishi Heavy Ind. Ltd.        |   |                |
|                   | 53       | KR 10-1999-0070368  | 09/15/1999                     | Samsung Electronics Co.<br>Ltd.   |   |                |
|                   | 54       | WO 2011/149600<br>(EFACT.012WO)   | 12/01/2011                     | EcoFactor, Inc.                   |   |                |
|                   | 55       | WO 2012/024534<br>(EFACT.013WO)   | 02/23/2012                     | EcoFactor, Inc.                   |   |                |
|                   | 56       | WO 2013/187996  | 12/19/2013                     | EcoFactor, Inc.                   |   |                |

#### NON PATENT LITERATURE DOCUMENTS

| Examiner Initials | Cite No. | Include name of the author (in CAPITAL LETTERS), title of the article (when appropriate), title of the item (book, magazine, journal, serial, symposium, catalog, etc.), date, page(s), volume-issue number(s), publisher, city and/or country where published. | T <sup>1</sup> |
|-------------------|----------|---|----------------|
|                   | 57       | International Search Report and Written Opinion for PCT/US2013/035726 (EFACT.014WO), dated 8/6/13.  |                |
|                   | 58       | International Preliminary Report on Patentability in PCT/US2013/035726 dated 12/16/2014 (EFACT.014WO).  |                |

20900442:ad  
061215

|   |                 |
|---|-----------------|
| Examiner Signature  | Date Considered |
| <p><b>*Examiner:</b> Initial if reference considered, whether or not citation is in conformance with MPEP 609. Draw line through citation if not in conformance and not considered. Include copy of this form with next communication to applicant.</p> |                 |

T<sup>1</sup> - Place a check mark in this area when an English language translation is attached.



Espacenet

Bibliographic data: JPH05189659 (A) — 1993-07-30

## METHOD AND DEVICE FOR CALCULATING RATE OF CENTRAL AIR-CONDITIONING DEVICE

No documents available for this priority number.

**Inventor(s):** SEKIGUCHI KYOICHI; KABETA AKIRA ± (SEKIGUCHI KYOICHI, ; KABETA AKIRA)

**Applicant(s):** HITACHI BILL SHISETSU ENG KK ± (HITACHI BILL SHISETSU ENG KK)

**Classification:** - international: *F24F5/00; G07F15/08*; (IPC1-7): F24F5/00; G07F15/08  
- cooperative:

**Application number:** JP19920003090 19920110

**Priority number (s):** JP19920003090 19920110

**Also published as:** JPH071511 (B2)

Abstract of JPH05189659 (A)

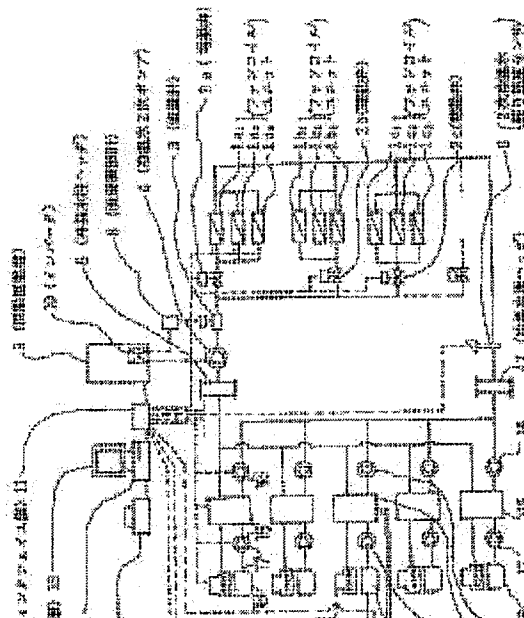

PURPOSE: To provide automatic rate calculating method and device capable of optionally operating individual load side apparatuses (e.g. fan coil units) by improving a central air-conditioning equipment utilizing an absorption type water cooling/heating machine having inexpensive energy cost. CONSTITUTION:; Plural fan coil units (1aa to 1a3) having the same or similar load pattern (a load rate and a load time band) are operated as one piping system and monitored and controlled by a computer 12 through a motor-operated valve 2a, the working electric energy, gas flow rate and consumed amount of water of respective apparatuses constituting the air-conditioning equipment are detected and inputted to the computer, running cost is calculated and the quantity of energy used by respective load side apparatuses is calculated, and the running cost is proportionally distributed in accordance with the quantity of used energy.

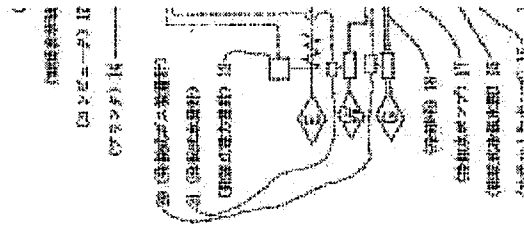

Last updated: 09.10.2013 Worldwide Database 5.8.11.5; 93p

(19)日本国特許庁 (JP)

(12) 公開特許公報 (A)

(11)特許出願公開番号

特開平5-189659

(43)公開日 平成5年(1993)7月30日

| (51)Int.Cl. <sup>5</sup> | 識別記号    | 庁内整理番号  | F I | 技術表示箇所 |
|--------------------------|---------|---------|-----|--------|
| G 0 7 F 15/08            | 1 0 2   | 9028-3E |     |        |
| F 2 4 F 5/00             | 1 0 1 Z | 6803-3L |     |        |

審査請求 有 請求項の数3(全 7 頁)

|          |                 |         |   |
|----------|-----------------|---------|---|
| (21)出願番号 | 特願平4-3090       | (71)出願人 | 391048050<br>日立ビル施設エンジニアリング株式会社<br>東京都千代田区神田和泉町1番地          |
| (22)出願日  | 平成4年(1992)1月10日 | (72)発明者 | 関口 恭一<br>東京都足立区中川四丁目16番29号 日立ビル施設エンジニアリング株式会社日立ビルシステム研究センタ内 |
|          |                 | (72)発明者 | 壁田 昭<br>東京都千代田区神田和泉町1番地 日立ビル施設エンジニアリング株式会社内                 |
|          |                 | (74)代理人 | 弁理士 秋本 正実   |

(54)【発明の名称】 セントラル冷暖房装置の料金算出方法および同料金算出装置

(57)【要約】

【目的】 エネルギーコストの安い吸収式冷温水機を用いたセントラル冷暖房設備を改良して、個々の負荷側機器(例えばファンコイルユニット)を任意に操作し得る、自動的料金計算方法、および同装置を提供する。

【構成】 負荷パターン(負荷率および負荷時間帯)が同様なし類似のファンコイルユニット(1a<sub>1</sub>, 1a<sub>2</sub>, 1a<sub>3</sub>)を一つの配管系とし、電動弁2aを介してコンピュータ12によって監視、制御するとともに、冷暖房設備を構成している各機器の使用電力量、ガス流量、水道水量を検出して上記コンピュータに入力してランニングコストを算出し、かつ、各負荷側機器が利用したエネルギー量を算出し、ランニングコストを利用エネルギー量によって比例配分する。

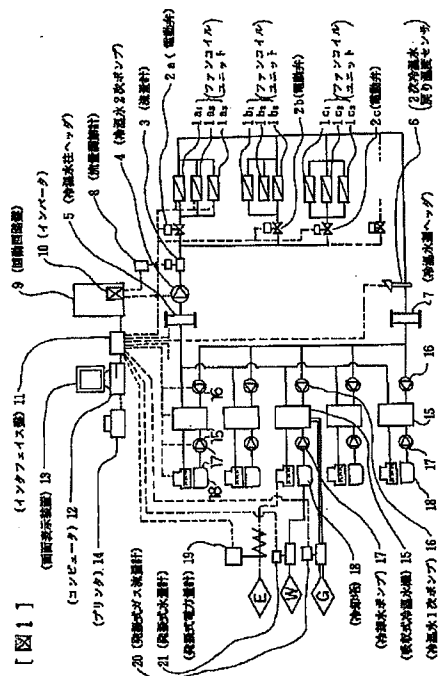



## 【特許請求の範囲】

【請求項1】 グループ毎に区分した多数の負荷側機器をグループ毎に接続した複数の配管系と、上記複数の配管系のそれぞれに設けられた電動弁と、上記多数の負荷側機器に冷温水を供給する複数の吸収式冷温水機およびその補機よりなる機器と、以上に述べた各機器の運転戻り信号を入力されるとともに、該各機器に対して運転指令信号を出力するセントラル冷暖房装置の料金を算定する方法であって、前記の各機器が消費した電力をコンピュータに入力して金額に換算し、同じく、消費した水道水量を前記のコンピュータに入力して金額に換算し、同じく、消費した燃料ガス量を前記のコンピュータに入力して金額に換算し、前記各機器に要した付帯経費を前記のコンピュータに入力し、上記の入力値に基づいて、前記のコンピュータにより当該冷暖房設備のランニングコストを算出し、一方、前記負荷側機器の戻り信号に基づいて、多数の負荷側機器のそれぞれについて利用したエネルギー量を算出し、前記のランニングコストに、要すれば係数を乗じて、多数の負荷側機器それぞれの利用エネルギー量に比例配分することを特徴とする、セントラル冷暖房装置の料金算出方法。

【請求項2】 グループ毎に区分した多数の負荷側機器をグループ毎に接続した複数の配管系と、上記複数の配管系のそれぞれに設けられた電動弁と、上記多数の負荷側機器に冷温水を供給する複数の吸収式冷温水機およびその補機よりなる機器と、以上に述べた各機器の運転戻り信号を入力されるとともに、該各機器に対して運転指令信号を出力するセントラル冷暖房装置の料金を算出する装置であって、上記の各機器が消費する電力を検出する電力量計と、水道水量を検出する水量計と、燃料ガス量を検出するガス流量計とを具備しており、上記電力量計の出力信号と、水量計の出力信号と、ガス流量計の出力信号とを入力されて、電気料金、水道料金およびガス料金を算出する演算機能を有するとともに、多数の負荷側機器のそれぞれについて、利用エネルギー量を算出する演算機能を有し、かつ、料金合計を各負荷側機器の利用エネルギーについて比例配分する演算機能を有するコンピュータを具備していることを特徴とする、セントラル冷暖房装置の料金算出装置。

【請求項3】 前記のコンピュータは、前記多数の負荷側機器のそれぞれについて、その能力を記憶する記憶回路と、その運転時間を算定するタイマ回路とを有しており、上記の能力に運転時間を乗じて負荷側機器ごとに利用エネルギー量を算出するものであることを特徴とする、

請求項2に記載したセントラル冷暖房装置の料金算出装置。

## 【発明の詳細な説明】

## 【0001】

【産業上の利用分野】本発明は、細分化された負荷側機器を備えたセントラル冷暖房装置において、多数の負荷側機器ごとに適正な料金を自動的に算出する方法、および自動的に算出する装置に関するものである。

## 【0002】

【従来の技術】集合住宅やテナントビルなどの空調を行う場合、空調負荷が細分化され、かつそれらの空調負荷の時間帯が雑多であって、監視、制御が困難である。集合住宅においては、居住している多数の家族のそれぞれが独自の生活様式を有しているため空調負荷のパターンが多様であることは避け難い。テナントビルにおいては集合住宅に比してこうした問題が少ないとされてきたが、最近ではテナントビルにおいても空調負荷のパターンが多様化する傾向にある。このように、細分化された空調負荷のそれぞれが多様なパターンを有しているという条件下においては、従来一般に電動式パッケージエアコンを用いた個別空調方式が用いられていて、セントラル冷暖房は適用できないとされていた。その理由は、多様化した空調時間帯や負荷変動に対応して緻密な監視、制御が困難なこと、および、多数の空調負荷のそれぞれについて個別に、適正な料金を算出できないことであった。

## 【0003】

【発明が解決しようとする課題】集合住宅やテナントビルにおける個別空調方式とセントラル冷暖房方式とを比較すると、個別空調方式は一般に設備コストもランニングコストも割高である。また、ビル全体としての受電容量も大きく設定しなければならない。また、個別空調方式ではビルの外壁に多数の屋外機が設置されてビルの美観を損ねるといった問題も有る。セントラル冷暖房方式は経済的に有利であるにも拘らず、使い勝手の面から昨今のビル空調にマッチしないとして敬遠されている。このように、集合住宅の各家庭やテナントビルの各入居者が、多少のコスト高を承知で使い勝手の良いことを求めるのは、現状ではやむを得ないことではあるが、エネルギー資源の節約という社会的な要請に背くものである。特に、エネルギー資源に乏しい我国の産業を考え合わせると、国家的養成に背くものと言っても過言ではない。本発明は上述の事情に鑑みて為されたものであって、集合住宅やテナントビルなどのように負荷が細分化されている冷暖房設備において、集中熱源機として、ランニングコストが安く、ビル全体の受電容量を抑制し得る吸収式冷温水機を用い、かつ、各居住者のそれぞれが負荷側機器を自由に操作することができ、しかも各負荷側機器ごとに適正な料金を自動的に算出し得る方法、および、上記の方法を実施するに好適な算出装置を提供すること

を目的とする。

【0004】

【課題を解決するための手段】上記の目的を達成するために創作した本発明の基本的原理は、多数の空調負荷（例えばファンコイルユニット）を、空調時間帯が類似しているもの毎のグループに区分して配管系を構成し、グループ単位の監視、制御を行うとともに、消費電力料金、ガス料金、水道料金等を合計したランニングコストを、上記多数の空調負荷（例えばファンコイルユニット）毎の利用エネルギー量に比例配分するものである。上述の原理に基づく具体的な手法として本発明に係る方法は、グループ毎に区分した多数の負荷側機器をグループ毎に接続した複数の配管系と、上記複数の配管系のそれぞれに設けられた電動弁と、上記多数の負荷側機器に冷温水を供給する複数の吸収式冷温水機およびその補機よりなる機器と、以上に述べた各機器の運転戻り信号を入力されるとともに、該各機器に対して運転指令信号を出力するセントラル冷暖房装置の料金を算定する方法であって、前記の各機器が消費した電力をコンピュータに入力して金額に換算し、同じく、消費した水道水量を前記のコンピュータに入力して金額に換算し、同じく、消費した燃料ガス量を前記のコンピュータに入力して金額に換算し、前記各機器に要した付帯経費を前記のコンピュータに入力し、上記の入力値に基づいて、前記のコンピュータにより当該冷暖房設備のランニングコストを算出し、一方、前記負荷側機器の戻り信号に基づいて、多数の負荷側機器のそれぞれについて利用したエネルギー量を算出し、前記のランニングコストに、要すれば係数を乗じて、多数の負荷側機器それぞれの利用エネルギー量に比例配分することを特徴とする。

【0005】また、上記の発明方法を実施するために構成した本発明に係る料金の算定装置は、グループ毎に区分した多数の負荷側機器をグループ毎に接続した複数の配管系と、上記複数の配管系のそれぞれに設けられた電動弁と、上記多数の負荷側機器に冷温水を供給する複数の吸収式冷温水機およびその補機よりなる機器と、以上に述べた各機器の運転戻り信号を入力されるとともに、該各機器に対して運転指令信号を出力するセントラル冷暖房装置の料金を算出する装置であって、上記の各機器が消費する電力を検出する電力量計と、水道水量を検出する水量計と、燃料ガス量を検出するガス流量計とを具備しており、上記電力量計の出力信号と、水量計の出力信号と、ガス流量計の出力信号とを入力されて、電気料金、水道料金およびガス料金を算出する演算機能を有するとともに、多数の負荷側機器のそれぞれについて、利用エネルギー量を算出する演算機能を有し、かつ、料金合計を各負荷側機器の利用エネルギーについて比例配分する演算機能を有するコンピュータを具備していることを特徴とする。

【0006】

【作用】上記の算出装置を用いて前記の算出方法を実施すると、電気料金、ガス料金、水道料金などのランニングコストが自動的に集計されるとともに、多数の負荷側機器（例えばファンコイルユニット）毎に利用したエネルギー量が算出され、かつ、前記のランニングコストが上記の利用エネルギー量について比例配分されて、適正な料金が自動的に算出される。

【0007】

【実施例】図1は本発明に係る料金算出装置を備えたセントラル冷暖房設備の1実施例を示す系統図である。吸収式冷温水機の負荷側機器としてのファンコイルユニットは多数配置されている。本発明において多数とは10以上の整数を言うものとする。これら多数のファンコイルユニットを、その使用条件に基づいて同一ないし類似の負荷パターン（すなわち負荷率と負荷時間帯との関係状態）に区分し、同一ないし類似の負荷パターンを有するファンコイルユニット1 a<sub>1</sub>、同1 a<sub>2</sub>、同1 a<sub>3</sub>をグループaとして一つの配管系を形成し、電動弁2 aおよび流量計3を介して可変流量形の冷温水2次ポンプ4の吐出口に接続する。この冷温水2次ポンプ4は冷温水往ヘッダ5から冷温水を供給され、後述のごとく前記流量計3を介して多数の負荷側機器（ファンコイルユニット）に冷温水を圧送して循環させる。負荷側機器を流通した冷温水は2次冷温水戻り温度センサ6を経て冷温水還ヘッダ7に流入する。図示の1 b<sub>1</sub>、1 b<sub>2</sub>、1 b<sub>3</sub>は、相互に負荷パターンの類似するファンコイルユニットであって一つの配管系として接続され、電動弁2 bを介してbグループとして前記流量計3の下流側に分岐接続されている。同様に、負荷パターンの類似するファンコイルユニット1 c<sub>1</sub>、1 c<sub>2</sub>、1 c<sub>3</sub>は、cグループとして電動弁2 cを介して前記流量計3の下流側に分岐接続されている。前記流量計3の出力信号は流量調節計8を介して動力回路盤9のインバータ10に接続され、インタフェイス盤11を介してコンピュータ12に入力される。同様に、前記の電動弁2 a、同2 b、同2 cの開閉指令信号および開閉戻り信号もインタフェイス盤11を介してコンピュータ12に接続されている。上記のコンピュータ12には、前記ファンコイルユニットの能力および冷温水流量、並びに、次に詳述する吸収式冷温水機15の能力を予め入力しておく。本実施例（図1）においては、前記冷温水還ヘッダ7と冷温水往ヘッダ5との間に5基の吸収式冷温水機15が並列に接続されている。これら5基の吸収式冷温水機15のそれぞれは、冷温水1次ポンプ16を備えており、かつ、冷却水ポンプ17を介して冷却塔18に接続されている。そして、これらの機器で消費される電力Eは発振式電力量計19によりインタフェイス盤11を介してコンピュータ12に入力される。また消費されるガスGは発振式ガス流量計20で、消費される水Wは発振式水量計21で、それぞれインタフェイス盤11を介してコンピュータ12

に入力される。これらのデータは、後述の空調エネルギー課金計算、冷温水可変流量制御、および冷温水発生機の運転台数制御に用いられる。前記のコンピュータ12には居住者リスト、各居住者のファンコイルユニットの配分、電気、ガス、水道のエネルギー単価、および料金計算式を入力し、記憶させておく。以上のように構成された装置(図1)において、各居住者が各居住区内に設けられているファンコイルユニットのスイッチ(図示せず)を任意に操作すると、その運転戻り信号をコンピュータ12が検知し、吸収式冷温水機15とその補機に対して運転指令を出力し、電動弁に対しては開指令を出力する。複数基(本例において5機)の吸収式冷温水機15は、負荷総量の大小に応じて必要台数だけ運転する。すなわち、戻り信号を入力されたファンコイルユニットの能力の合計量をその時点における総負荷量とし、この総負荷量に比して必要かつ充分な台数(端数は切り上げて計算して算出する)の吸収式冷温水機15を運転する。その算定方法の1例を次に示す。ファンコイルユニットの総数を200台とし、それぞれのファンコイルユニットの能力を、FCU-1, FCU-2, FCU-3 ……FCU-200と表わすことにする。そして、各ファンコイルユニットの能力が、

|         |     |                |        |
|---------|-----|----------------|--------|
| FCU-1   | ……… | $\alpha_1$     | kcal/h |
| FCU-2   | ……… | $\alpha_2$     | kcal/h |
| FCU-3   | ……… | $\alpha_3$     | kcal/h |
| ………     | ……… |                |        |
| ………     | ……… |                |        |
| ………     | ……… |                |        |
| FCU-200 | ……… | $\alpha_{200}$ | kcal/h |

であり、  
 $\alpha_1 + \alpha_2 + \dots + \alpha_{200} = \alpha t$

とする。一方、吸収式冷温水機15の1基の能力をQ kcal/hとすると、その数は5基であるから、  
 $Q \times 5 = Qt \dots \dots \dots (1)$

ここで、 $\alpha t$ と $Qt$ とは必ずしも同値ではないので、  
 $K = Qt / \alpha t \dots \dots \dots (2)$

という係数Kを設ける。  
 【0008】ここで、FCU-1, FCU-5, FCU-12に戻り信号があったとすると、  
 $\alpha 1 + \alpha 5 + \alpha 12 \dots \dots \dots (3)$

従って、吸収式冷温水機の必要運転台数は、 $K \times (\alpha 1 + \alpha 5 + \alpha 12) / Q$ となり、この値を切り上げた数字を要求運転台数Nとする。

【0009】上記の要求運転台数Nの算出は、各機器が標準条件で定格の能力を発揮するものと仮定して、負荷側機器が必要とするカロリーを熱源機器1基の能力で除したものである。しかし、実際の運転状態においては各機器が定格状態で作動するとは限らず、若干の余裕を以って作動している場合が多い。従って、必ずしも上記の運転台数Nの吸収式冷温水機15を運転しなくても良い

場合がある。例えば外気温が余り高くなく冷房運転を行ったり、外気温が余り低くない時に暖房運転を行う場合は、前記のようにして算出した台数Nを運転しなくても足りる。このような、運転状態における余裕の程度の状態(負荷率)は、2次冷温水戻り温度センサ6によって検出される2次冷温水の戻り温度によって判断し得る。すなわち、定格状態における2次冷温水は冷温水往ヘッダ5から7℃で流出し、冷温水還ヘッダ7に12℃で流入する。この冷温水ヘッダ7に流入する2次冷温水の戻り温度が12℃よりも低ければ運転状態に余裕があり、12℃よりも高ければ余裕が無いことになる。そこで、2次冷温水戻り温度に基づいて算出する必要運転台数N'を、次のように設定する。冷房運転の場合、

| 2次冷温水戻り温度 | 温度による  |
|-----------|--------|
| センサ6の検出値  | 必要運転台数 |
| 9.5℃以下    | N' = 1 |
| 11.0℃以下   | N' = 2 |
| 12.5℃以下   | N' = 3 |
| 14.0℃以下   | N' = 4 |
| 14.0℃以上   | N' = 5 |

(全数運転)

実際の運転においては、前述した要求運転台数Nと、上記の温度による必要運転台数N'とをコンピュータ12が比較演算し、いずれか低い方の値をとって吸収式冷温水機15の運転台数を決定し、運転指令信号を出力して運転の監視・制御を行う。また、前記と同様にして暖房運転の場合は、

| 2次冷温水戻り温度 | 温度による必要 |
|-----------|---------|
| センサ6の検出値  | 運転台数    |
| 56.5℃以上   | N' = 1  |
| 55.0℃以上   | N' = 2  |
| 53.5℃以上   | N' = 3  |
| 52.0℃以上   | N' = 4  |
| 52.0℃以下   | N' = 5  |

(全数運転)

なお、定格運転状態における暖房時の2次冷温水は60℃で流出し、55.5℃で流入する。暖房運転の場合も、前述した冷房運転の場合と同様にNとN'との内ではいずれか小さい方の値をとる。なお、冷、暖房いずれの場合においても、条件の境界付近での頻繁な運転台数の変化を避ける(N台目またはN'台目の吸収式冷温水機15の頻繁な発停動作を防止する)ため、不感時間を設けることが望ましい。また、吸収式冷温水機の運転台数制御については、5基の吸収式冷温水機15およびその付属機器の運転時間累計が平均化するよう、運転の優先順位を変更するローテーション機能を設けることも、公知技術を適用して行い得る。さらに、いずれかの吸収式冷温水機15およびその付属機器が故障した場合は、該故障機をスキップして次の吸収式冷温水機を運転するスキップ動作機能を付加しておくことが望ましい。

【0010】次に、電動弁2a、2bへの開閉制御、および同弁の開閉制御による冷温水の流量制御について説明する。多数（本例において200個）のファンコイルユニット1a<sub>1</sub>、1a<sub>2</sub>、1a<sub>3</sub>、1b<sub>1</sub>、1b<sub>2</sub>への内の何れかが運転されると、この運転を開始したファンコイルユニットの運転戻り信号がコンピュータ12に入力される。該コンピュータ12には、前述のごとく総べてのファンコイルユニットに関する各種の情報が入力されていて、運転戻り信号を受けたファンコイルユニットが属している配管系グループに接続されている電動弁（2a、もしくは2b、又は2cへの内の、いずれか1個以上）のみを開弁させ、他の電動弁は閉じておく。各電動弁の開閉状態が決定されると、冷温水の流量は開状態にある電動弁の必要流量の合計となり、可変流量形の冷温水2次ポンプ4はインバータ10により次に述べるようにして可変流量制御される。すなわち、コンピュータ12は流量調節計8に対して、必要流量に相当する制御用アナログ信号を出力し、又は、ポンプの回転速度-流量特性に基づいてインバータ10に対して必要回転速度に相当する制御用アナログ信号を出力する。また、ファンコイルユニットの運転戻り信号、電動弁の開閉戻り信号、吸収式冷温水機とその補機器の運転状態（運転・停止・故障など）戻り信号はインタフェイス盤11を介して瞬時にコンピュータ12が入力検知できるようになっているので、画面表示装置13によって運転状態を表示することができる。上記の表示は図でなくても表であっても良い。図2は監視画面の1例である。どのような形で運転状態を表示させるかは任意に設定することができる。また、プリンタ14によってプリントアウトしても良い。このようにして冷暖房設備を構成している各種機器の一括監視が可能である。

【0011】上述のようにして運転状態を監視し制御すると同時に、次に述べるようにして冷暖房料金に関する課金算定を自動的に行わせる。各居住者がファンコイルユニットを操作して運転状態にすると、コンピュータ12はその運転戻り信号によってこれを検知し、当該ファンコイルユニットの運転時間タイマをカウントし始める。このタイマは、当該ファンコイルユニットが停止状態になるとカウントを停止する。上記のタイマは、料金決算の決算日に至るまで積算を続け、料金決算日に運転時間にファンコイルユニットの能力を乗じ、当該ファンコイルユニットの利用熱量を算出する。その具体的な方法は次のごとくである。ファンコイルユニットFCU-1の時間当たり熱量を $\alpha_1 \text{ kcal/h}$ とし、その使用時間を $t_1 \text{ h}$ とする。ファンコイルユニットFCU-2の時間当たり熱量を $\alpha_2 \text{ kcal/h}$ とし、その使用時

間を $t_2 \text{ h}$ とする。ファンコイルユニットFCU-3の時間当たり熱量を $\alpha_3 \text{ kcal/h}$ とし、以下同様にしてFCU-4からFCU-199までについて時間当たり熱量と使用時間とを定めて、ファンコイルユニットFCU-200の時間当たり熱量を $\alpha_{200} \text{ kcal/h}$ とし、その使用時間を $t_{200} \text{ h}$ とする。これにより、各ファンコイルユニットの冷暖房利用料金（ランニングコスト原価）は、電気料金+ガス料金+水道料金+付帯経費を、当該ファンコイルユニットの時間当たり熱量×使用時間について比例配分して求められる。すなわち、

（電気料金+ガス料金+水道料金+付帯経費）×（当該ファンコイルユニットの時間当たり熱量×当該ファンコイルユニットの使用時間）÷（ $\alpha_1 t_1 + \alpha_2 t_2 + \alpha_3 t_3 + \dots + \alpha_{200} t_{200}$ ）となる。

居住者が複数のファンコイルユニットを利用している場合は、予めコンピュータ12に入力しておけば、居住者ごとの冷暖房利用料金を自動的に算出してプリンタ14で打ち出すことができる。

【0012】

【発明の効果】以上説明したように、本発明の料金算出装置を用いて本発明の料金算出方法を実施すると、集合住宅やテナントビルなどのように負荷が細分化されているセントラル冷暖房設備において、集中熱源機として、ランニングコストの安い吸収式冷温水機を用い、かつ、居住者のそれぞれが負荷側機器を自由に操作することができ、しかも、自由に操作して運転された多数の負荷側機器のそれぞれが利用したエネルギー量に基づく適正な料金を自動的に算出することができる。

【図面の簡単な説明】

【図1】本発明の1実施例における吸収式冷温水機を用いた冷暖房設備の配管および制御系統図である。

【図2】上記実施例に係る吸収式冷温水機を用いた冷暖房設備における監視画面の平面図である。

【符号の説明】

1a<sub>1</sub>、1a<sub>2</sub>、1a<sub>3</sub>、1b<sub>1</sub>、1b<sub>2</sub>、1b<sub>3</sub>、1c<sub>1</sub>、1c<sub>2</sub>、1c<sub>3</sub>…負荷側機器としてのファンコイルユニット、2a、2b、2c…電動弁、3…流量計、4…冷温水2次ポンプ、5…冷温水往ヘッダ、6…2次冷温水戻り温度センサ、7…冷温水還ヘッダ、8…流量調節計、9…動力回路盤、10…インバータ、11…インタフェイス盤、12…コンピュータ、13…画面表示装置、14…プリンタ、15…吸収式冷温水機、16…冷温水1次ポンプ、17…冷却水ポンプ、18…冷却塔、19…発振式電力量計、20…発振式水量計、21…発振式ガス流量計。

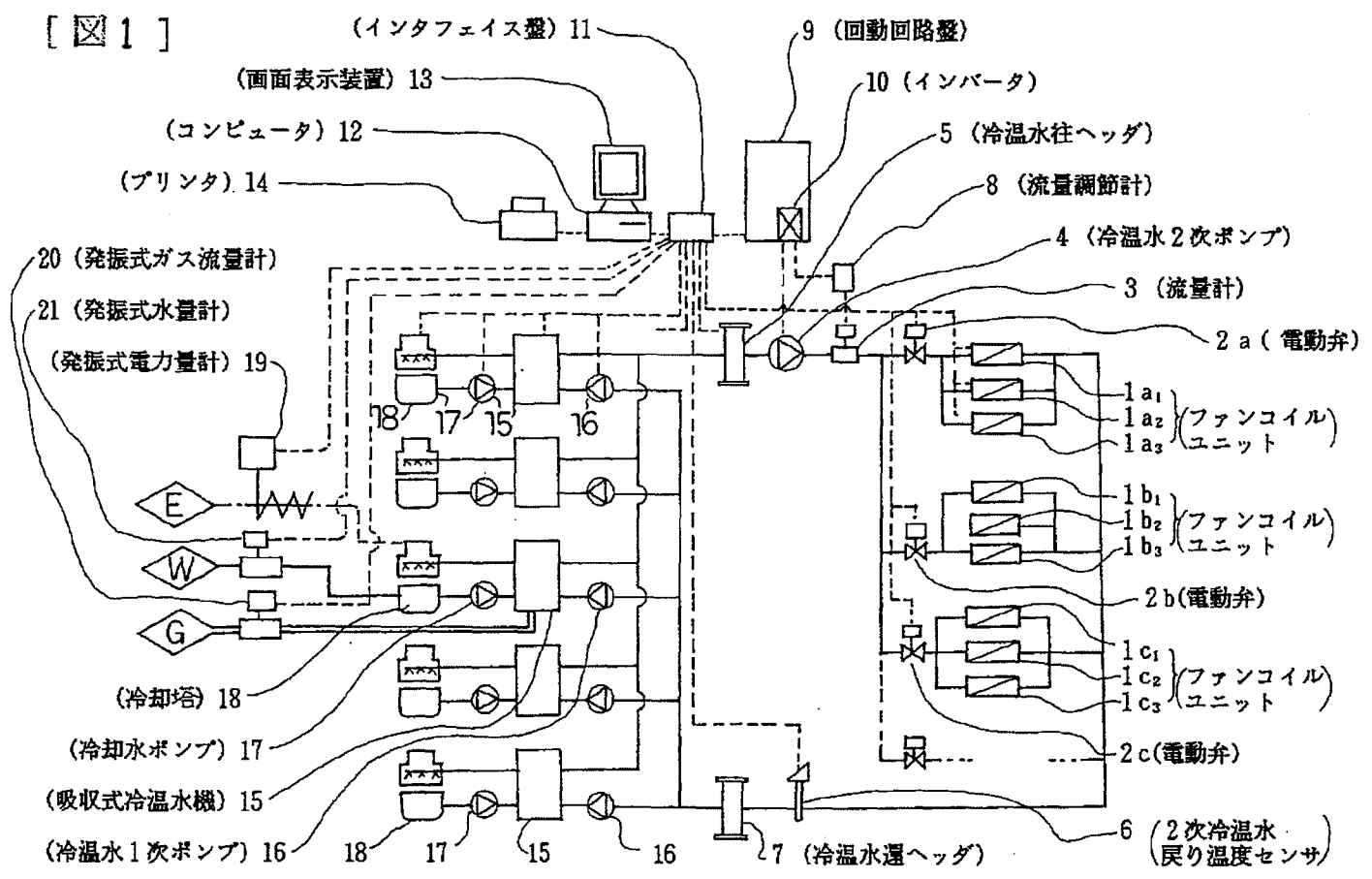

[ 図 1 ]

【 図 1 】

( 6 )

特開平5-189659

運転モード1
運転状態表示
1991-07-15 18:20

自動運転中

停止中

|         |                     |
|---------|---------------------|
| 冷却水入口   | 30.7 ℃              |
| 一次冷温水入口 | 14.5 ℃              |
| 一次冷温水出口 | 8.2 ℃               |
| 二次冷却水往管 | 9.0 ℃               |
| 二次冷却水還管 | 14.8 ℃              |
| 室内温度    | 25.8 ℃              |
| 外気温度    | 31.2 ℃              |
| 外気温度    | 31.2 ℃              |
| ガス      | 220 Nm <sup>3</sup> |
| 電気      | 84 kWh              |

FCU

スケジュール

料金

入居者

請求

印字

終了

[X] 2]

[X] 2]

(7)

特開平5-189659



Espacenet

## Bibliographic data: JP2010038377 (A) — 2010-02-18

## AIR CONDITIONING CHARGE CALCULATING DEVICE

No documents available for this priority number.

**Inventor(s):** HIRAMATSU SEIJI ± (HIRAMATSU SEIJI)

**Applicant(s):** MITSUBISHI HEAVY IND LTD ± (MITSUBISHI HEAVY IND LTD)

**Classification:** - international: **F24F11/02**  
- cooperative:

**Application number:** JP20080198259 20080731

**Priority number(s):** JP20080198259 20080731

## Abstract of JP2010038377 (A)

**PROBLEM TO BE SOLVED:** To calculate an air conditioning charge by a simple process by resolving complications of software. ; **SOLUTION:** The air conditioning charge calculating device is equipped with a timer device 4, and a central control unit 3 acquiring a charge coefficient associated with a signal inputted from the timer device 4, and calculating the air conditioning charge by using the acquired charge coefficient and power consumption information. ; **COPYRIGHT:** (C) 2010,JPO&INPIT

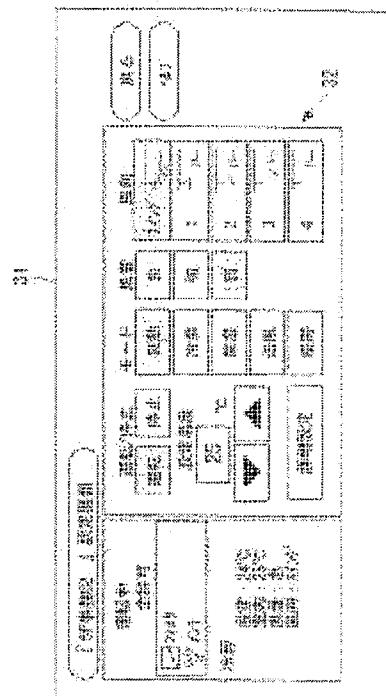

Last updated: 09.10.2013 Worldwide  
Database 5.8.11.5; 93p

(19) 日本国特許庁(JP)

(12) 公開特許公報(A)

(11) 特許出願公開番号

特開2010-38377

(P2010-38377A)

(43) 公開日 平成22年2月18日(2010.2.18)

|                                |                       |             |
|--------------------------------|-----------------------|-------------|
| (51) Int. Cl.                  | F 1                   | テーマコード (参考) |
| <b>F 2 4 F 11/02 (2006.01)</b> | F 2 4 F 11/02 1 0 3 D | 3 L 0 6 0   |
|                                | F 2 4 F 11/02 1 0 2 T | 3 L 0 6 1   |
|                                | F 2 4 F 11/02 Z       |             |

審査請求 未請求 請求項の数 4 O L (全 7 頁)

(21) 出願番号 特願2008-198259 (P2008-198259)  
 (22) 出願日 平成20年7月31日 (2008. 7. 31)

(71) 出願人 000006208  
 三菱重工業株式会社  
 東京都港区港南二丁目16番5号  
 (74) 代理人 100112737  
 弁理士 藤田 考晴  
 (74) 代理人 100118913  
 弁理士 上田 邦生  
 (72) 発明者 平松 誠司  
 愛知県清須市西枇杷島町旭3丁目1番地  
 三菱重工業株式会社冷熱事業本部内  
 Fターム(参考) 3L060 AA08 CC10 CC19 EE22  
 3L061 BA05 BA06

(54) 【発明の名称】 空調料金計算装置

(57) 【要約】

【課題】ソフトウェアの煩雑さを解消でき、簡便な処理で空調使用料金を計算すること。

【解決手段】タイマ装置4と、タイマ装置4から入力された信号に関連付けられている課金係数を取得し、取得した課金係数と電力消費情報とを用いて空調使用料金を計算する中央制御装置3とを備える空調料金計算装置を提供する。

【選択図】 図2

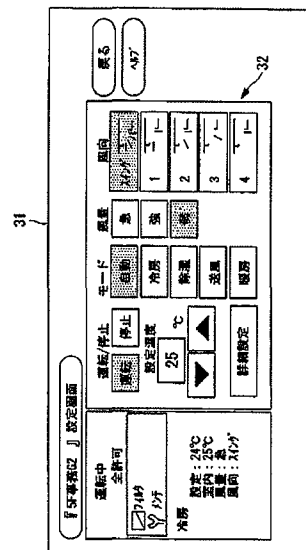



**【特許請求の範囲】****【請求項1】**

空気調和システムの空調料金を計算する空調料金計算装置であって、  
時間帯と出力する信号とが関連付けられたスケジュール情報を有し、該スケジュール情報に基づいて出力信号を切り替えるタイマ手段と、  
該タイマ手段から出力される信号と課金係数とが関連付けられている課金テーブルを有し、該タイマ手段から入力された信号に関連付けられている課金係数を該課金テーブルから取得し、取得した課金係数と電力消費情報とを用いて空調使用料金を計算する料金計算手段と  
を具備する空調料金計算装置。

**【請求項2】**

前記タイマ手段から入力される信号はデジタル信号であり、時間帯に応じてオンオフが切り替えられる請求項1に記載の空調料金計算装置。

**【請求項3】**

前記料金計算手段は、前記室外機及び複数の前記室内機にネットワークを介して接続されるとともに、前記マルチ型空気調和装置の運転スケジュールの管理機能を有する中央制御装置に備えられている請求項1または請求項2に記載の空調料金計算装置。

**【請求項4】**

1台の室外機と複数の室内機とが接続されるマルチ型空気調和装置にネットワークを介して接続されるとともに、該マルチ型空気調和装置の運転スケジュールの管理機能を有する中央制御装置であって、

時間帯に応じて出力する信号を切り替えるタイマ手段と接続され、該タイマ手段から受信した信号に応じた課金情報と電力消費情報とを用いて空調使用料金を計算する中央制御装置。

**【発明の詳細な説明】****【技術分野】****【0001】**

本発明は、1台の室外機に対して、複数台の室内機が接続されるマルチ型空気調和装置に関するものである。

**【背景技術】****【0002】**

1台の室外機に対して複数台の室内機が接続されるマルチ型空気調和装置が知られている。例えば、1台の室外機に対して20台以上の室内機を接続することのできる大型のマルチ型空気調和装置では、複数のテナントにより室内機が使用される場合も少なくない。このような場合、室外機で使用された電気料金については、各室内機の運転時間等で室外機の電気料金を按分し、これに基づいて各テナントの電気料金を決定することが提案されている。

また、特許文献1には、複数の動力を用いて駆動される空調機の料金を計算する方法が開示されている。

【特許文献1】特開2006-125734号公報

**【発明の開示】****【発明が解決しようとする課題】****【0003】**

ところで、近年では、定時と定時外とで電気料金の単価を変えたい、定時の時間帯を曜日毎に変更したい等の様々な要望があり、この要望に応じるために、空調の制御を行う集中制御装置において予め定時と定時外の時間帯を設定し、時間帯に応じて電気料金の単価を変更することが提案されている。

しかしながら、集中コントローラにおいて電気料金の単価の管理及び計算を行おうとすると、ソフトウェアが煩雑になる、処理が煩雑になる、多くのメモリ容量を必要とする等の種々の問題があり結果的に非常にハイグレードで高価な製品でしか実現できなかった。

## 【0004】

本発明は、上記問題を解決するためになされたもので、ソフトウェアの煩雑さを解消でき、簡便な処理で空調使用料金を計算することのできる空調料金計算装置を提供することを目的とする。

## 【課題を解決するための手段】

## 【0005】

上記課題を解決するために、本発明は以下の手段を採用する。

本発明は、空気調和システムの空調料金を計算する空調料金計算装置であって、空気調和装置の空調料金を計算する空調料金計算装置であって、時間帯と出力する信号とが関連付けられたスケジュール情報を有し、該スケジュール情報に基づいて出力信号を切り替えるタイマ手段と、該タイマ手段から出力される信号と課金係数とが関連付けられている課金テーブルを有し、該タイマ手段から入力された信号に関連付けられている課金係数を該課金テーブルから取得し、取得した課金係数と電力消費情報とを用いて空調使用料金を計算する料金計算手段とを具備する空調料金計算装置を提供する。

## 【0006】

上記構成によれば、タイマ手段と料金計算手段とを接続し、タイマ手段から入力される信号に基づいて課金係数を変更することとしたので、料金計算手段においては、煩雑な処理を行うことなく、簡便な処理及び比較的少ないメモリ容量で空調使用料金の計算を行うことが可能となる。

上記空気調和システムとは、少なくとも1台の室外機と少なくとも1台の室内機を有していればよい。

## 【0007】

上記空調料金計算装置において、前記タイマ手段から入力される信号はデジタル信号であり、時間帯に応じてオンオフが切り替えられることとしてもよい。

## 【0008】

このように、デジタル信号によって時間帯の切り替えを通知するので、時間帯を容易に判定することができる。

## 【0009】

上記空調料金計算装置において、前記料金計算手段は、前記室外機及び複数の前記室内機にネットワークを介して接続されるとともに、前記マルチ型空気調和装置の運転スケジュールの管理機能を有する中央制御装置に備えられていることとしてもよい。

## 【0010】

このように、中央制御装置が料金計算手段を備えるので、追加装置を必要とせず、既存の設備を用いて空調使用料金の計算を行うことができる。

## 【0011】

本発明は、1台の室外機と複数の室内機とが接続されるマルチ型空気調和装置にネットワークを介して接続されるとともに、該マルチ型空気調和装置の運転スケジュールの管理機能を有する中央制御装置であって、時間帯に応じて出力する信号を切り替えるタイマ手段と接続され、該タイマ手段から受信した信号に応じた課金情報と電力消費情報とを用いて空調使用料金を計算する中央制御装置を提供する。

## 【発明の効果】

## 【0012】

本発明によれば、ソフトウェアの煩雑さを解消でき、簡便な処理により空調使用料金を計算することができるという効果を奏する。

## 【発明を実施するための最良の形態】

## 【0013】

以下に、本発明に係る空調料金計算装置の一実施形態について、図面を参照して説明する。

図1は、本実施形態に係る空調料金計算装置及び該空調料金計算装置が適用されるマルチ型空気調和装置の概略構成を示したブロック図である。

図1に示されるように、一台の室外機1と、複数の室内機2とを備えるマルチ型空調和装置を複数組備える空調システムに、中央制御装置(センターコンソール)3が接続されている。各室外機1、各室内機2、及び中央制御装置3とは、共通のネットワークを介して接続されている。

図1では、8台の室内機2が設けられている場合を示しているが、室内機2の接続台数については、最大接続台数(例えば、128台)の範囲内で任意に決定することが可能である。

【0014】

中央制御装置3は、図2に示されるように、表示部31及びタッチパネル式の入力部32を備えている。例えば、マルチ型空調和装置が設置されたビルの管理者は、この中央制御装置3の表示部31に表示される情報を確認しながら、タッチパネル式の入力部32を操作することにより、室内機2の運転・運転停止、運転モード、風量、風向等を設定することができるようになっている。また、ビルの管理人は、運転スケジュール、室内機のグループ化等を入力設定することができるようになっている。運転スケジュールは、全ての室内機において共通であってもよいし、グループ毎に設定されていてもよい。

【0015】

また、中央制御装置3は、少なくとも2つの外部入力接点(図示略)を有しており、1つの外部入力接点には図1に示したタイマ装置4が接続され、もう一つの外部入力接点には図1に示した電力量計が接続されており、電力量の計測を実施している。本来、前者のタイマ装置用の外部入力接点は、緊急時に全ての空調機を停止させる緊急停止制御入力用、もしくは電力量が規定値を超えた場合に、電力量を下げる制御を実施するためのデマンド入力用として中央制御装置3に設けられたものであり、本実施形態においては、この外部接点を料金計算のために用いる。つまり、本実施形態では、異なる用途のために予め設けられていた中央制御装置3の外部接点を料金計算のために代用するものである。

【0016】

具体的には、外部接点が開状態から閉状態に変化した場合に、換言すると、入力信号がオフからオンに切り替えられた場合に、特殊制御開始入力と判断していたところ、この外部入力に関するソフトウェアが変更されることにより、外部接点が開状態から閉状態に変化した場合に、後述するように、定時の時間帯から定時外の時間帯に切り替わったと判定するようになっている。

【0017】

タイマ装置4は、時間帯に応じて出力する信号を切り替えるように構成されている。具体的には、タイマ装置4は、時間帯と出力する信号とが関連付けられたスケジュール情報を有しており、このスケジュール情報に基づいて出力信号を切り替える。例えば、タイマ装置4は、図3に示されるように、1日においてオフ信号(第1の信号)を出力する時間帯と、オン信号(第2の信号)を出力する時間帯とが登録されたスケジュール情報を有している。ここでは、定時の時間帯にオフ信号を、定時外の時間帯にオン信号が出力されるようにスケジュールリングされている。

【0018】

図3の例では、スケジュール情報は、平日、土曜日、休祝日の3パターン設けられており、平日は、8時から17時までが定時、土曜日は8時から14時までが定時、休祝日は終日定時外とするスケジュール情報が登録されている。なお、上記オン信号とオフ信号とは逆に設定されていてもよい。

【0019】

また、本実施形態に係る中央制御装置3は、上記タイマ装置4から入力される信号に基づいて、各室内機2の空調使用料金を計算する機能(料金計算手段)を備えている。また、中央制御装置3には、外部入力端子を介してマルチ型空調和装置の電力消費量が入力されるようになっている。

【0020】

具体的には、中央制御装置3は、定時の時間帯に対応する課金係数K1円/kWh及び

定時外の時間帯に対応する課金係数 $K2$ 円/kWhを保有しており、これらの課金係数 $K1$ 、 $K2$ をタイマ4から入力される信号に基づいて選択し、選択した課金係数 $K1$ 、 $K2$ をその時間帯における消費電力量に乘算することで空調使用料金を計算する。

## 【0021】

例えば、中央制御装置3は、CPU（中央演算装置）、ROM（Read Only Memory）、RAM（Random Access Memory）等を備えており、例えば、ROMには、タイマ装置4から入力される信号に基づいて空調使用料金を計算するための処理手順がプログラムの形式で格納されている。このプログラムをCPUがRAM等に読み出して実行することにより、後述する料金計算を実現させる。

## 【0022】

次に、上記構成を示すマルチ型空調和装置における空調料金の計算方法について説明する。

まず、タイマ装置4は、図3に示したスケジュール情報に基づいて、現在の時間帯に応じた信号を中央制御装置4に出力する。これにより、定時の時間帯にはオフ信号が定時外の時間帯にはオン信号が出力される。

## 【0023】

中央制御装置3には、タイマ装置4からの信号に基づいて定時の時間帯か否かを判定し、この判定結果に応じた課金係数を取得する。そして、取得した課金係数を外部入力端子を介して入力されるマルチ型空調和装置の電力消費量に乘算することで、空調使用料金を算出する。

図4(a)乃至(c)は、定時の時間帯と定時外の時間帯とで区分された平日、土曜日、休祝日の消費電力量をそれぞれ示した図である。

## 【0024】

これにより、例えば、平日における定時の時間帯の消費電力が $Ci1$ kWh、定時外の時間帯の消費電力が $Co1$ kWh、土曜日の定時の時間帯の消費電力が $Ci2$ kWh、定時外の時間帯の消費電力が $Co2$ kWh、休祝日の定時外の時間帯の消費電力が $Co3$ kWhとすると、1週間における定時の時間帯の電気料金及び定時外の時間帯の電気料金は、以下のように計算される。

## 【0025】

定時の時間帯における電気料金： $K1 \times (Ci1 + Ci2)$  円

定時外の時間帯における電気料金： $K2 \times (Co1 + Co2 + Co3)$  円

## 【0026】

このようにして、電気料金が求められた後は、例えば、各室内機の使用時間等に応じて電気料金が按分されることで、各室内機の使用料金、更には、各テナントへの請求料金が確定することとなる。

## 【0027】

以上、説明してきたように、本実施形態に係る空調料金計算装置によれば、中央制御装置が有する既存の外部接点にタイマ装置4を接続し、タイマ装置4から入力される開閉信号（オン・オフ信号）に基づいて定時の時間帯か否かを判定することとしたので、中央制御装置において煩雑な処理を行うことなく、簡便な処理及び比較的少ないメモリ容量で空調使用料金の計算を行うことができる。

また、緊急停止等に使用される目的で予め設けられていた外部接点を代用することにより、簡便なソフトウェアの変更を行うだけで、空調使用料金の計算を中央制御装置3において実現させることができる。これにより、設計変更に伴う時間や労力を削減することができる。

## 【0028】

なお、上記実施形態においては、異なる用途を目的として、中央制御装置3に予め設けられていた外部接点を介してタイマ装置4からの信号を入力することとしたが、これに代えて、他の通信ポートや他の通信媒体を介して中央制御装置3とタイマ装置4との間の通信を行うこととしてもよい。また、タイマ装置4の機能を中央制御装置3内に設けること

としてもよい。

【0029】

更に、本実施形態では、定時の時間帯か否かにより課金係数を切り替えることとしていたが、時間帯を細分化し、細分化したそれぞれの時間帯に対応する互いに異なる出力信号をスケジュール情報に登録しておき、また、各時間帯に対応する課金係数を課金テーブルに登録しておくことで、より細かい課金を行うことが可能となる。

上記互いに異なる出力信号としては、例えば、周波数等がそれぞれ異なるデジタル信号を使用することができる。

【0030】

また、本実施形態では、中央制御装置に空調使用料金の計算機能を持たせた場合について説明したが、マルチ型空調和装置に通信媒体を介して接続される装置を新たに設け、この装置に上述した空調使用料金の計算機能を持たせ、料金計算手段として機能させることとしてもよい。

また、本実施形態では、中央制御装置3に電力量計5を接続する場合について述べたが、空調和機がガスヒートポンプの場合には、電力量計5に代えてガス流量計が接続されてもよい。

【図面の簡単な説明】

【0031】

【図1】本発明の一実施形態に係る空調料金計算装置及び該空調料金計算装置が適用されるマルチ型空調和システムの全体構成を示したブロック図である。

【図2】図1に示した中央制御装置の概略構成を示した図である。

【図3】スケジュール情報の一例を示した図である。

【図4】タイマ装置からの信号に基づいて消費電力量を定時と定時外に区分した図である。

【符号の説明】

【0032】

- 1 室外機
- 2 室内機
- 3 中央制御装置
- 4 タイマ装置
- 5 電力量計
- 31 表示部
- 32 入力部

【図1】

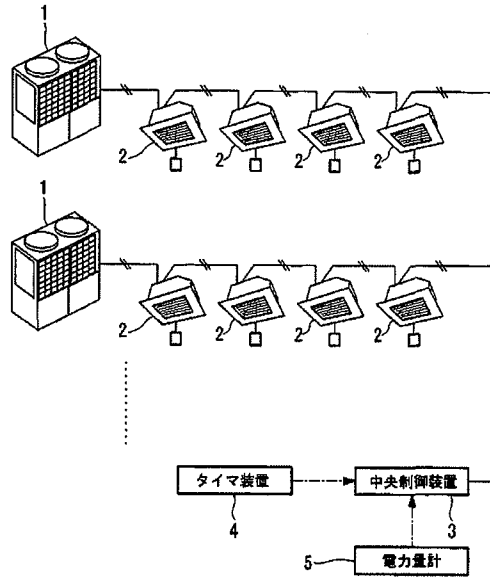

【図2】

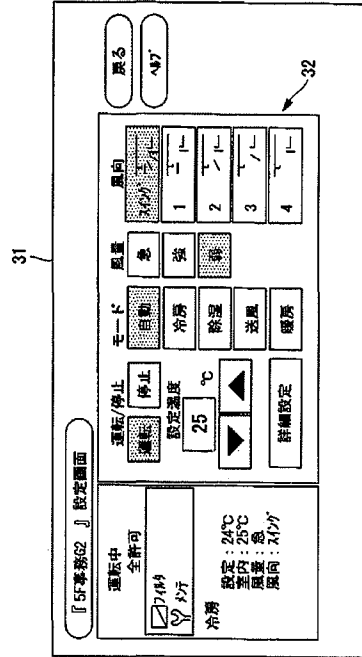

【図3】

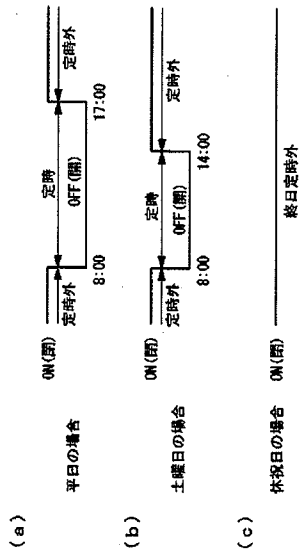

【図4】

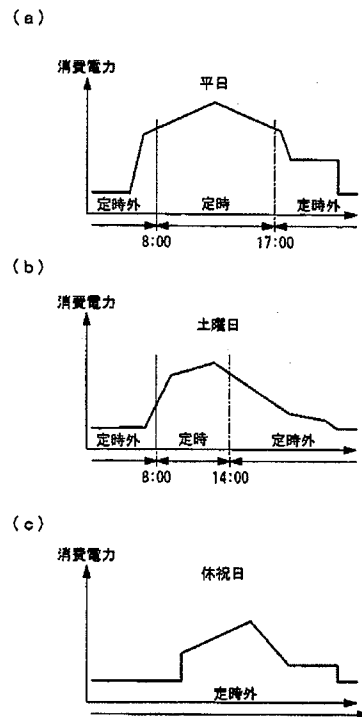

(8)

特開2010-38377(P2010-38377A)



Espacenet

Bibliographic data: JP2010286218 (A) — 2010-12-24

## AIR CONDITIONING RATE CALCULATION DEVICE AND AIR CONDITIONING RATE CALCULATION METHOD

No documents available for this priority number.

Inventor(s): HIRAMATSU SEIJI ± (HIRAMATSU SEIJI)

Applicant(s): MITSUBISHI HEAVY IND LTD ± (MITSUBISHI HEAVY IND LTD)

Classification: - international: F24F11/02  
- cooperative:

Application number: JP20090142184 20090615

Priority number(s): JP20090142184 20090615

Abstract of JP2010286218 (A)

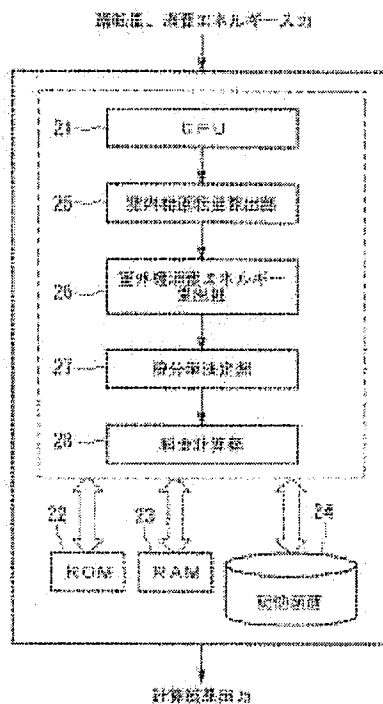



PROBLEM TO BE SOLVED: To perform appropriate proportional rate division with respect to the standby power of an outdoor unit. ; SOLUTION: The air-conditioning-rate calculation device 5 for proportionally dividing the utility rate of an air conditioning system constituted by connecting a plurality of indoor units connected to at least one outdoor unit or including a plurality of refrigerant systems to each of the indoor units or a user of each indoor unit includes: a first calculation means 25 which calculates an operation quantity of each of the plurality of indoor units; a second calculation means 26 which calculates a consumed energy quantity of the outdoor unit; a proportional division rate determination means 27 which determines a proportional division rate of the consumed energy quantity of the outdoor unit based on the operation quantity of each indoor unit; and a rate calculation means 28 which calculates a utility rate of the outdoor unit based on the consumed energy quantity of the outdoor unit and the proportional division rate. ; COPYRIGHT: (C)2011,JPO&INPIT

Last updated: 09.10.2013 Worldwide Database 5.8.11.5; 93p

(19) 日本国特許庁(JP)

(12) 公開特許公報(A)

(11) 特許出願公開番号

特開2010-286218

(P2010-286218A)

(43) 公開日 平成22年12月24日(2010.12.24)

(51) Int. Cl.

F24F 11/02 (2006.01)

F1

F24F 11/02 103D  
F24F 11/02 103C

テーマコード(参考)

3L061

審査請求 未請求 請求項の数 7 OL (全 10 頁)

(21) 出願番号

特願2009-142184 (P2009-142184)

(22) 出願日

平成21年6月15日(2009.6.15)

(71) 出願人 000006208

三菱重工業株式会社  
東京都港区港南二丁目16番5号

(74) 代理人 100112737

弁理士 藤田 考晴

(74) 代理人 100118913

弁理士 上田 邦生

(72) 発明者 平松 誠司

東京都港区港南二丁目16番5号 三菱重工業株式会社内

Fターム(参考) 3L061 BA04 BA05 BF06 BF08

(54) 【発明の名称】 空調料金計算装置及び空調料金計算方法

(57) 【要約】

【課題】 室外機の待機電力について適正な料金按分をすることを目的とする。

【解決手段】 少なくとも一つの室外機に対して複数の室内機を接続して構成される1または複数の冷媒系統を備える空調システムの使用料金を、前記各室内機又は前記各室内機の利用者に按分する空調料金計算装置5であって、複数の室内機の運転量をそれぞれ算出する第1算出手段25と、室外機の消費エネルギー量を算出する第2算出手段26と、各室内機の運転量に基づいて、前記室外機の消費エネルギー量の按分率を決定する按分率決定手段27と、室外機の消費エネルギー量と前記按分率とに基づいて前記室外機の使用料金を計算する料金計算手段28と、を備える。

【選択図】 図2

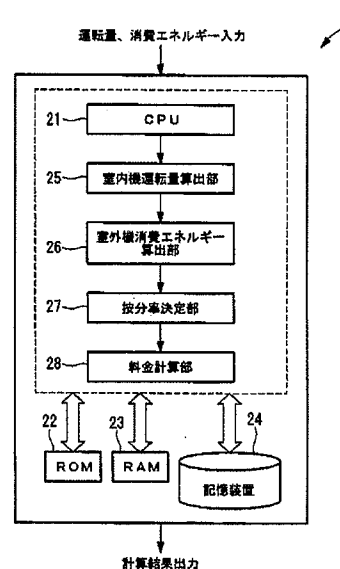

**【特許請求の範囲】****【請求項1】**

少なくとも一つの室外機に対して複数の室内機を接続して構成される1または複数の冷媒システムを備える空調システムの使用料金を、前記各室内機又は前記各室内機の利用者に按分する空調料金計算装置であって、

前記複数の室内機の運転量をそれぞれ算出する第1算出手段と、

前記室外機の消費エネルギー量を算出する第2算出手段と、

前記各室内機の運転量に基づいて、前記室外機の消費エネルギー量の按分率を決定する按分率決定手段と、

前記室外機の消費エネルギー量と前記按分率とに基づいて前記室外機の使用料金を計算する料金計算手段と、

を備えたことを特徴とする空調料金計算装置。

**【請求項2】**

少なくとも一つの室外機に対して複数の室内機を接続して構成される1または複数の冷媒システムを備える空調システムの使用料金を、前記各室内機又は前記各室内機の利用者に按分する空調料金計算装置であって、

前記複数の室内機の運転量をそれぞれ所定期間毎に算出する第1算出手段と、

前記室外機の消費エネルギー量を所定期間毎に算出する第2算出手段と、

前記所定期間毎の各室内機の運転量に基づいて、前記所定期間毎の前記室外機の消費エネルギー量の按分率を決定すると共に、所定期間のうち第1の所定期間の前記各室内機の運転量が零である場合に、所定期間のうち第2の所定期間における前記各室内機の運転量に基づいて、前記第1の所定期間の前記室外機の消費エネルギー量の按分率を決定する按分率決定手段と、

前記室外機の消費エネルギー量と前記按分率とに基づいて前記室外機の所定期間毎の使用料金を計算する料金計算手段と、

を備えたことを特徴とする空調料金計算装置。

**【請求項3】**

前記按分率決定手段は、前記第1の所定期間及び前記第2の所定期間の前記各室内機の運転量が零である場合に、所定期間のうち第3の所定期間における前記各室内機の運転量に基づいて、前記第1の所定期間の前記室外機の消費エネルギー量の按分率を決定することを特徴とする請求項2に記載の空調料金計算装置。

**【請求項4】**

前記所定期間が一日間であり、かつ、前記第2の所定期間が前記第1の所定期間の翌日又は前日であることを特徴とする請求項3に記載の空調料金計算装置。

**【請求項5】**

前記第3の期間は、前記第2の期間以降又は以前の前記各室内機の運転量が零とならない日であることを特徴とする請求項3又は請求項4に記載の空調料金計算装置。

**【請求項6】**

少なくとも一つの室外機に対して複数の室内機を接続して構成される1または複数の冷媒システムを備える空調システムの使用料金を、前記各室内機又は前記各室内機の利用者に按分する空調料金計算方法であって、

前記複数の室内機の運転量をそれぞれ算出する第1算出ステップと、

前記室外機の消費エネルギー量を算出する第2算出ステップと、

前記各室内機の運転量に基づいて、前記室外機の運転量の按分率を決定する按分率決定ステップと、

前記室外機の消費エネルギー量と前記按分率とに基づいて前記室外機の使用料金を計算する料金計算ステップと、

を備えたことを特徴とする空調料金計算方法。

**【請求項7】**

少なくとも一つの室外機に対して複数の室内機を接続して構成される1または複数の冷媒系統を備える空調システムの使用料金を、前記各室内機又は前記各室内機の使用者に按分する空調料金計算方法であって、

前記複数の室内機の運転量をそれぞれ所定期間毎に算出する第1算出ステップと、

前記室外機の消費エネルギー量を所定期間毎に算出する第2算出ステップと、

前記所定期間毎の各室内機の運転量に基づいて、前記所定期間毎の前記室外機の消費エネルギー量の按分率を決定すると共に、所定期間のうち第1の所定期間の前記各室内機の運転量が零である場合に、所定期間のうち第2の所定期間における前記各室内機の運転量に基づいて、前記第1の所定期間の前記室外機の消費エネルギー量の按分率を決定する按分率決定ステップと、

前記室外機の消費エネルギー量と前記按分率とに基づいて前記室外機の所定期間毎の使用料金を計算する料金計算ステップと、

を備えることを特徴とする空調料金計算方法。

【技術分野】

【0001】

本発明は、空調料金計算装置に係り、特に、少なくとも一つの室外機と複数の室内機とを有する空調システムを集中管理し、該空調システムの消費エネルギーにかかる料金を按分計算する空調料金計算装置に関するものである。

【背景技術】

【0002】

従来より、少なくとも一つの室外機に対して複数の室内機を接続して構成される1または複数の冷媒系統を備えるマルチ空調システムが知られている。そして、オフィスビルやテナントビル等では、このようなマルチ空調システムを集中管理して、複数の室内機の使用それぞれに対して空調システムの使用料金を按分することが行われている。

例えば、特許文献1には、一台又は複数台の室外ユニットと複数台の室内ユニットとを接続して構成される複数の冷媒系統を備える空調システムにおいて、各冷媒系統の運転制御および全冷媒系統で消費する全エネルギー消費量を各冷媒系統毎に按分し、さらに、それぞれの室内ユニット毎に按分させることで、各冷媒系統毎に運転状態が異なっても適正な料金按分を行う技術が開示されている。

【図面の簡単な説明】

【0019】

【図1】本発明の実施形態に係る空調料金計算装置が適用される空調システムの概略構成を示すブロック図である。

【図2】本発明の実施形態に係る空調料金計算装置の概略構成を示すブロック図である。

【図3】本発明の実施形態に係る空調料金計算装置にかかる記憶装置に記憶される運転時間及び消費電力量の例を示す図表である。

【図4】本発明の実施形態に係る空調料金計算装置にかかる空調料金計算処理の流れを示すフローチャートである。

【符号の説明】

【0041】

- 1 空調システム
- 2 室外機
- 3 a～3 d 室内機
- 5 空調料金計算装置
- 25 室内機運転量算出部
- 26 室外機消費エネルギー算出部
- 27 按分率決定部
- 28 料金計算部

【図1】

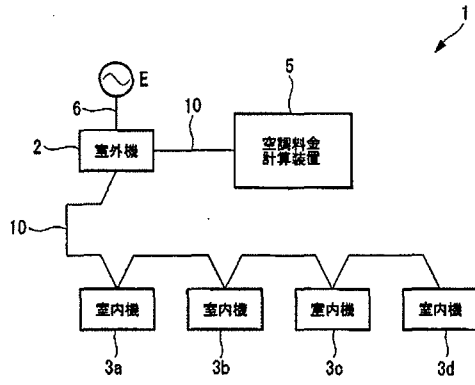

【図2】

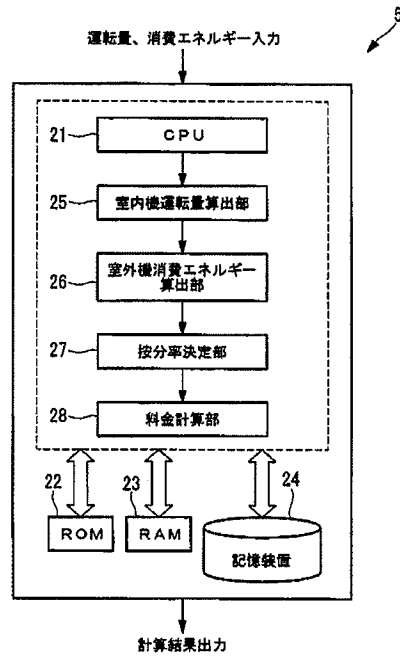

【図3】

| 年月日        | 室外機  | 室内機3a | 室内機3b | 室内機3c | 室内機3d |
|------------|------|-------|-------|-------|-------|
| ：          | ：    | ：     | ：     | ：     | ：     |
| 2009年4月24日 | 10kw | 0     | 0     | 0     | 0     |
| 2009年4月25日 | 30kw | 0     | 0     | 0     | 0     |
| 2009年4月26日 | 20kw | 0     | 20h   | 0     | 10h   |
| ：          | ：    | ：     | ：     | ：     | ：     |
| 4月分        | 60kw |       | 40h   |       | 20h   |

【図4】

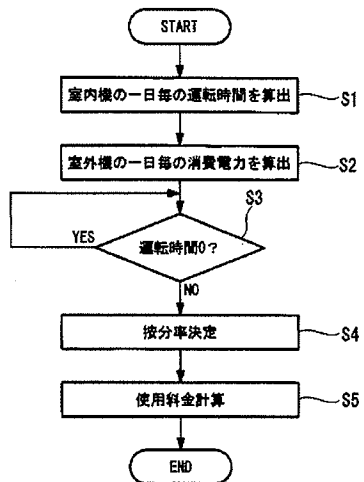





Print Save Error Report

(19) KOREAN INTELLECTUAL PROPERTY OFFICE

KOREAN PATENT ABSTRACTS

(11) Registration number: 100285833 B1  
 (45) Issue date: 16.04.2001  
 (24) Registration date: 08.01.2001

(21) Application number: 1019980005162 (73) Proprietor:  
 (22) Application date: 19.02.1998 (72) Inventor: ● CHOI, GWANG SU  
 (51) Int. Cl: F24F 11/02

(54) AIR CONDITIONER WITH METERING FUNCTION AND METHOD FOR CONTROLLING OPERATION OF AIR CONDITIONER

(57) Abstract:

PURPOSE: An air conditioner with metering function and its control method is provided to prevent power waste by displaying the power consumption and corresponding electric charge.

CONSTITUTION: An air conditioner comprises a key input unit(110) for permitting a user to input operation command and set a target electric charge; a temperature sensing unit(160) for sensing the indoor temperature; a load driving unit(140) for performing cooling or heating operation by driving a compressor and motor; a power detection unit(120) for detecting power consumed during cooling or heating operation; a micro computer(130) for controlling operation of the load driving unit in accordance with the operation command input through the key input unit and the indoor temperature sensed by the temperature sensing unit, calculating an electric charge and estimated electric charge from the power detected by the power detection unit, and controlling operation of the load driving unit in accordance with the result of comparison between the target electric charge and the estimated electric charge; and a display unit(150) for selectively displaying the operation state, electric charge and estimated electric charge in accordance with the control of the micro computer.

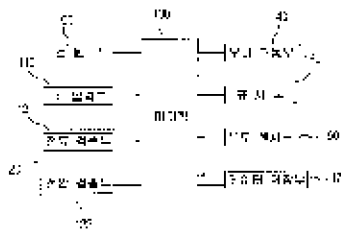

copyright KIPO 2002

※ If you cannot see the image above, please install the TIFF Viewer and try again.

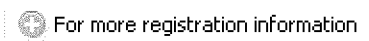

Legal Status

| No. | Receipt/Delivery No. | Receipt/Delivery Date | Document Title (KOR.) | Status (KOR.) |
|-----|----------------------|-----------------------|-----------------------|---------------|
|     |                      |                       |                       |               |

|    |                     |            |   |                                   |
|----|---------------------|------------|---|-----------------------------------|
| 1  | 1-1-1998-0016443-41 | 1998.02.19 | Request for Examination<br>(출원심사청구서)                                  | Acceptance<br>(수리)                |
| 2  | 1-1-1998-0016441-50 | 1998.02.19 | Patent Application<br>(특허출원서)   | Acceptance<br>(수리)                |
| 3  | 1-1-1998-0016442-06 | 1998.02.19 | Notification of assignment of agent<br>(대리인선임신고서)                     | Acceptance<br>(수리)                |
| 4  | 4-1-1999-0002075-52 | 1999.01.08 | Notification of change of applicant's information<br>(출원인정보변경(경정)신고서) | Acceptance<br>(수리)                |
| 5  | 4-1-1999-0027796-82 | 1999.02.03 | Notification of change of applicant's information<br>(출원인정보변경(경정)신고서) | Acceptance<br>(수리)                |
| 6  | 4-1-1999-0119956-71 | 1999.09.18 | Notification of change of applicant's information<br>(출원인정보변경(경정)신고서) | Acceptance<br>(수리)                |
| 7  | 4-1-2000-0106069-21 | 2000.08.09 | Notification of change of applicant's information<br>(출원인정보변경(경정)신고서) | Acceptance<br>(수리)                |
| 8  | 9-5-2000-0205036-79 | 2000.08.21 | Notification of reason for refusal<br>(의견제출통지서)                       | Dispatched<br>(발송처리완료)            |
| 9  | 1-1-2000-5317817-51 | 2000.10.19 | Written Opinion<br>(의견서)  | Acceptance<br>(수리)                |
| 10 | 1-1-2000-5317818-07 | 2000.10.19 | Amendment to Description, etc.<br>(명세서등보정서)                           | Acceptance of amendment<br>(보정승인) |
| 11 | 9-5-2000-0331688-94 | 2000.12.21 | Decision to grant<br>(등록사정서)  | Dispatched<br>(발송처리완료)            |
| 12 | 4-1-2002-0039038-35 | 2002.04.30 | Notification of change of applicant's information<br>(출원인정보변경(경정)신고서) | Acceptance<br>(수리)                |
| 13 | 4-1-2002-0079231-78 | 2002.10.11 | Notification of change of applicant's information<br>(출원인정보변경(경정)신고서) | Acceptance<br>(수리)                |
| 14 | 4-1-2003-0000806-26 | 2003.01.07 | Notification of change of applicant's information<br>(출원인정보변경(경정)신고서) | Acceptance<br>(수리)                |
| 15 | 4-1-2003-5079986-93 | 2003.12.02 | Notification of change of applicant's information<br>(출원인정보변경(경정)신고서) | Acceptance<br>(수리)                |
| 16 | 4-1-2005-5072608-11 | 2005.07.15 | Notification of change of applicant's information<br>(출원인정보변경(경정)신고서) | Acceptance<br>(수리)                |
| 17 | 4-1-2005-5079334-14 | 2005.08.02 | Notification of change of applicant's information<br>(출원인정보변경(경정)신고서) | Acceptance<br>(수리)                |
| 18 | 4-1-2012-5132663-40 | 2012.06.21 | Notification of change of applicant's information<br>(출원인정보변경(경정)신고서) | Acceptance<br>(수리)                |

(19) World Intellectual Property Organization  
International Bureau



(43) International Publication Date  
1 December 2011 (01.12.2011)

(10) International Publication Number  
**WO 2011/149600 A3**

(51) International Patent Classification:  
F24F 11/02 (2006.01) H04Q 9/04 (2006.01)

(74) Agent: KING, John, R.; Knobbe, Martens, Olson & Bear, LLP, 2040 Main Street, 14th Floor, Irvine, CA 92614 (US).

(21) International Application Number:  
PCT/US2011/032537

(81) Designated States (unless otherwise indicated, for every kind of national protection available): AE, AG, AL, AM, AO, AT, AU, AZ, BA, BB, BG, BH, BR, BW, BY, BZ, CA, CH, CL, CN, CO, CR, CU, CZ, DE, DK, DM, DO, DZ, EC, EE, EG, ES, FI, GB, GD, GE, GH, GM, GT, HN, HR, HU, ID, IL, IN, IS, JP, KE, KG, KM, KN, KP, KR, KZ, LA, LC, LK, LR, LS, LT, LU, LY, MA, MD, ME, MG, MK, MN, MW, MX, MY, MZ, NA, NG, NI, NO, NZ, OM, PE, PG, PH, PL, PT, RO, RS, RU, SC, SD, SE, SG, SK, SL, SM, ST, SV, SY, TH, TJ, TM, TN, TR, TT, TZ, UA, UG, US, UZ, VC, VN, ZA, ZM, ZW.

(22) International Filing Date:  
14 April 2011 (14.04.2011)

(25) Filing Language: English

(26) Publication Language: English

(30) Priority Data:  
12/788,246 26 May 2010 (26.05.2010) US

(71) Applicant (for all designated States except US): ECO-FACTOR, INC. [US/US]; 423 Broadway, #801, Millbrae, CA 94030 (US).

(84) Designated States (unless otherwise indicated, for every kind of regional protection available): ARIPO (BW, GH, GM, KE, LR, LS, MW, MZ, NA, SD, SL, SZ, TZ, UG, ZM, ZW), Eurasian (AM, AZ, BY, KG, KZ, MD, RU, TJ, TM), European (AL, AT, BE, BG, CH, CY, CZ, DE, DK, EE, ES, FI, FR, GB, GR, HR, HU, IE, IS, IT, LT, LU,

(72) Inventor; and  
(75) Inventor/Applicant (for US only): STEINBERG, John, Douglas [US/US]; 873 Hacienda Way, Millbrae, CA 94030 (US).

[Continued on next page]

(54) Title: SYSTEM AND METHOD FOR USING A MOBILE ELECTRONIC DEVICE TO OPTIMIZE AN ENERGY MANAGEMENT SYSTEM

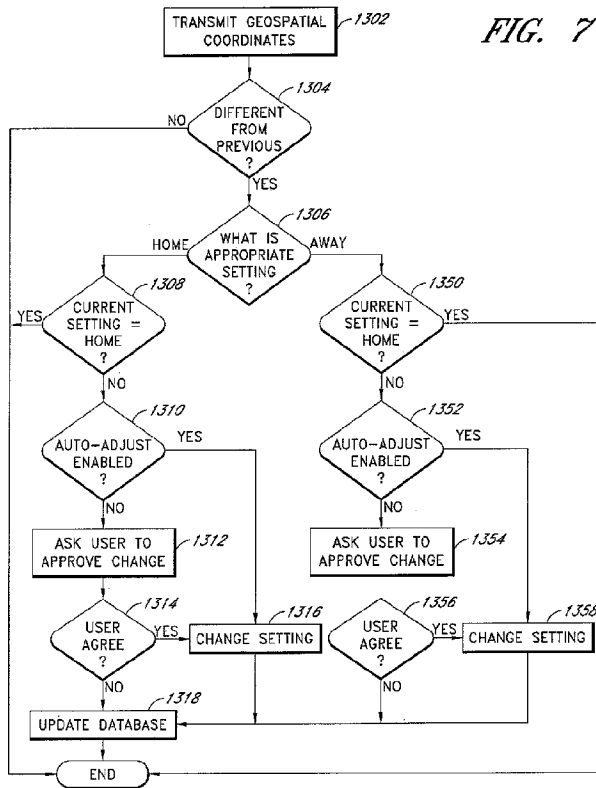

FIG. 7

(57) Abstract: Embodiments of the invention comprise systems and methods for using the geographic location of networked consumer electronics devices as indications of occupancy of a structure for purposes of automatically adjusting the temperature setpoint on a thermostatic HVAC control. At least one thermostat is located inside a structure and is used to control an HVAC system in the structure. At least one mobile electronic device is used to indicate the state of occupancy of the structure. The state of occupancy is used to alter the setpoint on the thermostatic HVAC control to reduce unneeded conditioning of unoccupied spaces.

WO 2011/149600 A3



LV, MC, MK, MT, NL, NO, PL, PT, RO, RS, SE, SI, SK, SM, TR), OAPI (BF, BJ, CF, CG, CI, CM, GA, GN, GQ, GW, ML, MR, NE, SN, TD, TG).

— before the expiration of the time limit for amending the claims and to be republished in the event of receipt of amendments (Rule 48.2(h))

**Declarations under Rule 4.17:**

— as to applicant's entitlement to apply for and be granted a patent (Rule 4.17(ii))

**(88) Date of publication of the international search report:**



2 February 2012

**Published:**

— with international search report (Art. 21(3))

## INTERNATIONAL SEARCH REPORT

International application No.  
**PCT/US2011/032537**

| <b>A. CLASSIFICATION OF SUBJECT MATTER</b>  |   |   |
|---|---|---|
| <i>F24F 11/02(2006.01)i, H04Q 9/04(2006.01)i</i>  |   |   |
| According to International Patent Classification (IPC) or to both national classification and IPC   |   |   |
| <b>B. FIELDS SEARCHED</b>   |   |   |
| Minimum documentation searched (classification system followed by classification symbols)<br>F24F 11/02; G06F 17/00; G05D 23/00; F25B 9/00  |   |   |
| Documentation searched other than minimum documentation to the extent that such documents are included in the fields searched<br>Korean utility models and applications for utility models<br>Japanese utility models and applications for utility models   |   |   |
| Electronic data base consulted during the international search (name of data base and, where practicable, search terms used)<br>eKOMPASS(KIPO internal) & Keywords: mobile, geographic, location, temperature   |   |   |
| <b>C. DOCUMENTS CONSIDERED TO BE RELEVANT</b>   |   |   |
| Category*   | Citation of document, with indication, where appropriate, of the relevant passages        | Relevant to claim No.   |
| A   | US 2006-0214014 A1 (CULLEN BASH et al.) 28 September 2006<br>See Abstract                 | 1-22  |
| A   | US 2004-0176880 A1 (MICHAEL L. OBRADOVICH et al.) 09 September 2004<br>See Column 124-126 | 1-22  |
| <input type="checkbox"/> Further documents are listed in the continuation of Box C. <input checked="" type="checkbox"/> See patent family annex.  |   |   |
| <p>* Special categories of cited documents:</p> <p>"A" document defining the general state of the art which is not considered to be of particular relevance</p> <p>"E" earlier application or patent but published on or after the international filing date</p> <p>"L" document which may throw doubts on priority claim(s) or which is cited to establish the publication date of citation or other special reason (as specified)</p> <p>"O" document referring to an oral disclosure, use, exhibition or other means</p> <p>"P" document published prior to the international filing date but later than the priority date claimed</p> <p>"T" later document published after the international filing date or priority date and not in conflict with the application but cited to understand the principle or theory underlying the invention</p> <p>"X" document of particular relevance; the claimed invention cannot be considered novel or cannot be considered to involve an inventive step when the document is taken alone</p> <p>"Y" document of particular relevance; the claimed invention cannot be considered to involve an inventive step when the document is combined with one or more other such documents, such combination being obvious to a person skilled in the art</p> <p>"&amp;" document member of the same patent family</p> |   |   |
| Date of the actual completion of the international search<br>12 DECEMBER 2011 (12.12.2011)  |   | Date of mailing of the international search report<br><b>12 DECEMBER 2011 (12.12.2011)</b>  |
| Name and mailing address of the ISA/KR<br> Korean Intellectual Property Office<br>Government Complex-Daejeon, 189 Cheongsu-ro,<br>Seo-gu, Daejeon 302-701, Republic of Korea<br>Facsimile No. 82-42-472-7140   |   | Authorized officer<br>JANG, GI JEONG<br>Telephone No. 82-42-481-5498<br> |

**INTERNATIONAL SEARCH REPORT**

Information on patent family members

International application No.

**PCT/US2011/032537**

| Patent document cited in search report | Publication date | Patent family member(s) | Publication date |
|--|------------------|-------------------------|------------------|
| US 2006-0214014 A1                     | 28.09.2006       | US 7640760 B2           | 05.01.2010       |
| US 2004-0176880 A1                     | 09.09.2004       | AT 356734 T             | 15.04.2007       |
|  |                  | AT 399110 T             | 15.07.2008       |
|  |                  | AU 6245398 A            | 26.08.1998       |
|  |                  | AU 6245398 A            | 26.08.1998       |
|  |                  | CA 2283843 A1           | 13.08.1998       |
|  |                  | CA 2283843 C            | 20.11.2007       |
|  |                  | CA 2596489 A1           | 13.08.1998       |
|  |                  | DE 69837318 D1          | 16.10.2008       |
|  |                  | EP 0956219 A2           | 17.11.1999       |
|  |                  | EP 0956219 A2           | 30.10.2002       |
|  |                  | EP 0956219 A4           | 24.01.2001       |
|  |                  | EP 0956219 B1           | 25.06.2008       |
|  |                  | JP 2002-505631 A        | 19.02.2002       |
|  |                  | JP 2002-505631 T        | 19.02.2002       |
|  |                  | JP 2002-505631 T        | 19.02.2002       |
|  |                  | US 06009355A A          | 28.12.1999       |
|  |                  | US 06131060A A          | 10.10.2000       |
|  |                  | US 2001-0020202 A1      | 06.09.2001       |
|  |                  | US 2001-0021887 A1      | 13.09.2001       |
|  |                  | US 2001-0029410 A1      | 11.10.2001       |
|  |                  | US 2001-0038414 A1      | 08.11.2001       |
|  |                  | US 2002-0065585 A1      | 30.05.2002       |
|  |                  | US 2002-0082751 A1      | 27.06.2002       |
|  |                  | US 2002-0082752 A1      | 27.06.2002       |
|  |                  | US 2002-0156555 A1      | 24.10.2002       |
|  |                  | US 2002-0198635 A1      | 26.12.2002       |
|  |                  | US 2003-0004616 A1      | 02.01.2003       |
|  |                  | US 2004-0162645 A1      | 19.08.2004       |
|  |                  | US 2004-0162646 A1      | 19.08.2004       |
|  |                  | US 2005-0165513 A1      | 28.07.2005       |
|  |                  | US 2005-0203674 A1      | 15.09.2005       |
|  |                  | US 2006-0200285 A1      | 07.09.2006       |
|  |                  | US 2010-0175014 A1      | 08.07.2010       |
|  |                  | US 6175782 B1           | 16.01.2001       |
|  |                  | US 6233506 B1           | 15.05.2001       |
|  |                  | US 6282464 B1           | 28.08.2001       |
|  |                  | US 6330497 B1           | 11.12.2001       |
|  |                  | US 6438465 B2           | 20.08.2002       |
|  |                  | US 6449535 B1           | 10.09.2002       |
|  |                  | US 6459961 B1           | 01.10.2002       |
|  |                  | US 6542794 B2           | 01.04.2003       |
|  |                  | US 6542795 B2           | 01.04.2003       |
|  |                  | US 6577928 B2           | 10.06.2003       |
|  |                  | US 6587758 B2           | 01.07.2003       |
|  |                  | US 6587759 B2           | 01.07.2003       |
|  |                  | US 6859687 B2           | 22.02.2005       |
|  |                  | US 6922616 B2           | 26.07.2005       |

**INTERNATIONAL SEARCH REPORT**

Information on patent family members

International application No.

**PCT/US2011/032537**

| Patent document<br>cited in search report | Publication<br>date | Patent family<br>member(s) | Publication<br>date |
|---|---------------------|----------------------------|---------------------|
|   |                     | US 7062362 B2              | 13.06.2006          |
|   |                     | US 7124004 B2              | 17.10.2006          |
|   |                     | US 7171291 B2              | 30.01.2007          |
|   |                     | US 7499778 B2              | 03.03.2009          |
|   |                     | WO 98-34812 A2             | 13.08.1998          |
|   |                     | WO 98-34812A2              | 13.08.1998          |
|   |                     | WO 98-34812A3              | 05.11.1998          |
|   |                     | WO 98-34812A3              | 05.11.1998          |





(51) International Patent Classification:

F24F 11/02 (2006.01) H04L 12/16 (2006.01)  
H04L 12/12 (2006.01)

(21) International Application Number:

PCT/US2011/048316

(22) International Filing Date:

18 August 2011 (18.08.2011)

(25) Filing Language:

English

(26) Publication Language:

English

(30) Priority Data:

12/860,821 20 August 2010 (20.08.2010) US

(71) Applicant (for all designated States except US): **ECO-FACTOR, INC.** [US/US]; 432 Broadway, #801, Millbrae, CA 94030 (US).

(72) Inventor; and

(75) Inventor/Applicant (for US only): **STEINBERG, John, Douglas** [US/US]; 873 Hacienda Way, Millbrae, CA 94030 (US).

(74) Agent: **KING, John, R.**; Knobbe, Martens, Olson & Bear, LLP, 2040 Main Street, 14th Floor, Irvine, CA 92614 (US).

(81) Designated States (unless otherwise indicated, for every kind of national protection available): AE, AG, AL, AM, AO, AT, AU, AZ, BA, BB, BG, BH, BR, BW, BY, BZ, CA, CH, CL, CN, CO, CR, CU, CZ, DE, DK, DM, DO,

DZ, EC, EE, EG, ES, FI, GB, GD, GE, GH, GM, GT, HN, HR, HU, ID, IL, IN, IS, JP, KE, KG, KM, KN, KP, KR, KZ, LA, LC, LK, LR, LS, LT, LU, LY, MA, MD, ME, MG, MK, MN, MW, MX, MY, MZ, NA, NG, NI, NO, NZ, OM, PE, PG, PH, PL, PT, QA, RO, RS, RU, SC, SD, SE, SG, SK, SL, SM, ST, SV, SY, TH, TJ, TM, TN, TR, TT, TZ, UA, UG, US, UZ, VC, VN, ZA, ZM, ZW.

(84) Designated States (unless otherwise indicated, for every kind of regional protection available): ARIPO (BW, GH, GM, KE, LR, LS, MW, MZ, NA, SD, SL, SZ, TZ, UG, ZM, ZW), Eurasian (AM, AZ, BY, KG, KZ, MD, RU, TJ, TM), European (AL, AT, BE, BG, CH, CY, CZ, DE, DK, EE, ES, FI, FR, GB, GR, HR, HU, IE, IS, IT, LT, LU, LV, MC, MK, MT, NL, NO, PL, PT, RO, RS, SE, SI, SK, SM, TR), OAPI (BF, BJ, CF, CG, CI, CM, GA, GN, GQ, GW, ML, MR, NE, SN, TD, TG).

Declarations under Rule 4.17:

— as to applicant's entitlement to apply for and be granted a patent (Rule 4.17(ii))

Published:

— with international search report (Art. 21(3))  
— before the expiration of the time limit for amending the claims and to be republished in the event of receipt of amendments (Rule 48.2(h))

(88) Date of publication of the international search report:

31 May 2012

(54) Title: SYSTEM AND METHOD FOR OPTIMIZING USE OF PLUG-IN AIR CONDITIONERS AND PORTABLE HEATERS

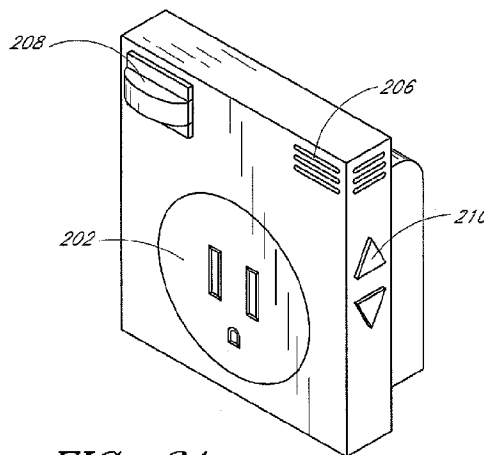



FIG. 3A

(57) Abstract: Thermostatic HVAC and other energy management controls that are connected to a computer network. For instance, remotely managed load switches incorporating thermostatic controllers inform an energy management system, to provide enhanced efficiency, and to verify demand response with plug-in air conditioners and heaters. At least one load control device at a first location comprises a temperature sensor and a microprocessor. The load control device is configured to connect or disconnect electrical power to the an attached air conditioner or heater, and the microprocessor is configured to communicate over a network. In addition, the load control device is physically separate from an air conditioner or heater but located inside the space conditioned by the air conditioner or heater.

WO 2012/024534 A3

## INTERNATIONAL SEARCH REPORT

International application No.  
**PCT/US2011/048316**

| <b>A. CLASSIFICATION OF SUBJECT MATTER</b>   |  |   |
|--|--|---|
| <i>F24F 11/02(2006.01)i, H04L 12/12(2006.01)i, H04L 12/16(2006.01)i</i>  |  |   |
| According to International Patent Classification (IPC) or to both national classification and IPC  |  |   |
| <b>B. FIELDS SEARCHED</b>  |  |   |
| Minimum documentation searched (classification system followed by classification symbols)<br>F24F 11/02; H05K 7/20; F04D 27/00; F24F 11/00; F24F 13/08; F24H 9/20; F24F 3/044  |  |   |
| Documentation searched other than minimum documentation to the extent that such documents are included in the fields searched<br>Korean utility models and applications for utility models<br>Japanese utility models and applications for utility models  |  |   |
| Electronic data base consulted during the international search (name of data base and, where practicable, search terms used)<br>eKOMPASS(KIPO internal) & Keywords: control, temperature, compare, database  |  |   |
| <b>C. DOCUMENTS CONSIDERED TO BE RELEVANT</b>  |  |   |
| Category*  | Citation of document, with indication, where appropriate, of the relevant passages             | Relevant to claim No.   |
| Y  | KR 10-1994-0011902 A (Koryo Digital Elect. Co.) 22 June 1994<br>See Abstract, Claim 1          | 1-33  |
| Y  | KR 10-2000-0059532 A (Dang Hae System Co.) 05 October 2000<br>See Claims 3, 4                  | 1-33  |
| Y  | EP 0415747 A2 (SHAW, ALLAN, DR. et al.) 06 March 1991<br>See Claim 1                           | 1-33  |
| Y  | US 2008-0198549 A1 (RASMUSSEN NEIL et al.) 21 August 2008<br>See Claim 1, Fig. 4, Para. 67, 82 | 1-33  |
| <input type="checkbox"/> Further documents are listed in the continuation of Box C. <input checked="" type="checkbox"/> See patent family annex.   |  |   |
| * Special categories of cited documents:<br>"A" document defining the general state of the art which is not considered to be of particular relevance<br>"E" earlier application or patent but published on or after the international filing date<br>"L" document which may throw doubts on priority claim(s) or which is cited to establish the publication date of citation or other special reason (as specified)<br>"O" document referring to an oral disclosure, use, exhibition or other means<br>"P" document published prior to the international filing date but later than the priority date claimed<br>"T" later document published after the international filing date or priority date and not in conflict with the application but cited to understand the principle or theory underlying the invention<br>"X" document of particular relevance; the claimed invention cannot be considered novel or cannot be considered to involve an inventive step when the document is taken alone<br>"Y" document of particular relevance; the claimed invention cannot be considered to involve an inventive step when the document is combined with one or more other such documents, such combination being obvious to a person skilled in the art<br>"&" document member of the same patent family |  |   |
| Date of the actual completion of the international search<br>27 MARCH 2012 (27.03.2012)  |  | Date of mailing of the international search report<br><b>09 APRIL 2012 (09.04.2012)</b>   |
| Name and mailing address of the ISA/KR<br> Korean Intellectual Property Office<br>Government Complex-Daejeon, 189 Cheongsu-ro,<br>Seo-gu, Daejeon 302-701, Republic of Korea<br>Facsimile No. 82-42-472-7140  |  | Authorized officer<br>JANG, GI JEONG<br>Telephone No. 82-42-481-5498<br> |

**INTERNATIONAL SEARCH REPORT**

Information on patent family members

International application No.

**PCT/US2011/048316**

| Patent document cited in search report | Publication date | Patent family member(s)  | Publication date   |
|--|------------------|--|--|
| KR 10-1994-0011902 A                   | 22.06.1994       | None   |  |
| KR 10-2000-0059532 A                   | 05.10.2000       | None   |  |
| EP 0415747 A2                          | 06.03.1991       | CA 2024221 A1<br>CN 1050762 A<br>EP 0415747 A3<br>JP 03-099150 A<br>NZ235064A<br>US 05058388A A  | 01.03.1991<br>17.04.1991<br>15.01.1992<br>24.04.1991<br>25.02.1993<br>22.10.1991   |
| US 2008-0198549 A1                     | 21.08.2008       | AU 2007-207648 A1<br>CA 2637351 A1<br>CN 101385408 A<br>EP 1974592 A2<br>JP 2009-524151 A<br>KR 10-2008-0097200 A<br>US 2007-0163748 A1<br>US 2007-0165377 A1<br>US 2007-0167125 A1<br>US 2009-0259343 A1<br>US 7365973 B2<br>WO 2007-084489 A2<br>WO 2007-084489 A3 | 26.07.2007<br>26.07.2007<br>11.03.2009<br>01.10.2008<br>25.06.2009<br>04.11.2008<br>19.07.2007<br>19.07.2007<br>19.07.2007<br>15.10.2009<br>29.04.2008<br>26.07.2007<br>26.07.2007 |



- (51) **International Patent Classification:**  
F24F 11/02 (2006.01) G06Q 50/06 (2012.01)  
G05D 23/00 (2006.01)
- (21) **International Application Number:**  
PCT/US2013/035726
- (22) **International Filing Date:**  
9 April 2013 (09.04.2013)
- (25) **Filing Language:** English
- (26) **Publication Language:** English
- (30) **Priority Data:**  
13/523,697 14 June 2012 (14.06.2012) US
- (71) **Applicant:** ECOFACTOR, INC. [US/US]; 423 Broadway, #801, Millbrae, CA 94030 (US).
- (72) **Inventors:** HUBLOU, Scott, Douglas; 747 Lakeview Way, Redwood City, CA 94062 (US). STEINBERG, John, Douglas; 873 Hacienda Way, Millbrae, CA 94030 (US).
- (74) **Agent:** KING, John, R.; Knobbe, Martens, Olson & Bear, LLP, 2040 Main Street, 14th Floor, Irvine, CA 92614 (US).

- (81) **Designated States** (unless otherwise indicated, for every kind of national protection available): AE, AG, AL, AM, AO, AT, AU, AZ, BA, BB, BG, BH, BN, BR, BW, BY, BZ, CA, CH, CL, CN, CO, CR, CU, CZ, DE, DK, DM, DO, DZ, EC, EE, EG, ES, FI, GB, GD, GE, GH, GM, GT, HN, HR, HU, ID, IL, IN, IS, JP, KE, KG, KM, KN, KP, KR, KZ, LA, LC, LK, LR, LS, LT, LU, LY, MA, MD, ME, MG, MK, MN, MW, MX, MY, MZ, NA, NG, NI, NO, NZ, OM, PA, PE, PG, PH, PL, PT, QA, RO, RS, RU, RW, SC, SD, SE, SG, SK, SL, SM, ST, SV, SY, TH, TJ, TM, TN, TR, TT, TZ, UA, UG, US, UZ, VC, VN, ZA, ZM, ZW.
- (84) **Designated States** (unless otherwise indicated, for every kind of regional protection available): ARIPO (BW, GH, GM, KE, LR, LS, MW, MZ, NA, RW, SD, SL, SZ, TZ, UG, ZM, ZW), Eurasian (AM, AZ, BY, KG, KZ, RU, TJ, TM), European (AL, AT, BE, BG, CH, CY, CZ, DE, DK, EE, ES, FI, FR, GB, GR, HR, HU, IE, IS, IT, LT, LU, LV, MC, MK, MT, NL, NO, PL, PT, RO, RS, SE, SI, SK, SM, TR), OAPI (BF, BJ, CF, CG, CI, CM, GA, GN, GQ, GW, ML, MR, NE, SN, TD, TG).

**Declarations under Rule 4.17:**

— as to applicant's entitlement to apply for and be granted a patent (Rule 4.17(ii))

[Continued on next page]

(54) **Title:** SYSTEM AND METHOD FOR OPTIMIZING USE OF INDIVIDUAL HVAC UNITS IN MULTI-UNIT CHILLER-BASED SYSTEMS

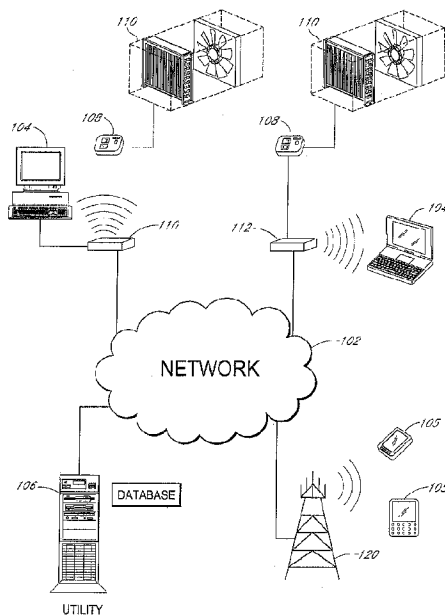

FIG. 2

(57) **Abstract:** Systems are disclosed for allocating the cost of operating an HVAC system of a multiunit structure. The HVAC system comprises at least a first component that consumes energy based on thermostatic settings in a particular unit of the multiunit structure. In addition, associated with the multiunit structure, is a second component such as a central heating and air conditioning unit. The run time associated with the first component as reported by the thermostatic controller is used as a determinant of the cost of operation of the second component.



---

— *as to the applicant's entitlement to claim the priority of the earlier application (Rule 4.17(iii))*

**Published:**

— *with international search report (Art. 21(3))*

SYSTEM AND METHOD FOR OPTIMIZING USE OF INDIVIDUAL HVAC UNITS  
IN MULTI-UNIT CHILLER-BASED SYSTEMS

BACKGROUND OF THE INVENTION

Field of the Invention

**[0001]** This invention relates to the use of thermostatic HVAC controls that are connected to a computer network. More specifically, the present invention pertains to the use of communicating thermostats to inform an energy management system, to accurately allocate operational costs across multiple users in a multi-user and/or multi-tenant context, to provide enhanced efficiency, and to verify demand response.

**[0002]** People have sought to control the temperature inside buildings using a variety of approaches for thousands of years. For most of that time, heating has been much easier to accomplish than cooling. The adoption of vapor-compression-based systems in the early part of the 20<sup>th</sup> century made it common for the first time to reliably chill inside environments well below ambient temperatures. This technological advance led to major changes in architecture (windows in many commercial buildings transmit light, but are no longer used to admit airflow), in society (enabling the development of cities in places previously inhospitable to most human preferences), and in dependence on energy from fossil fuels.

**[0003]** The HVAC systems used in most single-family residences today are generally different from those used in larger buildings. In residential and automotive systems, a refrigerant (formerly chlorofluorocarbons such as Freon, but today a number of different materials are used due to the ozone-depleting characteristics of CFCs) circulates between a mechanical compressor and an evaporator located inside the space to be conditioned, or in ductwork connected to the conditioned space. When operated as an air conditioner, the compressor converts the refrigerant from gaseous to liquid form, thereby extracting considerable heat from it. That heat is then transferred to the outside air. The newly chilled liquid is then circulated to the evaporator under high pressure through insulated tubing. Once it reaches the evaporator, which is located inside an air handler in which the air is conditioned by being forced past the evaporator

by a fan, the pressure on the liquid is removed, at which point the liquid re-converts into a gas, thereby absorbing heat from the air being blown across the evaporator. The refrigerant is then transported in gaseous form back to the compressor to repeat the cycle. Thus heat is transferred from the air in the conditioned space to the refrigerant, and then from the refrigerant to the outside air.

**[0004]** Many HVAC systems in large buildings include upsized versions of this type of system. Others use different technologies, such as absorption chillers, which require less electricity, but instead require a significant heat source.

**[0005]** Because these systems work primarily by moving heat rather than by creating it, many modern systems can also in effect “work backwards” – that is, rather than transfer heat from the air in the conditioned space and transfer it to the refrigerant and then the outside air, these systems, known as heat pumps, can collect heat from the outside air and transfer it to the refrigerant and then to the conditioned space. Thus many buildings can use the same system to deliver both cooling and heating.

**[0006]** In the single-family residential and automotive contexts, this approach is aided by the fact that reasonably short runs of refrigerant lines between compressor and evaporator are possible. But in large, multi-tenant buildings, this approach is problematic. Long refrigerant lines are expensive and difficult to maintain. They are also lossy, so that a significant percentage of the work done by the compressor is effectively wasted before it ever chills the conditioned space.

**[0007]** Another difficulty with this approach is that different tenants are likely to have different preferences for inside temperature, as well as different conditions (such as solar gain, number of heat-producing machines and people inside the space, etc.) Efficiently regulating comfort in such conditions is difficult with such a system.

**[0008]** Because of these difficulties, a common approach in such buildings is to add a second, intermediate medium to transfer heat from a centralized plant to each conditioned space. Water is commonly used for this purpose. Relative to gases like Freon, water has extremely high thermal mass.

This property leads to several benefits in such systems. First, water's high thermal mass allows the centralized chillers to effectively store cold in advance of the need to deliver cold air in conditioned spaces, thereby permitting a small amount of load shifting. Second, when the cold water is circulated, losses are easier to control. Third, the network of low-pressure water pipes is easier to build and maintain as compared to high-pressure refrigerant lines. Fourth, the circulatory system is easily modulated in individual air handlers, enabling easier control of the distribution of cooling. And fifth, larger compressors tend to be more efficient than smaller ones, which leads to stronger preferences for centralized systems as building size increases. These systems are often referred to as chiller-based systems. Where individual systems in the single-family residential context may generally be sized from 2-4 tons of cooling capacity (24,000 – 48,000 BTU/hour), chiller-based systems are typically 15-1500 tons (180,000 to 18,000,000 BTU/h). From an overall system efficiency standpoint, these chiller-based systems can be as much as 50-100% more efficient than systems designed for single-family residences. However, these systems generally share an important drawback.

**[0009]** Thermal space conditioning is the largest use of energy on average in American residences. In a typical single-family residence, where heavy air conditioning use in July is followed by receipt of a large electricity bill in August, there is a delayed but more or less effective feedback loop incentivizing consumers to avoid waste. But in central chiller-based systems, a significant portion of the energy used in cooling an individual space is consumed by a central plant that may supply conditioning to as many as hundreds or even thousands of units. These systems require large motors – in large buildings, chillers often require motors that deliver hundreds of horsepower or more – that are often the largest single use of energy in the building. Determining the amount of energy properly allocated to a given unit is generally impossible. Landlords and building owners can allocate the cost based on square footage or other static means, but when price does not vary with usage, there is little or no incentive to conserve. Thus occupants tend not manage energy consumption for efficiency, and waste is common.



## SUMMARY OF THE INVENTION

**[0010]** Thus it would be desirable to offer a system that combined the mechanical efficiency of a centrally chilled system with the ability to price the service based upon metered use of individually conditioned systems, which tends to lead to improved behavioral efficiency.

**[0011]** It would also be desirable to offer a system that can respond to information about the presence or absence of occupants of individual conditioned spaces within a larger structure, including information generated by mobile devices such as cell phones, and by other devices located within the conditioned spaces, such as personal computers and home entertainment systems.

**[0012]** It would also be desirable to offer a system that can calculate thermal properties, such as dynamic signatures, of individual conditioned spaces within a larger structure.

**[0013]** It would also be desirable to offer a system that can reduce energy use in individual conditioned spaces within a larger structure by offering just-in-time space conditioning.

**[0014]** It would also be desirable to offer a system that can adapt the programming of HVAC systems to user inputs.

**[0015]** It would also be desirable to offer a system that can shape and shed electrical loads related to HVAC while reducing or eliminating negative effects on occupant comfort.

**[0016]** It would also be desirable to offer a system that can recognize performance degradations in HVAC performance over time where a central chiller supplies multiple separate habitable spaces.

**[0017]** It would also be desirable to offer a system that can use data collected from one or more thermostats in different units of a multi-dwelling unit building in order to correct for anomalous or missing data from another thermostat in another unit.

**[0018]** It would also be desirable to offer a system that can execute specific patterns of setpoint variations on order to reduce energy consumption while minimizing adverse effects to comfort. In one embodiment, the invention comprises a chiller-based HVAC system, a networked thermostat, a local network connecting the load-control switch to a larger network such as the Internet, and a

server in bi-directional communication with such networked load-control switch and device.

**[0019]** In one embodiment, a system allocates the cost of operating an HVAC system where the HVAC system comprises at least a first component that consumes energy based at least in part on whether equipment associated with an individual unit of occupancy in a building comprised of a plurality of occupancy units is "on" or "off", and at least a second component that is associated with a plurality of occupancy units that consumes energy at least in part whether or not the first component is "on or "off".

**[0020]** The HVAC system comprises a thermostatic controller comprising a thermostat, the thermostatic controller configured to that turn on or off a first component that is associated with an individual unit of occupancy at least in part based on temperature readings from inside the individual unit of occupancy, and that is capable of reporting that the first component that is associated with the individual unit of occupancy is on or off.

**[0021]** The HVAC system further comprises at least a processor not located inside the individual unit of occupancy that is in communication with the thermostat and a database for storing data reported by the thermostat.

**[0022]** In addition, where at least the run time associated with the first component that is associated with the individual unit of occupancy as reported by the thermostatic controller is a determinant of the cost of operation of a second component that is associated with a plurality of units allocated to the individual unit of occupancy.

**[0023]** In yet another embodiment, the second component includes at least a central chiller. In addition, the individual unit of occupancy is an apartment. Still further, the thermostatic controller communicates at least in part via a wireless network. Moreover, the thermostatic controller communicates at least in part via the Internet.

**[0024]** In yet other embodiments, the medium used to transfer heat between the first component and the second component is water. Also, the medium used to transfer heat between the first component and the second component is steam. Furthermore, the individual unit of occupancy is a non-residential commercial space. In addition, the building comprises multiple stories.

**[0025]** An additional embodiment relates to a method for allocating the cost of operating an HVAC system where the HVAC system comprises at least a first component that consumes energy based at least in part on whether equipment associated with an individual unit of occupancy in a building comprised of a plurality of occupancy units is "on" or "off", and at least a second component that is associated with a plurality of occupancy units that consumes energy at least in part whether or not the first component is "on or "off."

**[0026]** The method comprises measuring the runtime of a first component with a thermostatic controller that turns on or off the first component that is associated with the individual unit of occupancy at least in part based on temperature readings from inside the individual unit of occupancy, and that is capable of reporting that the first component that is associated with the individual unit of occupancy is on or off.

**[0027]** The method also measures the runtime of at least the second component that is associated with a plurality of occupancy units that consumes energy at least in part whether or not the first component is "on or "off."

**[0028]** In addition, the method calculates the cost of operating the HVAC system to be allocated to the individual unit of occupancy based at least in part on the run time associated with the first component that is associated with the individual unit of occupancy as reported by the thermostatic controller relative to the cost of operation of the second component that is associated with a plurality of units allocated to the individual unit of occupancy.

**[0029]** In yet other embodiments, the second component includes at least a central chiller and the individual unit of occupancy is an apartment. Still further, the thermostatic controller communicates at least in part via a wireless network such as the Internet.

**[0030]** Moreover, the medium used to transfer heat between the first component and the second component is water. In an other example, the medium used to transfer heat between the first component and the second component is steam. Also, the individual occupancy units are non-residential commercial spaces. In addition, the building comprises multiple stories.

**[0031]** In another embodiment, a system allocates the cost of operating an HVAC system where the HVAC system comprises at least a first component

that is associated with an individual unit of occupancy in a building comprised of a plurality of occupancy units, and at least a second component that is associated with a plurality of occupancy units.

**[0032]** The system comprises a thermostatic controller that turns on or off the first component that is associated with the individual unit of occupancy at least in part based on temperature readings from inside the individual unit of occupancy, and that is capable of reporting that the first component that is associated with the individual unit of occupancy is on or off.

**[0033]** Furthermore, the system comprises at least a processor not located inside the individual unit of occupancy that is in communication with the thermostat and a database for storing data reported by the thermostat.

**[0034]** Where at least the run time associated with the first component that is associated with the individual unit of occupancy as reported by the thermostatic controller is a determinant of the cost of operation of the second component that is associated with a plurality of units allocated to the individual unit of occupancy.

**[0035]** For purposes of summarizing the disclosure, certain aspects, advantages and novel features of the inventions have been described herein. It is to be understood that not necessarily all such advantages may be achieved in accordance with any particular embodiment of the invention. Thus, embodiments of the invention may be carried out in a manner that achieves one advantage or group of advantages as taught herein without necessarily achieving other advantages as may be taught or suggested herein.

#### BRIEF DESCRIPTION OF THE DRAWINGS

**[0036]** Figure 1 shows an example of an overall environment in which an embodiment of the invention may be used.

**[0037]** Figure 2 shows a high-level illustration of the architecture of a network showing the relationship between the major elements of one embodiment of the subject invention.

**[0038]** Figures 3a, 3b and 3c are simplified schematics of central chiller HVAC systems used in multi-unit buildings.

**[0039]** Figure 4 shows a high-level schematic of the thermostat used as part of an embodiment of the subject invention.

**[0040]** Figure 5 shows one embodiment of the database structure used as part of an embodiment of the subject invention.

**[0041]** Figures 6a and 6b illustrate pages of a website that may be used with an embodiment of the subject invention.

**[0042]** Figures 7a, 7b, 7c, 7d, 7e, 7f and 7g are flowcharts showing the steps involved in the operation of different embodiments of the subject invention.

**[0043]** Figure 8 is a flowchart that shows how the invention can be used to select different HVAC settings based upon its ability to identify the location of a potential occupant using a mobile device connected to the system.

**[0044]** Figure 9 is a flowchart that shows how the invention can be used to select different HVAC settings based upon its ability to identify which of multiple potential occupants is using the mobile device connected to the system.

**[0045]** Figures 10a and 10b show how comparing inside temperature and outside temperature and other variables for a given conditioned space permits calculation of dynamic signatures.

**[0046]** Figure 11 is a flow chart for a high level version of the process of calculating the appropriate just-in-time turn-on time for the HVAC system in a given conditioned space.

**[0047]** Figure 12 is a more detailed flowchart listing the steps in the process of calculating the appropriate turn-on time in a given conditioned space for a just-in-time event.

**[0048]** Figures 13a, 13b, 13c and 13d show the steps shown in the flowchart in Figure 12 in the form of a graph of temperature and time.

**[0049]** Figure 14 shows a table of some of the data used by an embodiment of the subject invention to predict temperatures.

**[0050]** Figure 15 shows an embodiment of the subject invention as applied in a specific conditioned space on a specific day.

**[0051]** Figure 16 shows an embodiment of the subject invention as applied in a different specific conditioned space on a specific day.

**[0052]** Figures 17, 17-1 and 17-2 shows a table of predicted rates of change in temperature inside a given conditioned space for a range of temperature differentials between inside and outside.

**[0053]** Figure 18 shows how manual inputs can be recognized and recorded by an embodiment of the subject invention.

**[0054]** Figure 19 shows how an embodiment of the subject invention uses manual inputs to interpret manual overrides and make short-term changes in response thereto.

**[0055]** Figure 20 shows how an embodiment of the subject invention uses manual inputs to make long-term changes to interpretive rules and to setpoint scheduling.

**[0056]** Figure 21 is a flow chart illustrating the steps involved in generating a demand reduction event for a given subscriber.

**[0057]** Figure 22 is a flow chart illustrating the steps involved in confirming that a demand reduction event has taken place.

**[0058]** Figure 23 is a representation of the movement of messages and information between the components of an embodiment of the subject invention.

**[0059]** Figures 24a and 24b show graphical representations of inside and outside temperatures in two different conditioned spaces, one with high thermal mass and one with low thermal mass.

**[0060]** Figures 25a and 25b show graphical representations of inside and outside temperatures in the same conditioned spaces as in Figures 24a and 24b, showing the cycling of the air conditioning systems in those conditioned spaces.

**[0061]** Figures 26a and 26b show graphical representations of inside and outside temperatures in the same conditioned space as in Figures 24a and 25a, showing the cycling of the air conditioning on two different days in order to demonstrate the effect of a change in operating efficiency on the parameters measured by the thermostat.

**[0062]** Figures 27a and 27b show the effects of employing a pre-cooling strategy in two different conditioned spaces.

**[0063]** Figures 28a and 28b show graphical representations of inside and outside temperatures in two different conditioned spaces in order to

demonstrate how the system can correct for erroneous readings in one conditioned space by referencing readings in another.

**[0064]** Figure 29 is a flowchart illustrating the steps involved in calculating the effective thermal mass of a conditioned space using an embodiment of the subject invention.

**[0065]** Figure 30 is a flowchart illustrating the steps involved in determining whether an HVAC system has developed a problem that impairs efficiency using an embodiment of the subject invention.

**[0066]** Figure 31 is a flowchart illustrating the steps involved in correcting for erroneous readings in one conditioned space by referencing readings in another using an embodiment of the subject invention.

**[0067]** Figure 32 shows the conventional programming of a programmable thermostat over a 24-hour period.

**[0068]** Figure 33 shows the programming of a programmable thermostat over a 24-hour period using ramped setpoints.

**[0069]** Figure 34 shows the steps required for the core function of the ramped setpoint algorithm.

**[0070]** Figure 35 shows a flowchart listing steps in the process of deciding whether to implement the ramped setpoint algorithm using an embodiment of the subject invention.

**[0071]** Figure 36 shows the browser as seen on the display of the computer used as part of an embodiment of the subject invention.

**[0072]** Figure 37 is a flowchart showing the steps involved in the operation of one embodiment of the subject invention.

**[0073]** Figure 38 is a flowchart that shows how an embodiment of the invention can be used to select different HVAC settings based upon its ability to identify which of multiple potential occupants is using the computer attached to the system.

#### DETAILED DESCRIPTION OF THE PREFERRED EMBODIMENTS

**[0074]** **Figure 1** shows an example of an overall environment 100 in which an embodiment of the invention may be used. The environment 100 includes an interactive communication network 102 with computers 104

connected thereto. Also connected to network 102 are mobile devices 105, and one or more server computers 106, which store information and make the information available to computers 104 and mobile devices 105. The network 102 allows communication between and among the computers 104, mobile devices 105 and servers 106.

**[0075]** Presently preferred network 102 comprises a collection of interconnected public and/or private networks that are linked together by a set of standard protocols to form a distributed network. While network 102 is intended to refer to what is now commonly referred to as the Internet, it is also intended to encompass variations which may be made in the future, including changes additions to existing standard protocols. It also includes various networks used to connect mobile and wireless devices, such as cellular networks.

**[0076]** When a user of an embodiment of the subject invention wishes to access information on network 102 using computer 104 or mobile device 105, the user initiates connection from his computer 104 or mobile device 105. For example, the user invokes a browser, which executes on computer 104 or mobile device 105. The browser, in turn, establishes a communication link with network 102. Once connected to network 102, the user can direct the browser to access information on server 106.

**[0077]** One popular part of the Internet is the World Wide Web. The World Wide Web contains a large number of computers 104 and servers 106, which store HyperText Markup Language (HTML) and other documents capable of displaying graphical and textual information. HTML is a standard coding convention and set of codes for attaching presentation and linking attributes to informational content within documents.

**[0078]** The servers 106 that provide offerings on the World Wide Web are typically called websites. A website is often defined by an Internet address that has an associated electronic page. Generally, an electronic page is a document that organizes the presentation of text graphical images, audio and video.

**[0079]** In addition to delivering content in the form of web pages, network 102 may also be used to deliver computer applications that have traditionally been executed locally on computers 104. This approach is



sometimes known as delivering hosted applications, or SaaS (Software as a Service). Where a network connection is generally present, SaaS offers a number of advantages over the traditional software model: only a single instance of the application has to be maintained, patched and updated; users may be able to access the application from a variety of locations, etc. Hosted applications may offer users most or all of the functionality of a local application without having to install the program, simply by logging into the application through a browser.

**[0080]** In addition to the Internet, the network 102 can comprise a wide variety of interactive communication media. For example, network 102 can include local area networks, interactive television networks, telephone networks, wireless data systems, two-way cable systems, and the like.

**[0081]** In one embodiment, computers 104 and servers 106 are conventional computers that are equipped with communications hardware such as modem, a network interface card or wireless networking such as 802.11 or cellular radio-based systems. The computers include processors such as those sold by Intel and AMD. Other processors may also be used, including general-purpose processors, multi-chip processors, embedded processors and the like.

**[0082]** Computers 104 can also be microprocessor-controlled home entertainment equipment including advanced televisions, televisions paired with home entertainment/media centers, and wireless remote controls.

**[0083]** Computers 104 and mobile devices 105 may utilize a browser or other application configured to interact with the World Wide Web or other remotely served applications. Such browsers may include Microsoft Explorer, Mozilla, Firefox, Opera, Chrome or Safari. They may also include browsers or similar software used on handheld, home entertainment and wireless devices.

**[0084]** The storage medium may comprise any method of storing information. It may comprise random access memory (RAM), electronically erasable programmable read only memory (EEPROM), read only memory (ROM), hard disk, floppy disk, CD-ROM, optical memory, or other method of storing data.

**[0085]** Computers 104 and 106 and mobile devices 105 may use an operating system such as Microsoft Windows, Apple Mac OS, Linux, Unix or the

like, or may use simpler embedded operating systems with limited ability to run applications.

**[0086]** Computers 106 may include a range of devices that provide information, sound, graphics and text, and may use a variety of operating systems and software optimized for distribution of content via networks.

**[0087]** Mobile devices 105 can also be handheld and wireless devices such as personal digital assistants (PDAs), cellular telephones and other devices capable of accessing the network. Mobile devices 105 can use a variety of means for establishing the location of each device at a given time. Such methods may include the Global Positioning System (GPS), location relative to cellular towers, connection to specific wireless access points, or other means

**[0088]** **Figure 2** illustrates in further detail the architecture of the specific components connected to network 102 showing the relationship between the major elements of one embodiment of the subject invention. Attached to the network are thermostats 108 and computers 104 of various users. Connected to thermostats 108 are individual air handlers 110. Each air handler may supply conditioned air to an entire apartment or unit, or multiple air handlers may be used in a given space. Each user may be connected to the server 106 via wired or wireless connection such as Ethernet or a wireless protocol such as IEEE 802.11, via a modem or gateway 112 that connects the computer and thermostat to the Internet via a broadband connection such as a digital subscriber line (DSL), cellular radio or other method of connection to the World Wide Web. The thermostats 108 may be connected locally via a wired connection such as Ethernet or Homeplug or other wired network, or wirelessly via IEEE802.11, 802.15.4, or other wireless network, which may include a gateway 112. Server 106 contains content to be served as web pages and viewed by computers 104, software to manage thermostats 108, software to manage the operation of thermostats 108, as well as databases containing information used by the servers.

**[0089]** Also attached to the Network may be cellular radio towers 120, or other means to transmit and receive wireless signals in communication with mobile devices 105. Such communication may use GPRS, GSM, CDMA, EvDO,

EDGE or other protocols and technologies for connecting mobile devices to a network.

**[0090]** **Figure 3a** shows a simplified high-level schematic of a representative sample of one kind of chiller-based air conditioning system with which the subject invention may be used. The system includes two water loops. Secondary loop 202 absorbs heat from inside the conditioned space; primary loop 204 transfers that heat to the outside air. Chiller 206 is where the heat is exchanged between the two loops. Pumps 208a and 208b force water to move through the primary and secondary loops. Heat is transferred to the outside air in cooling tower 210, where fan 212 blows air past the water that has absorbed heat in the chiller. (Some system architectures use heat exchangers inside the cooling tower; others directly expose the water to the air.)

**[0091]** Water in the secondary loop emerges from the chiller and is sent to through pipes to individual air handlers 110. In some implementations, the chilled water always flows through the same path regardless of the settings of thermostats 108. If thermostat 108 is in cooling mode, then fan 214 blows air from inside the conditioned unit across the air handler, transferring heat from the air to the water being transported through the air handler 110. If thermostat 108 is in off mode, then fan 214 does not move air across the air handler, and negligible heat transfer takes place. In the simplest case, the thermostat is binary: the fan is off or it is on. Alternatively, the fan may have two or more discrete speeds, or may even be controlled by a potentiometer that permits infinite adjustment of speed within the fan's range.

**[0092]** **Figure 3b** shows a schematic of an alternative chiller-based HVAC system with which the subject invention may be used. The system architecture is roughly similar to the system shown in Fig 3a, but in this embodiment, there are valves 216 that may be used to divert chilled water away from air handlers 110. These valves may be controlled by thermostats 108. This approach may be used in order to, for example, allow users to run the fan without "running the air conditioner", which may increase comfort at lower cost due the well-known value of moving air in order to increase comfort in warm conditions.

**[0093]** With the systems shown in Figures 3a and 3b, it is possible to allocate at least a portion the energy use associated with an individual air handler with data generated by or otherwise available at each individual thermostat.

**[0094]** **Figure 3c** shows a schematic of an alternative chiller-based HVAC system with which the subject invention may be used. The system architecture is roughly similar to that shown in Figures 3a and 3b, but in this embodiment, there are also means for measuring the temperature of the water in the secondary loop at at least two places: temperature sensor 220a measures the temperature of the water in the secondary loop prior to circulation through heat exchangers 110 (WT1); temperature sensor 220b measures the temperature of the water in the secondary loop after circulation through heat exchangers 110 (WT2). The difference between these two ( $\Delta$ WT) gives a measure of the amount of cooling accomplished by the loop overall. When the air handlers in each unit in the loop are all off and/or when the valves determining whether to route the loop through the air handlers are all set to bypass,  $\Delta$ WT will be relatively small, and this baseline value may be thought of as system overhead or deadweight loss. When the air handlers in each unit in the loop are all on and/or when the valves determining whether to route the loop through the air handlers are all set to send the water through each air handler,  $\Delta$ WT will be relatively large. The difference between the two cases represents a measure of the work done by the HVAC system, and can be used to calculate the energy use attributable to the units in a given loop.

**[0095]** Figure 3c also includes a means 222 for varying the speed of the fan in cooling tower 210. Some chiller-based systems increase efficiency under dynamic load conditions by varying the speed of the motor driving the fan (and/or by increasing or decreasing the speed with which water is pumped through the primary and/or secondary loops). A variation on the system shown in Figure 3c would be a system in which the flow rate of the water circulating between the central chiller and the individual occupancy units may be varied by increasing or decreasing the work done by the pumps that circulate the water.

**[0096]** **Figure 4** shows a high-level block diagram of thermostat 108 used as part of an embodiment of the subject invention. Thermostat 108 includes temperature sensing means 252, which may be a thermistor, thermal diode or

other means commonly used in the design of electronic thermostats. It includes a microprocessor 254, memory 256, a display 258, a power source 260, a relay 262, which turns the blower motor in the air handler on and off in response to a signal from the microprocessor, and contacts by which the relay is connected to the wires that lead to the blower motor. In systems in which the thermostat controls a valve that determines the flow of water through the air handler, a relay, potentiometer or other device will control the valve.

**[0097]** To allow the thermostat to communicate bi-directionally with the computer network, the thermostat also includes means 264 to connect the thermostat to a local computer or to a wireless network. Such means could be in the form of Ethernet, wireless protocols such as IEEE 802.11, IEEE 802.15.4, Bluetooth, cellular systems such as CDMA, GSM and GPRS, or other wireless protocols. Communication means 264 may include one or more antennae 266. Thermostat 108 may also include controls 268 allowing users to change settings directly at the thermostat, but such controls are not necessary to allow the thermostat to function for all parts of part of the subject invention. Such controls may consist of buttons, switches, dials, etc. Thermostat 108 may also include means to vary additional system parameters, such as variable fan speed, opening and closing valves that regulate the flow of the heat transfer medium, etc. Thermostat 108 should be capable of communicating such parameters to servers 106, and of allowing remote control of such parameters as well.

**[0098]** The data used to manage the subject invention is stored on one or more servers 106 within one or more databases. As shown in **Figure 5**, the overall database structure 300 may include temperature database 400, thermostat settings database 500, energy bill database 600, chiller system variable database 700, weather database 800, user database 900, transaction database 1000, product and service database 1100, user location database 1200 and such other databases as may be needed to support these and additional features. Alternatively, data may be managed using a distributed file system such as Apache Hadoop.

**[0099]** Users of connected thermostats 108 may create personal accounts. Each user's account will store information in database 900, which tracks various attributes relative to users of the system. Such attributes may

include the location and size of the user's unit within a building (e.g., the southwest corner, 11<sup>th</sup> floor); the specific configuration of the air handler and other unit-specific equipment in the user's unit; the user's preferred temperature settings, whether the user is a participant in a demand response program, etc.

**[0100]** User personal accounts may also associate one or more mobile devices with such personal accounts. For mobile devices with the capability for geopositioning awareness, these personal accounts will have the ability log such positioning data over time in database 1200.

**[0101]** In one embodiment, a background application installed on mobile device 105 shares geopositioning data for the mobile device with the application running on server 106 that logs such data. Based upon this data, server 106 runs software that interprets said data (as described in more detail below). Server 106 may then, depending on context, (a) transmit a signal to thermostat 108 changing setpoint because occupancy has been detected at a time when the system did not expect occupancy (or vice versa); or (b) transmit a message to mobile device 105 that asks the user if the server should change the current setpoint, alter the overall programming of the system based upon a new occupancy pattern, etc. Such signaling activity may be conducted via email, text message, pop-up alerts, voice messaging, or other means.

**[0102]** **Figures 6a** and **6b** illustrate a website that may be provided to assist users and others to interact with an embodiment of the subject invention. The website will permit thermostat users to perform through the web browser substantially all of the programming functions traditionally performed directly at the physical thermostat, such as choosing temperature set points, the time at which the thermostat should be at each set point, etc. Preferably the website will also allow users to accomplish more advanced tasks such as allow users to program in vacation settings for times when the HVAC system may be turned off or run at more economical settings, and to set macros that will allow changing the settings of the temperature for all periods with a single gesture such as a mouse click.

**[0103]** As shown in **Figure 6a**, screen 351 of website 350 displays current temperature 352 as sensed by thermostat 108. Clicking on "up" arrow 354 raises the setpoint 358; clicking the down arrow 356 lowers setpoint 358.

Screen 351 may also convey information about the outside weather conditions, such as a graphic representation 360 of the sun, clouds, etc. In conditioned spaces with multiple thermostats, screen 351 may allow users to select from multiple devices to adjust or monitor. Users will be able to use screen 351 by selecting, for example, master bedroom thermostat 362, living room thermostat 364, game room thermostat 366, or basement thermostat 368.

**[0104]** As shown in **Figure 6b**, screen 370 allows users to establish programming schedules. Row 372 shows a 24-hour period. Programming row 374 displays various programming periods and when they are scheduled, such as away setting 376, which begins at approximately 8AM and runs until approximately 5:30PM. When the away setting 376 is highlighted, the user can adjust the starting time and ending time for the setting by dragging the beginning time 378 to the left to choose an earlier start time, and dragging it to the right to make it later. Similarly, the user can drag ending time 380 to the left to make it earlier, and to the right to make it later. While away setting 376 is highlighted, the user can also change heating setpoint 382 by clicking on up arrow 384 or down arrow 386, and cooling setpoint 388 by clicking on up arrow 390 or down arrow 392. The user can save the program by clicking on save button 394.

**[0105]** **Figure 7a** illustrates how an embodiment of the subject invention can be used to calculate the cost of operation of the chiller and other common portions of the HVAC system to be allocated to a given conditioned space using the cycle time of the blower for the air handler in that conditioned space.

**[0106]** In step 402 the server retrieves from database 300 the cycling data for a given air handler for a specified time interval (such as for one minute). Such data could indicate that for the interval in question the fan in the air handler was "on," or that it was "off". In step 404 the server retrieves from database 300 the cost per minute of run time for the air handler. This number is likely to be a function of several variables, which may include the cost per kilowatt hour of electricity (or the cost of other energy sources), the operating cost per time interval for the chiller unit associated with the air handler, and the number (and perhaps size) of other air handlers also associated with the same chiller. For example, a given chiller may be connected to 75 air handlers, and cost \$50 per

hour to operate when electricity costs \$0.09/kWh. In step 406 the server computes the cost to operate the individual air handler for the specified time interval. For example, if during a given minute the cost to operate a given chiller is \$1.50, and during that minute 20 air handlers are operating, then the chiller cost for each air handler would be \$0.075 for that minute. In step 408 the server determines whether there are additional time intervals for which operating cost is to be calculated. If there are additional intervals, the server returns to step 402. If not, in step 410 the server calculates the allocated HVAC cost for all of the individual time intervals.

**[0107] Figure 7b** illustrates how an embodiment of the subject invention can be used to calculate the cost of operation of the HVAC system to be allocated to a given conditioned space using the cycle time of the blower for the air handler in that conditioned space plus variable speed data for that blower.

**[0108]** In step 502 the server retrieves from database 300 the cycling data for a given air handler for a specified time interval (such as for one minute). Such data could indicate that for the interval in question the fan in the air handler was "on," or that it was "off". In step 504 the server retrieves from database 300 values for the speed of the fan in the air handler for the specified time interval. Such data may be expressed as a percentage of maximum speed, as a direct measurement of revolutions per minute, as a measurement of the current drawn by the electric motor powering the fan, or some other measurement. In step 506 the server retrieves from database 300 the cost per minute of run time for the air handler given the actual fan speed as retrieved in step 504. This number is also likely to be a function of variables including the cost per kilowatt/hour of electricity, the overall operating cost per time interval for the chiller unit associated with the air handler, and the number (and perhaps size) of other air handlers also associated with the same chiller. In step 508 the server computes the cost to operate the individual air handler for the specified time interval. In step 510 the server determines whether there are additional time intervals for which operating cost is to be calculated. If there are additional intervals, the server returns to step 502. If not, in step 512 the server calculates the allocated HVAC cost for all of the individual time intervals.



**[0109]** **Figure 7c** illustrates how an embodiment of the subject invention can be used to calculate the cost of operation of the HVAC system to be allocated to a given conditioned space using the cycle time of the blower for the air handler in that conditioned space plus data from other blowers in other units. This approach permits calculation of variable operating costs – that is, it permits the amount allocated to a given unit to vary as actual operating cost change with the demands placed on the system by other units.

**[0110]** In step 602 the server retrieves from database 300 the cycling data for the first air handler to be evaluated for a specified time interval (such as for one minute). Such data could indicate that for the interval in question the fan in the air handler was “on,” or that it was “off”. In step 604 the server retrieves from database 300 the cycling data for the next air handler to be evaluated for the specified time interval. The server continues to retrieve cycling data for additional air handlers until in step 606 the server retrieves from database 300 the cycling data for the last air handler to be evaluated.

**[0111]** In step 608 the server retrieves additional data to be used to allocate overall operating costs during the specified interval. Such data may include static data such as the square footage of each separate unit in the building, the relative location of each unit (because units with more south and west-facing windows are likely to have higher cooling loads, etc.), the size of each air handler and/or its included blower motor, or dynamic data such as the actual and/or predicted temperature rise (in the case of cooling) or drop (in the case of heating) for each air handler. In step 610 the server retrieves from database 300 the cost per minute of run time for the complete chiller system for the time increment being evaluated. This number may be calculated or actually measured, and will likely be a function of the cost of a kilowatt-hour of electricity, the overall operating cost per time interval for the chiller unit associated with the air handler, and the number (and perhaps size) of other air handlers also associated with the same chiller.

**[0112]** In step 612 the server calculates the cost of operating the first air handler for the time increment being evaluated. This cost will likely be a function of the overall cost per minute calculated in step 610, as well as the other parameters retrieved in steps 602-608. Specifically, the method described in

Figure 7c is intended to vary the allocated cost for a given unit during a given interval based upon the load placed upon the chiller not just by that unit, but by other units as well. This approach would allow equitable full allocation of chiller operating costs regardless of the number of units operating at a given time. Alternatively, the sources for the data used for this calculation may be sensor data sourced from the controlled system rather than stored values retrieved from a database.

**[0113]** In step 614 the server repeats the process followed in step 612 for the same time increment for the next air handler to be evaluated.

**[0114]** The server continues to calculate operating costs for additional time increments until in step 616 the server calculates operating costs for the last air handler to be evaluated for that time increment.

**[0115]** In step 618 the server determines whether additional time segments will require evaluation. If more time segments do require calculation, the server returns to step 602. If not, the server proceeds to step 620, in which it calculates the total allocated operating cost allocated to the first air handler for the relevant intervals.

**[0116]** The process disclosed in Figure 7c may be repeated for each of the air handlers connected to a given chiller.

**[0117]** **Figure 7d** illustrates how an embodiment of the subject invention can be used to calculate the cost of operation of the HVAC system to be allocated to a given conditioned space using the cycle time and fan speed of the blower for the air handler in that conditioned space plus data from other blowers in other units.

**[0118]** In step 702 the server retrieves from database 300 the cycling data for the first air handler to be evaluated for a specified time interval (such as for one minute). Such data could indicate that for the interval in question the fan in the air handler was "on," or that it was "off". In step 704 the server retrieves from database 300 values for the speed of the fan in the air handler for the specified time interval. Such data may be expressed as a percentage of maximum speed, as a direct measurement of revolutions per minute, as a measurement of the current drawn by the electric motor powering the fan, or some other measurement.

**[0119]** In step 706 the server retrieves from database 300 the cycling data for the next air handler to be evaluated for the specified time interval, and in step 708 the server retrieves from database 300 values for the speed of the fan in the next air handler for the specified time interval. The server continues to retrieve cycling data and fan speed values for additional air handlers until in steps 710 and 712 the server retrieves from database 300 the cycling and fan speed data for the last air handler to be evaluated.

**[0120]** In step 714 the server retrieves additional data that may be used to allocate overall operating costs during the specified interval. Such data may include static data such as the square footage of each separate unit in the building, the relative location of each unit (because units with more south and west-facing windows are likely to have higher loads, etc.), the size of each air handler and/or its included blower motor, or dynamic data such as the actual or predicted temperature rise (in the case of cooling) or drop (in the case of heating) for each air handler.

**[0121]** In step 716 the server retrieves from database 300 the cost per minute of run time for the complete chiller system for the time increment being evaluated. This number may be calculated or actually measured, and will likely be a function of the cost of a kilowatt-hour of electricity, the overall operating cost per time interval for the chiller unit associated with the air handler, and the number (and perhaps size) of other air handlers also associated with the same chiller. Alternatively, the sources for the data used for this calculation may be sensor data sourced from the controlled system rather than stored values retrieved from a database.

**[0122]** In step 718 the server calculates the cost of operating the first air handler for the time increment being evaluated. This cost will likely be a function of the overall cost per minute calculated in step 716, as well as the other parameters retrieved in steps 702-714. Specifically, the method described in Figure 7d is intended to vary the allocated cost for a given unit during a given interval based upon the load placed upon the chiller not just by that unit, but by other units as well. This approach would allow equitable full allocation of chiller operating costs regardless of the number of units operating at a given time, even where the individual units employ variable-speed fans.

**[0123]** In step 720 the server calculates the cost of operating the next air handler for the time increment being evaluated. The server continues to calculate operating costs for additional air handlers until in step 722 the server calculates operating costs for the last air handler to be evaluated for that time increment.

**[0124]** In step 724 the server determines whether there are additional time intervals for which operating costs are to be calculated. If there are additional intervals, the server returns to step 702. If not, in step 726 the server calculates the allocated HVAC cost for all of the individual time intervals.

**[0125]** **Figure 7e** illustrates how an embodiment of the subject invention can be used to calculate the cost of operation of the HVAC system to be allocated to a given conditioned space where the thermostat for a given unit operates by opening and closing a valve that determines whether the coolant in secondary loop 202 circulates through air handler in that conditioned space 110 plus data from other valves connected to the air handlers in other units.

**[0126]** In step 802 the server retrieves from database 300 the cycling data for a given air handler for a specified time interval (such as for one minute). Such data could indicate that for the interval in question the valve that determines whether secondary coolant is circulated through the air handler was "on," or "off". In step 804 the server retrieves from database 300 values for the speed of the fan in the air handler for the specified time interval. Such data may be expressed as a percentage of maximum speed, as a direct measurement of revolutions per minute, as a measurement of the current drawn by the electric motor powering the fan, or some other measurement. In step 806 the server retrieves from database 300 the cost per minute of run time for the air handler given both the valve status and actual fan speed as retrieved in step 804. This number is also likely to be a function of the cost per kilowatt/hour of electricity, the overall operating cost per time interval for the chiller unit associated with the air handler, and the number (and perhaps size) of other air handlers also associated with the same chiller. In step 808 the server computes the cost to operate the individual air handler for the specified time interval. In step 810 the server determines whether there are additional time intervals for which operating cost is to be calculated. If there are additional intervals, the server returns to step 802. If not,

in step 812 the server calculates the allocated HVAC cost for all of the individual time intervals.

**[0127]** **Figure 7f** illustrates how an embodiment of the subject invention can be used to calculate the cost of operation of the HVAC system to be allocated to a given conditioned space where server 106 has access to information regarding the overall change in temperature for the coolant in secondary loop 202.

**[0128]** This information may come from sensors 220a and 220b. This information can be useful because the energy required to operate the chiller may be expected to vary based upon the load placed on it by all of the connected air handlers. A large temperature rise from inlet to outlet may be expected to require the chiller to use more energy in order to reject the heat the air handlers add to the coolant; a minor temperature rise in coolant temperature will require less energy to dissipate. It may therefore be advantageous to allow the overall operating costs being allocated to individual air handlers to vary based upon overall operating costs as approximated by the temperature rise in the secondary coolant.

**[0129]** In step 902 the server retrieves information about absolute and/or relative coolant temperatures as it enters and leaves the air handlers being evaluated.

**[0130]** In step 904 the server retrieves from database 300 the cycling data for the first air handler to be evaluated for a specified time interval (such as for one minute). Such data could indicate that for the interval in question the fan in the air handler was "on," or that it was "off". In step 906 the server retrieves from database 300 values for the speed of the fan in the air handler for the specified time interval. Such data may be expressed as a percentage of maximum speed, as a direct measurement of revolutions per minute, as a measurement of the current drawn by the electric motor powering the fan, or some other measurement.

**[0131]** In step 908 the server retrieves from database 300 the cycling data for the next air handler to be evaluated for the specified time interval, and in step 910 the server retrieves from database 300 values for the speed of the fan in the next air handler for the specified time interval. The server continues to

retrieve cycling data and fan speed values for additional air handlers until in steps 912 and 914 the server retrieves from database 300 the cycling and fan speed data for the last air handler to be evaluated.

**[0132]** In step 916 the server retrieves additional data that may be used to allocate overall operating costs during the specified interval. Such data may include static data such as the square footage of each separate unit in the building, the relative location of each unit (because units with more south and west-facing windows are likely to have higher loads, etc.), the size of each air handler and/or its included blower motor, or dynamic data such as the actual and/or predicted temperature rise (in the case of cooling) or drop (in the case of heating) for each air handler.

**[0133]** In step 918 the server retrieves from database 300 the cost per minute of run time for the complete chiller system for the time increment being evaluated. This number may be calculated or actually measured, and will likely be a function of the cost of a kilowatt-hour of electricity, the overall operating cost per time interval for the chiller unit associated with the air handler, and the number (and perhaps size) of other air handlers also associated with the same chiller.

**[0134]** In step 920 the server calculates the cost of operating the first air handler for the time increment being evaluated. This cost will likely be a function of the overall cost per minute calculated in step 922, as well as the other parameters retrieved in steps 902-916. Specifically, the method described in Figure 7f is intended to vary the allocated cost for a given unit during a given interval based upon the load placed upon the chiller not just by that unit, but by other units as well. This approach would allow equitable full allocation of chiller operating costs regardless of the number of units operating at a given time, even where the individual units employ variable-speed fans.

**[0135]** In step 922 the server calculates the cost of operating the next air handler for the time increment being evaluated. The server continues to calculate operating costs for additional air handlers until in step 924 the server calculates operating costs for the last air handler to be evaluated for that time increment.

**[0136]** In step 926 the server determines whether there are additional time intervals for which operating costs are to be calculated. If there are additional intervals, the server returns to step 902. If not, in step 928 the server calculates the allocated HVAC cost for all of the individual time intervals.

**[0137]** **Figure 7g** illustrates how an embodiment of the subject invention can be used to calculate the cost of operation of the HVAC system to be allocated to a given conditioned space where server 106 has access to information regarding the speed of the fan or fans used to chill the primary loop 204 of chiller 206.

**[0138]** This information may come from sensors attached to the motor or motors, or from control circuitry that determines the voltage and/or current supplied to the motor, or even from external power sources used to drive especially large systems. This information can be useful because the energy required to operate the chiller may be expected to vary based upon the load placed on it by all of the connected air handlers. When loads are greater, the fan(s) will have to work harder in order to reject the heat the air handlers add to the secondary loop, which are in turn transferred to the primary loop; a minor temperature rise in secondary loop coolant temperature will require less energy to dissipate, thus permitting the fan(s) to run more slowly. It may therefore be advantageous to allow the overall operating costs being allocated to individual air handlers to vary based upon overall operating costs as approximated by the speed of the fans used to chill the primary loop coolant.

**[0139]** In step 1002 the server retrieves information about the energy consumption associated with operation of the main chiller fans 212. Such information may include rotational speed, current draw, diesel fuel flow rate (in the case of diesel-fueled engines turning the fans), or other means of measuring or estimating energy use.

**[0140]** In step 1004 the server retrieves from database 300 the cycling data for the first air handler to be evaluated for a specified time interval (such as for one minute). Such data could indicate that for the interval in question the fan in the air handler was "on," or that it was "off". In step 1006 the server retrieves from database 300 values for the speed of the fan in the air handler for the specified time interval. Such data may be expressed as a percentage of

maximum speed, as a direct measurement of revolutions per minute, as a measurement of the current drawn by the electric motor powering the fan, or some other measurement.

**[0141]** In step 1008 the server retrieves from database 300 the cycling data for the next air handler to be evaluated for the specified time interval, and in step 1010 the server retrieves from database 300 values for the speed of the fan in the next air handler for the specified time interval. The server continues to retrieve cycling data and fan speed values for additional air handlers until in steps 1012 and 1014 the server retrieves from database 300 the cycling and fan speed data for the last air handler to be evaluated.

**[0142]** In step 1016 the server retrieves additional data that may be used to allocate overall operating costs during the specified interval. Such data may include static data such as the square footage of each separate unit in the building, the relative location of each unit (because units with more south and west-facing windows are likely to have higher loads, etc.), the size of each air handler and/or its included blower motor, or dynamic data such as the actual or predicted temperature rise (in the case of cooling) or drop (in the case of heating) for each air handler.

**[0143]** In step 1018 the server retrieves from database 300 the cost per minute of run time for the complete chiller system for the time increment being evaluated. This number may be calculated or actually measured, and will likely be a function of the cost of a kilowatt-hour of electricity, the overall operating cost per time interval for the chiller unit associated with the air handler, and the number (and perhaps size) of other air handlers also associated with the same chiller.

**[0144]** In step 1020 the server calculates the cost of operating the first air handler for the time increment being evaluated. This cost will likely be a function of the overall cost per minute calculated in step 1022, as well as the other parameters retrieved in steps 1002-1016. Specifically, the method described in Figure 7g is intended to vary the allocated cost for a given unit during a given interval based upon the load placed upon the chiller not just by that unit, but by other units as well. This approach would allow equitable full



allocation of chiller operating costs regardless of the number of units operating at a given time, even where the individual units employ variable-speed fans.

**[0145]** In step 1022 the server calculates the cost of operating the next air handler for the time increment being evaluated. The server continues to calculate operating costs for additional air handlers until in step 1024 the server calculates operating costs for the last air handler to be evaluated for that time increment.

**[0146]** In step 1026 the server determines whether there are additional time intervals for which operating costs are to be calculated. If there are additional intervals, the server returns to step 1002. If not, in step 1028 the server calculates the allocated HVAC cost for all of the individual time intervals.

**[0147]** It should be noted that the processes described above in the context of air conditioning and the circulation of a coolant can be applied in other contexts as well, such as a hydronic system in which a heated fluid is circulated, steam-based systems, etc.

**[0148]** Other central-plant HVAC system topologies are also possible. So long as it is possible to measure at least one dynamic aspect of the cost of operating the common aspects of the system, and at least one dynamic aspect of the system that is controlled separately for individual occupancy units, it will be possible to allocate operating costs to some degree based upon such measurements.

**[0149]** In addition to being used to help properly allocate the cost of operating a centralized chiller-based HVAC system, the subject invention may also be used to help enable and encourage owners, tenants and other occupants of units conditioned by such systems to be more energy efficient.

**[0150]** One of the most significant ways to cut HVAC energy use without adversely affecting comfort is to avoid heating and cooling spaces when they are unoccupied. Directly sensing occupancy with motion sensors is common in the hospitality industry, but is more problematic in multi-room contexts. It also requires expensive retrofitting in existing structures.

**[0151]** Adding occupancy detection capability to residential HVAC systems could also add considerable value in the form of energy savings without significant tradeoff in terms of comfort. But the systems used in hotels do not

easily transfer to the single-family residential context. Hotel rooms tend to be small enough that a single motion sensor is sufficient to determine with a high degree of accuracy whether or not the room is occupied. A single motion sensor in the average home today would have limited value because there are likely to be many places one or more people could be home and active yet invisible to the motion sensor. The most economical way to include a motion sensor in a traditional programmable thermostat would be to build it into the thermostat itself. But thermostats are generally located in hallways, and thus are unlikely to be exposed to the areas where people tend to spend their time. Wiring a home with multiple motion sensors in order to maximize the chances of detecting occupants would involve considerable expense, both for the sensors themselves and for the considerable cost of installation, especially in the retrofit market. Yet if control is ceded to a single-sensor system that cannot reliably detect presence, the resulting errors would likely lead the homeowner to reject the system.

**[0152]** Although progress in residential HVAC control has been slow, tremendous technological change has come to the tools used for personal communication. When programmable thermostats were first offered, telephones were virtually all tethered by wires to a wall jack. But now a large percentage of the population carries at least one mobile device capable of sending and receiving voice or data or even video (or a combination thereof) from almost anywhere by means of a wireless network. These devices create the possibility that a consumer can, with an appropriate mobile device and a network-enabled HVAC system, control his or her HVAC system even when away from home. But systems that rely on active management decisions by consumers are likely to yield sub-optimal energy management outcomes, because consumers are unlikely to devote the attention and effort required to fully optimize energy use on a daily basis.

**[0153]** Many new mobile devices now incorporate another significant new technology – the ability to geolocate the device (and thus, presumably, the user of the device). One method of locating such devices uses the Global Positioning System (GPS). The GPS system uses a constellation of orbiting satellites with very precise clocks to triangulate the position of a device anywhere on earth based upon arrival times of signals received from those satellites by the

device. Another approach to geolocation triangulates using signals from multiple cell phone towers. Such systems can enable a variety of so-called "location based services" to users of enabled devices. These services are generally thought of as aids to commerce like pointing users to restaurants or gas stations, etc.

**[0154]** The subject invention can actually indirectly detect and even anticipate some occupancy changes without a direct occupancy sensor by using information about the behavior and location of users of that space as gathered from other electronic devices used by those actual or potential occupants.

**[0155]** **Figure 8** is a high-level flowchart showing the steps involved in the operation of one embodiment of the subject invention in order to use a mobile device to assist in the process of determining whether to condition a given space for occupancy. In step 1302, mobile device 105 transmits geopositioning information to server 106 via the Internet. In step 1304 the server compares the latest geopositioning data point to previous data points in order to determine whether a change in location or vector of movement has occurred. In step 1306 the server evaluates the geopositioning data in order to determine whether the temperature settings for the HVAC system for the structure associated with the mobile device 105 should be optimized for an unoccupied structure, or for an occupied structure in light of the movement (or lack thereof) in the geopositioning data. If the server 106 determines that the home should be in occupied or "home" mode, then in step 1308 the server queries database 300 to determine whether thermostat 108 is already set for home or away mode. If thermostat 108 is already in home mode, then the application terminates for a specified interval. If the HVAC settings then in effect are intended to apply when the home is unoccupied, then in step 1310 the application will retrieve from database 300 the user's specific preferences for how to handle this situation. If the user has previously specified (at the time that the program was initially set up or subsequently modified) that the user prefers that the system automatically change settings under such circumstances, the application then proceeds to step 1316, in which it changes the programmed setpoint for the thermostat to the setting intended for the space when occupied. If the user has previously specified that the application should not make such changes without further user input,

then in step 1312 the application transmits a command to the location specified by the user (generally mobile device 105) directing the device display a message informing the user that the current setting assumes an unoccupied space and asking the user to choose whether to either keep the current settings or revert to the pre-selected setting for an occupied home. If the user selects to retain the current setting, then in step 1318 the application will write to database 300 the fact that the user has so elected and terminate. If the user elects to change the setting, then in step 1316 the application transmits the revised setpoint to the thermostat. In step 1318 the application writes the updated setting information to database 300.

**[0156]** If the server 106 determines in step 1306 that the home should be in unoccupied or away mode, then in step 1350 the server queries database 300 to determine whether thermostat 108 is set for set for home or away mode. If thermostat 108 is already in home mode, then the application terminates for a specified interval. If the HVAC settings then in effect are intended to apply when the home is occupied, then in step 1352 the application will retrieve from database 300 the user's specific preferences for how to handle this situation. If the user has previously specified (at the time that the program was initially set up or subsequently modified) that the user prefers that the system automatically change settings under such circumstances, the application then proceeds to step 1358, in which it changes the programmed setpoint for the thermostat to the setting intended for the space when unoccupied. If the user has previously specified that the application should not make such changes without further user input, then in step 1354 the application transmits a command to the location specified by the user (generally mobile device 105) directing the device display a message informing the user that the current setting assumes an unoccupied space and asking the user to choose whether to either keep the current settings or revert to the pre-selected setting for an occupied home. If the user selects to retain the current setting, then in step 1318 the application will write to database 300 the fact that the user has so elected and terminate. If the user elects to change the setting, then in step 1316 the application transmits the revised setpoint to the thermostat. In step 1318 the application writes the updated setting information to database 300. If thermostat 108 is already in away mode, the

program ends. If it was in home mode, then in step 1314 server 108 initiates a state change to put thermostat 108 in away mode. In either case, the server then in step 1316 writes the state change to database 300. In each case the server can also send a message to the person who owns the mobile device requesting, confirming or announcing the state change.

**[0157]** **Figure 9** is a flowchart that shows one process by which the subject invention can be used to select different HVAC settings based upon its ability to identify which of multiple potential occupants is using the mobile device attached to the system. The process shown assumes (a) a static hierarchy of temperature preferences as between multiple occupants (that is, that for a given conditioned space, mobile user #1's preferences will always control the outcome if mobile user #1 is present, that mobile user #2's preferences yield to #1's, but always prevail over user #3, etc.); and (b) that there are no occupants to consider who are not associated with a ge positioning-enabled mobile device. Other heuristics may be applied in order to account for more dynamic interactions of preferences, for situations in which some occupants do not have enabled mobile devices, etc.

**[0158]** In step 1402 server 106 retrieves the most recent geospatial coordinates from the mobile device 105 associated with mobile user #1. In step 1404 server 106 uses current and recent coordinates to determine whether mobile user #1's "home" (or "occupied") settings should be applied. If server 106 determines that User #1's home settings should be applied, then in step 1406 server 106 applies the correct setting and transmits it to the thermostat(s). In step 1408, server 106 writes to database 300 the geospatial information used to adjust the programming. If after performing step 1404, the server concludes that mobile user #1's "home" settings should not be applied, then in step 1412 server 106 retrieves the most recent geospatial coordinates from the mobile device 105 associated with mobile user #2. In step 1414 server 106 uses current and recent coordinates to determine whether mobile user #2's "home" settings should be applied. If server 106 determines that User #2's home settings should be applied, then in step 1416 server 106 applies the correct setting and transmits it to the thermostat(s). In step 1408, server 106 writes to database 300 the geospatial and other relevant information used to adjust the programming. If after performing

step 1414, the server concludes that mobile user #2's "home" settings should not be applied, then in step 1422 server 106 retrieves the most recent geospatial coordinates from the mobile device 105 associated with mobile user #N. In step 1424 server 106 uses current and recent coordinates to determine whether mobile user #N's "home" settings should be applied. If server 106 determines that User #N's home settings should be applied, then in step 1426 server 106 applies the correct setting and transmits it to the thermostat(s). In step 1408, server 106 writes to database 300 the geospatial information used to adjust the programming.

**[0159]** If none of the mobile devices associated with a given home or other structure report geospatial coordinates consistent with occupancy, then in step 1430 the server instructs the thermostat(s) to switch to or maintain the "away" setting.

**[0160]** Additional energy-saving and comfort-enhancing functionality is also envisioned as part of the subject invention. For example, information from historic data may be used to predict how long it will take a regular user to reach a conditioned space from the current coordinates, and the estimated arrival time may be used to calculate optimal cycling strategies for the HVAC system. Thus the longer it is predicted to take the mobile device user to arrive at home, the later the subject invention will switch to an occupied setting. In addition, information about traffic conditions may be integrated into these calculations, so that the geospatial data relative to mobile device 105 may indicate that a user is taking his or her normal route, but because of a traffic jam, is likely to arrive later than would otherwise be expected. The characteristics of a given location may be used to infer arrival times as well. For example, if the geospatial data indicates that the user of mobile device 105 has arrived at the supermarket on his way to the conditioned space, a delay of 20 minutes is likely, whereas if the user has parked at a restaurant, the delay is likely to be one hour.

**[0161]** It is also possible to incorporate more sophisticated heuristics in incorporating the varying preferences of multiple occupants of a given structure. For example, rules can be structured so that User #1's preferences control during the heating season, but not during the cooling season; User #2's preferences might control during certain times of the day but not others; User #3's

preferences may take precedence whenever they result in a more energy efficient strategy, but not when they result in increased energy use, and so on.

**[0162]** The subject invention is capable of delivering additional techniques that increase comfort and efficiency. In addition to using the system to allow better signaling and control of the HVAC system, which relies primarily on communication running from the server to the thermostat, the bi-directional communication will also allow thermostat 108 to regularly measure and send to the server information about the temperature in the conditioned space. By comparing outside temperature, inside temperature, thermostat settings, cycling behavior of the HVAC system, and other variables, the system will be capable of numerous diagnostic and controlling functions beyond those of a standard thermostat. It will also be capable of using the known physical relationship between different conditioned spaces (that is, the fact that, for example, one apartment might be directly above another) to understand and optimize the use of energy in those spaces. Thus if the occupants of an apartment on the 10<sup>th</sup> floor maintain very high winter setpoints, thereby reducing the need to run the heating for the unit directly above it on the 11<sup>th</sup> floor (because heat rises), the cost allocation system could, if desired, share some of the cost of that heating between units, or could advise the occupant of the 10<sup>th</sup> floor unit of these facts, or otherwise use the data to reinforce more energy-efficient choices.

**[0163]** For example, **Fig. 10a** shows a graph of inside temperature, outside temperature and HVAC activity for a 24-hour period in a specific hypothetical conditioned space. When outside temperature 1502 increases, inside temperature 1504 follows, but with some delay because of the thermal mass of the building, unless the air conditioning 1506 operates to counteract this effect. When the air conditioning turns on, the inside temperature stays constant (or rises at a much lower rate or even falls) despite the rising outside temperature. In this example, frequent and heavy use of the air conditioning results in only a very slight temperature increase inside the space of 4 degrees, from 72 to 76 degrees, despite the increase in outside temperature from 80 to 100 degrees.

**[0164]** **Figure 10b** shows a graph of the same conditioned space on the same day, but assumes that the air conditioning is turned off from noon to

7PM. As expected, the inside temperature 1504a rises with increasing outside temperatures 1502 for most of that period, reaching 88 degrees at 7PM. Because server 106 logs the temperature readings from inside each conditioned space (whether once per minute or over some other interval), as well as the timing and duration of air conditioning cycles, database 300 will contain a history of the thermal performance of each such space. That performance data will allow the server 106 to calculate an effective thermal mass for each such space – that is, the speed with which the temperature inside a given conditioned space will change in response to changes in outside temperature. Because the server will also log these inputs against other inputs including time of day, humidity, etc. the server will be able to predict, at any given time on any given day, the rate at which inside temperature should change for given inside and outside temperatures. Because the server also logs similar data from other thermostats in other units in the same building, it is also possible to predict how temperatures and setpoints in one unit will affect temperatures and system run times on adjacent units.

**[0165]** The ability to predict the rate of change in inside temperature in a given space under varying conditions may be applied by in effect holding the desired future inside temperature as a constraint and using the ability to predict the rate of change to determine when the HVAC system must be turned on in order to reach the desired temperature at the desired time. The ability of an HVAC system to vary turn-on time in order to achieve a setpoint with minimum energy use may be thought of as Just In Time (JIT) optimization.

**[0166]** Figure 11 shows a flowchart illustrating the high-level process for controlling a just-in-time (JIT) event for a specific occupied space. In step 1512, the server determines whether a specific thermostat 108 is scheduled to run the preconditioning program. If, not, the program terminates. If it so scheduled, then in step 1514 the server retrieves the predetermined target time when the preconditioning is intended to have been completed (TT). Using TT as an input, in step 1516 the server then determines the time at which the computational steps required to program the preconditioning event will be performed (ST). In step 1518, performed at start time ST, the server begins the process of actually calculating the required parameters, as discussed in greater



detail below. Then in 1520 specific setpoint changes are transmitted to the thermostat so that the temperature inside the home may be appropriately changed as intended.

**[0167]** Figure 12 shows a more detailed flowchart of the process. In step 1532, the server retrieves input parameters used to create a JIT event for a specific occupied space. These parameters include the maximum time allowed for a JIT event for thermostat 108 (MTI); the target time the system is intended to hit the desired temperature (TT); and the desired inside temperature at TT (TempTT). It is useful to set a value for MTI because, for example, it will be reasonable to prevent the HVAC system from running a preconditioning event if it would be expected to take 8 hours, which might be prohibitively expensive.

**[0168]** In step 1534, the server retrieves data used to calculate the appropriate start time with the given input parameters. This data may include a set of algorithmic learning data (ALD), composed of historic readings from the thermostat, together with associated weather data, such as outside temperature, solar radiation, humidity, wind speed and direction, etc.; together with weather forecast data for the subject location for the period when the algorithm is scheduled to run (the weather forecast data, or WFD). The forecasting data can be as simple as a listing of expected temperatures for a period of hours subsequent to the time at which the calculations are performed, or may include more detailed tables including humidity, solar radiation, wind, etc. Alternatively, it can include additional information such as some or all of the kinds of data collected in the ALD.

**[0169]** In step 1536, the server uses the ALD and the WFD to create prediction tables that determine the expected rate of change or slope of inside temperature for each minute of HVAC cycle time ( $\Delta T$ ) for the relevant range of possible pre-existing inside temperatures and outside climatic conditions. An example of a simple prediction table is illustrated in Figs. 17-1 and 17.2.

**[0170]** In step 1538, the server uses the prediction tables created in step 1106, combined with input parameters TT and Temp(TT) to determine the time at which slope  $\Delta T$  intersects with predicted initial temperature PT. The time between PT and TT is the key calculated parameter: the preconditioning time interval, or PTI.

**[0171]** In step 1540, the server checks to confirm that the time required to execute the pre-conditioning event PTI does not exceed the maximum parameter MTI. If PTI exceeds MTI, the scheduling routine concludes and no ramping setpoints are transmitted to the thermostat.

**[0172]** If the system is perfect in its predictive abilities and its assumptions about the temperature inside the home are completely accurate, then in theory the thermostat can simply be reprogrammed once – at time PT, the thermostat can simply be reprogrammed to Temp(TT). However, there are drawbacks to this approach. First, if the server has been overly conservative in its predictions as to the possible rate of change in temperature caused by the HVAC system, the inside temperature will reach TT too soon, thus wasting energy and at least partially defeating the purpose of running the preconditioning routine in the first place. If the server is too optimistic in its projections, there will be no way to catch up, and the home will not reach Temp(TT) until after TT. Thus it would be desirable to build into the system a means for self-correcting for slightly conservative start times without excessive energy use. Second, the use of setpoints as a proxy for actual inside temperatures in the calculations is efficient, but can be inaccurate under certain circumstances. In the winter (heating) context, for example, if the actual inside temperature is a few degrees above the setpoint (which can happen when outside temperatures are warm enough that the home's natural "set point" is above the thermostat setting), then setting the thermostat to Temp(TT) at time PT will almost certainly lead to reaching TT too soon as well.

**[0173]** The currently preferred solution to both of these possible inaccuracies is to calculate and program a series of intermediate settings between Temp(PT) and Temp(TT) that are roughly related to  $\Delta T$ .

**[0174]** Thus if MTI is greater than PTI, then in step 1542 the server calculates the schedule of intermediate setpoints and time intervals to be transmitted to the thermostat. Because thermostats cannot generally be programmed with steps of less than 1 degree F,  $\Delta T$  is quantized into discrete interval data of at least 1 degree F each. For example, if Temp(PT) is 65 degrees F, Temp(TT) is 72 degrees F, and PT is 90 minutes, the thermostat might be programmed to be set at 66 for 10 minutes, 67 for 12 minutes, 68 for 15

minutes, etc. The server may optionally limit the process by assigning a minimum programming interval (e.g., at least ten minutes between setpoint changes) to avoid frequent switching of the HVAC system, which can reduce accuracy because of the thermostat's compressor delay circuit, which may prevent quick corrections. The duration of each individual step may be a simple arithmetic function of the time PTI divided by the number of whole-degree steps to be taken; alternatively, the duration of each step may take into account second order thermodynamic effects relating to the increasing difficulty of "pushing" the temperature inside a conditioned space further from its natural setpoint given outside weather conditions, etc. (that is, the fact that on a cold winter day it may take more energy to move the temperature inside the home from 70 degrees F to 71 than it does to move it from 60 degrees to 61).

**[0175]** In step 1544, the server schedules setpoint changes calculated in step 1112 for execution by the thermostat.

**[0176]** With this system, if actual inside temperature at PT is significantly higher than Temp(PT), then the first changes to setpoints will have no effect (that is, the HVAC system will remain off), and the HVAC system will not begin using energy, until the appropriate time, as shown in Figure 12. Similarly, if the server has used conservative predictions to generate  $\Delta T$ , and the HVAC system runs ahead of the predicted rate of change, the incremental changes in setpoint will delay further increases until the appropriate time in order to again minimize unnecessary energy use.

**[0177]** Figures 13(a) through 13(d) shows the steps in the preconditioning process as a graph of temperature and time. Figure 13(a) shows step 1532, in which inputs target time TT 1552, target temperature Temp(TT) 1554, maximum conditioning interval MTI 1556 and the predicted inside temperature during the period of time the preconditioning event is likely to begin Temp(PT) 1558 are retrieved.

**[0178]** Figure 13(b) shows the initial calculations performed in step 1538, in which expected rate of change in temperature  $\Delta T$  1560 inside the home is generated from the ALD and WFD using Temp(TT) 1554 at time TT 1552 as the endpoint.

**[0179]** Figure 13(c) shows how in step 1538  $\Delta T$  1560 is used to determine start time PT 1562 and preconditioning time interval PTI 1564. It also shows how in step 1540 the server can compare PTI with MTI to determine whether or not to instantiate the pre-conditioning program for the thermostat.

**[0180]** Figure 13(d) shows step 1542, in which specific ramped setpoints 1566 are generated. Because of the assumed thermal mass of the system, actual inside temperature at any given time will not correspond to setpoints until some interval after each setpoint change. Thus initial ramped setpoint 1216 may be higher than Temp(PT) 1558, for example.

**[0181]** Figure 14 shows an example of the types of data that may be used by the server in order to calculate  $\Delta T$  1560. Such data may include inside temperature 1572, outside temperature 1574, cloud cover 1576, humidity 1578, barometric pressure 1580, wind speed 1582, and wind direction 1584.

**[0182]** Each of these data points should be captured at frequent intervals. In the currently preferred embodiment, as shown in Figure 14, the interval is once every 60 seconds.

**[0183]** Figure 15 shows application of the subject invention in a conditioned space. Temperature and setpoints are plotted for the 4-hour period from 4AM to 8AM with temperature on the vertical axis and time on the horizontal axis. The winter nighttime setpoint 1592 is 60 degrees F; the morning setpoint temperature 1594 is 69 degrees F. The outside temperature 1596 is approximately 45 degrees F. The target time TT 1598 for the setpoint change to morning setting is 6:45AM. In the absence of the subject invention, the occupant could program the thermostat to change to the new setpoint at 6:45, but there is an inherent delay between a setpoint change and the response of the temperature inside the home. (In this space on this day, the delay is approximately fifty minutes.) Thus if the occupant truly desired to achieve the target temperature at the target time, some anticipation would be necessary. The amount of anticipation required depends upon numerous variables, including the capacity and state of tune of the HVAC system, the thermal properties of the building envelope, current and recent weather conditions, etc.

**[0184]** After calculating the appropriate slope  $\Delta T$  1560 by which to ramp inside temperature in order to reach the target as explained above, the server

transmits a series of setpoints 1566 to the thermostat because the thermostat is presumed to only accept discrete integers as program settings. (If a thermostat is capable of accepting finer settings, as in the case of some thermostats designed to operate in regions in which temperature is generally denoted in Centigrade rather than Fahrenheit, which accept settings in half-degree increments, tighter control may be possible.) In any event, in the currently preferred embodiment of the subject invention, programming changes are quantized such that the frequency of setpoint changes is balanced between the goal of minimizing network traffic and the frequency of changes made on the one hand and the desire for accuracy on the other. Balancing these considerations may result in some cases in either more frequent changes or in larger steps between settings. As shown in Fig. 15, the setpoint “stairsteps” from 60 degrees F to 69 degrees F in nine separate setpoint changes over a period of 90 minutes.

**[0185]** Because the inside temperature 1599 when the setpoint management routine was instantiated at 5:04 AM was above the “slope” and thus above the setpoint, the HVAC system was not triggered and no energy was used unnecessarily heating the space before such energy use was required. Actual energy usage does not begin until 5:49 AM.

**[0186]** Figure 16 shows application of the subject invention in a different conditioned space during a similar four-hour interval. In Figure 16, the predicted slope  $\Delta T$  1560 is less conservative relative to the actual performance of the home and HVAC system, so there is no off cycling during the preconditioning event – the HVAC system turns on at approximately 4:35 AM and stays on continuously during the event. The conditioned space reaches the target temperature Temp(TT) roughly two minutes prior to target time TT.

**[0187]** Figures 17-1 and 17-2 shows a simple prediction table. The first column 1602 lists a series of differentials between outside and inside temperatures. Thus when the outside temperature is 14 degrees and the inside temperature is 68 degrees, the differential is -54 degrees; when the outside temperature is 94 degrees and the inside temperature is 71 degrees, the differential is 13 degrees. The second column 1604 lists the predicted rate of change in inside temperature  $\Delta T$  1210 assuming that the furnace is running in terms of degrees Fahrenheit of change per hour. A similar prediction table will be

generated for predicted rates of change when the air conditioner is on; additional tables may be generated that predict how temperatures will change when the HVAC system is off.

**[0188]** Alternatively, the programming of the just-in-time setpoints may be based not on a single rate of change for the entire event, but on a more complex multivariate equation that takes into account the possibility that the rate of change may be different for events of different durations, as well as other variables such as wind speed, humidity, solar conditions (cloudy vs. clear), etc.

**[0189]** The method for calculating start times may also optionally take into account not only the predicted temperature at the calculated start time, but may incorporate measured inside temperature data from immediately prior to the scheduled start time in order to update calculations, or may employ more predictive means to extrapolate what the inside temperature is likely to be based upon outside temperatures, etc.

**[0190]** Significant energy savings are possible if HVAC control systems can reliably detect when a space is unoccupied. Explicit occupancy sensors are widely available, and can generally accomplish this, though this task is much easier in single-room spaces like hotel rooms than it is in multi-room spaces like larger homes. But the subject invention can accomplish some of the benefits of explicit occupancy detection by recognizing manual interaction with the physical thermostat – the buttons on the thermostat itself can only be pressed if someone is there to press them.

**[0191]** Some thermostats are capable of explicitly reporting manual overrides, but others are not. Where, as with the subject invention, an energy management service may make frequent changes to thermostat setpoints, disambiguating human interactions is of great importance.

**[0192]** Because the instant invention is capable of recording the setpoint actually used at a connected thermostat over time, it is also capable of inferring manual setpoint changes (as, for example, entered by pushing the “up” or “down” arrow on the control panel of the device) even when such overrides of the pre-set program are not specifically recorded as such by the thermostat.

**[0193]** In order to adapt programming to take into account the manual overrides entered into the thermostat, it is first necessary to determine when a

manual override has in fact occurred. Most thermostats, including many two-way communicating devices, do not record such inputs locally, and neither recognize nor transmit the fact that a manual override has occurred. Furthermore, in a system as described herein, frequent changes in setpoints may be initiated by algorithms running on the server, thereby making it impossible to infer a manual override from the mere fact that the setpoint has changed. It is therefore necessary to deduce the occurrence of such events from the data that the subject invention does have access to.

**[0194]** Figure 18 illustrates the currently preferred method for detecting the occurrence of a manual override event. In step 1702, the server retrieves the primary data points used to infer the occurrence of a manual override from one or more databases in overall database structure 300. The data should include each of the following: for the most recent point at which it can obtain such data (time0) the actual setpoint as recorded at the thermostat at (A0); for the point immediately prior to time0 (time-1), the actual setpoint recorded for the thermostat (A-1); for time0 the setpoint as scheduled by server 106 according to the basic setpoint programming (S0), and for time-1 the setpoint as scheduled by server 106 according to the standard setpoint programming (S-1). In step 1704, the server retrieves any additional automated setpoint changes C that have been scheduled for the thermostat by server 106 at time0. Such changes may include algorithmic changes intended to reduce energy consumption, etc. In step 1706 the server calculates the difference (dA) between A0 and A-1; for example, if the actual setpoint is 67 degrees at T-1 and 69 at T0, dA is +2; if the setpoint at T-1 is 70 and the setpoint at T0 is 66, dA is -4. In step 1708, the server performs similar steps in order to calculate dS, the difference between S0 and S-1. This is necessary because, for example, the setpoint may have been changed because the server itself had just executed a change, such as a scheduled change from "away" (or unoccupied) to "home" (or occupied) mode. In step 1710 the server evaluates and sums all active algorithms and other server-initiated strategies to determine their net effect on setpoint at time0. For example, if one algorithm has increased setpoint at time0 by 2 degrees as a short-term energy savings measure, but another algorithm has decreased the setpoint by one degree to

compensate for expected subjective reactions to weather conditions, the net algorithmic effect  $sC$  is +1 degree.

**[0195]** In step 1712, the server calculates the value for  $M$ , where  $M$  is equal to the difference between actual setpoints  $dA$ , less the difference between scheduled setpoints  $dS$ , less the aggregate of algorithmic change  $sC$ . In step 1714 the server evaluates this difference. If the difference equals zero, the server concludes that no manual override has occurred, and the routine terminates. But if the difference is any value other than zero, then the server concludes that a manual override has occurred. Thus in step 1716 the server logs the occurrence and magnitude of the override to one or more databases in overall database structure 300.

**[0196]** The process of interpreting a manual override is shown in Figure 19. Step 1802 is the detection of an override, as described in detail in Figure 18. In step 1804 the server retrieves the stored rules for the subject thermostat 108. Such rules may include weather and time-related inferences such as "if outside temperature is greater than 85 degrees and inside temperature is more than 2 degrees above setpoint and manual override lowers setpoint by 3 or more degrees, then revert to original setpoint in 2 hours," or "if heating setpoint change is scheduled from 'away' to 'home' within 2 hours after detected override, and override increases setpoint by at least 2 degrees, then change to 'home' setting," or the like. In step 1806 the server retrieves contextual data required to interpret the manual override. Such data may include current and recent weather conditions, current and recent inside temperatures, etc. This data is helpful because it is likely that manual overrides are at least in part deterministic: that is, that they may often be explained by such contextual data, and such understanding can permit anticipation of the desire on the part of the occupants to override and to adjust programming accordingly, so as to obviate the need for such changes. The amount of data may be for a period of a few hours to as long as several days or more. Recent data may be more heavily weighted than older data in order to assure rapid adaptation to situations in which manual overrides represent stable changes such as changes in work schedules, etc.

**[0197]** In step 1808 the server retrieves any relevant override data from the period preceding the specific override being evaluated that has not yet been



evaluated by and incorporated into the long-term programming and rules engines as described below in Figure 19. In step 1810 the server evaluates the override and determines which rule, if any, should be applied as a result of the override. In step 1812 the server determines whether to alter the current setpoint as a result of applying the rules in step 1810. If no setpoint change is indicated, then the routine ends. If a setpoint change is indicated, then in step 1814 the server transmits the setpoint change to the thermostat for execution, and in step 1816 it records that change to one or more databases in overall database structure 300.

**[0198]** In order to ensure that both the stored rules for interpreting manual overrides and the programming itself continue to most accurately reflect the intentions of the occupants, the server will periodically review both the rules used to interpret overrides and the setpoint scheduling employed. Figure 20 shows the steps used to incorporate manual overrides into the long-term rules and setpoint schedule. In step 1902 the server retrieves the stored programming for a given thermostat as well as the rules for interpreting overrides for that thermostat. In step 1904 the server retrieves the recent override data as determined using the process described in Figures 18 and 19 to be evaluated for possible revisions to the rules and the programming. In step 1906 the server retrieves the contextual data regarding overrides retrieved in step 1904 (Because the process illustrated in Figure 20 is not presently expected to be executed as a real-time process, and is expected to be run anywhere from once per day to once per month, the range and volume of contextual data to be evaluated is likely to be greater than in the process illustrated in Figure 19).

**[0199]** In step 1908 the server interprets the overrides in light of the existing programming schedule, rules for overrides, contextual data, etc. In step 1910 the server determines whether, as a result of those overrides as interpreted, the rules for interpreting manual overrides should be revised. If the rules are not to be revised, the server moves to step 1914. If the rules are to be revised, then in step 1912 the server revises the rules and the new rules are stored in one or more databases in overall database structure 300. In step 1914 the server determines whether any changes to the baseline programming for the thermostat should be revised. If not, the routine terminates. If revisions are warranted, then in step 1916 the server retrieves from database 900 the permissions the server

has to make autonomous changes to settings. If the server has been given permission to make the proposed changes, then in step 1918 the server revises the thermostat's programming and writes the changes to one or more databases in overall database structure 300. If the server has not been authorized to make such changes autonomously, then in step 1920 the server transmits the recommendation to change settings to the customer in the manner previously specified by the customer, such as email, changes to the customer's home page as displayed on website 200, etc.

**[0200]** Additional means of implementing the instant invention may be achieved using variations in system architecture. For example, much or even all of the work being accomplished by remote server 106 may also be done by thermostat 108 if that device has sufficient processing capabilities, memory, etc. Alternatively, these steps may be undertaken by a local processor such as a local personal computer, or by a dedicated appliance having the requisite capabilities, such as gateway 112.

**[0201]** Demand for electricity varies widely from winter to summer, and from early morning to late afternoon. Air conditioning is a major component of peak load. The traditional approach to dealing with high demand on hot days is to build increase supply – build new power plants, or buy additional capacity on the spot market. But because many people now consider reducing loads to be a superior strategy for matching electricity supply to demand when the grid is stressed, the ability to shed load by turning off air conditioners during peak events has become a useful tool for managing loads. A key component of any such system is the ability to document and verify that a given air conditioner has actually turned off. Data logging hardware can accomplish this, but due to the cost is usually only deployed for statistical sampling. The instant invention provides a means to verify demand response without additional hardware such as a data logger.

**[0202]** Thermostats 108 record temperature readings at frequent intervals, such as once per minute. Because server 106 logs the temperature readings from inside each conditioned space (whether once per minute or over some other interval), as well as the timing and duration of air conditioning cycles, database 300 will contain a history of the thermal performance of each

conditioned space. That performance data will allow the server 106 to calculate an effective thermal mass for each such space – that is, the speed with the temperature inside a given space is expected to change in response to changes in outside temperature. Because the server will also log these inputs against other inputs including time of day, humidity, etc. the server will be able to predict, at any given time on any given day, the rate at which inside temperature should change for given inside and outside temperatures. This will permit remote verification of load shedding by the air conditioner without directly measuring or recording the electrical load drawn by the air conditioner, and without requiring reliance on bare HVAC cycling data, which is susceptible to manipulation.

**[0203]** Figure 21 shows the steps followed in order to initiate air conditioner shutoff. When a summer peak demand situation occurs, the utility will transmit an email or other signal 2202 to server 106 requesting a reduction in load. Server 106 will determine 2204 if a given conditioned space is served by the utility seeking reduction; determine 2206 if a given user has agreed to reduce peak demand; and determine 2208 if a reduction of consumption by the user is required or desirable in order to achieve the reduction in demand requested by the utility or demand response aggregator. The server will transmit 2210 a signal to the user's thermostat 108 signaling the thermostat to shut off the air conditioner 110.

**[0204]** Figure 22 shows the steps followed in order to verify that a specific air conditioner has in fact been shut off. Server 106 will receive and monitor 2302 the temperature readings sent by the user's thermostat 108. The server then calculates 2304 the temperature reading to be expected for that thermostat given inputs such as current and recent outside temperature, recent inside temperature readings, the calculated thermal mass of the structure, temperature readings in other conditioned spaces such as other units within the same building, etc. The server will compare 2306 the predicted reading with the actual reading. If the server determines that the temperature inside the conditioned space is rising at roughly the rate predicted if the air conditioning is shut off, then the server confirms 2308 that the air conditioning has been shut off. If the temperature reading from the thermostat shows no increase, or significantly less increase than predicted by the model, then the server concludes 2310 that

the air conditioning was not switched off, and that no contribution to the demand response request was made.

**[0205]** For example, assume that on at 3PM on date Y utility X wishes to trigger a demand reduction event. A server at utility X transmits a message to the server at demand reduction service provider Z requesting W megawatts of demand reduction. The demand reduction service provider server determines that it will turn off the air conditioner for conditioned space A in order to contribute to the required demand reduction. At the time the event is triggered, the inside temperature as reported by the thermostat in conditioned space A is 72 degrees F. The outside temperature near conditioned space A is 96 degrees Fahrenheit. The inside temperature at conditioned space B, which is not part of the demand reduction program, but is both connected to the demand reduction service server and located geographically proximate to conditioned space A, is 74F. Because the air conditioner in conditioned space A has been turned off, the temperature inside conditioned space A begins to rise, so that at 4PM it has increased to 79F. Because the server is aware of the outside temperature, which remains at 96F, and of the rate of temperature rise inside conditioned space A on previous days on which temperatures have been at or near 96F, and the temperature in conditioned space B, which has risen only to 75F because the air conditioning in conditioned space B continues to operate normally, the server is able to confirm with a high degree of certainty that the air conditioner in conditioned space A has indeed been shut off.

**[0206]** In contrast, if the HVAC system for conditioned space A has been tampered with, so that a demand reduction signal from the server does not actually result in shutting off the air conditioner for conditioned space A, when the server compares the rate of temperature change in conditioned space A against the other data points, the server will receive data inconsistent with the rate of increase predicted. As a result, it will conclude that the air conditioner has not been shut off in conditioned space A as expected, and may not credit conditioned space A with the financial credit that would be associated with demand reduction compliance, or may trigger a business process that could result in termination of conditioned space A's participation in the demand reduction program.

**[0207]** **Figure 23** illustrates the movement of signals and information between the components of one embodiment of the subject invention to trigger and verify a demand reduction response. Where demand response events are undertaken on behalf of a utility by a third party, participants in the communications may include electric utility server 2400, demand reduction service server 106, and thermostat 108. In step 2402 the electric utility server 2400 transmits a message to demand reduction service server 106 requesting a demand reduction of a specified duration and size. Demand reduction service server 106 uses database 300 to determine which subscribers should be included in the demand reduction event. For each included subscriber, the server then sends a signal 2404 to the subscriber's thermostat 108 instructing it (a) to shut down at the appropriate time or (b) to allow the temperature as measured by the thermostat to increase to a certain temperature at the specified time, depending upon the agreement between the owner (or tenant, or facilities manager as the case may be) and the demand reduction service provider. The server then receives 2406 temperature measurements from the subscriber's thermostat. At the conclusion of the demand reduction event, the server transmits a signal 2408 to the thermostat permitting the thermostat to signal its attached HVAC system to resume cooling, if the system has been shut off, or to reduce the target temperature to its non-demand reduction setting, if the target temperature was merely increased. If thermostat 108 is capable of storing scheduling information, these instructions may be transmitted prior to the time they are to be executed and stored locally. After determining the total number of subscribers actually participating in the DR event, the server then calculates the total demand reduction achieved and sends a message 2410 to the electric utility confirming such reduction.

**[0208]** Additional steps may be included in the process. For example, if the subscriber has previously requested that notice be provided when a peak demand reduction event occurs, the server may also send an alert, which may be in the form of an email or text message or an update to the personalized web page for that user, or both. If the server determines that a given conditioned space has (or has not) complied with the terms of its demand reduction

agreement, the server may send a message to the subscriber confirming that fact.

**[0209]** It should also be noted that in some climate zones, peak demand events occur during extreme cold weather rather than (or in addition to) during hot weather. The same process as discussed above could be employed to reduce demand by shutting off electric heaters and monitoring the rate at which temperatures fall.

**[0210]** It should also be noted that the peak demand reduction service can be performed directly by an electric utility, so that the functions of server 106 can be combined with the functions of server 2400.

**[0211]** It should also be noted that additional variations are possible in a situation in which a building has multiple separately occupancy units owned or managed by a single entity. Additional variations are possible where a central chiller is combined with multiple air handlers in individual occupancy units, such as apartments or separate retail or office spaces. For example, a landlord may enter into an overall demand response contract that calls for delivery of several megawatts or more of load shedding, and achieve that goal by managing the thermostats in individual units. The landlord may incentivize tenants to agree to participate by sharing some of the benefit of the demand response payments with tenants that cooperate, and allocating payment (or credit against payments owed by the tenant to the landlord) based on the degree to which the load was actually reduced in that unit. The processes described in Figures 7a through 7g may easily be adapted to accomplish this.

**[0212]** The system installed in a subscriber's home may optionally include additional temperature sensors at different locations within the building. These additional sensors may be connected to the rest of the system via a wireless system such as 802.11 or 802.15.4, or may be connected via wires. Additional temperature and/or humidity sensors may allow increased accuracy of the system, which can in turn increase user comfort, energy savings or both.

**[0213]** The bi-directional communication between server 106 and thermostat 108 will also allow thermostat 108 to regularly measure and send to server 106 information about the temperature in the conditioned space. By comparing outside temperature, inside temperature, thermostat settings, cycling

behavior of the HVAC system, and other variables, the system will be capable of numerous diagnostic and controlling functions beyond those of a standard thermostat.

**[0214]** For example, **Fig. 24a** shows a graph of inside temperature and outside temperature for a 24-hour period in conditioned space A, assuming no HVAC activity. Conditioned space A has double-glazed windows and is well insulated. When outside temperature 2502 increases, inside temperature 2504 follows, but with significant delay because of the thermal mass of the building.

**[0215]** **Figure 24b** shows a graph of inside temperature and outside temperature for the same 24-hour period in conditioned space B. Conditioned space B is identical to conditioned space A except that it (i) is located a block away and (ii) has single-glazed windows and is poorly insulated. Because the two spaces are so close to each other, outside temperature 2502 is the same in Figure 24a and Figure 24b. But the lower thermal mass of conditioned space B means that the rate at which the inside temperature 2506 changes in response to the changes in outside temperature is much greater.

**[0216]** The differences in thermal mass will affect the cycling behavior of the HVAC systems in the two conditioned spaces as well. **Figure 25a** shows a graph of inside temperature and outside temperature in conditioned space A for the same 24-hour period as shown in Figure 24a, but assuming that the air conditioning is being used to try to maintain an internal temperature of 70 degrees. Outside temperatures 2502 are the same as in Figures 24a and 24b. Inside temperature 2608 is maintained within the range determined by thermostat 108 by the cycling of the air conditioner. Because of the high thermal mass of the conditioned space, the air conditioning does not need to run for very long to maintain the target temperature, as shown by shaded areas 2610.

**[0217]** **Figure 25b** shows a graph of inside temperature 2612 and outside temperature 2502 for the same 24-hour period in conditioned space B, assuming use of the air conditioning as in Figure 25a. Because of the lower thermal mass of conditioned space B, the air conditioning system in conditioned space B has to run longer in order to maintain the same target temperature range, as shown by shaded areas 2614.

**[0218]** Because server 106 logs the temperature readings from inside each conditioned space (whether once per minute or over some other interval), as well as the timing and duration of air conditioning cycles, database 300 will contain a history of the thermal performance of each system and each conditioned space. That performance data will allow the server 106 to calculate an effective thermal mass for each such structure – that is, the speed with the temperature inside a given conditioned space will change in response to changes in outside temperature and differences between inside and outside temperatures. Because the server 106 will also log these inputs against other inputs including time of day, humidity, etc. the server will be able to predict, at any given time on any given day, the rate at which inside temperature should change for given inside and outside temperatures.

**[0219]** The server will also record the responses of each occupancy unit to changes in outside conditions and cycling behavior over time. That will allow the server to diagnose problems as and when they develop. For example, **Figure 26a** shows a graph of outside temperature 2702, inside temperature 2704 and HVAC cycle times 2706 in conditioned space A for a specific 24-hour period on date X. Assume that, based upon comparison of the performance of conditioned space A on date X relative to conditioned space A's historical performance, and in comparison to the performance of conditioned space A relative to other nearby conditioned spaces on date X, the HVAC system in conditioned space A is presumed to be operating at normal efficiency, and that conditioned space A is in the 86<sup>th</sup> percentile as compared to those other conditioned spaces. **Figure 26b** shows a graph of outside temperature 2708, inside temperature 2710 and HVAC cycle times 2712 in conditioned space A for the 24-hour period on date X+1. Conditioned space A's HVAC system now requires significantly longer cycle times in order to try to maintain the same internal temperature. If those longer cycle times were due to higher outside temperatures, those cycle times probably would not indicate the existence of any problems. But because server 106 is aware of the outside temperature, the system can eliminate that possibility as an explanation for the higher cycle times. Because server 106 is aware of the cycle times in nearby conditioned spaces, it can determine that, for example, on date X+1 the efficiency of conditioned space



A is only in the 23<sup>rd</sup> percentile. The server may be programmed with a series of heuristics, gathered from predictive models and past experience, correlating the drop in efficiency and the time interval over which it has occurred with different possible causes. For example, a 50% drop in efficiency in one day may be correlated with a refrigerant leak, especially if followed by a further drop in efficiency on the following day. A reduction of 10% over three months may be correlated with a clogged filter. Based upon the historical data recorded by the server, the server 106 will be able to alert the appropriate responsible person that there is a problem and suggest a possible cause.

**[0220]** Because the system will be able to calculate effective thermal mass relative to each HVAC system or air handler, it will be able to determine the cost effectiveness of strategies such as pre-cooling for specific conditioned spaces under different conditions. **Figure 27a** shows a graph of outside temperature 2802, inside temperature 2804 and HVAC cycling times 2806 in conditioned space A for a specific 24-hour period on date Y assuming that the system has used a pre-cooling strategy to avoid running the air conditioning during the afternoon, when rates are highest. Because conditioned space A has high thermal mass, the space is capable of “banking” cooling, and energy consumed during off-peak hours is in effect stored, allowing the conditioned space to remain cool even when the system is turned off. Temperatures keep rising during the period the air conditioning is off, but because thermal mass is high, the rate of increase is low, and the conditioned space is still comfortable several hours later. Although the pre-cooling cycle time is relatively long, the effective ratepayer may still benefit if electricity prices vary at different times of the day, and if the price per kilowatt during the morning pre-cooling phase is lower than the price during the peak load period, or if other incentives are provided. **Figure 27b** shows a graph of the same outside temperature 2802 in conditioned space B as in conditioned space A in Figure 27a for the same 24-hour period and using the same pre-cooling strategy as shown by cycling times 2806. But because conditioned space B has significantly less thermal mass, using additional energy in order to pre-cool the space does not have the desired effect; inside temperature 2808 warms up so fast that the cooling that had been banked is quickly lost. Thus the system will recommend that conditioned space A

pre-cool in order to save money, but not recommend pre-cooling for conditioned space B.

**[0221]** The subject invention can also help compensate for anomalies such as measurement inaccuracies due to factors such as poor thermostat location. It is well known that thermostats should be placed in a location that will be likely to experience “average” temperatures for the overall conditioned space, and should be isolated from windows and other influences that could bias the temperatures they “see.” But for various reasons, not all thermostat installations fit that ideal. **Figure 28a** shows a graph of outside temperature 2902, the actual average inside temperature for the entire conditioned space 2904, and inside temperature as read by the thermostat 2906 in conditioned space C for a specific 24-hour period on September 15<sup>th</sup>, assuming that the thermostat is located so that for part of the afternoon on that day the thermostat is in direct sunlight. Until the point at which the sun hits the thermostat, the average inside temperature and temperature as read by the thermostat track very closely. But when the direct sunlight hits the thermostat, the thermostat and the surrounding area can heat up, causing the internal temperature as read by the thermostat to diverge significantly from the average temperature for the rest of the conditioned space. A conventional thermostat has no way of distinguishing this circumstance from a genuinely hot day, and will both over-cool the rest of the conditioned space and waste considerable energy when it cycles the air conditioner in order to reduce the temperature as sensed by the thermostat. If the air conditioning remains off, this phenomenon will manifest as a spike in temperature as measured by the thermostat. If the air conditioning turns on (and has sufficient capacity to respond to the distorted temperature signal caused by the sunlight), this phenomenon will likely manifest as relatively small changes in the temperature as sensed by the thermostat, but significantly increased HVAC usage (as well as excessively lowered temperatures in the rest of the conditioned space, but this result may not be directly measured in a single-sensor environment). The subject system, in contrast, has multiple mechanisms that will allow it to correct for such distortions. First, because the subject system compares the internal readings from conditioned space C with the external temperature, it will be obvious that the rise in sensed temperature at 4:00PM is not correlated with a corresponding change

in outside temperature. Second, because the system is also monitoring the readings from the thermostat in nearby conditioned space D, which (as shown in **Figure 28b**) is exposed to the same outside temperature 602, but has no sudden rise in measured internal afternoon temperature 2908, the system has further validation that the temperature increase is not caused by climatic conditions. And finally, because the system has monitored and recorded the temperature readings from the thermostat in conditioned space C for each previous day, and has compared the changing times of the aberration with the progression of the sun, the system can distinguish the patterns likely to indicate solar overheating from other potential causes.

**[0222]** Another application for the subject invention is to determine the thermal characteristics of individual units within a larger building, and use that information to detect and recognize defects, and faults in the HVAC systems and building envelopes.

**[0223]** **Figure 29** illustrates the steps involved in calculating comparative thermal mass, or the thermal mass index for a specific conditioned space within a larger structure. In step 3002, the server retrieves climate data related to conditioned space X. Such data may include current outside temperature, outside temperature during the preceding hours, outside humidity, wind direction and speed, whether the sun is obscured by clouds, and other factors. In step 3004, the server retrieves HVAC duty cycle data for conditioned space X. Such data may include target settings for the thermostat in current and previous periods, the timing of switch-on and switch-off events and other data. In step 3006, the server retrieves data regarding recent temperature readings as recorded by the thermostat in conditioned space X. In step 3008, the server retrieves profile data for conditioned space X. Such data may include square footage, when the conditioned space was built and/or renovated, the extent to which it is insulated, its location within the larger structure, the make, model and age of the associated HVAC hardware specific that unit, and other data. In step 3010, the server retrieves the current inside temperature reading as transmitted by the thermostat. In step 3012, the server calculates the thermal mass index for the conditioned space under the relevant conditions; that is, for example, it may calculate the likely rate of change for internal temperature in conditioned space X

from a starting point of 70 degrees when the outside temperature is 85 degrees at 3:00PM on August 10<sup>th</sup> when the wind is blowing at 5 mph from the north and the sky is cloudy. The server may accomplish this by applying a basic algorithm that weighs each of these external variables as well as variables for various characteristics of the conditioned space itself (such as size, level of insulation, method of construction, etc.) and data from other conditioned spaces and environments.

**[0224]** This approach may be used to recognize and diagnose changes in operating parameters of the HVAC system over time, both generally and in individual units. **Figure 30** illustrates the steps involved in one method for diagnosing defects in the HVAC system for specific conditioned space X. In step 3102, the server retrieves climate data related to conditioned space X. Such data may include current outside temperature, outside temperature during the preceding hours, outside humidity, wind direction and speed, whether the sun is obscured by clouds, and other factors. In step 3104, the server retrieves HVAC duty cycle data for conditioned space X. Such data may include target settings for the thermostat in current and previous periods, the timing of switch-on and switch-off events and other data. In step 3106, the server retrieves data regarding current and recent temperature readings as recorded by the thermostat in conditioned space X. In step 3108, the server retrieves profile data for conditioned space X. Such data may include square footage, when the conditioned space was built and/or renovated, the extent to which it is insulated, its location within the larger structure, make, model and age of HVAC equipment associated with that specific unit, if any, and other data. In step 3110, the server retrieves comparative data from other conditioned spaces that have thermostats that also report to the server. Such data may include interior temperature readings, outside temperature for those specific locations, duty cycle data for the HVAC systems at those locations, profile data for the structures and HVAC systems associated with those conditioned spaces and the calculated thermal mass index for those other conditioned spaces. In step 3112, the server calculates the current relative efficiency of conditioned space X as compared to other conditioned spaces. Those comparisons will take into account differences in size, location, age, etc. in making those comparisons.

**[0225]** The server will also take into account that comparative efficiency is not absolute, but will vary depending on conditions. For example, a conditioned space that has extensive south-facing windows is likely to experience significant solar gain. On sunny winter days, that home will appear more efficient than on cloudy winter days. That same conditioned space will appear more efficient at times of day and year when trees or overhangs shade those windows than it will when summer sun reaches those windows. Thus the server may calculate efficiency under varying conditions.

**[0226]** For example, in step 3114 the server compares the HVAC system's efficiency, corrected for the relevant conditions, to its efficiency in the past. If the current efficiency is substantially the same as the historical efficiency, the server concludes 3116 that there is no defect and the diagnostic routine ends. If the efficiency has changed, the server proceeds to compare the historical and current data against patterns of changes known to indicate specific problems. For example, in step 3118, the server compares that pattern of efficiency changes against the known pattern for a clogged air filter, which is likely to show a slow, gradual degradation over a period of weeks or even months. If the pattern of degradation matches the clogged filter paradigm, the server creates and transmits to the appropriate party a message 3120 alerting the party to the possible problem. If the problem does not match the clogged filter paradigm, the system compares 3122 the pattern to the known pattern for a refrigerant leak, which is likely to show degradation over a period of a few hours to a few days. If the pattern of degradation matches the refrigerant leak paradigm, the server creates and transmits to the appropriate party a message 3124 alerting the party to the possible problem. If the problem does not match the refrigerant leak paradigm, the system compares 3126 the pattern to the known pattern for an open window or door, which is likely to show significant changes for relatively short periods at intervals uncorrelated with climatic patterns. If the pattern of degradation matches the open door/window paradigm, the server creates and transmits to the appropriate party a message 3128 alerting the party to the possible problem. If the problem does not match the open door/window paradigm, the system continues to step through remaining know patterns N 3130

until either a pattern is matched 3132 or the list has been exhausted without a match 3134.

**[0227] Figure 31** illustrates the steps involved in one method for diagnosing inaccurate thermostat readings due to improper location. In step 3202, the server retrieves climate data related to conditioned space X. Such data may include current outside temperature, outside temperature during the preceding hours, outside humidity, wind direction and speed, whether the sun is obscured by clouds, and other factors. In step 3204, the server retrieves HVAC duty cycle data for conditioned space X. Such data may include target settings for the thermostat in current and previous periods, the timing of switch-on and switch-off events and other data. In step 3206, the server retrieves data regarding current and recent temperature readings as recorded by the thermostat in conditioned space X. In step 3208, the server retrieves profile data for conditioned space X. Such data may include square footage, when the space was built and/or renovated, the extent to which it is insulated, its location within the larger structure, make, model and age of HVAC hardware specific to that space, if any, and other data. In step 3210, the server retrieves comparative data from other conditioned spaces that have thermostats that also report to the server. Such data may include interior temperature readings, outside temperature for those specific locations, duty cycle data for the HVAC systems at those locations, profile data for the structures and HVAC systems in those conditioned spaces and the calculated thermal mass index for those other conditioned spaces. In step 3212, the server calculates the expected thermostat temperature reading based upon the input data. In step 3214, the server compares the predicted and actual values. If the calculated and actual values are at least roughly equivalent, the server concludes 3216 that there is no thermostat-related anomaly. If the calculated and actual values are not roughly equivalent, the server retrieves additional historical information about past thermostat readings in step 3218. In step 3220, the server retrieves solar progression data, i.e., information regarding the times at which the sun rises and sets on the days being evaluated at the location of the conditioned space being evaluated, and the angle of the sun at that latitude, etc. In step 3222, the server compares the characteristics of the anomalies over time, to see if, for example, abnormally high

readings began at 3:12 on June 5<sup>th</sup>, 3:09 on June 6<sup>th</sup>, 3:06 on June 7<sup>th</sup>, and the solar progression data suggests that at the conditioned space being analyzed, that sun would be likely to reach a given place in that unit three minutes earlier on each of those days. If the thermostat readings do not correlate with the solar progression data, the server may conclude 3224 that the sun is not causing the distortion by directly hitting the thermostat. If the thermostat readings do correlate with solar progression, the server then calculates 3226 the predicted duration of the distortion caused by the sun. In step 3228, the server calculates the appropriate setpoint information to be used by the thermostat to maintain the desired temperature and correct for the distortion for the expected length of the event. For example, if the uncorrected setpoint during the predicted event is 72 degrees, and the sun is expected to elevate the temperature reading by eight degrees, the server will instruct the thermostat to maintain a setpoint of 80 degrees. In step 3230, the server sends the appropriate party a message describing the problem.

**[0228]** The instant invention may also be used to implement additional energy savings by implementing small, repeated changes in setpoint for individual conditioned spaces. Because energy consumption is strongly correlated with setpoint – that is, the further a given setpoint diverges from the balance point (the natural inside temperature assuming no HVAC activity) in a given conditioned space under given conditions, the higher energy consumption will be to maintain temperature at that setpoint), energy will be saved by any strategy that over a given time frame lowers the average heating setpoint or raises the cooling setpoint. It is therefore possible to save energy by adopting a strategy that takes advantage of human insensitivity to slow temperature ramping by incorporating a user's desired setpoint within the range of the ramp, but setting the average target temperature below the desired setpoint in the case of heating, and above it in the case of cooling. For example, a ramped summer setpoint that consisted of a repeated pattern of three phases of equal length set at 72°F, 73°F, and 74°F would create an effective average setpoint of 73°F, but would generally be experienced by occupants as yielding equivalent comfort as in a room set at a constant 72°F. Energy savings resulting from this approach have been shown to be in the range of 4-6%.

**[0229]** The subject invention can automatically generate optimized ramped setpoints for individual conditioned spaces in a larger building that could save energy without compromising the comfort of the occupants. It would also be advantageous to create a temperature control system that could incorporate adaptive algorithms that could automatically determine when the ramped setpoints should not be applied due to a variety of exogenous conditions that make application of such ramped setpoints undesirable.

**[0230]** **Figure 32** represents the conventional programming of a thermostat and the resulting behavior of a conditioned space's HVAC system in the air conditioning context. The morning setpoint 3302 of 74 degrees remains constant from midnight until 9:00AM, and the inside temperature 3304 varies more or less within the limits of the hysteresis band (which is generally set by the thermostat) during that entire period. When the setpoint changes to 80 degrees 3306, the inside temperature 3308 rises until it reaches and then varies within the hysteresis band around the new setpoint, and so on. Whether the average temperature is equal to, greater or less than the nominal setpoint will depend on weather conditions, the dynamic signature of the structure, and the efficiency and size of the HVAC system. But in most cases the average temperature will be at least roughly equivalent to the nominal setpoint.

**[0231]** **Figure 33** represents implementation of a three-phase ramped setpoint derived from the same user preferences as manifested by the settings shown in figure 32. Thus the user-selected setpoint for the morning is still 74 degrees, and is reflected in the setpoint 3404 at the start of each three-step cycle, but because (in the air conditioning context) the setpoint requested by the user is the lowest of the three discrete steps, rather than the middle step, the average setpoint will be one degree higher 3402 (in the case of 1 degree steps between setpoints), and the resulting average inside temperature will be roughly one degree warmer than the average temperature without use of the ramped setpoints, thereby saving energy.

**[0232]** In the currently preferred embodiment, the implementation of the ramped setpoints may be dynamic based upon both conditions inside the structure and other planned setpoint changes. Thus, for example, the ramped setpoints 3406, 3408 and 3410 may be timed so that the 9AM change in user-



determined setpoint from 74 degrees to 80 degrees is in effect anticipated, and the period in which the air conditioner is not used can be extended prior to the scheduled start time for the less energy-intensive setpoint. Similarly, because the server 106 is aware that a lower setpoint will begin at 5PM, the timing can be adjusted to avoid excessively warm temperatures immediately prior to the scheduled setpoint change, which could cause noticeable discomfort relative to the new setpoint if the air conditioner is incapable of quickly reducing inside temperature on a given day based upon the expected slope of inside temperatures at that time 3412.

**[0233]** In order to implement such ramped setpoints automatically, algorithms may be created. These algorithms may be generated and/or executed as instructions on remote server 106 and the resulting setpoint changes can be transmitted to a given thermostat on a just-in-time basis or, if the thermostat 108 is capable of storing future settings, they may be transferred in batch mode to such thermostats. Basic parameters used to generate such algorithms include:

- the number of discrete phases to be used;
- the temperature differential associated with each phase; and
- the duration of each phase.

**[0234]** In order to increase user comfort and thus maximize consumer acceptance, additional parameters may be considered, including:

- time of day
- outside weather conditions
- recent history of manual inputs; and
- recent pre-programmed setpoint changes.

**[0235]** Time of day may be relevant because, for example, if the home is typically unoccupied at a given time, there is no need for perceptual programming. Outside weather is relevant because comfort is dependent not just on temperature as sensed by a thermostat, but also includes radiant differentials. On extremely cold days, even if the inside dry-bulb temperature is within normal comfort range, radiant losses due to cold surfaces such as single-glazed windows can cause subjective discomfort; thus on such days occupants may be more sensitive to ramping. Recent manual inputs (e.g., programming overrides) may create situations in which exceptions should be taken; depending on the context,

recent manual inputs may either suspend the ramping of setpoints or simply alter the baseline temperature from which the ramping takes place.

**[0236]** **Figure 34** shows the steps used in an embodiment of the core ramped setpoint algorithm in the context of a remotely managed thermostat system. In step 3502 the application determines whether to instantiate the algorithm based upon external scheduling criteria. Such information may include previously learned occupancy patterns, previously learned temperature preferences, responses to previous implementations of energy-savings strategies, etc. In step 3504 the application running on a remote server retrieves from the thermostat the data generated by or entered into the thermostat, including current temperature settings, HVAC status and inside temperature. The algorithm performs preliminary logical tests at that point to determine whether further processing is required. For example, in the heating context, if the inside temperature as reported by the thermostat 108 is more than 1 degree higher than the current setpoint, the algorithm may determine that running the ramped setpoint program will have no effect and therefore terminate. In step 3506 the algorithm advances to the next phase from the most recent phase; i.e., if the algorithm is just starting, the phase changes from "0" to "1"; if it has just completed the third phase of a three-phase ramp, the phase will change from "2" to "0". In step 3508 the application determines if the current phase is "0". If it is, then in step 3510 the algorithm determines whether current setpoint equals the setpoint in the previous phase. If so, which implies no manual overrides or other setpoint adjustments have occurred during the most recent phase, then in step 3512 the algorithm sets the new setpoint back to the previous phase "0" setpoint. If not, then in step 3514, the algorithm keeps the current temperature setting as setpoint for this new phase. In step 3516, the algorithm logs the resulting new setpoint as the new phase "0" setpoint for use in subsequent phases.

**[0237]** Returning to the branch after step 3508, if the current phase at that point is not phase "0", then in step 3520, the algorithm determines whether the current setpoint is equal to the setpoint temperature in the previous phase. If not, which implies setpoints have been adjusted by the occupants, thermostat schedules, or other events, then in step 3522, the application resets the phase to "0", resets the new setpoint associated with phase "0" to equal the current

temperature setting, and sets the current setting to that temperature. Alternatively, if the current temperature setting as determined in step 3520 is equal to the setpoint in the previous phase, then in step 3524 new setpoint is made to equal current setpoint plus the differential associated with each phase change. In step 3526 the "previous-phase setpoint" variable is reset to equal the new setpoint in anticipation of its use during a subsequent iteration.

**[0238] Figure 35** shows one embodiment of the overall control application implementing the algorithm described in Figure 35. In step 3602, the control application retrieves the current setting from the thermostat. In step 3604, the setting is logged in database 300. In step 3606, the control program determines whether other algorithms that have higher precedence than the ramped setpoint algorithm are to be run. If another algorithm is to be run prior to the ramped setpoint algorithm, then the other program is executed in step 3608. If there are no alternate algorithms that should precede the ramped setpoint application then in step 3610, the control program determines whether the thermostat has been assigned to execute the ramped setpoint program. If not, the control program skips the remaining actions in the current iteration. If the program is set to run, then in step 3612 the algorithm retrieves from database 300 the rules and parameters governing the implementation of the algorithm for the current application of the program. In step 3614, the algorithm determines whether one or more conditions that preclude application of the algorithm, such as extreme outside weather conditions, whether the home is likely to be occupied, execution of a conflicting algorithm, etc. If any of the exclusionary conditions apply, the application skips execution of the ramped setpoint algorithm for the current iteration. If not, the application proceeds to step 3616 in which the application determines whether the setpoint has been altered by manual overrides, thermostat setback schedule changes, or other algorithms as compared to the previous value as stored in database 300. If the setpoint has been altered, the application proceeds to step 3620 discussed below. In step 3618, the program described in Figure 34 is executed. In step 3620, the application resets the phase to "0". Certain temperature setting variables are reset in anticipation of their use in subsequent phases. These variables include the new phase 0 temperature setting, which is anchored to the current actual

temperature setting, and the new previous-phase setpoint, which will be used for identifying setpoint, overrides in the subsequent phase.

**[0239]** In step 3622, the system records the changes to the thermostat settings to database 300. In step 3624, the system records the changes to the phase status of the algorithm to database 300. In step 3626, the application determines whether the new temperature setting differs from the current setting. If they are the same, the application skips applying changes to the thermostat. If they are different, then in step 3628, the application transmits revised settings to the thermostat. In step 3630, the application then hibernates for the specified duration until it is invoked again by beginning at step 3602 again.

**[0240]** The subject invention may also be used to detect occupancy of a specific conditioned space through the use of software related to electronic devices located inside the conditioned structure, such as the browser running on computer or other device 104. **Figure 36** represents the screen of a computer, television or other device 104 using a graphical user interface connected to the Internet. The screen shows that a browser 3700 is displayed on computer 104. In one embodiment, a background application installed on computer 104 detects activity by a user of the computer, such as cursor movement, keystrokes or otherwise, and signals the application running on server 106 that activity has been detected. Conversely, a lack of activity on devices normally associated with an individual occupancy unit may suggest, but cannot conclusively show, that the unit is occupied. Server 106 may then, depending on context, (a) transmit a signal to thermostat 108 changing setpoint because occupancy has been detected at a time when the system did not expect occupancy (or that non-occupancy has been inferred when occupancy is assumed to be the norm); (b) signal the background application running on computer 104 to trigger a software routine that instantiates a pop-up window 3702 that asks the user if the server should change the current setpoint, alter the overall programming of the system based upon a new occupancy pattern, etc. The user can respond by clicking the cursor on "yes" button 3704 or "No" button 3706. Equivalent means of signalling activity may be employed with interactive television programming, gaming systems, etc.

**[0241]** **Figure 37** is a flowchart showing the steps involved in the operation of one embodiment of the subject invention. In step 3802, computer 104 transmits a message to server 106 via the Internet indicating that there is user activity on computer 104. This activity can be in the form of keystrokes, cursor movement, input via a television remote control, etc. In step 3804 the application queries database 300 to retrieve setting information for the associated HVAC system. In step 3806 the application determines whether the current HVAC program is intended to apply when the conditioned space is occupied or unoccupied. If the HVAC settings then in effect are intended to apply to an occupied unit, then the application terminates for a specified interval. If the HVAC settings then in effect are intended to apply when the home is unoccupied, then in step 3808 the application will retrieve from database 300 the user's specific preferences for how to handle this situation. If the user has previously specified (at the time that the program was initially set up or subsequently modified) that the user prefers that the system automatically change settings under such circumstances, the application then proceeds to step 3816, in which it changes the programmed setpoint for the thermostat to the setting intended for the conditioned space when occupied. If the user has previously specified that the application should not make such changes without further user input, then in step 3810 the application transmits a command to computer 104 directing the browser to display a message informing the user that the current setting assumes an unoccupied conditioned space and asking the user in step 3812 to choose whether to either keep the current settings or revert to the pre-selected setting for an occupied conditioned space. If the user elects to retain the current setting, then in step 3814 the application will write to database 300 the fact that the users has so elected and terminate. If the user elects to change the setting, then in step 3816 the application transmits the revised setpoint to the thermostat. In step 3814 the application writes the updated setting information to database 300. Similar logic may be used to proceed from a lack of activity on computer 104 to a conclusion that the HVAC settings should be optimized for an unoccupied state.

**[0242]** **Figure 38** is a flowchart that shows how the subject invention can be used to select different HVAC settings based upon its ability to identify which of multiple potential occupants is using the computer or other device

connected to the system. In step 3902 computer 104 transmits to server 106 information regarding the type of activity detected on computer 104. Such information could include the specific program or channel being watched if, for example, computer 104 is used to watch television. The information matching, for example, TV channel 7 at 4:00 PM on a given date to specific content may be made by referring to Internet-based or other widely available scheduling sources for such content. In step 3904 server 106 retrieves from database 300 previously logged data regarding viewed programs. In step 3906 server 106 retrieves previously stored data regarding the occupants of the conditioned space. For example, upon initiating the service, one or more users may have filled out online questionnaires sharing their age, gender, schedules, viewing preferences, etc. In step 3908, server 106 compares the received information about user activity to previously stored information retrieved from database 300 about the occupants and their viewing preferences. For example, if computer 104 indicates to server 106 that the computer is being used to watch golf, the server may conclude that an adult male is watching; if computer 104 indicates that it is being used to watch children's programming, server 106 may conclude that a child is watching. In step 3910 the server transmits a query to the user in order to verify the match, asking, in effect, "Is that you, Bob?" In step 3912, based upon the user's response, the application determines whether the correct user has been identified. If the answer is no, then the application proceeds to step 3916. If the answer is yes, then in step 3914 the application retrieves the temperature preferences for the identified occupant. In step 3916 the application writes to database 300 the programming information and information regarding matching of users to that programming.

**[0243]** In an alternative embodiment, the application running on computer 104 may respond to general user inputs (that is, inputs not specifically intended to instantiate communication with the remote server) by querying the user whether a given action should be taken. For example, in a system in which the computer 104 is a web-enabled television or web-enabled set-top device connected to a television as a display, software running on computer 104 detects user activity, and transmits a message indicating such activity to server 106. The trigger for this signal may be general, such as changing channels or adjusting volume with the remote control or a power-on event. Upon receipt by server 106

of this trigger, server 106 transmits instructions to computer 104 causing it to display a dialog box asking the user whether the user wishes to change HVAC settings.

**[0244]** Alternatively, server 106 may use biometric data provided by computer 104, such as fingerprints (which some computers and other devices now require for log-in), retinal scans, or other methods for identifying the user of an electronic device.

**[0245]** Those skilled in the relevant arts will likely recognize ways to apply the subject invention in additional contexts. In addition to use with chiller-based HVAC systems as described herein, the subject invention is also capable of use with other centralized systems including steam boilers, hydronic centralized heating, etc. The subject invention will be of value whenever a central plant is used to deliver space conditioning to separately owned or rented spaces, regardless of the means of generating and moving the conditioning (heating or cooling) medium.

**[0246]** Embodiments of the invention are also described above with reference to flow chart illustrations and/or block diagrams of methods, components, apparatus, systems, and the like. It will be understood that each block of the flow chart illustrations and/or block diagrams as well as each component, apparatus and system can be individually implemented or in any combination.

**[0247]** While particular embodiments of the present invention have been shown and described, it is apparent that changes and modifications may be made without departing from the invention in its broader aspects, and, therefore, that the invention may be carried out in other ways without departing from the true spirit and scope.

WHAT IS CLAIMED IS:

1. A system for allocating the cost of operating an HVAC system where the HVAC system comprises at least a first component that consumes energy based at least in part on whether equipment associated with an individual unit of occupancy in a building comprised of a plurality of occupancy units is "on" or "off", and at least a second component that is associated with a plurality of occupancy units that consumes energy at least in part whether or not the first component is "on or "off", the HVAC system comprising:

a thermostatic controller comprising a thermostat, the thermostatic controller configured to that turn on or off a first component that is associated with an individual unit of occupancy at least in part based on temperature readings from inside the individual unit of occupancy, and that is capable of reporting that the first component that is associated with the individual unit of occupancy is on or off;

at least a processor not located inside the individual unit of occupancy that is in communication with the thermostat;

a database for storing data reported by the thermostat; and

where at least the run time associated with the first component that is associated with the individual unit of occupancy as reported by the thermostatic controller is a determinant of the cost of operation of a second component that is associated with a plurality of units allocated to the individual unit of occupancy.

2. A system as in claim 1 in which the second component includes at least a central chiller.

3. A system as in claim 1 in which the individual unit of occupancy is an apartment.

4. A system as in claim 1 in which the thermostatic controller communicates at least in part via a wireless network.

5. A system as in claim 1 in which the thermostatic controller communicates at least in part via the Internet.

6. A system as in claim 1 in which the medium used to transfer heat between the first component and the second component is water.



7. A system as in claim 1 in which the medium used to transfer heat between the first component and the second component is steam.

8. A system as in claim 1 in which the individual unit of occupancy is a non-residential commercial space.

9. A system as in claim 1 in which the building comprises multiple stories.

10. A method for allocating the cost of operating an HVAC system where the HVAC system comprises at least a first component that consumes energy based at least in part on whether equipment associated with an individual unit of occupancy in a building comprised of a plurality of occupancy units is "on" or "off", and at least a second component that is associated with a plurality of occupancy units that consumes energy at least in part whether or not said first component is "on or "off", the method comprising:

measuring the runtime of a first component with a thermostatic controller that turns on or off said first component that is associated with the individual unit of occupancy at least in part based on temperature readings from inside the individual unit of occupancy, and that is capable of reporting that the first component that is associated with the individual unit of occupancy is on or off;

measuring the runtime of at least the second component that is associated with a plurality of occupancy units that consumes energy at least in part whether or not the first component is "on or "off";

calculating the cost of operating the HVAC system to be allocated to the individual unit of occupancy based at least in part on the run time associated with the first component that is associated with the individual unit of occupancy as reported by the thermostatic controller relative to the cost of operation of the second component that is associated with a plurality of units allocated to the individual unit of occupancy.

11. A method as in claim 10 in which the second component includes at least a central chiller.

12. A method as in claim 10 in which the individual unit of occupancy is an apartment.

13. A method as in claim 10 in which the thermostatic controller communicates at least in part via a wireless network.

14. A method as in claim 10 in which the thermostatic controller communicates at least in part via the Internet.

15. A method as in claim 10 in which the medium used to transfer heat between the first component and the second component is water.

16. A method as in claim 10 in which the medium used to transfer heat between the first component and the second component is steam.

17. A method as in claim 10 in which the individual occupancy units are non-residential commercial spaces.

18. A method as in claim 10 in which the building comprises multiple stories.

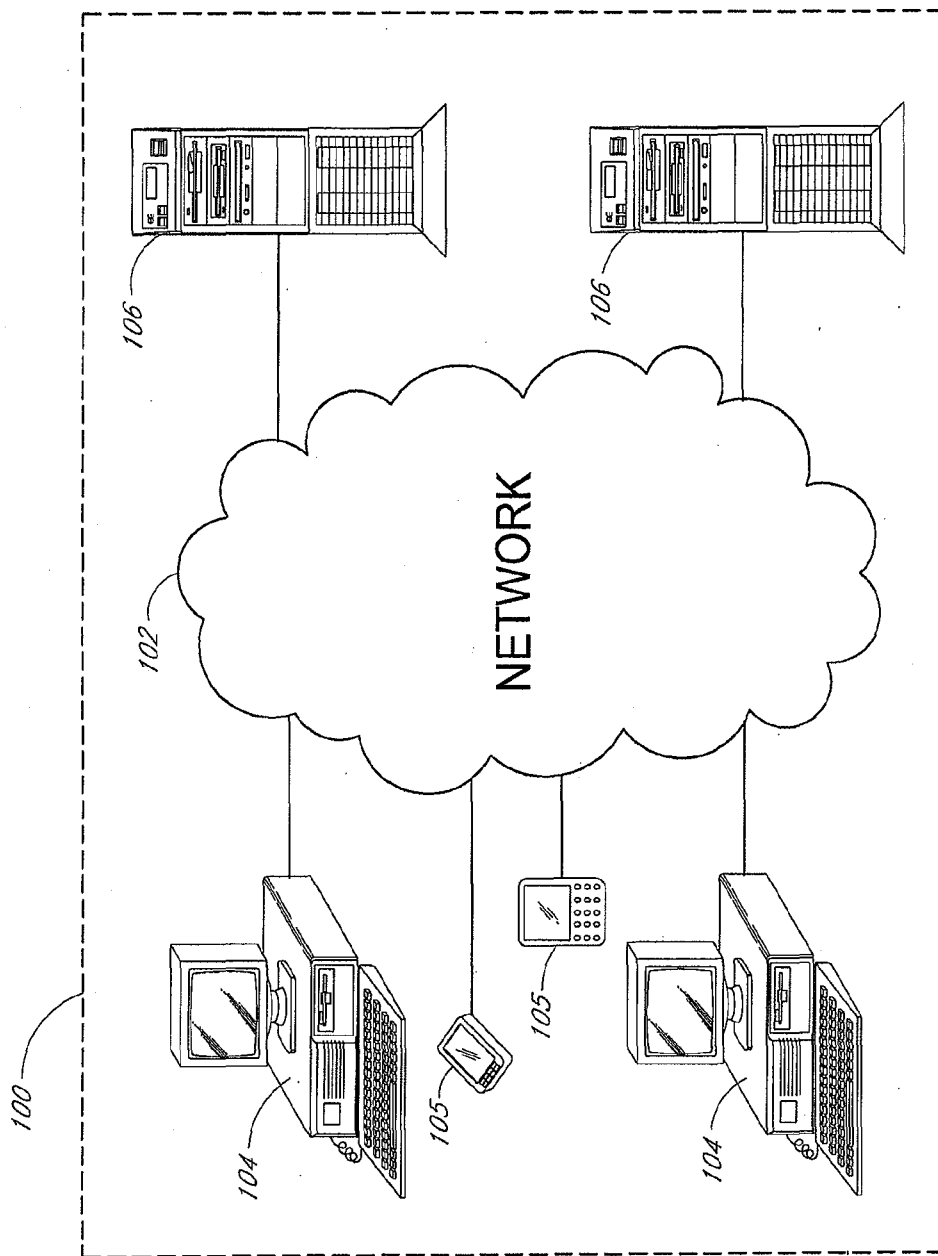

FIG. 1

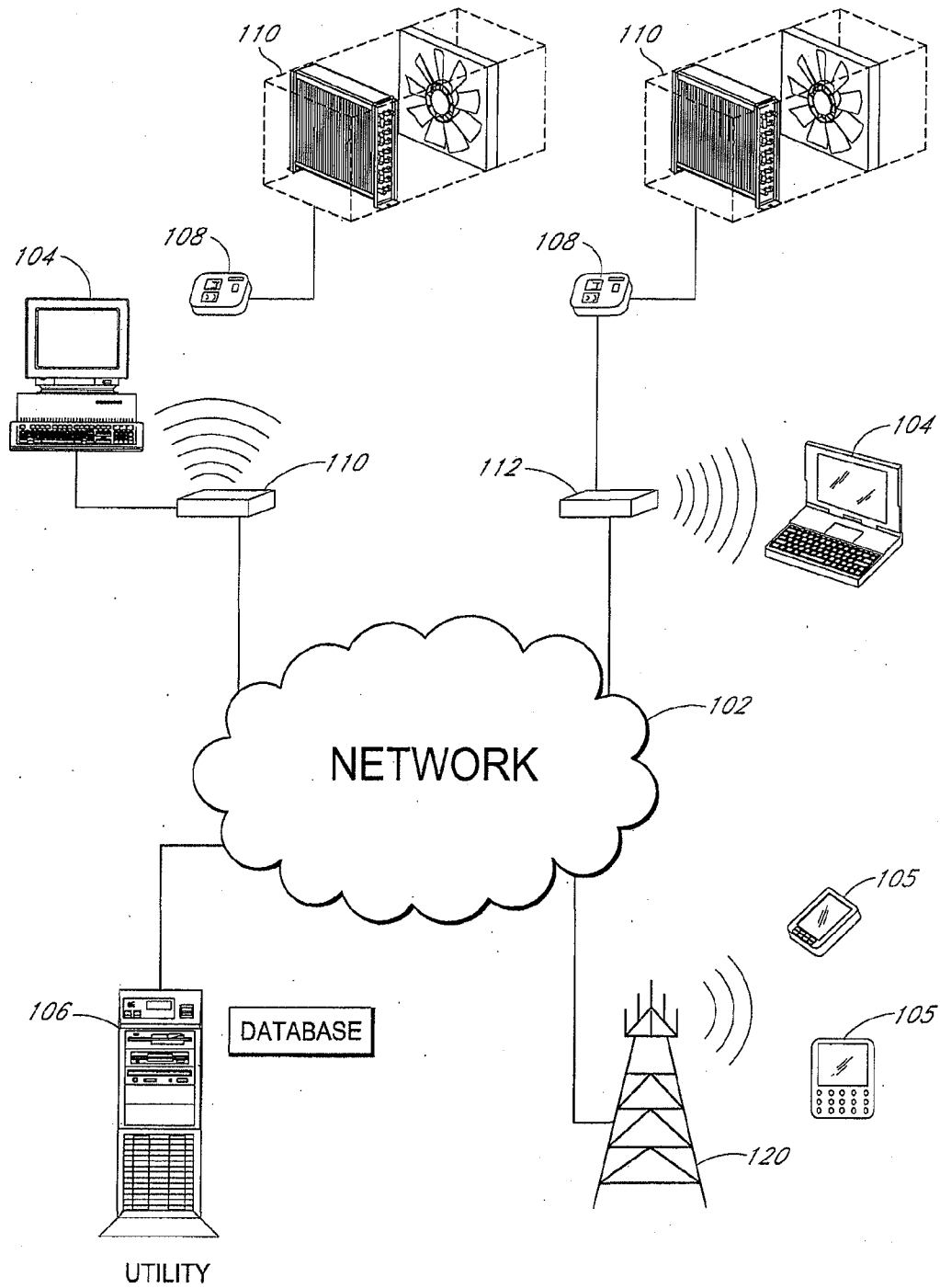

FIG. 2

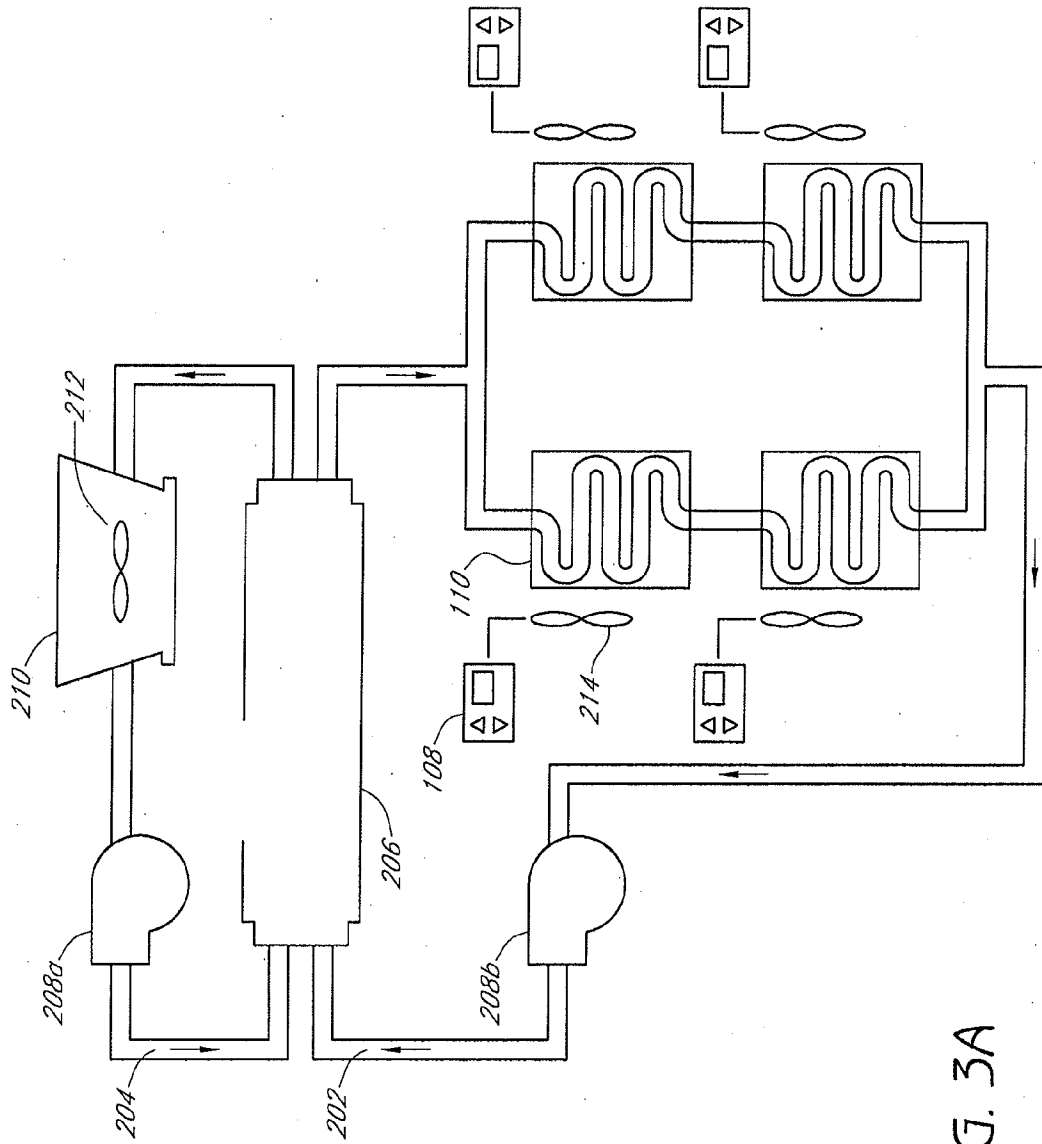

FIG. 3A

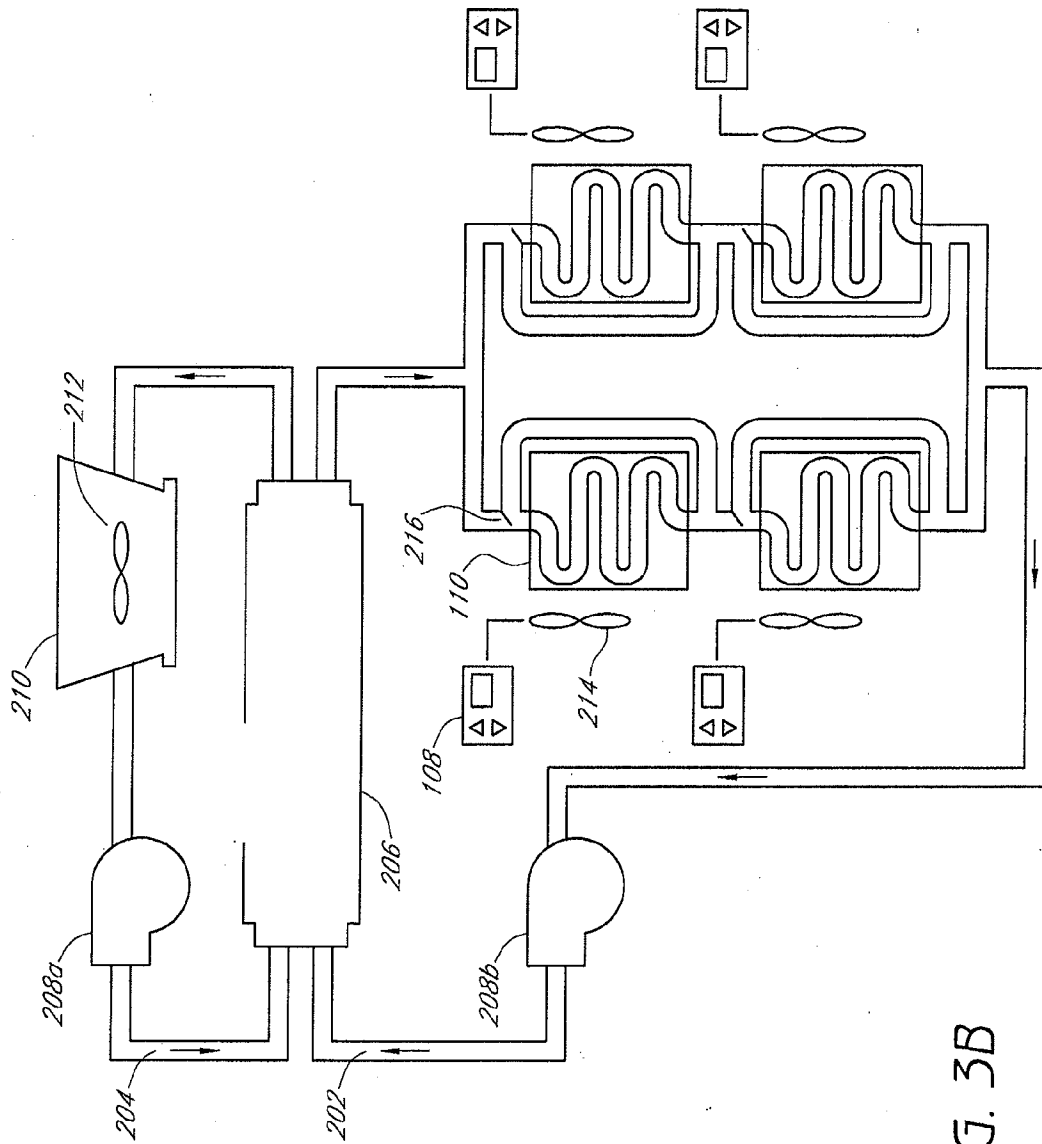

FIG. 3B

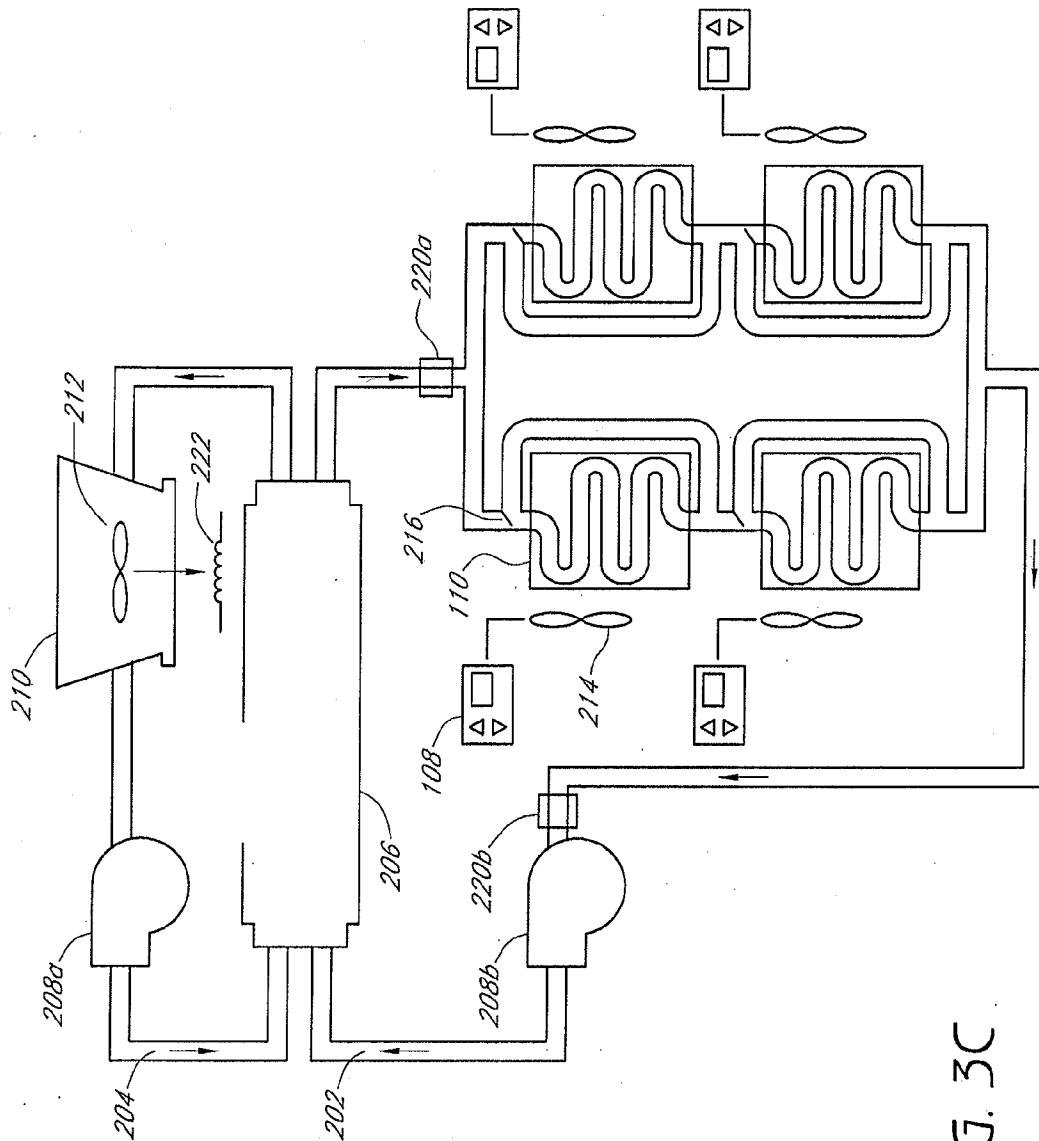

FIG. 3C

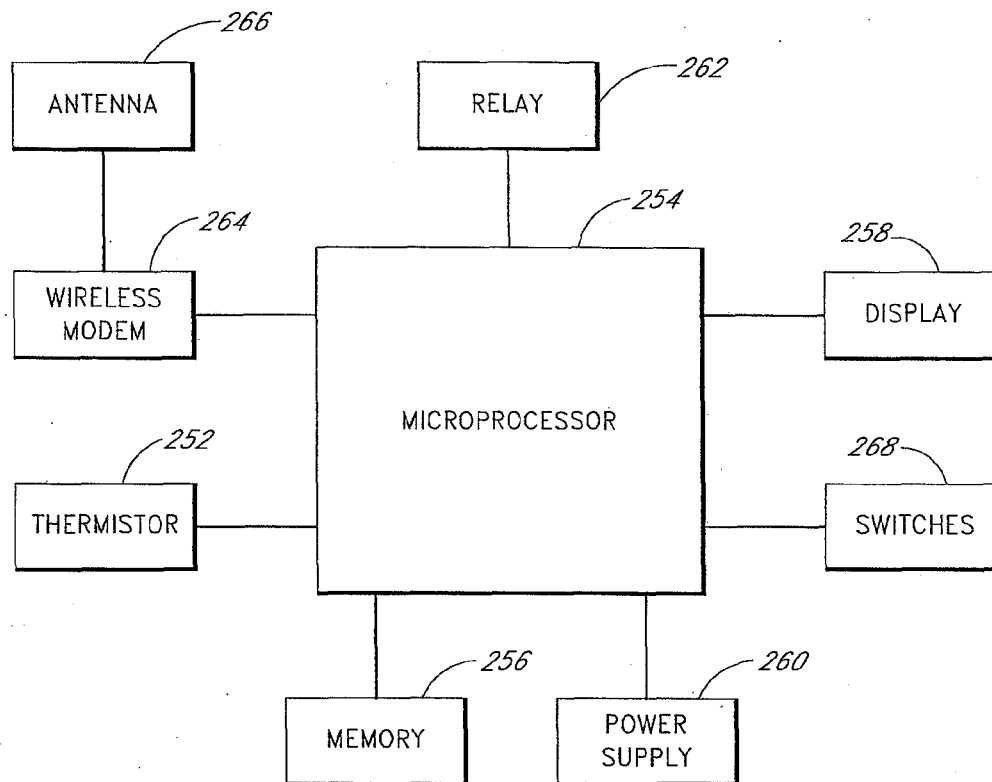

FIG. 4



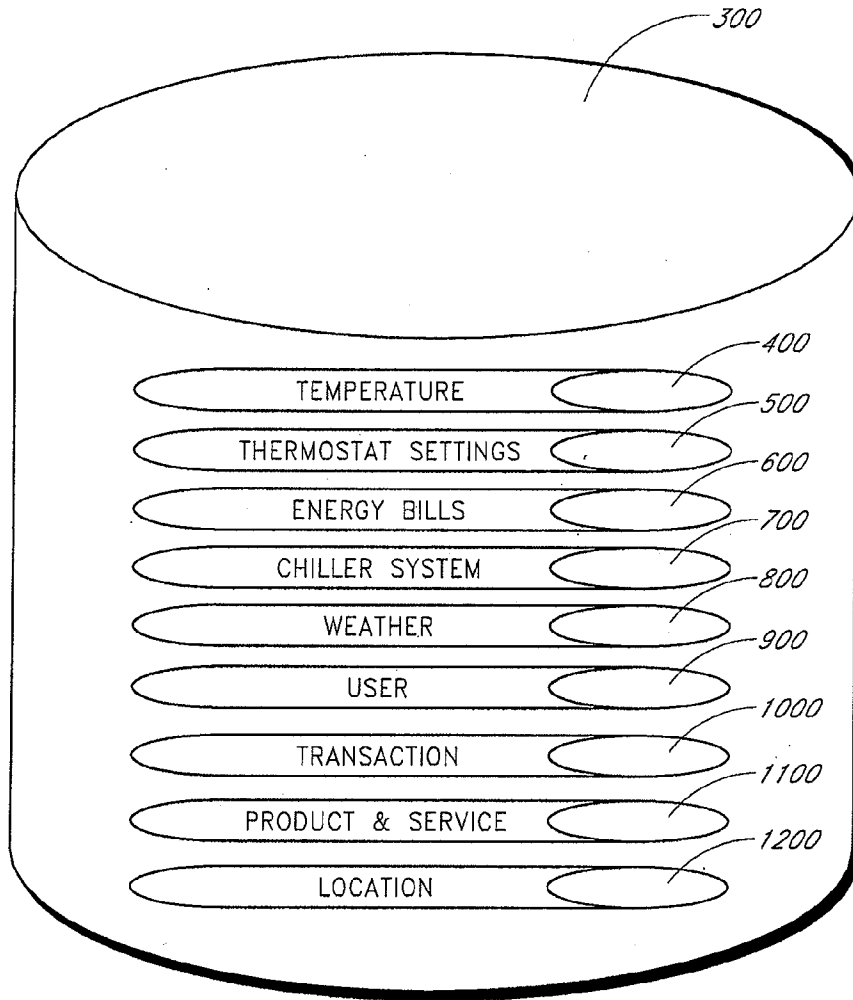

FIG. 5

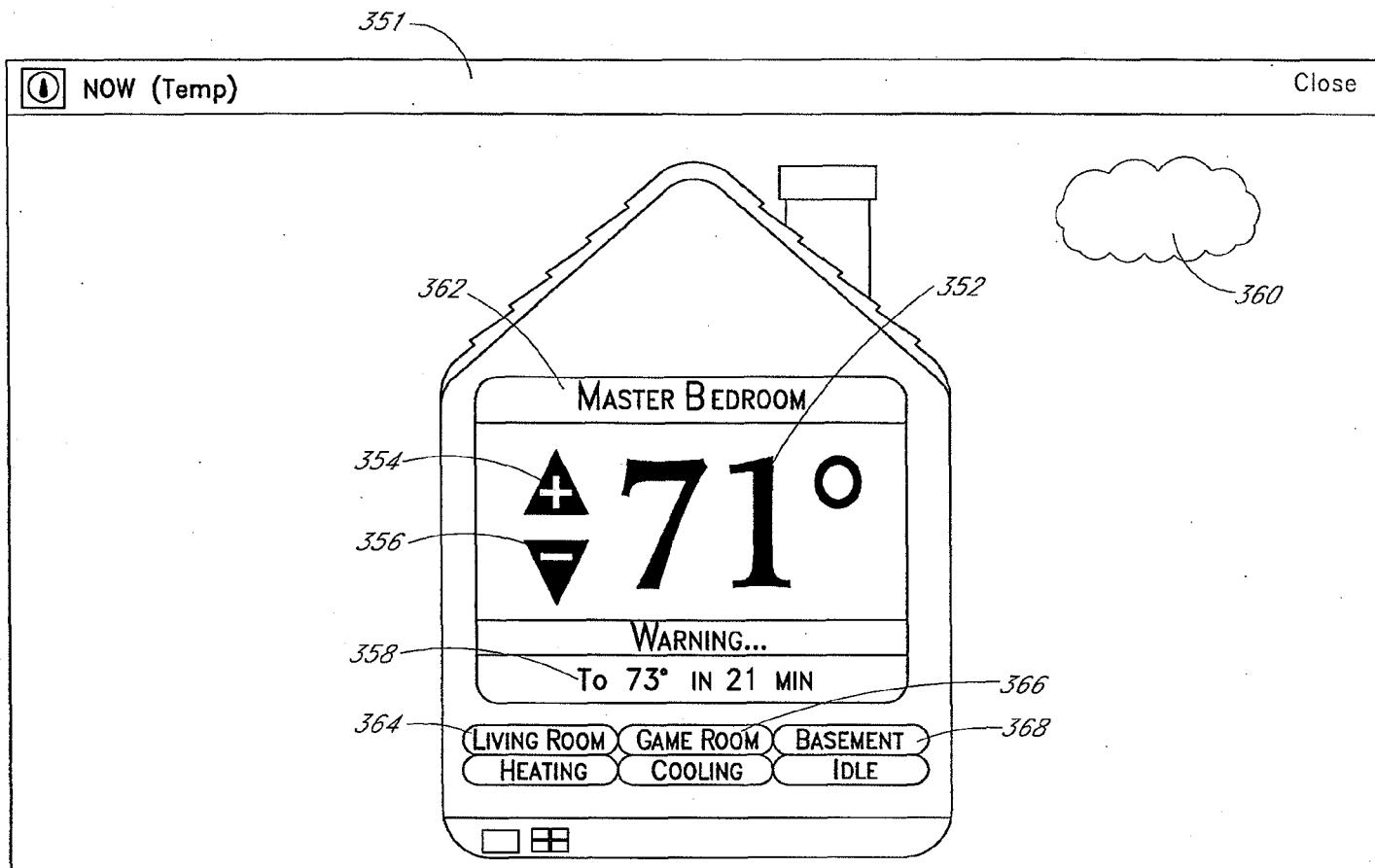

FIG. 6A

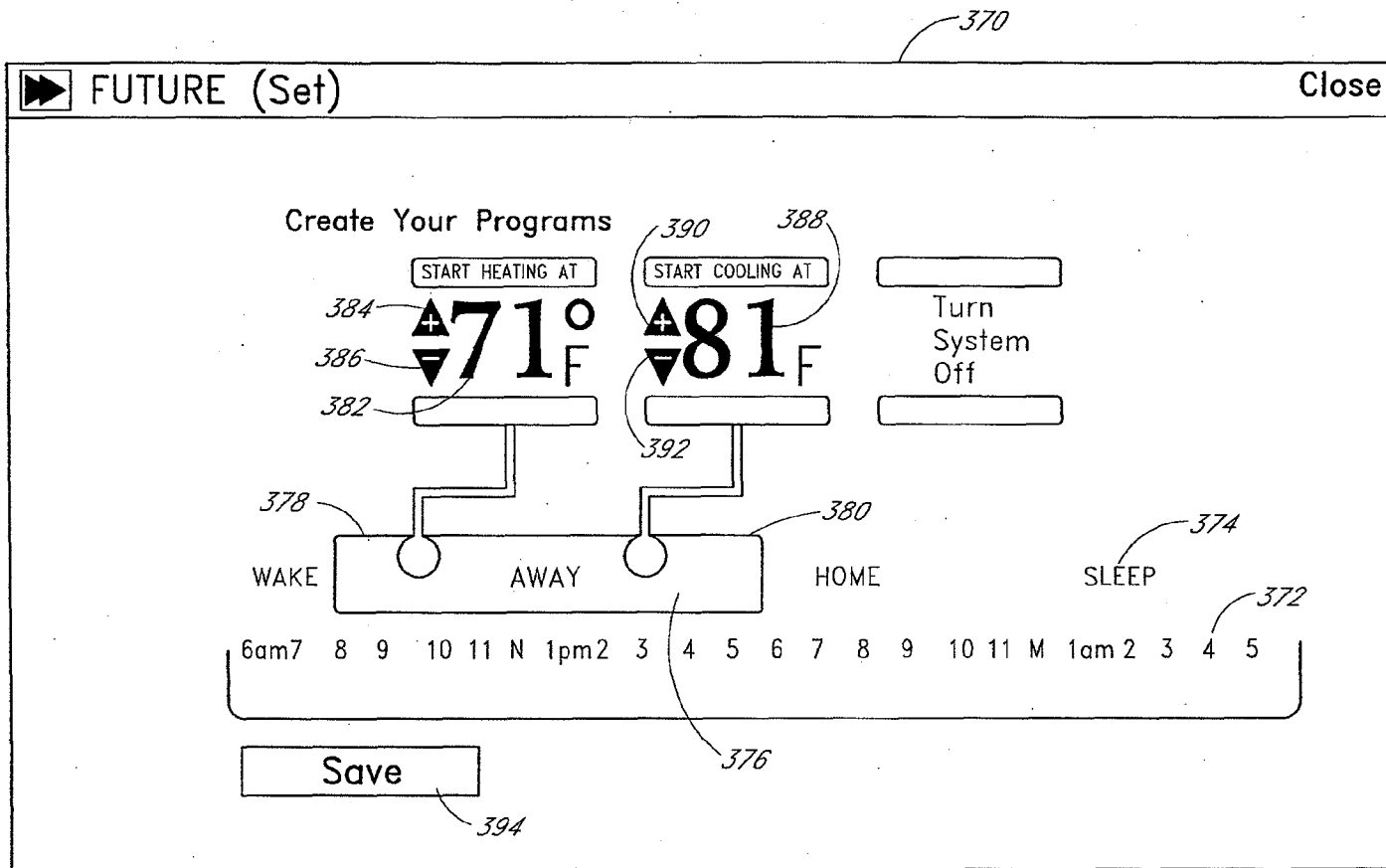

FIG. 6B

10/52

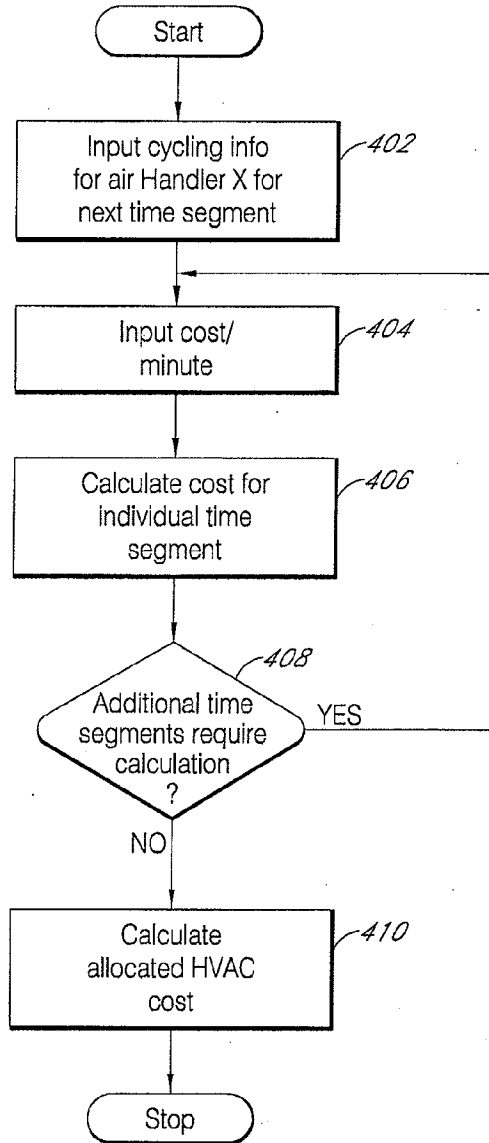

FIG. 7A

11/52

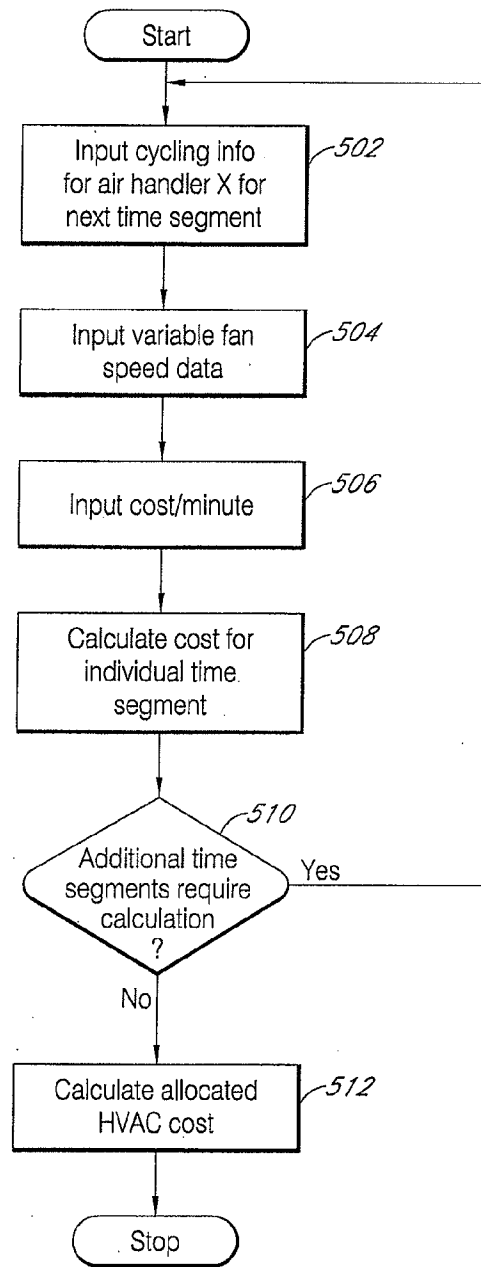

FIG. 7B

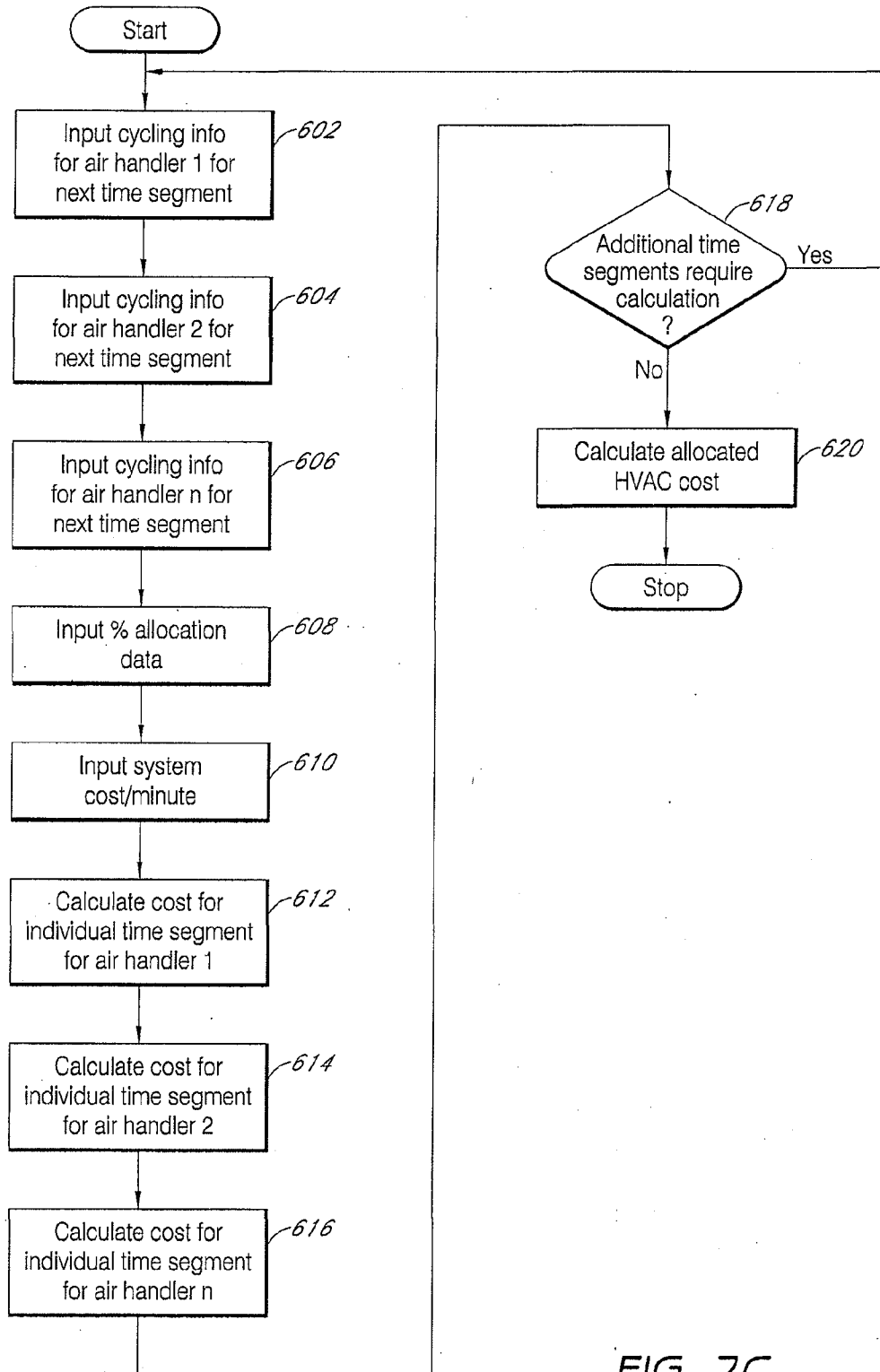

FIG. 7C

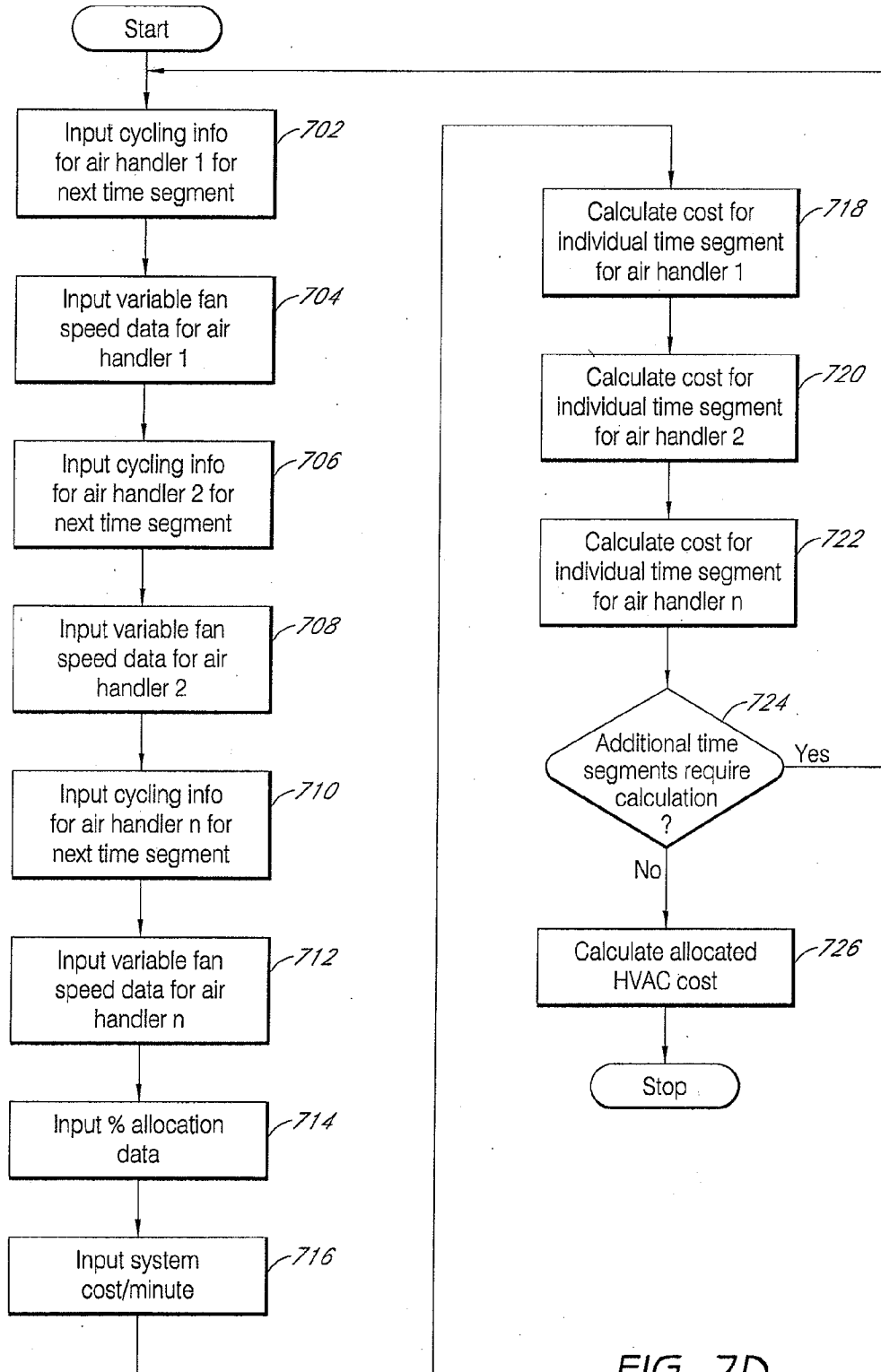

FIG. 7D

14/52

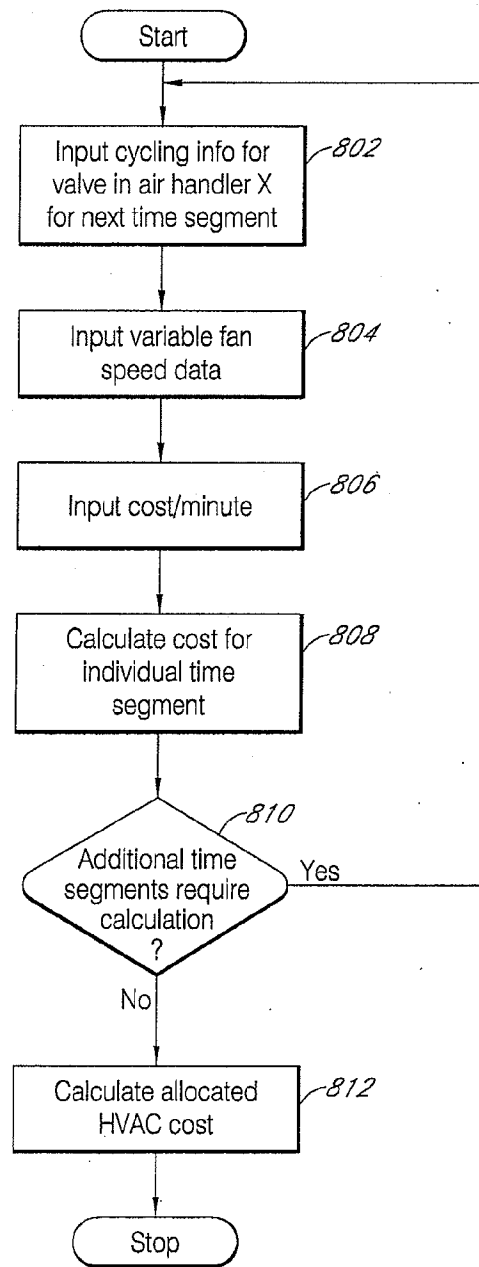

FIG. 7E



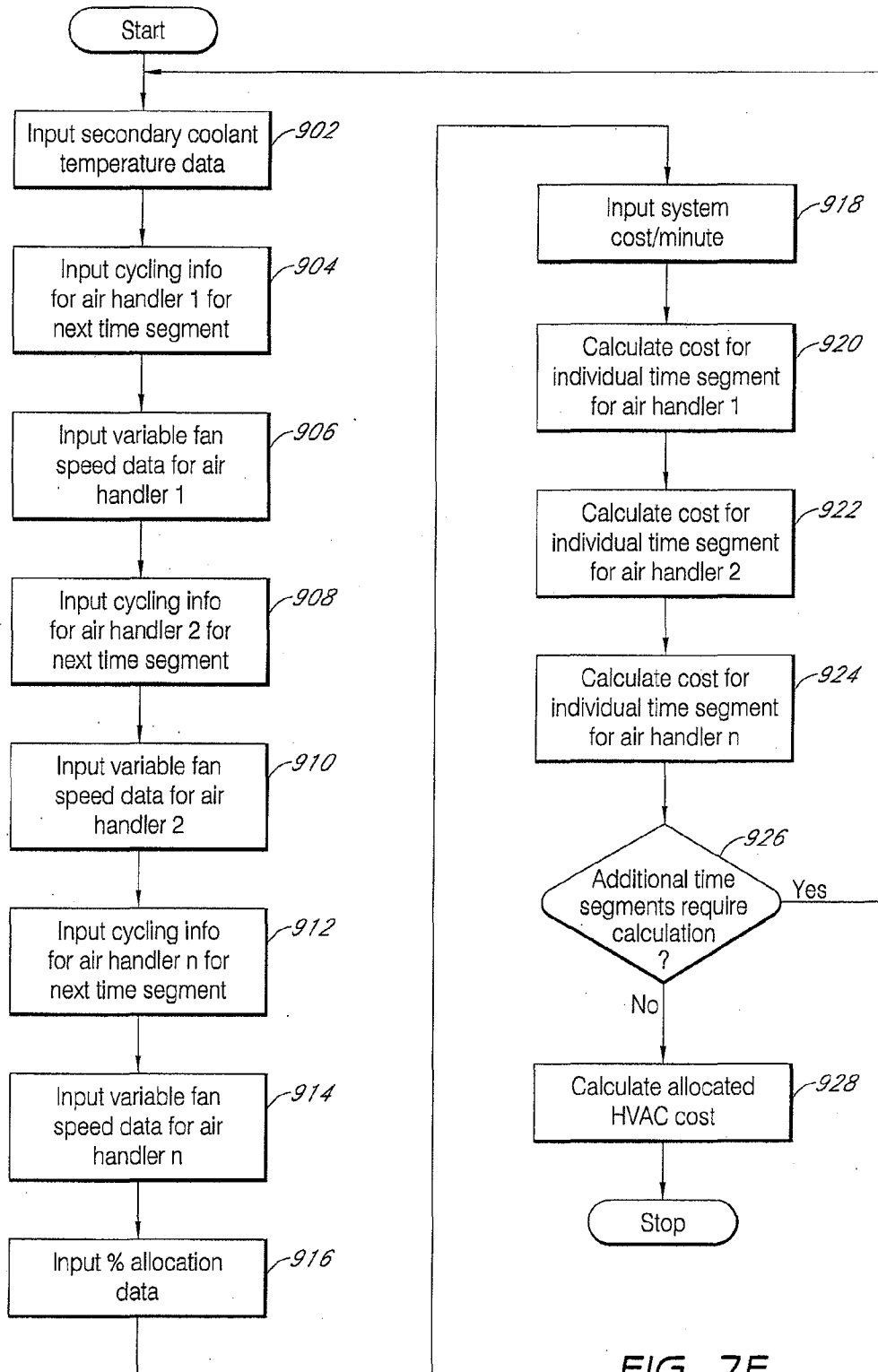

FIG. 7F

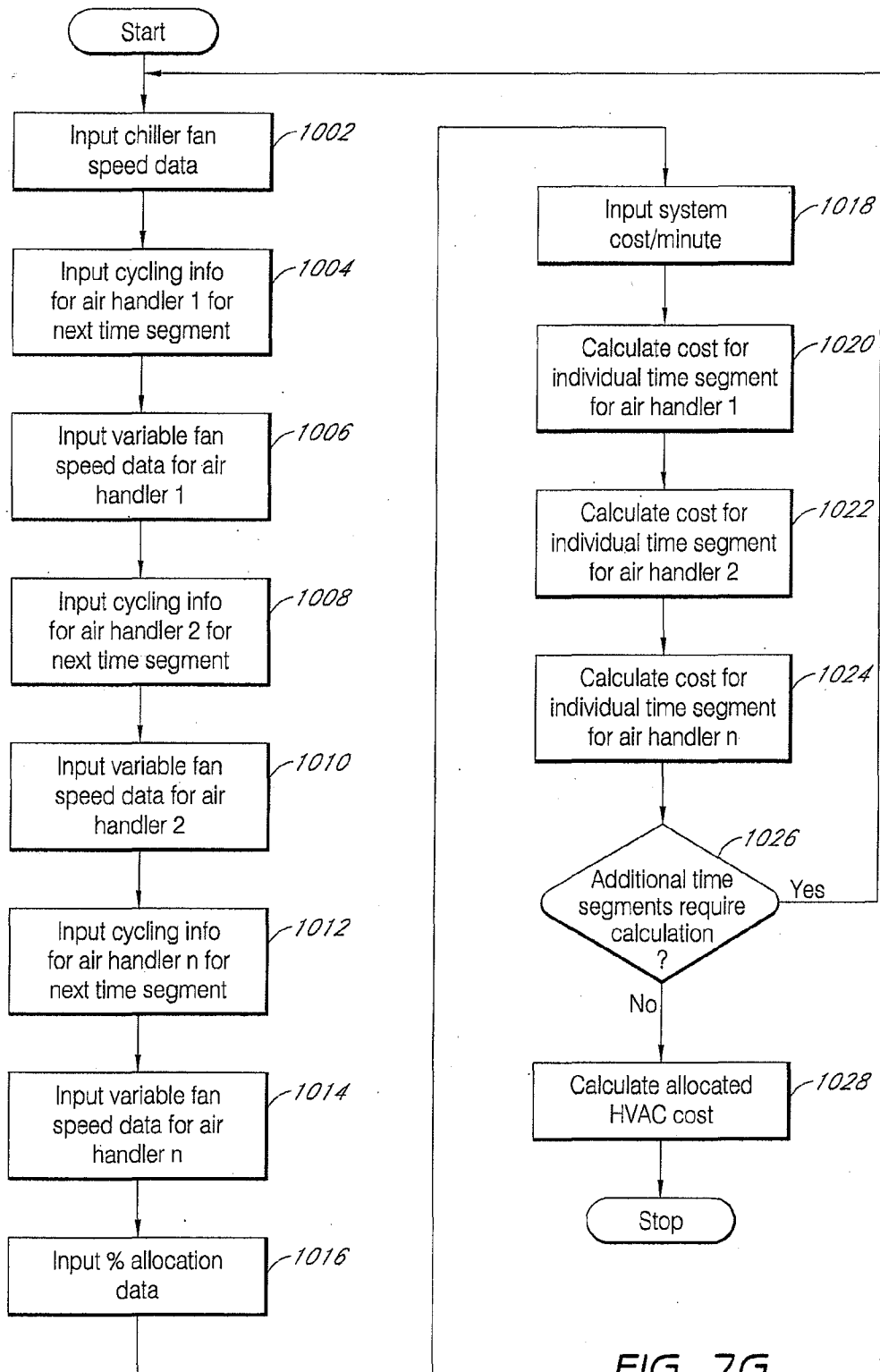

FIG. 7G

17/52

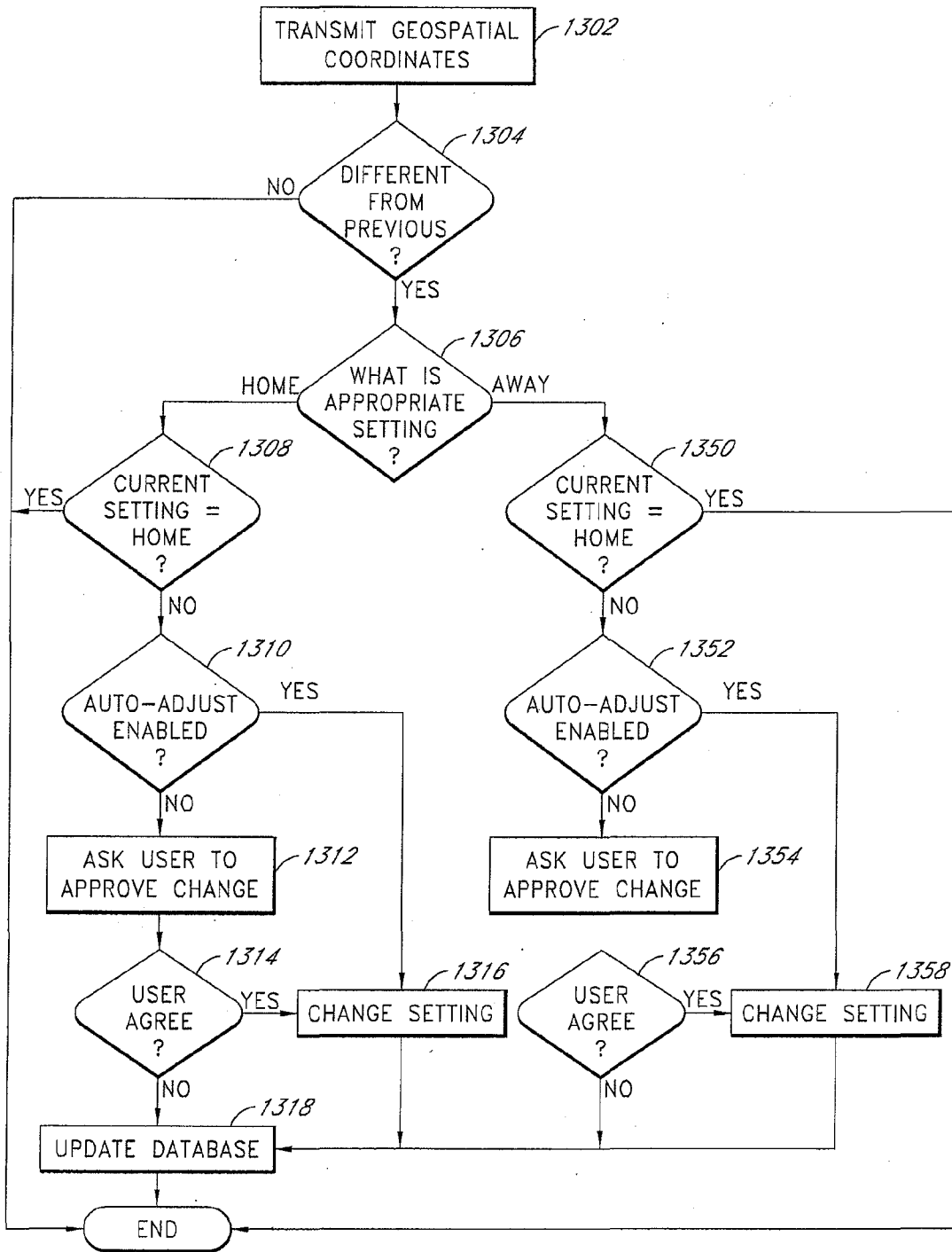

FIG. 8

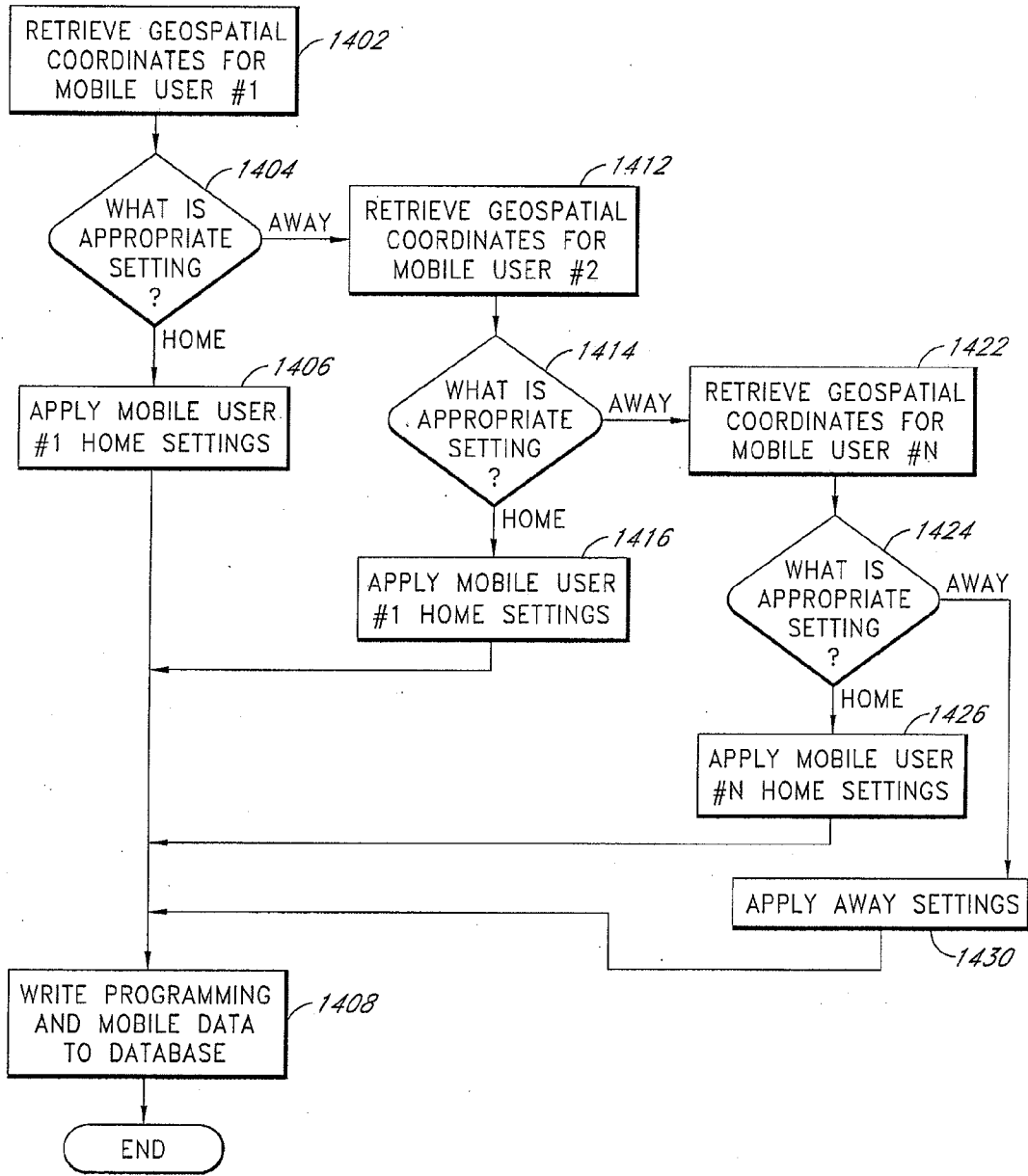

FIG. 9

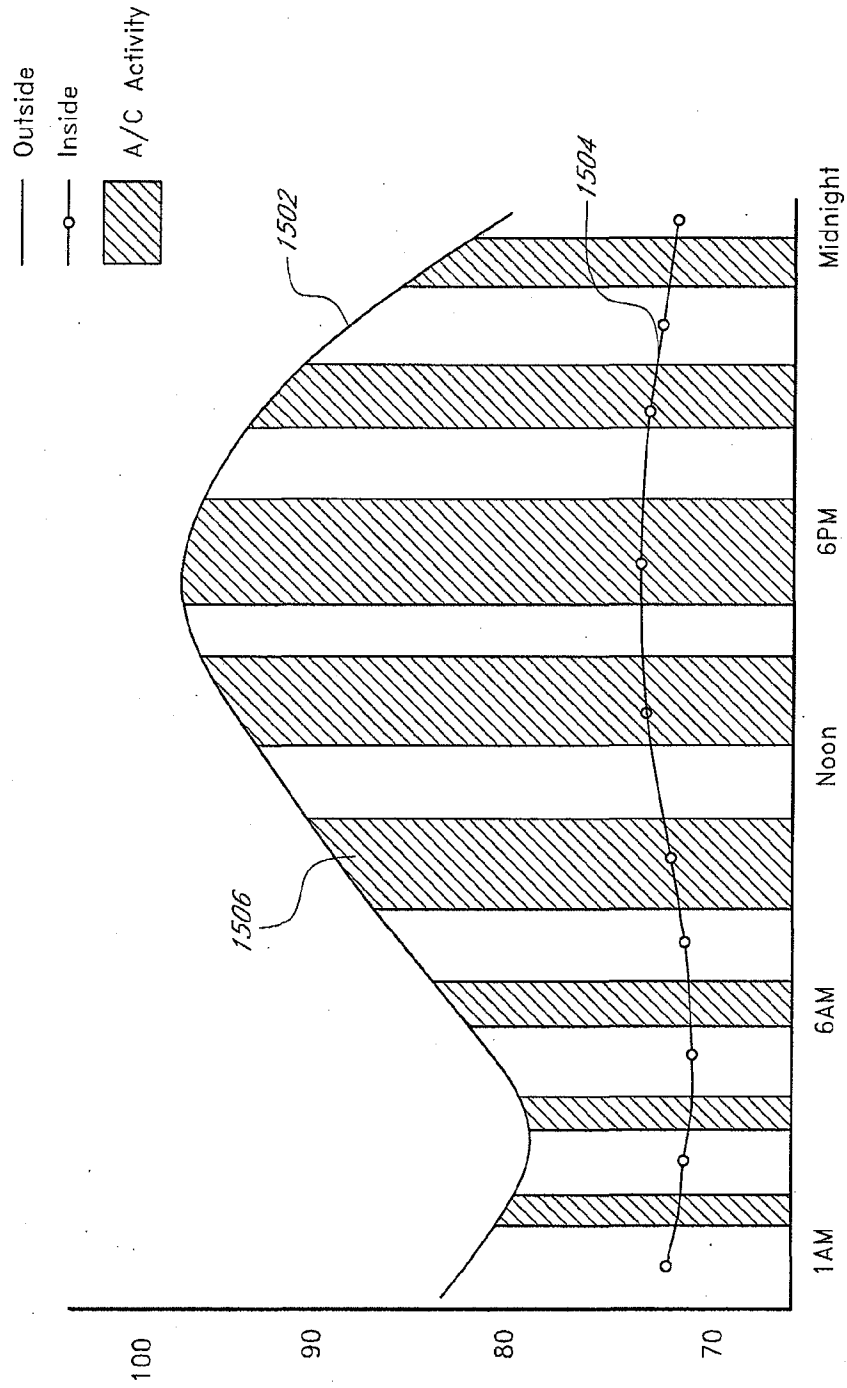

FIG. 10A

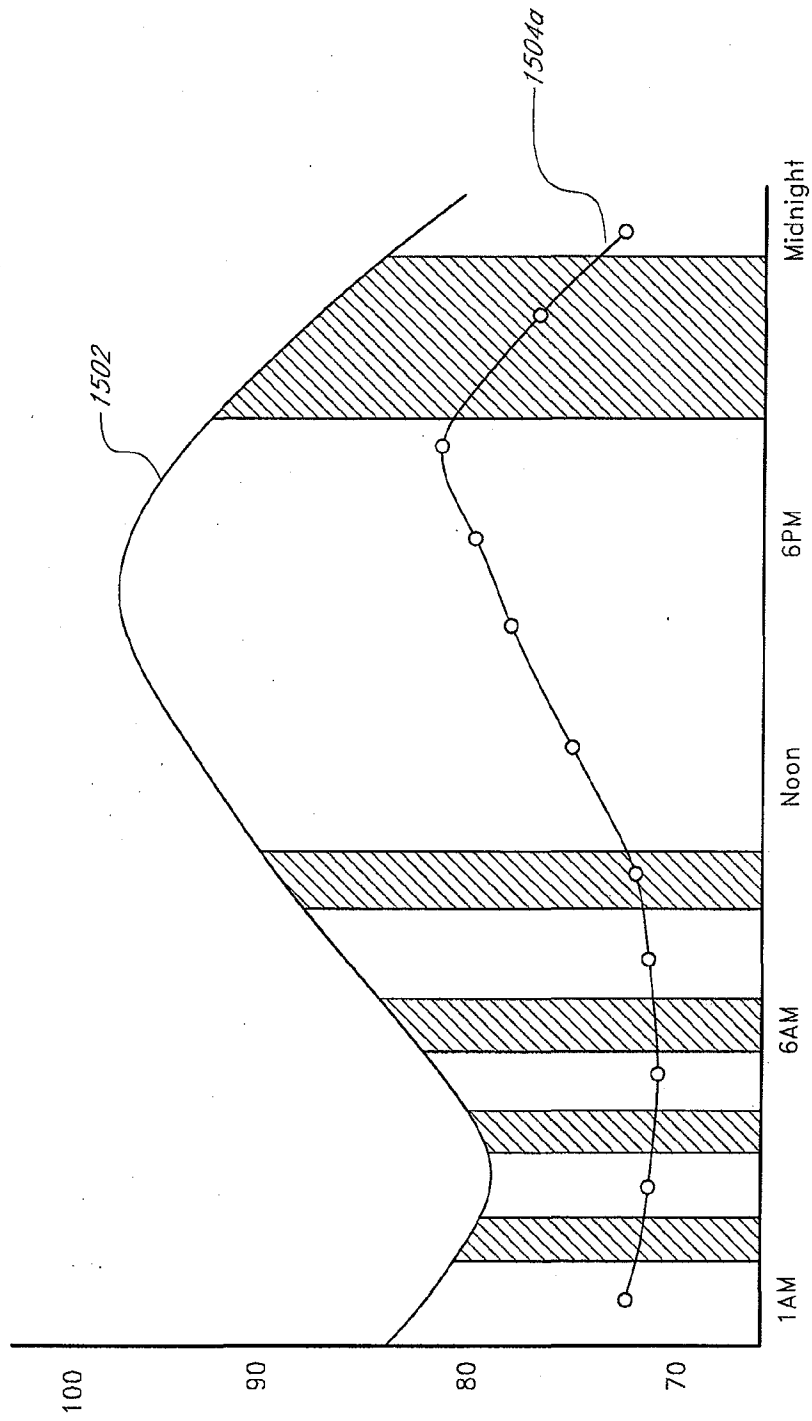

FIG. 10B

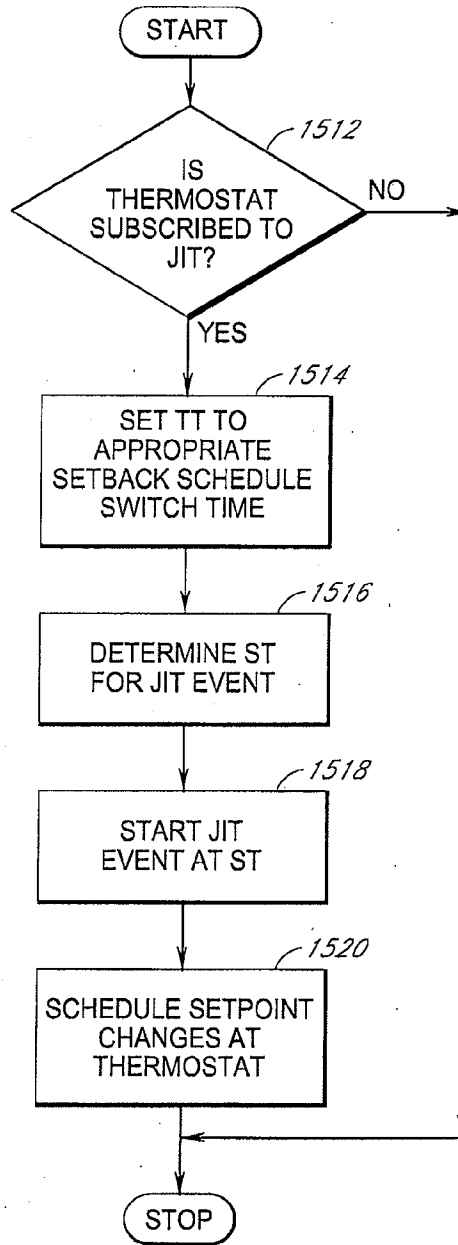

FIG. 11

22/52

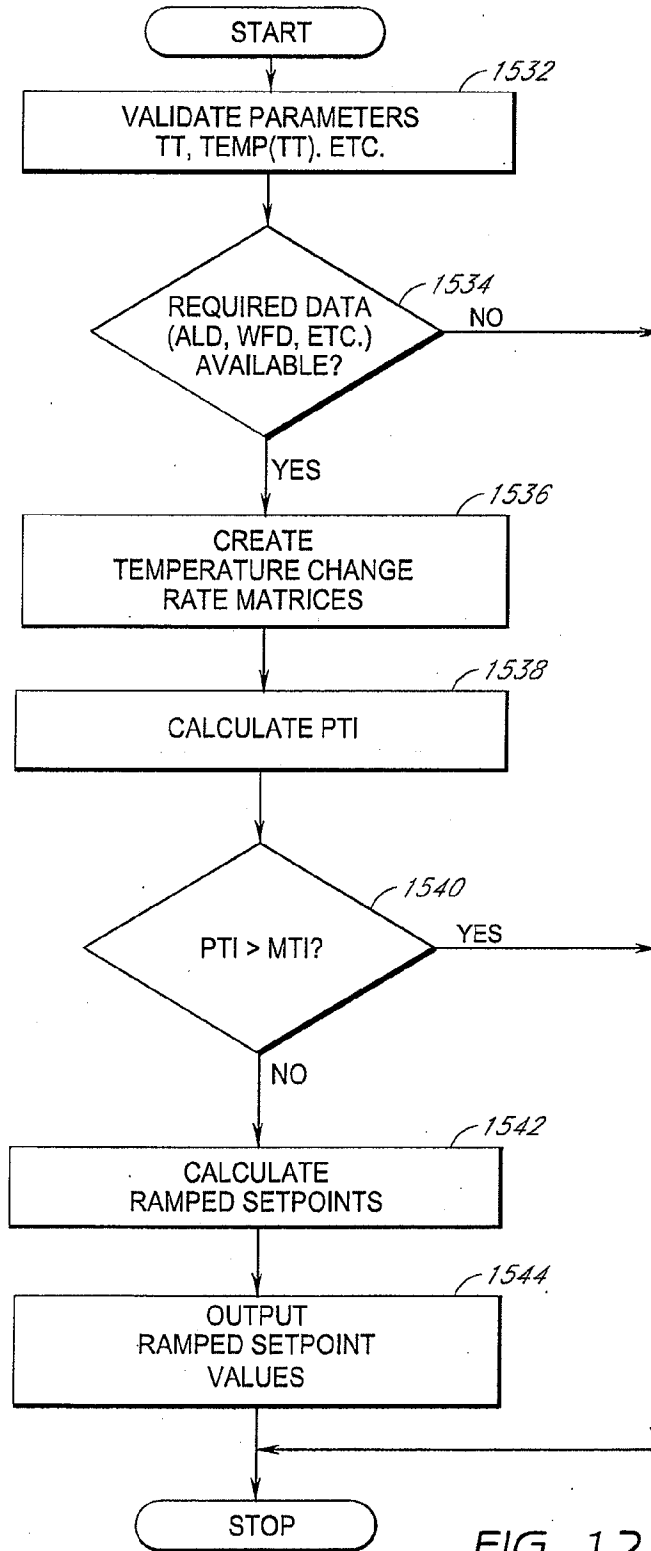

FIG. 12



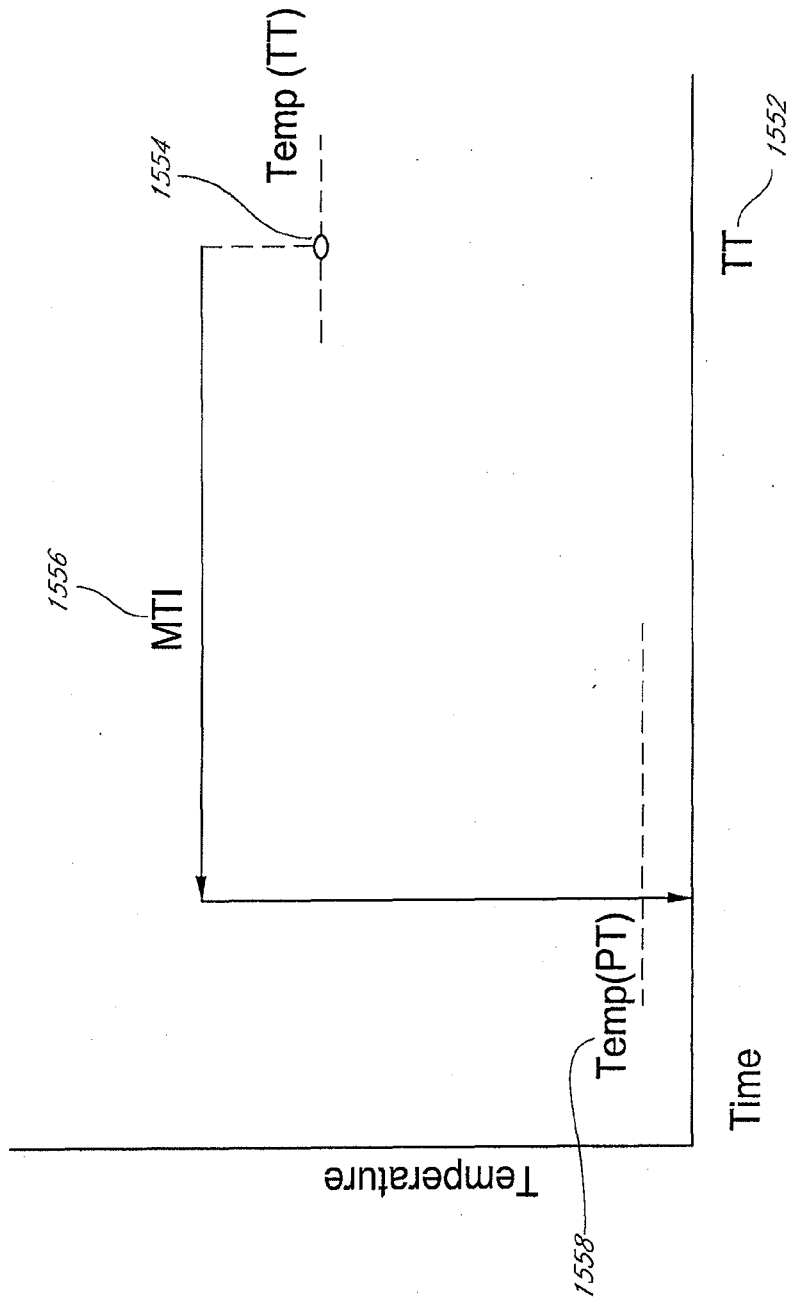

FIG. 13A

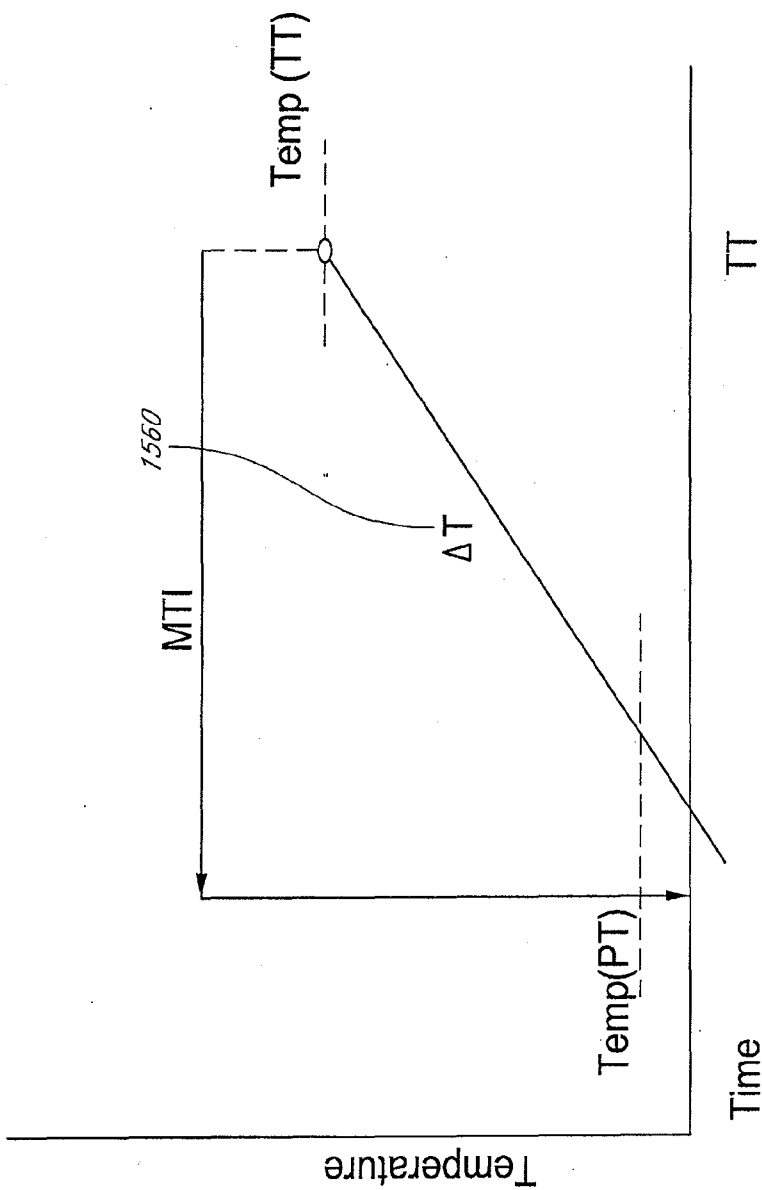

FIG. 13B

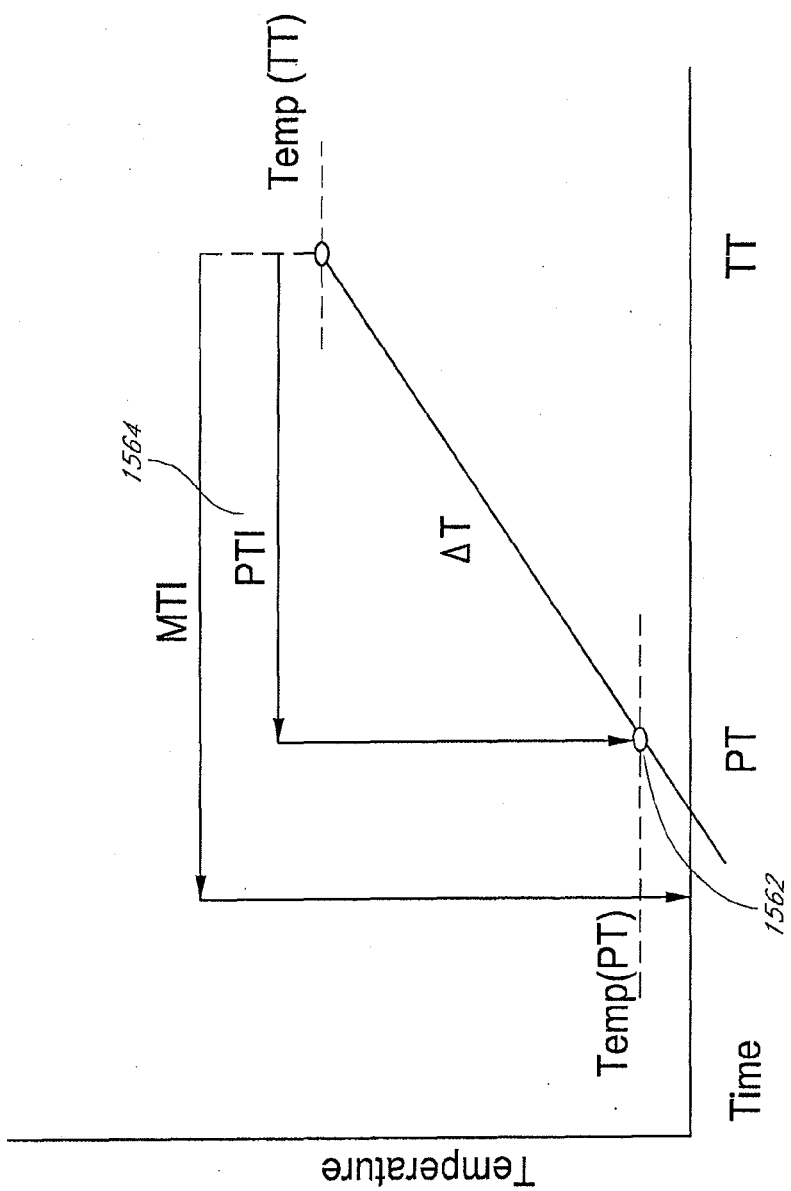

FIG. 13C

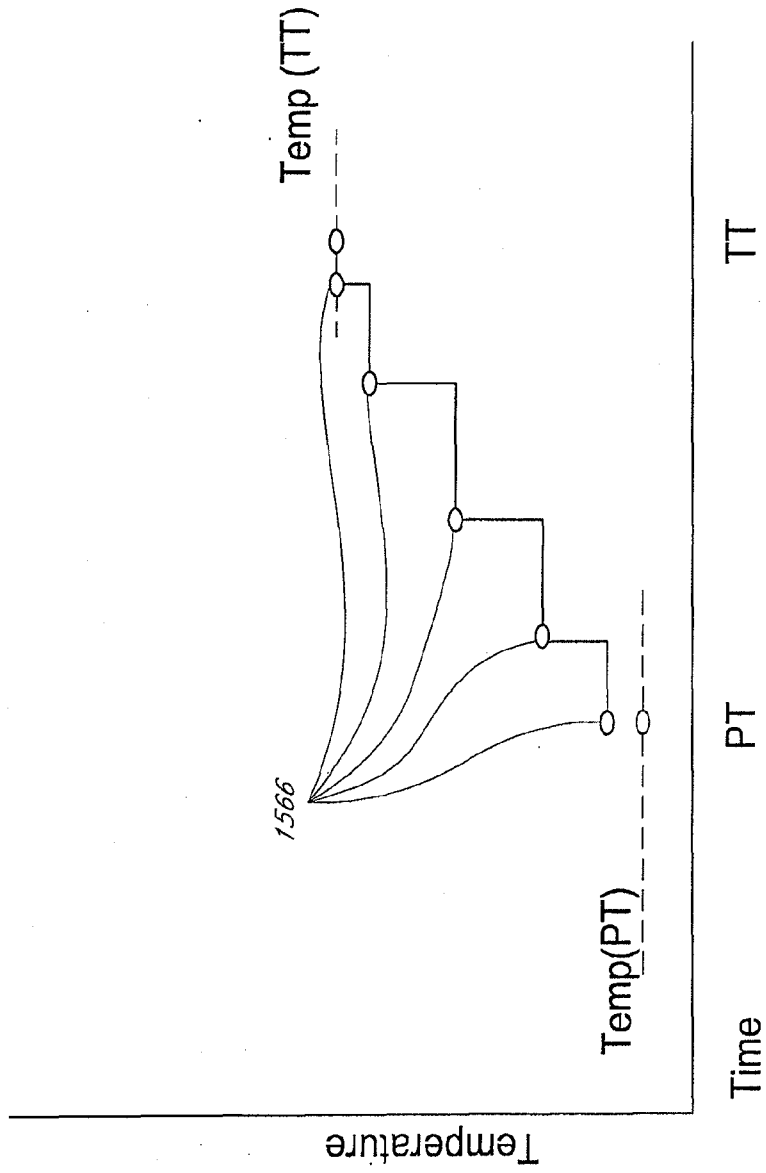

FIG. 13D

FIG. 14

| Time<br>(hh24:mm) | Temperature  |               | Outside/Conditions |          |                                 |                  |                | Inside Conditions |              |           |              |           |           |            |           |
|-------------------|--------------|---------------|--------------------|----------|---------------------------------|------------------|----------------|-------------------|--------------|-----------|--------------|-----------|-----------|------------|-----------|
|                   | Inside Temp. | Outside Temp. | Conditions         | Humidity | Pressure                        | Wind Speed       | Wind Direction | Cool Setting      | Heat Setting | Hold Mode | Schd Setting | Schd Cool | Schd Heat | Hvac State | Hvac Mode |
| 2009/04/10 11:00  | 69.70        | 54.00         | Mostly Cloudy      | 74%      | 29.89in/<br>1012.1hPa<br>Steady | 1.0mph<br>1.6kph | SE             | 80.00             | 71.00        | Off       | Out/Day      | 80.00     | 65.00     | Heat       | Heat      |
| 2009/04/10 11:01  | 69.69        | 54.10         | Overcast           | 74%      | 29.89in/<br>1012.1hPa<br>Rising | 2.0mph<br>3.2kph | SE             | 80.00             | 71.00        | Off       | Out/Day      | 80.00     | 65.00     | Heat       | Heat      |
| 2009/04/10 11:02  | 69.60        | 54.10         | Overcast           | 74%      | 29.89in/<br>1012.1hPa<br>Steady | 2.0mph<br>3.2kph | SE             | 80.00             | 71.00        | Off       | Out/Day      | 80.00     | 65.00     | Heat       | Heat      |
| 2009/04/10 11:03  | 69.70        | 54.10         | Overcast           | 74%      | 29.89in/<br>1012.1hPa<br>Rising | 2.0mph<br>3.2kph | SE             | 80.00             | 71.00        | Off       | Out/Day      | 80.00     | 65.00     | Heat       | Heat      |
| 2009/04/10 11:04  | 69.70        | 54.10         | Overcast           | 74%      | 29.89in/<br>1012.1hPa<br>Steady | 2.0mph<br>3.2kph | SE             | 80.00             | 71.00        | Off       | Out/Day      | 80.00     | 65.00     | Heat       | Heat      |
| 2009/04/10 11:05  | 69.70        | 54.10         | Overcast           | 74%      | 29.89in/<br>1012.1hPa<br>Rising | 2.0mph<br>3.2kph | SE             | 80.00             | 71.00        | Off       | Out/Day      | 80.00     | 65.00     | Heat       | Heat      |
| 2009/04/10 11:06  | 69.80        | 54.70         | Overcast           | 72%      | 29.89in/<br>1012.1hPa<br>Steady | 2.0mph<br>3.2kph | SE             | 80.00             | 71.00        | Off       | Out/Day      | 80.00     | 65.00     | Heat       | Heat      |
| 2009/04/10 11:07  | 69.80        | 54.70         | Overcast           | 72%      | 29.89in/<br>1012.1hPa<br>Rising | 2.0mph<br>3.2kph | SE             | 80.00             | 71.00        | Off       | Out/Day      | 80.00     | 65.00     | Heat       | Heat      |
| 2009/04/10 11:08  | 70.00        | 54.70         | Overcast           | 72%      | 29.89in/<br>1012.1hPa<br>Steady | 2.0mph<br>3.2kph | SE             | 80.00             | 71.00        | Off       | Out/Day      | 80.00     | 65.00     | Heat       | Heat      |
| 2009/04/10 11:09  | 70.00        | 54.70         | Overcast           | 72%      | 29.89in/<br>1012.1hPa<br>Rising | 2.0mph<br>3.2kph | SE             | 80.00             | 71.00        | Off       | Out/Day      | 80.00     | 65.00     | Heat       | Heat      |
| 2009/04/10 11:10  | 70.00        | 54.70         | Overcast           | 72%      | 29.89in/<br>1012.1hPa<br>Steady | 2.0mph<br>3.2kph | SE             | 80.00             | 71.00        | Off       | Out/Day      | 80.00     | 65.00     | Heat       | Heat      |

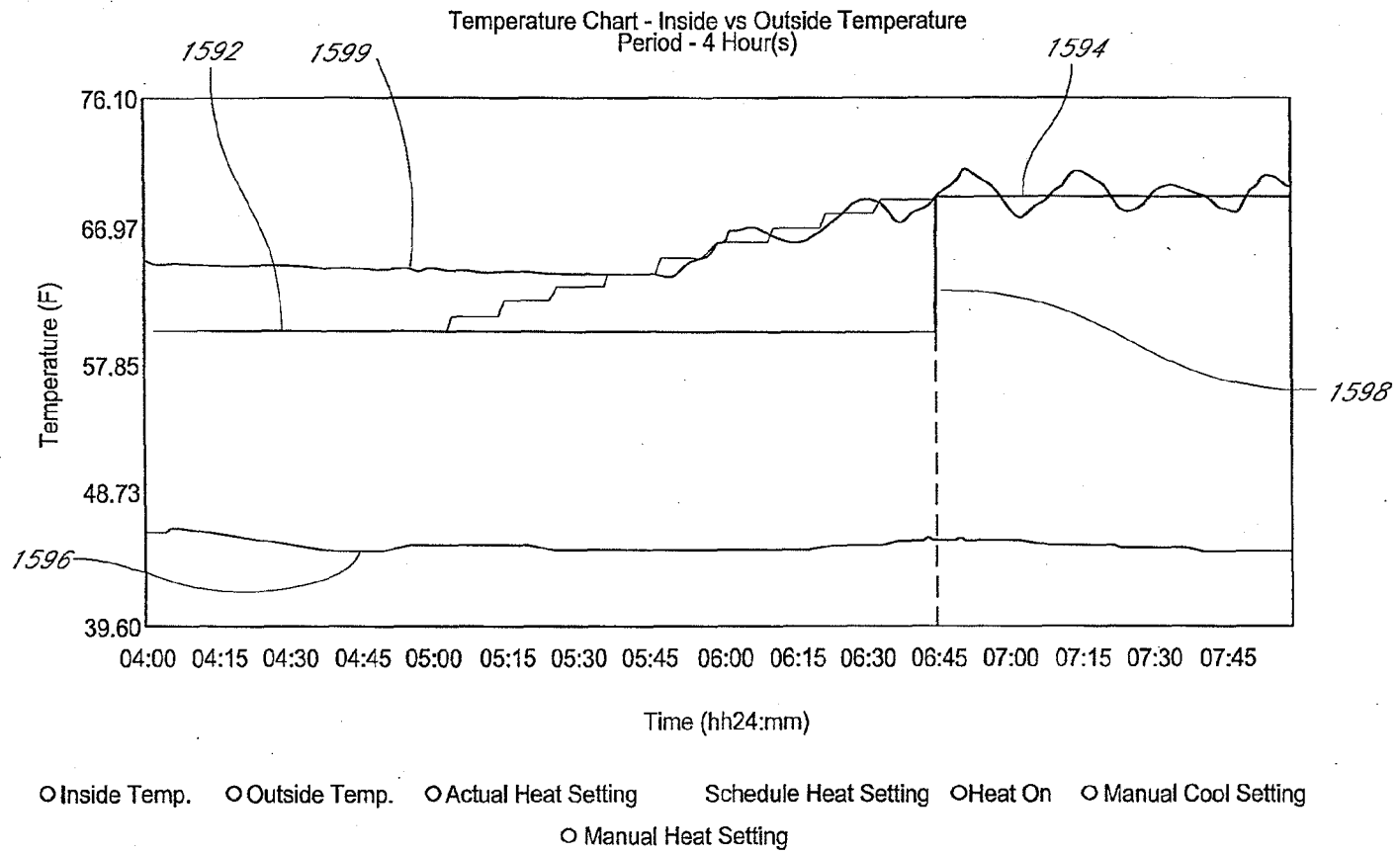

FIG. 15

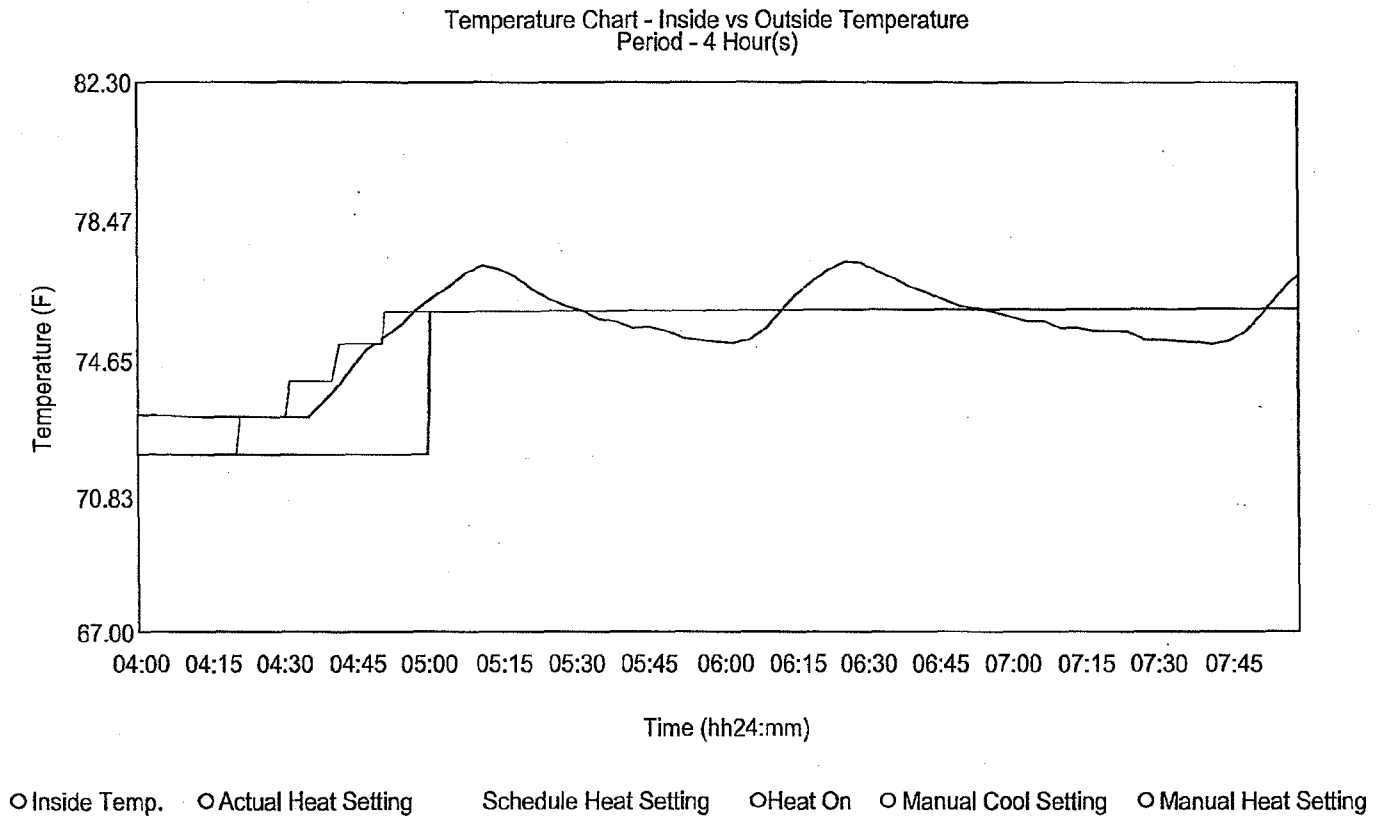

FIG. 16

FIG. 17-1

---

FIG. 17-2

FIG. 17

1602                      1604

FIG. 17-1

| Outside/Inside Difference, Degrees F | Predicted Inside Temp Change, Degrees F/hour | Outside/Inside Difference, Degrees F | Predicted Inside Temp Change, Degrees F/hour | Outside/Inside Difference, Degrees F | Predicted Inside Temp Change, Degrees F/hour | Outside/Inside Difference, Degrees F | Predicted Inside Temp Change, Degrees F/hour |
|--------------------------------------|--|--------------------------------------|--|--------------------------------------|--|--------------------------------------|--|
| -99                                  | -1.20945425                                  | -49                                  | 0.61355475                                   | 1                                    | 2.43656376                                   | 51                                   | 4.25957277                                   |
| -98                                  | -1.17299407                                  | -48                                  | 0.65001493                                   | 2                                    | 2.47302394                                   | 52                                   | 4.29603295                                   |
| -97                                  | -1.13653389                                  | -47                                  | 0.68647511                                   | 3                                    | 2.50948412                                   | 53                                   | 4.33249313                                   |
| -96                                  | -1.10007371                                  | -46                                  | 0.72293529                                   | 4                                    | 2.5459443                                    | 54                                   | 4.36895331                                   |
| -95                                  | -1.06361353                                  | -45                                  | 0.75939547                                   | 5                                    | 2.58240448                                   | 55                                   | 4.40541349                                   |
| -94                                  | -1.02715335                                  | -44                                  | 0.79585565                                   | 6                                    | 2.61886466                                   | 56                                   | 4.44187367                                   |
| -93                                  | -0.99069317                                  | -43                                  | 0.83231583                                   | 7                                    | 2.65532484                                   | 57                                   | 4.47833385                                   |
| -92                                  | -0.95423299                                  | -42                                  | 0.86877602                                   | 8                                    | 2.69178502                                   | 58                                   | 4.51479403                                   |
| -91                                  | -0.91777281                                  | -41                                  | 0.9052362                                    | 9                                    | 2.7282452                                    | 59                                   | 4.55125421                                   |
| -90                                  | -0.88131263                                  | -40                                  | 0.94169638                                   | 10                                   | 2.76470538                                   | 60                                   | 4.58771439                                   |
| -89                                  | -0.84485245                                  | -39                                  | 0.97815656                                   | 11                                   | 2.80116556                                   | 61                                   | 4.62417457                                   |
| -88                                  | -0.80839227                                  | -38                                  | 1.01461674                                   | 12                                   | 2.83762574                                   | 62                                   | 4.66063475                                   |
| -87                                  | -0.77193209                                  | -37                                  | 1.05107692                                   | 13                                   | 2.87408592                                   | 63                                   | 4.69709493                                   |
| -86                                  | -0.73547191                                  | -36                                  | 1.0542371                                    | 14                                   | 2.9105461                                    | 64                                   | 4.73355511                                   |
| -85                                  | -0.69901173                                  | -35                                  | 1.12399728                                   | 15                                   | 2.94700628                                   | 65                                   | 4.77001529                                   |
| -84                                  | -0.66255155                                  | -34                                  | 1.16045746                                   | 16                                   | 2.98346646                                   | 66                                   | 4.80647547                                   |
| -83                                  | -0.62609137                                  | -33                                  | 1.19691764                                   | 17                                   | 3.01992664                                   | 67                                   | 4.84293565                                   |
| -82                                  | -0.58963119                                  | -32                                  | 1.23337782                                   | 18                                   | 3.05638682                                   | 68                                   | 4.87939583                                   |
| -81                                  | -0.55317101                                  | -31                                  | 1.269838                                     | 19                                   | 3.092847                                     | 69                                   | 4.91585601                                   |
| -80                                  | -0.51671083                                  | -30                                  | 1.30629818                                   | 20                                   | 3.12930718                                   | 70                                   | 4.95231619                                   |
| -79                                  | -0.48025065                                  | -29                                  | 1.34275836                                   | 21                                   | 3.16576736                                   | 71                                   | 4.98877637                                   |
| -78                                  | -0.44379047                                  | -28                                  | 1.37921854                                   | 22                                   | 3.20222754                                   | 72                                   | 5.02523655                                   |

30/52



|     |             |  |     |            |  |    |            |  |    |            |
|-----|-------------|--|-----|------------|--|----|------------|--|----|------------|
| -77 | -0.40733029 |  | -27 | 1.41567872 |  | 23 | 3.23868772 |  | 73 | 5.06169673 |
| -76 | -0.37087011 |  | -26 | 1.4521389  |  | 24 | 3.27514791 |  | 74 | 5.09815691 |
| -75 | -0.33440993 |  | -25 | 1.48859908 |  | 25 | 3.31160809 |  | 75 | 5.13461709 |
| -74 | -0.29794975 |  | -24 | 1.52505926 |  | 26 | 3.34806827 |  | 76 | 5.17107727 |
| -73 | -0.26148957 |  | -23 | 1.56151944 |  | 27 | 3.38452845 |  | 77 | 5.20753745 |
| -72 | -0.22502939 |  | -22 | 1.59797962 |  | 28 | 3.42098663 |  | 78 | 5.24399763 |
| -71 | -0.18856921 |  | -21 | 1.6344398  |  | 29 | 3.45744881 |  | 79 | 5.28045781 |
| -70 | -0.15210903 |  | -20 | 1.67089998 |  | 30 | 3.49390899 |  | 80 | 5.31691799 |
| -69 | -0.11564885 |  | -19 | 1.70736016 |  | 31 | 3.53036917 |  | 81 | 5.35337817 |
| -68 | -0.07918867 |  | -18 | 1.74382034 |  | 32 | 3.56682935 |  | 82 | 5.38983835 |
| -67 | -0.04272849 |  | -17 | 1.78028052 |  | 33 | 3.60328953 |  | 83 | 5.42629853 |
| -66 | -0.00626831 |  | -16 | 1.8167407  |  | 34 | 3.63974971 |  | 84 | 5.46275871 |
| -65 | 0.03019187  |  | -15 | 1.85320088 |  | 35 | 3.67620989 |  | 85 | 5.49921889 |
| -64 | 0.06665205  |  | -14 | 1.88966106 |  | 36 | 3.74913025 |  | 86 | 5.53567907 |
| -63 | 0.10311223  |  | -13 | 1.92612124 |  | 37 | 3.74913025 |  | 87 | 5.57213925 |
| -62 | 0.13957241  |  | -12 | 1.96258142 |  | 38 | 3.78559043 |  | 88 | 5.60859943 |
| -61 | 0.17603259  |  | -11 | 1.9990416  |  | 39 | 3.82205061 |  | 89 | 5.64505962 |
| -60 | 0.21249277  |  | -10 | 2.03550178 |  | 40 | 3.85851079 |  | 90 | 5.6815198  |
| -59 | 0.24895295  |  | -9  | 2.07196196 |  | 41 | 3.89497097 |  | 91 | 5.71797998 |
| -58 | 0.28541313  |  | -8  | 2.10842214 |  | 42 | 3.93143115 |  | 92 | 5.75444016 |
| -57 | 0.32187331  |  | -7  | 2.14488232 |  | 43 | 3.96789133 |  | 93 | 5.79090034 |
| -56 | 0.35833349  |  | -6  | 2.1813425  |  | 44 | 4.00435151 |  | 94 | 5.82736052 |
| -55 | 0.39479367  |  | -5  | 2.21780268 |  | 45 | 4.04081169 |  | 95 | 5.8638207  |
| -54 | 0.43125385  |  | -4  | 2.25426286 |  | 46 | 4.07727187 |  | 96 | 5.90028088 |
| -53 | 0.46771403  |  | -3  | 2.29072304 |  | 47 | 4.11373205 |  | 97 | 5.93674106 |
| -52 | 0.50417421  |  | -2  | 2.32718322 |  | 48 | 4.15019223 |  | 98 | 5.97320124 |
| -51 | 0.54063439  |  | -1  | 2.3636434  |  | 49 | 4.18665241 |  | 99 | 6.00966142 |
| -50 | 0.57709457  |  | 0   | 2.40010358 |  | 50 | 4.22311259 |  |    |            |

FIG. 17-2

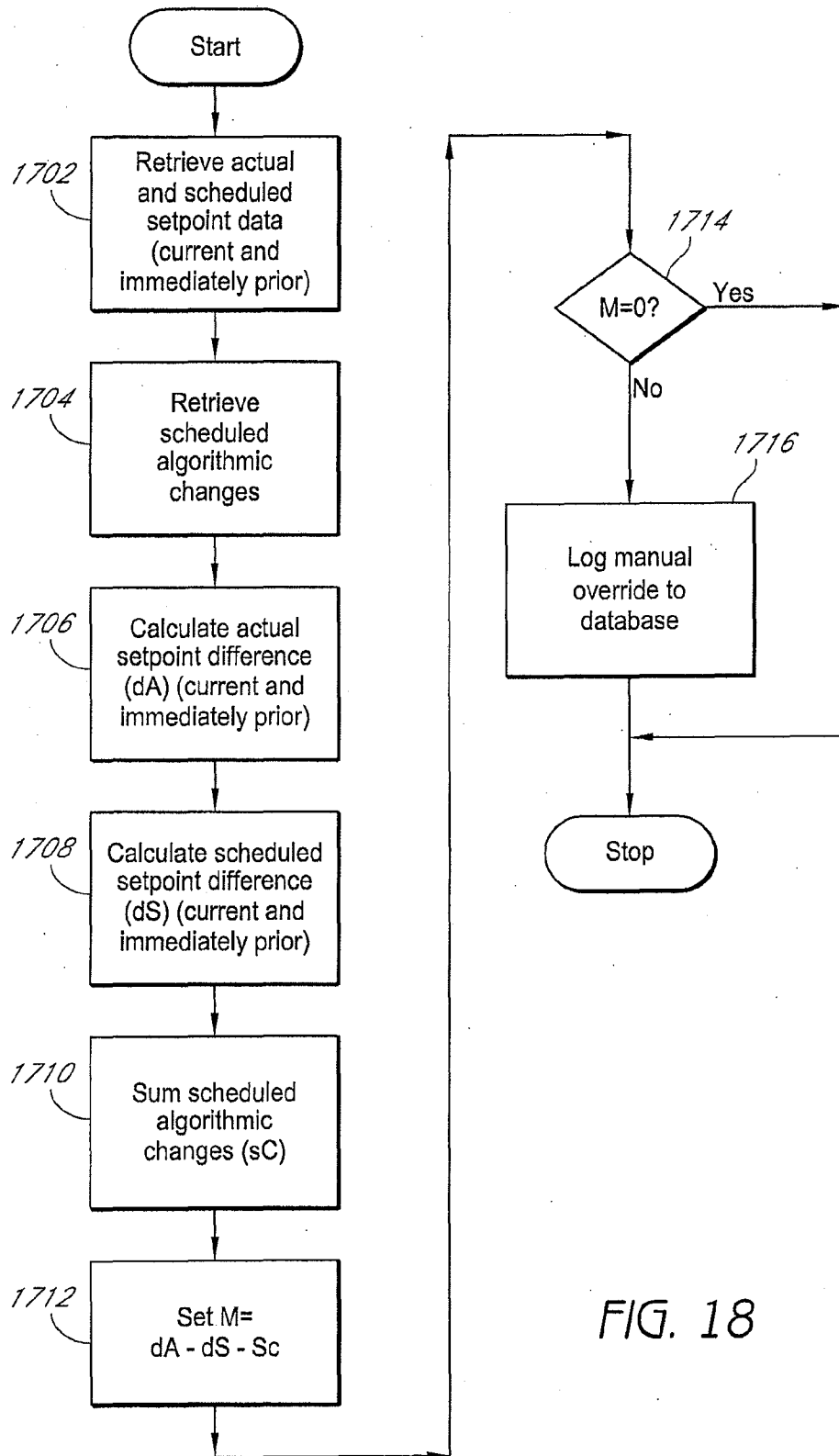

FIG. 18

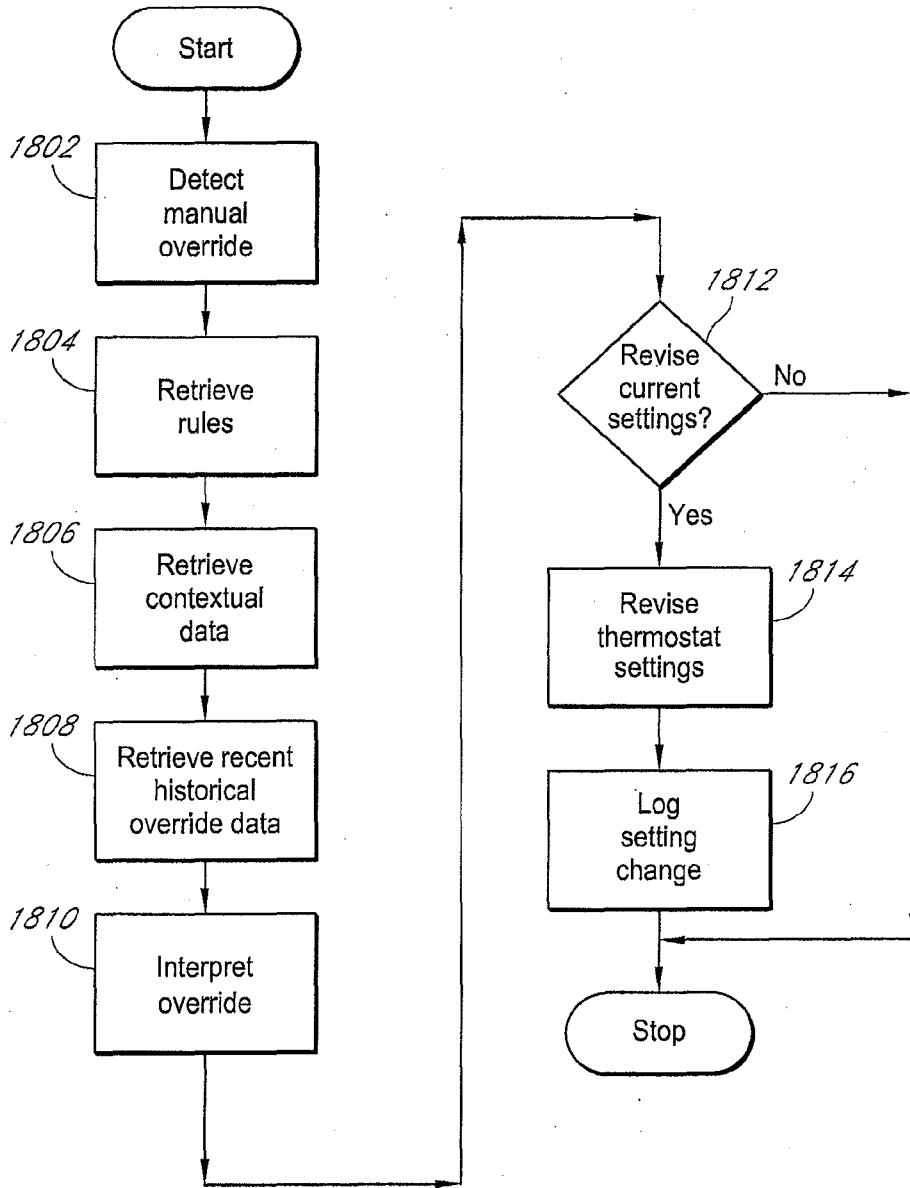

FIG. 19

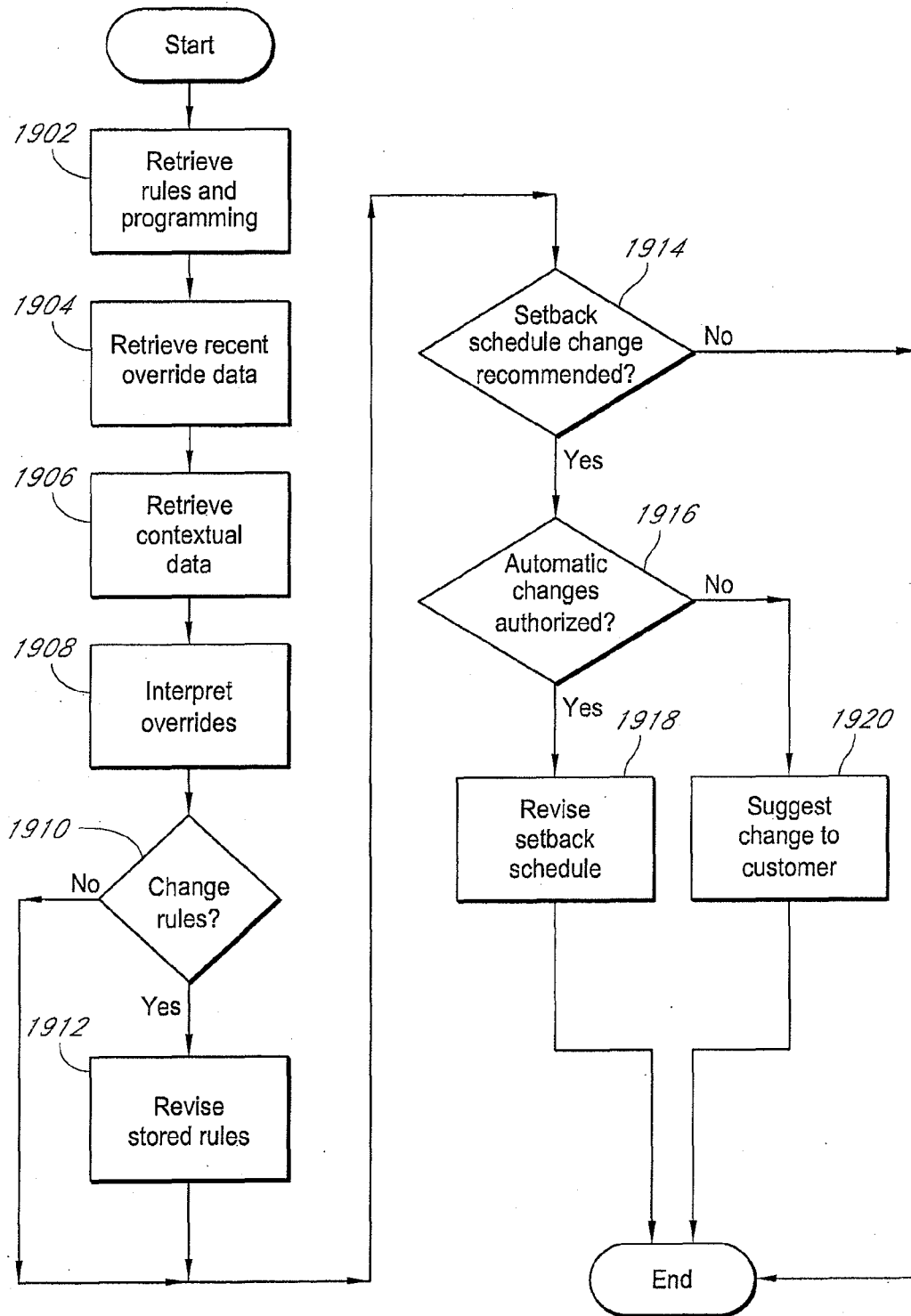

FIG. 20

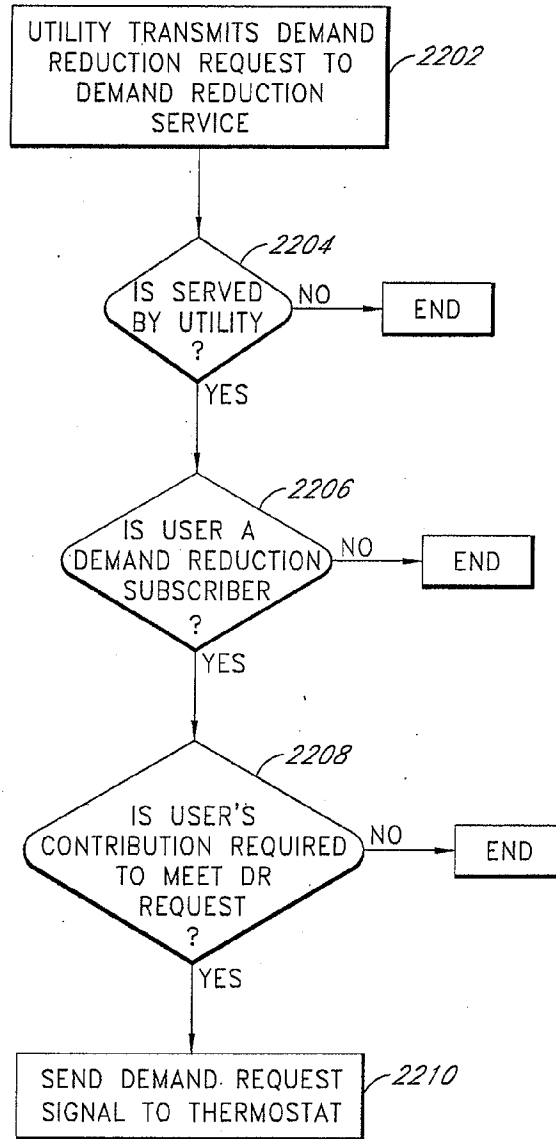

FIG. 21

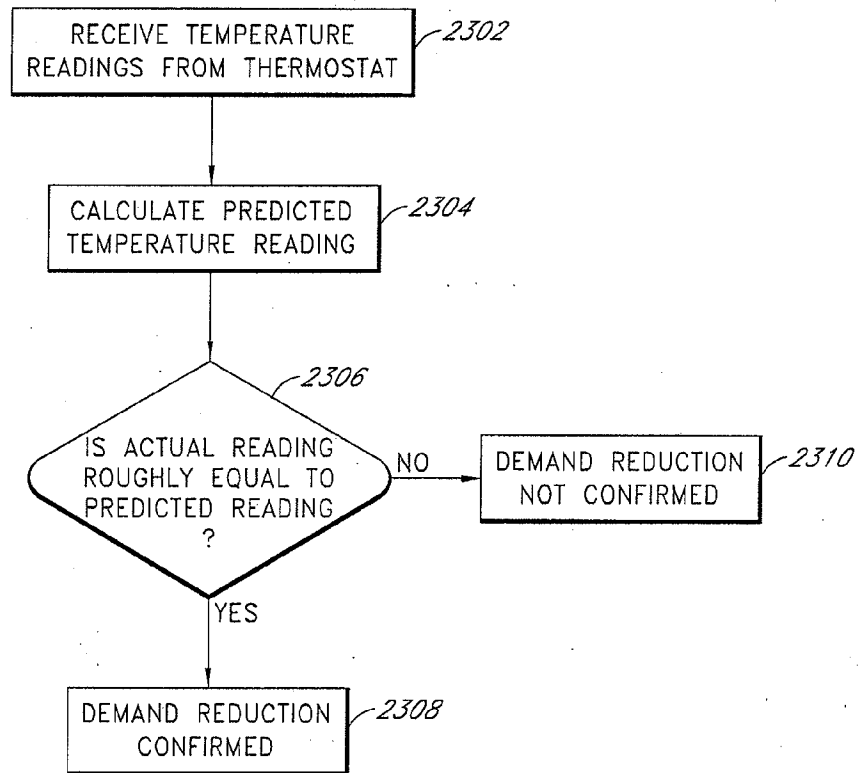

FIG. 22

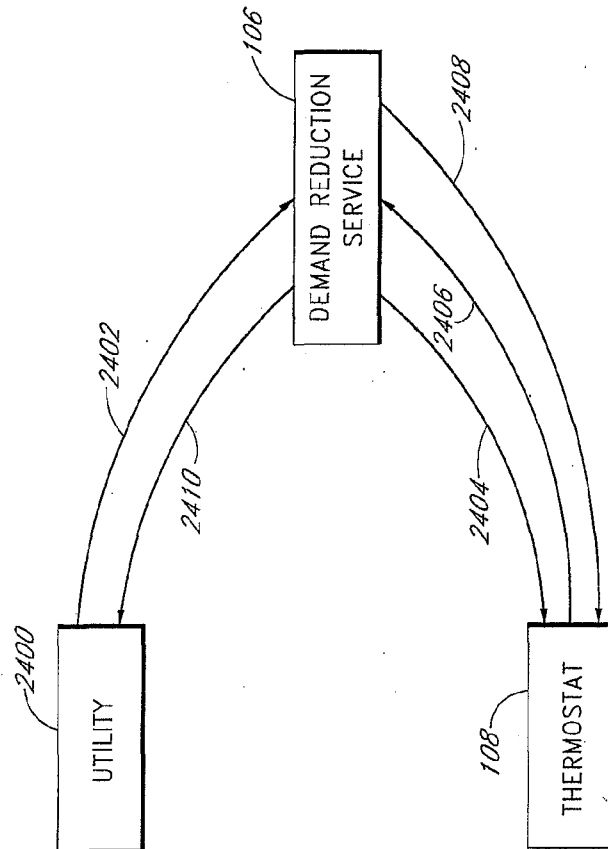

FIG. 23

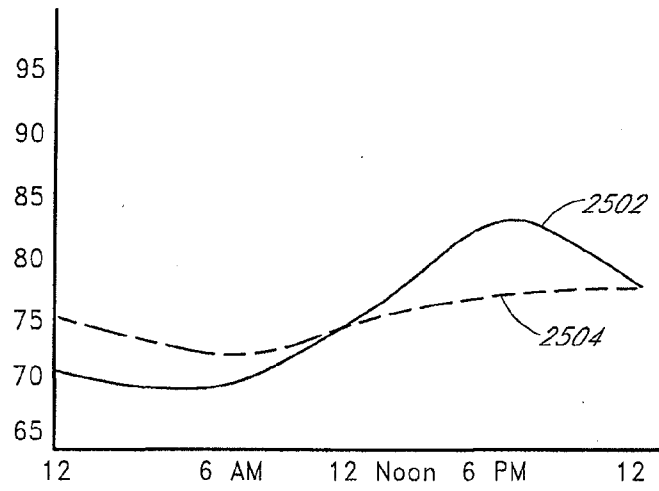

FIG. 24A

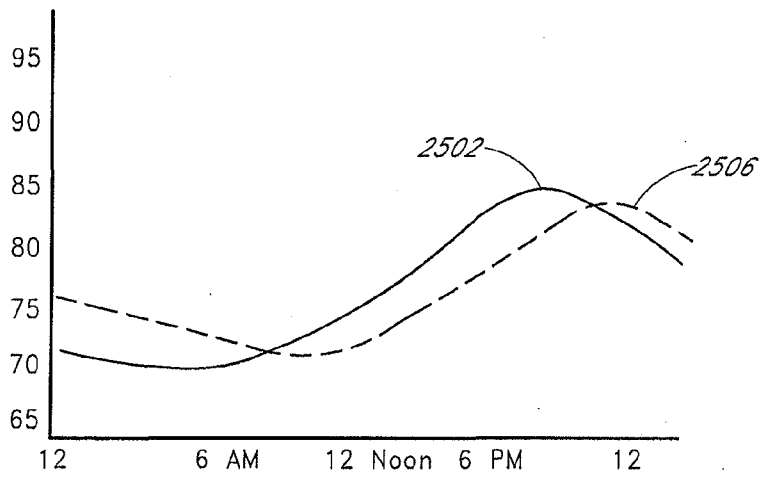

FIG. 24B



39/52

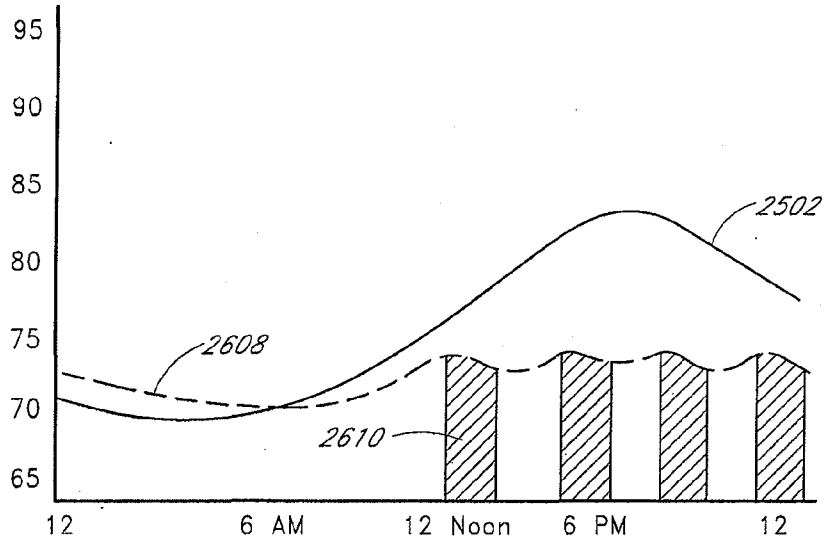

FIG. 25A

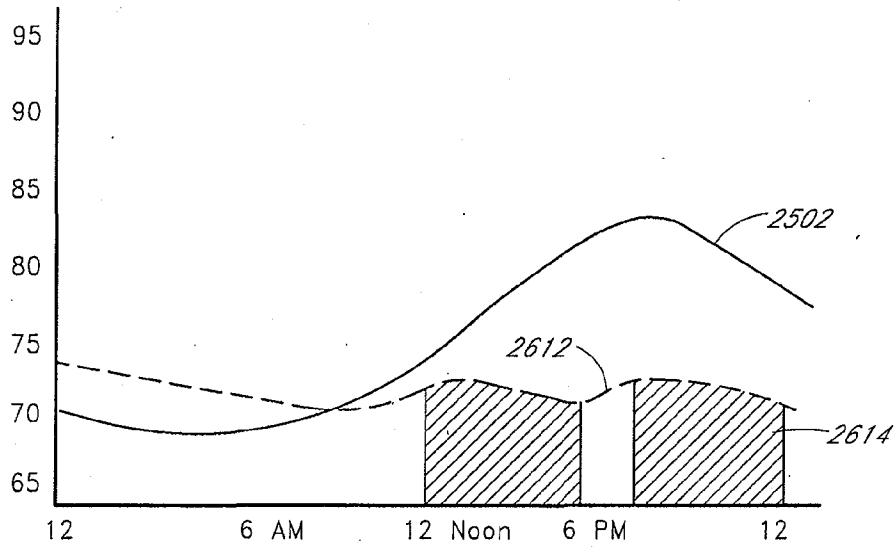

FIG. 25B

40/52

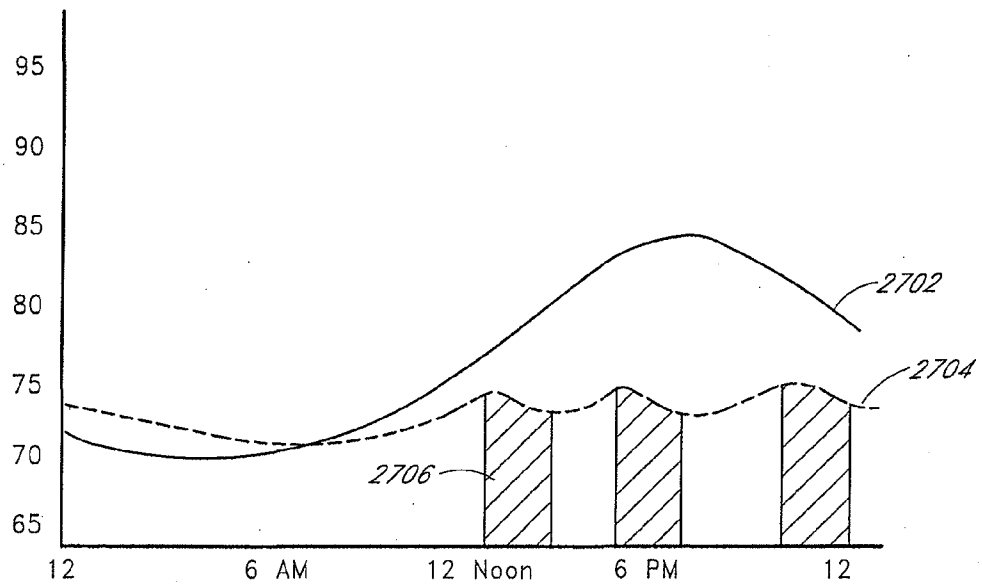

FIG. 26A

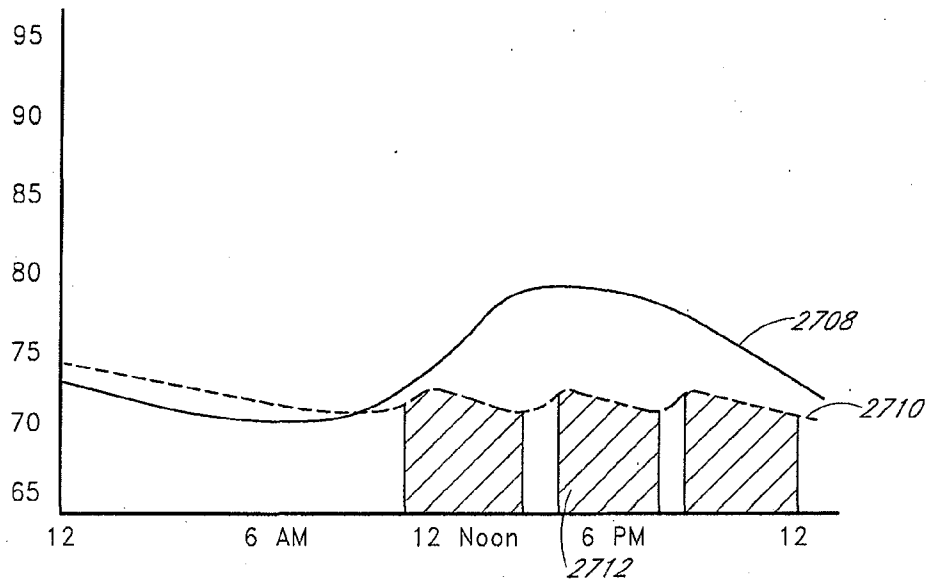

FIG. 26B

41/52

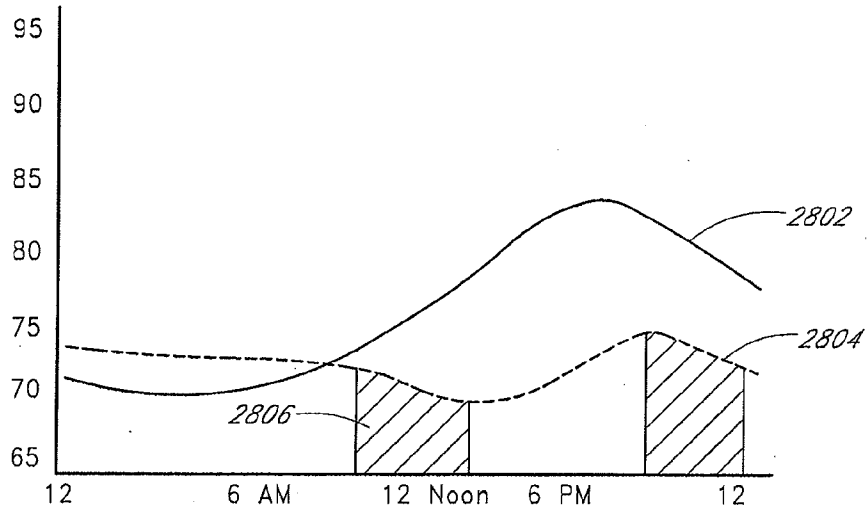

FIG. 27A

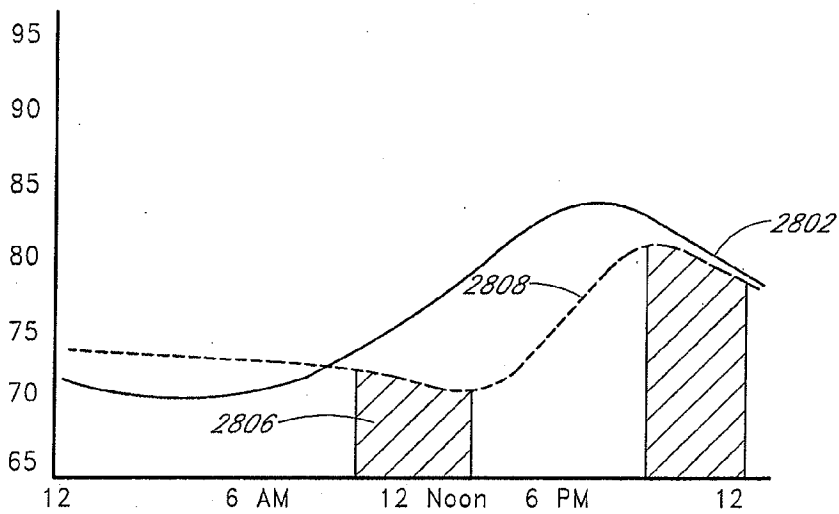

FIG. 27B

42/52

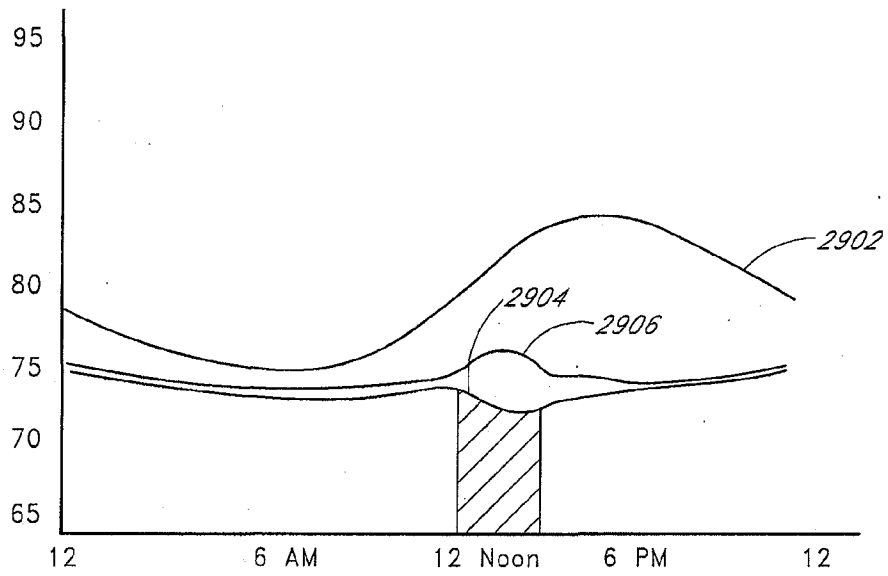

FIG. 28A

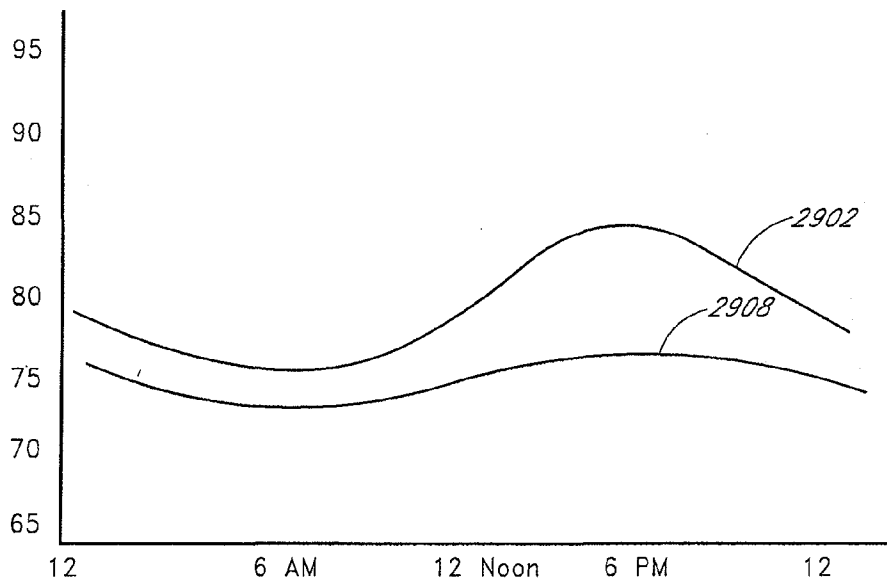

FIG. 28B

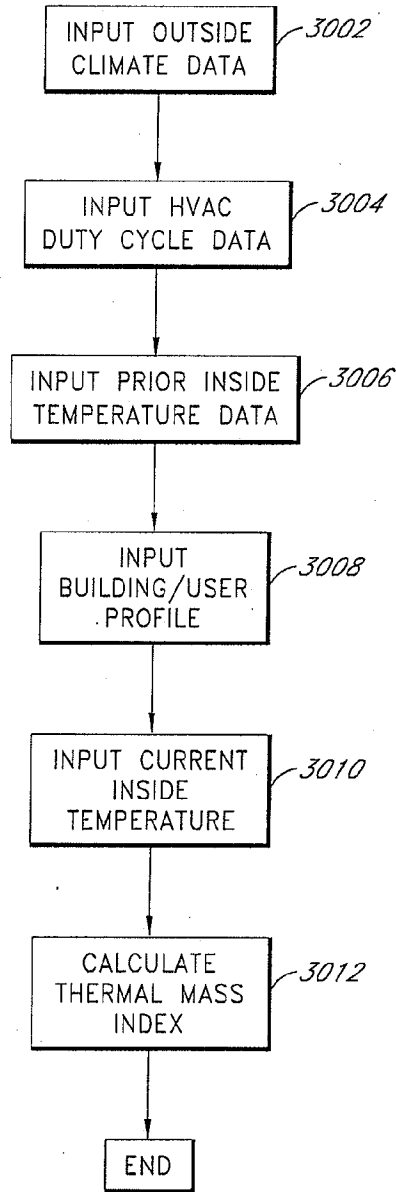

FIG. 29

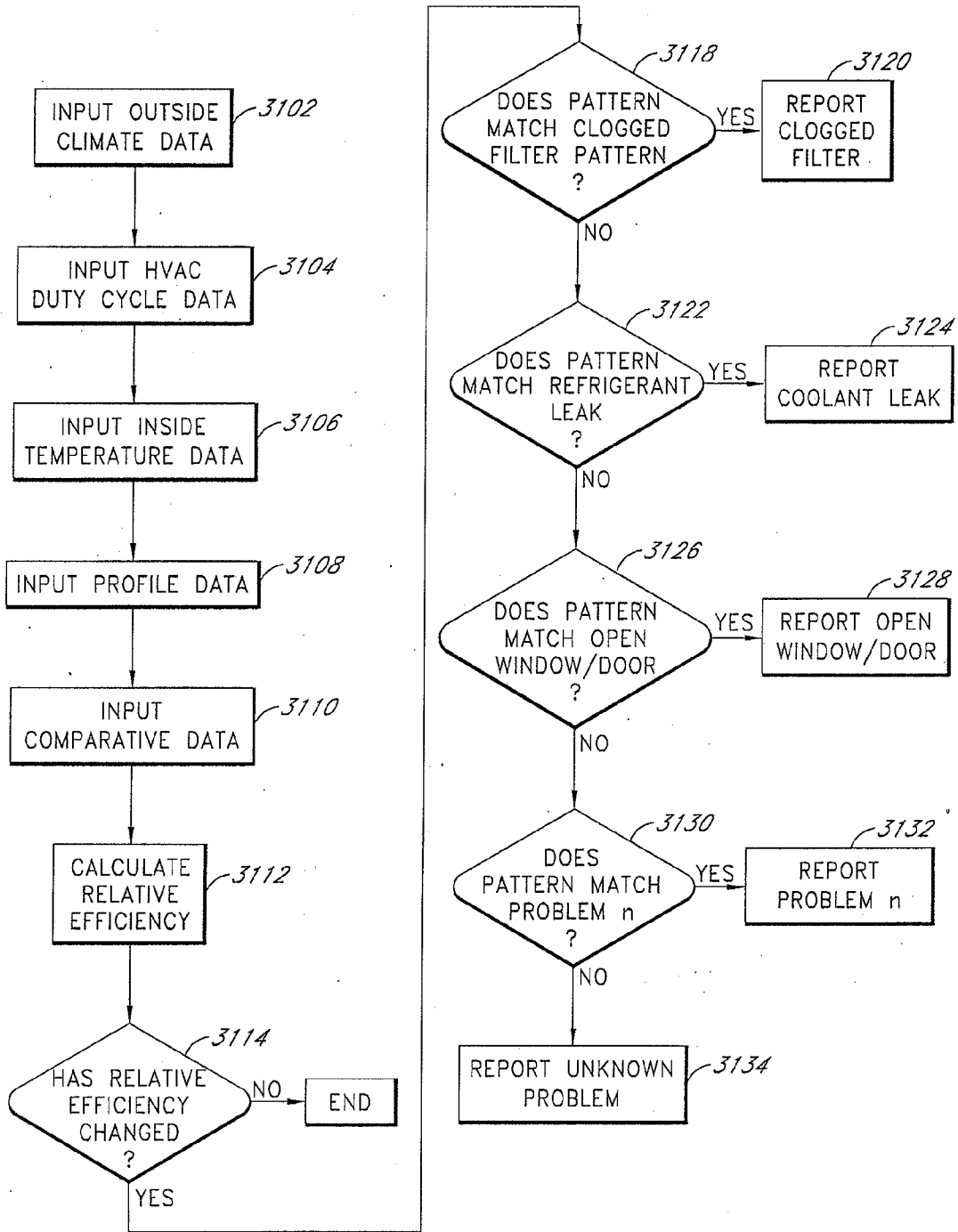

FIG. 30

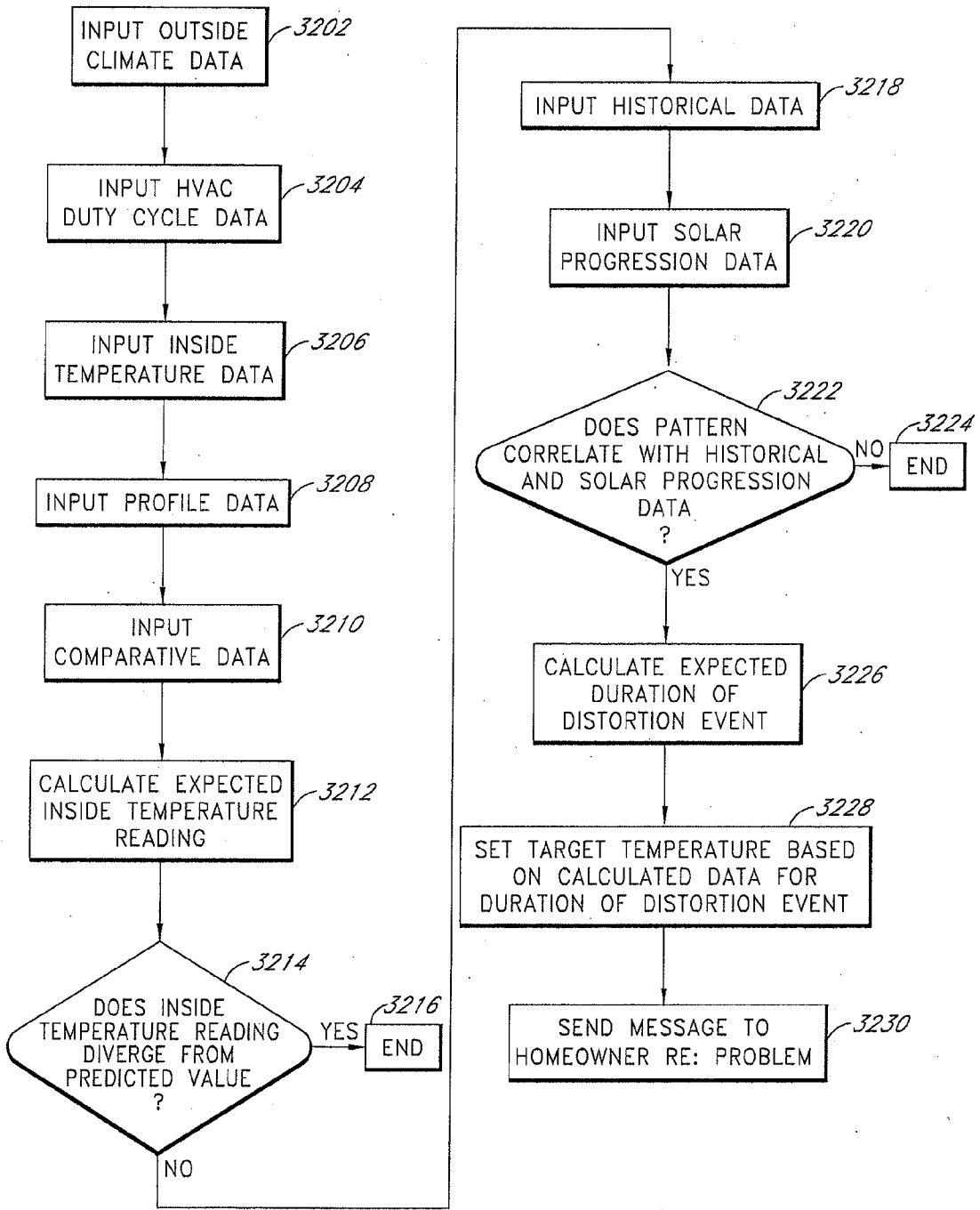

FIG. 31

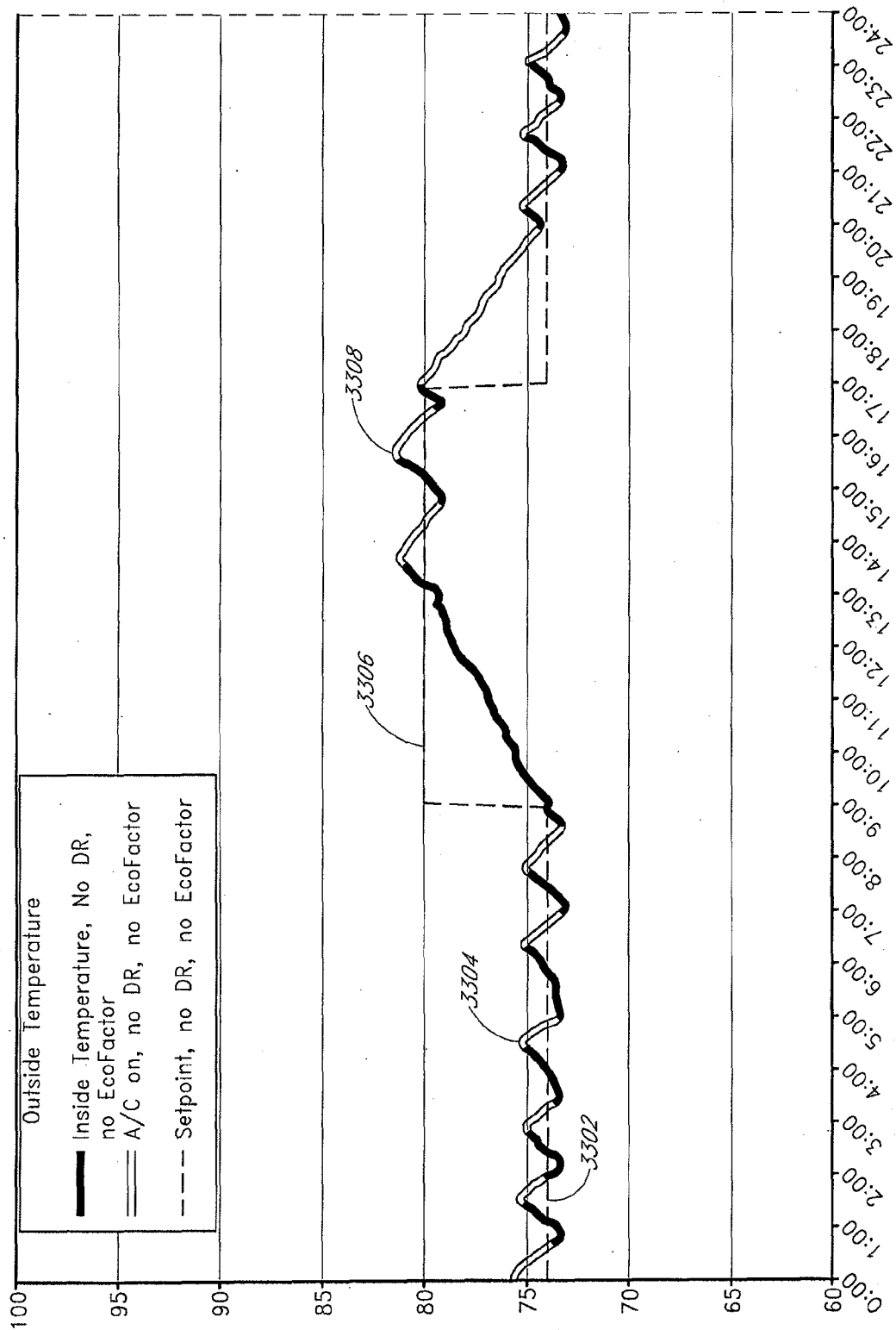

FIG. 32



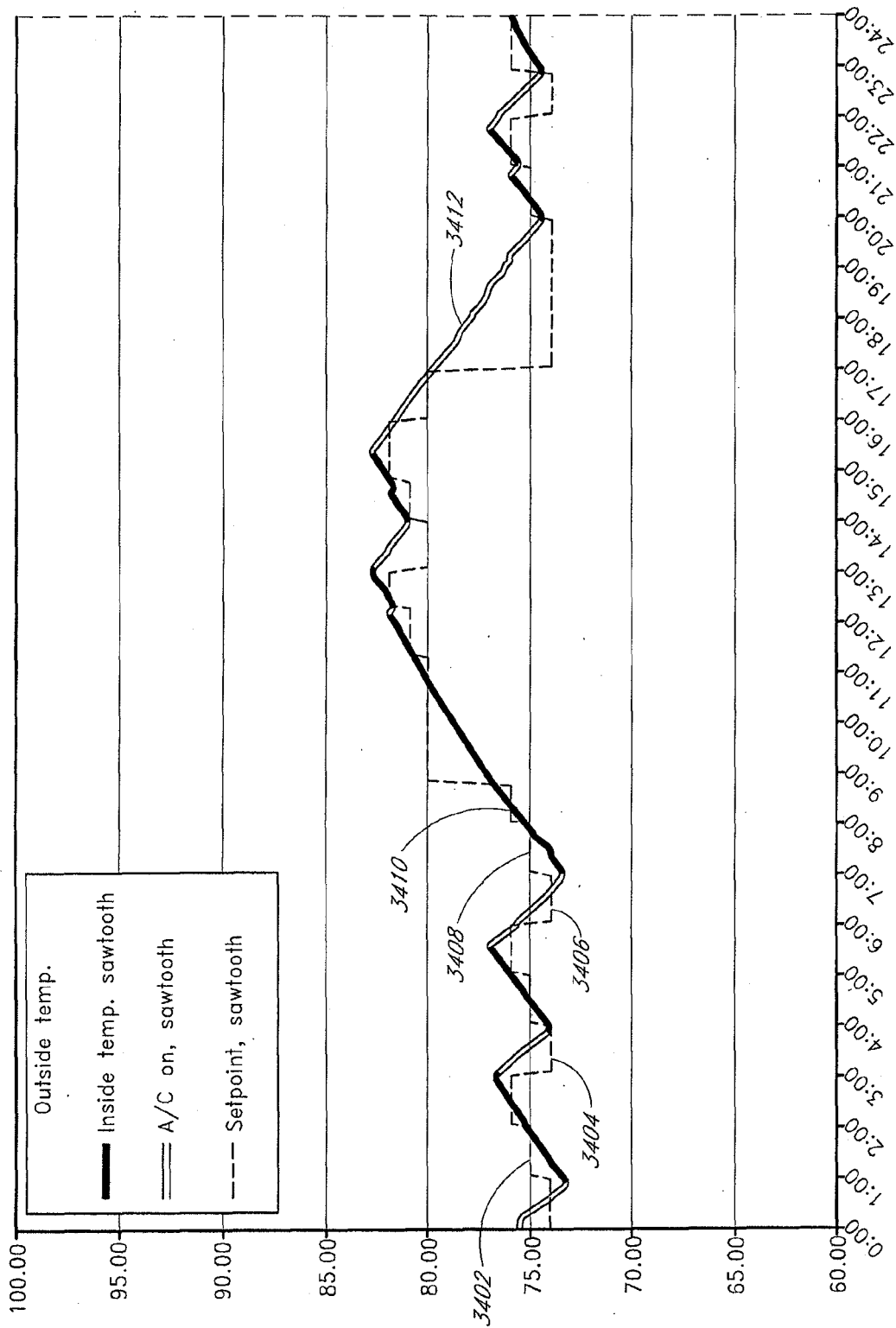

FIG. 33

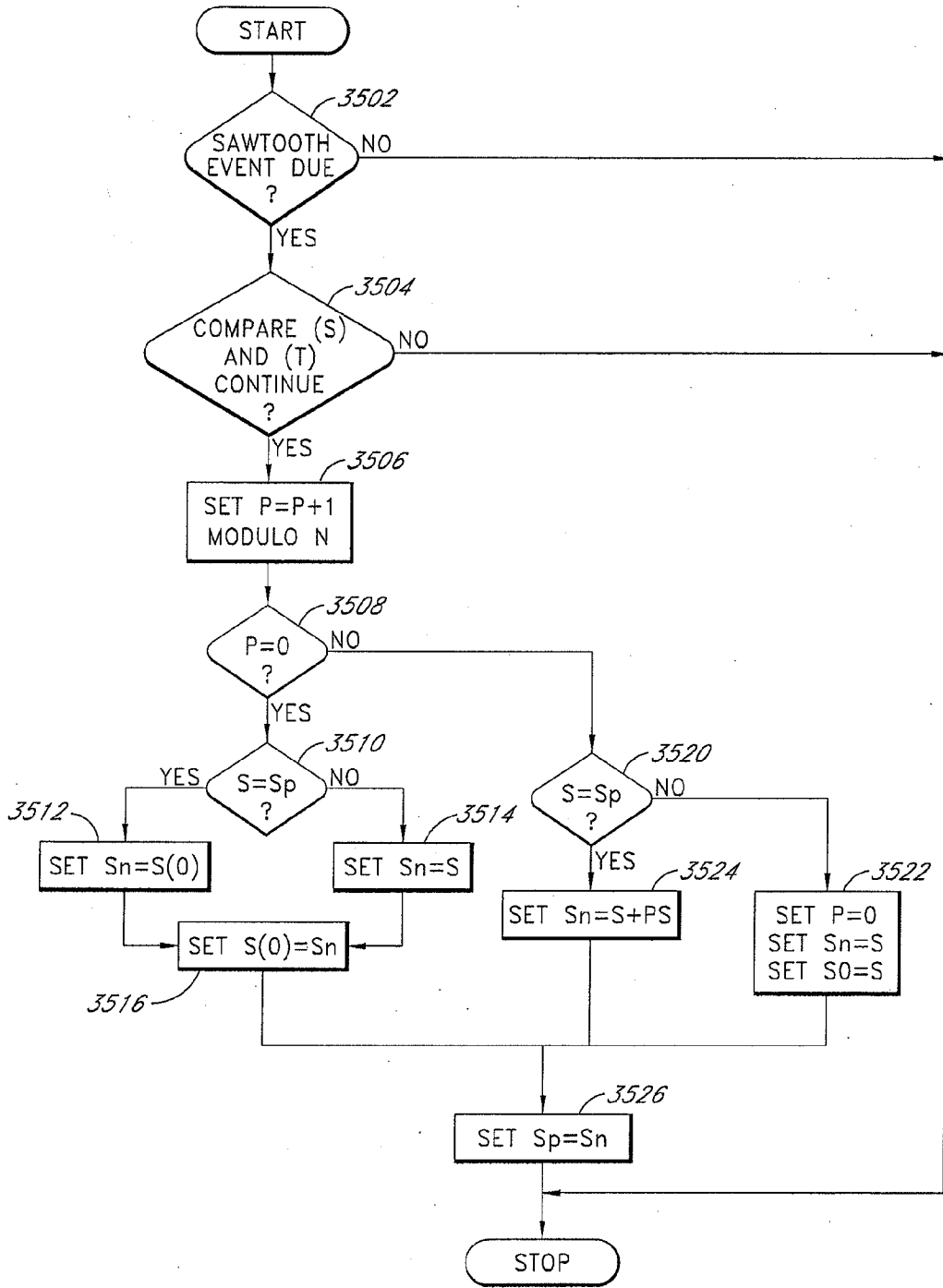

FIG. 34

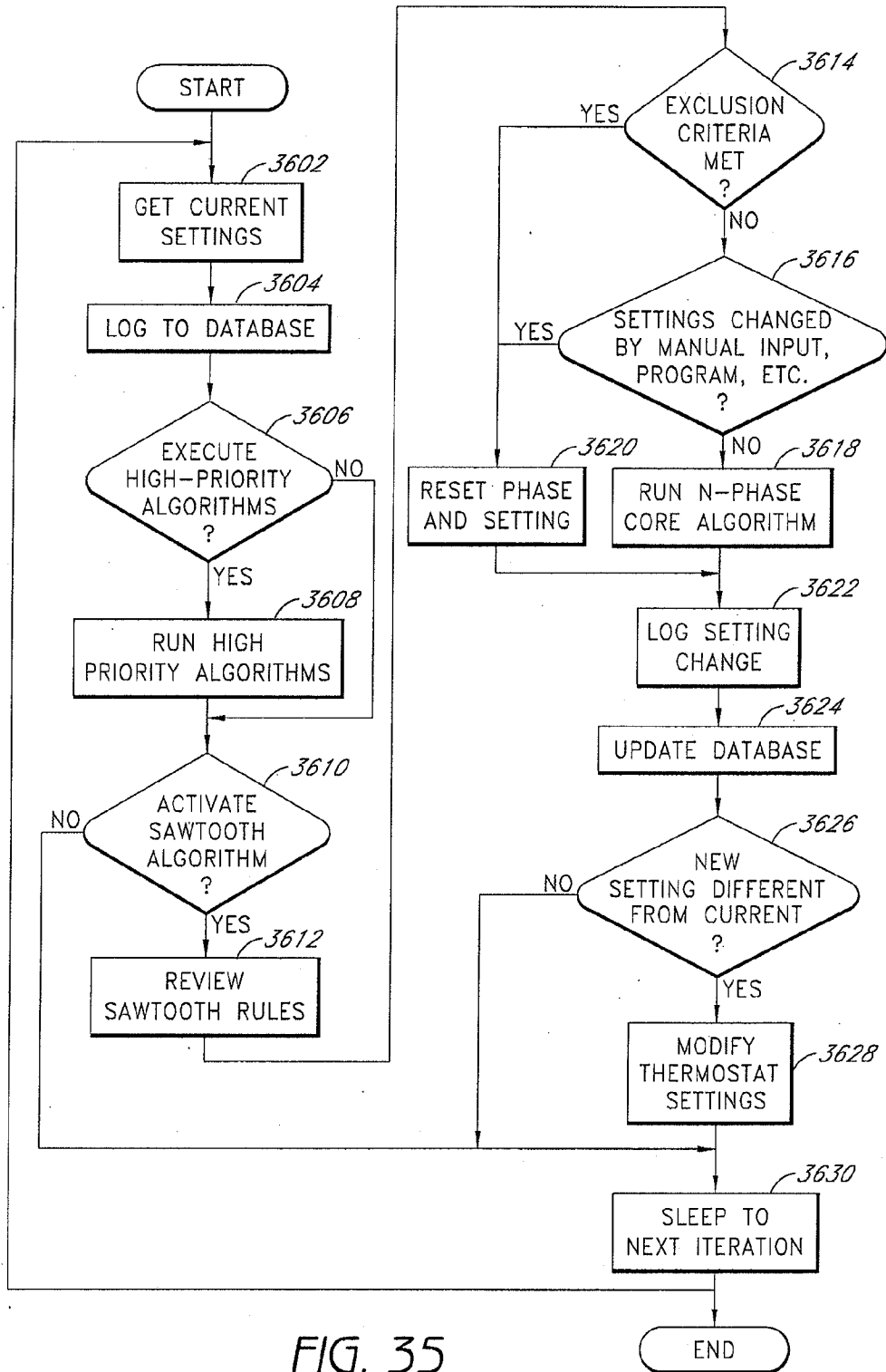

FIG. 35

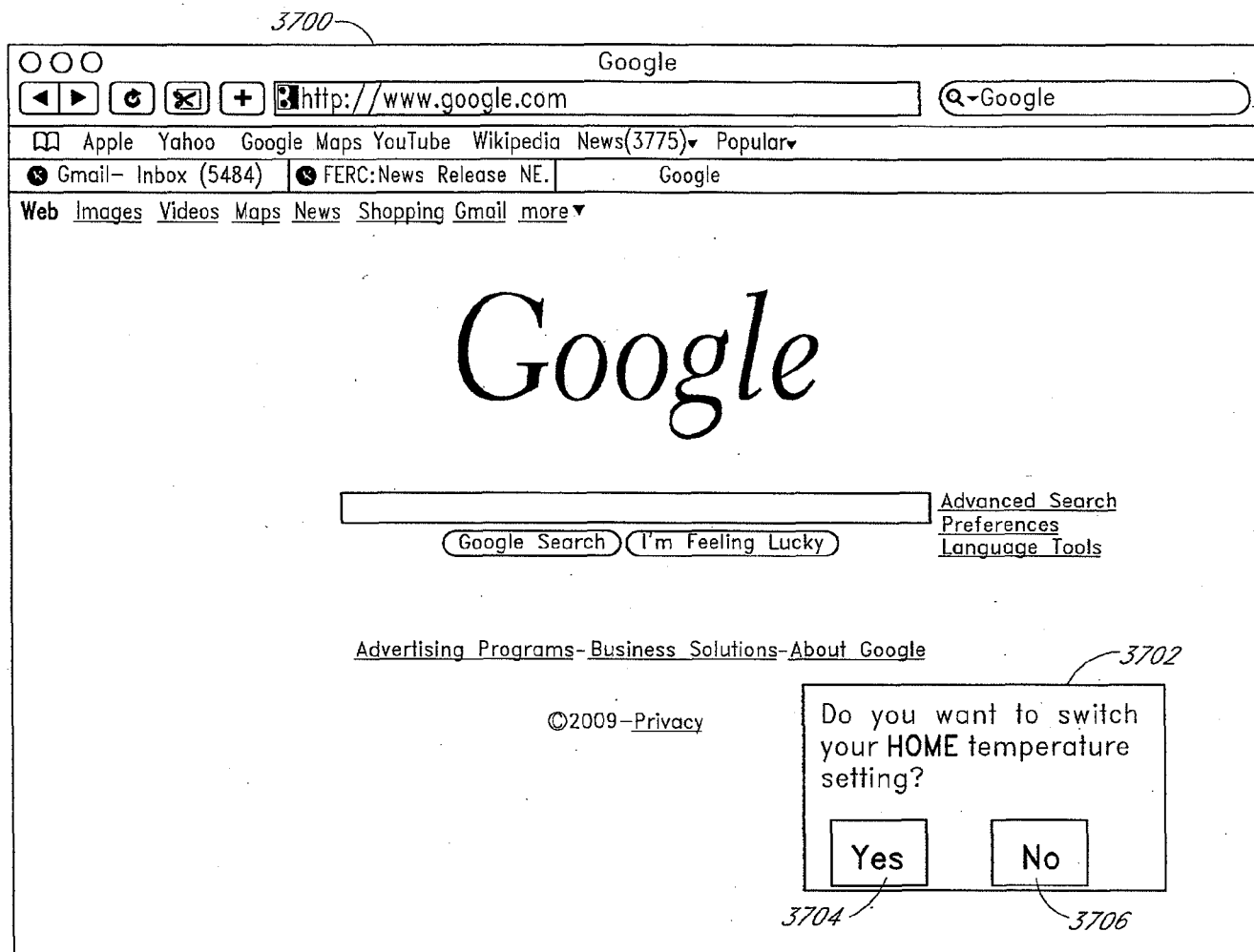

FIG. 36

51/52

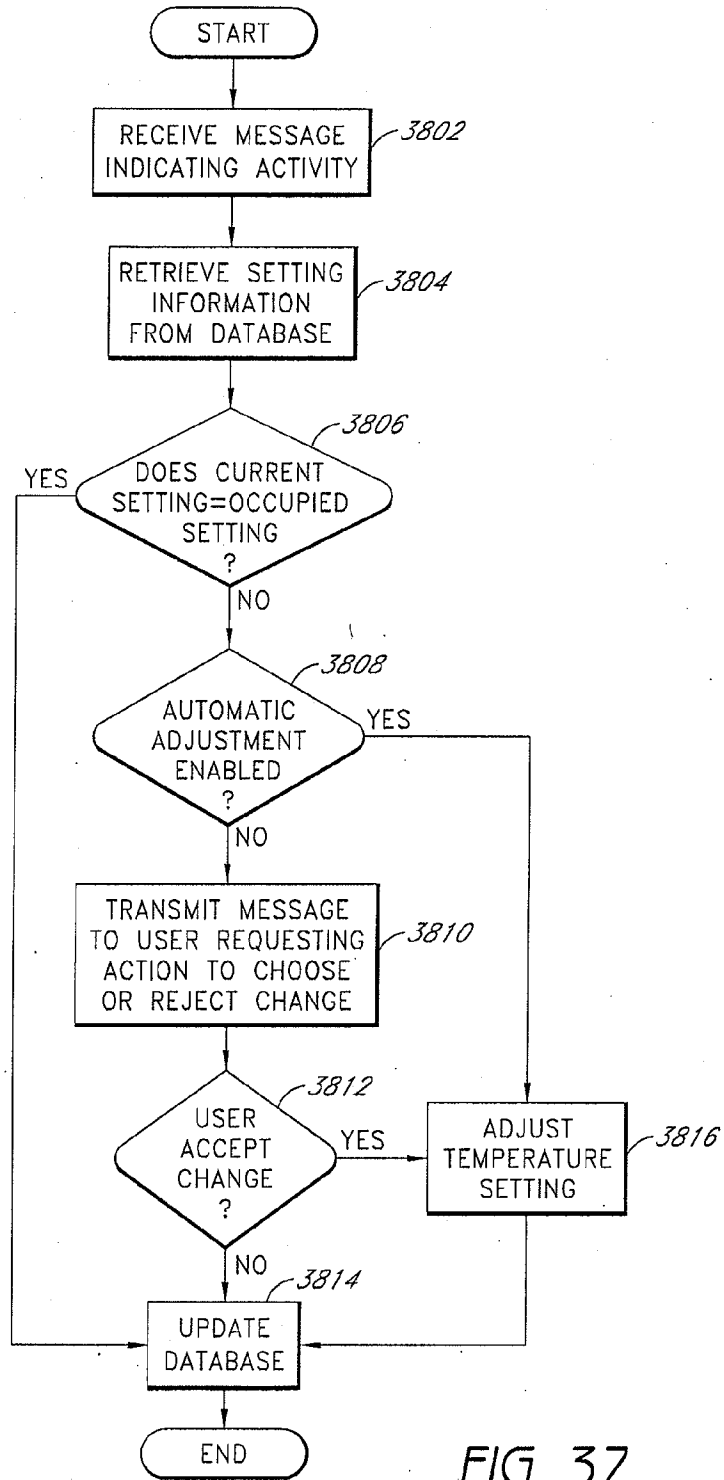

FIG. 37

52/52

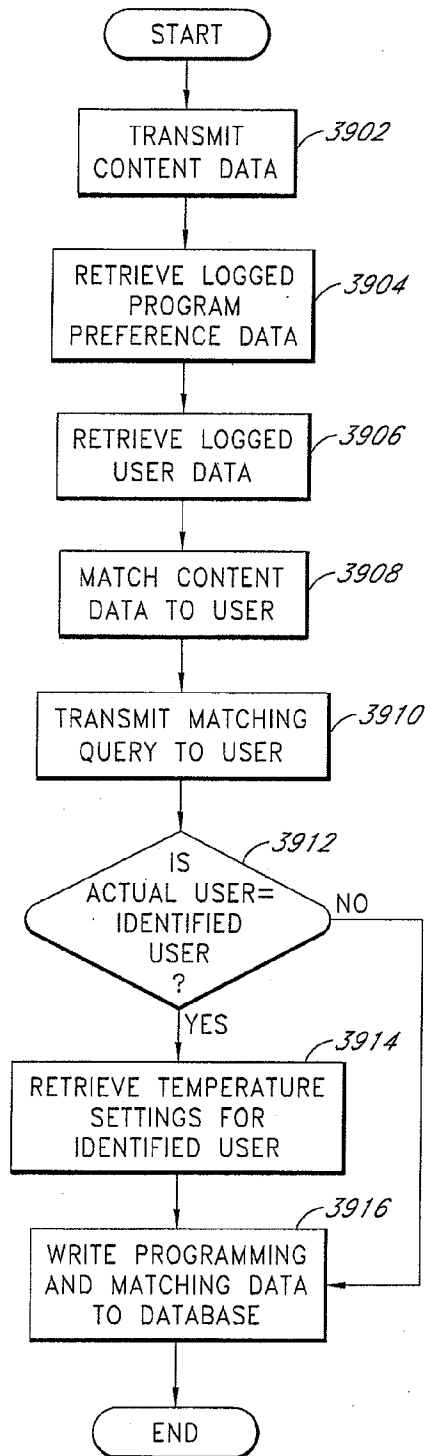



FIG. 38

| <b>A. CLASSIFICATION OF SUBJECT MATTER</b><br><b>F24F 11/02(2006.01)i, G05D 23/00(2006.01)i, G06Q 50/06(2012.01)i</b>   |   |  |
|---|---|--|
| According to International Patent Classification (IPC) or to both national classification and IPC   |   |  |
| <b>B. FIELDS SEARCHED</b>   |   |  |
| Minimum documentation searched (classification system followed by classification symbols)<br>F24F 11/02; F23N 1/00; F24F 5/00; G07F 15/08; G05D 23/00; G06Q 50/06   |   |  |
| Documentation searched other than minimum documentation to the extent that such documents are included in the fields searched<br>Korean utility models and applications for utility models<br>Japanese utility models and applications for utility models   |   |  |
| Electronic data base consulted during the international search (name of data base and, where practicable, search terms used)<br>eKOMPASS(KIPO internal) & keywords: HVAC system, running cost, thermostat, and processor  |   |  |
| <b>C. DOCUMENTS CONSIDERED TO BE RELEVANT</b>   |   |  |
| Category*   | Citation of document, with indication, where appropriate, of the relevant passages                              | Relevant to claim No.  |
| A   | JP 2010-286218 A (MITSUBISHI HEAVY IND. LTD.) 24 December 2010<br>See paragraphs [0021]-[0025] and figures 1,2. | 1-18   |
| A   | KR 10-1999-0070368 A (SAMSUNG ELECTRONICS CO., LTD.) 15 September 1999<br>See abstract and figures 3,4.         | 1-18   |
| A   | JP 05-189359 A (HITACHI BILL SHISETSU ENG. KK.) 30 July 1993<br>See abstract and figure 1.                      | 1-18   |
| A   | JP 2010-038377 A (MITSUBISHI HEAVY IND. LTD.) 18 February 2010<br>See abstract and figures 1,2.                 | 1-18   |
| A   | US 6786421 B2 (ROSEN, HOWARD) 07 September 2004<br>See abstract and figure 1A.                                  | 1-18   |
| <input type="checkbox"/> Further documents are listed in the continuation of Box C. <input checked="" type="checkbox"/> See patent family annex.  |   |  |
| <p>* Special categories of cited documents:</p> <p>"A" document defining the general state of the art which is not considered to be of particular relevance</p> <p>"E" earlier application or patent but published on or after the international filing date</p> <p>"L" document which may throw doubts on priority claim(s) or which is cited to establish the publication date of citation or other special reason (as specified)</p> <p>"O" document referring to an oral disclosure, use, exhibition or other means</p> <p>"P" document published prior to the international filing date but later than the priority date claimed</p> <p>"T" later document published after the international filing date or priority date and not in conflict with the application but cited to understand the principle or theory underlying the invention</p> <p>"X" document of particular relevance; the claimed invention cannot be considered novel or cannot be considered to involve an inventive step when the document is taken alone</p> <p>"Y" document of particular relevance; the claimed invention cannot be considered to involve an inventive step when the document is combined with one or more other such documents, such combination being obvious to a person skilled in the art</p> <p>"&amp;" document member of the same patent family</p> |   |  |
| Date of the actual completion of the international search<br>05 August 2013 (05.08.2013)  |   | Date of mailing of the international search report<br><b>06 undefined 2013 (06.08.2013)</b>  |
| Name and mailing address of the ISA/KR<br> Korean Intellectual Property Office<br>189 Cheongsa-ro, Seo-gu, Daejeon Metropolitan City,<br>302-701, Republic of Korea<br>Facsimile No. +82-42-472-7140   |   | Authorized officer<br><br>KIM Jin Ho<br><br>Telephone No. +82-42-481-8699<br><br> |

**INTERNATIONAL SEARCH REPORT**

Information on patent family members

International application No.

**PCT/US2013/035726**

| Patent document cited in search report | Publication date | Patent family member(s)  | Publication date   |
|--|------------------|--|--|
| JP 2010-286218 A                       | 24/12/2010       | None   |  |
| KR 10-1999-0070368 A                   | 15/09/1999       | CN 1119579 C<br>CN 1226663 A<br>CN 1226663 C<br>JP 03011715 B2<br>JP 11-281122 A<br>US 6145328 A | 27/08/2003<br>25/08/1999<br>25/08/1999<br>21/02/2000<br>15/10/1999<br>14/11/2000 |
| JP 05-189659 A                         | 30/07/1993       | JP 07001511 B2   | 11/01/1995   |
| JP 2010-038377 A                       | 18/02/2010       | None   |  |
| US 6786421 B2                          | 07/09/2004       | US 2003-0142121 A1<br>US 2004-0074978 A1<br>US 6824069 B2<br>US 7152806 B1                       | 31/07/2003<br>22/04/2004<br>30/11/2004<br>26/12/2006                             |



## PATENT COOPERATION TREATY

From the INTERNATIONAL SEARCHING AUTHORITY

To:  
KING, JOHN, R.  
  
KNOBBE, MARTENS, OLSON & BEAR, LLP 2040 MAIN  
STREET, 14TH FLOOR IRVINE CA 92614 USA

PCT

**NOTIFICATION OF TRANSMITTAL OF  
THE INTERNATIONAL SEARCH REPORT AND  
THE WRITTEN OPINION OF THE INTERNATIONAL  
SEARCHING AUTHORITY, OR THE DECLARATION**

(PCT Rule 44.1)

Date of mailing  
(day/month/year) 06 undefined 2013 (06.08.2013)

Applicant's or agent's file reference  
EFACT014WO

FOR FURTHER ACTION See paragraphs 1 and 4 below

International application No.  
**PCT/US2013/035726**

International filing date  
(day/month/year) **09 April 2013 (09.04.2013)**

Applicant  
**ECOFACOR, INC.**

1.  The applicant is hereby notified that the international search report and the written opinion of the International Searching Authority have been established and are transmitted herewith.  
**Filing of amendments and statement under Article 19:**  
The applicant is entitled, if he so wishes, to amend the claims of the international application (see Rule 46):  
**When?** The time limit for filing such amendments is normally two months from the date of transmittal of the international search report.  
**Where?** Directly to the International Bureau of WIPO, 34 chemin des Colombettes  
1211 Geneva 20, Switzerland, Facsimile No.: +41 22 338 82 70  
**For more detailed instructions, see PCT Applicant's Guide, International Phase, paragraphs 9.004 - 9.011.**
2.  The applicant is hereby notified that no international search report will be established and that the declaration under Article 17(2)(a) to that effect and the written opinion of the International Searching Authority are transmitted herewith.
3.  **With regard to any protest against payment of (an) additional fee(s) under Rule 40.2, the applicant is notified that:**  
 the protest together with the decision thereon has been transmitted to the International Bureau together with any request to forward the texts of both the protest and the decision thereon to the designated Offices.  
 no decision has been made yet on the protest; the applicant will be notified as soon as a decision is made.

## 4. Reminders

The applicant may submit comments on an informal basis on the written opinion of the International Searching Authority to the International Bureau. The International Bureau will send a copy of such comments to all designated Offices unless an international preliminary examination report has been or is to be established. Following the expiration of 30 months from the priority date, these comments will also be made available to the public.

Shortly after the expiration of **18 months** from the priority date, the international application will be published by the International Bureau. If the applicant wishes to avoid or postpone publication, a notice of withdrawal of the international application, or of the priority claim, must reach the International Bureau before the completion of the technical preparations for international publication (Rules 90bis.1 and 90bis.3).

Within **19 months** from the priority date, but only in respect of some designated Offices, a demand for international preliminary examination must be filed if the applicant wishes to postpone the entry into the national phase **until 30 months** from the priority date (in some Offices even later); otherwise, the applicant must, **within 20 months** from the priority date, perform the prescribed acts for entry into the national phase before those designated Offices.

In respect of other designated Offices, the time limit of **30 months** (or later) will apply even if no demand is filed within 19 months.

For details about the applicable time limits, Office by Office, see [www.wipo.int/pct/en/texts/time\\_limits.html](http://www.wipo.int/pct/en/texts/time_limits.html) and the PCT Applicant's Guide, National Chapters.

Name and mailing address of the ISA/KR  
 Korean Intellectual Property Office  
189 Cheongsa-ro, Seo-gu, Daejeon Metropolitan  
City, 302-701, Republic of Korea  
Facsimile No. 82-42-472-7140

Authorized officer  
  
COMMISSIONER  
  
Telephone No. 82-42-481-8753

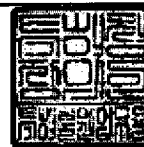

Received Orange County Docketing

AUG 18 2013

Knobbe, Martens, Olson & Bear LLP

\* Attention

Copies of the documents cited in the international search report can be searched in the following Korean Intellectual Property Office English website for three months from the date of mailing of the international search report.

<http://www.kipo.go.kr/en/> => PCT Services => PCT Services

ID : PCT international application number

PW : **HZE474K4**

Inquiries related to PCT International Search Report or Written Opinion prepared by KIPO as an International Searching Authority can be answered not only by KIPO but also through IPKC (Intellectual Property Korea Center), located in Vienna, VA, which functions as a PCT Help Desk for PCT applicants.

Homepage: <http://www.ipkcenter.com>

Email: [ipkc@ipkcenter.com](mailto:ipkc@ipkcenter.com)

## PATENT COOPERATION TREATY

## PCT

## INTERNATIONAL SEARCH REPORT

(PCT Article 18 and Rules 43 and 44)

|   |  |  |
|---|--|--|
| Applicant's or agent's file reference<br>EFACT014WO       | <b>FOR FURTHER ACTION</b> see Form PCT/ISA/220 as well as, where applicable, item 5 below. |  |
| International application No.<br><b>PCT/US2013/035726</b> | International filing date ( <i>day/month/year</i> )<br><b>09 April 2013 (09.04.2013)</b>   | (Earliest) Priority Date ( <i>day/month/year</i> )<br><b>14 June 2012 (14.06.2012)</b> |
| Applicant<br><b>ECOFACOR, INC.</b>                        |  |  |

This International search report has been prepared by this International Searching Authority and is transmitted to the applicant according to Article 18. A copy is being transmitted to the International Bureau.

This international search report consists of a total of 3 sheets.

It is also accompanied by a copy of each prior art document cited in this report.

1. **Basis of the report**

a. With regard to the language, the international search was carried out on the basis of:

- the international application in the language in which it was filed  
 a translation of the international application into \_\_\_\_\_, which is the language of a translation furnished for the purposes of international search (Rules 12.3(a) and 23.1(b))

b.  This international search report has been established taking into account the rectification of an obvious mistake authorized by or notified to this Authority under Rule 91 (Rule 43.6bis(a)).

c.  With regard to any nucleotide and/or amino acid sequence disclosed in the international application, see Box No. I.

2.  Certain claims were found unsearchable (See Box No. II)

3.  Unity of invention is lacking (See Box No. III)

4. With regard to the title,

- the text is approved as submitted by the applicant.  
 the text has been established by this Authority to read as follows:

5. With regard to the abstract,

- the text is approved as submitted by the applicant.  
 the text has been established, according to Rule 38.2, by this Authority as it appears in Box No. IV. The applicant may, within one month from the date of mailing of this international search report, submit comments to this Authority.

6. With regard to the drawings,

- a. the figure of the drawings to be published with the abstract is Figure No. 2  
 as suggested by the applicant.  
 as selected by this Authority, because the applicant failed to suggest a figure.  
 as selected by this Authority, because this figure better characterizes the invention.
- b.  none of the figure is to be published with the abstract.

## INTERNATIONAL SEARCH REPORT

International application No.  
**PCT/US2013/035726****A. CLASSIFICATION OF SUBJECT MATTER****F24F 11/02(2006.01)i, G05D 23/00(2006.01)i, G06Q 50/06(2012.01)i**

According to International Patent Classification (IPC) or to both national classification and IPC

**B. FIELDS SEARCHED**

Minimum documentation searched (classification system followed by classification symbols)

F24F 11/02; F23N 1/00; F24F 5/00; G07F 15/08; G05D 23/00; G06Q 50/06

Documentation searched other than minimum documentation to the extent that such documents are included in the fields searched

Korean utility models and applications for utility models

Japanese utility models and applications for utility models

Electronic data base consulted during the international search (name of data base and, where practicable, search terms used)

eKOMPASS(KIPO internal) &amp; keywords: HVAC system, running cost, thermostat, and processor

**C. DOCUMENTS CONSIDERED TO BE RELEVANT**

| Category* | Citation of document, with indication, where appropriate, of the relevant passages                              | Relevant to claim No. |
|-----------|---|-----------------------|
| A         | JP 2010-286218 A (MITSUBISHI HEAVY IND. LTD.) 24 December 2010<br>See paragraphs [0021]-[0025] and figures 1,2. | 1-18                  |
| A         | KR 10-1999-0070368 A (SAMSUNG ELECTRONICS CO., LTD.) 15 September 1999<br>See abstract and figures 3,4.         | 1-18                  |
| A         | JP 05-189659 A (HITACHI BILL SHISETSU ENG. KK.) 30 July 1993<br>See abstract and figure 1.                      | 1-18                  |
| A         | JP 2010-038377 A (MITSUBISHI HEAVY IND. LTD.) 18 February 2010<br>See abstract and figures 1,2.                 | 1-18                  |
| A         | US 6786421 B2 (ROSEN, HOWARD) 07 September 2004<br>See abstract and figure 1A.                                  | 1-18                  |

 Further documents are listed in the continuation of Box C. See patent family annex.

\* Special categories of cited documents:

"A" document defining the general state of the art which is not considered to be of particular relevance

"E" earlier application or patent but published on or after the international filing date

"L" document which may throw doubts on priority claim(s) or which is cited to establish the publication date of citation or other special reason (as specified)

"O" document referring to an oral disclosure, use, exhibition or other means

"P" document published prior to the international filing date but later than the priority date claimed

"T" later document published after the international filing date or priority date and not in conflict with the application but cited to understand the principle or theory underlying the invention

"X" document of particular relevance; the claimed invention cannot be considered novel or cannot be considered to involve an inventive step when the document is taken alone

"Y" document of particular relevance; the claimed invention cannot be considered to involve an inventive step when the document is combined with one or more other such documents, such combination being obvious to a person skilled in the art

"&amp;" document member of the same patent family

Date of the actual completion of the international search

05 August 2013 (05.08.2013)

Date of mailing of the international search report

**06 undefined 2013 (06.08.2013)**

Name and mailing address of the ISA/KR

 Korean Intellectual Property Office  
 189 Cheongsa-ro, Seo-gu, Daejeon Metropolitan City,  
 302-701, Republic of Korea

Facsimile No. +82-42-472-7140

Authorized officer

KIM Jin Ho

Telephone No. +82-42-481-8699



## INTERNATIONAL SEARCH REPORT

Information on patent family members

International application No.

PCT/US2013/035726

| Patent document cited in search report | Publication date | Patent family member(s) | Publication date |
|--|------------------|-------------------------|------------------|
| JP 2010-286218 A                       | 24/12/2010       | None                    |                  |
| KR 10-1999-0070368 A                   | 15/09/1999       | CN 1119579 C            | 27/08/2003       |
|  |                  | CN 1226663 A            | 25/08/1999       |
|  |                  | CN 1226663 C            | 25/08/1999       |
|  |                  | JP 03011715 B2          | 21/02/2000       |
|  |                  | JP 11-281122 A          | 15/10/1999       |
|  |                  | US 6145328 A            | 14/11/2000       |
| JP 05-189659 A                         | 30/07/1993       | JP 07001511 B2          | 11/01/1995       |
| JP 2010-038377 A                       | 18/02/2010       | None                    |                  |
| US 6786421 B2                          | 07/09/2004       | US 2003-0142121 A1      | 31/07/2003       |
|  |                  | US 2004-0074978 A1      | 22/04/2004       |
|  |                  | US 6824069 B2           | 30/11/2004       |
|  |                  | US 7152806 B1           | 26/12/2006       |

## PATENT COOPERATION TREATY

From the  
INTERNATIONAL SEARCHING AUTHORITY

|  |
|--|
| To:<br>KING, JOHN, R.<br><br>KNOBBE, MARTENS, OLSON & BEAR, LLP 2040 MAIN STREET, 14TH FLOOR IRVINE CA 92614 USA |
|--|

# PCT

WRITTEN OPINION OF THE  
INTERNATIONAL SEARCHING AUTHORITY

(PCT Rule 43bis.1)

|  |   |
|--|---|
| Date of mailing<br>(day/month/year) <b>06 undefined 2013 (06.08.2013)</b>  |   |
| Applicant's or agent's file reference<br>EFACT014WO  | <b>FOR FURTHER ACTION</b><br>See paragraph 2 below                              |
| International application No.<br><b>PCT/US2013/035726</b>  | International filing date (day/month/year)<br><b>09 April 2013 (09.04.2013)</b> |
|  | Priority date(day/month/year)<br>14 June 2012 (14.06.2012)                      |
| International Patent Classification (IPC) or both national classification and IPC<br><b>F24F 11/02(2006.01)i, G05D 23/00(2006.01)i, G06Q 50/06(2012.01)i</b> |   |
| Applicant<br><b>ECOFACOR, INC.</b>   |   |



1. This opinion contains indications relating to the following items:

- Box No. I Basis of the opinion
- Box No. II Priority
- Box No. III Non-establishment of opinion with regard to novelty, inventive step and industrial applicability
- Box No. IV Lack of unity of invention
- Box No. V Reasoned statement under Rule 43bis.1(a)(i) with regard to novelty, inventive step or industrial applicability; citations and explanations supporting such statement
- Box No. VI Certain documents cited
- Box No. VII Certain defects in the international application
- Box No. VIII Certain observations on the international application

2. **FURTHER ACTION**

If a demand for international preliminary examination is made, this opinion will be considered to be a written opinion of the International Preliminary Examining Authority ("IPEA") except that this does not apply where the applicant chooses an Authority other than this one to be the IPEA and the chosen IPEA has notified the International Bureau under Rule 66.1bis(b) that written opinions of this International Searching Authority will not be so considered.

If this opinion is, as provided above, considered to be a written opinion of the IPEA, the applicant is invited to submit to the IPEA a written reply together, where appropriate, with amendments, before the expiration of 3 months from the date of mailing of Form PCT/ISA/220 or before the expiration of 22 months from the priority date, whichever expires later.  
For further options, see Form PCT/ISA/220.

|  |  |  |
|--|--|--|
|  <p>Name and mailing address of the ISA/KR<br/>Korean Intellectual Property Office<br/>189 Cheongsu-ro, Seo-gu, Daejeon<br/>Metropolitan City, 302-701, Republic of<br/>Korea<br/>Facsimile No. +82-42-472-7140</p> | <p>Date of completion of this opinion</p> <p>05 August 2013 (05.08.2013)</p> | <p>Authorized officer</p> <p>KIM Jin Ho</p> <p>Telephone No. +82-42-481-8699</p>  |
|--|--|--|

**WRITTEN OPINION OF THE  
INTERNATIONAL SEARCHING AUTHORITY**

International application No.

**PCT/US2013/035726****Box No. 1 Basis of this opinion**

1. With regard to the **language**, this opinion has been established on the basis of :

- the international application in the language in which it was filed
- a translation of the international application into \_\_\_\_\_, which is the language of a translation furnished for the purposes of international search (Rules 12.3(a) and 23.1(b))

2.  This opinion has been established taking into account the **rectification of an obvious mistake** authorized by or notified to this Authority under Rule 91 (Rule 43*bis*.1(a))

3. With regard to any **nucleotide and/or amino acid sequence** disclosed in the international application, this opinion has been established on the basis of:

a. a sequence listing filed or furnished

- on paper
- in electronic form

b. time of filing or furnishing

- contained in the international application as filed.
- filed together with the international application in electronic form.
- furnished subsequently to this Authority for the purposes of search.

4.  In addition, in the case that more than one version or copy of a sequence listing has been filed or furnished, the required statements that the information in the subsequent or additional copies is identical to that in the application as filed or does not go beyond the application as filed, as appropriate, were furnished.

5. Additional comments:



**WRITTEN OPINION OF THE  
INTERNATIONAL SEARCHING AUTHORITY**

International application No.  
**PCT/US2013/035726**

**Box No. V Reasoned statement under Rule 43bis.1(a)(i) with regard to novelty, inventive step or industrial applicability;  
citations and explanations supporting such statement**

**1. Statement**

|                               |        |             |     |
|-------------------------------|--------|-------------|-----|
| Novelty (N)                   | Claims | <u>1-18</u> | YES |
|                               | Claims | <u>NONE</u> | NO  |
| Inventive step (IS)           | Claims | <u>1-18</u> | YES |
|                               | Claims | <u>NONE</u> | NO  |
| Industrial applicability (IA) | Claims | <u>1-18</u> | YES |
|                               | Claims | <u>NONE</u> | NO  |

**2. Citations and explanations :**

Reference is made to the following documents:

- D1: JP 2010-286218 A (MITSUBISHI HEAVY IND. LTD.) 24 December 2010  
 D2: KR 10-1999-0070368 A (SAMSUNG ELECTRONICS CO., LTD.) 15 September 1999  
 D3: JP 05-189659 A (HITACHI BILL SHISETSU ENG. KK.) 30 July 1993  
 D4: JP 2010-038377 A (MITSUBISHI HEAVY IND. LTD.) 18 February 2010  
 D5: S 6786421 B2 (ROSEN, HOWARD) 07 September 2004

**1. Novelty and Inventive Step**

**1.1 Independent claim 1**

None of the documents D1-D5 teach or fairly suggest a system for allocating the cost of operating an HVAC system comprising a thermostatic controller configured to turn on or off a first component associated with an individual unit of occupancy based on temperature reading from an inside of the individual unit of occupancy. Accordingly, claim 1 is not anticipated by any of the documents, nor is it obvious to a person skilled in the art by the documents, taken alone or in combination. Therefore, claim 1 is novel and involves an inventive step under PCT Article 33(2) and (3).

**1.2 Dependent claims 2-9**

Claims 2-9 are directly or indirectly dependent on claim 1 and therefore meet the requirements of PCT Article 33(2) and (3).

Continued on Supplemental Box

**WRITTEN OPINION OF THE  
INTERNATIONAL SEARCHING AUTHORITY**

International application No.

**PCT/US2013/035726**

**Supplemental Box**

In case the space in any of the preceding boxes is not sufficient.  
Continuation of: Box No. V

**1.3 Independent claim 10**

Claim 10 concerns a method for allocating the cost of operating an HVAC system, but it has the same technical features as claim 1. Thus, the same reasoning applies to claim 10. Therefore, claim 10 is novel and involves an inventive step under PCT Article 33(2) and (3).

**1.4 Dependent claims 11-18**

Claims 11-18 are directly or indirectly dependent on claim 10 and therefore meet the requirements of PCT Article 33(2) and (3).

**2. Industrial Applicability**

Claims 1-18 meet the requirement of industrial applicability under PCT Article 33(4).

**PATENT COOPERATION TREATY**

**PCT**

**INTERNATIONAL PRELIMINARY REPORT ON PATENTABILITY**

(Chapter I of the Patent Cooperation Treaty)

(PCT Rule 44bis)

|  |   |  |                  |
|--|---|--|------------------|
| Applicant's or agent's file reference<br>EFACT014WO  | <b>FOR FURTHER ACTION</b>   |  | See item 4 below |
| International application No.<br>PCT/US2013/035726   | International filing date ( <i>day/month/year</i> )<br>09 April 2013 (09.04.2013) | Priority date ( <i>day/month/year</i> )<br>14 June 2012 (14.06.2012) |                  |
| International Patent Classification (8th edition unless older edition indicated)<br>See relevant information in Form PCT/ISA/237 |   |  |                  |
| Applicant<br>ECOFACOR, INC.  |   |  |                  |

|  |                                     |   |                     |                          |            |          |                          |             |  |                          |            |                            |                                     |           |   |                          |            |                         |                          |             |  |                          |              |   |
|--|-------------------------------------|---|---------------------|--------------------------|------------|----------|--------------------------|-------------|--|--------------------------|------------|----------------------------|-------------------------------------|-----------|---|--------------------------|------------|-------------------------|--------------------------|-------------|--|--------------------------|--------------|---|
| <p>1. This international preliminary report on patentability (Chapter I) is issued by the International Bureau on behalf of the International Searching Authority under Rule 44 bis.1(a).</p> <p>2. This REPORT consists of a total of 5 sheets, including this cover sheet.</p> <p>In the attached sheets, any reference to the written opinion of the International Searching Authority should be read as a reference to the international preliminary report on patentability (Chapter I) instead.</p>  |                                     |   |                     |                          |            |          |                          |             |  |                          |            |                            |                                     |           |   |                          |            |                         |                          |             |  |                          |              |   |
| <p>3. This report contains indications relating to the following items:</p> <table border="0"> <tr> <td><input checked="" type="checkbox"/></td> <td>Box No. I</td> <td>Basis of the report</td> </tr> <tr> <td><input type="checkbox"/></td> <td>Box No. II</td> <td>Priority</td> </tr> <tr> <td><input type="checkbox"/></td> <td>Box No. III</td> <td>Non-establishment of opinion with regard to novelty, inventive step and industrial applicability</td> </tr> <tr> <td><input type="checkbox"/></td> <td>Box No. IV</td> <td>Lack of unity of invention</td> </tr> <tr> <td><input checked="" type="checkbox"/></td> <td>Box No. V</td> <td>Reasoned statement under Article 35(2) with regard to novelty, inventive step or industrial applicability; citations and explanations supporting such statement</td> </tr> <tr> <td><input type="checkbox"/></td> <td>Box No. VI</td> <td>Certain documents cited</td> </tr> <tr> <td><input type="checkbox"/></td> <td>Box No. VII</td> <td>Certain defects in the international application</td> </tr> <tr> <td><input type="checkbox"/></td> <td>Box No. VIII</td> <td>Certain observations on the international application</td> </tr> </table> <p>4. The International Bureau will communicate this report to designated Offices in accordance with Rules 44bis.3(c) and 93bis.1 but not, except where the applicant makes an express request under Article 23(2), before the expiration of 30 months from the priority date (Rule 44bis .2).</p> | <input checked="" type="checkbox"/> | Box No. I   | Basis of the report | <input type="checkbox"/> | Box No. II | Priority | <input type="checkbox"/> | Box No. III | Non-establishment of opinion with regard to novelty, inventive step and industrial applicability | <input type="checkbox"/> | Box No. IV | Lack of unity of invention | <input checked="" type="checkbox"/> | Box No. V | Reasoned statement under Article 35(2) with regard to novelty, inventive step or industrial applicability; citations and explanations supporting such statement | <input type="checkbox"/> | Box No. VI | Certain documents cited | <input type="checkbox"/> | Box No. VII | Certain defects in the international application | <input type="checkbox"/> | Box No. VIII | Certain observations on the international application |
| <input checked="" type="checkbox"/>  | Box No. I                           | Basis of the report   |                     |                          |            |          |                          |             |  |                          |            |                            |                                     |           |   |                          |            |                         |                          |             |  |                          |              |   |
| <input type="checkbox"/>   | Box No. II                          | Priority  |                     |                          |            |          |                          |             |  |                          |            |                            |                                     |           |   |                          |            |                         |                          |             |  |                          |              |   |
| <input type="checkbox"/>   | Box No. III                         | Non-establishment of opinion with regard to novelty, inventive step and industrial applicability  |                     |                          |            |          |                          |             |  |                          |            |                            |                                     |           |   |                          |            |                         |                          |             |  |                          |              |   |
| <input type="checkbox"/>   | Box No. IV                          | Lack of unity of invention  |                     |                          |            |          |                          |             |  |                          |            |                            |                                     |           |   |                          |            |                         |                          |             |  |                          |              |   |
| <input checked="" type="checkbox"/>  | Box No. V                           | Reasoned statement under Article 35(2) with regard to novelty, inventive step or industrial applicability; citations and explanations supporting such statement |                     |                          |            |          |                          |             |  |                          |            |                            |                                     |           |   |                          |            |                         |                          |             |  |                          |              |   |
| <input type="checkbox"/>   | Box No. VI                          | Certain documents cited   |                     |                          |            |          |                          |             |  |                          |            |                            |                                     |           |   |                          |            |                         |                          |             |  |                          |              |   |
| <input type="checkbox"/>   | Box No. VII                         | Certain defects in the international application  |                     |                          |            |          |                          |             |  |                          |            |                            |                                     |           |   |                          |            |                         |                          |             |  |                          |              |   |
| <input type="checkbox"/>   | Box No. VIII                        | Certain observations on the international application   |                     |                          |            |          |                          |             |  |                          |            |                            |                                     |           |   |                          |            |                         |                          |             |  |                          |              |   |

|   |   |
|---|---|
|   | Date of issuance of this report<br><b>16 December 2014 (16.12.2014)</b> |
| The International Bureau of WIPO<br>34, chemin des Colombettes<br>1211 Geneva 20, Switzerland | Authorized officer<br><br><b>Nora Lindner</b>                           |
| Facsimile No. +41 22 338 82 70  | e-mail: pt05.pct@wipo.int   |

PATENT COOPERATION TREATY

From the  
INTERNATIONAL SEARCHING AUTHORITY

To:  
KING, JOHN, R.  
  
KNOBBE, MARTENS, OLSON & BEAR, LLP 2040 MAIN STREET, 14TH FLOOR IRVINE CA 92614 USA

**PCT**

**WRITTEN OPINION OF THE  
INTERNATIONAL SEARCHING AUTHORITY**

(PCT Rule 43bis.1)

Date of mailing  
(day/month/year) **06 undefined 2013 (06.08.2013)**

Applicant's or agent's file reference  
EFACT014WO

**FOR FURTHER ACTION**  
See paragraph 2 below

International application No.  
**PCT/US2013/035726**

International filing date (day/month/year)  
**09 April 2013 (09.04.2013)**

Priority date(day/month/year)  
14 June 2012 (14.06.2012)

International Patent Classification (IPC) or both national classification and IPC  
**F24F 11/02(2006.01)i, G05D 23/00(2006.01)i, G06Q 50/06(2012.01)i**

Applicant  
**ECOFACOR, INC.**

1. This opinion contains indications relating to the following items:

- Box No. I Basis of the opinion
- Box No. II Priority
- Box No. III Non-establishment of opinion with regard to novelty, inventive step and industrial applicability
- Box No. IV Lack of unity of invention
- Box No. V Reasoned statement under Rule 43bis.1(a)(i) with regard to novelty, inventive step or industrial applicability; citations and explanations supporting such statement
- Box No. VI Certain documents cited
- Box No. VII Certain defects in the international application
- Box No. VIII Certain observations on the international application

2. **FURTHER ACTION**

If a demand for international preliminary examination is made, this opinion will be considered to be a written opinion of the International Preliminary Examining Authority ("IPEA") except that this does not apply where the applicant chooses an Authority other than this one to be the IPEA and the chosen IPEA has notified the International Bureau under Rule 66.1bis(b) that written opinions of this International Searching Authority will not be so considered.

If this opinion is, as provided above, considered to be a written opinion of the IPEA, the applicant is invited to submit to the IPEA a written reply together, where appropriate, with amendments, before the expiration of 3 months from the date of mailing of Form PCT/ISA/220 or before the expiration of 22 months from the priority date, whichever expires later.  
For further options, see Form PCT/ISA/220.

Name and mailing address of the ISA/KR  
Korean Intellectual Property Office  
189 Cheongsa-ro, Seo-gu, Daejeon  
Metropolitan City, 302-701, Republic of  
Korea  
Facsimile No. +82-42-472-7140

Date of completion of this opinion  
  
05 August 2013 (05.08.2013)

Authorized officer  
  
KIM Jin Ho  
  
Telephone No. +82-42-481-8699

WRITTEN OPINION OF THE  
INTERNATIONAL SEARCHING AUTHORITY

International application No.  
**PCT/US2013/035726**

**Box No. I Basis of this opinion**

1. With regard to the **language**, this opinion has been established on the basis of :
  - the international application in the language in which it was filed
  - a translation of the international application into \_\_\_\_\_, which is the language of a translation furnished for the purposes of international search (Rules 12.3(a) and 23.1(b))
2.  This opinion has been established taking into account the **rectification of an obvious mistake** authorized by or notified to this Authority under Rule 91 (Rule 43bis.1(a))
3. With regard to any **nucleotide and/or amino acid sequence** disclosed in the international application, this opinion has been established on the basis of:
  - a. a sequence listing filed or furnished
    - on paper
    - in electronic form
  - b. time of filing or furnishing
    - contained in the international application as filed.
    - filed together with the international application in electronic form.
    - furnished subsequently to this Authority for the purposes of search.
4.  In addition, in the case that more than one version or copy of a sequence listing has been filed or furnished, the required statements that the information in the subsequent or additional copies is identical to that in the application as filed or does not go beyond the application as filed, as appropriate, were furnished.
5. Additional comments:

**WRITTEN OPINION OF THE  
INTERNATIONAL SEARCHING AUTHORITY**

International application No.

**PCT/US2013/035726**

**Box No. V Reasoned statement under Rule 43bis.1(a)(i) with regard to novelty, inventive step or industrial applicability; citations and explanations supporting such statement**

1. Statement

|                               |        |      |     |
|-------------------------------|--------|------|-----|
| Novelty (N)                   | Claims | 1-18 | YES |
|                               | Claims | NONE | NO  |
| Inventive step (IS)           | Claims | 1-18 | YES |
|                               | Claims | NONE | NO  |
| Industrial applicability (IA) | Claims | 1-18 | YES |
|                               | Claims | NONE | NO  |

2. Citations and explanations :

Reference is made to the following documents:

D1: JP 2010-286218 A (MITSUBISHI HEAVY IND. LTD.) 24 December 2010

D2: KR 10-1999-0070368 A (SAMSUNG ELECTRONICS CO., LTD.) 15 September 1999

D3: JP 05-189659 A (HITACHI BILL SHISETSU ENG. KK.) 30 July 1993

D4: JP 2010-038377 A (MITSUBISHI HEAVY IND. LTD.) 18 February 2010

D5: S 6786421 B2 (ROSEN, HOWARD) 07 September 2004

1. Novelty and Inventive Step

1.1 Independent claim 1

None of the documents D1-D5 teach or fairly suggest a system for allocating the cost of operating an HVAC system comprising a thermostatic controller configured to turn on or off a first component associated with an individual unit of occupancy based on temperature reading from an inside of the individual unit of occupancy. Accordingly, claim 1 is not anticipated by any of the documents, nor is it obvious to a person skilled in the art by the documents, taken alone or in combination. Therefore, claim 1 is novel and involves an inventive step under PCT Article 33(2) and (3).

1.2 Dependent claims 2-9

Claims 2-9 are directly or indirectly dependent on claim 1 and therefore meet the requirements of PCT Article 33(2) and (3).

Continued on Supplemental Box

**Supplemental Box**

In case the space in any of the preceding boxes is not sufficient.

Continuation of : Box No. V

1.3 Independent claim 10

Claim 10 concerns a method for allocating the cost of operating an HVAC system, but it has the same technical features as claim 1. Thus, the same reasoning applies to claim 10. Therefore, claim 10 is novel and involves an inventive step under PCT Article 33(2) and (3).

1.4 Dependent claims 11-18

Claims 11-18 are directly or indirectly dependent on claim 10 and therefore meet the requirements of PCT Article 33(2) and (3).

2. Industrial Applicability

Claims 1-18 meet the requirement of industrial applicability under PCT Article 33(4).

## Electronic Patent Application Fee Transmittal

|   |  |
|---|--|
| <b>Application Number:</b>                  | 14082675   |
| <b>Filing Date:</b>                         | 18-Nov-2013  |
| <b>Title of Invention:</b>                  | SYSTEM, METHOD AND APPARATUS FOR IDENTIFYING MANUAL INPUTS TO AND ADAPTIVE PROGRAMMING OF A THERMOSTAT |
| <b>First Named Inventor/Applicant Name:</b> | John Douglas Steinberg   |
| <b>Filer:</b>                               | John R. King/Amy Durrant   |
| <b>Attorney Docket Number:</b>              | EFACT.007C1  |

Filed as Small Entity

### Filing Fees for Utility under 35 USC 111(a)

| Description                              | Fee Code | Quantity | Amount | Sub-Total in USD(\$) |
|--|----------|----------|--------|----------------------|
| <b>Basic Filing:</b>                     |          |          |        |                      |
| <b>Pages:</b>                            |          |          |        |                      |
| <b>Claims:</b>                           |          |          |        |                      |
| <b>Miscellaneous-Filing:</b>             |          |          |        |                      |
| <b>Petition:</b>                         |          |          |        |                      |
| <b>Patent-Appeals-and-Interference:</b>  |          |          |        |                      |
| <b>Post-Allowance-and-Post-Issuance:</b> |          |          |        |                      |
| <b>Extension-of-Time:</b>                |          |          |        |                      |



| Description                             | Fee Code | Quantity | Amount | Sub-Total in USD(\$) |
|---|----------|----------|--------|----------------------|
| <b>Miscellaneous:</b>                   |          |          |        |                      |
| Submission- Information Disclosure Stmt | 2806     | 1        | 90     | 90                   |
| <b>Total in USD (\$)</b>                |          |          |        | <b>90</b>            |

## Electronic Acknowledgement Receipt

|   |  |
|---|--|
| <b>EFS ID:</b>                              | 22711308   |
| <b>Application Number:</b>                  | 14082675   |
| <b>International Application Number:</b>    |  |
| <b>Confirmation Number:</b>                 | 3336   |
| <b>Title of Invention:</b>                  | SYSTEM, METHOD AND APPARATUS FOR IDENTIFYING MANUAL INPUTS TO AND ADAPTIVE PROGRAMMING OF A THERMOSTAT |
| <b>First Named Inventor/Applicant Name:</b> | John Douglas Steinberg   |
| <b>Customer Number:</b>                     | 20995  |
| <b>Filer:</b>                               | John R. King/Mason Leu   |
| <b>Filer Authorized By:</b>                 | John R. King   |
| <b>Attorney Docket Number:</b>              | EFACT.007C1  |
| <b>Receipt Date:</b>                        | 23-JUN-2015  |
| <b>Filing Date:</b>                         | 18-NOV-2013  |
| <b>Time Stamp:</b>                          | 14:04:13   |
| <b>Application Type:</b>                    | Utility under 35 USC 111(a)  |

### Payment information:

|  |                               |
|--|-------------------------------|
| Submitted with Payment                   | yes                           |
| Payment Type                             | Credit Card                   |
| Payment was successfully received in RAM | \$90                          |
| RAM confirmation Number                  | 328                           |
| Deposit Account                          | 111410                        |
| Authorized User                          | KNOBBE MARTENS OLSON AND BEAR |

The Director of the USPTO is hereby authorized to charge indicated fees and credit any overpayment as follows:

Charge any Additional Fees required under 37 C.F.R. Section 1.16 (National application filing, search, and examination fees)

Charge any Additional Fees required under 37 C.F.R. Section 254 (Patent application and reexamination processing fees)

|  |  |  |  |  |  |
|--|--|--|--|--|--|
|  |  |  |  |  |  |
|--|--|--|--|--|--|

**File Listing:**

| Document Number | Document Description | File Name                | File Size(Bytes)/<br>Message Digest                               | Multi Part /.zip | Pages (if appl.) |
|-----------------|----------------------|--------------------------|---|------------------|------------------|
| 1               |                      | EFACT-007C1_response.pdf | 530924<br><small>238e30f2b341ee40e56afb16a18928d2081b4b12</small> | yes              | 15               |

| Multipart Description/PDF files in .zip description   |  |       |     |  |  |
|---|--|-------|-----|--|--|
| Document Description                                  |  | Start | End |  |  |
| Amendment/Req. Reconsideration-After Non-Final Reject |  | 1     | 1   |  |  |
| Claims  |  | 2     | 7   |  |  |
| Applicant summary of interview with examiner          |  | 8     | 8   |  |  |
| Applicant Arguments/Remarks Made in an Amendment      |  | 9     | 15  |  |  |

**Warnings:**

**Information:**

|   |  |                     |  |     |   |
|---|--|---------------------|--|-----|---|
| 2 |  | EFACT-007C1_IDS.pdf | 529304<br><small>fc89f6e41d0599499f641c6f942fcddee80f90b48</small> | yes | 5 |
|---|--|---------------------|--|-----|---|

| Multipart Description/PDF files in .zip description |  |       |     |  |  |
|---|--|-------|-----|--|--|
| Document Description                                |  | Start | End |  |  |
| Transmittal Letter                                  |  | 1     | 2   |  |  |
| Information Disclosure Statement (IDS) Form (SB08)  |  | 3     | 5   |  |  |

**Warnings:**

**Information:**

|   |                   |                       |   |    |   |
|---|-------------------|-----------------------|---|----|---|
| 3 | Foreign Reference | EFACT-007C1_ref50.pdf | 626689<br><small>dde4ec17794675b0e8a7f0f745e04aec83e50eb8</small> | no | 9 |
|---|-------------------|-----------------------|---|----|---|

**Warnings:**

**Information:**

|   |                   |                       |   |    |   |
|---|-------------------|-----------------------|---|----|---|
| 4 | Foreign Reference | EFACT-007C1_ref51.pdf | 431508<br><small>da2a39ec227beaf629bb1a307d5e7cd5a3c22d4c</small> | no | 9 |
|---|-------------------|-----------------------|---|----|---|

**Warnings:**

|                                     |                       |                       |   |    |     |
|-------------------------------------|-----------------------|-----------------------|---|----|-----|
| <b>Information:</b>                 |                       |                       |   |    |     |
| 5                                   | Foreign Reference     | EFACT-007C1_ref52.pdf | 281986<br>7f0ac40df56ce12dbd5b0d8c26e6b2ba604e20de  | no | 10  |
| <b>Warnings:</b>                    |                       |                       |   |    |     |
| <b>Information:</b>                 |                       |                       |   |    |     |
| 6                                   | Foreign Reference     | EFACT-007C1_ref53.pdf | 172303<br>6334e8109eca78f0d7a31f9872efb893c329496c  | no | 2   |
| <b>Warnings:</b>                    |                       |                       |   |    |     |
| <b>Information:</b>                 |                       |                       |   |    |     |
| 7                                   | Foreign Reference     | EFACT-007C1_ref54.pdf | 170603<br>a72cfa7afa5940e8c8eb6f840fb6c0d15070181a  | no | 5   |
| <b>Warnings:</b>                    |                       |                       |   |    |     |
| <b>Information:</b>                 |                       |                       |   |    |     |
| 8                                   | Foreign Reference     | EFACT-007C1_ref55.pdf | 143473<br>868979a59fefeb5302bd23842bb974ccb98059bd  | no | 3   |
| <b>Warnings:</b>                    |                       |                       |   |    |     |
| <b>Information:</b>                 |                       |                       |   |    |     |
| 9                                   | Foreign Reference     | EFACT-007C1_ref56.pdf | 4384010<br>3c3f120b0a9c1a0a7fa2a64b9e54564ee26825f1 | no | 125 |
| <b>Warnings:</b>                    |                       |                       |   |    |     |
| <b>Information:</b>                 |                       |                       |   |    |     |
| 10                                  | Non Patent Literature | EFACT-007C1_ref57.pdf | 349875<br>9010dce732d0f3092692ecd2ba448f3dfd38b0f   | no | 10  |
| <b>Warnings:</b>                    |                       |                       |   |    |     |
| <b>Information:</b>                 |                       |                       |   |    |     |
| 11                                  | Non Patent Literature | EFACT-007C1_ref58.pdf | 165146<br>d79ffc7ab04925979c213297d3529bcf968cc5a3  | no | 5   |
| <b>Warnings:</b>                    |                       |                       |   |    |     |
| <b>Information:</b>                 |                       |                       |   |    |     |
| 12                                  | Fee Worksheet (SB06)  | fee-info.pdf          | 30849<br>e867485644d407e5658a8733a085330aeb70bca6   | no | 2   |
| <b>Warnings:</b>                    |                       |                       |   |    |     |
| <b>Information:</b>                 |                       |                       |   |    |     |
| <b>Total Files Size (in bytes):</b> |                       |                       | 7816670   |    |     |

**This Acknowledgement Receipt evidences receipt on the noted date by the USPTO of the indicated documents, characterized by the applicant, and including page counts, where applicable. It serves as evidence of receipt similar to a Post Card, as described in MPEP 503.**

**New Applications Under 35 U.S.C. 111**

**If a new application is being filed and the application includes the necessary components for a filing date (see 37 CFR 1.53(b)-(d) and MPEP 506), a Filing Receipt (37 CFR 1.54) will be issued in due course and the date shown on this Acknowledgement Receipt will establish the filing date of the application.**

**National Stage of an International Application under 35 U.S.C. 371**

**If a timely submission to enter the national stage of an international application is compliant with the conditions of 35 U.S.C. 371 and other applicable requirements a Form PCT/DO/EO/903 indicating acceptance of the application as a national stage submission under 35 U.S.C. 371 will be issued in addition to the Filing Receipt, in due course.**

**New International Application Filed with the USPTO as a Receiving Office**

**If a new international application is being filed and the international application includes the necessary components for an international filing date (see PCT Article 11 and MPEP 1810), a Notification of the International Application Number and of the International Filing Date (Form PCT/RO/105) will be issued in due course, subject to prescriptions concerning national security, and the date shown on this Acknowledgement Receipt will establish the international filing date of the application.**

|   |   |
|---|---|
| <b>Doc Code: DIST.E.FILE</b><br><b>Document Description: Electronic Terminal Disclaimer - Filed</b> | PTO/SB/26<br>U.S. Patent and Trademark Office<br>Department of Commerce |
|---|---|

|                             |  |
|-----------------------------|--|
| Electronic Petition Request | <b>TERMINAL DISCLAIMER TO OBIATE A DOUBLE PATENTING REJECTION OVER A "PRIOR" PATENT</b>                |
| Application Number          | 14082675   |
| Filing Date                 | 18-Nov-2013  |
| First Named Inventor        | John Steinberg   |
| Attorney Docket Number      | EFACT.007C1  |
| Title of Invention          | SYSTEM, METHOD AND APPARATUS FOR IDENTIFYING MANUAL INPUTS TO AND ADAPTIVE PROGRAMMING OF A THERMOSTAT |

- Filing of terminal disclaimer does not obviate requirement for response under 37 CFR 1.111 to outstanding Office Action
- This electronic Terminal Disclaimer is not being used for a Joint Research Agreement.

| Owner           | Percent Interest |
|-----------------|------------------|
| EcoFactor, Inc. | 100%             |

The owner(s) with percent interest listed above in the instant application hereby disclaims, except as provided below, the terminal part of the statutory term of any patent granted on the instant application which would extend beyond the expiration date of the full statutory term of prior patent number(s)

8596550

as the term of said prior patent is presently shortened by any terminal disclaimer. The owner hereby agrees that any patent so granted on the instant application shall be enforceable only for and during such period that it and the prior patent are commonly owned. This agreement runs with any patent granted on the instant application and is binding upon the grantee, its successors or assigns.

In making the above disclaimer, the owner does not disclaim the terminal part of the term of any patent granted on the instant application that would extend to the expiration date of the full statutory term of the prior patent, "as the term of said prior patent is presently shortened by any terminal disclaimer," in the event that said prior patent later:

- expires for failure to pay a maintenance fee;
- is held unenforceable;
- is found invalid by a court of competent jurisdiction;
- is statutorily disclaimed in whole or terminally disclaimed under 37 CFR 1.321;
- has all claims canceled by a reexamination certificate;
- is reissued; or
- is in any manner terminated prior to the expiration of its full statutory term as presently shortened by any terminal disclaimer.

Terminal disclaimer fee under 37 CFR 1.20(d) is included with Electronic Terminal Disclaimer request.

I certify, in accordance with 37 CFR 1.4(d)(4), that the terminal disclaimer fee under 37 CFR 1.20(d) required for this terminal disclaimer has already been paid in the above-identified application.

Applicant claims the following fee status:

- Small Entity
- Micro Entity
- Regular Undiscounted

I hereby declare that all statements made herein of my own knowledge are true and that all statements made on information and belief are believed to be true; and further that these statements were made with the knowledge that willful false statements and the like so made are punishable by fine or imprisonment, or both, under Section 1001 of Title 18 of the United States Code and that such willful false statements may jeopardize the validity of the application or any patent issued thereon.

THIS PORTION MUST BE COMPLETED BY THE SIGNATORY OR SIGNATORIES

I certify, in accordance with 37 CFR 1.4(d)(4) that I am:

- An attorney or agent registered to practice before the Patent and Trademark Office who is of record in this application  
  
Registration Number 34362
- A sole inventor
- A joint inventor; I certify that I am authorized to sign this submission on behalf of all of the inventors as evidenced by the power of attorney in the application
- A joint inventor; all of whom are signing this request

|           |                |
|-----------|----------------|
| Signature | /John R. King/ |
| Name      | John R. King   |

\*Statement under 37 CFR 3.73(b) is required if terminal disclaimer is signed by the assignee (owner).  
Form PTO/SB/96 may be used for making this certification. See MPEP § 324.

## Electronic Patent Application Fee Transmittal

|  |  |                 |               |                             |
|--|--|-----------------|---------------|-----------------------------|
| <b>Application Number:</b>                         | 14082675   |                 |               |                             |
| <b>Filing Date:</b>                                | 18-Nov-2013  |                 |               |                             |
| <b>Title of Invention:</b>                         | SYSTEM, METHOD AND APPARATUS FOR IDENTIFYING MANUAL INPUTS TO AND ADAPTIVE PROGRAMMING OF A THERMOSTAT |                 |               |                             |
| <b>First Named Inventor/Applicant Name:</b>        | John Douglas Steinberg   |                 |               |                             |
| <b>Filer:</b>                                      | John R. King/Heide Young   |                 |               |                             |
| <b>Attorney Docket Number:</b>                     | EFACT.007C1  |                 |               |                             |
| Filed as Small Entity                              |  |                 |               |                             |
| <b>Filing Fees for Utility under 35 USC 111(a)</b> |  |                 |               |                             |
| <b>Description</b>                                 | <b>Fee Code</b>  | <b>Quantity</b> | <b>Amount</b> | <b>Sub-Total in USD(\$)</b> |
| <b>Basic Filing:</b>                               |  |                 |               |                             |
| Statutory or Terminal Disclaimer                   | 1814   | 1               | 160           | 160                         |
| <b>Pages:</b>                                      |  |                 |               |                             |
| <b>Claims:</b>                                     |  |                 |               |                             |
| <b>Miscellaneous-Filing:</b>                       |  |                 |               |                             |
| <b>Petition:</b>                                   |  |                 |               |                             |
| <b>Patent-Appeals-and-Interference:</b>            |  |                 |               |                             |
| <b>Post-Allowance-and-Post-Issuance:</b>           |  |                 |               |                             |



| Description               | Fee Code | Quantity | Amount | Sub-Total in USD(\$) |
|---------------------------|----------|----------|--------|----------------------|
| <b>Extension-of-Time:</b> |          |          |        |                      |
| <b>Miscellaneous:</b>     |          |          |        |                      |
| <b>Total in USD (\$)</b>  |          |          |        | <b>160</b>           |

Doc Code: DISQ.E.FILE

Document Description: Electronic Terminal Disclaimer – Approved

Application No.: 14082675

Filing Date: 18-Nov-2013

Applicant/Patent under Reexamination: Steinberg et al.

Electronic Terminal Disclaimer filed on June 23, 2015

APPROVED

**This patent is subject to a terminal disclaimer**

DISAPPROVED

Approved/Disapproved by: Electronic Terminal Disclaimer automatically approved by EFS-Web

U.S. Patent and Trademark Office

## Electronic Acknowledgement Receipt

|   |  |
|---|--|
| <b>EFS ID:</b>                              | 22710757   |
| <b>Application Number:</b>                  | 14082675   |
| <b>International Application Number:</b>    |  |
| <b>Confirmation Number:</b>                 | 3336   |
| <b>Title of Invention:</b>                  | SYSTEM, METHOD AND APPARATUS FOR IDENTIFYING MANUAL INPUTS TO AND ADAPTIVE PROGRAMMING OF A THERMOSTAT |
| <b>First Named Inventor/Applicant Name:</b> | John Douglas Steinberg   |
| <b>Customer Number:</b>                     | 20995  |
| <b>Filer:</b>                               | John R. King/Heide Young   |
| <b>Filer Authorized By:</b>                 | John R. King   |
| <b>Attorney Docket Number:</b>              | EFACT.007C1  |
| <b>Receipt Date:</b>                        | 23-JUN-2015  |
| <b>Filing Date:</b>                         | 18-NOV-2013  |
| <b>Time Stamp:</b>                          | 14:47:21   |
| <b>Application Type:</b>                    | Utility under 35 USC 111(a)  |

### Payment information:

|  |                               |
|--|-------------------------------|
| Submitted with Payment                   | yes                           |
| Payment Type                             | Credit Card                   |
| Payment was successfully received in RAM | \$160                         |
| RAM confirmation Number                  | 1138                          |
| Deposit Account                          | 111410                        |
| Authorized User                          | KNOBBE MARTENS OLSON AND BEAR |

The Director of the USPTO is hereby authorized to charge indicated fees and credit any overpayment as follows:

Charge any Additional Fees required under 37 C.F.R. Section 1.16 (National application filing, search, and examination fees)

Charge any Additional Fees required under 37 C.F.R. Section 263 (Patent application and reexamination processing fees)

|  |  |  |  |  |  |
|--|--|--|--|--|--|
|  |  |  |  |  |  |
|--|--|--|--|--|--|

**File Listing:**

| Document Number | Document Description                 | File Name                | File Size(Bytes)/ Message Digest        | Multi Part /.zip | Pages (if appl.) |
|-----------------|--------------------------------------|--------------------------|---|------------------|------------------|
| 1               | Electronic Terminal Disclaimer-Filed | eTerminal-Disclaimer.pdf | 33498                                   | no               | 2                |
|                 |                                      |                          | 1c979049a8c8fb565bd94ca6c68ce21ed77539b |                  |                  |

**Warnings:**

**Information:**

|   |                      |              |  |    |   |
|---|----------------------|--------------|--|----|---|
| 2 | Fee Worksheet (SB06) | fee-info.pdf | 30664                                    | no | 2 |
|   |                      |              | fc1e23c350dcbe53bb9bdb933b904175e978b411 |    |   |

**Warnings:**

**Information:**

|                                     |       |
|-------------------------------------|-------|
| <b>Total Files Size (in bytes):</b> | 64162 |
|-------------------------------------|-------|

**This Acknowledgement Receipt evidences receipt on the noted date by the USPTO of the indicated documents, characterized by the applicant, and including page counts, where applicable. It serves as evidence of receipt similar to a Post Card, as described in MPEP 503.**

**New Applications Under 35 U.S.C. 111**

**If a new application is being filed and the application includes the necessary components for a filing date (see 37 CFR 1.53(b)-(d) and MPEP 506), a Filing Receipt (37 CFR 1.54) will be issued in due course and the date shown on this Acknowledgement Receipt will establish the filing date of the application.**

**National Stage of an International Application under 35 U.S.C. 371**

**If a timely submission to enter the national stage of an international application is compliant with the conditions of 35 U.S.C. 371 and other applicable requirements a Form PCT/DO/EO/903 indicating acceptance of the application as a national stage submission under 35 U.S.C. 371 will be issued in addition to the Filing Receipt, in due course.**

**New International Application Filed with the USPTO as a Receiving Office**

**If a new international application is being filed and the international application includes the necessary components for an international filing date (see PCT Article 11 and MPEP 1810), a Notification of the International Application Number and of the International Filing Date (Form PCT/RO/105) will be issued in due course, subject to prescriptions concerning national security, and the date shown on this Acknowledgement Receipt will establish the international filing date of the application.**

Under the Paperwork Reduction Act of 1995, no persons are required to respond to a collection of information unless it displays a valid OMB control number.

|   |   |                                  |                                       |
|---|---|----------------------------------|---------------------------------------|
| <b>PATENT APPLICATION FEE DETERMINATION RECORD</b><br>Substitute for Form PTO-875 | Application or Docket Number<br><b>14/082,675</b> | Filing Date<br><b>11/18/2013</b> | <input type="checkbox"/> To be Mailed |
|---|---|----------------------------------|---------------------------------------|

ENTITY:  LARGE  SMALL  MICRO

**APPLICATION AS FILED – PART I**

| FOR   | NUMBER FILED  | NUMBER EXTRA | RATE (\$) | FEE (\$) |
|---|---|--------------|-----------|----------|
| <input type="checkbox"/> BASIC FEE<br><small>(37 CFR 1.16(a), (b), or (c))</small>        | N/A   | N/A          | N/A       |          |
| <input type="checkbox"/> SEARCH FEE<br><small>(37 CFR 1.16(k), (l), or (m))</small>       | N/A   | N/A          | N/A       |          |
| <input type="checkbox"/> EXAMINATION FEE<br><small>(37 CFR 1.16(o), (p), or (q))</small>  | N/A   | N/A          | N/A       |          |
| TOTAL CLAIMS<br><small>(37 CFR 1.16(i))</small>   | minus 20 =  | *            | X \$ =    |          |
| INDEPENDENT CLAIMS<br><small>(37 CFR 1.16(h))</small>                                     | minus 3 =   | *            | X \$ =    |          |
| <input type="checkbox"/> APPLICATION SIZE FEE<br><small>(37 CFR 1.16(s))</small>          | If the specification and drawings exceed 100 sheets of paper, the application size fee due is \$310 (\$155 for small entity) for each additional 50 sheets or fraction thereof. See 35 U.S.C. 41(a)(1)(G) and 37 CFR 1.16(s). |              |           |          |
| <input type="checkbox"/> MULTIPLE DEPENDENT CLAIM PRESENT <small>(37 CFR 1.16(j))</small> |   |              |           |          |
| * If the difference in column 1 is less than zero, enter "0" in column 2.                 |   |              | TOTAL     |          |

**APPLICATION AS AMENDED – PART II**

|   | (Column 1)  | (Column 2)                       | (Column 3)                         | PRESENT EXTRA | RATE (\$)       | ADDITIONAL FEE (\$) |
|---|---|----------------------------------|------------------------------------|---------------|-----------------|---------------------|
| <b>AMENDMENT</b>  | <b>06/23/2015</b>   | CLAIMS REMAINING AFTER AMENDMENT | HIGHEST NUMBER PREVIOUSLY PAID FOR |               |                 |                     |
|   | Total <small>(37 CFR 1.16(i))</small>   | * 24                             | Minus                              | ** 24         | = 0             | X \$40 = 0          |
|   | Independent <small>(37 CFR 1.16(h))</small>                                   | * 3                              | Minus                              | ***3          | = 0             | X \$210 = 0         |
|   | <input type="checkbox"/> Application Size Fee <small>(37 CFR 1.16(s))</small> |                                  |                                    |               |                 |                     |
| <input type="checkbox"/> FIRST PRESENTATION OF MULTIPLE DEPENDENT CLAIM <small>(37 CFR 1.16(j))</small> |   |                                  |                                    |               |                 |                     |
|   |   |                                  |                                    |               | TOTAL ADD'L FEE | <b>0</b>            |

|   | (Column 1)  | (Column 2)                       | (Column 3)                         | PRESENT EXTRA | RATE (\$)       | ADDITIONAL FEE (\$) |
|---|---|----------------------------------|------------------------------------|---------------|-----------------|---------------------|
| <b>AMENDMENT</b>  |   | CLAIMS REMAINING AFTER AMENDMENT | HIGHEST NUMBER PREVIOUSLY PAID FOR |               |                 |                     |
|   | Total <small>(37 CFR 1.16(i))</small>   | *                                | Minus                              | **            | =               | X \$ =              |
|   | Independent <small>(37 CFR 1.16(h))</small>                                   | *                                | Minus                              | ***           | =               | X \$ =              |
|   | <input type="checkbox"/> Application Size Fee <small>(37 CFR 1.16(s))</small> |                                  |                                    |               |                 |                     |
| <input type="checkbox"/> FIRST PRESENTATION OF MULTIPLE DEPENDENT CLAIM <small>(37 CFR 1.16(j))</small> |   |                                  |                                    |               |                 |                     |
|   |   |                                  |                                    |               | TOTAL ADD'L FEE |                     |

\* If the entry in column 1 is less than the entry in column 2, write "0" in column 3.  
 \*\* If the "Highest Number Previously Paid For" IN THIS SPACE is less than 20, enter "20".  
 \*\*\* If the "Highest Number Previously Paid For" IN THIS SPACE is less than 3, enter "3".

The "Highest Number Previously Paid For" (Total or Independent) is the highest number found in the appropriate box in column 1.

LIE  
/CHRISTINE MOLLISH/

This collection of information is required by 37 CFR 1.16. The information is required to obtain or retain a benefit by the public which is to file (and by the USPTO to process) an application. Confidentiality is governed by 35 U.S.C. 122 and 37 CFR 1.14. This collection is estimated to take 12 minutes to complete, including gathering, preparing, and submitting the completed application form to the USPTO. Time will vary depending upon the individual case. Any comments on the amount of time you require to complete this form and/or suggestions for reducing this burden, should be sent to the Chief Information Officer, U.S. Patent and Trademark Office, U.S. Department of Commerce, P.O. Box 1450, Alexandria, VA 22313-1450. DO NOT SEND FEES OR COMPLETED FORMS TO THIS ADDRESS. **SEND TO: Commissioner for Patents, P.O. Box 1450, Alexandria, VA 22313-1450.**

If you need assistance in completing the form, call 1-800-PTO-9199 and select option 2.



UNITED STATES PATENT AND TRADEMARK OFFICE

UNITED STATES DEPARTMENT OF COMMERCE
United States Patent and Trademark Office
Address: COMMISSIONER FOR PATENTS
P.O. Box 1450
Alexandria, Virginia 22313-1450
www.uspto.gov

Table with 5 columns: APPLICATION NO., FILING DATE, FIRST NAMED INVENTOR, ATTORNEY DOCKET NO., CONFIRMATION NO.
14/082,675 11/18/2013 John Douglas Steinberg EFACT.007C1 3336

20995 7590 03/23/2015
KNOBBE MARTENS OLSON & BEAR LLP
2040 MAIN STREET
FOURTEENTH FLOOR
IRVINE, CA 92614

EXAMINER

NORMAN, MARC E

ART UNIT PAPER NUMBER

3744

NOTIFICATION DATE DELIVERY MODE

03/23/2015

ELECTRONIC

Please find below and/or attached an Office communication concerning this application or proceeding.

The time period for reply, if any, is set in the attached communication.

Notice of the Office communication was sent electronically on above-indicated "Notification Date" to the following e-mail address(es):

jayna.cartee@knobbe.com
efiling@knobbe.com



### **DETAILED ACTION**

The present application is being examined under the pre-AIA first to invent provisions.

#### ***CLAIM INTERPRETATION***

Use of the word “means” (or “step for”) in a claim with functional language creates a rebuttable presumption that the claim element is to be treated in accordance with 35 U.S.C. § 112(f) (pre-AIA 35 U.S.C. 112, sixth paragraph). The presumption that § 112(f) (pre-AIA § 112, sixth paragraph) is invoked is rebutted when the function is recited with sufficient structure, material, or acts within the claim itself to entirely perform the recited function.

Absence of the word “means” (or “step for”) in a claim creates a rebuttable presumption that the claim element is not to be treated in accordance with 35 U.S.C. § 112(f) (pre-AIA 35 U.S.C. 112, sixth paragraph). The presumption that § 112(f) (pre-AIA § 112, sixth paragraph) is not invoked is rebutted when the claim element recites function but fails to recite sufficiently definite structure, material or acts to perform that function.

Claim elements in this application that use the word “means” (or “step for”) are presumed to invoke § 112(f) except as otherwise indicated in an Office action. Similarly, claim elements that do not use the word “means” (or “step for”) are presumed not to invoke § 112(f) except as otherwise indicated in an Office action.



Art Unit: 3744

***Claim Rejections - 35 USC § 101***

35 U.S.C. 101 reads as follows:

Whoever invents or discovers any new and useful process, machine, manufacture, or composition of matter, or any new and useful improvement thereof, may obtain a patent therefor, subject to the conditions and requirements of this title.

Claims 1-24 are rejected under 35 U.S.C. 101 because the claimed invention is directed to a judicial exception (i.e., a law of nature, a natural phenomenon, or an abstract idea) without significantly more.

Claims 1-8 are directed to a method of detecting manual changes to a setpoint comprising a series of abstract ideas of accessing stored data, using stored data to predict, calculating, generating a value, detecting a manual change, and logging information to a database. The claims do not include additional elements that are sufficient to amount to significantly more than the judicial exception because the recited computer elements may be performed by any generic computer (see for example paragraph 0022 of Applicant's own specification regarding the computers being conventional computers). Further, accessing a database and logging to a database are considered insignificant, abstract pre- and post-solution, respectively.

Claims 9-16 are directed to a method of incorporating manual changes to a setpoint comprising a series of abstract ideas of accessing stored data, using stored data to predict, calculating, comparing, detecting a manual change, and changing a setpoint. The claims do not include additional elements that are sufficient to amount to significantly more than the judicial exception because method steps may be performed by any generic computer (again, see for example paragraph 0022 of Applicant's own specification regarding the computers being conventional computers). Further, accessing a database and changing a setpoint are considered

Art Unit: 3744

insignificant, abstract pre- and post-solution, respectively. The changing of a setpoint is considered, in and of itself, an abstract concept, absent any further positive recitation that the thermostatic controller controls operation of an HVAC system based on the changed setpoint.

Claims 17-24 are directed to an apparatus comprising a conventional computer configured to perform a series of abstract storing, communicating, calculating, and comparing functions. The claims do not include additional elements that are sufficient to amount to significantly more than the judicial exception because the abstract functions may be performed by any generic computer (again, see for example paragraph 0022 of Applicant's own specification regarding the computers being conventional computers).

Applicant is advised that these rejections are consistent with recent court decisions as well as the 2014 interim guidance on patent subject matter eligibility. Accordingly, the examination process for determining patent subject matter eligibility has altered since the prosecution of parent patent 8,596,550 B2, thus necessitating the above rejections.

### ***Double Patenting***

The nonstatutory double patenting rejection is based on a judicially created doctrine grounded in public policy (a policy reflected in the statute) so as to prevent the unjustified or improper timewise extension of the "right to exclude" granted by a patent and to prevent possible harassment by multiple assignees. A nonstatutory double patenting rejection is appropriate where the claims at issue are not identical, but at least one examined application claim is not patentably distinct from the reference claim(s) because the examined application claim is either anticipated by, or would have been obvious over, the reference claim(s). See, e.g., *In re Berg*,

Art Unit: 3744

140 F.3d 1428, 46 USPQ2d 1226 (Fed. Cir. 1998); *In re Goodman*, 11 F.3d 1046, 29 USPQ2d 2010 (Fed. Cir. 1993); *In re Longi*, 759 F.2d 887, 225 USPQ 645 (Fed. Cir. 1985); *In re Van Ornum*, 686 F.2d 937, 214 USPQ 761 (CCPA 1982); *In re Vogel*, 422 F.2d 438, 164 USPQ 619 (CCPA 1970); and *In re Thorington*, 418 F.2d 528, 163 USPQ 644 (CCPA 1969).

A timely filed terminal disclaimer in compliance with 37 CFR 1.321(c) or 1.321(d) may be used to overcome an actual or provisional rejection based on a nonstatutory double patenting ground provided the reference application or patent either is shown to be commonly owned with this application, or claims an invention made as a result of activities undertaken within the scope of a joint research agreement. A terminal disclaimer must be signed in compliance with 37 CFR 1.321(b).

The USPTO internet Web site contains terminal disclaimer forms which may be used. Please visit <http://www.uspto.gov/forms/>. The filing date of the application will determine what form should be used. A web-based eTerminal Disclaimer may be filled out completely online using web-screens. An eTerminal Disclaimer that meets all requirements is auto-processed and approved immediately upon submission. For more information about eTerminal Disclaimers, refer to <http://www.uspto.gov/patents/process/file/efs/guidance/eTD-info-I.jsp>.

Claims 1-24 are rejected on the ground of nonstatutory double patenting over claims 1-23 of U.S. Patent No. 8,596,550 B2 since the claims, if allowed, would improperly extend the “right to exclude” already granted in the patent.

The subject matter claimed in the instant application is fully disclosed in the patent and is covered by the patent since the patent and the application are claiming common subject matter, as follows:

Art Unit: 3744

Patented independent claims 1, 9, and 17, teach all of the essential elements of pending independent claims 1, 9, and 17. In particular, patented claim 1 teaches each of the recited accessing, using, calculating, generating, detecting, and logging steps of pending claim 1; patented claim 9 teaches all of the recited accessing, using, calculating, comparing, detecting, and changing steps of pending claim 9; patented claim 17 teaches an apparatus configured to perform the functions of storing the temperature measurements, use the stored data to predict changes in temperature, calculate scheduled setpoint programming, storing setpoints, and comparing setpoints, as recited. Any differences between the respective pending claims and patented claims appear to be either simple broadening of scope, or insignificant and obvious changes in how the generic computer apparatus that performs the claimed functions is recited.

Pending dependent claims 2-8, 10-16, and 18-23 correspond directly to patented 2-8, 10-16, and 18-23.

Pending claim 24 is directed to the further generic and obvious concept of a storage medium being a database.

Furthermore, there is no apparent reason why applicant was prevented from presenting claims corresponding to those of the instant application during prosecution of the application which matured into a patent. See *In re Schneller*, 397 F.2d 350, 158 USPQ 210 (CCPA 1968). See also MPEP § 804.

Art Unit: 3744

***Conclusion***

Any inquiry concerning this communication or earlier communications from the examiner should be directed to MARC NORMAN whose telephone number is (571)272-4812. The examiner can normally be reached on Mon.-Fri., 8:30-5:00.

If attempts to reach the examiner by telephone are unsuccessful, the examiner's supervisor, Cheryl Tyler can be reached on 571-272-4834. The fax phone number for the organization where this application or proceeding is assigned is 571-273-8300.

Information regarding the status of an application may be obtained from the Patent Application Information Retrieval (PAIR) system. Status information for published applications may be obtained from either Private PAIR or Public PAIR. Status information for unpublished applications is available through Private PAIR only. For more information about the PAIR system, see <http://pair-direct.uspto.gov>. Should you have questions on access to the Private PAIR system, contact the Electronic Business Center (EBC) at 866-217-9197 (toll-free). If you would like assistance from a USPTO Customer Service Representative or access to the automated information system, call 800-786-9199 (IN USA OR CANADA) or 571-272-1000.

/MARC NORMAN/  
Primary Examiner, Art Unit 3744

|                                   |                                       |   |             |
|-----------------------------------|---------------------------------------|---|-------------|
| <b>Notice of References Cited</b> | Application/Control No.<br>14/082,675 | Applicant(s)/Patent Under Reexamination<br>STEINBERG ET AL. |             |
|                                   | Examiner<br>MARC NORMAN               | Art Unit<br>3744  | Page 1 of 1 |

**U.S. PATENT DOCUMENTS**

| * | Document Number<br>Country Code-Number-Kind Code | Date<br>MM-YYYY | Name          | Classification |
|---|--|-----------------|---------------|----------------|
| * | A US-8,850,348 B2                                | 09-2014         | Fadell et al. | 715/771        |
| * | B US-2015/0025691 A1                             | 01-2015         | Fadell et al. | 700/276        |
| * | C US-2014/0316581 A1                             | 10-2014         | Fadell et al. | 700/276        |
| * | D US-2013/0173064 A1                             | 07-2013         | FADELL et al. | 700/276        |
|   | E US-  |                 |               |                |
|   | F US-  |                 |               |                |
|   | G US-  |                 |               |                |
|   | H US-  |                 |               |                |
|   | I US-  |                 |               |                |
|   | J US-  |                 |               |                |
|   | K US-  |                 |               |                |
|   | L US-  |                 |               |                |
|   | M US-  |                 |               |                |

**FOREIGN PATENT DOCUMENTS**

| * | Document Number<br>Country Code-Number-Kind Code | Date<br>MM-YYYY | Country | Name | Classification |
|---|--|-----------------|---------|------|----------------|
|   | N  |                 |         |      |                |
|   | O  |                 |         |      |                |
|   | P  |                 |         |      |                |
|   | Q  |                 |         |      |                |
|   | R  |                 |         |      |                |
|   | S  |                 |         |      |                |
|   | T  |                 |         |      |                |

**NON-PATENT DOCUMENTS**

| * | Document Number<br>Country Code-Number-Kind Code  | Date<br>MM-YYYY | Country | Name | Classification |
|---|---|-----------------|---------|------|----------------|
|   | Include as applicable: Author, Title Date, Publisher, Edition or Volume, Pertinent Pages) |                 |         |      |                |
|   | U   |                 |         |      |                |
|   | V   |                 |         |      |                |
|   | W   |                 |         |      |                |
|   | X   |                 |         |      |                |

\*A copy of this reference is not being furnished with this Office action. (See MPEP § 707.05(a).)  
Dates in MM-YYYY format are publication dates. Classifications may be US or foreign.

**UNITED STATES PATENT AND TRADEMARK OFFICE**

UNITED STATES DEPARTMENT OF COMMERCE  
**United States Patent and Trademark Office**  
 Address: COMMISSIONER FOR PATENTS  
 P.O. Box 1450  
 Alexandria, Virginia 22313-1450  
 www.uspto.gov

**BIB DATA SHEET**
**CONFIRMATION NO. 3336**

| SERIAL NUMBER  | FILING or 371(c)<br>DATE  | CLASS  | GROUP ART UNIT                | ATTORNEY DOCKET<br>NO.  |                           |                                |
|--|---|--|-------------------------------|---|---------------------------|--------------------------------|
| 14/082,675   | 11/18/2013  | 236  | 3744                          | EFACT.007C1   |                           |                                |
| <b>APPLICANTS</b><br>EcoFactor, Inc., Millbrae, CA, Assignee (with 37 CFR 1.172 Interest);   |   |  |                               |   |                           |                                |
| <b>INVENTORS</b><br>John Douglas Steinberg, Millbrae, CA;<br>Scott Douglas Hublou, Redwood City, CA;<br>Leo Cheung, Sunnyvale, CA;                 |   |  |                               |   |                           |                                |
| <b>** CONTINUING DATA *****</b><br>This application is a CON of 12/778,052 05/11/2010 PAT 8596550<br>which claims benefit of 61/215,999 05/12/2009 |   |  |                               |   |                           |                                |
| <b>** FOREIGN APPLICATIONS *****</b>   |   |  |                               |   |                           |                                |
| <b>** IF REQUIRED, FOREIGN FILING LICENSE GRANTED *** SMALL ENTITY **</b><br>11/29/2013  |   |  |                               |   |                           |                                |
| Foreign Priority claimed<br>35 USC 119(a-d) conditions met<br>Verified and Acknowledged  | <input type="checkbox"/> Yes <input checked="" type="checkbox"/> No<br><input type="checkbox"/> Yes <input checked="" type="checkbox"/> No<br>/MARC E NORMAN/<br>Examiner's Signature | <input type="checkbox"/> Met after Allowance<br>Initials | <b>STATE OR COUNTRY</b><br>CA | <b>SHEETS DRAWINGS</b><br>11  | <b>TOTAL CLAIMS</b><br>24 | <b>INDEPENDENT CLAIMS</b><br>3 |
| <b>ADDRESS</b><br>KNOBBE MARTENS OLSON & BEAR LLP<br>2040 MAIN STREET<br>FOURTEENTH FLOOR<br>IRVINE, CA 92614<br>UNITED STATES                     |   |  |                               |   |                           |                                |
| <b>TITLE</b><br>SYSTEM, METHOD AND APPARATUS FOR IDENTIFYING MANUAL INPUTS TO AND ADAPTIVE PROGRAMMING OF A THERMOSTAT                             |   |  |                               |   |                           |                                |
| <b>FILING FEE RECEIVED</b><br>960  | FEES: Authority has been given in Paper<br>No. _____ to charge/credit DEPOSIT ACCOUNT<br>No. _____ for following:   |  |                               | <input type="checkbox"/> All Fees<br><input type="checkbox"/> 1.16 Fees (Filing)<br><input type="checkbox"/> 1.17 Fees (Processing Ext. of time)<br><input type="checkbox"/> 1.18 Fees (Issue)<br><input type="checkbox"/> Other _____<br><input type="checkbox"/> Credit |                           |                                |

|  |  |  |
|--|--|--|
| <b><i>Index of Claims</i></b><br><br> | <b>Application/Control No.</b><br>14082675 | <b>Applicant(s)/Patent Under Reexamination</b><br>STEINBERG ET AL. |
|  | <b>Examiner</b><br>MARC NORMAN             | <b>Art Unit</b><br>3744  |

|   |                 |
|---|-----------------|
| ✓ | <b>Rejected</b> |
| = | <b>Allowed</b>  |

|   |                   |
|---|-------------------|
| - | <b>Cancelled</b>  |
| ÷ | <b>Restricted</b> |

|   |                     |
|---|---------------------|
| N | <b>Non-Elected</b>  |
| I | <b>Interference</b> |

|   |                 |
|---|-----------------|
| A | <b>Appeal</b>   |
| O | <b>Objected</b> |

Claims renumbered in the same order as presented by applicant
  CPA
  T.D.
  R.1.47

| CLAIM |          | DATE       |  |  |  |  |  |  |  |
|-------|----------|------------|--|--|--|--|--|--|--|
| Final | Original | 02/03/2015 |  |  |  |  |  |  |  |
|       | 1        | ✓          |  |  |  |  |  |  |  |
|       | 2        | ✓          |  |  |  |  |  |  |  |
|       | 3        | ✓          |  |  |  |  |  |  |  |
|       | 4        | ✓          |  |  |  |  |  |  |  |
|       | 5        | ✓          |  |  |  |  |  |  |  |
|       | 6        | ✓          |  |  |  |  |  |  |  |
|       | 7        | ✓          |  |  |  |  |  |  |  |
|       | 8        | ✓          |  |  |  |  |  |  |  |
|       | 9        | ✓          |  |  |  |  |  |  |  |
|       | 10       | ✓          |  |  |  |  |  |  |  |
|       | 11       | ✓          |  |  |  |  |  |  |  |
|       | 12       | ✓          |  |  |  |  |  |  |  |
|       | 13       | ✓          |  |  |  |  |  |  |  |
|       | 14       | ✓          |  |  |  |  |  |  |  |
|       | 15       | ✓          |  |  |  |  |  |  |  |
|       | 16       | ✓          |  |  |  |  |  |  |  |
|       | 17       | ✓          |  |  |  |  |  |  |  |
|       | 18       | ✓          |  |  |  |  |  |  |  |
|       | 19       | ✓          |  |  |  |  |  |  |  |
|       | 20       | ✓          |  |  |  |  |  |  |  |
|       | 21       | ✓          |  |  |  |  |  |  |  |
|       | 22       | ✓          |  |  |  |  |  |  |  |
|       | 23       | ✓          |  |  |  |  |  |  |  |
|       | 24       | ✓          |  |  |  |  |  |  |  |



|  |                      |                               |             |
|--|----------------------|-------------------------------|-------------|
| <b>INFORMATION DISCLOSURE<br/>STATEMENT BY APPLICANT</b> | Application No.      | 14/082675                     |             |
|  | Filing Date          | 11-18-2013                    |             |
|  | First Named Inventor | Steinberg, John Douglas et al |             |
|  | Art Unit             | 3744                          |             |
| <i>(Multiple sheets used when necessary)</i>             |                      | Examiner                      | Unknown     |
| SHEET 1 OF 8   |                      | Attorney Docket No.           | EFACT.007C1 |

**U.S. PATENT DOCUMENTS**

| Examiner Initials | Cite No. | Document Number<br>Number - Kind Code (if known)<br>Example: 1,234,567 B1 | Publication Date<br>MM-DD-YYYY | Name of Patentee or Applicant | Pages, Columns, Lines Where<br>Relevant Passages or Relevant<br>Figures Appear |
|-------------------|----------|---|--------------------------------|-------------------------------|--|
|                   | 1        | 4,136,732   | 01-1979                        | Demaray et al.                |  |
|                   | 2        | 4,341,345   | 07-1982                        | Hammer et al.                 |  |
|                   | 3        | 4,403,644   | 09-13-1983                     | Hebert                        |  |
|                   | 4        | 4,475,685   | 10-1984                        | Grimado, et al.               |  |
|                   | 5        | 4,655,279   | 04-1987                        | Harmon                        |  |
|                   | 6        | 4,674,027   | 06-16-1987                     | Thomas J. Beckey              |  |
|                   | 7        | 5,244,146   | 09-1993                        | Jefferson et al.              |  |
|                   | 8        | 5,270,952   | 12-1993                        | Adams et al.                  |  |
|                   | 9        | 5,314,004   | 05-1994                        | Strand et al.                 |  |
|                   | 10       | 5,462,225   | 10-1995                        | Massara et al.                |  |
|                   | 11       | 5,544,036   | 08-1996                        | Brown et al.                  |  |
|                   | 12       | 5,555,927   | 09-1996                        | Shah                          |  |
|                   | 13       | 5,572,438   | 11-05-1996                     | Ehlers, et al.                |  |
|                   | 14       | 5,682,949   | 11-04-1997                     | Ratcliffe et al.              |  |
|                   | 15       | 5,717,609   | 02-10-1998                     | Packa, et al.                 |  |
|                   | 16       | 5,818,347   | 10-06-1998                     | Dolan et al.                  |  |
|                   | 17       | 5,977,964   | 11-1999                        | Williams et al.               |  |
|                   | 18       | 6,115,713   | 09-05-2000                     | Pascucci, et al.              |  |
|                   | 19       | 6,145,751   | 11-14-2000                     | Ahmed                         |  |
|                   | 20       | 6,178,362   | 01-23-2001                     | Woolard, et al.               |  |
|                   | 21       | 6,260,765   | 07-2001                        | Natale et al.                 |  |
|                   | 22       | 6,351,693   | 02-26-2002                     | Monie                         |  |
|                   | 23       | 6,400,956   | 06-02-2002                     | Richton                       |  |
|                   | 24       | 6,400,996   | 06-04-2002                     | Hoffberg et al.               |  |
|                   | 25       | 6,437,692   | 08-20-2002                     | Petite, et al.                |  |
|                   | 26       | 6,478,233   | 11-12-2002                     | Shah                          |  |
|                   | 27       | 6,480,803   | 11-12-2002                     | Pierret, et al.               |  |
|                   | 28       | 6,483,906   | 11-19-2002                     | Lggulden, et al.              |  |
|                   | 29       | 6,536,675   | 03-25-2003                     | Pesko, et al.                 |  |

|                                  |                            |
|----------------------------------|----------------------------|
| Examiner Signature /Marc Norman/ | Date Considered 02/03/2015 |
|----------------------------------|----------------------------|

\*Examiner: Initial if reference considered, whether or not citation is in conformance with MPEP 609. Draw line through citation if not in conformance and not considered. Include copy of this form with next communication to applicant.

T<sup>1</sup> - Place a check mark in this area when an English language translation is attached. **ALL REFERENCES CONSIDERED EXCEPT WHERE LINED THROUGH.** /MN/

|  |                      |                               |
|--|----------------------|-------------------------------|
| <b>INFORMATION DISCLOSURE<br/>STATEMENT BY APPLICANT</b> | Application No.      | 14/082675                     |
|  | Filing Date          | 11-18-2013                    |
|  | First Named Inventor | Steinberg, John Douglas et al |
|  | Art Unit             | 3744                          |
| <i>(Multiple sheets used when necessary)</i>             | Examiner             | Unknown                       |
| SHEET 2 OF 8   | Attorney Docket No.  | EFACT.007C1                   |

**U.S. PATENT DOCUMENTS**

| Examiner Initials | Cite No. | Document Number<br>Number - Kind Code (if known)<br>Example: 1,234,567 B1 | Publication Date<br>MM-DD-YYYY | Name of Patentee or Applicant | Pages, Columns, Lines Where<br>Relevant Passages or Relevant<br>Figures Appear |
|-------------------|----------|---|--------------------------------|-------------------------------|--|
|                   | 30       | 6,542,076   | 04-01-2003                     | Joao                          |  |
|                   | 31       | 6,549,130   | 04-15-2003                     | Joao                          |  |
|                   | 32       | 6,574,537   | 06-02-2003                     | Kipersztok, et al.            |  |
|                   | 33       | 6,580,950   | 06-17-2003                     | Johnson                       |  |
|                   | 34       | 6,594,825   | 07-15-2003                     | Goldschmidtki, et al.         |  |
|                   | 35       | 6,595,430   | 07-22-2003                     | Shah                          |  |
|                   | 36       | 6,598,056   | 07-22-2003                     | Hull, et al.                  |  |
|                   | 37       | 6,619,555   | 09-16-2003                     | Rosen                         |  |
|                   | 38       | 6,622,097   | 09-16-2003                     | Hunter                        |  |
|                   | 39       | 6,622,115   | 09-16-2003                     | Brown, et al.                 |  |
|                   | 40       | 6,622,925   | 09-23-2003                     | Carner, et al.                |  |
|                   | 41       | 6,622,926   | 09-23-2003                     | Sartain, et al.               |  |
|                   | 42       | 6,628,997   | 09-30-2003                     | Fox, et al.                   |  |
|                   | 43       | 6,633,823   | 10-14-2003                     | Bartone, et al.               |  |
|                   | 44       | 6,643,567   | 11-04-2003                     | Kolk et al.                   |  |
|                   | 45       | 6,671,586   | 12-30-2003                     | Davis, et al.                 |  |
|                   | 46       | 6,695,218   | 02-24-2004                     | Fleckenstein                  |  |
|                   | 47       | 6,726,113   | 04-27-2004                     | Guo                           |  |
|                   | 48       | 6,731,992   | 05-04-2004                     | Ziegler                       |  |
|                   | 49       | 6,734,806   | 05-11-2004                     | Cratsley                      |  |
|                   | 50       | 6,772,052   | 08-03-2004                     | Amundsen                      |  |
|                   | 51       | 6,785,592   | 08-31-2004                     | Smith                         |  |
|                   | 52       | 6,785,630   | 08-31-2004                     | Kolk                          |  |
|                   | 53       | 6,789,739   | 09-14-2004                     | Rosen                         |  |
|                   | 54       | 6,853,959   | 02-08-2005                     | Ikeda, et al.                 |  |
|                   | 55       | 6,868,293   | 03-15-2005                     | Schurr                        |  |
|                   | 56       | 6,868,319   | 03-15-2005                     | Kipersztok, et al.            |  |
|                   | 57       | 6,882,712   | 04-19-2005                     | Iggulden, et al.              |  |
|                   | 58       | 6,889,908   | 05-10-2005                     | Crippen, et al.               |  |

|                    |               |                 |            |
|--------------------|---------------|-----------------|------------|
| Examiner Signature | /Marc Norman/ | Date Considered | 02/03/2015 |
|--------------------|---------------|-----------------|------------|

\***Examiner:** Initial if reference considered, whether or not citation is in conformance with MPEP 609. Draw line through citation if not in conformance and not considered. Include copy of this form with next communication to applicant.

T<sup>1</sup> - Place a check mark in this area when an English language translation is attached. **ALL REFERENCES CONSIDERED EXCEPT WHERE LINED THROUGH. /MN/**

|  |                      |                               |
|--|----------------------|-------------------------------|
| <b>INFORMATION DISCLOSURE<br/>STATEMENT BY APPLICANT</b> | Application No.      | 14/082675                     |
|  | Filing Date          | 11-18-2013                    |
|  | First Named Inventor | Steinberg, John Douglas et al |
|  | Art Unit             | 3744                          |
| <i>(Multiple sheets used when necessary)</i>             | Examiner             | Unknown                       |
| SHEET 3 OF 8   | Attorney Docket No.  | EFACT.007C1                   |

| U.S. PATENT DOCUMENTS |          |   |                                |                                |  |
|-----------------------|----------|---|--------------------------------|--------------------------------|--|
| Examiner Initials     | Cite No. | Document Number<br>Number - Kind Code (if known)<br>Example: 1,234,567 B1 | Publication Date<br>MM-DD-YYYY | Name of Patentee or Applicant  | Pages, Columns, Lines Where<br>Relevant Passages or Relevant<br>Figures Appear |
|                       | 59       | 6,891,838   | 10-10-2005                     | Petite, et al.                 |  |
|                       | 60       | 6,912,429   | 06-2005                        | Bilger                         |  |
|                       | 61       | 6,991,029   | 01-31-2006                     | Orfield, et al.                |  |
|                       | 62       | 7,009,493   | 03-07-2006                     | Howard                         |  |
|                       | 63       | 7,031,880   | 04-18-2006                     | Seem, et al.                   |  |
|                       | 64       | 7,039,532   | 05-02-2006                     | Hunter                         |  |
|                       | 65       | 7,061,393   | 06-2006                        | Buckingham et al.              |  |
|                       | 66       | 7,089,088   | 08-08-2006                     | Terry, et al.                  |  |
|                       | 67       | 7,130,719   | 10-31-2006                     | Ehlers, et al.                 |  |
|                       | 68       | 7,130,832   | 10-31-2006                     | Bannai, et al.                 |  |
|                       | 69       | 7,167,079   | 01-23-2007                     | Smyth, et al.                  |  |
|                       | 70       | 7,187,986   | 03-06-2007                     | Johnson, et al.                |  |
|                       | 71       | 7,205,892   | 04-17-2007                     | Luebke, et al.                 |  |
|                       | 72       | 7,215,746   | 05-08-2007                     | Iggulden, et al.               |  |
|                       | 73       | 7,216,015   | 05-08-2007                     | Poth, Robert J.                |  |
|                       | 74       | 7,231,424   | 06-11-2007                     | Bodin, et al.                  |  |
|                       | 75       | 7,232,075   | 06-19-2007                     | Rosen                          |  |
|                       | 76       | 7,242,988   | 07-2007                        | Hoffberg et al.                |  |
|                       | 77       | 7,260,823   | 08-2007                        | Schlack et al.                 |  |
|                       | 78       | 7,356,384   | 04-2008                        | Gull, et al.                   |  |
|                       | 79       | 7,483,964   | 01-2009                        | Jackson et al.                 |  |
|                       | 80       | 7,644,869   | 01-2010                        | Hoglund et al.                 |  |
|                       | 81       | 7,784,704   | 08-31-2010                     | Harter                         |  |
|                       | 82       | 7,848,900   | 12-07-2010                     | Steinberg, John Douglas et al. |  |
|                       | 83       | 7,894,943   | 02-22-2011                     | Sloup et al.                   |  |
|                       | 84       | 7,908,116   | 03-15-2011                     | Steinberg, John Douglas et al. |  |
|                       | 85       | 7,908,117   | 03-15-2011                     | Steinberg, John Douglas et al. |  |
|                       | 86       | 8,010,237   | 08-30-2011                     | Cheung, Leo et al.             |  |
|                       | 87       | 8,019,567   | 09-13-2011                     | Steinberg, John Douglas et al. |  |

|                    |               |                 |            |
|--------------------|---------------|-----------------|------------|
| Examiner Signature | /Marc Norman/ | Date Considered | 02/03/2015 |
|--------------------|---------------|-----------------|------------|

\*Examiner: Initial if reference considered, whether or not citation is in conformance with MPEP 609. Draw line through citation if not in conformance and not considered. Include copy of this form with next communication to applicant.

T<sup>1</sup> - Place a checkmark in the appropriate box if a language translation is attached.  
ALL REFERENCES CONSIDERED EXCEPT WHERE LINED THROUGH. /MN/

|  |                      |                               |
|--|----------------------|-------------------------------|
| <b>INFORMATION DISCLOSURE<br/>STATEMENT BY APPLICANT</b> | Application No.      | 14/082675                     |
|  | Filing Date          | 11-18-2013                    |
|  | First Named Inventor | Steinberg, John Douglas et al |
|  | Art Unit             | 3744                          |
| <i>(Multiple sheets used when necessary)</i>             | Examiner             | Unknown                       |
| SHEET 4 OF 8   | Attorney Docket No.  | EFACT.007C1                   |

| U.S. PATENT DOCUMENTS |          |   |                                |                                |  |
|-----------------------|----------|---|--------------------------------|--------------------------------|--|
| Examiner Initials     | Cite No. | Document Number<br>Number - Kind Code (if known)<br>Example: 1,234,567 B1 | Publication Date<br>MM-DD-YYYY | Name of Patentee or Applicant  | Pages, Columns, Lines Where<br>Relevant Passages or Relevant<br>Figures Appear |
|                       | 88       | 8,090,477   | 01-03-2012                     | Steinberg, John Douglas        |  |
|                       | 89       | 8,131,497   | 03-06-2012                     | Steinberg, John Douglas et al. |  |
|                       | 90       | 8,131,506   | 03-06-2012                     | Steinberg, John Douglas et al. |  |
|                       | 91       | 8,180,492   | 05-15-2012                     | Steinberg, John Douglas        |  |
|                       | 92       | 8,340,826   | 12-25-2012                     | Steinberg, John Douglas        |  |
|                       | 93       | 8,412,488   | 04-02-2013                     | Steinberg, John Douglas et al. |  |
|                       | 94       | 8,423,322   | 04-16-2013                     | Steinberg, John Douglas et al. |  |
|                       | 95       | 8,457,797   | 06-04-2013                     | Imes, et al.                   |  |
|                       | 96       | H2176   | 12-2006                        | Meyer et al.                   |  |
|                       | 97       | 13/861,189  | 04-11-2013                     | Steinberg, John Douglas et al. |  |
|                       | 98       | 2003/0040934  | 02-27-2003                     | Skidmore, et al.               |  |
|                       | 99       | 2004/0176880  | 09-09-2004                     | Obradovich, et al.             |  |
|                       | 100      | 2005/0222889  | 10-06-2005                     | Lai, et al.                    |  |
|                       | 101      | 2005/0288822  | 12-29-2005                     | Rayburn                        |  |
|                       | 102      | 2006/0045105  | 03-2006                        | Dobosz et al.                  |  |
|                       | 103      | 2006/0214014  | 09-28-2006                     | Bash, et al.                   |  |
|                       | 104      | 2007/0043477  | 02-22-2007                     | Elhers, et al.                 |  |
|                       | 105      | 2007/0045431  | 03-03-2007                     | Chapman, et al.                |  |
|                       | 106      | 2007/0146126  | 06-2007                        | Wang                           |  |
|                       | 107      | 2008/0083234  | 04-10-2008                     | Krebs et al.                   |  |
|                       | 108      | 2008/0198549  | 08-21-2008                     | Rasmussen, et al.              |  |
|                       | 109      | 2008/0281472  | 11-2008                        | Podgorny et al.                |  |
|                       | 110      | 2009/0052859  | 02-2009                        | Greenberger et al.             |  |
|                       | 111      | 2009/0099699  | 04-16-2009                     | Steinberg, John Douglas et al. |  |
|                       | 112      | 2009/0125151  | 05-14-2009                     | Steinberg, John Douglas et al. |  |
|                       | 113      | 2009/0240381  | 09-2009                        | Lane                           |  |
|                       | 114      | 2009/0281667  | 11-2009                        | Masui, et al.                  |  |
|                       | 115      | 2010/0019052  | 01-2010                        | Yip                            |  |
|                       | 116      | 2010/0070086  | 03-2010                        | Harrod, et al.                 |  |

|                    |               |                 |            |
|--------------------|---------------|-----------------|------------|
| Examiner Signature | /Marc Norman/ | Date Considered | 02/03/2015 |
|--------------------|---------------|-----------------|------------|

\*Examiner: Initial if reference considered, whether or not citation is in conformance with MPEP 609. Draw line through citation if not in conformance and not considered. Include copy of this form with next communication to applicant.

T<sup>1</sup> - Place a check mark in this area when a cited language or passage is attached. ALL REFERENCES CONSIDERED EXCEPT WHERE LINED THROUGH. /MN/

|  |                      |                               |
|--|----------------------|-------------------------------|
| <b>INFORMATION DISCLOSURE<br/>STATEMENT BY APPLICANT</b> | Application No.      | 14/082675                     |
|  | Filing Date          | 11-18-2013                    |
|  | First Named Inventor | Steinberg, John Douglas et al |
|  | Art Unit             | 3744                          |
| <i>(Multiple sheets used when necessary)</i>             | Examiner             | Unknown                       |
| SHEET 5 OF 8   | Attorney Docket No.  | EFACT.007C1                   |

| U.S. PATENT DOCUMENTS |          |   |                                |                                |  |
|-----------------------|----------|---|--------------------------------|--------------------------------|--|
| Examiner Initials     | Cite No. | Document Number<br>Number - Kind Code (if known)<br>Example: 1,234,567 B1 | Publication Date<br>MM-DD-YYYY | Name of Patentee or Applicant  | Pages, Columns, Lines Where<br>Relevant Passages or Relevant<br>Figures Appear |
|                       | 117      | 2010/0070089  | 03-2010                        | Harrod, et al.                 |  |
|                       | 118      | 2010/0070093  | 03-2010                        | Harrod, et al.                 |  |
|                       | 119      | 2010/0156608  | 06-2010                        | BAE et al.                     |  |
|                       | 120      | 2010/0162285  | 06-2010                        | Cohen et al.                   |  |
|                       | 121      | 2010/0211224  | 08-2010                        | Keeling, et al.                |  |
|                       | 122      | 2010/0235004  | 09-2010                        | Thind                          |  |
|                       | 123      | 2010/0282857  | 11-11-2010                     | Steinberg                      |  |
|                       | 124      | 2010/0289643  | 11-2010                        | Trundle, et al.                |  |
|                       | 125      | 2010/0308119  | 12-09-2010                     | Steinberg, John Douglas et al. |  |
|                       | 126      | 2010/0318227  | 12-16-2010                     | Steinberg, John Douglas et al. |  |
|                       | 127      | 2011/0031323  | 02-2011                        | Nold, et al.                   |  |
|                       | 128      | 2011/0046792  | 02-24-2011                     | Imes, et al.                   |  |
|                       | 129      | 2011/0046798  | 02-24-2011                     | Imes, et al.                   |  |
|                       | 130      | 2011/0046799  | 02-24-2011                     | Imes, et al.                   |  |
|                       | 131      | 2011/0046800  | 02-24-2011                     | Imes, et al.                   |  |
|                       | 132      | 2011/0046801  | 02-24-2011                     | Imes, et al.                   |  |
|                       | 133      | 2011/0051823  | 03-03-2011                     | Imes, et al.                   |  |
|                       | 134      | 2011/0054699  | 03-03-2011                     | Imes, et al.                   |  |
|                       | 135      | 2011/0054710  | 03-03-2011                     | Imes, et al.                   |  |
|                       | 136      | 2011/0173542  | 07-14-2011                     | Imes, et al.                   |  |
|                       | 137      | 2011/0202185  | 08-18-2011                     | Imes, et al.                   |  |
|                       | 138      | 2011/0214060  | 09-01-2011                     | Imes, et al.                   |  |
|                       | 139      | 2011/0224838  | 09-15-2011                     | Imes, et al.                   |  |
|                       | 140      | 2011/0246898  | 10-06-2011                     | Imes, et al.                   |  |
|                       | 141      | 2011/0290893  | 12-01-2011                     | Steinberg                      |  |
|                       | 142      | 2011/0307101  | 12-15-2011                     | Imes, et al.                   |  |
|                       | 143      | 2011/0307103  | 12-15-2011                     | Cheung, et al.                 |  |
|                       | 144      | 2012/0023225  | 01-26-2012                     | Imes, et al.                   |  |
|                       | 145      | 2012/0046859  | 02-23-2012                     | Imes, et al.                   |  |

|                    |               |                 |            |
|--------------------|---------------|-----------------|------------|
| Examiner Signature | /Marc Norman/ | Date Considered | 02/03/2015 |
|--------------------|---------------|-----------------|------------|

\*Examiner: Initial if reference considered, whether or not citation is in conformance with MPEP 609. Draw line through citation if not in conformance and not considered. Include copy of this form with next communication to applicant.

T<sup>1</sup> - Place a checkmark in this area when an English language translation is attached. **ALL REFERENCES CONSIDERED EXCEPT WHERE LINED THROUGH. /MN/**

|  |                      |                               |
|--|----------------------|-------------------------------|
| <b>INFORMATION DISCLOSURE<br/>STATEMENT BY APPLICANT</b> | Application No.      | 14/082675                     |
|  | Filing Date          | 11-18-2013                    |
|  | First Named Inventor | Steinberg, John Douglas et al |
|  | Art Unit             | 3744                          |
| <i>(Multiple sheets used when necessary)</i>             | Examiner             | Unknown                       |
| SHEET 6 OF 8   | Attorney Docket No.  | EFACT.007C1                   |

**U.S. PATENT DOCUMENTS**

| Examiner Initials | Cite No. | Document Number<br>Number - Kind Code (if known)<br>Example: 1,234,567 B1 | Publication Date<br>MM-DD-YYYY | Name of Patentee or Applicant  | Pages, Columns, Lines Where<br>Relevant Passages or Relevant<br>Figures Appear |
|-------------------|----------|---|--------------------------------|--------------------------------|--|
|                   | 146      | 2012/0064923  | 03-15-2012                     | Imes, et al.                   |  |
|                   | 147      | 2012/0065935  | 03-15-2012                     | Steinberg, John Douglas et al. |  |
|                   | 148      | 2012/0072033  | 03-22-2012                     | Imes, et al.                   |  |
|                   | 149      | 2012/0086562  | 04-12-2012                     | Steinberg                      |  |
|                   | 150      | 2012/0093141  | 04-19-2012                     | Imes, et al.                   |  |
|                   | 151      | 2012/0101637  | 04-26-2012                     | Imes, et al.                   |  |
|                   | 152      | 2012/0135759  | 05-31-2012                     | Imes, et al.                   |  |
|                   | 153      | 2012/0158350  | 06-21-2012                     | Steinberg, et al.              |  |
|                   | 154      | 2012/0215725  | 08-23-2012                     | Imes, et al.                   |  |
|                   | 155      | 2012/0221151  | 08-30-2012                     | Steinberg, John Douglas        |  |
|                   | 156      | 2012/0221718  | 08-30-2012                     | Imes, et al.                   |  |
|                   | 157      | 2012/0252430  | 10-04-2012                     | Imes, et al.                   |  |
|                   | 158      | 2012/0324119  | 12-20-2012                     | Imes, et al.                   |  |
|                   | 159      | 2013/0053054  | 02-28-2013                     | Lovitt, et al.                 |  |
|                   | 160      | 2013/0054758  | 02-28-2013                     | Imes, et al.                   |  |
|                   | 161      | 2013/0054863  | 02-28-2013                     | Imes, et al.                   |  |
|                   | 162      | 2013/0060387  | 03-07-2013                     | Imes, et al.                   |  |
|                   | 163      | 2013/0144445  | 06-06-2013                     | Steinberg, John Douglas        |  |
|                   | 164      | 2013/0144453  | 06-06-2013                     | Subbloie                       |  |
|                   | 165      | 2013/0167035  | 06-27-2013                     | Imes, et al.                   |  |
|                   | 166      | 2013/0338837  | 12-19-2013                     | Hublou, Scott Douglas et al.   |  |

**FOREIGN PATENT DOCUMENTS**

| Examiner Initials | Cite No. | Foreign Patent Document<br>Country Code-Number-Kind Code<br>Example: JP 1234567 A1 | Publication Date<br>MM-DD-YYYY | Name of Patentee or Applicant | Pages, Columns, Lines<br>Where Relevant Passages or<br>Relevant Figures Appear | T <sup>1</sup> |
|-------------------|----------|--|--------------------------------|-------------------------------|--|----------------|
|                   | 167      | EP 0415747   | 03-06-1991                     | Shaw, et al.                  |  |                |
|                   | 168      | KR 10-1994-0011902   | 06-22-1994                     | Koryo Digital Elect. Co.      |  |                |
|                   | 169      | KR 10-2000-0059532   | 10-05-2000                     | Dang Hae System Co.           |  |                |

**NON PATENT LITERATURE DOCUMENTS**

|                    |               |                 |            |
|--------------------|---------------|-----------------|------------|
| Examiner Signature | /Marc Norman/ | Date Considered | 02/03/2015 |
|--------------------|---------------|-----------------|------------|

\*Examiner: Initial if reference considered, whether or not citation is in conformance with MPEP 609. Draw line through citation if not in conformance and not considered. Include copy of this form with next communication to applicant.

T<sup>1</sup> - Place a check mark in this area when an English language translation is attached. **ALL REFERENCES CONSIDERED EXCEPT WHERE LINED THROUGH. /MN/**

|  |                      |                               |
|--|----------------------|-------------------------------|
| <b>INFORMATION DISCLOSURE<br/>STATEMENT BY APPLICANT</b> | Application No.      | 14/082675                     |
|  | Filing Date          | 11-18-2013                    |
|  | First Named Inventor | Steinberg, John Douglas et al |
|  | Art Unit             | 3744                          |
| <i>(Multiple sheets used when necessary)</i>             | Examiner             | Unknown                       |
| SHEET 7 OF 8   | Attorney Docket No.  | EFACT.007C1                   |

| Examiner Initials | Cite No. | Include name of the author (in CAPITAL LETTERS), title of the article (when appropriate), title of the item (book, magazine, journal, serial, symposium, catalog, etc.), date, page(s), volume-issue number(s), publisher, city and/or country where published.        | T <sup>1</sup> |
|-------------------|----------|--|----------------|
|                   | 170      | ARENS, et al., "How Ambient Intelligence Will Improve Habitability and Energy Efficiency in Buildings", 2005, research paper, Center for the Built Environment, Controls and Information Technology  |                |
|                   | 171      | Bourhan, et al., "Cynamic model of an HVAC system for control analysis", Elsevier 2004   |                |
|                   | 172      | Brush, et al., Preheat – Controlling Home Heating with Occupancy Prediction, 2013  |                |
|                   | 173      | Comverge SuperStat Flyer, prior to June 28, 2007   |                |
|                   | 174      | Control4 Wireless Thermostat Brochure, 2006  |                |
|                   | 175      | Cooper Power Systems Web Page, 2000-2009   |                |
|                   | 176      | Emerson Climate Technologies, "Network Thermostat for E2 Building Controller Installation and Operation Manual", 2007  |                |
|                   | 177      | Enernoc Web Page, 2004-2009  |                |
|                   | 178      | Enerwise Website, 1999-2009  |                |
|                   | 179      | Gupta, Adding GPS-Control to Traditional Thermostats: An Exploration of Potential Energy Savings and Design Challenges, MIT, 2009  |                |
|                   | 180      | Gupta, et al., A Persuasive GPS-Controlled Thermostat System, MIT, 2008  |                |
|                   | 181      | Honeywell Programmable Thermostat Owner's Guide, www.honeywell.com/yourhome, 2004  |                |
|                   | 182      | Honeywell, "W7600/W7620 Controller Reference Manual, HW0021207, October, 1992  |                |
|                   | 183      | Johnson Controls, "T600HCx-3 Single-Stage Thermostats", 2006   |                |
|                   | 184      | JOHNSON CONTROLS, Touch4 building automation system brochure, 2007   |                |
|                   | 185      | KILICOTTE, et al., "Dynamic Controls for Energy Efficiency and Demand Response: Framework Concepts and a New Construction Study Case in New York", Proceedings of the 2006 ACEEE Summer Study of Energy Efficiency in Buildings, Pacific Grove, CA, August 13-18, 2006 |                |
|                   | 186      | Krumm, et al., Learning Time-Based Presence Probabilities, June 2011   |                |
|                   | 187      | LIN, et al., "Multi-Sensor Single-Actuator Control of HVAC Systems", 2002  |                |
|                   | 188      | PIER, Southern California Edison, Demand Responsive Control of Air Conditioning via Programmable Communicating Thermostats Draft Report, 2006  |                |

|                    |               |                 |            |
|--------------------|---------------|-----------------|------------|
| Examiner Signature | /Marc Norman/ | Date Considered | 02/03/2015 |
|--------------------|---------------|-----------------|------------|

\***Examiner:** Initial if reference considered, whether or not citation is in conformance with MPEP 609. Draw line through citation if not in conformance and not considered. Include copy of this form with next communication to applicant.

T<sup>1</sup> - Place a check mark in this area when an English language translation is attached.  
**ALL REFERENCES CONSIDERED EXCEPT WHERE LINED THROUGH. /MN/**

|  |                      |                               |
|--|----------------------|-------------------------------|
| <b>INFORMATION DISCLOSURE<br/>STATEMENT BY APPLICANT</b> | Application No.      | 14/082675                     |
|  | Filing Date          | 11-18-2013                    |
|  | First Named Inventor | Steinberg, John Douglas et al |
|  | Art Unit             | 3744                          |
| <i>(Multiple sheets used when necessary)</i>             | Examiner             | Unknown                       |
| SHEET 8 OF 8   | Attorney Docket No.  | EFACT.007C1                   |

**NON PATENT LITERATURE DOCUMENTS**

| Examiner<br>Initials | Cite<br>No. | Include name of the author (in CAPITAL LETTERS), title of the article (when appropriate), title of the item (book, magazine, journal, serial, symposium, catalog, etc.), date, page(s), volume-issue number(s), publisher, city and/or country where published. | T <sup>1</sup> |
|----------------------|-------------|---|----------------|
|                      | <b>189</b>  | Proliphix Thermostat Brochure, prior to June 2007   |                |
|                      | <b>190</b>  | Raji, "Smart Networks for Control", IEEE Spectrum, June 1994  |                |
|                      | <b>191</b>  | Scott, et al., Home Heating Using GPS-Based Arrival Prediction, 2010  |                |
|                      | <b>192</b>  | WANG, et al., "Opportunities to Save Energy and Improve Comfort by Using Wireless Sensor Networks in Buildings," (2003), Center for Environmental Design Research   |                |
|                      | <b>193</b>  | WETTER, et al., A comparison of deterministic and probabilistic optimization algorithms for nonsmooth simulation-based optimization., Building and Environment 39, 2004, Pages 989-999  |                |
|                      | <b>194</b>  | Written Opinion and Search Report for PCT/US2011/032537, dated 12/12/11 (our reference EFACT.012WO)   |                |

16970945:ad  
010614

|                    |               |                 |            |
|--------------------|---------------|-----------------|------------|
| Examiner Signature | /Marc Norman/ | Date Considered | 02/03/2015 |
|--------------------|---------------|-----------------|------------|

**\*Examiner:** Initial if reference considered, whether or not citation is in conformance with MPEP 609. Draw line through citation if not in conformance and not considered. Include copy of this form with next communication to applicant.

T<sup>1</sup> - Place a check mark in this area when an English language translation is attached. ~~ALL REFERENCES CONSIDERED EXCEPT WHERE LINED THROUGH. /MN/~~



|  |  |  |
|--|--|--|
| <b>Search Notes</b><br><br> | <b>Application/Control No.</b><br><br>14082675 | <b>Applicant(s)/Patent Under Reexamination</b><br><br>STEINBERG ET AL. |
|  | <b>Examiner</b><br><br>MARC NORMAN             | <b>Art Unit</b><br><br>3744  |

| CPC- SEARCHED   |        |          |
|---|--------|----------|
| Symbol  | Date   | Examiner |
| F24F 11/0009, 001, 0012, 006; 2011/0009, 001, 0012, 0013, 006, 0061, 0063, 0075 | 2/3/15 | MN       |

| CPC COMBINATION SETS - SEARCHED |      |          |
|---------------------------------|------|----------|
| Symbol                          | Date | Examiner |
|                                 |      |          |

| US CLASSIFICATION SEARCHED |            |        |          |
|----------------------------|------------|--------|----------|
| Class                      | Subclass   | Date   | Examiner |
| 236                        | 1C, 51, 94 | 2/3/15 | MN       |
| 700                        | 276, 278   | 2/3/15 | MN       |
| 62                         | 161, 163   | 2/3/15 | MN       |

| SEARCH NOTES  |        |          |
|---|--------|----------|
| Search Notes  | Date   | Examiner |
| consulted prosecution history of parent case 12/778,052 | 2/3/15 | MN       |

| INTERFERENCE SEARCH     |                         |      |          |
|-------------------------|-------------------------|------|----------|
| US Class/<br>CPC Symbol | US Subclass / CPC Group | Date | Examiner |
|                         |                         |      |          |

|  |  |
|--|--|
|  |  |
|--|--|



UNITED STATES PATENT AND TRADEMARK OFFICE

UNITED STATES DEPARTMENT OF COMMERCE
United States Patent and Trademark Office
Address: COMMISSIONER FOR PATENTS
P.O. Box 1450
Alexandria, Virginia 22313-1450
www.uspto.gov

Table with 4 columns: APPLICATION NUMBER (14/082,675), FILING OR 371(C) DATE (11/18/2013), FIRST NAMED APPLICANT (John Douglas Steinberg), ATTY. DOCKET NO./TITLE (EFACT.007C1)

CONFIRMATION NO. 3336

PUBLICATION NOTICE

20995
KNOBBE MARTENS OLSON & BEAR LLP
2040 MAIN STREET
FOURTEENTH FLOOR
IRVINE, CA 92614



Title: SYSTEM, METHOD AND APPARATUS FOR IDENTIFYING MANUAL INPUTS TO AND ADAPTIVE PROGRAMMING OF A THERMOSTAT

Publication No. US-2014-0188290-A1

Publication Date: 07/03/2014

NOTICE OF PUBLICATION OF APPLICATION

The above-identified application will be electronically published as a patent application publication pursuant to 37 CFR 1.211, et seq. The patent application publication number and publication date are set forth above.

The publication may be accessed through the USPTO's publically available Searchable Databases via the Internet at www.uspto.gov. The direct link to access the publication is currently http://www.uspto.gov/patft/.

The publication process established by the Office does not provide for mailing a copy of the publication to applicant. A copy of the publication may be obtained from the Office upon payment of the appropriate fee set forth in 37 CFR 1.19(a)(1). Orders for copies of patent application publications are handled by the USPTO's Office of Public Records. The Office of Public Records can be reached by telephone at (703) 308-9726 or (800) 972-6382, by facsimile at (703) 305-8759, by mail addressed to the United States Patent and Trademark Office, Office of Public Records, Alexandria, VA 22313-1450 or via the Internet.

In addition, information on the status of the application, including the mailing date of Office actions and the dates of receipt of correspondence filed in the Office, may also be accessed via the Internet through the Patent Electronic Business Center at www.uspto.gov using the public side of the Patent Application Information and Retrieval (PAIR) system. The direct link to access this status information is currently http://pair.uspto.gov/. Prior to publication, such status information is confidential and may only be obtained by applicant using the private side of PAIR.

Further assistance in electronically accessing the publication, or about PAIR, is available by calling the Patent Electronic Business Center at 1-866-217-9197.

Office of Data Management, Application Assistance Unit (571) 272-4000, or (571) 272-4200, or 1-888-786-0101

**PATENT APPLICATION FEE DETERMINATION RECORD**

Substitute for Form PTO-875

Application or Docket Number  
14/082,675

**APPLICATION AS FILED - PART I**

(Column 1) (Column 2)

| FOR   | NUMBER FILED  | NUMBER EXTRA |
|---|---|--------------|
| BASIC FEE<br>(37 CFR 1.16(a), (b), or (c))        | N/A   | N/A          |
| SEARCH FEE<br>(37 CFR 1.16(k), (l), or (m))       | N/A   | N/A          |
| EXAMINATION FEE<br>(37 CFR 1.16(o), (p), or (q))  | N/A   | N/A          |
| TOTAL CLAIMS<br>(37 CFR 1.16(j))                  | 24 minus 20 = *   | 4            |
| INDEPENDENT CLAIMS<br>(37 CFR 1.16(h))            | 3 minus 3 = *   |              |
| APPLICATION SIZE FEE<br>(37 CFR 1.16(s))          | If the specification and drawings exceed 100 sheets of paper, the application size fee due is \$310 (\$155 for small entity) for each additional 50 sheets or fraction thereof. See 35 U.S.C. 41(a)(1)(G) and 37 CFR 1.16(s). |              |
| MULTIPLE DEPENDENT CLAIM PRESENT (37 CFR 1.16(j)) |   |              |

\* If the difference in column 1 is less than zero, enter "0" in column 2.

**SMALL ENTITY**

| RATE(\$) | FEE(\$) |
|----------|---------|
| N/A      | 70      |
| N/A      | 300     |
| N/A      | 360     |
| x 40 =   | 160     |
| x 210 =  | 0.00    |
|          | 0.00    |
| TOTAL    | 890     |

**OR OTHER THAN SMALL ENTITY**

| RATE(\$) | FEE(\$) |
|----------|---------|
| N/A      |         |
| N/A      |         |
| N/A      |         |
|          |         |
|          |         |
|          |         |
| TOTAL    |         |

**APPLICATION AS AMENDED - PART II**

(Column 1) (Column 2) (Column 3)

| AMENDMENT A   | CLAIMS REMAINING AFTER AMENDMENT |       | HIGHEST NUMBER PREVIOUSLY PAID FOR | PRESENT EXTRA |
|---|----------------------------------|-------|------------------------------------|---------------|
|   | Total<br>(37 CFR 1.16(i))        | *     | Minus                              | **            |
| Independent<br>(37 CFR 1.16(h))                                 | *                                | Minus | ***                                | =             |
| Application Size Fee (37 CFR 1.16(s))                           |                                  |       |                                    |               |
| FIRST PRESENTATION OF MULTIPLE DEPENDENT CLAIM (37 CFR 1.16(j)) |                                  |       |                                    |               |

**SMALL ENTITY**

| RATE(\$)        | ADDITIONAL FEE(\$) |
|-----------------|--------------------|
| x =             |                    |
| x =             |                    |
|                 |                    |
|                 |                    |
| TOTAL ADD'L FEE |                    |

**OR OTHER THAN SMALL ENTITY**

| RATE(\$)        | ADDITIONAL FEE(\$) |
|-----------------|--------------------|
| x =             |                    |
| x =             |                    |
|                 |                    |
|                 |                    |
| TOTAL ADD'L FEE |                    |

(Column 1) (Column 2) (Column 3)

| AMENDMENT B   | CLAIMS REMAINING AFTER AMENDMENT |       | HIGHEST NUMBER PREVIOUSLY PAID FOR | PRESENT EXTRA |
|---|----------------------------------|-------|------------------------------------|---------------|
|   | Total<br>(37 CFR 1.16(i))        | *     | Minus                              | **            |
| Independent<br>(37 CFR 1.16(h))                                 | *                                | Minus | ***                                | =             |
| Application Size Fee (37 CFR 1.16(s))                           |                                  |       |                                    |               |
| FIRST PRESENTATION OF MULTIPLE DEPENDENT CLAIM (37 CFR 1.16(j)) |                                  |       |                                    |               |

| RATE(\$)        | ADDITIONAL FEE(\$) |
|-----------------|--------------------|
| x =             |                    |
| x =             |                    |
|                 |                    |
|                 |                    |
| TOTAL ADD'L FEE |                    |

**OR OTHER THAN SMALL ENTITY**

| RATE(\$)        | ADDITIONAL FEE(\$) |
|-----------------|--------------------|
| x =             |                    |
| x =             |                    |
|                 |                    |
|                 |                    |
| TOTAL ADD'L FEE |                    |

\* If the entry in column 1 is less than the entry in column 2, write "0" in column 3.  
 \*\* If the "Highest Number Previously Paid For" IN THIS SPACE is less than 20, enter "20".  
 \*\*\* If the "Highest Number Previously Paid For" IN THIS SPACE is less than 3, enter "3".  
 The "Highest Number Previously Paid For" (Total or Independent) is the highest found in the appropriate box in column 1.



UNITED STATES PATENT AND TRADEMARK OFFICE

UNITED STATES DEPARTMENT OF COMMERCE  
United States Patent and Trademark Office  
Address: COMMISSIONER FOR PATENTS  
P.O. Box 1450  
Alexandria, Virginia 22313-1450  
www.uspto.gov

| APPLICATION NUMBER | FILING OR 371(C) DATE | FIRST NAMED APPLICANT  | ATTY. DOCKET NO./TITLE |
|--------------------|-----------------------|------------------------|------------------------|
| 14/082,675         | 11/18/2013            | John Douglas Steinberg | EFACT.007C1            |

**CONFIRMATION NO. 3336**

20995  
KNOBBE MARTENS OLSON & BEAR LLP  
2040 MAIN STREET  
FOURTEENTH FLOOR  
IRVINE, CA 92614

**NOTICE**



Date Mailed: 03/24/2014

**INFORMATIONAL NOTICE TO APPLICANT**

Applicant is notified that the above-identified application contains the deficiencies noted below. No period for reply is set forth in this notice for correction of these deficiencies. However, if a deficiency relates to the inventor's oath or declaration, the applicant must file an oath or declaration in compliance with 37 CFR 1.63, or a substitute statement in compliance with 37 CFR 1.64, executed by or with respect to each actual inventor no later than the expiration of the time period set in the "Notice of Allowability" to avoid abandonment. See 37 CFR 1.53(f).

The item(s) indicated below are also required and should be submitted with any reply to this notice to avoid further processing delays.

- A properly executed inventor's oath or declaration has not been received for the following inventor(s):  
John Douglas Steinberg  
Scott Douglas Hublou  
Leo Cheung



UNITED STATES PATENT AND TRADEMARK OFFICE

UNITED STATES DEPARTMENT OF COMMERCE
United States Patent and Trademark Office
Address: COMMISSIONER FOR PATENTS
P.O. Box 1450
Alexandria, Virginia 22313-1450
www.uspto.gov

Table with 7 columns: APPLICATION NUMBER, FILING or 371(c) DATE, GRP ART UNIT, FIL FEE REC'D, ATTY. DOCKET NO, TOT CLAIMS, IND CLAIMS. Row 1: 14/082,675, 11/18/2013, 3744, 960, EFACT.007C1, 24, 3

CONFIRMATION NO. 3336

UPDATED FILING RECEIPT



20995
KNOBBE MARTENS OLSON & BEAR LLP
2040 MAIN STREET
FOURTEENTH FLOOR
IRVINE, CA 92614

Date Mailed: 03/24/2014

Receipt is acknowledged of this non-provisional patent application. The application will be taken up for examination in due course. Applicant will be notified as to the results of the examination. Any correspondence concerning the application must include the following identification information: the U.S. APPLICATION NUMBER, FILING DATE, NAME OF APPLICANT, and TITLE OF INVENTION. Fees transmitted by check or draft are subject to collection. Please verify the accuracy of the data presented on this receipt. If an error is noted on this Filing Receipt, please submit a written request for a Filing Receipt Correction. Please provide a copy of this Filing Receipt with the changes noted thereon. If you received a "Notice to File Missing Parts" for this application, please submit any corrections to this Filing Receipt with your reply to the Notice. When the USPTO processes the reply to the Notice, the USPTO will generate another Filing Receipt incorporating the requested corrections

Inventor(s)

John Douglas Steinberg, Millbrae, CA;
Scott Douglas Hublou, Redwood City, CA;
Leo Cheung, Sunnyvale, CA;

Applicant(s)

EcoFactor, Inc., Millbrae, CA

Assignment For Published Patent Application

EcoFactor, Inc., Millbrae, CA

Power of Attorney: The patent practitioners associated with Customer Number 20995

Domestic Priority data as claimed by applicant

This application is a CON of 12/778,052 05/11/2010 PAT 8596550
which claims benefit of 61/215,999 05/12/2009

Foreign Applications for which priority is claimed (You may be eligible to benefit from the Patent Prosecution Highway program at the USPTO. Please see http://www.uspto.gov for more information.) - None.

Foreign application information must be provided in an Application Data Sheet in order to constitute a claim to foreign priority. See 37 CFR 1.55 and 1.76.

If Required, Foreign Filing License Granted: 11/29/2013

The country code and number of your priority application, to be used for filing abroad under the Paris Convention, is US 14/082,675

Projected Publication Date: 07/03/2014

Non-Publication Request: No

Early Publication Request: No

**\*\* SMALL ENTITY \*\***

**Title**

SYSTEM, METHOD AND APPARATUS FOR IDENTIFYING MANUAL INPUTS TO AND ADAPTIVE PROGRAMMING OF A THERMOSTAT

**Preliminary Class**

236

**Statement under 37 CFR 1.55 or 1.78 for AIA (First Inventor to File) Transition Applications: No**

**PROTECTING YOUR INVENTION OUTSIDE THE UNITED STATES**

Since the rights granted by a U.S. patent extend only throughout the territory of the United States and have no effect in a foreign country, an inventor who wishes patent protection in another country must apply for a patent in a specific country or in regional patent offices. Applicants may wish to consider the filing of an international application under the Patent Cooperation Treaty (PCT). An international (PCT) application generally has the same effect as a regular national patent application in each PCT-member country. The PCT process **simplifies** the filing of patent applications on the same invention in member countries, but **does not result** in a grant of "an international patent" and does not eliminate the need of applicants to file additional documents and fees in countries where patent protection is desired.

Almost every country has its own patent law, and a person desiring a patent in a particular country must make an application for patent in that country in accordance with its particular laws. Since the laws of many countries differ in various respects from the patent law of the United States, applicants are advised to seek guidance from specific foreign countries to ensure that patent rights are not lost prematurely.

Applicants also are advised that in the case of inventions made in the United States, the Director of the USPTO must issue a license before applicants can apply for a patent in a foreign country. The filing of a U.S. patent application serves as a request for a foreign filing license. The application's filing receipt contains further information and guidance as to the status of applicant's license for foreign filing.

Applicants may wish to consult the USPTO booklet, "General Information Concerning Patents" (specifically, the section entitled "Treaties and Foreign Patents") for more information on timeframes and deadlines for filing foreign patent applications. The guide is available either by contacting the USPTO Contact Center at 800-786-9199, or it can be viewed on the USPTO website at <http://www.uspto.gov/web/offices/pac/doc/general/index.html>.

For information on preventing theft of your intellectual property (patents, trademarks and copyrights), you may wish to consult the U.S. Government website, <http://www.stopfakes.gov>. Part of a Department of Commerce initiative, this website includes self-help "toolkits" giving innovators guidance on how to protect intellectual property in specific countries such as China, Korea and Mexico. For questions regarding patent enforcement issues, applicants may call the U.S. Government hotline at 1-866-999-HALT (1-866-999-4258).

**LICENSE FOR FOREIGN FILING UNDER**  
**Title 35, United States Code, Section 184**  
**Title 37, Code of Federal Regulations, 5.11 & 5.15**

**GRANTED**

The applicant has been granted a license under 35 U.S.C. 184, if the phrase "IF REQUIRED, FOREIGN FILING LICENSE GRANTED" followed by a date appears on this form. Such licenses are issued in all applications where the conditions for issuance of a license have been met, regardless of whether or not a license may be required as set forth in 37 CFR 5.15. The scope and limitations of this license are set forth in 37 CFR 5.15(a) unless an earlier license has been issued under 37 CFR 5.15(b). The license is subject to revocation upon written notification. The date indicated is the effective date of the license, unless an earlier license of similar scope has been granted under 37 CFR 5.13 or 5.14.

This license is to be retained by the licensee and may be used at any time on or after the effective date thereof unless it is revoked. This license is automatically transferred to any related applications(s) filed under 37 CFR 1.53(d). This license is not retroactive.

The grant of a license does not in any way lessen the responsibility of a licensee for the security of the subject matter as imposed by any Government contract or the provisions of existing laws relating to espionage and the national security or the export of technical data. Licensees should apprise themselves of current regulations especially with respect to certain countries, of other agencies, particularly the Office of Defense Trade Controls, Department of State (with respect to Arms, Munitions and Implements of War (22 CFR 121-128)); the Bureau of Industry and Security, Department of Commerce (15 CFR parts 730-774); the Office of Foreign Assets Control, Department of Treasury (31 CFR Parts 500+) and the Department of Energy.

**NOT GRANTED**

No license under 35 U.S.C. 184 has been granted at this time, if the phrase "IF REQUIRED, FOREIGN FILING LICENSE GRANTED" DOES NOT appear on this form. Applicant may still petition for a license under 37 CFR 5.12, if a license is desired before the expiration of 6 months from the filing date of the application. If 6 months has lapsed from the filing date of this application and the licensee has not received any indication of a secrecy order under 35 U.S.C. 181, the licensee may foreign file the application pursuant to 37 CFR 5.15(b).

---

***SelectUSA***

The United States represents the largest, most dynamic marketplace in the world and is an unparalleled location for business investment, innovation, and commercialization of new technologies. The U.S. offers tremendous resources and advantages for those who invest and manufacture goods here. Through SelectUSA, our nation works to promote and facilitate business investment. SelectUSA provides information assistance to the international investor community; serves as an ombudsman for existing and potential investors; advocates on behalf of U.S. cities, states, and regions competing for global investment; and counsels U.S. economic development organizations on investment attraction best practices. To learn more about why the United States is the best country in the world to develop technology, manufacture products, deliver services, and grow your business, visit <http://www.SelectUSA.gov> or call +1-202-482-6800.



UNITED STATES PATENT AND TRADEMARK OFFICE

UNITED STATES DEPARTMENT OF COMMERCE  
United States Patent and Trademark Office  
Address: COMMISSIONER FOR PATENTS  
P.O. Box 1450  
Alexandria, Virginia 22313-1450  
www.uspto.gov

| APPLICATION NUMBER | FILING OR 371(C) DATE | FIRST NAMED APPLICANT  | ATTY. DOCKET NO./TITLE |
|--------------------|-----------------------|------------------------|------------------------|
| 14/082,675         | 11/18/2013            | John Douglas Steinberg | EFACT.007C1            |

**CONFIRMATION NO. 3336**

**POA ACCEPTANCE LETTER**



20995  
KNOBBE MARTENS OLSON & BEAR LLP  
2040 MAIN STREET  
FOURTEENTH FLOOR  
IRVINE, CA 92614

Date Mailed: 03/24/2014

**NOTICE OF ACCEPTANCE OF POWER OF ATTORNEY**

This is in response to the Power of Attorney filed 03/07/2014.

The Power of Attorney in this application is accepted. Correspondence in this application will be mailed to the above address as provided by 37 CFR 1.33.

/cnguyen/

Office of Data Management, Application Assistance Unit (571) 272-4000, or (571) 272-4200, or 1-888-786-0101



## TRANSMITTAL FOR POWER OF ATTORNEY TO ONE OR MORE REGISTERED PRACTITIONERS

NOTE: This form is to be submitted with the Power of Attorney by Applicant form (PTO/AIA/82B) to identify the application to which the Power of Attorney is directed, in accordance with 37 CFR 1.5, unless the application number and filing date are identified in the Power of Attorney by Applicant form. If neither form PTO/AIA/82A nor form PTO/AIA82B identifies the application to which the Power of Attorney is directed, the Power of Attorney will not be recognized in the application.

|                        |  |
|------------------------|--|
| Application Number     | 14/082675  |
| Filing Date            | November 18, 2013  |
| First Named Inventor   | John Douglas Steinberg   |
| Title                  | SYSTEM, METHOD AND APPARATUS FOR IDENTIFYING MANUAL INPUTS TO AND ADAPTIVE PROGRAMMING OF A THERMOSTAT |
| Art Unit               | 3744   |
| Examiner Name          | Unknown  |
| Attorney Docket Number | EFACT.007C1  |

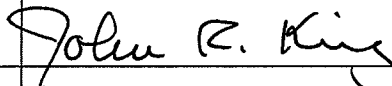
| SIGNATURE of Applicant or Patent Practitioner      |   |                     |          |
|--|---|---------------------|----------|
| Signature  |  | Date (Optional)     | 3-7-2014 |
| Name   | John R. King  | Registration Number | 34362    |
| Title (if Applicant is a juristic entity)          | Attorney of Record  |                     |          |
| Applicant Name (if Applicant is a juristic entity) | EcoFactor, Inc.   |                     |          |

**NOTE:** This form must be signed in accordance with 37 CFR 1.33. See 37 CFR 1.4(d) for signature requirements and certifications. If more than one applicant, use multiple forms.

\*Total of 1 forms are submitted.

This collection of information is required by 37 CFR 1.131, 1.32, and 1.33. The information is required to obtain or retain a benefit by the public which is to file (and by the USPTO to process) an application. Confidentiality is governed by 35 U.S.C. 122 and 37 CFR 1.11 and 1.14. This collection is estimated to take 3 minutes to complete, including gathering, preparing, and submitting the completed application form to the USPTO. Time will vary depending upon the individual case. Any comments on the amount of time you require to complete this form and/or suggestions for reducing this burden, should be sent to the Chief Information Officer, U.S. Patent and Trademark Office, U.S. Department of Commerce, P.O. Box 1450, Alexandria, VA 22313-1450. DO NOT SEND FEES OR COMPLETED FORMS TO THIS ADDRESS. **SEND TO: Commissioner for Patents, P.O. Box 1450, Alexandria, VA 22313-1450.**

If you need assistance in completing the form, call 1-800-PTO-9199 and select option 2.

Under the Paperwork Reduction Act of 1995, no persons are required to respond to a collection of information unless it displays a valid OMB control number

POWER OF ATTORNEY BY APPLICANT

I hereby revoke all previous powers of attorney given in the application identified in either the attached transmittal letter or the boxes below.

Table with 2 columns: Application Number, Filing Date

(Note: The boxes above may be left blank if information is provided on form PTO/AIA/82A.)

I hereby appoint the Patent Practitioner(s) associated with the following Customer Number as my/our attorney(s) or agent(s), and to transact all business in the United States Patent and Trademark Office connected therewith for the application referenced in the attached transmittal letter (form PTO/AIA/82A) or identified above: 20995

OR

I hereby appoint Practitioner(s) named in the attached list (form PTO/AIA/82C) as my/our attorney(s) or agent(s), and to transact all business in the United States Patent and Trademark Office connected therewith for the patent application referenced in the attached transmittal letter (form PTO/AIA/82A) or identified above. (Note: Complete form PTO/AIA/82C.)

Please recognize or change the correspondence address for the application identified in the attached transmittal letter or the boxes above to:

The address associated with the above-mentioned Customer Number

OR

The address associated with Customer Number:

OR

Form with fields: Firm or Individual Name, Address, City, State, Zip, Country, Telephone, Email

I am the Applicant (if the Applicant is a juristic entity, list the Applicant name in the box):

EcoFactor, Inc.

- Inventor or Joint Inventor (title not required below)
Legal Representative of a Deceased or Legally Incapacitated Inventor (title not required below)
Assignee or Person to Whom the Inventor is Under an Obligation to Assign (provide signer's title if applicant is a juristic entity)
Person Who Otherwise Shows Sufficient Proprietary Interest (e.g., a petition under 37 CFR 1.46(b)(2) was granted in the application or is concurrently being filed with this document) (provide signer's title if applicant is a juristic entity)

SIGNATURE of Applicant for Patent

The undersigned (whose title is supplied below) is authorized to act on behalf of the applicant (e.g., where the applicant is a juristic entity).

Signature, Name (John Douglas Steinberg), Title (EVP of Business Development), Date (Optional) 11/7/13

NOTE: Signature - This form must be signed by the applicant in accordance with 37 CFR 1.33. See 37 CFR 1.4 for signature requirements and certifications. If more than one applicant, use multiple forms.

Total of 1 forms are submitted.

**IN THE UNITED STATES PATENT AND TRADEMARK OFFICE**

Applicant : Steinberg, et al.

App. No : 14/082,675

Filed : November 18, 2013

For : SYSTEM, METHOD AND APPARATUS FOR IDENTIFYING  
MANUAL INPUTS TO AND ADAPTIVE PROGRAMMING OF  
A THERMOSTAT

Examiner : Unknown

Art Unit : 3744

**RESCISSION OF ANY PRIOR DISCLAIMERS AND REQUEST TO REVISIT ART**

Commissioner for Patents  
P.O. Box 1450  
Alexandria, VA 22313-1450

Dear Sir:

The claims of the present application are different and possibly broader in scope than the claims pursued in the parent application(s). To the extent any prior amendments or characterizations of the scope of any claim or referenced art could be construed as a disclaimer of any subject matter supported by the present disclosure, Applicant hereby rescinds and retracts such disclaimer.

Please charge any additional fees, including any fees for additional extension of time, or credit overpayment to Deposit Account No. 11-1410.

Respectfully submitted,  
KNOBBE, MARTENS, OLSON & BEAR, LLP

Dated: 3-7-2014

By: John R. King  
John R. King  
Registration No. 34,362  
Attorney of Record  
Customer No. 20,995  
(949) 760-0404

**IN THE UNITED STATES PATENT AND TRADEMARK OFFICE**

Applicant : Steinberg, et al.

App. No : 14/082,675

Filed : November 18, 2013

For : SYSTEM, METHOD AND APPARATUS FOR IDENTIFYING  
MANUAL INPUTS TO AND ADAPTIVE PROGRAMMING OF  
A THERMOSTAT

Examiner : Unknown

Art Unit : 3744

**RESCISSION OF ANY PRIOR DISCLAIMERS AND REQUEST TO REVISIT ART**

Commissioner for Patents  
P.O. Box 1450  
Alexandria, VA 22313-1450

Dear Sir:

The claims of the present application are different and possibly broader in scope than the claims pursued in the parent application(s). To the extent any prior amendments or characterizations of the scope of any claim or referenced art could be construed as a disclaimer of any subject matter supported by the present disclosure, Applicant hereby rescinds and retracts such disclaimer.

Please charge any additional fees, including any fees for additional extension of time, or credit overpayment to Deposit Account No. 11-1410.

Respectfully submitted,  
KNOBBE, MARTENS, OLSON & BEAR, LLP

Dated: 3-7-2014

By: John R. King  
John R. King  
Registration No. 34,362  
Attorney of Record  
Customer No. 20,995  
(949) 760-0404

**INFORMATION DISCLOSURE STATEMENT**

Inventor : John Douglas Steinberg, et al.  
App. No. : 14/082675  
Filed : November 18, 2013  
For : SYSTEM, METHOD AND APPARATUS FOR IDENTIFYING  
MANUAL INPUTS TO AND ADAPTIVE PROGRAMMING OF A  
THERMOSTAT  
Examiner : Unknown  
Art Unit : 3744  
Conf. No. : 3336

Commissioner for Patents  
P.O. Box 1450  
Alexandria, VA 22313-1450

**References and Listing**

Submitted herewith in the above-identified application is an Information Disclosure Statement listing references for consideration. References numbered 1-189 and 191-194 are of record in U.S. Patent Application No. 12/778052, filed May 11, 2010, which is relied upon for an earlier filing date under 35 USC 120. Accordingly, copies of references numbered 1-189 and 191-194 are not submitted pursuant to 37 CFR 1.98(d).

**Timing of Disclosure**

This Information Disclosure Statement is being filed before the receipt of a First Office Action on the merits, and presumably no fee is required. If a First Office Action on the merits was mailed before the mailing date of this Statement, the Commissioner is authorized to charge the fee set forth in 37 CFR 1.17(p) to Deposit Account No. 11-1410.

Respectfully submitted,  
KNOBBE, MARTENS, OLSON & BEAR, LLP

Dated: 3-7-2014

By: John R. King  
John R. King  
Registration No. 34,362  
Attorney of Record  
Customer No. 20995  
(949) 760-0404

|  |                      |                               |
|--|----------------------|-------------------------------|
| <b>INFORMATION DISCLOSURE<br/>STATEMENT BY APPLICANT</b> | Application No.      | 14/082675                     |
|  | Filing Date          | 11-18-2013                    |
|  | First Named Inventor | Steinberg, John Douglas et al |
|  | Art Unit             | 3744                          |
| <i>(Multiple sheets used when necessary)</i>             | Examiner             | Unknown                       |
| SHEET 1 OF 8   | Attorney Docket No.  | EFACT.007C1                   |

| U.S. PATENT DOCUMENTS |          |   |                                |                               |  |
|-----------------------|----------|---|--------------------------------|-------------------------------|--|
| Examiner Initials     | Cite No. | Document Number<br>Number - Kind Code (if known)<br>Example: 1,234,567 B1 | Publication Date<br>MM-DD-YYYY | Name of Patentee or Applicant | Pages, Columns, Lines Where<br>Relevant Passages or Relevant<br>Figures Appear |
|                       | 1        | 4,136,732   | 01-1979                        | Demaray et al.                |  |
|                       | 2        | 4,341,345   | 07-1982                        | Hammer et al.                 |  |
|                       | 3        | 4,403,644   | 09-13-1983                     | Hebert                        |  |
|                       | 4        | 4,475,685   | 10-1984                        | Grimado, et al.               |  |
|                       | 5        | 4,655,279   | 04-1987                        | Harmon                        |  |
|                       | 6        | 4,674,027   | 06-16-1987                     | Thomas J. Beckey              |  |
|                       | 7        | 5,244,146   | 09-1993                        | Jefferson et al.              |  |
|                       | 8        | 5,270,952   | 12-1993                        | Adams et al.                  |  |
|                       | 9        | 5,314,004   | 05-1994                        | Strand et al.                 |  |
|                       | 10       | 5,462,225   | 10-1995                        | Massara et al.                |  |
|                       | 11       | 5,544,036   | 08-1996                        | Brown et al.                  |  |
|                       | 12       | 5,555,927   | 09-1996                        | Shah                          |  |
|                       | 13       | 5,572,438   | 11-05-1996                     | Ehlers, et al.                |  |
|                       | 14       | 5,682,949   | 11-04-1997                     | Ratcliffe et al.              |  |
|                       | 15       | 5,717,609   | 02-10-1998                     | Packa, et al.                 |  |
|                       | 16       | 5,818,347   | 10-06-1998                     | Dolan et al.                  |  |
|                       | 17       | 5,977,964   | 11-1999                        | Williams et al.               |  |
|                       | 18       | 6,115,713   | 09-05-2000                     | Pascucci, et al.              |  |
|                       | 19       | 6,145,751   | 11-14-2000                     | Ahmed                         |  |
|                       | 20       | 6,178,362   | 01-23-2001                     | Woolard, et al.               |  |
|                       | 21       | 6,260,765   | 07-2001                        | Natale et al.                 |  |
|                       | 22       | 6,351,693   | 02-26-2002                     | Monie                         |  |
|                       | 23       | 6,400,956   | 06-02-2002                     | Richton                       |  |
|                       | 24       | 6,400,996   | 06-04-2002                     | Hoffberg et al.               |  |
|                       | 25       | 6,437,692   | 08-20-2002                     | Petite, et al.                |  |
|                       | 26       | 6,478,233   | 11-12-2002                     | Shah                          |  |
|                       | 27       | 6,480,803   | 11-12-2002                     | Pierret, et al.               |  |
|                       | 28       | 6,483,906   | 11-19-2002                     | Lggulden, et al.              |  |
|                       | 29       | 6,536,675   | 03-25-2003                     | Pesko, et al.                 |  |

|   |                 |
|---|-----------------|
| Examiner Signature  | Date Considered |
| *Examiner: Initial if reference considered, whether or not citation is in conformance with MPEP 609. Draw line through citation if not in conformance and not considered. Include copy of this form with next communication to applicant. |                 |

T<sup>1</sup> - Place a check mark in this area when an English language translation is attached.

|  |                      |                               |
|--|----------------------|-------------------------------|
| <b>INFORMATION DISCLOSURE<br/>STATEMENT BY APPLICANT</b> | Application No.      | 14/082675                     |
|  | Filing Date          | 11-18-2013                    |
|  | First Named Inventor | Steinberg, John Douglas et al |
|  | Art Unit             | 3744                          |
| <i>(Multiple sheets used when necessary)</i>             | Examiner             | Unknown                       |
| SHEET 2 OF 8   | Attorney Docket No.  | EFACT.007C1                   |

| U.S. PATENT DOCUMENTS |          |   |                                |                               |  |
|-----------------------|----------|---|--------------------------------|-------------------------------|--|
| Examiner Initials     | Cite No. | Document Number<br>Number - Kind Code (if known)<br>Example: 1,234,567 B1 | Publication Date<br>MM-DD-YYYY | Name of Patentee or Applicant | Pages, Columns, Lines Where<br>Relevant Passages or Relevant<br>Figures Appear |
|                       | 30       | 6,542,076   | 04-01-2003                     | Joao                          |  |
|                       | 31       | 6,549,130   | 04-15-2003                     | Joao                          |  |
|                       | 32       | 6,574,537   | 06-02-2003                     | Kipersztok, et al.            |  |
|                       | 33       | 6,580,950   | 06-17-2003                     | Johnson                       |  |
|                       | 34       | 6,594,825   | 07-15-2003                     | Goldschmidtki, et al.         |  |
|                       | 35       | 6,595,430   | 07-22-2003                     | Shah                          |  |
|                       | 36       | 6,598,056   | 07-22-2003                     | Hull, et al.                  |  |
|                       | 37       | 6,619,555   | 09-16-2003                     | Rosen                         |  |
|                       | 38       | 6,622,097   | 09-16-2003                     | Hunter                        |  |
|                       | 39       | 6,622,115   | 09-16-2003                     | Brown, et al.                 |  |
|                       | 40       | 6,622,925   | 09-23-2003                     | Carner, et al.                |  |
|                       | 41       | 6,622,926   | 09-23-2003                     | Sartain, et al.               |  |
|                       | 42       | 6,628,997   | 09-30-2003                     | Fox, et al.                   |  |
|                       | 43       | 6,633,823   | 10-14-2003                     | Bartone, et al.               |  |
|                       | 44       | 6,643,567   | 11-04-2003                     | Kolk et al.                   |  |
|                       | 45       | 6,671,586   | 12-30-2003                     | Davis, et al.                 |  |
|                       | 46       | 6,695,218   | 02-24-2004                     | Fleckenstein                  |  |
|                       | 47       | 6,726,113   | 04-27-2004                     | Guo                           |  |
|                       | 48       | 6,731,992   | 05-04-2004                     | Ziegler                       |  |
|                       | 49       | 6,734,806   | 05-11-2004                     | Cratsley                      |  |
|                       | 50       | 6,772,052   | 08-03-2004                     | Amundsen                      |  |
|                       | 51       | 6,785,592   | 08-31-2004                     | Smith                         |  |
|                       | 52       | 6,785,630   | 08-31-2004                     | Kolk                          |  |
|                       | 53       | 6,789,739   | 09-14-2004                     | Rosen                         |  |
|                       | 54       | 6,853,959   | 02-08-2005                     | Ikeda, et al.                 |  |
|                       | 55       | 6,868,293   | 03-15-2005                     | Schurr                        |  |
|                       | 56       | 6,868,319   | 03-15-2005                     | Kipersztok, et al.            |  |
|                       | 57       | 6,882,712   | 04-19-2005                     | Iggulden, et al.              |  |
|                       | 58       | 6,889,908   | 05-10-2005                     | Crippen, et al.               |  |

|   |                 |
|---|-----------------|
| Examiner Signature  | Date Considered |
| <p><b>*Examiner:</b> Initial if reference considered, whether or not citation is in conformance with MPEP 609. Draw line through citation if not in conformance and not considered. Include copy of this form with next communication to applicant.</p> |                 |

T<sup>1</sup> - Place a check mark in this area when an English language translation is attached.

|  |                      |                               |
|--|----------------------|-------------------------------|
| <b>INFORMATION DISCLOSURE<br/>STATEMENT BY APPLICANT</b> | Application No.      | 14/082675                     |
|  | Filing Date          | 11-18-2013                    |
|  | First Named Inventor | Steinberg, John Douglas et al |
|  | Art Unit             | 3744                          |
| <i>(Multiple sheets used when necessary)</i>             | Examiner             | Unknown                       |
| SHEET 3 OF 8   | Attorney Docket No.  | EFACT.007C1                   |

**U.S. PATENT DOCUMENTS**

| Examiner Initials | Cite No. | Document Number<br>Number - Kind Code (if known)<br>Example: 1,234,567 B1 | Publication Date<br>MM-DD-YYYY | Name of Patentee or Applicant  | Pages, Columns, Lines Where<br>Relevant Passages or Relevant<br>Figures Appear |
|-------------------|----------|---|--------------------------------|--------------------------------|--|
|                   | 59       | 6,891,838   | 10-10-2005                     | Petite, et al.                 |  |
|                   | 60       | 6,912,429   | 06-2005                        | Bilger                         |  |
|                   | 61       | 6,991,029   | 01-31-2006                     | Orfield, et al.                |  |
|                   | 62       | 7,009,493   | 03-07-2006                     | Howard                         |  |
|                   | 63       | 7,031,880   | 04-18-2006                     | Seem, et al.                   |  |
|                   | 64       | 7,039,532   | 05-02-2006                     | Hunter                         |  |
|                   | 65       | 7,061,393   | 06-2006                        | Buckingham et al.              |  |
|                   | 66       | 7,089,088   | 08-08-2006                     | Terry, et al.                  |  |
|                   | 67       | 7,130,719   | 10-31-2006                     | Ehlers, et al.                 |  |
|                   | 68       | 7,130,832   | 10-31-2006                     | Bannai, et al.                 |  |
|                   | 69       | 7,167,079   | 01-23-2007                     | Smyth, et al.                  |  |
|                   | 70       | 7,187,986   | 03-06-2007                     | Johnson, et al.                |  |
|                   | 71       | 7,205,892   | 04-17-2007                     | Luebke, et al.                 |  |
|                   | 72       | 7,215,746   | 05-08-2007                     | Iggulden, et al.               |  |
|                   | 73       | 7,216,015   | 05-08-2007                     | Poth, Robert J.                |  |
|                   | 74       | 7,231,424   | 06-11-2007                     | Bodin, et al.                  |  |
|                   | 75       | 7,232,075   | 06-19-2007                     | Rosen                          |  |
|                   | 76       | 7,242,988   | 07-2007                        | Hoffberg et al.                |  |
|                   | 77       | 7,260,823   | 08-2007                        | Schlack et al.                 |  |
|                   | 78       | 7,356,384   | 04-2008                        | Gull, et al.                   |  |
|                   | 79       | 7,483,964   | 01-2009                        | Jackson et al.                 |  |
|                   | 80       | 7,644,869   | 01-2010                        | Hoglund et al.                 |  |
|                   | 81       | 7,784,704   | 08-31-2010                     | Harter                         |  |
|                   | 82       | 7,848,900   | 12-07-2010                     | Steinberg, John Douglas et al. |  |
|                   | 83       | 7,894,943   | 02-22-2011                     | Sloup et al.                   |  |
|                   | 84       | 7,908,116   | 03-15-2011                     | Steinberg, John Douglas et al. |  |
|                   | 85       | 7,908,117   | 03-15-2011                     | Steinberg, John Douglas et al. |  |
|                   | 86       | 8,010,237   | 08-30-2011                     | Cheung, Leo et al.             |  |
|                   | 87       | 8,019,567   | 09-13-2011                     | Steinberg, John Douglas et al. |  |

|   |                 |
|---|-----------------|
| Examiner Signature  | Date Considered |
| <p><b>*Examiner:</b> Initial if reference considered, whether or not citation is in conformance with MPEP 609. Draw line through citation if not in conformance and not considered. Include copy of this form with next communication to applicant.</p> |                 |

T<sup>1</sup> - Place a check mark in this area when an English language translation is attached.



|  |                      |                               |
|--|----------------------|-------------------------------|
| <b>INFORMATION DISCLOSURE<br/>STATEMENT BY APPLICANT</b> | Application No.      | 14/082675                     |
|  | Filing Date          | 11-18-2013                    |
|  | First Named Inventor | Steinberg, John Douglas et al |
|  | Art Unit             | 3744                          |
| <i>(Multiple sheets used when necessary)</i>             | Examiner             | Unknown                       |
| SHEET 4 OF 8   | Attorney Docket No.  | EFACT.007C1                   |

| U.S. PATENT DOCUMENTS |          |   |                                |                                |  |
|-----------------------|----------|---|--------------------------------|--------------------------------|--|
| Examiner Initials     | Cite No. | Document Number<br>Number - Kind Code (if known)<br>Example: 1,234,567 B1 | Publication Date<br>MM-DD-YYYY | Name of Patentee or Applicant  | Pages, Columns, Lines Where<br>Relevant Passages or Relevant<br>Figures Appear |
|                       | 88       | 8,090,477   | 01-03-2012                     | Steinberg, John Douglas        |  |
|                       | 89       | 8,131,497   | 03-06-2012                     | Steinberg, John Douglas et al. |  |
|                       | 90       | 8,131,506   | 03-06-2012                     | Steinberg, John Douglas et al. |  |
|                       | 91       | 8,180,492   | 05-15-2012                     | Steinberg, John Douglas        |  |
|                       | 92       | 8,340,826   | 12-25-2012                     | Steinberg, John Douglas        |  |
|                       | 93       | 8,412,488   | 04-02-2013                     | Steinberg, John Douglas et al. |  |
|                       | 94       | 8,423,322   | 04-16-2013                     | Steinberg, John Douglas et al. |  |
|                       | 95       | 8,457,797   | 06-04-2013                     | Imes, et al.                   |  |
|                       | 96       | H2176   | 12-2006                        | Meyer et al.                   |  |
|                       | 97       | 13/861,189  | 04-11-2013                     | Steinberg, John Douglas et al. |  |
|                       | 98       | 2003/0040934  | 02-27-2003                     | Skidmore, et al.               |  |
|                       | 99       | 2004/0176880  | 09-09-2004                     | Obradovich, et al.             |  |
|                       | 100      | 2005/0222889  | 10-06-2005                     | Lai, et al.                    |  |
|                       | 101      | 2005/0288822  | 12-29-2005                     | Rayburn                        |  |
|                       | 102      | 2006/0045105  | 03-2006                        | Dobosz et al.                  |  |
|                       | 103      | 2006/0214014  | 09-28-2006                     | Bash, et al.                   |  |
|                       | 104      | 2007/0043477  | 02-22-2007                     | Elhers, et al.                 |  |
|                       | 105      | 2007/0045431  | 03-03-2007                     | Chapman, et al.                |  |
|                       | 106      | 2007/0146126  | 06-2007                        | Wang                           |  |
|                       | 107      | 2008/0083234  | 04-10-2008                     | Krebs et al.                   |  |
|                       | 108      | 2008/0198549  | 08-21-2008                     | Rasmussen, et al.              |  |
|                       | 109      | 2008/0281472  | 11-2008                        | Podgorny et al.                |  |
|                       | 110      | 2009/0052859  | 02-2009                        | Greenberger et al.             |  |
|                       | 111      | 2009/0099699  | 04-16-2009                     | Steinberg, John Douglas et al. |  |
|                       | 112      | 2009/0125151  | 05-14-2009                     | Steinberg, John Douglas et al. |  |
|                       | 113      | 2009/0240381  | 09-2009                        | Lane                           |  |
|                       | 114      | 2009/0281667  | 11-2009                        | Masui, et al.                  |  |
|                       | 115      | 2010/0019052  | 01-2010                        | Yip                            |  |
|                       | 116      | 2010/0070086  | 03-2010                        | Harrod, et al.                 |  |

|   |                 |
|---|-----------------|
| Examiner Signature  | Date Considered |
| *Examiner: Initial if reference considered, whether or not citation is in conformance with MPEP 609. Draw line through citation if not in conformance and not considered. Include copy of this form with next communication to applicant. |                 |

T<sup>1</sup> - Place a check mark in this area when an English language translation is attached.

|  |                      |                               |
|--|----------------------|-------------------------------|
| <b>INFORMATION DISCLOSURE<br/>STATEMENT BY APPLICANT</b> | Application No.      | 14/082675                     |
|  | Filing Date          | 11-18-2013                    |
|  | First Named Inventor | Steinberg, John Douglas et al |
|  | Art Unit             | 3744                          |
| <i>(Multiple sheets used when necessary)</i>             | Examiner             | Unknown                       |
| SHEET 5 OF 8   | Attorney Docket No.  | EFACT.007C1                   |

| U.S. PATENT DOCUMENTS |          |   |                                |                                |  |
|-----------------------|----------|---|--------------------------------|--------------------------------|--|
| Examiner Initials     | Cite No. | Document Number<br>Number - Kind Code (if known)<br>Example: 1,234,567 B1 | Publication Date<br>MM-DD-YYYY | Name of Patentee or Applicant  | Pages, Columns, Lines Where<br>Relevant Passages or Relevant<br>Figures Appear |
|                       | 117      | 2010/0070089  | 03-2010                        | Harrod, et al.                 |  |
|                       | 118      | 2010/0070093  | 03-2010                        | Harrod, et al.                 |  |
|                       | 119      | 2010/0156608  | 06-2010                        | BAE et al.                     |  |
|                       | 120      | 2010/0162285  | 06-2010                        | Cohen et al.                   |  |
|                       | 121      | 2010/0211224  | 08-2010                        | Keeling, et al.                |  |
|                       | 122      | 2010/0235004  | 09-2010                        | Thind                          |  |
|                       | 123      | 2010/0282857  | 11-11-2010                     | Steinberg                      |  |
|                       | 124      | 2010/0289643  | 11-2010                        | Trundle, et al.                |  |
|                       | 125      | 2010/0308119  | 12-09-2010                     | Steinberg, John Douglas et al. |  |
|                       | 126      | 2010/0318227  | 12-16-2010                     | Steinberg, John Douglas et al. |  |
|                       | 127      | 2011/0031323  | 02-2011                        | Nold, et al.                   |  |
|                       | 128      | 2011/0046792  | 02-24-2011                     | Imes, et al.                   |  |
|                       | 129      | 2011/0046798  | 02-24-2011                     | Imes, et al.                   |  |
|                       | 130      | 2011/0046799  | 02-24-2011                     | Imes, et al.                   |  |
|                       | 131      | 2011/0046800  | 02-24-2011                     | Imes, et al.                   |  |
|                       | 132      | 2011/0046801  | 02-24-2011                     | Imes, et al.                   |  |
|                       | 133      | 2011/0051823  | 03-03-2011                     | Imes, et al.                   |  |
|                       | 134      | 2011/0054699  | 03-03-2011                     | Imes, et al.                   |  |
|                       | 135      | 2011/0054710  | 03-03-2011                     | Imes, et al.                   |  |
|                       | 136      | 2011/0173542  | 07-14-2011                     | Imes, et al.                   |  |
|                       | 137      | 2011/0202185  | 08-18-2011                     | Imes, et al.                   |  |
|                       | 138      | 2011/0214060  | 09-01-2011                     | Imes, et al.                   |  |
|                       | 139      | 2011/0224838  | 09-15-2011                     | Imes, et al.                   |  |
|                       | 140      | 2011/0246898  | 10-06-2011                     | Imes, et al.                   |  |
|                       | 141      | 2011/0290893  | 12-01-2011                     | Steinberg                      |  |
|                       | 142      | 2011/0307101  | 12-15-2011                     | Imes, et al.                   |  |
|                       | 143      | 2011/0307103  | 12-15-2011                     | Cheung, et al.                 |  |
|                       | 144      | 2012/0023225  | 01-26-2012                     | Imes, et al.                   |  |
|                       | 145      | 2012/0046859  | 02-23-2012                     | Imes, et al.                   |  |

|                    |                 |
|--------------------|-----------------|
| Examiner Signature | Date Considered |
|--------------------|-----------------|

\***Examiner:** Initial if reference considered, whether or not citation is in conformance with MPEP 609. Draw line through citation if not in conformance and not considered. Include copy of this form with next communication to applicant.

T<sup>1</sup> - Place a check mark in this area when an English language translation is attached.

|  |                      |                               |
|--|----------------------|-------------------------------|
| <b>INFORMATION DISCLOSURE<br/>STATEMENT BY APPLICANT</b> | Application No.      | 14/082675                     |
|  | Filing Date          | 11-18-2013                    |
|  | First Named Inventor | Steinberg, John Douglas et al |
|  | Art Unit             | 3744                          |
| <i>(Multiple sheets used when necessary)</i>             | Examiner             | Unknown                       |
| SHEET 6 OF 8   | Attorney Docket No.  | EFACT.007C1                   |

| U.S. PATENT DOCUMENTS |          |   |                                |                                |  |
|-----------------------|----------|---|--------------------------------|--------------------------------|--|
| Examiner Initials     | Cite No. | Document Number<br>Number - Kind Code (if known)<br>Example: 1,234,567 B1 | Publication Date<br>MM-DD-YYYY | Name of Patentee or Applicant  | Pages, Columns, Lines Where<br>Relevant Passages or Relevant<br>Figures Appear |
|                       | 146      | 2012/0064923  | 03-15-2012                     | Imes, et al.                   |  |
|                       | 147      | 2012/0065935  | 03-15-2012                     | Steinberg, John Douglas et al. |  |
|                       | 148      | 2012/0072033  | 03-22-2012                     | Imes, et al.                   |  |
|                       | 149      | 2012/0086562  | 04-12-2012                     | Steinberg                      |  |
|                       | 150      | 2012/0093141  | 04-19-2012                     | Imes, et al.                   |  |
|                       | 151      | 2012/0101637  | 04-26-2012                     | Imes, et al.                   |  |
|                       | 152      | 2012/0135759  | 05-31-2012                     | Imes, et al.                   |  |
|                       | 153      | 2012/0158350  | 06-21-2012                     | Steinberg, et al.              |  |
|                       | 154      | 2012/0215725  | 08-23-2012                     | Imes, et al.                   |  |
|                       | 155      | 2012/0221151  | 08-30-2012                     | Steinberg, John Douglas        |  |
|                       | 156      | 2012/0221718  | 08-30-2012                     | Imes, et al.                   |  |
|                       | 157      | 2012/0252430  | 10-04-2012                     | Imes, et al.                   |  |
|                       | 158      | 2012/0324119  | 12-20-2012                     | Imes, et al.                   |  |
|                       | 159      | 2013/0053054  | 02-28-2013                     | Lovitt, et al.                 |  |
|                       | 160      | 2013/0054758  | 02-28-2013                     | Imes, et al.                   |  |
|                       | 161      | 2013/0054863  | 02-28-2013                     | Imes, et al.                   |  |
|                       | 162      | 2013/0060387  | 03-07-2013                     | Imes, et al.                   |  |
|                       | 163      | 2013/0144445  | 06-06-2013                     | Steinberg, John Douglas        |  |
|                       | 164      | 2013/0144453  | 06-06-2013                     | Subbloie                       |  |
|                       | 165      | 2013/0167035  | 06-27-2013                     | Imes, et al.                   |  |
|                       | 166      | 2013/0338837  | 12-19-2013                     | Hublou, Scott Douglas et al.   |  |

| FOREIGN PATENT DOCUMENTS |          |  |                                |                                  |  |                |
|--------------------------|----------|--|--------------------------------|----------------------------------|--|----------------|
| Examiner Initials        | Cite No. | Foreign Patent Document<br>Country Code-Number-Kind Code<br>Example: JP 1234567 A1 | Publication Date<br>MM-DD-YYYY | Name of Patentee or<br>Applicant | Pages, Columns, Lines<br>Where Relevant Passages or<br>Relevant Figures Appear | T <sup>1</sup> |
|                          | 167      | EP 0415747   | 03-06-1991                     | Shaw, et al.                     |  |                |
|                          | 168      | KR 10-1994-0011902   | 06-22-1994                     | Koryo Digital Elect. Co.         |  |                |
|                          | 169      | KR 10-2000-0059532   | 10-05-2000                     | Dang Hae System Co.              |  |                |

|  |
|--|
| <b>NON PATENT LITERATURE DOCUMENTS</b> |
|--|

|                    |                 |
|--------------------|-----------------|
| Examiner Signature | Date Considered |
|--------------------|-----------------|

\*Examiner: Initial if reference considered, whether or not citation is in conformance with MPEP 609. Draw line through citation if not in conformance and not considered. Include copy of this form with next communication to applicant.

T<sup>1</sup> - Place a check mark in this area when an English language translation is attached.

|  |                      |                               |
|--|----------------------|-------------------------------|
| <b>INFORMATION DISCLOSURE<br/>STATEMENT BY APPLICANT</b> | Application No.      | 14/082675                     |
|  | Filing Date          | 11-18-2013                    |
|  | First Named Inventor | Steinberg, John Douglas et al |
|  | Art Unit             | 3744                          |
| <i>(Multiple sheets used when necessary)</i>             | Examiner             | Unknown                       |
| SHEET 7 OF 8   | Attorney Docket No.  | EFACT.007C1                   |

| Examiner Initials | Cite No. | Include name of the author (in CAPITAL LETTERS), title of the article (when appropriate), title of the item (book, magazine, journal, serial, symposium, catalog, etc.), date, page(s), volume-issue number(s), publisher, city and/or country where published.        | T <sup>1</sup> |
|-------------------|----------|--|----------------|
|                   | 170      | ARENS, et al., "How Ambient Intelligence Will Improve Habitability and Energy Efficiency in Buildings", 2005, research paper, Center for the Built Environment, Controls and Information Technology  |                |
|                   | 171      | Bourhan, et al., "Cynamic model of an HVAC system for control analysis", Elsevier 2004   |                |
|                   | 172      | Brush, et al., Preheat – Controlling Home Heating with Occupancy Prediction, 2013  |                |
|                   | 173      | Comverge SuperStat Flyer, prior to June 28, 2007   |                |
|                   | 174      | Control4 Wireless Thermostat Brochure, 2006  |                |
|                   | 175      | Cooper Power Systems Web Page, 2000-2009   |                |
|                   | 176      | Emerson Climate Technologies, "Network Thermostat for E2 Building Controller Installation and Operation Manual", 2007  |                |
|                   | 177      | Enernoc Web Page, 2004-2009  |                |
|                   | 178      | Enerwise Website, 1999-2009  |                |
|                   | 179      | Gupta, Adding GPS-Control to Traditional Thermostats: An Exploration of Potential Energy Savings and Design Challenges, MIT, 2009  |                |
|                   | 180      | Gupta, et al., A Persuasive GPS-Controlled Thermostat System, MIT, 2008  |                |
|                   | 181      | Honeywell Programmable Thermostat Owner's Guide, www.honeywell.com/yourhome, 2004  |                |
|                   | 182      | Honeywell, "W7600/W7620 Controller Reference Manual, HW0021207, October, 1992  |                |
|                   | 183      | Johnson Controls, "T600HCx-3 Single-Stage Thermostats", 2006   |                |
|                   | 184      | JOHNSON CONTROLS, Touch4 building automation system brochure, 2007   |                |
|                   | 185      | KILICOTTE, et al., "Dynamic Controls for Energy Efficiency and Demand Response: Framework Concepts and a New Construction Study Case in New York", Proceedings of the 2006 ACEEE Summer Study of Energy Efficiency in Buildings, Pacific Grove, CA, August 13-18, 2006 |                |
|                   | 186      | Krumm, et al., Learning Time-Based Presence Probabilities, June 2011   |                |
|                   | 187      | LIN, et al., "Multi-Sensor Single-Actuator Control of HVAC Systems", 2002  |                |
|                   | 188      | PIER, Southern California Edison, Demand Responsive Control of Air Conditioning via Programmable Communicating Thermostats Draft Report, 2006  |                |

|   |                 |
|---|-----------------|
| Examiner Signature  | Date Considered |
| * <b>Examiner:</b> Initial if reference considered, whether or not citation is in conformance with MPEP 609. Draw line through citation if not in conformance and not considered. Include copy of this form with next communication to applicant. |                 |

T<sup>1</sup> - Place a check mark in this area when an English language translation is attached.

|  |                      |                               |
|--|----------------------|-------------------------------|
| <b>INFORMATION DISCLOSURE<br/>STATEMENT BY APPLICANT</b> | Application No.      | 14/082675                     |
|  | Filing Date          | 11-18-2013                    |
|  | First Named Inventor | Steinberg, John Douglas et al |
|  | Art Unit             | 3744                          |
| <i>(Multiple sheets used when necessary)</i>             | Examiner             | Unknown                       |
| SHEET 8 OF 8   | Attorney Docket No.  | EFACT.007C1                   |

**NON PATENT LITERATURE DOCUMENTS**

| Examiner<br>Initials | Cite<br>No. | Include name of the author (in CAPITAL LETTERS), title of the article (when appropriate), title of the item (book, magazine, journal, serial, symposium, catalog, etc.), date, page(s), volume-issue number(s), publisher, city and/or country where published. | T <sup>1</sup> |
|----------------------|-------------|---|----------------|
|                      | <b>189</b>  | Proliphix Thermostat Brochure, prior to June 2007   |                |
|                      | <b>190</b>  | Raji, "Smart Networks for Control", IEEE Spectrum, June 1994  |                |
|                      | <b>191</b>  | Scott, et al., Home Heating Using GPS-Based Arrival Prediction, 2010  |                |
|                      | <b>192</b>  | WANG, et al., "Opportunities to Save Energy and Improve Comfort by Using Wireless Sensor Networks in Buildings," (2003), Center for Environmental Design Research   |                |
|                      | <b>193</b>  | WETTER, et al., A comparison of deterministic and probabilistic optimization algorithms for nonsmooth simulation-based optimization., Building and Environment 39, 2004, Pages 989-999  |                |
|                      | <b>194</b>  | Written Opinion and Search Report for PCT/US2011/032537, dated 12/12/11 (our reference EFACT.012WO)   |                |

16970945:ad  
010614

|   |                 |
|---|-----------------|
| Examiner Signature  | Date Considered |
| <p><b>*Examiner:</b> Initial if reference considered, whether or not citation is in conformance with MPEP 609. Draw line through citation if not in conformance and not considered. Include copy of this form with next communication to applicant.</p> |                 |

T<sup>1</sup> - Place a check mark in this area when an English language translation is attached.

## Electronic Patent Application Fee Transmittal

|   |  |
|---|--|
| <b>Application Number:</b>                  | 14082675   |
| <b>Filing Date:</b>                         | 18-Nov-2013  |
| <b>Title of Invention:</b>                  | SYSTEM, METHOD AND APPARATUS FOR IDENTIFYING MANUAL INPUTS TO AND ADAPTIVE PROGRAMMING OF A THERMOSTAT |
| <b>First Named Inventor/Applicant Name:</b> | John Douglas Steinberg   |
| <b>Filer:</b>                               | John R. King/Amy Durrant   |
| <b>Attorney Docket Number:</b>              | EFACT.007C1  |

Filed as Small Entity

### Utility under 35 USC 111(a) Filing Fees

| Description                              | Fee Code | Quantity | Amount | Sub-Total in USD(\$) |
|--|----------|----------|--------|----------------------|
| <b>Basic Filing:</b>                     |          |          |        |                      |
| <b>Pages:</b>                            |          |          |        |                      |
| <b>Claims:</b>                           |          |          |        |                      |
| <b>Miscellaneous-Filing:</b>             |          |          |        |                      |
| <b>Petition:</b>                         |          |          |        |                      |
| <b>Patent-Appeals-and-Interference:</b>  |          |          |        |                      |
| <b>Post-Allowance-and-Post-Issuance:</b> |          |          |        |                      |
| <b>Extension-of-Time:</b>                |          |          |        |                      |
| Extension - 1 month with \$0 paid        | 306 2251 | 1        | 100    | 100                  |

| Description              | Fee Code | Quantity | Amount | Sub-Total in USD(\$) |
|--------------------------|----------|----------|--------|----------------------|
| <b>Miscellaneous:</b>    |          |          |        |                      |
| <b>Total in USD (\$)</b> |          |          |        | <b>100</b>           |

## Electronic Acknowledgement Receipt

|   |  |
|---|--|
| <b>EFS ID:</b>                              | 18404201   |
| <b>Application Number:</b>                  | 14082675   |
| <b>International Application Number:</b>    |  |
| <b>Confirmation Number:</b>                 | 3336   |
| <b>Title of Invention:</b>                  | SYSTEM, METHOD AND APPARATUS FOR IDENTIFYING MANUAL INPUTS TO AND ADAPTIVE PROGRAMMING OF A THERMOSTAT |
| <b>First Named Inventor/Applicant Name:</b> | John Douglas Steinberg   |
| <b>Customer Number:</b>                     | 20995  |
| <b>Filer:</b>                               | John R. King/Anthony Bonilla   |
| <b>Filer Authorized By:</b>                 | John R. King   |
| <b>Attorney Docket Number:</b>              | EFACT.007C1  |
| <b>Receipt Date:</b>                        | 07-MAR-2014  |
| <b>Filing Date:</b>                         | 18-NOV-2013  |
| <b>Time Stamp:</b>                          | 17:33:31   |
| <b>Application Type:</b>                    | Utility under 35 USC 111(a)  |

### Payment information:

|  |                               |
|--|-------------------------------|
| Submitted with Payment                   | yes                           |
| Payment Type                             | Credit Card                   |
| Payment was successfully received in RAM | \$100                         |
| RAM confirmation Number                  | 5044                          |
| Deposit Account                          | 111410                        |
| Authorized User                          | KNOBBE MARTENS OLSON AND BEAR |

The Director of the USPTO is hereby authorized to charge indicated fees and credit any overpayment as follows:

Charge any Additional Fees required under 37 C.F.R. Section 1.16 (National application filing, search, and examination fees)

Charge any Additional Fees required under 37 C.F.R. Section 308 (Patent application and reexamination processing fees)



| <b>File Listing:</b>   |  |                              |  |                         |                         |
|------------------------|--|------------------------------|--|-------------------------|-------------------------|
| <b>Document Number</b> | <b>Document Description</b>                                | <b>File Name</b>             | <b>File Size(Bytes)/ Message Digest</b>            | <b>Multi Part /.zip</b> | <b>Pages (if appl.)</b> |
| 1                      | Applicant Response to Pre-Exam Formalities Notice          | EFACT-007C1_response.pdf     | 46932<br>44fd2d69b98addec373260fbf58bbfbd684888d   | no                      | 2                       |
| <b>Warnings:</b>       |  |                              |  |                         |                         |
| <b>Information:</b>    |  |                              |  |                         |                         |
| 2                      |  | EFACT-007C1_cleanversion.pdf | 860698<br>b62b856e3aab57c3ec7b594d768302a951b0abf9 | yes                     | 17                      |
|                        | <b>Multipart Description/PDF files in .zip description</b> |                              |  |                         |                         |
|                        | <b>Document Description</b>                                |                              | <b>Start</b>                                       | <b>End</b>              |                         |
|                        | Specification  |                              | 1  | 12                      |                         |
|                        | Claims   |                              | 13   | 16                      |                         |
|                        | Abstract   |                              | 17   | 17                      |                         |
| <b>Warnings:</b>       |  |                              |  |                         |                         |
| <b>Information:</b>    |  |                              |  |                         |                         |
| 3                      | Applicant Arguments/Remarks Made in an Amendment           | EFACT-007C1_subversion.pdf   | 858850<br>ab23c625038c773d8c9076083eaf48158a0949d3 | no                      | 17                      |
| <b>Warnings:</b>       |  |                              |  |                         |                         |
| <b>Information:</b>    |  |                              |  |                         |                         |
| 4                      | Power of Attorney  | EFACT-007C1_poa.pdf          | 176782<br>36e686d21f74f98ecf79918385e5a2c5d18fe8bd | no                      | 2                       |
| <b>Warnings:</b>       |  |                              |  |                         |                         |
| <b>Information:</b>    |  |                              |  |                         |                         |
| 5                      | Miscellaneous Incoming Letter                              | EFACT-007C1_rescission.pdf   | 35967<br>4b1667556e66d08719762ab8391a9d3ade0af87a  | no                      | 1                       |
| <b>Warnings:</b>       |  |                              |  |                         |                         |
| <b>Information:</b>    |  |                              |  |                         |                         |
| 6                      |  | EFACT-007C1_ids.pdf          | 546273<br>5945fee6e4759a2743ad479aea32ab21258fe8d6 | yes                     | 9                       |
|                        | <b>Multipart Description/PDF files in .zip description</b> |                              |  |                         |                         |
|                        | <b>Document Description</b>                                |                              | <b>Start</b>                                       | <b>End</b>              |                         |
|                        | Transmittal Letter   |                              | 1  | 1                       |                         |

|   |  |                     |  |         |   |
|---|--|---------------------|--|---------|---|
|   | Information Disclosure Statement (IDS) Form (SB08) |                     | 2  |         | 9 |
| <b>Warnings:</b>  |  |                     |  |         |   |
| <b>Information:</b>   |  |                     |  |         |   |
| 7   | Non Patent Literature                              | EFACT-007C1_REF.pdf | 616314                                   | no      | 7 |
|   |  |                     | a701a7b133c612224031b0de3d68f12d43e7be37 |         |   |
| <b>Warnings:</b>  |  |                     |  |         |   |
| <b>Information:</b>   |  |                     |  |         |   |
| 8   | Fee Worksheet (SB06)                               | fee-info.pdf        | 30624                                    | no      | 2 |
|   |  |                     | 297c7498f448646a77885d61efdb9b8f26094ee0 |         |   |
| <b>Warnings:</b>  |  |                     |  |         |   |
| <b>Information:</b>   |  |                     |  |         |   |
|   |  |                     | <b>Total Files Size (in bytes):</b>      | 3172440 |   |
| <p><b>This Acknowledgement Receipt evidences receipt on the noted date by the USPTO of the indicated documents, characterized by the applicant, and including page counts, where applicable. It serves as evidence of receipt similar to a Post Card, as described in MPEP 503.</b></p> <p><b><u>New Applications Under 35 U.S.C. 111</u></b><br/> <b>If a new application is being filed and the application includes the necessary components for a filing date (see 37 CFR 1.53(b)-(d) and MPEP 506), a Filing Receipt (37 CFR 1.54) will be issued in due course and the date shown on this Acknowledgement Receipt will establish the filing date of the application.</b></p> <p><b><u>National Stage of an International Application under 35 U.S.C. 371</u></b><br/> <b>If a timely submission to enter the national stage of an international application is compliant with the conditions of 35 U.S.C. 371 and other applicable requirements a Form PCT/DO/EO/903 indicating acceptance of the application as a national stage submission under 35 U.S.C. 371 will be issued in addition to the Filing Receipt, in due course.</b></p> <p><b><u>New International Application Filed with the USPTO as a Receiving Office</u></b><br/> <b>If a new international application is being filed and the international application includes the necessary components for an international filing date (see PCT Article 11 and MPEP 1810), a Notification of the International Application Number and of the International Filing Date (Form PCT/RO/105) will be issued in due course, subject to prescriptions concerning national security, and the date shown on this Acknowledgement Receipt will establish the international filing date of the application.</b></p> |  |                     |  |         |   |

**IN THE UNITED STATES PATENT AND TRADEMARK OFFICE**

|           |  |
|-----------|--|
| Inventor  | : John Douglas Steinberg   |
| App. No.  | : 14/082675  |
| Filed     | : November 18, 2013  |
| For       | : SYSTEM, METHOD AND APPARATUS FOR IDENTIFYING MANUAL INPUTS TO AND ADAPTIVE PROGRAMMING OF A THERMOSTAT |
| Examiner  | : Unknown  |
| Art Unit  | : 3744   |
| Conf. No. | : 3336   |

**RESPONSE TO NOTICE TO FILE CORRECTED APPLICATION PAPERS**

**Mail Stop Amendment**  
Commissioner for Patents  
P.O. Box 1450  
Alexandria, VA 22313-1450

Dear Sir:

In response to the Notice to File Corrected Application Papers mailed December 9, 2013, Applicants respectfully submit the following comments.

Application No.: 14/082675  
Filing Date: November 18, 2013

**REMARKS**

Applicant has submitted a substitute specification that changes the brief description of the drawings. In particular, instead of referring to Figure 6, the substitute specification refers to Figures 6A and 6B. In addition, a summary of Figure 10 has been added.

Applicant submits these changes do not add new matter.

Applicant is also not submitting substitute drawings. In light of the changes made to the specification, it does not appear that any changes to the drawings are necessary.

Please charge any additional fees, including any fees for additional extension of time, or credit overpayment to Deposit Account No. 11-1410.

Respectfully submitted,

KNOBBE, MARTENS, OLSON & BEAR, LLP

Dated: 3-7-2014

By: John R. King  
John R. King  
Registration No. 34,362  
Attorney of Record  
Customer No. 20995  
(949) 760-0404

17423788:ad  
030714

SYSTEM, METHOD AND APPARATUS FOR IDENTIFYING MANUAL INPUTS TO  
AND ADAPTIVE PROGRAMMING OF A THERMOSTAT

INCORPORATION BY REFERENCE TO RELATED APPLICATIONS

**[0001]** This application hereby incorporates herein by reference under 37 C.F.R. § 1.57 the entirety of the disclosure of each application set forth in the foreign and domestic priority sections of the Application Data Sheet filed herewith.

BACKGROUND OF THE INVENTION

Field of the Invention

**[0002]** Programmable thermostats have been available for more than 20 years. Programmable thermostats offer two types of advantages as compared to non-programmable devices. On the one hand, programmable thermostats can save energy in large part because they automate the process of reducing conditioning during times when the space is unoccupied, or while occupants are sleeping, and thus reduce energy consumption.

**[0003]** On the other hand, programmable thermostats can also enhance comfort as compared to manually changing setpoints using a non-programmable thermostat. For example, during the winter, a homeowner might manually turn down the thermostat from 70 degrees F to 64 degrees when going to sleep and back to 70 degrees in the morning. The drawback to this approach is that there can be considerable delay between the adjustment of the thermostat and the achieving of the desired change in ambient temperature, and many people find getting out of bed, showering, etc. in a cold house unpleasant. A programmable thermostat allows homeowners to anticipate the desired result by programming a pre-conditioning of the home. So, for example, if the homeowner gets out of bed at 7AM, setting the thermostat to change from the overnight setpoint of 64 degrees to 70 at 6AM can make the house comfortable when the consumer gets up. The drawback to this approach is that the higher temperature will cost more to maintain, so the increase in comfort is purchased at the cost of higher energy usage.

**[0004]** But all of the advantages of a programmable thermostat depend on the match between the preferences of the occupants and the actual settings employed. If, for example, the thermostat is set to warm up the house on winter mornings at 7AM, but the homeowner gets up at 5:30, the homeowner is likely to be dissatisfied. If a homeowner has programmed her thermostat to cool down the house at 5PM each afternoon based on the assumption that she will come home at 6PM, but her schedule changes and she begins to arrive home at 4:30 each day, she is likely to be uncomfortable and either make frequent manual changes or go through the generally non-intuitive process of reprogramming the thermostat to match her new schedule. Because the limited interface on most thermostats, that process may take considerable effort, which leads many users to avoid reprogramming their thermostats for long periods or even to skip doing so entirely.

**[0005]** But even if a homeowner is able to align her schedule with the programming of her thermostat, there are additional difficulties associated with choosing proper temperatures at those times. If the temperatures programmed into a thermostat do not accurately reflect the preferences of the occupants, those occupants are likely to resort to manual overrides of the programmed settings. The need to correct the "mistakes" of the thermostat is likely to annoy many users. And because people tend to overshoot the desired temperature when they make such manual changes, these overrides are likely to result in excessive heating and cooling, and thus unnecessary energy use. That is, if a person feels uncomfortable on a summer afternoon when the setting is 73 degrees, they are likely to change it to 68 or 69 rather than 71 or 72 degrees, even if 72 degrees might have made enough of a difference.

**[0006]** It would therefore be advantageous to have a means for adapting to signaling from occupants in the form of manual temperature changes and incorporating the information contained in such gestures into long-term programming. It would also be desirable to take into account both outside weather conditions and the thermal characteristics of individual homes in order to improve the ability to dynamically achieve the best possible balance between comfort and energy savings.

## BRIEF DESCRIPTION OF THE DRAWINGS

**[0007]** Figure 1 shows an example of an overall environment in which an embodiment of the invention may be used.

**[0008]** Figure 2 shows a high-level illustration of the architecture of a network showing the relationship between the major elements of one embodiment of the subject invention.

**[0009]** Figure 3 shows an embodiment of the website to be used as part of the subject invention.

**[0010]** Figure 4 shows a high-level schematic of the thermostat used as part of the subject invention.

**[0011]** Figure 5 shows one embodiment of the database structure used as part of the subject invention.

**[0012]** Figures 6A and 6B show how comparing inside temperature against outside temperature and other variables permits calculation of dynamic signatures.

**[0013]** Figure 7 shows how manual inputs can be recognized and recorded by the subject invention.

**[0014]** Figure 8 shows how the subject invention uses manual inputs to interpret manual overrides and make short-term changes in response thereto.

**[0015]** Figure 9 shows how the subject invention uses manual inputs to alter long-term changes to interpretive rules and to setpoint scheduling.

**[0016]** Figure 10 shows an example of some of the contextual data that may be used by the server in order to interpret manual overrides.

## DETAILED DESCRIPTION OF THE PREFERRED EMBODIMENT

**[0017]** **Figure 1** shows an example of an overall environment 100 in which an embodiment of the invention may be used. The environment 100 includes an interactive communication network 102 with computers 104 connected thereto. Also connected to network 102 are one or more server computers 106, which store

information and make the information available to computers 104. The network 102 allows communication between and among the computers 104 and 106.

**[0018]** Presently preferred network 102 comprises a collection of interconnected public and/or private networks that are linked to together by a set of standard protocols to form a distributed network. While network 102 is intended to refer to what is now commonly referred to as the Internet, it is also intended to encompass variations which may be made in the future, including changes additions to existing standard protocols.

**[0019]** One popular part of the Internet is the World Wide Web. The World Wide Web contains a large number of computers 104 and servers 106, which store HyperText Markup Language (HTML) and other documents capable of displaying graphical and textual information. HTML is a standard coding convention and set of codes for attaching presentation and linking attributes to informational content within documents.

**[0020]** The servers 106 that provide offerings on the World Wide Web are typically called websites. A website is often defined by an Internet address that has an associated electronic page. Generally, an electronic page is a document that organizes the presentation of text graphical images, audio and video.

**[0021]** In addition to the Internet, the network 102 can comprise a wide variety of interactive communication media. For example, network 102 can include local area networks, interactive television networks, telephone networks, wireless data systems, two-way cable systems, and the like.

**[0022]** Network 102 can also comprise servers 106 that provide services other than HTML documents. Such services may include the exchange of data with a wide variety of "edge" devices, some of which may not be capable of displaying web pages, but that can record, transmit and receive information.

**[0023]** In one embodiment, computers 104 and servers 106 are conventional computers that are equipped with communications hardware such as modem or a network interface card. The computers include processors such as those sold by Intel and AMD. Other processors may also be used, including



general-purpose processors, multi-chip processors, embedded processors and the like.

**[0024]** Computers 104 can also be handheld and wireless devices such as personal digital assistants (PDAs), cellular telephones and other devices capable of accessing the network.

**[0025]** Computers 104 may utilize a browser configured to interact with the World Wide Web. Such browsers may include Microsoft Explorer, Mozilla, Firefox, Opera or Safari. They may also include browsers used on handheld and wireless devices.

**[0026]** The storage medium may comprise any method of storing information. It may comprise random access memory (RAM), electronically erasable programmable read only memory (EEPROM), read only memory (ROM), hard disk, floppy disk, CD-ROM, optical memory, or other method of storing data.

**[0027]** Computers 104 and 106 may use an operating system such as Microsoft Windows, Apple Mac OS, Linux, Unix or the like.

**[0028]** Computers 106 may include a range of devices that provide information, sound, graphics and text, and may use a variety of operating systems and software optimized for distribution of content via networks.

**[0029]** **Figure 2** illustrates in further detail the architecture of the specific components connected to network 102 showing the relationship between the major elements of one embodiment of the subject invention. Attached to the network are thermostats 108 and computers 104 of various users. Connected to thermostats 108 are HVAC units 110. The HVAC units may be conventional air conditioners, heat pumps, or other devices for transferring heat into or out of a building. Each user may be connected to server 106 via wired or wireless connection such as Ethernet or a wireless protocol such as IEEE 802.11, and router and/or gateway or wireless access point 112 that connects the computer and thermostat to the Internet via a broadband connection such as a digital subscriber line (DSL) or other form of broadband connection to the World Wide Web. In one embodiment, thermostat management server 106 is in communication with the network 102. Server 106 contains the content to be served as web pages and viewed by computers 104, as

well as databases containing information used by the servers, and applications used to remotely manage thermostats 108.

**[0030]** In the currently preferred embodiment, the website 200 includes a number of components accessible to the user, as shown in **Figure 3**. Those components may include a means to store temperature settings 202, a means to enter information about the user's home 204, a means to enter the user's electricity bills 206, and means to elect to enable the subject invention 208.

**[0031]** **Figure 4** shows a high-level block diagram of thermostat 108 used as part of the subject invention. Thermostat 108 includes temperature sensing means 252, which may be a thermistor, thermal diode or other means commonly used in the design of electronic thermostats. It includes a microprocessor 254, memory 256, a display 258, a power source 260, and at least one relay 262, which turns the HVAC system on and off in response to a signal from the microprocessor, and contacts by which the relay is connected to the wires that lead to the HVAC system. To allow the thermostat to communicate bi-directionally with the computer network, the thermostat also includes means 264 to connect the thermostat to a local computer or to a wired or wireless network. Such means could be in the form of Ethernet, wireless protocols such as IEEE 802.11, IEEE 802.15.4, Bluetooth, or other wireless protocols. The thermostat may be connected to the computer network directly via wired or wireless Internet Protocol connection. Alternatively, the thermostat may connect wirelessly to a gateway such as an IP-to-Zigbee gateway, an IP-to-Z-wave gateway, or the like. Where the communications means enabled include wireless communication, antenna 266 will also be included. The thermostat 250 may also include controls 268 allowing users to change settings directly at the thermostat, but such controls are not necessary to allow the thermostat to function.

**[0032]** The data used to generate the content delivered in the form of the website and to automate control of thermostat 108 is stored on one or more servers 106 within one or more databases. As shown in **Figure 5**, the overall database structure 300 may include temperature database 400, thermostat settings database 500, energy bill database 600, HVAC hardware database 700, weather database 800, user database 900, transaction database 1000, product and service database

1100 and such other databases as may be needed to support these and additional features.

**[0033]** The website will allow users of connected thermostats 108 to create personal accounts. Each user's account will store information in database 900, which tracks various attributes relative to users. Such attributes may include the make and model of the specific HVAC equipment in the user's home; the age and square footage of the home, the solar orientation of the home, the location of the thermostat in the home, the user's preferred temperature settings, etc.

**[0034]** As shown in Figure 3, the website 200 will permit thermostat users to perform through the web browser substantially all of the programming functions traditionally performed directly at the physical thermostat, such as temperature set points, the time at which the thermostat should be at each set point, etc. Preferably the website will also allow users to accomplish more advanced tasks such as allow users to program in vacation settings for times when the HVAC system may be turned off or run at more economical settings, and set macros that will allow changing the settings of the temperature for all periods with a single gesture such as a mouse click.

**[0035]** In addition to using the system to allow better signaling and control of the HVAC system, which relies primarily on communication running from the server to the thermostat, the bi-directional communication will also allow the thermostat 108 to regularly measure and send to the server information about the temperature in the building. By comparing outside temperature, inside temperature, thermostat settings, cycling behavior of the HVAC system, and other variables, the system will be capable of numerous diagnostic and controlling functions beyond those of a standard thermostat.

**[0036]** For example, **Fig. 6a** shows a graph of inside temperature, outside temperature and HVAC activity for a 24-hour period. When outside temperature 302 increases, inside temperature 304 follows, but with some delay because of the thermal mass of the building, unless the air conditioning 306 operates to counteract this effect. When the air conditioning turns on, the inside temperature stays constant (or rises at a much lower rate or even falls) despite the rising outside

temperature. In this example, frequent and heavy use of the air conditioning results in only a very slight temperature increase inside the house of 4 degrees, from 72 to 76 degrees, despite the increase in outside temperature from 80 to 100 degrees.

**[0037]** **Figure 6b** shows a graph of the same house on the same day, but assumes that the air conditioning is turned off from noon to 7PM. As expected, the inside temperature 304a rises with increasing outside temperatures 302 for most of that period, reaching 88 degrees at 7PM. Because server 106 logs the temperature readings from inside each house (whether once per minute or over some other interval), as well as the timing and duration of air conditioning cycles, database 300 will contain a history of the thermal performance of each house. That performance data will allow server 106 to calculate an effective thermal mass for each such structure – that is, the speed with the temperature inside a given building will change in response to changes in outside temperature. Because the server will also log these inputs against other inputs including time of day, humidity, etc. the server will be able to predict, at any given time on any given day, the rate at which inside temperature should change for given inside and outside temperatures.

**[0038]** The ability to predict the rate of change in inside temperature in a given house under varying conditions may be applied by in effect holding the desired future inside temperature as a constraint and using the ability to predict the rate of change to determine when the HVAC system must be turned on in order to reach the desired temperature at the desired time.

**[0039]** In order to adapt programming to take into account the manual overrides entered into the thermostat, it is first necessary to determine when a manual override has in fact occurred. Most thermostats, including two-way communicating devices discussed herein, do not record such inputs locally, and neither recognize nor transmit the fact that a manual override has occurred. Furthermore, in a system as described herein, frequent changes in setpoints may be initiated by algorithms running on the server, thereby making it impossible to infer a manual override from the mere fact that the setpoint has changed. It is therefore necessary to deduce the occurrence of such events from the data that the subject invention does have access to.

**[0040]** Figure 7 illustrates the currently preferred method for detecting the occurrence of a manual override event. In step 1002, the server retrieves the primary data points used to infer the occurrence of a manual override from one or more databases in overall database structure 300. The data should include each of the following: for the most recent point for which it can obtain such data (time0) the actual setpoint as recorded at the thermostat (A0); for the point immediately prior to time0, (time-1), the actual setpoint recorded for the thermostat (A-1); for time0 the setpoint as scheduled by server 106 according to the standard setpoint programming (S0), and for time-1 the setpoint as scheduled by server 106 according to the standard setpoint programming (S-1). In step 1004, the server retrieves any additional automated setpoint changes C that have been scheduled for the thermostat by server 106 at time0. Such changes may include algorithmic changes intended to reduce energy consumption, etc. In step 1006 the server calculates the difference (dA) between A0 and A-1; for example, if the setpoint at T0 is 67 degrees at T-1 and 69 at T0, dA is +2; if the setpoint at T-1 is 70 and the setpoint at T0 is 66, dA is -4. In step 1008, the server performs similar steps in order to calculate dS, the difference between S0 and S-1. This is necessary because, for example, the setpoint may have been changed because the server itself had just executed a change, such as a scheduled change from "away" to "home" mode. In step 1010 the server evaluates and sums all active algorithms and other server-initiated strategies to determine their net effect on setpoint at time0. For example, if one algorithm has increased setpoint at time0 by 2 degrees as a short-term energy savings measure, but another algorithm has decreased the setpoint by one degree to compensate for expected subjective reactions to weather conditions, the net algorithmic effect sC is +1 degree.

**[0041]** In step 1012, the server calculates the value for M, where M is equal to the difference between actual setpoints dA, less the difference between scheduled setpoints dS, less the aggregate of algorithmic change sC. In step 1014 the server evaluates this difference. If the difference equals zero, the server concludes that no manual override has occurred, and the routine terminates. But if the difference is any value other than zero, then the server concludes that a manual

override has occurred. Thus in step 1016 the server logs the occurrence of an override to one or more databases in overall database structure 300.

**[0042]** The process of interpreting a manual override is shown in **Figure 8**. 1102 is the detection of an override, as described in detail in Figure 7. In step 1104 the server retrieves contextual data required to interpret the manual override. Such data may include current and recent weather conditions, current and recent inside temperatures, etc. This data is helpful because it is likely that manual overrides are at least in part deterministic: that is, that they may often be explained by such contextual data, and that such understanding can permit anticipation of the desire on the part of the occupants to override and to adjust programming accordingly, so as to anticipate and obviate the need for such changes. In step 1106 the server retrieves any override data from the period preceding the specific override being evaluated that has not yet been evaluated by and incorporated into the long-term programming and rules engines as described below in Figure 9. The amount of data may be for a period of a few hours to as long as several days or more. Recent data will be more heavily weighted than older data in order to assure rapid adaptation to situations in which manual overrides represent stable changes such as changes in work schedules, etc. In step 1108 the server retrieves the stored rules for the subject thermostat 108. Such rules may include weather and time-related inferences such as "if outside temperature is greater than 85 degrees and inside temperature is more than 2 degrees above setpoint and manual override lowers setpoint by 3 or more degrees, then revert to original setpoint in 2 hours," or "if heating setpoint change is scheduled from "away" to "home" within following 2 hours after detected override, and override increases setpoint by at least 2 degrees, then change to "home" setting," or the like. In step 1110 the server applies the rules to the override and determines which rule, if any, should be applied as a result of the override. In step 1112 the server determines whether to alter the current setpoint as a result of applying the rules in step 1110. If no setpoint change is indicated, then the server proceeds to step 1118. If a setpoint change is indicated, then in step 1114 the server transmits the setpoint change to the thermostat, and in step 1116 it records that change to one or more databases in overall database structure 300.

**[0043]** In order to ensure that both the stored rules for interpreting manual overrides and the programming itself continue to most accurately reflect the intentions of the occupants, the server will periodically review both the rules used to interpret overrides and the setpoint scheduling employed. **Figure 9** shows the steps used to incorporate manual overrides into the long-term rules and setpoint schedule. In step 1202 the server retrieves the stored programming for a given thermostat as well as the rules for interpreting overrides for that thermostat. In step 1204 the server retrieves the recent override data as recorded in Figures 7 and 8 to be evaluated for possible revisions to the rules and the programming. In step 1206 the server retrieves the contextual data regarding overrides retrieved in step 1204 (Because the process illustrated in Figure 9 is not presently expected to be executed as a real-time process, and to be run anywhere from once per day to once per month, the range and volume of contextual data to be evaluated is likely to be greater than in the process illustrated in Figure 8). In step 1208 the server interprets the overrides in light of the existing programming schedule, rules for overrides, contextual data, etc. In step 1210 the server determines whether, as a result of those overrides as interpreted, the rules for interpreting manual overrides should be revised. If the rules are not to be revised, the server moves to step 1214. If the rules are to be revised, then in step 1212 the server revises the rules and the new rules are stored in one or more databases in overall database structure 300. In step 1214 the server determines whether any changes to the baseline programming for the thermostat should be revised. If not the routine terminates. If revisions are warranted, then in step 1216 the server retrieves from database 900 the permissions the server has to make autonomous changes to settings. If the server has been given permission to make the proposed changes, then in step 1218 the server revises the thermostat's programming and writes the changes to one or more databases in overall database structure 300. If the server has not been authorized to make such changes autonomously, then in step 1220 the server transmits the recommendation to change settings to the customer in the manner previously specified by the customer, such as email, changes to the customer's home page as displayed on website 200, etc.

**[0044]** Figure 10 shows an example of some of the contextual data that may be used by the server in order to interpret manual overrides. Such data may include inside temperature 1302, outside temperature 1304, cloud cover 1306, humidity 1308, barometric pressure 1310, wind speed 1312, and wind direction 1314.

**[0045]** Each of these data points should be captured at frequent intervals. In the preferred embodiment, as shown in Figure 10, the interval is once every 60 seconds.

**[0046]** Additional means of implementing the instant invention may be achieved using variations in system architecture. For example, much or even all of the work being accomplished by remote server 106 may also be done by thermostat 108 if that device has sufficient processing capabilities, memory, etc. Alternatively, some or all of these steps may be undertaken by a local processor such as a local personal computer, gateway 112, or by a dedicated appliance having the requisite capabilities.

**[0047]** While certain embodiments of the inventions have been described, these embodiments have been presented by way of example only, and are not intended to limit the scope of the inventions. Indeed, the novel methods and systems described herein may be embodied in a variety of other forms; furthermore, various omissions, substitutions and changes in the form of the methods and systems described herein may be made without departing from the spirit of the inventions. The accompanying claims and their equivalents are intended to cover such forms or modifications as would fall within the scope and spirit of the inventions.



WHAT IS CLAIMED IS:

1. A method for detecting manual changes to the setpoint for a thermostatic controller comprising:

accessing stored data comprising a plurality of internal temperature measurements taken within a structure and a plurality of outside temperature measurements;

using the stored data to predict changes in temperature inside the structure in response to at least changes in outside temperatures;

calculating with at least one computer, scheduled programming of the thermostatic controller for one or more times, the scheduled programming comprising at least a first automated setpoint at a first time;

generating with the at least one computer, a difference value based on comparing an actual setpoint at the first time for the thermostatic controller to the first automated setpoint for the thermostatic controller;

detecting a manual change to the first automated setpoint by determining whether the actual setpoint and the first automated setpoint are the same or different based on the difference value; and

logging the manual change to a database.

2. A method as in Claim 1 where the thermostatic controller operates a system for changing the air temperature in a structure.

3. A method as in Claim 1 where the thermostatic controller operates a heating, ventilation and air conditioning system.

4. A method as in Claim 1 where the thermostatic controller operates a heating, ventilation and air conditioning system in a single family residence.

5. A method as in Claim 1 in which the at least one computer communicates with the thermostatic control device.

6. A method as in Claim 5 in which the at least one computer is not located in the same structure as the thermostatic controller.

7. A method as in Claim 5 in which the at least one computer sets programming for the thermostatic controller.

8. A method as in Claim 1 in which the thermostatic controller is programmable.

9. A method for incorporating manual changes to the setpoint for a thermostatic controller, the method comprising:

accessing stored data comprising a plurality of internal temperature measurements taken within a structure and a plurality of outside temperature measurements;

using the stored data to predict changes in temperatures inside the structure in response to at least changes in outside temperatures;

calculating scheduled programming of setpoints in the thermostatic controller based on the predicted rate of change, the scheduled programming comprising at least a first automated setpoint at a first time and a second automated setpoint at a second time;

comparing the actual setpoint at the first time for the thermostatic controller to the first automated setpoint for the thermostatic controller;

detecting a manual change to the first automated setpoint by determining whether the actual setpoint and the first automated setpoint are the same or different;

changing the second automated setpoint at the second time based on at least one rule for the interpretation of the manual change.

10. A method as in Claim 9 where the thermostatic controller operates a system for changing the air temperature in a structure.

11. A method as in Claim 9 where the thermostatic controller operates a heating, ventilation and air conditioning system.

12. A method as in Claim 9 where the thermostatic controller operates a heating, ventilation and air conditioning system in a single family residence.

13. A method as in Claim 9 in which at least one computer is in communication with the thermostatic control device.

14. A method as in Claim 13 in which the at least one computer is not located in the same structure as the thermostatic controller.

15. A method as in Claim 13 in which the at least one computer sets programming for the thermostatic controller.

16. A system as in Claim 9 in which the thermostatic controller is programmable.

17. An apparatus for detecting manual changes to one or more setpoints for a thermostatic controller, the apparatus comprising:

at least an electronic storage medium comprising stored data of a plurality of internal temperature measurements taken within a structure and a plurality of outside temperature measurements;

computer hardware configured to communicate with the electronic storage medium and with a programmable communicating thermostat, the computer hardware configured to use the stored data to predict a rate of change of temperatures inside the structure in response to changes in outside temperatures;

the computer hardware further configured to calculate scheduled setpoint programming of the programmable communicating thermostat for one or more times based on the predicted rate of change, the scheduled programming comprising one or more automated setpoints;

wherein the computer hardware is further configured to store in the electronic storage medium, the one or more automated setpoints associated with the scheduled programming for the programmable communicating thermostat;

wherein the computer hardware is further configured to obtain actual setpoint programming of the programmable communicating thermostat and store the actual setpoint programming in the electronic storage medium; and

wherein the computer hardware is further configured to compare the one or more automated setpoints associated with the scheduled setpoint programming with the actual setpoint programming.

18. An apparatus as in claim 17 where the programmable communicating thermostat operates a system for changing the air temperature in a structure.

19. An apparatus as in claim 17 where the programmable communicating thermostat operates a heating, ventilation and air conditioning system.

20. An apparatus as in claim 17 where the programmable communicating thermostat operates a heating, ventilation and air conditioning system in a single family residence.

21. An apparatus as in claim 17 further comprising the programmable communicating thermostat.

22. An apparatus as in claim 17 in which the computer hardware is not located in the same structure as the programmable communicating thermostat.

23. An apparatus as in claim 17 in which the computer hardware sets programming for the programmable communicating thermostat.

24. An apparatus as in claim 17 in which the electronic storage medium comprises one or more databases.

# SYSTEM, METHOD AND APPARATUS FOR IDENTIFYING MANUAL INPUTS TO AND ADAPTIVE PROGRAMMING OF A THERMOSTAT

## ABSTRACT OF THE DISCLOSURE

Systems and methods are disclosed for incorporating manual changes to the setpoint for a thermostatic controller into long-term programming of the thermostatic controller. For example, one or more of the exemplary systems compares the actual setpoint at a given time for the thermostatic controller to an expected setpoint for the thermostatic controller in light of the scheduled programming. A determination is then made as to whether the actual setpoint and the expected setpoint are the same or different. Furthermore, a manual change to the actual setpoint for the thermostatic controller is compared to previously recorded setpoint data for the thermostatic controller. At least one rule is then applied for the interpretation of the manual change in light of the previously recorded setpoint data.

17414057  
030614

SYSTEM, METHOD AND APPARATUS FOR IDENTIFYING MANUAL INPUTS TO  
AND ADAPTIVE PROGRAMMING OF A THERMOSTAT

INCORPORATION BY REFERENCE TO RELATED APPLICATIONS

**[0001]** This application hereby incorporates herein by reference under 37 C.F.R. § 1.57 the entirety of the disclosure of each application set forth in the foreign and domestic priority sections of the Application Data Sheet filed herewith.

BACKGROUND OF THE INVENTION

Field of the Invention

**[0002]** Programmable thermostats have been available for more than 20 years. Programmable thermostats offer two types of advantages as compared to non-programmable devices. On the one hand, programmable thermostats can save energy in large part because they automate the process of reducing conditioning during times when the space is unoccupied, or while occupants are sleeping, and thus reduce energy consumption.

**[0003]** On the other hand, programmable thermostats can also enhance comfort as compared to manually changing setpoints using a non-programmable thermostat. For example, during the winter, a homeowner might manually turn down the thermostat from 70 degrees F to 64 degrees when going to sleep and back to 70 degrees in the morning. The drawback to this approach is that there can be considerable delay between the adjustment of the thermostat and the achieving of the desired change in ambient temperature, and many people find getting out of bed, showering, etc. in a cold house unpleasant. A programmable thermostat allows homeowners to anticipate the desired result by programming a pre-conditioning of the home. So, for example, if the homeowner gets out of bed at 7AM, setting the thermostat to change from the overnight setpoint of 64 degrees to 70 at 6AM can make the house comfortable when the consumer gets up. The drawback to this approach is that the higher temperature will cost more to maintain, so the increase in comfort is purchased at the cost of higher energy usage.

**[0004]** But all of the advantages of a programmable thermostat depend on the match between the preferences of the occupants and the actual settings employed. If, for example, the thermostat is set to warm up the house on winter mornings at 7AM, but the homeowner gets up at 5:30, the homeowner is likely to be dissatisfied. If a homeowner has programmed her thermostat to cool down the house at 5PM each afternoon based on the assumption that she will come home at 6PM, but her schedule changes and she begins to arrive home at 4:30 each day, she is likely to be uncomfortable and either make frequent manual changes or go through the generally non-intuitive process of reprogramming the thermostat to match her new schedule. Because the limited interface on most thermostats, that process may take considerable effort, which leads many users to avoid reprogramming their thermostats for long periods or even to skip doing so entirely.

**[0005]** But even if a homeowner is able to align her schedule with the programming of her thermostat, there are additional difficulties associated with choosing proper temperatures at those times. If the temperatures programmed into a thermostat do not accurately reflect the preferences of the occupants, those occupants are likely to resort to manual overrides of the programmed settings. The need to correct the "mistakes" of the thermostat is likely to annoy many users. And because people tend to overshoot the desired temperature when they make such manual changes, these overrides are likely to result in excessive heating and cooling, and thus unnecessary energy use. That is, if a person feels uncomfortable on a summer afternoon when the setting is 73 degrees, they are likely to change it to 68 or 69 rather than 71 or 72 degrees, even if 72 degrees might have made enough of a difference.

**[0006]** It would therefore be advantageous to have a means for adapting to signaling from occupants in the form of manual temperature changes and incorporating the information contained in such gestures into long-term programming. It would also be desirable to take into account both outside weather conditions and the thermal characteristics of individual homes in order to improve the ability to dynamically achieve the best possible balance between comfort and energy savings.

## BRIEF DESCRIPTION OF THE DRAWINGS

**[0007]** Figure 1 shows an example of an overall environment in which an embodiment of the invention may be used.

**[0008]** Figure 2 shows a high-level illustration of the architecture of a network showing the relationship between the major elements of one embodiment of the subject invention.

**[0009]** Figure 3 shows an embodiment of the website to be used as part of the subject invention.

**[0010]** Figure 4 shows a high-level schematic of the thermostat used as part of the subject invention.

**[0011]** Figure 5 shows one embodiment of the database structure used as part of the subject invention.

**[0012]** ~~Figure 6 shows~~ Figures 6A and 6B show how comparing inside temperature against outside temperature and other variables permits calculation of dynamic signatures.

**[0013]** Figure 7 shows how manual inputs can be recognized and recorded by the subject invention.

**[0014]** Figure 8 shows how the subject invention uses manual inputs to interpret manual overrides and make short-term changes in response thereto.

**[0015]** Figure 9 shows how the subject invention uses manual inputs to alter long-term changes to interpretive rules and to setpoint scheduling.

**[0016]** Figure 10 shows an example of some of the contextual data that may be used by the server in order to interpret manual overrides.

## DETAILED DESCRIPTION OF THE PREFERRED EMBODIMENT

**[0017]** **Figure 1** shows an example of an overall environment 100 in which an embodiment of the invention may be used. The environment 100 includes an interactive communication network 102 with computers 104 connected thereto. Also connected to network 102 are one or more server computers 106, which store



information and make the information available to computers 104. The network 102 allows communication between and among the computers 104 and 106.

**[0018]** Presently preferred network 102 comprises a collection of interconnected public and/or private networks that are linked to together by a set of standard protocols to form a distributed network. While network 102 is intended to refer to what is now commonly referred to as the Internet, it is also intended to encompass variations which may be made in the future, including changes additions to existing standard protocols.

**[0019]** One popular part of the Internet is the World Wide Web. The World Wide Web contains a large number of computers 104 and servers 106, which store HyperText Markup Language (HTML) and other documents capable of displaying graphical and textual information. HTML is a standard coding convention and set of codes for attaching presentation and linking attributes to informational content within documents.

**[0020]** The servers 106 that provide offerings on the World Wide Web are typically called websites. A website is often defined by an Internet address that has an associated electronic page. Generally, an electronic page is a document that organizes the presentation of text graphical images, audio and video.

**[0021]** In addition to the Internet, the network 102 can comprise a wide variety of interactive communication media. For example, network 102 can include local area networks, interactive television networks, telephone networks, wireless data systems, two-way cable systems, and the like.

**[0022]** Network 102 can also comprise servers 106 that provide services other than HTML documents. Such services may include the exchange of data with a wide variety of "edge" devices, some of which may not be capable of displaying web pages, but that can record, transmit and receive information.

**[0023]** In one embodiment, computers 104 and servers 106 are conventional computers that are equipped with communications hardware such as modem or a network interface card. The computers include processors such as those sold by Intel and AMD. Other processors may also be used, including

general-purpose processors, multi-chip processors, embedded processors and the like.

**[0024]** Computers 104 can also be handheld and wireless devices such as personal digital assistants (PDAs), cellular telephones and other devices capable of accessing the network.

**[0025]** Computers 104 may utilize a browser configured to interact with the World Wide Web. Such browsers may include Microsoft Explorer, Mozilla, Firefox, Opera or Safari. They may also include browsers used on handheld and wireless devices.

**[0026]** The storage medium may comprise any method of storing information. It may comprise random access memory (RAM), electronically erasable programmable read only memory (EEPROM), read only memory (ROM), hard disk, floppy disk, CD-ROM, optical memory, or other method of storing data.

**[0027]** Computers 104 and 106 may use an operating system such as Microsoft Windows, Apple Mac OS, Linux, Unix or the like.

**[0028]** Computers 106 may include a range of devices that provide information, sound, graphics and text, and may use a variety of operating systems and software optimized for distribution of content via networks.

**[0029]** **Figure 2** illustrates in further detail the architecture of the specific components connected to network 102 showing the relationship between the major elements of one embodiment of the subject invention. Attached to the network are thermostats 108 and computers 104 of various users. Connected to thermostats 108 are HVAC units 110. The HVAC units may be conventional air conditioners, heat pumps, or other devices for transferring heat into or out of a building. Each user may be connected to server 106 via wired or wireless connection such as Ethernet or a wireless protocol such as IEEE 802.11, and router and/or gateway or wireless access point 112 that connects the computer and thermostat to the Internet via a broadband connection such as a digital subscriber line (DSL) or other form of broadband connection to the World Wide Web. In one embodiment, thermostat management server 106 is in communication with the network 102. Server 106 contains the content to be served as web pages and viewed by computers 104, as

well as databases containing information used by the servers, and applications used to remotely manage thermostats 108.

**[0030]** In the currently preferred embodiment, the website 200 includes a number of components accessible to the user, as shown in **Figure 3**. Those components may include a means to store temperature settings 202, a means to enter information about the user's home 204, a means to enter the user's electricity bills 206, and means to elect to enable the subject invention 208.

**[0031]** **Figure 4** shows a high-level block diagram of thermostat 108 used as part of the subject invention. Thermostat 108 includes temperature sensing means 252, which may be a thermistor, thermal diode or other means commonly used in the design of electronic thermostats. It includes a microprocessor 254, memory 256, a display 258, a power source 260, and at least one relay 262, which turns the HVAC system on and off in response to a signal from the microprocessor, and contacts by which the relay is connected to the wires that lead to the HVAC system. To allow the thermostat to communicate bi-directionally with the computer network, the thermostat also includes means 264 to connect the thermostat to a local computer or to a wired or wireless network. Such means could be in the form of Ethernet, wireless protocols such as IEEE 802.11, IEEE 802.15.4, Bluetooth, or other wireless protocols. The thermostat may be connected to the computer network directly via wired or wireless Internet Protocol connection. Alternatively, the thermostat may connect wirelessly to a gateway such as an IP-to-Zigbee gateway, an IP-to-Z-wave gateway, or the like. Where the communications means enabled include wireless communication, antenna 266 will also be included. The thermostat 250 may also include controls 268 allowing users to change settings directly at the thermostat, but such controls are not necessary to allow the thermostat to function.

**[0032]** The data used to generate the content delivered in the form of the website and to automate control of thermostat 108 is stored on one or more servers 106 within one or more databases. As shown in **Figure 5**, the overall database structure 300 may include temperature database 400, thermostat settings database 500, energy bill database 600, HVAC hardware database 700, weather database 800, user database 900, transaction database 1000, product and service database

1100 and such other databases as may be needed to support these and additional features.

**[0033]** The website will allow users of connected thermostats 108 to create personal accounts. Each user's account will store information in database 900, which tracks various attributes relative to users. Such attributes may include the make and model of the specific HVAC equipment in the user's home; the age and square footage of the home, the solar orientation of the home, the location of the thermostat in the home, the user's preferred temperature settings, etc.

**[0034]** As shown in Figure 3, the website 200 will permit thermostat users to perform through the web browser substantially all of the programming functions traditionally performed directly at the physical thermostat, such as temperature set points, the time at which the thermostat should be at each set point, etc. Preferably the website will also allow users to accomplish more advanced tasks such as allow users to program in vacation settings for times when the HVAC system may be turned off or run at more economical settings, and set macros that will allow changing the settings of the temperature for all periods with a single gesture such as a mouse click.

**[0035]** In addition to using the system to allow better signaling and control of the HVAC system, which relies primarily on communication running from the server to the thermostat, the bi-directional communication will also allow the thermostat 108 to regularly measure and send to the server information about the temperature in the building. By comparing outside temperature, inside temperature, thermostat settings, cycling behavior of the HVAC system, and other variables, the system will be capable of numerous diagnostic and controlling functions beyond those of a standard thermostat.

**[0036]** For example, **Fig. 6a** shows a graph of inside temperature, outside temperature and HVAC activity for a 24-hour period. When outside temperature 302 increases, inside temperature 304 follows, but with some delay because of the thermal mass of the building, unless the air conditioning 306 operates to counteract this effect. When the air conditioning turns on, the inside temperature stays constant (or rises at a much lower rate or even falls) despite the rising outside

temperature. In this example, frequent and heavy use of the air conditioning results in only a very slight temperature increase inside the house of 4 degrees, from 72 to 76 degrees, despite the increase in outside temperature from 80 to 100 degrees.

**[0037]** **Figure 6b** shows a graph of the same house on the same day, but assumes that the air conditioning is turned off from noon to 7PM. As expected, the inside temperature 304a rises with increasing outside temperatures 302 for most of that period, reaching 88 degrees at 7PM. Because server 106 logs the temperature readings from inside each house (whether once per minute or over some other interval), as well as the timing and duration of air conditioning cycles, database 300 will contain a history of the thermal performance of each house. That performance data will allow server 106 to calculate an effective thermal mass for each such structure – that is, the speed with the temperature inside a given building will change in response to changes in outside temperature. Because the server will also log these inputs against other inputs including time of day, humidity, etc. the server will be able to predict, at any given time on any given day, the rate at which inside temperature should change for given inside and outside temperatures.

**[0038]** The ability to predict the rate of change in inside temperature in a given house under varying conditions may be applied by in effect holding the desired future inside temperature as a constraint and using the ability to predict the rate of change to determine when the HVAC system must be turned on in order to reach the desired temperature at the desired time.

**[0039]** In order to adapt programming to take into account the manual overrides entered into the thermostat, it is first necessary to determine when a manual override has in fact occurred. Most thermostats, including two-way communicating devices discussed herein, do not record such inputs locally, and neither recognize nor transmit the fact that a manual override has occurred. Furthermore, in a system as described herein, frequent changes in setpoints may be initiated by algorithms running on the server, thereby making it impossible to infer a manual override from the mere fact that the setpoint has changed. It is therefore necessary to deduce the occurrence of such events from the data that the subject invention does have access to.

**[0040]** Figure 7 illustrates the currently preferred method for detecting the occurrence of a manual override event. In step 1002, the server retrieves the primary data points used to infer the occurrence of a manual override from one or more databases in overall database structure 300. The data should include each of the following: for the most recent point for which it can obtain such data (time0) the actual setpoint as recorded at the thermostat (A0); for the point immediately prior to time0, (time-1), the actual setpoint recorded for the thermostat (A-1); for time0 the setpoint as scheduled by server 106 according to the standard setpoint programming (S0), and for time-1 the setpoint as scheduled by server 106 according to the standard setpoint programming (S-1). In step 1004, the server retrieves any additional automated setpoint changes C that have been scheduled for the thermostat by server 106 at time0. Such changes may include algorithmic changes intended to reduce energy consumption, etc. In step 1006 the server calculates the difference (dA) between A0 and A-1; for example, if the setpoint at T0 is 67 degrees at T-1 and 69 at T0, dA is +2; if the setpoint at T-1 is 70 and the setpoint at T0 is 66, dA is -4. In step 1008, the server performs similar steps in order to calculate dS, the difference between S0 and S-1. This is necessary because, for example, the setpoint may have been changed because the server itself had just executed a change, such as a scheduled change from "away" to "home" mode. In step 1010 the server evaluates and sums all active algorithms and other server-initiated strategies to determine their net effect on setpoint at time0. For example, if one algorithm has increased setpoint at time0 by 2 degrees as a short-term energy savings measure, but another algorithm has decreased the setpoint by one degree to compensate for expected subjective reactions to weather conditions, the net algorithmic effect sC is +1 degree.

**[0041]** In step 1012, the server calculates the value for M, where M is equal to the difference between actual setpoints dA, less the difference between scheduled setpoints dS, less the aggregate of algorithmic change sC. In step 1014 the server evaluates this difference. If the difference equals zero, the server concludes that no manual override has occurred, and the routine terminates. But if the difference is any value other than zero, then the server concludes that a manual

override has occurred. Thus in step 1016 the server logs the occurrence of an override to one or more databases in overall database structure 300.

**[0042]** The process of interpreting a manual override is shown in **Figure 8**. 1102 is the detection of an override, as described in detail in Figure 7. In step 1104 the server retrieves contextual data required to interpret the manual override. Such data may include current and recent weather conditions, current and recent inside temperatures, etc. This data is helpful because it is likely that manual overrides are at least in part deterministic: that is, that they may often be explained by such contextual data, and that such understanding can permit anticipation of the desire on the part of the occupants to override and to adjust programming accordingly, so as to anticipate and obviate the need for such changes. In step 1106 the server retrieves any override data from the period preceding the specific override being evaluated that has not yet been evaluated by and incorporated into the long-term programming and rules engines as described below in Figure 9. The amount of data may be for a period of a few hours to as long as several days or more. Recent data will be more heavily weighted than older data in order to assure rapid adaptation to situations in which manual overrides represent stable changes such as changes in work schedules, etc. In step 1108 the server retrieves the stored rules for the subject thermostat 108. Such rules may include weather and time-related inferences such as “if outside temperature is greater than 85 degrees and inside temperature is more than 2 degrees above setpoint and manual override lowers setpoint by 3 or more degrees, then revert to original setpoint in 2 hours,” or “if heating setpoint change is scheduled from “away” to “home” within following 2 hours after detected override, and override increases setpoint by at least 2 degrees, then change to “home” setting,” or the like. In step 1110 the server applies the rules to the override and determines which rule, if any, should be applied as a result of the override. In step 1112 the server determines whether to alter the current setpoint as a result of applying the rules in step 1110. If no setpoint change is indicated, then the server proceeds to step 1118. If a setpoint change is indicated, then in step 1114 the server transmits the setpoint change to the thermostat, and in step 1116 it records that change to one or more databases in overall database structure 300.

**[0043]** In order to ensure that both the stored rules for interpreting manual overrides and the programming itself continue to most accurately reflect the intentions of the occupants, the server will periodically review both the rules used to interpret overrides and the setpoint scheduling employed. **Figure 9** shows the steps used to incorporate manual overrides into the long-term rules and setpoint schedule. In step 1202 the server retrieves the stored programming for a given thermostat as well as the rules for interpreting overrides for that thermostat. In step 1204 the server retrieves the recent override data as recorded in Figures 7 and 8 to be evaluated for possible revisions to the rules and the programming. In step 1206 the server retrieves the contextual data regarding overrides retrieved in step 1204 (Because the process illustrated in Figure 9 is not presently expected to be executed as a real-time process, and to be run anywhere from once per day to once per month, the range and volume of contextual data to be evaluated is likely to be greater than in the process illustrated in Figure 8). In step 1208 the server interprets the overrides in light of the existing programming schedule, rules for overrides, contextual data, etc. In step 1210 the server determines whether, as a result of those overrides as interpreted, the rules for interpreting manual overrides should be revised. If the rules are not to be revised, the server moves to step 1214. If the rules are to be revised, then in step 1212 the server revises the rules and the new rules are stored in one or more databases in overall database structure 300. In step 1214 the server determines whether any changes to the baseline programming for the thermostat should be revised. If not the routine terminates. If revisions are warranted, then in step 1216 the server retrieves from database 900 the permissions the server has to make autonomous changes to settings. If the server has been given permission to make the proposed changes, then in step 1218 the server revises the thermostat's programming and writes the changes to one or more databases in overall database structure 300. If the server has not been authorized to make such changes autonomously, then in step 1220 the server transmits the recommendation to change settings to the customer in the manner previously specified by the customer, such as email, changes to the customer's home page as displayed on website 200, etc.



**[0044]** Figure 10 shows an example of some of the contextual data that may be used by the server in order to interpret manual overrides. Such data may include inside temperature 1302, outside temperature 1304, cloud cover 1306, humidity 1308, barometric pressure 1310, wind speed 1312, and wind direction 1314.

**[0045]** Each of these data points should be captured at frequent intervals. In the preferred embodiment, as shown in Figure 10, the interval is once every 60 seconds.

**[0046]** Additional means of implementing the instant invention may be achieved using variations in system architecture. For example, much or even all of the work being accomplished by remote server 106 may also be done by thermostat 108 if that device has sufficient processing capabilities, memory, etc. Alternatively, some or all of these steps may be undertaken by a local processor such as a local personal computer, gateway 112, or by a dedicated appliance having the requisite capabilities.

**[0047]** While certain embodiments of the inventions have been described, these embodiments have been presented by way of example only, and are not intended to limit the scope of the inventions. Indeed, the novel methods and systems described herein may be embodied in a variety of other forms; furthermore, various omissions, substitutions and changes in the form of the methods and systems described herein may be made without departing from the spirit of the inventions. The accompanying claims and their equivalents are intended to cover such forms or modifications as would fall within the scope and spirit of the inventions.

WHAT IS CLAIMED IS:

1. A method for detecting manual changes to the setpoint for a thermostatic controller comprising:

accessing stored data comprising a plurality of internal temperature measurements taken within a structure and a plurality of outside temperature measurements;

using the stored data to predict changes in temperature inside the structure in response to at least changes in outside temperatures;

calculating with at least one computer, scheduled programming of the thermostatic controller for one or more times, the scheduled programming comprising at least a first automated setpoint at a first time;

generating with the at least one computer, a difference value based on comparing an actual setpoint at the first time for the thermostatic controller to the first automated setpoint for the thermostatic controller;

detecting a manual change to the first automated setpoint by determining whether the actual setpoint and the first automated setpoint are the same or different based on the difference value; and

logging the manual change to a database.

2. A method as in Claim 1 where the thermostatic controller operates a system for changing the air temperature in a structure.

3. A method as in Claim 1 where the thermostatic controller operates a heating, ventilation and air conditioning system.

4. A method as in Claim 1 where the thermostatic controller operates a heating, ventilation and air conditioning system in a single family residence.

5. A method as in Claim 1 in which the at least one computer communicates with the thermostatic control device.

6. A method as in Claim 5 in which the at least one computer is not located in the same structure as the thermostatic controller.

7. A method as in Claim 5 in which the at least one computer sets programming for the thermostatic controller.

8. A method as in Claim 1 in which the thermostatic controller is programmable.

9. A method for incorporating manual changes to the setpoint for a thermostatic controller, the method comprising:

accessing stored data comprising a plurality of internal temperature measurements taken within a structure and a plurality of outside temperature measurements;

using the stored data to predict changes in temperatures inside the structure in response to at least changes in outside temperatures;

calculating scheduled programming of setpoints in the thermostatic controller based on the predicted rate of change, the scheduled programming comprising at least a first automated setpoint at a first time and a second automated setpoint at a second time;

comparing the actual setpoint at the first time for the thermostatic controller to the first automated setpoint for the thermostatic controller;

detecting a manual change to the first automated setpoint by determining whether the actual setpoint and the first automated setpoint are the same or different;

changing the second automated setpoint at the second time based on at least one rule for the interpretation of the manual change.

10. A method as in Claim 9 where the thermostatic controller operates a system for changing the air temperature in a structure.

11. A method as in Claim 9 where the thermostatic controller operates a heating, ventilation and air conditioning system.

12. A method as in Claim 9 where the thermostatic controller operates a heating, ventilation and air conditioning system in a single family residence.

13. A method as in Claim 9 in which at least one computer is in communication with the thermostatic control device.

14. A method as in Claim 13 in which the at least one computer is not located in the same structure as the thermostatic controller.

15. A method as in Claim 13 in which the at least one computer sets programming for the thermostatic controller.

16. A system as in Claim 9 in which the thermostatic controller is programmable.

17. An apparatus for detecting manual changes to one or more setpoints for a thermostatic controller, the apparatus comprising:

at least an electronic storage medium comprising stored data of a plurality of internal temperature measurements taken within a structure and a plurality of outside temperature measurements;

computer hardware configured to communicate with the electronic storage medium and with a programmable communicating thermostat, the computer hardware configured to use the stored data to predict a rate of change of temperatures inside the structure in response to changes in outside temperatures;

the computer hardware further configured to calculate scheduled setpoint programming of the programmable communicating thermostat for one or more times based on the predicted rate of change, the scheduled programming comprising one or more automated setpoints;

wherein the computer hardware is further configured to store in the electronic storage medium, the one or more automated setpoints associated with the scheduled programming for the programmable communicating thermostat;

wherein the computer hardware is further configured to obtain actual setpoint programming of the programmable communicating thermostat and store the actual setpoint programming in the electronic storage medium; and

wherein the computer hardware is further configured to compare the one or more automated setpoints associated with the scheduled setpoint programming with the actual setpoint programming.

18. An apparatus as in claim 17 where the programmable communicating thermostat operates a system for changing the air temperature in a structure.

19. An apparatus as in claim 17 where the programmable communicating thermostat operates a heating, ventilation and air conditioning system.

20. An apparatus as in claim 17 where the programmable communicating thermostat operates a heating, ventilation and air conditioning system in a single family residence.

21. An apparatus as in claim 17 further comprising the programmable communicating thermostat.

22. An apparatus as in claim 17 in which the computer hardware is not located in the same structure as the programmable communicating thermostat.

23. An apparatus as in claim 17 in which the computer hardware sets programming for the programmable communicating thermostat.

24. An apparatus as in claim 17 in which the electronic storage medium comprises one or more databases.

SYSTEM, METHOD AND APPARATUS FOR IDENTIFYING MANUAL INPUTS TO  
AND ADAPTIVE PROGRAMMING OF A THERMOSTAT

ABSTRACT OF THE DISCLOSURE

Systems and methods are disclosed for incorporating manual changes to the setpoint for a thermostatic controller into long-term programming of the thermostatic controller. For example, one or more of the exemplary systems compares the actual setpoint at a given time for the thermostatic controller to an expected setpoint for the thermostatic controller in light of the scheduled programming. A determination is then made as to whether the actual setpoint and the expected setpoint are the same or different. Furthermore, a manual change to the actual setpoint for the thermostatic controller is compared to previously recorded setpoint data for the thermostatic controller. At least one rule is then applied for the interpretation of the manual change in light of the previously recorded setpoint data.

17414025  
030614



UNITED STATES PATENT AND TRADEMARK OFFICE

UNITED STATES DEPARTMENT OF COMMERCE
United States Patent and Trademark Office
Address: COMMISSIONER FOR PATENTS
P.O. Box 1450
Alexandria, Virginia 22313-1450
www.uspto.gov

Table with 7 columns: APPLICATION NUMBER, FILING or 371(c) DATE, GRP ART UNIT, FIL FEE REC'D, ATTY. DOCKET NO, TOT CLAIMS, IND CLAIMS. Row 1: 14/082,675, 11/18/2013, 3744, 960, EFACT.007C1, 24, 3

CONFIRMATION NO. 3336

FILING RECEIPT

20995
KNOBBE MARTENS OLSON & BEAR LLP
2040 MAIN STREET
FOURTEENTH FLOOR
IRVINE, CA 92614



Date Mailed: 12/09/2013

Receipt is acknowledged of this non-provisional patent application. The application will be taken up for examination in due course. Applicant will be notified as to the results of the examination. Any correspondence concerning the application must include the following identification information: the U.S. APPLICATION NUMBER, FILING DATE, NAME OF APPLICANT, and TITLE OF INVENTION. Fees transmitted by check or draft are subject to collection. Please verify the accuracy of the data presented on this receipt. If an error is noted on this Filing Receipt, please submit a written request for a Filing Receipt Correction. Please provide a copy of this Filing Receipt with the changes noted thereon. If you received a "Notice to File Missing Parts" for this application, please submit any corrections to this Filing Receipt with your reply to the Notice. When the USPTO processes the reply to the Notice, the USPTO will generate another Filing Receipt incorporating the requested corrections

Inventor(s)

John Douglas Steinberg, Millbrae, CA;
Scott Douglas Hublou, Redwood City, CA;
Leo Cheung, Sunnyvale, CA;

Applicant(s)

EcoFactor, Inc., Millbrae, CA

Assignment For Published Patent Application

EcoFactor, Inc., Millbrae, CA

Power of Attorney: None

Domestic Priority data as claimed by applicant

This application is a CON of 12/778,052 05/11/2010 PAT 8596550
which claims benefit of 61/215,999 05/12/2009

Foreign Applications for which priority is claimed (You may be eligible to benefit from the Patent Prosecution Highway program at the USPTO. Please see http://www.uspto.gov for more information.) - None.

Foreign application information must be provided in an Application Data Sheet in order to constitute a claim to foreign priority. See 37 CFR 1.55 and 1.76.

If Required, Foreign Filing License Granted: 11/29/2013

The country code and number of your priority application, to be used for filing abroad under the Paris Convention, is US 14/082,675

Projected Publication Date: To Be Determined - pending completion of Corrected Papers

Non-Publication Request: No

Early Publication Request: No

**\*\* SMALL ENTITY \*\***

**Title**

SYSTEM, METHOD AND APPARATUS FOR IDENTIFYING MANUAL INPUTS TO AND ADAPTIVE PROGRAMMING OF A THERMOSTAT

**Preliminary Class**

236

**Statement under 37 CFR 1.55 or 1.78 for AIA (First Inventor to File) Transition Applications: No**

**PROTECTING YOUR INVENTION OUTSIDE THE UNITED STATES**

Since the rights granted by a U.S. patent extend only throughout the territory of the United States and have no effect in a foreign country, an inventor who wishes patent protection in another country must apply for a patent in a specific country or in regional patent offices. Applicants may wish to consider the filing of an international application under the Patent Cooperation Treaty (PCT). An international (PCT) application generally has the same effect as a regular national patent application in each PCT-member country. The PCT process **simplifies** the filing of patent applications on the same invention in member countries, but **does not result** in a grant of "an international patent" and does not eliminate the need of applicants to file additional documents and fees in countries where patent protection is desired.

Almost every country has its own patent law, and a person desiring a patent in a particular country must make an application for patent in that country in accordance with its particular laws. Since the laws of many countries differ in various respects from the patent law of the United States, applicants are advised to seek guidance from specific foreign countries to ensure that patent rights are not lost prematurely.

Applicants also are advised that in the case of inventions made in the United States, the Director of the USPTO must issue a license before applicants can apply for a patent in a foreign country. The filing of a U.S. patent application serves as a request for a foreign filing license. The application's filing receipt contains further information and guidance as to the status of applicant's license for foreign filing.

Applicants may wish to consult the USPTO booklet, "General Information Concerning Patents" (specifically, the section entitled "Treaties and Foreign Patents") for more information on timeframes and deadlines for filing foreign patent applications. The guide is available either by contacting the USPTO Contact Center at 800-786-9199, or it can be viewed on the USPTO website at <http://www.uspto.gov/web/offices/pac/doc/general/index.html>.

For information on preventing theft of your intellectual property (patents, trademarks and copyrights), you may wish to consult the U.S. Government website, <http://www.stopfakes.gov>. Part of a Department of Commerce initiative, this website includes self-help "toolkits" giving innovators guidance on how to protect intellectual property in specific countries such as China, Korea and Mexico. For questions regarding patent enforcement issues, applicants may call the U.S. Government hotline at 1-866-999-HALT (1-866-999-4258).



**LICENSE FOR FOREIGN FILING UNDER**  
**Title 35, United States Code, Section 184**  
**Title 37, Code of Federal Regulations, 5.11 & 5.15**

**GRANTED**

The applicant has been granted a license under 35 U.S.C. 184, if the phrase "IF REQUIRED, FOREIGN FILING LICENSE GRANTED" followed by a date appears on this form. Such licenses are issued in all applications where the conditions for issuance of a license have been met, regardless of whether or not a license may be required as set forth in 37 CFR 5.15. The scope and limitations of this license are set forth in 37 CFR 5.15(a) unless an earlier license has been issued under 37 CFR 5.15(b). The license is subject to revocation upon written notification. The date indicated is the effective date of the license, unless an earlier license of similar scope has been granted under 37 CFR 5.13 or 5.14.

This license is to be retained by the licensee and may be used at any time on or after the effective date thereof unless it is revoked. This license is automatically transferred to any related applications(s) filed under 37 CFR 1.53(d). This license is not retroactive.

The grant of a license does not in any way lessen the responsibility of a licensee for the security of the subject matter as imposed by any Government contract or the provisions of existing laws relating to espionage and the national security or the export of technical data. Licensees should apprise themselves of current regulations especially with respect to certain countries, of other agencies, particularly the Office of Defense Trade Controls, Department of State (with respect to Arms, Munitions and Implements of War (22 CFR 121-128)); the Bureau of Industry and Security, Department of Commerce (15 CFR parts 730-774); the Office of Foreign Assets Control, Department of Treasury (31 CFR Parts 500+) and the Department of Energy.

**NOT GRANTED**

No license under 35 U.S.C. 184 has been granted at this time, if the phrase "IF REQUIRED, FOREIGN FILING LICENSE GRANTED" DOES NOT appear on this form. Applicant may still petition for a license under 37 CFR 5.12, if a license is desired before the expiration of 6 months from the filing date of the application. If 6 months has lapsed from the filing date of this application and the licensee has not received any indication of a secrecy order under 35 U.S.C. 181, the licensee may foreign file the application pursuant to 37 CFR 5.15(b).

---

***SelectUSA***

The United States represents the largest, most dynamic marketplace in the world and is an unparalleled location for business investment, innovation, and commercialization of new technologies. The U.S. offers tremendous resources and advantages for those who invest and manufacture goods here. Through SelectUSA, our nation works to promote and facilitate business investment. SelectUSA provides information assistance to the international investor community; serves as an ombudsman for existing and potential investors; advocates on behalf of U.S. cities, states, and regions competing for global investment; and counsels U.S. economic development organizations on investment attraction best practices. To learn more about why the United States is the best country in the world to develop technology, manufacture products, deliver services, and grow your business, visit <http://www.SelectUSA.gov> or call +1-202-482-6800.



UNITED STATES PATENT AND TRADEMARK OFFICE

UNITED STATES DEPARTMENT OF COMMERCE
United States Patent and Trademark Office
Address: COMMISSIONER FOR PATENTS
P.O. Box 1450
Alexandria, Virginia 22313-1450
www.uspto.gov

Table with 4 columns: APPLICATION NUMBER (14/082,675), FILING OR 371(C) DATE (11/18/2013), FIRST NAMED APPLICANT (John Douglas Steinberg), ATTY. DOCKET NO./TITLE (EFACT.007C1)

CONFIRMATION NO. 3336
FORMALITIES LETTER

20995
KNOBBE MARTENS OLSON & BEAR LLP
2040 MAIN STREET
FOURTEENTH FLOOR
IRVINE, CA 92614



Date Mailed: 12/09/2013

NOTICE TO FILE CORRECTED APPLICATION PAPERS

Filing Date Granted

An application number and filing date have been accorded to this application. The application is informal since it does not comply with the regulations for the reason(s) indicated below. Applicant is given TWO MONTHS from the date of this Notice within which to correct the informalities indicated below. Extensions of time may be obtained by filing a petition accompanied by the extension fee under the provisions of 37 CFR 1.136(a).

The required item(s) identified below must be timely submitted to avoid abandonment:

- A substitute specification in compliance with 37 CFR 1.52, 1.121(b)(3), and 1.125, is required. The substitute specification must be submitted with markings and be accompanied by a clean version (without markings) as set forth in 37 CFR 1.125(c) and a statement that the substitute specification contains no new matter (see 37 CFR 1.125(b)). The specification, claims, and/or abstract page(s) submitted is not acceptable and cannot be scanned or properly stored because:
- The application contains drawings, but the specification does not contain a brief description of the several views of the drawings as required by 37 CFR 1.74 and 37 CFR 1.77(b)(7).
- Replacement drawings in compliance with 37 CFR 1.84 and 37 CFR 1.121(d) are required. The drawings submitted are not acceptable because:
- More than one figure is present and each figure is not labeled "Fig." with a consecutive Arabic numeral (1, 2, etc.) or an Arabic numeral and capital letter in the English alphabet (A, B, etc.)(see 37 CFR 1.84(u)(1)). See Figure(s) 6. A brief description of the several views of the drawings (see 37 CFR 1.74) should be added or amended to correspond to the corrected numbering of the figures. See also 37 CFR 1.77(b)(7).

Applicant is cautioned that correction of the above items may cause the specification and drawings page count to exceed 100 pages. If the specification and drawings exceed 100 pages, applicant will need to submit the required application size fee.

Items Required To Avoid Processing Delays:

Applicant is notified that the above-identified application contains the deficiencies noted below. No period for reply is set forth in this notice for correction of these deficiencies. However, if a deficiency relates to the inventor's oath or declaration, the applicant must file an oath or declaration in compliance with 37 CFR 1.63, or a substitute statement in compliance with 37 CFR 1.64, executed by or with respect to each actual inventor no later than the expiration of the time period set in the "Notice of Allowability" to avoid abandonment. See 37 CFR 1.53(f).

- A properly executed inventor's oath or declaration has not been received for the following inventor(s):
John Douglas Steinberg

Scott Douglas Hublou  
Leo Cheung

Applicant may submit the inventor's oath or declaration at any time before the Notice of Allowance and Fee(s) Due, PTOL-85, is mailed.

Replies must be received in the USPTO within the set time period or must include a proper Certificate of Mailing or Transmission under 37 CFR 1.8 with a mailing or transmission date within the set time period. For more information and a suggested format, see Form PTO/SB/92 and MPEP 512.

Replies should be mailed to:

Mail Stop Missing Parts  
Commissioner for Patents  
P.O. Box 1450  
Alexandria VA 22313-1450

Registered users of EFS-Web may alternatively submit their reply to this notice via EFS-Web.  
<https://sportal.uspto.gov/authenticate/AuthenticateUserLocalEPF.html>

For more information about EFS-Web please call the USPTO Electronic Business Center at **1-866-217-9197** or visit our website at <http://www.uspto.gov/ebc>.

If you are not using EFS-Web to submit your reply, you must include a copy of this notice.

/tmelesse/

---

Office of Data Management, Application Assistance Unit (571) 272-4000, or (571) 272-4200, or 1-888-786-0101

**PATENT APPLICATION FEE DETERMINATION RECORD**

Substitute for Form PTO-875

Application or Docket Number  
14/082,675

**APPLICATION AS FILED - PART I**

(Column 1) (Column 2)

| FOR   | NUMBER FILED  | NUMBER EXTRA |
|---|---|--------------|
| BASIC FEE<br>(37 CFR 1.16(a), (b), or (c))        | N/A   | N/A          |
| SEARCH FEE<br>(37 CFR 1.16(k), (l), or (m))       | N/A   | N/A          |
| EXAMINATION FEE<br>(37 CFR 1.16(o), (p), or (q))  | N/A   | N/A          |
| TOTAL CLAIMS<br>(37 CFR 1.16(j))                  | 24 minus 20 = *   | 4            |
| INDEPENDENT CLAIMS<br>(37 CFR 1.16(h))            | 3 minus 3 = *   |              |
| APPLICATION SIZE FEE<br>(37 CFR 1.16(s))          | If the specification and drawings exceed 100 sheets of paper, the application size fee due is \$310 (\$155 for small entity) for each additional 50 sheets or fraction thereof. See 35 U.S.C. 41(a)(1)(G) and 37 CFR 1.16(s). |              |
| MULTIPLE DEPENDENT CLAIM PRESENT (37 CFR 1.16(j)) |   |              |

\* If the difference in column 1 is less than zero, enter "0" in column 2.

**SMALL ENTITY**

| RATE(\$) | FEE(\$) |
|----------|---------|
| N/A      | 70      |
| N/A      | 300     |
| N/A      | 360     |
| x 40 =   | 160     |
| x 210 =  | 0.00    |
|          | 0.00    |
| TOTAL    | 890     |

**OR OTHER THAN SMALL ENTITY**

| RATE(\$) | FEE(\$) |
|----------|---------|
| N/A      |         |
| N/A      |         |
| N/A      |         |
|          |         |
|          |         |
|          |         |
| TOTAL    |         |

**APPLICATION AS AMENDED - PART II**

(Column 1) (Column 2) (Column 3)

| AMENDMENT A   |                                       | CLAIMS REMAINING AFTER AMENDMENT |       | HIGHEST NUMBER PREVIOUSLY PAID FOR | PRESENT EXTRA |
|---|---------------------------------------|----------------------------------|-------|------------------------------------|---------------|
|   | Total<br>(37 CFR 1.16(i))             | *                                | Minus | **                                 | =             |
|   | Independent<br>(37 CFR 1.16(h))       | *                                | Minus | ***                                | =             |
|   | Application Size Fee (37 CFR 1.16(s)) |                                  |       |                                    |               |
| FIRST PRESENTATION OF MULTIPLE DEPENDENT CLAIM (37 CFR 1.16(j)) |                                       |                                  |       |                                    |               |

**SMALL ENTITY**

| RATE(\$)        | ADDITIONAL FEE(\$) |
|-----------------|--------------------|
| x =             |                    |
| x =             |                    |
|                 |                    |
|                 |                    |
| TOTAL ADD'L FEE |                    |

**OR OTHER THAN SMALL ENTITY**

| RATE(\$)        | ADDITIONAL FEE(\$) |
|-----------------|--------------------|
| x =             |                    |
| x =             |                    |
|                 |                    |
|                 |                    |
| TOTAL ADD'L FEE |                    |

(Column 1) (Column 2) (Column 3)

| AMENDMENT B   |                                       | CLAIMS REMAINING AFTER AMENDMENT |       | HIGHEST NUMBER PREVIOUSLY PAID FOR | PRESENT EXTRA |
|---|---------------------------------------|----------------------------------|-------|------------------------------------|---------------|
|   | Total<br>(37 CFR 1.16(i))             | *                                | Minus | **                                 | =             |
|   | Independent<br>(37 CFR 1.16(h))       | *                                | Minus | ***                                | =             |
|   | Application Size Fee (37 CFR 1.16(s)) |                                  |       |                                    |               |
| FIRST PRESENTATION OF MULTIPLE DEPENDENT CLAIM (37 CFR 1.16(j)) |                                       |                                  |       |                                    |               |

| RATE(\$)        | ADDITIONAL FEE(\$) |
|-----------------|--------------------|
| x =             |                    |
| x =             |                    |
|                 |                    |
|                 |                    |
| TOTAL ADD'L FEE |                    |

**OR OTHER THAN SMALL ENTITY**

| RATE(\$)        | ADDITIONAL FEE(\$) |
|-----------------|--------------------|
| x =             |                    |
| x =             |                    |
|                 |                    |
|                 |                    |
| TOTAL ADD'L FEE |                    |

\* If the entry in column 1 is less than the entry in column 2, write "0" in column 3.  
 \*\* If the "Highest Number Previously Paid For" IN THIS SPACE is less than 20, enter "20".  
 \*\*\* If the "Highest Number Previously Paid For" IN THIS SPACE is less than 3, enter "3".  
 The "Highest Number Previously Paid For" (Total or Independent) is the highest found in the appropriate box in column 1.

Under the Paperwork Reduction Act of 1995, no persons are required to respond to a collection of information unless it contains a valid OMB control number.

|   |  |                        |             |
|---|--|------------------------|-------------|
| <b>Application Data Sheet 37 CFR 1.76</b>   |  | Attorney Docket Number | EFACT.007C1 |
|   |  | Application Number     |             |
| Title of Invention  | SYSTEM, METHOD AND APPARATUS FOR IDENTIFYING MANUAL INPUTS TO AND ADAPTIVE PROGRAMMING OF A THERMOSTAT |                        |             |
| The application data sheet is part of the provisional or nonprovisional application for which it is being submitted. The following form contains the bibliographic data arranged in a format specified by the United States Patent and Trademark Office as outlined in 37 CFR 1.76. This document may be completed electronically and submitted to the Office in electronic format using the Electronic Filing System (EFS) or the document may be printed and included in a paper filed application. |  |                        |             |

**Secrecy Order 37 CFR 5.2**

|                          |   |
|--------------------------|---|
| <input type="checkbox"/> | Portions or all of the application associated with this Application Data Sheet may fall under a Secrecy Order pursuant to 37 CFR 5.2 (Paper filers only. Applications that fall under Secrecy Order may not be filed electronically.) |
|--------------------------|---|

**Inventor Information:**

|   |                   |                       |                    |                               |                                       |
|---|-------------------|-----------------------|--------------------|-------------------------------|---------------------------------------|
| <b>Inventor 1</b>   |                   |                       |                    |                               | <input type="button" value="Remove"/> |
| <b>Legal Name</b>   |                   |                       |                    |                               |                                       |
| <b>Prefix</b>   | <b>Given Name</b> | <b>Middle Name</b>    | <b>Family Name</b> | <b>Suffix</b>                 |                                       |
|   | John              | Douglas               | Steinberg          |                               |                                       |
| <b>Residence Information (Select One)</b> <input checked="" type="radio"/> US Residency <input type="radio"/> Non US Residency <input type="radio"/> Active US Military Service |                   |                       |                    |                               |                                       |
| <b>City</b>   | Millbrae          | <b>State/Province</b> | Ca                 | <b>Country of Residence i</b> | US                                    |
| <b>Mailing Address of Inventor:</b>   |                   |                       |                    |                               |                                       |
| <b>Address 1</b>  | 873 Hacienda Way  |                       |                    |                               |                                       |
| <b>Address 2</b>  |                   |                       |                    |                               |                                       |
| <b>City</b>   | Millbrae          | <b>State/Province</b> | CA                 |                               |                                       |
| <b>Postal Code</b>  | 94030             | <b>Country i</b>      | US                 |                               |                                       |
| <b>Inventor 2</b>   |                   |                       |                    |                               | <input type="button" value="Remove"/> |
| <b>Legal Name</b>   |                   |                       |                    |                               |                                       |
| <b>Prefix</b>   | <b>Given Name</b> | <b>Middle Name</b>    | <b>Family Name</b> | <b>Suffix</b>                 |                                       |
|   | Scott             | Douglas               | Hublou             |                               |                                       |
| <b>Residence Information (Select One)</b> <input checked="" type="radio"/> US Residency <input type="radio"/> Non US Residency <input type="radio"/> Active US Military Service |                   |                       |                    |                               |                                       |
| <b>City</b>   | Redwood City      | <b>State/Province</b> | CA                 | <b>Country of Residence i</b> | US                                    |
| <b>Mailing Address of Inventor:</b>   |                   |                       |                    |                               |                                       |
| <b>Address 1</b>  | 747 Lakeview Way  |                       |                    |                               |                                       |
| <b>Address 2</b>  |                   |                       |                    |                               |                                       |
| <b>City</b>   | Redwood City      | <b>State/Province</b> | CA                 |                               |                                       |
| <b>Postal Code</b>  | 94062             | <b>Country i</b>      | US                 |                               |                                       |
| <b>Inventor 3</b>   |                   |                       |                    |                               | <input type="button" value="Remove"/> |
| <b>Legal Name</b>   |                   |                       |                    |                               |                                       |
| <b>Prefix</b>   | <b>Given Name</b> | <b>Middle Name</b>    | <b>Family Name</b> | <b>Suffix</b>                 |                                       |
|   | Leo               |                       | Cheung             |                               |                                       |
| <b>Residence Information (Select One)</b> <input checked="" type="radio"/> US Residency <input type="radio"/> Non US Residency <input type="radio"/> Active US Military Service |                   |                       |                    |                               |                                       |

Under the Paperwork Reduction Act of 1995, no persons are required to respond to a collection of information unless it contains a valid OMB control number.

|   |  |                        |             |                                    |    |
|---|--|------------------------|-------------|------------------------------------|----|
| <b>Application Data Sheet 37 CFR 1.76</b>   |  | Attorney Docket Number | EFACT.007C1 |                                    |    |
|   |  | Application Number     |             |                                    |    |
| Title of Invention  | SYSTEM, METHOD AND APPARATUS FOR IDENTIFYING MANUAL INPUTS TO AND ADAPTIVE PROGRAMMING OF A THERMOSTAT |                        |             |                                    |    |
| City  | Sunnyvale  | State/Province         | CA          | Country of Residence i             | US |
| <b>Mailing Address of Inventor:</b>   |  |                        |             |                                    |    |
| Address 1   | 708 Jackpine Court   |                        |             |                                    |    |
| Address 2   |  |                        |             |                                    |    |
| City  | Sunnyvale  | State/Province         | CA          |                                    |    |
| Postal Code   | 94086  | Country i              | US          |                                    |    |
| All Inventors Must Be Listed - Additional Inventor Information blocks may be generated within this form by selecting the <b>Add</b> button. |  |                        |             | <input type="button" value="Add"/> |    |

**Correspondence Information:**

|  |                    |  |   |  |
|--|--------------------|--|---|--|
| Enter either Customer Number or complete the Correspondence Information section below. For further information see 37 CFR 1.33(a). |                    |  |   |  |
| <input type="checkbox"/> An Address is being provided for the correspondence information of this application.                      |                    |  |   |  |
| Customer Number  | 20995              |  |   |  |
| Email Address  | efiling@knobbe.com | <input type="button" value="Add Email"/> | <input type="button" value="Remove Email"/> |  |

**Application Information:**

|   |  |   |  |  |
|---|--|---|--|--|
| Title of the Invention                  | SYSTEM, METHOD AND APPARATUS FOR IDENTIFYING MANUAL INPUTS TO AND ADAPTIVE PROGRAMMING OF A THERMOSTAT |   |  |  |
| Attorney Docket Number                  | EFACT.007C1  | Small Entity Status Claimed <input checked="" type="checkbox"/> |  |  |
| Application Type                        | Nonprovisional   |   |  |  |
| Subject Matter                          | Utility  |   |  |  |
| Total Number of Drawing Sheets (if any) | 11   | Suggested Figure for Publication (if any)                       |  |  |

**Publication Information:**

|  |
|--|
| <input type="checkbox"/> Request Early Publication (Fee required at time of Request 37 CFR 1.219)  |
| <input type="checkbox"/> <b>Request Not to Publish.</b> I hereby request that the attached application not be published under 35 U.S.C. 122(b) and certify that the invention disclosed in the attached application <b>has not and will not</b> be the subject of an application filed in another country, or under a multilateral international agreement, that requires publication at eighteen months after filing. |

**Representative Information:**

|   |                 |                       |                        |                       |                                   |
|---|-----------------|-----------------------|------------------------|-----------------------|-----------------------------------|
| Representative information should be provided for all practitioners having a power of attorney in the application. Providing this information in the Application Data Sheet does not constitute a power of attorney in the application (see 37 CFR 1.32). Either enter Customer Number or complete the Representative Name section below. If both sections are completed the customer Number will be used for the Representative Information during processing. |                 |                       |                        |                       |                                   |
| Please Select One:  |                 |                       |                        |                       |                                   |
| <input checked="" type="radio"/>  | Customer Number | <input type="radio"/> | US Patent Practitioner | <input type="radio"/> | Limited Recognition (37 CFR 11.9) |

Under the Paperwork Reduction Act of 1995, no persons are required to respond to a collection of information unless it contains a valid OMB control number.

|   |  |                        |             |
|---|--|------------------------|-------------|
| <b>Application Data Sheet 37 CFR 1.76</b> |  | Attorney Docket Number | EFACT.007C1 |
|   |  | Application Number     |             |
| Title of Invention                        | SYSTEM, METHOD AND APPARATUS FOR IDENTIFYING MANUAL INPUTS TO AND ADAPTIVE PROGRAMMING OF A THERMOSTAT |                        |             |
| Customer Number                           | 20995  |                        |             |

### Domestic Benefit/National Stage Information:

This section allows for the applicant to either claim benefit under 35 U.S.C. 119(e), 120, 121, or 365(c) or indicate National Stage entry from a PCT application. Providing this information in the application data sheet constitutes the specific reference required by 35 U.S.C. 119(e) or 120, and 37 CFR 1.78.

|   |                    |                                       |                                    |
|---|--------------------|---------------------------------------|------------------------------------|
| Prior Application Status  | Pending            | <input type="button" value="Remove"/> |                                    |
| Application Number  | Continuity Type    | Prior Application Number              | Filing Date (YYYY-MM-DD)           |
|   | Continuation of    | 12/778052                             | 2010-05-11                         |
| Prior Application Status  | Expired            | <input type="button" value="Remove"/> |                                    |
| Application Number  | Continuity Type    | Prior Application Number              | Filing Date (YYYY-MM-DD)           |
| 12/778052   | non provisional of | 61/215999                             | 2009-05-12                         |
| Additional Domestic Benefit/National Stage Data may be generated within this form by selecting the <b>Add</b> button. |                    |                                       | <input type="button" value="Add"/> |

### Foreign Priority Information:

This section allows for the applicant to claim priority to a foreign application. Providing this information in the application data sheet constitutes the claim for priority as required by 35 U.S.C. 119(b) and 37 CFR 1.55(d). When priority is claimed to a foreign application that is eligible for retrieval under the priority document exchange program (PDX) the information will be used by the Office to automatically attempt retrieval pursuant to 37 CFR 1.55(h)(1) and (2). Under the PDX program, applicant bears the ultimate responsibility for ensuring that a copy of the foreign application is received by the Office from the participating foreign intellectual property office, or a certified copy of the foreign priority application is filed, within the time period specified in 37 CFR 1.55(g)(1).

|  |                      |                          |  |
|--|----------------------|--------------------------|--|
| <input type="button" value="Remove"/>  |                      |                          |  |
| Application Number   | Country <sup>i</sup> | Filing Date (YYYY-MM-DD) | Access Code <sup>l</sup> (if applicable) |
|  |                      |                          |  |
| Additional Foreign Priority Data may be generated within this form by selecting the <b>Add</b> button. |                      |                          | <input type="button" value="Add"/>       |

|   |  |             |
|---|--|-------------|
| <b>Application Data Sheet 37 CFR 1.76</b> | Attorney Docket Number   | EFACT.007C1 |
|   | Application Number   |             |
| Title of Invention                        | SYSTEM, METHOD AND APPARATUS FOR IDENTIFYING MANUAL INPUTS TO AND ADAPTIVE PROGRAMMING OF A THERMOSTAT |             |

## Statement under 37 CFR 1.55 or 1.78 for AIA (First Inventor to File) Transition Applications

|  |
|--|
| <p>This application (1) claims priority to or the benefit of an application filed before March 16, 2013 and (2) also contains, or contained at any time, a claim to a claimed invention that has an effective filing date on or after March 16, 2013.</p> <p><input type="checkbox"/> NOTE: By providing this statement under 37 CFR 1.55 or 1.78, this application, with a filing date on or after March 16, 2013, will be examined under the first inventor to file provisions of the AIA.</p> |
|--|

## Authorization to Permit Access:

|  |
|--|
| <p><input type="checkbox"/> Authorization to Permit Access to the Instant Application by the Participating Offices</p>   |
| <p>If checked, the undersigned hereby grants the USPTO authority to provide the European Patent Office (EPO), the Japan Patent Office (JPO), the Korean Intellectual Property Office (KIPO), the World Intellectual Property Office (WIPO), and any other intellectual property offices in which a foreign application claiming priority to the instant patent application is filed access to the instant patent application. See 37 CFR 1.14(c) and (h). This box should not be checked if the applicant does not wish the EPO, JPO, KIPO, WIPO, or other intellectual property office in which a foreign application claiming priority to the instant patent application is filed to have access to the instant patent application.</p> <p>In accordance with 37 CFR 1.14(h)(3), access will be provided to a copy of the instant patent application with respect to: 1) the instant patent application-as-filed; 2) any foreign application to which the instant patent application claims priority under 35 U.S.C. 119(a)-(d) if a copy of the foreign application that satisfies the certified copy requirement of 37 CFR 1.55 has been filed in the instant patent application; and 3) any U.S. application-as-filed from which benefit is sought in the instant patent application.</p> <p>In accordance with 37 CFR 1.14(c), access may be provided to information concerning the date of filing this Authorization.</p> |

## Applicant Information:

|  |
|--|
| <p>Providing assignment information in this section does not substitute for compliance with any requirement of part 3 of Title 37 of CFR to have an assignment recorded by the Office.</p> |
|--|



|   |  |             |
|---|--|-------------|
| <b>Application Data Sheet 37 CFR 1.76</b> | Attorney Docket Number   | EFACT.007C1 |
|   | Application Number   |             |
| Title of Invention                        | SYSTEM, METHOD AND APPARATUS FOR IDENTIFYING MANUAL INPUTS TO AND ADAPTIVE PROGRAMMING OF A THERMOSTAT |             |

|   |  |                                       |
|---|--|---------------------------------------|
| <b>Applicant 1</b>  |  | <input type="button" value="Remove"/> |
| <p>If the applicant is the inventor (or the remaining joint inventor or inventors under 37 CFR 1.45), this section should not be completed. The information to be provided in this section is the name and address of the legal representative who is the applicant under 37 CFR 1.43; or the name and address of the assignee, person to whom the inventor is under an obligation to assign the invention, or person who otherwise shows sufficient proprietary interest in the matter who is the applicant under 37 CFR 1.46. If the applicant is an applicant under 37 CFR 1.46 (assignee, person to whom the inventor is obligated to assign, or person who otherwise shows sufficient proprietary interest) together with one or more joint inventors, then the joint inventor or inventors who are also the applicant should be identified in this section.</p> |  |                                       |
| <input type="button" value="Clear"/>  |  |                                       |
| <input checked="" type="radio"/> Assignee   | <input type="radio"/> Legal Representative under 35 U.S.C. 117         | <input type="radio"/> Joint Inventor  |
| <input type="radio"/> Person to whom the inventor is obligated to assign.   | <input type="radio"/> Person who shows sufficient proprietary interest |                                       |
| If applicant is the legal representative, indicate the authority to file the patent application, the inventor is:   |  |                                       |
| Name of the Deceased or Legally Incapacitated Inventor : <input type="text"/>   |  |                                       |
| If the Applicant is an Organization check here. <input checked="" type="checkbox"/>   |  |                                       |
| Organization Name   | EcoFactor, Inc.  |                                       |
| <b>Mailing Address Information:</b>   |  |                                       |
| Address 1   | 423 Broadway, #801   |                                       |
| Address 2   |  |                                       |
| City  | Millbrae   | State/Province CA                     |
| Country <sup>i</sup>  | US   | Postal Code 94030                     |
| Phone Number  |  | Fax Number                            |
| Email Address   |  |                                       |
| Additional Applicant Data may be generated within this form by selecting the Add button.  |  | <input type="button" value="Add"/>    |

## Assignee Information including Non-Applicant Assignee Information:

|   |  |
|---|--|
| <p>Providing assignment information in this section does not substitute for compliance with any requirement of part 3 of Title 37 of CFR to have an assignment recorded by the Office.</p>  |  |
| <b>Assignee 1</b>   |  |
| <p>Complete this section if assignee information, including non-applicant assignee information, is desired to be included on the patent application publication. An assignee-applicant identified in the "Applicant Information" section will appear on the patent application publication as an applicant. For an assignee-applicant, complete this section only if identification as an assignee is also desired on the patent application publication.</p> |  |
| <input type="button" value="Remove"/>   |  |
| If the Assignee is an Organization check here. <input type="checkbox"/>   |  |

Under the Paperwork Reduction Act of 1995, no persons are required to respond to a collection of information unless it contains a valid OMB control number.

|   |  |             |
|---|--|-------------|
| <b>Application Data Sheet 37 CFR 1.76</b> | Attorney Docket Number   | EFACT.007C1 |
|   | Application Number   |             |
| Title of Invention                        | SYSTEM, METHOD AND APPARATUS FOR IDENTIFYING MANUAL INPUTS TO AND ADAPTIVE PROGRAMMING OF A THERMOSTAT |             |

|        |            |             |             |        |
|--------|------------|-------------|-------------|--------|
| Prefix | Given Name | Middle Name | Family Name | Suffix |
|        |            |             |             |        |

**Mailing Address Information:**

|               |  |                |  |  |
|---------------|--|----------------|--|--|
| Address 1     |  |                |  |  |
| Address 2     |  |                |  |  |
| City          |  | State/Province |  |  |
| Country i     |  | Postal Code    |  |  |
| Phone Number  |  | Fax Number     |  |  |
| Email Address |  |                |  |  |

Additional Assignee Data may be generated within this form by selecting the Add button.

**Signature:**

NOTE: This form must be signed in accordance with 37 CFR 1.33. See 37 CFR 1.4 for signature requirements and certifications

|                  |                |           |                   |                     |       |
|------------------|----------------|-----------|-------------------|---------------------|-------|
| <b>Signature</b> | /John R. King/ |           | Date (YYYY-MM-DD) | 2013-11-18          |       |
| First Name       | John           | Last Name | King              | Registration Number | 34362 |

Additional Signature may be generated within this form by selecting the Add button.

This collection of information is required by 37 CFR 1.76. The information is required to obtain or retain a benefit by the public which is to file (and by the USPTO to process) an application. Confidentiality is governed by 35 U.S.C. 122 and 37 CFR 1.14. This collection is estimated to take 23 minutes to complete, including gathering, preparing, and submitting the completed application data sheet form to the USPTO. Time will vary depending upon the individual case. Any comments on the amount of time you require to complete this form and/or suggestions for reducing this burden, should be sent to the Chief Information Officer, U.S. Patent and Trademark Office, U.S. Department of Commerce, P.O. Box 1450, Alexandria, VA 22313-1450. DO NOT SEND FEES OR COMPLETED FORMS TO THIS ADDRESS. **SEND TO: Commissioner for Patents, P.O. Box 1450, Alexandria, VA 22313-1450.**

## Privacy Act Statement

The Privacy Act of 1974 (P.L. 93-579) requires that you be given certain information in connection with your submission of the attached form related to a patent application or patent. Accordingly, pursuant to the requirements of the Act, please be advised that: (1) the general authority for the collection of this information is 35 U.S.C. 2(b)(2); (2) furnishing of the information solicited is voluntary; and (3) the principal purpose for which the information is used by the U.S. Patent and Trademark Office is to process and/or examine your submission related to a patent application or patent. If you do not furnish the requested information, the U.S. Patent and Trademark Office may not be able to process and/or examine your submission, which may result in termination of proceedings or abandonment of the application or expiration of the patent.

The information provided by you in this form will be subject to the following routine uses:

1. The information on this form will be treated confidentially to the extent allowed under the Freedom of Information Act (5 U.S.C. 552) and the Privacy Act (5 U.S.C. 552a). Records from this system of records may be disclosed to the Department of Justice to determine whether the Freedom of Information Act requires disclosure of these records.
2. A record from this system of records may be disclosed, as a routine use, in the course of presenting evidence to a court, magistrate, or administrative tribunal, including disclosures to opposing counsel in the course of settlement negotiations.
3. A record in this system of records may be disclosed, as a routine use, to a Member of Congress submitting a request involving an individual, to whom the record pertains, when the individual has requested assistance from the Member with respect to the subject matter of the record.
4. A record in this system of records may be disclosed, as a routine use, to a contractor of the Agency having need for the information in order to perform a contract. Recipients of information shall be required to comply with the requirements of the Privacy Act of 1974, as amended, pursuant to 5 U.S.C. 552a(m).
5. A record related to an International Application filed under the Patent Cooperation Treaty in this system of records may be disclosed, as a routine use, to the International Bureau of the World Intellectual Property Organization, pursuant to the Patent Cooperation Treaty.
6. A record in this system of records may be disclosed, as a routine use, to another federal agency for purposes of National Security review (35 U.S.C. 181) and for review pursuant to the Atomic Energy Act (42 U.S.C. 218(c)).
7. A record from this system of records may be disclosed, as a routine use, to the Administrator, General Services, or his/her designee, during an inspection of records conducted by GSA as part of that agency's responsibility to recommend improvements in records management practices and programs, under authority of 44 U.S.C. 2904 and 2906. Such disclosure shall be made in accordance with the GSA regulations governing inspection of records for this purpose, and any other relevant (i.e., GSA or Commerce) directive. Such disclosure shall not be used to make determinations about individuals.
8. A record from this system of records may be disclosed, as a routine use, to the public after either publication of the application pursuant to 35 U.S.C. 122(b) or issuance of a patent pursuant to 35 U.S.C. 151. Further, a record may be disclosed, subject to the limitations of 37 CFR 1.14, as a routine use, to the public if the record was filed in an application which became abandoned or in which the proceedings were terminated and which application is referenced by either a published application, an application open to public inspections or an issued patent.
9. A record from this system of records may be disclosed, as a routine use, to a Federal, State, or local law enforcement agency, if the USPTO becomes aware of a violation or potential violation of law or regulation.

SYSTEM, METHOD AND APPARATUS FOR IDENTIFYING MANUAL INPUTS TO  
AND ADAPTIVE PROGRAMMING OF A THERMOSTAT

INCORPORATION BY REFERENCE TO RELATED APPLICATIONS

**[0001]** This application hereby incorporates herein by reference under 37 C.F.R. § 1.57 the entirety of the disclosure of each application set forth in the foreign and domestic priority sections of the Application Data Sheet filed herewith.

BACKGROUND OF THE INVENTION

Field of the Invention

**[0002]** Programmable thermostats have been available for more than 20 years. Programmable thermostats offer two types of advantages as compared to non-programmable devices. On the one hand, programmable thermostats can save energy in large part because they automate the process of reducing conditioning during times when the space is unoccupied, or while occupants are sleeping, and thus reduce energy consumption.

**[0003]** On the other hand, programmable thermostats can also enhance comfort as compared to manually changing setpoints using a non-programmable thermostat. For example, during the winter, a homeowner might manually turn down the thermostat from 70 degrees F to 64 degrees when going to sleep and back to 70 degrees in the morning. The drawback to this approach is that there can be considerable delay between the adjustment of the thermostat and the achieving of the desired change in ambient temperature, and many people find getting out of bed, showering, etc. in a cold house unpleasant. A programmable thermostat allows homeowners to anticipate the desired result by programming a pre-conditioning of the home. So, for example, if the homeowner gets out of bed at 7AM, setting the thermostat to change from the overnight setpoint of 64 degrees to 70 at 6AM can make the house comfortable when the consumer gets up. The drawback to this approach is that the higher temperature will cost more to maintain, so the increase in comfort is purchased at the cost of higher energy usage.

**[0004]** But all of the advantages of a programmable thermostat depend on the match between the preferences of the occupants and the actual settings employed. If, for example, the thermostat is set to warm up the house on winter mornings at 7AM, but the homeowner gets up at 5:30, the homeowner is likely to be dissatisfied. If a homeowner has programmed her thermostat to cool down the house at 5PM each afternoon based on the assumption that she will come home at 6PM, but her schedule changes and she begins to arrive home at 4:30 each day, she is likely to be uncomfortable and either make frequent manual changes or go through the generally non-intuitive process of reprogramming the thermostat to match her new schedule. Because the limited interface on most thermostats, that process may take considerable effort, which leads many users to avoid reprogramming their thermostats for long periods or even to skip doing so entirely.

**[0005]** But even if a homeowner is able to align her schedule with the programming of her thermostat, there are additional difficulties associated with choosing proper temperatures at those times. If the temperatures programmed into a thermostat do not accurately reflect the preferences of the occupants, those occupants are likely to resort to manual overrides of the programmed settings. The need to correct the "mistakes" of the thermostat is likely to annoy many users. And because people tend to overshoot the desired temperature when they make such manual changes, these overrides are likely to result in excessive heating and cooling, and thus unnecessary energy use. That is, if a person feels uncomfortable on a summer afternoon when the setting is 73 degrees, they are likely to change it to 68 or 69 rather than 71 or 72 degrees, even if 72 degrees might have made enough of a difference.

**[0006]** It would therefore be advantageous to have a means for adapting to signaling from occupants in the form of manual temperature changes and incorporating the information contained in such gestures into long-term programming. It would also be desirable to take into account both outside weather conditions and the thermal characteristics of individual homes in order to improve the ability to dynamically achieve the best possible balance between comfort and energy savings.

## BRIEF DESCRIPTION OF THE DRAWINGS

**[0007]** Figure 1 shows an example of an overall environment in which an embodiment of the invention may be used.

**[0008]** Figure 2 shows a high-level illustration of the architecture of a network showing the relationship between the major elements of one embodiment of the subject invention.

**[0009]** Figure 3 shows an embodiment of the website to be used as part of the subject invention.

**[0010]** Figure 4 shows a high-level schematic of the thermostat used as part of the subject invention.

**[0011]** Figure 5 shows one embodiment of the database structure used as part of the subject invention.

**[0012]** Figure 6 shows how comparing inside temperature against outside temperature and other variables permits calculation of dynamic signatures.

**[0013]** Figure 7 shows how manual inputs can be recognized and recorded by the subject invention.

**[0014]** Figure 8 shows how the subject invention uses manual inputs to interpret manual overrides and make short-term changes in response thereto.

**[0015]** Figure 9 shows how the subject invention uses manual inputs to alter long-term changes to interpretive rules and to setpoint scheduling.

## DETAILED DESCRIPTION OF THE PREFERRED EMBODIMENT

**[0016]** **Figure 1** shows an example of an overall environment 100 in which an embodiment of the invention may be used. The environment 100 includes an interactive communication network 102 with computers 104 connected thereto. Also connected to network 102 are one or more server computers 106, which store information and make the information available to computers 104. The network 102 allows communication between and among the computers 104 and 106.

**[0017]** Presently preferred network 102 comprises a collection of interconnected public and/or private networks that are linked to together by a set of

standard protocols to form a distributed network. While network 102 is intended to refer to what is now commonly referred to as the Internet, it is also intended to encompass variations which may be made in the future, including changes additions to existing standard protocols.

**[0018]** One popular part of the Internet is the World Wide Web. The World Wide Web contains a large number of computers 104 and servers 106, which store HyperText Markup Language (HTML) and other documents capable of displaying graphical and textual information. HTML is a standard coding convention and set of codes for attaching presentation and linking attributes to informational content within documents.

**[0019]** The servers 106 that provide offerings on the World Wide Web are typically called websites. A website is often defined by an Internet address that has an associated electronic page. Generally, an electronic page is a document that organizes the presentation of text graphical images, audio and video.

**[0020]** In addition to the Internet, the network 102 can comprise a wide variety of interactive communication media. For example, network 102 can include local area networks, interactive television networks, telephone networks, wireless data systems, two-way cable systems, and the like.

**[0021]** Network 102 can also comprise servers 106 that provide services other than HTML documents. Such services may include the exchange of data with a wide variety of "edge" devices, some of which may not be capable of displaying web pages, but that can record, transmit and receive information.

**[0022]** In one embodiment, computers 104 and servers 106 are conventional computers that are equipped with communications hardware such as modem or a network interface card. The computers include processors such as those sold by Intel and AMD. Other processors may also be used, including general-purpose processors, multi-chip processors, embedded processors and the like.

**[0023]** Computers 104 can also be handheld and wireless devices such as personal digital assistants (PDAs), cellular telephones and other devices capable of accessing the network.

**[0024]** Computers 104 may utilize a browser configured to interact with the World Wide Web. Such browsers may include Microsoft Explorer, Mozilla, Firefox, Opera or Safari. They may also include browsers used on handheld and wireless devices.

**[0025]** The storage medium may comprise any method of storing information. It may comprise random access memory (RAM), electronically erasable programmable read only memory (EEPROM), read only memory (ROM), hard disk, floppy disk, CD-ROM, optical memory, or other method of storing data.

**[0026]** Computers 104 and 106 may use an operating system such as Microsoft Windows, Apple Mac OS, Linux, Unix or the like.

**[0027]** Computers 106 may include a range of devices that provide information, sound, graphics and text, and may use a variety of operating systems and software optimized for distribution of content via networks.

**[0028]** **Figure 2** illustrates in further detail the architecture of the specific components connected to network 102 showing the relationship between the major elements of one embodiment of the subject invention. Attached to the network are thermostats 108 and computers 104 of various users. Connected to thermostats 108 are HVAC units 110. The HVAC units may be conventional air conditioners, heat pumps, or other devices for transferring heat into or out of a building. Each user may be connected to server 106 via wired or wireless connection such as Ethernet or a wireless protocol such as IEEE 802.11, and router and/or gateway or wireless access point 112 that connects the computer and thermostat to the Internet via a broadband connection such as a digital subscriber line (DSL) or other form of broadband connection to the World Wide Web. In one embodiment, thermostat management server 106 is in communication with the network 102. Server 106 contains the content to be served as web pages and viewed by computers 104, as well as databases containing information used by the servers, and applications used to remotely manage thermostats 108.

**[0029]** In the currently preferred embodiment, the website 200 includes a number of components accessible to the user, as shown in **Figure 3**. Those components may include a means to store temperature settings 202, a means to



enter information about the user's home 204, a means to enter the user's electricity bills 206, and means to elect to enable the subject invention 208.

**[0030]** **Figure 4** shows a high-level block diagram of thermostat 108 used as part of the subject invention. Thermostat 108 includes temperature sensing means 252, which may be a thermistor, thermal diode or other means commonly used in the design of electronic thermostats. It includes a microprocessor 254, memory 256, a display 258, a power source 260, and at least one relay 262, which turns the HVAC system on and off in response to a signal from the microprocessor, and contacts by which the relay is connected to the wires that lead to the HVAC system. To allow the thermostat to communicate bi-directionally with the computer network, the thermostat also includes means 264 to connect the thermostat to a local computer or to a wired or wireless network. Such means could be in the form of Ethernet, wireless protocols such as IEEE 802.11, IEEE 802.15.4, Bluetooth, or other wireless protocols. The thermostat may be connected to the computer network directly via wired or wireless Internet Protocol connection. Alternatively, the thermostat may connect wirelessly to a gateway such as an IP-to-Zigbee gateway, an IP-to-Z-wave gateway, or the like. Where the communications means enabled include wireless communication, antenna 266 will also be included. The thermostat 250 may also include controls 268 allowing users to change settings directly at the thermostat, but such controls are not necessary to allow the thermostat to function.

**[0031]** The data used to generate the content delivered in the form of the website and to automate control of thermostat 108 is stored on one or more servers 106 within one or more databases. As shown in **Figure 5**, the overall database structure 300 may include temperature database 400, thermostat settings database 500, energy bill database 600, HVAC hardware database 700, weather database 800, user database 900, transaction database 1000, product and service database 1100 and such other databases as may be needed to support these and additional features.

**[0032]** The website will allow users of connected thermostats 108 to create personal accounts. Each user's account will store information in database 900, which tracks various attributes relative to users. Such attributes may include

the make and model of the specific HVAC equipment in the user's home; the age and square footage of the home, the solar orientation of the home, the location of the thermostat in the home, the user's preferred temperature settings, etc.

**[0033]** As shown in Figure 3, the website 200 will permit thermostat users to perform through the web browser substantially all of the programming functions traditionally performed directly at the physical thermostat, such as temperature set points, the time at which the thermostat should be at each set point, etc. Preferably the website will also allow users to accomplish more advanced tasks such as allow users to program in vacation settings for times when the HVAC system may be turned off or run at more economical settings, and set macros that will allow changing the settings of the temperature for all periods with a single gesture such as a mouse click.

**[0034]** In addition to using the system to allow better signaling and control of the HVAC system, which relies primarily on communication running from the server to the thermostat, the bi-directional communication will also allow the thermostat 108 to regularly measure and send to the server information about the temperature in the building. By comparing outside temperature, inside temperature, thermostat settings, cycling behavior of the HVAC system, and other variables, the system will be capable of numerous diagnostic and controlling functions beyond those of a standard thermostat.

**[0035]** For example, **Fig. 6a** shows a graph of inside temperature, outside temperature and HVAC activity for a 24-hour period. When outside temperature 302 increases, inside temperature 304 follows, but with some delay because of the thermal mass of the building, unless the air conditioning 306 operates to counteract this effect. When the air conditioning turns on, the inside temperature stays constant (or rises at a much lower rate or even falls) despite the rising outside temperature. In this example, frequent and heavy use of the air conditioning results in only a very slight temperature increase inside the house of 4 degrees, from 72 to 76 degrees, despite the increase in outside temperature from 80 to 100 degrees.

**[0036]** **Figure 6b** shows a graph of the same house on the same day, but assumes that the air conditioning is turned off from noon to 7PM. As expected, the

inside temperature 304a rises with increasing outside temperatures 302 for most of that period, reaching 88 degrees at 7PM. Because server 106 logs the temperature readings from inside each house (whether once per minute or over some other interval), as well as the timing and duration of air conditioning cycles, database 300 will contain a history of the thermal performance of each house. That performance data will allow server 106 to calculate an effective thermal mass for each such structure – that is, the speed with the temperature inside a given building will change in response to changes in outside temperature. Because the server will also log these inputs against other inputs including time of day, humidity, etc. the server will be able to predict, at any given time on any given day, the rate at which inside temperature should change for given inside and outside temperatures.

**[0037]** The ability to predict the rate of change in inside temperature in a given house under varying conditions may be applied by in effect holding the desired future inside temperature as a constraint and using the ability to predict the rate of change to determine when the HVAC system must be turned on in order to reach the desired temperature at the desired time.

**[0038]** In order to adapt programming to take into account the manual overrides entered into the thermostat, it is first necessary to determine when a manual override has in fact occurred. Most thermostats, including two-way communicating devices discussed herein, do not record such inputs locally, and neither recognize nor transmit the fact that a manual override has occurred. Furthermore, in a system as described herein, frequent changes in setpoints may be initiated by algorithms running on the server, thereby making it impossible to infer a manual override from the mere fact that the setpoint has changed. It is therefore necessary to deduce the occurrence of such events from the data that the subject invention does have access to.

**[0039]** **Figure 7** illustrates the currently preferred method for detecting the occurrence of a manual override event. In step 1002, the server retrieves the primary data points used to infer the occurrence of a manual override from one or more databases in overall database structure 300. The data should include each of the following: for the most recent point for which it can obtain such data (time0) the

actual setpoint as recorded at the thermostat (A0); for the point immediately prior to time0, (time-1), the actual setpoint recorded for the thermostat (A-1); for time0 the setpoint as scheduled by server 106 according to the standard setpoint programming (S0), and for time0 the setpoint as scheduled by server 106 according to the standard setpoint programming (S-1). In step 1004, the server retrieves any additional automated setpoint changes C that have been scheduled for the thermostat by server 106 at time0. Such changes may include algorithmic changes intended to reduce energy consumption, etc. In step 1006 the server calculates the difference (dA) between A0 and A-1; for example, if the setpoint at T0 is 67 degrees at T-1 and 69 at T0, dA is +2; if the setpoint at T-1 is 70 and the setpoint at T0 is 66, dA is -4. In step 1008, the server performs similar steps in order to calculate dS, the difference between S0 and S-1. This is necessary because, for example, the setpoint may have been changed because the server itself had just executed a change, such as a scheduled change from "away" to "home" mode. In step 1010 the server evaluates and sums all active algorithms and other server-initiated strategies to determine their net effect on setpoint at time0. For example, if one algorithm has increased setpoint at time0 by 2 degrees as a short-term energy savings measure, but another algorithm has decreased the setpoint by one degree to compensate for expected subjective reactions to weather conditions, the net algorithmic effect sC is +1 degree.

**[0040]** In step 1012, the server calculates the value for M, where M is equal to the difference between actual setpoints dA, less the difference between scheduled setpoints dS, less the aggregate of algorithmic change sC. In step 1014 the server evaluates this difference. If the difference equals zero, the server concludes that no manual override has occurred, and the routine terminates. But if the difference is any value other than zero, then the server concludes that a manual override has occurred. Thus in step 1016 the server logs the occurrence of an override to one or more databases in overall database structure 300.

**[0041]** The process of interpreting a manual override is shown in **Figure 8**. 1102 is the detection of an override, as described in detail in Figure 7. In step 1104 the server retrieves contextual data required to interpret the manual override. Such

data may include current and recent weather conditions, current and recent inside temperatures, etc. This data is helpful because it is likely that manual overrides are at least in part deterministic: that is, that they may often be explained by such contextual data, and that such understanding can permit anticipation of the desire on the part of the occupants to override and to adjust programming accordingly, so as to anticipate and obviate the need for such changes. In step 1106 the server retrieves any override data from the period preceding the specific override being evaluated that has not yet been evaluated by and incorporated into the long-term programming and rules engines as described below in Figure 9. The amount of data may be for a period of a few hours to as long as several days or more. Recent data will be more heavily weighted than older data in order to assure rapid adaptation to situations in which manual overrides represent stable changes such as changes in work schedules, etc. In step 1108 the server retrieves the stored rules for the subject thermostat 108. Such rules may include weather and time-related inferences such as “if outside temperature is greater than 85 degrees and inside temperature is more than 2 degrees above setpoint and manual override lowers setpoint by 3 or more degrees, then revert to original setpoint in 2 hours,” or “if heating setpoint change is scheduled from “away” to “home” within following 2 hours after detected override, and override increases setpoint by at least 2 degrees, then change to “home” setting,” or the like. In step 1110 the server applies the rules to the override and determines which rule, if any, should be applied as a result of the override. In step 1112 the server determines whether to alter the current setpoint as a result of applying the rules in step 1110. If no setpoint change is indicated, then the server proceeds to step 1118. If a setpoint change is indicated, then in step 1114 the server transmits the setpoint change to the thermostat, and in step 1116 it records that change to one or more databases in overall database structure 300.

**[0042]** In order to ensure that both the stored rules for interpreting manual overrides and the programming itself continue to most accurately reflect the intentions of the occupants, the server will periodically review both the rules used to interpret overrides and the setpoint scheduling employed. **Figure 9** shows the steps used to incorporate manual overrides into the long-term rules and setpoint schedule.

In step 1202 the server retrieves the stored programming for a given thermostat as well as the rules for interpreting overrides for that thermostat. In step 1204 the server retrieves the recent override data as recorded in Figures 7 and 8 to be evaluated for possible revisions to the rules and the programming. In step 1206 the server retrieves the contextual data regarding overrides retrieved in step 1204 (Because the process illustrated in Figure 9 is not presently expected to be executed as a real-time process, and to be run anywhere from once per day to once per month, the range and volume of contextual data to be evaluated is likely to be greater than in the process illustrated in Figure 8). In step 1208 the server interprets the overrides in light of the existing programming schedule, rules for overrides, contextual data, etc. In step 1210 the server determines whether, as a result of those overrides as interpreted, the rules for interpreting manual overrides should be revised. If the rules are not to be revised, the server moves to step 1214. If the rules are to be revised, then in step 1212 the server revises the rules and the new rules are stored in one or more databases in overall database structure 300. In step 1214 the server determines whether any changes to the baseline programming for the thermostat should be revised. If not the routine terminates. If revisions are warranted, then in step 1216 the server retrieves from database 900 the permissions the server has to make autonomous changes to settings. If the server has been given permission to make the proposed changes, then in step 1218 the server revises the thermostat's programming and writes the changes to one or more databases in overall database structure 300. If the server has not been authorized to make such changes autonomously, then in step 1220 the server transmits the recommendation to change settings to the customer in the manner previously specified by the customer, such as email, changes to the customer's home page as displayed on website 200, etc.

**[0043]** **Figure 10** shows an example of some of the contextual data that may be used by the server in order to interpret manual overrides. Such data may include inside temperature 1302, outside temperature 1304, cloud cover 1306, humidity 1308, barometric pressure 1310, wind speed 1312, and wind direction 1314.

**[0044]** Each of these data points should be captured at frequent intervals. In the preferred embodiment, as shown in Figure 10, the interval is once every 60 seconds.

**[0045]** Additional means of implementing the instant invention may be achieved using variations in system architecture. For example, much or even all of the work being accomplished by remote server 106 may also be done by thermostat 108 if that device has sufficient processing capabilities, memory, etc. Alternatively, some or all of these steps may be undertaken by a local processor such as a local personal computer, gateway 112, or by a dedicated appliance having the requisite capabilities.

**[0046]** While certain embodiments of the inventions have been described, these embodiments have been presented by way of example only, and are not intended to limit the scope of the inventions. Indeed, the novel methods and systems described herein may be embodied in a variety of other forms; furthermore, various omissions, substitutions and changes in the form of the methods and systems described herein may be made without departing from the spirit of the inventions. The accompanying claims and their equivalents are intended to cover such forms or modifications as would fall within the scope and spirit of the inventions.

WHAT IS CLAIMED IS:

1. A method for detecting manual changes to the setpoint for a thermostatic controller comprising:

accessing stored data comprising a plurality of internal temperature measurements taken within a structure and a plurality of outside temperature measurements;

using the stored data to predict changes in temperature inside the structure in response to at least changes in outside temperatures;

calculating with at least one computer, scheduled programming of the thermostatic controller for one or more times, the scheduled programming comprising at least a first automated setpoint at a first time;

generating with the at least one computer, a difference value based on comparing an actual setpoint at the first time for the thermostatic controller to the first automated setpoint for the thermostatic controller;

detecting a manual change to the first automated setpoint by determining whether the actual setpoint and the first automated setpoint are the same or different based on the difference value; and

logging the manual change to a database.

2. A method as in Claim 1 where the thermostatic controller operates a system for changing the air temperature in a structure.

3. A method as in Claim 1 where the thermostatic controller operates a heating, ventilation and air conditioning system.

4. A method as in Claim 1 where the thermostatic controller operates a heating, ventilation and air conditioning system in a single family residence.

5. A method as in Claim 1 in which the at least one computer communicates with the thermostatic control device.

6. A method as in Claim 5 in which the at least one computer is not located in the same structure as the thermostatic controller.

7. A method as in Claim 5 in which the at least one computer sets programming for the thermostatic controller.



8. A method as in Claim 1 in which the thermostatic controller is programmable.

9. A method for incorporating manual changes to the setpoint for a thermostatic controller, the method comprising:

accessing stored data comprising a plurality of internal temperature measurements taken within a structure and a plurality of outside temperature measurements;

using the stored data to predict changes in temperatures inside the structure in response to at least changes in outside temperatures;

calculating scheduled programming of setpoints in the thermostatic controller based on the predicted rate of change, the scheduled programming comprising at least a first automated setpoint at a first time and a second automated setpoint at a second time;

comparing the actual setpoint at the first time for the thermostatic controller to the first automated setpoint for the thermostatic controller;

detecting a manual change to the first automated setpoint by determining whether the actual setpoint and the first automated setpoint are the same or different;

changing the second automated setpoint at the second time based on at least one rule for the interpretation of the manual change.

10. A method as in Claim 9 where the thermostatic controller operates a system for changing the air temperature in a structure.

11. A method as in Claim 9 where the thermostatic controller operates a heating, ventilation and air conditioning system.

12. A method as in Claim 9 where the thermostatic controller operates a heating, ventilation and air conditioning system in a single family residence.

13. A method as in Claim 9 in which at least one computer is in communication with the thermostatic control device.

14. A method as in Claim 13 in which the at least one computer is not located in the same structure as the thermostatic controller.

15. A method as in Claim 13 in which the at least one computer sets programming for the thermostatic controller.

16. A system as in Claim 9 in which the thermostatic controller is programmable.

17. An apparatus for detecting manual changes to one or more setpoints for a thermostatic controller, the apparatus comprising:

at least an electronic storage medium comprising stored data of a plurality of internal temperature measurements taken within a structure and a plurality of outside temperature measurements;

computer hardware configured to communicate with the electronic storage medium and with a programmable communicating thermostat, the computer hardware configured to use the stored data to predict a rate of change of temperatures inside the structure in response to changes in outside temperatures;

the computer hardware further configured to calculate scheduled setpoint programming of the programmable communicating thermostat for one or more times based on the predicted rate of change, the scheduled programming comprising one or more automated setpoints;

wherein the computer hardware is further configured to store in the electronic storage medium, the one or more automated setpoints associated with the scheduled programming for the programmable communicating thermostat;

wherein the computer hardware is further configured to obtain actual setpoint programming of the programmable communicating thermostat and store the actual setpoint programming in the electronic storage medium; and

wherein the computer hardware is further configured to compare the one or more automated setpoints associated with the scheduled setpoint programming with the actual setpoint programming.

18. An apparatus as in claim 17 where the programmable communicating thermostat operates a system for changing the air temperature in a structure.

19. An apparatus as in claim 17 where the programmable communicating thermostat operates a heating, ventilation and air conditioning system.

20. An apparatus as in claim 17 where the programmable communicating thermostat operates a heating, ventilation and air conditioning system in a single family residence.

21. An apparatus as in claim 17 further comprising the programmable communicating thermostat.

22. An apparatus as in claim 17 in which the computer hardware is not located in the same structure as the programmable communicating thermostat.

23. An apparatus as in claim 17 in which the computer hardware sets programming for the programmable communicating thermostat.

24. An apparatus as in claim 17 in which the electronic storage medium comprises one or more databases.

# SYSTEM, METHOD AND APPARATUS FOR IDENTIFYING MANUAL INPUTS TO AND ADAPTIVE PROGRAMMING OF A THERMOSTAT

## ABSTRACT OF THE DISCLOSURE

Systems and methods are disclosed for incorporating manual changes to the setpoint for a thermostatic controller into long-term programming of the thermostatic controller. For example, one or more of the exemplary systems compares the actual setpoint at a given time for the thermostatic controller to an expected setpoint for the thermostatic controller in light of the scheduled programming. A determination is then made as to whether the actual setpoint and the expected setpoint are the same or different. Furthermore, a manual change to the actual setpoint for the thermostatic controller is compared to previously recorded setpoint data for the thermostatic controller. At least one rule is then applied for the interpretation of the manual change in light of the previously recorded setpoint data.

16654546  
111213

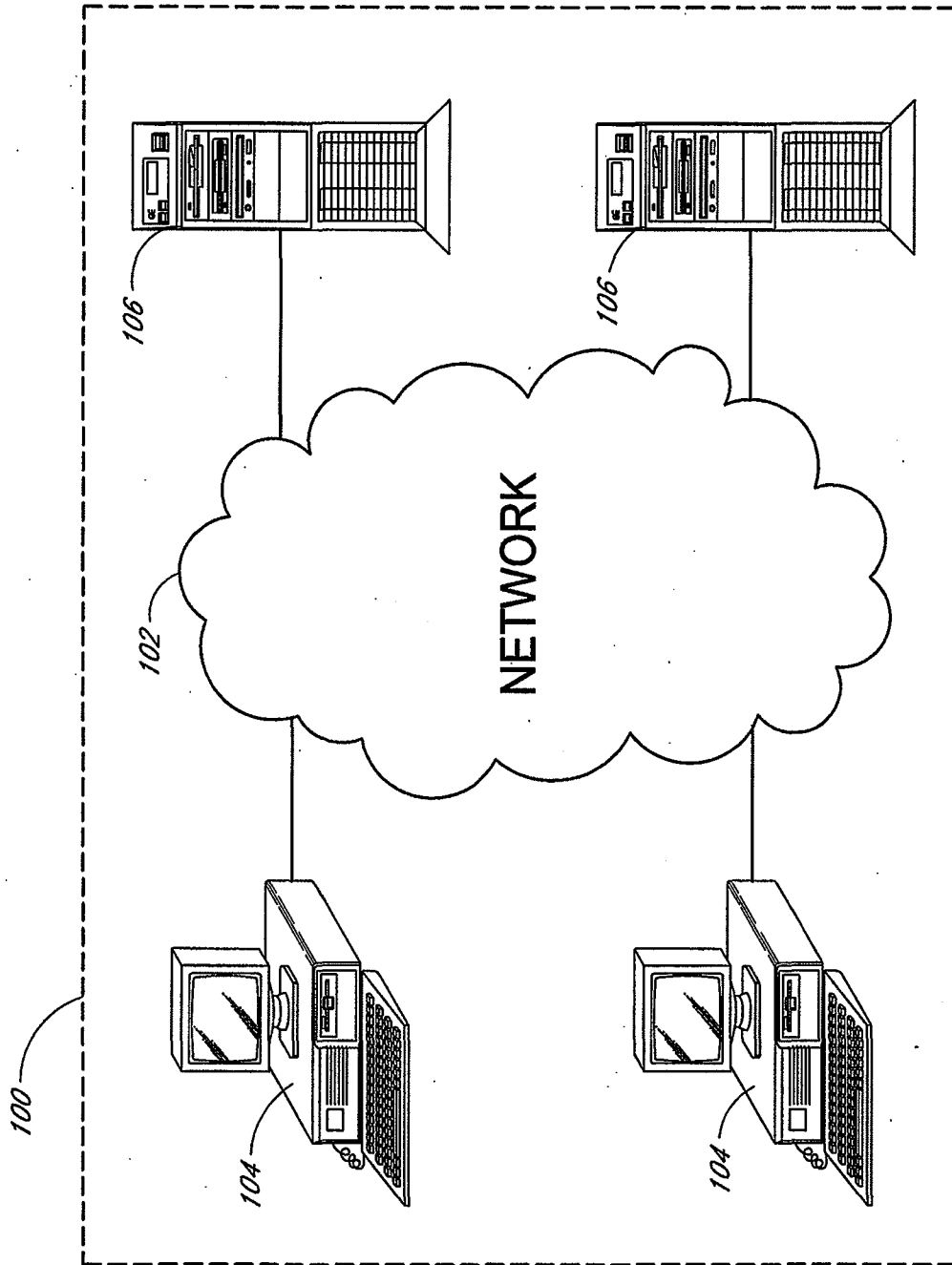

FIG. 1

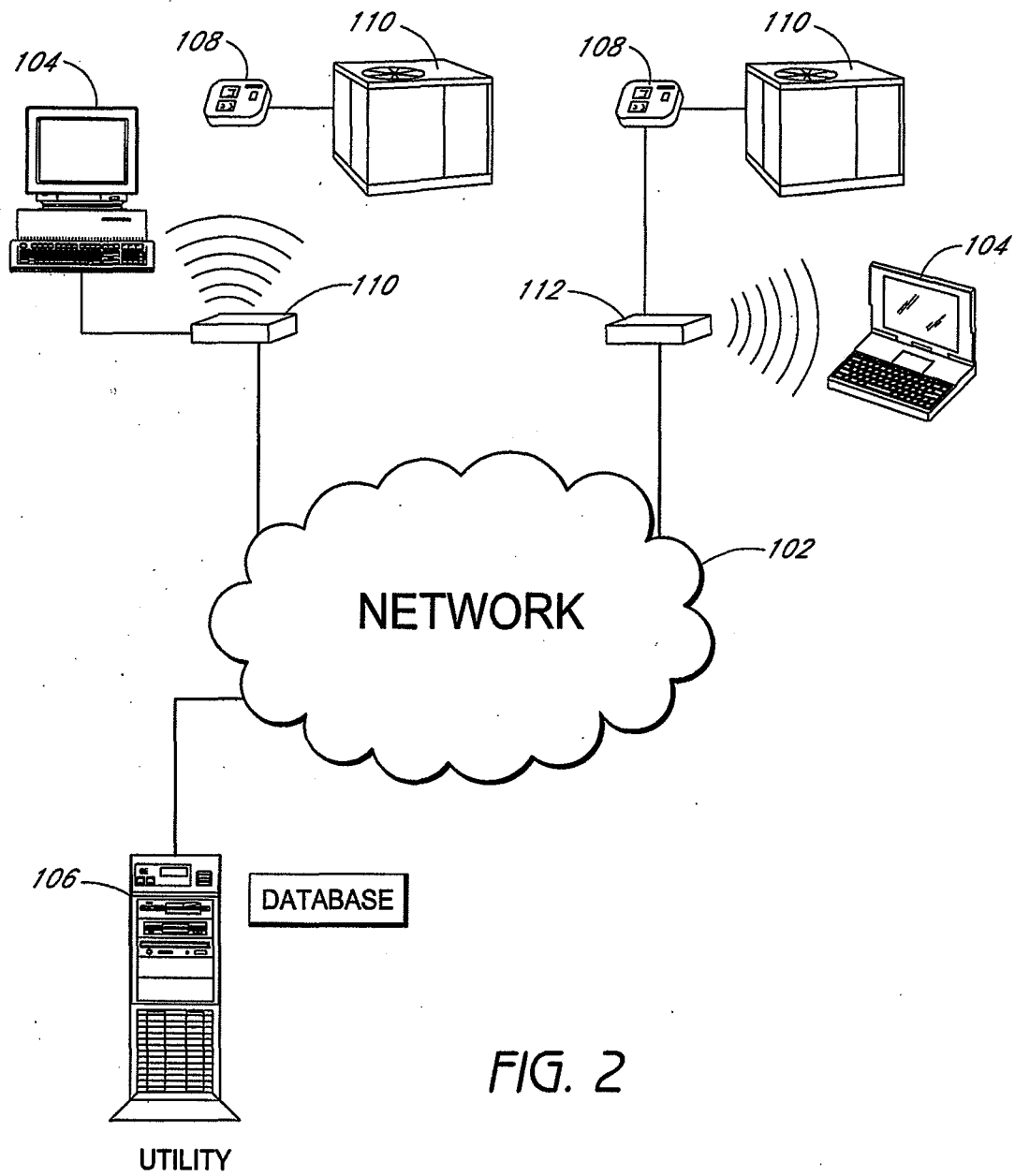
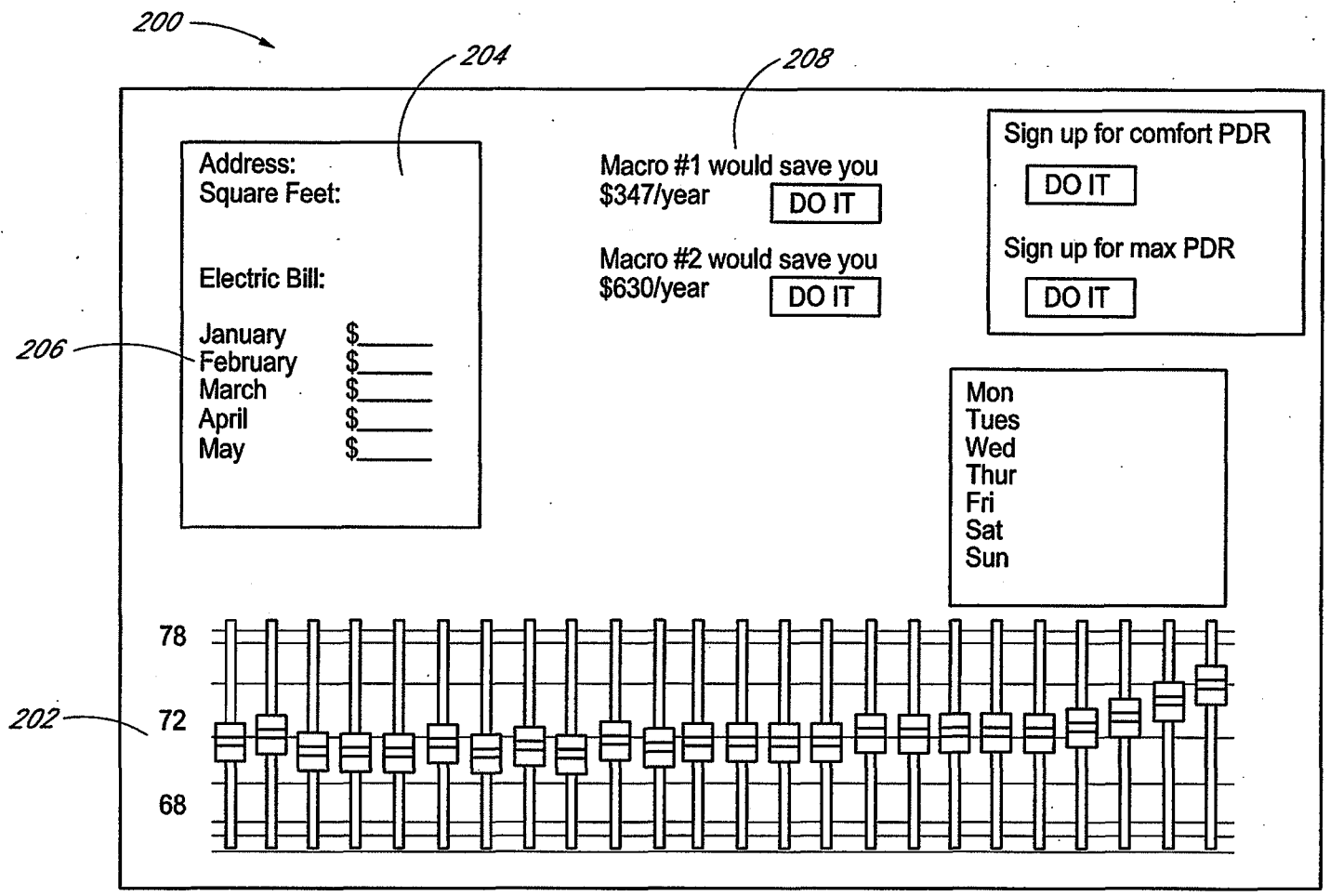

FIG. 2



3/11

FIG. 3

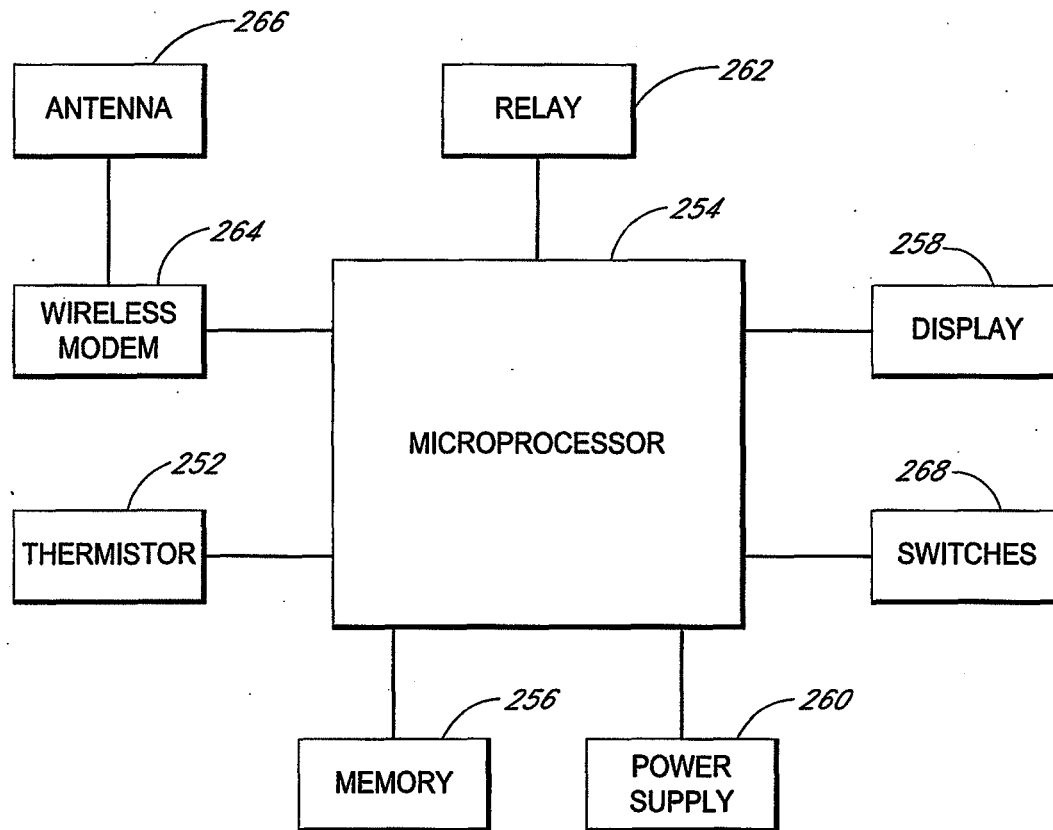

FIG. 4



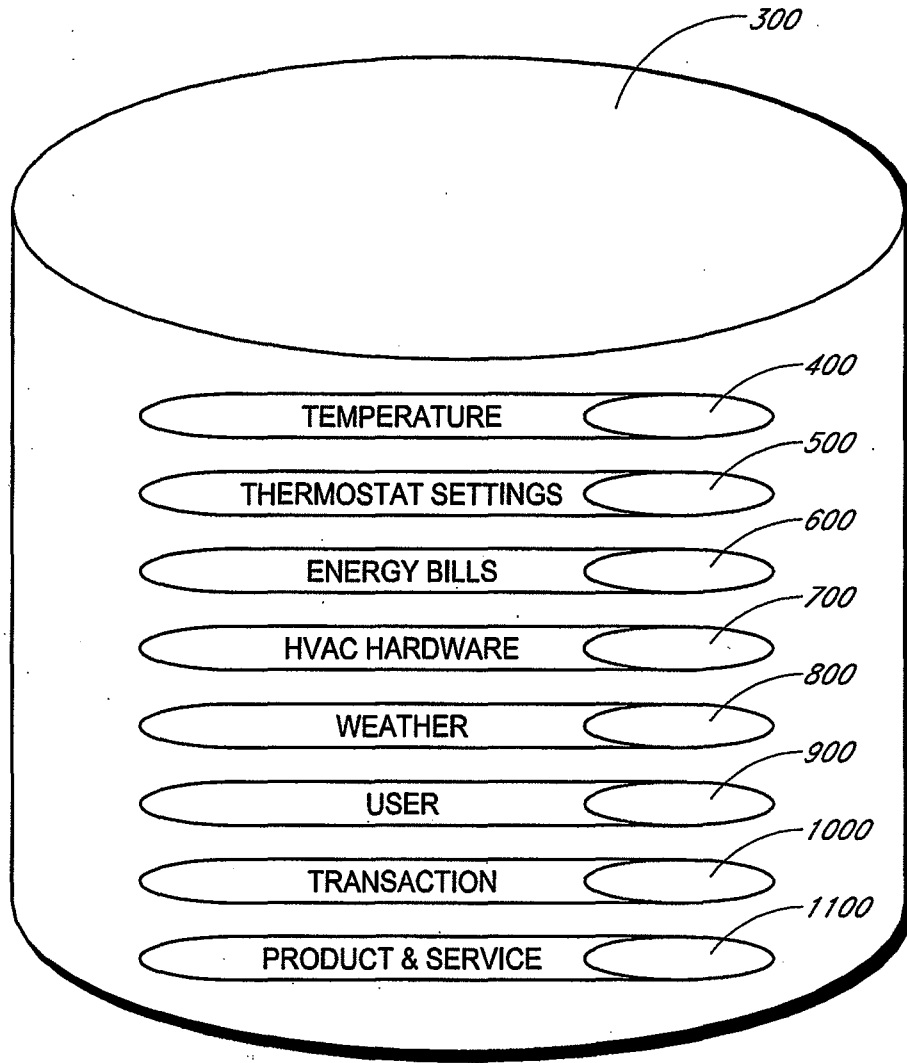
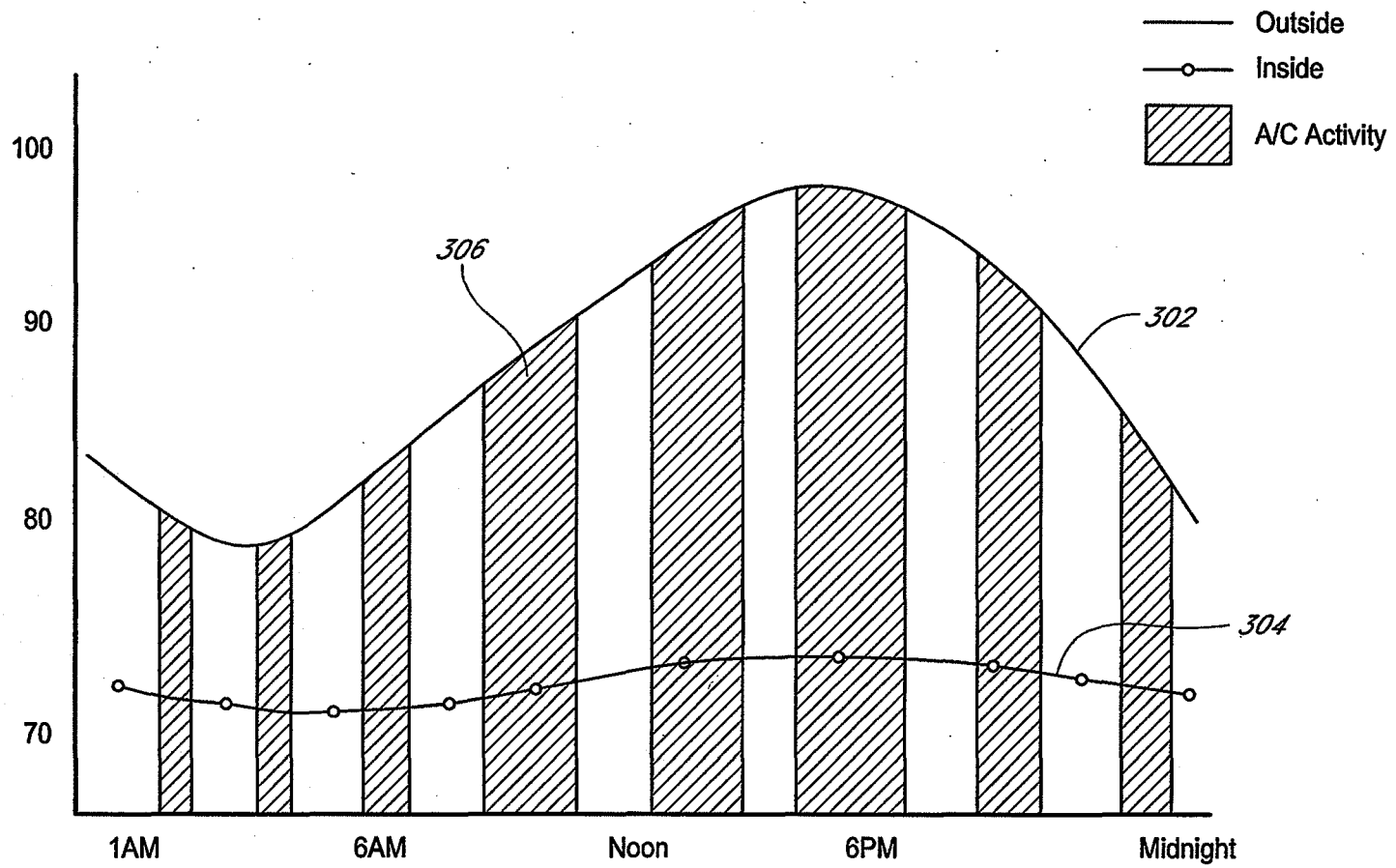

FIG. 5



6/11

FIG. 6A

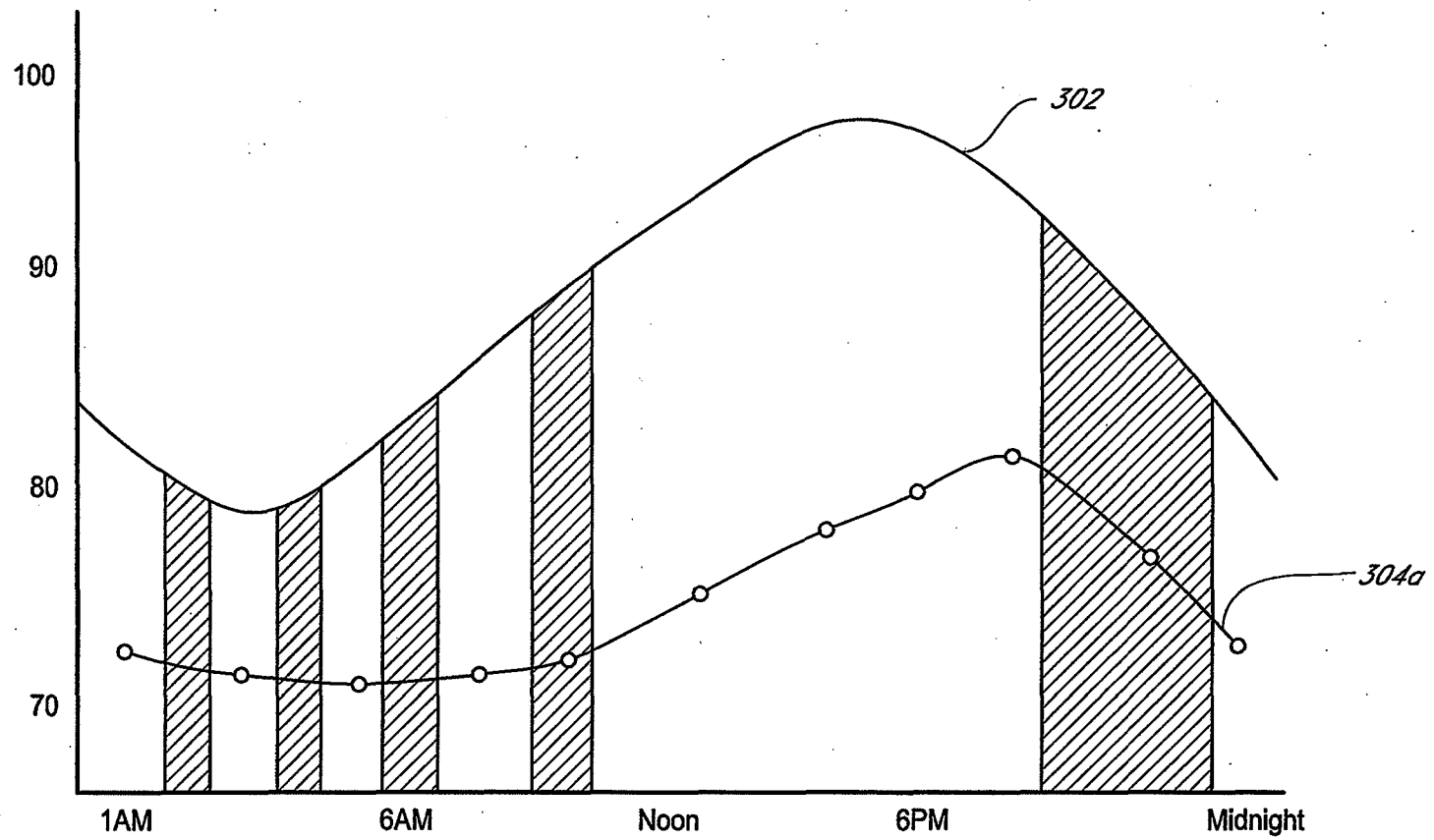

FIG. 6B

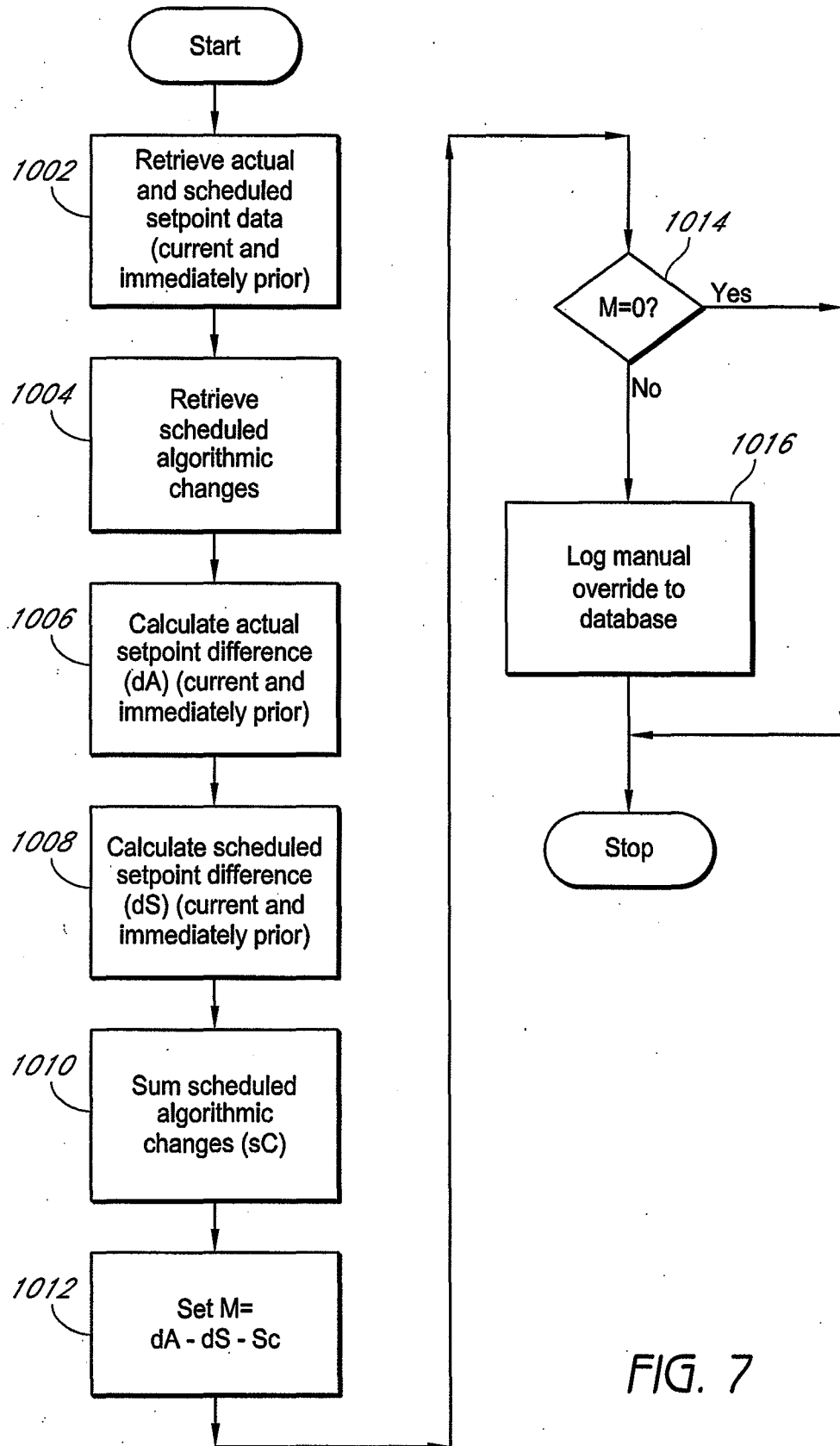

FIG. 7

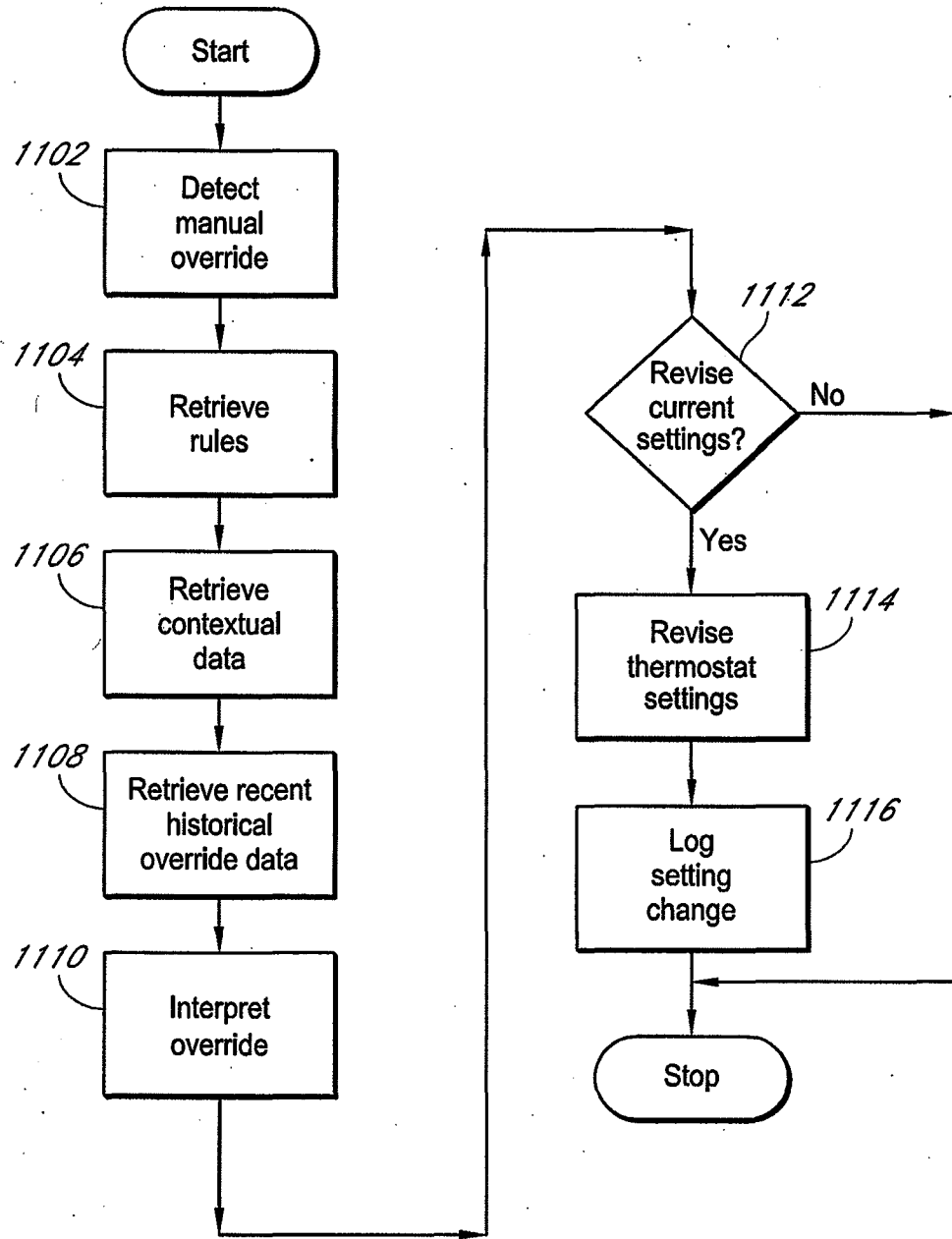

FIG. 8

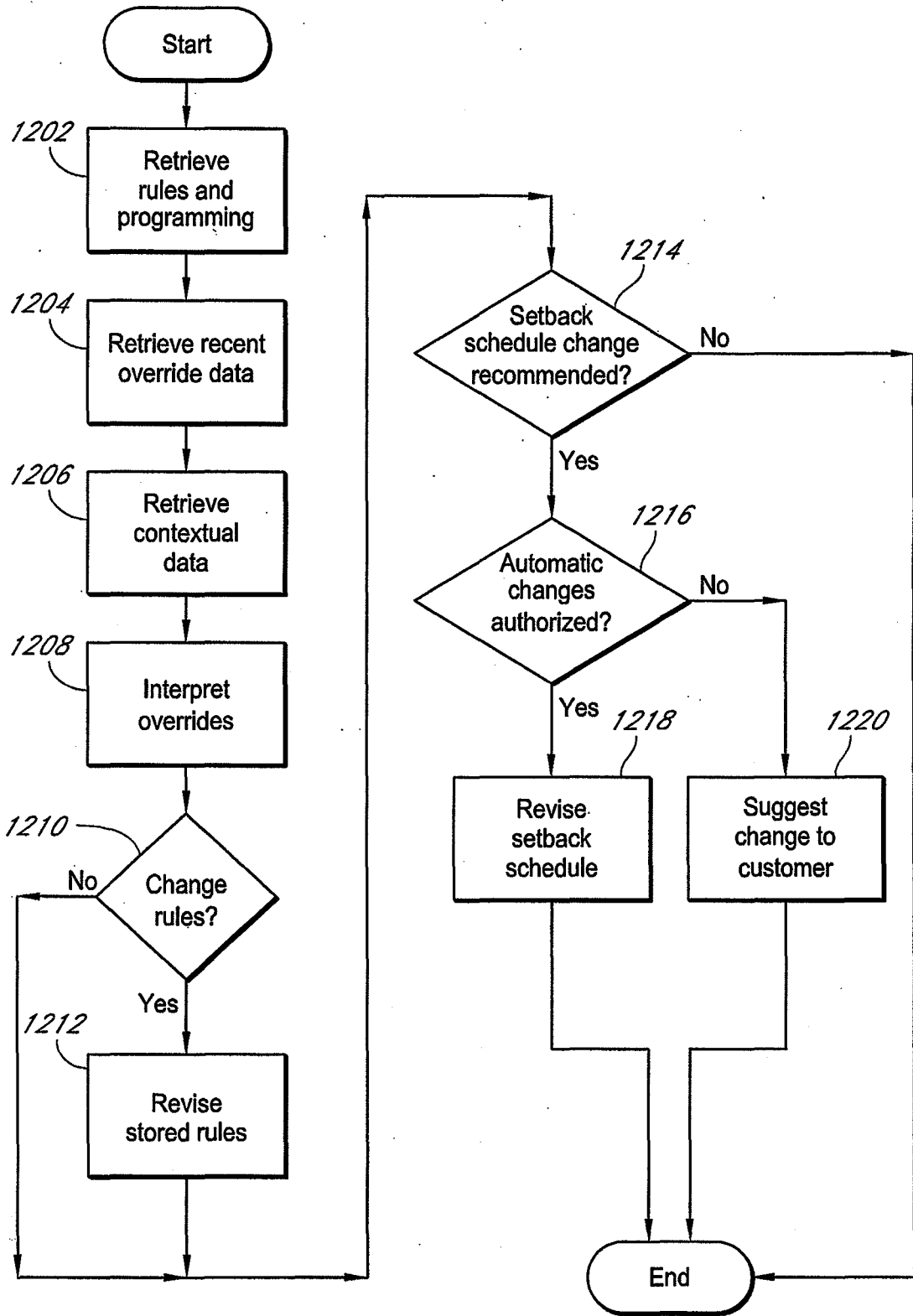

FIG. 9

| Time<br>(hh24:mm)   | Temperature  |               | Outside Conditions |          |                                 |                  |                | Inside Conditions |              |           |              |           |           |            |           |
|---------------------|--------------|---------------|--------------------|----------|---------------------------------|------------------|----------------|-------------------|--------------|-----------|--------------|-----------|-----------|------------|-----------|
|                     | Inside Temp. | Outside Temp. | Conditions         | Humidity | Pressure                        | Wind Speed       | Wind Direction | Cool Setting      | Heat Setting | Hold Mode | Schd Setting | Schd Cool | Schd Heat | Hvac State | Hvac Mode |
| 2009/04/10<br>11:00 | 69.70        | 54.00         | Mostly Cloudy      | 74%      | 29.89in/<br>1012.1hPa<br>Steady | 1.0mph<br>1.6kph | SE             | 80.00             | 71.00        | Off       | Out/Day      | 80.00     | 65.00     | Heat       | Heat      |
| 2009/04/10<br>11:01 | 69.69        | 54.10         | Overcast           | 74%      | 29.89in/<br>1012.1hPa<br>Rising | 2.0mph<br>3.2kph | SE             | 80.00             | 71.00        | Off       | Out/Day      | 80.00     | 65.00     | Heat       | Heat      |
| 2009/04/10<br>11:02 | 69.60        | 54.10         | Overcast           | 74%      | 29.89in/<br>1012.1hPa<br>Steady | 2.0mph<br>3.2kph | SE             | 80.00             | 71.00        | Off       | Out/Day      | 80.00     | 65.00     | Heat       | Heat      |
| 2009/04/10<br>11:03 | 69.70        | 54.10         | Overcast           | 74%      | 29.89in/<br>1012.1hPa<br>Rising | 2.0mph<br>3.2kph | SE             | 80.00             | 71.00        | Off       | Out/Day      | 80.00     | 65.00     | Heat       | Heat      |
| 2009/04/10<br>11:04 | 69.70        | 54.10         | Overcast           | 74%      | 29.89in/<br>1012.1hPa<br>Steady | 2.0mph<br>3.2kph | SE             | 80.00             | 71.00        | Off       | Out/Day      | 80.00     | 65.00     | Heat       | Heat      |
| 2009/04/10<br>11:05 | 69.70        | 54.10         | Overcast           | 74%      | 29.89in/<br>1012.1hPa<br>Rising | 2.0mph<br>3.2kph | SE             | 80.00             | 71.00        | Off       | Out/Day      | 80.00     | 65.00     | Heat       | Heat      |
| 2009/04/10<br>11:06 | 69.80        | 54.70         | Overcast           | 72%      | 29.89in/<br>1012.1hPa<br>Steady | 2.0mph<br>3.2kph | SE             | 80.00             | 71.00        | Off       | Out/Day      | 80.00     | 65.00     | Heat       | Heat      |
| 2009/04/10<br>11:07 | 69.80        | 54.70         | Overcast           | 72%      | 29.89in/<br>1012.1hPa<br>Rising | 2.0mph<br>3.2kph | SE             | 80.00             | 71.00        | Off       | Out/Day      | 80.00     | 65.00     | Heat       | Heat      |
| 2009/04/10<br>11:08 | 70.00        | 54.70         | Overcast           | 72%      | 29.89in/<br>1012.1hPa<br>Steady | 2.0mph<br>3.2kph | SE             | 80.00             | 71.00        | Off       | Out/Day      | 80.00     | 65.00     | Heat       | Heat      |
| 2009/04/10<br>11:09 | 70.00        | 54.70         | Overcast           | 72%      | 29.89in/<br>1012.1hPa<br>Rising | 2.0mph<br>3.2kph | SE             | 80.00             | 71.00        | Off       | Out/Day      | 80.00     | 65.00     | Heat       | Heat      |
| 2009/04/10<br>11:10 | 70.00        | 54.70         | Overcast           | 72%      | 29.89in/<br>1012.1hPa<br>Steady | 2.0mph<br>3.2kph | SE             | 80.00             | 71.00        | Off       | Out/Day      | 80.00     | 65.00     | Heat       | Heat      |

11/11

FIG. 10

## Electronic Patent Application Fee Transmittal

|  |  |                 |               |                             |
|--|--|-----------------|---------------|-----------------------------|
| <b>Application Number:</b>                     |  |                 |               |                             |
| <b>Filing Date:</b>                            |  |                 |               |                             |
| <b>Title of Invention:</b>                     | SYSTEM, METHOD AND APPARATUS FOR IDENTIFYING MANUAL INPUTS TO AND ADAPTIVE PROGRAMMING OF A THERMOSTAT |                 |               |                             |
| <b>First Named Inventor/Applicant Name:</b>    | John Douglas Steinberg   |                 |               |                             |
| <b>Filer:</b>                                  | John R. King/Amy Durrant   |                 |               |                             |
| <b>Attorney Docket Number:</b>                 | EFACT.007C1  |                 |               |                             |
| Filed as Small Entity                          |  |                 |               |                             |
| <b>Utility under 35 USC 111(a) Filing Fees</b> |  |                 |               |                             |
| <b>Description</b>                             | <b>Fee Code</b>  | <b>Quantity</b> | <b>Amount</b> | <b>Sub-Total in USD(\$)</b> |
| <b>Basic Filing:</b>                           |  |                 |               |                             |
| Utility filing Fee (Electronic filing)         | 4011   | 1               | 70            | 70                          |
| Utility Search Fee                             | 2111   | 1               | 300           | 300                         |
| Utility Examination Fee                        | 2311   | 1               | 360           | 360                         |
| <b>Pages:</b>                                  |  |                 |               |                             |
| <b>Claims:</b>                                 |  |                 |               |                             |
| Claims in excess of 20                         | 2202   | 4               | 40            | 160                         |
| <b>Miscellaneous-Filing:</b>                   |  |                 |               |                             |
| Late Filing Fee for Oath or Declaration        | 2051   | 1               | 70            | 70                          |



| Description                              | Fee Code | Quantity | Amount                   | Sub-Total in USD(\$) |
|--|----------|----------|--------------------------|----------------------|
| <b>Petition:</b>                         |          |          |                          |                      |
| <b>Patent-Appeals-and-Interference:</b>  |          |          |                          |                      |
| <b>Post-Allowance-and-Post-Issuance:</b> |          |          |                          |                      |
| <b>Extension-of-Time:</b>                |          |          |                          |                      |
| <b>Miscellaneous:</b>                    |          |          |                          |                      |
|  |          |          | <b>Total in USD (\$)</b> | <b>960</b>           |

## Electronic Acknowledgement Receipt

|   |  |
|---|--|
| <b>EFS ID:</b>                              | 17428531   |
| <b>Application Number:</b>                  | 14082675   |
| <b>International Application Number:</b>    |  |
| <b>Confirmation Number:</b>                 | 3336   |
| <b>Title of Invention:</b>                  | SYSTEM, METHOD AND APPARATUS FOR IDENTIFYING MANUAL INPUTS TO AND ADAPTIVE PROGRAMMING OF A THERMOSTAT |
| <b>First Named Inventor/Applicant Name:</b> | John Douglas Steinberg   |
| <b>Customer Number:</b>                     | 20995  |
| <b>Filer:</b>                               | John R. King/Daniela Lopez   |
| <b>Filer Authorized By:</b>                 | John R. King   |
| <b>Attorney Docket Number:</b>              | EFACT.007C1  |
| <b>Receipt Date:</b>                        | 18-NOV-2013  |
| <b>Filing Date:</b>                         |  |
| <b>Time Stamp:</b>                          | 15:22:30   |
| <b>Application Type:</b>                    | Utility under 35 USC 111(a)  |

### Payment information:

|  |             |
|--|-------------|
| Submitted with Payment                   | yes         |
| Payment Type                             | Credit Card |
| Payment was successfully received in RAM | \$960       |
| RAM confirmation Number                  | 2109        |
| Deposit Account                          |             |
| Authorized User                          |             |

### File Listing:

| Document Number | Document Description | File Name | File Size(Bytes)/ Message Digest | Multi Part /.zip | Pages (if appl.) |
|-----------------|----------------------|-----------|----------------------------------|------------------|------------------|
|                 |                      | 390       |                                  |                  |                  |

|                                     |  |                               |   |            |    |
|-------------------------------------|--|-------------------------------|---|------------|----|
| 1                                   | Application Data Sheet                                     | EFACT-007C1_ADS.pdf           | 1505534<br>eecbaa43d6700077ff54d802b06f3262d8d46fe2 | no         | 7  |
| <b>Warnings:</b>                    |  |                               |   |            |    |
| <b>Information:</b>                 |  |                               |   |            |    |
| 2                                   |  | EFACT-007C1_specification.pdf | 864458<br>2da3ee8ec329877b93fafa2c128212a67c580c9   | yes        | 17 |
|                                     | <b>Multipart Description/PDF files in .zip description</b> |                               |   |            |    |
|                                     | <b>Document Description</b>                                |                               | <b>Start</b>  | <b>End</b> |    |
|                                     | Specification  |                               | 1   | 12         |    |
|                                     | Claims   |                               | 13  | 16         |    |
|                                     | Abstract   |                               | 17  | 17         |    |
| <b>Warnings:</b>                    |  |                               |   |            |    |
| <b>Information:</b>                 |  |                               |   |            |    |
| 3                                   | Drawings-only black and white line drawings                | EFACT-007C1_drawings.pdf      | 265138<br>fd1ab80a04d170a0b27c59e0dec145719dc7d80b  | no         | 11 |
| <b>Warnings:</b>                    |  |                               |   |            |    |
| <b>Information:</b>                 |  |                               |   |            |    |
| 4                                   | Fee Worksheet (SB06)                                       | fee-info.pdf                  | 38181<br>48d3e1d492137717d88a2fa45e2f4af9a7abdc8b   | no         | 2  |
| <b>Warnings:</b>                    |  |                               |   |            |    |
| <b>Information:</b>                 |  |                               |   |            |    |
| <b>Total Files Size (in bytes):</b> |  |                               | 2673311   |            |    |

**This Acknowledgement Receipt evidences receipt on the noted date by the USPTO of the indicated documents, characterized by the applicant, and including page counts, where applicable. It serves as evidence of receipt similar to a Post Card, as described in MPEP 503.**

**New Applications Under 35 U.S.C. 111**

**If a new application is being filed and the application includes the necessary components for a filing date (see 37 CFR 1.53(b)-(d) and MPEP 506), a Filing Receipt (37 CFR 1.54) will be issued in due course and the date shown on this Acknowledgement Receipt will establish the filing date of the application.**

**National Stage of an International Application under 35 U.S.C. 371**

**If a timely submission to enter the national stage of an international application is compliant with the conditions of 35 U.S.C. 371 and other applicable requirements a Form PCT/DO/EO/903 indicating acceptance of the application as a national stage submission under 35 U.S.C. 371 will be issued in addition to the Filing Receipt, in due course.**

**New International Application Filed with the USPTO as a Receiving Office**

**If a new international application is being filed and the international application includes the necessary components for an international filing date (see PCT Article 11 and MPEP 1810), a Notification of the International Application Number and of the International Filing Date (Form PCT/RO/105) will be issued in due course, subject to prescriptions concerning national security, and the date shown on this Acknowledgement Receipt will establish the international filing date of the application.**