

AO 120 (Rev. 08/10)

TO: <b>Mail Stop 8</b> <b>Director of the U.S. Patent and Trademark Office</b> <b>P.O. Box 1450</b> <b>Alexandria, VA 22313-1450</b>	<b>REPORT ON THE</b> <b>FILING OR DETERMINATION OF AN</b> <b>ACTION REGARDING A PATENT OR</b> <b>TRADEMARK</b>
---	---

In Compliance with 35 U.S.C. § 290 and/or 15 U.S.C. § 1116 you are hereby advised that a court action has been filed in the U.S. District Court Central District of California, Southern Division on the following

Trademarks or  Patents. (  the patent action involves 35 U.S.C. § 292.);

DOCKET NO. 2:21-cv-08004	DATE FILED 10/7/2021	U.S. DISTRICT COURT Central District of California, Southern Division
PLAINTIFF SCRAMOGE TECHNOLOGY LTD.		DEFENDANT MOPHIE INC.
PATENT OR TRADEMARK NO.	DATE OF PATENT OR TRADEMARK	HOLDER OF PATENT OR TRADEMARK
1 9,490,652	11/8/2016	SCRAMOGE TECHNOLOGY LIMITED
2 10,193,392	1/29/2019	SCRAMOGE TECHNOLOGY LIMITED
3 7,825,537	11/2/2010	SCRAMOGE TECHNOLOGY LIMITED
4		
5		

In the above—entitled case, the following patent(s)/ trademark(s) have been included:

DATE INCLUDED	INCLUDED BY <input type="checkbox"/> Amendment <input type="checkbox"/> Answer <input type="checkbox"/> Cross Bill <input type="checkbox"/> Other Pleading	
PATENT OR TRADEMARK NO.	DATE OF PATENT OR TRADEMARK	HOLDER OF PATENT OR TRADEMARK
1		
2		
3		
4		
5		

In the above—entitled case, the following decision has been rendered or judgement issued:

DECISION/JUDGEMENT
--------------------

CLERK	(BY) DEPUTY CLERK	DATE
-------	-------------------	------

Copy 1—Upon initiation of action, mail this copy to Director Copy 3—Upon termination of action, mail this copy to Director  
 Copy 2—Upon filing document adding patent(s), mail this copy to Director Copy 4—Case file copy

AO 120 (Rev. 08/10)

TO: <b>Mail Stop 8</b> <b>Director of the U.S. Patent and Trademark Office</b> <b>P.O. Box 1450</b> <b>Alexandria, VA 22313-1450</b>	<b>REPORT ON THE</b> <b>FILING OR DETERMINATION OF AN</b> <b>ACTION REGARDING A PATENT OR</b> <b>TRADEMARK</b>
---	---

In Compliance with 35 U.S.C. § 290 and/or 15 U.S.C. § 1116 you are hereby advised that a court action has been filed in the U.S. District Court Central District of California, Western Division on the following

Trademarks or  Patents. (  the patent action involves 35 U.S.C. § 292.);

DOCKET NO. 2:21-cv-08035	DATE FILED 10/8/2021	U.S. DISTRICT COURT Central District of California, Western Division
PLAINTIFF SCRAMOGE TECHNOLOGY LTD.		DEFENDANT BELKIN INTERNATIONAL, INC.
PATENT OR TRADEMARK NO.	DATE OF PATENT OR TRADEMARK	HOLDER OF PATENT OR TRADEMARK
1 9,490,652	11/8/2016	SCRAMOGE TECHNOLOGY LIMITED
2 10,193,392	1/29/2019	SCRAMOGE TECHNOLOGY LIMITED
3 7,825,537	11/2/2010	SCRAMOGE TECHNOLOGY LIMITED
4		
5		

In the above—entitled case, the following patent(s)/ trademark(s) have been included:

DATE INCLUDED	INCLUDED BY <input type="checkbox"/> Amendment <input type="checkbox"/> Answer <input type="checkbox"/> Cross Bill <input type="checkbox"/> Other Pleading	
PATENT OR TRADEMARK NO.	DATE OF PATENT OR TRADEMARK	HOLDER OF PATENT OR TRADEMARK
1		
2		
3		
4		
5		

In the above—entitled case, the following decision has been rendered or judgement issued:

DECISION/JUDGEMENT
--------------------

CLERK	(BY) DEPUTY CLERK	DATE
-------	-------------------	------

Copy 1—Upon initiation of action, mail this copy to Director Copy 3—Upon termination of action, mail this copy to Director  
 Copy 2—Upon filing document adding patent(s), mail this copy to Director Copy 4—Case file copy

AO 120 (Rev. 08/10)

<b>TO:</b> <p style="text-align: center;"><b>Mail Stop 8</b>  <b>Director of the U.S. Patent and Trademark Office</b>  <b>P.O. Box 1450</b>  <b>Alexandria, VA 22313-1450</b></p>	<b>REPORT ON THE</b> <b>FILING OR DETERMINATION OF AN</b> <b>ACTION REGARDING A PATENT OR</b> <b>TRADEMARK</b>
--	---

In Compliance with 35 U.S.C. § 290 and/or 15 U.S.C. § 1116 you are hereby advised that a court action has been filed in the U.S. District Court Western District of Texas on the following

Trademarks or  Patents. (  the patent action involves 35 U.S.C. § 292.);

DOCKET NO. <b>6:21-cv-01138</b>	DATE FILED <b>11/4/2021</b>	U.S. DISTRICT COURT <b>Western District of Texas</b>
PLAINTIFF <b>SCRAMOGE TECHNOLOGY LIMITED</b>		DEFENDANT <b>GOOGLE LLC</b>
PATENT OR TRADEMARK NO.	DATE OF PATENT OR TRADEMARK	HOLDER OF PATENT OR TRADEMARK
1 10,193,392	1/29/2016	Scramoge Technology Limited
2 7,825,537	11/2/2010	Scramoge Technology Limited
3		
4		
5		

In the above—entitled case, the following patent(s)/ trademark(s) have been included:

DATE INCLUDED	INCLUDED BY <input type="checkbox"/> Amendment <input type="checkbox"/> Answer <input type="checkbox"/> Cross Bill <input type="checkbox"/> Other Pleading	
PATENT OR TRADEMARK NO.	DATE OF PATENT OR TRADEMARK	HOLDER OF PATENT OR TRADEMARK
1		
2		
3		
4		
5		

In the above—entitled case, the following decision has been rendered or judgement issued:

DECISION/JUDGEMENT
--------------------

CLERK	(BY) DEPUTY CLERK	DATE
-------	-------------------	------

Copy 1—Upon initiation of action, mail this copy to Director Copy 3—Upon termination of action, mail this copy to Director  
 Copy 2—Upon filing document adding patent(s), mail this copy to Director Copy 4—Case file copy

**Print**

**Save As...**

**Reset**

AO 120 (Rev. 08/10)

TO: <b>Mail Stop 8</b> <b>Director of the U.S. Patent and Trademark Office</b> <b>P.O. Box 1450</b> <b>Alexandria, VA 22313-1450</b>	<b>REPORT ON THE</b> <b>FILING OR DETERMINATION OF AN</b> <b>ACTION REGARDING A PATENT OR</b> <b>TRADEMARK</b>
---	---

In Compliance with 35 U.S.C. § 290 and/or 15 U.S.C. § 1116 you are hereby advised that a court action has been filed in the U.S. District Court Central District of California, Eastern Division on the following

Trademarks or  Patents. (  the patent action involves 35 U.S.C. § 292.);

DOCKET NO. 5:21-cv-01712	DATE FILED 10/7/2021	U.S. DISTRICT COURT Central District of California, Eastern Division
PLAINTIFF SCRAMOGE TECHNOLOGY LTD.		DEFENDANT ANKER INNOVATIONS LTD. and FANTASIA TRADING LLC D/B/A ANKERDIRECT
PATENT OR TRADEMARK NO.	DATE OF PATENT OR TRADEMARK	HOLDER OF PATENT OR TRADEMARK
1 9,490,652	11/8/2016	SCRAMOGE TECHNOLOGY LTD.
2 10,193,392	1/29/2019	SCRAMOGE TECHNOLOGY LTD.
3 7,825,537	11/2/2010	SCRAMOGE TECHNOLOGY LTD.
4		
5		

In the above—entitled case, the following patent(s)/ trademark(s) have been included:

DATE INCLUDED	INCLUDED BY <input type="checkbox"/> Amendment <input type="checkbox"/> Answer <input type="checkbox"/> Cross Bill <input type="checkbox"/> Other Pleading	
PATENT OR TRADEMARK NO.	DATE OF PATENT OR TRADEMARK	HOLDER OF PATENT OR TRADEMARK
1		
2		
3		
4		
5		

In the above—entitled case, the following decision has been rendered or judgement issued:

DECISION/JUDGEMENT
--------------------

CLERK	(BY) DEPUTY CLERK	DATE
-------	-------------------	------

Copy 1—Upon initiation of action, mail this copy to Director Copy 3—Upon termination of action, mail this copy to Director  
 Copy 2—Upon filing document adding patent(s), mail this copy to Director Copy 4—Case file copy

AO 120 (Rev. 08/10)

TO: <b>Mail Stop 8</b> <b>Director of the U.S. Patent and Trademark Office</b> <b>P.O. Box 1450</b> <b>Alexandria, VA 22313-1450</b>	<b>REPORT ON THE</b> <b>FILING OR DETERMINATION OF AN</b> <b>ACTION REGARDING A PATENT OR</b> <b>TRADEMARK</b>
---	---

In Compliance with 35 U.S.C. § 290 and/or 15 U.S.C. § 1116 you are hereby advised that a court action has been filed in the U.S. District Court Western District of Texas on the following

Trademarks or  Patents. (  the patent action involves 35 U.S.C. § 292.);

DOCKET NO. 6:21-cv-00902-ADA	DATE FILED 8/30/2021	U.S. DISTRICT COURT Western District of Texas
PLAINTIFF SCRAMOGE TECHNOLOGY LIMITED		DEFENDANT SAMSUNG ELECTRONICS CO., LTD.; and SAMSUNG ELECTRONICS AMERICA, INC.
PATENT OR TRADEMARK NO.	DATE OF PATENT OR TRADEMARK	HOLDER OF PATENT OR TRADEMARK
1 9,490,652	11/8/2016	Scramoge Technology Limited
2 10,199,876	2/5/2019	Scramoge Technology Limited
3 10,193,392	1/29/2019	Scramoge Technology Limited
4		
5		

In the above—entitled case, the following patent(s)/ trademark(s) have been included:

DATE INCLUDED 10/14/2021	INCLUDED BY <input checked="" type="checkbox"/> Amendment <input type="checkbox"/> Answer <input type="checkbox"/> Cross Bill <input type="checkbox"/> Other Pleading	
PATENT OR TRADEMARK NO.	DATE OF PATENT OR TRADEMARK	HOLDER OF PATENT OR TRADEMARK
1 7,825,537	11/2/2010	Scramoge Technology Limited
2		
3		
4		
5		

In the above—entitled case, the following decision has been rendered or judgement issued:

DECISION/JUDGEMENT
--------------------

CLERK	(BY) DEPUTY CLERK	DATE
-------	-------------------	------

Copy 1—Upon initiation of action, mail this copy to Director Copy 3—Upon termination of action, mail this copy to Director  
 Copy 2—Upon filing document adding patent(s), mail this copy to Director Copy 4—Case file copy

Print

Save As...

Reset



UNITED STATES PATENT AND TRADEMARK OFFICE

UNITED STATES DEPARTMENT OF COMMERCE
United States Patent and Trademark Office
Address: COMMISSIONER FOR PATENTS
P.O. Box 1450
Alexandria, Virginia 22313-1450
www.uspto.gov

Table with 5 columns: APPLICATION NO., ISSUE DATE, PATENT NO., ATTORNEY DOCKET NO., CONFIRMATION NO.
Row 1: 12/271.023, 11/02/2010, 7825537, 7162-0448US0, 3269

68085 7590 10/13/2010
HARRIS CORPORATION
C/O FOX ROTHSCHILD, LLP
997 Lenox Drive
Building 3
Lawrenceville, NJ 08543-5231

ISSUE NOTIFICATION

The projected patent number and issue date are specified above.

Determination of Patent Term Adjustment under 35 U.S.C. 154 (b)
(application filed on or after May 29, 2000)

The Patent Term Adjustment is 113 day(s). Any patent to issue from the above-identified application will include an indication of the adjustment on the front page.

If a Continued Prosecution Application (CPA) was filed in the above-identified application, the filing date that determines Patent Term Adjustment is the filing date of the most recent CPA.

Applicant will be able to obtain more detailed information by accessing the Patent Application Information Retrieval (PAIR) WEB site (http://pair.uspto.gov).

Any questions regarding the Patent Term Extension or Adjustment determination should be directed to the Office of Patent Legal Administration at (571)-272-7702. Questions relating to issue and publication fee payments should be directed to the Application Assistance Unit (AAU) of the Office of Data Management (ODM) at (571)-272-4200.

APPLICANT(s) (Please see PAIR WEB site http://pair.uspto.gov for additional applicants):

Benjamin Freer, Rochester, NY;



## Electronic Patent Application Fee Transmittal

<b>Application Number:</b>	12271023			
<b>Filing Date:</b>	14-Nov-2008			
<b>Title of Invention:</b>	INDUCTIVE POWER TRANSFER SYSTEM AND METHOD			
<b>First Named Inventor/Applicant Name:</b>	Benjamin Freer			
<b>Filer:</b>	Robert Joseph Sacco/Joyce Dougherty			
<b>Attorney Docket Number:</b>	7162-0448US0			
Filed as Large Entity				
<b>Utility under 35 USC 111(a) Filing Fees</b>				
<b>Description</b>	<b>Fee Code</b>	<b>Quantity</b>	<b>Amount</b>	<b>Sub-Total in USD(\$)</b>
<b>Basic Filing:</b>				
<b>Pages:</b>				
<b>Claims:</b>				
<b>Miscellaneous-Filing:</b>				
<b>Petition:</b>				
<b>Patent-Appeals-and-Interference:</b>				
<b>Post-Allowance-and-Post-Issuance:</b>				
Utility Appl issue fee	1501	1	1510	1510
Publ. Fee- early, voluntary, or normal	1504	1	300	300



Description	Fee Code	Quantity	Amount	Sub-Total in USD(\$)
<b>Extension-of-Time:</b>				
<b>Miscellaneous:</b>				
<b>Total in USD (\$)</b>				<b>1810</b>

## Electronic Acknowledgement Receipt

<b>EFS ID:</b>	8493043
<b>Application Number:</b>	12271023
<b>International Application Number:</b>	
<b>Confirmation Number:</b>	3269
<b>Title of Invention:</b>	INDUCTIVE POWER TRANSFER SYSTEM AND METHOD
<b>First Named Inventor/Applicant Name:</b>	Benjamin Freer
<b>Customer Number:</b>	68085
<b>Filer:</b>	Robert Joseph Sacco/Joyce Dougherty
<b>Filer Authorized By:</b>	Robert Joseph Sacco
<b>Attorney Docket Number:</b>	7162-0448US0
<b>Receipt Date:</b>	24-SEP-2010
<b>Filing Date:</b>	14-NOV-2008
<b>Time Stamp:</b>	14:28:50
<b>Application Type:</b>	Utility under 35 USC 111(a)

### Payment information:

Submitted with Payment	yes
Payment Type	Deposit Account
Payment was successfully received in RAM	\$1810
RAM confirmation Number	721
Deposit Account	080870
Authorized User	

The Director of the USPTO is hereby authorized to charge indicated fees and credit any overpayment as follows:  
 Charge any Additional Fees required under 37 C.F.R. Section 1.17 (Patent application and reexamination processing fees)

<b>File Listing:</b>					
<b>Document Number</b>	<b>Document Description</b>	<b>File Name</b>	<b>File Size(Bytes)/ Message Digest</b>	<b>Multi Part /.zip</b>	<b>Pages (if appl.)</b>
1	Issue Fee Payment (PTO-85B)	int9A.PDF	111188	no	1
			b20587c64dff9c49970785df9b4b2362a2f6c4f		
<b>Warnings:</b>					
<b>Information:</b>					
2	Fee Worksheet (PTO-875)	fee-info.pdf	32168	no	2
			f3806c1e071a1e6525d2ca6e39d9afde70cd9e27		
<b>Warnings:</b>					
<b>Information:</b>					
<b>Total Files Size (in bytes):</b>			143356		
<p>This Acknowledgement Receipt evidences receipt on the noted date by the USPTO of the indicated documents, characterized by the applicant, and including page counts, where applicable. It serves as evidence of receipt similar to a Post Card, as described in MPEP 503.</p> <p><b><u>New Applications Under 35 U.S.C. 111</u></b>  If a new application is being filed and the application includes the necessary components for a filing date (see 37 CFR 1.53(b)-(d) and MPEP 506), a Filing Receipt (37 CFR 1.54) will be issued in due course and the date shown on this Acknowledgement Receipt will establish the filing date of the application.</p> <p><b><u>National Stage of an International Application under 35 U.S.C. 371</u></b>  If a timely submission to enter the national stage of an international application is compliant with the conditions of 35 U.S.C. 371 and other applicable requirements a Form PCT/DO/EO/903 indicating acceptance of the application as a national stage submission under 35 U.S.C. 371 will be issued in addition to the Filing Receipt, in due course.</p> <p><b><u>New International Application Filed with the USPTO as a Receiving Office</u></b>  If a new international application is being filed and the international application includes the necessary components for an international filing date (see PCT Article 11 and MPEP 1810), a Notification of the International Application Number and of the International Filing Date (Form PCT/RO/105) will be issued in due course, subject to prescriptions concerning national security, and the date shown on this Acknowledgement Receipt will establish the international filing date of the application.</p>					

UNITED STATES PATENT AND TRADEMARK OFFICE  
COMMISSIONER FOR PATENTS  
P.O. BOX 1450  
ALEXANDRIA VA 22313-1451

PRESORTED  
FIRST-CLASS MAIL  
U.S. POSTAGE PAID  
POSTEDIGITAL  
NNNNN

HARRIS CORPORATION  
C/O FOX ROTHSCHILD, LLP  
997 Lenox Drive  
Building 3  
Lawrenceville, NJ 08543-5231



**Courtesy Reminder for  
Application Serial No: 12/271,023**

Attorney Docket No: 7162-0448US0  
Customer Number: 68085  
Date of Electronic Notification: 09/08/2010

This is a courtesy reminder that new correspondence is available for this application. The official date of notification of the outgoing correspondence will be indicated on the form PTOL-90 accompanying the correspondence.

An email notification regarding the correspondence was sent to the following email address(es) associated with your customer number:

ipdocket@foxrothschild.com

Please verify that these email addresses are correct.

To view your correspondence online or update your email addresses, please visit us anytime at <https://sportal.uspto.gov/secure/myportal/privatepair>. If you have any questions, please email the Electronic Business Center (EBC) at [EBC@uspto.gov](mailto:EBC@uspto.gov) or call 1-866-217-9197.



UNITED STATES PATENT AND TRADEMARK OFFICE

UNITED STATES DEPARTMENT OF COMMERCE
United States Patent and Trademark Office
Address: COMMISSIONER FOR PATENTS
P.O. Box 1450
Alexandria, Virginia 22313-1450
www.uspto.gov

NOTICE OF ALLOWANCE AND FEE(S) DUE

68085 7590 09/08/2010

HARRIS CORPORATION
C/O FOX ROTHSCHILD, LLP
997 Lenox Drive
Building 3
Lawrenceville, NJ 08543-5231

EXAMINER

RILEY, SHAWN

ART UNIT PAPER NUMBER

2838

DATE MAILED: 09/08/2010

Table with 5 columns: APPLICATION NO., FILING DATE, FIRST NAMED INVENTOR, ATTORNEY DOCKET NO., CONFIRMATION NO.
12/271,023 11/14/2008 Benjamin Freer 7162-0448US0 3269

TITLE OF INVENTION: INDUCTIVE POWER TRANSFER SYSTEM AND METHOD

Table with 7 columns: APPLN. TYPE, SMALL ENTITY, ISSUE FEE DUE, PUBLICATION FEE DUE, PREV. PAID ISSUE FEE, TOTAL FEE(S) DUE, DATE DUE
nonprovisional NO \$1510 \$300 \$0 \$1810 12/08/2010

THE APPLICATION IDENTIFIED ABOVE HAS BEEN EXAMINED AND IS ALLOWED FOR ISSUANCE AS A PATENT. PROSECUTION ON THE MERITS IS CLOSED. THIS NOTICE OF ALLOWANCE IS NOT A GRANT OF PATENT RIGHTS. THIS APPLICATION IS SUBJECT TO WITHDRAWAL FROM ISSUE AT THE INITIATIVE OF THE OFFICE OR UPON PETITION BY THE APPLICANT. SEE 37 CFR 1.313 AND MPEP 1308.

THE ISSUE FEE AND PUBLICATION FEE (IF REQUIRED) MUST BE PAID WITHIN THREE MONTHS FROM THE MAILING DATE OF THIS NOTICE OR THIS APPLICATION SHALL BE REGARDED AS ABANDONED. THIS STATUTORY PERIOD CANNOT BE EXTENDED. SEE 35 U.S.C. 151. THE ISSUE FEE DUE INDICATED ABOVE DOES NOT REFLECT A CREDIT FOR ANY PREVIOUSLY PAID ISSUE FEE IN THIS APPLICATION. IF AN ISSUE FEE HAS PREVIOUSLY BEEN PAID IN THIS APPLICATION (AS SHOWN ABOVE), THE RETURN OF PART B OF THIS FORM WILL BE CONSIDERED A REQUEST TO REAPPLY THE PREVIOUSLY PAID ISSUE FEE TOWARD THE ISSUE FEE NOW DUE.

HOW TO REPLY TO THIS NOTICE:

I. Review the SMALL ENTITY status shown above.

If the SMALL ENTITY is shown as YES, verify your current SMALL ENTITY status:

- A. If the status is the same, pay the TOTAL FEE(S) DUE shown above.
B. If the status above is to be removed, check box 5b on Part B - Fee(s) Transmittal and pay the PUBLICATION FEE (if required) and twice the amount of the ISSUE FEE shown above, or

If the SMALL ENTITY is shown as NO:

- A. Pay TOTAL FEE(S) DUE shown above, or
B. If applicant claimed SMALL ENTITY status before, or is now claiming SMALL ENTITY status, check box 5a on Part B - Fee(s) Transmittal and pay the PUBLICATION FEE (if required) and 1/2 the ISSUE FEE shown above.

II. PART B - FEE(S) TRANSMITTAL, or its equivalent, must be completed and returned to the United States Patent and Trademark Office (USPTO) with your ISSUE FEE and PUBLICATION FEE (if required). If you are charging the fee(s) to your deposit account, section "4b" of Part B - Fee(s) Transmittal should be completed and an extra copy of the form should be submitted. If an equivalent of Part B is filed, a request to reapply a previously paid issue fee must be clearly made, and delays in processing may occur due to the difficulty in recognizing the paper as an equivalent of Part B.

III. All communications regarding this application must give the application number. Please direct all communications prior to issuance to Mail Stop ISSUE FEE unless advised to the contrary.

IMPORTANT REMINDER: Utility patents issuing on applications filed on or after Dec. 12, 1980 may require payment of maintenance fees. It is patentee's responsibility to ensure timely payment of maintenance fees when due.

**PART B - FEE(S) TRANSMITTAL**

**Complete and send this form, together with applicable fee(s), to: Mail Mail Stop ISSUE FEE  
 Commissioner for Patents  
 P.O. Box 1450  
 Alexandria, Virginia 22313-1450  
 or Fax (571)-273-2885**

**INSTRUCTIONS:** This form should be used for transmitting the ISSUE FEE and PUBLICATION FEE (if required). Blocks 1 through 5 should be completed where appropriate. All further correspondence including the Patent, advance orders and notification of maintenance fees will be mailed to the current correspondence address as indicated unless corrected below or directed otherwise in Block 1, by (a) specifying a new correspondence address; and/or (b) indicating a separate "FEE ADDRESS" for maintenance fee notifications.

CURRENT CORRESPONDENCE ADDRESS (Note: Use Block 1 for any change of address)

68085                      7590                      09/08/2010

**HARRIS CORPORATION**  
**C/O FOX ROTHSCHILD, LLP**  
 997 Lenox Drive  
 Building 3  
 Lawrenceville, NJ 08543-5231

Note: A certificate of mailing can only be used for domestic mailings of the Fee(s) Transmittal. This certificate cannot be used for any other accompanying papers. Each additional paper, such as an assignment or formal drawing, must have its own certificate of mailing or transmission.

**Certificate of Mailing or Transmission**

I hereby certify that this Fee(s) Transmittal is being deposited with the United States Postal Service with sufficient postage for first class mail in an envelope addressed to the Mail Stop ISSUE FEE address above, or being facsimile transmitted to the USPTO (571) 273-2885, on the date indicated below.

_____ (Depositor's name)
_____ (Signature)
_____ (Date)

APPLICATION NO.	FILING DATE	FIRST NAMED INVENTOR	ATTORNEY DOCKET NO.	CONFIRMATION NO.
12/271,023	11/14/2008	Benjamin Freer	7162-0448US0	3269

TITLE OF INVENTION: INDUCTIVE POWER TRANSFER SYSTEM AND METHOD

APPLN. TYPE	SMALL ENTITY	ISSUE FEE DUE	PUBLICATION FEE DUE	PREV. PAID ISSUE FEE	TOTAL FEE(S) DUE	DATE DUE
nonprovisional	NO	\$1510	\$300	\$0	\$1810	12/08/2010

EXAMINER	ART UNIT	CLASS-SUBCLASS
RILEY, SHAWN	2838	323-247000

<p>1. Change of correspondence address or indication of "Fee Address" (37 CFR 1.363).</p> <p><input type="checkbox"/> Change of correspondence address (or Change of Correspondence Address form PTO/SB/122) attached.</p> <p><input type="checkbox"/> "Fee Address" indication (or "Fee Address" Indication form PTO/SB/47; Rev 03-02 or more recent) attached. <b>Use of a Customer Number is required.</b></p>	<p>2. For printing on the patent front page, list</p> <p>(1) the names of up to 3 registered patent attorneys or agents OR, alternatively, 1 _____</p> <p>(2) the name of a single firm (having as a member a registered attorney or agent) and the names of up to 2 registered patent attorneys or agents. If no name is listed, no name will be printed. 2 _____</p> <p>3 _____</p>
---	---

3. ASSIGNEE NAME AND RESIDENCE DATA TO BE PRINTED ON THE PATENT (print or type)

PLEASE NOTE: Unless an assignee is identified below, no assignee data will appear on the patent. If an assignee is identified below, the document has been filed for recordation as set forth in 37 CFR 3.111. Completion of this form is NOT a substitute for filing an assignment.

(A) NAME OF ASSIGNEE \_\_\_\_\_ (B) RESIDENCE: (CITY and STATE OR COUNTRY) \_\_\_\_\_

Please check the appropriate assignee category or categories (will not be printed on the patent):  Individual  Corporation or other private group entity  Government

<p>4a. The following fee(s) are submitted:</p> <p><input type="checkbox"/> Issue Fee</p> <p><input type="checkbox"/> Publication Fee (No small entity discount permitted)</p> <p><input type="checkbox"/> Advance Order - # of Copies _____</p>	<p>4b. Payment of Fee(s): (Please first reapply any previously paid issue fee shown above)</p> <p><input type="checkbox"/> A check is enclosed.</p> <p><input type="checkbox"/> Payment by credit card. Form PTO-2038 is attached.</p> <p><input type="checkbox"/> The Director is hereby authorized to charge the required fee(s), any deficiency, or credit any overpayment, to Deposit Account Number _____ (enclose an extra copy of this form).</p>
---	--

5. Change in Entity Status (from status indicated above)

a. Applicant claims SMALL ENTITY status. See 37 CFR 1.27.  b. Applicant is no longer claiming SMALL ENTITY status. See 37 CFR 1.27(g)(2).

NOTE: The Issue Fee and Publication Fee (if required) will not be accepted from anyone other than the applicant; a registered attorney or agent; or the assignee or other party in interest as shown by the records of the United States Patent and Trademark Office.

Authorized Signature \_\_\_\_\_ Date \_\_\_\_\_

Typed or printed name \_\_\_\_\_ Registration No. \_\_\_\_\_

This collection of information is required by 37 CFR 1.311. The information is required to obtain or retain a benefit by the public which is to file (and by the USPTO to process) an application. Confidentiality is governed by 35 U.S.C. 122 and 37 CFR 1.14. This collection is estimated to take 12 minutes to complete, including gathering, preparing, and submitting the completed application form to the USPTO. Time will vary depending upon the individual case. Any comments on the amount of time you require to complete this form and/or suggestions for reducing this burden, should be sent to the Chief Information Officer, U.S. Patent and Trademark Office, U.S. Department of Commerce, P.O. Box 1450, Alexandria, Virginia 22313-1450. DO NOT SEND FEES OR COMPLETED FORMS TO THIS ADDRESS. SEND TO: Commissioner for Patents, P.O. Box 1450, Alexandria, Virginia 22313-1450.

Under the Paperwork Reduction Act of 1995, no persons are required to respond to a collection of information unless it displays a valid OMB control number.



UNITED STATES PATENT AND TRADEMARK OFFICE

UNITED STATES DEPARTMENT OF COMMERCE
United States Patent and Trademark Office
Address: COMMISSIONER FOR PATENTS
P. O. Box 1450
Alexandria, Virginia 22313-1450
www.uspto.gov

Table with 5 columns: APPLICATION NO., FILING DATE, FIRST NAMED INVENTOR, ATTORNEY DOCKET NO., CONFIRMATION NO.
Row 1: 12/271,023, 11/14/2008, Benjamin Freer, 7162-0448US0, 3269
Row 2: 68085, 7590, 09/08/2010
Text: HARRIS CORPORATION, C/O FOX ROTHSCHILD, LLP, 997 Lenox Drive, Building 3, Lawrenceville, NJ 08543-5231
Text: EXAMINER RILEY, SHAWN
Text: ART UNIT 2838, PAPER NUMBER
Text: DATE MAILED: 09/08/2010

Determination of Patent Term Adjustment under 35 U.S.C. 154 (b)
(application filed on or after May 29, 2000)

The Patent Term Adjustment to date is 113 day(s). If the issue fee is paid on the date that is three months after the mailing date of this notice and the patent issues on the Tuesday before the date that is 28 weeks (six and a half months) after the mailing date of this notice, the Patent Term Adjustment will be 113 day(s).

If a Continued Prosecution Application (CPA) was filed in the above-identified application, the filing date that determines Patent Term Adjustment is the filing date of the most recent CPA.

Applicant will be able to obtain more detailed information by accessing the Patent Application Information Retrieval (PAIR) WEB site (http://pair.uspto.gov).

Any questions regarding the Patent Term Extension or Adjustment determination should be directed to the Office of Patent Legal Administration at (571)-272-7702. Questions relating to issue and publication fee payments should be directed to the Customer Service Center of the Office of Patent Publication at 1-(888)-786-0101 or (571)-272-4200.

<b>Notice of Allowability</b>	<b>Application No.</b>	<b>Applicant(s)</b>	
	12/271,023	FREER, BENJAMIN	
	<b>Examiner</b>	<b>Art Unit</b>	
	Shawn Riley	2838	

**-- The MAILING DATE of this communication appears on the cover sheet with the correspondence address--**

All claims being allowable, PROSECUTION ON THE MERITS IS (OR REMAINS) CLOSED in this application. If not included herewith (or previously mailed), a Notice of Allowance (PTOL-85) or other appropriate communication will be mailed in due course. **THIS NOTICE OF ALLOWABILITY IS NOT A GRANT OF PATENT RIGHTS.** This application is subject to withdrawal from issue at the initiative of the Office or upon petition by the applicant. See 37 CFR 1.313 and MPEP 1308.

1.  This communication is responsive to 16 July 2010 amendment and remarks.
2.  The allowed claim(s) is/are 1-28.
3.  Acknowledgment is made of a claim for foreign priority under 35 U.S.C. § 119(a)-(d) or (f).
  - a)  All    b)  Some\*    c)  None    of the:
    1.  Certified copies of the priority documents have been received.
    2.  Certified copies of the priority documents have been received in Application No. \_\_\_\_\_.
    3.  Copies of the certified copies of the priority documents have been received in this national stage application from the International Bureau (PCT Rule 17.2(a)).

\* Certified copies not received: \_\_\_\_\_.

Applicant has THREE MONTHS FROM THE "MAILING DATE" of this communication to file a reply complying with the requirements noted below. Failure to timely comply will result in ABANDONMENT of this application.  
**THIS THREE-MONTH PERIOD IS NOT EXTENDABLE.**

4.  A SUBSTITUTE OATH OR DECLARATION must be submitted. Note the attached EXAMINER'S AMENDMENT or NOTICE OF INFORMAL PATENT APPLICATION (PTO-152) which gives reason(s) why the oath or declaration is deficient.
5.  CORRECTED DRAWINGS ( as "replacement sheets") must be submitted.
  - (a)  including changes required by the Notice of Draftsperson's Patent Drawing Review ( PTO-948) attached
    - 1)  hereto or 2)  to Paper No./Mail Date \_\_\_\_\_.
  - (b)  including changes required by the attached Examiner's Amendment / Comment or in the Office action of Paper No./Mail Date \_\_\_\_\_.

**Identifying indicia such as the application number (see 37 CFR 1.84(c)) should be written on the drawings in the front (not the back) of each sheet. Replacement sheet(s) should be labeled as such in the header according to 37 CFR 1.121(d).**
6.  DEPOSIT OF and/or INFORMATION about the deposit of BIOLOGICAL MATERIAL must be submitted. Note the attached Examiner's comment regarding REQUIREMENT FOR THE DEPOSIT OF BIOLOGICAL MATERIAL.

**Attachment(s)**

- |   |   |
|---|---|
| <ol style="list-style-type: none"> <li>1. <input type="checkbox"/> Notice of References Cited (PTO-892)</li> <li>2. <input type="checkbox"/> Notice of Draftsperson's Patent Drawing Review (PTO-948)</li> <li>3. <input type="checkbox"/> Information Disclosure Statements (PTO/SB/08),<br/>Paper No./Mail Date _____</li> <li>4. <input type="checkbox"/> Examiner's Comment Regarding Requirement for Deposit of Biological Material</li> </ol> | <ol style="list-style-type: none"> <li>5. <input type="checkbox"/> Notice of Informal Patent Application</li> <li>6. <input type="checkbox"/> Interview Summary (PTO-413),<br/>Paper No./Mail Date _____.</li> <li>7. <input type="checkbox"/> Examiner's Amendment/Comment</li> <li>8. <input type="checkbox"/> Examiner's Statement of Reasons for Allowance</li> <li>9. <input type="checkbox"/> Other _____.</li> </ol> |
|---|---|

/Shawn Riley/  
 Primary Examiner, Art Unit 2838



<b>Issue Classification</b> 	<b>Application/Control No.</b> 12/271,023	<b>Applicant(s)/Patent under Reexamination</b> FREER, BENJAMIN
	<b>Examiner</b> Shawn Riley	<b>Art Unit</b> 2838

ISSUE CLASSIFICATION												
ORIGINAL						INTERNATIONAL CLASSIFICATION						
CLASS			SUBCLASS			CLAIMED			NON-CLAIMED			
307			42			H	5	K	1	/2		
CROSS REFERENCES						H	1	F	21	/4		
CLASS	SUBCLASS (ONE SUBCLASS PER BLOCK)					B	60	L	9	/0		
336	115									/		
701	22									/		
										/		
										/		
										/		
----- (Assistant Examiner) (Date)						/Shawn Riley/Aug 2010			<b>Total Claims Allowed: 28</b>			
(Legal Instruments Examiner) (Date)						(Primary Examiner) (Date)			O.G. Print Claim(s) 1		O.G. Print Fig. 2	

<input checked="" type="checkbox"/> Claims renumbered in the same order as presented by applicant		<input type="checkbox"/> CPA		<input type="checkbox"/> T.D.		<input type="checkbox"/> R.1.47	
Final	Original	Final	Original	Final	Original	Final	Original
	1		31		61		91
	2		32		62		92
	3		33		63		93
	4		34		64		94
	5		35		65		95
	6		36		66		96
	7		37		67		97
	8		38		68		98
	9		39		69		99
	10		40		70		100
	11		41		71		101
	12		42		72		102
	13		43		73		103
	14		44		74		104
	15		45		75		105
	16		46		76		106
	17		47		77		107
	18		48		78		108
	19		49		79		109
	20		50		80		110
	21		51		81		111
	22		52		82		112
	23		53		83		113
	24		54		84		114
	25		55		85		115
	26		56		86		116
	27		57		87		117
	28		58		88		118
	29		59		89		119
	30		60		90		120
							121
							122
							123
							124
							125
							126
							127
							128
							129
							130
							131
							132
							133
							134
							135
							136
							137
							138
							139
							140
							141
							142
							143
							144
							145
							146
							147
							148
							149
							150
							151
							152
							153
							154
							155
							156
							157
							158
							159
							160
							161
							162
							163
							164
							165
							166
							167
							168
							169
							170
							171
							172
							173
							174
							175
							176
							177
							178
							179
							180
							181
							182
							183
							184
							185
							186
							187
							188
							189
							190
							191
							192
							193
							194
							195
							196
							197
							198
							199
							200
							201
							202
							203
							204
							205
							206
							207
							208
							209
							210

**EAST Search History**

**EAST Search History (Interference)**

Ref #	Hits	Search Query	DBs	Default Operator	Plurals	Time Stamp
L7	59	(base and power and parameter and monitor\$4 and automatic\$4 and target and current).clm.	US-PGPUB; UPAD	OR	ON	2010/08/26 13:21

**8/ 26/ 2010 1:22:18 PM**

**C:\ Documents and Settings\ sriley1\ My Documents\ EAST\ Workspaces  
 \ default1.wsp**



Docket No.: 7162-0448US0  
RF-491  
(PATENT)

**IN THE UNITED STATES PATENT AND TRADEMARK OFFICE**

---

In re Patent Application of:  
Benjamin Freer

Application No.: 12/271,023

Confirmation No.: 3269

Filed: Nov. 14, 2008

Art Unit: 2838

For: **INDUCTIVE POWER TRANSFER SYSTEM  
AND METHOD**

---

Examiner: RILEY, Shawn

**AMENDMENT**

MS Amendment  
Commissioner for Patents  
P.O. Box 1450  
Alexandria, VA 22313-1450

Dear Sir:

**INTRODUCTORY COMMENTS**

In response to the Office Action dated May 7, 2010, please amend the above-identified U.S. patent application as follows:

**Amendments to the Claims** are reflected in the listing of claims which begins on page 2 of this paper.

**Remarks/Arguments** begin on page 8 of this paper.

**AMENDMENTS TO THE CLAIMS**

1. (Original) A method for inductively transferring power from a base unit providing input power, to a target unit providing output power, where the base unit and the target unit are electrically isolated, comprising:

positioning a second inductive element of said target unit within a predetermined distance of a first inductive element of said base unit;

applying a time varying electric current to said first inductive element to produce a time varying magnetic field, said time varying magnetic field induces an electric current in said second inductive element;

monitoring at least one parameter indicative of an efficiency of power transfer from said base unit to said target unit;

automatically adjusting at least one characteristic of said time varying electric current responsive to said parameter to maximize an efficiency of power transfer from said base unit to said target unit.

2. (Original) The method according to claim 1, wherein said characteristic comprises at least one of a frequency of said time varying current and a duty cycle of said time varying current.

3. (Original) The method according to claim 1, further comprising producing said time varying electric current by switching a DC voltage source using an electronically controlled switch element.

4. (Original) The method according to claim 3, further comprising communicating said time varying electric current to a load in said base unit, and selecting said parameter to be a measured current or voltage associated with said load.

5. (Currently Amended) The method according to claim 4, further comprising wherein said selectively controlling step further comprises comparing said measured current or voltage to a constant reference value.

6. (Original) The method according to claim 1, further comprising producing said time varying magnetic field with a DC to DC type switching mode power supply circuit.

7. (Currently Amended) The method according to claim 6, further comprising utilizing said first inductive element as a primary energy storage component in a said DC to DC conversion process of said DC to DC type switching mode power supply circuit.

8. (Original) The method according to claim 1, wherein said automatically adjusting step further comprises automatically adjusting said characteristic to induce an oscillation in said second inductive element at a frequency to be approximately equal to a self-resonant frequency of said second inductive element.

9. (Currently Amended) The method according to claim 1, further comprising responsive to a re-positioning of said second inductive element from a first position to a second position, automatically selectively re-adjusting said characteristic to maximize said efficiency, wherein said first position differs from said second position with regard to at least one characteristic selected from the group consisting of distance and orientation relative to said first inductive element primary inductor.

10. (Original) The method according to claim 1, further comprising responsive to a substitution of a target unit with a different target unit, automatically selectively re-adjusting said characteristic to maximize said efficiency.

11. (Original) The method according to claim 1, further comprising rectifying an output current induced in said second inductive element to produce a DC output.

12. (Currently Amended) An inductive power transfer system, comprising:  
a base unit comprising a first inductive element configured for providing input power to a second inductive element of a target unit providing output power, said base unit electrically isolated from said target unit;

a positioning structure provided on at least one of said base unit and said target unit for removably positioning said second inductive element at a predetermined orientation and distance relative to said first inductive element;

a switch element configured for selectively applying a time varying electric current to said first inductive element to produce a time varying magnetic field, said time varying magnetic field inducing an electric current in said second inductive element; and

a control circuit configured for monitoring at least one parameter indicative of an efficiency of power transfer from said base unit to said target unit, and automatically adjusting at least one characteristic of said time varying electric current responsive to said parameter to maximize an efficiency of power transfer from said base unit to said target unit.

13. (Original) The system of claim 12, wherein said characteristic comprises at least one of a frequency of said time varying current and a duty cycle of said time varying current.

14. (Original) The system of claim 12, wherein said switch element is electronically controlled, and wherein said switch element is configured for coupling and decoupling a DC voltage source to said first inductive element to produce said time varying current.

15. (Original) The system of claim 14, further comprising a load circuit coupled to said first inductive element, and where said parameter comprises a current or voltage associated with said load.

16. (Original) The system of claim 15, wherein said control circuit automatically selectively adjusts said characteristic based on a comparison of said measured current or voltage to a constant reference value.

17. (Currently Amended) The system of claim 12, wherein said base unit further comprises a DC to DC type switching mode power supply, said DC to DC type switching mode power supply circuit producing said time varying magnetic field.

18. (Currently Amended) The system of claim 17[[15]], wherein said first inductive element comprises a primary energy storage component of said DC to DC type switching mode power supply circuit.

19. (Currently Amended) The system of claim 12, wherein said control circuit is further configured during said automatically selectively adjusting for automatically selectively adjusting a[[said]] frequency to be approximately equal to a self-resonant frequency of said second inductive element.

20. (Currently Amended) The system of claim 12, wherein said control circuit is further configured during said automatically selectively adjusting for automatically selectively re-adjusting a said frequency to maximize said efficiency responsive to a re-positioning of said second inductive element from a first position to a ca second position, wherein said first position differs from said second position with regard to at least one characteristic selected from the group consisting of distance and orientation relative to said first inductive element ~~primary-inductor~~.

21. (Currently Amended) The system of claim 12, wherein said control circuit is further configured during said automatically selectively adjusting for automatically selectively re-adjusting a said frequency to maximize said efficiency responsive to a substitution of a target unit with a different target unit[[,]].



22. (Currently Amended) The system of claim 12, wherein said target unit further comprises a rectifying element configured to produce a DC output by rectifying an output current induced in said second inductive element.

23. (Currently Amended) A DC-DC converter, comprising:

an input circuit for receiving a DC input voltage;

an output circuit electrically coupled to said input circuit, said output circuit comprising a load sub-circuit electrically coupled to a converter sub-circuit, said converter sub-circuit comprising at least a first inductive element and at least one switch element having a switch control node, said switch control node responsive to a first control voltage for selectively alternating said switch element between an open state and a closed state; and

a control circuit having an input node electrically coupled to a node within said load sub-circuit and an output node electrically coupled to said switch control node, said control circuit generating at said output node a periodic voltage signal adjustable to one or more operating frequencies based on a difference between a second control voltage at said input node and a reference voltage;

wherein an inductance and a physical arrangement of said first inductive element is selected for said first inductive element to generate a permeating magnetic field that at least partially permeates a second inductive element electrically isolated from said first inductive element, wherein said permeating magnetic field induces a substantially self-resonant oscillation in said second inductive element for at least one of said operating frequencies, and wherein said control circuit is further configured to adjust said periodic voltage signal to adjust a ~~an internal~~ voltage level at said input ~~internal~~ node to minimize said difference.

24. (Currently Amended) The DC-DC converter of claim 23, wherein said first or second inductive element comprises at least a first inductor.

25. (Currently Amended) The DC-DC converter of claim 24, wherein a first directional vector defining a first inductor coil axis of said first inductive element ~~inductor~~ and a second directional vector defining a second inductor coil axis of said second inductive element are substantially parallel.

26. (Currently Amended) The DC-DC converter of claim 23[[24]], wherein ~~an said one of said~~ operating frequency of said converter sub-circuit ~~frequencies~~ is at least 1 MHz, and wherein said first inductive element ~~inductor~~ has an inductance of at least 100nH.

27. (Original) The DC-DC converter of claim 23, wherein said first inductive element and said switch element are electrically coupled in series between said input circuit and said load sub-circuit, and wherein said converter sub-circuit further comprises a rectifier element electrically coupled to a common node between said first inductive element and said switch element.

28. (New) A method for inductively transferring power from a base unit providing input power, to a target unit providing output power, where the base unit and the target unit are electrically isolated from each other, comprising:

positioning a second inductive element of said target unit within a predetermined distance of a first inductive element of said base unit;

applying a time varying electric current to said first inductive element to produce a time varying magnetic field having an operating frequency, said time varying magnetic field inducing an electric current in said second inductive element;

monitoring at least one parameter of an electronic component of said base unit that is indicative of an efficiency of power transfer from said base unit to said target unit; and

automatically adjusting said operating frequency based on a value of said parameter to maximize said efficiency of power transfer from said base unit to said target unit.

## REMARKS

These remarks are in response to the Non-Final Office Action mailed May 7, 2010 ("Office Action"). This reply is timely filed. At the time of the Office Action, claims 1-27 were pending in the application.

### I. Status of the Claims

Claims 5, 7, 9, 12, and 20-26 have been amended. No new subject matter has been introduced by the claim amendments. Claim 28 has been added.

Claim 21 has been objected to under 35 C.F.R. §1.75(a). Claims 1-27 have been rejected under 35 U.S.C. §102(b). The objection and rejections are set forth in detail below.

### II. Interview Summary

Applicant thanks the Examiner for discussing the present application with its representative on July 1, 2010. During said discussion, features of the present invention were discussed which Applicant believes are distinguishable from a cited reference, namely U.S. Pat. No. 6,421,600 to Ross. The Examiner was unwilling to make a decision that the present invention as recited in independent claims 1, 12 and 23 distinguish over the cited reference. In this regard, the Examiner indicated that further review of the cited reference is needed in view of our discussion. As such, we have included arguments herein discussing how independent claims 1, 12 and 23 distinguish over the cited reference.

### III. Claim Objection

In the Office Action, claim 21 was objected to under 35 C.F.R. §1.75(a) because of a typographical error. Claim 21 has been amended to correct said error.

IV. Claim Rejections Under 35 U.S.C. §102

In the Office Action, claims 1-27 were rejected under 35 U.S.C. §102(e) as being anticipated by U.S. Patent No. 6,421,600 to Ross ("Ross"). Applicant respectfully traverses the Examiner's rejections.

Claims 1-22

Ross generally discloses a vehicle **12** comprising a power meter **34** and an onboard power module **20** mounted on an assembly **44**.<sup>1</sup> The onboard power module **20** comprises a coil **42** for facilitating the coupling of power from a roadway power module **24**.<sup>2</sup> The roadway power module **24** also comprises a coil **40** coupled to a power conditioner **28**.<sup>3</sup> The power conditioner **28** applies an AC electrical current to the coil **40** operating at a coupling frequency **f1**.<sup>4</sup> The coupling frequency **f1** has a value between 1 kHz and 10 kHz.<sup>5</sup> As a result of the current flowing through the coil **40**, a magnetic field is generated that varies at the coupling frequency **f1**.<sup>6</sup> Such varying magnetic field cuts through the coil **42** and induces a voltage therein.<sup>7</sup> The power received at the vehicle **12** through coil **42** is monitored by the power meter **34**.<sup>8</sup> The power meter **34** provides a means for a power utility company to monitor power usage, and thus collect payment for the electrical power provided to the vehicle **12**.<sup>9</sup>

Notably, power can be coupled to the vehicle **12** when it is traveling and/or stopped.<sup>10</sup> In the traveling scenario, an air gap is provided between the coils **40** and **42**.<sup>11</sup> In the stopped scenario, the

<sup>1</sup> See FIG. 2 and col. 11, line 54 through col. 12, line 24 of Ross.

<sup>2</sup> See FIG. 2 of Ross.

<sup>3</sup> See FIG. 2 of Ross.

<sup>4</sup> See col. 11, line 58 through col. 12, line 7 of Ross.

<sup>5</sup> See col. 14, lines 5-7 of Ross.

<sup>6</sup> See col. 11, line 66 through col. 12, line 2 of Ross.

<sup>7</sup> See col. 12, lines 2-4 of Ross.

<sup>8</sup> See col. 10, lines 41-45 and col. 14, lines 39-42 of Ross.

<sup>9</sup> See col. 10, lines 41-45 and col. 14, lines 39-65 of Ross.

<sup>10</sup> See col. 12, line 48 through col. 13, line 5 of Ross.

<sup>11</sup> See col. 12, lines 60-64 of Ross.

air gap between the coils **40** and **42** is reduced to zero or near zero.<sup>12</sup> The reduction of the air gap is facilitated by the assembly **44** which can move horizontally and vertically.<sup>13</sup> In effect, the coil **40** can be moved to an optimal position over coil **42** for power transfer when the vehicle is traveling or comes to its stopped location.<sup>14</sup>

In the stopped scenario, the batteries of the vehicle **12** can be re-charged using a charge pad **24'** that is disposed in the ground (e.g., the floor of a garage). The charge pad **24'** and associated power conditioner **28** collectively operate in two modes. In the first mode, low levels of continuous energy flow (e.g., 200 watts to 500 watts) is provided. The rate of the energy flow is thermostatically controlled based on the interior temperature of the vehicle **12**.<sup>15</sup> In the second mode, a high level of continuous energy flow (e.g., 6 Kilo-Watts to 10 Killo-Watts) is provided for a particular duration (e.g., 1-2 hours).<sup>16</sup>

However, Ross fails to disclose the method recited in independent claim 1. More particularly, Ross fails to disclose and/or suggest automatically adjusting at least one characteristic of a time varying electric current applied to an inductive element of a base unit in response to a parameter to maximize an efficiency of power transfer from the base unit to a target unit, wherein the parameter is a measured parameter that is indicative of an efficiency of power transfer from the base unit to the target unit. Rather, Ross discloses and/or suggests automatically adjusting a magnitude of a magnetic field responsive to a parameter that is indicative of an interior temperature of a vehicle **12**.<sup>17</sup> Notably, the magnitude of the magnetic field is not adjusted to maximize the efficiency of power transfer from the base unit **28, 24** to the target unit **12** as recited in claim 1. Instead, the magnitude of the magnetic field is adjusted to regulate the interior temperature of the target unit **12**.<sup>18</sup>

---

<sup>12</sup> See col. 12, lines 48-56 of Ross.

<sup>13</sup> See col. 12, lines 43-56 of Ross.

<sup>14</sup> See col. 12, line 43 through col. 13, line 5 of Ross.

<sup>15</sup> See col. 22, lines 19-26 of Ross.

<sup>16</sup> See col. 22, lines 36-41 of Ross.

<sup>17</sup> See col. 22, lines 13-35 of Ross.

<sup>18</sup> See col. 22, lines 13-35 of Ross.

Ross also discloses and/or suggests measuring an electrical power received at the vehicle 12.<sup>19</sup> However, the measurement is not used in Ross to automatically maximize efficiency by adjusting at least one characteristic of a time varying electric current applied to an inductive element 40 of a base unit 28, 24 as recited in independent claim 1. Instead, the measured electrical power of Ross is used by a power utility company to bill the appropriate owner of the vehicle 12 for the electrical power that has been used.<sup>20</sup>

Notably, Ross does disclose a solution for maximizing the coupling efficiency of power transfer from a base unit 28, 24 to a target unit 12.<sup>21</sup> However, this solution involves changing the distance and alignment between the primary and secondary coils 40, 42,<sup>22</sup> rather than varying a characteristic of a time varying electric current applied to the coil 40 of a base unit 28, 24 as recited in independent claim 1. One can appreciate that the solution of Ross is more complex, costly and prone to mechanical breakdown as compared to the solution presented in independent claim 1.

Therefore, independent claim 1 is not anticipated by Ross. As such, independent claim 1 is in condition for allowance. Independent claim 12 is similar to claim 1, albeit different in some ways. Thus, independent claim 12 is at least allowable for substantially the same reasons as independent claim 1, as discussed herein. Each of the dependant claims 2-11 and 13-22 is allowable at least by virtue of its dependence on a respective allowable base claim 1 or 12.

#### Claims 23-27

With regard to independent claim 23, Ross fails to disclose a control circuit generating at an output node a periodic voltage signal adjustable to one or more operating frequencies based on a difference between a second control voltage at an input node and a reference voltage. As such, independent claim 23 is not anticipated by Ross. Therefore, independent claim 23 is in condition

---

<sup>19</sup> See col. 10, lines 41-45 of Ross.

<sup>20</sup> See col. 10, lines 41-45 and col. 14, lines 39-65 of Ross.

<sup>21</sup> See col. 12, line 43 through col. 13, line 5 of Ross.

<sup>22</sup> See col. 12, lines 15-21 of Ross.

for allowance. Each of the dependant claims 24-27 is allowable at least by virtue of its dependence on an allowable base claim 23.

V. New Claim 28

New claim 28 also distinguishes from Ross. Ross fails to disclose and/or suggest automatically adjusting an operating frequency of a time varying magnetic field to maximize an efficiency of power transfer from a base unit to a target unit. Ross also fails to disclose monitoring a measured parameter of an electronic component of a base unit that is indicative of an efficiency of power transfer from the base unit to the target unit. Rather, Ross discloses and/or suggests automatically adjusting a magnitude of a magnetic field based on a parameter indicating of an interior temperature of a target unit 12.<sup>23</sup> Notably, the magnitude of the magnetic field is not adjusted to maximize the efficiency of power transfer from the base unit **28, 24** to the target unit **12** as recited in new claim 28. Instead, the magnitude of the magnetic field is adjusted to regulate the interior temperature of the target unit **12**.<sup>24</sup>

Please charge Deposit Account No. 80-0870 in the amount of \$220 pursuant to Fee Code 1201 for one (1) independent claim in excess of three (3).

---

<sup>23</sup> See col. 22, lines 13-35 of Ross.

<sup>24</sup> See col. 22, lines 13-35 of Ross.

Application No.: 12/271,023  
Amendment dated: July 16, 2010  
Reply to Office Action dated May 7, 2010

Docket No.: 7162-0448US0

VI. Conclusion

Applicant has made every effort to present claims which distinguish over the prior art, and it is believed that all claims are in condition for allowance. Nevertheless, Applicant invites the Examiner to call the undersigned if it is believed that a telephonic interview would expedite the prosecution of the application to an allowance. In view of the forgoing remarks, Applicant respectfully requests reconsideration and prompt allowance of the pending claims. Please charge any deficiencies, or credit any overpayment to Deposit Account No. 08-0870.

Dated: July 16, 2010

Respectfully submitted,

By 

Robert J. Sacco

Registration No.: 35,667

FOX ROTHSCHILD, LLP

997 Lenox Drive

Building 3

Princeton, NJ 08648-2311

Tel: 561-835-9600

Attorneys/Agents For Applicant



## Electronic Patent Application Fee Transmittal

<b>Application Number:</b>	12271023			
<b>Filing Date:</b>	14-Nov-2008			
<b>Title of Invention:</b>	INDUCTIVE POWER TRANSFER SYSTEM AND METHOD			
<b>First Named Inventor/Applicant Name:</b>	Benjamin Freer			
<b>Filer:</b>	Robert Joseph Sacco/Joyce Dougherty			
<b>Attorney Docket Number:</b>	17162/0210146-US0			
Filed as Large Entity				
<b>Utility under 35 USC 111(a) Filing Fees</b>				
<b>Description</b>	<b>Fee Code</b>	<b>Quantity</b>	<b>Amount</b>	<b>Sub-Total in USD(\$)</b>
<b>Basic Filing:</b>				
<b>Pages:</b>				
<b>Claims:</b>				
Independent claims in excess of 3	1201	1	220	220
<b>Miscellaneous-Filing:</b>				
<b>Petition:</b>				
<b>Patent-Appeals-and-Interference:</b>				
<b>Post-Allowance-and-Post-Issuance:</b>				
<b>Extension-of-Time:</b>				

Description	Fee Code	Quantity	Amount	Sub-Total in USD(\$)
<b>Miscellaneous:</b>				
<b>Total in USD (\$)</b>				<b>220</b>

## Electronic Acknowledgement Receipt

<b>EFS ID:</b>	8032279
<b>Application Number:</b>	12271023
<b>International Application Number:</b>	
<b>Confirmation Number:</b>	3269
<b>Title of Invention:</b>	INDUCTIVE POWER TRANSFER SYSTEM AND METHOD
<b>First Named Inventor/Applicant Name:</b>	Benjamin Freer
<b>Customer Number:</b>	68085
<b>Filer:</b>	Robert Joseph Sacco/Joyce Dougherty
<b>Filer Authorized By:</b>	Robert Joseph Sacco
<b>Attorney Docket Number:</b>	17162/0210146-US0
<b>Receipt Date:</b>	16-JUL-2010
<b>Filing Date:</b>	14-NOV-2008
<b>Time Stamp:</b>	14:22:56
<b>Application Type:</b>	Utility under 35 USC 111(a)

### Payment information:

Submitted with Payment	yes
Payment Type	Deposit Account
Payment was successfully received in RAM	\$220
RAM confirmation Number	560
Deposit Account	080870
Authorized User	

The Director of the USPTO is hereby authorized to charge indicated fees and credit any overpayment as follows:  
 Charge any Additional Fees required under 37 C.F.R. Section 1.17 (Patent application and reexamination processing fees)

<b>File Listing:</b>					
<b>Document Number</b>	<b>Document Description</b>	<b>File Name</b>	<b>File Size(Bytes)/ Message Digest</b>	<b>Multi Part /.zip</b>	<b>Pages (if appl.)</b>
1		int225.PDF	375735 a02fb9fb0a19aed2d019571175319b23d4987a49	yes	13
<b>Multipart Description/PDF files in .zip description</b>					
		<b>Document Description</b>	<b>Start</b>	<b>End</b>	
		Amendment/Req. Reconsideration-After Non-Final Reject	1	1	
		Claims	2	7	
		Applicant Arguments/Remarks Made in an Amendment	8	13	
<b>Warnings:</b>					
<b>Information:</b>					
2	Fee Worksheet (PTO-875)	fee-info.pdf	30569 5a66339e66daa95b5b6bf4c58771565604f46ebc	no	2
<b>Warnings:</b>					
<b>Information:</b>					
<b>Total Files Size (in bytes):</b>			406304		
<p>This Acknowledgement Receipt evidences receipt on the noted date by the USPTO of the indicated documents, characterized by the applicant, and including page counts, where applicable. It serves as evidence of receipt similar to a Post Card, as described in MPEP 503.</p> <p><b><u>New Applications Under 35 U.S.C. 111</u></b>  If a new application is being filed and the application includes the necessary components for a filing date (see 37 CFR 1.53(b)-(d) and MPEP 506), a Filing Receipt (37 CFR 1.54) will be issued in due course and the date shown on this Acknowledgement Receipt will establish the filing date of the application.</p> <p><b><u>National Stage of an International Application under 35 U.S.C. 371</u></b>  If a timely submission to enter the national stage of an international application is compliant with the conditions of 35 U.S.C. 371 and other applicable requirements a Form PCT/DO/EO/903 indicating acceptance of the application as a national stage submission under 35 U.S.C. 371 will be issued in addition to the Filing Receipt, in due course.</p> <p><b><u>New International Application Filed with the USPTO as a Receiving Office</u></b>  If a new international application is being filed and the international application includes the necessary components for an international filing date (see PCT Article 11 and MPEP 1810), a Notification of the International Application Number and of the International Filing Date (Form PCT/RO/105) will be issued in due course, subject to prescriptions concerning national security, and the date shown on this Acknowledgement Receipt will establish the international filing date of the application.</p>					

Under the Paperwork Reduction Act of 1995, no persons are required to respond to a collection of information unless it displays a valid OMB control number.

<b>PATENT APPLICATION FEE DETERMINATION RECORD</b> Substitute for Form PTO-875				Application or Docket Number <b>12/271,023</b>		Filing Date <b>11/14/2008</b>		<input type="checkbox"/> To be Mailed						
<b>APPLICATION AS FILED – PART I</b>														
(Column 1)			(Column 2)			SMALL ENTITY <input type="checkbox"/>		OR		OTHER THAN SMALL ENTITY				
FOR		NUMBER FILED	NUMBER EXTRA		RATE (\$)	FEE (\$)	OR		RATE (\$)	FEE (\$)				
<input checked="" type="checkbox"/> BASIC FEE <small>(37 CFR 1.16(a), (b), or (c))</small>		N/A	N/A		N/A				N/A	<b>330</b>				
<input type="checkbox"/> SEARCH FEE <small>(37 CFR 1.16(k), (l), or (m))</small>		N/A	N/A		N/A				N/A					
<input type="checkbox"/> EXAMINATION FEE <small>(37 CFR 1.16(o), (p), or (q))</small>		N/A	N/A		N/A				N/A					
TOTAL CLAIMS <small>(37 CFR 1.16(i))</small>		minus 20 =	*		X \$ =		OR		X \$ =					
INDEPENDENT CLAIMS <small>(37 CFR 1.16(h))</small>		minus 3 =	*		X \$ =				X \$ =					
<input type="checkbox"/> APPLICATION SIZE FEE <small>(37 CFR 1.16(s))</small>		If the specification and drawings exceed 100 sheets of paper, the application size fee due is \$250 (\$125 for small entity) for each additional 50 sheets or fraction thereof. See 35 U.S.C. 41(a)(1)(G) and 37 CFR 1.16(s).												
<input type="checkbox"/> MULTIPLE DEPENDENT CLAIM PRESENT <small>(37 CFR 1.16(j))</small>														
* If the difference in column 1 is less than zero, enter "0" in column 2.														
TOTAL					TOTAL					<b>330</b>				
<b>APPLICATION AS AMENDED – PART II</b>														
(Column 1)			(Column 2)			(Column 3)			SMALL ENTITY		OR		OTHER THAN SMALL ENTITY	
AMENDMENT	<b>07/16/2010</b>	CLAIMS REMAINING AFTER AMENDMENT		HIGHEST NUMBER PREVIOUSLY PAID FOR	PRESENT EXTRA	RATE (\$)	ADDITIONAL FEE (\$)	OR		RATE (\$)	ADDITIONAL FEE (\$)			
	Total <small>(37 CFR 1.16(i))</small>	* 28	Minus	** 27	= 1	X \$ =		OR		X \$52=	<b>52</b>			
	Independent <small>(37 CFR 1.16(h))</small>	* 3	Minus	***3	= 0	X \$ =		OR		X \$220=	<b>0</b>			
	<input type="checkbox"/> Application Size Fee <small>(37 CFR 1.16(s))</small>													
	<input type="checkbox"/> FIRST PRESENTATION OF MULTIPLE DEPENDENT CLAIM <small>(37 CFR 1.16(j))</small>													
TOTAL ADD'L FEE					TOTAL ADD'L FEE					<b>52</b>				
AMENDMENT		CLAIMS REMAINING AFTER AMENDMENT		HIGHEST NUMBER PREVIOUSLY PAID FOR	PRESENT EXTRA	RATE (\$)	ADDITIONAL FEE (\$)	OR		RATE (\$)	ADDITIONAL FEE (\$)			
	Total <small>(37 CFR 1.16(i))</small>	*	Minus	**	=	X \$ =		OR		X \$ =				
	Independent <small>(37 CFR 1.16(h))</small>	*	Minus	***	=	X \$ =		OR		X \$ =				
	<input type="checkbox"/> Application Size Fee <small>(37 CFR 1.16(s))</small>													
	<input type="checkbox"/> FIRST PRESENTATION OF MULTIPLE DEPENDENT CLAIM <small>(37 CFR 1.16(j))</small>													
TOTAL ADD'L FEE					TOTAL ADD'L FEE									
* If the entry in column 1 is less than the entry in column 2, write "0" in column 3.														
** If the "Highest Number Previously Paid For" IN THIS SPACE is less than 20, enter "20".														
*** If the "Highest Number Previously Paid For" IN THIS SPACE is less than 3, enter "3".														
The "Highest Number Previously Paid For" (Total or Independent) is the highest number found in the appropriate box in column 1.														

Legal Instrument Examiner:  
/KIMBERLY JONES/

This collection of information is required by 37 CFR 1.16. The information is required to obtain or retain a benefit by the public which is to file (and by the USPTO to process) an application. Confidentiality is governed by 35 U.S.C. 122 and 37 CFR 1.14. This collection is estimated to take 12 minutes to complete, including gathering, preparing, and submitting the completed application form to the USPTO. Time will vary depending upon the individual case. Any comments on the amount of time you require to complete this form and/or suggestions for reducing this burden, should be sent to the Chief Information Officer, U.S. Patent and Trademark Office, U.S. Department of Commerce, P.O. Box 1450, Alexandria, VA 22313-1450. DO NOT SEND FEES OR COMPLETED FORMS TO THIS ADDRESS. SEND TO: Commissioner for Patents, P.O. Box 1450, Alexandria, VA 22313-1450.

If you need assistance in completing the form, call 1-800-PTO-9199 and select option 2.



UNITED STATES PATENT AND TRADEMARK OFFICE

UNITED STATES DEPARTMENT OF COMMERCE  
United States Patent and Trademark Office  
Address: COMMISSIONER FOR PATENTS  
P.O. Box 1450  
Alexandria, Virginia 22313-1450  
www.uspto.gov

APPLICATION NO.	FILING DATE	FIRST NAMED INVENTOR	ATTORNEY DOCKET NO.	CONFIRMATION NO.
12/271,023	11/14/2008	Benjamin Freer	17162/0210146-US0	3269
68085	7590	07/09/2010	EXAMINER	
HARRIS CORPORATION C/O FOX ROTHSCHILD, LLP 997 Lenox Drive Building 3 Lawrenceville, NJ 08543-5231			RILEY, SHAWN	
			ART UNIT	PAPER NUMBER
			2838	
			MAIL DATE	DELIVERY MODE
			07/09/2010	PAPER

**Please find below and/or attached an Office communication concerning this application or proceeding.**

The time period for reply, if any, is set in the attached communication.

<b>Interview Summary</b>	<b>Application No.</b>	<b>Applicant(s)</b>	
	12/271,023	FREER, BENJAMIN	
	<b>Examiner</b>	<b>Art Unit</b>	
	Shawn Riley	2838	

All participants (applicant, applicant's representative, PTO personnel):

- (1) Examiner Riley. (3)\_\_\_\_\_.
- (2) Attorney Thorstad Forsyth #56,455. (4)\_\_\_\_\_.

Date of Interview: 01 July 2010.

Type: a)  Telephonic b)  Video Conference  
c)  Personal [copy given to: 1)  applicant 2)  applicant's representative]

Exhibit shown or demonstration conducted: d)  Yes e)  No.  
If Yes, brief description: \_\_\_\_\_.

Claim(s) discussed: 1 and 28.

Identification of prior art discussed: Ross (U.S. Patent 6,421,600).

Agreement with respect to the claims f)  was reached. g)  was not reached. h)  N/A.

Substance of Interview including description of the general nature of what was agreed to if an agreement was reached, or any other comments: Discussed differences between prior art and claims 1 and 28. No agreement was reached.

(A fuller description, if necessary, and a copy of the amendments which the examiner agreed would render the claims allowable, if available, must be attached. Also, where no copy of the amendments that would render the claims allowable is available, a summary thereof must be attached.)

THE FORMAL WRITTEN REPLY TO THE LAST OFFICE ACTION MUST INCLUDE THE SUBSTANCE OF THE INTERVIEW. (See MPEP Section 713.04). If a reply to the last Office action has already been filed, APPLICANT IS GIVEN A NON-EXTENDABLE PERIOD OF THE LONGER OF ONE MONTH OR THIRTY DAYS FROM THIS INTERVIEW DATE, OR THE MAILING DATE OF THIS INTERVIEW SUMMARY FORM, WHICHEVER IS LATER, TO FILE A STATEMENT OF THE SUBSTANCE OF THE INTERVIEW. See Summary of Record of Interview requirements on reverse side or on attached sheet.

/Shawn Riley/  
Primary Examiner, Art Unit 2838

## Summary of Record of Interview Requirements

### Manual of Patent Examining Procedure (MPEP), Section 713.04, Substance of Interview Must be Made of Record

A complete written statement as to the substance of any face-to-face, video conference, or telephone interview with regard to an application must be made of record in the application whether or not an agreement with the examiner was reached at the interview.

### Title 37 Code of Federal Regulations (CFR) § 1.133 Interviews Paragraph (b)

In every instance where reconsideration is requested in view of an interview with an examiner, a complete written statement of the reasons presented at the interview as warranting favorable action must be filed by the applicant. An interview does not remove the necessity for reply to Office action as specified in §§ 1.111, 1.135. (35 U.S.C. 132)

#### 37 CFR §1.2 Business to be transacted in writing.

All business with the Patent or Trademark Office should be transacted in writing. The personal attendance of applicants or their attorneys or agents at the Patent and Trademark Office is unnecessary. The action of the Patent and Trademark Office will be based exclusively on the written record in the Office. No attention will be paid to any alleged oral promise, stipulation, or understanding in relation to which there is disagreement or doubt.

The action of the Patent and Trademark Office cannot be based exclusively on the written record in the Office if that record is itself incomplete through the failure to record the substance of interviews.

It is the responsibility of the applicant or the attorney or agent to make the substance of an interview of record in the application file, unless the examiner indicates he or she will do so. It is the examiner's responsibility to see that such a record is made and to correct material inaccuracies which bear directly on the question of patentability.

Examiners must complete an Interview Summary Form for each interview held where a matter of substance has been discussed during the interview by checking the appropriate boxes and filling in the blanks. Discussions regarding only procedural matters, directed solely to restriction requirements for which interview recordation is otherwise provided for in Section 812.01 of the Manual of Patent Examining Procedure, or pointing out typographical errors or unreadable script in Office actions or the like, are excluded from the interview recordation procedures below. Where the substance of an interview is completely recorded in an Examiners Amendment, no separate Interview Summary Record is required.

The Interview Summary Form shall be given an appropriate Paper No., placed in the right hand portion of the file, and listed on the "Contents" section of the file wrapper. In a personal interview, a duplicate of the Form is given to the applicant (or attorney or agent) at the conclusion of the interview. In the case of a telephone or video-conference interview, the copy is mailed to the applicant's correspondence address either with or prior to the next official communication. If additional correspondence from the examiner is not likely before an allowance or if other circumstances dictate, the Form should be mailed promptly after the interview rather than with the next official communication.

The Form provides for recordation of the following information:

- Application Number (Series Code and Serial Number)
- Name of applicant
- Name of examiner
- Date of interview
- Type of interview (telephonic, video-conference, or personal)
- Name of participant(s) (applicant, attorney or agent, examiner, other PTO personnel, etc.)
- An indication whether or not an exhibit was shown or a demonstration conducted
- An identification of the specific prior art discussed
- An indication whether an agreement was reached and if so, a description of the general nature of the agreement (may be by attachment of a copy of amendments or claims agreed as being allowable). Note: Agreement as to allowability is tentative and does not restrict further action by the examiner to the contrary.
- The signature of the examiner who conducted the interview (if Form is not an attachment to a signed Office action)

It is desirable that the examiner orally remind the applicant of his or her obligation to record the substance of the interview of each case. It should be noted, however, that the Interview Summary Form will not normally be considered a complete and proper recordation of the interview unless it includes, or is supplemented by the applicant or the examiner to include, all of the applicable items required below concerning the substance of the interview.

A complete and proper recordation of the substance of any interview should include at least the following applicable items:

- 1) A brief description of the nature of any exhibit shown or any demonstration conducted,
- 2) an identification of the claims discussed,
- 3) an identification of the specific prior art discussed,
- 4) an identification of the principal proposed amendments of a substantive nature discussed, unless these are already described on the Interview Summary Form completed by the Examiner,
- 5) a brief identification of the general thrust of the principal arguments presented to the examiner,  
(The identification of arguments need not be lengthy or elaborate. A verbatim or highly detailed description of the arguments is not required. The identification of the arguments is sufficient if the general nature or thrust of the principal arguments made to the examiner can be understood in the context of the application file. Of course, the applicant may desire to emphasize and fully describe those arguments which he or she feels were or might be persuasive to the examiner.)
- 6) a general indication of any other pertinent matters discussed, and
- 7) if appropriate, the general results or outcome of the interview unless already described in the Interview Summary Form completed by the examiner.

Examiners are expected to carefully review the applicant's record of the substance of an interview. If the record is not complete and accurate, the examiner will give the applicant an extendable one month time period to correct the record.

### Examiner to Check for Accuracy

If the claims are allowable for other reasons of record, the examiner should send a letter setting forth the examiner's version of the statement attributed to him or her. If the record is complete and accurate, the examiner should place the indication, "Interview Record OK" on the paper recording the substance of the interview along with the date and the examiner's initials.





UNITED STATES PATENT AND TRADEMARK OFFICE

UNITED STATES DEPARTMENT OF COMMERCE  
United States Patent and Trademark Office  
Address: COMMISSIONER FOR PATENTS  
P.O. Box 1450  
Alexandria, Virginia 22313-1450  
www.uspto.gov

APPLICATION NUMBER	FILING OR 371(C) DATE	FIRST NAMED APPLICANT	ATTY. DOCKET NO./TITLE
12/271,023	11/14/2008	Benjamin Freer	17162/0210146-US0

**CONFIRMATION NO. 3269**

68085  
HARRIS CORPORATION  
C/O FOX ROTHSCHILD, LLP  
997 Lenox Drive  
Building 3  
Lawrenceville, NJ 08543-5231

**PUBLICATION NOTICE**



**Title:**INDUCTIVE POWER TRANSFER SYSTEM AND METHOD

**Publication No.**US-2010-0123451-A1

**Publication Date:**05/20/2010

**NOTICE OF PUBLICATION OF APPLICATION**

The above-identified application will be electronically published as a patent application publication pursuant to 37 CFR 1.211, et seq. The patent application publication number and publication date are set forth above.

The publication may be accessed through the USPTO's publically available Searchable Databases via the Internet at [www.uspto.gov](http://www.uspto.gov). The direct link to access the publication is currently <http://www.uspto.gov/patft/>.

The publication process established by the Office does not provide for mailing a copy of the publication to applicant. A copy of the publication may be obtained from the Office upon payment of the appropriate fee set forth in 37 CFR 1.19(a)(1). Orders for copies of patent application publications are handled by the USPTO's Office of Public Records. The Office of Public Records can be reached by telephone at (703) 308-9726 or (800) 972-6382, by facsimile at (703) 305-8759, by mail addressed to the United States Patent and Trademark Office, Office of Public Records, Alexandria, VA 22313-1450 or via the Internet.

In addition, information on the status of the application, including the mailing date of Office actions and the dates of receipt of correspondence filed in the Office, may also be accessed via the Internet through the Patent Electronic Business Center at [www.uspto.gov](http://www.uspto.gov) using the public side of the Patent Application Information and Retrieval (PAIR) system. The direct link to access this status information is currently <http://pair.uspto.gov/>. Prior to publication, such status information is confidential and may only be obtained by applicant using the private side of PAIR.

Further assistance in electronically accessing the publication, or about PAIR, is available by calling the Patent Electronic Business Center at 1-866-217-9197.

Office of Data Management, Application Assistance Unit (571) 272-4000, or (571) 272-4200, or 1-888-786-0101



UNITED STATES PATENT AND TRADEMARK OFFICE

UNITED STATES DEPARTMENT OF COMMERCE
United States Patent and Trademark Office
Address: COMMISSIONER FOR PATENTS
P.O. Box 1450
Alexandria, Virginia 22313-1450
www.uspto.gov

Table with 5 columns: APPLICATION NO., FILING DATE, FIRST NAMED INVENTOR, ATTORNEY DOCKET NO., CONFIRMATION NO. Includes details for HARRIS CORPORATION and examiner RILEY, SHAWN.

Please find below and/or attached an Office communication concerning this application or proceeding.

The time period for reply, if any, is set in the attached communication.

<b>Office Action Summary</b>	<b>Application No.</b> 12/271,023	<b>Applicant(s)</b> FREER, BENJAMIN	
	<b>Examiner</b> Shawn Riley	<b>Art Unit</b> 2838	

-- The MAILING DATE of this communication appears on the cover sheet with the correspondence address --

**Period for Reply**

A SHORTENED STATUTORY PERIOD FOR REPLY IS SET TO EXPIRE 3 MONTH(S) OR THIRTY (30) DAYS, WHICHEVER IS LONGER, FROM THE MAILING DATE OF THIS COMMUNICATION.

- Extensions of time may be available under the provisions of 37 CFR 1.136(a). In no event, however, may a reply be timely filed after SIX (6) MONTHS from the mailing date of this communication.
- If NO period for reply is specified above, the maximum statutory period will apply and will expire SIX (6) MONTHS from the mailing date of this communication.
- Failure to reply within the set or extended period for reply will, by statute, cause the application to become ABANDONED (35 U.S.C. § 133). Any reply received by the Office later than three months after the mailing date of this communication, even if timely filed, may reduce any earned patent term adjustment. See 37 CFR 1.704(b).

**Status**

- 1)  Responsive to communication(s) filed on \_\_\_\_.
- 2a)  This action is **FINAL**.                      2b)  This action is non-final.
- 3)  Since this application is in condition for allowance except for formal matters, prosecution as to the merits is closed in accordance with the practice under *Ex parte Quayle*, 1935 C.D. 11, 453 O.G. 213.

**Disposition of Claims**

- 4)  Claim(s) 1-27 is/are pending in the application.  
    4a) Of the above claim(s) \_\_\_\_ is/are withdrawn from consideration.
- 5)  Claim(s) \_\_\_\_ is/are allowed.
- 6)  Claim(s) 1-27 is/are rejected.
- 7)  Claim(s) \_\_\_\_ is/are objected to.
- 8)  Claim(s) \_\_\_\_ are subject to restriction and/or election requirement.

**Application Papers**

- 9)  The specification is objected to by the Examiner.
- 10)  The drawing(s) filed on \_\_\_\_ is/are: a)  accepted or b)  objected to by the Examiner.  
    Applicant may not request that any objection to the drawing(s) be held in abeyance. See 37 CFR 1.85(a).  
    Replacement drawing sheet(s) including the correction is required if the drawing(s) is objected to. See 37 CFR 1.121(d).
- 11)  The oath or declaration is objected to by the Examiner. Note the attached Office Action or form PTO-152.

**Priority under 35 U.S.C. § 119**

- 12)  Acknowledgment is made of a claim for foreign priority under 35 U.S.C. § 119(a)-(d) or (f).  
    a)  All    b)  Some \*    c)  None of:  
    1.  Certified copies of the priority documents have been received.  
    2.  Certified copies of the priority documents have been received in Application No. \_\_\_\_.  
    3.  Copies of the certified copies of the priority documents have been received in this National Stage application from the International Bureau (PCT Rule 17.2(a)).

\* See the attached detailed Office action for a list of the certified copies not received.

**Attachment(s)**

- |  |   |
|--|---|
| 1) <input checked="" type="checkbox"/> Notice of References Cited (PTO-892)  | 4) <input type="checkbox"/> Interview Summary (PTO-413)<br>Paper No(s)/Mail Date. ____. |
| 2) <input type="checkbox"/> Notice of Draftsperson's Patent Drawing Review (PTO-948)   | 5) <input type="checkbox"/> Notice of Informal Patent Application                       |
| 3) <input checked="" type="checkbox"/> Information Disclosure Statement(s) (PTO/SB/08)<br>Paper No(s)/Mail Date <u>nov2008</u> . | 6) <input type="checkbox"/> Other: ____.  |

### DETAILED ACTION

#### Claim Objections

1. Claim 21 is objected to under 37 C.F.R. 1.75(a) because of the following informalities: typo at end of paragraph. Appropriate correction is required.

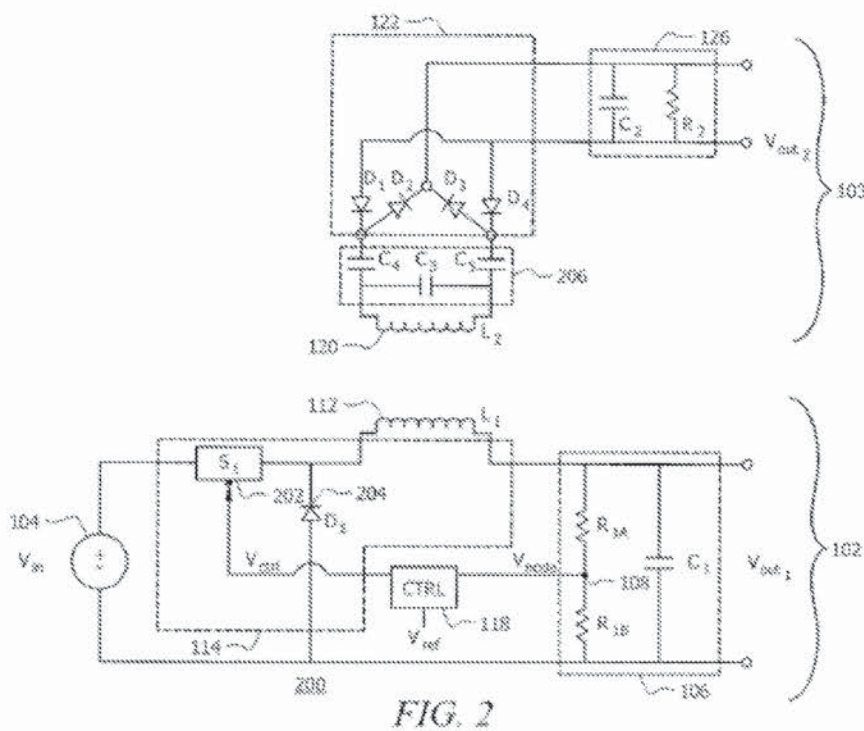

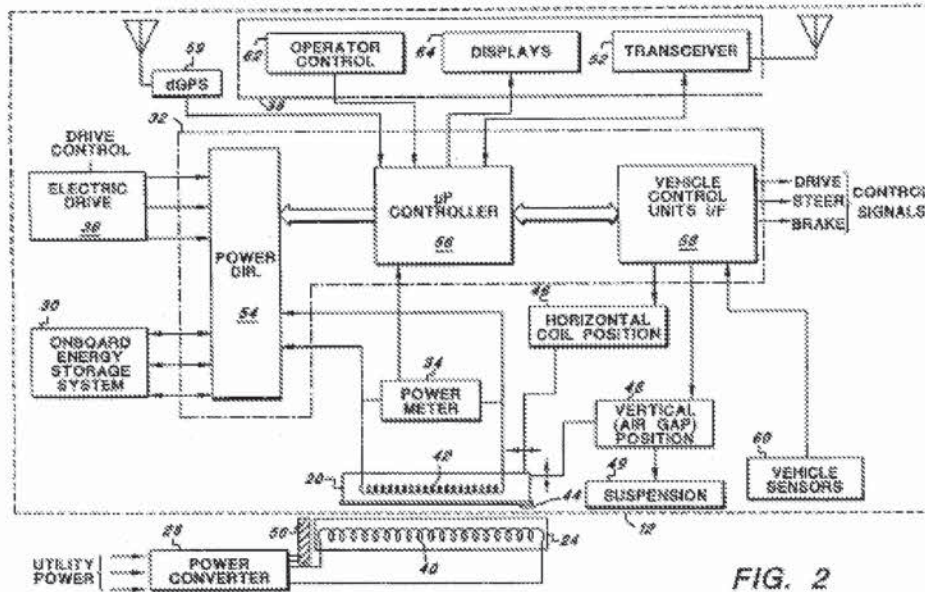

U.S. Patent Jul. 16, 2002 Sheet 2 of 18 U.S. 6,421,600 B1

**Claim Rejections - 35 U.S.C. § 102**

1. The following is a quotation of the appropriate paragraphs of 35 U.S.C. § 102 that  
A person shall be entitled to a patent unless --  
(b) the invention was patented or described in a printed publication in this or a foreign country or in public use or on sale in this country, more than one year prior to the date of application for patent in the United States.
2. Claims 1-27 are rejected under 35 U.S.C. §102(b) as being fully anticipated by Ross (U.S. Patent 6,421,600). Ross shows,<sup>1</sup> (in, e.g., the(ir) figures 2, 7A, and 11 and corresponding disclosure)

<sup>1</sup> Note claims will be addressed individually and the material in parentheses are the examiner's annotated comments. Further unless needed for clarity reasons, recited limitation(s), will be annotated only upon their first occurrence. Claims that are not annotated are seen as having already had the invention(s) addressed previously in an annotated claim and may be repeated for convenience of the

As to claim 1. A method for inductively transferring power from a base unit (including 28/50/40/24) providing input power, to a target unit (including 20/42/34/46/48/etc.) providing output power, where the base unit and the target unit are electrically isolated (via the air gap), comprising: positioning (via 46/48) a second inductive element (20) of said target unit within a predetermined distance of a first inductive element of said base unit; applying a time varying electric current to said first inductive element to produce a time varying magnetic field, said time varying magnetic field induces an electric current in said second inductive element (by definition); monitoring at least one parameter indicative of an efficiency of power transfer from said base unit to said target unit (e.g., 34); automatically adjusting at least one characteristic of said time varying electric current responsive to said parameter to maximize an efficiency of power transfer from said base unit to said target unit (via, e.g., 56).

As to claim 2. The method according to claim 1, wherein said characteristic comprises at least one of a frequency (see, e.g. figure 7a and 11) of said time varying current and a duty cycle of said time varying current.

As to claim 3. The method according to claim 1, further comprising producing said time varying electric current by switching a DC voltage source (126, e.g., can be used to rectify and than inverter the power depending on the design of the power Mod/Demod as the name implies) using an electronically controlled switch element.

As to claim 4. The method according to claim 3, further comprising communicating (e.g., 124) said time varying electric current to a load in said base unit, and selecting said parameter to be a measured current or voltage associated with said load.

As to claim 5. The method according to claim 4, wherein said selectively controlling step further comprises comparing said measured current or voltage to a constant reference value (e.g., from 41 to/from 124).

---

applicant/examiner. Bolded words/phrases indicate rejected material based 112 paragraph rejections. Underlined words/phrases indicate objected to material. For method claims, note that under MPEP 2112.02, the principles of inherency, if a prior art device, in its normal and usual operation, would necessarily perform the method claimed, then the method claimed will be considered to be anticipated by the prior art device. When the prior art device is the same as a device described in the specification for carrying out the claimed method, it can be assumed the device will inherently perform the claimed process. In re King, 801 F.2d 1324, 231 USPQ 136 (Fed. Cir. 1986). Therefore the previous rejections based on the apparatus will not be repeated.

As to claim 6. The method according to claim 1, further comprising producing said time varying magnetic field with a DC to DC type switching mode power supply circuit (as described in the specification).

As to claim 7. The method according to claim 6, further comprising utilizing said first inductive element as a primary energy storage component in said DC to DC conversion process of said switching mode power supply circuit (first inductor, e.g., 40).

As to claim 8. The method according to claim 1, wherein said automatically adjusting step further comprises automatically adjusting said characteristic to induce an oscillation in said second inductive element at a frequency to be approximately equal to a self-resonant frequency of said second inductive element (that is describe in the specification to maximize efficiency by reducing losses).

As to claim 9. The method according to claim 1, further comprising responsive to a re-positioning of said second inductive element from a first position to a second position, automatically selectively re-adjusting said characteristic to maximize said efficiency, wherein said first position differs from said second position with regard to at least one characteristic selected from the group consisting of distance and orientation relative to said primary inductor (already addressed in above rejections, see, e.g. vertical repositioning of 48 and horizontal positioning provided by 46).

As to claim 10. The method according to claim 1, further comprising responsive to a substitution of a target unit with a different target unit, automatically selectively re-adjusting said characteristic to maximize said efficiency (as previously stated).

As to claim 11. The method according to claim 1, further comprising rectifying an output current induced in said second inductive element to produce a DC output (this occurs at, e.g., 30).

12. An inductive power transfer system, comprising: a base unit comprising a first inductive element configured for providing input power to a second inductive element of a target unit providing output power, said base unit electrically isolated from said target unit; positioning structure provided on at least one of said base unit and said target unit for removably positioning said second inductive element at a predetermined orientation and distance relative to said first inductive element; a switch element configured for selectively applying a time varying electric current to said first inductive element to produce a time varying magnetic field, said time varying magnetic field inducing an electric current in said second inductive element; a control circuit configured for monitoring at least one parameter indicative of an efficiency of power transfer from said base unit to said target unit, and automatically adjusting at least one characteristic of said time varying electric current responsive to said parameter to maximize an

efficiency of power transfer from said base unit to said target unit.

13. The system of claim 12, wherein said characteristic comprises at least one of a frequency of said time varying current and a duty cycle of said time varying current.

14. The system of claim 12, wherein said switch element is electronically controlled, and wherein said switch element is configured for coupling and decoupling a DC voltage source to said first inductive element to produce said time varying current.

15. The system of claim 14, further comprising a load circuit coupled to said first inductive element, and where said parameter comprises a current or voltage associated with said load.

16. The system of claim 15, wherein said control circuit automatically selectively adjusts said characteristic based on a comparison of said measured current or voltage to a constant reference value.

17. The system of claim 12, wherein said base unit further comprises a DC to DC type switching mode power supply, said DC to DC type switching mode power supply circuit producing said time varying magnetic field.

18. The system of claim 15, where said first inductive element comprises a primary energy storage component of said DC to DC type switching mode power supply circuit.

19. The system of claim 12, wherein said control circuit is further configured during said selectively adjusting for automatically selectively adjusting said frequency to be approximately equal to a self-resonant frequency of said second inductive element.

20. The system of claim 12, wherein said control circuit is further configured during said selectively adjusting for automatically selectively re-adjusting said frequency to maximize said efficiency responsive to a re-positioning of said second inductive element from a first position to a second position, wherein said first position differs from said second position with regard to at least one characteristic selected from the group consisting of distance and orientation relative to said primary inductor.

21. The system of claim 12, wherein said control circuit is further configured during said selectively adjusting for automatically selectively re-adjust said frequency to maximize said efficiency responsive to a substitution of a target unit with a different target unit.

22. The system of claim 12, wherein said target unit further comprises rectifying element for to produce a DC output by rectifying an output current induced in said second inductive element.

23. A DC-DC converter, comprising: a input circuit for receiving a DC input voltage; an output circuit electrically coupled to said input circuit, said output circuit comprising a load sub-circuit electrically coupled to a converter sub-circuit, said converter sub-circuit comprising at least a first inductive element and at least one switch element having a switch control node, said switch control node responsive to a first control voltage for selectively alternating said switch element between an open state and a closed state; and a control circuit having an input node electrically coupled to a node within said load sub-circuit and an output node electrically coupled to said switch control node, said control circuit generating at said output node a periodic voltage signal adjustable to one or more operating frequencies based on a difference between a second control voltage at said input node and a reference voltage; wherein an inductance and a physical arrangement of said first inductive element is selected for said first inductive element to generate a permeating magnetic field that at least partially permeates a second inductive element electrically isolated from said first



inductive element, wherein said permeating magnetic field induces a substantially self-resonant oscillation in said second inductive element for at least one of said operating frequencies, and wherein said control circuit is further configured to adjust said periodic voltage signal to adjust an internal voltage level at said internal node to minimize said difference.

24. The DC-DC converter of claim 23, wherein said inductive element comprises at least a first inductor.

25. The DC-DC converter of claim 24, wherein a first directional vector defining a first inductor coil axis of said first inductor and a second directional vector defining a second inductor coil axis of said second inductive element are substantially parallel.

26. The DC-DC converter of claim 24, wherein said one of said operating frequencies is at least 1 MHz, and wherein said first inductor has an inductance of at least 100nH.

27. The DC-DC converter of claim 23, wherein said first inductive element and said switch element are electrically coupled in series between said input circuit and said load sub-circuit, and wherein said converter sub-circuit further comprises a rectifier element electrically coupled to a common node between said first inductive element and said switch element.

### *Allowable Subject Matter*

3. No claims are allowable over the prior art of record.

### *Conclusion*

**N.B.** Any inquiry from other than the applicant/attorney of record (~~THAT INCLUDES SECRETARIAL AND ANY OTHER TYPE OF SUPPORT STAFF~~) concerning this communication or earlier communications from the Examiner should be directed to the Patent Electronic Business Center (EBC) at 1.866.217.9197.

Any inquiry from a member of the press concerning this communication or earlier communications from the Examiner or the application should be directed to the Office of Public Affairs at 703.305.8341. Any inquiry from the applicant or an attorney of record concerning this communication or earlier communications from the Examiner should be directed to Examiner Riley whose telephone number is 571.272.2083. The Examiner can normally be reached Monday through Thursday from 7:30-6:00 p.m. Eastern Standard Time. The Examiner's Supervisor is Monica Lewis may be reached on 571-272-1838. Any inquiry about a case's location, retrieval of a case, or receipt of an amendment into a case or information regarding sent correspondence to a case should be directed to 2800's Customer Service Center at 571.272.2815. Any papers to be sent by fax MUST BE sent to fax number **571-273-8300**. Any inquiry of a general nature of this application should be directed to the Group receptionist whose

Application/Control Number: 12/271,023

Page 8

Art Unit: 2838

telephone number is 571.272.2800. Status information of cases may be found at <http://pair-direct.uspto.gov> wherein unpublished application information is found through private PAIR and published application information is found through public PAIR. For more information about the PAIR system, see <http://pair-direct.uspto.gov>. Further help on using the PAIR system is available at 1.866.217.9197 (Electronic Business Center). If you would like assistance from a USPTO Customer Service Representative or access to the automated information system, call 800-786-9199 (IN USA OR CANADA) or 571-272-1000.

May 2010

/Shawn Riley/  
**Primary Examiner AU 2838**

<b>Notice of References Cited</b>	Application/Control No. 12/271,023	Applicant(s)/Patent Under Reexamination FREER, BENJAMIN	
	Examiner Shawn Riley	Art Unit 2838	Page 1 of 1

**U.S. PATENT DOCUMENTS**

*	Document Number Country Code-Number-Kind Code	Date MM-YYYY	Name	Classification
*	A US-5,831,841	11-1998	Nishino, Shuzo	307/10.1
*	B US-6,421,600	07-2002	Ross, Howard R.	701/117
	C US-			
	D US-			
	E US-			
	F US-			
	G US-			
	H US-			
	I US-			
	J US-			
	K US-			
	L US-			
	M US-			

**FOREIGN PATENT DOCUMENTS**

*	Document Number Country Code-Number-Kind Code	Date MM-YYYY	Country	Name	Classification
	N				
	O				
	P				
	Q				
	R				
	S				
	T				

**NON-PATENT DOCUMENTS**

*	Include as applicable: Author, Title Date, Publisher, Edition or Volume, Pertinent Pages)
U	
V	
W	
X	

\*A copy of this reference is not being furnished with this Office action. (See MPEP § 707.05(a).)  
Dates in MM-YYYY format are publication dates. Classifications may be US or foreign.

**Index of Claims**



Application/Control No.

12/271,023

Examiner

Shawn Riley

Applicant(s)/Patent under Reexamination

FREER, BENJAMIN

Art Unit

2838

√	Rejected
=	Allowed

-	(Through numeral) Cancelled
+	Restricted

N	Non-Elected
I	Interference

A	Appeal
O	Objected

Claim		Date			
Final	Original	5/1/10			
1	√				
2	√				
3	√				
4	√				
5	√				
6	√				
7	√				
8	√				
9	√				
10	√				
11	√				
12	√				
13	√				
14	√				
15	√				
16	√				
17	√				
18	√				
19	√				
20	√				
21	√				
22	√				
23	√				
24	√				
25	√				
26	√				
27	√				
28					
29					
30					
31					
32					
33					
34					
35					
36					
37					
38					
39					
40					
41					
42					
43					
44					
45					
46					
47					
48					
49					
50					

Claim		Date			
Final	Original				
51					
52					
53					
54					
55					
56					
57					
58					
59					
60					
61					
62					
63					
64					
65					
66					
67					
68					
69					
70					
71					
72					
73					
74					
75					
76					
77					
78					
79					
80					
81					
82					
83					
84					
85					
86					
87					
88					
89					
90					
91					
92					
93					
94					
95					
96					
97					
98					
99					
100					

Claim		Date			
Final	Original				
101					
102					
103					
104					
105					
106					
107					
108					
109					
110					
111					
112					
113					
114					
115					
116					
117					
118					
119					
120					
121					
122					
123					
124					
125					
126					
127					
128					
129					
130					
131					
132					
133					
134					
135					
136					
137					
138					
139					
140					
141					
142					
143					
144					
145					
146					
147					
148					
149					
150					





Receipt date: 11/14/2008

PTO/SB/08b (09-08)  
 Approved for use through 10/31/2008. OMB 0651-0031  
 U.S. Patent and Trademark Office; U.S. DEPARTMENT OF COMMERCE

Under the Paperwork Reduction Act of 1995, no persons are required to respond to a collection of information unless it contains a valid OMB control number.

Substitute for form 1449/PTO  <b>INFORMATION DISCLOSURE STATEMENT BY APPLICANT</b>  <i>(Use as many sheets as necessary)</i>				<b>Complete if Known</b>	
				Application Number	Not Yet Assigned
				Filing Date	Concurrently Herewith
				First Named Inventor	Benjamin Freer
				Art Unit	N/A
				Examiner Name	Not Yet Assigned
Sheet	2	of	2	Attorney Docket Number	17162/0210146-US0

NON PATENT LITERATURE DOCUMENTS			
Examiner Initials	Cite No. <sup>1</sup>	Include name of the author (in CAPITAL LETTERS), title of the article (when appropriate), title of the item (book, magazine, journal, serial, symposium, catalog, etc.), date, page(s), volume-issue number(s), publisher, city and/or country where published.	T <sup>2</sup>

Examiner Signature	Date Considered	
--------------------	-----------------	--

\*EXAMINER: Initial if reference considered, whether or not citation is in conformance with MPEP 609. Draw line through citation if not in conformance and not considered. Include copy of this form with next communication to applicant.

<sup>1</sup>Applicant's unique citation designation number (optional). <sup>2</sup>Applicant is to place a check mark here if English language Translation is attached.



UNITED STATES PATENT AND TRADEMARK OFFICE

UNITED STATES DEPARTMENT OF COMMERCE  
 United States Patent and Trademark Office  
 Address: COMMISSIONER FOR PATENTS  
 P.O. Box 1450  
 Alexandria, Virginia 22313-1450  
 www.uspto.gov

BIB DATA SHEET

CONFIRMATION NO. 3269

<b>SERIAL NUMBER</b> 12/271,023	<b>FILING or 371(c) DATE</b> 11/14/2008 <b>RULE</b>	<b>CLASS</b> 361	<b>GROUP ART UNIT</b> 2838	<b>ATTORNEY DOCKET NO.</b> 17162/0210146-US0		
<b>APPLICANTS</b> Benjamin Freer, Rochester, NY;						
<b>** CONTINUING DATA *****</b>						
<b>** FOREIGN APPLICATIONS *****</b>						
<b>** IF REQUIRED, FOREIGN FILING LICENSE GRANTED **</b> 11/24/2008						
Foreign Priority claimed <input type="checkbox"/> Yes <input checked="" type="checkbox"/> No	35 USC 119(a-d) conditions met <input type="checkbox"/> Yes <input type="checkbox"/> No	<input type="checkbox"/> Met after Allowance Initials	<b>STATE OR COUNTRY</b> NY	<b>SHEETS DRAWINGS</b> 4	<b>TOTAL CLAIMS</b> 27	<b>INDEPENDENT CLAIMS</b> 3
<b>ADDRESS</b> HARRIS CORPORATION C/O FOX ROTHSCHILD, LLP 997 Lenox Drive Building 3 Lawrenceville, NJ 08543-5231 UNITED STATES						
<b>TITLE</b> INDUCTIVE POWER TRANSFER SYSTEM AND METHOD						
<b>FILING FEE RECEIVED</b> 1454	FEES: Authority has been given in Paper No. _____ to charge/credit DEPOSIT ACCOUNT No. _____ for following:		<input type="checkbox"/> All Fees <input type="checkbox"/> 1.16 Fees (Filing) <input type="checkbox"/> 1.17 Fees (Processing Ext. of time) <input type="checkbox"/> 1.18 Fees (Issue) <input type="checkbox"/> Other _____ <input type="checkbox"/> Credit			





UNITED STATES PATENT AND TRADEMARK OFFICE

UNITED STATES DEPARTMENT OF COMMERCE
United States Patent and Trademark Office
Address: COMMISSIONER FOR PATENTS
P.O. Box 1450
Alexandria, Virginia 22313-1450
www.uspto.gov

Table with 7 columns: APPLICATION NUMBER, FILING or 371(c) DATE, GRP ART UNIT, FIL FEE REC'D, ATTY. DOCKET NO, TOT CLAIMS, IND CLAIMS. Row 1: 12/271,023, 11/14/2008, 2836, 1454, 17162/0210146-USO, 27, 3

CONFIRMATION NO. 3269

FILING RECEIPT



68085
HARRIS CORPORATION
C/O DARBY & DARBY PC
P.O. BOX 770
CHURCH STREET STATION
NEW YORK, NY 10008-0770

Date Mailed: 12/01/2008

Receipt is acknowledged of this non-provisional patent application. The application will be taken up for examination in due course. Applicant will be notified as to the results of the examination. Any correspondence concerning the application must include the following identification information: the U.S. APPLICATION NUMBER, FILING DATE, NAME OF APPLICANT, and TITLE OF INVENTION. Fees transmitted by check or draft are subject to collection. Please verify the accuracy of the data presented on this receipt. If an error is noted on this Filing Receipt, please submit a written request for a Filing Receipt Correction. Please provide a copy of this Filing Receipt with the changes noted thereon. If you received a "Notice to File Missing Parts" for this application, please submit any corrections to this Filing Receipt with your reply to the Notice. When the USPTO processes the reply to the Notice, the USPTO will generate another Filing Receipt incorporating the requested corrections

Applicant(s)

Benjamin Freer, Rochester, NY;

Assignment For Published Patent Application

Harris Corporation, Melbourne, FL

Power of Attorney: The patent practitioners associated with Customer Number 68085

Domestic Priority data as claimed by applicant

Foreign Applications

Permission to Access - A proper Authorization to Permit Access to Application by Participating Offices (PTO/SB/39 or its equivalent) has been received by the USPTO.

If Required, Foreign Filing License Granted: 11/24/2008

The country code and number of your priority application, to be used for filing abroad under the Paris Convention, is US 12/271,023

Projected Publication Date: 05/20/2010

Non-Publication Request: No

Early Publication Request: No

**Title**

INDUCTIVE POWER TRANSFER SYSTEM AND METHOD

**Preliminary Class**

361

**PROTECTING YOUR INVENTION OUTSIDE THE UNITED STATES**

Since the rights granted by a U.S. patent extend only throughout the territory of the United States and have no effect in a foreign country, an inventor who wishes patent protection in another country must apply for a patent in a specific country or in regional patent offices. Applicants may wish to consider the filing of an international application under the Patent Cooperation Treaty (PCT). An international (PCT) application generally has the same effect as a regular national patent application in each PCT-member country. The PCT process **simplifies** the filing of patent applications on the same invention in member countries, but **does not result** in a grant of "an international patent" and does not eliminate the need of applicants to file additional documents and fees in countries where patent protection is desired.

Almost every country has its own patent law, and a person desiring a patent in a particular country must make an application for patent in that country in accordance with its particular laws. Since the laws of many countries differ in various respects from the patent law of the United States, applicants are advised to seek guidance from specific foreign countries to ensure that patent rights are not lost prematurely.

Applicants also are advised that in the case of inventions made in the United States, the Director of the USPTO must issue a license before applicants can apply for a patent in a foreign country. The filing of a U.S. patent application serves as a request for a foreign filing license. The application's filing receipt contains further information and guidance as to the status of applicant's license for foreign filing.

Applicants may wish to consult the USPTO booklet, "General Information Concerning Patents" (specifically, the section entitled "Treaties and Foreign Patents") for more information on timeframes and deadlines for filing foreign patent applications. The guide is available either by contacting the USPTO Contact Center at 800-786-9199, or it can be viewed on the USPTO website at <http://www.uspto.gov/web/offices/pac/doc/general/index.html>.

For information on preventing theft of your intellectual property (patents, trademarks and copyrights), you may wish to consult the U.S. Government website, <http://www.stopfakes.gov>. Part of a Department of Commerce initiative, this website includes self-help "toolkits" giving innovators guidance on how to protect intellectual property in specific countries such as China, Korea and Mexico. For questions regarding patent enforcement issues, applicants may call the U.S. Government hotline at 1-866-999-HALT (1-866-999-4158).

**LICENSE FOR FOREIGN FILING UNDER****Title 35, United States Code, Section 184****Title 37, Code of Federal Regulations, 5.11 & 5.15****GRANTED**

The applicant has been granted a license under 35 U.S.C. 184, if the phrase "IF REQUIRED, FOREIGN FILING LICENSE GRANTED" followed by a date appears on this form. Such licenses are issued in all applications where the conditions for issuance of a license have been met, regardless of whether or not a license may be required as

set forth in 37 CFR 5.15. The scope and limitations of this license are set forth in 37 CFR 5.15(a) unless an earlier license has been issued under 37 CFR 5.15(b). The license is subject to revocation upon written notification. The date indicated is the effective date of the license, unless an earlier license of similar scope has been granted under 37 CFR 5.13 or 5.14.

This license is to be retained by the licensee and may be used at any time on or after the effective date thereof unless it is revoked. This license is automatically transferred to any related applications(s) filed under 37 CFR 1.53(d). This license is not retroactive.

The grant of a license does not in any way lessen the responsibility of a licensee for the security of the subject matter as imposed by any Government contract or the provisions of existing laws relating to espionage and the national security or the export of technical data. Licensees should apprise themselves of current regulations especially with respect to certain countries, of other agencies, particularly the Office of Defense Trade Controls, Department of State (with respect to Arms, Munitions and Implements of War (22 CFR 121-128)); the Bureau of Industry and Security, Department of Commerce (15 CFR parts 730-774); the Office of Foreign Assets Control, Department of Treasury (31 CFR Parts 500+) and the Department of Energy.

**NOT GRANTED**

No license under 35 U.S.C. 184 has been granted at this time, if the phrase "IF REQUIRED, FOREIGN FILING LICENSE GRANTED" DOES NOT appear on this form. Applicant may still petition for a license under 37 CFR 5.12, if a license is desired before the expiration of 6 months from the filing date of the application. If 6 months has lapsed from the filing date of this application and the licensee has not received any indication of a secrecy order under 35 U.S.C. 181, the licensee may foreign file the application pursuant to 37 CFR 5.15(b).

Under the Paperwork Reduction Act of 1995, no persons are required to respond to a collection of information unless it displays a valid OMB control number.

<b>UTILITY                  PATENT APPLICATION                  TRANSMITTAL</b>  (ONLY FOR NEW NONPROVISIONAL APPLICATIONS UNDER 37 CFR 1.53(B))	Attorney Docket No. <b>17162/0210146-US0</b>	
	First Inventor <b>Benjamin Freer</b>	
	Title	<b>INDUCTIVE POWER TRANSFER SYSTEM AND METHOD</b>
	Express Mail Label No.	

<b>APPLICATION ELEMENTS</b> <i>See MPEP chapter 600 concerning utility patent application contents.</i>	<b>ADDRESS TO:</b> Commissioner for Patents P.O. Box 1450 Alexandria, VA 22313-1450
--	---

1. <input type="checkbox"/> Fee Transmittal Form (e.g., PTO/SB/17) 2. <input type="checkbox"/> Applicant claims small entity status. See 37 CFR 1.27. 3. <input checked="" type="checkbox"/> Specification [Total Pages <u>24</u> ] Both the claims and abstract must start on a new page (For information on the preferred arrangement, see MPEP 608.01(a)) 4. <input checked="" type="checkbox"/> Drawing(s) (35 U.S.C. 113) [Total Sheets <u>4</u> ] 5. Oath or Declaration [Total Sheets <u>3</u> ] a. <input checked="" type="checkbox"/> Newly executed (original or copy) b. <input type="checkbox"/> A copy from a prior application (37 CFR 1.63(d)) (for continuation/divisional with Box 18 completed) i. <input type="checkbox"/> DELETION OF INVENTOR(S) Signed statement attached deleting inventor(s) name in the prior application, see 37 CFR 1.63(d)(2) and 1.33(b). 6. <input checked="" type="checkbox"/> Application Data Sheet. See 37 CFR 1.76 7. <input type="checkbox"/> CD-ROM or CD-R in duplicate, large table or Computer Program (Appendix) <input type="checkbox"/> Landscape Table on CD 8. Nucleotide and/or Amino Acid Sequence Submission (if applicable, items a. - c. are required) a. <input type="checkbox"/> Computer Readable Form (CRF) b. Specification Sequence Listing on: i. <input type="checkbox"/> CD-ROM or CD-R (2 copies); or ii. <input type="checkbox"/> Paper c. <input type="checkbox"/> Statements verifying identity of above copies	<b>ACCOMPANYING APPLICATION PARTS</b> 9. <input type="checkbox"/> Assignment Papers (cover sheet & document(s)) Name of Assignee <input style="width: 100%; height: 20px;" type="text"/> 10. <input type="checkbox"/> 37 CFR 3.73(b) Statement (when there is an assignee) <input type="checkbox"/> Power of Attorney 11. <input type="checkbox"/> English Translation Document (if applicable) 12. <input checked="" type="checkbox"/> Information Disclosure Statement (PTO/SB/08 or PTO-1449) <input type="checkbox"/> Copies of citations attached 13. <input type="checkbox"/> Preliminary Amendment 14. <input type="checkbox"/> Return Receipt Postcard (MPEP 503) (Should be specifically itemized) 15. <input type="checkbox"/> Certified Copy of Priority Document(s) (if foreign priority is claimed) 16. <input type="checkbox"/> Nonpublication Request under 35 U.S.C.122 (b)(2)(B)(i). Applicant must attach form PTO/SB/35 or equivalent. 17. <input checked="" type="checkbox"/> Other: <input style="width: 100%; height: 20px;" type="text"/> PTO Form SB39
---	---

18. If a CONTINUING APPLICATION, check appropriate box, and supply the requisite information below and in the first sentence of the specification following the title, or in an Application Data Sheet under 37 CFR 1.76:

Continuation  Divisional  Continuation-in-part (CIP) of prior application No.: \_\_\_\_\_

Prior application information: Examiner \_\_\_\_\_ Art Unit: \_\_\_\_\_

**19. CORRESPONDENCE ADDRESS**

The address associated with Customer Number:  68085 OR  Correspondence address below

Name	
Address	
City	State
Country	Zip Code
Telephone	Email

Signature	/Flynn Barrison 53,970/	Date	November 14, 2008
Name (Print/Type)	Robert J. Sacco	Registration No. (Attorney/Agent)	35,667

## **Application Data Sheet**

### **Application Information**

Application Type::	Regular
Subject Matter::	Utility
Suggested Group Art Unit::	N/A
CD-ROM or CD-R?::	None
Sequence submission?::	None
Computer Readable Form (CRF)?::	No
Title::	INDUCTIVE POWER TRANSFER SYSTEM AND METHOD
Attorney Docket Number::	17162/0210146-US0
Request for Early Publication?::	No
Request for Non-Publication?::	No
Suggested Drawing Figure::	1
Total Drawing Sheets::	4
Small Entity?::	No
Petition included?::	No
Secrecy Order in Parent Appl.?::	No

### **Applicant Information**

Applicant Authority Type::	Inventor
Primary Citizenship Country::	US
Status::	Full Capacity
Given Name::	Benjamin
Family Name::	Freer
City of Residence::	Rochester
State or Province of Residence::	NY
Country of Residence::	US

Street of mailing address:: 2329 East Ridge Rd  
Apt 1  
City of mailing address:: Rochester  
State or Province of mailing address:: NY  
Postal or Zip Code of mailing address:: 14622

**Correspondence Information**

Correspondence Customer Number:: 68085

**Representative Information**

Representative Customer Number:: 68085

**Domestic Priority Information**

**Foreign Priority Information**

**Assignee Information**

Assignee name:: Harris Corporation  
Street of mailing address:: 1025 West NASA Boulevard  
City of mailing address:: Melbourne  
State or Province of mailing address:: FL  
Postal or Zip Code of mailing address:: 32919

**IN THE UNITED STATES PATENT AND TRADEMARK OFFICE**  
**COMBINED DECLARATION AND POWER OF ATTORNEY**

As the below named inventor, I hereby declare that:

My residence, post office address and citizenship are as stated below next to my name.

I believe I am the original, first and sole inventor of the subject matter which is described and claimed and for which a patent is sought on the invention entitled:

**INDUCTIVE POWER TRANSFER SYSTEM AND METHOD**

the specification of which is attached hereto.

I hereby state that I have reviewed and understand the contents of the above identified specification, including the claims, as amended by an amendment, if any, specifically referred to herein. I do not know and do not believe that the same was ever known or used in the United States of America before my or our invention thereof or patented or described in any printed publication in any country before my or our invention thereof, or more than one year prior to this application, or in public use or on sale in the United States of America more than one year prior to this application, that the invention has not been patented or made the subject of an inventor's certificate issued before the date of this application in any country foreign to the United States of America on an application filed by me or my legal representatives or assigned more than twelve months prior to this application.

I acknowledge the duty to disclose all information known to me that is material to patentability as defined in Title 37, Code of Federal Regulations, § 1.56.

**FOREIGN PRIORITY CLAIM**

I hereby claim foreign priority benefits under Title 35, United States Code § 119(a)-(d) of any foreign application(s) for patent or inventor's certificate listed below and have also identified below any foreign application for patent or inventor's certificate having a filing date before that of the application on which priority is claimed:

no such foreign applications have been filed

such foreign application have been filed as follows:

**EARLIEST FOREIGN APPLICATION(S), IF ANY FILED WITHIN 12 MONTHS  
(6 MONTHS FOR DESIGN) PRIOR TO THIS U.S. APPLICATION**

Application Number	Country	Date of Filing	Priority Claimed Under 35 USC 119
			___ Yes No ___

ALL FOREIGN APPLICATION(S), IF ANY FILED MORE THAN 12 MONTHS  
(6 MONTHS FOR DESIGN) PRIOR TO THIS U.S. APPLICATION

Application Number	Country	Date of Filing

CLAIM FOR BENEFIT OF EARLIER U.S. PROVISIONAL APPLICATIONS

I hereby claim priority benefits under Title 35, United States Code §119(e), of any United States provisional patent application(s) listed below:

no such U.S. provisional applications have been filed.

such U.S. provisional application have been filed as follows:

Application Number	Date of Filing	Priority Claimed Under 35 USC 119
		Yes No

CLAIM FOR BENEFIT OF EARLIER U.S./PCT APPLICATION(S)

I hereby claim the benefit under Title 35, United States Code, §120 of the United States application(s) listed below and, insofar as the subject matter of each of the claims of this application is not disclosed in the prior United States application in the manner provided by the first paragraph of Title 35, United States Code, §112, I acknowledge the duty to disclose all information that is material to patentability in accordance with Title 37, Code of Federal Regulations, §1.56 which became available to me between the filing date of the prior application and the national or PCT international filing date of this application:

no such U.S./PCT applications have been filed.

such U.S./PCT application have been filed as follows:

Application Number	Date of Filing	Status (Patented/Pending/Abandoned)

I hereby declare that all statements made herein of my own knowledge are true and that all statements made on information and belief are believed to be true; and further that these statements were made with the knowledge that willful false statements and the like so made are punishable by fine or imprisonment, or both, under Section 1001 of Title 18 of the United States Code and that such willful false statements may jeopardize the validity of the application or any patent issued thereon.



I hereby appoint the practitioners under Customer Number 68085

jointly, and each of them severally, my attorneys at law/patent agent(s), with full power of substitution, delegation and revocation, to prosecute this application, to make alterations and amendments therein, to receive the patent, and to transact all business in the U. S. Patent and Trademark Office connected therewith.

Please mail all correspondence to **Customer Number 68085**, whose address is:

**Darby & Darby P.C.**  
P.O. Box 770  
Church Street Station  
New York, NY 10008-0770

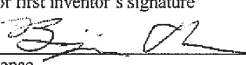
Full name of sole or first inventor <b>Benjamin Freer</b>	
Sole or first inventor's signature 	Date 11/11/08
Residence <b>Rochester, New York</b>	
Citizenship <b>US</b>	
Mailing Address 2329 East Ridge Rd Apt 1 Rochester, New York 14622	





## Electronic Patent Application Fee Transmittal

<b>Application Number:</b>					
<b>Filing Date:</b>					
<b>Title of Invention:</b>	INDUCTIVE POWER TRANSFER SYSTEM AND METHOD				
<b>First Named Inventor/Applicant Name:</b>	Benjamin Freer				
<b>Filer:</b>	Jay Philip Lessler/Lillian Garcia				
<b>Attorney Docket Number:</b>	17162/0210146-US0				
Filed as Large Entity					
<b>Utility under 35 USC 111(a) Filing Fees</b>					
<b>Description</b>	<b>Fee Code</b>	<b>Quantity</b>	<b>Amount</b>	<b>Sub-Total in USD(\$)</b>	
<b>Basic Filing:</b>					
Utility application filing	1011	1	330	330	
Utility Search Fee	1111	1	540	540	
Utility Examination Fee	1311	1	220	220	
<b>Pages:</b>					
<b>Claims:</b>					
Claims in excess of 20	1202	7	52	364	
<b>Miscellaneous-Filing:</b>					
<b>Petition:</b>					

Description	Fee Code	Quantity	Amount	Sub-Total in USD(\$)
<b>Patent-Appeals-and-Interference:</b>				
<b>Post-Allowance-and-Post-Issuance:</b>				
<b>Extension-of-Time:</b>				
<b>Miscellaneous:</b>				
<b>Total in USD (\$)</b>				<b>1454</b>

## Electronic Acknowledgement Receipt

<b>EFS ID:</b>	4289862
<b>Application Number:</b>	12271023
<b>International Application Number:</b>	
<b>Confirmation Number:</b>	3269
<b>Title of Invention:</b>	INDUCTIVE POWER TRANSFER SYSTEM AND METHOD
<b>First Named Inventor/Applicant Name:</b>	Benjamin Freer
<b>Customer Number:</b>	68085
<b>Filer:</b>	Jay Philip Lessler/Lillian Garcia
<b>Filer Authorized By:</b>	Jay Philip Lessler
<b>Attorney Docket Number:</b>	17162/0210146-US0
<b>Receipt Date:</b>	14-NOV-2008
<b>Filing Date:</b>	
<b>Time Stamp:</b>	12:30:36
<b>Application Type:</b>	Utility under 35 USC 111(a)

### Payment information:

Submitted with Payment	yes
Payment Type	Deposit Account
Payment was successfully received in RAM	\$ 1454
RAM confirmation Number	9672
Deposit Account	040100
Authorized User	

The Director of the USPTO is hereby authorized to charge indicated fees and credit any overpayment as follows:  
 Charge any Additional Fees required under 37 C.F.R. Section 1.17 (Patent application and reexamination processing fees)

<b>File Listing:</b>					
<b>Document Number</b>	<b>Document Description</b>	<b>File Name</b>	<b>File Size(Bytes)/ Message Digest</b>	<b>Multi Part /.zip</b>	<b>Pages (if appl.)</b>
1		AppForEFiling.PDF	351206	yes	41
			27aa4cd16a645426fde1bb3dd3e32ce97b20711		
<b>Multipart Description/PDF files in .zip description</b>					
	<b>Document Description</b>		<b>Start</b>		<b>End</b>
	Transmittal of New Application		1		1
	Application Data Sheet		2		3
	Oath or Declaration filed		4		6
	Authorization to access Appl. by Trilateral Office		7		7
	Specification		8		24
	Claims		25		30
	Abstract		31		31
	Drawings-only black and white line drawings		32		35
	Information Disclosure Statement Letter		36		39
	Information Disclosure Statement (IDS) Filed (SB/08)		40		41
<b>Warnings:</b>					
<b>Information:</b>					
2	Fee Worksheet (PTO-06)	fee-info.pdf	36494	no	2
			a30babff2a90d78f62143ba2cd2113e78cfe69fa		
<b>Warnings:</b>					
<b>Information:</b>					
<b>Total Files Size (in bytes):</b>			387700		

This Acknowledgement Receipt evidences receipt on the noted date by the USPTO of the indicated documents, characterized by the applicant, and including page counts, where applicable. It serves as evidence of receipt similar to a Post Card, as described in MPEP 503.

**New Applications Under 35 U.S.C. 111**

If a new application is being filed and the application includes the necessary components for a filing date (see 37 CFR 1.53(b)-(d) and MPEP 506), a Filing Receipt (37 CFR 1.54) will be issued in due course and the date shown on this Acknowledgement Receipt will establish the filing date of the application.

**National Stage of an International Application under 35 U.S.C. 371**

If a timely submission to enter the national stage of an international application is compliant with the conditions of 35 U.S.C. 371 and other applicable requirements a Form PCT/DO/EO/903 indicating acceptance of the application as a national stage submission under 35 U.S.C. 371 will be issued in addition to the Filing Receipt, in due course.

**New International Application Filed with the USPTO as a Receiving Office**

If a new international application is being filed and the international application includes the necessary components for an international filing date (see PCT Article 11 and MPEP 1810), a Notification of the International Application Number and of the International Filing Date (Form PCT/RO/105) will be issued in due course, subject to prescriptions concerning national security, and the date shown on this Acknowledgement Receipt will establish the international filing date of the application.



## Electronic Acknowledgement Receipt

<b>EFS ID:</b>	4289862
<b>Application Number:</b>	12271023
<b>International Application Number:</b>	
<b>Confirmation Number:</b>	3269
<b>Title of Invention:</b>	INDUCTIVE POWER TRANSFER SYSTEM AND METHOD
<b>First Named Inventor/Applicant Name:</b>	Benjamin Freer
<b>Customer Number:</b>	68085
<b>Filer:</b>	Jay Philip Lessler/Lillian Garcia
<b>Filer Authorized By:</b>	Jay Philip Lessler
<b>Attorney Docket Number:</b>	17162/0210146-US0
<b>Receipt Date:</b>	14-NOV-2008
<b>Filing Date:</b>	
<b>Time Stamp:</b>	12:30:36
<b>Application Type:</b>	Utility under 35 USC 111(a)

### Payment information:

Submitted with Payment	yes
Payment Type	Deposit Account
Payment was successfully received in RAM	\$ 1454
RAM confirmation Number	9672
Deposit Account	040100
Authorized User	

The Director of the USPTO is hereby authorized to charge indicated fees and credit any overpayment as follows:  
 Charge any Additional Fees required under 37 C.F.R. Section 1.17 (Patent application and reexamination processing fees)

<b>File Listing:</b>					
<b>Document Number</b>	<b>Document Description</b>	<b>File Name</b>	<b>File Size(Bytes)/ Message Digest</b>	<b>Multi Part /.zip</b>	<b>Pages (if appl.)</b>
1		AppForEFiling.PDF	351206	yes	41
			27aa4cd16a645426fde1bb3dd3e32ce97b20711		
<b>Multipart Description/PDF files in .zip description</b>					
	<b>Document Description</b>		<b>Start</b>		<b>End</b>
	Transmittal of New Application		1		1
	Application Data Sheet		2		3
	Oath or Declaration filed		4		6
	Authorization to access Appl. by Trilateral Office		7		7
	Specification		8		24
	Claims		25		30
	Abstract		31		31
	Drawings-only black and white line drawings		32		35
	Information Disclosure Statement Letter		36		39
	Information Disclosure Statement (IDS) Filed (SB/08)		40		41
<b>Warnings:</b>					
<b>Information:</b>					
2	Fee Worksheet (PTO-06)	fee-info.pdf	36494	no	2
			a30babff2a90d78f62143ba2cd2113e78cfe69fa		
<b>Warnings:</b>					
<b>Information:</b>					
<b>Total Files Size (in bytes):</b>			387700		

This Acknowledgement Receipt evidences receipt on the noted date by the USPTO of the indicated documents, characterized by the applicant, and including page counts, where applicable. It serves as evidence of receipt similar to a Post Card, as described in MPEP 503.

**New Applications Under 35 U.S.C. 111**

If a new application is being filed and the application includes the necessary components for a filing date (see 37 CFR 1.53(b)-(d) and MPEP 506), a Filing Receipt (37 CFR 1.54) will be issued in due course and the date shown on this Acknowledgement Receipt will establish the filing date of the application.

**National Stage of an International Application under 35 U.S.C. 371**

If a timely submission to enter the national stage of an international application is compliant with the conditions of 35 U.S.C. 371 and other applicable requirements a Form PCT/DO/EO/903 indicating acceptance of the application as a national stage submission under 35 U.S.C. 371 will be issued in addition to the Filing Receipt, in due course.

**New International Application Filed with the USPTO as a Receiving Office**

If a new international application is being filed and the international application includes the necessary components for an international filing date (see PCT Article 11 and MPEP 1810), a Notification of the International Application Number and of the International Filing Date (Form PCT/RO/105) will be issued in due course, subject to prescriptions concerning national security, and the date shown on this Acknowledgement Receipt will establish the international filing date of the application.

**IN THE UNITED STATES PATENT AND TRADEMARK OFFICE**

---

In re Patent Application of:  
Benjamin Freer

Application No.: Not Yet Assigned

Confirmation No.: N/A

Filed: Concurrently Herewith

Art Unit: N/A

---

For: **INDUCTIVE POWER TRANSFER SYSTEM  
AND METHOD**

---

Examiner: Not Yet Assigned

**INFORMATION DISCLOSURE STATEMENT (IDS)**

Commissioner for Patents  
P.O. Box 1450  
Alexandria, VA 22313-1450

Dear Sir:

This Information Disclosure Statement is submitted in accordance with 37 C.F.R. 1.97, 1.98, and it is requested that the information set forth in this statement and in the listed documents be considered during the pendency of the above-identified application, and any other application relying on the filing date of the above-identified application or cross-referencing it as a related application.

1. This IDS should be considered, in accordance with 37 C.F.R. 1.97, as it is filed:  
(Check one of the boxes A-D)

- A. within three months of the filing date of the above-identified national application or within three months of the entry into the national stage of the above identified national application
- B. before the mailing date of a first office action on the merits, or a first office action after filing a request for continued examination.
- C. after (A) and (B) above, but before final rejection or allowance, and Applicants have made the necessary statement in box "i" below or paid the necessary fee in box "ii" below.

(check one of the boxes “i” and “ii” below:)

- i. Counsel states that, upon information and belief, each item of information listed herein was (check one of boxes (a) or (b))
  - (a) first cited in any communication from a foreign patent office in a counterpart foreign application not more than three months prior to the filing of this IDS; or
  - (b) not cited in a communication from a foreign patent office in a counterpart foreign application and, to the knowledge of undersigned after making reasonable inquiry, was not known to any individual designated in 1.56(c) more than three months prior to the filing of this IDS.
- ii. Payment in the amount of the fee set forth in 1. 17(p), presently believed to be \$180, is enclosed.
- D. after (A), (B) and (C) above, but before payment of the issue fee: Applicant petitions under 37 C.F.R. 1.97(d) for the consideration of this IDS. Under 37 CFR 1.17(p) payment in the amount of \$180.00 is enclosed. Counsel certifies that, upon information and belief, each item of information listed herein was

(check one of the boxes “a” and “b” below:)

- (a) first cited in any communication from a foreign patent office in a counterpart foreign application not more than three months prior to the filing of this IDS; or
- (b) was not cited in a communication from a foreign patent office in a counterpart foreign application and, to the knowledge of undersigned after making reasonable inquiry, was not known to any individual designated in 1.56(c) more than three months prior to the filing of this IDS.

2. In accordance with 37 C.F.R. 1.98, this IDS includes a list (e.g., form PTO/SB/08) of all patents, publications, or other information submitted for consideration by the office, either incorporated into this IDS or as an attachment hereto. A copy of each document listed is attached, except as explained below.

(check boxes A, B and/or C and fill in blanks, if appropriate.)

- A. Pursuant to the Notice issued by the United States Patent and Trademark Office dated August 5, 2003 waiving the requirements of 37 C.F.R. § 1.98(a)(2)(ii), a copy/copies of the U.S. Patent(s) and/or U.S. Patent Application Publication(s) on PTO/SB/08 is/are not being submitted.
- B. Document(s) \_\_\_\_\_ is (are) deemed substantially cumulative to document(s) \_\_\_\_\_, and, in accordance with 1.98(c), only a copy of each of the latter documents is enclosed.
- C. Certain documents were previously cited by or submitted to the Office in the following prior applications, which are relied upon under 35 U.S.C. 120:

<<INSERT SERIAL NO. & FILING DATE>>

Applicant identifies these documents by attaching hereto copies of the forms PTO-892, PTO-1449 and/or PTO/SB/08 from the files of the prior application(s) or a fresh PTO/SB/08 listing these documents, and request that they be considered and made of record in accordance with 1.98(d). Per 37 CFR 1.98(d), copies of these documents need not be filed in this application.

- 3. Cite Nos. \_\_\_\_\_ are not in the English language. In accordance with 1.98(c), Applicant states:
  - An English translation of each document (or of the pertinent portions thereof), or a copy of each corresponding English-language patent or application, or English-language abstract (or claim) is enclosed.
  - The requirement for a concise explanation of the relevance of any foreign language document is satisfied by the attached search report; citation of the documents cited in the search report shall not be construed as an admission that they are or are considered to be, material to patentability of the subject matter claimed herein (See MPEP §609).
  - A concise explanation of the relevance of document(s) \_\_\_\_\_ is set forth as follows: [Insert concise explanation of relevance]
  - A concise explanation of the relevance of document(s) \_\_\_\_\_ can be found on page(s) \_\_\_\_\_ of the specification.
  - A concise explanation of document(s) \_\_\_\_\_ can be found on the attached sheet.

- 4. No explanation of relevance is necessary for documents in the English language (see reply to Comments 67 in the preamble to the final rules; 1135 OG 13 at 20).
- 5. Other information being provided for the examiner's consideration follows:

6. In accordance with 37 C.F.R. 1.97(g) and (h), the filing of this IDS should not be construed as a representation that a search has been made or that information cited is, or is considered to be, material to patentability as defined in §1.56 (b), or that any cited document listed or attached is (or constitutes) prior art. Unless otherwise indicated, the date of publication indicated for an item is taken from the face of the item and Applicant reserves the right to prove that the date of publication is in fact different.

Early and favorable consideration is earnestly solicited.

The Commissioner is authorized to charge any deficiency of up to \$300.00 or credit any excess in this fee due with this submission to Deposit Account No. 08-0870.

Dated: November 14, 2008

Respectfully submitted,

By /Flynn Barrison 53,970/  
Robert J. Sacco  
Registration No.: 35,667  
DARBY & DARBY P.C.  
Financial Center at the Gardens  
3801 PGA Boulevard, Suite 605  
Palm Beach Gardens, Florida 33410-2757  
(561) 209-1500  
(561) 209-1501 (Fax)  
Attorneys/Agents For Applicant

Under the Paperwork Reduction Act of 1995, no persons are required to respond to a collection of information unless it displays a valid OMB control number.

<b>AUTHORIZATION TO PERMIT                  ACCESS TO APPLICATION BY                  PARTICIPATING OFFICES</b>	<i>COMPLETE IF KNOWN</i>	
	Application Number	Not Yet Assigned
	Filing Date	Concurrently Herewith
	First Named Inventor	Benjamin Freer
	Attorney Docket Number	17162/0210146-US0
Title (Required)	INDUCTIVE POWER TRANSFER SYSTEM AND METHOD	

Send completed form to: Commissioner for Patents  
 P.O. Box 1450, Alexandria, VA 22313-1450

The undersigned hereby grants the USPTO authority to provide the European Patent Office (EPO), the Japan Patent Office (JPO), and any other intellectual property offices in which a foreign application claiming priority to the above-identified application is filed access to the above-identified patent application. See 37 CFR 1.14(c) and (h).

In accordance with 37 CFR 1.14(h)(3), access will be provided to a copy of the application-as-filed with respect to: 1) the above-identified application, 2) any foreign application to which the above-identified application claims priority under 35 USC 119(a)-(d) if a copy of the foreign application that satisfies the certified copy requirement of 37 CFR 1.55 has been filed in the above-identified US application, and 3) any U.S. application from which benefit is sought in the above-identified application.

In accordance with 37 CFR 1.14(c), access may be provided to information concerning the date of filing the Authorization to Permit Access to Application by Participating Offices.

This written authorization should be submitted prior to the filing of a subsequent foreign application, in which priority is claimed to the above-identified patent application, with any intellectual property office (e.g., the EPO or JPO). However, if applicant does not wish the EPO, JPO, or other intellectual property office in which a foreign application claiming priority to the above-identified application is filed to have access to the application, this written authorization should not be filed.

No fee will be charged under 37 CFR 1.19(b)(1) for providing a participating intellectual property office with an electronic copy of the above-identified application.

**This form must be signed by an authorized party in accordance with 37 CFR 1.14(c).**

\_\_\_\_\_/Flynn Barrison 53,970/  
 Signature

\_\_\_\_\_/November 14, 2008/  
 Date

\_\_\_\_\_/Robert J. Sacco/  
 Printed or Typed Name

\_\_\_\_\_/ (561) 209-1500 /  
 Telephone Number

\_\_\_\_\_/Attorney for Applicant(s)/  
 Title

\_\_\_\_\_/35,667/  
 Registration Number, if applicable



## INDUCTIVE POWER TRANSFER SYSTEM AND METHOD

### FIELD OF THE INVENTION

**[0001]** The present invention relates to supplying electrical power wirelessly, and more particularly to systems and method for inductively supplying electrical power.

### BACKGROUND

**[0002]** Inductive power transfer has been proposed as one method for wirelessly providing electrical power. In such a power transfer method, mutual inductance generally results in power being wirelessly transferred from a primary coil (or simply "primary") in a power supply circuit to a secondary coil (or simply "secondary") in a secondary circuit. Typically, the secondary circuit is electrically coupled with a device, such as a lamp, a motor, a battery charger or any other device powered by electricity. The wireless connection provides a number of advantages over conventional hardwired connections. A wireless connection can reduce the chance of shock and can provide a relatively high level of electrical isolation between the power supply circuit and the secondary circuit. Inductive couplings can also make it easier for a consumer to replace limited-life components. For example, in the context of lighting devices, an inductively powered lamp assembly can be easily replaced without the need to make direct electrical connections. This not only makes the process easier to perform, but also limits the risk of exposure to electric shock.

**[0003]** In general, the use of inductive power has been limited to niche applications, such as for connections in wet environments, due to power transfer efficiency concerns. Several methods have been proposed to improve the efficiency of the inductive coupling, typically focused on the configuration of the primary and secondary coils. Such methods typically require

not only close proximity of the primary and the secondary coils, but also careful tuning of the coil designs to match with one another to maximize the efficiency of the inductive coupling. This has placed significant limitations on the overall design and adaptability of inductively powered devices by increasing cost and complexity of conventional designs. Furthermore, even when such complex designs are used, the amount of power that can be transferred is further limited, reducing the amount of efficiency gains.

#### SUMMARY

**[0004]** Embodiments of the present invention provide systems and methods for inductively transferring power. For example, in a first embodiment of the present invention, a method is provided for inductively transferring power from a base unit providing input power to a target unit providing output power, where the base unit and the target unit are electrically isolated. The method can include positioning a second inductive element of the target unit within a predetermined distance of a first inductive element of the base unit and applying a time varying electric current to the first inductive element to produce a time varying magnetic field, the time varying magnetic field inducing an electric current in the second inductive element. The method can also include monitoring at least one parameter indicative of an efficiency of power transfer from the base unit to the target unit and automatically adjusting at least one characteristic of the time varying electric current responsive to the parameter to maximize an efficiency of power transfer from the base unit to the target unit.

**[0005]** In a second embodiment of the present invention, an inductive power transfer system is provided. The system can include a base unit including a first inductive element configured for providing input power to a second inductive element of a target unit providing output power,

where the base unit is electrically isolated from the target unit. The system can also include a positioning structure provided on at least one of the base unit and the target unit for removably positioning the second inductive element at a predetermined orientation and distance relative to the first inductive element. The system can further include a switch element for selectively applying a time varying electric current to the first inductive element to produce a time varying magnetic field, the time varying magnetic field inducing an electric current in the second inductive element. The system can also include a control circuit configured for monitoring at least one parameter indicative of an efficiency of power transfer from the base unit to the target unit and for automatically adjusting at least one characteristic of the time varying electric current responsive to the parameter to maximize an efficiency of power transfer from the base unit to the target unit.

**[0006]** In a third embodiment of the present invention, A DC-DC converter is provided. The converter can include a input circuit for receiving a DC input voltage and an output circuit electrically coupled to the input circuit. The output circuit can comprise a load sub-circuit electrically coupled to a converter sub-circuit including at least a first inductive element and at least one switch element having a switch control node responsive to a first control voltage for selectively alternating the switch element between an open state and a closed state. The convertor can also include a control circuit having an input node electrically coupled to a node within the load sub-circuit and an output node electrically coupled to the switch control node, the control circuit generating at the output node a periodic voltage signal adjustable to one or more operating frequencies based on a difference between a second control voltage at the input node and a reference voltage. In the converter, an inductance and a physical arrangement of the first inductive element is selected for the first inductive element to generate a permeating magnetic

field that at least partially permeates a second inductive element electrically isolated from the first inductive element, where the permeating magnetic field induces a substantially self-resonant oscillation in the second inductive element for at least one of the operating frequencies. Furthermore, the control circuit is further configured to adjust the periodic voltage signal to adjust an internal voltage level at the internal node to minimize the difference.

#### BRIEF DESCRIPTION OF THE DRAWINGS

**[0007]** FIG. 1 shows a block diagram of a DC-DC converter circuit in accordance with an embodiment of the present invention.

**[0008]** FIG. 2 shows a schematic of a DC-DC converter circuit in FIG. 1 using a buck converter topology in the base unit and a full-waver rectifier circuit in the target unit.

**[0009]** FIG. 3A shows the base unit of the inductive DC-DC converter circuit in FIG. 1 arranged according to a boost convertor topology.

**[0010]** FIG. 3B shows the base unit of the inductive DC-DC converter circuit in FIG. 1 arranged according to a buck-boost convertor topology.

**[0011]** FIG. 4 is a plot showing power efficiency and power transferred as a function of input power consumed for an inductive DC-DC converter circuit having a buck converter topology in accordance with an embodiment of the present invention.

#### DETAILED DESCRIPTION

**[0012]** The present invention is described with reference to the attached figures, wherein like reference numerals are used throughout the figures to designate similar or equivalent elements. The figures are not drawn to scale and they are provided merely to illustrate the instant invention.

Several aspects of the invention are described below with reference to example applications for illustration. It should be understood that numerous specific details, relationships, and methods are set forth to provide a full understanding of the invention. One having ordinary skill in the relevant art, however, will readily recognize that the invention can be practiced without one or more of the specific details or with other methods. In other instances, well-known structures or operations are not shown in detail to avoid obscuring the invention. The present invention is not limited by the illustrated ordering of acts or events, as some acts may occur in different orders and/or concurrently with other acts or events. Furthermore, not all illustrated acts or events are required to implement a methodology in accordance with the present invention.

**[0013]** A block diagram of an inductive DC-DC converter circuit 100 for inductive power transfer in accordance with an embodiment of the present invention is shown in FIG. 1. The circuit 100 can include a base unit 102 providing input power and a target unit 103 providing output power, where the base unit 102 and the target unit 103 are electrically isolated. The target unit 103 can be electrically coupled to one or more electronic devices to provide power. By way of example, and not by way of limitation, these devices can include batteries, display units, keypads, and the like. The base unit 102 can include a DC voltage supply 104 for providing an input DC voltage ( $V_{in}$ ). The base unit 102 can include a load 106 having an impedance  $Z_1$  having at least one internal node 108. In some embodiments, the load 106 can also be used to provide a wired output voltage  $V_{out1}$ . However, the invention is not limited in this regard and the load 106 can provide multiple output voltages.

**[0014]** As shown in FIG. 1, the DC voltage supply 104 and the load 106 are electrically coupled via a converter sub-circuit 110. The converter sub-circuit 110 includes an first inductive element 112 and a switching network 114 for directing current to or from the first inductive

element 112 at an operating frequency. In FIG. 1, first inductive element 112 comprises an inductor L1. The switching network 114 can include an input node N2 for receiving a periodic voltage signal Vctrl for adjusting an operating frequency of the converter sub-circuit based on a voltage at node 108. The input node 116 and the internal node 108 can be electrically coupled via a controller element (CTRL) 118. The CTRL 118 can be configured to monitor the voltage Vnode at node 108 and to adjust Vctrl at node 116. Vctrl can be adjusted by CTRL 118 responsive to comparing Vnode to a reference voltage Vref. In some embodiments, as shown in FIG. 1, Vref can be provided to CTRL 118. In other embodiments, Vref can be internally generated. Details of the operation of the converter sub-circuit 110 and CTRL 118 will be described in further detail below with respect to FIGs. 2, 3A, and 3B.

**[0015]** In operation for inductive power transfer, the first inductive element 112 is utilized as the primary coil in the base unit 102 for transferring power to the target unit 103. In particular, the power can be transferred to the target unit 103 via a secondary coil formed from a second inductive element 120 in the target unit 103. As shown in FIG. 1, the secondary coil can be a second inductor L2. The second inductive element 120 can be electrically coupled to a rectifying element 122 for generating a DC voltage signal between node 124 and node 125 of the rectifying element 122 for the time-varying signal generated by the second inductive element 120 in response to coupling with the first inductive element 112. This generated DC voltage signal can then be applied across a second load 126 with an impedance Z2 in the target unit 103 to produce an output DC voltage Vout2.

**[0016]** One of ordinary skill in the art will recognize that the amount of power transferred from the base unit 102 to the target unit 103 is dependent on the amount of magnetic coupling between the first inductive element 112 and the second inductive element 120. In conventional

designs, the amount of magnetic coupling is adjusted by matching the inductor coil design of the inductive elements 112, 120. However, this typically results in a base unit design compatible with only a particular target unit design, limiting the flexibility of the base unit to power additional target units. Furthermore, because a high degree of inductor coil matching is generally required, the operational margin for such base unit/target unit combinations is also limited.

**[0017]** An alternate method of efficiently transferring power between the base unit 102 and the target unit 103 is to provide operating conditions that result in a resistance of the primary coil to falls to approximately zero and an impedance of the secondary coil becoming increasingly resistive. This causes the input resistance of the primary coil to also become increasingly resistive and the amount of power transferred between the primary and secondary coils is also increased, as in a conventional power transfer, enhancing power transfer efficiency. This phenomena occurs when a least a portion of the time-varying magnetic field generated by a primary coil operated at one or more switching frequencies permeates the secondary coil and induces an oscillation in the secondary coil at its self resonant frequency, i.e., a self-resonant oscillation. Accordingly, in the various embodiments of the present invention, rather than attempting to precisely match the coil characteristics of the first inductive element 112 and the second inductive element 120, as in conventional designs, the switching network 114 is used to adjust the operating frequency of the existing first inductive element 112. The operating frequency can then be adjusted until the self-resonant oscillation is induced in the second inductive element 120. The operating frequency for the base unit for inducing the self-resonant oscillation in the second inductive element can vary depending on the separation between the first inductive element 112 and the second inductive element 120, as the separation affects the

magnetic field inducing an oscillation in the second inductive element 120. Additionally, the operating frequency for the base unit can also vary depending on the configuration of the rectifying element 122 and the second load 126.

**[0018]** Therefore, in the various embodiments of the present invention, a first inductive element 112 configuration can be selected such that, for at least at one operating frequency, magnetic coupling to the second inductive element 120 at a pre-determined distance occurs that transfers power proportional to a simple voltage divider of the load 106 and the input resistance of the first inductive element 112. Although inducing a self resonant oscillation provides the most efficient power transfer, the invention is not limited in this regard. In the some embodiments of the present invention, the inductive DC-DC converter 100 can be configured operate in proximity to the self-resonant frequency, albeit at a reduced efficiency. That is, if the oscillation at the second inductive element 120 does not occur at its self-resonant frequency, the input resistance of the primary coil (the first inductive element 112) is decreased. As a result, the amount of power transferred is also decreased, decreasing power transfer efficiency.

**[0019]** Although the first inductive element 112 can be paired with any type of switching network to adjust an operating frequency, a converter sub-circuit comprising a DC-DC switching mode power supply circuit (SMC circuit) can be used to provide both the first inductive element 112 and the switching network 114. SMC circuits are designed to convert one DC voltage to another by storing energy in a magnetic component (typically an inductor or a transformer) for a period of time. In operation, adjustment of the duty cycle (the ratio of on/off time) of a switching element within the SMC circuit adjusts the amount of power transferred to a load in the SMC circuit. More importantly, by adjusting the duty cycle, the operating frequency of the



magnetic component (the inductor) in SMC circuit can also be adjusted. Accordingly, one aspect of present invention provides for using an SMC circuit to provide the converter sub-circuit 110.

**[0020]** In order to provide operation of the second inductive element 120 at its self resonant frequency, the CTRL 118 can be configured to indirectly monitor the amount of power transferred to the second inductive element 120 by monitoring the voltage generated across at least a portion of the load 106. That is, as the frequency of oscillation in the second inductive element 120 approaches its self-resonant frequency, the input impedance of the first inductive element 112 becomes substantially more resistive and the amount of power transferred to the target unit 103 increases. Consequently, the voltage dropped across other portions of the base unit, including the load 106, approaches the values expected for a substantially resistive input impedance for the first inductive element 112. Accordingly, by configuring the CTRL 118 to monitor the voltage level at a node of the load 106, such as Vnode at node 108, the CTRL 118 can adjust the duty cycle for the SMC circuit to cause a particular voltage level at node 108. Therefore, the amount of power the amount of power transferred to the target unit 103 is effectively controlled and maximized. In some configurations of the inductive DC-DC converter 200, minimizing the voltage value Vnode at node 108 can result in a self-resonant oscillation in the second inductive element. However, in other configurations of the inductive DC-DC converter 200, even after such minimizing of Vnode, the second inductive element 120 may still not oscillate at its self-resonant frequency. For example, if processing variations result in variations in the first and second inductive elements 112, 120 (or any other elements), the self-resonant frequency expected for the second inductive element 120 can vary and a different voltage value for Vnode can be needed to maximize power transfer. Accordingly, in such cases, the power transfer still occur, albeit at a lower efficiency, until a new voltage value for Vnode is

selected. An inductive DC-DC converter using an SMC circuit is conceptually illustrated with respect to FIG. 2.

**[0021]** FIG. 2 shows a schematic of an inductive DC-DC converter circuit 200 including an SMC circuit, in particular a buck convertor topology. In FIG. 2, the circuit 200 includes a base unit 102 and a target unit 103, as previously described with respect to FIG. 1. However, in FIG. 2, the first inductive element 112 and the switching network 114 are configured as an SMC circuit having a buck converter topology. A switch element 202, a rectifying element 204, and the first inductive element 112 are arranged such that when switch element 202 is closed, the current path in circuit 200 follows a loop formed by the DC voltage supply 104, the first inductive element 112, and the load 106. When the switch element 202 is open, the current path in circuit 200 follows a loop formed by the rectifier element 204, the first inductive element 112, and the load 106. Accordingly, first inductive element 112, rectifier element 204, and switching element 202 can be referred to collectively as an SMC sub-circuit 112, 204, 202.

**[0022]** In some embodiments of the present invention, the switch element 202 comprises a single switch S1 having a control node N2 that responds in a control signal. The single switch S1 can comprise any type of electrically controlled switch, including, but not limited to, bipolar junction (BJT) transistors and field effect (FET) transistors. In such devices, the control node N2 can comprise the base of the BJT or the gate of the FET transistor. As shown in FIG. 2, the rectifying element 204 can comprise a diode D1. However, the invention is not limited in this regard. In some embodiments, the rectifying element 204 can also comprise any type of synchronously electrically controlled switch, including, but not limited to, bipolar junction (BJT) transistors and field effect (FET) transistors. That is, a switch that closes when switch S1 is open

and vice versa. In such embodiments, the control signal for the rectifying element 204 can be a complement or inverse of the control signal being provided to the switch element 202.

**[0023]** As shown in FIG. 2, the load 106 includes resistors R1A and R1B and capacitor C1. However, the invention is not limited to solely this configuration for the load 106 and any combination of resistors, capacitors, and inductors can be used to form the load 106. In FIG. 2, node 108 is the common node between resistors R1A and R1B. Additionally, as previously described, the load 106 can be used to provide an output voltage  $V_{out1}$ .

**[0024]** As previously described, the target unit 103 includes a second inductive element 120, a rectifier circuit 122, and a load 126. As shown in FIG. 2, the rectifier element 122 can include diodes D1-D4 in a full-wave rectification configuration for generating a DC voltage signal from the time-varying signal generated by the second inductive element 120. However, the invention is not limited in this regard. For example, any arrangement of components suitable for half-wave rectification or full-wave rectification can be used with the various embodiments of the present invention. Also as shown in FIG. 2, the load 126 in the target unit 103 includes a capacitor C2 and a resistor R2. However, the invention is not limited in this regard and any combination of resistors, capacitors, and/or inductors can be used in load 126.

**[0025]** In some embodiments, to improve magnetic coupling between the first and second inductive elements 112, 120, a capacitor network 206 can be used to electrically couple the second inductive element 120 to the rectifier circuit 122. Such a capacitive network 206 can include one or more capacitors (C3) in parallel with the second inductive element 120. The capacitive can also include one or more capacitors (C4, C5) to electrically couple the second inductive element 120 to the rectifier circuit 122. The capacitive network 206 can be used to reduce the imaginary component in the target unit 103, thus presenting a more resistive load

without altering the operating frequency in the base unit 102 required for inducing a self-resonant oscillation in the second inductive element 120.

**[0026]** In operation, circuit 200 provides an output voltage  $V_{out2}$  as follows. First, the base unit 102 and the target unit 103 are placed and aligned in relative proximity to each other. Since the fields lines of the magnetic field generated by the base unit will have a particular direction, the second inductive element 120 can be positioned in the path of the field lines of the generated magnetic field. For example in the case of hand-wired air coil inductors having inductances between 100 nH and 500 nH and an utilizing operating frequency of 1-4 MHz, the first and second inductive elements can to be positioned within a distance of 10-15 cm or less to maximize power transfer. This distance, however, can vary depending on the amount of power being transferred, the operating frequency, and the inductances of the inductor coils.

Furthermore, in the case of inductor coils, the coil axis of each of the inductor coils can be placed along a common parallel direction. That is, an arrangement can be selected such that the dot product of the directional vector for an axis of each of the inductor coils is chosen to be one or approximately one. However, precise alignment is not required in the various embodiments of the present invention and the directional vectors need only be substantially parallel. For example, the Present Inventors have found that the alignment variation to cause a 10% decrease in power transfer efficiency is  $> 25$  degrees. In some embodiments of the present invention, a positioning structure(s) 115, such as contacting or interlocking protrusions or edges can be provided on a support and/or housing of the base unit 102 and/or the target unit 103 to facilitate alignment.

**[0027]** Although exemplary types of inductor coils, are described above, the invention is not limited in this regard. For example, any type of discrete inductor coils, including but not limited to cylindrical inductor coils, single or multilayer inductor coils, wire spiral inductor coils, and

toroidal inductor coils can be used in the various embodiments of the present invention. Furthermore, integrated inductor coils, such as printed circuit board (PCB) micro-strip spiral coils or spiral coils formed on an integrated circuit (IC) can also be used with the various embodiments of the present invention. Additionally, the inductance values and operating frequencies presented above are for illustrative purposes only. For example, in some other embodiments, the inductances values can be 1-100 uH and the corresponding operating frequencies can be 400-500 MHz. However, the present invention is not limited in this regard. Any combination of operating frequencies and inductance values can be used in the various embodiments of the present invention.

**[0028]** After the first and second inductive elements 112, 120 are positioned and aligned, an input voltage  $V_{in}$  can be provided by the DC input supply 104 and a control signal can provided at node 116 of the switching element 202 ( and rectifier element 204, if applicable) by CTRL 118 based on the voltage  $V_{node}$  at node N1. As previously described, CTRL 118 is configured to provide a periodic voltage signal, where the frequency of the periodic voltage signal  $V_{ctrl}$  specifies the duty cycle for the switching element 202. Although the buck converter topology shown in FIG. 2 is typically operated using a square wave signal, the invention is not limited in this regard. Other types of periodic voltage signals, including, but not limited to sinusoidal, triangular, or sawtooth waveforms can also be generated by CTRL 118.

**[0029]** As a result of the periodic voltage signal  $V_{ctrl}$ , the CTRL 118 causes the switching element 202 to open and close at a frequency of  $V_{ctrl}$ . Consequently, the base unit 102 alternates between the two current paths described above. As a result of these alternating current paths, the first inductive element 112 continually charges and discharges. However, one of ordinary skill in the art will recognize that the buck convertor topology provides a steady state

voltage output voltage  $V_{out1}$  across load 106. Furthermore, as a constant voltage results across load 106, a steady-state output voltage  $V_{node}$  also develops at node 108.

**[0030]** As noted above, the voltage dropped across the load 106 can be predicted when the second inductive element 120 is at its self-resonant frequency. Consequently, the voltage at an inner node of the load 106 ( $V_{ctrl}$ ) can also be predicted. Therefore, by utilizing  $V_{ref}$  as a setpoint for  $V_{ctrl}$ , CTRL 118 can adjust the duty cycle of for the SMC sub-circuit 112, 202, 204, which adjusts the operating frequency of the first inductive element 112 and thus the amount of power transferred to the target unit 103. Accordingly, as conditions vary, whether due to changes in the placement of the base unit 102 relative to the target unit 103 or due to changes in the characteristics of components in the base unit 102 or the target unit 103, the CTRL 118 can compare  $V_{node}$  to  $V_{ref}$  and compensate  $V_{ctrl}$  appropriately. For example, if the CTRL 118 detects a difference between  $V_{node}$  and  $V_{ref}$ , the duty cycle can be adjusted until the difference is minimized.

**[0031]** Therefore, in the various embodiments of the present invention, the CTRL 118 can include logic for determining a value of  $V_{ctrl}$  from  $V_{node}$  and  $V_{ref}$  values. In one exemplary embodiment, the logic can comprise logic for accessing a lookup table for adjusting  $V_{ctrl}$ . In another exemplary embodiment, the logic can comprise logic that adjusts  $V_{ctrl}$  based on an actual difference between  $V_{ctrl}$  and  $V_{ref}$ , a magnitude of this actual difference, or both. These exemplary embodiments are provided by way of example and not by way of limitation. One of ordinary skill in the art will readily recognize that various methods and devices for implementing CTRL 118 are available. For example, a power supply can include a circuit for automatically adjusting the frequency of operation for the pulse width modulation being used by implementing an error amplifier for obtaining a value for  $V_{ctrl}$  based on  $V_{ref}$  and  $V_{node}$ .

**[0032]** The present invention is not limited to a buck converter topology. In other embodiments of the invention, the arrangement of the first inductive element 112, the switch element 202, and the rectifying element 204 in the base unit can be changed to provide alternative topologies for the SMC sub-circuit 112, 202, 204 in FIG. 2. For example, in some embodiments, a boost converter topology or an buck-boost or inverting converter topology can be used.

**[0033]** FIG. 3A shows a first alternate base unit 300 for the circuit in FIG. 2 having a first alternate topology for the SMC sub-circuit in FIG. 2 in accordance with another embodiment of the present invention. As shown in FIG. 3A, the arrangement of the first inductive element 112, the switching element 202, and the rectifying element 204 in the base unit 300 provides a boost converter topology. That is the switch element 202, the rectifying element 204, and the first inductive element 112 are arranged such that when switch element 202 is closed, the current path in base unit 300 follows a loop comprising the DC voltage supply 104, the first inductive element 112, and the closed switching element 202. When the switching element 202 is open, the current path in the base unit 300 follows a loop comprising the DC voltage supply 104, the first inductive element 112, the rectifier element 204, and the load 106.

**[0034]** FIG. 3B shows a second alternate base unit 350 for the circuit in FIG. 2 having a second alternate topology for the SMC sub-circuit in FIG. 2 in accordance with yet another embodiment of the present invention. As shown in FIG. 3B, the arrangement of the first inductive element 112, the switching element 202, and the rectifying element 204 in the base unit 300 provides a buck-boost or inverting converter topology. That is, the switch element 202, the rectifying element 204, and the first inductive element 112 are arranged in base unit 350 such that when switch element 202 is closed, the current path in base unit 300 follows a loop

comprising the DC voltage supply 104, and the closed switching element 202, and the first inductive element 112. In the buck-boost topology, the rectifying element 204 blocks current from reaching the load 106. When the switching element 202 is open, the current path in the base unit 300 follows a loop comprising the rectifier element 204, the first inductive element 112, and the load 106.

**[0035]** The exemplary SMC sub-circuit configurations in FIGs. 2, 3A, and 3B are presented by way of example and not by way of limitation. In other embodiments, other combinations and arrangements of inductive elements, switching elements, and rectifying elements can be provided. For example, in some embodiments, multiple inductive elements can be provided for transferring power to multiple target units. Regardless of how the SMC sub-circuit is configured, by continually adjusting  $V_{node}$  to  $V_{ref}$ , the SMC circuit can maintain an efficient transfer of power to the target unit. This is illustrated by the data shown in FIG. 4.

**[0036]** FIG. 4 is a plot showing power efficiency and power transferred versus power consumed for an inductive DC-DC converter circuit configured in accordance with an embodiment of the present invention using a buck converter topology. The base unit was implemented using a DC785 high frequency buck converter, manufactured by LINEAR TECHNOLOGY CORPORATION, but with the original inductor replaced with a hand-wound inductor of approximately 150 nH. The target unit was implemented using a MBR160 diode, manufactured by ON SEMICONDUCTOR, modified to include a hand-wound inductor of approximately 500 nH. A dynamic load was used to measure the output power.

**[0037]** As shown in FIG. 4, curve 402 shows the amount of power transferred to the target unit as a function of the amount of power consumed in the base unit. Curve 404 shows the efficiency of the power transfer versus the amount of power consumed. As shown in curves 402



and 404, as the amount of power transferred by the inventive circuit is substantially proportional to the amount of the power consumed. Furthermore, as the amount of power consumed is increased, the amount of power transferred and the efficiency of the transfer process is also increased. For example, when ~0.45 W of power is consumed, ~77% of the consumed power is being transferred. However, when ~0.7 W of power is consumed, ~92% of the consumed power is consumed. Accordingly, for higher power transfers, the SM circuit provides an increased efficiency power transfer as compared to conventional methods, such as coil driver-based, class-E amplifier-based, or error amplifier-based inductive DC-DC converters.

**[0038]** Although the invention has been illustrated and described with respect to one or more implementations, equivalent alterations and modifications will occur to others skilled in the art upon the reading and understanding of this specification and the annexed drawings. In particular regard to the various functions performed by the above described components (assemblies, devices, circuits, systems, etc.), the terms (including a reference to a “means”) used to describe such components are intended to correspond, unless otherwise indicated, to any component which performs the specified function of the described component (e.g., that is functionally equivalent), even though not structurally equivalent to the disclosed structure which performs the function in the herein illustrated exemplary implementations of the invention. In addition, while a particular feature of the invention may have been disclosed with respect to only one of several implementations, such feature may be combined with one or more other features of the other implementations as may be desired and advantageous for any given or particular application. Furthermore, to the extent that the terms “including”, “includes”, “having”, “has”, “with”, or variants thereof are used in either the detailed description and/or the claims, such terms are intended to be inclusive in a manner similar to the term “comprising.”

## CLAIMS

What is claimed is:

1. A method for inductively transferring power from a base unit providing input power, to a target unit providing output power, where the base unit and the target unit are electrically isolated, comprising:

positioning a second inductive element of said target unit within a predetermined distance of a first inductive element of said base unit;

applying a time varying electric current to said first inductive element to produce a time varying magnetic field, said time varying magnetic field induces an electric current in said second inductive element;

monitoring at least one parameter indicative of an efficiency of power transfer from said base unit to said target unit;

automatically adjusting at least one characteristic of said time varying electric current responsive to said parameter to maximize an efficiency of power transfer from said base unit to said target unit.

2. The method according to claim 1, wherein said characteristic comprises at least one of a frequency of said time varying current and a duty cycle of said time varying current.

3. The method according to claim 1, further comprising producing said time varying electric current by switching a DC voltage source using an electronically controlled switch element.

4. The method according to claim 3, further comprising communicating said time varying electric current to a load in said base unit, and selecting said parameter to be a measured current or voltage associated with said load.
5. The method according to claim 4, wherein said selectively controlling step further comprises comparing said measured current or voltage to a constant reference value.
6. The method according to claim 1, further comprising producing said time varying magnetic field with a DC to DC type switching mode power supply circuit.
7. The method according to claim 6, further comprising utilizing said first inductive element as a primary energy storage component in said DC to DC conversion process of said switching mode power supply circuit.
8. The method according to claim 1, wherein said automatically adjusting step further comprises automatically adjusting said characteristic to induce an oscillation in said second inductive element at a frequency to be approximately equal to a self-resonant frequency of said second inductive element.
9. The method according to claim 1, further comprising responsive to a re-positioning of said second inductive element from a first position to a second position, automatically selectively re-adjusting said characteristic to maximize said efficiency, wherein said first position differs from said second position with regard to at least one characteristic selected from the group consisting of distance and orientation relative to said primary inductor.

10. The method according to claim 1, further comprising responsive to a substitution of a target unit with a different target unit, automatically selectively re-adjusting said characteristic to maximize said efficiency.

11. The method according to claim 1, further comprising rectifying an output current induced in said second inductive element to produce a DC output.

12. An inductive power transfer system, comprising:

a base unit comprising a first inductive element configured for providing input power to a second inductive element of a target unit providing output power, said base unit electrically isolated from said target unit;

positioning structure provided on at least one of said base unit and said target unit for removably positioning said second inductive element at a predetermined orientation and distance relative to said first inductive element;

a switch element configured for selectively applying a time varying electric current to said first inductive element to produce a time varying magnetic field, said time varying magnetic field inducing an electric current in said second inductive element;

a control circuit configured for monitoring at least one parameter indicative of an efficiency of power transfer from said base unit to said target unit, and automatically adjusting at least one characteristic of said time varying electric current responsive to said parameter to maximize an efficiency of power transfer from said base unit to said target unit.

13. The system of claim 12, wherein said characteristic comprises at least one of a frequency of said time varying current and a duty cycle of said time varying current.

14. The system of claim 12, wherein said switch element is electronically controlled, and wherein said switch element is configured for coupling and decoupling a DC voltage source to said first inductive element to produce said time varying current.

15. The system of claim 14, further comprising a load circuit coupled to said first inductive element, and where said parameter comprises a current or voltage associated with said load.

16. The system of claim 15, wherein said control circuit automatically selectively adjusts said characteristic based on a comparison of said measured current or voltage to a constant reference value.

17. The system of claim 12, wherein said base unit further comprises a DC to DC type switching mode power supply, said DC to DC type switching mode power supply circuit producing said time varying magnetic field.

18. The system of claim 15, where said first inductive element comprises a primary energy storage component of said DC to DC type switching mode power supply circuit.

19. The system of claim 12, wherein said control circuit is further configured during said selectively adjusting for automatically selectively adjusting said frequency to be approximately equal to a self-resonant frequency of said second inductive element.

20. The system of claim 12, wherein said control circuit is further configured during said selectively adjusting for automatically selectively re-adjusting said frequency to maximize said efficiency responsive to a re-positioning of said second inductive element from a first position to

ca second position, wherein said first position differs from said second position with regard to at least one characteristic selected from the group consisting of distance and orientation relative to said primary inductor.

21. The system of claim 12, wherein said control circuit is further configured during said selectively adjusting for automatically selectively re-adjust said frequency to maximize said efficiency responsive to a substitution of a target unit with a different target unit,.

22. The system of claim 12, wherein said target unit further comprises rectifying element for to produce a DC output by rectifying an output current induced in said second inductive element.

23. A DC-DC converter, comprising:  
a input circuit for receiving a DC input voltage;  
an output circuit electrically coupled to said input circuit, said output circuit comprising a load sub-circuit electrically coupled to a converter sub-circuit, said converter sub-circuit comprising at least a first inductive element and at least one switch element having a switch control node, said switch control node responsive to a first control voltage for selectively alternating said switch element between an open state and a closed state; and  
a control circuit having an input node electrically coupled to a node within said load sub-circuit and an output node electrically coupled to said switch control node, said control circuit generating at said output node a periodic voltage signal adjustable to one or more operating frequencies based on a difference between a second control voltage at said input node and a reference voltage;

wherein an inductance and a physical arrangement of said first inductive element is selected for said first inductive element to generate a permeating magnetic field that at least partially permeates a second inductive element electrically isolated from said first inductive element, wherein said permeating magnetic field induces a substantially self-resonant oscillation in said second inductive element for at least one of said operating frequencies, and wherein said control circuit is further configured to adjust said periodic voltage signal to adjust an internal voltage level at said internal node to minimize said difference.

24. The DC-DC converter of claim 23, wherein said inductive element comprises at least a first inductor.

25. The DC-DC converter of claim 24, wherein a first directional vector defining a first inductor coil axis of said first inductor and a second directional vector defining a second inductor coil axis of said second inductive element are substantially parallel.

26. The DC-DC converter of claim 24, wherein said one of said operating frequencies is at least 1 MHz, and wherein said first inductor has an inductance of at least 100nH.

27. The DC-DC converter of claim 23, wherein said first inductive element and said switch element are electrically coupled in series between said input circuit and said load sub-circuit, and wherein said converter sub-circuit further comprises a rectifier element electrically coupled to a common node between said first inductive element and said switch element.

## **INDUCTIVE POWER TRANSFER SYSTEM AND METHOD**

### **ABSTRACT**

An inductive power transfer system includes a base unit comprising a first inductive element for providing input power to a second inductive element of a target unit providing output power, a positioning structure provided on at least one of the base unit and the target unit for removably positioning the second inductive element at a predetermined orientation and distance relative to the first inductive element, a switch element configured for selectively applying a time varying electric current to the first inductive element to produce a time varying magnetic field for inducing an electric current in the second inductive element, and a control circuit for monitoring one parameter indicative of an efficiency of power transfer and automatically selectively adjusting at least one characteristic of the time varying electric current responsive to the parameter to maximize an efficiency of power transfer from the base unit to the target unit.



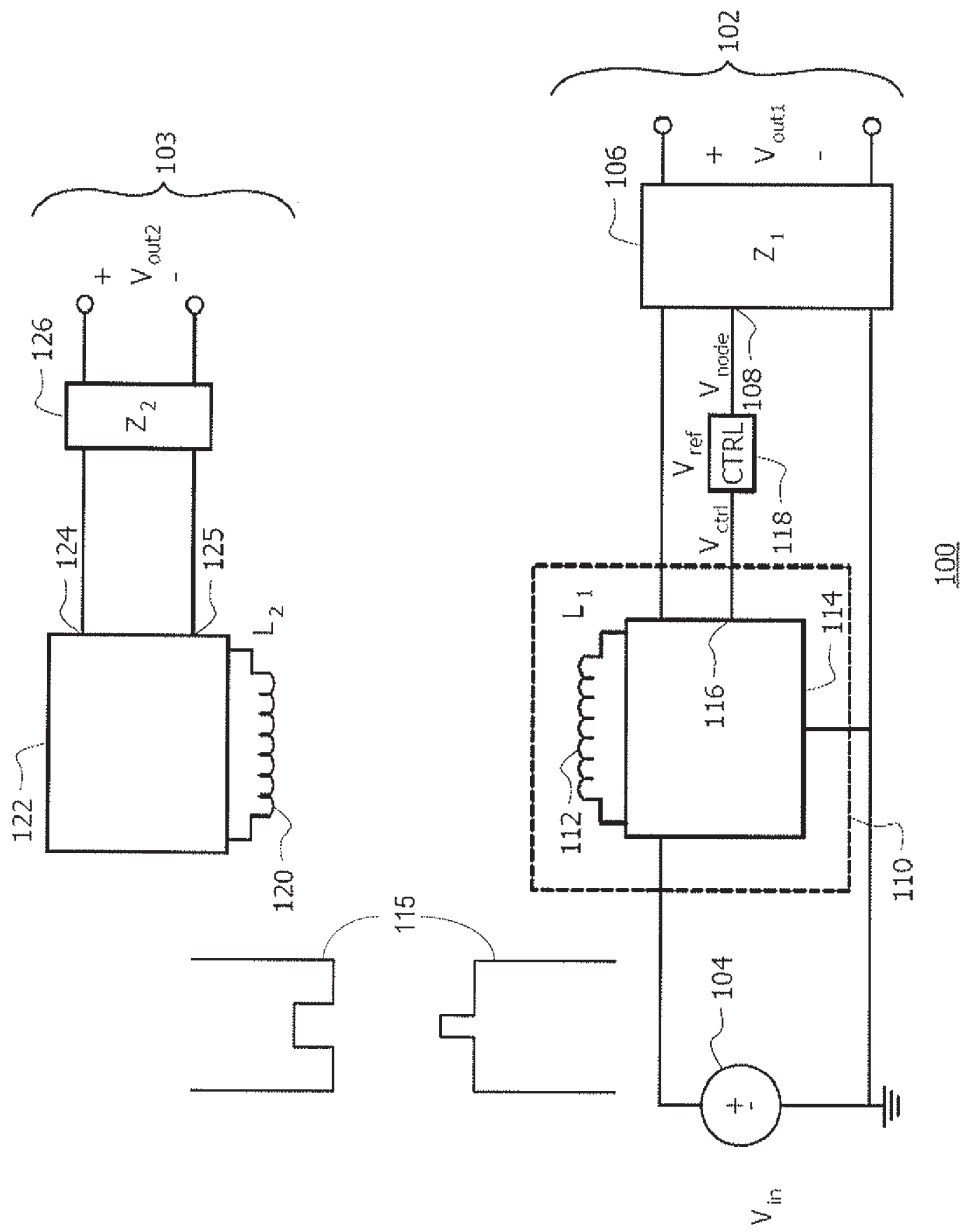

FIG. 1

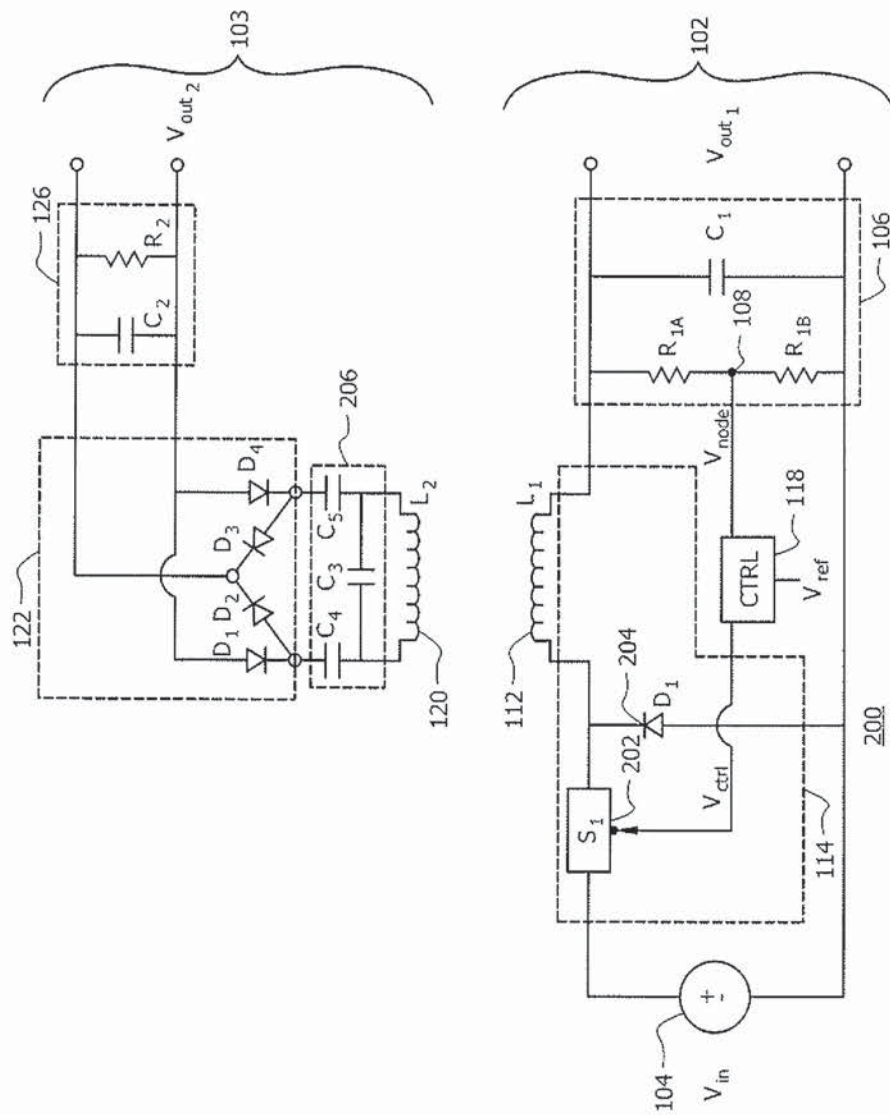

FIG. 2

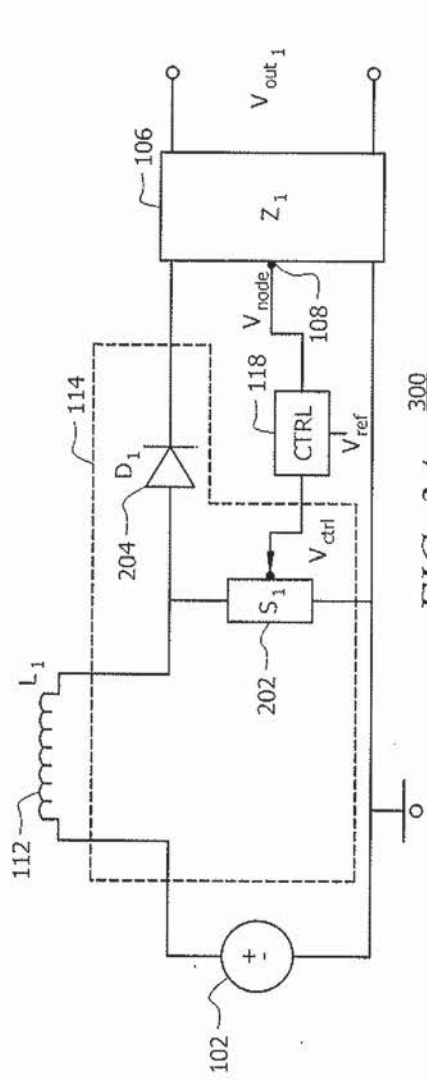

FIG. 3A 300

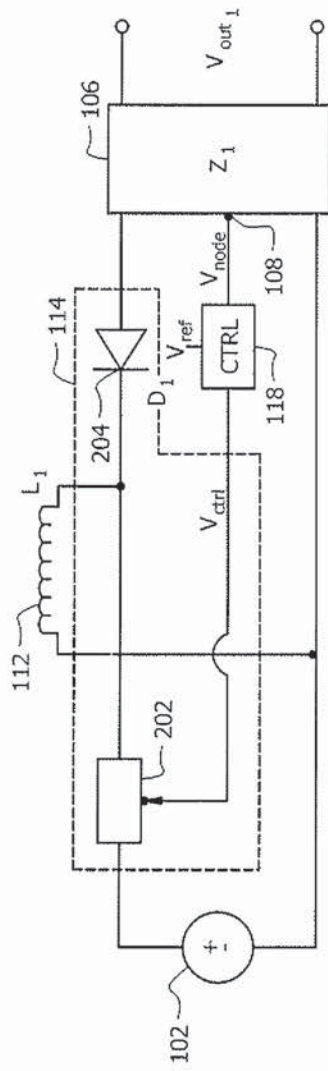

FIG. 3B 350

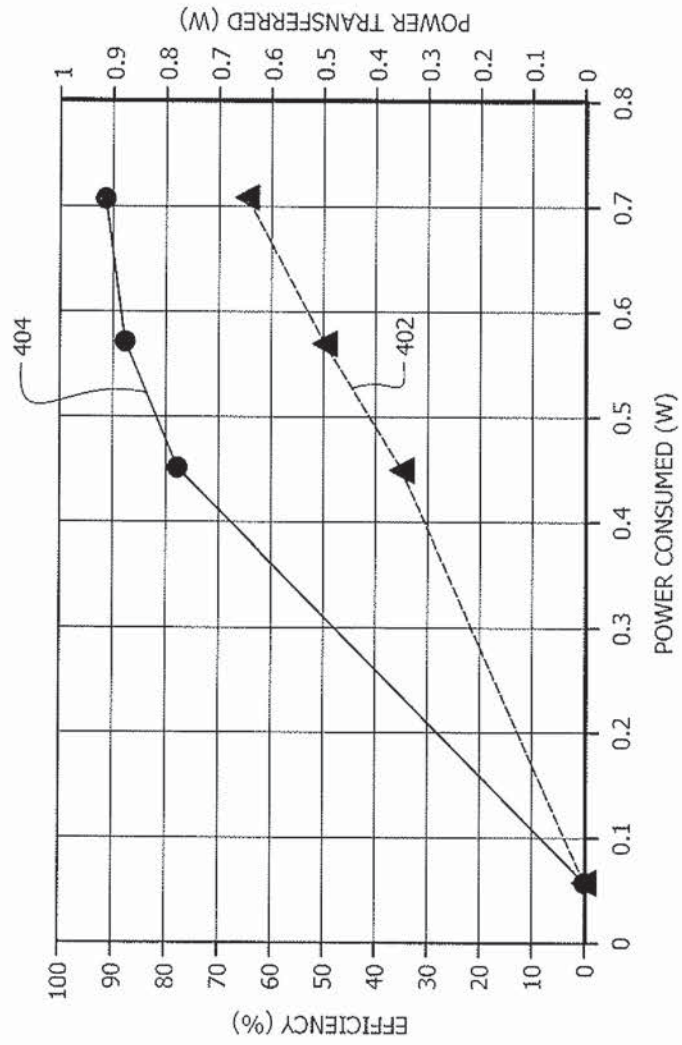

FIG. 4

Filing Date: 11/14/08

Approved for use through 7/31/2006. OMB 0651-0032

U.S. Patent and Trademark Office; U.S. DEPARTMENT OF COMMERCE

Under the Paperwork Reduction Act of 1995, no persons are required to respond to a collection of information unless it displays a valid OMB control number.

PATENT APPLICATION FEE DETERMINATION RECORD Substitute for Form PTO-875					Application or Docket Number <b>12/271,023</b>					
<b>APPLICATION AS FILED – PART I</b>										
(Column 1)			(Column 2)		SMALL ENTITY		OR	OTHER THAN SMALL ENTITY		
FOR	NUMBER FILED	NUMBER EXTRA	RATE (\$)	FEE (\$)	RATE (\$)	FEE (\$)		RATE (\$)	FEE (\$)	
BASIC FEE (37 CFR 1.16(a), (b), or (c))	N/A	N/A	N/A		N/A	<b>330</b>		N/A	<b>540</b>	
SEARCH FEE (37 CFR 1.16(k), (l), or (m))	N/A	N/A	N/A		N/A	<b>220</b>		N/A	<b>364</b>	
EXAMINATION FEE (37 CFR 1.16(o), (p), or (q))	N/A	N/A	N/A		N/A	<b>220</b>		N/A	<b>364</b>	
TOTAL CLAIMS (37 CFR 1.16(i))	27	minus 20 = 7	x\$26		x\$52	<b>364</b>	OR	x\$220		
INDEPENDENT CLAIMS (37 CFR 1.16(h))	3	minus 3 = *	x\$110							
APPLICATION SIZE FEE (37 CFR 1.16(s))	If the specification and drawings exceed 100 sheets of paper, the application size fee due is \$270 (\$135 for small entity) for each additional 50 sheets or fraction thereof. See 35 U.S.C. 41(a)(1)(G) and 37 CFR									
MULTIPLE DEPENDENT CLAIM PRESENT (37 CFR 1.16(j))			195		390					
			TOTAL		TOTAL	<b>1454</b>				
* If the difference in column 1 is less than zero, enter "0" in column 2.										
<b>APPLICATION AS AMENDED – PART II</b>										
(Column 1)		(Column 2)		(Column 3)		SMALL ENTITY		OR	OTHER THAN SMALL ENTITY	
AMENDMENT A	CLAIMS REMAINING AFTER AMENDMENT	HIGHEST NUMBER PREVIOUSLY PAID FOR	PRESENT EXTRA	RATE (\$)	ADDITIONAL FEE (\$)	RATE (\$)	ADDITIONAL FEE (\$)		RATE (\$)	ADDITIONAL FEE (\$)
	Total (37 CFR 1.16(i))	*	Minus **	=	X =	X =	X =	OR	X =	X =
	Independent (37 CFR 1.16(h))	*	Minus ***	=	X =	X =	X =	OR	X =	X =
	Application Size Fee (37 CFR 1.16(s))			N/A		N/A		OR	N/A	
	FIRST PRESENTATION OF MULTIPLE DEPENDENT CLAIM (37 CFR 1.16(j))			N/A		N/A		OR	N/A	
			TOTAL ADD'T FEE		TOTAL ADD'T FEE		OR	TOTAL ADD'T FEE		
* If the entry in column 1 is less than the entry in column 2, write "0" in column 3.										
** If the "Highest Number Previously Paid For" IN THIS SPACE is less than 20, enter "20".										
*** If the "Highest Number Previously Paid For" IN THIS SPACE is less than 3, enter "3".										
The "Highest Number Previously Paid For" (Total or Independent) is the highest number found in the appropriate box in column 1.										

This collection of information is required by 37 CFR 1.16. The information is required to obtain or retain a benefit by the public which is to file (and by the USPTO to process) an application. Confidentiality is governed by 35 U.S.C. 122 and 37 CFR 1.14. This collection is estimated to take 12 minutes to complete, including gathering, preparing, and submitting the completed application form to the USPTO. Time will vary depending upon the individual case. Any comments on the amount of time you require to complete this form and/or suggestions for reducing this burden, should be sent to the Chief Information Officer, U.S. Patent and Trademark Office, U.S. Department of Commerce, P.O. Box 1450, Alexandria, VA 22313-1450. DO NOT SEND FEES OR COMPLETED FORMS TO THIS ADDRESS. SEND TO: Commissioner for Patents, P.O. Box 1450, Alexandria, VA 22313-1450.

If you need assistance in completing the form, call 1-800-PTO-9199 and select option 2.