

UNITED STATES PATENT AND TRADEMARK OFFICE
CERTIFICATE OF CORRECTION

PATENT NO. : 9,509,440 B2
APPLICATION NO. : 14/390904
DATED : November 29, 2016
INVENTOR(S) : Hammarwall et al.

Page 1 of 1

It is certified that error appears in the above-identified patent and that said Letters Patent is hereby corrected as shown below:

In the Specification

In Column 12, Line 25, delete “MO” and insert -- $N \geq 0$ --, therefor.

In the Claims

In Column 16, Line 38, in Claim 5, delete “nod e” and insert -- node --, therefor.

In Column 16, Line 40, in Claim 5, delete “configuration” and insert -- configuration, --, therefor.

In Column 16, Line 56, in Claim 8, delete “method,” and insert -- method --, therefor.

In Column 20, Line 12, in Claim 25, delete “fallback” and insert -- fallback, --, therefor.

Signed and Sealed this
Twelfth Day of September, 2017



Joseph Matal
*Performing the Functions and Duties of the
Under Secretary of Commerce for Intellectual Property and
Director of the United States Patent and Trademark Office*

**UNITED STATES PATENT AND TRADEMARK OFFICE
CERTIFICATE OF CORRECTION**

Page 1 of 1

PATENT NO. : 9,509,440 B2

APPLICATION NO. : 14/390,904

ISSUE DATE : November 29, 2016

INVENTOR(S) : Hammarwall, et al.

It is certified that an error appears or errors appear in the above-identified patent and that said Letters Patent is hereby corrected as shown below:

In Column 12, Line 25, delete "MO" and insert - - $N \geq 0$ - -, therefor.

In Column 16, Line 38, in Claim 5, delete "nod e" and insert - - node - -, therefor.

In Column 16, Line 40, in Claim 5, delete "configuration" and insert - - configuration, - -, therefor.

In Column 16, Line 56, in Claim 8, delete "method," and insert - - method - -, therefor.

In Column 20, Line 12, in Claim 25, delete "fallback" and insert - - fallback, - -, therefor.

MAILING ADDRESS OF SENDER (Please do not use customer number below):

6300 Legacy, MS EVR 1-C-11
Plano, TX 75024
972-583-8656

This collection of information is required by 37 CFR 1.322, 1.323, and 1.324. The information is required to obtain or retain a benefit by the public which is to file (and by the USPTO to process) an application. Confidentiality is governed by 35 U.S.C. 122 and 37 CFR 1.14. This collection is estimated to take 1.0 hour to complete, including gathering, preparing, and submitting the completed application form to the USPTO. Time will vary depending upon the individual case. Any comments on the amount of time you require to complete this form and/or suggestions for reducing this burden, should be sent to the Chief Information Officer, U.S. Patent and Trademark Office, U.S. Department of Commerce, P.O. Box 1450, Alexandria, VA 22313-1450. DO NOT SEND FEES OR COMPLETED FORMS TO THIS ADDRESS. SEND TO: **Attention Certificate of Corrections Branch, Commissioner for Patents, P.O. Box 1450, Alexandria, VA 22313-1450.**

If you need assistance in completing the form, call 1-800-PTO-9199 and select option 2.

Privacy Act Statement

The **Privacy Act of 1974 (P.L. 93-579)** requires that you be given certain information in connection with your submission of the attached form related to a patent application or patent. Accordingly, pursuant to the requirements of the Act, please be advised that: (1) the general authority for the collection of this information is 35 U.S.C. 2(b)(2); (2) furnishing of the information solicited is voluntary; and (3) the principal purpose for which the information is used by the U.S. Patent and Trademark Office is to process and/or examine your submission related to a patent application or patent. If you do not furnish the requested information, the U.S. Patent and Trademark Office may not be able to process and/or examine your submission, which may result in termination of proceedings or abandonment of the application or expiration of the patent.

The information provided by you in this form will be subject to the following routine uses:

1. The information on this form will be treated confidentially to the extent allowed under the Freedom of Information Act (5 U.S.C. 552) and the Privacy Act (5 U.S.C. 552a). Records from this system of records may be disclosed to the Department of Justice to determine whether disclosure of these records is required by the Freedom of Information Act.
2. A record from this system of records may be disclosed, as a routine use, in the course of presenting evidence to a court, magistrate, or administrative tribunal, including disclosures to opposing counsel in the course of settlement negotiations.
3. A record in this system of records may be disclosed, as a routine use, to a Member of Congress submitting a request involving an individual, to whom the record pertains, when the individual has requested assistance from the Member with respect to the subject matter of the record.
4. A record in this system of records may be disclosed, as a routine use, to a contractor of the Agency having need for the information in order to perform a contract. Recipients of information shall be required to comply with the requirements of the Privacy Act of 1974, as amended, pursuant to 5 U.S.C. 552a(m).
5. A record related to an International Application filed under the Patent Cooperation Treaty in this system of records may be disclosed, as a routine use, to the International Bureau of the World Intellectual Property Organization, pursuant to the Patent Cooperation Treaty.
6. A record in this system of records may be disclosed, as a routine use, to another federal agency for purposes of National Security review (35 U.S.C. 181) and for review pursuant to the Atomic Energy Act (42 U.S.C. 218(c)).
7. A record from this system of records may be disclosed, as a routine use, to the Administrator, General Services, or his/her designee, during an inspection of records conducted by GSA as part of that agency's responsibility to recommend improvements in records management practices and programs, under authority of 44 U.S.C. 2904 and 2906. Such disclosure shall be made in accordance with the GSA regulations governing inspection of records for this purpose, and any other relevant (*i.e.*, GSA or Commerce) directive. Such disclosure shall not be used to make determinations about individuals.
8. A record from this system of records may be disclosed, as a routine use, to the public after either publication of the application pursuant to 35 U.S.C. 122(b) or issuance of a patent pursuant to 35 U.S.C. 151. Further, a record may be disclosed, subject to the limitations of 37 CFR 1.14, as a routine use, to the public if the record was filed in an application which became abandoned or in which the proceedings were terminated and which application is referenced by either a published application, an application open to public inspection or an issued patent.
9. A record from this system of records may be disclosed, as a routine use, to a Federal, State, or local law enforcement agency, if the USPTO becomes aware of a violation or potential violation of law or regulation.

IN THE UNITED STATES PATENT & TRADEMARK OFFICE

IN RE APPLICATION OF: U.S. Patent No. 9,509,440

USPTO CONFIRMATION CODE: 7239

APPLICATION NO.: 14/390,904

PCT FILED: June 26, 2014

U.S. FILED: October 06, 2014

EXAMINER: Diane Lo

GROUP ART UNIT: 2466

FOR: METHOD AND RADIO NODE FOR ENABLING USE OF HIGH ORDER
MODULATION IN A RADIO COMMUNICATION WITH A USER EQUIPMENT

37 CFR 1.322 & 37 CFR 1.323 REQUEST FOR CERTIFICATE OF CORRECTION
FOR USPTO AND/OR APPLICANT MISTAKE

HONORABLE COMMISSIONER OF PATENTS & TRADEMARKS

SIR:

The following is a request for a certificate of correction in Serial Number 14/390,904, now Patent Number 9,509,440.

A certificate of correction under 35 USC 254 is respectfully requested in the above-identified patent.

All errors were the fault of the USPTO, no fee required. In the event that a further fee is required, please charge the amount to our Deposit Account No. 50-1379.

The exact locations where the errors appear in the patent and patent application are as follows:

In Column 12, Line 25, delete “MO” and insert - - $N \geq 0$ - -, therefor.
(ORIGINALLY FILED SPECIFICATION DATED OCTOBER 6, 2014,
PAGE 19 (PAGE 283 OF FW), LINE 12)

In Column 16, Line 38, in Claim 5, delete “nod e” and insert - - node - -, therefor.
(AMENDMENTS TO THE CLAIMS DATED JULY 1, 2016, PAGE 3 OF 15,
CLAIM 31, LINE 1)

In Column 16, Line 40, in Claim 5, delete “configuration” and
insert - - configuration, - -, therefor.
(AMENDMENTS TO THE CLAIMS DATED JULY 1, 2016, PAGE 3 OF 15,
CLAIM 31, LINE 3)

In Column 16, Line 56, in Claim 8, delete “method,” and
insert - - method - -, therefor.
(AMENDMENTS TO THE CLAIMS DATED JULY 1, 2016, PAGE 4 OF 15,
CLAIM 36, LINE 1)

In Column 20, Line 12, in Claim 25, delete “fallback” and
insert - - fallback, - -, therefor.
(AMENDMENTS TO THE CLAIMS DATED JULY 1, 2016, PAGE 11 OF 15,
CLAIM 51, LINE 27)

The requested corrections are attached on Form PTO 1050.

Respectfully Submitted

, 2017

DATE

/Ronald J. Ward, Reg#54870/

Ronald J. Ward
Registration No. 54,870
Attorney of Record

Electronic Acknowledgement Receipt

EFS ID:	28583668
Application Number:	14390904
International Application Number:	
Confirmation Number:	7239
Title of Invention:	Method and Radio Node for Enabling Use of High Order Modulation in a Radio Communication with a User Equipment
First Named Inventor/Applicant Name:	David Hammarwall
Customer Number:	24112
Filer:	Steven Ware Smith/Michelle Sanderson
Filer Authorized By:	Steven Ware Smith
Attorney Docket Number:	4015-8999 / P41223-US2
Receipt Date:	09-MAR-2017
Filing Date:	06-OCT-2014
Time Stamp:	14:57:47
Application Type:	U.S. National Stage under 35 USC 371

Payment information:

Submitted with Payment	no
------------------------	----

File Listing:

Document Number	Document Description	File Name	File Size(Bytes)/ Message Digest	Multi Part /.zip	Pages (if appl.)
1	Request for Certificate of Correction	P41223- US2_2017-03-09_CoC_PTO-105 0.pdf	122960 <small>0e4aa4edc7ccc41e078af791cf31e0799d8e1a1</small>	no	2

Warnings:

IPR2022-00457

Information:				
2	Transmittal Letter	P41223- US2_2017-03-09_CoC_Request _Letter.pdf	111786 9349ebcab2a21a7832a31fe165779be91f531fce	no 3
Warnings:				
Information:				
Total Files Size (in bytes):			234746	
<p>This Acknowledgement Receipt evidences receipt on the noted date by the USPTO of the indicated documents, characterized by the applicant, and including page counts, where applicable. It serves as evidence of receipt similar to a Post Card, as described in MPEP 503.</p> <p><u>New Applications Under 35 U.S.C. 111</u> If a new application is being filed and the application includes the necessary components for a filing date (see 37 CFR 1.53(b)-(d) and MPEP 506), a Filing Receipt (37 CFR 1.54) will be issued in due course and the date shown on this Acknowledgement Receipt will establish the filing date of the application.</p> <p><u>National Stage of an International Application under 35 U.S.C. 371</u> If a timely submission to enter the national stage of an international application is compliant with the conditions of 35 U.S.C. 371 and other applicable requirements a Form PCT/DO/EO/903 indicating acceptance of the application as a national stage submission under 35 U.S.C. 371 will be issued in addition to the Filing Receipt, in due course.</p> <p><u>New International Application Filed with the USPTO as a Receiving Office</u> If a new international application is being filed and the international application includes the necessary components for an international filing date (see PCT Article 11 and MPEP 1810), a Notification of the International Application Number and of the International Filing Date (Form PCT/RO/105) will be issued in due course, subject to prescriptions concerning national security, and the date shown on this Acknowledgement Receipt will establish the international filing date of the application.</p>				



UNITED STATES PATENT AND TRADEMARK OFFICE

UNITED STATES DEPARTMENT OF COMMERCE
United States Patent and Trademark Office
Address: COMMISSIONER FOR PATENTS
P. O. Box 1450
Alexandria, Virginia 22313-1450
www.uspto.gov

APPLICATION NO.	ISSUE DATE	PATENT NO.	ATTORNEY DOCKET NO.	CONFIRMATION NO.
14/390,904	11/29/2016	9509440	4015-8999 / P41223-US2	7239

24112 7590 11/09/2016
COATS & BENNETT, PLLC
1400 Crescent Green, Suite 300
Cary, NC 27518

ISSUE NOTIFICATION

The projected patent number and issue date are specified above.

Determination of Patent Term Adjustment under 35 U.S.C. 154 (b)
(application filed on or after May 29, 2000)

The Patent Term Adjustment is 56 day(s). Any patent to issue from the above-identified application will include an indication of the adjustment on the front page.

If a Continued Prosecution Application (CPA) was filed in the above-identified application, the filing date that determines Patent Term Adjustment is the filing date of the most recent CPA.

Applicant will be able to obtain more detailed information by accessing the Patent Application Information Retrieval (PAIR) WEB site (<http://pair.uspto.gov>).

Any questions regarding the Patent Term Extension or Adjustment determination should be directed to the Office of Patent Legal Administration at (571)-272-7702. Questions relating to issue and publication fee payments should be directed to the Application Assistance Unit (AAU) of the Office of Data Management (ODM) at (571)-272-4200.

APPLICANT(s) (Please see PAIR WEB site <http://pair.uspto.gov> for additional applicants):

David Hammarwall, Vallentuna, SWEDEN;
TELEFONAKTIEBOLAGET L M ERICSSON (PUBL.), Stockholm, SWEDEN;
Meng Wang, SUNDBYBERG, SWEDEN;

The United States represents the largest, most dynamic marketplace in the world and is an unparalleled location for business investment, innovation, and commercialization of new technologies. The USA offers tremendous resources and advantages for those who invest and manufacture goods here. Through SelectUSA, our nation works to encourage and facilitate business investment. To learn more about why the USA is the best country in the world to develop technology, manufacture products, and grow your business, visit SelectUSA.gov.

PART B - FEE(S) TRANSMITTAL

Complete and send this form, together with applicable fee(s), to: **Mail** Mail Stop ISSUE FEE
Commissioner for Patents
P.O. Box 1450
Alexandria, Virginia 22313-1450
 or **Fax** (571)-273-2885

INSTRUCTIONS: This form should be used for transmitting the ISSUE FEE and PUBLICATION FEE (if required). Blocks 1 through 5 should be completed where appropriate. All further correspondence including the Patent, advance orders and notification of maintenance fees will be mailed to the current correspondence address as indicated unless corrected below or directed otherwise in Block 1, by (a) specifying a new correspondence address; and/or (b) indicating a separate "Fee" ADDRESS for maintenance fee notifications.

CURRENT CORRESPONDENCE ADDRESS (Note the Block 1 for any change of address)

04112 2590 07/31/2016
COATS & BENNETT, PLLC
 1400 Crescent Green, Suite 300
 Cary, NC 27518

Note: A certificate of mailing can only be used for domestic mailings of the Fees) Transmittal. This certificate cannot be used for any other accompanying papers. Each additional paper, such as an assignment or formal drawing, must have its own certificate of mailing or transmission.

Certificate of Mailing or Transmission

I hereby certify that this Fee(s) Transmittal is being deposited with the United States Postal Service with sufficient postage for first class mail in an envelope addressed to the Mail Stop ISSUE FEE address above, or being facsimile transmitted to the USPTO (571) 273-2885, on the date indicated below.

Depositor's name
Signature
Date

APPLICATION NO.	FILING DATE	FIRST NAMED INVENTOR	ATTORNEY DOCKET NO.	CONFIRMATION NO.
14/390,904	10/06/2014	David Hammarwall	4015-8999 / P41223-US2	7139

TITLE OF INVENTION: Method and Radio Node for Enabling Use of High Order Modulation in a Radio Communication with a User Equipment

APPLN. TYPE	ENTITY STATUS	ISSUE FEE DUE	PUBLICATION FEE DUE	PREV. PAID ISSUE FEE	TOTAL FEE(S) DUE	DATE DUE
nonprovisional	UNDISCOUNTED	\$960	\$0	\$0	\$960	10/27/2016

EXAMINER	ART UNIT	CLASSIFICATION
LO, DIANE LEE	2466	370-329000

1. Change of correspondence address or indication of "Fee Address" (37 CFR 1.363).

- Change of correspondence address (or Change of Correspondence Address form PTO/SB/122) attached.
- "Fee Address" indication (or "Fee Address" Indication form PTO/SB/47, Rev 03-02, or more recent) attached. Use of a Customer Number is required.

2. For printing on the patent front page, list

- (1) The names of up to 3 registered patent attorneys or agents OR, alternatively,
- (2) The name of a single firm (having as a member a registered attorney or agent) and the names of up to 2 registered patent attorneys or agents. If no name is listed, no name will be printed.

1. Coats & Bennett, P.L.L.C.
 2. _____
 3. _____

3. ASSIGNEE NAME AND RESIDENCE DATA TO BE PRINTED ON THE PATENT (print or type)

PLEASE NOTE: Unless an assignee is identified below, an assignee data will appear on the patent. If an assignee is identified below, the document has been filed for recordation as set forth in 37 CFR 3.11. Completion of this form is NOT a substitute for filing an assignment.

(A) NAME OF ASSIGNEE

(B) RESIDENCE: (CITY and STATE OR COUNTRY)

Telefonaktiebolaget LM Ericsson (publ)

Stockholm, Sweden

Please check the appropriate assignee category or categories (will not be printed on the patent): Individual Corporation or other private group entity Government

4a. The following fee(s) are submitted:

- Issue Fee
- Publication Fee (No small entity discount permitted)
- Advance Order - # of Copies _____

4b. Payment of Fee(s): (Please first reapply any previously paid issue fee shown above)

- A check is enclosed.
- Payment by credit card. Form PTO-2038 is attached.
- The director is hereby authorized to charge the required fee(s), any deficiency, or credits any overpayment, to Deposit Account Number 18-1167. (enclose an extra copy of this form.)

5. Change in Entity Status (from status indicated above)

- Applicant certifying micro entity status. See 37 CFR 1.29
- Applicant asserting small entity status. See 37 CFR 1.27
- Applicant changing to regular undiscouted fee status.

NOTE: Absent a valid certification of Micro Entity Status (see forms PTO/SB/15A and 15B), issue fee payment in the micro entity amount will not be accepted at the risk of application abandonment.

NOTE: If the application was previously under micro entity status, checking this box will be taken to be a notification of loss of entitlement to micro entity status.

NOTE: Checking this box will be taken to be a notification of loss of entitlement to small or micro entity status, as applicable.

NOTE: This form must be signed in accordance with 37 CFR 1.31 and 1.33. See 37 CFR 1.4 for signature requirements and certifications.

Authorized Signature

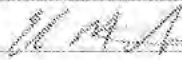

Date October 20, 2016

Typed or printed name Eli M. Sheets

Registration No. 68,958

Electronic Patent Application Fee Transmittal

Application Number:	14390904				
Filing Date:	06-Oct-2014				
Title of Invention:	Method and Radio Node for Enabling Use of High Order Modulation in a Radio Communication with a User Equipment				
First Named Inventor/Applicant Name:	David Hammarwall				
Filer:	Eli Sheets/Leslie Ruckdeschel				
Attorney Docket Number:	4015-8999 / P41223-US2				
Filed as Large Entity					
Filing Fees for U.S. National Stage under 35 USC 371					
Description	Fee Code	Quantity	Amount	Sub-Total in USD(\$)	
Basic Filing:					
Pages:					
Claims:					
Miscellaneous-Filing:					
Petition:					
Patent-Appeals-and-Interference:					
Post-Allowance-and-Post-Issuance:					

Description	Fee Code	Quantity	Amount	Sub-Total in USD(\$)
UTILITY APPL ISSUE FEE	1501	1	960	960
PUBL. FEE- EARLY, VOLUNTARY, OR NORMAL	1504	1	0	0
Extension-of-Time:				
Miscellaneous:				
Total in USD (\$)				960

Electronic Acknowledgement Receipt

EFS ID:	27272913
Application Number:	14390904
International Application Number:	
Confirmation Number:	7239
Title of Invention:	Method and Radio Node for Enabling Use of High Order Modulation in a Radio Communication with a User Equipment
First Named Inventor/Applicant Name:	David Hammarwall
Customer Number:	24112
Filer:	Eli Sheets/Leslie Ruckdeschel
Filer Authorized By:	Eli Sheets
Attorney Docket Number:	4015-8999 / P41223-US2
Receipt Date:	20-OCT-2016
Filing Date:	06-OCT-2014
Time Stamp:	13:43:55
Application Type:	U.S. National Stage under 35 USC 371

Payment information:

Submitted with Payment	yes
Payment Type	EFT
Payment was successfully received in RAM	\$960
RAM confirmation Number	102016INTEFSW13444600
Deposit Account	
Authorized User	

The Director of the USPTO is hereby authorized to charge indicated fees and credit any overpayment as follows:

IPR2022-00457

--	--	--	--	--	--

File Listing:

Document Number	Document Description	File Name	File Size(Bytes)/ Message Digest	Multi Part /.zip	Pages (if appl.)
1	Issue Fee Payment (PTO-85B)	Issue_Fee_Transmittal.pdf	534801	no	1
			ba7035d58b880c57517ed92590e60bc7f0242846		

Warnings:

Information:

2	Fee Worksheet (SB06)	fee-info.pdf	32825	no	2
			7ab0f7bfb6489e164e01270091f292a10dfdd63		

Warnings:

Information:

Total Files Size (in bytes):	567626
-------------------------------------	--------

This Acknowledgement Receipt evidences receipt on the noted date by the USPTO of the indicated documents, characterized by the applicant, and including page counts, where applicable. It serves as evidence of receipt similar to a Post Card, as described in MPEP 503.

New Applications Under 35 U.S.C. 111

If a new application is being filed and the application includes the necessary components for a filing date (see 37 CFR 1.53(b)-(d) and MPEP 506), a Filing Receipt (37 CFR 1.54) will be issued in due course and the date shown on this Acknowledgement Receipt will establish the filing date of the application.

National Stage of an International Application under 35 U.S.C. 371

If a timely submission to enter the national stage of an international application is compliant with the conditions of 35 U.S.C. 371 and other applicable requirements a Form PCT/DO/EO/903 indicating acceptance of the application as a national stage submission under 35 U.S.C. 371 will be issued in addition to the Filing Receipt, in due course.

New International Application Filed with the USPTO as a Receiving Office

If a new international application is being filed and the international application includes the necessary components for an international filing date (see PCT Article 11 and MPEP 1810), a Notification of the International Application Number and of the International Filing Date (Form PCT/RO/105) will be issued in due course, subject to prescriptions concerning national security, and the date shown on this Acknowledgement Receipt will establish the international filing date of the application.



UNITED STATES PATENT AND TRADEMARK OFFICE

UNITED STATES DEPARTMENT OF COMMERCE
United States Patent and Trademark Office
Address: COMMISSIONER FOR PATENTS
P.O. Box 1450
Alexandria, Virginia 22313-1450
www.uspto.gov

NOTICE OF ALLOWANCE AND FEE(S) DUE

24112 7590 07/27/2016
COATS & BENNETT, PLLC
1400 Crescent Green, Suite 300
Cary, NC 27518

EXAMINER

LO, DIANE LEE

ART UNIT PAPER NUMBER

2466

DATE MAILED: 07/27/2016

Table with 5 columns: APPLICATION NO., FILING DATE, FIRST NAMED INVENTOR, ATTORNEY DOCKET NO., CONFIRMATION NO.

14/390,904 10/06/2014 David Hammarwall 4015-8999 / P41223-US2 7239

TITLE OF INVENTION: Method and Radio Node for Enabling Use of High Order Modulation in a Radio Communication with a User Equipment

Table with 7 columns: APPLN. TYPE, ENTITY STATUS, ISSUE FEE DUE, PUBLICATION FEE DUE, PREV. PAID ISSUE FEE, TOTAL FEE(S) DUE, DATE DUE

nonprovisional UNDISCOUNTED \$960 \$0 \$0 \$960 10/27/2016

THE APPLICATION IDENTIFIED ABOVE HAS BEEN EXAMINED AND IS ALLOWED FOR ISSUANCE AS A PATENT. PROSECUTION ON THE MERITS IS CLOSED. THIS NOTICE OF ALLOWANCE IS NOT A GRANT OF PATENT RIGHTS. THIS APPLICATION IS SUBJECT TO WITHDRAWAL FROM ISSUE AT THE INITIATIVE OF THE OFFICE OR UPON PETITION BY THE APPLICANT. SEE 37 CFR 1.313 AND MPEP 1308.

THE ISSUE FEE AND PUBLICATION FEE (IF REQUIRED) MUST BE PAID WITHIN THREE MONTHS FROM THE MAILING DATE OF THIS NOTICE OR THIS APPLICATION SHALL BE REGARDED AS ABANDONED. THIS STATUTORY PERIOD CANNOT BE EXTENDED. SEE 35 U.S.C. 151. THE ISSUE FEE DUE INDICATED ABOVE DOES NOT REFLECT A CREDIT FOR ANY PREVIOUSLY PAID ISSUE FEE IN THIS APPLICATION. IF AN ISSUE FEE HAS PREVIOUSLY BEEN PAID IN THIS APPLICATION (AS SHOWN ABOVE), THE RETURN OF PART B OF THIS FORM WILL BE CONSIDERED A REQUEST TO REAPPLY THE PREVIOUSLY PAID ISSUE FEE TOWARD THE ISSUE FEE NOW DUE.

HOW TO REPLY TO THIS NOTICE:

I. Review the ENTITY STATUS shown above. If the ENTITY STATUS is shown as SMALL or MICRO, verify whether entitlement to that entity status still applies.

If the ENTITY STATUS is the same as shown above, pay the TOTAL FEE(S) DUE shown above.

If the ENTITY STATUS is changed from that shown above, on PART B - FEE(S) TRANSMITTAL, complete section number 5 titled "Change in Entity Status (from status indicated above)".

For purposes of this notice, small entity fees are 1/2 the amount of undiscounted fees, and micro entity fees are 1/2 the amount of small entity fees.

II. PART B - FEE(S) TRANSMITTAL, or its equivalent, must be completed and returned to the United States Patent and Trademark Office (USPTO) with your ISSUE FEE and PUBLICATION FEE (if required). If you are charging the fee(s) to your deposit account, section "4b" of Part B - Fee(s) Transmittal should be completed and an extra copy of the form should be submitted. If an equivalent of Part B is filed, a request to reapply a previously paid issue fee must be clearly made, and delays in processing may occur due to the difficulty in recognizing the paper as an equivalent of Part B.

III. All communications regarding this application must give the application number. Please direct all communications prior to issuance to Mail Stop ISSUE FEE unless advised to the contrary.

IMPORTANT REMINDER: Utility patents issuing on applications filed on or after Dec. 12, 1980 may require payment of maintenance fees. It is patentee's responsibility to ensure timely payment of maintenance fees when due.

PART B - FEE(S) TRANSMITTAL

**Complete and send this form, together with applicable fee(s), to: Mail Mail Stop ISSUE FEE
 Commissioner for Patents
 P.O. Box 1450
 Alexandria, Virginia 22313-1450
 or Fax (571)-273-2885**

INSTRUCTIONS: This form should be used for transmitting the ISSUE FEE and PUBLICATION FEE (if required). Blocks 1 through 5 should be completed where appropriate. All further correspondence including the Patent, advance orders and notification of maintenance fees will be mailed to the current correspondence address as indicated unless corrected below or directed otherwise in Block 1, by (a) specifying a new correspondence address; and/or (b) indicating a separate "FEE ADDRESS" for maintenance fee notifications.

CURRENT CORRESPONDENCE ADDRESS (Note: Use Block 1 for any change of address)

24112 7590 07/27/2016
COATS & BENNETT, PLLC
 1400 Crescent Green, Suite 300
 Cary, NC 27518

Note: A certificate of mailing can only be used for domestic mailings of the Fee(s) Transmittal. This certificate cannot be used for any other accompanying papers. Each additional paper, such as an assignment or formal drawing, must have its own certificate of mailing or transmission.

Certificate of Mailing or Transmission

I hereby certify that this Fee(s) Transmittal is being deposited with the United States Postal Service with sufficient postage for first class mail in an envelope addressed to the Mail Stop ISSUE FEE address above, or being facsimile transmitted to the USPTO (571) 273-2885, on the date indicated below.

(Depositor's name)
(Signature)
(Date)

APPLICATION NO.	FILING DATE	FIRST NAMED INVENTOR	ATTORNEY DOCKET NO.	CONFIRMATION NO.
14/390,904	10/06/2014	David Hammarwall	4015-8999 / P41223-US2	7239

TITLE OF INVENTION: Method and Radio Node for Enabling Use of High Order Modulation in a Radio Communication with a User Equipment

APPLN. TYPE	ENTITY STATUS	ISSUE FEE DUE	PUBLICATION FEE DUE	PREV. PAID ISSUE FEE	TOTAL FEE(S) DUE	DATE DUE
nonprovisional	UNDISCOUNTED	\$960	\$0	\$0	\$960	10/27/2016

EXAMINER	ART UNIT	CLASS-SUBCLASS
LO, DIANE LEE	2466	370-329000

1. Change of correspondence address or indication of "Fee Address" (37 CFR 1.363).

- Change of correspondence address (or Change of Correspondence Address form PTO/SB/122) attached.
- "Fee Address" indication (or "Fee Address" Indication form PTO/SB/47; Rev 03-02 or more recent) attached. **Use of a Customer Number is required.**

2. For printing on the patent front page, list

- (1) The names of up to 3 registered patent attorneys or agents OR, alternatively, 1 _____
- (2) The name of a single firm (having as a member a registered attorney or agent) and the names of up to 2 registered patent attorneys or agents. If no name is listed, no name will be printed. 2 _____
- 3 _____

3. ASSIGNEE NAME AND RESIDENCE DATA TO BE PRINTED ON THE PATENT (print or type)

PLEASE NOTE: Unless an assignee is identified below, no assignee data will appear on the patent. If an assignee is identified below, the document has been filed for recordation as set forth in 37 CFR 3.11. Completion of this form is NOT a substitute for filing an assignment.

(A) NAME OF ASSIGNEE _____ (B) RESIDENCE: (CITY and STATE OR COUNTRY) _____

Please check the appropriate assignee category or categories (will not be printed on the patent) : Individual Corporation or other private group entity Government

4a. The following fee(s) are submitted:

- Issue Fee
- Publication Fee (No small entity discount permitted)
- Advance Order - # of Copies _____

4b. Payment of Fee(s): (Please first reapply any previously paid issue fee shown above)

- A check is enclosed.
- Payment by credit card. Form PTO-2038 is attached.
- The director is hereby authorized to charge the required fee(s), any deficiency, or credits any overpayment, to Deposit Account Number _____ (enclose an extra copy of this form).

5. Change in Entity Status (from status indicated above)

- Applicant certifying micro entity status. See 37 CFR 1.29
- Applicant asserting small entity status. See 37 CFR 1.27
- Applicant changing to regular undiscounted fee status.

NOTE: Absent a valid certification of Micro Entity Status (see forms PTO/SB/15A and 15B), issue fee payment in the micro entity amount will not be accepted at the risk of application abandonment.

NOTE: If the application was previously under micro entity status, checking this box will be taken to be a notification of loss of entitlement to micro entity status.

NOTE: Checking this box will be taken to be a notification of loss of entitlement to small or micro entity status, as applicable.

NOTE: This form must be signed in accordance with 37 CFR 1.31 and 1.33. See 37 CFR 1.4 for signature requirements and certifications.

Authorized Signature _____ Date _____

Typed or printed name _____ Registration No. _____



UNITED STATES PATENT AND TRADEMARK OFFICE

UNITED STATES DEPARTMENT OF COMMERCE
United States Patent and Trademark Office
Address: COMMISSIONER FOR PATENTS
P.O. Box 1450
Alexandria, Virginia 22313-1450
www.uspto.gov

Table with 5 columns: APPLICATION NO., FILING DATE, FIRST NAMED INVENTOR, ATTORNEY DOCKET NO., CONFIRMATION NO.
14/390,904 10/06/2014 David Hammarwall 4015-8999 / P41223-US2 7239

24112 7590 07/27/2016
COATS & BENNETT, PLLC
1400 Crescent Green, Suite 300
Cary, NC 27518

EXAMINER

LO, DIANE LEE

ART UNIT PAPER NUMBER

2466

DATE MAILED: 07/27/2016

Determination of Patent Term Adjustment under 35 U.S.C. 154 (b)
(Applications filed on or after May 29, 2000)

The Office has discontinued providing a Patent Term Adjustment (PTA) calculation with the Notice of Allowance.

Section 1(h)(2) of the AIA Technical Corrections Act amended 35 U.S.C. 154(b)(3)(B)(i) to eliminate the requirement that the Office provide a patent term adjustment determination with the notice of allowance. See Revisions to Patent Term Adjustment, 78 Fed. Reg. 19416, 19417 (Apr. 1, 2013). Therefore, the Office is no longer providing an initial patent term adjustment determination with the notice of allowance. The Office will continue to provide a patent term adjustment determination with the Issue Notification Letter that is mailed to applicant approximately three weeks prior to the issue date of the patent, and will include the patent term adjustment on the patent. Any request for reconsideration of the patent term adjustment determination (or reinstatement of patent term adjustment) should follow the process outlined in 37 CFR 1.705.

Any questions regarding the Patent Term Extension or Adjustment determination should be directed to the Office of Patent Legal Administration at (571)-272-7702. Questions relating to issue and publication fee payments should be directed to the Customer Service Center of the Office of Patent Publication at 1-(888)-786-0101 or (571)-272-4200.

OMB Clearance and PRA Burden Statement for PTOL-85 Part B

The Paperwork Reduction Act (PRA) of 1995 requires Federal agencies to obtain Office of Management and Budget approval before requesting most types of information from the public. When OMB approves an agency request to collect information from the public, OMB (i) provides a valid OMB Control Number and expiration date for the agency to display on the instrument that will be used to collect the information and (ii) requires the agency to inform the public about the OMB Control Number's legal significance in accordance with 5 CFR 1320.5(b).

The information collected by PTOL-85 Part B is required by 37 CFR 1.311. The information is required to obtain or retain a benefit by the public which is to file (and by the USPTO to process) an application. Confidentiality is governed by 35 U.S.C. 122 and 37 CFR 1.14. This collection is estimated to take 12 minutes to complete, including gathering, preparing, and submitting the completed application form to the USPTO. Time will vary depending upon the individual case. Any comments on the amount of time you require to complete this form and/or suggestions for reducing this burden, should be sent to the Chief Information Officer, U.S. Patent and Trademark Office, U.S. Department of Commerce, P.O. Box 1450, Alexandria, Virginia 22313-1450. DO NOT SEND FEES OR COMPLETED FORMS TO THIS ADDRESS. SEND TO: Commissioner for Patents, P.O. Box 1450, Alexandria, Virginia 22313-1450. Under the Paperwork Reduction Act of 1995, no persons are required to respond to a collection of information unless it displays a valid OMB control number.

Privacy Act Statement

The Privacy Act of 1974 (P.L. 93-579) requires that you be given certain information in connection with your submission of the attached form related to a patent application or patent. Accordingly, pursuant to the requirements of the Act, please be advised that: (1) the general authority for the collection of this information is 35 U.S.C. 2(b)(2); (2) furnishing of the information solicited is voluntary; and (3) the principal purpose for which the information is used by the U.S. Patent and Trademark Office is to process and/or examine your submission related to a patent application or patent. If you do not furnish the requested information, the U.S. Patent and Trademark Office may not be able to process and/or examine your submission, which may result in termination of proceedings or abandonment of the application or expiration of the patent.

The information provided by you in this form will be subject to the following routine uses:

1. The information on this form will be treated confidentially to the extent allowed under the Freedom of Information Act (5 U.S.C. 552) and the Privacy Act (5 U.S.C. 552a). Records from this system of records may be disclosed to the Department of Justice to determine whether disclosure of these records is required by the Freedom of Information Act.
2. A record from this system of records may be disclosed, as a routine use, in the course of presenting evidence to a court, magistrate, or administrative tribunal, including disclosures to opposing counsel in the course of settlement negotiations.
3. A record in this system of records may be disclosed, as a routine use, to a Member of Congress submitting a request involving an individual, to whom the record pertains, when the individual has requested assistance from the Member with respect to the subject matter of the record.
4. A record in this system of records may be disclosed, as a routine use, to a contractor of the Agency having need for the information in order to perform a contract. Recipients of information shall be required to comply with the requirements of the Privacy Act of 1974, as amended, pursuant to 5 U.S.C. 552a(m).
5. A record related to an International Application filed under the Patent Cooperation Treaty in this system of records may be disclosed, as a routine use, to the International Bureau of the World Intellectual Property Organization, pursuant to the Patent Cooperation Treaty.
6. A record in this system of records may be disclosed, as a routine use, to another federal agency for purposes of National Security review (35 U.S.C. 181) and for review pursuant to the Atomic Energy Act (42 U.S.C. 218(c)).
7. A record from this system of records may be disclosed, as a routine use, to the Administrator, General Services, or his/her designee, during an inspection of records conducted by GSA as part of that agency's responsibility to recommend improvements in records management practices and programs, under authority of 44 U.S.C. 2904 and 2906. Such disclosure shall be made in accordance with the GSA regulations governing inspection of records for this purpose, and any other relevant (i.e., GSA or Commerce) directive. Such disclosure shall not be used to make determinations about individuals.
8. A record from this system of records may be disclosed, as a routine use, to the public after either publication of the application pursuant to 35 U.S.C. 122(b) or issuance of a patent pursuant to 35 U.S.C. 151. Further, a record may be disclosed, subject to the limitations of 37 CFR 1.14, as a routine use, to the public if the record was filed in an application which became abandoned or in which the proceedings were terminated and which application is referenced by either a published application, an application open to public inspection or an issued patent.
9. A record from this system of records may be disclosed, as a routine use, to a Federal, State, or local law enforcement agency, if the USPTO becomes aware of a violation or potential violation of the provisions of

Notice of Allowability	Application No. 14/390,904	Applicant(s) HAMMARWALL ET AL.	
	Examiner DIANE LO	Art Unit 2466	AIA (First Inventor to File) Status Yes

-- The MAILING DATE of this communication appears on the cover sheet with the correspondence address--

All claims being allowable, PROSECUTION ON THE MERITS IS (OR REMAINS) CLOSED in this application. If not included herewith (or previously mailed), a Notice of Allowance (PTOL-85) or other appropriate communication will be mailed in due course. **THIS NOTICE OF ALLOWABILITY IS NOT A GRANT OF PATENT RIGHTS.** This application is subject to withdrawal from issue at the initiative of the Office or upon petition by the applicant. See 37 CFR 1.313 and MPEP 1308.

1. This communication is responsive to amendment received 07/01/2016.
 A declaration(s)/affidavit(s) under **37 CFR 1.130(b)** was/were filed on _____.
2. An election was made by the applicant in response to a restriction requirement set forth during the interview on _____; the restriction requirement and election have been incorporated into this action.
3. The allowed claim(s) is/are 27-33,36-44 and 47-58. As a result of the allowed claim(s), you may be eligible to benefit from the **Patent Prosecution Highway** program at a participating intellectual property office for the corresponding application. For more information, please see http://www.uspto.gov/patents/init_events/pph/index.jsp or send an inquiry to PPHfeedback@uspto.gov.
4. Acknowledgment is made of a claim for foreign priority under 35 U.S.C. § 119(a)-(d) or (f).

Certified copies:

a) All b) Some *c) None of the:

1. Certified copies of the priority documents have been received.
2. Certified copies of the priority documents have been received in Application No. _____.
3. Copies of the certified copies of the priority documents have been received in this national stage application from the International Bureau (PCT Rule 17.2(a)).

* Certified copies not received: _____.

Applicant has THREE MONTHS FROM THE "MAILING DATE" of this communication to file a reply complying with the requirements noted below. Failure to timely comply will result in ABANDONMENT of this application.

THIS THREE-MONTH PERIOD IS NOT EXTENDABLE.

5. CORRECTED DRAWINGS (as "replacement sheets") must be submitted.
 including changes required by the attached Examiner's Amendment / Comment or in the Office action of Paper No./Mail Date _____.
Identifying indicia such as the application number (see 37 CFR 1.84(c)) should be written on the drawings in the front (not the back) of each sheet. Replacement sheet(s) should be labeled as such in the header according to 37 CFR 1.121(d).
6. DEPOSIT OF and/or INFORMATION about the deposit of BIOLOGICAL MATERIAL must be submitted. Note the attached Examiner's comment regarding REQUIREMENT FOR THE DEPOSIT OF BIOLOGICAL MATERIAL.

Attachment(s)

- | | |
|--|--|
| <ol style="list-style-type: none"> 1. <input type="checkbox"/> Notice of References Cited (PTO-892) 2. <input type="checkbox"/> Information Disclosure Statements (PTO/SB/08),
Paper No./Mail Date _____ 3. <input type="checkbox"/> Examiner's Comment Regarding Requirement for Deposit
of Biological Material 4. <input type="checkbox"/> Interview Summary (PTO-413),
Paper No./Mail Date _____. | <ol style="list-style-type: none"> 5. <input type="checkbox"/> Examiner's Amendment/Comment 6. <input checked="" type="checkbox"/> Examiner's Statement of Reasons for Allowance 7. <input type="checkbox"/> Other _____. |
|--|--|

/DIANE LO/
Primary Examiner, Art Unit 2466

REASONS FOR ALLOWANCE

The following is an examiner's statement of reasons for allowance:

The closest prior arts on record fail to teach "instructing the first UE to apply a second table configuration in the radio communication, the second table configuration comprising at least one of a second MCS table and a second CQI table, wherein the first entry for the lowest modulation order in the first MCS table is maintained in the second MCS table as the fallback, and an entry for the lowest coding rate of the lowest modulation order in the first CQI table is maintained in the second CQI table as the fallback" in conjunction with all disclosed steps of functions or all disclosed structures performing corresponding functions in claims 27, 38, 49, 50, 51, and 52.

Any comments considered necessary by applicant must be submitted no later than the payment of the issue fee and, to avoid processing delays, should preferably accompany the issue fee. Such submissions should be clearly labeled "Comments on Statement of Reasons for Allowance".

Conclusion

Any inquiry concerning this communication or earlier communications from the examiner should be directed to DIANE LO whose telephone number is (571)270-1952. The examiner can normally be reached on Monday to Friday, 8:00 am-4:30 pm EST.

If attempts to reach the examiner by telephone are unsuccessful, the examiner's supervisor, Faruk Hamza can be reached on (571)272-7969. The fax phone number for the organization where this application or proceeding is assigned is 571-273-8300.

Information regarding the status of an application may be obtained from the Patent Application Information Retrieval (PAIR) system. Status information for published applications may be obtained from either Private PAIR or Public PAIR. Status information for unpublished applications is available through Private PAIR only. For more information about the PAIR system, see <http://pair-direct.uspto.gov>. Should you have questions on access to the Private PAIR system, contact the Electronic Business Center (EBC) at 866-217-9197 (toll-free). If you would like assistance from a USPTO Customer Service Representative or access to the automated information system, call 800-786-9199 (IN USA OR CANADA) or 571-272-1000.

/DIANE LO/
Primary Examiner, Art Unit 2466

EAST Search History

EAST Search History (Prior Art)

Ref #	Hits	Search Query	DBs	Default Operator	Plurals	Time Stamp
L1	233	(fall-back or fallback) with (MCS or modulation)	US-PGPUB; USPAT; USOCR; FPRS; EPO; JPO; DERWENT; IBM_TDB	ADJ	ON	2016/07/25 13:00
L2	6	(fall-back or fallback) with (MCS or modulation) NEAR3 second	US-PGPUB; USPAT; USOCR; FPRS; EPO; JPO; DERWENT; IBM_TDB	ADJ	ON	2016/07/25 13:08
L10	64	H04L1\$.cpc. AND (CQI SAME MCS with second with table)	US-PGPUB; USPAT; USOCR; FPRS; EPO; JPO; DERWENT; IBM_TDB	ADJ	ON	2016/07/25 13:55
L11	92	H04L1\$.cpc. AND (fall-back or fallback) with (MCS or modulation)	US-PGPUB; USPAT; USOCR; FPRS; EPO; JPO; DERWENT; IBM_TDB	ADJ	ON	2016/07/25 13:55
L12	28	H04W72\$.cpc. AND (CQI SAME MCS with second with table)	US-PGPUB; USPAT; USOCR; FPRS; EPO; JPO; DERWENT; IBM_TDB	ADJ	ON	2016/07/25 13:57
L13	28	H04W72\$.cpc. AND (CQI with MCS with second with table)	US-PGPUB; USPAT; USOCR; FPRS; EPO; JPO; DERWENT; IBM_TDB	ADJ	ON	2016/07/25 13:57
L14	2	H04W72\$.cpc. AND (CQI with MCS with second with table AND fallback)	US-PGPUB; USPAT; USOCR; FPRS; EPO; JPO; DERWENT; IBM_TDB	ADJ	ON	2016/07/25 13:59
L15	1	David NEAR3 Hammarwall AND (CQI with MCS with second with table).clm.	US-PGPUB; USPAT; USOCR; FPRS; EPO; JPO; DERWENT; IBM_TDB	ADJ	ON	2016/07/25 14:00
L16	1	L15	US-PGPUB; USPAT; USOCR; FPRS; EPO; JPO; DERWENT; IBM_TDB	ADJ	ON	2016/07/25 14:00
S1	2	"14390904"	US-PGPUB; USPAT; USOCR; FPRS; EPO; JPO; DERWENT; IBM_TDB	ADJ	ON	2016/02/25 12:01

S2	1	David NEAR3 Hammarwall AND (CQI with MCS with second with table).clm.	US-PGPUB; USPAT; USOCR; FPRS; EPO; JPO; DERWENT; IBM_TDB	ADJ	ON	2016/02/25 16:28
S3	1	Meng NEAR3 Wang AND (CQI with MCS with second with table).clm.	US-PGPUB; USPAT; USOCR; FPRS; EPO; JPO; DERWENT; IBM_TDB	ADJ	ON	2016/02/25 16:29
S4	0	Ericsson.as. AND (CQI with MCS with second with table).clm.	US-PGPUB; USPAT; USOCR; FPRS; EPO; JPO; DERWENT; IBM_TDB	ADJ	ON	2016/02/25 16:29
S5	6	(CQI with MCS with second with table).clm.	US-PGPUB; USPAT; USOCR; FPRS; EPO; JPO; DERWENT; IBM_TDB	ADJ	ON	2016/02/25 16:30
S6	64	(CQI with MCS with second with table)	US-PGPUB; USPAT; USOCR; FPRS; EPO; JPO; DERWENT; IBM_TDB	ADJ	ON	2016/02/25 16:42
S7	3	(CQI with MCS with second with table) AND (maintain\$3 with fallback)	US-PGPUB; USPAT; USOCR; FPRS; EPO; JPO; DERWENT; IBM_TDB	ADJ	ON	2016/02/25 16:42
S8	3	(CQI with MCS with second with table) AND (fallback)	US-PGPUB; USPAT; USOCR; FPRS; EPO; JPO; DERWENT; IBM_TDB	ADJ	ON	2016/02/25 22:54
S9	6	(US-20150381310-\$ or US-20150358111-\$ or US-20150016553-\$).did. or (US-9198070-\$ or US-8654745-\$ or US-8488709-\$).did.	US-PGPUB; USPAT	ADJ	ON	2016/02/29 00:58
S10	52	H04L1\$.cpc. AND (CQI with MCS with second with table)	US-PGPUB; USPAT; USOCR; FPRS; EPO; JPO; DERWENT; IBM_TDB	ADJ	ON	2016/02/29 11:53
S11	5	H04L1\$.cpc. AND (CQI with MCS with second with table).clm.	US-PGPUB; USPAT; USOCR; FPRS; EPO; JPO; DERWENT; IBM_TDB	ADJ	ON	2016/02/29 11:54
S12	18	(CQI with MCS with second with table AND TBS)	US-PGPUB; USPAT; USOCR; FPRS; EPO; JPO; DERWENT; IBM_TDB	ADJ	ON	2016/02/29 12:01
S13	59	table SAME modulation SAME fallback	US-PGPUB; USPAT; USOCR; FPRS; EPO; JPO; DERWENT; IBM_TDB	ADJ	ON	2016/07/21 11:08

S14	28	table with fallback SAME (MCS or modulation)	US-PGPUB; USPAT; USOCR; FPRS; EPO; JPO; DERWENT; IBM_TDB	ADJ	ON	2016/07/21 11:21
S15	9	table SAME fallback SAME (MCS)	US-PGPUB; USPAT; USOCR; FPRS; EPO; JPO; DERWENT; IBM_TDB	ADJ	ON	2016/07/21 11:31
S16	8	fallback SAME (MCS) with table	US-PGPUB; USPAT; USOCR; FPRS; EPO; JPO; DERWENT; IBM_TDB	ADJ	ON	2016/07/21 13:39
S17	28	((fall-back or fallback) with (MCS or modulation order)	US-PGPUB; USPAT; USOCR; FPRS; EPO; JPO; DERWENT; IBM_TDB	ADJ	ON	2016/07/21 13:41
S18	5	((fall-back or fallback) with (MCS or modulation order) AND (CQI with (fall-back or fallback))	US-PGPUB; USPAT; USOCR; FPRS; EPO; JPO; DERWENT; IBM_TDB	ADJ	ON	2016/07/21 14:30
S19	28	((fall-back or fallback) with (MCS or modulation order)	US-PGPUB; USPAT; USOCR; FPRS; EPO; JPO; DERWENT; IBM_TDB	ADJ	ON	2016/07/21 14:31
S20	1	((fall-back or fallback) with (MCS or modulation order)).clm.	US-PGPUB; USPAT; USOCR; FPRS; EPO; JPO; DERWENT; IBM_TDB	ADJ	ON	2016/07/21 14:32
S21	28	((fall-back or fallback) with (MCS or modulation order))	US-PGPUB; USPAT; USOCR; FPRS; EPO; JPO; DERWENT; IBM_TDB	ADJ	ON	2016/07/21 14:33
S22	1	David NEAR3 Hammarwall AND (CQI with MCS with second with table).clm.	US-PGPUB; USPAT; USOCR; FPRS; EPO; JPO; DERWENT; IBM_TDB	ADJ	ON	2016/07/21 14:47
S23	1	S22	US-PGPUB; USPAT; USOCR; FPRS; EPO; JPO; DERWENT; IBM_TDB	ADJ	ON	2016/07/21 14:47
S24	706	s3]	US-PGPUB; USPAT; USOCR; FPRS; EPO; JPO; DERWENT; IBM_TDB	ADJ	ON	2016/07/21 14:49
S25	1	Meng NEAR3 Wang AND (CQI with MCS with second with table).clm.	US-PGPUB; USPAT; USOCR; FPRS; EPO; JPO; DERWENT; IBM_TDB	ADJ	ON	2016/07/21 14:49

EAST Search History

S26	1	S25	US-PGPUB; USPAT; USOCR; FPRS; EPO; JPO; DERWENT; IBM_TDB	ADJ	ON	2016/07/21 14:49
S27	8	(CQI with MCS with second with table).clm.	US-PGPUB; USPAT; USOCR; FPRS; EPO; JPO; DERWENT; IBM_TDB	ADJ	ON	2016/07/21 14:50
S28	8	S27	US-PGPUB; USPAT; USOCR; FPRS; EPO; JPO; DERWENT; IBM_TDB	ADJ	ON	2016/07/21 14:50
S29	1	(CQI with MCS with second with table AND (fall-back or fallback)).clm.	US-PGPUB; USPAT; USOCR; FPRS; EPO; JPO; DERWENT; IBM_TDB	ADJ	ON	2016/07/21 14:51
S32	5	"20040003069"	US-PGPUB; USPAT; USOCR; FPRS; EPO; JPO; DERWENT; IBM_TDB	ADJ	ON	2016/07/21 18:57

7/ 25/ 2016 2:00:27 PM

C:\Users\dlo1\Documents\EAST\Workspaces\14390904.wsp

Search Notes 	Application/Control No. 14390904	Applicant(s)/Patent Under Reexamination HAMMARWALL ET AL.
	Examiner DIANE LO	Art Unit 2466

CPC- SEARCHED		
Symbol	Date	Examiner

CPC COMBINATION SETS - SEARCHED		
Symbol	Date	Examiner

US CLASSIFICATION SEARCHED			
Class	Subclass	Date	Examiner

SEARCH NOTES		
Search Notes	Date	Examiner
EAST search (US-PGPUB, USPAT, FPRS, EPO, JPO, DERWENT) - see search history printout	2/29/2016	DLL
Inventor and Assignee search in EAST	2/29/2016	DLL
H04L 1/all (text search only - see search history printout)	2/29/2016	DLL
update EAST search	7/25/2016	DLL
NPL search	7/25/2016	DLL

INTERFERENCE SEARCH			
US Class/ CPC Symbol	US Subclass / CPC Group	Date	Examiner
	see interference search history printout	7/25/2016	DLL

--	--

Issue Classification 	Application/Control No. 14390904	Applicant(s)/Patent Under Reexamination HAMMARWALL ET AL.
	Examiner DIANE LO	Art Unit 2466

CPC						
Symbol					Type	Version
H04L		1		0005	F	2013-01-01
H04L		1		0003	I	2013-01-01
H04L		1		0009	I	2013-01-01
H04L		1		0016	I	2013-01-01
H04L		1		0025	I	2013-01-01
H04L		1		0026	I	2013-01-01
H04L		1		0011	I	2013-01-01
H04W		72		082	I	2013-01-01

CPC Combination Sets							
Symbol				Type	Set	Ranking	Version

NONE		Total Claims Allowed:	
(Assistant Examiner)	(Date)	28	
/DIANE LO/ Primary Examiner, Art Unit 2466	07/25/2016	O.G. Print Claim(s)	O.G. Print Figure
(Primary Examiner)	(Date)	27	2

Issue Classification 	Application/Control No. 14390904	Applicant(s)/Patent Under Reexamination HAMMARWALL ET AL.
	Examiner DIANE LO	Art Unit 2466

US ORIGINAL CLASSIFICATION						INTERNATIONAL CLASSIFICATION											
CLASS			SUBCLASS			CLAIMED				NON-CLAIMED							
CROSS REFERENCE(S) CLASS SUBCLASS (ONE SUBCLASS PER BLOCK)						H	0	4	L	1 / 00 (2006.0)							
						H	0	4	W	72 / 08							

NONE		Total Claims Allowed:	
(Assistant Examiner)	(Date)	28	
/DIANE LO/ Primary Examiner, Art Unit 2466	07/25/2016	O.G. Print Claim(s)	O.G. Print Figure
(Primary Examiner)	(Date)	27	2

Issue Classification 	Application/Control No. 14390904	Applicant(s)/Patent Under Reexamination HAMMARWALL ET AL.
	Examiner DIANE LO	Art Unit 2466

<input type="checkbox"/> Claims renumbered in the same order as presented by applicant																<input type="checkbox"/> CPA		<input type="checkbox"/> T.D.		<input type="checkbox"/> R.1.47	
Final	Original	Final	Original	Final	Original	Final	Original	Final	Original	Final	Original	Final	Original	Final	Original						
1	27	16	43																		
2	28	17	44																		
3	29		45																		
4	30		46																		
5	31	18	47																		
6	32	19	48																		
7	33	21	49																		
	34	23	50																		
	35	25	51																		
8	36	27	52																		
9	37	10	53																		
11	38	20	54																		
12	39	22	55																		
13	40	24	56																		
14	41	26	57																		
15	42	28	58																		

NONE		Total Claims Allowed:	
(Assistant Examiner)	(Date)	28	
/DIANE LO/ Primary Examiner, Art Unit 2466	07/25/2016	O.G. Print Claim(s)	O.G. Print Figure
(Primary Examiner)	(Date)	27	2

EAST Search History

EAST Search History (Interference)

Ref #	Hits	Search Query	DBs	Default Operator	Plurals	Time Stamp
L3	1	((fall-back or fallback) with (MCS or modulation) NEAR3 second).clm.	US-PGPUB; USPAT	ADJ	ON	2016/07/25 13:15
L4	8	((fall-back or fallback) with (MCS or modulation) with (table or second or first)).clm.	US-PGPUB; USPAT	ADJ	ON	2016/07/25 13:16
L5	1	((fall-back or fallback) with (MCS or modulation) AND CQI).clm.	US-PGPUB; USPAT	ADJ	ON	2016/07/25 13:34
L6	3	((fall-back or fallback) AND (MCS or modulation) AND CQI).clm.	US-PGPUB; USPAT	ADJ	ON	2016/07/25 13:39
S30	1	((fall-back or fallback) with (MCS or modulation order)).clm.	US-PGPUB; USPAT	ADJ	ON	2016/07/21 15:18
S31	8	((fall-back or fallback) with (CQI or MCS or modulation order)).clm.	US-PGPUB; USPAT	ADJ	ON	2016/07/21 15:19
S33	1	"20040003069"	US-PGPUB; USPAT	ADJ	ON	2016/07/21 18:57

7/25/2016 1:40:33 PM

C:\Users\dlo1\Documents\EAST\Workspaces\14390904.wsp

Index of Claims 	Application/Control No. 14390904	Applicant(s)/Patent Under Reexamination HAMMARWALL ET AL.
	Examiner DIANE LO	Art Unit 2466

✓	Rejected	-	Cancelled	N	Non-Elected	A	Appeal
=	Allowed	+	Restricted	I	Interference	O	Objected

Claims renumbered in the same order as presented by applicant
 CPA
 T.D.
 R.1.47

CLAIM		DATE							
Final	Original	02/28/2016	07/25/2016						
1	27	✓	=						
2	28	✓	=						
3	29	✓	=						
4	30	✓	=						
5	31	✓	=						
6	32	✓	=						
7	33	✓	=						
	34	✓	-						
	35	✓	-						
8	36	✓	=						
9	37	✓	=						
11	38	✓	=						
12	39	✓	=						
13	40	✓	=						
14	41	✓	=						
15	42	✓	=						
16	43	✓	=						
17	44	✓	=						
	45	✓	-						
	46	✓	-						
18	47	✓	=						
19	48	✓	=						
21	49	✓	=						
23	50	✓	=						
25	51	✓	=						
27	52	✓	=						
10	53		=						
20	54		=						
22	55		=						
24	56		=						
26	57		=						
28	58		=						

Application Ser. No. 14/390,904
Attorney Docket No. 4015-8999
Client Docket No. P41223-US2

IN THE UNITED STATES PATENT AND TRADEMARK OFFICE

In re Application of Hammarwall et al.)	
Serial No.: 14/390,904)	
Filed: October 6, 2014)	Examiner: Diane Lee Lo
For: Method and Radio Node for Enabling Use)	Group Art Unit: 2466
of High Order Modulation in a Radio)	Confirmation No.: 7239
Communication with a User Equipment)	
Docket No: 4015-8999)	

Mail Stop Amendment
Commissioner for Patents
P.O. Box 1450
Alexandria, VA 22313-1450

AMENDMENT AND RESPONSE TO OFFICE ACTION

This paper is being filed in response to the Office Action mailed March 1, 2016 having a reply due date of July 1, 2016 by virtue of the one-month extension of time requested and paid concurrent with the present filing. Reconsideration is respectfully requested in light of the amendments and/or remarks below. The Office is hereby authorized to charge any fees required for entry of this paper to Deposit Account 18-1167.

CLAIM AMENDMENTS

1-26. (Canceled)

27. (Currently Amended) A method performed by a radio node of a cellular network, the radio node being operable to apply a first table configuration in radio communications with User Equipments (UEs), the first table configuration comprising at least one of a first Modulation and Coding Scheme (MCS) table and a first Channel Quality Indicator (CQI) table, wherein the at least one of the first MCS table and the first CQI table support a certain maximum modulation order, the method comprising:

detecting that a higher modulation order, which is higher than the maximum modulation order of the first table configuration, is potentially possible to use in a radio communication between the radio node and a first UE; and
instructing the first UE to apply a second table configuration in the radio communication, the second table configuration comprising at least one of a second MCS table and a second CQI table; table.

wherein the at least one of the second MCS table and the second CQI table support the higher modulation order; order.

wherein at least one entry for at least one modulation order in the at least one of the first MCS table and the first CQI table is maintained in the at least one of the second MCS table and the second CQI table as a fallback in case it is desirable to use the at least one modulation order in the at least one of the first MCS table and the first CQI table when the second table configuration is applied; and

wherein the at least one modulation order in the at least one of the first MCS table and the first CQI table comprises a lowest modulation order of the first table configuration, and

wherein the first entry for the lowest modulation order in the first MCS table is maintained in the second MCS table as the fallback, and an entry for the lowest coding rate of the lowest modulation order in the first CQI table is maintained in the second CQI table as the fallback.

28. (Previously Presented) The method of claim 27, wherein the radio node instructs the first UE to apply the second table configuration in the radio communication between the radio node and the first UE when a performance related parameter of signals communicated between the radio node and the first UE is above a threshold.
29. (Previously Presented) The method of claim 28, wherein the performance related parameter comprises a Signal to Interference and Noise Ratio.
30. (Previously Presented) The method of claim 28, wherein the radio node instructs a second UE to apply the first table configuration in a radio communication between the radio node and the second UE when the performance related parameter of signals communicated between the radio node and the second UE is below the threshold.
31. (Previously Presented) The method of claim 30, wherein the radio node instructs the second UE by sending an instruction to the second UE to apply the first table configuration, or by not sending an instruction to the second UE to apply the second table configuration.
32. (Previously Presented) The method of claim 27, wherein the at least one of the second MCS table and the second CQI table is a modification of the at least one of the first MCS table and the first CQI table, respectively, where a set of entries have been added for the

higher modulation order and a set of entries for the at least one modulation order in the at least one of the first MCS table and the first CQI table have been removed.

33. (Previously Presented) The method of claim 32, wherein the number of added entries for the higher modulation order and the number of removed entries for the at least one modulation order in the at least one of the first MCS table and the first CQI table are equal such that the first and second MCS tables are of equal size and/or the first and second CQI tables are of equal size.
34. (Canceled).
35. (Canceled).
36. (Previously Presented) The method of claim 27, wherein the at least one of the second MCS table and the second CQI table is a modification of the at least one of the first MCS table and the first CQI table, respectively, where all entries of the at least one of the first MCS table and the first CQI table have been maintained in the at least one of the second MCS table and the second CQI table and a set of entries for the higher modulation order have been added.
37. (Previously Presented) The method of claim 27, wherein the first and second table configurations further comprise a Transport Block Size table corresponding to the first and second MCS tables, respectively.
38. (Currently Amended) A radio node of a cellular network, the radio node being operable to apply a first table configuration in radio communications with User Equipments (UEs), the first table configuration comprising at least one of a first Modulation and Coding Scheme (MCS) table and a first Channel Quality Indicator (CQI) table, wherein the at

least one of the first MCS table and the first CQI table support a certain maximum modulation order, the radio node comprising:

one or more processing circuits configured to function as:

a logic circuit configured to detect that a higher modulation order, which is higher than the maximum modulation order of the first table configuration, is potentially possible to use in a radio communication between the radio node and a first UE;

an instructing circuit configured to instruct the first UE to apply a second table configuration in the radio communication, the second table configuration comprising at least one of a second MCS table and a second CQI table;

wherein the at least one of the second MCS table and the second CQI table support the higher modulation ~~order;~~ order.

wherein at least one entry for at least one modulation order in the at least one of the first MCS table and the first CQI table is maintained in the at least one of the second MCS table and the second CQI table as a fallback in case it is desirable to use the at least one modulation order in the at least one of the first MCS table and the first CQI table when the second table configuration is applied,

wherein the at least one modulation order in the at least one of the first MCS table and the first CQI table comprises a lowest modulation order of the first table configuration, and

wherein the first entry for the lowest modulation order in the first MCS table is maintained in the second MCS table as the fallback, and an entry for the lowest coding rate of the lowest modulation order in the first CQI table is maintained in the second CQI table as the fallback.

39. (Previously Presented) The radio node of claim 38, wherein the radio node is configured to instruct the first UE to apply the second table configuration in the radio communication between the radio node and the first UE when a performance related parameter of signals communicated between the radio node and the first UE is above a threshold.
40. (Previously Presented) The radio node of claim 39, wherein the performance related parameter comprises a Signal to Interference and Noise Ratio.
41. (Previously Presented) The radio node of claim 39, wherein the radio node is configured to instruct a second UE to apply the first table configuration in a radio communication between the radio node and the second UE when the performance related parameter of signals communicated between the radio node and the second UE is below the threshold.
42. (Previously Presented) The radio node of claim 41, wherein the radio node is configured to instruct the second UE by sending an instruction to the second UE to apply the first table configuration, or by not sending an instruction to the second UE to apply the second table configuration.
43. (Previously Presented) The radio node of claim 38, wherein the at least one of the second MCS table and the second CQI table is a modification of the at least one of the first MCS table and the first CQI table, respectively, where a set of entries have been added for the higher modulation order and a set of entries for the at least one modulation order in the at least one of the first MCS table and the first CQI table have been removed.

44. (Previously Presented) The radio node of claim 43, wherein the number of added entries for the higher modulation order and the number of removed entries for the at least one modulation order in the at least one of the first MCS table and the first CQI table are equal such that the first and second MCS tables are of equal size and/or the first and second CQI tables are of equal size.
45. (Canceled)
46. (Canceled)
47. (Previously Presented) The radio node of claim 38, wherein the at least one of the second MCS table and the second CQI table is a modification of the at least one of the first MCS table and the first CQI table, respectively, where all entries of the at least one of the first MCS table and the first CQI table have been maintained in the at least one of the second MCS table and the second CQI table and a set of entries for the higher modulation order have been added.
48. (Previously Presented) The radio node of claim 38, wherein the first and second table configurations further comprise a Transport Block Size table corresponding to the first and second MCS tables, respectively.
49. (Currently Amended) A method performed by a User Equipment (UE), the UE being operable to apply a first table configuration in a radio communication with a radio node of a cellular network, the first table configuration comprising at least one of a first Modulation and Coding Scheme (MCS) table and a first Channel Quality Indicator (CQI) table, wherein the at least one of the first MCS table and the first CQI table support a certain maximum modulation order, the method comprising:

receiving an instruction from the radio node to apply a second table configuration in the radio communication, the second table configuration comprising at least one of a second MCS table and a second CQI table, wherein the at least one of the second MCS table and the second CQI table support a higher modulation order which is higher than the maximum modulation order of the first table configuration;

applying the second table configuration in the radio communication with the radio node,

wherein at least one entry for at least one modulation order in the at least one of the first MCS table and the first CQI table is maintained in the at least one of the second MCS table and the second CQI table as a fallback in case it is desirable to use the at least one modulation order in the at least one of the first MCS table and the first CQI table when the second table configuration is applied,

wherein the at least one modulation order in the at least one of the first MCS table and the first CQI table comprises a lowest modulation order of the first table configuration, and

wherein the first entry for the lowest modulation order in the first MCS table is maintained in the second MCS table as the fallback, and an entry for the lowest coding rate of the lowest modulation order in the first CQI table is maintained in the second CQI table as the fallback.

50. (Currently Amended) A User Equipment (UE), the UE being operable to apply a first table configuration in a radio communication with a radio node of a cellular network, the first table configuration comprising at least one of a first Modulation and Coding Scheme

(MCS) table and a first Channel Quality Indicator (CQI) table, wherein the at least one of the first MCS table and the first CQI table support a certain maximum modulation order, the UE comprising:

one or more processing circuits configured to function as:

a communication circuit configured to receive an instruction from the radio node to apply a second table configuration in the radio communication, the second table configuration comprising at least one of a second MCS table and a second CQI table, wherein the at least one of the second MCS table and the second CQI table support a higher modulation order which is higher than the maximum modulation order of the first table configuration; and

a logic circuit configured to apply the second table configuration in the radio communication with the radio node,

wherein at least one entry for at least one modulation order in the at least one of the first MCS table and the first CQI table is maintained in the at least one of the second MCS table and the second CQI table as a fallback in case it is desirable to use the at least one modulation order in the at least one of the first MCS table and the first CQI table when the second table configuration is applied,

wherein the at least one modulation order in the at least one of the first MCS table and the first CQI table comprises a lowest modulation order of the first table configuration, and

wherein the first entry for the lowest modulation order in the first MCS table is maintained in the second MCS table as the fallback, and an entry for the

lowest coding rate of the lowest modulation order in the first CQI table is maintained in the second CQI table as the fallback.

51. (Currently Amended) A computer program product stored in a non-transitory computer readable medium for controlling a radio node of a cellular network, the radio node being operable to apply a first table configuration in radio communications with User Equipments (UEs), the first table configuration comprising at least one of a first Modulation and Coding Scheme (MCS) table and a first Channel Quality Indicator (CQI) table, wherein the at least one of the first MCS table and the first CQI table support a certain maximum modulation order, the computer program product comprising software instructions which, when run on one or more processing circuits of the radio node, causes the radio node to:
- detect that a higher modulation order, which is higher than the maximum modulation order of the first table configuration, is potentially possible to use in a radio communication between the radio node and a first UE; and
 - instruct the first UE to apply a second table configuration in the radio communication, the second table configuration comprising at least one of a second MCS table and a second CQI table; table,
 - wherein the at least one of the second MCS table and the second CQI table support the higher modulation order; order,
 - wherein at least one entry for at least one modulation order in the at least one of the first MCS table and the first CQI table is maintained in the at least one of the second MCS table and the second CQI table as a fallback in case it is desirable to use the at least one modulation order in the at least one of the first MCS table and the first CQI table when the second table configuration is applied,

wherein the at least one modulation order in the at least one of the first MCS table
and the first CQI table comprises a lowest modulation order of the first table
configuration, and
wherein the first entry for the lowest modulation order in the first MCS table is
maintained in the second MCS table as the fallback, and an entry for the lowest
coding rate of the lowest modulation order in the first CQI table is maintained in
the second CQI table as the fallback.

52. (Currently Amended) A computer program product stored in a non-transitory computer readable medium for controlling a User Equipment (UE), the UE being operable to apply a first table configuration in a radio communication with a radio node of a cellular network, the first table configuration comprising at least one of a first Modulation and Coding Scheme (MCS) table and a first Channel Quality Indicator (CQI) table, wherein the at least one of the first MCS table and the first CQI table support a certain maximum modulation order, the computer program product comprising software instructions which, when run on one or more processing circuits of the UE, causes the UE to:
- receive an instruction from the radio node to apply a second table configuration in the radio communication, the second table configuration comprising at least one of a second MCS table and a second CQI table, wherein the at least one of the second MCS table and the second CQI table support a higher modulation order which is higher than the maximum modulation order of the first table configuration; and
 - apply the second table configuration in the radio communication with the radio node,

wherein at least one entry for at least one modulation order in the at least one of the first MCS table and the first CQI table is maintained in the at least one of the second MCS table and the second CQI table as a fallback in case it is desirable to use the at least one modulation order in the at least one of the first MCS table and the first CQI table when the second table configuration is applied,
wherein the at least one modulation order in the at least one of the first MCS table and the first CQI table comprises a lowest modulation order of the first table configuration, and
wherein the first entry for the lowest modulation order in the first MCS table is maintained in the second MCS table as the fallback, and an entry for the lowest coding rate of the lowest modulation order in the first CQI table is maintained in the second CQI table as the fallback,

53. (New) The method of claim 1, wherein selecting the fallback for a transmission indicates use of the first table configuration for a next transmission.
54. (New) The radio node of claim 38, wherein selecting the fallback for a transmission indicates use of the first table configuration for a next transmission.
55. (New) The method of claim 49, wherein selecting the fallback for a transmission indicates use of the first table configuration for a next transmission.
56. (New) The UE of claim 50, wherein selecting the fallback for a transmission indicates use of the first table configuration for a next transmission.

57. (New) The computer program product of claim 51, wherein selecting the fallback for a transmission indicates use of the first table configuration for a next transmission.

58. (New) The computer program product of claim 52, wherein selecting the fallback for a transmission indicates use of the first table configuration for a next transmission.

REMARKS

Claims Amendments

Independent claims 27, 38, and 49-52 have been amended to further define that an entry for the lowest modulation order in the first modulation and coding scheme (MCS) table is maintained in the second MCS table as the fallback, and an entry for the lowest coding rate of the lowest modulation order in the first channel quality index (CQI) table is maintained in the second CQI table as the fallback. New claims 53-58 are added. Support for the amendments and the new claims can be found at least in paragraphs [0042] and [0096] of the application publication and in original claims 34, 35, 45, and 46, which have been canceled. No new matter is added.

The claimed invention relates to techniques for supporting higher-order modulation (*e.g.*, higher than 64QAM) by selecting, at a UE or a base station, a first table configuration having lower-order MCS and CQI tables or a second table configuration having higher-order MCS and CQI tables for communication between the UE and base station. For instance, if the UE or base station determines that a higher-order modulation scheme than those in the first table configuration may potentially be utilized, the second table configuration can be selected. Furthermore, the MCS and CQI tables of the second table configuration may contain an entry corresponding to the lowest modulation order supported by the first table configuration. This entry serves as a fallback position that may save the radio link in the event of rapidly degrading channel conditions that are unable to support communication using the higher-order modulation techniques.

Rejection Under 35 U.S.C. § 102(a)(2)

The Non-Final Office action rejects each of the previously pending claims as anticipated by Marinier et al. (US 2015/0358111). The Applicant respectfully submits that Marinier fails to disclose each and every aspect of the presently pending claims, as amended.

Marinier discloses methods for implementing higher order modulation techniques in wireless communication by providing multiple modulation and coding scheme (MCS) tables and channel quality index (CQI) tables, each of which may be utilized under different conditions (see Marinier, [0072]-[0074]). In a particular embodiment, Marinier discloses that a UE or base

station determines whether to use a first table governing lower-order modulation techniques or a second table governing higher-order modulation techniques (see *Marinier*, [0072]).

Furthermore, *Marinier* teaches that the second table can contain one or more entries related to the lower-order modulation techniques in addition to entries related to the higher-order modulation techniques (see *Marinier*, [0072]).

Marinier does not disclose, however, that the one or more lower-order modulation entries in the second table contain at least the lowest modulation order supported by the first table for fallback purposes. Each of the presently pending independent claims has been amended to include this aspect. As such, *Marinier* fails to disclose each and every aspect of the amended independent claims. For this reason, the Applicant respectfully submits that the presently pending independent claims are in condition for allowance. Furthermore, each of the presently pending dependent claims depends upon one of these allowable independent claims, and is therefore likewise allowable.

Thus, for the above reasons, the Applicant respectfully submits that the presently pending claims, as amended, are in condition for allowance and requests the Examiner to issue a Notice of Allowance accordingly.

Respectfully submitted,
COATS & BENNETT, P.L.L.C.

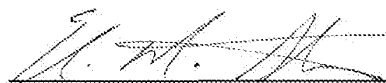

Eli M. Sheets
Registration No.: 68,958
Telephone: (919) 719-4830

Dated: July 1, 2016

Electronic Patent Application Fee Transmittal

Application Number:	14390904				
Filing Date:	06-Oct-2014				
Title of Invention:	Method and Radio Node for Enabling Use of High Order Modulation in a Radio Communication with a User Equipment				
First Named Inventor/Applicant Name:	David Hammarwall				
Filer:	Eli Sheets/Leslie Ruckdeschel				
Attorney Docket Number:	4015-8999 / P41223-US2				
Filed as Large Entity					
Filing Fees for U.S. National Stage under 35 USC 371					
Description	Fee Code	Quantity	Amount	Sub-Total in USD(\$)	
Basic Filing:					
Pages:					
Claims:					
Claims in excess of 20	1615	2	80	160	
Miscellaneous-Filing:					
Petition:					
Patent-Appeals-and-Interference:					
Post-Allowance-and-Post-Issuance:					

Description	Fee Code	Quantity	Amount	Sub-Total in USD(\$)
Extension-of-Time:				
Extension - 1 month with \$0 paid	1251	1	200	200
Miscellaneous:				
Total in USD (\$)				360

Electronic Acknowledgement Receipt

EFS ID:	26239012
Application Number:	14390904
International Application Number:	
Confirmation Number:	7239
Title of Invention:	Method and Radio Node for Enabling Use of High Order Modulation in a Radio Communication with a User Equipment
First Named Inventor/Applicant Name:	David Hammarwall
Customer Number:	24112
Filer:	Eli Sheets/Leslie Ruckdeschel
Filer Authorized By:	Eli Sheets
Attorney Docket Number:	4015-8999 / P41223-US2
Receipt Date:	01-JUL-2016
Filing Date:	06-OCT-2014
Time Stamp:	12:36:11
Application Type:	U.S. National Stage under 35 USC 371

Payment information:

Submitted with Payment	yes
Payment Type	EFT
Payment was successfully received in RAM	\$360
RAM confirmation Number	070116INTEFSW12371100
Deposit Account	null
Authorized User	Leslie Ruckdeschel

The Director of the USPTO is hereby authorized to charge indicated fees and credit any overpayment as follows:

IPR2022-00457

File Listing:					
Document Number	Document Description	File Name	File Size(Bytes)/ Message Digest	Multi Part /.zip	Pages (if appl.)
1		Response_OA.pdf	4091889	yes	15
			ee8cbae5fe8a0287065c9dc5c3e6b70cd787629b		
Multipart Description/PDF files in .zip description					
Document Description			Start	End	
Amendment/Req. Reconsideration-After Non-Final Reject			1	1	
Claims			2	13	
Applicant Arguments/Remarks Made in an Amendment			14	15	
Warnings:					
Information:					
2	Fee Worksheet (SB06)	fee-info.pdf	32540	no	2
			f974f9fa98673b073b734dd58c2f10887bca5b47		
Warnings:					
Information:					
Total Files Size (in bytes):			4124429		

This Acknowledgement Receipt evidences receipt on the noted date by the USPTO of the indicated documents, characterized by the applicant, and including page counts, where applicable. It serves as evidence of receipt similar to a Post Card, as described in MPEP 503.

New Applications Under 35 U.S.C. 111

If a new application is being filed and the application includes the necessary components for a filing date (see 37 CFR 1.53(b)-(d) and MPEP 506), a Filing Receipt (37 CFR 1.54) will be issued in due course and the date shown on this Acknowledgement Receipt will establish the filing date of the application.

National Stage of an International Application under 35 U.S.C. 371

If a timely submission to enter the national stage of an international application is compliant with the conditions of 35 U.S.C. 371 and other applicable requirements a Form PCT/DO/EO/903 indicating acceptance of the application as a national stage submission under 35 U.S.C. 371 will be issued in addition to the Filing Receipt, in due course.

New International Application Filed with the USPTO as a Receiving Office

If a new international application is being filed and the international application includes the necessary components for an international filing date (see PCT Article 11 and MPEP 1810), a Notification of the International Application Number and of the International Filing Date (Form PCT/RO/105) will be issued in due course, subject to prescriptions concerning national security, and the date shown on this Acknowledgement Receipt will establish the international filing date of the application.

Under the Paperwork Reduction Act of 1995, no persons are required to respond to a collection of information unless it displays a valid OMB control number.

PATENT APPLICATION FEE DETERMINATION RECORD Substitute for Form PTO-875	Application or Docket Number 14/390,904	Filing Date 10/06/2014	<input type="checkbox"/> To be Mailed
---	---	----------------------------------	---------------------------------------

ENTITY: LARGE SMALL MICRO

APPLICATION AS FILED – PART I

FOR	NUMBER FILED ¹	NUMBER EXTRA	RATE (\$)	FEE (\$)
<input type="checkbox"/> BASIC FEE (37 CFR 1.16(a), (b), or (c))	N/A	N/A	N/A	
<input type="checkbox"/> SEARCH FEE (37 CFR 1.16(k), (l), or (m))	N/A	N/A	N/A	
<input type="checkbox"/> EXAMINATION FEE (37 CFR 1.16(e), (f), or (g))	N/A	N/A	N/A	
TOTAL CLAIMS (37 CFR 1.16(i))	minus 20 =	*	X \$ =	
INDEPENDENT CLAIMS (37 CFR 1.16(h))	minus 3 =	*	X \$ =	
<input type="checkbox"/> APPLICATION SIZE FEE (37 CFR 1.16(s))	If the specification and drawings exceed 100 sheets of paper, the application size fee due is \$310 (\$155 for small entity) for each additional 50 sheets or fraction thereof. See 35 U.S.C. 41(a)(1)(G) and 37 CFR 1.16(s).			
<input type="checkbox"/> MULTIPLE DEPENDENT CLAIM PRESENT (37 CFR 1.16(j))				
* If the difference in column 1 is less than zero, enter "0" in column 2.			TOTAL	

APPLICATION AS AMENDED – PART II

	(Column 1)	(Column 2)	(Column 3)	(Column 4)	RATE (\$)	ADDITIONAL FEE (\$)
AMENDMENT	07/01/2016	CLAIMS REMAINING AFTER AMENDMENT	HIGHEST NUMBER PREVIOUSLY PAID FOR	PRESENT EXTRA		
	Total (37 CFR 1.16(i))	* 28	Minus ** 26	= 2	X \$80 =	160
	Independent (37 CFR 1.16(h))	* 6	Minus *** 6	= 0	X \$420 =	0
	<input type="checkbox"/> Application Size Fee (37 CFR 1.16(s))					
<input type="checkbox"/> FIRST PRESENTATION OF MULTIPLE DEPENDENT CLAIM (37 CFR 1.16(j))						
					TOTAL ADD'L FEE	160

	(Column 1)	(Column 2)	(Column 3)	(Column 4)	RATE (\$)	ADDITIONAL FEE (\$)
AMENDMENT		CLAIMS REMAINING AFTER AMENDMENT	HIGHEST NUMBER PREVIOUSLY PAID FOR	PRESENT EXTRA		
	Total (37 CFR 1.16(i))	*	Minus **	=	X \$ =	
	Independent (37 CFR 1.16(h))	*	Minus ***	=	X \$ =	
	<input type="checkbox"/> Application Size Fee (37 CFR 1.16(s))					
<input type="checkbox"/> FIRST PRESENTATION OF MULTIPLE DEPENDENT CLAIM (37 CFR 1.16(j))						
					TOTAL ADD'L FEE	

* If the entry in column 1 is less than the entry in column 2, write "0" in column 3.
 ** If the "Highest Number Previously Paid For" IN THIS SPACE is less than 20, enter "20".
 *** If the "Highest Number Previously Paid For" IN THIS SPACE is less than 3, enter "3".

The "Highest Number Previously Paid For" (Total or Independent) is the highest number found in the appropriate box in column 1.

LIE
/TARA WASHINGTON/

This collection of information is required by 37 CFR 1.16. The information is required to obtain or retain a benefit by the public which is to file (and by the USPTO to process) an application. Confidentiality is governed by 35 U.S.C. 122 and 37 CFR 1.14. This collection is estimated to take 12 minutes to complete, including gathering, preparing, and submitting the completed application form to the USPTO. Time will vary depending upon the individual case. Any comments on the amount of time you require to complete this form and/or suggestions for reducing this burden, should be sent to the Chief Information Officer, U.S. Patent and Trademark Office, U.S. Department of Commerce, P.O. Box 1450, Alexandria, VA 22313-1450. DO NOT SEND FEES OR COMPLETED FORMS TO THIS ADDRESS. **SEND TO: Commissioner for Patents, P.O. Box 1450, Alexandria, VA 22313-1450.**

If you need assistance in completing the form, call 1-800-PTO-9199 and select option 2.



UNITED STATES PATENT AND TRADEMARK OFFICE

UNITED STATES DEPARTMENT OF COMMERCE
United States Patent and Trademark Office
Address: COMMISSIONER FOR PATENTS
P. O. Box 1450
Alexandria, Virginia 22313-1450
www.uspto.gov

Table with columns: APPLICATION NO., FILING DATE, FIRST NAMED INVENTOR, ATTORNEY DOCKET NO., CONFIRMATION NO.
Row 1: 14/390,904, 10/06/2014, David Hammarwall, 4015-8999 / P41223-US2, 7239
Row 2: 24112, 7590, 03/01/2016, COATS & BENNETT, PLLC, 1400 Crescent Green, Suite 300, Cary, NC 27518
Row 3: EXAMINER, L.O, DIANE LEE
Row 4: ART UNIT, PAPER NUMBER, 2466
Row 5: MAIL DATE, DELIVERY MODE, 03/01/2016, PAPER

Please find below and/or attached an Office communication concerning this application or proceeding.

The time period for reply, if any, is set in the attached communication.

Office Action Summary	Application No. 14/390,904	Applicant(s) HAMMARWALL ET AL.	
	Examiner DIANE LO	Art Unit 2466	AIA (First Inventor to File) Status Yes

-- The MAILING DATE of this communication appears on the cover sheet with the correspondence address --

Period for Reply

A SHORTENED STATUTORY PERIOD FOR REPLY IS SET TO EXPIRE 3 MONTHS FROM THE MAILING DATE OF THIS COMMUNICATION.

- Extensions of time may be available under the provisions of 37 CFR 1.136(a). In no event, however, may a reply be timely filed after SIX (6) MONTHS from the mailing date of this communication.
- If NO period for reply is specified above, the maximum statutory period will apply and will expire SIX (6) MONTHS from the mailing date of this communication.
- Failure to reply within the set or extended period for reply will, by statute, cause the application to become ABANDONED (35 U.S.C. § 133). Any reply received by the Office later than three months after the mailing date of this communication, even if timely filed, may reduce any earned patent term adjustment. See 37 CFR 1.704(b).

Status

- 1) Responsive to communication(s) filed on 10/06/2014.
 A declaration(s)/affidavit(s) under **37 CFR 1.130(b)** was/were filed on _____.
- 2a) This action is **FINAL**. 2b) This action is non-final.
- 3) An election was made by the applicant in response to a restriction requirement set forth during the interview on _____; the restriction requirement and election have been incorporated into this action.
- 4) Since this application is in condition for allowance except for formal matters, prosecution as to the merits is closed in accordance with the practice under *Ex parte Quayle*, 1935 C.D. 11, 453 O.G. 213.

Disposition of Claims*

- 5) Claim(s) 27-52 is/are pending in the application.
5a) Of the above claim(s) _____ is/are withdrawn from consideration.
- 6) Claim(s) _____ is/are allowed.
- 7) Claim(s) 27-52 is/are rejected.
- 8) Claim(s) _____ is/are objected to.
- 9) Claim(s) _____ are subject to restriction and/or election requirement.

* If any claims have been determined allowable, you may be eligible to benefit from the **Patent Prosecution Highway** program at a participating intellectual property office for the corresponding application. For more information, please see http://www.uspto.gov/patents/init_events/pph/index.jsp or send an inquiry to PPHfeedback@uspto.gov.

Application Papers

- 10) The specification is objected to by the Examiner.
- 11) The drawing(s) filed on 10/06/2014 is/are: a) accepted or b) objected to by the Examiner.
Applicant may not request that any objection to the drawing(s) be held in abeyance. See 37 CFR 1.85(a).
Replacement drawing sheet(s) including the correction is required if the drawing(s) is objected to. See 37 CFR 1.121(d).

Priority under 35 U.S.C. § 119

- 12) Acknowledgment is made of a claim for foreign priority under 35 U.S.C. § 119(a)-(d) or (f).

Certified copies:

- a) All b) Some** c) None of the:
1. Certified copies of the priority documents have been received.
2. Certified copies of the priority documents have been received in Application No. _____.
3. Copies of the certified copies of the priority documents have been received in this National Stage application from the International Bureau (PCT Rule 17.2(a)).

** See the attached detailed Office action for a list of the certified copies not received.

Attachment(s)

- 1) Notice of References Cited (PTO-892)
- 2) Information Disclosure Statement(s) (PTO/SB/08a and/or PTO/SB/08b)
Paper No(s)/Mail Date _____
- 3) Interview Summary (PTO-413)
Paper No(s)/Mail Date. _____
- 4) Other: _____

DETAILED ACTION

This is response to Application 14/390,904 filed on 10/06/2014 in which claims 27-52 are presented for examination.

Claim Rejections - 35 USC § 102

1. In the event the determination of the status of the application as subject to AIA 35 U.S.C. 102 and 103 (or as subject to pre-AIA 35 U.S.C. 102 and 103) is incorrect, any correction of the statutory basis for the rejection will not be considered a new ground of rejection if the prior art relied upon, and the rationale supporting the rejection, would be the same under either status.

2. The following is a quotation of the appropriate paragraphs of 35 U.S.C. 102 that form the basis for the rejections under this section made in this Office action:

A person shall be entitled to a patent unless –

(a)(2) the claimed invention was described in a patent issued under section 151, or in an application for patent published or deemed published under section 122(b), in which the patent or application, as the case may be, names another inventor and was effectively filed before the effective filing date of the claimed invention.

3. Claims 27-52 are rejected under 35 U.S.C. 102(a)(2) as being anticipated by Marinier et al. (US 2015/0358111 A1).

4. **Regarding claim 27**, Marinier teaches a method performed by a radio node of a cellular network, the radio node being operable to apply a first table configuration in radio communications with User Equipments (UEs), the first table configuration comprising at least one of a first Modulation and Coding Scheme (MCS) table and a first Channel Quality Indicator (CQI) table, wherein the at least one of the first MCS table and the first CQI table support a certain maximum modulation order (Figure 1A, *Paragraphs [0014], [0059] to [0062], and [0072] multiple MCS tables, TBS tables and CQI tables to support higher or modulation*), the method comprising:

detecting that a higher modulation order, which is higher than the maximum modulation order of the first table configuration, is potentially possible to use in a radio communication between the radio node and a first UE (*Paragraph [0003] and [0062] multiple MCS tables; first table valid to 64 QAM/maximum modulation order of the first table; second table valid up to 256 QAM*);

instructing the first UE to apply a second table configuration in the radio communication, the second table configuration comprising at least one of a second MCS table and a second CQI table (*Paragraph [0014] and [0059] UE uses multiple MCS and CQI tables to support higher modulation; CQI table used based on MCS indicated by network in DCI or higher layer signaling*);

wherein the at least one of the second MCS table and the second CQI table support the higher modulation order (*Paragraph [0072] multiple CQI tables to allow for higher order modulation*);

wherein at least one entry for at least one modulation order in the at least one of the first MCS table and the first CQI table is maintained in the at least one of the second MCS table and the second CQI table as a fallback in case it is desirable to use the at least one modulation order in the at least one of the first MCS table and the first CQI table when the second table configuration is applied (*Paragraph [0062] and [0072] second tables for MCS and CQI include orders or values of first set*).

5. **Regarding claim 38**, Marinier teaches a radio node of a cellular network (*Figure 1A and 1B*), the radio node being operable to apply a first table configuration in radio communications with User Equipments (UEs), the first table configuration comprising at least one of a first Modulation and Coding Scheme (MCS) table and a first Channel Quality Indicator (CQI) table, wherein the at least one of the first MCS table and the first CQI table support a certain maximum modulation order (*Paragraphs [0014], [0059] to [0062], and [0072] multiple MCS tables, TBS tables and CQI tables to support higher or modulation*), the radio node comprising:

one or more processing circuits (*Figure 1A and 1B*) configured to function as: a logic circuit configured to detect that a higher modulation order, which is higher than the maximum

modulation order of the first table configuration, is potentially possible to use in a radio communication between the radio node and a first UE (*Paragraph [0003] and [0062] multiple MCS tables; first table valid to 64 QAM/maximum modulation order of the first table; second table valid up to 256 QAM*);

an instructing circuit configured to instruct the first UE to apply a second table configuration in the radio communication, the second table configuration comprising at least one of a second MCS table and a second CQI table (*Paragraph [0014] and [0059] UE uses multiple MCS and CQI tables to support higher modulation; CQI table used based on MCS indicated by network in DCI or higher layer signaling*); wherein the at least one of the second MCS table and the second CQI table support the higher modulation order (*Paragraph [0072] multiple CQI tables to allow for higher order modulation*);

wherein at least one entry for at least one modulation order in the at least one of the first MCS table and the first CQI table is maintained in the at least one of the second MCS table and the second CQI table as a fallback in case it is desirable to use the at least one modulation order in the at least one of the first MCS table and the first CQI table when the second table configuration is applied (*Paragraph [0062] and [0072] second tables for MCS and CQI include orders or values of first set*).

6. **Regarding claims 28 and 39**, Marinier teaches, wherein the radio node instructs the first UE to apply the second table configuration in the radio communication between the radio node and the first UE when a performance related parameter of signals

communicated between the radio node and the first UE is above a threshold (*Paragraph [0059]-[0062] network indicates to device an MCS; a higher order modulation is provided than 64 QAM/threshold*).

7. **Regarding claims 29 and 40**, Marinier teaches wherein the performance related parameter comprises a Signal to Interference and Noise Ratio (*Paragraphs [0057], [0060], and [0061]*).

8. **Regarding claims 30 and 41**, Marinier teaches wherein the radio node instructs a second UE to apply the first table configuration in a radio communication between the radio node and the second UE when the performance related parameter of signals communicated between the radio node and the second UE is below the threshold (*Paragraph [0057]-[0062] network indicates to device an MCS*).

9. **Regarding claims 31 and 42**, Marinier teaches wherein the radio node instructs the second UE by sending an instruction to the second UE to apply the first table configuration, or by not sending an instruction to the second UE to apply the second table configuration (*Paragraph [0057]-[0062] network indicates to device an MCS*).

10. **Regarding claims 32 and 43**, Marinier teaches wherein the at least one of the second MCS table and the second CQI table is a modification of the at least one of the first MCS table and the first CQI table, respectively, where a set of entries have been

added for the higher modulation order and a set of entries for the at least one modulation order in the at least one of the first MCS table and the first CQI table have been removed (*Paragraph [0062] and [0072] second tables for MCS and CQI include orders or values of first set*).

11. **Regarding claims 33 and 44**, Marinier teaches wherein the number of added entries for the higher modulation order and the number of removed entries for the at least one modulation order in the at least one of the first MCS table and the first CQI table are equal such that the first and second MCS tables are of equal size and/or the first and second CQI tables are of equal size (*Paragraph [0062] 32 element MCS table and 16 element CQI table*).

12. **Regarding claims 34 and 45**, Marinier teaches, wherein the at least one modulation order in the at least one of the first MCS table and the first CQI table comprises a lowest modulation order of the first table configuration (*Paragraph [0062] and [0072] second tables for MCS and CQI include orders or values of first set*).

13. **Regarding claims 35 and 46**, Marinier teaches wherein: the first entry for the lowest modulation order in the first MCS table is maintained in the second MCS table as the fallback; an entry for the lowest coding rate of the lowest modulation order in the first CQI table is maintained in the second CQI table as the fallback (*Paragraph [0062] and [0072] second tables for MCS and CQI include orders or values of first set*).

14. **Regarding claims 36 and 47**, Marinier teaches wherein the at least one of the second MCS table and the second CQI table is a modification of the at least one of the first MCS table and the first CQI table, respectively, where all entries of the at least one of the first MCS table and the first CQI table have been maintained in the at least one of the second MCS table and the second CQI table and a set of entries for the higher modulation order have been added (*Paragraph [0062] and [0072] second tables for MCS and CQI include orders or values of first set*).

15. **Regarding claims 37 and 48**, Marinier teaches wherein the first and second table configurations further comprise a Transport Block Size table corresponding to the first and second MCS tables, respectively (*paragraph [0067] TBS index obtained from MCS index*).

16. **Regarding claim 49**, Marinier teaches a method performed by a User Equipment (UE), the UE being operable to apply a first table configuration in a radio communication with a radio node of a cellular network, the first table configuration comprising at least one of a first Modulation and Coding Scheme (MCS) table and a first Channel Quality Indicator (CQI) table, wherein the at least one of the first MCS table and the first CQI table support a certain maximum modulation order (Figure 1A, *Paragraphs [0014], [0059] to [0062], and [0072] multiple MCS tables, TBS tables and CQI tables to support higher or modulation*), the method comprising:

receiving an instruction from the radio node to apply a second table configuration in the radio communication, the second table configuration comprising at least one of a second MCS table and a second CQI table, wherein the at least one of the second MCS table and the second CQI table support a higher modulation order which is higher than the maximum modulation order of the first table configuration (*Paragraph [0014] and [0059] UE uses multiple MCS and CQI tables to support higher modulation; CQI table used based on MCS indicated by network in DCI or higher layer signaling*);

applying the second table configuration in the radio communication with the radio node (Figure 1A, *Paragraphs [0014], [0059] to [0062], and [0072] multiple MCS tables, TBS tables and CQI tables to support higher or modulation*).

17. **Regarding claim 50**, Marinier teaches a User Equipment (UE), the UE being operable to apply a first table configuration in a radio communication with a radio node of a cellular network, the first table configuration comprising at least one of a first Modulation and Coding Scheme (MCS) table and a first Channel Quality Indicator (CQI) table, wherein the at least one of the first MCS table and the first CQI table support a certain maximum modulation order (Figure 1A, *Paragraphs [0014], [0059] to [0062], and [0072] multiple MCS tables, TBS tables and CQI tables to support higher or modulation*), the UE comprising:

one or more processing circuits configured to function as: a communication circuit configured to receive an instruction from the radio node to apply a second table

configuration in the radio communication, the second table configuration comprising at least one of a second MCS table and a second CQI table, wherein the at least one of the second MCS table and the second CQI table support a higher modulation order which is higher than the maximum modulation order of the first table configuration (*Paragraph [0014] and [0059] UE uses multiple MCS and CQI tables to support higher modulation; CQI table used based on MCS indicated by network in DCI or higher layer signaling*);

a logic circuit configured to apply the second table configuration in the radio communication with the radio node (Figure 1A, *Paragraphs [0014], [0059] to [0062], and [0072] multiple MCS tables, TBS tables and CQI tables to support higher or modulation*).

18. **Regarding claim 51**, Marinier teaches a computer program product stored in a non-transitory computer readable medium for controlling a radio node of a cellular network, the radio node being operable to apply a first table configuration in radio communications with User Equipments (UEs), the first table configuration comprising at least one of a first Modulation and Coding Scheme (MCS) table and a first Channel Quality Indicator (CQI) table, wherein the at least one of the first MCS table and the first CQI table support a certain maximum modulation order (Figure 1A, *Paragraphs [0014], [0059] to [0062], and [0072] multiple MCS tables, TBS tables and CQI tables to support higher or modulation*), the computer program product comprising software

instructions which, when run on one or more processing circuits of the radio node, causes the radio node to:

detect that a higher modulation order, which is higher than the maximum modulation order of the first table configuration, is potentially possible to use in a radio communication between the radio node and a first UE (*Paragraph [0003] and [0062] multiple MCS tables; first table valid to 64 QAM/maximum modulation order of the first table; second table valid up to 256 QAM*);

instruct the first UE to apply a second table configuration in the radio communication, the second table configuration comprising at least one of a second MCS table and a second CQI table (*Paragraph [0014] and [0059] UE uses multiple MCS and CQI tables to support higher modulation; CQI table used based on MCS indicated by network in DCI or higher layer signaling*);

wherein the at least one of the second MCS table and the second CQI table support the higher modulation order (*Paragraph [0072] multiple CQI tables to allow for higher order modulation*);

wherein at least one entry for at least one modulation order in the at least one of the first MCS table and the first CQI table is maintained in the at least one of the second MCS table and the second CQI table as a fallback in case it is desirable to use the at least one modulation order in the at least one of the first MCS table and the first CQI table when the second table configuration is applied (*Paragraph [0062] and [0072] second tables for MCS and CQI include orders or values of first set*).

19. **Regarding claim 52**, Marinier teaches a computer program product stored in a non-transitory computer readable medium for controlling a User Equipment (UE), the UE being operable to apply a first table configuration in a radio communication with a radio node of a cellular network, the first table configuration comprising at least one of a first Modulation and Coding Scheme (MCS) table and a first Channel Quality Indicator (CQI) table, wherein the at least one of the first MCS table and the first CQI table support a certain maximum modulation order (Figure 1A, *Paragraphs [0014], [0059] to [0062], and [0072] multiple MCS tables, TBS tables and CQI tables to support higher or modulation*), the computer program product comprising software instructions which, when run on one or more processing circuits of the UE, causes the UE to:

receive an instruction from the radio node to apply a second table configuration in the radio communication, the second table configuration comprising at least one of a second MCS table and a second CQI table, wherein the at least one of the second MCS table and the second CQI table support a higher modulation order which is higher than the maximum modulation order of the first table configuration (*Paragraph [0014] and [0059] UE uses multiple MCS and CQI tables to support higher modulation; CQI table used based on MCS indicated by network in DCI or higher layer signaling*);

apply the second table configuration in the radio communication with the radio node (*Paragraph [0014] and [0059] UE uses multiple MCS and CQI tables to support higher modulation; CQI table used based on MCS indicated by network in DCI or higher layer signaling*).

Conclusion

Any inquiry concerning this communication or earlier communications from the examiner should be directed to DIANE LO whose telephone number is (571)270-1952. The examiner can normally be reached on Monday to Friday, 8:00 am-4:30 pm EST.

If attempts to reach the examiner by telephone are unsuccessful, the examiner's supervisor, Faruk Hamza can be reached on (571)272-7969. The fax phone number for the organization where this application or proceeding is assigned is 571-273-8300.

Information regarding the status of an application may be obtained from the Patent Application Information Retrieval (PAIR) system. Status information for published applications may be obtained from either Private PAIR or Public PAIR. Status information for unpublished applications is available through Private PAIR only. For more information about the PAIR system, see <http://pair-direct.uspto.gov>. Should you have questions on access to the Private PAIR system, contact the Electronic Business Center (EBC) at 866-217-9197 (toll-free). If you would like assistance from a USPTO Customer Service Representative or access to the automated information system, call 800-786-9199 (IN USA OR CANADA) or 571-272-1000.

/DIANE LO/
Primary Examiner, Art Unit 2466

Notice of References Cited	Application/Control No. 14/390,904	Applicant(s)/Patent Under Reexamination HAMMARWALL ET AL.	
	Examiner DIANE LO	Art Unit 2466	Page 1 of 1

U.S. PATENT DOCUMENTS

*	Document Number Country Code-Number-Kind Code	Date MM-YYYY	Name	CPC Classification	US Classification
*	A US-2015/0358111 A1	12-2015	Marinier; Paul	H04L1/0003	370/329
	B US-				
	C US-				
	D US-				
	E US-				
	F US-				
	G US-				
	H US-				
	I US-				
	J US-				
	K US-				
	L US-				
	M US-				

FOREIGN PATENT DOCUMENTS

*	Document Number Country Code-Number-Kind Code	Date MM-YYYY	Country	Name	CPC Classification
	N				
	O				
	P				
	Q				
	R				
	S				
	T				

NON-PATENT DOCUMENTS

*	Document Number Country Code-Number-Kind Code	Date MM-YYYY	Country	Name	CPC Classification
	Include as applicable: Author, Title Date, Publisher, Edition or Volume, Pertinent Pages)				
	U				
	V				
	W				
	X				

*A copy of this reference is not being furnished with this Office action. (See MPEP § 707.05(a).)
Dates in MM-YYYY format are publication dates. Classifications may be US or foreign.

Search Notes 	Application/Control No. 14390904	Applicant(s)/Patent Under Reexamination HAMMARWALL ET AL.
	Examiner DIANE LO	Art Unit 2466

CPC- SEARCHED		
Symbol	Date	Examiner

CPC COMBINATION SETS - SEARCHED		
Symbol	Date	Examiner

US CLASSIFICATION SEARCHED			
Class	Subclass	Date	Examiner

SEARCH NOTES		
Search Notes	Date	Examiner
EAST search (US-PGPUB, USPAT, FPRS, EPO, JPO, DERWENT) - see search history printout	2/29/2016	DLL
Inventor and Assignee search in EAST	2/29/2016	DLL
H04L 1/all (text search only - see search history printout)	2/29/2016	DLL

INTERFERENCE SEARCH			
US Class/ CPC Symbol	US Subclass / CPC Group	Date	Examiner

--	--

Receipt date: 11/24/2014

14390904 - GAIL: 2466

Doc code: IDS

Doc description: Information Disclosure Statement (IDS) Filed

Approved for use through 07/31/2012. OMB 0651-0031
U.S. Patent and Trademark Office; U.S. DEPARTMENT OF COMMERCE

Under the Paperwork Reduction Act of 1995, no persons are required to respond to a collection of information unless it contains a valid OMB control number.

INFORMATION DISCLOSURE STATEMENT BY APPLICANT (Not for submission under 37 CFR 1.99)	Application Number	13390904
	Filing Date	2014-10-06
	First Named Inventor	Hammarwall
	Art Unit	
	Examiner Name	
	Attorney Docket Number	4015-8999 / P41223-US2

U.S. PATENTS						Remove
Examiner Initial*	Cite No	Patent Number	Kind Code ¹	Issue Date	Name of Patentee or Applicant of cited Document	Pages, Columns, Lines where Relevant Passages or Relevant Figures Appear
	1					

If you wish to add additional U.S. Patent citation information please click the Add button. Add

U.S. PATENT APPLICATION PUBLICATIONS						Remove
Examiner Initial*	Cite No	Publication Number	Kind Code ¹	Publication Date	Name of Patentee or Applicant of cited Document	Pages, Columns, Lines where Relevant Passages or Relevant Figures Appear
	1					

If you wish to add additional U.S. Published Application citation information please click the Add button. Add

FOREIGN PATENT DOCUMENTS								Remove
Examiner Initial*	Cite No	Foreign Document Number ³	Country Code ² j	Kind Code ⁴	Publication Date	Name of Patentee or Applicant of cited Document	Pages, Columns, Lines where Relevant Passages or Relevant Figures Appear	T ⁵
/D.L./	1	102624481	CN	A	2012-08-01	ZTE Corporation	Machine English Translation	<input checked="" type="checkbox"/>
/D.L./	2	2013123961	WO	A1	2013-08-29	Nokia Siemens Networks Oy		<input type="checkbox"/>
/D.L./	3	2014109915	WO	A1	2014-07-17	Qualcomm Incorporated		<input type="checkbox"/>

INFORMATION DISCLOSURE STATEMENT BY APPLICANT (Not for submission under 37 CFR 1.99)	Application Number		13390904	14390904 - GAU: 2466	
	Filing Date		2014-10-06		
	First Named Inventor	Hammarwall			
	Art Unit				
	Examiner Name				
	Attorney Docket Number		4015-8999 / P41223-US2		

If you wish to add additional Foreign Patent Document citation information please click the Add button				Add
NON-PATENT LITERATURE DOCUMENTS			Remove	
Examiner Initials*	Cite No	Include name of the author (in CAPITAL LETTERS), title of the article (when appropriate), title of the item (book, magazine, journal, serial, symposium, catalog, etc), date, pages(s), volume-issue number(s), publisher, city and/or country where published.	T ⁵	
/D.L./	1	PANASONIC, "Discussion on 256QAM for Downlink in Small Cell Deployments", 3GPP TSG-RAN WG1 Meeting 72bis, 2013-04-15, pp. 1-6, R1-131328, Chicago, US	<input type="checkbox"/>	
/D.L./	2	HUAWEI, et al., "Standard Impacts to Support Higher Order Modulation", 3GPP TSG-RAN WG1 Meeting 73, 2013-05-20, pp. 1-2, R1-131853, Fukuoka, JP	<input type="checkbox"/>	
/D.L./	3	HTC, "On Small Cell Enhancement for improved Spectral Efficiency", 3GPP TSG RAN WG1 Meeting #72, 2013-01-28, pp. 1-4, R1-130311, St. Julian's, Malta	<input type="checkbox"/>	
/D.L./	4	INTEL CORPORATION, "CQI/MCS/TBS Tables for 256QAM and Relevant Signaling", 3GPP TSG RAN WG1 Meeting #76, 2014-02-10, pp. 1-8, R1-140118, Prague, Czech Republic	<input type="checkbox"/>	
If you wish to add additional non-patent literature document citation information please click the Add button				Add
EXAMINER SIGNATURE				
Examiner Signature	/Diane Lo/		Date Considered	02/25/2016
*EXAMINER: Initial if reference considered, whether or not citation is in conformance with MPEP 609. Draw line through a citation if not in conformance and not considered. Include copy of this form with next communication to applicant.				
¹ See Kind Codes of USPTO Patent Documents at www.USPTO.GOV or MPEP 901.04. ² Enter office that issued the document, by the two-letter code (WIPO Standard ST.3). ³ For Japanese patent documents, the indication of the year of the reign of the Emperor must precede the serial number of the patent document. ⁴ Kind of document by the appropriate symbols as indicated on the document under WIPO Standard ST.16 if possible. ⁵ Applicant is to place a check mark here if English language translation is attached.				

INFORMATION DISCLOSURE STATEMENT BY APPLICANT (Not for submission under 37 CFR 1.99)	Application Number	13390904	14390904 - GAU: 2466
	Filing Date	2014-10-06	
	First Named Inventor	Hammarwall	
	Art Unit		
	Examiner Name		
	Attorney Docket Number	4015-8999 / P41223-US2	

CERTIFICATION STATEMENT

Please see 37 CFR 1.97 and 1.98 to make the appropriate selection(s):

That each item of information contained in the information disclosure statement was first cited in any communication from a foreign patent office in a counterpart foreign application not more than three months prior to the filing of the information disclosure statement. See 37 CFR 1.97(e)(1).

OR

That no item of information contained in the information disclosure statement was cited in a communication from a foreign patent office in a counterpart foreign application, and, to the knowledge of the person signing the certification after making reasonable inquiry, no item of information contained in the information disclosure statement was known to any individual designated in 37 CFR 1.56(c) more than three months prior to the filing of the information disclosure statement. See 37 CFR 1.97(e)(2).

- See attached certification statement.
- The fee set forth in 37 CFR 1.17 (p) has been submitted herewith.
- A certification statement is not submitted herewith.

SIGNATURE

A signature of the applicant or representative is required in accordance with CFR 1.33, 10.18. Please see CFR 1.4(d) for the form of the signature.

Signature	/John R. Owen Reg. No. 42055/	Date (YYYY-MM-DD)	2014-11-24
Name/Print	John R. Owen	Registration Number	42055

This collection of information is required by 37 CFR 1.97 and 1.98. The information is required to obtain or retain a benefit by the public which is to file (and by the USPTO to process) an application. Confidentiality is governed by 35 U.S.C. 122 and 37 CFR 1.14. This collection is estimated to take 1 hour to complete, including gathering, preparing and submitting the completed application form to the USPTO. Time will vary depending upon the individual case. Any comments on the amount of time you require to complete this form and/or suggestions for reducing this burden, should be sent to the Chief Information Officer, U.S. Patent and Trademark Office, U.S. Department of Commerce, P.O. Box 1450, Alexandria, VA 22313-1450. **DO NOT SEND FEES OR COMPLETED FORMS TO THIS ADDRESS. SEND TO: Commissioner for Patents, P.O. Box 1450, Alexandria, VA 22313-1450.**

Privacy Act Statement

The Privacy Act of 1974 (P.L. 93-579) requires that you be given certain information in connection with your submission of the attached form related to a patent application or patent. Accordingly, pursuant to the requirements of the Act, please be advised that: (1) the general authority for the collection of this information is 35 U.S.C. 2(b)(2); (2) furnishing of the information solicited is voluntary; and (3) the principal purpose for which the information is used by the U.S. Patent and Trademark Office is to process and/or examine your submission related to a patent application or patent. If you do not furnish the requested information, the U.S. Patent and Trademark Office may not be able to process and/or examine your submission, which may result in termination of proceedings or abandonment of the application or expiration of the patent.

The information provided by you in this form will be subject to the following routine uses:

1. The information on this form will be treated confidentially to the extent allowed under the Freedom of Information Act (5 U.S.C. 552) and the Privacy Act (5 U.S.C. 552a). Records from this system of records may be disclosed to the Department of Justice to determine whether the Freedom of Information Act requires disclosure of these records.
2. A record from this system of records may be disclosed, as a routine use, in the course of presenting evidence to a court, magistrate, or administrative tribunal, including disclosures to opposing counsel in the course of settlement negotiations.
3. A record in this system of records may be disclosed, as a routine use, to a Member of Congress submitting a request involving an individual, to whom the record pertains, when the individual has requested assistance from the Member with respect to the subject matter of the record.
4. A record in this system of records may be disclosed, as a routine use, to a contractor of the Agency having need for the information in order to perform a contract. Recipients of information shall be required to comply with the requirements of the Privacy Act of 1974, as amended, pursuant to 5 U.S.C. 552a(m).
5. A record related to an International Application filed under the Patent Cooperation Treaty in this system of records may be disclosed, as a routine use, to the International Bureau of the World Intellectual Property Organization, pursuant to the Patent Cooperation Treaty.
6. A record in this system of records may be disclosed, as a routine use, to another federal agency for purposes of National Security review (35 U.S.C. 181) and for review pursuant to the Atomic Energy Act (42 U.S.C. 218(c)).
7. A record from this system of records may be disclosed, as a routine use, to the Administrator, General Services, or his/her designee, during an inspection of records conducted by GSA as part of that agency's responsibility to recommend improvements in records management practices and programs, under authority of 44 U.S.C. 2904 and 2906. Such disclosure shall be made in accordance with the GSA regulations governing inspection of records for this purpose, and any other relevant (i.e., GSA or Commerce) directive. Such disclosure shall not be used to make determinations about individuals.
8. A record from this system of records may be disclosed, as a routine use, to the public after either publication of the application pursuant to 35 U.S.C. 122(b) or issuance of a patent pursuant to 35 U.S.C. 151. Further, a record may be disclosed, subject to the limitations of 37 CFR 1.14, as a routine use, to the public if the record was filed in an application which became abandoned or in which the proceedings were terminated and which application is referenced by either a published application, an application open to public inspections or an issued patent.
9. A record from this system of records may be disclosed, as a routine use, to a Federal, State, or local law enforcement agency, if the USPTO becomes aware of a violation or potential violation of law or regulation.

EAST Search History

EAST Search History (Prior Art)

Ref #	Hits	Search Query	DBs	Default Operator	Plurals	Time Stamp
L1	52	H04L1\$.cpc. AND (CQI with MCS with second with table)	US-PGPUB; USPAT; USOCR; FPRS; EPO; JPO; DERWENT; IBM_TDB	ADJ	ON	2016/02/29 11:53
L2	5	H04L1\$.cpc. AND (CQI with MCS with second with table).clm.	US-PGPUB; USPAT; USOCR; FPRS; EPO; JPO; DERWENT; IBM_TDB	ADJ	ON	2016/02/29 11:54
L3	18	(CQI with MCS with second with table AND TBS)	US-PGPUB; USPAT; USOCR; FPRS; EPO; JPO; DERWENT; IBM_TDB	ADJ	ON	2016/02/29 12:01
S1	2	"14390904"	US-PGPUB; USPAT; USOCR; FPRS; EPO; JPO; DERWENT; IBM_TDB	ADJ	ON	2016/02/25 12:01
S2	1	David NEAR3 Hammarwall AND (CQI with MCS with second with table).clm.	US-PGPUB; USPAT; USOCR; FPRS; EPO; JPO; DERWENT; IBM_TDB	ADJ	ON	2016/02/25 16:28
S3	1	Meng NEAR3 Wang AND (CQI with MCS with second with table).clm.	US-PGPUB; USPAT; USOCR; FPRS; EPO; JPO; DERWENT; IBM_TDB	ADJ	ON	2016/02/25 16:29
S4	0	Ericsson.as. AND (CQI with MCS with second with table).clm.	US-PGPUB; USPAT; USOCR; FPRS; EPO; JPO; DERWENT; IBM_TDB	ADJ	ON	2016/02/25 16:29
S5	6	(CQI with MCS with second with table).clm.	US-PGPUB; USPAT; USOCR; FPRS; EPO; JPO; DERWENT; IBM_TDB	ADJ	ON	2016/02/25 16:30
S6	64	(CQI with MCS with second with table)	US-PGPUB; USPAT; USOCR; FPRS; EPO; JPO; DERWENT; IBM_TDB	ADJ	ON	2016/02/25 16:42
S7	3	(CQI with MCS with second with table) AND (maintain\$3 with fallback)	US-PGPUB; USPAT; USOCR; FPRS; EPO; JPO; DERWENT; IBM_TDB	ADJ	ON	2016/02/25 16:42

IPR2022-00457

Apple EX1002 Page 73

EAST Search History

S8	3	(QOI with MCS with second with table) AND (fallback)	US-PGPUB; USPAT; USOCR; FPRS; EPO; JPO; DERWENT; IBM_TDB	ADJ	ON	2016/02/25: 22:54
S9	6	(US-20150381310-\$ or US-20150358111-\$ or US-20150016553-\$).did. or (US-9198070-\$ or US-8654745-\$ or US-8488709-\$).did.	US-PGPUB; USPAT	ADJ	ON	2016/02/29: 00:58

2/ 29/ 2016 12:02:01 PM

C:\ Users\dlo1\ Documents\ EAST\ Workspaces\ 14390904.wsp



UNITED STATES PATENT AND TRADEMARK OFFICE

UNITED STATES DEPARTMENT OF COMMERCE
 United States Patent and Trademark Office
 Address: COMMISSIONER FOR PATENTS
 P.O. Box 1450
 Alexandria, Virginia 22313-1450
 www.uspto.gov

BIB DATA SHEET

CONFIRMATION NO. 7239

SERIAL NUMBER	FILING or 371(c) DATE	CLASS	GROUP ART UNIT	ATTORNEY DOCKET NO.		
14/390,904	10/06/2014	370	2466	4015-8999 / P41223-US2		
APPLICANTS TELEFONAKTIEBOLAGET L M ERICSSON (PUBL), Stockholm, SWEDEN;						
INVENTORS David Hammarwall, Vallentuna, SWEDEN; Meng Wang, SUNDBYBERG, SWEDEN;						
** CONTINUING DATA ***** This application is a 371 of PCT/SE2014/050803 06/26/2014 which claims benefit of 61/863,935 08/09/2013						
** FOREIGN APPLICATIONS *****						
** IF REQUIRED, FOREIGN FILING LICENSE GRANTED ** 09/21/2015						
Foreign Priority claimed <input type="checkbox"/> Yes <input checked="" type="checkbox"/> No 35 USC 119(a-d) conditions met <input type="checkbox"/> Yes <input checked="" type="checkbox"/> No Verified and Acknowledged <u>/DIANE LEE LO/</u> <small>Examiner's Signature</small>		<input type="checkbox"/> Met after Allowance Initials	STATE OR COUNTRY SWEDEN	SHEETS DRAWINGS 7	TOTAL CLAIMS 26	INDEPENDENT CLAIMS 6
ADDRESS COATS & BENNETT, PLLC 1400 Crescent Green, Suite 300 Cary, NC 27518 UNITED STATES						
TITLE Method and Radio Node for Enabling Use of High Order Modulation in a Radio Communication with a User Equipment						
FILING FEE RECEIVED 3220	FEES: Authority has been given in Paper No. _____ to charge/credit DEPOSIT ACCOUNT No. _____ for following:			<input type="checkbox"/> All Fees <input type="checkbox"/> 1.16 Fees (Filing) <input type="checkbox"/> 1.17 Fees (Processing Ext. of time) <input type="checkbox"/> 1.18 Fees (Issue) <input type="checkbox"/> Other _____ <input type="checkbox"/> Credit		

Receipt date: 10/06/2014

14390904 - GAIL: 2466

Doc code: IDS

Doc description: Information Disclosure Statement (IDS) Filed

Approved for use through 07/31/2012. OMB 0651-0031
U.S. Patent and Trademark Office; U.S. DEPARTMENT OF COMMERCE

Under the Paperwork Reduction Act of 1995, no persons are required to respond to a collection of information unless it contains a valid OMB control number.

INFORMATION DISCLOSURE STATEMENT BY APPLICANT (Not for submission under 37 CFR 1.99)	Application Number		
	Filing Date		
	First Named Inventor	Hammarwall	
	Art Unit		
	Examiner Name		
	Attorney Docket Number	4015-8999 / P41223-US2	

U.S. PATENTS						Remove
Examiner Initial*	Cite No	Patent Number	Kind Code ¹	Issue Date	Name of Patentee or Applicant of cited Document	Pages, Columns, Lines where Relevant Passages or Relevant Figures Appear
	1					

If you wish to add additional U.S. Patent citation information please click the Add button. Add

U.S. PATENT APPLICATION PUBLICATIONS						Remove
Examiner Initial*	Cite No	Publication Number	Kind Code ¹	Publication Date	Name of Patentee or Applicant of cited Document	Pages, Columns, Lines where Relevant Passages or Relevant Figures Appear
	1					

If you wish to add additional U.S. Published Application citation information please click the Add button. Add

FOREIGN PATENT DOCUMENTS								Remove
Examiner Initial*	Cite No	Foreign Document Number ³	Country Code ² j	Kind Code ⁴	Publication Date	Name of Patentee or Applicant of cited Document	Pages, Columns, Lines where Relevant Passages or Relevant Figures Appear	T ⁵
	1							<input type="checkbox"/>

If you wish to add additional Foreign Patent Document citation information please click the Add button. Add

NON-PATENT LITERATURE DOCUMENTS			Remove
Examiner Initials*	Cite No	Include name of the author (in CAPITAL LETTERS), title of the article (when appropriate), title of the item (book, magazine, journal, serial, symposium, catalog, etc), date, pages(s), volume-issue number(s), publisher, city and/or country where published.	T ⁵

INFORMATION DISCLOSURE STATEMENT BY APPLICANT (Not for submission under 37 CFR 1.99)	Application Number		14390904 - GAU: 2466	
	Filing Date			
	First Named Inventor	Hammarwall		
	Art Unit			
	Examiner Name			
	Attorney Docket Number		4015-8999 / P41223-US2	

/D.L./	1	3RD GENERATION PARTNERSHIP PROJECT, "LTE; Evolved Universal Terrestrial Radio Access (E-UTRA); Physical layer procedures (3GPP TS 36.213 version 11.2.0 Release 11)", Technical Specification, ETSI TS 136 213 V11.2.0, 2013-04-01, pp. 1-175, ETSI, France	<input type="checkbox"/>
If you wish to add additional non-patent literature document citation information please click the Add button Add			
EXAMINER SIGNATURE			
Examiner Signature	/Diane Lo/		Date Considered 02/25/2016
*EXAMINER: Initial if reference considered, whether or not citation is in conformance with MPEP 609. Draw line through a citation if not in conformance and not considered. Include copy of this form with next communication to applicant.			
<small> ¹ See Kind Codes of USPTO Patent Documents at www.USPTO.GOV or MPEP 901.04. ² Enter office that issued the document, by the two-letter code (WIPO Standard ST.3). ³ For Japanese patent documents, the indication of the year of the reign of the Emperor must precede the serial number of the patent document. ⁴ Kind of document by the appropriate symbols as indicated on the document under WIPO Standard ST.16 if possible. ⁵ Applicant is to place a check mark here if English language translation is attached. </small>			

INFORMATION DISCLOSURE STATEMENT BY APPLICANT (Not for submission under 37 CFR 1.99)	Application Number		14390904 - GAU: 2466	
	Filing Date			
	First Named Inventor	Hammarwall		
	Art Unit			
	Examiner Name			
	Attorney Docket Number	4015-8999 / P41223-US2		

CERTIFICATION STATEMENT

Please see 37 CFR 1.97 and 1.98 to make the appropriate selection(s):

That each item of information contained in the information disclosure statement was first cited in any communication from a foreign patent office in a counterpart foreign application not more than three months prior to the filing of the information disclosure statement. See 37 CFR 1.97(e)(1).

OR

That no item of information contained in the information disclosure statement was cited in a communication from a foreign patent office in a counterpart foreign application, and, to the knowledge of the person signing the certification after making reasonable inquiry, no item of information contained in the information disclosure statement was known to any individual designated in 37 CFR 1.56(c) more than three months prior to the filing of the information disclosure statement. See 37 CFR 1.97(e)(2).

- See attached certification statement.
- The fee set forth in 37 CFR 1.17 (p) has been submitted herewith.
- A certification statement is not submitted herewith.

SIGNATURE

A signature of the applicant or representative is required in accordance with CFR 1.33, 10.18. Please see CFR 1.4(d) for the form of the signature.

Signature	/John R. Owen Reg. No. 42055/	Date (YYYY-MM-DD)	2014-10-06
Name/Print	John R. Owen	Registration Number	42055

This collection of information is required by 37 CFR 1.97 and 1.98. The information is required to obtain or retain a benefit by the public which is to file (and by the USPTO to process) an application. Confidentiality is governed by 35 U.S.C. 122 and 37 CFR 1.14. This collection is estimated to take 1 hour to complete, including gathering, preparing and submitting the completed application form to the USPTO. Time will vary depending upon the individual case. Any comments on the amount of time you require to complete this form and/or suggestions for reducing this burden, should be sent to the Chief Information Officer, U.S. Patent and Trademark Office, U.S. Department of Commerce, P.O. Box 1450, Alexandria, VA 22313-1450. **DO NOT SEND FEES OR COMPLETED FORMS TO THIS ADDRESS. SEND TO: Commissioner for Patents, P.O. Box 1450, Alexandria, VA 22313-1450.**

Privacy Act Statement

The Privacy Act of 1974 (P.L. 93-579) requires that you be given certain information in connection with your submission of the attached form related to a patent application or patent. Accordingly, pursuant to the requirements of the Act, please be advised that: (1) the general authority for the collection of this information is 35 U.S.C. 2(b)(2); (2) furnishing of the information solicited is voluntary; and (3) the principal purpose for which the information is used by the U.S. Patent and Trademark Office is to process and/or examine your submission related to a patent application or patent. If you do not furnish the requested information, the U.S. Patent and Trademark Office may not be able to process and/or examine your submission, which may result in termination of proceedings or abandonment of the application or expiration of the patent.

The information provided by you in this form will be subject to the following routine uses:

1. The information on this form will be treated confidentially to the extent allowed under the Freedom of Information Act (5 U.S.C. 552) and the Privacy Act (5 U.S.C. 552a). Records from this system of records may be disclosed to the Department of Justice to determine whether the Freedom of Information Act requires disclosure of these records.
2. A record from this system of records may be disclosed, as a routine use, in the course of presenting evidence to a court, magistrate, or administrative tribunal, including disclosures to opposing counsel in the course of settlement negotiations.
3. A record in this system of records may be disclosed, as a routine use, to a Member of Congress submitting a request involving an individual, to whom the record pertains, when the individual has requested assistance from the Member with respect to the subject matter of the record.
4. A record in this system of records may be disclosed, as a routine use, to a contractor of the Agency having need for the information in order to perform a contract. Recipients of information shall be required to comply with the requirements of the Privacy Act of 1974, as amended, pursuant to 5 U.S.C. 552a(m).
5. A record related to an International Application filed under the Patent Cooperation Treaty in this system of records may be disclosed, as a routine use, to the International Bureau of the World Intellectual Property Organization, pursuant to the Patent Cooperation Treaty.
6. A record in this system of records may be disclosed, as a routine use, to another federal agency for purposes of National Security review (35 U.S.C. 181) and for review pursuant to the Atomic Energy Act (42 U.S.C. 218(c)).
7. A record from this system of records may be disclosed, as a routine use, to the Administrator, General Services, or his/her designee, during an inspection of records conducted by GSA as part of that agency's responsibility to recommend improvements in records management practices and programs, under authority of 44 U.S.C. 2904 and 2906. Such disclosure shall be made in accordance with the GSA regulations governing inspection of records for this purpose, and any other relevant (i.e., GSA or Commerce) directive. Such disclosure shall not be used to make determinations about individuals.
8. A record from this system of records may be disclosed, as a routine use, to the public after either publication of the application pursuant to 35 U.S.C. 122(b) or issuance of a patent pursuant to 35 U.S.C. 151. Further, a record may be disclosed, subject to the limitations of 37 CFR 1.14, as a routine use, to the public if the record was filed in an application which became abandoned or in which the proceedings were terminated and which application is referenced by either a published application, an application open to public inspections or an issued patent.
9. A record from this system of records may be disclosed, as a routine use, to a Federal, State, or local law enforcement agency, if the USPTO becomes aware of a violation or potential violation of law or regulation.

<i>Index of Claims</i> 	Application/Control No. 14390904	Applicant(s)/Patent Under Reexamination HAMMARWALL ET AL.
	Examiner DIANE LO	Art Unit 2466

✓	Rejected	-	Cancelled	N	Non-Elected	A	Appeal
=	Allowed	÷	Restricted	I	Interference	O	Objected

Claims renumbered in the same order as presented by applicant
 CPA
 T.D.
 R.1.47

CLAIM		DATE									
Final	Original	02/28/2016									
	27	✓									
	28	✓									
	29	✓									
	30	✓									
	31	✓									
	32	✓									
	33	✓									
	34	✓									
	35	✓									
	36	✓									
	37	✓									
	38	✓									
	39	✓									
	40	✓									
	41	✓									
	42	✓									
	43	✓									
	44	✓									
	45	✓									
	46	✓									
	47	✓									
	48	✓									
	49	✓									
	50	✓									
	51	✓									
	52	✓									



UNITED STATES PATENT AND TRADEMARK OFFICE

UNITED STATES DEPARTMENT OF COMMERCE
United States Patent and Trademark Office
Address: COMMISSIONER FOR PATENTS
P.O. Box 1450
Alexandria, Virginia 22313-1450
www.uspto.gov

APPLICATION NUMBER	FILING OR 371(C) DATE	FIRST NAMED APPLICANT	ATTY. DOCKET NO./TITLE
14/390,904	10/06/2014	David Hammarwall	4015-8999 / P41223-US2

CONFIRMATION NO. 7239

24112
COATS & BENNETT, PLLC
1400 Crescent Green, Suite 300
Cary, NC 27518

PUBLICATION NOTICE



0C00000079654281

Title: Method and Radio Node for Enabling Use of High Order Modulation in a Radio Communication with a User Equipment

Publication No. US-2015-0381310-A1

Publication Date: 12/31/2015

NOTICE OF PUBLICATION OF APPLICATION

The above-identified application will be electronically published as a patent application publication pursuant to 37 CFR 1.211, et seq. The patent application publication number and publication date are set forth above.

The publication may be accessed through the USPTO's publically available Searchable Databases via the Internet at www.uspto.gov. The direct link to access the publication is currently <http://www.uspto.gov/patft/>.

The publication process established by the Office does not provide for mailing a copy of the publication to applicant. A copy of the publication may be obtained from the Office upon payment of the appropriate fee set forth in 37 CFR 1.19(a)(1). Orders for copies of patent application publications are handled by the USPTO's Office of Public Records. The Office of Public Records can be reached by telephone at (703) 308-9726 or (800) 972-6382, by facsimile at (703) 305-8759, by mail addressed to the United States Patent and Trademark Office, Office of Public Records, Alexandria, VA 22313-1450 or via the Internet.

In addition, information on the status of the application, including the mailing date of Office actions and the dates of receipt of correspondence filed in the Office, may also be accessed via the Internet through the Patent Electronic Business Center at www.uspto.gov using the public side of the Patent Application Information and Retrieval (PAIR) system. The direct link to access this status information is currently <http://pair.uspto.gov/>. Prior to publication, such status information is confidential and may only be obtained by applicant using the private side of PAIR.

Further assistance in electronically accessing the publication, or about PAIR, is available by calling the Patent Electronic Business Center at 1-866-217-9197.

Office of Data Management, Application Assistance Unit (571) 272-4000, or (571) 272-4200, or 1-888-786-0101



UNITED STATES PATENT AND TRADEMARK OFFICE

UNITED STATES DEPARTMENT OF COMMERCE
United States Patent and Trademark Office
Address: COMMISSIONER FOR PATENTS
P.O. Box 15150
Alexandria, Virginia 22313-1450
www.uspto.gov

APPLICATION NUMBER	FILING or 371(c) DATE	GRP ART UNIT	FIL FEE REC'D	ATTY DOCKET NO	TOT CLAIMS	IND CLAIMS
14/390,904	10/06/2014		3220	4015-8999 / P41223-US2	26	6

CONFIRMATION NO. 7239

FILING RECEIPT



24112
COATS & BENNETT, PLLC
1400 Crescent Green, Suite 300
Cary, NC 27518

Date Mailed: 09/22/2015

Receipt is acknowledged of this non-provisional patent application. The application will be taken up for examination in due course. Applicant will be notified as to the results of the examination. Any correspondence concerning the application must include the following identification information: the U.S. APPLICATION NUMBER, FILING DATE, NAME OF APPLICANT, and TITLE OF INVENTION. Fees transmitted by check or draft are subject to collection. Please verify the accuracy of the data presented on this receipt. **If an error is noted on this Filing Receipt, please submit a written request for a Filing Receipt Correction. Please provide a copy of this Filing Receipt with the changes noted thereon. If you received a "Notice to File Missing Parts" for this application, please submit any corrections to this Filing Receipt with your reply to the Notice. When the USPTO processes the reply to the Notice, the USPTO will generate another Filing Receipt incorporating the requested corrections**

Inventor(s)

David Hammarwall, Vallentuna, SWEDEN;
Meng Wang, SUNDBYBERG, SWEDEN;

Applicant(s)

TELEFONAKTIEBOLAGET L M ERICSSON (PUBL), Stockholm, SWEDEN;

Power of Attorney: The patent practitioners associated with Customer Number 24112

Domestic Priority data as claimed by applicant

This application is a 371 of PCT/SE2014/050803 06/26/2014
which claims benefit of 61/863,935 08/09/2013

Foreign Applications for which priority is claimed (You may be eligible to benefit from the Patent Prosecution Highway program at the USPTO. Please see <http://www.uspto.gov> for more information.) - None.

Foreign application information must be provided in an Application Data Sheet in order to constitute a claim to foreign priority. See 37 CFR 1.55 and 1.76.

If Required, Foreign Filing License Granted: 09/21/2015

The country code and number of your priority application, to be used for filing abroad under the Paris Convention, is **US 14/390,904**

Projected Publication Date: 12/31/2015

Non-Publication Request: No

Early Publication Request: No

Title

Method and Radio Node for Enabling Use of High Order Modulation in a Radio Communication with a User Equipment

Preliminary Class

Statement under 37 CFR 1.55 or 1.78 for AIA (First Inventor to File) Transition Applications: No

PROTECTING YOUR INVENTION OUTSIDE THE UNITED STATES

Since the rights granted by a U.S. patent extend only throughout the territory of the United States and have no effect in a foreign country, an inventor who wishes patent protection in another country must apply for a patent in a specific country or in regional patent offices. Applicants may wish to consider the filing of an international application under the Patent Cooperation Treaty (PCT). An international (PCT) application generally has the same effect as a regular national patent application in each PCT-member country. The PCT process **simplifies** the filing of patent applications on the same invention in member countries, but **does not result** in a grant of "an international patent" and does not eliminate the need of applicants to file additional documents and fees in countries where patent protection is desired.

Almost every country has its own patent law, and a person desiring a patent in a particular country must make an application for patent in that country in accordance with its particular laws. Since the laws of many countries differ in various respects from the patent law of the United States, applicants are advised to seek guidance from specific foreign countries to ensure that patent rights are not lost prematurely.

Applicants also are advised that in the case of inventions made in the United States, the Director of the USPTO must issue a license before applicants can apply for a patent in a foreign country. The filing of a U.S. patent application serves as a request for a foreign filing license. The application's filing receipt contains further information and guidance as to the status of applicant's license for foreign filing.

Applicants may wish to consult the USPTO booklet, "General Information Concerning Patents" (specifically, the section entitled "Treaties and Foreign Patents") for more information on timeframes and deadlines for filing foreign patent applications. The guide is available either by contacting the USPTO Contact Center at 800-786-9199, or it can be viewed on the USPTO website at <http://www.uspto.gov/web/offices/pac/doc/general/index.html>.

For information on preventing theft of your intellectual property (patents, trademarks and copyrights), you may wish to consult the U.S. Government website, <http://www.stopfakes.gov>. Part of a Department of Commerce initiative, this website includes self-help "toolkits" giving innovators guidance on how to protect intellectual property in specific countries such as China, Korea and Mexico. For questions regarding patent enforcement issues, applicants may call the U.S. Government hotline at 1-866-999-HALT (1-866-999-4258).

LICENSE FOR FOREIGN FILING UNDER
Title 35, United States Code, Section 184
Title 37, Code of Federal Regulations, 5.11 & 5.15

GRANTED

The applicant has been granted a license under 35 U.S.C. 184, if the phrase "IF REQUIRED, FOREIGN FILING LICENSE GRANTED" followed by a date appears on this form. Such licenses are issued in all applications where the conditions for issuance of a license have been met, regardless of whether or not a license may be required as set forth in 37 CFR 5.15. The scope and limitations of this license are set forth in 37 CFR 5.15(a) unless an earlier license has been issued under 37 CFR 5.15(b). The license is subject to revocation upon written notification. The date indicated is the effective date of the license, unless an earlier license of similar scope has been granted under 37 CFR 5.13 or 5.14.

This license is to be retained by the licensee and may be used at any time on or after the effective date thereof unless it is revoked. This license is automatically transferred to any related applications(s) filed under 37 CFR 1.53(d). This license is not retroactive.

The grant of a license does not in any way lessen the responsibility of a licensee for the security of the subject matter as imposed by any Government contract or the provisions of existing laws relating to espionage and the national security or the export of technical data. Licensees should apprise themselves of current regulations especially with respect to certain countries, of other agencies, particularly the Office of Defense Trade Controls, Department of State (with respect to Arms, Munitions and Implements of War (22 CFR 121-128)); the Bureau of Industry and Security, Department of Commerce (15 CFR parts 730-774); the Office of Foreign Assets Control, Department of Treasury (31 CFR Parts 500+) and the Department of Energy.

NOT GRANTED

No license under 35 U.S.C. 184 has been granted at this time, if the phrase "IF REQUIRED, FOREIGN FILING LICENSE GRANTED" DOES NOT appear on this form. Applicant may still petition for a license under 37 CFR 5.12, if a license is desired before the expiration of 6 months from the filing date of the application. If 6 months has lapsed from the filing date of this application and the licensee has not received any indication of a secrecy order under 35 U.S.C. 181, the licensee may foreign file the application pursuant to 37 CFR 5.15(b).

SelectUSA

The United States represents the largest, most dynamic marketplace in the world and is an unparalleled location for business investment, innovation, and commercialization of new technologies. The U.S. offers tremendous resources and advantages for those who invest and manufacture goods here. Through SelectUSA, our nation works to promote and facilitate business investment. SelectUSA provides information assistance to the international investor community; serves as an ombudsman for existing and potential investors; advocates on behalf of U.S. cities, states, and regions competing for global investment; and counsels U.S. economic development organizations on investment attraction best practices. To learn more about why the United States is the best country in the world to develop technology, manufacture products, deliver services, and grow your business, visit <http://www.SelectUSA.gov> or call +1-202-482-6800.

PATENT APPLICATION FEE DETERMINATION RECORD Substitute for Form PTO-875	Application or Docket Number 14/390,904
---	--

APPLICATION AS FILED - PART I			SMALL ENTITY		OR	OTHER THAN SMALL ENTITY	
	(Column 1)	(Column 2)					
FOR	NUMBER FILED	NUMBER EXTRA	RATE(\$)	FEE(\$)		RATE(\$)	FEE(\$)
BASIC FEE <small>(37 CFR 1.16(a), (b), or (c))</small>	N/A	N/A	N/A			N/A	280
SEARCH FEE <small>(37 CFR 1.16(k), (l), or (m))</small>	N/A	N/A	N/A			N/A	480
EXAMINATION FEE <small>(37 CFR 1.16(o), (p), or (q))</small>	N/A	N/A	N/A			N/A	720
TOTAL CLAIMS <small>(37 CFR 1.16(j))</small>	26	minus 20 = * 6				x 80 =	480
INDEPENDENT CLAIMS <small>(37 CFR 1.16(h))</small>	6	minus 3 = * 3				x 420 =	1260
APPLICATION SIZE FEE <small>(37 CFR 1.16(s))</small>	If the specification and drawings exceed 100 sheets of paper, the application size fee due is \$310 (\$155 for small entity) for each additional 50 sheets or fraction thereof. See 35 U.S.C. 41(a)(1)(G) and 37 CFR 1.16(s).						0.00
MULTIPLE DEPENDENT CLAIM PRESENT (37 CFR 1.16(j))							0.00
* If the difference in column 1 is less than zero, enter "0" in column 2.			TOTAL			TOTAL	3220

APPLICATION AS AMENDED - PART II					SMALL ENTITY		OR	OTHER THAN SMALL ENTITY		
	(Column 1)	(Column 2)	(Column 3)							
AMENDMENT A	CLAIMS REMAINING AFTER AMENDMENT	MINUS	HIGHEST NUMBER PREVIOUSLY PAID FOR	PRESENT EXTRA	RATE(\$)	ADDITIONAL FEE(\$)		RATE(\$)	ADDITIONAL FEE(\$)	
	Total <small>(37 CFR 1.16(i))</small>	*	Minus	**	=			x	=	
	Independent <small>(37 CFR 1.16(h))</small>	*	Minus	***	=			x	=	
	Application Size Fee (37 CFR 1.16(s))									
	FIRST PRESENTATION OF MULTIPLE DEPENDENT CLAIM (37 CFR 1.16(j))									
					TOTAL ADD'L FEE			TOTAL ADD'L FEE		
AMENDMENT B	CLAIMS REMAINING AFTER AMENDMENT	MINUS	HIGHEST NUMBER PREVIOUSLY PAID FOR	PRESENT EXTRA	RATE(\$)	ADDITIONAL FEE(\$)		RATE(\$)	ADDITIONAL FEE(\$)	
	Total <small>(37 CFR 1.16(i))</small>	*	Minus	**	=			x	=	
	Independent <small>(37 CFR 1.16(h))</small>	*	Minus	***	=			x	=	
	Application Size Fee (37 CFR 1.16(s))									
	FIRST PRESENTATION OF MULTIPLE DEPENDENT CLAIM (37 CFR 1.16(j))									
					TOTAL ADD'L FEE			TOTAL ADD'L FEE		
<p>* If the entry in column 1 is less than the entry in column 2, write "0" in column 3.</p> <p>** If the "Highest Number Previously Paid For" IN THIS SPACE is less than 20, enter "20".</p> <p>*** If the "Highest Number Previously Paid For" IN THIS SPACE is less than 3, enter "3".</p> <p>The "Highest Number Previously Paid For" (Total or Independent) is the highest found in the appropriate box in column 1.</p>										



UNITED STATES PATENT AND TRADEMARK OFFICE

UNITED STATES DEPARTMENT OF COMMERCE
United States Patent and Trademark Office
Address: COMMISSIONER FOR PATENTS
P.O. Box 1550
Alexandria, Virginia 22313-1450
www.uspto.gov

U.S. APPLICATION NUMBER NO.	FIRST NAMED INVENTOR	ATTY. DOCKET NO.
14/390,904	David Hammarwall	4015-8999 / P41223-US2

24112
COATS & BENNETT, PLLC
1400 Crescent Green, Suite 300
Cary, NC 27518

INTERNATIONAL APPLICATION NO.
PCT/SE2014/050803

I.A. FILING DATE	PRIORITY DATE
06/26/2014	08/09/2013

CONFIRMATION NO. 7239
371 ACCEPTANCE LETTER



Date Mailed: 09/22/2015

NOTICE OF ACCEPTANCE OF APPLICATION UNDER 35 U.S.C 371 AND 37 CFR 1.495

The applicant is hereby advised that the United States Patent and Trademark Office, in its capacity as a Designated / Elected Office (37 CFR 1.495), has ACCEPTED the above identified international application for national patentability examination in the United States Patent and Trademark Office.

The United States Application Number assigned to the application is shown above. A Filing Receipt will be issued for the present application in due course. **THE DATE APPEARING ON THE FILING RECEIPT AS THE "FILING DATE or 371(c) DATE" IS THE DATE ON WHICH THE LAST OF THE 35 U.S.C. 371 (c)(1) and (c)(2) REQUIREMENTS HAS BEEN RECEIVED IN THE OFFICE. THIS DATE IS SHOWN BELOW.** The filing date of the above identified application is the international filing date of the international application (Article 11(3) and 35 U.S.C. 363)

10/06/2014
DATE OF RECEIPT OF 35 U.S.C.
371(c)(1) and (c)(2) REQUIREMENTS

The following items have been received:

- Copy of the International Application filed on 10/06/2014
- English Translation of the IA filed on 10/06/2014
- Copy of the International Search Report filed on 10/06/2014
- Preliminary Amendments filed on 10/06/2014
- Information Disclosure Statements filed on 10/06/2014
- Inventor's Oath or Declaration filed on 10/06/2014
- Request for Immediate Examination filed on 10/06/2014
- U.S. Basic National Fees filed on 10/06/2014
- Assignee Statement for PGPUB filed on 10/06/2014
- Priority Documents filed on 10/06/2014
- Power of Attorney filed on 10/06/2014
- Application Data Sheet (37 CFR 1.76) filed on 10/06/2014

Applicant is reminded that any communications to the United States Patent and Trademark Office must be mailed to the address given in the heading and include the U.S. application no. shown above (37 CFR 1.5)

PATRICIA A BOOKER

Telephone: (571) 272-3882

INFORMATION DISCLOSURE STATEMENT BY APPLICANT (Not for submission under 37 CFR 1.99)	Application Number	13390904
	Filing Date	2014-10-06
	First Named Inventor	Hammarwall
	Art Unit	
	Examiner Name	
	Attorney Docket Number	4015-8999 / P41223-US2

U.S. PATENTS						Remove
Examiner Initial*	Cite No	Patent Number	Kind Code ¹	Issue Date	Name of Patentee or Applicant of cited Document	Pages, Columns, Lines where Relevant Passages or Relevant Figures Appear
	1					

If you wish to add additional U.S. Patent citation information please click the Add button. Add

U.S. PATENT APPLICATION PUBLICATIONS						Remove
Examiner Initial*	Cite No	Publication Number	Kind Code ¹	Publication Date	Name of Patentee or Applicant of cited Document	Pages, Columns, Lines where Relevant Passages or Relevant Figures Appear
	1					

If you wish to add additional U.S. Published Application citation information please click the Add button. Add

FOREIGN PATENT DOCUMENTS								Remove
Examiner Initial*	Cite No	Foreign Document Number ³	Country Code ² j	Kind Code ⁴	Publication Date	Name of Patentee or Applicant of cited Document	Pages, Columns, Lines where Relevant Passages or Relevant Figures Appear	T ⁵
	1	102624481	CN	A	2012-08-01	ZTE Corporation	Machine English Translation	<input checked="" type="checkbox"/>
	2	2013123961	WO	A1	2013-08-29	Nokia Siemens Networks Oy		<input type="checkbox"/>
	3	2014109915	WO	A1	2014-07-17	Qualcomm Incorporated		<input type="checkbox"/>

INFORMATION DISCLOSURE STATEMENT BY APPLICANT (Not for submission under 37 CFR 1.99)	Application Number	13390904
	Filing Date	2014-10-06
	First Named Inventor	Hammarwall
	Art Unit	
	Examiner Name	
	Attorney Docket Number	4015-8999 / P41223-US2

If you wish to add additional Foreign Patent Document citation information please click the Add button **Add**

NON-PATENT LITERATURE DOCUMENTS Remove

Examiner Initials*	Cite No	Include name of the author (in CAPITAL LETTERS), title of the article (when appropriate), title of the item (book, magazine, journal, serial, symposium, catalog, etc), date, pages(s), volume-issue number(s), publisher, city and/or country where published.	T ⁵
	1	PANASONIC, "Discussion on 256QAM for Downlink in Small Cell Deployments", 3GPP TSG-RAN WG1 Meeting 72bis, 2013-04-15, pp. 1-6, R1-131328, Chicago, US	<input type="checkbox"/>
	2	HUAWEI, et al., "Standard Impacts to Support Higher Order Modulation", 3GPP TSG-RAN WG1 Meeting 73, 2013-05-20, pp. 1-2, R1-131853, Fukuoka, JP	<input type="checkbox"/>
	3	HTC, "On Small Cell Enhancement for improved Spectral Efficiency", 3GPP TSG RAN WG1 Meeting #72, 2013-01-28, pp. 1-4, R1-130311, St. Julian's, Malta	<input type="checkbox"/>
	4	INTEL CORPORATION, "CQI/MCS/TBS Tables for 256QAM and Relevant Signaling", 3GPP TSG RAN WG1 Meeting #76, 2014-02-10, pp. 1-8, R1-140118, Prague, Czech Republic	<input type="checkbox"/>

If you wish to add additional non-patent literature document citation information please click the Add button **Add**

EXAMINER SIGNATURE

Examiner Signature		Date Considered	
--------------------	--	-----------------	--

*EXAMINER: Initial if reference considered, whether or not citation is in conformance with MPEP 609. Draw line through a citation if not in conformance and not considered. Include copy of this form with next communication to applicant.

¹ See Kind Codes of USPTO Patent Documents at www.USPTO.GOV or MPEP 901.04. ² Enter office that issued the document, by the two-letter code (WIPO Standard ST.3). ³ For Japanese patent documents, the indication of the year of the reign of the Emperor must precede the serial number of the patent document. ⁴ Kind of document by the appropriate symbols as indicated on the document under WIPO Standard ST.16 if possible. ⁵ Applicant is to place a check mark here if English language translation is attached.

INFORMATION DISCLOSURE STATEMENT BY APPLICANT (Not for submission under 37 CFR 1.99)	Application Number	13390904
	Filing Date	2014-10-06
	First Named Inventor	Hammarwall
	Art Unit	
	Examiner Name	
	Attorney Docket Number	4015-8999 / P41223-US2

CERTIFICATION STATEMENT

Please see 37 CFR 1.97 and 1.98 to make the appropriate selection(s):

That each item of information contained in the information disclosure statement was first cited in any communication from a foreign patent office in a counterpart foreign application not more than three months prior to the filing of the information disclosure statement. See 37 CFR 1.97(e)(1).

OR

That no item of information contained in the information disclosure statement was cited in a communication from a foreign patent office in a counterpart foreign application, and, to the knowledge of the person signing the certification after making reasonable inquiry, no item of information contained in the information disclosure statement was known to any individual designated in 37 CFR 1.56(c) more than three months prior to the filing of the information disclosure statement. See 37 CFR 1.97(e)(2).

See attached certification statement.

The fee set forth in 37 CFR 1.17 (p) has been submitted herewith.

A certification statement is not submitted herewith.

SIGNATURE

A signature of the applicant or representative is required in accordance with CFR 1.33, 10.18. Please see CFR 1.4(d) for the form of the signature.

Signature	/John R. Owen Reg. No. 42055/	Date (YYYY-MM-DD)	2014-11-24
Name/Print	John R. Owen	Registration Number	42055

This collection of information is required by 37 CFR 1.97 and 1.98. The information is required to obtain or retain a benefit by the public which is to file (and by the USPTO to process) an application. Confidentiality is governed by 35 U.S.C. 122 and 37 CFR 1.14. This collection is estimated to take 1 hour to complete, including gathering, preparing and submitting the completed application form to the USPTO. Time will vary depending upon the individual case. Any comments on the amount of time you require to complete this form and/or suggestions for reducing this burden, should be sent to the Chief Information Officer, U.S. Patent and Trademark Office, U.S. Department of Commerce, P.O. Box 1450, Alexandria, VA 22313-1450. **DO NOT SEND FEES OR COMPLETED FORMS TO THIS ADDRESS. SEND TO: Commissioner for Patents, P.O. Box 1450, Alexandria, VA 22313-1450.**

Privacy Act Statement

The Privacy Act of 1974 (P.L. 93-579) requires that you be given certain information in connection with your submission of the attached form related to a patent application or patent. Accordingly, pursuant to the requirements of the Act, please be advised that: (1) the general authority for the collection of this information is 35 U.S.C. 2(b)(2); (2) furnishing of the information solicited is voluntary; and (3) the principal purpose for which the information is used by the U.S. Patent and Trademark Office is to process and/or examine your submission related to a patent application or patent. If you do not furnish the requested information, the U.S. Patent and Trademark Office may not be able to process and/or examine your submission, which may result in termination of proceedings or abandonment of the application or expiration of the patent.

The information provided by you in this form will be subject to the following routine uses:

1. The information on this form will be treated confidentially to the extent allowed under the Freedom of Information Act (5 U.S.C. 552) and the Privacy Act (5 U.S.C. 552a). Records from this system of records may be disclosed to the Department of Justice to determine whether the Freedom of Information Act requires disclosure of these records.
2. A record from this system of records may be disclosed, as a routine use, in the course of presenting evidence to a court, magistrate, or administrative tribunal, including disclosures to opposing counsel in the course of settlement negotiations.
3. A record in this system of records may be disclosed, as a routine use, to a Member of Congress submitting a request involving an individual, to whom the record pertains, when the individual has requested assistance from the Member with respect to the subject matter of the record.
4. A record in this system of records may be disclosed, as a routine use, to a contractor of the Agency having need for the information in order to perform a contract. Recipients of information shall be required to comply with the requirements of the Privacy Act of 1974, as amended, pursuant to 5 U.S.C. 552a(m).
5. A record related to an International Application filed under the Patent Cooperation Treaty in this system of records may be disclosed, as a routine use, to the International Bureau of the World Intellectual Property Organization, pursuant to the Patent Cooperation Treaty.
6. A record in this system of records may be disclosed, as a routine use, to another federal agency for purposes of National Security review (35 U.S.C. 181) and for review pursuant to the Atomic Energy Act (42 U.S.C. 218(c)).
7. A record from this system of records may be disclosed, as a routine use, to the Administrator, General Services, or his/her designee, during an inspection of records conducted by GSA as part of that agency's responsibility to recommend improvements in records management practices and programs, under authority of 44 U.S.C. 2904 and 2906. Such disclosure shall be made in accordance with the GSA regulations governing inspection of records for this purpose, and any other relevant (i.e., GSA or Commerce) directive. Such disclosure shall not be used to make determinations about individuals.
8. A record from this system of records may be disclosed, as a routine use, to the public after either publication of the application pursuant to 35 U.S.C. 122(b) or issuance of a patent pursuant to 35 U.S.C. 151. Further, a record may be disclosed, subject to the limitations of 37 CFR 1.14, as a routine use, to the public if the record was filed in an application which became abandoned or in which the proceedings were terminated and which application is referenced by either a published application, an application open to public inspections or an issued patent.
9. A record from this system of records may be disclosed, as a routine use, to a Federal, State, or local law enforcement agency, if the USPTO becomes aware of a violation or potential violation of law or regulation.

**Espacenet****Bibliographic data: CN102624481 (A) — 2012-08-01**

Self-adaptive modulation and coding method and apparatus

Inventor(s): SHUAI ZHANG; JIN XU; XU JUN ± (ZHANG SHUAI, ; XU JIN, ; XU JUN)

Applicant(s): ZTE CORP ± (ZTE CORPORATION)

Classification: - **international:** *H04L1/00; H04L27/36*
- **cooperative:**

Application number: CN2011134103 20110131

Priority number(s): CN2011134103 20110131

Abstract of CN102624481 (A)

The invention provides a self-adaptive modulation and coding method and an apparatus. The method comprises the following steps that: a pilot signal is sent to a terminal; a receiving terminal carries out channel measurement according to the pilot signal and then feedbacks a channel quality indicator; and according to the channel quality indicator, a modulation and coding scheme (MCS) is selected from a modified MCS table and data are issued based on the MCS. According to the self-adaptive modulation and coding method and the apparatus, on the basis of current supporting of a modulation mode with up to 64 quadrature amplitude modulation (QAM), a modulation mode with up to 256 QAM can be supported; and moreover, a modulation mode with a higher order can also be supported; therefore, a data transmission rate can be improved.



(12) 发明专利申请

(10) 申请公布号 CN 102624481 A

(43) 申请公布日 2012.08.01

(21) 申请号 201110034103.6

(22) 申请日 2011.01.31

(71) 申请人 中兴通讯股份有限公司

地址 518057 广东省深圳市南山区高新技术产业园科技南路中兴通讯大厦法务部

(72) 发明人 张帅 许进 徐俊

(74) 专利代理机构 北京安信方达知识产权代理有限公司 11262

代理人 李健 龙洪

(51) Int. Cl.

H04L 1/00 (2006.01)

H04L 27/36 (2006.01)

权利要求书 1 页 说明书 11 页 附图 7 页

(54) 发明名称

自适应调制编码方法及装置

(57) 摘要

本发明提供了一种自适应调制编码方法及装置,其中,该自适应调制编码方法包括:向终端发送导频信号;接收终端根据所述导频信号进行信道测量后反馈的信道质量指示;根据所述信道质量指示从修改后的调制编码方式(MCS)表中选择调制编码方式,并根据所述调制编码方式下发数据。上述自适应调制编码方法及装置,可以在现有的最高支持64QAM的调制方式的基础上,最高支持256QAM的调制方式;并且还可以支持更高阶数的调制方式;从而提高数据的传输速率。

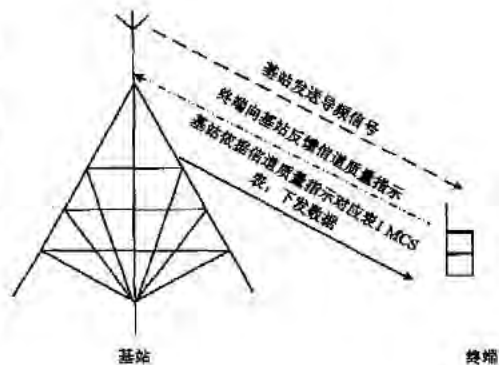

CN 102624481 A

1. 一种自适应调制编码方法,所述方法包括:
向终端发送导频信号;
接收终端根据所述导频信号进行信道测量后反馈的信道质量指示;
根据所述信道质量指示从修改后的调制编码方式(MCS)表中选择调制编码方式,并根据所述调制编码方式下发数据。
2. 根据权利要求1所述的自适应调制编码方法,其特征在于:
所述修改后的MCS表支持256正交幅度调制(QAM)的调制方式。
3. 根据权利要求1或2所述的自适应调制编码方法,其特征在于:
所述修改后的MCS表为在原MCS表的基础上增加了多个MCS内容的MCS表,其中,增加的多个MCS内容用新增的一个或多个比特来指示;或者,
所述修改后的MCS表为对原MCS表中的内容进行了重新解释的MCS表。
4. 一种自适应调制编码方法,所述方法包括:
接收终端发送的参考信号;
根据所述参考信号从修改后的调制编码方式(MCS)表中选择调制编码方式,并反馈给终端,以便所述终端根据所述调制编码方式向所述基站发送数据。
5. 根据权利要求4所述的自适应调制编码方法,其特征在于:
所述修改后的MCS表支持256正交幅度调制(QAM)的调制方式。
6. 根据权利要求4或5所述的自适应调制编码方法,其特征在于:
所述修改后的MCS表为在原MCS表的基础上增加了多个MCS内容的MCS表,其中,增加的多个MCS内容用新增的一个或多个比特来指示;或者,
所述修改后的MCS表为对原MCS表中的内容进行了重新解释的MCS表。
7. 一种自适应调制编码装置,所述自适应调制编码装置包括:
发送模块,用于向终端发送导频信号;
接收模块,用于接收终端根据所述导频信号进行信道测量后反馈的信道质量指示;
选择下发模块,用于根据所述信道质量指示从修改后的调制编码方式(MCS)表中选择调制编码方式,并根据所述调制编码方式下发数据。
8. 根据权利要求7所述的自适应调制编码装置,其特征在于:
所述修改后的MCS表支持256正交幅度调制(QAM)的调制方式。
9. 一种自适应调制编码装置,所述自适应调制编码装置包括:
接收模块,用于接收终端发送的参考信号;
选择反馈模块,用于根据所述参考信号从修改后的调制编码方式(MCS)表中选择调制编码方式,并反馈给终端,以便所述终端根据所述调制编码方式向所述基站发送数据。
10. 根据权利要求9所述的自适应调制编码装置,其特征在于:
所述修改后的MCS表支持256正交幅度调制(QAM)的调制方式。

自适应调制编码方法及装置

技术领域

[0001] 本发明涉及移动通信技术,尤其涉及一种自适应调制编码方法及装置。

背景技术

[0002] 在移动通信系统中,由于无线衰落信道时变的特点,使得通信过程存在大量的不确定性,一方面为了提高系统吞吐量,采用传输速率较高的高阶调制和少冗余纠错码进行通信,这样在无线衰落信道信噪比较理想时系统吞吐量确实得到了很大的提高,但当信道处于深衰落时,则无法保障通信可靠稳定地进行;另一方面,为了保障通信的可靠性,采用传输速率较低的低阶调制和大冗余纠错码进行通信,即在无线信道处于深衰落时保障通信可靠稳定地进行,然而当信道信噪比较高时,由于传输速率较低,制约了系统吞吐量的提高,从而造成了资源的浪费,在移动通信技术的发展早期,人们对抗无线衰落信道的时变特性,只能采用加大发射机的发射功率,使用低阶大冗余的调制编码方法来保障系统在信道深衰落时的通信质量,还无暇考虑如何提高系统的吞吐量,随着技术水平的进步,出现了可根据信道状态自适应地调节其发射功率,调制编码方式以及数据的帧长来克服信道的时变特性,从而获得最佳通信效果的技术,被称为自适应技术。

[0003] 现有标准中上行和下行最高支持 64 正交幅度调制 (QAM) 的调制编码方式,为了提高数据传输速率,兼容现有无线传输网络,最高支持 256QAM 的调制编码方式。但现有技术中没有支持 256QAM 的调制编码方式的实现方法。

发明内容

[0004] 为了解决上述技术问题,本发明提供了一种自适应调制编码方法及装置,以达到在兼容现有无线传输网络的基础上,最高支持 256QAM 甚至更高调制阶数的调制编码方式,从而提高数据传输速率。

[0005] 本发明提供了一种自适应调制编码方法,该方法包括:

[0006] 向终端发送导频信号;

[0007] 接收终端根据所述导频信号进行信道测量后反馈的信道质量指示;

[0008] 根据所述信道质量指示从修改后的调制编码方式 (MCS) 表中选择调制编码方式,并根据所述调制编码方式下发数据。

[0009] 优选地,上述自适应调制编码方法可具有如下特点:

[0010] 所述修改后的 MCS 表支持 256 正交幅度调制 (QAM) 的调制方式。

[0011] 优选地,上述自适应调制编码方法还可具有如下特点:

[0012] 所述修改后的 MCS 表为在原 MCS 表的基础上增加了多个 MCS 内容的 MCS 表,其中,增加的多个 MCS 内容用新增的一个或多个比特来指示;或者,

[0013] 所述修改后的 MCS 表为对原 MCS 表中的内容进行了重新解释的 MCS 表。

[0014] 本发明还提供了一种自适应调制编码方法,所述方法包括:

[0015] 接收终端发送的参考信号;

- [0016] 根据所述参考信号从修改后的调制编码方式 (MCS) 表中选择调制编码方式, 并反馈给终端, 以便所述终端根据所述调制编码方式向所述基站发送数据。
- [0017] 优选地, 上述自适应调制编码方法可具有如下特点:
- [0018] 所述修改后的 MCS 表支持 256 正交幅度调制 (QAM) 的调制方式。
- [0019] 优选地, 上述自适应调制编码方法还可具有如下特点:
- [0020] 所述修改后的 MCS 表为在原 MCS 表的基础上增加了多个 MCS 内容的 MCS 表, 其中, 增加的多个 MCS 内容用新增的一个或多个比特来指示; 或者,
- [0021] 所述修改后的 MCS 表为对原 MCS 表中的内容进行了重新解释的 MCS 表。
- [0022] 本发明还提供了一种自适应调制编码装置, 所述自适应调制编码装置包括:
- [0023] 发送模块, 用于向终端发送导频信号;
- [0024] 接收模块, 用于接收终端根据所述导频信号进行信道测量后反馈的信道质量指示;
- [0025] 选择下发模块, 用于根据所述信道质量指示从修改后的调制编码方式 (MCS) 表中选择调制编码方式, 并根据所述调制编码方式下发数据。
- [0026] 优选地, 上述自适应调制编码装置可具有如下特点:
- [0027] 所述修改后的 MCS 表支持 256 正交幅度调制 (QAM) 的调制方式。
- [0028] 本发明还提供了一种自适应调制编码装置, 所述自适应调制编码装置包括:
- [0029] 接收模块, 用于接收终端发送的参考信号;
- [0030] 选择反馈模块, 用于根据所述参考信号从修改后的调制编码方式 (MCS) 表中选择调制编码方式, 并反馈给终端, 以便所述终端根据所述调制编码方式向所述基站发送数据。
- [0031] 优选地, 上述自适应调制编码装置可具有如下特点:
- [0032] 所述修改后的 MCS 表支持 256 正交幅度调制 (QAM) 的调制方式。
- [0033] 上述自适应调制编码方法及装置, 可以在现有的最高支持 64QAM 的调制方式的基础上, 最高支持 256QAM 的调制方式; 并且还可以支持更高阶数的调制方式; 从而提高数据的传输速率。

附图说明

- [0034] 图 1 是本发明下行数据传输实施例一的示意图;
- [0035] 图 2 是本发明下行数据传输实施例二的示意图;
- [0036] 图 3 是本发明下行数据传输实施例三的示意图;
- [0037] 图 4 是本发明下行数据传输实施例四的示意图;
- [0038] 图 5 是本发明上行数据传输实施例一的示意图;
- [0039] 图 6 是本发明上行数据传输实施例二的示意图;
- [0040] 图 7 是本发明上行数据传输实施例三的示意图;
- [0041] 图 8 是本发明上行数据传输实施例四的示意图;
- [0042] 图 9 是本发明自适应调制编码装置实施例一的结构示意图;
- [0043] 图 10 是本发明自适应调制编码装置实施例二的结构示意图。

具体实施方式

[0044] 下面结合附图和具体实施方式对本发明作进一步详细的说明。

[0045] 本发明提供了一种自适应调制编码方法,在下行传输方向上,上述方法包括:

[0046] 步骤 a,基站向终端发送导频信号;

[0047] 步骤 b,终端根据导频信号进行信道测量,反馈信道质量指示;

[0048] 步骤 c,基站收到终端发送的信道质量指示,在修改后的 MCS(调制编码方式, Modulation and Coding Scheme) 表中选择合适的调制编码方式,并下发数据。

[0049] 进一步地,对于步骤 c,在现有系统的 MCS 基础上,增加若干比特用于支持 256QAM 的调制方式。

[0050] 具体地,增加的 MCS 可以是表 1、表 2 中的任意一种或几种,其中每一行代表一种 MCS:MCS Index 为调制编码方式索引,modulation order 为调制方式。

[0051] 表 1 新增 MCS 表

MCS Index I_{MCS}	Modulation Order Q_m
32	8
33	8
34	8
35	8
36	8
37	8

[0052]

[0053] 具体地,新增 MCS 还可以有如下形式:

[0054] 表 2 新增 MCS 表

MCS Index I_{MCS}	Modulation Order Q_m
32	8
33	8
34	8
35	8
36	8
37	8
38	8
39	8

[0055]

[0056] 进一步,对于步骤 c,保持现有系统中 MCS 索引的比特数目不变,对 MCS 进行重新解释,以支持 256QAM 的调制方式。

[0057] 具体地,重新解释的内容可以是表 3、表 4 中的内容,其中随着 MCS index 和 TBS Index 的增加,调制阶数逐渐递增,且调制阶数最高支持 256QAM(如表 3、表 4 中的加粗部分),其中 TBS Index 为传输块大小索引:

[0058] 表 3 重新解释的 MCS 表

MCS Index I_{MCS}	Modulation Order Q_m	TBS Index I_{TBS}
0	2	0
1	2	1

[0059]

[0060]

2	2	2
3	2	3
4	2	4
5	4	5
6	4	6
7	4	7
8	4	8
9	4	9
10	4	10
11	4	10
12	6	11
13	6	12
14	6	13
15	6	14
16	6	15
17	6	16
18	6	17
19	6	18
20	6	19
21	6	20
22	6	21
23	6	22
24	8	23
25	8	24
26	8	25
27	8	26
28	2	reserved
29	4	
30	6	
31	8	

[0061] 具体地,重新解释的 MCS 表还可以有如下形式:

[0062] 表 4 重新解释的 MCS 表

[0063]

MCS Index I_{MCS}	Modulation Order Q_m	TBS Index I_{TBS}
0	2	0
1	2	1
2	2	2
3	4	3
4	4	4
5	4	5
6	4	6
7	4	7
8	4	8
9	6	8
10	6	9
11	6	10

[0064]

12	6	11
13	6	12
14	6	13
15	6	14
16	6	15
17	6	16
18	6	17
19	6	18
20	6	19
21	6	20
22	8	21
23	8	22
24	8	23
25	8	24
26	8	25
27	8	26
28	2	reserved
29	4	
30	6	
31	8	

[0065] 本发明还提供了一种自适应调制编码方法,在上行传输方向上,上述方法包:

[0066] 步骤 e,终端向基站发送参考信号;

[0067] 步骤 f,基站根据终端发送的参考信号,从修改后的 MCS 表中选择合适的调制编码方式,反馈给终端;

[0068] 步骤 g,终端依据基站反馈的调制编码方式,向基站发送数据。

[0069] 进一步地,对于步骤 f,在现有系统的 MCS 基础上,增加若干比特用于支持 256QAM 的调制方式。

[0070] 具体地,增加的 MCS 可以是下表 5、表 6 中的任意一种或几种,其中每一行代表一种 MCS, Redundancy Version 为冗余版本:

[0071] 表 5 新增的 MCS 表

[0072]

MCS Index I_{MCS}	Modulation Order Q_m	TBS Index I_{TBS}	Redundancy Version r_{Vid}
32	8	26	0
33	8	27	0
34	8	28	0

[0073]

35	8	29	0
36	8	30	0
37-63	reserved		

[0074] 具体地,新增 MCS 还可以有如下形式:

[0075] 表 6 新增的 MCS 表

[0076]

MCS Index	Modulation Order	TBS Index	Redundancy Version
I_{MCS}	Q_m	I_{TBS}	r_{Vidx}
32	8	26	0
33	8	27	0
34	8	28	0
35	8	29	0
36	8	30	0
37	8	31	0
38	8	31	0
39-63	reserved		

[0077] 进一步地,对于步骤 f,保持现有系统中调制编码方式索引的比特数目不变,对 MCS 进行重新解释,以支持 256QAM 的调制方式。

[0078] 具体地,重新解释的内容可以是表 7、表 8 中的内容,其中随着 MCS index 和 TBS Index 的增加,调制阶数逐渐递增,且调制阶数最高支持 256QAM(如表 7、表 8 中的加粗部分):

[0079] 具体地,重新解释的 MCS 表还可以有如下形式:

[0080] 表 7 重新解释的 MCS 表

[0081]

MCS Index	Modulation Order	TBS Index	Redundancy Version
I_{MCS}	Q_m	I_{TBS}	r_{Vidx}
0	2	0	0
1	2	1	0
2	2	2	0
3	2	3	0
4	2	4	0
5	2	5	0
6	2	6	0
9	2	7	0
8	2	8	0
9	4	9	0

[0082]

10	4	10	0
11	4	11	0
12	4	12	0
13	4	13	0
14	4	14	0
15	4	15	0
16	4	16	0
17	6	16	0
18	6	17	0
19	6	18	0
20	6	19	0
21	6	20	0
22	6	21	0
23	8	22	0
24	8	23	0
25	8	24	0
26	8	25	0
27	8	26	0
28	reserved		1
29			2
30			3
31			4

[0083] 具体地,重新解释的 MCS 表还可以有如下形式:

[0084] 表 8 重新解释的 MCS 表

[0085]

MCS Index I_{MCS}	Modulation Order Q_m	TBS Index I_{TBS}	Redundancy Version V_{idx}
0	2	0	0
1	2	1	0
2	2	2	0
3	2	3	0
4	2	4	0
5	2	5	0
6	2	6	0
9	4	7	0
8	4	8	0
9	4	9	0
10	4	10	0
11	4	11	0
12	4	12	0
13	4	13	0
14	4	14	0
15	6	14	0
16	6	15	0
17	6	16	0
18	6	17	0
19	6	18	0
20	6	19	0

[0086]	21	8	20	0
	22	8	21	0
	23	8	22	0
	24	8	23	0
	25	8	24	0
	26	8	25	0
	27	8	26	0
	28	reserved		1
	29			2
	30			3
	31			4

[0087] 本发明实施例提供了一种自适应调制编码方法,该方法包括:

[0088] 下行方向,基站向终端发送导频信号;基站接收终端根据上述导频信号进行信道测量后反馈的信道质量指示;基站根据上述信道质量指示从修改后的调制编码方式(MCS)表中选择调制编码方式,并根据上述调制编码方式下发数据;

[0089] 上行方向,基站接收终端发送的参考信号,基站根据上述参考信号从修改后的调制编码方式(MCS)表中选择调制编码方式,并反馈给终端,以便上述终端根据上述调制编码方式向上述基站发送数据。

[0090] 下面将通过几个实施例具体说明如何利用本发明的方法确定自适应调制编码方式,进而完成数据编码及发送。

[0091] 实施例一

[0092] 如图1所示,是本发明下行数据传输实施例一的示意图,在该实施例中,终端接收基站发送的导频信号,并向基站反馈信道质量,基站依据此信道质量指示,从表1中选择合适的调制编码方式,下发数据。

[0093] 如表1所示,在原有系统的5比特MCS指示的基础上增加1比特,用于指示新增加的6级MCS,这6级MCS用于指示256QAM的调制方式,如表1的MCS Index 32到MCS Index 37。增加后的MCS索引用6比特指示。

[0094] 其中,基站依据信道质量指示,选择合适的调制编码方式,例如选择的MCS Index等于35,其含义为当前下行数据的调制方式为256QAM。

[0095] 实施例二

[0096] 如图2所示,是本发明下行数据传输实施例二的示意图,在该实施例中,终端接收基站发送的导频信号,并向基站反馈信道质量,基站依据此信道质量指示,从表2中选择合适的调制编码方式,下发数据。

[0097] 如表2所示,在原有系统的5比特MCS指示的基础上增加1比特,用于指示新增加的8级MCS,这8级MCS用于指示256QAM的调制方式,如表2的MCS Index 32到MCS Index 39。增加后的MCS索引用6比特指示。

[0098] 其中,基站依据信道质量指示,选择合适的调制编码方式,例如选择的MCS Index等于38,其含义为当前下行数据的调制方式为256QAM。

[0099] 实施例三

[0100] 如图3所示,是本发明下行数据传输实施例三的示意图,在该实施例中,终端接收基站发送的导频信号,并向基站反馈信道质量,基站依据此信道质量指示,从表3中选择合适的调制编码方式,下发数据。

[0101] 基站选择合适的调制编码方式下发数据：此时基站使用与原有系统相同比特数目的 MCS，基站依据表 3 所示的 MCS Index 重新解释 MCS 的内容。

[0102] 例如基站依据此信道质量指示，选择的 MCS Index 等于 26，在原系统中的含义是当前下行数据的调制方式为 64QAM，而此时基站利用表 3 的内容重新解释为：当前下行数据的调制方式为 256QAM。

[0103] 实施例四

[0104] 如图 4 所示，是本发明下行数据传输实施例四的示意图，在该实施例中，终端接收基站发送的导频信号，并向基站反馈信道质量，基站依据此信道质量指示，从表 4 中选择合适的调制编码方式，下发数据。

[0105] 基站选择合适的调制编码方式下发数据：此时基站使用与原有系统相同比特数目的 MCS，基站依据表 4 所示的 MCS Index 重新解释 MCS 的内容。

[0106] 例如基站依据此信道质量指示，选择的 MCS Index 等于 23，在原系统中的含义是当前下行数据的调制方式为 64QAM，而此时基站利用表 4 的内容重新解释为：当前下行数据的调制方式为 256QAM。

[0107] 实施例五

[0108] 如图 5 所示，是本发明上行数据传输实施例一的示意图，在该实施例中，基站接收终端发送的参考信号，从表 5 中选择合适的调制编码方式，反馈给终端；终端依据基站反馈的调制编码方式，向基站发送数据。

[0109] 如表 5 所示，在原有系统的 5 比特 MCS 指示的基础上增加 1 比特用于指示新增加的 5 级 MCS，这 5 级 MCS 用于指示 256QAM 的调整方式，如表 5 的 MCS Index 32 到 MCS Index 36。增加后的 MCS 索引用 6 比特指示。

[0110] 其中，基站接收到参考信号并选择合适的调制编码方式反馈给终端，例如，基站反馈给终端的 MCS Index 等于 33，其含义为当前下行数据的调制方式为 256QAM。终端依据此 MCS index 选择合适的调制编码方式，并发送数据。

[0111] 实施例六

[0112] 如图 6 所示，是本发明上行数据传输实施例二的示意图，在该实施例中，基站接收终端发送的参考信号，从表 6 中选择合适的调制编码方式，反馈给终端；终端依据基站反馈的调制编码方式，向基站发送数据。

[0113] 如表 6 所示，在原有系统的 5 比特 MCS 指示的基础上增加 1 比特，用于指示新增加的 7 级 MCS，这 5 级 MCS 用于指示 256QAM 的调整方式，如表 6 的 MCS Index 32 到 MCS Index 38。增加后的 MCS 索引用 6 比特指示。

[0114] 其中，基站接收到参考信号并选择合适的调制编码方式反馈给终端，例如，基站反馈给终端的 MCS Index 等于 36，其含义为当前下行数据的调制方式为 256QAM。终端依据此 MCS index 选择合适的调制编码方式，并发送数据。

[0115] 实施例七

[0116] 如图 7 所示，是本发明上行数据传输实施例三的示意图，在该实施例中，基站接收终端发送的参考信号，从表 7 中选择合适的调制编码方式，反馈给终端；终端依据基站反馈的调制编码方式，向基站发送数据。

[0117] 基站选择合适的调制编码方式反馈给终端是指：基站使用与原有系统相同比特数

目的 MCS, 基站依据表 7 所示的 MCS Index 重新解释 MCS 的内容。

[0118] 例如基站选择的 MCS Index 等于 26, 在原系统中的含义是当前下行数据的调制方式为 64QAM, 而此时基站利用表 7 的内容重新解释为: 当前下行数据的调制方式为 256QAM。

[0119] 实施例八

[0120] 如图 8 所示, 是本发明上行数据传输实施例四的示意图, 在该实施例中, 基站接收终端发送的参考信号, 从表 8 中选择合适的调制编码方式, 反馈给终端; 终端依据基站反馈的调制编码方式, 向基站发送数据。

[0121] 基站选择合适的调制编码方式反馈给终端是指, 基站使用与原有系统相同比特数目的 MCS, 基站依据表 8 所示的 MCS Index 重新解释 MCS 的内容。

[0122] 例如基站选择的 MCS Index 等于 27, 在原系统中的含义是当前下行数据的调制方式为 64QAM, 而此时基站利用表 8 的内容重新解释为: 当前下行数据的调制方式为 256QAM。

[0123] 上述自适应调制编码方法, 可以在现有的最高支持 64QAM 的调制方式的基础上, 最高支持 256QAM 的调制方式; 并且, 随着技术的发展, 还可以支持更高阶数的调制方式; 从而提高数据的传输速率。

[0124] 如图 9 所示, 是本发明自适应调制编码装置实施例一的结构示意图, 该自适应调制编码装置包括发送模块 11、接收模块 12 和选择下发模块 13, 其中: 发送模块用于向终端发送导频信号; 接收模块用于接收终端根据上述导频信号进行信道测量后反馈的信道质量指示; 选择下发模块用于根据上述信道质量指示从修改后的调制编码方式 (MCS) 表中选择调制编码方式, 并根据上述调制编码方式下发数据。

[0125] 其中, 上述修改后的 MCS 表支持 256 正交幅度调制 (QAM) 的调制方式; 上述修改后的 MCS 表为在原 MCS 表的基础上增加了多个 MCS 内容的 MCS 表, 其中, 增加的多个 MCS 内容用新增的一个或多个比特来指示, 具体可参见表 1- 表 2; 或者, 上述修改后的 MCS 表为对原 MCS 表中的内容进行了重新解释的 MCS 表, 具体可参见表 3- 表 4。

[0126] 该自适应调制编码装置可以位于基站内, 在下行传输方向上, 可实现选择 256QAM 的调制方式, 具体实现方式可参见图 1- 图 4, 此处不再赘述。

[0127] 如图 10 所示, 是本发明自适应调制编码装置实施例二的结构示意图, 该自适应调制编码装置包括接收模块 21 和选择反馈模块 22, 其中: 接收模块用于接收终端发送的参考信号; 选择反馈模块用于根据上述参考信号从修改后的调制编码方式 (MCS) 表中选择调制编码方式, 并反馈给终端, 以便上述终端根据上述调制编码方式向上述自适应调制编码装置发送数据。

[0128] 其中, 上述修改后的 MCS 表支持 256 正交幅度调制 (QAM) 的调制方式; 上述修改后的 MCS 表为在原 MCS 表的基础上增加了多个 MCS 内容的 MCS 表, 其中, 增加的多个 MCS 内容用新增的一个或多个比特来指示, 具体可参见表 5- 表 6; 或者, 上述修改后的 MCS 表为对原 MCS 表中的内容进行了重新解释的 MCS 表, 具体可参见表 7- 表 8。

[0129] 该自适应调制编码装置可以位于基站内, 在上行传输方向上, 可实现选择 256QAM 的调制方式, 具体实现方式可参见图 5- 图 8, 此处不再赘述。

[0130] 本领域普通技术人员可以理解上述方法中的全部或部分步骤可通过程序来指令相关硬件完成, 上述程序可以存储于计算机可读存储介质中, 如只读存储器、磁盘或光盘等。可选地, 上述实施例的全部或部分步骤也可以使用一个或多个集成电路来实现。相应

地,上述实施例中的各模块/单元可以采用硬件的形式实现,也可以采用软件功能模块的形式实现。本发明不限制于任何特定形式的硬件和软件的结合。

[0131] 以上实施例仅用以说明本发明的技术方案而非限制,仅仅参照较佳实施例对本发明进行了详细说明。本领域的普通技术人员应当理解,可以对本发明的技术方案进行修改或者等同替换,而不脱离本发明技术方案的精神和范围,均应涵盖在本发明的权利要求范围当中。



图 1



图 2

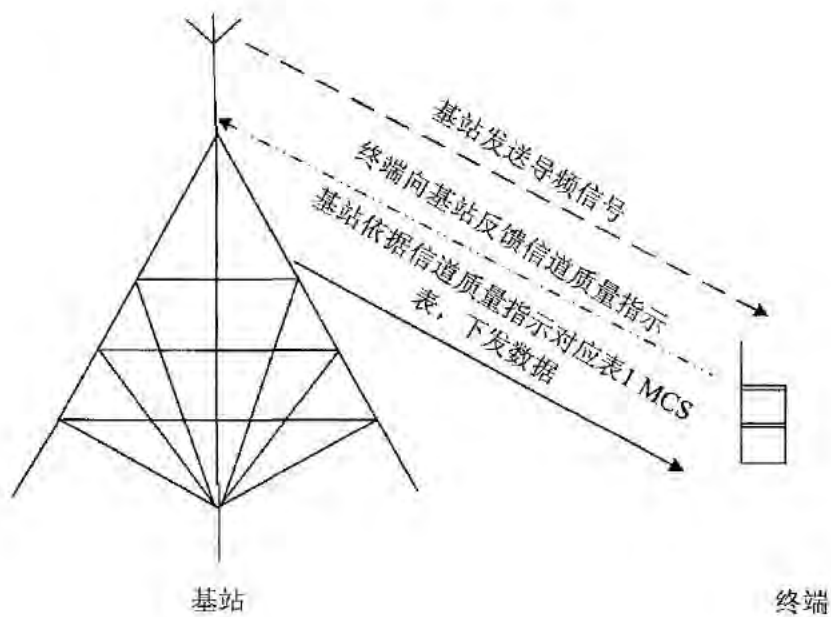

图 3

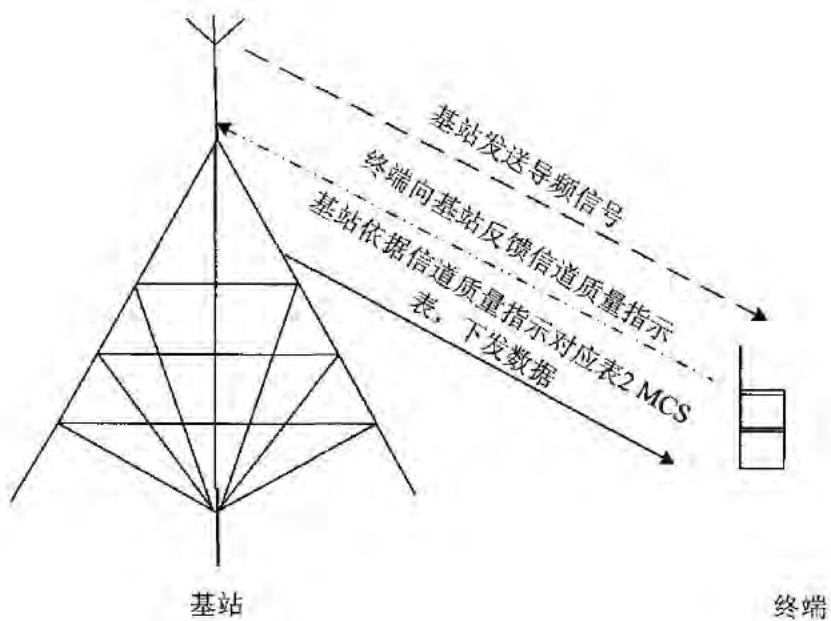

图 4

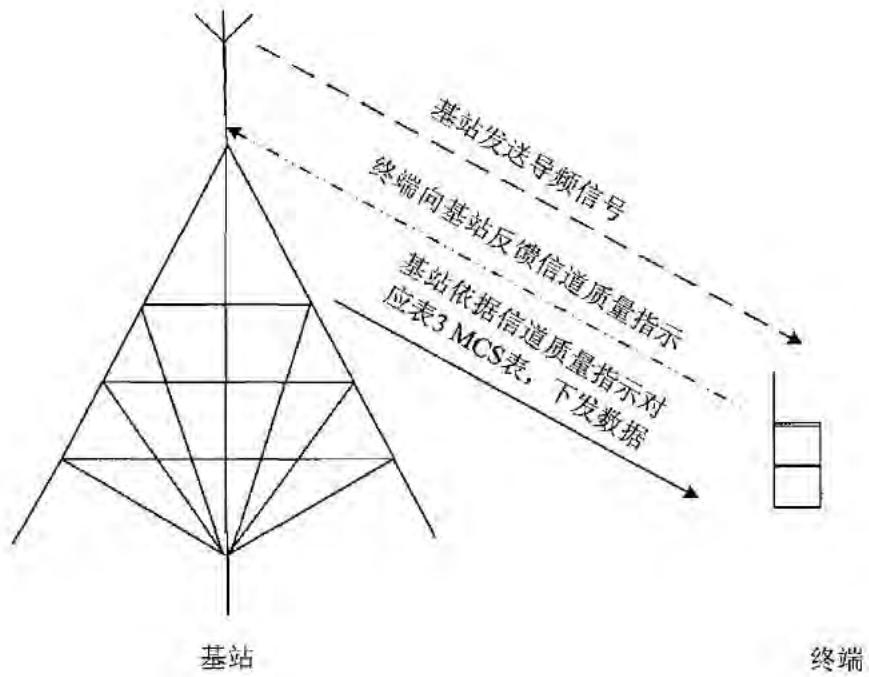

图5

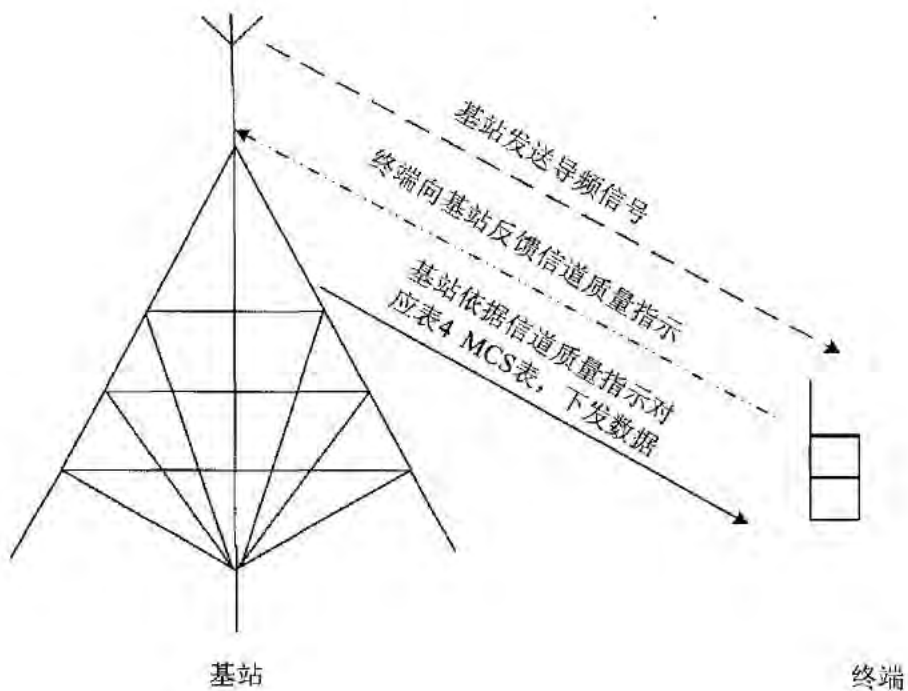

图 6

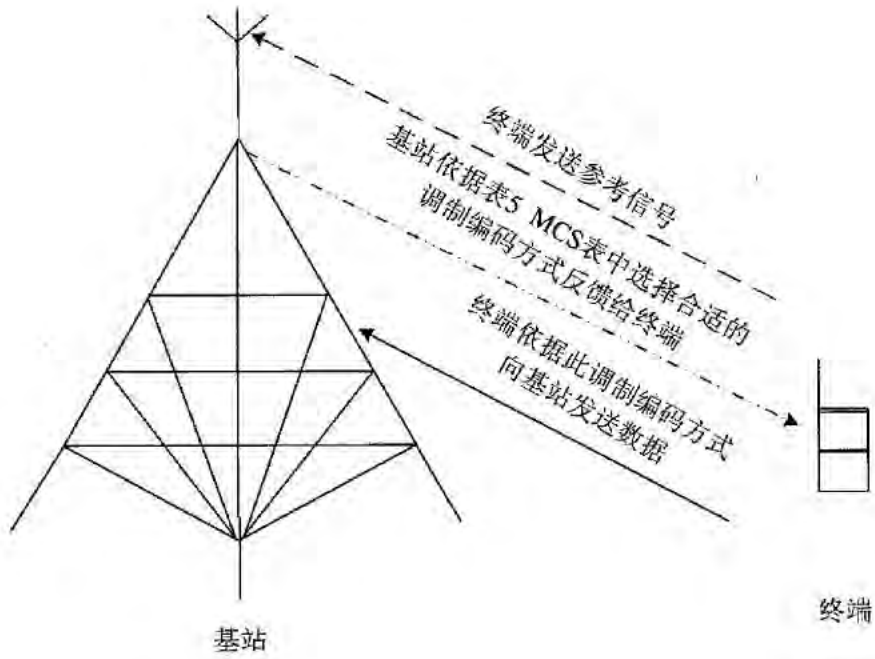

图 7

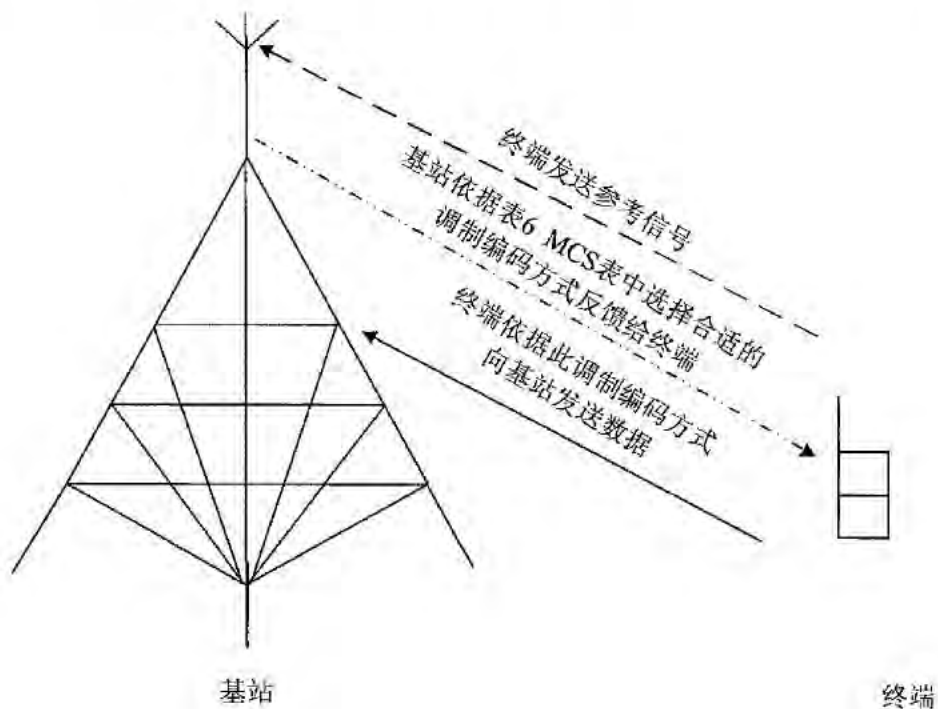

图 8

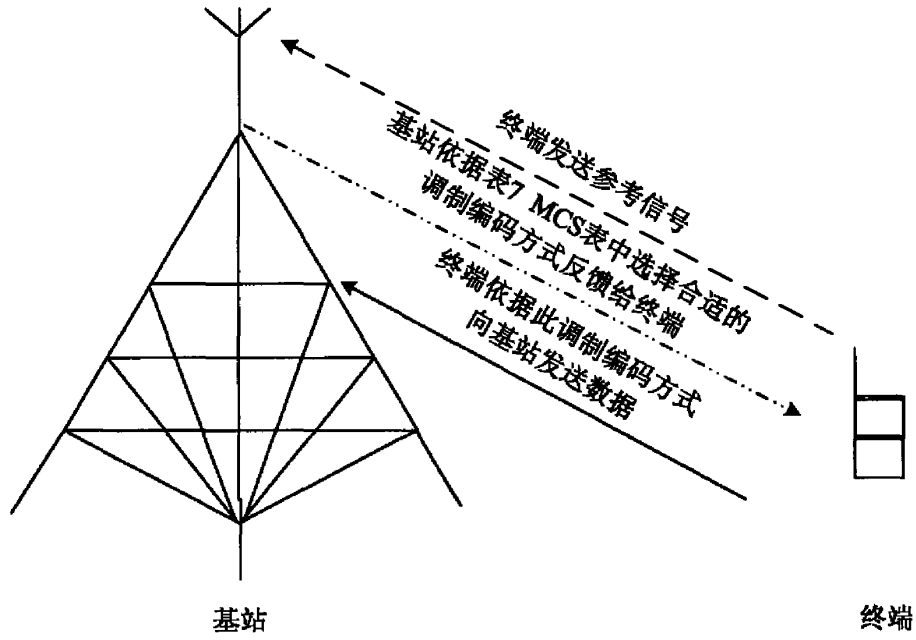

图9

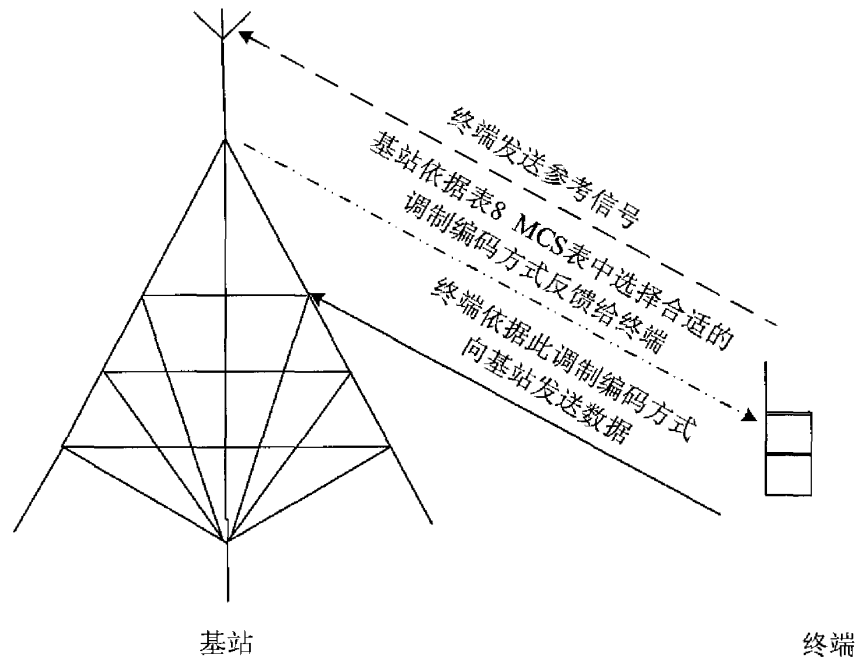

图10

**Espacenet****Bibliographic data: CN102624481 (A) — 2012-08-01**

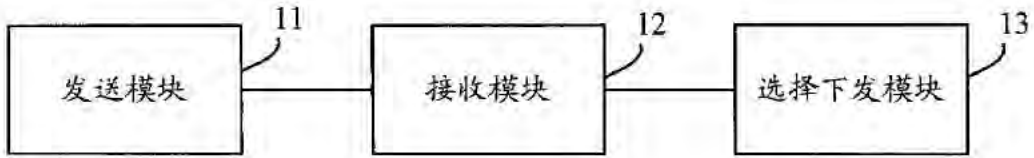
Self-adaptive modulation and coding method and apparatus

Inventor(s): SHUAI ZHANG; JIN XU; XU JUN ± (ZHANG SHUAI, ; XU JIN, ; XU JUN)

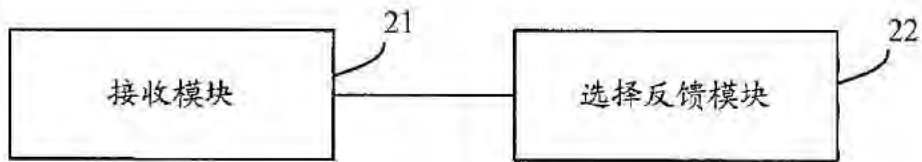
Applicant(s): ZTE CORP ± (ZTE CORPORATION)

Classification: - **international:** *H04L1/00; H04L27/36*
- **cooperative:**

Application number: CN2011134103 20110131

Priority number(s): CN2011134103 20110131

Abstract of CN102624481 (A)

The invention provides a self-adaptive modulation and coding method and an apparatus. The method comprises the following steps that: a pilot signal is sent to a terminal; a receiving terminal carries out channel measurement according to the pilot signal and then feedbacks a channel quality indicator; and according to the channel quality indicator, a modulation and coding scheme (MCS) is selected from a modified MCS table and data are issued based on the MCS. According to the self-adaptive modulation and coding method and the apparatus, on the basis of current supporting of a modulation mode with up to 64 quadrature amplitude modulation (QAM), a modulation mode with up to 256 QAM can be supported; and moreover, a modulation mode with a higher order can also be supported; therefore, a data transmission rate can be improved.



Notice

This translation is machine-generated. It cannot be guaranteed that it is intelligible, accurate, complete, reliable or fit for specific purposes. Critical decisions, such as commercially relevant or financial decisions, should not be based on machine-translation output.

DESCRIPTION CN102624481

[0001]

Art

[0002]

The present invention relates to mobile communication technology, and more particularly to an adaptive modulation and coding method and apparatus.

[0003]

BACKGROUND

[0004]

In a mobile communication system, due to the varying characteristics of the wireless fading channel, the communication process is the large number of such uncertainties, on the one hand in order to improve system throughput, the use of higher transmission rates and higher order modulation and less redundant error correcting code communication, so that the wireless fading channel SNR ideal system throughput indeed been greatly improved, but the channel is in deep fading, it can not guarantee reliable communication stably, on the

other hand, in order to safeguard reliable communications resistance, a lower transmission rate lower order modulation and large redundancy error correction code to communicate, is to protect the wireless channel is in deep fading, reliable and stable communication, however, when the channel SN R is high, since the transmission rate compared with low, limiting the increase system throughput, resulting in a waste of resources in the early development of mobile communication technology, people against wireless fading channel varying characteristics, can only be used to increase the transmission power of the transmitter, the use of low-level large the modulation coding method of redundancy to protect the system when the communication quality of the deep fading channel, and also time to think about how to improve the system throughput, as the technology level of progress, there has to adaptively adjust its transmit power based on the channel state, a modulation and encoding frame length of the data to overcome the time-varying characteristics of a channel, to obtain the best results of communication technique is called adaptive techniques.

[0005]

Existing standards in the uplink and downlink up to 64 quadrature amplitude modulation (QAM) modulation and coding schemes, in order to improve data transfer rates, compatibility with existing wireless transmission network, up to 256QAM modulation and coding scheme.

However, the prior art implementation of the 256QAM modulation and coding scheme is not supported.

[0006]

SUMMARY

[0007]

In order to solve the above technical problem, the present invention provides an adaptive modulation and coding method and apparatus, in order to achieve compatibility with existing wireless transmission network, based on up to 256QAM modulation or higher order modulation and coding scheme, thereby improving data transmission rate.

[0008]

The present invention provides an adaptive modulation and coding method comprising

[0009]

Transmits a pilot signal to the terminal;

[0010]

Receiving terminal according to the channel quality of the pilot signal for channel measurement after the feedback indication;

[0011]

Indicating selection of a modulation coding scheme from the table in the modified modulation and coding scheme (MCS), and the outgoing data of the modulation and coding scheme according to the following based on the channel quality.

[0012]

Preferably, the above-described adaptive modulation and coding method may have the following characteristics

[0013]

MCS table supports 256 of the modified quadrature amplitude modulation (QAM) modulation scheme

[0014]

Preferably, the above-described adaptive modulation and coding method may further have the following

characteristics

[001 5]

Said modified M C S table based on the original M C S table based on the increase of content of a plurality of M C S M C S table, wherein the increase in the content of a plurality of M C S with the new one or more bits to indicate; or

[001 6]

The modified M C S M C S table for the original contents of the table has been re- interpreted M C S table.

[001 7]

The present invention also provides an adaptive modulation and coding the method comprising

[001 8]

Receiving a reference signal sent from the terminal;

[001 9]

Selected according to the modified reference signal from a modulation and coding scheme (M C S) table, modulation and coding schemes, and the feedback to the terminal, so that the terminal transmits data to the base station in accordance with the modulation and coding scheme.

[0020]

Preferably, the above- described adaptive modulation and coding method may have the following characteristics

[0021]

MCS table supports 256 of the modified quadrature amplitude modulation (QAM) modulation scheme

[0022]

Preferably, the above-described adaptive modulation and coding method may further have the following characteristics

[0023]

Said modified MCS table based on the original MCS table based on the increase of content of a plurality of MCS MCS table, wherein the increase in the content of a plurality of MCS with the new one or more bits to indicate, or

[0024]

The modified MCS MCS table for the original contents of the table has been re-interpreted MCS table

[0025]

The present invention also provides an adaptive modulation and coding apparatus of the adaptive modulation and coding apparatus comprising

[0026]

Transmitting module for transmitting a pilot signal to the terminal;

[0027]

A receiving module for receiving the terminal after the channel quality indication of the feedback channel based on said measured pilot signals;

[0028]

Select delivery module for selecting a modulation and coding method based on the channel quality indication from the modified modulation and coding scheme (MCS) table, and send the data modulation and coding schemes according to the following

[0029]

Preferably, the above-described adaptive modulation and coding apparatus may have the following characteristics

[0030]

MCS table supports 256 of the modified quadrature amplitude modulation (QAM) modulation scheme

[0031]

The present invention also provides an adaptive modulation and coding apparatus of the adaptive modulation and coding apparatus comprising

[0032]

A receiving module for receiving a reference signal sent from the terminal;

[0033]

Selection of the feedback module, for selecting a reference signal based on the modulation and coding scheme after modification (MCS) table, modulation and coding schemes, and the feedback to the terminal, so that the terminal transmits data to the base station in accordance with the modulation and coding scheme.

[0034]

Preferably, the above-described adaptive modulation and coding apparatus may have the following characteristics

[0035]

MCS table supports 256 of the modified quadrature amplitude modulation (QAM) modulation scheme

[0036]

Said adaptive modulation and coding method and apparatus, the highest possible on the basis of existing support 64QAM modulation scheme, the highest support 256QAM modulation; and can also support higher-order modulation; thereby increasing the data transfer rate.

[0037]

Brief description

[0038]

Figure 1 is a schematic view of a downlink data transmission embodiment of the present invention is one;

[0039]

Figure 2 is a schematic view of a downlink data transmission embodiment of the present invention II;

[0040]

Figure 3 is a schematic diagram of the present invention, a downlink data transmission in the third example;

[0041]

Figure 4 is a schematic diagram of the four downlink data transmission embodiment of the present invention;

[0042]

Figure 5 is a schematic diagram of the present invention, the uplink data transmission in Embodiment 1;

[0043]

Figure 6 is a schematic view of the uplink data transmission embodiment of the present invention II;

[0044]

Figure 7 is a schematic diagram of three of the uplink data transmission embodiment of the present invention;

[0045]

Figure 8 is a schematic diagram of four uplink data transmission embodiment of the present invention;

[0046]

Figure 9 is a schematic structural view of the present invention is an adaptive modulation and coding apparatus of the embodiment;

[0047]

Figure 10 is a structural schematic view of the second adaptive modulation and coding apparatus according to the present invention.

[0048]

Specific embodiments

[0049]

Below in connection with the accompanying drawings and specific embodiments of the present invention will be further described in detail.

[0050]

The present invention provides an adaptive modulation and coding methods in the downlink transmission direction, said method comprising

[0051]

Step a, the base station transmits a pilot signal to the terminal;

[0052]

Step b, the terminal performs channel measurement according to a pilot signal, the feedback channel quality indication;

[0053]

Step c, base station receive channel quality indication sent by the terminal, in the modified MCS (modulation and coding scheme, Modulation and Coding Scheme) of the table to select the appropriate modulation and coding schemes, and issued data

[0054]

Further, for step c, the MCS on the basis of the existing system, increasing the number of bits used to support 256QAM modulation.

[0055]

Specifically, the MCS may be added in Table 1, Table 2, in any one or several, in which each row represents a MCS: MCS Index modulation coding scheme index, modulation order of the modulation scheme

[0056]

Table 1 New MCS table

[0058]

Specifically, the new MCS also can have the following forms

[0059]

Table 2 New MCS table

[0061]

Further, for the step c, the number of bits to maintain the existing system MCS index unchanged reinterpretation of the MCS to support 256QAM modulation.

[0062]

Specifically, the content can be reinterpreted in Table 3 and Table 4, the contents of which increases with the MCS index and TBS Index, the modulation order is gradually increasing, and the modulation order up to 256QAM (as shown in Table 3, Table 4 The bold part), where TBS Index for the transport block size index

[0063]

Table 3 reinterpretation of MCS table

[0066]

Specifically, the reinterpretation of the MCS table also can have the following forms

[0067]

Table 4 reinterpretation of MCS table

[0070]

The present invention also provides a method for adaptive modulation and coding on the uplink transmission direction, the method described above package:

[0071]

Step e, the terminal transmits a reference signal to the base station;

[0072]

Step f, the base station based on the reference signal transmitted by the terminal, select the appropriate modulation and coding schemes M C S from the modified table, back to the terminal;

[0073]

Step g, the terminal station based on the feedback of the modulation and coding scheme, the transmission data to the base station.

[0074]

Further, for the step f, the M C S on the basis of the existing system, increasing the number of bits used to support 256Q A M modulation.

[0075]

Specifically, the M C S may be added in T able 5, T able 6, any one or more, where each row represents a M C S, Redundancy V ersion of the redundancy version:

[0076]

Table 5 new M C S table

[0079]

Specifically, the new M C S also can have the following forms

[0080]

Table 6 new M C S table

[0082]

Further, for the step f, the number of bits to maintain an existing system modulation and coding scheme index is the same, re- interpretation of the M C S to support 256Q A M modulation.

[0083]

Specifically, the content can be re- explained in Table 7, T able 8, the content of which increases as the M C S index and T B S Index, and gradually increasing the modulation order, and the modulation order of up to 256Q A M (as shown in Table 7, T able 8 The bold part):

[0084]

Specifically, the reinterpretation of the M C S table also can have the following forms

[0085]

Table 7 reinterpretation of M C S table

[0088]

Specifically, the reinterpretation of the MCS table also can have the following forms

[0089]

Table 8 reinterpretation of MCS table

[0092]

The embodiment provides an adaptive modulation and coding method of the present invention, the method comprising

[0093]

The downstream direction, the base station transmits to the terminal of the pilot signal; base station receives the terminal after the channel measurement feedback channel quality indication based on the pilot signal; the base station indicating a selected modulation code from the modified modulation and coding scheme (MCS) table based on the channel quality mode, and send the data according to the above-described modulation and coding schemes;

[0094]

The uplink direction, the base station receives a reference signal sent by the terminal, the base station selects based on the modified reference signal from the modulation and coding scheme (MCS) table, modulation and coding schemes, and feedback to the terminal, the terminal sends to the base station based on the modulation and coding schemes data.

[0095]

Several embodiments will now be specifically described by using the method of the present invention is how to determine the adaptive modulation and coding scheme, and then complete the data coding and the transmission.

[0096]

Example one

[0097]

Figure 1 is a schematic diagram of a downlink data transmission embodiment of the present invention, in this embodiment, the conductive terminal receives the pilot signal transmitted by the base station, a channel quality feedback to the base station, the base station based on the channel quality indication from Table 1 select the appropriate modulation and coding scheme, issued data.

[0098]

As shown in Table 1, on the basis of five-bit MCS indicated by the original system adds a bit indicating that a new increase in the six MCS, MCS is used to indicate that six of the 256QAM modulation scheme, MCS Index 32 in Table 1 the MCS Index 37.

MCS index increase after six bits indicate

[0099]

Wherein the base station based on the channel quality indicator, to select the appropriate modulation and coding scheme, such as choosing the MCS Index equal to 35, meaning the downlink data for the current modulation scheme is 256QAM.

[0100]

Example two

[0101]

Figure 2 is a schematic diagram of the second downlink data transmission embodiment of the present invention, in this embodiment, the conductive terminal receives the pilot signal transmitted by the base station, a channel quality feedback to the base station, the base station based on the channel quality indication from Table 2 select the appropriate modulation and coding scheme, issued data

[0102]

As shown, on the basis of five-bit MCS indicated on the increase in the original system 21 bit for indicating the newly added 8 MCS, which is used to indicate eight MCS 256QAM modulation scheme, MCS Index 32 in Table 2 the MCS Index 39.

MCS index increase after six bits indicate

[0103]

Wherein the base station based on the channel quality indicator, to select the appropriate modulation and coding schemes, such as MCS Index equal to 38 selected, meaning the downlink data for the current modulation scheme is 256QAM.

[0104]

Example three

[0105]

Figure 3 is a schematic diagram of the three downlink data transmission embodiment of the present invention, in this embodiment, the conductive terminal receives the pilot signal transmitted by the base station, a channel quality feedback to the base station, the base station based on the channel quality indication from Table 3 select the appropriate modulation and coding scheme, issued data

[0106]

Send the data to select the appropriate modulation and coding the base station mode: In this case the base station uses the same bit number of the original system MCS, MCS based on the base station as shown in Table 3 Index reinterpreted MCS content

[0107]

For example, a base station according to this channel quality indication, the selected MCS Index equal to 26, meaning in the original system is the current modulation scheme of downlink data for the 64QAM, but this time the contents of the base station using Table 3 reinterpreted as a current modulation method of downlink data for the 256QAM.

[0108]

Example four

[0109]

Figure 4 is a schematic diagram of the four downlink data transmission embodiment of the present invention, in this embodiment, the conductive terminal receives the pilot signal transmitted by the base station, a channel quality feedback to the base station, the base station based on the channel quality indication from Table 4 select the appropriate modulation and coding scheme, issued data

[0110]

Send the data to select the appropriate modulation and coding the base station mode. In this case the base station uses the same bit number of the original system MCS, MCS based on the base station as shown in Table 4 Index reinterpreted MCS content.

[0111]

For example, a base station according to this channel quality indication, the selected MCS Index equal to 23, meaning in the original system is the current modulation scheme of downlink data for the 64QAM, but this time the contents of the base station using Table 4 is reinterpreted as a current modulation method of downlink data for the 256QAM.

[0112]

Example five

[0113]

Figure 5 is a schematic diagram of one embodiment of the uplink data transmission of the present invention, in this embodiment, the base station receives a reference signal sent by the terminal to select an appropriate modulation and coding scheme from Table 5, the feedback to the terminal; a terminal based on the base station feedback modulation and coding scheme, the transmission data to the base station.

[0114]

As shown in Table 5, based on the MCS indicated by the bit 5 of the original system adds an additional bit is used to indicate level 5 MCS, this level of 5 MCS 256QAM for indicating an adjustment method, such as a table of MCS 5 to Index 32 MCS Index 36.

MCS index increase after six bits indicate.

[0115]

Wherein the base station receives a reference signal and selects the appropriate modulation and coding scheme is fed back to the terminal, e.g., base station back to the MCS Index is equal to the terminal 33, which means the current modulation scheme of the downlink data 256QAM.

Terminal according to this MCS index to select the appropriate modulation and coding scheme, and sends the data

[0116]

Sixth Embodiment

[0117]

Figure 6 is a schematic diagram of the second uplink data transmission embodiment of the present invention, in this embodiment, the base station receives a reference signal sent by the terminal to select an appropriate modulation and coding scheme from Table 6, the feedback to the terminal; a terminal based on the base station feedback modulation and coding scheme, the transmission data to the base station.

[0118]

As shown in Table 6, on the basis of five-bit MCS indicated by the original system adds a bit indicating that a new increase in the seven MCS, this level of 5 MCS 256QAM for indicating an adjustment method, such as a table of MCS 6 Index 32 the MCS Index 38.

MCS index increase after six bits indicate

[0119]

Wherein the base station receives a reference signal and selects the appropriate modulation and coding scheme is fed back to the terminal, e.g., base station back to the MCS Index is equal to the terminal 36, which means the current modulation scheme of the downlink data 256QAM.

Terminal according to this MCS index to select the appropriate modulation and coding scheme, and sends the data

[0120]

Seventh Embodiment

[0121]

Figure 7 is a schematic diagram of the three uplink data transmission embodiment of the present invention, in this embodiment, the base station receives a reference signal sent by the terminal to select an appropriate modulation and coding scheme from Table 7, the feedback to the terminal; a terminal based on the base station feedback modulation and coding scheme, the transmission data to the base station.

[0122]

The base station selects an appropriate modulation and coding scheme is the feedback to the terminal: The base station uses the same number of bits with the original system MCS, the base station based on MCS 7 shown in Table Index reinterpretation MCS content

[0123]

Such as base stations selected MCS Index is equal to 26, meaning in the original system is the current downlink data modulation scheme for 64QAM, but this time the base station uses the contents of Table 7 reinterpreted as the current downlink data modulation scheme for 256QAM.

[0124]

Example eight

[0125]

Figure 8 is a schematic diagram of the four uplink data transmission embodiment of the present invention, in this embodiment, the base station receives a reference signal sent by the terminal to select an appropriate modulation and coding scheme from Table 8, the feedback to the terminal; a terminal based on the base station feedback modulation and coding scheme, the transmission data to the base station.

[0126]

The base station selects an appropriate modulation and coding scheme is the feedback to the terminal, the base station uses the same number of bits with the original system MCS, MCS Index shown in Table 8, based on the base station to re-interpret the contents of MCS.

[0127]

Such as base stations selected MCS Index is equal to 27, meaning in the original system is the current downlink data modulation scheme for 64QAM, but this time the base station uses the contents of Table 8 reinterpreted as the current downlink data modulation scheme for 256QAM.

[0128]

Said adaptive modulation and coding method, on the basis of existing supports up to 64QAM modulation scheme, the highest support 256QAM modulation; and, with the development of technology, you can also support higher-order modulation; thereby improving the data transfer rate.

[0129]

9 is a schematic diagram of a structure of an adaptive modulation and coding apparatus according to the present invention, the adaptive modulation and coding apparatus includes a transmission module 11, reception module 12 and the selection module 13 is issued, wherein: the transmission module is used to the terminal sends a pilot signal; receiving module for receiving terminal channel measurement after feedback channel quality indication based on the pilot signal; select delivery module is used to indicate A according to the channel quality C choose from a revised modulation and coding scheme (MCS) table modulation and coding scheme, and the modulation and coding scheme based on the above data is sent.

[0130]

W herein said modified MCS table supports 256 quadrature amplitude modulation (QAM) modulation; above the modified MCS table based on the original table adds multiple MCS table of content, which increased more than MCS contents with the new one or more bits to indicate specifically refer to Table 1 to Table 2; or the revised MCS table for the original contents of the table has been re-interpreted the MCS table, specifically to see Table 3 - Table 4.

[0131]

The adaptive modulation and coding apparatus may be located within a base station, in the downlink transmission direction can be selected to achieve the 256QAM modulation scheme, a particular implementation can be found in Figures 1- 4, are not mentioned here.

[0132]

As shown in Figure 10 is a schematic structural view of the present invention, an adaptive modulation coding apparatus according to the second embodiment, the adaptive modulation and coding apparatus comprises a receiving module 21 and the selection of the feedback module 22, wherein: a receiving module for receiving a reference signal sent from the terminal; selected based on the feedback module is used to select the reference signal from the modulation and coding scheme after modification (MCS) table, modulation and coding schemes, and feedback to the terminal, so that the terminal transmits data to the adaptive modulation and coding apparatus according to the modulation coding scheme.

[0133]

Wherein said modified MCS table supports 256 quadrature amplitude modulation (QAM) modulation; above the modified MCS table based on the original table adds multiple MCS table of content, which increased more than MCS contents with the new one or more bits to indicate, specifically Table 5- Table 6; or the revised MCS table for the original contents of the table has been re-interpreted the MCS table, specifically to see Table 7- Table 8.

[0134]

The adaptive modulation and coding apparatus may be located within the base station on the uplink transmission direction can be selected to achieve the 256QAM modulation scheme, a particular implementation can be found in Figures 5 to 8 are not described here.

[0135]

This will be understood by those of ordinary skill in the above-described method may be all or part of the steps by a program instructing related hardware, the above-described program may be stored in a computer-readable storage medium, such as read only memory, a magnetic disk or optical disk.

Optionally, all or part of the steps of the above embodiments may also be implemented using one or more integrated circuits.

Accordingly, the above-described embodiment, each module / unit may be realized in the form of hardware, the software can also be used in the form of functional modules.

The present invention is not limited to any particular form of the combination of hardware and software.

[0136]

The above embodiments are merely provided for describing the technical solutions of the present invention, not limitation, with reference to only a preferred embodiment of the present invention has been described in detail.

Of ordinary skill in the art will appreciate, the technical solutions of the present invention can be modified or replaced with equivalents without departing from the spirit and scope of the technical solutions of the present invention shall be covered by the scope of the claims of the present invention, among the requirements



Notice

This translation is machine-generated. It cannot be guaranteed that it is intelligible, accurate, complete, reliable or fit for specific purposes. Critical decisions, such as commercially relevant or financial decisions, should not be based on machine-translation output.

CLAIMS CN102624481

[0001]

An adaptive modulation and coding method comprising

Transmits a pilot signal to the terminal;

Receiving terminal according to the channel quality of the pilot signal for channel measurement after the feedback indication;

Indicating selection of a modulation coding scheme from the table in the modified modulation and coding scheme (MCS), and the outgoing data of the modulation and coding scheme according to the following based on the channel quality.

[0002]

The adaptive modulation and coding method as claimed in claim 1, characterized in that

MCS table supports 256 of the modified quadrature amplitude modulation (QAM) modulation scheme

[0003]

The adaptive modulation and coding method according to claim 1 or claim 2, characterized in that

Said modified MCS table based on the original MCS table based on the increase of content of a plurality of MCS MCS table, wherein the increase in the content of a plurality of MCS with the new one or more bits to indicate; or

The modified MCS MCS table for the original contents of the table has been re-interpreted MCS table.

[0004]

An adaptive modulation and coding the method comprising

Receiving a reference signal sent from the terminal;

Selected according to the modified reference signal from a modulation and coding scheme (MCS) table, modulation and coding schemes, and the feedback to the terminal, so that the terminal transmits data to the base station in accordance with the modulation and coding scheme.

[0005]

The adaptive modulation and coding method as claimed in claim 4, characterized in that

MCS table supports 256 of the modified quadrature amplitude modulation (QAM) modulation scheme.

[0006]

The adaptive modulation and coding method according to claim 4 or claim 5, wherein:

Said modified MCS table based on the original MCS table based on the increase of content of a plurality of MCS MCS table, wherein the increase in the content of a plurality of MCS with the new one or more bits to indicate; or

The modified MCS MCS table for the original contents of the table has been re-interpreted MCS table

[0007]

A daptive modulation and coding apparatus of the adaptive modulation and coding apparatus comprising

Transmitting module for transmitting a pilot signal to the terminal;

A receiving module for receiving the terminal after the channel quality indication of the feedback channel based on said measured pilot signals;

Select delivery module for selecting a modulation and coding method based on the channel quality indication from the modified modulation and coding scheme (MCS) table, and send the data modulation and coding schemes according to the following

[0008]

The adaptive modulation and coding apparatus according to claim 7, characterized in that:

MCS table supports 256 of the modified quadrature amplitude modulation (QAM) modulation scheme

[0009]

A daptive modulation and coding apparatus of the adaptive modulation and coding apparatus comprising

A receiving module for receiving a reference signal sent from the terminal;

Selection of the feedback module, for selecting a reference signal based on the modulation and coding scheme after modification (MCS) table, modulation and coding schemes, and the feedback to the terminal, so that the terminal transmits data to the base station in accordance with the modulation and coding scheme.

[001 0]

The adaptive modulation and coding apparatus of claim 9, wherein:

MCS table supports 256 of the modified quadrature amplitude modulation (QAM) modulation scheme

(12) INTERNATIONAL APPLICATION PUBLISHED UNDER THE PATENT COOPERATION TREATY (PCT)

(19) World Intellectual Property
Organization
International Bureau



(10) International Publication Number
WO 2013/123961 A1

(43) International Publication Date
29 August 2013 (29.08.2013)

- (51) International Patent Classification:
H04L 1/00 (2006.01)
- (21) International Application Number:
PCT/EP2012/052828
- (22) International Filing Date:
20 February 2012 (20.02.2012)
- (25) Filing Language: English
- (26) Publication Language: English
- (71) Applicant (for all designated States except US): **NOKIA SIEMENS NETWORKS OY** [FI/FI]; Karaportti 3, FI-02610 Espoo (FI).
- (72) Inventors; and
- (75) Inventors/Applicants (for US only): **LAHETKANGAS, Eeva** [FI/FI]; Kangasrinne 6 A 1, FI-90240 Oulu (FI). **RAAF, Bernhard** [DE/DE]; Knollerweg 14, 82061 Neuried (DE). **PAJUKOSKI, Kari Pekka** [FI/FI]; Purantie 3, FI-90240 Oulu (FI). **TIIROLA, Esa Tapani** [FI/FI]; Porttikellonkuja 12, FI-90450 Kempele (FI).

- (81) Designated States (unless otherwise indicated, for every kind of national protection available): AE, AG, AL, AM, AO, AT, AU, AZ, BA, BB, BG, BH, BR, BW, BY, BZ, CA, CH, CL, CN, CO, CR, CU, CZ, DE, DK, DM, DO, DZ, EC, EE, EG, ES, FI, GB, GD, GE, GH, GM, GT, HN, HR, HU, ID, IL, IN, IS, JP, KE, KG, KM, KN, KP, KR, KZ, LA, LC, LK, LR, LS, LT, LU, LV, MA, MD, ME, MG, MK, MN, MW, MX, MY, MZ, NA, NG, NI, NO, NZ, OM, PE, PG, PH, PL, PT, QA, RO, RS, RU, RW, SC, SD, SE, SG, SK, SL, SM, ST, SV, SY, TH, TJ, TM, TN, TR, TT, TZ, UA, UG, US, UZ, VC, VN, ZA, ZM, ZW.
- (84) Designated States (unless otherwise indicated, for every kind of regional protection available): ARIPO (BW, GH, GM, KE, LR, LS, MW, MZ, NA, RW, SD, SL, SZ, TZ, UG, ZM, ZW), Eurasian (AM, AZ, BY, KG, KZ, MD, RU, TJ, TM), European (AL, AT, BE, BG, CH, CY, CZ, DE, DK, EE, ES, FI, FR, GB, GR, HR, HU, IE, IS, IT, LT, LU, LV, MC, MK, MT, NL, NO, PL, PT, RO, RS, SE, SI, SK, SM, TR), OAPI (BF, BJ, CF, CG, CI, CM, GA, GN, GQ, GW, ML, MR, NE, SN, TD, TG).

[Continued on next page]

(54) Title: CONTROLLING A MODULATION AND CODING SCHEME FOR A TRANSMISSION BETWEEN A BASE STATION AND A USER EQUIPMENT

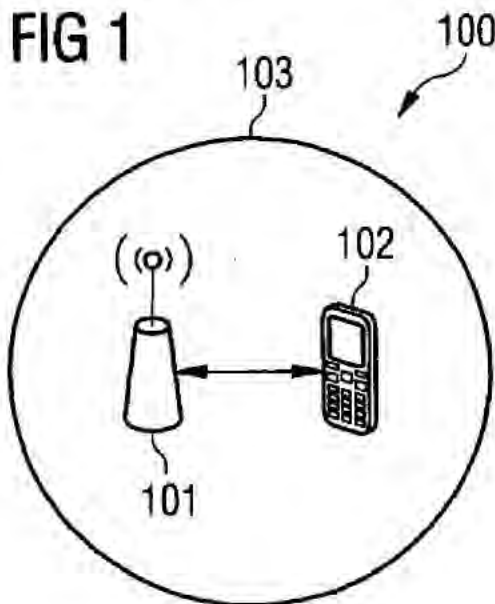

(57) Abstract: It is described a method for controlling a modulation and coding scheme for a transmission between a base station (101) and a user equipment (102), wherein the modulation and coding scheme is selectable based on a first modulation and coding scheme table comprising entries corresponding to a plurality of modulation and coding schemes with a first maximum modulation order or based on a second modulation and coding scheme table comprising entries corresponding to a plurality of modulation and coding schemes with a second maximum modulation order. The method comprises selecting, by the base station (101), the first modulation and coding scheme table or the second modulation and coding scheme table, and controlling, by the base station (101), the modulation and coding scheme for the transmission between the base station (101) and the user equipment (102) based on the selected modulation and coding scheme table.

WO 2013/123961 A1

WO 2013/123961 A1



Published:

-- with international search report (Art. 21(3))

DESCRIPTION

Title

5

Controlling a modulation and coding scheme for a transmission between a base station and a user equipment

10 Field of invention

The present invention relates to the field of cellular networks, especially to an evolution of LTE networks, and in particular to networks comprising LTE networks and evolved LTE networks.

15

Art Background

20 There have been further developments for LTE, for instance relating to a Beyond 4G (B4G) radio system which is assumed to be commercially available in 2020. It might however also be introduced in an evolution of LTE at any date within any new release.

25 LTE provides a peak bit rate of 30 bps/Hz by using 64QAM modulation and 8x8 MIMO transmission. As a result, B4G may require a higher order modulation, for instance 256QAM, than 64QAM in order to meet future requirements. Higher order modulations may be relevant for example in relay backhaul due to better channel quality and better radio frequency (RF) properties which are more easily feasible for relays than for user equipments (UEs) or for isolated indoor cells where the UEs are close by and therefore both having a good link to the access point and no or very little interference from other
30 access points due to attenuation by the walls.

The modulation order determination of LTE Release 10 is described in TS 36.213 V10.3, chapter 7.1.7 and CQI definition in chapter 7.2.3. In LTE (and LTE-Advanced), theoretical spectral efficiency is restricted by 64QAM modulation. An improved spectral efficiency
35 may be gained with extension to 256QAM.

In the LTE standard, there is defined a MCS (modulation and coding scheme) index and modulation table and CQI (channel quality indicator) table. These are used for determining and selecting appropriate modulation and coding schemes. The current tables support up to 64QAM. The problem is how to introduce a 256QAM extension or any other higher order modulation extension for LTE while maintaining backward compatibility and avoiding too much complexity.

There may be a need for an improved and flexible system and method being adapted to allow an extension to a higher order modulation while remaining backward compatible for LTE. In particular it is desirable to maintain signaling formats in particular utilize the same number of bits as otherwise different encoding schemes need to be used and potentially so called blind decoding has to be applied.

15 Summary of the Invention

This need may be met by the subject matter according to the independent claims. Advantageous embodiments of the present invention are described by the dependent claims.

20 According to a first aspect of the invention there is provided a method for controlling a modulation and coding scheme for a transmission between a base station and a user equipment, wherein the modulation and coding scheme is selectable based on a first modulation and coding scheme table comprising entries corresponding to a plurality of modulation and coding schemes with a first maximum modulation order or based on a
25 second modulation and coding scheme table comprising entries corresponding to a plurality of modulation and coding schemes with a second maximum modulation order. The method comprises selecting, by the base station, the first modulation and coding scheme table or the second modulation and coding scheme table, and controlling, by the base station, the modulation and coding scheme for the transmission between the base station
30 and the user equipment based on the selected modulation and coding scheme table.

This aspect of the invention is based on the idea to extend the modulation and coding scheme table to a higher order modulation while remaining backward compatible. The first table may support for instance up to 64QAM (quadrature amplitude modulation) and the
35 second table may support for instance up to 256QAM, or any other higher order modulation extension. It should be noted that although 256QAM is explicitly mentioned herein, any other higher modulation order than that used for the first table may be used, for in-

stance also 128QAM or in general a higher modulation and coding scheme (MCS) which may be characterized by either modulation order or coding scheme of both.

5 The idea of this method is to introduce a higher order modulation while still supporting a modulation and coding scheme (MCS) table being introduced for a lower modulation order.

10 The term "modulation order" in this context may be determined by the number of the different symbols that can be transmitted using it. In general MCS also considers different code rates and thus indicates the average number of payload bits that can be transmitted per symbol. The first maximum modulation order and the second maximum modulation order may be the same or may be different.

15 The term "modulation and coding scheme table" may refer to the MCS table being defined in LTE and being used for determining and selecting appropriate modulation and coding schemes. The second table may be an extended MCS table being based on the MCS as defined in LTE but comprising entries corresponding to a higher order modulation. For instance, the backward compatibility may be ensured by having a first table exactly as it is currently defined in the LTE standard.

20 The first and the second table may be different in some respects. For instance, one table may be biased more towards low MCS and the second towards high MCS values. For example, one table may have more MCS values below a certain threshold MCS. Also the density of MCS values at lower MCS may be higher in one table or the center of gravity or average of the MCS values may be lower in one table. In one embodiment, one table is a mirror image of the other, for instance being mirrored at the middle MCS.

30 The term "base station" in this context may denote any kind of physical entity being able to communicate with a user equipment or any other network device by selecting a modulation and coding scheme from such a MCS table. A base station in this context may be any kind of network device providing the required functionality for the method, it may also be a transceiver node in communication with a centralized entity. The base station may be for example a NodeB or eNB.

35 The base station may either inform the UE explicitly about a change of the used MCS table or may inform and select the MCS table implicitly as part of the capability enquiry procedure.

According to an embodiment of the invention, the second maximum modulation order is higher than the first maximum modulation order. In particular, the first maximum modulation order corresponds to 64QAM and the second maximum modulation order corresponds to 256QAM.

It should be noted that also other modulation orders may be used, for instance 128QAM.

Furthermore, a few high MCSs may be included in the first table to be able to quickly react in case the channel gets suddenly better.

According to a further embodiment of the invention, the maximum modulation order may correspond to the highest modulation and coding scheme (MCS). Further, the highest modulation and coding scheme may be the same for both tables.

According to a further embodiment of the invention, the method further comprises determining, by the base station, actual channel conditions of a radio transmission channel being used for the transmission between the base station and the user equipment, determining, by the base station, a maximum supported modulation order based on the determined actual channel conditions, and selecting, by the base station, the first modulation and coding scheme table or the second modulation and coding scheme table based on a comparison of the maximum supported modulation order with the first maximum modulation order and the second maximum modulation order.

If the actual channel conditions do not support the higher order modulation or if the user equipment (UE) is not able to support the higher order modulation, the base station may perform the modulation and coding for the transmission based on the first table. If the actual channel conditions are good enough for the higher order modulation and if the UE supports the higher order modulation, the base station may perform the modulation and coding based on the second table supporting a higher order modulation, for instance up to 256QAM.

According to a further embodiment of the invention, the method further comprises transmitting information to the user equipment being indicative for the selected modulation and coding scheme table.

The base station may provide a signal to the UE comprising information about the selected and used MCS table. The UE may then perform, based on this information, further actions, like CQI reports.

- 5 According to a further embodiment of the invention, transmitting information to the user equipment is based on radio resource control signalling.

By using a common signalling, the UE may be easily informed about the selected MCS table. This information may also be included in any information signal comprising information for the UE in view of any other resource control.

10 According to a further embodiment of the invention, transmitting information to the user equipment is based on implicit signalling.

15 This may refer to the case, wherein the UE may receive information from the base station and may determine based on this information the selected MCS table. This may be the case for instance as part of the capability enquiry procedure which also makes the capability available to the eNB. During this kind of set up procedure, where the eNB determines capabilities of the UE, the tables may be switched and the UE may be informed implicitly

20 without specific signalling.

According to a further embodiment of the invention, the method further comprises receiving confirmation information from the user equipment being indicative for a performed change of the selected modulation and coding scheme table.

25

The base station may carry out the change from one table to the selected MCS table after receiving the confirmation signal from the UE. The confirmation signal may thus be indicative for a final change of the MCS tables to be carried out by the base station.

30 According to a further embodiment of the invention, the first modulation and coding scheme table and the second modulation and coding scheme table each comprise a common subset of equal entries being arranged at same positions within the first modulation and coding scheme table and the second modulation and coding scheme table. In particular, the method further comprises after transmitting the information to the user

35 equipment being indicative for the selected modulation and coding scheme table and before receiving the confirmation information from the user equipment, controlling the modulation and coding scheme for the transmission between the base station and the user

equipment based on the selected modulation and coding scheme table based on the common subset of entries.

5 By using common entries in both MCS tables, the base station may use the common entries as long as there is no confirmation signal from the UE. This may provide the advantage that there is no misunderstanding and wrong modulation and coding as both parts (base station and UE) are using the same modulation and coding scheme (although they may possibly use different tables).

10 According to a further embodiment of the invention, controlling an initial transmission between the base station and the user equipment is based on the first modulation and coding scheme table.

15 The base station and the UE may use the MCS table having the lower maximum modulation order at the start of each communication. This may provide the advantage that each communication starts with the same table and afterwards the base station may decide whether to change the MCS table or not. The change may then be performed based on the actual channel conditions if the UE can support the MCS table supporting the higher order modulation.

20 According to a further embodiment of the invention, the bits of carrying a modulation and coding scheme index are the same for the first modulation and coding scheme table and for the second modulation and coding scheme table.

25 Thus, it may be ensured that there is a backward compatibility without having to amend the MCS tables in their existing form nor the coding and transmission mechanisms that are employed to convey the selection out of that table. In a more specific embodiment, the tables may have the same size. In particular, parts of the first MCS table and the second MCS table are equal, providing common entries as explained above. Entries of the first
30 MCS table relating to very low modulation orders may be exchanged (redefined) for the second MCS table and may comprise the higher order modulations.

35 According to a further embodiment of the invention, the actual channel conditions are determined based on a channel quality indicator being selectable based on a first channel quality indicator table supporting the first maximum modulation order or based on a second channel quality indicator table supporting the second maximum modulation order, the method comprising receiving, by the base station, a channel quality indicator from the

user equipment, and determining, by the base station, the actual channel conditions of the radio transmission channel being used for the transmission between the base station and the user equipment based on the received channel quality indicator.

5 Like the MCS tables, also the CQI tables may be selected based on the selection of the MCS tables. If there is a switch or change from the first MCS table to the second MCS table, there may also be change from the first CQI table to the second CQI table. The UE may thus determine the CQI based on a table which corresponds to the selected MCS table.

10

According to a further embodiment of the invention, the method further comprises selecting, by the base station, the first channel quality indicator table or the second channel quality indicator table based on the selected modulation and coding scheme table, and transmitting information to the user equipment being indicative for the selected channel quality indicator table.

15

The information of the selected CQI table may be provided to the UE from the base station. The information may also be provided implicitly by informing the user equipment of the selected MCS table.

20

According to a further embodiment of the invention, the first channel quality indicator table and the second channel quality indicator table each comprise a common subset of equal entries being arranged at same positions within the first channel quality indicator table and the second channel quality indicator table.

25

Like the MCS tables, also the CQI tables may comprise a common subset. Thus, it may be ensured that, during switching, there are no misunderstandings between the UE and the base station.

30 According to a second aspect of the invention, there is provided a base station for controlling a modulation and coding scheme for a transmission between the base station and a user equipment, wherein the modulation and coding scheme is selectable based on a first modulation and coding scheme table comprising entries corresponding to a plurality of modulation and coding schemes with a first maximum modulation order or based on a
35 second modulation and coding scheme table comprising entries corresponding to a plurality of modulation and coding schemes with a second maximum modulation order. The base station comprises a selection unit being adapted to select the first modulation and

coding scheme table or the second modulation and coding scheme table, and a control unit being adapted to control the modulation and coding scheme for the transmission between the base station and the user equipment based on the selected modulation and coding scheme table.

5

The base station may be any type of access point or point of attachment, which is capable of providing a wireless access to a cellular network system. Thereby, the wireless access may be provided for a user equipment or for any other network element, which is capable of communicating in a wireless manner. The base station may be a NodeB, eNB, home NodeB or HeNB, or any other kind of access point or also a multihop node or relay. The base station may in particular be used for a B4G, LTE or 3GPP cell and communication.

10

The base station may comprise a receiving unit, for example a receiver as known by a skilled person. The base station may also comprise a transmitting or sending unit, for example a transmitter. The receiver and the transmitter may be implemented as one single unit, for example as a transceiver. The transceiver or the receiving unit and the sending unit may be adapted to communicate with the user equipment via an antenna.

15

The base station further comprises a selection unit and a control unit. The selection unit and the control unit may be implemented as single units or may be implemented for example as part of a standard control unit, like a CPU or a microcontroller.

20

In one embodiment, the base station may further comprise a determination unit being adapted to determine actual channel conditions of a radio transmission channel being used for the transmission between the base station and the user equipment, and being adapted to determine a maximum supported modulation order based on the determined actual channel conditions. The selection unit may be adapted to select the first modulation and coding scheme table or the second modulation and coding scheme table based on a comparison of the maximum supported modulation order with the first maximum modulation order and the second maximum modulation order.

25

30

The determination unit may be implemented as a single unit or may be implemented for example as part of a standard control unit, like a CPU or a microcontroller.

35

The user equipment (UE) may be any type of communication end device, which is capable of connecting with the described base station. The UE may be in particular a cellular mo-

mobile phone, a Personal Digital Assistant (PDA), a notebook computer, a printer and/or any other movable communication device.

5 The user equipment may comprise a receiving unit or receiver which is adapted for receiving signals from the base station. The user equipment may comprise a transmitting unit for transmitting signals. The transmitting unit may be a transmitter as known by a skilled person. The receiver and the transmitting unit may be implemented as one single unit, for example as a transceiver. The transceiver or the receiver and the transmitting unit may be adapted to communicate with the base station via an antenna.

10

The user equipment may further comprise a control unit for controlling and configuring the transmission based on information received from the base station being indicative for a selected MCS table. The control unit may be implemented as a single unit or may be implemented for example as part of a standard control unit, like a CPU or a microcontroller.

15

According to a third aspect of the invention, there is provided a cellular network system. The cellular network system comprises a base station as described above.

20 Generally herein, the method and embodiments of the method according to the first aspect may include performing one or more functions described with regard to the second or third aspect or an embodiment thereof. Vice versa, the base station or cellular network system and embodiments thereof according to the second and third aspect may include units or devices for performing one or more functions described with regard to the first aspect or an embodiment thereof.

25

According to a fourth aspect of the herein disclosed subject-matter, a computer program for controlling a modulation and coding scheme for a transmission between a base station and a user equipment is provided, the computer program being adapted for, when executed by a data processor assembly, controlling the method as set forth in the first aspect or an embodiment thereof.

30

As used herein, reference to a computer program is intended to be equivalent to a reference to a program element and/or a computer readable medium containing instructions for controlling a computer system to coordinate the performance of the above described method.

35

The computer program may be implemented as computer readable instruction code by use of any suitable programming language, such as, for example, JAVA, C++, and may be stored on a computer-readable medium (removable disk, volatile or non-volatile memory, embedded memory/processor, etc.). The instruction code is operable to program a computer or any other programmable device to carry out the intended functions. The computer program may be available from a network, such as the World Wide Web, from which it may be downloaded.

The herein disclosed subject matter may be realized by means of a computer program respectively software. However, the herein disclosed subject matter may also be realized by means of one or more specific electronic circuits respectively hardware. Furthermore, the herein disclosed subject matter may also be realized in a hybrid form, i.e. in a combination of software modules and hardware modules.

In the above there have been described and in the following there will be described exemplary embodiments of the subject matter disclosed herein with reference to a cellular network system, a base station and a method of controlling a modulation and coding scheme for a transmission between a base station and a user equipment. It has to be pointed out that of course any combination of features relating to different aspects of the herein disclosed subject matter is also possible. In particular, some embodiments have been described with reference to apparatus type embodiments whereas other embodiments have been described with reference to method type embodiments. However, a person skilled in the art will gather from the above and the following description that, unless otherwise notified, in addition to any combination of features belonging to one aspect also any combination between features relating to different aspects or embodiments, for example even between features of the apparatus type embodiments and features of the method type embodiments is considered to be disclosed with this application.

The aspects and embodiments defined above and further aspects and embodiments of the present invention are apparent from the examples to be described hereinafter and are explained with reference to the drawings, but to which the invention is not limited.

Brief Description of the Drawing

35

Figure 1 shows a cellular network system according to an exemplary embodiment of the present invention.

Figure 2 shows a simulation of spectral efficiency for 64QAM and 256QAM.

5 Figure 3 shows a simulation of spectral efficiency for 4x4 MIMO and 2x2 MIMO, each for 64QAM and 256QAM.

Figure 4 shows a base station and a user equipment within a cellular network system according to an exemplary embodiment of the invention.

10 It is noted that in different figures, similar or identical elements are provided with the same reference signs.

Detailed Description

15

In the following, embodiments of the herein disclosed subject matter are illustrated with reference to the drawings and reference to aspects of current standards, such as LTE, and their further developments. However, such reference to current standards is only exemplary and should not be considered as limiting the scope of the claims.

20

Figure 1 shows a cellular network system 100. A user equipment 102 is served by a first cell 103 of the cellular network system. The first cell is assigned to a base station 101.

25

The transmission and communication between the base station and the user equipment is controlled based on a modulation and coding scheme. The modulation and coding scheme is selectable based on a first modulation and coding scheme table comprising entries corresponding to a plurality of modulation and coding schemes with a first maximum modulation order or based on a second modulation and coding scheme table comprising entries corresponding to a plurality of modulation and coding schemes with a second maximum modulation order. In one embodiment, the second maximum modulation order is higher (for instance up to 256QAM) than the first maximum modulation order (for instance up to 64QAM).

30

35 The base station may determine actual channel conditions of the radio transmission channel being used for the transmission between the base station and the user equipment.

Then, the base station may determine a maximum supported modulation order based on the determined actual channel conditions and eventually based on information from the

user equipment which modulation order can be supported by the user equipment. The base station then selects the first modulation and coding scheme table or the second modulation and coding scheme table based on a comparison of the maximum supported modulation order with the first maximum modulation order and the second maximum modulation order. Thus, the modulation and coding scheme (MCS) for the transmission between the base station and the user equipment is controlled based on the selected modulation and coding scheme table.

The base station may also select the table based on any other information, for instance based on predefined selection criteria.

In LTE (and LTE-Advanced), theoretical spectral efficiency is restricted by 64QAM modulation. Figure 2 presents the simulated LTE-Advanced throughput with 8x8-MIMO and modulation restricted to 64QAM (reference number 201) (coding rate 8/9) in 1-tap Rayleigh channel with no spatial correlation. Spectral efficiency that would be gained with extension to 256QAM is also plotted to Figure 2 for comparison (reference number 202). It can be seen that extension to 256QAM starts to have effect around 25dB SNR range. In these figures the average SINR is plotted against the throughput. Even if the average is below the area whether 256QAM provides gain, due to fading the channel conditions may still be good for some time.

Throughput in LTE is restricted by MCS also in a more practical scenario (for example in case of relay backhaul) where there is high spatial channel correlation that restricts the usage of large ranks. This is illustrated in the Figure 3 where spectral efficiencies for 2x2 and 4x4 MIMO schemes with adaptive rank and MCS selections in high spatial correlation scenario are plotted as a function of average signal-to-noise ratio. For both 2x2 and 4x4 schemes two curves are presented, in one of which MCS is restricted to 64QAM (2x2: 304, 4x4: 302) and another one with MCS set extension to 256QAM (2x2: 303, 4x4: 301). It can be seen that extension to 256QAM increases the throughput already from around 10dB SNR range in these scenarios. That means the throughput is already compromised well below the maximum throughput that is possible with 64QAM.

The problem is how to introduce 256QAM for LTE to maintain backward compatibility and avoid too much complexity. 256QAM addition might need to be done to both MCS index and modulation table and CQI table defined in LTE standard.

In Release 10, a new DCI format 2c was added in order to support close loop MIMO with up to 8 layers. One straightforward solution would be to define new DCI format for 256QAM (and use more than 5 bits for the modulation and coding scheme field in the DCI). This is no desirable solution because it doubles the number of DCI formats resulting
5 in a significant complexity increment. In UMTS there was also an extension from 16 QAM to 64 QAM by adding one extra signalling bit [R1-070635 R1-070570]. The extra bit can either be provided by defining an new DCI format at the expense of worse decoding performance and more blind decodings or at least more optional DCI sizes. Or the bit is
10 "stolen" from some other signaling, limiting the possibilities there, e.g. in HSDPA the bit is stolen from the code allocation table which only supports half as many entries if 64QAM is enabled.

Another possible solution would be to take the existing MCS/CQI index table as a basis and change the usage of it so that only a subset of the current MCS values would be
15 used, e.g. drop every third to make room for the additional 256QAM values. This causes a coarser adaptation of the channel conditions and is therefore undesirable. In the following, this method is called sub-sampling.

The idea of the herein described method is to define a new procedure which allows to use
20 256QAM in good channel conditions using the existing DCI formats. For this purpose, additional new MCS and CQI index tables with extension to 256QAM ($Q_m=8$) may be generated. The new tables have the same size as the usual ones. Decision whether original index table or the table with 256QAM extension is used is either determined by the base station (or eNB) and the switching is indicated to the UE with a signalling message or de-
25 cided in implicit way.

In one embodiment, there is a common index area common for both the original table and the table with 256QAM extension where MCS/CQI index, modulation order and TBS index
30 are identical and are also in identical positions in both tables. Only this common MCS index area might be used while switching the tables to avoid ambiguities.

In one embodiment, the MCS/CQI index table with 256QAM extension is formed so that room for the TB (transport block) sizes related to 256QAM is taken from originally low TB sizes. Furthermore, there may be a few common modulation / TB sizes in the common
35 MCS index area from the low range of the modulation set for such situations where extended 256QAM table is in use and channel conditions drop quickly. These indexes can be sub-sampled from the low TBS area.

A two step switching procedure may be provided for CQI index table switching in order to make sure the UE is aware of the switching and does not use ambiguous table entries during switching. The MCS table may already be switched to the 256QAM version.

5

There could be also a few common modulation / TB sizes in the common MCS index area from the high range of the modulation set for such situations where 256QAM should be used quickly e.g. during initial call setup before an explicit selection takes place or in order to allow quick reaction towards better qualities.

10

The herein described second tables for the MCS and CQI index tables may be generated corresponding to 36.213 table 7.1.7-1 but with extension to 256QAM ($Q_m=8$). One option is that the original table 7.1.7-1 and table with 256QAM extension are switched by eNB with an RRC-message (alternatively also MAC / or control signalling messages could be considered). In this case, algorithm responsible of this switching is eNB vendor specific but will obviously take CQI reports from the UE into account. The UE may be responsible of switching the MCS index table according to the RRC message and sending an acknowledgement to eNB about the received RRC message (the acknowledgement may not be essential, it may help however to avoid backward compatibility issues as a UE not supporting the switching will not acknowledge the command).

15

20

Since it takes about 100-200ms for a RRC message to take effect in the UE (processing delays of higher layers haven't been standardized and depend on how often they have to be retransmitted in case of detection errors) and because (1) RRC messages can get lost and (2) there is uncertainty related to the starting time when the new configuration is taken into use by the UE, there may need to be a MCS index area common for both tables, which allows data scheduling also during the time of uncertainty. This may ensure that an MCS from that area is understood correctly no matter whether the switching already took place or not. This common area may be continuous, i.e. has continuous MCS entries to allow a fine adaptation during switching as well. MCS index, modulation order and TBS index may be identical in both MCS index tables on this area. For instance, only this common MCS index area can be used during the RRC procedure switching the tables and before eNB has received an acknowledgement from UE that it has received the RRC message switching the MCS index table. The common index area may be used also if implicit table switching is used and, in this case, only the common area can be used during the implicit switching procedure.

25

30

35

Additionally, there may be a few common low modulation / TB sizes in the common MCS index area for such situations where extended 256QAM table is in use and channel conditions drop quickly. TB sizes that are required to transmit the switching command may be available in the common MCS index area.

5

New TB sizes may be introduced in the MCS / CQI index table with 256QAM extension in order to increase spectral efficiency with 256QAM:

- Room for these new TB sizes can be taken from current low TB sizes (QPSK and possibly low 16QAM)
- 10 • The reserved TBS size for QAM may also be in the low modulation common MCS area. This MCS is used for retransmissions with bad channel conditions, in particular if the previous initial transmission was done with a higher MCS, in particular a higher Modulation Order, or with a different number of assigned resources. However, it might not be necessary to also have the reserved entry for 256QAM included.
- 15 • There can be also some 256QAM entries in the common area for situations like call setup where 256QAM would be useful to be utilized quickly (with a cost of losing the backwards compatibility and having less entries available in the “ordinary” range). Such a default “compromise” MCS table, where sub-sampling is used to achieve a higher dynamic range can be used as soon as the eNB is aware of the capabilities of the UE. A switch from the legacy table, i.e., with lower maximum modulation order, to that compromise table, i.e., with higher maximum modulation order, could be done implicitly as part of the capability enquiry procedure which also makes the capability available to the eNB. Subsequently, an explicit switching to a table focusing on low or high MCS may be done, but also an explicit switching to such a sub-sampled table in case the channel conditions vary so quickly that it is not feasible to do explicit switching.
- 20
- 25

30 An example of the MCS index and modulation table with 256QAM extension is shown in Table 1. The MCS indexes 12 to 31 refer to the continuous common MCS index area. The MCS indexes 0, 5 and 10 refer to a sub-sampled low modulation common MCS index area and the MCS indexes 1 to 4, 6 to 9 and 11 refer to the 256QAM extension.

MCS Index I_{MCS}	Modulation Order Q_m	TBS Index I_{TBS}
0	2	0
1	8	26
2	8	27
3	8	28
4	8	29
5	2	5
6	8	30
7	8	31
8	8	32
9	8	33
10	4	9
11	8	reserved
12	4	11
13	4	12
14	4	13
15	4	14
16	4	15
17	6	15
18	6	16
19	6	17
20	6	18
21	6	19
22	6	20
23	6	21
24	6	22
25	6	23
26	6	24
27	6	25
28	6	26
29	2	reserved
30	4	
31	6	

Table 1: Example for a MCS index table

Similarly to the MCS index table, a new CQI index table with 256QAM extension and with common index area be used. The CQI tables are switched with the same RRC message responsible for MCS index table switching. In another case, the CQI tables may be

5 switched implicitly. The eNB may be responsible of handling possible error situations caused by the unawareness which table the UE is using at an exact time during this RRC procedure. The eNB can for example simply ignore non-common CQI indexes, round

10 them to the closest common index or take a risk and decide to which table they most probably are related to, based on some heuristics. Such error cases can happen because contrary to MCS selection, where the eNB initiates the change and can therefore avoid

15 ambiguous entries during switching, for CQI the UE isn't aware of the imminent switching and thus cannot avoid them (unless it avoids them always which is pointless). In order to increase the likelihood that the eNB can pick the right decision in case of ambiguous table entries, the minimum differences in TBS for any MCS index should be maximized. This is

20 the case in Table 1, because the entries are arranged in increasing TBS for both the 256 and QAM cases. If the 256 QAM cases were ordered inversely, for MCS index 9 there would be a TBS of 26 (in case of 256QAM) or 8 (in case of QPSK) i.e. a difference of $26-8=18$, while in Table 1 the difference is $33-8=25$. The higher the difference the less likely the eNB cannot use heuristics (e.g. if the channel really changed by that amount of 25

25 steps). For the same reason it may be beneficial to place the reserved 256QAM entry at the highest MCS index, i.e., for MCS index 11 in Table 1. The reserved entry is only relevant for downlink, not for uplink. Therefore, in the uplink table it can be easily dropped and replaced by the normal entry for QAM (in Table 1 with TBS 10).

30 In order to avoid ambiguous CQI reports during the switching time, a two step switching procedure can be employed: in a first command the eNB announces the switching. From then on the UE only uses CQI reports from the common MCS area. In a second command the eNB commands to perform the switching. From then on the UE fully uses the high MCS table. Despite the fact that there are now two ambiguous periods, there is no risk for

35 misinterpretations: During both ambiguous periods the UE uses either a well defined MCS table (the original one during the first ambiguous period and the final one during the second one) or only MCSs from the common MCS area and in this common area there is no risk of misunderstanding. This is due to the fact that the entries from the common MCS area may be coded identically in both tables. This will make the order of the entries in the high MCS area non-consecutive but this is a minor complexity and can be solved e.g. by implementing a lookup-table.

The message flow according to this embodiment can then be like this:

- 1) From eNB to UE: RRC message to switch MCS table and restrict CQI reporting to the common index area. The eNB only uses common index area for MCS
- 5 2) From UE to eNB: confirmation (and implicitly message), the eNB can now use the complete index area of the new MCS table, the eNB knows that the UE will use new CQI table (initially only the common index area).
- 3) From eNB to UE: confirmation, the UE can now use the full index area of the new CQI table.

10

Despite there are actually two handshakes, it might not take 4 messages but only 2 because the middle message may have a double meaning on both CQI and MCS tables.

15

Another approach to avoid ambiguous CQI reports is to allow the UE to initiate the switching of tables for CQI and the eNB to initiate switching for MCS. Then always the originator of a message switches to corresponding tables and can thus restrict usage to the common index area during the ambiguous period.

20

A new UE category is needed with 256QAM included in order to indicate UE's capability to support 256QAM. In case the UE does not support 256QAM, the above mentioned process and MCS/CQI index tables with 256QAM extensions are not used. Alternatively the eNB can transmit the switching command, and determine from the response, whether the UE supports 256QAM. In the initial access phase, 256QAM and thus the MCS table of the higher modulation order should not be used since the eNB does not yet know the UEs capabilities.

25

30

The process presented above can be used for extensions to even higher MCSs. Also the process can be extended to cover more than two tables to switch between. Common MCSs that are represented in two or more tables should always be at identical positions. There can be differences in the size and forming of the common index areas between the tables, for example it can be possible to have different level sub-samplings in different tables. For example, there may be 3 tables, low, mid and high. Then the mid table can include every second MCS entry in the low modulation area, while the high table only uses every 4th entry there (similar to Table 1), and these entries are selected from the ones which are also present in the mid table. This is possible because 2 is a divider of 4, therefore the sub sampling of the high table should not select every 3rd or 5th entry which would

35

not be compatible. This may also be used for Table 1 that covers a broader range of CQI values.

5 There are numerous advantages in the proposed solution. The existing DCI format design is unchanged. This allows to support 256 QAM for each DL DCI formats while maintaining the existing DCI blind decoding burden at the UE. The proposed scheme provides easy means for the eNB to avoid complicated error cases due to signaling errors. The proposed design allows to keep the basic functionality of the existing DL resource allocation (CQI/MCS index table) unchanged. Hence, it has only minimal impact to the DL scheduler
10 operation.

Figure 4 shows a cellular network system 400 according to an exemplary embodiment of the invention. The cellular network system comprises a base station 101 and a user equipment 102 being served by the base station.
15

In the following, the base station is described with a determination unit. However, it should be noted that the determination unit is optional.

20 The base station comprises a determination unit 402 being adapted to determine actual channel conditions of a radio transmission channel being used for the transmission between the base station 101 and the user equipment 102, and being adapted to determine a maximum supported modulation order based on the determined actual channel conditions. The base station further comprises a selection unit 403 being adapted to select the first modulation and coding scheme table or the second modulation and coding scheme
25 table based on any predefined criterion or on a comparison of the maximum supported modulation order with the first maximum modulation order and the second maximum modulation order. Moreover, the base station comprises a control unit 404 being adapted to control the modulation and coding scheme for the transmission between the base station and the user equipment based on the selected modulation and coding scheme table.

30 The base station may be any type of access point or point of attachment, which is capable of providing a wireless access to a cellular network system. Thereby, the wireless access may be provided for the user equipment, or for any other network element, which is capable of communicating in a wireless manner. The base station may be a NodeB, eNB,
35 home NodeB or HeNB, or any other kind of access point.

The base station may comprise a receiving unit, for example a receiver as known by a skilled person. The base station may also comprise a transmitting or sending unit, for example a transmitter. The receiver and the transmitter may be implemented as one single unit, for example as a transceiver 401. The transceiver or the receiving unit and the sending unit may be adapted to communicate with the user equipment via an antenna.

The determination unit 402, the selection unit 403 and the control unit 404 may be implemented as single units or may be implemented for example as part of a standard control unit, like a CPU or a microcontroller.

The user equipment (UE) may be any type of communication end device, which is capable of connecting with the described base station. The UE may be in particular a cellular mobile phone, a Personal Digital Assistant (PDA), a notebook computer, a printer and/or any other movable communication device.

The user equipment may comprise a receiving unit or receiver which is adapted for receiving signals from the base station. The user equipment may comprise a transmitting unit for transmitting signals. The transmitting unit may be a transmitter as known by a skilled person. The receiver and the transmitting unit may be implemented as one single unit, for example as a transceiver 405. The transceiver or the receiver and the transmitting unit may be adapted to communicate with the base station via an antenna.

The user equipment may further comprise a control unit 406 for controlling and configuring the transmission based on information received from the base station being indicative for a selected MCS table. The control unit may be implemented as a single unit or may be implemented for example as part of a standard control unit, like a CPU or a microcontroller.

Having regard to the subject matter disclosed herein, it should be mentioned that, although some embodiments refer to a "base station", "eNB", etc., it should be understood that each of these references is considered to implicitly disclose a respective reference to the general term "network component" or, in still other embodiments, to the term "network access node". Also other terms which relate to specific standards or specific communication techniques are considered to implicitly disclose the respective general term with the desired functionality.

It should further be noted that a base station as disclosed herein is not limited to dedicated entities as described in some embodiments. Rather, the herein disclosed subject matter may be implemented in various ways in various locations in the communication network while still providing the desired functionality.

5

According to embodiments of the invention, any suitable entity (e.g. components, units and devices) disclosed herein, e.g. the determination unit, are at least in part provided in the form of respective computer programs which enable a processor device to provide the functionality of the respective entities as disclosed herein. According to other embodi-
10 ments, any suitable entity disclosed herein may be provided in hardware. According to other - hybrid - embodiments, some entities may be provided in software while other entities are provided in hardware.

It should be noted that any entity disclosed herein (e.g. components, units and devices)
15 are not limited to a dedicated entity as described in some embodiments. Rather, the herein disclosed subject matter may be implemented in various ways and with various granularities on device level while still providing the desired functionality. Further, it should be noted that according to embodiments a separate entity (e.g. a software module, a
hardware module or a hybrid module) may be provided for each of the functions disclosed
20 herein. According to other embodiments, an entity (e.g. a software module, a hardware module or a hybrid module (combined software/hardware module)) is configured for providing two or more functions as disclosed herein.

It should be noted that the term "comprising" does not exclude other elements or steps. It
25 may also be possible in further refinements of the invention to combine features from different embodiments described herein above. It should also be noted that reference signs in the claims should not be construed as limiting the scope of the claims.

List of reference signs:

	100	Cellular network system
	101	Base station
5	102	User equipment
	103	Cell
	201	8x8 MIMO for 64QAM
	202	8x8 MIMO for 256QAM
10	301	4x4 MIMO for 256QAM
	302	4x4 MIMO for 64QAM
	303	2x2 MIMO for 256QAM
	304	2x2 MIMO for 64QAM
15	400	Cellular network system
	401	Transceiver of the base station
	402	Determination unit of the base station
	403	Selection unit of the base station
20	404	Control unit of the base station
	405	Transceiver of the user equipment
	406	Control unit of the user equipment

CLAIMS:

1. A method for controlling a modulation and coding scheme for a transmission between a base station (101) and a user equipment (102), wherein the modulation and coding scheme is selectable based on a first modulation and coding scheme table comprising entries corresponding to a plurality of modulation and coding schemes with a first maximum modulation order or based on a second modulation and coding scheme table comprising entries corresponding to a plurality of modulation and coding schemes with a second maximum modulation order, , the method comprising
- selecting, by the base station (101), the first modulation and coding scheme table or the second modulation and coding scheme table, and
- controlling, by the base station (101), the modulation and coding scheme for the transmission between the base station (101) and the user equipment (102) based on the selected modulation and coding scheme table.
2. The method as set forth in claim 1, wherein the second maximum modulation order is higher than the first maximum modulation order, in particular wherein the first maximum modulation order corresponds to 64QAM and the second modulation order corresponds to 256QAM.
3. The method as set forth in claim 2, the method further comprising
- determining, by the base station (101), actual channel conditions of a radio transmission channel being used for the transmission between the base station (101) and the user equipment (102),
- determining, by the base station (101), a maximum supported modulation order based on the determined actual channel conditions, and
- selecting, by the base station (101), the first modulation and coding scheme table or the second modulation and coding scheme table based on a comparison of the maximum supported modulation order with the first maximum modulation order and the second maximum modulation order.
4. The method as set forth in any one of the preceding claims, the method further comprising
- transmitting information to the user equipment (102) being indicative for the selected modulation and coding scheme table.

5. The method as set forth in claim 4, wherein transmitting information to the user equipment (102) is based on radio resource control signalling.
6. The method as set forth in any one of the claims 4 or 5, wherein transmitting information to the user equipment (102) is based on implicit signalling.
7. The method as set forth in any one of the claims 3 to 5, the method further comprising
receiving a confirmation information from the user equipment (102) being indicative
for a performed change of the selected modulation and coding scheme table.
8. The method as set forth in claim 7, wherein the first modulation and coding scheme table and the second modulation and coding scheme table each comprise a common subset of equal entries being arranged at same positions within the first modulation and coding scheme table and the second modulation and coding scheme table,
in particular wherein the method further comprises,
after transmitting the information to the user equipment (102) being indicative for the selected modulation and coding scheme table and before receiving the confirmation information from the user equipment (102), controlling the modulation and coding scheme for the transmission between the base station (101) and the user equipment (102) based on the selected modulation and coding scheme table based on the common subset of entries.
9. The method as set forth in any one of the preceding claims, wherein controlling an initial transmission between the base station (101) and the user equipment (102) is based on the first modulation and coding scheme table.
10. The method as set forth in any one of the preceding claims, wherein the bits of carrying a modulation and coding scheme index are the same for the first modulation and coding scheme table and for the second modulation and coding scheme table.
11. The method as set forth in any one of the preceding claims, wherein the actual channel conditions are determined based on a channel quality indicator being selectable based on a first channel quality indicator table supporting the first maximum modulation order or based on a second channel quality indicator table supporting the second maximum modulation order, the method comprising

- receiving, by the base station (101), a channel quality indicator from the user equipment (102), and
determining, by the base station (101), the actual channel conditions of the radio transmission channel being used for the transmission between the base station (101) and the user equipment (102) based on the received channel quality indicator.
- 5
12. The method as set forth in claim 11, the method further comprising
selecting, by the base station (101), the first channel quality indicator table or the second channel quality indicator table based on the selected modulation and coding
10 scheme table, and
transmitting information to the user equipment (102) being indicative for the selected channel quality indicator table.
13. The method as set forth in any one of the claims 11 or 12, wherein the first channel
15 quality indicator table and the second channel quality indicator table each comprise a common subset of equal entries being arranged at same positions within the first channel quality indicator table and the second channel quality indicator table.
14. A base station (101) for controlling a modulation and coding scheme for a transmission between the base station (101) and a user equipment (102), wherein the modulation and coding scheme is selectable based on a first modulation and coding scheme table comprising entries corresponding to a plurality of modulation and coding schemes with a first maximum modulation order or based on a second modulation and coding scheme table comprising entries corresponding to a plurality of modulation and coding schemes
25 with a second maximum modulation order, the base station (101) comprising
a selection unit (403) being adapted to select the first modulation and coding scheme table or the second modulation and coding scheme table, and
a control unit (404) being adapted to control the modulation and coding scheme for the transmission between the base station (101) and the user equipment (102) based on
30 the selected modulation and coding scheme table.
15. A cellular network system (100), the cellular network system (100) comprising a base station (101) as set forth in claim 14.

1/2

FIG 1

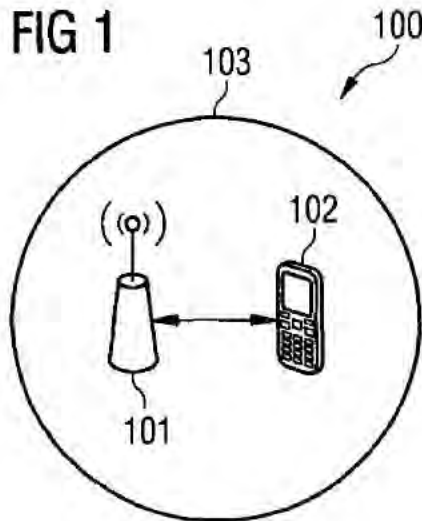

FIG 2

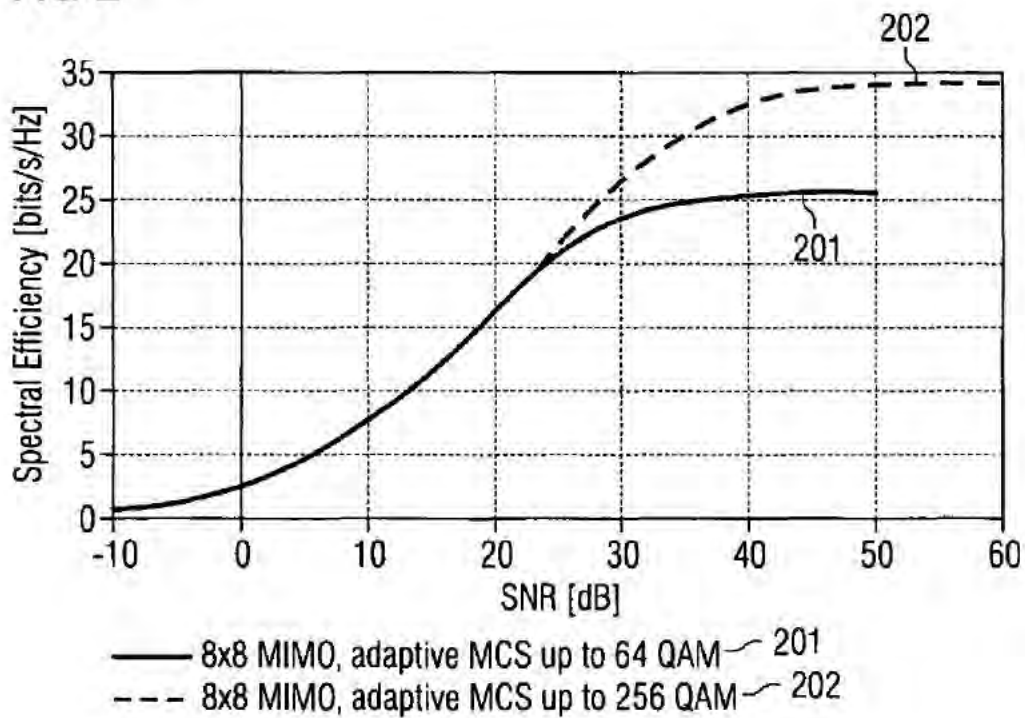

FIG 3

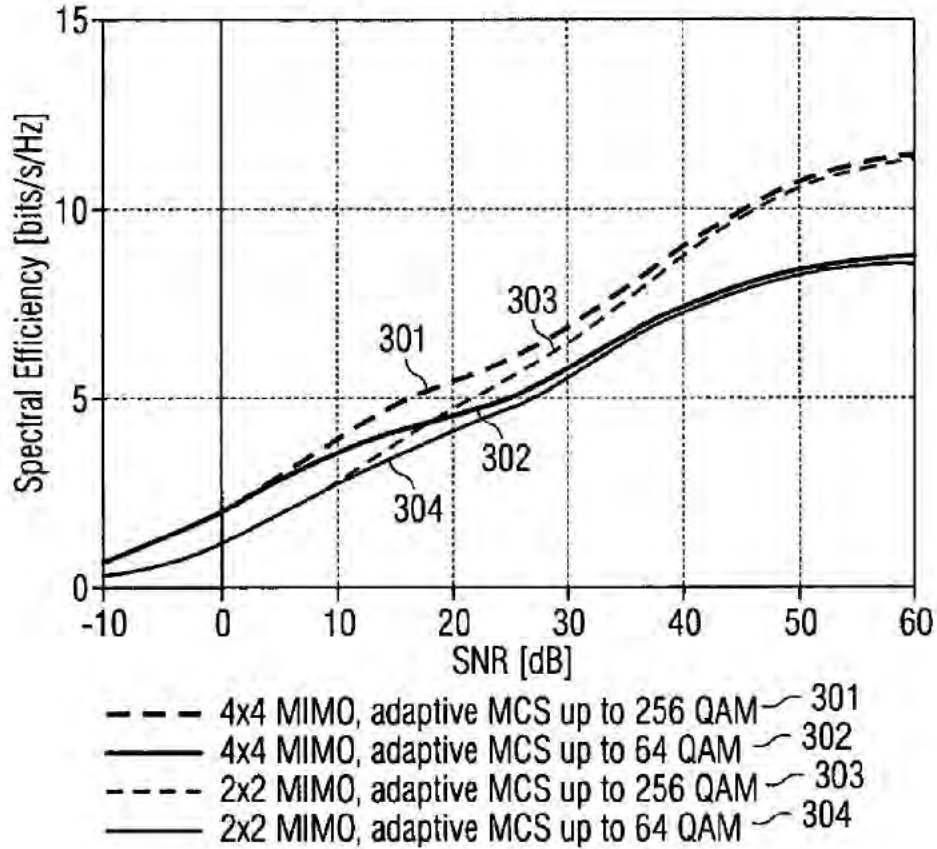
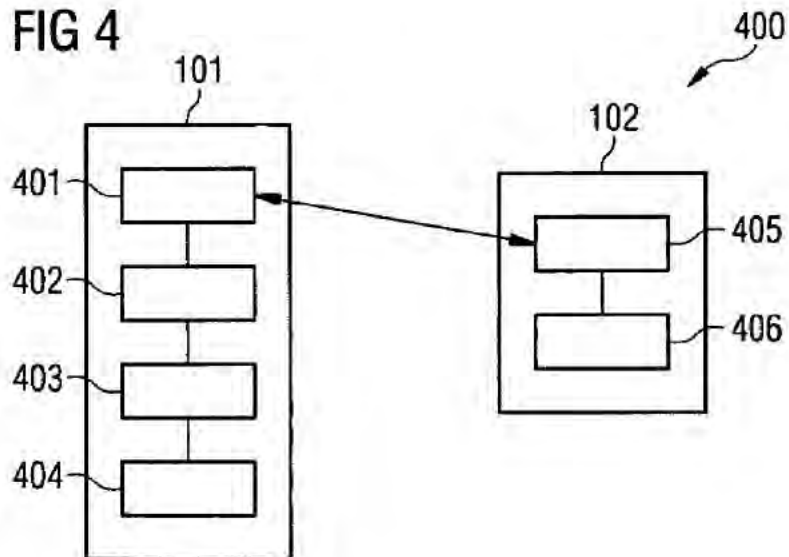

FIG 4



INTERNATIONAL SEARCH REPORT

International application No
PCT/EP2012/052828

A. CLASSIFICATION OF SUBJECT MATTER INV. H04L1/00 ADD.		
According to International Patent Classification (IPC) or to both national classification and IPC		
B. FIELDS SEARCHED Minimum documentation searched (classification system followed by classification symbols) H04L		
Documentation searched other than minimum documentation to the extent that such documents are included in the fields searched		
Electronic data base consulted during the international search (name of data base and, where practicable, search terms used) EPO-Internal, WPI Data, INSPEC, COMPENDEX		
C. DOCUMENTS CONSIDERED TO BE RELEVANT		
Category*	Citation of document, with indication, where appropriate, of the relevant passages	Relevant to claim No.
X	EP 1 903 692 A1 (MATSUSHITA ELECTRIC IND- CO LTD [JP]) 26 March 2008 (2008-03-26) column 5, paragraph 17 - column 6, paragraph 25 column 7, paragraphs 31,36 column 9, paragraphs 46,47 column 14, paragraph 90 - column 15, paragraph 93; figures 4,8,10,15,17 -----	1-10,14, 15
X	EP 1 845 742 A1 (MATSUSHITA ELECTRIC IND CO LTD [JP]) 17 October 2007 (2007-10-17) column 4, paragraph 17 - paragraph 19 column 7, paragraph 38 - paragraph 42 column 8, paragraph 50 - column 9, paragraph 52 column 12, paragraph 81 column 13, paragraph 82 - paragraph 85; figures 13,14 -----	1-3,9, 14,15
-/--		
<input checked="" type="checkbox"/> Further documents are listed in the continuation of Box C. <input checked="" type="checkbox"/> See patent family annex.		
* Special categories of cited documents :		
A document defining the general state of the art which is not considered to be of particular relevance *E* earlier application or patent but published on or after the international filing date *L* document which may throw doubts on priority claim(s) or which is cited to establish the publication date of another citation or other special reason (as specified) *O* document referring to an oral disclosure, use, exhibition or other means *P* document published prior to the international filing date but later than the priority date claimed	*T* later document published after the international filing date or priority date and not in conflict with the application but cited to understand the principle or theory underlying the invention *X* document of particular relevance; the claimed invention cannot be considered novel or cannot be considered to involve an inventive step when the document is taken alone *Y* document of particular relevance; the claimed invention cannot be considered to involve an inventive step when the document is combined with one or more other such documents, such combination being obvious to a person skilled in the art *&* document member of the same patent family	
Date of the actual completion of the international search <p align="center">28 September 2012</p>	Date of mailing of the international search report <p align="center">05/10/2012</p>	
Name and mailing address of the ISA/ European Patent Office, P.B. 5818 Patentlaan 2 NL - 2280 HV Rijswijk Tel. (+31-70) 340-2040, Fax: (+31-70) 340-3016	Authorized officer <p align="center">Papantoniou, Antonis</p>	

INTERNATIONAL SEARCH REPORT

International application No
PCT/EP2012/052828

C(Continuation). DOCUMENTS CONSIDERED TO BE RELEVANT		
Category*	Citation of document, with indication, where appropriate, of the relevant passages	Relevant to claim No.
A	<p>US 2007/160122 A1 (YOSHIDA SHOUSEI [JP]) 12 July 2007 (2007-07-12) page 1, right-hand column, paragraph 7 - paragraph 8 page 2, left-hand column, paragraph 11 page 4, left-hand column, paragraph 41 - right-hand column, paragraph 48 page 5, left-hand column, paragraph 55 - right-hand column, paragraph 60; figures 5,6a,6b,6c</p> <p style="text-align: center;">-----</p>	1,14,15
A	<p>US 2007/117570 A1 (NOH SEOL-HYUN [KR] ET AL) 24 May 2007 (2007-05-24) page 4, left-hand column, paragraph 44 page 4, right-hand column, paragraph 47 - paragraph 50</p> <p style="text-align: center;">-----</p>	1,14,15

INTERNATIONAL SEARCH REPORT

Information on patent family members

International application No

PCT/EP2012/052828

Patent document cited in search report	Publication date	Patent family member(s)	Publication date
EP 1903692	A1	26-03-2008	
		BR PI0615360 A2	17-05-2011
		CA 2619489 A1	22-02-2007
		CN 101243625 A	13-08-2008
		EP 1903692 A1	26-03-2008
		JP 4823225 B2	24-11-2011
		KR 20080045137 A	22-05-2008
		US 2009141648 A1	04-06-2009
		US 2012008517 A1	12-01-2012
		WO 2007020994 A1	22-02-2007

EP 1845742	A1	17-10-2007	
		CN 101112111 A	23-01-2008
		EP 1845742 A1	17-10-2007
		JP 2006217173 A	17-08-2006
		US 2009010211 A1	08-01-2009
		WO 2006082761 A1	10-08-2006

US 2007160122	A1	12-07-2007	
		US 2007160122 A1	12-07-2007
		WO 2005076512 A1	18-08-2005

US 2007117570	A1	24-05-2007	
		KR 20070048426 A	09-05-2007
		US 2007117570 A1	24-05-2007

(12) INTERNATIONAL APPLICATION PUBLISHED UNDER THE PATENT COOPERATION TREATY (PCT)

(19) World Intellectual Property Organization
International Bureau



(10) International Publication Number
WO 2014/109915 A1

(43) International Publication Date
17 July 2014 (17.07.2014)

- (51) International Patent Classification: *H04L 1/00* (2006.01)
- (21) International Application Number: PCT/US2013/077844
- (22) International Filing Date: 26 December 2013 (26.12.2013)
- (25) Filing Language: English
- (26) Publication Language: English
- (30) Priority Data:
 - 61/750,601 9 January 2013 (09.01.2013) US
 - 14/140,098 24 December 2013 (24.12.2013) US
- (71) Applicant: QUALCOMM INCORPORATED [US/US]; ATTN: International IP Administration, 5775 Morehouse Drive, San Diego, California 92121-1714 (US).
- (72) Inventors: CHEN, Wanshi; 5775 Morehouse Drive, San Diego, California 92121-1714 (US). GAAL, Peter; 5775 Morehouse Drive, San Diego, California 92121-1714 (US). LUO, Tao; 5775 Morehouse Drive, San Diego, California 92121-1714 (US). XU, Hao; 5775 Morehouse Drive, San Diego, California 92121-1714 (US).
- (74) Agent: KARREN, J., Scott; Holland & Hart LLP, P.O. Box 11583, Salt Lake City, UT 84110 (US).
- (81) Designated States (unless otherwise indicated, for every kind of national protection available): AE, AG, AL, AM, AO, AT, AU, AZ, BA, BB, BG, BH, BN, BR, BW, BY, BZ, CA, CH, CL, CN, CO, CR, CU, CZ, DE, DK, DM, DO, DZ, EC, EE, EG, ES, FI, GB, GD, GE, GH, GM, GT, HN, HR, HU, ID, IL, IN, IR, IS, JP, KE, KG, KN, KP, KR, KZ, LA, LC, LK, LR, LS, LT, LU, LY, MA, MD, ME, MG, MK, MN, MW, MX, MY, MZ, NA, NG, NI, NO, NZ, OM, PA, PE, PG, PH, PL, PT, QA, RO, RS, RU, RW, SA, SC, SD, SE, SG, SK, SL, SM, ST, SV, SY, TH, TJ, TM, TN, TR, TT, TZ, UA, UG, US, UZ, VC, VN, ZA, ZM, ZW.
- (84) Designated States (unless otherwise indicated, for every kind of regional protection available): ARIPO (BW, GH, GM, KE, LR, LS, MW, MZ, NA, RW, SD, SL, SZ, TZ, UG, ZM, ZW), Eurasian (AM, AZ, BY, KG, KZ, RU, TJ, TM), European (AL, AT, BE, BG, CH, CY, CZ, DE, DK, EE, ES, FI, FR, GB, GR, HR, HU, IE, IS, IT, LT, LU, LV, MC, MK, MT, NL, NO, PL, PT, RO, RS, SE, SI, SK, SM, TR), OAPI (BF, BJ, CF, CG, CI, CM, GA, GN, GQ, GW, KM, ML, MR, NE, SN, TD, TG).

[Continued on next page]

(54) Title: IDENTIFYING MODULATION AND CODING SCHEMES AND CHANNEL QUALITY INDICATORS

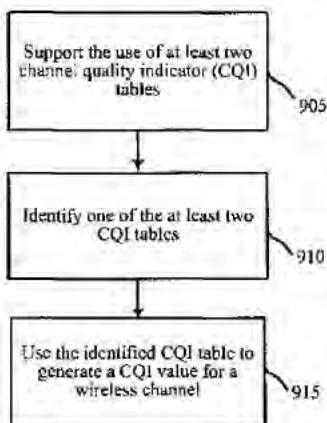

(57) Abstract: Methods, systems, and devices are described for wireless communications. The use of at least two channel quality indicator (CQI) tables is supported. One of the at least two CQI table is identified. The identified CQI table is used to generate a CQI value for a wireless channel. In addition, the use of at least two modulation and coding scheme (MCS) tables is supported. A transmission is received via a wireless channel. One of the at least two MCS tables is identified to use for the received transmission. Further, a transport block size (TBS) table is identified that is mapped from the identified MCS table. The identified TBS table is used to determine a size of the received transmission.

FIG. 9

900

WO 2014/109915 A1

Published:

— with international search report (Art. 21(3))

— before the expiration of the time limit for amending the claims and to be republished in the event of receipt of amendments (Rule 48.2(h))

IDENTIFYING MODULATION AND CODING SCHEMES AND CHANNEL QUALITY INDICATORS

CROSS REFERENCES

[0001] The present Application for Patent claims priority to U.S. Patent Application
5 No. 14/140,098 by Chen et al., entitled "Identifying Modulation and Coding Schemes and
Channel Quality Indicators," filed December 24, 2013; and U.S. Provisional Patent
Application No. 61/750,601 by Chen et al., entitled "Identifying Modulation and Coding
Schemes and Channel Quality Indicators," filed January 9, 2013, assigned to the assignee
hereof.

BACKGROUND

10 [0002] The following relates generally to wireless communication, and more specifically to
systems and methods to indicate a modulation and coding scheme (MCS) and a channel
quality indicator (CQI) value for a wireless channel for wireless communication systems that
support a higher order MCS. Wireless communications systems are widely deployed to
15 provide various types of communication content such as voice, video, packet data,
messaging, broadcast, and so on. These systems may be multiple-access systems capable of
supporting communication with multiple users by sharing the available system resources
(e.g., time, frequency, and power). Examples of such multiple-access systems include code-
division multiple access (CDMA) systems, time-division multiple access (TDMA) systems,
20 frequency-division multiple access (FDMA) systems, and orthogonal frequency-division
multiple access (OFDMA) systems.

[0003] Generally, a wireless multiple-access communications system may include a
number of base stations, each simultaneously supporting communication for multiple mobile
devices. Base stations may communicate with mobile devices on downstream and upstream
25 links. Each base station has a coverage range, which may be referred to as the coverage area
of the cell. A base station may grant a mobile device resources for upstream transmissions.
The grant may be based on CQI data about the downstream channel. The base station and
mobile device may access a CQI reporting table and an MCS table to determine the CQI
value from the CQI data as well as the MCS to use for a transmission. As wireless

communication systems increase their support of additional MCSs, existing CQI tables and MCS tables may not include data entries that account for these additional MCSs that are supported by the communication system.

SUMMARY

5 [0004] The described features generally relate to one or more improved systems, methods, and/or apparatuses for selecting between different modulation and coding scheme (MCS) tables to identify an MCS to use for a transmission as well as selecting between different channel quality indicator (CQI) tables to identify a CQI value about a wireless channel. In one example, the selected MCS table may be used to look-up a size of a transport block that is being transmitted. The various MCS and CQI tables may support modulation schemes up to at least 256 Quadrature Amplitude Modulation (QAM).

[0005] In one example, a method for wireless communication is described. The use of at least two CQI tables may be supported. One of the at least two CQI tables may be identified. The identified CQI table may be used to generate a CQI value for a wireless channel.

15 [0006] In one configuration, a same number of bits may be used to represent the CQI value regardless of which CQI table is identified. The identification of the CQI table may be based at least in part on an identification of channel state information (CSI), from a plurality of CSI identifications. Each of the plurality of CSI identifications may be associated with a set of subframes, where the set of subframes may be determined based at least in part on a semi-static configuration or a semi-static indication.

[0007] In one example, a first CQI table may be identified to use for a first channel state information (CSI) process. A second CQI table may be identified to use for a second CSI process. The second CSI process may be different than the first CSI process.

25 [0008] Identifying one of the at least two CQI tables may include selecting the CQI table to use to generate the CQI value according to a predefined configuration setting. Identifying one of the at least two CQI tables may include dynamically selecting the CQI table to use to generate the CQI value.

[0009] In one example, a determination may be made as to whether the CQI value is to be transmitted via a control channel or a data channel. Upon determining that the CQI value is

to be transmitted via the control channel, a first CQI table to use may be identified. A first number of bits may be used to represent the CQI value based on the first CQI table. Upon determining that the CQI value is to be transmitted via the data channel, a second CQI table to use may be identified. A second number of bits may be used to represent the CQI value based on the second CQI table. The second CQI table may be different from the first CQI table. In addition, the second number of bits may be greater than the first number of bits.

[0010] In one configuration, a determination may be made as to whether the CQI value is part of a P-CSI report or an aperiodic channel state information (A-CSI) report. Upon determining that the CQI value is part of the P-CSI report, a first CQI table to use may be identified. Upon determining that the CQI value is part of the A-CSI report, a second CQI table to use may be identified. In one example, the second CQI table may be different from the first CQI table.

[0011] In one example, a first CQI value may be generated using a first CQI table. A second CQI value may be generated using a second CQI table. The first CQI value and the second CQI value may be transmitted via a wireless channel in a single subframe.

[0012] The at least two CQI tables may include at least one common data entry. A CQI table may include a listing of CQI values. Each CQI value may be mapped to a spectral efficiency value. In one example, at least one of the identified CQI reporting tables may support 256 Quadrature Amplitude Modulation (QAM).

[0013] An apparatus for wireless communication is also described. The apparatus may include a processor and a memory in electronic communication with the processor. Instructions may be stored in the memory. The instructions may be executable by the processor to support the use of at least two CQI reporting tables, identify one of the at least two CQI tables, and use the identified CQI table to generate a CQI value for a wireless channel.

[0014] An apparatus for wireless communication is further described. The apparatus may include means for supporting the use of at least two CQI reporting tables, means for identifying one of the at least two CQI tables, and means for using the identified CQI table to generate a CQI value for a wireless channel.

5 [0015] A computer program product for managing wireless communications is also described. The computer program product may include a non-transitory computer-readable medium storing instructions executable by a processor to support the use of at least two channel CQI reporting tables, identify one of the at least two CQI tables, and use the identified CQI table to generate a CQI value for a wireless channel.

10 [0016] A method for wireless communication is further described. The use of at least two MCS tables is supported. A transmission may be received via a wireless channel. One of the at least two MCS tables may be identified to use for the received transmission. In one example, the identified MCS table may be used to determine an MCS to use for the received transmission.

15 [0017] A first transport block size (TBS) table may be mapped from a first MCS table and a second TBS table may be mapped from a second MCS table. The second TBS table may include at least one TBS that is greater than a maximum TBS in the first TBS table. In one example, a TBS table mapped from the identified MCS table may be identified. The identified TBS table may be used to determine a size of the received transmission.

[0018] Identifying one of the at least two MCS tables may include determining a type of transmission used to transmit the received transmission via the wireless channel, and identifying one of the at least two MCS tables to use for the received transmission based at least in part on the type of transmission.

20 [0019] Identifying one of the at least two MCS tables may also include identifying a type of control channel used to transmit the received transmission, and identifying one of the at least two MCS tables to use for the received transmission based at least in part on the identified type of control channel. In one example, the identified MCS table may be used to determine an MCS to use for an uplink transmission.

25 [0020] A first number of bits may be used to represent a first MCS based on a first MCS table. A second number of bits may be used to represent a second MCS based on a second MCS table. The first number of bits may be the same as the second number of bits. The second number of bits may be greater than the first number of bits.

[0021] Identifying one of the at least two MCS tables may further include dynamically selecting the MCS table to use for the received transmission, and/or selecting the MCS table to use for the received transmission according to a predefined configuration setting.

5 [0022] An apparatus for wireless communication is further described. The apparatus may include a processor and a memory in electronic communication with the processor. Instructions may be stored in the memory. The instructions may be executable by the processor to support the use of at least two MCS tables, receive a transmission via a wireless channel, and identify one of the at least two MCS tables to use for the received transmission.

10 [0023] A further apparatus for wireless communication is described. The apparatus may include means for supporting the use of at least two MCS tables, means for receiving a transmission via a wireless channel, and means for identifying one of the at least two MCS tables to use for the received transmission.

15 [0024] A computer program product for managing wireless communications is also described. The computer program product may include a non-transitory computer-readable medium storing instructions executable by a processor to support the use of at least two MCS tables, receive a transmission via a wireless channel, and identify one of the at least two MCS tables to use for the received transmission.

20 [0025] A further method for wireless communication is also described. The use of at least two MCS tables may be supported. One of the at least two MCS tables may be identified. The identified MCS table may be used to identify an MCS for a transmission.

[0026] In one example, a CQI value may be identified. The identified MCS may be based at least in part on the received CQI value. Using the identified MCS table to identify the MCS may include selecting the MCS for a downlink transmission. Using the identified MCS table to identify the MCS may include selecting the MCS for an uplink transmission.

25 [0027] In one configuration, the identification of one of the at least two MCS tables is based at least in part on a downlink control information (DCI) format. A first number of bits may be used to represent a first MCS based on a first MCS table. A second number of bits may be used to represent a second MCS based on a second MCS table. The first number of bits may be the same as the second number of bits. The second number of bits may be
30 greater than the first number of bits.

[0028] In one example, a single MCS table may be associated with each assignment of a physical downlink shared channel (PDSCH). At least two codewords to be transmitted via a single physical downlink shared channel (PDSCH) may be identified. The identified one of the at least two MCS tables may be used for downlink transmissions of the at least two
5 codewords.

[0029] In one example, a type of control channel to be used for the transmission may be identified. One of the at least two MCS tables to use for the transmission may be identified based at least in part on the identified type of control channel.

[0030] A set of candidates for a control channel transmission may be identified. One of the
10 at least two MCS tables to use for the control channel transmission may be identified based at least in part on the identified set of candidates. A first set of candidates may be associated with a common search space, and a second set of candidates may be associated with a user equipment specific search space. At least one candidate associated with both the common search space and the user equipment search space may be identified. One of the at least two
15 MCS tables may be identified based at least in part on a predefined rule.

[0031] In one configuration, a type of the transmission to occur on a wireless channel may be identified. One of the at least two MCS tables to use for the transmission may be identified based at least in part on the identified type of transmission.

[0032] Identifying one of the at least two MCS tables may include dynamically selecting
20 the MCS table to use for the transmission. The dynamic selection of the MCS table may be performed by an information field in downlink control information, where the information field may select one of a plurality of sets of configurations, where each set of configuration may include parameters including an MCS table indicator and at least one of a rate matching parameter and a quasi-co-location indication parameter. Identifying one of the at least two
25 MCS tables may include selecting the MCS table to use for the transmission according to a predefined configuration setting.

[0033] In one example, an MCS table may include a listing of MCSs. Each MCS may be mapped to at least one of a modulation scheme and a TBS. A first TBS table may be mapped from a first MCS table and a second TBS table may be mapped from a second MCS table.

The second TBS table may include at least one TBS that is greater than a maximum TBS in the first TBS table. At least one of the identified MCS tables may support 256QAM.

[0034] An apparatus for wireless communication is also described. The apparatus may include processor and a memory in electronic communication with the processor.

- 5 Instructions may be stored in the memory. The instructions may be executable by the processor to support the use of at least two MCS tables, identify one of the at least two MCS tables, and use the identified MCS table to identify an MCS for a transmission.

- [0035]** A further apparatus for wireless communication is described. The apparatus may include means for supporting the use of at least two MCS tables, means for identifying one of the at least two MCS tables, and means for using the identified MCS table to identify an MCS
10 for a transmission.

- [0036]** A computer program product for managing wireless communications is also described. The computer program product may include a non-transitory computer-readable medium storing instructions executable by a processor to support the use of at least two MCS
15 tables, identify one of the at least two MCS tables, and use the identified MCS table to identify an MCS for a transmission.

[0037] A further method for wireless communication is also described. The use of at least two CQI tables is supported. CQI data may be received for a wireless channel. One of the at least two CQI tables to use to identify a CQI value may be identified based on the CQI data.

- 20 **[0038]** In one example, a same number of bits may be used to represent the CQI value regardless of which CQI table is identified. Identifying one of the at least two CQI tables may include selecting the CQI table to use to identify the CQI value according to a predefined configuration setting. Identifying one of the at least two CQI tables may include dynamically selecting the CQI table to use to identify the CQI value.

- 25 **[0039]** An apparatus for wireless communication is further described. The apparatus may include a processor and a memory in electronic communication with the processor. Instructions may be stored in the memory. The instructions may be executable by the processor to support the use of at least two CQI tables, receive CQI data for a wireless channel, and identify one of the at least two CQI tables to use to identify a CQI value based
30 on the CQI data.

[0040] A further apparatus for wireless communication is described. The apparatus may include means for supporting the use of at least two CQI tables, means for receiving CQI data for a wireless channel, and means for identifying one of the at least two CQI tables to use to identify a CQI value based on the CQI data.

5 [0041] A computer program product for managing wireless communications is also described. The computer program product may include a non-transitory computer-readable medium storing instructions executable by a processor to support the use of at least two CQI tables, receive CQI data for a wireless channel, and identify one of the at least two CQI tables to use to identify a CQI value based on the CQI data.

10 [0042] Further scope of the applicability of the described methods and apparatuses will become apparent from the following detailed description, claims, and drawings. The detailed description and specific examples are given by way of illustration only, since various changes and modifications within the spirit and scope of the description will become apparent to those skilled in the art.

15

BRIEF DESCRIPTION OF THE DRAWINGS

[0043] A further understanding of the nature and advantages of the present invention may be realized by reference to the following drawings. In the appended figures, similar components or features may have the same reference label. Further, various components of the same type may be distinguished by following the reference label by a dash and a second
20 label that distinguishes among the similar components. If only the first reference label is used in the specification, the description is applicable to any one of the similar components having the same first reference label irrespective of the second reference label.

[0044] FIG. 1 shows a block diagram of a wireless communications system;

[0045] FIG. 2 is a block diagram illustrating one example of a UE in accordance with the
25 present systems and methods;

[0046] FIG. 3 shows a block diagram illustrating a further example of the UE;

[0047] FIG. 4A is a block diagram illustrating a further example of the UE for implementing the functionality of the present systems and methods;

- [0048] FIG. 4B is an example of two examples of CQI tables in accordance with the present systems and methods;
- [0049] FIG. 4C is an example of two examples of MCS tables in accordance with the present systems and methods;
- 5 [0050] FIG. 5 shows a block diagram of an example of a eNB;
- [0051] FIG. 6 shows a block diagram of a further example of the eNB;
- [0052] FIG. 7 is a block diagram illustrating one example of the eNB for implementing the functionality of the present systems and methods;
- [0053] FIG. 8 is a block diagram of a MIMO communication system including an eNB and
10 a mobile device;
- [0054] FIG. 9 is a flow chart of a method for managing wireless communications for higher order MCS by supporting additional CQI tables;
- [0055] FIG. 10 is a flow chart of a method for selecting different CQI tables based on a medium of transmission;
- 15 [0056] FIG. 11 is a flow chart of a method for selecting between different CQI tables based on a reporting schedule of the CQI value;
- [0057] FIG. 12 is a flow chart of a method for selecting an MCS table to identify an MCS for a received transmission’
- [0058] FIG. 13 is a flow chart of a method for selecting an MCS tables to identify an MCS
20 for a received transmission as well as a size of the transmission;
- [0059] FIG. 14 is a flow chart of a method for selecting between different MCS tables to identify an MCS for a transmission;
- [0060] FIG. 15 is a flow chart of a method for mapping different MCS tables to transport block size (TBS) tables and selecting an MCS table based on a downlink control information
25 (DCI) format; and
- [0061] FIG. 16 is a flow chart of a method to select a CQI table to identify a CQI value that is based on received CQI data.

DETAILED DESCRIPTION

- [0062]** Wireless communication standards may support various modulation and coding schemes for downlink and uplink transmissions. In one configuration, Quadrature Phase Shift Keying (QPSK), 16QAM, and 64QAM may be examples of schemes supported by a wireless communication standard. In one example, five bits may be used to represent an MCS to be used for a transmission. Using a five bit MCS may provide up to 32 possible MCSs to choose from for a transmission. An MCS table based on a five bit MCS may include a list of MCS indices from 0 to 31. Each index may correspond to at least one modulation scheme to be used for a transmission. In addition, each MCS index may be mapped to at least one transport block size (TBS) look-up index. The TBS look-up index may indicate a size of a transport block to be transmitted using the corresponding MCS.
- [0063]** In addition, a channel quality indicator (CQI) table, may be used to identify a CQI value for a wireless channel. A UE may be configured to report on channel quality using a CQI message. In LTE, both periodic and aperiodic (or event triggered) reporting of CQI is supported. CQI messages may be transmitted on the physical uplink control channel (PUCCH) on the primary component carrier, and not on a secondary component carrier (SCC). Alternatively or additionally, PUCCH may be transmitted on a secondary component carrier when two or more carriers do not have ideal backhaul as part of multi-flow operation or when there is a need to balance PUCCH overhead on different carriers. The CQI value may then be used to select a particular MCS to use for a transmission on the wireless channel. Currently, a CQI value may be represented using a number of bits, such as four bits. A CQI table may include a listing of CQI indices corresponding to the 16 possible CQI values (if four bits are used to represent the CQI value). Each CQI index value may be mapped to additional data that can be used to select an MCS.
- [0064]** In one example, a wireless communication standard may support schemes up to at least 256QAM. Additional MCS tables and CQI tables may be used to allow for these additional modulation schemes. Devices in a wireless communication system may select an appropriate CQI and MCS table to use to identify a CQI value of a wireless channel and the appropriate MCS to use for a transmission on that wireless channel.
- [0065]** The following description provides examples, and is not limiting of the scope, applicability, or configuration set forth in the claims. Changes may be made in the function

and arrangement of elements discussed without departing from the spirit and scope of the disclosure. Various examples may omit, substitute, or add various procedures or components as appropriate. For instance, the methods described may be performed in an order different from that described, and various steps may be added, omitted, or combined. Also, features
5 described with respect to certain examples may be combined in other examples.

[0066] Referring first to **FIG. 1**, a diagram illustrates an example of a wireless communications system 100. The system 100 includes base stations (or cells) 105, communication devices 115, and a core network 130. The base stations 105 may communicate with the communication devices 115 under the control of a base station
10 controller, which may be part of the core network 130 or the base stations 105 in various examples. Base stations 105 may communicate control information and/or user data with the core network 130 through backhaul links 132. In some examples, the base stations 105 may communicate, either directly or indirectly, with each other over backhaul links 134, which may be wired or wireless communication links. The system 100 may support operation on
15 multiple carriers (waveform signals of different frequencies). According to various examples, the UE operating in a multicarrier system (also referred to as carrier aggregation) is configured to aggregate certain functions of multiple carriers, such as control and feedback functions, on the same carrier, which may be referred to as a “primary carrier.” The remaining carriers that depend on the primary carrier for support are referred to as associated
20 secondary carriers. For example, the UE may aggregate control functions such as those provided by the optional dedicated channel (DCH), the nonscheduled grants, a physical uplink control channel (PUCCH), and/or a physical downlink control channel (PDCCH). Multi-carrier transmitters may transmit modulated signals simultaneously on the multiple carriers. For example, each communication link 125 may be a multi-carrier signal modulated
25 according to various radio technologies. Each modulated signal may be sent on a different carrier and may carry control information (e.g., reference signals, control channels, etc.), overhead information, data, etc.

[0067] The base stations 105 may wirelessly communicate with the devices 115 via one or more base station antennas. Each of the base station 105 sites may provide communication
30 coverage for a respective geographic area 110. In some examples, base stations 105 may be referred to as a base transceiver station, a radio base station, an access point, a radio

transceiver, a basic service set (BSS), an extended service set (ESS), a NodeB, an evolved NodeB (eNodeB or eNB), Home NodeB, a Home eNodeB, or some other suitable terminology. The coverage area 110 for a base station may be divided into sectors making up only a portion of the coverage area. The system 100 may include base stations 105 of
5 different types (*e.g.*, macro, micro, and/or pico base stations). There may be overlapping coverage areas for different technologies.

[0068] In some examples, the system 100 may be an LTE/LTE-A network. In LTE/LTE-A networks, the terms evolved Node B (eNB) and user equipment (UE) may be generally used to describe the base stations 105 and devices 115, respectively. The system 100 may be a
10 Heterogeneous LTE/LTE-A network in which different types of eNBs provide coverage for various geographical regions. For example, each eNB 105 may provide communication coverage for a macro cell, a pico cell, a femto cell, and/or other types of cell. A macro cell generally covers a relatively large geographic area (*e.g.*, several kilometers in radius) and may allow unrestricted access by UEs with service subscriptions with the network provider.
15 A pico cell would generally cover a relatively smaller geographic area and may allow unrestricted access by UEs with service subscriptions with the network provider. A femto cell would also generally cover a relatively small geographic area (*e.g.*, a home) and, in addition to unrestricted access, may also provide restricted access by UEs having an association with the femto cell (*e.g.*, UEs in a closed subscriber group (CSG), UEs for users
20 in the home, and the like). An eNB for a macro cell may be referred to as a macro eNB. An eNB for a pico cell may be referred to as a pico eNB. And, an eNB for a femto cell may be referred to as a femto eNB or a home eNB. An eNB may support one or multiple (*e.g.*, two, three, four, and the like) cells. In one example, an eNB 105 selects between various modulation and coding schemes (MCSs) to use for a transmission to a UE 115. The selected
25 MCS may be based at least in part on a channel quality indicator (CQI) value reported from the UE 115. The eNB 105 may select between various CQI tables to identify the table corresponding to the CQI value received from the UE 115. The eNB 105 may also select between various MCS tables to identify the table from which an MCS may be identified for a transmission on the downlink and/or a transmission on the uplink. The selected MCS table
30 may be based at least in part on the CQI value received from the UE 115.

- [0069] The core network 130 may communicate with the eNBs 105 via a backhaul 132 (e.g., S1, etc.). The eNBs 105 may also communicate with one another, e.g., directly or indirectly via backhaul links 134 (e.g., X2, etc.) and/or via backhaul links 132 (e.g., through core network 130). The wireless system 100 may support synchronous or asynchronous operation. For synchronous operation, the eNBs may have similar frame timing, and transmissions from different eNBs may be approximately aligned in time. For asynchronous operation, the eNBs may have different frame timing, and transmissions from different eNBs may not be aligned in time. The techniques described herein may be used for either synchronous or asynchronous operations.
- 10 [0070] The UEs 115 may be dispersed throughout the wireless system 100, and each UE may be stationary or mobile. A UE 115 may also be referred to by those skilled in the art as a mobile station, a subscriber station, a mobile unit, a subscriber unit, a wireless unit, a remote unit, a mobile device, a wireless device, a wireless communications device, a remote device, a mobile subscriber station, an access terminal, a mobile terminal, a wireless terminal, a remote terminal, a handset, a user agent, a mobile client, a client, or some other suitable terminology. A UE 115 may be a cellular phone, a personal digital assistant (PDA), a wireless modem, a wireless communication device, a handheld device, a tablet computer, a laptop computer, a cordless phone, a wireless local loop (WLL) station, or the like. A UE may be able to communicate with macro eNBs, pico eNBs, femto eNBs, relays, and the like.
- 15 20 In one configuration, the UE 115 may be able to select between various CQI tables to identify a table to use to generate the CQI value to report to the eNB 105. In addition, the UE 115 may be able to select between various MCS tables to identify the MCS table to use to identify the MCS that is being used for a downlink transmission and/or to identify the MCS that the UE 115 may use for an uplink transmission.
- 25 [0071] The transmission links 125 shown in network 100 may include uplink transmissions from a mobile device 115 to a base station 105, and/or downlink transmissions, from a base station 105 to a mobile device 115. The downlink transmissions may also be called forward link transmissions while the uplink transmissions may also be called reverse link transmissions. While the wireless system 100 is described in relation to LTE/LTE-Advanced architectures, those skilled in the art will readily appreciate, the various concepts presented throughout this disclosure may be extended to other types of wireless networks.
- 30

[0072] FIG. 2 is a block diagram 200 illustrating one example of a UE 115-a, in accordance with the present systems and methods. The UE 115-a may be an example of the UE 115 of FIG. 1. The UE 115-a may include a UE receiver module 205, a UE table selection module 210, and a UE transmitter module 215. Each of these components may be in communication with each other.

[0073] These components of the UE 115-a may, individually or collectively, be implemented with one or more application-specific integrated circuits (ASICs) adapted to perform some or all of the applicable functions in hardware. Alternatively, the functions may be performed by one or more other processing units (or cores), on one or more integrated circuits. In other examples, other types of integrated circuits may be used (e.g., Structured/Platform ASICs, Field Programmable Gate Arrays (FPGAs), and other Semi-Custom ICs), which may be programmed in any manner known in the art. The functions of each unit may also be implemented, in whole or in part, with instructions embodied in a memory, formatted to be executed by one or more general or application-specific processors.

[0074] In one configuration, the receiver module 205 may include a cellular receiver and may receive transmissions from an eNB 105. The UE table selection module 210 may control the selection of a table to use to generate and/or identify certain information. The selection of the table may be based on predefined configuration settings of the UE 115-a. In one example, the selection module 210 may dynamically select the table to use based on one or more factors. In some cases, the generated and/or identified information resulting from the selected table may be transmitted via the UE transmitter module 215. Details regarding the UE table selection module 210 will be described below.

[0075] FIG. 3 is a block diagram 300 illustrating one example of a UE 115-b in accordance with the present systems and methods. The UE 115-b may be an example of the UE 115 illustrated in FIGS. 1 and/or 2. The UE 115-b may include a UE receiver module 205, a UE table selection module 210-a, and a UE transmitter module 215, as previously described. Each of these components may be in communication with each other.

[0076] These components of the UE 115-b may, individually or collectively, be implemented with one or more application-specific integrated circuits (ASICs) adapted to perform some or all of the applicable functions in hardware. Alternatively, the functions may be performed by one or more other processing units (or cores), on one or more integrated

circuits. In other examples, other types of integrated circuits may be used (*e.g.*, Structured/Platform ASICs, Field Programmable Gate Arrays (FPGAs), and other Semi-Custom ICs), which may be programmed in any manner known in the art. The functions of each unit may also be implemented, in whole or in part, with instructions embodied in a
5 memory, formatted to be executed by one or more general or application-specific processors.

[0077] In one example, the UE 115-b may support the use of at least two CQI tables. In one configuration, the UE table selection module 210-a may include a CQI table selection module 305. The CQI table selection module 305 may identify one of the CQI tables supported by the UE 115-b. The identified table may be used to generate a CQI value for a
10 wireless channel. A number of bits may be used to represent the CQI value. In one example, the number of bits used to represent the generated CQI value may remain the same regardless of the CQI table that is identified by the CQI table selection module 305. For example, four bits may be used to represent a CQI value. By using four bits, the CQI value may be one of 16 possible index values on a single CQI table. A CQI index value may be a factor that is
15 used to identify an MCS to use for a received transmission and/or a transmission to be transmitted. As wireless communication standards increase the types of MCSs that may be used for transmissions, additional CQI tables may be used to allow the CQI value to still be represented by four bits.

[0078] In addition to supporting the use of multiple CQI tables, the UE 115-b may also
20 support the use of at least two MCS tables. The UE table selection module 210-a may include an MCS table selection module 310. Transmission received by the UE receiver module 205 may have been modulated and encoded using a particular MCS at the transmitting device (*e.g.*, an eNB 105). Upon receiving a transmission, the MCS table selection module 310 may select one of the at least two MCS tables to use for the received
25 transmission. In one example, the identified MCS table may be used to determine the MCS to apply to the received transmission in order to demodulate and decode the transmitted information. In addition, when the UE 115-b has information to be transmitted via an uplink to the eNB 105, the eNB 105 may assign a particular MCS for the UE 115-b to use for the uplink transmission. The MCS table selection module 310 may select a particular MCS table
30 and then identify the assigned MCS to use based on the selected MCS table.

[0079] In addition, the identified MCS table may also be used to identify a size of a received transmission. For example, the transmission may include a transport block (*i.e.*, codeword) of particular size. This may be referred to herein as the transport block size (TBS). In one example, a TBS table that indicates the size of the transport block may be mapped from a particular MCS table supported by the UE 115-b. Upon identifying the MCS table to use to determine the MCS to use for the received transmission, the MCS selection module 310 may use the selected MCS table to look-up the TBS table that has been mapped from the selected MCS table. As a result, the UE 115-b may determine the size of the received transport block.

10 [0080] FIG. 4A is a block diagram 400 illustrating one example of a UE 115-c in accordance with the present systems and methods. The UE 115-c may be an example of the UE 115 illustrated in FIGS. 1, 2, and/or 3. In one configuration, the UE 115-c may include a UE receiver module 205, a UE table selection module 210-b, a CQI value generation module 425, an MCS identification module 430, and a UE transmitter module 215. Each of these components may be in communication with each other.

[0081] These components of the UE 115-c may, individually or collectively, be implemented with one or more application-specific integrated circuits (ASICs) adapted to perform some or all of the applicable functions in hardware. Alternatively, the functions may be performed by one or more other processing units (or cores), on one or more integrated circuits. In other examples, other types of integrated circuits may be used (*e.g.*, Structured/Platform ASICs, Field Programmable Gate Arrays (FPGAs), and other Semi-Custom ICs), which may be programmed in any manner known in the art. The functions of each unit may also be implemented, in whole or in part, with instructions embodied in a memory, formatted to be executed by one or more general or application-specific processors.

25 [0082] In one configuration, the UE table selection module 210-b may include a CQI table selection module 305-a. The module 305-a may select one CQI table, from a plurality of CQI tables. The selected table may then be used by the CQI value generation module 425 to generate the CQI value for a wireless channel, such as a downlink channel.

[0083] In one example, the UE 115-c may support the use of a legacy CQI table (*e.g.*, a table used for QPSK, 16QAM, and 64 QAM schemes) and a new CQI table used for higher

order schemes, such as 256QAM. An example of a legacy CQI table used for lower order schemes is shown below as Table 1.

CQI Index	Modulation Scheme	Code Rate x 1024	Efficiency
0	Out of Range		
1	QPSK	78	0.1523
2	QPSK	120	0.2344
3	QPSK	193	0.3770
4	QPSK	308	0.6016
5	QPSK	449	0.8770
6	QPSK	602	1.1758
7	16QAM	378	1.4766
8	16QAM	490	1.9141
9	16QAM	616	2.4063
10	64QAM	466	2.7305
11	64QAM	567	3.3223
12	64QAM	666	3.9023
13	64QAM	772	4.5234
14	64QAM	873	5.1152
15	64QAM	948	5.5547

TABLE 1

[0084] The new table may include enhanced spectral efficiencies as compared to the legacy table. In one example, the new CQI table may include non-uniform spectral efficiency entries (e.g., fine granularity at high spectral efficiency and coarse granularity at low spectral efficiency). The different CQI tables may also be associated with different downlink channel

information (DCI) formats used by the eNB 105. For example, the legacy CQI table may be associated with DCI format 1A while the new CQI table may be associated with DCI format 2D. The different types of control information correspond to different DCI message sizes. DCI is therefore categorized into different DCI formats, where a format corresponds to a certain message size. The Physical Downlink Control Channel (PDCCH) is used to carry downlink control information (DCI) which signals allocation of resources to the UE. In one configuration, the legacy and new CQI tables may have one or more common data entries between them. An example of a new CQI table used for higher order schemes is shown below as Table 2.

CQI Index	Modulation Scheme	Code Rate x 1024	Efficiency
0	Out of Range		
1	QPSK	78	0.1523
2	QPSK	193	0.3770
3	QPSK	449	0.8770
4	16QAM	378	1.4766
5	16QAM	490	1.9141
6	16QAM	616	2.4063
7	64QAM	466	2.7305
8	64QAM	567	3.3223
9	64QAM	666	3.9023
10	64QAM	772	4.5234
11	64QAM	873	5.1152
12	64QAM	948	5.5547
13	256QAM	792	6.0313
14	256QAM	873	6.8203

15	256QAM	948	7.4063
----	--------	-----	--------

TABLE 2

[0085] In one configuration, each CQI value generated and reported by the UE 115-c may be based on a single CQI table. For example, the UE 115-c may use a single CQI table in accordance with Radio Resource Control (RRC) protocols. As previously described, the UE 115-c may support more than one CQI table and may determine which table to use based on various factors.

[0086] In one example, the CQI table selection module may include a channel state information (CSI) reporting identification module 405, and a channel identification module 410. In one configuration, the CSI reporting identification module 405 may identify periodic channel state information (P-CSI) from a plurality of P-CSI identifications. In one configuration, two P-CSI sets may be identified. A first P-CSI set may be associated with the legacy CQI table while a second P-CSI set may be associated with the new CQI table. As an example, a first P-CSI set may be associated with a restricted CSI measurement subframe set 1 and a second P-CSI set may be associated with a restricted CSI measurement subframe set 2, where the two restricted measurement subframe sets are configured by higher layers. As another example, in a time-division-duplex (TDD) system, a first P-CSI set may be associated with a set of measurement subframes where the set of subframes are subject to dynamic change of transmission directions (downlink or uplink), and a second P-CSI set may be associated with a set of downlink subframes for measurements where the set of subframes are not subject to dynamic change of transmission directions. Similarly, the CSI reporting identification module 405 may identify aperiodic channel state information (A-CSI) from a plurality of A-CSI identifications. In one configuration, two A-CSI sets may be identified. A first A-CSI set may be associated with the legacy CQI table while a second A-CSI set may be associated with the new CQI table.

[0087] The CSI module 405 may also identify one or more CSI processes and the CQI table selection module 305-a may select a different CQI table to use for each different CSI process. For example, the CSI reporting identification module 405 may identify a first CSI process and a second CSI process. The CQI table selection module 305-a may identify a first CQI table to use for the first CSI process and a second CQI table to use for the second CSI process.

[0088] In one configuration, the CSI reporting identification module 405 may also determine whether a CQI value is to be part of a P-CSI report or whether it is to be a part of an aperiodic CSI (A-CSI) report. Based on this determination, the CQI table selection module 305-a may select a first CQI table to use if the CQI value (based from the first CQI table) is to be part of a P-CSI report, or the module 305-a may select a second CQI table to use if the CQI value (based from the second CQI table) is to be part of an A-CSI report.

[0089] In one example, the CQI table selection module 305-a may also include a channel identification module 410. The module 410 may determine the type of channel to be used to transmit a CQI value. For example, the module 410 may determine whether the CQI value is to be transmitted via a control channel or a data channel. If the CQI value is to be transmitted via the control channel, the CQI table selection module 305-a may identify a first CQI table to use to generate the CQI value. In one example, the CQI value generated from the first table may be represented by a first number of bits, such as, but not limited to, four bits. If the CQI value is to be transmitted via the data channel, the CQI table selection module 305-a may identify a second CQI table to use. The second table may be different from the first table and the CQI value generated from the second CQI table may be represented by a different number of bits than had the CQI value been generated using the first table. In one example, if the first table is used to generate a 4-bit CQI value, the second table may be used to generate a 5-bit CQI value. In one example, the number of bits used to represent the CQI value may remain the same, regardless of the CQI table that is selected to use to generate the value.

[0090] In one example, a first set of ranks (e.g., rank 1) may be associated with a first CQI table, and a second set of ranks (e.g., rank 2 and higher) may be associated with a second CQI table.

[0091] In one example, a UE can be dynamically indicated which CQI table to be used. As an example, a 1-bit information field can be included in downlink control information (DCI) to indicate which one of two CQI tables to be used for aperiodic CQI reporting.

[0092] In some examples, the UE 115-c may generate and report multiple CQI values using multiple CQI tables in a single subframe. In one example, a first CQI value may be generated by the CQI value generation module 425 using a first CQI table. The module 425 may also generate a second CQI value using a second CQI table that is different from the first

CQI table. The two CQI values may be transmitted to an eNB 105, for example, during a single subframe via the UE transmitter module 215.

[0093] In one configuration, each CQI table may include a listing of CQI index values. Each index value may represent a CQI value. As standards for wireless communication support higher orders of MCSs, additional CQI tables may be used that include these higher order schemes. The use of additional CQI tables may allow for CQI values to continue to use the same bit-width to represent the values. Each CQI index value may be mapped to a spectral efficiency value. As mentioned previously, at least one of the CQI tables may include non-uniform spectral efficiency data entries.

10 [0094] In one configuration, the UE table selection module 210-b may also include an MCS table selection module 310-a. The module 310-a may identify one MCS table, from a plurality of MCS tables. The identified table may then be used by the MCS identification module 430 to identify the MCS to use for a received transmission or a transmission that is to be transmitted on a wireless channel, such as an uplink channel.

15 [0095] In one example, the UE 115-c may support the use of a legacy MCS table (e.g., a table used for QPSK, 16QAM, and 64 QAM schemes) and a new MCS table used for higher order schemes, such as 256QAM. An example of a legacy MCS table used for lower order schemes is shown below as Table 3. Table 3 illustrates a number of MCS indices, a corresponding modulation order, and a corresponding TBS index for each MCS index value.

MCS Index	Modulation Order	TBS Index
0	2	0
1	2	1
2	2	2
3	2	3
4	2	4
5	2	5
6	2	6

7	2	7
8	2	8
9	2	9
10	4	9
11	4	10
12	4	11
13	4	12
14	4	13
15	4	14
16	4	15
17	6	15
18	6	16
19	6	17
20	6	18
21	6	19
22	6	20
23	6	21
24	6	22
25	6	23
26	6	24
27	6	25
28	6	26

29	2	Reserved
30	4	
31	6	

TABLE 3

[0096] The different MCS tables may be associated with different downlink channel information (DCI) formats. For example, the legacy MCS table may be associated with DCI format 1A while the new MCS table may be associated with DCI format 2D. In one configuration, the legacy and new MCS tables may have one or more common data entries between them. In one example, the legacy and new MCS tables may have the same number of entries. In another example, the new MCS table may have a larger number of entries than that of the legacy table (e.g., a 6-bit table may be used for the new MCS table and a 5-bit table may be used for the legacy table). An example of a new 5-bit MCS table used for higher order schemes is shown below as Table 4. In this example, four entries (MCS Indexes 28-31) are reserved to possibly indicate four different modulation orders for retransmissions.

MCS Index	Modulation Order	TBS Index
0	2	0
1	2	1
2	2	2
3	2	3
4	2	4
5	2	6
6	2	7
7	2	8
8	2	9
9	4	10

10	4	11
11	4	12
12	4	13
13	4	14
14	4	15
15	6	16
16	6	17
17	6	18
18	6	19
19	6	20
20	6	21
21	6	22
22	6	23
23	6	24
24	8	25
25	8	26
26	8	27
27	8	28
28	2	Reserved
29	4	
30	6	
31	8	

TABLE 4

[0097] Another example of a new 5-bit MCS table used for higher order schemes is shown below as Table 5. In this example, three entries (MCS Indexes 29-31) are reserved to possibly indicate three different modulation orders for retransmissions in order to make it possible to have 29 explicit entries.

MCS Index	Modulation Order	TBS Index
0	2	0
1	2	1
2	2	2
3	2	3
4	2	4
5	2	5
6	2	6
7	2	7
8	2	8
9	2	9
10	4	10
11	4	11
12	4	12
13	4	13
14	4	14
15	4	15
16	6	16
17	6	17

18	6	18
19	6	19
20	6	20
21	6	21
22	6	22
23	6	23
24	6	24
25	8	25
26	8	26
27	8	27
28	8	28
29	4	Reserved
30	6	
31	8	

TABLE 5

[0098] In one configuration, each MCS identified by the MCS identification module 430 may be based on a single MCS table. For example, the UE 115-c may use a single MCS table in accordance with Radio Resource Control (RRC) protocols. As previously described, the UE 115-c may support more than one MCS table and may determine which table to use based on various factors.

[0099] In one example, the MCS table selection module 310-a may include a transmission type identification module 415, and a control channel identification module 420. In one configuration, the transmission type identification module 415 may identify a type of transmission used to transmit information to the UE 115-c from an eNB 105. Examples of transmission types may include broadcast, random access response, unicast, multi-cast, etc. The module 415 may also identify a type of scheduling used to transmit the received

transmission. For example, the transmission type identification module 415 may identify a semi-persistent scheduling (SPS) of a service and the MCS table selection module 310-a may select a particular MCS table based on this determination. Thus, based on the identified transmission type, the MCS table selection module 310-a may identify an MCS table to use to
5 identify an MCS for a transmission.

[0100] The control channel identification module 420 may identify a type of control channel used to transmit a received transmission. For example, the module 420 may identify a physical downlink control channel (PDCCH) was used and the MCS table selection module 310-a may identify the legacy MCS table to use to identify the MCS. If the module 420
10 identifies the control channel as being an enhanced PDCCH (ePDCCH), the MCS table selection module 310-a may select the new MCS table to use. In addition to the type of channel used for the transmission, the MCS table selection module 310-a may also identify the MCS table to use based on an index of a received subframe or a subframe type (e.g., whether it is a multimedia broadcast single-frequency network (MBSFN) subframe or not).

[0101] The MCS identification module 430 may identify the MCS to use for the transmission based on the selected table. The module 430 may also identify the TBS of the transmission. In one example, a first TBS table may be mapped from a first MCS table. In addition, a second TBS table may be mapped from a second MCS table. In one example, the second TBS table may include at least one TBS entry that is greater than a maximum TBS
20 entry of the first TBS table. The MCS identification module 430 may use the selected MCS table to look-up the corresponding TBS table and identify the size of the transmission. In one configuration, the MCS identification module 430 may use a first number of bits to represent the MCS identified from a first MCS table. For a different MCS table, the module 430 may use a second number of bits to represent the MCS. The second number of bits may be greater
25 than the first number of bits. In one example, the number of bits used to represent the MCS may remain the same regardless of the MCS table that is identified.

[0102] FIG. 4B shows two examples of a CQI table in accordance with the present systems and methods. An example of an old, or legacy, CQI table 450 (e.g., a table used for QPSK, 16QAM, and 64QAM schemes) as well as an example of a new CQI table 460 (e.g., a table
30 used for higher order schemes, such as 256QAM) are shown. In some cases, the old CQI

table 450 and the new CQI table 460 are examples of the old CQI table and the new CQI table of FIG. 4A.

[0103] FIG. 4C shows two examples of an MCS table in accordance with the present systems and methods. An example of an old, or legacy, MCS table 470 (*e.g.*, a table used for QPSK, 16QAM, and 64QAM schemes) as well as an example of a new MCS table 480 (*e.g.*, a table used for higher order schemes, such as 256QAM) are shown. In some cases, the old MCS table 470 and the new MCS table 480 are examples of the old MCS table and the new MCS table of FIG. 4A.

[0104] FIG. 5 is a block diagram 500 illustrating one example of an eNB 105-a, in accordance with the present systems and methods. The eNB 105-a may be an example of the eNB 105 of FIG. 1. The eNB 105-a may include an eNB receiver module 505, an eNB table selection module 510, and an eNB transmitter module 515. Each of these components may be in communication with each other.

[0105] These components of the eNB 105-a may, individually or collectively, be implemented with one or more application-specific integrated circuits (ASICs) adapted to perform some or all of the applicable functions in hardware. Alternatively, the functions may be performed by one or more other processing units (or cores), on one or more integrated circuits. In other examples, other types of integrated circuits may be used (*e.g.*, Structured/Platform ASICs, Field Programmable Gate Arrays (FPGAs), and other Semi-Custom ICs), which may be programmed in any manner known in the art. The functions of each unit may also be implemented, in whole or in part, with instructions embodied in a memory, formatted to be executed by one or more general or application-specific processors.

[0106] In one configuration, the receiver module 505 may include a cellular receiver and may receive transmissions from a UE 115. The eNB table selection module 510 may control the selection of a table to use to generate and/or identify certain information. The selection of the table may be based on predefined configuration settings of the eNB 105-a. In one example, the selection module 510 may dynamically select the table to use based on one or more factors. In some cases, the generated and/or identified information resulting from the selected table may be transmitted via the eNB transmitter module 515. Details regarding the eNB table selection module 510 will be described below.

5 [0107] FIG. 6 is a block diagram 600 illustrating one example to of an eNB 105-b in accordance with the present systems and methods. The eNB 105-b may be an example of the eNB 105 illustrated in FIGS. 1 and/or 5. The eNB 105-b may include an eNB receiver module 505, an eNB table selection module 510-a, and an eNB transmitter module 515, as previously described. Each of these components may be in communication with each other.

10 [0108] These components of the eNB 105-b may, individually or collectively, be implemented with one or more application-specific integrated circuits (ASICs) adapted to perform some or all of the applicable functions in hardware. Alternatively, the functions may be performed by one or more other processing units (or cores), on one or more integrated circuits. In other examples, other types of integrated circuits may be used (*e.g.*,
Structured/Platform ASICs, Field Programmable Gate Arrays (FPGAs), and other Semi-Custom ICs), which may be programmed in any manner known in the art. The functions of each unit may also be implemented, in whole or in part, with instructions embodied in a memory, formatted to be executed by one or more general or application-specific processors.

15 [0109] In one example, the eNB 105-b may support the use of at least two CQI tables that may be either predetermined or configured by RRC protocols. In one configuration, the eNB table selection module 510-a may include a CQI table selection module 605. The CQI table selection module 605 may identify one the CQI tables supported by the eNB 105-b. The identified table may be used to identify a CQI value from received CQI data about a wireless
20 channel. A number of bits may be used to represent the CQI value. In one example, the number of bits used to represent the identified CQI value may remain the same regardless of the table that is identified by the table selection module 605.

[0110] In addition to supporting the use of multiple CQI tables, the eNB 105-b may also support the use of at least two MCS tables. The eNB table selection module 510-a may
25 include an MCS table selection module 610. Transmissions to be transmitted by the eNB transmitter module 515 may be modulated and encoded using a particular MCS. The MCS table selection module 610 may select one of the at least two MCS tables to use for the transmission. In one example, the identified MCS table may be used to determine the MCS to apply to the transmission based on the identified CQI value of the wireless channel that
30 will carry the transmission. In addition, when a UE 115 has information to be transmitted via

an uplink to the eNB 105-b, the eNB 105-b may assign a particular MCS for the UE 115 to use for the uplink transmission.

[0111] In one example, the eNB table selection module may also include a TBS table mapping module 615. In one configuration, an MCS table may be mapped to a TBS table to allow the UE 115 to determine a size of a transmission. In one example, the TBS table mapping module 615 may map a TBS table that indicates the size of a transport block to be transmitted from a particular MCS table supported by the eNB 105-b. When the UE 115 identifies the MCS table that was used to generate the MCS for the transmission, the UE 115 may also use the selected MCS table to look-up the TBS table that has been mapped from the selected MCS table. As a result, the UE 115 may determine the size of a received transport block.

[0112] In one configuration, one or more TBS tables may be mapped from a new MCS table being used to identify MCSs for transmissions via a physical downlink shared channel (PDSCH). New TBS index values in the one or more TBS tables that are mapped from MCS index values in the new MCS table may be defined. In one example, the new TBS index values may be, for example, greater than 26, which is a current maximum number of TBS index values mapped from legacy MCS tables. The number of TBS index values may increase to facilitate an increase of downlink and/or uplink transmission rates and/or peak rates. In another example, a first transport block size resulting from a TBS index value mapped from the new MCS table may be different from a second TBS resulting from a same TBS index value mapped from the legacy MCS table. As an example, the first TBS may be larger than the second TBS. This may facilitate an increase of downlink and/or uplink transmission rates and/or peak rates.

[0113] FIG. 7 is a block diagram 700 illustrating one example of an eNB 105-c in accordance with the present systems and methods. The eNB 105-c may be an example of the eNB 105 illustrated in FIGS. 1, 5, and/or 6. In one configuration, the eNB 105-c may include an eNB receiver module 505, an eNB table selection module 510-b, a CQI value identification module 720, an MCS generation module 725, and an eNB transmitter module 515. Each of these components may be in communication with each other.

[0114] These components of the UE 115-c may, individually or collectively, be implemented with one or more application-specific integrated circuits (ASICs) adapted to

perform some or all of the applicable functions in hardware. Alternatively, the functions may be performed by one or more other processing units (or cores), on one or more integrated circuits. In other examples, other types of integrated circuits may be used (*e.g.*, Structured/Platform ASICs, Field Programmable Gate Arrays (FPGAs), and other Semi-
5 Custom ICs), which may be programmed in any manner known in the art. The functions of each unit may also be implemented, in whole or in part, with instructions embodied in a memory, formatted to be executed by one or more general or application-specific processors.

[0115] In one configuration, the eNB table selection module 510-b may include a CQI table selection module 605. The eNB 105-c may support the use of a legacy CQI table and new
10 CQI table. The module 605 may select one CQI table, from a plurality of CQI tables used by a UE to generate a CQI value. The selected table may then be used by the CQI value identification module 720 to identify a CQI value from CQI data received for a wireless channel, such as a downlink channel.

[0116] In one example, the eNB 105-c may support the use of a legacy MCS table (*e.g.*, a
15 table used for QPSK, 16QAM, and 64 QAM schemes) and a new MCS table used for higher order schemes, such as 256QAM. In one example, the different MCS tables may be associated with different DCI formats. For example, the legacy MCS table may be associated with DCI format 1A while the new MCS table may be associated with DCI format 2D. In one configuration, the legacy and new MCS tables may have one or more common data
20 entries between them. In one example, the legacy and new MCS tables may have the same number of entries. In another example, the new MCS table may have a larger number of entries than that of the legacy table (*e.g.*, a 6-bit table may be used for the new MCS table and a 5-bit table may be used for the legacy table).

[0117] In one configuration, each MCS identified by the MCS generation module 725 may
25 be based on a single MCS table. In one configuration, each assignment of a PDSCH by the eNB 105-c may be associated with a single MCS table. As previously described, the eNB 105-c may support the use of more than one MCS table and may determine which table to use based on various factors.

[0118] In one example, the MCS table selection module 610-a may include at least one of a
30 DCI format identification module 705, a candidate identification module 710, and a transmission type identification module 715. The DCI format identification module 705 may

identify the DCI format of the transmission. The MCS table selection module 610-a may select the MCS table to use for the transmission based on the identified DCI format.

[0119] The candidate identification module 710 may identify a set of control channel decoding candidates that are to receive a control channel transmission. One of the MCS tables may be identified by the MCS table selection module 610-a based at least in part on the identified set of candidates. As an example, a decoding candidate in a common search space is associated with a legacy MCS table, and a decoding candidate in a UE-specific search space is associated with a new MCS table. If there is an overlap between the common search space and the UE-specific search space, a predefined rule can be used. As an example, if a decoding candidate belongs to both the common search space and the UE-specific search space, a legacy MCS table is determined. Alternatively, a new MCS table is determined. The candidate identification module 710 may also identify a type of control channel to be used for the transmission. The MCS table to use may be identified based on the type of control channel. For example, the module 710 may identify a PDCCH to be used for the transmission and the MCS table selection module 610-a may identify the legacy MCS table to use to generate the MCS for the transmission. If the module 710 identifies the control channel as being an ePDCCH, the MCS table selection module 610-a may select the new MCS table to use. In addition to the type of channel used for the transmission, the MCS table selection module 610-a may also identify the MCS table to use based on an index of a received subframe.

[0120] In one configuration, the transmission type identification module 715 may identify a type of transmission to be used for the transmission. Examples of transmission types may include broadcast, random access response, unicast, multi-cast, etc. The module 715 may also identify a type of scheduling used for the transmission. For example, the transmission type identification module 715 may identify a semi-persistent scheduling (SPS) of a service and the MCS table selection module 610-a may select a particular MCS table based on this determination. Thus, based on the identified transmission type, the MCS table selection module 610-a may identify an MCS table to use to identify an MCS for a transmission.

[0121] The MCS generation module 725 may determine the MCS to use for the transmission based on the selected table as well as the identified CQI value for the wireless channel. In one configuration, the MCS generation module 725 may use a first number of

bits to represent the MCS based on a first MCS table. For a different MCS table, the module 725 may use a second number of bits to represent the MCS. The second number of bits may be greater than the first number of bits. In one example, the number of bits used to represent the MCS may remain the same regardless of the MCS table that is used. The MCS may be selected for downlink or uplink transmissions. In one example, multiple transport blocks (e.g., codewords) may be transmitted via a single PDSCH. In one example, the same MCS table may be used by the MCS generation module 725 to identify the MCSs for downlink transmissions of each separate transport block. In another example, different MCS tables may be used by the MCS generation module 725 to identify the MCSs to use for downlink transmissions of each separate transport block. As an example, a PDSCH transmission of a first set of ranks (e.g., rank 1) may be associated with a first MCS table, and a PDSCH transmission of a second set of ranks (e.g., rank 2 and higher) may be associated with a second MCS table.

[0122] A UE may be under a coordinated multi-point (CoMP) operation. In this case, a PDSCH rate-matching and Quasi-co-location Indication (PQI) information field may be included in downlink control information (DCI) to dynamically indicate to the UE which one out of up to four PQI parameters configured by higher layers is to be used for a particular PDSCH transmission. An MCS table indication can be included in some or all sets of PQI parameters configured by higher layers. The indication can be one or more bits. As an example, a one-bit indication can indicate whether a legacy or a new MCS table is to be used for the corresponding PDSCH transmission. The inclusion of the MCS table indication in PQI makes it possible to support CoMP for a UE with cells of different releases. That is, some cells may support 256QAM, while other cells may not. In addition, the UE may experience different channel conditions from each of the cells in CoMP and consequently, some of the cells may be suitable for enabling 256QAM while other cells may be not. A given cell may be more suitable for enabling 256QAM at one time, but becomes more suitable for disabling 256QAM later. The inclusion of the MCS table indication in PQI is thus beneficial in enabling/disabling 256QAM for different cells and/or different subframes in a dynamic manner.

[0123] FIG. 8 is a block diagram of a MIMO communication system 800 including an eNB 105-d and a UE 115-d. This system 800 may illustrate aspects of the system 100 of FIG. 1.

The eNB 105-d may be an example of the eNB 105 of FIGS. 1, 5, 6, and/or 7. The UE 115-d may be an example of the UE 115 of FIGS. 1, 2, 3, and/or 4A. The eNB 105-d may be equipped with antennas 834-a through 834-x, and the UE 115-d may be equipped with antennas 852-a through 852-n. In the system 800, the eNB 105-d may be able to send data over multiple communication links at the same time. Each communication link may be called a “layer” and the “rank” of the communication link may indicate the number of layers used for communication. For example, in a 2x2 MIMO system where eNB 105-d transmits two “layers,” the rank of the communication link between the eNB 105-d and the UE 115-d is two.

10 [0124] At the eNB 105-d, a transmit processor 820 may receive data from a data source. The transmit processor 820 may process the data. The transmit processor 820 may also generate reference symbols, and a cell-specific reference signal. A transmit (TX) MIMO processor 830 may perform spatial processing (*e.g.*, precoding) on data symbols, control symbols, and/or reference symbols, if applicable, and may provide output symbol streams to the transmit modulators 832-a through 832-x. Each modulator 832 may process a respective output symbol stream (*e.g.*, for OFDM, etc.) to obtain an output sample stream. Each modulator 832 may further process (*e.g.*, convert to analog, amplify, filter, and upconvert) the output sample stream to obtain a downlink signal. In one example, downlink signals from modulators 832-a through 832-x may be transmitted via the antennas 834-a through 834-x, respectively.

[0125] At the UE 115-d, the UE antennas 852-a through 852-n may receive the downlink signals from the eNB 105-d and may provide the received signals to the demodulators 854-a through 854-n, respectively. Each demodulator 854 may condition (*e.g.*, filter, amplify, downconvert, and digitize) a respective received signal to obtain input samples. Each demodulator 854 may further process the input samples (*e.g.*, for OFDM, etc.) to obtain received symbols. A MIMO detector 856 may obtain received symbols from all the demodulators 854-a through 854-n, perform MIMO detection on the received symbols if applicable, and provide detected symbols. A receive processor 858 may process (*e.g.*, demodulate, deinterleave, and decode) the detected symbols, providing decoded data for the UE 115-d to a data output, and provide decoded control information to a processor 880, or memory 882. In one example, the processor 880 may include a UE table selection module

210-c to implement the systems and methods described herein. The UE table selection module 210-c may be examples of the module 210 of FIGS. 2, 3, and/or 4A.

[0126] On the uplink, at the UE 115-d, a transmit processor 864 may receive and process data from a data source. The transmit processor 864 may also generate reference symbols for a reference signal. The symbols from the transmit processor 864 may be precoded by a transmit MIMO processor 866 if applicable, further processed by the demodulators 854-a through 854-n (*e.g.*, for SC-FDMA, etc.), and be transmitted to the eNB 105-d in accordance with the transmission parameters received from the eNB 105-d. At the eNB 105-d, the uplink signals from the UE 115-d may be received by the antennas 834, processed by the demodulators 832, detected by a MIMO detector 836 if applicable, and further processed by a receive processor. The receive processor 838 may provide decoded data to a data output and to the processor 840. The processor 840 may include an eNB table selection module 510-c to implement the systems and methods described herein. The module 510-c may be an example of the eNB table selection module 510 of FIGS. 5, 6, and/or 7. The components of the UE 115-d may, individually or collectively, be implemented with one or more Application Specific Integrated Circuits (ASICs) adapted to perform some or all of the applicable functions in hardware. Each of the noted modules may be a means for performing one or more functions related to operation of the system 800.

[0127] Similarly, the components of the eNB 105-d may, individually or collectively, be implemented with one or more Application Specific Integrated Circuits (ASICs) adapted to perform some or all of the applicable functions in hardware. Each of the noted components may be a means for performing one or more functions related to operation of the system 800.

[0128] The communication networks that may accommodate some of the various disclosed examples may be packet-based networks that operate according to a layered protocol stack. For example, communications at the bearer or Packet Data Convergence Protocol (PDCP) layer may be IP-based. A Radio Link Control (RLC) layer may perform packet segmentation and reassembly to communicate over logical channels. A Medium Access Control (MAC) layer may perform priority handling and multiplexing of logical channels into transport channels. The MAC layer may also use Hybrid ARQ (HARQ) to provide retransmission at the MAC layer to improve link efficiency. At the Physical layer, the transport channels may be mapped to Physical channels.

[0129] FIG. 9 is a flow chart illustrating one example of a method 900 for wireless communications. For clarity, the method 900 is described below with reference to the UE 115 of FIGS. 1, 2, 3, 4A, and/or 8. In some cases, the method 900 is described below with reference to the example CQI tables of FIG. 4B. In one implementation, the UE table selection module 210 of FIGS. 2, 3, 4A, and/or 8 may execute one or more sets of codes to control the functional elements of the UE 115 to perform the functions described below.

[0130] At block 905, the use of at least two CQI tables may be supported. At block 910, one of the at least two CQI tables may be identified. At block 915, the identified CQI table may be used to generate a CQI value for a wireless channel. For example, the CQI value may be generated for a downlink channel. In one example, a same number of bits may be used to represent the CQI value independent of the selected CQI table to use. At least one of the CQI tables may support 256QAM.

[0131] Therefore, the method 900 may provide for managing wireless communications for higher order MCS by supporting additional CQI tables. It should be noted that the method 900 is just one implementation and that the operations of the method 900 may be rearranged or otherwise modified such that other implementations are possible.

[0132] FIG. 10 is a flow chart illustrating one example of a method 1000 for wireless communications. For clarity, the method 1000 is described below with reference to the UE 115 of FIGS. 1, 2, 3, 4A, and/or 8. In some cases, the method 1000 is described below with reference to the example CQI tables of FIG. 4B. In one implementation, the UE table selection module 210 of FIGS. 2, 3, 4A, and/or 8 may execute one or more sets of codes to control the functional elements of the UE 115 to perform the functions described below.

[0133] At block 1005, the use of at least two CQI tables may be supported. At block 1010, a determination may be made as to whether a CQI value is to be transmitted via a control channel or a data channel. If it is determined that the CQI value is to be transmitted via a control channel, at block 1015, a first CQI table may be identified. At block 1020, the first CQI table may be used to generate a CQI value represented by a first number of bits.

[0134] If, however, it is determined that the CQI value is to be transmitted via a data channel, at block 1025, a second CQI table may be identified that is different from the first CQI table. At block 1030, the second CQI table may be used to generate a CQI value

represented by a second number of bits. In one example, the second number of bits is different than the first number of bits. In one configuration, the second number of bits is greater than the first number of bits. In another example, the number of bits used to represent the CQI value remains the same regardless of the CQI table that is identified. At block 1035,
5 the CQI value may be transmitted via a wireless channel.

[0135] Thus, the method 1000 may provide for selection of different CQI tables based on whether a CQI value is transmitted via a data channel or control channel. It should be noted that the method 1000 is just one implementation and that the operations of the method 1000 may be rearranged or otherwise modified such that other implementations are possible.

10 [0136] FIG. 11 is a flow chart illustrating one example of a method 1100 for wireless communications. For clarity, the method 1100 is described below with reference to the UE 115 of FIGS. 1, 2, 3, 4A, and/or 8. In some cases, the method 1100 is described below with reference to the example CQI tables of FIG. 4B. In one implementation, the UE table selection module 210 of FIGS. 2, 3, 4A, and/or 8 may execute one or more sets of codes to
15 control the functional elements of the UE 115 to perform the functions described below.

[0137] At block 1105, the use of at least two CQI tables may be supported. At block 1110, a determination may be made as to whether a CQI value is to be part of P-CSI reporting or A-CSI reporting. If it is determined that the CQI value is to be part of P-CSI reporting, at block 1115, a first CQI table may be identified. At block 1120, the first CQI table may be used to
20 generate a CQI value.

[0138] If, however, it is determined that the CQI value is to be part of A-CSI reporting, at block 1125, a second CQI table may be identified that is different from the first CQI table. At block 1130, the second CQI table may be used to generate a CQI value. In one example, the number of bits used to represent the generated CQI value is the same and is independent
25 of the selected CQI table. At block 1135, the CQI value may be transmitted via a wireless channel.

[0139] Thus, the method 1100 may provide for a selection of different CQI tables based on a reporting schedule of the CQI value. It should be noted that the method 1100 is just one implementation and that the operations of the method 1100 may be rearranged or otherwise
30 modified such that other implementations are possible.

[0140] FIG. 12 is a flow chart illustrating one example of a method 1200 for wireless communications. For clarity, the method 1200 is described below with reference to the UE 115 of FIGS. 1, 2, 3, 4A, and/or 8. In some cases, the method 1200 is described below with reference to the example MCS tables of FIG. 4C. In one implementation, the UE table selection module 210 of FIGS. 2, 3, 4A, and/or 8 may execute one or more sets of codes to control the functional elements of the UE 115 to perform the functions described below.

[0141] At block 1205, the use of at least two MCS tables may be supported. At block 1210, a transmission may be received via a wireless channel. For example, the transmission may be received from an eNB 105 via a downlink channel. At block 1215, one of the MCS tables may be identified for the received transmission. The identified MCS table may be used to identify an MCS to apply to the received transmission. The identified MCS may indicate a demodulation and decoding scheme to apply to the received transmission. At least one of the MCS tables may support a higher order modulation scheme, such as, but not limited to 256QAM.

[0142] Thus, the method 1200 may provide for a selection of different MCS tables to identify an MCS for the received transmission. It should be noted that the method 1200 is just one implementation and that the operations of the method 1200 may be rearranged or otherwise modified such that other implementations are possible.

[0143] FIG. 13 is a flow chart illustrating one example of a method 1300 for wireless communications. For clarity, the method 1300 is described below with reference to the UE 115 of FIGS. 1, 2, 3, 4A, and/or 8. In some cases, the method 1300 is described below with reference to the example MCS tables of FIG. 4C. In one implementation, the UE table selection module 210 of FIGS. 2, 3, 4A, and/or 8 may execute one or more sets of codes to control the functional elements of the UE 115 to perform the functions described below.

[0144] At block 1305, the use of at least two MCS tables may be supported. At block 1310, a transmission may be received via a wireless channel. At block 1315, one of the MCS tables may be identified to use for the received transmission. At block 1320, the identified MCS table may be used to determine an MCS to use on the received transmission. At block 1325, the identified MCS table may also be used to identify a size of the received transmission. As previously explained, each MCS index value included in an MCS table may be mapped to a TBS table that indicates the size of a transport block being transmitted.

[0145] Therefore, the method 1300 may provide for a selection of different MCS tables to identify an MCS for the received transmission as well as a size of the transmission. It should be noted that the method 1300 is just one implementation and that the operations of the method 1300 may be rearranged or otherwise modified such that other implementations are possible.

[0146] With regards to the UE 115, the present systems and methods may be implemented as a new capability on the UE 115. In another example, the present systems and methods may be implemented into current UE categories and/or by adding new UE categories. The present systems and methods may increase a maximum size that the UE is able to process in a subframe and/or a transport block currently defined in each UE category may be increased.

[0147] In one example, the present systems and methods may be applied to uplink transmissions if higher order MCS (e.g., 256QAM) are supported for the uplink. In one configuration, new MCS tables used to identify MCSs for uplink transmissions may be different from the new MCS tables used to determine MCSs for downlink transmissions.

[0148] FIG. 14 is a flow chart illustrating one example of a method 1400 for wireless communications. For clarity, the method 1400 is described below with reference to the eNB 105 of FIGS. 1, 5, 6, 7, and/or 8. In some cases, the method 1400 is described below with reference to the example MCS tables of FIG. 4C. In one implementation, the eNB table selection module 510 of FIGS. 5, 6, 7, and/or 8 may execute one or more sets of codes to control the functional elements of the eNB 105 to perform the functions described below.

[0149] At block 1405, the use of at least two MCS tables may be supported. At block 1410, one of the MCS tables may be identified. The identified MCS table may be used, at block 1415, to identify an MCS for a transmission. The identified MCS may be for a downlink transmission. In one configuration, the identified MCS may be for an uplink transmission. At least one of the MCS tables may support a higher order modulation scheme, such as, but not limited to 256QAM.

[0150] Thus, the method 1400 may provide for a selection of different MCS tables to identify an MCS for a transmission. It should be noted that the method 1400 is just one implementation and that the operations of the method 1400 may be rearranged or otherwise modified such that other implementations are possible.

[0151] FIG. 15 is a flow chart illustrating one example of a method 1500 for wireless communications. For clarity, the method 1500 is described below with reference to the eNB 105 of FIGS. 1, 5, 6, 7, and/or 8. In some cases, the method 1500 is described below with reference to the example MCS tables of FIG. 4C. In one implementation, the eNB table selection module 510 of FIGS. 5, 6, 7, and/or 8 may execute one or more sets of codes to control the functional elements of the eNB 105 to perform the functions described below.

[0152] At block 1505, the use of at least two MCS tables may be supported. At block 1510, each of the MCS tables may be mapped to a TBS table. At block 1520, a DCI format may be identified. At block 1525, one of the MCS tables may be identified based at least in part on the identified DCI format. At block 1530, the identified MCS table may be used to identify an MCS for a transmission.

[0153] Therefore, the method 1500 may provide for mapping different MCS tables to TBS tables and selecting an MCS table based on a DCI format. It should be noted that the method 1500 is just one implementation and that the operations of the method 1500 may be rearranged or otherwise modified such that other implementations are possible.

[0154] FIG. 16 is a flow chart illustrating one example of a method 1600 for wireless communications. For clarity, the method 1600 is described below with reference to the eNB 105 of FIGS. 1, 5, 6, 7, and/or 8. In some cases, the method 1600 is described below with reference to the example CQI tables of FIG. 4B. In one implementation, the eNB table selection module 510 of FIGS. 5, 6, 7, and/or 8 may execute one or more sets of codes to control the functional elements of the eNB 105 to perform the functions described below.

[0155] At block 1605, the use of at least two CQI tables may be supported. At block 1610, CQI data for a wireless channel may be received. At block 1615, one of the CQI tables may be identified. The identified table may be used to identify a CQI value based on the received CQI data.

[0156] Thus, the method 1600 may provide for a selection of a CQI table to identify a CQI value that is based on received CQI data. It should be noted that the method 1600 is just one implementation and that the operations of the method 1600 may be rearranged or otherwise modified such that other implementations are possible.

- [0157]** The detailed description set forth above in connection with the appended drawings describes exemplary examples and does not represent the only examples that may be implemented or that are within the scope of the claims. The term "exemplary" used throughout this description means "serving as an example, instance, or illustration," and not "preferred" or "advantageous over other examples." The detailed description includes specific details for the purpose of providing an understanding of the described techniques. These techniques, however, may be practiced without these specific details. In some instances, well-known structures and devices are shown in block diagram form in order to avoid obscuring the concepts of the described examples.
- [0158]** Techniques described above may be used for various wireless communications systems such as CDMA, TDMA, FDMA, OFDMA, SC-FDMA, and other systems. The terms "system" and "network" are often used interchangeably. A CDMA system may implement a radio technology such as CDMA2000, Universal Terrestrial Radio Access (UTRA), etc. CDMA2000 covers IS-2000, IS-95, and IS-856 standards. IS-2000 Releases 0 and A are commonly referred to as CDMA2000 1X, 1X, etc. IS-856 (TIA-856) is commonly referred to as CDMA2000 1xEV-DO, High Rate Packet Data (HRPD), etc. UTRA includes Wideband CDMA (WCDMA) and other variants of CDMA. A TDMA system may implement a radio technology such as Global System for Mobile Communications (GSM). An OFDMA system may implement a radio technology such as Ultra Mobile Broadband (UMB), Evolved UTRA (E-UTRA), IEEE 802.11 (Wi-Fi), IEEE 802.16 (WiMAX), IEEE 802.20, Flash-OFDM, etc. UTRA and E-UTRA are part of Universal Mobile Telecommunication System (UMTS). 3GPP Long Term Evolution (LTE) and LTE-Advanced (LTE-A) are new releases of UMTS that use E-UTRA. UTRA, E-UTRA, UMTS, LTE, LTE-A, and GSM are described in documents from an organization named "3rd Generation Partnership Project" (3GPP). CDMA2000 and UMB are described in documents from an organization named "3rd Generation Partnership Project 2" (3GPP2). The techniques described herein may be used for the systems and radio technologies mentioned above as well as other systems and radio technologies. The description below, however, describes an LTE system for purposes of example, and LTE terminology is used in much of the description below, although the techniques are applicable beyond LTE applications.

[0159] Information and signals may be represented using any of a variety of different technologies and techniques. For example, data, instructions, commands, information, signals, bits, symbols, and chips that may be referenced throughout the above description may be represented by voltages, currents, electromagnetic waves, magnetic fields or particles, optical fields or particles, or any combination thereof.

[0160] The various illustrative blocks and modules described in connection with the disclosure herein may be implemented or performed with a general-purpose processor, a digital signal processor (DSP), an application specific integrated circuit (ASIC), a field programmable gate array (FPGA) or other programmable logic device, discrete gate or transistor logic, discrete hardware components, or any combination thereof designed to perform the functions described herein. A general-purpose processor may be a microprocessor, but in the alternative, the processor may be any conventional processor, controller, microcontroller, or state machine. A processor may also be implemented as a combination of computing devices, e.g., a combination of a DSP and a microprocessor, multiple microprocessors, one or more microprocessors in conjunction with a DSP core, or any other such configuration.

[0161] The functions described herein may be implemented in hardware, software executed by a processor, firmware, or any combination thereof. If implemented in software executed by a processor, the functions may be stored on or transmitted over as one or more instructions or code on a computer-readable medium. Other examples and implementations are within the scope and spirit of the disclosure and appended claims. For example, due to the nature of software, functions described above can be implemented using software executed by a processor, hardware, firmware, hardwiring, or combinations of any of these. Features implementing functions may also be physically located at various positions, including being distributed such that portions of functions are implemented at different physical locations. Also, as used herein, including in the claims, “or” as used in a list of items prefaced by “at least one of” indicates a disjunctive list such that, for example, a list of “at least one of A, B, or C” means A or B or C or AB or AC or BC or ABC (i.e., A and B and C).

[0162] Computer-readable media includes both computer storage media and communication media including any medium that facilitates transfer of a computer program from one place to another. A storage medium may be any available medium that can be

accessed by a general purpose or special purpose computer. By way of example, and not limitation, computer-readable media can comprise RAM, ROM, EEPROM, CD-ROM or other optical disk storage, magnetic disk storage or other magnetic storage devices, or any other medium that can be used to carry or store desired program code means in the form of instructions or data structures and that can be accessed by a general-purpose or special-
5 purpose computer, or a general-purpose or special-purpose processor. Also, any connection is properly termed a computer-readable medium. For example, if the software is transmitted from a website, server, or other remote source using a coaxial cable, fiber optic cable, twisted pair, digital subscriber line (DSL), or wireless technologies such as infrared, radio, and
10 microwave, then the coaxial cable, fiber optic cable, twisted pair, DSL, or wireless technologies such as infrared, radio, and microwave are included in the definition of medium. Disk and disc, as used herein, include compact disc (CD), laser disc, optical disc, digital versatile disc (DVD), floppy disk and blu-ray disc where disks usually reproduce data magnetically, while discs reproduce data optically with lasers. Combinations of the above
15 are also included within the scope of computer-readable media.

[0163] The previous description of the disclosure is provided to enable a person skilled in the art to make or use the disclosure. Various modifications to the disclosure will be readily apparent to those skilled in the art, and the generic principles defined herein may be applied to other variations without departing from the spirit or scope of the disclosure. Throughout
20 this disclosure the term "example" or "exemplary" indicates an example or instance and does not imply or require any preference for the noted example. Thus, the disclosure is not to be limited to the examples and designs described herein but is to be accorded the widest scope consistent with the principles and novel features disclosed herein.

[0164] What is claimed is:

25

CLAIMS

- 1 1. A method for wireless communications, comprising:
2 supporting the use of at least two channel quality indicator (CQI) tables;
3 identifying one of the at least two CQI tables; and
4 using the identified CQI table to generate a CQI value for a wireless channel.
- 1 2. The method of claim 1, wherein a same number of bits is used to
2 represent the CQI value regardless of which CQI table is identified.
- 1 3. The method of claim 1, wherein the identification of the CQI table is
2 based at least in part on an identification of channel state information (CSI), from a plurality
3 of CSI identifications, where the CSI is at least one of a periodic CSI or an aperiodic CSI.
- 1 4. The method of claim 3, wherein each of the plurality of CSI
2 identifications is associated with a set of subframes, where the set of subframes are
3 determined based at least in part on a semi-static configuration or a semi-static indication.
- 1 5. The method of claim 1, further comprising:
2 identifying a first CQI table to use for a first channel state information (CSI)
3 process; and
4 identifying a second CQI table to use for a second CSI process, the second
5 CSI process being different than the first CSI process.
- 1 6. The method of claim 1, wherein the identifying one of the at least two
2 CQI tables comprises:
3 selecting the CQI table to use to generate the CQI value according to a
4 predefined configuration setting.
- 1 7. The method of claim 1, wherein the identifying one of the at least two
2 CQI tables comprises:
3 dynamically selecting the CQI table to use to generate the CQI value.
- 1 8. The method of claim 1, further comprising:
2 determining whether the CQI value is to be transmitted via a control channel
3 or a data channel; and

4 upon determining that the CQI value is to be transmitted via the control
5 channel, identifying a first CQI table to use; and
6 upon determining that the CQI value is to be transmitted via the data channel,
7 identifying a second CQI table to use, the second CQI table being different from the first CQI
8 table.

1 9. The method of claim 8, further comprising:
2 upon identifying the first CQI table, using a first number of bits to represent
3 the CQI value based on the first CQI table; and
4 upon identifying the second CQI table, using a second number of bits to
5 represent the CQI value based on the second CQI table, the second number of bits being
6 greater than the first number of bits.

1 10. The method of claim 1, further comprising:
2 determining whether the CQI value is part of a periodic channel state
3 information (P-CSI) report or an aperiodic channel state information (A-CSI) report;
4 upon determining that the CQI value is part of the P-CSI report, identifying a
5 first CQI table to use; and
6 upon determining that the CQI value is part of the A-CSI report, identifying a
7 second CQI table to use, the second CQI table being different from the first CQI table.

1 11. The method of claim 1, further comprising:
2 generating a first CQI value using a first CQI table;
3 generating a second CQI value using a second CQI table; and
4 transmitting the first CQI value and the second CQI value via a wireless
5 channel in a single subframe.

1 12. The method of claim 1, wherein the at least two CQI tables comprise at
2 least one common data entry.

1 13. The method of claim 1, wherein a CQI table comprises a listing of CQI
2 values, each CQI value being mapped to a spectral efficiency value.

1 14. The method of claim 1, wherein at least one of the identified CQI
2 reporting tables supports 256 Quadrature Amplitude Modulation (QAM).

1 15. An apparatus for wireless communications, comprising:
2 a processor;
3 a memory in electronic communication with the processor; and
4 instructions stored in the memory, the instructions being executable by the
5 processor to:
6 support the use of at least two channel quality indicator (CQI)
7 reporting tables;
8 identify one of the at least two CQI tables; and
9 use the identified CQI table to generate a CQI value for a wireless
10 channel.

1 16. The apparatus of claim 15, wherein a same number of bits is used to
2 represent the CQI value regardless of which CQI table is identified.

1 17. The apparatus of claim 15, wherein the identification of the CQI table
2 is based at least in part on an identification of channel state information (CSI), from a
3 plurality of CSI identifications, where the CSI is at least one of a periodic CSI or an aperiodic
4 CSI.

1 18. The apparatus of claim 17, wherein each of the plurality of CSI
2 identifications is associated with a set of subframes, where the set of subframes are
3 determined based at least in part on a semi-static configuration or a semi-static indication.

1 19. The apparatus of claim 15, wherein the instructions are executable by
2 the processor to:
3 identify a first CQI table to use for a first channel state information (CSI)
4 process; and
5 identify a second CQI table to use for a second CSI process, the second CSI
6 process being different than the first CSI process.

1 20. The apparatus of claim 15, wherein the instructions to identify one of
2 the at least two CQI tables are executable by the processor to:
3 select the CQI table to use to generate the CQI value according to a predefined
4 configuration setting.

1 21. The apparatus of claim 15, wherein the instructions to identify one of
2 the at least two CQI tables are executable by the processor to:

3 dynamically select the CQI table to use to generate the CQI value.

1 22. The apparatus of claim 15, wherein the instructions are executable by
2 the processor to:

3 determine whether the CQI value is to be transmitted via a control channel or a
4 data channel; and

5 upon determining that the CQI value is to be transmitted via the control
6 channel, identify a first CQI table to use; and

7 upon determining that the CQI value is to be transmitted via the data channel,
8 identify a second CQI table to use, the second CQI table being different from the first CQI
9 table.

1 23. The apparatus of claim 15, wherein the instructions are executable by
2 the processor to:

3 upon identifying the first CQI table, use a first number of bits to represent the
4 CQI value based on the first CQI table; and

5 upon identifying the second CQI table, use a second number of bits to
6 represent the CQI value based on the second CQI table, the second number of bits being
7 greater than the first number of bits.

1 24. The apparatus of claim 15, wherein the instructions are executable by
2 the processor to:

3 determine whether the CQI value is part of a periodic channel state
4 information (P-CSI) report or an aperiodic channel state information (A-CSI) report;

5 upon determining that the CQI value is part of the P-CSI report, identify a first
6 CQI table to use; and

7 upon determining that the CQI value is part of the A-CSI report, identify a
8 second CQI table to use, the second CQI table being different from the first CQI table.

1 25. The apparatus of claim 15, wherein the instructions are executable by
2 the processor to:

3 generate a first CQI value using a first CQI table;
4 generate a second CQI value using a second CQI table; and
5 transmit the first CQI value and the second CQI value via a wireless channel
6 in a single subframe.

1 26. The apparatus of claim 15, wherein the at least two CQI tables
2 comprise at least one common data entry.

1 27. The apparatus of claim 15, wherein a CQI table comprises a listing of
2 CQI values, each CQI value being mapped to a spectral efficiency value.

1 28. The apparatus of claim 15, wherein at least one of the identified CQI
2 reporting tables supports 256 Quadrature Amplitude Modulation (QAM).

1 29. An apparatus for wireless communications, comprising:
2 means for supporting the use of at least two channel quality indicator (CQI)
3 reporting tables;
4 means for identifying one of the at least two CQI tables; and
5 means for using the identified CQI table to generate a CQI value for a wireless
6 channel.

1 30. The apparatus of claim 29, wherein a same number of bits is used to
2 represent the CQI value regardless of which CQI table is identified.

1 31. The apparatus of claim 29, wherein the identification of the CQI table
2 is based at least in part on an identification of channel state information (CSI), from a
3 plurality of CSI identifications, where the CSI is at least one of a periodic CSI or an aperiodic
4 CSI.

1 32. The apparatus of claim 31, wherein each of the plurality of CSI
2 identifications is associated with a set of subframes, where the set of subframes are
3 determined based at least in part on a semi-static configuration or a semi-static indication.

1 33. The apparatus of claim 29, further comprising:
2 means for determining whether the CQI value is to be transmitted via a control
3 channel or a data channel; and

4 upon determining that the CQI value is to be transmitted via the control
5 channel, means for identifying a first CQI table to use; and
6 upon determining that the CQI value is to be transmitted via the data channel,
7 means for identifying a second CQI table to use, the second CQI table being different from
8 the first CQI table.

1 34. The apparatus of claim 33, further comprising:
2 upon identifying the first CQI table, means for using a first number of bits to
3 represent the CQI value based on the first CQI table; and
4 upon identifying the second CQI table, means for using a second number of
5 bits to represent the CQI value based on the second CQI table, the second number of bits
6 being greater than the first number of bits.

1 35. A computer program product for managing wireless communications,
2 the computer program product comprising a non-transitory computer-readable medium
3 storing instructions executable by a processor to:
4 support the use of at least two channel quality indicator (CQI) reporting tables;
5 identify one of the at least two CQI tables; and
6 use the identified CQI table to generate a CQI value for a wireless channel.

1 36. A method for wireless communications, comprising:
2 supporting the use of at least two modulation and coding scheme (MCS)
3 tables;
4 receiving a transmission via a wireless channel; and
5 identifying one of the at least two MCS tables to use for the received
6 transmission.

1 37. The method of claim 36, further comprising:
2 using the identified MCS table to determine an MCS to use for the received
3 transmission.

1 38. The method of claim 36, wherein a first transport block size (TBS)
2 table is mapped from a first MCS table and a second TBS table is mapped from a second

3 MCS table, the second TBS table comprising at least one TBS that is greater than a maximum
4 TBS in the first TBS table.

1 39. The method of claim 38, further comprising:
2 identifying a TBS table mapped from the identified MCS table;
3 using the identified TBS table to determine a size of the received transmission.

1 40. The method of claim 36, wherein the identifying one of the at least two
2 MCS tables comprises:
3 determining a type of transmission used to transmit the received transmission
4 via the wireless channel; and
5 identifying one of the at least two MCS tables to use for the received
6 transmission based at least in part on the type of transmission.

1 41. The method of claim 36, wherein the identifying one of the at least two
2 MCS tables comprises:
3 identifying a type of control channel used to transmit the received
4 transmission; and
5 identifying one of the at least two MCS tables to use for the received
6 transmission based at least in part on the identified type of control channel.

1 42. The method of claim 36, further comprising:
2 using the identified MCS table to determine an MCS to use for an uplink
3 transmission.

1 43. The method of claim 36, wherein a first number of bits is used to
2 represent a first MCS based on a first MCS table, and a second number of bits is used to
3 represent a second MCS based on a second MCS table.

1 44. The method of claim 43, wherein the first number of bits is the same as
2 the second number of bits.

1 45. The method of claim 36, wherein the identifying one of the at least two
2 MCS tables comprises:
3 dynamically selecting the MCS table to use for the received transmission.

1 46. The method of claim 36, wherein identifying one of the at least two
2 MCS tables comprises:
3 selecting the MCS table to use for the received transmission according to a
4 predefined configuration setting.

1 47. An apparatus for wireless communications, comprising:
2 a processor;
3 a memory in electronic communication with the processor; and
4 instructions stored in the memory, the instructions being executable by the
5 processor to:
6 support the use of at least two modulation and coding scheme (MCS)
7 tables;
8 receive a transmission via a wireless channel; and
9 identify one of the at least two MCS tables to use for the received
10 transmission.

1 48. The apparatus of claim 47, wherein the instructions are executable by
2 the processor to:
3 use the identified MCS table to determine an MCS to use for the received
4 transmission.

1 49. The apparatus of claim 47, wherein a first transport block size (TBS)
2 table is mapped from a first MCS table and a second TBS table is mapped from a second
3 MCS table, the second TBS table comprising at least one TBS that is greater than a maximum
4 TBS in the first TBS table.

1 50. The apparatus of claim 49, wherein the instructions are executable by
2 the processor to:
3 identify a TBS table mapped from the identified MCS table;
4 use the identified TBS table to determine a size of the received transmission.

1 51. The apparatus of claim 47, wherein the instructions to identify one of
2 the at least two MCS tables are executable by the processor to:

3 determine a type of transmission used to transmit the received transmission via
4 the wireless channel; and
5 identify one of the at least two MCS tables to use for the received transmission
6 based at least in part on the type of transmission.

1 52. The apparatus of claim 47, wherein the instructions to identify one of
2 the at least two MCS tables are executable by the processor to:
3 identify a type of control channel used to transmit the received transmission;
4 and
5 identify one of the at least two MCS tables to use for the received transmission
6 based at least in part on the identified type of control channel.

1 53. The apparatus of claim 47, wherein the instructions are executable by
2 the processor to:
3 use the identified MCS table to determine an MCS to use for an uplink
4 transmission.

1 54. The apparatus of claim 47, wherein a first number of bits is used to
2 represent a first MCS based on a first MCS table, and a second number of bits is used to
3 represent a second MCS based on a second MCS table.

1 55. The apparatus of claim 54, wherein the first number of bits is the same
2 as the second number of bits.

1 56. The apparatus of claim 47, wherein the instructions to identify one of
2 the at least two MCS tables are executable by the processor to:
3 dynamically select the MCS table to use for the received transmission.

1 57. The apparatus of claim 47, wherein the instructions to identify one of
2 the at least two MCS tables are executable by the processor to:
3 select the MCS table to use for the received transmission according to a
4 predefined configuration setting.

1 58. An apparatus for wireless communications, comprising:

2 means for supporting the use of at least two modulation and coding scheme
3 (MCS) tables;
4 means for receiving a transmission via a wireless channel; and
5 means for identifying one of the at least two MCS tables to use for the
6 received transmission.

1 59. The apparatus of claim 58, further comprising:
2 means for using the identified MCS table to determine an MCS to use for the
3 received transmission.

1 60. The apparatus of claim 58, wherein a first number of bits is used to
2 represent a first MCS based on a first MCS table, and a second number of bits is used to
3 represent a second MCS based on a second MCS table.

1 61. The apparatus of claim 60, wherein the first number of bits is the same
2 as the second number of bits.

1 62. A computer program product for managing wireless communications,
2 the computer program product comprising a non-transitory computer-readable medium
3 storing instructions executable by a processor to:
4 support the use of at least two modulation and coding scheme (MCS) tables;
5 receive a transmission via a wireless channel; and
6 identify one of the at least two MCS tables to use for the received
7 transmission.

1 63. A method for wireless communications, comprising:
2 supporting the use of at least two modulation and coding scheme (MCS)
3 tables;
4 identifying one of the at least two MCS tables; and
5 using the identified MCS table to identify an MCS for a transmission.

1 64. The method of claim 63, further comprising:
2 identifying a channel quality indicator (CQI) value, the identified MCS being
3 based at least in part on the received CQI value.

1 65. The method of claim 63, wherein the using the identified MCS table to
2 identify the MCS comprises:
3 selecting the MCS for a downlink transmission.

1 66. The method of claim 63, wherein the using the identified MCS table to
2 identify the MCS comprises:
3 selecting the MCS for an uplink transmission.

1 67. The method of claim 63, wherein the identification of one of the at
2 least two MCS tables is based at least in part on a downlink control information (DCI)
3 format.

1 68. The method of claim 63, wherein a first number of bits is used to
2 represent a first MCS based on a first MCS table, and a second number of bits is used to
3 represent a second MCS based on a second MCS table.

1 69. The method of claim 68, wherein the first number of bits is the same as
2 the second number of bits.

1 70. The method of claim 63, further comprising:
2 associating a single MCS table with each assignment of a physical downlink
3 shared channel (PDSCH).

1 71. The method of claim 63, further comprising:
2 identifying at least two codewords to be transmitted via a single physical
3 downlink shared channel (PDSCH); and
4 using the identified one of the at least two MCS tables for downlink
5 transmissions of the at least two codewords.

1 72. The method of claim 63, further comprising:
2 identifying a type of control channel to be used for the transmission; and
3 identifying one of the at least two MCS tables to use for the transmission
4 based at least in part on the identified type of control channel.

1 73. The method of claim 63, further comprising:

2 identifying a set of candidates for a control channel transmission; and
3 identifying one of the at least two MCS tables to use for the control channel
4 transmission based at least in part on the identified set of candidates.

1 74. The method of claim 73, wherein a first set of candidates are
2 associated with a common search space, and a second set of candidates are associated with a
3 user equipment specific search space.

1 75. The method of claim 74, further comprising:
2 identifying at least one candidate associated with both the common search
3 space and the user equipment search space; and
4 identifying one of the at least two MCS tables based at least in part on a
5 predefined rule.

1 76. The method of claim 63, further comprising:
2 identifying a type of the transmission to occur on a wireless channel; and
3 identifying one of the at least two MCS tables to use for the transmission
4 based at least in part on the identified type of transmission.

1 77. The method of claim 63, wherein the identifying one of the at least two
2 MCS tables comprises:
3 dynamically selecting the MCS table to use for the transmission.

1 78. The method of claim 77, wherein the dynamic selection of the MCS
2 table is performed by an information field in downlink control information, where the
3 information field selects one of a plurality of sets of configurations, where each set of
4 configuration comprises parameters including an MCS table indicator and at least one of a
5 rate matching parameter and a quasi-co-location indication parameter.

1 79. The method of claim 63, wherein identifying one of the at least two
2 MCS tables comprises:
3 selecting the MCS table to use for the transmission according to a predefined
4 configuration setting.

1 80. The method of claim 63, wherein an MCS table comprises a listing of
2 MCSs, each MCS being mapped to at least one of a modulation scheme and a transport block
3 size (TBS).

1 81. The method of claim 80, wherein a first TBS table is mapped from a
2 first MCS table and a second TBS table is mapped from a second MCS table, the second TBS
3 table comprising at least one TBS that is greater than a maximum TBS in the first TBS table.

1 82. The method of claim 63, wherein at least one of the identified MCS
2 tables supports 256 Quadrature Amplitude Modulation (QAM).

1 83. An apparatus for wireless communications, comprising:
2 a processor;
3 a memory in electronic communication with the processor; and
4 instructions stored in the memory, the instructions being executable by the
5 processor to:
6 support the use of at least two modulation and coding scheme (MCS)
7 tables;
8 identify one of the at least two MCS tables; and
9 use the identified MCS table to identify an MCS for a transmission.

1 84. The apparatus of claim 83, wherein the instructions are executable by
2 the processor to:
3 identify a channel quality indicator (CQI) value, the identified MCS being
4 based at least in part on the received CQI value.

1 85. The apparatus of claim 83, wherein the instructions to use the
2 identified MCS table to identify the MCS are executable by the processor to:
3 select the MCS for a downlink transmission.

1 86. The apparatus of claim 83, wherein the instructions to use the
2 identified MCS table to identify the MCS are executable by the processor to:
3 select the MCS for an uplink transmission.

1 87. The apparatus of claim 83, wherein the identification of one of the at
2 least two MCS tables is based at least in part on a downlink control information (DCI)
3 format.

1 88. The apparatus of claim 83, wherein a first number of bits is used to
2 represent a first MCS based on a first MCS table, and a second number of bits is used to
3 represent a second MCS based on a second MCS table.

1 89. The apparatus of claim 83, wherein the first number of bits is the same
2 as the second number of bits.

1 90. The apparatus of claim 83, wherein the instructions are executable by
2 the processor to:
3 associate a single MCS table with each assignment of a physical downlink
4 shared channel (PDSCH).

1 91. The apparatus of claim 83, wherein the instructions are executable by
2 the processor to:
3 identify at least two codewords to be transmitted via a single physical
4 downlink shared channel (PDSCH); and
5 use the identified one of the at least two MCS tables for downlink
6 transmissions of the at least two codewords.

1 92. The apparatus of claim 83, wherein the instructions are executable by
2 the processor to:
3 identify a type of control channel to be used for the transmission; and
4 identify one of the at least two MCS tables to use for the transmission based at
5 least in part on the identified type of control channel.

1 93. The apparatus of claim 83, wherein the instructions are executable by
2 the processor to:
3 identify a set of candidates for a control channel transmission; and
4 identify one of the at least two MCS tables to use for the control channel
5 transmission based at least in part on the identified set of candidates.

1 94. The apparatus of claim 93, wherein a first set of candidates are
2 associated with a common search space, and a second set of candidates are associated with a
3 user equipment specific search space.

1 95. The apparatus of claim 94, wherein the instructions are executable by
2 the processor to:
3 identify at least one candidate associated with both the common search space
4 and the user equipment search space; and
5 identify one of the at least two MCS tables based at least in part on a
6 predefined rule.

1 96. The apparatus of claim 83, wherein the instructions are executable by
2 the processor to:
3 identify a type of the transmission to occur on a wireless channel; and
4 identify one of the at least two MCS tables to use for the transmission based at
5 least in part on the identified type of transmission.

1 97. The apparatus of claim 83, wherein the instructions to identify one of
2 the at least two MCS tables are executable by the processor to:
3 dynamically select the MCS table to use for the transmission.

1 98. The apparatus of claim 97, wherein the dynamic selection of the MCS
2 table is performed by an information field in downlink control information, where the
3 information field selects one of a plurality of sets of configurations, where each set of
4 configuration comprises parameters including an MCS table indicator and at least one of a
5 rate matching parameter and a quasi-co-location indication parameter.

1 99. The apparatus of claim 83, wherein the instructions to identify one of
2 the at least two MCS tables are executable by the processor to:
3 select the MCS table to use for the transmission according to a predefined
4 configuration setting.

1 100. The apparatus of claim 83, wherein an MCS table comprises a listing
2 of MCSs, each MCS being mapped to at least one of a modulation scheme and a transport
3 block size (TBS).

1 101. The apparatus of claim 100, wherein a first TBS table is mapped from
2 a first MCS table and a second TBS table is mapped from a second MCS table, the second
3 TBS table comprising at least one TBS that is greater than a maximum TBS in the first TBS
4 table.

1 102. The apparatus of claim 83, wherein at least one of the identified MCS
2 tables supports 256 Quadrature Amplitude Modulation (QAM).

1 103. An apparatus for wireless communications, comprising:
2 means for supporting the use of at least two modulation and coding scheme
3 (MCS) tables;
4 means for identifying one of the at least two MCS tables; and
5 means for using the identified MCS table to identify an MCS for a
6 transmission.

1 104. The apparatus of claim 103, further comprising:
2 means for selecting the MCS for downlink transmission.

1 105. The apparatus of claim 103, further comprising:
2 means for selecting the MCS for an uplink transmission.

1 106. A computer program product for managing wireless communications,
2 the computer program product comprising a non-transitory computer-readable medium
3 storing instructions executable by a processor to:
4 support the use of at least two modulation and coding scheme (MCS) tables;
5 identify one of the at least two MCS tables; and
6 use the identified MCS table to identify an MCS for a transmission.

1 107. A method for wireless communications, comprising:
2 supporting the use of at least two channel quality indicator (CQI) tables;
3 receiving CQI data for a wireless channel; and

4 identifying one of the at least two CQI tables to use to identify a CQI value
5 based on the CQI data.

1 108. The method of claim 107, wherein a same number of bits is used to
2 represent the CQI value regardless of which CQI table is identified.

1 109. The method of claim 107, wherein the identifying one of the at least
2 two CQI tables comprises:
3 selecting the CQI table to use to identify the CQI value according to a
4 predefined configuration setting.

1 110. The method of claim 107, wherein the identifying one of the at least
2 two CQI tables comprises:
3 dynamically selecting the CQI table to use to identify the CQI value.

1 111. An apparatus for wireless communications, comprising:
2 a processor;
3 a memory in electronic communication with the processor; and
4 instructions stored in the memory, the instructions being executable by the
5 processor to:
6 support the use of at least two channel quality indicator (CQI) tables;
7 receive CQI data for a wireless channel; and
8 identify one of the at least two CQI tables to use to identify a CQI
9 value based on the CQI data.

1 112. An apparatus for wireless communications, comprising:
2 means for supporting the use of at least two channel quality indicator (CQI)
3 tables;
4 means for receiving CQI data for a wireless channel; and
5 means for identifying one of the at least two CQI tables to use to identify a
6 CQI value based on the CQI data.

1 113. A computer program product for managing wireless communications,
2 the computer program product comprising a non-transitory computer-readable medium
3 storing instructions executable by a processor to:

- 4 support the use of at least two channel quality indicator (CQI) tables;
- 5 receive CQI data for a wireless channel; and
- 6 identify one of the at least two CQI tables to use to identify a CQI value based
- 7 on the CQI data.

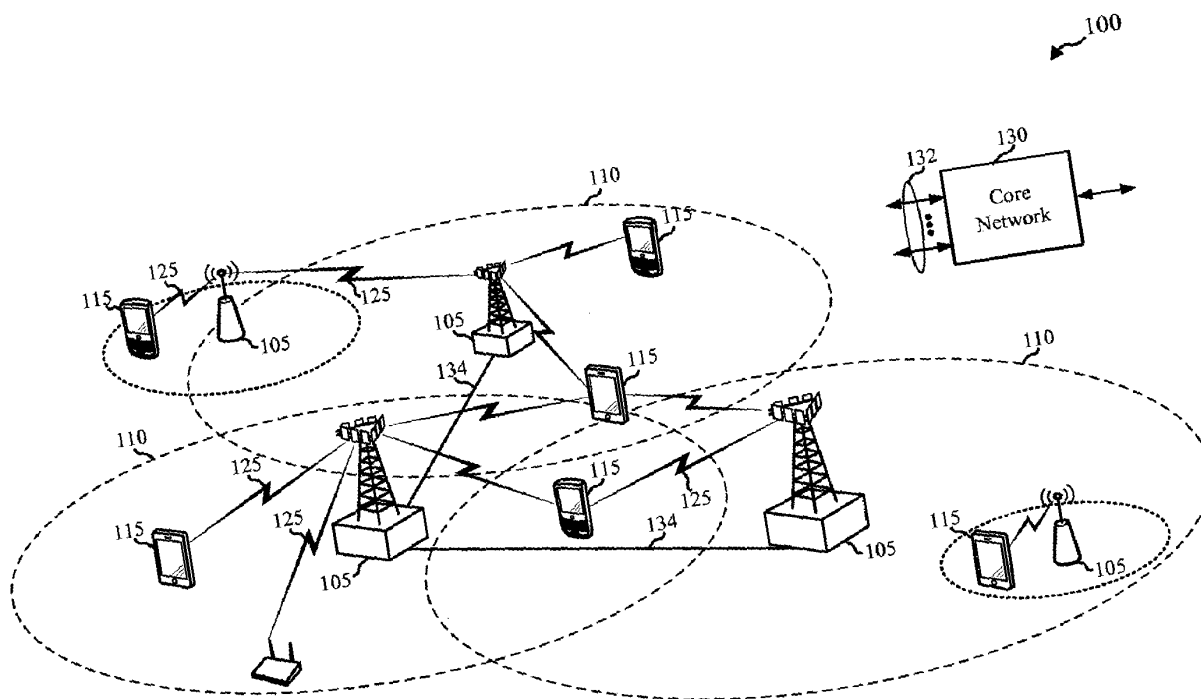

FIG. 1

WO 2014/109915

1/18

PCT/US2013/07844

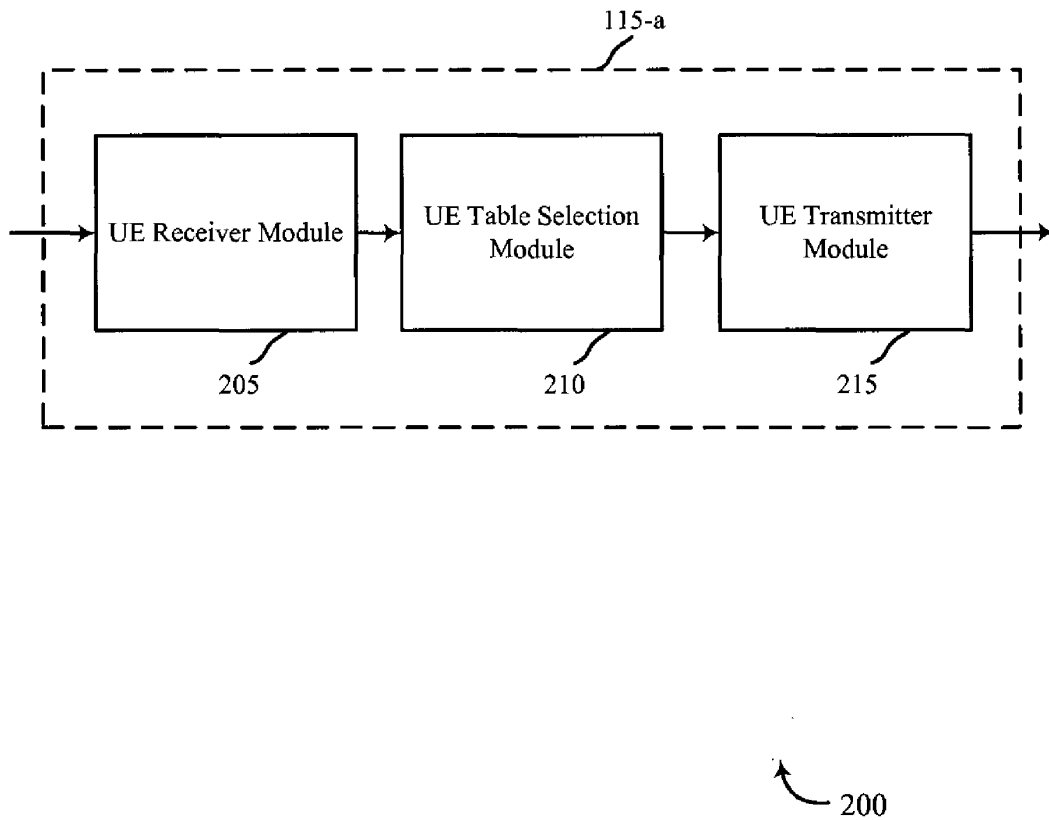

FIG. 2

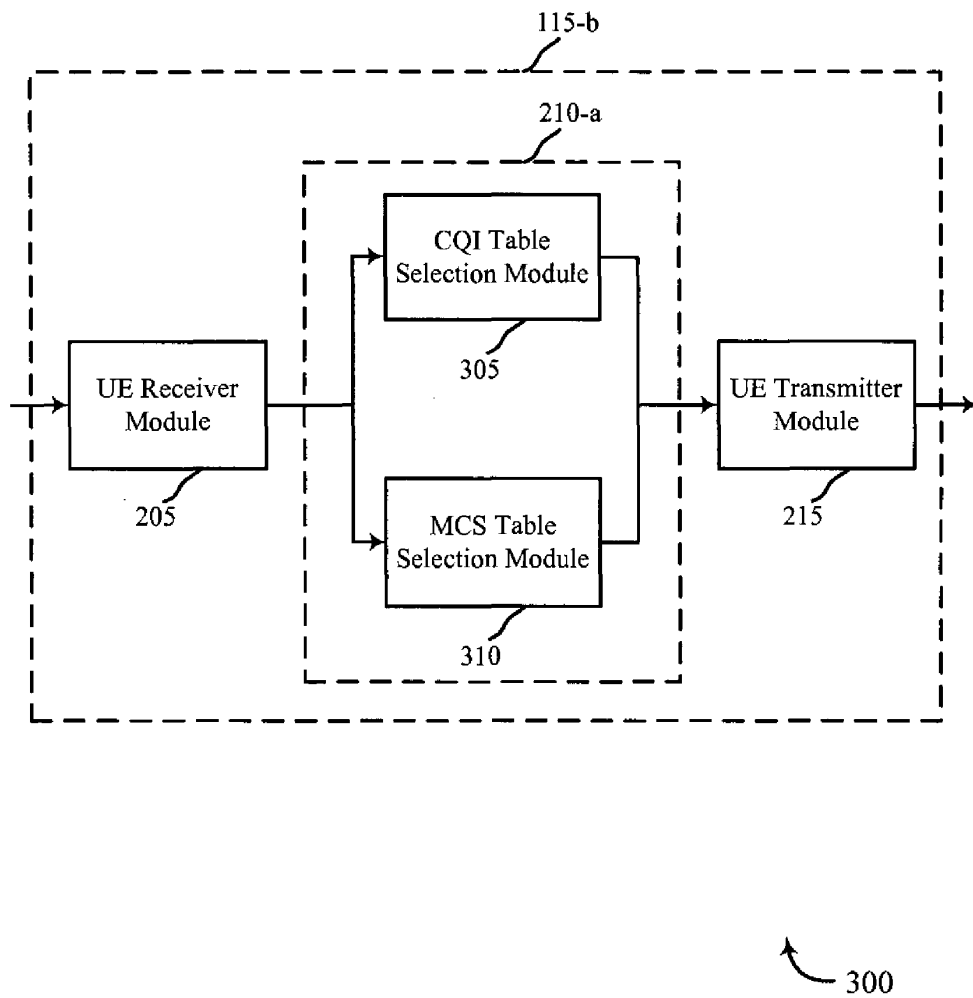

FIG. 3

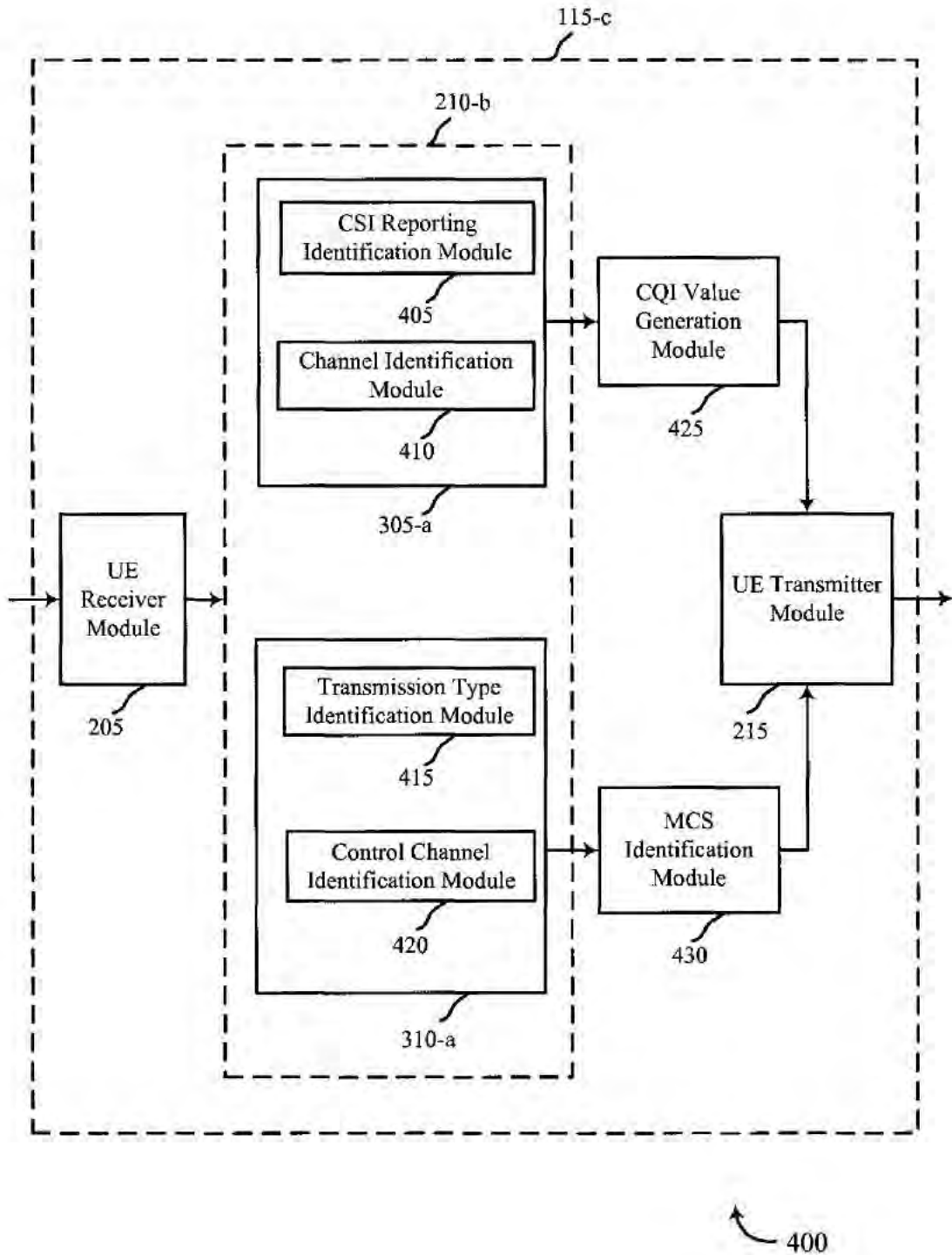

FIG. 4A

450

CQI Index	Modulation Scheme	Code Rate x 1024	Efficiency
0	Out of Range		
1	QPSK	78	0.1523
2	QPSK	120	0.2344
3	QPSK	193	0.377
4	QPSK	308	0.6016
5	QPSK	449	0.877
6	QPSK	602	1.1758
7	16QAM	378	1.4766
8	16QAM	490	1.9141
9	16QAM	616	2.4063
10	64QAM	466	2.7305
11	64QAM	567	3.3223
12	64QAM	666	3.9023
13	64QAM	772	4.5234
14	64QAM	873	5.1152
15	64QAM	948	5.5547

Old CQI Table

460

CQI Index	Modulation Scheme	Code Rate x 1024	Efficiency
0	Out of Range		
1	QPSK	78	0.1523
2	QPSK	193	0.377
3	QPSK	449	0.877
4	16QAM	378	1.4766
5	16QAM	490	1.9141
6	16QAM	616	2.4063
7	64QAM	466	2.7305
8	64QAM	567	3.3223
9	64QAM	666	3.9023
10	64QAM	772	4.5234
11	64QAM	873	5.1152
12	64QAM	948	5.5547
13	256QAM	792	6.0313
14	256QAM	873	6.8203
15	256QAM	948	7.4063

New CQI Table

FIG. 4B

470 

 480

MCS Index	Modulation Order	TBS Index
0	2	0
1	2	1
2	2	2
3	2	3
4	2	4
5	2	5
6	2	6
7	2	7
8	2	8
9	2	9
10	4	9
11	4	10
12	4	11
13	4	12
14	4	13
15	4	14
16	4	15
17	6	15
18	6	16
19	6	17
20	6	18
21	6	19
22	6	20
23	6	21
24	6	22
25	6	23
26	6	24
27	6	25
28	6	26
29	2	Reserved
30	4	
31	6	

Old MCS Table

MCS Index	Modulation Order	TBS Index
0	2	0
1	2	1
2	2	2
3	2	3
4	2	4
5	2	5
6	2	6
7	2	7
8	2	8
9	2	9
10	4	10
11	4	11
12	4	12
13	4	13
14	4	14
15	4	15
16	6	16
17	6	17
18	6	18
19	6	19
20	6	20
21	6	21
22	6	22
23	6	23
24	6	24
25	8	25
26	8	26
27	8	27
28	8	28
29	4	Reserved
30	6	
31	8	

New MCS Table

FIG. 4C

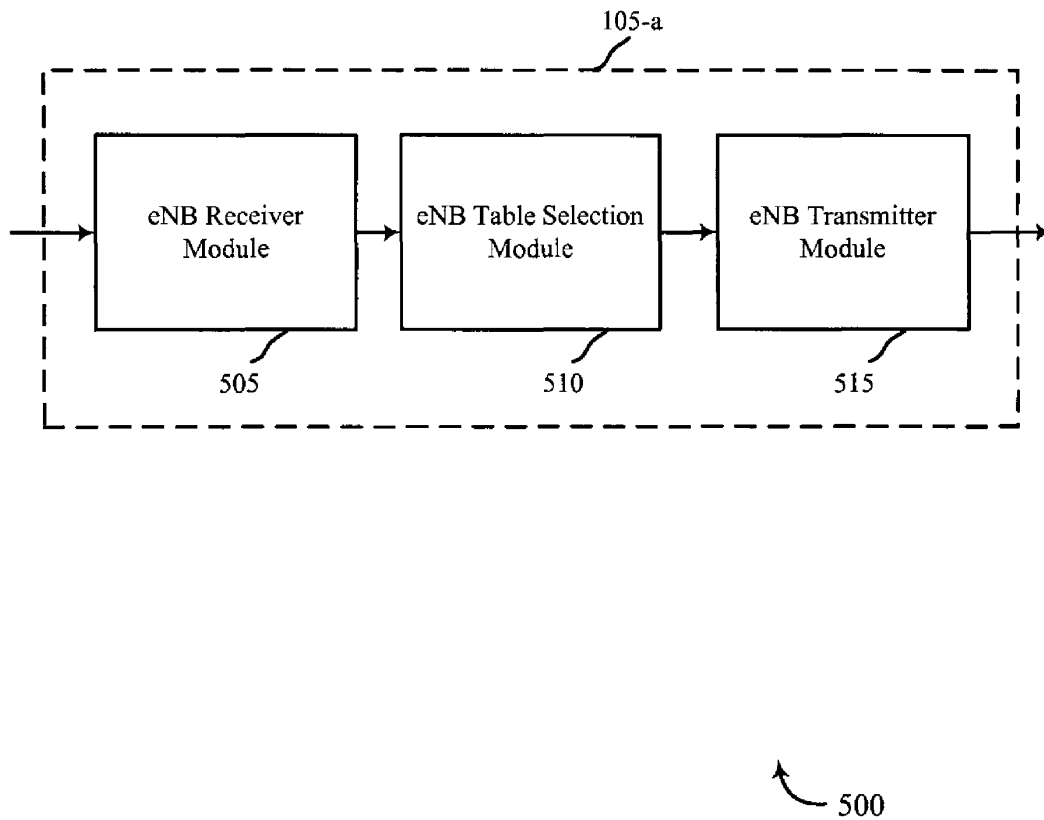

FIG. 5

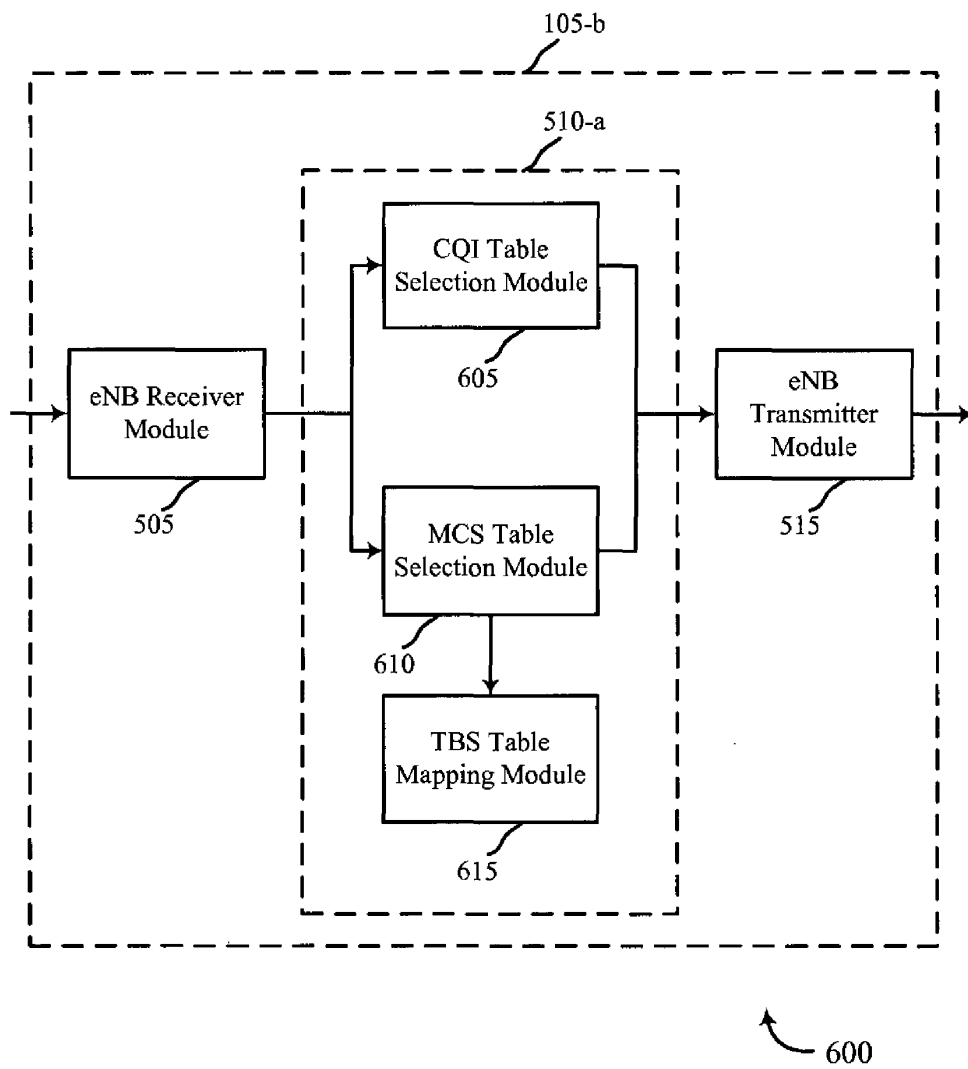

FIG. 6

9/18

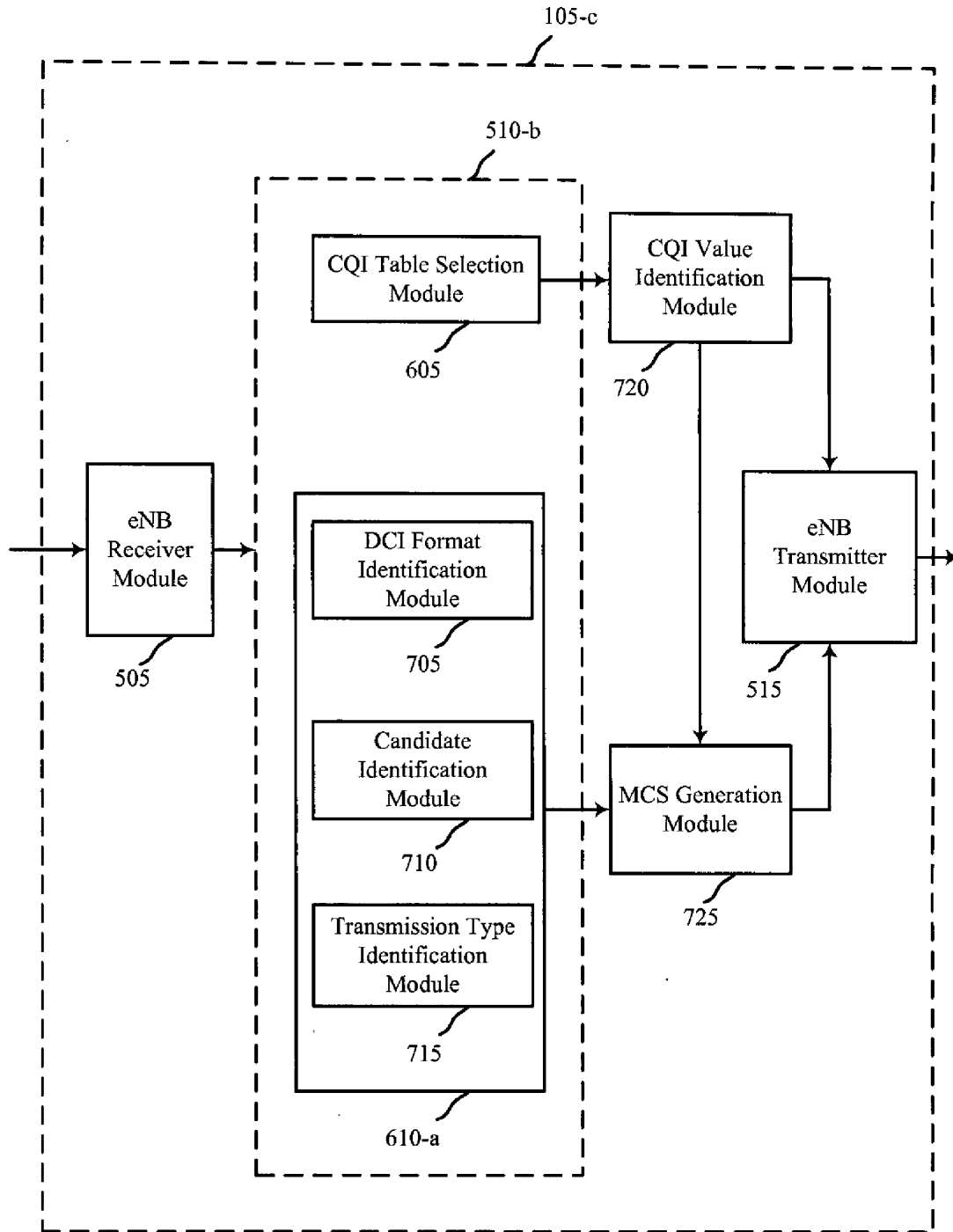

FIG. 7

700

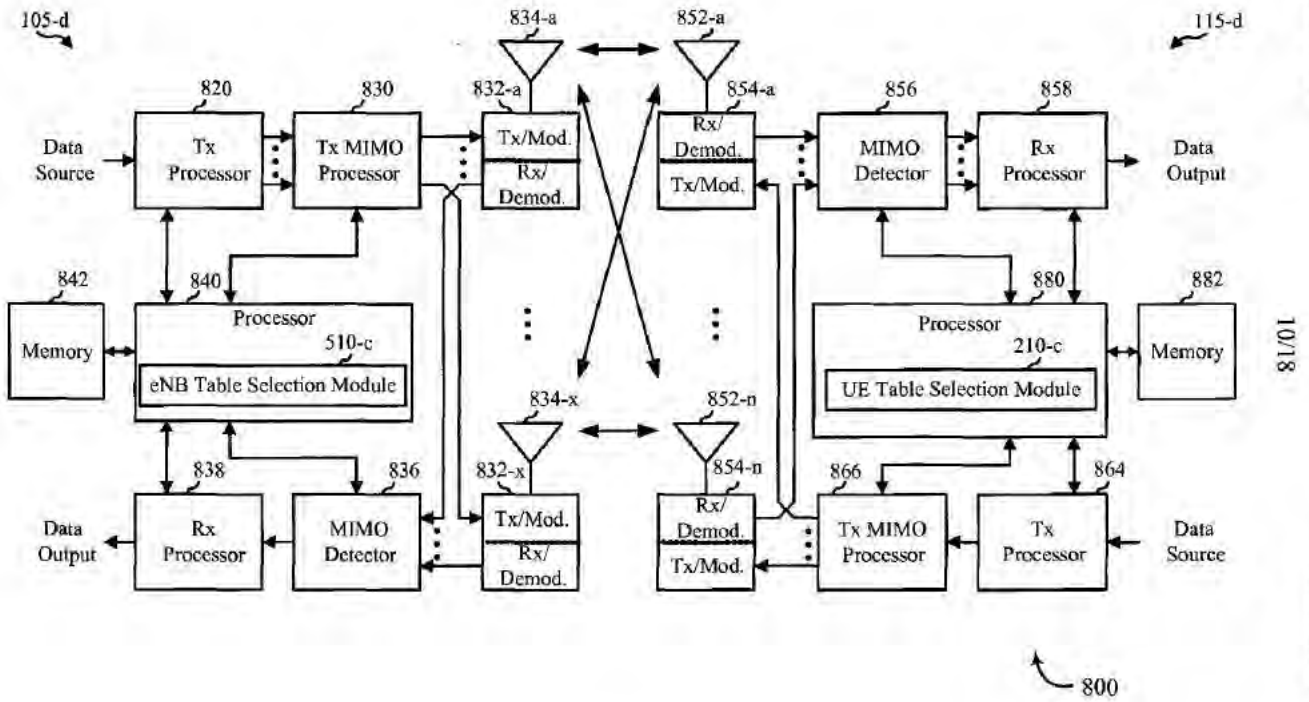
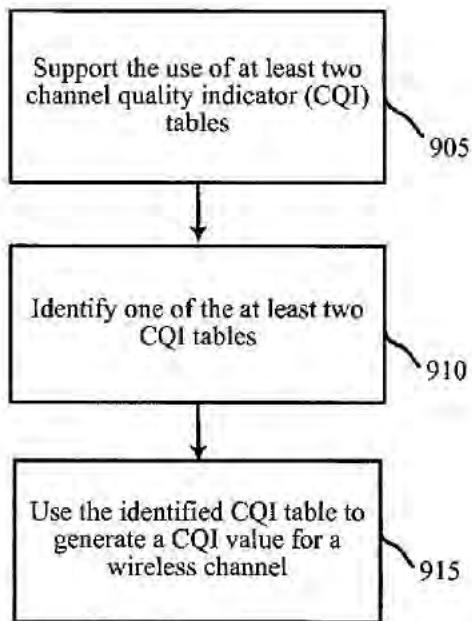

FIG. 8

10/18

WO 2014/109915

PCT/US2013/07844



900

FIG. 9

12/18

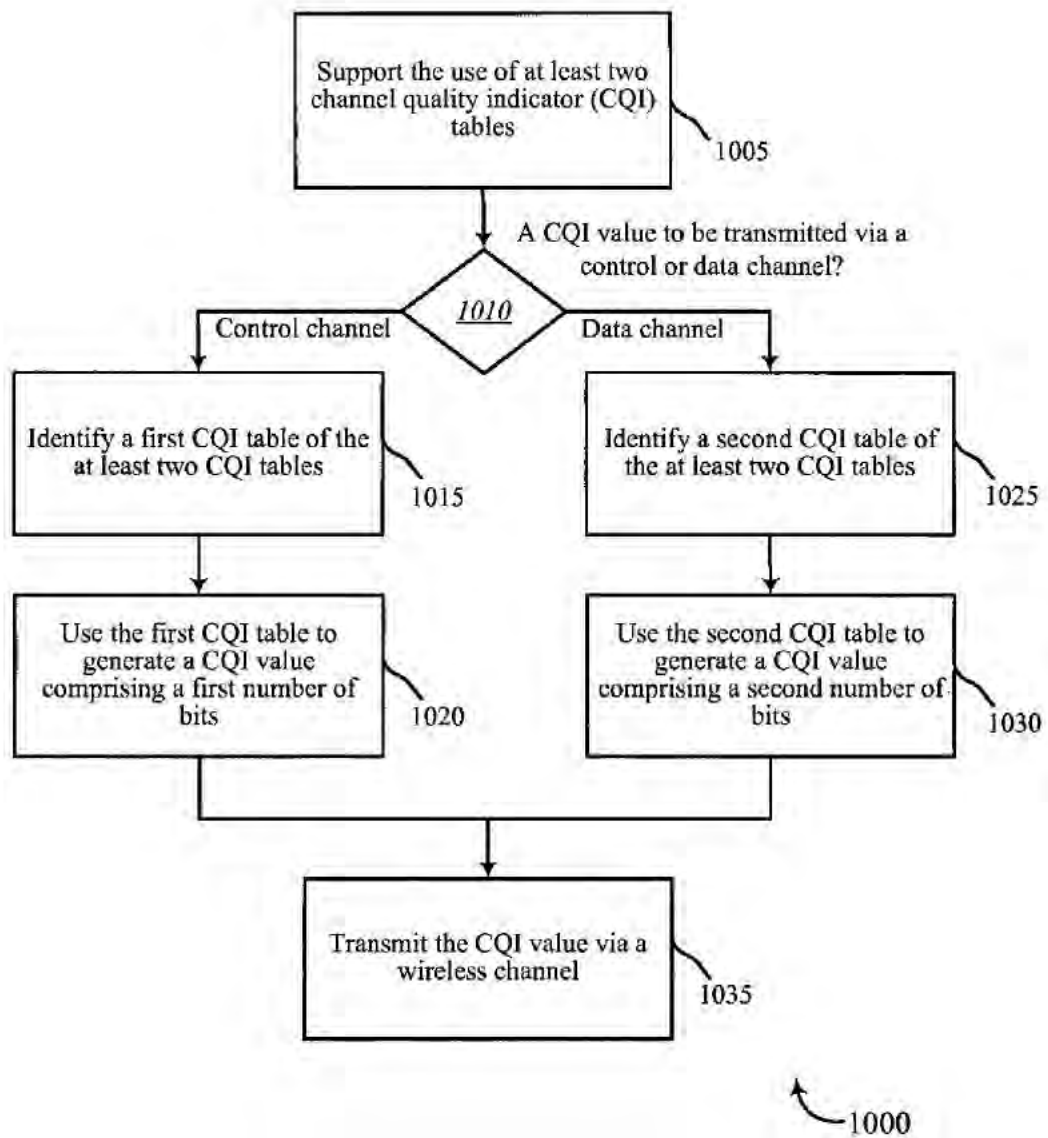

FIG. 10

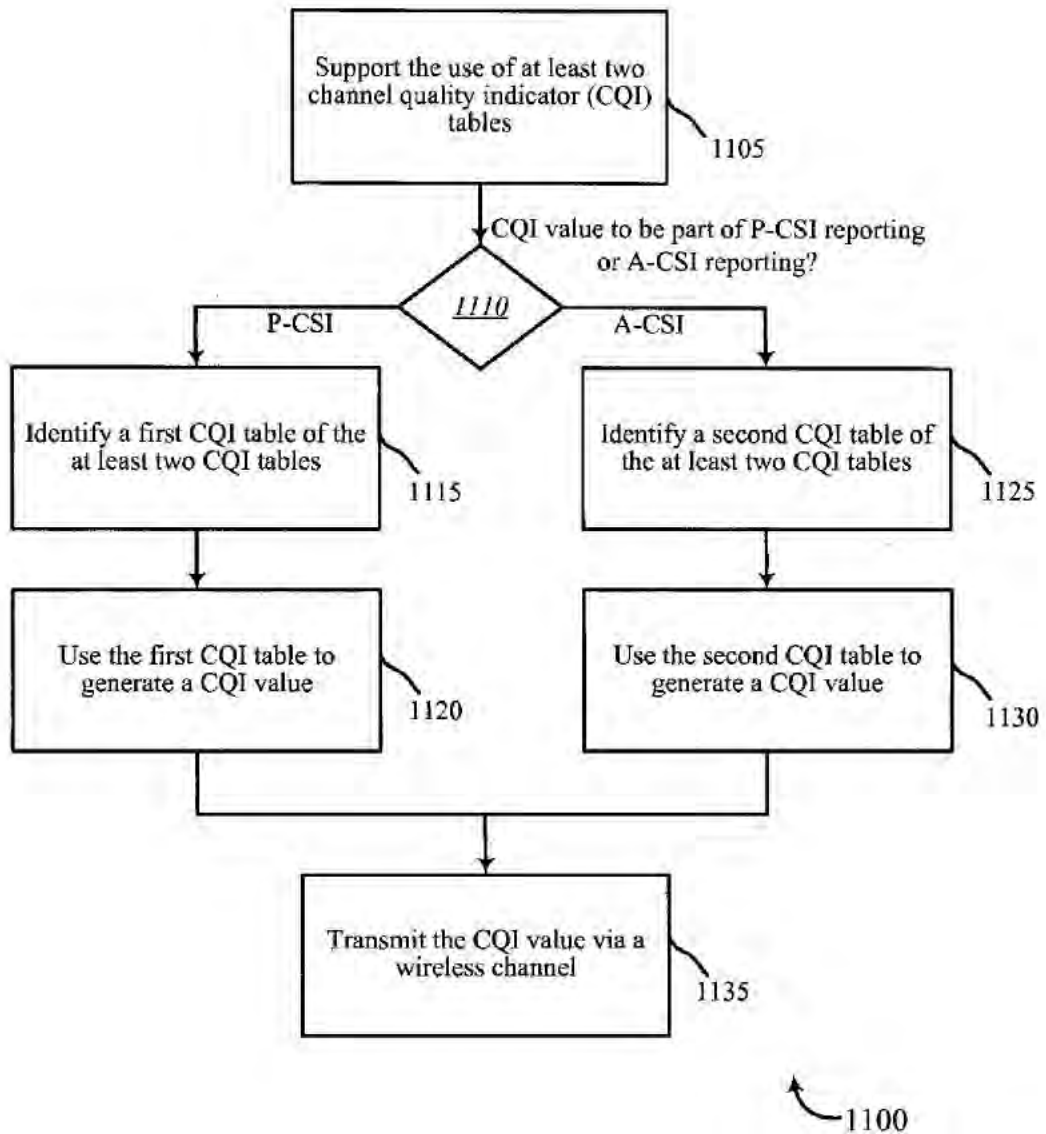
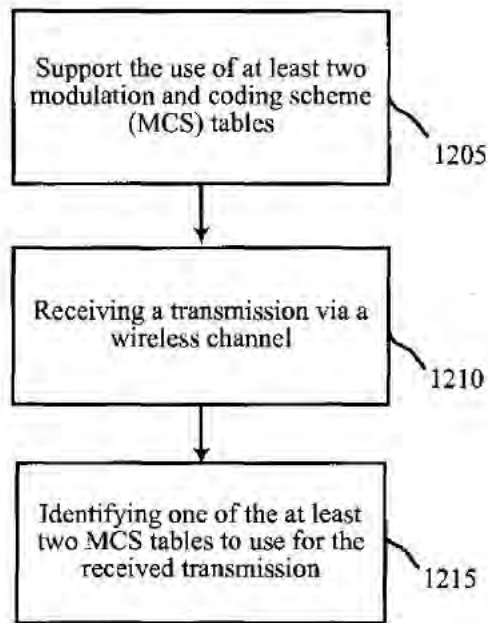

FIG. 11



1200

FIG. 12

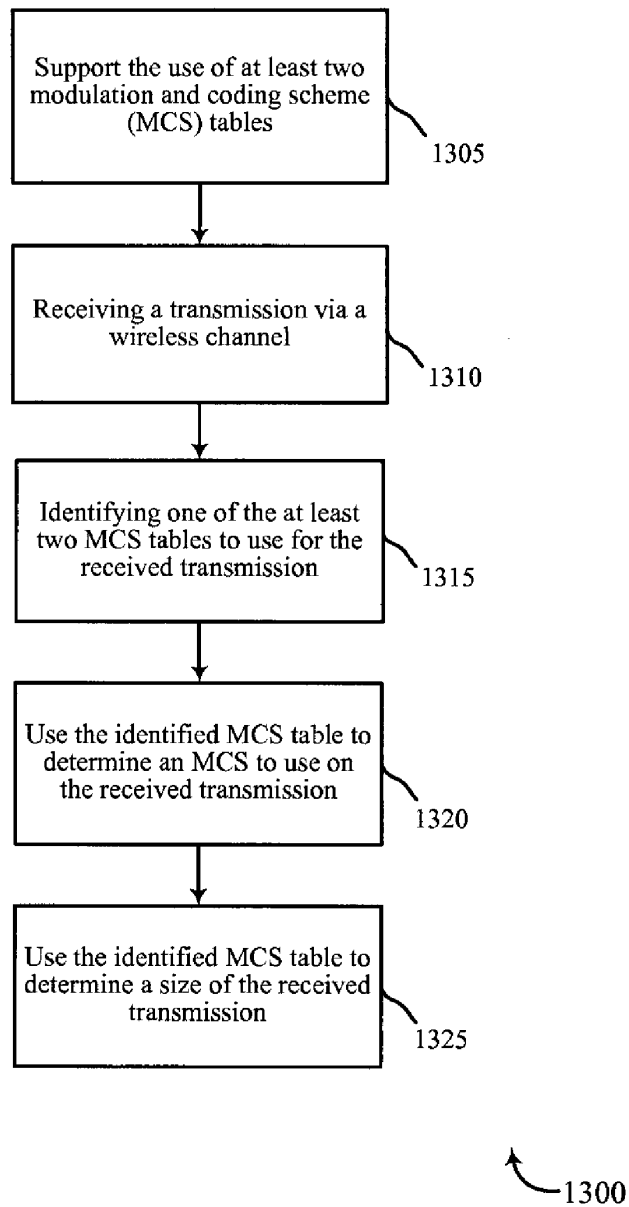
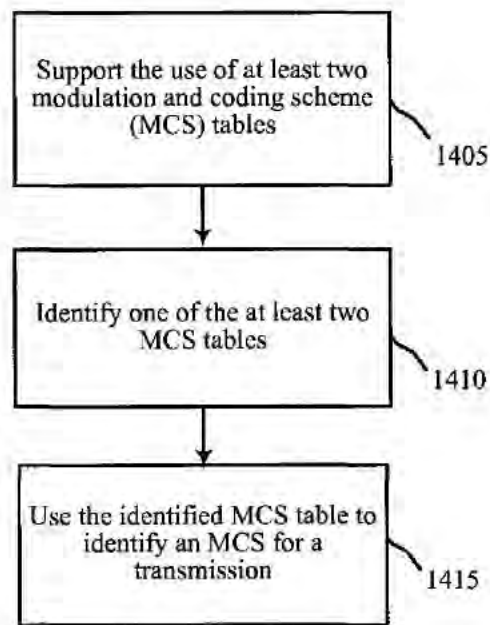

FIG. 13



1400

FIG. 14

17/18

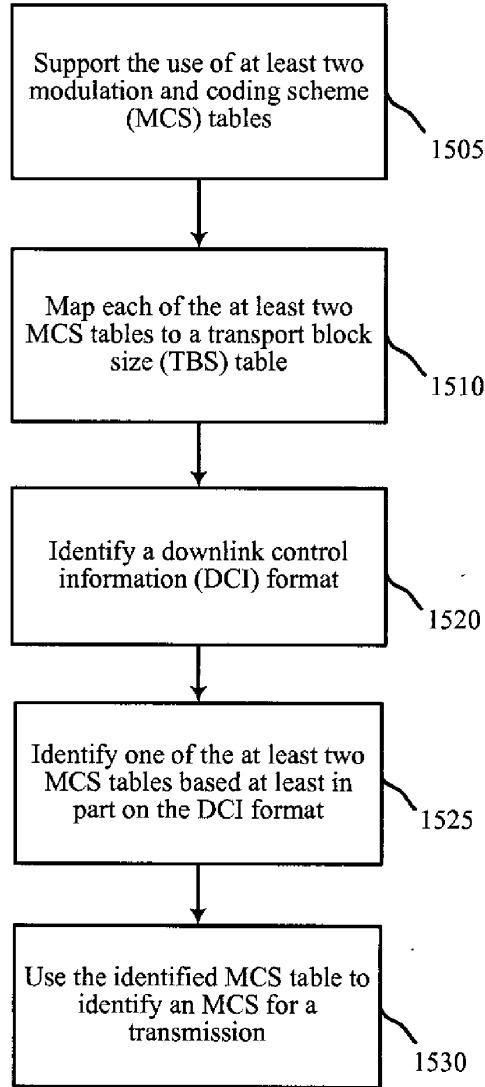

1500

FIG. 15

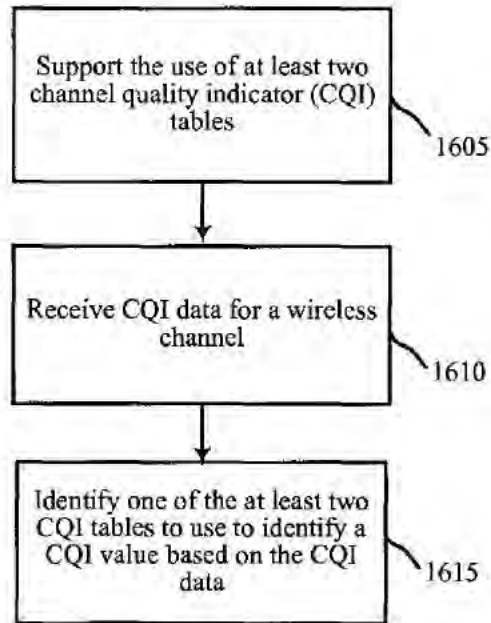

1600

FIG. 16

INTERNATIONAL SEARCH REPORT

International application No
PCT/US2013/077844

A. CLASSIFICATION OF SUBJECT MATTER INV. H04L1/00 ADD.		
According to International Patent Classification (IPC) or to both national classification and IPC		
B. FIELDS SEARCHED Minimum documentation searched (classification system followed by classification symbols) H04L		
Documentation searched other than minimum documentation to the extent that such documents are included in the fields searched		
Electronic data base consulted during the international search (name of data base and, where practicable, search terms used) EPO-Internal, COMPENDEX, INSPEC, IBM-TDB, WPI Data		
C. DOCUMENTS CONSIDERED TO BE RELEVANT		
Category*	Citation of document, with indication, where appropriate, of the relevant passages	Relevant to claim No.
X	US 2009/163142 A1 (PI ZHOUYUE [US] ET AL) 25 June 2009 (2009-06-25) page 4, paragraph 40 page 9, paragraph 59	1-11,13, 15-25, 27, 29-35, 107-113
X	US 8 340 212 B2 (FUTAGI SADAKI [JP] ET AL) 25 December 2012 (2012-12-25) column 4, line 59 - column 5, line 31; figures 2,8,9 column 1, line 46 - line 50 ----- -/--	1-8, 11-13, 15-22, 25-27, 29-33, 35, 107-113
<input checked="" type="checkbox"/> Further documents are listed in the continuation of Box C.		
<input checked="" type="checkbox"/> See patent family annex.		
* Special categories of cited documents :		
A document defining the general state of the art which is not considered to be of particular relevance *E* earlier application or patent but published on or after the international filing date *L* document which may throw doubts on priority claim(s) or which is cited to establish the publication date of another citation or other special reason (as specified) *O* document referring to an oral disclosure, use, exhibition or other means *P* document published prior to the international filing date but later than the priority date claimed	*T* later document published after the international filing date or priority date and not in conflict with the application but cited to understand the principle or theory underlying the invention *X* document of particular relevance; the claimed invention cannot be considered novel or cannot be considered to involve an inventive step when the document is taken alone *Y* document of particular relevance; the claimed invention cannot be considered to involve an inventive step when the document is combined with one or more other such documents, such combination being obvious to a person skilled in the art *&* document member of the same patent family	
Date of the actual completion of the international search 20 May 2014	Date of mailing of the international search report 28/05/2014	
Name and mailing address of the ISA/ European Patent Office, P.B. 5818 Patentlaan 2 NL - 2280 HV Rijswijk Tel. (+31-70) 340-2040, Fax: (+31-70) 340-3016	Authorized officer Kazaniecki, Daniel	

INTERNATIONAL SEARCH REPORT

International application No
PCT/US2013/077844

C(Continuation). DOCUMENTS CONSIDERED TO BE RELEVANT		
Category*	Citation of document, with indication, where appropriate, of the relevant passages	Relevant to claim No.
X	<p>US 8 040 912 B2 (IMAMURA DAICHI [JP] ET AL) 18 October 2011 (2011-10-18)</p> <p>column 10, line 41 - column 12, line 63; figure 4</p> <p>-----</p>	<p>1-8, 11-22, 25-33, 35, 107-113</p>
X	<p>US 2007/070956 A1 (SEKI HIROYUKI [JP]) 29 March 2007 (2007-03-29)</p> <p>page 4, paragraph 76 - paragraph 78</p> <p>-----</p>	<p>1-8, 11-13, 15-22, 25-27, 29-33, 35, 107-113</p>
X	<p>US 2009/245408 A1 (MUJTABA SYED AON [US] ET AL) 1 October 2009 (2009-10-01)</p> <p>page 3, paragraph 39</p> <p>-----</p>	<p>1-8, 11-22, 25-33, 35, 107-113</p>
X	<p>US 2008/049813 A1 (KUROSE KENGO [JP] ET AL) 28 February 2008 (2008-02-28)</p> <p>page 6, paragraph 94</p> <p>-----</p>	<p>1-8, 11-13, 15-22, 25-27, 29-33, 35, 107-113</p>
X	<p>QUALCOMM EUROPE ET AL: "Definition of MIMO operation on Hs-PDSCH, preferred precoding and CQI reporting procedures, modified CQI tables", 3GPP DRAFT; R1-071229, 3RD GENERATION PARTNERSHIP PROJECT (3GPP), MOBILE COMPETENCE CENTRE ; 650, ROUTE DES LUCIOLES ; F-06921 SOPHIA-ANTIPOLIS CEDEX ; FRANCE, vol. RAN WG1, no. St. Louis, USA; 20070218, 18 February 2007 (2007-02-18), XP050105191, [retrieved on 2007-02-18] page 1</p> <p>-----</p> <p style="text-align: center;">-/--</p>	<p>1-8, 11-13, 15-22, 25-27, 29-33, 35, 107-113</p>

INTERNATIONAL SEARCH REPORT

International application No
PCT/US2013/077844

C(Continuation). DOCUMENTS CONSIDERED TO BE RELEVANT		
Category*	Citation of document, with indication, where appropriate, of the relevant passages	Relevant to claim No.
X	US 2008/188259 A1 (BLANZ JOSEF J [DE] ET AL) 7 August 2008 (2008-08-07) page 5, paragraph 58 -----	1-8, 11-13, 15-22, 25-27, 29-33, 35, 107-113
X	US 2006/287743 A1 (SAMPATH HEMANTH [US] ET AL) 21 December 2006 (2006-12-21) page 5, paragraph 49 -----	1-8, 11-22, 25-33, 107-113
X	"WF on CSI Process Definition Samsung, Intel, Qualcomm, NAL LG Electronics", 3GPP DRAFT; R1-125336 WF ON CSI PROCESS DEFINITION - FINAL, 3RD GENERATION PARTNERSHIP PROJECT (3GPP), MOBILE COMPETENCE CENTRE ; 650, ROUTE DES LUCIOLES ; F-06921 SOPHIA-ANTIPOLIS CEDEX ; FRANCE 15 November 2012 (2012-11-15), XP050663175, Retrieved from the Internet: URL: http://www.3gpp.org/ftp/tsg_ran/WG1_RL1/TSGR1_71/Docs/ [retrieved on 2012-11-15] the whole document -----	1,3-5, 10,15, 17-19, 24,29, 31,32, 35,107, 111-113
X	US 2011/026623 A1 (SRINIVASA SUDHIR [US] ET AL) 3 February 2011 (2011-02-03) page 14, paragraph 155 page 17, paragraph 202 -----	36-106
X	CN 102 624 481 A (ZTE CORP) 1 August 2012 (2012-08-01) abstract -----	36-106
X	US 2007/066242 A1 (YI BYOUNG-HA [KR] ET AL) 22 March 2007 (2007-03-22) page 2, paragraph 22 -----	36-106
X	US 2009/010211 A1 (SUMASU ATSUSHI [JP] ET AL) 8 January 2009 (2009-01-08) page 2, paragraph 31 -----	36-106
X	US 2011/235604 A1 (INOUE TAKAMICHI [JP] ET AL) 29 September 2011 (2011-09-29) page 4, paragraph 62 page 10, paragraph 187 -----	36-106

-/--

Electronic Acknowledgement Receipt

EFS ID:	20776180
Application Number:	14390904
International Application Number:	
Confirmation Number:	7239
Title of Invention:	Method and Radio Node for Enabling Use of High Order Modulation in a Radio Communication with a User Equipment
First Named Inventor/Applicant Name:	David Hammarwall
Customer Number:	24112
Filer:	John R. Owen/Katya Fox
Filer Authorized By:	John R. Owen
Attorney Docket Number:	4015-8999 / P41223-US2
Receipt Date:	24-NOV-2014
Filing Date:	
Time Stamp:	09:59:34
Application Type:	U.S. National Stage under 35 USC 371

Payment information:

Submitted with Payment	no
------------------------	----

File Listing:

Document Number	Document Description	File Name	File Size(Bytes)/ Message Digest	Multi Part /.zip	Pages (if appl.)
1	Transmittal Letter	IDS_Cover_Letter.pdf	14495 <small>c6a5735efcd02d89940cb545f03594c3e4b32aef</small>	no	1

Warnings:

Information:

IPR2022-00457

2	Information Disclosure Statement (IDS) Form (SB08)	IDS.pdf	612790	no	4
			8e837a4bc01b89159575b11cec5f498ec07d78ab		
Warnings:					
Information:					
A U.S. Patent Number Citation or a U.S. Publication Number Citation is required in the Information Disclosure Statement (IDS) form for autoloading of data into USPTO systems. You may remove the form to add the required data in order to correct the Informational Message if you are citing U.S. References. If you chose not to include U.S. References, the image of the form will be processed and be made available within the Image File Wrapper (IFW) system. However, no data will be extracted from this form. Any additional data such as Foreign Patent Documents or Non Patent Literature will be manually reviewed and keyed into USPTO systems.					
3	Foreign Reference	CN102624481.pdf	1574246	no	21
			707c7d0f3903be8c804fdcfcaeff20bd61e77684e		
Warnings:					
Information:					
4	Foreign Reference	CN102624481_translation.pdf	145430	no	29
			2eef43ed9c6297e8cc5a14ea99b0482f2bee5e4		
Warnings:					
Information:					
5	Non Patent Literature	R1-130311.pdf	385908	no	4
			a1a683fec03fc1eba1472d5986edd0cf8c95fc9		
Warnings:					
Information:					
6	Non Patent Literature	R1-131328.pdf	594314	no	6
			25f3be043b7c0b5ca00ef6cce71a61b1ae448338		
Warnings:					
Information:					
7	Non Patent Literature	R1-131853.pdf	198340	no	2
			9fcb1bae715231a51c45fd134b1619fe544bdd7b		
Warnings:					
Information:					
8	Non Patent Literature	R1-140118.pdf	863540	no	8
			dea339805fa57c6100771299f27c6ee4f7dd9baf		
Warnings:					
Information:					
9	Foreign Reference	WO2013123961A1.pdf	2549441	no	32
			1b0e9e8b9868195d640b063ee5f936088686e2f		
Warnings:					
Information:					

10	Foreign Reference	WO2014109915A1.pdf	6196390	no	84
			9314360b8e03740b769bb75a786f3ac9e7f7f304		

Warnings:

Information:

Total Files Size (in bytes):

13134894

This Acknowledgement Receipt evidences receipt on the noted date by the USPTO of the indicated documents, characterized by the applicant, and including page counts, where applicable. It serves as evidence of receipt similar to a Post Card, as described in MPEP 503.

New Applications Under 35 U.S.C. 111

If a new application is being filed and the application includes the necessary components for a filing date (see 37 CFR 1.53(b)-(d) and MPEP 506), a Filing Receipt (37 CFR 1.54) will be issued in due course and the date shown on this Acknowledgement Receipt will establish the filing date of the application.

National Stage of an International Application under 35 U.S.C. 371

If a timely submission to enter the national stage of an international application is compliant with the conditions of 35 U.S.C. 371 and other applicable requirements a Form PCT/DO/EO/903 indicating acceptance of the application as a national stage submission under 35 U.S.C. 371 will be issued in addition to the Filing Receipt, in due course.

New International Application Filed with the USPTO as a Receiving Office

If a new international application is being filed and the international application includes the necessary components for an international filing date (see PCT Article 11 and MPEP 1810), a Notification of the International Application Number and of the International Filing Date (Form PCT/RO/105) will be issued in due course, subject to prescriptions concerning national security, and the date shown on this Acknowledgement Receipt will establish the international filing date of the application.

IN THE UNITED STATES PATENT AND TRADEMARK OFFICE

In re Application of **Hammarwall, et al.**)
Serial No.: **14/390904**)
Filed: **October 6, 2014**) Examiner: TBA
For: **Method and Radio Node for Enabling Use**) Group Art Unit: TBA
of High Order Modulation in a Radio) Confirmation No.: 7239
Communication with a User Equipment)
Attorney's Docket No: **4015-8999 / P41223-US2**)

MS AMENDMENT
Commissioner for Patents
P.O. Box 1450
Alexandria, VA 22313-1450

INFORMATION DISCLOSURE STATEMENT

In accordance with 37 C.F.R. 1.56, counsel wishes to make of record the attached items of information for the Examiner's consideration in connection with this application. Also enclosed is Form PTO/SB/08a for the Examiner's convenience in making such consideration of record. Inclusion herein of any particular item of information is not to be construed as an admission that same is prior art.

The Commissioner is hereby authorized to charge any fees that may be required or credit any overpayment to Deposit Account 18-1167.

Respectfully submitted,
COATS & BENNETT, P.L.L.C.

Dated: 24 November 2014

/John R. Owen Reg. No. 42055/
John R. Owen
Registration No.: 42,055
Telephone: (919) 854-1844

TRANSMITTAL LETTER TO THE UNITED STATES DESIGNATED/ELECTED OFFICE (DO/EO/US) CONCERNING A SUBMISSION UNDER 35 U.S.C. 371		Attorney Docket No. 4015-8999 / P41223-US2
		U.S. Application No. (if known, see 37 CFR 1.5)
International Application No. PCT/SE2014/050803	International Filing Date 2014-06-26	Priority Date Claimed 2013-08-09
Title of Invention Method and Radio Node for Enabling Use of High Order Modulation in a Radio Communication with a User Equipment		
First Named Inventor Hammarwall, David		
Applicant herewith submits to the United States Designated/Elected Office (DO/EO/US) the following items and other information.		
1. <input checked="" type="checkbox"/> This is an express request to begin national examination procedures (35 U.S.C. 371(f)). NOTE: The express request under 35 U.S.C. 371(f) will not be effective unless the requirements under 35 U.S.C. 371(c)(1), (2), and (4) for payment of the basic national fee, copy of the International Application and English translation thereof (if required), and the oath or declaration of the inventor(s) have been received.		
2. <input checked="" type="checkbox"/> A copy of the International Application (35 U.S.C. 371(c)(2)) is attached hereto (not required if the International Application was previously communicated by the International Bureau or was filed in the United States Receiving Office (RO/US)).		
3. An English language translation of the International Application (35 U.S.C. 371(c)(2))		
a. <input checked="" type="checkbox"/> is attached hereto.		
b. <input type="checkbox"/> has been previously submitted under 35 U.S.C. 154(d)(4).		
4. An oath or declaration of the inventor(s) (35 U.S.C. 371(c)(4))		
a. <input checked="" type="checkbox"/> is attached.		
b. <input type="checkbox"/> was previously filed in the international phase under PCT Rule 4.17(iv).		
Items 5 to 8 below concern amendments made in the international phase.		
<u>PCT Article 19 and 34 amendments</u>		
5. <input type="checkbox"/> Amendments to the claims under PCT Article 19 are attached (not required if communicated by the International Bureau) (35 U.S.C. 371(c)(3)).		
6. <input type="checkbox"/> English translation of the PCT Article 19 amendment is attached (35 U.S.C. 371(c)(3)).		
7. <input type="checkbox"/> English translation of annexes (Article 19 and/or 34 amendments only) of the International Preliminary Examination Report is attached (35 U.S.C. 371(c)(5)).		
<u>Cancellation of amendments made in the international phase</u>		
8a. <input type="checkbox"/> Do not enter the amendment made in the international phase under PCT Article 19.		
8b. <input type="checkbox"/> Do not enter the amendment made in the international phase under PCT Article 34.		
NOTE: A proper amendment made in English under Article 19 or 34 will be entered in the U.S. national phase application absent a clear instruction from applicant not to enter the amendment(s).		
The following items 9 to 17 concern a document(s) or information included.		
9. <input checked="" type="checkbox"/> An Information Disclosure Statement under 37 CFR 1.97 and 1.98.		
10. <input checked="" type="checkbox"/> A preliminary amendment.		
11. <input checked="" type="checkbox"/> An Application Data Sheet under 37 CFR 1.76.		
12. <input type="checkbox"/> A substitute specification. NOTE: A substitute specification cannot include claims. See 37 CFR 1.125(b).		
13. <input checked="" type="checkbox"/> A power of attorney and/or change of address letter.		
14. <input type="checkbox"/> A computer-readable form of the sequence listing in accordance with PCT Rule 13ter.3 and 37 CFR 1.821-1.825.		
15. <input checked="" type="checkbox"/> Assignment papers (<i>cover sheet and document(s)</i>). Name of Assignee: <u>Telefonaktiebolaget L M Ericsson (publ)</u>		
16. <input checked="" type="checkbox"/> 37 CFR 3.73(c) Statement (<i>when there is an Assignee</i>).		

This collection of information is required by 37 CFR 1.414 and 1.491-1.492. The information is required to obtain or retain a benefit by the public, which is to file (and by the USPTO to process) an application. Confidentiality is governed by 35 U.S.C. 122 and 37 CFR 1.11 and 1.14. This collection is estimated to take 15 minutes to complete, including gathering, preparing, and submitting the completed application form to the USPTO. Time will vary depending upon the individual case. Any comments on the amount of time you require to complete this form and/or suggestions for reducing this burden should be sent to the Chief Information Officer, U.S. Patent and Trademark Office, U.S. Department of Commerce, P.O. Box 1450, Alexandria, VA 22313-1450. DO NOT SEND FEES OR COMPLETED FORMS TO THIS ADDRESS. SEND TO: Mail Stop PCT, Commissioner for Patents, P.O. Box 1450, Alexandria, VA 22313-1450.

Under the Paperwork Reduction Act of 1995, no persons are required to respond to a collection of information unless it displays a valid OMB control number.

U.S. APPLN. No. (if known – see 37 CFR 1.5)	INTERNATIONAL APPLICATION No. PCT/SE2014/050803	ATTORNEY DOCKET No. 4015-8999 / P41223-US2
17. <input type="checkbox"/> Other items or information:		
The following fees have been submitted.		
18. <input checked="" type="checkbox"/> Basic national fee (37 CFR 1.492(a)) \$280		CALCULATIONS PTO USE ONLY
19. <input checked="" type="checkbox"/> Examination fee (37 CFR 1.492(c)) If the written opinion prepared by ISA/US or the international preliminary examination report prepared by IPEA/US indicates all claims satisfy provisions of PCT Article 33(1)-(4) \$0 All other situations \$720		\$ 280 \$ 720
20. <input checked="" type="checkbox"/> Search fee (37 CFR 1.492(b)) If the written opinion prepared by ISA/US or the international preliminary examination report prepared by IPEA/US indicates all claims satisfy provisions of PCT Article 33(1)-(4) \$0 Search fee (37 CFR 1.445(a)(2)) has been paid on the international application to the USPTO as an International Searching Authority \$120 International Search Report prepared by an ISA other than the US and provided to the Office or previously communicated to the US by the IB \$480 All other situations \$600		600 \$
TOTAL OF 18, 19, and 20 =		\$ 1600
<input type="checkbox"/> Additional fee for specification and drawings filed in paper over 100 sheets (excluding sequence listing in compliance with 37 CFR 1.821(c) or (e) in an electronic medium or computer program listing in an electronic medium) (37 CFR 1.492(j)). Fee for each additional 50 sheets of paper or fraction thereof \$400		
Total Sheets	Extra Sheets	Number of each addition 50 or fraction thereof (round up to a whole number)
- 100 =	/ 50 =	x \$400
Surcharge of \$140.00 for furnishing any of the search fee, examination fee, or the oath or declaration after the date of commencement of the national stage (37 CFR 1.492(h)).		\$
CLAIMS	NUMBER FILED	NUMBER EXTRA
Total claims	26 - 20 =	6
Independent claims	6 - 3 =	3
MULTIPLE DEPENDENT CLAIM(S) (if applicable)		+ \$780
Processing fee of \$140.00 for furnishing the English translation later than 30 months from the earliest claimed priority date (37 CFR 1.492(i)).		\$
TOTAL OF ABOVE CALCULATIONS =		\$ 3340
<input type="checkbox"/> Applicant asserts small entity status. See 37 CFR 1.27. Fees above are reduced by ½.		
<input type="checkbox"/> Applicant certifies micro entity status. See 37 CFR 1.29. Fees above are reduced by ¾. Applicant must attach form PTO/SB/15A or B or equivalent.		
TOTAL NATIONAL FEE =		\$ 3340
Fee for recording the enclosed assignment (37 CFR 1.21(h)). The assignment must be accompanied by an appropriate cover sheet (37 CFR 3.28, 3.31). \$40.00 per property.		\$
TOTAL FEES ENCLOSED =		\$ 3340
Amount to be refunded:		\$
Amount to be charged:		\$

Under the Paperwork Reduction Act of 1995, no persons are required to respond to a collection of information unless it displays a valid OMB control number.

a. A check in the amount of \$ _____ to cover the above fees is enclosed.

b. Please charge my Deposit Account No. _____ in the amount of \$ _____ to cover the above fees.

c. The Director is hereby authorized to charge additional fees which may be required, or credit any overpayment, to Deposit Account No. ¹⁸¹¹⁶⁷ _____ as follows:

i. any required fee.

ii. any required fee except for excess claims fees required under 37 CFR 1.492(d) and (e) and multiple dependent claim fee required under 37 CFR 1.492(f).

d. Fees are to be charged to a credit card. **WARNING:** Information on this form may become public. Credit card information should not be included on this form. Provide credit card information and authorization on PTO-2038. The PTO-2038 should only be mailed or faxed to the USPTO. However, when paying the basic national fee, the PTO-2038 may NOT be faxed to the USPTO.

ADVISORY: If filing by EFS-Web, do **NOT** attach the PTO-2038 form as a PDF along with your EFS-Web submission. Please be advised that this is **not** recommended and by doing so your **credit card information may be displayed via PAIR**. To protect your information, it is recommended to pay fees online by using the electronic payment method.

NOTE: Where an appropriate time limit under 37 CFR 1.495 has not been met, a petition to revive (37 CFR 1.137(a) or (b)) must be filed and granted to restore the International Application to pending status.

Correspondence Address

The address associated with Customer Number: ²⁴¹¹² _____ **OR** Correspondence address below

Name					
Address					
City		State		Zip Code	
Country			Telephone		
Email					

Signature	/John R. Owen Reg. No. 42055/	Date	6 October 2014
Name (Print/Type)	John R. Owen	Registration No. (Attorney/Agent)	42055

Privacy Act Statement

The **Privacy Act of 1974 (P.L. 93-579)** requires that you be given certain information in connection with your submission of the attached form related to a patent application or patent. Accordingly, pursuant to the requirements of the Act, please be advised that: (1) the general authority for the collection of this information is 35 U.S.C. 2(b)(2); (2) furnishing of the information solicited is voluntary; and (3) the principal purpose for which the information is used by the U.S. Patent and Trademark Office is to process and/or examine your submission related to a patent application or patent. If you do not furnish the requested information, the U.S. Patent and Trademark Office may not be able to process and/or examine your submission, which may result in termination of proceedings or abandonment of the application or expiration of the patent.

The information provided by you in this form will be subject to the following routine uses:

1. The information on this form will be treated confidentially to the extent allowed under the Freedom of Information Act (5 U.S.C. 552) and the Privacy Act (5 U.S.C. 552a). Records from this system of records may be disclosed to the Department of Justice to determine whether disclosure of these records is required by the Freedom of Information Act.
2. A record from this system of records may be disclosed, as a routine use, in the course of presenting evidence to a court, magistrate, or administrative tribunal, including disclosures to opposing counsel in the course of settlement negotiations.
3. A record in this system of records may be disclosed, as a routine use, to a Member of Congress submitting a request involving an individual, to whom the record pertains, when the individual has requested assistance from the Member with respect to the subject matter of the record.
4. A record in this system of records may be disclosed, as a routine use, to a contractor of the Agency having need for the information in order to perform a contract. Recipients of information shall be required to comply with the requirements of the Privacy Act of 1974, as amended, pursuant to 5 U.S.C. 552a(m).
5. A record related to an International Application filed under the Patent Cooperation Treaty in this system of records may be disclosed, as a routine use, to the International Bureau of the World Intellectual Property Organization, pursuant to the Patent Cooperation Treaty.
6. A record in this system of records may be disclosed, as a routine use, to another federal agency for purposes of National Security review (35 U.S.C. 181) and for review pursuant to the Atomic Energy Act (42 U.S.C. 218(c)).
7. A record from this system of records may be disclosed, as a routine use, to the Administrator, General Services, or his/her designee, during an inspection of records conducted by GSA as part of that agency's responsibility to recommend improvements in records management practices and programs, under authority of 44 U.S.C. 2904 and 2906. Such disclosure shall be made in accordance with the GSA regulations governing inspection of records for this purpose, and any other relevant (*i.e.*, GSA or Commerce) directive. Such disclosure shall not be used to make determinations about individuals.
8. A record from this system of records may be disclosed, as a routine use, to the public after either publication of the application pursuant to 35 U.S.C. 122(b) or issuance of a patent pursuant to 35 U.S.C. 151. Further, a record may be disclosed, subject to the limitations of 37 CFR 1.14, as a routine use, to the public if the record was filed in an application which became abandoned or in which the proceedings were terminated and which application is referenced by either a published application, an application open to public inspection or an issued patent.
9. A record from this system of records may be disclosed, as a routine use, to a Federal, State, or local law enforcement agency, if the USPTO becomes aware of a violation or potential violation of law or regulation.

Under the Paperwork Reduction Act of 1995, no persons are required to respond to a collection of information unless it contains a valid OMB control number.

Application Data Sheet 37 CFR 1.76		Attorney Docket Number	4015-8999 / P41223-US2
		Application Number	
Title of Invention	Method and Radio Node for Enabling Use of High Order Modulation in a Radio Communication with a User Equipment		
The application data sheet is part of the provisional or nonprovisional application for which it is being submitted. The following form contains the bibliographic data arranged in a format specified by the United States Patent and Trademark Office as outlined in 37 CFR 1.76. This document may be completed electronically and submitted to the Office in electronic format using the Electronic Filing System (EFS) or the document may be printed and included in a paper filed application.			

Secrecy Order 37 CFR 5.2

<input type="checkbox"/>	Portions or all of the application associated with this Application Data Sheet may fall under a Secrecy Order pursuant to 37 CFR 5.2 (Paper filers only. Applications that fall under Secrecy Order may not be filed electronically.)
--------------------------	---

Inventor Information:

Inventor 1					<input type="button" value="Remove"/>
Legal Name					
Prefix	Given Name	Middle Name	Family Name	Suffix	
	David		Hammarwall		
Residence Information (Select One) <input type="radio"/> US Residency <input checked="" type="radio"/> Non US Residency <input type="radio"/> Active US Military Service					
City	Vallentuna	Country of Residence i	SE		
Mailing Address of Inventor:					
Address 1	Hällmarksvägen 59				
Address 2					
City	Vallentuna	State/Province			
Postal Code	SE-18653	Country i	SE		
Inventor 2					<input type="button" value="Remove"/>
Legal Name					
Prefix	Given Name	Middle Name	Family Name	Suffix	
	Meng		Wang		
Residence Information (Select One) <input type="radio"/> US Residency <input checked="" type="radio"/> Non US Residency <input type="radio"/> Active US Military Service					
City	Solna	Country of Residence i	SE		
Mailing Address of Inventor:					
Address 1	Signalistgatan 14				
Address 2					
City	Solna	State/Province			
Postal Code	SE-16972	Country i	SE		
All Inventors Must Be Listed - Additional Inventor Information blocks may be generated within this form by selecting the Add button.					<input type="button" value="Add"/>

Correspondence Information:

IPR2022-00457

Apple EX1002 Page 266

Under the Paperwork Reduction Act of 1995, no persons are required to respond to a collection of information unless it contains a valid OMB control number.

Application Data Sheet 37 CFR 1.76		Attorney Docket Number	4015-8999 / P41223-US2
		Application Number	
Title of Invention	Method and Radio Node for Enabling Use of High Order Modulation in a Radio Communication with a User Equipment		

Enter either Customer Number or complete the Correspondence Information section below.
For further information see 37 CFR 1.33(a).

An Address is being provided for the correspondence information of this application.

Customer Number	24112		
Email Address		<input type="button" value="Add Email"/>	<input type="button" value="Remove Email"/>

Application Information:

Title of the Invention	Method and Radio Node for Enabling Use of High Order Modulation in a Radio Communication with a User Equipment		
Attorney Docket Number	4015-8999 / P41223-US2	Small Entity Status Claimed	<input type="checkbox"/>
Application Type	Nonprovisional		
Subject Matter	Utility		
Total Number of Drawing Sheets (if any)	7	Suggested Figure for Publication (if any)	5

Filing By Reference :

Only complete this section when filing an application by reference under 35 U.S.C. 111(c) and 37 CFR 1.57(a). Do not complete this section if application papers including a specification and any drawings are being filed. Any domestic benefit or foreign priority information must be provided in the appropriate section(s) below (i.e., "Domestic Benefit/National Stage Information" and "Foreign Priority Information").

For the purposes of a filing date under 37 CFR 1.53(b), the description and any drawings of the present application are replaced by this reference to the previously filed application, subject to conditions and requirements of 37 CFR 1.57(a).

Application number of the previously filed application	Filing date (YYYY-MM-DD)	Intellectual Property Authority or Country

Publication Information:

Request Early Publication (Fee required at time of Request 37 CFR 1.219)

Request Not to Publish. I hereby request that the attached application not be published under 35 U.S.C. 122(b) and certify that the invention disclosed in the attached application **has not and will not** be the subject of an application filed in another country, or under a multilateral international agreement, that requires publication at eighteen months after filing.

Representative Information:

Representative information should be provided for all practitioners having a power of attorney in the application. Providing this information in the Application Data Sheet does not constitute a power of attorney in the application (see 37 CFR 1.32). Either enter Customer Number or complete the Representative Name section below. If both sections are completed the customer number will be used for the Representative Information during processing.

Please Select One:	<input checked="" type="radio"/> Customer Number	<input type="radio"/> US Patent Practitioner	<input type="radio"/> Limited Recognition (37 CFR 11.9)
Customer Number	24112	IPR2022-00457	

Under the Paperwork Reduction Act of 1995, no persons are required to respond to a collection of information unless it contains a valid OMB control number.

Application Data Sheet 37 CFR 1.76		Attorney Docket Number	4015-8999 / P41223-US2
		Application Number	
Title of Invention	Method and Radio Node for Enabling Use of High Order Modulation in a Radio Communication with a User Equipment		

Domestic Benefit/National Stage Information:

This section allows for the applicant to either claim benefit under 35 U.S.C. 119(e), 120, 121, or 365(c) or indicate National Stage entry from a PCT application. Providing this information in the application data sheet constitutes the specific reference required by 35 U.S.C. 119(e) or 120, and 37 CFR 1.78.

When referring to the current application, please leave the application number blank.

Prior Application Status	Pending	<input type="button" value="Remove"/>	
Application Number	Continuity Type	Prior Application Number	Filing Date (YYYY-MM-DD)
	a 371 of international	PCT/SE2014/050803	2014-06-26
Prior Application Status	Expired	<input type="button" value="Remove"/>	
Application Number	Continuity Type	Prior Application Number	Filing Date (YYYY-MM-DD)
PCT/SE2014/050803	Claims benefit of provisional	61/863935	2013-08-09
Additional Domestic Benefit/National Stage Data may be generated within this form by selecting the Add button.			<input type="button" value="Add"/>

Foreign Priority Information:

This section allows for the applicant to claim priority to a foreign application. Providing this information in the application data sheet constitutes the claim for priority as required by 35 U.S.C. 119(b) and 37 CFR 1.55(d). When priority is claimed to a foreign application that is eligible for retrieval under the priority document exchange program (PDX) ⁱthe information will be used by the Office to automatically attempt retrieval pursuant to 37 CFR 1.55(h)(1) and (2). Under the PDX program, applicant bears the ultimate responsibility for ensuring that a copy of the foreign application is received by the Office from the participating foreign intellectual property office, or a certified copy of the foreign priority application is filed, within the time period specified in 37 CFR 1.55(g)(1).

<input type="button" value="Remove"/>			
Application Number	Country ⁱ	Filing Date (YYYY-MM-DD)	Access Code ⁱ (if applicable)
Additional Foreign Priority Data may be generated within this form by selecting the Add button.			<input type="button" value="Add"/>

Under the Paperwork Reduction Act of 1995, no persons are required to respond to a collection of information unless it contains a valid OMB control number.

Application Data Sheet 37 CFR 1.76		Attorney Docket Number	4015-8999 / P41223-US2
		Application Number	
Title of Invention	Method and Radio Node for Enabling Use of High Order Modulation in a Radio Communication with a User Equipment		

Statement under 37 CFR 1.55 or 1.78 for AIA (First Inventor to File) Transition Applications

<p>This application (1) claims priority to or the benefit of an application filed before March 16, 2013 and (2) also contains, or contained at any time, a claim to a claimed invention that has an effective filing date on or after March 16, 2013.</p> <p><input type="checkbox"/> NOTE: By providing this statement under 37 CFR 1.55 or 1.78, this application, with a filing date on or after March 16, 2013, will be examined under the first inventor to file provisions of the AIA.</p>
--

Authorization to Permit Access:

<p><input type="checkbox"/> Authorization to Permit Access to the Instant Application by the Participating Offices</p>
<p>If checked, the undersigned hereby grants the USPTO authority to provide the European Patent Office (EPO), the Japan Patent Office (JPO), the Korean Intellectual Property Office (KIPO), the World Intellectual Property Office (WIPO), and any other intellectual property offices in which a foreign application claiming priority to the instant patent application is filed access to the instant patent application. See 37 CFR 1.14(c) and (h). This box should not be checked if the applicant does not wish the EPO, JPO, KIPO, WIPO, or other intellectual property office in which a foreign application claiming priority to the instant patent application is filed to have access to the instant patent application.</p> <p>In accordance with 37 CFR 1.14(h)(3), access will be provided to a copy of the instant patent application with respect to: 1) the instant patent application-as-filed; 2) any foreign application to which the instant patent application claims priority under 35 U.S.C. 119(a)-(d) if a copy of the foreign application that satisfies the certified copy requirement of 37 CFR 1.55 has been filed in the instant patent application; and 3) any U.S. application-as-filed from which benefit is sought in the instant patent application.</p> <p>In accordance with 37 CFR 1.14(c), access may be provided to information concerning the date of filing this Authorization.</p>

Applicant Information:

Providing assignment information in this section does not substitute for compliance with any requirement of part 3 of Title 37 of CFR to have an assignment recorded by the Office.

Under the Paperwork Reduction Act of 1995, no persons are required to respond to a collection of information unless it contains a valid OMB control number.

Application Data Sheet 37 CFR 1.76	Attorney Docket Number	4015-8999 / P41223-US2
	Application Number	
Title of Invention	Method and Radio Node for Enabling Use of High Order Modulation in a Radio Communication with a User Equipment	

Applicant 1		<input type="button" value="Remove"/>
<p>If the applicant is the inventor (or the remaining joint inventor or inventors under 37 CFR 1.45), this section should not be completed. The information to be provided in this section is the name and address of the legal representative who is the applicant under 37 CFR 1.43; or the name and address of the assignee, person to whom the inventor is under an obligation to assign the invention, or person who otherwise shows sufficient proprietary interest in the matter who is the applicant under 37 CFR 1.46. If the applicant is an applicant under 37 CFR 1.46 (assignee, person to whom the inventor is obligated to assign, or person who otherwise shows sufficient proprietary interest) together with one or more joint inventors, then the joint inventor or inventors who are also the applicant should be identified in this section.</p>		
<input type="button" value="Clear"/>		
<input checked="" type="radio"/> Assignee	<input type="radio"/> Legal Representative under 35 U.S.C. 117	<input type="radio"/> Joint Inventor
<input type="radio"/> Person to whom the inventor is obligated to assign.	<input type="radio"/> Person who shows sufficient proprietary interest	
If applicant is the legal representative, indicate the authority to file the patent application, the inventor is:		
Name of the Deceased or Legally Incapacitated Inventor : <input type="text"/>		
If the Applicant is an Organization check here. <input checked="" type="checkbox"/>		
Organization Name	Telefonaktiebolaget L M Ericsson (publ)	
Mailing Address Information:		
Address 1	SE-164 83	
Address 2		
City	Stockholm	State/Province
Country ⁱ	SE	Postal Code
Phone Number		Fax Number
Email Address		
Additional Applicant Data may be generated within this form by selecting the Add button.		<input type="button" value="Add"/>

Assignee Information including Non-Applicant Assignee Information:

<p>Providing assignment information in this section does not substitute for compliance with any requirement of part 3 of Title 37 of CFR to have an assignment recorded by the Office.</p>
Assignee 1
<p>Complete this section if assignee information, including non-applicant assignee information, is desired to be included on the patent application publication. An assignee-applicant identified in the "Applicant Information" section will appear on the patent application publication as an applicant. For an assignee-applicant, complete this section only if identification as an assignee is also desired on the patent application publication.</p>
<input type="button" value="Remove"/>
If the Assignee or Non-Applicant Assignee is an Organization check here. <input type="checkbox"/>

IPR2022-00457

Apple EX1002 Page 270

Under the Paperwork Reduction Act of 1995, no persons are required to respond to a collection of information unless it contains a valid OMB control number.

Application Data Sheet 37 CFR 1.76		Attorney Docket Number	4015-8999 / P41223-US2	
		Application Number		
Title of Invention	Method and Radio Node for Enabling Use of High Order Modulation in a Radio Communication with a User Equipment			

Prefix	Given Name	Middle Name	Family Name	Suffix

Mailing Address Information For Assignee including Non-Applicant Assignee:

Address 1				
Address 2				
City		State/Province		
Country i		Postal Code		
Phone Number		Fax Number		
Email Address				

Additional Assignee or Non-Applicant Assignee Data may be generated within this form by selecting the Add button.

Signature:

NOTE: This form must be signed in accordance with 37 CFR 1.33. See 37 CFR 1.4 for signature requirements and certifications

Signature	/John R. Owen Reg. No. 42055/		Date (YYYY-MM-DD)	2014-10-06	
First Name	John	Last Name	Owen	Registration Number	42055

Additional Signature may be generated within this form by selecting the Add button.

This collection of information is required by 37 CFR 1.76. The information is required to obtain or retain a benefit by the public which is to file (and by the USPTO to process) an application. Confidentiality is governed by 35 U.S.C. 122 and 37 CFR 1.14. This collection is estimated to take 23 minutes to complete, including gathering, preparing, and submitting the completed application data sheet form to the USPTO. Time will vary depending upon the individual case. Any comments on the amount of time you require to complete this form and/or suggestions for reducing this burden, should be sent to the Chief Information Officer, U.S. Patent and Trademark Office, U.S. Department of Commerce, P.O. Box 1450, Alexandria, VA 22313-1450. DO NOT SEND FEES OR COMPLETED FORMS TO THIS ADDRESS. **SEND TO: Commissioner for Patents, P.O. Box 1450, Alexandria, VA 22313-1450.**

Privacy Act Statement

The Privacy Act of 1974 (P.L. 93-579) requires that you be given certain information in connection with your submission of the attached form related to a patent application or patent. Accordingly, pursuant to the requirements of the Act, please be advised that: (1) the general authority for the collection of this information is 35 U.S.C. 2(b)(2); (2) furnishing of the information solicited is voluntary; and (3) the principal purpose for which the information is used by the U.S. Patent and Trademark Office is to process and/or examine your submission related to a patent application or patent. If you do not furnish the requested information, the U.S. Patent and Trademark Office may not be able to process and/or examine your submission, which may result in termination of proceedings or abandonment of the application or expiration of the patent.

The information provided by you in this form will be subject to the following routine uses:

1. The information on this form will be treated confidentially to the extent allowed under the Freedom of Information Act (5 U.S.C. 552) and the Privacy Act (5 U.S.C. 552a). Records from this system of records may be disclosed to the Department of Justice to determine whether the Freedom of Information Act requires disclosure of these records.
2. A record from this system of records may be disclosed, as a routine use, in the course of presenting evidence to a court, magistrate, or administrative tribunal, including disclosures to opposing counsel in the course of settlement negotiations.
3. A record in this system of records may be disclosed, as a routine use, to a Member of Congress submitting a request involving an individual, to whom the record pertains, when the individual has requested assistance from the Member with respect to the subject matter of the record.
4. A record in this system of records may be disclosed, as a routine use, to a contractor of the Agency having need for the information in order to perform a contract. Recipients of information shall be required to comply with the requirements of the Privacy Act of 1974, as amended, pursuant to 5 U.S.C. 552a(m).
5. A record related to an International Application filed under the Patent Cooperation Treaty in this system of records may be disclosed, as a routine use, to the International Bureau of the World Intellectual Property Organization, pursuant to the Patent Cooperation Treaty.
6. A record in this system of records may be disclosed, as a routine use, to another federal agency for purposes of National Security review (35 U.S.C. 181) and for review pursuant to the Atomic Energy Act (42 U.S.C. 218(c)).
7. A record from this system of records may be disclosed, as a routine use, to the Administrator, General Services, or his/her designee, during an inspection of records conducted by GSA as part of that agency's responsibility to recommend improvements in records management practices and programs, under authority of 44 U.S.C. 2904 and 2906. Such disclosure shall be made in accordance with the GSA regulations governing inspection of records for this purpose, and any other relevant (i.e., GSA or Commerce) directive. Such disclosure shall not be used to make determinations about individuals.
8. A record from this system of records may be disclosed, as a routine use, to the public after either publication of the application pursuant to 35 U.S.C. 122(b) or issuance of a patent pursuant to 35 U.S.C. 151. Further, a record may be disclosed, subject to the limitations of 37 CFR 1.14, as a routine use, to the public if the record was filed in an application which became abandoned or in which the proceedings were terminated and which application is referenced by either a published application, an application open to public inspections or an issued patent.
9. A record from this system of records may be disclosed, as a routine use, to a Federal, State, or local law enforcement agency, if the USPTO becomes aware of a violation or potential violation of law or regulation.

METHOD AND RADIO NODE FOR ENABLING USE OF HIGH ORDER MODULATION IN A RADIO COMMUNICATION WITH A USER EQUIPMENT

Technical field

The present disclosure relates generally to a radio node of a cellular network, a User Equipment, UE and methods therein, for enabling use of a high order modulation when communicating radio signals.

Background

In this field, the term “User Equipment, UE” is commonly used and will be used in this disclosure to represent any wireless terminal or device capable of radio communication with a cellular network including receiving downlink signals transmitted from a serving radio node and sending uplink signals to the radio node. For example, the term User Equipment, UE could be exchanged by the term “wireless device”. Further, the term “radio node”, also commonly referred to as a base station, e-nodeB, eNB, etc., represents any node of a cellular network that can communicate uplink and downlink radio signals with UEs. The radio nodes described here may, without limitation, include so-called macro nodes and low power nodes such as micro, pico, femto, Wifi and relay nodes, to mention some customary examples. Throughout this disclosure, the term “eNB” is often used but can be exchanged by the term radio node.

Link adaptation in systems according to Long Term Evolution, LTE, is based on adaptive modulation and coding, which controls data rate by adaptively adjusting the modulation scheme and/or channel coding rate according to the radio-link conditions. In this procedure, the Modulation and Coding Scheme, MCS, adopted for Physical Downlink Shared Channel, PDSCH, transmission must be indicated in downlink MCS signaling by the serving radio node to the UE. By uplink signaling, the UE informs the radio node about corresponding radio-link, i.e. channel, conditions through Channel Quality Indicator, CQI signaling, including sending CQI reports to the radio node.

This is generally illustrated in Fig. 1 in which a radio node 100 of a cellular network is serving two UEs denoted UE1 and UE2. In this example, UE1 and UE2 both

report quality measurements made on the channel used by sending CQI reports to the radio node 100 which selects a suitable MCS for each UE based on their CQI reporting and signals the selected MCS to the UEs, respectively. Link adaptation is made in this way for individual UEs on a dynamic basis since the radio-link conditions may change rapidly. The selection of a suitable MCS can thus be made individually for each UE.

In current LTE systems, the set of available modulation schemes for both downlink and uplink includes Quadrature Phase-Shift Keying, QPSK, 16 Quadrature Amplitude Modulation, QAM, and 64QAM, corresponding to two, four and six bits carried per modulation symbol, respectively. In this field, the number of bits carried per modulation symbol is usually referred to as the modulation order, Q_m .

In brief, the serving radio node selects a suitable MCS based on CQI reporting from the UE and signals the selected MCS to the UE with reference to a predefined MCS index table which is known to the UE. The MCS index table maps MCS indices to modulation order and a Transport Block Size, TBS, index. Further, the UE determines a CQI value based on signal measurements and the CQI is signaled from the UE to the radio node with reference to a likewise predefined CQI index table which maps CQI indices to modulation forms and code rates. In this description, the term “modulation form” is used for short to indicate a modulation format, method or scheme.

In LTE, especially for scenarios with good channel conditions where the Signal-to-Interference-and-Noise Ratio, SINR, is high, e.g. in small-cell environments where the UE is close to its serving radio node, a straightforward means to provide higher data rate for the UE with given transmission bandwidth is to use higher-order modulation that allows for more bits of information to be carried per modulation symbol, as compared to the modulation schemes mentioned above where the highest possible data rate is provided by 64QAM carrying six bits per modulation symbol. However, it is a problem that the control signaling schemes, methods, formats or protocols of today do not support any modulation with higher order than six bits per symbol, as in 64QAM. It is also a problem that additional control

signaling would be required between the UE and the serving radio node if higher data rate is to be achieved by using higher-order modulation.

Summary

It is an object of embodiments described herein to address at least some of the problems and issues outlined above. It is possible to achieve this object and others by using a radio node, a UE and methods therein as defined in the attached independent claims.

According to one aspect, a method is performed by a radio node of a cellular network. The radio node is operable to apply a first table configuration in radio communications with User Equipments, UEs, the first table configuration comprising at least one of a first Modulation and Coding Scheme, MCS, table and a first Channel Quality Indicator, CQI, table wherein the at least one of the first MCS table and the first CQI table support a certain maximum modulation order.

In this method, the radio node detects that a higher modulation order which is higher than the maximum modulation order of the first table configuration is potentially possible to use in a radio communication between the radio node and a first UE. The radio node then instructs the first UE to apply a second table configuration in the radio communication. The second table configuration comprises at least one of a second MCS table and a second CQI table wherein the at least one of the second MCS table and the second CQI table support the higher modulation order. Furthermore, at least one entry for at least one modulation order in the at least one of the first MCS table and the first CQI table is maintained in the at least one of the second MCS table and the second CQI table as a fall-back in case it is desirable to use the at least one modulation order in the at least one of the first MCS table and the first CQI table when the second table configuration is applied.

According to another aspect, a radio node of a cellular network is operable to apply a first table configuration in radio communications with User Equipments, UEs, the first table configuration comprising at least one of a first Modulation and Coding Scheme, MCS, table and a first Channel Quality Indicator, CQI, table

wherein the at least one of the first MCS table and the first CQI table support a certain maximum modulation order. The radio node comprises a logic unit configured to detect that a higher modulation order which is higher than the maximum modulation order of the first table configuration is potentially possible to use in a radio communication between the radio node and a first UE.

The radio node also comprises an instructing unit configured to instruct the first UE to apply a second table configuration in the radio communication, the second table configuration comprising at least one of a second MCS table and a second CQI table wherein the at least one of the second MCS table and the second CQI table support the higher modulation order. At least one entry for at least one modulation order in the at least one of the first MCS table and the first CQI table is maintained in the at least one of the second MCS table and the second CQI table as a fall-back in case it is desirable to use the at least one modulation order in the at least one of the first MCS table and the first CQI table when the second table configuration is applied.

According to another aspect, a method is performed by a User Equipment, UE, being operable to apply a first table configuration in a radio communication with a radio node of a cellular network. The first table configuration comprises at least one of a first Modulation and Coding Scheme, MCS, table and a first Channel Quality Indicator, CQI, table wherein the at least one of the first MCS table and the first CQI table support a certain maximum modulation order. In this method, the UE receives an instruction from the radio node to apply a second table configuration in the radio communication, the second table configuration comprising at least one of a second MCS table and a second CQI table wherein the at least one of the second MCS table and the second CQI table support a higher modulation order which is higher than the maximum modulation order of the first table configuration. The UE further applies the second table configuration in the radio communication with the radio node.

According to another aspect, a User Equipment, UE, is operable to apply a first table configuration in a radio communication with a radio node of a cellular network, the first table configuration comprising at least one of a first Modulation

and Coding Scheme, MCS, table and a first Channel Quality Indicator, CQI, table wherein the at least one of the first MCS table and the first CQI table support a certain maximum modulation order. The UE comprises a communication unit which is configured to receive an instruction from the radio node to apply a second table configuration in the radio communication, the second table configuration comprising at least one of a second MCS table and a second CQI table wherein the at least one of the second MCS table and the second CQI table support a higher modulation order which is higher than the maximum modulation order of the first table configuration. The UE also comprises a logic unit which is configured to apply the second table configuration in the radio communication with the radio node.

When using any of the above methods and nodes, it is possible to achieve a higher data rate in the radio communication between the radio node and the UE by using the higher modulation order of the second table configuration, e.g. when the radio or channel conditions are favorable, instead of being limited to the maximum modulation order of the first table configuration.

A computer program is also provided comprising instructions which, when executed on at least one processor, cause the at least one processor to carry out either of the above methods. A carrier is also provided which contains the above computer program, wherein the carrier is one of an electronic signal, optical signal, radio signal, or computer readable storage medium.

The above methods and nodes may be configured and implemented according to different optional embodiments to accomplish further features and benefits, to be described below.

Brief description of drawings

The solution will now be described in more detail by means of exemplary embodiments and with reference to the accompanying drawings, in which:

Fig. 1 is a communication scenario illustrating how link adaptation can be achieved, according to the prior art.

Fig. 2 is a table used for MCS signaling from a radio node to a UE, according to a first table configuration.

Fig. 3 is a table used for CQI signaling from a UE to a radio node, according to the first table configuration.

Fig. 4 is a flow chart illustrating a procedure in a radio node, according to some possible embodiments.

Fig. 5 is a block diagram illustrating an example of how a radio node may be configured and operate, according to further possible embodiments.

Fig. 6 is a flow chart illustrating a procedure in a UE, according to some possible embodiments.

Fig. 7 is a block diagram illustrating an example of how a UE may be configured and operate, according to further possible embodiments.

Fig. 8 is an example of a modified table used for MCS signaling from a radio node to a UE, according to according to a second table configuration.

Fig. 9 is an example of a modified table used for CQI signaling from a UE to a radio node, according to the second table configuration.

Fig. 10 is an example of a modified table used for mapping a Transport Block Size, TBS, index to a data rate, according to further possible embodiments.

Detailed description

In this solution it has been recognized that the above-described control signaling for MCS and CQI indication can be re-designed in order to adopt higher-order modulation schemes in LTE systems. In particular, the MCS and CQI index tables used for such signaling can be modified such that the current maximum modulation order can be increased without requiring any extra signaling bits. In this disclosure, the term higher-order modulation may refer to modulation schemes that are higher than 64QAM, such as e.g. 256QAM allowing eight bits per symbol, or even higher modulation of 512QAM, and so forth.

Briefly described, a first table configuration is initially applied in radio communication between a radio node and a UE. The first table configuration comprises a first MCS table and/or a first CQI table which tables support a certain maximum modulation order, e.g. 6. An example of the first MCS table is shown in Fig. 2 and an example of the first CQI table is shown in Fig. 3. The first MCS table and the first CQI table are thus predefined and known to the UE, for example the tables currently used in LTE for signaling between radio nodes and UEs for enabling link adaptation as described above although other MCS and CQI tables are also possible to use in the first table configuration. In these examples it can be seen that the maximum modulation order supported by the first MCS table and the first CQI table is $Q_m = 6$ which corresponds to 64QAM.

When detecting that a higher modulation order which is higher than the maximum modulation order of the first table configuration is potentially possible to use in the above communication, e.g. based on CQI reports from the UE, the radio node instructs the UE to apply a second table configuration that supports the higher modulation order. The second table configuration comprises a second MCS table and/or a second CQI table having additional entries that support the higher modulation order. Examples of how such tables of the second table configuration can be configured will be described in more detail later below. In this solution, at least one entry for at least one modulation order is maintained, i.e. kept, from the table(s) of the first table configuration as a fall-back in case it would become desirable or even necessary to use the least one modulation order of the first table configuration when the second table configuration is applied, such as when the radio conditions get worse and only the least one modulation order of the first table configuration, e.g. the lowest modulation order, is possible to use for keeping the radio connection.

It will now be described how link adaptation can be achieved in general according to LTE.

For downlink data transmission in LTE, the radio node typically selects the MCS depending on the CQI feedback transmitted by the UE in the uplink, as illustrated

in Fig. 1. The CQI feedback indicates the present channel condition and possible data rate, or more specifically a modulation and coding scheme MCS, that can be supported by the downlink channel given the present channel condition and UE receiver.

The LTE specifications are designed to provide signaling between the radio node and the UE. In the downlink, the information about the MCS adopted for PDSCH transmission is indicated by a five-bit field in the Downlink Control Information, DCI, transmitted from the radio node to the UE. This MCS field corresponds to the MCS index table shown in Fig. 2. In this table, there is room for 32 combinations or entries, where 29 entries are used to signal an adopted MCS, each entry corresponding to a modulation order and a Transport Block Size, TBS, while 3 entries are reserved, e.g., to support adaptive retransmissions. All possible TBS can be described by a TBS table mapping a TBS index, I_{TBS} , and an allocation bandwidth into the corresponding transport block size (in bits).

In the uplink, the UE reports CQI to assist the serving radio node to select the appropriate MCS to apply for downlink transmissions. Typically, the CQIs are derived from measurements made by the UE on downlink reference signals transmitted by the serving radio node. For example, the reported CQI may represent the highest MCS that is supported for a PDSCH transmission, e.g. with a transport block error rate probability not exceeding 10%. The CQI is signaled from the UE to the radio node with reference to a predefined CQI index table, as shown in Fig. 3. A 4-bit CQI value corresponds to a particular MCS out of 16 combinations corresponding to CQI index 0-15 in the CQI index table. It should be noted that the CQI table is parameterized in terms of coding rate, as opposed to transport block size. Thus, the selected and signaled CQI indicates the highest modulation and coding rate at which the block error rate measured at UE does not exceed 10%. Based on the CQI feedback from the UE and other information, the radio node is able to select a proper MCS index from the MCS table and notify the UE accordingly by MCS signaling.

Current LTE systems support three modulation schemes for both downlink and uplink: QPSK, 16QAM and 64QAM. Accordingly, the MCS index table, the CQI index table and the corresponding fields for indication in DCI are designed for these three modulation schemes. However, higher-order modulation schemes are not supported in current LTE specifications. In order to support higher-order modulation, i.e. higher than the above schemes QPSK, 16QAM and 64QAM, UEs must support an additional MCS/CQI table that also includes specific entries for new modulation schemes. The modification of MCS/CQI table may require re-designing the DCI format and possibly also the Uplink Control Information, UCI, format.

Typically, the additional MCS/CQI tables are used in scenarios with high Signal-to-Noise Ratio, SNR, or SINR which allow for higher-order modulation to be used thanks to the high signal quality. In scenarios with relatively low SNR or SINR, on the other hand, the current MCS/CQI tables supporting QPSK, 16QAM and 64QAM are useful to achieve link robustness. Hence, a solution has been devised with flexibility to adopt appropriate MCS/CQI tables based on channel conditions as follows.

As mentioned above, current LTE systems only support modulation up to 64QAM, while it may be desirable to use higher-order modulation, e.g. 256QAM, to increase the data rate when the signal quality allows. To support higher-order modulation, adaptations and/or extensions to the current control signaling in terms of the MCS index table, the CQI index table and the corresponding fields in DCI/UCI are required. This can be solved by the embodiments described herein.

In this disclosure, an alternative design of an MCS index table and/or of a CQI index table supporting higher-order modulation is described which can be used for LTE systems, which can be supported in addition to basic MCS and CQI tables such as the current design of the MCS index table and the CQI index table shown in Fig. 2 and Fig. 3, respectively.

In the current LTE specification, the MCS and CQI tables support modulation schemes up to 64QAM, e.g. as illustrated in Figs 2 and 3. The proposed new MCS

and CQI index tables are able to support modulation higher than 64QAM, without necessarily extending the number of bits in the DCI/UCI formats, or the number of entries in the MCS table and in the CQI table, respectively. In this solution, it is possible to select higher-order modulation schemes e.g. in the high-SINR scenarios or generally when a performance related parameter, such as SINR, of signals communicated between a radio node and a UE is above a certain threshold.

In the new MCS/CQI tables, new entries for higher-order modulation are added and designed to provide sufficient resolution to cover the high-SINR region. Meanwhile, a large part of the existing entries in current MCS and/or CQI tables may be preserved. The current MCS and/or CQI tables may be comprised in a first table configuration while the new MCS and/or CQI tables supporting a higher-order modulation may be comprised in a second table configuration. This has the advantage that the number of new MCS/CQI formats a UE and a radio node has to implement may be minimized. In other words, the UE and the radio node need to support only one extra MCS table and/or CQI table of the second table configuration in order to enable the higher-order modulation.

In a possible embodiment, at least one MCS entry, e.g. the lowest MCS entry with MCS index 0, in the MCS table and/or at least one CQI entry, e.g. the lowest CQI entry for the lowest coding rate of the lowest modulation order with CQI index 1, in the CQI table is preserved or maintained from the basic MCS and/or CQI table, to ensure proper communication between the radio node and the UE under poor channel or radio conditions. Thus, a fallback is provided in case it is only possible or desirable to use a modulation order lower than the higher modulation order, e.g. the lowest modulation order, when the second table configuration is applied. This provides flexibility and robustness in case of changing channel or radio conditions, and provides a robust format to, for example, signal control-plane data, and/or to reconfigure the UE to assume the basic MCS and/or CQI table suitable for poor/normal channel or radio conditions. By employing embodiments described herein, the link adaption in LTE systems may be enhanced to support higher-order modulation schemes, which can significantly improve the spectral efficiency e.g. in

high SINR scenarios, while maintaining robustness in case of worsening radio conditions.

It should be noted that although terminology from 3GPP LTE is used in this disclosure to describe various exemplifying embodiments, this should not be seen as limiting the scope of usage to only the aforementioned system. Other wireless systems, including WCDMA, WiMAX, and Ultra Mobile Broadband, UMB, may also benefit from exploiting embodiments described herein.

It should also be noted that terminology such as radio node should be considered non-limiting and in general “radio node” could be considered as device 1 and “UE” could be considered as device 2 and these two devices may communicate with each other over some radio channel in the manner described herein.

In the following, the solution will be explained in more detail by some exemplary embodiments. It should be noted that these embodiments are not mutually exclusive. Components from one embodiment may be utilized in another embodiment wherever appropriate.

The MCS index table and CQI index table used in current LTE specification are shown in Fig. 2 and Fig. 3, respectively. A possible design of alternative MCS and CQI index tables will now be described as well as the mechanism by which the radio node and the UE can switch between the proposed new MCS/CQI tables of the second table configuration and the MCS/CQI tables of the first table configuration. It should be noted that the solution is not limited to the specific examples of MCS/CQI tables described herein and that any MCS/CQI tables may be used in accordance with the embodiments described herein.

An example of a procedure, performed by a radio node of a cellular network when the solution is employed, will now be described with reference to the flow chart in Fig. 4. Some possible but non-limiting embodiments will also be described which may be used for the radio node. In this procedure, it is assumed that the radio node is operable to apply a first table configuration in radio communications with UEs, and that the first table configuration comprises at least one of a first MCS

table and a first CQI table wherein the at least one of the first MCS table and the first CQI table support a certain maximum modulation order. As said above, the maximum modulation order supported by the currently used MCS/CQI tables is $Q_m = 6$ which corresponds to 64QAM, and the currently used MCS/CQI tables may, without limitation, be used as the first table configuration in this solution.

A first **action 400** illustrates that the radio node detects that a higher modulation order which is higher than the maximum modulation order of the first table configuration is potentially possible to use in a radio communication between the radio node and a first UE. For example, this may be detected when a performance related parameter, e.g. SINR, of signals communicated between the radio node and the second UE is above a certain threshold.

Another **action 402** illustrates that the radio node instructs the first UE to apply a second table configuration in the radio communication. The second table configuration comprises at least one of a second MCS table and a second CQI table wherein the at least one of the second MCS table and the second CQI table support the higher modulation order. Furthermore, at least one entry for at least one modulation order in the at least one of the first MCS table and the first CQI table is maintained in the at least one of the second MCS table and the second CQI table as a fall-back in case it is desirable to use the at least one modulation order in the at least one of the first MCS table and the first CQI table when the second table configuration is applied. In other words, the at least one of the second MCS table and the second CQI table includes at least one entry for at least one modulation order, e.g. the lowest modulation order, that is also included in the at least one of the first MCS table and the first CQI table, in order to provide said fall-back. Such a fall-back may be desirable, and even necessary, if the signal quality, e.g. as indicated by the CQI reports from the UE, suddenly deteriorates and no modulation order higher than the lowest one is suitable or even possible to use for achieving robustness.

In a possible embodiment, the radio node may instruct the first UE to apply the second table configuration in the radio communication between the radio node and

the first UE when a performance related parameter of signals communicated between the radio node and the first UE is above a threshold. The performance related parameter may be derived from CQI reports provided by the first UE containing measurements of downlink reference signals transmitted by the radio node.

In another possible embodiment, the radio node may instruct a second UE to apply the first table configuration in a radio communication between the radio node and the second UE when the performance related parameter of signals communicated between the radio node and the second UE is below the threshold. In yet a possible embodiment, the radio node may in this case instruct the second UE explicitly by sending an instruction to the second UE to apply the first table configuration, or implicitly by not sending an instruction to the second UE to apply the second table configuration which indicates to the second UE that it should apply the first table configuration. Furthermore, the radio node may instruct the first UE as well to apply the first table configuration again, if the performance related parameter of signals between the radio node and the first UE would fall below the threshold. In either of the latter embodiments, the performance related parameter may comprise a Signal-to-Interference-and-Noise Ratio, SINR.

It was mentioned above that the MCS and CQI index tables of the second table configuration may be created by modifying the MCS and CQI index tables of the first table configuration, e.g. the tables shown in Figs 2 and 3, such that the current maximum modulation order can be increased. This may be done without requiring any extra signaling bits. In one possible embodiment, the at least one of the second MCS table and the second CQI table may be a modification of the at least one of the first MCS table and the first CQI table, respectively, where a set of entries for the higher modulation order have been added and a set of entries for the at least one modulation order in the at least one of the first MCS table and the first CQI table have been removed in the respective second tables. In another possible embodiment, the at least one modulation order in the at least one of the first MCS table and the first CQI table may comprise a lowest modulation order of the first table configuration. It will be described later below how the above-

mentioned modification of the first MCS table and the first CQI table may be done in more detail with reference to examples shown in Figs 8 and 9.

It was also mentioned above that at least one entry for the at least one modulation order, e.g. the lowest modulation order, in the at least one of the first MCS table and the first CQI table is maintained, i.e. kept, in the at least one of the second MCS table and the second CQI table as a fall-back in case the signal quality deteriorates while using the second table configuration. In another possible embodiment, the first entry for the lowest modulation order in the first MCS table may be maintained in the second MCS table as the fall-back, and an entry for the lowest coding rate of the lowest modulation order in the first CQI table may be maintained in the second CQI table as the fall-back. This embodiment will be illustrated in more detail later below.

In another possible embodiment, the number of added entries for the higher modulation order and the number of removed entries for the lowest modulation order may be equal such that the first and second MCS tables are of equal size and/or the first and second CQI tables are of equal size. Thereby, no extra bits are needed in the signaling of MCS and/or CQI, respectively, for supporting the second table configuration in addition to the first table configuration.

In another possible embodiment, the at least one of the second MCS table and the second CQI table may be a modification of the at least one of the first MCS table and the first CQI table, respectively, where all entries of the at least one of the first MCS table and the first CQI table have been maintained, i.e. kept, in the at least one of the second MCS table and the second CQI table and a set of entries for the higher modulation order have been added. In yet a possible embodiment, the first and second table configurations may further comprise a Transport Block Size, TBS, table corresponding to the first and second MCS tables, respectively. The TBS table maps a TBS index, I_{TBS} , and an allocation bandwidth into the corresponding transport block size, e.g. given in number of bits.

A detailed but non-limiting example of how a radio node may be structured with some possible functional entities such as modules, circuits or units, to bring about

the above-described functionality of the radio node, is illustrated by the block diagram in Fig. 5. In this figure, the radio node 500 is operable to apply a first table configuration in radio communications with UEs, the first table configuration comprising at least one of a first Modulation and Coding Scheme, MCS, table and a first Channel Quality Indicator, CQI, table wherein the at least one of the first MCS table and the first CQI table support a certain maximum modulation order.

The radio node 500 may be configured to operate according to any of the examples and embodiments of employing the solution as described above and as follows. In particular, the radio node 500 may comprise means arranged or configured to perform the actions of the flow chart in Fig. 4 and the embodiments described above, where appropriate. In order to put any of this into practice, the radio node 500 may be implemented with a communication circuit C, a memory M and an operable processor P comprising various functional units as described below.

More specifically, the radio node 500 comprises means, such as a **logic unit 500a**, configured to detect that a higher modulation order which is higher than the maximum modulation order of the first table configuration is potentially possible to use in a radio communication between the radio node 500 and a first UE 502. This detecting operation may be performed as described for action 400 above.

The radio node 500 also comprises means, such as an **instructing unit 500b**, configured to instruct the first UE 502 to apply a second table configuration in the radio communication, the second table configuration comprising at least one of a second MCS table and a second CQI table wherein the at least one of the second MCS table and the second CQI table support the higher modulation order, and wherein at least one entry for at least one modulation order in the at least one of the first MCS table and the first CQI table is maintained in the at least one of the second MCS table and the second CQI table as a fall-back in case it is desirable to use the at least one modulation order in the at least one of the first MCS table and the first CQI table when the second table configuration is applied. This instructing operation may be performed as described for action 402 above.

An example of a procedure, performed by a UE when the solution is employed, will now be described with reference to the flow chart in Fig. 6. In this procedure, it is assumed that the UE is operable to apply a first table configuration in a radio communication with a radio node of a cellular network, the first table configuration comprising at least one of a first Modulation and Coding Scheme, MCS, table and a first Channel Quality Indicator, CQI, table wherein the at least one of the first MCS table and the first CQI table support a certain maximum modulation order.

A first **action 600** illustrates that the UE receives an instruction from the radio node to apply a second table configuration in the radio communication, the second table configuration comprising at least one of a second MCS table and a second CQI table wherein the at least one of the second MCS table and the second CQI table support a higher modulation order which is higher than the maximum modulation order of the first table configuration. In another **action 602**, the UE applies the second table configuration in the radio communication with the radio node, which may include receiving MCS signaling from the radio node with reference to the second MCS table and/or sending CQI reports to the radio node with reference to the second CQI table, in accordance with the second table configuration.

A detailed but non-limiting example of how a UE may be structured with some possible functional entities such as modules, circuits or units, to bring about the above-described functionality of the UE, is illustrated by the block diagram in Fig. 7. In this figure, the UE 700 is operable to apply a first table configuration in a radio communication with a serving radio node 702 of a cellular network, the first table configuration comprising at least one of a first Modulation and Coding Scheme, MCS, table and a first Channel Quality Indicator, CQI, table wherein the at least one of the first MCS table and the first CQI table support a certain maximum modulation order.

The UE 700 may be configured to operate according to any of the examples and embodiments of employing the solution as described above and as follows. In particular, the UE 700 may comprise means arranged or configured to perform the actions of the flow chart in Fig. 6. In order to put any of this into practice, the UE

700 may be implemented with a communication circuit C, a memory M and an operable processor P comprising various functional units as described below.

More specifically, the UE 700 comprises means, such as a **communication unit 700a**, configured to receive an instruction from the radio node 702 to apply a second table configuration in the radio communication, the second table configuration comprising at least one of a second MCS table and a second CQI table wherein the at least one of the second MCS table and the second CQI table support a higher modulation order which is higher than the maximum modulation order of the first table configuration. The UE 700 also comprises means, such as a **logic unit 700b**, configured to apply the second table configuration in the radio communication with the radio node 702. This is illustrated in the figure by the UE 700 receiving MCS signaling from the radio node 702 with reference to the second MCS table and/or sending CQI reports to the radio node 702, with reference to the second CQI table in accordance with the second table configuration.

It should be noted that Figs 5 and 7 illustrate various functional units in the radio node 500 and the UE 700, respectively, and the skilled person is able to implement these functional units in practice using suitable software and hardware. Thus, the solution is generally not limited to the shown structures of the radio node 500 and the UE 700, and the functional units 500a-b and 700a-b may be configured to operate according to any of the features described in this disclosure, where appropriate.

The functional units 500a-b and 700a-b described above can be implemented in the radio node 500 and the UE 700, respectively, by means of program modules of a respective computer program comprising code means which, when run by the processor P in each node causes the radio node 500 and the UE 700 to perform the above-described actions and procedures. Each processor P may comprise a single Central Processing Unit (CPU), or could comprise two or more processing units. For example, each processor P may include a general purpose microprocessor, an instruction set processor and/or related chips sets and/or a special purpose microprocessor such as an Application Specific Integrated Circuit (ASIC). Each processor P may also comprise a storage for caching purposes.

Each computer program may be carried by a computer program product in each of the radio node 500 and the UE 700 in the form of a memory having a computer readable medium and being connected to the processor P. The computer program product or memory M in each of the radio node 500 and the UE 700 may thus comprise a computer readable medium on which the computer program is stored e.g. in the form of computer program modules or the like. For example, the memory M in each node may be a flash memory, a Random-Access Memory (RAM), a Read-Only Memory (ROM) or an Electrically Erasable Programmable ROM (EEPROM), and the program modules could in alternative embodiments be distributed on different computer program products in the form of memories within the respective radio node 500 and UE 700.

The solution described herein may be implemented in the respective radio node 500 and UE 700 by a computer program comprising instructions which, when executed on at least one processor, cause the at least one processor to carry out the actions according to any of the above embodiments. The solution may also be implemented at the respective radio node 500 and UE 700 in a carrier containing the above computer program, wherein the carrier is one of an electronic signal, optical signal, radio signal, or computer readable storage medium.

It will now be described in more detail how the first MCS and CQI tables shown in Figs 2 and 3 can be modified to create the second MCS and CQI tables, which is exemplified in the modified MCS table shown in Fig. 8 and in the modified CQI table shown in Fig. 9.

MCS index table

In an illustrative example, a first MCS table of the above-described first table configuration is used for downlink transmission to one UE, such as UE1 in Fig. 1, and for downlink transmission to another UE, such as UE2 in Fig. 1, a second MCS table of the above-described second table configuration is used.

In another illustrative example, the first MCS table is the current MCS table of the first table configuration in specification as shown in Fig. 2, and the second MCS table is a modified new MCS table of the second table configuration that supports

a modulation order higher than the maximum modulation order supported by the first MCS table, i.e. the second MCS table contains entries for higher-order modulation. An example of a second MCS table is shown in Fig. 8 which has been modified from the first MCS table of Fig. 2.

In another illustrative example, the radio node can use either current MCS table or proposed alternative MCS table for DL transmission. In a further example, the information about the MCS table that is to be used may be part of a DCI message, in which case it typically applies to a single specific subframe, or it may be part of a Radio Resource Control, RRC message or a Medium Access Control, MAC message, in which case it typically applies until further notice.

In another illustrative example, the proposed MCS index table of the second table configuration may have $32+N$ rows where $N \geq 0$ is a non-negative integer. The columns of the table represent the same parameters as those of the MCS index table shown in Fig. 2, which include MCS index I_{MCS} , modulation order Q_m and TBS index I_{TBS} . Each table row or entry, that corresponds to one MCS, is indexed by the MCS index I_{MCS} and contains a particular combination of modulation order and TBS index.

In another illustrative example, in the proposed MCS index table of the second table configuration, M rows, i.e., M MCS indices may be used to indicate the MCSs including pairs of one higher-order modulation scheme and one TBS index, where M is a non-negative integer with $M > N$.

In another illustrative example, $32+N-M$ MCS entries in Fig. 2 may be re-used in the new MCS table of the second table configuration. In other words, $M-N$ MCS entries in Fig. 2 are not included in the new MCS table.

The current TBS table in the specification is illustrated in Table 7.1.7.2.1-1 in the document called 3GPP TS 36.213 V11.2.0 (2013-04). In another example, the rows of TBS values corresponding to the TBS indices contained in said $M-N$ MCSs may be removed from the TBS table of the first table configuration. Meanwhile, M

new rows of TBS values corresponding to said M MCSs for higher-order modulation are added to said TBS table.

In a further illustrative example, when $N=0$, the new MCS table of the second table configuration may keep the same size as the MCS table in Fig. 2 and M MCSs for higher-order modulation in Fig. 8 replaces M MCSs in Fig. 2. In a further example, the lowest MCS, corresponding to MCS index 0, may be preserved or kept in the new MCS table of the second table configuration in Fig. 8. In a further example, the subsequent M lowest MCSs (corresponding to MCS indices 1 through M) are excluded in the new MCS table of the second table configuration. An example of such a new MCS table is shown in Fig. 8. Compared to Fig. 2, the MCSs with indices from 1 to 6 for modulation order 2 (QPSK) have been removed in Fig. 8, whereas the lowest MCS is preserved. Instead, 6 MCSs for modulation order 8 (256QAM) have been added to the MCS table in Fig. 8.

In order to create the TBS table of the second table configuration, rows of TBS values corresponding to the removed and added MCSs should be removed and added accordingly from and to the TBS table of the first table configuration. Other MCS entries are re-used in the new MCS table and the indices in this table are rearranged, i.e. renumbered, from beginning. Fig. 10 illustrates an example of a proposed TBS table of the second table configuration, table dimension is 27×110 , with index 21-26 for 256QAM, corresponding to the table in Fig. 9, where "NV" denotes new values. For the example shown in Fig. 10, the rows with index 1-6 for QPSK are removed and 6 new rows of TBS values for 256QAM have been added at the end of the table. This new TBS table of the second table configuration shall be consistent with the TBS index in said new MCS table of the second table configuration.

Fig. 10 will now be explained in more detail. Fig. 10 shows the Transport Block Size table in the specification 36.213 Table 7.1.7.2.1-1. The transport block size, i.e. the number of bits carried by a transport block is determined by both adopted MCS and the number of pair of resource blocks which is denoted N_{PRB} in the table. For each MCS index in the MCS table, there are 110 possible numbers of

PRB, 1-110. This is why the TBS table has a size of 110 columns and 27 rows that correspond to different MCSs, although they are not one-to-one mappings to the MCS table. If new MCS indices are added for 256QAM, the TBS entries for 256QAM need also be calculated and specified. Hence, in the new MCS table, the new entries for 256QAM must contain the TBS indices for corresponding new TBS values.

In another illustrative example, the lowest MCS, i.e. the entry with MCS index 0 in the MCS table of the first table configuration shown in Fig. 2 may be re-used in the new MCS table of the second table configuration. This is to ensure that the communication between the radio node and UE works properly even when the radio link experiences very poor channel condition, which may be called a low SINR scenario or similar.

In another illustrative example, when the new MCS table of the second table configuration is in use and the entry for lowest MCS is selected for a transmission, this indicates that it is difficult to support higher-order modulation due to variation of channel quality, bad radio conditions or other issues, and that a more robust MCS is needed. Hence, the MCS table used in the next transmission may automatically fall back to the first MCS table of the first table configuration, which may without limitation be the MCS table of the current standard, which allows for selection of any of the entries of e.g. the lowest modulation order.

In another illustrative example, the MCS field in DCI may be extended by one or more bits to indicate the MCS index when $N > 0$, that is, the new MCS table of the second table configuration may have more than 32 MCS indices. However, this expansion of the MCS table may require one or more extra bits in the DCI.

CQI index table

The design of the new, or second, CQI index table of the second table configuration is similar to that of the new, or second, MCS index table of the second table configuration.

In an illustrative example, a first CQI table of the first table configuration may be used for radio transmission from the first UE to the radio node, while in the radio transmission from the second UE to the radio node, a second CQI table of the second table configuration may be used, or vice versa.

In another illustrative example, said first CQI table and second CQI table are the current CQI table in specification and a modified CQI table that contains entries for higher-order modulation, respectively. An example of a second CQI table of the second table configuration is shown in Fig. 9 which has been modified from the first CQI table of the first table configuration in Fig. 3.

In another illustrative example, a UE can use either the current CQI table of the first table configuration or the new CQI table of the second table configuration for transmission. In further examples, the information about the CQI table that is to be used may be part of a UCI message or part of a RRC or MAC message.

In another illustrative example, the proposed CQI table of the second table configuration has $16+N$ rows where $N \geq 0$ is a non-negative integer. The columns of the new CQI table represent the same parameters as those of the CQI table shown in Fig. 3, which include CQI index, modulation form, code rate and efficiency. Each table row or entry, that is one CQI, is indexed by a CQI index and contains a particular combination of a modulation order and code rate. The value of efficiency is calculated based on modulation order and code rate.

In another illustrative example, in the proposed CQI index table of the second table configuration, M rows, i.e., M CQI indices are used to indicate the CQI including pairs of one higher-order modulation scheme, one coding rate and resultant efficiency value, where M is a non-negative integer with $M > N$. In a further embodiment, the coding rates for higher-order modulation are defined and added to the CQI table.

In another illustrative example, $16+N-M$ CQIs in Fig. 3 are re-used in the alternative CQI table of the second table configuration. In a further embodiment,

when $N=0$, the new CQI table keeps the same size as the CQI table in Fig. 3 and M CQIs for higher-order modulation replaces M CQIs in Fig. 3.

In a further example, the lowest CQI corresponding to CQI index 1 is preserved in the new CQI table of the second table configuration. In a further embodiment, the subsequent M lowest CQIs, corresponding to CQI indices 2 through $M+1$, are excluded in the new CQI table of the second table configuration. An example of such an embodiment is provided in Fig. 9. Compared to Fig. 3, the CQIs with indices from 2 to 5 for modulation order 2 (QPSK) have been removed, whereas the lowest CQI is preserved. Instead, 4 CQIs for modulation order 8 (256QAM) have been added to the table in Fig. 9. Other CQIs are re-used in the table and their indices are rearranged.

As mentioned above, the lowest CQI, i.e. the entry with index 1 in Fig. 3, may be re-used in the new CQI table of the second table configuration. This is to ensure that the communication between the radio node and UE works properly even when the radio link experiences very poor channel condition.

In another illustrative example, when the new CQI table of the second table configuration is in use and the entry for lowest CQI is selected, this indicates that it is difficult to support higher-order modulation due to variation of channel quality or other issues. Hence, the CQI table used in next transmission may automatically fall back to the first CQI table of the first table configuration which may without limitation be the CQI table in the current standard.

In another illustrative example, the CQI field in uplink control signaling may be extended by one or more bits to indicate the CQI index when $N>0$, that is, the new CQI table has more than 16 CQIs. However, this expansion of the CQI table may require one or more extra bits in the DCI.

Potential advantages

The embodiments described herein may have the following advantages:

- The process of link adaptation in LTE systems may be enhanced to support higher-order modulation schemes in an efficient manner, which may significantly improve the spectral efficiency in a cellular network, particularly in high SINR or SNR scenarios.
- At least one MCS entry, e.g. the lowest MCS entry with MCS index 0, in the MCS table and at least one CQI entry, e.g. the lowest CQI entry for the lowest coding rate of the lowest modulation order with CQI index 1, in the CQI table may be preserved from the first table configuration as a fallback in the second table configuration to ensure proper communication between the radio node and UE when the radio link experiences very poor channel condition.
- The size of the current MCS table may be preserved, or minimally expanded.
- The implementation effort in the radio node and UEs may be kept to a minimum by sharing the majority of the MCS/CQI entries in the first and second MCS/CQI tables, respectively.
- The solution may be applied for both downlink and uplink transmissions.

While the solution has been described with reference to specific exemplary embodiments, the description is generally only intended to illustrate the inventive concept and should not be taken as limiting the scope of the solution. For example, the terms “radio node”, “User Equipment, UE”, “table configuration”, and “modulation order” have been used throughout this description, although any other corresponding entities, functions, and/or parameters could also be used having the features and characteristics described here. The solution is defined by the appended claims.

Abbreviations

LTE	long-term evolution
PDSCH	physical downlink shared channel

MCS	modulation and coding scheme
eNB	E-UTRAN NodeB
UE	user equipment
CQI	channel-quality indicator
QPSK	quadrature phase-shift keying
16QAM	16 quadrature amplitude modulation
64QAM	64 quadrature amplitude modulation
SINR	signal-to-interference-and-noise ratio
DCI	downlink control information
GSM	global system for mobile communications
WCDMA	wideband code-division multiple access
WiMAX	worldwide interoperability for microwave access
UMB	ultra mobile broadband

CLAIMS

1. A method performed by a radio node (500) of a cellular network, the radio node (500) being operable to apply a first table configuration in radio communications with User Equipments, UEs, the first table configuration comprising at least one of a first Modulation and Coding Scheme, MCS, table and a first Channel Quality Indicator, CQI, table wherein the at least one of the first MCS table and the first CQI table support a certain maximum modulation order, the method comprising:

- detecting (400) that a higher modulation order which is higher than the maximum modulation order of the first table configuration is potentially possible to use in a radio communication between the radio node (500) and a first UE (502), and

- instructing (402) the first UE (502) to apply a second table configuration in the radio communication, the second table configuration comprising at least one of a second MCS table and a second CQI table wherein the at least one of the second MCS table and the second CQI table support the higher modulation order, and wherein at least one entry for at least one modulation order in the at least one of the first MCS table and the first CQI table is maintained in the at least one of the second MCS table and the second CQI table as a fall-back in case it is desirable to use the at least one modulation order in the at least one of the first MCS table and the first CQI table when the second table configuration is applied.

2. A method according to claim 1, wherein the radio node (500) instructs the first UE (502) to apply the second table configuration in the radio communication between the radio node (500) and the first UE (502) when a performance related parameter of signals communicated between the radio node (500) and the first UE (502) is above a threshold.

3. A method according to claim 2, wherein the radio node (500) instructs a second UE to apply the first table configuration in a radio communication between the radio node (500) and the second UE when the performance related parameter

of signals communicated between the radio node (500) and the second UE is below the threshold.

4. A method according to claim 2 or 3, wherein the performance related parameter comprises a Signal to Interference and Noise Ratio, SINR.
5. A method according to claim 3, wherein the radio node (500) instructs the second UE by sending an instruction to the second UE to apply the first table configuration, or by not sending an instruction to the second UE to apply the second table configuration.
6. A method according to any of claims 1-5, wherein the at least one of the second MCS table and the second CQI table is a modification of the at least one of the first MCS table and the first CQI table, respectively, where a set of entries have been added for the higher modulation order and a set of entries for the at least one modulation order in the at least one of the first MCS table and the first CQI table have been removed.
7. A method according to any of claims 1-6, wherein the at least one modulation order in the at least one of the first MCS table and the first CQI table comprises a lowest modulation order of the first table configuration.
8. A method according to claim 7, wherein the first entry for the lowest modulation order in the first MCS table is maintained in the second MCS table as the fall-back, and an entry for the lowest coding rate of the lowest modulation order in the first CQI table is maintained in the second CQI table as the fall-back.
9. A method according to claim 6 and any of claims 7-8, wherein the number of added entries for the higher modulation order and the number of removed entries for the at least one modulation order in the at least one of the first MCS table and the first CQI table are equal such that the first and second MCS tables are of equal size and/or the first and second CQI tables are of equal size.
10. A method according to any of claims 1-5, wherein the at least one of the second MCS table and the second CQI table is a modification of the at least one of

the first MCS table and the first CQI table, respectively, where all entries of the at least one of the first MCS table and the first CQI table have been maintained in the at least one of the second MCS table and the second CQI table and a set of entries for the higher modulation order have been added.

11. A method according to any of claims 1-10, wherein the first and second table configurations further comprise a Transport Block Size, TBS, table corresponding to the first and second MCS tables, respectively.

12. A radio node (500) of a cellular network, the radio node (500) being operable to apply a first table configuration in radio communications with User Equipments, UEs, the first table configuration comprising at least one of a first Modulation and Coding Scheme, MCS, table and a first Channel Quality Indicator, CQI, table wherein the at least one of the first MCS table and the first CQI table support a certain maximum modulation order, the radio node (500) comprising:

- a logic unit (500a) configured to detect that a higher modulation order which is higher than the maximum modulation order of the first table configuration is potentially possible to use in a radio communication between the radio node (500) and a first UE (502), and

- an instructing unit (500b) configured to instruct the first UE (502) to apply a second table configuration in the radio communication, the second table configuration comprising at least one of a second MCS table and a second CQI table wherein the at least one of the second MCS table and the second CQI table support the higher modulation order, and wherein at least one entry for at least one modulation order in the at least one of the first MCS table and the first CQI table is maintained in the at least one of the second MCS table and the second CQI table as a fall-back in case it is desirable to use the at least one modulation order in the at least one of the first MCS table and the first CQI table when the second table configuration is applied.

13. A radio node (500) according to claim 12, wherein the radio node (500) is configured to instruct the first UE (502) to apply the second table configuration in

the radio communication between the radio node (500) and the first UE (502) when a performance related parameter of signals communicated between the radio node (500) and the first UE (502) is above a threshold.

14. A radio node (500) according to claim 13, wherein the radio node (500) is configured to instruct a second UE to apply the first table configuration in a radio communication between the radio node (500) and the second UE when the performance related parameter of signals communicated between the radio node (500) and the second UE is below the threshold.

15. A radio node (500) according to claim 13 or 14, wherein the performance related parameter comprises a Signal to Interference and Noise Ratio, SINR.

16. A radio node (500) according to claim 14, wherein the radio node (500) is configured to instruct the second UE by sending an instruction to the second UE to apply the first table configuration, or by not sending an instruction to the second UE to apply the second table configuration.

17. A radio node (500) according to any of claims 12-16, wherein the at least one of the second MCS table and the second CQI table is a modification of the at least one of the first MCS table and the first CQI table, respectively, where a set of entries have been added for the higher modulation order and a set of entries for the at least one modulation order in the at least one of the first MCS table and the first CQI table have been removed.

18. A radio node (500) according to any of claims 12-17, wherein the at least one modulation order in the at least one of the first MCS table and the first CQI table comprises a lowest modulation order of the first table configuration.

19. A radio node (500) according to claim 18, wherein the first entry for the lowest modulation order in the first MCS table is maintained in the second MCS table as the fall-back, and an entry for the lowest coding rate of the lowest modulation order in the first CQI table is maintained in the second CQI table as the fall-back.

20. A radio node (500) according to claim 17 and any of claims 18-19, wherein the number of added entries for the higher modulation order and the number of removed entries for the at least one modulation order in the at least one of the first MCS table and the first CQI table are equal such that the first and second MCS tables are of equal size and/or the first and second CQI tables are of equal size.

21. A radio node (500) according to any of claims 12-16, wherein the at least one of the second MCS table and the second CQI table is a modification of the at least one of the first MCS table and the first CQI table, respectively, where all entries of the at least one of the first MCS table and the first CQI table have been maintained in the at least one of the second MCS table and the second CQI table and a set of entries for the higher modulation order have been added.

22. A radio node (500) according to any of claims 12-21, wherein the first and second table configurations further comprise a Transport Block Size, TBS, table corresponding to the first and second MCS tables, respectively.

23. A method performed by a User Equipment, UE (700), the UE (700) being operable to apply a first table configuration in a radio communication with a radio node (702) of a cellular network, the first table configuration comprising at least one of a first Modulation and Coding Scheme, MCS, table and a first Channel Quality Indicator, CQI, table wherein the at least one of the first MCS table and the first CQI table support a certain maximum modulation order, the method comprising:

- receiving (600) an instruction from the radio node (702) to apply a second table configuration in the radio communication, the second table configuration comprising at least one of a second MCS table and a second CQI table wherein the at least one of the second MCS table and the second CQI table support a higher modulation order which is higher than the maximum modulation order of the first table configuration, and

- applying (602) the second table configuration in the radio communication with the radio node (702).

24. A User Equipment, UE (700), the UE (700) being operable to apply a first table configuration in a radio communication with a radio node (702) of a cellular network, the first table configuration comprising at least one of a first Modulation and Coding Scheme, MCS, table and a first Channel Quality Indicator, CQI, table wherein the at least one of the first MCS table and the first CQI table support a certain maximum modulation order, the UE comprising:

- a communication unit (700a) configured to receive an instruction from the radio node (702) to apply a second table configuration in the radio communication, the second table configuration comprising at least one of a second MCS table and a second CQI table wherein the at least one of the second MCS table and the second CQI table support a higher modulation order which is higher than the maximum modulation order of the first table configuration, and

- a logic unit (700b) configured to apply the second table configuration in the radio communication with the radio node (702).

25. A computer program comprising instructions which, when executed on at least one processor, cause the at least one processor to carry out the method according to any one of claims 1-11 and 23.

26. A carrier containing the computer program of claim 25, wherein the carrier is one of an electronic signal, optical signal, radio signal, or computer readable storage medium.

ABSTRACT

A method and radio node (500) for enabling higher-order modulation in a radio communication with a first UE (502). A first table configuration comprises at least one of a first Modulation and Coding Scheme, MCS, table and a first Channel Quality Indicator, CQI, table which tables support a certain maximum modulation order. When the radio node (500) detects that a modulation order higher than the maximum modulation order of the first table configuration is potentially possible to use in the radio communication, the radio node (500) instructs the first UE (502) to apply a second table configuration which comprises at least one of a second MCS table and a second CQI table which second tables support the higher modulation order. At least one entry for at least one modulation order in the tables of the first table configuration is maintained in the tables of the second table configuration as a fall-back in case it is desirable to use the at least one modulation order of the first table configuration when the second table configuration is applied. Thereby, a higher data rate can be achieved in the radio communication.

(Fig. 5)

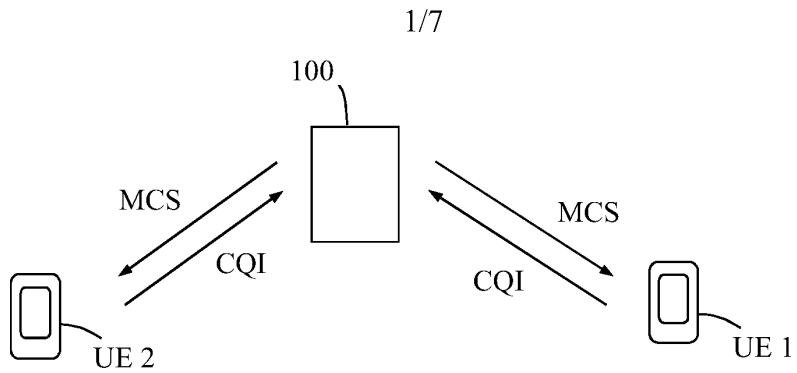

Fig. 1 (Prior art)

MCS Index I_{MCS}	Modulation Order Q_m	TBS Index I_{TBS}
0	2	0
1	2	1
2	2	2
3	2	3
4	2	4
5	2	5
6	2	6
7	2	7
8	2	8
9	2	9
10	4	9
11	4	10
12	4	11
13	4	12
14	4	13
15	4	14
16	4	15
17	6	15
18	6	16
19	6	17
20	6	18
21	6	19
22	6	20
23	6	21
24	6	22
25	6	23
26	6	24
27	6	25
28	6	26
29	2	reserved
30	4	
31	6	

Fig. 2

CQI index	modulation	code rate x 1024	efficiency
0	out of range		
1	QPSK	78	0.1523
2	QPSK	120	0.2344
3	QPSK	193	0.3770
4	QPSK	308	0.6016
5	QPSK	449	0.8770
6	QPSK	602	1.1758
7	16QAM	378	1.4766
8	16QAM	490	1.9141
9	16QAM	616	2.4063
10	64QAM	466	2.7305
11	64QAM	567	3.3223
12	64QAM	666	3.9023
13	64QAM	772	4.5234
14	64QAM	873	5.1152
15	64QAM	948	5.5547

Fig. 3

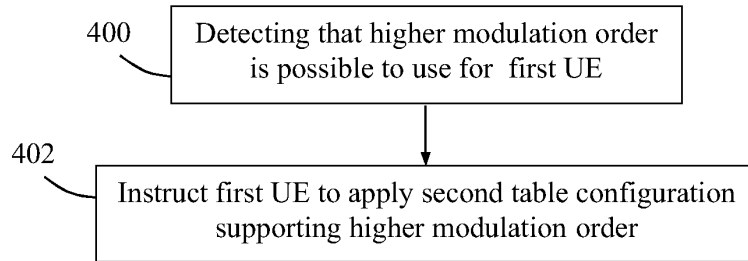

Fig. 4

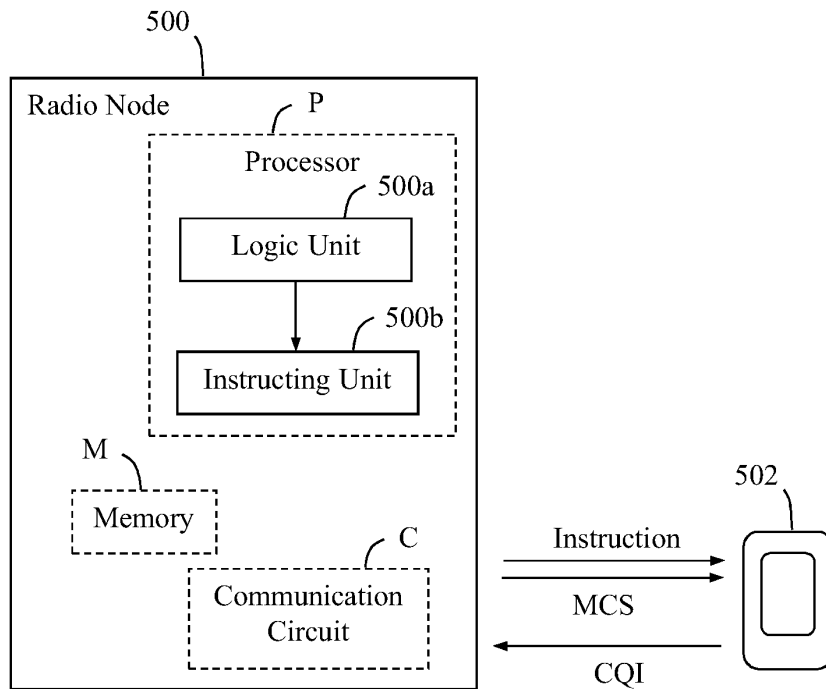

Fig. 5

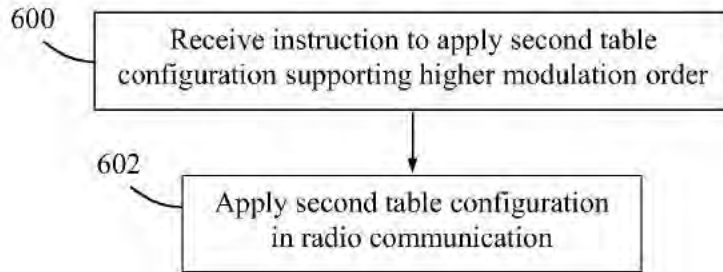

Fig. 6

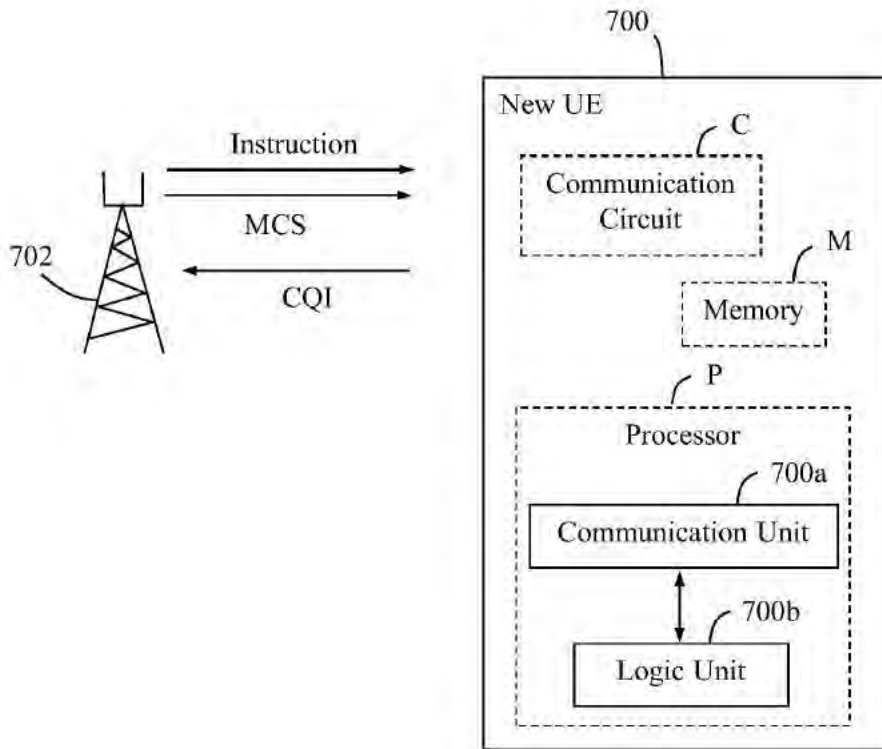

Fig. 7

<u>MCS Index</u>	<u>Modulation Order</u>	<u>TBS Index</u>
I_{MCS}	Q_m	I_{TBS}
0	2	0
1	2	1
2	2	2
3	2	3
4	2	4
5	2	5
6	2	6
7-1	2	7
8-2	2	8
9-3	2	9
10-4	4	9
11-5	4	10
12-6	4	11
13-7	4	12
14-8	4	13
15-9	4	14
16-10	4	15
17-11	6	15
18-12	6	16
19-13	6	17
20-14	6	18
21-15	6	19
22-16	6	20
23-17	6	21
24-18	6	22
25-19	6	23
26-20	6	24
27-21	6	25
28-22	6	26
23	8	New index
24	8	New index
25	8	New index
26	8	New index
27	8	New index
28	8	New index
29	2	reserved
30	4	
31	6	

Fig. 8

<u>CQI index</u>	<u>modulation</u>	<u>code rate x 1024</u>	<u>efficiency</u>
<u>0</u>	<u>out of range</u>		
<u>1</u>	<u>QPSK</u>	<u>78</u>	<u>0.1523</u>
<u>2</u>	<u>QPSK</u>	<u>120</u>	<u>0.2344</u>
<u>3</u>	<u>QPSK</u>	<u>193</u>	<u>0.3770</u>
<u>4</u>	<u>QPSK</u>	<u>308</u>	<u>0.6016</u>
<u>5</u>	<u>QPSK</u>	<u>449</u>	<u>0.8770</u>
<u>6-2</u>	<u>QPSK</u>	<u>602</u>	<u>1.1758</u>
<u>7-3</u>	<u>16QAM</u>	<u>378</u>	<u>1.4766</u>
<u>8-4</u>	<u>16QAM</u>	<u>490</u>	<u>1.9141</u>
<u>9-5</u>	<u>16QAM</u>	<u>616</u>	<u>2.4063</u>
<u>10-6</u>	<u>64QAM</u>	<u>466</u>	<u>2.7305</u>
<u>11-7</u>	<u>64QAM</u>	<u>567</u>	<u>3.3223</u>
<u>12-8</u>	<u>64QAM</u>	<u>666</u>	<u>3.9023</u>
<u>13-9</u>	<u>64QAM</u>	<u>772</u>	<u>4.5234</u>
<u>14-10</u>	<u>64QAM</u>	<u>873</u>	<u>5.1152</u>
<u>15-11</u>	<u>64QAM</u>	<u>948</u>	<u>5.5547</u>
<u>12</u>	<u>256QAM</u>	<u>New value</u>	<u>New value</u>
<u>13</u>	<u>256QAM</u>	<u>New value</u>	<u>New value</u>
<u>14</u>	<u>256QAM</u>	<u>New value</u>	<u>New value</u>
<u>15</u>	<u>256QAM</u>	<u>New value</u>	<u>New value</u>

Fig. 9

l_{TBS}	N_{PRB}									
	1	2	3	4	108	109	110
0	16	32	56	88	2984	2984	3112
1	24	56	88	144	4008	4008	4008
2	32	72	144	176	4776	4968	4968
3	40	104	176	208	6200	6456	6456
4	56	120	208	256	7736	7736	7992
5	72	144	224	328	9528	9528	9528
6	328	176	256	392	11448	11448	11448
7 1	104	224	328	472	12960	13536	13536
8 2	120	256	392	536	15264	15264	15264
9 3	136	296	456	616	16992	16992	17568
10 4	144	328	504	680	19080	19080	19080
11 5	176	376	584	776	22152	22152	22152
12 6	208	440	680	904	24496	24496	25456
13 7	224	488	744	1000	27376	28336	28336
14 8	256	552	840	1128	30576	31704	31704
15 9	280	600	904	1224	32856	34008	34008
16 10	328	632	968	1288	35160	35160	35160
17 11	336	696	1064	1416	39232	39232	39232
18 12	376	776	1160	1544	42368	43816	43816
19 13	408	840	1288	1736	46888	46888	46888
20 14	440	904	1384	1864	51024	51024	51024
21 15	488	1000	1480	1992	55056	55056	55056
22 16	520	1064	1608	2152	59256	59256	59256
23 17	552	1128	1736	2280	61664	61664	63776
24 18	584	1192	1800	2408	66592	66592	66592
25 19	616	1256	1864	2536	68808	68808	71112
26 20	712	1480	2216	2984	75376	75376	75376
21	NV	NV	NV	NV	NV	NV	NV
22	NV	NV	NV	NV	NV	NV	NV
23	NV	NV	NV	NV	NV	NV	NV
24	NV	NV	NV	NV	NV	NV	NV
25	NV	NV	NV	NV	NV	NV	NV
26	NV	NV	NV	NV	NV	NV	NV

Fig. 10

PCT REQUEST

Print Out (Original in Electronic Form)

0	For receiving Office use only	
0-1	International Application No.	
0-2	International Filing Date	
0-3	Name of receiving Office and "PCT International Application"	
0-4	Form PCT/RO/101 PCT Request	
0-4-1	Prepared Using	PCT Online Filing Version 3.5.000.235 MT/FOP 20020701/0.20.5.20
0-5	Petition The undersigned requests that the present international application be processed according to the Patent Cooperation Treaty	
0-6	Receiving Office (specified by the applicant)	Swedish Patent and Registration Office (RO/SE)
0-7	Applicant's or agent's file reference	P41223WO1
I	Title of Invention	METHOD AND RADIO NODE FOR ENABLING USE OF HIGH ORDER MODULATION IN A RADIO COMMUNICATION WITH A USER EQUIPMENT
II	Applicant	
II-1	This person is	Applicant only
II-2	Applicant for	All designated States
II-4	Name	Telefonaktiebolaget L M Ericsson (publ)
II-5	Address	SE-164 83 Stockholm Sweden
II-6	State of nationality	SE
II-7	State of residence	SE
II-8	Telephone No.	+46 10 719 0000
II-9	Facsimile No.	+46 10 71 75695
II-10	e-mail	patent.development@ericsson.com
II-10(a)	E-mail authorization The receiving Office, the International Searching Authority, the International Bureau and the International Preliminary Examining Authority are authorized to use this e-mail address, if the Office or Authority so wishes, to send notifications issued in respect of this international application:	exclusively in electronic form (no paper notifications will be sent)

PCT REQUEST

Print Out (Original in Electronic Form)

III-1	Applicant and/or inventor	
III-1-1	This person is	Inventor only
III-1-3	Inventor for	
III-1-4	Name (LAST, First)	HAMMARWALL, David
III-1-5	Address	Hällmarksvägen 59 SE-186 53 VALLENTUNA Sweden
III-2	Applicant and/or inventor	
III-2-1	This person is	Inventor only
III-2-3	Inventor for	
III-2-4	Name (LAST, First)	WANG, Meng
III-2-5	Address	Signalistgatan 14 SE-169 72 SOLNA Sweden
IV-1	Agent or common representative; or address for correspondence	
	The person identified below is hereby/ has been appointed to act on behalf of the applicant(s) before the competent International Authorities as:	Agent
IV-1-1	Name (LAST, First)	BOU FAICAL, Roger
IV-1-2	Address	Ericsson AB Patent Unit Kista RAN1 SE-164 80 Stockholm Sweden
IV-1-3	Telephone No.	+46 10 7134981
IV-1-4	Facsimile No.	+46 10 7175695
IV-1-5	e-mail	patent.development@ericsson.com
IV-1-5(a)	E-mail authorization) The receiving Office, the International Searching Authority, the International Bureau and the International Preliminary Examining Authority are authorized to use this e-mail address, if the Office or Authority so wishes, to send notifications issued in respect of this international application:	exclusively in electronic form (no paper notifications will be sent)
V	DESIGNATIONS	
V-1	The filing of this request constitutes under Rule 4.9(a), the designation of all Contracting States bound by the PCT on the international filing date, for the grant of every kind of protection available and, where applicable, for the grant of both regional and national patents.	
VI-1	Priority claim of earlier national application	
VI-1-1	Filing date	09 August 2013 (09.08.2013)
VI-1-2	Number	61/863,935
VI-1-3	Country	US

PCT REQUEST

Print Out (Original in Electronic Form)

VI-2	Priority document request The International Bureau is requested to obtain from a digital library a certified copy of the earlier application(s) identified above as item(s), using, where applicable, the access code(s) indicated:	VI-1 Access code: 6638	
VI-3	Incorporation by reference : where an element of the international application referred to in Article 11(1)(iii)(d) or (e) or a part of the description, claims or drawings referred to in Rule 20.5(a) is not otherwise contained in this international application but is completely contained in an earlier application whose priority is claimed on the date on which one or more elements referred to in Article 11(1)(iii) were first received by the receiving Office, that element or part is, subject to confirmation under Rule 20.6, incorporated by reference in this international application for the purposes of Rule 20.6.		
VII-1	International Searching Authority Chosen	European Patent Office (EPO) (ISA/EP)	
VIII	Declarations	Number of declarations	
VIII-1	Declaration as to the identity of the inventor	-	
VIII-2	Declaration as to the applicant's entitlement, as at the international filing date, to apply for and be granted a patent	1	
VIII-3	Declaration as to the applicant's entitlement, as at the international filing date, to claim the priority of the earlier application	1	
VIII-4	Declaration of inventorship (only for the purposes of the designation of the United States of America)	-	
VIII-5	Declaration as to non-prejudicial disclosures or exceptions to lack of novelty	-	

PCT REQUEST

Print Out (Original in Electronic Form)

VIII-2-1	Declaration: Entitlement to apply for and be granted a patent Declaration as to the applicant's entitlement, as at the international filing date, to apply for and be granted a patent (Rules 4.17(ii) and 51bis.1(a)(ii)), in a case where the declaration under Rule 4.17(iv) is not appropriate: Name (LAST, First)	In relation to this international application Telefonaktiebolaget L M Ericsson (publ) is entitled to apply for and be granted a patent by virtue of the following:
VIII-2-1(i)		ERICSSON AB is entitled as employer of the inventor, HAMMARWALL, David and the inventor WANG, Meng
VIII-2-1(vii)		transfer of entitlement from ERICSSON AB to Telefonaktiebolaget L M Ericsson (publ) by way of a general Assignment on transfer of ownership to invention already made and to be made in the future by employees of ERICSSON AB, dated 27 February 2003 (27.02.2003)

PCT REQUEST

Print Out (Original in Electronic Form)

VIII-3-1	<p>Declaration: Entitlement to claim priority Declaration as to the applicant's entitlement, as at the international filing date, to claim the priority of the earlier application specified below, where the applicant is not the applicant who filed the earlier application or where the applicant's name has changed since the filing of the earlier application (Rules 4.17(iii) and 51bis.1(a)(iii))</p> <p>Name</p>	<p>In relation to this international application</p> <p>Telefonaktiebolaget L M Ericsson (publ) is entitled to claim priority of earlier application No. 61/863,935 by virtue of the following:</p>
VIII-3-1(i)		<p>ERICSSON AB is entitled as employer of the inventor, HAMMARWALL, David and the inventor WANG, Meng</p>
VIII-3-1(vii)		<p>transfer of entitlement from ERICSSON AB to Telefonaktiebolaget L M Ericsson (publ) by way of a general Assignment on transfer of ownership to invention already made and to be made in the future by employees of ERICSSON AB, dated 27 February 2003 (27.02.2003)</p>

PCT REQUEST

Print Out (Original in Electronic Form)

IX	Check list	Number of sheets	Electronic file(s) attached
IX-1	Request (including declaration sheets)	6	✓
IX-2	Description	25	✓
IX-3	Claims	6	✓
IX-4	Abstract	1	✓
IX-5	Drawings	7	✓
IX-7	TOTAL	45	
	Accompanying Items	Paper document(s) attached	Electronic file(s) attached
IX-8	Fee calculation sheet	-	✓
IX-18	PCT-SAFE physical media	-	-
IX-19	Other	Pre-conversion archive	✓
IX-20	Figure of the drawings which should accompany the abstract	5	
IX-21	Language of filing of the international application	English	
X-1	Signature of applicant, agent or common representative	/Roger Bou Faical/	
X-1-1	Name (LAST, First)	BOU FAICAL, Roger	
X-1-2	Name of signatory	BOU FAICAL, Roger	
X-1-3	Capacity (if such capacity is not obvious from reading the request)	(Representative)	

FOR RECEIVING OFFICE USE ONLY

10-1	Date of actual receipt of the purported international application	
10-2	Drawings:	
10-2-1	Received	
10-2-2	Not received	
10-3	Corrected date of actual receipt due to later but timely received papers or drawings completing the purported international application	
10-4	Date of timely receipt of the required corrections under PCT Article 11(2)	
10-5	International Searching Authority	ISA/EP
10-6	Transmittal of search copy delayed until search fee is paid	

FOR INTERNATIONAL BUREAU USE ONLY

11-1	Date of receipt of the record copy by the International Bureau	
-------------	---	--



SWEDISH PATENT AND REGISTRATION OFFICE

Acknowledgement of receipt

We hereby acknowledge receipt of your request for the processing of an international application according to the Patent Cooperation Treaty as follows:

Submission number	1000052941	
PCT application number	PCT/SE2014/050803	
Date of receipt	26 June 2014	
Receiving Office	Swedish Patent and Registration Office	
Your reference	P41223WO1	
Applicant	Telefonaktiebolaget L M Ericsson (publ)	
Number of applicants	1	
Country	SE	
Title	METHOD AND RADIO NODE FOR ENABLING USE OF HIGH ORDER MODULATION IN A RADIO COMMUNICATION WITH A USER EQUIPMENT	
Documents submitted	eolf-pkda.xml eolf-appb.xml eolf-fees.xml eolf-othd-000001.pdf (32 p.) eolf-appb-P000001.pdf (7 p.) eolf-othd-000002.zip	eolf-requ.xml eolf-decl.xml eolf-vlog.xml eolf-abst.txt eolf-draw.txt
Submitted by	CN=Angela Norén 12457	
Method of submission	Online	
Date and time receipt generated	26 June 2014, 17:47:58 (CEST)	
Digest	BE:02:7A:65:DD:D5:44:CB:8C:0B:98:8B:1D:2D:AD:5E:78:E3:89:CE	

IPR2022-00457

Apple EX1002 Page 318

/Swedish Patent and Registration Office/

IN THE UNITED STATES PATENT AND TRADEMARK OFFICE

In re Application of **Hammarwall, et al.**)
Serial No.: **TBD**) Examiner: **TBD**
Filed: **TBD**) Group Art Unit: **TBD**
For: **Method and Radio Node for Enabling Use**)
of High Order Modulation in a Radio)
Communication with a User Equipment)
Attorney's Docket No: **4015-8999 / P41223-US2**)

Mail Stop PCT
Commissioner for Patents
P.O. Box 1450
Alexandria, VA 22313-1450

PRELIMINARY AMENDMENT

Please be advised that this is a **U.S. National Stage Filing of PCT Application**

PCT/SE2014/050803.

Prior to examination, please amend the application as indicated below.

AMENDMENTS TO THE CLAIMS

1-26. (Canceled)

27. (New) A method performed by a radio node of a cellular network, the radio node being operable to apply a first table configuration in radio communications with User Equipments (UEs), the first table configuration comprising at least one of a first Modulation and Coding Scheme (MCS) table and a first Channel Quality Indicator (CQI) table, wherein the at least one of the first MCS table and the first CQI table support a certain maximum modulation order, the method comprising:

detecting that a higher modulation order, which is higher than the maximum modulation order of the first table configuration, is potentially possible to use in a radio communication between the radio node and a first UE;

instructing the first UE to apply a second table configuration in the radio communication, the second table configuration comprising at least one of a second MCS table and a second CQI table;

wherein the at least one of the second MCS table and the second CQI table support the higher modulation order;

wherein at least one entry for at least one modulation order in the at least one of the first MCS table and the first CQI table is maintained in the at least one of the second MCS table and the second CQI table as a fallback in case it is desirable to use the at least one modulation order in the at least one of the first MCS table and the first CQI table when the second table configuration is applied.

28. (New) The method of claim 27, wherein the radio node instructs the first UE to apply the second table configuration in the radio communication between the radio node and the first UE when a performance related parameter of signals communicated between the radio node and the first UE is above a threshold.
29. (New) The method of claim 28, wherein the performance related parameter comprises a Signal to Interference and Noise Ratio.
30. (New) The method of claim 28, wherein the radio node instructs a second UE to apply the first table configuration in a radio communication between the radio node and the second UE when the performance related parameter of signals communicated between the radio node and the second UE is below the threshold.
31. (New) The method of claim 30, wherein the radio node instructs the second UE by sending an instruction to the second UE to apply the first table configuration, or by not sending an instruction to the second UE to apply the second table configuration.
32. (New) The method of claim 27, wherein the at least one of the second MCS table and the second CQI table is a modification of the at least one of the first MCS table and the first CQI table, respectively, where a set of entries have been added for the higher modulation order and a set of entries for the at least one modulation order in the at least one of the first MCS table and the first CQI table have been removed.
33. (New) The method of claim 32, wherein the number of added entries for the higher modulation order and the number of removed entries for the at least one modulation order in the at least one of the first MCS table and the first CQI table are equal such that the first and second MCS tables are of equal size and/or the first and second CQI tables are of equal size.

34. (New) The method of claim 27, wherein the at least one modulation order in the at least one of the first MCS table and the first CQI table comprises a lowest modulation order of the first table configuration.
35. (New) The method of claim 34, wherein:
 - the first entry for the lowest modulation order in the first MCS table is maintained in the second MCS table as the fallback;
 - an entry for the lowest coding rate of the lowest modulation order in the first CQI table is maintained in the second CQI table as the fallback.
36. (New) The method of claim 27, wherein the at least one of the second MCS table and the second CQI table is a modification of the at least one of the first MCS table and the first CQI table, respectively, where all entries of the at least one of the first MCS table and the first CQI table have been maintained in the at least one of the second MCS table and the second CQI table and a set of entries for the higher modulation order have been added.
37. (New) The method of claim 27, wherein the first and second table configurations further comprise a Transport Block Size table corresponding to the first and second MCS tables, respectively.

38. (New) A radio node of a cellular network, the radio node being operable to apply a first table configuration in radio communications with User Equipments (UEs), the first table configuration comprising at least one of a first Modulation and Coding Scheme (MCS) table and a first Channel Quality Indicator (CQI) table, wherein the at least one of the first MCS table and the first CQI table support a certain maximum modulation order, the radio node comprising:

one or more processing circuits configured to function as:

a logic circuit configured to detect that a higher modulation order, which is higher than the maximum modulation order of the first table configuration, is potentially possible to use in a radio communication between the radio node and a first UE;

an instructing circuit configured to instruct the first UE to apply a second table configuration in the radio communication, the second table configuration comprising at least one of a second MCS table and a second CQI table;

wherein the at least one of the second MCS table and the second CQI table support the higher modulation order;

wherein at least one entry for at least one modulation order in the at least one of the first MCS table and the first CQI table is maintained in the at least one of the second MCS table and the second CQI table as a fallback in case it is desirable to use the at least one modulation order in the at least one of the first MCS table and the first CQI table when the second table configuration is applied.

39. (New) The radio node of claim 38, wherein the radio node is configured to instruct the first UE to apply the second table configuration in the radio communication between the radio node and the first UE when a performance related parameter of signals communicated between the radio node and the first UE is above a threshold.

40. (New) The radio node of claim 39, wherein the performance related parameter comprises a Signal to Interference and Noise Ratio.
41. (New) The radio node of claim 39, wherein the radio node is configured to instruct a second UE to apply the first table configuration in a radio communication between the radio node and the second UE when the performance related parameter of signals communicated between the radio node and the second UE is below the threshold.
42. (New) The radio node of claim 41, wherein the radio node is configured to instruct the second UE by sending an instruction to the second UE to apply the first table configuration, or by not sending an instruction to the second UE to apply the second table configuration.
43. (New) The radio node of claim 38, wherein the at least one of the second MCS table and the second CQI table is a modification of the at least one of the first MCS table and the first CQI table, respectively, where a set of entries have been added for the higher modulation order and a set of entries for the at least one modulation order in the at least one of the first MCS table and the first CQI table have been removed.
44. (New) The radio node of claim 43, wherein the number of added entries for the higher modulation order and the number of removed entries for the at least one modulation order in the at least one of the first MCS table and the first CQI table are equal such that the first and second MCS tables are of equal size and/or the first and second CQI tables are of equal size.
45. (New) The radio node of claim 38, wherein the at least one modulation order in the at least one of the first MCS table and the first CQI table comprises a lowest modulation order of the first table configuration.

46. (New) The radio node of claim 45, wherein:
the first entry for the lowest modulation order in the first MCS table is maintained in the second MCS table as the fallback;
an entry for the lowest coding rate of the lowest modulation order in the first CQI table is maintained in the second CQI table as the fallback.
47. (New) The radio node of claim 38, wherein the at least one of the second MCS table and the second CQI table is a modification of the at least one of the first MCS table and the first CQI table, respectively, where all entries of the at least one of the first MCS table and the first CQI table have been maintained in the at least one of the second MCS table and the second CQI table and a set of entries for the higher modulation order have been added.
48. (New) The radio node of claim 38, wherein the first and second table configurations further comprise a Transport Block Size table corresponding to the first and second MCS tables, respectively.
49. (New) A method performed by a User Equipment (UE), the UE being operable to apply a first table configuration in a radio communication with a radio node of a cellular network, the first table configuration comprising at least one of a first Modulation and Coding Scheme (MCS) table and a first Channel Quality Indicator (CQI) table, wherein the at least one of the first MCS table and the first CQI table support a certain maximum modulation order, the method comprising:
receiving an instruction from the radio node to apply a second table configuration in the radio communication, the second table configuration comprising at least one of a second MCS table and a second CQI table, wherein the at least one of the second MCS table and the second CQI table support a higher modulation order

which is higher than the maximum modulation order of the first table configuration;

applying the second table configuration in the radio communication with the radio node.

50. (New) A User Equipment (UE), the UE being operable to apply a first table configuration in a radio communication with a radio node of a cellular network, the first table configuration comprising at least one of a first Modulation and Coding Scheme (MCS) table and a first Channel Quality Indicator (CQI) table, wherein the at least one of the first MCS table and the first CQI table support a certain maximum modulation order, the UE comprising:

one or more processing circuits configured to function as:

a communication circuit configured to receive an instruction from the radio node to apply a second table configuration in the radio communication, the second table configuration comprising at least one of a second MCS table and a second CQI table, wherein the at least one of the second MCS table and the second CQI table support a higher modulation order which is higher than the maximum modulation order of the first table configuration;

a logic circuit configured to apply the second table configuration in the radio communication with the radio node.

51. (New) A computer program product stored in a non-transitory computer readable medium for controlling a radio node of a cellular network, the radio node being operable to apply a first table configuration in radio communications with User Equipments (UEs), the first table configuration comprising at least one of a first Modulation and Coding Scheme (MCS) table and a first Channel Quality Indicator (CQI) table, wherein the at least one of the first MCS table and the first CQI table support a certain maximum modulation order, the computer program product comprising software instructions which, when run on one or more processing circuits of the radio node, causes the radio node to:
- detect that a higher modulation order, which is higher than the maximum modulation order of the first table configuration, is potentially possible to use in a radio communication between the radio node and a first UE;
 - instruct the first UE to apply a second table configuration in the radio communication, the second table configuration comprising at least one of a second MCS table and a second CQI table;
- wherein the at least one of the second MCS table and the second CQI table support the higher modulation order;
- wherein at least one entry for at least one modulation order in the at least one of the first MCS table and the first CQI table is maintained in the at least one of the second MCS table and the second CQI table as a fallback in case it is desirable to use the at least one modulation order in the at least one of the first MCS table and the first CQI table when the second table configuration is applied.

52. (New) A computer program product stored in a non-transitory computer readable medium for controlling a User Equipment (UE), the UE being operable to apply a first table configuration in a radio communication with a radio node of a cellular network, the first table configuration comprising at least one of a first Modulation and Coding Scheme (MCS) table and a first Channel Quality Indicator (CQI) table, wherein the at least one of the first MCS table and the first CQI table support a certain maximum modulation order, the computer program product comprising software instructions which, when run on one or more processing circuits of the UE, causes the UE to:
- receive an instruction from the radio node to apply a second table configuration in the radio communication, the second table configuration comprising at least one of a second MCS table and a second CQI table, wherein the at least one of the second MCS table and the second CQI table support a higher modulation order which is higher than the maximum modulation order of the first table configuration;
 - apply the second table configuration in the radio communication with the radio node.

REMARKS

The foregoing claim amendments are submitted prior to examination on the merits. The amendments cancel claims 1-26, and add new claims 27-52. New claims 27-52 are similar to now canceled claims 1-26, but are written to eliminate multiple dependent claims, and to better comport the language of the claims with U.S. practice. No new matter has been added, and the amendments are not submitted for reasons related to patentability over any prior art.

Entry of the amendments is requested prior to examination on the merits.

Respectfully submitted,
COATS & BENNETT P.L.L.C.

/John R. Owen Reg. No. 42055/
John R. Owen
Registration No. 42,055
Telephone: (919) 854-1844

Date: 6 October 2014

DECLARATION (37 CFR 1.63) FOR UTILITY OR DESIGN APPLICATION USING AN APPLICATION DATA SHEET (37 CFR 1.76)	Attorney Docket Number	P41223 WO1
--	------------------------	------------

Title of Invention	METHOD AND RADIO NODE FOR ENABLING USE OF HIGH ORDER MODULATION IN A RADIO COMMUNICATION WITH A USER EQUIPMENT
---------------------------	--

As the below named inventor, I hereby declare that:

This declaration is directed to:

The attached application, or

United States application or PCT international application number PCT/SE2014/050803, filed on June 26, 2014

The above-identified application was made or authorized to be made by me.

I believe that I am the original inventor or an original joint inventor of a claimed invention in the application.

I have reviewed and understand the contents of the above identified application, including the claims, as amended by any amendment specifically referred to above.

I am aware of the duty to disclose information which is material to patentability as defined in 37 CFR 1.56, including for continuation-in-part applications, material information which became available between the filing date of the prior application and the national or PCT international filing date of the continuation-in-part application.

I hereby acknowledge that any willful false statement made in this declaration is punishable under 18 U.S.C. 1001 by fine or imprisonment of not more than five (5) years, or both.

LEGAL NAME OF INVENTOR

Inventor: David Hammarwall

Date (Optional):

Signature:



DECLARATION (37 CFR 1.63) FOR UTILITY OR DESIGN APPLICATION USING AN APPLICATION DATA SHEET (37 CFR 1.76)	Attorney Docket Number	P41223 WO1
--	------------------------	------------

Title of Invention	METHOD AND RADIO NODE FOR ENABLING USE OF HIGH ORDER MODULATION IN A RADIO COMMUNICATION WITH A USER EQUIPMENT
<p>As the below named inventor, I hereby declare that:</p> <p>This declaration is directed to:</p> <p><input type="checkbox"/> The attached application, or</p> <p><input type="checkbox"/> United States application or PCT international application number PCT/SE2014/050803, filed on June 26, 2014</p> <p>The above-identified application was made or authorized to be made by me.</p> <p>I believe that I am the original inventor or an original joint inventor of a claimed invention in the application.</p> <p>I have reviewed and understand the contents of the above identified application, including the claims, as amended by any amendment specifically referred to above.</p> <p>I am aware of the duty to disclose information which is material to patentability as defined in 37 CFR 1.56, including for continuation-in-part applications, material information which became available between the filing date of the prior application and the national or PCT international filing date of the continuation-in-part application.</p> <p>I hereby acknowledge that any willful false statement made in this declaration is punishable under 18 U.S.C. 1001 by fine or imprisonment of not more than five (5) years, or both.</p>	
LEGAL NAME OF INVENTOR	
Inventor: Meng Wang	Date (Optional):
Signature: 	

POWER OF ATTORNEY

The undersigned, being duly authorized representatives of **TELEFONAKTIEBOLAGET L M ERICSSON (PUBL)** (hereinafter referred to as "Ericsson") having its registered office at SE-164 83 Stockholm, Sweden, does hereby authorize **Coats & Bennett P.L.L.C. practitioners associated with United States Patent and Trademark Office Customer Number 24112** to represent Ericsson before the United States Patent and Trademark Office in any and all matters regarding patents or patent applications filed by Ericsson or wherein Ericsson is the assignee of the entire interest thereto.

This Power of Attorney shall include the right for **Coats & Bennett P.L.L.C. practitioners associated with United States Patent and Trademark Office Customer Number 24112** to sign and submit in Ericsson's name and on Ericsson's behalf any document, notification, filing, petition or request in connection with any patent applications or patents owned by or assigned to Ericsson.

This Power of Attorney does not include the right to appoint substitutes but only the persons associated with the above United States Patent and Trademark Office Customer Number.

We hereby revoke all previous authorization, if any made, in respect of same matter or proceeding. This Power of Attorney shall be valid for **five (5) years** from the date hereof unless earlier revoked. This Power of Attorney may be revoked at any time by Ericsson.

Stockholm, Sweden on

TELEFONAKTIEBOLAGET L M ERICSSON (PUBL)

By:

Mr. John Han
Vice President, Patent Development

By:

Mrs. Lena Lundholm Carlsson
CST Manager and PPO

Date:

January 18th, 2012

Date:

January 18th, 2012

I, the undersigned, Anne-Marie Bonde, Notary Public of the City of Stockholm

hereby certify that

John Han and Lena Lundholm Carlsson

duly authorized to sign for

TELEFONAKTIEBOLAGET L M ERICSSON (PUBL)

have issued and signed the foregoing document

Fee 400 :-

Stockholm [Date] 20.01.2012

Crowns

Ex officio:

Signature: Notary Public of the City of Stockholm



Under the Paperwork Reduction Act of 1995, no persons are required to respond to a collection of information unless it displays a valid OMB control number.

STATEMENT UNDER 37 CFR 3.73(c)

Applicant/Patent Owner: Telefonaktiebolaget L M Ericsson (publ)

Application No./Patent No.: TBA Filed/Issue Date: TBA

Titled: Method and Radio Node for Enabling Use of High Order Modulation in a Radio Communication with a User Equipment

Telefonaktiebolaget L M Ericsson (publ), a corporation

(Name of Assignee)

(Type of Assignee, e.g., corporation, partnership, university, government agency, etc.)

states that, for the patent application/patent identified above, it is (choose **one** of options 1, 2, 3 or 4 below):

- 1. The assignee of the entire right, title, and interest.
- 2. An assignee of less than the entire right, title, and interest (check applicable box):
 - The extent (by percentage) of its ownership interest is _____%. Additional Statement(s) by the owners holding the balance of the interest must be submitted to account for 100% of the ownership interest.
 - There are unspecified percentages of ownership. The other parties, including inventors, who together own the entire right, title and interest are:

Additional Statement(s) by the owner(s) holding the balance of the interest must be submitted to account for the entire right, title, and interest.

- 3. The assignee of an undivided interest in the entirety (a complete assignment from one of the joint inventors was made). The other parties, including inventors, who together own the entire right, title, and interest are:

Additional Statement(s) by the owner(s) holding the balance of the interest must be submitted to account for the entire right, title, and interest.

- 4. The recipient, via a court proceeding or the like (e.g., bankruptcy, probate), of an undivided interest in the entirety (a complete transfer of ownership interest was made). The certified document(s) showing the transfer is attached.

The interest identified in option 1, 2 or 3 above (not option 4) is evidenced by either (choose **one** of options A or B below):

- A. An assignment from the inventor(s) of the patent application/patent identified above. The assignment was recorded in the United States Patent and Trademark Office at Reel _____, Frame _____, or for which a copy thereof is attached.
- B. A chain of title from the inventor(s), of the patent application/patent identified above, to the current assignee as follows:

1. From: _____ To: _____

The document was recorded in the United States Patent and Trademark Office at Reel _____, Frame _____, or for which a copy thereof is attached.

2. From: _____ To: _____

The document was recorded in the United States Patent and Trademark Office at Reel _____, Frame _____, or for which a copy thereof is attached.

This collection of information is required by 37 CFR 3.73(b). The information is required to obtain or retain a benefit by the public which is to file (and by the USPTO to process) an application. Confidentiality is governed by 35 U.S.C. 122 and 37 CFR 1.11 and 1.14. This collection is estimated to take 12 minutes to complete, including gathering, preparing, and submitting the completed application form to the USPTO. Time will vary depending upon the individual case. Any comments on the amount of time you require to complete this form and/or suggestions for reducing this burden, should be sent to the Chief Information Officer, U.S. Patent and Trademark Office, U.S. Department of Commerce, P.O. Box 1450, Alexandria, VA 22313-1450. DO NOT SEND FEES OR COMPLETED FORMS TO THIS ADDRESS. **SEND TO: Commissioner for Patents, P.O. Box 1450, Alexandria, VA 22313-1450.**

STATEMENT UNDER 37 CFR 3.73(c)

3. From: _____ To: _____

The document was recorded in the United States Patent and Trademark Office at
Reel _____, Frame _____, or for which a copy thereof is attached.

4. From: _____ To: _____

The document was recorded in the United States Patent and Trademark Office at
Reel _____, Frame _____, or for which a copy thereof is attached.

5. From: _____ To: _____

The document was recorded in the United States Patent and Trademark Office at
Reel _____, Frame _____, or for which a copy thereof is attached.

6. From: _____ To: _____

The document was recorded in the United States Patent and Trademark Office at
Reel _____, Frame _____, or for which a copy thereof is attached.

Additional documents in the chain of title are listed on a supplemental sheet(s).

As required by 37 CFR 3.73(c)(1)(i), the documentary evidence of the chain of title from the original owner to the assignee was, or concurrently is being, submitted for recordation pursuant to 37 CFR 3.11.

[NOTE: A separate copy (i.e., a true copy of the original assignment document(s)) must be submitted to Assignment Division in accordance with 37 CFR Part 3, to record the assignment in the records of the USPTO. See MPEP 302.08]

The undersigned (whose title is supplied below) is authorized to act on behalf of the assignee.

/John R. Owen Reg. No. 42055/

6 October 2014

Signature

Date

John R. Owen

42055

Printed or Typed Name

Title or Registration Number

Privacy Act Statement

The **Privacy Act of 1974 (P.L. 93-579)** requires that you be given certain information in connection with your submission of the attached form related to a patent application or patent. Accordingly, pursuant to the requirements of the Act, please be advised that: (1) the general authority for the collection of this information is 35 U.S.C. 2(b)(2); (2) furnishing of the information solicited is voluntary; and (3) the principal purpose for which the information is used by the U.S. Patent and Trademark Office is to process and/or examine your submission related to a patent application or patent. If you do not furnish the requested information, the U.S. Patent and Trademark Office may not be able to process and/or examine your submission, which may result in termination of proceedings or abandonment of the application or expiration of the patent.

The information provided by you in this form will be subject to the following routine uses:

1. The information on this form will be treated confidentially to the extent allowed under the Freedom of Information Act (5 U.S.C. 552) and the Privacy Act (5 U.S.C. 552a). Records from this system of records may be disclosed to the Department of Justice to determine whether disclosure of these records is required by the Freedom of Information Act.
2. A record from this system of records may be disclosed, as a routine use, in the course of presenting evidence to a court, magistrate, or administrative tribunal, including disclosures to opposing counsel in the course of settlement negotiations.
3. A record in this system of records may be disclosed, as a routine use, to a Member of Congress submitting a request involving an individual, to whom the record pertains, when the individual has requested assistance from the Member with respect to the subject matter of the record.
4. A record in this system of records may be disclosed, as a routine use, to a contractor of the Agency having need for the information in order to perform a contract. Recipients of information shall be required to comply with the requirements of the Privacy Act of 1974, as amended, pursuant to 5 U.S.C. 552a(m).
5. A record related to an International Application filed under the Patent Cooperation Treaty in this system of records may be disclosed, as a routine use, to the International Bureau of the World Intellectual Property Organization, pursuant to the Patent Cooperation Treaty.
6. A record in this system of records may be disclosed, as a routine use, to another federal agency for purposes of National Security review (35 U.S.C. 181) and for review pursuant to the Atomic Energy Act (42 U.S.C. 218(c)).
7. A record from this system of records may be disclosed, as a routine use, to the Administrator, General Services, or his/her designee, during an inspection of records conducted by GSA as part of that agency's responsibility to recommend improvements in records management practices and programs, under authority of 44 U.S.C. 2904 and 2906. Such disclosure shall be made in accordance with the GSA regulations governing inspection of records for this purpose, and any other relevant (*i.e.*, GSA or Commerce) directive. Such disclosure shall not be used to make determinations about individuals.
8. A record from this system of records may be disclosed, as a routine use, to the public after either publication of the application pursuant to 35 U.S.C. 122(b) or issuance of a patent pursuant to 35 U.S.C. 151. Further, a record may be disclosed, subject to the limitations of 37 CFR 1.14, as a routine use, to the public if the record was filed in an application which became abandoned or in which the proceedings were terminated and which application is referenced by either a published application, an application open to public inspection or an issued patent.
9. A record from this system of records may be disclosed, as a routine use, to a Federal, State, or local law enforcement agency, if the USPTO becomes aware of a violation or potential violation of law or regulation.

ASSIGNMENT

This Assignment is made by:

HAMMARWALL, David

**Hällmarksvägen 59
SE-186 53 VALLENTUNA
Sweden
Signalistgatan 14
SE-169 72 SOLNA
Sweden**

WANG, Meng

(hereinafter referred to as "Assignor(s)") in favor, and for the benefit and behoof of, Telefonaktiebolaget L M Ericsson (publ), a corporation duly organized under and pursuant to the laws of Sweden and having its principal place of business at SE-164 83 Stockholm, Sweden (hereinafter referred to as "Assignee").

For good, sufficient and adequate consideration, the receipt of which is hereby acknowledged, the Assignor(s) have, as of the Effective Date, sold, assigned, transferred, and set over, and by these presents, and to the extent any transferable or assignable rights still remain with the inventor, do hereby sell, assign, transfer, and set over, unto the Assignee, its successors, legal representatives, and assigns the entire right, title, and interest in and to the following inventions, application(s) for Letters Patent, and any and all Letters Patent or Patents in all countries and pursuant to all multilateral treaty organizations, including Sweden, the United States of America, the Patent Cooperation Treaty and European Patent Convention, that may be granted therefor and thereon, and in and to any and all divisions, continuations, continuations-in-part, conversions and utility models of said application(s), and reissues and extensions of said Letters Patent or Patents, the same to be held and enjoyed by the Assignee, for its use and behoof and the use and the behoof of its successors, legal representatives, and assigns, to the full end of the term or terms for which Letters Patent, Patents and Utility Models may be granted as fully and entirely as the same would have been held and enjoyed by the Assignor(s) had this sale and assignment not been made:

METHOD AND RADIO NODE FOR ENABLING USE OF HIGH ORDER MODULATION IN A RADIO COMMUNICATION WITH A USER EQUIPMENT

including, but not limited to, the application(s) for Letters Patent and Utility Model filed in:

Country Code	Priority Application(s)	Filing Date(s)
WO	PCT/SE2014/050803	2014-06-26
		- -

The Effective date is the earliest date of the above listed Filing Date(s).

Assignor(s) hereby authorize and request Assignee's Attorneys to insert the serial number and filing date of said application(s) for Letter Patent or Utility Model, when known. The assignment of the above mentioned rights includes a transfer of the whole right to use a priority (including priority according to any convention, multilateral agreement, bilateral agreement and national law) of the above mentioned application(s) for Letter Patent and Utility Model in all countries and multilateral treaty organizations wherein no residual rights shall remain with the Assignor(s). Assignor(s) hereby request

ASSIGNMENT

that said Letters Patent, Patent or Utility Model be issued to Assignee as the Assignee of said inventions, the Letters Patent, Patent or Utility Model to be issued for the sole use and behoof of the Assignee, its successors, legal representatives, and assigns. Assignee alone hereinafter has the entire disposal of the invention and possesses entire ownership to any domestic and foreign patents or utility models granted thereafter. The rights granted hereunder shall include all rights to institute legal actions, obtain remedies and recover and retain damages in respect to said Letters Patent, Patent or Utility Model.

The Assignor(s) and Assignee hereby understand and agree that with the execution of this Assignment, to the extent necessary or appropriate, national and/or regional applications may be filed by the Assignee as the applicant and on behalf of the assignor.

To the extent Assignee is entitled to receive the rights hereunder pursuant to this Assignment, each of the Assignor(s) hereby covenants and agrees to and with the Assignee, its successors, legal representatives, and assigns, that, at the time of the Effective Date, the Assignor(s) were the sole and lawful owners of the entire right, title, and interest in and to the inventions and application(s) for Letters Patent or Utility Models above-mentioned, and that the same are unencumbered, and that the Assignor(s) have good and full right and lawful authority to sell and convey the same in the manner herein set forth.

Further, and for the same consideration, the Assignor(s) hereby covenant(s) and agree(s) to and with the Assignee, its successors, legal representatives, and assigns that the Assignor(s) will, whenever counsel of the Assignee, or the counsel of its successors, legal representatives, and assigns, shall advise that any proceeding in connection with said inventions or said application(s) for Letters Patent or Utility Model, or any proceeding in connection with Letters Patent or Utility Model for said inventions, in any country and any multilateral treaty organization, including interference proceedings, is lawful and desirable, or that any division, continuation, continuation-in-part, conversion or Utility Model of any application(s) for Letters Patent or Utility Model, or any reissue or extension of any Letters Patent to be obtained thereon, is lawful and desirable, sign all papers and documents, take all lawful oaths, and do all acts necessary or required to be done for the procurement, maintenance, enforcement, and defense of Letters Patent or Utility Model for said inventions, without charge to Assignee, its successors, legal representatives, and assigns, but at the cost and expense of the Assignee, its successors, legal representatives, and assigns. If any of the Assignor(s) is prevented by any obstacles from signing said documents in person, this Assignment shall be valid as a Power of Attorney for the Assignee to sign these documents on behalf of any such Assignor(s) or, in the event of the death of the latter, the estate thereof.

This Assignment shall be governed by and construed under, and any dispute, controversy or claim related hereto shall be decided in accordance with, the laws of:

Sweden

without regard to the conflicts of laws provisions thereof. Any dispute, controversy or claim arising under, out of or relating to this Assignment and any subsequent amendments of this Assignment, including, without limitation, its formation, validity, binding effect, interpretation, performance, breach or termination, as well as non-contractual claims, shall be referred to and finally determined by arbitration in accordance with the WIPO Arbitration Rules. The arbitral tribunal shall consist of a sole arbitrator. The place of

ASSIGNMENT

arbitration shall be in the country of the inventor's residence. The language to be used in the arbitral proceedings shall be English.

No modifications shall be made to this Assignment unless in writing and signed by each of the Assignor(s) and Assignee. If any of the provisions of this Assignment shall be deemed invalid or unenforceable, then the entire Assignment shall be construed as if not containing the particular invalid or unenforceable provision or provisions, and the rights and obligations of Assignee and Assignor(s) shall be construed and enforced accordingly. Assignee's failure to exercise any option made available as a result hereof, shall not be construed as a waiver of such provisions, rights, or options, or affect the validity of this Assignment. Assignor covenants and agrees that it will not take any actions in violation of this Assignment.

Subsequent assignment from any of the assignors to the assignee purporting to convey the subject matter specified herein for a particular country, patent office, or jurisdiction shall not invalidate any provision of this assignment and any such subsequent assignment shall act as a further confirmation of the assignment herein.

Date: September 18, 2019 Signature on behalf of 
Assignee Roger Bou Faical

ASSIGNMENT

Title: METHOD AND RADIO NODE FOR ENABLING USE OF HIGH ORDER MODULATION IN A RADIO COMMUNICATION WITH A USER EQUIPMENT

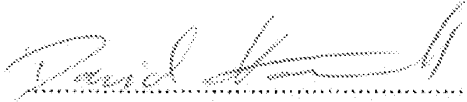
Date August 4, 2014 Signature of Assignor 
HAMMARWALL, David

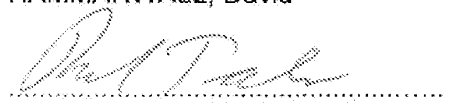
Date August 4, 2014 Witnessed by 
Name: Paul Teder
Address: Palissadgränd 24
187 46 TÄBY
Sweden

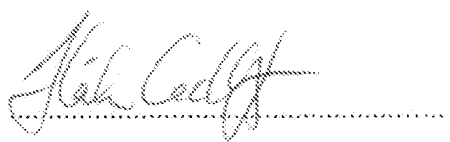
Date August 4, 2014 Witnessed by 
Name: Håkan Cedlöf
Address: Börjesonsvägen 28
16850 BROMMA
Sweden

ASSIGNMENT

Title: METHOD AND RADIO NODE FOR ENABLING USE OF HIGH ORDER MODULATION IN A RADIO COMMUNICATION WITH A USER EQUIPMENT

Date 2014-07-03 Signature of Assignor 
WANG, Meng

Date 2014-07-03 Witnessed by 
Name: RICARDO BUSCO SERRANO
Address: VÄSTGÖTAGRÄND 5 LÖN 1405
14117 STOCKHOLM
SWEDEN

Date 2014-07-03 Witnessed by 
Name: NABIL SEBBA
Address: Blicklochvägen 6
19164 Sollentuna
SWEDEN

INFORMATION DISCLOSURE STATEMENT BY APPLICANT (Not for submission under 37 CFR 1.99)	Application Number		
	Filing Date		
	First Named Inventor	Hammarwall	
	Art Unit		
	Examiner Name		
	Attorney Docket Number	4015-8999 / P41223-US2	

U.S. PATENTS						Remove
Examiner Initial*	Cite No	Patent Number	Kind Code ¹	Issue Date	Name of Patentee or Applicant of cited Document	Pages, Columns, Lines where Relevant Passages or Relevant Figures Appear
	1					

If you wish to add additional U.S. Patent citation information please click the Add button. Add

U.S. PATENT APPLICATION PUBLICATIONS						Remove
Examiner Initial*	Cite No	Publication Number	Kind Code ¹	Publication Date	Name of Patentee or Applicant of cited Document	Pages, Columns, Lines where Relevant Passages or Relevant Figures Appear
	1					

If you wish to add additional U.S. Published Application citation information please click the Add button. Add

FOREIGN PATENT DOCUMENTS								Remove
Examiner Initial*	Cite No	Foreign Document Number ³	Country Code ² j	Kind Code ⁴	Publication Date	Name of Patentee or Applicant of cited Document	Pages, Columns, Lines where Relevant Passages or Relevant Figures Appear	T ⁵
	1							<input type="checkbox"/>

If you wish to add additional Foreign Patent Document citation information please click the Add button. Add

NON-PATENT LITERATURE DOCUMENTS			Remove
Examiner Initials*	Cite No	Include name of the author (in CAPITAL LETTERS), title of the article (when appropriate), title of the item (book, magazine, journal, serial, symposium, catalog, etc), date, pages(s), volume-issue number(s), publisher, city and/or country where published.	T ⁵

**INFORMATION DISCLOSURE
STATEMENT BY APPLICANT**
(Not for submission under 37 CFR 1.99)

Application Number	
Filing Date	
First Named Inventor	Hammarwall
Art Unit	
Examiner Name	
Attorney Docket Number	4015-8999 / P41223-US2

1	3RD GENERATION PARTNERSHIP PROJECT, "LTE; Evolved Universal Terrestrial Radio Access (E-UTRA); Physical layer procedures (3GPP TS 36.213 version 11.2.0 Release 11)", Technical Specification, ETSI TS 136 213 V11.2.0, 2013-04-01, pp. 1-175, ETSI, France	<input type="checkbox"/>
---	---	--------------------------

If you wish to add additional non-patent literature document citation information please click the Add button **Add**

EXAMINER SIGNATURE

Examiner Signature		Date Considered	
--------------------	--	-----------------	--

*EXAMINER: Initial if reference considered, whether or not citation is in conformance with MPEP 609. Draw line through a citation if not in conformance and not considered. Include copy of this form with next communication to applicant.

¹ See Kind Codes of USPTO Patent Documents at www.USPTO.GOV or MPEP 901.04. ² Enter office that issued the document, by the two-letter code (WIPO Standard ST.3). ³ For Japanese patent documents, the indication of the year of the reign of the Emperor must precede the serial number of the patent document. ⁴ Kind of document by the appropriate symbols as indicated on the document under WIPO Standard ST.16 if possible. ⁵ Applicant is to place a check mark here if English language translation is attached.

**INFORMATION DISCLOSURE
STATEMENT BY APPLICANT**
(Not for submission under 37 CFR 1.99)

Application Number	
Filing Date	
First Named Inventor	Hammarwall
Art Unit	
Examiner Name	
Attorney Docket Number	4015-8999 / P41223-US2

CERTIFICATION STATEMENT

Please see 37 CFR 1.97 and 1.98 to make the appropriate selection(s):

That each item of information contained in the information disclosure statement was first cited in any communication from a foreign patent office in a counterpart foreign application not more than three months prior to the filing of the information disclosure statement. See 37 CFR 1.97(e)(1).

OR

That no item of information contained in the information disclosure statement was cited in a communication from a foreign patent office in a counterpart foreign application, and, to the knowledge of the person signing the certification after making reasonable inquiry, no item of information contained in the information disclosure statement was known to any individual designated in 37 CFR 1.56(c) more than three months prior to the filing of the information disclosure statement. See 37 CFR 1.97(e)(2).

See attached certification statement.

The fee set forth in 37 CFR 1.17 (p) has been submitted herewith.

A certification statement is not submitted herewith.

SIGNATURE

A signature of the applicant or representative is required in accordance with CFR 1.33, 10.18. Please see CFR 1.4(d) for the form of the signature.

Signature	/John R. Owen Reg. No. 42055/	Date (YYYY-MM-DD)	2014-10-06
Name/Print	John R. Owen	Registration Number	42055

This collection of information is required by 37 CFR 1.97 and 1.98. The information is required to obtain or retain a benefit by the public which is to file (and by the USPTO to process) an application. Confidentiality is governed by 35 U.S.C. 122 and 37 CFR 1.14. This collection is estimated to take 1 hour to complete, including gathering, preparing and submitting the completed application form to the USPTO. Time will vary depending upon the individual case. Any comments on the amount of time you require to complete this form and/or suggestions for reducing this burden, should be sent to the Chief Information Officer, U.S. Patent and Trademark Office, U.S. Department of Commerce, P.O. Box 1450, Alexandria, VA 22313-1450. DO NOT SEND FEES OR COMPLETED FORMS TO THIS ADDRESS. **SEND TO: Commissioner for Patents, P.O. Box 1450, Alexandria, VA 22313-1450.**

Privacy Act Statement

The Privacy Act of 1974 (P.L. 93-579) requires that you be given certain information in connection with your submission of the attached form related to a patent application or patent. Accordingly, pursuant to the requirements of the Act, please be advised that: (1) the general authority for the collection of this information is 35 U.S.C. 2(b)(2); (2) furnishing of the information solicited is voluntary; and (3) the principal purpose for which the information is used by the U.S. Patent and Trademark Office is to process and/or examine your submission related to a patent application or patent. If you do not furnish the requested information, the U.S. Patent and Trademark Office may not be able to process and/or examine your submission, which may result in termination of proceedings or abandonment of the application or expiration of the patent.

The information provided by you in this form will be subject to the following routine uses:

1. The information on this form will be treated confidentially to the extent allowed under the Freedom of Information Act (5 U.S.C. 552) and the Privacy Act (5 U.S.C. 552a). Records from this system of records may be disclosed to the Department of Justice to determine whether the Freedom of Information Act requires disclosure of these records.
2. A record from this system of records may be disclosed, as a routine use, in the course of presenting evidence to a court, magistrate, or administrative tribunal, including disclosures to opposing counsel in the course of settlement negotiations.
3. A record in this system of records may be disclosed, as a routine use, to a Member of Congress submitting a request involving an individual, to whom the record pertains, when the individual has requested assistance from the Member with respect to the subject matter of the record.
4. A record in this system of records may be disclosed, as a routine use, to a contractor of the Agency having need for the information in order to perform a contract. Recipients of information shall be required to comply with the requirements of the Privacy Act of 1974, as amended, pursuant to 5 U.S.C. 552a(m).
5. A record related to an International Application filed under the Patent Cooperation Treaty in this system of records may be disclosed, as a routine use, to the International Bureau of the World Intellectual Property Organization, pursuant to the Patent Cooperation Treaty.
6. A record in this system of records may be disclosed, as a routine use, to another federal agency for purposes of National Security review (35 U.S.C. 181) and for review pursuant to the Atomic Energy Act (42 U.S.C. 218(c)).
7. A record from this system of records may be disclosed, as a routine use, to the Administrator, General Services, or his/her designee, during an inspection of records conducted by GSA as part of that agency's responsibility to recommend improvements in records management practices and programs, under authority of 44 U.S.C. 2904 and 2906. Such disclosure shall be made in accordance with the GSA regulations governing inspection of records for this purpose, and any other relevant (i.e., GSA or Commerce) directive. Such disclosure shall not be used to make determinations about individuals.
8. A record from this system of records may be disclosed, as a routine use, to the public after either publication of the application pursuant to 35 U.S.C. 122(b) or issuance of a patent pursuant to 35 U.S.C. 151. Further, a record may be disclosed, subject to the limitations of 37 CFR 1.14, as a routine use, to the public if the record was filed in an application which became abandoned or in which the proceedings were terminated and which application is referenced by either a published application, an application open to public inspections or an issued patent.
9. A record from this system of records may be disclosed, as a routine use, to a Federal, State, or local law enforcement agency, if the USPTO becomes aware of a violation or potential violation of law or regulation.

Electronic Patent Application Fee Transmittal

Application Number:				
Filing Date:				
Title of Invention:	Method and Radio Node for Enabling Use of High Order Modulation in a Radio Communication with a User Equipment			
First Named Inventor/Applicant Name:	David Hammarwall			
Filer:	John R. Owen/Katya Fox			
Attorney Docket Number:	4015-8999 / P41223-US2			
Filed as Large Entity				
U.S. National Stage under 35 USC 371 Filing Fees				
Description	Fee Code	Quantity	Amount	Sub-Total in USD(\$)
Basic Filing:				
National Stage Fee	1631	1	280	280
National Stage Search - all other cases	1632	1	600	600
National Stage Exam - all other cases	1633	1	720	720
Pages:				
Claims:				
Claims in excess of 20	1615	6	80	480
Independent claims in excess of 3	1614	3	420	1260
Miscellaneous-Filing:				

Description	Fee Code	Quantity	Amount	Sub-Total in USD(\$)
Petition:				
Patent-Appeals-and-Interference:				
Post-Allowance-and-Post-Issuance:				
Extension-of-Time:				
Miscellaneous:				
Total in USD (\$)				3340

Electronic Acknowledgement Receipt

EFS ID:	20338046
Application Number:	14390904
International Application Number:	PCT/SE2014/050803
Confirmation Number:	7239
Title of Invention:	Method and Radio Node for Enabling Use of High Order Modulation in a Radio Communication with a User Equipment
First Named Inventor/Applicant Name:	David Hammarwall
Customer Number:	24112
Filer:	John R. Owen/Katya Fox
Filer Authorized By:	John R. Owen
Attorney Docket Number:	4015-8999 / P41223-US2
Receipt Date:	06-OCT-2014
Filing Date:	
Time Stamp:	15:40:09
Application Type:	U.S. National Stage under 35 USC 371

Payment information:

Submitted with Payment	yes
Payment Type	Electronic Funds Transfer
Payment was successfully received in RAM	\$ 3340
RAM confirmation Number	2119
Deposit Account	
Authorized User	

File Listing:

Document Number	Document Description	File Name	File Size(Bytes) Message Digest	Multi-Part / Zip	Pages (if appl.)
					IPR2022-00457

1	Transmittal of New Application	Transmittal.pdf	217911	no	4
			13318734feaebc56e0fb15f34b9ee7c759587913		
Warnings:					
Information:					
2	Application Data Sheet	ADS.pdf	1561381	no	7
			69864748f7563b7058bd4558ac781d8994b1492		
Warnings:					
Information:					
3		Application.pdf	210668	yes	32
			a0904a8c6c4408e007b2a5bfbcca7a63c0b73400		
Multipart Description/PDF files in .zip description					
Document Description			Start	End	
Specification			1	25	
Claims			26	31	
Abstract			32	32	
Warnings:					
Information:					
4	Drawings-only black and white line drawings	Drawings.pdf	59680	no	7
			4107db1acd7b623c669059a50b2800ed367ba18d		
Warnings:					
Information:					
5	Documents submitted with 371 Applications	PCT_Request.pdf	45888	no	6
			85a8ec3349710693d8932edd073873447390d020		
Warnings:					
Information:					
6	Documents submitted with 371 Applications	PCT_Receipt.pdf	51197	no	2
			8d434fa18f805b19ced442922ebc19e8dcea8adf		
Warnings:					
Information:					
7	Preliminary Amendment	Preliminary_Amendment.pdf	42979	no	11
			497d1c745ca9688b747cfc700d8024116d552d6b		
Warnings:					
Information:					

8	Oath or Declaration filed	Declaration.pdf	1396716	no	2
			873cf836d6981e9b69f7d5943cd720207a915250		
Warnings:					
Information:					
9	Power of Attorney	POA.pdf	927756	no	1
			53e297355923e6d5259f2bf44cdeefb4f6cc01d		
Warnings:					
Information:					
10	Assignee showing of ownership per 37 CFR 3.73.	Statement_373c.pdf	48451	no	3
			2fa81380611a89a9cbac6cbf976b5a12e0b3223f		
Warnings:					
Information:					
11	Assignee showing of ownership per 37 CFR 3.73.	Assignment.pdf	3822774	no	5
			4da8b5c3af7d363005507667f5ab976674c15155		
Warnings:					
Information:					
12	Information Disclosure Statement (IDS) Form (SB08)	IDS.pdf	612290	no	4
			05679a57a6b079e7ee552dbbcc709c94c1274d		
Warnings:					
Information:					
A U.S. Patent Number Citation or a U.S. Publication Number Citation is required in the Information Disclosure Statement (IDS) form for autoloading of data into USPTO systems. You may remove the form to add the required data in order to correct the Informational Message if you are citing U.S. References. If you chose not to include U.S. References, the image of the form will be processed and be made available within the Image File Wrapper (IFW) system. However, no data will be extracted from this form. Any additional data such as Foreign Patent Documents or Non Patent Literature will be manually reviewed and keyed into USPTO systems.					
13	Non Patent Literature	ETSI_TS_136213.pdf	14467233	no	175
			f6558edd84b8a8cdf08636014dd1145e009551124		
Warnings:					
Information:					
14	Fee Worksheet (SB06)	fee-info.pdf	38206	no	2
			f638bbe4bf0d1b6d4e72ffe2e8173c9fb7b6db3		
Warnings:					
Information:					
Total Files Size (in bytes):			23503130		

This Acknowledgement Receipt evidences receipt on the noted date by the USPTO of the indicated documents, characterized by the applicant, and including page counts, where applicable. It serves as evidence of receipt similar to a Post Card, as described in MPEP 503.

New Applications Under 35 U.S.C. 111

If a new application is being filed and the application includes the necessary components for a filing date (see 37 CFR 1.53(b)-(d) and MPEP 506), a Filing Receipt (37 CFR 1.54) will be issued in due course and the date shown on this Acknowledgement Receipt will establish the filing date of the application.

National Stage of an International Application under 35 U.S.C. 371

If a timely submission to enter the national stage of an international application is compliant with the conditions of 35 U.S.C. 371 and other applicable requirements a Form PCT/DO/EO/903 indicating acceptance of the application as a national stage submission under 35 U.S.C. 371 will be issued in addition to the Filing Receipt, in due course.

New International Application Filed with the USPTO as a Receiving Office

If a new international application is being filed and the international application includes the necessary components for an international filing date (see PCT Article 11 and MPEP 1810), a Notification of the International Application Number and of the International Filing Date (Form PCT/RO/105) will be issued in due course, subject to prescriptions concerning national security, and the date shown on this Acknowledgement Receipt will establish the international filing date of the application.

PCT

Print Out (Original in Electronic Form)

VIII-3-1	Declaration: Entitlement to claim priority Declaration as to the applicant's entitlement, as at the international filing date, to claim the priority of the earlier application specified below, where the applicant is not the applicant who filed the earlier application or where the applicant's name has changed since the filing of the earlier application (Rules 4.17(iii) and 51bis.1(a)(iii)) Name	<p>In relation to this international application</p> <p>Telefonaktiebolaget L M Ericsson (publ) is entitled to claim priority of earlier application No. 61/863,935 by virtue of the following:</p>
VIII-3-1(i)		ERICSSON AB is entitled as employer of the inventor, HAMMARWALL, David and the inventor WANG, Meng
VIII-3-1(vii)		transfer of entitlement from ERICSSON AB to Telefonaktiebolaget L M Ericsson (publ) by way of a general Assignment on transfer of ownership to invention already made and to be made in the future by employees of ERICSSON AB, dated 27 February 2003 (27.02.2003)

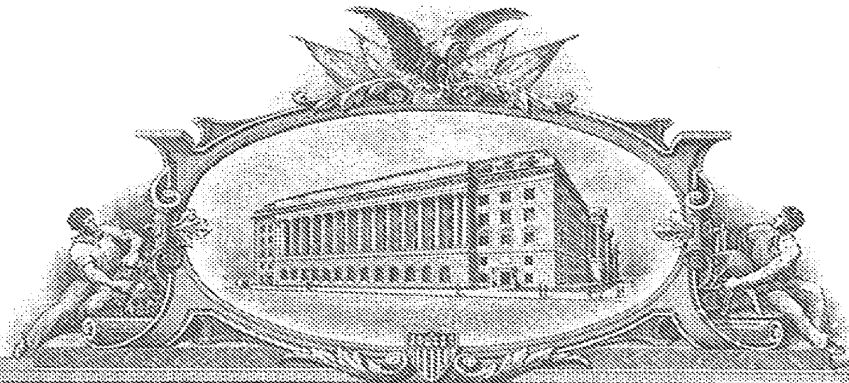

THE UNITED STATES OF AMERICA

TO ALL TO WHOM THESE PRESENTS SHALL COME:

UNITED STATES DEPARTMENT OF COMMERCE

United States Patent and Trademark Office

July 02, 2014

THIS IS TO CERTIFY THAT ANNEXED HERETO IS A TRUE COPY FROM THE RECORDS OF THE UNITED STATES PATENT AND TRADEMARK OFFICE OF THOSE PAPERS OF THE BELOW IDENTIFIED PATENT APPLICATION THAT MET THE REQUIREMENTS TO BE GRANTED A FILING DATE UNDER 35 USC 111.

APPLICATION NUMBER: 61/863,935
FILING DATE: August 09, 2013

THE COUNTRY CODE AND NUMBER OF YOUR PRIORITY APPLICATION, TO BE USED FOR FILING ABROAD UNDER THE PARIS CONVENTION, IS US61/863,935



Certified by

David J. Kappas

Under Secretary of Commerce
for Intellectual Property
and Director of the United States
Patent and Trademark Office

IPR2022-00457

Under the Paperwork Reduction Act of 1995, no persons are required to respond to a collection of information unless it contains a valid OMB control number.

Application Data Sheet 37 CFR 1.76		Attorney Docket Number	PS54636US00
		Application Number	
Title of Invention	METHOD AND RADIO NODE FOR ENABLING USE OF HIGH ORDER MODULATION IN A RADIO COMMUNICATION WITH A USER EQUIPMENT		
The application data sheet is part of the provisional or nonprovisional application for which it is being submitted. The following form contains the bibliographic data arranged in a format specified by the United States Patent and Trademark Office as outlined in 37 CFR 1.76. This document may be completed electronically and submitted to the Office in electronic format using the Electronic Filing System (EFS) or the document may be printed and included in a paper filed application.			

Secrecy Order 37 CFR 5.2

Portions or all of the application associated with this Application Data Sheet may fall under a Secrecy Order pursuant to 37 CFR 5.2 (Paper filers only. Applications that fall under Secrecy Order may not be filed electronically.)

Inventor Information:

Inventor 1					<input type="button" value="Remove"/>
Legal Name					
Prefix	Given Name	Middle Name	Family Name	Suffix	
	David		HAMMARWALL		
Residence Information (Select One) <input type="radio"/> US Residency <input checked="" type="radio"/> Non US Residency <input type="radio"/> Active US Military Service					
City	Vallentuna	Country of Residence i	SE		
Mailing Address of Inventor:					
Address 1	Hällmarksvägen 59				
Address 2					
City	Vallentuna	State/Province			
Postal Code	SE-186 53	Country i	SE		
Inventor 2					<input type="button" value="Remove"/>
Legal Name					
Prefix	Given Name	Middle Name	Family Name	Suffix	
	Meng		WANG		
Residence Information (Select One) <input type="radio"/> US Residency <input checked="" type="radio"/> Non US Residency <input type="radio"/> Active US Military Service					
City	Solna	Country of Residence i	SE		
Mailing Address of Inventor:					
Address 1	Signalistgatan 14				
Address 2					
City	Solna	State/Province			
Postal Code	SE-169 72	Country i	SE		
All Inventors Must Be Listed - Additional Inventor Information blocks may be generated within this form by selecting the Add button.					<input type="button" value="Add"/>

Correspondence Information:

IPR2022-00457

Apple EX1002 Page 355

Under the Paperwork Reduction Act of 1995, no persons are required to respond to a collection of information unless it contains a valid OMB control number.

Application Data Sheet 37 CFR 1.76	Attorney Docket Number	PS54636US00
	Application Number	
Title of Invention	METHOD AND RADIO NODE FOR ENABLING USE OF HIGH ORDER MODULATION IN A RADIO COMMUNICATION WITH A USER EQUIPMENT	

Enter either Customer Number or complete the Correspondence Information section below.
For further information see 37 CFR 1.33(a).

An Address is being provided for the correspondence information of this application.

Customer Number	11754		
Email Address	valeacases@valea.se	<input type="button" value="Add Email"/>	<input type="button" value="Remove Email"/>
Email Address	sarah.rodriguez@valea.se	<input type="button" value="Add Email"/>	<input type="button" value="Remove Email"/>

Application Information:

Title of the Invention	METHOD AND RADIO NODE FOR ENABLING USE OF HIGH ORDER MODULATION IN A RADIO COMMUNICATION WITH A USER EQUIPMENT		
Attorney Docket Number	PS54636US00	Small Entity Status Claimed	<input type="checkbox"/>
Application Type	Provisional		
Subject Matter	Utility		
Total Number of Drawing Sheets (if any)	7	Suggested Figure for Publication (if any)	

Publication Information:

Request Early Publication (Fee required at time of Request 37 CFR 1.219)

Request Not to Publish. I hereby request that the attached application not be published under 35 U.S.C. 122(b) and certify that the invention disclosed in the attached application **has not and will not** be the subject of an application filed in another country, or under a multilateral international agreement, that requires publication at eighteen months after filing.

Representative Information:

Representative information should be provided for all practitioners having a power of attorney in the application. Providing this information in the Application Data Sheet does not constitute a power of attorney in the application (see 37 CFR 1.32). Either enter Customer Number or complete the Representative Name section below. If both sections are completed the customer Number will be used for the Representative Information during processing.

Please Select One:	<input checked="" type="radio"/> Customer Number	<input type="radio"/> US Patent Practitioner	<input type="radio"/> Limited Recognition (37 CFR 11.9)
Customer Number	11754		

Domestic Benefit/National Stage Information:

This section allows for the applicant to either claim benefit under 35 U.S.C. 119(e), 120, 121, or 365(c) or indicate National Stage entry from a PCT application. Providing this information in the application data sheet constitutes the specific reference required by 35 U.S.C. 119(e) or 120, and 37 CFR 1.78.

Prior Application Status			<input type="button" value="Remove"/>
Application Number	Continuity Type	Prior Application Number	Filing Date (YYYY-MM-DD)
			IPR2022-00457

Under the Paperwork Reduction Act of 1995, no persons are required to respond to a collection of information unless it contains a valid OMB control number.

Application Data Sheet 37 CFR 1.76	Attorney Docket Number	PS54636US00
	Application Number	
Title of Invention	METHOD AND RADIO NODE FOR ENABLING USE OF HIGH ORDER MODULATION IN A RADIO COMMUNICATION WITH A USER EQUIPMENT	

Additional Domestic Benefit/National Stage Data may be generated within this form by selecting the **Add** button.

Foreign Priority Information:

This section allows for the applicant to claim priority to a foreign application. Providing this information in the application data sheet constitutes the claim for priority as required by 35 U.S.C. 119(b) and 37 CFR 1.55(d). When priority is claimed to a foreign application that is eligible for retrieval under the priority document exchange program (PDX) the information will be used by the Office to automatically attempt retrieval pursuant to 37 CFR 1.55(h)(1) and (2). Under the PDX program, applicant bears the ultimate responsibility for ensuring that a copy of the foreign application is received by the Office from the participating foreign intellectual property office, or a certified copy of the foreign priority application is filed, within the time period specified in 37 CFR 1.55(g)(1).

Application Number	Country ⁱ	Filing Date (YYYY-MM-DD)	Access Code ^j (if applicable)

Additional Foreign Priority Data may be generated within this form by selecting the **Add** button.

Statement under 37 CFR 1.55 or 1.78 for AIA (First Inventor to File) Transition Applications

This application (1) claims priority to or the benefit of an application filed before March 16, 2013 and (2) also contains, or contained at any time, a claim to a claimed invention that has an effective filing date on or after March 16, 2013.



NOTE: By providing this statement under 37 CFR 1.55 or 1.78, this application, with a filing date on or after March 16, 2013, will be examined under the first inventor to file provisions of the AIA.

Authorization to Permit Access:

Authorization to Permit Access to the Instant Application by the Participating Offices

Under the Paperwork Reduction Act of 1995, no persons are required to respond to a collection of information unless it contains a valid OMB control number.

Application Data Sheet 37 CFR 1.76		Attorney Docket Number	PS54636US00
		Application Number	
Title of Invention	METHOD AND RADIO NODE FOR ENABLING USE OF HIGH ORDER MODULATION IN A RADIO COMMUNICATION WITH A USER EQUIPMENT		

If checked, the undersigned hereby grants the USPTO authority to provide the European Patent Office (EPO), the Japan Patent Office (JPO), the Korean Intellectual Property Office (KIPO), the World Intellectual Property Office (WIPO), and any other intellectual property offices in which a foreign application claiming priority to the instant patent application is filed access to the instant patent application. See 37 CFR 1.14(c) and (h). This box should not be checked if the applicant does not wish the EPO, JPO, KIPO, WIPO, or other intellectual property office in which a foreign application claiming priority to the instant patent application is filed to have access to the instant patent application.

In accordance with 37 CFR 1.14(h)(3), access will be provided to a copy of the instant patent application with respect to: 1) the instant patent application-as-filed; 2) any foreign application to which the instant patent application claims priority under 35 U.S.C. 119(a)-(d) if a copy of the foreign application that satisfies the certified copy requirement of 37 CFR 1.55 has been filed in the instant patent application; and 3) any U.S. application-as-filed from which benefit is sought in the instant patent application.

In accordance with 37 CFR 1.14(c), access may be provided to information concerning the date of filing this Authorization.

Applicant Information:

Providing assignment information in this section does not substitute for compliance with any requirement of part 3 of Title 37 of CFR to have an assignment recorded by the Office.			
Applicant 1			<input type="button" value="Remove"/>
If the applicant is the inventor (or the remaining joint inventor or inventors under 37 CFR 1.45), this section should not be completed. The information to be provided in this section is the name and address of the legal representative who is the applicant under 37 CFR 1.43; or the name and address of the assignee, person to whom the inventor is under an obligation to assign the invention, or person who otherwise shows sufficient proprietary interest in the matter who is the applicant under 37 CFR 1.46. If the applicant is an applicant under 37 CFR 1.46 (assignee, person to whom the inventor is obligated to assign, or person who otherwise shows sufficient proprietary interest) together with one or more joint inventors, then the joint inventor or inventors who are also the applicant should be identified in this section.			
<input type="button" value="Clear"/>			
<input checked="" type="radio"/> Assignee	<input type="radio"/> Legal Representative under 35 U.S.C. 117	<input type="radio"/> Joint Inventor	
<input type="radio"/> Person to whom the inventor is obligated to assign.		<input type="radio"/> Person who shows sufficient proprietary interest	
If applicant is the legal representative, indicate the authority to file the patent application, the inventor is:			
Name of the Deceased or Legally Incapacitated Inventor : <input type="text"/>			
If the Applicant is an Organization check here. <input checked="" type="checkbox"/>			
Organization Name	TELEFONAKTIEBOLAGET L M ERICSSON (publ)		
Mailing Address Information:			
Address 1	A Swedish Company		
Address 2			
City	Stockholm	State/Province	
Country ⁱ	SE	Postal Code	SE-164 83
Phone Number		Fax Number	

IPR2022-00457

Under the Paperwork Reduction Act of 1995, no persons are required to respond to a collection of information unless it contains a valid OMB control number.

Application Data Sheet 37 CFR 1.76		Attorney Docket Number	PS54636US00
		Application Number	
Title of Invention	METHOD AND RADIO NODE FOR ENABLING USE OF HIGH ORDER MODULATION IN A RADIO COMMUNICATION WITH A USER EQUIPMENT		
Email Address			
Additional Applicant Data may be generated within this form by selecting the Add button.			<input type="button" value="Add"/>

Non-Applicant Assignee Information:

Providing assignment information in this section does not substitute for compliance with any requirement of part 3 of Title 37 of CFR to have an assignment recorded by the Office.				
Assignee 1				
Complete this section only if non-applicant assignee information is desired to be included on the patent application publication in accordance with 37 CFR 1.215(b). Do not include in this section an applicant under 37 CFR 1.46 (assignee, person to whom the inventor is obligated to assign, or person who otherwise shows sufficient proprietary interest), as the patent application publication will include the name of the applicant(s).				
				<input type="button" value="Remove"/>
If the Assignee is an Organization check here. <input type="checkbox"/>				
Prefix	Given Name	Middle Name	Family Name	Suffix
Mailing Address Information:				
Address 1				
Address 2				
City		State/Province		
Country i	Postal Code			
Phone Number		Fax Number		
Email Address				
Additional Assignee Data may be generated within this form by selecting the Add button.				<input type="button" value="Add"/>

Signature:

NOTE: This form must be signed in accordance with 37 CFR 1.33. See 37 CFR 1.4 for signature requirements and certifications				
Signature	/Sarah Rodriguez/		Date (YYYY-MM-DD)	2013-08-09
First Name	Sarah	Last Name	RODRIGUEZ	Registration Number
Additional Signature may be generated within this form by selecting the Add button.				<input type="button" value="Add"/>

Under the Paperwork Reduction Act of 1995, no persons are required to respond to a collection of information unless it contains a valid OMB control number.

Application Data Sheet 37 CFR 1.76	Attorney Docket Number	PS54636US00
	Application Number	
Title of Invention	METHOD AND RADIO NODE FOR ENABLING USE OF HIGH ORDER MODULATION IN A RADIO COMMUNICATION WITH A USER EQUIPMENT	

This collection of information is required by 37 CFR 1.76. The information is required to obtain or retain a benefit by the public which is to file (and by the USPTO to process) an application. Confidentiality is governed by 35 U.S.C. 122 and 37 CFR 1.14. This collection is estimated to take 23 minutes to complete, including gathering, preparing, and submitting the completed application data sheet form to the USPTO. Time will vary depending upon the individual case. Any comments on the amount of time you require to complete this form and/or suggestions for reducing this burden, should be sent to the Chief Information Officer, U.S. Patent and Trademark Office, U.S. Department of Commerce, P.O. Box 1450, Alexandria, VA 22313-1450. DO NOT SEND FEES OR COMPLETED FORMS TO THIS ADDRESS. **SEND TO: Commissioner for Patents, P.O. Box 1450, Alexandria, VA 22313-1450.**

Privacy Act Statement

The Privacy Act of 1974 (P.L. 93-579) requires that you be given certain information in connection with your submission of the attached form related to a patent application or patent. Accordingly, pursuant to the requirements of the Act, please be advised that: (1) the general authority for the collection of this information is 35 U.S.C. 2(b)(2); (2) furnishing of the information solicited is voluntary; and (3) the principal purpose for which the information is used by the U.S. Patent and Trademark Office is to process and/or examine your submission related to a patent application or patent. If you do not furnish the requested information, the U.S. Patent and Trademark Office may not be able to process and/or examine your submission, which may result in termination of proceedings or abandonment of the application or expiration of the patent.

The information provided by you in this form will be subject to the following routine uses:

1. The information on this form will be treated confidentially to the extent allowed under the Freedom of Information Act (5 U.S.C. 552) and the Privacy Act (5 U.S.C. 552a). Records from this system of records may be disclosed to the Department of Justice to determine whether the Freedom of Information Act requires disclosure of these records.
2. A record from this system of records may be disclosed, as a routine use, in the course of presenting evidence to a court, magistrate, or administrative tribunal, including disclosures to opposing counsel in the course of settlement negotiations.
3. A record in this system of records may be disclosed, as a routine use, to a Member of Congress submitting a request involving an individual, to whom the record pertains, when the individual has requested assistance from the Member with respect to the subject matter of the record.
4. A record in this system of records may be disclosed, as a routine use, to a contractor of the Agency having need for the information in order to perform a contract. Recipients of information shall be required to comply with the requirements of the Privacy Act of 1974, as amended, pursuant to 5 U.S.C. 552a(m).
5. A record related to an International Application filed under the Patent Cooperation Treaty in this system of records may be disclosed, as a routine use, to the International Bureau of the World Intellectual Property Organization, pursuant to the Patent Cooperation Treaty.
6. A record in this system of records may be disclosed, as a routine use, to another federal agency for purposes of National Security review (35 U.S.C. 181) and for review pursuant to the Atomic Energy Act (42 U.S.C. 218(c)).
7. A record from this system of records may be disclosed, as a routine use, to the Administrator, General Services, or his/her designee, during an inspection of records conducted by GSA as part of that agency's responsibility to recommend improvements in records management practices and programs, under authority of 44 U.S.C. 2904 and 2906. Such disclosure shall be made in accordance with the GSA regulations governing inspection of records for this purpose, and any other relevant (i.e., GSA or Commerce) directive. Such disclosure shall not be used to make determinations about individuals.
8. A record from this system of records may be disclosed, as a routine use, to the public after either publication of the application pursuant to 35 U.S.C. 122(b) or issuance of a patent pursuant to 35 U.S.C. 151. Further, a record may be disclosed, subject to the limitations of 37 CFR 1.14, as a routine use, to the public if the record was filed in an application which became abandoned or in which the proceedings were terminated and which application is referenced by either a published application, an application open to public inspections or an issued patent.
9. A record from this system of records may be disclosed, as a routine use, to a Federal, State, or local law enforcement agency, if the USPTO becomes aware of a violation or potential violation of law or regulation.

Doc Code: **TR.PROV**
 Document Description: Provisional Cover Sheet (SB16)

PTO/SB/16 (11-08)
 Approved for use through 05/31/2015. OMB 0651-0032
 U.S. Patent and Trademark Office: U.S. DEPARTMENT OF COMMERCE

Under the Paperwork Reduction Act of 1995, no persons are required to respond to a collection of information unless it displays a valid OMB control number

Provisional Application for Patent Cover Sheet
 This is a request for filing a PROVISIONAL APPLICATION FOR PATENT under 37 CFR 1.53(c)

Inventor(s)

Inventor 1	Remove
------------	--------

Given Name	Middle Name	Family Name	City	State	Country
David		HAMMARWALL	Vallentuna		SE

Inventor 2	Remove
------------	--------

Given Name	Middle Name	Family Name	City	State	Country
Meng		WANG	Solna		SE

All Inventors Must Be Listed – Additional Inventor Information blocks may be generated within this form by selecting the **Add** button. Add

Title of Invention	METHOD AND RADIO NODE FOR ENABLING USE OF HIGH ORDER MODULATION IN A RADIO COMMUNICATION WITH A USER EQUIPMENT
---------------------------	--

Attorney Docket Number (if applicable)	PS54636US00
--	-------------

Correspondence Address

Direct all correspondence to (select one):

<input checked="" type="radio"/> The address corresponding to Customer Number	<input type="radio"/> Firm or Individual Name
Customer Number	11754

The invention was made by an agency of the United States Government or under a contract with an agency of the United States Government.

<input checked="" type="radio"/> No.
<input type="radio"/> Yes, the invention was made by an agency of the United States Government. The U.S. Government agency name is:
<input type="radio"/> Yes, the invention was under a contract with an agency of the United States Government. The name of the U.S. Government agency and Government contract number are:

Under the Paperwork Reduction Act of 1995, no persons are required to respond to a collection of information unless it displays a valid OMB control number

Entity Status
Applicant asserts small entity status under 37 CFR 1.27 or applicant certifies micro entity status under 37 CFR 1.29

- Applicant asserts small entity status under 37 CFR 1.27
- Applicant certifies micro entity status under 37 CFR 1.29. Applicant must attach form PTO/SB/15A or B or equivalent.
- No

Warning

Petitioner/applicant is cautioned to avoid submitting personal information in documents filed in a patent application that may contribute to identity theft. Personal information such as social security numbers, bank account numbers, or credit card numbers (other than a check or credit card authorization form PTO-2038 submitted for payment purposes) is never required by the USPTO to support a petition or an application. If this type of personal information is included in documents submitted to the USPTO, petitioners/applicants should consider redacting such personal information from the documents before submitting them to USPTO. Petitioner/applicant is advised that the record of a patent application is available to the public after publication of the application (unless a non-publication request in compliance with 37 CFR 1.213(a) is made in the application) or issuance of a patent. Furthermore, the record from an abandoned application may also be available to the public if the application is referenced in a published application or an issued patent (see 37 CFR 1.14). Checks and credit card authorization forms PTO-2038 submitted for payment purposes are not retained in the application file and therefore are not publicly available.

Signature

Please see 37 CFR 1.4(d) for the form of the signature.

Signature	/Sarah Rodriguez/			Date (YYYY-MM-DD)	2013-08-09
First Name	Sarah	Last Name	RODRIGUEZ	Registration Number (If appropriate)	66219

This collection of information is required by 37 CFR 1.51. The information is required to obtain or retain a benefit by the public which is to file (and by the USPTO to process) an application. Confidentiality is governed by 35 U.S.C. 122 and 37 CFR 1.11 and 1.14. This collection is estimated to take 8 hours to complete, including gathering, preparing, and submitting the completed application form to the USPTO. Time will vary depending upon the individual case. Any comments on the amount of time you require to complete this form and/or suggestions for reducing this burden, should be sent to the Chief Information Officer, U.S. Patent and Trademark Office, U.S. Department of Commerce, P.O. Box 1450, Alexandria, VA 22313-1450. **DO NOT SEND FEES OR COMPLETED FORMS TO THIS ADDRESS. This form can only be used when in conjunction with EFS-Web. If this form is mailed to the USPTO, it may cause delays in handling the provisional application.**

Privacy Act Statement

The Privacy Act of 1974 (P.L. 93-579) requires that you be given certain information in connection with your submission of the attached form related to a patent application or patent. Accordingly, pursuant to the requirements of the Act, please be advised that : (1) the general authority for the collection of this information is 35 U.S.C. 2(b)(2); (2) furnishing of the information solicited is voluntary; and (3) the principal purpose for which the information is used by the U.S. Patent and Trademark Office is to process and/or examine your submission related to a patent application or patent. If you do not furnish the requested information, the U.S. Patent and Trademark Office may not be able to process and/or examine your submission, which may result in termination of proceedings or abandonment of the application or expiration of the patent.

The information provided by you in this form will be subject to the following routine uses:

1. The information on this form will be treated confidentially to the extent allowed under the Freedom of Information Act (5 U.S.C. 552) and the Privacy Act (5 U.S.C. 552a). Records from this system of records may be disclosed to the Department of Justice to determine whether disclosure of these records is required by the Freedom of Information Act.
2. A record from this system of records may be disclosed, as a routine use, in the course of presenting evidence to a court, magistrate, or administrative tribunal, including disclosures to opposing counsel in the course of settlement negotiations.
3. A record in this system of records may be disclosed, as a routine use, to a Member of Congress submitting a request involving an individual, to whom the record pertains, when the individual has requested assistance from the Member with respect to the subject matter of the record.
4. A record in this system of records may be disclosed, as a routine use, to a contractor of the Agency having need for the information in order to perform a contract. Recipients of information shall be required to comply with the requirements of the Privacy Act of 1974, as amended, pursuant to 5 U.S.C. 552a(m).
5. A record related to an International Application filed under the Patent Cooperation Treaty in this system of records may be disclosed, as a routine use, to the International Bureau of the World Intellectual Property Organization, pursuant to the Patent Cooperation Treaty.
6. A record in this system of records may be disclosed, as a routine use, to another federal agency for purposes of National Security review (35 U.S.C. 181) and for review pursuant to the Atomic Energy Act (42 U.S.C. 218(c)).
7. A record from this system of records may be disclosed, as a routine use, to the Administrator, General Services, or his/her designee, during an inspection of records conducted by GSA as part of that agency's responsibility to recommend improvements in records management practices and programs, under authority of 44 U.S.C. 2904 and 2906. Such disclosure shall be made in accordance with the GSA regulations governing inspection of records for this purpose, and any other relevant (i.e., GSA or Commerce) directive. Such disclosure shall not be used to make determinations about individuals.
8. A record from this system of records may be disclosed, as a routine use, to the public after either publication of the application pursuant to 35 U.S.C. 122(b) or issuance of a patent pursuant to 35 U.S.C. 151. Further, a record may be disclosed, subject to the limitations of 37 CFR 1.14, as a routine use, to the public if the record was filed in an application which became abandoned or in which the proceedings were terminated and which application is referenced by either a published application, an application open to public inspection or an issued patent.
9. A record from this system of records may be disclosed, as a routine use, to a Federal, State, or local law enforcement agency, if the USPTO becomes aware of a violation or potential violation of law or regulation.

METHOD AND RADIO NODE FOR ENABLING USE OF HIGH ORDER MODULATION IN A RADIO COMMUNICATION WITH A USER EQUIPMENT

Technical field

The present disclosure relates generally to a method and a radio node of a cellular network for enabling use of a high order modulation when communicating radio signals with a User Equipment, UE.

Background and summary

In this field, the term "User Equipment, UE" is commonly used and will be used in this disclosure to represent any user-controlled wireless terminal or device capable of radio communication including receiving downlink signals transmitted from a serving radio node and sending uplink signals to the radio node. Further, the term "radio node", also commonly referred to as a base station, e-nodeB, eNB, etc., represents any node of a wireless communication network that can communicate uplink and downlink radio signals with UEs. The radio nodes described here may, without limitation, include so-called macro nodes and low power nodes such as micro, pico, femto, Wifi and relay nodes, to mention some customary examples. Throughout this disclosure, the term "eNB" is often used but can be exchanged by the term radio node.

Link adaptation in systems according to Long Term Evolution, LTE, is based on adaptive modulation and coding, which controls data rate by adaptively adjusting the modulation scheme and/or channel coding rate according to the radio-link conditions. In this procedure, the MCS (Modulation and Coding Scheme) adopted for PDSCH transmission must be indicated by the eNB to the UE and the UE, by uplink signaling, informs the eNB about corresponding channel conditions through CQI reporting, including sending CQI reports to the eNB. This is generally illustrated in Fig. 1.

In current LTE systems, the set of modulation scheme for both downlink and uplink includes QPSK, 16QAM and 64QAM, corresponding to two, four and six bits per modulation symbol, respectively. In LTE, especially for scenarios with good channel conditions such as high SINR, e.g. in small-cell environments with

terminals close to cell site, a straightforward means to provide higher data rate with given transmission bandwidth is the use of higher-order modulation that allows for more bits of information to be carried per modulation symbol. Hence, in order to adopt higher-order modulation schemes in LTE systems, there is a need to re-design the control signaling for MCS and CQI indication, in particular, the MCS and CQI index tables. In this disclosure, the term higher-order modulation may refer to modulation schemes that are higher than 64QAM, such as e.g. 256QAM, 512QAM, and so forth.

For downlink data transmission in LTE, the eNB typically selects the MCS depending on the CQI (Channel Quality Indicator) feedback transmitted by the UE in the uplink, as illustrated in Figure 1. The CQI feedback indicates the data rate (or more specifically a modulation and coding scheme MCS) that can be supported by the downlink channel given the present channel condition and UE receiver.

The LTE specifications are designed to provide signaling for indication between eNB and UE. In the downlink, the knowledge about the MCS adopted for PDSCH transmission is indicated by a five-bit field in the DCI (Downlink Control Information). This MCS field corresponds to the MCS index table as shown in Fig. 2. In this table, of 32 combinations, 29 are used to signal a MCS, each corresponding to a modulation and a transport block size (TBS), while 3 are reserved (e.g., to support adaptive retransmissions). All possible TBS can be described by a TBS table mapping a TBS index, I_{TBS} , and an allocation bandwidth into the corresponding transport block size (in bits).

In the uplink, the UE reports CQI to assist eNB to select the appropriate MCS for downlink transmission. Typically, the CQIs are derived from measurements made by the UE on downlink reference signals. It should be noted that the reported CQI represents the highest MCS that is supported for a PDSCH transmission, with a transport block error rate probability not exceeding 10%. The CQI is signaled to the eNB by the means of CQI index table, as shown in Fig. 3. A 4-bit CQI value corresponds to a particular MCS out of 16 combinations in the CQI index table.

Note that the CQI table is parameterized in terms of coding rate, as opposed to transport block size. However, for a given assumed allocation bandwidth (given by the CQI reference resource), there is a one-to-one mapping between a CQI and a corresponding MCS (i.e., the reported CQI should not be interpreted as the maximum supported code rate, but the maximum supported corresponding MCS).

Current LTE systems support three modulation schemes for both downlink and uplink: QPSK, 16QAM and 64QAM. Accordingly, the MCS index table, CQI index table and the corresponding fields for indication in DCI are designed for these three modulation schemes. However, higher-order modulation schemes are not supported in current LTE specifications. In order to support higher-order modulation, i.e. higher than the above schemes QPSK, 16QAM and 64QAM, UEs must support an additional MCS/CQI table that includes specific entries for new modulation schemes. The modification of MCS/CQI table, naturally, requires re-designing the DCI/UCI formats.

Typically, the additional MCS/CQI tables are used in high SNR region that is suitable for high-order modulation. In the relatively low SNR region, on the other hand, current MCS/CQI tables are desired for link robustness. Hence, some mechanisms with flexibility to adopt appropriate MCS/CQI tables based on channel conditions have become necessary.

In conclusion, current LTE systems support modulation up to 64QAM. To support higher-order modulation, adaptations and/or extensions to the current control signaling in term of MCS index table, CQI index table and the corresponding fields in DCI/UCI are required.

In this disclosure, an alternative design of MCS index table and/or of a CQI index table is described which can be used for LTE systems, which is/are to be supported in addition to a basic (the current) MCS and/or CQI table.

In current LTE specification, the MCS and CQI tables support modulation schemes up to 64QAM. The proposed new MCS and CQI index tables are able to support modulation higher than 64QAM, without necessarily extending the number of bits

in the DCI/UCI formats, or the number of entries in the MCS table/CQI table, respectively. Typically, higher-order modulation schemes are selected in the high-SINR scenarios or generally when a performance related parameter, such as SINR, of signals communicated between a radio node and a UE is above a certain threshold.

In the new MCS/CQI tables, new entries for higher-order modulation are added and designed to provide sufficient resolution to cover the high-SINR region. Meanwhile, a large part of the existing entries in current MCS and/or CQI tables are preserved. The current MCS and/or CQI tables may be called a first table configuration while the new current MCS and/or CQI tables supporting a higher-order modulation may be called a second table configuration. This has the advantage that the number of new MCS/CQI formats a UE/eNB has to implement is minimized.

An embodiment of the disclosed solution is that the lowest MCS entry in the new MCS table and/or that in CQI table is preserved or kept from the basic MCS and/or CQI table, to ensure proper communication between eNB and UE under poor channel condition, thus providing a fallback in case in case it is only possible to use the lowest modulation order when the second table configuration is applied. This provides resilience to changing channel conditions, and provides a robust format to, for example, signal control-plane data, and/or reconfigure the UE to assume the basic MCS and/or CQI table suitable for poor/normal channel conditions. Through this invention, the link adaption in LTE systems is enhanced to support higher-order modulation schemes, which can significantly improve the spectral efficiency in high SINR scenarios.

Detailed description

It should be noted that although terminology from 3GPP LTE is used in this disclosure to describe various exemplifying embodiments, this should not be seen as limiting the scope of usage to only the aforementioned system. Other wireless systems, including WCDMA, WiMAX, and UMB, may also benefit from exploiting the ideas covered within this disclosure.

Also note that terminology such as base station/eNB should be considered non-limiting and does in particular not imply a certain hierarchical relation between the two; in general “eNB” could be considered as device 1 and “UE” could be considered as device 2 and these two devices communicate with each other over some radio channel.

In this section, the solution will be explained in more detail by some exemplary embodiments. It should be noted that these embodiments are not mutually exclusive. Components from one embodiment may be tacitly assumed to be present in another embodiment and it will be obvious to a person skilled in the art how those components may be used in other exemplifying embodiments.

The MCS index table and CQI index table used in current LTE specification are shown in Fig. 2 and Fig. 3, respectively. In the sequel, we describe a design of alternative MCS and CQI index tables as well as the mechanism by which eNB/UE can switch between the proposed new MCS/CQI tables and current MCS/CQI tables, i.e. according to the described second and first table configurations.

MCS index table

In a possible embodiment, a first MCS table is used for downlink transmission to one UE (such as UE1 in Figure 1), and in the downlink transmission to another UE (such as UE2 in Figure 1), a second MCS table is used. In a further such embodiment the first and second UE may be one and the same UE.

In another embodiment, the first MCS table and second MCS table are either the current MCS table of the first table configuration in specification (see Fig. 2) or a modified new MCS table of the second table configuration table that supports a modulation order higher than the maximum modulation order supported by the first MCS table, i.e. the second MCS table contains entries for higher-order modulation.

In another embodiment, eNB can use either current MCS table or proposed alternative MCS table for DL transmission. In a further embodiment, the information about the MCS table that is (to be) used is part of a DCI message (in

which case it typically applies to a single specific subframe), or is part of a RRC or MAC message (in which case it typically applies until further notice).

In another embodiment, the proposed MCS index table has $32+N$ rows where $N \geq 0$ is a non-negative integer. The columns of the table represent the same parameters as those of the MCS index table shown in Fig. 2, which include MCS index I_{MCS} , modulation order Q_m and TBS index I_{TBS} . Each table row, that is one MCS, is indexed by an MCS index and contains a particular combination of modulation order and TBS (transport block size) table index.

In another embodiment, in the proposed MCS index table, M rows, i.e., M MCS indices are used to indicate the MCSs including pairs of one higher-order modulation scheme and one TBS index, where M is a non-negative integer with $M > N$.

In another embodiment, $32+N-M$ MCS entries in Fig. 2 may be re-used in the new table. In other words, $M-N$ MCSs in Fig. 2 are not included in the new table.

The current TBS table in the specification is illustrated in Table 7.1.7.2.1-1 in the document called 3GPP TS 36.213 V11.2.0 (2013-04). In another embodiment, the rows of TBS values corresponding to the TBS indices contained in said $M-N$ MCSs are removed from the TBS table. Meanwhile, M new rows of TBS values corresponding to said M MCSs for higher-order modulation are added to said TBS table.

In a further embodiment, when $N=0$, the new table keeps the same size as Fig. 2 and M MCSs for higher-order modulation replaces M MCSs in Fig. 2. In a further such embodiment, the lowest MCS (corresponding to MCS index 0) is preserved or kept in the new MCS table. In a further such embodiment, the subsequent M lowest MCSs (corresponding to MCS indices 1 through M) are excluded in the new (alternate) MCS table. An example of such an embodiment is shown in Fig. 4. Compared to Fig. 2, the MCSs with indices from 1 to 6 for modulation order 2 (QPSK) have been removed, whereas the lowest MCS is preserved. Instead, 6 MCSs for modulation order 8 (256QAM) have been added to the table in Fig. 4.

Meanwhile in the TBS table, rows of TBS values corresponding to the removed and added MCSs are removed and added accordingly. Other MCSs are re-used in the table and the indices in this table are rearranged from beginning. Fig. 6 illustrates an example of a proposed TBS table (dimension 21*110) with index 21-26 for 256QAM (corresponding to the table in Fig. 5), where NV = new values. For the example shown in Fig. 6, the rows with index 1-6 for QPSK are removed and 6 new rows of TBS values for 256QAM have been added at the end of the table. This new TBS table shall be consistent with the TBS index in said new MCS table.

In another embodiment, the lowest MCS, i.e. the entry with MCS index 0 in Fig. 2, may be re-used in the new table for any case. This is to ensure that the communication between eNB and UE works properly even when the radio link experiences very poor channel condition, which may be called a low SINR scenario or similar.

In another embodiment, when the new MCS table is in use and the entry for lowest MCS is selected, this indicates that it is difficult to support higher-order modulation due to variation of channel quality or other issues. Hence, the MCS table used in next transmission will automatically fall back to the MCS table in current standard, i.e. to the first MCS table.

In another embodiment, the MCS field in DCI is extended by one or more bits to indicate the MCS index when $N > 0$, that is, the alternative MCS table has more than 32 MCS indices.

CQI index table

The design of the new, or second, CQI index table of the second table configuration is similar to that of the new, or second, MCS index table of the second table configuration.

In a possible embodiment, a first CQI table may be used for radio transmission from the first UE to eNB, while in the radio transmission from the second UE to eNB, a second CQI table is used, or vice versa. In a further such embodiment said first and second UE may be the same UE.

In another embodiment, said first CQI table and second CQI table are either current CQI table in specification or a modified CQI table that contains entries for higher-order modulation.

In another embodiment, a UE can use either the current CQI table or the proposed alternative CQI table for transmission. In a further embodiment, the information about the CQI table that is (to be) used is part of a UCI message or part of a RRC or MAC message.

In another embodiment, the proposed CQI index table has $16+N$ rows where $N \geq 0$ is a non-negative integer. The columns of the table represent the same parameters as those of the table shown in Fig. 3, which include CQI index, modulation order, code rate and efficiency. Each table row, that is one CQI, is indexed by a CQI index and contains a particular combination of a modulation order and code rate. The value of efficiency is calculated based on modulation order and code rate.

In another embodiment, in the proposed CQI index table, M rows, i.e., M CQI indices are used to indicate the CQI including pairs of one higher-order modulation scheme, one coding rate and resultant efficiency value, where M is a non-negative integer with $M > N$. In a further embodiment, the coding rates for higher-order modulation are defined and added to the CQI table.

In another embodiment, $16+N-M$ CQIs in Fig. 3 are re-used in the alternative CQI table. In a further such embodiment, when $N=0$, it keeps the same size as the table in Fig. 3 and M CQIs for higher-order modulation replaces M CQIs in Fig. 3. In a further such embodiment, the lowest CQI (corresponding to CQI index 1) is preserved in the proposed CQI table. In a further such embodiment the subsequent M lowest CQIs (corresponding to CQI indices 2 through $M+1$) are excluded in the new (alternate) CQI table. An example of such embodiment is provided in Fig. 5. Compared to Fig. 3, the CQIs with indices from 2 to 5 for modulation order 2 (QPSK) have been removed, whereas the lowest CQI is preserved. Instead, 4 CQIs for modulation order 8 (256QAM) have been added to

the table in Fig. 5. Other CQIs are re-used in the table and their indices are rearranged.

In another embodiment, the lowest CQI, i.e. the entry with index 1 in Fig. 3, must be re-used in the new table for any case. This is to ensure that the communication between eNB and UE works properly even when the radio link experiences very poor channel condition.

In another embodiment, when the new CQI table is in use and the entry for lowest CQI is selected, this indicates that it is difficult to support higher-order modulation due to variation of channel quality or other issues. Hence, the CQI table used in next transmission will automatically fall back to the CQI table in current standard.

In another embodiment, the CQI field in uplink control signaling is extended by one or more bits to indicate the CQI index when $N > 0$, that is, the new CQI index table has more than 16 CQIs.

Potential advantages

The embodiments described herein may have the following advantages:

- The process of link adaptation in LTE systems may be enhanced to support higher-order modulation schemes in an efficient manner, which may significantly improve the spectral efficiency in a cellular network, particularly in high SINR scenarios.
- The lowest MCS entry in MCS table and that in CQI table may be preserved as a fallback to ensure proper communication between eNB and UE when the radio link experiences very poor channel condition.
- The size of the current MCS table may be preserved, or minimally expanded.

- The implementation effort in eNB and UEs may be kept to a minimum by sharing the majority of the MCS/CQI among the current and a new alternate MCS/CQI tables.
- The solution may be applied in both downlink and uplink.

While the solution has been described with reference to specific exemplary embodiments, the description is generally only intended to illustrate the inventive concept and should not be taken as limiting the scope of the solution. For example, the terms "radio node", "User Equipment, UE", "table configuration", and "modulation order" have been used throughout this description, although any other corresponding entities, functions, and/or parameters could also be used having the features and characteristics described here. The solution is defined by the appended claims.

Abbreviations

LTE	long-term evolution
PDSCH	physical downlink shared channel
MCS	modulation and coding scheme
eNB	E-UTRAN NodeB
UE	user equipment
CQI	channel-quality indicator
QPSK	quadrature phase-shift keying
16QAM	16 quadrature amplitude modulation
64QAM	64 quadrature amplitude modulation
SINR	signal-to-interference-and-noise ratio
DCI	downlink control information
GSM	global system for mobile communications
WCDMA	wideband code-division multiple access
WiMAX	worldwide interoperability for microwave access

UMB ultra mobile broadband

Some definitions of possible features and embodiments are outlined below, partly with reference to Figs 7-10.

1. A method is performed by a radio node (200) of a cellular network, the radio node being operable for applying a first table configuration in radio communications with User Equipments, UEs, the first table configuration comprising a first Modulation and Coding Scheme, MCS, table and/or a first Channel Quality Indicator, CQI, table wherein the first MCS table and/or the first CQI table support a certain maximum modulation order, the method comprising:
 - detecting (100) that a modulation order higher than the maximum modulation order of the first table configuration is potentially possible to use in a radio communication between the radio node and a first UE, and
 - instructing (102) the first UE to apply a second table configuration in the radio communication, the second table configuration comprising a second MCS table and/or a second CQI table wherein the second MCS table and/or the second CQI table support a modulation order higher than the maximum modulation order of the first table configuration, and wherein at least one entry for the lowest modulation order in the first MCS table and/or the first CQI table is kept in the second MCS table and/or the second CQI table as a fall-back in case it is only possible to use the lowest modulation order when the second table configuration is applied.
2. In a possible embodiment, the radio node instructs the first UE to apply the second table configuration in the radio communication between the radio node and the first UE when a performance related parameter of signals communicated between the radio node and the first UE is above a threshold.
3. In another possible embodiment, the radio node instructs a second UE to apply the first table configuration in a radio communication between the radio node and the second UE when the performance related parameter of signals communicated between the radio node and the second UE is below the threshold.
4. In another possible embodiment, the performance related parameter comprises a Signal to Interference and Noise Ratio, SINR.

5. In another possible embodiment, the radio node instructs the second UE by sending an instruction to the second UE to apply the first table configuration, or by not sending an instruction to the second UE to apply the second table configuration.

6. In another possible embodiment, the second MCS table and/or the second CQI table are modifications of the first MCS table and/or the first CQI table, respectively, where a set of entries for the higher modulation order have been added and a set of entries for a lowest modulation order have been removed.

7. In another possible embodiment, at least one entry for the lowest modulation order in the first MCS table and/or the first CQI table is kept in the second MCS table and/or the second CQI table as a fall-back in case it is only possible to use the lowest modulation order when the second table configuration is applied.

8. In another possible embodiment, the number of added entries for the higher modulation order and the number of removed entries for the lowest modulation order are equal such that the first and second MCS tables are of equal size and/or the first and second CQI tables are of equal size.

9. In another possible embodiment, the second MCS table and/or the second CQI table are modifications of the first MCS table and/or the first CQI table, respectively, where all entries of the first MCS table and/or the first CQI table have been kept in the second MCS table and/or the second CQI table and a set of entries for the higher modulation order have been added.

10. In another possible embodiment, the first and second table configurations further comprise a Transport Block Size, TBS, table corresponding to the first and second MCS tables, respectively.

11. A radio node (200) of a cellular network is also described, the radio node being operable for applying a first table configuration in radio communications with User Equipments, UEs, the first table configuration comprising a first Modulation

and Coding Scheme, MCS, table and/or a first Channel Quality Indicator, CQI, table wherein the first MCS table and/or the first CQI table support a certain maximum modulation order, the radio node comprising:

- a logic unit (200a) configured to detect that a modulation order higher than the maximum modulation order of the first table configuration is potentially possible to use in a radio communication between the radio node and a first UE, and
- an instructing unit (200b) configured to instruct the first UE to apply a second table configuration in the radio communication, the second table configuration comprising a second MCS table and/or a second CQI table wherein the second MCS table and/or the second CQI table support a modulation order higher than the maximum modulation order of the first table configuration, and wherein at least one entry for the lowest modulation order in the first MCS table and/or the first CQI table is kept in the second MCS table and/or the second CQI table as a fall-back in case it is only possible to use the lowest modulation order when the second table configuration is applied.

12. In further possible embodiments, the radio node is configured to perform the method of any of the above radio node method embodiments, where appropriate.

13. A method is also performed by a User Equipment, UE (400), the UE being operable for applying a first table configuration in a radio communication with a radio node of a cellular network, the first table configuration comprising a first Modulation and Coding Scheme, MCS, table and/or a first Channel Quality Indicator, CQI, table wherein the first MCS table and/or the first CQI table support a certain maximum modulation order, the method comprising:

- receiving (300) an instruction from the radio node to apply a second table configuration in the radio communication, the second table configuration comprising a second MCS table and/or a second CQI table wherein the second MCS table and/or the second CQI table support a modulation order higher than the maximum modulation order of the first table configuration, and

- applying (302) the second table configuration in the radio communication with the radio node.

14. A User Equipment, UE, (400) is also described, the UE being operable for applying a first table configuration in a radio communication with a radio node (402) of a cellular network, the first table configuration comprising a first Modulation and Coding Scheme, MCS, table and/or a first Channel Quality Indicator, CQI, table wherein the first MCS table and/or the first CQI table support a certain maximum modulation order, the UE comprising:

- a communication unit (400a) configured to receive an instruction from the radio node to apply a second table configuration in the radio communication, the second table configuration comprising a second MCS table and/or a second CQI table wherein the second MCS table and/or the second CQI table support a modulation order higher than the maximum modulation order of the first table configuration, and

- a logic unit (400b) configured to apply the second table configuration in the radio communication with the radio node.

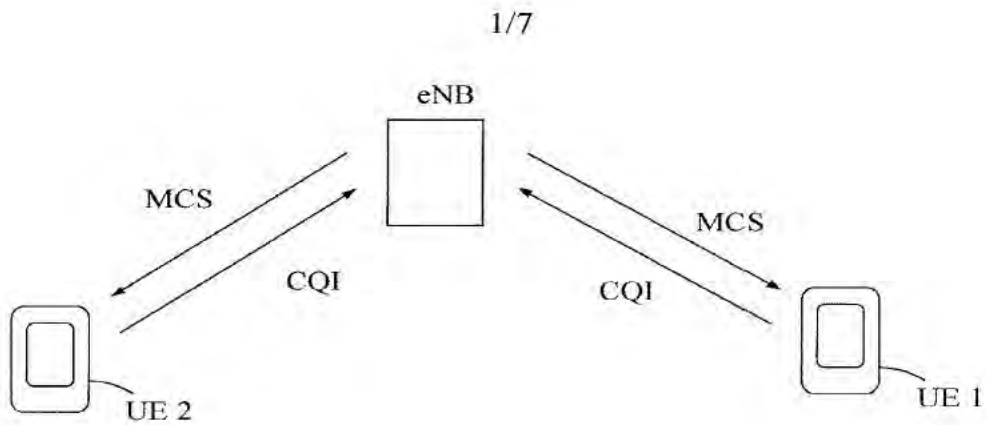

Fig. 1

MCS Index I_{MCS}	Modulation Order Q_m	TBS Index I_{TBS}
0	2	0
1	2	1
2	2	2
3	2	3
4	2	4
5	2	5
6	2	6
7	2	7
8	2	8
9	2	9
10	4	9
11	4	10
12	4	11
13	4	12
14	4	13
15	4	14
16	4	15
17	6	15
18	6	16
19	6	17
20	6	18
21	6	19
22	6	20
23	6	21
24	6	22
25	6	23
26	6	24
27	6	25
28	6	26
29	2	reserved
30	4	
31	6	

Fig. 2 Basic MCS index table

CQI index	modulation	code rate x 1024	efficiency
0	out of range		
1	QPSK	78	0.1523
2	QPSK	120	0.2344
3	QPSK	193	0.3770
4	QPSK	308	0.6016
5	QPSK	449	0.8770
6	QPSK	602	1.1758
7	16QAM	378	1.4766
8	16QAM	490	1.9141
9	16QAM	616	2.4063
10	64QAM	466	2.7305
11	64QAM	567	3.3223
12	64QAM	666	3.9023
13	64QAM	772	4.5234
14	64QAM	873	5.1152
15	64QAM	948	5.5547

Fig. 3 Basic CQI index table

MCS Index I_{MCS}	Modulation Order Q_m	TBS Index I_{TBS}
0	2	0
1	2	1
2	2	2
3	2	3
4	2	4
5	2	5
6	2	6
7 1	2	7
8 2	2	8
9 3	2	9
10 4	4	9
11 5	4	10
12 6	4	11
13 7	4	12
14 8	4	13
15 9	4	14
16 10	4	15
17 11	6	15
18 12	6	16
19 13	6	17
20 14	6	18
21 15	6	19
22 16	6	20
23 17	6	21
24 18	6	22
25 19	6	23
26 20	6	24
27 21	6	25
28 22	6	26
23	8	New index
24	8	New index
25	8	New index
26	8	New index
27	8	New index
28	8	New index
29	2	reserved
30	4	
31	6	

Fig. 4 Example of MCS index table with MCS index 23-28 added for 256QAM

<u>CQI index</u>	<u>modulation</u>	<u>code rate x 1024</u>	<u>efficiency</u>
<u>0</u>	<u>out of range</u>		
<u>1</u>	<u>QPSK</u>	<u>78</u>	<u>0.1523</u>
<u>2</u>	<u>QPSK</u>	<u>120</u>	<u>0.2344</u>
<u>3</u>	<u>QPSK</u>	<u>193</u>	<u>0.3770</u>
<u>4</u>	<u>QPSK</u>	<u>308</u>	<u>0.6016</u>
<u>5</u>	<u>QPSK</u>	<u>449</u>	<u>0.8770</u>
<u>6-2</u>	<u>QPSK</u>	<u>602</u>	<u>1.1758</u>
<u>7-3</u>	<u>16QAM</u>	<u>378</u>	<u>1.4766</u>
<u>8-4</u>	<u>16QAM</u>	<u>490</u>	<u>1.9141</u>
<u>9-5</u>	<u>16QAM</u>	<u>616</u>	<u>2.4063</u>
<u>10-6</u>	<u>64QAM</u>	<u>466</u>	<u>2.7305</u>
<u>11-7</u>	<u>64QAM</u>	<u>567</u>	<u>3.3223</u>
<u>12-8</u>	<u>64QAM</u>	<u>666</u>	<u>3.9023</u>
<u>13-9</u>	<u>64QAM</u>	<u>772</u>	<u>4.5234</u>
<u>14-10</u>	<u>64QAM</u>	<u>873</u>	<u>5.1152</u>
<u>15-11</u>	<u>64QAM</u>	<u>948</u>	<u>5.5547</u>
<u>12</u>	<u>256QAM</u>	<u>New value</u>	<u>New value</u>
<u>13</u>	<u>256QAM</u>	<u>New value</u>	<u>New value</u>
<u>14</u>	<u>256QAM</u>	<u>New value</u>	<u>New value</u>
<u>15</u>	<u>256QAM</u>	<u>New value</u>	<u>New value</u>

Fig. 5 Example of CQI index table with CQI index 12 - 15 added for 256QAM

I _{TBS}	N _{PRB}									
	1	2	3	4	108	109	110
0	16	32	56	88	2984	2984	3112
1	24	56	88	144	4008	4008	4008
2	32	72	144	176	4776	4968	4968
3	40	104	176	208	6200	6456	6456
4	56	120	208	256	7736	7736	7992
5	72	144	224	328	9528	9528	9528
6	328	176	256	392	11448	11448	11448
7 1	104	224	328	472	12960	13536	13536
8 2	120	256	392	536	15264	15264	15264
9 3	136	296	456	616	16992	16992	17568
10 4	144	328	504	680	19080	19080	19080
11 5	176	376	584	776	22152	22152	22152
12 6	208	440	680	904	24496	24496	25456
13 7	224	488	744	1000	27376	28336	28336
14 8	256	552	840	1128	30576	31704	31704
15 9	280	600	904	1224	32856	34008	34008
16 10	328	632	968	1288	35160	35160	35160
17 11	336	696	1064	1416	39232	39232	39232
18 12	376	776	1160	1544	42368	43816	43816
19 13	408	840	1288	1736	46888	46888	46888
20 14	440	904	1384	1864	51024	51024	51024
21 15	488	1000	1480	1992	55056	55056	55056
22 16	520	1064	1608	2152	59256	59256	59256
23 17	552	1128	1736	2280	61664	61664	63776
24 18	584	1192	1800	2408	66592	66592	66592
25 19	616	1256	1864	2536	68808	68808	71112
26 20	712	1480	2216	2984	75376	75376	75376
21	NV	NV	NV	NV	NV	NV	NV
22	NV	NV	NV	NV	NV	NV	NV
23	NV	NV	NV	NV	NV	NV	NV
24	NV	NV	NV	NV	NV	NV	NV
25	NV	NV	NV	NV	NV	NV	NV
26	NV	NV	NV	NV	NV	NV	NV

Fig. 6 Example of TBS table (dimension 21*110) with index 21-26 for 256QAM (corresponding to Fig. 5), NV = new values

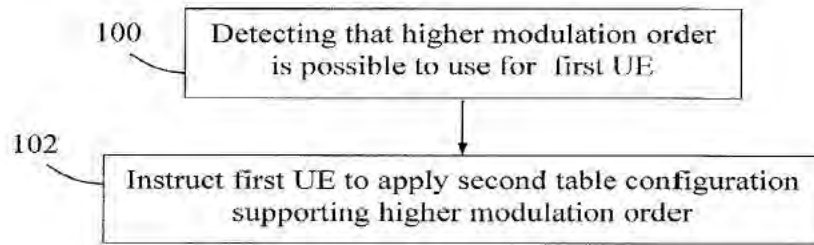

Fig. 7

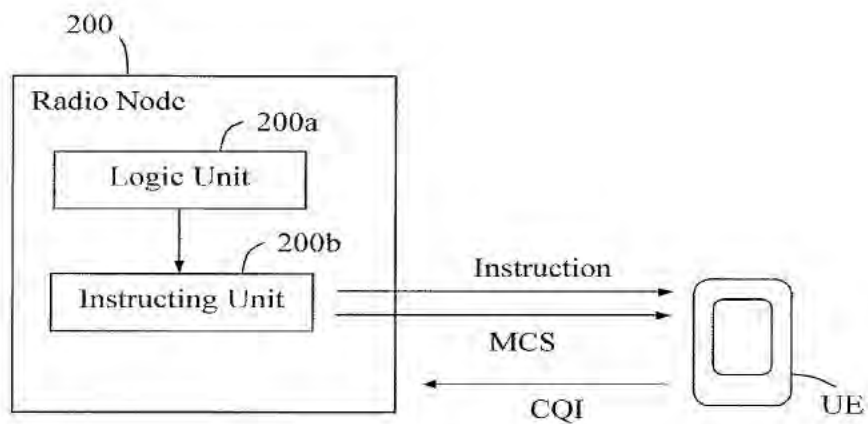

Fig. 8

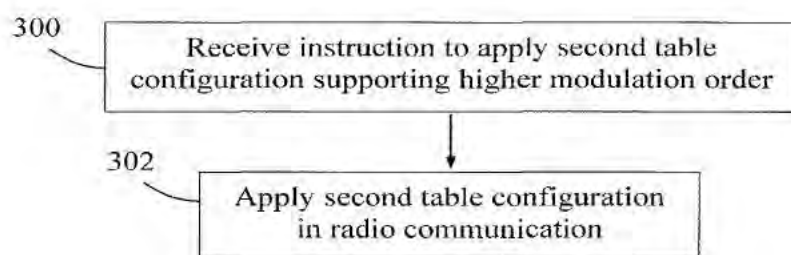

Fig. 9

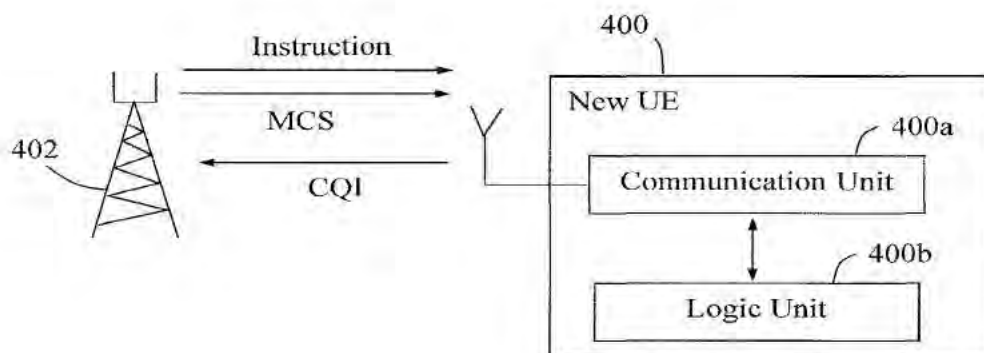

Fig. 10

Electronic Acknowledgement Receipt

EFS ID:	16544384
Application Number:	61863935
International Application Number:	
Confirmation Number:	6638
Title of Invention:	METHOD AND RADIO NODE FOR ENABLING USE OF HIGH ORDER MODULATION IN A RADIO COMMUNICATION WITH A USER EQUIPMENT
First Named Inventor/Applicant Name:	David HAMMARWALL
Customer Number:	11754
Filer:	Sarah Janelle Rodriguez/Anne Jansson
Filer Authorized By:	Sarah Janelle Rodriguez
Attorney Docket Number:	PS54636US00
Receipt Date:	09-AUG-2013
Filing Date:	
Time Stamp:	08:47:40
Application Type:	Provisional

Payment information:

Submitted with Payment	yes
Payment Type	Credit Card
Payment was successfully received in RAM	\$ 260
RAM confirmation Number	7504
Deposit Account	
Authorized User	

File Listing:

Document Number	Document Description	File Name	File Size(Bytes) Message Digest	Multi-Part (.zip)	Pages (if appl.)

1	Application Data Sheet	ADS.pdf	1505207	no	7
			528b52129cdf1e9ee9a9f2a35af13294ebf0e8db		
Warnings:					
Information:					
2	Provisional Cover Sheet (SB16)	SB16.pdf	1477173	no	3
			38988dfcb174bf1d01b2c24c71b5d3c9634ac510		
Warnings:					
Information:					
3	Specification	Specification.pdf	482758	no	15
			1155aa9608d4de19301447128f0b29615d8a06d30		
Warnings:					
Information:					
4	Drawings-only black and white line drawings	Drawings.pdf	167673	no	7
			d3fb706c0d16033eedc349300c5a0914897117a7		
Warnings:					
Information:					
5	Fee Worksheet (SB06)	fee-info.pdf	29867	no	2
			b89d97aabc7841786f388049a22ac932d17c7f8		
Warnings:					
Information:					
Total Files Size (in bytes):				3662678	

This Acknowledgement Receipt evidences receipt on the noted date by the USPTO of the indicated documents, characterized by the applicant, and including page counts, where applicable. It serves as evidence of receipt similar to a Post Card, as described in MPEP 503.

New Applications Under 35 U.S.C. 111

If a new application is being filed and the application includes the necessary components for a filing date (see 37 CFR 1.53(b)-(d) and MPEP 506), a Filing Receipt (37 CFR 1.54) will be issued in due course and the date shown on this Acknowledgement Receipt will establish the filing date of the application.

National Stage of an International Application under 35 U.S.C. 371

If a timely submission to enter the national stage of an international application is compliant with the conditions of 35 U.S.C. 371 and other applicable requirements a Form PCT/DO/EO/903 indicating acceptance of the application as a national stage submission under 35 U.S.C. 371 will be issued in addition to the Filing Receipt, in due course.

New International Application Filed with the USPTO as a Receiving Office

If a new international application is being filed and the international application includes the necessary components for an international filing date (see PCT Article 11 and MPEP 1810), a Notification of the International Application Number and of the International Filing Date (Form PCT/RO/105) will be issued in due course, subject to prescriptions concerning national security, and the date shown on this Acknowledgement Receipt will establish the international filing date of the application.

**DOCUMENT MADE AVAILABLE UNDER THE
PATENT COOPERATION TREATY (PCT)**

International application number:	PCT/SE2014/050803
International filing date:	26 June 2014 (26.06.2014)
Document type:	Certified copy of priority document
Document details:	Country/Office: US
	Number: 61/863,935
	Filing date: 09 August 2013 (09.08.2013)
Date of receipt at the International Bureau:	02 July 2014 (02.07.2014)

Remark: Priority document submitted or transmitted to the International Bureau in compliance with Rule 17.1(a),(b) or (b-bis)

PCT

Print Out (Original in Electronic Form)

VIII-2-1	Declaration: Entitlement to apply for and be granted a patent Declaration as to the applicant's entitlement, as at the international filing date, to apply for and be granted a patent (Rules 4.17(ii) and 51bis.1(a)(ii)), in a case where the declaration under Rule 4.17(iv) is not appropriate: Name (LAST, First)	In relation to this international application Telefonaktiebolaget L M Ericsson (publ) is entitled to apply for and be granted a patent by virtue of the following:
VIII-2-1(i)		ERICSSON AB is entitled as employer of the inventor, HAMMARWALL, David and the inventor WANG, Meng
VIII-2-1(vii)		transfer of entitlement from ERICSSON AB to Telefonaktiebolaget L M Ericsson (publ) by way of a general Assignment on transfer of ownership to invention already made and to be made in the future by employees of ERICSSON AB, dated 27 February 2003 (27.02.2003)

PCT REQUEST

Print Out (Original in Electronic Form)

0	For receiving Office use only	
0-1	International Application No.	PCT/SE2014/050803
0-2	International Filing Date	26 June 2014 (26.06.2014)
0-3	Name of receiving Office and "PCT International Application"	RO/SE
0-4	Form PCT/RO/101 PCT Request	
0-4-1	Prepared Using	PCT Online Filing Version 3.5.000.235 MT/FOP 20020701/0.20.5.20
0-5	Petition The undersigned requests that the present international application be processed according to the Patent Cooperation Treaty	
0-6	Receiving Office (specified by the applicant)	Swedish Patent and Registration Office (RO/SE)
0-7	Applicant's or agent's file reference	P41223WO1
I	Title of Invention	METHOD AND RADIO NODE FOR ENABLING USE OF HIGH ORDER MODULATION IN A RADIO COMMUNICATION WITH A USER EQUIPMENT
II	Applicant	
II-1	This person is	Applicant only
II-2	Applicant for	All designated States
II-4	Name	Telefonaktiebolaget L M Ericsson (publ)
II-5	Address	SE-164 83 Stockholm Sweden
II-6	State of nationality	SE
II-7	State of residence	SE
II-8	Telephone No.	+46 10 719 0000
II-9	Facsimile No.	+46 10 71 75695
II-10	e-mail	patent.development@ericsson.com
II-10(a)	E-mail authorization The receiving Office, the International Searching Authority, the International Bureau and the International Preliminary Examining Authority are authorized to use this e-mail address, if the Office or Authority so wishes, to send notifications issued in respect of this international application:	exclusively in electronic form (no paper notifications will be sent)

PCT REQUEST

Print Out (Original in Electronic Form)

III-1	Applicant and/or inventor	
III-1-1	This person is	Inventor only
III-1-3	Inventor for	
III-1-4	Name (LAST, First)	HAMMARWALL, David
III-1-5	Address	Hällmarksvägen 59 SE-186 53 VALLENTUNA Sweden
III-2	Applicant and/or inventor	
III-2-1	This person is	Inventor only
III-2-3	Inventor for	
III-2-4	Name (LAST, First)	WANG, Meng
III-2-5	Address	Signalistgatan 14 SE-169 72 SOLNA Sweden
IV-1	Agent or common representative; or address for correspondence	
	The person identified below is hereby/ has been appointed to act on behalf of the applicant(s) before the competent International Authorities as:	Agent
IV-1-1	Name (LAST, First)	BOU FAICAL, Roger
IV-1-2	Address	Ericsson AB Patent Unit Kista RAN1 SE-164 80 Stockholm Sweden
IV-1-3	Telephone No.	+46 10 7134981
IV-1-4	Facsimile No.	+46 10 7175695
IV-1-5	e-mail	patent.development@ericsson.com
IV-1-5(a)	E-mail authorization) The receiving Office, the International Searching Authority, the International Bureau and the International Preliminary Examining Authority are authorized to use this e-mail address, if the Office or Authority so wishes, to send notifications issued in respect of this international application:	exclusively in electronic form (no paper notifications will be sent)
V	DESIGNATIONS	
V-1	The filing of this request constitutes under Rule 4.9(a), the designation of all Contracting States bound by the PCT on the international filing date, for the grant of every kind of protection available and, where applicable, for the grant of both regional and national patents.	
VI-1	Priority claim of earlier national application	
VI-1-1	Filing date	09 August 2013 (09.08.2013)
VI-1-2	Number	61/863,935
VI-1-3	Country	US

PCT REQUEST

Print Out (Original in Electronic Form)

VI-2	Priority document request The International Bureau is requested to obtain from a digital library a certified copy of the earlier application(s) identified above as item(s), using, where applicable, the access code(s) indicated:	VI-1 Access code: 6638	
VI-3	Incorporation by reference : where an element of the international application referred to in Article 11(1)(iii)(d) or (e) or a part of the description, claims or drawings referred to in Rule 20.5(a) is not otherwise contained in this international application but is completely contained in an earlier application whose priority is claimed on the date on which one or more elements referred to in Article 11(1)(iii) were first received by the receiving Office, that element or part is, subject to confirmation under Rule 20.6, incorporated by reference in this international application for the purposes of Rule 20.6.		
VII-1	International Searching Authority Chosen	European Patent Office (EPO) (ISA/EP)	
VIII	Declarations	Number of declarations	
VIII-1	Declaration as to the identity of the inventor	–	
VIII-2	Declaration as to the applicant's entitlement, as at the international filing date, to apply for and be granted a patent	1	
VIII-3	Declaration as to the applicant's entitlement, as at the international filing date, to claim the priority of the earlier application	1	
VIII-4	Declaration of inventorship (only for the purposes of the designation of the United States of America)	–	
VIII-5	Declaration as to non-prejudicial disclosures or exceptions to lack of novelty	–	

PCT REQUEST

Print Out (Original in Electronic Form)

VIII-2-1	Declaration: Entitlement to apply for and be granted a patent Declaration as to the applicant's entitlement, as at the international filing date, to apply for and be granted a patent (Rules 4.17(ii) and 51bis.1(a)(ii)), in a case where the declaration under Rule 4.17(iv) is not appropriate: Name (LAST, First)	In relation to this international application Telefonaktiebolaget L M Ericsson (publ) is entitled to apply for and be granted a patent by virtue of the following:
VIII-2-1(i)		ERICSSON AB is entitled as employer of the inventor, HAMMARWALL, David and the inventor WANG, Meng
VIII-2-1(vii)		transfer of entitlement from ERICSSON AB to Telefonaktiebolaget L M Ericsson (publ) by way of a general Assignment on transfer of ownership to invention already made and to be made in the future by employees of ERICSSON AB, dated 27 February 2003 (27.02.2003)

PCT REQUEST

Print Out (Original in Electronic Form)

VIII-3-1	<p>Declaration: Entitlement to claim priority Declaration as to the applicant's entitlement, as at the international filing date, to claim the priority of the earlier application specified below, where the applicant is not the applicant who filed the earlier application or where the applicant's name has changed since the filing of the earlier application (Rules 4.17(iii) and 51bis.1(a)(iii))</p> <p>Name</p>	<p>In relation to this international application</p> <p>Telefonaktiebolaget L M Ericsson (publ) is entitled to claim priority of earlier application No. 61/863,935 by virtue of the following:</p>
VIII-3-1(i)		<p>ERICSSON AB is entitled as employer of the inventor, HAMMARWALL, David and the inventor WANG, Meng</p>
VIII-3-1(vii)		<p>transfer of entitlement from ERICSSON AB to Telefonaktiebolaget L M Ericsson (publ) by way of a general Assignment on transfer of ownership to invention already made and to be made in the future by employees of ERICSSON AB, dated 27 February 2003 (27.02.2003)</p>

PCT REQUEST

Print Out (Original in Electronic Form)

IX	Check list	Number of sheets	Electronic file(s) attached
IX-1	Request (including declaration sheets)	6	✓
IX-2	Description	25	✓
IX-3	Claims	6	✓
IX-4	Abstract	1	✓
IX-5	Drawings	7	✓
IX-7	TOTAL	45	
	Accompanying Items	Paper document(s) attached	Electronic file(s) attached
IX-8	Fee calculation sheet	-	✓
IX-18	PCT-SAFE physical media	-	-
IX-19	Other	Pre-conversion archive	✓
IX-20	Figure of the drawings which should accompany the abstract	5	
IX-21	Language of filing of the international application	English	
X-1	Signature of applicant, agent or common representative	/Roger Bou Faical/	
X-1-1	Name (LAST, First)	BOU FAICAL, Roger	
X-1-2	Name of signatory	BOU FAICAL, Roger	
X-1-3	Capacity (if such capacity is not obvious from reading the request)	(Representative)	

FOR RECEIVING OFFICE USE ONLY

10-1	Date of actual receipt of the purported international application	26 June 2014 (26.06.2014)
10-2	Drawings:	
10-2-1	Received	
10-2-2	Not received	
10-3	Corrected date of actual receipt due to later but timely received papers or drawings completing the purported international application	
10-4	Date of timely receipt of the required corrections under PCT Article 11(2)	
10-5	International Searching Authority	ISA/EP
10-6	Transmittal of search copy delayed until search fee is paid	

FOR INTERNATIONAL BUREAU USE ONLY

11-1	Date of receipt of the record copy by the International Bureau	
------	--	--

From the INTERNATIONAL BUREAU

PCT

NOTIFICATION OF THE RECORDING OF A CHANGE

(PCT Rule 92bis.1 and
Administrative Instructions, Section 422)

To:

BOU FAICAL, Roger
Ericsson AB
Patent Unit Kista RAN1
SE-164 80 Stockholm
SUÈDE

Date of mailing (<i>day/month/year</i>) 27 February 2015 (27.02.2015)	IMPORTANT NOTIFICATION
Applicant's or agent's file reference P41223WO1	
International application No. PCT/SE2014/050803	International filing date (<i>day/month/year</i>) 26 June 2014 (26.06.2014)

1. The following indications appeared on record concerning:

the applicant the inventor the agent the common representative

Name and Address WANG, Meng Signalistgatan 14 SE-169 72 Solna Sweden	State of Nationality	State of Residence
	Telephone No.	
	Facsimile No.	
	E-mail address	

2. The International Bureau hereby notifies the applicant that the following change has been recorded concerning:

the person the name the address the nationality the residence

Name and Address WANG, Meng Oxensternas allé 12 S-174 64 SUNDBYBERG Sweden	State of Nationality	State of Residence
	Telephone No.	
	Facsimile No.	
	E-mail address <input type="checkbox"/> Notifications by e-mail authorized	

3. Further observations, if necessary:

4. A copy of this notification has been sent to:

<input checked="" type="checkbox"/> the receiving Office	<input type="checkbox"/> the International Preliminary Examining Authority
<input type="checkbox"/> the International Searching Authority	<input checked="" type="checkbox"/> the designated Offices concerned
<input type="checkbox"/> the Authority(ies) specified for supplementary search	<input type="checkbox"/> the elected Offices concerned
	<input type="checkbox"/> other:

The International Bureau of WIPO 34, chemin des Colombettes 1211 Geneva 20, Switzerland	Authorized officer Malek David e-mail pt03.pct@wipo.int Telephone No. +41 22 338 74 03
Facsimile No. +41 22 338 70 80	

(12) INTERNATIONAL APPLICATION PUBLISHED UNDER THE PATENT COOPERATION TREATY (PCT)

(19) World Intellectual Property Organization
International Bureau



(10) International Publication Number
WO 2015/020587 A1

(43) International Publication Date
12 February 2015 (12.02.2015)

- (51) International Patent Classification:
H04L 1/00 (2006.01)
- (21) International Application Number:
PCT/SE2014/050803
- (22) International Filing Date:
26 June 2014 (26.06.2014)
- (25) Filing Language:
English
- (26) Publication Language:
English
- (30) Priority Data:
61/863,935 9 August 2013 (09.08.2013) US
- (71) Applicant: TELEFONAKTIEBOLAGET L M ERICSSON (PUBL) [SE/SE]; SE-164 83 Stockholm (SE).
- (72) Inventors: HAMMARWALL, David; Hällmarksvägen 59, SE-186 53 Vallentuna (SE). WANG, Meng; Signalistgatan 14, SE-169 72 Solna (SE).
- (74) Agent: BOU FAICAL, Roger; Ericsson AB, Patent Unit Kista RAN1, SE-164 80 Stockholm (SE).

- (81) Designated States (unless otherwise indicated, for every kind of national protection available): AE, AG, AL, AM, AO, AT, AU, AZ, BA, BB, BG, BH, BN, BR, BW, BY, BZ, CA, CH, CL, CN, CO, CR, CU, CZ, DE, DK, DM, DO, DZ, EC, EE, EG, ES, FI, GB, GD, GE, GH, GM, GT, HN, HR, HU, ID, IL, IN, IR, IS, JP, KE, KG, KN, KP, KR, KZ, LA, LC, LK, LR, LS, LT, LU, LY, MA, MD, ME, MG, MK, MN, MW, MX, MY, MZ, NA, NG, NI, NO, NZ, OM, PA, PE, PG, PH, PL, PT, QA, RO, RS, RU, RW, SA, SC, SD, SE, SG, SK, SL, SM, ST, SV, SY, TH, TJ, TM, TN, TR, TT, TZ, UA, UG, US, UZ, VC, VN, ZA, ZM, ZW.
- (84) Designated States (unless otherwise indicated, for every kind of regional protection available): ARIPO (BW, GH, GM, KE, LR, LS, MW, MZ, NA, RW, SD, SL, SZ, TZ, UG, ZM, ZW), Eurasian (AM, AZ, BY, KG, KZ, RU, TJ, TM), European (AL, AT, BE, BG, CH, CY, CZ, DE, DK, EE, ES, FI, FR, GB, GR, HR, HU, IE, IS, IT, LT, LU, LV, MC, MK, MT, NL, NO, PL, PT, RO, RS, SE, SI, SK, SM, TR), OAPI (BF, BJ, CF, CG, CI, CM, GA, GN, GQ, GW, KM, ML, MR, NE, SN, TD, TG).

[Continued on next page]

(54) Title: METHOD AND RADIO NODE FOR ENABLING USE OF HIGH ORDER MODULATION IN A RADIO COMMUNICATION WITH A USER EQUIPMENT



WO 2015/020587 A1

MCS Index	Modulation Order	TBS Index
ν_{MCS}	Q_m	ν_{TBS}
0	2	0
1	2	1
2	2	2
3	2	3
4	2	4
5	2	5
6	2	6
7	2	7
8	2	8
9	2	9
10	4	10
11	4	11
12	4	12
13	4	13
14	4	14
15	4	15
16	6	16
17	6	17
18	6	18
19	6	19
20	6	20
21	6	21
22	6	22
23	6	23
24	6	24
25	6	25
26	8	26
27	8	27
28	8	28
29	8	29
30	8	30
31	8	31

Fig. 8

(57) Abstract: A method and radio node (500) for enabling higher-order modulation like 256QAM in LTE. A first table configuration comprises at least one of a first Modulation and Coding Scheme, MCS, table and a first Channel Quality Indicator, CQI, table which tables support a certain maximum modulation order. When the radio node (500) detects that a modulation order higher than the maximum modulation order of the first table configuration is potentially possible to use in the radio communication, the radio node (500) instructs the first UE (502) to apply a second table configuration which comprises at least one of a second MCS table and a second CQI table which second tables support the higher modulation order. At least one entry for at least one modulation order in the tables of the first table configuration is maintained in the tables of the second table configuration as a fall-back in case it is desirable to use the at least one modulation order of the first table configuration when the second table configuration is applied. Thereby, a higher data rate can be achieved in the radio communication. A legacy MCS table and a new MCS table having entries with 256QAM are provided with the signalling to switch between these tables.

Declarations under Rule 4.17:

- *as to applicant's entitlement to apply for and be granted a patent (Rule 4.17(ii))*
- *as to the applicant's entitlement to claim the priority of the earlier application (Rule 4.17(iii))*

Published:

- *with international search report (Art. 21(3))*

METHOD AND RADIO NODE FOR ENABLING USE OF HIGH ORDER MODULATION IN A RADIO COMMUNICATION WITH A USER EQUIPMENT

Technical field

The present disclosure relates generally to a radio node of a cellular network, a User Equipment, UE and methods therein, for enabling use of a high order modulation when communicating radio signals.

Background

In this field, the term “User Equipment, UE” is commonly used and will be used in this disclosure to represent any wireless terminal or device capable of radio communication with a cellular network including receiving downlink signals transmitted from a serving radio node and sending uplink signals to the radio node. For example, the term User Equipment, UE could be exchanged by the term “wireless device”. Further, the term “radio node”, also commonly referred to as a base station, e-nodeB, eNB, etc., represents any node of a cellular network that can communicate uplink and downlink radio signals with UEs. The radio nodes described here may, without limitation, include so-called macro nodes and low power nodes such as micro, pico, femto, Wifi and relay nodes, to mention some customary examples. Throughout this disclosure, the term “eNB” is often used but can be exchanged by the term radio node.

Link adaptation in systems according to Long Term Evolution, LTE, is based on adaptive modulation and coding, which controls data rate by adaptively adjusting the modulation scheme and/or channel coding rate according to the radio-link conditions. In this procedure, the Modulation and Coding Scheme, MCS, adopted for Physical Downlink Shared Channel, PDSCH, transmission must be indicated in downlink MCS signaling by the serving radio node to the UE. By uplink signaling, the UE informs the radio node about corresponding radio-link, i.e. channel, conditions through Channel Quality Indicator, CQI signaling, including sending CQI reports to the radio node.

This is generally illustrated in Fig. 1 in which a radio node 100 of a cellular network is serving two UEs denoted UE1 and UE2. In this example, UE1 and UE2 both

report quality measurements made on the channel used by sending CQI reports to the radio node 100 which selects a suitable MCS for each UE based on their CQI reporting and signals the selected MCS to the UEs, respectively. Link adaptation is made in this way for individual UEs on a dynamic basis since the radio-link conditions may change rapidly. The selection of a suitable MCS can thus be made individually for each UE.

In current LTE systems, the set of available modulation schemes for both downlink and uplink includes Quadrature Phase-Shift Keying, QPSK, 16 Quadrature Amplitude Modulation, QAM, and 64QAM, corresponding to two, four and six bits carried per modulation symbol, respectively. In this field, the number of bits carried per modulation symbol is usually referred to as the modulation order, Q_m .

In brief, the serving radio node selects a suitable MCS based on CQI reporting from the UE and signals the selected MCS to the UE with reference to a predefined MCS index table which is known to the UE. The MCS index table maps MCS indices to modulation order and a Transport Block Size, TBS, index. Further, the UE determines a CQI value based on signal measurements and the CQI is signaled from the UE to the radio node with reference to a likewise predefined CQI index table which maps CQI indices to modulation forms and code rates. In this description, the term "modulation form" is used for short to indicate a modulation format, method or scheme.

In LTE, especially for scenarios with good channel conditions where the Signal-to-Interference-and-Noise Ratio, SINR, is high, e.g. in small-cell environments where the UE is close to its serving radio node, a straightforward means to provide higher data rate for the UE with given transmission bandwidth is to use higher-order modulation that allows for more bits of information to be carried per modulation symbol, as compared to the modulation schemes mentioned above where the highest possible data rate is provided by 64QAM carrying six bits per modulation symbol. However, it is a problem that the control signaling schemes, methods, formats or protocols of today do not support any modulation with higher order than six bits per symbol, as in 64QAM. It is also a problem that additional control

signaling would be required between the UE and the serving radio node if higher data rate is to be achieved by using higher-order modulation.

Summary

It is an object of embodiments described herein to address at least some of the problems and issues outlined above. It is possible to achieve this object and others by using a radio node, a UE and methods therein as defined in the attached independent claims.

According to one aspect, a method is performed by a radio node of a cellular network. The radio node is operable to apply a first table configuration in radio communications with User Equipments, UEs, the first table configuration comprising at least one of a first Modulation and Coding Scheme, MCS, table and a first Channel Quality Indicator, CQI, table wherein the at least one of the first MCS table and the first CQI table support a certain maximum modulation order.

In this method, the radio node detects that a higher modulation order which is higher than the maximum modulation order of the first table configuration is potentially possible to use in a radio communication between the radio node and a first UE. The radio node then instructs the first UE to apply a second table configuration in the radio communication. The second table configuration comprises at least one of a second MCS table and a second CQI table wherein the at least one of the second MCS table and the second CQI table support the higher modulation order. Furthermore, at least one entry for at least one modulation order in the at least one of the first MCS table and the first CQI table is maintained in the at least one of the second MCS table and the second CQI table as a fall-back in case it is desirable to use the at least one modulation order in the at least one of the first MCS table and the first CQI table when the second table configuration is applied.

According to another aspect, a radio node of a cellular network is operable to apply a first table configuration in radio communications with User Equipments, UEs, the first table configuration comprising at least one of a first Modulation and Coding Scheme, MCS, table and a first Channel Quality Indicator, CQI, table

wherein the at least one of the first MCS table and the first CQI table support a certain maximum modulation order. The radio node comprises a logic unit configured to detect that a higher modulation order which is higher than the maximum modulation order of the first table configuration is potentially possible to use in a radio communication between the radio node and a first UE.

The radio node also comprises an instructing unit configured to instruct the first UE to apply a second table configuration in the radio communication, the second table configuration comprising at least one of a second MCS table and a second CQI table wherein the at least one of the second MCS table and the second CQI table support the higher modulation order. At least one entry for at least one modulation order in the at least one of the first MCS table and the first CQI table is maintained in the at least one of the second MCS table and the second CQI table as a fall-back in case it is desirable to use the at least one modulation order in the at least one of the first MCS table and the first CQI table when the second table configuration is applied.

According to another aspect, a method is performed by a User Equipment, UE, being operable to apply a first table configuration in a radio communication with a radio node of a cellular network. The first table configuration comprises at least one of a first Modulation and Coding Scheme, MCS, table and a first Channel Quality Indicator, CQI, table wherein the at least one of the first MCS table and the first CQI table support a certain maximum modulation order. In this method, the UE receives an instruction from the radio node to apply a second table configuration in the radio communication, the second table configuration comprising at least one of a second MCS table and a second CQI table wherein the at least one of the second MCS table and the second CQI table support a higher modulation order which is higher than the maximum modulation order of the first table configuration. The UE further applies the second table configuration in the radio communication with the radio node.

According to another aspect, a User Equipment, UE, is operable to apply a first table configuration in a radio communication with a radio node of a cellular network, the first table configuration comprising at least one of a first Modulation

and Coding Scheme, MCS, table and a first Channel Quality Indicator, CQI, table wherein the at least one of the first MCS table and the first CQI table support a certain maximum modulation order. The UE comprises a communication unit which is configured to receive an instruction from the radio node to apply a second table configuration in the radio communication, the second table configuration comprising at least one of a second MCS table and a second CQI table wherein the at least one of the second MCS table and the second CQI table support a higher modulation order which is higher than the maximum modulation order of the first table configuration. The UE also comprises a logic unit which is configured to apply the second table configuration in the radio communication with the radio node.

When using any of the above methods and nodes, it is possible to achieve a higher data rate in the radio communication between the radio node and the UE by using the higher modulation order of the second table configuration, e.g. when the radio or channel conditions are favorable, instead of being limited to the maximum modulation order of the first table configuration.

A computer program is also provided comprising instructions which, when executed on at least one processor, cause the at least one processor to carry out either of the above methods. A carrier is also provided which contains the above computer program, wherein the carrier is one of an electronic signal, optical signal, radio signal, or computer readable storage medium.

The above methods and nodes may be configured and implemented according to different optional embodiments to accomplish further features and benefits, to be described below.

Brief description of drawings

The solution will now be described in more detail by means of exemplary embodiments and with reference to the accompanying drawings, in which:

Fig. 1 is a communication scenario illustrating how link adaptation can be achieved, according to the prior art.

Fig. 2 is a table used for MCS signaling from a radio node to a UE, according to a first table configuration.

Fig. 3 is a table used for CQI signaling from a UE to a radio node, according to the first table configuration.

Fig. 4 is a flow chart illustrating a procedure in a radio node, according to some possible embodiments.

Fig. 5 is a block diagram illustrating an example of how a radio node may be configured and operate, according to further possible embodiments.

Fig. 6 is a flow chart illustrating a procedure in a UE, according to some possible embodiments.

Fig. 7 is a block diagram illustrating an example of how a UE may be configured and operate, according to further possible embodiments.

Fig. 8 is an example of a modified table used for MCS signaling from a radio node to a UE, according to according to a second table configuration.

Fig. 9 is an example of a modified table used for CQI signaling from a UE to a radio node, according to the second table configuration.

Fig. 10 is an example of a modified table used for mapping a Transport Block Size, TBS, index to a data rate, according to further possible embodiments.

Detailed description

In this solution it has been recognized that the above-described control signaling for MCS and CQI indication can be re-designed in order to adopt higher-order modulation schemes in LTE systems. In particular, the MCS and CQI index tables used for such signaling can be modified such that the current maximum modulation order can be increased without requiring any extra signaling bits. In this disclosure, the term higher-order modulation may refer to modulation schemes that are higher than 64QAM, such as e.g. 256QAM allowing eight bits per symbol, or even higher modulation of 512QAM, and so forth.

Briefly described, a first table configuration is initially applied in radio communication between a radio node and a UE. The first table configuration comprises a first MCS table and/or a first CQI table which tables support a certain maximum modulation order, e.g. 6. An example of the first MCS table is shown in Fig. 2 and an example of the first CQI table is shown in Fig. 3. The first MCS table and the first CQI table are thus predefined and known to the UE, for example the tables currently used in LTE for signaling between radio nodes and UEs for enabling link adaptation as described above although other MCS and CQI tables are also possible to use in the first table configuration. In these examples it can be seen that the maximum modulation order supported by the first MCS table and the first CQI table is $Q_m = 6$ which corresponds to 64QAM.

When detecting that a higher modulation order which is higher than the maximum modulation order of the first table configuration is potentially possible to use in the above communication, e.g. based on CQI reports from the UE, the radio node instructs the UE to apply a second table configuration that supports the higher modulation order. The second table configuration comprises a second MCS table and/or a second CQI table having additional entries that support the higher modulation order. Examples of how such tables of the second table configuration can be configured will be described in more detail later below. In this solution, at least one entry for at least one modulation order is maintained, i.e. kept, from the table(s) of the first table configuration as a fall-back in case it would become desirable or even necessary to use the least one modulation order of the first table configuration when the second table configuration is applied, such as when the radio conditions get worse and only the least one modulation order of the first table configuration, e.g. the lowest modulation order, is possible to use for keeping the radio connection.

It will now be described how link adaptation can be achieved in general according to LTE.

For downlink data transmission in LTE, the radio node typically selects the MCS depending on the CQI feedback transmitted by the UE in the uplink, as illustrated

in Fig. 1. The CQI feedback indicates the present channel condition and possible data rate, or more specifically a modulation and coding scheme MCS, that can be supported by the downlink channel given the present channel condition and UE receiver.

The LTE specifications are designed to provide signaling between the radio node and the UE. In the downlink, the information about the MCS adopted for PDSCH transmission is indicated by a five-bit field in the Downlink Control Information, DCI, transmitted from the radio node to the UE. This MCS field corresponds to the MCS index table shown in Fig. 2. In this table, there is room for 32 combinations or entries, where 29 entries are used to signal an adopted MCS, each entry corresponding to a modulation order and a Transport Block Size, TBS, while 3 entries are reserved, e.g., to support adaptive retransmissions. All possible TBS can be described by a TBS table mapping a TBS index, I_{TBS} , and an allocation bandwidth into the corresponding transport block size (in bits).

In the uplink, the UE reports CQI to assist the serving radio node to select the appropriate MCS to apply for downlink transmissions. Typically, the CQIs are derived from measurements made by the UE on downlink reference signals transmitted by the serving radio node. For example, the reported CQI may represent the highest MCS that is supported for a PDSCH transmission, e.g. with a transport block error rate probability not exceeding 10%. The CQI is signaled from the UE to the radio node with reference to a predefined CQI index table, as shown in Fig. 3. A 4-bit CQI value corresponds to a particular MCS out of 16 combinations corresponding to CQI index 0-15 in the CQI index table. It should be noted that the CQI table is parameterized in terms of coding rate, as opposed to transport block size. Thus, the selected and signaled CQI indicates the highest modulation and coding rate at which the block error rate measured at UE does not exceed 10%. Based on the CQI feedback from the UE and other information, the radio node is able to select a proper MCS index from the MCS table and notify the UE accordingly by MCS signaling.

Current LTE systems support three modulation schemes for both downlink and uplink: QPSK, 16QAM and 64QAM. Accordingly, the MCS index table, the CQI index table and the corresponding fields for indication in DCI are designed for these three modulation schemes. However, higher-order modulation schemes are not supported in current LTE specifications. In order to support higher-order modulation, i.e. higher than the above schemes QPSK, 16QAM and 64QAM, UEs must support an additional MCS/CQI table that also includes specific entries for new modulation schemes. The modification of MCS/CQI table may require re-designing the DCI format and possibly also the Uplink Control Information, UCI, format.

Typically, the additional MCS/CQI tables are used in scenarios with high Signal-to-Noise Ratio, SNR, or SINR which allow for higher-order modulation to be used thanks to the high signal quality. In scenarios with relatively low SNR or SINR, on the other hand, the current MCS/CQI tables supporting QPSK, 16QAM and 64QAM are useful to achieve link robustness. Hence, a solution has been devised with flexibility to adopt appropriate MCS/CQI tables based on channel conditions as follows.

As mentioned above, current LTE systems only support modulation up to 64QAM, while it may be desirable to use higher-order modulation, e.g. 256QAM, to increase the data rate when the signal quality allows. To support higher-order modulation, adaptations and/or extensions to the current control signaling in terms of the MCS index table, the CQI index table and the corresponding fields in DCI/UCI are required. This can be solved by the embodiments described herein.

In this disclosure, an alternative design of an MCS index table and/or of a CQI index table supporting higher-order modulation is described which can be used for LTE systems, which can be supported in addition to basic MCS and CQI tables such as the current design of the MCS index table and the CQI index table shown in Fig. 2 and Fig. 3, respectively.

In the current LTE specification, the MCS and CQI tables support modulation schemes up to 64QAM, e.g. as illustrated in Figs 2 and 3. The proposed new MCS

and CQI index tables are able to support modulation higher than 64QAM, without necessarily extending the number of bits in the DCI/UCI formats, or the number of entries in the MCS table and in the CQI table, respectively. In this solution, it is possible to select higher-order modulation schemes e.g. in the high-SINR scenarios or generally when a performance related parameter, such as SINR, of signals communicated between a radio node and a UE is above a certain threshold.

In the new MCS/CQI tables, new entries for higher-order modulation are added and designed to provide sufficient resolution to cover the high-SINR region. Meanwhile, a large part of the existing entries in current MCS and/or CQI tables may be preserved. The current MCS and/or CQI tables may be comprised in a first table configuration while the new MCS and/or CQI tables supporting a higher-order modulation may be comprised in a second table configuration. This has the advantage that the number of new MCS/CQI formats a UE and a radio node has to implement may be minimized. In other words, the UE and the radio node need to support only one extra MCS table and/or CQI table of the second table configuration in order to enable the higher-order modulation.

In a possible embodiment, at least one MCS entry, e.g. the lowest MCS entry with MCS index 0, in the MCS table and/or at least one CQI entry, e.g. the lowest CQI entry for the lowest coding rate of the lowest modulation order with CQI index 1, in the CQI table is preserved or maintained from the basic MCS and/or CQI table, to ensure proper communication between the radio node and the UE under poor channel or radio conditions. Thus, a fallback is provided in case it is only possible or desirable to use a modulation order lower than the higher modulation order, e.g. the lowest modulation order, when the second table configuration is applied. This provides flexibility and robustness in case of changing channel or radio conditions, and provides a robust format to, for example, signal control-plane data, and/or to reconfigure the UE to assume the basic MCS and/or CQI table suitable for poor/normal channel or radio conditions. By employing embodiments described herein, the link adaption in LTE systems may be enhanced to support higher-order modulation schemes, which can significantly improve the spectral efficiency e.g. in

high SINR scenarios, while maintaining robustness in case of worsening radio conditions.

It should be noted that although terminology from 3GPP LTE is used in this disclosure to describe various exemplifying embodiments, this should not be seen as limiting the scope of usage to only the aforementioned system. Other wireless systems, including WCDMA, WiMAX, and Ultra Mobile Broadband, UMB, may also benefit from exploiting embodiments described herein.

It should also be noted that terminology such as radio node should be considered non-limiting and in general "radio node" could be considered as device 1 and "UE" could be considered as device 2 and these two devices may communicate with each other over some radio channel in the manner described herein.

In the following, the solution will be explained in more detail by some exemplary embodiments. It should be noted that these embodiments are not mutually exclusive. Components from one embodiment may be utilized in another embodiment wherever appropriate.

The MCS index table and CQI index table used in current LTE specification are shown in Fig. 2 and Fig. 3, respectively. A possible design of alternative MCS and CQI index tables will now be described as well as the mechanism by which the radio node and the UE can switch between the proposed new MCS/CQI tables of the second table configuration and the MCS/CQI tables of the first table configuration. It should be noted that the solution is not limited to the specific examples of MCS/CQI tables described herein and that any MCS/CQI tables may be used in accordance with the embodiments described herein.

An example of a procedure, performed by a radio node of a cellular network when the solution is employed, will now be described with reference to the flow chart in Fig. 4. Some possible but non-limiting embodiments will also be described which may be used for the radio node. In this procedure, it is assumed that the radio node is operable to apply a first table configuration in radio communications with UEs, and that the first table configuration comprises at least one of a first MCS

table and a first CQI table wherein the at least one of the first MCS table and the first CQI table support a certain maximum modulation order. As said above, the maximum modulation order supported by the currently used MCS/CQI tables is $Q_m = 6$ which corresponds to 64QAM, and the currently used MCS/CQI tables may, without limitation, be used as the first table configuration in this solution.

A first **action 400** illustrates that the radio node detects that a higher modulation order which is higher than the maximum modulation order of the first table configuration is potentially possible to use in a radio communication between the radio node and a first UE. For example, this may be detected when a performance related parameter, e.g. SINR, of signals communicated between the radio node and the second UE is above a certain threshold.

Another **action 402** illustrates that the radio node instructs the first UE to apply a second table configuration in the radio communication. The second table configuration comprises at least one of a second MCS table and a second CQI table wherein the at least one of the second MCS table and the second CQI table support the higher modulation order. Furthermore, at least one entry for at least one modulation order in the at least one of the first MCS table and the first CQI table is maintained in the at least one of the second MCS table and the second CQI table as a fall-back in case it is desirable to use the at least one modulation order in the at least one of the first MCS table and the first CQI table when the second table configuration is applied. In other words, the at least one of the second MCS table and the second CQI table includes at least one entry for at least one modulation order, e.g. the lowest modulation order, that is also included in the at least one of the first MCS table and the first CQI table, in order to provide said fall-back. Such a fall-back may be desirable, and even necessary, if the signal quality, e.g. as indicated by the CQI reports from the UE, suddenly deteriorates and no modulation order higher than the lowest one is suitable or even possible to use for achieving robustness.

In a possible embodiment, the radio node may instruct the first UE to apply the second table configuration in the radio communication between the radio node and

the first UE when a performance related parameter of signals communicated between the radio node and the first UE is above a threshold. The performance related parameter may be derived from CQI reports provided by the first UE containing measurements of downlink reference signals transmitted by the radio node.

In another possible embodiment, the radio node may instruct a second UE to apply the first table configuration in a radio communication between the radio node and the second UE when the performance related parameter of signals communicated between the radio node and the second UE is below the threshold. In yet a possible embodiment, the radio node may in this case instruct the second UE explicitly by sending an instruction to the second UE to apply the first table configuration, or implicitly by not sending an instruction to the second UE to apply the second table configuration which indicates to the second UE that it should apply the first table configuration. Furthermore, the radio node may instruct the first UE as well to apply the first table configuration again, if the performance related parameter of signals between the radio node and the first UE would fall below the threshold. In either of the latter embodiments, the performance related parameter may comprise a Signal-to-Interference-and-Noise Ratio, SINR.

It was mentioned above that the MCS and CQI index tables of the second table configuration may be created by modifying the MCS and CQI index tables of the first table configuration, e.g. the tables shown in Figs 2 and 3, such that the current maximum modulation order can be increased. This may be done without requiring any extra signaling bits. In one possible embodiment, the at least one of the second MCS table and the second CQI table may be a modification of the at least one of the first MCS table and the first CQI table, respectively, where a set of entries for the higher modulation order have been added and a set of entries for the at least one modulation order in the at least one of the first MCS table and the first CQI table have been removed in the respective second tables. In another possible embodiment, the at least one modulation order in the at least one of the first MCS table and the first CQI table may comprise a lowest modulation order of the first table configuration. It will be described later below how the above-

mentioned modification of the first MCS table and the first CQI table may be done in more detail with reference to examples shown in Figs 8 and 9.

It was also mentioned above that at least one entry for the at least one modulation order, e.g. the lowest modulation order, in the at least one of the first MCS table and the first CQI table is maintained, i.e. kept, in the at least one of the second MCS table and the second CQI table as a fall-back in case the signal quality deteriorates while using the second table configuration. In another possible embodiment, the first entry for the lowest modulation order in the first MCS table may be maintained in the second MCS table as the fall-back, and an entry for the lowest coding rate of the lowest modulation order in the first CQI table may be maintained in the second CQI table as the fall-back. This embodiment will be illustrated in more detail later below.

In another possible embodiment, the number of added entries for the higher modulation order and the number of removed entries for the lowest modulation order may be equal such that the first and second MCS tables are of equal size and/or the first and second CQI tables are of equal size. Thereby, no extra bits are needed in the signaling of MCS and/or CQI, respectively, for supporting the second table configuration in addition to the first table configuration.

In another possible embodiment, the at least one of the second MCS table and the second CQI table may be a modification of the at least one of the first MCS table and the first CQI table, respectively, where all entries of the at least one of the first MCS table and the first CQI table have been maintained, i.e. kept, in the at least one of the second MCS table and the second CQI table and a set of entries for the higher modulation order have been added. In yet a possible embodiment, the first and second table configurations may further comprise a Transport Block Size, TBS, table corresponding to the first and second MCS tables, respectively. The TBS table maps a TBS index, I_{TBS} , and an allocation bandwidth into the corresponding transport block size, e.g. given in number of bits.

A detailed but non-limiting example of how a radio node may be structured with some possible functional entities such as modules, circuits or units, to bring about

the above-described functionality of the radio node, is illustrated by the block diagram in Fig. 5. In this figure, the radio node 500 is operable to apply a first table configuration in radio communications with UEs, the first table configuration comprising at least one of a first Modulation and Coding Scheme, MCS, table and a first Channel Quality Indicator, CQI, table wherein the at least one of the first MCS table and the first CQI table support a certain maximum modulation order.

The radio node 500 may be configured to operate according to any of the examples and embodiments of employing the solution as described above and as follows. In particular, the radio node 500 may comprise means arranged or configured to perform the actions of the flow chart in Fig. 4 and the embodiments described above, where appropriate. In order to put any of this into practice, the radio node 500 may be implemented with a communication circuit C, a memory M and an operable processor P comprising various functional units as described below.

More specifically, the radio node 500 comprises means, such as a **logic unit 500a**, configured to detect that a higher modulation order which is higher than the maximum modulation order of the first table configuration is potentially possible to use in a radio communication between the radio node 500 and a first UE 502. This detecting operation may be performed as described for action 400 above.

The radio node 500 also comprises means, such as an **instructing unit 500b**, configured to instruct the first UE 502 to apply a second table configuration in the radio communication, the second table configuration comprising at least one of a second MCS table and a second CQI table wherein the at least one of the second MCS table and the second CQI table support the higher modulation order, and wherein at least one entry for at least one modulation order in the at least one of the first MCS table and the first CQI table is maintained in the at least one of the second MCS table and the second CQI table as a fall-back in case it is desirable to use the at least one modulation order in the at least one of the first MCS table and the first CQI table when the second table configuration is applied. This instructing operation may be performed as described for action 402 above.

An example of a procedure, performed by a UE when the solution is employed, will now be described with reference to the flow chart in Fig. 6. In this procedure, it is assumed that the UE is operable to apply a first table configuration in a radio communication with a radio node of a cellular network, the first table configuration comprising at least one of a first Modulation and Coding Scheme, MCS, table and a first Channel Quality Indicator, CQI, table wherein the at least one of the first MCS table and the first CQI table support a certain maximum modulation order.

A first **action 600** illustrates that the UE receives an instruction from the radio node to apply a second table configuration in the radio communication, the second table configuration comprising at least one of a second MCS table and a second CQI table wherein the at least one of the second MCS table and the second CQI table support a higher modulation order which is higher than the maximum modulation order of the first table configuration. In another **action 602**, the UE applies the second table configuration in the radio communication with the radio node, which may include receiving MCS signaling from the radio node with reference to the second MCS table and/or sending CQI reports to the radio node with reference to the second CQI table, in accordance with the second table configuration.

A detailed but non-limiting example of how a UE may be structured with some possible functional entities such as modules, circuits or units, to bring about the above-described functionality of the UE, is illustrated by the block diagram in Fig. 7. In this figure, the UE 700 is operable to apply a first table configuration in a radio communication with a serving radio node 702 of a cellular network, the first table configuration comprising at least one of a first Modulation and Coding Scheme, MCS, table and a first Channel Quality Indicator, CQI, table wherein the at least one of the first MCS table and the first CQI table support a certain maximum modulation order.

The UE 700 may be configured to operate according to any of the examples and embodiments of employing the solution as described above and as follows. In particular, the UE 700 may comprise means arranged or configured to perform the actions of the flow chart in Fig. 6. In order to put any of this into practice, the UE

700 may be implemented with a communication circuit C, a memory M and an operable processor P comprising various functional units as described below.

More specifically, the UE 700 comprises means, such as a **communication unit 700a**, configured to receive an instruction from the radio node 702 to apply a second table configuration in the radio communication, the second table configuration comprising at least one of a second MCS table and a second CQI table wherein the at least one of the second MCS table and the second CQI table support a higher modulation order which is higher than the maximum modulation order of the first table configuration. The UE 700 also comprises means, such as a **logic unit 700b**, configured to apply the second table configuration in the radio communication with the radio node 702. This is illustrated in the figure by the UE 700 receiving MCS signaling from the radio node 702 with reference to the second MCS table and/or sending CQI reports to the radio node 702, with reference to the second CQI table in accordance with the second table configuration.

It should be noted that Figs 5 and 7 illustrate various functional units in the radio node 500 and the UE 700, respectively, and the skilled person is able to implement these functional units in practice using suitable software and hardware. Thus, the solution is generally not limited to the shown structures of the radio node 500 and the UE 700, and the functional units 500a-b and 700a-b may be configured to operate according to any of the features described in this disclosure, where appropriate.

The functional units 500a-b and 700a-b described above can be implemented in the radio node 500 and the UE 700, respectively, by means of program modules of a respective computer program comprising code means which, when run by the processor P in each node causes the radio node 500 and the UE 700 to perform the above-described actions and procedures. Each processor P may comprise a single Central Processing Unit (CPU), or could comprise two or more processing units. For example, each processor P may include a general purpose microprocessor, an instruction set processor and/or related chips sets and/or a special purpose microprocessor such as an Application Specific Integrated Circuit (ASIC). Each processor P may also comprise a storage for caching purposes.

Each computer program may be carried by a computer program product in each of the radio node 500 and the UE 700 in the form of a memory having a computer readable medium and being connected to the processor P. The computer program product or memory M in each of the radio node 500 and the UE 700 may thus comprise a computer readable medium on which the computer program is stored e.g. in the form of computer program modules or the like. For example, the memory M in each node may be a flash memory, a Random-Access Memory (RAM), a Read-Only Memory (ROM) or an Electrically Erasable Programmable ROM (EEPROM), and the program modules could in alternative embodiments be distributed on different computer program products in the form of memories within the respective radio node 500 and UE 700.

The solution described herein may be implemented in the respective radio node 500 and UE 700 by a computer program comprising instructions which, when executed on at least one processor, cause the at least one processor to carry out the actions according to any of the above embodiments. The solution may also be implemented at the respective radio node 500 and UE 700 in a carrier containing the above computer program, wherein the carrier is one of an electronic signal, optical signal, radio signal, or computer readable storage medium.

It will now be described in more detail how the first MCS and CQI tables shown in Figs 2 and 3 can be modified to create the second MCS and CQI tables, which is exemplified in the modified MCS table shown in Fig. 8 and in the modified CQI table shown in Fig. 9.

MCS index table

In an illustrative example, a first MCS table of the above-described first table configuration is used for downlink transmission to one UE, such as UE1 in Fig. 1, and for downlink transmission to another UE, such as UE2 in Fig. 1, a second MCS table of the above-described second table configuration is used.

In another illustrative example, the first MCS table is the current MCS table of the first table configuration in specification as shown in Fig. 2, and the second MCS table is a modified new MCS table of the second table configuration that supports

a modulation order higher than the maximum modulation order supported by the first MCS table, i.e. the second MCS table contains entries for higher-order modulation. An example of a second MCS table is shown in Fig. 8 which has been modified from the first MCS table of Fig. 2.

In another illustrative example, the radio node can use either current MCS table or proposed alternative MCS table for DL transmission. In a further example, the information about the MCS table that is to be used may be part of a DCI message, in which case it typically applies to a single specific subframe, or it may be part of a Radio Resource Control, RRC message or a Medium Access Control, MAC message, in which case it typically applies until further notice.

In another illustrative example, the proposed MCS index table of the second table configuration may have $32+N$ rows where $N \geq 0$ is a non-negative integer. The columns of the table represent the same parameters as those of the MCS index table shown in Fig. 2, which include MCS index I_{MCS} , modulation order Q_m and TBS index I_{TBS} . Each table row or entry, that corresponds to one MCS, is indexed by the MCS index I_{MCS} and contains a particular combination of modulation order and TBS index.

In another illustrative example, in the proposed MCS index table of the second table configuration, M rows, i.e., M MCS indices may be used to indicate the MCSs including pairs of one higher-order modulation scheme and one TBS index, where M is a non-negative integer with $M > N$.

In another illustrative example, $32+N-M$ MCS entries in Fig. 2 may be re-used in the new MCS table of the second table configuration. In other words, $M-N$ MCS entries in Fig. 2 are not included in the new MCS table.

The current TBS table in the specification is illustrated in Table 7.1.7.2.1-1 in the document called 3GPP TS 36.213 V11.2.0 (2013-04). In another example, the rows of TBS values corresponding to the TBS indices contained in said $M-N$ MCSs may be removed from the TBS table of the first table configuration. Meanwhile, M

new rows of TBS values corresponding to said M MCSs for higher-order modulation are added to said TBS table.

In a further illustrative example, when $N=0$, the new MCS table of the second table configuration may keep the same size as the MCS table in Fig. 2 and M MCSs for higher-order modulation in Fig. 8 replaces M MCSs in Fig. 2. In a further example, the lowest MCS, corresponding to MCS index 0, may be preserved or kept in the new MCS table of the second table configuration in Fig. 8. In a further example, the subsequent M lowest MCSs (corresponding to MCS indices 1 through M) are excluded in the new MCS table of the second table configuration. An example of such a new MCS table is shown in Fig. 8. Compared to Fig. 2, the MCSs with indices from 1 to 6 for modulation order 2 (QPSK) have been removed in Fig. 8, whereas the lowest MCS is preserved. Instead, 6 MCSs for modulation order 8 (256QAM) have been added to the MCS table in Fig. 8.

In order to create the TBS table of the second table configuration, rows of TBS values corresponding to the removed and added MCSs should be removed and added accordingly from and to the TBS table of the first table configuration. Other MCS entries are re-used in the new MCS table and the indices in this table are rearranged, i.e. renumbered, from beginning. Fig. 10 illustrates an example of a proposed TBS table of the second table configuration, table dimension is 27×110 , with index 21-26 for 256QAM, corresponding to the table in Fig. 9, where "NV" denotes new values. For the example shown in Fig. 10, the rows with index 1-6 for QPSK are removed and 6 new rows of TBS values for 256QAM have been added at the end of the table. This new TBS table of the second table configuration shall be consistent with the TBS index in said new MCS table of the second table configuration.

Fig. 10 will now be explained in more detail. Fig. 10 shows the Transport Block Size table in the specification 36.213 Table 7.1.7.2.1-1. The transport block size, i.e. the number of bits carried by a transport block is determined by both adopted MCS and the number of pair of resource blocks which is denoted N_{PRB} in the table. For each MCS index in the MCS table, there are 110 possible numbers of

PRB, 1-110. This is why the TBS table has a size of 110 columns and 27 rows that correspond to different MCSs, although they are not one-to-one mappings to the MCS table. If new MCS indices are added for 256QAM, the TBS entries for 256QAM need also be calculated and specified. Hence, in the new MCS table, the new entries for 256QAM must contain the TBS indices for corresponding new TBS values.

In another illustrative example, the lowest MCS, i.e. the entry with MCS index 0 in the MCS table of the first table configuration shown in Fig. 2 may be re-used in the new MCS table of the second table configuration. This is to ensure that the communication between the radio node and UE works properly even when the radio link experiences very poor channel condition, which may be called a low SINR scenario or similar.

In another illustrative example, when the new MCS table of the second table configuration is in use and the entry for lowest MCS is selected for a transmission, this indicates that it is difficult to support higher-order modulation due to variation of channel quality, bad radio conditions or other issues, and that a more robust MCS is needed. Hence, the MCS table used in the next transmission may automatically fall back to the first MCS table of the first table configuration, which may without limitation be the MCS table of the current standard, which allows for selection of any of the entries of e.g. the lowest modulation order.

In another illustrative example, the MCS field in DCI may be extended by one or more bits to indicate the MCS index when $N > 0$, that is, the new MCS table of the second table configuration may have more than 32 MCS indices. However, this expansion of the MCS table may require one or more extra bits in the DCI.

CQI index table

The design of the new, or second, CQI index table of the second table configuration is similar to that of the new, or second, MCS index table of the second table configuration.

In an illustrative example, a first CQI table of the first table configuration may be used for radio transmission from the first UE to the radio node, while in the radio transmission from the second UE to the radio node, a second CQI table of the second table configuration may be used, or vice versa.

In another illustrative example, said first CQI table and second CQI table are the current CQI table in specification and a modified CQI table that contains entries for higher-order modulation, respectively. An example of a second CQI table of the second table configuration is shown in Fig. 9 which has been modified from the first CQI table of the first table configuration in Fig. 3.

In another illustrative example, a UE can use either the current CQI table of the first table configuration or the new CQI table of the second table configuration for transmission. In further examples, the information about the CQI table that is to be used may be part of a UCI message or part of a RRC or MAC message.

In another illustrative example, the proposed CQI table of the second table configuration has $16+N$ rows where $N \geq 0$ is a non-negative integer. The columns of the new CQI table represent the same parameters as those of the CQI table shown in Fig. 3, which include CQI index, modulation form, code rate and efficiency. Each table row or entry, that is one CQI, is indexed by a CQI index and contains a particular combination of a modulation order and code rate. The value of efficiency is calculated based on modulation order and code rate.

In another illustrative example, in the proposed CQI index table of the second table configuration, M rows, i.e., M CQI indices are used to indicate the CQI including pairs of one higher-order modulation scheme, one coding rate and resultant efficiency value, where M is a non-negative integer with $M > N$. In a further embodiment, the coding rates for higher-order modulation are defined and added to the CQI table.

In another illustrative example, $16+N-M$ CQIs in Fig. 3 are re-used in the alternative CQI table of the second table configuration. In a further embodiment,

when $N=0$, the new CQI table keeps the same size as the CQI table in Fig. 3 and M CQIs for higher-order modulation replaces M CQIs in Fig. 3.

In a further example, the lowest CQI corresponding to CQI index 1 is preserved in the new CQI table of the second table configuration. In a further embodiment, the subsequent M lowest CQIs, corresponding to CQI indices 2 through $M+1$, are excluded in the new CQI table of the second table configuration. An example of such an embodiment is provided in Fig. 9. Compared to Fig. 3, the CQIs with indices from 2 to 5 for modulation order 2 (QPSK) have been removed, whereas the lowest CQI is preserved. Instead, 4 CQIs for modulation order 8 (256QAM) have been added to the table in Fig. 9. Other CQIs are re-used in the table and their indices are rearranged.

As mentioned above, the lowest CQI, i.e. the entry with index 1 in Fig. 3, may be re-used in the new CQI table of the second table configuration. This is to ensure that the communication between the radio node and UE works properly even when the radio link experiences very poor channel condition.

In another illustrative example, when the new CQI table of the second table configuration is in use and the entry for lowest CQI is selected, this indicates that it is difficult to support higher-order modulation due to variation of channel quality or other issues. Hence, the CQI table used in next transmission may automatically fall back to the first CQI table of the first table configuration which may without limitation be the CQI table in the current standard.

In another illustrative example, the CQI field in uplink control signaling may be extended by one or more bits to indicate the CQI index when $N>0$, that is, the new CQI table has more than 16 CQIs. However, this expansion of the CQI table may require one or more extra bits in the DCI.

Potential advantages

The embodiments described herein may have the following advantages:

- The process of link adaptation in LTE systems may be enhanced to support higher-order modulation schemes in an efficient manner, which may significantly improve the spectral efficiency in a cellular network, particularly in high SINR or SNR scenarios.
- At least one MCS entry, e.g. the lowest MCS entry with MCS index 0, in the MCS table and at least one CQI entry, e.g. the lowest CQI entry for the lowest coding rate of the lowest modulation order with CQI index 1, in the CQI table may be preserved from the first table configuration as a fallback in the second table configuration to ensure proper communication between the radio node and UE when the radio link experiences very poor channel condition.
- The size of the current MCS table may be preserved, or minimally expanded.
- The implementation effort in the radio node and UEs may be kept to a minimum by sharing the majority of the MCS/CQI entries in the first and second MCS/CQI tables, respectively.
- The solution may be applied for both downlink and uplink transmissions.

While the solution has been described with reference to specific exemplary embodiments, the description is generally only intended to illustrate the inventive concept and should not be taken as limiting the scope of the solution. For example, the terms “radio node”, “User Equipment, UE”, “table configuration”, and “modulation order” have been used throughout this description, although any other corresponding entities, functions, and/or parameters could also be used having the features and characteristics described here. The solution is defined by the appended claims.

Abbreviations

LTE	long-term evolution
PDSCH	physical downlink shared channel

MCS	modulation and coding scheme
eNB	E-UTRAN NodeB
UE	user equipment
CQI	channel-quality indicator
QPSK	quadrature phase-shift keying
16QAM	16 quadrature amplitude modulation
64QAM	64 quadrature amplitude modulation
SINR	signal-to-interference-and-noise ratio
DCI	downlink control information
GSM	global system for mobile communications
WCDMA	wideband code-division multiple access
WiMAX	worldwide interoperability for microwave access
UMB	ultra mobile broadband

CLAIMS

1. A method performed by a radio node (500) of a cellular network, the radio node (500) being operable to apply a first table configuration in radio communications with User Equipments, UEs, the first table configuration comprising at least one of a first Modulation and Coding Scheme, MCS, table and a first Channel Quality Indicator, CQI, table wherein the at least one of the first MCS table and the first CQI table support a certain maximum modulation order, the method comprising:

- detecting (400) that a higher modulation order which is higher than the maximum modulation order of the first table configuration is potentially possible to use in a radio communication between the radio node (500) and a first UE (502), and
- instructing (402) the first UE (502) to apply a second table configuration in the radio communication, the second table configuration comprising at least one of a second MCS table and a second CQI table wherein the at least one of the second MCS table and the second CQI table support the higher modulation order, and wherein at least one entry for at least one modulation order in the at least one of the first MCS table and the first CQI table is maintained in the at least one of the second MCS table and the second CQI table as a fall-back in case it is desirable to use the at least one modulation order in the at least one of the first MCS table and the first CQI table when the second table configuration is applied.

2. A method according to claim 1, wherein the radio node (500) instructs the first UE (502) to apply the second table configuration in the radio communication between the radio node (500) and the first UE (502) when a performance related parameter of signals communicated between the radio node (500) and the first UE (502) is above a threshold.

3. A method according to claim 2, wherein the radio node (500) instructs a second UE to apply the first table configuration in a radio communication between the radio node (500) and the second UE when the performance related parameter

of signals communicated between the radio node (500) and the second UE is below the threshold.

4. A method according to claim 2 or 3, wherein the performance related parameter comprises a Signal to Interference and Noise Ratio, SINR.
5. A method according to claim 3, wherein the radio node (500) instructs the second UE by sending an instruction to the second UE to apply the first table configuration, or by not sending an instruction to the second UE to apply the second table configuration.
6. A method according to any of claims 1-5, wherein the at least one of the second MCS table and the second CQI table is a modification of the at least one of the first MCS table and the first CQI table, respectively, where a set of entries have been added for the higher modulation order and a set of entries for the at least one modulation order in the at least one of the first MCS table and the first CQI table have been removed.
7. A method according to any of claims 1-6, wherein the at least one modulation order in the at least one of the first MCS table and the first CQI table comprises a lowest modulation order of the first table configuration.
8. A method according to claim 7, wherein the first entry for the lowest modulation order in the first MCS table is maintained in the second MCS table as the fall-back, and an entry for the lowest coding rate of the lowest modulation order in the first CQI table is maintained in the second CQI table as the fall-back.
9. A method according to claim 6 and any of claims 7-8, wherein the number of added entries for the higher modulation order and the number of removed entries for the at least one modulation order in the at least one of the first MCS table and the first CQI table are equal such that the first and second MCS tables are of equal size and/or the first and second CQI tables are of equal size.
10. A method according to any of claims 1-5, wherein the at least one of the second MCS table and the second CQI table is a modification of the at least one of

the first MCS table and the first CQI table, respectively, where all entries of the at least one of the first MCS table and the first CQI table have been maintained in the at least one of the second MCS table and the second CQI table and a set of entries for the higher modulation order have been added.

11. A method according to any of claims 1-10, wherein the first and second table configurations further comprise a Transport Block Size, TBS, table corresponding to the first and second MCS tables, respectively.

12. A radio node (500) of a cellular network, the radio node (500) being operable to apply a first table configuration in radio communications with User Equipments, UEs, the first table configuration comprising at least one of a first Modulation and Coding Scheme, MCS, table and a first Channel Quality Indicator, CQI, table wherein the at least one of the first MCS table and the first CQI table support a certain maximum modulation order, the radio node (500) comprising:

- a logic unit (500a) configured to detect that a higher modulation order which is higher than the maximum modulation order of the first table configuration is potentially possible to use in a radio communication between the radio node (500) and a first UE (502), and

- an instructing unit (500b) configured to instruct the first UE (502) to apply a second table configuration in the radio communication, the second table configuration comprising at least one of a second MCS table and a second CQI table wherein the at least one of the second MCS table and the second CQI table support the higher modulation order, and wherein at least one entry for at least one modulation order in the at least one of the first MCS table and the first CQI table is maintained in the at least one of the second MCS table and the second CQI table as a fall-back in case it is desirable to use the at least one modulation order in the at least one of the first MCS table and the first CQI table when the second table configuration is applied.

13. A radio node (500) according to claim 12, wherein the radio node (500) is configured to instruct the first UE (502) to apply the second table configuration in

the radio communication between the radio node (500) and the first UE (502) when a performance related parameter of signals communicated between the radio node (500) and the first UE (502) is above a threshold.

14. A radio node (500) according to claim 13, wherein the radio node (500) is configured to instruct a second UE to apply the first table configuration in a radio communication between the radio node (500) and the second UE when the performance related parameter of signals communicated between the radio node (500) and the second UE is below the threshold.

15. A radio node (500) according to claim 13 or 14, wherein the performance related parameter comprises a Signal to Interference and Noise Ratio, SINR.

16. A radio node (500) according to claim 14, wherein the radio node (500) is configured to instruct the second UE by sending an instruction to the second UE to apply the first table configuration, or by not sending an instruction to the second UE to apply the second table configuration.

17. A radio node (500) according to any of claims 12-16, wherein the at least one of the second MCS table and the second CQI table is a modification of the at least one of the first MCS table and the first CQI table, respectively, where a set of entries have been added for the higher modulation order and a set of entries for the at least one modulation order in the at least one of the first MCS table and the first CQI table have been removed.

18. A radio node (500) according to any of claims 12-17, wherein the at least one modulation order in the at least one of the first MCS table and the first CQI table comprises a lowest modulation order of the first table configuration.

19. A radio node (500) according to claim 18, wherein the first entry for the lowest modulation order in the first MCS table is maintained in the second MCS table as the fall-back, and an entry for the lowest coding rate of the lowest modulation order in the first CQI table is maintained in the second CQI table as the fall-back.

20. A radio node (500) according to claim 17 and any of claims 18-19, wherein the number of added entries for the higher modulation order and the number of removed entries for the at least one modulation order in the at least one of the first MCS table and the first CQI table are equal such that the first and second MCS tables are of equal size and/or the first and second CQI tables are of equal size.

21. A radio node (500) according to any of claims 12-16, wherein the at least one of the second MCS table and the second CQI table is a modification of the at least one of the first MCS table and the first CQI table, respectively, where all entries of the at least one of the first MCS table and the first CQI table have been maintained in the at least one of the second MCS table and the second CQI table and a set of entries for the higher modulation order have been added.

22. A radio node (500) according to any of claims 12-21, wherein the first and second table configurations further comprise a Transport Block Size, TBS, table corresponding to the first and second MCS tables, respectively.

23. A method performed by a User Equipment, UE (700), the UE (700) being operable to apply a first table configuration in a radio communication with a radio node (702) of a cellular network, the first table configuration comprising at least one of a first Modulation and Coding Scheme, MCS, table and a first Channel Quality Indicator, CQI, table wherein the at least one of the first MCS table and the first CQI table support a certain maximum modulation order, the method comprising:

- receiving (600) an instruction from the radio node (702) to apply a second table configuration in the radio communication, the second table configuration comprising at least one of a second MCS table and a second CQI table wherein the at least one of the second MCS table and the second CQI table support a higher modulation order which is higher than the maximum modulation order of the first table configuration, and

- applying (602) the second table configuration in the radio communication with the radio node (702).

24. A User Equipment, UE (700), the UE (700) being operable to apply a first table configuration in a radio communication with a radio node (702) of a cellular network, the first table configuration comprising at least one of a first Modulation and Coding Scheme, MCS, table and a first Channel Quality Indicator, CQI, table wherein the at least one of the first MCS table and the first CQI table support a certain maximum modulation order, the UE comprising:

- a communication unit (700a) configured to receive an instruction from the radio node (702) to apply a second table configuration in the radio communication, the second table configuration comprising at least one of a second MCS table and a second CQI table wherein the at least one of the second MCS table and the second CQI table support a higher modulation order which is higher than the maximum modulation order of the first table configuration, and

- a logic unit (700b) configured to apply the second table configuration in the radio communication with the radio node (702).

25. A computer program comprising instructions which, when executed on at least one processor, cause the at least one processor to carry out the method according to any one of claims 1-11 and 23.

26. A carrier containing the computer program of claim 25, wherein the carrier is one of an electronic signal, optical signal, radio signal, or computer readable storage medium.

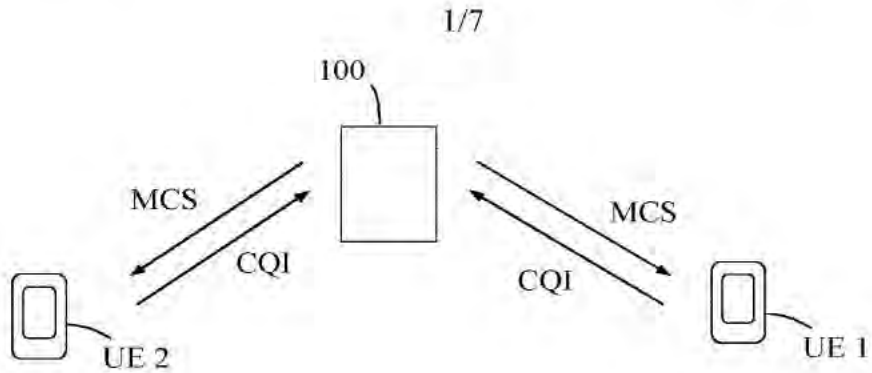

Fig. 1 (Prior art)

MCS Index I_{MCS}	Modulation Order Q_m	TBS Index I_{TBS}
0	2	0
1	2	1
2	2	2
3	2	3
4	2	4
5	2	5
6	2	6
7	2	7
8	2	8
9	2	9
10	4	9
11	4	10
12	4	11
13	4	12
14	4	13
15	4	14
16	4	15
17	6	15
18	6	16
19	6	17
20	6	18
21	6	19
22	6	20
23	6	21
24	6	22
25	6	23
26	6	24
27	6	25
28	6	26
29	2	reserved
30	4	
31	6	

Fig. 2

2/7

CQI index	modulation	code rate x 1024	efficiency
0	out of range		
1	QPSK	78	0.1523
2	QPSK	120	0.2344
3	QPSK	193	0.3770
4	QPSK	308	0.6016
5	QPSK	449	0.8770
6	QPSK	602	1.1758
7	16QAM	378	1.4766
8	16QAM	490	1.9141
9	16QAM	616	2.4063
10	64QAM	466	2.7305
11	64QAM	567	3.3223
12	64QAM	666	3.9023
13	64QAM	772	4.5234
14	64QAM	873	5.1152
15	64QAM	948	5.5547

Fig. 3

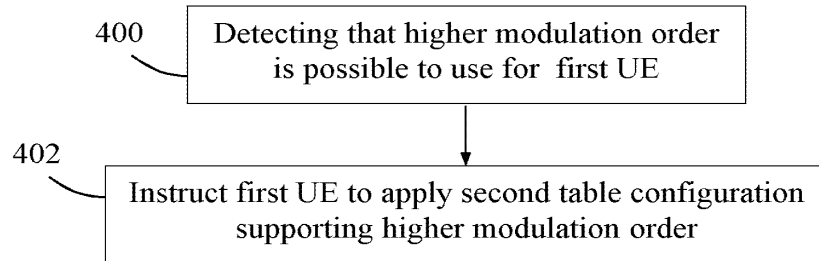

Fig. 4

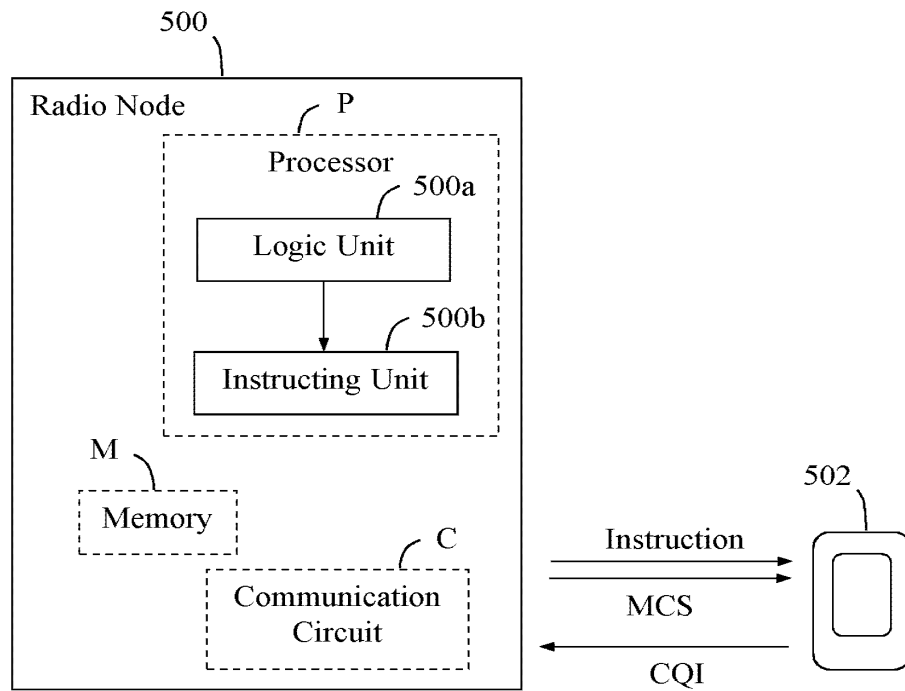

Fig. 5

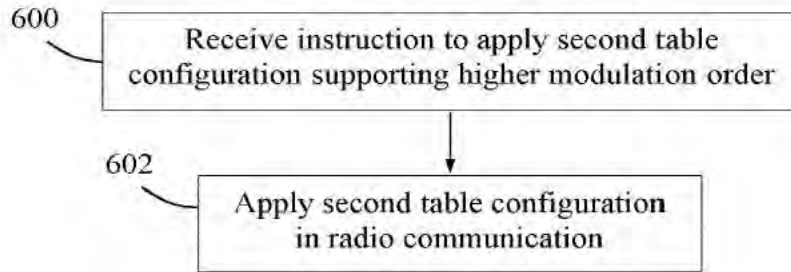

Fig. 6

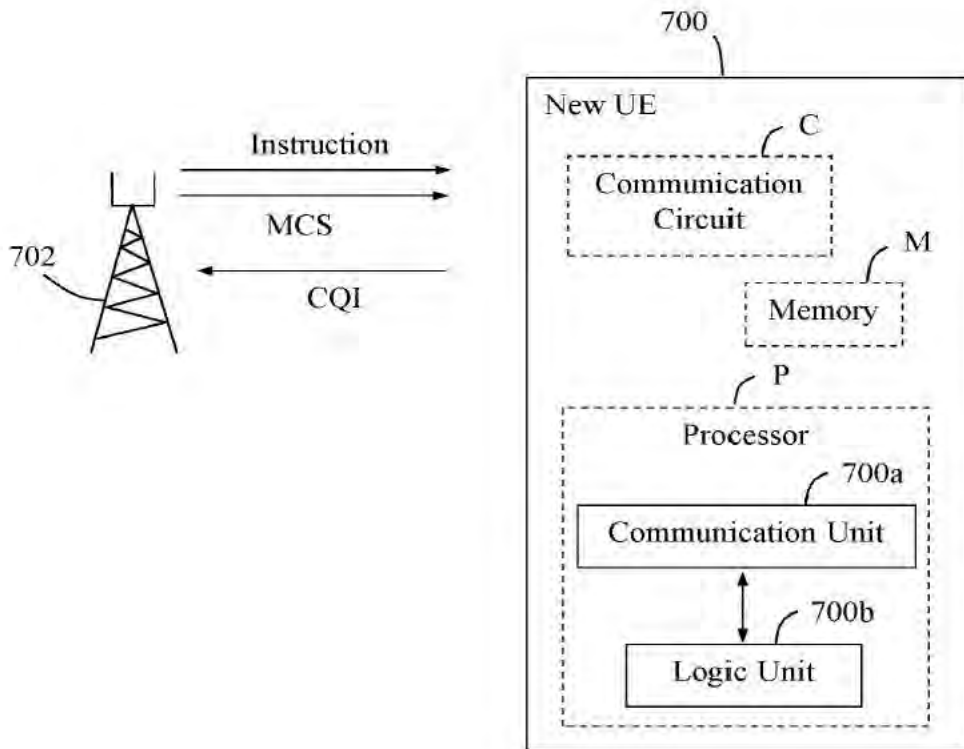

Fig. 7

<u>MCS Index</u>	<u>Modulation Order</u>	<u>TBS Index</u>
I_{MCS}	Q_m	I_{TBS}
0	2	0
1	2	1
2	2	2
3	2	3
4	2	4
5	2	5
6	2	6
7 1	2	7
8 2	2	8
9 3	2	9
10 4	4	9
11 5	4	10
12 6	4	11
13 7	4	12
14 8	4	13
15 9	4	14
16 10	4	15
17 11	6	15
18 12	6	16
19 13	6	17
20 14	6	18
21 15	6	19
22 16	6	20
23 17	6	21
24 18	6	22
25 19	6	23
26 20	6	24
27 21	6	25
28 22	6	26
23	8	New index
24	8	New index
25	8	New index
26	8	New index
27	8	New index
28	8	New index
29	2	reserved
30	4	
31	6	

Fig. 8

<u>CQI index</u>	<u>modulation</u>	<u>code rate x 1024</u>	<u>efficiency</u>
<u>0</u>	<u>out of range</u>		
<u>1</u>	<u>QPSK</u>	<u>78</u>	<u>0.1523</u>
<u>2</u>	<u>QPSK</u>	<u>120</u>	<u>0.2344</u>
<u>3</u>	<u>QPSK</u>	<u>193</u>	<u>0.3770</u>
<u>4</u>	<u>QPSK</u>	<u>308</u>	<u>0.6016</u>
<u>5</u>	<u>QPSK</u>	<u>449</u>	<u>0.8770</u>
<u>6-2</u>	<u>QPSK</u>	<u>602</u>	<u>1.1758</u>
<u>7-3</u>	<u>16QAM</u>	<u>378</u>	<u>1.4766</u>
<u>8-4</u>	<u>16QAM</u>	<u>490</u>	<u>1.9141</u>
<u>9-5</u>	<u>16QAM</u>	<u>616</u>	<u>2.4063</u>
<u>10-6</u>	<u>64QAM</u>	<u>466</u>	<u>2.7305</u>
<u>11-7</u>	<u>64QAM</u>	<u>567</u>	<u>3.3223</u>
<u>12-8</u>	<u>64QAM</u>	<u>666</u>	<u>3.9023</u>
<u>13-9</u>	<u>64QAM</u>	<u>772</u>	<u>4.5234</u>
<u>14-10</u>	<u>64QAM</u>	<u>873</u>	<u>5.1152</u>
<u>15-11</u>	<u>64QAM</u>	<u>948</u>	<u>5.5547</u>
<u>12</u>	<u>256QAM</u>	<u>New value</u>	<u>New value</u>
<u>13</u>	<u>256QAM</u>	<u>New value</u>	<u>New value</u>
<u>14</u>	<u>256QAM</u>	<u>New value</u>	<u>New value</u>
<u>15</u>	<u>256QAM</u>	<u>New value</u>	<u>New value</u>

Fig. 9

I _{TBS}	N _{PRB}									
	1	2	3	4	108	109	110
0	16	32	56	88	2984	2984	3112
1	24	56	88	144	4008	4008	4008
2	32	72	144	176	4776	4968	4968
3	40	104	176	208	6200	6456	6456
4	56	120	208	256	7736	7736	7992
5	72	144	224	328	9528	9528	9528
6	328	176	256	392	11448	11448	11448
7 1	104	224	328	472	12960	13536	13536
8 2	120	256	392	536	15264	15264	15264
9 3	136	296	456	616	16992	16992	17568
10 4	144	328	504	680	19080	19080	19080
11 5	176	376	584	776	22152	22152	22152
12 6	208	440	680	904	24496	24496	25456
13 7	224	488	744	1000	27376	28336	28336
14 8	256	552	840	1128	30576	31704	31704
15 9	280	600	904	1224	32856	34008	34008
16 10	328	632	968	1288	35160	35160	35160
17 11	336	696	1064	1416	39232	39232	39232
18 12	376	776	1160	1544	42368	43816	43816
19 13	408	840	1288	1736	46888	46888	46888
20 14	440	904	1384	1864	51024	51024	51024
21 15	488	1000	1480	1992	55056	55056	55056
22 16	520	1064	1608	2152	59256	59256	59256
23 17	552	1128	1736	2280	61664	61664	63776
24 18	584	1192	1800	2408	66592	66592	66592
25 19	616	1256	1864	2536	68808	68808	71112
26 20	712	1480	2216	2984	75376	75376	75376
21	NV	NV	NV	NV	NV	NV	NV
22	NV	NV	NV	NV	NV	NV	NV
23	NV	NV	NV	NV	NV	NV	NV
24	NV	NV	NV	NV	NV	NV	NV
25	NV	NV	NV	NV	NV	NV	NV
26	NV	NV	NV	NV	NV	NV	NV

Fig. 10

Document code: WFEE

United States Patent and Trademark Office
Sales Receipt for Accounting Date: 09/21/2015

PBOOKER ADJ #00000012 Mailroom Dt: 10/06/2014
Seq No: 2119 Sales Acctg Dt: 10/07/2014 14390904
02 FC : 1632 -600.00 OP

Document code: WFEE

United States Patent and Trademark Office
Sales Receipt for Accounting Date: 09/21/2015

PBOOKER SALE #00000012 Mailroom Dt: 10/06/2014 14390904
01 FC : 1642 480.00 OP

Under the Paperwork Reduction Act of 1995, no persons are required to respond to a collection of information unless it displays a valid OMB control number.

PATENT APPLICATION FEE DETERMINATION RECORD Substitute for Form PTO-875	Application or Docket Number 14/390,904	Filing Date 10/06/2014	<input type="checkbox"/> To be Mailed
---	---	----------------------------------	---------------------------------------

ENTITY: LARGE SMALL MICRO

APPLICATION AS FILED – PART I

FOR	NUMBER FILED	NUMBER EXTRA	RATE (\$)	FEE (\$)
<input type="checkbox"/> BASIC FEE (37 CFR 1.16(a), (b), or (c))	N/A	N/A	N/A	
<input type="checkbox"/> SEARCH FEE (37 CFR 1.16(k), (l), or (m))	N/A	N/A	N/A	
<input type="checkbox"/> EXAMINATION FEE (37 CFR 1.16(e), (f), or (g))	N/A	N/A	N/A	
TOTAL CLAIMS (37 CFR 1.16(i))	minus 20 = *	*	X \$ =	
INDEPENDENT CLAIMS (37 CFR 1.16(h))	minus 3 = *	*	X \$ =	
<input type="checkbox"/> APPLICATION SIZE FEE (37 CFR 1.16(s))	If the specification and drawings exceed 100 sheets of paper, the application size fee due is \$310 (\$155 for small entity) for each additional 50 sheets or fraction thereof. See 35 U.S.C. 41(a)(1)(G) and 37 CFR 1.16(s).			
<input type="checkbox"/> MULTIPLE DEPENDENT CLAIM PRESENT (37 CFR 1.16(j))				
* If the difference in column 1 is less than zero, enter "0" in column 2.			TOTAL	

APPLICATION AS AMENDED – PART II

	(Column 1)	(Column 2)	(Column 3)	PRESENT EXTRA	RATE (\$)	ADDITIONAL FEE (\$)
AMENDMENT	10/06/2014	CLAIMS REMAINING AFTER AMENDMENT	HIGHEST NUMBER PREVIOUSLY PAID FOR			
	Total (37 CFR 1.16(i))	* 26	Minus ** 26	= 0	X \$80 =	0
	Independent (37 CFR 1.16(f))	* 6	Minus *** 6	= 0	X \$420 =	0
	<input type="checkbox"/> Application Size Fee (37 CFR 1.16(s))					
<input type="checkbox"/> FIRST PRESENTATION OF MULTIPLE DEPENDENT CLAIM (37 CFR 1.16(j))						
					TOTAL ADD'L FEE	0

	(Column 1)	(Column 2)	(Column 3)	PRESENT EXTRA	RATE (\$)	ADDITIONAL FEE (\$)
AMENDMENT		CLAIMS REMAINING AFTER AMENDMENT	HIGHEST NUMBER PREVIOUSLY PAID FOR			
	Total (37 CFR 1.16(i))	*	Minus **	=	X \$ =	
	Independent (37 CFR 1.16(f))	*	Minus ***	=	X \$ =	
	<input type="checkbox"/> Application Size Fee (37 CFR 1.16(s))					
<input type="checkbox"/> FIRST PRESENTATION OF MULTIPLE DEPENDENT CLAIM (37 CFR 1.16(j))						
					TOTAL ADD'L FEE	

* If the entry in column 1 is less than the entry in column 2, write "0" in column 3.
 ** If the "Highest Number Previously Paid For" IN THIS SPACE is less than 20, enter "20".
 *** If the "Highest Number Previously Paid For" IN THIS SPACE is less than 3, enter "3".
 The "Highest Number Previously Paid For" (Total or independent) is the highest number found in the appropriate box in column 1.

LIE
/MARY PEOPLES/

This collection of information is required by 37 CFR 1.16. The information is required to obtain or retain a benefit by the public which is to file (and by the USPTO to process) an application. Confidentiality is governed by 35 U.S.C. 122 and 37 CFR 1.14. This collection is estimated to take 12 minutes to complete, including gathering, preparing, and submitting the completed application form to the USPTO. Time will vary depending upon the individual case. Any comments on the amount of time you require to complete this form and/or suggestions for reducing this burden, should be sent to the Chief Information Officer, U.S. Patent and Trademark Office, U.S. Department of Commerce, P.O. Box 1450, Alexandria, VA 22313-1450. DO NOT SEND FEES OR COMPLETED FORMS TO THIS ADDRESS. **SEND TO: Commissioner for Patents, P.O. Box 1450, Alexandria, VA 22313-1450.**

If you need assistance in completing the form, call 1-800-PTO-9199 and select option 2.