



US007178720B1

(12) **United States Patent**  
**Strubbe et al.**

(10) **Patent No.:** **US 7,178,720 B1**  
(45) **Date of Patent:** **Feb. 20, 2007**

(54) **METHODS, COMPUTER-READABLE MEDIA, AND COMPUTER PROGRAM PRODUCT FOR INTELLIGENT SELECTION OF ITEMS ENCODED ONTO PORTABLE MACHINE-PLAYABLE ENTERTAINMENT MEDIA**

5,933,811 A	8/1999	Angles et al.
5,940,809 A	8/1999	Musmanno
6,029,149 A	2/2000	Dykstra
6,055,513 A	4/2000	Katz
6,088,686 A	7/2000	Walker
6,135,349 A	10/2000	Zirkel
6,138,911 A	10/2000	Fredregill
6,199,762 B1	3/2001	Hohle
6,226,624 B1	5/2001	Watson
6,314,089 B1	11/2001	Szlam

(75) Inventors: **Todd B. Strubbe**, Omaha, NE (US);  
**David C. Mussman**, Omaha, NE (US);  
**Rocco L. Adornato**, Omaha, NE (US)

(73) Assignee: **West Corporation**, Omaha, NE (US)

(\* ) Notice: Subject to any disclaimer, the term of this patent is extended or adjusted under 35 U.S.C. 154(b) by 0 days.

(Continued)

**OTHER PUBLICATIONS**

CNN, Software To Limit Tracking Cell Phone Users, www.cnn.com, Jan. 19, 2004.

(21) Appl. No.: **10/954,688**

(Continued)

(22) Filed: **Sep. 30, 2004**

Primary Examiner—Seung Ho Lee

(51) **Int. Cl.**  
**G06F 17/00** (2006.01)

(57) **ABSTRACT**

(52) **U.S. Cl.** ..... **235/375; 235/383; 235/385; 725/25**

(58) **Field of Classification Search** ..... **725/4, 725/23, 25, 26; 235/376**  
See application file for complete search history.

Methods, computer-readable media, and computer program products for encoding data representing offered items that are selected for specific respective viewers onto machine-playable storage media, with the media storing data representing at least one entertainment feature. The method can include receiving one or more requests from given viewers related to obtaining instance of entertainment media for viewing, and identifying given ones of the viewers. One or more additional data elements relating to a given viewer are obtaining using, at least in part, the data identifying the given viewer. One or more items to be offered to the given viewer are selected based at least in part on analysis of the additional data element. Data representing the offered item is then encoding onto a given instance of the machine-readable entertainment medium and the medium is then presented to the viewer. Computer-readable media and computer program products for realizing the foregoing method are also disclosed.

(56) **References Cited**

**U.S. PATENT DOCUMENTS**

4,812,628 A	3/1989	Boston	
4,845,658 A	7/1989	Gifford	
4,967,366 A	10/1990	Kaehler	
5,010,485 A	4/1991	Bigari	
5,532,735 A	7/1996	Blahut et al.	
5,535,130 A	7/1996	Long	
5,592,378 A	1/1997	Cameron et al.	
5,679,940 A	10/1997	Templeton	
5,732,400 A	3/1998	Mandler	
5,838,314 A *	11/1998	Neel et al.	725/8
5,870,721 A	2/1999	Norris	
5,878,403 A	3/1999	DeFrancesco	
5,890,137 A	3/1999	Koreeda	
5,914,472 A	6/1999	Foladare	

**30 Claims, 17 Drawing Sheets**

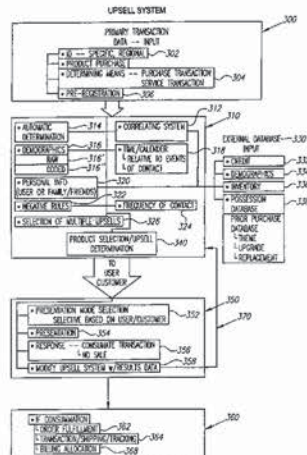

U.S. PATENT DOCUMENTS

6,424,706	B1	7/2002	Katz	
6,567,787	B1	5/2003	Walker	
6,571,279	B1	5/2003	Herz	
6,574,614	B1	6/2003	Kesel	
6,598,026	B1	7/2003	Herz	
6,823,319	B1	11/2004	Lynch	
6,942,143	B1*	9/2005	Iida et al.	235/379
2001/0014868	A1	8/2001	Herz	
2002/0026496	A1	2/2002	Boyer	
2003/0172000	A1	9/2003	Foster	
2003/0196204	A1*	10/2003	Thiagarajan et al.	725/61
2003/0229897	A1	12/2003	Frisco	
2004/0019900	A1*	1/2004	Knightbridge et al.	725/23
2004/0143838	A1*	7/2004	Rose	725/25
2005/0132404	A1*	6/2005	Clapp	725/60

OTHER PUBLICATIONS

Tedeschi, Bob. E-Commerce Report; Demand Among Marketers For Advertising Next To Search Results Could Soon Outpace Supply, The New York Times, Jul. 19, 2004.  
 CMF: Associated Press; "Telemarketing Firm Agrees to Alter Sales Policy," Times Union, Sep. 19, 2002, 2 pgs.  
 Bloomberg; "Web Sites Help Consumers Shop for Hard-to-find Credit Card Deals," Las Vegas Journal, Feb. 28, 1999, 3 pgs.  
 Fitzgerald, Kate; "Putting Tech Into Telemarketing," Credit Card Management, Jul. 1999, v12n4p. 34, 8 pgs.  
 CMF: Lumpur, Kuala; "Credit Card Ties Up With Alumni Life," Jan. 2, 1996, 2 pgs.  
 Meece, Mickey; "Fertile Sales Turf: Fee-Based Card Services Memberworks' Gary Johnson Counts the Way He Can Sell to Cardholders," American Banker, v162n68p. 15, 4 pgs.

Steel, James; "Combating Counterfeit Credit Cards: The Technological Challenge," Credit World, May/Jun. 1995, v83n5p. 16, 3 pgs.  
 Throne, Adam; "Capital One's Call Center Soars to New Heights," Call Center Magazine, Mar. 2001, v14n3p. 84, 4 pgs.  
 Nett, Walt, Sweet Deals Can Lull The Unaware Credit Card User, Arizona Daily Star, Jun. 19, 1994, p. 1.D.  
 Levine, Kay. Anchorage Daily News. Troubleshooter; [Final Edition 30]. Anchorage, Alaska, Jul. 16, 1991. p. B.2.  
 Geller, Lois. Direct Marketing. "10 ways to joggle you out of your direct marketing doldrums". Garden City. Feb. 1998. vol. 60, Iss. 10. p. 18, 4 pgs.  
 Whelan, Carolyn. Electronic News. "DirectTV chooses ATI after AT&T deal folds". New York. Dec. 15, 1997. vol. 43, Iss. 2198. p. 44, 1 pgs.  
 Stern, Linda. Home Office Computing. "Save \$60K this year". Boulder. Jan. 1998. vol. 16, Iss. 1. p. 58, 6 pgs.  
 Kislik, Elizabeth. Catalog Age. "Beyond the thought that counts". New Canaan. Jul. 1997. vol. 14, Iss. 7, p. 199, 2 pgs.  
 Galvin, Brian. Telemarketing & Call Center Solutions. "Focus On: The Inbound call center outlook-how emerging technologies will change your business". Norwalk, Apr. 1997. vol. 15, Iss. 10. p. 24, 5 pgs.  
 Reilly, Brian. Advertising Age's Business Marketing. "Upselling strategies hit the net". Chicago. Dec. 1996. vol. 81, Iss. 10. p. M1, 2 pgs.  
 M2 Presswire. "FIJITSU: Fijitsu introduces developer's toolkit for Edify Electronic Workforce platform". Coventry. Mar. 3, 1998. p. 1.

\* cited by examiner

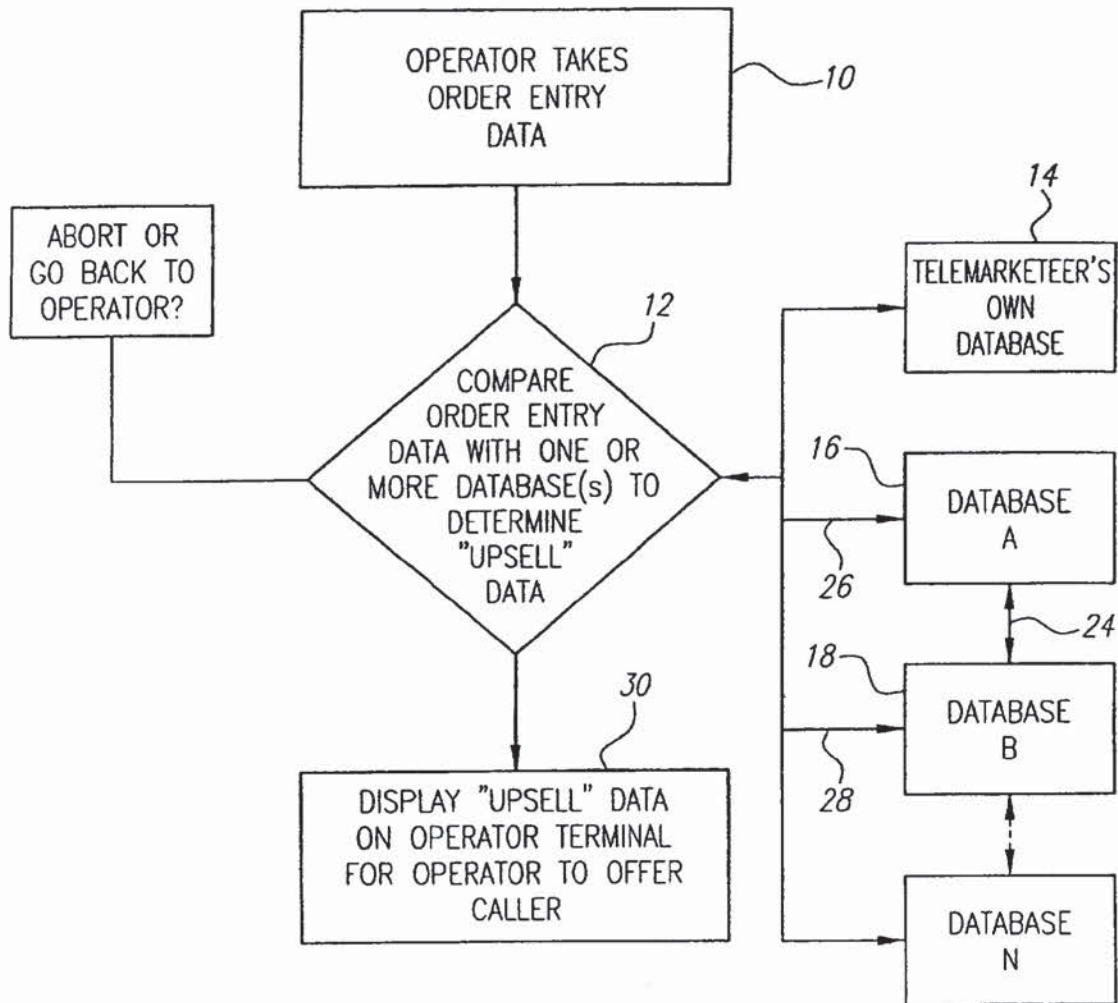

FIG. 1

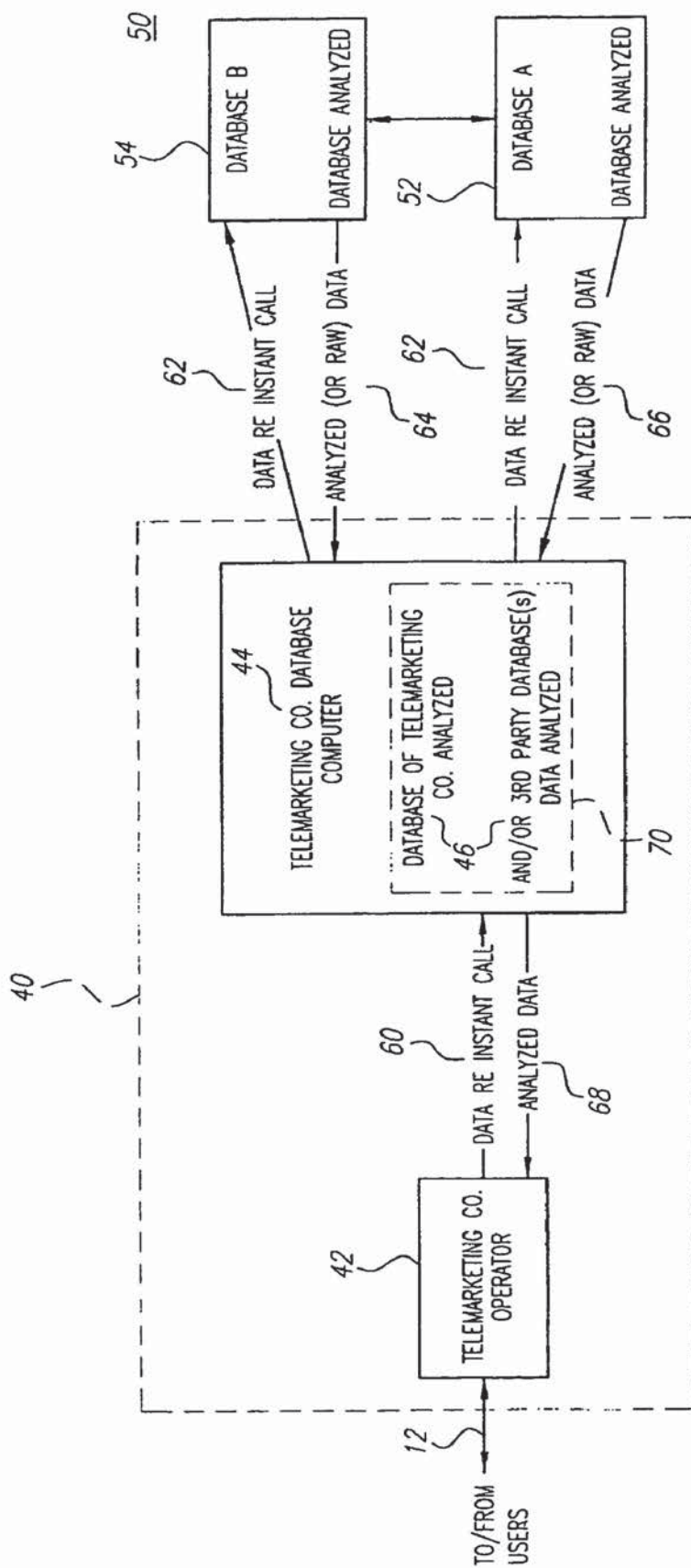

FIG. 2

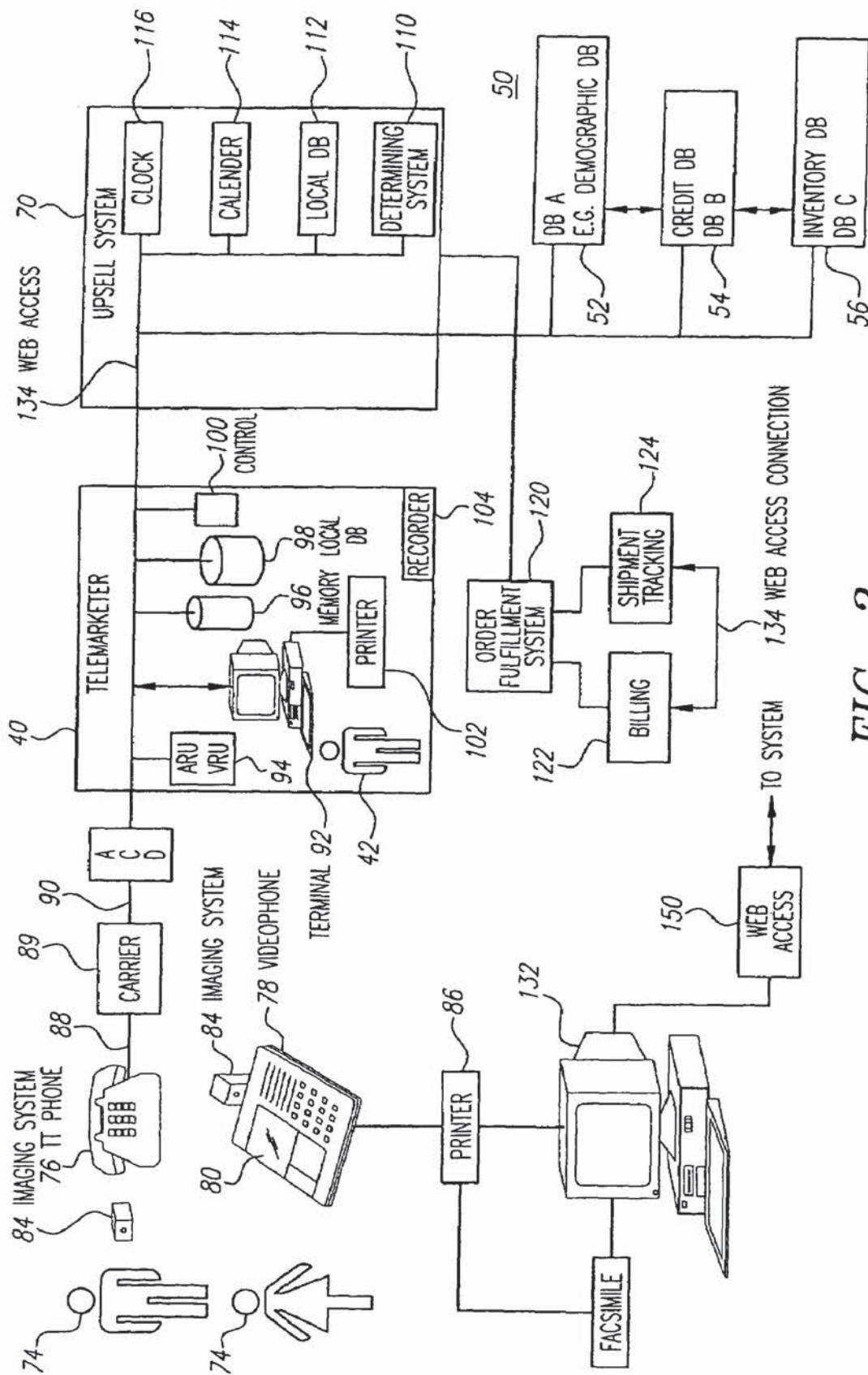

FIG. 3

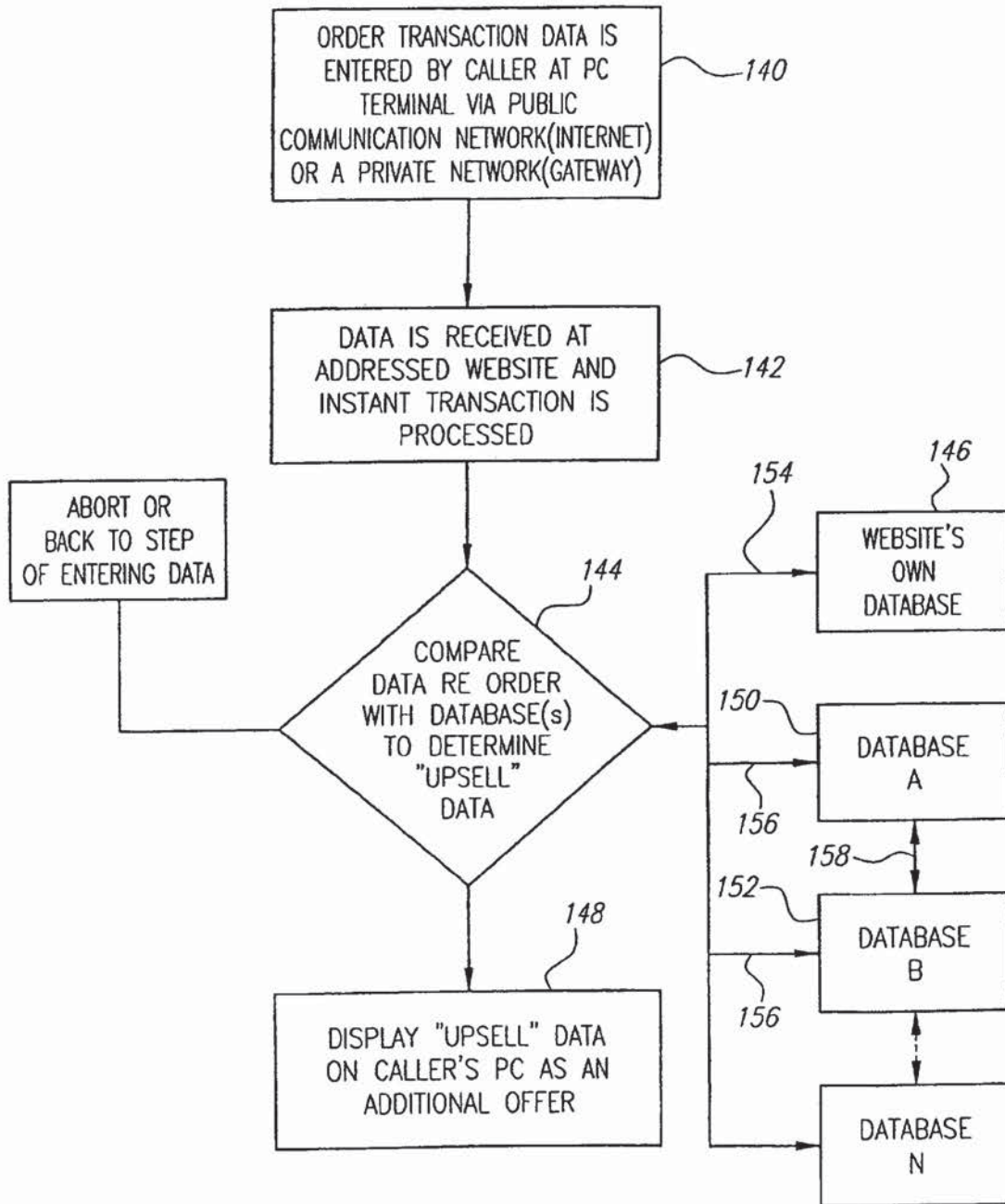

FIG. 4

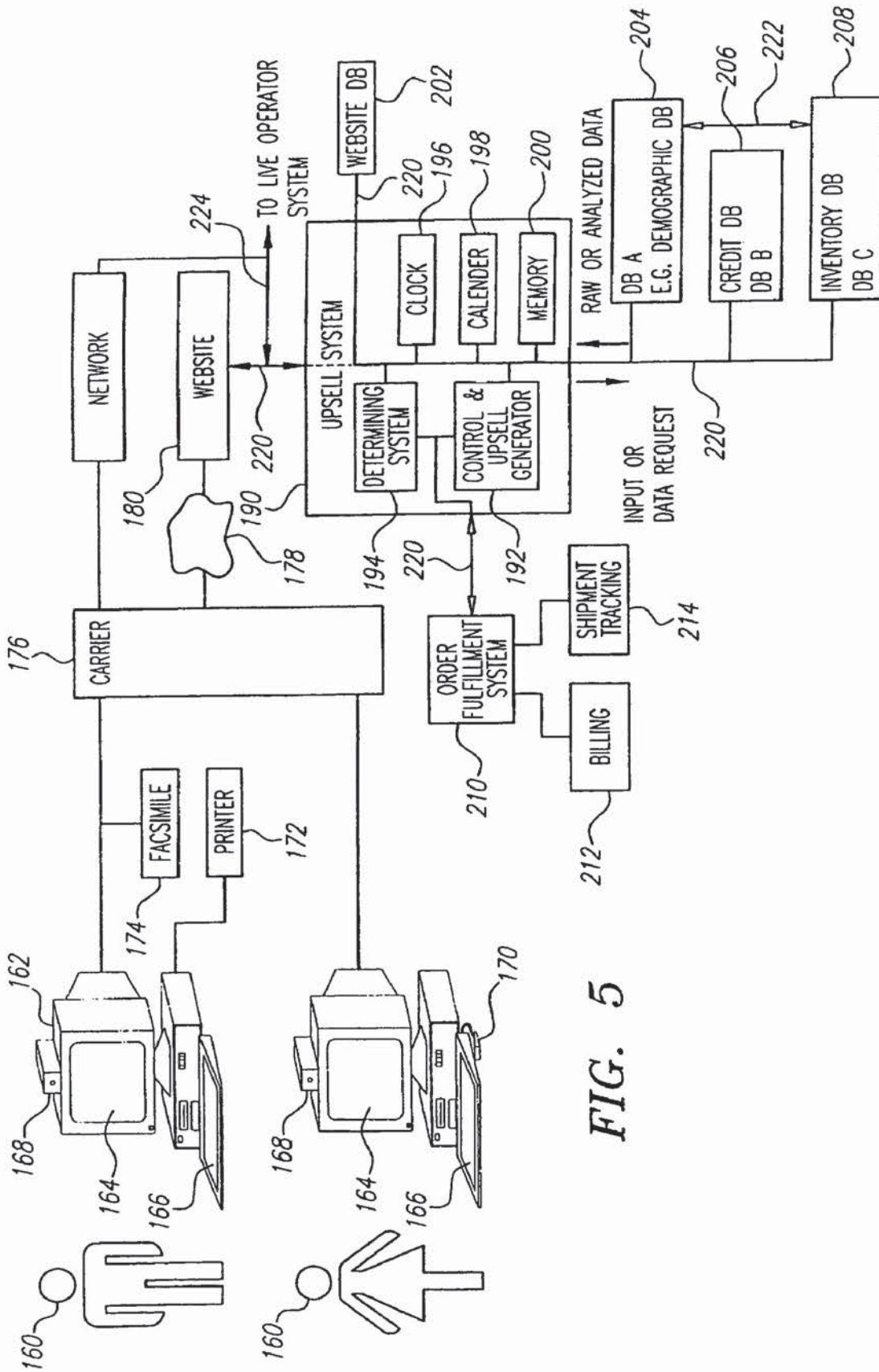

FIG. 5

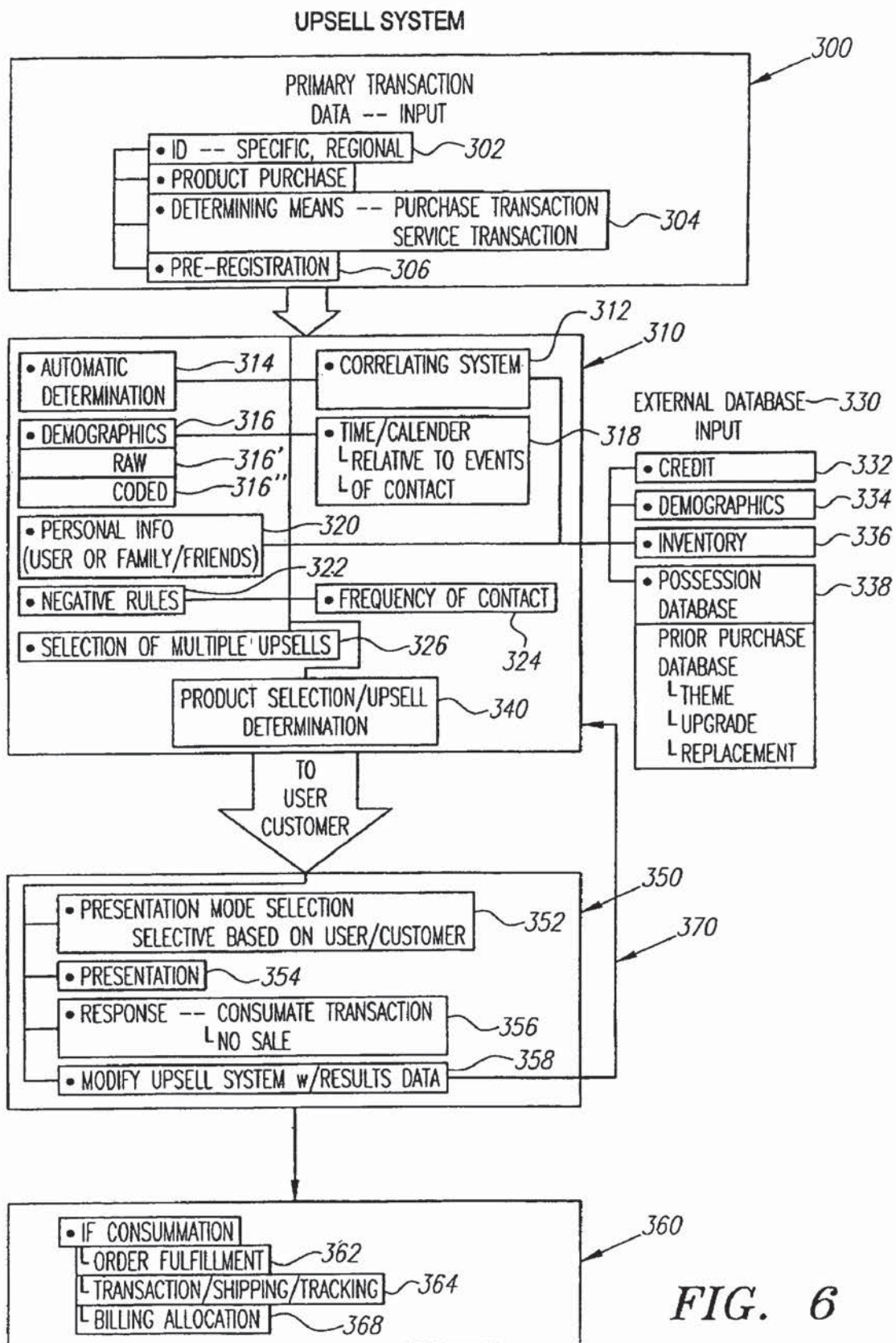
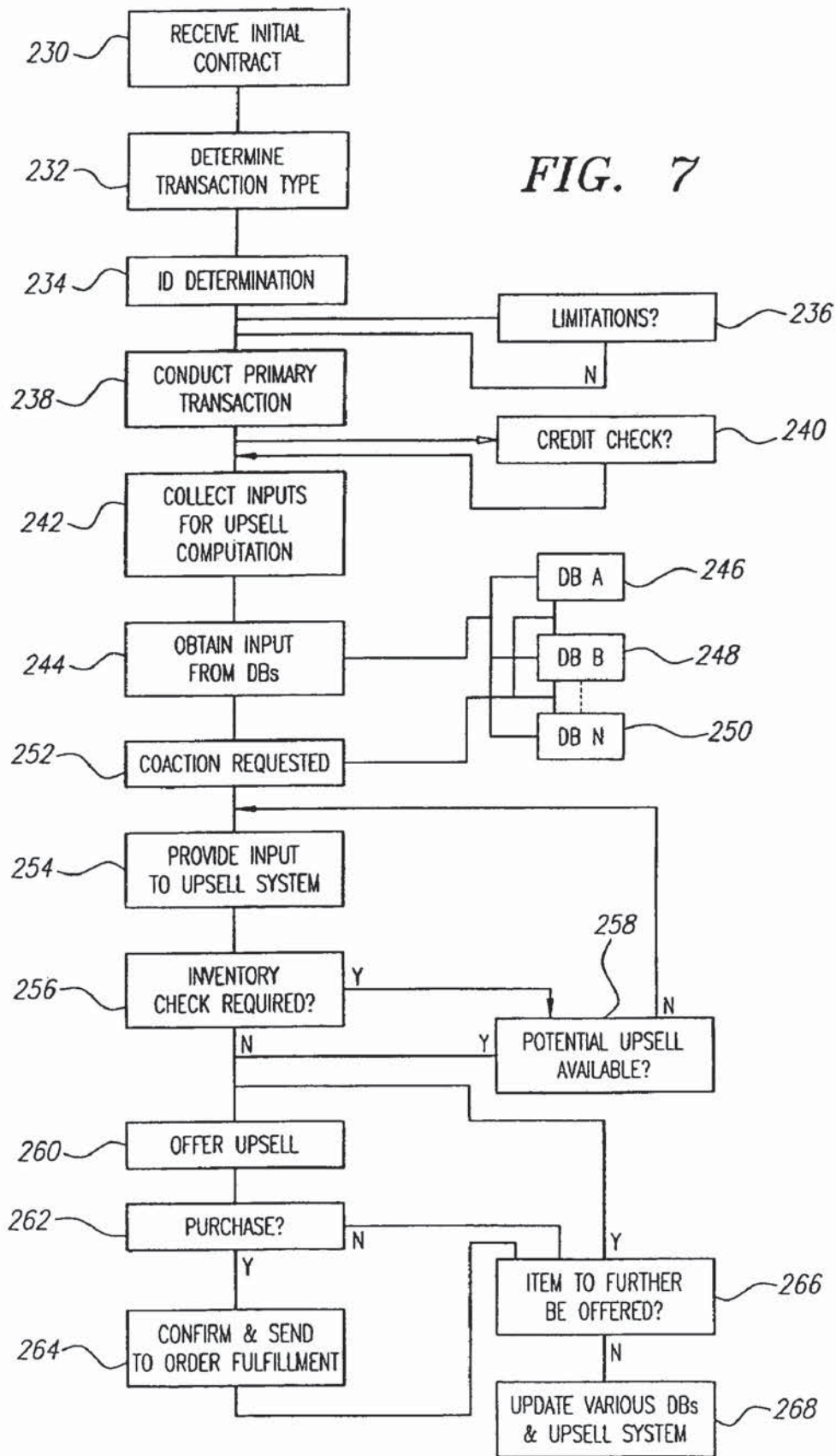

FIG. 6



FIG. 7



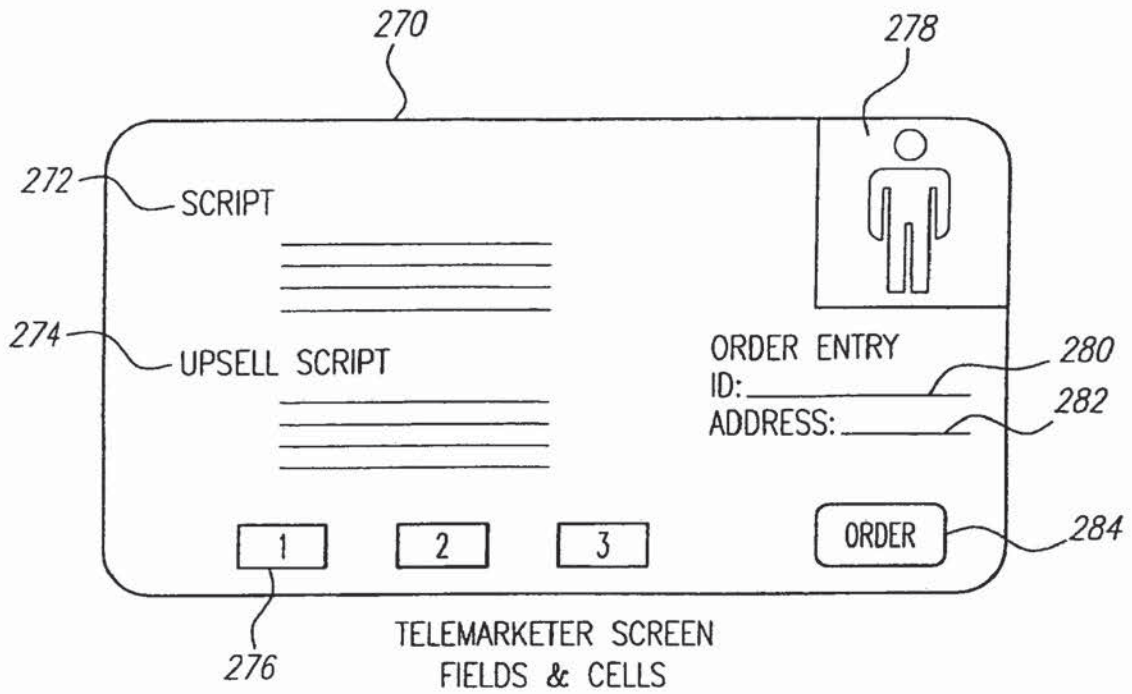

FIG. 8

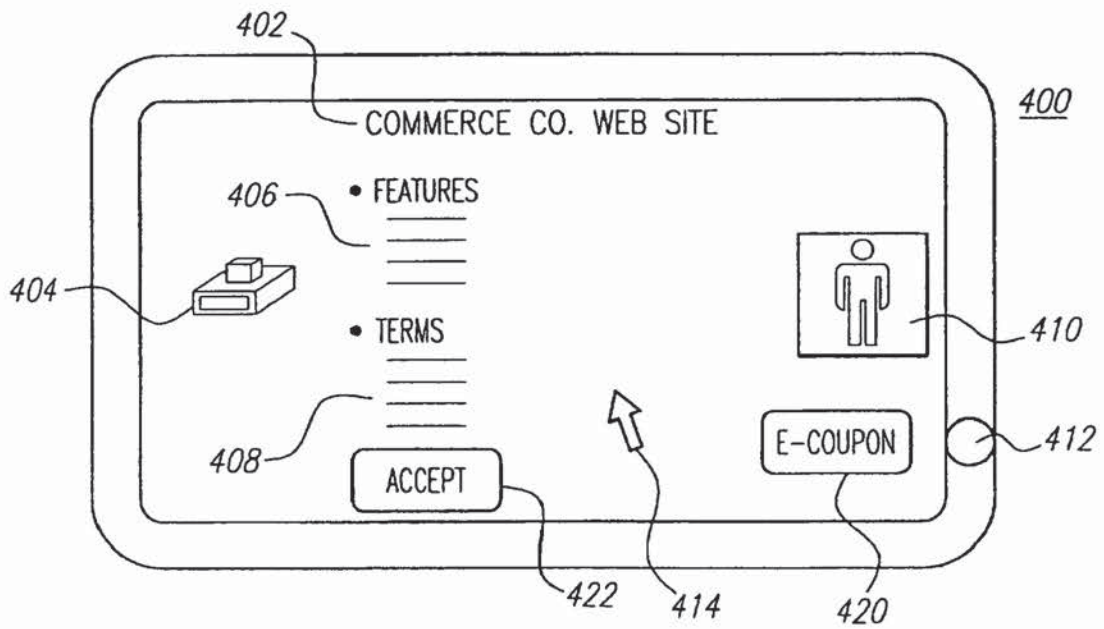

FIG. 9

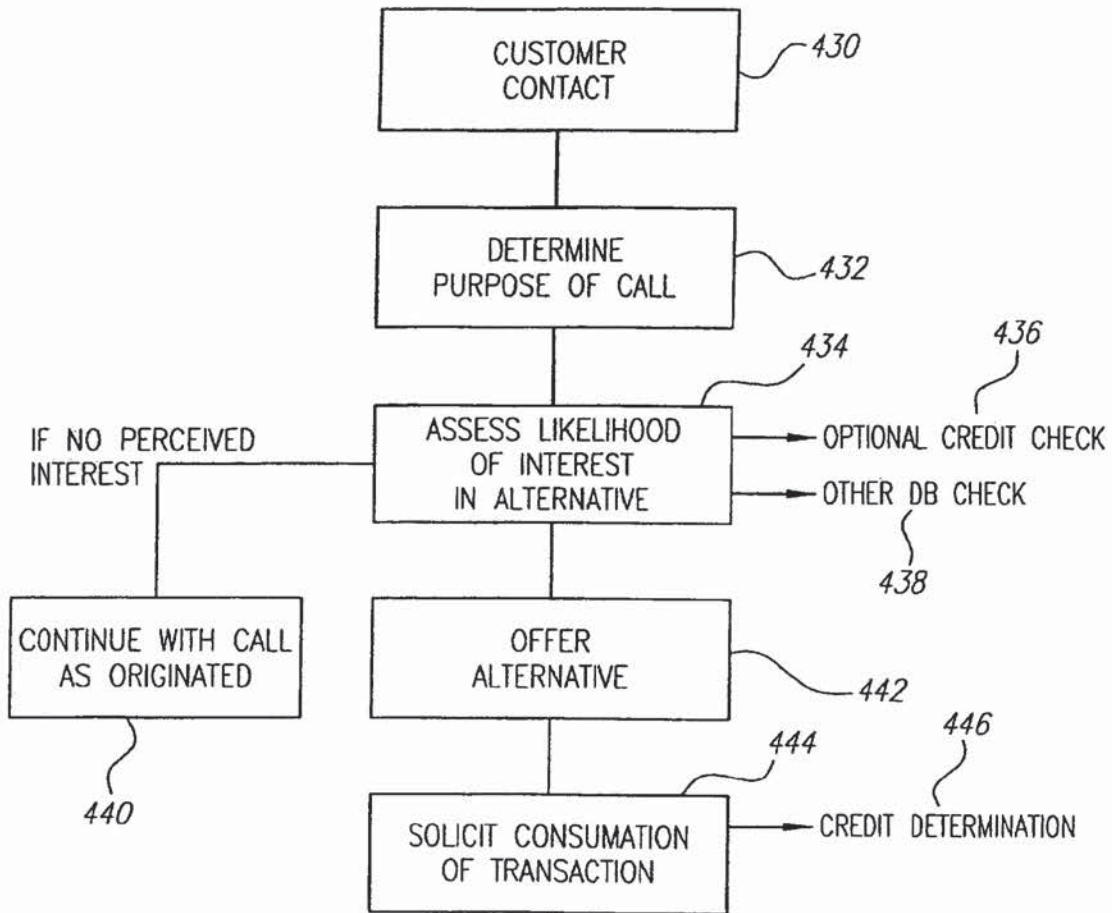

FIG. 10

Figure 11

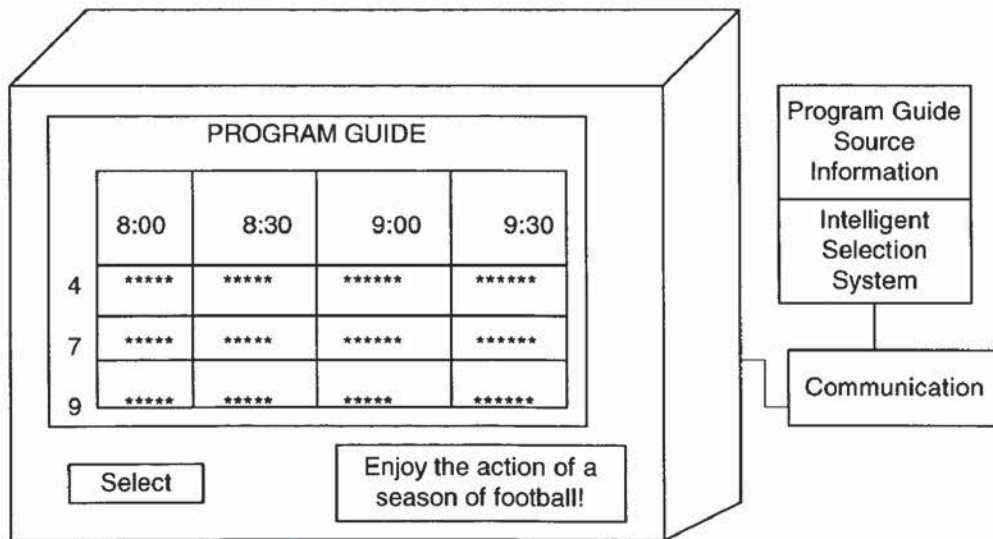
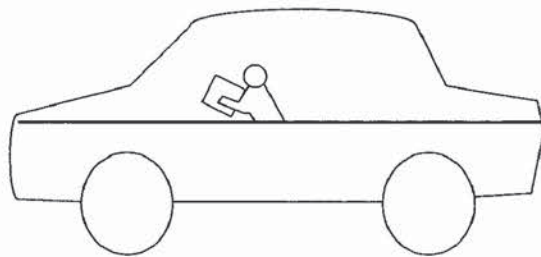
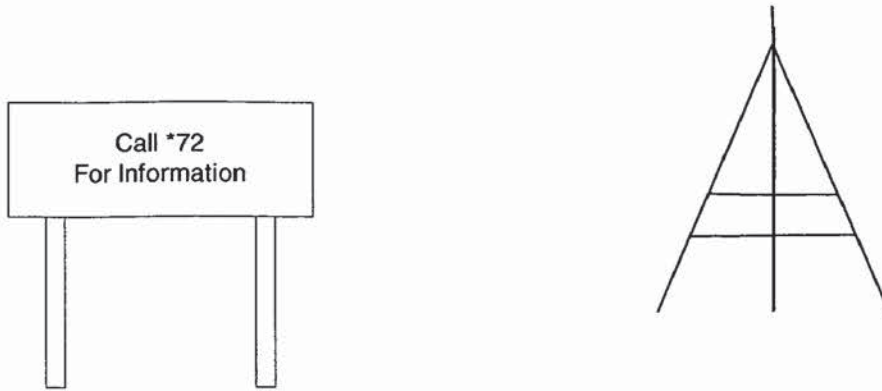

Figure 12

Figure 13

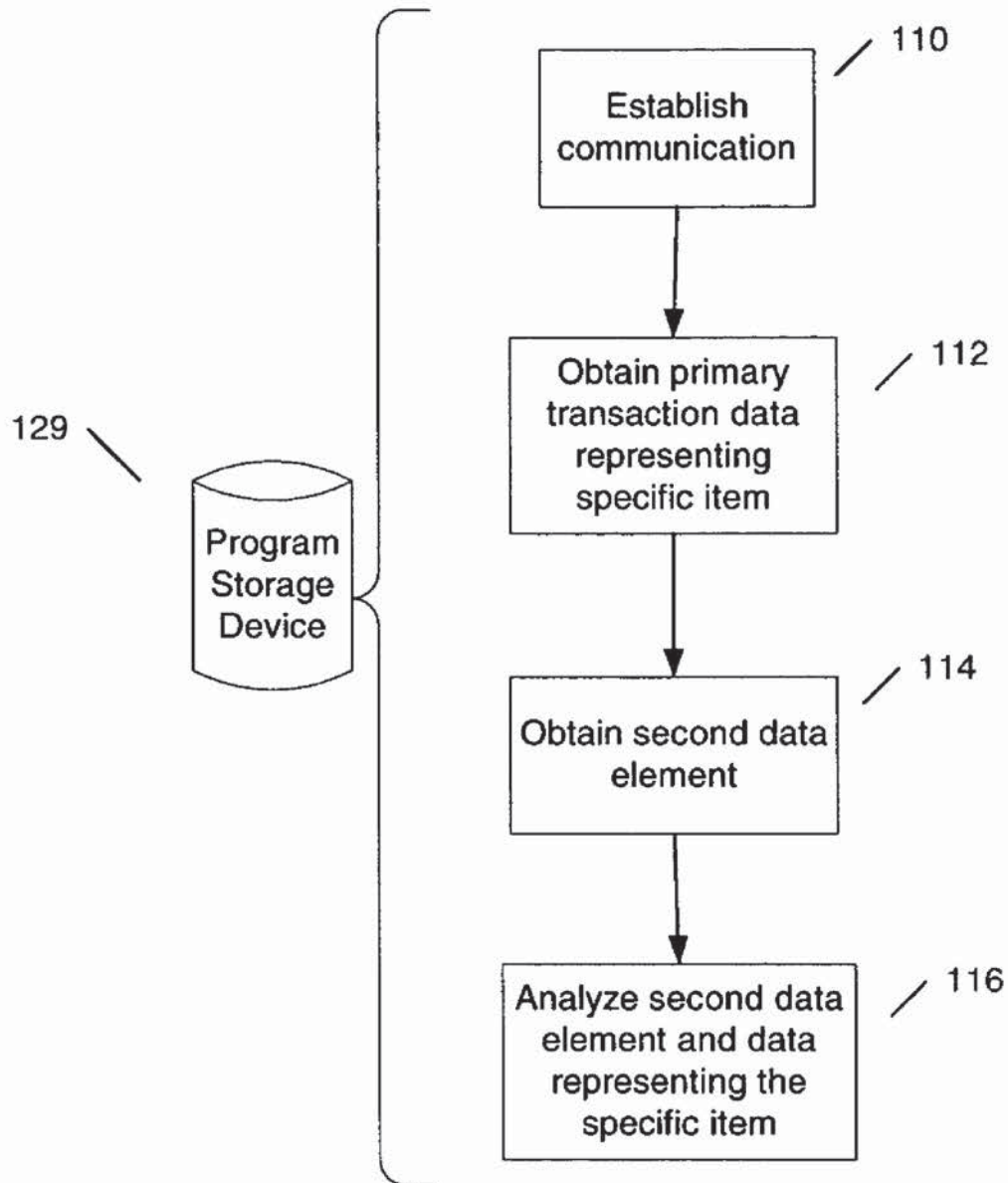

Figure 14

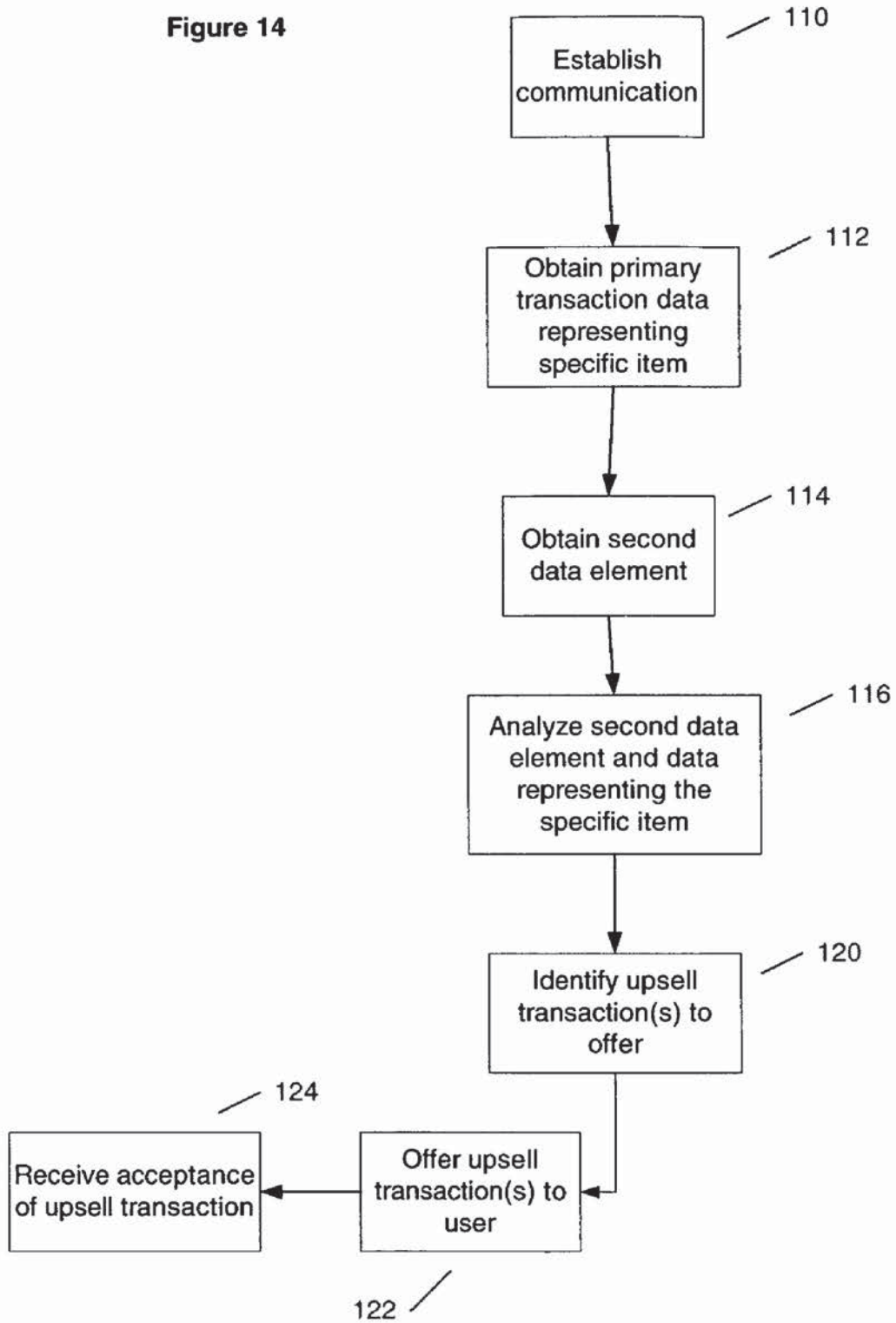

Figure 15

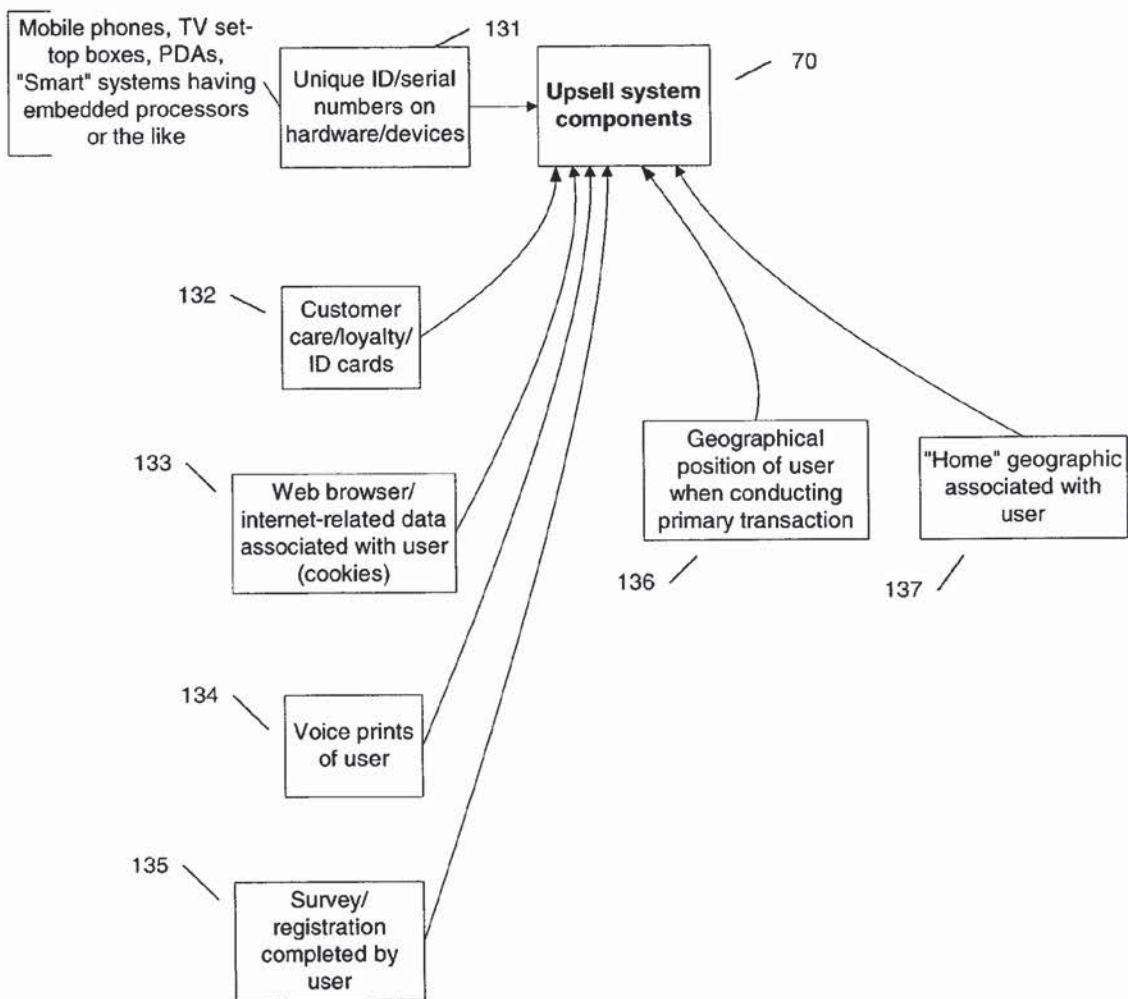
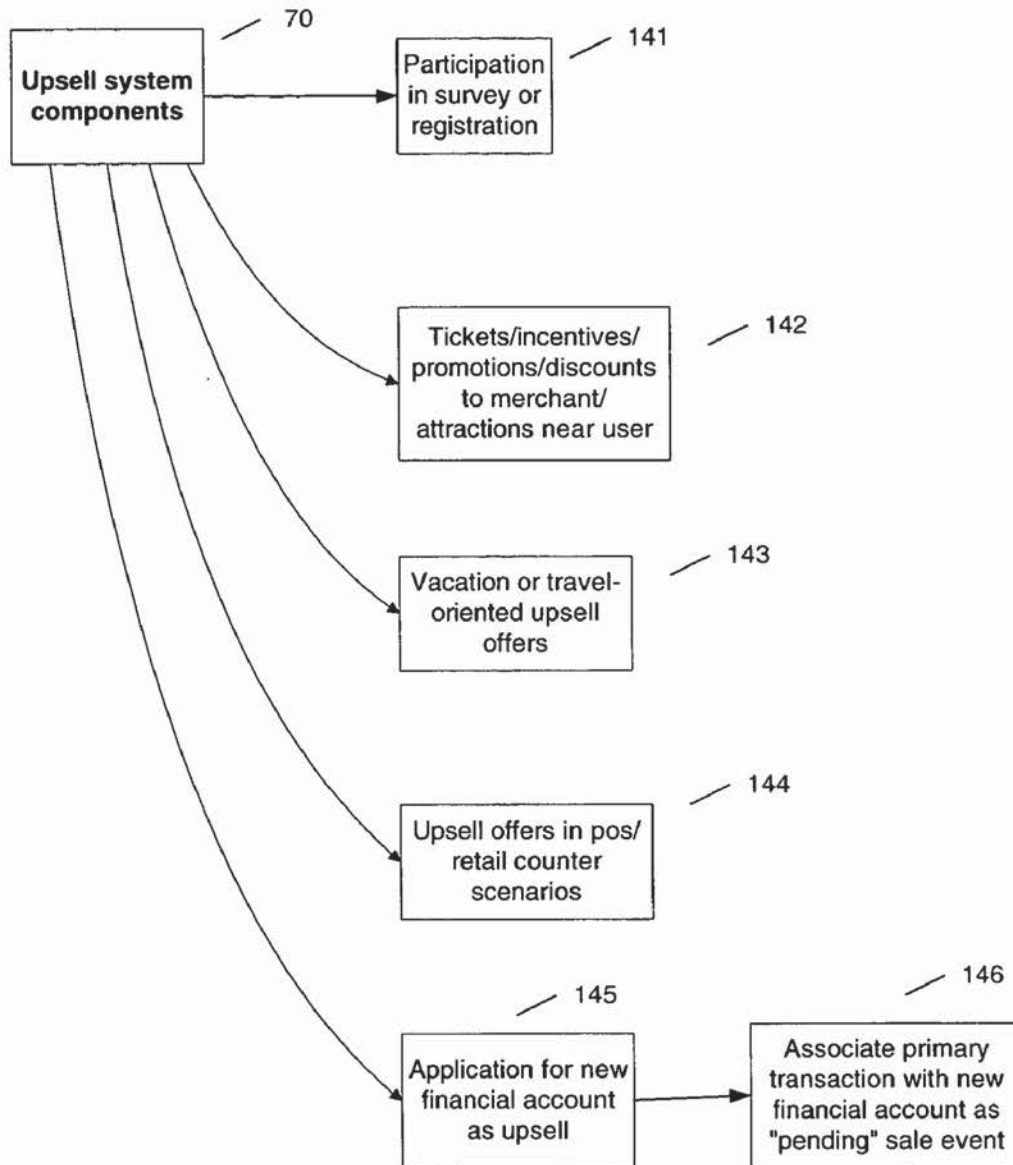

Figure 16





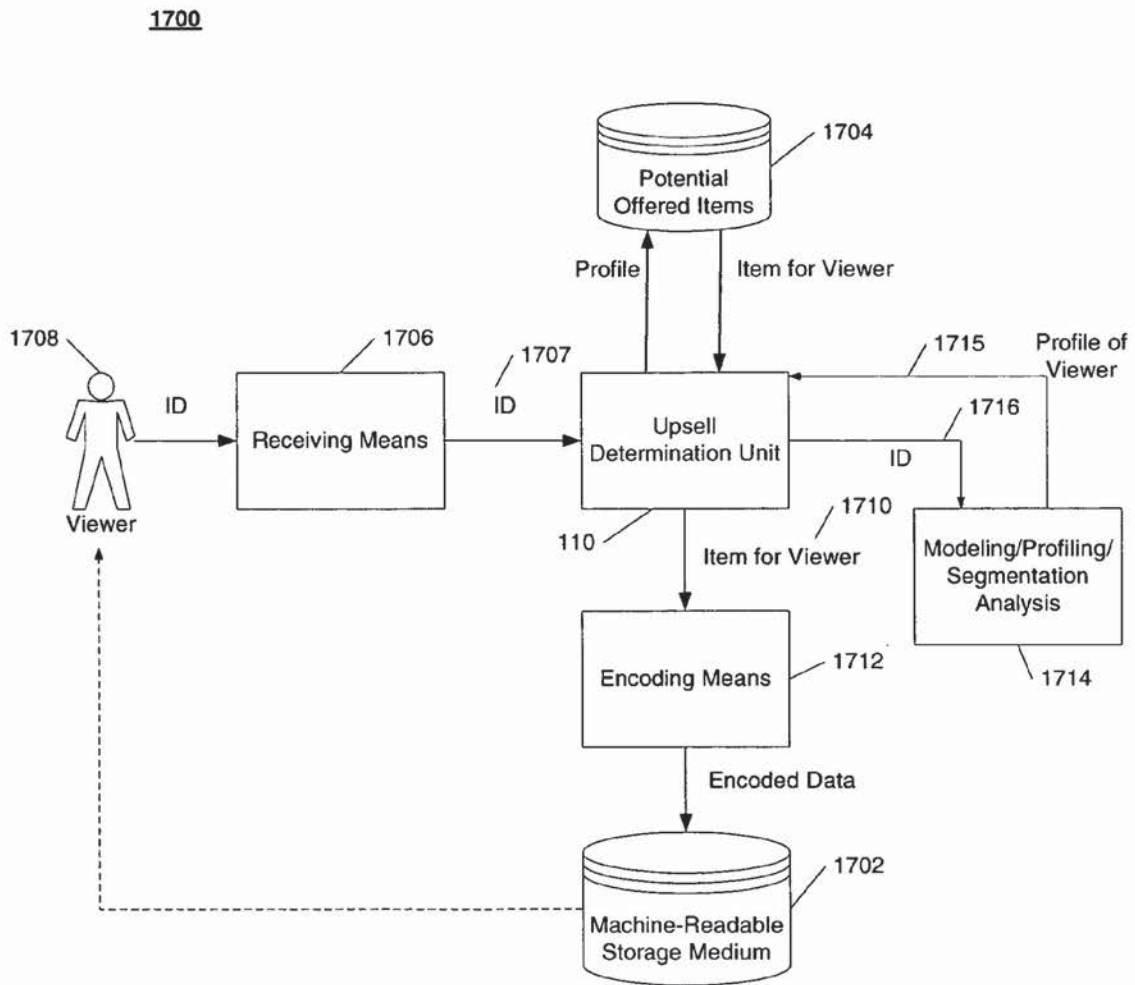

Figure 17

1702

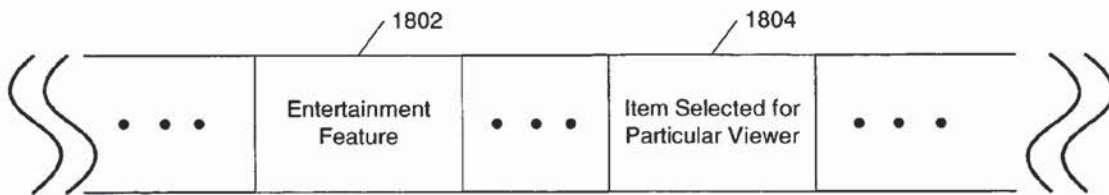

Figure 18

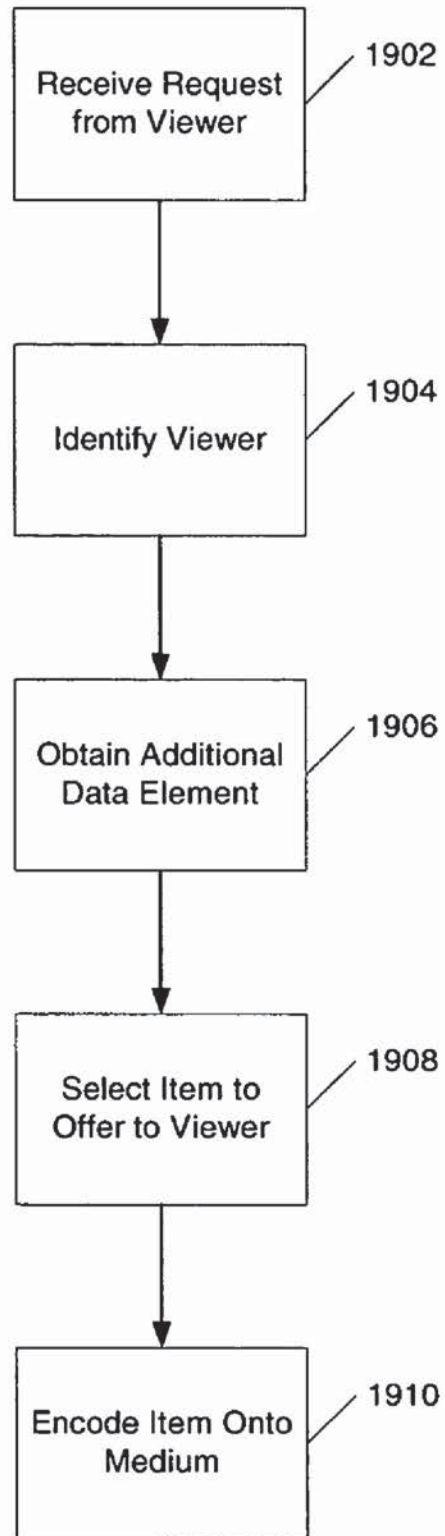

Figure 19

1

**METHODS, COMPUTER-READABLE  
MEDIA, AND COMPUTER PROGRAM  
PRODUCT FOR INTELLIGENT SELECTION  
OF ITEMS ENCODED ONTO PORTABLE  
MACHINE-PLAYABLE ENTERTAINMENT  
MEDIA**

RELATED APPLICATION INFORMATION

This application contains subject matter that is related to application Ser. No. 10/335,060, filed 31 Dec. 2002, entitled "Methods and Apparatus for Intelligent Selection of Goods and Services in Telephonic and Electronic Commerce."

This application also contains subject matter that is related to application Ser. No. 09/907,724, filed Jul. 17, 2001, entitled "Methods and Apparatus for Intelligent Selection of Goods and Services in Telephonic and Electronic Commerce."

This application also contains subject matter that related to application Ser. No. 09/691,392, filed Oct. 17, 2000, entitled "Methods and Apparatus for Intelligent Selection of Goods and Services in Telephonic and Electronic Commerce."

This application also contains subject matter that related to application Ser. No. 09/505,619, filed Feb. 16, 2000, also entitled "Methods and Apparatus for Intelligent Selection of Goods and Services in Telephonic and Electronic Commerce", which is a continuation of application Ser. No. 09/038,399, similarly entitled "Methods and Apparatus for Intelligent Selection of Goods and Services in Telephonic and Electronic Commerce", now issued as U.S. Pat. No. 6,055,513.

Each of the foregoing patents and applications is hereby incorporated in its entirety herein by this reference as if set forth verbatim herein.

BRIEF DESCRIPTION OF THE DRAWINGS

FIG. 1 is a simplified flowchart demonstrating aspects of the upsell system.

FIG. 2 is a block diagram of a system for implementing the methods of this upsell system.

FIG. 3 is a flowchart for an Internet-based order transaction in accordance with the invention.

FIG. 4 is a block diagram of a system adapted for telemarketing applications.

FIG. 5 is a block diagram of a system adapted for Internet or other electronic commerce use.

FIG. 6 is a block diagram of the functional aspects of the system.

FIG. 7 is a detailed flowchart for one implementation of the methods of these inventions.

FIG. 8 shows a representative screen display for a telemarketing operator.

FIG. 9 shows a exemplary display for a Internet-based display.

FIG. 10 shows a flowchart for a customer service application.

FIG. 11 shows a depiction of a potential customer interacting via a wireless device.

FIG. 12 shows a plan view of a possible on-screen programming guide in conjunction with an upsell determination.

FIG. 13 is a flowchart illustrating processing performed by another embodiment of the invention.

FIG. 14 is a flowchart illustrating additional, optimal processing that the invention can perform.

2

FIG. 15 is a block diagram illustrating the sources of various inputs to the upsell system components.

FIG. 16 is a block diagram illustrating several examples of inputs to the upsell system.

FIG. 17 is a block diagram illustrating a system and related data flows adapted to interact with viewers of entertainment media and to encode items selected specifically for respective viewers onto instances of the media as delivered to the viewers.

FIG. 18 is a schematic diagram of an instance of the media as it may be encoded by the system illustrated in FIG. 17.

FIG. 19 is a flowchart illustrating processing performed in connection with selecting items specifically for respective viewers and encoding data presenting these items onto instances of the media as delivered to the viewers

OVERVIEW OF THE INVENTION

Apparatus and methods are provided for effecting remote commerce, such as in telemarketing (either inbound or outbound) and in electronic commerce, which are particularly adapted for the intelligent selection and proffer of products, services or information to a user or customer. In one implementation of the invention, the system and methods obtain input information for the system from a primary transaction, identify one or more goods or services for possible proffer and upsell to the customer based at least in part upon the primary transaction data information provided to the system, and thereafter, offer the user or customer one or more items determined to be among the optimum upsells.

In one aspect of the invention, a method provides offers of an item constituting a good or a service in the form of an offer for purchase of the item to potential customers as users of the system, utilizing an electronic communications device, such as a telephone, videophone or computer, comprising the steps of, first, establishing communication via the electronic communications device between the user and the system for purpose of a primary transaction; second, obtaining primary transaction data with respect to the transaction, including determining the identity of the prospective customer; third, obtaining at least a second data element relating to the user for the upsell determination; fourth, utilizing at least in part the primary transaction data and the second data element and determining at least one good or service item for prospective upsell to the prospective customer; and fifth, offering the item to the prospective customer.

In the preferred implementation of the inventions, the input information for the system includes primary transaction data and at least a second data element obtained from a database, especially a remote, third party database or databases. Primary transaction data may include data relating to or reflecting the initial or primary contact from the customer to the system. In operation, one or more databases may be accessed, either in parallel or series, to collect and assemble input information for the system to determine the upsell or intelligent product selection.

One example of primary transaction data includes transaction determining data, which provides an indication of the purpose of the call, for example, whether the primary contact was for purchase of a product, for a service request or an inquiry. Such transaction determination data may either be used to consummate the primary transaction or not. By way of example, a user initiating remote contact with a source of sales or services might initially contact the source desiring repair of a defective product, whereupon the transaction determination data indicating a repair contact may then be used as an input to the system identifying responses

3

to be proffered. In such a circumstance, while the primary transaction data reflect a service contact, the customer may be offered in response a sales transaction for a new product which includes the functionalities of the product which formed the basis for the primary transaction.

Yet another aspect of primary transaction data may include customer identification data. Such data may be specific data in that it uniquely identifies the contact, such as in person specific data comprising an electronic address, an e-mail address, customer number, billing data or credit card number. Customer identification data may in some instances be less than person specific data, such as residence specific data. For example, a caller's telephone number, such as may be automatically supplied by the automatic number identification (ANI) service or other forms of caller identification, may identify a customer to the level of a residence. Optionally, additional data may be requested so as to specify a subset, e.g., a unique resident, from the household. At yet a less specific level of geographic granularity, identification data may include zip code data or other geographic identifier. Identification data may be obtained automatically from a carrier, such as through the use of ANI for telephonic communications, or through an electronic identifier for electronic commerce, such as transactions over the Internet. Alternatively, non-automatic entry may be utilized, such as where the customer or operator effects data entry.

Yet further aspects of the input information for the system may include a correlation system for matching primary transaction data or other input data with a corresponding or keyed designator number for obtaining yet further input information. For example, while an initial contact to a telemarketer may automatically obtain the caller's telephone number, such as from ANI, a correlation system may then provide a designator, such as a social security number, which may be utilized as an index or key for accessing yet further data bases or sources of information. For example, a caller's telephone number as provided as primary transaction data via ANI may through the correlation system result in a social security number or credit card number which may then be used to determine the credit worthiness of the caller from a database check. The collection of input information for the system may be effected based upon local resident databases, such as a telemarketer's database, or through use of third party databases, such as credit card or credit worthiness databases, or possibly, a combination of both local and remote databases. Any form or content for a local or remote database may be utilized which is consistent with the goals and objects of the invention.

Beyond credit databases and identification databases, numerous other options may be utilized. A demographic database may be utilized to identify direct or predicted attributes of the customer. Specific input information regarding the customer, such as age, sex, income, profession, education level, family status, lifestyle, and/or interests, may be used as separate and discrete inputs, or may be effectively combined to provide a coded designator based upon demographics, socioeconomic analysis or otherwise to provide a coded designator. A third party database provider, such as a credit card issuer (e.g., Visa, MasterCard, American Express), may not wish to provide specific, raw data with respect to a user, such as where they would specifically identify a customer's income as may be known to the credit card issuer through the credit application. In such circumstances, processed data may be provided such as through the use of the coded designator, previously mentioned. In this way, the third party database may provide responsive, effective information for the upsell determination, but yet pre-

4

serve in confidence the specific details known to it regarding the user which is a customer of both the upsell service and the credit card company. Yet another type of third party database may include subscription information, such as telephone services subscription information as maintained by telephone companies or other carriers. Such information may include the types of service, such as call waiting, three-way conferencing or the like.

Yet another possible input to the system includes inventory data. Such data serves to minimize or preclude the offering of goods or services to a potential customer which are not then available, or which will not be available in a timely manner. Such inventory information may be used in a positive manner, such as an input for possible offers of an upsell, or in a negative manner, such as where a potential upsell has been determined but is then deleted from the possible proffers based upon its undesirable inventory status.

Yet another possible variable for use in the upsell or other selecting of a good or service for offer to the prospective customer is geographic information. Specifically, the geographic location of the potential customer may be utilized as a factor in the determination. By way of example, a customer utilizing a wireless device, such as a cellular phone, Palm Pilot VII, or other wireless communication or web access device, may provide geographic position information regarding the user of the system. That information may be obtained via global positioning satellite (GPS) information, or may be taken from a knowledge of the base station position or access device position. In the wired domain, the geographic position information may be obtained at various levels of granularity, such as through the use of area code information, or more specifically, exchange information, or yet even more particularly, through the use of various databases which map telephone numbers to specific geographies, such as a caller's street address. The geographic position of the user may be determined via an access point to a system, such as where a customer utilizes an automated teller machine (ATM), an electronic signature device, or a vending machine for purchase of transportation tickets or other items on a network. The geographic position of the user is known based upon their interaction with the network.

The geographic information may be utilized in combination with other information in determining an offer or upsell. By way of example, the system or access device may know the position of a potential user of a good or service based upon position information from a GPS system, and may utilize that information in offering a good or service, such as a discount coupon, at a geographically local store. Such an offer may be made as the result of a caller contacting the system, or may be provided in an outbound or push based context where the system contacts the potential user of the offer, such as by calling their cellular phone or other wireless device. The geographic position information may additionally be combined with data or information regarding the geography of the person. For example, if the positional information indicates that the person is in a casino at midnight, it may be a valid assumption to assume that the person is not risk averse. In yet another particular application involving a wireless communication device, a display, such as a billboard, may provide a telephone number or code (e.g., \*72). By dialing the number, the system may generate a tailored response regarding the good, service or information upon any number of factors, such as knowing the identity of the caller via the mobile identification number (MIN), plus any associated information known about the caller. The use of a code on the billboard may be combined

with the knowledge of the base station receiving the call, to uniquely designate the billboard and the requested information.

Another application of the upsell system is in conjunction with on-screen programming guides. Such on-screen programming guides present a viewer of a television or other display with information regarding programming, entertainment or other information categorized in a predefined manner, such as by channel and time. In such a system, the selection (either made or considered) by the user may be provided as input to the decision system. For example, if a viewer selects a Pay-Per-View sports event, that selection may be used as an input to the system as described generally in this application which then results in the selection and offer of another good, service or set of information for the potential customer. Continuing with the example of an order for a Pay-Per-View sporting event, the system may determine, through the various methods described herein, to offer the viewer a series of entertainment events, such as a seasonal football schedule. The input device for such an onscreen programming guide application in the upsell context could be a remote control operated by the viewer.

Yet another class of database information may include third party databases relating to items believed to be possessed by or desired by the customer. For example, a possession database may indicate that the system user possesses a certain formalware pattern, or has a certain number of place settings of a pattern. The status information regarding the possession and/or completeness of a set may be utilized as an input to the system to identify an upsell to the customer. In yet another aspect, a registry database which reflects desired goods or services may be consulted as yet further input information for the system for identifying the proffer.

The system for identifying the potential proffer utilizes the input information so as to generate one or more outputs comprising potential proffers to the user. Various selection methodologies are available, including historical selection criteria keying the proffer to what has effectively resulted in sales or successful transactions in the past, or proffers based upon demographic profile or other inputs as a designator for a potential upsell. In yet other selection methodologies, theme sales may be utilized such as where further goods are required to complete a set, such as a formal ware set.

In yet other aspects, the invention may include actions taken upon the historical factors relating to a specific customer or customer type. For example, the system may adapt to reduce the number or frequency of upsells if it is determined that the customer is unlikely to purchase, or a pattern or time basis to the customer's purchasing is detected or expected. Yet another historical factor may include a quality factor, such as where it has been determined or assumed that the customer is interested in a certain level of quality, and accordingly, the selection of the proffer is based in part upon the quality. In yet another aspect based upon historical factors for a specific customer, knowledge of a user's possession, such as based upon a prior purchase, may be utilized in the proffer. For example, where a computer sales entity possesses the knowledge that the customer owns a particular model of computer, that information may be utilized in the selection of a proffer, such as in the offer of increased computer memory, a new version of a software application or the like. Yet another historical factor may include obsolescence of possessed materials, such as through the passage of time whereby the possessed item becomes worn, outdated, or outgrown.

Yet other factors affecting the upsell may be based beyond those particular to the user. For example, proximity to key calendar events for others, birthdays, anniversaries or other typical gift giving days, may be utilized as a factor in the selection of the upsell. Further, the time of the contact may be utilized, such as where a user contacts the system during the nighttime, wherein an upsell more likely to sell to a 'night owl' will be offered as opposed to what is believed to effectively sell to a 'morning person'. Offers may vary based upon day of the week, or day of the month, such as correlation or actual or expected paydays.

In one aspect of the invention, multiple actions may be taken in one transaction. For example, while a credit verification is being effected for a primary transaction, a second credit check may be performed to determine available credit, which is in turn used as an input to the upsell determination system. In yet another aspect, multiple upsells may be selected, whereby multiple potential purchases are offered to the user either simultaneously or serially, and if serially, the reaction to an earlier offer may be utilized in the decision for subsequent offers.

After the upsells have been identified, they are offered to the user. In the telemarketing application, a script directed towards the sale of the selected product is provided to the telemarketing representative. In an electronic commerce environment, a display or other communication of the offer is made, such as through textual data, video, and/or audio communication. Additionally, information may be provided by additional or other modes of communication, such as e-mail, facsimile, independent phone contact, cable contact, etc. The proffer is typically accompanied by a solicitation to consummate the transaction. The results of the proffer response thereto may be utilized in the modification or updating of the system for identifying later upsells.

In one aspect of this invention, a method is provided for presentation of information to users of an electronic system comprising the steps of, first, establishing communication between a user of the system and the electronic system, second, determining characteristics of the user based at least in part upon the communication between the user of the system and the electronic system, third, determining the mode of presentation for the user based at least in part on the determined characteristics of the user, and fourth, presenting the information to the user in the determined mode.

In yet further aspects of the consummation of either or both of the primary transaction or the derivative, upsell transaction, an order fulfillment system may be utilized. Upon receipt of indication that the transaction is to be consummated, the system may so designate the product, and may automatically provide for shipping and billing of the user. Optionally, tracking of the item may be included.

In operation, a user establishes communication with a telemarketer (either with the user establishing communication in an inbound environment or with the telemarketer establishing communication in an outbound environment) or through other electronic contact, such as through a website contact or hit, upon which identity information regarding the user is either automatically obtained such as through the use of ANI or manually obtained, such as through entry of identification information by the user. The identity information may be specific to the user, or may be more generalized such as information relating to the type of primary transaction or interaction. A second data element is then obtained, preferably from a second, and most preferably remote, database which is then used in conjunction with the primary transaction or primary interaction data so as to select a subset of potential offers of goods, services or information

to the user. Upon selection, the goods, services or information are provided to the user, and if the interaction is for the purpose of sale, the transaction is preferably consummated. In the preferred embodiment, inventory checks for the proposed offer, as well as a credit authorization for the proposed offer, are made during the course of the communication, and most preferably, prior to the offer of the secondary item. In yet another aspect, the inventions relate to the intelligent selection and proffer of goods, services or information based upon an initial contact generating at least partial identification data, utilizing a remote, external database to develop yet further identification or information respecting the user, utilizing the collected information in the selection of the good, service or information to be provided to the user, and providing the same to the user. In one application, a user is identified during the course of a primary transaction, and identification information is utilized in an access of a credit card database, whereby raw, processed or coded designator information is obtained from the credit card provider, wherein the information is utilized in the selection of the further good, service or information to be provided to the user. In yet another aspect of this invention, the mode of presentation of the information to the user is based at least in part upon the identification information respecting the user. The mode of presentation may be varied based on demographic information, such as age, sex, income, occupation, education level, family status, lifestyle or interests.

In yet another aspect of this system, an electronic system permits the user of a web or other electronic commerce system to interact with a live operator. In this way, what has heretofore been merely communication between a user and a non-human system may divert the transaction to an operator/transaction assistant.

#### DETAILED DESCRIPTION OF THE INVENTION

FIG. 1 shows a hybrid block diagram and flowchart of one implementation of the system and methods of these inventions. The simplified depiction of FIG. 1 reflects aspects of a telemarketing implementation, though it will be understood that various structures and functionalities may be extended to other implementations, such as electronic commerce and the like.

By way of terminology, when the terms "user", "system user", "customer", "potential customer", "contact" or equivalent terminology is used, those terms are meant to refer to a person or entity to whom the efforts of the offering are at least in part directed. Variations in meaning as to this terminology may be taken from context, as necessary. The terms "good(s)" and "service(s)" while distinct, are intended within the scope of the patent to be used interchangeably, where appropriate given the context. When appropriate from context, a good or service may include a coupon, ticket, card or other promotional material, including printed material, having a value designator. Further, a "service" may include information or entertainment. The term "upsell" means an offer or provision of a good or service which is selected for offer to the customer and differs from the good or service for which the primary contact was made. The term "upsell" is not limited to the context in which a primary transaction is intended to be a sales transaction, but additionally includes the offer of a good or service offered in accordance with the selection criteria of the invention even if the primary transaction is not principally sales motivated, such as where an initial contact is for service or repair purposes. The use of

"he" is gender neutral, and may be read as "he", "she" or "it". When the term "and" or "or" is used, they may be read in the conjunctive or the disjunctive, where appropriate from context.

Various aspects of the invention provide systems and methods for intelligently processing at least one primary transaction involving at least one user accessing a system using a communications device. The term "system" refers to any computer-based processing system that automates any type of interaction with the user. The term "communications device" refers to any hardware (for example devices having embedded processors or other "smart" hardware) useful for enabling the user to access any local, regional, national, or global communications networks such as local-area or wide-area computer networks (LANs or WANs, respectively). Example LANs can include computer networks linking various components of a merchant's computer infrastructure, while example WANs can include networks such as the Internet or the World Wide Web. The term "communications device" also refer to hardware enabling the user to access other wired or wireless communication networks such as the various public switched telephone networks (PSTNs) operating in different areas radio networks, cellular telephone networks, cable or broadcast television networks, satellite-based communications networks, or other similar networks currently existing or developed in the future.

Initially, a system user contacts the system for purpose of a primary transaction. As explained, however, the transaction need not be a consummated transaction. If the system user is a potential customer contacting a telemarketing system, at action (statement) block 10 a telemarketing operator may interact with the potential customer and take the order entry data for the primary transaction. Either upon completion of the primary transaction, such as through consummation of a sale or by program flow to further action prior to consummation of a sale, action (decision) block 12 is arrived at wherein data, such as order data or other primary transaction data is compared to one or more databases for analysis. The primary transaction may be a contact for a sale or other commercial transaction, a service or repair transaction or interaction, or may be for the purpose of an inquiry.

As depicted, a first database 14 coacts with action block 12. Typically, the database 14 is a locally resident database, such as the telemarketers own database. It should be understood that a locally resident database refers to any database configured for any access by the telemarketer, not necessarily one that is located at the telemarketer's site. Database 14, if a resident database, may handle matters requiring relatively quicker response, such as correlating automatic number identification (ANI) information received over the telephone or communication network with other identification or prior transaction information on the caller.

One or more other databases (database A—database N), such as database A 16 and database B 18 may be coupled to action block 12. As depicted, database A 16 is coupled via coupling path 24 to database B 18. Additionally, coupling path 26 interconnects action block 12 and database A 16. Similarly, action block 12 is coupled to database B 18 via coupling path 28. Any of the databases 14, 16, 18 may be interconnected as desired consistent with the intended functionalities of the systems described herein. Thus, though not expressly shown, the resident database 14 may couple to database B 18, either directly or via a path such as through action block 12 to coupling path 28, or via action block 12, coupling path 26, database A 16 and coupling path 24. These databases may be accessed simultaneously, or in any com-

combination of parallel, serial, sequential or time access. Preferably, the accessing of multiple databases is performed in a manner to minimize any delay in effecting a real-time proffer to the user.

Secured communications are preferably utilized within some or all of the system. For example, encrypted messages or data may be utilized, such as when transmitting raw or analyzed data from, to or between databases. Further, privacy concerns are addressed by precluding or inhibiting the sharing of information between users, or between various database owners or content providers. Further, security qualification or entitlement restrictions may be utilized such as to the entire system, or parts of the system, such as databases.

Sources of input information for the system, such as primary transaction data and other input data for the upsell identifying system may come from any or all of action block 10, or other databases 14, 16 and 18. It will be understood by those skilled in the art that the number and interconnection of the various databases 14, 16 and 18 has been simplified for expository convenience, and is not intended to be a limitation on the scope or teaching of the invention. From action block 12, after the system identifies one or more upsell items for offering to the potential customer, offering block 30 serves to provide the selected items to the potential customer. In the telemarketing application, the telemarketer would at this stage have text or other information available to provide to the customer. Typically, a screen pop including a text directed towards the sale of the upsell item would appear, at which point, the telemarketing sales representative would verbally make the sales presentation to the caller.

Various descriptions of the structure and function of the embodiments is provided in this patent. However, as is understood by those skilled in the art, the performance of a given functionality may be distributed among one or more components, and conversely, multiple structures may be required to achieve a desired functionality. While the detailed descriptions herein have been provided with respect to certain allocations of functionality and structure to various items (such as elements of a block diagram or flowchart) the underlying inventions herein should not be limited to the allocation of those structures, functions, diagrammatic representations or labeling selected for expository convenience herein. By way of example, while routing of telephone calls and computer-based call handling have historically been relatively discrete, segregable functions, and further segregable based upon discrete equipment, the trend is towards integration and distribution of functionality more broadly within a system. Accordingly, the understanding of the inventions herein should be based upon the functionality, as implemented by selected structures, though not necessarily upon which particular unit of structure in which the functionality resides.

FIG. 2 is a block diagram of a simplified embodiment of structure usable to achieve the functionality of these inventions when suitably adapted for such use. FIG. 3 is a more detailed schematic diagram of one possible implementation of a structure for use in implementing the functionalities of the inventions here. When feasible, the same numbering will be used in various figures to describe any corresponding element. FIG. 2 shows a block diagram of a telemarketing system 40 adapted for communication with one or more databases 50, as well as a database 42 which may be integral or resident within the telemarketing system 40. Within the telemarketing system 40 are grouped various functionalities, including the telemarketing company operator 42, the database 44 resident at the telemarketing system 40 with its

attendant computer for processing and control, as well as a computer 46 for analysis of the inputs and generation of one or more outputs for provision to the user. One or more external databases 50 may be included within the system. A first database A 52 and a second database B 54 are depicted, though it is to be understood that the selection of two databases 50, and the interconnection there between, is selected for expository convenience and is not intended to reflect any limitation on the structure or functionality of the system, provided the functionalities of the invention may be achieved.

FIG. 3 shows a block diagram of one implementation of a telemarketing system at a greater level of detail as compared to FIG. 2. While the following description is generally provided in the context of inbound telemarketing, the inventions herein may also equally be applied to outbound telemarketing. Users 74 (also known as customers, or potential customers) access the telemarketing system 40 via any known manner of telephone, telephonic instrument or its equivalent. As shown, telephone 76 comprises a touch-tone phone having a handpiece including a speaker and receiver, as well as an array of alphanumeric buttons for actuation by the customer 74. Alternatively, video phone 78 provides for both audio communication as well as image or video communication. The video phone 78 includes an array of alphanumeric buttons, a video display 80, typically a handset, and some imaging system 82, comprising a camera or other image generating system. A conventional touch-tone phone 76 may be utilized in association with a separate imaging system 84, if desired. In yet other modes, the customer or user 74 may interact with any other form of man-machine interface which is consistent with the goals and functionalities of these inventions. By way of example, but not of limitation, the customer 74 may interact with a computer, whether standalone or networked (by local area network (LAN), wide area network (WAN) or otherwise), which includes a communication capability (modem, etc.), or may comprise access capabilities to the Internet or web or internet television type systems. Yet further examples of devices permitting interaction between the user and the system include automated teller machines (ATMs), ATM-like devices found at grocery stores, gas stations, car washes, or the like, electronic signature devices used in credit card or other types of transactions, networked vending machines offering airline, train, bus, or other travel tickets, other types of networked vending machines, or essentially any electronic device adapted to provide communicative interaction with the user. Many of these devices may include textual displays, potentially video displays and optionally audio displays. Yet other display devices permitting interactivity include various wireless devices, such as the Palm Pilot VII, and Nokia communicator. Various other devices principally for entertainment and game play include the Sony Playstation and the Microsoft X machine. Yet another display device which may include an input capability comprises electronic books (e-books). Various input technologies may be utilized to contact the system, whether touch-tone input, keypad or mouse input, voice response technology, including nuanced voice recognition technology, remote controls, touch screens, etc. Yet another form of input device includes smart cards. A smart card stores information, such as information about the possessor of the smart card. That information may be provided from the card for use in the system. A smart card may include identification data, other personal information or preference data. Any or all of that information may be utilized in order to make a better selection of a good or service for offer to the customer. While the particu-



lar implementations and embodiments of the user 74 interface may vary, any interface which provides output to the customer 74 and permits return entry consistent with the functionalities to be achieved herein is acceptable.

Optionally, other devices such as a printer 89 may be included. These various devices then interface with a carrier 89. The interconnection 88 between the end instruments 76, 78 may be of any mode or manner, such as a copper wire connection, optical fiber, cable connection, wireless connection, cellular connection, satellite connection, or any other mode or manner of connection. Similarly, the communication path 88, and carrier 89 may utilize any type or mixture of carrier technologies, whether analog, digital, ISDN, or at any rate of speed consistent with the achievement of the functionalities described herein. Preferably, the carrier 89 includes the ability for provision of more advanced telephony services, including the provision of DNIS, the dialed number identification service, and some form of caller identification such as automatic number identification (ANI, caller ID, etc.). Typically, the DNIS and ANI information are provided from the carrier 89 to the telemarketer 40 over connection 90, and may be either in-band or out of band signaling, such as D-channel signaling in current time division multiplexed modes of operation.

FIG. 3 depicts the telemarketing system 40, and separately identifies the upsell system components 70. The upsell system components 70 may be optionally included broadly within the telemarketing system 40, or may be provided on a standalone basis, such as where the upsell system 70 is geographically distinct from the telemarketing system 40, and indeed where the upsell system 70 may be resident at a third party location and be utilized by one or more telemarketing systems 40.

The telemarketing system 40 interacts with the carrier 89 via communication path 90. Optionally, this path may include various additional structures and functionalities as known to those skilled in the art. For example, automatic call distributors may be utilized at the front end of the telemarketing system 40 so as to serve a routing, holding and/or load leveling function, either done or in combination with other hardware and/or software. Within the telemarketing system 40, one or more operators 42, typically wearing headsets for audio communication, interface with terminals 92 which provide for at least textual display, and optionally, graphic image or video display. The operator 42 interfaces with the terminal 92 through any mode or mechanism, such as a keyboard, mouse or other pointing device, or any other man-machine interface for data entry or communication. Conventionally, the operator 42 is a live operator, though optionally the generation of audio images or video for presentation to the customer 74 may be synthesized or simulated or represent virtual reality. By way of example, a text-to-speech unit or other form of recorded speech may be utilized. An audio response unit 94, also termed an interactive voice response unit, may be utilized to provide some or all of the customer 74 interaction. Additional structures and functionalities required for the operation of the telemarketing system 40 may include local memory 96, local database 98, control (processor unit) 100 to provide overall coordination and control of the various components of the telemarketing system 40 and its interaction with the other units described. Additionally, a printer 102 may be provided for generating a hard copy record, such as of order transactions. Additionally, a recording unit 104, whether for audio, images, or both, may be included.

The upsell system 70 typically includes a determining or type analysis system or unit 110 which serves to receive the

various inputs for the determining unit and to generate outputs relating to possible upsells for the customer 74. Optionally, a local database 112 is provided within the upsell system 70. Chronological information, such as provided from a calendar 114 and/or clock 116 may be utilized within the system. The databases 50, whether resident or external, are shown as database A 52, in this depiction being a demographics database, database B 54 being a credit database and database C being an inventory database.

Optionally, the system may include an order fulfillment system or unit 120 which is coupled to receive outputs from the telemarketing system 40 and/or the upsell system 70 indicative of a consummated transaction requiring fulfillment. Optionally, a billing unit 122 and shipping/tracking unit 124 may be utilized in conjunction with the order fulfillment system 120. An electronic notification (such as by e-mail) that an item has been shipped may be provided.

A simplified interconnection is provided in FIG. 2 and FIG. 3. The selection and arrangement of the interconnection, as well as its implementation, are matters which are known to those skilled in the art and depends upon the particular technology in which the system is implemented. Any interconnection or mode of implementation may be utilized which is consistent with the achieving of the goals and functionalities of these inventions. Yet other modes of accessing the system may be utilized. For example, electronic or web access 130 generically depicts access through communication networks, such as through Internet access, cable, television, direct broadcast, satellite broadcast, e-mail, facsimile, voicemail or otherwise. The web access 130 may connect via web access connection 134 to some or all of the various portions of the system, such as the shipping/tracking unit 124 so as to check on shipping or delivery information, the billing unit 122, or to directly access the upsell system 70 as a variation on the point of entry into the overall system. When considering access in a non-telephonic, though still electronic manner, reference should also be made to the descriptions of FIGS. 4 and 5 relating to Internet or web-based access and systems.

The depictions in FIG. 2 and FIG. 3 will be used now for a brief description of one mode of interaction of the customer 74 with the telemarketing system. A customer 74 may utilize a video phone 78 to dial a toll-free telephone number in response to observing a promotion for a good or service. The carrier 89 effects telephonic connection to the telemarketing system 40 preferably providing DNIS information which is utilized by the control unit 100 and local database 98 to provide a textual display on terminal 92 for use by the live operator 42 in interacting with the customer 74. Additionally, the carrier 89 may provide caller identification data, such as ANI data, which may be utilized by the control unit 100 to retrieve information from the database 98 particular to the customer 74. In addition to database 98, geographic designator programs exist which may be utilized to receive ANI data and to identify the geographic location of a customer such as by zip code, or more particularly, by zip code plus four. Based upon the retrieved information as provided to the live operator 42, a dialog is conducted relating to the primary transaction for which the customer 74 made the primary or initial contact with the system. While handling the primary transaction, the system may access one or more databases 50, such as a credit database 54 and a inventory database 56. If the user's credit card number has been obtained, such as during the primary transaction, or is otherwise known to the telemarketer through prior contacts or is divined via a correlation system, the credit card number may be utilized to obtain raw or analyzed data regarding the

caller. The response from the credit card issuer or processor may be specific, such as providing data on the user's income, sex, history of purchase transactions or any other personal or demographic information known to it, or may provide a analyzed, coded message in response. The credit information, personal information, demographic information, possession information or other form of input data is then used by the system to generate the upsells or other real time provision of a secondary transaction. The secondary transaction may relate to the offer of a good or a service, or to a coupon, ticket, card or other promotional material having a variable or designated value for the purchase, lease or other acquisition in the future of a good or a service. In the preferred embodiment, there is a real time offer during a real time transaction. If the transaction is consummated, an indication may be provided to an order fulfillment unit 120 and attendant units such as the billing unit 122 and shipping/tracking unit 124.

Within the contemplation of the inventions, while a customer 74 is interacting with the operator 42 with respect to the primary transaction, the upsell system 70 is obtaining various input information for generation of a potential upsell item. As shown in FIG. 2, data regarding the instant call 60 may pass from the telemarketing system 40 to various databases 50, such as directly through path 62, or alternatively, from database A 52 to database B 54 via path 70. Database A 52 may provide in return, analyzed or raw data 66, and similarly database B 54 may provide analyzed or raw data 64 to the analysis system 70 for processing in accordance with the inventions herein. Upon generating the potential upsells, that information is provided to the telemarketing system 40, for presentation to the operator 42 on the terminal 92. As described in more detail in connection with FIG. 8, multiple options may be presented for selection by the operator 42. If a transaction is then consummated with respect to the upsell, the order fulfillment unit 120 and associated units may be utilized as in connection with the primary transaction. As described further below, the data from the proffer of the upsell may then be utilized in subsequent transactions, such as by storing the information in memory 96, or by utilizing it in connection with the determining unit 110.

Reference has been made to the provision of analyzed or raw data 66 in connection with databases 52, 54. The following discussion applies generally with respect to the form of data provided. A database access may provide raw data, such as specific data relating to a given user, e.g., a particular user's income. A system may also provide analyzed or processed data, such as where not all of the data provided is raw data, but includes processed data, e.g., a coded designation indicative of certain aspects of the user. By way of example, third party database possessors often maintain substantial raw data specific to their customers. Financial institutions and transaction processors, such as banks, brokerages, credit card issuers, credit card processors, have extensive databases either from data provided to them such as through application, forms or which is known to them due to their continued course of contact. For example, a credit card company may both know specific raw data relating to a customer through the customer's indication of its income on the original application, but may also possess data relating to purchases (such as transaction frequency, amount, type, item and location) which are obtained in the course of processing the transactions of the user. The third party database owner may be unwilling or unable, e.g., due to legal restrictions, from providing the raw data to other parties for their use in telemarketing or elec-

tronic commerce applications. However, process data which does not specifically reveal information of the user may be provided. For example, a coded designator may be provided from the third party database to the transaction or upsell processor, typically through agreed upon codes and formats, whereby the required information is provided, but in a generic enough manner so as not to raise privacy or other concerns. For example, a designator code XYZ may relate to a user with an income over \$50,000, expected net worth of \$75,000, is a homeowner, and has an interest in stereo equipment. In this way, the specific confidential information of the user may be preserved, while providing effective input for the processing or upsell system. One or more coded designators may be provided. Coded designators may be provided at a finer level of granularity, such as one designator to indicate whether or not the user is a homeowner, has an income within a defined range, etc. In this way, multiple designation may provide a more complete description.

FIG. 4 shows a simplified flowchart and block diagram depicting an Internet, web-based or other electronic commerce system for performance of the inventions herein. FIG. 5 shows a detailed block diagram of one optional implementation of such a system. To the extent that description provided with respect to other figures described the same or similar structure or functionality, the description is incorporated herein by reference.

As shown in FIG. 4, a user interacts with the system via contact block 140 such as by having a primary transaction comprising an Internet order transaction being entered or effectuated by a user at a personal computer (PC) terminal. During the course of the primary transaction, processing step 142 serves to receive data at a address website and process the primary transaction. That transaction may be optionally consummated or not as suits the overall purpose of the transaction. By way of example, if the upsell serves to obviate the purpose for the primary transaction, such as when the primary transaction is for customer service or repair, and the upsell is successful in providing the customer with a new product in replacement thereof, then the primary transaction need not be consummated in the manner contemplated by the user at the point of initial contact 140. Continuing with the flow of the program, at analysis block 140, the various inputs for use by the analysis system are collected, and subsequently analyzed. In the course of this collection and analysis, various sites, such as the websites own database, 144, remote database A 150 and/or remote database B 152 may be accessed. The coupling 154 between the analysis system 144 and the website database 146, as well as the couplings 156 to the external or other databases, 152, as well as any coupling 158 between the databases 146 (coupling to other databases not shown), 150, 152, may be implemented as known by those skilled in the art. The particular selection of interconnections between various components is left to selection of implementation, where the implementation merely needs to be consistent with the goals, objects and functionalities of this invention. Upon completion of the analysis at analysis block 144, the output of the analysis block 144 is provided to the user through action block 148. The upsell data may then be displayed on the caller's PC as an additional offer, or in lieu of the primary transaction.

FIG. 5 depicts one or more users 160 (also referred to as customers or potential customers) who interface with the system via a computer 162. Typically, the computer 162 includes a display 164, such as a CRT or flat panel display, some input device such as a keyboard 166, and optionally a mouse 170 or other pointing device, and may optionally

include an imaging unit 168 to image the user 160. Additional devices such as a printer 172, such as to provide a permanent transaction record or to print images regarding proffered goods or services may be included. Similarly, a facsimile machine 174 may be included, and may be connected to a telephone system for effective communication. Again, any type of human/machine interface consistent with achieving the goals and functionalities of the instant inventions may be utilized with this system. A carrier 176, such as an on-line access service, cable access service, network, or other wired or wireless connection may be used to access the desired website 180. As depicted, connection path 178 is provided which serves as a generalized descriptor for a path, such as a Internet established routing, network routing, or other routing for connection of the user 160 for the website 180. The term website 180 is not intended to be a term of limitation, but rather of generic description, to be an intermediate or terminal node or contact point in the effecting of the electronic provision of goods or services so as to result in commerce or information transfer. While the website 180 may be a site on the Worldwide Web (WWW), it need not be so. The underlying aspects of this invention more broadly encompass the functionalities and structures to achieve them, as those particular implementations to achieve them are modified over time.

The upsell system 190 includes a control and upsell generator system 192, such as implemented through a special purpose computer or a general purpose computer program or otherwise adapted to achieve the functionalities described herein. The program may be implemented in a linear programmed fashion, or may use other decisional bases, such as expert systems, fuzzy logic, neural networks, adaptive systems, or other decisional systems known to the art, and which effectuate the desired functionalities of the inventions. Further, a determining unit 194 may be included to provide an indication of the purpose of the original contact in the primary transaction. Clock 196 and calendar 198 provide date or chronology information, and may be combined as a single unit. Memory 200 may serve to store program information, input information to the control and upsell generator 192 or other data required for effective operation of the system. The website 180 may include its own database 202, either directly connected to the website 180 or to the upsell system 190. Various databases, including database A 204, e.g., a demographics database, database B 206, e.g., a credit database, and database C 208, e.g., an inventory database, may be accessed. Optionally, an order fulfillment unit 210, and associated billing units 212 and shipping/tracking unit 214 may be included as described in more detail with the telemarketing system. The interconnects 220 between the website 180 and the upsell system 190, and between the upsell system and various databases 202, 204, 206, 208, as well as the coupling from the upsell system 190 to the order fulfillment unit 210. Optionally, a connection 224 to a live operator system, such as the telemarketing system previously described, may be utilized. In this way, while an initial access for a primary transaction is provided to a website, through program flow (where the operator may initiate contact with the user) or at the election of the user (where the user may initiate contact with an operator) 160 may be placed in connection with an operator. Such an option provides for the ability to provide individualized interaction between the user 160 and the overall system for the provision of electronic commerce or information transfer.

The various steps in the typical operation of the overall system will now be described, with contemplation that the

description may apply to telemarketing-based systems as well as electronic commerce-based systems, the applicability of the particulars to be taken from context. The description will relate to FIG. 6 which shows various interconnected functionalities, and will relate to other figures when noted. Broadly, the following discussion will relate to the primary transaction, both as to the data and completion or consummation of the primary transaction second, to the upsell determination or other identification of specific proffers to the user, and finally the conveyance of that information to the user and the action or consummation taken after that provision of information to the user.

As to the primary transaction data 300, in a first aspect the primary transaction data may include a type of contact component 304. The type of contact may designate a purpose, particularly a primary purpose, for the original contact by the user. By way of example, a type of contact may be a purchase contact, or alternatively, may be a service contact. A system such as the determining unit 194 (FIG. 5) may generate the indication of the type of contact. The type of contact may be determined from the address information utilized by the user, such as where different telephone numbers are provided for sales as opposed to services, in which case the dialed number or DNIS information directly provides indication of type of contact. Alternatively, the selection may be designated by the customer, such as where a menu selection is provided, e.g., press 1 for sales, press 2 for service. The type of contact may also be indeterminant, such as when the user has contacted a site without a specific purpose in mind. The type of contact may be defined at various levels of specificity, such as an indication that the type of contact was for purchasing generally, though without intent as to purchase of a specific item, to the presumption that the type of contact was specifically for purpose of a particular product.

A second aspect of the primary transaction data may include customer identification 302. Customer identification may be specific to a customer. Examples of specific customer identification would include a user's social security number, customer number, personal identification (PIN) number or other designator uniquely identifying the user. In the electronic realm, the customer identification may comprise an e-mail address, e.g., jasmith@aol.com, and Internet provider identification, or a source designator on a network. Various forms of electronic signatures may be provided which serve an identification, verification and authentication function. At a lesser level of specificity, namely, one at which a specific user may not be identified, various forms of identification exists. For example, a telephone number may provide geographic indication, such as through knowledge of its area code, or provide even more geographic specificity through the prefix. Other geographic descriptors, such as zip code or the finest level of geographic granularity (zip code plus 4) may be utilized. A residential customer number may not yet specify a particular customer within a household or location. Other forms of address, such as fax number, may be utilized to provide a local identification.

The user may be identified in yet other terms. For example, the user may be identified based upon the specific items being purchased, or more broadly, the type of item being purchased.

Further, the user may be identified by a quality factor, that is, some indication as to the perceived quality of the goods the purchaser may be interested in, such as based upon the initial contact. If the potential customer has contacted the system with respect to a high-end product, the system may classify the caller as one interested in high-end goods.

Further, the timing of contact may be utilized to classify a caller. For example, a "night owl" who contacts the system after midnight to purchase computer products may be identified differently from a user who contacts the system at 6:30 in the morning.

As yet another aspect of identification, multiple individual items of identification may be combined or otherwise utilized in combination to provide yet further identification, confirmation or verification of identity.

While user identity may be obtained from the particular contact with the system, that identity, or further identifying data, may be entered during a preliminary or registration phase 306. In such a phase, additional information may be acquired. The data may be acquired in response to specific questions, or through an iterative or interactive approach.

Optionally, the forms of identification may be used in combination to provide higher level of specificity, such as to move from a local identification to a specific customer identification. One mode is to utilize further specific identification, such as initials, or to otherwise designate an identity. Alternatively, or in combination, once the suspected specific customer identification is arrived at, this may be confirmed with the user, e.g., by confirming "Is this John Smith?". Verification may be utilized, such as through provision of personal data, or through provision of an electronic signature or other secure and verifiable means of identification.

The identification may be obtained either automatically or in a non-automatic fashion. Automatic collection of identification may include the receipt of ANI information or electronic identification for electronic commerce or information provision. Non-automatic methods may include data entry, typically in response to prompts, such as through use of an interactive voice response unit.

The final aspect of the primary transaction is the completion or consummation of the primary transaction. In one implementation, the primary transaction may be completed, such as through consummation of a sale or completion of a service call or request. In yet other aspects, the primary transaction may be concluded, though not with the provision of the originally contemplated good or service. For example, in the context of a service contact, if the upsell is successful in providing the user with a replacement product, the primary transaction need not be completed. Optionally, at the caller's discretion, the primary transaction could be completed, such as where a caller does purchase a replacement product, but yet still wishes to obtain service on the product which form the basis for the original contact, and for the upsell.

After the primary transaction phase 300, the item selection phase 310 is entered. Within the overall contemplation of the system, it may be desirable to include a correlation unit 312 for matching one or more initial contact designators with yet another designator adapted for use in subsequent processing, such as database access. For example, when a caller's telephone number is obtained, and a specific identification arrived at, the correlation unit may provide the user's social security number for further access to databases in which that number provides a key or address. By way of example, third party databases may require specific forms of identification for accessing the databases, such as a combination of social security number and PIN number and that information may be provided from the correlation unit based upon the identification data obtained from the user. In this way, different outputs may be utilized for accessing third party databases, keyed to those databases, without requiring the user to excessively input identification information.

Once the correlation unit has obtained unique, individual identification, it may provide the other forms of identification to yet further databases or other components in the system.

The identification of an upsell product or offer is divided into the aspects of identification and obtaining of inputs 300, the upsell determination 310, the output for subsequent offer 350 and, if applicable, order handling 360. As to the inputs for the upsell determination, they include the identification data 302, described previously. Further, demographic data 316 may be utilized relating to the user. The demographic data may be obtained from a database and be either raw data 316' or analyzed data 316". Data relating specifically to the customer 320 may include age, sex, income (either actual or estimated), profession or occupation, education level, family status, e.g., married, divorced, widowed, children, grandchildren, and specific data relating to them, lifestyle indicators, e.g., active outdoor, etc., address (specific address, city of residence, county of residence, state of residence, zip code, zip code plus 4), known interests, known subscriptions, known affiliations (e.g., service organization, alumni association, fraternal organizations, charitable organizations, etc.). In addition to specific information on users, the user may be associated with a code or designator which indicates others of a expected or suspected similar set of interests or reactions to an upsell. For example, the system may identify by code "422" those who are males in the 35-40 year old age bracket, with incomes in excess of \$40,000 per year, with an interest in computers. That code may then be used as an input to the upsell selection system.

Credit data 332 may be checked in the course of the primary transaction, as well as in the course of generating inputs or processing for the upsell determination. In one aspect, the credit verification may take place in conjunction with a credit verification for the primary transaction. If the primary transaction is a purchase transaction, the credit verification may be obtained for the primary transaction, and then either obtain a specific credit authorization for an amount equal to the expected upsell, or obtain an indication of the amount of available credit remaining. If the amount of available credit remaining is provided, that will provide an indication of the preferably upper bound on the cost of the upsell offer.

For some appropriate types of primary transactions, a fica score or other comparable credit score is used to assess credit risk. A fica score may also be combined with other data such as loan-to-value percentage, home equity, net income, or other factors used to determine credit risk. Ideally, the factors used by the system will be based upon historic data that more clearly identify the level of risk. If it is available, a given system may incorporate data obtained from prior customers or users of the system, which will reflect the attributes expected of future customers. A credit risk score may then be assessed and used as an input in processing the upsell determination.

Yet another form of database information includes inventory data 336. In determining the items for upsell, the inventory database may be consulted before, during, or after the upsell determination. The upsell may discount the offering of a product which is unavailable at that time. In another aspect, the system may yet still offer the product if it will become available in a timely manner. As yet a further aspect of inventory status, a delivery time window may be included, such that if the product cannot be obtained from inventory and delivered to the customer in a timely manner, that product is not offered as an upsell.

Third party possession 338 databases may be utilized. A manufacturer may maintain a database which maintains what it believes to be an accurate count of items possessed by the user, or an intended recipient of the sale or upsell. For example, a seller of china or formal dining services may maintain a database of the number of place settings of a particular pattern owned by a potential recipient of yet further settings or related goods. In this way, an input to the upsell determination unit may include the offer of specific items of merchandise which complete or compliment existing possessions.

Turning now to the upsell determination 340 or the selection of the product or service for offer, generally, the system comprises a multiple input, dynamic, preferably real-time system for the selection of a suggested product or service to offer to a potential customer or user. The process includes the identification or selection of a set or subset of all possible goods or services available for offer, with the goal of optimizing the likelihood of upsell, as well as achieving customer satisfaction.

In one aspect, the upsell determination system may utilize, in whole or in part, a system which bases the offer of an upsell based upon prior successful upsells. Thus, if a customer is categorized as being in class 422 who called a telemarketer to buy product X, and was successfully upsold product Y, if a later customer in class 422 contacts the system, the past success may be utilized as a factor in again offering the product Y to the caller.

Various historical factors relating to a specific customer, or to known classes of customers may be utilized. The selection criteria may include negative decision criteria, such as not trying to upsell a customer on an item that the system knows he has previously purchased, or has previously been offered but declined to purchase. Yet another form of negative decision criteria consists of not offering as an upsell a product which is competitive to the underlying or primary transaction. The competitiveness of the primary transaction and the upsell transaction may be in the nature of different types of goods for the same purpose, such as where the primary transaction relates to a gas barbecue but the upsell transaction relates to a charcoal barbecue. Alternatively, the competitive nature may relate to the source of the goods or the sponsor of the call, such as where the primary transaction relates to a first merchandiser, but the second or upsell transaction would relate to a second merchandiser believed to be competitive to the first merchandiser. By way of example, if the primary transaction consisted of a call to LL Bean, the upsell transaction may be subject to a negative criteria such as to not offer an upsell to Lands End. The negative criteria constituting the competitive goods or vendors may be defined in a list stored in memory within the system.

In yet another aspect, a negative criteria may consist of a determination that the caller simply is not a good prospect for a potential upsell. For example, if it is determined by the system that the probability of consummating the upsell transaction is less than a certain percent, e.g., 20%, it may not be economically beneficial to continue with the interaction with the user. This negative criteria has particular applicability where toll or transport charges are incurred by the sponsor of the system, e.g., such as where a telemarketer pays the charges for the "toll free" call to the telemarketer. In one form of a business model, the sponsor of a primary transaction may be willing to permit an upsell offer to be made, for a fee, upon the completion of the primary transaction. The fee may be a monetary fee, a service fee, an upsell offer made during a primary transaction of another

sponsor, or other consideration. For example, if LL Bean is the sponsor of the primary transaction portion of the call to a telemarketer or a contact to a website, they may be willing to permit an upsell offer to be made on behalf of another vendor in return for a fee. Considered in light of the negative decision criteria, if the cost of the fee to offer the upsell paid to the sponsor of the primary transaction exceeds the probability weighted return to the sponsor of the upsell, the negative decision criteria may suggest to forego the upsell offer with regard to that user or caller. To provide a specific example, if the sponsor of the potential upsell must pay the sponsor of the primary transaction \$3.00 for the opportunity to offer an upsell to the customer of the primary transaction vendor, and if the return for a consummated upsell transaction is \$10.00, if the probability of consummating the upsell is less than 30%, the negative decision criteria may be set such that the upsell is not made, or that an alternative upsell is offered.

In yet another implementation of a negative criteria, a list may be obtained or generated which comprises a list of potential customers to whom no offer is to be made. The negative criteria may relate to the upsell transaction, or more generally, to both the primary transaction and necessarily, the upsell transaction. Such a list might consist of customers who have exhibited high historical rates of return of merchandise, or who have engaged in illegal or fraudulent activity in the past.

With regard to the negative decision criteria, various actions are possible. One option is to block the call or contact such that the caller or user never is able to even initially access the system. Yet another action may consist of shortening the call so as to terminate the interaction earlier than would otherwise be expected.

In yet another aspect of an upsell transaction, it may occur that a caller or Internet user has requested to be included on a "do not call (or contact)" list. When a person contacts the system and is identified as being on such a list, it may be desirable to offer them the good, service or information that the vendor is otherwise precluded from offering. By way of example, a person may have requested to be on a do not call list regarding long distance phone service solicitations. Should that person call or contact a system for a primary transaction, and is then identified as a person on a do not call list, the vendor who is precluded from contacting the potential customer may pay a premium for the chance to upsell their service to the potential customer.

The system may utilize prior purchases as a factor in determining the upsell for offer. Prior purchases may indicate areas of interest, suggesting the offer of further goods within that general area of interest. For example, a customer who has previously purchased clothing for use in mountain biking may be more susceptible to an offer for mountain bike related goods or services. In a similar vein, theme sales may be utilized. When it is known that the customer has previously purchased a portion of a set, the completion of the set may be a goal. Certain theme sales are based on periodic introduction of a new item, such as a yearly addition of a tree ornament or the like.

Other factors affecting the upsell may include inputs comprising areas of interest, such as based upon known subscriptions, prior contact of the user to other sites, such as other Internet sites may be utilized by the system to determine a user's possible interests, and therefore, their susceptibility to the upsell of particular goods or services. Yet another aspect of basing the upsell selection on prior purchases may include upgrades to prior purchases. For example, where the system determines that the user has

previously purchased a computer of a given make and model, the system may offer as an upsell a good or service particularly adapted to improve the performance of the system of the user, such as provision of additional memory, or other modified component. Similarly, if a user is known to have a given version of software, the system may elect to offer a new version of the software. Obsolescence of prior purchases may be determined. This may be from the passage of time, updating of a product, or outgrowing of a prior purchase.

Yet other facts affecting an upsell may include relative considerations. For example, relative proximity to key calendared dates **318** for the user, or others associated with the user, may be incorporated. The relationship of traditional gift giving days to the date of contact may be utilized. Examples would include proximity to known birth dates, Christmas, Hanukkah, anniversaries, Valentines Day, etc. Further, family or relationship status may be utilized, such as offers of products for purchase for children, grandchildren, or others with whom there is a known established relationship.

The frequency of the upsell may be varied based upon expected receptiveness to the upsell at that time. Certain users may, through past particular experience with that user or through assumed desirability based upon studies of others, may determine the frequency with which upsells should be offered, whether to offer an upsell every time there is a contact, every other time, only in association with certain days or date (such as pay days), etc. The frequency may also be decreased if the user has manifested a lack of receptiveness to the offers in the past, or to a certain type or class of offer.

Multiple upsell items **326** may be utilized. In the telemarketing context, the telemarketer may have displayed to them multiple options, either for selection by the telemarketer, or for sequential presentation to the caller. In the electronic commerce context, multiple offers may be made such as on a screen, or provided sequentially to the caller.

The third main component of the upsell consists of the actual offer **350** of the upsell to the user. In the event of a telemarketing upsell offer, the typical mode would include a display on the telemarketers screen of various script or product information **354**, which is then provided to the caller. FIG. 8 shows a representative screen for a telemarketer display. The display **270** may include script **272** for use by the telemarketer for interaction with the caller. Specific upsell scripts **274** may be provided, either as a single option for the telemarketer, or to provide multiple options for selection by the telemarketer. Soft keys or icons **276** provide for selective identification of entry by the telemarketer. Various text or numeric based fields **280**, **282** may be provided for entry of information, such as order entry, and specifically including identification data **280** and address data **282**. This data may be initially provided automatically from the system, for possible confirmation by the telemarketer, or may be initially input by the telemarketer. Optionally, if image information is provided during the transaction, image **278** may be depicted on the display **270**. By way of example, if a video phone system is utilized, the image of the caller may be displayed. Additionally, or alternatively, if image or video is provided from the telemarketer to the customer, those images may also appear on the telemarketer's screen **270** in region **278** to provide the telemarketer the same (though possibly in reduced size such as a picture-in-picture) which is simultaneously being provided to the customer. An order entry icon, tab or button bar **284** may be utilized.

By way of further example, the offer may be presented to the user by modes of communication other than those utilized for the primary transaction. For example, if the primary transaction is conducted by telephone, the upsell offer may be presented by a wireless device such as a personal digital assistant (PDA), cellular/wireless telephone, or other device. As another example, if the primary transaction is conducted by an internet web connection, television/internet connection, interactive television, or similar mode, the upsell offer may be presented by telephone. All other combinations of modes of communication are also possible, including e-mail, facsimile, cable contact, and others that are described herein or otherwise known in the art.

The mode or manner of the offer **352** to the customer may also be varied. The customer's prior history or a determined optimum mode or manner of offer based upon customer designation may be utilized. Certain customers or customer designations may be best offered the upsell in a business-like, straight-forward manner, e.g., "We have a special offer for you today . . .". Other potential customers who have manifested less than an eagerness to be upsold in the past may be initially addressed with a message of an apologetic tone, e.g., "I know you do not typically consider other times, but we have something that we think you will find worth your time to consider . . .". Yet other presentations may be in a more elaborate or flowery manner, such as in the addition of music, other audio, images, video. The coded designators, or other data regarding the user, may be used in determining the mode or manner of the offer.

If the upsell is consummated **356**, the order may be confirmed. That confirmation may be printed, if desired. Further, the customer may be provided with a confirmation number. If a shipping/tracking unit **364** is utilized, the tracking information, and the mode of accessing that system, may be provided to the customer. In the event the upsell offer is not consummated, the user may be offered an alternative upsell **358**. The alternative upsell may be determined before the initial upsell, or may be recomputed, wherein one of the inputs to the determination system includes the negative result from the first upsell offer. Optionally, the customer may be queried regarding their reaction, either positive or negative, with respect to the initial upsell offer, so as to provide yet further specific inputs to the upsell determination system.

The system may be modified over time. For example, the success of prior upsells of specific items may be further incorporated in the decision as to the upsell offers **370**. This modification of the rules over time may be either done in real time, or on a periodic basis, such as in a batch mode. Further, the system may receive data from users after the receipt and use of their obtained goods or services, such as wherein the customer satisfaction with the goods and services is then incorporated in the decision criteria for the upsell offer.

FIG. 7 shows a flowchart for one possible path through the system. Upon receiving an initial contact **230**, the transaction type may be determined at step **232**. Various identification determinations **234** may be collected and then used in determining whether any limitations **236** are to be applied, which if not, the transaction may then be conducted at step **238**. Optionally, a credit check **240** may be performed, either for the primary transaction alone, or further, for a potential upsell. The inputs having been collected **242** from prior interaction, database checks **244** may contact and interact with database A **246**, database B **248**, . . . database N **250**, possibly under control when coaction **252** is required. The inputs having been collected are then provided

254 to the system. Optional inventory checks 256 may be performed and then utilized step 258 to determine if the potential upsell item is available. Once the upsell has been determined, the upsell may be offered in step 260, which if purchased at step 262 may then be confirmed and sent to order fulfillment step 264. Optionally, further items may be offered, step 266, in which case the upsell determination may be repeated, or the previously determined second upsell item offered. Typically at the end of the transaction, at step 268 the system will update various databases as appropriate and the upsell system, including the criteria for determining the upsell.

In the offering mode of the website, one variation may include the ability to transfer from the website to a live operator. Such a transfer may be useful wherein the potential customer is interested in obtaining further information regarding the offered product, or has queries which cannot easily be addressed in a web or electronic commerce context. As described in connection with the telemarketing screen, FIG. 8, the screen for the electronic commerce applications may include a display of the live operator, and may also include a display on the live operator console of the customer, if desired.

With regard to the billing system, in one aspect of this invention, it is possible to allocate billing 368 for use of the system. For example, if the primary transaction is financed by company A, and an upsell in the economic interest of company B is successfully effected, piggy-backing on the primary transaction of company A, an accord or allocation may be made between company B and company A regarding payment for the services. Typically, company B would make a contribution to company A, or in some manner reduce the cost for company A to conduct the primary transaction. Consistent with the allocation of expenses between two or more companies, it should be expressly noted that in the upsell system of this invention, the goods or services offered may come from independent sources. That is, the primary transaction may relate to a good or service from company A, and the upsell relate to a good or service from company B, where company A is unaffiliated with company B.

FIG. 9 shows a highly simplified depiction of a display such as used in one implementation of a electronic commerce application utilizing the inventions of this system. The overall display 400 may include textual information 402 identifying the affiliation of the provider of the good or service. A graphical depiction 404 of the good or service may be provided, which is either a still image or includes motion. Information regarding features 406 may be provided as well as may be the terms 408 of sale, lease or other interchange. Optionally, a display 410 provides a video feed such as from a telemarketing or other operator assisting the user, or provides a created image regarding a assistant for the transaction. Speakers 412 may be optionally utilized to provide audio information, either being one-way communication or two-way communication. Typically, some sort of a pointer 414 is displayed on screen 400 to designate the area of data for entry. For example, an acceptance 422 region may be clicked, or double clicked as required, to accept an offer. Optionally, an electronic coupon 420 or other form of coupon may be provided to the user in a real time manner for later use. The coupon may be for a discount on a later purchase, or may otherwise be a form of incentive to the customer, such as the award of credits which may be accumulated for exchange into other goods or services.

FIG. 10 shows a high level flowchart for a customer service operation. Upon customer contact 430, the purpose of the call 432 may be determined. The purpose may be

determined such as from knowledge of DNIS as indicating a customer service number, or by response by the customer to queries, such as from a live operator or interactive voice response system (e.g., press 1 for purchase, press 2 for service . . . ). Decision block 434 optionally provides a preliminary assessment of the likelihood of interest in an upsell or alternative presentation. In the event an offer is to be made, checks such as a credit check 436 or other database check 438 may be made. The input data is then provided to a processing, upsell system (as described previously) from which an alternative 442 may be generated and offered. The system may optionally then solicit consummation of the transaction 444, and may, if required, again access for credit determination 446. In the event that it is perceived at decision block 434 that no interest exists in an upsell, the system may continue with the call as originated 440. By way of example, assume that a user calls a service number regarding an integrated cellular phone and paging system. The system may obtain the ANI (or mobile identification number) and determine based upon the DNIS that a particular customer is calling a service number. After optionally confirming that the call relates to the repair of the phone/pager associated with the ANI or MIN, the system may determine that this product is sufficiently old that an upsell should be offered for a replacement item. By accessing a database, such as the cellular systems local database, it may be determined that the caller has a now supplanted model of phone, and possesses sufficient credit worthiness to purchase a new system. At that point, the system may offer the caller a purchase option for the replacement item, thereby effecting an upsell from one transaction type, namely, a service contact, into a separate type of transaction, such as a purchase transaction of a replacement or superior item. In this way, an upsell is effected.

FIG. 11 shows a perspective view of a wireless system which utilizes position information in a potential upsell or intelligent information selection application. A wireless unit may be operated by a user, shown within the automobile. The wireless device communicates with an antenna. The signal from the wireless unit sends identification information, such as a mobile identification number (MIN). Additionally, position information such as from a GPS receiver may be provided. Combined cellular and GPS systems may be utilized. Yet other position detection systems may be utilized, such as triangulation based systems. As shown, a billboard may provide advertisement information and prompt the caller to dial a telephone number or code, e.g., \*72, for further information. A response to the inquiry may utilize the identification information, such as the MIN, as described within this application and utilize that information to intelligently select a good, service or other information for presentation to the user. By way of example, certain vehicles are currently equipped with systems which place an outgoing wireless call to a service, but also provide position information regarding the caller. One such system is the OnStar system which may be activated either by the caller depressing a button which causes the preprogrammed dialing of the number corresponding to the service, as well as to provide geographic GPS information. Alternatively, the system is designed to automatically call the service in the event of an accident, such as would be indicated by the deployment of a safety system, such as the airbags deploying. Such a contact to a service identifies both the calling vehicle (e.g., through use of the MIN) plus provides geography information, and optionally, provides information regarding the status of the call, e.g., was the call initiated by the caller or automatically activated because of a safety based call. Some

or all of that information may be utilized in a automated system, with or without the additional use of live operators, to select information, goods or services for presentation to the potential customer. For example, if the call were automatically initiated because of airbag deployment, the system could utilize that information, optionally with other information keyed to the identity of the user, such as hotel preferences to select an offer a hotel based upon the assumption that they would reside in that geography for the night. Rather than merely providing a recommendation untailed to the particular caller, the use of the identification information coupled with knowledge about that caller and their circumstance may lead to a better selection of good, service or information.

Considering wireless devices more broadly, a customer utilizing a wireless device, such as a cellular phone, Palm Pilot VII, or other wireless communication or web access device, may provide geographic position information regarding the user of the system. That information may be obtained via global positioning satellite (GPS) information, or may be taken from a knowledge of the base station position. In the wired domain, the geographic position information may be obtained at various levels of granularity, such as through the use of area code information, or more specifically, exchange information, or yet even more particularly, through the use of various databases which map telephone numbers to specific geographies, such as a caller's street address. The geographic position of the user may be determined via an access point to a system, such as where a customer utilizes an automated teller machine (ATM) on a network. The geographic position of the user is known based upon their interaction with the network. By way of example, a person accessing an ATM network is identified by information read from the magnetic strip of the bankcard (or provided by a smart card type technology). The identification is of both the customer and of their bank. The bank knows the geographic location of the ATM. From this information, it may be inferred that the customer is outside of their ordinary geography, and presumptively on a trip. In certain circumstances, it may be safe to assume that the user is on vacation, such as where the ATM is located at a resort location or entertainment facility. That information may be utilized by an intelligent system to provide goods, service or information to the user, such as to provide coupons to the ATM user for a free children's meal.

The geographic information may be utilized in combination with other information in determining an offer or upsell. By way of example, the system may know the position of a potential user of a good or service based upon position information from a GPS system, and may utilize that information in offering a good or service, such as a discount coupon, at a geographically local store. Such an offer may be made as the result of a caller contacting the system, or may be provided in an outbound or push based context where the system contacts the potential user of the offer, such as by calling their cellular phone or other wireless device. The geographic position information may additionally be combined with data or information regarding the geography of the person. For example, if the positional information indicates that the person is in a casino at midnight, it may be a valid assumption to assume that the person is not risk averse.

FIG. 12 shows a on-screen programming guide on a display and a input device, such as a remote control. The on-screen programming guide typically includes a display as a function of time and channel. Ordinarily, the program guide displays programming from the current time forward for a number of hours. Channel information is displayed

either simultaneously or in a scrolling manner. Within the contemplation of this system, the on-screen programming guide may provide input information into the decision system, such as by receiving an indication of a program which is selected, or is being considered. The user input device, such as the remote control, may provide position control of a cursor or other marker on the on-screen display. Alternatively, direct entry of data by the user on the pad of the remote control, or from a more fully functional keyboard may be utilized. Preferably, infrared communication between the remote control and the television or display including the on-screen programming guide is utilized.

By way of example, if a viewer selects a Pay-Per-View sports event, that selection may be used as an input to the system as described generally in this application which then results in the selection and offer of another good, service or set of information for the potential customer. Continuing with the example of an order for a Pay-Per-View sporting event, the system may determine, through the various methods described herein, to offer the viewer a series of entertainment events, such as a seasonal football schedule. The input device for such an onscreen programming guide application in the upsell context could be a remote control operated by the viewer.

According to various embodiments of the invention, the method can comprise at least the following steps, summarized in FIG. 13, which is a flowchart illustrating an example process flow provided by the invention. Communication is established via the communications device between the user and the system to facilitate a primary transaction involving at least one specific item selected by the user (block 110). Primary transaction data relating to the primary transaction is obtained, with the primary transaction data including data representing an identity of the user and the item involved in the primary transaction (block 112). At least a second data element relating to the user is obtained using the data representing the identity of the user (block 114). The method then analyzes the second data element and the data representing the specific item to determine whether to offer upsell transactions to the user (block 116).

FIG. 14 is a flowchart illustrating additional, optimal processing that the invention can perform. According to additional embodiments of the invention, the method can also include the number of upsell transactions to offer to the user is identified using at least the data representing the item and the second data element if upsells are to be offered to the user, the method can include identifying at least one specific upsell transaction to offer the user, with the identification process using at least the data representing the item and the second data element as input (block 120). The upsell transaction can then be offered to the user, either in an appropriate electronic format or by verbal presentation by a human agent (block 122). The offered upsell transaction can then be accepted or declined by the user (block 124).

The method can include identifying any number of specific upsell transactions to offer the user, including zero upsell transactions. For example, an analysis of the second data element and the identity of the user may reveal that no possible upsell transaction has a reasonably good probability of being accepted, and that the most prudent course for a given user currently conducting a given primary transaction is not to offer any upsell transaction at all. For example, the cost of proceeding with the upsell transaction may exceed the profit or return expected from offering the upsell transaction. More specifically, if the probability of the upsell being accepted times the expected profit of the upsell is less than the cost of offering the upsell, (connect time, agent



processing time, etc.) then the upsell may be a losing proposition and not worth offering. In other embodiments of the invention, the method can include identifying one or more specific upsell transactions to offer to the user. Those skilled in the art will thus recognize that the processing represented by blocks 120, 122, and 124 may or may not be performed in each transaction processed by the invention.

FIG. 15 is a block diagram illustrating the sources of various inputs to the upsell system components 70. The method can obtain the primary transaction data by obtaining at least one identifier that uniquely identifies the user, for example, by obtaining a voice print or other biometric data associated with the user and using this voice print or biometric data to establish the identity of the user (block 134). In the voice print example, the user's voice print can be analyzed using known speech recognition software to build a model of the user's voice, with this model serving as an index used to access a database of previously stored voice models associated with various users. A voice print corresponding to the given user can be located, for example, by comparing the voice print to voice prints in the database, and accessing the second data element based upon that comparison. Once the user's identity is established, the method can obtain the second data element using the voice print, with the second data element being, for example, data representing the user's previous purchases and behavior.

To facilitate the method of the invention, the identity of the user must be determined in order to obtain information related to that specific user or to obtain modeling information derived from similarly situated users. Accordingly, in other embodiments of the invention, obtaining the primary transaction data can include obtaining a unique identifier related to the specific communications device or hardware associated with the user (block 131). For example, the method might obtain a unique identifier for a wireless device used by the user to conduct remote commerce, such as a unique serial number associated with a particular cellular phone. Example devices may include at least one of the following: a set-top television box, a remote control used in conjunction with such a set-top box or with the television itself without a set-top box, a wireless telephone, or a personal digital assistant coupled and enabled to communicate over a wireless network. Other examples of hardware suitable for conducting and/or transmitting upsell transactions include devices operating under the Short Message Service (SMS) standard, which enables users to exchange short alphanumeric messages over devices such as pages, mobile phones, PDAs, or the like. These embodiments are discussed in more detail below.

In other embodiments of the method, obtaining primary transaction data can include customer identification number from a tangible item presented by the user when conducting the primary transaction (block 132). For example, the method might obtain primary transaction data by accessing data from a physical card presented by the user at a kiosk or check-out counter in a retail environment, such as a grocery store, home improvement warehouse, or other types of commercial environments. Common examples of suitable cards are customer loyalty, identification (ID), or customer care cards issued to selected customers by stores, which cards may store customer-specific data in the form of magnetic strips or bar codes, which may in turn be scanned-in at the kiosk or check-out counter using optical or other suitable equipment. Once the customer is identified using this data, the customer's identity may be used as at least part of the input to the upsell determination process. The cus-

tommer can then be offered upsells through the kiosk or other equipment, preferably in real time with the primary transaction.

Further embodiments of the method obtain the primary transaction data by processing files residing on the user's computer system and being associated with web browser or other software running or residing on the computer system (block 133). Such files are commonly referred to as "cookies" in the art, and typically store data associated with the user in text or other formats. The files can be used to obtain either the primary transaction data or the second data element used as inputs to the upsell determination process. Specifically, the files may contain information directly identifying the user, or the files may contain click-stream data or other browser history data identifying those web sites visited by the user. Also, the user's login/password information may be stored on the system, which information can in turn be processed if necessary as input to the upsell system components 70. This click-stream or history data may indicate areas of interest to the user, and analysis of this data may help guide the upsell determination process toward one or more optimum upsell offers.

Elaborating further on the embodiments mentioned above regarding set-top television boxes (shown as part of block 131), various aspects of the method contemplate establishing communication with the user via hardware adapted to process television signals from a network and converting them into a format suitable for viewing by the user. Common examples of such hardware might include converters, decoders, de-scramblers, or other hardware having similar functionality that may be used with broadcast, cable, or satellite-based communications systems, including for example television systems. Other embodiments of the invention include such hardware that is separately and uniquely addressable. For example, known addressable converters enable cable television subscribers to view pay-per-view events transmitted over the cable television network. After the subscriber has paid the fee to view the event, the network can send a signal to the subscriber's uniquely addressable converter that enables the viewer to watch the event.

The instant invention can be extended to operate in the above context by capitalizing on the ability of such uniquely-addressable hardware to identify the subscriber/user, while also supporting the capture and tracking of viewing habits and other behavior of the subscriber/user. For example, the user may conduct the primary transaction via the satellite, cable, or interactive television network, rather than the telephone-based embodiments described elsewhere. In this application of the invention, the method could identify the user by determining the identity of the uniquely-addressable hardware that the subscriber/user is using to conduct the transaction. For example, the network may associate a unique serial number or other identifier corresponding to each uniquely-addressable hardware item distributed to receptive subscribers. By accessing this serial number or other unique identifier as stored by the network, the method can identify the user corresponding to this identifier without requiring the user to identify himself/herself. Once obtained in this manner, the identity of the user can be fed as input to the upsell determination process in the same manner as discussed elsewhere in the instant application. The identifier associated with the set-top box can also be used to obtain the second data element used as further input to the upsell determination process. The upsell transaction identified by the upsell determination process for offer can then be presented to the user via a network, for

example, a satellite television network, and the user can accept the offered upsell transaction using the same network.

In this embodiment of the invention, the user can conduct one or more primary transactions via the television network, with the method operating to recommend appropriate upsell transactions to the user. The term "primary transaction" as used in the context of this application will be understood to include but not be limited to the following types of activities conducted using the television network: purchases of goods and/or services; viewing of television shows, events, movies, "infomercials," or other subject matter; playing of interactive games or other forms entertainment supported by the television network; or inquiries about good and/or services advertised or otherwise featured via the television network. In addition to the definition of "upsell" given above, the term "upsell transaction" will be understood to include, but not be limited to, the following activities that may be related in some manner to the subject matter of the primary transaction: offers to purchase or otherwise obtain goods and services; suggestions, offers, and/or discounts related to viewing television shows and/or movies; offers to apply for credit card accounts or other financial instruments; or coupons, promotions, or other advertisements targeted based on the user's identity, viewing habits, and past behavior.

For example, a user may inquire about or order memorabilia associated with the American Civil War via a television network after viewing an advertisement or infomercial relating to that subject matter. The method could then operate to recommend a movie, documentary, or other television show relating to history in general, or to the American Civil War in particular. As another example, the above scenario may play out in reverse: the viewer may watch a historical documentary, and in turn the method may identify and offer an advertisement or discount relating to the subject matter of the documentary. As yet another example, the user may use an interactive television service to order a movie or pay-per-view event for viewing, and the method may then identify and offer a promotion or discount coupon for a local pizza delivery service. Those skilled in the art will recognize that these examples serve merely to illustrate various aspects of the invention, but do not limit the scope of possible applications for the invention as described herein.

Various aspects of the invention also contemplate using internet-based communication technologies such as e-mail, or messaging technologies supported by web browsers, such as the Instant Messenger™ technology offered by ICQ.com, America OnLine, Inc. (www.aol.com) and others. Specifically, the method can include offering the upsell transaction using browser-based messenger technology, and receiving an acceptance from the user using browser-based messenger technology. This messenger technology can be implemented using any suitable technology, such as SMS, person-to-person networking protocols, IP networking, or the like.

As noted above, the method can include generating zero or more possible upsell transaction for offer to the user. Along these same lines, various aspects of the method can also include selecting zero or more of the generated upsell transactions to offer to the user. This selection process can be done by either an automated process or by a live human operator, either of which can in turn present the selected upsell transaction(s) to the user.

Various aspects of the method include obtaining the second data element used as part of the input to the upsell determination process from a variety of sources, including obtaining information related to a survey taken by the user,

or a registration completed by the user (block 135). The method can analyze the survey responses or the registration information as the second data element related to the user for the purposes of determining what, if any, upsell transaction(s) to offer to the user. The terms "survey" and "registration" as used herein refer to any information provided by the user in response to an interactive question-and-answer questionnaire or any other type of information-gathering method utilized by a merchant or other information-gathering entity. Common, but non-limiting, examples might include warranty registration cards that are completed and returned by the user after purchasing consumer goods at retail outlets, bridal or other types of gift registries established to facilitate or organize gift-giving related to certain occasions, or electronic or internet-based versions of the above. Surveys or registrations that gather information related to factors such as user's demographic profile, financial/employment data, outside interests or the like, may be particularly useful for providing the second data element used in the upsell determination process, which in turn can identify the upsell transaction(s) to be offered the user by analyzing data provided by the user when completing the survey or registration.

Turning briefly to FIG. 16, a block diagram illustrating several non-limiting examples of various outputs generated by the upsell system components 70, in other embodiments of the invention, the method can include offering the user as an upsell transaction an opportunity to participate in a survey or to complete a registration of some type, possibly in exchange for an incentive to be received by the user (block 141). The entity receiving the information resulting from the survey or registration may provide the incentive to the user, either directly or through an intermediary.

Returning to FIG. 15, other embodiments of the invention consider the geographic location of the user when determining which, if any upsell transaction(s) to offer the user (block 136). In these embodiments, obtaining the indexing data includes at least in part obtaining the geographic location from which the user is conducting the primary transaction. For example, where the user is dialing a call center on a Public Switched Telephone Network (PSTN) or a wireless network, the number of the handset from which the caller is originating the call can be made available using known ANI technology, or variations on this technology as appropriate to support wireless callers. The originating telephone number can then be run against known databases, including but not limited to those available from Targusinfo (www.targusinfo.com) to identify a geographic location corresponding to that originating telephone number. As another example, if the user is using a set-top television box to conduct the primary transaction, the physical location of the box itself can be obtained, typically via the network connecting the box to the entity with which the user is transacting. For wireless callers using mobile handsets or calling from vehicle-based originating sets (for example, the OnStar™ system offered by General Motors and other automobile manufacturers), the satellite communications network supporting such calls can often pinpoint the caller's approximate, and possibly exact, physical location as the call progresses.

Referring to FIG. 16, once the location of the user is established, offering the upsell transaction can include offering the user tickets, discounts, coupons, or promotions related to merchants or events based upon or near the user's geographic location (block 142). As non-limiting examples, the merchants or events can include theaters, concerts, sporting events, stores, restaurants, or the like.

31

Other embodiments of the invention may find application in the context of Automated Teller Machines (ATMs). In these embodiments, the user establishes communication with the system via a banking/financial network, thereby enabling the user to conduct, as the primary transaction, a financial transaction (withdrawal, deposit, balance inquiry, etc.) at an ATM machine located at the user's geographic location. The method then can offer an upsell transaction based on the geographic location of the user when accessing the ATM. In additional embodiments, the method of identifying the upsell transaction can include determining that the geographic location of the user when accessing the ATM is different than a "home" location associated with the user (block 137 of FIG. 15). This circumstance may suggest that the user is on vacation or holiday, or is on a business trip, and the method can factor-in this circumstance when offering the upsell transaction (block 143 in FIG. 16). For example, the offered upsell transaction may be more related to tourist or travel activities than if the user were closer to his/her home location, and for example, may be more directed to tourist attractions, travel discounts, lodging, entertainment, local events, or the like. The method can, but does not necessarily, facilitate operation of these embodiments of the invention by a business relationship with chambers-of-commerce or similar organizations in the area local to the ATM accessed by the user.

Other embodiments of the invention include establishing communication via a first communications medium to conduct the primary transaction and offering the upsell transaction via a second communication medium that is different from the first communication medium. As a non-limiting example, the method can enable the user to establish communication with the system via an internet web page to conduct the primary transaction, and can offer the upsell transaction by sending data or signals representing the upsell transaction via a wireless communications network to a handheld device associated with the user. More generally, the method can include establishing communication and conducting the primary transaction via a first communications network, and then offering the upsell transaction via a second communications network.

Referring to block 144 in FIG. 16, other embodiments of the invention may find application in a commercial point-of-sale (POS) environment, for example, in a consumer/retail or in a business-to-business warehouse environment. In these embodiments, the user can establish communication with the upsell system by interacting with a device located at the commercial establishment. These devices could be located at a checkout counter, or distributed throughout the aisles of the establishment. As a non-limiting example, this embodiment of the invention could be deployed in a retail home improvement warehouse to ensure that the user has obtained all parts and equipment necessary to complete a given project, as well as recommending or offering other upsell transactions based on the user's interest in the given project. In this example, obtaining the second data element can include obtaining a list of items that the user has previously purchased, and the method can identify the upsell transaction by analyzing the list of previously purchased items. More specifically, the method can compare the list of items previously purchased by the user to a list of items related to item involved in the primary transaction, and identify which items the user needs for a project that he/she has not purchased before. The method can then identify which items the user needs to complete the project related to the primary transaction and offer those items as upsell transactions. This aspect of the method may be particularly

32

advantageous for preventing the user from making duplicate purchases of the same item for different projects, as well as ensuring that the user need only make one trip to acquire all of the items necessary to complete a given project.

Additional embodiments of the method can include offering the upsell transaction via a paper receipt issued to the user after the user completes a purchase of goods and/or services. In these embodiments, the method can identify the upsell transaction by analyzing a geographic location of the user before offering the upsell transaction to the user, and can offer an upsell transaction related to a merchant near the user via the paper receipt issued to the user after the primary transaction is complete. In other embodiments, the method can identify the upsell transaction by analyzing the subject matter to which the primary transaction pertains, and can offer the user via the paper receipt an upsell transaction to another merchant for subject matter that may be related to the subject matter of the primary transaction. In any of these embodiments, the user may accept the offered upsell transaction by presenting the paper receipt in-person at a merchant establishment.

Various embodiments of the invention also include using the method to identify at least one application for a new financial account to be offered to the user as an upsell transaction (block 145 of FIG. 16). Illustrative types of new financial accounts might include new credit card accounts, new debit card accounts, credit lines, new loans of any type, insurance policies, or the like. If the subject matter of the primary transaction conducted with the user suggests that the user has an interest in a specific area, further embodiments of the invention can tailor the financial account offered as the upsell transaction accordingly. Also, if for whatever reason, the user's credit card fails to authorize as payment for the primary transaction, the method can offer an application for the new application as an upsell. For example, if the primary transaction pertains to home improvement, home renovation, purchase of new appliances, or the like, the method may offer as a new financial account a home equity credit line or a second mortgage product that may be of interest to the user in financing the primary transaction or other similar transactions. As another example, if the primary transaction pertains to memorabilia, souvenirs, or if the user otherwise manifests an interest in a specific area (sports, history, politics, schools, alumni associations, or the like), then the method may offer as an upsell transaction a financial account having a theme corresponding to, benefiting, or otherwise relating to that specific area. Non-limiting examples of these types of financial accounts include credit cards bearing sports team logos, endowments or trusts benefiting an academic institution or charity, offers to contribute to or join historical societies or historical preservation organizations, or the like.

Referring to block 146 in FIG. 16, other embodiments of the method include associating the primary transaction with the new financial account, as described in co-pending patent application Ser. No. 10/157,522, METHODS, SYSTEMS, AND COMPUTER READABLE MEDIA FOR CREATING AND PROCESSING PENDING TRANSACTIONS ASSOCIATED WITH APPLICATIONS FOR FINANCIAL ACCOUNTS, filed on May 29, 2002 and Ser. No. 10/186,214, METHODS, SYSTEMS, AND COMPUTER READABLE MEDIA FOR CREATING AND PROCESSING PENDING TRANSACTIONS ASSOCIATED WITH APPLICATIONS FOR FINANCIAL ACCOUNTS, filed on Jun. 28, 2002. Each of these applications is incorporated herein by this reference. Specifically, in those embodiments of the method that offer as an upsell a new financial account,

if this financial account can facilitate payment for the primary transaction (a new credit card or other type of charge account, for example), these embodiments of the method can charge the primary transaction to that new financial account, thereby associating the primary transaction with the application for the new financial account as a “pending” transaction against that new account.

The term “pending” is used in the context of this application to refer to the temporary status of the primary transaction while the application for the new financial account is processed for ultimate approval or denial. If the application is approved, the “pending” transaction is processed fully as the first transaction logged against the new account. The pending transaction will then be reported on the account statement when the latter is issued in due course. If the transaction is denied, the “pending” transaction is never fully processed because there is no underlying account against which to process it. The “pending” transaction can be ultimately dispositioned in a number of different ways: by simply abandoning it without ever finalizing or processing it and notifying the user of the same; by obtaining an alternative means for payment from the user during the primary transaction, and resorting to that alternative means after the application is rejected; or by obtaining the alternative means for payment from the user during a follow-up contact with the user and charging the primary/“pending” transaction to the alternative means.

The invention also provides a program storage device 129 (see FIG. 13) readable by a computer or other machine, embodying a program of instructions executable by the machine to perform the various aspects of the method as discussed and claimed herein, and as illustrated in the Figures, for performing the various functional aspects of the method as set forth herein. Generally speaking, the program storage device 129 can be implemented using any technology based upon materials having specific magnetic, optical, or semiconductor properties that render them suitable for storing computer data, whether such technology involves either volatile or non-volatile storage media. Specific examples of such media can include, but are not limited to, magnetic hard or floppy disks drives, optical drives or CD-ROMs, and any memory technology based on semiconductors or other materials, whether implemented as read-only or random access memory. In short, this embodiment of the invention may reside either on a medium directly addressable by the computer’s processor (main memory, however implemented) or on a medium indirectly accessible to the processor (secondary storage media such as hard disk drives, tape drives, CD-ROM drives, floppy drives, or the like). Consistent with the above teaching, program storage device 129 can be affixed permanently or removably to a bay, socket, connector, or other hardware provided by the cabinet, motherboard, or other component of a given computer system.

For the purpose of conciseness, and in the interest of avoiding undue duplication of elements in the drawings, only FIG. 13 shows the program storage device 129. However, those skilled in the art will recognize that an application program stored on program storage device 129 could implement all functionality illustrated in any of the drawings or discussed anywhere in the description.

#### Portable Media Embodiments

FIG. 17 is a block diagram illustrating various aspects of the invention that provide systems 1700 for recording data representing one or more offered items 1704 onto a medium

1702 that is pre-recorded with content, such as an entertainment feature or event. Illustrative embodiments of these systems 1700 can comprise means 1706 for receiving data 1707 that identifies specific viewers 1708. Suitable examples of receiving means 1706 can include a manually-operated data entry interface such as a keyboard or keypad, a card reader, an optical scanner, or the like. Any of these receiving means 1706 may be operated either by employees of a business establishment or by viewers or customers 1708 themselves in a self-service environment. Further embodiments of the receiving means 1706 can comprise, at least in part, an Internet website with which respective viewers 1708 can interact to research and select respective titles of the media 1702 for viewing. The identification data 1707 obtained using any of these receiving means 1706 can take any form suitable for determining the identity of the given viewer 1708, including, as illustrative but non-limiting examples, telephone numbers, NACRSZ (Name, Address, City, State, Zip) information, account numbers, e-mail addresses, or the like.

The system 1700 can also include an embodiment of the upsell determination unit 110, which communicates with the receiving means 1706 to input or receive data 1707 identifying respective specific viewers 1708. The upsell determination unit 110 further uses at least this identifying data 1707 to select from among potential items 1704 a particular item 1710 to offer to specific viewers 1708 or groups of viewers 1708.

The system 1700 also includes means 1712 for encoding the data representing the respective offered items 1710 onto respective machine-readable storage media 1702 that are delivered or shipped to respective customers or viewers 1708. This encoding means 1712 can communicate directly with the upsell determination unit 110, or can communicate with the upsell determination unit 110 via at least one component intermediate the encoding means 1712 and the upsell determination unit 110. More particularly, the upsell determination unit 110 can be networked to the encoding means 1712. The encoding means 1712 is preferably adapted to record data representing a given offered item 1710 selected for a given specific viewer 1708 onto a portion of the storage medium 1702, with another portion of the storage medium 1702 being either previously or contemporaneously recorded a main or titled entertainment feature. These aspects of the invention are addressed in more detail in connection with FIG. 18. As described herein, the main entertainment feature on a given medium 1702 typically corresponds to the title printed on the medium 1702. Those skilled in the art will appreciate that the exact implementation of the encoding means 1712 may vary depending on the implementation of the media 1702 itself, with the encoding means 1712 being compatible with the media 1702.

FIG. 18 is a schematic diagram illustrating further aspects of the invention relating to the machine-readable storage medium 1702 as encoded with data representing one or more offers that are selected as taught herein. Given the teachings herein, those skilled in the art can choose from any number of technologies to implement the media 1702 and corresponding players, whether currently known or developed hereafter, and details of these implementations and particular are not included herein. As those skilled in the art will understand, data representing the entertainment feature, and the offered item as discussed below, can be loaded and stored onto a medium 1702 readable by a computer, media player, or other suitable machine. Generally speaking, the media 1702 can be implemented using any known or later-developed technology based upon materials having specific mag-

netic, optical, semiconductor or other properties that render them suitable for storing computer- or machine-readable data, whether such technology involves volatile or non-volatile storage. Specific examples of such media 1702 can include, but are not limited to, magnetic-based hard or floppy disks drives, optical drives or CD-ROMs, and any memory technology based on semiconductors or other materials, whether implemented as read-only or random access memory, as well as readily portable media such as DVD, VHS, MEMORY STICK™ (www.memorystick.com), or other technologies equivalent to any of the foregoing. In short, this embodiment of the invention may reside either on a medium 1702 directly addressable by the computer's or machine's microprocessor (e.g., residing in main memory, however implemented), or on a medium indirectly accessible to the processor (e.g., residing in secondary storage media such as hard disk drives, tape drives, DVD, VHS, or other media, CD-ROM drives, floppy drives, or the other portable media discussed above). Consistent with the above teaching, the media 1702 can be affixed permanently or removably to or within a bay, socket, connector, or other hardware provided by a cabinet, motherboard, or other component of a given machine, media player, or computer system.

Whatever form the media 1702 may take, it preferably comprises at least a first portion 1802, which contains, e.g., data representing a main entertainment feature that is displayed to a viewer on command. The term "main entertainment feature" is used herein to refer to content stored on the medium 1702 that corresponds to or is associated with the title of the medium 1702. This main entertainment feature is conventional and can take any number of illustrative forms, including a movie, a sporting event, or any other form of pre-recorded subject matter. Typically, but not necessarily, the data representing the main entertainment feature is recorded in bulk onto the storage medium 1702 before the storage medium 1702 reaches the point of retail sale or distribution. For example, assuming the teachings herein are implemented in the context of retail movie rentals, data representing a given movie or other feature may be encoded onto multiple copies of the media 1702 during a conventional manufacturing process. Some of these given copies could then be distributed using conventional means without applying the teachings herein. Other copies of these media 1702 could be encoded or recorded, after manufacture, with data representing the specially-selected items or offers 1710 as discussed herein. The term "encoded" is used herein to refer to any translation, transformation, or conversion process necessary to store signals comprising the main entertainment feature or the offered items onto the media 1702 in respective locations 1802 and 1804.

The storage medium also contains at least a second portion 1804 that contains data representing one or more offered items 1710 that are selected using the teachings provided herein. In illustrative embodiments of the invention, offered items 1710 can be selected for specific, particular viewers 1708 using, at least in part, the upsell determination unit 110 discussed herein, and then recorded onto a given storage medium 1702 at a point of sale or distribution. The second portion 1804 can store data representing offered items 1710 in the illustrative form of one or more advertisements provided on behalf of a third party merchant (not shown). In further illustrative embodiments, the advertisement is selected to provide the viewer 1708 an incentive or inducement to contact the merchant or other specific third party. In these embodiments, the upsell determination unit 110, as taught herein, can select an item 1710

from a given third party whose products or services are determined to be of potential particular interest to the given viewer 1708 of the medium 1702. The subject matter of the offered item 1710 as stored in location 1804 as described herein can take any number of forms, including discounts, offers, coupons, or other items. These advertisements, as encoded or recorded onto the second portion 1804 of the medium 1702, might include a telephone number, a website URL, or an e-mail address associated with the third party on whose behalf the item 1710 is offered. In these embodiments, the invention can function to increase or drive contact traffic to the third party, or to an entity acting on behalf of the third party. This traffic can take the form of inbound telephone calls, e-mails, website hits, or the like.

For a non-limiting application of the instant teaching, movie trailers, advertisements, or other type of items are provided conventionally on media 1702 rented by viewers. Such conventional advertisements are typically added to the media 1702 in bulk on a "one size fits all" basis, meaning that different viewers 1708 of a given title would see the same trailers, advertisements, or other added material, regardless of the demographic profile or other characteristics of the viewers 1708. Thus, these "one size fits all" items may or may not interest a given viewer 1708. If the items do not interest the viewer 1708, he or she will likely skip past them, thereby resulting in a lost or wasted marketing opportunity. In contrast, according to various aspects of the instant invention, different viewers 1708 of a given title might see different items 1710, with these items 1710 being selected based on parameters specific to these given viewers 1708 or groups of similarly-situated viewers 1708. Because the items 1710 encoded are intelligently selected for given viewers 1708, there is a higher probability that the items 1710 will attract the viewer's 1708 attention and hold the viewer's 1708 interest through the entire item 1710, thereby making the most of the marketing opportunity presented by having the medium 1702 played by the viewer 1708.

The invention as disclosed herein can be implemented in a physical, brick-and-mortar storefront to encode or record custom-selected, offered items 1710 onto media 1702 rented to viewers 1708 in a customer-facing retail context (e.g., conventional video rental outlets), in an Internet context in connection with a website serving as an interface with which viewers 1708 interact to select particular instances of media 1702 for viewing, or in other contexts. Turning first to the retail storefront context, in these embodiments, the second portion 1804 of the media 1702 can be recorded with the data representing the offered items 1710 in connection with a transaction during which a given instance of the medium 1702 passes to a retail user or viewer 1708 to enable that viewer 1708 to play, or display, or otherwise perceive entertainment features and the offered items 1710 encoded onto the medium 1702.

Turning now to the Internet website context, the second or further portion 1804 of the media 1702 can be recorded with the data representing one or more offered items 1710 at a non-retail location, in response to an order received from the specific viewer 1708 via the Internet website. Such non-retail locations could include warehouses, distribution centers, or other facilities where numerous copies of the media 1702 are stored pending shipment to viewers 1708. In these embodiments, the further portion 1804 of the media 1702 can be recorded with data representing the offered items 1710 before shipment of the medium 1702 to the customer or viewer 1708.

In any of the above illustrative contexts, a given instance of the physical medium 1702 itself may be obtained and

viewed by a plurality of successive users or viewers 1708, until the medium 1702 itself reaches the end of its operational lifetime, or until it may be prematurely damaged, destroyed, or rendered inoperable before the typical mean-time-to-failure (MTTF) associated with the medium 1702. In any event, the further portion 1804 of the medium 1702, which stores the custom-selected offered items 1710, can be re-written a plurality of times over the effective lifetime of the medium 1702 to contain respective data representing different offered items 1710 that are selected for different specific viewers 1708 as that medium 1702 is obtained by successive or consecutive viewers 1708. Thus, this further portion 1804 of the medium 1702 is typically a re-writeable storage area that can be implemented using any number of known technologies that support a write-many-times capability. In contrast, the portion 1802 of the medium 1702 containing the main entertainment feature is typically written only once during the lifetime of the particular medium 1702, and likewise can be implemented with any number of known technologies suitable for supporting a write-once capability.

Those skilled in the art will recognize that the drawing figures herein, including, e.g., FIGS. 17 and 18, depict illustrative rather than limiting aspects of the invention. In particular, the contents of these drawings are chosen for convenience and clarity in illustration, and implementations of the invention may differ from the drawing figures without departing from the scope of the invention.

FIG. 19 is a flow chart illustrating process flow provided by other embodiments of the invention. In particular, the invention also provides methods of encoding data representing offered items 1710 that are selected based on data specific to respective viewers 1708 onto machine readable entertainment media 1702 to be delivered to such viewers 1708. Various aspects of these methods can comprise, at least in part, receiving respective requests (block 1902) from given viewers 1708 or customers that are in some way related to obtaining the entertainment media 1702 for viewing, either through ownership or rental arrangements with a merchant. The given viewers 1708 are respectively identified (block 1904), and at least one additional data element relating to a given viewer 1708 is obtained (block 1906) using, at least in part, the identification data 1707. One or more items 1710 to be offered or presented to the given viewer 1708 via the entertainment medium 1702 are selected (block 1908) based, at least in part, on analysis of the additional data element, and data representing the offered item 1710 is encoded (block 1910) onto given instances of the medium 1702 that are ultimately transferred to the viewer 1708.

Turning to various components of the method in more detail, the method can be implemented in an Internet website application, in a brick-and-mortar storefront application, or in other applications. Regarding website applications, and expanding further on block 1902, the method can include receiving requests from viewers 1708 at least in part via an Internet website, for example a website associated with a merchant dealing in renting or selling entertainment-oriented media to consumers. As a non-limiting example, NETFLIX® provides a media rental service via their website www.netflix.com. These requests, and data related thereto, can take the form of: account log-in requests; queries relating to various titles or other parameters pertaining to the entertainment media 1702; requests to rent or obtain various titles of the media 1702; or other transactions as such may be received from remote viewers 1708 or

potential viewers 1708 via a website or other facility associated with a wide area communications network.

Expanding further on block 1904, the method can further include identifying the given viewer 1708 by analyzing data associated with such viewers 1708 when they access an Internet website to obtain a given instance of the entertainment media 1702. More particularly, the given user or viewer 1708 may be identified by accessing "cookie" files that store data related to given viewers 1708, or by referring to a telephone number, an account number, an IP address, or other unique parameter associated with a given viewer 1708, or any other suitable and/or equivalent identification means or process. Cookie files are well known in the art as small text files stored on client or server machines.

Expanding further on block 1906, in obtaining the additional data element, various aspects of the method can include obtaining data representing past transaction history, home location of the viewer 1708, or any other demographic data relating to a given viewer 1708. Further, the method can include analyzing subject matter of any current or past request received from the given viewer 1708. Any of the foregoing data can be input into the upsell determination unit 110, along with the other types of input data discussed herein. Further input into the upsell determination unit 110 can include data resulting from profiling a given viewer 1708 or from performing modeling or segmentation analysis of the viewer 1708, based at least in part on the additional data element. This analysis and related data flows are represented in FIG. 17 by the reference signs 1714, 1715, and 1716.

Regarding physical storefront embodiments, the method can include identifying the customer, viewer, or potential viewer 1708 by any means known in the retail art. Processing associated with this embodiment has been described in connection with the structure shown in FIG. 17.

Expanding on blocks 1908 and 1910, any of the above embodiments of the invention can also include real time processing and structure to support the same. Certain real-time aspects of the invention can include selecting one or more items 1710 to offer to a given viewer 1708 in real time with receiving a request, access, query, or other transaction related to a given medium 1702 from the given viewer 1708, or selecting these offered items 1710 in real time with identifying the given viewer 1708. Further real-time aspects can include encoding the data representing the offered items 1710 onto the medium 1702 in real time with receiving the above request, access, or query from the given viewer 1708, or can also include encoding the data representing the offered item 1710 onto the medium 1702 in real time with selecting that item 1710 for the given viewer 1708.

One or more offered items 1710 may be selected for encoding onto a medium 1702 to be delivered to a given viewer 1708, or separate items 1710 may be encoded onto respective, separate media 1702 delivered to the viewer 1708. In any event, data representing the offered items 1710 can be encoded onto the media 1702, at least in part, by writing the data onto a write-many or re-writable field 1804 allocated within the medium 1702. If the method is implemented in a physical storefront embodiment wherein the media 1702 are transferred personally to the viewers 1708, the data representing the offered item 1710 can be encoded onto the media 1702 at a retail kiosk located in a physical storefront, with the kiosk either being operated by employees of a business enterprise, or by the viewers 1708 themselves in a self-service environment.

If the method is implemented in an Internet web page embodiment wherein the media 1702 are ultimately shipped

to the viewers 1708 rather than being personally delivered, the data representing the offered item 1710 might be encoded onto the media 1702 at a non-retail location. Illustrative but non-limiting examples of non-retail locations might include a warehouse, order fulfillment facility where orders are processed, or other distribution point from which the media 1702 are shipped.

Having been encoded with the data representing the offered items 1710, the media 1702 can then be presented to given viewers 1708 to enable them to play the media 1702 as their convenience. In physical storefront embodiments, the media 1702 may be ejected from a kiosk or other device that encoded the data onto the media 1702, with the media then transferred to the viewer 1708. The kiosk or other device may be either a self-serve apparatus operated by retail customers, or may be a behind-the-counter device or system operated by employees of the storefront. In Internet embodiments, the media 1702 can be shipped to the viewer 1708 using any known conventional means after being encoded by a similar device or system located at the non-retail location.

Those skilled in the art will also understand that a computer programmed in accordance with the above teaching using known programming languages provides means for realizing the various functions, methods, and processes as described and claimed herein and as illustrated in the drawing figures attached hereto. A suitable computer program product constructed as taught herein can implement the various aspects of the method discussed above and shown in the drawing figures, and can be coded using any suitable programming or scripting language. However, it is to be understood that the invention as described herein is not dependent on any particular operating system, environment, or programming language. Example operating systems include, without limitation, LINUX, UNIX, or any of the Windows™-family of operating systems, and example languages include without limitation a variety of structured and object-oriented languages such as C, C++, Visual Basic, Java, Perl, or the like.

Those skilled in the art, when reading this description, will understand that unless expressly stated to the contrary, the use of the singular or the plural number herein is illustrative, rather than limiting, of the instant invention. Accordingly, where a given term is discussed in the singular number, it will be well understood that the invention also contemplates a plural number of the item corresponding to the given term and vice versa, unless expressly stated herein to the contrary.

The foregoing cited references, patents and publications are hereby incorporated herein by reference, as if fully set forth herein. Although the foregoing invention has been described in some detail by way of illustration and example for purposes of clarity and understanding, it may be readily apparent to those of ordinary skill in the art in light of the teachings of this invention that certain changes and modifications may be made thereto without departing from the spirit or scope of the appended claims.

We claim:

1. A method of encoding data representing offered items that are selected for specific respective viewers onto machine-readable storage media, the media storing data representing at least one entertainment feature, the method comprising at least the following:

receiving at least one request from at least one given viewer related to obtaining at least one instance media for viewing;

identifying the given viewer based on the obtaining of the at least one instance media for viewing;

obtaining at least one additional data element relating to the given viewer using, at least in part, data identifying the given viewer;

selecting at least one item to be offered to the given viewer based at least in part on analysis of the additional data element; and

encoding data representing the at least one offered item onto a given instance of the machine-readable storage medium.

2. The method of claim 1, wherein receiving at least one request includes receiving a request from the viewer via an Internet website.

3. The method of claim 1, wherein receiving at least one request includes receiving at least one account log-in request from the viewer via an Internet website.

4. The method of claim 1, wherein receiving at least one request includes receiving at least one query from the viewer via an Internet website.

5. The method of claim 1, wherein receiving at least one request includes receiving at least one request from the viewer to select at least one particular medium via an Internet website.

6. The method of claim 1, wherein receiving at least one request includes receiving at least one request from the viewer to obtain for viewing at least one particular medium via an Internet website.

7. The method of claim 1, wherein receiving at least one request includes receiving the request from the viewer at a physical storefront location.

8. The method of claim 1, wherein identifying the given user is performed in connection with the viewer accessing an Internet website that is related to obtaining the media.

9. The method of claim 1, wherein identifying the given viewer includes accessing cookie files that store data related to given viewers.

10. The method of claim 1, wherein identifying the given viewer is performed using at least one of a telephone number, an account number, an email address, and an IP address associated with the given viewer.

11. The method of claim 1, wherein obtaining at least one additional data element includes obtaining data representing at least one of past transaction history of the given viewer, home location of the given viewer, and demographic data pertaining to the given viewer.

12. The method of claim 1, wherein obtaining at least one additional data element includes analyzing a subject matter of the request received from the given viewer.

13. The method of claim 1, further comprising profiling the given viewer based at least in part on the additional data element.

14. The method of claim 1, further comprising performing one of a modeling and a segmentation analysis of the given viewer based at least in part on the additional data element.

15. The method of claim 1, wherein selecting at least one item is performed in real time with receiving the request from the given viewer.

16. The method of claim 1, wherein selecting at least one item is performed in real time with identifying the given viewer.

17. The method of claim 1, wherein encoding data is performed in real time with identifying the given viewer.

18. The method of claim 1, wherein encoding data is performed in real time with receiving the request from the given viewer.

41

19. The method of claim 1, wherein encoding data is performed in real time with selecting the at least one item for the given viewer.

20. The method of claim 1, further comprising selecting at least a further item specifically for the given viewer. 5

21. The method of claim 20, further comprising encoding data representing at least the further upsell item onto the given instance of the storage media.

22. The method of claim 1, wherein encoding data includes, at least in part, writing the data onto a write-many field allocated within the given instance of the media. 10

23. The method of claim 1, wherein encoding data is performed at at least one retail kiosk located in a physical storefront.

24. The method of claim 1, wherein encoding data is performed at at least one non-retail location. 15

25. The method of claim 1, further comprising presenting the given instance of the media to the given viewer.

26. The method of claim 25, wherein presenting the given instance of the media includes ejecting a medium from a kiosk. 20

27. The method of claim 25, wherein presenting the given instance of the media includes ejecting a medium from an automated kiosk.

28. The method of claim 25, wherein presenting the given instance of the media includes shipping a given instance of the media to the viewer. 25

29. At least one program storage device readable by a machine, tangibly embodying a program of instructions executable by the machine to perform a method of encoding data representing offered items that are selected for specific respective viewers onto machine-readable storage media, the media storing data representing at least one entertainment feature, the method comprising at least the following: 30

receiving at least one request from at least one given viewer related to obtaining at least one instance media for viewing; 35

identifying the given viewer based on the obtaining of the at least one instance media for viewing;

42

obtaining at least one additional data element relating to the given viewer using, at least in part, data identifying the given viewer;

selecting at least one item to be offered to the given viewer based at least in part on analysis of the additional data element; and

encoding data representing the at least one offered item onto a given instance of the machine-readable storage medium.

30. A computer program product comprising a computer useable medium having a computer readable code means embodied in said medium for encoding data representing offered items that are selected for specific respective viewers onto machine-readable storage media, the media storing data representing at least one entertainment feature, the computer readable program code in said computer program product comprising at least the following:

computer readable program code means for causing the computer to receive at least one request from at least one given viewer related to obtaining at least one instance media for viewing;

computer readable program code means for causing the computer to identify the given viewer based on the obtaining of the at least one instance media for viewing;

computer readable program code means for causing the computer to obtain at least one additional data element relating to the given viewer using, at least in part, data identifying the given viewer;

computer readable program code means for causing the computer to select at least one item to be offered to the given viewer based at least in part on analysis of the additional data element; and

computer readable program code means for causing the computer to encode data representing the at least one offered item onto a given instance of the machine-readable storage medium.

\* \* \* \* \*