

Under the Paperwork Reduction Act of 1995, no persons are required to respond to a collection of information unless it contains a valid OMB control number.

Application Data Sheet 37 CFR 1.76		Attorney Docket Number	025124-0509
		Application Number	
Title of Invention	METHOD AND APPARATUS FOR OUTPUTTING A MESSAGE AT A GAME MACHINE		
The application data sheet is part of the provisional or nonprovisional application for which it is being submitted. The following form contains the bibliographic data arranged in a format specified by the United States Patent and Trademark Office as outlined in 37 CFR 1.76. This document may be completed electronically and submitted to the Office in electronic format using the Electronic Filing System (EFS) or the document may be printed and included in a paper filed application.			

Secrecy Order 37 CFR 5.2

Portions or all of the application associated with this Application Data Sheet may fall under a Secrecy Order pursuant to 37 CFR 5.2 (Paper filers only. Applications that fall under Secrecy Order may not be filed electronically.)

Inventor Information:

Inventor 1					<input type="button" value="Remove"/>
Legal Name					
Prefix	Given Name	Middle Name	Family Name	Suffix	
	Jay	S.	Walker		
Residence Information (Select One) <input checked="" type="radio"/> US Residency <input type="radio"/> Non US Residency <input type="radio"/> Active US Military Service					
City	Ridgefield	State/Province	CT	Country of Residence	US
Mailing Address of Inventor:					
Address 1	260 Oscaleta Road				
Address 2					
City	Ridgefield	State/Province	CT		
Postal Code	06877	Country	US		
Inventor 2					<input type="button" value="Remove"/>
Legal Name					
Prefix	Given Name	Middle Name	Family Name	Suffix	
	James	A.	Jorasch		
Residence Information (Select One) <input checked="" type="radio"/> US Residency <input type="radio"/> Non US Residency <input type="radio"/> Active US Military Service					
City	Stamford	State/Province	CT	Country of Residence	US
Mailing Address of Inventor:					
Address 1	25 Forest Street				
Address 2	Apartment 5G				
City	Stamford	State/Province	CT		
Postal Code	06901	Country	US		
Inventor 3					<input type="button" value="Remove"/>
Legal Name					
Prefix	Given Name	Middle Name	Family Name	Suffix	
	Russell	P.	Sammon		
Residence Information (Select One) <input checked="" type="radio"/> US Residency <input type="radio"/> Non US Residency <input type="radio"/> Active US Military Service					

Application Data Sheet 37 CFR 1.76		Attorney Docket Number	025124-0509		
		Application Number			
Title of Invention	METHOD AND APPARATUS FOR OUTPUTTING A MESSAGE AT A GAME MACHINE				
City	San Francisco	State/Province	CA	Country of Residence ⁱ	US
Mailing Address of Inventor:					
Address 1	1361 Guerrero Street				
Address 2					
City	San Francisco	State/Province	CA		
Postal Code	94110	Country ⁱ	US		
Inventor 4	<input type="button" value="Remove"/>				
Legal Name					
Prefix	Given Name	Middle Name	Family Name	Suffix	
	Stephen	C.	Tulley		
Residence Information (Select One) <input checked="" type="radio"/> US Residency <input type="radio"/> Non US Residency <input type="radio"/> Active US Military Service					
City	Fairfield	State/Province	CT	Country of Residence ⁱ	US
Mailing Address of Inventor:					
Address 1	115 Ruane Street				
Address 2					
City	Fairfield	State/Province	CT		
Postal Code	06824	Country ⁱ	US		
Inventor 5	<input type="button" value="Remove"/>				
Legal Name					
Prefix	Given Name	Middle Name	Family Name	Suffix	
	Steven	M.	Santisi		
Residence Information (Select One) <input checked="" type="radio"/> US Residency <input type="radio"/> Non US Residency <input type="radio"/> Active US Military Service					
City	Ridgefield	State/Province	CT	Country of Residence ⁱ	Us
Mailing Address of Inventor:					
Address 1	80 Lounsbury Lane				
Address 2					
City	Ridgefield	State/Province	CT		
Postal Code	06877	Country ⁱ	US		
All Inventors Must Be Listed - Additional Inventor Information blocks may be generated within this form by selecting the Add button. <input type="button" value="Add"/>					

Correspondence Information:

Enter either Customer Number or complete the Correspondence Information section below.
For further information see 37 CFR 1.33(a).

An Address is being provided for the correspondence information of this application.

Application Data Sheet 37 CFR 1.76		Attorney Docket Number	025124-0509
		Application Number	
Title of Invention	METHOD AND APPARATUS FOR OUTPUTTING A MESSAGE AT A GAME MACHINE		
Customer Number	29159		
Email Address	patents@ngelaw.com	<input type="button" value="Add Email"/>	<input type="button" value="Remove Email"/>

Application Information:

Title of the Invention	METHOD AND APPARATUS FOR OUTPUTTING A MESSAGE AT A GAME MACHINE		
Attorney Docket Number	025124-0509	Small Entity Status Claimed	<input type="checkbox"/>
Application Type	Nonprovisional		
Subject Matter	Utility		
Suggested Class (if any)		Sub Class (if any)	
Suggested Technology Center (if any)			
Total Number of Drawing Sheets (if any)	18	Suggested Figure for Publication (if any)	

Publication Information:

<input type="checkbox"/>	Request Early Publication (Fee required at time of Request 37 CFR 1.219)
<input type="checkbox"/>	Request Not to Publish. I hereby request that the attached application not be published under 35 U.S.C. 122(b) and certify that the invention disclosed in the attached application has not and will not be the subject of an application filed in another country, or under a multilateral international agreement, that requires publication at eighteen months after filing.

Representative Information:

Representative information should be provided for all practitioners having a power of attorney in the application. Providing this information in the Application Data Sheet does not constitute a power of attorney in the application (see 37 CFR 1.32). Either enter Customer Number or complete the Representative Name section below. If both sections are completed the customer Number will be used for the Representative Information during processing.			
Please Select One:	<input checked="" type="radio"/> Customer Number	<input type="radio"/> US Patent Practitioner	<input type="radio"/> Limited Recognition (37 CFR 11.9)
Customer Number	29159		

Domestic Benefit/National Stage Information:

This section allows for the applicant to either claim benefit under 35 U.S.C. 119(e), 120, 121, or 365(c) or indicate National Stage entry from a PCT application. Providing this information in the application data sheet constitutes the specific reference required by 35 U.S.C. 119(e) or 120, and 37 CFR 1.78.			
Prior Application Status	Pending	<input type="button" value="Remove"/>	
Application Number	Continuity Type	Prior Application Number	Filing Date (YYYY-MM-DD)
	Continuation of	13632328	2012-10-01
Prior Application Status	Patented	<input type="button" value="Remove"/>	

Under the Paperwork Reduction Act of 1995, no persons are required to respond to a collection of information unless it contains a valid OMB control number.

Application Data Sheet 37 CFR 1.76		Attorney Docket Number	025124-0509		
		Application Number			
Title of Invention	METHOD AND APPARATUS FOR OUTPUTTING A MESSAGE AT A GAME MACHINE				
Application Number	Continuity Type	Prior Application Number	Filing Date (YYYY-MM-DD)	Patent Number	Issue Date (YYYY-MM-DD)
13632328	Continuation of	10685143	2003-10-14	8282488	2012-10-09
Prior Application Status	Expired			<input type="button" value="Remove"/>	
Application Number	Continuity Type	Prior Application Number	Filing Date (YYYY-MM-DD)		
10685143	non provisional of	60418397	2002-10-11		
Additional Domestic Benefit/National Stage Data may be generated within this form by selecting the Add button.					<input type="button" value="Add"/>

Foreign Priority Information:

This section allows for the applicant to claim benefit of foreign priority and to identify any prior foreign application for which priority is not claimed. Providing this information in the application data sheet constitutes the claim for priority as required by 35 U.S.C. 119(b) and 37 CFR 1.55(a).			
			<input type="button" value="Remove"/>
Application Number	Country i	Filing Date (YYYY-MM-DD)	Priority Claimed
			<input type="radio"/> Yes <input checked="" type="radio"/> No
Additional Foreign Priority Data may be generated within this form by selecting the Add button.			<input type="button" value="Add"/>

Authorization to Permit Access:

<input type="checkbox"/> Authorization to Permit Access to the Instant Application by the Participating Offices
If checked, the undersigned hereby grants the USPTO authority to provide the European Patent Office (EPO), the Japan Patent Office (JPO), the Korean Intellectual Property Office (KIPO), the World Intellectual Property Office (WIPO), and any other intellectual property offices in which a foreign application claiming priority to the instant patent application is filed access to the instant patent application. See 37 CFR 1.14(c) and (h). This box should not be checked if the applicant does not wish the EPO, JPO, KIPO, WIPO, or other intellectual property office in which a foreign application claiming priority to the instant patent application is filed to have access to the instant patent application.
In accordance with 37 CFR 1.14(h)(3), access will be provided to a copy of the instant patent application with respect to: 1) the instant patent application-as-filed; 2) any foreign application to which the instant patent application claims priority under 35 U.S.C. 119(a)-(d) if a copy of the foreign application that satisfies the certified copy requirement of 37 CFR 1.55 has been filed in the instant patent application; and 3) any U.S. application-as-filed from which benefit is sought in the instant patent application.
In accordance with 37 CFR 1.14(c), access may be provided to information concerning the date of filing this Authorization.

Applicant Information:

Providing assignment information in this section does not substitute for compliance with any requirement of part 3 of Title 37 of CFR to have an assignment recorded by the Office.

Application Data Sheet 37 CFR 1.76	Attorney Docket Number	025124-0509
	Application Number	
Title of Invention	METHOD AND APPARATUS FOR OUTPUTTING A MESSAGE AT A GAME MACHINE	

Applicant 1			
<p>If the applicant is the inventor (or the remaining joint inventor or inventors under 37 CFR 1.45), this section should not be completed. The information to be provided in this section is the name and address of the legal representative who is the applicant under 37 CFR 1.43; or the name and address of the assignee, person to whom the inventor is under an obligation to assign the invention, or person who otherwise shows sufficient proprietary interest in the matter who is the applicant under 37 CFR 1.46. If the applicant is an applicant under 37 CFR 1.46 (assignee, person to whom the inventor is obligated to assign, or person who otherwise shows sufficient proprietary interest) together with one or more joint inventors, then the joint inventor or inventors who are also the applicant should be identified in this section.</p>			
			<input type="button" value="Remove"/>
<input checked="" type="radio"/> Assignee	<input type="radio"/> Legal Representative under 35 U.S.C. 117		
<input type="radio"/> Person to whom the inventor is obligated to assign.	<input type="radio"/> Person who shows sufficient proprietary interest		
If applicant is the legal representative, indicate the authority to file the patent application, the inventor is:			
Name of the Deceased or Legally Incapacitated Inventor : <input type="text"/>			
If the Assignee is an Organization check here. <input checked="" type="checkbox"/>			
Organization Name	IGT		
Mailing Address Information:			
Address 1	9295 Prototype Drive		
Address 2			
City	Reno	State/Province	NV
Country ⁱ	US	Postal Code	89521-8986
Phone Number		Fax Number	
Email Address			
Additional Applicant Data may be generated within this form by selecting the Add button.			<input type="button" value="Add"/>

Signature:

NOTE: This form must be signed in accordance with 37 CFR 1.33. See 37 CFR 1.4 for signature requirements and certifications					
Signature	/Adam H. Masia/		Date (YYYY-MM-DD)	2012-10-19	
First Name	Adam	Last Name	Masia	Registration Number	35602
Additional Signature may be generated within this form by selecting the Add button.			<input type="button" value="Add"/>		

Under the Paperwork Reduction Act of 1995, no persons are required to respond to a collection of information unless it contains a valid OMB control number.

Application Data Sheet 37 CFR 1.76		Attorney Docket Number	025124-0509
		Application Number	
Title of Invention	METHOD AND APPARATUS FOR OUTPUTTING A MESSAGE AT A GAME MACHINE		

This collection of information is required by 37 CFR 1.76. The information is required to obtain or retain a benefit by the public which is to file (and by the USPTO to process) an application. Confidentiality is governed by 35 U.S.C. 122 and 37 CFR 1.14. This collection is estimated to take 23 minutes to complete, including gathering, preparing, and submitting the completed application data sheet form to the USPTO. Time will vary depending upon the individual case. Any comments on the amount of time you require to complete this form and/or suggestions for reducing this burden, should be sent to the Chief Information Officer, U.S. Patent and Trademark Office, U.S. Department of Commerce, P.O. Box 1450, Alexandria, VA 22313-1450. DO NOT SEND FEES OR COMPLETED FORMS TO THIS ADDRESS. **SEND TO: Commissioner for Patents, P.O. Box 1450, Alexandria, VA 22313-1450.**

Privacy Act Statement

The Privacy Act of 1974 (P.L. 93-579) requires that you be given certain information in connection with your submission of the attached form related to a patent application or patent. Accordingly, pursuant to the requirements of the Act, please be advised that: (1) the general authority for the collection of this information is 35 U.S.C. 2(b)(2); (2) furnishing of the information solicited is voluntary; and (3) the principal purpose for which the information is used by the U.S. Patent and Trademark Office is to process and/or examine your submission related to a patent application or patent. If you do not furnish the requested information, the U.S. Patent and Trademark Office may not be able to process and/or examine your submission, which may result in termination of proceedings or abandonment of the application or expiration of the patent.

The information provided by you in this form will be subject to the following routine uses:

1. The information on this form will be treated confidentially to the extent allowed under the Freedom of Information Act (5 U.S.C. 552) and the Privacy Act (5 U.S.C. 552a). Records from this system of records may be disclosed to the Department of Justice to determine whether the Freedom of Information Act requires disclosure of these records.
2. A record from this system of records may be disclosed, as a routine use, in the course of presenting evidence to a court, magistrate, or administrative tribunal, including disclosures to opposing counsel in the course of settlement negotiations.
3. A record in this system of records may be disclosed, as a routine use, to a Member of Congress submitting a request involving an individual, to whom the record pertains, when the individual has requested assistance from the Member with respect to the subject matter of the record.
4. A record in this system of records may be disclosed, as a routine use, to a contractor of the Agency having need for the information in order to perform a contract. Recipients of information shall be required to comply with the requirements of the Privacy Act of 1974, as amended, pursuant to 5 U.S.C. 552a(m).
5. A record related to an International Application filed under the Patent Cooperation Treaty in this system of records may be disclosed, as a routine use, to the International Bureau of the World Intellectual Property Organization, pursuant to the Patent Cooperation Treaty.
6. A record in this system of records may be disclosed, as a routine use, to another federal agency for purposes of National Security review (35 U.S.C. 181) and for review pursuant to the Atomic Energy Act (42 U.S.C. 218(c)).
7. A record from this system of records may be disclosed, as a routine use, to the Administrator, General Services, or his/her designee, during an inspection of records conducted by GSA as part of that agency's responsibility to recommend improvements in records management practices and programs, under authority of 44 U.S.C. 2904 and 2906. Such disclosure shall be made in accordance with the GSA regulations governing inspection of records for this purpose, and any other relevant (i.e., GSA or Commerce) directive. Such disclosure shall not be used to make determinations about individuals.
8. A record from this system of records may be disclosed, as a routine use, to the public after either publication of the application pursuant to 35 U.S.C. 122(b) or issuance of a patent pursuant to 35 U.S.C. 151. Further, a record may be disclosed, subject to the limitations of 37 CFR 1.14, as a routine use, to the public if the record was filed in an application which became abandoned or in which the proceedings were terminated and which application is referenced by either a published application, an application open to public inspections or an issued patent.
9. A record from this system of records may be disclosed, as a routine use, to a Federal, State, or local law enforcement agency, if the USPTO becomes aware of a violation or potential violation of law or regulation.

UNITED STATES PATENT APPLICATION
FOR
METHOD AND APPARATUS FOR
OUTPUTTING A MESSAGE AT A GAME MACHINE

INVENTORS:

JAY S. WALKER
JAMES A. JORASCH
RUSSELL P. SAMMON
STEPHEN C. TULLEY
STEVEN M. SANTISI

PRIORITY CLAIM

[0001] This application is a continuation of, claims priority to and the benefit of U.S. Patent Application No. 13/632,328, filed on October 1, 2012, which is a continuation of, claims priority to and the benefit of U.S. Patent Application No. 10/685,143, filed on October 14, 2003, which issued as U.S. Patent No. 8,282,488 on October 9, 2012, which claims priority to and the benefit of U.S. Provisional Patent Application No. 60/418,397, filed on October 11, 2002, the entire contents of which are each incorporated herein by reference.

RELATED APPLICATIONS

[0002] The present application is related to the following commonly-owned, co-pending U.S. Patent Applications:

(i) U.S. Patent Application Serial No. 09/603,677, filed on June 26, 2000, entitled "METHOD AND APPARATUS FOR SELECTING A SUPPLEMENTAL PRODUCT TO OFFER FOR SALE DURING A TRANSACTION", the entirety of which is incorporated by reference herein for all purposes;

(ii) U.S. Patent Application Serial No. 09/993,228, filed on November 14, 2001, entitled "METHOD AND APPARATUS FOR DYNAMIC RULE

AND/OR OFFER GENERATION", the entirety of which is incorporated by reference herein for all purposes;

(iii) U.S. Patent Reissue Application Serial No. 10/222,523, filed August 16, 2002, entitled "GAMING DEVICE FOR OPERATING IN A REVERSE PAYOUT MODE AND A METHOD OF OPERATING SAME", the entirety of which is incorporated by reference herein for all purposes;

(iv) U.S. Patent Application Serial No. 09/879,299, filed June 12, 2001, entitled "SYSTEM AND METHOD FOR AUTOMATED PLAY OF MULTIPLE GAMING DEVICES", the entirety of which is incorporated by reference herein for all purposes;

(v) U.S. Patent Application Serial No. 10/121,243, filed April 11, 2002, entitled "METHODS AND SYSTEMS FOR FACILITATING PLAY AT A GAMING DEVICE BY MEANS OF THIRD PARTY OFFERS", the entirety of which is incorporated by reference herein for all purposes;

(vi) U.S. Patent Application Serial No. 10/419,304 filed April 18, 2003, entitled "GAMING DEVICE METHODS AND APPARATUS EMPLOYING MODIFIED PAYOUTS", the entirety of which is incorporated by reference herein for all purposes;

(vii) U.S. Patent Application Serial No. 10/417,436 filed April 16, 2003, entitled "METHOD AND APPARATUS FOR OPTIMIZING THE RATE OF PLAY OF A GAMING DEVICE", the entirety of which is incorporated by reference herein for all purposes;

(viii) U.S. Patent Application Serial No. 10/361,201, filed February 7, 2003, entitled "GAMING DEVICE AND METHOD OF OPERATION THEREOF", the entirety of which is incorporated by reference herein for all purposes;

(ix) U.S. Patent Application Serial No. 10/414,511 filed April 15, 2003, entitled "METHOD AND APPARATUS FOR BONUS ROUND PLAY", the entirety of which is incorporated by reference herein for all purposes;

(x) U.S. Patent Application Serial No. 10/328,116, filed December 20, 2002, entitled "METHOD AND APPARATUS FOR OUTPUTTING

OUTCOMES OF A GAMING DEVICE", the entirety of which is incorporated by reference herein for all purposes;

(xi) U.S. Patent Application Serial No. 10/254,831, filed September 25, 2002, entitled "METHOD AND APPARATUS FOR LINKED PLAY GAMING", the entirety of which is incorporated by reference herein for all purposes;

(xii) U.S. Patent Application Serial No. 10/007,874, filed November 12, 2001, entitled "ELECTRONIC AMUSEMENT DEVICE AND METHOD FOR PROPAGATING A PERFORMANCE ADJUSTMENT SIGNAL", the entirety of which is incorporated by reference herein for all purposes;

(xiii) U.S. Patent Application Serial No. 10/322,107, filed December 18, 2002, entitled "FREE LONG DISTANCE CALLS ON SLOT MACHINES", the entirety of which is incorporated by reference herein for all purposes;

(xiv) U.S. Patent Application Serial No. 10/419,478, filed April 18, 2003, entitled "METHOD AND APPARATUS FOR ENABLING A PLAYER TO SELECT FEATURES ON A GAMING DEVICE", the entirety of which is incorporated by reference herein for all purposes; and

(xv) U.S. Patent Application Serial No. 10/420,068, filed April 21, 2003, entitled "METHOD AND APPARATUS FOR MANAGING FEATURES ON A GAMING DEVICE", the entirety of which is incorporated by reference herein for all purposes.

FIELD OF THE INVENTION

[0003] The present invention relates to gaming devices. More specifically, the present invention relates to methods and apparatus for providing messages to players at a gaming machine.

BACKGROUND OF THE INVENTION

[0004] There are currently over 500,000 slot machines in operation that together generate more than \$15 billion in annual revenue for United

States casinos. Most casinos generate more than half of their gaming revenues from slot machines and some individual casinos offer three or four thousand slot machines at a single location. In fact, two different casinos in Connecticut each provide more than six thousand gaming devices for players.

[0005] The variations of games and features of all the different game machines available at a single casino can be overwhelming to players. In addition, casinos frequently have many opportunities to market to players and recognize that interacting with customers may lead to a more profitable relationship with players. Further, to keep experienced and frequent players interested, casinos continually modify and upgrade game machines. Thus, for a variety of reasons, there is a need for systems and methods to provide information to (or otherwise communicate with) players at game machines.

[0006] Currently, casinos will frequently hire hosts and hostesses to cater to players who make large wagers or play frequently. However, this method of communicating with players is typically too costly to implement for all players at a casino.

BRIEF DESCRIPTION OF THE DRAWINGS

[0007] FIG. 1 is a block diagram illustrating an example system 100 according to some embodiments of the present invention.

[0008] FIG. 2 is a block diagram illustrating an example of the details of a game machine 104 as depicted in FIG. 1 according to some embodiments of the present invention.

[0009] FIG. 3 is a block diagram illustrating an example of the details of a controller 102 as depicted in FIG. 1 according to some embodiments of the present invention.

[0010] FIG. 4 is a table illustrating an example data structure of an example player database 308 as depicted in FIG. 3 for use in some embodiments of the present invention.

[0011] FIG. 5 is a table illustrating an example data structure of an example promotional message database 310 as depicted in FIG. 3 for use in some embodiments of the present invention.

[0012] FIG. 6 is a table illustrating an example data structure of an example instructive message database 312 as depicted in FIG. 3 for use in some embodiments of the present invention.

[0013] FIG. 7 is a table illustrating an example data structure of an example status message database 314 as depicted in FIG. 3 for use in some embodiments of the present invention.

[0014] FIG. 8 is a table illustrating an example data structure of an example hypothetical information database 316 as depicted in FIG. 3 for use in some embodiments of the present invention.

[0015] FIG. 9 is a table illustrating an example data structure of an example activity-benefit offer database 318 as depicted in FIG. 3 for use in some embodiments of the present invention.

[0016] FIG. 10 is a table illustrating an example data structure of an example combination message database 320 as depicted in FIG. 3 for use in some embodiments of the present invention.

[0017] FIGs. 11A and 11B are tables illustrating an example data structure of example trigger condition databases 322A, 322B for use in some embodiments of the present invention.

[0018] FIG. 12 is a table illustrating an example data structure of an example message representation database 324 as depicted in FIG. 3 for use in some embodiments of the present invention.

[0019] FIG. 13 is a table illustrating an example data structure of an example message formatting database 326 as depicted in FIG. 3 for use in some embodiments of the present invention.

[0020] FIGs. 14A and 14B are a tables illustrating an example data structure of an example message queue database 328 at two different times 328A, 328B for use in some embodiments of the present invention.

[0021] FIG. 15 is a table illustrating an example data structure of an example suppression condition database 330 as depicted in FIG. 3 for use in some embodiments of the present invention.

[0022] FIG. 16 is a table illustrating an example data structure of an example message history database 332 as depicted in FIG. 3 for use in some embodiments of the present invention.

[0023] FIG. 17 is a flow diagram illustrating an exemplary process for outputting a message at a gaming machine according to and for use in some embodiments of the present invention.

DETAILED DESCRIPTION OF SOME EMBODIMENTS OF THE INVENTION

[0024] The disclosed invention overcomes the above and other drawbacks of the prior art by allowing a casino, or other entity, to use a game machine to provide relevant information at appropriate times, and/or in response to appropriate events, to players using a game machine. The present invention provides a dynamic and flexible system adapted to interact with players on an individual basis by aiding in the management, determination, distribution, and delivery of promotional, inspirational, instructive, informational, communicative, incentive, and other types of messages.

[0025] Various methods are provided that may be used to ensure that receiving messages at a game machine enhances a player's overall gaming experience. The present invention provides systems and methods useful to selectively output helpful and desirable messages to players while minimizing interference with the player's gaming and to avoid any irritating "spam" effect created by overwhelming players with unsolicited, unwanted, and/or irrelevant messages. The present invention may be used to allow game machines to cater to all players with the same level of service and attention previously provided exclusively to "high rollers" by hosts and hostesses.

[0026] A variety of different types of messages may be output at game machines, including promotional messages (e.g., "Sign up for a credit card"), instructive messages (e.g., "Press and hold the spin button for 10 seconds to activate Auto-Play Mode"), and communication messages (e.g., "Hey Alice, how's it going? from Bob"). The present invention may employ a variety of different methods to output a message to a player at a game machine. For example, messages may be output in "pop-up" windows, in sidebars, in different colors, in different fonts, in different languages, via a celebrity voice, or in different media formats (e.g., text, audio, video). Outputting a message to a player may include determining how to output the message to the specific player based on preferences, special needs, or other factors.

[0027] In some embodiments, a message may be output to a player based on a trigger condition. For example, a message may be output to a player when a trigger condition occurs, thereby ensuring that the message is output at an appropriate time (e.g., when the player would be interested in viewing the message). Messages may be output based on a variety of different factors, including a player's gaming activities (e.g., what games are played and when), a player's other activities (e.g., arrival and departure from a casino), preferences (e.g., no messages during the first five minutes of gaming at a game machine), other messages (e.g., similar messages, or messages that have been output recently), and other players (e.g., friends of a player).

[0028] Other aspects of the present invention include features that may be used to directly enhance a player's experience. For example, messages timed and targeted to make a player aware of opportunities available to him may be presented using a humorous animated character. Further, other features of the invention help optimize the effectiveness of messages. For example, output of messages may be delayed when a player is busy or would not be interested in receiving a message. In another example, messages may be prioritized so that messages that would be most interesting to a player are output first. In another example,

messages may be categorized or sorted for a player so that the player can easily find a message in which he is interested.

[0029] The present invention allows a casino, via a game machine, to output appropriate messages in an appropriate way to appropriate players at appropriate times. Various methods are provided for identifying players who would be interested in receiving messages, are likely to accept messages, and/or are/would be valuable customers. Various different types of messages, beneficial to players, casinos, and other parties, may be presented that are relevant and helpful while repetitive, annoying, and irrelevant messages are filtered or suppressed.

[0030] In addition, messages may be output in such a manner so as not to interfere with gaming or other activities. This feature of the invention benefits both players and casinos. By providing means to output messages in ways acceptable to players, the present invention avoids distracting players from gaming which may otherwise reduce a casino's revenues.

[0031] Messages may be output in such a manner that they attract a player's attention. This may be beneficial to players, casinos, and other interested parties (e.g., subsidizers), because players may pay more attention to messages. By presenting messages only at appropriate times and in a manner a player understands, the present invention avoids annoying or distracting a player who is already occupied, e.g., cognitively engrossed in the middle of a hot streak during game play. Further, with the use of the present invention, players will be able to pay closer attention to messages that are output at the right time. This may be beneficial to players, casinos, and other interested parties (e.g., subsidizers).

[0032] The present invention is also beneficial to players in that players may learn about features on game machines. These features may greatly enhance a player's enjoyment of his gaming experience while casinos and/or other parties may receive additional revenues based on the use of these otherwise ignored features. The present invention facilitates proprietors of features to promote the features to players. Such

promotional messages may inform players of products or services. Players may learn about products or services that are enjoyable or helpful and they may receive various types of benefits, including discounts, free products or services, gaming-related benefits, and other forms of consideration.

[0033] The present invention may allow casinos to earn additional revenues from players and third-party subsidizers, while subsidizers may market products or services to players. Further, instructive messages may inform players about games and game machines which may allow players to improve their game play, increasing their chances of winning a jackpot, and facilitating their enjoyment of the gaming experience. The present invention may alleviate player frustration and/or confusion while operating a game machine. As a result, players may enjoy games more with a better understanding of the games. Likewise, informative status messages and communication messages may be helpful to players. A player may no longer need to stop gaming in order to determine status information or just to communicate with another party (e.g., friends and family members of the player). In addition, casinos and/or other parties may receive additional revenues based on some status messages or the use of communication services.

[0034] With these and other advantages and features of the invention that will become hereinafter apparent, the nature of the invention may be more clearly understood by reference to the following detailed description of the invention, the appended claims and to the several drawings included herein.

[0035] In the following description, reference is made to the accompanying drawings that form a part hereof, and in which are shown, by way of illustration, specific embodiments in which the invention may be practiced. These embodiments are described in sufficient detail to enable those skilled in the art to practice the invention, and it is to be understood that other embodiments may be utilized and that structural, logical, software, and electrical changes may be made without departing from the scope of the present invention. The following description is, therefore, not

to be taken in a limited sense, and the scope of the present invention is defined by the appended claims.

A. TERMS

[0036] Throughout the description that follows and unless otherwise indicated, the following terms may include and/or encompass the example meanings provided in this section. These terms and illustrative example meanings are provided to clarify the language selected to describe embodiments of the invention both in the specification and in the appended claims.

[0037] The terms “player” and “user” shall be synonymous and may refer to any person or entity that plays or operates a game machine.

[0038] The terms “game machine,” “gaming device,” and “gaming machine” shall be synonymous and may refer to any electrical, mechanical, electro-mechanical, software, combination thereof, and/or other device that may accept a wager, may follow a process to generate an outcome, and may authorize the payment of winnings based on the outcome. The outcome may be randomly generated, as with a slot machine; may be generated through a combination of randomness and user skill, as with video poker; or may be generated entirely through user skill. A gaming device may include any gaming machine and/or system, including slot machines, video poker machines, video bingo machines, video roulette machines, video keno machines, keno terminals, pachinko machines, video blackjack machines, arcade games, video games, pinball machines, skill crane machines, video lottery terminals, online gaming systems, game consoles, personal computers logged into online gaming sites, gaming device simulations, sports or race betting machine, etc. Gaming devices may or may not be owned and/or maintained by a casino and/or may or may not exist within a casino location. Gaming devices may be activated by a player pressing a spin button (including buttons labeled “bet”, “wager”, “deal”, “start”, “go”, “hit”, and/or the like), pulling a handle, and/or any other method to initiate the generation of an outcome. In some embodiments,

game machines may include communications facilities. In embodiments of the invention addressing table game play such as blackjack, craps, roulette, baccarat, Keno, Bingo, and the like, a game machine may be hardware located at the game table suitable for displaying a message to a player.

[0039] The term "casino" may refer to the owner of gaming devices, owners' agents, and/or any entity who may profit from players' use of the gaming devices.

[0040] The term "casino location" may refer to the physical geographic site, complex, or building where gaming devices owned and/or operated by a casino are located. In the case of an online casino, casino location may refer to the address (e.g., the uniform resource locator (URL)) of the online casino's Web site or facility.

[0041] The terms "handle pull" and "spin" shall be synonymous and may refer to an action that initiates a single play at a gaming device. In some embodiments, a handle pull may refer to a single complete game (or hand) or in other embodiments, the term may refer to a play related to a single wager. For example, in video blackjack, a user might play a single game in which he splits a pair of sevens, requiring an additional wager. This single game may be considered to include one or multiple handle pulls in different embodiments.

[0042] The terms "controller," "server," and "casino server" shall be synonymous and may refer to any device that may communicate with one or more game machines, one or more third-party servers, one or more remote controllers, one or more player devices, and/or other network nodes, and may be capable of relaying communications to and from each.

[0043] The term "user terminal" and "remote controller" shall be synonymous and may refer to any device that may communicate with one or more casino servers, one or more gaming devices, one or more third-party service provider servers, one or more player devices, and/or other network nodes. User terminals may, for example, include personal computers, laptop computers, handheld computers, telephones, kiosks,

automated teller machines, gaming devices, game consoles, and/or vending machines. They may include facilities to support secure communications using encryption or the like.

[0044] The terms "player device" and "user device" shall be synonymous and may refer to any device owned or used by a user or consumer capable of accessing and/or displaying online and/or offline content. Player devices may communicate with one or more casino servers, one or more gaming devices, one or more third-party service provider servers, one or more user terminals, and/or other network nodes. In some embodiments, player devices may, for example, include gaming devices, personal computers, personal digital assistants, point-of-sale terminals, point-of-display terminals, kiosks, telephones, cellular phones, automated teller machines (ATMs), pagers, and combinations of such devices.

[0045] The term "input device" may refer to a device that is used to receive an input. An input device may communicate with or be part of another device such as a point-of-sale terminal, a point-of-display terminal, a user terminal, a server, a player device, a gaming device (e.g., a pressure sensor in a "spin" button on a gaming device), a controller, etc. Some examples of input devices include: a "spin" or "deal" button and/or a handle on a gaming device, a bar-code scanner, a magnetic stripe reader (e.g., to read a player tracking card), a computer keyboard, a computer mouse, a point-of-sale terminal keypad, a touch-screen, a microphone, an infrared sensor, a sonic ranger, a computer port, a video camera, a motion detector, a digital camera, a network card, a universal serial bus (USB) port, a GPS receiver, a radio frequency identification (RFID) receiver, an RF receiver, a radio antenna (e.g., for receiving inputs from a second slot machine), a thermometer, a pressure sensor, a biometric input device (e.g., a fingerprint or retinal scanner), a location sensor (e.g., a global positioning system card), a voice recognition module, a coin or bill acceptor, and a weight scale/pressure sensor. For game machines, examples of common input devices include: a button on a video poker machine, a lever on a slot

machine, a touch screen on a video poker machine, a magnetic stripe reader to read a player tracking card inserted into a slot machine, and a motion sensor to determine if a player is standing in front of a game machine.

[0046] The term "output device" may refer to a device that is used to output information. An output device may communicate with or be part of another device (e.g., a gaming device, a point-of-sale terminal, a point-of-display terminal, a player device, a casino device, a controller, etc.). Some possible output devices include: a cathode ray tube (CRT) video monitor, liquid crystal display (LCD) screen, light emitting diode (LED), an LED screen, a printer, an audio speaker, an infra-red transmitter/port (e.g., for communicating with a second slot machine), a radio transmitter, an electric motor, a coupon or product dispenser, a Braille computer monitor, a coin or bill dispenser. For game machines, examples of common output devices include: a cathode ray tube (CRT) monitor on a video poker machine; a bell on a slot machine (e.g., rings when a player wins); an LED display of a player's credit balance on a slot machine; an LCD display of a personal digital assistant (PDA) for displaying keno numbers; a printer to provide a cashless gaming receipt; and a progressive jackpot meter bolted onto the top of a game machine.

[0047] The terms "I/O device" and "input/output device" shall be synonymous and may refer to any combination of input and/or output devices.

[0048] The term "player tracking card" may refer to a device that may be capable of identifying and/or storing information about a consumer who is a casino player. Typically player tracking cards may be accessed by gaming devices and magnetic card readers operated by casino staff. The information stored on the player tracking card may include identifying information, as well as financial information, such as a number of gambling credits remaining. The card may be machine readable, for example, by a gaming device. According to some embodiments of the present invention, a player tracking card may store player and/or membership and/or player

preference information such as a player's desired rate of play. Alternatively information on the card may merely be a pointer to information stored on a server.

[0049] The term "gross winnings" may refer to a player's total winnings for a session or time period, without regard to the amounts wagered during the session.

[0050] The term "net winnings" may refer to a player's total winnings for a session or time period, less the total amount wagered during that time period.

[0051] The term "parameter" may refer to a physical characteristic of a gaming device, its displayed text, graphics, video, audio, games, features, options, or any aspect of the way in which a gaming device operates. For example, the amount of time the gaming device allows its reels to spin after a single handle pull may be a parameter of the gaming device. The sensitivity of a button of the gaming device may be another parameter. A third parameter may be the volume at which the gaming device produces sound. A fourth parameter may be a status of a player selectable mode of operation of the gaming device, e.g., whether a "Betting the Don't," "Auto-Play Mode," and/or a "Jackpot Only" feature is enabled. A "game play" parameter may refer to a parameter related to a characteristic of a gaming device specific to the experience of playing the game of the gaming device. For example, the pace of the game may be considered a game play parameter, whereas the clock speed of the gaming device's processor would likely not be considered a game play parameter.

[0052] The terms "feature" and "option" may be synonymous and may refer to a parameter that may affect how a game operates on a game machine. Features may affect processes like operating a game, displaying game play, determining outcomes, or outputting game results. Features may include modes of operation of a game machine.

[0053] The terms "reel resolution" and "resolution" shall be synonymous and may refer to the perceptible actions of a gaming device that are displayed to give the perception that the gaming device is working

to generate an outcome. Modern gaming devices typically use very fast processors to generate outcomes almost instantaneously. The sounds and displays typically presented by such gaming devices are not actually related to the generation of the outcomes. In an attempt to enhance the gaming experience, modern gaming devices may create the perception that the sounds and displays must complete or "resolve" before the outcome may finally be presented. These "reel resolution" actions (including sounds, displays, animations, flashing lights, etc.) by the gaming device typically take orders of magnitude longer to complete than the processor of the gaming device takes to generate an outcome. However, in early slot machines, the time it took for the reels to stop spinning (or to "resolve") was the time it took for the gaming device to generate an outcome. Reel resolution may refer to any actions or displays by the gaming device between the time a player initiates a handle pull and the time the gaming device displays the outcome. In video poker and/or video blackjack type games, resolution may refer to actions or displays presented while the player waits to see the cards he is dealt. In a bonus round, reel resolution may refer to actions or displays presented while the player watches computation of bonus points or other outcomes.

[0054] The terms "reel resolution time" or "resolution time" shall be synonymous and may refer to the time it takes between a handle pull and final presentation of the resulting outcome. Reel resolution time may be almost instantaneous or in the case of elaborate bonus round animations, for example, may take several minutes.

[0055] The terms "session," "gaming session," "gambling session," and "play session" shall be synonymous and may refer to a series of plays at one gaming device, a series of plays at multiple gaming devices, and/or a continuous period of time spent gambling in a casino or home PC location.

[0056] The terms "products," "goods," "merchandise," and "services" shall be synonymous and may refer to anything licensed, leased, sold, available for sale, available for lease, available for licensing, and/or

offered or presented for sale, lease, or licensing including packages of products, subscriptions to products, contracts, information, services, and intangibles.

[0057] The term "merchant" may refer to an entity who may offer to sell, lease, and/or license one or more products to a consumer (for the consumer or on behalf of another) or to other merchants. For example, merchants may include sales agents, sales channels, individuals, companies, manufacturers, distributors, direct sellers, re-sellers, subsidizers, and/or retailers. Merchants may transact out of buildings including stores, outlets, malls, casinos, and warehouses, and/or they may transact via any number of additional methods including mail order catalogs, vending machines, online web sites, and/or via telephone marketing. Note that a producer or manufacturer may choose not to sell to customers directly and in such a case, a retailer may serve as the manufacturer's or producer's sales channel or agent.

[0058] The term "subsidizer" may refer to an entity that provides a subsidy to a casino or other party operating a controller (e.g., in exchange for the player's promise to perform an activity). A third-party subsidizer may be a merchant operating independently from a casino except that the casino may present offers to players that benefit the third-party subsidizer.

[0059] The term "message" may refer to any communication, in any form, intended to be presented to a player or other party. Messages may be of one or a combination of types. For example, message types may include status messages, promotional messages, instructive messages, hypothetical information messages, activity-benefit offer messages, and/or communication messages. Status message may include messages that inform a player of a condition or event that occurs. Examples of status messages may include reminders, updates, news alerts, and/or sports scores. Instructive messages may include messages that provide instructive information relating to a game machine and/or game play. Examples of instructive messages may include help messages, tips and tricks, demonstrations, and hypothetical information

about past game play. Communication messages may include messages generated by one or more people that are intended for a player. For example, friends may send a communication message to a player at a game machine. Promotional messages may include messages that promote one or more products to a player. Examples of promotional messages may include advertisements, offers for free products, offers to sell products, and activity-benefit offers. Combination messages may include messages that fall into multiple categories and/or include multiple types of messages. For example, a message describing a feature may be both instructive message and a promotional message.

[0060] The term "activity-benefit offer" may refer to an offer that includes a description of an activity to be performed by a player (and/or may include player's promise to perform the activity) and a benefit to be received if this activity is performed. In some embodiments of the invention, an activity-benefit offer may be output to a player as a message and a player may have an opportunity to accept or reject the activity-benefit offer. The activity may be an action or task that may be performed by, or on behalf of, a player in exchange for the benefit. The benefit may be a product or other form of value provided to, or on behalf of, a player in exchange for performing the activity.

[0061] The term "response" may refer to an indication provided by a player that is based on a message. For example, a message may be a question. A player may provide a response of "yes" or "no" to the question.

[0062] The term "representation" may refer to a method of outputting a message and/or a format in which a message is presented. For example, a message may have a plurality of message representations (e.g., one in English, one in Spanish, one in green, one in yellow, one in audio, etc.).

[0063] The term "partition" may refer to a video screen or an area of a video screen that is used to display related information. Some common examples of partitions include windows, split-screen displays, sidebars, headers, and footers.

[0064] The term “category” may refer to a grouping of one or more messages. For example, all messages of a certain type may fall into a single category (e.g., all messages relating to food, all status messages).

[0065] The term “presenter” may refer to an entity that presents a message to a player via a game machine. For example, a celebrity in a video message may be a presenter, or a cartoon character may present a message to a player.

[0066] The term “visual cue” may refer to an aspect of a visual display of a message. Examples of visual cues include color, fonts, window borders, and location.

[0067] The term “queue” may refer to an ordered list of messages that may be output. For example, the first message in a queue may be output when a trigger condition occurs.

[0068] The term “outputting” may refer to presenting, displaying, revealing, and/or indicating information. Note that outputting a message may include outputting a representation of the message.

[0069] The term “trigger condition” may refer to a condition that, upon its occurrence or satisfaction, results in a controller outputting a message at a game machine. For example, a message may be output to a player when the player exits a bonus round on a game machine in a system where “exiting a bonus round” is specified as an occurrence of a trigger condition.

[0070] The term “factor” may refer to information that may affect a process. For example, various factors may affect whether a trigger condition occurs or whether a message is output to a player.

[0071] The term “suppressing” may refer to preventing, canceling, delaying, or not outputting information. For example, a message may be suppressed if it is no longer relevant to a player and should not be output.

[0072] The term “suppression condition” may refer to a condition that, upon its occurrence or satisfaction, results in a controller and/or a game machine suppressing a message. For example, a message may be suppressed if a player is currently playing a bonus round on a game

machine in a system where “playing a bonus round” is specified as an occurrence of a suppression condition.

[0073] The term “payout” may refer to a prize that is provided to a player based on the outcome of a game. A payout may be any form of consideration, including money, products (e.g., a new car, a hotel room for the night, dinner, a shoe shine, tickets to a show), and alternate currencies (e.g., comp points, frequent flyer miles).

B. SYSTEM

[0074] An example embodiment of the system 100 of the present invention is depicted in FIG. 1. The system 100 according to some embodiments of the present invention may include one or more controllers 102 (an example of which is depicted in FIG. 3) in one or two-way communication with one or more game machines 104 (an example of which is depicted in FIG. 2) via a network such as, for example, the Internet or via another communications link. Although not pictured, other casino devices besides game machines 104 may be connected to the controller 102. Likewise, servers of other casinos and other establishments may be in direct or indirect communication with the controller 102. Note that in some embodiments, the system may consist of only a game machine 104.

[0075] In operation, the controller 102 may function under the control of a casino, merchant, subsidizer, or other entity that may also control use of the game machines 104. For example, the controller 102 may be a server in a merchant’s network. In some embodiments, the controller 102 may also be a merchant’s server.

[0076] In the embodiment pictured in FIG. 1, communication between the controller 102, the game machines 104, and/or third-party servers (not pictured), may be direct and/or via a network such as the Internet. Each of the controller 102 and the game machines 104 may comprise, for example, computers, such as those based on the Intel® Pentium® or Centrino™ processor, that are adapted to communicate with each other. Any number of third-party servers (not pictured), external

casino servers (not pictured), and/or game machines 104 may be in direct or indirect, one or two-way communication with the controller 102. The controller 102 and/or the game machines 104 may each be physically proximate to each other or geographically remote from each other. The controller 102 and/or the game machines 104 may each include input/output devices.

[0077] As indicated above, communication between the controller 102 and the game machines 104 may be direct or indirect, such as over an Internet Protocol (IP) network such as the Internet, an intranet, or an extranet through a web site maintained by the controller 102 (and/or a third-party server) on a remote server or over an online data network including commercial on-line service providers, bulletin board systems, routers, gateways, and the like. In some embodiments, the nodes may communicate with each other over local area networks including any combination of Ethernet, Token Ring, FDDI Full Duplex Technology (FFDT), and the like, radio frequency communications, infrared communications, microwave communications, cable television systems, satellite links, Wide Area Networks (WAN), Asynchronous Transfer Mode (ATM) networks, Public Switched Telephone Network (PSTN), other wireless networks, and the like. Communication between the controller 102 and the game machines 104 (and any other devices) may be encrypted to ensure privacy, provide security, and prevent fraud.

[0078] Those skilled in the art will understand that devices in communication with each other need not be continually transmitting to each other. On the contrary, such devices need only transmit to each other as necessary, and may actually refrain from exchanging data most of the time. For example, a device in communication with another device via the Internet may not transmit data to the other device for weeks or months at a time.

[0079] The controller 102 (and/or a third-party server) may function as a "Web server" that presents and/or generates Web pages which are documents stored on Internet-connected computers accessible via the

World Wide Web using protocols such as, e.g., the hyper-text transfer protocol ("HTTP"). Such documents typically include one or more hyper-text markup language ("HTML") files, associated graphics, sound, and script files. A Web server allows communication with the controller 102 in a manner known in the art. The game machines 104 may use a web browser, such as NAVIGATOR[®] published by NETSCAPE[®] for accessing HTML forms generated or maintained by or on behalf of the controller 102 and/or a third-party server.

[0080] As indicated above, the controller 102 and/or a third-party server may include or be part of, e.g., processor based cash registers, telephones, interactive voice response (IVR) systems such as the ML400-IVR[™] sold by Missing Link, Inc. of New Britain, CT, cellular/wireless phones, vending machines, pagers, gaming devices including slot machines, personal computers, portable types of computers, such as a laptop computer, a wearable computer, a palm-top computer, a hand-held computer, a smart card, and/or a Personal Digital Assistant ("PDA"). Further details of the controller 102 and the game machines 104 are provided below with respect to FIGs. 2 and 3.

[0081] As indicated above, in some embodiments of the invention, the controller 102 (and/or a third-party server) may include game machines 104. In addition, the controller 102 may communicate with users directly instead of through the game machines 104. Although not pictured, the controller 102, a third-party server, and/or the game machines 104 may also be in communication with one or more consumer and/or merchant credit institutions to effect currency transactions and may do so directly or via a secure financial network such as the Fedwire network maintained by the United States Federal Reserve System, the Automated Clearing House (ACH) Network, the Clearing House Interbank Payments System (CHIPS), or the like.

[0082] In operation, the controller 102 and the game machines 104 may exchange information about the use of the game machines 104 by individual players, data about the players, messages, and the like. In

embodiments with a third-party server, the controller 102 and/or the game machines 104 may exchange information about the use of the game machines 104 by individual players, data about the players, messages, and the like via the third-party server. The game machines 104 may, for example, provide information related to parameters and conditions to the controller 102 (and/or a third-party server). The game machines 104 may further provide gambling performance and player data to the controller 102 (and/or a third-party server). The controller 102 (and/or a third-party server) may provide messages for a player and/or historical information about the player to the game machines 104 in the casino location or to remote gaming devices.

[0083] It is worthwhile to note that the system 100 may be arranged into a variety of configurations, with functionality residing in various locations. Various information may be transmitted between different devices. For example, the controller 102 may control most aspects of outputting a message. It may determine a message to output, determine when to output the message, and determine how to output the message. The message may then be transmitted to a game machine 104 and output to the player by the game machine 104.

[0084] In some embodiments as indicated above, the controller 102 may reside in a game machine 104. For example, a game machine 104 may control most aspects of outputting a message. A game machine 104 may not even have a network connection. In some embodiments, a message may be determined by the controller 102, but a game machine 104 may control when to output the message. For example, a game machine 104 may suppress a message that is transmitted by the controller 102.

[0085] In some embodiments, a message may be determined by the controller 102, and the controller 102 may determine a representation for the message and a trigger condition. This information may be transmitted to a game machine 104 and then the game machine 104 may output the representation of the message when a trigger condition occurs.

In some embodiments, a game machine 104 may determine that a trigger condition has occurred and query the controller 102 to determine a message to output. The controller 102 may then transmit a message to the game machine 104 for output by the game machine 104. Note that a wide variety of other configurations are possible. It should be understood that methods of the invention may be implemented by one or more game machines 104, one or more controllers 102, other devices, and/or any combination thereof.

C. DEVICES

[0086] FIG. 2 is a block diagram illustrating details of an example of a game machine 104 of FIG. 1. As indicated above, a game machine 104 may include all of the functionality and structure of a controller 102 in some embodiments of the invention. In the particular example embodiment depicted in FIGs. 2 and 3, the game machine 104 is shown as distinct from the controller 102 but at least includes hardware and software operable to respond to instructions from the controller 102 and includes one or more game machine programs (not pictured) to execute the methods of the present invention or portions thereof as indicated above in the text describing the system in operation.

[0087] FIG. 3 is a block diagram illustrating details of an example of the controller 102 of FIG. 1 (and/or an example of a third-party server). The controller 102 is operative to manage the system 100 and execute the methods of the present invention. The controller 102 may be implemented as one or more system controllers, one or more dedicated hardware circuits, one or more appropriately programmed general purpose computers, or any other similar electronic, mechanical, electro-mechanical, and/or human operated device.

[0088] The controller 102 (and/or a third-party server) may include a processor 302, such as one or more Intel® Pentium® processors. The processor 302 may include or be coupled to one or more clocks or timers (not pictured), an input device 338, an output device 340, and one or more

communication ports 336 through which the processor 302 communicates with other devices such as the game machines 104 and/or a third-party server. The processor 302 is also in communication with a data storage device 304. The data storage device 304 may include any appropriate combination of magnetic, optical and/or semiconductor memory, and may include, for example, additional processors, communication ports, Random Access Memory ("RAM"), Read-Only Memory ("ROM"), a compact disc and/or a hard disk. The processor 302 and the storage device 304 may each be, for example: (i) located entirely within a single computer or other computing device; or (ii) connected to each other by a remote communication medium, such as a serial port cable, a LAN, a telephone line, radio frequency transceiver, a fiber optic connection or the like. In some embodiments for example, the controller 102 may comprise one or more computers (or processors 302) that are connected to a remote server computer operative to maintain databases, where the data storage device 304 is comprised of the combination of the remote server computer and the associated databases.

[0089] The data storage device 304 may store a server program 306 for controlling the processor 302. The processor 302 performs instructions of the server program 306, and thereby operates in accordance with the present invention, and particularly in accordance with the methods described in detail herein. The present invention may be embodied as a computer program developed using an object oriented language that allows the modeling of complex systems with modular objects to create abstractions that are representative of real world, physical objects and their interrelationships. However, it would be understood by one of ordinary skill in the art that the invention as described herein can be implemented in many different ways using a wide range of programming techniques as well as general purpose hardware systems or dedicated controllers. The server program 306 may be stored in a compressed, uncompiled and/or encrypted format. The server program 306 furthermore may include program elements that may be generally useful, such as an operating system, a

database management system and device drivers for allowing the processor 302 to interface with computer peripheral devices. Appropriate general purpose program elements are known to those skilled in the art, and need not be described in detail herein.

[0090] Further, the server program 306 is operative to execute a number of invention-specific, objects, modules and/or subroutines which may include (but are not limited to) one or more routines to identify a player at a game machine 104; one or more routines to retrieve messages from databases; one or more routines to receive information about a user; one or more routines to retrieve historical data regarding a player; one or more routines to send messages to a game machine 104; one or more routines to send signals to a game machine 104 to adjust a parameter; one or more routines for receiving information from a game machine 104; one or more routines to store player performance information; one or more routines to store player preference information; one or more routines to facilitate and control communications between game machines 104 and/or third-party servers; one or more routines to restore a game machine 104 to using its default parameter values; and/or one or more routines to control databases or software objects that track information regarding users, casinos, merchants supplying prizes, other third-parties, gambling results, game machines 104 and awarding prizes. Examples of some of these routines and their operation are described below in conjunction with the flowchart depicted in FIG. 17.

[0091] In addition to the server program 306, the data storage device 304 is operative to store any number of databases useful to execute the processes of the present invention. The particular embodiment depicted in FIG. 3 includes thirteen examples of databases including a player database 308; several types of message databases 310, 312, 314, 316, 318, 320; a trigger condition database 322; a message representation database 324; a message formatting database 326; a message queue database 328; a suppression condition database 330; and a message

history database 332. The purpose and function of each of these databases are described in detail below with respect to FIGs. 4 through 16.

[0092] According to some embodiments of the present invention, the instructions of the server program 306 may be read into a main memory of the processor 302 from another computer-readable medium, such from a ROM to a RAM. Execution of sequences of the instructions in the server program 306 causes processor 302 to perform the process steps described herein. In alternative embodiments, hard-wired circuitry or integrated circuits may be used in place of, or in combination with, software instructions for implementation of the processes of the present invention. Thus, embodiments of the present invention are not limited to any specific combination of hardware, firmware, and/or software.

[0093] Turning back to FIG. 2, a block diagram depicting an example game machine 104 may include a processor 202 coupled to a data storage device 204, a sensor 216, a random number generator 218, a communications port 220, an input device 222, an output device 224, a hopper controller 226A coupled to a hopper 226B, a clock (not pictured), a video controller 226C coupled to a touch screen 226D, a coin acceptor controller 226E coupled to a coin acceptor 226F, a bill acceptor controller 226G coupled to a bill acceptor 226H, a reel controller 228 coupled to reels 228A, 228B, 228C, RAM 230, ROM 232 and/or a player tracking card reader (not pictured).

[0094] A game machine may include a payment system 226A-H that performs two main functions: accepting payment from a player (e.g., a wager) and providing payment to a player (e.g., a payout). It should be noted that payment is not limited to money but may also include other types of consideration, including products, services, and alternate currencies (e.g., casino chips). Exemplary methods of accepting payment from a player include: receiving hard currency (i.e., coins or bills) via a coin or bill acceptor 226F, 226H; receiving an alternate currency (e.g., a paper cashless gaming voucher, a coupon, a casino token); receiving a payment identifier (e.g., a credit card number, a debit card number, a player tracking

card number) and then debiting the account identified by the payment identifier accordingly; and/or determining/verifying that a player has performed a value-added activity (e.g. in fulfillment of a "activity-benefit offer" based agreement). Exemplary methods of providing payment to a player include: dispensing hard currency (i.e., coins or bills) via e.g., a hopper 226B; dispensing an alternate currency (e.g., a paper cashless gaming voucher, a coupon, a casino token); crediting a player account (e.g., a bank account or other financial account) identified by a payment identifier (e.g., a credit card number, a debit card number, a player tracking card number); and/or providing a product or service to the player (e.g., a jackpot may be a new car).

[0095] Note that while using the present invention, a player may operate multiple game machines 104. Examples include: a player may simultaneously play two side-by-side game machines; a player may play a slot machine and then continue his gambling session at a video poker machine; and a player may use a telephone or other device to remotely operate two or more game machines.

[0096] In some embodiments, a game machine 104 may allow a player to play a game of skill rather than a game of chance. Examples of games of skill include skill cranes, skee-ball, pinball, and some video games. Such an embodiment may be more appealing to certain players or may be permitted in areas where it is illegal to gamble on games of chance.

[0097] The data storage device 204 may store a game machine program (not pictured) for controlling the processor 202. The processor 202 performs instructions of the game machine program, and thereby operates in accordance with the present invention, and particularly in accordance with the methods described in detail herein. As with the casino server program 306 described above, the game machine program may be embodied as a computer program developed using an object oriented language that allows the modeling of complex systems with modular objects to create abstractions that are representative of real world, physical objects and their interrelationships. However, it would be understood by

one of ordinary skill in the art that the invention as described herein can be implemented in many different ways using a wide range of programming techniques as well as general purpose hardware systems or dedicated controllers. The game machine program may be stored in a compressed, uncompiled and/or encrypted format. The game machine program furthermore may include program elements that may be generally useful, such as an operating system, a database management system and device drivers for allowing the processor 202 to interface with computer peripheral devices. As stated above, appropriate general purpose program elements are known to those skilled in the art, and need not be described in detail herein.

[0098] Further, as with the server program 306 described above, the game machine program may be operative to execute a number of invention-specific, objects, modules and/or subroutines which may include (but are not limited to) one or more routines to identify a player at the game machine 104; one or more routines to output messages; one or more routines to receive information about a user; one or more routines to implement rules regarding adjusting parameters; one or more routines to adjust parameters; one or more routines to receive messages from a controller 102; one or more routines to receive signals from a controller 102 to adjust parameters; one or more routines to send information to a controller 102; one or more routines to store player performance information; one or more routines to store player preference information; one or more routines to facilitate and control communications between the game machine 104 and/or third-party servers; one or more routines to restore the game machine 104 to using its default parameter values; and/or one or more routines to control databases or software objects that track information regarding users, casinos, merchants supplying prizes, other third-parties, gambling results, other gaming devices, and awarding prizes. Examples of some of these routines and their operation are described below in conjunction with the flowchart depicted in FIG 17.

[0099] As with the server program 306, according to some embodiments of the present invention, the instructions of the game machine program may be read into a main memory of the processor 202 from another computer-readable medium, such from a ROM 232 to a RAM 230. Execution of sequences of the instructions in the game machine program causes processor 202 to perform the process steps described herein. In alternative embodiments, hard-wired circuitry or integrated circuits may be used in place of, or in combination with, software instructions for implementation of the processes of the present invention. Thus, embodiments of the present invention are not limited to any specific combination of hardware, firmware, and/or software. In addition to the game machine program, the storage device 204 may also be operative to store databases.

[00100] Although the databases are depicted as residing on the controller 102 in the example embodiment of FIG. 3, it should be understood that these databases could just as easily be implemented on the game machine 104. Likewise, a game machine 104 may store a redundant copy of the controller's databases to protect against data loss or for any number of other reasons. In embodiments in which, for example, the controller 102 serves/controls multiple casinos operated by different entities, a casino may wish to have a local copy of the portions of the databases that include entries related to that casino and exclude other casinos' access to that casino's information. Thus, in some embodiments of a game machine 104 according to the present invention there may be included local copies of some portions of the databases. Such a redundant configuration may provide enhanced system performance by reducing network communications. A game machine program may include one or more routines to respond to requests from other gaming devices for player data, message data, trigger condition data, representation data, formatting data, queue data, suppression condition data, and message history data. Such a distributed configuration may provide enhanced system security by allowing different casinos to store and maintain their own databases. In

some embodiments, local versions of the databases are not stored on the game machines 104 at all and instead, the game machine program accesses casino server databases which are stored and maintained exclusively on the controller 102. Likewise, in some embodiments, the databases may only exist on a third-party server and thus, both the controller 102 and the game machines 104 may access a third-party server for the data.

D. DATABASES

[00101] As will be understood by those skilled in the art, the schematic illustrations and accompanying descriptions of the sample databases presented herein are exemplary arrangements for stored representations of information. Any number of other arrangements may be employed besides those suggested by the tables shown. For example, even though thirteen separate databases are illustrated, the invention could be practiced effectively using one, two, twenty, thirty, or more functionally equivalent databases. Similarly, the illustrated entries of the databases represent exemplary information only; those skilled in the art will understand that the number and content of the entries can be different from those illustrated herein. Further, despite the depiction of the databases as tables, an object-based model could be used to store and manipulate the data types of the present invention and likewise, object methods or behaviors can be used to implement the processes of the present invention. These processes are described below in detail with respect to FIG. 17.

[00102] As indicated above, it should be noted that although the example embodiment depicted in FIG. 3 includes thirteen particular databases stored in storage device 304, other database arrangements may be used which would still be in keeping with the spirit and scope of the present invention. In other words, the present invention could be implemented using any number of different database files or data structures, as opposed to the thirteen depicted in FIG. 3. Further, the

individual database files could be stored on different devices (e.g., located on different storage devices in different geographic locations, such as on a server or a game machine 104). Likewise, the programs 206, 306 could also be located remotely from the storage devices 204, 304 and/or on another server. As indicated above, the programs 206, 306 may include instructions for retrieving, manipulating, and storing data in the databases as may be useful in performing the methods of the invention as will be further described below.

1. Player Database

[00103] Turning to FIG. 4, a tabular representation of an embodiment of a player database 308 according to some embodiments of the present invention is illustrated. This particular tabular representation of a player database 308 includes six sample records or entries which each include information regarding a particular player. In some embodiments of the invention, a player database 308 is used to track information about players including identity, contact information, preferences, performance history, comp points, current activity, and demographics. Those skilled in the art will recognize that such a player database 308 may include any number of entries or additional fields.

[00104] The particular tabular representation of a player database 308 depicted in FIG. 4 includes five fields. The fields may include: (i) a player identifier field 400 that may store a representation uniquely identifying the player; (ii) a name field 402 that may store a representation of the player's name; (iii) comp points field 406 that may store a representation of the number of comp points a player has earned; (iv) a current activity field 406 that may store a description of what the player is doing and where he is doing it at the current time; and (v) a notes field 408 that may store further information regarding the player.

[00105] The example player database 308 depicted in FIG. 4 provides example data to illustrate the meaning of the information stored in this database embodiment. A player identifier 500 (e.g., "PLAYER-1-

02834555") may be used to identify and index players listed in the player database 308. In this example, "PLAYER-1-02834555" identifies a player named "Anne Red" as indicated by the player name field 402. According to the database, Anne Red has 1,846 comp points, is operating slot machine #12, enjoys traveling, and has visited Mexico three times in the last year.

[00106] As will be described in detail below, a variety of different types of messages are possible, including promotional messages, instructive messages, status messages, communication messages, and activity-benefit offers, hypothetical information messages, and combination messages. Information about messages may be stored in one or more message databases.

[00107] Turning to FIG. 5, a tabular representation of an embodiment of a promotional message database 310 according to some embodiments of the present invention is illustrated. This particular tabular representation of a promotional message database 310 includes seven sample records or entries which each include information regarding a promotional message. In some embodiments of the invention, a promotional message database 310 is used to track information about promotional messages including message identity, use, and message content. Those skilled in the art will recognize that such a promotional message database 310 may include any number of entries or additional fields.

[00108] The particular tabular representation of a promotional message database 310 depicted in FIG. 5 includes two fields. The fields may include: (i) a promotional message identifier field 500 that may store a representation uniquely identifying the promotional message and (ii) a promotional message field 502 that may store a representation of a description of the message to be output or, in some embodiments, the actual message.

[00109] The example promotional message database 310 depicted in FIG. 5 provides example data to illustrate the meaning of the information stored in this database embodiment. A promotional message identifier 500

(e.g., "PROMO-1-85923475") may be used to identify and index promotional messages listed in the promotional message database 310. In this example, "PROMO-1-85923475" identifies a promotional message that reads "Get two steak dinners for the price of one at Alice's restaurant."

[00110] Turning to FIG. 6, a tabular representation of an embodiment of an instructive message database 312 according to some embodiments of the present invention is illustrated. This particular tabular representation of an instructive message database 312 includes five sample records or entries which each include information regarding an instructive message. In some embodiments of the invention, an instructive message database 312 is used to track information about instructive messages including message identity, use, and message content. Those skilled in the art will recognize that such an instructive message database 312 may include any number of entries or additional fields.

[00111] The particular tabular representation of an instructive message database 312 depicted in FIG. 6 includes two fields. The fields may include: (i) an instructive message identifier field 600 that may store a representation uniquely identifying the instructive message and (ii) an instructive message field 502 that may store a representation of a description of the message to be output or, in some embodiments, the actual message.

[00112] The example instructive message database 312 depicted in FIG. 6 provides example data to illustrate the meaning of the information stored in this database embodiment. An instructive message identifier 600 (e.g., "INSTR-1-642985152") may be used to identify and index instructive messages listed in the instructive message database 312. In this example, "INSTR-1-642985152" identifies an instructive message that reads "Press and hold the spin button for ten seconds to activate 'Auto-Play' mode."

[00113] Turning to FIG. 7, a tabular representation of an embodiment of a status message database 314 according to some embodiments of the present invention is illustrated. This particular tabular representation of a status message database 314 includes five sample

records or entries which each include information regarding a status message. In some embodiments of the invention, a status message database 314 is used to track information about status messages including message identity, use, and message content. Those skilled in the art will recognize that such a status message database 314 may include any number of entries or additional fields.

[00114] The particular tabular representation of a status message database 314 depicted in FIG. 7 includes two fields. The fields may include: (i) a status message identifier field 700 that may store a representation uniquely identifying the status message and (ii) a status message field 702 that may store a representation of a description of the message to be output or, in some embodiments, the actual message.

[00115] The example status message database 314 depicted in FIG. 7 provides example data to illustrate the meaning of the information stored in this database embodiment. A status message identifier 700 (e.g., "STATUS-1-56189345") may be used to identify and index status messages listed in the status message database 314. In this example, "STATUS-1-56189345" identifies a status message that reads "You currently have X comp points" where X is filled in based on information regarding a targeted player from the player database 308.

[00116] Turning to FIG. 8, a tabular representation of an embodiment of a hypothetical information message database 316 according to some embodiments of the present invention is illustrated. This particular tabular representation of an hypothetical information message database 316 includes five sample records or entries which each include information regarding a hypothetical information message. In some embodiments of the invention, a hypothetical information message database 316 is used to track information about hypothetical information messages including message identity, use, and message content. Those skilled in the art will recognize that such a hypothetical information message database 316 may include any number of entries or additional fields.

[00117] The particular tabular representation of a hypothetical information message database 316 depicted in FIG. 8 includes two fields. The fields may include: (i) a hypothetical information message identifier field 800 that may store a representation uniquely identifying the hypothetical information message and (ii) a hypothetical information message field 802 that may store a representation of a description of the message to be output or, in some embodiments, the actual message.

[00118] The example hypothetical information message database 316 depicted in FIG. 8 provides example data to illustrate the meaning of the information stored in this database embodiment. A hypothetical information message identifier 800 (e.g., "HYP-1-093275126") may be used to identify and index hypothetical information messages listed in the hypothetical information message database 316. In this example, "HYP-1-093275126" identifies a hypothetical information message that reads "If you had only bet 1 coin instead of three coins last spin, you would have only won 10 coins instead of 40."

[00119] Turning to FIG. 9, a tabular representation of an embodiment of an activity-benefit offer database 318 according to some embodiments of the present invention is illustrated. This particular tabular representation of an activity-benefit offer database 318 includes nine sample records or entries which each include information regarding an activity-benefit offer. In some embodiments of the invention, an activity-benefit offer database 318 is used to track information about activity-benefit offers including message identity, use, and offer content including activities and benefits. Those skilled in the art will recognize that such an activity-benefit offer database 318 may include any number of entries or additional fields.

[00120] The particular tabular representation of an activity-benefit offer database 318 depicted in FIG. 9 includes three fields. The fields may include: (i) an activity-benefit offer identifier field 900 that may store a representation uniquely identifying the activity-benefit offer; (ii) an activity field 902 that may store a representation of a description of the activity to

be output as part of the offer or, in some embodiments, the actual offer message or activity portion of the message; and (iii) a benefit field 904 that may store a representation of a description of the benefit to be output as part of the offer or, in some embodiments, the actual offer message or benefit portion of the offer message.

[00121] The example activity-benefit offer database 318 depicted in FIG. 9 provides example data to illustrate the meaning of the information stored in this database embodiment. An activity-benefit offer identifier 900 (e.g., "OFF-1-23480923") may be used to identify and index offers listed in the activity-benefit offer database 318. In this example, "OFF-1-23480923" identifies an offer where if the player can "Play at least 20 games on a Rascally Rabbit Slot Machine" he will receive "5 credits" in exchange for doing so.

[00122] Turning to FIG. 10, a tabular representation of an embodiment of a combination message database 320 according to some embodiments of the present invention is illustrated. This particular tabular representation of a combination message database 320 includes five sample records or entries which each include information regarding a combination message. In some embodiments of the invention, a combination message database 320 is used to track information about combination messages including message identity, use, and message content. Those skilled in the art will recognize that such a combination message database 320 may include any number of entries or additional fields.

[00123] The particular tabular representation of a combination message database 320 depicted in FIG. 10 includes two fields. The fields may include: (i) a combination message identifier field 1000 that may store a representation uniquely identifying the combination message and (ii) a combination message field 1002 that may store a representation of a description of the message to be output or, in some embodiments, the actual message.

[00124] The example combination message database 320 depicted in FIG. 10 provides example data to illustrate the meaning of the information stored in this database embodiment. A combination message identifier 1000 (e.g., "COMBO-1-84151451") may be used to identify and index combination messages listed in the combination message database 320. In this example, "COMBO-1-84151451" identifies a combination message that reads "The only way to win the maximum jackpot is by betting three coins per spin. Would you like to increase your bet size to 3 coins per spin?"

[00125] Turning to FIGs. 11A and 11B, tabular representations of an embodiment of trigger condition databases 322A, 322B according to some embodiments of the present invention are illustrated. These particular tabular representations of trigger condition databases 322A, 322B includes seven and six sample records or entries respectively, which each include information regarding a particular trigger condition. Each of the two databases 322A, 322B depicted represents a different set of trigger conditions. Note that a given set of trigger conditions (e.g., 322A) may be active only certain times, for certain players, and/or for certain messages. In some embodiments of the invention, a trigger condition database 322 is used to track information about triggers including conditions and messages to output. A trigger condition database 322 may be useful in determining when to output a message to a player. Those skilled in the art will recognize that such a trigger condition database 322 may include any number of entries or additional fields.

[00126] The particular tabular representation of a trigger condition database 322A depicted in FIG. 11A includes seven fields. The particular tabular representation of a trigger condition database 322B depicted in FIG. 11B includes six fields. The fields may include: (i) a trigger condition for outputting messages field 1100A, 1100B that may store a representation of an indication of the trigger condition (e.g., a Boolean expression) and (ii) a message(s) to output field 1102A, 1102B that may store a representation of

an indication of what message(s) to output when the trigger condition occurs.

[00127] The example trigger condition databases 322A, 322B depicted in FIGs. 11A and 11B provide example data to illustrate the meaning of the information stored in these database embodiments. In the first example record of database 322A, the next message waiting in the queue (e.g. message queue database 328A of FIG. 14A) is output when the player reaches the end of a game and the priority of the next message in the queue is greater than or equal to "300."

[00128] Turning to FIG. 12, a tabular representation of an embodiment of a message representation database 324 according to some embodiments of the present invention is illustrated. This particular tabular representation of a message representation database 324 includes six sample records or entries which each include information regarding a particular message representation. In some embodiments of the invention, a message representation database 324 is used to track information about message representations including message identity and the different types of representations available for the message. Those skilled in the art will recognize that such a message representation database 324 may include any number of entries or additional fields.

[00129] The particular tabular representation of a message representation database 324 depicted in FIG. 12 includes five fields. The fields may include: (i) a message identifier field 1200 that may store a representation uniquely identifying the message with which the representation data is associated; (ii) a text representation field 1202 that may store a representation of an indication of whether a text representation of the message is available; (iii) a Spanish text representation field 1206 that may store a representation of an indication of whether a Spanish text representation of the message is available; (iv) an audio representation field 1206 that may store a representation of an indication of whether an audio representation of the message is available; and (v) a Spanish audio representation field 1208 that may store a representation of an indication of

whether a Spanish audio representation of the message is available. In some embodiments, additional fields such as a video representation field or a picture-in-picture representation field might be included.

[00130] Turning to FIG. 13, a tabular representation of an embodiment of a message formatting database 326 according to some embodiments of the present invention is illustrated. This particular tabular representation of a message formatting database 326 includes six sample records or entries which each include information regarding a particular message formatting for a given player. In some embodiments of the invention, message formatting database 326 may be useful in generating a representation of a message to output to a player. Those skilled in the art will recognize that such a message formatting database 326 may include any number of entries or additional fields.

[00131] The particular tabular representation of a message formatting database 326 depicted in FIG. 13 includes five fields. The fields may include: (i) a player identifier field that may store a representation uniquely identifying the player; (ii) a message category field 1300 that may store a representation of the message category; (iii) a type of partition or window field 1302 that may store a representation of the type of partition or window to be used when the message is output; (iv) a color of message border field 1304 that may store a description of the color of the message border; (v) a message title field 1308 that may store a representation of a message title to be displayed; and (vi) a sound upon output field 1310 that may store a representation of a sound to be played when the message is output. This version of a message formatting database 326 shows how messages may be formatted according to their categories. For example, all messages about features may be formatted the same way. As shown, according to some embodiments, the controller 102 may store a different message formatting database 326 for each player.

[00132] Turning to FIGs. 14A and 14B, a tabular representation of an embodiment of a message queue database 328 according to some embodiments of the present invention is illustrated. These particular

tabular representations include three and four sample records or entries respectively, which each include information regarding a particular message. A message queue database 328 may be useful in controlling the order that messages are output to a player. Those skilled in the art will recognize that such a message queue database 328 may include any number of entries or additional fields.

[00133] A message queue database 328 stores an ordered list of messages that may be output to a player at a game machine. As shown in these figures, the order of the list may be dependent on the priorities of the messages, which may be determined using a point system. For each message in the queue, the message queue database 328 may store an indication of the position in the queue 1400A, an indication of the message 1402A (e.g., a message identifier), and an indication of a point value for the message 1404A. Note that FIG. 14B shows how a higher priority message (e.g. "HYP-3-093275126") may be inserted into the queue while FIG. 14A shows the database before this message was inserted.

[00134] Turning to FIG. 15, a tabular representation of an embodiment of a suppression condition database 330 according to some embodiments of the present invention is illustrated. This particular tabular representation of a suppression condition database 330 includes eight sample records or entries which each include information regarding a particular suppression condition. In some embodiments of the invention, a suppression condition database 330 is used to determine when to suppress a message that would have been output to a player. Those skilled in the art will recognize that such a database may include any number of entries or additional fields. For each suppression condition, this version of the suppression condition database 330 stores an indication of the suppression condition 1500 (e.g., a Boolean expression); a result of suppression 1502 (e.g., delay the message, cancel the message, put the message in the queue); and a trigger condition for delayed output 1504 (if applicable).

[00135] Turning to FIG. 16, a tabular representation of an embodiment of a message history database 332 according to some

embodiments of the present invention is illustrated. This particular tabular representation includes seven sample records or entries which each include information regarding a particular message. In some embodiments of the invention, a message history database 332 is used to track information about messages that have already been output to one or more players. Those skilled in the art will recognize that such a database may include any number of entries or additional fields. For each message that has been output, this database stores what message was output 1600 (e.g., a message identifier); what player received the message 1602 (e.g., a player identifier); the time when the message was output 1604; and the player's response to the message 1606 (if any).

[00136] The use of each of these databases is described in more detail below with respect to the methods of the present invention.

E. PROCESS DESCRIPTIONS

[00137] The system discussed above, including the hardware components and the databases, are useful to perform the methods of the invention. However, it should be understood that not all of the above described components and databases are necessary to perform any of the present invention's methods. In fact, in some embodiments, none of the above described system is required to practice the present invention's methods. The system described above is an example of a system that would be useful in practicing the invention's methods. For example, the status message database 314 described above with respect to FIG. 7 is useful for storing status messages, but it is not absolutely necessary to have such a database in order to perform the methods of the invention. In other words, the methods described below may be practiced using, for example, a game machine program that is able to create messages as needed without having to access a database.

[00138] Referring to FIG. 17, a flowchart is depicted that represent some embodiments of the present invention that may be performed by the

controller 102, a game machine 104, and/or the casino. It must be understood that the particular arrangement of elements in the flowchart of FIG. 17, as well as the number and order of example steps of various methods discussed herein, is not meant to imply a fixed order, sequence, quantity, and/or timing to the steps; embodiments of the present invention can be practiced in any order, sequence, and/or timing that is practicable. Likewise, the labels used to reference the individual steps of the methods are not meant to imply a fixed order, sequence, quantity, and/or timing to the steps. In other words, for example, Step 1704 may be followed by Step 1702 in some situations and Step 1706 in others.

[00139] In general terms and referring to FIG. 17, method steps of an embodiment of the present invention may be summarized as follows. In Step 1702, a message is determined. In Step 1704, a representation of the message is determined. In Step 1706, the system 100 waits for a trigger condition to occur. In Step 1708, the message is output to a player at a game machine.

[00140] In the subsections that follow, each of these steps will now be discussed in greater detail. Note that not all of these steps are required to perform the methods of the present invention and that additional and/or alternative steps are also discussed below. Also note that the above general steps represent features of only some of the embodiments of the present invention and that they may be combined and/or subdivided in any number of different ways so that methods of the present invention include more or fewer actual steps. For example, in some embodiments many additional steps may be added to update and maintain the databases described above, but as indicated, it is not necessary to use the above described databases in all embodiments of the invention. In other words, the methods of the present invention may contain any number of steps that are practicable to implement the several different inventive processes described herein.

(1) Determine A Message

[00141] In Step 1702, a message is determined from among a variety of different types of messages. Examples of some message types include: (A) status messages, (B) instructive messages, (C) communication messages, (D) hypothetical information about past game play messages, (E) promotional messages, (F) activity-benefit offers, and (G) combination messages. Many other types of messages are possible. Each of the listed message types is described in detail below. Note that a message may be any information that may be output to a player using an output device on a game machine. Messages may be output in a variety of different forms, including text, audio, video, and images.

(A) Status Messages

[00142] A status message may be a message that informs a player of a condition or event that occurs. Different types of status messages include:

- (i) gaming-related messages
- (ii) messages about complimentaries (i.e., "comps")
- (iii) messages about enabled features on a game machine
- (iv) messages relating to a player's visit to a casino
- (v) reminders and alerts based on a player's digital calendar
- (vi) news alerts
- (vii) messages about other parties
- (viii) messages about processes in progress
- (ix) messages about waiting in line
- (x) messages about activities that a player may perform

[00143] Examples of gaming-related messages include:

- (i) messages relating to events on the game machine (e.g., "You just won 100 coins!")
- (ii) messages relating to conditions of the game machine (e.g., "You only have 10 credits left.")

(iii) messages relating to prizes (e.g., "The progressive jackpot is now up to \$142,234")

(iv) gaming statistics (e.g., "This slot machine has paid out over \$13,345 in the last 24 hours.")

(v) messages relating to other games, including games not played on the game machine. For example, a series of status messages may inform a player of numbers that are picked during a keno game.

(vi) messages relating to games that a player is not playing. For example, a player who is operating a video poker machine may receive a message that informs him that 4 out of 5 seats are occupied at the progressive jackpot bank of slot machines behind him.

(vii) offers to place bets (e.g., proposition bets). For example, a player may receive a message from another player asking him whether he'd like to bet \$10 on whether Barry Bonds will hit a home run on his next at bat.

[00144] Examples of messages about comps include:

(i) "You currently have 2234 comp points."

(ii) "You have enough comp points to purchase a hotel room for the night."

(iii) "You just earned 10 comp points because your friend Bob signed up for a player tracking card."

[00145] Examples of messages about enabled features include:

(i) "Auto-Play Mode is engaged. Press any button to stop Auto-Play Mode."

(ii) "Your contract for Double Payouts will expire in 15 minutes."

(iii) "Balance Bonus is enabled. You earn 1 coin for every 15 minutes that you keep your credit balance above 100 coins."

(iv) "Auto-Play Mode has been cancelled."

[00146] Examples of messages relating to a player's visit to a casino include:

- (i) "Your hotel room has been cleaned."
- (ii) "Your table for two at the Blue Moon restaurant is ready."
- (iii) "Your hotel room phone has one message. Press here to play the message."
- (iv) "Checkout time for the hotel is 11:00am. It is currently 10:03am."
- (v) "Your plane flight to Cleveland, Ohio leaves in 3 hours."

[00147] The controller 102 may store a digital calendar for a player. This digital calendar may be used to track information about a player's activities at a casino (including planned activities). Status messages may be output to a player based on his calendar. Examples include:

- (i) "Your plane flight to Cleveland, Ohio leaves in 3 hours."
- (ii) "You have a dinner reservation for 9pm at the Blue Moon restaurant. It is currently 8:45pm."

[00148] Examples of news alerts include:

- (i) sports scores and events (e.g., "The US now leads Mexico 2-0 in World Cup soccer." or "Jerome Bettis just scored a touchdown for the Pittsburgh Steelers, bringing his total to 3 this year. This puts you in 3rd place in your fantasy football league.")
- (ii) updates about current events (e.g., "Wildfire in Arizona continues to spread.")
- (iii) gaming-related news (e.g., "John Smith just won \$100,000 on a Rascally Rabbit video poker machine.")
- (iv) weather predictions (e.g., "It's going to be cool and windy tonight, with temperatures dropping into the mid-50's.")

[00149] Examples of messages about other parties (e.g., other players, friends of a player, family members of a player) include:

- (i) "Your friend Bob just won 100 coins."
- (ii) "Last hour, a player won 1000 coins at this game machine."
- (iii) "Your friend Bob just started gaming on game machine #423 in the green room."
- (iv) "Would you like to see a video (in picture-in-picture) of your friend Alice's bonus round?"
- (v) "Press the yes button if you would like to see you husband (in a live full-motion video teleconference)"

[00150] The controller may store a "buddy list" (not shown) of other parties who are associated with a player. This buddy list may be useful in determining messages about other parties.

[00151] Examples of messages relating to processes in progress include:

- (i) "Your purchase is pending."
- (ii) "Your credit card application is being reviewed. Please wait..."

[00152] Examples of messages relating to a player waiting in line include:

- (i) "You are 5th in line to play the Wheel of Riches game machine."
- (ii) "There are only 3 people ahead of you in line for the breakfast buffet at Alice's Restaurant. Your name will likely be called within the next 5 minutes."
- (iii) "You are 6th in line to receive tickets for the 'Broadway Bandits' musical."

[00153] Note that allowing a player to wait in line while he is operating a game machine may be particularly helpful to players. Players will no longer have to halt their gaming activities in order to wait in line, and may therefore enjoy their casino visit by spending more of their time gaming and less time standing around waiting in line.

[00154] Examples of messages about activities that a player may perform include:

- (i) "You only need to play 68 more games to earn a your free dinner at Alice's restaurant."
- (ii) "You have only 10 more minutes to earn double comp points." (e.g., in an example in which players only earn double comp points for a limited amount of time)

[00155] The controller may store status messages in a status message database 314, such as the one shown in FIG. 7.

(B) Instructive Messages

[00156] An instructive message may be a message that provides instructive information relating to a game machine. Examples of instructive messages include:

- (i) instructions for operating a game machine
- (ii) descriptions of the rules of a game
- (iii) game strategies and tips for game play
- (iv) descriptions of features or options in a game
- (v) demonstrations
- (vi) hypothetical information about past game play

[00157] Examples of instructions for operating a game machine include:

- (i) "To select an item on the touch screen, touch it lightly with your finger."

(ii) "Press the 'spin' button to place your bet and see whether you win."

(iii) "Press the 'Cash out' button to end your gaming session and receive all the money in your credit balance."

(iv) "Press and hold the 'Spin' button for 10 seconds to activate Auto-Play Mode."

(v) "To guess where the rascally rabbit is, use your finger to touch a rabbit hole on the touch screen."

[00158] Examples of game strategies and tips for game play include:

(i) "If you bet 3 coins per spin, then you get to use an improved payout table that increases the maximum jackpot value."

(ii) "The only way to win the maximum jackpot is by betting 3 coins per spin."

(iii) strategies for playing a bonus round on a game machine. For example, "If you build up a big stash of money, consider ending your bonus round. If you spin the wheel again, you might land on a Thief who will steal all your money."

(iv) descriptions of which outcomes are most favorable or least favorable to a player, even if these outcomes are determined by chance. For example, a tip for a bonus round might be, "To make the most money, you want to hatch all the chickens and then find the golden egg. This way, you get 10 coins for each chicken and 300 coins for the golden egg. If you crack open the golden egg first, you only get the 300 coins for the golden egg."

(v) "Plums are less common than cherries, so getting a plum-plum-plum outcome pays you more money."

(vi) recommending that a player activate or deactivate a feature on the game machine

(vii) recommending that a player change a pattern of game play (e.g., "Don't discard your aces.")

[00159] Examples of descriptions of the rules of a game include:

(i) "A poker hand consists of 5 cards. The Ace is considered the highest card, followed by Kings, Queens, Jacks, etc. The lowest card is a two. The object of the game is to get the best hand possible. You wager a certain number of coins/credits, usually between 1 and 5. The machine then deals you five cards. You can keep or discard as many cards as you like. To keep a card, click the "hold" button underneath or on the card. Click on deal/draw to replace the cards you choose not to keep. The cards not being held are replaced with new cards. If your new set of cards contains a winning hand, you get paid."

(ii) "If you crack open an egg with an alligator in it, the bonus round ends."

(iii) "Your bonus round is over. At the end of the bonus round, you get 10 coins for each chicken that you hatched."

(iv) "If you line up 3 car icons while the green light is on, you win a new car!"

(v) "You're only allowed one guess as to where the rascally rabbit is."

(vi) explaining why a payout occurred or did not occur for given outcome. For example, an outcome on a 5 reel video slot machine may be "bar, cherry, lemon, lemon, lemon". Some players may be confused as to why this outcome does not provide a payout, so the video slot machine may output a message to the player, "A payout is only provided if you match 3 symbols using reels #1, 2, and 3. No payout is provided if you match 3 symbols on reels #3, 4, and 5."

[00160] Examples of demonstrations include:

(i) A video screen on a game machine may display a video of a player operating the game machine or a cartoon of an animated character operating the game machine.

(ii) A player may be prompted to provide a series of inputs to a game machine in an interactive demonstration

(iii) A player may take a virtual tour of a game machine. See U.S. Application No. 10/414,511 entitled "Method and Apparatus for Bonus Round Play" (which is incorporated herein by reference) for a description of an example method of introducing a player to a bonus round on a game machine.

[00161] Examples of descriptions of features or options in a game include:

(i) "3D Graphics Mode takes your gaming to a whole new level. With 3D Graphics Mode, the two-dimensional images that you see right now on your game machine are transformed into life-like three-dimensional images. They really jump out at you and make the game more exciting!"

(ii) "Speed-play Mode is great for players who don't like sitting around waiting for the reels on their slot machine to stop spinning. In speed-play mode, the reels on your slot machine spin faster, but for only half the time that they spin in normal mode. This means that you don't have to wait as long between spins and can increase your chances of winning a jackpot by placing bets more quickly. Speed-play mode is appropriate for intermediate and expert-level slot machine players."

(iii) "Auto-Play Mode lets you gamble without pressing lots of buttons. When you activate auto-play mode on a game machine, the game machine will place bets and generate outcomes for you automatically- you don't have to do a thing. The game machine will continue placing bets automatically until you win a jackpot, your credit balance falls below 10 coins, or you press any key on the game machine to signal it to stop."

[00162] A wide variety of features are possible on a game machine 104. Some instructive messages (e.g., descriptions of features on game machines) may also help to promote a product or service to a player.

Therefore these messages may be both instructional messages and promotional messages.

[00163] The controller 102 may store instructive messages in an instructive message database 312, such as the one shown in FIG. 6.

(C) Communication Messages

[00164] A player may also receive a communication message at a game machine 104. A communication message may be any message generated by a person that is intended for a player. Examples include:

- (i) A player at a casino in Las Vegas may receive an instant message from a friend who is logged onto the Internet in Miami, Florida.
- (ii) A first player at a casino may receive a voice message (e.g., a telephone call) from a second player who is operating a game machine in another area of the casino.
- (iii) A video phone on a game machine may display a video of a casino representative alerting a player that his bags have been packed for checkout of the hotel.

[00165] See U.S. Application No. 10/655,969 entitled "Method and Apparatus for Player Communication" (which is incorporated herein by reference) for descriptions of various example methods of enabling a player to communicate with a casino representative.

[00166] Messages may be output in a variety of different forms, including text, audio, video, and images. Various parties may send communication messages to a player, including, for example:

- (i) other players – For example, players at a casino may use telephones on game machines to speak with each other or send a video of a big win to another player via the game machine.
- (ii) non-players (e.g., friends and family members) – For example, a friend of a player may log onto the Internet and send a player an instant message or email. The player may receive this instant message or email at his game machine.

(iii) casino employees – For example, a casino employee may instruct a player on how to operate a game machine, or enable a player to purchase products or services (e.g., show tickets) through the game machine.

(D) Hypothetical Information Based on Past Game Play Messages

[00167] In some embodiments, a type of message that describes “hypothetical information based on past game play” may be used to re-characterize past game play based on an altered parameter or variable. Examples of this type of message include:

- (i) “If you didn’t have Gambling Loss Insurance, you would have lost 500 coins in the last hour.”
- (ii) “If you had been using Betting the Don’t Mode, you would have won your last 5 games.”
- (iii) “Congratulations, you won a 200 coin jackpot! Without your Double Jackpot Wild Card, this jackpot would have only been 100 coins.”
- (iv) “If you had been playing in Speed Play Mode, you could have won this jackpot in 45 minutes instead of 1.5 hours.”
- (v) “If you had only bet 1 coin instead of 3 coins last spin, you would have only won 100 coins instead of 400.”

[00168] In order to generate such messages, the controller 102 may perform the following steps, which are described in detail below:

- (a) tracking information about game play using at least one game machine.
- (b) identifying at least one parameter of the game play.
- (c) determining a hypothetical result or other information about game play that would have occurred if the at least one parameter were altered.

(d) generating a message describing the hypothetical result or other information.

[00169] The controller may store a hypothetical information message database 316 such as the one shown in FIG. 8.

(a) Tracking Game Play

[00170] Information about past game play may be stored by the controller 102 in a game tracking database (not shown). This information may in turn be useful for generating hypothetical information about past game play. Examples of information that may be stored in a game tracking database include:

- (i) inputs to games (e.g., bet size, pay line selection, spin button pressed)
- (ii) times of games (e.g., time that a bet was placed, time that a game started, times of rounds of a game, time that a game ended, time that a payout was provided, durations of various events)
- (iii) payout tables for games (e.g., 10 coins for "cherry-cherry-cherry", 20 coins for "cherry-cherry-bar")
- (iv) values of parameters of game play (see details below)
- (v) which player plays a game
- (vi) which game machine a game is played on
- (vii) what game is played
- (viii) random numbers generated by a game machine (e.g., to determine results of a game)
- (ix) outcomes of games (e.g., "full house" in video poker, "cherry-cherry-bar" on a slot machine, "19" in video blackjack)
- (x) probabilities of outcomes
- (xi) payouts provided based out outcomes (e.g., 20 coins, \$5, free spin)

[00171] As used herein, the term "game play" is used to refer to at least one game played on at least one game machine. Note that:

- (i) Game play may refer to a single game or a plurality of games.
- (ii) Game play may refer to games played by a single player or a plurality of players.
- (iii) Game play may refer to games played at a single game machine or a plurality of game machines.

[00172] Note that a wide variety of parameters may affect game play on a game machine, including inputs by a player, variables in a computer program that controls a game machine, and random numbers generated by a random number generator. The controller may track the values of any or all of these parameters in the game tracking database.

(b) Identifying a Parameter of Game Play

[00173] In order to generate hypothetical information about game play, the controller may identify at least one parameter of game play. Various parameters may affect game play on a game machine, including:

- (i) inputs provided by a player (e.g., bet size, pay line selection, feature selection, etc.)
- (ii) features or options that are enabled during a game
- (iii) features or options that are disabled during a game
- (iv) parameters that may be altered by a player
- (v) random numbers generated by a game machine or the controller
- (vi) variables in a computer program that controls the game machine

[00174] In some embodiments, one property of a parameter is that a parameter affects game play in some way. Examples of how parameters affect game play include:

- (i) The size of a bet placed by a player (i.e., a parameter) may affect the value of a payout provided to the player.
- (ii) A player may activate Speed-Play Mode on a game machine. This may decrease the amount of time that it takes to play a game.
- (iii) A player may activate "Bet the Don't" Mode on a game machine. This may alter the payout table of the game machine.
- (iv) A player may activate "Win or Whammy" Mode on a game machine. This may alter the payout table of the game machine and the way that bets are placed on the game machine.
- (v) A player may select a pay line on a slot machine. This may affect an outcome on the slot machine.
- (vi) A random number generated by a game machine may affect what outcome occurs on the game machine and thereby affect what payout is provided to a player (if any).

[00175] A parameter may be controllable by a player. Examples of players controlling the values of parameters include:

- (i) A player may indicate the size of bet that he would like to place.
- (ii) A player may activate a feature on a game machine.
- (iii) A player may deactivate a feature on a game machine.

(c) Determining Hypothetical Information

[00176] One way for the controller to generate hypothetical information about past game play is to determine an alternate result of past game play that would have occurred if a parameter had a different value. For example, the game tracking database may show that a player won a payout of 100 coins for betting 1 coin and obtaining an outcome of "bar-bar-bar" on a slot machine. The controller may in turn determine that if the player had bet 3 coins on that spin (i.e., the bet size parameter was 3

instead of 1), the player would have won 400 coins for obtaining the outcome "bar-bar-bar."

[00177] The concept of hypothetical information is easily understood in contrast to "actual game play." Actual game play involves receiving a bet from a player, determining an outcome of a game, and providing a payout to a player contingent on the outcome of the game. In contrast, hypothetical information may involve determining the hypothetical values of bets, outcomes, or payouts, but there are no bets being placed and no payouts being provided. Hypothetical information answers the question, "What would have happened if...?"

[00178] Various different types of hypothetical information are possible, including:

- (i) payouts that a player would have won if at least one parameter had a different value
- (ii) outcomes that would have occurred on a game machine if at least one parameter had a different value
- (iii) durations of games
- (iv) intermediate events in games
- (v) other events or conditions that may occur at a game machine
- (vi) aggregate information about a plurality of games (e.g., a total amount of money won or lost by a player, an average rate of play)
- (vii) projections of potential future payouts

[00179] Note that the controller may determine hypothetical information about past game play based on both:

- (i) past values of one or more parameters (e.g., including a random number generated by the game machine), and
- (ii) a new value of at least one parameter. For example, if a feature was enabled during actual play, then hypothetical information may be generated by determining what would have happened if the feature had

been disabled (i.e., the new value of the feature parameter may be "disabled").

[00180] The controller may use the same computer program to generate hypothetical information as was used to generate an actual outcome on a game machine. For example, to generate an actual outcome on a game machine, the controller may run a computer program with a first set of parameters. Then, to generate a hypothetical outcome on a game machine, the controller may run the same computer program with an altered set of parameters. For example, to determine the actual result of a game, the controller may run a computer program with the bet size parameter set to "1 coin". The controller may also determine a hypothetical result of the game by running the computer program with the bet size parameter set to "3 coins."

(d) Generate A Message

[00181] The controller may then generate a message including the hypothetical information. For example, a player may win a jackpot in just 1 hour when operating a game machine in Speed Play Mode. Based on this game play, the controller may determine that a player would have taken 4 hours to win the jackpot had he instead been operating the game machine in Regular Speed Mode. Based on this determination, the controller may generate a message, "Speed Play Mode saved you 3 hours of time! If you had been operating this game machine in regular mode instead of Speed Play Mode, it would have taken you 4 hours to win this jackpot!"

(E) Promotional Messages

[00182] A promotional message may be a message that promotes a product or service to a player. Examples of promotional messages include:

- (i) advertisements

- (ii) offers to give free products or services to a player
- (iii) offers to sell products or services to a player
- (iv) activity-benefit offers

[00183] Examples of advertisements include:

(i) an advertisement for a feature on a game machine. For example, a message may display an image of a game machine operating in 3D Graphics Mode and ask a player if he would like to activate 3D Graphics Mode on his game machine.

(ii) an advertisement for a product or service. For example, a message may be a television commercial about fabric softener. In a second example, a message may be a banner advertisement describing a discount office furniture store.

(iii) an advertisement for a game that a player is currently playing. For example, a message may point out the entertainment value of a game that a player is currently playing: "There are over 100 different rabbit animations. See if you can view them all!" In a second example, a game machine with a bonus round may display a message, "This bonus round is all about pressing your luck. How daring are you? Are you willing to run the risk of having a thief steal your stash?"

[00184] Examples of messages that offer free products or services to a player include:

(i) Offers for free trials of products or services. For example, a message may offer a player a free 6-month trial subscription to a magazine (a \$12 value).

(ii) Offers for free usage of a feature on a game machine. For example, a message may offer a player 30 free minutes of operating a game machine in double-jackpot mode (a \$5 value).

[00185] Examples of offers to sell products or services to a player include:

- (i) "Buy 2 tank tops from Acme, and get a third one for free"
- (ii) "20% off all cellular telephones when you sign up for one year of mobile phone service."

[00186] The controller may store promotional messages in a promotional message database 310, such as the one shown in FIG. 5.

(F) Activity-Benefit Offers

[00187] An activity-benefit offer generally includes two components:

- (i) an activity that should be performed by the player (or obligation to be completed)
- (ii) a benefit to be provided to the player contingent on the performance of the activity

[00188] As used herein, the term "activity-benefit offer" is used for convenience, since activities and benefits are often presented to a player simultaneously in a single message. For easier readability, the word "offer" will occasionally be used to refer to an activity-benefit offer. However, it should be clear to the reader that activity-benefit offers represent one specific type of offer and that a variety of other types of offers and messages are possible.

[00189] An activity-benefit offer may be output to a player, and the player may have an opportunity to respond by accepting or rejecting the offer. If the player accepts the offer, then he agrees to perform the activity and receive the benefit specified in the offer.

[00190] The controller 102 may store activity-benefit offers in an activity-benefit offer database 318, such as the one shown in Figure 9.

(a) Activities

[00191] In order to earn a benefit, a player may be required to perform an activity. Examples of activities include:

- (i) signing up for a new credit card

- (ii) answering survey questions about a product or service

[00192] In many cases, an activity has value to a subsidizer. For example, a credit card issuer may be willing to pay up to \$50 to get a customer to sign up for a new credit card, since acquiring this customer will likely result in more than \$50 of profits for the credit card issuer. A casino or other party may receive a subsidy from a subsidizer based on an activity-benefit offer.

[00193] Basic types of activities include:

- (i) purchasing a product or service
- (ii) using a product or service
- (iii) selling a product or service
- (iv) providing a product or service
- (v) providing information
- (vi) viewing information
- (vii) performing an action
- (viii) telling a friend about a product or service
- (ix) gambling-related activities

[00194] Note that there are many other types of activities and that some activities do not fit clearly into any one category. The discussion below provides examples of each of these basic types of activities.

[00195] Examples of purchasing a product or service:

- (i) signing up for a magazine subscription
- (ii) buying \$20 worth of books from Amazon.com
- (iii) signing up for a warranty

[00196] Examples of using a product or service:

- (i) receiving a new credit card
- (ii) using a new long distance telephone provider

- (iii) printing at least 100 pages per week from an HP laser printer
- (iv) receiving 3 free issues of a magazine

[00197] Examples of providing a product or service:

- (i) providing legal advice, medical advice
- (ii) donating an old television set

[00198] Examples of selling a product or service:

- (i) selling a used product on eBay
- (ii) providing tax advice at a rate of \$10 per hour

[00199] Examples of providing information:

- (i) answering survey questions
- (ii) providing product ratings and reviews
- (iii) indicating demographic information, purchasing information

[00200] Examples of viewing information:

- (i) watching a television commercial or other advertisement
- (ii) listening to an audio tape about the health dangers of smoking cigarettes
- (iii) reading a pamphlet that explains how to use a product

[00201] Examples of performing an action:

- (i) playing a game of chance or a game of skill. Examples of gambling related activities are described in more detail below.
- (ii) applying for a credit card
- (iii) performing a repeated action (e.g. purchasing a product from a retailer at least once a month for the duration of an insurance policy, maintaining a minimum balance on a credit card)
- (iv) performing a customer-segmenting activity (i.e. an activity that allows a seller to segment its customer base). For example, a casino may segment its player base by asking a player to perform an activity over

an extended period of time (since some players will not have the time to perform such activities). Note that if a customer-segmenting activity has no value to a subsidizer, then there may not be a subsidizer.

(v) convincing another party (e.g., another player) to perform one or more activities. For example, a first player may perform an activity of convincing 3 of his friends to sign up for magazine subscriptions.

[00202] Examples of gambling-related activities include:

- (i) playing a game for a designated period of time
- (ii) playing a designated number of games (e.g., 200 handle pulls at a slot machine)
- (iii) placing a designated number (or dollar value) of bets
- (iv) winning a designated number of games
- (v) winning a designated jackpot
- (vi) winning a designated amount of money
- (vii) playing a designated game
- (viii) playing a game at a designated slot machine
- (ix) playing a game in a designated fashion (e.g., always make the maximum bet, always hit with 16 in blackjack)
- (x) signing up for a player tracking card
- (xi) providing gambling-related information (e.g., inserting a player tracking card, answering survey questions)
- (xii) maintaining a credit balance on a game machine (e.g., always at least 100 credits)

[00203] In addition, an activity may include an expiration condition. Examples include:

- (i) an activity must be finished by a designated time (e.g., before 6pm tonight)
- (ii) an activity must be started before a designated event (e.g., before the end of a baseball game)

- (iii) an activity must be performed before a designated occurrence (e.g., before another player wins a jackpot of \$100 or more)
- (iv) an activity must be performed before a designated condition is true (e.g., while there are at least 4 players at a particular bank of slot machines)

[00204] An activity may include a time-based requirement. Examples include:

- (i) an activity must be finished by a designated time (e.g., before 6pm tonight)
- (ii) an activity must be started after a designated event (e.g., after eating dinner)
- (iii) an activity must take place during a designated time period (e.g., between 4am and 8am)

[00205] In addition, there may be restrictions as to how and where an activity is performed. Examples include:

- (i) an activity must be performed while a player is at the casino

[00206] Note that a player may have to perform multiple activities in order to receive a benefit. For example:

- (i) A player may have to play 100 hands of video blackjack today and eat lunch at the casino buffet tomorrow.
- (ii) A player have to perform a repeated activity (e.g., purchasing a product from a retailer at least once a month for the duration of an insurance policy, maintaining a balance on a credit card)

[00207] According to some embodiments, a player's completion of an activity may be based on activities of other players. Examples include:

- (i) a player may perform a competitive activity (i.e., an activity where success is determined relative to at least one other player). For

example, a player may have to win a hand of poker or win a slot machine tournament.

(ii) a player may perform a team activity (i.e., an activity where players work together to accomplish a common goal). For example, all the players at a bank of slot machines may have to work together to increase a progressive jackpot to be greater than \$10,000.

[00208] According to some embodiments, the player may have to perform one of a plurality of activities. This means that the player may have a choice of what activity to perform. For example, a player may be required to either gamble continuously for the next hour or buy a ticket to a boxing match. If the player performs either activity, then he will receive a benefit.

[00209] According to some embodiments, a player may receive help in performing an activity. In this case, one or more other parties may perform an activity in the place of the player. Examples include:

(i) A player may be required to perform an activity of playing a slot machine continuously for 4 hours. The player may enlist three friends to help him perform this activity- each person plays the slot machine for one hour, and then gives up his seat to the next person.

(ii) A player may be required to perform an activity of signing up for 3 magazine subscriptions. As it turns out, the player is only interested in receiving two magazines: Scientific American and Soap Opera Digest. Fortunately, the player's friend also wants a subscription to Scientific American. Together, they sign up for 3 magazine subscriptions, and the player receives the benefit.

(iii) A player may be required to perform an activity of completing a Tae-Bo workout. This player doesn't enjoy Tae-Bo, but his wife does. So the player's wife performs the activity of completing the Tae-Bo workout.

[00210] Alternatively, it may not be permissible for a player to receive help in performing an activity.

[00211] According to some embodiments, it may be permissible for an activity to have been performed in the past. For example, a player may be asked to perform an activity of placing at least \$100 worth of bets at video poker. If the player has already placed \$150 worth of bets at video poker, then this may constitute performance of the activity. Note that a player may be asked to provide evidence that he performed an activity in the past (e.g., by inserting his player tracking card or providing a receipt).

[00212] According to some embodiments, it may be permissible for a player to make a forward commitment to perform an activity. In some cases, the player completes the activity just by making the agreement (e.g., agreeing to purchase a product or service), and the benefit may be provided to the player almost immediately after making the agreement. According to some embodiments, a forward commitment is an agreement to perform an activity at some point in the future. For example, a player may be required to perform an activity of test-driving a Ford Escort. The player may agree to take the test drive later (e.g., once he returns home from visiting the casino), thereby completing the activity. A benefit may then be provided to the player. Note that forward commitments may include time-based requirements and expiration conditions.

[00213] According to some embodiments, a forward commitment may be penalty-secured. This means that a player may be penalized for not completing the activity specified in the forward commitment. For example, a player's credit card may be charged \$100 if he does not complete an activity by a specified date. Examples of penalties include:

(i) monetary penalties that may be charged to a player's credit card, debit card, player account or other financial account. According to some embodiments, a player may be required to provide a payment identifier (e.g., a credit card number) when signing up for a penalty-secured forward commitment.

- (ii) denial of products or services (e.g., the player may not be permitted use of the casino limousine). Penalties that involve denial of products or services may be temporary.
- (iii) the player may be required to perform one or more additional activities
- (iv) other forms of consideration

[00214] Note that penalty-securing a forward commitment may be necessary to avoid a number of different methods of gaming or taking advantage of the system. For example, if a forward commitment was not penalty secured, then a player may promise to perform an activity, receive a benefit, and then never perform the activity as promised.

(b) Benefits

[00215] In exchange for performing an activity a player may receive a benefit. A variety of different benefits are possible, including:

- (i) money (e.g., money or slot machine credits)
- (ii) products (e.g., a souvenir watch, a sweatshirt, a magazine subscription)
- (iii) services (e.g., a free meal, a haircut)
- (iv) discounts on products or services (e.g., 50% off the list price of a hotel room)
- (v) alternate currencies (e.g., comp points, non-convertible casino chips)
- (vi) an entry into a game of chance (e.g., a lottery ticket, a free spin on a slot machine)
- (vii) other consideration

[00216] Determining a benefit may also include determining the value of the benefit. For example, the controller may determine the value of a benefit based on factors like a player's current credit balance on a game machine, or an amount of money that a player has lost during a

period of time. Money may be provided to a player in a variety of different ways, including:

- (i) as a lump sum payment (e.g., through a check)
- (ii) as a recurring payment (e.g., \$100 a month for the next 3 months)
- (iii) by crediting a player's financial account (e.g., bank account, credit card account, casino player account)

[00217] According to some embodiments, a benefit may be provided using a game machine. Examples include:

- (i) A player may receive a benefit of 50 credits on a slot machine that he is operating.
- (ii) Additional functionality on a game machine may be enabled as a benefit. For example, a player may receive a benefit of being able to bet 5 coins per hand on a video poker machine that usually only lets players bet 3 coins per hand.
- (iii) Odds or payout tables for a game machine may be altered to provide a benefit to a player.
- (iv) A game machine may include a product dispenser that dispenses a product to a player (e.g., a coupon, a gift certificate, tickets to a show or sporting event).
- (v) A hopper on a game machine may dispense coins to a player.

[00218] According to some embodiments, a benefit may be provided using a communication device. Examples include:

- (i) A player may use a telephone on a game machine (i.e., a communication device) to make long distance phone calls to his friends and family.
- (ii) A broadcast of a championship boxing match may be transmitted to a closed circuit television that is operated by a player.

(iii) A communication device may include a product dispenser that dispenses a product to a player (e.g., a coupon, a gift certificate, tickets to a show or sporting event).

[00219] According to some embodiments, a benefit may be provided to a party associated with the player (e.g., a friend of the player, a family member, a charity). While providing a benefit to a player's favorite charity may not provide a tangible benefit to the player, the player does receive an intangible benefit (e.g., he may feel altruistic and good-hearted). For this reason, benefits to friends of players may be particularly motivational for a player.

[00220] According to some embodiments, a benefit provided to a friend of a player may be contingent on the friend performing one or more activities. For example, a player's friend may be asked to perform an activity in order to receive a benefit. Activities that may be performed by friends are similar to those described above.

(c) Determining Whether an Activity Is Performed

[00221] According to some embodiments, the controller may determine whether a player has performed an activity designated by an activity-benefit offer. This may be helpful when determining whether to provide a benefit to the player (since this benefit will typically not be provided if a player fails to perform the activity).

[00222] The method of determining whether an activity is performed is often dependent on the type of activity that a player has been prompted to perform. For example, if a player is prompted to perform an activity of making 100 handle pulls at a slot machine, then the controller may monitor the number of handle pulls that the player has made at the slot machine. Different types of activities that a player may be prompted to perform are described above. Examples of ways that the controller may determine whether an activity has been performed include:

- (i) receiving information from a casino representative (e.g., a casino rep may indicate that a player has filled out an application for a new credit card or agreed to purchase a magazine subscription)
- (ii) receiving information from the player (e.g., when a player performs an activity of making a forward commitment to test drive an automobile)
- (iii) receiving information from one or more other computer systems (e.g., if a player is required to perform an activity of signing up for a new credit card, then the controller may receive information from a credit bureau)
- (iv) monitoring a player's activities at one or more slot machines (e.g., by communicating with a slot machine through a communication network)
- (v) storing data regarding a player's gambling activities (e.g., in the player database 308 shown in FIG. 5)
- (vi) receiving information from one or more slot machines
- (vii) receiving information from one or more point-of-sale terminals (e.g., for activities in which the player is required to purchase a product or service)
- (viii) monitoring conditions related to the activity (e.g., monitoring the current time if the activity has an expiration date)

[00223] Note that in many cases, the activity to be performed by a player comprises making an agreement or forward commitment (e.g., agreeing to purchase a product or service). In this case, the player may complete the activity just by making the agreement, and have the benefit provided to him almost immediately.

[00224] According to some embodiments, a player may use an authentication code to prove that he performed one or more activities. This authentication code may be an alphanumeric code, password, or other information that provides the controller with a reasonable assurance that the player performed one or more activities as required. According to some

embodiments, an authentication code is produced using a cryptographic algorithm (e.g., a cryptographic hash function). Typically an authentication code is produced by a device that has the ability to determine whether a player performed an activity. For example, a slot machine may output an authentication code indicating that a player made 100 handle pulls at that slot machine. An authentication code may be output using an output device (e.g. a printer, a video monitor).

[00225] According to some embodiments, the controller may have incomplete information as to whether a player performed an activity. For example, a dealer at a casino may be responsible for verifying that a player has gambled at least \$300 at blackjack, but the dealer may forget to perform this job. In this case, the controller may resolve this situation in one of a variety of different ways, including:

- (i) assume that the player did in fact complete the activity and provide the benefit to the player.
- (ii) assume that the player did not complete the activity and not provide the benefit to the player.
- (iii) provide a reduced or alternative benefit to the player
- (iv) offer to allow the player to perform a second activity to earn the benefit.
- (v) ask other employees (or even other players) whether the activity was completed.

[00226] According to some embodiments, a player may be reminded of an activity-benefit offer while performing an activity. Examples include:

- (i) a video screen on a slot machine may display a message to the player telling him how much longer he has to gamble before he earns a benefit.
- (ii) an animated character in a video game may remind the player that if he continues to play the game well, he may be able to win a benefit.

(iii) A casino rep may use a communication device to communicate with a player and remind him to perform an activity. Similarly, a casino rep may remind player of a benefit that he may receive for performing the activity, or other terms of an accepted activity-benefit offer.

[00227] According to some embodiments, the controller may indicate to the player whether or not he has successfully performed an activity. Examples include:

(i) A slot machine that is being operated by the player may display a text message, "Nice work! You just won a subscription to People magazine."

(ii) A strobe light on top of a video poker machine may flash and an audio speaker may proclaim to a player, "Whoops! You just missed your opportunity to earn 100 comp points."

(iii) A video monitor on a slot machine may display a message, "You're not done yet! If you play 113 more handle pulls at this slot machine, then you'll win a pair of tickets to Wrestlemania."

(iv) The controller may prompt a casino rep to communicate with the player. For example, a casino rep may use a communication device to congratulate a player on performing an activity correctly.

(d) Providing a Benefit to a Player

[00228] According to some embodiments, if a player performs an activity specified in an activity-benefit offer, then he may receive a benefit. Possible benefits that may be provided to a player who performs activities are described below.

[00229] According to some embodiments, a benefit provided to a player may be determined based on the activity performed. Examples include:

(i) The benefit may be based on what activity is performed. For example, a player may be given a choice of gambling for 3 hours at a slot

machine or gambling for 3 hours at a video poker machine. If the player gambles for 3 hours at the slot machine, then he earns tickets to a musical. If the player gambles for 3 hours at a video poker machine, then he earns tickets to a comedy show.

(ii) The benefit may be based on how well an activity is performed. For example, a player may be given the opportunity to earn 5 comp points for every survey question he answers. If the player answers 12 survey questions, then he earns 60 comp points.

[00230] Note that a benefit may be provided by a variety of different parties, including:

- (i) the controller (e.g., by crediting a player's financial account)
- (ii) the casino (e.g., a casino employee may mail a check)
- (iii) the casino rep (e.g., the casino rep may give a player 500 credits)
- (iv) another party (e.g., a subsidizer, a product manufacturer, a service provider, a fulfillment house)

[00231] While the above methods of providing benefits to a player may result from the acceptance by a player of one or more activity-benefit offers, it should also be noted that the casino may provide benefits to players without the requirement that they accept an activity-benefit offer. For example, a premium player on the floor who has been playing for more than two hours may trigger the controller to identify the player and have a casino rep communicate with the player and provide him a comp such as a free dinner or show.

[00232] According to some embodiments, a player may not perform the activity specified in an activity-benefit offer. The controller may respond to this occurrence in at least one of a variety of ways, including:

- (i) not providing the benefit to the player
- (ii) providing a reduced or alternative benefit to the player

- (iii) offering to allow the player to perform a second activity to earn the benefit
- (iv) not presenting activity-benefit offers to that player in the future

[00233] According to some embodiments, a player may be penalized if he does not perform an activity specified in an offer. For example, the controller may output an activity-benefit offer to the player in which the player gets \$15 if he pulls the handle of a slot machine 100 times. However, if the player accepts this activity-benefit offer and does not spin the slot reel 100 times, then the player will be penalized \$15. Similarly, a player's performance of an activity may be penalty-secured. A description of how forward commitments may be penalty-secured is provided above.

(G) Combination Messages

[00234] A wide variety of messages are possible, including messages that do not easily fit into one of the categories described above. For example, a message may fall into multiple categories. Examples include:

(i) "You have earned enough comp points for a hotel room. Would you like to cash in your comp points for a hotel room tonight?" Note that this message is both a status message (informing a player that he earned enough comp points for a hotel room) and a promotional message (asking the player if he would like to cash in his comp points).

(ii) "The only way to win the maximum jackpot is by betting 3 coins per spin. Would you like to increase your bet size to 3 coins per spin?" Note that this message is both an instructive message (instructing a player how to win the maximum jackpot) and a promotional message (asking the player whether he would like to bet 3 coins per spin).

(iii) "The only way to win the maximum jackpot is by betting 3 coins per spin. You are currently betting 2 coins per spin. Would you like to increase your bet size to 3 coins per spin?" Note that this message may

be considered to fall into three categories: an instructive message (instructing a player how to win the maximum jackpot), a status message (informing the player that he is currently betting 2 coins per spin), and a promotional message (asking the player whether he would like to bet 3 coins per spin).

(iv) “Your plane flight to return home to Cleveland leaves in 3 hours. Would you like to check if you can catch a later flight?” Note that this message is both a status message and a promotional message.

(v) “If you had been playing in Speed Play Mode, you could have won this jackpot in 45 minutes instead of 1.5 hours. Speed Play Mode speeds up the operation of a slot machine (e.g., makes the reels stop spinning more quickly), thereby enabling you to play more games in a shorter period of time.” Note that this message is both a hypothetical message about past game play and an instructive message describing how speed play mode works.

(vi) “Your contract for Double Payouts will expire in 5 minutes. If you agree to switch your long distance phone service provider to MCI, then your contract for Double Payouts will be extended for another 15 minutes.” Note that this message is both a status message (informing a player that his contract for double payouts is about to expire) and an activity-benefit offer (offering the player a benefit of an extended contract if he switches his long distance phone service provider).

[00235] For clarity, messages that fall into multiple categories may be referred to collectively as combination messages. The controller may store a combination message database 320, such as the one shown in FIG. 10.

[00236] It is anticipated that players may be more receptive to promotional messages if they are accompanied by status messages, instructive messages, or hypothetical information about past game play (henceforth referred to as “informative messages” for convenience). This is because the informative message may help to show the player why a

promotional message is appealing, interesting, or valuable. Promotional messages may be accompanied by informative messages in a variety of different ways, including:

- (i) a combination message may be both a promotional message and an informative message (see examples above)
- (ii) a promotional message may be output after an informative message is output
- (iii) a promotional message may be output before an informative message is output
- (iv) a series of informative messages may be followed by a promotional message

(2) Determine A Representation of the Message

[00237] In Step 1704, a representation of the message may be determined from among a variety of different representations and based upon many different factors. In other words, any given message may be output in a variety of different ways. For example, a message may be output in English or Spanish, in text or audio, or in green or blue. The term "representation" is used to refer to a method of formatting and outputting a message. A message may have one or more representations. For example, a message may have four representations:

- (i) a text representation in English
- (ii) a text representation in Spanish
- (iii) an audio representation in English
- (iv) an audio representation in Spanish

[00238] Outputting a message may include outputting a representation of a message. In addition, the method of the invention thus may include determining a representation for a message.

[00239] According to some embodiments, a plurality of representations of a message may be output. Examples include:

(i) For example, a text message, "You get a free spin each time you insert a \$10 bill" may be displayed in a pop-up window (a first representation), and an audio recording describing the message may be played (a second representation).

(ii) A message may include a movie with an audio soundtrack that describes the message. In addition, a text version of the message (e.g., closed captioning) may be output along with the movie.

(iii) A message may be output on a plurality of game machines. For example, a text message may be output on both of two game machines that are right next to each other. In a second example, a first half of a message may be output on a first game machine and a second half of a message may be output on a second game machine.

[00240] Representations of a message may differ from each other in variety of ways, including:

- (i) media format (e.g., text, audio, video)
- (ii) language (e.g., English, Spanish, French)
- (iii) presenter (e.g., a celebrity, a man with a Texas accent)
- (iv) partitions (e.g., pop-up windows, sidebars)
- (v) visual cues (e.g., color, font, animation)
- (vi) categories (e.g., food messages, help messages, news messages)
- (vii) output devices (e.g., CRT screen, LCD screen, audio speaker, on the video reels of a slot machine, on another are of a gaming device).

[00241] These variations on representations are described in detail below.

[00242] Different representations of a message may be stored in a database, such as the message representation database 324 shown in

FIG. 12. Alternatively, or in addition, different representations of a message may be generated by a computer system (e.g., the controller 102, or a game machine 104).

[00243] A message may be represented in a variety of different media formats, including:

(i) text – For example, a text message may be displayed on a video screen.

(ii) audio – For example, a 'beep' sound may be output anytime a message is displayed on a video screen. In a second example, a recorded voice may describe a message to a player. According to some embodiments, a message may be output in audio form only and may not have a video component.

(iii) video – For example, a sequence of images (e.g., a movie) may be displayed to a player using a video screen. For example, an activity-benefit offer may be output to a player

(iv) binary – For example, an LED on a slot machine may act as a warning light- lighting up to indicate a message to a player and turning off to indicate no message.

(v) icons – Messages may be represented by pictures. For example, a status message indicating that a player's table reservation is ready may be represented by a picture of a plate of food.

[00244] A message may be presented in a plurality of ways. For example, a message may include both a text component and an audio component.

[00245] A message may have a plurality of representations in different languages. For example, a message may have a first representation in English and a second representation in Spanish. In a second example, a message may have a text representation in English, a text representation in Chinese, an audio representation in English, and an audio representation in Chinese.

[00246] It may be particularly useful to have representations of messages for the disabled. Examples include:

- (i) for the vision-impaired – For example, a message may be output in Braille or large font text.
- (ii) for the hearing-impaired – For example, a video message may have closed-captioning text, or a message may be transmitted to a player's hearing aid using a Bluetooth radio channel. In a second example, a message may include a video of a presenter describing a message in sign language.

[00247] Examples of languages for a representation of a message include:

- (i) spoken languages (e.g., English, Spanish, French, German, Chinese, Arabic, Hindi)
- (ii) written languages (e.g., Braille, Latin)
- (iii) computer languages (e.g., HTML, XML, binary)

[00248] Representing a message in multiple languages may be particularly helpful for foreign players who are visiting a casino.

[00249] A message may have a presenter (e.g., a character that presents the message to a player). Examples of presenters include:

- (i) a person speaking in an audio message
- (ii) a synthesized voice in an audio message
- (iii) a person in a video message
- (iv) a plurality of speakers in an audio message
- (v) an animated character in a video message – For example, an avatar, virtual assistant, or other on-screen character may be displayed to a player in conjunction with a message. For example, an animated rabbit may be displayed on video screen and “talk” to a player, thereby outputting one or more messages. Indications from the rabbit may be provided as both text (e.g., displayed using a speech bubble as a partition), or as audio

(e.g., an audio recording may be played, allowing the rabbit to “speak” to the player.)

(vi) A portion of a game may be modified to indicate a message. For example, icons on the reels of a slot machine may be modified to indicate a message. In a second example, a message may be output by changing the design of a deck of cards in video poker.

[00250] It is anticipated that players may pay more attention to representations of message that include certain presenters. For example, a player may pay extra attention to a message that is presented by his favorite celebrity.

[00251] According to some embodiments, a game machine may include multiple video screens or multiple “windows” represented on a single video screen. The term partition may refer to a video screen or an area of a video screen that is used to display related information. Some common examples of partitions include windows, split-screen displays, sidebars, headers, and footers.

[00252] According to some embodiments, a message may be output to using a partition. For example:

- (i) A game machine may include a video screen, and a partition of the video screen may be used to output a message to a player.
- (ii) A message may be output in a partition on a game machine.
- (iii) A partition on a game machine may display a message.
- (iv) A partition on a game machine may output a message.

[00253] Examples of partitioning include:

- (i) A slot machine may have a single video screen that is split in half. The left side of the screen (i.e., a first partition) may shown a messages and information relating to messages and the right side of the screen (i.e., a second partition) may show an image of slot machine reels used in playing games on the slot machine.

(ii) A slot machine may have two video screens, each one corresponding to a partition. The first video screen displays slot machine reels and is used to indicate outcomes during games played on the slot machine. The second video screen is used to output messages to players.

(iii) A game machine may have a single video screen that is split into 3 partitions: a header, a sidebar, and a main window.

(iv) sidebar – For example, a portion of a video screen along the left or right side of the video screen may be designated as a partition.

(v) header – For example, a portion of a video screen along the top of the video screen may be designated as a partition.

(vi) footer – For example, a portion of a video screen along the bottom of the video screen may be designated as a partition. For example, a footer on a video screen may be reserved to display messages and alert to a player based on the player's current activities.

(vii) windows - A video screen may be subdivided into one or more movable partitions (a.k.a. "windows") and an immovable partition (a.k.a. "a desktop"). Each window may be a different partition, and it may be possible to have partitions overlap (i.e., a first partition may obscure some or all of a second partition).

(viii) picture-in-picture – A video screen may be divided into two partitions. The first partition may take up most of the video screen, except that a portion of the first partition may be obscured by the second partition, which is overlaid on top of the first partition. The second partition may be significantly smaller than the first partition.

(ix) pop-up-window – A new partition may be created on a video screen and this partition may display a message to a player.

(x) pay table – A game machine may include a pay table (e.g., that describes one or more payouts that may be provided to players based on. A message may be displayed to a player overlaid on the pay table or on a partition associated with the pay table (e.g., a header or footer).

(xi) on the reels of a slot machine.

(xii) in a bonus round.

(xiii) progressive meter – A game machine may include an auxiliary display screen like a progressive meter, which may be bolted onto the top of the game machine or built-into the game machine. This auxiliary display may be used to display a message to a player.

[00254] A partition may be created to output a message. That is, the following steps may be performed:

- (i) creating a partition
- (ii) outputting a message in the partition

[00255] Creating a partition may include one or more of the following steps:

- (i) determining a location for the partition
- (ii) determining a size and/or shape of the partition
- (iii) allocating memory for the partition

[00256] A partition may be closed, removed, or hidden based on various factors and conditions. Examples of closing or hiding partitions include:

- (i) A player may indicate that a partition should be closed.
- (ii) A player may indicate that a partition should be hidden.
- (iii) A partition may automatically be closed after a predetermined period of time.

[00257] Closing or hiding a partition may include one or more of the following steps:

- (i) ceasing to display the partition
- (ii) freeing memory that was allocated for the partition

[00258] Partitions may be on separate video screens. For example, a slot machine that has two video monitors may have three partitions: two partitions on the first monitor and a third partition on the second monitor.

[00259] Partitions may or may not be rectangular. For example, a video screen may display partitions that are shaped like pieces of a pie.

[00260] There may or may not be a visible border between partitions.

[00261] Partitions may or may not be movable. For example, a player may move a partition (a.k.a. "a window") by clicking and dragging. According to some embodiments, a partition may move on its own (e.g., to avoid obscuring a game result).

[00262] A first partition may obscure a portion of a second partition. For example, partitions may be organized into layers. A partition that is on layer #1 may be obscured by any partition on layer #2, which in turn may be obscured by any partition on layer #3. According to some embodiments, only the overlapping portions of partitions may be obscured.

[00263] There may or may not be a limit on the number of partitions allowable on one or more video screens.

[00264] The contents of separate partitions may be controlled by separate devices. For example, a slot machine may have two partitions: a first video screen and a second video screen. The first video screen may be controlled by the slot machine, whereas the second video screen by the controller.

[00265] A partition may be transparent, allowing a player to view portions of a video screen that would otherwise have been obscured by the partition.

[00266] A partition may have a background. This background may show a solid color, a pattern, or an image. Information displayed in the partition may be overlaid on the background.

[00267] According to some embodiments, processes involving partitions may be animated. For example, if a new partition is created by double-clicking on an icon, an animated sequence may be displayed showing the partition expanding from the icon.

[00268] A partition may have associated audio or sounds. For example, jungle noises may be output by a speaker on a video poker

machine while a player is navigating a "Jungle Theme" category displayed in a partition.

[00269] If a message is output in a visual format (e.g., text, images, video), then a representation of the message may include various visual cues. Examples of visual cues that may vary between representations include:

(i) color – For example, promotional message may be output in red text and instructive messages may be output in blue text.

(ii) windows – For example, a first window may show messages relating to features, a second window may show communication messages from other players, and a third window may show activity-benefit offers. In a second example, a message may be output as a text overlay on spinning a video screen showing spinning slot machine reels.

(iii) titles – For example, a message may be displayed in a window with a title bar that indicates the topic of the message.

(iv) fonts – For example, messages that offer supplementary benefits may be in bold, while messages relating to team play may be in italics.

(v) highlighting – For example, selected features may be highlighted, whereas unselected features may not be highlighted. In a second example, keywords in a message (e.g., "dinner", "movie", "credits", "bonus") may be highlighted.

(vi) order – For example, short messages may be listed first, followed by longer messages

(vii) borders – For example, messages may be displayed in pop-up windows with colored borders. A red border may indicate that a message is an advertisement; a green border may indicate that a message is an instructive message.

(viii) backgrounds – For example, a message may be output in a partition with a green background, indicating that the message is a update on a World Cup soccer score.

(ix) location – For example, messages relating to features may be displayed in a first location, and advertisements for consumer products may be displayed in a second location.

(x) animation – For example, alerts about activity-benefit offers may be animated to bounce up and down. In a second example, messages that offer benefits to a player and may emit floating “\$” signs.

(xi) audio – For example, whenever a status message relating to a baseball game is displayed, a crowd noise sound may be output by a game machine. In a second example, a voice synthesizer may say “Status Message” when a player selects a pop-up window containing a message.

(xii) overlay – For example, messages relating to payouts on a game machine may be displayed as text overlaid on the game machine’s payout table.

[00270] A visual cue may be used to indicate a category for a message (e.g., an important message, a de-emphasized message, a message about a feature).

[00271] A representation of a message may include an indication of a category of the message. Examples of categories of messages include:

- (i) promotional messages
- (ii) instructive messages
- (iii) status messages
- (iv) communication messages
- (v) messages relating to features
- (vi) messages relating to activity-benefit offers
- (vii) messages relating to hypothetical information about past game play
- (viii) messages from a specific friend of a player
- (ix) messages that offer benefits to a player
- (x) short messages
- (xi) long messages
- (xii) reminders based on a player’s digital calendar

- (xiii) messages relating to food and meals (e.g., reminders, advertisements)
- (xiv) messages relating to travel
- (xv) urgent messages
- (xvi) advertisements for consumer products
- (xvii) messages that include the keyword "dinner"

[00272] Categories may be organized into a hierarchy. For example, messages may be divided into categories of promotional messages, communication messages, and status messages (many other categories are also possible). Within the "promotional messages" category, messages may be further subdivided into advertisements for consumer products, advertisements for services, promotional messages about features, and activity benefit offers (many other categories are also possible). Alternatively, there may be no hierarchy of categories.

[00273] A message may pertain to a plurality of categories. For example, a message may fall into both the "reminders" category and the "messages relating to features" category.

[00274] A message may be categorized based on a variety of criteria, including:

- (i) a type of a message
- (ii) content of a message
- (iii) properties of a message
- (iv) one or more indications by a player – For example, a player may indicate how he would like messages to be categorized (e.g., by creating his own categories).
- (v) one or more indications by another party (e.g., a casino employee)
- (vi) originator of a message
- (vii) an importance of a message
- (viii) a length of a message
- (ix) a time that a message originated

[00275] Categories may be indicated in a variety of different ways. For example, various visual cues may be used to indicate what category or categories a message belongs in. Examples include:

[00276] Icons for important (“hot”) messages may be shown in red, while less important (“cool”) messages may be shown in blue.

[00277] A title bar on a partition may indicate a category of a message.

[00278] An indication of a plurality of categories may be output for a single message. For example, a red border on a pop-up window that displays a message may indicate that the message is urgent, and a title bar on the pop-up window may indicate that the message relates to a player’s dinner reservation.

[00279] Messages that offer benefits to a player and may emit floating “\$” signs.

[00280] A status message describing a jackpot that was just awarded to a player at a nearby game machine may be displayed as text overlaid on a payout table of a game machine.

[00281] An unimportant message may be displayed in “grayed out” text so that it does not needlessly attract a player’s attention.

[00282] A message may be output using an output device. Examples include:

[00283] An LCD screen may display text representation of a message.

[00284] A CRT monitor may display a video message to a player.

[00285] An audio speaker may output an audio representation of a message.

[00286] A message may be output using a shared or public output device. Examples include:

(i) A bank of game machines may share a large display screen (e.g., for displaying information about a shared progressive jackpot). One or more messages may be output to players at the bank of game machines using this large display screen.

(ii) A message may be displayed on a 15 foot projection television that is viewable by everyone in the sports book section of a casino.

(iii) An audio speaker at a slot machine may play a message that can be heard by the player as well as other players and casino employees who are nearby.

(iv) On a television in the room of a player.

(v) Over a loud speaker system.

[00287] A message may be output to a player privately. Examples include:

(i) A message may be displayed on a small portion of a video screen that is only visible to a player.

(ii) An audio message may be output to a player who is wearing headphones.

(iii) Printed on the back of a cashless gaming receipt.

[00288] A player may carry an electronic device such as a cell phone, PDA (personal digital assistant), or laptop computer. This electronic device may display a message to a player. Examples include:

(i) A game machine may use a Bluetooth wireless connection to transmit a message to a player's PDA. Upon receiving the message from the game machine, the PDA may display the message to the player. For example, the PDA may beep and display the message on an LCD screen.

(ii) The controller may determine a message to be output to a player and transmit this message to a player's cell phone using a communication network (e.g., a 3G wireless network). The player's cell phone may then display the message to the player.

(iii) When visiting a casino, a player may rent or borrow a tablet computer, which he may then carry with him as he moves about the casino. Among other things, this tablet computer may output messages to the player. For example, the tablet computer may communicate with game machines and/or the controller to determine and output message to a player.

(iv) A game machine may be associated with a portable electronic device that a player may remove and carry with him throughout the casino. This portable electronic device may output messages to the player (e.g., messages relating to the game machine). For example, commonly owned Application Serial No. 08/774,487 entitled "Automated Play Gaming Device", now issued as U.S. Patent No. 6,012,983, (which is incorporated herein by reference) and Application Serial No. 09/437,204, also entitled "Automated Play Gaming Device", now issued as U.S. Patent No. 6,244,957 (which is also incorporated herein by reference) include examples of how a player may lock a game machine in "auto-play" mode and then receive updates (i.e., status messages) relating to game play on this game machine.

[00289] An electronic device that is used to output a message to a player may be a player device. Commonly owned Application Serial No. 10/655,154 entitled, "Method and Apparatus for Providing a Complimentary Service to a Player" (which is incorporated herein by reference) includes examples of a variety of different types of player devices and includes details about how a player device may be used to provide a service to a player. One type of service that may be provided by the player devices is a communications service. Outputting a message to a player may be a form of communications service. Commonly owned Application Serial No. 10/655,154 also includes details about how a player may rent or borrow a player device from a casino or other party.

[00290] A message may be output using an output device on a neighboring game machine. For example, a player may be operating slot

machine #2 at a bank of slot machines. Slot machine #3, which may be immediately to the right of slot machine #2, may be unoccupied. A message for a player operating slot machine #2 may be output using slot machine #3. Outputting a message to a player using a neighboring game machine may be particularly useful in embodiments in which:

(i) A neighboring game machine includes an output device that is not present on a game machine that is being operated by a player. For example, a player may be operating a game machine that does not have an audio speaker, whereas a neighboring game machine may have stereo sound.

(ii) Screen space on a game machine is limited. For example, a neighboring game machine may be used to display messages that do not fit on the display screen of a game machine that a player is operating.

(iii) Outputting a message to a player using a neighboring game machine may help to attract the player's attention to the neighboring game machine. For example, a neighboring game machine may be more profitable to a casino than a game machine that a player is currently operating. In order to entice the player to switch game machines and play the neighboring game machine, a message may be output to the player using the neighboring game machine.

[00291] According to various embodiments, the method of the invention may include one or more of the following steps:

- (i) determining a representation of a message
- (ii) identifying a representation of a message
- (iii) selecting a representation of a message
- (iv) generating a representation of a message
- (v) creating a representation of a message
- (vi) determining how to present a message
- (vii) determining what way to present a message
- (viii) determining a manner of presenting a message

[00292] Note that determining a representation of a message may include one or more of the following:

- (i) determining a media format for the message (e.g., text, audio, video)
- (ii) determining a language for the message (e.g., Chinese, German)
- (iii) determining a presenter for the message (e.g., a celebrity, an animated character)
- (iv) determining a partition for the message (e.g., a pop-up window, a sidebar)
- (v) determining at least one visual cue the message (e.g., color, highlighting, font)
- (vi) determining a category for a message

[00293] A representation of a message that is output to a player may be determined based on a variety of factors. Some general categories of factors include:

- (i) content of the message
- (ii) characteristics of the player
- (iii) other messages
- (iv) indications provided by the player
- (v) indications provided by other parties (e.g., a casino representative, a friend of a player)
- (vi) other players associated with the player
- (vii) time-related factors
- (viii) activities of a player

[00294] Note that these categories of factors are also factors listed for trigger conditions and are discussed in detail below in the text describing trigger conditions. To avoid repetition, these categories of factors are not discussed in detail here. However, examples of determining

a representation of a message based on various factors are provided below.

[00295] A representation of a message may be determined based on content of the message. For example:

- (i) Promotional messages may be output in green text, whereas status messages may be output in yellow text.
- (ii) A message from a first advertiser may include the first advertiser's product logo; a message from a second advertiser may include the second advertiser's product logo.
- (iii) The size of a window that displays a message may be proportional to the amount of benefit offered by the message or the amount of subsidy provided by a third party.
- (iv) A message relating to food may be presented by a first animated character (e.g. a pot-bellied pig); a message relating to gaming may be presented by a second animated character (e.g., a tiger in a zoot-suit).
- (v) Messages with important content may be output in bold fonts and/or bright colors.

[00296] A representation of a message may be determined based on characteristics of a player. Examples include:

- (i) A player who speaks Japanese may have a message output to him in Japanese.
- (ii) Messages may be output to a blind player in audio format, whereas a deaf player may not receive audio messages at all, only text or video messages.
- (iii) a player's preferences – For example, a player may prefer that a certain category of messages be output in a particular way. See below for further details about categories of messages and further details about a player customizing output of one or more messages.
- (iv) a player's proclivity towards certain representations – For example, it may be determined that a player pays more attention to video

messages than to text-only messages. Based on this determination, a video representation of a message may be output to a player.

[00297] A representation of a message may be determined based on other messages. Examples include:

- (i) Contrasting colors may be used to differentiate between different messages. So if a first message is output in blue, a second message may be output in a different color than blue (e.g., red).
- (ii) Two messages in the same category may be output in the same sidebar window.
- (iii) The same presenter (e.g., a celebrity voice) may be used for all messages during a particular gaming session.
- (iv) Messages from different categories may be displayed using different representations. For example, all status messages may be output with an animated rabbit as a presenter, and all promotional messages may be output with a banker character wearing a tuxedo and top hat as a presenter.

[00298] A representation of a message may be determined based on activities by a player. Examples of a player's activities that may affect a representation of a message include:

- (i) a player's gaming activities – For example, a message may be output in a sidebar window if a player is in the middle of a bonus round on a game machine, whereas a message may be output in a pop-up window if a player has just won a jackpot on a game machine.
- (ii) operation of a game machine by a player – For example, a message may be output in audio if a player is currently navigating a on-screen menu on a game machine, whereas a message may be output as text in a picture-in-picture window if a player is watching a television show on a game machine.
- (iii) non-gaming activities by a player – For example, a food message from a restaurant may be output in a first window if a player has

eaten at the restaurant before, whereas the food message may be output in a second window if the player not eaten at the restaurant before.

[00299] A representation of a message may be determined based on characteristics of a game machine. Examples of factors relating to characteristics of a game machine:

(i) an output device of the game machine – For example, a message may be output in video format if a game machine has a color video screen and audio speaker. Otherwise a message may be output in text format.

(ii) hardware of the game machine – For example, a message may be output in audio format if a game machine does not have a fast enough processor to decode a streaming video representation of the message.

[00300] The controller may store a message representation database 324, such as the one shown in FIG. 12. Note that, for any given message, one or more representations may be available. For example, PROMO-1-85923475 is available as an English text version, a Spanish text version, and an English audio version. Determining a representation for a message may include selecting a representation from the message representation database.

[00301] The controller may store a message formatting database 326, such as the one shown in FIG. 13. Information stored in the message formatting database may be useful in formatting a message to generate a representation of the message. For example, the message formatting database 326 in FIG. 13 shows that a preferred representation of features on game machines for player PLAYER-1-02834555 is to have the message output in a header with a green border and a message title of "Features". An audio signal may be output also. Note that a message formatting database 326 may be used independently or in conjunction with a message representation database 324 such as the one shown in FIG. 12. For

example, a representation selected from the message representation database 324 may be formatted according to the message formatting database 326.

[00302] Note that there may only be one representation of a message, in which case the controller may simply output the representation of the message to a player at a game machine.

(3) Awaiting A Trigger Condition

[00303] In Step 1706, the system waits for a trigger condition associated with the message and/or the representation of the message to occur. Thus, one way to control the output of messages is to output a message based on a trigger condition. That is, for example:

- (i) A message may be output when a trigger condition occurs.
- (ii) A message may be output when a trigger condition is true.
- (iii) A message may be output in response to a trigger condition.
- (iv) A message may be output in response to a trigger condition occurring.
- (v) A message may be output in response to a trigger condition being true.
- (vi) A message may be output at substantially the same time that a trigger condition occurs.
- (vii) A message may be output at substantially the same time that a trigger condition becomes true.
- (viii) A message may be output because of a trigger condition.
- (ix) A message may be output because a trigger condition occurred.
- (x) A message may be output because a trigger condition is true.

[00304] A trigger condition may be a condition that causes a message to be output at a game machine.

[00305] Note that trigger conditions may be useful in enabling a variety of different functions, including:

- (i) determining when to output a message
- (ii) determining an appropriate time to output a message
- (iii) determining what message to output
- (iv) determining how to output a message. For example, a trigger condition may be used to determine a representation of a message or categorize a message. See above for details about representations of messages, examples of determining a representation based on various factors, and categorizing messages.
- (v) determining an order in which to output a plurality of messages (see message ordering below for details)
- (vi) delaying output of a message until a trigger condition occurs. For example, it may be annoying to output a message to a player while he is in the middle of winning streak or busy configuring features on a game machine. Therefore, outputting a message to a player may be delayed until an appropriate time. See below for further details about delaying output of a message.

[00306] According to some embodiments, a trigger condition may be a Boolean expression. This Boolean expression may reference one or more variables (i.e., factors) and may include Boolean modifiers and conjunctions (e.g. AND, OR, XOR, NOT, NAND), comparators (e.g., >, <, =, >=, <=, !=), mathematical operations (e.g. +, -, *, /, mean, standard deviation, logarithm, derivative, integral), and constants (e.g. \$10, 20 coins, 300 credits, 0.02, 15%, pi, TRUE, yellow, "raining"). Examples of Boolean expressions include:

- (i) (fifty_dollar_bill_inserted) AND
(player_tracking_card_inserted)
- (ii) (time_of_day > 6pm) AND (empty_hotel_rooms > 30) AND
NOT (player_staying_at_hotel)

- (iii) (help_button_pressed = TRUE)
- (iv) (free_money_hotline_phone_on_hook = FALSE)

[00307] A trigger condition may be based on one or more factors. That is, for example:

- (i) one or more factors may affect the occurrence of a trigger condition
- (ii) one or more factors may affect whether a trigger condition is true
- (iii) one or more factors may cause a trigger condition to occur
- (iv) one or more factors may cause a trigger condition to become true
- (v) one or more factors may affect the output of a message
- (vi) a message may be output based on one or more factors

[00308] General categories of factors include:

- (i) activities by a player (including a player's gaming activities and non-gaming activities)
- (ii) a player's visit to a casino (e.g., arrival, hotel stay, meals, entertainment)
- (iii) characteristics of a player
- (iv) other players associated with the player
- (v) opportunities for revenue management of a casino
- (vi) messages that may be output to a player (including the current message)
- (vii) indications provided by the player
- (viii) indications provided by other parties (e.g., a casino rep, a friend of a player)
- (ix) time-related factors
- (x) characteristics of a game machine

[00309] The controller may store a trigger condition database 322, such as the one shown in FIG. 11A or the one in FIG. 11B. According to this database, a message may be output if a trigger condition is true. For example, "OFF-3-23480923" may be output if a nearby player wins a jackpot.

[00310] In some cases, the trigger condition database 322 indicates that the "NEXT MESSAGE IN QUEUE" should be output; this means that a message from the message queue database 328 shown in FIGs. 14A and 14B may be output.

[00311] According to some embodiments, a message may be output based on factors relating to a player's gaming activities. For example, a message may be output to a player if the player has played a certain number of games, or if he has maintained a certain rate of play.

[00312] Examples of factors relating to a player's gaming activities include:

- (i) an amount of play
- (ii) a rate of play
- (iii) a credit balance
- (iv) comp points earned
- (v) events at a game machine that is operated by a player
- (vi) statistics relating to usage of a game machine by a player
- (vii) characteristics of a game machine
- (viii) gaming activities not performed at a game machine (e.g., lottery tickets, keno, video games)
- (ix) past, present, and anticipated gaming activities

[00313] Examples of factors relating to an amount of play include:

- (i) a duration of play (e.g., how many minutes a player has operated a game machine)
- (ii) how many games a player has played
- (iii) how many comp points a player has earned

- (iv) how long a player uses a feature on the game machine (e.g., how long a player operates a game machine in 3D Graphics Mode)
- (v) how long a condition has been true (e.g., How long has the player maintained a rate of play of more than 7 games per minute? For how many games has the player's credit balance been above 40 coins?)
- (vi) how many spins in a row have been a winner.

[00314] Note that an amount of play may be measured in a variety of different units, including:

- (i) time (e.g., seconds, minutes, hours)
- (ii) occurrences (e.g., number of spins, number of games)
- (iii) currency (e.g., number of coins, dollar value, comp points)

[00315] Examples of factors relating to a player's rate of play include:

- (i) amount of currency per minute (e.g., coins per minute, dollars per minute)
- (ii) average amount of currency per minute (e.g., on a game machine that he is currently operating, on all game machines that he has played since acquiring a player device)
- (iii) average amount of currency per spin
- (iv) average number of games per minute
- (v) Whether a player is currently operating a game machine (i.e., is his rate of play greater than zero?)
- (vi) reel resolution time as set by the casino or in some embodiments, by the player

[00316] According to some embodiments, a rate of play may be measured as an amount of play per unit. For example, the controller may track an average amount of currency bet per spin (e.g., 2.3 coins/spin) or an average amount of currency bet per minute (e.g., 16.7 coins/minute). Examples of units for a rate of play include:

- (i) per session
- (ii) per game (e.g., a spin on a slot machine, a hand of video poker)
- (iii) per minute (or other unit of time – seconds, hours, days, etc.)
- (iv) per event (e.g., per spin, per usage of a feature, per card selection in video poker, per coin bet)

[00317] Examples of factors relating to a player's credit balance. Examples include:

- (i) current credit balance on a game machine
- (ii) a current credit balance on a plurality of game machines (e.g., in an embodiment in which a player may operate a plurality of game machines simultaneously, or store a credit balance on a game machine)
- (iii) average credit balance (e.g., on a game machine that he is currently operating, on all game machines that he has played since acquiring a player device)

[00318] Commonly owned Application Serial No. 10/419,306 entitled "Method and Apparatus for Providing A Bonus to a Player Based On a Credit Balance" (which is incorporated herein by reference) includes a description of providing a benefit for a player based on his credit balance on a game machine.

[00319] According to some embodiments, a trigger condition may be based on a number of comp points earned by a player. Comp points may be provided to a player for a variety of different reasons, as are known to those skilled in the art.

[00320] Examples of factors relating to events at one or more game machines include:

- (i) outcomes that are generated by a game machine

- (ii) intra-game events (e.g., a player is dealt a card in video poker, a player discards a card in video poker, a player gains access to a bonus round on a slot machine)
- (iii) payouts that are provided by a game machine (e.g., 10 coin payout, a \$100 jackpot)
- (iv) money is inserted into a game machine by a player (e.g., using a bill acceptor or a coin slot)
- (v) money is removed from a game machine by a player (e.g., a player presses the 'cash out' button)
- (vi) a bonus is provided to a player (e.g., a player may earn a 10 coin bonus for inserting a \$20 bill into a game machine)
- (vii) a player identifies himself (e.g., a player may insert a player tracking card into the game machine)
- (viii) a feature is activated or deactivated. According to some embodiments, a player may receive a service as long as a feature is enabled. For example, a player may receive free telephone service as long as the player operates a game machine in auto-play mode.
- (ix) a player operates an input device on a game machine (e.g., a player presses the 'spin' button on a slot machine, a player uses a touch screen to select a card on a video poker machine)
- (x) information may be output to a player using an output device (e.g., a message may be displayed to a player on a video screen alerting him that he only has 10 coins left)
- (xi) indications from sensors – For example, a game machine may have a weight sensor that determines when a player is standing in front of the game machine. In a second example, a game machine may have a microphone that may be used to determine when a player is speaking (e.g., with a friend).
- (xii) navigation of menus on a game machine. For example, a player may use one or more menus on a game machine to select a feature or indicate his preferences.

[00321] In addition to events themselves, information about events may be factors that affect a trigger condition. Examples of information about events include:

- (i) what event occurred
- (ii) when the event occurred (e.g., what date, what time of day, ordering of events)
- (iii) how often an event occurred (e.g., 14 times, an average of 32.6 times per hour)
- (iv) how much money was added/removed/involved in the event (e.g., How much money did a player insert into a game machine? How large was a payout provided to a player?)
- (v) results of the event (e.g., What was a player's credit balance after he won a jackpot? What is the state of a program on a game machine after the game machine's software is upgraded?)
- (vi) what caused an event to occur (e.g., why did a player win a jackpot of 100 coins?)
- (vii) other information describing the event (e.g., what authentication code was provided, what activation code was provided)

[00322] Examples of statistics relating to usage of one or more game machines include:

- (i) totals
- (ii) averages
- (iii) percentages and ratios
- (iv) revenues (i.e., "win")
- (v) theoretical win
- (vi) total payouts won
- (vii) play patterns (events, times, order, speed of play, strategies used by players)

[00323] Examples of totals include:

- (i) a total amount of time (e.g., how many hours a game machine is operated, how many minutes a feature is used)
- (ii) a total number of occurrences of an event (e.g., a total number of offers accepted by players, a total number of times that a feature is activated)
- (iii) a total value of a plurality of events (e.g., a total amount of money cashed out of a game machine, a total amount of payouts provided)

[00324] Examples of averages include:

- (i) average credit balance
- (ii) average coin-in per spin
- (iii) an average number of occurrences of an event (e.g., an average number of spins per minute)
- (iv) an average value of a plurality of events (e.g., an average credit balance, an average price of hotel rooms sold to players through a game machine)

[00325] Note that averages may be calculated on a 'per unit' basis. For example, the controller may calculate an average coin-in per game (e.g., 2.3 coins per game) or an average coin-in per session (e.g., 312 coins per session). Examples of units for averages include:

- (i) per session
- (ii) per game (e.g., a spin on a slot machine, a hand of video poker)
- (iii) per minute (or other unit of time – seconds, hours, days, etc.)
- (iv) per event (e.g., per usage of a feature, per card selection in video poker)

[00326] Examples of percentages and ratios include:

- (i) a percentage of time (e.g., what percentage of time a game machine spends waiting for an input from a player)

- (ii) a percentage of events (e.g., what percentage of offers presented to a player are accepted)
- (iii) a percentage of games (e.g., what percentage of games are played with a particular feature enabled)
- (iv) a percentage of sessions (e.g., what percentage of sessions are longer than 3 hours)

[00327] Examples of characteristics of a game machine include:

- (i) a location of the game machine (e.g., is a game machine located near an entrance to a casino) Note that a game machine may be portable.
- (ii) which player or players are operating the gaming machine -- For example, it may be possible for a plurality of players to operate a game machine simultaneously (e.g., as a team, or competitively).
- (iii) output devices of the game machine (e.g., is an output device currently in use and therefore not available to output a message)
- (iv) input devices of the game machine (e.g., is an input device currently in use and therefore not available for a player to use to respond to a message)
- (v) hardware of the game machine (e.g., does the game machine have enough memory to store a message?)

[00328] Examples of factors relating to gaming activities that may not be performed at a game machine include:

- (i) lottery tickets – For example, a message may be output to a player when a lottery drawing is about to occur.
- (ii) sports betting – For example, a message may be output to a player based on a sporting event that the player has bet on.
- (iii) bingo – For example, a message may be output to a player based on the start of a new round of bingo.

[00329] Note that factors may relate to a player's past, present, or anticipated future gaming activities. Examples include:

(i) past gaming activities – For example, a message may be output based on a player's average rate of play over the last hour.

(ii) present gaming activities – For example, a message may be output based on a current outcome achieved by the player.

(iii) anticipated future gaming activities – For example, a message may be output to a player if the player is standing in front of a game machine that is not in use. As discussed above, a game machine 104 may include one or more sensors that may assist it in determining that a player is standing nearby. In a second example, a message may be output to a player based on the player's indication that he plans to play games for the next 3 hours.

[00330] A message may be output based on factors relating to messages. For example, here are some exemplary trigger conditions relating to messages:

(i) (promotional_messages_last_hour < 5) That is, only output a message to a player if the total number of promotional messages in the last hour is less than 5. Otherwise, delay outputting the message.

(ii) (current_time – time_of_last_message) => 5 minutes) That is, make sure that there are at least 5 minutes between messages being output to a player.

(iii) (NOT (buddy_list_has_received_message (message#14351, 24 hours))) That is, don't output a message to a player if somebody on his buddy list has already received the same message in the last 24 hours.

(iv) (queued_to_output (message #293457)) That is, output this message if message #293457 is already queued to output. For example, this trigger condition may be useful for outputting two messages at the same time or back-to-back.

(v) (related_topics (message #1234213, messages #4980524))

That is, two messages may be output simultaneously if their topics are related. For example, a promotional message relating to a restaurant may be output at the same time as a status message reminding a player about his dinner reservation at the restaurant.

[00331] Note that trigger conditions include factors relating to a variety of different types of messages. Examples of different types of messages include:

(i) the message to be output – For example, a trigger condition to output message PROMO-1-85923475 may be based on the content of message PROMO-1-85923475 (e.g., the amount of discount provided by the message). In a second example, a trigger condition to output a status message relating to the score of a baseball game may be based on the time of the message (e.g., when the score of the baseball game changed).

(ii) past messages – messages that have already been output to a player. For example, there may be a restriction that only one promotional message can be output to a player every 5 minutes. In a second example, an activity benefit offer may be output to a player based on his response to a previous promotional message. In a third example, a less detailed message promoting a product or feature may be output to a player if the player has already received a more detailed message about the product or feature.

(iii) future messages – messages that may be output to a player in the future. For example, if two promotional messages are already slated to be output to a player, then the controller may refrain from outputting additional promotional messages to the player. In a second example, if a player is scheduled to receive level 1 and level 2 instructive messages for the Golden Egg slot machine, then the player may additionally be scheduled to receive a level 3 instructive message for the Golden Egg slot machine.

(iv) current messages -- messages that are currently being output to a player. For example, an instructive message describing how to operate a game machine may be being output to a player. If it appears that the player does not understand the message, then a second instructive message may be output to the player.

(v) messages output to other players, including past messages to other players, future messages to other players, and current messages to other players. For example, an activity-benefit offer may be output to a player if 3 of the 4 friends on his buddy list have already received activity-benefit offers themselves.

[00332] For example, it may be particularly beneficial to output a promotional message based on one or more other messages that may be output (e.g., past, current, or future messages). For example:

(i) An instructive message relating to Auto-Play Mode may be output to a player. Based on this instructive message, an activity-benefit offer relating to Auto-Play Mode may be output the player. For example, the activity benefit offer may be output in the same window as the instructive message.

(ii) A communication message including the word "dinner" may be queued to be output to a player in the future. In addition, an advertisement for a local restaurant may be queued to be output to a player. Based on the similar topics of these two messages, the order of the queue of messages may be modified so that the messages are output sequentially.

[00333] According to some embodiments, the invention may include a step of determining a promotional message based on one or more other messages that may be output. See below for details about determining a first message based on a second message.

[00334] As described above, the controller 102 may store a message history database 332. One example of a message history

database is shown in FIG. 16. This database 332 may be useful in tracking messages that have already been output to players and thereby enable the controller 102 to output a message based on one or more past messages.

[00335] As described above, the controller 102 may store a message queue database 328. One example of a message queue database 328 is shown in FIGs. 14A and 14B. This database may be useful in tracking messages that may be output to players and thereby enable the controller to identify players based on future messages.

[00336] Examples of factors relating to messages include:

- (i) statistics relating to messages
- (ii) responses to messages
- (iii) content of messages
- (iv) outputting of messages

[00337] Each of these factors is described in detail below.

[00338] Statistics relating to messages include:

- (i) an amount of messages
- (ii) a rate of messages
- (iii) totals
- (iv) averages
- (v) percentages and ratios

[00339] Note that statistics may relate to past, future, and current messages to a player or to other players. Information stored by the controller in various databases (e.g., a message history database) may be useful in determining statistics. Each of these different types of statistics is described in detail below.

[00340] Examples of factors relating to an amount of messages include:

- (i) a number of messages (e.g., 10 messages)
- (ii) a duration of one or more messages (e.g., how many seconds or messages a player has viewed)

(iii) an amount of information in one or more messages (e.g., 50Mb of messages)

(iv) an amount of benefits offered by one or more messages (e.g., \$30 worth of discounts)

[00341] Examples of factors relating to a rate of messages include:

(i) an amount of messages per unit time (e.g., 10 messages per hour, 5 minutes of messages per hour of gaming)

(ii) a duration between messages (e.g., 8 minutes)

(iii) a rate of messages per game play (e.g., 1 message every 20 spins, 0.05 messages per spin)

[00342] A rate of messages may be measured as an amount of messages per unit. For example, the controller may track an average number of messages output to a player per game play (e.g., 0.1 messages/spin) or a total value of messages per session (e.g., \$52/session). Examples of units for a rate of messages include:

(i) per session

(ii) per game play (e.g., a spin on a slot machine, a hand of video poker)

(iii) per minute (or other unit of time – seconds, hours, days, etc.)

(iv) per event (e.g., per spin, per usage of a feature, per card selection in video poker, per coin bet)

(v) per bill inserted.

(vi) per room per night stayed in a hotel.

[00343] Examples of factors relating to a total of messages include:

(i) a total number of messages output to a player

(ii) a total duration of instructive messages output during a session

- (iii) a total number of promotional messages output to all players
- (iv) a total amount of benefits offered to friends of a player
- (v) a total number of messages to a given bank of game machines (e.g. to ensure that all offers aren't output to the same bank of game machines)

[00344] Examples of factors relating to an average of messages include:

- (i) an average duration between messages to a player
- (ii) an average number of messages from a specific sponsor output per hour
- (iii) an average benefit offered to a player in one or more promotional offers

[00345] Examples of factors relating to a percentage or ratio of messages include:

- (i) a percentage of messages of a certain type
- (ii) a percentage of messages that are status messages relating to a player's visit to a casino
- (iii) a percentage of accepted activity-benefit offers that provide discounts on products
- (iv) a ratio of promotional messages to other types of messages

[00346] When a messages is output to a player, the player may respond or react to this message in various ways, including:

- (i) acknowledging that the message was received (e.g., pressing an "OK" button on a touch screen)
- (ii) removing, hiding, or deleting the message (e.g., closing or minimizing a pop-up window that displays the message)
- (iii) accepting or declining an offer (e.g., pressing an "I accept, sign me up!" button on a touch screen)

- (iv) performing or not performing an activity specified in a promotional message or activity-benefit offer
- (v) accepting or receiving a benefit provided by a promotional message or activity-benefit offer
- (vi) requesting additional information (e.g., "This was an useful instructive message, please give me more like it.")
- (vii) indicating an opinion about the message (e.g., "I don't need to be reminded about my dinner reservation.")
- (viii) storing the message for later review.

[00347] Responses or indications by a player (e.g., such as those described above) may be factors in outputting a message to a player. For example, if a player accepts an activity-benefit offer, then this may trigger an additional promotional offer to be output to the player. For future messages or current messages, anticipated responses by a player may be factors. Other players' responses to messages may also be considered as factors in outputting a message to a player.

[00348] Messages may be also be output based on the content of past, future, or current messages. Examples of factors relating to the content of messages include:

- (i) similarities in the content of messages – For example, two messages with similar content may be output in the same partition. In a second example, two communication messages from the same party may be output in the same color.
- (ii) differences in the content of messages – For example, promotional messages relating to food and beverages may be output in a first partition, and instructive messages about game play may be output in a second partition.
- (iii) parameters of a message (e.g., what size discount is offered by an activity-benefit offer, what sort of instruction is provided by an instructive message)

(iv) a category of a message (e.g., a promotional messages from Acme, a communication message from player #124)

(v) a representation of a message (e.g., what partition or presenter is used to output a message, what language a message is in, visual cues in outputting a message). For example, a message may be output in a partition if no other message has been output in this partition during the last 5 minutes.

(vi) a length of a message

(vii) a time when a message originated

(viii) a time when a message is output

(ix) an originator of a message

(x) an importance of a message

[00349] Messages may also be output based on output of other messages. As described above, messages may be output to a player in various different representations. Various factors relating to the output of past, future, or current messages may affect the output of a message. Examples of factors relating to outputting messages include:

(i) what output device is used to output a message (e.g., audio speaker or video screen; video screen #1 vs. video screen #2)

(ii) a representation of a message that is output (e.g., including media format, language, presenter, partition, visual cues, and category)

(iii) responses to messages – For example, a message may be output in green if previous messages output in green have elicited positive responses from a player.

[00350] As mentioned above, a message may be output based on factors such as:

(i) non-gaming activities by a player

(ii) events relating to a player's visit to a casino (e.g., arrival, hotel stay, meals, entertainment)

(iii) characteristics of a player

(iv) other players associated with the player

- (v) opportunities for revenue management of a casino
- (vi) time-related factors
- (vii) indications by various parties
- (viii) other gaming activities at a casino

[00351] A message may be output based on a player's non-gaming activities. General categories of non-gaming activities include:

- (i) communication (e.g., a player may talk with a friend or a casino representative)
- (ii) food and beverages (e.g., a player may consume a complimentary beverage)
- (iii) visit to a casino (e.g., a player may stay at a hotel associated with a casino)
- (iv) entertainment (e.g., a player may watch a show or sporting event)
- (v) arrival and departure (e.g., a player may fly to Las Vegas to visit a casino)

[00352] A message may be output based on communication by/with a player. Examples of communication by/with a player include:

- (i) a player may talk with a friend who is sitting at a nearby game machine
- (ii) a player may use a cellular telephone to talk with a friend
- (iii) a player may communicate using a game machine (e.g., by using a keyboard to send instant messages to his friends)
- (iv) a player may see gaming results of another player

[00353] A message may be output based on food and beverages consumed by a player. Examples of factors relating to food and beverages consumed by a player include:

- (i) the player receives a complimentary beverage
- (ii) the player requests a complimentary product or service

- (iii) the player receives a complimentary product or service
- (iv) meals eaten by the player at restaurant associated with the casino
- (v) whether the player has purchased a meal at restaurant associated with the casino
- (vi) a player consumes a food or beverage item

[00354] A message may be output based on a player's visit to a casino. Examples of factors relating to a player's visit to a casino include:

- (i) when a player arrives at the casino
- (ii) whether the player has reserved a hotel room at the casino
- (iii) visits by a player to his hotel room
- (iv) when a player checks into a hotel
- (v) when a player checks out of a hotel
- (vi) phone calls, voicemail, email, or faxes that a player receives at a casino (e.g., in his hotel room)
- (vii) previous visits to the casino by the player

[00355] A message may be output based on entertainment consumed by a player. Examples of factors relating to entertainment include:

- (i) a player attends a show or sporting event
- (ii) a player views a movie or other entertainment while using a game machine – For example, a partition or window on a game machine may display a television show to a player so that the player can continue gaming while still watching his favorite TV show. In a second example, a player may use a portable internet terminal to view entertaining web content while operating a game machine.

- (iii) entertainers at a casino visit players at their game machines

[00356] Examples of characteristics of players include:

(i) a player's preferences (e.g. hobbies, interests) See below for further details of how a player may indicate his preferences for receiving messages.

(ii) a player's demographic group

(iii) what language a player speaks

(iv) messages that have been output to the player in the past

(v) information stored in the player database 308

(vi) information determined by a casino representative (e.g., by talking to the player)

(vii) the player's hobbies and interests (e.g., sailing, golf)

(viii) physical characteristics of the player (e.g., age, height, weight, nationality, gender, dress and appearance)

(ix) psychological characteristics of the player (e.g., creativity, risk-aversion)

(x) the player's marital status

(xi) the player's occupation, income, work hours, credit report

(xii) the player's medical history

[00357] According to some embodiments, the controller may output a message to a first player based on events or conditions relating to other players who are in some way associated with the first player. Conditions relating to other players are similar to the conditions listed above and elsewhere thought the specification. For example, a message may be output to a first player based on the gaming activities of a second player. Examples of other players associated with the player include:

(i) a player who is operating a nearby slot machine. For example, if a first player wins a jackpot, then the controller may output a message to a second player at a nearby slot machine.

(ii) a player who is sharing a room with the player

(iii) a player who arrived on the same bus as the player

(iv) family members, friends, and other associates of the player

[00358] Conditions or events relating to revenue management of a casino may also be considered when outputting a message. Examples include:

(i) To maximize revenues, a casino may want to fill all of its hotel rooms on a Wednesday night. If it is 6pm on Wednesday night and the casino hotel is only half full, then this may result in a trigger condition (e.g. offering a free or discounted room to the player if he agrees to perform some obligation).

(ii) To maximize revenue, a casino may desire to maximize the number of slot machines that are being played at any given time. A trigger condition may occur if only 10% of the slot machines in a casino are currently being played (e.g. play slots and get a pair of show tickets for the price of one).

[00359] Examples of time-related factors include:

(i) a duration of time since an event took place.

(ii) a duration of time since a condition occurred. For example, a message may be output 5 minutes after a condition occurs, thereby making it less obvious to a player that the message is being output based on the condition.

(iii) a time of the day, week, month, or year – For example, a message may be output on the first Tuesday of every month.

(iv) the current time of day is 6pm, which is when the player usually eats dinner

(v) the current time of day is 8am, and the player must check out of the hotel at 11am

[00360] Indications by various parties may be factors in outputting a message. Examples include:

(i) A player may provide an indication. For example, a player may press a button on a game machine to indicate that he would like to receive a message.

(ii) A casino employee may provide an indication. For example, a casino employee review information about a player that is stored in a database (e.g., the player database shown in Figure 4). Based on this review, the casino employee may indicate that a player seems confused and may need assistance in learning how to play a game.

(iii) An associate of a player (e.g., a friend or relative) may provide an indication. For example, a player's friend may indicate that the player is about to cash out and should receive a reminder relating to his hotel room bill. In a second example, a friend of a player may indicate that the player just lost \$50 at another casino and would be interested in earning the money back.

[00361] A message may be output based on a player's gaming activities. Alternatively, or in addition, a message may be output to a player based on gaming activities at a casino that are not necessarily performed by the player. For example, a message may be output to a player based on the average utilization of a game machine over the last month. Examples of factors relating to gaming activities at a casino include:

(i) overall usage of a game machine that a player is operating (i.e., including usage by other players) See below for examples of factors relating to usage of at least one game machine.

(ii) usage of other game machines at a casino (e.g., nearby game machines, game machines of the same type, game machines that share a progressive jackpot, game machines with a common theme, game machines that are associated with a game machine operated by the player). See below for examples of factors relating to usage of at least one game machine.

(iii) gaming activities at a casino that do not involve game machines (e.g., table games, betting on horse races and other sporting events)

[00362] Examples of factors relating to usage of one or more game machines include:

(i) whether a game machine is currently in use. For example, an unoccupied game machine may output a message to a nearby player (e.g., a player who is walking by the game machine). In a second example, a message relating to first game machine that is unoccupied may be output on a second game machine that is being operated by a player (e.g., a player who has been waiting to play the first game machine).

(ii) when a game machine was last used (e.g., a player just stopped using a game machine)

(iii) overall utilization of one or more game machine (e.g., measured as what percentage of time a game machine is in use). For example, a message may be output to a player if 90% of all the game machines on the floor of a casino are in use.

(iv) events at one or more game machines. For example, a message may be output to a player if a game machine near the player just awarded a jackpot.

(v) statistics relating to usage of one or more game machine. For example, a message may be output to a player if the average rate of play on a group of progressive jackpot game machines is greater than 15 coins/minute.

(vi) past, present, or anticipated usage of at least one game machine. For example, if a show at a casino just finished, then there may be large number of players entering the gaming floor of a casino. Based on this, a message may be output when the show finishes.

[00363] According to some embodiments, a plurality of messages may be output at a game machine.

(i) Two messages may be output simultaneously.

(ii) A first message may be output, and then a second message may be output.

[00364] According to various embodiments, the method of the invention may include one or more of the following steps:

- (i) identifying a plurality of messages
- (ii) determining a plurality of messages
- (iii) selecting a plurality of messages
- (iv) outputting a plurality of messages

[00365] According to some embodiments, the method of the invention may include determining an order in which to output the plurality of messages. Variations include:

- (i) ordering the plurality of messages
- (ii) determining an order of the plurality of messages
- (iii) sorting the plurality of messages
- (iv) prioritizing the plurality of messages
- (v) determining priorities of the plurality of messages
- (vi) determining an index for each of the plurality of messages
- (vii) selecting a message to output first

[00366] For example, the controller may use a point system to order messages. A scoring function may be used to determine a point value for each of a plurality of messages. Then the controller may sort the messages according to their point values (e.g., so that the messages with the highest point values are output first). For example, one scoring function might be:

$$\begin{aligned} \text{point_value} = & \quad (\text{max_benefit_from_message}) * 2 \\ & + (\text{priority_of_message_originator}) * 3 \\ & - (\text{length_of_message}) \end{aligned}$$

[00367] According to this scoring function, a promotional offer from Joe's Flowers that offers a player \$5 off any order of \$10 or more may receive a point value of 15:

- (i) $(\text{max_benefit_from_message} = 5) * 2 = 10$
- (ii) $(\text{priority_of_message_originator} = 3) * 3 = 9$
- (iii) $\text{length_of_message} = 4$
- (iv) $\text{total point value} = 10 + 9 - 4 = 15$

[00368] In comparison, a status offer alerting a player that his restaurant table is ready may be scored as having a point value of 25. Therefore, the status offer about the player's restaurant table may be output before the promotional offer about Joe's Flowers.

[00369] Of course there are a variety of other ways to order messages. For example, the controller may use a rules-based system to order messages. These rules may guide the ordering of messages being output. For example, one set of rules for ordering messages might be:

- (i) Status messages should always be output first.
- (ii) If there are multiple status messages, the status messages should be output simultaneously.
- (iii) After all status messages have been output, any communication messages should be output.
- (iv) If there are multiple communication messages, they should be output in order of time, with messages from a player's friends and family output first.
- (v) Promotional offers that do not provide benefits should be output last.
- (vi) Messages describing promotional offers should be output based on the expected value of each message to the casino

[00370] Messages may be ordered based on a variety of different criteria, including:

- (i) one or more indications by a player -- For example, a player may indicate that he would like to receive status messages first, followed by communication messages and promotional messages. According to

various embodiment, a player may specify one or more rules for a rules system and/or a scoring function for a points system.

(ii) one or more indications by another party (e.g., a casino employee) – For example, a casino employee may adjust the weights of various parameters in a scoring function.

(iii) a type of a message

(iv) content of a message

(v) properties of a message

(vi) originator of a message

(vii) an importance of a message

(viii) a length of a message

(ix) a time that a message originated

(x) expected value of messages – For example, messages may be ordered according to their expected value to a casino, with message that have the highest expected value being output first.

(xi) random numbers – For example, if two messages are of equal priority, the controller may randomly select one of the messages to be output first.

[00371] Messages may be output in order. Variations include:

(i) outputting a plurality of messages in order

(ii) outputting a plurality of messages based on an order

(iii) outputting a plurality of messages based on a sort

(iv) outputting a plurality of messages based on one or more priorities

[00372] The controller may store a message queue database 328, such as the one shown in FIGs. 14A and 14B. The message queue database may store an ordered list of messages to be output to a player. For example, the message queue 328 shown in Figures 14A and 14B is ordered according to priority, with higher priority messages to be output before lower priority messages.

[00373] Output of a message may be prevented or suppressed. For example, the controller or a game machine may prevent a message from being output to a player if the message would be distracting to the player.

[00374] Suppressing a message may include:

- (i) preventing the message from being output
- (ii) not outputting the message
- (iii) canceling output of the message
- (iv) delaying output of the message
- (v) outputting a message through a different device

[00375] A message may be suppressed for a variety of reasons, including:

- (i) wrong time – For example, a player may currently be busy with another activity or enjoying a winning streak.
- (ii) wrong content – For example, a message may be a duplicate of a previous message.
- (iii) wrong representation - For example, a message may not be in the language of the player

[00376] Benefits of suppressing a message include:

- (i) Players may no longer be annoyed or bothered by inappropriate messages.
- (ii) Players may not be distracted from their gaming as often.
- (iii) Since inappropriate messages may be suppressed, players may pay closer attention to those messages that are output.

[00377] One way to control the suppression of messages is to suppress a message based on a suppression condition. That is,

- (i) A message may be suppressed when a suppression condition is true.
- (ii) A message may be suppressed because of a suppression condition.
- (iii) A message may be suppressed because a suppression condition is true.

[00378] Note that a suppression condition may be thought of as the opposite of a trigger condition:

- (i) A message may be output when a trigger condition is true.
- (ii) A message may be not output when a suppression condition is true.

[00379] According to some embodiments, a suppression condition may be a Boolean expression.

[00380] A suppression condition may be based on one or more factors. That is,

- (i) a message may be suppressed based on one or more factors
- (ii) one or more factors may cause a message to be suppressed
- (iii) one or more factors may affect whether a suppression condition is true

[00381] General categories of factors that may cause a message to be suppressed include:

- (i) a player's gaming activities
- (ii) a player's non-gaming activities
- (iii) characteristics of a player
- (iv) other players associated with the player
- (v) opportunities for revenue management of a casino
- (vi) other messages that have been presented or will be presented
- (vii) indications provided by the player
- (viii) indications provided by other parties (e.g., a casino representative, a friend of a player)
- (ix) time-related factors

[00382] Note that these categories of factors are the same as the factors listed for trigger conditions discussed in detail above. A message

may be suppressed based on any of the factors listed for trigger conditions. Some examples of suppressing messages based on various factors are provided below.

[00383] A message may be suppressed based on a player's gaming activities. Examples of factors relating to a player's gaming activities include:

(i) rate of play. For example, a message may be suppressed if a player's speed of play is faster than a threshold value, since this may indicate that the player is focused on gaming and should not be disturbed.

(ii) game content. For example, a message may be suppressed if a player is currently playing a bonus round, or if a player is faced with a particularly difficult decision in game play (e.g., in video poker). In a second example, a message may be suppressed while a player is waiting for the reels of a slot machine to stop spinning.

(iii) sensors on a game machine. For example, a game machine may include a microphone to determine whether a player is in the middle of a conversation with a friend. In a second example, a drink holder on a game machine may include a weight sensor to determine whether a player is currently sipping his drink.

(iv) operation of a game machine. For example, a message may be suppressed if a player is currently navigating menus on a game machine to activate a feature.

(v) events at a game machine. For example, all hypothetical info messages may be suppressed for 15 minutes after a player wins a payout of more than 100 coins.

(vi) indications by a player. For example, a message may be suppressed if a player presses the "cash out" button on a slot machine or inserts a dollar bill into a bill acceptor on a video poker machine.

[00384] A message may be suppressed based on characteristics of a game machine. Examples of factors relating to characteristics of a game machine:

(i) a location of the game machine – For example, a message may be suppressed if a game machine is located in an area where other players may be able to view the message.

(ii) output devices of the game machine – For example, a message may be suppressed if a game machine does not have a video screen suitable for outputting the message.

(iii) input devices of the game machine – For example, a message may be suppressed if a game machine does not have a touch screen that a player could use to respond to a message.

(iv) hardware of the game machine – For example, a message may be suppressed if a game machine does not have a fast enough processor to decode a streaming video.

[00385] A message may be suppressed based on a player's non-gaming activities. Examples of factors relating to a player's non-gaming activities include:

(i) communication – For example, a player may communicate with other players, friends, or relatives while operating a game machine (e.g., because they are nearby, or by using a cellular telephone, or a communication device on a game machine).

(ii) entertainment – For example, a player may watch a television show (e.g., a sporting event) while at a game machine. Messages may be output to the player during commercial breaks or other appropriate intermissions in the entertainment.

(iii) food and drinks – For example, a message may be suppressed if a player is currently busy ordering or consuming a complimentary drink.

[00386] A message may be suppressed based on messages that may be output to a player. Examples of factors relating to messages include:

- (i) current, past, and future messages – For example, a message may be suppressed if a player has already received, is currently receiving, or is scheduled to receive the message or a similar message.
- (ii) messages to other players – For example, a message may be suppressed if a friend of a player has already received, is currently receiving, or is scheduled to receive the message or a similar message.
- (iii) statistics relating to messages – For example, there may be a limit on the number of messages that a player should receive during a certain period of time (e.g., a maximum of 5 messages per hour).
- (iv) the message itself – For example, a communication message may be suppressed if the communication message contains profanity or vulgar language.

[00387] A message may be suppressed based on time-related factors. An example of a factor relating to time includes a duration of time since an event or condition occurred. For example, messages may be suppressed for the first 10 minutes that a player operates a game machine. In a second example, a message may be suppressed for 5 minutes after a player accepts an activity-benefit offer.

[00388] A message may be suppressed based on characteristics of a player. Examples of factors relating to characteristics of a player include:

- (i) A status message that is only available in English may be suppressed if a player only speaks French.
- (ii) A promotional message relating to cigarettes may be suppressed if a player is trying to quit smoking.
- (iii) The audio portion of a movie message may be suppressed if a player is deaf or hard of hearing.

[00389] A message may be suppressed based on an indication from a player or another party. Examples of indications from various parties include:

(i) A player may indicate that he would rather not receive instructive messages when playing video poker.

(ii) A casino employee may indicate that a player should not receive any promotional messages relating to alcohol.

[00390] Suppressing a message may include delaying output of the message. Output of a message may be delayed until a trigger condition occurs. For example, the controller may determine that an advertisement for Acme laundry detergent should be output to a player. However, this message may be suppressed because the player is currently playing a bonus round on a game machine (i.e., a suppression condition). The advertisement may later be output after the bonus round is over (i.e., a trigger condition).

[00391] Suppressing a message may include canceling or deleting the message. That is, a suppressed message may be completely removed from a message queue database 328.

[00392] The controller may store a suppression condition database 330, such as the one shown in FIG. 15. In the depicted example version of the suppression condition database 330, a message will be suppressed if any of the listed suppression conditions are true. If a message is suppressed, it may be:

(i) delayed until a trigger condition occurs -- For example, if a player is currently playing a bonus round on a game machine, a message may be suppressed. The message may later be output if the bonus round ends and the player wins a bonus payout of less than 100 coins.

(ii) cancelled -- For example, if a player does not speak the language of a message (e.g., a message is in English, but the player only speaks French), then the message may be cancelled and not output at all.

(iii) put in the message queue -- For example, a message may be put back into a message queue database 328 (as shown in FIGs. 14A and 14B). The message may then be output later (e.g., based on a trigger condition).

(4) Output The Message

[00393] In Step 1708, the message and/or the representation are output to the player at a game machine. The game machine may be operated by a player, who may or may not be identified. For example, a player may or may not have inserted a player tracking card into the game machine. Variations of outputting a message at a game machine may include:

- (i) outputting an indication of a message
- (ii) outputting a representation of a message
- (iii) displaying a message
- (iv) revealing a message
- (v) indicating a message
- (vi) outputting a message through a game machine
- (vii) outputting a message on a game machine
- (viii) outputting a message using a game machine
- (ix) outputting a message using an output device at a game machine
- (x) outputting a message by transmitting it to a game machine
- (xi) a game machine outputs a message
- (xii) outputting a message using a device associated with a game machine (e.g., a player tracking card reader)
- (xiii) outputting a message using a device associated with a plurality of game machines (e.g., a central display for progressive jackpot)

[00394] A player may customize how messages are output to him, when messages are output to him, or what type of messages are output to him. For example, a player may indicate that he prefers to receive messages when he presses the cash out button on a game machine. In order to customize how messages are output to him, a player

may indicate his preferences. Various ways that a player may indicate his preferences and thereby customize how messages are output to him are now described.

[00395] One way for a player to indicate a preference is by indicating a rule or condition for outputting one or more messages. A rule may be a trigger condition, a suppression condition, or an indication that is convertible to a trigger condition or suppression condition (e.g., a text phrase or a selection from a list of options).

[00396] A player may indicate a preference for at least one specific type of message. Examples include:

- (i) A player may indicate that he only wants to receive promotional messages at the beginning or end of his gaming sessions.
- (ii) A player may indicate that he that he would like status messages to be output to him in audio format.
- (iii) A player may indicate that instructive messages should not be output to him after he has been playing a game machine for more than 10 minutes.
- (iv) A player may request that she receive instructions any time she starts playing a game that she has never played before.

[00397] A player may indicate a preference for all messages. Examples include:

- (i) A player may indicate that no messages of any type should be output to him while he is playing a bonus round.
- (ii) "All messages should be output in pop-up windows."

[00398] A player may indicate a preference of when to output one or more messages. Examples include:

- (i) "Output messages at the beginning of a gaming session when I insert my player tracking card."
- (ii) "Output an instructive message the first time I win access to a bonus round on a game machine."

(iii) "Instructive messages should be output in between game plays (i.e., after the end of a game play and before the beginning of the next game play)."

(iv) A player may indicate that he would like to receive messages at the present time (e.g., "Now is a good time to output messages.")

[00399] A player may indicate a preference of when to not output one or more messages. In some cases, rules for when messages should not be output may be more common than rules for when messages should be output. Examples include:

(i) "Don't output a message in the middle of a winning streak."

(ii) A player may indicate, "It's okay to output messages anytime except when I'm in the middle of composing an instant message."

(iii) A player may operate an input device on a game machine to indicate that he would not like to receive any promotional messages until after he has won a payout of at least 10 coins on a game machine.

(iv) A player may indicate that he does not want to receive any messages at the present time (e.g., "Don't output any messages for the next 5 minutes." or "Postpone any messages for 5 minutes.") This feature may be particularly useful if a player is in the middle of a winning streak on a game machine, is busy conversing with a friend, or otherwise would not be able to devote his full attention to a message that is output.

[00400] A player may indicate a preference of how to output one or more messages. Examples include:

(i) "Status messages should be output in audio format."

(ii) "Instructive messages should be output in green text in the header window on my game machine."

(iii) "Pop-up windows that display messages should close automatically in 5 seconds."

(iv) "Please transmit all status messages to my PDA."

[00401] A player may indicate a preference of how not to output one or more messages. Examples include:

- (i) "If a game machine that I'm operating has a music soundtrack, don't output messages in audio format."
- (ii) "If a message is longer than 50 words, don't output it using the footer partition. Output it in a pop-up window."

[00402] A player may indicate a preference based on a message that is output to him. For example, a message may be output to a player and then the player may indicate whether he likes or dislikes the manner in which the message was output. Examples include:

- (i) When a message is output in a manner that a player likes (e.g., an instructive message is displayed when the player is confused), the player may press a "thumbs up" button on a game machine. When a message is output in an inappropriate manner (e.g., a non-urgent status message is output right in the middle of a player's bonus round), the player may press a "thumbs down" button on the game machine.
- (ii) A player may indicate what he likes or dislikes about the output of a message. For example, a player may indicate that the timing of the messages was good, but that he would prefer that the message be output in a pop-up window as opposed to a header partition. In second example, a player may indicate that he would prefer that a message be output in both audio and text form instead of just audio form.

[00403] An indication of a player's preference relating to at least one message may be stored in a database, such as the player database 306 shown in FIG. 4. For example, the player database may store an indication that a player prefers to receive instructive messages at the start of his gaming session, but not during the middle of his gaming session.

[00404] A player may indicate his preferences using an input device on a game machine. The game device may in turn transmit an indication to the controller. Examples include:

(i) A player may use a touch screen on a game machine to navigate one or more menus and select what types of messages he would like to receive and when he would like to receive these messages.

(ii) A player may press a button on a slot machine marked "Give me an offer."

(iii) A player may use a touch screen on a slot machine to indicate that he would like help in understanding how to play a game.

(iv) A player may pick up a telephone on the side of a game machine, thereby identifying himself and initiating a telephone call to check the phone messages in his hotel room.

[00405] A player may indicate his preferences using a computer terminal. Note that computer terminals may take various forms, including: a personal computer, a set-top box, a kiosk, a notebook computer, a tablet computer, a personal digital assistant (PDA), a cellular telephone. Examples include:

(i) A player may use a personal computer with a web connection to log onto a casino's web site and indicate what types of messages he would like to receive while operating a game machine.

(ii) A player may use a kiosk at a casino to indicate what messages he would like to receive.

(iii) A player may dial a toll-free number using his cellular telephone and navigate a series of audio menus to indicate that he would like to receive messages.

(iv) A player may use a set-top box in his hotel room at a casino to indicate that he would like to receive an alert when his bed is turned down and a 1-hour reminder before checkout.

(v) A casino employee may use a PDA to identify a player who should receive an activity-benefit offer. Commonly owned Application

Serial No. 10/212,636 entitled "Method and Apparatus for Generating Directives for Personnel" (which is incorporated herein by reference) includes a more detailed description of this embodiment.

(vi) A friend of a player may use a personal computer to send a communication message to a player. The friend may indicate a player's email address or username when sending the communication message to the player.

[00406] A player may indicate his preferences by filling out a form. For example, a player may fill out a registration form at a casino's front desk. For example, a player may use a No. 2 pencil to check off his preferences on a multiple choice form. These preferences may then be entered into a computer system (e.g., the controller), so that messages may be output to the player based on the preferences.

A player may indicate one or more preferences by selecting a preference from a multiple-choice menu. Examples include:

(i) A game machine or computer terminal may display a list of preferences on a touch screen. To indicate his preferences, a player may select preferences from the list using the touch screen.

(ii) A plurality of multiple-choice menus may be presented to a player. For example, a first menu may allow a player to select what type of messages he would like to make a rule for (e.g., status messages about sporting events), and a second menu may allow a player to indicate his preferences regarding outputting this type of message (e.g., delay messages until the end of my session, but not longer than 1 hour).

(iii) An interactive voice-recognition unit (IVRU) may offer a player a list of preferences (e.g., in audio) and the player may select his preferences by saying the name of at least one preference that is on the list.

[00407] Alternatively, a player may not be able to customize the output of messages. An indication of a player's preference may be

stored in a trigger condition database 322 (e.g., FIGs. 11A and 11B), or a suppression condition database 330 (e.g., FIG. 15).

F. ALTERNATE EMBODIMENTS

[00408] Features or options may refer to any parameter that may affect how a game operates on a game machine. Features may affect the processes like operating a game, displaying game play, determining outcomes, or outputting game results.

[00409] Game machines may have many features. Examples include:

- (i) 3D Graphics Mode
- (ii) Make Money on Losing Outcomes
- (iii) Bet Allocation System
- (iv) Auto-Play Mode
- (v) Sponsor Offers
- (vi) Jackpot Only
- (vii) Customizable Speed of Play
- (viii) Customizable Symbols on Slot Reels
- (ix) Customizable Payout Table
- (x) Virtual Assistant Provides Help
- (xi) Tutorial on How to Use a Game Machine
- (xii) Comp Points For Your Friends
- (xiii) Group Jackpots
- (xiv) Better Odds if Nearby Players Win Jackpots
- (xv) Watch Video Clips While You Gamble
- (xvi) "Rascally Rabbit" Bonus Round

[00410] A variety of different types of features are possible, including:

- (i) features that are only available for one game
- (ii) features that are available for a plurality of games

- (iii) features that are available for all games
- (iv) features that are only available on one game machine
- (v) features that are available for a plurality of game machines
- (vi) features that are available for all game machines
- (vii) features that are available for one player
- (viii) features that are available for a plurality of players
- (ix) features that are available for all players

[00411] Examples include:

(i) According to some embodiments, "Auto-Play Mode" (a feature) may only be available on slot machines and pachinko machines, but not on video poker machines or video blackjack machines.

(ii) A particular bonus round feature may work on all types of machines, but be best suited for card games like video blackjack and video poker.

[00412] Note that a feature may be a feature of a game and/or a feature of a game machine. According to some embodiments, it may be possible to use multiple features simultaneously on a single game or game machine. For example, a player may play a video poker machine using a "Group Jackpot" feature and a "Virtual Assistant" feature.

[00413] According to some embodiments, a first feature may not be compatible with a second feature. For example, it may not be possible for "Make Money on Losing Outcomes" (a first feature) and "Jackpot Only" (a second feature) to operate simultaneously. Therefore, players may be prevented from using these features simultaneously.

[00414] According to some embodiments, a casino may provide a payment to a proprietor of a feature. For example, a casino pay a licensing fee a game manufacturer who builds game machines that include a feature. Commonly owned Application Serial No. 10/420,068 entitled "Method and Apparatus for Managing Features on A Gaming Device" (which is incorporated herein by reference) includes a method of tracking usage of features on a game machine and determining payments to be made to proprietors of features.

[00415] In some embodiments, after a message is output to a player, the player may respond or react to the message. Responding to a message may include:

- (i) providing an indication
- (ii) indicating a response
- (iii) inputting a response
- (iv) accepting an offer

[00416] Examples of responses include:

- (i) "Yes, I'd like to accept this activity-benefit offer"
- (ii) "No, thank you"
- (iii) "Please sign me up for a 3-month trial subscription to 'Speed Fishing' magazine"
- (iv) "I don't understand" (e.g., as a response to an instructive message)
- (v) "Tell me more" (e.g., as a response to a status message)
- (vi) "Don't give me any more messages like this"
- (vii) "Close window" (e.g., for a message that is output in a partition)

[00417] Accordingly, a method of the invention may include one or more of the following steps:

- (i) determining a response by a player
- (ii) receiving a response from a player
- (iii) receiving an indication of a response from a player

[00418] A player may respond to a message using a game machine. Examples include:

- (i) A player may use an input device (e.g., a touch screen) on a game machine to indicate his response to a message.
- (ii) A player may speak a response (e.g. by saying "Yes" or "No") and a voice recognition module on a game machine may process the response.
- (iii) A game machine may present a list of possible responses to a player and a player may select at least one response from the list.

[00419] Various actions may be performed based on a player's response to a message, including:

(i) outputting a message
(ii) determining a message
(iii) activating or deactivating a feature on a game machine. For example, a player may indicate that he would like to activate a feature on a game machine.

(iv) hiding, removing, or otherwise concealing the message. For example, a player may indicate that he is finished reading a text message and that a window that is displaying the text message should be closed.

(v) transmitting an indication to another party. For example, an indication of a player's response to a message may be transmitted to a subsidizer, or to a computer terminal for review by a casino employee.

(vi) providing a benefit to a player (e.g., a player may get a free spin on a slot machine for responding to a message)

(vii) storing an indication in a database. For example, a player may indicate that he would like to accept an activity-benefit offer. An indication of this acceptance may be stored in database for future reference (e.g., to track whether the player performs the activity specified in the offer).

(viii) selling a product or service to the player. For example, a player may indicate that he would like to sign up for AT&T long distance telephone service.

[00420] A player may not respond to a message or may not respond in a manner the game machine 104 can interpret/understand. Various actions may be taken based on a player not responding to a message, including:

(i) outputting the message again
(ii) outputting the message again in a different representation
(iii) outputting a different message
(iv) hiding, removing, or otherwise concealing the message. For example, a pop-up window that displays a message may automatically be closed if a player does not respond to the message.

[00421] If a player does not respond to a message, an action (e.g., outputting a second message, closing a pop-up window) may be performed based on a trigger condition. Examples include:

(i) A pop-up window for a message may be closed automatically when a player starts a new game on a game machine (e.g., the player presses the spin button)

(ii) A message may be removed from a header on a video screen after 15 seconds (a time-based trigger condition)

(iii) A sidebar window on a game machine may display one message at a time.

(iv) A first message may be hidden from view when a second message is output.

(v) An audio message may be output again if a player does not respond to the message within 15 seconds.

[00422] In some embodiments, a player may respond to a message while the message is being output. For example, a player may interrupt an audio message by pressing a 'Cancel' button on a game machine. In some embodiments, an indication of a player's response to a message may be stored in a message history database 332, such as the one shown in FIG. 16.

[00423] Messages may be output to a player free of charge. Alternatively, a player may be compensated for receiving messages. Alternatively, a player may pay a fee or provide other consideration based on at least one message that is output to him. For example, a player may pay \$0.02 for each message that is output to him. Examples of consideration that may be provided by a player include:

(i) money (e.g., in dollars)

(ii) alternate currencies (e.g., casino tokens, frequent flyer miles, credits on a game machine, comp points) Note that an alternate currency may or may not be interchangeable with money.

(iii) activities – For example, a player may agree to switch his long distance telephone service provider in exchange for receiving messages for free.

[00424] An amount of consideration that a player provides may be based a variety of different factors, including:

(i) a number of messages output to the player – For example, a player may pay 2 comp points per message for 35 messages, for a total of 70 comp points.

(ii) content of messages that are output – For example, a player may pay 1 comp point for each status message that is output and 5 comp points for each instructional message that is output. In a second example, a player may have to answer 1 survey question for every 5 communication messages he receives.

(iii) a duration of time receiving messages – For example, a player may pay \$5 for a day's worth of messages, or \$1 per hour for messages.

(iv) timing of messages – For example, real-time status messages relating to stock market prices may cost a player 5 frequent flyer miles per message, whereas delayed status messages relating to stock market prices may be free.

[00425] Receiving consideration from a player may include debiting an account associated with the player. Examples include:

(i) A credit balance on a game machine operated by a player may be decreased.

(ii) A player's credit card account may be charged based on one or more messages.

(iii) A balance of comp points associated with a player's casino account may be debited.

(iv) A player's bank account may be debited based on one or more messages.

(v) A charge may be added to a player's hotel bill at a hotel associated with a casino where a player is gaming.

[00426] Receiving a payment from a player may include receiving an indication of a payment identifier from the player. Examples of payment identifiers include:

- (i) a credit card number
- (ii) a debit card number
- (iii) a financial account number
- (iv) a billing address
- (v) a player account number
- (vi) a player's hotel room number – For example, any messages that a player receives may be charged to the player's hotel room.

[00427] A player may receive a benefit based on at least one message that is output to him. For example, a player may receive a bonus of \$1 in credits if he agrees to have messages output to him during his gaming session. Providing a benefit to a player based on one or more messages may motivate him to pay closer attention to the one or more messages. Having players pay attention to messages may be beneficial for a variety of different parties, including:

- (i) Advertisers – For example, advertisers and other parties may be willing to pay to have promotional messages output to players.
- (ii) Players – For example, messages may provide useful information to players, including information about bonuses and offers.
- (iii) Casinos – For example, messages may help to make player's gaming experience more enjoyable, or motivate players to play for longer periods of times or bet larger amounts of money.

[00428] Examples of benefits that may be provided to players based on messages that are output include:

- (i) money (e.g., money or slot machine credits)
- (ii) products (e.g., a souvenir watch, a sweatshirt, a magazine subscription)
- (iii) services (e.g., a free meal, a haircut)

(iv) discounts on products or services (e.g., 50% off the list price of a hotel room)

(v) alternate currencies (e.g., comp points, non-convertible casino chips)

(vi) an entry into a game of chance (e.g., a lottery ticket, a free spin on a slot machine)

(vii) other considerations

[00429] In some embodiments, game play on a game machine may be affected by the output of a message. Examples include:

(i) At least a portion of a game may be delayed or paused based on output of a message. For example, a message may be output in a pop up window while the reels of a video slot machine are spinning. The reels of the video slot machine may continue spinning until the player finishes reading the message and closes the pop-up window.

(ii) A game machine may initiate "auto-play mode" based on output of a message. For example, a game machine may automatically play itself (i.e., place a bet, determine an outcome, provide a payout if appropriate, and repeat this process) while a player views or responds to a message. Commonly owned Application Serial No. 08/774,487 entitled "Automated Play Gaming Device", now issued as U.S. Patent No. 6,012,983 (which is incorporated herein by reference) commonly owned Application Serial No. 09/437,204, also entitled "Automated Play Gaming Device", now issued as U.S. Patent No. 6,244,957 (which is incorporated herein by reference), and commonly owned Application Serial No. 10/331,438 entitled "Method and Apparatus for Automatically Operating A Game Machine" (which is incorporated herein by reference) include various embodiments in which a game machine may automatically play itself, sometimes without any interaction from a player. Note that commonly owned Application Serial No. 10/331,438 includes examples of entering auto-play mode in response to a trigger (e.g., the output of a message on a game machine).

(iii) As mentioned earlier, a portion of a game may be modified to output a message to a player. For example, one or more symbols on the reels of a video slot machine may be altered to display a message to a player.

[00430] Altering game play based on output of a message may be helpful to players because:

(i) A player may view and respond to the message at his leisure. A player may no longer feel rushed to viewing a message in order to get back to his gaming activities.

(ii) A player may pay more attention to a message if it does not impede his game play.

(iii) A player may be able to view and/or respond to more messages while a game machine is in auto-play mode, since he is no longer encumbered by the process of operating the game machine.

[00431] A method to output a message based on an existing message is described above. Similarly, a message may be determined based on an existing message. According to some embodiments, the invention may include the following steps:

- (i) determining a first message
- (ii) outputting the first message to a player at a game machine
- (iii) determining a second message based on the first message
- (iv) outputting the second message to the player at the game machine

[00432] Note that the first message and the second message may be output in any order. For example, the second message may be output before the first message. Since the words "first" and "second" may imply an ordering to the messages, the following phrases will be used in the discussion below:

- (i) existing message – A message that has already been determined, and may or may not have already been output.

(ii) new message – A message that is determined based on the existing message. In the steps above, this would have been the “second message”

[00433] An indication of an existing message may be stored in a list of past messages, a list of future messages, or a list of current messages. For example, a new message may be determined based on an existing message stored in any of the following databases:

- (i) a message history database 332
- (ii) a message queue database 328
- (iii) a current message database (e.g., corresponds to messages that are currently displayed in windows on the screen)

[00434] Note that a new message may be determined at various different times, including:

(i) after the message is output. For example, a status message may be output to a player and then an instructive message may be determined based on this status message.

(ii) before the first messages is output. For example, future messages (i.e., messages to be output in the future) may be stored in a queue to be output. A new message to be output may be determined based on one or more messages in this queue.

[00435] Examples include:

(i) A communication message may be transmitted to a player from his friend. This communication message may include the words “plane” or “airplane” indicating that the friend is discussing air travel with the player. Based on this communication message, the controller may determine an advertisement relating to air travel and output it to the player.

(ii) A status message may inform player that he needs to check out of his hotel room in the next 30 minutes or pay for an additional night at the hotel. Based on this status message, an activity-benefit offer relating to

the player's hotel room may be output "If you sign up for a new credit card, then you can stay in your hotel room for an additional night for no extra charge."

(iii) A promotional and/or instructional message describing use and/or advantages of a feature may be transmitted to a player. For example, the message may describe "Auto-Play Mode" and detail its operation and advantages. Subsequent messages promoting "Auto-Play Mode" may be less detailed with respect to the first message (e.g., subsequent messages may simply remind the player that "Auto-Play Mode" is available) so as not to annoy the player with repetitive information. Of course, subsequent messages could also be more detailed.

[00436] In addition to outputting one or more messages to a player, a game machine 104 may also output additional information such as information about past messages. Outputting information about past messages may include displaying a list of information about one or more past messages. For example, a game machine may display a "message history" window that shows a list of messages that have been output to a player in the past. A list of information about past messages may include information about all past messages to a player, or a subset of past messages to a player (e.g., all messages output to a player in the last 1 hour, all instructive messages output to a player, offers that were output to a player and accepted by the player). Information about past messages may include:

- (i) titles of one or more messages
- (ii) representations of one or more messages
- (iii) categories for one or more messages
- (iv) indications of how or when one or more messages were output (e.g., a date and time)
- (v) indications of a player's responses to one or more messages

[00437] In some embodiments, a player may be able to search, sort, or otherwise navigate a list of information about past messages.

H. CONCLUSION

[00438] It is clear from the foregoing discussion that the disclosed systems and methods to facilitate outputting a message at a game machine represents an improvement in the art of gaming. While the method and apparatus of the present invention has been described in terms of its presently preferred and alternate embodiments, those skilled in the art will recognize that the present invention may be practiced with modification and alteration within the spirit and scope of the appended claims. The specifications and drawings are, accordingly, to be regarded in an illustrative rather than a restrictive sense.

[00439] Further, even though only certain embodiments have been described in detail, those having ordinary skill in the art will certainly appreciate and understand that many modifications, changes, and enhancements are possible without departing from the teachings thereof. All such modifications are intended to be encompassed within the following claims.

CLAIMS

The invention is claimed as follows:

1. A gaming system comprising:
 - at least one output device;
 - at least one input device;
 - at least one processor; and
 - at least one memory device which stores a plurality of instructions, which when executed by the at least one processor, cause the at least one processor to operate with the at least one output device and the at least one input device to:
 - (a) identify a player placing at least one wager on at least one play of a game,
 - (b) track information associated with the identified player,
 - (c) if a first set of information associated with the identified player is tracked and a message trigger condition occurs in association with the identified player:
 - (i) determine, based at least in part on the first set of tracked information, a first message, and
 - (ii) output the determined first message to the identified player, and
 - (d) if a second, different set of information associated with the identified player is tracked and the message trigger condition occurs in association with the identified player:
 - (i) determine, based at least in part on the second set of tracked information, a second, different message, and
 - (ii) output the determined second message to the identified player.

2. The gaming system of Claim 1, wherein the message trigger condition occurs based on at least one selected from the group consisting of: a gaming activity of the identified player, a non-gaming activity of the identified player, at least one preference of the identified player, an activity of another player separate from the identified player, and an output of another message.

3. The gaming system of Claim 1, wherein the determined message is at least one selected from the group consisting of: a status message, an instructive message, a communication message, a promotional message, an activity-benefit offer, a hypothetical information message and a recommendation of a feature.

4. The gaming system of Claim 1, wherein the tracked information associated with the identified player is at least one selected from the group consisting of: an identity of the player, contact information of the player, at least one preference of the player, at least one wagering performance history of the player, an amount of comp points accumulated by the player, a current activity of the player, at least one demographic of the player, at least one input made by the player, wagering information associated with the player and non-wagering information associated with the player.

5. The gaming system of Claim 1, wherein when executed by the at least one processor, the plurality of instructions cause the at least one processor to output, in a partition including a pop-up window, one of: (i) the determined first message, and (ii) the determined second message.

6. The gaming system of Claim 1, wherein the first message is associated with a first representation and the second message is associated with a second, different representation.

7. The gaming system of Claim 1, wherein the message trigger condition which occurs in association with the first set of tracked information is different than the message trigger condition which occurs in association with the second set of tracked information.

8. The gaming system of Claim 1, wherein when executed by the at least one processor, the plurality of instructions cause the at least one processor to suppress any output of any of the messages if the message trigger condition does not occur.

9. A method of operating a gaming system, said method comprising:

(a) causing at least one processor to execute a plurality of instructions to identify a player placing at least one wager on at least one play of a game,

(b) causing the at least one processor to execute the plurality of instructions to track information associated with the identified player,

(c) if a first set of information associated with the identified player is tracked and a message trigger condition occurs in association with the identified player:

(i) causing the at least one processor to execute the plurality of instructions to determine, based at least in part on the first set of tracked information, a first message, and

(ii) causing at least one output device to output the determined first message to the identified player, and

(d) if a second, different set of information associated with the identified player is tracked and the message trigger condition occurs in association with the identified player:

(i) causing the at least one processor to execute the plurality of instructions to determine, based at least in part on the second set of tracked information, a second, different message, and

(ii) causing the at least one output device to output the determined second message to the identified player.

10. The method of Claim 9, wherein the message trigger condition occurs based on at least one selected from the group consisting of: a gaming activity of the identified player, a non-gaming activity of the identified player, at least one preference of the identified player, an activity of another player separate from the identified player, and an output of another message.

11. The method of Claim 9, wherein the determined message is at least one selected from the group consisting of: a status message, an instructive message, a communication message, a promotional message, an activity-benefit offer, a hypothetical information message and a recommendation of a feature.

12. The method of Claim 9, wherein the tracked information associated with the identified player is at least one selected from the group consisting of: an identity of the player, contact information of the player, at least one preference of the player, at least one wagering performance history of the player, an amount of comp points accumulated by the player, a current activity of the player, at least one demographic of the player, at least one input made by the player, wagering information associated with the player and non-wagering information associated with the player.

13. The method of Claim 9, which includes causing the at least one output device to output, in a partition including a pop-up window, one of: (i) the determined first message, and (ii) the determined second message.

14. The method of Claim 9, wherein the first message is associated with a first representation and the second message is associated with a second, different representation.

15. The method of Claim 9, wherein the message trigger condition which occurs in association with the first set of tracked information is different than the message trigger condition which occurs in association with the second set of tracked information.

16. The method of Claim 9, which includes causing the at least one processor to execute the plurality of instructions to suppress any output of any of the messages if the message trigger condition does not occur.

17. The method of Claim 9, which is executed through a data network.

18. The method of Claim 17, wherein the data network is an internet.

ABSTRACT

The invention allows a casino, or other entity, via a game machine, to provide relevant information at appropriate times, and/or in response to appropriate events, to players using the game machine. A dynamic and flexible system adapted to interact with players on an individual basis by aiding in the management, determination, distribution, and delivery of promotional, inspirational, instructive, informational, communicative, incentive, and other types of messages, is provided. Various methods are provided to ensure that receiving messages at a game machine enhances a player's overall gaming experience by selectively outputting helpful and desirable messages to players while minimizing interference with the players' gaming and to avoid overwhelming players with unsolicited, unwanted, and/or irrelevant messages.

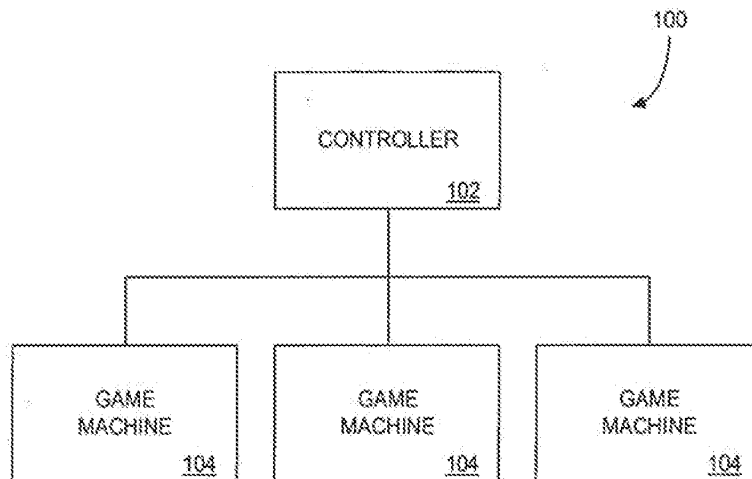

FIG. 1

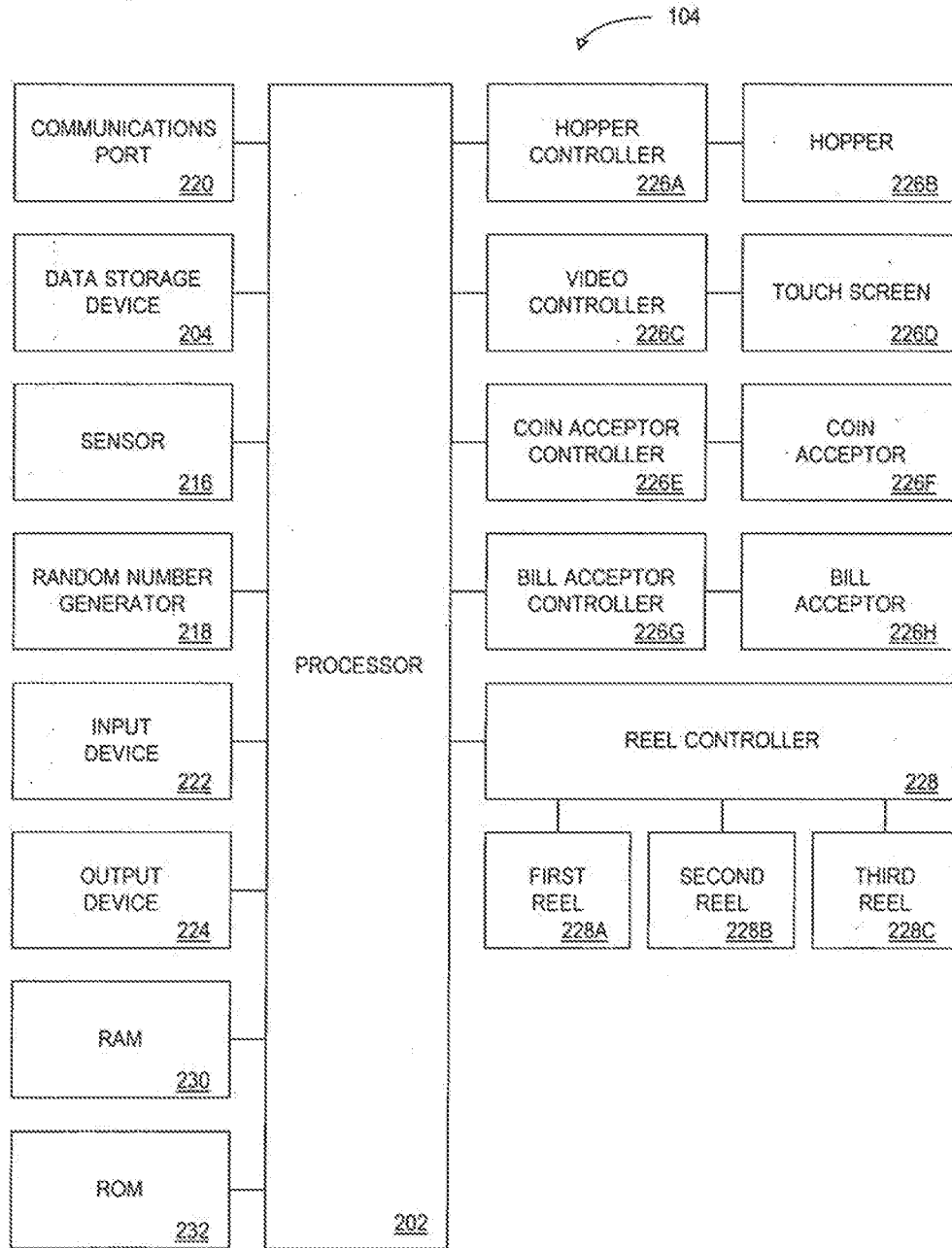

FIG. 2

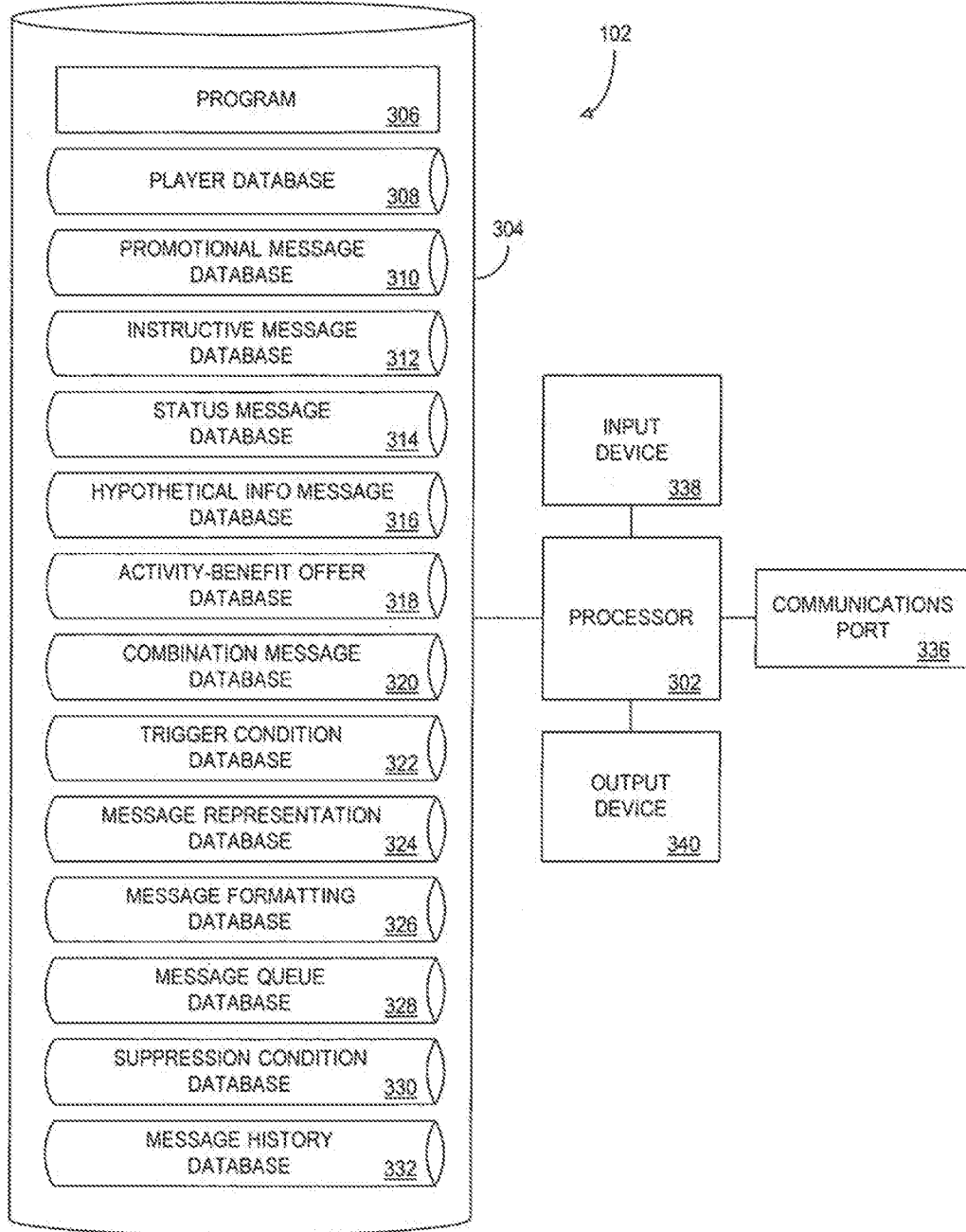

FIG. 3

308 ↗

PLAYER IDENTIFIER	NAME	COMP POINTS	CURRENT ACTIVITY	NOTES
400 PLAYER-1-02834555	402 ANNE RED	404 1,846 POINTS	406 OPERATING SLOT MACHINE #12	408 ENJOYS TRAVELLING. HAS VISITED MEXICO THREE TIMES IN LAST YEAR
PLAYER-2-02834555	JEFF YELLOW	8,902 POINTS	OPERATING VIDEO POKER MACHINE #57	AGE 66, RETIRED MECHANICAL ENGINEER LOVES GADGETS
PLAYER-3-02834555	JIM BLUE	579 POINTS	OPERATING SLOT MACHINE #81	AGE 50, AVID READER OF SCIENCE FICTION BOOKS AND COMIC BOOKS
PLAYER-4-02834555	ANONYMOUS	N/A	OPERATING SLOT MACHINE #175	N/A
PLAYER-5-02834555	JOHN GREEN	2,984 POINTS	OPERATING COMP KIOSK #62	JUST BOUGHT A NEW HOUSE. HAS A SIX MONTH OLD BABY
PLAYER-6-02834555	MARY PURPLE	3,371 POINTS	PLAYING AT BLACKJACK TABLE #23, POSITION #2	AGE 25, ENJOYS MOUNTAIN BIKING, DRIVES A 1983 TOYOTA TERCEL

FIG. 4

310 →

PROMOTIONAL MESSAGE IDENTIFIER	PROMOTIONAL MESSAGE
PROMO-1-85923475	"GET TWO STEAK DINNERS FOR THE PRICE OF ONE AT ALICE'S RESTAURANT"
PROMO-2-85923475	"ACME LAUNDRY DETERGENT IS OFFERING A FREE ONE-YEAR SUPPLY OF LAUNDRY DETERGENT TO THE NEXT PERSON TO WIN A JACKPOT ON A RASCALLY RABBIT SLOT MACHINE"
PROMO-3-85923475	"BUY THIS TRAVEL ALARM CLOCK FOR ONLY \$9.99" <INCLUDES PICTURE OF ALARM CLOCK AND LIST OF FEATURES>
PROMO-4-85923475	"CONGRATULATIONS! YOU QUALIFY FOR A 20% DISCOUNT ON TICKETS TO THE CHAMPIONSHIP BOXING MATCH TONIGHT. WOULD YOU LIKE TO BUY TICKETS?"
PROMO-5-85923475	"WOULD YOU LIKE TO SIGN UP FOR A FREE 3-MONTH SUBSCRIPTION TO 'AUTOMOBILE FUN' MAGAZINE?"
PROMO-6-85923475	"WOULD YOU LIKE TO ACTIVATE AUTO-PLAY MODE FOR A COST OF ONLY 5 COINS?"
PROMO-7-85923475	"WOULD YOU LIKE TO PURCHASE A HOTEL ROOM FOR TONIGHT FOR 500 COMP POINTS?"

FIG. 5

312

INSTRUCTIVE MESSAGE IDENTIFIER	INSTRUCTIVE MESSAGE
600	502
INSTR-1-642985152	"PRESS AND HOLD THE SPIN BUTTON FOR TEN SECONDS TO ACTIVATE 'AUTO-PLAY' MODE"
INSTR-2-642985152	"IF YOU BET 3 COINS PER SPIN, THEN YOU GET TO USE AN IMPROVED PAYOUT TABLE WITH A BIGGER MAXIMUM JACKPOT"
INSTR-3-642985152	"IF YOU CRACK OPEN AN EGG WITH AN ALLIGATOR IN IT, THE BONUS ROUND ENDS"
INSTR-4-642985152	"GETTING A STRAIGHT PAYS 4 COINS; GETTING A STRAIGHT FLUSH PAYS 50 COINS"
INSTR-5-642985152	"TO CHECK THE VOICEMAIL IN YOUR HOTEL ROOM, PRESS THE 'CHECK MESSAGES' BUTTON ON THE LEFT SIDE OF THIS GAME MACHINE"

FIG. 6

314

STATUS MESSAGE IDENTIFIER	STATUS MESSAGE
STATUS-1-56189345	"YOU CURRENTLY HAVE X COMP POINTS" <WHERE X IS FILLED IN BASED ON PLAYER DATABASE>
STATUS-2-56189345	"RED SOX 9, YANKEES 5, BOTTOM OF THE 6TH INNING"
STATUS-3-56189345	"BALANCE BONUS IS ENABLED YOU WILL EARN 1 COIN FOR EVERY 15 MINUTES THAT YOU KEEP YOUR CREDIT BALANCE ABOVE 100 COINS."
STATUS-4-56189345	"YOUR TABLE FOR TWO AT BILL'S RESTAURANT IS READY"
STATUS-5-56189345	"YOU HAVE EARNED ENOUGH COMP POINTS TO RECEIVE A HOTEL ROOM."

FIG. 7

316

HYPOTHETICAL INFORMATION MESSAGE IDENTIFIER	HYPOTHETICAL INFORMATION MESSAGE
800 HYP-1-083275126	802 "IF YOU HAD ONLY BET 1 COIN INSTEAD OF 3 COINS LAST SPIN, YOU WOULD HAVE ONLY WON 10 COINS INSTEAD OF 40."
HYP-2-083275126	"IF YOU HAD BEEN USING BETTING THE DONT MODE, YOU WOULD HAVE WON YOUR LAST 5 SPINS."
HYP-3-083275126	"IF YOU HAD BEEN USING A PLAYER TRACKING CARD, YOU WOULD HAVE EARNED \$27 COMP POINTS TODAY, ENOUGH FOR A FREE DINNER AT ALICE'S RESTAURANT."
HYP-4-083275126	"IF YOU DIDNT HAVE GAMBLING LOSS INSURANCE, YOU WOULD HAVE LOST 500 COINS IN THE LAST HOUR."
HYP-5-083275126	"IF YOU HAD BEEN PLAYING IN SPEED PLAY MODE, YOU COULD HAVE WON THIS JACKPOT IN 45 MINUTES INSTEAD OF 1.5 HOURS.*"

FIG. 8

318 ↗

ACTIVITY-BENEFIT OFFER IDENTIFIER	ACTIVITY	BENEFIT
OFF-1-23480923	PLAY AT LEAST 20 GAMES ON A RASCALLY RABBIT SLOT MACHINE	5 CREDITS
OFF-2-23480923	SIGN UP FOR 3-MONTH TRIAL SUBSCRIPTION TO TRAVEL MAGAZINE	ACTIVATION OF 3D GRAPHICS MODE FOR NEXT 48 HOURS
OFF-3-23480923	PURCHASE A BOOK FROM CONGO.COM DURING THE NEXT 2 WEEKS	DOUBLE JACKPOT VALUES FOR NEXT 100 GAMES
OFF-4-23480923	ANSWER 10 SURVEY QUESTIONS ABOUT HEART DISEASE	ONE FREE GAME
OFF-5-23480923	TEST DRIVE A FORD DURING NEXT MONTH	\$5.00 CASH, DISPENSED BY GAME MACHINE
OFF-6-23480923	PURCHASE A BOOK FROM CONGO.COM DURING THE NEXT 2 WEEKS	INSTANT MESSAGING ENABLED ON GAME MACHINES
OFF-7-23480923	SIGN UP FOR A GRAND BANK CREDIT CARD	IMMEDIATE ENTRY INTO BONUS ROUND ON GAME MACHINE
OFF-8-23480923	SIGN UP FOR A GRAND BANK CREDIT CARD	FREE TOASTER OVEN
OFF-9-23480923	TEST DRIVE A FORD AND SIGN UP FOR A GRAND BANK CREDIT CARD	6 FREE MEALS AT ALICE'S RESTAURANT

FIG. 9

320

COMBINATION MESSAGE IDENTIFIER	COMBINATION MESSAGE
COMBO-1-84151451	"THE ONLY WAY TO WIN THE MAXIMUM JACKPOT IS BY BETTING 3 COINS PER SPIN. WOULD YOU LIKE TO INCREASE YOUR BET SIZE TO 3 COINS PER SPIN?"
COMBO-2-84151451	"YOUR PLANE FLIGHT TO RETURN HOME TO CLEVELAND LEAVES IN 3 HOURS. WOULD YOU LIKE TO CHECK IF YOU CAN CATCH A LATER FLIGHT?"
COMBO-3-84151451	"YOUR CONTRACT FOR DOUBLE PAYOUTS WILL EXPIRE IN 5 MINUTES. IF YOU AGREE TO SWITCH YOUR LONG DISTANCE TELEPHONE PROVIDER, THEN YOUR CONTRACT FOR DOUBLE PAYOUTS WILL BE EXTENDED FOR AN ADDITIONAL 15 MINUTES."
COMBO-4-84151451	"YOUR DINNER RESERVATION IS READY. WOULD YOU LIKE TO ACTIVATE AUTO-PLAY MODE TO OPERATE THIS GAME MACHINE WHILE YOU ARE AT DINNER?"
COMBO-5-84151451	"IF YOU HAD BEEN PLAYING A GOLDEN EGG VIDEO POKER MACHINE, YOU WOULD HAVE WON \$39 LAST HOUR. WOULD YOU LIKE TO CHANGE THIS SLOT MACHINE INTO A GOLDEN EGG SLOT MACHINE?"

FIG. 10

322A →

TRIGGER CONDITION FOR OUTPUTTING MESSAGE	MESSAGE(S) TO OUTPUT
1100A (END_OF_GAME) AND (PRIORITY_OF_NEXT_MESSAGE_IN_QUEUE >= 300)	1102A NEXT MESSAGE IN QUEUE
(PLAYER_EARNS_COMP_POINTS) AND (NEW_NUMBER_OF_COMP_POINTS > 2000) AND NOT(MESSAGE_ALREADY_OUTPUT (STATUS-5-5618345))	STATUS-5-5618345
(HATCH_EGG_BUTTON_PRESSED_AFTER_ROUND_OVER > 3 TIMES) (BONUS_ROUND_OVER) AND	INSTR-3-642385152
(PLAYER_CASHES_OUT_OF_GAME_MACHINE)	NEXT 3 MESSAGES IN QUEUE
(PLAYER_IS (PLAYER-2-02834555)) AND (DATE = 7/15/2002) AND (TIME_OF_DAY = 3:05PM)	COMBO-2-84151451
(PLAYER_WINS_PRIZE) AND (PRIZE_VALUE >= 100 COINS)	ANY PROMOTIONAL MESSAGE
(GAMES_PLAYED_WITHOUT_ENTRY_INTO_BONUS_ROUND = 100) AND (NOT (MESSAGE_ALREADY_OUTPUT (OFF-7-23480923)) OR (MESSAGE_IN_QUEUE (OFF-8-23480923)))	OFF-7-23480923

FIG. 11A

322B

TRIGGER CONDITION FOR OUTPUTTING MESSAGE	MESSAGE(S) TO OUTPUT
1100B (TIME_SINCE_LAST_MESSAGE_OUTPUT = 15 MINUTES)	1102B NEXT MESSAGE IN QUEUE
(NEARBY_PLAYER_WINS_JACKPOT)	OFF-3-23480923
(COMMUNICATION_MESSAGE_TO_PLAYER_INCLUDES_TEXT ("CAR"))	PROMO-5-85923475
(PLAYER_MAKES_DINNER_RESERVATION_AT_ALICES_RESTAURANT)	OFF-9-23480923 AND HYP-3-093275128
(TIME = 10:00PM) AND (HOTEL_OCCUPANCY_RATE < 50%) AND (PLAYER_NOT_STAYING_AT_HOTEL) AND (NUMBER_OF_COMP_POINTS > 500)	PROMO-7-85923475
(COMMUNICATION_MESSAGE_RECEIVED) AND NOT(CURRENTLY_IN_BONUS_ROUND)	ANY COMMUNICATION MESSAGES RECEIVED

FIG. 11B

324

MESSAGE IDENTIFIER 1200	TEXT REPRESENTATION AVAILABLE? 1202	SPANISH TEXT REPRESENTATION AVAILABLE? 1204	AUDIO REPRESENTATION AVAILABLE? 1206	SPANISH AUDIO REPRESENTATION AVAILABLE? 1208
PROMO-1-85923475	YES	YES	YES	NO
INSTR-5-642388152	NO	NO	YES	YES
STATUS-2-56189345	YES	YES	NO	YES
HYP-1-093275126	YES	NO	YES	NO
OFF-S-23480923	YES	YES	YES	YES
COMBO-3-84151451	NO	YES	NO	NO

FIG. 12

326

MESSAGE FORMATTING DATABASE FOR PLAYER 1-02634555									
MESSAGE CATEGORY	1300	TYPE OF PARTITION OR WINDOW	1302	COLOR OF MESSAGE BORDER	1304	MESSAGE TITLE	1308	SOUND UPON OUTPUT	1310
FEATURES ON GAME MACHINES		HEADER		GREEN		"FEATURES"		BEEP	
COMMUNICATION MESSAGES FROM SKIBUM@AOL.COM		MESSAGING WINDOW		LIGHT BLUE		"SKIBUM SAYS:"		TELEPHONE RING	
ALL OTHER COMMUNICATION MESSAGES		MESSAGING WINDOW		DARK BLUE		NONE		NONE	
HOTEL, RESTAURANT, AND TRAVEL MESSAGES		POP-UP WINDOW		RED		TIME OF DAY		PARROT SQUAWK	
SPORTS SCORES		SCROLLING FOOTER		N/A		NAME OF SPORT		NONE	
COMP POINTS		POP-UP WINDOW		RED		CURRENT BALANCE OF COMP POINTS		RINGING BELL MELODY	

FIG. 13

328A

POSITION IN MESSAGE QUEUE 1400A	MESSAGE TO OUTPUT 1402A	PRIORITY OF MESSAGE 1404A
1	STATUS-4-56189345	456
2	PROMO-1-85923475	289
3	INSTR-1-642985152	95

FIG. 14A

328B

POSITION IN MESSAGE QUEUE 1400B	MESSAGE TO OUTPUT 1402B	PRIORITY OF MESSAGE 1404B
1	STATUS-4-56189345	456
2	HYP-3-093275126	321
3	PROMO-1-85923475	289
4	INSTR-1-642985152	95

FIG. 14B

330

SUPPRESSION CONDITION	RESULT OF SUPPRESSION	TRIGGER CONDITION FOR DELAYED OUTPUT (IF APPLICABLE)
1500 (CURRENT_GAME_STATE = "BONUS_ROUND")	1502 DELAY UNTIL TRIGGER CONDITION	1504 (BONUS_ROUND_OVER) AND (BONUS_PRIZE_VALUE < 100 COINS)
(NUMBER_OF_MESSAGES_IN_LAST_15_MINUTES > 5)	DELAY UNTIL TRIGGER CONDITION	(TIME_SINCE_LAST_MESSAGE_OUTPUT = 15 MINUTES)
PLAYER_DOES_NOT_SPEAK (MESSAGE_LANGUAGE (CURRENT_MESSAGE))	CANCEL MESSAGE	N/A
((CURRENT_TIME - LOGON_TIME) < 5 MINUTES) AND (CREDIT_BALANCE > 10 CREDITS))	DELAY UNTIL TRIGGER CONDITION	(CREDIT_BALANCE <= 10 CREDITS) OR (AVERAGE_RATE_OF_PLAY < 6 GAMES/MINUTE)
((ALREADY_OUTPUT_TO_PLAYER (CURRENT_MESSAGE)) OR (ALREADY_OUTPUT_TO_PLAYER (MESSAGES_SIMILAR_TO (CURRENT_MESSAGE))))	CANCEL MESSAGE	N/A
(AVERAGE_RATE_OF_PLAY > 10 COINS/MINUTE)	DELAY UNTIL TRIGGER CONDITION	(TIME_BETWEEN_SPINS > 8 SECONDS)
(DO_NOT_DISTURB_BUTTON_PRESSED) AND (MESSAGE_PRIORITY < 200)	PUT MESSAGE IN QUEUE	N/A
MICROPHONE_ON_GAME_MACHINE_SENSES (PLAYER_IS_SPEAKING)	DELAY UNTIL TRIGGER CONDITION	(SPIN_BUTTON_PRESSED)

FIG. 15

332

MESSAGE THAT WAS OUTPUT	RECIPIENT OF MESSAGE	TIME WHEN MESSAGE WAS OUTPUT	PLAYER'S RESPONSE TO MESSAGE (IF ANY)
PROMO-1-85923475	PLAYER-1-02834555	8/16/01 1:47PM	N/A
OFF-3-23480923	PLAYER-2-02834555	8/16/01 1:50PM	OFFER ACCEPTED
HYP-3-093275126	PLAYER-3-02834555	8/16/01 2:01PM	PLAYER SIGNS UP FOR PLAYER TRACKING CARD
STATUS-1-55189345	PLAYER-4-02834555	8/16/01 2:03PM	N/A
PROMO-7-85923475	PLAYER-4-02834555	8/16/01 2:03PM	PLAYER PURCHASES HOTEL ROOM FOR THE NIGHT
COMBO-4-84151451	PLAYER-5-02834555	8/16/01 2:05PM	"NO, THANK YOU"
INSTR-4-642985152	PLAYER-2-02834555	8/16/01 2:09PM	N/A

FIG. 16

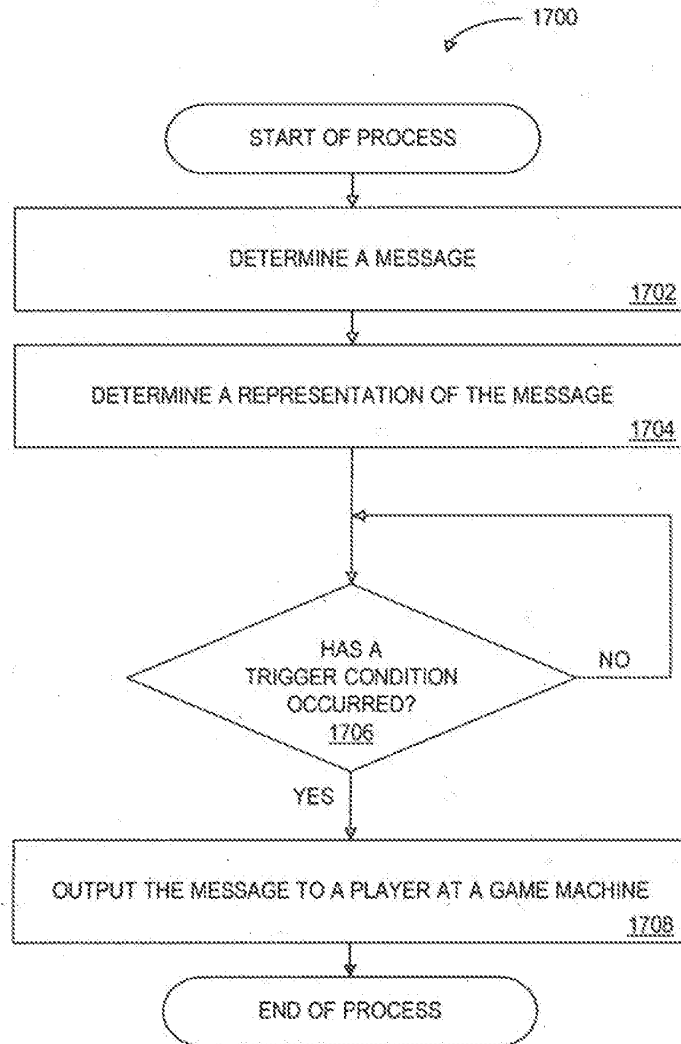

FIG. 17

Electronic Patent Application Fee Transmittal

Application Number:				
Filing Date:				
Title of Invention:	METHOD AND APPARATUS FOR OUTPUTTING A MESSAGE AT A GAME MACHINE			
First Named Inventor/Applicant Name:	Jay S. Walker			
Filer:	Adam H. Masia/Carrie Mollo			
Attorney Docket Number:	025124-0509			
Filed as Large Entity				
Utility under 35 USC 111(a) Filing Fees				
Description	Fee Code	Quantity	Amount	Sub-Total in USD(\$)
Basic Filing:				
Utility application filing	1011	1	390	390
Utility Search Fee	1111	1	620	620
Utility Examination Fee	1311	1	250	250
Pages:				
Utility Appl Size fee per 50 sheets >100	1081	1	320	320
Claims:				
Miscellaneous-Filing:				
Petition:				

Description	Fee Code	Quantity	Amount	Sub-Total in USD(\$)
Patent-Appeals-and-Interference:				
Post-Allowance-and-Post-Issuance:				
Extension-of-Time:				
Miscellaneous:				
Total in USD (\$)				1580

Electronic Acknowledgement Receipt

EFS ID:	14263883
Application Number:	13680852
International Application Number:	
Confirmation Number:	6364
Title of Invention:	METHOD AND APPARATUS FOR OUTPUTTING A MESSAGE AT A GAME MACHINE
First Named Inventor/Applicant Name:	Jay S. Walker
Customer Number:	29159
Filer:	Adam H. Masia/Mavis Benson
Filer Authorized By:	Adam H. Masia
Attorney Docket Number:	025124-0509
Receipt Date:	19-NOV-2012
Filing Date:	
Time Stamp:	16:40:29
Application Type:	Utility under 35 USC 111(a)

Payment information:

Submitted with Payment	yes
Payment Type	Deposit Account
Payment was successfully received in RAM	\$1580
RAM confirmation Number	4559
Deposit Account	502261
Authorized User	

File Listing:

Document Number	Document Description	File Name	File Size(Bytes)/ Message Digest	Multi Part /.zip	Pages (if appl.)
-----------------	----------------------	-----------	----------------------------------	------------------	------------------

1	Application Data Sheet	025124-0509-ApplicationDataSheet.pdf	1397183 2dd4e9b79c29e75430a92850cecec08fde2258ca	no	7
Warnings:					
Information:					
2		025124-0509-Specification.pdf	449763 8488b7d0700f702e52d4e86c831afeff03e66a	yes	151
Multipart Description/PDF files in .zip description					
Document Description		Start	End		
Specification		1	144		
Claims		145	150		
Abstract		151	151		
Warnings:					
Information:					
3	Drawings-only black and white line drawings	025124-0509-Figures.pdf	1827606 59dde227c7d07aaaf6307bbe94b0a86cf2e9cd8	no	18
Warnings:					
Information:					
4	Fee Worksheet (SB06)	fee-info.pdf	36755 300adac28ee9955456b2e5b1818759f56ad73c62	no	2
Warnings:					
Information:					
Total Files Size (in bytes):			3711307		

This Acknowledgement Receipt evidences receipt on the noted date by the USPTO of the indicated documents, characterized by the applicant, and including page counts, where applicable. It serves as evidence of receipt similar to a Post Card, as described in MPEP 503.

New Applications Under 35 U.S.C. 111

If a new application is being filed and the application includes the necessary components for a filing date (see 37 CFR 1.53(b)-(d) and MPEP 506), a Filing Receipt (37 CFR 1.54) will be issued in due course and the date shown on this Acknowledgement Receipt will establish the filing date of the application.

National Stage of an International Application under 35 U.S.C. 371

If a timely submission to enter the national stage of an international application is compliant with the conditions of 35 U.S.C. 371 and other applicable requirements a Form PCT/DO/EO/903 indicating acceptance of the application as a national stage submission under 35 U.S.C. 371 will be issued in addition to the Filing Receipt, in due course.

New International Application Filed with the USPTO as a Receiving Office

If a new international application is being filed and the international application includes the necessary components for an international filing date (see PCT Article 11 and MPEP 1810), a Notification of the International Application Number and of the International Filing Date (Form PCT/RO/105) will be issued in due course, subject to prescriptions concerning national security, and the date shown on this Acknowledgement Receipt will establish the international filing date of the application.



UNITED STATES PATENT AND TRADEMARK OFFICE

UNITED STATES DEPARTMENT OF COMMERCE
United States Patent and Trademark Office
Address: COMMISSIONER FOR PATENTS
P.O. Box 1450
Alexandria, Virginia 22313-1450
www.uspto.gov

Table with 6 columns: APPLICATION NUMBER, FILING or 371(e) DATE, GRP ART UNIT, FIL FEE REC'D, ATTY. DOCKET NO, TOT CLAIMS, IND CLAIMS. Values: 13/680,852, 11/19/2012, 3714, 1580, 025124-0509, 18, 2

CONFIRMATION NO. 6364

FILING RECEIPT

29159
Neal, Gerber & Eisenberg LLP
2 N. LaSalle Street
Suite 1700
Chicago, IL 60602-3801



Date Mailed: 12/20/2012

Receipt is acknowledged of this non-provisional patent application. The application will be taken up for examination in due course. Applicant will be notified as to the results of the examination. Any correspondence concerning the application must include the following identification information: the U.S. APPLICATION NUMBER, FILING DATE, NAME OF APPLICANT, and TITLE OF INVENTION. Fees transmitted by check or draft are subject to collection. Please verify the accuracy of the data presented on this receipt. If an error is noted on this Filing Receipt, please submit a written request for a Filing Receipt Correction. Please provide a copy of this Filing Receipt with the changes noted thereon. If you received a "Notice to File Missing Parts" for this application, please submit any corrections to this Filing Receipt with your reply to the Notice. When the USPTO processes the reply to the Notice, the USPTO will generate another Filing Receipt incorporating the requested corrections

Inventor(s)

Jay S. Walker, Ridgefield, CT;
James A. Jorasch, Stamford, CT;
Russell P. Sammon, San Francisco, CA;
Stephen C. Tulley, Fairfield, CT;
Steven M. Santisi, Ridgefield, CT;

Applicant(s)

IGT, Reno, NV

Assignment For Published Patent Application

IGT, Reno, NV

Power of Attorney: None

Domestic Priority data as claimed by applicant

This application is a CON of 13/632,328 10/01/2012
which is a CON of 10/685,143 10/14/2003 PAT 8282488
which claims benefit of 60/418,397 10/11/2002

Foreign Applications for which priority is claimed (You may be eligible to benefit from the Patent Prosecution Highway program at the USPTO. Please see http://www.uspto.gov for more information.) - None.

Foreign application information must be provided in an Application Data Sheet in order to constitute a claim to foreign priority. See 37 CFR 1.55 and 1.76.

If Required, Foreign Filing License Granted: 12/12/2012

The country code and number of your priority application, to be used for filing abroad under the Paris Convention, is US 13/680,852

Projected Publication Date: 03/28/2013

Non-Publication Request: No

Early Publication Request: No

Title

METHOD AND APPARATUS FOR OUTPUTTING A MESSAGE AT A GAME MACHINE

Preliminary Class

463

PROTECTING YOUR INVENTION OUTSIDE THE UNITED STATES

Since the rights granted by a U.S. patent extend only throughout the territory of the United States and have no effect in a foreign country, an inventor who wishes patent protection in another country must apply for a patent in a specific country or in regional patent offices. Applicants may wish to consider the filing of an international application under the Patent Cooperation Treaty (PCT). An international (PCT) application generally has the same effect as a regular national patent application in each PCT-member country. The PCT process **simplifies** the filing of patent applications on the same invention in member countries, but **does not result** in a grant of "an international patent" and does not eliminate the need of applicants to file additional documents and fees in countries where patent protection is desired.

Almost every country has its own patent law, and a person desiring a patent in a particular country must make an application for patent in that country in accordance with its particular laws. Since the laws of many countries differ in various respects from the patent law of the United States, applicants are advised to seek guidance from specific foreign countries to ensure that patent rights are not lost prematurely.

Applicants also are advised that in the case of inventions made in the United States, the Director of the USPTO must issue a license before applicants can apply for a patent in a foreign country. The filing of a U.S. patent application serves as a request for a foreign filing license. The application's filing receipt contains further information and guidance as to the status of applicant's license for foreign filing.

Applicants may wish to consult the USPTO booklet, "General Information Concerning Patents" (specifically, the section entitled "Treaties and Foreign Patents") for more information on timeframes and deadlines for filing foreign patent applications. The guide is available either by contacting the USPTO Contact Center at 800-786-9199, or it can be viewed on the USPTO website at <http://www.uspto.gov/web/offices/pac/doc/general/index.html>.

For information on preventing theft of your intellectual property (patents, trademarks and copyrights), you may wish to consult the U.S. Government website, <http://www.stopfakes.gov>. Part of a Department of Commerce initiative, this website includes self-help "toolkits" giving innovators guidance on how to protect intellectual property in specific countries such as China, Korea and Mexico. For questions regarding patent enforcement issues, applicants may call the U.S. Government hotline at 1-866-999-HALT (1-866-999-4158).

LICENSE FOR FOREIGN FILING UNDER
Title 35, United States Code, Section 184
Title 37, Code of Federal Regulations, 5.11 & 5.15

GRANTED

The applicant has been granted a license under 35 U.S.C. 184, if the phrase "IF REQUIRED, FOREIGN FILING LICENSE GRANTED" followed by a date appears on this form. Such licenses are issued in all applications where the conditions for issuance of a license have been met, regardless of whether or not a license may be required as set forth in 37 CFR 5.15. The scope and limitations of this license are set forth in 37 CFR 5.15(a) unless an earlier license has been issued under 37 CFR 5.15(b). The license is subject to revocation upon written notification. The date indicated is the effective date of the license, unless an earlier license of similar scope has been granted under 37 CFR 5.13 or 5.14.

This license is to be retained by the licensee and may be used at any time on or after the effective date thereof unless it is revoked. This license is automatically transferred to any related applications(s) filed under 37 CFR 1.53(d). This license is not retroactive.

The grant of a license does not in any way lessen the responsibility of a licensee for the security of the subject matter as imposed by any Government contract or the provisions of existing laws relating to espionage and the national security or the export of technical data. Licensees should apprise themselves of current regulations especially with respect to certain countries, of other agencies, particularly the Office of Defense Trade Controls, Department of State (with respect to Arms, Munitions and Implements of War (22 CFR 121-128)); the Bureau of Industry and Security, Department of Commerce (15 CFR parts 730-774); the Office of Foreign Assets Control, Department of Treasury (31 CFR Parts 500+) and the Department of Energy.

NOT GRANTED

No license under 35 U.S.C. 184 has been granted at this time, if the phrase "IF REQUIRED, FOREIGN FILING LICENSE GRANTED" DOES NOT appear on this form. Applicant may still petition for a license under 37 CFR 5.12, if a license is desired before the expiration of 6 months from the filing date of the application. If 6 months has lapsed from the filing date of this application and the licensee has not received any indication of a secrecy order under 35 U.S.C. 181, the licensee may foreign file the application pursuant to 37 CFR 5.15(b).

SelectUSA

The United States represents the largest, most dynamic marketplace in the world and is an unparalleled location for business investment, innovation and commercialization of new technologies. The USA offers tremendous resources and advantages for those who invest and manufacture goods here. Through SelectUSA, our nation works to encourage, facilitate, and accelerate business investment. To learn more about why the USA is the best country in the world to develop technology, manufacture products, and grow your business, visit SelectUSA.gov.

PATENT APPLICATION FEE DETERMINATION RECORD Substitute for Form PTO-875						Application or Docket Number 13/680,852				
APPLICATION AS FILED - PART I										
		(Column 1)	(Column 2)		SMALL ENTITY		OR	OTHER THAN SMALL ENTITY		
FOR	NUMBER FILED	NUMBER EXTRA		RATE(\$)	FEE(\$)			RATE(\$)	FEE(\$)	
BASIC FEE (37 CFR 1.16(a), (b), or (c))	N/A	N/A		N/A				N/A	390	
SEARCH FEE (37 CFR 1.16(k), (l), or (m))	N/A	N/A		N/A				N/A	620	
EXAMINATION FEE (37 CFR 1.16(o), (p), or (q))	N/A	N/A		N/A				N/A	250	
TOTAL CLAIMS (37 CFR 1.16(i))	18	minus 20 =	*				OR	x 62 =	0.00	
INDEPENDENT CLAIMS (37 CFR 1.16(h))	2	minus 3 =	*				OR	x 250 =	0.00	
APPLICATION SIZE FEE (37 CFR 1.16(s))	If the specification and drawings exceed 100 sheets of paper, the application size fee due is \$310 (\$155 for small entity) for each additional 50 sheets or fraction thereof. See 35 U.S.C. 41(a)(1)(G) and 37 CFR 1.16(s).								320	
MULTIPLE DEPENDENT CLAIM PRESENT (37 CFR 1.16(j))										
* If the difference in column 1 is less than zero, enter "0" in column 2.				TOTAL				TOTAL	1580	
APPLICATION AS AMENDED - PART II										
		(Column 1)	(Column 2)	(Column 3)	SMALL ENTITY		OR	OTHER THAN SMALL ENTITY		
AMENDMENT A	CLAIMS REMAINING AFTER AMENDMENT		HIGHEST NUMBER PREVIOUSLY PAID FOR	PRESENT EXTRA	RATE(\$)	ADDITIONAL FEE(\$)			RATE(\$)	ADDITIONAL FEE(\$)
	Total (37 CFR 1.16(i))	*	Minus	**	=		OR	x	=	
	Independent (37 CFR 1.16(h))	*	Minus	***	=		OR	x	=	
	Application Size Fee (37 CFR 1.16(s))									
	FIRST PRESENTATION OF MULTIPLE DEPENDENT CLAIM (37 CFR 1.16(j))									
					TOTAL ADD'L FEE		OR	TOTAL ADD'L FEE		
AMENDMENT B	CLAIMS REMAINING AFTER AMENDMENT		HIGHEST NUMBER PREVIOUSLY PAID FOR	PRESENT EXTRA	RATE(\$)	ADDITIONAL FEE(\$)			RATE(\$)	ADDITIONAL FEE(\$)
	Total (37 CFR 1.16(i))	*	Minus	**	=		OR	x	=	
	Independent (37 CFR 1.16(h))	*	Minus	***	=		OR	x	=	
	Application Size Fee (37 CFR 1.16(s))									
	FIRST PRESENTATION OF MULTIPLE DEPENDENT CLAIM (37 CFR 1.16(j))									
					TOTAL ADD'L FEE		OR	TOTAL ADD'L FEE		
<p>* If the entry in column 1 is less than the entry in column 2, write "0" in column 3.</p> <p>** If the "Highest Number Previously Paid For" IN THIS SPACE is less than 20, enter "20".</p> <p>*** If the "Highest Number Previously Paid For" IN THIS SPACE is less than 3, enter "3".</p> <p>The "Highest Number Previously Paid For" (Total or Independent) is the highest found in the appropriate box in column 1.</p>										



UNITED STATES PATENT AND TRADEMARK OFFICE

UNITED STATES DEPARTMENT OF COMMERCE
United States Patent and Trademark Office
Address: COMMISSIONER FOR PATENTS
P.O. Box 1450
Alexandria, Virginia 22313-1450
www.uspto.gov

Table with 4 columns: APPLICATION NUMBER (13/680,852), FILING OR 371(C) DATE (11/19/2012), FIRST NAMED APPLICANT (Jay S. Walker), ATTY. DOCKET NO./TITLE (025124-0509)

CONFIRMATION NO. 6364

FORMALITIES LETTER



29159
Neal, Gerber & Eisenberg LLP
2 N. LaSalle Street
Suite 1700
Chicago, IL 60602-3801

Date Mailed: 12/20/2012

NOTICE TO FILE MISSING PARTS OF NONPROVISIONAL APPLICATION

FILED UNDER 37 CFR 1.53(b)

Filing Date Granted

Items Required To Avoid Abandonment:

An application number and filing date have been accorded to this application. The item(s) indicated below, however, are missing.

Applicant is given TWO MONTHS from the date of this Notice within which to file all required items below to avoid abandonment. Extensions of time may be obtained by filing a petition accompanied by the extension fee under the provisions of 37 CFR 1.136(a).

- A surcharge (for late submission of the basic filing fee, search fee, examination fee or inventor's oath or declaration) as set forth in 37 CFR 1.16(f) of \$ 130 for a non-small entity, must be submitted.

SUMMARY OF FEES DUE:

Total fee(s) required within TWO MONTHS from the date of this Notice is \$ 130 for a non-small entity

- \$ 130 Surcharge.

Items Required To Avoid Processing Delays:

Applicant is notified that the above-identified application contains the deficiencies noted below. No period for reply is set forth in this notice for correction of these deficiencies. However, if a deficiency relates to the inventor's oath or declaration, the applicant must file an oath or declaration in compliance with 37 CFR 1.63, or a substitute statement in compliance with 37 CFR 1.64, executed by or with respect to each actual inventor no later than the expiration of the time period set in the "Notice of Allowability" to avoid abandonment. See 37 CFR 1.53(f).

- A properly executed inventor's oath or declaration has not been received for the following inventor(s): all
Applicant may submit the inventor's oath or declaration at any time before the Notice of Allowance and Fee(s) Due, PTOL-85, is mailed.

Replies must be received in the USPTO within the set time period or must include a proper Certificate of Mailing or Transmission under 37 CFR 1.8 with a mailing or transmission date within the set time period. For more information and a suggested format, see Form PTO/SB/92 and MPEP 512.

Replies should be mailed to:

Mail Stop Missing Parts
Commissioner for Patents
P.O. Box 1450
Alexandria VA 22313-1450

Registered users of EFS-Web may alternatively submit their reply to this notice via EFS-Web.
<https://sportal.uspto.gov/authenticate/AuthenticateUserLocalEPF.html>

For more information about EFS-Web please call the USPTO Electronic Business Center at **1-866-217-9197** or visit our website at <http://www.uspto.gov/ebc>.

If you are not using EFS-Web to submit your reply, you must include a copy of this notice.

/mhteklu/

Office of Data Management, Application Assistance Unit (571) 272-4000, or (571) 272-4200, or 1-888-786-0101

POWER OF ATTORNEY TO PROSECUTE APPLICATIONS BEFORE THE USPTO

I hereby revoke all previous powers of attorney given in the application identified in the attached statement under 37 CFR 3.73(b).

I hereby appoint:

Practitioners associated with the Customer Number: 29159

OR
 Practitioner(s) named below (if more than ten patent practitioners are to be named, then a customer number must be used):

Name	Registration Number	Name	Registration Number

as attorney(s) or agent(s) to represent the undersigned before the United States Patent and Trademark Office (USPTO) in connection with any and all patent applications assigned only to the undersigned according to the USPTO assignment records or assignment documents attached to this form in accordance with 37 CFR 3.73(b).

Please change the correspondence address for the application identified in the attached statement under 37 CFR 3.73(b) to:

The address associated with Customer Number: 29159

OR

<input type="checkbox"/> Firm or Individual Name			
Address			
City	State	Zip	
Country			
Telephone	Email		

Assignee Name and Address:

IGT
9295 Prototype Drive
Reno, Nevada 89521

A copy of this form, together with a statement under 37 CFR 3.73(b) (Form PTO/SB/96 or equivalent) is required to be filed in each application in which this form is used. The statement under 37 CFR 3.73(b) may be completed by one of the practitioners appointed in this form if the appointed practitioner is authorized to act on behalf of the assignee, and must identify the application in which this Power of Attorney is to be filed.

SIGNATURE of Assignee of Record

The individual whose signature and title is supplied below is authorized to act on behalf of the assignee

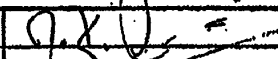
Signature		Date	1/6/2006
Name	J. Kenneth Creighton	Telephone	
Title	Assistant General Counsel/Assistant Secretary		

This collection of information is required by 37 CFR 1.31, 1.32 and 1.33. The information is required to obtain or retain a benefit by the public which is to file (and by the USPTO to process) an application. Confidentiality is governed by 35 U.S.C. 122 and 37 CFR 1.11 and 1.14. This collection is estimated to take 3 minutes to complete, including gathering, preparing, and submitting the completed application form to the USPTO. Time will vary depending upon the individual case. Any comments on the amount of time you require to complete this form and/or suggestions for reducing this burden, should be sent to the Chief Information Officer, U.S. Patent and Trademark Office, U.S. Department of Commerce, P.O. Box 1460, Alexandria, VA 22313-1460. DO NOT SEND FREE OR COMPLETED FORMS TO THIS ADDRESS. SEND TO: Commissioner for Patents, P.O. Box 1460, Alexandria, VA 22313-1460.

If you need assistance in completing the form, call 1-800-PTO-9199 and select option 2.

STATEMENT UNDER 37 CFR 3.73(c)Applicant/Patent Owner: Jay S. Walker et al.Application No./Patent No.: 13/680,852 Filed/Issue Date: November 19, 2012Titled: METHOD AND APPARATUS FOR OUTPUTTING A MESSAGE AT A GAME MACHINE

IGT _____, a corporation

(Name of Assignee)

(Type of Assignee, e.g., corporation, partnership, university, government agency, etc.)

states that, for the patent application/patent identified above, it is (choose **one** of options 1, 2, 3 or 4 below):

1. The assignee of the entire right, title, and interest.
2. An assignee of less than the entire right, title, and interest (check applicable box):
- The extent (by percentage) of its ownership interest is _____%. Additional Statement(s) by the owners holding the balance of the interest must be submitted to account for 100% of the ownership interest.
- There are unspecified percentages of ownership. The other parties, including inventors, who together own the entire right, title and interest are:

Additional Statement(s) by the owner(s) holding the balance of the interest must be submitted to account for the entire right, title, and interest.

3. The assignee of an undivided interest in the entirety (a complete assignment from one of the joint inventors was made). The other parties, including inventors, who together own the entire right, title, and interest are:

Additional Statement(s) by the owner(s) holding the balance of the interest must be submitted to account for the entire right, title, and interest.

4. The recipient, via a court proceeding or the like (e.g., bankruptcy, probate), of an undivided interest in the entirety (a complete transfer of ownership interest was made). The certified document(s) showing the transfer is attached.

The interest identified in option 1, 2 or 3 above (not option 4) is evidenced by either (choose **one** of options A or B below):

- A. An assignment from the inventor(s) of the patent application/patent identified above. The assignment was recorded in the United States Patent and Trademark Office at Reel _____, Frame _____, or for which a copy thereof is attached.
- B. A chain of title from the inventor(s), of the patent application/patent identified above, to the current assignee as follows:

1. From: _____ To: _____

The document was recorded in the United States Patent and Trademark Office at
Reel _____, Frame _____, or for which a copy thereof is attached.

2. From: _____ To: _____

The document was recorded in the United States Patent and Trademark Office at
Reel _____, Frame _____, or for which a copy thereof is attached.

[Page 1 of 2]

This collection of information is required by 37 CFR 3.73(b). The information is required to obtain or retain a benefit by the public which is to file (and by the USPTO to process) an application. Confidentiality is governed by 35 U.S.C. 122 and 37 CFR 1.11 and 1.14. This collection is estimated to take 12 minutes to complete, including gathering, preparing, and submitting the completed application form to the USPTO. Time will vary depending upon the individual case. Any comments on the amount of time you require to complete this form and/or suggestions for reducing this burden, should be sent to the Chief Information Officer, U.S. Patent and Trademark Office, U.S. Department of Commerce, P.O. Box 1450, Alexandria, VA 22313-1450. DO NOT SEND FEES OR COMPLETED FORMS TO THIS ADDRESS. **SEND TO: Commissioner for Patents, P.O. Box 1450, Alexandria, VA 22313-1450.**

If you need assistance in completing the form, call 1-800-PTO-9199 and select option 2.

STATEMENT UNDER 37 CFR 3.73(c)

3. From: _____ To: _____

The document was recorded in the United States Patent and Trademark Office at
Reel _____, Frame _____, or for which a copy thereof is attached.

4. From: _____ To: _____

The document was recorded in the United States Patent and Trademark Office at
Reel _____, Frame _____, or for which a copy thereof is attached.

5. From: _____ To: _____

The document was recorded in the United States Patent and Trademark Office at
Reel _____, Frame _____, or for which a copy thereof is attached.

6. From: _____ To: _____

The document was recorded in the United States Patent and Trademark Office at
Reel _____, Frame _____, or for which a copy thereof is attached.

Additional documents in the chain of title are listed on a supplemental sheet(s).

As required by 37 CFR 3.73(c)(1)(i), the documentary evidence of the chain of title from the original owner to the assignee was, or concurrently is being, submitted for recordation pursuant to 37 CFR 3.11.

[NOTE: A separate copy (i.e., a true copy of the original assignment document(s)) must be submitted to Assignment Division in accordance with 37 CFR Part 3, to record the assignment in the records of the USPTO. See MPEP 302.08]

The undersigned (whose title is supplied below) is authorized to act on behalf of the assignee.

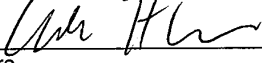

Signature

Adam H. Masia

Printed or Typed Name

January 14, 2013

Date

Attorney of Record

Title or Registration Number

PATENT ASSIGNMENT

NOW, THEREFORE, for good and valuable consideration, the receipt of which is hereby acknowledged, Walker Digital, LLC, a Delaware limited liability company, having offices at Two High Ridge Park Rd., Stamford, CT 06905, ("Assignor"), subject to the terms of the Purchase and License Agreement made and entered into between the parties hereto on August, 10, 2009 (the "Purchase and License Agreement") does hereby sell, assign, transfer, and convey unto IGT, a Nevada corporation, having an office at 9295 Prototype Drive, Reno NV 89521 ("Assignee"), or its designees, all right, title, and interest that exist today and may exist in the future in and to any and all of the following (collectively "the Patent Rights"):

(a) the provisional patent applications, patent applications, and patents listed in attached Schedule A ("the Patents");

(b) all patents and patent applications (i) to which any of the Patents directly or indirectly claims priority and (ii) for which any of the Patents directly or indirectly forms a basis for priority and are filed after August 6, 2009;

(c) all reissues, reexaminations, extensions, continuations, continuations in part filed after August 6, 2009, continuing prosecution applications, requests for continuing examinations, divisions, registrations of any item in any of the foregoing categories (a) and (b);

(d) all foreign patents, patent applications, and counterparts relating to any item in any of the foregoing categories (a) through (c), including, without limitation, certificates of invention, utility models, industrial design protection, design patent protection;

(e) all items in any of the foregoing in categories (a) through (d), whether or not expressly listed in Schedule A, and whether or not claims in any of the foregoing have been rejected, withdrawn, cancelled, or the like;

(f) all rights to apply in any or all countries of the world for patents, certificates of invention, utility models, industrial design protections, design patent protections, or other governmental grants or issuances of any type related to any item in any of the foregoing categories (a) through (e), including, without limitation, under the Paris Convention for the Protection of Industrial Property, the International Patent Cooperation Treaty, or any other convention, treaty, agreement, or understanding;

(g) all causes of action (whether known or unknown or whether currently pending, filed, or otherwise) and other enforcement rights under, or on account of, any of the Patents and/or any item in any of the foregoing categories (a) through (f), including, without limitation, all causes of action and other enforcement rights for:

- (i) damages, past, present, or future;
 - (ii) injunctive relief;
 - (iii) any other remedies of any kind for past, current, and future infringement;
- and

- (iv) all rights to collect royalties and other payments under or on account of any of the Patents and/or any item in any of the foregoing categories (a) through (f).

AND for the same consideration, Assignor hereby represents and warrants to Assignee, its successors, legal representatives, and assigns, that, at the time of execution and delivery of these presents, except for any rights, titles, and/or interests that have arisen to Assignee under law or that have already been transferred to Assignee, Assignor is the sole and lawful owner of the entire right, title, and interest in and to the said inventions and application for the above-mentioned Patents, and that the same are unencumbered, except as expressly set forth in the Purchase and License Agreement and that Assignor has good and full right and lawful authority to sell and convey the same in the manner according to the terms of this Patent Assignment and the Purchase and License Agreement.

AND for the same consideration, set forth herein and in the Purchase and License Agreement, Assignor hereby covenants and agrees to and with Assignee, its successors, legal representatives, and assigns, that Assignor will sign all papers and documents, take all lawful oaths and do all acts necessary or required to be done for the procurement, maintenance, enforcement, and defense of any Patents and Patent applications for said inventions, whenever counsel of Assignee, or counsel of its successors, legal representatives and assigns, shall advise: that any proceeding in connection with said inventions, or said Patent application, or any proceeding in connection with any Patents or Patent applications for said inventions in any country, including but not limited to interference proceedings, is lawful and desirable; or, that any division, continuation, or continuation-in-part filed after August 6, 2009 of any Patent application, or any reissue, reexamination, or extension of any Patent, to be obtained thereon, is lawful and desirable.

AND Assignor hereby authorizes the respective patent office or governmental agency in each jurisdiction to issue any and all patents, certificates of invention, utility models, or other governmental grants or issuances that may be granted upon any of the Patent Rights in the name of Assignee, as the assignee to the entire interest therein.

AND the terms and conditions of this Assignment of Patent Rights will inure to the benefit of Assignee, its successors, assigns, and other legal representatives and will be binding upon Assignor, its successors, assigns, and other legal representatives.

IN WITNESS WHEREOF this Assignment of Patent Rights is executed at _____
on _____.

ASSIGNOR:

Walker Digital, LLC

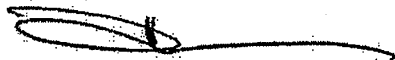

Jay S. Walker, Chief Executive Officer

STATE OF CT)
COUNTY OF Fairfield) ss.

On October 26th, 09, before me, Manjola Alevy, Notary Public in and for said State, personally appeared Jay S. Walker, personally known to me (or proved to me on the basis of satisfactory evidence) to be the person whose name is subscribed to the within instrument and acknowledged to me that he/she executed the same in his/her authorized capacity, and that by his/her signature on the instrument the person, or the entity upon behalf of which the person acted, executed the instrument.

WITNESS my hand and official seal.

Signature

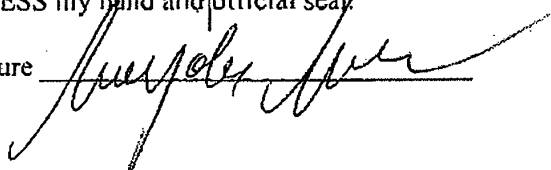

(Seal)

City/County of _____
State of Connecticut
Subscribed and sworn to before me
this 26th day of October, 09
by Jay Walker
Manjola Alevy Notary Public
MANJOLA MEMA
My commission expires September 30, 2013

Schedule A

WIPO Doc No.	Appl. No.	File Date	Invention Title	Country	Patent No.	Inventor
00-018	01920875.0	15-Oct-2002	SYSTEMS AND METHODS FOR ALLOCATING AN OUTCOME AMOUNT AMONG A TOTAL NUMBER OF EVENTS	EP		Tulley, Stephen C
00-018-C1	11/385644	21-Mar-2006	SYSTEMS AND METHODS FOR ALLOCATING AN OUTCOME AMOUNT AMONG A TOTAL NUMBER OF EVENTS	US		Tulley, Stephen C
00-018-C2	11/456353	10-Jul-2006	SYSTEMS AND METHODS FOR ALLOCATING AN OUTCOME AMOUNT AMONG A TOTAL NUMBER OF EVENTS	US		Tulley, Stephen C
00-018-C3	11/456359	10-Jul-2006	SYSTEMS AND METHODS FOR ALLOCATING AN OUTCOME AMOUNT AMONG A TOTAL NUMBER OF EVENTS	US		Tulley, Stephen C
00-032	09/597801	20-Jun-2000	GAMING TOKEN HAVING A VARIABLE VALUE	US	7267614	Jorasch, James A
00-032-1	11/321793	29-Dec-2005	GAMING TOKEN HAVING A VARIABLE VALUE	US		Jorasch, James A
00-032-2	11/329872	11-Jan-2006	GAMING TOKEN HAVING A VARIABLE VALUE	US		Jorasch, James A
00-032-3	11/331550	13-Jan-2006	GAMING TOKEN HAVING A VARIABLE VALUE	US		Jorasch, James A
00-032-4	11/361152	24-Feb-2006	GAMING TOKEN HAVING A VARIABLE VALUE	US	7549920	Jorasch, James A
00-032-C1	11/338551	14-Aug-2007	GAMING TOKEN HAVING A VARIABLE VALUE	US		Jorasch, James A
00-054	09/609720	30-Jun-2000	METHOD AND APPARATUS FOR PLAYING A CARD GAME INCLUDING A MORTGAGING OPTION	US	6523829	Walker, Jay S
00-059-C2	11/427429	29-Jun-2006	METHOD AND APPARATUS FOR OFFERING FORWARD COMMITMENT AGREEMENTS	US		Walker, Jay S
01-007	2002256220	19-Aug-2003	METHODS AND SYSTEMS FOR FACILITATING PLAY AT A GAMING DEVICE BY MEANS OF THIRD PARTY OFFERS	AU	2002256220	Walker, Jay S
01-007	02725669.2	03-Sep-2003	METHODS AND SYSTEMS FOR FACILITATING PLAY AT A GAMING DEVICE BY MEANS OF THIRD PARTY OFFERS	EP		Walker, Jay S
01-007	10/121243	11-Apr-2002	METHODS AND SYSTEMS FOR FACILITATING PLAY AT A GAMING DEVICE BY MEANS OF THIRD PARTY OFFERS	US	7094149	Walker, Jay S

MMF

WI Docket No.	App. #	Filed Date	Invention Title	Country	Patent	First Named Inventor
01-007-C1	11/378199	17-Mar-2006	METHODS AND SYSTEMS FOR FACILITATING PLAY AT A GAMING DEVICE BY MEANS OF THIRD PARTY OFFERS	US		Walker, Jay S
01-007-C2	11/422392	06-Jun-2006	METHODS AND SYSTEMS FOR FACILITATING PLAY AT A GAMING DEVICE BY MEANS OF THIRD PARTY OFFERS	US		Walker, Jay S
01-009-C1	11/422436	06-Jun-2006	METHOD AND APPARATUS FOR GAMING WITH ALTERNATE VALUE PAYOUTS	US		Walker, Jay S
01-010	02744396.9	19-Dec-2003	METHOD AND APPARATUS FOR PLANNING AND CUSTOMIZING A GAMING EXPERIENCE	EP		Walker, Jay S
01-010	10/174432	17-Jun-2002	METHOD AND APPARATUS FOR PLANNING AND CUSTOMIZING A GAMING EXPERIENCE	US		Walker, Jay S
01-011	10/175232	18-Jun-2002	METHOD AND APPARATUS FOR PROVIDING CREDITS FOR GAME PLAY	US	7473177	Walker, Jay S
01-011-C1	12/349078	06-Jan-2009	METHOD AND APPARATUS FOR PROVIDING CREDITS FOR GAME PLAY	US		Walker, Jay S
01-016	10/176765	20-Jun-2002	METHODS AND SYSTEMS FOR DOCUMENTING A PLAYER'S EXPERIENCE IN A CASINO ENVIRONMENT	US		Walker, Jay S
01-016-C1	11/422798	07-Jun-2006	METHODS AND SYSTEMS FOR DOCUMENTING A PLAYER'S EXPERIENCE IN A CASINO ENVIRONMENT	US		Walker, Jay S
01-016-C3	11/422805	07-Jun-2006	METHODS AND SYSTEMS FOR DOCUMENTING A PLAYER'S EXPERIENCE IN A CASINO ENVIRONMENT	US		Walker, Jay S
01-017	10/171495	13-Jun-2002	METHOD AND APPARATUS FOR OFFERING AND PROVIDING CONSOLATION PRIZES	US		Walker, Jay S
01-020	10/205305	24-Jul-2002	METHOD AND APPARATUS FOR OFFERING A GUARANTEED WIN	US		Walker, Jay S
01-021	10/187120	28-Jun-2002	METHOD AND APPARATUS FOR MANAGING HOTEL TRANSACTIONS FROM A GAMING DEVICE	US		Friesen, Scott
01-021-C1	12/237123	24-Sep-2008	METHOD AND APPARATUS FOR MANAGING HOTEL TRANSACTIONS FROM A GAMING DEVICE	US		Friesen, Scott

RF

WI Patent No.	App. #	Filed Date	Invention Title	Country	Patent #	Pat. Named Inventor
01-024	09/879299	12-Jun-2001	SYSTEM AND METHOD FOR AUTOMATED PLAY OF MULTIPLE GAMING DEVICES	US	6634942	Walker, Jay S
01-024-C1	10/159722	30-May-2002	SYSTEM AND METHOD FOR AUTOMATED PLAY OF MULTIPLE GAMING DEVICES	US	6969317	Walker, Jay S
01-024-C2	11/217588	01-Sep-2005	METHOD AND HANDHELD APPARATUS FOR FACILITATING REMOTE PLAY OF A SLOT MACHINE	US	7588495	Walker, Jay S
01-024-C3	11/422817	07-Jun-2006	SYSTEM AND METHOD FOR AUTOMATED PLAY OF MULTIPLE GAMING DEVICES	US		Walker, Jay S
01-024-C4	11/422821	07-Jun-2006	SYSTEM AND METHOD FOR AUTOMATED PLAY OF MULTIPLE GAMING DEVICES	US		Walker, Jay S
01-026-1	11/552793	25-Oct-2006	METHOD AND APPARATUS FOR GENERATING DIRECTIVES FOR PERSONNEL	US		Walker, Jay S
01-034	09/965328	27-Sep-2001	METHOD AND APPARATUS FOR AWARDED AND REDEEMING PREPAID TELEPHONE TIME	US	6690779	Walker, Jay S
01-037	10/298621	15-Nov-2002	METHOD AND APPARATUS FOR FACILITATING PLAY OF A GAMING DEVICE	US		Walker, Jay S
01-045	10/001089	02-Nov-2001	GAMING DEVICE FOR A FLAT RATE PLAY SESSION AND A METHOD OF OPERATING SAME	US	7140964	Walker, Jay S
01-045-C1	10/985131	10-Nov-2004	GAMING DEVICE FOR A FLAT RATE PLAY SESSION AND A METHOD OF OPERATING SAME	US	7156739	Walker, Jay S
01-045-C2	10/986529	10-Nov-2004	GAMING DEVICE FOR A FLAT RATE PLAY SESSION AND A METHOD OF OPERATING SAME	US		Walker, Jay S
01-045-C4	11/425037	19-Jun-2006	GAMING DEVICE FOR A FLAT RATE PLAY SESSION AND A METHOD OF OPERATING SAME	US		Walker, Jay S
01-052	10/635986	07-Aug-2003	SYSTEM AND METHOD FOR REMOTE AUTOMATED PLAY OF A GAMING DEVICE	US		Walker, Jay S
01-052-C1	11/424000	14-Jun-2006	SYSTEM AND METHOD FOR REMOTE AUTOMATED PLAY OF A GAMING DEVICE	US	7476153	Walker, Jay S

JK

WB Device No	App No	File Date	Invention Title	Country	Patent	File Name (Inventor)
01-052-C2	11/424006	14-Jun-2006	SYSTEM AND METHOD FOR REMOTE AUTOMATED PLAY OF A GAMING DEVICE	US	7607981	Walker, Jay S
01-052-C3	11/424009	14-Jun-2006	SYSTEM AND METHOD FOR REMOTE AUTOMATED PLAY OF A GAMING DEVICE	US	7524244	Walker, Jay S
01-053	10/636520	07-Aug-2003	SYSTEM AND METHOD FOR COMMUNICATING GAME SESSION INFORMATION	US		Walker, Jay S
01-053-C2	11/423043	08-Jun-2006	SYSTEM AND METHOD FOR COMMUNICATING GAME SESSION INFORMATION	US		Walker, Jay S
01-053-C3	11/423055	08-Jun-2006	SYSTEM AND METHOD FOR COMMUNICATING GAME SESSION INFORMATION	US		Walker, Jay S
02-002	10/077873	15-Feb-2002	APPARATUS AND METHOD FOR FACILITATING PLAY OF A GAMING DEVICE WITH A PLURALITY OF BALANCES	US		Jorasch, James A
02-003	10/112712	29-Mar-2002	SYSTEM AND METHOD FOR ADVERTISING/SALES AT A GAMING DEVICE	US	6890256	Walker, Jay S
02-009	10/419303	18-Apr-2003	METHOD AND APPARATUS FOR PROVIDING A TIME BASED PAYMENT FROM A GAMING DEVICE	US		Walker, Jay S
02-010	10/417436	16-Apr-2003	METHOD AND APPARATUS FOR OPTIMIZING THE RATE OF PLAY OF A GAMING DEVICE	US		Walker, Jay S
02-012-C1	11/424905	19-Jun-2006	SYSTEMS AND METHODS FOR FACILITATING PLAY USING REVERSED PAYOUT TABLES	US		Walker, Jay S
02-013-3	11/462877	07-Aug-2006	METHOD AND APPARATUS FOR AUTOMATICALLY OPERATING A GAME MACHINE	US		Walker, Jay S
02-013-C2	11/428601	05-Jul-2006	METHOD AND APPARATUS FOR AUTOMATICALLY OPERATING A GAME MACHINE	US		Walker, Jay S
02-014	10/414511	15-Apr-2003	METHOD AND APPARATUS FOR BONUS ROUND PLAY	US	7275990	Walker, Jay S
02-014-C1	11/425296	20-Jun-2006	METHOD AND APPARATUS FOR BONUS ROUND PLAY	US		Walker, Jay S
02-014-C4	12/121065	15-May-2008	METHOD AND APPARATUS FOR BONUS ROUND PLAY	US		Walker, Jay S
02-015	2003228618	13-Sep-2004	METHOD AND APPARATUS FOR ENABLING A PLAYER TO SELECT FEATURES ON A GAMING DEVICE	AU	2003228618	Walker, Jay S

985

WIPO Doc. No.	Appl. No.	File Date	Invention Title	Country	Parent #	Inventor
02-015	10/419478	18-Apr-2003	METHOD AND APPARATUS FOR ENABLING A PLAYER TO SELECT FEATURES ON A GAMING DEVICE	US		Walker, Jay S
02-017	2003221975	13-Sep-2004	GAMING DEVICE METHODS AND APPARATUS EMPLOYING AUDIO/VIDEO PROGRAMMING OUTCOME PRESENTATION	AU	2003221975	Walker, Jay S
02-017	2007200579	07-Feb-2007	GAMING DEVICE METHODS AND APPARATUS EMPLOYING AUDIO/VIDEO PROGRAMMING OUTCOME PRESENTATION	AU		Walker, Jay S
02-017	03718438.9	17-Sep-2004	GAMING DEVICE METHODS AND APPARATUS EMPLOYING AUDIO/VIDEO PROGRAMMING OUTCOME PRESENTATION	EP		Walker, Jay S
02-017	10/417758	16-Apr-2003	GAMING DEVICE METHODS AND APPARATUS EMPLOYING AUDIO/VIDEO PROGRAMMING OUTCOME PRESENTATION	US		Walker, Jay S
02-018	2003221973	16-Apr-2003	METHODS AND APPARATUS EMPLOYING AUTOMATIC AUDIO/VIDEO PROGRAMMING TO INITIATE GAME PLAY AT A GAMING DEVICE	AU		Walker, Jay S
02-018	2007202170	15-May-2007	METHODS AND APPARATUS EMPLOYING AUTOMATIC AUDIO/VIDEO PROGRAMMING TO INITIATE GAME PLAY AT A GAMING DEVICE	AU		Walker, Jay S
02-018	03718436.3	28-Sep-2004	METHODS AND APPARATUS EMPLOYING AUTOMATIC AUDIO/VIDEO PROGRAMMING TO INITIATE GAME PLAY AT A GAMING DEVICE	EP		Walker, Jay S
02-018	10/417733	16-Apr-2003	METHODS AND APPARATUS EMPLOYING AUTOMATIC AUDIO/VIDEO PROGRAMMING TO INITIATE GAME PLAY AT A GAMING DEVICE	US		Walker, Jay S
02-018-C3	11/674256	13-Feb-2007	METHODS AND APPARATUS EMPLOYING AUTOMATIC AUDIO/VIDEO PROGRAMMING TO INITIATE GAME PLAY AT A GAMING DEVICE	US		Walker, Jay S

885

WI Docket No.	App. #	File Date	Invention Title	Country	Patent	Inventor
02-018-C4	11/674269	13-Feb-2007	METHODS AND APPARATUS EMPLOYING AUDIO/VIDEO PROGRAMMING TO INITIATE GAME PLAY AT A GAMING DEVICE	US		Walker, Jay S
02-019	10/419306	18-Apr-2003	METHOD AND APPARATUS FOR PROVIDING A BONUS TO A PLAYER BASED ON A CREDIT BALANCE	US		Walker, Jay S
02-021	10/419304	18-Apr-2003	GAMING DEVICE METHOD AND APPARATUS EMPLOYING MODIFIED PAYOUTS	US	7563167	Walker, Jay S
02-021-C1	11/428716	05-Jul-2006	GAMING DEVICE METHOD AND APPARATUS EMPLOYING MODIFIED PAYOUTS	US		Walker, Jay S
02-022	10/420066	21-Apr-2003	METHOD AND APPARATUS FOR EMPLOYING FLAT RATE PLAY	US		Walker, Jay S
02-022-C1	11/428638	05-Jul-2006	METHOD AND APPARATUS FOR EMPLOYING FLAT RATE PLAY	US		Walker, Jay S
02-022-C2	11/428642	05-Jul-2006	METHOD AND APPARATUS FOR EMPLOYING FLAT RATE PLAY	US		Walker, Jay S
02-022-C3	11/691015	26-Mar-2007	METHOD AND APPARATUS FOR EMPLOYING FLAT RATE PLAY	US		Walker, Jay S
02-022-C4	11/691065	26-Mar-2007	METHOD AND APPARATUS FOR EMPLOYING FLAT RATE PLAY	US		Walker, Jay S
02-023	10/328116	20-Dec-2002	METHOD AND APPARATUS FOR OUTPUTTING OUTCOMES OF A GAMING DEVICE	US	7467999	Walker, Jay S
02-023-C1	11/942014	19-Nov-2007	METHOD AND APPARATUS FOR OUTPUTTING OUTCOMES OF A GAMING DEVICE	US		Walker, Jay S
02-024	10/395621	21-Mar-2003	METHODS AND APPARATUS FOR MANAGING AN ACCOUNT TO FUND BENEFITS FOR A PLAYER	US	7416485	Walker, Jay S
02-024-1	12/190984	13-Aug-2008	METHODS AND APPARATUS FOR MANAGING AN ACCOUNT TO FUND BENEFITS FOR A PLAYER	US		Walker, Jay S
02-027-1	11/465228	17-Aug-2006	METHODS AND APPARATUS FOR PROVIDING COMMUNICATIONS SERVICES AT A GAMING MACHINE	US		Walker, Jay S

888

WIPO Patent No.	App. No.	File Date	Invention Title	Country	Patent	First Named Inventor
02-027-2	11/465265	17-Aug-2006	METHODS AND APPARATUS FOR PROVIDING COMMUNICATIONS SERVICES AT A GAMING MACHINE	US		Walker, Jay S
02-027-3	11/465295	17-Aug-2006	METHODS AND APPARATUS FOR PROVIDING COMMUNICATIONS SERVICES AT A GAMING MACHINE	US		Walker, Jay S
02-027-C1	11/456459	10-Jul-2006	METHODS AND APPARATUS FOR PROVIDING COMMUNICATIONS SERVICES AT A GAMING MACHINE	US		Walker, Jay S
02-029	10/395529	21-Mar-2003	METHOD AND APPARATUS FOR PROVIDING ENTERTAINMENT CONTENT AT A GAMING DEVICE	US	7241219	Walker, Jay S
02-029-C1	11/670721	02-Feb-2007	METHOD AND APPARATUS FOR PROVIDING ENTERTAINMENT CONTENT AT A GAMING DEVICE	US		Walker, Jay S
02-029-C2	11/670755	02-Feb-2007	METHOD AND APPARATUS FOR PROVIDING ENTERTAINMENT CONTENT AT A GAMING DEVICE	US		Walker, Jay S
02-030	10/420981	22-Apr-2003	GAMING DEVICE METHOD AND APPARATUS EMPLOYING ALTERNATE PAYOUT FEATURES	US		Walker, Jay S
02-039	10/655154	04-Sep-2003	METHOD AND APPARATUS FOR PROVIDING A COMPLIMENTARY SERVICE TO A PLAYER	US		Walker, Jay S
02-040	2008201125	10-Mar-2008	METHOD AND APPARATUS FOR OUTPUTTING A MESSAGE AT A GAME MACHINE	AU		Walker, Jay S
02-040	03779102.7	12-Apr-2005	METHOD AND APPARATUS FOR OUTPUTTING A MESSAGE AT A GAME MACHINE	EP		Walker, Jay S
02-040	10/685143	14-Oct-2003	METHOD AND APPARATUS FOR OUTPUTTING A MESSAGE AT A GAME MACHINE	US		Walker, Jay S
02-044A	10/885570	06-Jul-2004	METHODS AND SYSTEMS FOR PROVIDING PAPER BASED OUTCOMES	US		Walker, Jay S
02-044A-C1	11/422341	06-Jun-2006	METHODS AND SYSTEMS FOR PROVIDING PAPER BASED OUTCOMES	US		Walker, Jay S
02-058	10/6555969	04-Sep-2003	METHOD AND APPARATUS FOR PLAYER COMMUNICATION	US		Walker, Jay S

WD Docket No.	App. #	File Date	Invention Title	Country	Patent #	First Named Inventor
02-060	10/852388	24-May-2004	METHOD AND APPARATUS FOR PROVIDING ELECTRONIC CREDITS AT A GAMING DEVICE WITHOUT FIRST REQUIRING PAYMENT THEREFOR	US		Walker, Jay S
02-060-C1	12/511268	29-Jul-2009	METHOD AND APPARATUS FOR PROVIDING ELECTRONIC CREDITS AT A GAMING DEVICE WITHOUT FIRST REQUIRING PAYMENT THEREFOR	US		Walker, Jay S
02-063	11/743353	02-May-2007	METHOD AND APPARATUS FOR PROVIDING A BONUS TO A PLAYER	US		Walker, Jay S
02-066	10/213464	05-Aug-2002	SYSTEMS AND METHODS FOR FACILITATING PLAY OF A CASINO GAME VIA EXPIRING PREPAID PLAYS OF THE CASINO GAME	US	7086947	Walker, Jay S
02-066-C1	11/413928	28-Apr-2006	SYSTEMS AND METHODS FOR FACILITATING PLAY OF A CASINO GAME VIA EXPIRING PREPAID PLAYS OF THE CASINO GAME	US	7458892	Walker, Jay S
02-066-C1-1	12/256014	22-Oct-2008	SYSTEMS AND METHODS FOR FACILITATING PLAY OF A CASINO GAME VIA EXPIRING PREPAID PLAYS OF THE CASINO GAME	US		Walker, Jay S
02-070	10/202192	23-Jul-2002	METHOD AND APPARATUS FOR VIDEO POKER	US	7201655	Walker, Jay S
02-070-C1	11/695167	02-Apr-2007	METHOD AND APPARATUS FOR VIDEO POKER	US	7476542	Walker, Jay S
02-075	04794613.2	08-May-2006	METHOD AND APPARATUS FOR DERIVING INFORMATION FROM A GAMING DEVICE	EP		Walker, Jay S
02-075	10/681075	08-Oct-2003	METHOD AND APPARATUS FOR DERIVING INFORMATION FROM A GAMING DEVICE	US		Walker, Jay S
02-081	10/689975	21-Oct-2003	GAMING DEVICE METHOD AND APPARATUS EMPLOYING ALTERNATE PAYOUT FEATURES	US		Walker, Jay S
02-081-C1	11/456875	12-Jul-2006	GAMING DEVICE METHOD AND APPARATUS EMPLOYING ALTERNATE PAYOUT FEATURES	US		Walker, Jay S
02-081-C2	11/456877	12-Jul-2006	GAMING DEVICE METHOD AND APPARATUS EMPLOYING ALTERNATE PAYOUT FEATURES	US		Walker, Jay S

888

Patent No.	App. No.	File Date	Invention Title	Country	Patent No.	First Named Inventor
02-091	10/317193	11-Dec-2002	SYSTEMS AND METHODS FOR DETERMINING AN OUTCOME OF A GAME ON A GAMING DEVICE BASED ON A FACTOR OTHER THAN A RANDOM NUMBER	US	7160189	Walker, Jay S
02-091-C1	11/565741	01-Dec-2006	SYSTEMS AND METHODS FOR DETERMINING AN OUTCOME OF A GAME ON A GAMING DEVICE BASED ON A FACTOR OTHER THAN A RANDOM NUMBER	US		Walker, Jay S
02-097	10/341450	10-Jan-2003	SYSTEM AND METHOD FOR PLAYING A GAME INCLUDING A MORTGAGING OPTION	US	7111845	Walker, Jay S
02-097-C1	11/428645	05-Jul-2006	SYSTEM AND METHOD FOR PLAYING A GAME INCLUDING A MORTGAGING OPTION	US		Walker, Jay S
03-001	10/430021	05-May-2003	ELECTRONIC GAMING DEVICE AND METHOD FOR OPERATING SAME	US		Walker, Jay S
03-002	10/365154	11-Feb-2003	METHOD AND APPARATUS FOR PROVIDING INSURANCE POLICIES FOR GAMBLING LOSSES	US	6869362	Walker, Jay S
03-005	10/787356	26-Feb-2004	METHOD AND APPARATUS FOR PLAY OF A GAME WITH NEGATIVE OUTCOMES	US		Walker, Jay S
03-007	10/793140	03-Mar-2004	METHOD AND APPARATUS FOR PAYOUTS DETERMINED BASED ON A SET COMPLETION GAME	US		Walker, Jay S
03-007-C1	11/456621	11-Jul-2006	METHOD AND APPARATUS FOR PAYOUTS DETERMINED BASED ON A SET COMPLETION GAME	US		Walker, Jay S
03-009	10/778984	13-Feb-2004	SYSTEM AND METHOD ENABLING EXTENSION OF A TIME ELEMENT IN A GAME	US		Walker, Jay S
03-010	10/788124	26-Feb-2004	METHODS AND APPARATUS FOR REPRESENTING PLAY IN A REVERSE MODE	US	7452272	Walker, Jay S
03-010-C1	12/269129	12-Nov-2008	METHODS AND APPARATUS FOR REPRESENTING PLAY IN A REVERSE MODE	US		Walker, Jay S
03-011	10/784845	23-Feb-2004	METHOD AND APPARATUS FOR SETTING GAME PARAMETERS	US	7427233	Walker, Jay S

898

WB Patent No.	App. No.	File Date	Invention	Country	Patent	Inventor
03-011-1	11/556399	03-Nov-2006	METHOD AND APPARATUS FOR SETTING GAME PARAMETERS	US		Walker, Jay S
03-013	10/791029	02-Mar-2004	METHOD AND APPARATUS FOR ALTERNATE DISPLAY INFORMATION	US		Walker, Jay S
03-015	10/374023	25-Feb-2003	SYSTEM AND METHOD FOR FACILITATING PLAY OF A GAME WITH USER-SELECTED ELEMENTS	US	7004834	Walker, Jay S
03-015-C1	11/304301	15-Dec-2005	SYSTEM AND METHOD FOR FACILITATING PLAY OF A GAME WITH USER-SELECTED ELEMENTS	US		Walker, Jay S
03-018	2008207348	15-Aug-2008	METHOD AND SYSTEM FOR MANAGING GAME CONFIRMATIONS	AU		
03-018	10/791028	02-Mar-2004	METHOD AND SYSTEM FOR MANAGING GAME CONFIRMATIONS	US		Walker, Jay S
03-019-C1	11/426457	26-Jun-2006	METHOD AND APPARATUS FOR DETERMINING AND PRESENTING OUTCOMES AT A GAMING DEVICE	US		Walker, Jay S
03-021	10/793345	04-Mar-2004	SYSTEMS AND METHODS FOR PRESENTING AN OUTCOME AMOUNT VIA A TOTAL NUMBER OF EVENTS	US	7452270	Walker, Jay S
03-021-C1	12/270398	13-Nov-2008	SYSTEMS AND METHODS FOR PRESENTING AN OUTCOME AMOUNT VIA A TOTAL NUMBER OF EVENTS	US		Walker, Jay S
03-022	10/794981	04-Mar-2004	METHOD AND APPARATUS FOR ASSOCIATING SYMBOLS WITH A STATE OF A GAMING DEVICE	US		Walker, Jay S
03-026	10/790934	02-Mar-2004	METHOD AND APPARATUS FOR PROVIDING REGULAR ENTRANCE INTO A BONUS GAME	US		Walker, Jay S
03-027-C1	11/428425	03-Jul-2006	SYSTEMS AND METHODS FOR EXECUTING GAMES EMPLOYING BONUS AMOUNTS BASED ON BONUS CHARACTERISTICS	US		Walker, Jay S
03-027-C3	12/511772	29-Jul-2009	SYSTEMS AND METHODS FOR EXECUTING GAMES EMPLOYING BONUS AMOUNTS BASED ON BONUS CHARACTERISTICS	US		Walker, Jay S
03-028	10/790167	01-Mar-2004	GAME BASED ON SPEED OF PLAY	US		Walker, Jay S

885

WB Docket No.	App. #	File Date	Invention Title	Country	Patent #	First Named Inventor
03-040	10/459678	11-Jun-2003	APPARATUS PROVIDING PAYOUTS PROPORTIONAL TO WAGERS AND METHODS FOR OPERATING SAME	US		Walker, Jay S
03-040-C1	11/456617	11-Jul-2006	APPARATUS PROVIDING PAYOUTS PROPORTIONAL TO WAGERS AND METHODS FOR OPERATING SAME	US		Walker, Jay S
03-041	10/619066	14-Jul-2003	METHOD AND SYSTEM FOR VIDEO POKER	US	7056207	Walker, Jay S
03-041-C1	11/412438	27-Apr-2006	METHOD AND SYSTEM FOR VIDEO POKER	US		Walker, Jay S
03-046	10/946496	21-Sep-2004	METHODS AND SYSTEMS FOR REPLAYING A PLAYER'S EXPERIENCE IN A CASINO ENVIRONMENT	US		Walker, Jay S
03-046-C3	12/104155	16-Apr-2008	METHODS AND SYSTEMS FOR REPLAYING A PLAYER'S EXPERIENCE IN A CASINO ENVIRONMENT	US		Walker, Jay S
03-052	10/968342	18-Oct-2004	SYSTEMS AND METHODS FOR DETERMINING A LEVEL OF REWARD	US		Walker, Jay S
03-063	10/770231	02-Feb-2004	METHOD AND APPARATUS FOR DIRECTING A GAME IN ACCORDANCE WITH SPEED OF PLAY	US		Walker, Jay S
03-063-C2	11/428419	03-Jul-2006	METHOD AND APPARATUS FOR DIRECTING A GAME IN ACCORDANCE WITH SPEED OF PLAY	US		Walker, Jay S
03-067	11/456920	12-Jul-2006	PRODUCTS AND PROCESSES FOR CASHLESS GAMING	US		Walker, Jay S
04-007	2005232645	03-Nov-2006	METHODS AND APPARATUS FOR FACILITATING USAGE OF A SUPPLEMENTAL TICKET AT A GAMING DEVICE	AU		Tedesco, Robert C
04-007	05732367.7	06-Nov-2006	METHODS AND APPARATUS FOR FACILITATING USAGE OF A SUPPLEMENTAL TICKET AT A GAMING DEVICE	EP		Tedesco, Robert C
04-007	11/719119	11-May-2007	METHODS AND APPARATUS FOR FACILITATING USAGE OF A SUPPLEMENTAL TICKET AT A GAMING DEVICE	US		Tedesco, Robert C
04-011	11/568350	26-Oct-2006	APPARATUS, SYSTEMS AND METHODS FOR FACILITATING A PAYOUT OF A GAMING DEVICE	US		Walker, Jay S
04-015	11/113703	25-Apr-2005	APPARATUS, SYSTEMS AND METHODS FOR FACILITATING A PAYOUT OF A GAMING DEVICE	US		Walker, Jay S

898

US Patent No.	App. No.	Filed Date	Invention Title	Country	Patent	First Named Inventor
04-029	10/908688	23-May-2005	GAMING DEVICE METHODS AND APPARATUS EMPLOYING AUDIO/VIDEO PROGRAMMING OUTCOME PRESENTATION	US		Walker, Jay S
04-029-C1	11/423045	08-Jun-2006	GAMING DEVICE METHODS AND APPARATUS EMPLOYING AUDIO/VIDEO PROGRAMMING OUTCOME PRESENTATION	US		Walker, Jay S
04-029-C2	11/423051	08-Jun-2006	GAMING DEVICE METHODS AND APPARATUS EMPLOYING AUDIO/VIDEO PROGRAMMING OUTCOME PRESENTATION	US		Walker, Jay S
04-029-C3	11/423059	08-Jun-2006	GAMING DEVICE METHODS AND APPARATUS EMPLOYING AUDIO/VIDEO PROGRAMMING OUTCOME PRESENTATION	US		Walker, Jay S
04-031	2005258093	19-Dec-2006	PRODUCTS AND PROCESSES FOR EMPLOYING VIDEO TO INITIATE GAME PLAY AT A GAMING DEVICE	AU		Walker, Jay S
04-031	05762044.5	03-Jan-2007	PRODUCTS AND PROCESSES FOR EMPLOYING VIDEO TO INITIATE GAME PLAY AT A GAMING DEVICE	EP		Walker, Jay S
04-031	11/570643	14-Dec-2006	PRODUCTS AND PROCESSES FOR EMPLOYING VIDEO TO INITIATE GAME PLAY AT A GAMING DEVICE	US		Walker, Jay S
04-032	10/908725	24-May-2005	METHODS AND APPARATUS FOR OPERATING A GAMING DEVICE	US		Walker, Jay S
04-033	11/160363	21-Jun-2005	APPARATUS AND METHODS FOR FACILITATING AUTOMATED PLAY OF GAME MACHINE	US		Walker, Jay S
04-034	10/908957	02-Jun-2005	METHOD AND APPARATUS FOR FACILITATING PLAY OF A GAMING DEVICE	US		Walker, Jay S
04-035	11/160410	22-Jun-2005	METHODS AND APPARATUS FOR FACILITATING A PAYOUT AT A GAMING DEVICE USING AUDIO/VIDEO CONTENT	US		Walker, Jay S

898

WIJ Pocket No.	Appl. #	File Date	Invention Title	Country	Patent #	First Named Inventor
04-035-C1	11/841387	20-Aug-2007	METHODS AND APPARATUS FOR FACILITATING A PAYOUT AT A GAMING DEVICE USING AUDIO/VIDEO CONTENT	US		Walker, Jay S
04-036	11/160150	06-Jun-2005	METHOD AND APPARATUS FOR FACILITATING ENTRY INTO BONUS ROUNDS	US		Walker, Jay S
04-042	200580034574	10-Apr-2007	SYSTEMS, METHODS AND APPARATUS FOR FACILITATING PLAY OF A GAMING DEVICE IN ACCORDANCE WITH A CONTRACT	CN		Walker, Jay S
04-042	05779722.7	22-Feb-2007	SYSTEMS, METHODS AND APPARATUS FOR FACILITATING PLAY OF A GAMING DEVICE IN ACCORDANCE WITH A CONTRACT	EP		Walker, Jay S
04-048	11/251290	14-Oct-2005	GAMING DEVICE OPERABLE TO FACILITATE AUDIO OUTPUT VIA A HEADSET AND METHODS RELATED THERETO	US		Walker, Jay S
04-052	11/245852	07-Oct-2005	METHODS AND APPARATUS FOR PLAYING VIDEO POKER WITH A CARD REPLICATING FUNCTION	US		Walker, Jay S
04-052-C1	11/456869	12-Jul-2006	METHODS AND APPARATUS FOR PLAYING VIDEO POKER WITH A CARD REPLICATING FUNCTION	US		Walker, Jay S
04-053	11/251468	14-Oct-2005	METHOD AND APPARATUS FOR FACILITATING PLAY OF A GAMING DEVICE	US		Walker, Jay S
04-054	11/258508	25-Oct-2005	METHOD AND APPARATUS FOR PLAYING VIDEO POKER WITH A REDRAW FUNCTION	US		Walker, Jay S
04-055	11/257245	24-Oct-2005	METHODS AND APPARATUS FOR FACILITATING GAMBLING LOSS INSURANCE POLICIES WITHOUT REQUIRING A SERVER THEREFORE	US	7393279	Walker, Jay S
04-059	11/008554	09-Dec-2004	METHOD AND APPARATUS FOR PROVIDING INSURANCE POLICIES FOR GAMBLING LOSSES	US	7494416	Walker, Jay S

985

W/O Docket No.	Appl. #	File Date	Invention Title	Country	Patent #	First Named Inventor
04-059-C1	11/423166	09-Jun-2006	METHOD AND APPARATUS FOR PROVIDING INSURANCE POLICIES FOR GAMBLING LOSSES	US	7416486	Walker, Jay S
04-059-C12	11/676987	20-Feb-2007	METHOD AND APPARATUS FOR PROVIDING INSURANCE POLICIES FOR GAMBLING LOSSES	US		Walker, Jay S
04-059-C2	11/423168	09-Jun-2006	METHOD AND APPARATUS FOR PROVIDING INSURANCE POLICIES FOR GAMBLING LOSSES	US		Walker, Jay S
04-059-C6	11/676835	20-Feb-2007	METHOD AND APPARATUS FOR PROVIDING INSURANCE POLICIES FOR GAMBLING LOSSES	US		Walker, Jay S
04-059-C9	11/676919	20-Feb-2007	METHOD AND APPARATUS FOR PROVIDING INSURANCE POLICIES FOR GAMBLING LOSSES	US		Walker, Jay S
04-060	11/026222	30-Dec-2004	METHODS AND APPARATUS FOR FACILITATING INTERACTION WITH A GAMING DEVICE	US	7485040	Walker, Jay S
04-060-C2	11/423267	09-Jun-2006	METHODS AND APPARATUS FOR FACILITATING INTERACTION WITH A GAMING DEVICE	US		Walker, Jay S
04-064	11/434309	15-May-2006	METHOD AND SYSTEM FOR MONITORING GAMING DEVICE PLAY AND DETERMINING COMPLIANCE STATUS	US		Walker, Jay S
05-001	2006204673	17-Jan-2007	METHODS AND SYSTEMS FOR DETERMINING AND SELLING WAGERING GAME OUTCOMES TO BE VIEWED REMOTELY	AU		Walker, Jay S
05-001	06718708.8	04-Jan-2007	METHODS AND SYSTEMS FOR DETERMINING AND SELLING WAGERING GAME OUTCOMES TO BE VIEWED REMOTELY	EP		Walker, Jay S
05-001	2007-549734	29-Jun-2007	METHODS AND SYSTEMS FOR DETERMINING AND SELLING WAGERING GAME OUTCOMES TO BE VIEWED REMOTELY	JP		Walker, Jay S
05-001	200608524-5	05-Dec-2006	METHODS AND SYSTEMS FOR DETERMINING AND SELLING WAGERING GAME OUTCOMES TO BE VIEWED REMOTELY	SG		Walker, Jay S

995

WIPO Patent No.	App. No.	File Date	Invention Title	Country	Patent No.	First Named Inventor
05-001	11/333683	17-Jan-2006	METHODS AND SYSTEMS FOR DETERMINING AND SELLING WAGERING GAME OUTCOMES TO BE VIEWED REMOTELY	US		Walker, Jay S
05-001-C1	11/423461	12-Jun-2006	METHODS AND SYSTEMS FOR DETERMINING AND SELLING WAGERING GAME OUTCOMES TO BE VIEWED REMOTELY	US		Walker, Jay S
05-001-C2	11/423462	12-Jun-2006	METHODS AND SYSTEMS FOR DETERMINING AND SELLING WAGERING GAME OUTCOMES TO BE VIEWED REMOTELY	US		Walker, Jay S
05-001-C3	11/423463	12-Jun-2006	METHODS AND SYSTEMS FOR DETERMINING AND SELLING WAGERING GAME OUTCOMES TO BE VIEWED REMOTELY	US		Walker, Jay S
05-002	11/327215	06-Jan-2006	METHODS AND APPARATUS FOR FACILITATING REMOTE VIEWING OF GAMING OUTCOMES	US		Walker, Jay S
05-002-C2	11/428661	05-Jul-2006	METHODS AND APPARATUS FOR FACILITATING REMOTE VIEWING OF GAMING OUTCOMES	US		Walker, Jay S
05-004	11/354438	15-Feb-2006	METHODS AND SYSTEMS FOR DETERMINING AND SELLING WAGERING GAME OUTCOMES TO BE VIEWED REMOTELY	US		Walker, Jay S
05-007	11/044810	27-Jan-2005	SYSTEM TO DETERMINE CASINO OFFERS	US	7063618	Walker, Jay S
05-007-C1	11/367465	03-Mar-2006	SYSTEM TO DETERMINE CASINO OFFERS	US		Walker, Jay S
05-007-C2	11/428588	05-Jun-2006	SYSTEM TO DETERMINE CASINO OFFERS	US		Walker, Jay S
05-008	11/073896	07-Mar-2005	METHODS AND SYSTEMS FOR FACILITATING A SECONDARY CARD GAME	US	7416186	Walker, Jay S
05-008-C1	11/457038	12-Jul-2006	METHODS AND SYSTEMS FOR FACILITATING A SECONDARY CARD GAME	US		Walker, Jay S
05-015	200716697-8	08-Oct-2007	METHODS, SYSTEMS AND APPARATUS FOR FACILITATING CASHOUT OPTIONS AT A GAMING DEVICE	SG	136439	Walker, Jay S

995

WI Docket No.	Appl. #	File Date	Invention Title	Country	Patent #	First Name Inventor
05-015-C1	11/465471	18-Aug-2006	METHODS, SYSTEMS AND APPARATUS FOR FACILITATING CASHOUT OPTIONS AT A GAMING DEVICE	US		Walker, Jay S
05-015-C2	11/465475	18-Aug-2006	METHODS, SYSTEMS AND APPARATUS FOR FACILITATING CASHOUT OPTIONS AT A GAMING DEVICE	US		Walker, Jay S
05-015-C3	11/465478	18-Aug-2006	METHODS, SYSTEMS AND APPARATUS FOR FACILITATING CASHOUT OPTIONS AT A GAMING DEVICE	US		Walker, Jay S
05-015-C4	11/746751	10-May-2007	METHODS, SYSTEMS AND APPARATUS FOR FACILITATING CASHOUT OPTIONS AT A GAMING DEVICE	US		Walker, Jay S
05-019	11/270016	09-Nov-2005	SYSTEMS, METHODS AND APPARATUS FOR FACILITATING A FLAT RATE PLAY SESSION ON A GAMING DEVICE AND EXAMPLE PLAYER INTERFACES TO A FACILITATE SUCH	US		Walker, Jay S
05-028	11/530757	11-Sep-2006	APPARATUS, SYSTEMS AND METHODS FOR FACILITATING A NEGATIVE CREDIT BALANCE OF A GAMING DEVICE	US		Walker, Jay S
05-028-C1	11/538096	03-Oct-2006	APPARATUS, SYSTEMS AND METHODS FOR FACILITATING A NEGATIVE CREDIT BALANCE OF A GAMING DEVICE	US		Walker, Jay S
05-028-C2	11/538101	03-Oct-2006	APPARATUS, SYSTEMS AND METHODS FOR FACILITATING A NEGATIVE CREDIT BALANCE OF A GAMING DEVICE	US		Walker, Jay S
05-028-C3	11/538113	03-Oct-2006	APPARATUS, SYSTEMS AND METHODS FOR FACILITATING A NEGATIVE CREDIT BALANCE OF A GAMING DEVICE	US		Walker, Jay S
05-029	11/424695	16-Jun-2006	EFFICIENT CUSTOMIZED MEDIA CREATION THROUGH PRE-ENCODING OF COMMON ELEMENTS	US		Nee, Jr., Patrick W.

898

WD Docket No.	App#	FILE DATE	Invention Title	Country	Patent#	Inventor
05-033	11/254352	20-Oct-2005	METHODS AND APPARATUS FOR FACILITATING A FLAT RATE PLAY SESSION AND FOR EXTENDING SAME	US		Walker, Jay S
05-033-C1	11/428848	06-Jul-2006	METHODS AND APPARATUS FOR FACILITATING A FLAT RATE PLAY SESSION AND FOR EXTENDING SAME	US		Walker, Jay S
05-034	11/243398	04-Oct-2005	METHOD AND APPARATUS FOR FACILITATING GAME PLAY WITH A MORTGAGING OPTION	US		Walker, Jay S
05-036	11/297017	08-Dec-2005	SYSTEMS AND METHODS FOR POST-PLAY GAMING BENEFITS	US		Walker, Jay S
05-040	11/274740	14-Nov-2005	PRODUCTS AND PROCESSES FOR PROVIDING A BENEFIT ACCORDING TO A PATTERN IN OUTCOMES	US		Walker, Jay S
05-042	11/268315	07-Nov-2005	METHOD AND APPARATUS FOR OFFERING A FLAT RATE GAMING SESSION WITH OPTIONAL GAME FEATURES	US		Walker, Jay S
05-043-C1	11/423486	12-Jun-2006	BUDGET-DEFINED FLAT RATE PLAY CONTRACT PARAMETERS	US		Walker, Jay S
05-043-C2	11/423488	12-Jun-2006	BUDGET-DEFINED FLAT RATE PLAY CONTRACT PARAMETERS	US	7503851	Walker, Jay S
05-043-C3	11/423492	12-Jun-2006	BUDGET-DEFINED FLAT RATE PLAY CONTRACT PARAMETERS	US		Walker, Jay S
05-044	11/273534	14-Nov-2005	METHOD AND APPARATUS FOR OFFERING A FLAT RATE GAMING SESSION WITH TIME EXTENSION AWARDS	US		Walker, Jay S
05-045	11/274586	14-Nov-2005	PRODUCTS AND PROCESSES FOR DETERMINING A BENEFIT BASED ON PATTERNS OF OUTCOMES	US		Walker, Jay S
05-049	11/273510	14-Nov-2005	METHODS AND APPARATUS FOR FACILITATING ACCELERATED PLAY OF A FLAT RATE PLAY GAMING SESSION	US		Walker, Jay S
05-050	11/273093	14-Nov-2005	METHODS AND APPARATUS FOR REVIEWING GAME PLAY OF A FLAT RATE PLAY SESSION	US		Walker, Jay S
05-051	11/273159	14-Nov-2005	METHODS AND APPARATUS FOR PAUSING A FLAT RATE PLAY GAMING SESSION	US		Walker, Jay S

898

WIPO Document No.	Appl. No.	File Date	Invention Title	Country	Patent No.	First Named Inventor
05-053	11/361757	24-Feb-2006	METHOD AND APPARATUS FOR ENABLING A PLAYER TO SIMULTANEOUSLY CONTROL GAME PLAY ON MULTIPLE GAMING DEVICES	US		Walker, Jay S
05-053-C2	11/428886	06-Jul-2006	METHOD AND APPARATUS FOR ENABLING A PLAYER TO SIMULTANEOUSLY CONTROL GAME PLAY ON MULTIPLE GAMING DEVICES	US		Walker, Jay S
05-054	11/336245	20-Jan-2006	METHOD AND APPARATUS FOR DETERMINING A GAME SERIES COMPRISING A PLURALITY OF INDIVIDUALLY SELECTABLE WAGERING GAMES	US		Walker, Jay S
05-054-C1	11/456159	07-Jul-2006	METHOD AND APPARATUS FOR DETERMINING A GAME SERIES COMPRISING A PLURALITY OF INDIVIDUALLY SELECTABLE WAGERING GAMES	US		Walker, Jay S
05-055	11/299341	09-Dec-2005	METHOD AND APPARATUS FOR USING CONDITIONAL PARAMETERS TO ALTERNATE BETWEEN WAGERING GAMES	US		Walker, Jay S
05-056	11/576907	09-Apr-2007	FACILITATING A FLAT RATE PLAY SESSION WITH A PARALLEL GAME	US		Walker, Jay S
05-058	2007240477	22-Sep-2008	SYSTEMS AND METHODS FOR CUSTOMIZED GAMING LIMITS	AU		Walker, Jay S
05-058	2646138	16-Sep-2008	SYSTEMS AND METHODS FOR CUSTOMIZED GAMING LIMITS	CA		Walker, Jay S
05-058	2007800140151	20-Oct-2008	SYSTEMS AND METHODS FOR CUSTOMIZED GAMING LIMITS	CN		Walker, Jay S
05-058	07760393.4	26-Sep-2008	SYSTEMS AND METHODS FOR CUSTOMIZED GAMING LIMITS	EP		Walker, Jay S
05-058	200603582-8	29-May-2006	SYSTEMS AND METHODS FOR CUSTOMIZED GAMING LIMITS	SG		Walker, Jay S
05-058	11/408288	20-Apr-2006	SYSTEMS AND METHODS FOR CUSTOMIZED GAMING LIMITS	US		Walker, Jay S

SPF

WB Docket No.	Appl. #	File Date	Invention Title	Country	Patent #	First Named Inventor
05-058	2008/07930	16-Sep-2008	SYSTEMS AND METHODS FOR CUSTOMIZED GAMING LIMITS	ZA		Walker, Jay S
05-058-C1	12/511656	29-Jul-2009	SYSTEMS AND METHODS FOR CUSTOMIZED GAMING LIMITS	US		Walker, Jay S
05-059	SEE REMARKS	01-Aug-2008	GAMING SYSTEMS AND APPARATUS FOR DETECTING A SIGNAL INDICATIVE OF A PROBLEM GAMBLER AND DISPATCHING AN EVENT IN RESPONSE THERETO	CN		Walker, Jay S
05-059	200804178-2	02-Jun-2008	GAMING SYSTEMS AND APPARATUS FOR DETECTING A SIGNAL INDICATIVE OF A PROBLEM GAMBLER AND DISPATCHING AN EVENT IN RESPONSE THERETO	SG		Walker, Jay S
05-059	11/814546	23-Jul-2007	GAMING SYSTEMS AND APPARATUS FOR DETECTING A SIGNAL INDICATIVE OF A PROBLEM GAMBLER AND DISPATCHING AN EVENT IN RESPONSE THERETO	US		Walker, Jay S
05-065	11/303385	16-Dec-2005	FACILITATING PLAY OF A GAMING DEVICE IN ACCORDANCE WITH A CONTRACT	US		Walker, Jay S
05-066	SEE REMARKS	04-Jul-2008	METHOD AND APPARATUS FOR COMPENSATING PARTICIPATION IN MARKETING RESEARCH	CN		Walker, Jay S
05-066	11/326843	06-Jan-2006	METHOD AND APPARATUS FOR COMPENSATING PARTICIPATION IN MARKETING RESEARCH	US		Walker, Jay S
05-067	07734627.8	21-Oct-2008	CONTENT DETERMINATIVE GAME SYSTEMS AND METHODS FOR KENO AND LOTTERY GAMES	EP		Walker, Jay S
05-067	12/294155	23-Sep-2008	CONTENT DETERMINATIVE GAME SYSTEMS AND METHODS FOR KENO AND LOTTERY GAMES	US		Walker, Jay S
05-068	11/343000	30-Jan-2006	AUDITING DATA TRANSFER IN ELECTRONIC GAME DEVICE SYSTEMS	US		Nee, Jr., Patrick W.

898

WI Docket No.	Appl. #	File Date	Invention Title	Country	Parent #	List Named Inventor
05-069	11/321802	29-Dec-2005	SYSTEMS, METHODS AND APPARATUS FOR OFFERING AN EXTENSION OF A FLAT PLAY SESSION BASED ON AN ENDING CREDIT BALANCE	US		Walker, Jay S
06-001	11/348045	06-Feb-2006	METHOD AND APPARATUS FOR INFLUENCING CASH OUTS FROM A GAMING DEVICE	US		Walker, Jay S
06-002	11/392444	29-Mar-2006	METHODS AND SYSTEMS FOR DETERMINING A BATCH RUN OF SESSIONS	US		Walker, Jay S
06-003	200603583-6	29-May-2006	METHODS AND APPARATUS FOR FREE PLAY MODE OPERATION OF GAMING DEVICES	SG		Walker, Jay S
06-003	11/406131	18-Apr-2006	METHODS AND APPARATUS FOR FREE PLAY MODE OPERATION OF GAMING DEVICES	US		Walker, Jay S
06-004	11/384124	17-Mar-2006	SECURITY METHODS AND APPARATUS FOR A TANGIBLE MEDIUM CONTAINING WAGERING GAME OUTCOMES	US		Walker, Jay S
06-005	11/433857	12-May-2006	METHODS AND SYSTEMS FOR PROVIDING ACCESSORY DEVICES USABLE TO FACILITATE REMOTELY VIEWABLE WAGERING GAME OUTCOMES	US		Walker, Jay S
06-007	11/393939	29-Mar-2006	METHODS AND APPARATUS FOR DETERMINING HYBRID WAGERING GAME SESSIONS	US		Walker, Jay S
06-008	11/391843	29-Mar-2006	METHODS AND SYSTEMS FOR DETERMINING AND SELLING WAGERING GAME OUTCOMES FOR A PLURALITY OF PLAYERS	US		Walker, Jay S
06-009	11/392059	29-Mar-2006	METHODS AND SYSTEMS FOR DETERMINING AND SELLING OUTCOMES FOR SLOT MACHINE GAMES TO BE VIEWED REMOTELY	US		Walker, Jay S
06-010	11/392828	29-Mar-2006	METHODS AND SYSTEMS FOR DETERMINING AND SELLING OUTCOMES FOR ROULETTE GAMES TO BE VIEWED REMOTELY	US		Walker, Jay S
06-0108	11/936205	07-Nov-2007	DETERMINING AND SELLING OUTCOMES FOR TABLE GAMES TO BE VIEWED REMOTELY	US		Walker, Jay S

JJF

WB Packet No.	App. #	Filed Date	Invention Title	Country	Patent	First Named Inventor
06-011	11/393154	29-Mar-2006	METHODS AND SYSTEMS FOR DETERMINING AND SELLING OUTCOMES FOR DRAWING GAMES TO BE VIEWED REMOTELY	US		Walker, Jay S
06-012	11/394024	29-Mar-2006	METHODS AND SYSTEMS FOR DETERMINING AND SELLING OUTCOMES FOR STRATEGY GAMES TO BE VIEWED REMOTELY	US		Walker, Jay S
06-015	11/368100	17-Apr-2006	METHODS AND SYSTEMS FOR REPRESENTING OUTCOMES OF A CASINO GAME IN A NON-CASINO GAME FORMAT	US		Walker, Jay S
06-020	11/431896	10-May-2006	VIDEO CONTENT DETERMINATIVE KENO GAME SYSTEM AND METHOD	US		Walker, Jay S
06-020-1	11/970888	08-Jan-2008	VIDEO CONTENT DETERMINATIVE KENO GAME SYSTEM AND METHOD	US		Walker, Jay S
06-020-C1	11/423610	12-Jun-2006	VIDEO CONTENT DETERMINATIVE KENO GAME SYSTEM AND METHOD	US		Walker, Jay S
06-020-C2	11/423626	12-Jun-2006	VIDEO CONTENT DETERMINATIVE KENO GAME SYSTEM AND METHOD	US		Walker, Jay S
06-020-C3	11/423629	12-Jun-2006	VIDEO CONTENT DETERMINATIVE KENO GAME SYSTEM AND METHOD	US		Walker, Jay S
06-021	SEE REMARKS	04-Aug-2008	PROBLEM GAMBLING DETECTION IN TABLETOP GAMES	CN		Walker, Jay S
06-021	200804177-4	02-Jun-2008	PROBLEM GAMBLING DETECTION IN TABLETOP GAMES	SG		Walker, Jay S
06-021	11/422376	06-Jun-2006	PROBLEM GAMBLING DETECTION IN TABLETOP GAMES	US		Walker, Jay S
06-021-C1	11/422756	07-Jun-2006	PROBLEM GAMBLING DETECTION IN TABLETOP GAMES	US		Walker, Jay S
06-022	11/420617	26-May-2006	WAGERING GAME BENEFITS REDEEMABLE AT ANOTHER GAMING DEVICE	US		Walker, Jay S
06-024	11/814373	20-Jul-2007	METHOD AND APPARATUS FOR CONDITIONAL PAYOUTS IN A GAMING DEVICE	US		Walker, Jay S
06-025	11/577915	25-Apr-2007	SELECTIVE RESET FOR GAMING DEVICE	US		Walker, Jay S

898

WD Pocket No	Appl. #	File Date	Invention Title	Country	Patent #	First Named Inventor
06-026	11/684718	12-Mar-2007	SYSTEM AND METHOD FOR PRESENTING PAYOUT RANGES AND AUDIOVISUAL CLIPS AT A GAMING DEVICE	US		Walker, Jay S
06-027	11/577633	20-Apr-2007	PROVIDING BENEFITS TO PLAYERS WHO AGREE TO APPROPRIATION OF A PORTION OF FUTURE WINNINGS	US		Sammon, Russell P
06-029B	11/828114	25-Jul-2007	METHODS AND APPARATUS FOR FACILITATING GAMING SESSIONS VIA A SESSION TICKET	US		Walker, Jay S
06-030	11/816298	15-Aug-2007	CUSTOMIZABLE DISPLAY OF ROULETTE BETTING LAYOUT	US		Walker, Jay S
06-032	12/307705	06-Jan-2009	PROVIDING AND REDEMING PARTIAL WAGERING GAME OUTCOMES	US		Walker, Jay S
06-033	11/575368	15-Mar-2007	MULTIPLE POSITION SINGLE ROUND GAMING SLOT MACHINE AND METHOD	US		Walker, Jay S
06-034	11/845424	27-Aug-2007	WAGERING GAMES FEATURING AUDIOVISUAL OUTPUT AND INDICIA RELATED THERETO	US		Walker, Jay S
06-035	12/067694	21-Mar-2008	SYSTEMS AND METHODS FOR PORTABLE WAGERING MEDIUMS	US		Sammon, Russell P
06-036	11/855523	14-Sep-2007	METHOD AND APPARATUS FOR PROVIDING A BONUS TO A PLAYER	US		Walker, Jay S
06-037	11/765149	19-Jun-2007	APPARATUS, SYSTEMS AND METHODS FOR GAMING DEVICE FEATURING NEGATIVE CREDIT BALANCE	US		Nee, Jr., Patrick W.
06-044	11/465632	18-Aug-2006	GAMING DEVICE METHODS AND APPARATUS EMPLOYING AUDIO/VIDEO PROGRAMMING OUTCOME PRESENTATION	US		Walker, Jay S
06-046B	12/516843	29-May-2009	APPARATUS, SYSTEMS AND METHODS FOR HANDHELD GAMING, INCLUDING INTERACTIVE MAPS	US		Walker, Jay S
06-049	12/141649	18-Jun-2008	METHODS AND SYSTEMS FOR REPLAYING A PLAYER'S EXPERIENCE IN A CASINO ENVIRONMENT	US		Walker, Jay S

898

US Patent No.	Appl. No.	Filed Date	Invention Title	Country	Patent #	First-Named Inventor
07-001	11/735231	13-Apr-2007	INCREMENTAL REVELATION OF RESULTS IN A GAME OF CHANCE	US		Walker, Jay S
07-002	12/236736	24-Sep-2008	METHOD AND APPARATUS FOR DISPLAYING GAMING CONTENT	US		Walker, Jay S
07-003	200903817-5	04-Jun-2009	SELECTION OF MULTIPLE ROULETTE WHEELS	SG		Walker, Jay S
07-003	12/517661	04-Jun-2009	SELECTION OF MULTIPLE ROULETTE WHEELS	US		Walker, Jay S
07-005	12/295023	29-Sep-2008	METHODS AND APPARATUS FOR FACILITATING FLAT RATE PLAY SESSIONS	US		Walker, Jay S
07-005	PCT/US0854728	22-Feb-2008	METHODS AND APPARATUS FOR FACILITATING FLAT RATE PLAY SESSIONS	WO		Walker, Jay S
07-006	12/297665	20-Oct-2008	GAMEPLAY-ALTERING PORTABLE WAGERING MEDIA	US		Walker, Jay S
07-006	PCT/US0857821	21-Mar-2008	GAMEPLAY-ALTERING PORTABLE WAGERING MEDIA	WO		Walker, Jay S
07-007	PCT/US08/66584	11-Jun-2008	TABLE GAME SESSION PLAY	WO		Walker, Jay S
07-011	12/174466	16-Jul-2008	SESSION PLAY WITH HIGH VOLATILITY BET OPTION	US		Walker, Jay S
07-012	11/843479	22-Aug-2007	FACILITATING A PAYOUT AT A GAMING DEVICE USING AUDIOVISUAL CONTENT	US		Walker, Jay S
07-014	12/136667	10-Jun-2008	MULTIPLAYER GAMING DEVICE AND METHODS	US		Walker, Jay S
07-020	12/251855	15-Oct-2008	APPLICATIONS FOR GAMING DEVICES IN A NETWORKED ENVIRONMENT	US		Walker, Jay S
07-024	12/255361	21-Oct-2008	CONDITIONAL APPLICATION OF HIT CARD	US		Walker, Jay S
08-002	12/167717	03-Jul-2008	SYSTEM AND METHOD FOR PERSONALIZING PLAYING CARDS AT A TABLE GAME	US		Walker, Jay S
08-009	12/468901	20-May-2009	REMOTE GAMING ENVIRONMENT	US		Walker, Jay S
08-012	PCT/US0940023	09-Apr-2009	SYSTEM AND METHOD FOR CARD SHOE SECURITY AT A TABLE GAME	WO		Walker, Jay S
09-003	61/220197	24-Jun-2009	SYSTEM AND METHOD FOR TESTING THE SOBRIETY OF ONLINE GAMBLERS	US		Walker, Jay S

JF

US Patent No.	App. #	Filing Date	Invention Title	Country	Patent No.	Inventor
96-112	08/804060	21-Feb-1997	SYSTEM AND METHOD FOR GENERATING AND EXECUTING INSURANCE POLICIES FOR GAMBLING LOSSES	US	6113493	Walker, Jay S
96-112-1	09/168398	06-Oct-1998	SYSTEM AND METHOD FOR GENERATING AND EXECUTING INSURANCE POLICIES FOR GAMBLING LOSSES	US	6254482	Walker, Jay S
96-112-1-C1	09/816017	23-Mar-2001	SYSTEM AND METHOD FOR GENERATING AND EXECUTING INSURANCE POLICIES FOR GAMBLING LOSSES	US	6561903	Walker, Jay S
96-130	08/888962	07-Jul-1997	METHOD AND SYSTEM FOR AWARDDING FREQUENT FLYER MILES FOR CASINO PLAY	US	6379247	Walker, Jay S
96-154	08/774487	30-Dec-1996	AUTOMATED PLAY GAMING DEVICE	US	6012983	Walker, Jay S
96-154-C1	09/437204	09-Nov-1999	AUTOMATED PLAY GAMING DEVICE	US	6244957	Walker, Jay S
96-156	08/769085	18-Dec-1996	SLOT MACHINE ADVERTISING/SALES SYSTEM AND METHOD	US	6186893	Walker, Jay S
96-156-C1	09/S21869	08-Mar-2000	SLOT MACHINE ADVERTISING/SALES SYSTEM AND METHOD	US	6390917	Walker, Jay S
96-158	08/880838	23-Jun-1997	GAMING DEVICE FOR A FLAT RATE PLAY SESSION AND A METHOD OF OPERATING SAME	US	6077163	Walker, Jay S
96-158-C1	09/518760	03-Mar-2000	GAMING DEVICE FOR A FLAT RATE PLAY SESSION AND A METHOD OF OPERATING SAME	US	6319127	Walker, Jay S
96-161	08/885345	30-Jun-1997	A GAMING DEVICE FOR OPERATING IN A REVERSE PAYOUT MODE AND A METHOD OF OPERATING SAME	US	6113492	Walker, Jay S
96-161-R1	10/222523	16-Aug-2002	GAMING DEVICE FOR OPERATING IN A REVERSE PAYOUT MODE AND A METHOD OF OPERATING SAME	US	RE39817	Walker, Jay S
96-161-R3	11/542042	02-Oct-2006	GAMING DEVICE FOR OPERATING IN A REVERSE PAYOUT MODE AND A METHOD OF OPERATING SAME	US		Walker, Jay S
96-161-R4	11/542040	02-Oct-2006	GAMING DEVICE FOR OPERATING IN A REVERSE PAYOUT MODE AND A METHOD OF OPERATING SAME	US		Walker, Jay S

JJS

NO	Applicant	Filed Date	Invention Title	Country	Patent No.	First Named Inventor
96-162	08/775577	31-Dec-1996	REMOTE GAMING DEVICE	US	6001016	Walker, Jay S
96-162-C1	09/401205	22-Sep-1999	REMOTE GAMING DEVICE	US	6361437	Walker, Jay S
96-162-C2	09/991056	16-Nov-2001	REMOTE GAMING DEVICE	US	7066815	Walker, Jay S
96-166	08/892080	14-Jul-1997	SYSTEM AND METHOD FOR FUTURE VALUE WAGERING	US	6110042	Walker, Jay S
96-166-C1-1	11/435118	16-May-2006	SYSTEM AND METHOD FOR FUTURE VALUE WAGERING	US		Walker, Jay S
96-168	08/775598	31-Dec-1996	METHOD AND APPARATUS FOR MOTIVATING PLAYERS TO RETURN TO A CASINO USING PREMIUMS	US	6193608	Walker, Jay S
96-168-R1	10/282090	28-Oct-2002	METHOD AND APPARATUS FOR MOTIVATING PLAYERS TO RETURN TO A CASINO USING PREMIUMS	US	RE38733	Walker, Jay S
96-168-R1-C1	10/875144	23-Jun-2004	METHOD AND APPARATUS FOR MOTIVATING PLAYERS TO RETURN TO A CASINO USING PREMIUMS	US		Walker, Jay S
96-189	08/833034	03-Apr-1997	METHOD AND APPARATUS FOR USING A PLAYER INPUT CODE TO AFFECT A GAMBLING OUTCOME	US	6010404	Walker, Jay S
96-189-C1	09/439307	12-Nov-1999	METHOD AND APPARATUS FOR USING A PLAYER INPUT CODE TO AFFECT A GAMBLING OUTCOME	US	6343988	Walker, Jay S
96-189-C2	09/992147	19-Nov-2001	SYSTEMS AND METHODS WHEREIN A GAMBLING RESULT IS BASED ON A USER INPUT	US	6511376	Walker, Jay S
97-005	08/821437	21-Mar-1997	FREE LONG DISTANCE CALLS ON SLOT MACHINES	US	6139431	Walker, Jay S
97-005-C1	09/641903	18-Aug-2000	FREE LONG DISTANCE CALLS ON SLOT MACHINES	US	6530835	Walker, Jay S
97-005-C2	10/322107	18-Dec-2002	FREE LONG DISTANCE CALLS ON SLOT MACHINES	US	7101282	Walker, Jay S
97-014	08/820500	19-Mar-1997	METHOD AND APPARATUS FOR AWARDDING AND REDEEMING PREPAID TELEPHONE TIME	US	5909486	Walker, Jay S
97-014-1	09/044882	20-Mar-1998	METHOD AND APPARATUS FOR AWARDDING AND REDEEMING PREPAID TELEPHONE TIME	US	6368215	Walker, Jay S
97-014-2	09/044883	20-Mar-1998	METHOD AND APPARATUS FOR AWARDDING AND REDEEMING PREPAID TELEPHONE TIME	US	6229879	Walker, Jay S
97-014-3	09/044881	20-Mar-1998	METHOD AND APPARATUS FOR AWARDDING AND REDEEMING PREPAID TELEPHONE TIME	US	6377669	Walker, Jay S

998

WIPO Docket No.	App. #	File Date	Invention Title	Country	Patent #	First Named Inventor
97-014-4	09/045952	23-Mar-1998	METHOD AND APPARATUS FOR AWARING AND REDEEMING PREPAID TELEPHONE TIME	US	6327351	Walker, Jay S
97-015	68776/98	07-Apr-1998	SLOT DRIVEN VIDEO STORY	AU	721809	Walker, Jay S
97-015	98914416.7	10-Nov-1999	SLOT DRIVEN VIDEO STORY	EP		Walker, Jay S
97-015	08/832723	11-Apr-1997	SLOT DRIVEN VIDEO STORY	US	6234896	Walker, Jay S
97-015-C1	09/798719	02-Mar-2001	SLOT DRIVEN VIDEO STORY	US	6500068	Walker, Jay S
97-015-C2	10/272554	16-Oct-2002	SLOT DRIVEN VIDEO STORY	US	6893341	Walker, Jay S
97-015-C3	10/882859	01-Jul-2004	SLOT DRIVEN VIDEO STORY	US	7198572	Walker, Jay S
97-015-C4	11/677943	22-Feb-2007	SLOT DRIVEN VIDEO STORY	US		Walker, Jay S
97-015-C5	11/677955	22-Feb-2007	SLOT DRIVEN VIDEO STORY	US		Walker, Jay S
97-017	08/814889	12-Mar-1997	AN ELECTRONIC GAMING SYSTEM OFFERING PREMIUM ENTERTAINMENT SERVICES FOR ENHANCED PLAYER RETENTION	US	6113495	Walker, Jay S
97-017-C1	09/466720	17-Dec-1999	AN ELECTRONIC GAMING SYSTEM OFFERING PREMIUM ENTERTAINMENT SERVICES FOR ENHANCED PLAYER RETENTION	US	6582310	Walker, Jay S
97-031	08/886584	01-Jul-1997	METHOD AND APPARATUS FOR EXPIRATION OF PREPAID SLOT MACHINE PLAYS	US	6227972	Walker, Jay S
97-031-C1	09/805401	13-Mar-2001	METHOD AND APPARATUS FOR EXPIRATION OF PREPAID SLOT MACHINE PLAYS	US	6558255	Walker, Jay S
97-050	09/000628	30-Dec-1997	METHOD AND APPARATUS FOR DIRECTING A GAME WITH USER-SELECTED ELEMENTS	US	6174235	Walker, Jay S
97-050-C1	09/722761	27-Nov-2000	METHOD AND APPARATUS FOR DIRECTING A GAME WITH USER-SELECTED ELEMENTS	US	6561902	Walker, Jay S
97-077	08/947243	08-Oct-1997	GAMING METHOD AND APPARATUS HAVING A PROPORTIONAL PAYOUT	US	6213877	Walker, Jay S
97-077-C1	09/782998	14-Feb-2001	GAMING METHOD AND APPARATUS HAVING A PROPORTIONAL PAYOUT	US	6589115	Walker, Jay S

JJF

IND Docket No	Appl. No.	Filed At	Invention Title	Country	Patent No.	Inventor
97-159	09/001902	31-Dec-1997	METHOD AND APPARATUS FOR DIRECTING A GAME IN ACCORDANCE WITH SPEED OF PLAY	US	6238288	Walker, Jay S
97-159-C1	09/783251	14-Feb-2001	METHOD AND APPARATUS FOR DIRECTING A GAME IN ACCORDANCE WITH SPEED OF PLAY	US	6695700	Walker, Jay S
97-169	09/004885	09-Jan-1998	ELECTRONIC AMUSEMENT DEVICE AND METHOD FOR OPERATING SAME	US	6176781	Walker, Jay S
97-169-C1	09/706431	03-Nov-2000	ELECTRONIC AMUSEMENT DEVICE AND METHOD FOR OPERATING SAME	US	6533658	Walker, Jay S
97-169-C1-R1	11/084872	18-Mar-2005	ELECTRONIC AMUSEMENT DEVICE AND METHOD FOR OPERATING SAME	US		Walker, Jay S
97-475	09/055665	06-Apr-1998	METHOD AND APPARATUS FOR CONTROLLING A GAMING DEVICE HAVING A PLURALITY OF BALANCES	US	5967896	Jorasch, James A
97-475-C1	09/371341	10-Aug-1999	METHOD AND APPARATUS FOR CONTROLLING A GAMING DEVICE HAVING A PLURALITY OF BALANCES	US	6379248	Jorasch, James A
98-001	09/047577	24-Mar-1998	ELECTRONIC GAMING DEVICE AND METHOD FOR OPERATING SAME	US	6248016	Walker, Jay S
98-001-C1	09/839854	20-Apr-2001	ELECTRONIC GAMING DEVICE AND METHOD FOR OPERATING SAME	US	6332839	Walker, Jay S
98-001-C2	10/034695	20-Dec-2001	ELECTRONIC POKER DEVICE THAT PROVIDES A PAYOUT BASED ON A NUMBER OF CARDS REPLACED AND METHOD FOR OPERATING SAME	US	6569014	Walker, Jay S
98-003	09/102403	22-Jun-1998	GAMING DEVICE AND METHOD OF OPERATION THEREOF	US	6190256	Walker, Jay S
98-003-C1	09/716192	17-Nov-2000	GAMING DEVICE AND METHOD OF OPERATION THEREOF	US	6682422	Walker, Jay S
98-003-C2	10/729439	05-Dec-2003	GAMING DEVICE AND METHOD OF OPERATION THEREOF	US		Walker, Jay S
98-004	09/052667	31-Mar-1998	METHOD AND APPARATUS FOR OPERATING A GAMING DEVICE TO DISPENSE A SPECIFIED AMOUNT	US	6168522	Walker, Jay S

898

W/O Pocket No	App #	File Date	Inventor Title	Country	Patent #	Full Name Inventor
98-004-C1	09/709239	10-Nov-2000	METHOD AND APPARATUS FOR OPERATING A GAMING DEVICE TO DISPENSE A SPECIFIED AMOUNT	US	6537151	Walker, Jay S
98-004-C2	10/348629	21-Jan-2003	METHOD AND APPARATUS FOR OPERATING A GAMING DEVICE TO DISPENSE A SPECIFIED AMOUNT	US	6743097	Walker, Jay S
98-004-C3	10/829420	21-Apr-2004	METHOD AND APPARATUS FOR OPERATING A GAMING DEVICE TO DISPENSE A SPECIFIED AMOUNT	US	6932704	Walker, Jay S
98-004-C5	10/998529	29-Nov-2004	METHOD AND APPARATUS FOR OPERATING A GAMING DEVICE TO DISPENSE A SPECIFIED AMOUNT	US	7001277	Walker, Jay S
98-004-C6	10/999170	29-Nov-2004	METHOD AND APPARATUS FOR OPERATING A GAMING DEVICE TO DISPENSE A SPECIFIED AMOUNT	US	7261635	Walker, Jay S
98-006	09/109839	02-Jul-1998	VIDEO POKER DEVICE AND METHOD OF OPERATION THEREOF	US	6422940	Walker, Jay S
98-028	09/218258	22-Dec-1998	SYSTEM AND METHOD FOR AUTOMATICALLY INITIATING GAME PLAY ON AN ELECTRONIC GAMING DEVICE	US	6315662	Jorasch, James A
98-028-C1	09/950232	10-Sep-2001	SYSTEM AND METHOD FOR AUTOMATICALLY INITIATING GAME PLAY ON AN ELECTRONIC GAMING DEVICE	US	6939227	Jorasch, James A
98-028-C2	11/170942	30-Jun-2005	SYSTEM AND METHOD FOR AUTOMATICALLY INITIATING GAME PLAY ON AN ELECTRONIC GAMING DEVICE	US		Walker, Jay S
98-049	09/165184	02-Oct-1998	VIDEO POKER SYSTEM AND METHOD	US	6257979	Walker, Jay S
98-049-C1	09/858987	16-May-2001	VIDEO POKER SYSTEM AND METHOD	US	6592456	Walker, Jay S
98-073	09/223158	30-Dec-1998	METHOD AND APPARATUS FOR A PROGRESSIVE JACKPOT DETERMINANT	US	6203010	Jorasch, James A
99-075	09/538752	30-Mar-2000	SYSTEMS AND METHODS FOR RESOLVING A HAND OF BLACKJACK THAT RESULTS IN A PUSH	US	7156734	Walker, Jay S
99-075-R1	12/346342	30-Dec-2008	SYSTEMS AND METHODS FOR RESOLVING A HAND OF BLACKJACK THAT RESULTS IN A PUSH	US		Walker, Jay S

JRS

WI Docket No.	Appl. #	File Date	Invention Title	Country	Patent #	First Named Inventor
99-081	09/602869	23-Jun-2000	GAMES OF CHANCE WITH PLAYER-SPECIFIED ELEMENTS	US	6877745	Walker, Jay S
99-081-C1	10/988117	12-Nov-2004	GAMES OF CHANCE WITH PLAYER-SPECIFIED ELEMENTS	US		Walker, Jay S
99-098	09/709235	10-Nov-2000	METHOD AND APPARATUS FOR CONDUCTING FOCUS GROUPS USING NETWORKED GAMING DEVICES	US		Walker, Jay S
99-109	09/570335	15-May-2000	SYSTEM TO DETERMINE CASINO OFFERS	US	6848995	Walker, Jay S
99-110	09/609147	30-Jun-2000	METHOD AND APPARATUS FOR COMPENSATING PARTICIPATION IN MARKETING RESEARCH	US	7493267	Walker, Jay S
99-111	09/610120	30-Jun-2000	METHOD AND APPARATUS FOR PLAYING A CARD GAME INCLUDING A BUST INSURANCE OPTION	US	6540230	Walker, Jay S
99-111-1	10/361904	06-Feb-2003	METHOD AND APPARATUS FOR PLAYING A CARD GAME INCLUDING A BUST INSURANCE OPTION	US	6679497	Walker, Jay S

985

Electronic Acknowledgement Receipt

EFS ID:	14693408
Application Number:	13680852
International Application Number:	
Confirmation Number:	6364
Title of Invention:	METHOD AND APPARATUS FOR OUTPUTTING A MESSAGE AT A GAME MACHINE
First Named Inventor/Applicant Name:	Jay S. Walker
Customer Number:	29159
Filer:	Adam H. Masia/Mavis Benson
Filer Authorized By:	Adam H. Masia
Attorney Docket Number:	025124-0509
Receipt Date:	14-JAN-2013
Filing Date:	19-NOV-2012
Time Stamp:	16:49:53
Application Type:	Utility under 35 USC 111(a)

Payment information:

Submitted with Payment	no
------------------------	----

File Listing:

Document Number	Document Description	File Name	File Size(Bytes)/ Message Digest	Multi Part /.zip	Pages (if appl.)
1		025094-0509_poa_373.pdf	3489836 <small>a748f268fd71775c07ef21c9dfe8ccb59f18592b</small>	yes	35

Multipart Description/PDF files in .zip description		
Document Description	Start	End
Power of Attorney	1	1
Assignee showing of ownership per 37 CFR 3.73.	2	35
Warnings:		
Information:		
Total Files Size (in bytes):		3489836
<p>This Acknowledgement Receipt evidences receipt on the noted date by the USPTO of the indicated documents, characterized by the applicant, and including page counts, where applicable. It serves as evidence of receipt similar to a Post Card, as described in MPEP 503.</p> <p><u>New Applications Under 35 U.S.C. 111</u> If a new application is being filed and the application includes the necessary components for a filing date (see 37 CFR 1.53(b)-(d) and MPEP 506), a Filing Receipt (37 CFR 1.54) will be issued in due course and the date shown on this Acknowledgement Receipt will establish the filing date of the application.</p> <p><u>National Stage of an International Application under 35 U.S.C. 371</u> If a timely submission to enter the national stage of an international application is compliant with the conditions of 35 U.S.C. 371 and other applicable requirements a Form PCT/DO/EO/903 indicating acceptance of the application as a national stage submission under 35 U.S.C. 371 will be issued in addition to the Filing Receipt, in due course.</p> <p><u>New International Application Filed with the USPTO as a Receiving Office</u> If a new international application is being filed and the international application includes the necessary components for an international filing date (see PCT Article 11 and MPEP 1810), a Notification of the International Application Number and of the International Filing Date (Form PCT/RO/105) will be issued in due course, subject to prescriptions concerning national security, and the date shown on this Acknowledgement Receipt will establish the international filing date of the application.</p>		

Electronic Patent Application Fee Transmittal

Application Number:	13680852			
Filing Date:	19-Nov-2012			
Title of Invention:	METHOD AND APPARATUS FOR OUTPUTTING A MESSAGE AT A GAME MACHINE			
First Named Inventor/Applicant Name:	Jay S. Walker			
Filer:	Adam H. Masia/Luz Gonzalez			
Attorney Docket Number:	025124-0509			
Filed as Large Entity				
Utility under 35 USC 111(a) Filing Fees				
Description	Fee Code	Quantity	Amount	Sub-Total in USD(\$)
Basic Filing:				
Pages:				
Claims:				
Miscellaneous-Filing:				
Late filing fee for oath or declaration	1051	1	130	130
Petition:				
Patent-Appeals-and-Interference:				
Post-Allowance-and-Post-Issuance:				
Extension-of-Time:				

Description	Fee Code	Quantity	Amount	Sub-Total in USD(\$)
Miscellaneous:				
Total in USD (\$)				130

Electronic Acknowledgement Receipt

EFS ID:	14717802
Application Number:	13680852
International Application Number:	
Confirmation Number:	6364
Title of Invention:	METHOD AND APPARATUS FOR OUTPUTTING A MESSAGE AT A GAME MACHINE
First Named Inventor/Applicant Name:	Jay S. Walker
Customer Number:	29159
Filer:	Adam H. Masia/Luz Gonzalez
Filer Authorized By:	Adam H. Masia
Attorney Docket Number:	025124-0509
Receipt Date:	16-JAN-2013
Filing Date:	19-NOV-2012
Time Stamp:	16:49:05
Application Type:	Utility under 35 USC 111(a)

Payment information:

Submitted with Payment	yes
Payment Type	Deposit Account
Payment was successfully received in RAM	\$130
RAM confirmation Number	3943
Deposit Account	502261
Authorized User	
The Director of the USPTO is hereby authorized to charge indicated fees and credit any overpayment as follows: Charge any Additional Fees required under 37 C.F.R. Section 1.21 (Miscellaneous fees and charges)	

File Listing:					
Document Number	Document Description	File Name	File Size(Bytes)/ Message Digest	Multi Part /.zip	Pages (if appl.)
1	Fee Worksheet (SB06)	fee-info.pdf	30329 cd42e9304c76701f42e00c638eeb1cabdce3a798	no	2
Warnings:					
Information:					
Total Files Size (in bytes):			30329		
<p>This Acknowledgement Receipt evidences receipt on the noted date by the USPTO of the indicated documents, characterized by the applicant, and including page counts, where applicable. It serves as evidence of receipt similar to a Post Card, as described in MPEP 503.</p> <p><u>New Applications Under 35 U.S.C. 111</u> If a new application is being filed and the application includes the necessary components for a filing date (see 37 CFR 1.53(b)-(d) and MPEP 506), a Filing Receipt (37 CFR 1.54) will be issued in due course and the date shown on this Acknowledgement Receipt will establish the filing date of the application.</p> <p><u>National Stage of an International Application under 35 U.S.C. 371</u> If a timely submission to enter the national stage of an international application is compliant with the conditions of 35 U.S.C. 371 and other applicable requirements a Form PCT/DO/EO/903 indicating acceptance of the application as a national stage submission under 35 U.S.C. 371 will be issued in addition to the Filing Receipt, in due course.</p> <p><u>New International Application Filed with the USPTO as a Receiving Office</u> If a new international application is being filed and the international application includes the necessary components for an international filing date (see PCT Article 11 and MPEP 1810), a Notification of the International Application Number and of the International Filing Date (Form PCT/RO/105) will be issued in due course, subject to prescriptions concerning national security, and the date shown on this Acknowledgement Receipt will establish the international filing date of the application.</p>					



UNITED STATES PATENT AND TRADEMARK OFFICE

UNITED STATES DEPARTMENT OF COMMERCE
United States Patent and Trademark Office
Address: COMMISSIONER FOR PATENTS
P.O. Box 1450
Alexandria, Virginia 22313-1450
www.uspto.gov

Table with 4 columns: APPLICATION NUMBER (13/680,852), FILING OR 371(C) DATE (11/19/2012), FIRST NAMED APPLICANT (Jay S. Walker), ATTY. DOCKET NO./TITLE (025124-0509)

CONFIRMATION NO. 6364

PUBLICATION NOTICE



29159
Neal, Gerber & Eisenberg LLP
2 N. LaSalle Street
Suite 1700
Chicago, IL 60602-3801

Title:METHOD AND APPARATUS FOR OUTPUTTING A MESSAGE AT A GAME MACHINE

Publication No.US-2013-0079120-A1

Publication Date:03/28/2013

NOTICE OF PUBLICATION OF APPLICATION

The above-identified application will be electronically published as a patent application publication pursuant to 37 CFR 1.211, et seq. The patent application publication number and publication date are set forth above.

The publication may be accessed through the USPTO's publicly available Searchable Databases via the Internet at www.uspto.gov. The direct link to access the publication is currently http://www.uspto.gov/patft/.

The publication process established by the Office does not provide for mailing a copy of the publication to applicant. A copy of the publication may be obtained from the Office upon payment of the appropriate fee set forth in 37 CFR 1.19(a)(1). Orders for copies of patent application publications are handled by the USPTO's Office of Public Records. The Office of Public Records can be reached by telephone at (703) 308-9726 or (800) 972-6382, by facsimile at (703) 305-8759, by mail addressed to the United States Patent and Trademark Office, Office of Public Records, Alexandria, VA 22313-1450 or via the Internet.

In addition, information on the status of the application, including the mailing date of Office actions and the dates of receipt of correspondence filed in the Office, may also be accessed via the Internet through the Patent Electronic Business Center at www.uspto.gov using the public side of the Patent Application Information and Retrieval (PAIR) system. The direct link to access this status information is currently http://pair.uspto.gov/. Prior to publication, such status information is confidential and may only be obtained by applicant using the private side of PAIR.

Further assistance in electronically accessing the publication, or about PAIR, is available by calling the Patent Electronic Business Center at 1-866-217-9197.

Office of Data Management, Application Assistance Unit (571) 272-4000, or (571) 272-4200, or 1-888-786-0101

INFORMATION DISCLOSURE CITATION IN AN APPLICATION (Use several sheets if necessary) PTO Form 1449	Atty Docket No. 025124-0509	Application No. 13/680,852
	Applicant Walker et al.	Date Submitted March 28, 2013
	Filing Date November 19, 2012	Group 3714

U.S. PATENT DOCUMENTS						
Examiner's Initials	Document Number	Publication Date	Inventor	Class	Subclass	Filing Date If Appropriate
	4,695,053	September 1987	Vazquez et al.			
	4,760,527	July 1988	Sidley			
	5,290,033	March 1994	Bittner et al.			
	5,429,361	July 4, 1995	Raven et al.			
	5,611,730	March 1997	Weiss			
	5,971,849	October 1999	Falciglia			
	6,089,975	July 2000	Dunn			
	6,113,495	September 2000	Walker et al.			
	6,126,541	October 2000	Fuchs			
	6,139,431	October 2000	Walker et al.			
	6,176,781	January 2001	Walker et al.			
	6,227,446	May 2001	Haney et al.			
	6,270,411	August 2001	Gura et al.			
	6,302,790	October 2001	Brossard			
	6,409,602	June 2002	Wiltshire et al.			
	6,942,576	September 2005	Holt			
	6,942,574	September 2005	LeMay et al.			
	2003/0064769	April 2003	Muir			
	2003/0064782	April 3, 2003	Beaulieu et al.			
	2005/0096125	May 5, 2005	LeMay et al.			

FOREIGN PATENT DOCUMENTS							
Examiner's Initials	Document Number	Publication Date	Country	Class	Subclass	Translation	
						Yes	No
	GB 2 393 554	March 2004	United Kingdom				

Examiner's Initials	OTHER DOCUMENTS (Including Author, Title, Date, Pertinent Pages, Etc.)

Examiner:	Date Considered:
*Examiner: Initial if citation considered, whether or not citation is in conformance with MPEP Section 609; Draw line through citation if not in conformance and not considered. Include copy of this form with next communication to applicant.	

(12) **UK Patent Application** (19) **GB** (11) **2 393 554** (13) **A**

(43) Date of A Publication **31.03.2004**

(21) Application No: 0222228.9	(51) INT CL ⁷ : G07F 17/32 17/34
(22) Date of Filing: 25.09.2002	(52) UK CL (Edition W): G4V VAKA V117 V118 V119 V302C V306C V307 U1S S1172 S1174
(71) Applicant(s): David Jones 8D Stoney Brow, Roby Mill, UPHOLLAND, Lancashire, WN8 0QE, United Kingdom	(56) Documents Cited: EP 1120757 A2 WO 2001/082176 A1 WO 1994/016416 A1 WO 1994/010658 A1 DE 019944140 A1 DE 010060079 A1 US 6347738 B1
(72) Inventor(s): David Jones	(58) Field of Search: Other: Online: WPI, EPODOC, JAPIO
(74) Agent and/or Address for Service: David Jones 8D Stoney Brow, Roby Mill, UPHOLLAND, Lancashire, WN8 0QE, United Kingdom	

(54) Abstract Title: **Amusement machine with player recognition**

(57) A coin operated amusement machine is fitted with a finger print sensor 1. This enables the machine to recognise a previous player and allow an unfinished game to be continued. The machine can incorporate a keypad 2, for incorporation of a player's telephone number. This enables the machine to communicate with the player by voice or text message. The machine may be a fruit machine, a pin ball machine, a video game or a "skill with prize" machine (Figs 2-4, ns).

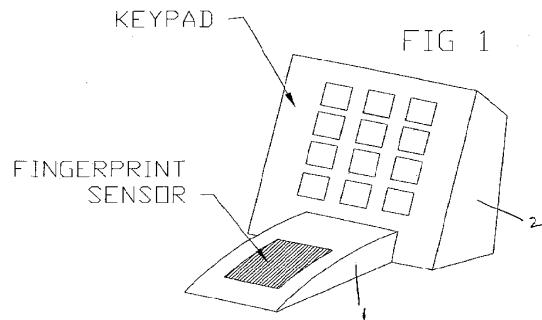

GB 2 393 554 A

At least one of these pages has been prepared from an original which was unsuitable for direct photoreproduction.

Printed on Recycled Paper

1/5

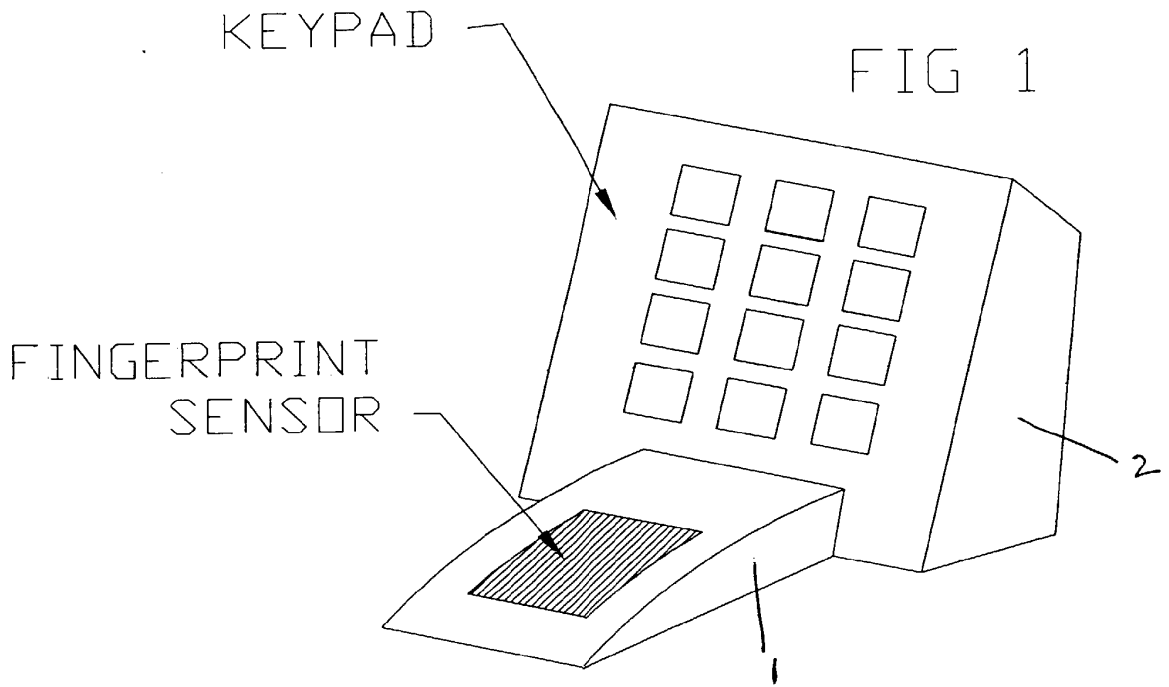

2/5

FIG 2

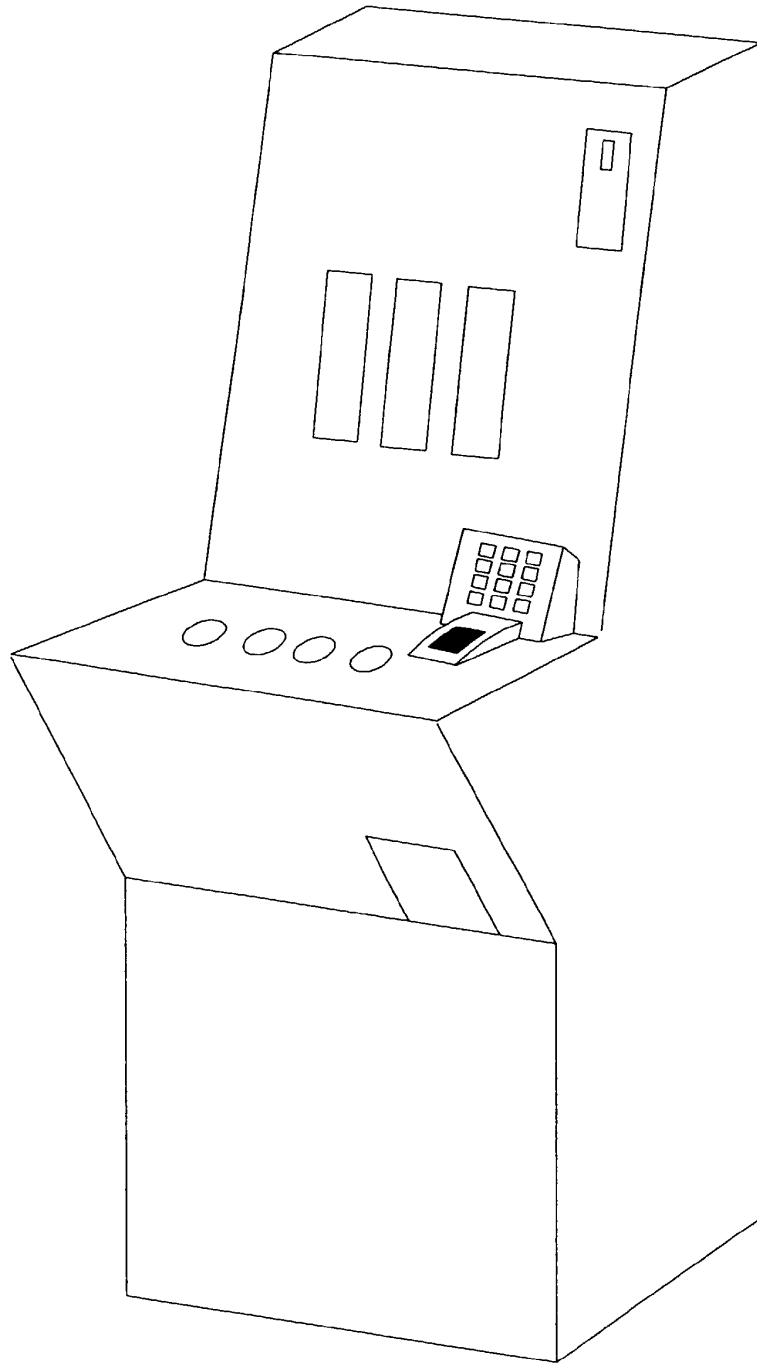

VIDEO SCREEN

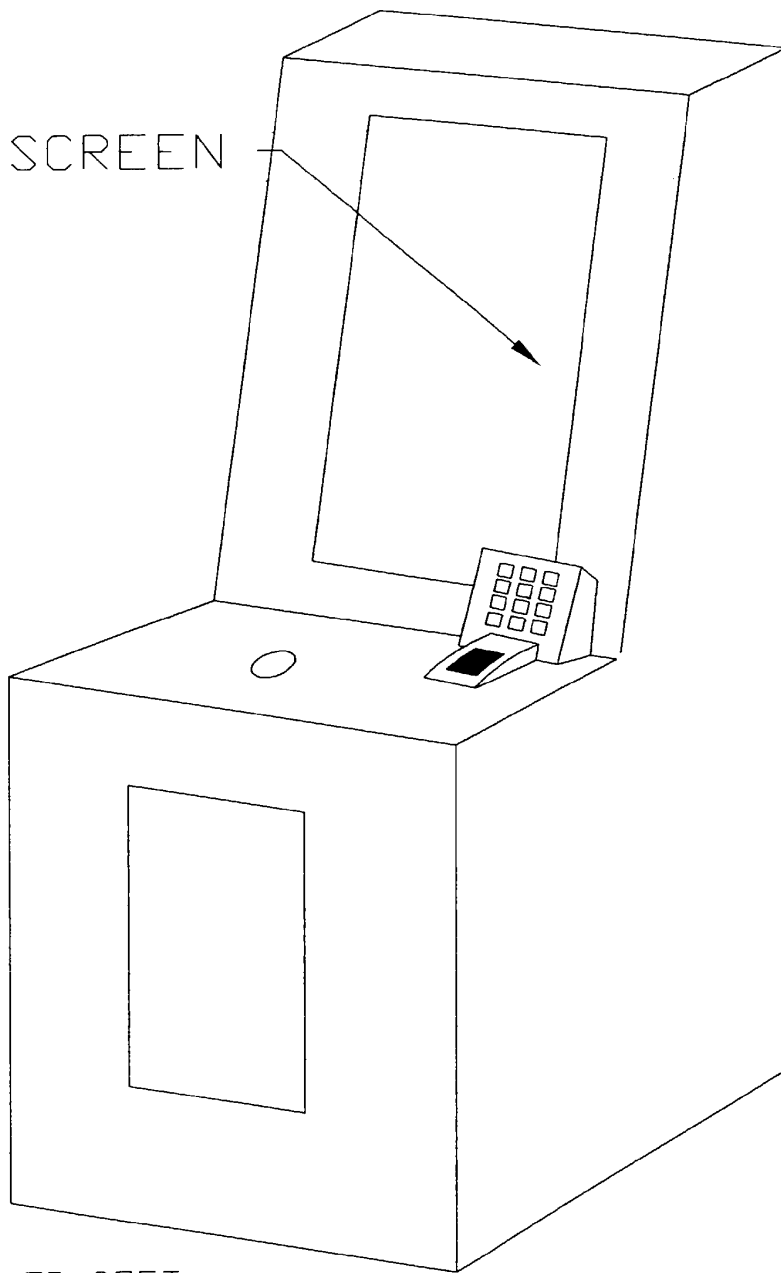

SWP, VIDEO OR SOFT
TERMINAL MACHINE

4/5

FIG 4

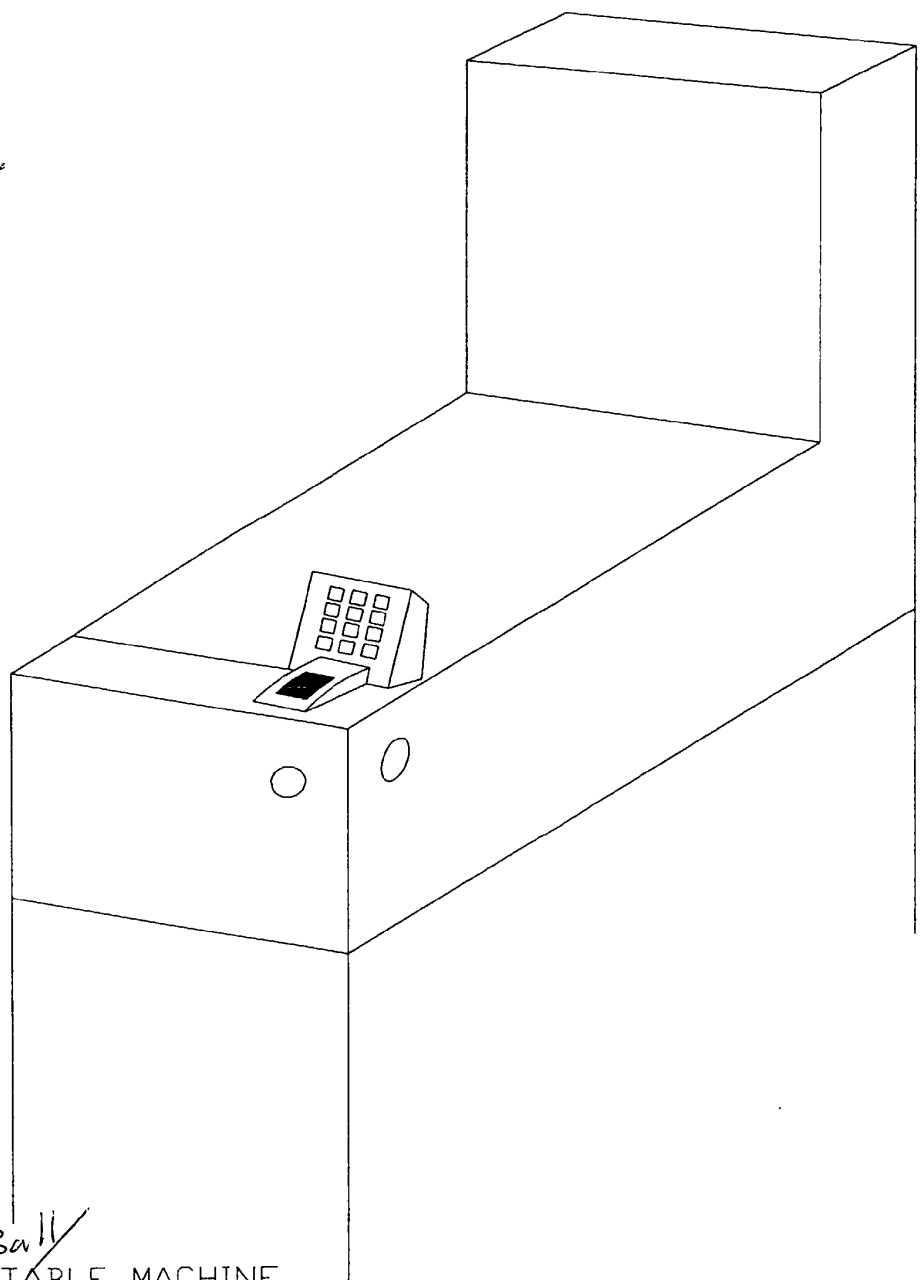

Ball
PIN TABLE MACHINE

s/s

FIG 5

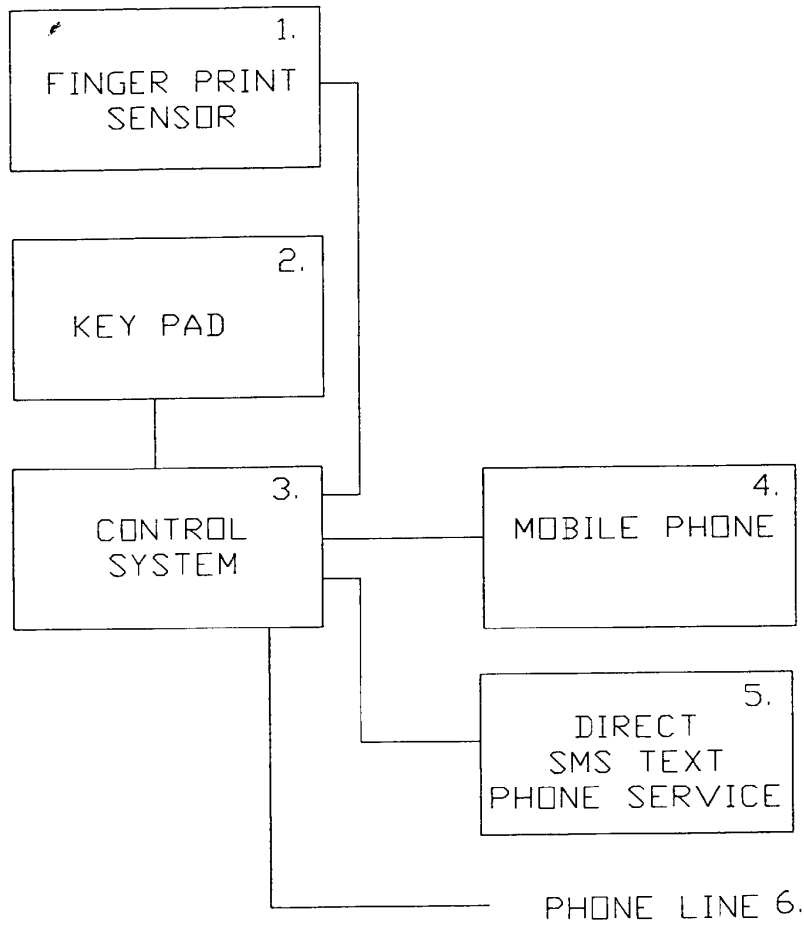

AMUSEMENT MACHINE
PLAYER RECOGNITION
SYSTEM EXAMPLE

AMUSEMENT MACHINE PLAYER RECOGNITION SYSTEM

This invention relates to a amusement machine player recognition system.

Amusement machines are well known and very popular they include machines such as:- fruit machines, Skill with prize machines, Pin Tables, Video games and novelty games. These games are not able to recognise the players who play on them. This invention allows the machine to recognise a player by his or her fingerprint and link that fingerprint to a phone number for further contact by phone or text message. This allows the machine to let a player continue where he or she left off in a previous game or reward a frequent players and other such features.

A specific embodiment of the invention will now be described by way of example with reference to the accompanying drawing in which:-

Figure 1 shows in perspective, The fingerprint sensor and keypad

Figure 2 shows an AWP with the sensor and keypad fitted.

Figure 3 shows an SWP/Video game/soft terminal with the sensor and keypad fitted

Figure 4 shows an PIN BALL/TABLE with the sensor and keypad fitted

Figure 5 shows an Amusement machine player recognition system example.

Referring to the drawing Fig.1 The Amusement machine player recognition system comprises of the following parts:-

1. Finger Print Sensor
2. Alpha/Numeric Keypad

The Person touches the sensor and it scans the fingerprint. a phone number is then punched into the keypad followed by a pin number, nickname or other personal information.

Referring to the drawing Fig.2 the AWP with the Amusement machine player recognition system fitted:-

1. Fruit machine/AWP
2. Finger Print Sensor
3. Alpha/Numeric Keypad

A fingerprint sensor and keypad are located on the machine. Once registered the player will be recognised by the machine. He/she would be able to return to where they left off in a previous playing session. this has not been possible before. He/she can be contacted via text or phone.

Referring to the drawing Fig.3 the SWP with the Amusement machine player recognition system fitted:-

1. SWP/video game or soft terminal
2. Finger Print Sensor
3. Alpha/Numeric Keypad

A fingerprint sensor and keypad are located on the machine. Once registered the player will be recognised by the machine. He/she would be able to return to where they left off in a previous playing session. this has not been possible before. He/she can be contacted via text or phone.

Referring to the drawing Fig.4 The Pin Table with the Amusement machine recognition system comprises of the following parts:-

1. PinTable
2. Finger Print Sensor
3. Alpha/Numeric Keypad

A fingerprint sensor and keypad are located on the machine. Once registered the player will be recognised by the machine. He/she would be able to return to where they left off in a previous playing session. this has not been possible before. He/she can be contacted via text or phone.

Referring to the drawing Fig.5 The Amusement machine player recognition system example:-

1. Finger Print Sensor
2. Alpha/Numeric Keypad
3. Control system
4. Mobile phone
5. direct sms text service
6. phone line

The system would consist of the above components. the persons fingerprint is scanned at 1. the persons mobile/telephone number in input at 2. the control system 3. can contact the person by text message at 4. 5. or 6.

- 4 -
CLAIMS

1. An amusement machine incorporating a player recognition system.
2. An amusement machine incorporating a player recognition system as in claim 1 that is coin operated.
3. An amusement machine incorporating a player recognition system as in claims 1 or 2 comprising keypad and mobile phone.
4. An amusement machine as in claim 3 that takes the form of a AWP amusement with prize (fruit machine or slot machine)
5. An amusement machine as in claim 3 that takes the form of a SWP skill with prize (skill with prize machine)
6. An amusement machine as in claim 3 that takes the form of a video game



INVESTOR IN PEOPLE

Application No: GB 0222228.9
Claims searched: 1 - 6

Examiner: Bridie Collier
Date of search: 4 April 2003

Patents Act 1977 : Search Report under Section 17

Documents considered to be relevant:

Category	Relevant to claims	Identity of document and passage or figure of particular relevance
X	1,2,4	DE 10060079 A (ADP) See abstract and fig
X	1,2,4	DE 19944140 A (SCHULZE) See abstract
X	1,2,4	EP 1120757 A2 (INTERNATIONAL) See col 4 para 12 and col 8 lines 25 - 27
X	1-6	WO 01/82176 A1 (GAMING) See P5 line 26 - P6 line 11
X	1-6	WO 94/16416 A1 (SPECIAL) See abstract
X	1-6	WO 94/10658 A1 (COMS21) See P4 line 7 - P5 line 10
X	1-6	US 6347738 B1 (INTERNATIONAL) See col 6 lines 5-11

Categories:

X	Document indicating lack of novelty or inventive step	A	Document indicating technological background and/or state of the art.
Y	Document indicating lack of inventive step if combined with one or more other documents of same category.	P	Document published on or after the declared priority date but before the filing date of this invention.
&	Member of the same patent family	E	Patent document published on or after, but with priority date earlier than, the filing date of this application.

Field of Search:

Search of GB, EP, WO & US patent documents classified in the following areas of the UKC^v:

Worldwide search of patent documents classified in the following areas of the IPC⁷:

The following online and other databases have been used in the preparation of this search report:

WPI, EPODOC, JAPIO

Electronic Acknowledgement Receipt

EFS ID:	15382743
Application Number:	13680852
International Application Number:	
Confirmation Number:	6364
Title of Invention:	METHOD AND APPARATUS FOR OUTPUTTING A MESSAGE AT A GAME MACHINE
First Named Inventor/Applicant Name:	Jay S. Walker
Customer Number:	29159
Filer:	Holby Abern/Mavis Benson
Filer Authorized By:	Holby Abern
Attorney Docket Number:	025124-0509
Receipt Date:	29-MAR-2013
Filing Date:	19-NOV-2012
Time Stamp:	16:38:07
Application Type:	Utility under 35 USC 111(a)

Payment information:

Submitted with Payment	no
------------------------	----

File Listing:

Document Number	Document Description	File Name	File Size(Bytes)/ Message Digest	Multi Part /.zip	Pages (if appl.)
1		trans0509Scan.pdf	208561 <small>e5c3134d7f32087a23742ca7e19d75843070c278</small>	yes	4

Multipart Description/PDF files in .zip description					
Document Description			Start	End	
Transmittal Letter			1	3	
Information Disclosure Statement (IDS) Form (SB08)			4	4	
Warnings:					
Information:					
2	Foreign Reference	GB2393554A.pdf	222488	no	11
			10593ea57105c8f35e1eafbc8ea109d9446a71bf		
Warnings:					
Information:					
Total Files Size (in bytes):			431049		
<p>This Acknowledgement Receipt evidences receipt on the noted date by the USPTO of the indicated documents, characterized by the applicant, and including page counts, where applicable. It serves as evidence of receipt similar to a Post Card, as described in MPEP 503.</p> <p><u>New Applications Under 35 U.S.C. 111</u> If a new application is being filed and the application includes the necessary components for a filing date (see 37 CFR 1.53(b)-(d) and MPEP 506), a Filing Receipt (37 CFR 1.54) will be issued in due course and the date shown on this Acknowledgement Receipt will establish the filing date of the application.</p> <p><u>National Stage of an International Application under 35 U.S.C. 371</u> If a timely submission to enter the national stage of an international application is compliant with the conditions of 35 U.S.C. 371 and other applicable requirements a Form PCT/DO/EO/903 indicating acceptance of the application as a national stage submission under 35 U.S.C. 371 will be issued in addition to the Filing Receipt, in due course.</p> <p><u>New International Application Filed with the USPTO as a Receiving Office</u> If a new international application is being filed and the international application includes the necessary components for an international filing date (see PCT Article 11 and MPEP 1810), a Notification of the International Application Number and of the International Filing Date (Form PCT/RO/105) will be issued in due course, subject to prescriptions concerning national security, and the date shown on this Acknowledgement Receipt will establish the international filing date of the application.</p>					

IN THE UNITED STATES PATENT AND TRADEMARK OFFICE

Inventor: Jay S. Walker et al.
Appl. No.: 13/680,852
Conf. No.: 6364
Filed: November 19, 2012
Title: METHOD AND APPARATUS FOR OUTPUTTING A MESSAGE AT A
GAMING MACHINE
Art Unit: 3714
Examiner: Unknown
Docket No.: 025124-0509

Commissioner for Patents
P.O. Box 1450
Alexandria, VA 22313-1450

INFORMATION DISCLOSURE STATEMENT TRANSMITTAL LETTER

Sir:

Submitted herewith is an Information Disclosure Statement for consideration in the above-identified application. In accordance with the provisions of 37 C.F.R. §§ 1.56, 1.97, and 1.98, Applicant requests that a citation and examination of the references cited on the enclosed PTO Form 1449 be made during the course of examination of the above-identified application for United States patent. Pursuant to 37 C.F.R. 1.98, copies of the foreign references and the non-patent literature can be found in the parent application, U.S. Patent Application No. 13/632,328, filed on October 1, 2012, and/or grandparent application, U.S. Patent Application No. 10/685,143, filed on October 14, 2003.

This Information Disclosure Statement is submitted as follows:

Submission without Certification

- [X] Within three months of filing of a national application; within three months of the date of entry of the national stage as set forth in 37 C.F.R. § 1.491 in an international application; before the mailing date of a first Office Action on the merits, or before the mailing of a first Office Action after the filing of a Request for Continued Examination.
- [] After the period specified above, but before the mailing date of a Final Action under 37 C.F.R. § 1.113, a Notice of Allowance under 37 C.F.R. § 1.311, or an Action that otherwise closes prosecution in the application and is accompanied by payment of the fee set forth in 37 C.F.R. § 1.17(p).

Submission with Certification

- [] Within three months of filing of a national application; within three months of the date of entry of the national stage as set forth in 37 C.F.R. § 1.491

in an international application; before the mailing date of a first Office Action on the merits, or before the mailing of a first Office Action after the filing of a Request for Continued Examination.

- [] After the period specified above, but before the mailing date of a Final Action under 37 C.F.R. § 1.113, a Notice of Allowance under 37 C.F.R. § 1.311, or an Action that otherwise closes prosecution in the application and is accompanied by the Certification specified in 37 C.F.R. § 1.97(e) which is set forth below.
- [] After the mailing date of a Final Action under 37 C.F.R. § 1.113, a Notice of Allowance under 37 C.F.R. § 1.311, or an Action that otherwise closes prosecution in the application and is accompanied by the fee set forth in 37 C.F.R. § 1.17(p) and the Certification specified in 37 C.F.R. § 1.97(e) which is set forth below.

Certification under 37 C.F.R. § 1.97

- [] The undersigned counsel for applicant(s) hereby certifies each item of information contained in the accompanying Information Disclosure Statement was first cited in any communication from a foreign patent office in a counterpart foreign application not more than **thirty days** prior to the filing of the Information Disclosure Statement.
- [] The undersigned counsel for applicant(s) hereby certifies each item of information contained in the accompanying Information Disclosure Statement was first cited in any communication from a foreign patent office in a counterpart foreign application not more than **three months** prior to the filing of the Information Disclosure Statement.
- [] The undersigned counsel for applicant(s) hereby certifies that no item of information contained in the accompanying Information Disclosure Statement was cited in a communication from a foreign patent office in a counterpart foreign application, and, to the knowledge of the undersigned, after making reasonable inquiry, no item of information contained in the accompanying Information Disclosure Statement was known to any individual designated in 37 C.F.R. § 1.56(c) not more than **thirty days** prior to the filing of the Information Disclosure Statement.
- [] The undersigned counsel for applicant(s) hereby certifies that no item of information contained in the accompanying Information Disclosure Statement was cited in a communication from a foreign patent office in a counterpart foreign application, and, to the knowledge of the undersigned, after making reasonable inquiry, no item of

information contained in the accompanying Information Disclosure Statement was known to any individual designated in 37 C.F.R. § 1.56(c) more than **three months** prior to the filing of the Information Disclosure Statement.

- A copy of a Search Report from a corresponding foreign patent application is enclosed.
- A check in the amount of \$180 to cover the required fee is enclosed.
- The Commissioner is hereby authorized to charge the amount of \$180 to cover the required fee to Deposit Account No. 502261.
- The Commissioner is hereby authorized to charge any additional fees which may be required, or credit any overpayment to Deposit Account No. 502261.

Respectfully submitted,

Neal, Gerber & Eisenberg LLP

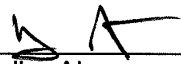
By: 
Holby Abern
Reg. No. 47,372
Customer No. 29159
Tel. No. (312) 269-8428

Date: March 28, 2013

PATENT APPLICATION FEE DETERMINATION RECORD Substitute for Form PTO-875						Application or Docket Number 13/680,852				
APPLICATION AS FILED - PART I										
		(Column 1)	(Column 2)		SMALL ENTITY		OR	OTHER THAN SMALL ENTITY		
FOR	NUMBER FILED	NUMBER EXTRA		RATE(\$)	FEE(\$)			RATE(\$)	FEE(\$)	
BASIC FEE (37 CFR 1.16(a), (b), or (c))	N/A	N/A		N/A				N/A	280	
SEARCH FEE (37 CFR 1.16(k), (l), or (m))	N/A	N/A		N/A				N/A	600	
EXAMINATION FEE (37 CFR 1.16(o), (p), or (q))	N/A	N/A		N/A				N/A	720	
TOTAL CLAIMS (37 CFR 1.16(i))	18	minus 20 =	*				OR	x 80 =	0.00	
INDEPENDENT CLAIMS (37 CFR 1.16(h))	2	minus 3 =	*				OR	x 420 =	0.00	
APPLICATION SIZE FEE (37 CFR 1.16(s))	If the specification and drawings exceed 100 sheets of paper, the application size fee due is \$310 (\$155 for small entity) for each additional 50 sheets or fraction thereof. See 35 U.S.C. 41(a)(1)(G) and 37 CFR 1.16(s).								400	
MULTIPLE DEPENDENT CLAIM PRESENT (37 CFR 1.16(j))									0.00	
* If the difference in column 1 is less than zero, enter "0" in column 2.				TOTAL			TOTAL		2000	
APPLICATION AS AMENDED - PART II										
		(Column 1)	(Column 2)	(Column 3)	SMALL ENTITY		OR	OTHER THAN SMALL ENTITY		
AMENDMENT A	CLAIMS REMAINING AFTER AMENDMENT		HIGHEST NUMBER PREVIOUSLY PAID FOR	PRESENT EXTRA	RATE(\$)	ADDITIONAL FEE(\$)			RATE(\$)	ADDITIONAL FEE(\$)
	Total (37 CFR 1.16(i))	*	Minus	**	=		OR	x	=	
	Independent (37 CFR 1.16(h))	*	Minus	***	=		OR	x	=	
	Application Size Fee (37 CFR 1.16(s))						OR			
	FIRST PRESENTATION OF MULTIPLE DEPENDENT CLAIM (37 CFR 1.16(j))						OR			
				TOTAL ADD'L FEE			OR	TOTAL ADD'L FEE		
AMENDMENT B	CLAIMS REMAINING AFTER AMENDMENT		HIGHEST NUMBER PREVIOUSLY PAID FOR	PRESENT EXTRA	RATE(\$)	ADDITIONAL FEE(\$)			RATE(\$)	ADDITIONAL FEE(\$)
	Total (37 CFR 1.16(i))	*	Minus	**	=		OR	x	=	
	Independent (37 CFR 1.16(h))	*	Minus	***	=		OR	x	=	
	Application Size Fee (37 CFR 1.16(s))						OR			
	FIRST PRESENTATION OF MULTIPLE DEPENDENT CLAIM (37 CFR 1.16(j))						OR			
				TOTAL ADD'L FEE			OR	TOTAL ADD'L FEE		
<p>* If the entry in column 1 is less than the entry in column 2, write "0" in column 3.</p> <p>** If the "Highest Number Previously Paid For" IN THIS SPACE is less than 20, enter "20".</p> <p>*** If the "Highest Number Previously Paid For" IN THIS SPACE is less than 3, enter "3".</p> <p>The "Highest Number Previously Paid For" (Total or Independent) is the highest found in the appropriate box in column 1.</p>										



UNITED STATES PATENT AND TRADEMARK OFFICE

UNITED STATES DEPARTMENT OF COMMERCE
United States Patent and Trademark Office
Address: COMMISSIONER FOR PATENTS
P.O. Box 1450
Alexandria, Virginia 22313-1450
www.uspto.gov

Table with 6 columns: APPLICATION NUMBER, FILING or 371(e) DATE, GRP ART UNIT, FIL FEE REC'D, ATTY. DOCKET NO, TOT CLAIMS, IND CLAIMS. Values: 13/680,852, 11/19/2012, 3714, 1710, 025124-0509, 18, 2

CONFIRMATION NO. 6364

UPDATED FILING RECEIPT

29159
Neal, Gerber & Eisenberg LLP
2 N. LaSalle Street
Suite 1700
Chicago, IL 60602-3801



Date Mailed: 04/01/2013

Receipt is acknowledged of this non-provisional patent application. The application will be taken up for examination in due course. Applicant will be notified as to the results of the examination. Any correspondence concerning the application must include the following identification information: the U.S. APPLICATION NUMBER, FILING DATE, NAME OF APPLICANT, and TITLE OF INVENTION. Fees transmitted by check or draft are subject to collection. Please verify the accuracy of the data presented on this receipt. If an error is noted on this Filing Receipt, please submit a written request for a Filing Receipt Correction. Please provide a copy of this Filing Receipt with the changes noted thereon. If you received a "Notice to File Missing Parts" for this application, please submit any corrections to this Filing Receipt with your reply to the Notice. When the USPTO processes the reply to the Notice, the USPTO will generate another Filing Receipt incorporating the requested corrections

Inventor(s)

Jay S. Walker, Ridgefield, CT;
James A. Jorasch, Stamford, CT;
Russell P. Sammon, San Francisco, CA;
Stephen C. Tulley, Fairfield, CT;
Steven M. Santisi, Ridgefield, CT;

Applicant(s)

IGT, Reno, NV

Assignment For Published Patent Application

IGT, Reno, NV

Power of Attorney: The patent practitioners associated with Customer Number 29159

Domestic Priority data as claimed by applicant

This application is a CON of 13/632,328 10/01/2012
which is a CON of 10/685,143 10/14/2003 PAT 8282488
which claims benefit of 60/418,397 10/11/2002

Foreign Applications for which priority is claimed (You may be eligible to benefit from the Patent Prosecution Highway program at the USPTO. Please see http://www.uspto.gov for more information.) - None.

Foreign application information must be provided in an Application Data Sheet in order to constitute a claim to foreign priority. See 37 CFR 1.55 and 1.76.

If Required, Foreign Filing License Granted: 12/12/2012

The country code and number of your priority application, to be used for filing abroad under the Paris Convention, is US 13/680,852

Projected Publication Date: Not Applicable

Non-Publication Request: No

Early Publication Request: No
Title

METHOD AND APPARATUS FOR OUTPUTTING A MESSAGE AT A GAME MACHINE

Preliminary Class

463

Statement under 37 CFR 1.55 or 1.78 for AIA (First Inventor to File) Transition Applications:

PROTECTING YOUR INVENTION OUTSIDE THE UNITED STATES

Since the rights granted by a U.S. patent extend only throughout the territory of the United States and have no effect in a foreign country, an inventor who wishes patent protection in another country must apply for a patent in a specific country or in regional patent offices. Applicants may wish to consider the filing of an international application under the Patent Cooperation Treaty (PCT). An international (PCT) application generally has the same effect as a regular national patent application in each PCT-member country. The PCT process **simplifies** the filing of patent applications on the same invention in member countries, but **does not result** in a grant of "an international patent" and does not eliminate the need of applicants to file additional documents and fees in countries where patent protection is desired.

Almost every country has its own patent law, and a person desiring a patent in a particular country must make an application for patent in that country in accordance with its particular laws. Since the laws of many countries differ in various respects from the patent law of the United States, applicants are advised to seek guidance from specific foreign countries to ensure that patent rights are not lost prematurely.

Applicants also are advised that in the case of inventions made in the United States, the Director of the USPTO must issue a license before applicants can apply for a patent in a foreign country. The filing of a U.S. patent application serves as a request for a foreign filing license. The application's filing receipt contains further information and guidance as to the status of applicant's license for foreign filing.

Applicants may wish to consult the USPTO booklet, "General Information Concerning Patents" (specifically, the section entitled "Treaties and Foreign Patents") for more information on timeframes and deadlines for filing foreign patent applications. The guide is available either by contacting the USPTO Contact Center at 800-786-9199, or it can be viewed on the USPTO website at <http://www.uspto.gov/web/offices/pac/doc/general/index.html>.

For information on preventing theft of your intellectual property (patents, trademarks and copyrights), you may wish to consult the U.S. Government website, <http://www.stopfakes.gov>. Part of a Department of Commerce initiative, this website includes self-help "toolkits" giving innovators guidance on how to protect intellectual property in specific countries such as China, Korea and Mexico. For questions regarding patent enforcement issues, applicants may call the U.S. Government hotline at 1-866-999-HALT (1-866-999-4158).

LICENSE FOR FOREIGN FILING UNDER
Title 35, United States Code, Section 184
Title 37, Code of Federal Regulations, 5.11 & 5.15

GRANTED

The applicant has been granted a license under 35 U.S.C. 184, if the phrase "IF REQUIRED, FOREIGN FILING LICENSE GRANTED" followed by a date appears on this form. Such licenses are issued in all applications where the conditions for issuance of a license have been met, regardless of whether or not a license may be required as set forth in 37 CFR 5.15. The scope and limitations of this license are set forth in 37 CFR 5.15(a) unless an earlier license has been issued under 37 CFR 5.15(b). The license is subject to revocation upon written notification. The date indicated is the effective date of the license, unless an earlier license of similar scope has been granted under 37 CFR 5.13 or 5.14.

This license is to be retained by the licensee and may be used at any time on or after the effective date thereof unless it is revoked. This license is automatically transferred to any related applications(s) filed under 37 CFR 1.53(d). This license is not retroactive.

The grant of a license does not in any way lessen the responsibility of a licensee for the security of the subject matter as imposed by any Government contract or the provisions of existing laws relating to espionage and the national security or the export of technical data. Licensees should apprise themselves of current regulations especially with respect to certain countries, of other agencies, particularly the Office of Defense Trade Controls, Department of State (with respect to Arms, Munitions and Implements of War (22 CFR 121-128)); the Bureau of Industry and Security, Department of Commerce (15 CFR parts 730-774); the Office of Foreign Assets Control, Department of Treasury (31 CFR Parts 500+) and the Department of Energy.

NOT GRANTED

No license under 35 U.S.C. 184 has been granted at this time, if the phrase "IF REQUIRED, FOREIGN FILING LICENSE GRANTED" DOES NOT appear on this form. Applicant may still petition for a license under 37 CFR 5.12, if a license is desired before the expiration of 6 months from the filing date of the application. If 6 months has lapsed from the filing date of this application and the licensee has not received any indication of a secrecy order under 35 U.S.C. 181, the licensee may foreign file the application pursuant to 37 CFR 5.15(b).

SelectUSA

The United States represents the largest, most dynamic marketplace in the world and is an unparalleled location for business investment, innovation, and commercialization of new technologies. The U.S. offers tremendous resources and advantages for those who invest and manufacture goods here. Through SelectUSA, our nation works to promote and facilitate business investment. SelectUSA provides information assistance to the international investor community; serves as an ombudsman for existing and potential investors; advocates on behalf of U.S. cities, states, and regions competing for global investment; and counsels U.S. economic development organizations on investment attraction best practices. To learn more about why the United States is the best country in the world to develop technology, manufacture products, deliver services, and grow your business, visit <http://www.SelectUSA.gov> or call +1-202-482-6800.



UNITED STATES PATENT AND TRADEMARK OFFICE

UNITED STATES DEPARTMENT OF COMMERCE
United States Patent and Trademark Office
Address: COMMISSIONER FOR PATENTS
P.O. Box 1450
Alexandria, Virginia 22313-1450
www.uspto.gov

APPLICATION NUMBER	FILING OR 371(C) DATE	FIRST NAMED APPLICANT	ATTY. DOCKET NO./TITLE
13/680,852	11/19/2012	Jay S. Walker	025124-0509

CONFIRMATION NO. 6364

29159
Neal, Gerber & Eisenberg LLP
2 N. LaSalle Street
Suite 1700
Chicago, IL 60602-3801

NOTICE



OC000000060142303

Date Mailed: 04/01/2013

INFORMATIONAL NOTICE TO APPLICANT

Applicant is notified that the above-identified application contains the deficiencies noted below. No period for reply is set forth in this notice for correction of these deficiencies. However, if a deficiency relates to the inventor's oath or declaration, the applicant must file an oath or declaration in compliance with 37 CFR 1.63, or a substitute statement in compliance with 37 CFR 1.64, executed by or with respect to each actual inventor no later than the expiration of the time period set in the "Notice of Allowability" to avoid abandonment. See 37 CFR 1.53(f).

The item(s) indicated below are also required and should be submitted with any reply to this notice to avoid further processing delays.

- A properly executed inventor's oath or declaration has not been received for the following inventor(s):
all
Applicant may submit the inventor's oath or declaration at any time before the Notice of Allowance and Fee(s) Due, PTOL-85, is mailed.



UNITED STATES PATENT AND TRADEMARK OFFICE

UNITED STATES DEPARTMENT OF COMMERCE
United States Patent and Trademark Office
Address: COMMISSIONER FOR PATENTS
P.O. Box 1450
Alexandria, Virginia 22313-1450
www.uspto.gov

APPLICATION NUMBER	FILING OR 371(C) DATE	FIRST NAMED APPLICANT	ATTY. DOCKET NO./TITLE
13/680,852	11/19/2012	Jay S. Walker	025124-0509

CONFIRMATION NO. 6364

POA ACCEPTANCE LETTER



OC000000060142351

29159
Neal, Gerber & Eisenberg LLP
2 N. LaSalle Street
Suite 1700
Chicago, IL 60602-3801

Date Mailed: 04/01/2013

NOTICE OF ACCEPTANCE OF POWER OF ATTORNEY

This is in response to the Power of Attorney filed 01/14/2013.

The Power of Attorney in this application is accepted. Correspondence in this application will be mailed to the above address as provided by 37 CFR 1.33.

/ydemisse/

Office of Data Management, Application Assistance Unit (571) 272-4000, or (571) 272-4200, or 1-888-786-0101

Doc Code: Oath

Document Description: Oath or declaration filed

Approved for use through 01/31/2014. OMB 0661-0032
U.S. Patent and Trademark Office; U.S. DEPARTMENT OF COMMERCE
PTO/AIA/06 (08-12)

Under the Paperwork Reduction Act of 1995, no persons are required to respond to a collection of information unless it contains a valid OMB control number.

DECLARATION FOR UTILITY OR DESIGN PATENT APPLICATION (37 CFR 1.63) <input type="checkbox"/> Declaration Submitted With Initial Filing OR <input checked="" type="checkbox"/> Declaration Submitted After Initial Filing (surcharge (37 CFR 1.16(f)) required)	Attorney Docket Number	025124-0508 (WK00036-004)
	First Named Inventor	Jay S. Walker
	<i>COMPLETE IF KNOWN</i>	
	Application Number	13/632,328
	Filing Date	October 1, 2012
	Art Unit	Unknown
	Examiner Name	Unknown

METHOD AND APPARATUS FOR OUTPUTTING A MESSAGE AT A GAME MACHINE

(Title of the Invention)

As a below named inventor, I hereby declare that:

This declaration is directed to:

The attached application,

OR

United States Application Number or PCT International application number 13/632,328
filed on October 1, 2012.

The above-identified application was made or authorized to be made by me.

I believe I am the original inventor or an original joint inventor of a claimed invention in the application.

I hereby acknowledge that any willful false statement made in this declaration is punishable under 18 U.S.C. 1001 by fine or imprisonment of not more than five (5) years, or both.

Authorization To Permit Access To Application by Participating Office

If checked, the undersigned hereby grants the USPTO authority to provide the European Patent Office (EPO), the Japan Patent Office (JPO), the Korean Intellectual Property Office (KIPO), the World Intellectual Property Office (WIPO), and any other intellectual property offices in which a foreign application claiming priority to the above-identified patent application is filed access to the above-identified patent application. See 37 CFR 1.14(c) and (h). This box should not be checked if the applicant does not wish the EPO, JPO, KIPO, WIPO, or other intellectual property office in which a foreign application claiming priority to the above-identified patent application is filed to have access to the above-identified patent application.

In accordance with 37 CFR 1.14(h)(3), access will be provided to a copy of the above-identified patent application with respect to: 1) the above-identified patent application-as-filed; 2) any foreign application to which the above-identified patent application claims priority under 35 U.S.C. 119(a)-(d) if a copy of the foreign application that satisfies the certified copy requirement of 37 CFR 1.55 has been filed in the above-identified patent application; and 3) any U.S. application-as-filed from which benefit is sought in the above-identified patent application.

In accordance with 37 CFR 1.14(c), access may be provided to information concerning the date of filing the Authorization to Permit Access to Application by Participating Offices.

[Page 1 of 2]

This collection of information is required by 35 U.S.C. 115 and 37 CFR 1.63. The information is required to obtain or retain a benefit by the public which is to file (and by the USPTO to process) an application. Confidentiality is governed by 35 U.S.C. 122 and 37 CFR 1.11 and 1.14. This collection is estimated to take 21 minutes to complete, including gathering, preparing, and submitting the completed application form to the USPTO. Time will vary depending upon the individual case. Any comments on the amount of time you require to complete this form and/or suggestions for reducing this burden, should be sent to the Chief Information Officer, U.S. Patent and Trademark Office, U.S. Department of Commerce, P.O. Box 1450, Alexandria, VA 22313-1450. DO NOT SEND FEES OR COMPLETED FORMS TO THIS ADDRESS. SEND TO: Commissioner for Patents, P.O. Box 1450, Alexandria, VA 22313-1450.

If you need assistance in completing the form, call 1-800-PTO-9199 and select option 2.

Under the Paperwork Reduction Act of 1995, no persons are required to respond to a collection of information unless it contains a valid OMB control number.

DECLARATION — Utility or Design Patent Application

Direct all correspondence to:	<input checked="" type="checkbox"/>	The address associated with Customer Number:	29159	OR	<input type="checkbox"/>	Correspondence address below
Name						
Address						
City			State		Zip	
Country		Telephone		Email		

WARNING:

Petitioner/applicant is cautioned to avoid submitting personal information in documents filed in a patent application that may contribute to identity theft. Personal information such as social security numbers, bank account numbers, or credit card numbers (other than a check or credit card authorization form PTO-2038 submitted for payment purposes) is never required by the USPTO to support a petition or an application. If this type of personal information is included in documents submitted to the USPTO, petitioners/applicants should consider redacting such personal information from the documents before submitting them to the USPTO. Petitioner/applicant is advised that the record of a patent application is available to the public after publication of the application (unless a non-publication request in compliance with 37 CFR 1.213(a) is made in the application) or issuance of a patent. Furthermore, the record from an abandoned application may also be available to the public if the application is referenced in a published application or an issued patent (see 37 CFR 1.14). Checks and credit card authorization forms PTO-2038 submitted for payment purposes are not retained in the application file and therefore are not publicly available. Petitioner/applicant is advised that documents which form the record of a patent application (such as the PTO/SB/01) are placed into the Privacy Act system of records DEPARTMENT OF COMMERCE, COMMERCE-PAT-7, System name: *Patent Application Files*. Documents not retained in an application file (such as the PTO-2038) are placed into the Privacy Act system of COMMERCE/PAT-TM-10, System name: *Deposit Accounts and Electronic Funds Transfer Profiles*.

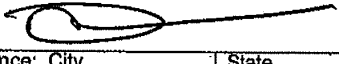
LEGAL NAME OF SOLE OR FIRST INVENTOR:			
(E.g., Given Name (first and middle (if any)) and Family Name or Surname)			
Jay S. Walker			
Inventor's Signature		Date (Optional)	
		May 6 th , 2013	
Residence: City	State	Country	
Ridgefield	CT	US	
Mailing Address			
260 Oscaleta Road			
City	State	Zip	Country
Ridgefield	CT	06877	US
<input checked="" type="checkbox"/> Additional inventors are being named on the <u>2</u> supplemental sheet(s) PTO/AIA/10 attached hereto			

Under the Paperwork Reduction Act of 1995, no persons are required to respond to a collection of information unless it contains a valid OMB control number.

SUPPLEMENTAL SHEET FOR DECLARATION	ADDITIONAL INVENTOR(S) Supplemental Sheet (for PTO/AIA/08,09) Page <u>1</u> of <u>2</u>
---	---

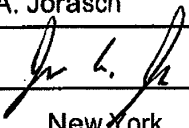
Legal Name of Additional Joint Inventor, if any: (E.g., Given Name (first and middle (if any)) and Family Name or Surname)			
James A. Jorasch			
Inventor's Signature 		Date (Optional) 5/3/2013	
Residence: City New York	State NY	Country USA	
Mailing Address 122 East 38th Street			
City New York	State NY	Zip 10016	Country USA
Legal Name of Additional Joint Inventor, if any: (E.g., Given Name (first and middle (if any)) and Family Name or Surname)			
Russell P. Sammon			
Inventor's Signature		Date (Optional)	
Residence: City San Francisco	State CA	Country USA	
Mailing Address 198 Emmett Court			
City San Francisco	State CA	Zip 94110	Country USA
Legal Name of Additional Joint Inventor, if any: (E.g., Given Name (first and middle (if any)) and Family Name or Surname)			
Stephen C. Tulley			
Inventor's Signature		Date (Optional)	
Residence: City Monroe	State CT	Country USA	
Mailing Address 563 Moose Hill Road			
City Monroe	State CT	Zip 06468	Country USA

This collection of information is required by 35 U.S.C. 115 and 37 CFR 1.63. The information is required to obtain or retain a benefit by the public which is to file (and by the USPTO to process) an application. Confidentiality is governed by 35 U.S.C. 122 and 37 CFR 1.11 and 1.14. This collection is estimated to take 21 minutes to complete, including gathering, preparing, and submitting the completed application form to the USPTO. Time will vary depending upon the individual case. Any comments on the amount of time you require to complete this form and/or suggestions for reducing this burden, should be sent to the Chief Information Officer, U.S. Patent and Trademark Office, U.S. Department of Commerce, P.O. Box 1450, Alexandria, VA 22313-1450. DO NOT SEND FEES OR COMPLETED FORMS TO THIS ADDRESS. SEND TO: Commissioner for Patents, P.O. Box 1450, Alexandria, VA 22313-1450.

If you need assistance in completing the form, call 1-800-PTO-9199 (1-800-786-9199) and select option 2.

SUPPLEMENTAL SHEET FOR DECLARATION	ADDITIONAL INVENTOR(S)
	Supplemental Sheet (for PTO/AIA/08,09) Page <u>2</u> of <u>2</u>

Legal Name of Additional Joint Inventor, if any:			
(E.g., Given Name (first and middle (if any)) and Family Name or Surname)			
Steven M. Santisi			
Inventor's Signature			Date (Optional)
Ridgefield	CT	US	
Residence: City	State	Country	
80 Lounsbury Lane			
Mailing Address			
Ridgefield	CT	06877	US
City	State	Zip	Country
Legal Name of Additional Joint Inventor, if any:			
(E.g., Given Name (first and middle (if any)) and Family Name or Surname)			
Inventor's Signature			Date (Optional)
Residence: City	State	Country	
Mailing Address			
City	State	Zip	Country
Legal Name of Additional Joint Inventor, if any:			
(E.g., Given Name (first and middle (if any)) and Family Name or Surname)			
Inventor's Signature			Date (Optional)
Residence: City	State	Country	
Mailing Address			
City	State	Zip	Country

This collection of information is required by 35 U.S.C. 115 and 37 CFR 1.63. The information is required to obtain or retain a benefit by the public which is to file (and by the USPTO to process) an application. Confidentiality is governed by 35 U.S.C. 122 and 37 CFR 1.11 and 1.14. This collection is estimated to take 21 minutes to complete, including gathering, preparing, and submitting the completed application form to the USPTO. Time will vary depending upon the individual case. Any comments on the amount of time you require to complete this form and/or suggestions for reducing this burden, should be sent to the Chief Information Officer, U.S. Patent and Trademark Office, U.S. Department of Commerce, P.O. Box 1450, Alexandria, VA 22313-1450. DO NOT SEND FEES OR COMPLETED FORMS TO THIS ADDRESS. SEND TO: Commissioner for Patents, P.O. Box 1450, Alexandria, VA 22313-1450.

If you need assistance in completing the form, call 1-800-PTO-9199 (1-800-786-9199) and select option 2.

DECLARATION FOR UTILITY OR DESIGN PATENT APPLICATION (37 CFR 1.63)		Attorney Docket Number	025124-0508 (WK00036-004)
		First Named Inventor	Jay S. Walker
<input type="checkbox"/> Declaration Submitted With Initial Filing OR <input checked="" type="checkbox"/> Declaration Submitted After Initial Filing (surcharge (37 CFR 1.16(f)) required)		<i>COMPLETE IF KNOWN</i>	
		Application Number	13/632,328
		Filing Date	October 1, 2012
		Art Unit	Unknown
		Examiner Name	Unknown

METHOD AND APPARATUS FOR OUTPUTTING A MESSAGE AT A GAME MACHINE

(Title of the Invention)

As a below named inventor, I hereby declare that:

This declaration is directed to:

The attached application,

OR

United States Application Number or PCT International application number 13/632,328
filed on October 1, 2012.

The above-identified application was made or authorized to be made by me.

I believe I am the original inventor or an original joint inventor of a claimed invention in the application.

I hereby acknowledge that any willful false statement made in this declaration is punishable under 18 U.S.C. 1001 by fine or imprisonment of not more than five (5) years, or both.

Authorization To Permit Access To Application by Participating Office

If checked, the undersigned hereby grants the USPTO authority to provide the European Patent Office (EPO), the Japan Patent Office (JPO), the Korean Intellectual Property Office (KIPO), the World Intellectual Property Office (WIPO), and any other intellectual property offices in which a foreign application claiming priority to the above-identified patent application is filed access to the above-identified patent application. See 37 CFR 1.14(c) and (h). This box should not be checked if the applicant does not wish the EPO, JPO, KIPO, WIPO, or other intellectual property office in which a foreign application claiming priority to the above-identified patent application is filed to have access to the above-identified patent application.

In accordance with 37 CFR 1.14(h)(3), access will be provided to a copy of the above-identified patent application with respect to: 1) the above-identified patent application-as-filed; 2) any foreign application to which the above-identified patent application claims priority under 35 U.S.C. 119(a)-(d) if a copy of the foreign application that satisfies the certified copy requirement of 37 CFR 1.55 has been filed in the above-identified patent application; and 3) any U.S. application-as-filed from which benefit is sought in the above-identified patent application.

In accordance with 37 CFR 1.14(c), access may be provided to information concerning the date of filing the Authorization to Permit Access to Application by Participating Offices.

[Page 1 of 2]

This collection of information is required by 35 U.S.C. 115 and 37 CFR 1.63. The information is required to obtain or retain a benefit by the public which is to file (and by the USPTO to process) an application. Confidentiality is governed by 35 U.S.C. 122 and 37 CFR 1.11 and 1.14. This collection is estimated to take 21 minutes to complete, including gathering, preparing, and submitting the completed application form to the USPTO. Time will vary depending upon the individual case. Any comments on the amount of time you require to complete this form and/or suggestions for reducing this burden, should be sent to the Chief Information Officer, U.S. Patent and Trademark Office, U.S. Department of Commerce, P.O. Box 1450, Alexandria, VA 22313-1450. DO NOT SEND FEES OR COMPLETED FORMS TO THIS ADDRESS. SEND TO: Commissioner for Patents, P.O. Box 1450, Alexandria, VA 22313-1450.

If you need assistance in completing the form, call 1-800-PTO-9199 and select option 2.

Under the Paperwork Reduction Act of 1995, no persons are required to respond to a collection of information unless it contains a valid OMB control number.

DECLARATION — Utility or Design Patent Application

Direct all correspondence to:	<input checked="" type="checkbox"/>	The address associated with Customer Number:	<input type="text" value="29159"/>	OR	<input type="checkbox"/>	Correspondence address below
Name						
Address						
City			State		Zip	
Country		Telephone		Email		
WARNING:						
<p>Petitioner/applicant is cautioned to avoid submitting personal information in documents filed in a patent application that may contribute to identity theft. Personal information such as social security numbers, bank account numbers, or credit card numbers (other than a check or credit card authorization form PTO-2038 submitted for payment purposes) is never required by the USPTO to support a petition or an application. If this type of personal information is included in documents submitted to the USPTO, petitioners/applicants should consider redacting such personal information from the documents before submitting them to the USPTO. Petitioner/applicant is advised that the record of a patent application is available to the public after publication of the application (unless a non-publication request in compliance with 37 CFR 1.213(a) is made in the application) or issuance of a patent. Furthermore, the record from an abandoned application may also be available to the public if the application is referenced in a published application or an issued patent (see 37 CFR 1.14). Checks and credit card authorization forms PTO-2038 submitted for payment purposes are not retained in the application file and therefore are not publicly available. Petitioner/applicant is advised that documents which form the record of a patent application (such as the PTO/SB/01) are placed into the Privacy Act system of records DEPARTMENT OF COMMERCE, COMMERCE-PAT-7, System name: <i>Patent Application Files</i>. Documents not retained in an application file (such as the PTO-2038) are placed into the Privacy Act system of COMMERCE/PAT-TM-10, System name: <i>Deposit Accounts and Electronic Funds Transfer Profiles</i>.</p>						
LEGAL NAME OF SOLE OR FIRST INVENTOR:						
(E.g., Given Name (first and middle (if any)) and Family Name or Surname)						
Jay S. Walker						
Inventor's Signature				Date (Optional)		
Residence: City		State		Country		
Ridgefield		CT		US		
Mailing Address						
260 Oscaleta Road						
City		State		Zip		Country
Ridgefield		CT		06877		US
<input checked="" type="checkbox"/> Additional inventors are being named on the <u>2</u> supplemental sheet(s) PTO/AIA/10 attached hereto						

[Page 2 of 2]

Under the Paperwork Reduction Act of 1995, no persons are required to respond to a collection of information unless it contains a valid OMB control number.

SUPPLEMENTAL SHEET FOR DECLARATION **ADDITIONAL INVENTOR(S)**
 Supplemental Sheet (for PTO/AIA/08,09) Page 1 of 2

Legal Name of Additional Joint Inventor, if any: (E.g., Given Name (first and middle (if any)) and Family Name or Surname)			
James A. Jorasch			
Inventor's Signature			Date (Optional)
Residence: City	New York	State	NY USA
122 East 38th Street			
Mailing Address			
City	New York	State	NY 10016 USA
Legal Name of Additional Joint Inventor, if any: (E.g., Given Name (first and middle (if any)) and Family Name or Surname)			
Russell P. Sammon			
Inventor's Signature			Date (Optional)
Residence: City	San Francisco	State	CA USA
198 Emmett Court			
Mailing Address			
City	San Francisco	State	CA 94110 USA
Legal Name of Additional Joint Inventor, if any: (E.g., Given Name (first and middle (if any)) and Family Name or Surname)			
Stephen C. Tulley			
Inventor's Signature			Date (Optional)
Residence: City	Monroe	State	CT USA
563 Moose Hill Road			
Mailing Address			
City	Monroe	State	CT 06468 USA

This collection of information is required by 35 U.S.C. 116 and 37 CFR 1.63. The information is required to obtain or retain a benefit by the public which is to file (and by the USPTO to process) an application. Confidentiality is governed by 35 U.S.C. 122 and 37 CFR 1.11 and 1.14. This collection is estimated to take 21 minutes to complete, including gathering, preparing, and submitting the completed application form to the USPTO. Time will vary depending upon the individual case. Any comments on the amount of time you require to complete this form and/or suggestions for reducing this burden, should be sent to the Chief Information Officer, U.S. Patent and Trademark Office, U.S. Department of Commerce, P.O. Box 1450, Alexandria, VA 22313-1450. DO NOT SEND FEES OR COMPLETED FORMS TO THIS ADDRESS. SEND TO: Commissioner for Patents, P.O. Box 1450, Alexandria, VA 22313-1450.

If you need assistance in completing the form, call 1-800-PTO-9199 (1-800-786-9199) and select option 2.

Under the Paperwork Reduction Act of 1995, no persons are required to respond to a collection of information unless it contains a valid OMB control number.

SUPPLEMENTAL SHEET FOR DECLARATION **ADDITIONAL INVENTOR(S)**
 Supplemental Sheet (for PTO/AIA/08,09) Page 2 of 2

Legal Name of Additional Joint Inventor, if any: (E.g., Given Name (first and middle (if any)) and Family Name or Surname)			
Steven M. Santisi			
Inventor's Signature <i>Steven M. Santisi</i>		Date (Optional) 6/1/13	
Ridgefield Residence: City	CT State	US Country	
80 Lounsbury Lane Mailing Address			
Ridgefield City	CT State	06877 Zip	US Country
Legal Name of Additional Joint Inventor, if any: (E.g., Given Name (first and middle (if any)) and Family Name or Surname)			
Inventor's Signature		Date (Optional)	
Residence: City	State	Country	
Mailing Address			
City	State	Zip	Country
Legal Name of Additional Joint Inventor, if any: (E.g., Given Name (first and middle (if any)) and Family Name or Surname)			
Inventor's Signature		Date (Optional)	
Residence: City	State	Country	
Mailing Address			
City	State	Zip	Country

This collection of information is required by 35 U.S.C. 116 and 37 CFR 1.63. The information is required to obtain or retain a benefit by the public which is to file (and by the USPTO to process) an application. Confidentiality is governed by 35 U.S.C. 122 and 37 CFR 1.11 and 1.14. This collection is estimated to take 21 minutes to complete, including gathering, preparing, and submitting the completed application form to the USPTO. Time will vary depending upon the individual case. Any comments on the amount of time you require to complete this form and/or suggestions for reducing this burden, should be sent to the Chief Information Officer, U.S. Patent and Trademark Office, U.S. Department of Commerce, P.O. Box 1450, Alexandria, VA 22313-1450. DO NOT SEND FEES OR COMPLETED FORMS TO THIS ADDRESS. SEND TO: Commissioner for Patents, P.O. Box 1450, Alexandria, VA 22313-1450.

If you need assistance in completing the form, call 1-800-PTO-9199 (1-800-786-9199) and select option 2.

DECLARATION FOR UTILITY OR DESIGN PATENT APPLICATION (37 CFR 1.63)		Attorney Docket Number	025124-0508 (WK00036-004)	
		First Named Inventor	Jay S. Walker	
<i>COMPLETE IF KNOWN</i>				
<input type="checkbox"/> Declaration Submitted With Initial Filing	OR	<input checked="" type="checkbox"/> Declaration Submitted After Initial Filing (surcharge (37 CFR 1.16(f)) required)	Application Number	13/632,328
			Filing Date	October 1, 2012
			Art Unit	Unknown
			Examiner Name	Unknown

METHOD AND APPARATUS FOR OUTPUTTING A MESSAGE AT A GAME MACHINE

(Title of the Invention)

As a below named inventor, I hereby declare that:

This declaration is directed to:

The attached application,

OR

United States Application Number or PCT International application number 13/632,328

filed on October 1, 2012.

The above-identified application was made or authorized to be made by me.

I believe I am the original inventor or an original joint inventor of a claimed invention in the application.

I hereby acknowledge that any willful false statement made in this declaration is punishable under 18 U.S.C. 1001 by fine or imprisonment of not more than five (5) years, or both.

Authorization To Permit Access To Application by Participating Office

If checked, the undersigned hereby grants the USPTO authority to provide the European Patent Office (EPO), the Japan Patent Office (JPO), the Korean Intellectual Property Office (KIPO), the World Intellectual Property Office (WIPO), and any other intellectual property offices in which a foreign application claiming priority to the above-identified patent application is filed access to the above-identified patent application. See 37 CFR 1.14(c) and (h). This box should not be checked if the applicant does not wish the EPO, JPO, KIPO, WIPO, or other intellectual property office in which a foreign application claiming priority to the above-identified patent application is filed to have access to the above-identified patent application.

In accordance with 37 CFR 1.14(h)(3), access will be provided to a copy of the above-identified patent application with respect to: 1) the above-identified patent application-as-filed; 2) any foreign application to which the above-identified patent application claims priority under 35 U.S.C. 119(a)-(d) if a copy of the foreign application that satisfies the certified copy requirement of 37 CFR 1.55 has been filed in the above-identified patent application; and 3) any U.S. application-as-filed from which benefit is sought in the above-identified patent application.

In accordance with 37 CFR 1.14(c), access may be provided to information concerning the date of filing the Authorization to Permit Access to Application by Participating Offices.

[Page 1 of 2]

This collection of information is required by 35 U.S.C. 115 and 37 CFR 1.63. The information is required to obtain or retain a benefit by the public which is to file (and by the USPTO to process) an application. Confidentiality is governed by 35 U.S.C. 122 and 37 CFR 1.11 and 1.14. This collection is estimated to take 21 minutes to complete, including gathering, preparing, and submitting the completed application form to the USPTO. Time will vary depending upon the individual case. Any comments on the amount of time you require to complete this form and/or suggestions for reducing this burden, should be sent to the Chief Information Officer, U.S. Patent and Trademark Office, U.S. Department of Commerce, P.O. Box 1450, Alexandria, VA 22313-1450. DO NOT SEND FEES OR COMPLETED FORMS TO THIS ADDRESS. **SEND TO: Commissioner for Patents, P.O. Box 1450, Alexandria, VA 22313-1450.**

If you need assistance in completing the form, call 1-800-PTO-9199 and select option 2.

Under the Paperwork Reduction Act of 1995, no persons are required to respond to a collection of information unless it contains a valid OMB control number.

DECLARATION — Utility or Design Patent Application

Direct all correspondence to:	<input checked="" type="checkbox"/>	The address associated with Customer Number:	<input type="text" value="29159"/>	OR	<input type="checkbox"/>	Correspondence address below
Name						
Address						
City			State		Zip	
Country		Telephone		Email		
WARNING:						
<p>Petitioner/applicant is cautioned to avoid submitting personal information in documents filed in a patent application that may contribute to identity theft. Personal information such as social security numbers, bank account numbers, or credit card numbers (other than a check or credit card authorization form PTO-2038 submitted for payment purposes) is never required by the USPTO to support a petition or an application. If this type of personal information is included in documents submitted to the USPTO, petitioners/applicants should consider redacting such personal information from the documents before submitting them to the USPTO. Petitioner/applicant is advised that the record of a patent application is available to the public after publication of the application (unless a non-publication request in compliance with 37 CFR 1.213(a) is made in the application) or issuance of a patent. Furthermore, the record from an abandoned application may also be available to the public if the application is referenced in a published application or an issued patent (see 37 CFR 1.14). Checks and credit card authorization forms PTO-2038 submitted for payment purposes are not retained in the application file and therefore are not publicly available. Petitioner/applicant is advised that documents which form the record of a patent application (such as the PTO/SB/01) are placed into the Privacy Act system of records DEPARTMENT OF COMMERCE, COMMERCE-PAT-7, System name: <i>Patent Application Files</i>. Documents not retained in an application file (such as the PTO-2038) are placed into the Privacy Act system of COMMERCE/PAT-TM-10, System name: <i>Deposit Accounts and Electronic Funds Transfer Profiles</i>.</p>						
LEGAL NAME OF SOLE OR FIRST INVENTOR:						
(E.g., Given Name (first and middle (if any)) and Family Name or Surname)						
Jay S. Walker						
Inventor's Signature				Date (Optional)		
Residence: City		State		Country		
Ridgefield		CT		US		
Mailing Address						
260 Oscaleta Road						
City		State		Zip		Country
Ridgefield		CT		06877		US
<input checked="" type="checkbox"/> Additional inventors are being named on the <u>2</u> supplemental sheet(s) PTO/AIA/10 attached hereto						

[Page 2 of 2]

Under the Paperwork Reduction Act of 1995, no persons are required to respond to a collection of information unless it contains a valid OMB control number.

SUPPLEMENTAL SHEET FOR DECLARATION**ADDITIONAL INVENTOR(S)**

Supplemental Sheet (for PTO/AIA/08,09)

Page 1 of 2

Legal Name of Additional Joint Inventor, if any:			
(E.g., Given Name (first and middle (if any)) and Family Name or Surname)			
James A. Jorasch			
Inventor's Signature			Date (Optional)
Residence: City	New York	State	NY USA
122 East 38th Street			
Mailing Address			
City	New York	State	NY 10016 USA
Legal Name of Additional Joint Inventor, if any:			
(E.g., Given Name (first and middle (if any)) and Family Name or Surname)			
Russell P. Sammon			
Inventor's Signature			Date (Optional)
Residence: City	San Francisco	State	CA USA
198 Emmett Court			
Mailing Address			
City	San Francisco	State	CA 94110 USA
Legal Name of Additional Joint Inventor, if any:			
(E.g., Given Name (first and middle (if any)) and Family Name or Surname)			
Stephen C. Tulley			
Inventor's Signature			Date (Optional)
			5/1/2013
Residence: City	Monroe	State	CT USA
563 Moose Hill Road			
Mailing Address			
City	Monroe	State	CT 06468 USA

This collection of information is required by 35 U.S.C. 116 and 37 CFR 1.63. The information is required to obtain or retain a benefit by the public which is to file (and by the USPTO to process) an application. Confidentiality is governed by 35 U.S.C. 122 and 37 CFR 1.11 and 1.14. This collection is estimated to take 21 minutes to complete, including gathering, preparing, and submitting the completed application form to the USPTO. Time will vary depending upon the individual case. Any comments on the amount of time you require to complete this form and/or suggestions for reducing this burden, should be sent to the Chief Information Officer, U.S. Patent and Trademark Office, U.S. Department of Commerce, P.O. Box 1450, Alexandria, VA 22313-1450. DO NOT SEND FEES OR COMPLETED FORMS TO THIS ADDRESS. SEND TO: Commissioner for Patents, P.O. Box 1450, Alexandria, VA 22313-1450.

If you need assistance in completing the form, call 1-800-PTO-9199 (1-800-786-9199) and select option 2.

SUPPLEMENTAL SHEET FOR DECLARATION	ADDITIONAL INVENTOR(S)
	Supplemental Sheet (for PTO/AIA/08,09) Page <u>2</u> of <u>2</u>

Legal Name of Additional Joint Inventor, if any:			
(E.g., Given Name (first and middle (if any)) and Family Name or Surname)			
Steven M. Santisi			
Inventor's Signature			Date (Optional)
Ridgefield Residence: City	CT State	US Country	
80 Lounsbury Lane			
Mailing Address			
Ridgefield City	CT State	06877 Zip	US Country
Legal Name of Additional Joint Inventor, if any:			
(E.g., Given Name (first and middle (if any)) and Family Name or Surname)			
Inventor's Signature			Date (Optional)
Residence: City	State	Country	
Mailing Address			
City	State	Zip	Country
Legal Name of Additional Joint Inventor, if any:			
(E.g., Given Name (first and middle (if any)) and Family Name or Surname)			
Inventor's Signature			Date (Optional)
Residence: City	State	Country	
Mailing Address			
City	State	Zip	Country

This collection of information is required by 35 U.S.C. 115 and 37 CFR 1.63. The information is required to obtain or retain a benefit by the public which is to file (and by the USPTO to process) an application. Confidentiality is governed by 35 U.S.C. 122 and 37 CFR 1.11 and 1.14. This collection is estimated to take 21 minutes to complete, including gathering, preparing, and submitting the completed application form to the USPTO. Time will vary depending upon the individual case. Any comments on the amount of time you require to complete this form and/or suggestions for reducing this burden, should be sent to the Chief Information Officer, U.S. Patent and Trademark Office, U.S. Department of Commerce, P.O. Box 1450, Alexandria, VA 22313-1450. DO NOT SEND FEES OR COMPLETED FORMS TO THIS ADDRESS. SEND TO: **Commissioner for Patents, P.O. Box 1450, Alexandria, VA 22313-1450.**

If you need assistance in completing the form, call 1-800-PTO-9199 (1-800-786-9199) and select option 2.

Electronic Patent Application Fee Transmittal

Application Number:	13680852			
Filing Date:	19-Nov-2012			
Title of Invention:	METHOD AND APPARATUS FOR OUTPUTTING A MESSAGE AT A GAME MACHINE			
First Named Inventor/Applicant Name:	Jay S. Walker			
Filer:	Holby Abern/Carrie Mollo			
Attorney Docket Number:	025124-0509			
Filed as Large Entity				
Utility under 35 USC 111(a) Filing Fees				
Description	Fee Code	Quantity	Amount	Sub-Total in USD(\$)
Basic Filing:				
Pages:				
Claims:				
Miscellaneous-Filing:				
Late Filing Fee for Oath or Declaration	1051	1	140	140
Petition:				
Patent-Appeals-and-Interference:				
Post-Allowance-and-Post-Issuance:				
Extension-of-Time:				

Description	Fee Code	Quantity	Amount	Sub-Total in USD(\$)
Miscellaneous:				
Total in USD (\$)				140

Electronic Acknowledgement Receipt

EFS ID:	16290418
Application Number:	13680852
International Application Number:	
Confirmation Number:	6364
Title of Invention:	METHOD AND APPARATUS FOR OUTPUTTING A MESSAGE AT A GAME MACHINE
First Named Inventor/Applicant Name:	Jay S. Walker
Customer Number:	29159
Filer:	Holby Abern/Carrie Mollo
Filer Authorized By:	Holby Abern
Attorney Docket Number:	025124-0509
Receipt Date:	11-JUL-2013
Filing Date:	19-NOV-2012
Time Stamp:	15:37:15
Application Type:	Utility under 35 USC 111(a)

Payment information:

Submitted with Payment	yes
Payment Type	Deposit Account
Payment was successfully received in RAM	\$140
RAM confirmation Number	2205
Deposit Account	502261
Authorized User	
The Director of the USPTO is hereby authorized to charge indicated fees and credit any overpayment as follows: Charge any Additional Fees required under 37 C.F.R. Section 1.21 (Miscellaneous fees and charges)	

File Listing:					
Document Number	Document Description	File Name	File Size(Bytes)/ Message Digest	Multi Part /.zip	Pages (if appl.)
1	Oath or Declaration filed	025124-0509-Declaration.pdf	838724 0c76bd32833f1ed9dfc2020e65623723f52dc792	no	12
Warnings:					
Information:					
2	Fee Worksheet (SB06)	fee-info.pdf	30268 a1e2bcecaf731be5d763781e18ad4f35c857f1	no	2
Warnings:					
Information:					
Total Files Size (in bytes):			868992		
<p>This Acknowledgement Receipt evidences receipt on the noted date by the USPTO of the indicated documents, characterized by the applicant, and including page counts, where applicable. It serves as evidence of receipt similar to a Post Card, as described in MPEP 503.</p> <p><u>New Applications Under 35 U.S.C. 111</u> If a new application is being filed and the application includes the necessary components for a filing date (see 37 CFR 1.53(b)-(d) and MPEP 506), a Filing Receipt (37 CFR 1.54) will be issued in due course and the date shown on this Acknowledgement Receipt will establish the filing date of the application.</p> <p><u>National Stage of an International Application under 35 U.S.C. 371</u> If a timely submission to enter the national stage of an international application is compliant with the conditions of 35 U.S.C. 371 and other applicable requirements a Form PCT/DO/EO/903 indicating acceptance of the application as a national stage submission under 35 U.S.C. 371 will be issued in addition to the Filing Receipt, in due course.</p> <p><u>New International Application Filed with the USPTO as a Receiving Office</u> If a new international application is being filed and the international application includes the necessary components for an international filing date (see PCT Article 11 and MPEP 1810), a Notification of the International Application Number and of the International Filing Date (Form PCT/RO/105) will be issued in due course, subject to prescriptions concerning national security, and the date shown on this Acknowledgement Receipt will establish the international filing date of the application.</p>					

INFORMATION DISCLOSURE CITATION IN AN APPLICATION (Use several sheets if necessary) PTO Form 1449	Atty Docket No. 025124-0509	Application No. 13/680,852
	Applicant IGT	Date Submitted August 8, 2013
	Filing Date November 19, 2012	Group 3714

U.S. PATENT DOCUMENTS							
Examiner's Initials	Document Number	Publication Date	Inventor	Class	Subclass	Filing Date If Appropriate	

FOREIGN PATENT DOCUMENTS								
Examiner's Initials	Document Number	Publication Date	Country	Class	Subclass	Translation		
						Yes	No	
	JP 2001-246166	September 11, 2001	JP			X		
	JP 10-201953	August 4, 1998	JP			X		

Examiner's Initials	OTHER DOCUMENTS (<i>Including Author, Title, Date, Pertinent Pages, Etc.</i>)
	Third Party Submission in Published Application Under 37 C.F.R. 1.99 filed for U.S. Patent Application No. 13/632,328, dated July 22, 2013 (2 pages)
	Third Party Submission Under 37 C.F.R. 1.290 Concise Description of Relevance filed for U.S. Patent Applicant No. 13/632,328, dated July 22, 2013 (7 pages).

Examiner:	Date Considered:
*Examiner: Initial if citation considered, whether or not citation is in conformance with MPEP Section 609; Draw line through citation if not in conformance and not considered. Include copy of this form with next communication to applicant.	

(19) 日本国特許庁 (J P)

(12) 公開特許公報 (A)

(11) 特許出願公開番号

特開2001-246166

(P2001-246166A)

(43) 公開日 平成13年9月11日(2001.9.11)

(51) Int.Cl. ⁷	識別記号	F I	キーワード(参考)
A 6 3 F 13/06		A 6 3 F 13/06	2 C 0 0 1
13/00		13/00	M

審査請求 未請求 請求項の数11 O L (全11頁)

(21) 出願番号 特願2000-150503(P2000-150503)

(22) 出願日 平成12年5月22日(2000.5.22)

(31) 優先権主張番号 特願平11-318531

(32) 優先日 平成11年11月9日(1999.11.9)

(33) 優先権主張国 日本(J P)

(31) 優先権主張番号 特願平11-371147

(32) 優先日 平成11年12月27日(1999.12.27)

(33) 優先権主張国 日本(J P)

(71) 出願人 000113414
株式会社ホリ
神奈川県横浜市都筑区佐江戸町640

(72) 発明者 橋口 貞男
神奈川県横浜市都筑区佐江戸町640 株式会社ホリ内

(72) 発明者 金子 伸亨
神奈川県横浜市都筑区佐江戸町640 株式会社ホリ内

(74) 代理人 100071283
弁理士 一色 健輔 (外3名)

最終頁に続く

(54) 【発明の名称】 複数の遊技者による対戦型のビデオゲームシステム、そのシステムに使用する手表示操作およびゲームプログラム記録媒体

(57) 【要約】

【課題】 実際の麻雀等のゲームと同じように、複数の遊技者が一堂に会して参加できる多人数対戦型家庭用ビデオゲームシステムを提供する。

【解決手段】 通常の家産用ビデオゲームシステムにおいて、参加する各遊技者に対応する手表示機能付き操作器20を備える。ゲームプログラムは、場の画像データと、各遊技者に対応する手の画像データを逐次生成、出力する。各遊技者はめいめいの操作器20に表示される手情報と共通のディスプレイ装置12に表示される場情報を参照して自らのアクションを決定し、入力する。この各遊技者からの入力情報がゲームの進行に反映され、逐次新たな場画像データおよび手画像データが生成出力される。

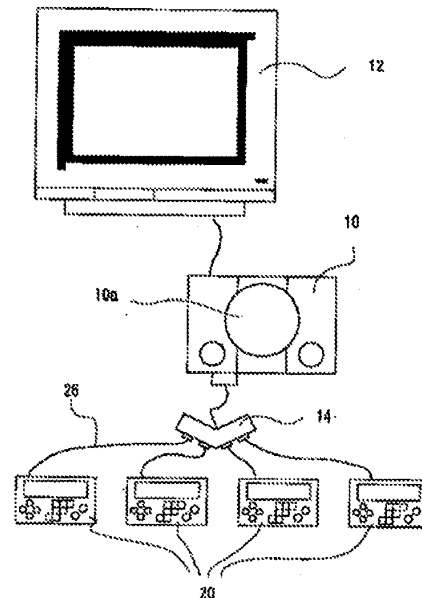

【特許請求の範囲】

【請求項1】 つぎの事項(1)(2)(3)により特定される発明。

(1) 着脱交換自在な記録媒体に記録されたゲームプログラムを実行するコンピュータであるビデオゲーム機と、このビデオゲーム機の映像出力端子に接続されるディスプレイ装置と、前記ビデオゲーム機のコントローラ接続端子に接続される複数の手表示操作器とにより構成されるビデオゲームシステムである。

(2) 前記ゲームプログラムは、前記の各手表示操作器にそれぞれ対応した手データを生成するとともに各手データに関連した共通の場データを生成するプロセスと、前記場データに基づいて場画像データを生成して前記ディスプレイ装置に向けて出力するプロセスと、前記各手データに基づいてそれぞれに対応する手画像データを生成してそれぞれに対応する前記手表示操作器に向けて出力するプロセスと、前記手表示操作器からの操作入力データを受け入れるとともにその操作入力データにตอบสนองして前記手データおよび前記場データを変化させるプロセスとを含んでいる。

(3) 前記手表示操作器は、前記ビデオゲーム機とデータをやり取りする通信手段と、この通信手段を通じて受け取った前記手画像データを一時記憶する手画像記憶手段と、これに記憶された前記手画像データを表示する表示パネルと、遊技者により操作される操作入力手段と、前記表示パネルに表示された手画像中の任意のピースを前記操作入力手段により特定するためのポインティング手段と、このポインティング手段によるピース特定データなどの前記操作入力手段により生成された操作入力データを前記通信手段を通じて前記ビデオゲーム機に受け渡すデータ出力手段とを備えている。

【請求項2】 請求項1に記載のビデオゲームシステムに含まれる前記手表示操作器であって、前記ビデオゲーム機とデータをやり取りする通信手段と、この通信手段を通じて受け取った前記手画像データを一時記憶する手画像記憶手段と、これに記憶された前記手画像データを表示する表示パネルと、遊技者により操作される操作入力手段と、前記表示パネルに表示された手画像中の任意のピースを前記操作入力手段により特定するためのポインティング手段と、このポインティング手段によるピース特定データなどの前記操作入力手段により生成された操作入力データを前記通信手段を通じて前記ビデオゲーム機に受け渡すデータ出力手段とを備えたことを特徴とする手表示操作器。

【請求項3】 請求項1に記載のビデオゲームシステムにおける前記ゲームプログラムを記録した媒体であって、そのゲームプログラムは、前記の各手表示操作器にそれぞれ対応した手データを生成するとともに各手データに関連した共通の場データを生成するプロセスと、前記場データに基づいて場画像データを生成して前記ディ

スプレイ装置に向けて出力するプロセスと、前記各手データに基づいてそれぞれに対応する手画像データを生成してそれぞれに対応する前記手表示操作器に向けて出力するプロセスと、前記手表示操作器からの操作入力データを受け入れるとともにその操作入力データにตอบสนองして前記手データおよび前記場データを変化させるプロセスとを含んでいることを特徴とする記録媒体。

【請求項4】 つぎの事項(41)(42)(43)により特定される発明。

(41) 着脱交換自在な記録媒体に記録されたゲームプログラムを実行するコンピュータであるビデオゲーム機と、このビデオゲーム機の映像出力端子に接続されるディスプレイ装置と、前記ビデオゲーム機のコントローラ接続端子に接続される複数の手表示操作器とにより構成されるビデオゲームシステムである。

(42) 前記ゲームプログラムは、前記の各手表示操作器にそれぞれ対応した手データを生成するとともに各手データに関連した共通の場データを生成するプロセスと、前記場データに基づいて場画像データを生成して前記ディスプレイ装置に向けて出力するプロセスと、前記各手データをそれぞれが個別に対応する前記手表示操作器に向けて出力するプロセスと、前記手表示操作器からの操作入力データを受け入れるとともにその操作入力データにตอบสนองして前記手データおよび前記場データを変化させるプロセスとを含んでいる。

(43) 前記手表示操作器は、前記ビデオゲーム機とデータをやり取りする通信手段と、前記手データに含まれるすべてのピース属性についてそれぞれ固有の属性圖案の画像データを記憶した圖案発生器と、前記通信手段を通じて受け取った前記手データ中の各ピースのピース属性に該当する属性圖案の画像データを前記圖案発生器から読み出して手画像記憶手段に一時記憶する手段と、前記手画像記憶手段に記憶された手画像データを表示パネルに表示する手段と、遊技者により操作される操作入力手段と、前記表示パネルに表示された手画像中の任意のピースを前記操作入力手段により特定するためのポインティング手段と、このポインティング手段によるピース特定データなどの前記操作入力手段により生成された操作入力データを前記通信手段を通じて前記ビデオゲーム機に受け渡す手段とを備えている。

【請求項5】 請求項4に記載のビデオゲームシステムに使用する前記手表示操作器であって、前記ビデオゲーム機とデータをやり取りする通信手段と、前記手データに含まれるすべてのピース属性についてそれぞれ固有の属性圖案の画像データを記憶した圖案発生器と、前記通信手段を通じて受け取った前記手データ中の各ピースのピース属性に該当する属性圖案の画像データを前記圖案発生器から読み出して手画像記憶手段に一時記憶する手段と、前記手画像記憶手段に記憶された手画像データを表示パネルに表示する手段と、遊技者により操作され

る操作入力手段と、前記表示パネルに表示された手画像中の任意のピースを前記操作入力手段により特定するためのポインティング手段と、このポインティング手段によるピース特定データなどの前記操作入力手段により生成された操作入力データを前記通信手段を通じて前記ビデオゲーム機に受け渡す手段とを備えたことを特徴とする手表示操作器。

【請求項6】 請求項4に記載のビデオゲームシステムにおける前記ゲームプログラムを記録した媒体であって、そのゲームプログラムは、前記の各手表示操作器にそれぞれ対応した手データを生成するとともに各手データに関連した共通の場データを生成するプロセスと、前記場データに基づいて場画像データを生成して前記ディスプレイ装置に向けて出力するプロセスと、前記各手データをそれぞれが個別に対応する前記手表示操作器に向けて出力するプロセスと、前記手表示操作器からの操作入力データを受け入れるとともにその操作入力データにตอบสนองして前記手データおよび前記場データを变化させるプロセスとを含んでいることを特徴とするゲームプログラム記録媒体。

【請求項7】 請求項2または5に記載の前記手表示操作器であって、所定のメモリを着脱交換自在に装着するためのメモリ装着部と、このメモリ装着部に装着されたメモリからデータを読み出すための読み出し制御手段とを備えたことを特徴とする手表示操作器。

【請求項8】 請求項7に記載の手表示操作器であって、前記メモリ装着部に装着されたメモリにデータを書き込むための書き込み手段を備えたことを特徴とする手表示操作器。

【請求項9】 請求項2または請求項5に記載の手表示操作器であって、前記手画像記憶手段としての所定のメモリを着脱交換自在に装着するためのメモリ装着部と、このメモリ装着部に装着されたメモリにデータを書き込むための書き込み手段と、前記メモリ装着部に装着されたメモリからデータを読み出すための読み出し制御手段とを備えたことを特徴とする手表示操作器。

【請求項10】 請求項5に記載の手表示操作器であって、前記図象発生器としての所定のメモリを着脱交換自在に装着するためのメモリ装着部と、このメモリ装着部に装着されたメモリからデータを読み出すための読み出し制御手段とを備えたことを特徴とする手表示操作器。

【請求項11】 請求項5に記載の手表示操作器であって、前記図象発生器および前記手画像記憶手段としての所定のメモリを着脱交換自在に装着するためのメモリ装着部と、このメモリ装着部に装着されたメモリからデータを読み出すための読み出し制御手段と、前記メモリ装着部に装着されたメモリにデータを書き込むための書き込み手段とを備えたことを特徴とする手表示操作器。

【発明の詳細な説明】

【0001】

【発明の属する技術分野】 この発明は、各遊技者が手持ちの情報（いわゆる“手”）を他の遊技者に対して隠匿しつつゲームを進行させる、麻雀ゲームやカードゲームなどの多人数参加対戦型ビデオゲームシステムに関する。また、その隠匿すべき情報を各遊技者に個別に表示する表示パネルを有する前記ビデオゲームシステム用手表示操作器に関する。また、その隠匿すべき情報を各操作器に設けられた表示パネルに個別に表示する機能を盛り入れたゲームプログラムを記録した記録媒体にも関する。

【0002】

【従来の技術】 従来の家庭用ビデオゲームでは、例えば麻雀などの多人数参加対戦型ゲームに複数の遊技者が参加して楽しむことができなかった。通常の麻雀では、捨て牌やポンなどの牌は、4人の全遊技者が参照できる情報（以下、“場情報”と呼ぶ）であるが、各遊技者の手持ち牌はゲーム終了までは当の遊技者のみが参照できる情報（以下、“手情報”と呼ぶ）である。従来の家庭用ビデオゲーム機には、この手情報を各遊技者に対して個別に表示する装置および機能がなかったために複数で参加することができなかった。

【0003】 すなわち、従来の麻雀ビデオゲームはコンピュータを相手に一人で楽しむしかなかった。ゲームの進行中、ディスプレイにはソモってくる由や、他のプレイヤーの手牌等が伏せて表示される。当の遊技者の手牌やポン、チー、それに他のプレイヤーの捨て牌やポン、チー等は表向きに表示され、これらを参照して遊技者は自分の捨て牌を決めたり、ポンやチーを鳴いたりする。他のプレイヤーによるソモや鳴きなどの操作は全てゲーム機のコンピュータが行う。

【0004】 コンピュータネットワーク通信を利用した麻雀ゲームもあり、こちらは複数（最大4人）の遊技者が参加して対戦できる。各遊技者のディスプレイには、他の参加者の手牌は表示されず、自分の手牌と全遊技者の捨て牌等が逐次表示される。この通信を利用したゲームシステムでは、参加する各遊技者がそれぞれ各自のディスプレイを有し、各遊技者が自分の手牌を他の遊技者に見られずに参照することができるため、複数参加が可能なのである。ところが、一般にネットワーク通信を利用した対戦型ゲームは、ゲーム参加料のみならず、ネット接続料など必要なため、参加回数が多くなると相当の費用がかかる。またシステム全体としては例えば、ゲームの進行を全体的に管理するサーバコンピュータの他に各参加者がめいめいのパソコンとディスプレイを有していることが必要のため、複数の遊技者が集まればいつでもどこでも手軽にゲームを始めることができるというわけではない。さらに通常は、参加者が各自の部屋などの別々の場所からゲームに参加することになるため、ゲームの進行や結果に伴う各遊技者の興奮などを含めて臨場感をリアルに味わうことができない。

【0005】 ネットワーク通信利用型のゲームに比べ

て、家庭用のビデオゲーム機は利用する回数がよほど少なくない限りトータルで安価であり、そしてなにより設置が簡単なので手軽に、かつまたテレビ受信器などのディスプレイ装置さえ有れば自宅でも外出先でも楽しむことができる。そして、このような家庭用のビデオゲーム機であっても、参加する各遊技者に対応する個別ディスプレイをゲーム機本体に接続して各遊技者に固有の手情報を個別に表示することができれば、複数の遊技者が参加して対戦することは可能である。ところが、従来のゲーム機は周辺機器とのデータ通信容量に制約があって、そのようなシステムは存在しなかった。

【0006】

【発明が解決しようとする課題】本発明では、実際の麻雀などのゲームと同じように、複数の遊技者が参加できる多人数対戦型家庭用ビデオゲームシステムを提供する。ネットワーク通信を利用して別々の場所から各遊技者が参加するのではなく、全遊技者が一堂に会して他の遊技者と共に臨場感を味わいつつ楽しめるゲームシステムである。このシステムに必要な装置は、1台のゲーム機本体と、テレビ受信器などのディスプレイ装置と、参加する遊技者の数と同じだけの操作器であって、ネットワーク通信を利用するシステムよりも遙かに簡潔である。また、上記のビデオゲームシステムに使用される、各遊技者が操作入力するための手表示機能付き操作器を提供する。さらに、複数の遊技者が参加して楽しめる、上記のような多人数対戦型家庭用ビデオゲームシステム用のゲームプログラムを記録した記録媒体を提供する。

【0007】

【課題を解決するための手段】===第1のタイプの発明群===

第1のタイプに属するビデオゲームシステムはつぎの事項(1)(2)(3)により特定されるものである。

(1) 着脱交換自在な記録媒体に記録されたゲームプログラムを実行するコンピュータであるビデオゲーム機と、このビデオゲーム機の映像出力端子に接続されるディスプレイ装置と、前記ビデオゲーム機のコントローラ接続端子に接続される複数の手表示操作器とにより構成されるビデオゲームシステムである。

(2) 前記ゲームプログラムは、前記の各手表示操作器にそれぞれ対応した手データを生成するとともに各手データに関連した共通の場データを生成するプロセスと、前記場データに基づいて場画像データを生成して前記ディスプレイ装置に向けて出力するプロセスと、前記各手データに基づいてそれぞれに対応する手画像データを生成してそれぞれに対応する前記手表示操作器に向けて出力するプロセスと、前記手表示操作器からの操作入力データを受け入れるとともにその操作入力データに応じて前記手データおよび前記場データを変化させるプロセスとを含んでいる。

(3) 前記手表示操作器は、前記ビデオゲーム機とデー

タをやり取りする通信手段と、この通信手段を通じて受け取った前記手画像データを一時記憶する手画像記憶手段と、これに記憶された前記手画像データを表示する表示パネルと、遊技者により操作される操作入力手段と、前記表示パネルに表示された手画像中の任意のピースを前記操作入力手段により特定するためのポインティング手段と、このポインティング手段によるピース特定データなどの前記操作入力手段により生成された操作入力データを前記通信手段を通じて前記ビデオゲーム機に受け渡すデータ出力手段とを備えている。

【0008】第1のタイプの発明群には、前述したビデオゲームシステムに使用する前記手表示操作器の発明と、前記ゲームプログラムを格納した記録媒体の発明が含まれる。

【0009】===第2のタイプの発明群===

第2のタイプに属するビデオゲームシステムはつぎの事項(41)(42)(43)により特定されるものである。

(41) 着脱交換自在な記録媒体に記録されたゲームプログラムを実行するコンピュータであるビデオゲーム機と、このビデオゲーム機の映像出力端子に接続されるディスプレイ装置と、前記ビデオゲーム機のコントローラ接続端子に接続される複数の手表示操作器とにより構成されるビデオゲームシステムである。

(42) 前記ゲームプログラムは、前記の各手表示操作器にそれぞれ対応した手データを生成するとともに各手データに関連した共通の場データを生成するプロセスと、前記場データに基づいて場画像データを生成して前記ディスプレイ装置に向けて出力するプロセスと、前記各手データをそれぞれが個別に対応する前記手表示操作器に向けて出力するプロセスと、前記手表示操作器からの操作入力データを受け入れるとともにその操作入力データに応じて前記手データおよび前記場データを変化させるプロセスとを含んでいる。

(43) 前記手表示操作器は、前記ビデオゲーム機とデータをやり取りする通信手段と、前記手データに含まれるすべてのピース属性についてそれぞれ固有の属性圖案の画像データを記憶した圖案発生器と、前記通信手段を通じて受け取った前記手データ中の各ピースのピース属性に該当する属性圖案の画像データを前記圖案発生器から読み出して手画像記憶手段に一時記憶する手段と、前記手画像記憶手段に記憶された手画像データを表示パネルに表示する手段と、遊技者により操作される操作入力手段と、前記表示パネルに表示された手画像中の任意のピースを前記操作入力手段により特定するためのポインティング手段と、このポインティング手段によるピース特定データなどの前記操作入力手段により生成された操作入力データを前記通信手段を通じて前記ビデオゲーム機に受け渡す手段とを備えている。

【0010】第2のタイプの発明群には、前述したビデオゲームシステムに使用する前記手表示操作器の発明

と、前記ゲームプログラムを格納した記録媒体の発明が含まれる。

【0011】====手表示操作器に関する応用発明群====

さらに、第1または第2の発明群における前記手表示操作器の応用発明群として、次のa~eの手表示操作器が含まれている。

a. 所定のメモリを着脱交換自在に装着するためのメモリ装着部と、このメモリ装着部に装着されたメモリからデータを読み出すための読み出し制御手段とを備えた手表示操作器。

b. 所定のメモリを着脱交換自在に装着するためのメモリ装着部と、前記メモリ装着部に装着されたメモリにデータを書き込むための書き込み手段とを備えた手表示操作器。

c. 前記手画像記憶手段としての所定のメモリを着脱交換自在に装着するためのメモリ装着部と、このメモリ装着部に装着されたメモリにデータを書き込むための書き込み手段と、前記メモリ装着部に装着されたメモリからデータを読み出すための読み出し制御手段とを備えた手表示操作器。

d. 前記圖案発生器としての所定のメモリを着脱交換自在に装着するためのメモリ装着部と、このメモリ装着部に装着されたメモリからデータを読み出すための読み出し制御手段とを備えた手表示操作器。

e. 前記圖案発生器および前記手画像記憶手段としての所定のメモリを着脱交換自在に装着するためのメモリ装着部と、このメモリ装着部に装着されたメモリからデータを読み出すための読み出し制御手段と、前記メモリ装着部に装着されたメモリにデータを書き込むための書き込み手段とを備えた手表示操作器。

【0012】

【発明の実施の形態】第1のタイプの発明を麻雀ゲームシステムに適用した実施例について図面を参照しつつ詳細に説明する。しかしながら本発明は麻雀ゲームに限定されるものではなく、同様に多人数対戦型の（ポーカーなどの）カードゲームなどに対しても適用できる。

【0013】====ハードウェアの概要====

この発明の一実施例によるビデオゲームシステムの外観概略を図1に示し、そのブロック構成を図2に示している。典型的な例として、株式会社ソニーコンピュータエンターテインメントの製品名「プレイステーション（登録商標）」の本体装置を使用し、これに本発明のコントローラを4個付加している。

【0014】よく知られているように、本体装置10のCDROMドライブ10aにゲームCDROM（ゲームプログラム記録媒体）10bをセットし、本体の電源を入れるとゲームプログラムが起動される。本体装置10の映像音響出力端子10cに接続された、ディスプレイ装置である通常のテレビ受像機12が、ゲーム映像とゲ

ーム音響の出力機器となる。本体装置にはコントローラなどの周辺機器を接続する2個のコネクタ10dがある。そのうち1つのコネクタに、多人数プレイ用アダプタ14を接続し、さらにこの多人数プレイ用アダプタ14に本発明の麻雀ゲーム用手表示機能付き操作器20を4個接続している。この多人数プレイ用アダプタ14は、コントローラなどの周辺機器を複数個（通常4個）接続することができる。

【0015】各手表示操作器20には、その操作器を操作する遊技者の手牌を表示する手画像データを表示するためのドットマトリクス型の液晶ディスプレイ22や、ツモや鳴き、リーチなどの通常の麻雀動作、およびゲーム進行の基本的な制御を指示するための操作入力手段である各種入力ボタン24a~24cなどが設けられている。

【0016】====ソフトウェアの概要====

本実施例では麻雀ゲームのゲームプログラムがCD-ROM10bに記録されてユーザに提供される。ゲームプログラムの機能は、ゲーム管理プロセス、ゲームアルゴリズムの進行処理プロセス、ゲーム映像音響データの出力プロセス、入力データ処理プロセスなどに分けて把握できる。

【0017】ゲーム管理プロセスはイニシャル処理やゲーム全体の進行の調整などを受け持つ。ゲームアルゴリズムの進行処理プロセスは、ゲームの進行状況を示すデータを逐次生成する。このゲームの進行状況を示すデータには主に、場データと手データとからなる。

【0018】前記場データは、各遊技者の捨て牌や鳴き牌など、実際のゲームにおいていわゆる場にオープンにされて全遊技者が常に参照する情報である。一方前記手データは、各遊技者が他の遊技者に見られないように個別に参照する手持ち牌、いわゆる一般的に“手”と呼ばれる情報である。これらの情報はゲームの進行につれて刻々と変化するが、ゲームアルゴリズムの進行処理プロセスは逐次その情報を生成している。

【0019】ゲーム映像音響データの出力プロセスは、場の画像データおよびゲームの各種音響データを生成し、これらをインターフェイス10eと映像音響出力端子10cを介してディスプレイ装置12に出力する。場画像データはディスプレイに表示され、音響データはディスプレイに備わるスピーカから出力される。ゲーム映像音響データ出力プロセスはまた、各操作器20ごとに手情報のビットマップ画像データを生成し、インターフェイス10fと前記多人数プレイ用アダプタ14を介してそれぞれ対応する操作器20に個別に出力する。

【0020】前記入力データ処理プロセスは、操作器20から入力された入力データを受け取り、これらのデータに反応して前記ゲームの進行状況を示すデータを逐次変化させる。具体的には、各遊技者が場の山からツモったり、捨て牌を切ったり、他の遊技者の捨て牌をボンシ

てそれらの牌を場オープンにするといった各遊戯者の操作入力を前記場データに逐一反映させたりする。

【0021】なお、本実施例では4人の遊戯者が参加して麻雀ゲームを行う例を示しているが、例えば3人の遊戯者が参加し、残り1人分をコンピュータに受け持たせるようにプログラムを作っておくこともできる。その場合は例えば、ゲーム開始時にいずれかの遊戯者が自分のコントローラの入力ボタンで、3人で参加するゲームのモードを選択するようによればよい。

【0022】====手表示操作器の構成====

手表示操作器20の外観例を図3に示した。本体部の上方には液晶ディスプレイ22が設置されており、各遊戯者の手牌を表す手データが逐次表示される。液晶ディスプレイの下側には入力手段である各種入力ボタン24a、24b、24cが設けられている。本体部の上側面側にはゲーム機本体側との通信経路となる通信コード26が備設されている。

【0023】図4は操作器20に内蔵されている電気制御系のブロック図を示している。入出力インターフェース回路28は、ゲーム機本体10とデータ通信を行う通信手段である。具体的には、前記手情報のドットマトリクス手画像データを表示するための各種制御信号を受信し、一方、各種入力ボタン24a～24cに対する操作信号をゲーム機本体10へ送信する。

【0024】マイコン21は各種操作信号を所定の形式のデータに変換してインターフェース回路28に与える。またマイコンは、インターフェース回路28を介してゲーム機本体10から受信したビットマップ画像データをビデオRAM23に書き込む。LCDドライバ25はビデオRAM23に書き込まれた画像データに従って液晶ディスプレイ22を駆動し、その画像を表示する。遊戯者は液晶ディスプレイ22に表示された手持ち牌と、前記ディスプレイ装置12に表示された場の画像を参照して、捨て牌や鳴きの決定を行い、決定の結果を各種入力ボタン24a～24cから入力する。

【0025】このとき、具体的には操作器20のポインティング機能を使用して捨て牌などの決定を入力する。当該遊戯者がツモる前の表示パネル22には13個の牌が表示されており、ツモると14牌が表示される。ここではいずれか1つの牌が太棒で囲まれて表示されており、入力ボタンのうちの矢印キー24cでこの太棒表示を別の牌に移動させることができる。捨てたい(取りたい)牌の上にこの太棒表示を移動させて所定のボタン

(図の“SEL”ボタンなど)を押すとその牌が捨てられることになり、そのことを伝える信号がゲーム機本体10へと送信される。本体10のゲームアルゴリズム進行処理プロセスではこの信号を受信し、新たな場データを生成する。ゲーム映像音響データの出力処理プロセスは、この新たな場データの場画像データを生成し出力する。なお、ポインティング機能において特定の牌を指し

示す方法としては、太棒で囲む以外に例えば、表示パネル22上に矢印を表示することによってある牌を指し示してもよい。

【0026】当該遊戯者がポンやカンなどを鳴いたときにも、それらの牌の画像は同様のプロセスを経てディスプレイ装置12に表示される。このとき今度は、その分操作器20の表示パネル22に表示される牌が減る。または、その他の手持ち牌と区別が付くようにして表示パネル22にも表示するようによればよい。

【0027】また、表示される手持ち牌の並び順は、ゲームプログラムの進行処理プロセスによって絵柄ごとに並べるなど適宜に配列した上で、ゲーム映像音響出力プロセスによって画像データを生成し、操作器20に送信する。または、操作器20の入力ボタン24a～cで各遊戯者が随時自由に並び替えられるようにしてもよい。その処理は操作器20のマイコン21とビデオRAM23を用いて行ってもよいし、ゲーム機本体10側のメインコンピュータ10gで行うこととしてもよい。

【0028】この発明に係る麻雀ゲームに使用される別の操作器30の実施例を図5に示している。この実施例では入力ボタンのうちの矢印キー24cの代わりに各手牌キー34dが設けられている。この各手牌キー34dは14個の牌に相当するAからNまでのキーが備わり、各キーを押せば対応する牌が(太棒で囲むなど)ポインティング表示されるようになっている。この操作器で、例えば捨て牌を選ぶには、所望の牌に対応するキーを押してから“SEL”ボタンを押せばよい。

【0029】====第2のタイプの発明群の実施例====

前記と同様な麻雀ゲームを実施例として第2のタイプの発明について詳しく説明する。ただし、第1のタイプの発明と共通する部分についての重複的な説明はできるだけ省き、第1のタイプの発明と異なる部分にスポットライトを当てて説明する。

【0030】この明細書では、麻雀牌の1つひとつや、トランプカードの1枚1枚のことをピースと呼び、麻雀牌の「東」とか「3万」などの牌の細分類種別や、トランプの「ハートの7」とか「スペードの4」などのカードの細分類種別のことをピース属性と呼ぶ。そして、各麻雀牌の図柄や、トランプの各カードの図柄のことを属性圖案と呼ぶ。

【0031】第1のタイプおよび第2のタイプのいずれの麻雀ゲームシステムにおいても、麻雀ゲームのアルゴリズムに基づいて手データや場データを生成するゲーム論理プロセス(ゲームアルゴリズムの進行処理プロセス)では、各麻雀牌(ピース)はそれぞれのピース属性を特定するデジタルコード(ピース属性ID)で表現されて演算に供される。そして、ゲーム論理プロセスが生成した場データに基づいて場画像データを生成するゲーム映像プロセスでは、ピース属性IDに対応づけられて

いる麻雀牌の図柄（属性圖案）のビットマップ画像データを生成することになる。そのために媒体に記録されたゲームプログラム中には、すべてのピース属性IDと各属性圖案の画像データとを対応づけして記録してある圖案集ファイルが存在する。その圖案集ファイルを用いて、場データに含まれる各ピースをピース属性IDに基づいて該当する属性圖案の画像データに変換することで、場画像データを生成し、その映像信号をディスプレイ装置12に供給する。

【0032】また第1のタイプの麻雀ゲームシステムでは、ゲームプログラムを実行するビデオゲーム機において、場データと同様に、各手データを前記圖案集ファイルを用いて手画像データに変換してから各手表示操作器20に供給していた。そのようにゲームプログラムが作られている。

【0033】しかし第2のタイプの麻雀ゲームシステムでは、ビデオゲーム機10から各手表示操作器20には、手画像データではなくて、その座標となる手データを送達する。手データはピース属性IDのデータ列であり、その手データを手画像データに変換する機能は手表示操作器20が受け持っている。

【0034】この第2のタイプの手表示操作器20の構成例を図6に示している。先に説明した図4の実施例と図面上で異なるのは、図6では圖案発生器60が存在することである。圖案発生器60はROMからなり、前述した圖案集ファイルと同様に、すべてのピース属性IDと各属性圖案の画像データとを対応づけして記録してある。圖案発生器60にピース属性IDをアドレスとして与えると対応する属性圖案のビットマップ画像データが読み出される。

【0035】図6において、手表示操作器20のマイコン21は、ビデオゲーム機から受け取った手データを内部のRAMに一時記憶するとともに、手データ中の各ピースのピース属性IDを圖案発生器60に与えることで属性圖案の画像データを発生させ、その画像データをビデオRAM23の所定位置に順次書き込んでいく。これによってビデオRAM23に手画像データが描くことになる。これがLCDドライバ25を介してLCD表示パネル22に表示される。

【0036】第1のタイプと第2のタイプを対比すると、ビデオゲーム機から各手表示操作器に転送するデータ量は第2のタイプの方が圧倒的に少なく、各手表示操作器の構成は第1のタイプの方が簡単であるということになる。ビデオゲーム機から各手表示操作器へのデータ転送速度に制約が多い場合は第2のタイプの方が適している。

【0037】====ポインティング手段の工夫====
手表示操作器20の表示パネル22に表示されている麻雀牌の座列にはカーソルが付着している。入力ボタン24a～24cの所定ものを操作することでカーソルが

移動し、カーソルで指し示す牌が変わる。この機能を実現するデータ処理をつぎのように行う。入力ボタンの操作によるカーソル移動リクエストデータをビデオゲーム機に伝え、これを認識したゲーム機が手表示操作器20のマイコン21にカーソル移動指令データを与える。この指令データを受けたマイコン21が表示上のカーソルを移動させる処理を実行する。こうすれば、たとえばデータ伝送エラーなどの可能性があっても、手表示操作器20に表示されているカーソルの位置（ピース特定データ）と、ビデオゲーム機のゲーム論理プロセスが認識しているピース特定データとの食い違いの発生をきわめて少なくできる。

【0038】====手表示操作器の応用発明群における実施例====

図7は上述の第1および第2タイプのゲームシステムにおける手表示操作器の応用発明群についてその実施例を構成図として示している。この手表示操作器20は、適宜なメモリを内蔵したメモリカセット70を着脱交換自在に装着するメモリスロット80と、このスロット80に装着したメモリカセットとマイコン21との間に介在するメモリインタフェース回路（メモリIF回路）90とを備えている。

【0039】マイコン21は、メモリカセット70の内蔵メモリの適宜なデータ記憶領域にメモリIF回路90を介してアクセスし、内蔵メモリがROMタイプであれば、適宜なデータを読み出すための処理を行い、RAMタイプであれば、そのメモリへのデータ書き込み処理も実行する。

【0040】ここで、メモリカセットが内蔵するメモリの形態の違いによる手表示操作器20の使用形態について説明する。なお、メモリがROMタイプであるときの手表示操作器を「読み出し専用タイプ」とし、メモリがRAMタイプであるときの手表示操作器を「書き換え可能タイプ」として類別し、それらのタイプ別の応用形態について説明する。

【0041】<読み出し専用タイプ>このタイプの手表示操作器としては、まず、上記の第2タイプの発明群における実施例に示した手表示操作器の圖案発生器をメモリカセットに置換したものが考えられる。例えば、麻雀ゲームであれば、メモリカセットを適宜に交換することで同じゲームであっても異なるデザインの牌を表示することが可能となる。また、同じ属性IDに異なる種類の圖案（牌やカードなど）の属性圖案データを対応付けすることで、異なるゲームに対応させることも可能となる。もちろん、内蔵ROMも必要がなくなる。あるいは、内蔵ROMによってあるゲームに専用用意された手表示操作器であっても他のゲームに使用することが可能となる。

【0042】さらに、麻雀の上がり役とその点数など、遊技者が参考にしたいゲームに関する情報（辞書情

報)を格納させておくことも可能である。それによって、例えば、役ができてないのに上がる「ちょんぼ」を防止したり、初心者でも点数計算を容易に行えるようにすることができる。

【0043】もちろん、メモリカセット内のメモリには上述のデータの他にプログラムも格納することができる。そして、ビデオゲーム機が実行するプログラム(ゲームアルゴリズムの進行処理プロセス)の一部(手表示操作器用プログラム)をこのメモリに格納し、手表示操作器のマイコンがそのプログラムを実行することでビデオゲーム機におけるデータ処理の負担を軽減することも可能であろう。

【0044】書き換え可能タイプメモリカセットに不揮発性メモリなど書き換え可能なメモリを内蔵させる。このメモリに書き込まれるデータとしては、中断したゲームを再開させるためのゲーム中断データはもちろん、上述の読み出し専用タイプの例で示した各種データを書き込むこととしてもよい。それによって、例えば、ゲームの開始前にビデオゲーム機側から各種データをダウンロードしてメモリカセット内のメモリに格納することとすれば、手表示操作器に加え、メモリカセット自体にも汎用性を持たせることができる。すなわち、ゲームごとに読み出し専用タイプの記録媒体を用意する必要がなくなる。

【0045】また、メモリカセットにビデオRAMに相当する別のメモリを内蔵させたり、カセット内のメモリの記憶領域の一部をビデオRAM領域として割り当てたりした形態も考えられる。この場合、LCDドライバがカセット内のビデオRAM領域から直接ビットマップ画像を読み出すような回路構成にすれば、手表示操作器にビデオRAMを内蔵させる必要がなくなる。

【0046】さらに、個人データを使用したゲームを実行する場合、ゲーム機本体に記録媒体を装着する形態よりも利便性が高い。例えば、複数の遊技者のそれぞれの個人データをメモリカセットの内蔵メモリに書き込む場合、ゲーム機本体に遊技者の人数分のメモリスロットを備えさせる必要がない。スロットを間違えて他の遊技者のメモリカセット内のメモリにデータを書き込んでしまうこともない。

【0047】

【発明の効果】本発明によれば、ネットワーク通信を介することなく、家庭におけるテレビ受信機などの共通ディスプレイの前に複数の参加遊技者が集まって、麻雀やカードゲームなどのビデオゲームを楽しむことができる。各自がめいめいパソコンや大型のディスプレイを用

意する必要がなくて簡易であるので、旅行先に携帯して楽しむことも容易にできる。もちろん全参加者が一堂に会して楽しむことができるので、実際の麻雀やポーカーなどのゲームを行うのと同じような熱気や臨場感を味わうことが可能である。

【0048】このビデオゲームシステムに使用される手表示操作器は、全参加者がめいめい1個ずつこれを有し、各自に固有の情報である手データを表示する。従って、例えば麻雀における手持ち牌などの情報を、他の遊技者は他の遊技者に見られずに参照しつつゲームを進めることができる。

【0049】さらに、所定のメモリを着脱交換自在に装着できるようにした手表示操作器によって、ゲームごとに専用の手表示操作器を用意する必要を無くして手表示操作器の汎用性を高めることができる。また、手表示操作器の機能をこの所定のメモリに置換させた構成とすることで、手表示操作器の内部回路構成を簡略化しコストダウンを達成することが可能となる。

【図面の簡単な説明】

【図1】この発明の一実施例によるビデオゲームシステムの概略構成図である。

【図2】同上実施例のシステムの電氣的構成の概略を示すブロック図である。

【図3】同上実施例による手表示操作器の外観図である。

【図4】図3の手表示操作器の電氣的構成の概略を示すブロック図である。

【図5】この発明の別の実施例における手表示操作器の外観図である。図3と異なる構成部分のみ、図3と異なる符号を付けて示している。

【図6】第2のタイプの発明による手表示操作器の実施例の電氣的構成の概略を示すブロック図である。

【図7】手表示操作器の応用発明における実施例の電氣的構成の概略を示すブロック図である。

【符号の説明】

- 10 ビデオゲーム機本体
- 12 ディスプレイ装置
- 20、30 手表示操作器
- 22 液晶ディスプレイ
- 24a~24c 入力ボタン
- 60 圖案発生器
- 70 メモリカセット
- 80 メモリスロット
- 90 メモリインタフェース回路

【図1】

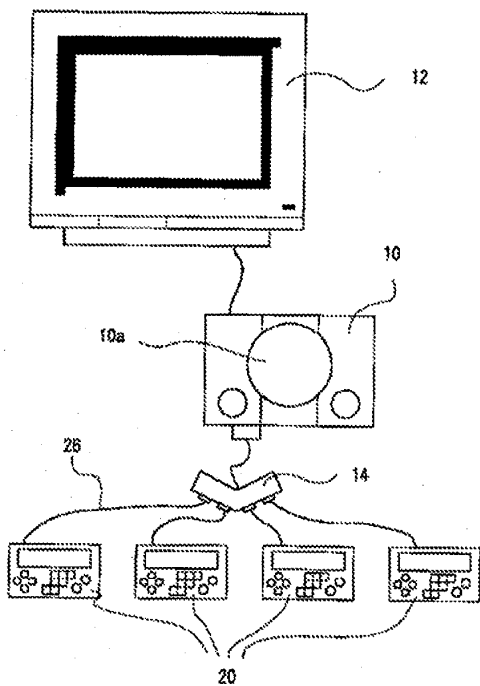

【図2】

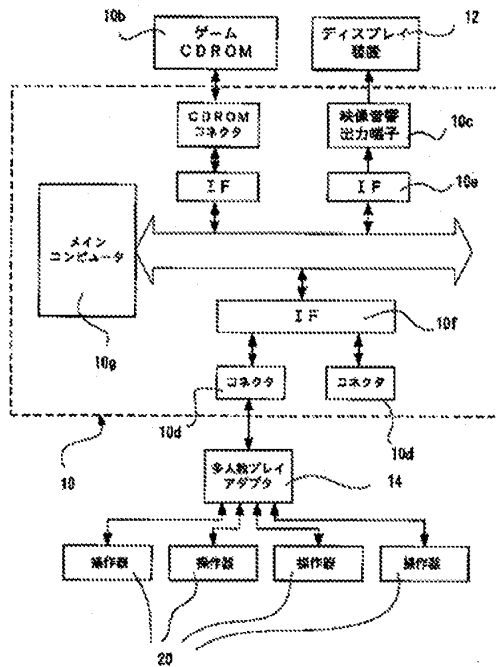

【図3】

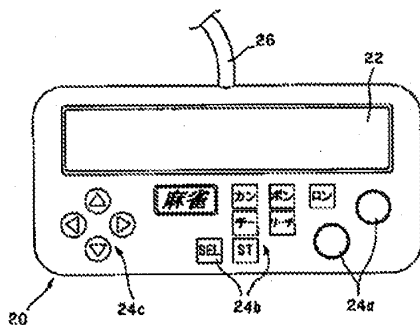

【図4】

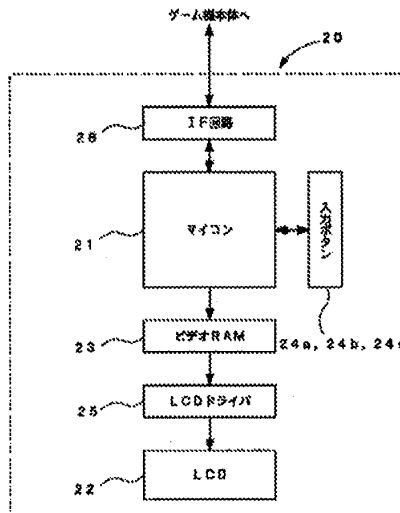

【図5】

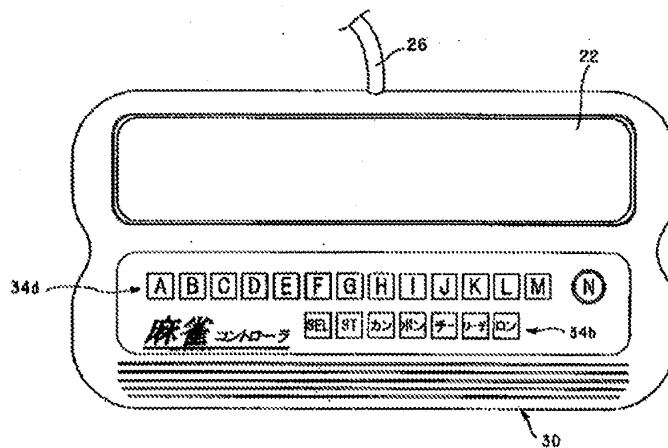

【図6】

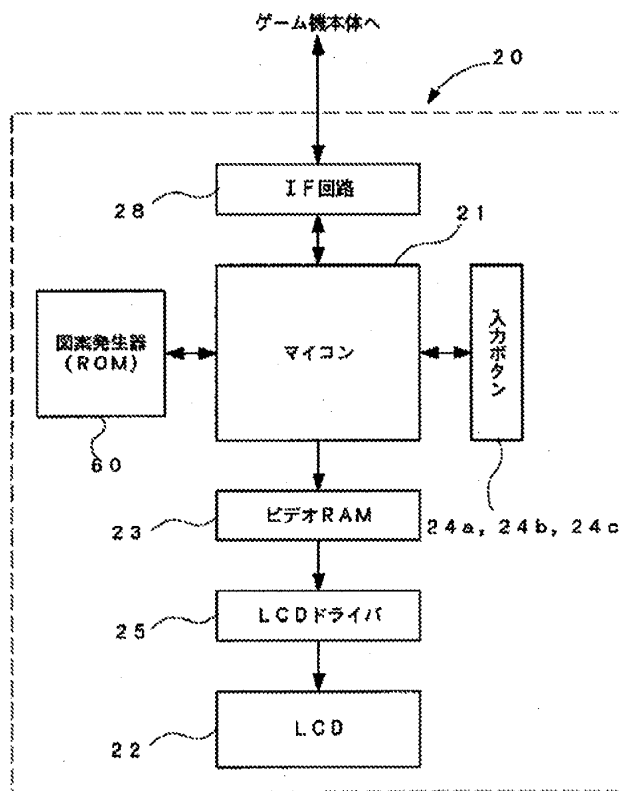

【図7】

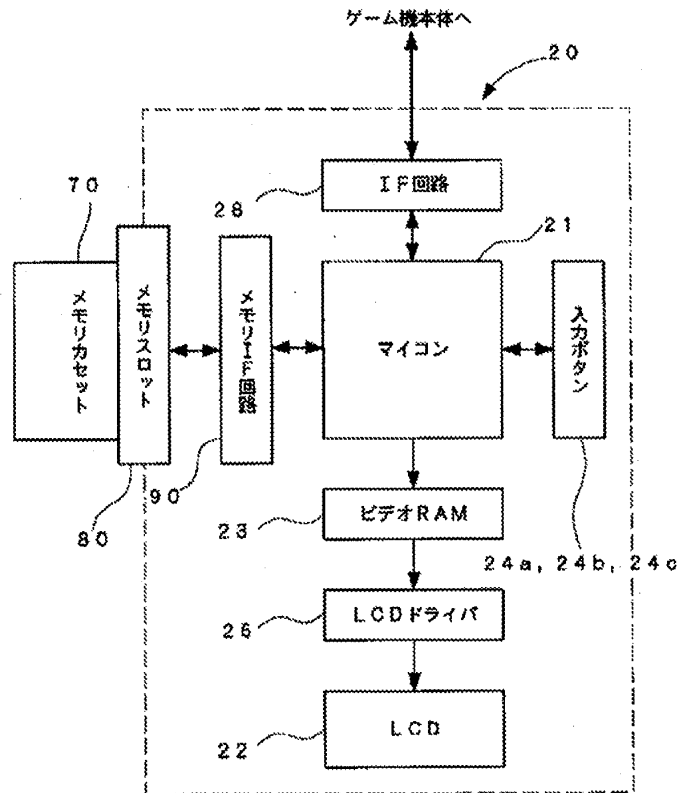

フロントページの続き

Fターム(参考) 2C001 A000 A012 A017 B000 B003
B005 B001 B002 C000 C001
C002 C000 C001 C002 C003
C008

PATENT ABSTRACTS OF JAPAN

(11)Publication number : 2001-246166
 (43)Date of publication of application : 11.09.2001

(51)Int.Cl. A63F 13/06
 A63F 13/00

(21)Application number : 2000-150503 (71)Applicant : HORI CO LTD
 (22)Date of filing : 22.05.2000 (72)Inventor : HASHIGUCHI SADAO
 KANEKO NOBUYUKI

(30)Priority
 Priority number : 11318531 Priority date : 09.11.1999 Priority country : JP
 11371147 27.12.1999 JP

(54) FIGHTING TYPE VIDEO GAME SYSTEM BY PLURAL PLAYERS, HAND DISPLAY MANIPULATOR USING THE SYSTEM, AND GAME PROGRAM RECORDING MEDIUM

(57)Abstract:

PROBLEM TO BE SOLVED: To provide a fighting type home video game system for plural players, which allows plural players to gather in a room and participate to the game like a real Mahjong game, or the like.

SOLUTION: Manipulators 20 with hand display functions corresponding to participating players are provided in an ordinary home video game system. A game program successively generates and outputs image data of a field and image data of a hand corresponding to each player. Each player determines and inputs his/her own action by referring to hand information displayed on each manipulator 20 and field information displayed on a common display 12. The information inputted by each player is reflected upon the progress of a game and new field image data and hand image data are successively generated and outputted.

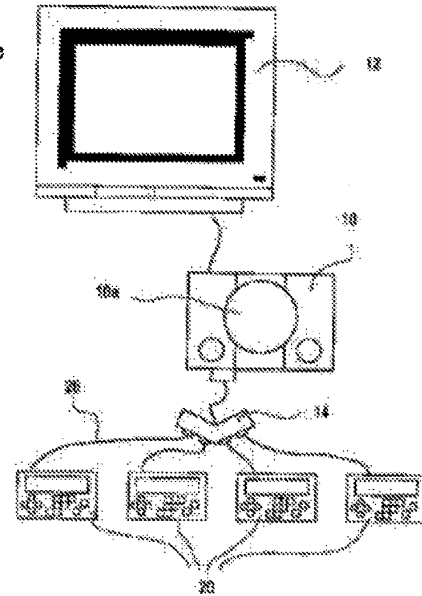

*** NOTICES ***

JPO and INPIT are not responsible for any damages caused by the use of this translation.

1. This document has been translated by computer. So the translation may not reflect the original precisely.
2. *** shows the word which can not be translated.
3. In the drawings, any words are not translated.

DETAILED DESCRIPTION

[Detailed Description of the Invention]

[0001]

[Field of the Invention] This invention relates to a lot of people participating waging-war type video game systems, such as a mah-jongg game, a card game, etc. which advance a game, each game person keeping secret information (what is called a "hand") on hand to other game persons. It is related with the aforementioned video game system manual display operation machine which has a display panel which displays individually the information which should be kept secret on each game person. It is related also with the recording medium which recorded the game program which took in the function which displays individually the information which should be kept secret on the display panel provided by each operation unit.

[0002]

[Description of the Prior Art] In the conventional home video game, for example in a lot of people waging-war type games, such as mah-jongg, two or more game persons were able to participate and were not able to enjoy themselves. although it throws away and tiles, such as a tile and Pons, are the information (it is hereafter called "place information") which all the game persons of four persons can refer to in the usual mah-jongg — each game person's stock — a tile is the information (it is hereafter called "hand information") to which only this game person can refer to a game end. Since the conventional home video game machine had the equipment and the function which display this hand information individually to each game person, it was not able to participate by plurality.

[0003] That is, the conventional mah-jongg video game had to be alone enjoyed against the computer. The mountain to which it comes as TSUMO, the hand of other players, etc. are turned down and displayed on a display during advance of a game. Other players throw away into this game person's hand, Pons and tsi, and it, a tile, Pons, tsi, etc. are displayed on public, and with reference to these, he deserts him, and a game person decides a tile or cries Pons and tsi. The computer of a game machine performs all operations of TSUMO by other players, a squeal, etc.

[0004] The mah-jongg game using computer network communication also occurs, and the game person of plurality (a maximum of four persons) participates, and it can be pitched here against each other. Other participants' hand is not displayed on each game person's display, but their own hand and all the game persons throw away into it, and, in a table, a tile etc. are shown in it one by one. Since each game person who participates has each one of displays in the game system using this communication, respectively and each game person can refer to his own hand, without other game persons seeing, two or more interventions are possible. However, since not only a game entry fee but the charge of Internet connection, etc. are required for the pitched-against each other type game which generally used network communication, if the number of times of intervention increases, it will require considerable expense. Since it is required for each participant other than a server computer who manages advance of a game on the whole as the whole system to have each one of personal computers and displays, if two or more game persons gather, a game cannot necessarily be

http://www4.ipdl.inpit.go.jp/cgi-bin/tran_web/cgi_ejje?atw_u=http%3A%2F%2Fwww4.ip... 7/11/2013

begun always anywhere easily. Since a participant will further usually participate in a game from separate places, such as each one of rooms, presence including each game person's agitation in accordance with advance of a game or a result, etc. cannot be tasted with reality.

[0005] Compared with a network communication use type game, the video game machine for home use is inexpensive in total, unless there is very little number of times of using, and since equipment is easy above all, if there are even display devices, such as a television reception machine, easily and again, a house or a place where one has gone can also enjoy it. And if the individual display corresponding to each game person who participates can be connected to a game machine body and hand information peculiar to each game person can be individually displayed even if it is such a video game machine for home use, two or more game persons are able to be participated and pitched against each other. However, the conventional game machine has restrictions in data-communications capacity with peripheral equipment, and such a system did not exist.

[0006]

[Problem to be solved by the invention] In the present invention, the a lot of people waging-war type home use video game system with which two or more game persons can participate is provided like games, such as actual mah-jongg. It is a game system which can be enjoyed each game person not participating from a separate place using network communication, but all the game persons meeting together, and tasting presence with other game persons. Equipment required for this system is only an operation unit which is the same as one a game machine body and display devices, such as a television reception machine, and the number of the game persons who participate, and is briefer for whether your being Haruka than the system using network communication. The operation unit with a manual display function used for the above-mentioned video game system for each game person to do an operational input is provided. The recording medium which recorded the above game programs for a lot of people waging-war type home use video game systems which two or more game persons can participate and enjoy is provided.

[0007]

[Means for solving problem]= 1st == type invention group == = the video game system belonging to a first type is specified by the following matter (1), (2), and (3).

(1) The video game machine which is a computer which executes the game program recorded on the recording medium in which attachment-and-detachment exchange is free. It is a video game system constituted with the display device connected to the image output terminal of this video game machine, and two or more manual display operation machines connected to the controller contact button of the aforementioned video game machine.

(2) The process of generating the common place data relevant to each hand data while the aforementioned game program generates the hand data corresponding to each aforementioned manual display operation machine, respectively. The process which generates place image data based on the aforementioned place data, and is outputted towards the aforementioned display device. The process outputted towards the aforementioned manual display operation machine which generates the hand image data corresponding to each based on each aforementioned hand data, and corresponds, respectively. While receiving the operational input data from the aforementioned manual display operation machine, the process to which it responds to the operational input data, and the aforementioned hand data and the aforementioned place data are changed is included.

(3) The aforementioned manual display operation machine is provided with the following.

A means of communication which exchanges the aforementioned video game machine and data.

A hand image storing means which stores temporarily the aforementioned hand image data received through this means of communication.

A display panel which displays the aforementioned hand image data memorized by this.

The operation input means operated by the game person and the pointing means for specifying any piece in the hand image displayed on the aforementioned display panel by the aforementioned operation input means, A data output means which delivers operational input data generated by the

aforementioned operation input means, such as piece specifying data based on this pointing means, to the aforementioned video game machine through the aforementioned means of communication.

[0008]Invention of the aforementioned manual display operation machine used for the video game system mentioned above and invention of a recording medium which stored the aforementioned game program are included in a first type of invention group.

[0009]= 2nd == type invention group == the video game system belonging to a second type is specified by the following matter (41), (42), and (43).

(41) The video game machine which is a computer which executes the game program recorded on the recording medium in which attachment-and-detachment exchange is free. It is a video game system constituted with the display device connected to the image output terminal of this video game machine, and two or more manual display operation machines connected to the controller contact button of the aforementioned video game machine.

(42) The process of generating the common place data relevant to each hand data while the aforementioned game program generates the hand data corresponding to each aforementioned manual display operation machine, respectively. The process which generates place image data based on the aforementioned place data, and is outputted towards the aforementioned display device. The process to which each outputs each aforementioned hand data towards the individually corresponding aforementioned manual display operation machine, and the process to which it responds to the operational input data, and the aforementioned hand data and the aforementioned place data are changed while receiving the operational input data from the aforementioned manual display operation machine are included.

(43) The aforementioned manual display operation machine is provided with the following.

A means of communication which exchanges the aforementioned video game machine and data.

A design generator which memorized image data of an attribute design respectively peculiar about all the piece attributes which are contained in the aforementioned hand data, and in which it deals.

A means to read image data of an attribute design applicable to the piece attribute of each piece in the aforementioned hand data received through the aforementioned means of communication from the aforementioned design generator, and to store temporarily at a hand image storing means.

A means to display the hand image data memorized by the aforementioned hand image storing means on a display panel. An operation input means operated by game person and a pointing means for specifying any piece in a hand image displayed on the aforementioned display panel by the aforementioned operation input means. A means to deliver operational input data generated by the aforementioned operation input means, such as piece specifying data based on this pointing means, to the aforementioned video game machine through the aforementioned means of communication.

[0010]Invention of the aforementioned manual display operation machine used for the video game system mentioned above and invention of a recording medium which stored the aforementioned game program are included in a second type of invention group.

[0011]= Application invention group == about == hand display operation machine = the manual display operation machine of following a-e is further contained as an application invention group of the aforementioned manual display operation machine in the 1st or a second invention group.

a. The manual display operation machine provided with the reading control means for reading data from the memory with which the memory applied part and this memory applied part for equipping with a predetermined memory, enabling free attachment-and-detachment exchange were equipped.

b. The manual display operation machine provided with the writing means for writing data in the memory with which the memory applied part and the aforementioned memory applied part for equipping with a predetermined memory, enabling free attachment-and-detachment exchange were equipped.

c. The memory applied part for equipping with the predetermined memory as the aforementioned

hand image storing means, enabling free attachment-and-detachment exchange, The manual display operation machine provided with the writing means for writing data in the memory with which this memory applied part was equipped, and the reading control means for reading data from the memory with which the aforementioned memory applied part was equipped.

d. The manual display operation machine provided with the reading control means for reading data from the memory with which the memory applied part and this memory applied part for equipping with the predetermined memory as the aforementioned design generator, enabling free attachment-and-detachment exchange were equipped.

e. The memory applied part for equipping with the predetermined memory as the aforementioned design generator and the aforementioned hand image storing means, enabling free attachment-and-detachment exchange, The manual display operation machine provided with the reading control means for reading data from the memory with which this memory applied part was equipped, and the writing means for writing data in the memory with which the aforementioned memory applied part was equipped.

[0012]

[Mode for carrying out the invention]It describes in detail, referring to Drawings for the working example which applied a first type of invention to the mah-jongg game system. However, the present invention is not limited to a mah jongg game, and can be similarly applied to a lot of people waging-war type card games (poker etc.) etc.

[0013]= Outline = of = hardware = the appearance outline of the video game system by one working example of this invention is shown in Fig.1, and that block configuration is shown in Fig.2.As a typical example, the main frame of the product name "PlayStation (registered trademark)" of SONY COMPUTER ENTERTAINMENT INC. was used, and four controllers of the present invention are added to this.

[0014]A game program will be started, if game CDROM(game program recording medium)10b is set to the CDROM drive 10a of the main frame 10 and a main part is turned on as known well. The usual television set 12 which was connected to the image output-power-of-sound terminal 10c of the main frame 10 and which is a display device serves as a game image and output equipment of game sound. There are the two connectors 10d which connect peripheral equipment, such as a controller, in the main frame. The adapter 14 for an a lot of people play was connected to one connector of them, and the four operation units 20 with a mah jongg game manual display function of the present invention are further connected to this adapter 14 for an a lot of people play. This adapter 14 for an a lot of people play can connect two or more (usually four pieces) peripheral equipment, such as a controller.

[0015]The liquid crystal display 22 dot-matrix type [for displaying the hand image data which displays the hand of the game person who operates the operation unit on each manual display operation machine 20], The various input buttons 24a-24c etc. which are the operation input means for instructing mah-jongg operation usual [such as TSUMO, a squeal, reach,] and fundamental control of game progress are provided.

[0016]= The outline of = software = in = this example, the game program of a mah jongg game is recorded on CD-ROM 10b, and a user is provided with it. The function of a game program is divided into a game managing process, the advance treatment process of a game algorithm, the output process of game image sound data, an input data treatment process, etc., and can be grasped.

[0017]A game managing process takes charge of an initial setting, adjustment of advance of the whole game, etc. The advance treatment process of a game algorithm generates the data in which the advancing state of a game is shown one by one. It mainly becomes data in which the advancing state of this game is shown from place data and hand data.

[0018]each game person throws away the aforementioned place data -- a tile and a squeal -- actual game ****, such as a tile, -- it is the information which is made open at what is called a place, and all the game persons always refer to, the stock which refers to the aforementioned hand

data individually on the other hand so that each game person may not be seen by other game persons — they are a tile and what is called information generally called a "hand." Although these pieces of information changes every moment along with advance of a game, the advance treatment process of a game algorithm is generating the information one by one.

[0019]The output process of game image sound data generates the image data of a place, and the various sound data of a game, and outputs these to the display device 12 via the interface 10e and the image output-power-of-sound terminal 10c. Place image data is displayed on a display and sound data is outputted from the loudspeaker with which a display is equipped. A game image sound data output process generates the bitmapped image data of hand information every operation unit 20, and outputs it to the operation unit 20 which corresponds via the interface 10f and the aforementioned adapter 14 for an a lot of people play, respectively individually again.

[0020]The aforementioned input data treatment process receives the input data from the operation unit 20, and changes the data in which it responds to these data and the advancing state of the aforementioned game is shown one by one. Each playing person makes the operational input of each playing person of TSUMO ***** and the game person of others [**** / throwing away and cutting a tile] throwing away from the mountain of a place, acting as Pons of the tile, and making those tiles open at a place reflect in the aforementioned place data in detail specifically.

[0021]Although this example shows the example for four persons' game person participating and performing a mah jongg game, three persons' game person can participate, for example, and a program can also be made so that a computer may be made to take charge of remaining 1 person. In that case, for example, one of game persons should just choose the mode of the game which is an input button of its own controller and participates by three persons at the time of a game start.

[0022]= Composition of == hand display operation machine = the example of appearance of == hand display operation machine 20 was shown in Fig.3. The liquid crystal display 22 is arranged above the body part, and, in a table, the hand data showing each game person's hand is shown one by one. Below the liquid crystal display, the various input buttons 24a, 24b, and 24c which are input means are provided. The communication cord 26 used as the communication path by the side of a game machine body is implanted in the upper surface part of a body part.

[0023]Fig.4 shows the block diagram of the electric control system built in the operation unit 20. The I/O interface circuit 28 is a means of communication which performs the game machine body 10 and data communications. The various control signals for displaying the dot-matrix hand image data of the aforementioned hand information are received specifically, and, on the other hand, the operation signal over the various input buttons 24a-24c is transmitted to the game machine body 10.

[0024]The microcomputer 21 converts various operation signals to the data of a predetermined form, and gives them to the interface circuitry 28. A microcomputer writes the bitmapped image data received from the game machine body 10 via the interface circuitry 28 in Video RAM 23. LCD driver 25 drives the liquid crystal display 22 according to the image data written in Video RAM 23, and displays the image. the stock as which the game person was displayed on the liquid crystal display 22 — with reference to the image of the place displayed on the aforementioned display device 12 as the tile, it throws away, determination of a tile or a squeal is performed, and the result of determination is input from the various input buttons 24a-24c.

[0025]It throws away [at this time, specifically the pointing function of the operation unit 20,], and determination of a tile etc. is input. 13 tiles are displayed for the game person concerned on the display panel 22 in front of TSUMO **, and TSUMO ** and 14 tiles are displayed. Any one tile is surrounded and displayed with the thick frame here, and this thick frame display can be moved to another tile by the arrow key 24c of the input buttons. When this thick frame display is moved on a tile (I would like to cut) to throw away and predetermined buttons ("SEL" button of a figure, etc.) are pushed, that tile will be thrown away, and the signal which transmits that is transmitted to the game machine body 10. In the game algorithm advance treatment process of the main part 10, this

signal is received and new place data is generated. The output process process of game image sound data generates and outputs the place image data of this new place data. It may point to a certain tile by displaying an arrow on the display panel 22 as a method of pointing to a specific tile in a pointing function besides surrounding with a thick frame.

[0026]Also when the game person concerned cries Pons, a can, etc., the image of those tiles is displayed on the display device 12 through the same process. Shortly at this time, the tiles displayed on the display panel 22 of that part operation unit 20 decrease in number. or other stocks — as a tile and distinction are attached, it may be made to display also on the display panel 22

[0027]the stock displayed — after [such as arranging for every pattern according to the advance treatment process of a game program,] arranging the order of a row of a tile suitably, by a game image output-power-of-sound process, it generates image data and transmits to the operation unit 20. Or each game person may be made to be freely rearranged by input button 24 a-c of the operation unit 20 at any time. It is good also as performing the processing using the microcomputer 21 and Video RAM 23 of the operation unit 20, and carrying out with the main computer 10g by the side of the game machine body 10.

[0028]The working example of another operation unit 30 used for the mah jongg game concerning this invention is shown in Fig.5. In this working example, each hand key 34d is provided instead of the arrow key 24c of the input buttons. Each of this hand key 34d is equipped with the key from A to N equivalent to 14 tiles, and a pointing indication (it surrounds with a thick frame) of the tile which corresponds if each key is pressed is given. What is necessary is to be this operation unit, and just to push a "SEL" button, after pressing the key corresponding to a desired tile in order to throw away, for example and to choose a tile.

[0029]= = describe in detail about a second type of invention by making the same mah jongg game as the working-example = = above of a second type of invention group into an working example. However, the duplication description about the portion which is common in a first type of invention is omitted as much as possible, and applies and describes a spotlight into a different portion from a first type of invention.

[0030]In this Description, one sheet is one-sheet called [of one per piece or cards card of a mah-jongg tile] piece, and the subclassification classification of cards, such as the subclassification classification of tiles, such as the "east" of a mah-jongg tile and "30,000", "7 of the heart" of cards, "4 of a spade", is called a piece attribute. And the pattern of each mah-jongg tile and the pattern of each card of cards are called an attribute design.

[0031]Also in a first type and a second type of which mah-jongg game system, In the game logic process (advance treatment process of a game algorithm) of generating hand data and place data based on the algorithm of a mah jongg game, each mah-jongg tile (piece) is expressed by the digital codes (piece attribute ID) which specify each piece attribute, and an operation is presented with it. And in the game image process of generating place image data based on the place data which the game logic process generated, the bitmapped image data of the pattern (attribute design) of the mah-jongg tile matched with piece attribute ID will be generated. Therefore, in the game program recorded on the medium, the collection file of designs which matches all the piece attribute ID and the image data of each attribute design, and has been recorded exists. By converting each piece contained in place data using the collection file of designs to the image data of an attribute design applicable based on piece attribute ID, place image data is generated and the video signal is supplied to the display device 12.

[0032]In the video game machine which executes a game program, like place data, after converting each hand data to hand image data using the aforementioned collection file of designs, in a first type of mah-jongg game system, each manual display operation machine 20 was supplied. The game program is made such.

[0033]However, in a second type of mah-jongg game system, not hand image data but the hand data used as the origin is sent to each manual display operation machine 20 from the video game

machine 10. Hand data is a data row of piece attribute ID, and the manual display operation machine 20 takes charge of the function which converts the hand data to hand image data.

[0034]The configuration example of this second type of manual display operation machine 20 is shown in Fig.6. That the design generator 60 exists differ on the working example of Fig.4 described previously, and Drawings at Fig.6.The design generator 60 consists of ROMs, matches all the piece attribute ID and the image data of each attribute design like the collection file of designs mentioned above, and is recorded. The bitmapped image data of an attribute design which corresponds if piece attribute ID is given to the design generator 60 as an address is read.

[0035]In Fig.6, the microcomputer 21 of the manual display operation machine 20, While storing temporarily the hand data received from the video game machine at internal RAM, the image data of an attribute design is generated by giving piece attribute ID of each piece in hand data to the design generator 60, and the image data is sequentially written in the predetermined position of Video RAM 23. Hand image data will be equal to Video RAM 23 by this. This is displayed on the LCD display panel 22 via LCD driver 25.

[0036]When a first type and second type are contrasted, it will be said that the data volume transmitted to each manual display operation machine from a video game machine has few a second type of directions overwhelmingly, and the composition of each manual display operation machine is simple for a first type of direction. When there are many restrictions, a second type of direction is suitable for the data transfer rate from a video game machine to each manual display operation machine.

[0037]= The device of == pointing means = cursor attaches to the arrangement of the mah-jongg tile currently displayed on the display panel 22 of == hand display operation machine 20. The tile which cursor moves by operating the predetermined thing of the input buttons 24a-24c and to which it points with cursor changes. Data processing which realizes this function is performed as follows. The cursor advance request data based on operation of an input button is transmitted to a video game machine, and the game machine which has recognized this gives cursor advance command data to the microcomputer 21 of the manual display operation machine 20. Processing to which the cursor on a display of the microcomputer 21 which received this command data is moved is performed. If it carries out like this, even if there are possibilities, such as a data transmission error, for example, generating of the inconsistency of the position (piece specifying data) of the cursor currently displayed on the manual display operation machine 20 and the piece specifying data which the game logic process of a video game machine recognizes can be lessened extremely.

[0038]= The working example in the application invention group of == hand display operation machine = == Fig.7 shows the working example as a configuration diagram about application invention of the manual display operation machine in the game system of the 1st and 2nd above-mentioned types. This manual display operation machine 20 is provided with the following.

The memory slot 80 which equips with the memory cassette 70 which contained a proper memory enabling free attachment-and-detachment exchange.

The memory interface circuit (memory IF circuit) 90 which interposes between a memory cassette and the microcomputer 21 with which this slot 80 was equipped.

[0039]The microcomputer 21 accesses the data storage area where the internal memory of the memory cassette 70 is proper via memory IF circuit 90, performs processing for reading proper data, if an internal memory is a ROM type, and if it is a RAM type, it will also perform data writing processing to the memory.

[0040]Here, it describes about the using form of the manual display operation machine 20 by the difference in the form of the memory which a memory cassette incorporates. A manual display operation machine in case a memory is a ROM type is considered as a "read-only type", a manual display operation machine in case a memory is a RAM type is classified as "a rewritable type", and it describes about the application form according to those types.

[0041]<Read-only type> What first replaced the design generator of the manual display operation machine shown in the working example in the invention group of the 2nd above-mentioned type by the memory cassette as this type of a manual display operation machine can be considered. For example, if it is a mah-jongg game, it will become possible to display the tile of a design which is different even if it is the same game in exchanging memory cassettes suitably. It becomes possible to also make it correspond to a different game by matching the attribute design data (a tile, a card, etc.) of the design of a kind which is different in the same attribute ID. Of course, built-in ROM is also no longer necessary. Or even if it is the manual display operation machine prepared for exclusive use for a certain game by built-in ROM, it becomes possible to use it for other games.

[0042]A role of going up, mark, etc. of mah-jongg are possible also for making the information (dictionary information) relevant to the game to which a game person wants to refer store. "*****" which goes up to the role not being made by it, for example can be prevented, or beginners can also make it possible to perform mark calculation easily.

[0043]Of course, a program is also storable in the memory in a memory cassette besides above-mentioned data. And a part of program (advance treatment process of a game algorithm) (manual display operation dexterous program) which a video game machine executes is stored in this memory. Probably, it will also be possible to ease the burden of data processing in a video game machine because the microcomputer of a manual display operation machine executes the program.

[0044]The memory in which rewritings, such as nonvolatile memory, are possible is made to build in a rewritable <type> memory cassette. It is good also as writing in the various data shown in the example above-mentioned read-only type as well as the game interruption data for making the interrupted game resume as data written in this memory. In addition to a manual display operation machine, flexibility can be given to the memory cassette itself, if various data is downloaded from the video game machine side before the start of a game and it stores in the memory in a memory cassette by it, for example. That is, the necessity of preparing a read-only type recording medium for every game is lost.

[0045]The form which made another memory equivalent to a Video RAM build in a memory cassette, or assigned a part of storage area of the memory in a cassette to it as a Video RAM region is also considered. In this case, if the circuit configuration that an LCD driver reads a bitmapped image from the Video RAM region in a cassette directly is used, the necessity of making a Video RAM building in a manual display operation machine will be lost.

[0046]When performing the game which uses personal data, convenience is higher than the form which equips a game machine body with a recording medium. For example, when writing each personal data of two or more game persons in the internal memory of a memory cassette, it is not necessary to make a game machine body equipped with the memory slot for a game person's number. A slot is mistaken and data is not written in the memory in other game persons' memory cassette.

[0047]

[Effect of the Invention]According to the present invention, two or more participating game persons can gather in front of common displays, such as a television reception machine in a home, via network communication, and video games, such as mah-jongg and a card game, can be enjoyed. It can also make it easy for each one to prepare neither a personal computer nor a large-sized display each one, and to carry and enjoy itself to a travel destination, since it is simple. Since all the participants can meet together, of course and he can enjoy himself, it is possible to taste heat and presence same with performing games, such as actual mah-jongg and poker.

[0048]All the participants have one of this at a time each one, and the manual display operation machine used for this video game system displays the hand data which is information peculiar to each one, therefore, a stock [in / for example / mah-jongg] — he can proceed a game, this game person referring to the information on a tile etc. without other game persons seeing.

[0049]With the manual display operation machine which enabled it to equip with a predetermined

memory, enabling free attachment-and-detachment exchange, the necessity of preparing a manual display operation machine for exclusive use for every game can be abolished, and the flexibility of a manual display operation machine can be improved. It becomes possible to simplify the internal circuit composition of a manual display operation machine, and to attain a cost cut by considering the function of a manual display operation machine as the composition made to replace by this predetermined memory.

[Translation done.]

(19)日本国特許庁 (J P)

(12) 公開特許公報 (A)

(11)特許出願公開番号

特開平10-201953

(43)公開日 平成10年(1998)8月4日

(51)IntCl. ⁸ A 6 3 F 9/22	識別記号	F 1 A 6 3 F 9/22	K B C E L
審査請求 有 請求項の数4 OL (全 39 頁)			

(21)出願番号	特願平9-306230	(71)出願人	000105637 コナミ株式会社 兵庫県神戸市中央区港島中町7丁目3番地の2
(22)出願日	平成9年(1997)11月7日	(72)発明者	神戸 良治 大阪市北区西天満4丁目15番10号 株式会社コナミコンピュータエンタテインメント大阪内
(31)優先権主張番号	特願平8-327880	(72)発明者	藤原 英之 大阪市北区西天満4丁目15番10号 株式会社コナミコンピュータエンタテインメント大阪内
(32)優先日	平8(1996)11月21日	(74)代理人	弁理士 小谷 悦司 (外3名)
(33)優先権主張国	日本 (J P)		

(54)【発明の名称】 麻雀ゲーム装置、麻雀ゲーム方法および記録媒体

(57)【要約】

【課題】 相手毎の人間性や癖に応じた表情や言葉などによって臨場感を得ると共に、当たり牌に対する危険度表示によるガイドンス機能によって麻雀ゲームを一層楽しむ。

【解決手段】 CPU 6は、記録媒体5から読み出された条件データ、画像データ、音声データおよびゲームプログラムデータをRAM8に保持させ、対戦キャラクター毎で、かつ、刻々と変化する対戦キャラクター毎の対戦状況による条件データ毎に顔の表情、顔の動き、メッセージおよび牌移動などの画像データおよび/または音声データを選択すると共に、プレイヤーの捨てようとする牌に対して対戦キャラクター毎の当たり牌となる危険度を複数段階で表示する画像データを選択して、テレビジョンモニター2やスピーカ4にゲーム画像や音声出力として出力させるように制御する。

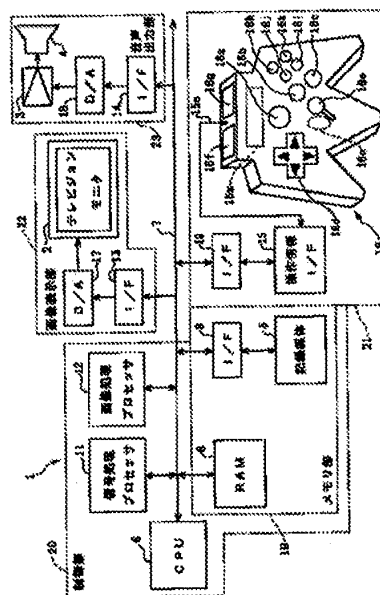

【特許請求の範囲】

【請求項1】 少なくともプレイヤーの手牌および捨牌内容と、対戦キャラクターの捨牌内容および顔が表示され、これらのプレイヤーおよび対戦キャラクターが順に摸牌および捨牌などの牌引き及び牌捨て動作を繰り返すことにより麻雀ゲームが進行する麻雀ゲーム装置であって、

プレイヤーの捨てようとする牌に対して対戦キャラクター毎の当たり牌となる危険度を複数段階で表示する画像データを得る制御部と、

前記制御部で得られた画像データを画像表示する画像表示部とを有することを特徴とする麻雀ゲーム装置。

【請求項2】 少なくともプレイヤーの手牌および捨牌内容と、対戦キャラクターの捨牌内容および顔が表示され、これらのプレイヤーおよび対戦キャラクターが順に摸牌および捨牌などの牌引き及び牌捨て動作を繰り返すことにより麻雀ゲームが進行する麻雀ゲーム装置であって、

プレイヤーの捨てようとする牌に対して対戦キャラクター毎の当たり牌となる危険度を複数段階で表示する画像データを得る制御部と、

前記制御部で得られた画像データを画像表示する画像表示部と、

前記制御部で得られた音声データを音声出力する音声出力部とを有することを特徴とする麻雀ゲーム装置。

【請求項3】 少なくともプレイヤーの手牌および捨牌内容と、対戦キャラクターの捨牌内容および顔が表示され、これらのプレイヤーおよび対戦キャラクターが順に摸牌および捨牌などの牌引き及び牌捨て動作を繰り返すことにより麻雀ゲームが進行する麻雀ゲーム方法であって、

プレイヤーの捨てようとする牌に対して対戦キャラクター毎の当たり牌となる危険度を複数段階で表示する画像データを得、これらの画像データおよび/または音声データを画像表示および/または音声出力させることを特徴とする麻雀ゲーム方法。

【請求項4】 少なくともプレイヤーの手牌および捨牌内容と、対戦キャラクターの捨牌内容および顔が表示され、これらのプレイヤーおよび対戦キャラクターが順に摸牌および捨牌などの牌引き及び牌捨て動作を繰り返すことにより麻雀ゲームが進行すると共に、

プレイヤーの捨てようとする牌に対して対戦キャラクター毎の当たり牌となる危険度を複数段階で表示する画像データを得、これらの画像データおよび/または音声データを画像表示および/または音声出力させるように制御させることを特徴とする麻雀ゲームプログラムが記録された記録媒体。

【発明の詳細な説明】

【0001】

【発明の属する技術分野】 本発明は、テレビゲームなど

に適用される麻雀ゲーム装置、麻雀ゲーム方法および、麻雀ゲームプログラムが記録された記録媒体に関する。

【0002】

【従来の技術】 従来、麻雀ゲーム装置は、プレイヤーが3人のCPUプレイヤーを相手にしてプレイするものであり、プレイヤーは自分の手牌を、麻雀卓のプレイ画面で見ながらコントローラを介して操作することで、プレイヤーおよびCPUプレイヤーが順に摸牌および捨牌を繰り返し、さらにはポン、チーおよびカンなどの鳴き牌をして手牌を順次完成に近づけ、他の3人のCPUプレイヤーと手牌の完成を競うことで麻雀ゲームを進行させていた。麻雀卓を上から見たプレイ画面には、プレイヤーの手牌内容の他に、通常の麻雀で目にする情報、例えば、他の3人のCPUプレイヤーの捨牌や、ポン、チーおよびカンなどの見せ牌などが3人のCPUプレイヤー毎に表示されており、プレイヤーはこれらの情報を見ながら他の3人のCPUプレイヤーの手牌の状態を予測して、自分の捨牌で相手の手牌完成牌となって振り込まないように注意してプレイしていた。最終的に自ら摸ってきた牌かまたは相手の捨牌かで自分かまたは相手が和了してその回の勝敗が決定することになる。このとき、和了した手牌内容に応じて点数が付けられ、自ら摸って和了した場合は他の3人から、相手の捨牌で和了した場合は振り込んだ相手からその点数をもらい、最終的な点数の大小で最終的な勝敗を決めていた。

【0003】

【発明が解決しようとする課題】 ところが、上記従来の麻雀ゲーム装置では、相手の捨牌から手牌内容やその完成度を予測して相手に振り込むことなく、自らの手牌をいち早く完成させて他のCPUプレイヤーよりも早く和了するという論理的なプロセスを楽しむことはできるが、その他に、麻雀ゲーム特有の相手毎の癖や人間性、心理さらには何げない言葉や顔色、動作などの臨場感がなく、それらをよんで相手の手牌内容やその完成度を総合的に予測して捨牌を考慮しつつプレイするという本当の麻雀の楽しみを得ることができないという問題を有していた。

【0004】

また、プレイヤーの捨牌に対して対戦CPUキャラクターの当たり牌となると、麻雀ゲームに負けることから麻雀ゲームを楽しむことができない。特に、本発明者等は、当たり牌の可能性についてのガイダンス機能がなければ、本当の麻雀ゲームに臨むについても、より高度な教育が為されてレベルアップが可能となり、麻雀ゲームを一層楽しむことができるものと考えた。

【0005】

本発明は、上記従来の問題を解決するもので、相手毎の人間性や癖に応じた表情や言葉などによって臨場感を得ると共に、当たり牌に対する危険度表示によるガイダンス機能によって麻雀ゲームを一層楽しむことができる麻雀ゲーム装置、麻雀ゲーム方法および記録媒体を提供することを目的とする。

【0006】

【課題を解決するための手段】本発明の麻雀ゲーム装置は、少なくともプレイヤーの手牌および捨牌内容と、対戦キャラクターの捨牌内容および顔が表示され、これらのプレイヤーおよび対戦キャラクターが順に摸牌および捨牌などの牌引き及び牌捨て動作を繰り返すことにより麻雀ゲームが進行する麻雀ゲーム装置であって、プレイヤーの捨てようとする牌に対して対戦キャラクター毎に当たり牌となる危険度を複数段階で表示する画像データを得る制御部と、制御部で得られた画像データを画像表示する画像表示部とを有することを特徴とするものである。また、本発明の麻雀ゲーム装置は、少なくともプレイヤーの手牌および捨牌内容と、対戦キャラクターの捨牌内容および顔が表示され、これらのプレイヤーおよび対戦キャラクターが順に摸牌および捨牌などの牌引き及び牌捨て動作を繰り返すことにより麻雀ゲームが進行する麻雀ゲーム装置であって、プレイヤーの捨てようとする牌に対して対戦キャラクター毎に当たり牌となる危険度を複数段階で表示する画像データを得る制御部と、制御部で得られた画像データを画像表示する画像表示部と、制御部で得られた音声データを音声出力する音声出力部とを有することを特徴とするものである。また、本発明の麻雀ゲーム方法としては、少なくともプレイヤーの手牌および捨牌内容と、対戦キャラクターの捨牌内容および顔が表示され、これらのプレイヤーおよび対戦キャラクターが順に摸牌および捨牌などの牌引き及び牌捨て動作を繰り返すことにより麻雀ゲームが進行する麻雀ゲーム方法であって、プレイヤーの捨てようとする牌に対して対戦キャラクター毎に当たり牌となる危険度を複数段階で表示する画像データを得、これらの画像データおよび/または音声データを画像表示および/または音声出力させることを特徴とするものである。さらに、本発明の記録媒体には、少なくともプレイヤーの手牌および捨牌内容と、対戦キャラクターの捨牌内容および顔が表示され、これらのプレイヤーおよび対戦キャラクターが順に摸牌および捨牌などの牌引き及び牌捨て動作を繰り返すことにより麻雀ゲームが進行すると共に、プレイヤーの捨てようとする牌に対して対戦キャラクター毎に当たり牌となる危険度を複数段階で表示する画像データを得、これらの画像データおよび/または音声データを画像表示および/または音声出力させるように制御させることを特徴とする麻雀ゲームプログラムが記録されている。

【0007】また、好ましくは、本発明の麻雀ゲーム装置は、少なくともプレイヤーの手牌および捨牌内容と、対戦キャラクターの捨牌内容および顔が表示され、これらのプレイヤーおよび対戦キャラクターが順に摸牌および捨牌などの牌引き及び牌捨て動作を繰り返すことにより麻雀ゲームが進行する麻雀ゲーム装置であって、対戦キャラクターの顔の表示、顔の動き、メッセージ並びに

牌引き及び牌捨て動作等の可変項目内の少なくとも何れかが、前記対戦キャラクターの対戦状況に応じた表示状態となるよう画像データを得ると共に、プレイヤーの捨てようとする牌に対して対戦キャラクター毎に当たり牌となる危険度を複数段階で表示する画像データを得る制御部と、制御部で得られた画像データを画像表示する画像表示部とを有することを特徴とするものである。また、好ましくは、本発明の麻雀ゲーム装置は、少なくともプレイヤーの手牌および捨牌内容と、対戦キャラクターの捨牌内容および顔が表示され、これらのプレイヤーおよび対戦キャラクターが順に摸牌および捨牌などの牌引き及び牌捨て動作を繰り返すことにより麻雀ゲームが進行する麻雀ゲーム装置であって、対戦キャラクターの顔の表示、顔の動き、メッセージ並びに牌引き及び牌捨て動作等の可変項目内の少なくとも何れかが、前記対戦キャラクターの対戦状況に応じた表示および/または出力状態となるよう画像データおよび/または音声データを得ると共に、プレイヤーの捨てようとする牌に対して対戦キャラクター毎に当たり牌となる危険度を複数段階で表示する画像データを得る制御部と、制御部で得られた画像データを画像表示する画像表示部と、制御部で得られた音声データを音声出力する音声出力部とを有することを特徴とするものである。また、好ましくは、本発明の麻雀ゲーム方法としては、少なくともプレイヤーの手牌および捨牌内容と、対戦キャラクターの捨牌内容および顔が表示され、これらのプレイヤーおよび対戦キャラクターが順に摸牌および捨牌などの牌引き及び牌捨て動作を繰り返すことにより麻雀ゲームが進行する麻雀ゲーム方法であって、対戦キャラクター毎の対戦状況に応じた顔の表情、顔の動き、メッセージおよび牌引き及び牌捨て動作の可変項目のうち少なくとも何れかになるように画像データおよび/または音声データを得ると共に、プレイヤーの捨てようとする牌に対して対戦キャラクター毎に当たり牌となる危険度を複数段階で表示する画像データを得、これらの画像データおよび/または音声データを画像表示および/または音声出力させることを特徴とするものである。さらに、好ましくは、本発明の記録媒体には、少なくともプレイヤーの手牌および捨牌内容と、対戦キャラクターの捨牌内容および顔が表示され、これらのプレイヤーおよび対戦キャラクターが順に摸牌および捨牌などの牌引き及び牌捨て動作を繰り返すことにより麻雀ゲームが進行すると共に、対戦キャラクター毎の対戦状況に応じた顔の表情、顔の動き、メッセージおよび牌引き及び牌捨て動作の可変項目のうち少なくとも何れかになるように画像データおよび/または音声データを得、かつ、プレイヤーの捨てようとする牌に対して対戦キャラクター毎に当たり牌となる危険度を複数段階で表示する画像データを得、これらの画像データおよび/または音声データを画像表示および/または音声出力させるように制御させることを特徴とする麻雀

ゲームプログラムが記録されている。

【0008】この構成により、プレイヤーの捨牌に対して対戦CPUキャラクター毎の当たり牌となる危険度を複数段階で対戦キャラクター毎に表示するので、プレイヤーに対する捨牌のガイダンスとなって、本来の麻雀ゲームに臨むについても、より高度な教育が為されてレベルアップが可能となり、麻雀ゲームが一層楽しめることになる。

【0009】また、対戦キャラクター毎で、かつ、刻々と変化する対戦キャラクター毎の対戦状況毎に顔の表情、顔の動き、メッセージおよび牌引き及び牌捨て動作を画像出力や音声出力するようにすれば、麻雀ゲーム特有の対戦キャラクターの人間性や癖、心理が顔の表情や何げないメッセージなどを通じて判断され、より臨場感のある麻雀ゲームを楽しむことが可能となると共に、それらをよんで対戦キャラクターの手牌内容やその完成度を総合的に予測して捨牌を考慮しつつプレイするという本来の麻雀の楽しみを得ることが可能となる。

【0010】また、好ましくは、本発明における画像データとしての対戦キャラクター毎の顔の表情とは、少なくとも笑顔、普通顔、悲しみ顔および怒り顔である。また、好ましくは、本発明における画像データの出力条件としての対戦状況とは、配牌時の手牌内容、自摸時の牌内容、捨牌時の牌内容、立直および和了内容のうち少なくとも何れかである。さらに、好ましくは、本発明における画像データとしての対戦キャラクター毎の顔の動きとは、牌を捨てた方向、鳴いた相手の方向および和了した相手の方向のうち少なくとも何れかの方向を見る動きである。さらに、好ましくは、本発明における画像データとしての対戦キャラクター毎の牌引き及び牌捨て動作とは、摸牌の動き、捨牌の動き、リーチ牌の動きおよび鳴き牌の動きのうち少なくとも何れかの動き方である。

【0011】これらの各データにより、より臨場感に富む画像が得られると共に、その画像に応じた麻雀対戦状況がより判断可能となって、対戦キャラクター毎の麻雀対戦状況を考慮しつつプレイするという本来の麻雀の楽しみが得られることになる。

【0012】

【発明の実施形態】以下、本発明の実施形態について図面を参照しながら説明する。

【0013】図1は、本発明の一実施形態における麻雀ゲーム装置のハード構成を示すブロック図である。

【0014】図1において、麻雀ゲーム装置1は、ゲーム機本体（図示せず）と、ゲームの画像を出力するためのテレビジョンモニタ2と、ゲームの音声を出力するためのプリメインアンプ3およびスピーカ4と、画像データ、音声データおよびプログラムデータからなるゲームデータの記録された記録媒体5とからなっている。ここで、記録媒体5は、例えば上記ゲームデータやオペレー

ティングシステムのプログラムデータの記憶されたROMなどがプラスチックケースに収納された、いわゆるROMカセットや、光ディスク、フレキシブルディスクなどである。

【0015】このゲーム機本体内の操作および制御システムは、各部を制御する中央演算処理装置（以下CPUという）6にアドレス、データおよびコントローラバスからなるバス7が接続されており、このバス7に、各種データを格納可能なRAM8、インターフェース回路9、10、信号処理プロセッサ11、画像描画処理プロセッサ12、インターフェース回路13、14がそれぞれ接続されている。このインターフェース回路10に操作情報インターフェース回路15を介してコントローラ16が接続され、コントローラ16からの操作信号に応じた指令をCPU6に行わせることができる。

【0016】この信号処理プロセッサ11は、主に2次元上における位置計算、光源計算や音声データの生成、加工処理を行い、また、画像描画処理プロセッサ12は、信号処理プロセッサ11における計算結果に基づいて、RAM8に対して描画すべき画像データの書き込み処理を行う。また、インターフェース回路13はD/Aコンバータ17を介してテレビジョンモニタ2に接続されて画像出力され、また、インターフェース回路14はD/Aコンバータ18さらにプリメインアンプ3を介してスピーカ4に接続されて音声出力されるようになっている。

【0017】ここで、麻雀ゲーム装置1は、用途に応じてその形態が異なっている。即ち、上記麻雀ゲーム装置1が、家庭用として構成されている場合においては、テレビジョンモニタ2、プリメインアンプ3およびスピーカ4は、ゲーム機本体とは別体で構成されている。また、上記麻雀ゲーム装置1が、業務用として構成されている場合においては、図1に示されている構成要素はすべて一体型の1つの筐体内に収納されている。また、上記麻雀ゲーム装置1が、パーソナルコンピュータやワークステーションを核として構成されている場合においては、上記テレビジョンモニタ2は、上記コンピュータ用のディスプレイに対応し、上記画像描画処理プロセッサ12は、上記記録媒体5に記録されているゲームプログラムデータの一部若しくはコンピュータの拡張スロットに搭載される拡張ボード上のハードウェアに対応し、上記インターフェース回路9、10、13、14、D/Aコンバータ16、17、操作情報インターフェース回路15は、コンピュータの拡張スロットに搭載される拡張ボード上のハードウェアに対応している。また、上記RAM8は、コンピュータ上のメインメモリまたは拡張メモリの各エリアに対応している。本実施形態では、上記麻雀ゲーム装置1が、家庭用として構成されている場合を例にとって説明する。

【0018】また、コントローラ16は、スタートボタ

ン16g、Aボタン16b、Bボタン16c、十字キー16d、スティック型コントローラ16e、左トリガボタン16f、右トリガボタン16g、C1ボタン16h、C2ボタン16i、C3ボタン16j、C4ボタン16k、コネクタ16m、奥行きトリガボタン16nなどを有する。ここで、コネクタ16mには、例えばゲームの進行状態などを一時的に記憶するためのメモリなどが着脱可能である。また、上記スティック型コントローラ16eは、上下左右のみならず、360度の方向に操作可能となっており、ジョイスティックと略同じ機能を有している。

【0019】次に、本発明の麻雀ゲーム装置1の機能ブロック構成について説明する。

【0020】以上のCPU6、信号処理プロセッサ11、画像描画処理プロセッサ12およびメモリ部(RAM8、インターフェース回路9および記録媒体5)19により制御部20が構成されており、記録媒体5に記録された画像データ、音声データおよびプログラムデータなどからなるゲームデータを、CPU6が、信号処理プロセッサ11で各種信号処理を行わせ、この各種信号処理に基づいて画像描画処理プロセッサ12で、RAM8に対して描画すべき画像データや音声データの書き込み処理を行うように制御する。

【0021】また、インターフェース回路10、操作情報インターフェース回路15およびコントローラ16により操作入力部21が構成されており、プレイヤーによるコントローラ16からの操作情報に応じた指令をCPU6に行わせることで、プレイヤーの手牌および捨牌内容や、対戦キャラクターの捨牌内容、メッセージおよび顔表情が表示された図2に示すような表示画面において、プレイヤーは、対戦キャラクターと順番に摸牌および捨牌などの牌引き及び牌捨て動作を繰り返すことにより麻雀ゲームを進行させることができる。この場合、捨牌とは河に捨てられている牌であり、手牌とは手持ちの牌であり、摸牌とは牌山から1枚もってきた牌で、自摸とは牌山から1枚もってくる行為である。

【0022】さらに、インターフェース回路13、D/Aコンバータ17およびテレビジョンモニタ2により画像表示部22が構成され、画像描画処理プロセッサ12で、RAM8に対して書き込み処理を行った画像データをインターフェース回路13さらにD/Aコンバータ17を介してテレビジョンモニタ2に入力することで、CPUキャラクター毎の麻雀対戦状況に応じた画像が画面に表示されることになる。

【0023】さらに、インターフェース回路14、D/Aコンバータ18、プリアンプ3およびスピーカ4により音声出力部23が構成され、画像描画処理プロセッサ12で、RAM8に対して書き込み処理を行った音声データをインターフェース回路14、D/Aコンバータ18さらにプリアンプ3を介してスピーカ4

に入力することで、CPUキャラクター毎の麻雀対戦状況に応じた音声出力されることになる。

【0024】ここで、記録媒体5に記録されたゲームデータによって制御されるCPU6を含めた制御部20について、以下にさらに詳しく本発明による動作を説明する。

【0025】制御部20は、臨場感を得て相手の手牌内容を総合的に予測するべく、対戦キャラクター毎の対戦状況に応じた顔の表情、顔の動き、メッセージおよび牌引き及び牌捨て動作の可変項目になるように画像データや音声データを得、これらの画像データや音声データを画像表示および/または音声出力させるように制御する。

【0026】また、制御部20は、麻雀対戦状況の流れに応じた対戦キャラクター毎の表情を得るべく、対戦キャラクター毎の対戦状況に応じて感情値が設定されており、その時点での感情値の合計に応じた顔の表情を示す画像データを選択して画像表示させるように制御する。

【0027】さらに、制御部20は、対戦キャラクター毎の対戦状況に応じて感情値が設定されており、その時点での感情値の合計に応じた顔の表情を示す画像データを選択すると共に、その時々々の対戦キャラクター毎の感情が優先的かつ強制的に表れるように、この感情値合計による表情選択に優先して所定時間のみ、特殊状況に応じた顔の表情を示す画像データを選択して画像表示させるように制御する。

【0028】さらに、制御部20は、麻雀対戦状況の時々に応じた対戦キャラクター毎の様子を表すべく、対戦キャラクター毎の対戦状況の各条件のうち優先順位の高い条件に対応した可変項目になるようにデータを選択して画像表示および/または音声出力させるように制御する。

【0029】さらに、制御部20は、気になる対戦キャラクターに対して対戦状況判断のポイントとするべく、プレイヤーの自摸時にメッセージ指定した対戦キャラクターのメッセージデータを選択して画像表示および/または音声出力させるように制御する。

【0030】以上において、対戦CPUキャラクター毎の顔の表情とは、笑い顔、普通顔、悲しみ顔および怒り顔の4種類である。対戦CPUキャラクターの表情が、例えば図3の前面の女性の内田の場合、図3は普通顔であり、図4は笑い顔であり、図5は悲しみ顔であり、図6は怒り顔であって、同様に他の対戦キャラクターの顔表情もそれぞれテレビジョンモニタ2の表示画面内に表示される。

【0031】また、対戦状況とは、配牌時の手牌内容、自摸時の牌内容、捨牌時の牌内容、立直および和了内容などである。また、対戦キャラクター毎の顔の動きとは、牌を捨てた方向、鳴いた相手の方向および和了した相手の方向のうち少なくとも何れかの方向を見る動きを

するものである。さらに、対戦キャラクター毎の牌引き及び牌捨て動作などの牌移動とは、摸牌の動き、捨牌の動き、リーチ牌の動きおよび鳴き牌の動きなどである。さらに、画像部の表示メッセージおよび音声出力は、対戦CPUキャラクター毎の顔の表情に対応させている。この場合、立直（リーチ）とは、門前で聴牌したとき、以後、アガリ牌以外は引き放りを条件に、宣言と同時に成立する。また、和了とはアガリのことである。さらに、向聴とは聴牌（アガリを持つ状態）までにかかる手数であり、例えば1向聴とはあと1枚の有効牌で聴牌となる状態である。

【0032】次に、画像データ、音声データおよびプログラムデータなどからなるゲームデータの具体的内容について詳しくその一例を説明する。

【0033】まず、対局開始配牌前、感情値（点数）の初期セットをし、対局中、その状況により感情値セットをし、セットした感情値とそのCPUキャラクターの状況によって顔の表情をセットする通常の場合であり、また、麻雀対局中において、CPUキャラクター毎の会話（メッセージ）および顔の表情をその麻雀対戦状況に応じて決定し、プレイヤー自身の自摸番のときに任意のCPUキャラクターに会話を求めた場合に、CPUキャラクターがその時点で、その状況に応じた会話をメッセージとして画面上に表示する場合である。

【0034】このCPUキャラクター毎の感情値の初期セットとは、例えば内田の場合、キャラクター別基本感情値初期セット（+128点）をし、持ち点による感情値セットおよび前局での状況による感情値セットをする。この場合の持ち点による感情値セットとは、スタート持ち点から400点増える毎に+1点とし、400点減る毎に-1点として計算する。例えばスタート持ち点を30000点とした場合に、持ち点が30400点となったときに+1点となり、持ち点が29600点となったときに-1点となる。また、この場合の前局での状況による感情値セットとは、前局で和了（あがっている）している場合（+3点）、満貫聴牌して和了できなかった場合（-3点）、おりていて振り込まなかった場合（+3点）、振り込んだ場合（-3点）、相手に自摸で和了された場合（-1点）をセットする。

【0035】また、対局中、その対戦状況による感情値セットとは、配牌時、自摸および捨牌時、和了時および流局時における次の各点数の合計を感情値としてセットしている。例えば内田の感情値の場合は、配牌時3向聴以下の場合（+10点）、配牌時5向聴以上の場合（-10点）、自摸で向聴アップの場合（+3点）、自分の捨牌時に、立直（リーチ）をかけるときではなく、自摸切りでかつその捨牌が不要牌の場合（-3点）、自分の捨牌時に、立直（リーチ）をかけるときではなく、自摸切りでかつその捨牌が不要牌ではなく、かつその自摸牌

が危険牌の場合（-3点）、自分の捨牌時に立直（リーチ）をかける場合（+10点）、自分の捨牌時に鳴かれた場合（-6点）、他家の捨牌時に、立直（リーチ）をかけられる場合（-10点）、他家の捨牌時に、鳴いた場合（+6点）、自分の和了時に、自摸和了した場合（+20点）、自分の和了時に、榮和した場合（+20点）、自分の和了時の得点計算後の持ち点（スタート持ち点からの差400点毎に±1）、他家の和了時に振り込んだ場合（-20点）、他家の和了時に自摸られた場合（-20点）、他家の和了時に満貫以上聴牌していた場合（-14点）、他家の和了時におりていて振り込まなかった場合（+14点）、他家の和了時の得点計算後の持ち点（スタート持ち点からの差400点毎に±1）、流局時に満貫以上聴牌していた場合（-14点）、流局時におりていて振り込まなかった場合（+14点）、流局時の得点計算後の持ち点（スタート持ち点からの差400点毎に±1）などである。

【0036】さらに、セットした感情値による顔の表情セットとは、通常は、セットした感情値に応じてCPUキャラクターの顔の表情を、笑い顔、普通顔、悲しみ顔および怒り顔の4種類に変化させる。それは配牌時、自摸および捨牌時、和了時および流局時などに刻々と変化させるようにする。このときの感情値の基準は以下に示す通りである。

【0037】
テンション高（感情値178点以上）：笑い顔
テンション普通（感情値88点～177点）：普通顔
テンション低い（感情値48点～87点）：悲しみ顔
テンション最低（感情値47点以下）：怒り顔
通常は、セットした感情値に応じてCPUキャラクターの顔の表情は変化しているが、次のCPUキャラクターの状況の場合には、以下に掲げる顔の表情が一瞬または一時だけ優先し、その後、再び通常動作（感情値による動作）による顔の表情に戻る。

【0038】配牌時に、配牌3向聴以下の場合、テンション最低以外で笑い顔、テンション最低で普通顔となる。

【0039】配牌5向聴以上の場合、テンション高で普通顔、テンション高以外で怒り顔となる。

【0040】また、自摸時に、向聴アップ自摸の場合、テンション最低以外で笑い顔、テンション最低で普通顔となる。

【0041】不要牌自摸の場合、テンション高で普通顔、テンション高以外で怒り顔となる。

【0042】危険牌自摸の場合、テンション高で普通顔、テンション高以外で悲しみ顔となる。

【0043】さらに、CPUキャラクターの顔の動きについては、他家のドラ切り時、他家が鳴いた場合は、一時そのドラを切った相手、鳴いた相手の方向に振り向くような顔の動きとする。ただし、他家が鳴いた時は、鳴

かれたその牌を切った人は一時怒り顔になり、その後、唸った人の方向に振り向くような顔の動きとなっている。

【0044】さらに、CPUキャラクターのリーチ牌、捨牌および鳴き牌の画像の動きが、上記感情値（テンション）によって変化すると共に、各CPUキャラクターによっても変化するようになっている。

【0045】次に、牌引き及び牌捨て動作の動きについて説明する。

【0046】まず、CPUキャラクター毎のリーチ牌の画像の動きは、上記感情値（テンション）によっても異

なるが、次の（表1）に示す通りである。この（表1）においては、Iは勢いを付けて上からリーチであり、Sはちょっとだけスライドさせてリーチであり、Oはその場に置くリーチであり、Kは牌を回転させて行うリーチである。男女のCPUキャラクターでも多少傾向があり、男性は勢いを付けて上からリーチをする動きをし、また、女性はちょっとだけスライドさせてリーチをする動きをする。

【0047】

【表1】

テンション 感情値	高い 178以上	ふつう 177-88	低い 87-48	最低（怒り） 47以下
徳河	S	S	S	S
藤田	K	K	K	K
豊臣	O	O	O	O
千野	S	S	S	S
武田	K	I	I	O
小塚	Y	N	N	N
ED	K	K	K	K
矢崎	S	S	S	S
宮古	I	S	S	S
吉永	O	O	O	O
法	S	S	S	S
工藤	I	S	S	S
尾崎	I	I	S	S
樹村	K	I	S	O
松村	S	S	O	O
茶室	K	I	S	S
長山	I	I	S	S
蟹沼	K	I	I	S
内田	I	I	S	S

I：勢いを付けて上からリーチ
S：ちょっとだけスライドさせてリーチ
O：その場におく
K：回転してリーチ

【0048】また、CPUキャラクター毎の捨牌の画像の動きは、上記感情値（テンション）によっても異なるが、次の（表2）に示す通りである。この（表2）においては、Tは図25aに示すように叩き付ける動きで牌を捨てる場合であり、Yは図25bに示すように緩やかに、ズームアップ、ズームダウンさせて牌を捨てる場合であり、Nは図25cに示すように縦、横と順番卓上を滑らせるようにして牌を捨てる場合であり、Iは図25

dに示すように怒りのバターンとして動き無しでいきなり牌を捨てる場合である。男女のCPUキャラクターでも多少傾向があり、男性は上から勢いよく叩き付けるように牌を捨てる動きをし、また、女性は緩やかに、ズームアップ、ズームダウンさせて牌を捨てる動きをする。

【0049】

【表2】

テンション 感情値	高い 178以上	ふつう 177-88	低い 87-48	最低(怒り) 47以下
徳河	Y	Y	Y	Y
鎌田	T	T	I	I
豊臣	T	Y	Y	N
千野	N	N	N	N
武田	T	T	T	T
小瀬	Y	N	N	N
ED	T	Y	N	I
矢崎	N	N	N	N
宮古	T	Y	Y	Y
吉永	Y	Y	Y	Y
法	Y	Y	N	N
工藤	T	Y	Y	N
尾崎	Y	Y	N	N
榎村	T	Y	N	I
松村	Y	Y	Y	Y
奈堂	T	Y	N	N
真山	Y	Y	Y	Y
藤沼	T	Y	N	N
内田	T	Y	Y	N

T: 叩き付ける動き

Y: 緩やかに、ズームアップ、ズームダウンする

N: 縦、横と卓上を滑らす

I: 動きなしでいきなり捨てる(怒りパターン)

【0050】さらに、CPUキャラクター毎の鳴き牌の画像の動きは、上記感情値(テンション)によっても異なるが、次の(表3)に示す通りである。この(表3)においては、Nはそのまま手元に持ってきて他の牌と合わせるような動きをするが、感情値(テンション)によって取る牌の高さ、ズーム率に変化し、感情値(テンシ

ョン)が高いほど拡大率が高くなる。また、Xは縦、横と取ってきて他の牌と合わせる動きをし、また、Kは牌を回転させながら取ってくる動きをする。

【0051】

【表3】

テンション 感情値	高い 178以上	ふつう 177-88	低い 87-48	最低(怒り) 47以下
徳河	N	N	N	N
輪田	K	N	N	N
兼臣	N	N	X	X
千野	X	X	X	X
武田	K	N	X	X
小澤	N	N	N	N
ED	K	K	K	N
矢崎	K	N	N	N
彦古	X	X	X	X
吉永	X	X	X	X
法	X	X	X	X
工藤	X	X	X	X
尾崎	N	N	X	X
樹村	K	X	N	N
松村	N	N	N	N
奈葉	K	N	X	X
長山	N	N	N	N
蟹沼	K	X	X	N
内田	N	N	X	X

N: そのまま手元を持ってきて他の牌と合わせる。
(テンションによってとる牌の高さ、
ズーム率が変わります。
テンションが高いほど拡大率が高くなります。)

X: 縦横と取ってきて他の牌と合わせる。

K: 回転しながらとってくる。

【0052】なお、以上の各種牌引き及び牌捨て動作に応じて牌の拾音や気合の音声なども変化させることもできる。

【0053】さらに、振牌の動きについても同様、手牌の左右何れかの端に持ってくる場合、手牌の横に置く場合、摸ってくるときにチラッと見る場合など各種あって、これらは、CPUキャラクター毎に異なっているし、麻雀対戦状況によっても異なっている。それらの条件に応じて画像出力するようにしている。

【0054】次に、CPUキャラクターの顔の表情とそのメッセージ(会話)や音声は、全て対戦状況項目番号の順に優先的に判定していき、条件を満たした項目でそれ以降の判定をやめ、その項目でのそのCPUキャラクター毎の会話データと顔表情データを同時にセットすると共に、必要であれば音声データをセットする。また、その項目での最終番号まで判定をしてきて、各条件を満たさない場合には、顔表情も会話も音声も全てスキップする。つまり、次のような条件項目に至ったときに、その条件項目毎に設定されているCPUキャラクター毎の顔の表情とそのメッセージ(会話)や音声などの変化項目が設定されて画像表示されることになる。

【0055】ただし、以下に示す例えば(14-1、通常顔)の「通常顔」とは、上記した感情値によって制御される顔の表情のことであり、14-1のナンバーは後

述べるメッセージ(会話)に対応している。(CPUキャラクター例:内田)

半荘開始時

1. 東家スタート(14-1、通常顔)
2. 南家スタート(14-2、通常顔)
3. 西家スタート(14-3、通常顔)
4. 北家スタート(14-4、通常顔)

半荘終了時

1. トップで半荘終了した(15-01、普通顔)
2. 最終持ち点が30000点以上でプレイヤーの最終持ち点よりも高い点で半荘終了した(15-02、普通顔)
3. 最終持ち点が30000点以上でプレイヤーの最終持ち点よりも低い点で半荘終了した(15-03、怒り顔)
4. 最終持ち点が30000点よりも低くて、プレイヤーの最終持ち点より高い点で半荘終了した(15-04、怒り顔)
5. 最終持ち点が30000点よりも低くて、プレイヤーの最終持ち点より低い点で半荘終了した(15-05、悲しみ顔)

立直(リーチ)をかける時

1. 追いかけ立直で、切る牌が危険牌(1-06、悲しみ顔)

2. 追いかけ立直 (1-05、普通顔)
 3. 6順目以内の立直 (1-01、怒り顔)
 4. ドラ切り立直 (1-04、悲しみ顔)
 5. 13順目以降の立直 (1-02、悲しみ顔)
 6. 上記条件1~5以外の立直 (1-03、普通顔)
- 立直 (リーチ) をかけられた時
1. 追いかけ立直をかけられた (2-02、悲しみ顔)
 2. 6順目以内の立直をかけられた (2-03、怒り顔)
 3. ドラ切り立直をかけられた (2-01、悲しみ顔)
 4. 自摸切り立直をかけられた (2-04、悲しみ顔)
 5. 上記条件1~4以外で、その時の自分の手牌が3向聴以上 (2-05、悲しみ顔)
 6. 上記条件1~4以外で、その時の自分の手牌が1~2向聴 (2-06、怒り顔)
 7. 上記条件1~4以外で、その時の自分の手牌が聴牌 (2-07、普通顔)
- ドラを暗カンした (3-02、笑い顔)
- ドラを暗カンされた (4-01、悲しみ顔)
- ドラを加カンした (3-03、普通顔)
- 鳴いた時 (明カン、ボン)
1. ドラを鳴いた (3-02、笑い顔)
 2. 一葉を削した (3-01、悲しみ顔)
 3. 役牌1鳴き (3-04、悲しみ顔)
- 鳴かれた時 (明カン、ボン)
1. ドラを鳴かれた、捨てたのがCPU自身のとき (4-01、悲しみ顔)
 2. ドラを鳴かれた、捨てたのがプレイヤーのとき (4-02、怒り顔)
 3. 一葉を削された (4-03、悲しみ顔)
- 以上の項目に当てはまらなかった時は、以下に示す鳴かれた時 (共通) → 鳴いた時 (チー)
1. 一葉を削した (3-01、悲しみ顔)
 2. ドラを含めて鳴いた (3-03、普通顔)
- 鳴かれた時 (チー)
1. 一葉を削された (4-03、悲しみ顔)
 2. ドラを含めてチーされた、捨てたのがCPU自身でその捨牌がドラの時 (4-01、悲しみ顔)
 3. ドラを含めてチーされた、捨てたのがプレイヤーでその捨牌がドラの時 (4-02、怒り顔)
- 以上の項目に当てはまらなかった時は、以下に示す鳴かれた時 (共通) → 鳴かれた時 (共通)
1. 鳴いた人が役牌1鳴きで6順目以内、持ち点2000点より低い時 (4-08、怒り顔)
 2. 鳴いた人が役牌1鳴きで6順目以内、さらにCPU自身も役牌をすでに鳴いている時 (4-05、怒り顔)
 3. 鳴いた人が役牌1鳴きで6順目以内の時 (4-04、普通顔)
 4. 鳴いた人が役牌1鳴きで7順目以降の時 (4-07、怒り顔)

5. 鳴いた人が1鳴きで役牌ではなく6順目以内の時 (4-08、悲しみ顔)
 6. 鳴いた人が1鳴きで役牌ではない字牌の鳴きで、7順目以降の時 (4-10、普通顔)
 7. 鳴いた人が1鳴きで役牌ではない鳴きで、7順目以降の時 (4-09、普通顔)
 8. 鳴いた人が2鳴きで役牌を含んで鳴いており、8順目以内の時 (4-11、怒り顔)
 9. 鳴いた人が3鳴きの時 (4-12、悲しみ顔)
 10. 鳴いた人が4鳴きの時 (4-13、悲しみ顔)
- CPU自身がカンをしてカンドラがのった時
1. CPU自身のカンドラが3枚以上のった (5-02、普通顔)
 2. CPU自身のカンドラが1枚以上のった (5-01、笑い顔)
 3. 他家のカンドラが3枚以上のった (5-04、悲しみ顔)
 4. 他家のカンドラが1枚以上のった (5-03、悲しみ顔)
- 他家がカンをしてカンドラがのった時
1. CPU自身のカンドラが3枚以上のった (6-02、普通顔)
 2. CPU自身のカンドラが1枚以上のった (6-01、普通顔)
 3. 他家のカンドラが3枚以上のった (6-04、怒り顔)
 4. 他家のカンドラが1枚以上のった (6-03、悲しみ顔)
- 牌を切る時
1. おりると決めた (7-01、悲しみ顔)
 2. おりていて、立直には安全牌だが照聴には危険牌を切る (7-03、悲しみ顔)
 3. おりていて危険牌を切る (7-02、悲しみ顔)
 4. おりていて、自摸時は最高危険牌で自摸切りではなく、安全牌を切る (7-05、怒り顔)
 5. おりていて、自摸時は最高危険牌で自摸切りではなく、立直には安全牌を切る (7-03、悲しみ顔)
 6. おりていて、自摸時は最高危険牌で自摸切りではない牌を切る (7-06、悲しみ顔)
 7. 最高危険牌を切る (7-04、怒り顔)
 8. 自摸時は最高危険牌で自摸切りではなく、安全牌を切る (7-03、怒り顔)
 9. 自摸時は最高危険牌で自摸切りではなく、立直に対して危険牌を切る (7-06、悲しみ顔)
- 和了時
1. 役満 (8-02、普通顔)
 2. 明ハネであがった (10-01、悲しみ顔)
 3. 南場以降でその和了によって持ち点が30000点以上になり、かつ新たにトップになった (8-01、笑い顔)

4. 3倍満、倍満 (8-03、笑い顔)
 5. 跳満 (8-04、笑い顔)
 6. 槍カン役を含めてあがった (10-02、笑い顔)
 7. 槍上開花を含めてあがった (8-06、笑い顔)
 8. 海底自摸した (8-07、普通顔)
 9. 河底榮和した (10-03、笑い顔)
 10. 一発役を含めて榮和した (10-04、普通顔)
 11. 一発役を含めて自摸和した (8-08、笑い顔)
 12. 高め、安めがある時の安め満貫の時 (8-09、悲しみ顔)
 13. 上記条件12以外の満貫の時 (8-05、笑い顔)
 14. 和了点の子の3200点以上で、高め、安めがある時の高めであがった時 (8-10、普通顔)
 15. 和了点の子の3200点以上で、高め、安めがある時の安めであがった時 (8-11、悲しみ顔)
 16. 和了点の子の3200点より低く立直をかけていて、裏ドラがのらなかった時 (8-15、悲しみ顔)
 17. 和了点の子の3200点より下で立直をかけておらず、和了点の子の1000点より上の時 (8-14、悲しみ顔)
 18. 和了点の子の3200点より下で立直をかけておらず、和了点の子の1000点以下の時 (8-16、悲しみ顔)
 19. 立直をかけていて立直後5順以上自摸切りして自摸和したか、または和了点の子の3200点以上自摸和した時 (8-12、悲しみ顔)
 20. 立直をかけていて立直後5順以上自摸切りして榮和したか、または和了点の子の3200点以上榮和した時 (8-05、笑い顔)
 21. 立直をかけていて立直後5順以上自摸切りしてあがった以外の状況で自摸和したか、または和了点の子の3200点以上自摸和した時 (8-13、悲しみ顔)
 22. 立直をかけていて立直後5順以上自摸切りしてあがった以外の状況で榮和したか、または和了点の子の3200点以上榮和した時 (10-05、普通顔)
- 和了された時 (CPU自身の得点に影響がある時)
1. 南場以降でトップを逆転された時 (9-01、悲しみ顔)
 2. 満貫以上自摸和された (9-02、悲しみ顔)
 3. 満貫以上榮和された (11-01、悲しみ顔)
 4. CPU自身が立直をかけていたのに自摸和された (9-03、悲しみ顔)
 5. CPU自身が立直をかけていたのに榮和された (11-02、悲しみ顔)
 6. 和了点の子の1000点以下を和了され、CPU自身は親だった (12-05、悲しみ顔)
 7. 和了点の子の1000点以下を和了され、CPU自身は子だった (11-04、悲しみ顔)
 8. 上記条件1~7以外の状況で自摸和された (9-0

4. 怒り顔)
 9. 上記条件1~7以外の状況で榮和された (11-03、悲しみ顔)
- 和了された時 (CPU自身の得点に影響がない時)
1. 頭ハネされた (12-02、悲しみ顔)
 2. 南場以降でトップを逆転された時 (12-01、悲しみ顔)
 3. 和了点の子の7700点以上であがられた (12-03、悲しみ顔)
 4. 和了点の子の3200点より下でCPU自身の満を繰られた時 (12-05、悲しみ顔)
 5. 上記条件1~4以外の状況であがられた (12-04、悲しみ顔)
- 流局時
1. 満貫以上聴牌して流局した (13-01、悲しみ顔)
 2. 立直をかけていて流局した (13-02、悲しみ顔)
 3. 聴牌して立直をかけておらず、和了点の子の1000点以下の手で流局した (13-04、悲しみ顔)
 4. 聴牌して立直をかけておらず、和了点の子の3200点以上の手で流局した (13-04、悲しみ顔)
 5. 上記条件1~4以外の状況で聴牌して流局した (13-05、怒り顔)
 6. 不聴であったがおりている状況で流局した (13-06、悲しみ顔)
 7. 上記条件6以外の状況で不聴で流局した (13-07、悲しみ顔)
- 九種ヤオ九牌倒牌による流局時
1. 倒牌したのがCPU自身であった時 (13-08、悲しみ顔)
 2. 倒牌したのがプレイヤーであった時 (13-09、普通顔)
- 三家和による流局時
1. CPU自身が和了者のうちの1人であった時 (13-10、怒り顔)
 2. CPU自身が振り込んだ (13-11、悲しみ顔)
- 四開カンによる流局時
1. 最後にカンしたのがそのCPU自身であった時 (13-12、悲しみ顔)
 2. 最後にカンしたのがプレイヤーであった時 (13-12、悲しみ顔)
- 四風子連打による流局時
1. 最後の風牌がそのCPU自身であった時 (13-13、普通顔)
 2. 最後の風牌がプレイヤーであった時 (13-15、怒り顔)
- 四家立直による流局時
1. 最後の立直者がそのCPU自身であった時 (13-14、普通顔)

2. 最後の立直者がプレイヤーであった時 (13-15, 怒り顔)

次に、CPUキャラクター自身の自摸番の時に自動的に
行う会話 (メッセージ) および音声について説明する。

ただし、以下に示す例えば (T-33, 悲しみ顔) の
「悲しみ顔」とは、CPUキャラクターの顔の表情を、
笑い顔、普通顔、悲しみ顔および怒り顔の4種類のうち
悲しみ顔の表情のことであり、T-33は後述する調子
メッセージ (会話) に対応している。また、例えば (笑
い声) や (驚き声) はCPUキャラクター毎の声であっ
て、(笑い声) や (驚き声) はその状況に応じて、(笑
い声) であれば例えば「クスマ」や「ワッハハ」、「フ
フ」など、(驚き声) であれば例えば「ギョー」や「ウ
ー」、「ヘー」など少なくとも一人4種類程度設定さ
れている。

【0056】1. おりていて、おりきれると判断した時
(T-33, 悲しみ顔)

2. おりていて、まだ、おりきれると判断したわけでは
ないが、安全時が2枚以上ある時 (笑い声)

3. CPUキャラクター自身が立直をかけていて、立直
後自摸切り牌数が7牌である。(T-22, 普通顔)

4. CPUキャラクター自身が立直をかけていて、立直
後自摸切り牌数が8牌である。(驚き声)

5. CPUキャラクター自身が立直をかけていて、立直
後自摸切り牌数が6牌である。(驚き声)

6. CPUキャラクター自身が立直をかけていて、立直
後自摸切り牌数が4牌である。(驚き声)

7. CPUキャラクター自身が立直をかけていて、立直
後自摸切り牌数が3牌である。(T-24, 怒り顔)

8. 誰か一人が立直をかけているが、CPUキャラク
ター自身はおりていなくて、また、CPUキャラクター自
身は立直をかけていなくて残り自摸があり、立直の一
発目が誰にもなく、3向聴になった時 (T-26, 笑
い顔)

9. 誰か一人が立直をかけているが、CPUキャラク
ター自身はおりていなくて、また、CPUキャラクター自
身は立直をかけていなくて残り自摸があり、立直の一
発目が誰にもなく、3向聴になった時でかつ上記条件8
の後 (笑い声)

10. 誰か一人が立直をかけているが、CPUキャラク
ター自身はおりていなくて、また、CPUキャラクター
自身は立直をかけていなくて残り自摸があり、立直の一
発目が誰にもなく、2向聴になった時 (T-27, 悲し
み顔)

11. 誰か一人が立直をかけているが、CPUキャラク
ター自身はおりていなくて、また、CPUキャラクター
自身は立直をかけていなくて残り自摸があり、立直の一
発目が誰にもなく、2向聴になった時でかつ上記条件1
0の後 (笑い声)

12. 誰か一人が立直をかけているが、CPUキャラク

ター自身はおりていなくて、また、CPUキャラクター
自身は立直をかけていなくて残り自摸があり、立直の一
発目が誰にもなく、1向聴になった時 (T-28, 怒り
顔)

13. 誰か一人が立直をかけているが、CPUキャラク
ター自身はおりていなくて、また、CPUキャラクター
自身は立直をかけていなくて残り自摸があり、立直の一
発目が誰にもなく、1向聴になった時でかつ上記条件1
2の後 (笑い声)

14. 誰も立直をかけておらず、また、CPUキャラク
ター自身はおりていなくて、CPUキャラクター自身の
あがり目がほぼ無くなった時 (驚き声)

15. 誰も立直をかけておらず、また、CPUキャラク
ター自身はおりていなくて、CPUキャラクター自身の
あがり目が無くなった時 (T-16, 悲しみ顔)

16. 誰も立直をかけておらず、また、CPUキャラク
ター自身はおりていなくて、配牌1順目で2向聴か3向
聴の時 (T-02, 普通顔)

17. 誰も立直をかけておらず、また、CPUキャラク
ター自身はおりていなくて、配牌1順目で2向聴か3向
聴の時、上記条件16の後 (笑い声)

18. 誰も立直をかけておらず、また、CPUキャラク
ター自身はおりていなくて、配牌1順目で1向聴の時
(T-01, 普通顔)

19. 誰も立直をかけておらず、また、CPUキャラク
ター自身はおりていなくて、配牌1順目で1向聴の時
で、上記条件18の後 (笑い声)

20. 誰も立直をかけておらず、また、CPUキャラク
ター自身はおりていなくて、配牌1順目ではなく、自摸
の流れが悪い時で4向聴以上 (T-10, 怒り顔)

21. 誰も立直をかけておらず、また、CPUキャラク
ター自身はおりていなくて、配牌1順目ではなく、自摸
の流れが悪い時で2向聴か3向聴の時 (T-09, 悲し
み顔)

22. 誰も立直をかけておらず、また、CPUキャラク
ター自身はおりていなくて、配牌1順目ではなく、自摸
の流れが悪い時で1向聴の時 (T-08, 悲しみ顔)

23. すでに上記条件20~22のどれかが起こって
おり、もう一度、同じ条件が起こった時 (うめき声)

24. 誰も立直をかけておらず、また、CPUキャラク
ター自身はおりていなくて、配牌1順目ではなく、残り
自摸数を考慮した時にCPUキャラクター自身のあがり
目が薄い時 (T-09, 悲しみ顔)

25. 誰も立直をかけておらず、また、CPUキャラク
ター自身はおりていなくて、配牌1順目ではなく、自摸
の流れが良い時で3向聴か2向聴の時 (T-16, 普通
顔)

26. 手牌が3向聴で条件25が発生した時は2向聴
で、または、手牌が2向聴で条件25が発生する時は3
向聴の時 (笑い声)

27. 誰も立直をかけておらず、また、CPUキャラクター自身はおりにていなくて、配牌1順目ではなく、自摸の流れが良い時で1向聴の時 (T-14、悲しみ顔)

28. すでに条件27が起こっており、もう一度同じ条件が発生した時 (笑い顔)

次に、プレイヤー自身の自摸番の時に、任意のCPUキャラクターに会話(メッセージ)を求めた場合に、その状況およびそのCPUキャラクター毎に会話セット(メッセージ)をセットすることについて説明する。

【0057】プレイヤー自身の自摸番の時に、プレイヤーが任意のCPUキャラクターに会話(メッセージ)を求めた場合にも、これまでの場合と同様に、以下の各状況を用いた番号の条件から優先的に判定していき、条件を満たした条件項目でそれ以降の判定をやめ、その条件項目での各CPUキャラクター毎の会話データと顔表情データを同時にセットするようになっている。(CPUキャラクター例:内田)

1. おりにていて、おりきれると判断した時 (T-33、悲しみ顔)
2. おりにていて、まだ、おりきれると判断したわけではないが、安全牌が2枚以上ある時 (T-34、普通顔)
3. おりにていて、おりきれると判断したわけではなく、安全牌も1枚しかないが、比較的安全そうな牌を安全牌に含めたらおりきれる時 (T-35、普通顔)
4. おりにていて、おりきれると判断したわけではなく、安全牌は1枚もないが、比較的安全そうな牌を安全牌に含めたらおりきれる時 (T-36、悲しみ顔)
5. おりにていて、おりきれると判断したわけではなく、安全牌も1枚しなくて、比較的安全そうな牌を持っている時 (T-37、悲しみ顔)
6. 上記条件1~5でありていている時 (T-38、悲しみ顔)
7. CPUキャラクター自身が立直をかけていて、一発目である時 (T-20、普通顔)
8. CPUキャラクター自身が立直をかけていて、立直後自摸切り牌数が7牌である。(T-22、普通顔)
9. CPUキャラクター自身が立直をかけていて、立直後自摸切り牌数が5牌か6牌である。(T-23、怒り顔)
10. CPUキャラクター自身が立直をかけていて、立直後自摸切り牌数が3牌か4牌である。(T-24、怒り顔)
11. CPUキャラクター自身が立直をかけていて、上記条件7~10以外の時 (T-21、普通顔)
12. 誰か一人が立直をかけているが、CPUキャラクター自身はおりにていなくて、また、CPUキャラクター自身は立直をかけていなくて、残り自摸が無い時 (T-30、悲しみ顔)
13. 誰か一人が立直をかけているが、CPUキャラクター自身はおりにていなくて、また、CPUキャラクター

自身は立直をかけていなくて、残り自摸があり、立直の一発目が誰にある (T-25、普通顔)

14. 誰か一人が立直をかけているが、CPUキャラクター自身はおりにていなくて、また、CPUキャラクター自身は立直をかけていなくて残り自摸があり、立直の一発目が誰にもなく、また、誰か一人の立直後自摸切り数が4順以内で、3向聴以上の時 (T-26、笑い顔)

15. 誰か一人が立直をかけているが、CPUキャラクター自身はおりにていなくて、CPUキャラクター自身は立直をかけていなくて残り自摸があり、立直の一発目が誰にもなく、また、誰か一人の立直後自摸切り数が4順以内で、2向聴の時 (T-27、悲しみ顔)

16. 誰か一人が立直をかけているが、CPUキャラクター自身はおりにていなくて、CPUキャラクター自身は立直をかけていなくて残り自摸があり、立直の一発目が誰にもなく、また、誰か一人の立直後自摸切り数が4順以内で、1向聴の時 (T-28、怒り顔)

17. 誰か一人が立直をかけているが、CPUキャラクター自身はおりにていなくて、CPUキャラクター自身は立直をかけていなくて残り自摸があり、立直の一発目が誰にもなく、また、誰か一人の立直後自摸切り数が4順以内で、聴牌の時 (T-29、普通顔)

18. 誰か一人が立直をかけているが、CPUキャラクター自身はおりにていなくて、CPUキャラクター自身は立直をかけていなくて残り自摸があり、立直の一発目が誰にもなく、また、立直者全員の立直後自摸切り数が5順以上で、2向聴以上の時 (T-30、悲しみ顔)

19. 誰か一人が立直をかけているが、CPUキャラクター自身はおりにていなくて、CPUキャラクター自身は立直をかけていなくて残り自摸があり、立直の一発目が誰にもなく、また、立直者全員の立直後自摸切り数が5順以上で、1向聴の時 (T-31、普通顔)

20. 誰か一人が立直をかけているが、CPUキャラクター自身はおりにていなくて、CPUキャラクター自身は立直をかけていなくて残り自摸があり、立直の一発目が誰にもなく、また、立直者全員の立直後自摸切り数が5順以上で、聴牌の時 (T-32、怒り顔)

21. 誰も立直をかけておらず、また、CPUキャラクター自身はおりにていなくて、CPUキャラクター自身のあがり目がほぼ無くなった時 (T-05、悲しみ顔)

22. 誰も立直をかけておらず、また、CPUキャラクター自身はおりにていなくて、CPUキャラクター自身のあがり目が無くなった時 (T-06、悲しみ顔)

23. 誰も立直をかけておらず、また、CPUキャラクター自身はおりにていなくて、配牌1順目で5向聴以上の時 (T-04、怒り顔)

24. 誰も立直をかけておらず、また、CPUキャラクター自身はおりにていなくて、配牌1順目で4向聴の時 (T-03、悲しみ顔)

25. 誰も立直をかけておらず、また、CPUキャラク

ター自身はおりにていなくて、配牌1順目で2向聴か3向聴の時 (T-02、普通顔)

26. 誰も立直をかけておらず、また、CPUキャラクター自身はおりにていなくて、配牌1順目で聴牌か1向聴の時 (T-01、普通顔)

27. 誰も立直をかけておらず、また、CPUキャラクター自身はおりにていなくて、配牌1順目ではなく、自摸の流れが悪い時で4向聴以上の時 (T-10、怒り顔)

28. 誰も立直をかけておらず、また、CPUキャラクター自身はおりにていなくて、配牌1順目ではなく、自摸の流れが悪い時で2向聴か3向聴の時 (T-09、悲しみ顔)

29. 誰も立直をかけておらず、また、CPUキャラクター自身はおりにていなくて、配牌1順目ではなく、自摸の流れが悪い時で1向聴の時 (T-08、悲しみ顔)

30. 誰も立直をかけておらず、また、CPUキャラクター自身はおりにていなくて、配牌1順目ではなく、自摸の流れが悪い時で聴牌の時 (T-07、悲しみ顔)

31. 誰も立直をかけておらず、また、CPUキャラクター自身はおりにていなくて、配牌1順目ではなく、2向聴以内でまわしうちをしている時 (T-12、普通顔)

32. 誰も立直をかけておらず、また、CPUキャラクター自身はおりにていなくて、配牌1順目ではなく、残り自摸数を考慮した時にCPUキャラクター自身のあがり目が薄い時 (T-11、悲しみ顔)

33. 誰も立直をかけておらず、また、CPUキャラクター自身はおりにていなくて、配牌1順目ではなく、残り自摸数を考慮した時にCPUキャラクター自身のあがり目が薄い時 (T-13、笑い顔)

34. 誰も立直をかけておらず、また、CPUキャラクター自身はおりにていなくて、配牌1順目ではなく、自摸の流れが良い時で聴牌か1向聴の時 (T-14、悲しみ顔)

35. 誰も立直をかけておらず、また、CPUキャラクター自身はおりにていなくて、配牌1順目ではなく、自摸の流れが良い時で3向聴か2向聴の時 (T-16、普通顔)

36. 誰も立直をかけておらず、また、CPUキャラクター自身はおりにていなくて、配牌1順目ではなく、自摸の流れが良い時で4向聴の時 (T-17、悲しみ顔)

37. 誰も立直をかけておらず、また、CPUキャラクター自身はおりにていなくて、配牌1順目ではなく、自摸の流れが良い時で5向聴以上の時 (T-19、悲しみ顔)

38. 誰も立直をかけておらず、また、CPUキャラクター自身はおりにていなくて、配牌1順目ではなく、自摸の流れが普通の時で聴牌の時 (T-14、悲しみ顔)

39. 誰も立直をかけておらず、また、CPUキャラクター自身はおりにていなくて、配牌1順目ではなく、自摸の流れが普通の時で1向聴の時 (T-15、普通顔)

40. 誰も立直をかけておらず、また、CPUキャラクター自身はおりにていなくて、配牌1順目ではなく、自摸の流れが普通の時で2向聴~4向聴の時 (T-17、悲しみ顔)

41. 誰も立直をかけておらず、また、CPUキャラクター自身はおりにていなくて、配牌1順目ではなく、自摸の流れが普通だが5向聴以上の時 (T-19、悲しみ顔)

42. 誰も立直をかけておらず、また、CPUキャラクター自身はおりにていなくて、配牌1順目ではなく、自摸の流れがあまり良くない時で聴牌の時 (T-15、普通顔)

43. 誰も立直をかけておらず、また、CPUキャラクター自身はおりにていなくて、配牌1順目ではなく、自摸の流れがあまり良くない時で1向聴の時 (T-17、悲しみ顔)

44. 誰も立直をかけておらず、また、CPUキャラクター自身はおりにていなくて、配牌1順目ではなく、自摸の流れがあまり良くない時で2向聴~4向聴の時 (T-18、悲しみ顔)

45. 誰も立直をかけておらず、また、CPUキャラクター自身はおりにていなくて、配牌1順目ではなく、自摸の流れがあまり良くない時でかつ5向聴以上の時 (T-19、悲しみ顔)

ここで、会話(メッセージ)の内容については、その状況およびそのCPUキャラクター毎に会話(メッセージ)をセットするように構成しているが、その具体例を、CPUキャラクターが内田の場合を一例に説明する。

【0058】まずは、対局中の会話(メッセージ)の具体例としては、

1-01:「ここが・・・勝負なの・・・」

1-02:「遅くなんて・・・ないよね・・・」

1-03:「ここでしたいの・・・勝負」

1-04:「これ捨てても・・・勝ちたいの」

1-05:「逃がさない・・・」

1-01:「運るよわ・・・この一手」

2-01:「・・・要らないのね、それ・・・」

2-02:「関係ないの・・・今のワタシには・・・」

2-03:「・・・ほやい、な」

2-04:「も・・・おりよ」

2-05:「ダメ・・・なの」

2-06:「まだ・・・負けない・・・」

2-07:「・・・ここから・・・よ」

3-01:「一発のこと・・・ゴメン」

3-02:「・・・いける」

3-03:「ここは、これで・・・いいの」

3-04:「お願い・・・このまま」

4-01:「・・・怖く、ないから・・・」

4-02:「切るから・・・そんなの・・・」

- 4-03:「壊された・・・一発・・・」
4-04:「・・・それだけなら、まだ・・・」
4-05:「来たのね・・・でもワタシが先・・・」
4-06:「・・・もう、帰りたいの」
4-07:「・・・なに、狙いは・・・」
4-08:「ワタシなら・・・どうしたろう」
4-09:「少しだけ・・・少しだけ見えた」
4-10:「麻雀って・・・生き方よ、そのヒトの・・・」
4-11:「・・・麻雀って、そんなものなの」
4-12:「麻雀って・・・打っているヒトを・・・映す」
4-13:「・・・麻雀って、こんなじゃない」
5-01:「このカン、正しかったのか・・・終わってみれば判る・・・」
5-02:「意味は・・・あったのね」
5-03:「これ・・・良くないカンだったの」
5-04:「・・・しまった、ワタシのせい」
6-01:「これが・・・ワタシの・・・進むべき道なの」
6-02:「・・・これは、なにかの・・・前触れ」
6-03:「それが、・・・あなた自身の運」
6-04:「・・・それでも・・・勝負は、捨てない」
7-01:「・・・まだ、続けなきゃいけないの」
7-02:「・・・通るかな・・・ここで」
7-03:「一手は・・・どうにか」
7-04:「捨てるよ・・・ここは」
7-05:「これは・・・切っちゃダメ」
7-06:「・・・通るの、・・・こんなどころで・・・」
8-01:「これなら・・・いける」
8-02:「・・・あと何回、一生のうちでアガれるかしら」
8-03:「アガれた・・・狙って」
8-04:「よし・・・ハネれた」
8-05:「よかった・・・考えた通りになって・・・」
8-06:「まさか・・・ここまでアタラなかったこと・・・」
8-07:「不思議なくらい・・・なに、狙いは・・・」
8-08:「当たった・・・楽しみが」
8-09:「・・・逆サイドだったら・・・」
8-10:「なんとか・・・高目か・・・」
8-11:「・・・低目、か」
8-12:「・・・普通なら、とっくにアタられてる・・・」
8-13:「ここが・・・ワタシの限界・・・なの」
8-14:「正しかったの・・・このアガリ」
8-15:「これしか・・・今は考えられない」
8-16:「ゴメン・・・しかたなかったの」
9-01:「しまった・・・今で転落」
9-02:「でも、それ・・・いいアガリ」
9-03:「勝てない・・・リーチしたのに」
9-04:「次は・・・負けないから」
10-01:「ゴメン、それ・・・ワタシの」
10-02:「それ・・・アタリなの」
10-03:「来た・・・やっとな最後に」
10-04:「一発・・・」
10-05:「待ったよ・・・長いこと」
10-06:「ここで・・・アガります」
11-01:「うそ・・・これなの」
11-02:「しかたない、か」
11-03:「うそ・・・これなの」
11-04:「小さいとは・・・思ってた」
12-01:「悲しい・・・こんなトップ勝ち」
12-02:「アガってたのに・・・な」
12-03:「ホントは・・・危なかったのね」
12-04:「ワタシもう・・・アガれないのね」
12-05:「ダメね・・・もっと親を大事にしなきゃ」
13-01:「ダメね・・・このクラスがアガれないと・・・」
13-02:「危険を冒してまで・・・何してたワタシ」
13-03:「ダメか・・・無茶してたの」
13-04:「ダメか・・・無茶してたの」
13-05:「無謀だったの」
13-06:「どうにもならない・・・ことだってある・・・」
13-07:「どうにもならない・・・ことだってある・・・」
13-08:「ゴメン・・・流しなくなった・・・」
13-09:「しないの・・・園土」
13-10:「都合よすぎる・・・」
13-11:「この上もなく・・・負けた気分・・・」
13-12:「ゴメン・・・流させて」
13-13:「同じ風を・・・分け持っていたことの偶然・・・」
13-14:「これは・・・ドローなのね」
13-15:「そっちの都合で・・・流さないで」
14-01:「賭けるから・・・この出振に」
14-02:「すぐに親は・・・もらうから」
14-03:「ワタシらしく・・・打つだけ・・・」
14-04:「北は・・・ワタシ好きだから」
15-01:「今回は・・・満足してイイの」
15-02:「今日みたいな打ち方・・・すればイイの」
15-03:「負けないから・・・今度は」
15-04:「負けないから・・・今度は」
15-05:「悔しくて・・・胸が痛い」
次に、調子の会話（メッセージ）の具体例としては、

- T-01: 「進めましょ・・・早く」
- T-02: 「できるわ・・・行きましょ」
- T-03: 「できるわ・・・気にしないで」
- T-04: 「やれるは・・・絶対」
- T-05: 「ありが・・・見えない」
- T-06: 「あっ・・・ダメ」
- T-07: 「もう少し・・・もう少しなの」
- T-08: 「進めない・・・」
- T-09: 「来ない・・・なぜ」
- T-10: 「負けない・・・見てて」
- T-11: 「無理かも・・・しれない」
- T-12: 「なに・・・早くしてくれないか」
- T-13: 「ワタシ、勝つから・・・覚えてて」
- T-14: 「ここからよ・・・飛来って」
- T-15: 「見えるわ・・・あなたの手」
- T-16: 「なんか・・・ドキドキする」
- T-17: 「全然だから・・・気にしないで」
- T-18: 「見えないわ・・・あなたの手」
- T-19: 「これも・・・飛来」
- T-20: 「まだ一発目よ、できるなら・・・逃げないで・・・戦って」
- T-21: 「ここは・・・アガりたいの」
- T-22: 「ワタシ・・・アガるから」
- T-23: 「ワタシ・・・負けないから」
- T-24: 「・・・ワタシまだ・・・あきらめてないから」
- T-25: 「今、まだ・・・一発目よ」
- T-26: 「さあ・・・続けましょ」
- T-27: 「うん・・・続けましょ」
- T-28: 「あきらめない」
- T-29: 「・・・追いついた」
- T-30: 「押って・・・集中したいの」
- T-31: 「感ってて・・・もう少しなの」
- T-32: 「ワタシ・・・オリエないから」
- T-33: 「勝て・・・ない」
- T-34: 「涙込みは・・・期待しないで」
- T-35: 「ワタシ・・・振り込まないから」
- T-36: 「あなたは・・・続けられるのね」
- T-37: 「ワタシ・・・続けられない」
- T-38: 「負けたく・・・ない」

また、ここで、記録媒体5に記録されたゲームデータによって制御されるCPU6を含めた制御部20の他の制御について、以下に説明する。

【0059】制御部20は、ゲームデータにより制御されて、臨場感を得て相手の手牌内容を総合的に予測するべく、対戦キャラクター毎の対戦状況に応じた顔の表情、顔の動き、メッセージおよび牌引き及び牌捨て動作の可変項目になるように画像データや音声データを得、これらの画像データや音声データを画像表示および/または音声出力させるようになっておくと共に、ボン、チ

ーおよびカンなどの鳴き牌時に、その鳴き牌の表示位置に重ならないように鳴き牌の表示位置とは反対側にCPUキャラクター毎の顔表情の表示域を順次移動させて表示させるようになっている。

【0060】また、制御部20は、ゲームデータにより制御されて、プレイヤーの見落とすことなく的確にプレイ可能なように、例えばカンなどの必要時に、そのアイコン表示が拡大されて、プレイヤーにとって可能なコマンド（例えばカン）が明るくなってはつきりと見えるように制御が為されるようになっている。

【0061】さらに、制御部20は、ゲームデータにより制御されて、ガイダンス機能や、的確なプレイとすべく、プレイヤーの検牌が対戦CPUキャラクター毎の当たり牌となる危険度を段階的に表示するようになっている。

【0062】上記構成により、以下、その動作を説明する。

【0063】まず、電源スイッチ（図示せず）がオンされ、麻雀ゲーム装置1に電源が投入される。このとき、CPU6は、記録媒体5に記録されているオペレーティングシステムに基づいて、記録媒体5から画像データ、音声データおよびゲームプログラムデータなどを読み出す。この読み出された画像データ、音声データおよびゲームプログラムデータの一部または全部は、RAM8上に保持されることになる。以降、CPU6は、RAM8上に記憶されているゲームプログラムデータや、ゲームプレイヤーが、コントローラ16を介して指示する内容に基づいて、ゲームを進行させるように制御する。即ち、CPU6は、コントローラ16を介してゲームプレイヤーから指示（摸牌、捨牌、リーチ牌、ボン、チー、カンおよびロンなど）される指示内容に基づいて、適宜、描画や音声出力のためのタスクとしてのコマンドを生成する。信号処理プロセッサ11は、上記コマンドに基づいて2次元平面上におけるキャラクタの位置などの計算、光源計算など、音声データの生成、加工処理を行う。

【0064】続いて、画像描画処理プロセッサ12は、上記計算結果に基づいて、RAM8上に描画すべき画像データの書き込み処理などを行う。RAM8に書き込まれた画像データは、インターフェース回路13を介してD/Aコンバータ17に供給され、ここでアナログ映像信号に変換された後にテレビジョンモニタ2に供給され、その画面上に画像として表示される。一方、信号処理プロセッサ11から出力された音声データは、インターフェース回路14を介してD/Aコンバータ18に供給され、ここで、アナログ音声信号に変換された後に、プリアンプを介してスピーカ4から音声として出力されることになる。これらによって、プレイヤーの手牌および捨牌内容と、対戦キャラクターの捨牌内容および顔の表情が各所定位置に表示され、これらのプレイヤーおよび対戦キャラクターが順に摸牌および捨牌などの牌

引き及び牌捨て動作を繰り返すことにより麻雀ゲームが進行することになる。図7は本発明の麻雀ゲーム装置によるCPUキャラクター毎の対戦状況に応じた顔表情変化などの変化項目制御ルーチンを示すフローチャートである。

【0065】図7に示すように、まず、ステップST1で、制御部20はゲームデータにより制御されて、対局開始配牌前にCPUキャラクター毎に感情値初期セットを実行する。次に、ステップST2で、制御部20はゲームデータにより制御されて、対局中、その麻雀対戦状況に応じた条件によって感情値がCPUキャラクター毎にセットされる。さらに、ステップST3で、制御部20はゲームデータにより制御されて、CPUキャラクター毎にセットされた感情値と、その麻雀対戦状況に応じた条件とにより、または何れかを優先させて、CPUキャラクター毎の顔の表情などの可変項目をセットし、これをテレビジョンモニタ2にゲーム画像として出力させるように制御する。つまり、通常は、感情値に基づいたCPUキャラクター毎の顔表情などの可変項目を通常セットとしているが、プレイヤーの自摸時に任意のCPUキャラクターに会話を求めたり、配牌を見て一瞬笑い顔になるなどの優先特殊条件に至った場合や、設定されている対戦状況に至った場合などには上記通常セットに優先してCPUキャラクター毎の顔表情やメッセージなどの可変項目をセットするようになっている。その後、ステップST4で、半荘終了かどうかを判定し、終了するまで上記ステップST1～ST3を繰り返す。終了した時点で、この麻雀ゲームを終了する。この場合の可変項目とは、CPUキャラクター毎の顔表情の他に、対戦CPUキャラクター毎の対戦状況に応じた顔の動き、メッセージおよび牌引き及び牌捨て動作、さらには音声などがある。

【0066】例えばCPUキャラクター毎の顔表情の表示画面例としては、図3～図6の内田（前面の女性）のように普通顔、笑い顔、悲しみ顔および怒り顔の4種類がある。また、例えばCPUキャラクター毎の会話（メッセージ）の表示画面例としては、図2にはボーン時のCPUキャラクターのメッセージ表示画面を示し、図8には対局開始時の、良くも悪くもない普通の配牌におけるメッセージ表示画面を示し、図9には危険牌を切る時のCPUキャラクターのメッセージ表示画面を示し、図10にはイーシャンテン時のCPUキャラクターのメッセージ表示画面を示し、図11にはリーチ時のCPUキャラクターのメッセージ表示画面を示している。

【0067】図12は図2のステップST1の感情値初期セット動作を示す制御ルーチンフローチャートである。

【0068】図12に示すように、CPUキャラクター例を内田（女性）として、まず、ステップST11で、制御部20はゲームデータにより制御されて、CPUキ

ャクター別基本感情値初期セット（128点）を実行する。次に、ステップST12で、制御部20はゲームデータにより制御されて、現在の持ち点による感情値セットを実行する。例えば、スタート持ち点30000点のときに30400点で感情値+1点、29600点で感情値-1点となる。さらに、ステップST13で、制御部20はゲームデータにより制御されて、前局での状況による感情値セットを実行する。例えば、和了していれば+3点で、さらに満貫以上を和了していれば+3点などである。以上により対局開始配牌前の感情値初期セット動作が終了する。

【0069】図13は図7のステップST3における任意のCPUキャラクターに会話（メッセージ）を求めた場合のCPUキャラクター毎の顔表情と会話（メッセージ）、音声の制御ルーチンフローチャートである。

【0070】図13に示すように、まず、ステップST21で、制御部20はゲームデータにより制御されて、対局中、その対戦状況によりCPUキャラクター毎の顔表情と会話（メッセージ）、音声などの変化項目セットを実行する。次に、ステップST22で、制御部20はゲームデータにより制御されて、対局中、プレイヤー自身の自摸番の時に、任意のCPUキャラクターに会話（メッセージ）を求めたかどうかを判断する。ステップST22で会話（メッセージ）を求めたと判断した場合には、ステップST23で、制御部20はゲームデータにより制御されて、その現時点での対戦状況によりCPUキャラクター毎の顔表情やメッセージなどの変化項目をセットする。また、ステップST22で会話（メッセージ）を求めていないと判断した場合、または、ステップST23の終了後には、ステップST24で、制御部20はゲームデータにより制御されて、半荘終了かどうかを判定し、終了するまで上記ステップST1～ST3を繰り返す。終了した時点で、この麻雀ゲームを終了する。この可変項目とは、対戦キャラクター毎の対戦状況に応じた顔の表情、顔の動き、メッセージおよび音声の他に、牌引き及び牌捨て動作などもある。

【0071】したがって、CPU6は、記録媒体5から読み出された条件データ、画像データ、音声データおよびゲームプログラムデータをRAM8に保持させ、対戦キャラクター毎で、かつ、顔と変化する対戦キャラクター毎の対戦状況による条件データ毎に顔の表情、顔の動き、メッセージおよび牌引き及び牌捨て動作などの画像データおよびまたは音声データを選択して、テレビジョンモニタ2やスピーカ4にゲーム画像や音声出力として出力させるように制御するため、麻雀ゲーム特有の対戦キャラクターの人間性や癖、心理が顔の表情や何げないメッセージなどを通じて判断され、より臨場感のある麻雀ゲームを楽しむことができると共に、それらを含んで対戦キャラクターの手牌内容やその完成度を総合的に予測して捨牌を考慮しつつプレイするという本来の麻

後の楽しみを得ることができる。

【0072】また、対戦キャラクター毎に対戦状況に応じた感情値合計に応じたその時点での顔の表情を画像表示するため、麻雀対戦状況の流れに応じた対戦キャラクター毎の表情が表示され、プレイヤーは臨場感を得ると共に、その表情に応じて麻雀対戦状況が判断可能となつて、対戦キャラクター毎の麻雀対戦状況を考慮しつつプレイするという本来の麻雀の楽しみを得ることができる。

【0073】さらに、この感情値合計による顔表情の選択に優先して、特殊状況に応じた顔の表情をその時々で表示するので、その時々に対戦キャラクター毎の感情が表れて、より臨場感を得ることができる。

【0074】さらに、対戦キャラクター毎の対戦状況の各条件のうち優先順位の高い条件に対応した可愛項目、つまり顔の表情や顔の動き、メッセージ、牌引き及び牌捨て動作になるように画像および/または音声出力するため、麻雀対戦状況の時々に応じた対戦キャラクター毎の様子が表われ、プレイヤーはより臨場感を得ると共に、その対戦キャラクター毎の様子に応じて麻雀対戦状況が判断可能となつて、対戦キャラクター毎の麻雀対戦状況を考慮しつつプレイするという本来の麻雀の一層の楽しみを得ることができる。

【0075】さらに、表示される対戦キャラクター毎の顔表情に対応するようにメッセージが出力されるため、麻雀対戦状況に応じた顔表情およびメッセージとなつて、対戦キャラクターの人間性や性格などがより表れて、より臨場感を得ることができる。

【0076】さらに、プレイヤーの自演時に対戦キャラクターを指定してメッセージを出力表示させるため、気になる対戦キャラクターに対して対戦状況判断のヒントが得られて、そのヒントを考慮しつつプレイするという本来の麻雀の一層の楽しみを得ることができる。

【0077】さらに、対戦状況による各条件や、顔の表情、顔の動き、牌引き及び牌捨て動作さらにはメッセージおよび音声などの各データを、よりリアルになるように細分化すれば、より臨場感に富む画像を畫ることができると共に、その画像に応じた麻雀対戦状況がより判断可能となつて、対戦キャラクター毎の麻雀対戦状況を考慮しつつプレイするという本来の麻雀の楽しみを得ることができる。

【0078】次に、ボン、チーおよびカンなどの鳴き牌時における顔表情の表示域を順次移動させる制御について説明する。

【0079】図14は、ボン、チーおよびカンなどの鳴き牌時における顔表情の表示域移動動作を示す制御ルーチンフローチャートである。

【0080】図14に示すように、まず、ステップST31で、制御部20はゲームデータにより制御されて、対局中、鳴き牌があるかどうかを判断する。次に、ス

テップST31で鳴き牌があった場合、ステップST32で、制御部20はゲームデータにより制御されて、鳴き牌があったCPUキャラクターの顔表情の表示域を鳴き牌が隠れないように鳴き牌表示域とは反対側に、その表示位置フラグを+1とするように制御する。また、ステップST31で鳴き牌がなかった場合にはステップST31の鳴き牌の有無判定を繰り返す。さらに、ステップST33で、制御部20はゲームデータにより制御されて、CPUキャラクターの顔表情の表示域の新たな表示位置データを取得して、鳴き牌表示域とは反対側にずらせて、鳴き牌が隠れないように顔表情を表示する。例えば図15では、右側のCPUキャラクターがボンで鳴き牌をまだしていない場合に顔表情の表示域が初期位置を示す画像表示例であり、図16では右側のCPUキャラクターがボンで1回目の鳴き牌をした場合に顔表情の表示域が下方向に移動した状態を示す画像表示例であり、図17では右側のCPUキャラクターが異なるボンで2回目の鳴き牌をした場合に顔表情の表示域がさらに下方向に移動した状態を示す画像表示例である。

【0081】したがって、ボン、チーおよびカンなどの鳴き牌時に、その鳴き牌の表示位置に重ならないように鳴き牌の表示位置とは反対側にCPUキャラクター毎の顔表情の表示域を順次移動させて表示するようにしたため、鳴き牌の表示とCPUキャラクター毎の顔表情の表示とが明確になって、必要な対戦状況が容易に得られることになる。

【0082】次に、これらのボン、チーおよびカンなどの鳴き牌やリーチ牌などが行える時に、それらに対応しているアイコンが拡大表示する場合について説明する。

【0083】図18および図19はアイコン拡大モードの動作を示す制御ルーチンフローチャートである。

【0084】図18に示すように、まず、ステップST41で、制御部20はゲームデータにより制御されて、対局中、ズームモードかノーマルモードかを判断し、ステップST41でズームモードであれば、ステップST42で、制御部20はゲームデータにより制御されて、コントローラ16の上キーが押されているかどうかを判断し、上キーが押されていれば、ステップST43で、制御部20はゲームデータにより制御されて、アイコン表示が消える。

【0085】また、ステップST41でズームモードではなく、ノーマルモードであるか、または、ステップST42でコントローラ16の上キーが押されていない場合は、制御部20はゲームデータにより制御されて、ステップST44のプレイヤーのターン(自演番)の有無判断に移行し、ステップST44でプレイヤーのターンがあったと判断した場合には、ステップST45で、制御部20はゲームデータにより制御されて、プレイヤーがカン、またはツモ和了できるかどうかを判断する。ステップST45でプレイヤーがカン、またはツモ和了でき

ないと判断した場合には、制御部20はゲームデータにより制御されて、プレイヤーがリーチできるかどうかを判断する。ステップST46でプレイヤーがリーチできないと判断した場合には、ステップST47で、制御部20はゲームデータにより制御されて、コントローラ16が下に入ったかどうかを判断する。

【0086】ここで、ステップST47でコントローラ16が下に入っていないければ、次の(表4)の状態1となって、ノーマル時は小さいアイコン表示で、ズーム時にはアイコン表示は消えている。また、ステップST47でコントローラ16が下に入っているか、または、ステップST45でプレイヤーがカン、またはツキ和了できると判断した場合には、次の(表4)の状態2となって、ノーマル時およびズーム時共に、アイコン表示が拡大されて、プレイヤーにとって可能なコマンド(例えばカン)が明るくなる。さらに、ステップST46でプレイヤーがリーチできると判断した場合には、次の(表4)の状態3となって、ノーマル時およびズーム時共に、小さいアイコン表示で、プレイヤーにとって可能なコマンド(例えばリーチ)が明るくなる。

【0087】さらに、ステップST44でプレイヤーのターンがなかったと判断した場合には、図19のステップST48で、制御部20はゲームデータにより制御さ

れて、プレイヤーにとってボン、カン、チー、ロンができるかどうかを判断する。ステップST48でボン、カン、チー、ロンができると判断した場合には、図19のステップST49で、制御部20はゲームデータにより制御されて、コントローラ16の上向きのキーが押されているかどうかを判断することになる。

【0088】ここで、ステップST48でプレイヤーにとってボン、カン、チー、ロンができないと判断した場合には、次の(表4)の状態1となって、ノーマル時は小さいアイコン表示で、ズーム時にはアイコン表示は消えている。また、ステップST49でコントローラ16の上向きのキーが押されていると判断した場合には、次の(表4)の状態4となって、ノーマル時には小さいアイコン表示で、プレイヤーにとって可能なコマンドが明るくなり、また、ズーム時には、アイコン表示が消えている。さらに、ステップST49でコントローラ16の上向きのキーが押されていないと判断した場合には、次の(表4)の状態2となって、ノーマル時およびズーム時共に、アイコン表示が拡大されて、プレイヤーにとって可能なコマンド(例えばカン)が明るくなる。

【0089】

【表4】

	ノーマル時	ズーム時
状態1	小さいアイコン	表示なし
状態2	大きくなって可能なコマンドが明るくなる。	
状態3	小さいアイコンで可能なコマンド(リーチ)が明るくなる。	
状態4	小さいアイコンで可能なコマンドが明るくなる。	表示なし

【0090】例えば図20は、ズーム時にアイコン表示が消えている状態1、4の場合を示す表示画面例である。また、図21ではプレイヤーにとってボン、カン、チーが可能なことを拡大されたアイコン表示で示す状態2の場合の表示画面例であり、また、図22はプレイヤーにとってロンが可能なことを拡大されたアイコン表示で示す状態2の場合の表示画面例である。さらに、図23は、ズーム時にも小さいアイコン表示がされている状態3の場合を示す表示画面例である。さらに、図24は、ノーマル時に小さいアイコン表示がされている状態1、3、4を示す表示画面例である。

【0091】したがって、上記状態2において、ノーマル時およびズーム時共に、アイコン表示が拡大されて、プレイヤーにとって可能なコマンド(例えばカン)が明るくなってはっきりと見えるように制御が為されているため、プレイヤーの見落としもなくなった的確にプレイ

することができ、麻雀ゲームを一層楽しむことができ

【0092】なお、アイコン表示において、ロン、カン、ボン、チー以外の表示、即ち、「option」は例えばBGMなどの音楽を聞くことができる。また、「option」の右側の表示は並び替え機能であり、清一色などのときにこの並び替え機能を用いて待ち牌を検討することもできる。さらにその右側の表示は点棒の表示であり、その時々を容易に知ることができる。

【0093】次に、捨て牌の危険度表示について説明する。図28の表示画面に示すように、CPUキャラクター毎の顔表情表示画面域における下側に危険度表示部101~105の5段階でカラー表示し、危険度が高くなるに従ってカラー表示が変化する。つまり、例えば危険度が低い方から順に101が紫色で、102が緑色で、

103が黄色で、104が橙色で、105が赤色であり、危険度が高くなるに従って棒線グラフが左から右側に長くなると共に、異なるカラー表示が順次増えていくようになっている。また、CPUキャラクターが機切りした捨牌にはシェイドをかけて少し薄暗く表示するようにしている。図26では捨牌に斜線を入れて区別している。

【0094】図27および図28は、本発明における捨て牌の危険度表示動作を示す制御ルーチンフローチャートである。ここで、以下に用いる言葉を定義すると、targetとは捨て牌の危険度を調べている対象のCPUキャラクターであり、otherとは捨て牌の危険度を調べている対象以外の他家のCPUキャラクターであり、MAINとはメインルーチン、SUBとは図27および図28に示す危険度表示処理のことである。

【0095】図27に示すように、まず、本発明のメインルーチン中に捨て牌の危険度表示モードを実行させた場合には、ステップST51でワークの初期化を実行し、ステップST52で、制御部20はゲームデータにより制御されて、調べたtargetの人数が4人よりも小さければ、次のステップST53に移行し、調べたtargetの人数が4人目となった時点で、本発明のメインルーチンに戻る。さらに、ステップST53で、制御部20はゲームデータにより制御されて、調べるtargetは対戦相手の番号かどうかを判断し、調べるtargetが対戦相手の番号でなければ、ステップST54で次の対戦相手を探るべく、対戦相手の番号を+1してステップST52の処理に戻る。また、ステップST53で、制御部20はゲームデータにより制御されて、調べるtargetが対戦相手の番号（例えば下を1番、前を2番、上を3番）であればステップST55以降の危険度検出処理を実行することになる。

【0096】次に、ステップST55で、制御部20はゲームデータにより制御されて、危険度検出処理のうち相手の捨牌中に現物牌があるかどうかを検出する現物牌処理を実行する。さらに、ステップST56で、制御部20はゲームデータにより制御されて、暗槓の処理を実行する。さらに、ステップST57で、制御部20はゲームデータにより制御されて、国士無双の処理を実行する。さらに、ステップST58で、制御部20はゲームデータにより制御されて、三元牌関連の処理を実行する。さらに、ステップST59で、制御部20はゲームデータにより制御されて、風牌関連の処理を実行する。さらに、ステップST60で、制御部20はゲームデータにより制御されて、壁の処理を実行する。さらに、ステップST61で、制御部20はゲームデータにより制御されて、股ざの処理（例えば5の数字が捨牌時に3、6などの数字が危険とする処理）を実行する。さらに、図28に示すように、ステップST62で、制御部20はゲームデータにより制御されて、ドラの処理を実行す

る。さらに、ステップST63で、制御部20はゲームデータにより制御されて、一色系の処理を実行する。さらに、ステップST64で、制御部20はゲームデータにより制御されて、チャンク系の処理を実行する。さらに、ステップST65で、制御部20はゲームデータにより制御されて、三色系の処理を実行する。さらに、ステップST66で、制御部20はゲームデータにより制御されて、裏筋の処理（例えば5の数字が捨牌時に3、6または1、4などの数字が危険とする処理）を実行する。さらに、ステップST67で、制御部20はゲームデータにより制御されて、中筋の処理（例えば1、8の数字が捨牌時に4、7などの数字が危険とする処理）を実行する。さらに、ステップST68で、制御部20はゲームデータにより制御されて、間4箇の処理（例えば1、6の数字が捨牌時に手牌の2、5などの数字が危険とする処理）を実行する。さらに、ステップST69で、制御部20はゲームデータにより制御されて、安全牌フラグの処理を実行する。さらに、ステップST70で、制御部20はゲームデータにより制御されて、各項目の危険度ポイントを全て加算する処理を実行する。さらに、ステップST71で、制御部20はゲームデータにより制御されて、ステップST70で加算された危険度ポイントを5段階に分割する処理を実行する。

【0097】図29は図27のステップST55における現物牌処理の動作を示す制御ルーチンフローチャートである。

【0098】図29に示すように、ステップST551で、制御部20はゲームデータにより制御されて、調べるtargetの捨牌に現物牌があるかどうかを判断し、現物牌があればステップST552で安全フラグをオンし、現物牌がなければステップST553に移行する。このステップST553で、制御部20はゲームデータにより制御されて、調べているtargetがリーチをしているかどうかを判断し、リーチをしていれば、ステップST554でtarget以外の対戦者のリーチ以降の捨牌に現物牌があるかどうかを判断し、また、リーチをしていなければ、ステップST555でtarget以外の対戦者の最後の捨牌に現物牌があるかどうかを判断する。

【0099】さらに、ステップST554で、制御部20はゲームデータにより制御されて、target以外の対戦者のリーチ以降の捨牌に現物牌があればステップST556で安全フラグをオンし、また、このステップST556の安全フラグ処理後か、または、ステップST554で現物牌がなければ、次の危険度表示処理であるステップST56の暗槓の処理に移行する。

【0100】また、ステップST555で、制御部20はゲームデータにより制御されて、target以外の対戦者の最後の捨牌に現物牌があればステップST557で安全フラグをオンし、また、このステップST557

の安全フラグ処理後か、または、ステップST555で現物牌がなければ、次の危険度表示処理であるステップST56の暗模の処理に移行する。

【0101】図30は図27のステップST56の暗模の処理における筋牌処理の動作を示す制御ルーチンフローチャートである。

【0102】図30に示すように、ステップST561で、制御部20はゲームデータにより制御されて、ステップST561でtargetの捨牌の筋牌であるかどうかを判断し、捨牌の筋牌であればステップST562に移行し、捨牌の筋牌でなければステップST563で手牌に危険度ポイントを加算して次のステップST562に移行する。

【0103】さらに、ステップST562で、制御部20はゲームデータにより制御されて、targetがリーチしているかどうかを判断し、リーチしていればステップST564でotherの捨牌の筋牌であるかどうかを判断し、リーチしていなければステップST565でotherの最後の捨牌の筋牌であるかどうかを判断する。する。

【0104】さらに、ステップST564で、制御部20はゲームデータにより制御されて、otherの捨牌の筋牌でなければステップST566で手牌に危険度ポイントを加算の後、または、ステップST564でotherの捨牌の筋牌であれば、次の暗模の処理における暗刻筋の処理に移行する。

【0105】また、ステップST565で、制御部20はゲームデータにより制御されて、otherの最後の捨牌の筋牌でなければステップST567で手牌に危険度ポイントを加算の後、または、ステップST565でotherの最後の捨牌の筋牌であれば、次の暗模の処理における暗刻筋の処理に移行する。

【0106】図31は図27のステップST56の暗模の処理における暗刻筋処理の動作を示す制御ルーチンフローチャートである。

【0107】図31に示すように、ステップST568で、制御部20はゲームデータにより制御されて、プレイヤーの手牌中に暗刻があるかどうかを判断し、暗刻があればステップST569で、その暗刻の筋牌に危険度ポイントを加算し、また、ステップST568で暗刻がないか、またはステップST569の危険度ポイント加算処理をする。

【0108】図32は図27のステップST57における国士無双の処理の動作を示す制御ルーチンフローチャートである。

【0109】図32に示すように、ステップST571で、制御部20はゲームデータにより制御されて、targetの捨牌の中張牌をチェックする。さらに、ステップST572で、制御部20はゲームデータにより制御されて、targetの鳴き牌をチェックする。その

後、ステップST573で、制御部20はゲームデータにより制御されて、プレイヤーの手牌が公九牌であるかどうかを判断し、公九牌であればステップST574の手牌に危険度ポイントを加算する。また、ステップST573でtargetの手牌が公九牌でなければ、ステップST574の危険度ポイント加算処理をジャンプ処理する。

【0110】図33は図27のステップST58における三元牌関連の処理の動作を示す制御ルーチンフローチャートである。

【0111】図33に示すように、ステップST581で、制御部20はゲームデータにより制御されて、targetの三元牌の鳴き牌のチェックをする。さらに、ステップST582で、制御部20はゲームデータにより制御されて、包の可能性はあるかどうかを判断し、包の可能性があればステップST583でプレイヤーの手牌が三元牌かどうかを判断する。ステップST583でプレイヤーの手牌が三元牌であれば、制御部20はゲームデータにより制御されて、ステップST584で手牌に危険度ポイントを加算する。また、ステップST583でプレイヤーの手牌が三元牌でなければ、ステップST584の危険度ポイント加算処理をジャンプ処理する。

【0112】図34は図27のステップST59における風牌関連の処理の動作を示す制御ルーチンフローチャートである。

【0113】図34に示すように、ステップST591で、制御部20はゲームデータにより制御されて、targetの風牌の鳴き牌をチェックする。さらに、ステップST592で、制御部20はゲームデータにより制御されて、包の可能性はあるかどうかを判断し、包の可能性があればステップST593でプレイヤーの手牌が風牌かどうかを判断する。ステップST593でプレイヤーの手牌が風牌であれば、制御部20はゲームデータにより制御されて、ステップST594で手牌に危険度ポイントを加算する。また、ステップST593でプレイヤーの手牌が風牌でなければ、ステップST594の危険度ポイント加算処理をジャンプ処理する。

【0114】図35は図27のステップST60における壁の処理の動作を示す制御ルーチンフローチャートである。

【0115】図35に示すように、ステップST601で、制御部20はゲームデータにより制御されて、河に出ている全ての牌をチェックする。その後、ステップST602で、制御部20はゲームデータにより制御されて、同じ牌が河に4枚既に出ているかどうかを判断し、4枚既であればステップST603で4枚壁時の処理をし、また、ステップST602で4枚既でなければ、ステップST604で同じ牌が河に3枚既に出ているかどうかを判断する。さらに、ステップST604で、制御

部20はゲームデータにより制御されて、3枚盤であればステップST605で3枚盤時の処理をし、また、ステップST604で3枚盤でなければ、ステップST606で盤がないときの処理をする。

【0116】図36は図27のステップST61における股ごの処理の動作を示す制御ルーチンフローチャートである。

【0117】図36に示すように、ステップST611で、制御部20はゲームデータにより制御されて、targetの捨牌を股ご筋牌があるかどうかを判断し、targetの捨牌を股ご筋牌があればステップST612でtargetの手牌に危険度ポイントを加算する。また、ステップST611でtargetの捨牌を股ご筋牌がなければステップST612の危険度ポイント加算処理をジャンプする。

【0118】図37は図27のステップST62におけるドラの処理の動作を示す制御ルーチンフローチャートである。

【0119】図37に示すように、ステップST621で、制御部20はゲームデータにより制御されて、targetの捨牌にドラ牌があるかどうかをチェックする。さらに、ステップST622で、制御部20はゲームデータにより制御されて、プレイヤーの手牌中にドラ牌があるかどうかを判断し、手牌中にドラ牌があればステップST623でその手牌に危険度ポイントを加算する処理をする。この危険度ポイント加算処理後か、または、ステップST622で手牌中にドラ牌がないと判断した場合には、ステップST624で、制御部20はゲームデータにより制御されて、手牌中にドラ牌の筋牌があるかどうかを判断する。さらに、ステップST624で手牌中にドラ牌の筋牌があると判断した場合にはステップST625でその手牌に危険度ポイントの加算処理をする。また、ステップST624で手牌中にドラ牌の筋牌がないと判断した場合にはステップST625の危険度ポイント加算処理をジャンプする。

【0120】図38は図27のステップST63～ST65における一色系の処理、チャンタ系の処理および三色系の処理の動作を示す制御ルーチンフローチャートである。

【0121】図37に示すように、ステップST631さらにステップST632で、制御部20はゲームデータにより制御されて、targetの捨牌さらに鳴き牌のチェックをする。さらに、ステップST633で、制御部20はゲームデータにより制御されて、targetの捨牌中で自捨切りのチェックをする。さらに、ステップST634で、制御部20はゲームデータにより制御されて、その手牌に危険度ポイントの加算処理をする。

【0122】図39は図27のステップST66における裏筋の処理の動作を示す制御ルーチンフローチャート

である。

【0123】図39に示すように、ステップST661で、制御部20はゲームデータにより制御されて、targetの捨牌の裏筋があるかどうかを判断し、targetの捨牌の裏筋があればステップST662でその手牌に危険度ポイントの加算処理をする。また、ステップST661でtargetの捨牌の裏筋がなければステップST662の危険度ポイント加算処理をジャンプする。

【0124】図40は図27のステップST67における中筋の処理の動作を示す制御ルーチンフローチャートである。

【0125】図40に示すように、ステップST671で、制御部20はゲームデータにより制御されて、targetの捨牌の中筋があるかどうかを判断し、targetの捨牌の中筋があればステップST672でその手牌に危険度ポイントの加算処理をする。また、ステップST671でtargetの捨牌の中筋がなければステップST672の危険度ポイント加算処理をジャンプする。

【0126】図41は図27のステップST68における間四間の処理の動作を示す制御ルーチンフローチャートである。

【0127】図41に示すように、ステップST681で、制御部20はゲームデータにより制御されて、targetの捨牌の間四間があるかどうかを判断し、targetの捨牌の間四間があればステップST682でその手牌に危険度ポイントの加算処理をする。また、ステップST681でtargetの捨牌の間四間がなければステップST682の危険度ポイント加算処理をジャンプする。

【0128】図42は図27のステップST69における安全牌フラグの処理の動作を示す制御ルーチンフローチャートである。

【0129】図42に示すように、まず、ステップST691で、制御部20はゲームデータにより制御されて、 $I=0$ とする。次に、ステップST692で、制御部20はゲームデータにより制御されて、targetの手牌の左から1番目の牌に安全牌フラグがオンかどうかを判断し、ステップST692でtargetの手牌の左から1番目の牌に安全牌フラグがオンであれば、ステップST693で危険度ポイントを初期化する。ステップST692でtargetの手牌の左から1番目の牌に安全牌フラグがオンでなければ、ステップST693の危険度ポイントの初期化処理をジャンプし、またはステップST693の危険度ポイントの初期化処理後に、ステップST694で、制御部20はゲームデータにより制御されて、 $I \geq 14$ かどうかを判断（14枚の手牌を全て確認）する。ステップST694で $I \geq 14$ になるまで安全牌フラグ1に+1を加えてステップST

692~ST694の各処理を繰り返す。ステップST695の「I++」は「I=I+1」である。

【0130】したがって、プレイヤーの捨牌が対戦CPUキャラクター毎の当たり牌となる可能性について、その危険度を複数の5段階として対戦CPUキャラクター毎に表示するため、プレイヤーに対するガイダンス機能と共に、当たり牌の見落としもなくなっているプレイすることができ、麻雀ゲームを一層楽しむことができる。

【0131】

【発明の効果】以上のように本発明によれば、プレイヤーの捨牌に対して対戦CPUキャラクター毎の当たり牌となる危険度を複数段階で対戦CPUキャラクター毎に表示するため、プレイヤーに対する捨牌のガイダンスとなつて、本当の麻雀ゲームに臨むについても、より高度な教育が為されてレベルアップを図ることができ、麻雀ゲームを一層楽しむことができる。

【0132】また、対戦CPUキャラクター毎で、かつ、刻々と変化する対戦CPUキャラクター毎の対戦状況毎に顔の表情、顔の動き、メッセージおよび牌引き及び牌捨て動作を画像出力や音声出力するようにすれば、対戦CPUキャラクターの人間性や癖、心理を顔の表情や何げないメッセージなどを通じて判断することができ、より臨場感のある麻雀ゲームを楽しむことができると共に、それらに基づいて対戦CPUキャラクターの手牌内容やその完成度を総合的に予測して捨牌を考慮しつつプレイするという本発明の麻雀の楽しみを得ることができる。

【図面の簡単な説明】

【図1】本発明の一実施形態における麻雀ゲーム装置のハード構成を示すブロック図である。

【図2】CPUキャラクターがポン時のメッセージ出力画面例を示す図1のテレビジョンモニタ2における表示画面図である。

【図3】CPUキャラクターの内田（前面の女性）の顔表情が愛通顔出力画面を示す図1のテレビジョンモニタ2における表示画面図である。

【図4】CPUキャラクターの内田（前面の女性）の顔表情が笑い顔出力画面を示す図1のテレビジョンモニタ2における表示画面図である。

【図5】CPUキャラクターの内田（前面の女性）の顔表情が悲しみ顔出力画面を示す図1のテレビジョンモニタ2における表示画面図である。

【図6】CPUキャラクターの内田（前面の女性）の顔表情が怒り顔出力画面を示す図1のテレビジョンモニタ2における表示画面図である。

【図7】本発明の麻雀ゲーム装置によるCPUキャラクター毎の対戦状況に応じた顔表情変化などの変化項目制御ルーチンを示すフローチャートである。

【図8】対局開始時で、良くも悪くもない普通の配牌時のメッセージ出力画面例を示す図1のテレビジョンモニ

タ2における表示画面図である。

【図9】危険牌を切る時のメッセージ出力画面例を示す図1のテレビジョンモニタ2における表示画面図である。

【図10】イーシャンテン時のメッセージ出力画面例を示す図1のテレビジョンモニタ2における表示画面図である。

【図11】リーチ時のメッセージ出力画面例を示す図1のテレビジョンモニタ2における表示画面図である。

【図12】図2のステップST1の感情値初期セット動作を示す制御ルーチンフローチャートである。

【図13】図3のステップST3における任意のCPUキャラクターに会話（メッセージ）を求めた場合のCPUキャラクター毎の顔表情と会話（メッセージ）、音声の制御ルーチンフローチャートである。

【図14】ポン、チーおよびカンなどの鳴き牌時における顔表情の表示域移動動作を示す制御ルーチンフローチャートである。

【図15】CPUキャラクターの顔表情表示域における初期位置画面例を示す図1のテレビジョンモニタ2における表示画面図である。

【図16】CPUキャラクターの顔表情表示域における1回目移動画面例を示す図1のテレビジョンモニタ2における表示画面図である。

【図17】CPUキャラクターの顔表情表示域における2回目移動画面例を示す図1のテレビジョンモニタ2における表示画面図である。

【図18】アイコン拡大モードの動作を示す制御ルーチンフローチャートである。

【図19】図18の続きのアイコン拡大モードの動作を示す制御ルーチンフローチャートである。

【図20】ズーム時にアイコン表示が消えている状態1、4の場合を示す図1のテレビジョンモニタ2における表示画面図である。

【図21】ポン、カン、チーが可能なことを拡大されたアイコン表示で示す図1のテレビジョンモニタ2における表示画面図である。

【図22】ロンが可能なことを拡大されたアイコン表示で示す図1のテレビジョンモニタ2における表示画面図である。

【図23】ズーム時にも小さいアイコン表示がされている状態3の場合を示す図1のテレビジョンモニタ2における表示画面図である。

【図24】ノーマル時に小さいアイコン表示がされている状態1、3、4を示す図1のテレビジョンモニタ2における表示画面図である。

【図25】本発明における捨牌の動き図であつて、aは叩き付ける動きで牌を捨てる場合を示す図、bは緩やかに、ズームアップ、ズームダウンさせて牌を捨てる場合を示す図、cは縦、横と麻雀卓上を滑らせるようにして

牌を捨てる場合を示す図、dは怒りのパターンとして動き無しでいきなり牌を捨てる場合を示す図である。

【図26】他家に対するプレイヤーの捨て牌の危険度表示を示す図1のテレビジョンモニター2における表示画面図である。

【図27】本発明における捨て牌の危険度表示動作を示す制御ルーチンフローチャートである。

【図28】図27に続く捨て牌の危険度表示動作を示す制御ルーチンフローチャートである。

【図29】図27のステップST55における現物牌処理の動作を示す制御ルーチンフローチャートである。

【図30】図27のステップST56の暗槓の処理における防牌処理の動作を示す制御ルーチンフローチャートである。

【図31】図27のステップST56の暗槓の処理における暗槓無処理の動作を示す制御ルーチンフローチャートである。

【図32】図27のステップST57における国士無双の処理の動作を示す制御ルーチンフローチャートである。

【図33】図27のステップST58における三元牌関連の処理の動作を示す制御ルーチンフローチャートである。

【図34】図27のステップST59における風牌関連の処理の動作を示す制御ルーチンフローチャートである。

【図35】図27のステップST60における盤の処理の動作を示す制御ルーチンフローチャートである。

【図36】図27のステップST61における股ぎの処理の動作を示す制御ルーチンフローチャートである。

【図37】図27のステップST62におけるドラの処理の動作を示す制御ルーチンフローチャートである。

【図38】図27のステップST63～ST65におけ

る一色系の処理、チャンタ系の処理および三色系の処理の動作を示す制御ルーチンフローチャートである。

【図39】図27のステップST66における裏筋の処理の動作を示す制御ルーチンフローチャートである。

【図40】図27のステップST67における中筋の処理の動作を示す制御ルーチンフローチャートである。

【図41】図27のステップST68における間四間の処理の動作を示す制御ルーチンフローチャートである。

【図42】図27のステップST69における安全牌プラグの処理の動作を示す制御ルーチンフローチャートである。

【符号の説明】

- 1 麻雀ゲーム装置
- 2 テレビジョンモニター
- 3 プリメインアンプ
- 4 スピーカ
- 5 記録媒体
- 6 CPU
- 7 バス
- 8 RAM
- 9, 10, 13, 14, 15 インターフェース回路 (I/P)
- 11 信号処理プロセッサ
- 12 画像描画処理プロセッサ
- 16 コントローラ
- 17, 18 D/Aコンバータ
- 19 メモリ部
- 20 制御部
- 21 操作入力部
- 22 画像表示部
- 23 音声出力部
- 101～105 危険度表示部

【図3】

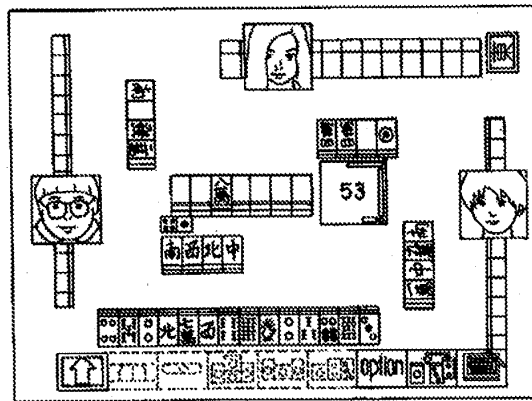

【図19】

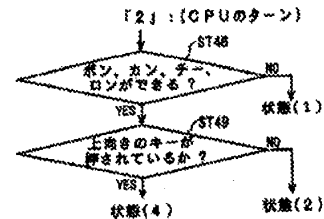

【図1】

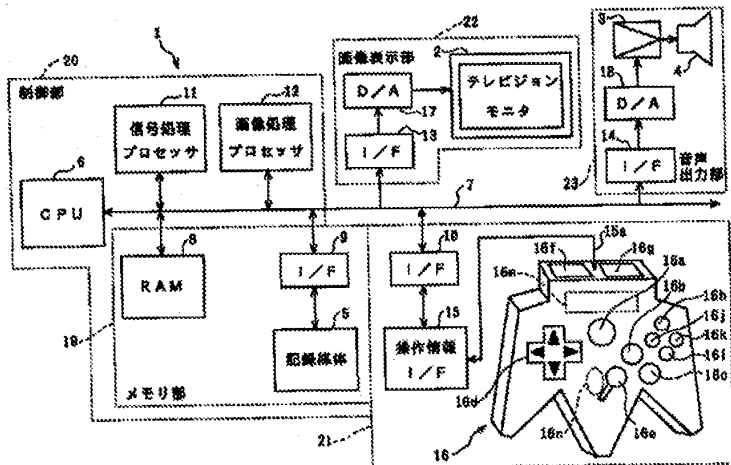

【図2】

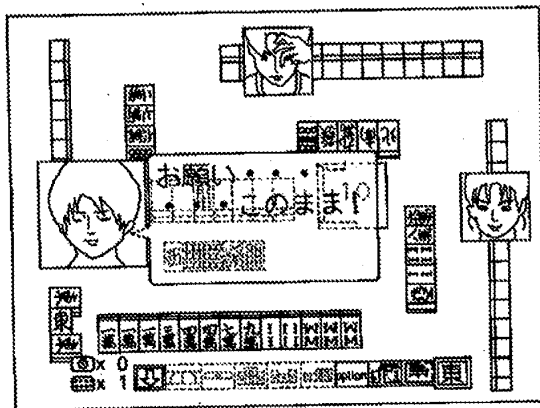

【図1.4】

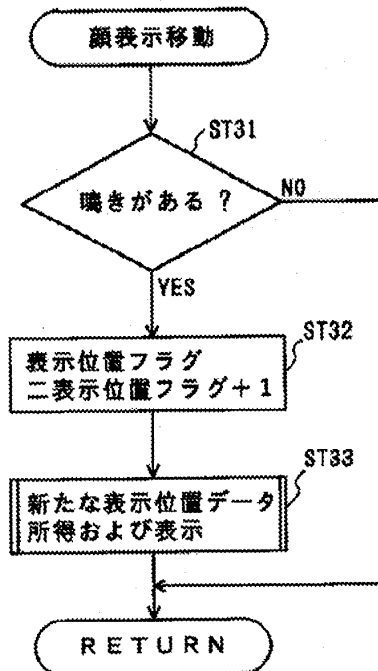

【図4】

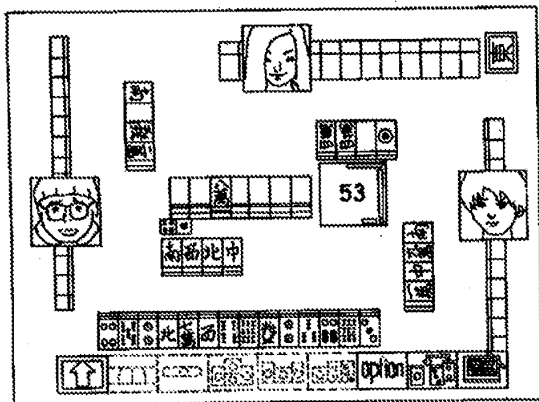

【図5】

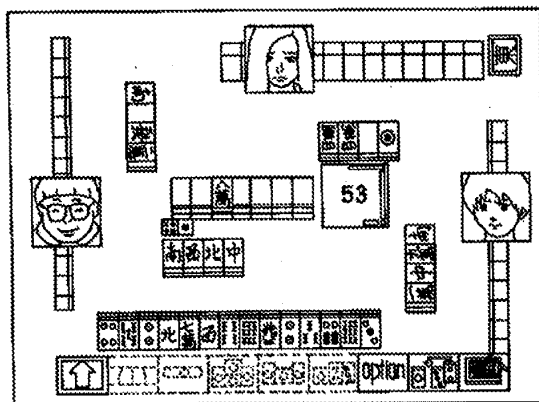

【図18】

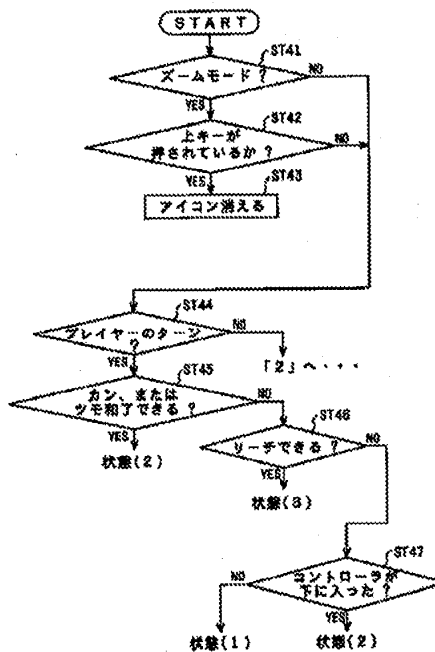

【図25】

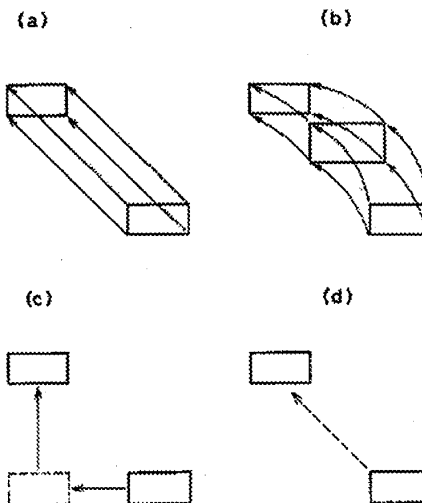

【図6】

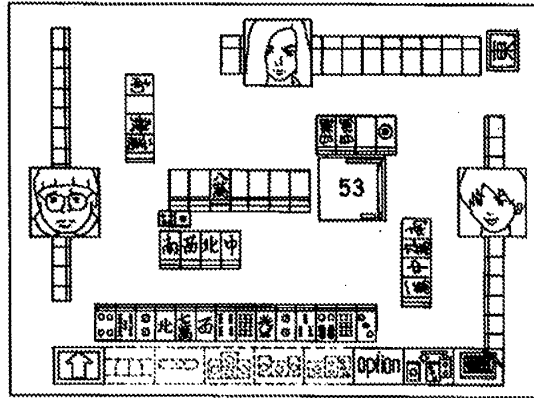

【図7】

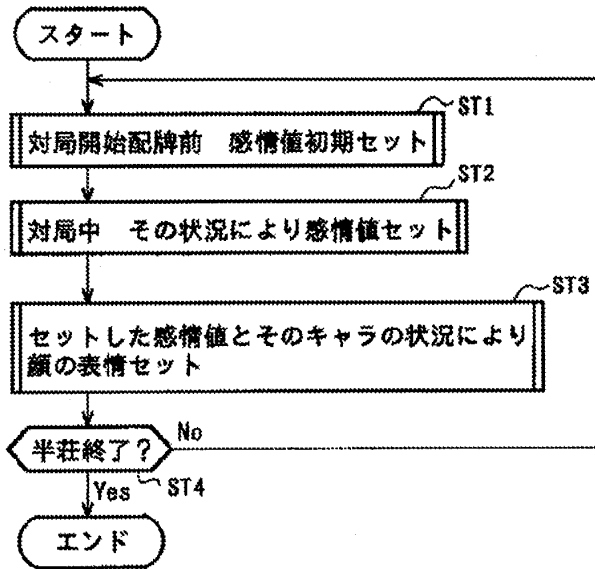

【図8】

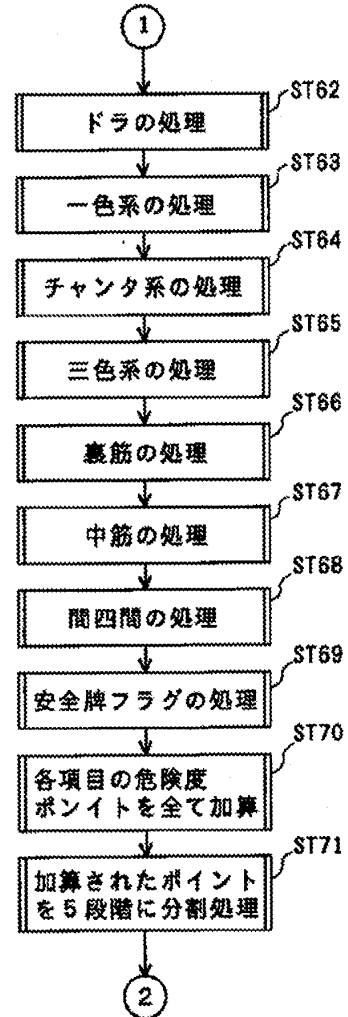

【図8】

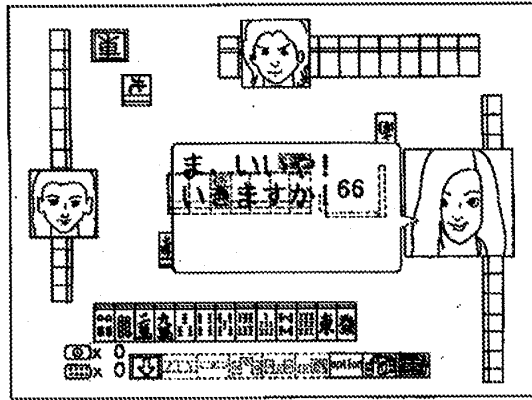

【図9.1】

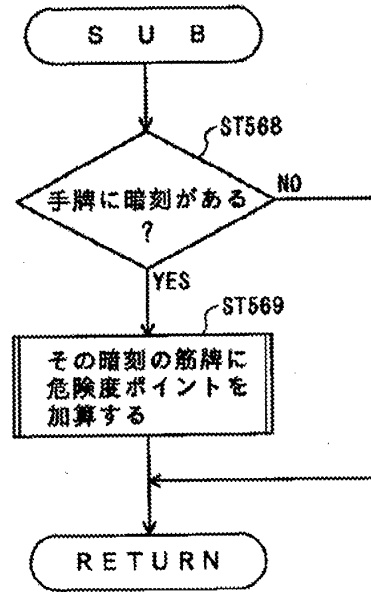

【図9】

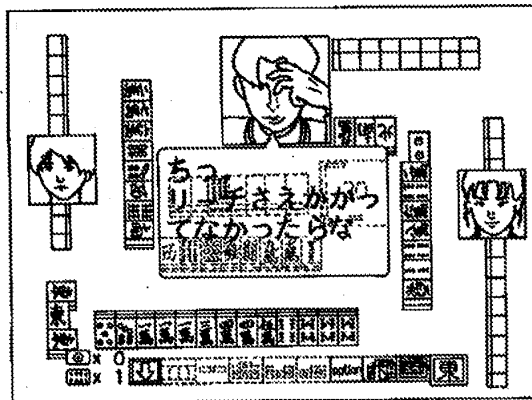

【図10】

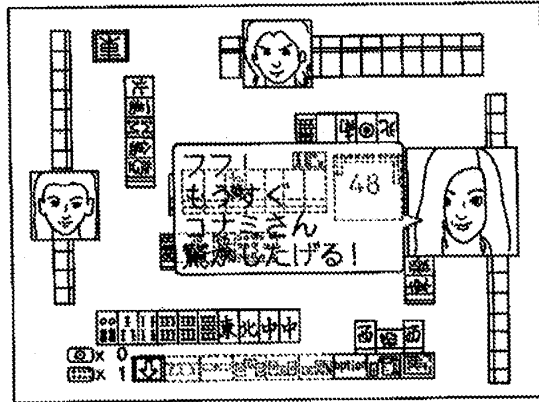

【図11】

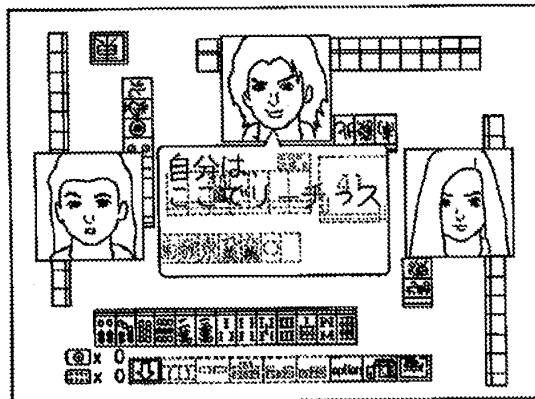

【図32】

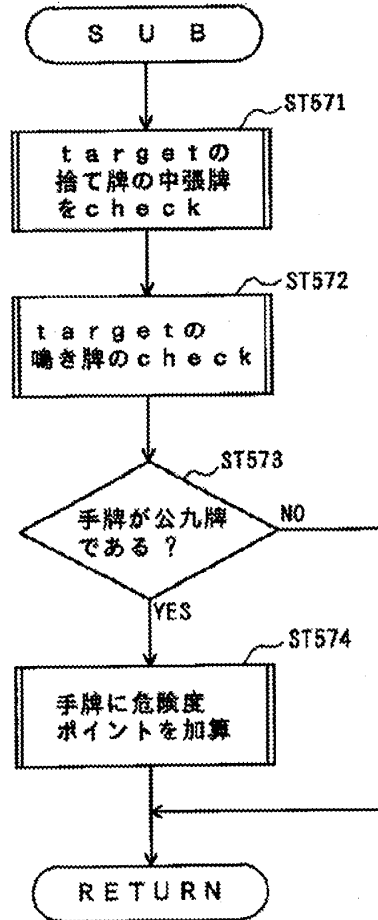

【図12】

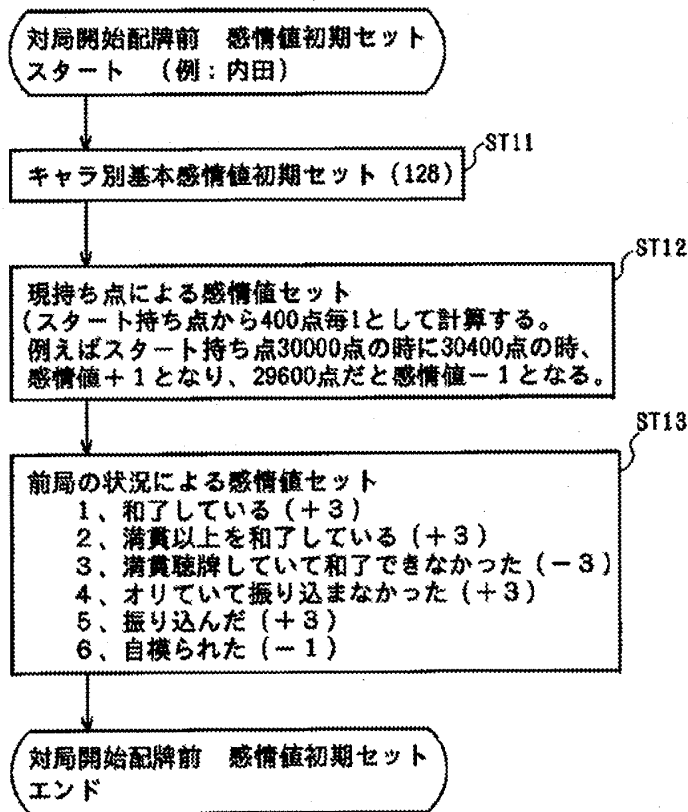

【図18】

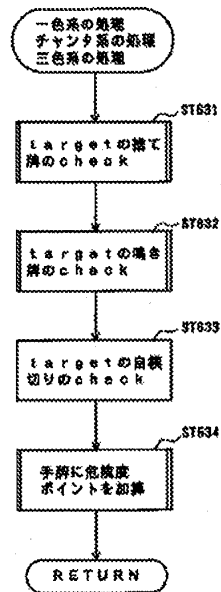

【図15】

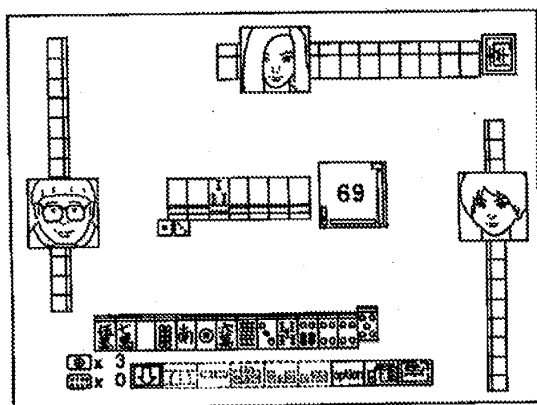

【図15】

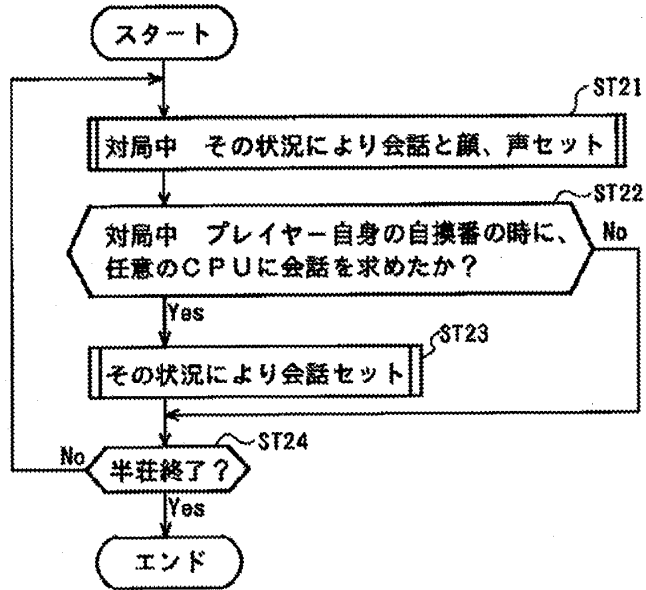

【図16】

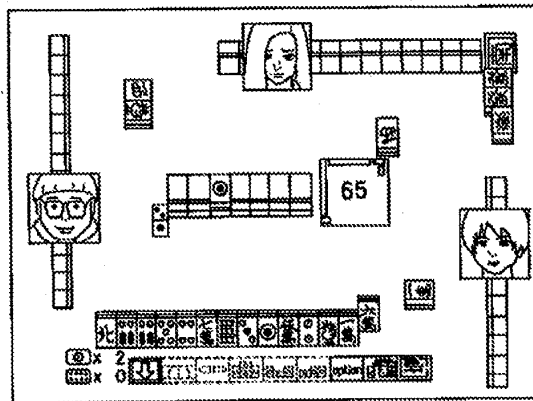

【図16】

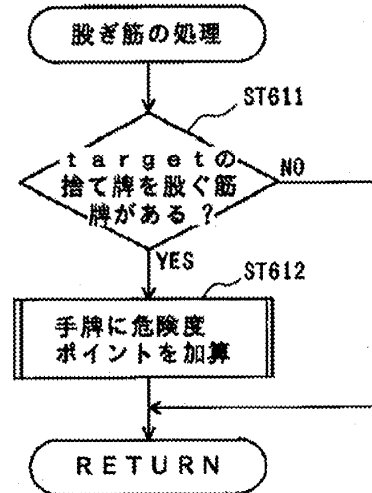

【図17】

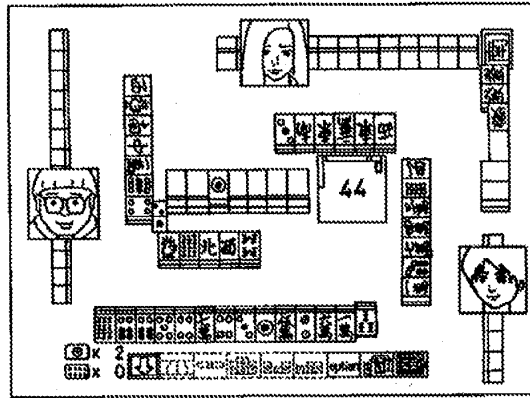

【図20】

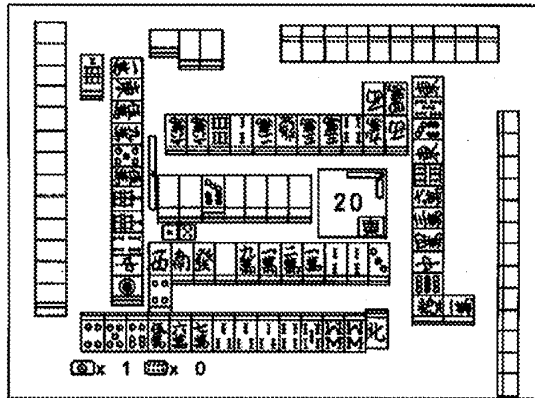

【図23】

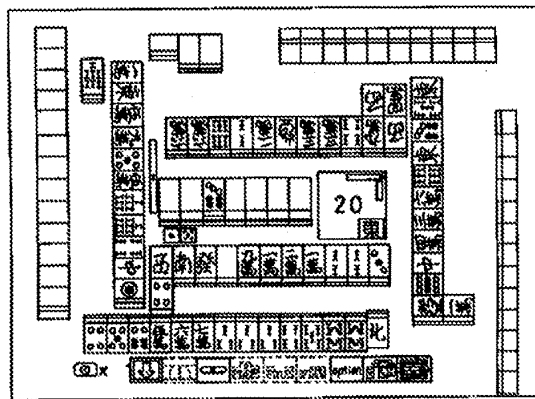

【図23】

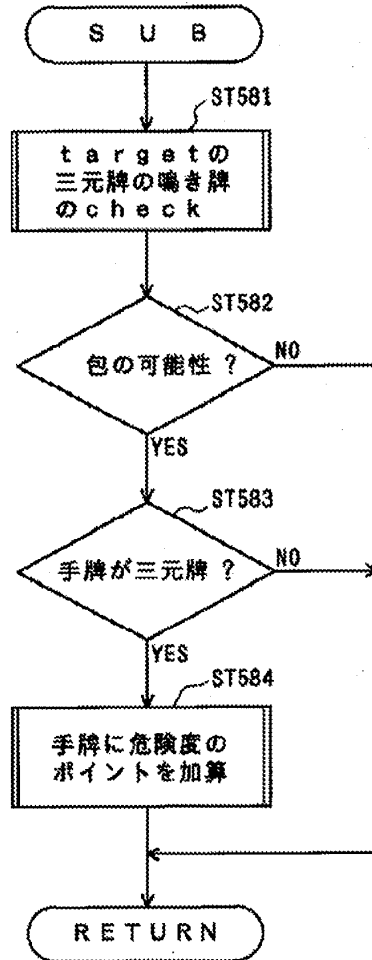

【図21】

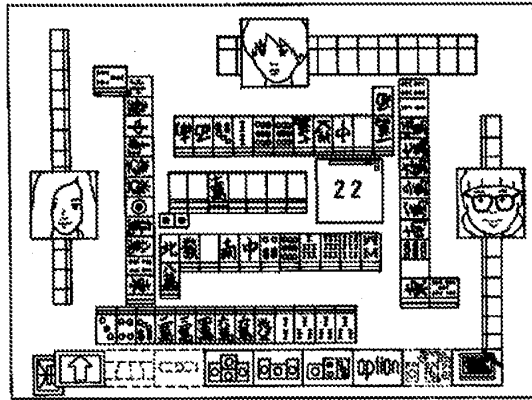

【図22】

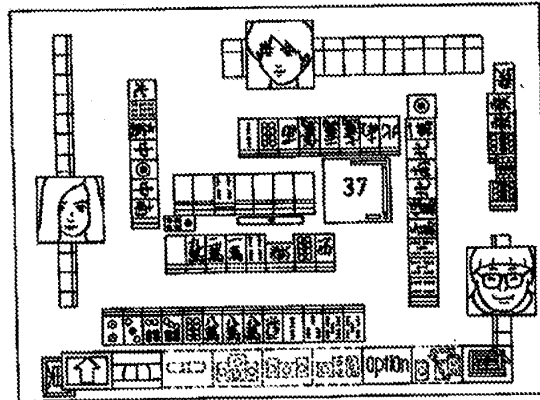

【図34】

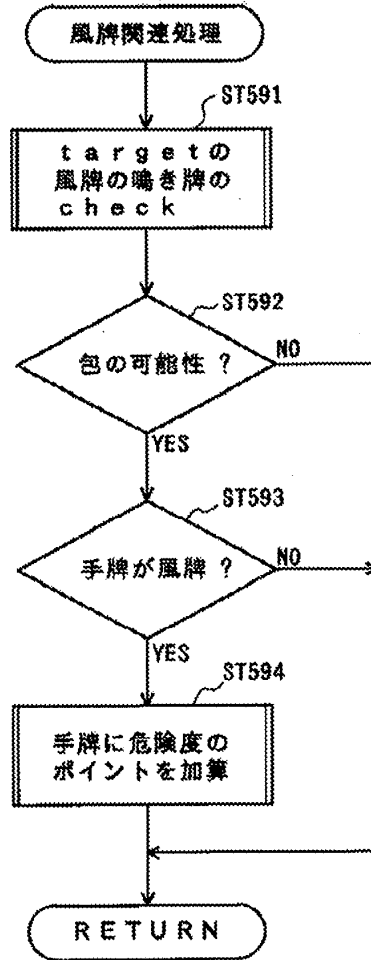

【図24】

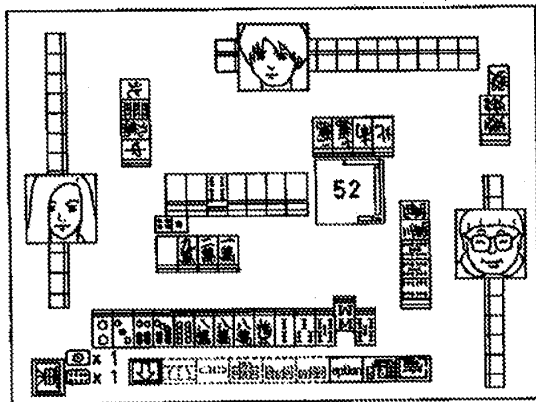

【図26】

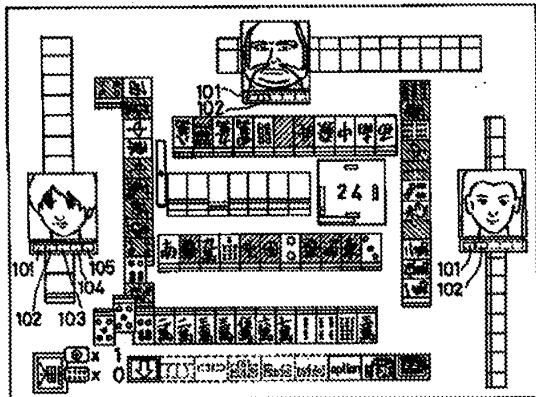

【図37】

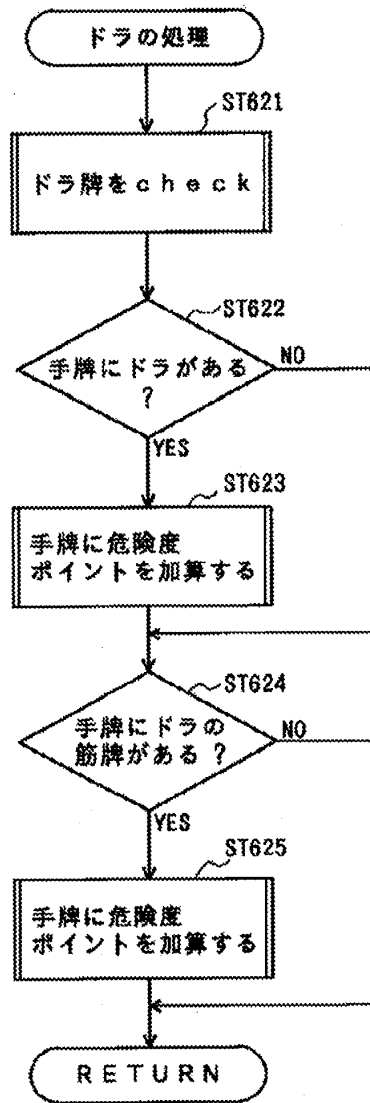

【図27】

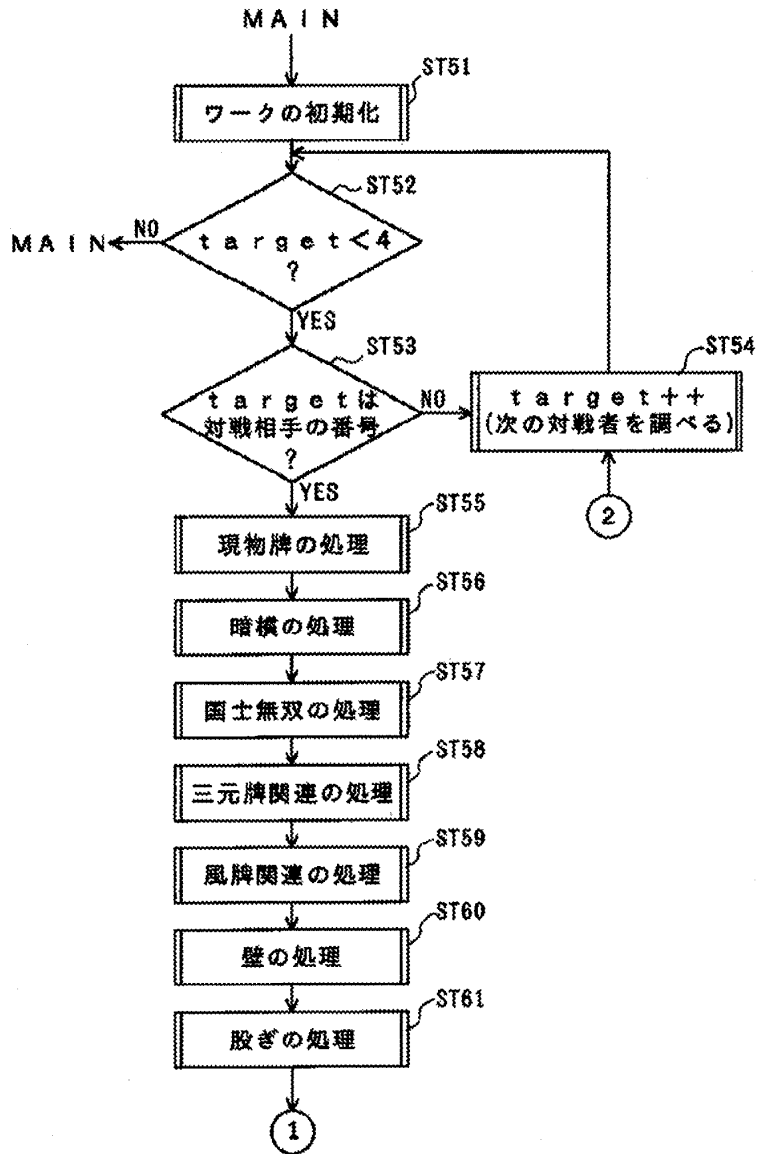

【図29】

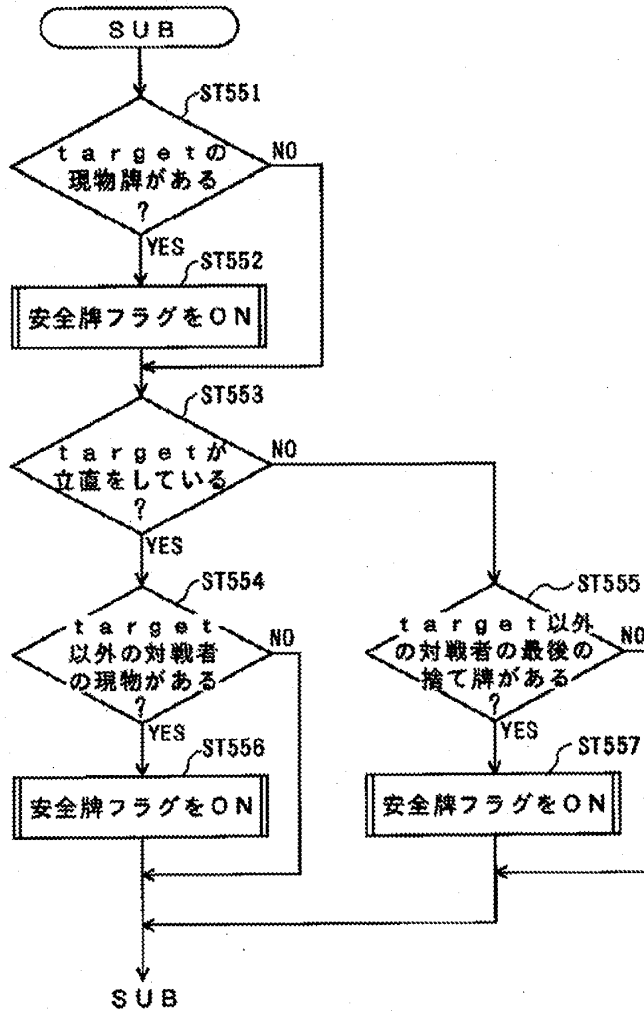

【図42】

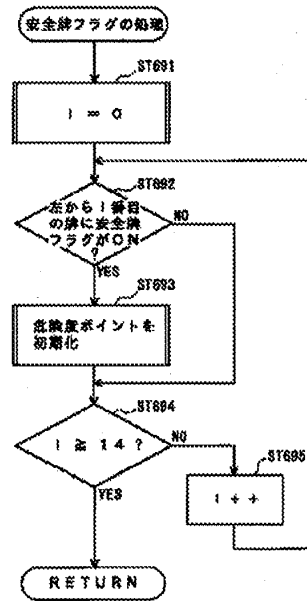

【図30】

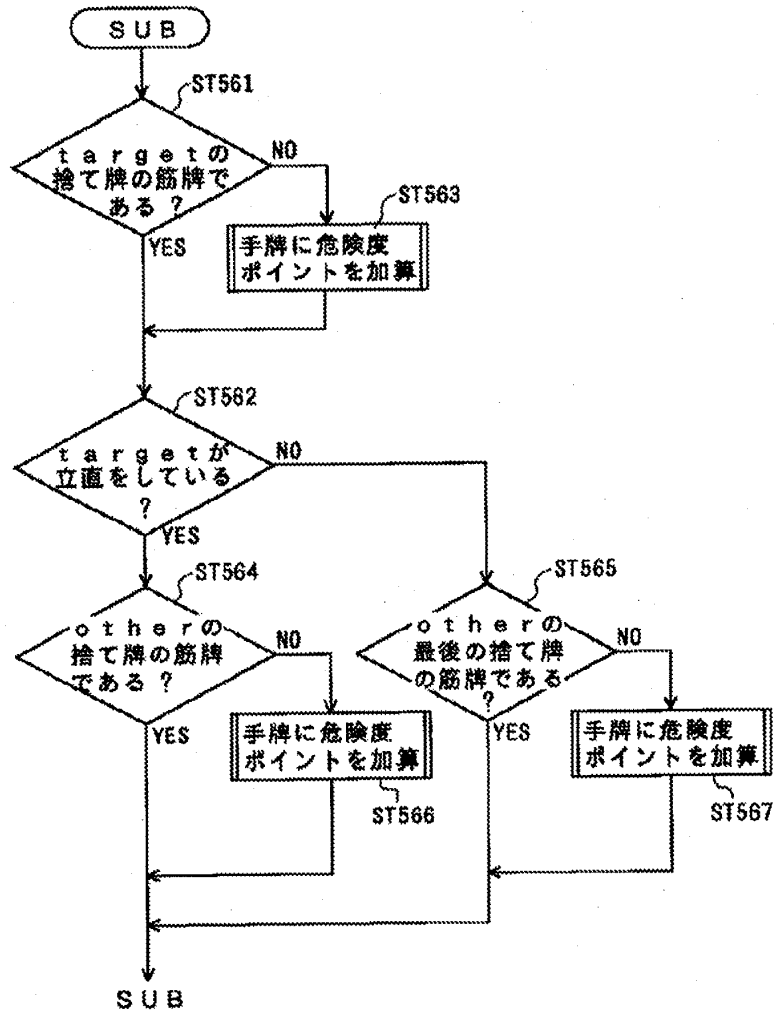

【図35】

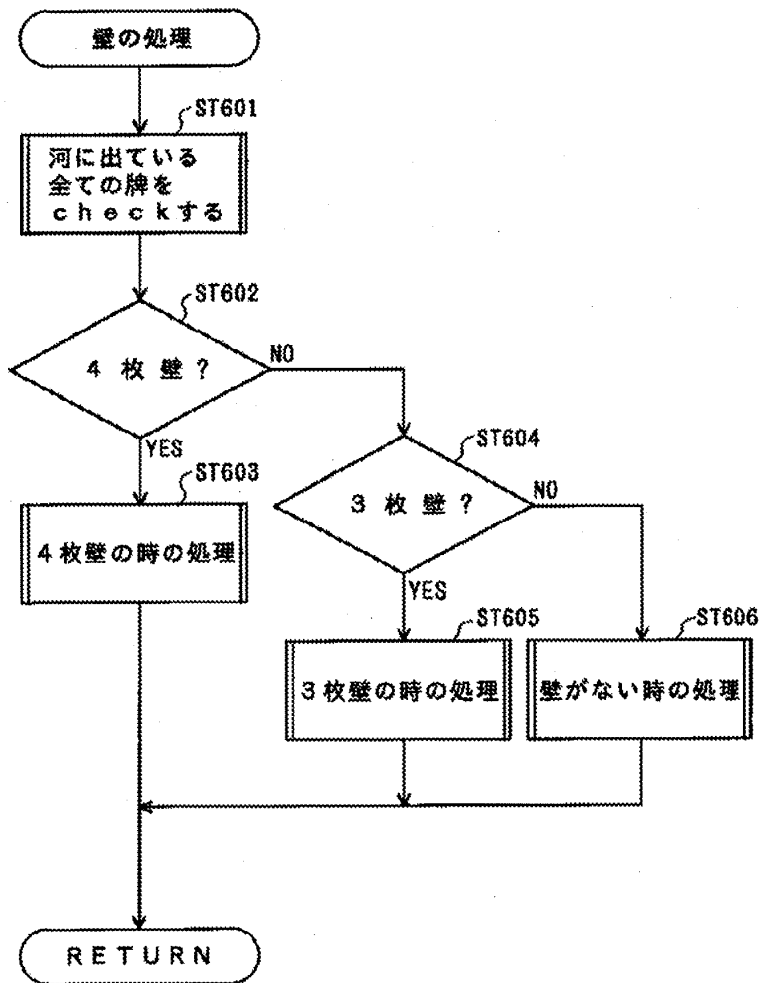

【図39】

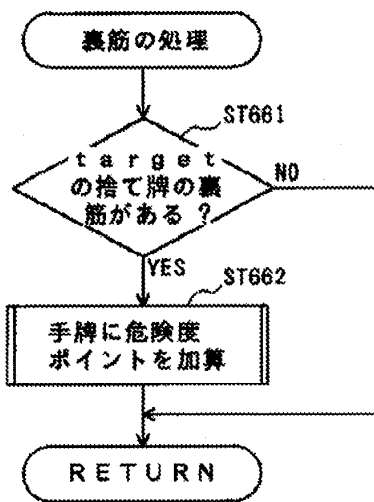

【図40】

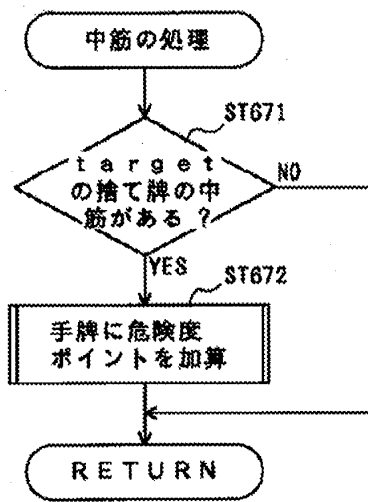

【図41】

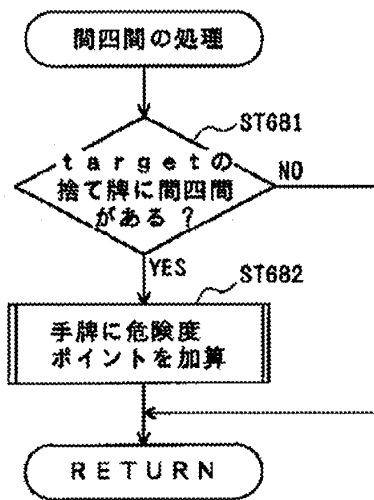

PATENT ABSTRACTS OF JAPAN

(11)Publication number : 10-201953

(43)Date of publication of application : 04.08.1998

(51)Int.Cl. A63F 9/22

(21)Application number : 09-306230

(71)Applicant : KONAMI CO LTD

(22)Date of filing : 07.11.1997

(72)Inventor : KANBE RYOJI
FUJIWARA HIDEYUKI

(30)Priority

Priority number : 08327880 Priority date : 21.11.1996 Priority country : JP

(54) MAHJONG GAME DEVICE, ITS METHOD, AND RECORDING MEDIUM

(57)Abstract:

PROBLEM TO BE SOLVED: To establish a sensor of presence at the site using an expression and words in accordance with personalities and habits of the mating parties and allow the player to enjoy himself a mahjong game with greater fun owing to a guidance function of displaying the degree of danger for encountering the hit mahjong piece.

SOLUTION: A CPU 6 holds in a RAM 8 conditions data, image data, voice data, and game program data which are read out of a recording medium 5, and selects image data and/or voice data for an expression and movement of the face, message, moved is mahjong piece, etc., for each piece of conditions data depending upon the playing situation of each mating character varying from time to time, and selects the image data representing at step the degree of danger to become the hit piece of the making character for his piece he is going to throw, and controls so that the data is fed to a TV monitor 2 or loudspeaker 4 in the form of game images or voice output.

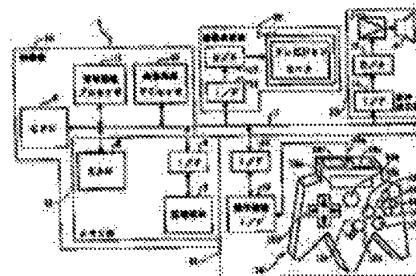

* NOTICES *

JPO and INPIT are not responsible for any damages caused by the use of this translation.

1. This document has been translated by computer. So the translation may not reflect the original precisely.
2. **** shows the word which can not be translated.
3. In the drawings, any words are not translated.

DETAILED DESCRIPTION

[Detailed Description of the Invention]

[0001]

[Field of the Invention] The present invention relates to the mah-jongg game equipment applied to a video game etc., the mah-jongg game method, and the recording medium with which the mah-jongg game program was recorded.

[0002]

[Description of the Prior Art] Conventionally, a player plays mah-jongg game equipment against three CPU players.

A player is operating its own hand via a controller, looking at on the play screen of a mah-jongg table. A player and a CPU player repeated **** and a discarded tile in order, Pons, tsi, a can, etc. cried further, a tile was carried out, a hand was brought close to completion sequentially, and a mah-jongg game was advanced by competing for completion of other three CPU players and a hand.

A discarded tile of information seen owing to the usual mah-jongg other than the contents of a hand of a player, for example, other three CPU players. Pons, tsi, a can, etc. show a mah-jongg table as a play screen seen from a top, and a tile etc. are displayed for every three CPU players.

a player predicts a state of a hand of other three CPU players, looking at these pieces of information -- one's discarded tile -- a partner's hand completion -- it became a tile, and it was playing carefully so that it might not transfer.

the tile to which it came as ***** eventually -- or a partner's discarded tile -- oneself -- or a partner will do win and the victory or defeat of the time will determine. At this time, when it gave according to the contents of a hand which carried out win and win was carried out to *****, from other three persons, when win was carried out by a partner's discarded tile, those mark were got from the partner who transferred, and final victory or defeat were decided by the size of final mark.

[0003]

[Problem to be solved by the invention] However, although the logical process of making it completing promptly and carrying out the win of one's hand earlier than other CPU players can be enjoyed in the above-mentioned conventional mah-jongg game equipment, without predicting the contents of a hand, and its completeness from a partner's discarded tile, and transferring a partner. In addition, a peculiarity, humanity, psychology, and also the language and the complexion for every partner peculiar to a mah-jongg game that are not, There is no presence, such as operation, and it had the problem that pleasure of the true mah-jongg of playing reading them, predicting a partner's contents of a hand and its completeness synthetically, and taking a discarded tile into consideration could not be obtained.

[0004] If a waging-war CPU character hits to the discarded tile of a player and it becomes a tile, since a mah-jongg game is lost, a mah-jongg game cannot be enjoyed. When especially the inventor hit and had a guidance function about the possibility of a tile, even if attached for attending a true mah-jongg game, it succeeded in more advanced education, and improvement of it was attained, and

http://www4.ipdl.inpit.go.jp/cgi-bin/tran_web_cgi_ejje?atw_u=http%3A%2F%2Fwww4.ip... 7/11/2013

it thought that a mah jongg game could be enjoyed further.

[0005]The present invention solves the above-mentioned conventional problem, and obtain presence with expression, language, etc. according to the humanity and the peculiarity for every partner, and. It aims at providing the mah jongg game equipment, the mah jongg game method, and recording medium which hit and can enjoy a mah jongg game further by the guidance function by the danger display to a tile.

[0006]

[Means for solving problem]The mah jongg game equipment of the present invention at least the present invention The hand and the contents of a discarded tile of the player, the contents of a discarded tile and a face of a waging-war character are displayed — these players and a waging-war character — order — tiles, such as **** and a discarded tile, — mah jongg game equipment with which a mah jongg game advances is characterized by comprising the following by repeating length and ***** operation:

A control part which obtains image data which displays danger which serves as a tile in every waging-war character to a tile which is going to throw away a player in two or more steps.

A picture display part which carries out image display of the image data obtained by a control part.

The present invention at least the mah jongg game equipment of the present invention The hand and the contents of a discarded tile of the player, the contents of a discarded tile and a face of a waging-war character are displayed — these players and a waging-war character — order — tiles, such as **** and a discarded tile, — mah jongg game equipment with which a mah jongg game advances is characterized by comprising the following by repeating length and ***** operation:

A control part which obtains image data which displays danger which serves as a tile in every waging-war character to a tile which is going to throw away a player in two or more steps.

A picture display part which carries out image display of the image data obtained by a control part.

A voice output part which carries out voice response of the voice data obtained by a control part.

As the mah jongg game method of the present invention, at least The hand and the contents of a discarded tile of the player, the contents of a discarded tile and the face of a waging-war character are displayed — these players and a waging-war character — order — tiles, such as **** and a discarded tile, — it being the mah jongg game method that a mah jongg game advances, and by repeating length and ***** operation, The image data which displays the danger which serves as a tile in every waging-war character to the tile which is going to throw away a player in two or more steps is obtained, and such image data and/or voice data are characterized by image display and/or carrying out voice response. To the recording medium of the present invention, at least The hand and the contents of a discarded tile of the player, the contents of a discarded tile and the face of a waging-war character are displayed — these players and a waging-war character — order — tiles, such as **** and a discarded tile, — a mah jongg game advancing by repeating length and ***** operation, and. The image data which displays the danger which serves as a tile in every waging-war character to the tile which is going to throw away a player in two or more steps is obtained, The mah-jongg game program making [image display and/or] it control to carry out voice response is recorded in such image data and/or voice data.

[0007]Preferably the present invention the mah jongg game equipment of the present invention, A hand of a player and the contents of a discarded tile, the contents of a discarded tile of a waging-war character, and a face are displayed at least, these players and a waging-war character — order — tiles, such as **** and a discarded tile, — mah jongg game equipment with which a mah jongg game advances is characterized by comprising the following by repeating length and ***** operation:

the display of the face of a waging-war character, a motion of a face, a message, and a tile — image data being obtained so that it may be in the displaying condition of the variable items, such as length and ***** operation, corresponding [any they are] to the waging-war situation of the aforementioned waging-war character at least, and. A control part which obtains image data which

displays danger which serves as a tile in every waging-war character to a tile which is going to throw away a player in two or more steps.

A picture display part which carries out image display of the image data obtained by a control part. Preferably the present invention the mah jongg game equipment of the present invention, A hand of a player and the contents of a discarded tile, the contents of a discarded tile of a waging-war character, and a face are displayed at least, these players and a waging-war character --- order --- tiles, such as **** and a discarded tile, --- mah jongg game equipment with which a mah jongg game advances is characterized by comprising the following by repeating length and ***** operation: the display of the face of a waging-war character, a motion of a face, a message, and a tile --- the inside of variable items, such as length and ***** operation, --- any they are at least, A control part which obtains image data which displays danger which image data and/or voice data are obtained so that it may be in a display and/or an output state according to a waging-war situation of the aforementioned waging-war character, and serves as a tile in every waging-war character to a tile which is going to throw away a player in two or more steps.

A picture display part which carries out image display of the image data obtained by a control part. A voice output part which carries out voice response of the voice data obtained by a control part. Preferably as the mah jongg game method of the present invention, The hand of a player and the contents of a discarded tile, the contents of a discarded tile of a waging-war character, and a face are displayed at least, these players and a waging-war character --- order --- tiles, such as **** and a discarded tile, --- it being the mah jongg game method that a mah jongg game advances, and by repeating length and ***** operation, the motion of a facial expression and a face, message, and tile according to the waging-war situation for every waging-war character --- image data and/or voice data being obtained so that it may become any to be at least among the variable items of length and ***** operation, and. The image data which displays the danger which serves as a tile in every waging-war character to the tile which is going to throw away a player in two or more steps is obtained, and such image data and/or voice data are characterized by image display and/or carrying out voice response. Preferably to the recording medium of the present invention, The hand of a player and the contents of a discarded tile, the contents of a discarded tile of a waging-war character, and a face are displayed at least, these players and a waging-war character --- order --- tiles, such as **** and a discarded tile, --- a mah jongg game advancing by repeating length and ***** operation, and. the motion of a facial expression and a face, message, and tile according to the waging-war situation for every waging-war character --- image data and/or voice data so that it may become any to be at least among the variable items of length and ***** operation, [obtain and] And the image data which displays the danger which serves as a tile in every waging-war character to the tile which is going to throw away a player in two or more steps is obtained, The mah-jongg game program making [image display and/or] it control to carry out voice response is recorded in such image data and/or voice data.

[0008] Since the danger which it hits for every waging-war CPU character to the discarded tile of a player, and serves as a tile by this composition is displayed for every waging-war character in two or more steps, Even if it becomes guidance of the discarded tile to a player and attaches for attending a true mah jongg game, it will succeed in more advanced education, improvement will become possible, and a mah jongg game can be enjoyed further.

[0009] every waging-war situation for every waging-war character which is every waging-war character and changes every moment --- a motion of a facial expression and a face, a message, and a tile --- length and ***** operation --- a generating picture, if it is made to carry out voice response. Become possible to enjoy the mah jongg game where the humanity of a waging-war character peculiar to a mah jongg game, and a peculiarity and psychology are judged through a facial expression, the message as for which what ** is not, etc. and which has presence more, and. It becomes possible to obtain pleasure of the original mah-jongg of playing reading them, predicting synthetically the contents of a hand of a waging-war character and its completeness, and taking a

discarded tile into consideration.

[0010] Preferably, he laughs it as the facial expression for every [as image data in the present invention] waging-war character at least, and they are a face, common face, and sadness face and an anger face. the waging-war situation as an output condition of image data [in / preferably / the present invention] — the contents of a hand at the time of a starting hand, and the tile at the time of a self-draw — the tile at the time of contents and a discarded tile — it is in any at least among contents, reorganization, and the contents of win. A motion of the face for every [as image data in the present invention] waging-war character is a motion which looks at which direction at least among the direction which threw away the tile, the direction of the partner who cried, and the direction of a partner which carried out win preferably. the tile for every [as image data / in / preferably / the present invention] waging-war character — length and ***** operation — a motion of ****, a motion of a discarded tile, and reach — a motion and squeal of a tile — it is how to move any at least among motions of a tile.

[0011] Pleasure of the original mah-jongg of playing judgment of the mah-jongg waging-war situation according to the image being attained, and taking [the image which is more rich in presence is acquired, and] into consideration the mah-jongg waging-war situation for every waging-war character with each of these data will be obtained.

[0012]

[Mode for carrying out the invention] Hereafter, it describes, referring to Drawings for the embodiment of the present invention.

[0013] Fig. 1 is a block diagram showing the hard structure of the mah jongg game equipment in one embodiment of the present invention.

[0014] In Fig. 1, the mah jongg game equipment 1 A game machine body (not shown). It consists of the recording medium 5 with which the game data consisting of the PURIME yne amplifier 3 and the loudspeaker 4, the image data and voice data, and program data for outputting the television monitor 2 for outputting the image of a game and the sound of a game was recorded. Here, the recording media 5 are what is called a ROM cassette in which ROM etc. to which the program data storage of the above-mentioned game data or the operating system was carried out, for example were stored by the plastic case, an optical disc, a flexible disk, etc.

[0015] The operation in this game machine body, and a control system, Each part to the central processing unit (henceforth CPU) 6 to control An address, The bus 7 which consists of data and a controller bus is connected, and RAM8 which can store various data, the interface circuits 9 and 10, the digital signal processor 11, the image drawing processing processor 12, and the interface circuits 13 and 14 are connected to this bus 7, respectively. The controller 16 is connected to this interface circuit 10 via the operation information interface circuit 15, and the instructions according to the operation signal from the controller 16 can be made to perform to CPU6.

[0016] Write ***** of the image data which this digital signal processor 11 should mainly perform position calculation on two dimensions, light source calculation, generation of voice data, and processing treatment, and the image drawing processing processor 12 should draw to RAM8 based on the calculation result in the digital signal processor 11. The generating picture of the interface circuit 13 is connected and carried out to the television monitor 2 via D/A converter 17, and via the PURIME yne amplifier 3, it is connected to the loudspeaker 4 and voice response of the interface circuit 14 is carried out to D/A converter 18 pan.

[0017] Here, the mah jongg game equipment 1 differs in the form according to the use. That is, when the above-mentioned mah jongg game equipment 1 is constituted as home use, the television monitor 2, the PURIME yne amplifier 3, and the loudspeaker 4 comprise a separate body with the game machine body. When the above-mentioned mah jongg game equipment 1 is constituted as business use, all the components shown in Fig. 1 are stored in one integral-type housing. In the case where the above-mentioned mah jongg game equipment 1 is constituted considering the personal computer and the workstation as a core, The above-mentioned television monitor 2 corresponds to

http://www4.ipdl.inpit.go.jp/cgi-bin/tran_web CGI_ejje?atw_u=http%3A%2F%2Fwww4.ip... 7/11/2013

the display for the above-mentioned computers, and the described image drawing processing processor 12. It corresponds to the hardware on the add-in board mounted on some Game-program data or the expansion slot of a computer currently recorded on the above-mentioned recording medium 5. The above-mentioned interface circuits 9, 10, 13, and 14, D/A converters 16 and 17, and the operation information interface circuit 15 correspond to the hardware on the add-in board mounted on the expansion slot of a computer. The above-mentioned RAM8 corresponds to each area of the main memory on a computer, or an expanded memory. According to this embodiment, the above-mentioned mah jongg game equipment 1 describes taking the case of the case where it is constituted as home use.

[0018]The controller 16 The start button 16a, the A button 16b, It has the B button 16c, 16 d of arrow keys, the stick type controller 16e, the left trigger button 16f, the right trigger button 16g, the C1 button 16h, the C2 button 16i, the C3 button 16j, the C4 button 16k, 16 m of connectors, and the depth trigger button 16n. Here, to 16 m of connectors, the memory for memorizing the stages of progress of a game, etc. temporarily, for example, etc. are removable, moreover — the above-mentioned stick type controller 16e has become operational not only to four directions but the direction of 360 degree — a joy stick — abbreviated — it has the same function.

[0019]Next, it describes about the functional block composition of the mah jongg game equipment 1 of the present invention.

[0020]The control part 20 is constituted by the above CPU6, digital signal processor 11, image drawing processing processor 12, and memory part (RAM8, interface circuit 9, and recording medium 5) 19. The game data consisting of image data, voice data, program data, etc. which were recorded on the recording medium 5, write ***** of the image data which CPU6 should make perform various signal processing by the digital signal processor 11, and it should draw to RAM8 by the image drawing processing processor 12 based on these various signal processing, or voice data — it controls like.

[0021]The operation input section 21 is constituted by the interface circuit 10, the operation information interface circuit 15, and the controller 16. By making the instructions according to the operation signal from the controller 16 by a player perform to CPU6. In a display screen as shown in the Fig.2 as which the hand and the contents of a discarded tile of the player, the contents of a discarded tile, of a waging-war character, a message, and face expression were displayed, a player, a waging-war character and turn — tiles, such as **** and a discarded tile, — a mah jongg game can be advanced by repeating length and ***** operation. In this case, a discarded tile is a tile thrown away into **, a hand is a tile on hand, **** is a tile to which it came also as one sheet from the tile pile, and a self-draw is an act to which it comes also as one sheet from a tile pile.

[0022]The picture display part 22 is constituted by the interface circuit 13, D/A converter 17, and the television monitor 2, and by the image drawing processing processor 12. In inputting into interface circuit 13 pan the image data which performed writing processing to RAM8 via D/A converter 17 at the television monitor 2, the image according to the mah-jongg waging-war situation for every CPU character will be displayed on a screen.

[0023]The voice output part 23 is constituted by the interface circuit 14, D/A converter 18, the PURIME yne amplifier 3, and the loudspeaker 4, and by the image drawing processing processor 12. The sound according to the mah-jongg waging-war situation for every CPU character will be outputted in inputting into the interface circuit 14 and D/A converter 18 pan the voice data which performed writing processing to RAM8 via the PURIME yne amplifier 3 at the loudspeaker 4.

[0024]Here, operation by the present invention is described in more detail below about the control part 20 including CPU6 controlled by the game data recorded on the recording medium 5.

[0025]So that the control part 20 may obtain presence and may predict a partner's contents of a hand synthetically, the motion of a facial expression and a face, message, and tile according to the waging-war situation for every waging-war character — obtaining image data and voice data so that it may become a variable item of length and ***** operation — such image data and voice data —

image display — and/or, it controls to carry out voice response.

[0026]According to the waging-war situation for every waging-war character, the feeling value is set up in order to obtain the expression for every waging-war character according to the flow of the mah-jongg waging-war situation, and the control part 20 is controlled to choose and carry out image display of the image data which shows the facial expression according to the sum total of the feeling value in the time.

[0027]The feeling value is set up according to the waging-war situation for every waging-war character, and choose the image data which shows the facial expression according to the sum total of the feeling value in the time, and the control part 20. It controls to choose and carry out image display of the image data with which give priority over the expression selection by this feeling value sum total, and only predetermined time indicates the facial expression according to a special situation to be so that the feeling for every occasional waging-war character of that appears preferentially and in emphasis.

[0028]furthermore — choosing data that the control part 20 should carry out the table of the situation for every waging-war character which the mah-jongg waging-war situation was sometimes alike, and responded, so that it may become a variable item corresponding to the high conditions of the priority among the monograph affairs of the waging-war situation for every waging-war character — image display — and/or, it controls to carry out voice response.

[0029]furthermore — choosing the message data of the waging-war character which carried out message specification at the time of the self-draw of a player so that the control part 20 may consider it as the hint of waging-war circumstantial judgment to the waging-war character to worry — image display — and/or, it controls to carry out voice response.

[0030]Above, the facial expression for every waging-war CPU character is four kinds of a laughter face, common face, and sadness face and an anger face. When the expression of a waging-war CPU character is Uchida, the woman of the front face of Fig.3, for example, Fig.3 is usually a face, Fig.4 is a laughter face, Fig.5 is a sadness face, Fig.6 is an anger face and the face expression of other waging-war characters is similarly displayed in the display screen of the television monitor 2, respectively.

[0031]a waging-war situation — the contents of a hand at the time of a starting hand, and the tile at the time of a self-draw — the tile at the time of contents and a discarded tile — they are contents, reorganization, the contents of win, etc. A motion of the face for every waging-war character carries out the motion which looks at which direction at least among the direction which threw away the tile, the direction of the partner who cried, and the direction of a partner which carried out win. the tile for every waging-war character — tiles, such as length and ***** operation, — movement — a motion of ****, a motion of a discarded tile, and reach — a motion and squeal of a tile — it is a motion of a tile etc. The display message and voice response of the image part are made to correspond to the facial expression for every waging-war CPU character. in this case, the time of starting calling with reorganization (reach) in the front of a gate — henceforth — AGARI — a tile — except is pulled, and is declared simultaneously materialized on condition of ****. Win is AGARI. furthermore — **** is this trouble by ready hand (state which waits for AGARI) — for example, ** for one — one more sheet — effective — it is in the state which is starting calling with a tile.

[0032]Next, the example is described in detail about the specific contents of the game data consisting of image data, voice data, program data, etc.

[0033]Carry out the initial set of a feeling value (mark) before a game start starting hand, and First, under a game, it is a usual case which sets a facial expression by the situation of the feeling value which carried out the feeling value set by the situation, and was set, and its CPU character, and is under [mah-jongg game] setting, The conversation (message) and the facial expression for every CPU character are decided according to the mah-jongg waging-war situation, When any CPU character is asked for conversation at the time of a player's own turn, it is a case where a CPU

character displays on a screen by making conversation according to the situation in the time into a message.

[0034]In the case of Uchida, the basic feeling value initial set classified by character (+128 points) is carried out, it has it, and a feeling value set with a point and the feeling value set by the situation in a front office are made the initial set of the feeling value for every CPU character of this, for example. It has in this case, and with a feeling value set with a point, whenever it increases by 400 points from start *****, it is considered as +one point, and whenever 400 points decrease, it calculates as -one point. For example, it becomes -1 point, when start ***** is made into 30000 points, it became +one point when it had and a point turned into 30400 points, and it has and a point turns into 29600 points. With the feeling value set by the situation in the front office in this case, When win (it has gone up) is being carried out in the front office (+three points) and the win beyond of limit hand is being carried out (+three points), When the limit hand ready hand was carried out, it was getting down when win was not able to be carried out (-three points), and does not transfer (+three points) and transfers (-three points), the case (-one point) where win is carried out to a partner by a self-draw is set.

[0035]With the feeling value set by the waging-war situation, the sum total of the following number of each point at the time of win and a flow office is set as a feeling value during a game at the time of a self-draw and a discarded tile at the time of a starting hand. In the case of Uchida's feeling value, at the time of a starting hand In for example, the case of below ** for three (+ten points). In more than ** for five (-ten points), at the time of a starting hand In the case of the *** rise by a self-draw (+three points). at the time of its discarded tile, it is not a time of applying reorganization (reach) — the self-draw end — and the discarded tile is unnecessary, when it is a tile (-three points), at the time of its discarded tile, it is not a time of applying reorganization (reach) — the self-draw end — and the discarded tile is unnecessary — a tile — not but, and the self-drawn tile is dangerous, when it is a tile (-three points) and applies reorganization (reach) at the time of its discarded tile (+ten points). When it cries at the time of its discarded tile (-six points) and reorganization (reach) can be applied at the time of the discarded tile of other houses (-ten points). When it cries at the time of the discarded tile of other houses (+six points) and self-draw win is carried out at the time of its win (+20 points), When it acts as Shigekazu at the time of its win (+20 points), have after the score calculation at the time of one's win, and A point (**1 per [from start *****] 400 differences), When it transfers at the time of the win of other houses (-20 points), at the time of the win of other houses In the self-draw **** case (-20 points). When it does not transfer (+14 points), when beyond limit hand has started calling at the time of the win of other houses (-14 points), are getting down at the time of the win of other houses, have after the score calculation at the time of the win of other houses, and A point (**1 per [from start *****] 400 differences), When beyond limit hand has started calling at the time of a flow office (-14 points), it is getting down at the time of a flow office, and when it does not transfer (+14 points), it has after the score calculation at the time of a flow office, and is a point (**1 per [from start *****] 400 differences) etc.

[0036]With the facial expression set by the set feeling value, the facial expression of a CPU character is usually changed to four kinds of a laughter face, common face, and sadness face and an anger face according to the set feeling value. It is made to change it every moment at the time of win and a flow office, etc. at the time of a self-draw and a discarded tile at the time of a starting hand. The standard of the feeling value at this time is as being shown below.

[0037]

tension quantity (178 or more feeling values): — laughter face tension common (88-point ~ 177 feeling values): — usually — a face — low-tensioned (48 points ~ 87 feeling values): — sadness face tension minimum (47 or less feeling values): — anger face usual. Although the facial expression of a CPU character is changing according to the set feeling value, in being in the situation of the following CPU character, the facial expression hung up over below has priority only for a moment or

temporarily, and returns to the facial expression by normal operation (operation by a feeling value) again after that.

[0038]At the time of a starting hand, in below ** for the starting hands 3, it laughs except the tension minimum and usually becomes a face by a face and the tension minimum.

[0039]In more than ** for the starting hands 5, it usually gets angry in tension quantity except a face and tension quantity, and becomes a face.

[0040]At the time of a self-draw, in the case of a **** rise self-draw, it laughs except the tension minimum and usually becomes a face by a face and the tension minimum.

[0041]unnecessary — a tile — in the case of a self-draw, it usually gets angry in tension quantity except a face and tension quantity, and becomes a face.

[0042]dangerous — a tile — in the case of a self-draw, it usually feels sad in tension quantity except a face and tension quantity, and becomes a face.

[0043>About a motion of the face of a CPU character, when other houses cry at the time of the DORA end of other houses, it is considered as a motion of a face which turns in the direction of the partner who cut the DORA temporarily, and the partner who cried. However, when other houses cry, the person who cut the tile which cried becomes an anger face temporarily, and has become a motion of a face which turns in the direction of the person who cried after that.

[0044]the reach of a CPU character — a tile, a discarded tile, and a squeal — a motion of the image of a tile changes with above-mentioned feeling values (tension), and it changes also with each CPU characters.

[0045]next, a tile — it describes about movement toward length and ***** operation.

[0046]first, the reach for every CPU character — although a motion of the image of a tile changes also with above-mentioned feeling values (tension), it is as being shown in the next (table 1). this (Table 1) — it sets, I attaches vigor and it is reach from a top, and S is made to slide just for a moment, and is reach, O is reach placed on that occasion, and K is reach performed by rotating a tile. The motion which there are some tendencies also in man and woman's CPU character, and a male does the motion which attaches vigor and carries out reach from a top, and a woman makes it slide just for a moment, and carries out reach is carried out.

[0047]

[Table 1]

テンション 感情値	高い 178以上	ふつう 177-88	低い 87-48	最低(怒り) 47以下
徳河	S	S	S	S
織田	K	K	K	K
豊臣	O	O	O	O
千野	S	S	S	S
武田	K	I	I	O
小澤	Y	N	N	N
ED	K	K	K	K
矢崎	S	S	S	S
宮古	I	S	S	S
西水	O	O	O	O
法	S	S	S	S
工藤	I	S	S	S
尾崎	I	I	S	S
榎村	K	I	S	O
松村	S	S	O	O
宗室	K	I	S	S
長山	I	I	S	S
無沼	K	I	I	S
内田	I	I	S	S

I : 勢いをつけて上からリーチ
S : ちょっとだけスライドさせてリーチ
O : その場におく
K : 回転してリーチ

[0048] Although a motion of the image of the discarded tile for every CPU character changes also with above-mentioned feeling values (tension), it is as being shown in the next (table 2), this (Table 2) — it setting, and T being a case where a tile is thrown away and by the motion thrown as shown in Fig.25 a, Y is zoom-in and a case where carry out a zoom down and a tile is thrown away, gently, as shown in Fig.25 b, N is a case where a tile is thrown away as it lets length, width, and a mah-jongg table slide, as shown in Fig.25 c, and I is a case where a tile is suddenly thrown away without a motion as a pattern of anger as shown in Fig.25 d. There are some tendencies also in man and woman's CPU character, a male does the motion which throws away a tile so that it may throw with sufficient vigor from a top, and a woman does gently zoom-in and the motion which carries out a zoom down and throws away a tile.

[0049]

[Table 2]

テンション 感情値	高い 178以上	ふつう 177-88	低い 87-48	最低(怒り) 47以下
徳河	Y	Y	Y	Y
織田	T	T	I	I
豊臣	T	Y	Y	N
千野	N	N	N	N
武田	T	T	T	T
小澤	Y	N	N	N
E D	T	Y	N	I
矢崎	N	N	N	N
富古	T	Y	Y	Y
吉永	Y	Y	Y	Y
法	Y	Y	N	N
工藤	T	Y	Y	N
尾崎	Y	Y	N	N
榎村	T	Y	N	I
松村	Y	Y	Y	Y
奈堂	T	Y	N	N
長山	Y	Y	Y	Y
藤沼	T	Y	N	N
内田	T	Y	Y	N

T : 叩き付ける動き
Y : 緩やかに、ズームアップ、ズームダウンする
N : 縦、横と卓上を滑らす
I : 動きなしでいきなり捨てる (怒りパターン)

[0050] Although it cries for every CPU character and a motion of the image of a tile changes also with above-mentioned feeling values (tension), it is as being shown in the next (table 3). this (Table 3) — although a motion which sets, brings N at hand as it is, and is doubled with other tiles is carried out, the height of the tile taken with a feeling value (tension) and a zoom rate change, and magnifying power becomes high, so that a feeling value (tension) is high. X carries out the motion which is taken with length and width and is doubled with other tiles, and K carries out the motion taken while rotating a tile.

[0051]
[Table 3]

テンション 感情値	高い 178以上	ふつう 177-88	低い 87-48	最低(怒り) 47以下
徳河	N	N	N	N
織田	K	N	N	N
豊臣	N	N	X	X
千野	X	X	X	X
武田	K	N	X	X
小澤	N	N	N	N
E D	K	K	K	N
矢崎	K	N	N	N
宮古	X	X	X	X
吉永	X	X	X	X
法	X	X	X	X
工藤	X	X	X	X
尾崎	N	N	X	X
樹村	K	X	N	N
松村	N	N	N	N
森重	K	N	X	X
長山	N	N	N	N
蟹沼	K	X	X	N
内田	N	N	X	X

N : そのまま手元に持ってきて他の牌と合わせる。

(テンションによってとる牌の高さ、

ズーム率が変わります。

テンションが高いほど拡大率が高くなります。)

X : 縦横と取ってきて他の牌と合わせる。

K : 回転しながらとってくる。

[0052]several kinds [more than] — a tile — **** of a tile, the sound of concentration, etc. can also be changed according to length and ***** operation.

[0053]Also about a motion of ****, when bringing to which end of the right and left of a hand, placing beside a hand similarly, coming as ** and regarding as CHIRATSU, it is in some numbers; and these differ for every CPU character and change also with mah-jongg waging-war situations. According to those conditions, it is made to carry out a generating picture.

[0054]Next, a facial expression, and its message (conversation) and sound of a CPU character, Judge all preferentially in order of the waging-war situation-items number, stop the judgment after it by the item by which conditions were fulfilled, and the conversation data and face expression data for every CPU character of the in the item are set simultaneously, and voice data will be set if required. Even if it judges to the last number in the item, in not fulfilling a monograph affair, it skips all also of face expression, conversation, and a sound. That is, when it results in the following condition items, image display of the change items, such as a facial expression for every CPU character set up for every condition items of the, its message (conversation), sound, will be set up and carried out.

[0055]However, for example, it is shown below, it is a facial expression controlled by (14-1 and the feeling value which it "is usually a face" of the face) usually described above, and the number of 14-1 corresponds to the message (conversation) mentioned later. (The example of a CPU character: Uchida)

It is 1. east house start (14-1, usually face) at the time of a halfround game start.

2. South player start (14-2, usually face)

3. South player start (14-3, usually face)

http://www4.ipdl.inpit.go.jp/cgi-bin/tran_web.cgi_ejje?atw_u=http%3A%2F%2Fwww4.jp... 7/11/2013

4. North player start (14-4, usually face)

The end of a halfround game was carried out at 1. top at the time of the end of a halfround game (15-01, usually face).

2. The last ***** carried out the end of a halfround game at the point higher than the last ***** of a player about 30000 or more points (15-02, usually face).

3. The last ***** carried out the end of a halfround game at the point lower than the last ***** of a player about 30000 or more points (15-03, anger face).

4. The last ***** carried out the end of a halfround game at the point that it is lower than 30000 points and higher than the last ***** of a player (15-04, anger face).

5. The last ***** carried out the end of a halfround game at the point that it is lower than 30000 points and lower than the last ***** of a player (15-05, sadness face).

when applying reorganization (reach), the tile which is 1, pursued and is cut with reorganization is dangerous — a tile (1-06, sadness face)

2. Pursue and reorganize (1-05, usually face).

Reorganization of the order [of 3.6] less than (1-01, anger face)

4. DORA end reorganization (1-04, sadness face)

Reorganization of the order [of 5.13] henceforth (1-02, sadness face)

6. Reorganization of those other than above-mentioned conditions 1 - 5 (1-03, usually face)

When reorganization (reach) was able to be applied, it 1. Pursued and reorganization was able to be applied (2-02, sadness face).

Reorganization of the order [of 2.6] less than was able to be applied (2-03, anger face).

3. DORA end reorganization was able to be applied (2-01, sadness face).

4. Self-draw end reorganization was able to be applied (2-04, sadness face).

5. Except the above-mentioned conditions 1 - 4, its hand is more than ** for three (2-05, sadness face). [at that time]

6. Except the above-mentioned conditions 1 - 4, its hand is ** for 1-2 (2-06, anger face). [at that time]

7. Its hand starts calling except the above-mentioned conditions 1 - 4 (2-07, usually face). [at that time]

The dark can of DORA was carried out (3-02, laughter face).

The dark can of DORA was carried out (4-01, sadness face).

The ** can of DORA was carried out (3-03, usually face).

When it cries (a ** can, Pons)

1. DORA was cried (3-02, laughter face).

2.1 shot was erased (3-01, sadness face).

3. *** 1 squeal (3-04, sadness face)

When it cries (a ** can, Pons)

1. When it is CPU itself that threw away in having cried DORA (4-01, sadness face)

2. When it is player that threw away in having cried DORA (4-02, anger face)

3.1 shot was erased (4-03, sadness face).

When not applied to the above item, when it cries to the time (common) of crying at which it is shown below (tsi)

1.1 shot was erased (3-01, sadness face).

2. It cried including DORA (3-03, usually face).

When it cries (tsi)

1.1 shot was erased (4-03, sadness face).

2. When it is [the discarded tile] DORA in CPU itself that threw away in tsi having been carried out including DORA (4-01, sadness face)

3. When it is [the discarded tile] DORA in player that threw away in tsi having been carried out including DORA (4-02, anger face)

When not applied to the above item, when it cries to the time (common) of crying at which it is shown below (common)

1. When person who cried has less than [order / of six] by **** 1 squeal and is lower than 20000 points (4-06, anger face).
 2. When person who cried has already cried **** further less than [order / of six] by **** 1 squeal in CPU itself (4-05, anger face)
 3. The person who cried is at **** 1 squeal at the time (4-04, usually face) of the order [of six] less than.
 4. The person who cried is at **** 1 squeal at the time (4-07, anger face) of the order [of seven] henceforth.
 5. The person who cried is at 1 squeal at the time (4-08, sadness face) of not **** but the order [of six] less than.
 6. At the squeal of the tile with letters which is not **** in 1 squeal, the person who cried is at the time (4-10, usually face) of the order [of seven] henceforth.
 7. At the squeal which is not **** in 1 squeal, the person who cried is at the time (4-09, usually face) of the order [of seven] henceforth.
 8. The person who cried is crying including **** by 2 squeals, and it is at the time (4-11, anger face) of the order [of eight] less than.
 9. When persons who cried are 3 squeals (4-12, sadness face)
 10. When the persons who cried are 4 squeals (4-13, sadness face)
- When the CPU itself carried out a can and Kandla got, Kandla of 1.CPU itself got three or more sheets (5-02, usually face).

2. CPU's own Kandla got one or more sheets (5-01, laughter face).
 3. Kandla of other houses got three or more sheets (5-04, sadness face).
 4. Kandla of other houses got one or more sheets (5-03, sadness face).
- When other houses carried out a can and Kandla got, Kandla of 1.CPU itself got three or more sheets (6-02, usually face).

2. CPU's own Kandla got one or more sheets (6-01, usually face).
3. Kandla of other houses got three or more sheets (6-04, anger face).
4. Kandla of other houses got one or more sheets (6-03, sadness face).

When cutting a tile, it decided "1. Got down" (7-01, sadness face).

2. --- dangerous to ****, although it is getting down and is harmless at reorganization --- a tile is cut (7-03, sadness face)
3. --- dangerous [getting down,] --- a tile is cut (7-02, sadness face)
4. --- getting down --- the time of a self-draw --- the highest --- dangerous --- not the self-draw end but an easy way out is cut with a tile (7-05, anger face)
5. --- getting down --- the time of a self-draw --- the highest --- dangerous --- not for the self-draw end but for reorganization, an easy way out is cut with a tile (7-03, sadness face)
6. --- getting down --- the time of a self-draw --- the highest --- dangerous --- the tile which is not the self-draw end is cut with a tile (7-06, sadness face)
7. the highest --- dangerous --- cut a tile (7-04, anger face)
8. a self-drawn tile --- the highest --- dangerous --- cut not the self-draw end but an easy way out with a tile (7-05, anger face)
9. the time of a self-draw --- the highest --- dangerous --- dangerous with a tile to not the self-draw end but reorganization --- cut a tile (7-06, sadness face)
- win --- the time --- 1. **** (8-02, usually face)
2. Head HANE went up (10-01, sadness face).
3. It had by the win henceforth [Nanba], and the point turned into 30000 or more points, and it became the being new top (8-01, laughter face).
- 4.3 time **, **** (8-03, laughter face)

http://www4.ipdl.inpit.go.jp/cgi-bin/tran_web_cgi_ejje?atw_u=http%3A%2F%2Fwww4.jp... 7/11/2013

5. **** (8-04, laughter face)
6. It went up including the role of a spear can (10-02, laughter face).
7. It went up including the bloom on ** (8-06, laughter face).
8. The submarine self-draw was carried out (8-07, usually face).
9. It acted as riverbed Shigekazu (10-03, laughter face).
- It acted as Shigekazu including the role of 10.1 shot (10-04, usually face).
- The self-draw sum was carried out including the role of 11.1 shot (8-08, laughter face).
12. At the time of comparatively cheap limit hand in case it raises and there is a slight low price (8-09, a sadness face)
13. At the time of limit hand other than the above-mentioned condition 12 (8-05, a laughter face)
14. win --- the time (8-10, usually face) of slight height in case a point raises by 3200 or more points of a child and there is a slight low price going up
15. win --- the time (8-11, sadness face) of it being comparatively cheap, in case a point raises by 3200 or more points of a child and there is a slight low price, and going up
16. win --- the time (8-15, sadness face) of a child being lower than 3200 points, the point having applied reorganization, and a reverse side drama not getting
17. win --- a point does not apply reorganization by Shimo from 3200 points of a child --- win --- a point --- the time (8-14, sadness face) above 1000 points of a child
18. win --- a point does not apply reorganization below 3200 points of a child --- win --- the time (8-16, sadness face) of a point being 1000 or less points of a child
19. or it applied and carried out the 5 or more order self-draw end of the reorganization of an after [reorganization] and carried out the self-draw sum --- or win --- the time (8-12, sadness face) of a child doing [a point] the 3200 or more point self-draw sum
20. or it applied and carried out the 5 or more order self-draw end of the reorganization of an after [reorganization] and acted as Shigekazu --- or win --- the time (8-05, laughter face) of a child acting [a point] as 3200 or more point Shigekazu
21. or it carried out the self-draw sum of the reorganization in the situation except having applied and carried out the 5 or more order self-draw end of an after [reorganization], and having gone up --- or win --- the time (8-13, sadness face) of a child doing [a point] the 3200 or more point self-draw sum
22. or it acted as Shigekazu of the reorganization in the situation except having applied and carried out the 5 or more order self-draw end of an after [reorganization], and having gone up --- or win --- the time (10-06, usually face) of a child acting [a point] as 3200 or more point Shigekazu
- When win is carried out (when it has influence on CPU's own score)
1. When the top is reversed henceforth [Nanba] (9-01, sadness face)
2. Beyond as for limit hand, the self-draw sum was carried out (9-02, sadness face).
3. Beyond limit hand acted as Shigekazu (11-01, sadness face).
4. The self-draw sum was carried out to the CPU itself having applied reorganization (9-03, sadness face).
5. It acted to the CPU itself having applied reorganization as Shigekazu (11-02, sadness face).
6. win --- the win of the point was carried out in 1000 or less points of a child, and the CPUs itself were parents (12-05, sadness face)
7. win --- the win of the point was carried out in 1000 or less points of a child, and the CPU itself was a child (11-04, sadness face)
8. The self-draw sum was carried out in the above-mentioned conditions 1 - situations other than seven (9-04, anger face).
9. It acted as Shigekazu in the above-mentioned conditions 1 - situations other than seven (11-03, sadness face).
- When win is carried out (when there is no influence in CPU's own score)
1. Head HANE was carried out (12-02, sadness face).

http://www4.ipdl.inpit.go.jp/cgi-bin/tran_web_cgi_ejje?atw_u=http%3A%2F%2Fwww4.jp... 7/11/2013

2. When the top is reversed henceforth [Nanba] (12-01, sadness face)
 3. 7700 or more points of a child covered the expenses of win (12-03, sadness face).
 4. When win has CPU's own parents kicked below 3200 points of child (12-05, sadness face)
 5. The above-mentioned conditions 1 - situations other than four went up (12-04, sadness face).
- At the time of a flow office, beyond 1. limit hand had started calling, and the flow office was carried out (13-01, sadness face).
2. The flow office of the reorganization was applied and carried out (13-02, sadness face).
 3. having started calling and not applying reorganization --- win --- the point carried out the flow office by the child's hand of 1000 or less points (13-04, sadness face)
 4. having started calling and not applying reorganization --- win --- the point carried out the flow office by the child's hand of 3200 or more points (13-04, sadness face)
 5. The flow office was started calling and carried out in the above-mentioned conditions 1 - situations other than four (13-05, anger face).
 6. Although it was non-**, the flow office was carried out in the situation where it is getting down (13-06, sadness face).
 7. The flow office was carried out by non-** in situations other than the above-mentioned condition 6 (13-07, sadness face).
- When it is the CPU itself which 1. **** carried out at the time of the flow office by 9 type Yao 9 ***** (13-08, sadness face)
2. When player **** (13-09, usually face)
- the time of the flow office by 3 **** --- the 1.CPU itself --- win --- the time (13-10, anger face) of being one in a person
2. The CPU itself transferred (13-11, sadness face).
- When the CPU itself carries out a can to the 1. last at the time of a flow office with 4 open cans (13-12, sadness face)
2. When player carries out can to last (13-12, sadness face)
- When the wind tile of the 1. last is the CPU itself at the time of the flow office by cardinal-winds child continuous hits (13-13, usually face)
2. When the last wind tile is player (13-15, anger face)
- When the reorganization person of the 1. last is the CPU itself at the time of the flow office by 4 house reorganization (13-14, usually face)
2. When the last reorganization person is player (13-15, anger face)
- Next, it describes about the conversation (message) and the sound which are automatically performed at the time of the turn of a CPU character itself. However, for example, it is shown below, the facial expression of a CPU character is corresponded to the laughter face and tune message (conversation) which is usually sadness facial expressions in four kinds of a face, a sadness face, and an anger face, and T-33 mentions later with the "sadness face" of (T-33 and a sadness face). It is the voice for every CPU character, for example (laughing voice) (surprise voice), (Laughing voice) According to the situation, if it is a (laughing voice) (for example, if "KUSUTSU", "WAHHAHA", "FUFU", etc. are (surprise voice)), "Guyot", at least one kind [about four] of "Wu", "HEE", etc. are set up (surprise voice).
- [0056]1. When it is getting down and judges that it can finish being (T-33, sadness face)
 2. Although it is not getting down and did not necessarily judge yet that it can finish being, when there are two or more easy ways out (laughing voice)
 3. the CPU character itself has applied reorganization --- the after-reorganization self-draw end --- a tile --- numbers are seven tiles. (T-22, usually face)
 4. the CPU character itself has applied reorganization --- the after-reorganization self-draw end --- a tile --- numbers are eight tiles. (Surprise voice)
 5. the CPU character itself has applied reorganization --- the after-reorganization self-draw end --- a tile --- numbers are six tiles. (Surprise voice)

http://www4.ipdl.inpit.go.jp/cgi-bin/tran_web/cgi_ejje?atw_u=http%3A%2F%2Fwww4.ip... 7/11/2013

6. the CPU character itself has applied reorganization — the after-reorganization self-draw end — a tile — numbers are four tiles. (Surprise voice)
7. the CPU character itself has applied reorganization — the after-reorganization self-draw end — a tile — numbers are three tiles. (T-24, anger face)
8. Although one someone had applied reorganization, when are not getting down from CPU character itself, and CPU character itself has not applied reorganization, it remains, and has self-draw, who does not have the first shot of reorganization and it becomes ** for three (T-26, laughter face)
9. the time of not getting down from the CPU character itself, and the CPU character itself not having applied reorganization, it remaining, and having a self-draw, and who not having the first shot of reorganization, and becoming ** for three, although one someone had applied reorganization — and the above-mentioned conditions 8 — back (laughing voice)
10. Although one someone had applied reorganization, when are not getting down from the CPU character itself, and the CPU character itself has not applied reorganization, it remains, and has a self-draw, who does not have the first shot of reorganization and it becomes ** for two (T-27, sadness face)
11. the time of not getting down from the CPU character itself, and the CPU character itself not having applied reorganization, it remaining, and having a self-draw, and who not having the first shot of reorganization, and becoming ** for two, although one someone had applied reorganization — and the above-mentioned conditions 10 — back (laughing voice)
12. Although one someone had applied reorganization, when are not getting down from the CPU character itself, and the CPU character itself has not applied reorganization, it remains, and has a self-draw, who does not have the first shot of reorganization and it becomes ** for one (T-28, anger face)
13. the time of not getting down from the CPU character itself, and the CPU character itself not having applied reorganization, it remaining, and having a self-draw, and who not having the first shot of reorganization, and becoming ** for one, although one someone had applied reorganization — and the above-mentioned conditions 12 — back (laughing voice)
14. When nobody applies reorganization, and it is not getting down from the CPU character itself and the stage fright eye of a CPU character itself is lost substantially (surprise voice)
15. When nobody applies reorganization, and it is not getting down from the CPU character itself and the stage fright eye of a CPU character itself is lost (T-16, sadness face)
16. Nobody applies reorganization, and it is not getting down from the CPU character itself, and is at eye starting hand 1 order at the time (T-02, usually face) of ** for two, or ** for three.
17. everyone — not applying reorganization and not getting down from the CPU character itself — eye starting hand 1 order — the time of ** for two, or ** for three — the above-mentioned conditions 16 — back (laughing voice)
18. Nobody applies reorganization, and it is not getting down from the CPU character itself, and is at eye starting hand 1 order at the time (T-01, usually face) of ** for one.
19. everyone — not applying reorganization and not getting down from the CPU character itself — eye starting hand 1 order — the time of ** for one — the above-mentioned conditions 18 — back (laughing voice)
20. It is more than ** for four (T-10, anger face) by the time which nobody applies reorganization and is not getting down from the CPU character itself and when not eye starting hand 1 order but the flow of a self-draw is bad.
21. It is at the time (T-09, sadness face) of ** for two, or ** for three by the time which nobody applies reorganization and is not getting down from the CPU character itself and when not eye starting hand 1 order but the flow of a self-draw is bad.
22. It is at the time (T-08, sadness face) of ** for one by the time which nobody applies reorganization and is not getting down from the CPU character itself and when not eye starting hand 1 order but the flow of a self-draw is bad.

23. When one of the above-mentioned conditions 20-22 has already happened and the same conditions happen once again (groan)

24. When nobody applies reorganization, and it is not getting down from the CPU character itself, not eye starting hand 1 order but the number of the remaining self-draws is taken into consideration and the stage fright eye of a CPU character itself is thin (T-09, sadness face)

25. It is at the time (T-16, usually face) of ** for three, or ** for two by the time with sufficient not eye starting hand 1 order but flow of a self-draw which nobody applies reorganization and is not getting down from the CPU character itself.

26. When a hand is ** for two when the conditions 25 occur in ** for three, or the conditions 25 occur in ** for two in a hand, it is at the time (laughing voice) of ** for three.

27. It is at the time (T-14, sadness face) of ** for one by the time with sufficient not eye starting hand 1 order but flow of a self-draw which nobody applies reorganization and is not getting down from the CPU character itself.

28. When the conditions 27 have already happened and the same conditions occur once again (laughing voice)

Next, when any CPU character is asked for conversation (message) at the time of a player's own turn, it describes about setting a conversation set (message) for every the situation and its CPU character.

[0057]Also when a player asks any CPU character for conversation (message) at the time of a player's own turn, Like an old case, each following situation is preferentially judged from the conditions of the young number, the judgment after it is stopped by the condition items by which conditions were fulfilled, and the conversation data and face expression data for every CPU character in the condition items are set simultaneously. (The example of a CPU character: Uchida)

1. When it is getting down and judges that it can finish being (T-33, sadness face)

2. Although it is not getting down and did not necessarily judge yet that it can finish being, when there are two or more easy ways out (T-34, usually face)

3. Although it is not getting down, it did not necessarily judge that it can finish being and there is also an easy way out, when including the tile which seems to be comparatively safe in an easy way out and it can finish being (T-35, usually face)

4. Although it is not getting down, it did not necessarily judge that it can finish being and an easy way out does not have one sheet, either, when including the tile which seems to be comparatively safe in an easy way out and it can finish being (T-36, sadness face)

5. When are not getting down, it does not necessarily judge that it can finish being, there is also an easy way out and it has a tile which seems to be comparatively safe (T-37, sadness face)

6. It is at the above-mentioned conditions 1-5 at the ***** time (T-38, sadness face).

7. When CPU character itself has applied reorganization and it is the first shot (T-20, usually face)

8. the CPU character itself has applied reorganization — the after-reorganization self-draw end — a tile — numbers are seven tiles. (T-22, usually face)

9. the CPU character itself has applied reorganization — the after-reorganization self-draw end — a tile — numbers are five tiles or six tiles. (T-23, anger face)

10. the CPU character itself has applied reorganization — the after-reorganization self-draw end — a tile — numbers are three tiles or four tiles. (T-24, anger face)

11. The CPU character itself has applied reorganization and it is at the times (T-21, usually face) other than the above-mentioned conditions 7 - 10.

12. Although one someone has applied reorganization, when it is not getting down from the CPU character itself, and the CPU character itself has not applied reorganization and there is no remaining self-draw (T-30, sadness face)

13. Although one someone has applied reorganization, it is not getting down from the CPU character itself, and the CPU character itself has not applied reorganization, the remaining self-draw occurs, and who has the first shot of reorganization (T-25, usually face).

14. Although one someone has applied reorganization, by not getting down from the CPU character itself, the CPU character itself has not applied reorganization, it remains, and a self-draw occurs, who does not have the first shot of reorganization, and one someone's number of the after-reorganization self-draw ends is less than 4 order, and it is at the time (T-26, laughter face) more than ** for three.
15. Although one someone has applied reorganization, by not getting down from the CPU character itself, the CPU character itself has not applied reorganization, it remains, and a self-draw occurs, who does not have the first shot of reorganization, and one someone's number of the after-reorganization self-draw ends is less than 4 order, and it is at the time (T-27, sadness face) of ** for two.
16. Although one someone has applied reorganization, by not getting down from the CPU character itself, the CPU character itself has not applied reorganization, it remains, and a self-draw occurs, who does not have the first shot of reorganization, and one someone's number of the after-reorganization self-draw ends is less than 4 order, and it is at the time (T-28, anger face) of ** for one.
17. Although one someone has applied reorganization, by not getting down from the CPU character itself, the CPU character itself has not applied reorganization, it remains, and a self-draw occurs, who does not have the first shot of reorganization, and one someone's number of the after-reorganization self-draw ends is less than 4 order, and it is at the time (T-29, usually face) of a ready hand.
18. Although one someone has applied reorganization, by not getting down from the CPU character itself, the CPU character itself has not applied reorganization, it remains, and a self-draw occurs, who does not have the first shot of reorganization, and all reorganization persons' number of the after-reorganization self-draw ends is 5 or more order, and it is at the time (T-30, sadness face) more than ** for two.
19. Although one someone has applied reorganization, by not getting down from the CPU character itself, the CPU character itself has not applied reorganization, it remains, and a self-draw occurs, who does not have the first shot of reorganization, and all reorganization persons' number of the after-reorganization self-draw ends is 5 or more order, and it is at the time (T-31, usually face) of ** for one.
20. Although one someone has applied reorganization, by not getting down from the CPU character itself, the CPU character itself has not applied reorganization, it remains, and a self-draw occurs, who does not have the first shot of reorganization, and all reorganization persons' number of the after-reorganization self-draw ends is 5 or more order, and it is at the time (T-32, anger face) of a ready hand.
21. When nobody applies reorganization, and it is not getting down from the CPU character itself and the stage fright eye of a CPU character itself is lost substantially (T-05, sadness face)
22. When nobody applies reorganization, and it is not getting down from the CPU character itself and the stage fright eye of a CPU character itself is lost (T-06, sadness face)
23. Nobody applies reorganization, and it is not getting down from the CPU character itself, and is at eye starting hand 1 order at the time (T-04, anger face) more than ** for five.
24. Nobody applies reorganization, and it is not getting down from the CPU character itself, and is at eye starting hand 1 order at the time (T-03 sadness face) of ** for four.
25. Nobody applies reorganization, and it is not getting down from the CPU character itself, and is at eye starting hand 1 order at the time (T-02, usually face) of ** for two, or ** for three.
26. Nobody applies reorganization, and it is not getting down from the CPU character itself, and is at eye starting hand 1 order at the time (T-01, usually face) of a ready hand or ** for one.
27. It is at the time (T-10, anger face) more than ** for four by the time which nobody applies reorganization and is not getting down from the CPU character itself and when not eye starting hand 1 order but the flow of a self-draw is bad.

http://www4.ipdl.inpit.go.jp/cgi-bin/tran_web_cgi_ejje?atw_u=http%3A%2F%2Fwww4.ip... 7/11/2013

28. It is at the time (T-09, sadness face) of ** for two, or ** for three by the time which nobody applies reorganization and is not getting down from the CPU character itself and when not eye starting hand 1 order but the flow of a self-draw is bad.
29. It is at the time (T-08, sadness face) of ** for one by the time which nobody applies reorganization and is not getting down from the CPU character itself and when not eye starting hand 1 order but the flow of a self-draw is bad.
30. At the time of the ready hand in the time which nobody applies reorganization and is not getting down from the CPU character itself and when not eye starting hand 1 order but the flow of a self-draw is bad (T-07, a sadness face)
31. When nobody applies reorganization, and not getting down, turning the CPU character itself not by eye starting hand 1 order but by ***** for two and carrying out inside (T-12, usually face)
32. When nobody applies reorganization, and it is not getting down from the CPU character itself, not eye starting hand 1 order but the number of the remaining self-draws is taken into consideration and the stage fright eye of a CPU character itself is thin (T-11, sadness face)
33. When nobody applies reorganization, and it is not getting down from the CPU character itself, not eye starting hand 1 order but the number of the remaining self-draws is taken into consideration and the stage fright eye of a CPU character itself is thin (T-13, laughter face)
34. It is at the time (T-14, sadness face) of a ready hand or ** for one by the time with sufficient not eye starting hand 1 order but flow of a self-draw which nobody applies reorganization and is not getting down from the CPU character itself.
35. It is at the time (T-16, usually face) of ** for three, or ** for two by the time with sufficient not eye starting hand 1 order but flow of a self-draw which nobody applies reorganization and is not getting down from the CPU character itself.
36. It is at the time (T-17, sadness face) of ** for four by the time with sufficient not eye starting hand 1 order but flow of a self-draw which nobody applies reorganization and is not getting down from the CPU character itself.
37. It is at the time (T-19, sadness face) more than ** for five by the time with sufficient not eye starting hand 1 order but flow of a self-draw which nobody applies reorganization and is not getting down from the CPU character itself.
38. At the time of the ready hand in the time which nobody applies reorganization and is not getting down from the CPU character itself and when not eye starting hand 1 order but the flow of a self-draw is ordinary (T-14, a sadness face)
39. It is at the time (T-15, usually face) of ** for one by the time which nobody applies reorganization and is not getting down from the CPU character itself and when not eye starting hand 1 order but the flow of a self-draw is ordinary.
40. It is at the time (T-17, sadness face) of ** for two - ** for four by the time which nobody applies reorganization and is not getting down from the CPU character itself and when not eye starting hand 1 order but the flow of a self-draw is ordinary.
41. When nobody applies reorganization, and it is not getting down from the CPU character itself and not eye starting hand 1 order but the flow of a self-draw is usually more than ** for five but (T-19, sadness face)
42. At the time of the ready hand in the time that nobody applies reorganization, and is not getting down from the CPU character itself, and not eye starting hand 1 order but the flow of a self-draw is not so good (T-15, usually a face)
43. It is at the time (T-17, sadness face) of ** for one by the time that nobody applies reorganization, and is not getting down from the CPU character itself, and not eye starting hand 1 order but the flow of a self-draw is not so good.
44. It is at the time (T-18, sadness face) of ** for two - ** for four by the time that nobody applies reorganization, and is not getting down from the CPU character itself, and not eye starting hand 1 order but the flow of a self-draw is not so good.

http://www4.ipdl.inpit.go.jp/cgi-bin/tran_web/cgi_ejje?atw_u=http%3A%2F%2Fwww4.jp... 7/11/2013

45. When nobody applies reorganization, and it is not getting down from the CPU character itself and not eye starting hand 1 order but the flow of a self-draw is not so good, it is at the time (T-19, sadness face) more than ** for five.

Here, about the contents of conversation (message), it constitutes so that conversation (message) may be set for every the situation and its CPU character, but the case where a CPU character is Uchida about the example is described to an example.

[0058]First of all, as an example of the conversation (message) under game, it is 1-01: "here ... it is a match .."

1-02: It is late... there "there is nothing",.

1-03: " it was here --- It is... the match "

1-04: Can come and even throw away... "he would like to win."

1-05: "Don't miss"...

1-01: It passes... "this way"

2-01: " ... not being needed --- it .. "

2-02: Is not related... "in present me" ..

2-03: ... "be already."

2-04: ** ... "get down."

2-05: "useless --- it is ... "

2-06: "--- yet ... it does not lose .. "

2-07: ... "from here" ---

3-01: The thing of one shot --- "I'm sorry"

3-02: ... "arrange."

3-03: It is this here, --- "good one"

3-04: The wish ... ["as it is"]

4-01: ... ["since there is nothing dreadfully"] ..

4-02: Since it cuts --- "it is ****" ..

4-03: It was kicked. --- "one shot" ..

4-04: "... if it is right --- yet .. "

4-05: "--- having come ... me --- the point .. "

4-06: ... "he would like to already return."

4-07: ... "what and aim" ..

4-08: If it is me ... "wax done what"

4-09: Only a few ... "only a few was visible."

4-10: "mah-jongg ... a way of life --- the Homo sapiens's .. "

4-11: ... "mah-jongg is such a thing."

4-12: Mah-jongg ... Homo sapiens who has struck ... "project."

4-13: ... "mah-jongg is what by which it does not come."

5-01: Were [this being Quan and] right? ... "if it finishes, understand" ..

5-02: A meaning ... "it suited."

5-03: This ... "he was Quan who is not good."

5-04: ... "firm cause of me"

6-01: "--- This ... --- of me --- it is a way which he should proceed --- "

6-02: "... this --- Something --- previous announcement"

6-03: "--- it ... your own fate "

6-04: ... "a --- match still does not throw away" away.

7-01: ... "it must still continue."

7-02: " ... it passes --- kana --- here --- "

7-03: Reach ... "how"

7-04: It throws away... ["here"]

7-05: "--- This ... ***** useless"

7-06: ... "Such a place --- passing and ..."
 8-01: If it is this ... "arrange."
 8-02: ... ["how many times the back is not AGA **** among lifetimes"]?
 8-03: AGA **** ... "aim."
 8-04: Give up... "it was able to bound."
 8-05: It was good... "it becomes as thought". --
 8-06: ... there was no ata so far. --- "by no means"
 8-07: To the extent that it is wonderful ... "what and aim" ---
 8-08: It hit... ["reading"]
 8-09: ... ["if it is a reverse side"] ---
 8-10: What ... ["or / being high /"] ---
 8-11: ... "low eye, **"
 8-12: "... if common --- long ago --- Ata ***** ---"
 8-13: "--- Here ... the limit of me --- it is .."
 8-14: Was right... "this AGARI"
 8-15: Only this ... "it cannot think now."
 8-16: I'm sorry ... "was unavoidable."
 9-01: It kept... "it is a fall at that present."
 9-02: But curve... "good AGARI"
 9-03: It cannot win... "reach was carried out."
 9-04: The next ... ["since it does not lose"]
 10-01: I'm sorry and it ... "me"
 10-02: It ... "it is a strike."
 10-03: It came... "at a fellow and the last"
 10-04: "One shot" ...
 10-05: It waited... "long thing"
 10-06: Here ... "AGARI measure"
 11-01: A lie ... "it is this."
 11-02: "Unavoidable **"
 11-03: A lie ... "it is this."
 11-04: It is small... "I considered."
 12-01: I am sad... "such a top victory"
 12-02: "... [AGA / that of **]"
 12-03: True ** ... "was dangerous."
 12-04: Also obtain me... there "there being AGA ** as for nothing"
 12-05: "--- being useless ... cherishing parents more --- *****"
 13-01: It is useless... ["if this class does not have AGA **"] ..
 13-02: Until it runs "risk ... having carried out what --- me ---"
 13-03: Or [being useless] ... "it was carrying out unreasonable."
 13-04: Or [being useless] ... "it was carrying out unreasonable."
 13-05: "Was reckless."
 13-06: It does not help... there "there are even things"
 13-07: It does not help... there "there are even things"
 13-08: I'm sorry ... "I would like to have come to pass"
 13-09: Do not carry out... "distinguished citizen"
 13-10: "Convenience is too good"
 13-11: There is also no this top... "temper in which it lost" ..
 13-12: I'm sorry ... "make it pass."
 13-13: "--- The same wind ... having divided and had --- by chance ..."
 13-14: This ... "it is a draw."

13-15: The convenience there ... ["without it passes"]
 14-01: Since it risks ... "to this ****"
 14-02: "— immediately — Parents ... since it is given — "
 14-03: Seemingly it is me... only "only strike" ..
 14-04: North ... ["since it is an I lover"]
 15-01: "this time ... being satisfied — II — "
 15-02: A stroke [like / today] ... "it will be II if it carries out."
 15-03: Since it does not lose ... "next time"
 15-04: Since it does not lose ... "next time"
 15-05: It is mortifying... "a breast is painful."
 the next — as the example of the conversation (message) of a tune — T-01: — " — it can proceed
 — ***** ... early"
 T-02: It can do... "going *****"
 T-03: It can do... ["without it cares"]
 T-04: "— it can do ... absolutely — "
 T-05: Stage fright... "it is not visible."
 T-06: **** ... ["useless"]
 T-07: "also obtaining ... to a slight degree and it being a few"
 T-08: "It cannot proceed"
 T-09: It does not come... "pat."
 T-10: It does not lose... "it is looking."
 T-11: Or [being impossible] ... "it is not found."
 T-12: What ... would you "carrying out early"?
 T-13: "— me — Since it wins ... remembering — "
 T-14: From [here] ... "mah-jongg"
 T-15: It is visible... "your hand"
 T-16: Something ... "throb."
 T-17: "— completely — therefore ... without it cares — "
 T-18: It is not visible... "your hand"
 T-19: Also this ... "mah-jongg"
 T-20: "— yet — the first shot — If it can do ... without it escapes .. fighting — "
 T-21: Here ... "AGARI ****"
 T-22: Me ... "from AGA **"
 T-23: Me ... ["since it does not lose"]
 T-24: ... it is I **... ["since it has not given up"]
 T-25: "now — yet ... the first shot — "
 T-26: "— Now ... continuing — ***** "
 T-27: "— It does not obtain... continuing — ***** "
 T-28: "Don't give up."
 T-29: ... "it caught up."
 T-30: Wait... "he would like to concentrate."
 T-31: It is silent... "it is already a few."
 T-32: Me ... ["since there is no cage **"]
 T-33: It can win.. there "there is nothing."
 T-34: Transfer ... ["without it expects"]
 T-35: Me ... ["since it does not transfer"]
 T-36: You ... "it is continued."
 T-37: Me ... "it is not continued."
 T-38: Would like to lose.. there "there is nothing."
 Here, it describes below about other control of the control part 20 including CPU6 controlled by the

http://www4.ipdl.inpit.go.jp/cgi-bin/tran_web_cgi_ejje?atw_u=http%3A%2F%2Fwww4.ip... 7/11/2013

game data recorded on the recording medium 5.

[0059]So that the control part 20 may be controlled by game data, may obtain presence and may predict a partner's contents of a hand synthetically, the motion of a facial expression and a face, message, and tile according to the waging-war situation for every waging-war character — image data and voice data so that it may become a variable item of length and ***** operation, [obtain and] such image data and voice data — image display — and/or, voice response being carried out and, the squeal of Pons, tsi, a can, etc. — a tile — the time — the squeal — it does not lap with the display position of a tile — as — a squeal — it is made to move to an opposite side sequentially, and the viewport of the face expression for every CPU character is made to display it on it as the display position of a tile

[0060]So that the control part 20 may be controlled by game data, and a player may overlook it and it can be played exactly [there is nothing and]. For example, at the time of the necessity for a can, etc., the icon display is expanded, and it succeeds in control so that a command (for example, can) possible for a player may become bright and may be in sight clearly.

[0061]The discarded tile of a player displays gradually the danger which it hits for every waging-war CPU character, and serves as a tile so that the control part 20 may be controlled by game data and may consider it as a guy danced function and an exact play.

[0062]By the above-mentioned composition, the operation is described hereafter.

[0063]First, an electric power switch (not shown) is turned on and a power supply is supplied to the mah jongg game equipment 1. At this time, CPU6 reads image data, voice data, the Game-pro gram data, etc. from the recording medium 5 based on the operating system currently recorded on the recording medium 5. Some or all of this read image data, voice data, and the Game-pro gram data will be held on RAM8. Henceforth, CPU6 is controlled based on the Game-pro gram data memorized on RAM8, and the contents which a game player instructs via the controller 16 to advance a game. That is, CPU8 generates the command as a task for drawing or voice response suitably based on the instruction contents (****, a discarded tile, reach a tile, Pons, tsi, a can, Ron, etc.) instructed from a game player via the controller 16. The digital signal processor 11 is based on the above-mentioned command, and performs generation of voice data, such as calculation of the position of the character on a two-dimensional plane, etc., and light source calculation, and processing treatment.

[0064]Then, the image drawing processing processor 12 performs writing processing etc. of the image data which should draw on RAM8 based on the above-mentioned calculation result. The image data written in RAM8 is supplied to D/A converter 17 via the interface circuit 13, after it is converted to an analog video signal here, it is supplied to the television monitor 2, and it is displayed as an image on the screen. On the other hand, the voice data outputted from the digital signal processor 11 is supplied to D/A converter 18 via the interface circuit 14, and after converting to an analog voice signal, it will be outputted as a sound from the loudspeaker 4 via the PURIME yne amplifier 3 here. The hand of a player and the contents of a discarded tile, the contents of a discarded tile of a waging-war character, and a facial expression are everywhere displayed on the regular position by these, these players and a waging-war character — order — tiles, such as **** and a discarded tile, — a mah jongg game will advance by repeating length and ***** operation.

Fig.7 is a flow chart which shows change item control routines, such as a face expression change according to the waging-war situation for every [by the mah jongg game equipment of the present invention] CPU character.

[0065]As shown in Fig.7, first, by step ST1, the control part 20 is controlled by game data, and performs a feeling value initial set for every CPU character before a game start starting hand. Next, the control part 20 is controlled by step ST2 with game data, and a feeling value is set for every CPU character during a game by the conditions according to the mah-jongg waging-war situation. By the feeling value which the control part 20 was controlled by game data, and was set for every CPU character by step ST3 and the conditions according to the mah-jongg waging-war situation, Or

priority is given to any they are, variable items, such as a facial expression for every CPU character, are set, and it controls to make this output to the television monitor 2 as a game image. That is, although variable items based on a feeling value, such as face expression for every CPU character, are usually considered as the set, usually, Ask any CPU character for conversation at the time of the self-draw of a player, or, When it results in priority special conditions, such as seeing a starting hand and becoming a laughter face for a moment, or when it results in the waging-war situation set up, priority is given over the above-mentioned usual set, and variable items, such as face expression for every CPU character and a message, are set. Then, when it judged whether it was the end of a halfround game, and the above-mentioned steps ST1-ST3 are repeated and it ends by step ST4 until it ends, this mah jongg game is ended. a motion of the face [variable item / in this case] according to the waging-war situation for every waging-war CPU character besides the face expression for every CPU character, a message, and a tile --- length and ***** operation --- there are a sound etc. further.

[0066]For example, as an example of a display screen of the face expression for every CPU character, there are usually four kinds, a face, a laughter face, a sadness face, and an anger face, like Uchida (front woman) of Fig.3 - Fig.6. For example as an example of a display screen of the conversation (message) for every CPU character, The message indicator screen of the CPU character at the time of Pons is shown in Fig.2. The message indicator screen in the ordinary starting hand which is not at the time of a game start often or bad is shown in Fig.8, dangerous to Fig.9 --- the message indicator screen of a CPU character when cutting a tile is shown, the message indicator screen of the CPU character at the time of ISHANTEN is shown in Fig.10, and the message indicator screen of the CPU character at the time of reach is shown in Fig.11.

[0067]Fig.12 is a control routine flow chart which shows feeling value initial set operation of step ST1 of Fig.2.

[0068]As shown in Fig.12, by making the example of a CPU character into Uchida (woman), first, by step ST11, the control part 20 is controlled by game data, and performs the basic feeling value initial set classified by CPU character (128 points). Next, by step ST12, the control part 20 is controlled by game data, and the present has it and it performs a feeling value set with a point. For example, at the time of 30000 start ***** , it becomes +one feeling value by 30400 points, and becomes feeling value-1 point by 29600 points. By step ST13, the control part 20 is controlled by game data, and performs the feeling value set by the situation in a front office. For example, if win is carried out and the win beyond of limit hand is further carried out by +three points, they are +three points etc. The feeling value initial set operation before a game start starting hand is completed by the above.

[0069]Fig.13 is the face expression for every CPU character at the time of asking any CPU character in step ST3 of Fig.7 for conversation (message), conversation (message), and an audio control routine flow chart.

[0070]As shown in Fig.13, first, by step ST21, the control part 20 is controlled by game data, and performs change item sets, such as face expression for every CPU character, conversation (message), and a sound, by the waging-war situation during a game. Next, the control part 20 is controlled by step ST22 with game data, and it is judged during a game at the time of a player's own turn whether any CPU character was asked for conversation (message). When it is judged that it asked for conversation (message) by step ST22, by step ST23, the control part 20 is controlled by game data, and sets change items, such as face expression for every CPU character, and a message, by the waging-war situation in this time. When it is judged that it is not asking for conversation (message) by step ST22, Or it is controlled by game data, the control part 20 judges whether it is the end of a halfround game, and after the end of step ST23, by step ST24, the above-mentioned steps ST1-ST3 are repeated, and when it is completed, it ends this mah jongg game, until it ends. everything but a motion of the facial expression [variable item / this] according to the waging-war situation for every waging-war character and a face, a message, and a sound --- a tile --- there are length, ***** operation, etc.

[0071]Therefore, CPU6 makes the condition data, the image data, voice data, and the Game-program data which were read from the recording medium 5 hold to RAM8, and it is every waging-war character, every [and / by the waging-war situation for every waging-war character which changes every moment] condition data -- a motion of a facial expression and a face, a message, and a tile -- image data and/or voice data, such as length and ***** operation, [choose and] In order to control to make it output to the television monitor 2 or the loudspeaker 4 as a game image or voice response, Can enjoy the mah-jongg game where the humanity of a waging-war character peculiar to a mah-jongg game, and a peculiarity and psychology are judged through a facial expression, the message as for which what ** is not, etc. and which has presence more, and. Pleasure of the original mah-jongg of playing reading them, predicting synthetically the contents of a hand of a waging-war character and its completeness, and taking a discarded tile into consideration can be obtained.

[0072]In order to carry out image display of the facial expression in the time of responding to the feeling value sum total according to a waging-war situation for every waging-war character, the expression for every waging-war character according to the flow of the mah-jongg waging-war situation is displayed, and a player obtains presence, and. According to the expression, judgment of a mah-jongg waging-war situation is attained, and pleasure of the original mah-jongg of playing taking into consideration the mah-jongg waging-war situation for every waging-war character can be obtained.

[0073]the facial expression give priority over selection of the face expression by this feeling value sum total, and corresponding to the special situation -- the -- since it sometimes comes out and displays, the feeling for every occasional waging-war character of that appears, and presence can be obtained more.

[0074]a motion of the variable item corresponding to the high conditions of the priority among the monograph affairs of the waging-war situation for every waging-war character, i.e., a facial expression, and a face, a message, and a tile, an image and/or in order to carry out voice response so that it may become length and ***** operation, a mah-jongg waging-war situation being sometimes alike, and the situation for every waging-war character which responded appearing, and a player obtaining presence more and. According to the situation for every waging-war character of the, judgment of a mah-jongg waging-war situation is attained, and much more pleasure of the original mah-jongg of playing taking into consideration the mah-jongg waging-war situation for every waging-war character can be obtained.

[0075]Since a message is outputted so that it may correspond to the face expression for every waging-war character displayed, it becomes the face expression and the message according to a mah-jongg waging-war situation, humanity, character, etc. of a waging-war character appear more, and presence can be obtained more.

[0076]Since a waging-war character is specified at the time of the self-draw of a player and output displaying of the message is carried out, the hint of waging-war circumstantial judgment is obtained to the waging-war character to worry, and much more pleasure of the original mah-jongg of playing taking the hint into consideration can be obtained.

[0077]a motion of the monograph affair by a waging-war situation, and a facial expression and a face and a tile -- the image which is more rich in presence being acquired, if each data of length and ***** operation and also a message, a sound, etc. is subdivided so that it may become more real, and. Judgment of the mah-jongg waging-war situation according to the image is attained, and pleasure of the original mah-jongg of playing taking into consideration the mah-jongg waging-war situation for every waging-war character can be obtained.

[0078]next, the squeal of Pons, tsi, a can, etc. -- a tile -- it describes about the control to which the viewport of the face expression at the time is moved sequentially.

[0079]Fig 14 -- the squeal of Pons, tsi, a can, etc. -- a tile -- it is a control routine flow chart which shows the viewport moving operation of the face expression at the time.

[0080]As shown in Fig.14, it is judged first whether by step ST31, the control part 20 is controlled by game data, cries during a game, and has a tile. Next, when it cries by step ST31 and there is a tile, by step ST32, the control part 20 is controlled by game data — a squeal — the viewport of the face expression of a CPU character with a tile — a squeal — a tile does not hide — as — a squeal — a tile — with viewport, it controls to an opposite side to set the display position flag to +1. When it cries by step ST31 and there is no tile, step ST31 cries and the existence judging of a tile is repeated. furthermore — the control part 20 being controlled by step ST33 with game data, and carrying out income of the new display position data of the viewport of the face expression of a CPU character — a squeal — a tile — with viewport, it can shift to an opposite side — a squeal — face expression is displayed so that a tile may not hide. For example, when a right-hand side CPU character cries by Pons and has not carried out the tile yet in Fig.15, the viewport of face expression is an example of image display which shows an initial position. In Fig.16, a right-hand side CPU character is an example of image display the viewport of face expression indicates the state where it moved downward to be by Pons the time [1st] when it cries and a tile is carried out. In Fig.17, a right-hand side CPU character is an example of image display which shows the state where the viewport of face expression moved downward further by the further Pons the time [2nd] when it cried and a tile was carried out.

[0081]therefore, the squeal of Pons, tsi, a can, etc. — a tile — the time — the squeal — it does not lap with the display position of a tile — as — a squeal — making it move to an opposite side sequentially, and having displayed the viewport of the face expression for every CPU character on it as the display position of the tile, [sake and] It will cry, the display of a tile and the display of the face expression for every CPU character will become clear, and a required waging-war situation will be acquired easily.

[0082]next, the squeal of these Pons, tsi, a can, etc. — a tile and reach — when a tile etc. can be performed, it describes about the case where the icon corresponding to them carries out an enlarged display.

[0083]Fig.18 and Fig.19 are control routine flow charts which show operation of icon expansion mode.

[0084]As shown in Fig.18, first, the control part 20 is controlled by step ST41 with game data, and a zoom mode or a normal mode is judged during a game, and it is step ST42 if it is a zoom mode in step ST41. If the control part 20 is controlled by game data, it judges whether the upper key of the controller 16 is pressed and the upper key is pressed, it is step ST43, and the control part 20 will be controlled by game data, and an icon display will disappear.

[0085]. [whether it is not a zoom mode but a normal mode in step ST41, and] Or if the upper key of the controller 16 is not pressed by step ST42. It is step ST45 when it is judged that the control part 20 was controlled by game data, shifted to existence judgment of the turn (turn) of the player of step ST44, and had the turn of a player by step ST44. The control part 20 is controlled by game data, and a player judges [a can or] whether TSUMO win can be carried out. It is judged whether as for the control part 20, a player is controlled by game data step ST45, a can or when it is judged that TSUMO win cannot be carried out, and the reach of the player can be carried out. When it is judged that the reach of the player cannot be carried out in step ST46, it is judged whether by step ST47, the control part 20 was controlled by game data, and the controller 16 entered downward.

[0086]Here, if the controller 16 is not downward contained by step ST47, it changed into the state 1 of the next (table 4), and it is a small icon display at the time of Normal, and the icon display has disappeared at the time of zoom. . [whether the controller 16 is downward contained by step ST47, and] Or by step ST45, a player will be in the state 2 of the next (table 4), a can or when it is judged that TSUMO win can be carried out, an icon display is expanded at both the times of Normal and zoom, and a possible command (for example, can) becomes bright for a player. When it is judged that the reach of the player can be carried out in step ST46, it will be in the state 3 of the next (table 4), and a possible command (for example, reach) will both become bright for a player by a small icon

display at the time of Normal and zoom.

[0087]When it is judged that there was no turn of a player step ST44, it is judged whether in step ST48 of Fig.19, the control part 20 is controlled by game data, and Pons, Quan, tsi, and Ron can do it for a player. When it is judged that Pons, Quan, tsi, and Ron can do it in step ST48, it will be judged whether by step ST49 of Fig.19, the control part 20 is controlled by game data, and the upward key of the controller 16 is pressed.

[0088]Here, when it is judged that Pons, Quan, tsi, and Ron cannot do it for a player in step ST48, it changed into the state 1 of the next (table 4), and it is a small icon display at the time of Normal, and the icon display has disappeared at the time of zoom. When it is judged that the upward key of the controller 16 is pressed by step ST49, it changed into the state 4 of the next (table 4), and the command possible for a player became bright by the small icon display at the time of Normal, and the icon display has disappeared at the time of zoom. When it is judged that the upward key of the controller 16 is not pressed by step ST49, it will be in the state 2 of the next (table 4), and an icon display is expanded at both the times of Normal and zoom, and a possible command (for example, Quan) becomes bright for a player.

[0089]

[Table 4]

	ノーマル時	ズーム時
状態 1	小さいアイコン	表示なし
状態 2	大きくなって可能なコマンドが明るくなる。	
状態 3	小さいアイコンで可能なコマンド（リーチ）が明るくなる。	
状態 4	小さいアイコンで可能なコマンドが明るくなる。	表示なし

[0090]For example, Fig.20 is an example of a display screen which shows the case where it is in the states 1 and 4 where the icon display has disappeared at the time of zoom. In Fig.21, it is an example of a display screen in the case of the state 2 which shows that Pons, a can, and tsi are possible for a player by the icon display to which it was expanded, and Fig.22 is an example of a display screen in the case of the state 2 which shows that Ron is possible for a player by the icon display to which it was expanded. Fig.23 is an example of a display screen which shows the case where it is in the state 3 where the icon display small also at the time of zoom is carried out. Fig.24 is an example of a display screen which shows the states 1, 3, and 4 where the icon display small at the time of Normal is carried out.

[0091]Therefore, since it succeeds in control so that an icon display may be expanded at both the times of Normal and zoom, a command (for example, can) possible for a player may become bright in the above-mentioned state 2 and it may be visible clearly. An oversight of a player can also be lost, it can play exactly and a mah jongg game can be enjoyed further.

[0092]In an icon display, the display of those other than Ron, a can, Pons, and tsi, i.e., "option", can listen to music, such as BGM. The display on the right of "option" is rearranged, it is a function, and can use and wait for this rearrangement function at the times, such as the Seiichi color, and can also examine a tile. Furthermore, the display of the right is a display of a point stick, and can know the occasional mark easily.

[0093]Next, it throws away and describes about the danger display of a tile. A color display changes as are shown in the display screen of Fig.26, and a color display is carried out to the bottom in the

face expression display screen region for every CPU character in five steps of the danger display parts 101-105 and danger becomes high. That is, in yellow, with orange, 101 is purple sequentially from the one where danger is lower, 102 is green, and in 103, 104 is [105] red, and a different color display increases [a bar line graph becomes long from the left to right-hand side as danger becomes high, and] sequentially, for example. He is trying to display on it somewhat gloomily, applying a shade to the discarded tile which the CPU character ***** (ed). In Fig.26, the slash is put in and distinguished to the discarded tile.

[0094] Fig.27 and Fig.28 are control routine flow charts in the present invention which throw away and show the danger display action of a tile. When the language used for below is defined here, target is a CPU character of the object which throws away and is investigating the danger of the tile, other is a CPU character of other houses other than the object which throws away and is investigating the danger of the tile, and is danger display processing which is indicated to be MAIN to a main routine and is indicated to be SUB to Fig.27 and Fig.28.

[0095] As shown in Fig.27, when it throws away into the main routine of the present invention and the danger display mode of a tile is performed first. By step ST51, perform initialization of a work and by step ST52, The control part 20 is controlled by game data, and if the number of investigated target is smaller than four persons, when it will shift to the following step ST53 and the number of investigated target will be the 4th person, it returns to the main routine of the present invention. The control part 20 is controlled by step ST53 with game data, and target to investigate judges whether it is a waging-war partner's number, and if target to investigate is not a waging-war partner's number, A waging-war partner's number is carried out +1, and it returns to processing of step ST52 in order to question the next waging-war partner by step ST54. The control part 20 is controlled by step ST53 with game data, and if target to investigate is a waging-war partner's number (they are [bottom / No. 1 and / No. 2 and] No. 3 about a top in a front), danger detection processing after step ST55 will be performed.

[0096] next — the control part 20 is controlled by step ST55 with game data — the inside of danger detection processing — the inside of a partner's discarded tile — the actual thing — the actual thing which detects whether there is any tile — a tile — processing is performed. By step ST56, the control part 20 is controlled by game data, and performs processing of ****. By step ST57, the control part 20 is controlled by game data, and performs processing of the most eminent person of the country. By step ST58, the control part 20 is controlled by game data, and performs three-fundamental-tiles-related processing. By step ST59, the control part 20 is controlled by game data, and performs wind tile-related processing. By step ST60, the control part 20 is controlled by game data, and performs processing of a wall. By step ST61, the control part 20 is controlled by game data, and performs processing (for example, processing which the tile with numbers of 5 makes dangerous [tiles with numbers, such as 3 and 6,] at the time of a discarded tile) of ****. As shown in Fig.28, by step ST62, the control part 20 is controlled by game data, and performs processing of DORA. By step ST63, the control part 20 is controlled by game data, and performs processing of an all system. By step ST64, the control part 20 is controlled by game data, and performs processing of a chanter system. By step ST65, the control part 20 is controlled by game data, and performs processing of three color systems. By step ST66, the control part 20 is controlled by game data, and performs processing (for example, processing which the tile with numbers of 5 makes dangerous [tiles with numbers, such as 3, 6, or 1, 4,] at the time of a discarded tile) of a back muscle. By step ST67, the control part 20 is controlled by game data, and performs processing (for example, processing which the tile with numbers of 1 and 8 makes dangerous [tiles with numbers, such as 4 and 7,] at the time of a discarded tile) of a score. By step ST68, the control part 20 is controlled by game data, and performs processing (for example, processing which the tile with numbers of 1 and 6 makes dangerous [tiles with numbers, such as 2, of a hand and 5,] at the time of a discarded tile) between between 4. By step ST69, the control part 20 is controlled by game data, and performs processing of an easy-way-out flag. By step ST70, the control part 20 is controlled by game data,

and performs processing adding all the danger points of each item. By step ST71, the control part 20 is controlled by game data, and performs processing which divides into five steps the danger point added by step ST70.

[0097]the actual thing [in / in Fig.29 / step ST55 of Fig.27] — a tile — it is a control routine flow chart which shows operation of processing.

[0098]the discarded tile of target which the control part 20 is controlled by game data, and is investigated by step ST551 as shown in Fig.29 — the actual thing — judging whether there is any tile — the actual thing — turning on a safe flag by step ST552, if there is a tile — the actual thing — if there is no tile, it will shift to step ST553. If the control part 20 is controlled by game data, it judges whether target currently investigated is carrying out reach and reach is carried out by this step ST553, step ST554 — the discarded tile after the reach of waging-war persons other than target — the actual thing — if it judges whether there is any tile and reach is not carried out — step ST555 — the discarded tile of the last of waging-war persons other than target — the actual thing — it is judged whether there is any tile.

[0099]The control part 20 is controlled by step ST554 with game data, the discarded tile after the reach of waging-war persons other than arget — the actual thing — a safe flag being turned on by step ST556, and in the safe flag processing back of this step ST556, if there is a tile, step ST554 [or] — the actual thing — if there is no tile, it will shift to processing of **** of step ST56 which is the next danger display processing.

[0100]The control part 20 is controlled by step ST555 with game data, the discarded tile of the last of waging-war persons other than arget — the actual thing — a safe flag being turned on by step ST557, and in the safe flag processing back of this step ST557, if there is a tile, step ST555 [or] — the actual thing — if there is no tile, it will shift to processing of **** of step ST56 which is the next danger display processing.

[0101]Fig.30 is a control routine flow chart which shows operation of the **** processing in processing of **** of step ST56 of Fig.27.

[0102]The control part 20 is controlled by step ST561 with game data to be shown in Fig.30. It judges whether it is **** of the discarded tile of target in step ST561, if it is **** of a discarded tile, it will shift to step ST562, and if it is not **** of a discarded tile, a danger point will be added to a hand by step ST563, and it will shift to the following step ST562.

[0103]The control part 20 is controlled by step ST562 with game data. If it judged whether target would carry out reach and reach is carried out, it judges whether it is **** of the discarded tile of other and reach is not carried out by step ST564, it is judged whether it is **** of the discarded tile of the last of other in step ST565. It carries out.

[0104]The control part 20 is controlled by step ST564 with game data. If it is not **** of the discarded tile of other, if it is **** of the discarded tile of other in step ST564 after adding a danger point to a hand, it will shift to processing of the concealed triplet muscle in processing of the next **** in step ST566.

[0105]The control part 20 is controlled by step ST565 with game data. If it is not **** of the discarded tile of the last of other, if it is **** of the discarded tile of the last of other in step ST565 after adding a danger point to a hand, it will shift to processing of the concealed triplet muscle in processing of the next **** in step ST567.

[0106]Fig.31 is a control routine flow chart which shows operation of the concealed triplet muscle processing in processing of **** of step ST56 of Fig.27.

[0107]It will be step ST569, if the control part 20 is controlled by game data, judges whether a concealed triplet is in the hand of a player and has a concealed triplet by step ST568, as shown in Fig.31. A danger point is added to **** of the concealed triplet, there is no concealed triplet step ST568, or danger point summing processing of step ST569 is carried out.

[0108]Fig.32 is a control routine flow chart which shows operation of processing of the most eminent person of the country in step ST57 of Fig.27.

[0109]As shown in Fig.32, by step ST571, the control part 20 is controlled by game data, and checks the tile with numbers from two to eight of the discarded tile of target. By step ST572, it is controlled by game data, target cries, and the control part 20 checks a tile. Then, by step ST573, the control part 20 is controlled by game data, judges whether the hand of a player is public 9 tile, and if it is public 9 tile, it will add a danger point to the hand of step ST574. If the hand of target is not public 9 tile in step ST573, jump processing of the danger point summing processing of step ST574 will be carried out.

[0110]Fig.33 is a control routine flow chart which shows operation of processing of the three-fundamental-tiles relation in step ST58 of Fig.27.

[0111]As shown in Fig.33, by step ST581, it is controlled by game data, the three fundamental tiles of target cry, and the control part 20 checks a tile. It judges whether by step ST582, the control part 20 is controlled by game data, and has the possibility of a package, and if there is possibility of a package, it will be judged by step ST583 whether the hands of a player are three fundamental tiles. If the hands of a player are three fundamental tiles in step ST583, the control part 20 will be controlled by game data, and will add a danger point to a hand by step ST584. If the hands of a player are not three fundamental tiles in step ST583, jump processing of the danger point summing processing of step ST584 will be carried out.

[0112]Fig.34 is a control routine flow chart which shows operation of processing of the wind tile relation in step ST59 of Fig.27.

[0113]As shown in Fig.34, by step ST591, it is controlled by game data, the wind tile of target cries, and the control part 20 checks a tile. It judges whether by step ST592, the control part 20 is controlled by game data, and has the possibility of a package, and if there is possibility of a package, it will be judged by step ST593 whether the hand of a player is a wind tile. If the hand of a player is a wind tile in step ST593, the control part 20 will be controlled by game data, and will add a danger point to a hand by step ST594. If the hand of a player is not a wind tile in step ST593, jump processing of the danger point summing processing of step ST594 will be carried out.

[0114]Fig.35 is a control routine flow chart which shows operation of processing of the wall in step ST60 of Fig.27.

[0115]As shown in Fig.35, by step ST601, the control part 20 is controlled by game data, and checks all the tiles which have appeared in **. Then, the control part 20 is controlled by step ST602 with game data, it is judged whether it judged whether the four same tiles would already have appeared in **, when it was a four-sheet wall, the time of a four-sheet wall was processed by step ST603, and if it is not a four-sheet wall in step ST602, the three same tiles have already appeared in ** by step ST604. By step ST604, the control part 20 is controlled by game data, if it is a three-sheet wall, it will process the time of a three-sheet wall by step ST605, and if it is not a three-sheet wall in step ST604, it will process the time of there being no wall step ST606.

[0116]Fig.36 is a control routine flow chart which shows operation of processing of **** in step ST61 of Fig.27.

[0117]If it judges whether the control part 20 is controlled by game data, and has **** in the discarded tile of target by step ST611 and there is **** about the discarded tile of target as shown in Fig.36, a danger point will be added to the hand of target by step ST612. If there is no **** about the discarded tile of target step ST611, the danger point summing processing of step ST612 will be jumped.

[0118]Fig.37 is a control routine flow chart which shows operation of processing of DORA in step ST62 of Fig.27.

[0119]the control part 20 is controlled by step ST621 with game data to be shown in Fig.37 — the discarded tile of target — DORA — it is confirmed whether there is any tile. furthermore — the control part 20 is controlled by step ST622 with game data — the inside of the hand of a player — DORA — judging whether there is any tile — the inside of a hand — DORA — if there is a tile, processing which adds a danger point to the hand by step ST623 will be carried out. this danger

point summing processing back or step ST622 — the inside of a hand — DORA — when it is judged that there is no tile, the control part 20 is controlled by step ST624 with game data — the inside of a hand — DORA — it is judged whether there is any **** of a tile. step ST624 — the inside of a hand — DORA — when it is judged that there is **** of a tile, summing processing of a danger point is carried out to the hand by step ST625. step ST624 — the inside of a hand — DORA — when it is judged that there is no **** of a tile, the danger point summing processing of step ST625 is jumped.

[0120]Fig.38 is a control routine flow chart which shows operation of processing of an all system in Steps ST63–ST65 of Fig.27, processing of a chanter system, and processing of three color systems.

[0121]As shown in Fig.37, to step ST631 pan, by step ST632, the control part 20 is controlled by game data, cries to the discarded tile pan of target, and checks a tile. By step ST633, the control part 20 is controlled by game data, and checks the self-draw end in the discarded tile of target. By step ST634, the control part 20 is controlled by game data, and carries out summing processing of a danger point to the hand.

[0122]Fig.39 is a control routine flow chart which shows operation of processing of the back muscle in step ST66 of Fig.27.

[0123]If it judges whether the control part 20 is controlled by game data, and has a back muscle of the discarded tile of target by step ST661 and there is a back muscle of the discarded tile of target as shown in Fig.39, summing processing of a danger point will be carried out to the hand by step ST662. If there is no back muscle of the discarded tile of target step ST661, the danger point summing processing of step ST662 will be jumped.

[0124]Fig.40 is a control routine flow chart which shows operation of processing of the score in step ST67 of Fig.27.

[0125]If it judges whether the control part 20 is controlled by game data, and has a score of the discarded tile of target by step ST671 and there is a score of the discarded tile of target as shown in Fig.40, summing processing of a danger point will be carried out to the hand by step ST672. If there is no score of the discarded tile of target step ST671, the danger point summing processing of step ST672 will be jumped.

[0126]Fig.41 is a control routine flow chart which shows operation of processing between four, while being able to set to step ST68 of Fig.27.

[0127]If it judges whether the control part 20 is controlled by game data, and has between four between the discarded tiles of target by step ST681 and there is between four between the discarded tiles of target as shown in Fig.41, summing processing of a danger point will be carried out to the hand by step ST682. If there is between [no] four between the discarded tiles of target step ST681, the danger point summing processing of step ST682 will be jumped.

[0128]Fig.42 is a control routine flow chart which shows operation of processing of the easy-way-out flag in step ST69 of Fig.27.

[0129]As shown in Fig.42, first, by step ST691, the control part 20 is controlled by game data, and is set to I= 0. Next, the control part 20 is controlled by step ST692 with game data. It judges whether an easy-way-out flag is ON from the left of the hand of target to the 1st tile, and from the left of the hand of target, to the 1st tile, if an easy-way-out flag is ON, a danger point will be initialized by step ST693 step ST692. By step ST692, to the 1st tile, if an easy-way-out flag is not ON, from the left of the hand of target, Jumping [or] the initialization processing of the danger point of step ST693, after the initialization processing of the danger point of step ST693, by step ST694, the control part 20 is controlled by game data, and judges whether it is D=14 (all of the hand of 14 sheets are checked). The easy-way-out flag I+1 is added, and each processing of Steps ST692–ST694 is repeated until it is set to D=14 by step ST694. "I++" of step ST695 is "I=I+1."

[0130]With therefore, a guidance function [as opposed to / in order to display the danger for every waging-war CPU character as two or more five steps about a possibility that it will hit for every

waging-war CPU character, and the discarded tile of a player will turn into a tile / a player], a hit --- an oversight of a tile can also be lost, it can play exactly and a mah jongg game can be enjoyed further.

[0131]

[Effect of the Invention]In order to display the danger which it hits for every waging-war CPU character to the discarded tile of a player, and serves as a tile for every waging-war character as mentioned above in two or more steps according to the present invention, Even if it becomes guidance of the discarded tile to a player and attaches for attending a true mah jongg game, it can succeed in more advanced education, improvement can be aimed at, and a mah jongg game can be enjoyed further.

[0132]every waging-war situation for every waging-war character which is every waging-war character and changes every moment --- a motion of a facial expression and a face, a message, and a tile --- length and ***** operation --- a generating picture, if it is made to carry out voice response, The humanity of a waging-war character, and a peculiarity and psychology can be judged through a facial expression, the message as for which what ** is not, etc., and can enjoy the mah jongg game which has presence more, and. Pleasure of the original mah-jongg of playing predicting synthetically the contents of a hand of a waging-war character and its completeness based on them, and taking a discarded tile into consideration can be obtained.

[Translation done.]

Electronic Acknowledgement Receipt

EFS ID:	16534398
Application Number:	13680852
International Application Number:	
Confirmation Number:	6364
Title of Invention:	METHOD AND APPARATUS FOR OUTPUTTING A MESSAGE AT A GAME MACHINE
First Named Inventor/Applicant Name:	Jay S. Walker
Customer Number:	29159
Filer:	Holby Abern/Luz Gonzalez
Filer Authorized By:	Holby Abern
Attorney Docket Number:	025124-0509
Receipt Date:	08-AUG-2013
Filing Date:	19-NOV-2012
Time Stamp:	17:33:35
Application Type:	Utility under 35 USC 111(a)

Payment information:

Submitted with Payment	no
------------------------	----

File Listing:

Document Number	Document Description	File Name	File Size(Bytes)/ Message Digest	Multi Part /.zip	Pages (if appl.)
1		025124-0509-IDSTL-1449.pdf	179017 <small>88fc28574fed413e3f8c16ec4c573928eaa8f363</small>	yes	4

Multipart Description/PDF files in .zip description					
Document Description			Start	End	
Transmittal Letter			1	3	
Information Disclosure Statement (IDS) Form (SB08)			4	4	
Warnings:					
Information:					
2	Foreign Reference	025124-0510-FR1.pdf	2222966 c0c0e92b9960840d9dc8191f54e4dc892a0f e996	no	21
Warnings:					
Information:					
3	Foreign Reference	025124-0510-FR2.pdf	6775305 5f977fde75f2ae8f91e2de23944e749737f15 f7a	no	72
Warnings:					
Information:					
4	Non Patent Literature	025124-0510-NPL1.pdf	86326 486602886f04ddf1baf4ca94a8a5ad163cd 8b55	no	2
Warnings:					
Information:					
5	Non Patent Literature	025124-0510-NPL2.pdf	222228 47e95f3c9f5f7e846002469e93e0cd8d7b08 bb9e	no	7
Warnings:					
Information:					
Total Files Size (in bytes):			9485842		

This Acknowledgement Receipt evidences receipt on the noted date by the USPTO of the indicated documents, characterized by the applicant, and including page counts, where applicable. It serves as evidence of receipt similar to a Post Card, as described in MPEP 503.

New Applications Under 35 U.S.C. 111

If a new application is being filed and the application includes the necessary components for a filing date (see 37 CFR 1.53(b)-(d) and MPEP 506), a Filing Receipt (37 CFR 1.54) will be issued in due course and the date shown on this Acknowledgement Receipt will establish the filing date of the application.

National Stage of an International Application under 35 U.S.C. 371

If a timely submission to enter the national stage of an international application is compliant with the conditions of 35 U.S.C. 371 and other applicable requirements a Form PCT/DO/EO/903 indicating acceptance of the application as a national stage submission under 35 U.S.C. 371 will be issued in addition to the Filing Receipt, in due course.

New International Application Filed with the USPTO as a Receiving Office

If a new international application is being filed and the international application includes the necessary components for an international filing date (see PCT Article 11 and MPEP 1810), a Notification of the International Application Number and of the International Filing Date (Form PCT/RO/105) will be issued in due course, subject to prescriptions concerning national security, and the date shown on this Acknowledgement Receipt will establish the international filing date of the application.

IN THE UNITED STATES PATENT AND TRADEMARK OFFICE

Applicant: IGT
Inventor: Jay S. Walker et al.
Appl. No.: 13/680,852
Conf. No.: 6364
Filed: November 19, 2012
Title: METHOD AND APPARATUS FOR OUTPUTTING A MESSAGE AT A
GAMING MACHINE
Art Unit: 3714
Examiner: Unknown
Docket No.: 025124-0509

Commissioner for Patents
P.O. Box 1450
Alexandria, VA 22313-1450

**SUPPLEMENTAL INFORMATION DISCLOSURE STATEMENT TRANSMITTAL
LETTER**

Sir:

Submitted herewith is a Supplemental Information Disclosure Statement for consideration in the above-identified application. In accordance with the provisions of 37 C.F.R. §§ 1.56, 1.97, and 1.98, Applicant requests that a citation and examination of the references cited on the enclosed PTO Form 1449 be made during the course of examination of the above-identified application for United States patent.

This Supplemental Information Disclosure Statement is submitted as follows:

Submission without Certification

- [X] Within three months of filing of a national application; within three months of the date of entry of the national stage as set forth in 37 C.F.R. § 1.491 in an international application; before the mailing date of a first Office Action on the merits, or before the mailing of a first Office Action after the filing of a Request for Continued Examination.
- [] After the period specified above, but before the mailing date of a Final Action under 37 C.F.R. § 1.113, a Notice of Allowance under 37 C.F.R. § 1.311, or an Action that otherwise closes prosecution in the application and is accompanied by payment of the fee set forth in 37 C.F.R. § 1.17(p).

Submission with Certification

- [] Within three months of filing of a national application; within three months of the date of entry of the national stage as set forth in 37 C.F.R. § 1.491 in an international application; before the mailing date of a first Office

Action on the merits, or before the mailing of a first Office Action after the filing of a Request for Continued Examination.

- [] After the period specified above, but before the mailing date of a Final Action under 37 C.F.R. § 1.113, a Notice of Allowance under 37 C.F.R. § 1.311, or an Action that otherwise closes prosecution in the application and is accompanied by the Certification specified in 37 C.F.R. § 1.97(e) which is set forth below.
- [] After the mailing date of a Final Action under 37 C.F.R. § 1.113, a Notice of Allowance under 37 C.F.R. § 1.311, or an Action that otherwise closes prosecution in the application and is accompanied by the fee set forth in 37 C.F.R. § 1.17(p) and the Certification specified in 37 C.F.R. § 1.97(e) which is set forth below.

Certification under 37 C.F.R. § 1.97

- [] The undersigned counsel for applicant(s) hereby certifies each item of information contained in the accompanying Information Disclosure Statement was first cited in any communication from a foreign patent office in a counterpart foreign application not more than **thirty days** prior to the filing of the Information Disclosure Statement.
- [] The undersigned counsel for applicant(s) hereby certifies each item of information contained in the accompanying Information Disclosure Statement was first cited in any communication from a foreign patent office in a counterpart foreign application not more than **three months** prior to the filing of the Information Disclosure Statement.
- [] The undersigned counsel for applicant(s) hereby certifies that no item of information contained in the accompanying Information Disclosure Statement was cited in a communication from a foreign patent office in a counterpart foreign application, and, to the knowledge of the undersigned, after making reasonable inquiry, no item of information contained in the accompanying Information Disclosure Statement was known to any individual designated in 37 C.F.R. § 1.56(c) not more than **thirty days** prior to the filing of the Information Disclosure Statement.
- [] The undersigned counsel for applicant(s) hereby certifies that no item of information contained in the accompanying Information Disclosure Statement was cited in a communication from a foreign patent office in a counterpart foreign application, and, to the knowledge of the undersigned, after making reasonable inquiry, no item of information contained in the accompanying Information

Disclosure Statement was known to any individual designated in 37 C.F.R. § 1.56(c) more than **three months** prior to the filing of the Information Disclosure Statement.

- A copy of a Search Report from a corresponding foreign patent application is enclosed.
- A check in the amount of \$180 to cover the required fee is enclosed.
- The Commissioner is hereby authorized to charge the amount of \$180 to cover the required fee to Deposit Account No. 502261.
- The Commissioner is hereby authorized to charge any additional fees which may be required, or credit any overpayment to Deposit Account No. 502261.

Respectfully submitted,

Neal, Gerber & Eisenberg LLP

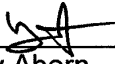
By: 
Holby Abern
Reg. No. 47,372
Customer No. 29159
Tel. No. (312) 269-8428

Date: August 8, 2013

INFORMATION DISCLOSURE CITATION IN AN APPLICATION (Use several sheets if necessary) PTO Form 1449	Atty Docket No. 025124-0509	Application No. 13/680,852
	Applicant IGT	Date Submitted November 25, 2013
	Filing Date November 19, 2012	Group 3714

U.S. PATENT DOCUMENTS						
Examiner's Initials	Document Number	Publication Date	Inventor	Class	Subclass	Filing Date If Appropriate
	6,126,541	10-2000	Fuchs, Anton			
	6,942,849	09-2005	Neesser et al.			
	6,089,975	07-2000	Dunn, Jerry B			
	6,113,495	09-2000	Walker et al.			
	6,139,431	10-2000	Walker et al.			
	6,270,411	08-2001	Gura et al.			
	6,302,790	10-2001	Brossard, Jean			
	6,942,574	09-2005	LeMay et al.			
	5,429,361	07-1995	Raven et al.			
	5,971,849	10-1999	Falciglia, Sal			
	4,695,053	09-1987	Vazquez et al.			
	5,611,730	03-1997	Weiss, Steven A.			

FOREIGN PATENT DOCUMENTS								
Examiner's Initials	Document Number	Publication Date	Country	Class	Subclass	Translation		
						Yes	No	

Examiner's Initials	OTHER DOCUMENTS (Including Author, Title, Date, Pertinent Pages, Etc.)
	Non-Final Office Action dated August 7, 2013 for Application No. 13/632,323.

Examiner:	Date Considered:
*Examiner: Initial if citation considered, whether or not citation is in conformance with MPEP Section 609; Draw line through citation if not in conformance and not considered. Include copy of this form with next communication to applicant.	

Electronic Acknowledgement Receipt

EFS ID:	17490216
Application Number:	13680852
International Application Number:	
Confirmation Number:	6364
Title of Invention:	METHOD AND APPARATUS FOR OUTPUTTING A MESSAGE AT A GAME MACHINE
First Named Inventor/Applicant Name:	Jay S. Walker
Customer Number:	29159
Filer:	Holby Abern/Luz Gonzalez
Filer Authorized By:	Holby Abern
Attorney Docket Number:	025124-0509
Receipt Date:	25-NOV-2013
Filing Date:	19-NOV-2012
Time Stamp:	16:37:22
Application Type:	Utility under 35 USC 111(a)

Payment information:

Submitted with Payment	no
------------------------	----

File Listing:

Document Number	Document Description	File Name	File Size(Bytes)/ Message Digest	Multi Part /.zip	Pages (if appl.)
1		025124-0509-SIDSTL-1449.pdf	314579 <small>264d50a203a9c2a961a957c952d0f6826f4874</small>	yes	4

Multipart Description/PDF files in .zip description					
Document Description			Start	End	
Transmittal Letter			1	3	
Information Disclosure Statement (IDS) Form (SB08)			4	4	
Warnings:					
Information:					
2	Non Patent Literature	025124-0509-NPL1.pdf	571544	no	13
			20220a18a1ee3e9d90aef94722c5473a5ef222f		
Warnings:					
Information:					
Total Files Size (in bytes):			886123		
<p>This Acknowledgement Receipt evidences receipt on the noted date by the USPTO of the indicated documents, characterized by the applicant, and including page counts, where applicable. It serves as evidence of receipt similar to a Post Card, as described in MPEP 503.</p> <p><u>New Applications Under 35 U.S.C. 111</u> If a new application is being filed and the application includes the necessary components for a filing date (see 37 CFR 1.53(b)-(d) and MPEP 506), a Filing Receipt (37 CFR 1.54) will be issued in due course and the date shown on this Acknowledgement Receipt will establish the filing date of the application.</p> <p><u>National Stage of an International Application under 35 U.S.C. 371</u> If a timely submission to enter the national stage of an international application is compliant with the conditions of 35 U.S.C. 371 and other applicable requirements a Form PCT/DO/EO/903 indicating acceptance of the application as a national stage submission under 35 U.S.C. 371 will be issued in addition to the Filing Receipt, in due course.</p> <p><u>New International Application Filed with the USPTO as a Receiving Office</u> If a new international application is being filed and the international application includes the necessary components for an international filing date (see PCT Article 11 and MPEP 1810), a Notification of the International Application Number and of the International Filing Date (Form PCT/RO/105) will be issued in due course, subject to prescriptions concerning national security, and the date shown on this Acknowledgement Receipt will establish the international filing date of the application.</p>					

IN THE UNITED STATES PATENT AND TRADEMARK OFFICE

Applicant: IGT
Inventor: Jay S. Walker et al.
Appl. No.: 13/680,852
Conf. No.: 6364
Filed: November 19, 2012
Title: METHOD AND APPARATUS FOR OUTPUTTING A MESSAGE AT A
GAMING MACHINE
Art Unit: 3714
Examiner: Unknown
Docket No.: 025124-0509

Commissioner for Patents
P.O. Box 1450
Alexandria, VA 22313-1450

**SUPPLEMENTAL INFORMATION DISCLOSURE STATEMENT TRANSMITTAL
LETTER**

Sir:

Submitted herewith is a Supplemental Information Disclosure Statement for consideration in the above-identified application. In accordance with the provisions of 37 C.F.R. §§ 1.56, 1.97, and 1.98, Applicant requests that a citation and examination of the references cited on the enclosed PTO Form 1449 be made during the course of examination of the above-identified application for United States patent.

This Supplemental Information Disclosure Statement is submitted as follows:

Submission without Certification

- Within three months of filing of a national application; within three months of the date of entry of the national stage as set forth in 37 C.F.R. §1.491 in an international application; before the mailing date of a first Office Action on the merits, or before the mailing of a first Office Action after the filing of a Request for Continued Examination.
- After the period specified above, but before the mailing date of a Final Action under 37 CFR 1.113, a Notice of Allowance under 37 CFR 1.311, or an Action that otherwise closes prosecution in the application and is accompanied by payment of the fee set forth in 37 CFR 1.17(p).

Submission with Certification

- Within three months of filing of a national application; within three months of the date of entry of the national stage as set forth in 37 C.F.R. §1.491 in an international application; before the mailing date of a first Office Action on the merits, or before the mailing of a first Office Action after the filing of a Request for Continued Examination.

- After the period specified above, but before the mailing date of a Final Action under 37 CFR 1.113, a Notice of Allowance under 37 CFR 1.311, or an Action that otherwise closes prosecution in the application and is accompanied by the Certification specified in 37 CFR 1.97(e) which is set forth below.
- After the mailing date of a Final Action under 37 CFR 1.113, a Notice of Allowance under 37 CFR 1.311, or an Action that otherwise closes prosecution in the application and is accompanied by the fee set forth in 37 CFR 1.17(p) and the Certification specified in 37 CFR 1.97(e) which is set forth below.

Certification under 37 CFR 1.97(e)

- The undersigned counsel for applicant(s) hereby certifies each item of information contained in the accompanying Information Disclosure Statement was first cited in any communication from a foreign patent office in a counterpart foreign application not more than three months prior to the filing of the Information Disclosure Statement.
- The undersigned counsel for applicant(s) hereby certifies that no item of information contained in the accompanying Information Disclosure Statement was cited in a communication from a foreign patent office in a counterpart foreign application, and, to the knowledge of the undersigned, after making reasonable inquiry, no item of information contained in the accompanying Information Disclosure Statement was known to any individual designated in 37 CFR 1.56(c) more than three months prior to the filing of the Information Disclosure Statement.
- A copy of a Search Report from a corresponding foreign patent application is enclosed.
- A check in the amount of \$180 to cover the required fee is enclosed.
- The Commissioner is hereby authorized to charge the amount of \$180 to cover the required fee to Deposit Account No. 50-2261.

Appl. No. 13/680,852

- [X] The Commissioner is hereby authorized to charge any additional fees which may be required, or credit any overpayment to Deposit Account No. 50-2261.

Respectfully submitted,

Neal, Gerber & Eisenberg LLP

BY:  _____

Holby M. Abern

Reg. No. 47,372

Customer No. 29159

Dated: November 25, 2013



UNITED STATES PATENT AND TRADEMARK OFFICE

UNITED STATES DEPARTMENT OF COMMERCE
United States Patent and Trademark Office
Address: COMMISSIONER FOR PATENTS
P.O. Box 1450
Alexandria, Virginia 22313-1450
www.uspto.gov

NOTICE OF ALLOWANCE AND FEE(S) DUE

29159 7590 04/01/2014
Neal, Gerber & Eisenberg LLP
(IGT)
2 N. LaSalle Street
Suite 1700
Chicago, IL 60602-3801

EXAMINER

HOEL, MATTHEW D

ART UNIT PAPER NUMBER

3714

DATE MAILED: 04/01/2014

Table with 5 columns: APPLICATION NO., FILING DATE, FIRST NAMED INVENTOR, ATTORNEY DOCKET NO., CONFIRMATION NO.

13/680,852 11/19/2012 Jay S. Walker 025124-0509 6364

TITLE OF INVENTION: METHOD AND APPARATUS FOR OUTPUTTING A MESSAGE AT A GAME MACHINE

Table with 7 columns: APPLN. TYPE, ENTITY STATUS, ISSUE FEE DUE, PUBLICATION FEE DUE, PREV. PAID ISSUE FEE, TOTAL FEE(S) DUE, DATE DUE

nonprovisional UNDISCOUNTED \$960 \$0 \$0 \$960 07/01/2014

THE APPLICATION IDENTIFIED ABOVE HAS BEEN EXAMINED AND IS ALLOWED FOR ISSUANCE AS A PATENT. PROSECUTION ON THE MERITS IS CLOSED. THIS NOTICE OF ALLOWANCE IS NOT A GRANT OF PATENT RIGHTS. THIS APPLICATION IS SUBJECT TO WITHDRAWAL FROM ISSUE AT THE INITIATIVE OF THE OFFICE OR UPON PETITION BY THE APPLICANT. SEE 37 CFR 1.313 AND MPEP 1308.

THE ISSUE FEE AND PUBLICATION FEE (IF REQUIRED) MUST BE PAID WITHIN THREE MONTHS FROM THE MAILING DATE OF THIS NOTICE OR THIS APPLICATION SHALL BE REGARDED AS ABANDONED. THIS STATUTORY PERIOD CANNOT BE EXTENDED. SEE 35 U.S.C. 151. THE ISSUE FEE DUE INDICATED ABOVE DOES NOT REFLECT A CREDIT FOR ANY PREVIOUSLY PAID ISSUE FEE IN THIS APPLICATION. IF AN ISSUE FEE HAS PREVIOUSLY BEEN PAID IN THIS APPLICATION (AS SHOWN ABOVE), THE RETURN OF PART B OF THIS FORM WILL BE CONSIDERED A REQUEST TO REAPPLY THE PREVIOUSLY PAID ISSUE FEE TOWARD THE ISSUE FEE NOW DUE.

HOW TO REPLY TO THIS NOTICE:

I. Review the ENTITY STATUS shown above. If the ENTITY STATUS is shown as SMALL or MICRO, verify whether entitlement to that entity status still applies.

If the ENTITY STATUS is the same as shown above, pay the TOTAL FEE(S) DUE shown above.

If the ENTITY STATUS is changed from that shown above, on PART B - FEE(S) TRANSMITTAL, complete section number 5 titled "Change in Entity Status (from status indicated above)".

For purposes of this notice, small entity fees are 1/2 the amount of undiscounted fees, and micro entity fees are 1/2 the amount of small entity fees.

II. PART B - FEE(S) TRANSMITTAL, or its equivalent, must be completed and returned to the United States Patent and Trademark Office (USPTO) with your ISSUE FEE and PUBLICATION FEE (if required). If you are charging the fee(s) to your deposit account, section "4b" of Part B - Fee(s) Transmittal should be completed and an extra copy of the form should be submitted. If an equivalent of Part B is filed, a request to reapply a previously paid issue fee must be clearly made, and delays in processing may occur due to the difficulty in recognizing the paper as an equivalent of Part B.

III. All communications regarding this application must give the application number. Please direct all communications prior to issuance to Mail Stop ISSUE FEE unless advised to the contrary.

IMPORTANT REMINDER: Utility patents issuing on applications filed on or after Dec. 12, 1980 may require payment of maintenance fees. It is patentee's responsibility to ensure timely payment of maintenance fees when due.

PART B - FEE(S) TRANSMITTAL

**Complete and send this form, together with applicable fee(s), to: Mail Mail Stop ISSUE FEE
 Commissioner for Patents
 P.O. Box 1450
 Alexandria, Virginia 22313-1450
 or Fax (571)-273-2885**

INSTRUCTIONS: This form should be used for transmitting the ISSUE FEE and PUBLICATION FEE (if required). Blocks 1 through 5 should be completed where appropriate. All further correspondence including the Patent, advance orders and notification of maintenance fees will be mailed to the current correspondence address as indicated unless corrected below or directed otherwise in Block 1, by (a) specifying a new correspondence address; and/or (b) indicating a separate "FEE ADDRESS" for maintenance fee notifications.

CURRENT CORRESPONDENCE ADDRESS (Note: Use Block 1 for any change of address)

29159 7590 04/01/2014
 Neal, Gerber & Eisenberg LLP
 (IGT)
 2 N. LaSalle Street
 Suite 1700
 Chicago, IL 60602-3801

Note: A certificate of mailing can only be used for domestic mailings of the Fee(s) Transmittal. This certificate cannot be used for any other accompanying papers. Each additional paper, such as an assignment or formal drawing, must have its own certificate of mailing or transmission.

Certificate of Mailing or Transmission

I hereby certify that this Fee(s) Transmittal is being deposited with the United States Postal Service with sufficient postage for first class mail in an envelope addressed to the Mail Stop ISSUE FEE address above, or being facsimile transmitted to the USPTO (571) 273-2885, on the date indicated below.

(Depositor's name)
(Signature)
(Date)

APPLICATION NO.	FILING DATE	FIRST NAMED INVENTOR	ATTORNEY DOCKET NO.	CONFIRMATION NO.
13/680,852	11/19/2012	Jay S. Walker	025124-0509	6364

TITLE OF INVENTION: METHOD AND APPARATUS FOR OUTPUTTING A MESSAGE AT A GAME MACHINE

APPLN. TYPE	ENTITY STATUS	ISSUE FEE DUE	PUBLICATION FEE DUE	PREV. PAID ISSUE FEE	TOTAL FEE(S) DUE	DATE DUE
nonprovisional	UNDISCOUNTED	\$960	\$0	\$0	\$960	07/01/2014

EXAMINER	ART UNIT	CLASS-SUBCLASS
HOEL, MATTHEW D	3714	463-025000

<p>1. Change of correspondence address or indication of "Fee Address" (37 CFR 1.363).</p> <p><input type="checkbox"/> Change of correspondence address (or Change of Correspondence Address form PTO/SB/122) attached.</p> <p><input type="checkbox"/> "Fee Address" indication (or "Fee Address" Indication form PTO/SB/47; Rev 03-02 or more recent) attached. Use of a Customer Number is required.</p>	<p>2. For printing on the patent front page, list</p> <p>(1) The names of up to 3 registered patent attorneys or agents OR, alternatively, 1 _____</p> <p>(2) The name of a single firm (having as a member a registered attorney or agent) and the names of up to 2 registered patent attorneys or agents. If no name is listed, no name will be printed. 2 _____</p> <p>3 _____</p>
---	---

3. ASSIGNEE NAME AND RESIDENCE DATA TO BE PRINTED ON THE PATENT (print or type)

PLEASE NOTE: Unless an assignee is identified below, no assignee data will appear on the patent. If an assignee is identified below, the document has been filed for recordation as set forth in 37 CFR 3.11. Completion of this form is NOT a substitute for filing an assignment.

(A) NAME OF ASSIGNEE _____ (B) RESIDENCE: (CITY and STATE OR COUNTRY) _____

Please check the appropriate assignee category or categories (will not be printed on the patent) : Individual Corporation or other private group entity Government

<p>4a. The following fee(s) are submitted:</p> <p><input type="checkbox"/> Issue Fee</p> <p><input type="checkbox"/> Publication Fee (No small entity discount permitted)</p> <p><input type="checkbox"/> Advance Order - # of Copies _____</p>	<p>4b. Payment of Fee(s): (Please first reapply any previously paid issue fee shown above)</p> <p><input type="checkbox"/> A check is enclosed.</p> <p><input type="checkbox"/> Payment by credit card. Form PTO-2038 is attached.</p> <p><input type="checkbox"/> The Director is hereby authorized to charge the required fee(s), any deficiency, or credits any overpayment, to Deposit Account Number _____ (enclose an extra copy of this form).</p>
---	---

<p>5. Change in Entity Status (from status indicated above)</p> <p><input type="checkbox"/> Applicant certifying micro entity status. See 37 CFR 1.29</p> <p><input type="checkbox"/> Applicant asserting small entity status. See 37 CFR 1.27</p> <p><input type="checkbox"/> Applicant changing to regular undiscounted fee status.</p>	<p>NOTE: Absent a valid certification of Micro Entity Status (see forms PTO/SB/15A and 15B), issue fee payment in the micro entity amount will not be accepted at the risk of application abandonment.</p> <p>NOTE: If the application was previously under micro entity status, checking this box will be taken to be a notification of loss of entitlement to micro entity status.</p> <p>NOTE: Checking this box will be taken to be a notification of loss of entitlement to small or micro entity status, as applicable.</p>
--	--

NOTE: This form must be signed in accordance with 37 CFR 1.31 and 1.33. See 37 CFR 1.4 for signature requirements and certifications.

Authorized Signature _____ Date _____

Typed or printed name _____ Registration No. _____



UNITED STATES PATENT AND TRADEMARK OFFICE

UNITED STATES DEPARTMENT OF COMMERCE
United States Patent and Trademark Office
Address: COMMISSIONER FOR PATENTS
P.O. Box 1450
Alexandria, Virginia 22313-1450
www.uspto.gov

Table with 5 columns: APPLICATION NO., FILING DATE, FIRST NAMED INVENTOR, ATTORNEY DOCKET NO., CONFIRMATION NO. Includes application details for Neal, Gerber & Eisenberg LLP and examiner information for HOEL, MATTHEW D.

Determination of Patent Term Adjustment under 35 U.S.C. 154 (b)

(application filed on or after May 29, 2000)

The Patent Term Adjustment to date is 72 day(s). If the issue fee is paid on the date that is three months after the mailing date of this notice and the patent issues on the Tuesday before the date that is 28 weeks (six and a half months) after the mailing date of this notice, the Patent Term Adjustment will be 72 day(s).

If a Continued Prosecution Application (CPA) was filed in the above-identified application, the filing date that determines Patent Term Adjustment is the filing date of the most recent CPA.

Applicant will be able to obtain more detailed information by accessing the Patent Application Information Retrieval (PAIR) WEB site (http://pair.uspto.gov).

Any questions regarding the Patent Term Extension or Adjustment determination should be directed to the Office of Patent Legal Administration at (571)-272-7702. Questions relating to issue and publication fee payments should be directed to the Customer Service Center of the Office of Patent Publication at 1-(888)-786-0101 or (571)-272-4200.

OMB Clearance and PRA Burden Statement for PTOL-85 Part B

The Paperwork Reduction Act (PRA) of 1995 requires Federal agencies to obtain Office of Management and Budget approval before requesting most types of information from the public. When OMB approves an agency request to collect information from the public, OMB (i) provides a valid OMB Control Number and expiration date for the agency to display on the instrument that will be used to collect the information and (ii) requires the agency to inform the public about the OMB Control Number's legal significance in accordance with 5 CFR 1320.5(b).

The information collected by PTOL-85 Part B is required by 37 CFR 1.311. The information is required to obtain or retain a benefit by the public which is to file (and by the USPTO to process) an application. Confidentiality is governed by 35 U.S.C. 122 and 37 CFR 1.14. This collection is estimated to take 12 minutes to complete, including gathering, preparing, and submitting the completed application form to the USPTO. Time will vary depending upon the individual case. Any comments on the amount of time you require to complete this form and/or suggestions for reducing this burden, should be sent to the Chief Information Officer, U.S. Patent and Trademark Office, U.S. Department of Commerce, P.O. Box 1450, Alexandria, Virginia 22313-1450. DO NOT SEND FEES OR COMPLETED FORMS TO THIS ADDRESS. SEND TO: Commissioner for Patents, P.O. Box 1450, Alexandria, Virginia 22313-1450. Under the Paperwork Reduction Act of 1995, no persons are required to respond to a collection of information unless it displays a valid OMB control number.

Privacy Act Statement

The Privacy Act of 1974 (P.L. 93-579) requires that you be given certain information in connection with your submission of the attached form related to a patent application or patent. Accordingly, pursuant to the requirements of the Act, please be advised that: (1) the general authority for the collection of this information is 35 U.S.C. 2(b)(2); (2) furnishing of the information solicited is voluntary; and (3) the principal purpose for which the information is used by the U.S. Patent and Trademark Office is to process and/or examine your submission related to a patent application or patent. If you do not furnish the requested information, the U.S. Patent and Trademark Office may not be able to process and/or examine your submission, which may result in termination of proceedings or abandonment of the application or expiration of the patent.

The information provided by you in this form will be subject to the following routine uses:

1. The information on this form will be treated confidentially to the extent allowed under the Freedom of Information Act (5 U.S.C. 552) and the Privacy Act (5 U.S.C. 552a). Records from this system of records may be disclosed to the Department of Justice to determine whether disclosure of these records is required by the Freedom of Information Act.
2. A record from this system of records may be disclosed, as a routine use, in the course of presenting evidence to a court, magistrate, or administrative tribunal, including disclosures to opposing counsel in the course of settlement negotiations.
3. A record in this system of records may be disclosed, as a routine use, to a Member of Congress submitting a request involving an individual, to whom the record pertains, when the individual has requested assistance from the Member with respect to the subject matter of the record.
4. A record in this system of records may be disclosed, as a routine use, to a contractor of the Agency having need for the information in order to perform a contract. Recipients of information shall be required to comply with the requirements of the Privacy Act of 1974, as amended, pursuant to 5 U.S.C. 552a(m).
5. A record related to an International Application filed under the Patent Cooperation Treaty in this system of records may be disclosed, as a routine use, to the International Bureau of the World Intellectual Property Organization, pursuant to the Patent Cooperation Treaty.
6. A record in this system of records may be disclosed, as a routine use, to another federal agency for purposes of National Security review (35 U.S.C. 181) and for review pursuant to the Atomic Energy Act (42 U.S.C. 218(c)).
7. A record from this system of records may be disclosed, as a routine use, to the Administrator, General Services, or his/her designee, during an inspection of records conducted by GSA as part of that agency's responsibility to recommend improvements in records management practices and programs, under authority of 44 U.S.C. 2904 and 2906. Such disclosure shall be made in accordance with the GSA regulations governing inspection of records for this purpose, and any other relevant (i.e., GSA or Commerce) directive. Such disclosure shall not be used to make determinations about individuals.
8. A record from this system of records may be disclosed, as a routine use, to the public after either publication of the application pursuant to 35 U.S.C. 122(b) or issuance of a patent pursuant to 35 U.S.C. 151. Further, a record may be disclosed, subject to the limitations of 37 CFR 1.14, as a routine use, to the public if the record was filed in an application which became abandoned or in which the proceedings were terminated and which application is referenced by either a published application, an application open to public inspection or an issued patent.
9. A record from this system of records may be disclosed, as a routine use, to a Federal, State, or local law enforcement agency, if the USPTO becomes aware of a violation or potential violation of law or regulation.

Notice of Allowability	Application No. 13/680,852	Applicant(s) WALKER ET AL.	
	Examiner Matthew D. Hoel	Art Unit 3714	AIA (First Inventor to File) Status No

-- The MAILING DATE of this communication appears on the cover sheet with the correspondence address--

All claims being allowable, PROSECUTION ON THE MERITS IS (OR REMAINS) CLOSED in this application. If not included herewith (or previously mailed), a Notice of Allowance (PTOL-85) or other appropriate communication will be mailed in due course. **THIS NOTICE OF ALLOWABILITY IS NOT A GRANT OF PATENT RIGHTS.** This application is subject to withdrawal from issue at the initiative of the Office or upon petition by the applicant. See 37 CFR 1.313 and MPEP 1308.

1. This communication is responsive to 11/19/2012.
 A declaration(s)/affidavit(s) under **37 CFR 1.130(b)** was/were filed on _____.
2. An election was made by the applicant in response to a restriction requirement set forth during the interview on _____; the restriction requirement and election have been incorporated into this action.
3. The allowed claim(s) is/are 1-18. As a result of the allowed claim(s), you may be eligible to benefit from the **Patent Prosecution Highway** program at a participating intellectual property office for the corresponding application. For more information, please see http://www.uspto.gov/patents/init_events/pph/index.jsp or send an inquiry to PPHfeedback@uspto.gov.
4. Acknowledgment is made of a claim for foreign priority under 35 U.S.C. § 119(a)-(d) or (f).

Certified copies:

- a) All b) Some *c) None of the:
1. Certified copies of the priority documents have been received.
 2. Certified copies of the priority documents have been received in Application No. _____.
 3. Copies of the certified copies of the priority documents have been received in this national stage application from the International Bureau (PCT Rule 17.2(a)).
- * Certified copies not received: _____.

Applicant has THREE MONTHS FROM THE "MAILING DATE" of this communication to file a reply complying with the requirements noted below. Failure to timely comply will result in ABANDONMENT of this application.
THIS THREE-MONTH PERIOD IS NOT EXTENDABLE.

5. CORRECTED DRAWINGS (as "replacement sheets") must be submitted.
 including changes required by the attached Examiner's Amendment / Comment or in the Office action of Paper No./Mail Date _____.
Identifying indicia such as the application number (see 37 CFR 1.84(c)) should be written on the drawings in the front (not the back) of each sheet. Replacement sheet(s) should be labeled as such in the header according to 37 CFR 1.121(d).
6. DEPOSIT OF and/or INFORMATION about the deposit of BIOLOGICAL MATERIAL must be submitted. Note the attached Examiner's comment regarding REQUIREMENT FOR THE DEPOSIT OF BIOLOGICAL MATERIAL.

Attachment(s)

- | | |
|--|--|
| 1. <input checked="" type="checkbox"/> Notice of References Cited (PTO-892) | 5. <input type="checkbox"/> Examiner's Amendment/Comment |
| 2. <input checked="" type="checkbox"/> Information Disclosure Statements (PTO/SB/08),
Paper No./Mail Date <u>See Continuation Sheet</u> | 6. <input checked="" type="checkbox"/> Examiner's Statement of Reasons for Allowance |
| 3. <input type="checkbox"/> Examiner's Comment Regarding Requirement for Deposit of Biological Material | 7. <input type="checkbox"/> Other _____. |
| 4. <input type="checkbox"/> Interview Summary (PTO-413),
Paper No./Mail Date _____. | |

/M. D. H./ Examiner, Art Unit 3714	/DAVID L LEWIS/ Supervisory Patent Examiner, Art Unit 3714
---------------------------------------	---

Continuation of Attachment(s) 2. Information Disclosure Statements (PTO/SB/08), Paper No./Mail Date: 03/29/2013; 08/08/2013; 11/25/2013.

Application/Control Number: 13/680,852
Art Unit: 3714

Page 2

DETAILED ACTION

Allowable Subject Matter

Claims 1 to 18 are allowed.

REASONS FOR ALLOWANCE

The following is an examiner's statement of reasons for allowance: The closest prior art is LeMay, et al. (6,942,574 B1). LeMay determines gaming activity associated with a player (1:17-11, 3:4-7, 3:21-23). LeMay selects a feature based on gaming activity (3:20-23). The feature may be selected based on input from a player (3:7-10). The message may make a recommendation of a feature to a player (3:14-19). The message may be a status message (5:41-47), an instructive message (3:14-19), a communication message (5:41-47), a promotional message (2:15-29), or an activity-benefit offer (3:55-60). This reference was overcome by the applicants in a Board decision (03-30-2012) in parent case 10/685,413. LeMay does not track a plurality of promotion offers and respective messages with their own respective play parameters that trigger the offer being offered when certain conditions are met as claimed. The promotion server controlling the promotional offers as claimed will have the advantage of centrally monitoring game play and ensuring that promotional offers are correctly offered when the trigger conditions are met based on game play. The tracking of different messages with different message triggering conditions as claimed is advantageous over the prior art by accurately tracking game play parameters ensuring that the correct messages are directed based on the actual game play parameters. The player tracking will ensure that the system is auditable and that marketing and promotions are accurately targeted to the correct audience. The examiner respects that the applicants may have different reasons for allowance.

Art Unit: 3714

Any comments considered necessary by applicant must be submitted no later than the payment of the issue fee and, to avoid processing delays, should preferably accompany the issue fee. Such submissions should be clearly labeled "Comments on Statement of Reasons for Allowance."

Citation of Pertinent Prior Art

The prior art made of record and not relied upon is considered pertinent to applicant's disclosure. LeMay, et al. (6,942,574 B1) determines gaming activity associated with a player (1:17-11, 3:4-7, 3:21-23). LeMay selects a feature based on gaming activity (3:20-23). The feature may be selected based on input from a player (3:7-10). The message may make a recommendation of a feature to a player (3:14-19). The message may be a status message (5:41-47), an instructive message (3:14-19), a communication message (5:41-47), a promotional message (2:15-29), or an activity-benefit offer (3:55-60).

Conclusion

Any inquiry concerning this communication or earlier communications from the examiner should be directed to Matthew D. Hoel whose telephone number is (571)272-5961. The examiner can normally be reached on 8:00 A.M. to 4:30 P.M..

If attempts to reach the examiner by telephone are unsuccessful, the examiner's supervisor, David L. Lewis can be reached on (571) 272-7673. The fax phone number for the organization where this application or proceeding is assigned is 571-273-8300.

Information regarding the status of an application may be obtained from the Patent Application Information Retrieval (PAIR) system. Status information for published applications may be obtained from either Private PAIR or Public PAIR. Status information for unpublished applications is available through Private PAIR only. For more information about the PAIR system, see <http://pair-direct.uspto.gov>. Should you have questions on access to the Private PAIR system, contact the Electronic Business Center (EBC) at 866-217-9197 (toll-free). If you would like assistance from a USPTO Customer Service Representative or access to the automated information system, call 800-786-9199 (IN USA OR CANADA) or 571-272-1000.

/M. D. H./
Examiner, Art Unit 3714
/DAVID L LEWIS/
Supervisory Patent Examiner, Art Unit 3714

Notice of References Cited	Application/Control No. 13/680,852	Applicant(s)/Patent Under Reexamination WALKER ET AL.	
	Examiner Matthew D. Hoel	Art Unit 3714	Page 1 of 1

U.S. PATENT DOCUMENTS

*	Document Number Country Code-Number-Kind Code	Date MM-YYYY	Name	Classification
*	A US-6,942,574	09-2005	LeMay et al.	463/41
	B US-			
	C US-			
	D US-			
	E US-			
	F US-			
	G US-			
	H US-			
	I US-			
	J US-			
	K US-			
	L US-			
	M US-			

FOREIGN PATENT DOCUMENTS

*	Document Number Country Code-Number-Kind Code	Date MM-YYYY	Country	Name	Classification
	N				
	O				
	P				
	Q				
	R				
	S				
	T				

NON-PATENT DOCUMENTS

*	Document Number Country Code-Number-Kind Code	Date MM-YYYY	Country	Name	Classification
	Include as applicable: Author, Title Date, Publisher, Edition or Volume, Pertinent Pages)				
	U				
	V				
	W				
	X				

*A copy of this reference is not being furnished with this Office action. (See MPEP § 707.05(a).)
Dates in MM-YYYY format are publication dates. Classifications may be US or foreign.



UNITED STATES PATENT AND TRADEMARK OFFICE

UNITED STATES DEPARTMENT OF COMMERCE
 United States Patent and Trademark Office
 Address: COMMISSIONER FOR PATENTS
 P.O. Box 1450
 Alexandria, Virginia 22313-1450
 www.uspto.gov

BIB DATA SHEET

CONFIRMATION NO. 6364

SERIAL NUMBER	FILING or 371(c) DATE	CLASS	GROUP ART UNIT	ATTORNEY DOCKET NO.		
13/680,852	11/19/2012	463	3714	025124-0509		
APPLICANTS IGT, Reno, NV INVENTORS Jay S. Walker, Ridgefield, CT; James A. Jorasch, Stamford, CT; Russell P. Sammon, San Francisco, CA; Stephen C. Tulley, Fairfield, CT; Steven M. Santisi, Ridgefield, CT; ** CONTINUING DATA ***** This application is a CON of 13/632,328 10/01/2012 which is a CON of 10/685,143 10/14/2003 PAT 8282488 which claims benefit of 60/418,397 10/11/2002 ** FOREIGN APPLICATIONS ***** ** IF REQUIRED, FOREIGN FILING LICENSE GRANTED ** 12/12/2012						
Foreign Priority claimed <input type="checkbox"/> Yes <input checked="" type="checkbox"/> No 35 USC 119(a-d) conditions met <input type="checkbox"/> Yes <input checked="" type="checkbox"/> No Verified and Acknowledged <u>/MATTHEW D. HOEL/</u> Examiner's Signature		<input type="checkbox"/> Met after Allowance Initials	STATE OR COUNTRY CT	SHEETS DRAWINGS 18	TOTAL CLAIMS 18	INDEPENDENT CLAIMS 2
ADDRESS Neal, Gerber & Eisenberg LLP (IGT) 2 N. LaSalle Street Suite 1700 Chicago, IL 60602-3801 UNITED STATES						
TITLE METHOD AND APPARATUS FOR OUTPUTTING A MESSAGE AT A GAME MACHINE						
FILING FEE RECEIVED 1850	FEES: Authority has been given in Paper No. _____ to charge/credit DEPOSIT ACCOUNT No. _____ for following:			<input type="checkbox"/> All Fees <input type="checkbox"/> 1.16 Fees (Filing) <input type="checkbox"/> 1.17 Fees (Processing Ext. of time) <input type="checkbox"/> 1.18 Fees (Issue) <input type="checkbox"/> Other _____ <input type="checkbox"/> Credit		

allowed clms.: 1-18.
 ind. clms.: 1 & 9.
 dep. clms.: 2-8 & 10-18.

EAST Search History

EAST Search History (Prior Art)

Ref #	Hits	Search Query	DBs	Default Operator	Plurals	Time Stamp
S1	5425	463/16.ccls.	US-PGPUB; USPAT; USOCR; FPRS; EPO; JPO; DERWENT; IBM_TDB	OR	ON	2014/02/24 22:58
S2	7192	463/20.ccls.	US-PGPUB; USPAT; USOCR; FPRS; EPO; JPO; DERWENT; IBM_TDB	OR	ON	2014/02/24 22:58
S3	2845	463/11-13.ccls.	US-PGPUB; USPAT; USOCR; FPRS; EPO; JPO; DERWENT; IBM_TDB	OR	ON	2014/02/24 22:58
S4	3475	463/17-19.ccls.	US-PGPUB; USPAT; USOCR; FPRS; EPO; JPO; DERWENT; IBM_TDB	OR	ON	2014/02/24 22:58
S5	7679	463/25.ccls.	US-PGPUB; USPAT; USOCR; FPRS; EPO; JPO; DERWENT; IBM_TDB	OR	ON	2014/02/24 22:58
S6	2053	463/26-28.ccls.	US-PGPUB; USPAT; USOCR; FPRS; EPO; JPO; DERWENT; IBM_TDB	OR	ON	2014/02/24 22:58
S7	6247	463/30-32.ccls.	US-PGPUB; USPAT; USOCR; FPRS; EPO; JPO; DERWENT; IBM_TDB	OR	ON	2014/02/24 22:59
S8	2345	463/40,41.ccls.	US-PGPUB; USPAT; USOCR; FPRS; EPO; JPO; DERWENT; IBM_TDB	OR	ON	2014/02/24 22:59
S9	8479	463/42.ccls.	US-PGPUB; USPAT; USOCR; FPRS; EPO; JPO; DERWENT; IBM_TDB	OR	ON	2014/02/24 22:59
S10	2	"US 20130130791"	US-PGPUB; USPAT; USOCR; DERWENT	OR	ON	2014/02/25 15:07
S11	1	"5553864".pn.	US-PGPUB; USPAT; USOCR	OR	ON	2014/02/25 17:48
S12	1	"5830065".pn.	US-PGPUB; USPAT; USOCR	OR	ON	2014/02/25 17:54
S13	1	"6425835".pn.	US-PGPUB; USPAT; USOCR	OR	ON	2014/02/25 17:55
S14	1	"6425825".pn.	US-PGPUB; USPAT; USOCR	OR	ON	2014/02/25 17:55
S15	1	"8317611".pn.	US-PGPUB; USPAT; USOCR	OR	ON	2014/02/25 17:59
S16	1	"7137892".pn.	US-PGPUB; USPAT; USOCR	OR	ON	2014/02/25 18:03
S17	1	"7867086".pn.	US-PGPUB; USPAT; USOCR	OR	ON	2014/02/25 18:04

EAST Search History (Interference)

< This search history is empty >

3/ 13/ 2014 4:10:43 PM

C:\Users\mhoel\Documents\EAST\Workspaces\02-24-2014.wsp

EAST Search History

EAST Search History (Prior Art)

Ref #	Hits	Search Query	DBs	Default Operator	Plurals	Time Stamp
L9	31	("20080146346" "20030089343" "20070243928" "20050060050" "7658674" "6645068" "20050250567" "20080108429" "7127069" "7762885" "20050043082" "20090191962" "7192350" "7485040" "7997972" "20050096123" "20090054148" "6609978" "20030216185" "20060052150" "20070254736" "20090036202" "20070259709" "6293865" "20080096650" "7455586" "5816918" "20030013513" "7717788" "20100029376" "20020029339").URN.	US-PGPUB; USPAT; USOCR	OR	ON	2014/03/13 20:10
L10	269	("2002/0029339" "2003/0013513" "2003/0089343" "2003/0216185" "2005/0043082" "2005/0060050" "2005/0096123" "2005/0250567" "2006/0052150" "2007/0243928").URN.	USPAT	OR	ON	2014/03/13 20:10
L11	181	("2007/0254736" "2007/0259709" "2008/0096650" "2008/0108429" "2008/0146346" "2009/0036202" "2009/0054148" "2009/0191962" "2010/0029376").URN.	USPAT	OR	ON	2014/03/13 20:10
L12	181	("2007/0254736" "2007/0259709" "2008/0096650" "2008/0108429" "2008/0146346" "2009/0036202" "2009/0054148" "2009/0191962" "2010/0029376").URN.	USPAT	OR	ON	2014/03/13 20:10
L17	650	("20010031664" "20010034259" "20020002075" "20020029339" "20020039923" "20020045473" "20020045477" "20020049909" "20020071557" "20020072404" "20020077169" "20020094859" "20020103027" "20020107066" "20020107073" "20020113369" "20020132660" "20020147043" "20020155891" "20020177479" "20020190469" "20030013513" "20030013532" "20030027625" "20030027629" "20030036426" "20030054881" "20030060247" "20030064798" "20030069071" "20030078101" "20030092477" "20030092484" "20030100360" "20030148812" "20030186745" "20030199320" "20040002385" "20040053681" "20040092315" "20040106449" "20040116183" "20040143495" "20040152518" "20040166940" "20040209674" "20040229683" "20040242297" "20040254010" "20050059494"	US-PGPUB; USPAT; USOCR	OR	ON	2014/03/13 20:10

"20060009284"	"20060059046"	
"20060063587"	"20060194631"	
"20060247037"	"20070202951"	"2043166"
	"3129004"	"3468476" "3796433"
"3852576"	"3931504"	"4191376"
"4240635"	"4398708"	"4430728"
"4454594"	"4592546"	"4624459"
"4667336"	"4745468"	"4815741"
"4854590"	"4856787"	"4869500"
"4876592"	"4890842"	"4982346"
"5022172"	"5025372"	"5057915"
"5069453"	"5076613"	"5080364"
"5083271"	"5099232"	"5116055"
"5137278"	"5179517"	"5229764"
"5231568"	"5259613"	"5269522"
"5280909"	"5282620"	"5283734"
"5286023"	"5292127"	"5321241"
"5324035"	"5344144"	"5362051"
"5362064"	"5370399"	"5373440"
"5392066")	.PN. OR ("5397125"	"5417430"
"5429361"	"5470079"	"5472194"
"5482289"	"5488411"	"5505457"
"5536016"	"5551692"	"5555497"
"5555991"	"5564700"	"5573248"
"5586936"	"5588650"	"5605334"
"5611730"	"5613912"	"5615109"
"5618232"	"5620182"	"5636346"
"5643086"	"5643088"	"5644727"
"5647592"	"5655961"	"5671412"
"5674128"	"5695402"	"5697844"
"5709604"	"5713574"	"5715403"
"5721827"	"5722890"	"5727786"
"5735525"	"5743800"	"5759101"
"5761547"	"5761647"	"5762552"
"5768382"	"5774870"	"5779549"
"5791991"	"5806852"	"5809482"
"5813913"	"5816918"	"5820459"
"5833537"	"5833538"	"5836817"
"5851147"	"5851149"	"5857175"
"5868619"	"5876284"	"5883620"
"5885158"	"5911626"	"5918211"
"5925127"	"5928082"	"5933811"
"5933813"	"5934999"	"5941772"
"5944314"	"5944606"	"5946646"
"5946664"	"5950173"	"5962831"
"5964463"	"5970143"	"5971271"
"5971850"	"5974403"	"5979757"
"5983196"	"5999808"	"6002772"
"6003013"	"6006257"	"6007426"
"6009410"	"6009412"	"6012045"
"6015344"	"6015347"	"6021362"
"6024642"	"6032955"	"6036601"
"6039648"	"6048268"	"6048269"
"6052512"	"6059658"	"6059659"
"6099407"	"6099408"	"6102799"
"6104815"	"6106396"	"6110041"
"6110043"	"6110044"	"6113098"
"6113495"	"6119101"	"6120376"
"6125185"	"6126167"	"6141006"
"6146273"	"6149522"	"6165070"
"6165072"	"6169976"	"6173267")
(.PN. OR	
"6178510"	"6183362"	"6183366"
"6186893"	"6196920"	"6203010"
"6210275"	"6213874"	"6213876"

		"6217448" "6223215" "6231445" "6251017" "6253374" "6254483" "6264561" "6266647" "6267671" "6267672" "6267675" "6283473" "6285868" "6293866" "6299532" "6306035" "6309298" "6319125" "6324519" "6331143" "6332099" "6336862" "6358147" "6364768" "6364769" "6368219" "6379251" "6381626" "6390917" "6425823" "6443843" "6446257" "6447395" "6449687" "6453319" "6454648" "6454649" "6464584" "6474649" "6478676" "6484148" "6500067" "6500068" "6508709" "6511377" "6527175" "6540609" "6558255" "6558256" "6565434" "6567786" "6567842" "6575832" "6592460" "6595859" "6606745" "6609969" "6609978" "6616533" "6620046" "6623357" "6625578" "6633850" "6634550" "6645068" "6656050" "6676522" "6692359" "6712702" "6729884" "6749504" "6749511" "6764395" "6786824" "6790142" "6800029" "6811483" "6814664" "6834856" "6843723" "6882978" "6885995" "6890256" "6892182" "6899626" "6907400" "6910968" "6912504" "6928414" "6939226" "6960136" "6966836" "6974385" "6993494" "7025674" "7038637" "7052392" "7054831" "7056208" "7076445" "7085733" "7086947" "7094149" "7139725" "7168617" "RE37371" "RE37885".PN. OR ("6293865" "6609978" "6645068" "7127069" "7192350" "7455586" "7485040" "7658674" "7717788" "7762885").URPN.				
L18	147	("20010041609" "20020039923" "20020077169" "20020155877" "20020155891" "20030054881" "20030054888" "20030064788" "20030109306" "20030125103" "20030141660" "20030148812" "20030186745" "20030195024" "20040002385" "20040077397" "20040106449" "20040116183" "20040152518" "20040198485" "20050059494" "20060009284" "20060059046" "20060063587" "20060194631" "20060247037" "3129004" "3468476" "4592546" "4815741" "4854590" "4869500" "4890842" "4982346" "5057915" "5076613" "5080364" "5099232" "5137278" "5231568" "5269522" "5362051" "5373440" "5392066" "5551692" "5555991" "5620182" "5643088" "5695402" "5697844" "5722890" "5791991" "5806852" "5813913" "5816918" "5851147" "5857175" "5883620" "5918211" "5928082" "5933811" "5933813" "5941772"	US- PGPUB; USPAT; USOCR	OR	ON	2014/03/13 20:11

		"5946646" "5946664" "5950173" "5962831" "5979757" "5991736" "6006257" "6007426" "6009410" "6009412" "6015344" "6024642" "6036601" "6039648" "6048268" "6102799" "6141006" "6165070" "6173267" "6183366" "6186893" "6196920" "6213874" "6234897" "6267672" "6267675" "6306035" "6322309" "6324519" "6379251" "6381626" "6390917" "6443843" "6447395" "6454649" "6484148" "6523824" "6540609" "6567786" "6567842" "6595859" "6606745" "6609969" "6616533" "6625578" "6633850" "6634550" "6645068" "6656050" "6712702" "6729884" "6749504" "6749511").PN. OR ("6764395" "6786824" "6790142" "6834856" "6882978" "6885995" "6890256" "6899626" "6907400" "6912504" "6928414" "6966836" "7025674" "7038637" "7052392" "7054831" "7056208" "7076445" "7085733" "7094149" "7139725" "7168617").PN. OR ("7997972").URPN.				
L19	1059	L9 or L10 or L11 or L12 or L17 or L18	US- PGPUB; USPAT; USOCR	OR	ON	2014/03/13 20:11
L22	1	"8282488".pn.	US- PGPUB; USPAT; USOCR	OR	ON	2014/03/13 20:26
L23	21	("20030064769" "20030064782" "20050096125" "4695053" "4760527" "5290033" "5429361" "5611730" "5971849" "6089975" "6113495" "6126541" "6139431" "6176781" "6227446" "6270411" "6302790" "6409602" "6942574" "6942576").PN. OR ("8282488").URPN.	US- PGPUB; USPAT; USOCR	OR	ON	2014/03/13 20:26
L24	81	("2003/0064769" "2003/0064782" "2005/0096125").URPN.	USPAT	OR	ON	2014/03/13 20:26
L25	2338	("1919922" "3671041" "3735982" "3770269" "3796433" "3810627" "3819186" "3834712" "3876208" "3889956" "3909002" "3958103" "3998462" "4033588" "4052057" "4072930" "4093215" "4124109" "4157829" "4193600" "4238127" "4254404" "4314336" "4335809" "4339134" "4339798" "4362303" "4372558" "4373719" "4373726" "4380334" "4421313" "4438433" "4441714" "4467424" "4494197" "4531187" "4575622" "4594663" "4636951" "4648600" "4650977" "4652998" "4669596" "4669730" "4675515" "4689742" "4743024" "4805907" "4809837" "4815741" "4824121" "4837728" "4856787"	US- PGPUB; USPAT; USOCR	OR	ON	2014/03/13 20:26

		"4889339" "4953869" "4969183" "4991848" "5038022" "5069453" "5113990" "5116055" "5119295" "5129652" "5179517" "5197094" "5236199" "5249800" "5257179" "5311570" "5321241" "5324035" "5326104" "5344144" "5393057" "5429361" "5430440" "5461664" "5470079" "5741183" "5882260" "5937390" "D251395").PN. OR ("4695053" "4760527" "5290033" "5429361" "5611730" "5971849" "6089975").URPN.				
L26	1598	("20010011954" "20040132535" "2537228" "3357703" "3735982" "4052057" "4082270" "4337864" "4506890" "4513880" "4515288" "4517558" "4542287" "4560161" "4572509" "4659008" "4670643" "4700948" "4704061" "4712799" "4718672" "4760527" "4816652" "4824121" "4856787" "4866515" "4882676" "4909513" "4926327" "4977583" "4991848" "5018021" "5031914" "5033744" "5042818" "5046735" "5116043" "5127651" "5178390" "5179517" "5234379" "5237157" "5259613" "5259616" "5267826" "5275398" "5276312" "5277424" "5305195" "5321241" "5326104" "5335484" "5338262" "5370399" "5372361" "5375830" "5382025" "5393057" "5393061" "5401023" "5404567" "5429361" "5430791" "5456648" "5465082" "5476259" "5488411" "5494294" "5520581" "5530232" "5530469" "5530852" "5531440" "5533627" "5548348" "5550561" "5553864" "5559313" "5560603" "5564700" "5578808" "5580053" "5586257" "5586937" "5590197" "5592212" "5592375" "5594661" "5597996" "5617331" "5619738" "5630757" "5638426" "5640192" "5643086" "5648880" "5649118" "5655961" "5664998" "5675828" "5680935" "5697843" "5722891" "5732950" "5735516" "5752882" "5755621" "5761647" "5770533" "5779549" "5788573" "5800268" "5833537" "5833540" "5845283" "5851148" "5851149" "5902983" "5903732" "5905248" "5913164" "5913515" "5918039" "5919088").PN. OR ("5919095" "5951653" "5958028" "5971271" "5971849" "5971851" "5974409" "5980093" "5983190" "5984780" "5991760" "5991790" "5996068" "6003066" "6003094" "6003123" "6004208" "6006989" "6012982" "6027025" "6027115" "6029973" "6039648" "6056642" "6085247" "6086066" "6089975" "6089977" "6089978" "6093102" "6104815" "6106396"	US- PGPUB; USPAT; USOCR	OR	ON	2014/03/13 20:27

		"6113495" "6139431" "6141737" "6149522" "6226589" "6234896" "6270411" "6302790" "6379246" "6629897" "6640184" "6769992" "D416054").PN. OR ("6113495" "6126541" "6139431" "6176781" "6227446" "6270411" "6302790" "6409602" "6942574" "6942576").URPN.				
L27	32	("20020153656" "20020157099" "20030157976" "20040048656" "20040166942" "20040268130" "20050055316" "20060148551" "20060172803" "20060287091" "20070060380" "20070071025" "20070082740" "20080039192" "20080076572" "20080220854" "20090325686" "20110003634" "20110065494" "20110177862" "5687968" "6508710" "6527270" "6527638" "6692003" "6935952" "6993499" "7209733" "7351149" "7607107" "8057300" "8282488").PN. OR ("8632392").URPN.	US- PGPUB; USPAT; USOCR	OR	ON	2014/03/13 20:27
L28	21	("20050096125" "5611730" "6089975" "6942576" "6942849" "5290033" "6227446" "6409602" "5429361" "6302790" "6139431" "6176781" "6942574" "20030064769" "20030064782" "4760527" "6113495" "4695053" "5971849" "6270411" "6126541").PN.	US- PGPUB; USPAT; USOCR	OR	ON	2014/03/13 20:27
L29	81	("2003/0064769" "2003/0064782" "2005/0096125").URPN.	USPAT	OR	ON	2014/03/13 20:27
L30	2338	("1919922" "3671041" "3735982" "3770269" "3796433" "3810627" "3819186" "3834712" "3876208" "3889956" "3909002" "3958103" "3998462" "4033588" "4052057" "4072930" "4093215" "4124109" "4157829" "4193600" "4238127" "4254404" "4314336" "4335809" "4339134" "4339798" "4362303" "4372558" "4373719" "4373726" "4380334" "4421313" "4438433" "4441714" "4467424" "4494197" "4531187" "4575622" "4594663" "4636951" "4648600" "4650977" "4652998" "4669596" "4669730" "4675515" "4689742" "4743024" "4805907" "4809837" "4815741" "4824121" "4837728" "4856787" "4889339" "4953869" "4969183" "4991848" "5038022" "5069453" "5113990" "5116055" "5119295" "5129652" "5179517" "5197094" "5236199" "5249800" "5257179" "5311570" "5321241" "5324035" "5326104" "5344144" "5393057" "5429361" "5430440" "5461664" "5470079" "5741183" "5882260" "5937390" "D251395").PN. OR ("4695053" "4760527" "5290033" "5429361" "5611730" "5971849" "6089975").URPN.	US- PGPUB; USPAT; USOCR	OR	ON	2014/03/13 20:28

L31	1598	("20010011954" "20040132535" "2537228" "3357703" "3735982" "4052057" "4082270" "4337864" "4506890" "4513880" "4515288" "4517558" "4542287" "4560161" "4572509" "4659008" "4670643" "4700948" "4704061" "4712799" "4718672" "4760527" "4816652" "4824121" "4856787" "4866515" "4882676" "4909513" "4926327" "4977583" "4991848" "5018021" "5031914" "5033744" "5042818" "5046735" "5116043" "5127651" "5178390" "5179517" "5234379" "5237157" "5259613" "5259616" "5267826" "5275398" "5276312" "5277424" "5305195" "5321241" "5326104" "5335484" "5338262" "5370399" "5372361" "5375830" "5382025" "5393057" "5393061" "5401023" "5404567" "5429361" "5430791" "5456648" "5465082" "5476259" "5488411" "5494294" "5520581" "5530232" "5530469" "5530852" "5531440" "5533627" "5548348" "5550561" "5553864" "5559313" "5560603" "5564700" "5578808" "5580053" "5586257" "5586937" "5590197" "5592212" "5592375" "5594661" "5597996" "5617331" "5619738" "5630757" "5638426" "5640192" "5643086" "5648880" "5649118" "5655961" "5664998" "5675828" "5680935" "5697843" "5722891" "5732950" "5735516" "5752882" "5755621" "5761647" "5770533" "5779549" "5788573" "5800268" "5833537" "5833540" "5845283" "5851148" "5851149" "5902983" "5903732" "5905248" "5913164" "5913515" "5918039" "5919088").PN. OR ("5919095" "5951653" "5958028" "5971271" "5971849" "5971851" "5974409" "5980093" "5983190" "5984780" "5991760" "5991790" "5996068" "6003066" "6003094" "6003123" "6004208" "6006989" "6012982" "6027025" "6027115" "6029973" "6039648" "6056642" "6085247" "6086066" "6089975" "6089977" "6089978" "6093102" "6104815" "6106396" "6113495" "6139431" "6141737" "6149522" "6226589" "6234896" "6270411" "6302790" "6379246" "6629897" "6640184" "6769992" "D416054").PN. OR ("6113495" "6126541" "6139431" "6176781" "6227446" "6270411" "6302790" "6409602" "6942574" "6942576").URPN.	US-PGPUB; USPAT; USOCR	OR	ON	2014/03/13 20:28
L32	13	("4992420" "5032399" "5358858" "5368845" "5427767" "5427769" "5494664" "5503865" "5756665" "5833953" "6036952").PN. OR	US-PGPUB; USPAT; USOCR	OR	ON	2014/03/13 20:28

EAST Search History

		("6942849").URPN.				
L33	3151	L23 or L24 or L25 or L26 or L27 or L28 or L29 or L30 or L31 or L32	US-PGPUB; USPAT; USOCR	OR	ON	2014/03/13 20:29

EAST Search History (Interference)

Ref #	Hits	Search Query	DBs	Default Operator	Plurals	Time Stamp
L5	3314	463/25.ccls.	US-PGPUB; UPAD	OR	ON	2014/03/13 20:08
L6	843	G07F17/323.cpc.	US-PGPUB; UPAD	OR	ON	2014/03/13 20:08
L7	856	G07F17/3239.cpc.	US-PGPUB; UPAD	OR	ON	2014/03/13 20:08
L8	801	G07F17/3255.cpc.	US-PGPUB; UPAD	OR	ON	2014/03/13 20:08

3/ 13/ 2014 9:01:01 PM

C:\Users\mhoel\Documents\EAST\Workspaces\13680852, 03-12-2014.wsp

INFORMATION DISCLOSURE CITATION IN AN APPLICATION (Use several sheets if necessary) PTO Form 1449	Atty Docket No. 025124-0509	Application No. 13/680,852
	Applicant Walker et al.	Date Submitted March 28, 2013
	Filing Date November 19, 2012	Group 3714

U.S. PATENT DOCUMENTS						
Examiner's Initials	Document Number	Publication Date	Inventor	Class	Subclass	Filing Date If Appropriate
/M.D.H./	4,695,053	September 1987	Vazquez et al.			
	4,760,527	July 1988	Sidley			
	5,290,033	March 1994	Bittner et al.			
	5,429,361	July 4, 1995	Raven et al.			
	5,611,730	March 1997	Weiss			
	5,971,849	October 1999	Falciglia			
	6,089,975	July 2000	Dunn			
	6,113,495	September 2000	Walker et al.			
	6,126,541	October 2000	Fuchs			
	6,139,431	October 2000	Walker et al.			
	6,176,781	January 2001	Walker et al.			
	6,227,446	May 2001	Haney et al.			
	6,270,411	August 2001	Gura et al.			
	6,302,790	October 2001	Brossard			
	6,409,602	June 2002	Wiltshire et al.			
	6,942,576	September 2005	Holt			
	6,942,574	September 2005	LeMay et al.			
	2003/0064769	April 2003	Muir			
	2003/0064782	April 3, 2003	Beaulieu et al.			
/M.D.H./	2005/0096125	May 5, 2005	LeMay et al.			

FOREIGN PATENT DOCUMENTS							
Examiner's Initials	Document Number	Publication Date	Country	Class	Subclass	Translation	
						Yes	No
/M.D.H./	GB 2 393 554	March 2004	United Kingdom				

Examiner's Initials	OTHER DOCUMENTS (Including Author, Title, Date, Pertinent Pages, Etc.)

Examiner: /Matthew D. Hoel/	Date Considered: 03/12/2014
*Examiner: Initial if citation considered, whether or not citation is in conformance with MPEP Section 609; Draw line through citation if not in conformance and not considered. Include copy of this form with next communication to applicant.	

INFORMATION DISCLOSURE CITATION IN AN APPLICATION (Use several sheets if necessary) PTO Form 1449	Atty Docket No. 025124-0509	Application No. 13/680,852
	Applicant IGT	Date Submitted August 8, 2013
	Filing Date November 19, 2012	Group 3714

U.S. PATENT DOCUMENTS							
Examiner's Initials	Document Number	Publication Date	Inventor	Class	Subclass	Filing Date If Appropriate	

FOREIGN PATENT DOCUMENTS								
Examiner's Initials	Document Number	Publication Date	Country	Class	Subclass	Translation		
						Yes	No	
/M.D.H./	JP 2001-246166	September 11, 2001	JP			X		
/M.D.H./	JP 10-201953	August 4, 1998	JP			X		

Examiner's Initials	OTHER DOCUMENTS (Including Author, Title, Date, Pertinent Pages, Etc.)
/M.D.H./	Third Party Submission in Published Application Under 37 C.F.R. 1.99 filed for U.S. Patent Application No. 13/632,328, dated July 22, 2013 (2 pages)
/M.D.H./	Third Party Submission Under 37 C.F.R. 1.290 Concise Description of Relevance filed for U.S. Patent Applicant No. 13/632,328, dated July 22, 2013 (7 pages).

Examiner: /Matthew D. Hoel/	Date Considered: 03/12/2014
*Examiner: Initial if citation considered, whether or not citation is in conformance with MPEP Section 609; Draw line through citation if not in conformance and not considered. Include copy of this form with next communication to applicant.	

EAST Search History

EAST Search History (Prior Art)

Ref #	Hits	Search Query	DBs	Default Operator	Plurals	Time Stamp
L17	2	"US 20130217453"	US-PGPUB; USPAT; USOCR; DERWENT	OR	ON	2014/03/13 23:14
L30	2	"US 20130150155"	US-PGPUB; USPAT; USOCR; DERWENT	OR	ON	2014/03/13 23:29
L50	2	"US 20130079134"	US-PGPUB; USPAT; USOCR; DERWENT	OR	ON	2014/03/13 23:57

EAST Search History (Interference)

Ref #	Hits	Search Query	DBs	Default Operator	Plurals	Time Stamp
L9	319777	(multi-platform or cross-platform or network).clm.	US-PGPUB; UPAD	OR	ON	2014/03/13 23:12
L10	60902	(first near2 (ID or identifier or identification or serial or number)).clm.	US-PGPUB; UPAD	OR	ON	2014/03/13 23:12
L11	52468	(second near2 (ID or identifier or identification or serial or number)).clm.	US-PGPUB; UPAD	OR	ON	2014/03/13 23:13
L12	17124	(toy or token or plaything or doll).clm.	US-PGPUB; UPAD	OR	ON	2014/03/13 23:13
L13	3485	((progress\$3 or advanc\$3 or (mov\$3 adj (forward or ahead)) or continu\$\$5) near2 (level or stage or scene or mission)).clm.	US-PGPUB; UPAD	OR	ON	2014/03/13 23:13
L14	360138	(multi-platform or cross-platform or network or platform).clm.	US-PGPUB; UPAD	OR	ON	2014/03/13 23:13
L15	382285	(track\$3 or monitor\$3 or profil\$3).clm.	US-PGPUB; UPAD	OR	ON	2014/03/13 23:13
L18	0	L10 same L11 same L12 same L13 same L14 same L15	US-PGPUB; UPAD	OR	ON	2014/03/13 23:16
L19	0	L10 and L11 and L12 and L13 and L14 and L15	US-PGPUB; UPAD	OR	ON	2014/03/13 23:16
L20	0	L10 and L11 and L12 and L13 and L15	US-PGPUB; UPAD	OR	ON	2014/03/13 23:17
L21	71404	(first near2 (ID or identifier or identification or serial or number or RF or RFID or transceiver)).clm.	US-PGPUB; UPAD	OR	ON	2014/03/13 23:19
L22	62228	(second near2 (ID or identifier or identification or serial or number or RF or RFID or transceiver)).clm.	US-PGPUB; UPAD	OR	ON	2014/03/13 23:19

L23	4	L14 same L12 same L21 same L22 same L15	US-PGPUB; UPAD	OR	ON	2014/03/13 23:20
L24	1827	((environment or playground or maze or labyrinth or structure or building or house or field) with (play or recreation)).clm.	US-PGPUB; UPAD	OR	ON	2014/03/13 23:22
L25	27682	(first with (transponder or transceiver or radio or (transmitter near2 receiver)) with (RF or radio or HF or UHF or VHF or bluetooth or IR or infrared or zigbee or wifi)).clm.	US-PGPUB; UPAD	OR	ON	2014/03/13 23:25
L26	23366	(second with (transponder or transceiver or radio or (transmitter near2 receiver)) with (RF or radio or HF or UHF or VHF or bluetooth or IR or infrared or zigbee or wifi)).clm.	US-PGPUB; UPAD	OR	ON	2014/03/13 23:25
L27	116079	((effect or sound or vibration or music or light or laser or animation) with (control\$4 or activat\$3 or enabl\$5)).clm.	US-PGPUB; UPAD	OR	ON	2014/03/13 23:27
L28	319915	((toy or token or body or device or machine or apparatus) with (ID or RFID or serial or identification or identif\$4 or serial or number)).clm.	US-PGPUB; UPAD	OR	ON	2014/03/13 23:28
L29	3	L24 same L25 same L26 same L27 same L28	US-PGPUB; UPAD	OR	ON	2014/03/13 23:29
L31	3915	((environment or playground or maze or labyrinth or structure or building or house or field) with (play or recreation or interactive)).clm.	US-PGPUB; UPAD	OR	ON	2014/03/13 23:31
L32	13	L25 same L26 same L27 same L28	US-PGPUB; UPAD	OR	ON	2014/03/13 23:32
L33	23011	((game or gaming or wager\$3 or bet or bets or betting or gambli\$3) near2 (system or device or apparatus or computer or client or machine or terminal)).clm.	US-PGPUB; UPAD	OR	ON	2014/03/13 23:34
L34	262332	(balance or total or score or winning or jackpot or pool).clm.	US-PGPUB; UPAD	OR	ON	2014/03/13 23:34
L35	17369	((track\$3 or surveil\$5 or monitor\$3) with (point or credit or winning or total or balance)).clm.	US-PGPUB; UPAD	OR	ON	2014/03/13 23:35
L36	309	(cashout or "cash out" or cash\$1out or "cash-out").clm.	US-PGPUB; UPAD	OR	ON	2014/03/13 23:36
L37	8128	((redeem\$4 or "cash in" or "cash-in" or cash\$1in or (cash\$3 adj in) or buy\$3 or purchas\$3) with (good or service)).clm.	US-PGPUB; UPAD	OR	ON	2014/03/13 23:37
L38	1	L33 same L34 same L35 same L36 same L37	US-PGPUB; UPAD	OR	ON	2014/03/13 23:37
L39	210475	((identif\$7 or monitor\$3 or check\$3 or track\$3 or surveil\$5 or determin\$5 or designat\$3) with (rule or regulation or criteria or standard or level or parameter)).clm.	US-PGPUB; UPAD	OR	ON	2014/03/13 23:48
L40	950	((promot\$3 or reward\$3 or award\$3) near2	US-	OR	ON	2014/03/13

		(server or host or client or backend)).clm.	PGPUB; UPAD			23:48
L41	11079	((theme or motif or background) or (type or sort or kind or variety) or (paytable or "pay table" or pay\$1table or "pay-table" or flare) or denomination) near2 (rule or regulation or criteria or standard or level or parameter)).clm.	US- PGPUB; UPAD	OR	ON	2014/03/13 23:51
L42	5901	((game or gaming or wager\$3 or bet or bets or betting or casino) with (network or Internet or intranet)).clm.	US- PGPUB; UPAD	OR	ON	2014/03/13 23:51
L43	1320	((redeem\$3 or redemption or award\$3 or reward\$3) with (offer or opportunity)).clm.	US- PGPUB; UPAD	OR	ON	2014/03/13 23:52
L44	0	L39 same L40 same L41 same L42 same L43	US- PGPUB; UPAD	OR	ON	2014/03/13 23:53
L45	1994	((redeem\$3 or redemption or award\$3 or reward\$3 or promotion\$2) with (offer or opportunity)).clm.	US- PGPUB; UPAD	OR	ON	2014/03/13 23:53
L46	0	L39 same L40 same L41 same L42 same L45	US- PGPUB; UPAD	OR	ON	2014/03/13 23:53
L47	11079	((theme or motif or background or type or sort or kind or variety or payable or "pay table" or pay\$1table or "pay-table" or flare or denomination) near2 (rule or regulation or criteria or standard or level or parameter)).clm.	US- PGPUB; UPAD	OR	ON	2014/03/13 23:55
L48	0	L39 same L40 same L47 same L45	US- PGPUB; UPAD	OR	ON	2014/03/13 23:57
L49	5	L39 same L40 same L45	US- PGPUB; UPAD	OR	ON	2014/03/13 23:57
L51	10263	((track\$3 or surveil\$5 or monitor\$3) with (player or patron or contestant or wageror or bettor or punter or gambler or customer or participant or adult or man or woman or child or teen or teenager or boy or girl or person or people or persons)).clm.	US- PGPUB; UPAD	OR	ON	2014/03/14 00:00
L52	7305	((bet or bets or betting or wager\$3 or punt\$3 or gamb\$3) with (game or contest or tournament or competition)).clm.	US- PGPUB; UPAD	OR	ON	2014/03/14 00:01
L53	57104	((message or notif\$4 or notification or SMS or text or "e-mail" or email or "electronic mail" or window or GUI or "graphical user interface") with (trigger or condition or rule or parameter or regulation or limit or threshold or level or maxim\$2 or minim\$2 or extrem\$2 or criteri\$2)).clm.	US- PGPUB; UPAD	OR	ON	2014/03/14 00:03
L54	17120	(first with (track\$3 or surveil\$5 or monitor\$3) with (data or datum or information)).clm.	US- PGPUB; UPAD	OR	ON	2014/03/14 00:04
L55	13750	(second with (track\$3 or surveil\$5 or monitor\$3) with (data or datum or information)).clm.	US- PGPUB; UPAD	OR	ON	2014/03/14 00:04
L56	1	L51 same L52 same L53 same L54 same	US-	OR	ON	2014/03/14

EAST Search History

	L55	PGPUB; UPAD	00:05
--	-----	----------------	-------

3/ 14/ 2014 12:07:25 AM

C:\Users\mhoel\Documents\EAST\Workspaces\03-13-2014.wsp

EAST Search History

EAST Search History (Prior Art)

Ref #	Hits	Search Query	DBs	Default Operator	Plurals	Time Stamp
S1	833	463/39.ccls.	US-PGPUB; USPAT; USOCR; FPRS; EPO; JPO; DERWENT; IBM_TDB	OR	ON	2014/03/12 18:46
S2	126	hoel.xa.	US-PGPUB; USPAT; USOCR; FPRS; EPO; JPO; DERWENT; IBM_TDB	OR	ON	2014/03/12 18:46
S3	15165	A63F13/10.CPC.	US-PGPUB; USPAT; USOCR; FPRS; EPO; JPO; DERWENT; IBM_TDB	OR	ON	2014/03/12 18:50
S4	16713	A63F13/12.CPC.	US-PGPUB; USPAT; USOCR; FPRS; EPO; JPO; DERWENT; IBM_TDB	OR	ON	2014/03/12 18:50
S5	3682	A63F13/02.CPC.	US-PGPUB; USPAT; USOCR; FPRS; EPO; JPO; DERWENT; IBM_TDB	OR	ON	2014/03/12 18:50
S6	305	A63F7/22.CPC.	US-PGPUB; USPAT; USOCR; FPRS; EPO; JPO; DERWENT; IBM_TDB	OR	ON	2014/03/12 18:50
S7	21	A63F7/30.CPC.	US-PGPUB; USPAT; USOCR; FPRS; EPO; JPO; DERWENT; IBM_TDB	OR	ON	2014/03/12 18:50
S8	3	A63F7/32.CPC.	US-PGPUB;	OR	ON	2014/03/12

EAST Search History

			USPAT; USOCR; FPRS; EPO; JPO; DERWENT; IBM_TDB			18:50
S9	323	A63F7/40.CPC.	US-PGPUB; USPAT; USOCR; FPRS; EPO; JPO; DERWENT; IBM_TDB	OR	ON	2014/03/12 18:50
S10	205	A63G31/02.CPC.	US-PGPUB; USPAT; USOCR; FPRS; EPO; JPO; DERWENT; IBM_TDB	OR	ON	2014/03/12 18:50
S11	393	E04H3/10.CPC.	US-PGPUB; USPAT; USOCR; FPRS; EPO; JPO; DERWENT; IBM_TDB	OR	ON	2014/03/12 18:51
S12	131	473/62.ccls.	US-PGPUB; USPAT; USOCR; FPRS; EPO; JPO; DERWENT; IBM_TDB	OR	ON	2014/03/12 18:51
S13	65	463/15.ccls.	US-PGPUB; USPAT; USOCR; FPRS; EPO; JPO; DERWENT; IBM_TDB	OR	ON	2014/03/12 18:51
S14	659	463/23.ccls.	US-PGPUB; USPAT; USOCR; FPRS; EPO; JPO; DERWENT; IBM_TDB	OR	ON	2014/03/12 18:51
S15	101	462/29.ccls.	US-PGPUB; USPAT; USOCR; FPRS; EPO; JPO; DERWENT; IBM_TDB	OR	ON	2014/03/12 18:51
S16	35	473/57.ccls.	US-PGPUB; USPAT; USOCR; FPRS; EPO; JPO; DERWENT;	OR	ON	2014/03/12 18:51

EAST Search History

			IBM_TDB			
S17	83	473/94.ccls.	US-PGPUB; USPAT; USOCR; FPRS; EPO; JPO; DERWENT; IBM_TDB	OR	ON	2014/03/12 18:51
S18	77	473/133.ccls.	US-PGPUB; USPAT; USOCR; FPRS; EPO; JPO; DERWENT; IBM_TDB	OR	ON	2014/03/12 18:51
S19	77	473/134.ccls.	US-PGPUB; USPAT; USOCR; FPRS; EPO; JPO; DERWENT; IBM_TDB	OR	ON	2014/03/12 18:51
S20	110	473/136.ccls.	US-PGPUB; USPAT; USOCR; FPRS; EPO; JPO; DERWENT; IBM_TDB	OR	ON	2014/03/12 18:52
S21	310	340/12.51.ccls.	US-PGPUB; USPAT; USOCR; FPRS; EPO; JPO; DERWENT; IBM_TDB	OR	ON	2014/03/12 18:53
S22	302	340/13.26.ccls.	US-PGPUB; USPAT; USOCR; FPRS; EPO; JPO; DERWENT; IBM_TDB	OR	ON	2014/03/12 18:53
S23	2140	342/29,42,51.ccls.	US-PGPUB; USPAT; USOCR; FPRS; EPO; JPO; DERWENT; IBM_TDB	OR	ON	2014/03/12 18:55
S24	2	"US 20130217453"	US-PGPUB; USPAT; USOCR; DERWENT	OR	ON	2014/03/12 19:46
S25	858	A63F9/183.CPC.	US-PGPUB; USPAT; USOCR; FPRS; EPO; JPO; DERWENT; IBM_TDB	OR	ON	2014/03/12 19:47

S26	120	A63F2009/245.CPC.	US-PGPUB; USPAT; USOCR; FPRS; EPO; JPO; DERWENT; IBM_TDB	OR	ON	2014/03/12 19:47
S27	509	A63F2009/2489.CPC.	US-PGPUB; USPAT; USOCR; FPRS; EPO; JPO; DERWENT; IBM_TDB	OR	ON	2014/03/12 19:47
S28	45	A63F2011/0097.CPC.	US-PGPUB; USPAT; USOCR; FPRS; EPO; JPO; DERWENT; IBM_TDB	OR	ON	2014/03/12 19:47
S29	122	"briggs, rick".in. or "weston, denise".in. or "mq gaming".as.	US-PGPUB; USPAT; USOCR	OR	ON	2014/03/12 20:01
S30	275	A63G33/00.cpc.	US-PGPUB; USPAT; USOCR; FPRS; EPO; JPO; DERWENT; IBM_TDB	OR	ON	2014/03/12 20:06
S31	1290	(RFID or "radio-frequency identification") and A63F.cpcl.	US-PGPUB; USPAT; USOCR; FPRS; EPO; JPO; DERWENT; IBM_TDB	OR	ON	2014/03/12 20:19
S32	1	Σ and "creative kingdoms".as.	US-PGPUB; USPAT; USOCR; FPRS; EPO; JPO; DERWENT; IBM_TDB	OR	ON	2014/03/12 20:19
S33	182	("20010018361" "20020005787" "20020032067" "20020038267" "20020052238" "20020058459" "20020068500" "20020107591" "20020123377" "20020128056" "20020158751" "20020193047" "20030013513" "20030069077" "20030106455" "20030144047" "20030193572" "20040033833" "20040092311" "20040198517" "20040204240" "20050143173" "20060154726" "3395920" "3707055" "3795805" "3949364" "3997156" "4063111" "4171737" "4282681" "4296929" "4412205" "4678450" "4858930" "4891032" "4910677"	US-PGPUB; USPAT; USOCR	OR	ON	2014/03/12 20:19

		"4967321" "5036442" "5114155" "5114344" "5127657" "5194048" "5223698" "5236200" "5319548" "5320358" "5356343" "5365214" "5378197" "5382026" "5411269" "5482510" "5498002" "5550721" "5580319" "5587740" "5651049" "5655053" "5674128" "5751273" "5757305" "5770533" "5785592" "5786626" "5810666" "5811896" "5830065" "5835576" "5836817" "5851149" "5853332" "5855483" "5865680" "5924695" "5942969" "5944533" "5946444" "5963136" "5964660" "5971270" "5996033" "6009458" "6012984" "6025830" "6075443" "6129549" "6132318" "6150947" "6160986" "6162122" "6162123" "6174242" "6196893" "6200216" "6206745" "6206782" "6210287" "6214155" "6220965" "6231451" "6234803" "6254101" "6264202" "6273425" "6280328" "6283871" "6290566" "6302793" "6328648" "6330427" "6352478" "6356867" "6368177" "6369908" "6371375" "6375578").PN. OR ("6404409" "6409379" "6414589" "6463257" "6463859" "6482067" "6490409" "6494457" "6509217" "6525660" "6526158" "6551188" "6569023" "6589120" "6595863" "6607123" "6609969" "6626728" "6632142" "6634949" "6682074" "6709336" "6746334" "6761637" "6773344" "7040998" "7052391" "7056221" "7059974" "7160196" "7337965" "RE37220").PN. OR ("7614958").URPN.				
S34	7809	463/25.ccls.	US-PGPUB; USPAT; USOCR; FPRS; EPO; JPO; DERWENT; IBM_TDB	OR	ON	2014/03/12 20:31
S35	101	462/29.ccls.	US-PGPUB; USPAT; USOCR; FPRS; EPO; JPO; DERWENT; IBM_TDB	OR	ON	2014/03/12 20:31
S36	2074	463/40.ccls.	US-PGPUB; USPAT; USOCR; FPRS; EPO; JPO; DERWENT; IBM_TDB	OR	ON	2014/03/12 20:31
S37	764	463/41.ccls.	US-PGPUB; USPAT; USOCR;	OR	ON	2014/03/12 20:31

EAST Search History

			FPRS; EPO; JPO; DERWENT; IBM_TDB			
S38	8607	463/42.ccls.	US-PGPUB; USPAT; USOCR; FPRS; EPO; JPO; DERWENT; IBM_TDB	OR	ON	2014/03/12 20:31
S39	2	"US 20130150155"	US-PGPUB; USPAT; USOCR; DERWENT	OR	ON	2014/03/12 20:32
S40	225	A63F2009/2402.CPC.	US-PGPUB; USPAT; USOCR; FPRS; EPO; JPO; DERWENT; IBM_TDB	OR	ON	2014/03/12 20:33
S41	211	A63F2009/2429.CPC.	US-PGPUB; USPAT; USOCR; FPRS; EPO; JPO; DERWENT; IBM_TDB	OR	ON	2014/03/12 20:33
S42	188	A63F2009/2433.CPC.	US-PGPUB; USPAT; USOCR; FPRS; EPO; JPO; DERWENT; IBM_TDB	OR	ON	2014/03/12 20:33
S43	181	A63F2009/2452.CPC.	US-PGPUB; USPAT; USOCR; FPRS; EPO; JPO; DERWENT; IBM_TDB	OR	ON	2014/03/12 20:33
S44	76	A63F2009/248.CPC.	US-PGPUB; USPAT; USOCR; FPRS; EPO; JPO; DERWENT; IBM_TDB	OR	ON	2014/03/12 20:33
S45	509	A63F2009/2489.CPC.	US-PGPUB; USPAT; USOCR; FPRS; EPO; JPO; DERWENT; IBM_TDB	OR	ON	2014/03/12 20:33
S46	400	A63F2250/485.CPC.	US-PGPUB; USPAT; USOCR; FPRS;	OR	ON	2014/03/12 20:34

			EPO; JPO; DERWENT; IBM_TDB			
S47	2389	A63F2300/105.CPC.	US-PGPUB; USPAT; USOCR; FPRS; EPO; JPO; DERWENT; IBM_TDB	OR	ON	2014/03/12 20:34
S49	2486	A63F2300/1062.CPC.	US-PGPUB; USPAT; USOCR; FPRS; EPO; JPO; DERWENT; IBM_TDB	OR	ON	2014/03/12 20:34
S50	3372	A63F2300/204.CPC.	US-PGPUB; USPAT; USOCR; FPRS; EPO; JPO; DERWENT; IBM_TDB	OR	ON	2014/03/12 20:34
S51	1404	A63F2300/402.CPC.	US-PGPUB; USPAT; USOCR; FPRS; EPO; JPO; DERWENT; IBM_TDB	OR	ON	2014/03/12 20:34
S52	2726	A63F2300/406.CPC.	US-PGPUB; USPAT; USOCR; FPRS; EPO; JPO; DERWENT; IBM_TDB	OR	ON	2014/03/12 20:35
S53	2152	A63F2300/807.CPC.	US-PGPUB; USPAT; USOCR; FPRS; EPO; JPO; DERWENT; IBM_TDB	OR	ON	2014/03/12 20:35
S54	530	A63F2300/1056.CPC.	US-PGPUB; USPAT; USOCR; FPRS; EPO; JPO; DERWENT; IBM_TDB	OR	ON	2014/03/12 20:35
S55	1761	A63F2300/1087.CPC.	US-PGPUB; USPAT; USOCR; FPRS; EPO; JPO; DERWENT; IBM_TDB	OR	ON	2014/03/12 20:35
S56	1031	A63F2300/1031.CPC.	US-PGPUB; USPAT;	OR	ON	2014/03/12 20:35

			USOCR; FPRS; EPO; JPO; DERWENT; IBM_TDB			
S57	1226	A63F2300/403.CPC.	US-PGPUB; USPAT; USOCR; FPRS; EPO; JPO; DERWENT; IBM_TDB	OR	ON	2014/03/12 20:35
S58	1005	A63h3/36.CPC.	US-PGPUB; USPAT; USOCR; FPRS; EPO; JPO; DERWENT; IBM_TDB	OR	ON	2014/03/12 20:35
S59	3902	A63h30/04.CPC.	US-PGPUB; USPAT; USOCR; FPRS; EPO; JPO; DERWENT; IBM_TDB	OR	ON	2014/03/12 20:36
S60	122	"barney, jonathan".in. or "weston, denise".in. or "creative kingdoms".as.	US-PGPUB; USPAT; USOCR	OR	ON	2014/03/12 20:37
S61	115	("20020028710" "20030040347" "20120004031" "20130116048" "4750733" "5452893" "7000469" "7337965" "7727090" "8287373" "6598978" "8531050" "2001366" "20010018361" "20030060286" "20060234601" "20120208638" "20130079141" "20130116051" "5779240" "6565444" "6739979" "7004847" "7117009" "7627139" "20060287084" "20130217453" "8475275" "6835135" "20050138851" "20120094759" "20120122575" "3949679" "4153250" "4846568" "6398908" "6545611" "6702672" "7488254" "8491389" "6739874" "20050278741" "20070100696" "5825350" "6400996" "6770863" "7056221" "7297059" "7775884" "5190285" "20020008622" "20040092311" "3336030" "3633904" "4932917" "5957779" "6554707" "7775882" "20130165228" "6560511" "20130303276" "5188368" "20030064812" "20050127868" "20050227579" "20120309528" "3468533" "4882717" "4960275" "5416535" "5991693" "6091342" "6095926" "6276353" "6567536" "6812583" "7059974" "7160196" "7168089" "7252572" "8373659" "D524298" "20050059488" "6924787" "8330284" "6726099"	US-PGPUB; USPAT; USOCR	OR	ON	2014/03/12 20:37

		"20060229134" "20120295710" "4645458" "5421575" "6227974" "6369794" "6561049" "7408453" "0973105" "20020036617" "8025573" "20030037075" "20040198517" "4175665" "5632878" "5702232" "6642837" "7288028" "7989971" "RE33662" "20040207597" "20130196727" "6184847" "6558225" "8608535"). FN.				
S62	165	("20010034257" "20010039206" "20010040591" "20010054082" "20020005787" "20020028710" "20020038267" "20020052238" "20020090985" "20020107591" "20020116615" "20020193047" "20030036425" "20030037075" "20030060286" "20030064812" "20030069077" "20030134679" "20030171145" "20030195037" "20040102247" "20040121834" "20040152499" "20040198158" "20040214642" "20050116020" "20050156883" "20050202866" "20050227579" "20050266907" "20070066396" "20070100696" "4282681" "4575621" "4627620" "4645458" "4695058" "4695953" "4817950" "4858930" "4882717" "4904222" "5048831" "5114155" "5114344" "5177311" "5194006" "5194048" "5231568" "5292124" "5292254" "5320358" "5320362" "5354057" "5356343" "5366229" "5378197" "5393074" "5429361" "5498002" "5512892" "5516105" "5613913" "5655053" "5724497" "5733131" "5751273" "5752880" "5775998" "5785592" "5786626" "5810666" "5811896" "5836817" "5853327" "5853332" "5855483" "5865680" "5901246" "5929848" "5942969" "5964660" "5980254" "5984788" "5996033" "6009458" "6012984" "6025830" "6076734" "6110041" "6129549" "6150947" "6162123" "6186902" "6200216" "6206745" "6234803" "6248019" "6254394" "6261180" "6265984" "6280327" "6280328" "6283871" "6290566" "6302793" "6302796" "6311782" "6328648" "6342010" "6352478" "6368177" "6371375" "6404409" "6426741" "6438193" "6482067" "6490409" "6494457" "6509217" "6525660" "6526158" "6527638" "6545611" "6545661" "6561049" "6626728" "6632142" "6634949" "6709336" "6729934" "6733390" "6761637" "6773344" "6796908" "6812583" "6905411" "6932698" "6967563" "6967566" "6982697" "7066781" "7081033" "7137899" "7168089" "7252572"	US-PGPUB; USPAT; USOCR	OR	ON	2014/03/12 20:39

		"7297059" "7359451" "7408453" "7445550" "7488231" "7500917" "7572191" "7674184" "7727090" "7749089" "7850527" "7878905" "7896742" "7989971" "8089458" "8164567" "8169406" "8184097" "RE33662").PN.				
S63	223	("1661058" "1789680" "2001366" "2752725" "2902023" "20010010514" "20010015123" "20010024973" "20010031662" "20010034257" "20010049302" "20020008622" "20020024500" "20020024675" "20020028071" "20020068500" "20020072418" "20020075335" "20020090992" "20020098887" "20020103026" "20020107069" "20020118147" "20020123377" "20020126026" "20020128056" "20020137427" "20020137567" "20020140745" "20020158751" "20020158843" "20020183961" "20030013513" "20030022736" "20030027634" "20030038778" "20030040347" "20030052860" "20030057808" "20030060286" "20030063068" "20030069077" "20030073505" "20030095101" "20030096652" "20030106455" "20030107178" "20030107551" "20030144047" "20030144056" "20030166416" "20030171190" "20030190967" "20030193572" "20030195041" "20030195046" "20030204361" "20030214259" "20030216176" "20030222851" "20030234914" "20040028258" "20040034289" "20040048666" "20040063480" "20040070564" "20040075650").PN.	US-PGPUB; USPAT; USOCR; FPRS; EPO; JPO; DERWENT; IBM_TDB	OR	ON	2014/03/12; 20:40
S64	155	("20040077423" "20040081313" "20040092311" "20040095317" "20040119693" "20040121834" "20040134341" "20040140954" "20040143413" "20040147317" "20040152499" "20040152515" "20040174287" "20040193413" "20040198517" "20040203638" "20040218104" "20040222969" "20040227725" "20040229693" "20040229696" "20040236453" "20040239626" "20040252109" "20040254020" "20040259651" "20040268393" "20050017454" "20050020369" "20050032582" "20050047621" "20050054457" "20050059503" "20050060586" "20050076161" "20050085298" "20050116020" "20050121756" "20050125826" "20050127868" "20050134555" "20050138851" "20050143173" "20050162389" "20050164601" "20050170889" "20050172734" "20050174324"	US-PGPUB; USPAT; USOCR; FPRS; EPO; JPO; DERWENT; IBM_TDB	OR	ON	2014/03/12; 20:41

		"20050176485" "20050179644" "20050202866" "20050210418" "20050210419" "20050212749" "20050212750" "20050212751" "20050212752" "20050212753" "20050212754" "20050212755" "20050212757" "20050212758" "20050212759" "20050212760" "20050212764" "20050212767" "20050215295" "20050215322" "20050217525" "20050227579") .pn.				
S65	192	("20050233808" "20050239548" "20050243061" "20050243062" "20050253806" "20050256675" "20050277465" "20050278741" "20060007115" "20060028446" "20060030385" "20060040720" "20060046849" "20060092133" "20060094502" "20060122474" "20060123146" "20060130739" "20060148563" "20060152487" "20060152488" "20060152489" "20060154726" "20060178212" "20060205507" "20060229134" "20060231794" "20060234601" "20060252475" "20060252477" "20060256081" "20060258452" "20060258471" "20060264260" "20060267935" "20060273907" "20060282873" "20060284842" "20060287085" "20060287086" "20060287087" "20070015588" "20070021208" "20070049374" "20070050597" "20070052177" "20070060391" "20070066394" "20070072680" "20070093291" "20070100696" "20070159362" "20070173705" "20070249425" "20070252815" "20070257884" "20070265075" "20070265076" "20070265088" "20080015017" "20080039202" "20080119270" "20080121782" "20080174550" "20080273011" "20080278445" "20090009294" "20090033621" "20090051653" "20090091084" "20090215534" "20090305799" "20090326851" "20100105475" "20100144436" "20100203932" "20100273556" "20100289744" "20110081969" "20110177853" "20110190052" "20120004031") .pn.	US-PGPUB; USPAT; USOCR; FPRS; EPO; JPO; DERWENT; IBM_TDB	OR	ON	2014/03/12 20:41
S66	455	("20120094759" "20120122575" "20120208638" "20120309528" "20130079141" "20130116048" "20130116051" "20130150155" "3135512" "3336030" "3454920" "3456134" "3468533" "3474241" "3572712" "3633904" "3660648" "3843127" "3949679" "3973257" "3978481" "4009619" "4038876" "4055341" "4153250" "4166406" "4175665" "4205785" "4231077" "4240638" "4287765" "4303978"	US-PGPUB; USPAT; USOCR; FPRS; EPO; JPO; DERWENT; IBM_TDB	OR	ON	2014/03/12 20:42

		"4318245"	"4321678"	"4325199"				
		"4337948"	"4342985"	"4402250"				
		"4425488"	"4443866"	"4450325"				
		"4503299"	"4514600"	"4514798"				
		"4540176"	"4546551"	"4558604"				
		"4561299"	"4575621"	"4578674"				
		"4595369"	"4623887"	"4623930"				
		"4627620"	"4645458"	"4750733"				
		"4761540"	"4766253"	"4787051"				
		"4816810"	"4819182"	"4839838"				
		"4843568"	"4849655"	"4851685"				
		"4858390"	"4862165"	"4882717"				
		"4914598"	"4918293"	"4957291"				
		"4960275"	"4961369"	"4964837"				
		"4969647"	"4980519"	"4988981"				
		"4994795"	"5011161"	"5045843"				
		"5058480"	"5059958"	"5062696"				
		"5068645"	"5124938"	"5128671"				
		"5136222"	"5138154"	"5145446"				
		"5166502"	"5170002"	"5175481"				
		"5178477"	"5181181"	"5184830"				
		"5192823"	"5202844"	"5207426"				
		"5212368"	"5213327"	"5232223").pn.				
S67	315	("5247651"	"5259626"	"5262777"	US-PGPUB;	OR	ON	2014/03/12
		"5277645"	"5279513"	"5280744"	USPAT;			20:43
		"5290964"	"5296871"	"5299967"	USOCR;			
		"5307325"	"5310192"	"5317394"	FPRS;			
		"5329276"	"5332322"	"5339095"	EPO; JPO;			
		"5357267"	"5359321"	"5359348"	DERWENT;			
		"5363120"	"5369580"	"5369889"	IBM_TDB			
		"5372365"	"5373857"	"5396265"				
		"5403238"	"5416535"	"5421575"				
		"5421590"	"5422956"	"5429361"				
		"5430435"	"5432864"	"5435561"				
		"5435569"	"5439199"	"5440326"				
		"5443261"	"5452893"	"5453053"				
		"5469194"	"5481957"	"5484355"				
		"5485171"	"5490058"	"5502486"				
		"5506605"	"5509806"	"5517183"				
		"5523800"	"5526022"	"5528265"				
		"5531443"	"5533933"	"5541860"				
		"5551701"	"5554980"	"5561543"				
		"5563628"	"5569085"	"5573011"				
		"5574479"	"5579025"	"5581484"				
		"5585584"	"5586767"	"5587558"				
		"5594465"	"5598187"	"5602569"				
		"5603658"	"5605505"	"5606343"				
		"5611731"	"5613913"	"5615132"				
		"5621459"	"5623581"	"5624117"				
		"5627565"	"5632878"	"5640152"				
		"5641288"	"5642931"	"5643087"				
		"5645077"	"5645277"	"5662332"				
		"5666138"	"5667217"	"5667220"				
		"5670845"	"5670988"	"5672090"				
		"5676450"	"5676673"	"5679004"				
		"5682181"	"5685776"	"5685778"				
		"5694340"	"5698784"	"5701131"				
		"5702232"	"5702305"	"5702323"				
		"5703623"	"5716216"	"5716281"				
		"5724106"	"5726675"	"5734371"				
		"5734373"	"5734807"	"5736970"				
		"5739811"	"5742331"	"5745226"				
		"5746602"	"5757354"	"5764224"				
		"5769719"	"5771038"	"5779240"				

		"5785317" "5791648" "5794081" "5796354" "5803740").pn.				
S68	271	("5803840" "5806849" "5807284" "5819206" "5820462" "5822713" "5825298" "5825350" "5831553" "5835077" "5835156" "5838138" "5841409" "5847854" "5850624" "5853327" "5854622" "5867146" "5874941" "5875257" "5893562" "5897437" "5898421" "5900867" "5902968" "5906542" "5908996" "5911634" "5912612" "5913019" "5913727" "5919149" "5923317" "5926780" "5929782" "5931739" "5947789" "5947868" "5955988" "5956035" "5957779" "5961386" "5967898" "5971271" "5973757" "5980254" "5982352" "5982356" "5984785" "5986570" "5986644" "5991085" "5991693" "5999168" "6001014" "6002394" "6010406" "6011526" "6012980" "6013007" "6016144" "6019680" "6020876" "6024647" "6026675" "6037882" "6044297" "6049823" "6052083" "6057788" "6058342" "6059576" "6060847" "6066075" "6069594" "6072467" "6072575" "6078789" "6079982" "6080063" "6081819" "6084315" "6084577" "6085805" "6087950" "6091342" "6095926" "6102406" "6110039" "6110041" "6115028" "6127990" "6137457" "6142870" "6142876" "6146278" "6148100" "6149490" "6155926" "6160405" "6160540" "6160986" "6162191" "6164808").pn.	US-PGPUB; USPAT; USOCR; FPRS; EPO; JPO; DERWENT; IBM_TDB	OR	ON	2014/03/12 20:43
S69	343	(""6171190"" ""6176837"" ""6181253"" ""6181329"" ""6183364"" ""6183365"" ""6184862"" ""6184863"" ""6191774"" ""6198295"" ""6198470"" ""6198471"" ""6200219"" ""6200253"" ""6201554"" ""6211861"" ""6217450"" ""6217478"" ""6220171"" ""6220964"" ""6222522"" ""6224191"" ""6224987"" ""6225987"" ""6226534"" ""6227966"" ""6227974"" ""6238291"" ""6239806"" ""6241611"" ""6243491"" ""6243658"" ""6245014"" ""6264558"" ""6267673"" ""6273819"" ""6276353"" ""6283862"" ""6290565"" ""6293684"" ""6297751"" ""6301534"" ""6304250"" ""6315673"" ""6322365"" ""6323614"" ""6323654"" ""6325718"" ""6328650"" ""6329648"" ""6331841"" ""6331856"" ""6337954"" ""6346047""	US-PGPUB; USPAT; USOCR; FPRS; EPO; JPO; DERWENT; IBM_TDB	OR	ON	2014/03/12 20:44

		""6347993"" ""6347998"" ""6356867"" ""6361396"" ""6361507"" ""6364735"" ""6368217"" ""6369794"" ""6371853"" ""6375566"" ""6375569"" ""6375572"" ""6377793"" ""6377906"" ""6386538"" ""6392613"" ""6394904"" ""6398908"" ""6400480"" ""6400996"" ""6409604"" ""6409687"" ""6415223"" ""6421056"" ""6424333"" ""6426719"" ""6445960"" ""6452494"" ""6456276"" ""6462769"" ""6463859"" ""6466198"" ""6466831"" ""6473070"" ""6473713"" ""6474159"" ""6484080"" ""6492981"" ""6496122"" ""6512511"" ""6517438"" ""6518952"" ""6530838"" ""6530841"" ""6538675"" ""6540607"" ""6540611"" ""6544124"" ""6544126"" ""6545611"" ""6551165"" ""6554707"" ""6554781"" ""6561049"" ""6565438"" ""6565444"" ""6567536"" ""6572108"" ""6575753"" ""6577350"" ""6579098"" ""6582299"" ""6582380"" ""6583783"" ""6585596"" ""6589120"" ""6590536"" ""6591677"" ""6595863"" ""6597342"" ""6597443"" ""6599194"" ""6605038"" ""6608563"" ""6609977"" ""6616452"" ""6616535"" ""6616607"" ""6628257"" ""6629019"" ""6632142"" ""6633155"" ""6636826"" ""6642837"" ""6650029"" ""6650313"" ""6650345"" ""6654001"" ""6672962"" ""6676520"" ""6677990"" ""6681629"" ""6682351"" ""6684062"" ""6686954"" ""6692170"" ""6693622"").pn.				
S70	134	("7568289" "7582016" "7596466" "7623115" "7627139" "7627451" "7662015" "7663509" "7704135" "7727090" "7741155" "7775882" "7775884" "7789741" "7796116" "7828295" "7883420" "7927216" "7942745" "7989971" "8248367" "8287373" "8368648" "8373659" "8384668" "0973105" "D220268" "D320624" "D322242" "D325225" "D328463" "D331058"	US-PGPUB; USPAT; USOCR; FPRS; EPO; JPO; DERWENT; IBM_TDB	OR	ON	2014/03/12 20:45

		"D338242" "D340042" "D342256" "D345164" "D350736" "D350782" "D351430" "D360903" "D362870" "D375326" "D376826" "D379832" "D393884" "D394264" "D395464" "D396468" "D397162" "D400885" "D402328" "D405071" "D407071" "D407761" "D410909" "D412940" "D419199" "D419200" "D429718" "D433381" "D442998" "D456410" "D456854" "D459727" "D460787" "D462683" "D464052" "D464950" "D473942" "D474763" "D486145" "D489361" "D491924" "D492285" "D495336" "D502468" "D503750" "D504298" "D504677" "D505424" "D524298" "D531228" "D531585" "D543246" "D556201" "D556760" "D559847" "D561178" "D563948" "D567243" "RE33662" "RE40324") .pn.				
S71	3732	G07F17/3223.CPC.	US-PGPUB; USPAT; USOCR; FPRS; EPO; JPO; DERWENT; IBM_TDB	OR	ON	2014/03/12 20:50
S72	555	G07F17/3225.CPC.	US-PGPUB; USPAT; USOCR; FPRS; EPO; JPO; DERWENT; IBM_TDB	OR	ON	2014/03/12 20:50
S73	2455	G07F17/3232.CPC.	US-PGPUB; USPAT; USOCR; FPRS; EPO; JPO; DERWENT; IBM_TDB	OR	ON	2014/03/12 20:50
S74	1697	G07F17/3234.CPC.	US-PGPUB; USPAT; USOCR; FPRS; EPO; JPO; DERWENT; IBM_TDB	OR	ON	2014/03/12 20:50
S75	1788	G07F17/3237.CPC.	US-PGPUB; USPAT; USOCR; FPRS; EPO; JPO; DERWENT; IBM_TDB	OR	ON	2014/03/12 20:51
S76	3130	G07F17/3239.CPC.	US-PGPUB; USPAT; USOCR; FPRS; EPO; JPO; DERWENT; IBM_TDB	OR	ON	2014/03/12 20:51

EAST Search History

S77	9415	G07F17/3244.CPC.	US-PGPUB; USPAT; USOCR; FPRS; EPO; JPO; DERWENT; IBM_TDB	OR	ON	2014/03/12 20:51
S78	2728	G07F17/3255.CPC.	US-PGPUB; USPAT; USOCR; FPRS; EPO; JPO; DERWENT; IBM_TDB	OR	ON	2014/03/12 20:51
S79	3228	G07F17/3258.CPC.	US-PGPUB; USPAT; USOCR; FPRS; EPO; JPO; DERWENT; IBM_TDB	OR	ON	2014/03/12 20:51
S80	4087	"smith, vincent".in. or "baerlocher, anthony".in. or "dewaal, daniel".in. or (IGT or IGY or "International Game Technology").as.	US-PGPUB; USPAT; USOCR	OR	ON	2014/03/12 20:53
S81	2859	G07F17/3227.cpc.	US-PGPUB; USPAT; USOCR; FPRS; EPO; JPO; DERWENT; IBM_TDB	OR	ON	2014/03/12 21:03
S82	3125	G07F17/323.cpc.	US-PGPUB; USPAT; USOCR; FPRS; EPO; JPO; DERWENT; IBM_TDB	OR	ON	2014/03/12 21:03
S83	5651	"walker, jay".in. or "jorasch, james".in. or "sammon, russell".in. or "tulley, stephen".in. or "santisi, steven".in. or (IGT or IGY or "International Game Technology").as.	US-PGPUB; USPAT; USOCR	OR	ON	2014/03/12 21:04
S84	944	S7 or S8 or S9 or S10 or S11	US-PGPUB; USPAT; USOCR; FPRS; EPO; JPO; DERWENT; IBM_TDB	OR	ON	2014/03/12 21:14
S85	3983	S12 or S13 or S14 or S15 or S16 or S17 or S18 or S19 or S20 or S21 or S22 or S23	US-PGPUB; USPAT; USOCR; FPRS; EPO; JPO; DERWENT; IBM_TDB	OR	ON	2014/03/12 21:15
S86	1479	S25 or S26 or S27 or S28	US-PGPUB; USPAT; USOCR;	OR	ON	2014/03/12 21:15

EAST Search History

			FPRS; EPO; JPO; DERWENT; IBM_TDB			
S87	2	"US 20130150155"	US-PGPUB; USPAT; USOCR; DERWENT	OR	ON	2014/03/13 18:41

EAST Search History (Interference)

< This search history is empty >

3/ 14/ 2014 7:08:22 PM

C:\Users\mhoel\Documents\EAST\Workspaces\03-12-2014.wsp

Search Notes 	Application/Control No. 13680852	Applicant(s)/Patent Under Reexamination WALKER ET AL.
	Examiner MATTHEW D HOEL	Art Unit 3714

CPC- SEARCHED		
Symbol	Date	Examiner
G07F 17/3223, G07F 17/3225, G07F 17/3232, G07F 17/3234, G07F 17/3237, G07F 17/3239, G07F 17/3244.	03/12/2014	MDH
G07F 17/3255, G07F 17/3258, G07F 17/3227, G07F 17/323.	03/12/2014	MDH

CPC COMBINATION SETS - SEARCHED		
Symbol	Date	Examiner

US CLASSIFICATION SEARCHED			
Class	Subclass	Date	Examiner
463	16,20,11-13,17-19,25,26-28,30-32,40-42	03/12/2014	MDH
463	39	03/12/2014	MDH

SEARCH NOTES		
Search Notes	Date	Examiner
inventor search, EAST, PALM. assignee search, EAST.	03/12/2014	MDH
interference claim word search, USPGPUB, UPAD.	03/12/2014	MDH
checked claims and forward- and back-cited references in parents 10/685/143 & 13/632,328.	03/12/2014	MDH

INTERFERENCE SEARCH			
US Class/ CPC Symbol	US Subclass / CPC Group	Date	Examiner
463	25	03/12/2014	MDH
G07F	17/323,3239,3255.	03/12/2014	MDH

/M.D.H./ Examiner.Art Unit 3714	
------------------------------------	--

Issue Classification 	Application/Control No. 13680852	Applicant(s)/Patent Under Reexamination WALKER ET AL.	
	Examiner MATTHEW D. HOEL	Art Unit 3714	

CPC					
Symbol				Type	Version
G07F	17	323		F	20130101
G07F	17	3239		A	20130101
G07F	17	3255		A	20130101

CPC Combination Sets				
Symbol	Type	Set	Ranking	Version

/MATTHEW D HOEL/ Examiner.Art Unit 3714 (Assistant Examiner)	03/13/2014 (Date)	Total Claims Allowed: 18	
/DAVID L LEWIS/ Supervisory Patent Examiner.Art Unit 3714 (Primary Examiner)	03/24/2014 (Date)	O.G. Print Claim(s) 1	O.G. Print Figure 3,9,17

Issue Classification 	Application/Control No. 13680852	Applicant(s)/Patent Under Reexamination WALKER ET AL.
	Examiner MATTHEW D. HOEL	Art Unit 3714

<input checked="" type="checkbox"/> Claims renumbered in the same order as presented by applicant <input type="checkbox"/> CPA <input type="checkbox"/> T.D. <input type="checkbox"/> R.1.47															
Final	Original	Final	Original	Final	Original	Final	Original	Final	Original	Final	Original	Final	Original	Final	Original
1	1	17	17												
2	2	18	18												
3	3														
4	4														
5	5														
6	6														
7	7														
8	8														
9	9														
10	10														
11	11														
12	12														
13	13														
14	14														
15	15														
16	16														

/MATTHEW D HOEL/ Examiner.Art Unit 3714 (Assistant Examiner)	03/13/2014 (Date)	Total Claims Allowed: 18	
/DAVID L LEWIS/ Supervisory Patent Examiner.Art Unit 3714 (Primary Examiner)	03/24/2014 (Date)	O.G. Print Claim(s) 1	O.G. Print Figure 3,9,17

INFORMATION DISCLOSURE CITATION IN AN APPLICATION (Use several sheets if necessary)	Atty Docket No.	Application No.
	025124-0509	13/680,852
	Applicant	Date Submitted
	IGT	November 25, 2013
	Filing Date	Group
	November 19, 2012	3714

PTO Form 1449

U.S. PATENT DOCUMENTS						
Examiner's Initials	Document Number	Publication Date	Inventor	Class	Subclass	Filing Date If Appropriate
/M.D.H./	6,126,541	10-2000	Fuchs, Anton			
	6,942,849	09-2005	Neesser et al.			
	6,089,975	07-2000	Dunn, Jerry B			
	6,113,495	09-2000	Walker et al.			
	6,139,431	10-2000	Walker et al.			
	6,270,411	08-2001	Gura et al.			
	6,302,790	10-2001	Brossard, Jean			
	6,942,574	09-2005	LeMay et al.			
	5,429,361	07-1995	Raven et al.			
	5,971,849	10-1999	Falciglia, Sal			
	4,695,053	09-1987	Vazquez et al.			
/M.D.H./	5,611,730	03-1997	Weiss, Steven A.			

FOREIGN PATENT DOCUMENTS								
Examiner's Initials	Document Number	Publication Date	Country	Class	Subclass	Translation		
						Yes	No	

Examiner's Initials	OTHER DOCUMENTS (Including Author, Title, Date, Pertinent Pages, Etc.)
/M.D.H./	Non-Final Office Action dated August 7, 2013 for Application No. 13/632,323.

Examiner: /Matthew D. Hoel/	Date Considered: 03/12/2014
*Examiner: Initial if citation considered, whether or not citation is in conformance with MPEP Section 609; Draw line through citation if not in conformance and not considered. Include copy of this form with next communication to applicant.	

PART B - FEE(S) TRANSMITTAL

Complete and send this form, together with applicable fee(s), to: **Mail Stop ISSUE FEE**
Commissioner for Patents
P.O. Box 1450
Alexandria, Virginia 22313-1450
 or **Fax (871)-273-2885**

INSTRUCTIONS: This form should be used for transmitting the ISSUE FEE and PUBLICATION FEE (if required). Blocks 1 through 5 should be completed where appropriate. All further correspondence including the Patent, advance orders and notification of maintenance fees will be mailed to the current correspondence address as indicated unless corrected below or directed otherwise in Block 1, by (a) specifying a new correspondence address; and/or (b) indicating a separate "FREE ADDRESS" for maintenance fee notifications.

CURRENT CORRESPONDENCE ADDRESS (If not Use Block 1 for any change of address)

29159 7590 04/01/2014
 Neal, Gerber & Eisenberg LLP
 (IGT)
 2 N. LaSalle Street
 Suite 1700
 Chicago, IL 60602-3801

Note: A certificate of mailing can only be used for domestic mailings of the Fee(s) Transmittal. This certificate cannot be used for any other accompanying papers. Each additional paper, such as an assignment or formal drawing, must have its own certificate of mailing or transmittal.

Certificate of Mailing or Transmittal

I hereby certify that this Fee(s) Transmittal is being deposited with the United States Postal Service with sufficient postage for first class mail in an envelope addressed to the Mail Stop ISSUE FEE address above, or being facsimile transmitted to the USPTO (571) 273-2885, on the date indicated below.

_____ (Depositor's name)
_____ (Signature)
_____ (Date)

APPLICATION NO.	FILED DATE	FIRST NAMED INVENTOR	ATTORNEY DOCKET NO.	CONFIRMATION NO.
13680852	11/19/2012	Jay S. Walker	025124-0509	6364

TITLE OF INVENTION: METHOD AND APPARATUS FOR OUTPUTTING A MESSAGE AT A GAME MACHINE

APPL. TYPE	ENTITY STATUS	ISSUE FEE DUE	PUBLICATION FEE DUE	PRV. PAID ISSUE FEE	TOTAL FEES DUE	DATE DUE
nonprovisional	UNDISCOUNTED	\$960	\$0	\$0	\$960	07/01/2014

EXAMINER	ART UNIT	CLASS-SUBCLASS
HOEL, MATTHEW D	3714	463-025000

1. Change of correspondence address or indication of "Free Address" (37 CFR 1.363):

Change of correspondence address (or Change of Correspondence Address Form PTO/SB/123) attached.

"Free Address" indication (or "Free Address" Indication form PTO/SB/47; Rev 03-02 or more recent) attached. Use of a Customer Number is required.

2. For printing on the patent front page, list

(1) The names of up to 3 registered patent attorneys or agents OR, alternatively, 1 Neal, Gerber & Eisenberg LLP

(2) The name of a single firm (having as a member a registered attorney or agent) and the names of up to 3 registered patent attorneys or agents. If no name is listed, no name will be printed.

2. _____

3. _____

3. ASSIGNEE NAME AND RESIDENCE DATA TO BE PRINTED ON THE PATENT (print or type)

PLEASE NOTE: Unless an assignee is identified below, no assignee data will appear on the patent. If an assignee is identified below, the document has been filed for recordation as set forth in 37 CFR 2.11. Completion of this form is NOT a substitute for filing an assignment.

(A) NAME OF ASSIGNEE: IGT

(B) RESIDENCE (CITY AND STATE OR COUNTRY): Las Vegas, Nevada

Please check the appropriate assignee category or categories (will not be printed on the patent): Individual Corporation or other private group entity Government

4a. The following fee(s) are submitted:

Issue Fee

Publication Fee (No small entity discount permitted)

Advance Order - # of Copies 3

4b. Payment of Fee(s): (Please first reapply any previously paid issue fee shown above)

A check is enclosed.

Payment by credit card. Form PTO-2038 is attached.

The Director is hereby authorized to charge the required fee(s), any deficiency, or credits any overpayment, to Deposit Account Number 502261 (enclose an extra copy of this form).

5. Change in Entity Status (from status indicated above)

Applicant certifying micro entity status. See 37 CFR 1.29

Applicant asserting small entity status. See 37 CFR 1.27

Applicant changing to regular undiscounted fee status.

NOTE: Absent a valid certification of Micro Entity Status (see forms PTO/SB/15A and 15B), issue fee payment in the micro entity amount will not be accepted at the risk of application abandonment.

NOTE: If the application was previously under micro entity status, checking this box will be taken to be a notification of loss of entitlement to micro entity status.

NOTE: Checking this box will be taken to be a notification of loss of entitlement to small or micro entity status, as applicable.

NOTE: This form must be signed in accordance with 37 CFR 1.31 and 1.33. See 37 CFR 1.3 for signature requirements and certifications.

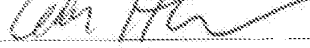
Authorized Signature  Date June 26, 2014

Typed or printed name Adam H. Masia Registration No. 35,602

Electronic Patent Application Fee Transmittal

Application Number:	13680852			
Filing Date:	19-Nov-2012			
Title of Invention:	METHOD AND APPARATUS FOR OUTPUTTING A MESSAGE AT A GAME MACHINE			
First Named Inventor/Applicant Name:	Jay S. Walker			
Filer:	Adam H. Masia/Luz Gonzalez			
Attorney Docket Number:	025124-0509			
Filed as Large Entity				
Utility under 35 USC 111(a) Filing Fees				
Description	Fee Code	Quantity	Amount	Sub-Total in USD(\$)
Basic Filing:				
Pages:				
Claims:				
Miscellaneous-Filing:				
Petition:				
Patent-Appeals-and-Interference:				
Post-Allowance-and-Post-Issuance:				
Utility Appl Issue Fee	1501	1	960	960
Extension-of-Time:				

Description	Fee Code	Quantity	Amount	Sub-Total in USD(\$)
Miscellaneous:				
Printed Copy of Patent - No Color	8001	3	3	9
Total in USD (\$)				969

Electronic Acknowledgement Receipt

EFS ID:	19418475
Application Number:	13680852
International Application Number:	
Confirmation Number:	6364
Title of Invention:	METHOD AND APPARATUS FOR OUTPUTTING A MESSAGE AT A GAME MACHINE
First Named Inventor/Applicant Name:	Jay S. Walker
Customer Number:	29159
Filer:	Adam H. Masia/Heather Ford
Filer Authorized By:	Adam H. Masia
Attorney Docket Number:	025124-0509
Receipt Date:	26-JUN-2014
Filing Date:	19-NOV-2012
Time Stamp:	11:52:35
Application Type:	Utility under 35 USC 111(a)

Payment information:

Submitted with Payment	yes
Payment Type	Deposit Account
Payment was successfully received in RAM	\$969
RAM confirmation Number	13763
Deposit Account	502261
Authorized User	
The Director of the USPTO is hereby authorized to charge indicated fees and credit any overpayment as follows: Charge any Additional Fees required under 37 C.F.R. Section 1.16 (National application filing, search, and examination fees) Charge any Additional Fees required under 37 C.F.R. Section 1.17 (Patent application and reexamination processing fees)	

Charge any Additional Fees required under 37 C.F.R. Section 1.19 (Document supply fees)
 Charge any Additional Fees required under 37 C.F.R. Section 1.20 (Post Issuance fees)
 Charge any Additional Fees required under 37 C.F.R. Section 1.21 (Miscellaneous fees and charges)

File Listing:

Document Number	Document Description	File Name	File Size(Bytes)/ Message Digest	Multi Part /.zip	Pages (if appl.)
1	Issue Fee Payment (PTO-85B)	025124-0509_paid.pdf	166356 8f3ebf018f84a7af36d02c3c72bab98cd6725129	no	1

Warnings:

Information:

2	Fee Worksheet (SB06)	fee-info.pdf	32063 5eaab5bac793db3409a5640e448a7af051de6743	no	2
---	----------------------	--------------	---	----	---

Warnings:

Information:

Total Files Size (in bytes):			198419
-------------------------------------	--	--	--------

This Acknowledgement Receipt evidences receipt on the noted date by the USPTO of the indicated documents, characterized by the applicant, and including page counts, where applicable. It serves as evidence of receipt similar to a Post Card, as described in MPEP 503.

New Applications Under 35 U.S.C. 111

If a new application is being filed and the application includes the necessary components for a filing date (see 37 CFR 1.53(b)-(d) and MPEP 506), a Filing Receipt (37 CFR 1.54) will be issued in due course and the date shown on this Acknowledgement Receipt will establish the filing date of the application.

National Stage of an International Application under 35 U.S.C. 371

If a timely submission to enter the national stage of an international application is compliant with the conditions of 35 U.S.C. 371 and other applicable requirements a Form PCT/DO/EO/903 indicating acceptance of the application as a national stage submission under 35 U.S.C. 371 will be issued in addition to the Filing Receipt, in due course.

New International Application Filed with the USPTO as a Receiving Office

If a new international application is being filed and the international application includes the necessary components for an international filing date (see PCT Article 11 and MPEP 1810), a Notification of the International Application Number and of the International Filing Date (Form PCT/RO/105) will be issued in due course, subject to prescriptions concerning national security, and the date shown on this Acknowledgement Receipt will establish the international filing date of the application.



UNITED STATES PATENT AND TRADEMARK OFFICE

UNITED STATES DEPARTMENT OF COMMERCE
United States Patent and Trademark Office
Address: COMMISSIONER FOR PATENTS
P.O. Box 1450
Alexandria, Virginia 22313-1450
www.uspto.gov

APPLICATION NO.	ISSUE DATE	PATENT NO.	ATTORNEY DOCKET NO.	CONFIRMATION NO.
13/680,852	08/05/2014	8795064	025124-0509	6364

29159 7590 07/16/2014
Neal, Gerber & Eisenberg LLP
(IGT)
2 N. LaSalle Street
Suite 1700
Chicago, IL 60602-3801

ISSUE NOTIFICATION

The projected patent number and issue date are specified above.

Determination of Patent Term Adjustment under 35 U.S.C. 154 (b)
(application filed on or after May 29, 2000)

The Patent Term Adjustment is 72 day(s). Any patent to issue from the above-identified application will include an indication of the adjustment on the front page.

If a Continued Prosecution Application (CPA) was filed in the above-identified application, the filing date that determines Patent Term Adjustment is the filing date of the most recent CPA.

Applicant will be able to obtain more detailed information by accessing the Patent Application Information Retrieval (PAIR) WEB site (<http://pair.uspto.gov>).

Any questions regarding the Patent Term Extension or Adjustment determination should be directed to the Office of Patent Legal Administration at (571)-272-7702. Questions relating to issue and publication fee payments should be directed to the Application Assistance Unit (AAU) of the Office of Data Management (ODM) at (571)-272-4200.

APPLICANT(s) (Please see PAIR WEB site <http://pair.uspto.gov> for additional applicants):

Jay S. Walker, Ridgefield, CT;
James A. Jorasch, Stamford, CT;
Russell P. Sammon, San Francisco, CA;
Stephen C. Tulley, Fairfield, CT;
Steven M. Santisi, Ridgefield, CT;
IGT, Reno, NV

The United States represents the largest, most dynamic marketplace in the world and is an unparalleled location for business investment, innovation, and commercialization of new technologies. The USA offers tremendous resources and advantages for those who invest and manufacture goods here. Through SelectUSA, our nation works to encourage and facilitate business investment. To learn more about why the USA is the best country in the world to develop technology, manufacture products, and grow your business, visit SelectUSA.gov.

IN THE UNITED STATES PATENT AND TRADEMARK OFFICE

Applicant: IGT
Inventors: Jay S. Walker et al.
Patent No.: 8,795,064 B2
Issued: August 5, 2014
Appl. No.: 13/680,852
Filed: November 19, 2012
Conf. No.: 6364
Title: METHOD AND APPARATUS FOR OUTPUTTING A MESSAGE AT A
GAME MACHINE
Art Unit: 3714
Examiner: Matthew D. Hoel
Docket No.: 025124-0509/WK00036-005

Certificate of Correction Branch
Commissioner for Patents
P.O. Box 1450
Alexandria, VA 22313-1450

REQUEST FOR CERTIFICATE OF CORRECTION
PURSUANT TO 37 C.F.R. § 1.322

Sir:

It is respectfully requested that the above-referenced patent be amended as follows.

IN THE CLAIMS

In Claim 1, Column 75, Line 38, replace "as" with --least--.

REMARKS

Upon the careful review of recently issued U.S. Patent No. 8,795,064 B2, the above-listed mistake was noted. Patentee prepared this Request for Certificate of Correction to correct this mistake. This mistake is of a clerical nature and of minor character, and occurred in good faith. Thus, the correction of this mistake does not make necessary a reexamination of the patent. Further, the requested change to the claim does not change the scope of Patentee's rights granted under this patent.

Since the above-listed mistake appears to be the fault of the Patent Office, Patentee is hereby requesting the issuance of a Certificate of Correction pursuant to 37 C.F.R. § 1.322. Evidence of the Patent Office's mistake can be found in Claim 1 of the Specification filed by Patentee on November 19, 2012. A proposed Certificate of Correction is submitted herewith. Since the error to the claim appears to be the fault of the Patent Office, Patentee believes that no fee is due. Should any fees be due in connection with this Request, please charge Deposit Account No. 502261 for payment of such fees.

Patentee respectfully solicits the granting of the requested Certificate of Correction. If there are any questions, please contact the undersigned.

Respectfully submitted,

Neal, Gerber & Eisenberg LLP

By: 

Kevin J. Cukierski
Reg. No. 66,717
Customer No. 29159
Tel. No. (312) 269-8448

Date: October 10, 2014

**UNITED STATES PATENT AND TRADEMARK OFFICE
CERTIFICATE OF CORRECTION**Page 1 of 1

PATENT NO. : 8,795,064 B2

APPLICATION NO.: 13/680,852

ISSUE DATE : August 5, 2014

INVENTOR(S) : Jay S. Walker

It is certified that an error appears or errors appear in the above-identified patent and that said Letters Patent is hereby corrected as shown below:

IN THE CLAIMS

In Claim 1, Column 75, Line 38, replace "as" with --least--.

MAILING ADDRESS OF SENDER (Please do not use customer number below):

2 North LaSalle Street, Suite 1700
Chicago, IL 60602

This collection of information is required by 37 CFR 1.322, 1.323, and 1.324. The information is required to obtain or retain a benefit by the public which is to file (and by the USPTO to process) an application. Confidentiality is governed by 35 U.S.C. 122 and 37 CFR 1.14. This collection is estimated to take 1.0 hour to complete, including gathering, preparing, and submitting the completed application form to the USPTO. Time will vary depending upon the individual case. Any comments on the amount of time you require to complete this form and/or suggestions for reducing this burden, should be sent to the Chief Information Officer, U.S. Patent and Trademark Office, U.S. Department of Commerce, P.O. Box 1450, Alexandria, VA 22313-1450. DO NOT SEND FEES OR COMPLETED FORMS TO THIS ADDRESS. **SEND TO: Attention Certificate of Corrections Branch, Commissioner for Patents, P.O. Box 1450, Alexandria, VA 22313-1450.**

If you need assistance in completing the form, call 1-800-PTO-9199 and select option 2.

Electronic Acknowledgement Receipt

EFS ID:	20387924
Application Number:	13680852
International Application Number:	
Confirmation Number:	6364
Title of Invention:	METHOD AND APPARATUS FOR OUTPUTTING A MESSAGE AT A GAME MACHINE
First Named Inventor/Applicant Name:	Jay S. Walker
Customer Number:	29159
Filer:	Kevin Joseph Cukierski/Carrie Mollo
Filer Authorized By:	Kevin Joseph Cukierski
Attorney Docket Number:	025124-0509
Receipt Date:	10-OCT-2014
Filing Date:	19-NOV-2012
Time Stamp:	16:03:18
Application Type:	Utility under 35 USC 111(a)

Payment information:

Submitted with Payment	no
------------------------	----

File Listing:

Document Number	Document Description	File Name	File Size(Bytes)/ Message Digest	Multi Part /.zip	Pages (if appl.)
1	Request for Certificate of Correction	025124-0509RCC.pdf	149777 005468&8a196784e3f1e46ec861b5fe9974b442e	no	3

Warnings:

Information:

Total Files Size (in bytes):

149777

This Acknowledgement Receipt evidences receipt on the noted date by the USPTO of the indicated documents, characterized by the applicant, and including page counts, where applicable. It serves as evidence of receipt similar to a Post Card, as described in MPEP 503.

New Applications Under 35 U.S.C. 111

If a new application is being filed and the application includes the necessary components for a filing date (see 37 CFR 1.53(b)-(d) and MPEP 506), a Filing Receipt (37 CFR 1.54) will be issued in due course and the date shown on this Acknowledgement Receipt will establish the filing date of the application.

National Stage of an International Application under 35 U.S.C. 371

If a timely submission to enter the national stage of an international application is compliant with the conditions of 35 U.S.C. 371 and other applicable requirements a Form PCT/DO/EO/903 indicating acceptance of the application as a national stage submission under 35 U.S.C. 371 will be issued in addition to the Filing Receipt, in due course.

New International Application Filed with the USPTO as a Receiving Office

If a new international application is being filed and the international application includes the necessary components for an international filing date (see PCT Article 11 and MPEP 1810), a Notification of the International Application Number and of the International Filing Date (Form PCT/RO/105) will be issued in due course, subject to prescriptions concerning national security, and the date shown on this Acknowledgement Receipt will establish the international filing date of the application.

UNITED STATES PATENT AND TRADEMARK OFFICE
CERTIFICATE OF CORRECTION

PATENT NO. : 8,795,064 B2
APPLICATION NO. : 13/680852
DATED : August 5, 2014
INVENTOR(S) : Jay S. Walker et al.

Page 1 of 1

It is certified that error appears in the above-identified patent and that said Letters Patent is hereby corrected as shown below:

IN THE CLAIMS

In Claim 1, Column 75, Line 38, replace "as" with --least--.

Signed and Sealed this
Sixteenth Day of December, 2014

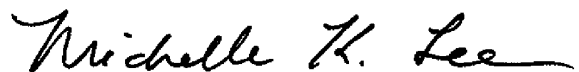

Michelle K. Lee
Deputy Director of the United States Patent and Trademark Office

AO (20 (Rev. 08/10))

TO: Mail Stop 8 Director of the U.S. Patent and Trademark Office P.O. Box 1450 Alexandria, VA 22313-1450	REPORT ON THE FILING OR DETERMINATION OF AN ACTION REGARDING A PATENT OR TRADEMARK
---	--

In Compliance with 35 U.S.C. § 290 and/or 15 U.S.C. § 1116 you are hereby advised that a court action has been filed in the U.S. District Court Western District of Texas on the following

Trademarks or Patents. (the patent action involves 35 U.S.C. § 292.)

DOCKET NO. 6:21-cv-331	DATE FILED 4/6/2021	U.S. DISTRICT COURT Western District of Texas
PLAINTIFF IGT and IGT Canada Solutions ULC		DEFENDANT Zynga Inc.
PATENT OR TRADEMARK NO.	DATE OF PATENT OR TRADEMARK	HOLDER OF PATENT OR TRADEMARK
1 See Attachment 1		
2		
3		
4		
5		

In the above—entitled case, the following patent(s)/ trademark(s) have been included:

DATE INCLUDED	INCLUDED BY <input type="checkbox"/> Amendment <input type="checkbox"/> Answer <input type="checkbox"/> Cross Bill <input type="checkbox"/> Other Pleading	
PATENT OR TRADEMARK NO.	DATE OF PATENT OR TRADEMARK	HOLDER OF PATENT OR TRADEMARK
1		
2		
3		
4		
5		

In the above—entitled case, the following decision has been rendered or judgement issued:

DECISION/JUDGEMENT

CLERK	(BY) DEPUTY CLERK	DATE
-------	-------------------	------

Copy 1—Upon initiation of action, mail this copy to Director Copy 3—Upon termination of action, mail this copy to Director
 Copy 2—Upon filing document adding patent(s), mail this copy to Director Copy 4—Case file copy

Attachment 1 to Form AO 120
IGT & IGT Canada Sols. ULC v. Zynga Inc. (W.D. Tex.)

Patent or Trademark No.	Date of Patent or Trademark	Holder of Patent or Trademark
8,708,791	Apr. 29, 2014	IGT
9,159,189	Oct. 13, 2015	IGT Canada Solutions ULC
7,168,089	Jan. 23, 2007	IGT
7,303,473	Dec. 4, 2007	IGT
8,795,064	Aug. 5, 2014	IGT
8,266,212	Sept. 11, 2012	IGT