



US006135881A

United States Patent [19]

[11] Patent Number: **6,135,881**

Abbott et al.

[45] Date of Patent: **Oct. 24, 2000**

- [54] **SPORTS FORECASTING GAME**
- [75] Inventors: **James P. Abbott**, Omaha, Nebr.;
Kenneth Mixter, Hanover, Pa.
- [73] Assignee: **Inventure, Inc.**, Baltimore, Md.
- [21] Appl. No.: **09/050,374**
- [22] Filed: **Mar. 31, 1998**

5,618,045	4/1997	Kagan et al.	463/40
5,639,084	6/1997	Kawasaki	473/421
5,735,743	4/1998	Murata et al.	463/35
5,769,714	6/1998	Weiner et al.	463/3
5,816,953	10/1998	Cleveland	473/459
5,860,862	1/1999	Junkin	463/40
5,890,906	4/1999	Macri et al.	434/247
5,911,582	6/1999	Redford et al.	434/307
5,988,861	11/1999	Baum	364/565

Primary Examiner—Jessica J. Harrison
Assistant Examiner—Minh Trinh
Attorney, Agent, or Firm—Hogan & Hartson, LLP; Celine Jimenez Crowson

Related U.S. Application Data

- [60] Provisional application No. 60/042,265, Mar. 31, 1997.
- [51] **Int. Cl.⁷** **A63F 9/22**
- [52] **U.S. Cl.** **463/3; 463/40; 463/9;**
463/1; 273/108.3
- [58] **Field of Search** 463/3, 2, 4, 36,
463/37, 38, 43, 44, 40, 41, 42; 273/1 E,
85 G, 317.6, 236, 138.2, 132, 108.1, 108.3,
277, 461

[57] ABSTRACT

A method of remotely interfacing with at least one player in a rule-based game over a communication medium operatively connected to one or more communication devices including a visual display wherein each player is associated with a communication device, includes visually displaying at one or more of the communication devices a form comprising a two-dimensional matrix having a cell at the juncture of each row and column and where each cell may be manipulated to reflect a game choice by the player, retrieving by a server each game choice made by the player before any subsequent game choice is made by the player, applying the rules of the game to determine what further game choices are available to the player based upon the game choices retrieved, generating a revised form reflecting game choices made by the player and game choices which are available for the player to make, transmitting the revised form to the communication device being used by the player, and visually displaying the revised form at the communication device being used by the player.

[56] References Cited

U.S. PATENT DOCUMENTS

4,215,861	8/1980	Nemeth	273/85 G
4,324,402	4/1982	Klose	273/88
4,496,148	1/1985	Morstain et al.	273/1 E
4,540,174	9/1985	Coppock	273/138 R
4,572,509	2/1986	Sitrick	273/85 G
4,592,546	6/1986	Fascenda et al.	273/1 E
4,662,635	5/1987	Enokian	273/94
4,722,526	2/1988	Tovar et al.	273/1 E
4,998,199	3/1991	Tashiro et al.	364/410
5,083,271	1/1992	Thacher et al.	364/411
5,263,723	11/1993	Pearson et al.	273/439
5,538,255	7/1996	Barker	463/41
5,586,257	12/1996	Pelzman	463/42

20 Claims, 6 Drawing Sheets

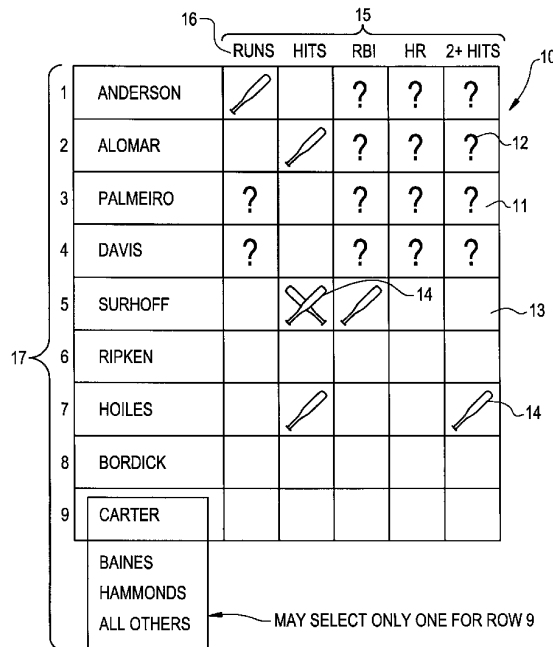








FIG. 1A

		15				
16		RUNS	HITS	RBI	HR	2+ HITS
1	ANDERSON			?	?	?
2	ALOMAR			?	?	?
3	PALMEIRO	?		?	?	?
4	DAVIS	?		?	?	?
5	SURHOFF					
6	RIPKEN					
7	HOILES					
8	BORDICK					
9	CARTER					
	BAINES					
	HAMMONDS					
	ALL OTHERS					

MAY SELECT ONLY ONE FOR ROW 9

FIG. 1B

PITCHING GRID










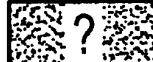
	IP 6+	K	IP-R	IP-H	Win
Starter					
	IP 3+	K	IP-R	IP-H	W/Sv
Relievers					

FIG. 2

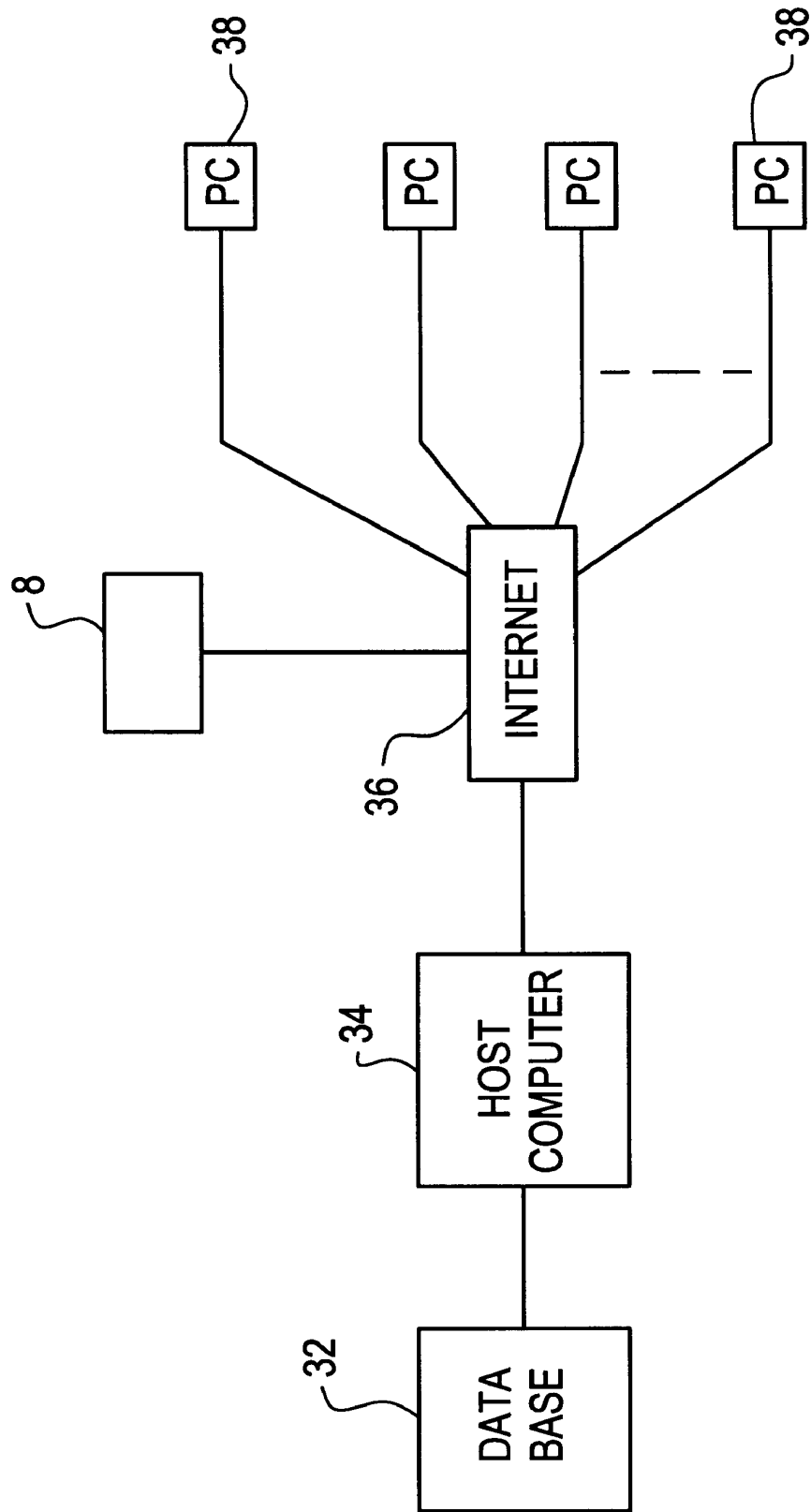
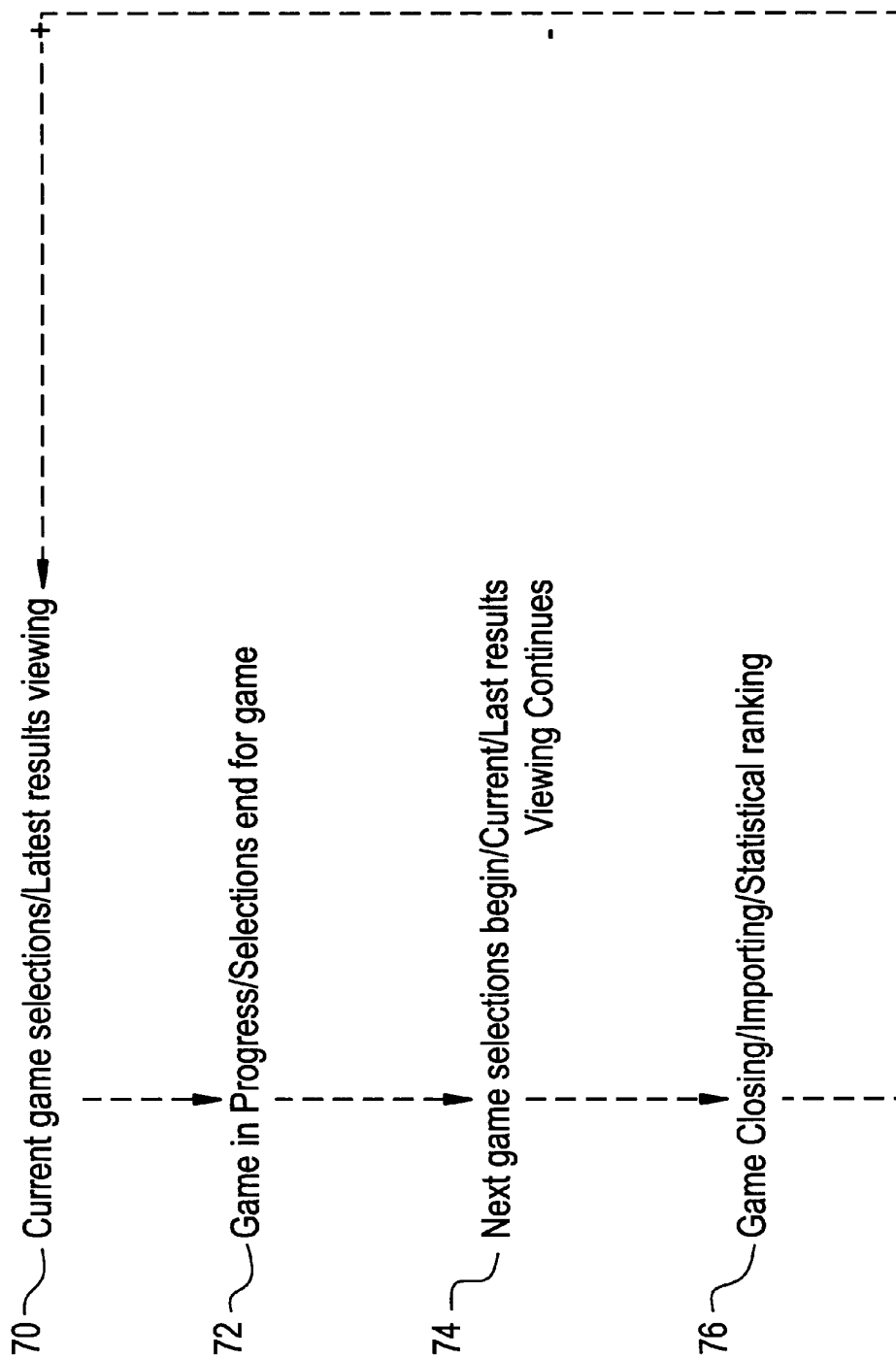


FIG. 3



Explore Litigation Insights

Docket Alarm provides insights to develop a more informed litigation strategy and the peace of mind of knowing you're on top of things.

Real-Time Litigation Alerts



Keep your litigation team up-to-date with **real-time alerts** and advanced team management tools built for the enterprise, all while greatly reducing PACER spend.

Our comprehensive service means we can handle Federal, State, and Administrative courts across the country.

Advanced Docket Research



With over 230 million records, Docket Alarm's cloud-native docket research platform finds what other services can't. Coverage includes Federal, State, plus PTAB, TTAB, ITC and NLRB decisions, all in one place.

Identify arguments that have been successful in the past with full text, pinpoint searching. Link to case law cited within any court document via Fastcase.

Analytics At Your Fingertips



Learn what happened the last time a particular judge, opposing counsel or company faced cases similar to yours.

Advanced out-of-the-box PTAB and TTAB analytics are always at your fingertips.

API

Docket Alarm offers a powerful API (application programming interface) to developers that want to integrate case filings into their apps.

LAW FIRMS

Build custom dashboards for your attorneys and clients with live data direct from the court.

Automate many repetitive legal tasks like conflict checks, document management, and marketing.

FINANCIAL INSTITUTIONS

Litigation and bankruptcy checks for companies and debtors.

E-DISCOVERY AND LEGAL VENDORS

Sync your system to PACER to automate legal marketing.