



US 20080226094A1

(19) **United States**

(12) **Patent Application Publication**
Rutschman

(10) **Pub. No.: US 2008/0226094 A1**

(43) **Pub. Date: Sep. 18, 2008**

(54) **HEADSET HAVING WIRELESSLY LINKED EARPIECES**

(75) Inventor: **Phillip Rutschman**, Seattle, WA (US)

Correspondence Address:
QUALCOMM INCORPORATED
5775 MOREHOUSE DR.
SAN DIEGO, CA 92121 (US)

(73) Assignee: **QUALCOMM Incorporated**, San Diego, CA (US)

(21) Appl. No.: **12/048,038**

(22) Filed: **Mar. 13, 2008**

Related U.S. Application Data

(60) Provisional application No. 60/918,252, filed on Mar. 14, 2007.

Publication Classification

(51) **Int. Cl.**
H04B 5/00 (2006.01)
H04B 3/00 (2006.01)
(52) **U.S. Cl.** **381/79; 381/77**

(57) **ABSTRACT**

A wireless headset includes a first earpiece and a second earpiece, where the first and second earpieces communicate with each other over a wireless link. In some configurations, the first earpiece includes both a primary wireless interface for receiving audio from an audio source and a secondary wireless interface transmitting a portion of the audio to the second earpiece. The earpieces can incorporate Near Field Communication (NFC) technology to provide the wireless link between each other. The wireless headset can be configured to synchronize audio output at the earpieces, and can also include a second-earpiece detection mechanism that permits the first earpiece to be used in either a stand-alone mode, with audio output at only the first earpiece, or full-headset mode, with audio output at both earpieces when the second earpiece is detected within wireless range of the first earpiece.

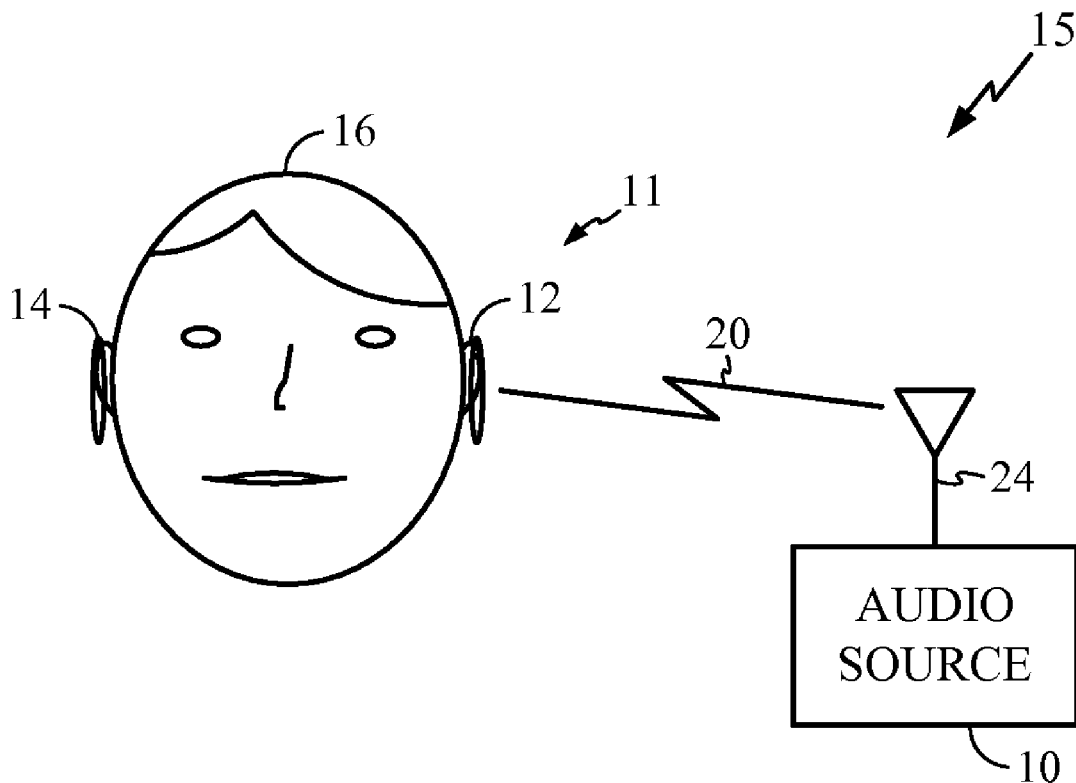

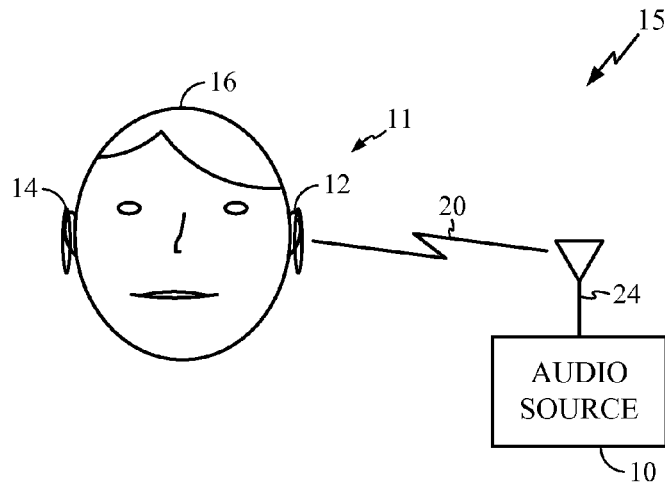

FIG. 1

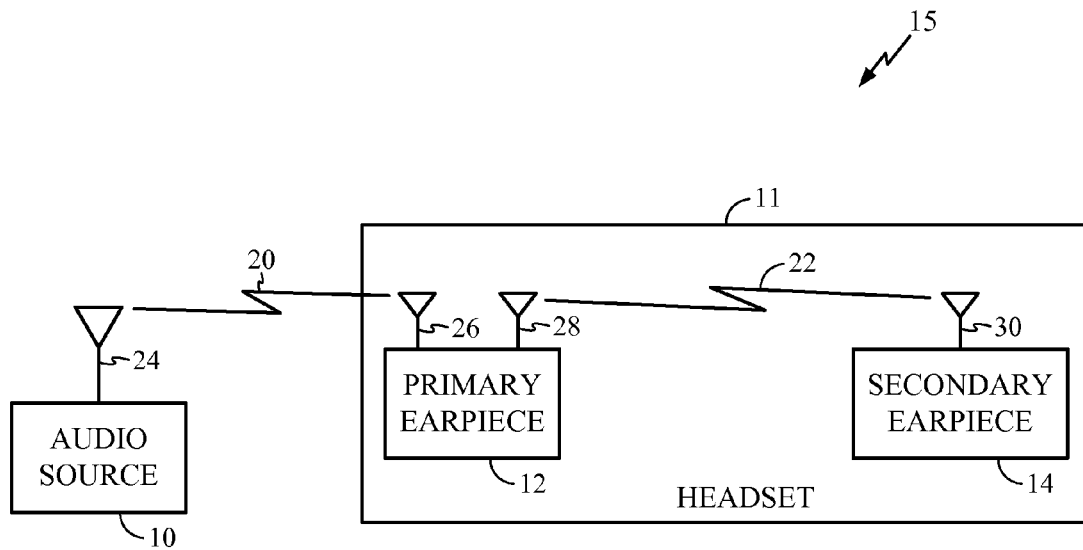

FIG. 2

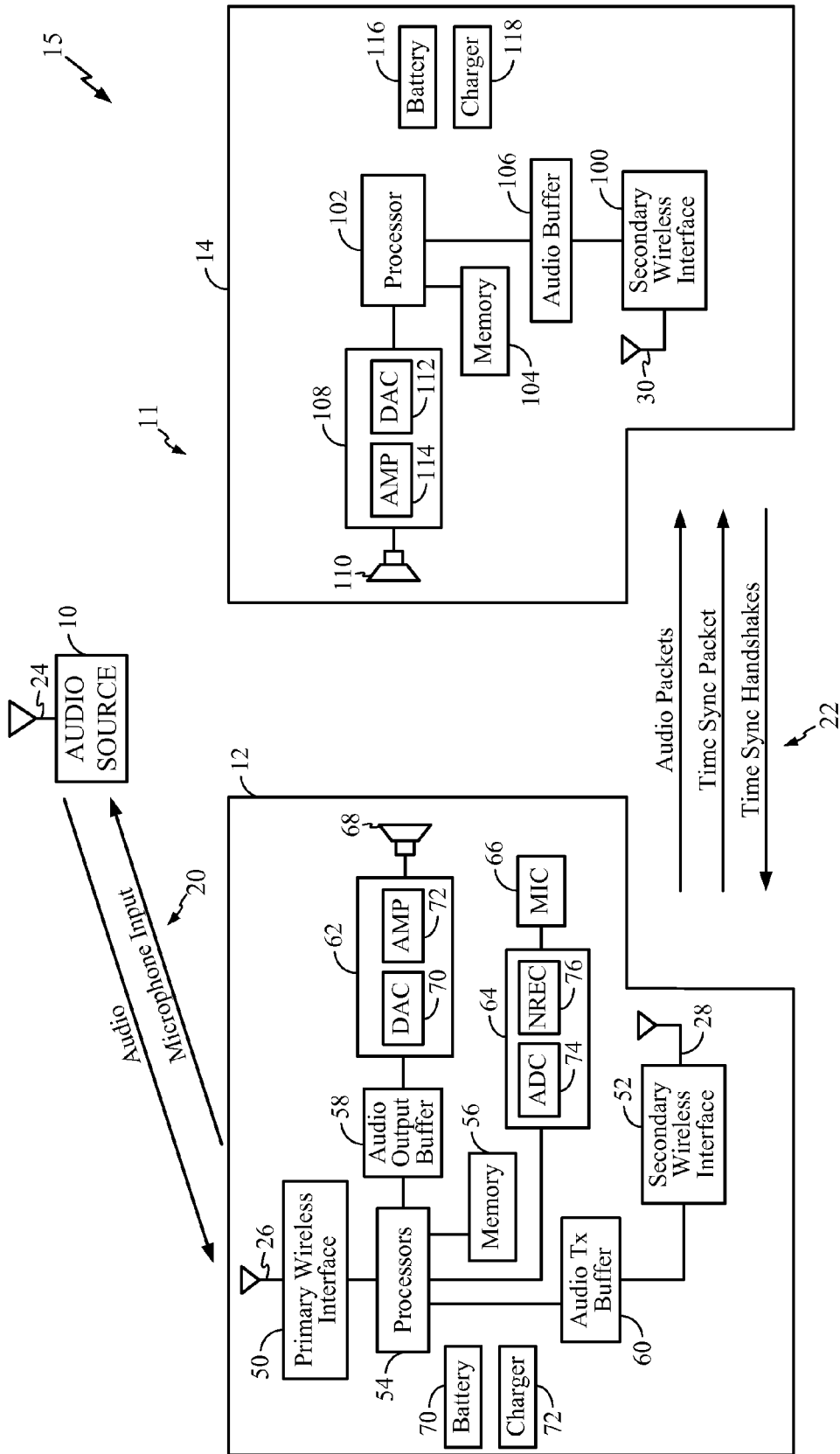

FIG. 3

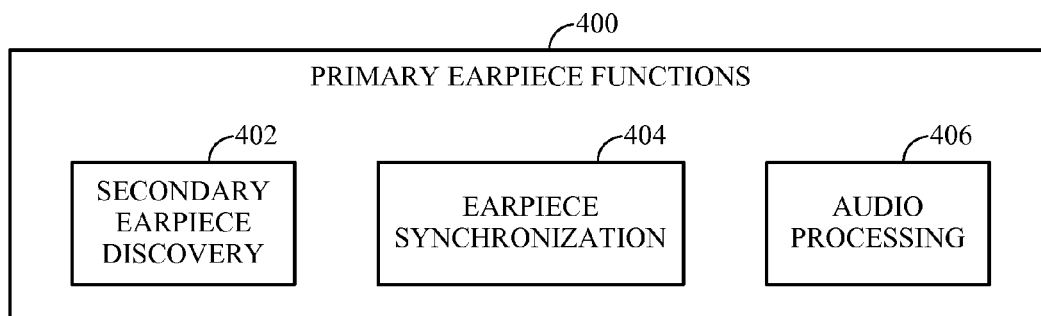

FIG. 4

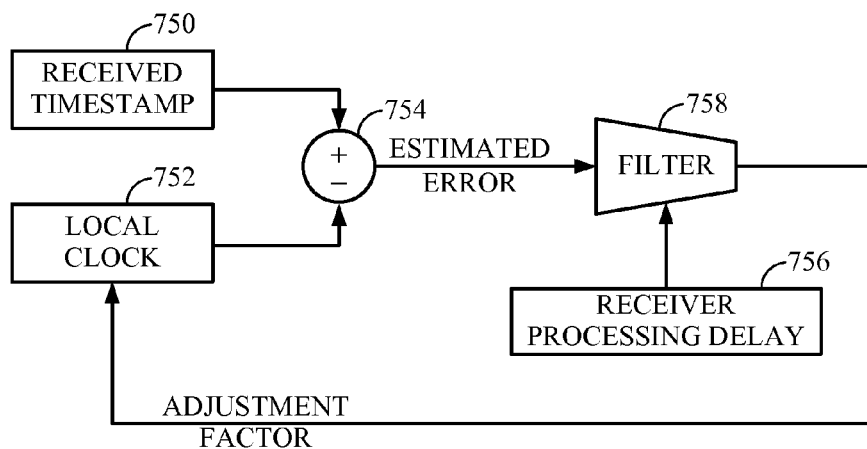

FIG. 8

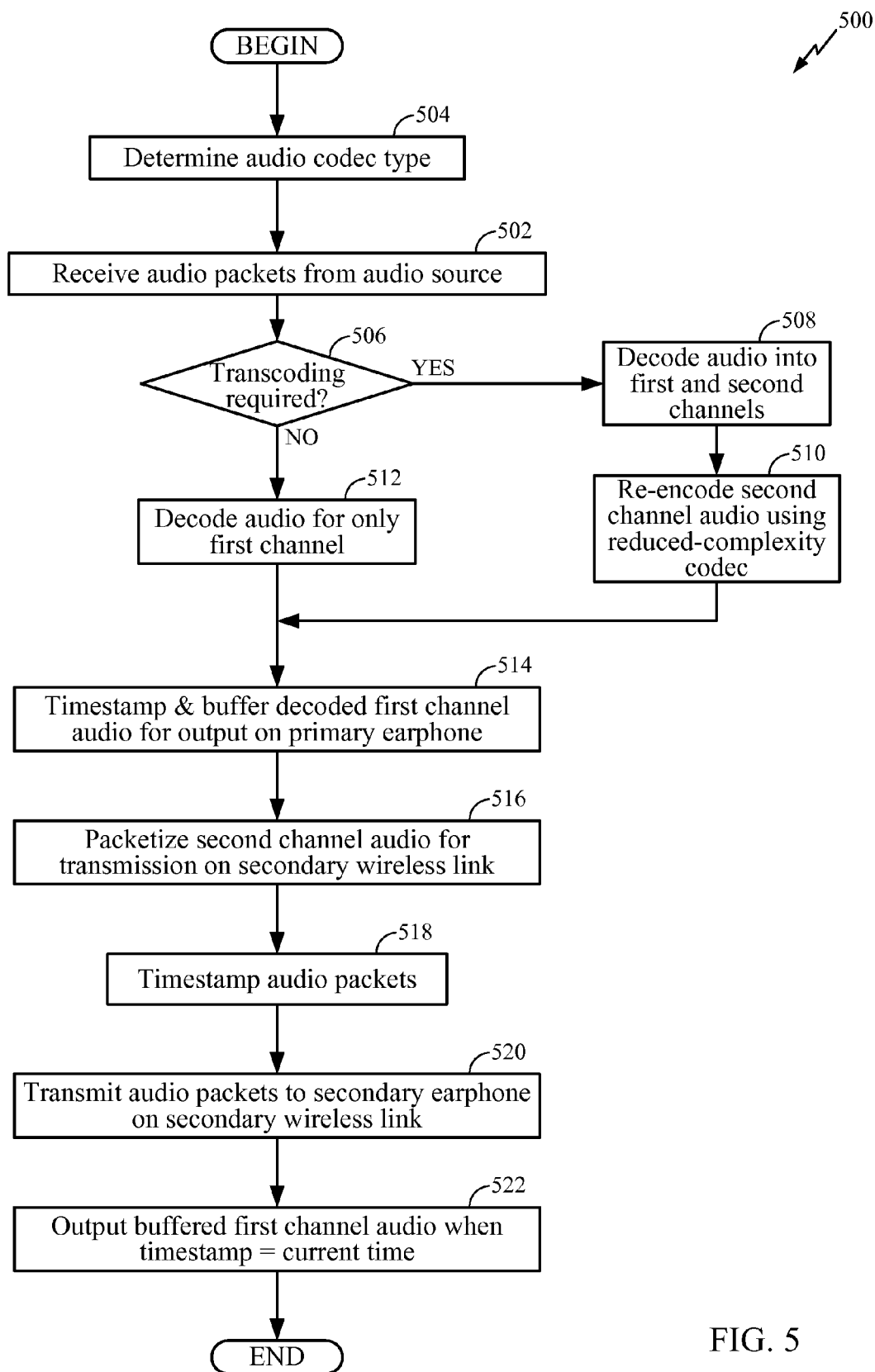

FIG. 5

Explore Litigation Insights

Docket Alarm provides insights to develop a more informed litigation strategy and the peace of mind of knowing you're on top of things.

Real-Time Litigation Alerts



Keep your litigation team up-to-date with **real-time alerts** and advanced team management tools built for the enterprise, all while greatly reducing PACER spend.

Our comprehensive service means we can handle Federal, State, and Administrative courts across the country.

Advanced Docket Research



With over 230 million records, Docket Alarm's cloud-native docket research platform finds what other services can't. Coverage includes Federal, State, plus PTAB, TTAB, ITC and NLRB decisions, all in one place.

Identify arguments that have been successful in the past with full text, pinpoint searching. Link to case law cited within any court document via Fastcase.

Analytics At Your Fingertips



Learn what happened the last time a particular judge, opposing counsel or company faced cases similar to yours.

Advanced out-of-the-box PTAB and TTAB analytics are always at your fingertips.

API

Docket Alarm offers a powerful API (application programming interface) to developers that want to integrate case filings into their apps.

LAW FIRMS

Build custom dashboards for your attorneys and clients with live data direct from the court.

Automate many repetitive legal tasks like conflict checks, document management, and marketing.

FINANCIAL INSTITUTIONS

Litigation and bankruptcy checks for companies and debtors.

E-DISCOVERY AND LEGAL VENDORS

Sync your system to PACER to automate legal marketing.