



US00632753B1

(12) **United States Patent**
Evans et al.

(10) **Patent No.:** **US 6,327,535 B1**
(45) **Date of Patent:** **Dec. 4, 2001**

(54) **LOCATION BEACONING METHODS AND SYSTEMS**

(75) Inventors: **Stephen S. Evans**, Redmond; **Gopal Parupudi**, Issaquah; **Burdette J. Holtgrewe**, Bellevue; **Edward F. Reus**, Woodinville; **Gregory Burns**, Seattle, all of WA (US)

(73) Assignee: **Microsoft Corporation**, Redmond, WA (US)

(*) Notice: Subject to any disclaimer, the term of this patent is extended or adjusted under 35 U.S.C. 154(b) by 0 days.

(21) Appl. No.: **09/543,646**

(22) Filed: **Apr. 5, 2000**

(51) **Int. Cl.**⁷ **G06F 17/10**

(52) **U.S. Cl.** **701/300; 701/207; 701/214; 701/216; 342/357.09**

(58) **Field of Search** **701/200, 201, 701/202, 206, 207, 214, 216, 300; 379/220, 221; 342/357.01, 357.02, 357.08, 357.09**

(56) **References Cited**

U.S. PATENT DOCUMENTS

5,499,032	*	3/1996	Kelley et al.	701/207
5,806,017	*	9/1998	Hancock	701/209
5,917,911	*	6/1999	Dabbish et al.	380/21
6,028,551	*	2/2000	Schoen et al.	342/357.16
6,216,087	*	4/2001	Want et al.	701/207

* cited by examiner

Primary Examiner—William A. Cuchlinski, Jr.
Assistant Examiner—Gertrude Arthur

(74) *Attorney, Agent, or Firm*—Lee & Hayes, PLLC

(57) **ABSTRACT**

Context-aware computing systems and methods are described. In particular embodiments, location aware systems and methods are described. In the described embodiments, hierarchical tree structures are utilized to ascertain a device context or location. The tree structures can be stored on or accessible to mobile computing devices so that the devices can determine their own particular context or location. In one embodiment, one of the tree structures comprises a Master World tree structure that contains nodes that represent geographical divisions of the Earth. Another of the tree structures can comprise a so-called Secondary World that contains nodes that represent physical or logical entities that are organization or company specific views of the world. A computing device can automatically determine its context or location by ascertaining a node on one or more of the tree structures and then traversing the tree structure to ascertain the complete context. A unique device architecture is described that permits context aware computing. The device architecture comprises a context service module, a common interface, and one or more context providers. The context providers provide information, through the common interface, that pertains to the context of a device, and the context service module processes the information to device the device's context. An application program interface (API)/events layer is provided through which various applications can call the device to ascertain the device's location so that location dependent goods or services can be rendered. A privacy manager is also provided in some embodiments to enforce privacy thereby protecting the granularity of the location information that is provided to the applications. In addition, unique location beacons are described that transmit information that can be used by the computing device to ascertain its location.

53 Claims, 9 Drawing Sheets

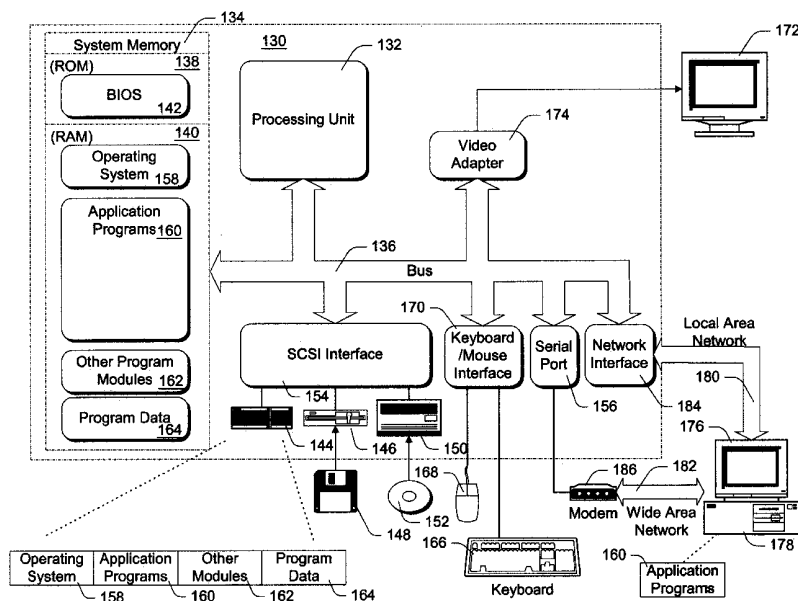

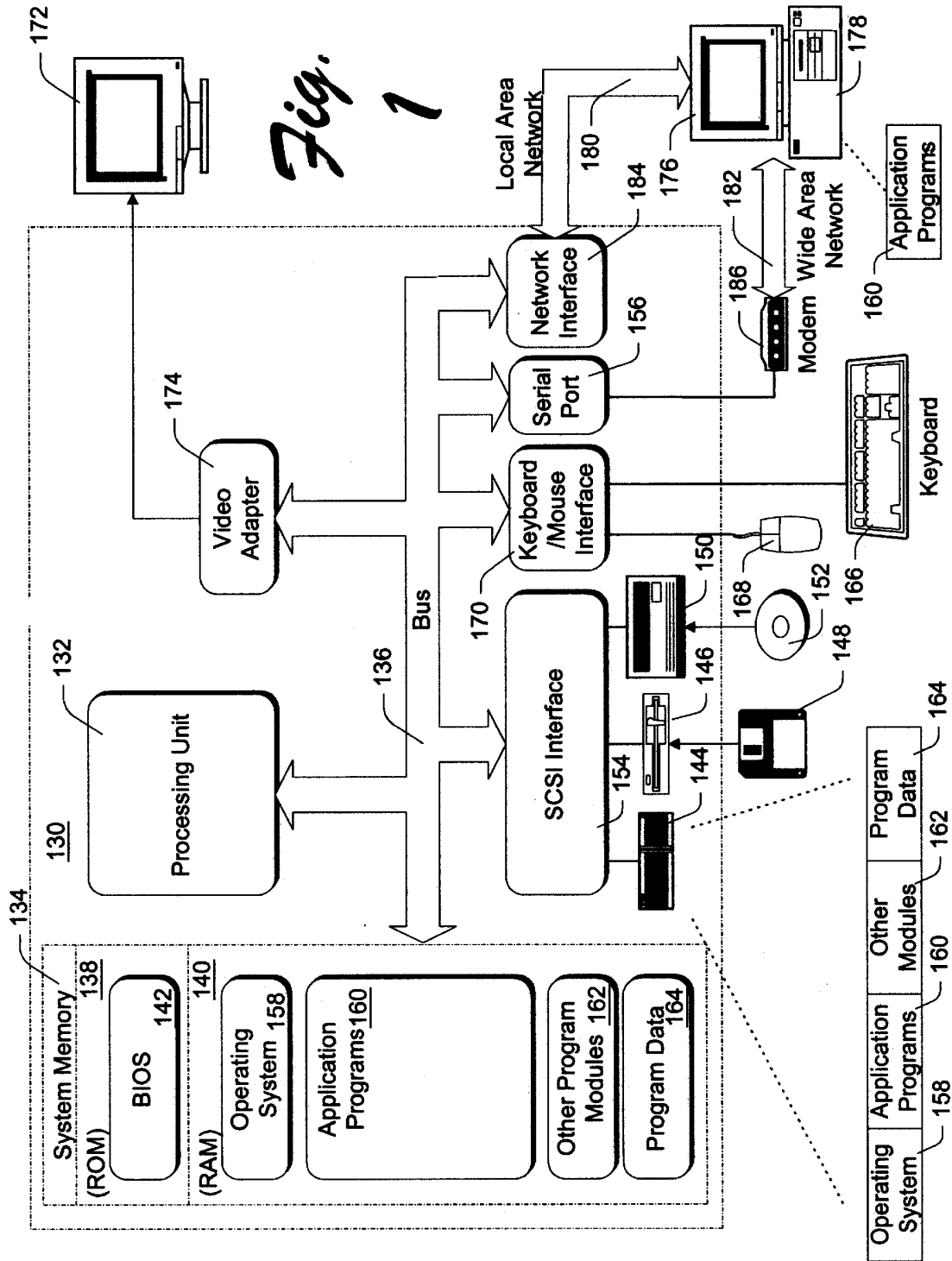

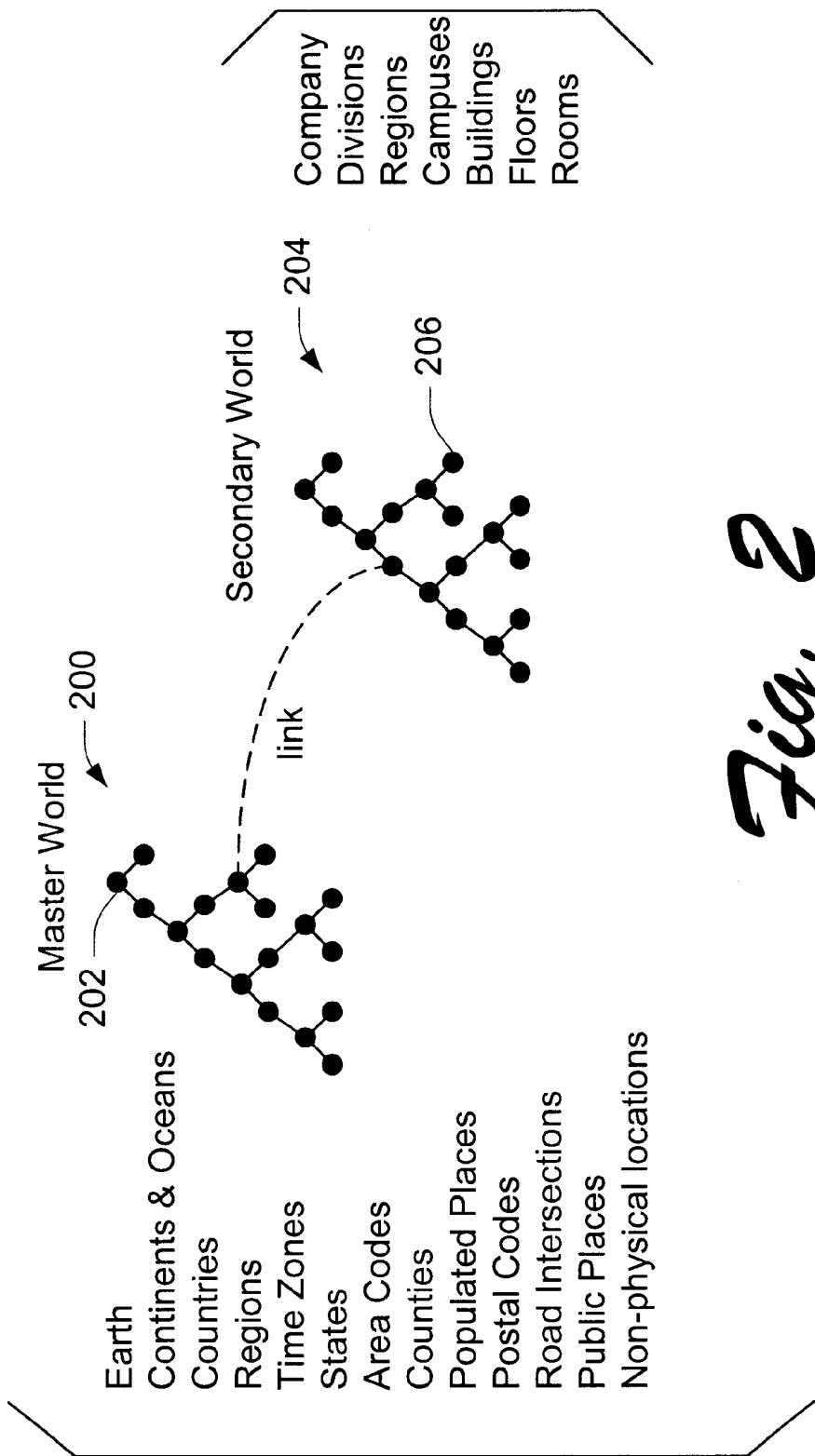

Fig. 2

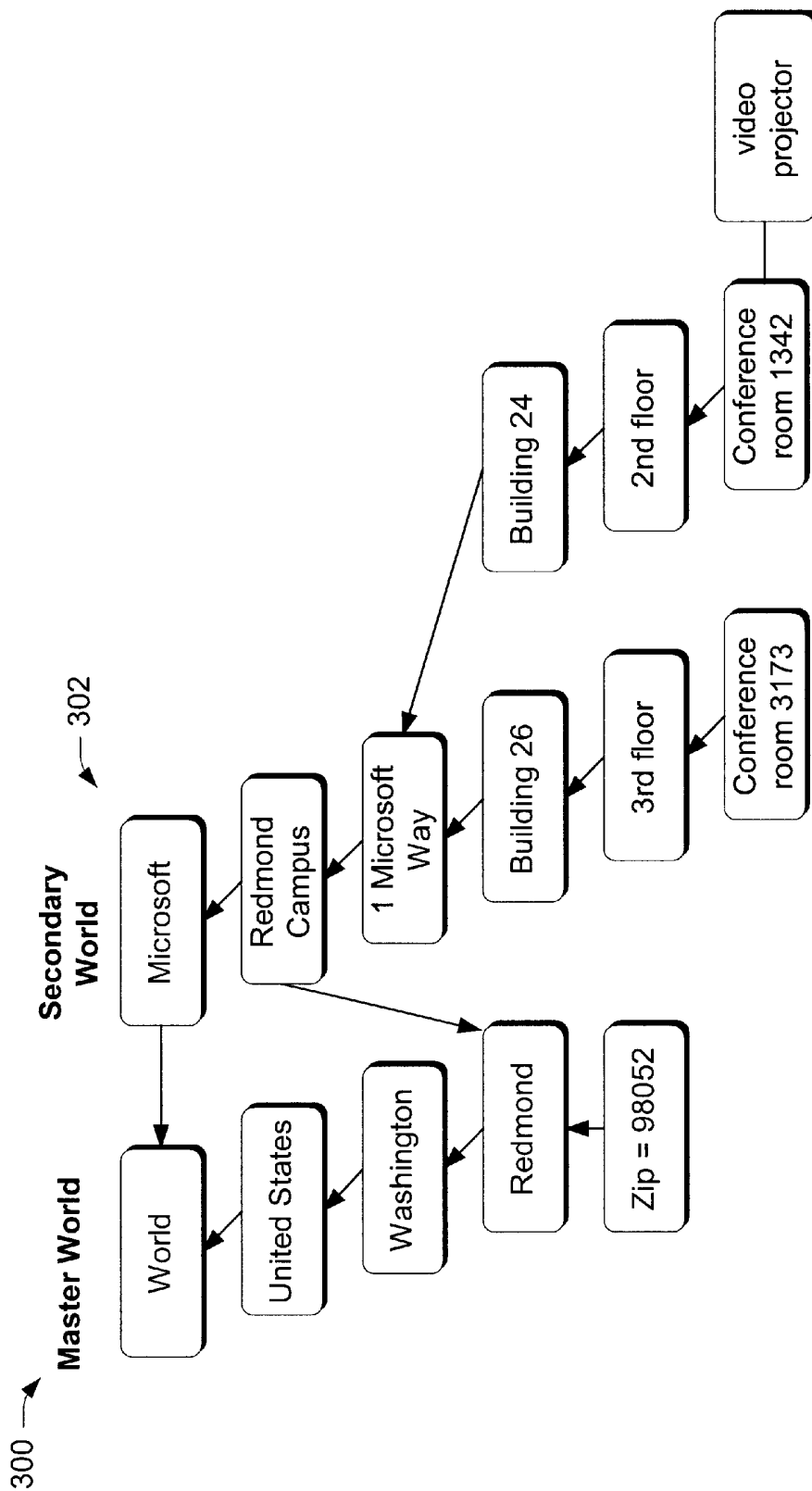

Fig. 3

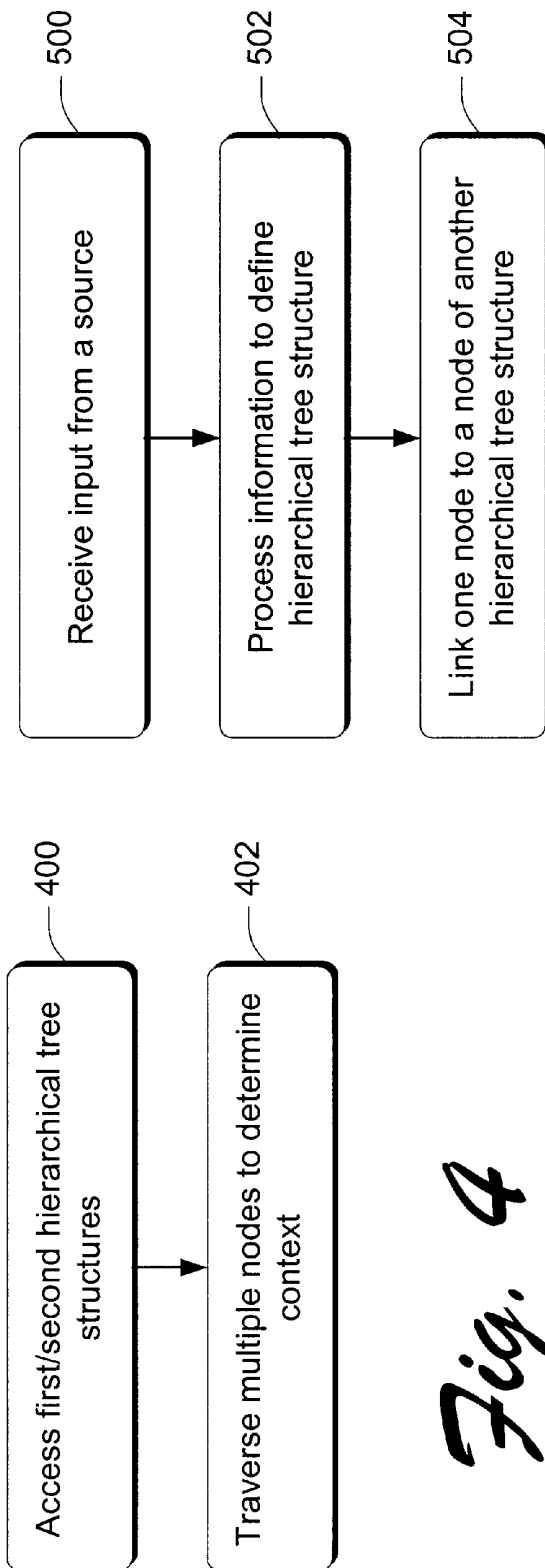

Fig. 4

Fig. 5

Explore Litigation Insights

Docket Alarm provides insights to develop a more informed litigation strategy and the peace of mind of knowing you're on top of things.

Real-Time Litigation Alerts



Keep your litigation team up-to-date with **real-time alerts** and advanced team management tools built for the enterprise, all while greatly reducing PACER spend.

Our comprehensive service means we can handle Federal, State, and Administrative courts across the country.

Advanced Docket Research



With over 230 million records, Docket Alarm's cloud-native docket research platform finds what other services can't. Coverage includes Federal, State, plus PTAB, TTAB, ITC and NLRB decisions, all in one place.

Identify arguments that have been successful in the past with full text, pinpoint searching. Link to case law cited within any court document via Fastcase.

Analytics At Your Fingertips



Learn what happened the last time a particular judge, opposing counsel or company faced cases similar to yours.

Advanced out-of-the-box PTAB and TTAB analytics are always at your fingertips.

API

Docket Alarm offers a powerful API (application programming interface) to developers that want to integrate case filings into their apps.

LAW FIRMS

Build custom dashboards for your attorneys and clients with live data direct from the court.

Automate many repetitive legal tasks like conflict checks, document management, and marketing.

FINANCIAL INSTITUTIONS

Litigation and bankruptcy checks for companies and debtors.

E-DISCOVERY AND LEGAL VENDORS

Sync your system to PACER to automate legal marketing.