

United States Patent [19]

Aviv

[11] Patent Number: **5,666,157**

[45] Date of Patent: **Sep. 9, 1997**

[54] **ABNORMALITY DETECTION AND SURVEILLANCE SYSTEM**

[75] Inventor: **David G. Aviv, New York, N.Y.**

[73] Assignee: **ARC Incorporated, New York, N.Y.**

[21] Appl. No.: **367,712**

[22] Filed: **Jan. 3, 1995**

[51] Int. Cl.⁶ **H04N 7/18**

[52] U.S. Cl. **348/152; 348/150; 348/154; 348/155; 348/161**

[58] Field of Search **348/143, 161, 348/150, 154, 155, 152; H04N 7/18**

[56] **References Cited**

U.S. PATENT DOCUMENTS

4,337,482	6/1982	Coutta	348/150
4,737,847	4/1988	Araki et al.	348/161
5,091,780	2/1992	Pomerleau	348/152

5,097,328	3/1992	Boyette	348/150
5,283,644	2/1994	Maeno	348/152
5,512,942	4/1996	Otsuki	348/152
5,546,072	8/1996	Creuseremee et al.	348/143

Primary Examiner—Howard W. Britton
Attorney, Agent, or Firm—Darby & Darby

[57] **ABSTRACT**

A surveillance system having at least one primary video camera for translating real images of a zone into electronic video signals at a first level of resolution. The system includes means for sampling movements of an individual or individuals located within the zone from the video signal output from at least one video camera. Video signals of sampled movements of the individual is electronically compared with known characteristics of movements which are indicative of individuals having a criminal intent. The level of criminal intent of the individual or individuals is then determined and an appropriate alarm signal is produced.

4 Claims, 5 Drawing Sheets

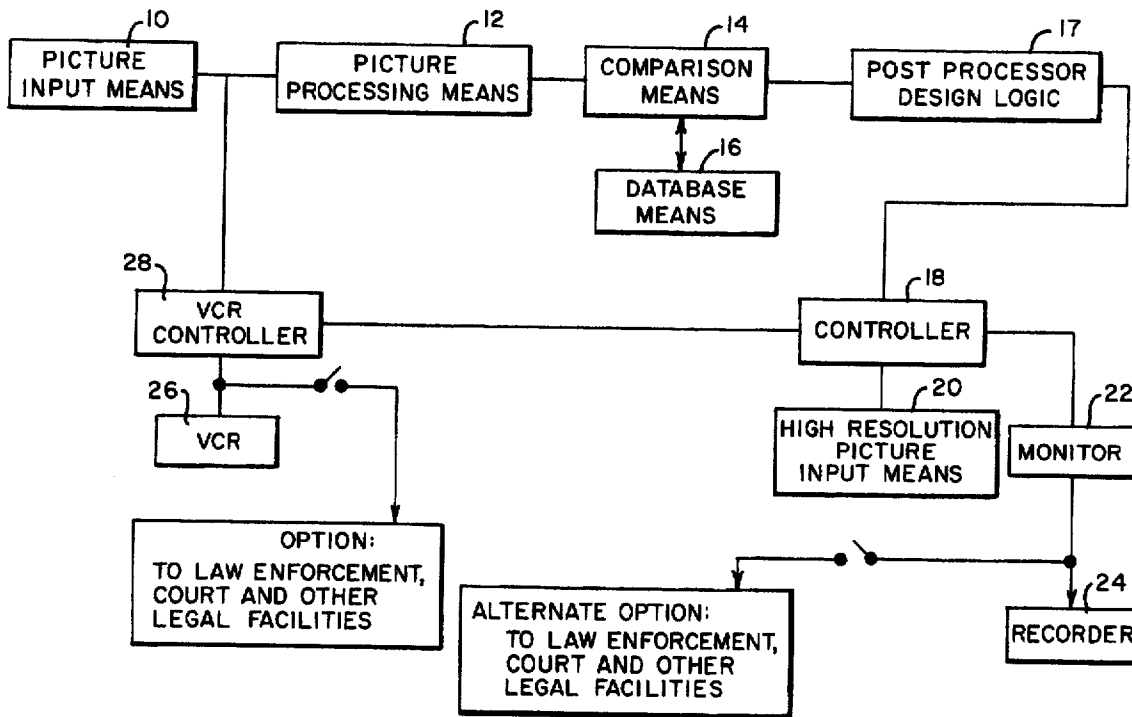

FIG. 1

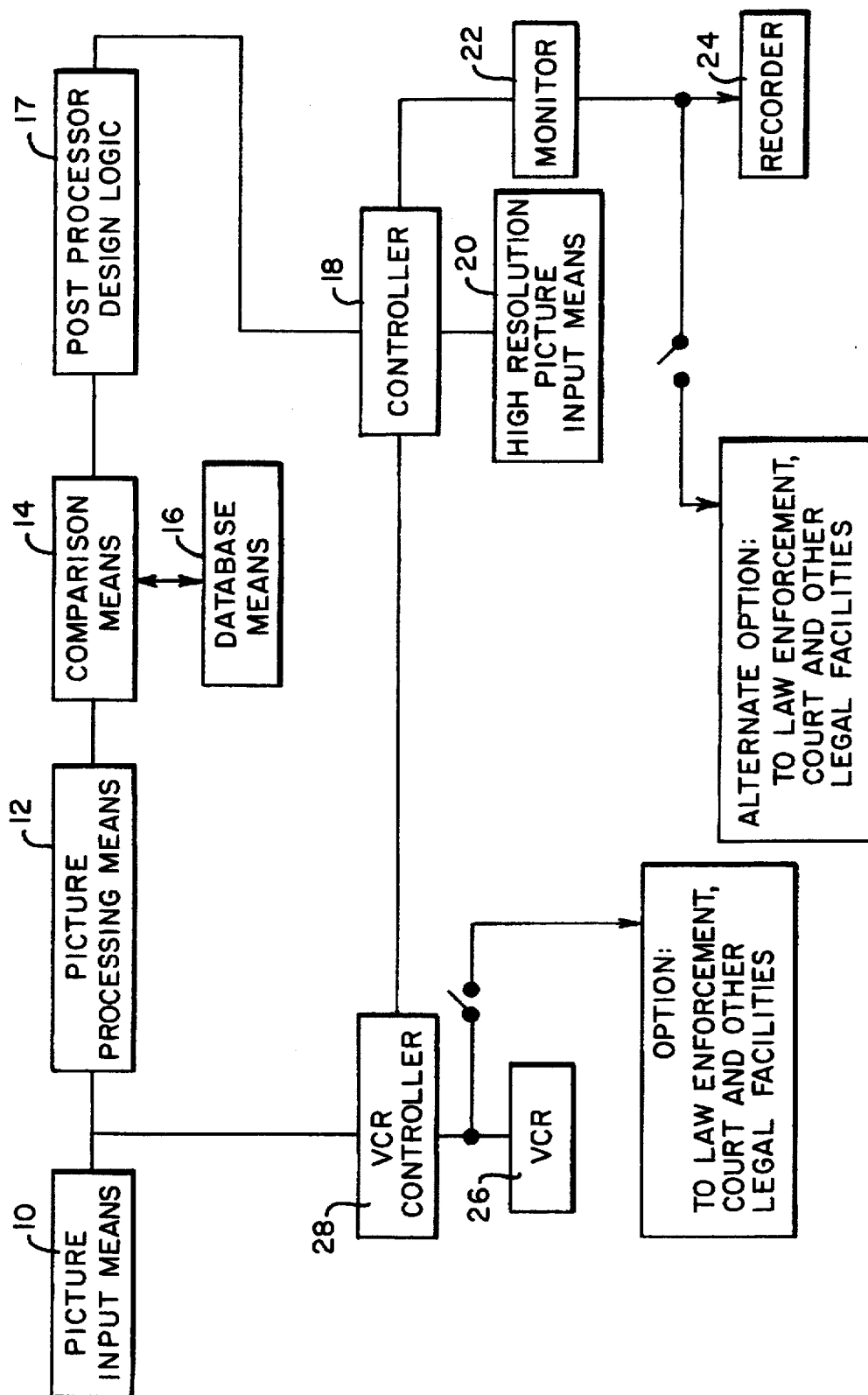

FIG. 2A

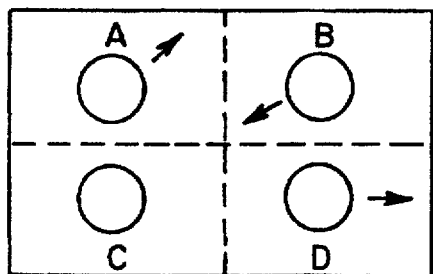

FIG. 2B

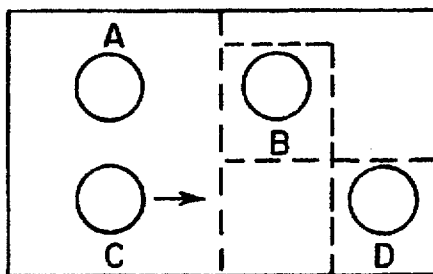

FIG. 2C

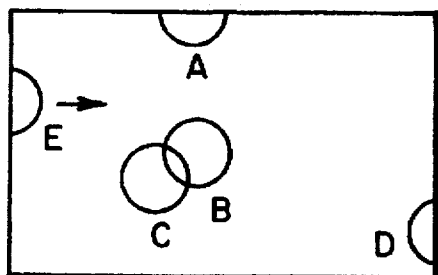

FIG. 2D

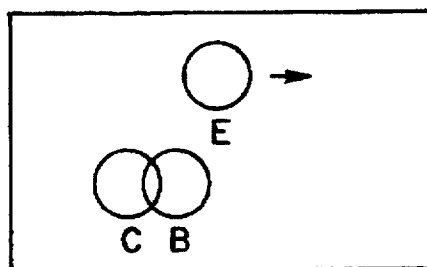

FIG. 2E

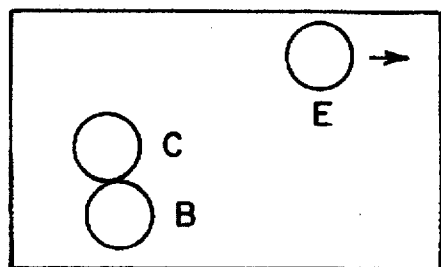
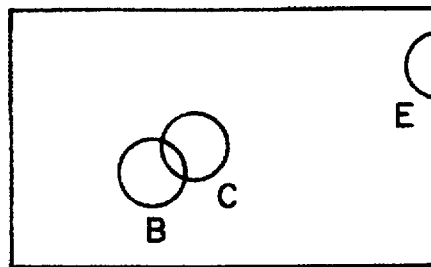

FIG. 2F



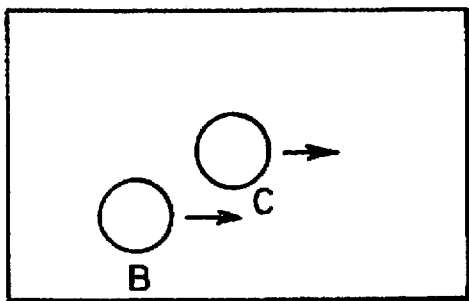

FIG. 2G

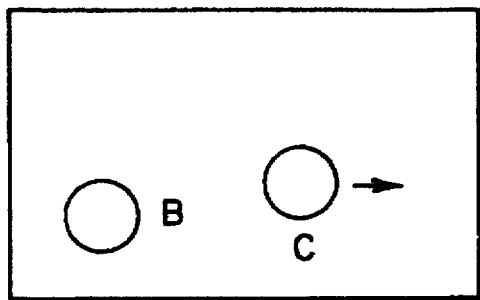

FIG. 2H

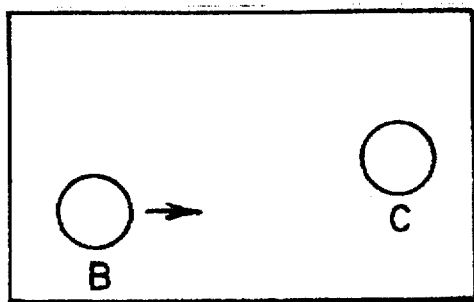

FIG. 2I

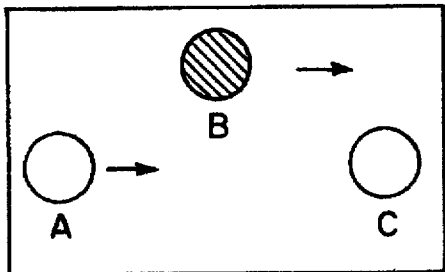

FIG. 3A

FIG. 3B

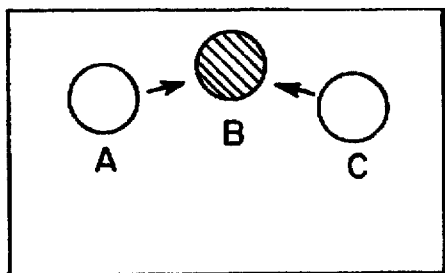
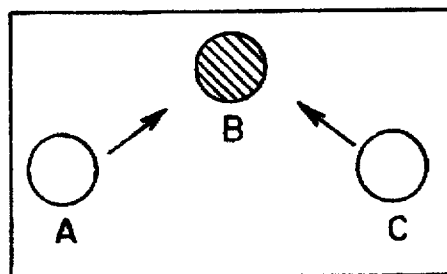
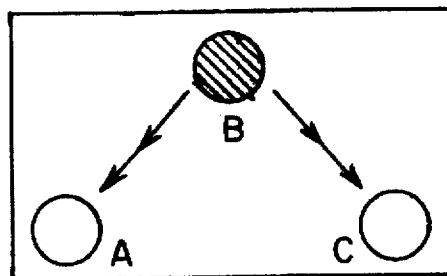

FIG. 3C

FIG. 3D



Explore Litigation Insights

Docket Alarm provides insights to develop a more informed litigation strategy and the peace of mind of knowing you're on top of things.

Real-Time Litigation Alerts



Keep your litigation team up-to-date with **real-time alerts** and advanced team management tools built for the enterprise, all while greatly reducing PACER spend.

Our comprehensive service means we can handle Federal, State, and Administrative courts across the country.

Advanced Docket Research



With over 230 million records, Docket Alarm's cloud-native docket research platform finds what other services can't. Coverage includes Federal, State, plus PTAB, TTAB, ITC and NLRB decisions, all in one place.

Identify arguments that have been successful in the past with full text, pinpoint searching. Link to case law cited within any court document via Fastcase.

Analytics At Your Fingertips



Learn what happened the last time a particular judge, opposing counsel or company faced cases similar to yours.

Advanced out-of-the-box PTAB and TTAB analytics are always at your fingertips.

API

Docket Alarm offers a powerful API (application programming interface) to developers that want to integrate case filings into their apps.

LAW FIRMS

Build custom dashboards for your attorneys and clients with live data direct from the court.

Automate many repetitive legal tasks like conflict checks, document management, and marketing.

FINANCIAL INSTITUTIONS

Litigation and bankruptcy checks for companies and debtors.

E-DISCOVERY AND LEGAL VENDORS

Sync your system to PACER to automate legal marketing.