

- [54] **RUNNERS WATCH**
- [75] Inventors: **John W. Lowrey**, 511 N. Hope St., Mansfield, La. 71052; **Tom M. Hyltin**, Dallas; **J. Scott Jamieson**, Arlington, both of Tex.
- [73] Assignee: **John W. Lowrey**, Mansfield, La.
- [21] Appl. No.: **242,889**
- [22] Filed: **Mar. 12, 1981**

4,071,892	1/1978	Genzling	364/565
4,134,026	1/1979	Sone et al.	307/247 A
4,202,350	5/1980	Walton	128/690
4,220,996	9/1980	Searcy	364/561
4,224,948	9/1980	Cramer et al.	128/690
4,285,041	8/1981	Smith	364/569

OTHER PUBLICATIONS

Omron Jogging Meter Specification Sheet, Omron Electronics, Inc., Schaumburg, Illinois.

Primary Examiner—Gary Chin
Attorney, Agent, or Firm—Jerry W. Mills

Related U.S. Application Data

- [63] Continuation-in-part of Ser. No. 60,594, Jul. 25, 1979, abandoned.
- [51] Int. Cl.³ **G01C 22/00**
- [52] U.S. Cl. **364/561; 364/565; 364/410; 235/105; 368/113; 368/244**
- [58] Field of Search **364/561, 565, 569, 705, 364/410; 307/247 A; 324/78 D, 166, 168, 171; 128/690; 235/92 MT, 92 DN, 105**

[57] **ABSTRACT**

A runners watch which includes a lightweight case dimensioned to be worn on the wrist of the wearer. A display face is formed on the case. Clock circuitry is disposed within the case for operating the display face in order to display the time of the day, the date and elapsed time to the wearer. A sensor in the case detects the stride of the wearer when the wearer is running or jogging. Circuitry within the case is responsive to the sensor for computing the distance traveled by the wearer. Circuitry within the case is also responsive to the sensor for computing the rate of travel by the wearer. Switches are provided on the case for being operated to display the computed distance and the computed rate of travel.

References Cited

U.S. PATENT DOCUMENTS

3,635,399	1/1972	Dahlquist et al.	235/105
3,818,194	6/1974	Biro	235/105
3,860,833	1/1975	Tyau	307/247 A
4,019,030	4/1977	Tamiz	235/105
4,022,014	5/1977	Lowdenslager	364/569
4,053,755	10/1977	Sherrill	364/561

16 Claims, 15 Drawing Figures

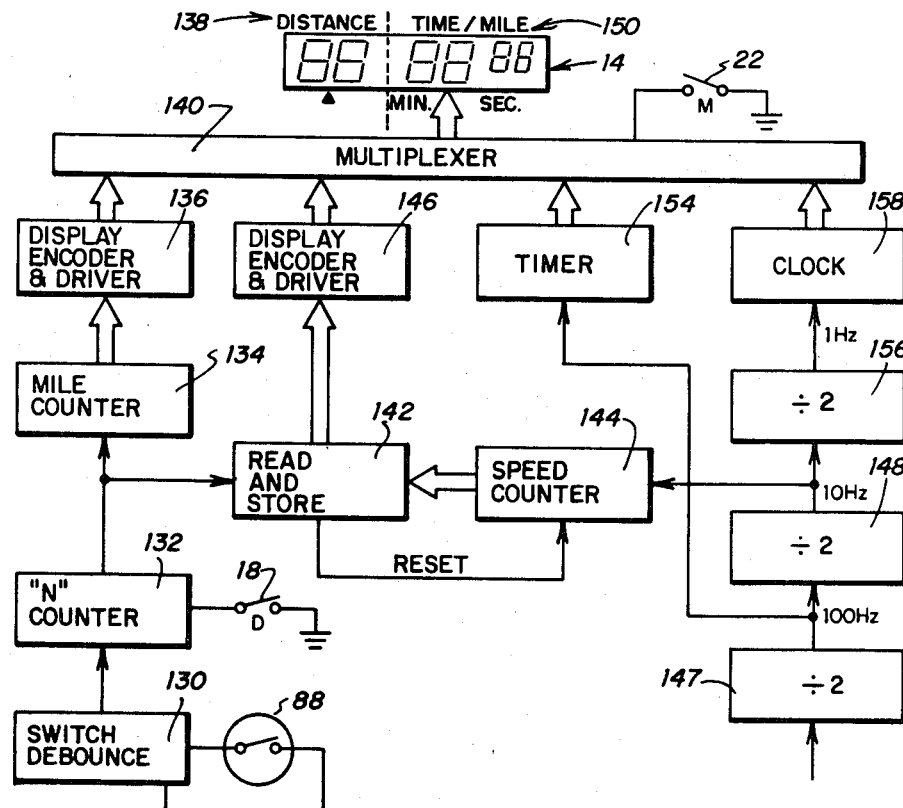

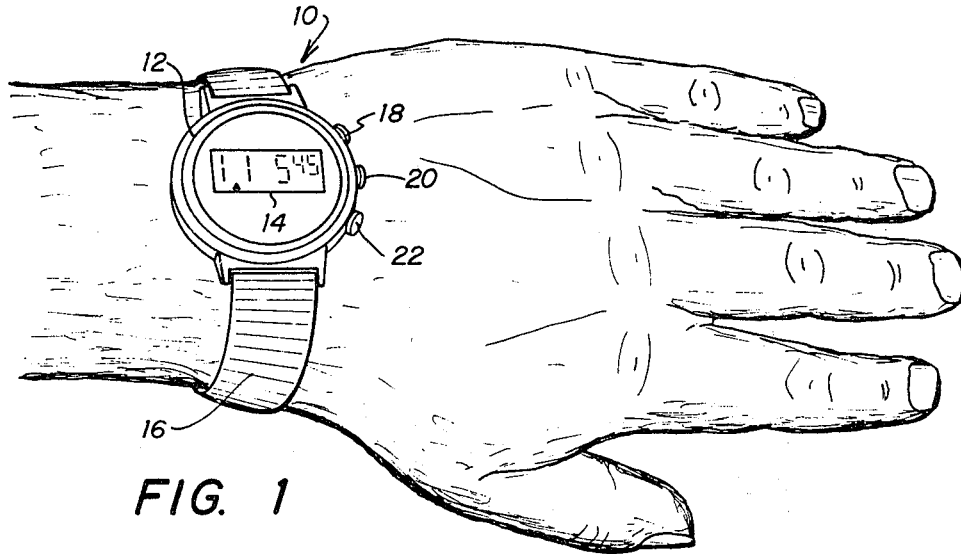

FIG. 1

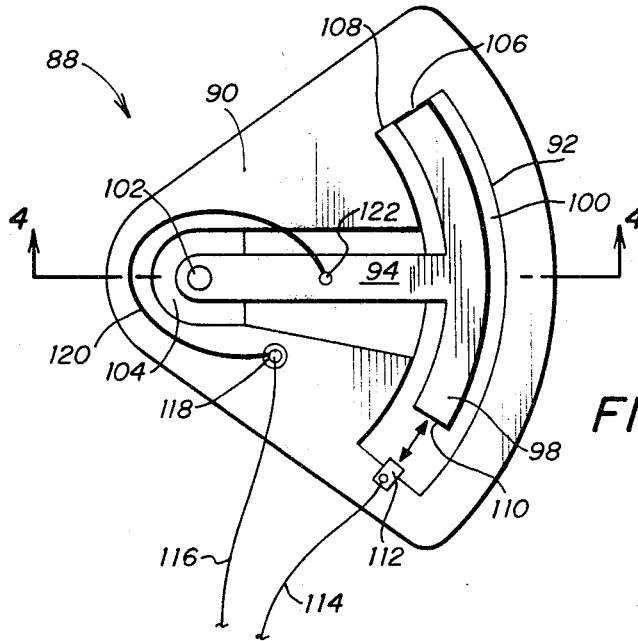

FIG. 3

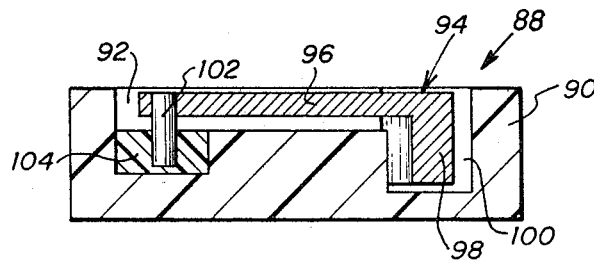

FIG. 4

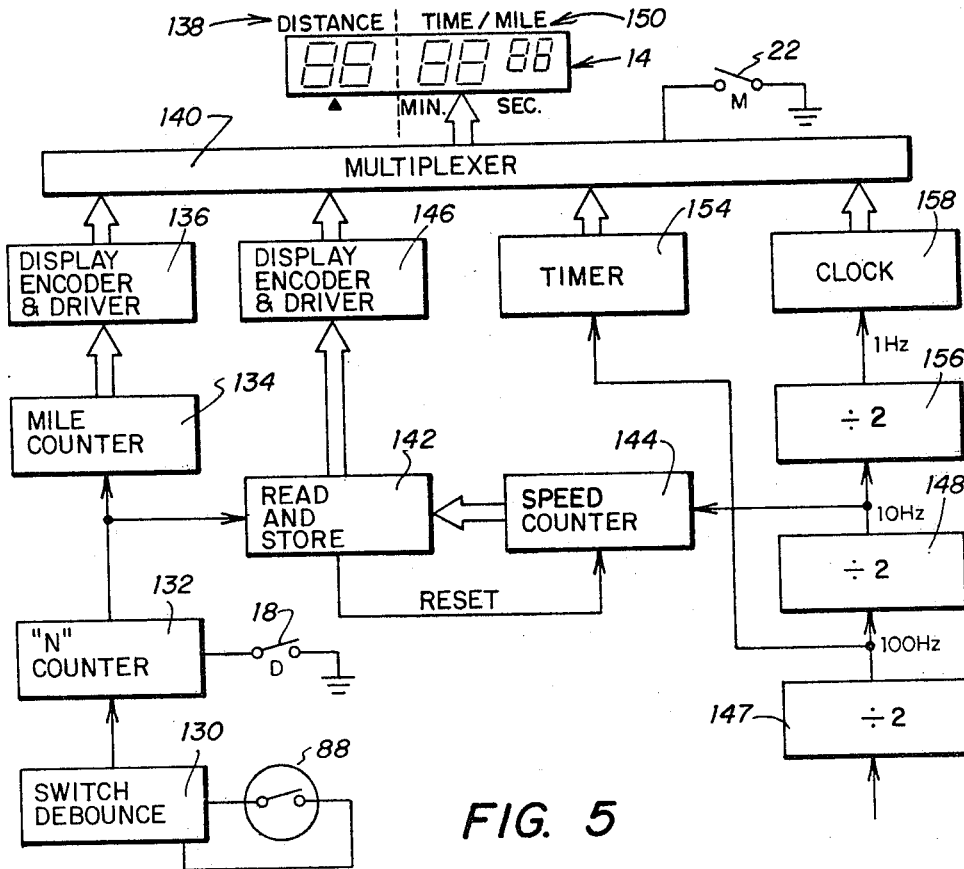

FIG. 5

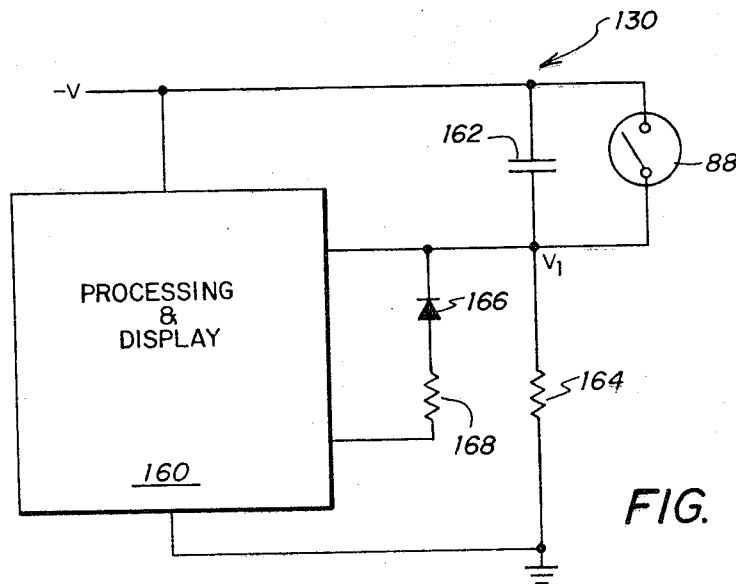
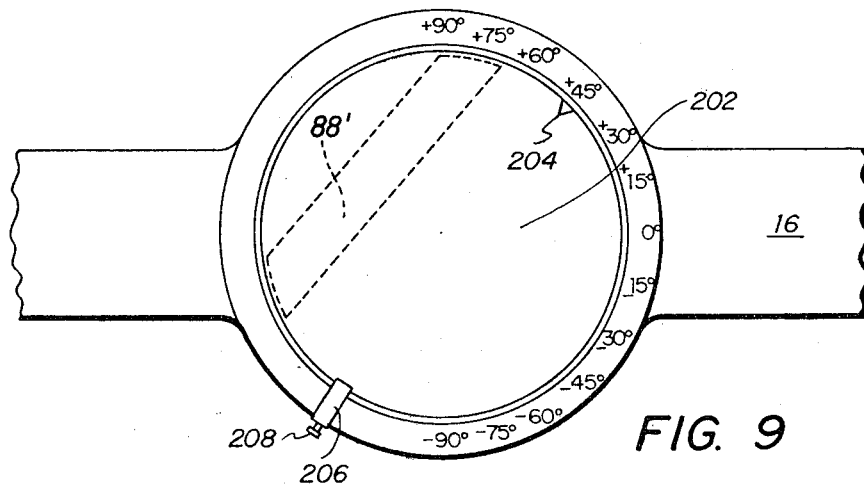
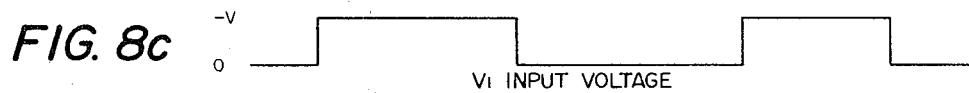
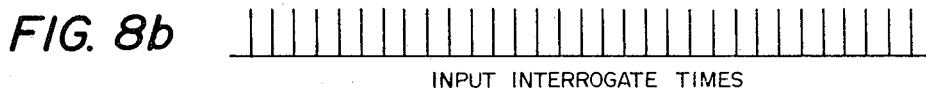
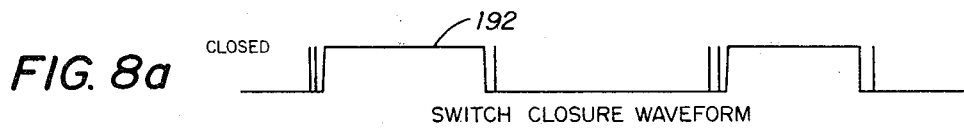
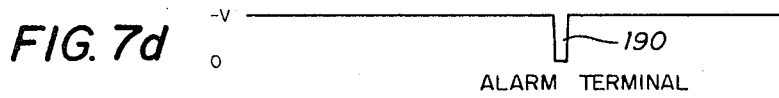
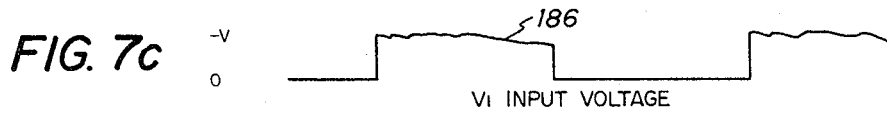
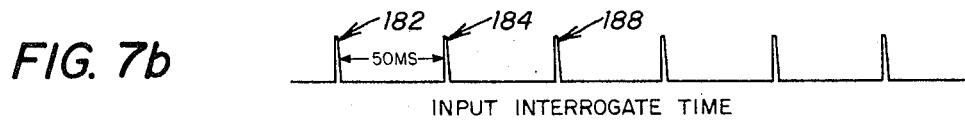
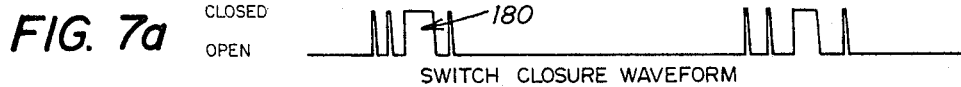

FIG. 6



RUNNERS WATCH

CROSS REFERENCE TO OTHER APPLICATIONS

This application is a continuation-in-part of Ser. No. 06/60,594, filed July 25, 1979, now abandoned.

FIELD OF THE INVENTION

This invention relates to timepieces and distance measuring devices, and more particularly relates to a runners watch for displaying the time of the day, the distance traveled by the runner and the rate of travel of the runner.

THE PRIOR ART

Pedometers of various types have long been used to measure the distance traveled by a person walking or running. Generally, such pedometers have been attached to the ankle, leg or waist of the wearer and have utilized a pendulum or the like in order to sense the motion of the wearer's leg. The pedometers have been calibrated according to the length of the stride taken by the wearer in order to mechanically display the distance walked or jogged. Examples of such previously developed pedometers are shown and described in U.S. Pat. Nos. 694,652, 962,679 and 3,818,194. Such previously developed pedometers have generally been located on a portion of the body making it difficult or impossible to read the distance traveled without removing the device or without stopping and bending over to read the output of the pedometer. Moreover, many previously developed pedometers calibrated according to the wearer's stride have tended to incorporate substantial inaccuracies in the distance traveled. Such pedometers are solely dependent on their accuracy by the accuracy to which the stride length can be measured and stored in the pedometer. Any inaccuracy in the stride length entered into the pedometer results in greater and greater errors as the distance increases. Moreover, many prior pedometers have suffered from inaccuracies due to bouncing of the sensor pendulum, thereby causing multiple readings indicating multiple strides when in fact only a single stride has occurred.

With the advent of jogging and running by the general populus, a need has arisen for a device for measuring the distance traveled with substantial accuracy. Moreover, a need has arisen for a device which may be normally worn during the day and which will also provide the time and date to the wearer. Moreover, many runners desire to know the rate of travel so that they will be able to run a distance in a prescribed time interval. Many runners base their running rate calculations on a mile distance and thus a need has arisen for a device which will continuously provide the runner with an accurate indication of the rate at which he is running based upon a mile distance.

At least on attempt has been made to provide a device for measuring distance traveled which may be viewed while running. For example, the Model JT5-JM8 Omron jogging meter manufactured and sold by Omron Electronics, Inc. of 650 Woodfield, Schaumburg, Ill., displays the distance traveled while positioned on the wrist of the wearer and also displays an elapsed time interval. However, the device is relatively large and bulky and is therefore able to be worn only during running. The weight of the Omron jogging meter is greater than optimum and could affect the running of

certain wearers. This device does not provide an indication of the time of day or date. In addition, this device provides no indication of rate of travel and its distance measuring capabilities are dependent upon the accuracy which the stride length of the wearer is input therein.

SUMMARY OF THE PRESENT INVENTION

In accordance with the present invention, a runners watch includes a case dimensioned to be worn on the wrist of the wearer. A display face is provided on the case and a clock within the case operates the display face to display the time of the day and the date to the wearer. A sensor in the case is provided to detect the strides of the wearer while the wearer is running. Circuitry within the case is responsive to the sensor for computing the distance traveled by the wearer. Circuitry within the case is also provided to compute the rate of travel of the wearer in response to the sensor. A switch is provided on the case which when operated displays the computed distance and the rate of travel.

In accordance with another aspect of the invention, a runners watch is provided which includes a case dimensioned to be worn on the wrist of the wearer. A display face on the case is provided. A sensor in the case detects the occurrence of strides of the wearer while the wearer is running. Circuitry within the case is responsive to the sensor for computing the distance traveled by the wearer and also for computing the rate of travel by the wearer. A switch is provided to display the computed distance and the computed rate of travel on the display face. A sensor includes a pivotable pendulum movable between open and closed positions, the pendulum normally being biased to its open position and movable to its closed position by the acceleration occurring when the wearer's foot hits the ground during a stride.

In accordance with another aspect of the invention, a runners watch includes a case dimensioned to be worn on the arm of the wearer. A display is provided on the case. A detector senses the occurrence of strides of the wearer. Circuitry stores a predetermined number of strides taken by the wearer over a prescribed distance. Means is responsive to the detector for counting the number of strides taken by the wearer. Circuitry is responsive to the store circuitry and counting circuitry for generating an indication when the wearer has taken the predetermined number of strides. Circuitry is responsive to the indication for incrementing on the display the displayed distance traveled by the wearer. A debounce circuit is provided in order to provide a true indication of each one stride to eliminate erroneous indications.

DESCRIPTION OF THE DRAWINGS

For a more complete understanding of the present invention and for other obvious advantages thereof, reference is now made to the following description, taken in conjunction with the accompanying drawings in which:

FIG. 1 is a perspective view of the preferred embodiment of the present runners watch;

FIG. 2 is a state diagram of various operations of the present runners watch;

FIG. 3 is a top view of the present motion detector;

FIG. 4 is a sectional view taken generally along the section lines 4—4 of FIG. 3;

FIG. 5 is a block diagram of the electrical portion of the invention;

Explore Litigation Insights

Docket Alarm provides insights to develop a more informed litigation strategy and the peace of mind of knowing you're on top of things.

Real-Time Litigation Alerts



Keep your litigation team up-to-date with **real-time alerts** and advanced team management tools built for the enterprise, all while greatly reducing PACER spend.

Our comprehensive service means we can handle Federal, State, and Administrative courts across the country.

Advanced Docket Research



With over 230 million records, Docket Alarm's cloud-native docket research platform finds what other services can't. Coverage includes Federal, State, plus PTAB, TTAB, ITC and NLRB decisions, all in one place.

Identify arguments that have been successful in the past with full text, pinpoint searching. Link to case law cited within any court document via Fastcase.

Analytics At Your Fingertips



Learn what happened the last time a particular judge, opposing counsel or company faced cases similar to yours.

Advanced out-of-the-box PTAB and TTAB analytics are always at your fingertips.

API

Docket Alarm offers a powerful API (application programming interface) to developers that want to integrate case filings into their apps.

LAW FIRMS

Build custom dashboards for your attorneys and clients with live data direct from the court.

Automate many repetitive legal tasks like conflict checks, document management, and marketing.

FINANCIAL INSTITUTIONS

Litigation and bankruptcy checks for companies and debtors.

E-DISCOVERY AND LEGAL VENDORS

Sync your system to PACER to automate legal marketing.