



US 20110131520A1

(19) **United States**

(12) **Patent Application Publication**  
Al-Shaykh et al.

(10) **Pub. No.: US 2011/0131520 A1**

(43) **Pub. Date: Jun. 2, 2011**

(54) **SYSTEM AND METHOD FOR  
TRANSFERRING MEDIA CONTENT FROM A  
MOBILE DEVICE TO A HOME NETWORK**

**Publication Classification**

(51) **Int. Cl.**  
*G06F 3/048* (2006.01)  
(52) **U.S. Cl.** ..... 715/772; 715/771

(76) **Inventors:** **Osama Al-Shaykh**, San Diego, CA (US); **Dann Wilkens**, Cardiff, CA (US); **Benjamin Indyk**, San Diego, CA (US)

(57) **ABSTRACT**

A system and a method transfer media content from a mobile device to a home network. A media application on the mobile device may be enabled to share media content with rendering devices in the home network. A user may enable and disable transfer of the media content from the media application to a target rendering device. Further, the media application may indicate visually the target rendering device and whether the media content is currently being transferred. Still further, the user may select a new target rendering device. Moreover, the media application may indicate network errors or other problems which may prevent the rendering of the media content and may enable the user to correct the network errors or the other problems.

(21) **Appl. No.: 12/927,925**

(22) **Filed: Nov. 29, 2010**

**Related U.S. Application Data**

(60) Provisional application No. 61/283,423, filed on Dec. 2, 2009.

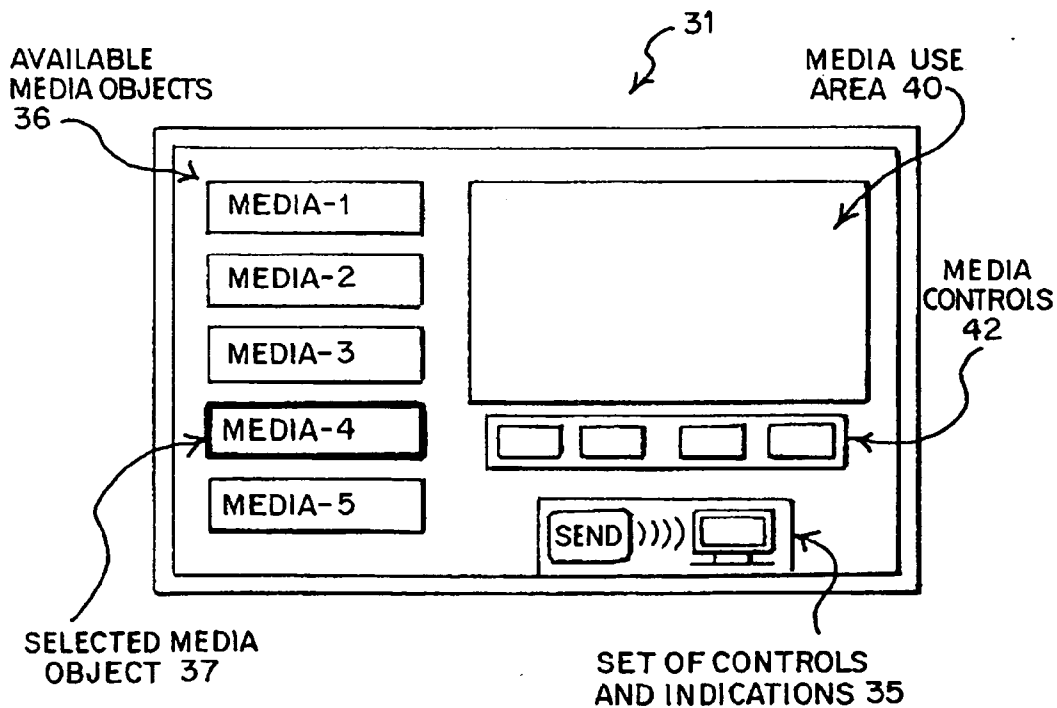

FIG. 1

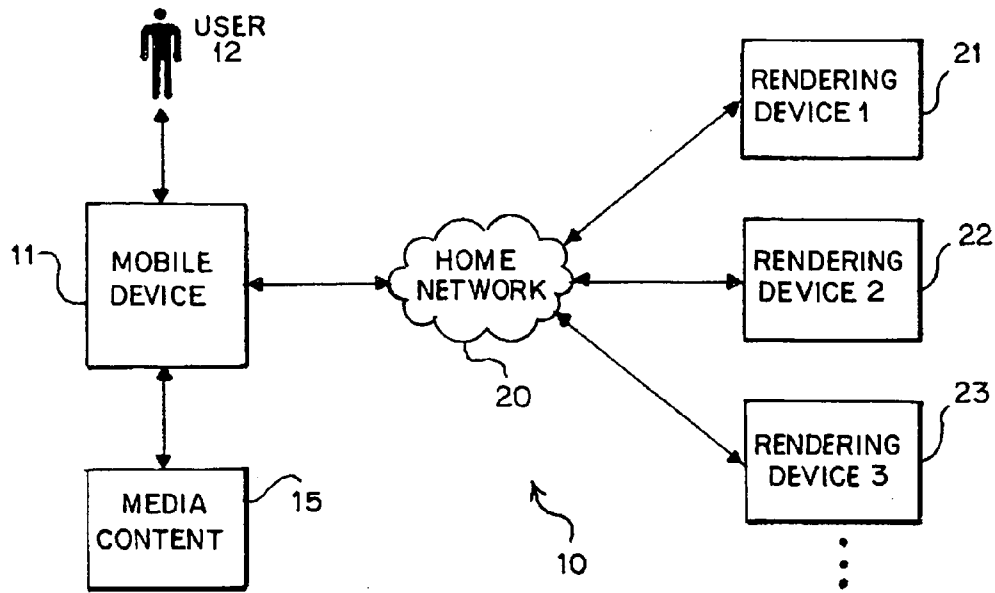

FIG. 2

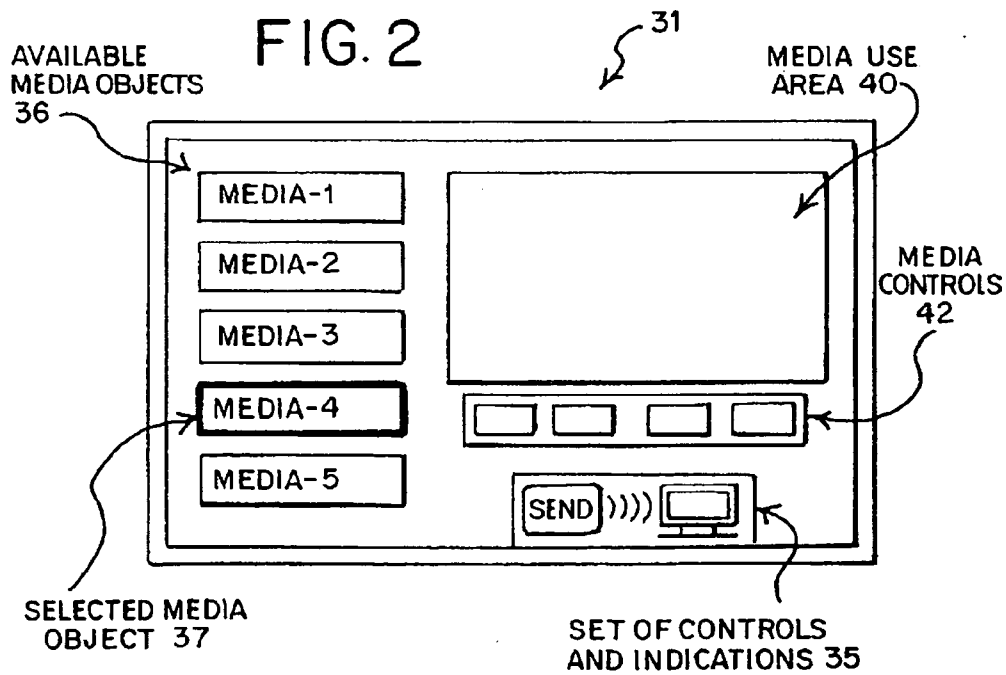

FIG. 3

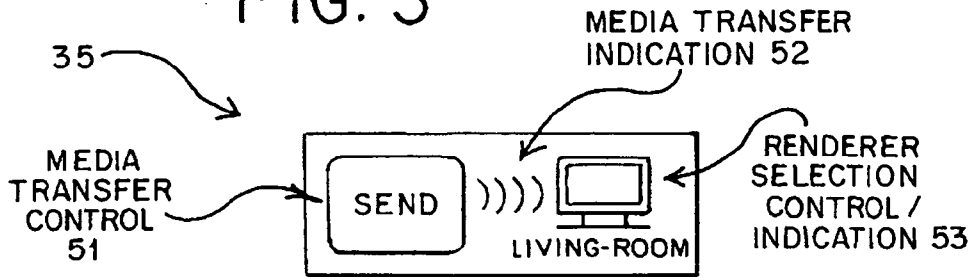

FIG. 4

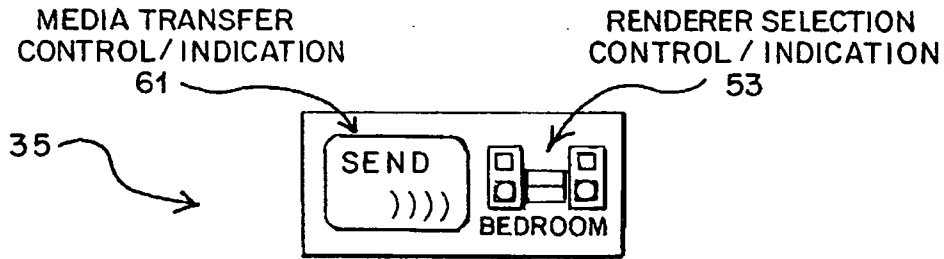
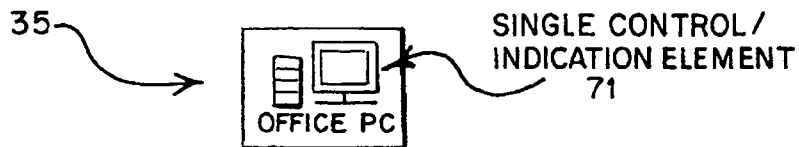
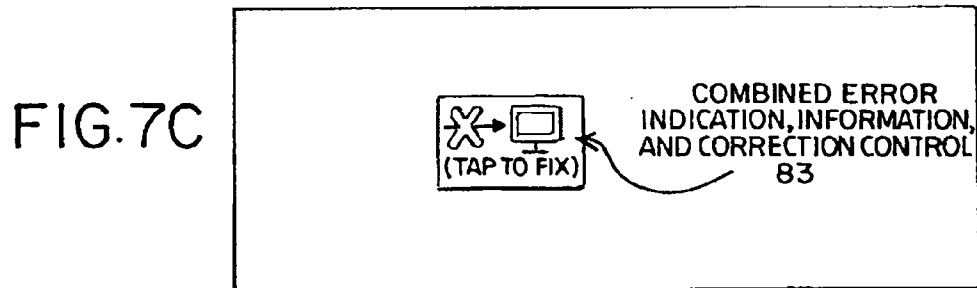
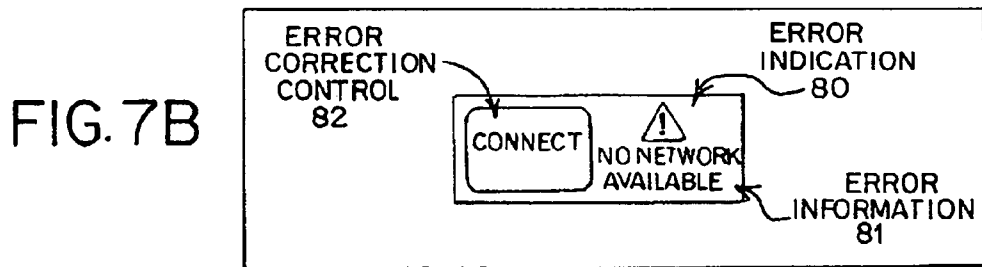
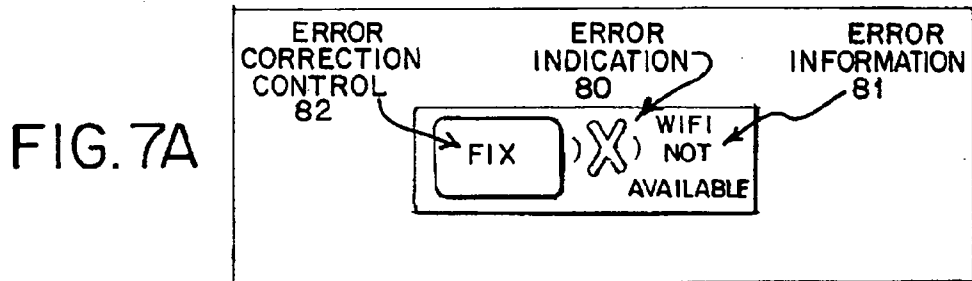
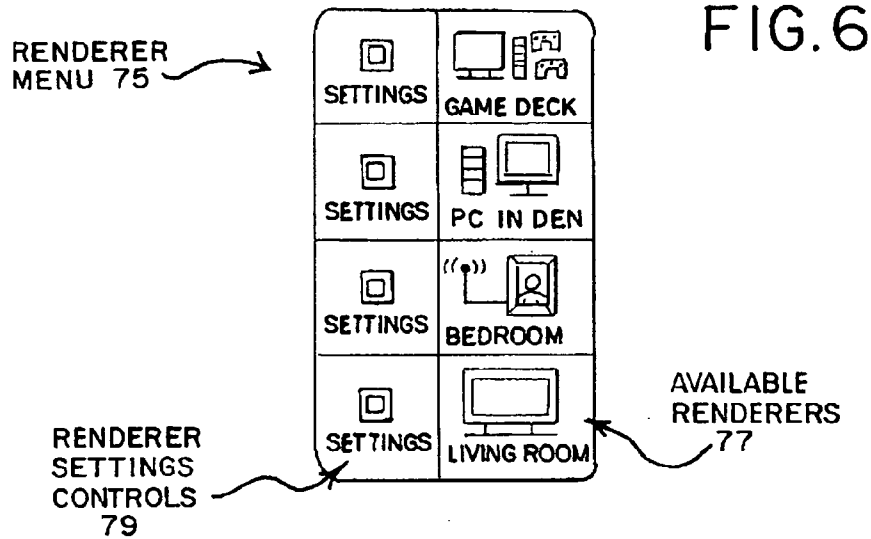
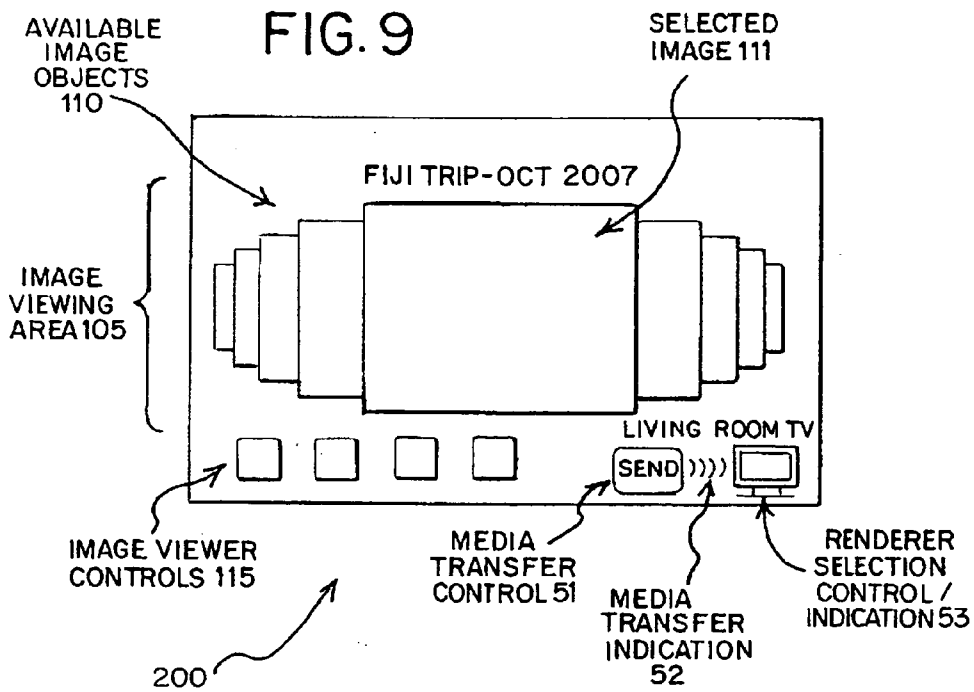
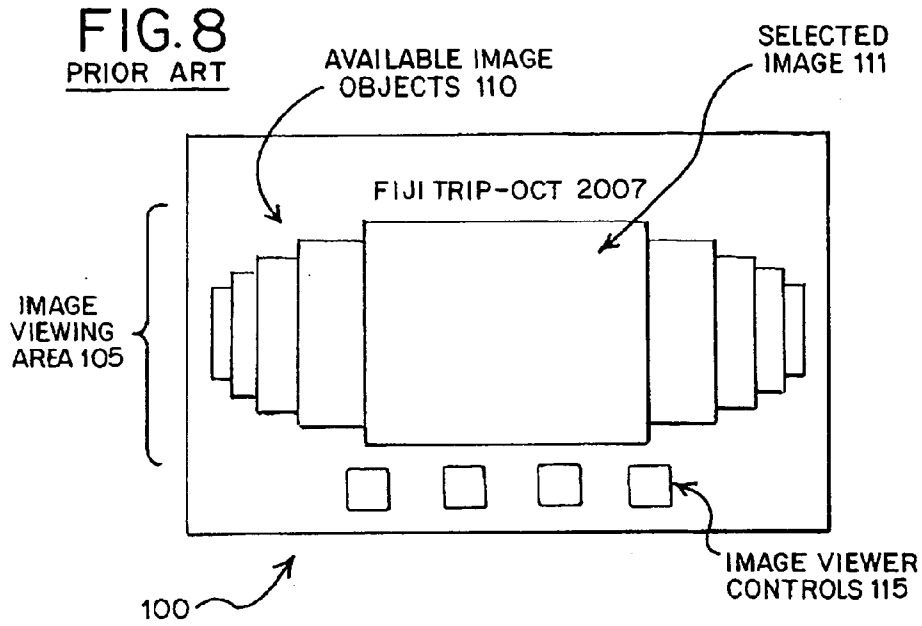

FIG. 5







# Explore Litigation Insights

Docket Alarm provides insights to develop a more informed litigation strategy and the peace of mind of knowing you're on top of things.

## Real-Time Litigation Alerts



Keep your litigation team up-to-date with **real-time alerts** and advanced team management tools built for the enterprise, all while greatly reducing PACER spend.

Our comprehensive service means we can handle Federal, State, and Administrative courts across the country.

## Advanced Docket Research



With over 230 million records, Docket Alarm's cloud-native docket research platform finds what other services can't. Coverage includes Federal, State, plus PTAB, TTAB, ITC and NLRB decisions, all in one place.

Identify arguments that have been successful in the past with full text, pinpoint searching. Link to case law cited within any court document via Fastcase.

## Analytics At Your Fingertips



Learn what happened the last time a particular judge, opposing counsel or company faced cases similar to yours.

Advanced out-of-the-box PTAB and TTAB analytics are always at your fingertips.

## API

Docket Alarm offers a powerful API (application programming interface) to developers that want to integrate case filings into their apps.

## LAW FIRMS

Build custom dashboards for your attorneys and clients with live data direct from the court.

Automate many repetitive legal tasks like conflict checks, document management, and marketing.

## FINANCIAL INSTITUTIONS

Litigation and bankruptcy checks for companies and debtors.

## E-DISCOVERY AND LEGAL VENDORS

Sync your system to PACER to automate legal marketing.