



US007453712B2

(12) **United States Patent**
Kim et al.

(10) **Patent No.:** **US 7,453,712 B2**
(45) **Date of Patent:** **Nov. 18, 2008**

(54) **HYBRID FLASH MEMORY DEVICE AND METHOD FOR ASSIGNING RESERVED BLOCKS THEREOF**

(75) Inventors: **Seon-Taek Kim**, Suwon-si (KR);
Byoung-Kook Lee, Suwon-si (KR)

(73) Assignee: **Samsung Electronics Co., Ltd.**,
Suwon-si, Gyeonggi-do (KR)

(*) Notice: Subject to any disclaimer, the term of this patent is extended or adjusted under 35 U.S.C. 154(b) by 42 days.

(21) Appl. No.: **11/613,366**

(22) Filed: **Dec. 20, 2006**

(65) **Prior Publication Data**
US 2008/0112238 A1 May 15, 2008

(30) **Foreign Application Priority Data**
Oct. 25, 2006 (KR) 10-2006-0104151

(51) **Int. Cl.**
GI1C 5/06 (2006.01)

(52) **U.S. Cl.** **365/63**; 365/200; 365/230.03

(58) **Field of Classification Search** 365/63,
365/200, 230.03, 185.33
See application file for complete search history.

(56) **References Cited**

U.S. PATENT DOCUMENTS

6,418,052 B1 7/2002 Shibata et al.
6,947,322 B2 9/2005 Anzai et al.
2006/0155917 A1* 7/2006 Di Sena et al. 711/103
2007/0233752 A1* 10/2007 Bangalore et al. 707/202

FOREIGN PATENT DOCUMENTS

JP 11-345491 12/1999

JP 2001-006374 12/2001
JP 2002-208287 7/2002
JP 2004-127481 4/2004
KR 1020040011387 2/2004
KR 1020050007653 1/2005
KR 1020060012696 2/2006
KR 1020060021548 3/2006
KR 1020070048384 5/2007

OTHER PUBLICATIONS

English Abstract for Publication No.: 2002-208287.
English Abstract for Publication No.: 1020050007653.
English Abstract for Publication No.: 1020060012696.
English Abstract for Publication No.: 1020060021548.
English Abstract for Publication No.: 1020070048384.

* cited by examiner

Primary Examiner—Thong Q Le
(74) *Attorney, Agent, or Firm*—F. Chau & Associates

(57) **ABSTRACT**

A hybrid flash memory device includes an array including a first area and a second area having a larger number of stored bits per cell than the first area. The device includes a hidden area including a first reserved block area and a second reserved block area, wherein the first reserved block area includes a plurality of first memory blocks having the same number of stored bits per cell as the first area, the second reserved block area includes a plurality of second memory blocks having the same number of stored bits per cell as the second area, and a flash translation layer configured to replace a bad block generated in the first main area with the first memory block and replace a bad block generated in the second main area with the second memory block, wherein the flash translation layer flexibly assigns functions of the first memory blocks or the second memory blocks depending on whether the first and second memory blocks are all used.

20 Claims, 7 Drawing Sheets

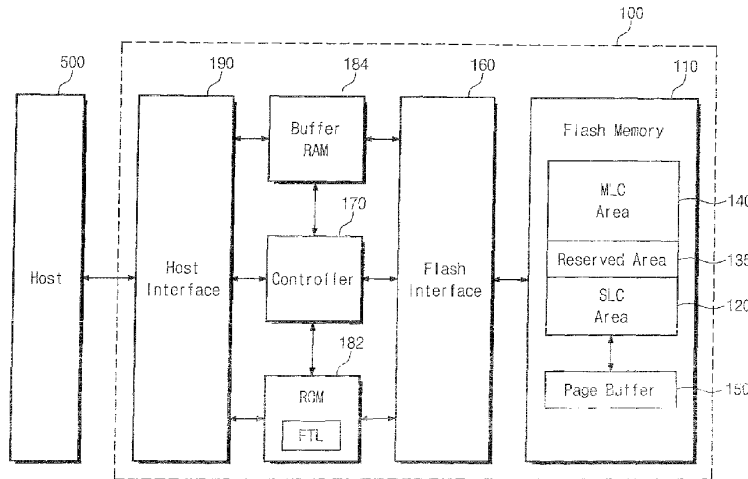

Fig. 1

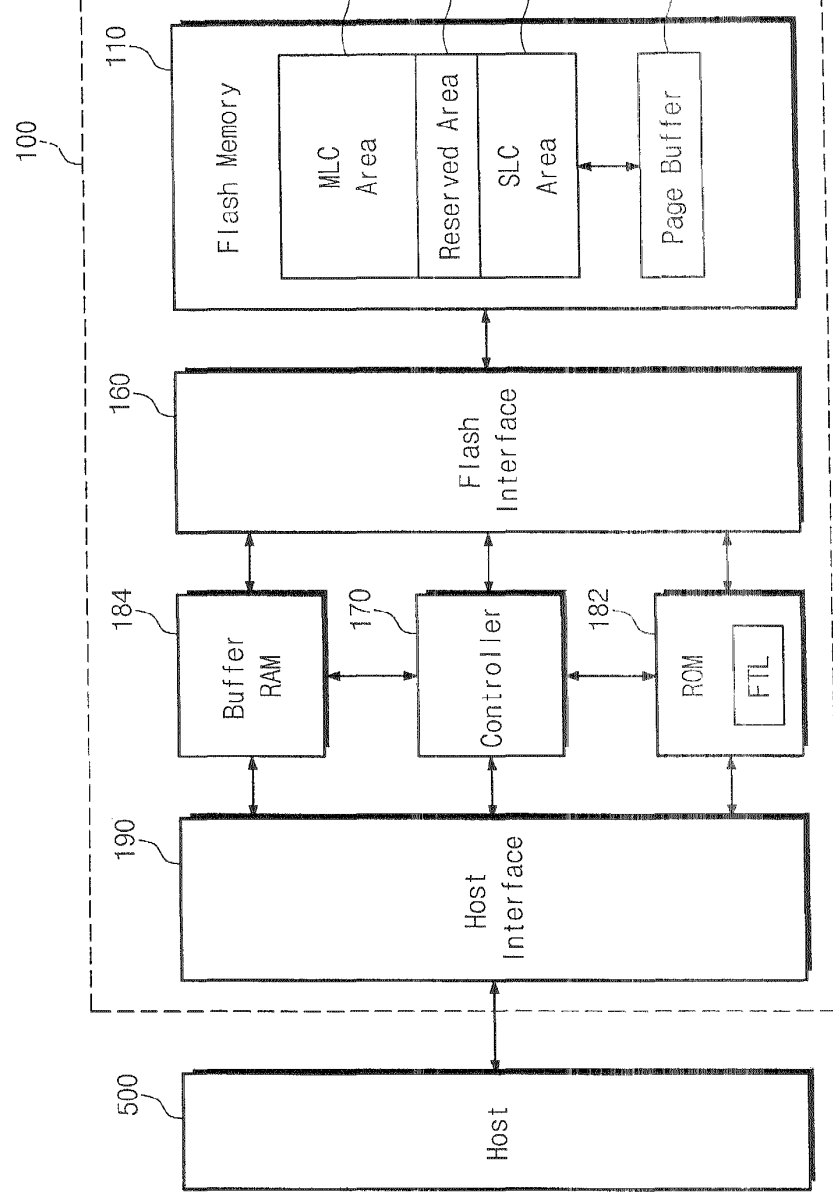

Fig. 2

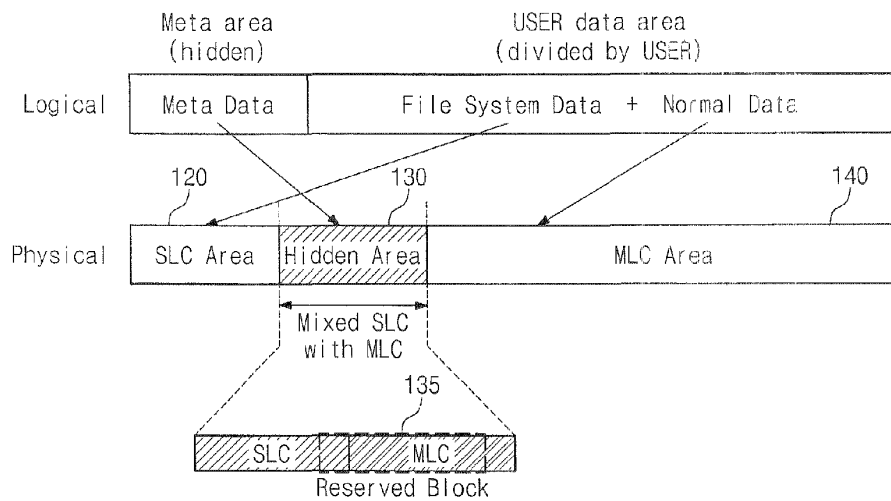

Fig. 3

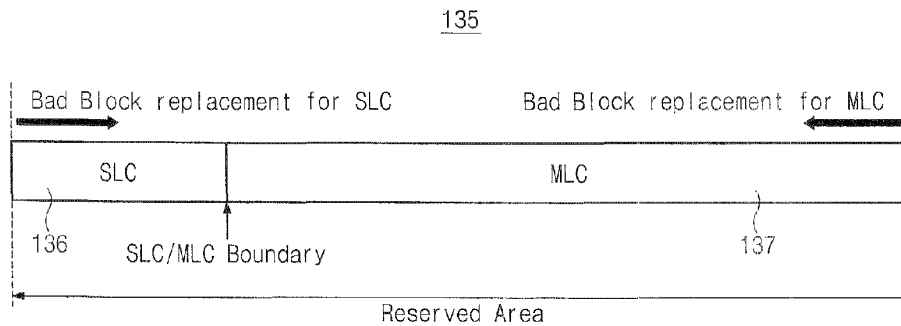

Fig. 4

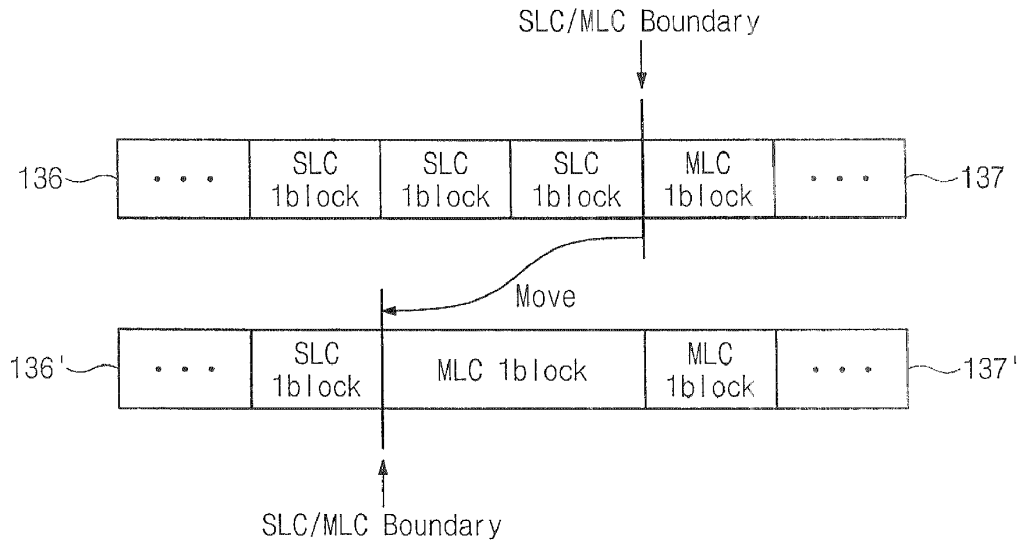

Fig. 5

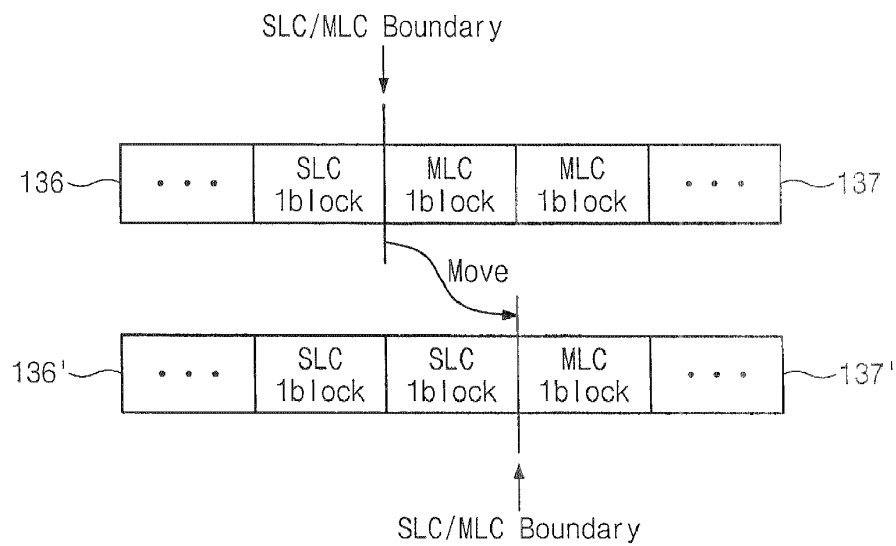
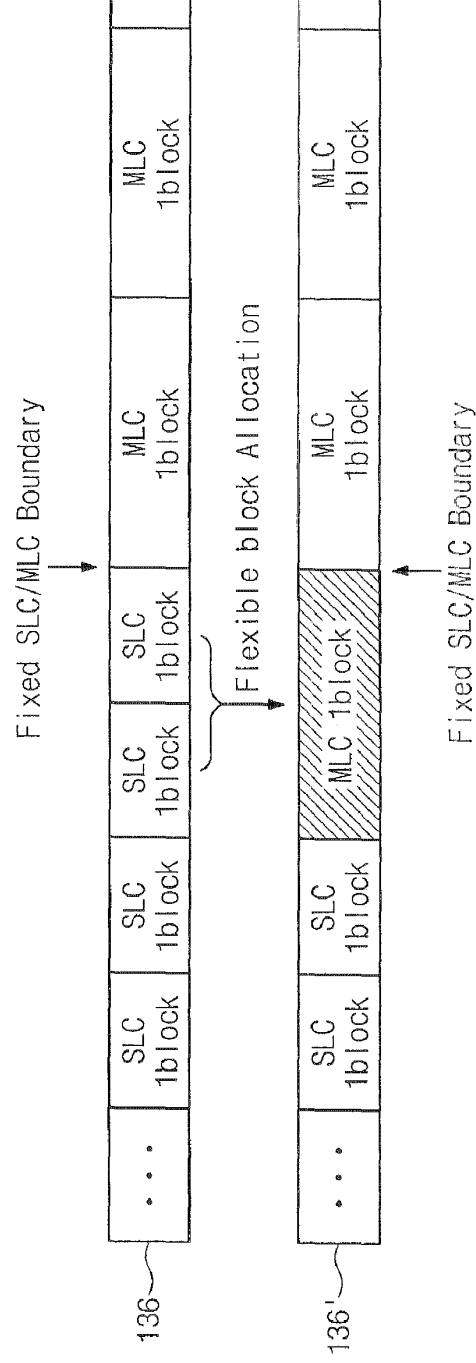

Fig. 6



Explore Litigation Insights

Docket Alarm provides insights to develop a more informed litigation strategy and the peace of mind of knowing you're on top of things.

Real-Time Litigation Alerts



Keep your litigation team up-to-date with **real-time alerts** and advanced team management tools built for the enterprise, all while greatly reducing PACER spend.

Our comprehensive service means we can handle Federal, State, and Administrative courts across the country.

Advanced Docket Research



With over 230 million records, Docket Alarm's cloud-native docket research platform finds what other services can't. Coverage includes Federal, State, plus PTAB, TTAB, ITC and NLRB decisions, all in one place.

Identify arguments that have been successful in the past with full text, pinpoint searching. Link to case law cited within any court document via Fastcase.

Analytics At Your Fingertips



Learn what happened the last time a particular judge, opposing counsel or company faced cases similar to yours.

Advanced out-of-the-box PTAB and TTAB analytics are always at your fingertips.

API

Docket Alarm offers a powerful API (application programming interface) to developers that want to integrate case filings into their apps.

LAW FIRMS

Build custom dashboards for your attorneys and clients with live data direct from the court.

Automate many repetitive legal tasks like conflict checks, document management, and marketing.

FINANCIAL INSTITUTIONS

Litigation and bankruptcy checks for companies and debtors.

E-DISCOVERY AND LEGAL VENDORS

Sync your system to PACER to automate legal marketing.