

**Universal Mobile Telecommunications System (UMTS);
UMTS Terrestrial Radio Access (UTRA);
Concept evaluation
(UMTS 30.06 version 3.0.0)**

The background of the lower half of the page features a large graphic of concentric, overlapping light blue and grey arcs, resembling a stylized signal or wave pattern. The word "UMTS" is printed in a bold, blue, sans-serif font in the upper right quadrant of this graphic.

UMTS

Universal Mobile
Telecommunications System



European Telecommunications Standards Institute

Reference

DTR/SMG-023006U (am001i04.PDF)

Keywords

Access, Air Interface, Radio, UMTS

ETSI Secretariat

Postal address

F-06921 Sophia Antipolis Cedex - FRANCE

Office address

650 Route des Lucioles - Sophia Antipolis
Valbonne - FRANCE
Tel.: +33 4 92 94 42 00 Fax: +33 4 93 65 47 16
Siret N° 348 623 562 00017 - NAF 742 C
Association à but non lucratif enregistrée à la
Sous-Préfecture de Grasse (06) N° 7803/88

X.400

c= fr; a=atlas; p=etsi; s=secretariat

Internet

secretariat@etsi.fr
<http://www.etsi.fr>

Copyright Notification

No part may be reproduced except as authorized by written permission.
The copyright and the foregoing restriction extend to reproduction in all media.

© European Telecommunications Standards Institute 1997.
All rights reserved.

Contents

Intellectual Property Rights.....	4
Foreword	4
1 Scope.....	5
2 References.....	5
Annex A: Concept Group Alpha α - Wideband Direct-Sequence CDMA	8
Annex B: Concept Group Beta β - Orthogonal Frequency Division Multiple Access (OFDMA)	174
Annex C: Concept Group Gamma γ - Wideband TDMA (WB-TDMA)	302
Annex D: Concept Group Delta δ - Wideband TDMA/CDMA.....	486
History	689

Intellectual Property Rights

IPRs essential or potentially essential to the present document may have been declared to ETSI. The information pertaining to these essential IPRs, if any, is publicly available for **ETSI members and non-members**, and can be found in ETR 314: "*Intellectual Property Rights (IPRs); Essential, or potentially Essential, IPRs notified to ETSI in respect of ETSI standards*", which is available **free of charge** from the ETSI Secretariat. Latest updates are available on the ETSI Web server (<http://www.etsi.fr/ipr>).

Pursuant to the ETSI Interim IPR Policy, no investigation, including IPR searches, has been carried out by ETSI. No guarantee can be given as to the existence of other IPRs not referenced in ETR 314 (or the updates on <http://www.etsi.fr/ipr>) which are, or may be, or may become, essential to the present document.

Foreword

This Technical Report (TR) has been produced by ETSI Special Mobile Group (SMG) of the European Telecommunications Standards Institute (ETSI). This Report has been elaborated by SMG2 "Radio aspects", as part of the evaluation of the Universal Mobile Telecommunications System UMTS Terrestrial Radio Access (UTRA) concepts. SMG2 have not been able to conclude that any single one of these concepts provides a better solution than the other concepts.

This Technical Report was prepared during the UTRA evaluation work of SMG2 as a possible basis for the UTRA standard. It is published with the understanding that the full details of the contents have not necessarily been reviewed by, or agreed by, ETSI SMG or SMG2.

NOTE: SMG 2 is responsible for the physical layer of the radio interface and the study of all radio engineering aspects of GSM, DCS 1800 and UMTS,

1 Scope

This document describes the detailed evaluation work towards the definition of the Universal Mobile Telecommunications System UMTS Terrestrial Radio Access (UTRA) within SMG2.

2 References

The documentation for the four concepts compiled in this report may also be found in the following ETSI SMG documentation:

For the α -concept:

- Tdoc SMG 903/97: "System Description Summary";
- Tdoc SMG 904/97: "Evaluation Summary";
- Tdoc SMG 905/97: "Evaluation Report".

For the β -concept:

- Tdoc SMG 894/97: "System Description Summary";
- Tdoc SMG 895/97: "Evaluation Summary";
- Tdoc SMG 896/97: "Evaluation Report".

For the γ -concept

- Tdoc SMG 900/97: "System Description Summary";
- Tdoc SMG 901/97: "Evaluation Summary";
- Tdoc SMG 902/97: "Evaluation Report".

For the δ -concept:

- Tdoc SMG 897/97: "System Description Summary";
- Tdoc SMG 898/97: "Evaluation Summary";
- Tdoc SMG 899/97: "Evaluation Report".

3 Summary of the UTRA definition procedure in SMG2

SMG2's detailed work towards the definition of the UMTS Terrestrial Radio Access (UTRA) within SMG2 was initiated by a workshop on radio access technologies held December 1996. Since then SMG2 have dealt with UMTS Terrestrial Radio Access at several meetings amongst these 4 SMG2 plenaries, 4 ad-hoc meetings dedicated to UMTS, a joint SMG2-ARIB workshop, a question and answer session and numerous concept group meetings.

In the first step of the process the procedure and time schedule for the UTRA definition was elaborated by SMG2 and agreed by SMG at SMG#21. Hereafter, the requirements impacting the UMTS Terrestrial Radio Access was collected and the high level requirements for the UMTS Terrestrial Radio Access documented and approved by SMG#22. The high level requirements were further detailed in UMTS 21.01.

At the same time UMTS 30.03 describing evaluation criteria for the UTRA definition procedure was elaborated. UMTS 21.01 and UMTS 30.03 were approved by SMG#22. In parallel with the work on these reference documents, SMG2 were collecting technical proposals for radio access technologies for the UMTS Terrestrial Radio Access.

These proposals grouped into the following five concepts:

- α -concept** based on wideband CDMA (WCDMA)
- β -concept** based on OFDMA
- γ -concept** based on wideband TDMA (WB-TDMA)
- δ -concept** based on TDMA with spreading (WB TDMA/CDMA)
- ϵ -concept** based on ODMA (Opportunity Driven Multiple Access)

This grouping was presented to SMG#22 for approval. Hereafter, SMG2 formed five concept groups to assist in evaluation of the different building blocks suggested. Through the period since SMG#22 detailed evaluation of the proposals have been performed and the different original proposals combined into one single proposal for UMTS Terrestrial Radio Access per concept group. Originally the intention was then to merge the concepts into one single concept for the UMTS Terrestrial Radio Access. Unfortunately, SMG2 have failed in doing so.

This leaves a situation where the concepts have been refined and their performance been evaluated in detail. Results of link level and system level results have been discussed within SMG2. Further the SMG2 have checked the different concept against the high level requirements. In general it can be said that the concepts can be claimed to fulfil the high level requirements. However, it should be noted that the area of private and residential operation and the use of unpaired spectrum are not areas on which the concept groups have placed the highest attention. Therefore the issue of UMTS deployment of private and residential operation will require further studies in SMG2 to ensure that the requirements in this area are properly met. The issue of how UMTS can be implemented to enable an operator to make the most effective use of the unpaired spectrum, has not been fully addressed and will require further studies in SMG2.

In particular it may be necessary to consider modification of any adopted UMTS Terrestrial Radio Access concept to improve these aspects of performance.

Regarding the results of the evaluation and refinement work performed, SMG2 has informed SMG about the following findings and conclusions regarding the epsilon concept (ODMA - Opportunity Driven Multiple Access):

- Investigation of relay systems has been carried out within the SMG2 considering the technology called Opportunity Driven Multiple Access – ODMA. The protocols used in ODMA are very similar to those of a packet radio system currently being trialed. System level simulations were carried out in accordance with UMTS 30.03 which showed that wide area high data rate coverage was possible in all environments using a subscriber relay system and that there was potential for increased capacity when used in a cellular hybrid.
- Feasibility studies were conducted to determine the practicality of supporting relaying using the basic WCDMA and WB TDMA/CDMA designs. The conclusion was that both the WCDMA and the WB TDMA/CDMA designs were sufficiently flexible to support relaying with negligible increase to the mobile station complexity or cost. These technologies can therefore offer the flexibility of simple relaying but also provide a suitable platform for advanced relay protocols such as ODMA.
- For the above reasons it was decided that relaying/ODMA should be presented as an enhancement to both WCDMA and WB TDMA/CDMA rather than as a standalone technology. As a result documentation from the studies of epsilon concept is included as a part of the evaluation reports on the alpha and delta concepts.

Regarding the four other concepts (α , β , γ , δ) SMG2 has not been able to obtain any further merging. Moreover, when the uncertainty on simulations and the differences in the assumptions made in order to evaluate that performance of the concepts are considered SMG2 has not be able to conclude that any single one of these concept provides a better solution than the other concepts.

Therefore SMG2 requested SMG to decide on the basis of which of the concepts α , β , γ , or δ SMG2 shall continue the work on the UMTS Terrestrial Radio Access. In order to assist SMG in making the decision SMG2 has prepared the following documentation for each of the concepts:

- A summary of system description for the concept
- A summary of the concept evaluation for the concept
- An evaluation report for the concept

It should be noted that SMG2 does not recommend SMG to make a direct comparison of the performance results for concept based directly on the values contained in the evaluation documentation. This due to the different nature of the concepts, which has lead to differences in the assumptions for the performance evaluation, which lead to differences in the results. Especially regarding guard bands SMG2 would like to highlight, that it is difficult to perform a direct comparison of Minimum Coupling Loss (MCL) based guard band analysis, as, e.g., the likelihood for different scenarios might be different for the different concepts.

SMG2 has not been able to reach a consensus on how the results of the evaluation should be compared, and is therefore unlikely to be able to reach a consensus on the technology for UMTS Terrestrial Radio Access in the foreseeable future. SMG2 therefore recommended to SMG that the best way forward for the elaboration of the UMTS radio interface would be for SMG to make a decision on one concept that should be used by SMG2 in the refinement phase.

It is the understanding of SMG2 that by deciding to base the UMTS Terrestrial Radio Access on a given concept, SMG approves the summary of the system description for that concept. This means that the further refinement of the selected concept is done with reference hereto. Meaning that changes in order to improve the concept shall be justified relative to the concept described in the summary system description.

Annex A:

Concept Group Alpha α - Wideband Direct-Sequence CDMA

This report contained in this annex was prepared during the evaluation work of SMG2 as a possible basis for the UTRA standard. It is published on the understanding that the full details of the contents have not necessarily been reviewed by, or agreed by, ETSI SMG or SMG2.

ETSI SMG#24
Madrid, Spain
December 15-19, 1997
Source: SMG2

TDoc SMG 903 / 97
Agenda item 4.1: UTRA

Concept Group Alpha -
Wideband Direct-Sequence CDMA:
System Description Summary

Concept Group Alpha - Wideband Direct-Sequence CDMA

System Description Summary

Introduction

Within the Alpha concept group in SMG2, a UTRA proposal based on wideband direct-sequence CDMA has been developed. The WCDMA concept is described in the Alpha group's evaluation document (Tdoc SMG2 359/97), that contains a system description section. This document presents a summary of the WCDMA system description.

The WCDMA system includes:

- Wideband CDMA carrier to offer a high degree of frequency diversity and high bit-rates
- Flexible physical layer for implementation of UMTS services, with support for large range of varying bit-rates with high granularity
- Built in support for co-existence and efficient handovers with GSM
- Feasible implementation from day one of UMTS, with possibility for performance enhancement using more demanding features like adaptive antennas and multi-user detection in the future

Key technical characteristics of the basic system

Table 1 below summarises the key technical characteristics of the WCDMA radio-interface.

Multiple-access scheme	DS-SS-SSMA
Duplex scheme	FDD / TDD
Chip rate	4.096 Mcps (expandable to 8.192 Mcps and 16.384 Mcps)
Carrier spacing (4.096 Mcps)	Flexible in the range 4.4-5.2 MHz (200 kHz carrier raster)
Frame length	10 ms
Inter-base station synchronisation	FDD mode: No accurate synchronisation needed TDD mode: Synchronisation needed
Multi-rate/variable-rate scheme	Variable-spreading factor and multi-code
Channel coding scheme	Convolutional coding (rate 1/2-1/3) Optional outer Reed-Solomon coding (rate 4/5)
Packet access	Dual mode (common and dedicated channel)

Table 1. WCDMA key technical characteristics.

Performance enhancing features

There exist a number of ways to enhance the performance of the WCDMA system. In general in CDMA, it is very easy to get immediate quality, coverage and capacity gains directly from link improvements. This is due to the single-cell reuse and the fact that power is the only shared resource. If one user's link is improved the transmit power can be lowered on that link, and all users in the system will benefit from this since they are sharing the same power resource.

Listed below are some performance enhancing features that can be applied to the WCDMA system:

- **Downlink antenna diversity.** Antenna diversity in the mobile station is not required in the concept. However, since antenna diversity gives a gain of around 3 dB in performance it can be employed in the terminal for better quality and system capacity.
- **Transmitter diversity.** Orthogonal transmit diversity, where the data stream is split into several streams and sent through different antennas, can be used in the downlink to get quality and capacity gains. This is a good way to get diversity gains in the downlink without increasing the mobile station complexity.
- **Receiver structures.** WCDMA is designed to work without requiring receivers for joint detection of multiple user signals. However, the potential capacity gains of such receivers in a WCDMA system have been recognised and taken into account in the design of the concept. In the uplink the possibility to use only short codes facilitates introduction of more advanced receiver structures with reasonable complexity.
- **Adaptive antennas.** Adaptive antennas are recognised as a way to greatly enhance capacity and coverage of the system. Solutions employing adaptive antennas are already supported in the WCDMA concept through the use of connection-dedicated pilot bits on both uplink and downlink. Moreover, adaptive antenna issues have been included in the design of the downlink common physical channels.
- **Support for relaying and ODMA.** A feasibility study conducted by the Alpha and Epsilon concept groups concluded that WCDMA can support relaying and the ODMA protocol with negligible increase in mobile complexity or cost. ODMA is an intelligent relaying protocol that sits upon the WCDMA radio sub-system. The protocol breaks difficult radio paths into a sequence of shorter hops which enables lower transmit powers or higher data rates to be used. It is the goal of the protocol to choose the least cost route through the relaying system when the relays are moving and the radio paths are dynamically changing. Simulations have shown that relaying has the potential to improve coverage and flexibility and may also increase capacity by lowering transmission powers and associated inter-cell interference.

System description

Physical channel structure, spreading and modulation

There exist two basic physical channels in WCDMA: the dedicated physical data channel and the dedicated physical control channel. The data channel is used to carry dedicated data generated at layer 2 and above, i.e. the dedicated logical channels. The control channel carries control information generated at layer 1. The control information consists of known pilot bits to support channel estimation for coherent detection, transmit power-control commands, and optional (variable-length) rate information. The rate information informs the receiver about the instantaneous rate of the different services and how services are multiplexed on the dedicated physical data channels.

The frame length on the physical channels is 10 ms, and each frame is divided into 16 slots of 0.625 ms each, corresponding to one power-control period. In the downlink the dedicated physical control and data channels are time-multiplexed within the slots, with one power-control command per slot. In the uplink control and data are code-multiplexed and transmitted in parallel.

In both uplink and downlink, the dedicated physical control and data channels are spread to the chip-rate using orthogonal variable rate spreading factor codes. These channelization codes have varying spreading factors to carry varying bit-rate services, i.e the channelization codes are of different lengths to match different user bit rates, with spreading factors from 4 up to 256. Using different channelization codes, several data and control channels of different rates can be spread to the chip-rate and still be orthogonal after spreading. Hence, multi-code transmission can be employed for the highest bit-rates, typically above 384 kbps, and several services of different rates can be transmitted in parallel with maintained orthogonality.

Spreading with the channelization codes is followed by scrambling. In the downlink the scrambling code is base-station specific 10 ms segment of a Gold code of length $2^{18}-1$. The number of available scrambling codes is as high as 512, making code planning trivial. In the uplink, the primary scrambling code is a complex code, built from extended VL-Kasami sequences of length 256. This short code facilitates the introduction of advanced receiver structures, such as multi-user detection. For cells without such receivers, a long secondary scrambling code is used for improved cross-correlation properties and interference averaging. The secondary scrambling code is a 10 ms segment from a Gold code of length $2^{41}-1$.

In uplink and downlink QPSK modulation is used, with root-raised cosine pulse-shaping filters (roll-off 0.22 in the frequency domain).

Channel coding and service multiplexing

WCDMA offers three basic service classes with respect to forward error correction coding: standard services with convolutional coding only ($BER \approx 10^{-3}$), high-quality services with additional outer Reed-Solomon coding ($BER \approx 10^{-6}$), and services with service-specific coding where WCDMA layer 1 does not apply any pre-specified channel coding. The latter class can be used to enable other coding schemes such as e.g. turbo-coding. Rate 1/2 or 1/3 convolutional codes are used, with block interleaving over one or several frames depending on delay requirements. The additional Reed-Solomon code employed is of rate 4/5, and is followed by symbol-wise inter-frame block interleaving.

Multiple services belonging to the same connection are, in normal cases, time multiplexed. Time multiplexing takes place both after possible outer coding and inner coding. After service multiplexing and channel coding, the multi-service data stream is mapped to one or several dedicated physical data channels. A second alternative for service multiplexing is to treat parallel services completely separate with separate channel coding/interleaving and map them to separate physical data channels in a multi-code fashion. With this alternative scheme, the power and consequently the quality of each service can be more independently controlled.

After channel coding and service multiplexing, the total bit rate is almost arbitrary. Rate matching is used to match the coded bit-rate to the limited set of possible bit-rates of a dedicated physical data channel. In the uplink puncturing and repetition is employed to match the rate, while in the downlink puncturing and repetition for the highest rate is used together with discontinuous transmission for the lower rates.

Using the above mentioned coding, interleaving and rate matching techniques the WCDMA concept has shown that rates of at least 2 Mbps can be achieved using a 4.096 Mcps carrier. Also, low bit-rates as well as high bit-rates can be supported efficiently, with high bit-rate granularity.

Radio resource functions

A fast and efficient random access procedure has been defined. The random access is based on slotted Aloha transmission of a random access burst. The burst contains a preamble part, where a base station specific preamble code is used to transmit a preamble sequence randomly picked by the mobile station. The preamble sequence is detected in the receiver using a matched filter, and tells the receiver what scrambling code has been used for the data part of the burst. Using this scheme, the base station may receive up to 80 random-access attempts within one 10 ms frame using only one matched filter for the preamble code.

The WCDMA system operates with a frequency re-use of one. Soft handover enables this, and gives capacity and coverage gains compared to hard handover. Seamless inter-frequency handover is needed for operation in hierarchical cell structures and handover to other systems e.g. GSM.

A key requirement for the support of seamless inter-frequency handover is the possibility for the mobile station to carry out cell search on a carrier frequency different from the current one, without affecting the ordinary data flow. For a mobile station with receiver diversity, there is a possibility for one of the receiver branches to temporarily be reallocated from diversity reception and instead carry out reception on a different carrier. A single-receiver mobile station uses slotted downlink transmission to do inter-frequency measurements. In the slotted mode, the information normally transmitted during a certain time, e.g. a 10 ms frame, is transmitted in less than that time, leaving an idle time that the mobile can use for measurements on other frequencies.

The FDD mode assumes asynchronous base stations. To enable asynchronous operation a fast cell search scheme has been defined. In the cell search procedure the mobile station acquires two synchronisation codes broadcasted by the base station, from which the mobile can determine the scrambling code and frame synchronisation of the base station.

Packet access

Due to the varying characteristics of packet data traffic in terms of packet size and packet intensity, a dual-mode packet-transmission scheme is used for WCDMA. With this scheme, packet transmission can either take place on a common fixed-rate channel or on a dedicated channel, with an adaptive choice of method based on the packet traffic characteristics. Small infrequent packets are typically transmitted on the common channel, while larger more frequent packets are transmitted on a dedicated channel.

Summary

In the development of the WCDMA concept a prerequisite has been to fulfil the UMTS requirements described in ETR-0401. To summarise, the following key features are included in the WCDMA concept for flexible and efficient support of UMTS service needs:

- Support for high data-rate transmission with 384 kbps wide-area coverage and 2 Mbps local area coverage. This can be achieved in a bandwidth of 5 MHz, including guardbands.
- High service flexibility, i.e. good support of multiple bearers and variable bit rates. This is achieved using a physical channel structure that allows multiple bearers on the same physical channel and supports changed user bit-rate on a frame-by-frame basis with very high granularity.
- High capacity and coverage in the basic system without the need for multi-user/joint-detection receivers, dynamic radio-resource-management algorithms and link adaptation, frequency planning etc. However, for future performance enhancements, features like multi-user detection, adaptive antennas, ODMA etc. are supported within the concept.
- Fast and efficient packet access using a dual mode access scheme (common or dedicated channel transmission) with adaptive mode selection based on packet traffic characteristics, together with an efficient random-access mechanism.
- Flexible system deployment with asynchronous base station operation in FDD mode, and spectrum-efficient deployment of hierarchical cell structures.
- Support for inter-frequency handover for operation with hierarchical cell structures, and inter-system handover with second generation systems like GSM.

ETSI SMG#24
Madrid, Spain
December 15-19, 1997
Source: SMG2

TDoc SMG2 904 / 97
Agenda item 4.1: UTRA

Concept Group Alpha
Wideband Direct-Sequence CDMA:
Evaluation Summary

Title: Summary of the Concept Evaluation for the Alpha Concept**Source:** SMG 2

Introduction

This document contains a short description on how the high level requirements that are relevant for the UMTS Terrestrial Radio Access (UTRA) concept are met by the WCDMA concept as being defined within concept group Alpha in SMG 2.

The high level requirements are defined in UMTS 21.02 version 3.0.0 [1], but are also part of TR 101 111 (UMTS 21.01 version 3.0.1) [2]. The latter report has been used to derive the boxes with the requirements as shown below.

The documents that has been issued to SMG 2 from the alpha group has been used in order to make this summary on how the requirements are fulfilled [1-10]. The detailed concept is described in the evaluation report [9] with a summary in [10] and the concept will not be described in detail here. To get a better and deeper understanding of the concept and its fulfilment of the requirements the reader is referred to the referenced documents.

The ODMA (Opportunity Driven Multiple Access) can be used with the Alpha concept WCDMA radio technology as described in the evaluation report [9]. That report also contains a section describing the fulfilment of the high level requirements of WCDMA with the enhancement of ODMA for the routing and access control.

It is shown that the Alpha concept will provide all characteristics in order to support the multitude of services and provide flexible coverage/capacity trade-offs also for future proof evolution.

Fulfilment of the High Level Requirements**Bearer Capabilities****Maximum User Bit Rates**

The UTRA should support a range of maximum user bit rates that depend upon a users current environment as follows:

Rural Outdoor: at least 144 kbit/s (goal to achieve 384 kbit/s), maximum speed: 500 km/h

Suburban Outdoor: at least 384 kbps (goal to achieve 512 kbit/s), maximum speed: 120 km/h

Indoor/Low range outdoor: at least 2Mbps, maximum speed: 10 km/h

It is desirable that the definition of UTRA should allow evolution to higher bit rates.

The transmission blocks have been defined to support up to 2048 kbps user data on one Radio Frequency (RF) Carrier having a transmission rate of 4.096 Mchips/second after spreading. There are error protection schemes defined for both transparent and non-transparent services for the whole range of user data bit rates.

- For Rural outdoor 384 kbps has been evaluated by using the Vehicular test environment as it is defined in UMTS 30.03. Up to 500 km/h is supported as shown in the SMG2 Q&A workshop [11].

- For Suburban Outdoor 384 kbps is supported for the required vehicle speed.
- For Indoor and low range outdoor environment 2048 kbps is supported.

The concept supports 8.196 and 16.392 Mcps, i.e. bit rates up to 4 and 8 Mbps respectively can be supported without large modifications.

Flexibility

Negotiation of bearer service attributes (bearer type, bit rate, delay, BER, up/down link symmetry, protection including none or unequal protection), parallel bearer services (service mix), real-time / non-real-time communication modes, adaptation of bearer service bit rate

Circuit switched and packet oriented bearers

Supports scheduling (and pre-emption) of bearers (including control bearers) according to priority

Adaptivity of link to quality, traffic and network load, and radio conditions (in order to optimise the link in different environments).

Wide range of bit rates should be supported with sufficient granularity

Variable bit rate real time capabilities should be provided.

Bearer services appropriate for speech shall be provided.

It is possible to provide bit rates from 100 bps up to 2 048 kbps with a granularity of 100 bps. The detailed bearer service is negotiated according to bearer type, bit rate(s), delay, BER etc. and during a call the transmitted bit rate can be changed on a 10 ms basis for efficient spectrum usage, e.g. utilising the variable rate nature of speech. The negotiated bearer characteristics can be different in the uplink and the downlink. Both circuit and packet oriented bearers are supported simultaneously to one user. Priority schemes are supported between e.g. circuit-oriented, like speech, and packet transmissions. This can be done easily since there are no need to time share a certain physical resource like a time slot. All users share the same frequency simultaneously and a packet user can instantly be placed on short hold if a higher priority user urgently needs the resource. In WCDMA the resource is total transmitted power. The more power the more resource a user takes.

The TDD mode can be used if asymmetry exists between the needed uplink and downlink traffic capacity to be able to achieve high flexibility. The FDD mode can also be used for the case that more downlink traffic capacity than uplink traffic capacity is needed.

Handover

Provide seamless (to user) handover between cells of one operator.

The UTRA should not prevent seamless HO between different operators or access networks.

Efficient handover between UMTS and 2nd generation systems, e.g. GSM, should be possible.

For the same operator or also between operators or access networks two types of handover are provided. Macro diversity is used for handover between cells using the same frequency (intra-RF HO) and will be the one used most often. It provides for a very good mechanism for seamless handover since no data is lost due to the handover execution. The quality to be provided to a user is then similar to wire-line connection since the loss of data due to the handover does not need to be considered. For inter-frequency handover, which occurs when the used RF-carrier can no longer be used or when a handover between HCS-layers should be performed, a hard handover scheme is used. This HO can be controlled by either the mobiles itself, e.g. if the MS quickly loses the served link in case of very fast changing propagation characteristics, or by the network as in GSM. The handover decision is supported by measurements by using slotted mode transmission for single receiver mobile stations.

Handover between UMTS and GSM depends on the type of multi-mode mobile station implementation. If dual receiver chains are used then the requirement is fulfilled easily. If the UMTS wideband receiver is used for the GSM reception, measurement slots to get knowledge of possible neighbouring GSM base stations. The handover is then performed as a normal hard handover.

Operational Requirements

Compatibility with services provided by present Core Transport Networks

ATM bearer services
GSM services
IP (Internet Protocol) based services
ISDN services

The design of the WCDMA concept has also included the interoperability with GSM radio access, see the handover section above, and naturally the services in GSM are supported also in the case of handover.

The provisioning of other types of services (networks) are possible since the available bit rates in WCDMA are in the range from 0.1 kbps up to 2 048 kbps in 0.1 kbps steps. There are both transparent and non-transparent transmission modes and several different types of services could be simultaneously used by the same user, i.e. multimedia is supported. The required flexibility in service provisioning like variable bit rate and multimedia services are easily provided, taking into account sharing of the radio resources with other users, since no allocations/re-allocations of physical resources are needed when the bit rate changes. It is only needed to adjust the spreading factors and power levels.

The ISDN basic rate access, (2B+D) 144 kbps, has been shown to be supported for wide area coverage. Other ISDN services up to 2048 kbps are also supported with local area coverage.

Radio Access Network Planning

If radio resource planning is required automatic planning shall be supported

In the existing systems, like GSM, they has been defined for basically a single type of quality criteria enabling the radio resource planning to deal with only one C/I requirement that was designed for speech. UMTS will need to support a multitude of different bearer services. A bearer service is characterised by bit rate, delay and bit error rate and for different services different settings will be used. This will create another dimension in the radio network planning to handle this to be able to offer the users the required coverage for the different services.

In WCDMA the common radio resource to be used by all users is power since a frequency re-use of one is used for all bearer services. There is no need to plan codes or code phase since the number of codes are sufficiently large and no inter-base synchronisation is needed. It is needed to plan the number of base stations needed for the level of traffic that is expected including the service mix. This can be done by an automatic planning tool with input parameters: expected services, radio propagation, mobile speeds, quality requirements etc.

Public Network Operators

It shall be possible to guarantee pre-determined levels of quality-of-service to public UMTS network operators in the presence of other authorised UMTS users.

This is done by allocating to each operator exclusive rights spectrum rights and ensure suitable guardbands between the operators.

Private and Residential Operators

The radio access scheme should be suitable for low cost applications where range, mobility and user speed may be limited.
 Multiple unsynchronised systems should be able to successfully coexist in the same environment.
 It should be possible to install basestations without co-ordination.
 Frequency planning should not be needed.

The mechanisms WCDMA can utilise to handle uncoordinated systems are by:

- Frequency avoidance techniques, e.g. not make an access on frequency that is to be disturbed.

- Power control is used to be able to minimise interference but still be able react on increased received interference
- Multi-user detection and interference cancellation techniques can be applied to mitigate interference from e.g. a single dominant interferer as is the most probably case in such operating environment. This will also give a low cost implementation since only one interferer needs to be taken care of.

Spectrum sharing with a so called low tier TDD/WCDMA-system, i.e. low output power mobiles, and FDD/WCDMA-system has also been shown to work in certain environments with limited impact on efficiency.

Efficient Spectrum Usage

Spectrum Efficiency

*High spectrum efficiency for typical mixtures of different bearer services.
Spectrum efficiency at least as good as GSM for low bit rate speech.*

The WCDMA system has been designed to efficiently handle a mixture of services, both for a single user and within cells for all users, without requiring any pre-planned allocation of services to frequencies or codes. All services share the same resource, which is the power.

It has been shown that the performance for speech is between 78-189 kbps/MHz/cell. The result depends on the radio propagation case and vehicle speed. The performance figures are higher than for GSM.

For a 384 kbps@BER=10⁻⁶ connection oriented service for vehicular 120 km/s the simulated performance is between 85-250 kbps/MHz/cell depending on whether antenna diversity or not is used in the downlink.

For a packet service in pedestrian environment and with traffic characteristics of 384 kbps then the performance is 470 to 565 kbps/MHz/cell, uplink and downlink respectively. For indoor packet services with 2048 kbps the performance is between 230 - 500 kbps/MHz/cell depending on whether or not downlink antenna diversity is used.

Variable Asymmetry of Total Band Usage

Variable division of radio resource between uplink and down link resources from a common pool (NB: This division could be in either frequency, time, or code domains)

This is primarily supported by the TDD-mode. It makes it possible to use a portion of the spectrum asymmetrically between the uplink and downlink. In case that FDD only is allowed, it is possible to pair different uplink and downlink portions by using a variable duplex distance. This means that a fixed duplex distance is not needed which enables a little more flexibility in term of asymmetric operation and to have an efficient use of the spectrum. However, it is not possible in this case to switch from a downlink allocation to an uplink allocation due to the FDD operation.

The FDD mode can also be used for the case of that more downlink traffic capacity than uplink traffic capacity is needed. The mechanism to use is the trade off between transmitted power and bit rate needed and the distance MS-to-BS for the uplink. The lower bit rate needed gives a larger coverage in the uplink since this link is power limited due to the MS while the downlink is not so much output power limited.

Spectrum utilisation

*Allow multiple operators to use the band allocated to UMTS without co-ordination¹.
It should be possible to operate the UTRA in any suitable frequency band that becomes available such as first & second generation system's bands.*

-

¹NOTE: The feasibility of spectrum sharing requires further study

Spectrum sharing, without any co-ordination, in the same geographical area and still guarantee a level of quality of service to the users is impossible in any system, see footnote 1. See also the answers to the Private and Residential Operators Requirement for answers related to shared spectrum between operators.

If neighbouring operators operates UMTS then the carrier spacing is 5 MHz yielding a 600 kHz total guardband. For co-sited operation no guardband is needed so the total guardband needed lies between 0 to 600 KHz.

Spectrum refarming is possible. The following figures are for uncoordinated operation between the neighbouring system and WCDMA. For coordinated operation with co-sited GSM and UMTS, the figures shown can be less. If the band is a GSM band 5.2 MHz needs to be cleared if the neighbours are GSM on one side and UMTS on the other band-edge. This results in a carrier spacing of 3 MHz between the first 200 KHz GSM carrier and the WCDMA carrier. If GSM is on both sides 5.6 MHz needs to be cleared. A 200 kHz frequency grid is assumed for the definition of WCDMA frequency carriers to support refarming.

Coverage / Capacity

The system should be flexible to support a variety of initial coverage/capacity configurations and facilitate coverage/capacity evolution

Flexible use of various cell types and relations between cells (e.g. indoor cells, hierarchical cells) within a geographical area without undue waste of radio resources.

Ability to support cost effective coverage in rural areas

The basic property of WCDMA is to have the trade-off between capacity and coverage. The less capacity that are needed the larger the cell can be. Since no frequency re-planning is needed, new cells can be inserted easily to facilitate capacity expansion. In case of asymmetric data traffic and when the major type of traffic in an area are more downlink than uplink it is possible to extend the coverage compared with a symmetric case since the uplink is limited by the mobile power and the interference is less. Note that it is the total sum of traffic that matters so certain individuals can have another asymmetry.

Different types of cells can be handled in the same geographical environment in a limited bandwidth. The basic spectrum building block is 4.4 MHz, without guardband considerations, to handle traffic up to 2 Mbps. A case where there are indoor cells, micro cells and macro cells overlapping each other 14.4 MHz of spectrum is required including necessary guardbands. If one neighbour is an GSM operator the spectrum needed becomes 14.7 MHz. A 15 MHz bandwidth is sufficient to have a three different overlapping cell layers in one geographical region. Sharing of a carrier can be done if the cells have a sufficiently propagation isolation.

Complexity/Cost

Mobile terminal Viability

Handportable and PCMCIA card sized UMTS terminals should be viable in terms of size, weight, operating time, range, effective radiated power and cost.

The WCDMA terminals and its required complexity is well understood, based on both the analytical calculations and also on the implemented test equipment. The calculated complexity for the base band shows that it could be implemented in the technology of today.

The peak power requirement is very close to the average power and thus this can be taken into account in dimensioning the power amplifier. Since continuous transmission is used for all types of services a duplexer is needed but it is already today used in many GSM terminals.

Network Complexity and Cost

The development and equipment cost should be kept at a reasonable level, taking into account the cost of cell sites, the associated network connections, signalling load and traffic overhead (e.g. due to handovers).

The WCDMA system are intended to be used in all environments. The link budgets have shown that it is possible to re-use GSM sites planned for 13 kbps speech service and still provide at least the 144 kbps circuit oriented service considering that the GSM sites are planned for approximately the same frequency band. Low and medium rate services can thus be provided by re-using the GSM-1800 sites.

Since the radio transmission resources are in a common pool, it is possible to share those in a site using sectored antennas. It is also possible to use as many sectors as needed in order to increase capacity. This is possible due to the frequency re-use of one. There is also no advanced adaptation mechanisms needed if the environment changes thus limiting the signalling needed and reconfiguration of the higher layers.

If WCDMA will be a world-wide standard, it is expected that the cost of base stations and associated equipment will benefit from a larger market. Interoperability between operators not only in Europe will also be much simpler since the core network will be based on GSM.

Mobile Station types

It should be possible to provide a variety of Mobile Station types of varying complexity, cost and capabilities in order to satisfy the needs of different types of users.

It will be possible to support a variety of mobile station types in terms of bit rate capabilities but also performance. In terms of performance, a low end data/speech terminal could be developed without antenna diversity while in more advanced terminals two antennas and receiver chains could be implemented for diversity reception.

It is also possible to have the same type of basic functionality in the lower layers of the MS, since all are using the same type of RF channel, but having different service capabilities in the higher layers. For instance, not everybody need a video encoder/decoder which influences the cost. A small number of mobile station types are needed. As an example there could be single or multi-code terminals and they could have antenna diversity or not.

All those types do not need any special considerations or replanning of the radio resources and base station sites. The performance gain from any advanced receiver techniques can be readily used for increasing the capacity.

Requirements from Bodies Outside SMG

Alignment with IMT-2000

UTRA shall meet at least the technical requirements for submission as a candidate technology for IMT 2000 (FPLMTS).

As shown in the alpha group documents issued to SMG2, in particular the evaluation report [9], the proposed WCDMA technology fulfils all the UTRA requirements. The UTRA requirements [2] do include the IMT-2000 requirements, or even exceed in some, so the IMT-2000 requirements are also fulfilled.

Minimum Bandwidth Allocation

It should be possible to deploy and operate a network in a limited bandwidth

The lowest bandwidth carrier rate is 4.096 MChips/s. This will provide at least 384 kbps in a vehicular environment and 2 Mbps in the indoor case. The minimum bandwidth required including guardbands is 5 MHz. For refarming issues, the case when one GSM operator is neighbour at one side of the band then it is required to have a 5.2 MHz band allocated for the WCDMA. If there are GSM operators at either side then 5.6 MHz is needed, including guardbands, i.e. 3 MHz of carrier spacing between the WCDMA carrier and the GSM carrier.

In case of co-ordinated case, as when it is the same operator of GSM and WCDMA, co-ordinated use of GSM and WCDMA the needed carrier spacing can be further relaxed.

Electro-Magnetic Compatibility (EMC)

The peak and average power and envelope variations have to be such that the degree of interference caused to other equipment is not higher than in today's systems.

Compared with GSM and similar TDMA-based systems the WCDMA technology improves the peak to average power ratio and envelope variations due to its continuous transmission properties and fast power control.

RF Radiation Effects

UMTS shall be operative at RF emission power levels which are in line with the recommendations related to electromagnetic radiation.

See the question above. The required E_b/N_0 requirements for the services are improved due to the fact that there is a continuous transmission yielding low envelope variations, peak-to average ratio is low and it uses fast power control. This will result in good link budgets minimising the RF emission power levels within the limits specified by the authorities. As a conclusion WCDMA will have smaller RF radiation effects and at least as good electro magnetic compatibility as GSM whilst offering higher bit rates.

Security

The UMTS radio interface should be able to accommodate at least the same level of protection as the GSM radio interface does.

From a ciphering point of view, all radio interface technologies offer the same level of protection as good as of GSM. Considering the WCDMA concept from a physical layer perspective, the only way that someone can detect a user's uplink signal and read the ciphered data is by using a matched filter since the data is spread. To do this, one must know the spreading code which is selected from a pool with 1 million codes and then also synchronise to the correct phase of the uplink transmission.

WCDMA offers therefore a much higher level of security than what is offered by ciphering alone which is what the GSM radio interface and similar technologies rely upon.

Coexistence with Other Systems

The UMTS Terrestrial Radio Access should be capable to co-exist with other systems within the same or neighbouring band depending on systems and regulations

Depending on what system it has to coexist with a separate analysis has to be made but it is unlikely that the requirement cannot be fulfilled. For GSM an analysis of the required guardbands have been made and it is 5.2 MHz if there is one GSM operator on one edge of the band while there is an UMTS operator on the other side of the band. If there is GSM operators on either side then 5.6 MHz is needed to operate one WCDMA carrier including the necessary guardbands. The figures are for uncoordinated use. In case of any co-ordination the figures can be relaxed.

Multimode Terminal Capability

It should be possible to implement dual mode UMTS/GSM terminals cost effectively.

The basic assumption here is that UMTS will not provide wide-area coverage from the beginning but instead work together with a GSM-900/1800 network and hence it is also needed to perform handover between the radio access schemes. To measure the GSM carriers in WCDMA-mode a slotted mode has been defined.

Separate RF filters are needed for dual mode operation. If dual receiver chains are used then the requirement is fulfilled easily. If the UMTS wideband receiver is used also for the GSM reception the WCDMA concept allows for measurement slots to get knowledge of possible neighbouring GSM base stations. The handover is then performed as a normal hard handover .

References

- [1] ETSI Technical Report, "Universal Mobile Telecommunications System; High level requirements relevant for the definition of the UMTS Terrestrial Radio Access (UTRA) concept (UMTS 21.02 version 3.0.0)," TR 21.02 V3.0.0 (1997-07)
 - [2] ETSI Technical Report, "Universal Mobile Telecommunications System; Requirements for the UMTS Terrestrial Radio Access system (UTRA) (UMTS 21.01 version 3.0.1)," TR 101 111 V3.0.1 (1997-10)
 - [3] Alpha Concept Group, "WCDMA Bearer Capabilities," Tdoc SMG 2 UMTS 137/97, November 17-21, 1997, Helsinki, Finland
 - [4] Alpha Concept Group, "Compliance WCDMA with Operational Requirements (ref. Agenda item 9.2)," Tdoc SMG 2 UMTS 157/97, November 17-21, 1997, Helsinki, Finland
 - [5] Alpha Concept Group, "Spectrum Usage of WCDMA," Tdoc SMG 2 UMTS 138/97, November 17-21, 1997, Helsinki, Finland
 - [6] Alpha Concept Group, "Compliance of WCDMA with Complexity/Cost Requirements (Ref. Agenda item 9.4)," Tdoc SMG 2 UMTS 158/97, November 17-21, 1997, Helsinki, Finland
 - [7] Alpha Concept Group, "Compliance of WCDMA with Other Requirements (Ref. Agenda item 8.5)," Tdoc SMG 2 UMTS 143/97, November 17-21, 1997, Helsinki, Finland
 - [8] Alpha Concept Group, "Compliance of WCDMA with multimode terminal capability (Ref. Agenda item 9.6)," Tdoc SMG 2 UMTS 138/97, November 17-21, 1997, Helsinki, Finland
 - [9] Alpha Concept Group, "Evaluation Report for the Alpha Concept," Tdoc SMG 2 359/97, December 1-5, 1997, Cork, Ireland
 - [10] Alpha Concept Group, "Summary of System Description for the Alpha Concept," Tdoc SMG 2 361/97, December 1-5, 1997, Cork, Ireland
 - [11] Alpha Concept Group, "WCDMA questions and Answers, (Version 1.0)," Tdoc SMG2 91/97, October 27-28, 1997, Taastrup, Denmark
-

**ETSI SMG
Meeting no 24
Madrid, Spain
15 - 19 December 1997**

Tdoc SMG 905/97

Source: SMG2

Concept Group Alpha - Wideband Direct-Sequence CDMA (WCDMA)

EVALUATION DOCUMENT (3.0)

Part 1: System Description Performance Evaluation

In the procedure to define the UMTS Terrestrial Radio Access (UTRA), the wideband DS-CDMA concept group (Alpha) will develop and evaluate a multiple access concept based on direct sequence code division. This group was formed around the DS-CDMA proposals from ACTS FRAMES Consortium (FMA2), Fujitsu, NEC and Panasonic. The main radio transmission technology (RTT) and parameters of the common concept from the Alpha group along with performance results are presented in this document.

<p>This document was prepared during the evaluation work of SMG2 as a possible basis for the UTRA standard. It is provided to SMG on the understanding that the full details of the contents have not necessarily been reviewed by, or agreed by, SMG2.</p>

1. INTRODUCTION	28
2. SYSTEM DESCRIPTION	30
2.1 WCDMA KEY FEATURES	30
2.2 WCDMA KEY TECHNICAL CHARACTERISTICS	30
2.3 WCDMA LOGICAL-CHANNEL STRUCTURE	31
2.3.1 <i>Common Control Channels</i>	31
2.3.1.1 BCCH - Broadcast Control Channel (DL)	31
2.3.1.2 FACH - Forward Access Channel (DL)	31
2.3.1.3 PCH - Paging Channel (DL)	31
2.3.1.4 RACH - Random Access Channel (UL)	31
2.3.2 <i>Dedicated Channels</i>	31
2.3.2.1 DCCH - Dedicated Control Channel (DL and UL)	31
2.3.2.2 DTCH - Dedicated Traffic Channel (DL and/or UL)	32
2.3.3 <i>Summary of logical-to-physical channel mapping</i>	32
2.4 WCDMA PHYSICAL-CHANNEL STRUCTURE	33
2.4.1 <i>Dedicated physical channels</i>	33
2.4.1.1 Downlink dedicated physical channels	33
2.4.1.2 Uplink dedicated physical channels	35
2.4.2 <i>Common physical channels</i>	36
2.4.2.1 Primary and Secondary Common Control Physical Channel (CCPCH)	36
2.4.2.2 Physical Random Access Channel	37
2.4.2.3 Synchronisation Channel	37
2.5 CHANNEL CODING AND SERVICE MULTIPLEXING	39
2.5.1 <i>Channel coding/interleaving for user services</i>	39
2.5.1.1 Inner coding/interleaving	39
2.5.1.2 Outer coding/interleaving	39
2.5.2 <i>Service multiplexing</i>	39
2.5.3 <i>Rate matching</i>	40
2.5.3.1 Uplink	40
2.5.3.2 Downlink	40
2.5.4 <i>Channel coding/interleaving for control channels</i>	41
2.5.4.1 Dedicated Control Channel	41
2.5.4.2 Downlink Common Control Channels	41
2.5.5 <i>Example mapping for the test services</i>	41
2.5.5.1 8 kbps bearer	41
2.5.5.2 144 kbps bearer	41
2.5.5.3 384 kbps bearer	42
2.5.5.4 480 kbps bearer	42
2.5.5.5 2.4 Mbps bearer	42

2.6 RADIO RESOURCE FUNCTIONS.....	43
2.6.1 <i>Random Access</i>	43
2.6.1.1 Random-Access burst structure.....	43
2.6.1.2 Random-Access procedure.....	44
2.6.2 <i>Code allocation</i>	45
2.6.2.1 Downlink.....	45
2.6.2.2 Uplink.....	45
2.6.3 <i>Power control</i>	45
2.6.3.1 Uplink power control.....	45
2.6.3.2 Downlink power control.....	46
2.6.4 <i>Initial cell search</i>	47
2.6.4.1 Step 1: Slot synchronisation.....	47
2.6.4.2 Step 2: Frame synchronisation and code-group identification.....	47
2.6.4.3 Step 3: Scrambling-code identification.....	48
2.6.5 <i>Handover</i>	48
2.6.5.1 Intra-frequency handover.....	48
2.6.5.2 Inter-frequency handover.....	48
2.7 WCDMA PACKET ACCESS.....	51
2.7.1 <i>Common-channel packet transmission</i>	51
2.7.2 <i>Dedicated-channel packet transmission</i>	51
2.7.2.1 Single-packet transmission.....	51
2.7.2.2 Multi-packet transmission.....	52
2.7.3 <i>Layer 2 overview</i>	53
2.7.3.1 Logical Link Control (LLC).....	53
2.7.3.2 Medium Access Control (MAC).....	54
2.7.3.3 Radio Link Control (RLC).....	54
2.7.4 <i>Packet data handover</i>	54
2.8 SUPPORT OF POSITIONING FUNCTIONALITY.....	55
2.9 SUPPORT OF TDD.....	56
2.9.1 <i>TDD operation</i>	56
2.9.1.1 Cellular public.....	56
2.9.1.2 Unlicensed private.....	57
2.9.2 <i>Frame structures</i>	57
2.9.3 <i>TDD advantages</i>	58
2.10 PERFORMANCE ENHANCING FEATURES.....	59
2.10.1 <i>Support of adaptive antennas</i>	59
2.10.2 <i>Support of advanced receiver structures</i>	59
2.10.3 <i>Support of transmitter diversity</i>	59
2.10.3.1 Transmitter diversity for FDD mode.....	59
2.10.3.2 Transmitter diversity for TDD mode.....	60

2.10.4 Optimised uplink pilot power	60
3. PERFORMANCE EVALUATION.....	61
3.1 IMPLEMENTATION OF WCDMA/FDD SIMULATIONS	61
3.1.1 Link-Level Simulations	62
3.1.1.1 Simulation Model.....	62
3.1.1.2 Searcher Performance	62
3.1.1.3 Channel Models	63
3.1.2 System-Level Simulations	64
3.1.2.1 Simulation Environment	64
3.1.2.2 Downlink Orthogonality	65
3.1.2.3 Soft / Softer Data Combining.....	65
3.1.2.4 Increase in TX Power due to Power Control.....	65
3.1.2.5 Radio Resource Management.....	66
3.1.2.6 Performance Measures	66
3.2 RESULTS.....	67
3.2.1 Link-Level Simulations	67
3.2.1.1 Speech Service	67
3.2.1.2 LCD Services	68
3.2.1.3 UDD Services	68
3.2.2 System-Level Simulations	69
3.2.2.1 Circuit-Switched Services	69
3.2.2.2 Packet Services	71
3.2.2.3 Mixed Services.....	72
3.3 SUMMARY OF SIMULATION RESULTS.....	73
4. CONCLUSIONS.....	75

Part 2:**Introduction****Answers to the Annex1 in ETR0402****Link budget calculation****Complexity and dual mode GSM/UMTS terminal analysis****Part 3:****Detailed simulation results and parameters****Part 4:****WCDMA/ODMA description**

Glossary of abbreviations used in the document:

ARQ	Automatic repeat request
BCCH	Broadcast Control Channel
BER	Bit error rate
BLER	Block error rate
BS	Base Station
CCPCH	Common Control Physical Channel
DL	Downlink (forward link)
DCCH	Dedicated Control Channel
DPCCH	Dedicated Physical Control Channel
DPDCH	Dedicated Physical Data Channel
DS-CDMA	Direct-Sequence Code Division Multiple Access
DTCH	Dedicated Traffic Channel
FACH	Forward Access Channel
FCH	Frame control header
FDD	Frequency Division Duplex
FER	Frame error rate
Mcps	Mega Chip Per Second
MS	Mobile Station
ODMA	Opportunity Driven Multiple Access
OVSF (codes)	Orthogonal Variable Spreading Factor (codes)
PCH	Paging Channel
PG	Processing gain
PRACH	Physical Random Access Channel
PUF	Power Up Function
RACH	Random Access Channel
SCH	Synchronization Channel
SF	Spreading factor
SIR	Signal-to-interference ratio
TDD	Time Division Duplex
UL	Uplink (reverse link)
VA	Voice activity
WCDMA	Wideband CDMA

1. INTRODUCTION

SMG has agreed on a process of selecting the UTRA concept before the end of 1997. According to this process WCDMA concept group presents an updated version of the Evaluation Document to the SMG2 UMTS Ad Hoc meeting, November 17-21, 1997. The Evaluation Document from each concept group should include of a description of the concept group's concept and simulation results using the models from ETR0402 and the services from Tdoc260/97 from SMG2#22. In this report the Wideband DS-CDMA (WCDMA) concept group (the Alpha concept group) presents its UTRA concept and its performance results.

The first inputs to the Alpha group (the concept group was then not officially started) were given at SMG2#21, March 3-7, 1997. The inputs were primarily from ACTS FRAMES¹ project (FMA2), Fujitsu, NEC, and Panasonic. These main inputs were based on concepts developed during several years and partly verified in test systems.

At the SMG2#22 meeting, May 12-16, 1997, five concept groups were created and officially approved at an SMG meeting thereafter. The Alpha Concept group is one of these groups. After that, the Alpha group has had the following meetings:

- In London, June 25, 1997, where a few basic assumptions of the WCDMA concept were agreed.
- In Rennes (an afternoon meeting at the SMG2 UMTS ad hoc, August 5-8, 1997), where more inputs to the Alpha concept group were given.
- In Stockholm September 15-16, 1997.
- In London, November 3-4, 1997

At all these meeting a number of companies have contributed with inputs to the Alpha concept development discussion. With all inputs and different proposals for the WCDMA concept, the Alpha group has gone through a merging process to one common WCDMA concept. This merging process was finalized at the Stockholm meeting where all participants agreed on one common WCDMA concept in the Alpha group. The Stockholm meeting had participants from 26 companies.

Having so many companies involved in the Alpha group has created a working technical discussion with feedback on the proposed solutions from companies with experience from several multiple-access techniques. Thus the merging process towards a common concept has resulted in the thoroughly reviewed concept accepted by all participants of the concept group.

In the development of the WCDMA concept presented in this report a prerequisite has been to fulfil the UMTS requirements described in ETR0401. To summarise, the following key features are included in the Alpha group's WCDMA concept for flexible and efficient support of UMTS service needs:

- Support for high data-rate transmission (384 kpbs with wide-area coverage and 2 Mbps with local area coverage). This can be achieved in a bandwidth of 5 MHz.
- High service flexibility, i.e., good support of multiple bearers and variable bit rates. This is achieved with a DPCCCH/DPDCH channel structure which allows multiple bearers on the same physical channel and which supports the user bit-rate to be changed on a frame-by-frame basis (10 ms) with a granularity as low as 100 bps.
- Good capacity and coverage in the basic system without the need for complex methods (complicated multi-user/joint-detection receivers, sophisticated dynamic radio-resource-management algorithms, complex link adaptation, frequency planning, etc.). However, in order to preserve future proofness, features like multi-user detection, adaptive antennas etc. are supported within the concept to be used for future performance enhancements.
- Efficient power control. This reduces the emitted interference (increased capacity) and reduces the transmission power (increased battery life time).

¹ ACTS FRAMES project consortium consists of several European industrial partners including CSEM/Pro Telecom, Ericsson, France Telecom, Nokia, Siemens and of several university partners. The project is partially funded by the European Commission.

- Efficient utilisation of the achievable frequency diversity with wideband signal.
- Efficient packet access with a very fast control channel for packet-access signalling and packet acknowledgements.
- Spectrum-efficient support of HCS.
- No periodicity in the envelope of the uplink transmitted signal avoids problems with audible interference.

The concept presented in this report has many similarities with the Wideband CDMA system which is currently being standardised in the Japanese standardisation body ARIB. This gives good possibilities for a standard not only for UMTS in Europe, but also for a global IMT2000 standard in ITU. In terms of system deployment this means cost efficiencies due to the economics of scale in the equipment manufacturing. It also facilitates roaming on a global basis.

The following is an outline of this document:

Part 1 begins with the Alpha concept description in Chapter 2 “System Description”.

The performance evaluation of the Alpha concept is described in Chapter 3. Chapter 3.1 describes how the FDD simulations have been implemented and interpreted from ETR0402. In Chapter 3.2 all FDD simulations results are presented and in Chapter 3.3 the FDD simulation results are summarised.

Finally, in Chapter 4, conclusions are presented.

The report also consists of Part 2, Part 3 and Part 4. Part 2 contains the first version of the Alpha group’s answers to Annex 1 of ETR0402. Part 3 contains the detailed simulation results and parameters used in the simulations as well as link budget calculations and dual mode GSM UMTS terminal issues. Part 4 contains the WCDMA/ODMA description.

This is the final version of the Alpha Group evaluation report, additional items may be provided if needed then later as an annex, but this document forms the basis for the UMTS standardisation if WCDMA is selected as the UMTS Terrestrial Radio Access (UTRA) concept as recommended by the Alpha group.

The concept group Alpha contact persons are:

Mikael Gudmundson	Ericsson	mikael.gudmundson@era-t.ericsson.se
Andy Bell	NEC	andy.bell@necotech.co.uk
Antti Toskala	Nokia	antti.toskala@research.nokia.com

Concept group has also an e-mail distribution list: smg2alpha@list.etsi.fr.

2. SYSTEM DESCRIPTION

2.1 WCDMA key features

Listed below are the key service- and operational features of the WCDMA radio-interface:

- Support for high-data-rate transmission (384 kbps with wide-area coverage, 2 Mbps with local coverage).
- High service flexibility with support of multiple parallel variable-rate services on each connection.
- Efficient packet access.
- Built-in support for future capacity/coverage-enhancing technologies, such as adaptive antennas, advanced receiver structures, and transmitter diversity.
- Support of inter-frequency handover for operation with hierarchical cell structures and handover to other systems, including handover to GSM.
- Both FDD and TDD operation.

2.2 WCDMA key technical characteristics

Table 1 summarises the key technical characteristics of the WCDMA radio-interface.

Multiple-Access scheme	DS-CDMA
Duplex scheme	FDD / TDD
Chip rate	4.096 Mcps (expandable to 8.192 Mcps and 16.384 Mcps)
Carrier spacing (4.096 Mcps)	Flexible in the range 4.4-5.2 MHz (200 kHz carrier raster)
Frame length	10 ms
Inter-BS synchronization	FDD mode: No accurate synchronization needed TDD mode: Synchronization needed
Multi-rate/Variable-rate scheme	Variable-spreading factor + Multi-code
Channel coding scheme	Convolutional coding (rate 1/2-1/3) Optional outer RS coding (rate 4/5)
Packet access	Dual mode (common and dedicated channel)

Table 1 WCDMA key technical characteristics

2.3 WCDMA Logical-Channel Structure

The WCDMA logical-channel structure basically follows the ITU recommendation ITU-R M.1035. The following logical-channel types are defined for WCDMA:

- Common Control Channels
 - Broadcast Control Channel (BCCH)
 - Forward-Access Channel (FACH)
 - Paging Channel (PCH)
 - Random-Access Channel (RACH)
- Dedicated Channels
 - Dedicated Control Channel (DCCH)
 - Dedicated Traffic Channel (DTCH)

These logical-channel types are described in more detail below.

2.3.1 Common Control Channels

2.3.1.1 BCCH - Broadcast Control Channel (DL)

The Broadcast Control Channel (BCCH) is a downlink point-to-multipoint channel that is used to broadcast system- and cell-specific information. The BCCH is mapped to the Primary Common Control Physical Channel (Primary CCPCH), see Section 2.4.2.1. The BCCH is always transmitted over the entire cell.

2.3.1.2 FACH - Forward Access Channel (DL)

The Forward Access Channel (FACH) is a downlink channel that is used to carry control information to a mobile station when the system knows the location cell of the mobile station. The FACH may also carry short user packets. The FACH is, together with the PCH, mapped to the Secondary Common Control Physical Channel (Secondary CCPCH), see Section 2.4.2.1. The FACH may be transmitted over only a part of the cell by using lobe-forming antennas.

2.3.1.3 PCH - Paging Channel (DL)

The Paging Channel (PCH) is a downlink channel that is used to carry control information to a mobile station when the system does not know the location cell of the mobile station. The PCH is, together with the FACH, mapped to the Secondary CCPCH. The PCH is always transmitted over the entire cell.

2.3.1.4 RACH - Random Access Channel (UL)

The Random Access Channel (RACH) is an uplink channel that is used to carry control information from a mobile station. The RACH may also carry short user packets. The RACH is mapped to the Physical Random Access Channel (PRACH), see Section 2.4.2.2. The RACH is always received from the entire cell.

2.3.2 Dedicated Channels

2.3.2.1 DCCH - Dedicated Control Channel (DL and UL)

The Dedicated Control Channel (DCCH) is a bidirectional channel that is used to carry control information between the network and a mobile station. The DCCH serves the same function as the two logical channels Stand-Alone Dedicated Control Channel (SDCCH) and Associated Control Channel (ACCH) defined within ITU-R M.1035. In WCDMA there is thus no distinction between dedicated control channels that are linked to a traffic channel and those that are not. The DCCH is, possibly together with one or several DTCHs, mapped to a Dedicated Physical Data Channel (DPDCH), see Section 2.4.1.1 and 2.4.1.2.

2.3.2.2 DTCH - Dedicated Traffic Channel (DL and/or UL)

The Dedicated Traffic Channel (DTCH) is a bidirectional or unidirectional channel that is used to carry user information between the network and a mobile station. A DTCH is, together with a DCCH and possibly other DTCHs, mapped to a Dedicated Physical Data Channel (DPDCH).

2.3.3 Summary of logical-to-physical channel mapping

Figure 1 summarises the mapping of logical channels to physical channels. The physical channels are described in detail in Section 2.4.

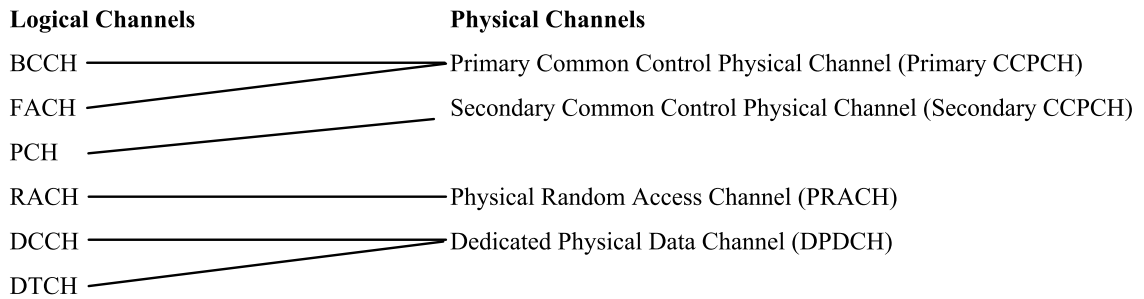


Figure 1 Logical-channel to physical-channel mapping

2.4 WCDMA Physical-Channel Structure

2.4.1 Dedicated physical channels

There are two types of dedicated physical channels, the Dedicated Physical Data Channel (DPDCH) and the Dedicated Physical Control Channel (DPCCH).

The DPDCH is used to carry dedicated data generated at layer 2 and above, i.e. the dedicated logical channels of Section 2.3.2.

The DPCCH is used to carry control information generated at layer 1. The control information consists of known pilot bits to support channel estimation for coherent detection, transmit power-control (TPC) commands, and (variable-length) rate information (RI). The rate information informs the receiver about the instantaneous rate of the different services multiplexed on the dedicated physical data channels.

2.4.1.1 Downlink dedicated physical channels

For the downlink, the DPDCH and the DPCCH are time multiplexed within each radio frame and transmitted with QPSK modulation.

2.4.1.1.1 Frame structure

Figure 2 shows the principle frame structure of the downlink DPDCH/DPCCH. Each frame of length 10 ms is split into 16 slots, each of length $T_{\text{slot}} = 0.625$ ms, corresponding to one power-control period. Within each slot, the DPDCH and the DPCCH are time multiplexed. The slots of Figure 2 correspond to the power-control periods, see Section 2.6.3

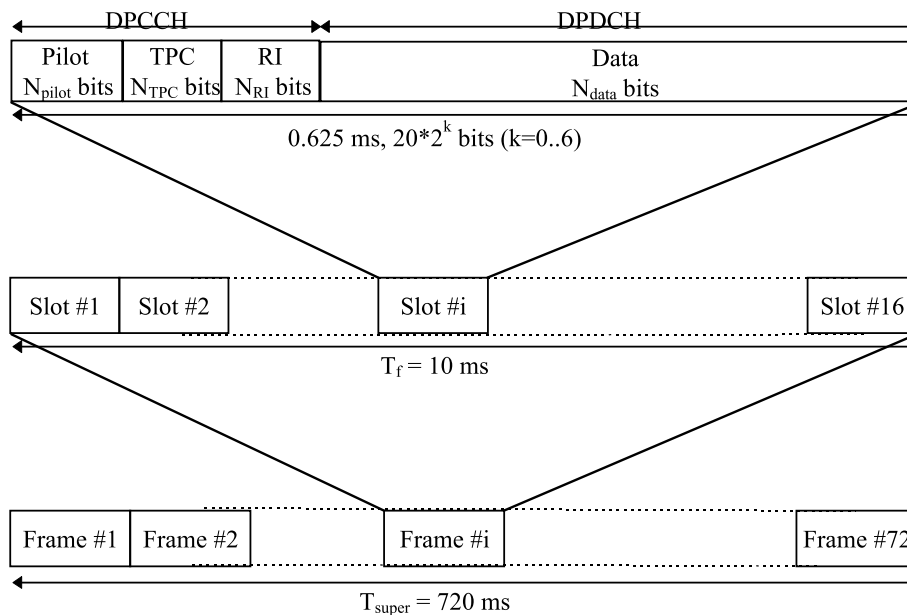


Figure 2 Frame structure for downlink dedicated physical channels.

The parameter k in Figure 2 determines the total number of bits per DPDCH/DPCCH slot. It is related to the spreading factor SF of the physical channel as $\text{SF} = 256/2^k$. The spreading factor may thus range from 256 down to 4.

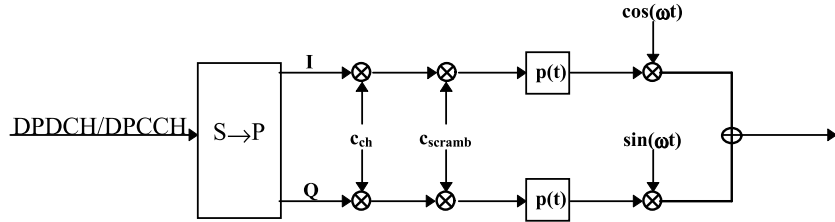
The exact number of bits of the different fields in Figure 2 (N_{pilot} , N_{TPC} , N_{RI} , and N_{data}) is yet to be determined and is also expected to vary for different spreading factors and service combinations.

Note that connection-dedicated pilot bits are transmitted also for the downlink in order to support the use of downlink adaptive antennas. With downlink adaptive antennas, an omni-directional pilot channel will, in general, not propagate over the same radio channel as a dedicated physical channel transmitted in a narrow lobe.

72 consecutive downlink frames constitute one WCDMA super frame of length 720 ms.

2.4.1.1.2 Spreading and modulation

Figure 3 illustrates the spreading and modulation for the DPDCH/DPCCH. Data modulation is QPSK where each pair of two bits are serial-to-parallel converted and mapped to the I and Q branch respectively. The I and Q branch are then spread to the chip rate with the same channelization code c_{ch} and subsequently scrambled by the same cell specific scrambling code c_{scramb} .



c_{ch} : channelization code
 c_{scramb} : scrambling code
 $p(t)$: pulse-shaping filter (root raised cosine, roll-off 0.22)

Figure 3 Spreading/modulation for downlink dedicated physical channels

For multi-code transmission, each additional DPDCH/DPCCH should also be spread/modulated according to Figure 3. Each additional DPDCH/DPCCH should be assigned its own channelization code.

The channelization codes of Figure 3 are Orthogonal Variable Spreading Factor (OVSF) codes that preserve the orthogonality between downlink channels of different rates and spreading factors. The OVSF codes can be defined using the code tree of Figure 4.

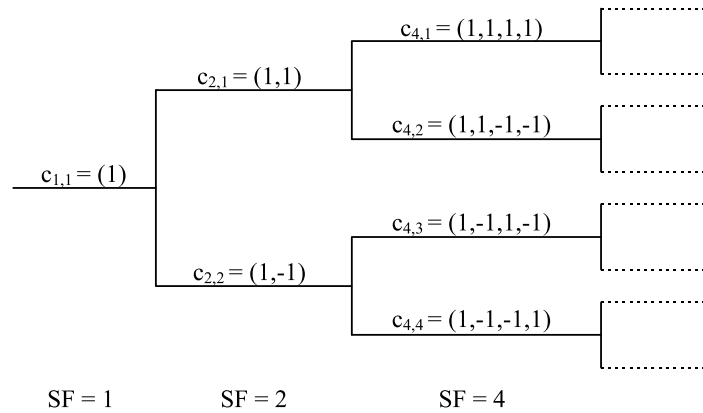


Figure 4 Code-tree for generation of Orthogonal Variable Spreading Factor (OVSF) codes

Each level in the code tree defines channelization codes of length SF, corresponding to a spreading factor of SF in Figure 3. All codes within the code tree cannot be used simultaneously within one cell. A code can be used in a cell if and only if no other code on the path from the specific code to the root of the tree or in the sub-tree below the specific code is used in the same cell. This means that the number of available channelization codes is not fixed but depends on the rate and spreading factor of each physical channel.

The downlink scrambling code c_{scramb} is a 40960 chips (10 ms) segment of a length $2^{18}-1$ Gold code repeated in each frame. The total number of available scrambling codes is 512, divided into 16 code groups with 32 codes in each group. The grouping of the downlink codes is done in order to facilitate a fast cell search, see Section 2.6.4.

The pulse-shaping filters are root raised cosine (RRC) with roll-off $\alpha=0.22$ in the frequency domain.

2.4.1.2 Uplink dedicated physical channels

For the uplink, the DPDCH and the DPCCH are IQ/code multiplexed within each radio frame and transmitted with dual-channel QPSK modulation. Each additional DPDCHs is code multiplexed on either the I- or the Q-branch with this first channel pair.

2.4.1.2.1 Frame structure

Figure 5 shows the principle frame structure of the uplink dedicated physical channels. Each frame of length 10 ms is split into 16 slots, each of length $T_{\text{slot}} = 0.625$ ms, corresponding to one power-control period. Within each slot, the DPDCH and the DPCCH are transmitted in parallel.

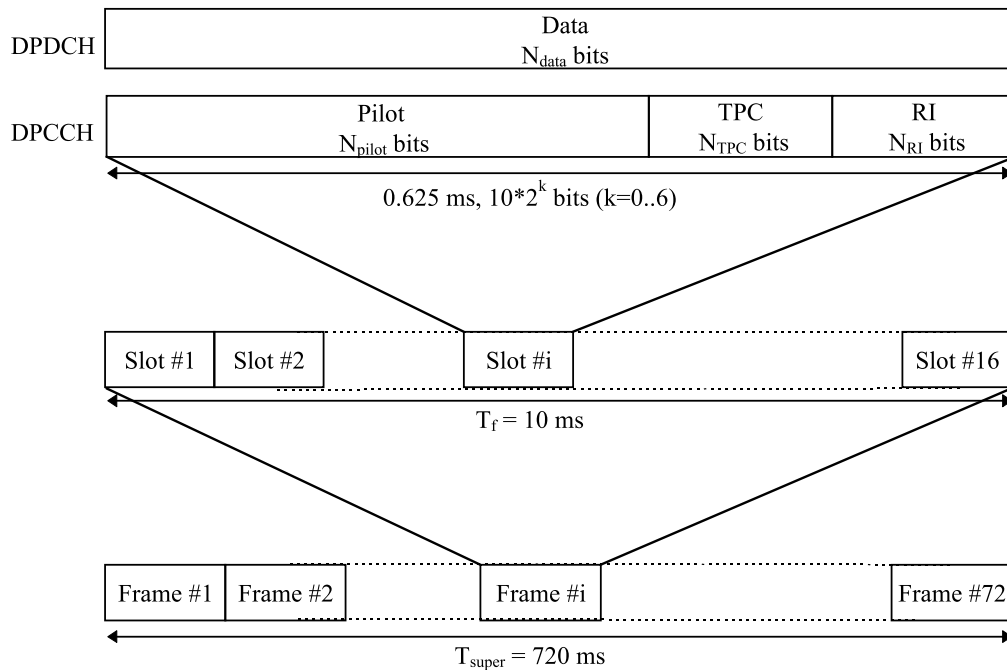


Figure 5 Frame structure for uplink dedicated physical channels

The parameter k in Figure 5 determines the number of bits per DPDCH or DPCCH slot. It is related to the spreading factor SF of the physical channel as $SF = 256/2^k$. The spreading factor may thus range from 256 down to 4. Note that the DPDCH and DPCCH may be of different rates, i.e. have different spreading factors and thus different values of k .

As for the downlink, the exact number of bits of the different fields in Figure 5 (N_{pilot} , N_{TPC} , N_{RI} , and N_{data}) is yet to be determined and is once again expected to vary for different spreading factors and service combinations.

72 consecutive uplink frames constitute one WCDMA super frame of length 720 ms.

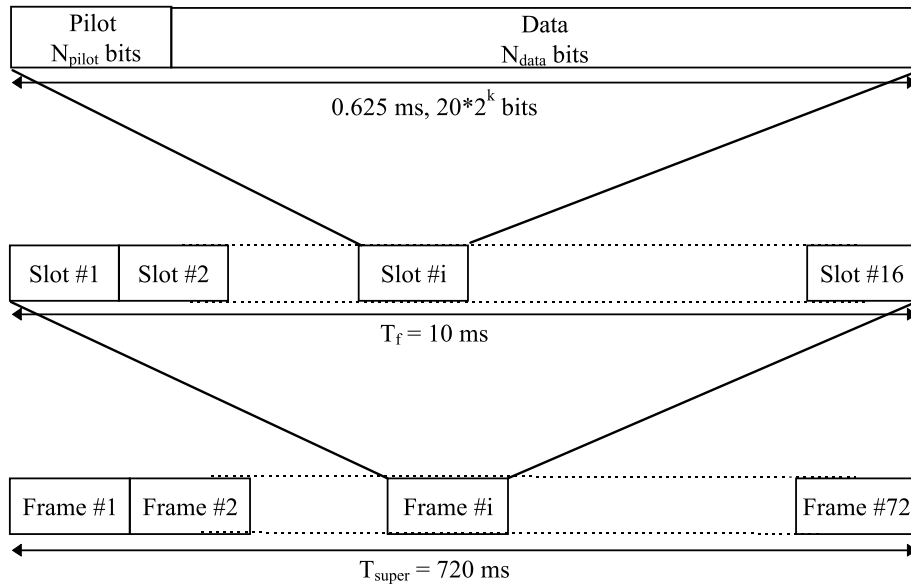


Figure 7 Frame structure for downlink Common Control Physical Channels

The CCPCH is modulated and spread in the same way as the Downlink Dedicated Physical Channels, see Figure 3.

In the case of the Secondary CCPCH, the FACH and PCH are time multiplexed on a frame-by-frame basis within the super-frame structure. The set of frames allocated to FACH and PCH respectively is broadcasted on the BCCH.

The main difference between a CCPCH and a downlink dedicated physical channel is that a CCPCH is not power controlled and is of constant rate. The main difference between the Primary and Secondary CCPCH is that the Primary CCPCH has a fixed predefined rate (32 kbps) while the Secondary CCPCH has a constant rate that may be different for different cells, depending on the capacity needed for FACH and PCH. Furthermore, a Primary CCPCH is continuously transmitted over the entire cell while a Secondary CCPCH is only transmitted when there is data available and may be transmitted in a narrow lobe in the same way as a dedicated physical channel (only valid for FACH frames).

2.4.2.2 Physical Random Access Channel

The Physical Random Access Channel is described in Section 2.6.1.

2.4.2.3 Synchronisation Channel

The Synchronisation Channel (SCH) is a downlink signal used for cell search, see Section 2.6.4.

The SCH consists of two sub channels, the Primary and Secondary SCH. Figure 8 illustrates the structure of the SCH:

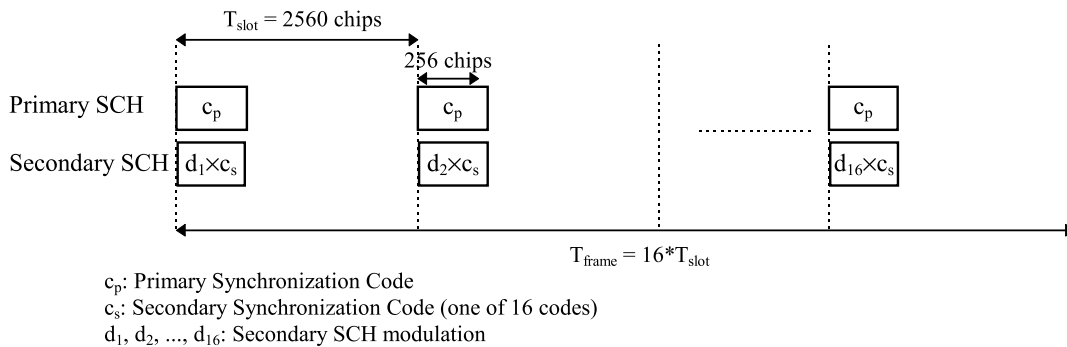


Figure 8 Structure of Synchronisation Channel (SCH)

The Primary SCH consists of an *unmodulated* orthogonal Gold code of length 256 chips, the Primary Synchronisation Code, transmitted once every slot. The Primary Synchronisation Code is the same for every base station in the system and is transmitted time-aligned with the slot boundary as illustrated in Figure 8.

The Secondary SCH consists of one *modulated* Orthogonal Gold code of length 256 chips, the Secondary Synchronisation Code, transmitted in parallel with the Primary Synchronization channel. The Secondary Synchronisation Code is chosen from a set of 16 different codes $\{c_1, c_2, \dots, c_{16}\}$ depending on to which of the 16 different code groups (see Section 2.4.1.1.2) the base station downlink scrambling code c_{scramb} belongs.

The Secondary SCH is modulated with a binary sequence d_1, d_2, \dots, d_{16} of length 16 bits which is repeated for each frame. The modulation sequence, which is the same for all base stations, has good cyclic autocorrelation properties.

The multiplexing of the SCH with the other downlink physical channels (DPDCH/DPCCH and CCPCH) is illustrated in Figure 9. The figure illustrates how the SCH is only transmitted intermittently (one codeword per slot) and also that the SCH is multiplexed *after* long code scrambling of the DPDCH/DPCCH and CCPCH. Consequently, the SCH is *non-orthogonal* to the other downlink physical channels.

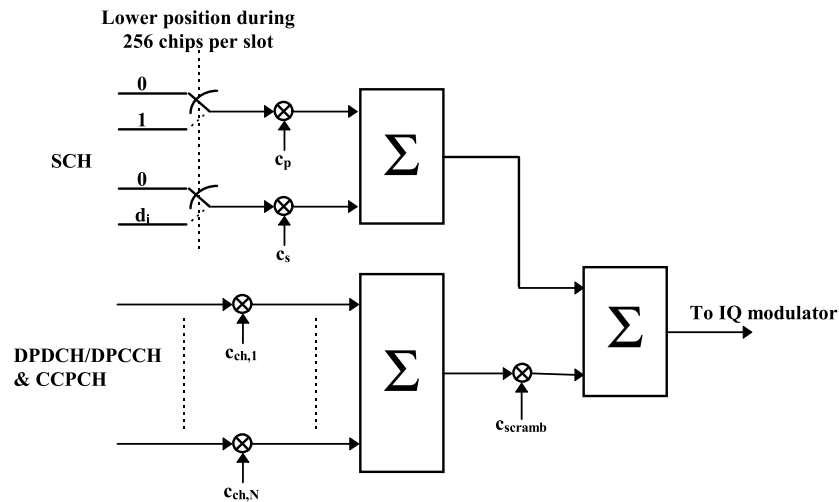


Figure 9 Multiplexing of SCH

The use of the SCH for cell search is described in detail in Section 2.6.4.

2.5 Channel Coding and Service Multiplexing

2.5.1 Channel coding/interleaving for user services

As shown in Figure 10, WCDMA offers three basic service classes with respect to forward-error-correction (FEC) coding:

- Standard-services with convolutional coding only
- High-quality services with additional outer Reed-Solomon coding
- Services with service-specific coding, i.e. services for which the WCDMA layer 1 does not apply any pre-specified channel coding.

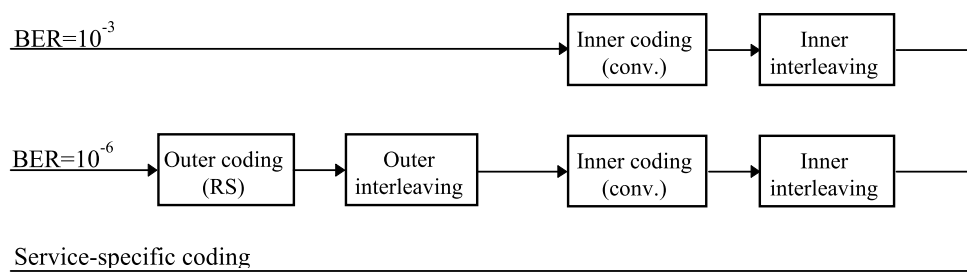


Figure 10 Basic FEC coding for WCDMA

2.5.1.1 Inner coding/interleaving

The inner convolutional coding is of rate 1/3 except for the highest rates where a rate 1/2 code is used. The code polynomials are given in octal form in Table 2.

Rate	Constraint length	Generator polynomial 1	Generator polynomial 2	Generator polynomial 3	Free distance
1/3	9	557	663	711	18
1/2	9	561	753	N/A	12

Table 2 Parameters for convolutional coding. Generator polynomials in octal form.

After convolutional coding, block interleaving is applied. For low-delay services, intra-frame interleaving over one 10 ms frame is applied. For services that allow for more delay, inter-frame interleaving over up to 15 frames (150 ms) is possible.

2.5.1.2 Outer coding/interleaving

The current assumption for the outer RS coding is a rate 4/5 code over the 2^8 -ary symbol alphabet.

After outer RS coding, symbol-wise inter-frame block interleaving is applied.

2.5.2 Service multiplexing

Multiple services belonging to the same connection are, in normal cases, time multiplexed. Time multiplexing may take place either before or after the inner or outer coding as illustrated in Figure 11.

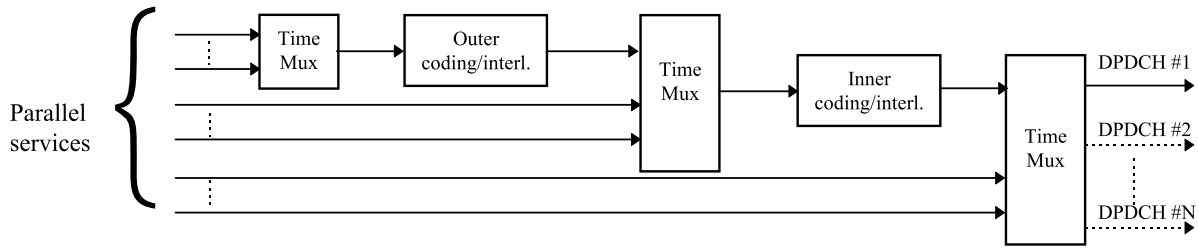


Figure 11 Service multiplexing of WCDMA

After service multiplexing and channel coding, the multi-service data stream is mapped to one or, if the total rate exceeds the upper limit for single-code transmission, several DPDCHs.

A second alternative for service multiplexing is to treat parallel services completely separate with separate channel coding/interleaving and mapping to separate DPDCHs in a multi-code fashion, see Figure 12. With this alternative scheme, the power and consequently the quality of each service can be separately and independently controlled. The disadvantage is the need for multi-code transmission which will have an impact on mobile-station complexity.

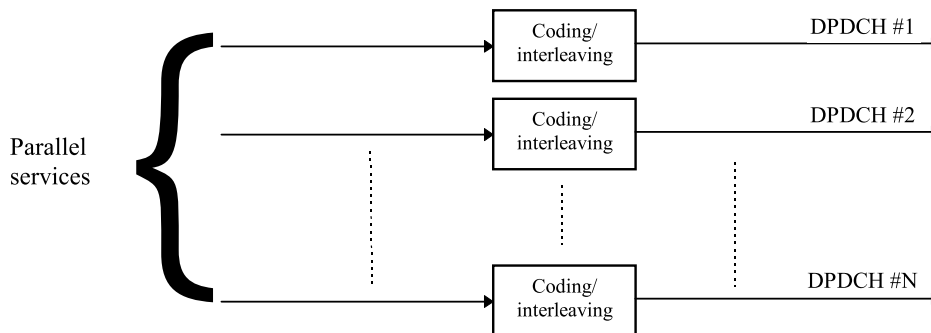


Figure 12 Alternative service multiplexing

2.5.3 Rate matching

After channel coding and service multiplexing, the total bit rate is almost arbitrary. The rate matching matches this rate to the limited set of possible bit rates of a Dedicated Physical Data Channel. The rate matching is somewhat different for uplink and downlink. The rule of unequal repetition for rate matching is given in part II of this document.

2.5.3.1 Uplink

For the uplink, rate matching to the closest uplink DPDCH bit rate is always based on unequal repetition (a subset of the bits repeated) or code puncturing. In general, code puncturing is chosen for bit rates less than $\approx 20\%$ above the closest lower DPDCH bit rate. For all other cases, unequal repetition is done to the closest higher DPDCH bit rate. The repetition/puncturing patterns follow a regular predefined rule, i.e. only the amount of repetition/puncturing needs to be agreed on. The correct repetition/puncturing pattern can then be directly derived at both the transmitter and receiver side.

2.5.3.2 Downlink

For the downlink, rate matching to the closest DPDCH bit rate, using either unequal repetition or code puncturing, is only done for the highest rate (after channel coding and service multiplexing) of a variable-rate connection and for fixed-rate connections. For lower rates of a variable-rate connection, the same repetition/puncturing pattern as for the highest rate is used and the remaining rate matching is based on discontinuous transmission where only a part of each slot is used for transmission. This approach is used in order to simplify the implementation of blind rate detection in the mobile station.

2.5.4 Channel coding/interleaving for control channels

2.5.4.1 Dedicated Control Channel

The dedicated control channel (DCCH) uses the same rate 1/3 convolutional coding as the traffic channels. Intra-frame block interleaving is carried out after channel coding. Mapping to the Dedicated Physical Data Channel is done in exactly the same way as for dedicated traffic channels.

2.5.4.2 Downlink Common Control Channels

The downlink common control channels (BCCH, FACH, and PCH) use the same rate 1/3 convolutional coding as the traffic channels. Intra-frame block interleaving is carried out after channel coding before mapping to the Primary and Secondary Common Control Physical Channels.

In the case of the Secondary CCPCH, the FACH and PCH are time multiplexed on a frame-by-frame basis within the super-frame structure. The set of frames allocated to FACH and PCH respectively is broadcasted on the BCCH.

2.5.5 Example mapping for the test services

This section exemplifies the general channel coding and service multiplexing for some of the services used in the performance evaluation. For simplicity, only the uplink mapping is shown.

2.5.5.1 8 kbps bearer

This bearer is used for the 8 kbps speech service. In this case, a 8 kbps speech frame appended with a 8 bits CRC is channel coded and mapped to a 32 kbps DPDCH according to Figure 13. Unequal repetition is used to match the 28.8 kbps data rate after channel coding to the closest DPDCH rate.

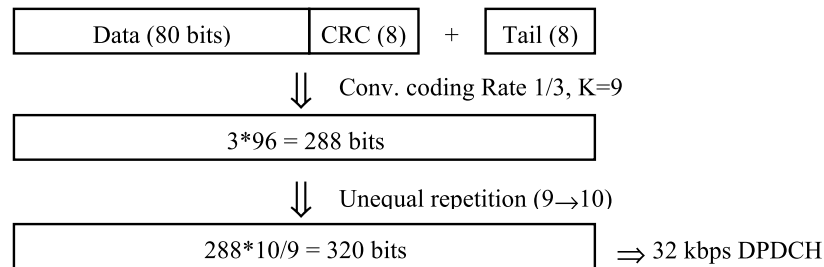


Figure 13 Channel coding and service mapping for an 8 kbps bearer (8 kbps speech service)

2.5.5.2 144 kbps bearer

This bearer is used for the 144 kbps LCD service. In this case, a 144 kbps data frame is RS coded, convolutional coded frame, and mapped to a 512 kbps DPDCH according to Figure 14. Code puncturing is used to match the 542.4 kbps data rate after channel coding to the closest DPDCH rate.

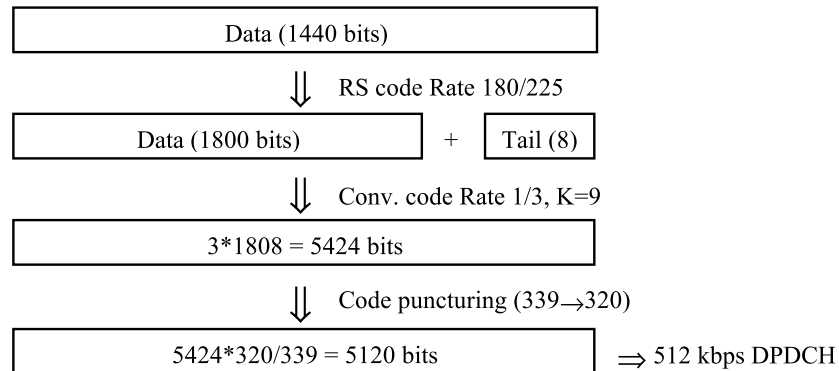


Figure 14 Channel coding and service mapping for a 144 kbps bearer (144 kbps LCD service)

2.5.5.3 384 kbps bearer

This bearer is used for the 384 kbps LCD service. In this case, a 384 kbps data frame is RS coded, convolutional coded frame, and mapped to a 1024 kbps DPDCH according to Figure 15. Unequal repetition is used to match the 964.8 kbps data rate after channel coding to the closest DPDCH rate.

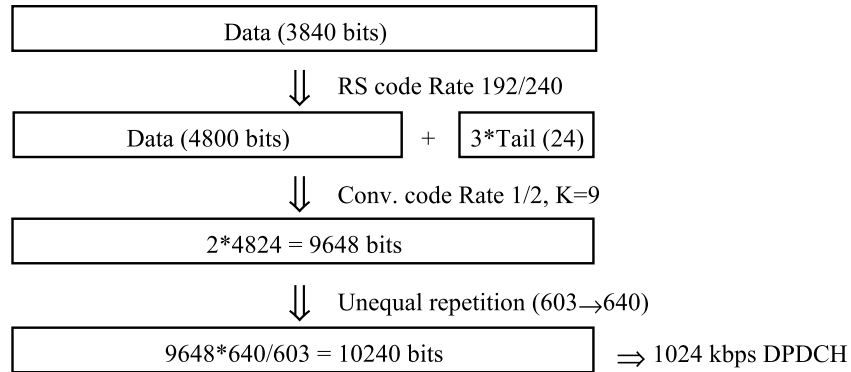


Figure 15 Channel coding and service mapping for a 384 kbps bearer (384 kbps LCD service)

2.5.5.4 480 kbps bearer

This bearer is used for the 384 kbps UDD service. In this case, 16 parallel blocks of 300 bits each are appended with a 12 bits header (CRC and Sequence Number). Each block is convolutionally encoded and mapped to a 1024 kbps DPDCH according to Figure 16. No rate matching is needed.

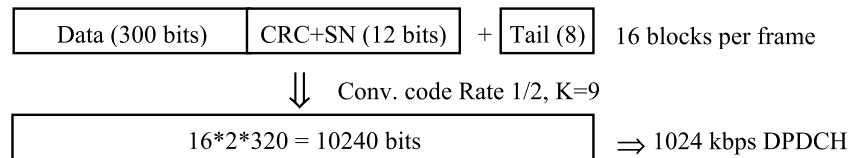


Figure 16 Channel coding and service mapping for a 480 kbps bearer (384 kbps UDD service)

2.5.5.5 2.4 Mbps bearer

This bearer is used for the 2.048 Mbps UDD service. In this case, 80 parallel blocks of 300 bits each are appended with a 12 bits header (CRC and Sequence Number). Each block is convolutionally encoded and mapped to a 5 parallel 1024 kbps DPDCHs according to Figure 17. No rate matching is needed.

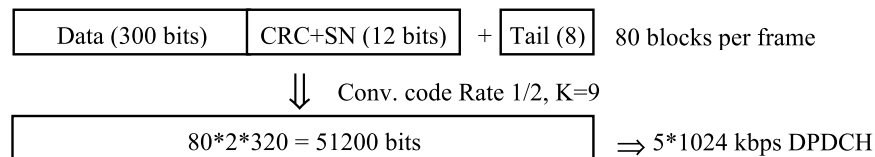


Figure 17 Channel coding and service mapping for a 2.4 Mbps bearer (2.048 Mbps UDD)

2.6 Radio Resource Functions

2.6.1 Random Access

2.6.1.1 Random-Access burst structure

The structure of the Random-Access burst is shown in Figure 18. The Random-Access burst consists of two parts, a preamble part of length $16 \cdot 256$ chips (1 ms) and a data part of variable length.

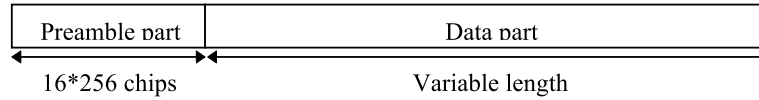
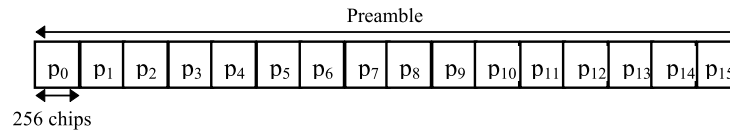


Figure 18 Structure of the Random-Access burst

2.6.1.1.1 Preamble part

Figure 19 shows the structure of the preamble part of the Random-Access burst.



p_0, p_1, \dots, p_{15} : Preamble sequence

Figure 19 Structure of Random-Access burst preamble part

The preamble consists of 16 symbols (the preamble sequence) spread by an Orthogonal Gold code (the preamble code) of length 256 chips.

The preamble sequence is randomly chosen from a set of 16 orthogonal code words of length 16. All 16 preamble sequences are available in each cell.

Neighbouring base stations use different preamble codes and information about what preamble code(s) are available in each cell is broadcasted on the BCCH.

2.6.1.1.2 Data part

Figure 20 shows the structure of the data part of the Random-Access burst. It consists of the following fields (the values in brackets are preliminary values):

- Mobile station identification (MS ID) [16 bits]. The MS ID is chosen at random by the mobile station at the time of each Random-Access attempt.
- Required Service [3 bits]. This field informs the base station what type of service is required (short packet transmission, dedicated-channel set-up, etc.)
- An optional user packet. The possibility to append uplink user packets directly to the Random-Access request is described in Section 2.7.1.
- A CRC to detect errors in the data part of the Random-Access burst [8 bits].

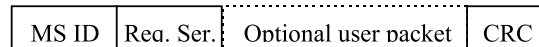


Figure 20 Structure of Random-Access burst data part

The spreading and modulation of the data part of the Random-Access burst is basically the same as for the uplink dedicated physical channels, see Figure 6. The scrambling code for the data part is chosen based on the base-station-specific preamble code, the randomly chosen preamble sequence, and the randomly chosen Random-Access time-offset, see 2.6.1.2. This guarantees that two simultaneous Random-Access attempts that use different preamble codes and/or different preamble sequences will not collide during the data part of the Random-Access bursts.

2.6.1.2 Random-Access procedure

Before making a Random-Access attempt, the mobile station should do the following

- Acquire chip and frame synchronisation to the target base station according to 2.6.4
- Acquire information about what Random-Access (preamble) codes are available in the cell from the BCCH
- Estimate the uplink path-loss from measurements of the received BS power and use this path-loss estimate, together with the uplink received interference level and received SIR target, to decide the transmit power of the Random-Access burst. The uplink interference level as well as the required received SIR are broadcasted on the BCCH.

The mobile station then transmits the Random-Access burst with a $n \cdot 2$ ms time-offset ($n=0..4$) relative to the received frame boundary, see Figure 21. The value of n , i.e. the time-offset, is chosen at random at each Random-Access attempt.

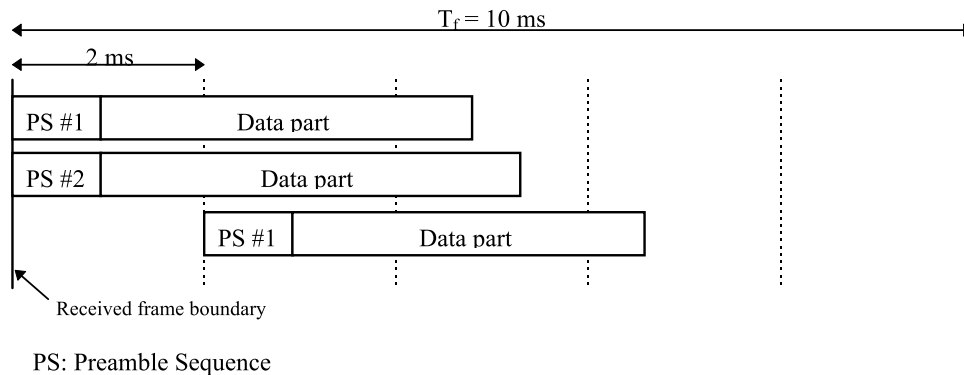


Figure 21 Possible transmission timing for parallel Random-Access attempts

A typical implementation of the base-station random-access receiver for a given preamble code and preamble sequence is illustrated in Figure 22. The received signal is fed to a matched filter, matched to the preamble code. The output of the matched filter is then correlated with the preamble sequence. The output of the preamble correlator will have peaks corresponding to the timing of any received Random-Access burst using the specific preamble code and preamble sequence. The estimated timing can then be used in an ordinary RAKE combiner for the reception of the data part of the Random-Access burst.

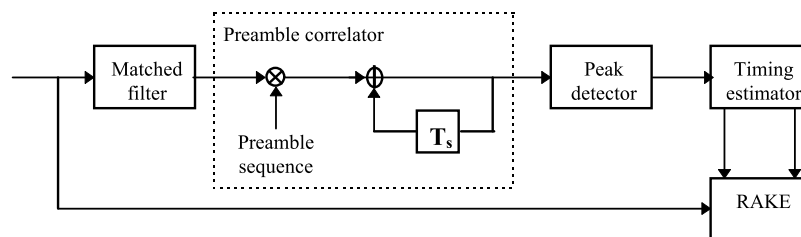


Figure 22 Base-station Random-Access receiver.

With this scheme, a base station may receive up to 80 (16 preamble sequences and 5 time-offsets) Random-Access attempts within one 10 ms frame using only one (preamble) matched filter.

Upon reception of the Random-Access burst, the base station responds with an Access Grant message on the FACH. In case the Random Access request is for a dedicated channel (circuit-switched or packet) and the request is granted, the Access Grant message includes a pointer to the dedicated physical channel(s) to use. As soon as the mobile station has moved to the dedicated channel, closed-loop power control is activated.

2.6.2 Code allocation

2.6.2.1 Downlink

2.6.2.1.1 Channelization codes

The channelization code for the BCCH is a predefined code which is the same for all cells within the system.

The channelization code(s) used for the Secondary Common Control Physical Channel is broadcasted on the BCCH.

The channelization codes for the downlink dedicated physical channels are decided by the network. The mobile station is informed about what downlink channelization codes to receive in the downlink Access Grant message that is the base-station response to an uplink Random Access request. The set of channelization codes may be changed during the duration of a connection, typically as a result of a change of service or an inter-cell handover. A change of downlink channelization codes is negotiated over the DCCH.

2.6.2.1.2 Scrambling code

The downlink scrambling code is assigned to the cell (sector) at the initial deployment. The mobile station learns about the downlink scrambling code during the cell search process, see Section 2.6.4.

2.6.2.2 Uplink

2.6.2.2.1 Channelization codes

Each connection is allocated at least one uplink channelization code, to be used for the Dedicated Physical Control Channel. In most cases, at least one additional uplink channelization code is allocated for a Dedicated Physical Data Channel. Further uplink channelization codes may be allocated if more than one DPDCH are required.

As different mobile stations use different uplink scrambling codes, the uplink channelization codes may be allocated with no co-ordination between different connections. The uplink channelization codes are therefore always allocated in a predetermined order. The mobile-station and network only need to agree on the number of uplink channelization codes. The exact codes to be used are then implicitly given.

2.6.2.2.2 Primary scrambling code

The uplink primary scrambling code is decided by the network. The mobile station is informed about what primary scrambling code to use in the downlink Access Grant message that is the base-station response to an uplink Random Access Request.

The primary scrambling code may, in rare cases, be changed during the duration of a connection. A change of uplink primary scrambling code is negotiated over the DCCH.

2.6.2.2.3 Secondary (optional) scrambling code

The secondary uplink scrambling code is an optional code, typically used in cells without multiuser detection in the base station. The mobile station is informed if a secondary scrambling code should be used in the Access Grant Message following a Random-Access request and in the handover message.

What secondary scrambling code to use is directly given by the primary scrambling code. No explicit allocation of the secondary scrambling code is thus needed.

2.6.3 Power control

2.6.3.1 Uplink power control

2.6.3.1.1 Closed loop power control

The uplink closed loop power control adjusts the mobile station transmit power in order to keep the received uplink Signal-to-Interference Ratio (SIR) at a given SIR target.

The base station should estimate the received DPCCH power after RAKE combining of the connection to be power control. Simultaneously, the base station should estimate the total uplink received interference in the current frequency band. The base station then generates TPC commands according to the following rule:

$SIR_{est} > SIR_{target,UL} \rightarrow$ TPC command = “down”

$SIR_{est} < SIR_{target,UL} \rightarrow$ TPC command = “up”

Upon the reception of a TPC command, the mobile station should adjust the transmit power of both the DPCCH and the DPDCH in the given direction with a step of Δ_{TPC} dB. The step size Δ_{TPC} is a parameter that may differ between different cells.

In case of soft handover, the mobile station should adjust the power with the largest step in the “down” direction ordered by the TPC commands received from each base station in the active set.

2.6.3.1.2 Outer loop (SIR target adjustment)

The outer loop adjusts the SIR target used by the closed-loop power control. The SIR target is independently adjusted for each connection based on the estimated quality of the connection. In addition, the power offset between the uplink DPDCH and DPCCH may be adjusted. How the quality estimate is derived differs for different service combinations. Typically a combination of estimated bit-error rate and frame-error rate is used.

2.6.3.1.3 Open-loop power control

Open-loop power control is used to adjust the transmit power of the physical Random-Access channel. Before the transmission of a Random-Access frame, the mobile station should measure the received power of the downlink Primary Common Control Physical Channel over a sufficiently long time to remove any effect of the non-reciprocal multi-path fading. From the power estimate and knowledge of the Primary CCPCH transmit power (broadcasted on the BCCH) the downlink path-loss including shadow fading can be found. From this path loss estimate and knowledge of the uplink interference level and the required received SIR, the transmit power of the physical Random-Access channel can be determined. The uplink interference level as well as the required received SIR are broadcasted on the BCCH.

2.6.3.2 Downlink power control

2.6.3.2.1 Closed loop power control

The downlink closed loop power control adjusts the base station transmit power in order to keep the received downlink SIR at a given SIR target

The mobile station should estimate the received DPCCH power after RAKE combining of the connection to be power control. Simultaneously, the mobile station should estimate the total downlink received interference in the current frequency band. The mobile station then generates TPC commands according to the following rule:

$SIR_{est} > SIR_{target,DL} \rightarrow$ TPC command = “down”

$SIR_{est} < SIR_{target,DL} \rightarrow$ TPC command = “up”

Upon the reception of a TPC command, the base station should adjust the transmit power in the given direction with a step of Δ_{TPC} dB. The step size Δ_{TPC} is a parameter that may differ between different cells.

2.6.3.2.2 Outer loop (SIR target adjustment)

The outer loop adjusts the SIR target used by the closed-loop power control. The SIR target is independently adjusted for each connection based on the estimated quality of the connection. In addition, the power offset between the downlink DPDCH and DPCCH may be adjusted. How the quality estimate is derived differs for different service combinations. Typically a combination of estimated bit-error rate and frame-error rate is used.

2.6.4 Initial cell search

During the initial cell search, the mobile station searches for the base station to which it has the lowest path loss. It then determines the downlink scrambling code and frame synchronisation of that base station. The initial cell search uses the synchronization channel (SCH) described in Section 2.4.2.3, the structure of which is repeated in Figure 23 below.

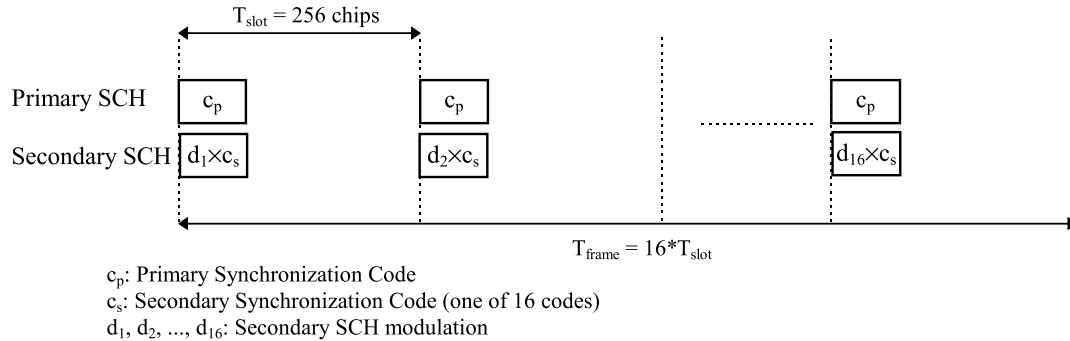


Figure 23 Structure of synchronization channel (SCH)

This initial cell search is carried out in three steps:

2.6.4.1 Step 1: Slot synchronisation

During the first step of the initial cell search procedure the mobile station uses the primary SCH to acquire slot synchronisation to the strongest base station. This is done with a single matched filter (or any similar device) matched to the primary synchronisation code c_p which is common to all base stations. The output of the matched filter will have peaks for each ray of each base station within range of the mobile station, see Figure 24. Detecting the position of the strongest peak gives the timing of the strongest base station modulo the slot length. For better reliability, the matched-filter output should be non-coherently accumulated over a number of slots.

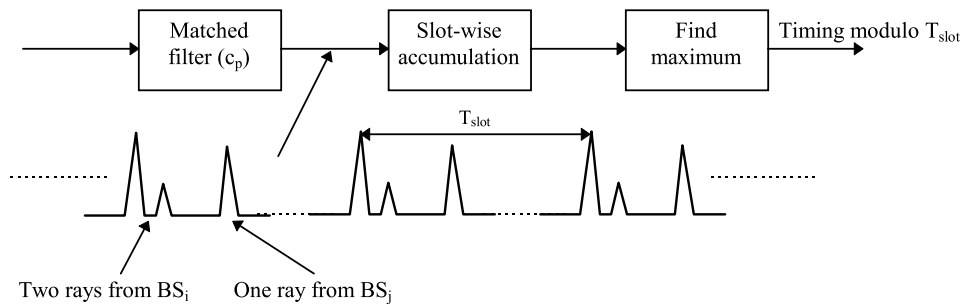


Figure 24 Matched-filter search for primary synchronization code to slot synchronization (timing modulo the slot length)

2.6.4.2 Step 2: Frame synchronisation and code-group identification

During the second step of the initial cell search procedure, the mobile station uses the secondary SCH to find frame synchronisation and identify the code group of the base station found in the first step. This is done by correlating the received signal at the positions of the Secondary Synchronisation Code with all possible (16) Secondary Synchronisation Codes. Note that the position of the Secondary Synchronisation Code is known after the first step, due to the known time offset between the Primary and the Secondary Synchronisation Codes. Furthermore, the unmodulated primary SCH can be used as a phase reference in the demodulation of the modulated SCH.

The correlation with the 16 different Secondary Synchronization Codes gives 16 different demodulated sequences. To achieve frame synchronization, the 16 demodulated sequences should be correlated with the 16 different cyclic shifts of the Secondary SCH modulation sequence $\{d_1, d_2, \dots, d_{16}\}$, giving a total

of 256 different correlation values. By identifying the code/shift pair that gives the maximum correlation value, the code group as well as the frame synchronization is determined.

2.6.4.3 Step 3: Scrambling-code identification

During the third and last step of the initial cell-search procedure, the mobile station determines the exact scrambling code used by the found base station. The scrambling code is identified through symbol-by-symbol correlation over the Primary CCPCH with all scrambling codes within the code group identified in the second step. Note that, from step 2, the frame boundary and consequently the start of the scrambling code is known. Correlation must be carried out symbol-wise, due to the unknown modulation of the primary CCPCH.

After the scrambling code has been identified, the Primary CCPCH can be detected, super-frame synchronisation can be acquired and the system- and cell specific BCCH information can be read.

2.6.5 Handover

2.6.5.1 Intra-frequency handover

2.6.5.1.1 Soft handover

When in active mode, the mobile station continuously searches for new base stations on the current carrier frequency. This cell search is carried out in basically the same way as the initial cell search described in Section 2.6.4. The main difference compared to the initial cell search is that an active mobile station has received a priority list from the network. This priority list describes in which order the downlink scrambling codes should be searched for and does thus significantly reduce the time and effort needed for the scrambling-code search (step 3) described in Section 2.6.4.3. Also the second step may be reduced if the priority list does only include scrambling codes belonging to a subset of the total set of code groups. The priority list is continuously updated to reflect the changing neighbourhood of a moving mobile station.

During the search, the mobile station monitors the received signal level broadcasted from neighbouring base stations, compares them to a set of thresholds, and reports them accordingly back to the base station. Based on this information the network orders the mobile station to add or remove base station links from its *active set*. The *active set* is defined as the set of base station from which the same user information is sent, simultaneously demodulated and coherently combined, i.e. the set of mobile terminals involved in the soft handover.

An example algorithm for reporting signal level and optimising the active set can be found in Tdoc SMG2 UMTS A16/97.

From the cell-search procedure, the mobile station knows the frame offset of the CCPCH of potential soft-handover candidates relative to that of the source base station(s) (the base stations currently within the active set). When a soft handover is to take place, this offset together with the frame offset between the DPDCH/DPCCH and the Primary CCPCH of the source base station, is used to calculate the required frame offset between the DPDCH/DPCCH and the Primary CCPCH of the destination base station (the base station to be added to the active set). This offset is chosen so that the frame offset between the DPDCH/DPCCH of the source and destination base stations at the mobile-station receiver is minimised. Note that the offset between the DPDCH/DPCCH and Primary CCPCH can only be adjusted in steps of one DPDCH/DPCCH symbol in order to preserve downlink orthogonality.

2.6.5.1.2 Softer handover

Softer handover is the special case of a soft handover between sectors/cells belonging to the same base station site. Conceptually, a softer handover is initiated and executed in the same way as an ordinary soft handover. The main differences are on the implementation level within the network. For softer handover, it is e.g. more feasible to do uplink maximum-ratio combining instead of selection combining as the combining is done on the BTS level rather than on the BSC level.

2.6.5.2 Inter-frequency handover

In WCDMA the vast majority of handovers are within one carrier frequency, i.e. intra-frequency handover. Inter-frequency handover may typically occur in the following situations:

- Handover between cells to which different number of carriers have been allocated, e.g. due to different capacity requirements (hot-spot scenarios).
- Handover between cells of different overlapping orthogonal cell layers using different carrier frequencies
- Handover between different operators/systems using different carrier frequencies including handover to GSM.

A key requirement for the support of seamless inter-frequency handover is the possibility for the mobile station to carry out cell search on a carrier frequency different from the current one, without affecting the ordinary data flow. WCDMA supports inter-frequency cell search in two different ways, a dual-receiver approach and a slotted-downlink-transmission approach.

2.6.5.2.1 Dual-receiver

For a mobile station with receiver diversity, there is a possibility for one of the receiver branches to temporarily be reallocated from diversity reception and instead carry out reception on a different carrier.

2.6.5.2.2 Slotted downlink transmission

With slotted downlink transmission, it is possible for a single-receiver mobile station to carry out measurements on other frequencies without affecting the ordinary data flow. The principle of slotted downlink transmission is illustrated in Figure 25. When in slotted mode, the information normally transmitted during a 10 ms frame is compressed in time, either by code puncturing or by reducing the spreading factor by a factor of 2. In this way, a time period of up to 5 ms is created during which the mobile-station receiver is idle and can be used for interfrequency measurements. Note that the idle slot is created without any loss of data as the number of information bits per frame is kept constant, while the processing gain is reduced by either reducing the spreading factor or increasing the coding rate. As illustrated in Figure 25, the instantaneous transmit power is increased in the slotted frame in order to keep the quality (BER, FER, etc.) unaffected by the reduced processing gain.

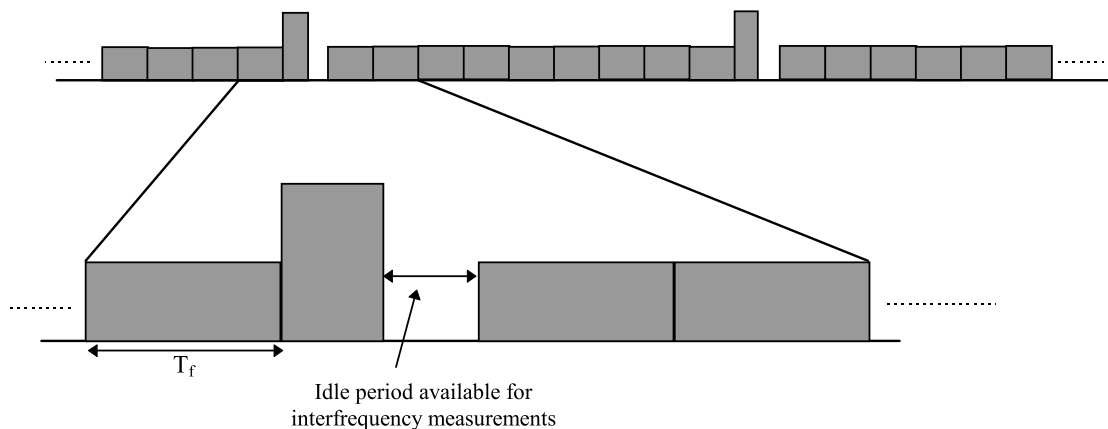


Figure 25 Downlink slotted transmission

When in slotted mode, slotted frames should occur periodically, as illustrated in Figure 25. The rate of slotted frames is variable and depends on the environment and the measurement requirements. It is estimated that a rate of slotted frames of 10 Hz, i.e. having a slotted frame every 100 ms is more than sufficient for e.g. the HCS environment.

For services that allows for a larger delay, e.g. data services with interleaving over several frames, multiple frames can be compressed together in order to create a short measurement slot. This is useful e.g. for high-rate services where a reduction of the processing gain of e.g. a factor of two may be difficult. As an example, for a 2 Mbps service, with interleaving of 5 frames (50 ms), a 5 ms idle slot can be created by reducing the processing gain with only 10% during 5 frames, see Figure 26.

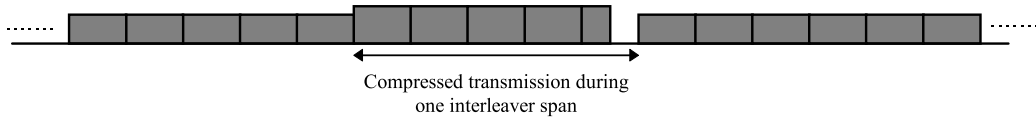


Figure 26 Multi-frame compressed mode for long-delay services

2.6.5.2.3 Measurements from GSM with slotted mode

The WCDMA concept has shown that although the frame length is different from GSM frame length, the dual mode terminal can be implemented also with a single receiver chain similar to other UTRA solutions. The more important aspect than the frame length is the higher level frame structure which must be able to facilitate measurements from GSM system. The WCDMA multiframe structure of 120 ms is identical to GSM and thus similar measurements and GSM carrier decode procedures can be provided as in GSM. The principle is indicated in Figure 27, which shows the identical measurement time as for GSM. For the power measurements additional blank slots can be used during which it is estimated that 9 200 kHz GSM carriers could be measured for their power level when using a GSM like RF parts resulting to similar measurement performance as with GSM.

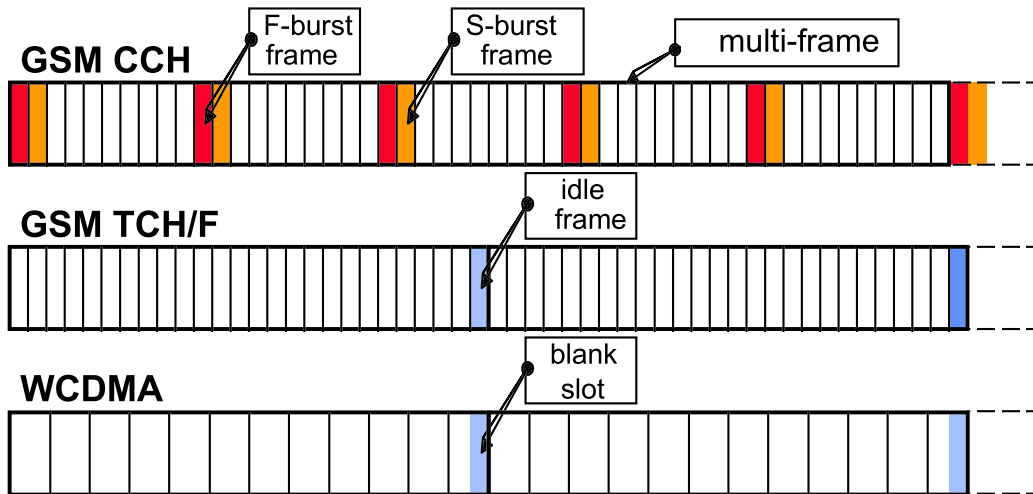


Figure 27. GSM measurement timing from WCDMA operation mode.

2.7 WCDMA Packet Access

Due to the varying characteristics of packet data traffic in terms of packet size and packet intensity, a dual-mode packet-transmission scheme is used for WCDMA. With this scheme, packet transmission can either take place on a common fixed-rate channel or on a dedicated channel.

2.7.1 Common-channel packet transmission

In this mode, an uplink packet is appended directly to a Random-Access burst. Common-channel packet transmission is typically used for short infrequent packets, where the link maintenance needed for a dedicated channel would lead to unacceptable overhead. Also the delay associated with a transfer to a dedicated channel is avoided. Note that, for common-channel packet transmission, only open-loop power control is in operation. Common-channel packet transmission should therefore be limited to short packets that only use a limited amount of capacity.

Figure 28 illustrates packet transmission on a common channel.

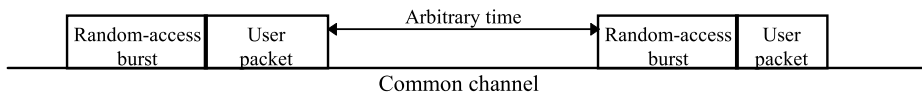


Figure 28 Packet transmission on common channel

2.7.2 Dedicated-channel packet transmission

In this mode, an initial Random-Access request is used to set up a dedicated channel for the packet transmission. On this dedicated channel, closed-loop power control is in operation. The dedicated channel can either be set up for the transmission of a single packet or for the transmission of a sequence of packets (multi-packet transmission).

2.7.2.1 Single-packet transmission

Single-packet transmission is typically used for the transmission of large infrequent packets. For single-packet transmission on a dedicated channel, the initial Random-Access request includes the amount of data to be transmitted. The network may respond to the access request in two different ways:

- With a short acknowledgement. A scheduling message is then sent to the mobile station at the time when the actual packet transmission can start. The scheduling message includes the transfer format, e.g. the bit rate, to be used for the packet transmission.
- With an immediate scheduling message, that either allows for immediate packet transmission, or that indicates at what time in the (near) future the mobile station may start its transmission.

Figure 29 illustrates single-packet transmission on a dedicated channel.

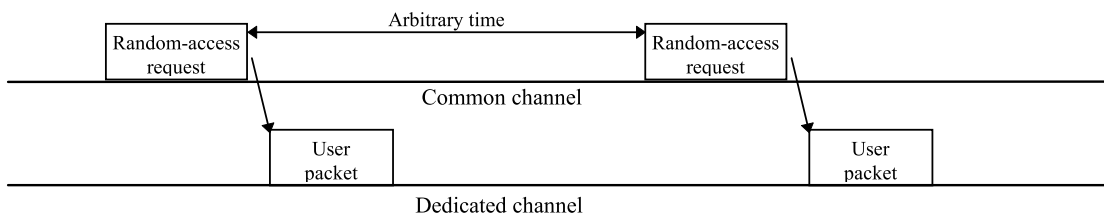


Figure 29 Single-packet transmission on dedicated channel

2.7.2.2 Multi-packet transmission

For multi-packet transmission on a dedicated channel an initial Random-Access request is used to set up a dedicated packet channel. On this channel, short packets may be transmitted without any scheduling, similar to the common-channel packet transmission. Larger packets may require that an access request is first sent by the mobile station on the dedicated channel. The network responds to this request in the same way as for the single-packet case

- With a short acknowledgement. A scheduling message is then sent to the mobile station at the time when the actual packet transmission can start. The scheduling message includes the transfer format, e.g. the bit rate, to be used for the packet transmission.
- With an immediate scheduling message, that either allows for immediate packet transmission, or that indicates at what time in the (near) future the mobile station may start its transmission.

Figure 30 illustrates multi-packet transmission on a dedicated channel. The link maintenance consists of power-control commands and pilot symbols needed to preserve power control and synchronization of the dedicated physical channel.

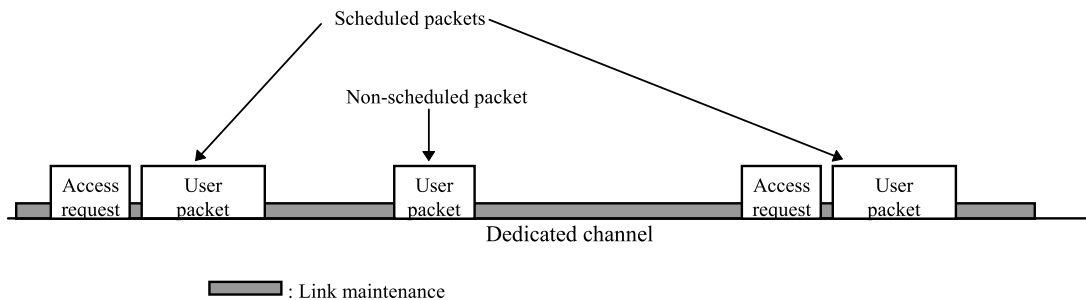


Figure 30 Multi-packet transmission on dedicated channel

2.7.3 Layer 2 overview

Figure 31 illustrates the general structure of layer 2. Main sublayers on layer 2 are logical link control (LLC) and medium access control (MAC). The software instances (LLCi) within LLC execute a selective retransmission protocol. The main responsibility of MAC is the multiplexing of different logical channels to the physical layer. MAC should provide very flexible means to combine different variable-rate real-time and non-real-time services with different QoS requirements to the same physical channel. Taking into account the random access procedure being able to process several simultaneous random access attempts, the transmissions are only limited by the soft capacity of the WCDMA system and thus the kind of request and allocation procedures that are executed in TDMA-based systems for each slot reservation are not needed. This is advantageous especially in the uplink with transmission coming from several mobiles to one base station as in the downlink the base station naturally has control of all the data sent as well as resources available for it. As indicated earlier for the very high bit rate packets, access request can be also used if desired.

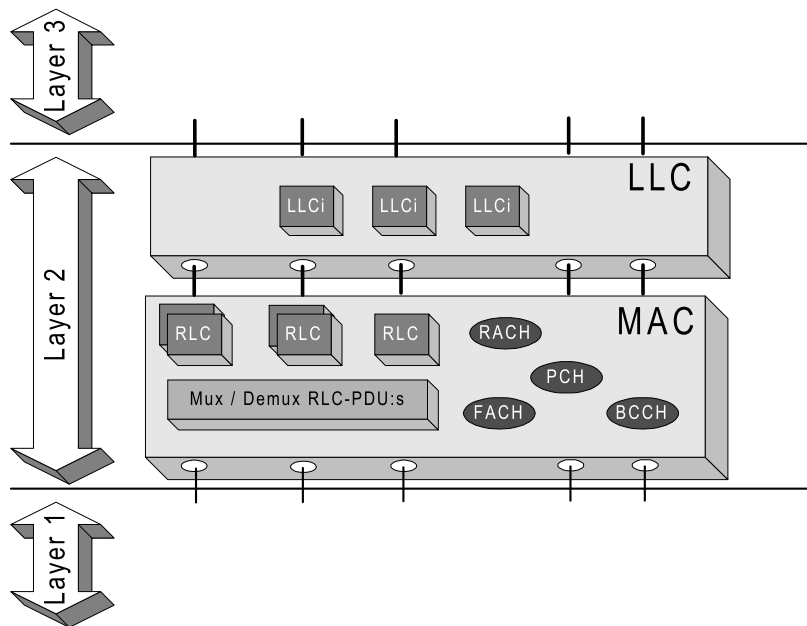


Figure 31. Layer 2 with connections to layer 1 and layer 3 control plane

A generic description of envisaged layer 2 functions is given in the following sections. One document on the subject has been distributed by Lucent Technologies during the Alpha meeting on 3-4.11.1997 (Data Link Control (DLC) Proposal for UMTS, Tdoc SMG2 UMTS A44 / 97) and these issues will be then defined further in the coming UMTS specification work.

2.7.3.1 Logical Link Control (LLC)

LLC sets up a logical link over the radio interface. Connection control facilities take care of connection establishment and release. User data transfer for non-real-time data is provided with error correction by selective retransmission including sequence control. Flow control functionality takes care of limiting the amount of data that can be sent without acknowledgements.

The retransmission features of LLC are seldom used and they are mainly intended to recover from errors relating to e.g. handovers.

2.7.3.2 Medium Access Control (MAC)

The main responsibility of the MAC sublayer is to manage the access to physical layer functions. In addition to allocating resources to user services and control channels, MAC controls the frame data rate signalling for different bearers.

A multiplexing / demultiplexing unit within MAC can mix services with equal QoS requirements on layer 2. Where different coding schemes are required, the data streams are transferred separately to the physical layer, which then provides coding, repetition and puncturing as requested by MAC.

MAC provides separate functionality and procedures for control channels including RACH, FACH, PCH and BCCH.

2.7.3.3 Radio Link Control (RLC)

The radio link control units within MAC are responsible for fulfilling QoS requirements over the radio interface. For non-real-time bearers RLC provides low-level selective retransmission ARQ functionality with CRC-based error detection.

2.7.4 Packet data handover

In the current simulation results the handover for packet data has been assumed to be hard handover, where connection unlike with LCD services is enabled only to a single base station. This results for the mobiles at the cell edge to not necessarily be optimal in terms of interference to the other cells in the system. In the Alpha group technical discussion in the London the method was proposed where the control channel (PCCH) would be in soft handover and packet data would be still routed via a single base station causing no network overhead. The data channel (PDCH) would thus be using thus hard handover.

This kind of operation would facilitate fast rerouting of the packet data as the synchronisation would exist to the most likely base stations for handover as they would be in the active set instead of the candidate set, similar to the LCD soft handover case. Clearly with this solution for the packet data the gains from diversity combining could not be achieved, but faster handover improves the performance otherwise although not offering diversity towards fading channel as such. The method will be studied in further phase of the standardisation work to fully see all the impacts to system operation and achievable improvements to packet data performance.

2.8 Support of positioning functionality

The wideband nature of the WCDMA facilitates the high resolution in position location as the resolution achievable is directly proportional to the channel symbol rate, in this case chip rate. The duration of one chip corresponds to approximately 73 meters in propagation distance and if the delay estimation operates on the accuracy of samples/chip then the achievable maximum accuracy is approximately 18 meters with the 4.096 Mc/s chip rate. Naturally there are then other inaccuracies that will cause degradation to the positioning but 18 meters can be considered as kind of lower bound on the positioning performance. With higher sampling rate or chip rate the bound is then naturally even lower.

With the WCDMA concept the position location has been discussed in two input documents in the Alpha meetings. The one example solution to use is the proposed power up function (PUF) which in the need for a MS to be heard by several base stations will increase the transmission power over short interval. Other aspects of the position mechanism are how the issue of actual measurement is done and whether that is based on loop around time or on Time Difference Of Arrival (TDOA) or other measures.

The exact solution will not be decided until the standardisation phase during 1998 and to what extent it need to be specified needs to be determined as well, but the presented alternatives in the Alpha group work show that the positioning can be provided with the WCDMA system concept.

2.9 Support of TDD

2.9.1 TDD operation

In this section the TDD part of the WCDMA concept is described. In the TDD mode, both forward and reverse link use the same frequency band, see Figure 32. The intention has been to keep the TDD mode as similar to the FDD mode as possible, in order to facilitate easy implementation of dual mode FDD/TDD phones as well as to facilitate reuse of IC's in single mode TDD phones. The control channel multiplexing and uplink and downlink spreading codes is therefore the same in TDD mode as in FDD mode.

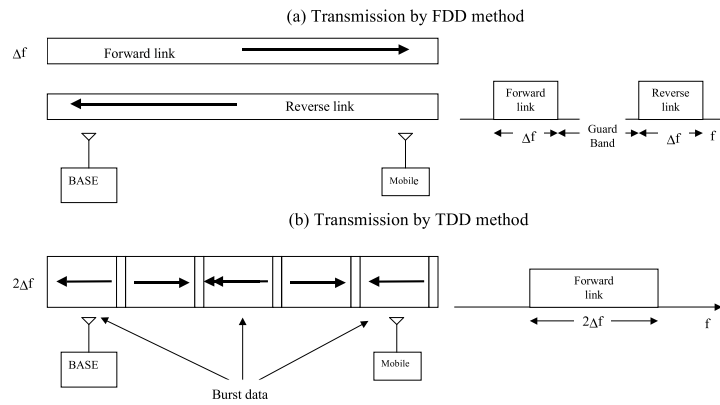


Figure 32 Principle for FDD and TDD operation

The TDD mode shares all key features of WCDMA, such as a high degree of service flexibility. There are two main reasons for the introduction of a TDD mode. The two reasons reflect two different target markets.

2.9.1.1 Cellular public

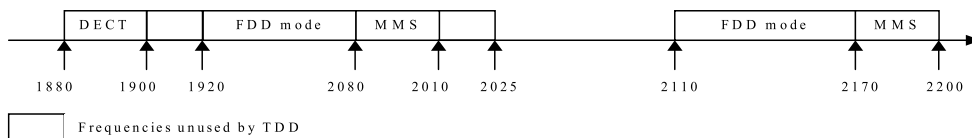


Figure 33 shows the spectrum allocated for UMTS in Europe, and shows two frequency bands which can not be utilised by a FDD system and for which a TDD mode is needed.

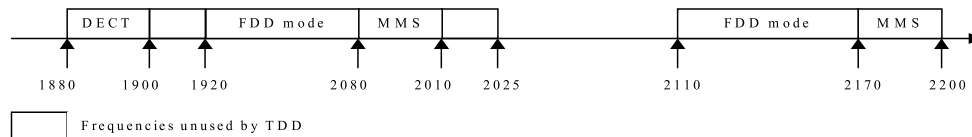


Figure 33 Spectrum allocation for UMTS

Figure 34 illustrates the fragmented nature of frequency allocations around the world and the potential for a TDD solution to utilise these and also second generation spectrum re-farming opportunities. There are obvious candidates even today in the 2010-2025 MHz band, the DECT and PHS allocations, the TDD WLL allocation in China and possibly in the 2110 to 2165MHz allocation in the US.

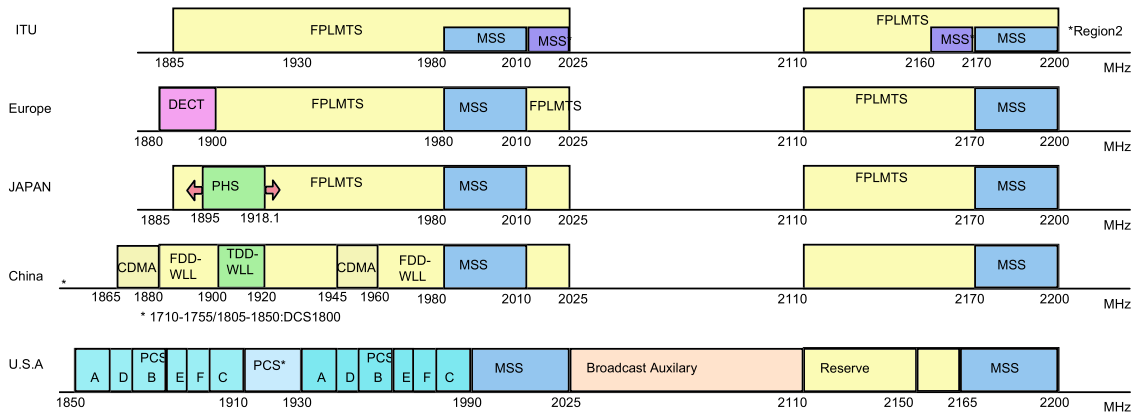


Figure 34 Frequency allocation around the world

2.9.1.2 Unlicensed private

Today most lower-power, small area cellular systems use TDD. In Europe DECT and in Japan PHS are both based on TDD-TDMA. It is reasonable to allow UMTS to address the need of these market segments. TDD allows several simplifications of the RF circuitry, as no duplexer is required. In addition as TDD use the same frequency band in both the uplink and downlink the fading patterns are highly correlated. This in turn facilitates several techniques to be used for mitigating multipath fading, such as open loop power control and transmit and receive antenna diversity, see 2.9.3.

2.9.2 Frame structures

The TDD mode is based on the same general frame structure as the FDD mode, i.e. a 10 ms frame split into 16 slots of 0.625ms each, compare Section 2.4.1. In TDD each slot can be used either for uplink or downlink. However two main modes are currently anticipated.

- Each slot of 0.625ms is used alternating for Rx and Tx, see Figure 35. This mode will allow the open loop power control to work up to a mobile-station speed of 120 km/h. This mode is intended for suburban outdoor environments as stipulated by 04.02.

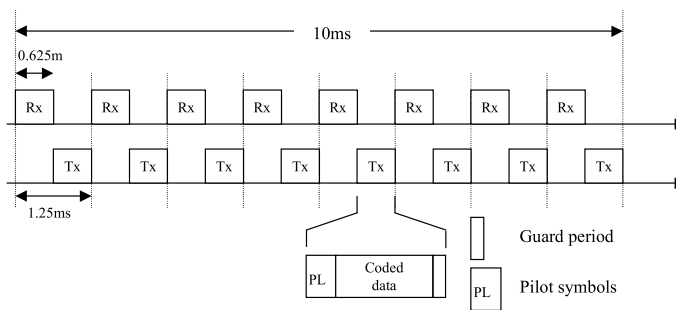


Figure 35 Suggested Rx/Tx cycle for cellular public applications

- Each frame of 10ms consists of one transmit block and one receive block, see Figure 36. The size of the receive block is a multiple of 0.625ms. This facilitates asymmetric services, with the maximum asymmetry being of the order of 15 to 1 (9.375 ms to 0.625ms). In this configuration speeds up to 10km/h can be accommodated with open loop power control. This mode is intended for indoor and low-speed outdoor use.

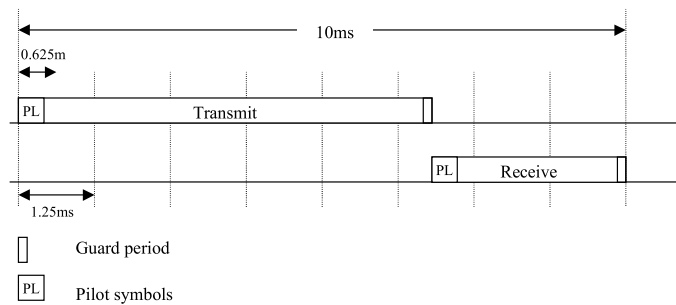


Figure 36 Suggested Rx/Tx cycle for unlicensed private use.

2.9.3 TDD advantages

Due to the high correlation of the channel in the forward and reverse directions, TDD offers several ways to improve system performance and simplify terminal equipment.

- Open loop power control.** Fast uplink open loop power control may be implemented in the mobile. In the downlink only slow power control is applied. At the mobile the received level can be compared with the expected level and the fading state of the channel can be estimated. As the channel is assumed to be reciprocal the state of the channel for the next mobile transmit burst can be estimated, and the transmit power level set accordingly.
- Base station transmit antenna selection.** In indoor environments path diversity gain can not be expected to be large (i.e. flat fading). Antenna diversity must therefore be used both in the mobile and the base station. Due to the high correlation of the forward and reverse path the mobile antenna diversity can be moved to the base station. This in turn reduces the interference and therefore improves the capacity of the system.
- Pre-RAKE combining diversity.** For outdoor use frequency selective fading can be expected. To take advantage of the path diversity the mobile must implement several RAKE fingers, which in turn will increase the cost of the unit. In a TDD system the RAKE combining can be carried out in the base station also for the downlink.
- Adaptive Antennas.** Channel estimation of the uplink facilitates not only the use of uplink reception techniques but also efficient implementation of adaptive antenna techniques for the downlink.

2.10 Performance enhancing features

In this section, a number of performance enhancing features, currently not seen as parts of the WCDMA concept are described. It can be assumed that during the refinement phase, most of these features will be included in the concept.

2.10.1 Support of adaptive antennas

Adaptive antennas are recognised as a way to enhance capacity and coverage of the system. As mentioned in Section 2.4.1, solutions employing adaptive antennas are already supported in the WCDMA concept through the use of connection-dedicated pilot bits on both uplink and downlink.

2.10.2 Support of advanced receiver structures

WCDMA is designed to work without requiring complex joint detection of multiple user signals. However, the potential capacity gains of such receivers in a WCDMA system have been recognised and taken into account in the design of the concept. In the uplink the possibility to use only short codes (no secondary scrambling code) facilitates more advanced receiver structures with reasonable complexity.

2.10.3 Support of transmitter diversity

Transmitter diversity in the downlink provides a means to achieve similar performance gains as for mobile-station receiver diversity without the complexity of a second mobile-station receiver. For the WCDMA concept, transmitter diversity is possible for both the FDD and the TDD mode.

2.10.3.1 Transmitter diversity for FDD mode

A typical transmit diversity technique such as delay transmit diversity has two main drawbacks - self-interference at locations with good SINR and requirement for additional Rake fingers in the mobile receiver.

However, in WCDMA, orthogonal transmit diversity (OTD) offers significant advantages in the downlink performance, while being free from the above problems.

The implementation of OTD is as follows. Coded bits are split into two data streams and transmitted via two separate antennas. Different orthogonal channelization codes are used per antenna for spreading. This maintains the orthogonality between the two output streams, and hence self-interference is eliminated in flat fading. Note that by splitting the coded data into two separate data streams, the effective number of channelization codes per user is the same as the case without OTD.

The above structure is highly flexible:

- It may be easily extended to more antennas (4, 8, etc.)

OTD may be an optional feature that can be turned on only if needed. In addition, it is possible to support a mixture of mobiles with and without OTD capability.

The additional required processing at the mobile station is small. Figure 37 illustrates Rake finger processing with OTD. It is important to note that the Pilot signal is also split and transmitted on both antennas which allows coherent detection of the signals received from both antenna. The data is processed using a Rake finger with parallel processing capability. Both transmitted signal streams are received simultaneously at the same delay (for a given multipath ray), hence no additional buffering and skewing of data is necessary. This significantly reduces the hardware complexity/cost associated with OTD implementation.

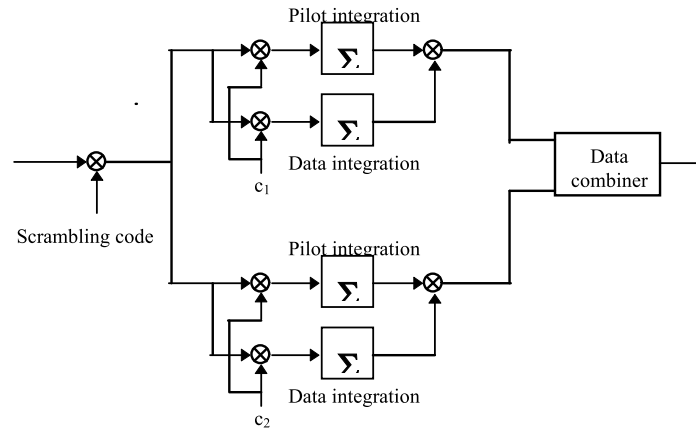


Figure 37 Rake finger processing with OTD

In the base station transmitter, the baseband processing (i.e. data splitting and separate spreaders) required for OTD already exists with multicode transmission in the downlink. From the OTD viewpoint, it is advantageous to employ multicode transmission for all data rates, and it is also recommended to match the number of codes assigned to the user with the number of transmit antennas.

Simulation results indicate that at high speeds, the improvement due to OTD over the system with no diversity is 2.5 dB and about 3 dB over delay transmit diversity. At slow speeds OTD is only slightly better than delay transmit diversity, but the improvement relative to the system with no diversity is as much as 7 dB. Furthermore at slow speeds OTD reduces the required power variance of the downlink fast forward power control.

2.10.3.2 Transmitter diversity for TDD mode

As discussed in, for TDD transmission there is full channel-reciprocity between uplink and downlink, due to the use of a common uplink/downlink carrier frequency. From uplink measurements, the base station may then decide the best antenna to use for the downlink transmissions and thus avoid downlink fades.

2.10.4 Optimised uplink pilot power

With the current uplink scheme, the uplink pilot power is constant for all rates within a variable-rate connection. By including additional variable-strength pilot-bits on the I branch, the uplink pilot power could be optimised for each rate within the rate set of a variable-rate connection.

3. PERFORMANCE EVALUATION

As a part of the work in the ETSI/SMG2 concept group Alpha, Wideband DS-CDMA, a performance evaluation of the WCDMA concept has been carried out by means of simulation for the FDD mode. Results exist also for the TDD mode, but not for the prioritised test cases.

The SMG document UMTS 30.03 ("30.03") [2] describes how this evaluation is to be made. It lists a large number of environments and services to be tested. In Tdoc SMG2 260/97 [3] a subset of all these test cases are listed as prioritised. In addition to this, at SMG2#23 some additional test cases were identified, see Tdoc SMG2 329/97 [4]. Simulation results obtained so far are for the test cases described in these two documents. The prioritised simulations from Tdoc SMG2 260/97 and Tdoc SMG2 329/97 are shown in Table 3.

Environment	Service mixture	Propagation model	Cell type	Link level	System level
Outdoor to indoor and pedestrian 3 km/h	UDD 384	Outdoor to indoor and pedestrian A	Micro	X	X
	Speech			X	X
	LCD 144			X	
	UDD 2048			X	
Indoor office 3 km/h	UDD 2048	Indoor office A	Pico	X	X
	Speech			X	
	LCD 384			X	
	50% speech + 50% UDD 384				X
	LCD 2048		(X)	(X)	
Vehicular 120 km/h	UDD 144	Vehicular A	Macro	X	
	Speech			X	X
	LCD 384			X	X
	50 % speech + 50 % UDD 384			(X)	(X)
Vehicular 120 km/h	Speech	Vehicular B	Macro	(X)	
Vehicular 250 km/h	Speech	Vehicular B	Macro	(X)	

Table 3. Required simulations according to Tdoc SMG2 260/97 and Tdoc SMG2 329/97. Optional results in brackets.

This document contains the WCDMA simulation results for the services in Table 3. Compared to the results presented in the draft 1.0 version of the Evaluation document [7], a number of improvements have been made, both on link-level and system-level. Also, results are presented for those services where results were missing in the previous version of this document.

3.1 Implementation of WCDMA/FDD simulations

For the moment the most comprehensive WCDMA simulation results come from the original FRAMES FMA2 proposal. In this section, the FMA2 simulation results are reported. However, the WCDMA concept differs in some areas compared to the FMA2 concept. The largest difference is that the WCDMA concept uses time multiplexed control information in the downlink while FMA2 uses code/IQ

multiplexing in both links. Hence, the simulation chain does not agree fully with the current WCDMA group concept. However, this difference between time and IQ/code multiplexing has been evaluated, and is being further evaluated, and there is evidence that there is no major performance difference between the two techniques. It can even be argued that the current WCDMA concept should have slightly better downlink performance compared to the original FMA2 downlink. The downlink performance figures presented here should then be slightly pessimistic.

Also, simulations performed by NEC agree well with the results obtained with the FMA2 simulation chain. The NEC simulations were done with time multiplexing in both uplink and downlink, and are described in [5].

3.1.1 Link-Level Simulations

3.1.1.1 Simulation Model

The WCDMA system description is the basis for the simulation model. However, the downlink simulations use the original FMA2 downlink, described in [1]. Once again one should note that the performance is basically the same.

In the simulations sampling was made at chip level, i.e. with no oversampling and no pulse-shaping filters. Comparative simulations showed negligible performance differences between the filtered and non-filtered case.

Fast power control is included in all simulations. Instead of sending the uplink power control commands on the downlink and vice versa, power control commands are passed through a binary symmetric channel with error probability of 1 %. Simulations have verified that the 1 % error probability agrees well with real errors on transmitted power control commands. Link-level simulations assume unlimited dynamic range for the fast power control, and the delay in the power control loop is one slot. The power amplifier is not modelled, i.e. an ideal amplifier is assumed.

The uplink simulations assume receiver antenna diversity with zero correlation between the antennas, while the downlink assumes one receiver antenna only. Ordinary RAKE reception is used in all simulations. Channel estimation is done through simple averaging of pilot symbols from two consecutive slots.

A fixed searcher is used in the receiver, i.e. the receiver knows the delay of all rays and picks up the energy of some rays using a fixed set of fingers in the RAKE. In the section on channel models the rays picked up by the RAKE are shown.

All interference is modelled as additive white Gaussian noise.

3.1.1.2 Searcher Performance

This chapter shows the results on the practical searcher in WCDMA derived from the testbed results presented in Tdoc SMG2 UMTS A41/97, [6]. The searcher used in the evaluation consisted of the following steps:

- Correlation between the received signal and the spreading code is calculated at each pilot symbol position with the specified timing resolution.
- Complex correlation values at the step 1 are summed up over the time length-1 (vector integration time) after removing pilot modulation for SINR improvement.
- Squared value of the summation obtained at the step 2 is summed up over the time length-2 (power integration time) for noise and interference smoothing.
- Path timings are selected in descending order from the timings with large squared value given at the step 3.

The number of path timings to be selected was equal to the number of fingers of the RAKE receiver at maximum. At step 4, the power level of a path candidate was compared with the noise and interference floor level as well as the level of the first selected path timing (the maximum power) so that path to be selected efficiently contributes to the path diversity effect at the RAKE receiver. The guard time is also introduced between the path timing already chosen and a path candidate for path separation. In order to

utilize path diversity effect due to multipaths coming at very close timing, the performance with the guard time of less than 1 chip duration often outperforms over the one with 1 chip guard time.

The BER performance with the adaptive searcher was compared to the one with fixed searcher, which knows the optimum setting of RAKE fingers in advance. Test were done both with and without power control and the test environment was set to Vehicular B with Doppler frequencies ranging from 5 Hz to 240 Hz. Two antenna branches were used, and one searcher was provided per one antenna branch. Path timings with the four largest powers were set to RAKE receiver fingers out of 8 path timing candidates, each 4 of which were detected by the searcher for each antenna. As a service, LCD 32kbps was used for evaluation.

From the results it can be concluded that the **performance degradation due to using the practical searcher is very little, 0.2-0.3 dB at most, if the proper parameter setting is used.**

In higher speed environment, though instantaneous power level of each channel path fluctuates due to Rayleigh fading more rapidly, the power level can be averaged for shorter observation time at searcher. Therefore, for UMTS link-level simulation, **the fixed searcher based on average power level gives a link performance very similar to the one with non-fixed searcher in high speed environment**, though it may not enjoy instantaneous path-selection diversity effect which only gives a small fraction of dB at most.

In practical environment, path timings (channel profile) vary according to the change of radio propagation. The higher the speed becomes, the more rapid change occurs in channel profile. This factor has not been considered in the UTRA link-level simulation based on 04.02. It is partly because the practical modeling of channel profile change is very difficult. But the main reason, we believe, is that properly designed searcher can track this channel change without significant performance degradation, which is explained below.

A good measure of this channel change is the de-correlation length of the long-term fading, at which the auto-correlation of shadowing becomes 0.5. A typical de-correlation length for vehicular environment is 20 m[2], which takes 288 ms when travelling at 250 km/h. With 80 ms path search time, the auto-correlation of shadowing based on the calculation in [2] is 0.82 at 250 km/h and 0.68 at 500 km/h. The studies for different searcher times have shown that degradation is at most 1 dB at BER of 10^{-3} with path search time of 20 ms, in the case of which the auto-correlation of shadowing is 0.95 at 250 km/h and 0.82 at 500 km/h. Therefore, the channel profile change is not so great even in high-speed vehicular environment. Thus a properly designed searcher tracks channel changes in practical situations without causing significant degradation in performance.

Thus it can be concluded that no significant performance degradation is caused by the implemented searcher. Also, the discussion indicates that path timing change is not so rapid to make searcher output obsolete at practical vehicle speeds. The studies done conclude that properly designed searcher gives no significant degradation to link-level performance in WCDMA and also that simulation results in the Alpha group evaluation document can be used for the performance comparison with other groups' results, if other groups also take the proper assumption into account.

3.1.1.3 Channel Models

The channel models given in 30.03 cannot be used right away, since the time resolution of the simulation model is one sample. For the simulations the following modelling of the 30.03 channel models was used:

Each ray is split into two rays, one to the sample to the left and one to the sample to the right. The power of these new rays is such that the sum is equal to the original power, and the power of each of the new rays is inversely proportional to the distance to the original ray. Finally, the power of all rays on one sample are added up and normalised. This yields a model with a number of independently Rayleigh fading rays on the sampling instants.

In the Vehicular B channel the delay spread is very large, so moving the rays to the nearest sampling instant have only marginal impact on the look of the impulse response. Hence, for this channel the rays have been moved instead of interpolated to sampling instants.

In the simulations the sampling time is equal to the chip time, resulting in the channel models in Figure 38 that were used in simulations.

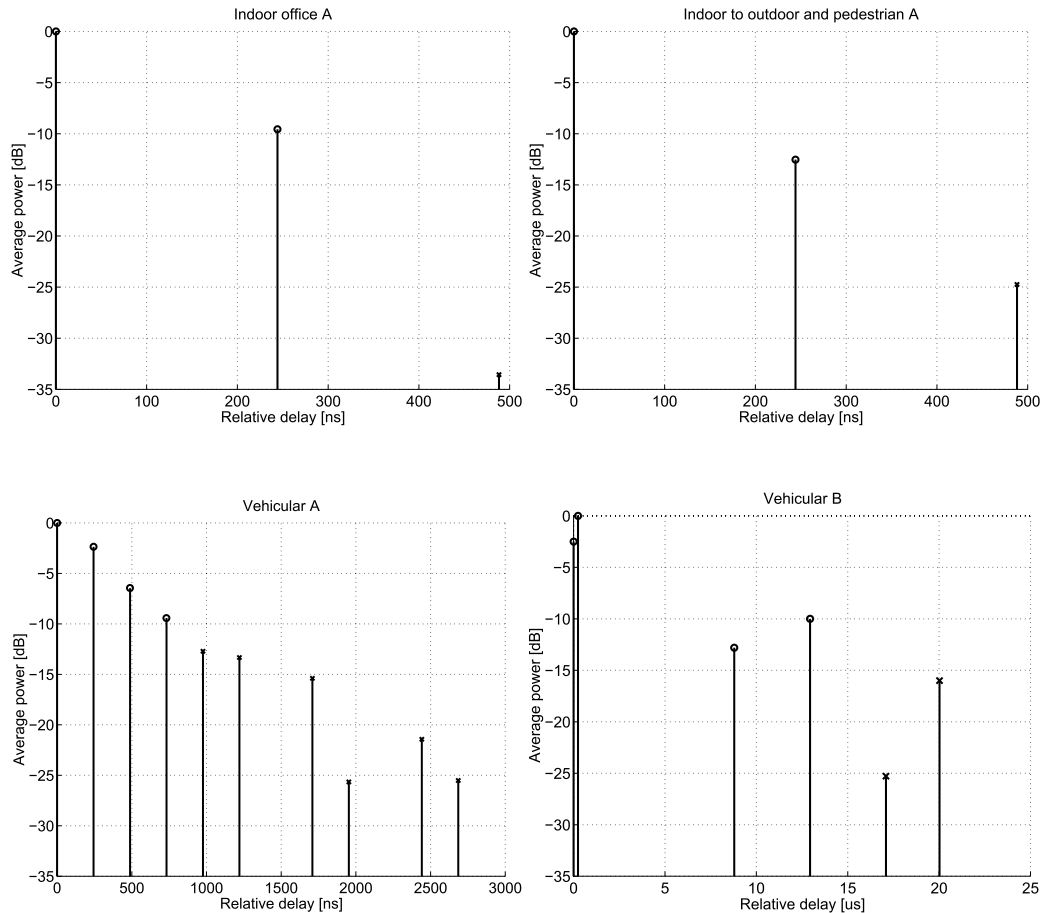


Figure 38. Modified channel models used in the simulations.

The rays picked up by the RAKE receiver are marked with “o” in the figure, while other rays are marked “x”. No special link simulations were made for soft handover situations. In a soft handover the result from two single connection RAKEs are combined. For the Vehicular case this would mean 8 RAKE fingers. However, the number of RAKE fingers can be lowered in soft handover without affecting the performance, so 4 - 6 fingers should suffice.

Simulations have been made for mobile station speeds of 3, 120 and 250 km/h, corresponding to Doppler frequencies of 5.6, 213 and 444 Hz respectively for the uplink.

3.1.2 System-Level Simulations

3.1.2.1 Simulation Environment

The simulation environments are described in 30.03. Implementation assumptions are described below.

The Outdoor to indoor and pedestrian deployment environment is a Manhattan-like environment with the block size of 200 m and low speed (3 km/h) users. The environment consists of 72 base stations and are located as described in 30.03. The base stations are using omni-directional antennas and are deployed 10 m above ground, which is below the roof tops. The radio propagation going above roof tops is also included in the system simulation model. The street width is 30 m and it is assumed that the pedestrians are moving in the middle of the street.

The Indoor office environment characterises a three floors office building where users are moving (3 km/h) between an office room to the corridor or vice versa. The base stations (60 base stations all using omni-directional antennas) are deployed in every second office room.

The Vehicular environment is a classic macro environment with site-to-site distance of 6 km. Tri-sector sites are used, i.e. each site is serving three sectors (cells). The speed of the mobile stations is

120 km/h. Wrap around is used in order to make an infinite cell plan, i.e. there are no border effects in the simulations.

3.1.2.2 Downlink Orthogonality

The downlink will not be perfectly orthogonal due to multipath propagation. The downlink orthogonality factor, i.e. the fraction of the total output power that will be experienced as intra-cell interference, has been calculated for the different environments and is presented in Table 4. An orthogonality factor of zero corresponds to a perfectly orthogonal downlink, while a factor of one is a completely non-orthogonal downlink. As seen in the table below, 40% of the power transmitted from the own cell will act as intra-cell interference in the Vehicular environment.

Propagation model	Orthogonality factor
Indoor office A	0.10
Outdoor to indoor and pedestrian A	0.06
Vehicular A	0.40

Table 4. Orthogonality factor for the environments' different propagation models.

The orthogonality factor has been derived in the following way:

Two simulations were made, one with white Gaussian noise and one with intra-cell interference. The BER was then plotted as a function of E_b/N_o and E_b/I_o respectively. These curves may differ significantly, where the E_b/I_o curve is to the left of the E_b/N_o curve. A difference of 10 dB means that a given E_b/I_o gives the same BER as $E_b/N_o = E_b/I_o + 10$. Consequently, a certain I_o in the system simulations is equivalent to having 10 dB less N_o in the link-level simulations. Hence, one can say that the orthogonality removes 90% of the interference, or we have an orthogonality factor of 10% (10% of the interference remains).

3.1.2.3 Soft / Softer Data Combining

For the Indoor office and the Outdoor to indoor and pedestrian environment soft handover is used between base stations. This means that the uplink C/I (or $SIR = PG \times C/I$) is calculated as selection diversity and the downlink as maximum ratio combining (a sum of the received C/I from each base station). For the Vehicular environment softer handover is used, i.e. the mobile is connected to several sectors belonging to the same site, which will affect the calculation of the uplink C/I . Therefore the uplink C/I for all sectors belonging to one site is calculated as maximum ratio combining. Soft handover in the Vehicular environment is treated as regular selection diversity.

The softer handover data combining (maximum ratio combining) is performed on layer 1 in the WCDMA concept. Softer handover is used only in the Vehicular environment. In the uplink and downlink the SIR during *softer* handover is modelled as:

$$SIR_{combined} = \sum_{sectors} SIR_{sector}$$

The combined downlink (maximum ratio combining) SIR during *soft* handover is modelled as:

$$SIR_{DL,combined} = \sum_{sectors} SIR_{sectors}$$

The combined uplink (selection diversity) SIR during *soft* handover is modelled as:

$$SIR_{UL,combined} = \max(SIR_{sector})$$

3.1.2.4 Increase in TX Power due to Power Control

One effect of the fast power control is that the transmitted power from each mobile will vary with time, and this can cause an increase in background interference power.

For the speech service the average transmitter power increase is used when calculating the interference to other cells (the power increase will not affect the own cell). A good model of the power increase is perfect tracking of the fast fading. This assumption is valid only for the 3 km/h cases (Indoor office and Outdoor to indoor and pedestrian). The power increase in the Vehicular environment is negligible since the power control cannot track the fading, and is therefore not included in the system simulations.

For the UDD simulations fast fading values from the link-level simulations are used in the system-level simulator to adjust the output power of the transmitters for each frame. This means that for each frame a new fading value will be used when calculating the gain matrix (including path loss, shadow fading and fast fading).

3.1.2.5 Radio Resource Management

Fast SIR based power control is assumed in both uplink and downlink, and the power of the transmitters are balanced to meet the averaged SIR during one frame.

The downlink power control may introduce a “near-far” problem if a user near the base station is interfered by the power transmitted to a user at the cell border, due to a non-orthogonal downlink. This problem is avoided by having a limited dynamic range in the downlink. A 20 dB dynamic range per bearer (traffic channel) is assumed in the simulations.

Soft/softer handover is used for the circuit-switched services. The soft/softer handover algorithm simply connects the strongest, based on pathloss (excluding fast fading), base stations within the handover window. The soft/softer handover window threshold is set to 3 dB and the algorithm is executed every 0.5 second and the maximum active set size is two. No significant performance improvement is expected by having an active set size of three or more in these environments. Measurement errors are not included. No soft handover is currently used in the packet simulations; the user simply connects to the strongest base station.

For the UDD service dedicated channel packet transmission is used. No random access / forward access signalling is included in the results.

We assume that a RLC block can be re-transmitted in the next frame, i.e. that the ACK/NACK channel is error free and infinitely fast. A packet data user is queued if no resources are available. If there is a choice between queuing two users, the latest arrived user is queued.

3.1.2.6 Performance Measures

Circuit-Switched Services

Two circuit-switched services, speech and LCD 384, have been evaluated by means of dynamic system simulations. The performance measure of the speech (8 kbps, 50% voice activity) and LCD 384 services is that 98% of the users are *satisfied*. A user is satisfied if all three of the following constraints are fulfilled:

1. The user does not get blocked when arriving to the system.
2. The user has sufficiently good quality more than 95% of the session time. The quality threshold is defined as $BER = 10^{-3}$ (speech) or $BER = 10^{-6}$ (LCD).
3. The user does not get dropped. A speech user is dropped if $BER > 10^{-3}$ during 5 s and a LCD 384 user is dropped if $BER > 10^{-6}$ during 26 s.

Packet Services

Two different packet data services have been evaluated: UDD 384 and UDD 2048.

The performance measure of the packet services is that 98% of the users are *satisfied*. A user is satisfied if all three of the following constraints are fulfilled:

1. The user does not get blocked.
2. The user does not get dropped.

The *active session throughput* shall not be below 38.4 kbps (UDD 384) or 204.8 kbps (UDD 2048).

The time waiting on ACK/NACK (i.e. when the transmitter buffer is empty) is not included when calculating the active session throughput. If the data packet that shall be transmitted has less bits than can be transmitted in a frame, dummy bits (or rather dummy blocks) are added. These dummy bits are not included when calculating the session throughput, however they will increase the interference in the system. A data packet will be divided into data blocks of 320 bits (300 information bits). Several blocks are then put into a frame, e.g. 8 blocks per frame for the UDD 384 service. For a detailed description, see section 3.2.1.3.

3.2 Results

3.2.1 Link-Level Simulations

The E_b/N_0 values presented here are the actual E_b/N_0 values needed in the receiver to achieve the corresponding BER, FER and BLER. The E_b/N_0 values include all overhead, i.e. the DPCCH (Dedicated Physical Control Channel: pilot bits, power control bits, FCH) and overhead on the DPDCHs (Dedicated Physical Data Channels) such as CRCs, block numbers and tail bits for the convolutional code. In other words, the E_b value contains all energy needed to transmit one information bit. Energy from common broadcast channels are not included in the link-level results.

The user bit stream is coded using convolutional codes and possibly also a Reed-Solomon code. After coding of the DPDCH rate matching is applied, using puncturing or repetition. On the DPCCH rate matching is always performed using repetition. The rate matching used for the different services are given below, e.g. 9/10 rate matching means “9 bits in, 10 bits out” or repetition of every 9:th bit.

All plots with link-level results are found in Part 3, together with tables specifying the parameters used for the simulations.

3.2.1.1 Speech Service

The speech-service simulations assume a hypothetical 8 kbps speech codec with a user BER requirement of 10^{-3} . The simulations have been carried out with interleaving over one frame only (10 ms) and two frames (20 ms), both of which should satisfy the UMTS requirements of a one-way delay of at most 20 ms. Larger inter-frame interleaving can be applied if more delay is allowed. This would improve performance, especially for medium-speed mobile terminals. A convolutional code of rate 1/3 with constraint length 9 was used for both uplink and downlink. Since the variable rate speech service only has two different bit rates, 0 and 8 kbps, blind rate detection is easily done. Hence, simulations have been made both with and without explicit rate information (FCH, Frame Control Header).

In the simulations the FCH was restricted to two values of the 64 possible. This yields an FCH word error rate of around 10^{-4} for all environments, which means that the rate detection will have virtually no impact on link quality.

The simulation results are shown in Table 5 below.

Environment & mobile speed	E_b/N_0 @ BER = 10^{-3} [dB] (Diversity / No diversity)			
	10 ms interl. With FCH	10 ms interl. No FCH	20 ms interl. With FCH	20 ms interl. No FCH
Indoor office A, 3 km/h	4.2 / 7.4	- / 7.1	3.7 / -	3.1 / 6.4
Outdoor to indoor and pedestrian A, 3 km/h	4.5 / 8.0	- / 7.5	4.1 / -	3.3 / 6.7
Vehicular A, 120 km/h	6.5 / 9.0	- / 8.8	6.1 / 8.0	5.0 / 7.6
Vehicular B, 120 km/h				4.9 / 7.7
Vehicular B, 250 km/h	7.0 / -		6.4 / -	6.0 / 8.2

Table 5. Link-level results, speech 8 kbps service.

3.2.1.2 LCD Services

In order to reach the $BER=10^{-6}$ requirement for LCD services, outer Reed-Solomon coding of rate 4/5 is used together with an inner convolutional code and interleaving over 120 ms. The inner convolutional coding is made over one frame or part of a frame.

LCD 144, 384 and 2048 have been simulated in different environments. The LCD 144 uses an inner convolutional code of rate 1/3, while the LCD 384 and 2048 services use a rate of 1/2.

Results are found in Table 6 below. The values without antenna diversity have been estimated from the simulated case with antenna diversity. Based on the speech and UDD simulations, a difference of 3 dB is assumed for the Indoor office and Outdoor to indoor and pedestrian environments, while a difference of 2.5 dB is assumed for the Vehicular environment.

Service	Environment & mobile speed	E_b/N_0 @ BER = 10^{-6} [dB] (Diversity / No diversity)
LCD 144	Outdoor to indoor and pedestrian A, 3 km/h	1.3 / 4.3
LCD 384	Indoor office A, 3 km/h	2.1 / 5.1
	Vehicular A, 120 km/h	3.1 / 5.6
LCD 2048	Indoor office A, 3 km/h	3.0 / 6.0

Table 6. Link-level results, LCD services.

3.2.1.3 UDD Services

For the UDD services, packets to be transmitted are divided into blocks of 320 bits each, which constitutes the retransmittable unit. The user data rates that have been simulated are 240 kbps, 480 kbps, and 2.4 Mbps. These rates are then used in the system-level simulations to get an active

session throughput of at least 10 % of the packet bit rate. The 320 bit blocks includes data, CRC, block number, and encoder tail.

Rate 1/2 convolutional coding with constraint length 9 is used, and on top of that an ARQ protocol. However, the effects of ARQ are included in the system-level simulations. The aim of the link-level simulations is to find the required E_b/N_0 to achieve certain BLERs. Interleaving is made over one or two frames (10-20 ms).

The performance of the FCH is very good for these services. Since the power of the DPCCH can be relatively high and still not affect the overhead too much, the FCH error rate is much less than 10^{-4} for the target BLER when there are 8 different FCH words to distinguish between.

Results are found in Table 7 below.

Service	Environment & mobile speed	Link-level bit rate [kbps]	E_b/N_0 @ BLER = 10% [dB] (Diversity / No diversity)
UDD 144	Vehicular A, 120 km/h	240	1.9 / 4.2
UDD 384	Indoor office A, 3 km/h	240	0.2 ¹ / 2.8
	Outdoor to indoor and pedestrian A, 3 km/h	240	0.2 / 3.2 ²
UDD 2048	Indoor office A, 3 km/h	480	0.2 / 2.8
		2400	0.7 / 3.3 ³
	Outdoor to indoor and pedestrian A, 3 km/h	480	0.2 / 3.2
		2400	0.6 / 3.6 ³

Table 7. Link-level results, UDD services.

Note 1: The simulation without antenna diversity shows that equal E_b/N_0 performance can be obtained for 240 and 480 kbps bearers. The 240 kbps figure with antenna diversity is thus assumed to be the same as the corresponding 480 kbps figure.

Note 2: The simulation with antenna diversity shows that equal E_b/N_0 performance can be obtained for 240 and 480 kbps bearers. The 240 kbps figure without antenna diversity is thus assumed to be the same as the corresponding 480 kbps figure.

Note 3: Estimated value without antenna diversity based on E_b/N_0 difference between 480 and 2400 kbps with antenna diversity.

3.2.2 System-Level Simulations

Dynamic system simulations have been performed for three different services in three different environments described in 30.03. In these simulations all base stations are assumed to be equipped with *one* 4.096 Mcps WCDMA carrier using 5 MHz carrier spacing (assuming 3 carriers within 15 MHz). It is likely that the concept will perform better if a larger bandwidth is used for higher data rates due to a better truncing efficiency. Therefore all results of higher data rate services shall be regarded as pessimistic results. Also, the simulations of the UDD services have only used a *fixed* bit-rate radio bearer, which will also decrease the performance of the UDD services.

The system simulation parameters are listed more in detail in Part 3.

3.2.2.1 Circuit-Switched Services

Two circuit-switched services, speech and LCD 384, have been evaluated by means of dynamic system simulations. The performance measure of the speech (8 kbps, 50% voice activity) and LCD 384

services is that 98% of the users are *satisfied*. No admission control has been used, therefore no users are blocked. Also, the simulation results show that cell capacity in all cases is limited by the requirement that a satisfied user must have sufficiently good quality more than 95% of the session time and not by the dropping criteria. This means that we have no blocking nor dropping in these simulation results, hence the offered load (Erlang capacity) is same as the served load.

The WCDMA concept uses fast power control also in downlink. This means that slow moving users can compensate for the fast channel fading, hence no substantial diversity gain from connecting more base stations (i.e. increase the maximum number of active set) is seen. Connecting more base stations will only increase the required capacity of base station to base station controller transmission. High speed users do not require good tracking of the fast channel fading due to the gain from coding and interleaving.

The system simulation parameters are listed in Part 3. In Table 8 speech results are found for 20 ms interleaving. LCD results are presented in Table 9.

The speech service is evaluated using 50% voice activity. However, the DPCCH is transmitted with constant bit-rate independent of the speech user information rate (8 kbps or 0 kbps information bit-rate). Therefore, the spectrum efficiency will increase more than 30% if a voice activity of 100% is used, due to the decreased DPCCH (relative) overhead.

A C/I based soft handover algorithm has been studied in the Outdoor to indoor and pedestrian environment, in order to show the improvements that can be achieved by such an algorithm. The basic strategy behind the C/I based algorithm is that the MSs connect to the BS/BSs that requires the lowest amount of output power. Since the handover decision is network evaluated in this case, the MSs still measure the pathlosses to different BSs and report them to the network. In the new scheme, the interference received at the different BSs is also added to the handover decision. Thus, no signaling of interference levels is required over the air interface. The increase in uplink spectrum efficiency (from 127 to 189 kbps/MHz/cell) is due to the load sharing, i.e. the downlink will be the limited link in that case. Another way to achieve a similar load sharing effect is to have a large active set and a large handover margin. The evident disadvantage of that approach is the increased number of mobiles in soft handover.

Service	Environment	E_b/N_o @ BER = 10^{-3} [dB] (UL / DL)	Cell capacity [Erlang/carrier/cell] (UL / DL)	Spectrum efficiency [kbps/MHz/cell] (UL / DL)
Speech (8 kbps, 50% VA)	Outdoor to indoor and pedestrian A	3.3 / 6.7	159 / 204 237 / -	127 / 163 189 / - (C/I based HO)
	Vehicular A	5.0 / 7.6	123 / 98	98 / 78

Table 8. Spectrum efficiency of the speech service: 8 kbps, 50% voice activity, 20 ms interleaving.

Service	Environment	E_b/N_o @ BER = 10^{-6} [dB] (UL / DL)	Cell capacity [Erlang/carrier/cell] (UL / DL)	Spectrum efficiency [kbps/MHz/cell] (UL / DL)
LCD 384	Vehicular A	3.1 / 5.6	1.8 / 1.1 5.3 / 3.2 (30 dBm MS, 8 Mcps)	138 / 85 204 / 123 (30 dBm MS, 8 Mcps)
		3.1 / 3.1 (ant div)	1.8 / 2.8 2.3 / 2.8 (30 dBm MS) 5.3 / 6.6 (30 dBm MS, 8 Mcps)	138 / 211 175 / 211 (30 dBm MS) 204 / 250 (30 dBm MS, 8 Mcps)

Table 9. Spectrum efficiency of the LCD services.

It is likely that the LCD 384 applications will be executed on a laptop, therefore antenna diversity in the downlink is assumed in some of the results. It can be seen from the LCD 384 results that noise has a large impact on the uplink capacity. To overcome this a mobile transmitted power of 30 dBm was also tested. Also, an 8 Mcps (with 30 dBm MS) carrier was tested to see the effect of increased truncing efficiency.

3.2.2.2 Packet Services

Two different packet data services have been evaluated: UDD 384 and UDD 2048. The performance measure of the packet services is that 98% of the users are *satisfied*.

New results are provided due to the new UDD performance definition, i.e. the 10% active session throughput requirement, see "CR's on UMTS 30.03 A001 and A002", Tdoc SMG 97-771. The results are found in Table 10 below.

The current implementation of the UDD 2048 service use fixed bearers; i.e. one or more codes of 480 kbps user bit-rate each. A real system will of course have a higher granularity of the bearers, but for simplicity only 5 different bearers have been tested in the system level simulations. The UDD 2048 (Indoor office A) performance has improved compared to the "100%" results due to better truncing efficiency. The spectrum efficiency is in the uplink 300 kbps/MHz/cell and downlink 244 kbps/MHz/cell. With downlink antenna diversity the downlink spectrum efficiency is 510 kbps/MHz/cell. The system simulation parameters and pdf of the active session throughput for different bearer choices are found in Part 3.

Also the UDD 384 service (Outdoor to indoor and pedestrian A) results have been improved. The spectrum efficiency is in the uplink 470 kbps/MHz/cell and in the downlink 565 kbps/MHz/cell. With antenna diversity the downlink will be code limited (i.e. 672 kbps/MHz/cell) and the coding may therefore be reduced in order to increase the spectrum efficiency above 672 kbps/MHz/cell.

Service	Environment	E_b/N_o @ BLER = 10% [dB] (UL/DL)	Spectrum efficiency [kbps/MHz/cell] (UL / DL)
UDD 2048	Indoor office A	0.2 / 2.8	300 / 230
		0.2 / 0.2 (DL ant div)	300 / 500 (DL ant div)
UDD 384	Outdoor to indoor and pedestrian A	0.2 / 3.2	470 / 565

Table 10. Spectrum efficiency of the UDD services.

3.2.2.3 Mixed Services

The UDD 384 is using a 240 kbps bearer and therefore we define the average number of packet user as the average session bit-rate divided with 240 kbps. The offered load is controlled so the number of packet and speech users is the same. The number of speech users is defined as the number of simultaneously transmitting (8 kbps) users.

The spectrum efficiency is calculated as:

$$\text{Spectrum efficiency} = \text{Cell capacity} \times (240 + 8) / 5 \text{ [kbps/MHz/cell]}$$

The results are found in Table 11 below.

Service	Environment	Cell capacity [Erlang/carrier/cell] (UL / DL)	Unsatisfied Speech Users [%] (UL / DL)	Unsatisfied UDD Users [%] (UL / DL)	Spectrum efficiency [kbps/MHz/cell] (UL / DL)
Speech + UDD 384	Indoor office A	6.3 / 4.2	2% / 2%	1% / 0.1%	315 / 207
		6.3 / 9.3 (DL ant div)	2% / 2%	1% / 0.2%	315 / 460 (DL ant div)

Table 11. Spectrum efficiency of the mixed service case.

3.3 Summary of Simulation Results

Table 12 summarises the results from the WCDMA/FDD link and system simulations.

Service	Environment & speed	E_b/N_o [dB] (UL / DL)	Cell capacity [Erlang/carrier/cell] (UL / DL)	Spectrum efficiency [kbps/MHz/cell] (UL / DL)	Notes
Speech	Indoor office A, 3 km/h	3.1 / 6.4			
8 kbps 50% VA	Outdoor to indoor and pedestrian A, 3 km/h	3.3 / 6.7	159 / 204 237 / -	127 / 163 189 / -	C/I based handover
	Vehicular A, 120 km/h	5.0 / 7.6	123 / 98	98 / 78	
	Vehicular B, 120 km/h	4.9 / 7.7			
	Vehicular B, 250 km/h	6.0 / 8.2			
LCD 144	Outdoor to indoor and pedestrian A, 3 km/h	1.3 / 4.3			
LCD 384	Indoor office A, 3 km/h	2.1 / 5.6			
	Vehicular A, 120 km/h	3.1 / 5.6 3.1 / 3.1	1.8 / 1.1 5.3 / 3.2 1.8 / 2.8 5.3 / 6.6	138 / 85 204 / 123 138 / 211 204 / 250	30 dBm MS, 8 Mcps DL antenna diversity DL antenna diversity, 30 dBm MS, 8 Mcps
LCD 2048	Indoor office A, 3 km/h	3.0 / 6.0			
UDD 144	Vehicular A, 120 km/h	1.9 / 4.2			
UDD 384	Indoor office A, 3 km/h	0.2 / 2.8			
	Outdoor to indoor and pedestrian A, 3 km/h	0.2 / 3.2		470 / 565	
UDD 2048	Indoor office A, 3 km/h	0.2 / 2.8 0.2 / 0.2		300 / 230 300 / 500	DL antenna diversity
	Outdoor to indoor and pedestrian A, 3 km/h	0.2 / 3.2			
Mixed speech + UDD 384	Indoor office A, 3 km/h		6.3 / 4.2 6.3 / 9.3	315 / 207 315 / 460	UDD DL antenna div.

Table 12. Summary of WCDMA/FDD simulation results.

References

- [1] "FMA - FRAMES Multiple Access, A Harmonized Concept for UMTS/IMT-2000: FMA2 - Wideband CDMA," ITU Workshop on Radio Transmission Technologies for IMT-2000, Toronto, Canada, September 10-11 1997.
- [2] UMTS 30.03, version 3.0.0, ETSI Technical Report, 1997-05.
- [3] Tdoc SMG2 260/97, "Common Workplan of SMG2 UTRA Concept Groups".
- [4] Tdoc SMG2 329/97, "Next simulation test cases".
- [5] Tdoc SMG2 UMTS A39/97, "Simulation Results".
- [6] Tdoc SMG2 UMTS A41/97, "Link-level Performance with Adaptive Searcher".
- [7] Tdoc SMG2 270/97, "Concept Group Alpha - Wideband Direct Sequence CDMA: Evaluation Document, draft 1.0".

4. CONCLUSIONS

This document has presented the wideband DS-CDMA concept proposed as UMTS Terrestrial Radio Access (UTRA) radio interface by the ETSI SMG2 Alpha (WCDMA) concept group. The proposed concept has been studied in a wide range of environments and has been shown to fulfil all the UTRA requirements. It can thus be recommended to be chosen as the UTRA air interface. The concept has several advantageous features including :

- Flexible multirate and service multiplexing concept for varying UMTS service needs.
- The wide range of UMTS services up to 2 Mbps supported with the concept.
- Support for two types of packet transmission for efficient packet access support.
- Future proofness taken into account into system design to enable later performance enhancements when even more capacity is needed after initial deployment.
- Flexible system deployment with asynchronous operation and efficient support for hierarchical cell structures.
- Competitive implementation complexity with the studied RAKE receiver solution compared to other UTRA options with no exponential elements in the complexity as a function of data rate.
- Competitive performance in terms of capacity and coverage compared to other UTRA concepts, especially the range with high bit rate applications shows generally several dBs of difference to competing solutions.
- Transmission concept which avoids audible interference problems and results in low power transmission with the aid of an efficient power-control scheme and utilisation of frequency diversity due to the wideband signal.

The studied aspects include also the dual-mode terminal implementation with GSM, which is taken into account when defining concept details to allow smooth migration between second generation systems and third generation wideband CDMA with UMTS service capability. Furthermore, as wideband CDMA solutions are currently being adopted for other regions as well, the concept offers very good opportunities for global roaming and improved cost efficiency due to larger volumes of the terminal and network equipment. The existing validators from several vendors for WCDMA equipment will also provide a faster development path towards UMTS roll-out.

ETSI SMG
Meeting no 24
Madrid, Spain
15 - 19 December 1997

Tdoc SMG 905/97

Source: SMG2

Concept Group Alpha - Wideband Direct-Sequence CDMA (WCDMA)

EVALUATION DOCUMENT (3.0)

Part 2: Annex 1 Answers Link Budget Calculation Complexity and dual mode GSM/UMTS terminal complexity analysis Rate Matching Principle

In the procedure to define the UMTS Terrestrial Radio Access (UTRA), the wideband DS-CDMA concept group (Alpha) will develop and evaluate a multiple access concept based on direct sequence code division. This group was formed around the DS-CDMA proposals from FRAMES Mode 2, Fujitsu, NEC and Panasonic. The main radio transmission technology (RTT) and parameters of the common concept from the Alpha group along with performance results are presented in this document

<p>This document was prepared during the evaluation work of SMG2 as a possible basis for the UTRA standard. It is provided to SMG on the understanding that the full details of the contents have not necessarily been reviewed by, or agreed by, SMG2.</p>

1 Introduction

In the evaluation process of the different concepts the questions in Annex 1 of ETR 0402 have to be answered. The Alpha group's set of answers to the Annex 1 questions is found in Chapter 2. Chapter 3 provides link budgets according to the link budget template given in ETR 0402. In Chapter 4 a complexity evaluation is presented and finally in Chapter 5 the principle for rate matching is shown.

2 Answers to Annex1 on ETR 0402

	A1.1	Test environment support
ti	A1.1.1	<p>In what test environments will the SRTT operate?</p> <p>Answer:</p> <p>Indoor office (I), Outdoor to indoor and pedestrian (P), Vehicular (V), and Mixed-cell pedestrian/vehicular (M)</p>
td	A1.1.2	<p>If the SRTT supports more than one test environment, what test environment does this technology description template address?</p> <p>Answer:</p> <p>The template addresses all four test environments.</p>
	A1.1.3	<p>Does the SRTT include any feature in support of FWA application ? Provide detail about impact of those features on the technical parameters provided in this template, stating whether the technical parameters provided apply for mobile as well as for FWA applications.</p> <p>Answer:</p> <p>The concept can be applied to FWA applications. No special features are needed for FWA operation.</p>
	A1.2	<p>Technical parameters</p> <p>Note : Parameters for both forward link and reverse link should be described separately, if necessary.</p>
ti	A1.2.1	<p>What is the minimum frequency band required to deploy the system (MHz)?</p> <p>Answer:</p> <p>FDD mode 2x5 MHz, TDD mode 5 MHz.</p>
it	A1.2.2	<p>What is the duplex method: TDD or FDD?</p> <p>Answer:</p> <p>Both FDD and TDD modes are specified.</p>
ti	A1.2.2.1	<p>What is the minimum up/down frequency separation for FDD?</p> <p>Answer:</p> <p>80 MHz in the UMTS band.</p>
ti	A1.2.2.2	<p>What is requirement of transmit/receive isolation? Does the proposal require a duplexer in either the mobile or base station.</p> <p>Answer:</p> <p>FDD mode: Duplexer needed. Transmit/receive isolation 80 dB.</p> <p>TDD mode: No duplexer needed.</p>
ti	A1.2.3	<p>Does the SRTT allow asymmetric transmission to use the available spectrum? Characterize.</p> <p>Answer:</p> <p>The possibility for a large range of uplink/downlink asymmetry on the connection level follows from the possibility of independent setting of uplink and downlink bearer-service characteristics (rate, delay, bit-error-rate etc.).</p> <p>The possibility for uplink/downlink asymmetry on the cell-level is due to the use of one-cell reuse, where downlink and uplink resources can independently of each other be moved between neighbouring cells.</p> <p>Asymmetry on a total-system level can be achieved with the proposed TDD mode where the total available time can be asymmetrically allocated to the uplink/downlink. For the FDD mode, total-system asymmetry is possible if and only if more bandwidth is allocated to downlink than uplink or vice versa.</p> <p>The SRTT allows for asymmetry in terms of different bit rates, bit error rates, delay, etc. between the uplink and downlink of a two-way connection. In TDD the spectrum can be divided asymmetrically in time between uplink and downlink.</p>

ti	A1.2.4	<p>What is the RF channel spacing (kHz)? In addition, does the SRTT use interleaved frequency allocation?</p> <p>Note: Interleaved frequency allocation; allocating the 2nd adjacent channel instead of adjacent channel at neighboring cluster cell is so called "interleaved frequency allocation". If a proponent is going to employ this allocation type, proponent should be stated at A1.2.4 and fill A1.2.15 of protection ratio for both of adjacent and 2nd adjacent channel.</p> <p>Answer:</p> <p>The SRTT uses an RF channel raster of 200 kHz. A fixed RF channel spacing is not defined but depends on the deployment scenario, e.g. if adjacent downlink carriers are of the same power or of significantly different power such as is e.g. the case for Hierarchical Cell Structures (HCS). The recommended RF channel spacing is 4.2-5 MHz for the 4.096 Mcps chip rate, 8.4-10 MHz for 8.192 Mcps, and 16.8-20 MHz for 16.384 Mcps.</p> <p>The SRTT does not use interleaved frequency allocation.</p>
ti	A1.2.5	<p>What is the bandwidth per duplex RF channel (MHz) measured at the 3 dB down points? It is given by (bandwidth per RF channel) x (1 for TDD and 2 for FDD). Please provide detail.</p> <p>Answer:</p> <p>FDD mode: 8.192 MHz (16.384 / 32.768 MHz) TDD mode: 4.096 MHz (8.192 / 16.384 MHz)</p>
ti	A1.2.5.1	<p>Does the proposal offer multiple or variable RF channel bandwidth capability? If so, are multiple bandwidths or variable bandwidths provided for the purposes of compensating the transmission medium for impairments but intended to be feature transparent to the end user?</p> <p>Answer:</p> <p>The basic chip rate of the SRTT is 4.096 Mcps corresponding to a channel bandwidth of ≈5MHz. Additional chip rates 8.192 Mcps and 16.384 Mcps, corresponding to bandwidths of ≈10MHz and ≈20MHz respectively, are also supported by the specification. Although services up to 2 Mbps are supported by the basic chip-rate (4.096 Mcps), high-rate services (> 500 kbps) are more efficiently supported by the higher chip-rates. The different bandwidths are not used to compensate for transmission medium impairments. The different bandwidths are transparent to the end user.</p>
ti	A1.2.6	<p>What is the RF channel bit rate (kbps)?</p> <p>Answer:</p> <p>RF channel bit rate: Variable (0 kbps, 16 kbps, 32 kbps, 64 kbps, 128 kbps, 256 kbps, 512 kbps, 1024 kbps) RF channel chip rate: 4.096 Mcps (8.192 Mcps, 16.384 Mcps)</p>

ti	A1.2.7	<p>Frame Structure : Describe the frame structure to give sufficient information such as;</p> <ul style="list-style-type: none"> - frame length - the number of time slots per frame - guard time or the number of guard bits - user information bit rate for each time slot - channel bit rate (after channel coding) - channel symbol rate (after modulation) - associated control channel (ACCH) bit rate - power control bit rate. <p>Note 1: Channel coding may include FEC, CRC, ACCH, power control bits and guard bits. Provide detail.</p> <p>Note 2: Describe the frame structure for forward link and reverse link, respectively.</p> <p>Note 3: Describe the frame structure for each user information rate</p> <p><u>Answer:</u></p> <p>Frame length: 10 ms</p> <p>Number of time slots per frame: 16 (time slot = power-control period).</p> <p>Guard time FDD-mode: None, TDD mode: 31.25 μs.</p> <p>User information bit rate for each time slot: Variable</p> <p>Channel bit rate (after channel coding and rate matching): UL: $16 \cdot 2^k$ kbps per IQ/branch (16/32/64/128/256/512/1024 kbps) DL: $32 \cdot 2^k$ kbps (32/64/128/256/512/1024/2048 kbps)</p> <p>Channel symbol rate (after modulation): $16 \cdot 2^k$ ksps (16/32/64/128/256/512/1024 ksps)</p> <p>Associated control channel bit rate: 0 and 16 kbps [preliminary assumption, still under study]</p> <p>Power-control rate: 1.6 kHz (possibility for variable rate in the range 500 Hz - 2 kHz)</p> <p>See also W-CDMA Evaluation Document, System Description part.</p>
ti	A1.2.8	<p>Does the SRTT use frequency hopping? If so characterize and explain particularly the impact (e.g. improvements) on system performance.</p> <p><u>Answer:</u></p> <p>The SRTT does not use frequency hopping.</p>
td	A1.2.8.1	<p>What is the hopping rate?</p> <p><u>Answer:</u> N/A</p>
td	A1.2.8.2	<p>What is the number of the hopping frequency sets?</p> <p><u>Answer:</u> N/A</p>
ti	A1.2.8.3	<p>Are base stations synchronized or non-synchronized?</p> <p><u>Answer:</u></p> <p>FDD mode_-</p> <p>No accurate inter-base station synchronization is needed. To simplify the handover procedure, an inter-base station synchronization accuracy on the order of 10 ms is preferred. Such synchronization can be achieved through the ordinary network, i.e. no external equipment such as GPS is needed for inter-base station synchronization.</p> <p>TDD mode - Inter-base station synchronization is needed in the order of $\pm 3 \mu$s. As the TDD mode is mainly considered for small-cell environments with low mobility, in order to reduce the guard-time requirements, the possibility to achieve the inter-base-station synchronization in an autonomous way, without the need for external systems, is currently being considered.</p>

ti	A1.2.9	Does the SRTT use spreading scheme? <u>Answer:</u> Yes, the SRTT is based on Direct-Sequence CDMA
td	A1.2.9.1	What is the chip rate (Mchip/s): Rate at input to modulator. <u>Answer:</u> 4.096 / 8.192 / 16.384 Mcps
td	A1.2.9.2	What is the processing gain: $10 \log(\text{Chip rate} / \text{Information rate})$. <u>Answer:</u> The processing gain depends on the specific service. The processing gain (chip-rate/information-rate) is variable in the range 3-46 dB for 4.096 Mcps.
td	A1.2.9.3	Explain the uplink and downlink code structures and provide the details about the types (e.g. PN code, Walsh code) and purposes (e.g. spreading, identification, etc.) of the codes. <u>Answer:</u> Channelization codes (UL & DL): Orthogonal Variable Spreading Factor codes. Spreading factor: 4-256 (4.096 Mcps) Primary scrambling code (UL): Short complex MS-specific code of length 256 chips based on extended Very-Large Kasami set. Secondary scrambling code (UL): Optional MS-specific code of length 10 ms (40960 chips). Segment of long Gold code. Scrambling code (DL): BS-specific code of length 10 ms (40960 chips). Segment of long Gold code. Short Orthogonal Gold codes used on Physical Random-Access channel and synchronization channel. See also W-CDMA Evaluation Document, System Description part.
ti	A1.2.10	Which access technology does the proposal use: TDMA, FDMA, CDMA, hybrid, or a new technology? In the case of CDMA which type of CDMA is used: Frequency Hopping (FH) or Direct Sequence (DS) or hybrid? Characterize. <u>Answer:</u> Single-carrier Wideband Direct-Sequence CDMA.
ti	A1.2.11	What is the baseband modulation technique? If both the data modulation and spreading modulation are required, please describe detail. What is the peak to average power ratio after baseband filtering (dB)? <u>Answer:</u> Data modulation: Dual-channel QPSK (UL), QPSK (DL) Spreading modulation: QPSK (UL), BPSK (DL). Root raised cosine pulse shaping, roll-off factor 0.22. Maximum peak-to-average ratio: ≤ 4.8 dB.

ti	A1.2.12	<p>What are the channel coding (error handling) rate and form for both the forward and reverse links? e.g.</p> <p>- Does the SRTT adopt FEC (Forward Error Correction) or other schemes?</p> <p>Answer:</p> <p>Convolutional inner code (rate 1/3 or rate 1/2, constraint length K=9) for BER=10⁻³ services. Optional outer Reed-Solomon code (rate 4/5) for BER=10⁻⁶ circuit-switched services. Possibility for service-specific coding. Unequal repetition and/or puncturing for rate matching.</p> <p>- Does the SRTT adopt unequal error protection? Please provide details.</p> <p>Answer:</p> <p>Unequal error protection is possible with code puncturing/repetition or with service-specific coding..</p> <p>- Does the SRTT adopt soft decision decoding or hard decision decoding? Please provide details.</p> <p>Answer:</p> <p>The decoding scheme of the SRTT is an implementation issue and is not covered by the SRTT description. There is nothing in the SRTT that prevents the use of either soft or hard decision decoding. The Rake receiver used in the simulations is well suited to provide soft decisions with maximal ratio combining.</p> <p>- Does the SRTT adopt iterative decoding (e.g. turbo codes)? Please provide details.</p> <p>Answer:</p> <p>Turbo codes is not an inherent part of the SRTT, but can be included as service-specific coding- Other schemes.</p>
ti	A1.2.13	<p>What is the bit interleaving scheme? Provide detailed description for both up link and down link.</p> <p>Answer:</p> <p>Inner interleaving: Block interleaving with variable block size (10-150 ms) Outer interleaving: Block interleaving with variable block size (10-150 ms)</p>
ti	A1.2.14	<p>Describe the taken approach for the receivers (MS and BS) to cope with multipath propagation effects (e.g. via equalizer, RAKE receiver, etc.).</p> <p>Answer:</p> <p>The processing gain of DS-CDMA supresses interference due to multipath propagation A RAKE receiver (or more advanced multi-user detectors) combines multiple paths and gives diversity gains.</p>
ti	A1.2.14.1	<p>Describe the robustness to intersymbol interference and the specific delay spread profiles that are best or worst for the proposal.</p> <p>Answer:</p> <p><u>WCDMA can handle time-dispersion up to 62.5 μs. This limit is due to the length of the uplink scrambling codes (256 chips). Within that range, the size of the delay spread does not, in itself, have any impact on the performance. On the other hand, the shape of the delay spread may have an impact on the performance. With multi-path reception (multiple received rays), the performance is improved for the following reasons:</u></p> <ul style="list-style-type: none"> • <u>Improved frequency diversity. This is especially the case for high mobile-station speeds where the fast power control does not compensate for the fast fading.</u> • <u>Reduced excess transmit power. This is especially the case for low mobile-station speeds where the fast power control creates excess transmit power when it compensates for the fast fading</u> <p><u>For a very large number of non-neglegible rays, there may be a performance degradation due to non-captured signal-energy (insufficient number of RAKE fingers). By increasing the number of RAKE fingers, this performance degradation can be removed.</u></p> <p><u>A good relation between performance and delay spread is impossible to give, as the performance does not directly depend on the size of the delay spread but on the size of the delay spread, see above.</u></p>

ti	A1.2.14.2	<p>Can rapidly changing delay spread profiles be accommodated? Please describe.</p> <p><u>Answer:</u></p> <p>Variations in path amplitudes/phases up to at least 500 Hz can be tracked with the pilot-bit-assisted coherent detection. Long term variations in the path profile, e.g. the occurrence of new paths can be tracked on a frame-by-frame basis (10 ms). The environment specific pilot configurations allow to make pilot configuration according to environment conditions without having the same overhead in all environments where propagation conditions are less severe.</p>
ti	A1.2.15	<p>What is the Adjacent channel protection ratio?</p> <p>In order to maintain robustness to adjacent channel interference, the SRTT should have some receiver characteristics that can withstand higher power adjacent channel interference. Specify the maximum allowed relative level of adjacent RF channel power in dBc. Please provide detail how this figure is assumed.</p> <p><u>Answer:</u></p> <p>45 dB.</p>
	A1.2.16	Power classes
ti	A1.2.16.1	<p>Mobile terminal emitted power: What is the radiated antenna power measured at the antenna? For terrestrial component, please give (in dBm). For satellite component, the mobile terminal emitted power should be given in EIRP (dBm).</p> <p><u>Answer:</u></p> <p>24 dBm (Nominal value, not limited by SRTT)</p>
ti	A1.2.16.1.1	<p>What is the maximum peak power transmitted while in active or busy state?</p> <p><u>Answer:</u></p> <p>30 dBm (Nominal value, not limited SRTT)</p>
ti	A1.2.16.1.2	<p>What is the time average power transmitted while in active or busy state? Provide detailed explanation used to calculate this time average power.</p> <p><u>Answer:</u></p> <p>100%, continuous transmission for DPCCH, for DPDCH on need basis 0-100%.</p>
ti	A1.2.16.2	Base station transmit power per RF carrier for terrestrial component
ti	A1.2.16.2.1	<p>What is the maximum peak transmitted power per RF carrier radiated from antenna?</p> <p><u>Answer:</u></p> <p>Not limited by the SRTT</p>
ti	A1.2.16.2.2	<p>What is the average transmitted power per RF carrier radiated from antenna?</p> <p><u>Answer:</u></p> <p>Not limited by the SRTT, nominal value 24 dBm per code channel.</p>
ti	A1.2.17	<p>What is the maximum number of voice channels available per RF channel that can be supported at one base station with 1 RF channel (TDD systems) or 1 duplex RF channel pair (FDD systems), while still meeting G.726 performance requirements?</p> <p><u>Answer:</u></p> <p>Depends on the environment and conditions but the SRTT allows the following number of data channels per carrier for 4.096 Mchips/s:</p> <p>256 with FDD, 128 with TDD.</p>

ti	A1.2.18	<p>Variable bit rate capabilities: Describe the ways the proposal is able to handle variable base band transmission rates. For example, does the SRTT use:</p> <p>-adaptive source and channel coding as a function of RF signal quality</p> <p>Answer:</p> <p>Source coding is not part of the SRTT. Adaptive source coding as a function of RF quality is possible. Adaptive channel coding as a function of RF signal quality is not needed due to power control and CDMA multirate scheme and spreading.</p> <p>-variable data rate as a function of user application</p> <p>Answer:</p> <p>The user rate can vary on a 10 ms basis with a granularity of 100 bps</p> <p>-variable voice/data channel utilization as a function of traffic mix requirements?</p> <p>Answer:</p> <p>The SRTT allows for variable voice/data channel utilization as a function of traffic mix requirements.</p> <p>-Characterize how the bit rate modification is performed. In addition, what are the advantages of your system proposal associated with variable bit rate capabilities?</p> <p>Answer:</p> <p>Different channel bit rates are possible by changing the spreading factor in factors of 2 from 256 down to 4. For the highest rates, multi-code transmission, i.e. transmission on several parallel code channels, is used. An arbitrary user bit rate after channel coding is matched to the closest possible channel bit rate by code puncturing/repetition.</p> <p>For variable-rate transmission, the rate can vary on a 10 ms basis. Explicit rate information, to simplify decoding, may be transmitted on a parallel control channel.</p> <p>Multiple variable services can be time multiplexed on one variable-rate physical channel or code multiplexed on different variable-rate physical channels.</p> <p>The advantages with this approach is that the bit rate can be varied on a frame-by-frame basis without any explicit resource allocation and negotiation. It also for the independent quality control of each service on a multi-service connection.</p>
----	---------	-------------------------------------------------------------------------------------------------------------------------------------------------------------------------------------------------------------------------------------------------------------------------------------------------------------------------------------------------------------------------------------------------------------------------------------------------------------------------------------------------------------------------------------------------------------------------------------------------------------------------------------------------------------------------------------------------------------------------------------------------------------------------------------------------------------------------------------------------------------------------------------------------------------------------------------------------------------------------------------------------------------------------------------------------------------------------------------------------------------------------------------------------------------------------------------------------------------------------------------------------------------------------------------------------------------------------------------------------------------------------------------------------------------------------------------------------------------------------------------------------------------------------------------------------------------------------------------------------------------------------------------------------------------------------------------------------------------------------------------------------------------------------------------------------------------------------------------------------------------------------------------------------------------------------------------------------------------------------------------------------------------------------------------------------------------------------------------------------------------

td	A1.2.18.1	<p>What are the user information bit rates in each variable bit rate mode?</p> <p>Answer:</p> <p>The user bit rate can be varied from 0-2048 kbps with a granularity of 100 bps.</p> <p>For a given connection, a sub-set of these rates are chosen at call set-up. During the call, the rate can be varied between the rates within the sub-set on a frame-by-frame basis. The sub-set of rates can also be changed during a call, e.g. due to the addition/removal of services..</p>
ti	A1.2.20	<p>Data services: Are there particular aspects of the proposed technologies which are applicable for the provision of circuit-switched, packet-switched or other data services like asymmetric data services? For each service class (A, B, C and D) a description of SRTT services should be provided, at least in terms of bit rate, delay and BER/FER.</p> <p>Note 1: See [draft new] Recommendation [FPLMTS.TMLG] for the definition of</p> <ul style="list-style-type: none"> - "circuit transfer mode" - "packet transfer mode" - "connectionless service" <p>and for the aid of understanding "circuit switched" and "packet switched" data services</p> <p>Note 2: See ITU-T Recommendation I.362 for details about the service classes A, B, C and D</p> <p>Answer:</p> <p>All service classes can be supported with the proposed SRTT.</p>
ti	A1.2.20.1	For delay constrained, connection oriented. (Class A)
ti	A1.2.20.2	For delay constrained, connection oriented, variable bit rate (Class B)
ti	A1.2.20.3	For delay unconstrained, connection oriented. (Class C)

ti	A1.2.20.4	For delay unconstrained, connectionless. (Class D)
ti	A1.2.21	<p>Simultaneous voice/data services: Is the proposal capable of providing multiple user services simultaneously with appropriate channel capacity assignment?</p> <p>Answer:</p> <p>Up to 16 parallel services can be provided with some limitations on the variable-rate properties of the different services. The different services can have independent bit rate, bit-error rate, delay, etc., and can have different transfer modes (packet/circuit-switched).</p>
		<p>Note : The followings describe the different techniques that are inherent or improve to a great extent the technology described above to be presented:</p> <p>Description for both BS and MS are required in attributes from A2..22 through A1.2.23.2.</p>
ti	A1.2.22	<p>Power control characteristics: Is power control scheme included in the proposal? Characterize the impact (e.g. improvements) of supported power control schemes on system performance.</p> <p>Answer:</p> <p>The SRTT uses fast closed-loop C/I based power control + slow quality-based power control on both uplink and downlink. Open loop power control is used for random access. The use of fast power control significantly improves the link-performance (BER as a function of E_b/N_0) especially in the case slow-moving mobile stations. For fast moving mobile stations (>100 km/h), there is no performance improvement due to fast power control.</p>
td	A1.2.22.1	<p>What is the power control step size in dB?</p> <p>Answer:</p> <p>UL: Variable in the range 0.25-1.5 dB DL: Variable in the range 0.25-1.5 dB</p>
td	A1.2.22.2	<p>What are the number of power control cycles per second?</p> <p>Answer:</p> <p>UL: 1.6 kHz (possibility for variable rate in the range 500 Hz - 2 kHz) DL: 1.6 kHz (possibility for variable rate in the range 500 Hz - 2 kHz)</p>
td	A1.2.22.3	<p>What is the power control dynamic range in dB?</p> <p>Answer:</p> <p>UL: 80 dB DL: 30 dB</p>
td	A1.2.22.4	<p>What is the minimum transmit power level with power control?</p> <p>Answer:</p> <p>-50 dBm at MS with highest power class</p>
td	A1.2.22.5	<p>What is the residual power variation after power control when SRTT is operating? Please provide details about the circumstances (e.g. in terms of system characteristics, environment, deployment, MS-speed, etc.) under which this residual power variation appears and which impact it has on the system performance.</p> <p>Answer:</p> <p>The residual power variation depends on the channel conditions, (Doppler spread and frequency selectivity). TBD</p>
ti	A1.2.23	<p>Diversity combining in mobile station and base station: Are diversity combining schemes incorporated in the design of the SRTT?</p> <p>Answer:</p> <p>Yes</p>

td	A1.2.23.1	<p>Describe the diversity techniques applied in the mobile station and at the base station, including micro diversity and macro diversity, characterizing the type of diversity used, for example:</p> <ul style="list-style-type: none"> - time diversity : repetition, RAKE-receiver, etc., - space diversity : multiple sectors, multiple satellite, etc., - frequency diversity : FH, wideband transmission, etc., - code diversity : multiple PN codes, multiple FH code, etc., - other scheme. <p>Characterize the diversity combining algorithm, for example, switch diversity, maximal ratio combining, equal gain combining. Additionally, provide supporting values for the number of receivers (or demodulators) per cell per mobile user. State the dB of performance improvement introduced by the use of diversity.</p> <p><u>Answer:</u></p> <p>Time diversity: Channel coding and interleaving in both uplink and downlink.</p> <p>Multipath diversity: RAKE receiver with maximum ratio combining in both BS and MS.</p> <p>Space diversity: Antenna diversity with maximum ratio combining in BS and optionally in MS. Possibility for orthogonal transmit diversity in the BS.</p> <p>Macro diversity: Soft (inter-site) handover with maximum ratio combining in downlink, selection combining in uplink. Softer (inter-sector) handover with maximum ratio combining in both uplink and downlink.</p> <p>Frequency diversity: Wideband carrier.</p> <p>For the mobile station: what is the minimum number of RF receivers (or demodulators) per mobile unit and what is the minimum number of antennas per mobile unit required for the purpose of diversity reception?</p> <p>These numbers should be consistent to that assumed in the link budget template in Annex 2 and that assumed in the calculation of the “capacity” defined at A1.3.1.5.</p> <p><u>Answer:</u></p> <p>Minimum one receiver/antenna (no downlink receiver diversity required by SRTT or used in the simulations).</p>
td	A1.2.23.2	<p>What is the degree of improvement expected in dB? Please also indicate the assumed condition such as BER and FER.</p> <p><u>Answer:</u></p> <p>For receiver antenna diversity the diversity gain is 2.5 - 3.5 dB in required E_b/N_0 for $BER=10^{-3}$. If power control is disabled the gain is much higher for the low speed cases. On top of the gain in reduced required E_b/N_0 there is a gain in decreased transmitted power. This gain can be up to 2.5 dB, depending on the environment.</p> <p>Orthogonal transmit diversity can also be employed, especially in the downlink. A gain similar to the gain with receiver antenna diversity is expected.</p> <p>All other diversity methods are inherent parts of the W-CDMA concept and therefore it is difficult to specify an explicit diversity gain figure in dB.</p>

ti	A1.2.24	<p>Handover/Automatic Radio Link Transfer (ALT) : Do the radio transmission technologies support handover?</p> <p>Characterize the type of handover strategy (or strategies) which may be supported, e.g. mobile station assisted handover. Give explanations on potential advantages, e.g. possible choice of handover algorithms. Provide evidence whenever possible.</p> <p><u>Answer</u></p> <p>The SRTT supports automatic handover. The handover scheme is based on a mobile assisted soft handover mechanism. The mobile station (MS) monitors the pilot signal levels received from neighboring base stations and reports to the network pilots crossing or above a given set of dynamic thresholds. Based on this information the network orders the MS to add or remove pilots from its <i>Active Set</i>. The <i>Active Set</i> is defined as the set of base station for which user signal is simultaneously demodulated and coherently combined. The same user information modulated by the appropriate base station code is sent from multiple base stations. Coherent combining of the different signals from different sectorized antennas, from different base stations, or from the same antenna but on different multiple path components is performed in the MS by the usage of Rake receivers. The signal transmitted by a mobile station is processed by base stations with which the mobile station is in soft handover. The received signal from different sectors of a base station (cell) can be combined in the base station, and the received signal from different base stations (cells) can be combined at the base station controller. Soft handover results in increased coverage range on the uplink. This soft handover mechanism results in seamless handover without any disruption of service. The spatial diversity obtained reduces the frame error rate in the handover regions and allows for improved performance in difficult radio environment.</p>
td	A1.2.24.1	<p>What is the break duration (sec) when a handover is executed? In this evaluation, a detailed description of the impact of the handover on the service performance should also be given. Explain how the estimate derived.</p> <p><u>Answer:</u></p> <p>Soft handover: No break duration (make before break) Hard handover: TBD</p>
td	A1.2.24.2	<p>For the proposed SRTT, can handover cope with rapid decrease in signal strength (e.g. street corner effect)?</p> <p>Give a detailed description of</p> <ul style="list-style-type: none"> - the way the handover detected, initiated and executed, - how long each of this action lasts (minimum/maximum time in msec), - the timeout periods for these actions. <p><u>Answer:</u></p> <p>The MS continuously searches for signal from new and existing BS. It also maintains two thresholds (e.g. pilot E_c/I_o) based on current combined quality of the down link soft handover legs to add newly detected BS or to drop existing BS from its soft handover 'active' set. The need to add or drop is sent in a message to the system which determines whether to execute the addition and deletion. The time it takes to perform the above actions depends on the searcher and infrastructure speed. When compared to the initial cell access the procedure is much faster as only the base stations indicated in the neighbour set need to be searched and thus the search time is greatly reduced and thus dependent on the size of the base station set to be searched. There is no time out period when soft or softer handover is performed.</p>
ti	A1.2.25	<p>Characterize how does the proposed SRTT react to the system deployment in terms of the evolution of coverage and capacity (e.g. necessity to add new cells and/or new carriers):</p> <ul style="list-style-type: none"> - in terms of frequency planning - in terms of the evolution of adaptive antenna technology using mobile identity codes (e.g. sufficient number of channel sounding codes in a TDMA type of system) - other relevant aspects <p><u>Answer:</u></p> <p>No frequency planning needed. No limitation in number of codes, current set considered offers unique code for 512 different base stations on each frequency.</p>

ti	A1.2.26	<p>Sharing frequency band capabilities: To what degree is the proposal able to deal with spectrum sharing among UMTS systems as well as with all other systems:</p> <ul style="list-style-type: none"> - spectrum sharing between operators <p>Answer: Spectrum sharing possible through frequency division.</p> <ul style="list-style-type: none"> - spectrum sharing between terrestrial and satellite UMTS systems <p>Answer: Spectrum sharing possible through frequency division.</p> <ul style="list-style-type: none"> - spectrum sharing between UMTS and non-UMTS systems <p>Answer: Spectrum sharing possible through frequency division.</p> <ul style="list-style-type: none"> - spectrum sharing between private and public UMTS operators <p>Answer: Spectrum sharing possible through frequency division.</p> <ul style="list-style-type: none"> - other sharing schemes <p>Answer: For uncoordinated systems, frequency sharing is possible through code division within one frequency band with some limitations</p>
ti	A1.2.27	<p>Dynamic channel allocation: Characterize the DCA schemes which may be supported and characterize their impact on system performance (e.g. in terms of adaptability to varying interference conditions, adaptability to varying traffic conditions, capability to avoid frequency planning, impact on the reuse distance, etc.)</p> <p>Answer: DCA not needed</p>
ti	A1.2.28	<p>Mixed cell architecture: How well do the technologies accommodate mixed cell architectures (pico, micro and macrocells)? Does the proposal provide pico, micro and macro cell user service in a single licensed spectrum assignment, with handoff as required between them? (terrestrial component only)</p> <p>Note: Cell definitions are as follows:</p> <ul style="list-style-type: none"> pico - cell hex radius $(r) < 100$ m micro - $100 \text{ m} < (r) < 1000$ m macro - $(r) > 1000$ m <p>Answer: The SRTT can provide pico, micro, and macro cells in one common frequency band or in separate frequency bands. In the later case, a total of 2*15 MHz spectrum assignment is needed. In either case, seamless handover is possible between the cell layers.</p>
ti	A1.2.29	<p>Describe any battery saver / intermittent reception capability</p> <p>Answer: During circuit switched operation the transmitter is continuously on. With packet traffic, depending on the packet-access mode, the receiver and transmitter can be used only periodically, i.e. being switched off until data is available for transmission or the base station indicates the mobile station that is to be received. In the latter case, the polling is done according to A1.2.29.1</p>
td	A1.2.29.1	<p>Ability of the mobile station to conserve standby battery power: Please provide details about how the proposal conserve standby battery power.</p> <p>Answer: The mobile station uses slotted reception when it is not on a dedicated traffic channel. Most of the circuits are turned off during the slots in a cycle that not assigned to that mobile station. They are powered-on only in time to receive the assigned slot for any possible pages or messages.</p>
td	A1.2.30	<p>Signaling transmission scheme: If the proposed system will use radio transmission technologies for signaling transmission different from those for user data transmission, describe details of signaling transmission scheme over the radio interface between terminals and base (satellite) stations.</p> <p>Answer: The signalling scheme for the SRTT is basically the same as for user data. User data and signalling is time multiplexed on layer 1.</p>

td	A1.2.30.1	<p>Describe the different signaling transfer schemes which may be supported, e.g. in connection with a call, outside a call.</p> <p>Does the SRTT support new techniques? Characterize.</p> <p>Does the SRTT support signalling enhancements for the delivery of multimedia services? Characterize.</p> <p><u>Answer:</u></p> <p>The SRTT does not limit the use of any advanced techniques. The physical layer provides means for transmission rate signalling which can be used also to indicate which services are active and thus introduction of an associated control channel with service negotiation is supported by the SRTT.</p>
ti	A1.2.31	<p>Does the SRTT support a Bandwidth on Demand (BOD) capability? Bandwidth on Demand refers specifically to the ability of an end-user to request multi-bearer services. Typically this is given as the capacity in the form of bits per second of throughput. Multi bearer services can be implemented by using such technologies as multi carrier, multi time slot or multi codes. If so, characterize these capabilities.</p> <p>Note: BOD does not refer to the self-adaptive feature of the radio channel to cope with changes in the transmission quality (see A1.2.5.1).</p> <p><u>Answer:</u></p> <p>Bandwidth on demand is supported with a granularity of 100 bps in the range 100 bps to 2.048 Mbps channel rate. The bandwidth-on-demand possibility is implemented by multiplexing the multi-bearer traffic on a single L1 traffic stream to be carried by the variable rate DPDCH resource, which is for low and medium rates a variable spreading factor single code channel and for higher rates a combination of variable spreading factor and multi-code transmission.</p>
ti	A1.2.32	<p>Does the SRTT support channel aggregation capability to achieve higher user bit rates?</p> <p><u>Answer:</u></p> <p>Channel aggregation to achieve higher rates is normally not needed with the proposed SRTT, due to the variable-bit-rate properties of each physical channel (0-1024 kbps). Channel aggregation (multi-code transmission) is supported and used for the highest user rates (up to 2 Mbps).</p>
	A1.3	Expected Performances
	A1.3.1	for terrestrial test environment only
ti	A1.3.1.1	<p>What is the achievable BER floor level (for voice)?</p> <p>Note: BER floor level under BER measuring condition defined in Annex 2 using the data rates indicated in section 1 of Annex 2.</p> <p><u>Answer:</u></p> <p>Below BER = 10^{-3}</p>
ti	A1.3.1.2	<p>What is the achievable BER floor level (for data)?</p> <p>Note: BER floor level under BER measuring condition defined in Annex 2 using the data rates indicated in section 1 of Annex 2.</p> <p><u>Answer:</u></p> <p>Below BER = 10^{-6}</p>
ti	A1.3.1.3	<p>What is the maximum tolerable delay spread (in nsec) to maintain the voice and data service quality requirements?</p> <p>Note: The BER is an error floor level measured with the Doppler shift given in the BER measuring conditions of ANNEX 2.</p> <p><u>Answer:</u></p> <p>Receiver-implementation dependent. The SRTT concept allows for a maximum time dispersion of 62.5 μs, see also A1.2.14.1.</p>

ti	A1.3.1.4	<p>What is the maximum tolerable doppler shift (in Hz) to maintain the voice and data service quality requirements?</p> <p>Note: The BER is an error floor level measured with the delay spread given in the BER measuring conditions of ANNEX 2.</p> <p><u>Answer:</u></p> <p>More than 500 Hz.</p>
ti	A1.3.1.5	<p>Capacity : The capacity of the radio transmission technology has to be evaluated assuming the deployment models described in ANNEX 2 and technical parameters from A1.2.22 through A1.2.23.2.</p>
ti	A1.3.1.5.1	<p>What is the voice traffic capacity per cell (not per sector): Provide the total traffic that can be supported by a single cell in Erlangs/MHz/cell in a total available assigned non-contiguous bandwidth of 30 MHz (15 MHz forward/15 MHz reverse) for FDD mode or contiguous bandwidth of 30 MHz for TDD mode. Provide capacities considering the model for the test environment in ANNEX 2. The procedure to obtain this value in described in ANNEX 2. The capacity supported by not a standalone cell but a single cell within contiguous service area should be obtained here.</p> <p><u>Answer:</u></p> <p>See Simulation Results.</p>
ti	A1.3.1.5.2	<p>What is the information capacity per cell (not per sector): Provide the total number of user-channel information bits which can be supported by a single cell in Mbps/MHz/cell in a total available assigned non-contiguous bandwidth of 30 MHz (15 MHz forward / 15 MHz reverse) for FDD mode or contiguous bandwidth of 30 MHz for TDD mode. Provide capacities considering the model for the test environment in ANNEX 2. The procedure to obtain this value in described in ANNEX 2. The capacity supported by not a standalone cell but a single cell within contiguous service area should be obtained here.</p> <p><u>Answer:</u></p> <p>See Simulation Results.</p>
ti	A1.3.1.6	<p>Does the SRTT support sectorization? If yes, provide for each sectorization scheme and the total number of user-channel information bits which can be supported by a single site in Mbps/MHz (and the number of sectors) in a total available assigned non-contiguous bandwidth of 30 MHz (15 MHz forward/15 MHz reverse) in FDD mode or contiguous bandwidth of 30 MHz in TDD mode.</p> <p><u>Answer:</u></p> <p>See Simulation Results.</p>
ti	A1.3.1.7	<p>Coverage efficiency: The coverage efficiency of the radio transmission technology has to be evaluated assuming the deployment models described in ANNEX 2.</p>
ti	A1.3.1.7.1	<p>What is the base site coverage efficiency in km^2/site for the lowest traffic loading in the voice only deployment model? Lowest traffic loading means the lowest penetration case described in ANNEX 2.</p> <p><u>Answer:</u></p> <p>See Link Budget Template.</p>
ti	A1.3.1.7.2	<p>What is the base site coverage efficiency in km^2/site for the lowest traffic loading in the data only deployment model? Lowest traffic loading means the lowest penetration case described in ANNEX 2.</p> <p><u>Answer:</u></p> <p>See Link Budget Template.</p>
ti	A1.3.3	<p>Maximum user bit rate (for data): Specify the maximum user bit rate (kbps) available in the deployment models described in ANNEX 2.</p> <p><u>Answer:</u></p> <p>At least 2048 kbps for 4.096 Mcps. Higher chip rates (with 8.192 or 16.384 Mcps) give better efficiency.</p>

ti	A1.3.4	<p>What is the maximum range in meters between a user terminal and a base station (prior to hand-off, relay, etc.) under nominal traffic loading and link impairments as defined in Annex 2?</p> <p>Answer:</p> <p>See Link Budget Template.</p>
ti	A1.3.5	<p>Describe the capability for the use of repeaters</p> <p>Answer:</p> <p>Repeaters can be used.</p>
ti	A1.3.6	<p>Antenna Systems : Fully describe the antenna systems that can be used and/or have to be used; characterize their impacts on systems performance, (terrestrial only) e.g.:</p> <p>- Does the SRTT have the capability for the use of remote antennas: Describe whether and how remote antenna systems can be used to extend coverage to low traffic density areas.</p> <p>Answer:</p> <p>Remote antennas can be used.</p> <p>- Does the SRTT have the capability for the use of distributed antennas: Describe whether and how distributed antenna designs are used, and in which UMTS test environments.</p> <p>Answer:</p> <p>Distributed antennas can be used.</p> <p>- Does the SRTT have the capability for the use of smart antennas (e.g. switched beam, adaptive, etc.): Describe how smart antennas can be used and what is their impact on system performance.</p> <p>Answer:</p> <p>Adaptive antennas are supported through the use of connection dedicated pilot bits in both uplink and downlink.</p> <p>- Other antenna systems.</p>
	A1.3.7	Delay (for voice)
ti	A1.3.7.1	<p>What is the radio transmission processing delay due to the overall process of channel coding, bit interleaving, framing, etc., not including source coding? This is given as transmitter delay from the input of the channel coder to the antenna plus the receiver delay from the antenna to the output of the channel decoder. Provide this information for each service being provided. In addition, a detailed description of how this parameter was calculated is required for both the up-link and the down-link.</p> <p>Answer:</p> <p>Service specific delay (depends on interleaving/channel-coding setting). Minimum delay: 12 ms for 10 ms interleaving, 2 ms for if non-interleaved mode is applied. Processing time of 2 ms included.</p>
ti	A1.3.7.2	<p>What is the total estimated round trip delay in msec to include both the processing delay, propagation delay (terrestrial only) and vocoder delay? Give the estimated delay associated with each of the key attributes described in Figure 1 of Annex 3 that make up the total delay provided.</p> <p>Answer:</p> <p>25 ms for 10 ms interleaving, not including vocoder delay.</p>
ti	A1.3.9	Description on the ability to sustain quality under certain extreme conditions.

ti	A1.3.9.1	<p>System overload (terrestrial only) : Characterize system behavior and performance in such conditions for each test services in Annex 2, including potential impact on adjacent cells. Describe the effect on system performance in terms of blocking grade of service for the cases that the load on a particular cell is 125%, 150%, 175%, and 200% of full load. Also describe the effect of blocking on the immediate adjacent cells. Voice service is to be considered here. Full load means a traffic loading which results in 1% call blocking with the BER of 10^{-3} maintained.</p> <p><u>Answer:</u></p> <p>Overload causes graceful degradation of system performance. The techniques commonly referred to as 'cell breathing' can also be applied. <i>I.e.</i>, when the loading of a cell in a system is overloaded, the up link interference is high and the effective range of MS is reduced due to power constraints. If the downlink power is reduced accordingly, then the MS on the border will be naturally handed over to the neighbouring cells, effectively reducing the coverage of the overloaded cell and decreasing its load without impacting the link performance.</p>
ti	A1.3.9.2	<p>Hardware failures: Characterize system behavior and performance in such conditions. Provide detailed explanation on any calculation.</p> <p><u>Answer:</u></p> <p>Implementation dependent.</p>
ti	A1.3.9.3	<p>Interference immunity: Characterize system immunity or protection mechanisms against interference. What is the interference detection method? What is the interference avoidance method?</p> <p><u>Answer:</u></p> <p>Interference is suppressed by the processing gain. Multi-user detection and/or interference cancellation can be used but is not required.</p>
ti	A1.3.10	<p>Characterize the adaptability of the proposed SRTT to different and/or time varying conditions (e.g. propagation, traffic, etc.) that are not considered in the above attributes of the section A1.3.</p> <p><u>Answer:</u></p> <p>Adaptive transmit power is used.</p>
	A1.4	Technology Design Constraints
ti	A1.4.1	Frequency stability : Provide transmission frequency stability (not oscillator stability) requirements of the carrier (include long term - 1 year - frequency stability requirements in ppm).
ti	A1.4.1.1	<p>For Base station transmission (terrestrial component only)</p> <p><u>Answer:</u></p> <p>0.02 ppm</p>
ti	A1.4.1.2	<p>For Mobile station transmission</p> <p><u>Answer:</u></p> <p>3 ppm (unlocked), 0.1 ppm (locked)</p>

ti	A1.4.2	<p>Out of band and spurious emissions: Specify the expected levels of base or satellite and mobile transmitter emissions outside the operating channel, as a function of frequency offset.</p> <p>Answer:</p> <p>Multicode case (K=4, 512 kbps) frequency offset (MHz) 0 2.5 5 7.5 10 OBO=6dB 0 -30 -37 -50 -58 OBO=9dB 0 -36 -44 -56 -65 OBO=12dB 0 -37 -47 -61 -70</p> <p>Single code case (K=1, 128 kbps) frequency offset (MHz) 0 2.5 5 7.5 10 OBO=6dB 0 -38 -43 -54 -60 OBO=9dB 0 -39 -44 -60 -66 OBO=12dB 0 -40 -46 -65 -70</p> <p>All results for a W-CDMA signal of bandwidth 5 MHz (4.096 Mcps with 0.22 Roll-off factor) for an example mobile amplifier.</p>
ti	A1.4.3	<p>Synchronisation requirements: Describe SRTT's timing requirements , e.g.</p> <p>- Is base station-to-base station or satellite LES-to-LES synchronisation required? Provide precise information, the type of synchronisation, i.e., synchronisation of carrier frequency, bit clock, spreading code or frame, and their accuracy.</p> <p>Answer:</p> <p>FDD - not required, TDD - synchronisation within $\pm 3\mu\text{s}$ required.</p> <p>- Is base station-to-network synchronisation required? (terrestrial only)</p> <p>Answer:</p> <p>Yes</p> <p>- State short-term frequency and timing accuracy of base station (or LES) transmit signal.</p> <p>Answer:</p> <p>Not specified</p> <p>- State source of external system reference and the accuracy required, if used at base station (orLES)(for example: derived from wireline network, or GPS receiver).</p> <p>Answer:</p> <p>FDD - not required, TDD - GPS receiver (example).</p> <p>- State free run accuracy of mobile station frequency and timing reference clock.</p> <p>Answer:</p> <p>3 ppm</p> <p>- State base-to-base bit time alignment requirement over a 24 hour period, in microseconds.</p> <p>Answer:</p> <p>10 ms when soft-handover between base stations is supported</p> <p>- For private systems: can multiple unsynchronized systems coexist in the same environment?</p> <p>Answer:</p> <p>For TDD synchronisation is a requirement for the same environment</p>
ti	A1.4.4	<p>Timing jitter : For base (or LES) and mobile station give:</p> <p>- the maximum jitter on the transmit signal,</p> <p>- the maximum jitter tolerated on the received signal.</p> <p>Timing jitter is defined as RMS value of the time variance normalized by symbol duration.</p> <p>Answer:</p> <p>TBD</p>

ti	A1.4.5	<p>Frequency synthesizer : What is the required step size, switched speed and frequency range of the frequency synthesizer of mobile stations?</p> <p><u>Answer:</u></p> <p>Step size 200 kHz, switched speed TBD, frequency range 140 MHz for UMTS band.</p>
td	A1.4.6.1	<p>Describe the special requirements on the fixed networks for the handover procedure. Provide handover procedure to be employed in proposed SRTT in detail.</p> <p><u>Answer:</u></p> <p>No special requirements.</p>
ti	A1.4.8	<p>Characterize any radio resource control capabilities that exist for the provision of roaming between a private (e.g., closed user group) and a public UMTS operating environment.</p> <p><u>Answer:</u></p> <p>TBD</p>
ti	A1.4.9	<p>Describe the estimated fixed signaling overhead (e.g., broadcast control channel, power control messaging). Express this information as a percentage of the spectrum which is used for fixed signaling. Provide detailed explanation on your calculations.</p> <p><u>Answer:</u></p> <p>In downlink, system and cell specific information are broadcasted in broadcast control channel.</p> <p>Reference (pilot) symbols for coherent detection, power control commands, and rate information are provided in dedicated physical control channel (DPCCH). In uplink, DPCCH uses fixed 16 kbps Q-branch channel, while DPDCH uses variable rate I-branch channel. In downlink, DPCCH is time multiplexed with DPDCH, and its rate can be variable depending on the DPDCH rate. The signalling overhead of DPCCH in dedicated physical channel is ranging from 2.8% up to 25% in downlink, while 5.9% - 33% in uplink.</p> <p>See system description for more details.</p>
ti	A1.4.10	<p>Characterize the linear and broadband transmitter requirements for base and mobile station. (terrestrial only)</p> <p><u>Answer:</u></p> <p>SRTT requires linear amplifier. At the mobile AB class amplifier can be used.</p> <p>High Power Amplifier are required to be linear in a 5/10/20 MHz band.</p> <p>At OBO = 6dB, IM3 was 38dB and IM5 = 54 dB for the HPA amplifier in section A1.4.2.</p>
ti	A1.4.11	<p>Are linear receivers required? Characterize the linearity requirements for the receivers for base and mobile station. (terrestrial only)</p> <p><u>Answer:</u></p> <p>Base station: Linear receiver required</p> <p>Mobile station: Linearity requirements depend on the terminal capabilities.</p>
ti	A1.4.12	<p>Specify the required dynamic range of receiver. (terrestrial only)</p> <p><u>Answer:</u></p> <p>80 dB for Automatic Gain Control, for AD-converter 4-6 bits sufficient for MS</p>

ti	A1.4.13	<p>What are the signal processing estimates for both the handportable and the base station?</p> <ul style="list-style-type: none"> - MOPS (Mega Operation Per Second) value of parts processed by DSP - gate counts excluding DSP - ROM size requirements for DSP and gate counts in kByte - RAM size requirements for DSP and gate counts in kByte <p>Note 1: At a minimum the evaluation should review the signal processing estimates (MOPS, memory requirements, gate counts) required for demodulation, equalization, channel coding, error correction, diversity processing (including RAKE receivers), adaptive antenna array processing, modulation, A-D and D-A converters and multiplexing as well as some IF and baseband filtering. For new technologies, there may be additional or alternative requirements (such as FFTs etc.).</p> <p>Note 2 : The signal processing estimates should be declared with the estimated condition such as assumed services, user bit rate and etc.</p> <p><u>Answer:</u></p> <table border="1" data-bbox="479 653 898 846"> <thead> <tr> <th>Service</th> <th>Uplink (BS)</th> <th>Downlink (MS)</th> </tr> </thead> <tbody> <tr> <td>8 kbits/s</td> <td>5</td> <td>5</td> </tr> <tr> <td>144 kbits/s</td> <td>9</td> <td>9</td> </tr> <tr> <td>384 kbits/s</td> <td>24</td> <td>21</td> </tr> <tr> <td>2048 kbits/s</td> <td>86</td> <td>83</td> </tr> </tbody> </table> <p>Answer given in million real multiplications with DSP with correlators included in the values via method described in section 4 in this document. There the power consumption estimates are given as well. The convolutional encoding/decoding is not included in the figures as it is the same regardless of the multiple access for the same data rate(s).</p>	Service	Uplink (BS)	Downlink (MS)	8 kbits/s	5	5	144 kbits/s	9	9	384 kbits/s	24	21	2048 kbits/s	86	83
Service	Uplink (BS)	Downlink (MS)															
8 kbits/s	5	5															
144 kbits/s	9	9															
384 kbits/s	24	21															
2048 kbits/s	86	83															
ti	A1.4.15	<p>Characterize the frequency planning requirements:</p> <ul style="list-style-type: none"> - Frequency reuse pattern: given the required C/I and the proposed technologies, specify the frequency cell reuse pattern (e.g. 3-cell, 7-cell, etc.) and, for terrestrial systems, the sectorization schemes assumed; <p><u>Answer:</u></p> <p>1-cell reuse, 3 sectorization is used, thus not limited to only 3 sectors as having larger number of sectors is strainingforward in the desing and does not require additional frequency considerations.</p> <ul style="list-style-type: none"> - Characterize the frequency management between different cell layers; <p><u>Answer:</u></p> <p>Frequency-separated cell layers</p> <ul style="list-style-type: none"> - Does the SRTT use interleaved frequency allocation? <p><u>Answer:</u></p> <p>Mainly No (1-cell reuse), but the adjacent carrier can be partly overlapping as the carrier spacing is restricted to the 200 kHz raster and thus on that raster carrier spacing from 4 to 5 MHz could be used.</p> <ul style="list-style-type: none"> - Are there any frequency channels with particular planning requirements? <p><u>Answer:</u></p> <p>No</p> <ul style="list-style-type: none"> - Can the SRTT support self planning techniques? <p><u>Answer:</u></p> <p>No frequency planning is needed with the proposed SRTT (1-cell reuse)</p> <ul style="list-style-type: none"> - All other relevant requirements <p>Note: Interleaved frequency allocation is to allocate the 2nd adjacent channel instead of adjacent channel at neighboring cluster cell.</p>															

ti	A1.4.16	Describe the capability of the proposed SRTT to facilitate the evolution of existing radio transmission technologies used in mobile telecommunication systems migrate toward this SRTT. Provide detail any impact and constraint on evolution. <u>Answer:</u> The detailed parameters of the SRTT have been chosen with the easy implementation of dual-mode UMTS/GSM.
ti	A1.4.16.1	Does the SRTT support backwards compatibility into GSM/DCS in terms of easy dual mode terminal implementation, spectrum co-existence and handover between UMTS and GSM/DCS? <u>Answer:</u> The detailed parameters of the SRTT, e.g. the the clock frequencies and carrier raster has been chosen to facilitate the easy implementation of dual-mode UMTS/GSM/DCS terminals. Handover between UMTS and GSM/DCS can be supported.
ti	A1.4.17	Are there any special requirements for base site implementation? Are there any features which simplify implementation of base sites? (terrestrial only) <u>Answer:</u> The base station configuration can be modular thus the number of user supported can be increased modularly if desired, similar to introducing new TX/RX units to a GSM base station with the difference being that RF hardware is not effected an only single R/TX per base station is required.
ti	A1.5	Information required for terrestrial link budget template: Proponents should fulfill the link budget template given in Table 1.3 of Annex 2 and answer the following questions.
ti	A1.5.1	What is the base station noise figure (dB)? <u>Answer:</u> See Link Budget Template.
ti	A1.5.2	What is the mobile station noise figure (dB)? <u>Answer:</u> See Link Budget Template.
ti	A1.5.3	What is the base station antenna gain (dBi)? <u>Answer:</u> See Link Budget Template.
ti	A1.5.4	What is the mobile station antenna gain (dBi)? <u>Answer:</u> See Link Budget Template.
ti	A1.5.5	What is the cable, connector and combiner losses (dB)? <u>Answer:</u> See Link Budget Template.
ti	A1.5.5	What are the number of traffic channels per RF carrier? <u>Answer:</u> Variable (depends on the rate of each traffic channel).
ti	A1.5.6	What is the SRTT operating point (BER/FER) for the required E_b/N_0 in the link budget template? <u>Answer:</u> For speech and LCD BER = 10^{-3} , for UDD BLER = 10%

ti	A1.5.7	What is the ratio of intra-sector interference to sum of intra-sector interference and inter-sector interference within a cell (dB)? <u>Answer:</u> Depends on the environment.
ti	A1.5.8	What is the ratio of in-cell interference to total interference (dB)? <u>Answer:</u> Depends on the environment
ti	A1.5.9	What is the occupied bandwidth (99%) (Hz)? <u>Answer:</u> 5 MHz
ti	A1.5.10	What is the information rate (dBHz)? <u>Answer:</u> Service dependent.

3 Link Budget Calculation

In the following pages a link budget is presented for the simulated test cases. The link budgets follows the link budget template in Annex 2 in ETR 0402, and also presents some range calculations using concept optimized parameters.

3.1 Basic Assumptions

Since it is the average transmitter power per traffic channel that is specified in ETR 0402, power control is included in the link-level simulations to find the coverage. However, this means that the transmitted power can be increased due to the power control, and this is compensated for in the row "Power control TX power increase". Also, the highest mobile TX power used is 24 dBm, which gives some margin to 30 dBm. This means that building an amplifier that can cope with the power peaks should be feasible.

The TX power increase is dependent on the environment and service. For speech and LCD soft handoff is assumed, while UDD uses no soft handoff. The values used are presented in Table 1.

Environment	Speech & LCD Uplink [dB]	Speech & LCD Downlink [dB]	UDD Uplink [dB]	UDD Downlink [dB]
Indoor office	0	2	2	4
Outdoor to indoor and pedestrian	0	2	2	4.5
Vehicular	0	0	0	0

Table 1. TX power increase in different environments.

The handoff gain and log-normal fade margin were calculated for 95% area coverage with a shadowing correlation of 50%. Values can be found in Table 2.

Environment	σ [dB]	α	Log-normal fade margin [dB]	Handoff gain (soft handoff) [dB]	Handoff gain (hard handoff) [dB]
Indoor office	12	3.0	15.4	6.1	5.9
Outdoor to indoor and pedestrian	10	4.0	11.3	5.0	4.7
Vehicular	10	3.76	11.3	5.0	4.7

Table 2. Log-normal fade margins and handoff gains.

Please note that the total TX EIRP is not computed. Also, the coverage analysis is done for an unloaded system. This means that the RX interference density is zero (set to -1000 dBm/Hz in the tables).

All link-budgets presented assume no antenna diversity in the downlink. If antenna diversity is assumed the maximum path loss in the downlink will increase by around 3 dB.

3.2 Concept Optimized Parameters

An alternative link budget is presented below the link budget according to ETR 0402, in which the antenna gains and TX powers are modified to more reasonable values.

The specified three sector antenna in the Vehicular environment has a gain of only 13 dBi, which is rather low. A more reasonable value of 17 dBi has been used. The mobile antenna gain is specified as 0 dBi for all services and environments. It is expected that a mobile station handling the high bit rates will not be used next to the ear. This is taken into account by increasing the gain to 2 dBi.

The average TX powers specified in ETR 0402 are quite low, especially for high bit rate services. Higher values are proposed (DL/UL): Indoor office A 13/10 dBm, Outdoor to indoor and pedestrian A 23/20, Vehicular A 30/24 dBm.

3.3 Link Budget Templates

		Downlink	Uplink	Downlink	Uplink	Downlink	Uplink
		Indoor	Indoor	Pedestr.	Pedestr.	Vehicular	Vehicular
		A	A	A	A	A	A
		Speech	Speech	Speech	Speech	Speech	Speech
Note		20 ms int	20 ms int	20 ms int	20 ms int	20 ms int	20 ms int
Bit rate	bit/s	8000	8000	8000	8000	8000	8000
Average TX power per traffic ch.	dBm	10	4	20	14	30	24
Maximum TX power per traffic ch.	dBm	10	4	20	14	30	24
Maximum total TX power	dBm	10	4	20	14	30	24
Cable, conn. and combiner losses	dB	2	0	2	0	2	0
TX antenna gain	dBi	2	0	10	0	13	0
TX EIRP per traffic channel	dBm	10	4	28	14	41	24
Total TX EIRP	dBm	10	4	28	14	41	24
RX antenna gain	dBi	0	2	0	10	0	13
Cable and connector losses	dB	0	2	0	2	0	2
Receiver noise figure	dB	5	5	5	5	5	5
Thermal noise density	dBm/Hz	-174	-174	-174	-174	-174	-174
RX interference density	dBm/Hz	-1000	-1000	-1000	-1000	-1000	-1000
Total effect. noise + interf. density	dBm/Hz	-169	-169	-169	-169	-169	-169
Information rate	dBHz	39.0	39.0	39.0	39.0	39.0	39.0
Required Eb/(No+Io)	dB	6.4	3.1	6.7	3.3	7.6	5.0
RX sensitivity	dB	-123.6	-126.9	-123.3	-126.7	-122.4	-125.0
Power control TX power increase	dB	2.0	0.0	2.0	0.0	0.0	0.0
Handoff gain	dB	6.1	6.1	5.0	5.0	5.0	5.0
Explicit diversity gain	dB	0	0	0	0	0	0
Other gain	dB	0	0	0	0	0	0
Log-normal fade margin	dB	15.4	15.4	11.3	11.3	11.3	11.3
Maximum path loss	dB	122.3	121.6	143.0	142.4	157.1	153.7
Maximum range	m	695.5	659.1	747.3	721.9	5894.6	4786.6
Coverage efficiency	km ² /site	1.5	1.4	1.8	1.6	22.6	14.9
Concept optimized parameters							
Maximum TX power per traffic ch.	dBm	13	10	23	20	30	24
TX antenna gain	dBi	2	0	10	0	17	0
RX antenna gain	dBi	0	2	0	10	0	17
Maximum path loss	dB	125.3	127.6	146.0	148.4	161.1	157.7
Maximum range	m	875.6	1044.6	888.1	1019.7	7530.7	6115.2
Coverage efficiency	km ² /site	2.4	3.4	2.5	3.3	36.8	24.3

Test environment		Downlink	Uplink	Downlink	Uplink
		Vehicular	Vehicular	Vehicular	Vehicular
Multipath channel class		B	B	B	B
Mobile speed		120 km/h	120 km/h	250 km/h	250 km/h
Test service		Speech	Speech	Speech	Speech
Note		20 ms int	20 ms int	20 ms int	20 ms int
Bit rate	bit/s	8000	8000	8000	8000
Average TX power per traffic ch.	dBm	30	24	30	24
Maximum TX power per traffic ch.	dBm	30	24	30	24
Maximum total TX power	dBm	30	24	30	24
Cable, conn. and combiner losses	dB	2	0	2	0
TX antenna gain	dBi	13	0	13	0
TX EIRP per traffic channel	dBm	41	24	41	24
Total TX EIRP	dBm	41	24	41	24
RX antenna gain	dBi	0	13	0	13
Cable and connector losses	dB	0	2	0	2
Receiver noise figure	dB	5	5	5	5
Thermal noise density	dBm/Hz	-174	-174	-174	-174
RX interference density	dBm/Hz	-1000	-1000	-1000	-1000
Total effect. noise + interf. density	dBm/Hz	-169	-169	-169	-169
Information rate	dBHz	39.0	39.0	39.0	39.0
Required Eb/(No+Io)	dB	7.7	4.9	8.2	6.0
RX sensitivity	dB	-122.3	-125.1	-121.8	-124.0
Power control TX power increase	dB	0.0	0.0	0.0	0.0
Handoff gain	dB	5.0	5.0	5.0	5.0
Explicit diversity gain	dB	0	0	0	0
Other gain	dB	0	0	0	0
Log-normal fade margin	dB	11.3	11.3	11.3	11.3
Maximum path loss	dB	157.0	153.8	156.5	152.7
Maximum range	m	5858.6	4816.0	5681.9	4502.3
Coverage efficiency	km ² /site	22.3	15.1	21.0	13.2
Concept optimized parameters					
Maximum TX power per traffic ch.	dBm	30	24	30	24
TX antenna gain	dBi	17	0	17	0
RX antenna gain	dBi	0	17	0	17
Maximum path loss	dB	161.0	157.8	160.5	156.7
Maximum range	m	7484.8	6152.8	7259.1	5752.0
Coverage efficiency	km ² /site	36.4	24.6	34.2	21.5

Test environment Multipath channel class Test service Note	Downlink		Uplink		Downlink		Uplink		Downlink		Uplink	
	Indoor LCD 384	Indoor LCD 384	Indoor LCD 2048	Indoor LCD 2048	Indoor LCD 2048	Indoor LCD 2048	Indoor LCD 144	Indoor LCD 144	Indoor LCD 144	Indoor LCD 144	Indoor LCD 144	Indoor LCD 384
Bit rate	384000	384000	2048000	2048000	2048000	2048000	144000	144000	144000	144000	144000	384000
Average TX power per traffic ch.	10	4	10	4	10	4	20	14	20	14	20	30
Maximum TX power per traffic ch.	10	4	10	4	10	4	20	14	20	14	20	30
Maximum total TX power	10	4	10	4	10	4	20	14	20	14	20	30
Cable, conn. and combiner losses	2	0	2	0	2	0	2	0	2	0	2	0
TX antenna gain	2	0	2	0	2	0	10	0	10	0	13	0
TX EIRP per traffic channel	10	4	10	4	10	4	28	14	28	14	41	24
Total TX EIRP	10	4	10	4	10	4	28	14	28	14	41	24
RX antenna gain	0	2	0	2	0	2	0	10	0	10	0	13
Cable and connector losses	0	2	0	2	0	2	0	2	0	2	0	2
Receiver noise figure	5	5	5	5	5	5	5	5	5	5	5	5
Thermal noise density	-174	-174	-174	-174	-174	-174	-174	-174	-174	-174	-174	-174
RX interference density	-1000	-1000	-1000	-1000	-1000	-1000	-1000	-1000	-1000	-1000	-1000	-1000
Total effect. noise + interf. density	-169	-169	-169	-169	-169	-169	-169	-169	-169	-169	-169	-169
Information rate	55.8	55.8	63.1	63.1	63.1	63.1	51.6	51.6	51.6	51.6	55.8	55.8
Required Eb/(No+l0)	5.1	2.1	6.0	3.0	6.0	3.0	4.3	1.3	4.3	1.3	5.6	3.1
RX sensitivity	-108.1	-111.1	-99.9	-102.9	-99.9	-102.9	-113.1	-116.1	-113.1	-116.1	-107.6	-110.1
Power control TX power increase	2.0	0.0	2.0	0.0	2.0	0.0	2.0	0.0	2.0	0.0	0.0	0.0
Handoff gain	6.1	6.1	6.1	6.1	6.1	6.1	5.0	5.0	5.0	5.0	5.0	5.0
Explicit diversity gain	0	0	0	0	0	0	0	0	0	0	0	0
Other gain	0	0	0	0	0	0	0	0	0	0	0	0
Log-normal fade margin	15.4	15.4	15.4	15.4	15.4	15.4	11.3	11.3	11.3	11.3	11.3	11.3
Maximum path loss	106.8	105.8	98.6	97.6	98.6	97.6	132.8	131.8	132.8	131.8	142.3	138.8
Maximum range	211.5	195.8	113.0	104.6	113.0	104.6	416.5	393.2	416.5	393.2	2379.6	1920.5
Coverage efficiency	0.1	0.1	0.0	0.0	0.0	0.0	0.5	0.5	0.5	0.5	3.7	2.4

(continued)

(concluded)

	Downlink		Uplink		Downlink		Uplink		Downlink		Uplink	
	Indoor	A	Indoor	A	Indoor	A	Pedestr	A	Vehicular	A	Vehicular	A
Test environment	LCD 384	LCD 384	LCD 2048	LCD 2048	LCD 2048	LCD 2048	LCD 144	LCD 144	LCD 384	LCD 384	LCD 384	LCD 384
Multipath channel class												
Test service												
Note												
Concept optimized parameters												
Maximum TX power per traffic ch.	13	10	13	10	10	20	23	20	30	24	24	24
TX antenna gain	2	2	2	2	2	2	10	2	17	2	2	2
RX antenna gain	2	2	2	2	2	2	2	10	2	17	17	17
Maximum path loss	111.8	113.8	103.6	105.6	105.6	137.8	139.8	139.8	148.3	144.8	144.8	144.8
Maximum range	310.4	361.9	165.8	193.3	193.3	555.5	623.2	623.2	3436.2	2773.3	2773.3	2773.3
Coverage efficiency	0.3	0.4	0.1	0.1	0.1	1.0	1.2	1.2	7.7	5.0	5.0	5.0

Test environment		Downlink	Uplink	Downlink	Uplink
		Indoor	Indoor	Indoor	Indoor
Multipath channel class		A	A	A	A
Test service		UDD 384	UDD 384	UDD 2048	UDD 2048
Note					
Bit rate	bit/s	240000	240000	480000	480000
Average TX power per traffic ch.	dBm	10	4	10	4
Maximum TX power per traffic ch.	dBm	10	4	10	4
Maximum total TX power	dBm	10	4	10	4
Cable, conn. and combiner losses	dB	2	0	2	0
TX antenna gain	dBi	2	0	2	0
TX EIRP per traffic channel	dBm	10	4	10	4
Total TX EIRP	dBm	10	4	10	4
RX antenna gain	dBi	0	2	0	2
Cable and connector losses	dB	0	2	0	2
Receiver noise figure	dB	5	5	5	5
Thermal noise density	dBm/Hz	-174	-174	-174	-174
RX interference density	dBm/Hz	-1000	-1000	-1000	-1000
Total effect. noise + interf. density	dBm/Hz	-169	-169	-169	-169
Information rate	dBHz	53.8	53.8	56.8	56.8
Required Eb/(No+Io)	dB	2.8	0.2	2.8	0.2
RX sensitivity	dB	-112.4	-115.0	-109.4	-112.0
Power control TX power increase	dB	4.0	2.0	4.0	2.0
Handoff gain	dB	5.9	5.9	5.9	5.9
Explicit diversity gain	dB	0	0	0	0
Other gain	dB	0	0	0	0
Log-normal fade margin	dB	15.4	15.4	15.4	15.4
Maximum path loss	dB	108.9	107.5	105.9	104.5
Maximum range	m	249.2	223.8	197.8	177.7
Coverage efficiency	km ² /site	0.20	0.16	0.12	0.10
Concept optimized parameters					
Maximum TX power per traffic ch.	dBm	13	10	13	10
TX antenna gain	dBi	2	2	2	2
RX antenna gain	dBi	2	2	2	2
Maximum path loss	dB	113.9	115.5	110.9	112.5
Maximum range	m	365.8	413.6	290.3	328.3
Coverage efficiency	km ² /site	0.42	0.54	0.26	0.34

Test environment		Downlink	Uplink	Downlink	Uplink	Downlink	Uplink
		Pedestr.	Pedestr.	Pedestr.	Pedestr.	Vehicular	Vehicular
Multipath channel class		A	A	A	A	A	A
Test service		UDD 384	UDD 384	UDD 2048	UDD 2048	UDD 144	UDD 144
Note							
Bit rate	bit/s	240000	240000	480000	480000	240000	240000
Average TX power per traffic ch.	dBm	20	14	20	14	30	24
Maximum TX power per traffic ch.	dBm	20	14	20	14	30	24
Maximum total TX power	dBm	20	14	20	14	30	24
Cable, conn. and combiner losses	dB	2	0	2	0	2	0
TX antenna gain	dBi	10	0	10	0	13	0
TX EIRP per traffic channel	dBm	28	14	28	14	41	24
Total TX EIRP	dBm	28	14	28	14	41	24
RX antenna gain	dBi	0	10	0	10	0	13
Cable and connector losses	dB	0	2	0	2	0	2
Receiver noise figure	dB	5	5	5	5	5	5
Thermal noise density	dBm/Hz	-174	-174	-174	-174	-174	-174
RX interference density	dBm/Hz	-1000	-1000	-1000	-1000	-1000	-1000
Total effect. noise + interf. density	dBm/Hz	-169	-169	-169	-169	-169	-169
Information rate	dBHz	53.8	53.8	56.8	56.8	53.8	53.8
Required Eb/(No+Io)	dB	3.2	0.2	3.2	0.2	4.2	1.9
RX sensitivity	dB	-112.0	-115.0	-109.0	-112.0	-111.0	-113.3
Power control TX power increase	dB	4.5	2.0	4.5	2.0	0.0	0.0
Handoff gain	dB	4.7	4.7	4.7	4.7	4.7	4.7
Explicit diversity gain	dB	0	0	0	0	0	0
Other gain	dB	0	0	0	0	0	0
Log-normal fade margin	dB	11.3	11.3	11.3	11.3	11.3	11.3
Maximum path loss	dB	128.9	128.4	125.9	125.4	145.4	141.7
Maximum range	m	332.4	323.0	279.5	271.6	2884.4	2299.6
Coverage efficiency	km ² /site	0.35	0.33	0.25	0.23	5.40	3.43
Concept optimized parameters							
Maximum TX power per traffic ch.	dBm	23	20	23	20	30	24
TX antenna gain	dBi	10	2	10	2	17	2
RX antenna gain	dBi	2	10	2	10	2	17
Maximum path loss	dB	133.9	136.4	130.9	133.4	151.4	147.7
Maximum range	m	443.3	511.9	372.8	430.5	4165.1	3320.6
Coverage efficiency	km ² /site	0.62	0.82	0.44	0.58	11.27	7.16

4 Complexity and dual mode GSM/UMTS terminal complexity analysis

This contains analysis of the terminal and base station receiver implementation complexity and of GSM/UMTS dual mode terminal implementation. In the next sections, first the implementation complexity criteria and methodology are presented. Then, detailed transceiver configurations for each service option are presented.

4.1 Implementation complexity criteria

In the complexity analysis following criteria were used:

- baseband complexity
- RF complexity
- modularity

In baseband complexity analysis the main emphasis was in the computational complexity of the receiver algorithm since it is the most complex baseband part of the receiver. In the RF complexity analysis power amplifier linearity, A/D and D/A converter requirements and the number of filters and mixers were considered. The modularity analysis concentrated to study the increase of complexity as a function of the bit rate increase.

Complexity of discrete RF component was considered more significant than complexity of baseband due to faster development of baseband technology like decrease of ASIC power consumption and increase of ASIC integration density. Also with W-CDMA one should note that the performance critical parts can be done with ASIC and do not need to be done with software thus more efficient implementation in terms of power consumption compared to implementing the similar functions with general purpose DSP. An example purpose of this is the correlators, which require only one bit multiplications and are therefore very well suited for ASIC implementation with low gate count per multiplier.

4.2 GSM/UMTS dual mode terminal implementation¹

Starting point was the assumption that in the beginning UMTS will not provide wide area coverage. Therefore, service coverage has to be ensured by use of dual mode terminal with existing second generation systems. Since GSM will be the major 2nd generation digital technology world-wide at the time of UMTS deployment, only GSM/UMTS dual mode terminal implementation was investigated. There are four different scenarios that can be considered

- GSM and UMTS are separate systems and mode of operation will be selected when the mobile is switched on or a call initiated. It is not possible to change the mode during a call.
- handover from UMTS to GSM during a call is possible
- handover from UMTS to GSM and vice versa is possible
- handover only from GSM to UMTS possible but this is not considered as interesting option and is not investigated further.

In the first option additional complexity from the hardware point of view comes mainly from the GSM receiver implementation, i.e. receiver has to be able to filter out the 200 kHz signal and to demodulate it with the MLSE receiver. Frequency hopping has to be also possible. However, in this mode power consumption of the original scheme is not increased that much since GSM and UMTS do not operate at the same time.

¹ Also triple mode GSM/DCS/UMTS terminal implementations are possible. However, since addition of the DCS mode into a UMTS terminal after GSM mode has been introduced would mean same extra complexity for all modes it is not included into analysis.

In the second option complexity increase depends on the desired level of handover. First alternative is to make a “blind” handover when the UMTS terminal does not need to measure the GSM BCCH channel. Second possibility is to have more seamless handover which means that the UMTS terminal has to have capabilities to measure GSM BCCH frequency during the UMTS call. This option is studied in here without the use of slotted mode for interfrequency UMTS or GSM measurements.

In the third option in addition to changes of second option GSM standard needs to be modified to include interworking with UMTS i.e. the new GSM terminals have to have capabilities to make handover from GSM to UMTS. Depending on the desired level of compatibility dual mode terminal can measure UMTS BCCH in the GSM mode or they can make a blind handover into UMTS carrier. In this scenario a change into GSM specification would be required so that new GSM terminal could measure the UMTS BCCH, which most likely differs from the GSM BCCH.

In the following the first and the second option are analyzed further since they are the most relevant ones.

In all scenarios for dual mode GSM/UMTS another duplexer and another RF filter are required for dual mode operation. (Which should be a valid statement for all UMTS schemes)

4.3 Study Methodology

The receiver complexity was analyzed by detailed break down of receiver structures. In baseband complexity analysis the main emphasis was in the computational complexity of the receiver algorithm. The complexity of each block in the baseband was analyzed separately by determining the number of real multiplications or instructions needed to perform the operation. The total number of instructions needed was calculated from this break down analysis. The power consumption and complexity were determined by the needed computational power. The support for GSM option in baseband was studied according to the baseband break down analysis.

As part of functions, at least correlators, will be done with ASIC, to achieve a single complexity figure in MIPS, methodology for “normalised” MIPS calculations from the ASIC implementable parts is presented. The reason why correlators are very suitable for hardware implementation is the 1 bit multiplication which is sufficient to be used in the correlators with the proposed Wideband CDMA concept from the alpha group.

The complexity analysis of RF parts was based on the following criteria: requirements of power amplifier linearity, requirements of A/D converter and the number of synthesisers, mixers and IF filters needed. The complexities of these criteria in each scheme were assessed.

4.3.1 General transceiver configuration

General transceiver configuration can be seen in Figure 4.1. The approach is a traditional CDMA transceiver where in the uplink the narrowband signal is spread, pulse shaped, and digital-analog converted for the direct up-sampling. On the receiver side harmonic downsampling is utilised after which the signal is converted to digital format. Dynamic range is decreased compared to TDMA systems due to spreading procedure. Fast power control also relaxes the dynamic range because of lower fading marginal. Still some non-linearities are likely to be accepted which are overcome by the robust nature of the DS-SS signal.

4.3.1.1 Transmitter

The transmitter structure does not need to buffer the outgoing data. Decrease can be mainly seen in the amount of required memory, while the high chip rate pulse shaping requires extra effort from the digital filters (could be perhaps done in an analog way). Depending on the chip rate, and oversampling ratio the DAC cost / power consumption is increased.

Interestingly the complexity is constant with respect to the data rate. This is because the effect of decreasing the spreading ratio can only be seen as increased PA power level while the digital signal dynamics stays the same. Still the memory requirements for the data path are low (no timeslot buffering).

4.3.1.2 Receiver

The receiver is a typical Rake type CDMA receiver utilising coherent reception in both channel impulse response estimation, and code tracking procedures. Basically each code channel to be despread needs two real correlators per path in case of BPSK channel and four in case of QPSK channels. Delay estimation is committed inside the possible channel delay spread, and sampling rate parameters are to be defined for this action. On the RF side lower dynamic range for the ADC is allowed due to spread spectrum nature of the signal. Generally, some 4-6 bits/chip is enough. 6 bits has been assumed in the analysis based on the following comment:

4.3.1.3 The ADC wordlength

Is likely to be affected by the following items:

- a) higher chip rate than in IS-95 and therefore higher sampling rate.
- b) different BER requirements for different services and hence different spectrum densities before spreading. In other words, the difference in power levels between users can be larger than the difference in data rates even if we completely ignore fades, inaccuracies of power control, etc.
- c) linearity of ADC

Consider 8 kbps speech transmission, and a 4 bit ADC in the downlink (or uplink) receiver. For a 5 MHz bandwidth, the simulation results from FRAMES indicate that the system is capable of supporting about 100 users per carrier per cell. Assume that total power of interfering signals from the other cells adds 40% to the composite power at the receiver input. Also assume ideal power control, and therefore no level variations around the nominal level at the ADC input, which is of course more than optimistic.

In the receiver, the AGC puts the composite signal, ie. its standard deviation, at 6 dB (ie. 1bit) below the max quantization level. 8 kbps signal is approx $[10*\log(100)+10*\log 1.4]=21.4$ dB below the composite, which corresponds to approx 3.5 bits, and therefore 4.5 bits below the peak quantization level and 0.5 bit below the lowest quantization level. This is not an impossible mode of operation in presence of thermal noise and noise-like interference. Quantization noise is not likely to be an issue - we are only interested in its power within the bandwidth, which equals data rate, and it will worst affect 2 Mbps signals, the actual impact depending on the oversampling ratio . However, as pointed out above, we may hit a problem with ADC linearity.

The dynamic range will be obviously bigger (by $10*\log 4=6$ dB, ie 1 bit) in a 20 Mhz bandwidth. It can be concluded that minimum 5 or 6 bits of wordlength will be required for the ADC, and an additional increase will be necessary to allow for imperfect power control.

4.3.1.4 Transmit/receiver filtering

One aspect to remember is the required filtering for the receive and transmit filters. With purely DSP based solutions effort is naturally needed due high symbol rates. In the current concept the roll-off is specified to be 0.22. This is kind of roll-off value that makes it possible to make the filtering with analog components, at least partly, thus greatly reducing power consumption and not contributing to the MIPS figures. More thighter roll-off requires to fully digital implementation. This is inherently different from the solutions like in IS-95 where it is obvious that analog components can not be used due different requirements in the filter transition band.

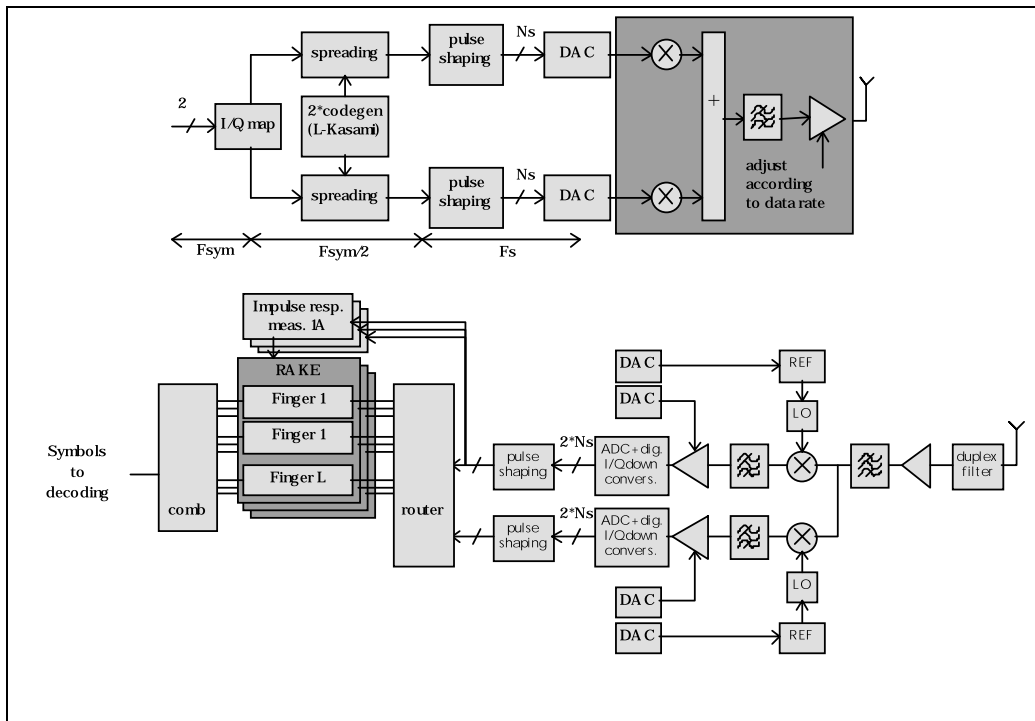


Figure 4.1. WCDMA General transceiver block diagram with dual receiver functionality.

In Table 4.1 are shown the formulas and parameters for calculating the baseband complexity of the W-CDMA mobile receiver. One sample per chip is assumed. In the calculations DLL (delay locked loop) is assumed to be incoherent. For the ones familiar with the analysis for FRAMES FMA2 do note that pilot symbols are now in the data stream and thus no separate correlators are needed for channel estimation from the pilot channel in the downlink direction. In the uplink as well the pilots symbols are in the data stream and thus no extra hardware is needed for the transmission at the mobile or for the reception at the base station.

Table 4.1. Formulas for calculating the baseband complexity of W-CDMA mobile receiver

Operation	Number of real multiplications needed	Parameter values
Correlators + code tracking	$F_{chip} * 2 * N_{channel} * L / 15.0$, F_{chip} =chip rate $N_{channel}$ =number of code channels L =number of Rake fingers The division by 15.0 is to take into account the low word length requirement of the correlator. The following reasoning has been used: <ul style="list-style-type: none"> 16-bit MAC = $16 * 16 + 32 + 32 = 320$ primitive operations multiply by 1 bit and add to 6-bit number = $6 * 1 + 6 + 10 = 22$ ref. units The word length factor = $320 / 22 \approx 15$	$F_{chip} = 4.096$ Mchip/s $N_{channel}$: Downlink/Uplink 8 kbit/s: 2/1+1 144 kbit/s: 2/1+1 384 kbit/s: 2/1+1 2048 kbit/s: 4/8+1 (BPSK channels) $L = 4$ For uplink the constant rate PCCH included with 16 kbits/s and spreading ratio 256. $1 * QPSK = 2 * BPSK$ channels
Delay estimation	$2 * L_{search} * R_{irsampling} * N_{channel}$ L_{search} =search window of delay taps in chips $R_{irsampling}$ =rate of estimating impulse response $N_{channel}$ =Number of channels to follow for delay estimation	$L_{search} = 100$ corresponding to delay spread of 20 μ s $R_{irsampling} = 100$ Hz $N_{channel} = 2$

		(can be 1 as well depending on the implementation)
Rake combining	$4 * R_{\text{symbol}} * L * N_{\text{channel}}$, R_{symbol} =symbol rate L =number of Rake fingers N_{channel} =number of QPSK code channels, see correlator section and note 2 BPSK = 1 QPSK 16 kbits/s BPSK PCCH in the uplink	R_{symbol} =Downlink/Uplink (kbits/s per channel) 8 kbit/s: 32/16+16 (PCCH) 144 kbit/s: 512/256+16 384 kbit/s: 1024/512+16 2048 kbit/s: 1024/512+16

Notes: In the analysis 4.096 Mcps/s assumed for all services, however the use of 8.192 Mcps/s or higher chip rate is not expected to change the results significantly as for using the higher chip rate for higher rate services will naturally increase the parameter F_{chip} but the parameter N_{channel} will be reduced respectively if the spreading ratio is kept constant and then the number of parallel code channels is reduced.

4.3.1.5 Transceiver RF architecture candidates analysis

The wideband nature of the system suggests that the receiver should filter out as much adjacent channel interference as possible on the analog side. This would make it possible to use lower sampling frequencies for the ADC.

Aspects that should be taken into account on the TX side are:

- Faster power control needed than in non-DS-SS approaches (assumed not to affect very much the total cost/power consumption)

Aspects that should be taken into account on the RX side are:

- Lower dynamic range than in slotted transmission due to spreading (hard limiting possible in case of DS-SS without affecting the performance too much)
- Expected to be more robust against non-linearities (compression etc.)
- Two IF sections are needed for inter-frequency handover for higher bit rates terminal when slotted mode is not used

4.3.2 Service classes

All the specified services can be supported using a single carrier. The following summarises the modes for the specified service classes. Note that some services are defined slightly different from the simulated ones, but regardless of the small differences the complexity estimates are valid with reasonable accuracy.

4.3.2.1 Downlink services

8 kbits/s, for rate 1/3 rate coding 24 kbits/s which in the analysis corresponds to a QPSK transmission with spreading ratio of 256 providing 32 kbits/s with well enough room to include all the overhead due pilot symbols and power control commands.

144 kbits/s, for rate 1/3 coding 432 kbits/s, resulting to a single QPSK channel with spreading ratio 16 having gross data rate of 512 kbits/s. Alternatively 1/2 rate coding with 288 kbits/s could use spreading ratio 32 with some puncturing.

384 kbits/s, for rate 1/2 coding with 768 kbits/s single QPSK channel with spreading ratio 8 and gross bit rate 1024 kbits/s. Alternatively 1/3 rate coding will fit to the same spreading ratio with approximately 12% of puncturing.

2048 kbits/s, for rate 1/2 coding four QPSK channels are needed with spreading ratio of 8 resulting to 4096 kbits/s gross data rate. Although this is calculated for 4.096 Mcps/s one should note that the

complexity is the same for the 8.192 Mc chips/s and also for higher bit rates as the number of channels decreases as the chip rate increases and the number of calculations is about the same.

In the downlink the pilot overhead is now time multiplexed in the data stream taking 2 out of 16 symbols in a 0.625 ms slot with spreading ratio 256. For higher rates the overhead percentage reduces naturally respectively.

4.3.2.2 Uplink services

The difference between uplink and downlink multiplexing results to somewhat different service implementations

8 kbits/s, 1/2 rate coding resulting to 16 kbits/s on a single code channel with spreading ratio 256.
 144 kbits/s, 1/2 rate coding resulting to 288 kbits/s on a single code channel with spreading ratio 16 with slight puncturing
 384 kbits/s, 1/2 rate coding resulting to 768 kbits/s on two code channels with spreading ratio 8. Note that simulated slightly differently with a single code channel with spreading ratio 4.
 2048 kbits/s, 1/2 rate coding resulting to 2048 kbits/s provided with spreading ratio 4 and four parallel code channels. (BPSK channels, two per branch with the effective total processing gain around 2). The complexity will be calculated for the case with processing gain of 8 and eight parallel channels and this result is valid for the higher chip rates as well, see the calculation principles for more details.

In the uplink the overhead due pilot symbols, power control and rate information is in the 16 kbits/s fixed rate control channel. This is included and should be noted in any comparison to other access schemes based on these figures if similar signalling is not included.

4.3.3 Support for GSM option

In order to implement a dual-receiver the following aspects need to be taken into account:

Baseband section:

- Transmission buffer more on the TX side
- MLSE block on the RX side

RF section:

- On the TX side possibly a more expensive PA in case of low-end UMTS terminal
- RX side with 200kHz IF filter + higher dynamic range ADC (maybe another ADC with low Fs)
- Second duplexer, and RX RF filter

Since the signal is continuous WCDMA needs dual receiver for GSM monitoring. If there is already the dual receiver due to interfrequency handover there is no additional changes.

This analysis is valid when no slotted mode is used, with the slotted mode the situation is similar than with the TDMA based concepts. The slotted mode is expected to be interesting alternative for low cost terminals, but for the high capability UMTS terminals the relative part of the GSM radio modem part is expected to be that low that the way how dual mode feature for GSM is introduced does not make a real difference to the cost of an UMTS terminal product.

4.3.4 Baseband power consumption

A complexity comparison of baseband parts for different (circuit switched) services is calculated in the table below and given as "normalised" real multiplications per second/ 10^6 for DSP implementation with the correlator complexity derived from ASIC implementation.

Table 4.2. Baseband complexity of the receivers (at BS average per user). [real multiplications per second/ 10^6]

kbit/s	Uplink (BS RAKE-receiver)	Downlink (MS RAKE-receiver)
8	5	5
144	9	9
384	24	21
2048	86	83

Notes on software / hardware implementation

The baseband complexity is calculated in real multiplications per second which does not reflect the different word length requirements of different receiver algorithms. If hardware implementation is used, those schemes that have low word length requirements are more favourable as is exactly the case with W-CDMA.

Power consumption estimate in [mW]

In the Table 4.3 a rough estimate of baseband power consumption is made with the assumption that power consumption per MIPS = 1.0 mW which is a fairly conservative estimate after 5 or 10 years. It should be noted that the complexity figures in previous tables don't include all the baseband processing e.g. source and channel coding and decoding and they are therefore optimistic. The values for coding/decoding is not dependent on the multiple access scheme and therefore not presented here. It has been assumed in the table below that 1 real multiplication requires 3 instructions on a signal processing device.

Table 4.3. Baseband power consumption (at BS average per user)

Baseband power consumption	8 kbit/s	144 kbit/s	384 kbit/s	2000 kbit/s
Uplink (BS)	20 mW	40 mW	90 mW	320 mW
Downlink (MS)	20 mW	40 mW	75 mW	300 mW

4.3.5 RF power consumption and cost

The RF power consumption is mainly determined by the power consumption of power amplifier, A/D converter, D/A converter and synthesisers.

In Table 4.4 an estimate of RF power consumption is shown. The used assumptions for calculating the power consumption of the power amplifier are shown in Table 4.4,

Table 4.4. Assumptions in calculating power amplifier power consumption

Maximum average output power	100 mW
Power amplifier efficiency	40 %
Power consumption at maximum output power	250 mW
Power consumption at minimum output power. It is here assumed that the minimum power consumption is 6 dB below the maximum power consumption.	250 mW/6 dB=63 mW

The power amplifier power consumption is assumed to be only 6 dB below the maximum power consumption even if output power is 30 - 80 dB below the maximum output power. This is because the efficiency of the power amplifier decreases as the output power decreases. Therefore, the power

amplifier takes power even if the transmission power in small cells is very low. On the other hand, two or more amplifiers can be used to improve the efficiency at low output powers.

The power consumption of the A/D converter in the receiver and the D/A converter in the transmitter depends on the sampling frequency, on the word length requirements, and on the proportional time the converter is on/off during the operation. Factors affecting the word length requirements are e.g. the number of modulation levels or/and parallel codes, the performance of automatic gain control in fading channel and the required SIR. An approximate formula for calculation of ADC and DAC power consumption = sampling frequency / $1e8 * 2^{bits}$ [mW]. Here it is assumed that the ADC and DAC power consumption together is 50 mW or less. For more exact values to be compared with other UMTS schemes, the word length requirements should be taken into account.

The power consumption of the synthesisers depends on the number of synthesisers needed. It is assumed that the power consumption of the synthesisers is 50 mW. This estimate is based on the power consumption of the current mobile terminals.

Table 4.5. Estimated total RF power consumption

	Power amplifier	ADC + DAC	Synthesisers	Total
At maximum output power	250 mW	50 mW	50 mW	350 mW
At minimum output power	63 mW	50 mW	50 mW	163 mW

4.3.6 Baseband vs. RF power consumption

The baseband power consumption should be compared to the power consumption of RF parts to find out which one is dominating in transmission mode. According to Table 4.5 the power consumption of RF parts at maximum output power is 500 mW or less. Therefore the baseband power consumption of Table 4.3 is significant compared to RF parts. For comparison, the power consumption of current GSM phones in talk mode at 250 mW average transmission power is typically 1500 mW including baseband, RF and all the other functions.

4.4 GSM/UMTS Dual mode terminal implementation

In the following table changes needed for the UMTS/GSM dual mode terminal are listed.

Table 4.6. The needed changes for UMTS terminals for dual mode UMTS/GSM operation

Change	Changes/additions due to GSM support (not simultaneous with UMTS)	Changes due to handover from UMTS to GSM	Notes
Impact	<ul style="list-style-type: none"> - GSM/DCS duplexer, and RF filter - 200kHz IF filter + higher dynamic range ADC - more transmission buffer on the TX side - MLSE block - possibly a more expensive PA in case of low-end UMTS terminal 	None (If dual receiver for interfrequency handover utilised) Second receiver if only slotted mode used for W-CDMA inter-frequency measurements	As GSM measurement during connection MLSE block extra regardless of DSP or ASIC implementation.

5 Rate Matching Principle

In the WCDMA concept an essential part of the flexibility is the used rate matching principle which allows basically any arbitrary information bit rate after channel encoding to be matched to the channel symbol rate in an efficient way. This section presents the simple rules for repetition/puncturing which are then known by both the receiver and transmitter and the needed operation for decoding can be interpreted based on the explicit rate information on the control channel.

The generic repetition and puncturing rule is as defined by the following algorithm:

Let's denote:

$S_N = \{N_1, N_2, \dots, N_L\}$ = ordered set (in ascending order from left to right) of allowed number of bits per frame

N_C = number of bits per frame after TCH and ACCH multiplexing

$S_0 = \{d_1, d_2, \dots, d_{N_C}\}$ = set of N_C data bits

P = maximum amount of puncturing allowed (tentatively 0.2, for further study)

The rate matching rule is as follows.

find N_i and N_{i+1} so that $N_i \leq N_C < N_{i+1}$

$j = 0$

$$z = \left\lceil \frac{N_{i+1}}{N_C} \right\rceil$$

if ($z > 1$ & $N_C \neq N_i$)

repeat every bit from set S_j z times

$$N_C = N_C z$$

if ($\frac{N_C - N_i}{N_C} < P$)

$$x = N_C$$

$$y = N_C - N_i$$

$$S_j = \{d_1, d_2, \dots, d_{N_C}\}$$

do while $y > 1$

$$z = \left\lceil \frac{x}{y} \right\rceil$$

$$k = \left\lfloor \frac{x}{z} \right\rfloor$$

$$x = x - k$$

```

     $y = y - k$ 
    puncture every  $z$ th bit from set  $S_j$ 
    form new set  $S_{j+1}$  from not punctured bits of set  $S_j$ 
     $j = j + 1$ 
end do
if  $y == 1$ 
    puncture last bit from set  $S_j$ 
else
     $x = N_C$ 
     $y = N_{i+1} - N_C$ 
     $S_j = \{d_1, d_2, \dots, d_{N_C}\}$ 
    do while  $y > 1$ 
         $z = \left\lfloor \frac{x}{y} \right\rfloor$ 
         $k = \left\lfloor \frac{x}{z} \right\rfloor$ 
         $x = x - k$ 
         $y = y - k$ 
        repeat every  $z$ th bit from set  $S_j$ 
        form new set  $S_{j+1}$  from not repeated bits of set  $S_j$ 
         $j = j + 1$ 
    end do
    if  $y == 1$ 
        repeat first bit from set  $S_j$ 
    end if
end if

```

**ETSI SMG
Meeting no 24
Madrid, Spain
15 - 19 December 1997**

Tdoc SMG 905/97

Source: SMG2

Concept Group Alpha - Wideband Direct-Sequence CDMA (WCDMA)

EVALUATION DOCUMENT (3.0)

Part 3: Detailed simulation results and parameters

In the procedure to define the UMTS Terrestrial Radio Access (UTRA), the wideband DS-SS CDMA concept group (Alpha) will develop and evaluate a multiple access concept based on direct sequence code division. This group was formed around the DS-SS CDMA proposals from FRAMES Mode 2, Fujitsu, NEC and Panasonic. The main radio transmission technology (RTT) and parameters of the common concept from the Alpha group along with performance results are presented in this document.

<p>This document was prepared during the evaluation work of SMG2 as a possible basis for the UTRA standard. It is provided to SMG on the understanding that the full details of the contents have not necessarily been reviewed by, or agreed by, SMG2.</p>

1. INTRODUCTION	117
2. LINK-LEVEL SIMULATIONS	117
2.1 Speech	118
2.2 LCD	128
2.3 UDD	130
3. SYSTEM-LEVEL SIMULATIONS	136
3.1 Speech	136
3.2 LCD	137
3.3 UDD	138
3.4 PDFs of Active Session Bit-rate	139
3.5 Satisfied Users versus Load	140
3.6 Some Notes on the Vehicular Environment	142

1. INTRODUCTION

This is the Part 3 of the Alpha (Wideband DS-CDMA) concept group evaluation document and presents detailed parameters and simulation result curves of the W-CDMA concept. This is a separate file for purely editorial reasons. This document contains two sections: link-level simulations and system-level simulations for the FDD mode.

In the sections with link-level simulations both detailed parameters used in each simulation and also curves with simulation results are presented. In system-level sections the detailed simulation parameters are presented. Also, some additional figures related to the sytem simulations are shown here.

2. LINK-LEVEL SIMULATIONS

In this section link-level simulation parameters for the different test cases are listed for the FDD mode, together with plots with simulation results. Note that the first row of each column in the parameter tables lists the number of the figure where the simulation result can be found.

2.1 Speech

Some improvements have been done to get better results than the previously presented values in Evaluation Document Draft 1.0. These improvements are due to:

- For 20 ms interleaving, both the coding and interleaving is now performed over 20 ms which implies less overhead for CRC and convolutional coding tail.
- Blind rate detection can be easily implemented since only two information bit-rates (0 and 8 kbps) are used and therefore the FCH bits can be used as pilot symbols.
- For the Vehicular environment, a smaller power control step is used (now 0.25 dB, before 0.5 dB).

2.1.1 Indoor Office A, 3 km/h

Figure number	1	1	1	2	2	2
Plot symbol	*	O	+	*	O	+
Service	Speech	Speech	Speech	Speech	Speech	Speech
Link-level bit rate	8 kbps	8 kbps	8 kbps	8 kbps	8 kbps	8 kbps
Channel type	Indoor A	Indoor A	Indoor A	Indoor A	Indoor A	Indoor A
Mobile speed	3 km/h	3 km/h	3 km/h	3 km/h	3 km/h	3 km/h
Antenna diversity	Yes	Yes	Yes	No	No	No
Chip rate [Mcps]	4.096	4.096	4.096	4.096	4.096	4.096
DPDCH						
Code allocation	1 × SF 128	1 × SF 128	1 × SF 128	1 × SF 128	1 × SF 128	1 × SF 128
Info / CRC / tail bits per frame	80 / 8 / 8	80 / 8 / 8	80 / 4 / 4	80 / 8 / 8	80 / 8 / 8	80 / 4 / 4
Convolutional code rate	1/3	1/3	1/3	1/3	1/3	1/3
Rate matching	9 / 10	9 / 10	33 / 40	9 / 10	9 / 10	33 / 40
Interleaver	10 ms	20 ms	20 ms	10 ms	10 ms	20 ms
DPCCH						
Code allocation	1 × SF 256	1 × SF 256	1 × SF 256	1 × SF 256	1 × SF 256	1 × SF 256
PC frequency [Hz]	800	800	800	800	800	800
PC step [dB]	1	1	1	1	1	1
Slots per frame	8	8	8	8	8	8
Pilot / PC / FCH bits per slot	12 / 4 / 4	12 / 4 / 4	16 / 4 / 0	12 / 4 / 4	16 / 4 / 0	16 / 4 / 0
Valid FCH words	2	2	-	2	-	-
DPCCH - DPDCH power [dB]	-3	-3	-3	-3	-3	-3

Table 1. Parameters for speech Indoor A simulations.

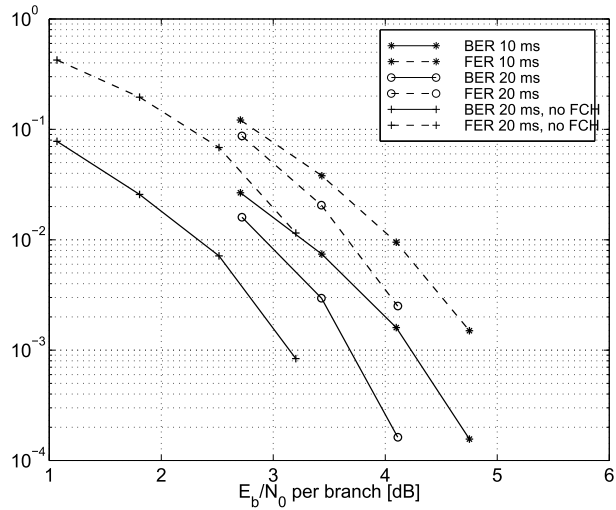


Figure 1. Speech, Indoor office A, with antenna diversity.

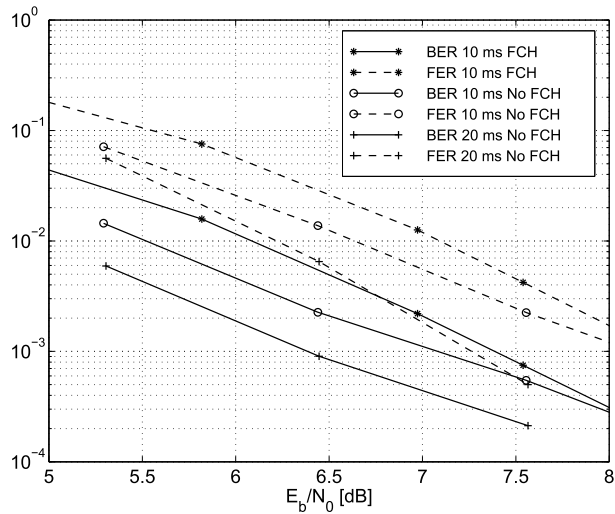


Figure 2. Speech, Indoor office A, without antenna diversity.

2.1.2 Outdoor to Indoor and Pedestrian A, 3 km/h

Figure number	3	3	3	4	4	4
Plot symbol	*	O	+	*	O	+
Service	Speech	Speech	Speech	Speech	Speech	Speech
Link-level bit rate	8 kbps	8 kbps	8 kbps	8 kbps	8 kbps	8 kbps
Channel type	Out. to In. A	Out. to In. A	Out. to In. A	Out. to In. A	Out. to In. A	Out. to In. A
Mobile speed	3 km/h	3 km/h	3 km/h	3 km/h	3 km/h	3 km/h
Antenna diversity	Yes	Yes	Yes	No	No	No
Chip rate [Mcps]	4.096	4.096	4.096	4.096	4.096	4.096
DPDCH						
Code allocation	1 × SF 128	1 × SF 128	1 × SF 128	1 × SF 128	1 × SF 128	1 × SF 128
Info / CRC / tail bits per frame	80 / 8 / 8	80 / 8 / 8	80 / 4 / 4	80 / 8 / 8	80 / 8 / 8	80 / 4 / 4
Convolutional code rate	1/3	1/3	1/3	1/3	1/3	1/3
Rate matching	9 / 10	9 / 10	33 / 40	9 / 10	9 / 10	33 / 40
Interleaver	10 ms	20 ms	20 ms	10 ms	10 ms	20 ms
DPCCH						
Code allocation	1 × SF 256	1 × SF 256	1 × SF 256	1 × SF 256	1 × SF 256	1 × SF 256
PC frequency [Hz]	800	800	800	800	800	800
PC step [dB]	1	1	1	1	1	1
Slots per frame	8	8	8	8	8	8
Pilot / PC / FCH bits per slot	12 / 4 / 4	12 / 4 / 4	16 / 4 / 0	12 / 4 / 4	16 / 4 / 0	16 / 4 / 0
Valid FCH words	2	2	0	2	-	-
DPCCH - DPDCH power [dB]	-3	-3	-3	-3	-3	-3

Table 2. Parameters for speech Outdoor to Indoor A simulations.

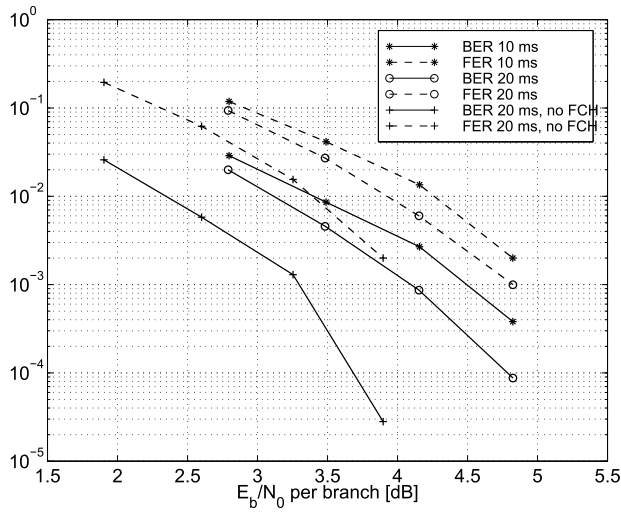


Figure 3. Speech, Outdoor to indoor and pedestrian A, with antenna diversity.

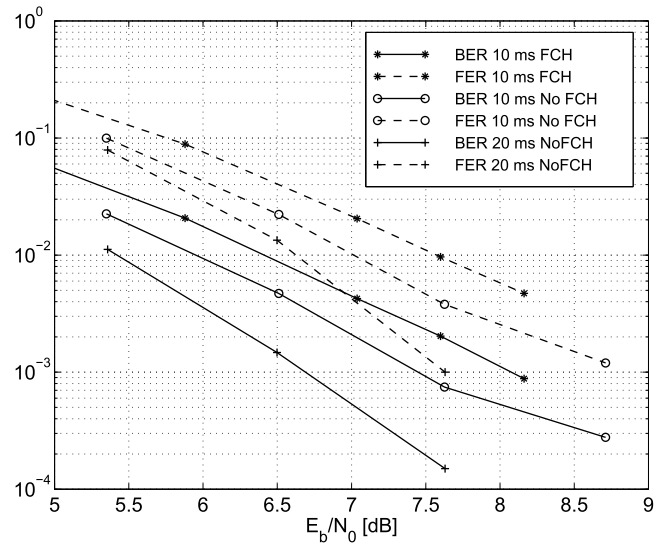


Figure 4. Speech, Outdoor to indoor and pedestrian A, without antenna diversity.

2.1.3 Vehicular A, 120 km/h

Figure number	5	5	5
Plot symbol	*	O	+
Service	Speech	Speech	Speech
Link-level bit rate	8 kbps	8 kbps	8 kbps
Channel type	Vehicular A	Vehicular A	Vehicular A
Mobile speed	120 km/h	120 km/h	120 km/h
Antenna diversity	Yes	Yes	Yes
Chip rate [Mcps]	4.096	4.096	4.096
DPDCH			
Code allocation	1 × SF 128	1 × SF 128	1 × SF 128
Info / CRC / tail bits per frame	80 / 8 / 8	80 / 8 / 8	80 / 4 / 4
Convolutional code rate	1/3	1/3	1/3
Rate matching	9 / 10	9 / 10	33 / 40
Interleaver	10 ms	20 ms	20 ms
DPCCH			
Code allocation	1 × SF 256	1 × SF 256	1 × SF 256
PC frequency [Hz]	1600	1600	1600
PC step [dB]	0.5	0.5	0.25
Slots per frame	16	16	16
Pilot / PC / FCH bits per slot	6 / 2 / 2	6 / 2 / 2	8 / 2 / 0
Valid FCH words	2	2	0
DPCCH - DPDCH power [dB]	-3	-3	-3

Table 3. Parameters for speech Vehicular A 120 km/h with antenna diversity simulations.

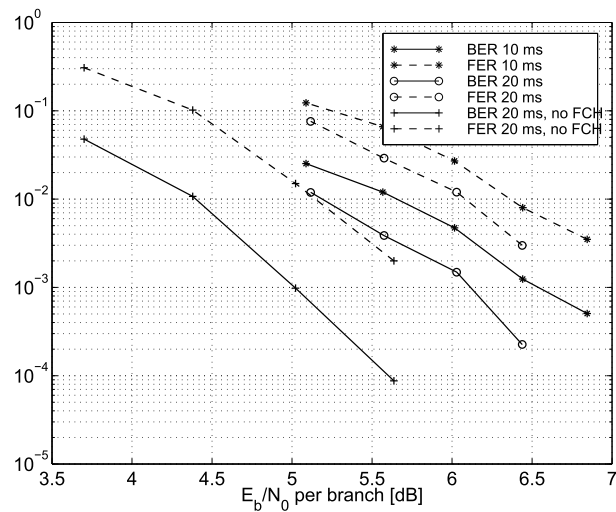


Figure 5. Speech, Vehicular A 120km/h, with antenna diversity.

Figure number	6	6	6	6
Plot symbol	*	O	+	□
Service	Speech	Speech	Speech	Speech
Link-level bit rate	8 kbps	8 kbps	8 kbps	8 kbps
Channel type	Vehicular A	Vehicular A	Vehicular A	Vehicular A
Mobile speed	120 km/h	120 km/h	120 km/h	120 km/h
Antenna diversity	No	No	No	No
Chip rate [Mcps]	4.096	4.096	4.096	4.096
DPDCH				
Code allocation	1 × SF 128	1 × SF 128	1 × SF 128	1 × SF 128
Info / CRC / tail bits per frame	80 / 8 / 8	80 / 8 / 8	80 / 4 / 4	80 / 4 / 4
Convolutional code rate	1/3	1/3	1/3	1/3
Rate matching	9 / 10	9 / 10	33 / 40	33 / 40
Interleaver	10 ms	10 ms	20 ms	20 ms
DPCCH				
Code allocation	1 × SF 256	1 × SF 256	1 × SF 256	1 × SF 256
PC frequency [Hz]	1600	1600	1600	1600
PC step [dB]	0.25	0.5	0.25	0.25
Slots per frame	16	16	16	16
Pilot / PC / FCH bits per slot	7 / 1 / 2	8 / 2 / 0	7 / 1 / 2	8 / 2 / 0
Valid FCH words	2	-	2	-
Dynamic range [dB]	-10:+10	-10:+10	-10:+10	-10:+10
DPCCH - DPDCH power [dB]	-3	-3	-3	-3

Table 4. Parameters for speech Vehicular A 120 km/h simulation without antenna diversity.

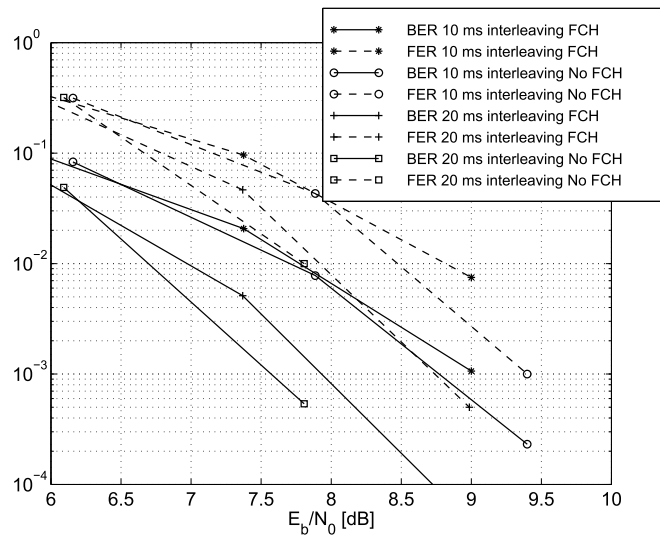


Figure 6. Speech, Vehicular A 120 km/h, without antenna diversity.

2.1.4 Vehicular B, 120 km/h

Figure number	7	8
Plot symbol	*	*
Service	Speech	Speech
Link-level bit rate	8 kbps	8 kbps
Channel type	Vehicular B	Vehicular B
Mobile speed	120 km/h	120 km/h
Antenna diversity	Yes	No
Chip rate [Meps]	4.096	4.096
DPDCH		
Code allocation	1 × SF 128	1 × SF 128
Info / CRC / tail bits per frame	80 / 4 / 4	80 / 4 / 4
Convolutional code rate	1/3	1/3
Rate matching	33 / 40	33 / 40
Interleaver	20 ms	20 ms
DPCCH		
Code allocation	1 × SF 256	1 × SF 256
PC frequency [Hz]	1600	1600
PC step [dB]	0.25	0.25
Slots per frame	16	16
Pilot / PC / FCH bits per slot	8 / 2 / 0	8 / 2 / 0
Valid FCH words	-	-
DPCCH - DPDCH power [dB]	-3	-3

Table 5. Parameters for speech Vehicular B 120 km/h simulations.

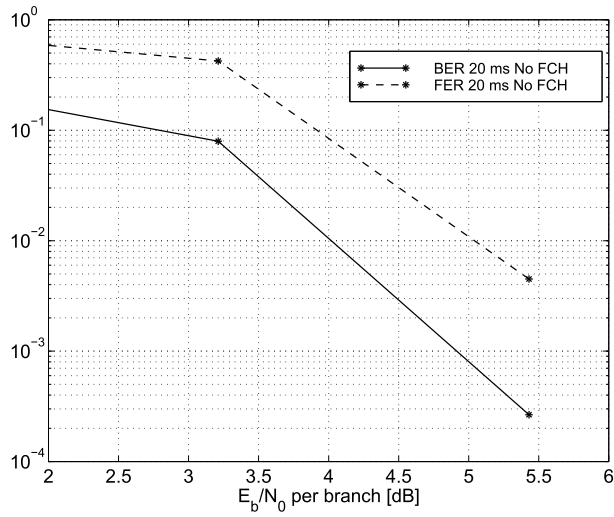


Figure 7. Speech, Vehicular B 120 km/h, with antenna diversity.

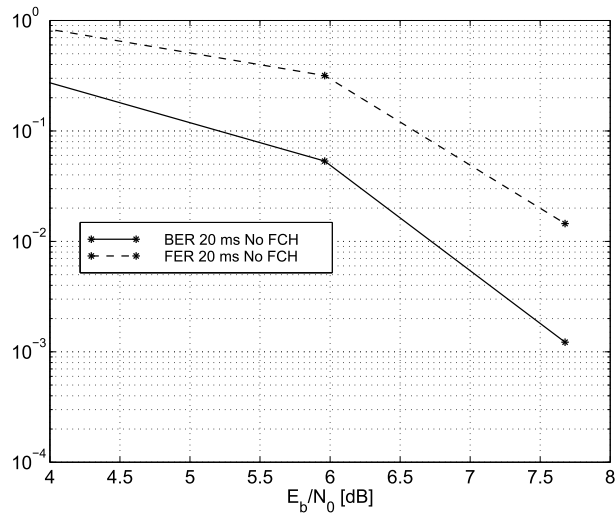


Figure 8. Speech, Vehicular B 120 km/h, without antenna diversity.

2.1.5 Vehicular B 250 km/h

Figure number	9	9	9	10
Plot symbol	*	O	+	*
Service	Speech	Speech	Speech	Speech
Link-level bit rate	8 kbps	8 kbps	8 kbps	8 kbps
Channel type	Vehicular B	Vehicular B	Vehicular B	Vehicular B
Mobile speed	250 km/h	250 km/h	250 km/h	250 km/h
Antenna diversity	Yes	Yes	Yes	No
Chip rate [Mcps]	4.096	4.096	4.096	4.096
DPDCH				
Code allocation	1 × SF 128	1 × SF 128	1 × SF 128	1 × SF 128
Info / CRC / tail bits per frame	80 / 8 / 8	80 / 4 / 4	80 / 4 / 4	80 / 4 / 4
Convolutional code rate	1/3	1/3	1/3	1/3
Rate matching	9 / 10	33 / 40	33 / 40	33 / 40
Interleaver	10 ms	20 ms	20 ms	20 ms
DPCCH				
Code allocation	1 × SF 256	1 × SF 256	1 × SF 256	1 × SF 256
PC frequency [Hz]	3200	3200	3200	3200
PC step [dB]	0.25	0.25	0.25	0.25
Slots per frame	32	32	32	32
Pilot / PC / FCH bits per slot	3 / 1 / 1	3 / 1 / 1	4 / 1 / 0	4 / 1 / 0
Valid FCH words	2	2	-	-
DPCCH - DPDCH power [dB]	-3	-3	-3	-3

Table 6. Parameters for speech Vehicular B 250 km/h simulations.

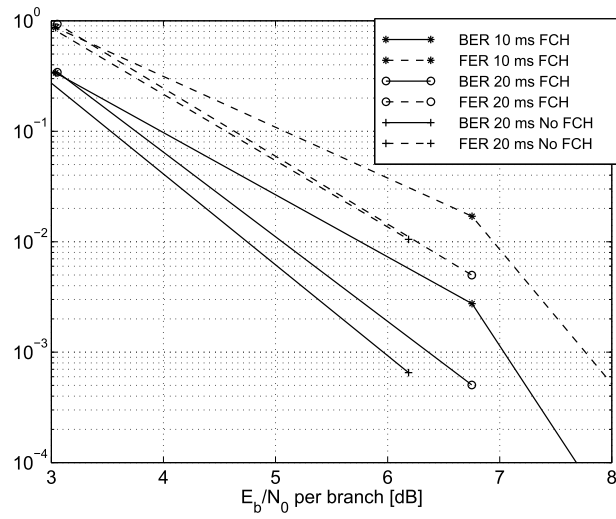


Figure 9. Speech, Vehicular B 250 km/h, with antenna diversity.

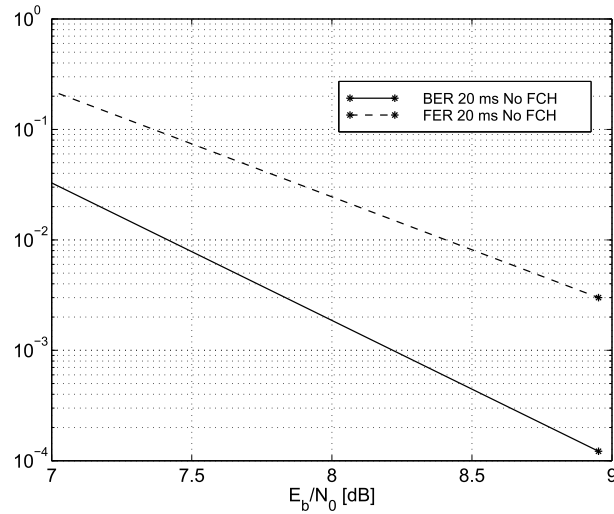


Figure 10. Speech, Vehicular B 250 km/h, without antenna diversity.

2.2 LCD

Figure number	11	11	11	12	12
Plot symbol	o	*	□	*	+
Service	LCD 144	LCD 384	LCD 384	LCD	LCD
Link-level bit rate	144 kbps	384 kbps	384 kbps	384 kbps	2048 kbps
Channel type	Out. to In. A	Indoor A	Vehicular A	Indoor A	Indoor A
Mobile speed	3 km/h	3 km/h	120 km/h	3 km/h	3 km/h
Antenna diversity	Yes	Yes	Yes	Yes	Yes
Chip rate [Mcps]	4.096	4.096	4.096	4.096	4.096
DPDCH					
Code allocation	1 × SF 8	1 × SF 4	1 × SF 4	1 × SF 4	5 × SF 4
Info / tail bits per frame	1440 / 8	3840 / 3 × 8	3840 / 3 × 8	3840 / 3 × 8	1440 / 8
Reed-Solomon code rate	180/225	192/240	192/240	192/240	192/240
Convolutional code rate	1/3	1/2	1/2	1/2	1/2
Rate matching	339/320	603/640	603/640	603/640	201 / 200
Inner interleaver [bits]	128 × 480	256 × 480	128 × 960	256 × 480	300 × 256
Outer interleaver [bytes]	225 × 12	80 × 90	240 × 30	80 × 90	240 × 160
DPCCH					
Code allocation	1 × SF 256	1 × SF 256	1 × SF 256	1 × SF 256	1 × SF 256
PC frequency [Hz]	800	800	1600	800	800
PC step [dB]	1	1	1	1	1
Slots per frame	8	8	16	8	8
Pilot / PC / FCH bits per slot	12 / 4 / 4	12 / 4 / 4	6 / 2 / 2	12 / 4 / 4	12 / 4 / 4
Valid FCH words	16	16	4	16	2
DPCCH - DPDCH power [dB]	-10§	-10	-10	-10	-10

Table 7. Parameters for LCD simulations.

Due to the fact that the simulation time to achieve a BER of 10^{-6} is so long, no results with RS coding are available at the moment for the LCD 2048 service. Using the results from the LCD 384 simulations, the performance can be estimated. Comparing with the results from the LCD 384 service in the Indoor office environment, a BER without RS coding of $6 \cdot 10^{-4}$ yields a BER with RS coding of 10^{-6} . For the LCD 2048 service, a BER without RS coding of $6 \cdot 10^{-3}$ is reached at approximately 2 dB, and by adding 1 dB for overhead due to the RS coding the E_b/N_0 for a RS coded BER of 10^{-6} is estimated to 3 dB.

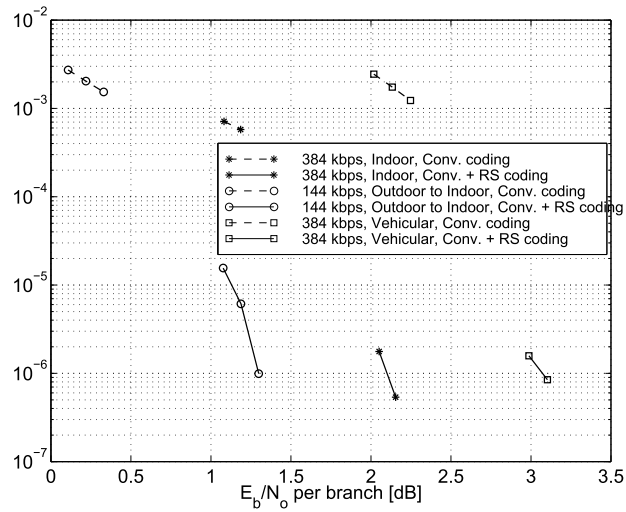


Figure 11. LCD 144 and LCD 384, with antenna diversity.

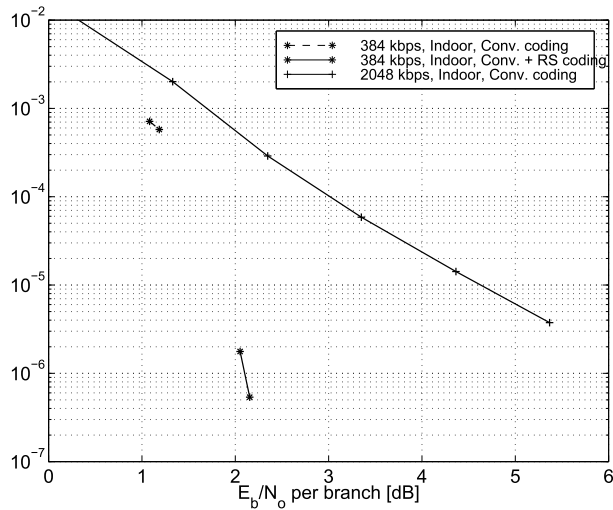


Figure 12. LCD 2048, with antenna diversity.

2.3 UDD

2.3.1 UDD 144

Figure number	13	14
Plot symbol	□	□
Service	UDD 144	UDD 144
Link-level bit rate	240 kbps	240 kbps
Channel type	Vehicular A	Vehicular A
Mobile speed	120 km/h	120 km/h
Antenna diversity	Yes	No
Chip rate [Mcps]	4.096	4.096
DPDCH		
Code allocation	1 × SF 8	1 × SF 8
Blocks per frame	8	8
Info / CRC +block nr/ tail bits per frame	300 / 12 / 8	300 / 12 / 8
Convolutional code rate	1/2	1/2
Rate matching	None	None
Interleaver	20 ms	20 ms
DPCCH		
Code allocation	1 × SF 256	1 × SF 256
PC frequency [Hz]	1600	1600
PC step [dB]	1	1
Slots per frame	16	16
Pilot / PC / FCH bits per slot	6 / 2 / 2	6 / 2 / 2
Valid FCH words	8	8
DPCCH - DPDCH power [dB]	-8	-10

Table 8. Parameters for UDD 144 Vehicular A 120 km/h simulations.

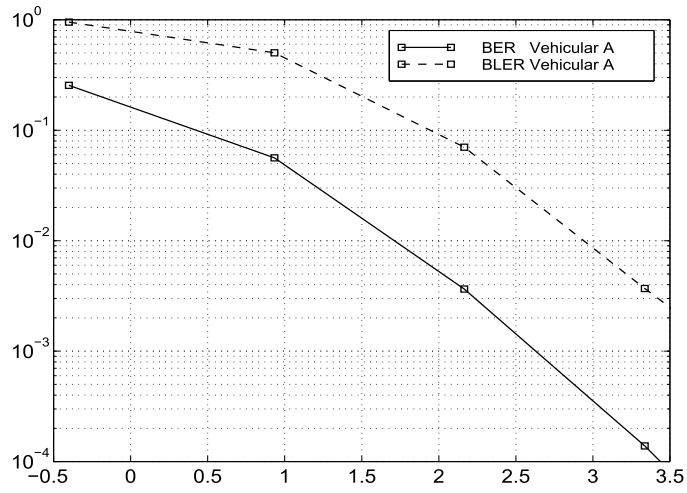


Figure 13. UDD 144, with antenna diversity.

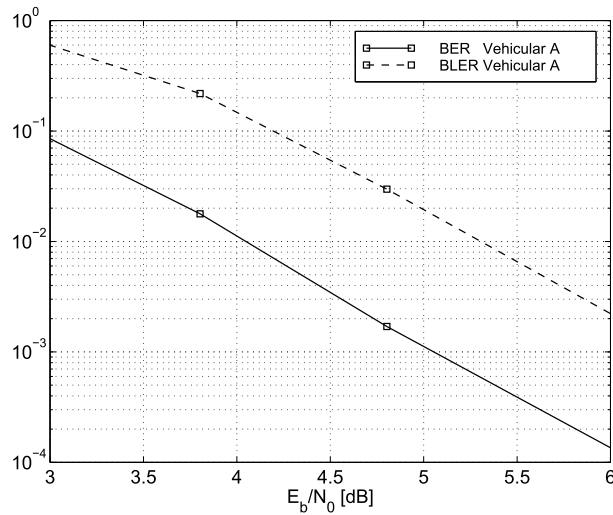


Figure 14. UDD 144, without antenna diversity.

2.3.2 UDD 384

Figure number	15	16
Plot symbol	o	*
Service	UDD 384	UDD 384
Link-level bit rate	240 kbps	240 kbps
Channel type	Out. to In. A	Indoor A
Mobile speed	3 km/h	3 km/h
Antenna diversity	Yes	No
Chip rate [Meps]	4.096	4.096
DPDCH		
Code allocation	1 × SF 8	1 × SF 8
Blocks per frame	8	8
Info / CRC +block nr/ tail bits per frame	300 / 12 / 8	300 / 12 / 8
Convolutional code rate	1/2	1/2
Rate matching	None	None
Interleaver	10 ms	10 ms
DPCCH		
Code allocation	1 × SF 256	1 × SF 256
PC frequency [Hz]	800	800
PC step [dB]	0.5	0.5
Slots per frame	8	8
Pilot / PC / FCH bits per slot	14 / 2 / 4	14 / 2 / 4
Valid FCH words	8	8
DPCCH - DPDCH power [dB]	-10	-10

Table 9. Parameters for UDD 384 simulations.

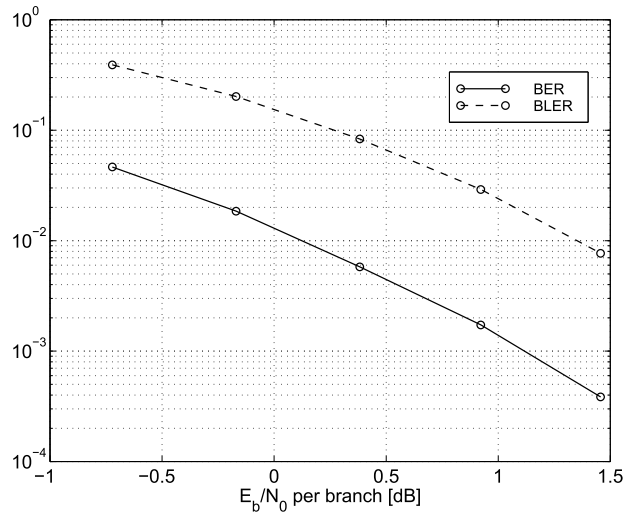


Figure 15. UDD 384, information bit rate 240 kbps, Outdoor to indoor and pedestrian A, with antenna diversity.

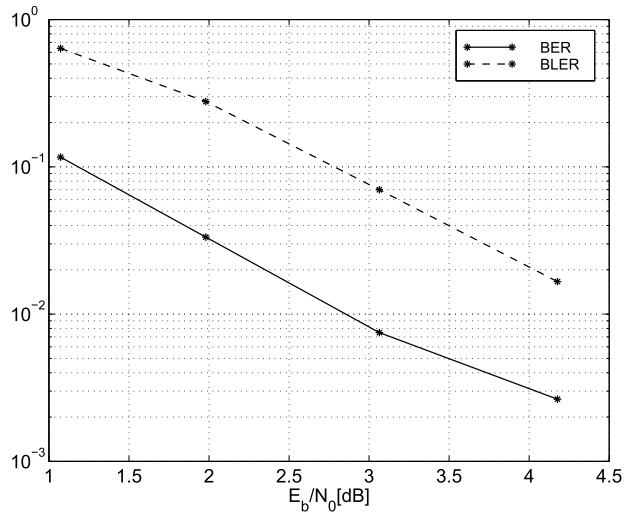


Figure 16. UDD 384, information bit rate 240 kbps, Indoor office A, without antenna diversity.

2.3.3 UDD 2048

Figure number	17	17	18	18	19	19
Plot symbol	*	o	*	o	*	o
Service	UDD 2048	UDD 2048	UDD 2048	UDD 2048	UDD 2048	UDD 2048
Link-level bit rate	480 kbps	480 kbps	480 kbps	480 kbps	2.4 Mbps	2.4 Mbps
Channel type	Indoor A	Out. to In. A	Indoor A	Out. to In. A	Indoor A	Out. to In. A
Mobile speed	3 km/h	3 km/h	3 km/h	3 km/h	3 km/h	3 km/h
Antenna diversity	Yes	Yes	No	No	Yes	Yes
Chip rate [Mcps]	4.096	4.096	4.096	4.096	4.096	4.096
DPDCH						
Code allocation	1 × SF 4	1 × SF 4	1 × SF 4	1 × SF 4	5 × SF 4	5 × SF 4
Blocks per frame	16	16	16	16	80	80
Info / CRC +block nr/ tail bits per frame	300 / 12 / 8	300 / 12 / 8	300 / 12 / 8	300 / 12 / 8	300 / 12 / 8	300 / 12 / 8
Convolutional code rate	1/2	1/2	1/2	1/2	1/2	1/2
Rate matching	None	None	None	None	None	None
Interleaver	10 ms	10 ms	10 ms	10 ms	10 ms	10 ms
DPCCH						
Code allocation	1 × SF 256	1 × SF 256	1 × SF 256	1 × SF 256	1 × SF 256	1 × SF 256
PC frequency [Hz]	800	800	800	800	800	800
PC step [dB]	1	1	1	1	1	1
Slots per frame	8	8	8	8	8	8
Pilot / PC / FCH bits per slot	12 / 4 / 4	12 / 4 / 4	12 / 4 / 4	12 / 4 / 4	12 / 4 / 4	12 / 4 / 4
Valid FCH words	8	8	8	8	8	8
DPCCH - DPDCH power [dB]	-10	-10	-10	-10	-12	-12

Table 10. Parameters for UDD 2048 simulations.

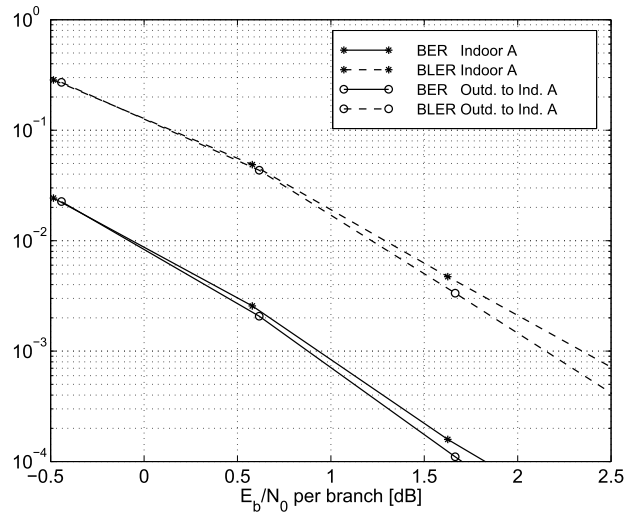


Figure 17. UDD 2048, information bit rate of 480 kbps, with antenna diversity.

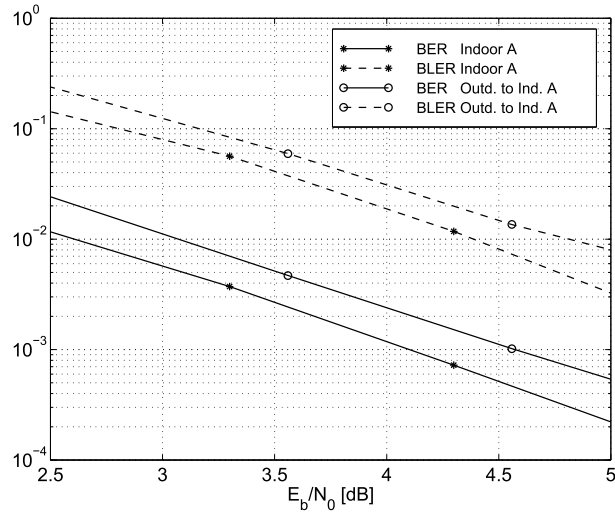


Figure 18. UDD 2048, information bit rate of 480 kbps, without antenna diversity.

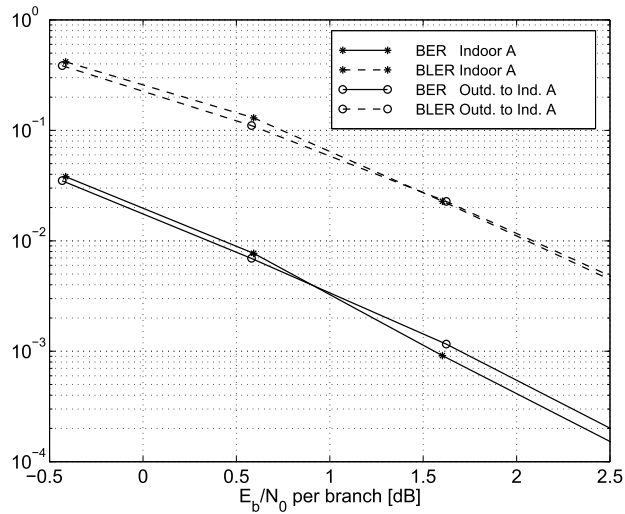


Figure 19. Link-level results for UDD 2048 with information bit rate of 2.4 Mbps with antenna diversity.

3. SYSTEM-LEVEL SIMULATIONS

This section describes the system simulation parameters used for the speech, LCD and UDD services, for the FDD mode.

3.1 Speech

Table 11. Parameters for FDD speech system simulations.

Service	Speech	Speech
Link-level bit rate	8 kbps	8 kbps
Channel type	Outdoor to indoor and pedestrian A	Vehicular A
Mobile speed	3 km/h	120 km/h
Antenna diversity (UL / DL)	Yes / No	Yes / No
Downlink orthogonality factor	0.06	0.40
Chip rate	4.096 Mcps	4.096 Mcps
Processing gain	27.1 dB	27.1 dB
Link-level assumptions		
UL E_b/N_0 @ BER=10^{-3}	3.3 dB	5.0 dB
DL E_b/N_0 @ BER=10^{-3}	6.7 dB	7.6 dB
DPDCH code allocation	1 × SF 128	1 × SF 128
DPCCH code allocation	1 × SF 256	1 × SF 256
Interleaver	20 ms	20 ms
Power settings		
UL TCH max power	14 dBm	24 dBm
UL PC dynamic range	80 dB	80 dB
DL TCH max power	20 dBm	30 dBm
DL PC dynamic range	20 dB	20 dB
DL broadcast channels power	26 dBm	37 dBm
UL noise power (F= 5 dB)	-102 dBm	-102 dBm
DL noise power (F= 5 dB)	-102 dBm	-102 dBm
HO algorithm settings		
Soft HO window	3 dB	3 dB
Softer HO window	N/A	3 dB
AS update rate	0.5 s	0.5 s
AS max size	2	2

3.2 LCD

Table 12. Parameters for FDD LCD system simulations.

Service	LCD 384
Link-level bit rate	384 kbps
Channel type	Vehicular A
Mobile speed	120 km/h
Antenna diversity (UL / DL)	Yes / No (Yes)
Downlink orthogonality factor	0.40
Chip rate	4.096 Mcps
Processing gain	10.3 dB
Link-level assumptions	
UL E_b/N_o @ BER=10^{-6}	3.1 dB
DL E_b/N_o @ BER=10^{-6}	5.6 dB (3.1 dB)
DPDCH code allocation	1 × SF 4
DPCCH code allocation	1 × SF 256
Interleaver	120 ms
Power settings	
UL TCH max power	24 dBm or 30 dBm
UL PC dynamic range	80 dB
DL TCH max power	30 dBm
DL PC dynamic range	20 dB
DL broadcast channels power	20 dBm
UL noise power (F= 5 dB)	-102 dBm
DL noise power (F= 5 dB)	-102 dBm
HO algorithm settings	
Soft HO window	3 dB
Softer HO window	3 dB
AS update rate	0.5 s
AS max size	2

3.3 UDD

Table 13. Parameters for FDD UDD system simulations.

Service	UDD 384	UDD 2048
Link-level bit rate	240 kbps	480-2880 kbps (1,2,3,4 & 6 codes)
Channel type	Outdoor to indoor and pedestrian A	Indoor A
Mobile speed	3 km/h	3 km/h
Antenna diversity (UL / DL)	Yes / No	Yes / No (Yes)
Downlink orthogonality	0.06	0.10
Chip rate	4.096 Mcps	4.096 Mcps
Processing gain	9.3 dB	9.3 dB
Link-level assumptions		
UL E_p/N_o @ BLER=10%	0.2 dB	0.2 dB: 1 code
DL E_p/N_o @ BLER=10%	3.2 dB	2.8 dB (0.2 dB): 1 code
DPDCH code allocation	1 × SF 8	1,2,3,4 & 6 × SF 4
DPCCH code allocation	1 × SF 256	1 × SF 256
Interleaver	10 ms	10 ms
Power settings		
UL TCH max power	14 dBm	4 dBm
UL PC dynamic range	80 dB	80 dB
DL TCH max power	20 dBm	10 dBm
DL PC dynamic range	20 dB	20 dB
DL broadcast channels power	13 dBm	-3 dBm
UL noise power (F= 5 dB)	-102 dBm	-102 dBm
DL noise power (F= 5 dB)	-102 dBm	-102 dBm
HO algorithm settings		
Soft HO window	N/A	N/A
Softer HO window	N/A	N/A
AS update rate	0.5 s	0.5 s
AS max size	1	1

3.4 PDFs of Active Session Bit-rate

The figures below show the UL session mean bit-rate for the UDD services (at 98% satisfied users), i.e. UDD 2048 in the Indoor office A environment and UDD 384 in the Outdoor to indoor and pedestrian A environment. The minimum required active session throughput is 204.8 kbps for the UDD 2048 service and 38.4 kbps for the UDD 384 service. Note for the UDD 2048 five separate simulations have been performed using different radio bearers (480, 960, 1440, 1920 and 2880 kbps bearers). The PDFs of the DL session mean bit-rate look very similar to the UL PDFs and therefore not shown here.

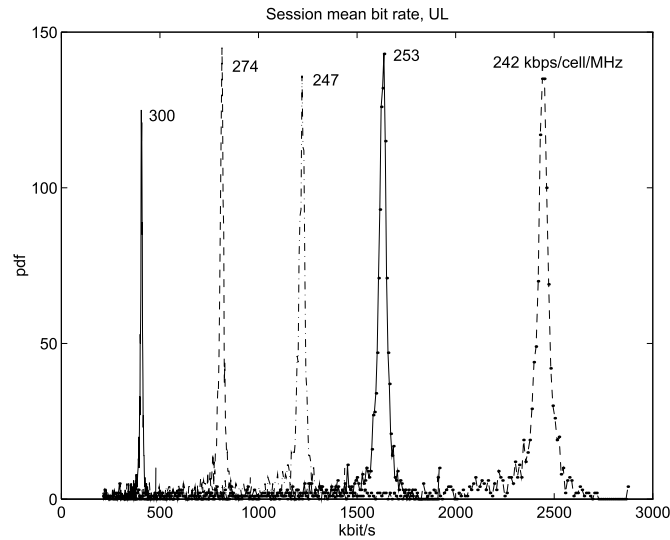


Figure 20. Pdf of uplink session mean bit rate for the UDD 2048 service in the Indoor A environment for 1, 2, 3, 4 and 6 codes. The maximum information bit-rate for one code is 480 kbps. The maximum spectrum efficiency in the uplink is when a single 480 kbps bearer is used (one code), but the other bearers (multicode) show also very good performance.

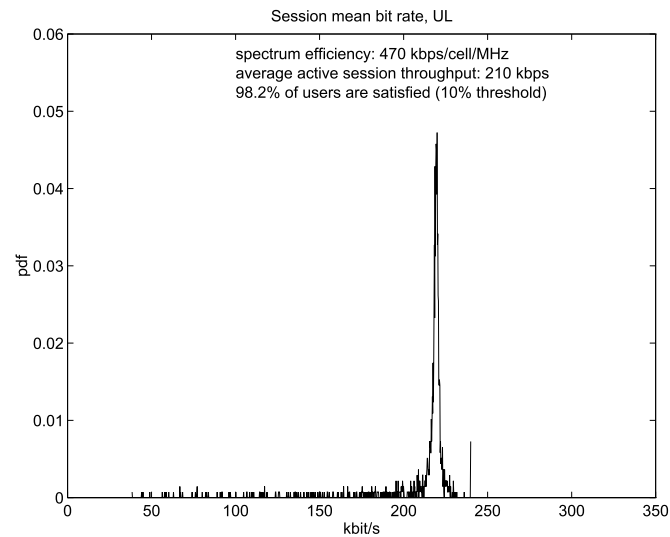
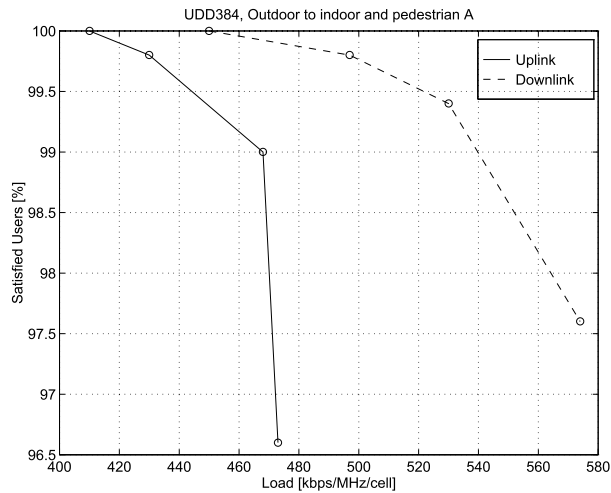
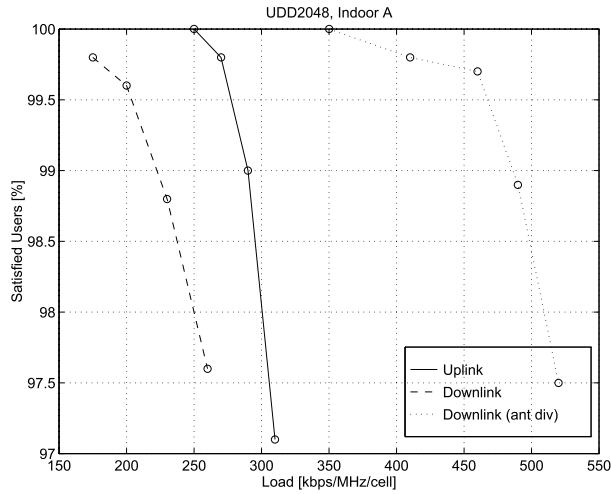
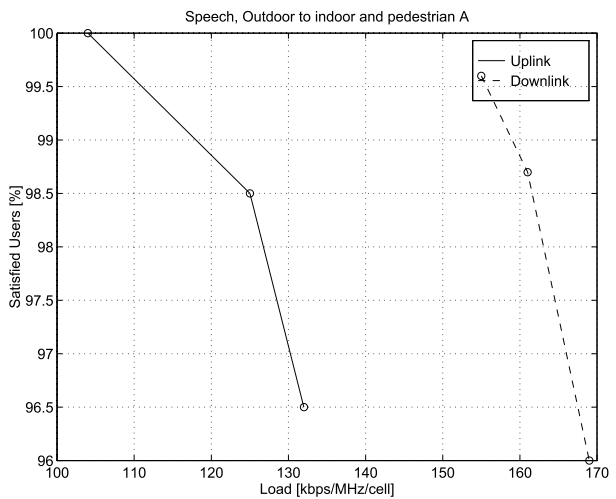


Figure 21. Pdf of uplink session mean bit-rate for UDD 384 service in the Outdoor to indoor and pedestrian A environment. The maximum information bit-rate for the bearer is 240 kbps. The spectrum efficiency in the uplink is 470 kbps/MHz/cell.

3.5 Satisfied Users versus Load

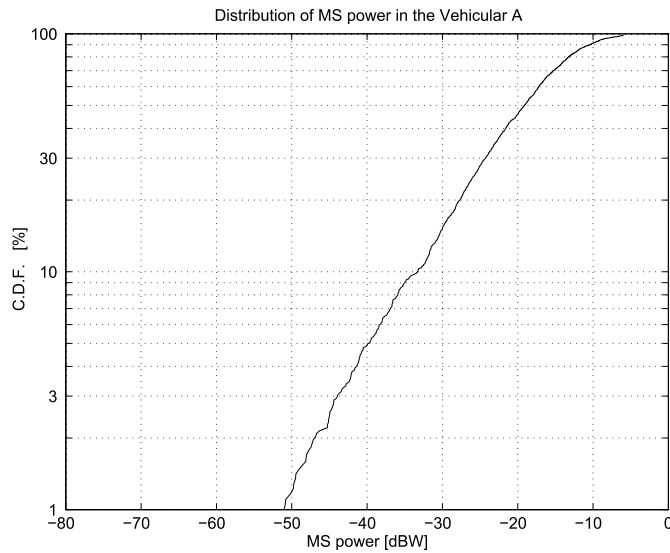
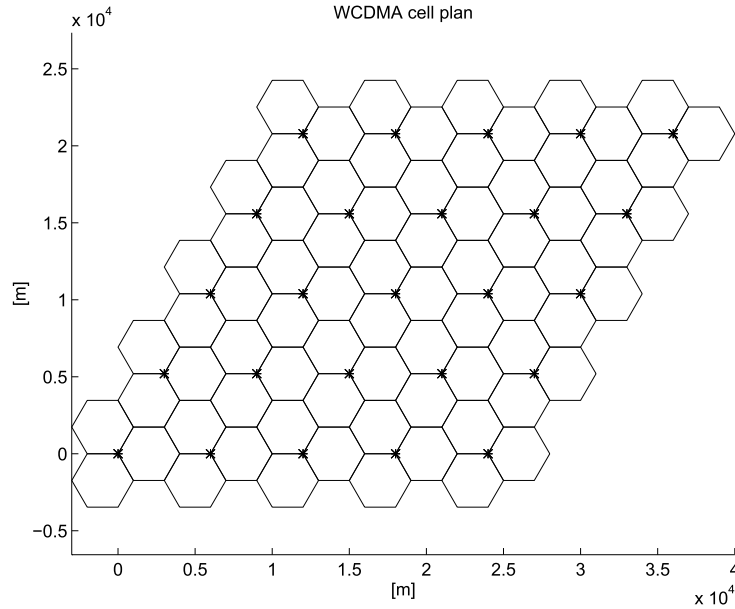
At the SMG2 Q&A Workshop curves that show “Satisfied users versus Load” were requested. Three examples are shown below: UDD 2048 (Indoor office A), UDD 384 (Outdoor to indoor and pedestrian A) and speech (Outdoor to indoor and pedestrian A). The requirement of this kind of curves was removed (due to long simulation time) by the change request: CSEM/Pro Telecom, Ericsson, France Telecom, Nokia, Siemens AG, "Change Request on UMTS 30.03 A001 and A002," Tdoc SMG 97-771, Budapest, 13-17 October, 1997.





3.6 Some Notes on the Vehicular Environment

The figures below show the cell plan (2 km cell radius or 6 km site-to-site distance) used and the MS power distribution in the Vehicular A environment. Wrap around is used and therefore statistics are collected from all cells (75 in the figure below). As seen in the figure showing the CDF of MS power, 99% of the MS are within 47 dB range, so an UL dynamic range of 80 dB will not effect the system capacity.



**ETSI SMG
Meeting no 24
Madrid, Spain
15 - 19 December 1997**

Tdoc SMG 905/97

Source: SMG2

**Concept Group Alpha -
Wideband Direct-Sequence CDMA (WCDMA)**

EVALUATION DOCUMENT (3.0)

**Part 4:
WCDMA/ODMA description**

This document was prepared during the evaluation work of SMG2 as a possible basis for the UTRA standard. It is provided to SMG on the understanding that the full details of the contents have not necessarily been reviewed by, or agreed by, SMG2.

1. INTRODUCTION

WCDMA satisfies the high level requirements for the UTRA and particular consideration has been given to the future evolution of the system in terms of performance and flexibility. Many advanced features have already been incorporated into the core design but WCDMA is also a suitable platform for the support of relaying.

Relaying is a widely used technique for radio packet data transmission both in commercial and military systems but it has so far not been widely used in Cellular systems. Relaying has the potential to improve coverage and flexibility but may also increase capacity by lowering transmission powers and associated intercell interference.

Within the ETSI SMG2 process for UTRA evaluation, investigation of relay systems was carried out within the Epsilon Concept Group by considering a technology called Opportunity Driven Multiple Access - ODMA. The protocols used in ODMA are very similar to those of a packet radio system currently being trialed in South Africa. System level simulations were carried out in accordance with UMTS 04.02 which showed that very wide area coverage was possible in all environments using a subscriber relay system and that there was potential for increased capacity when used in a cellular hybrid. Findings from the Epsilon evaluation work are recorded in this text.

A feasibility study was jointly conducted by the Alpha and Epsilon concept groups to determine the practicality of supporting relaying using the basic WCDMA design. The outcome of the study is included in this text and the basic conclusion was that the WCDMA design was sufficiently flexible to support relaying with negligible increase to the MS complexity or cost. WCDMA can therefore offer the flexibility of simple relaying but also provide a suitable platform for advanced relay protocols such as ODMA.

1.1 Terminology

The definition of terms listed below may help when reading the following text.

<i>Mobile or MS</i>	An ODMA terminal.
<i>Seed</i>	Roughly described as a deliberately placed Mobile that never moves and is always powered on.
<i>Gateway or BTS</i>	A fixed ODMA Node with interfaces to “the network” — the equivalent of a GSM base station.
<i>Node</i>	A Mobile, Seed or Gateway/BTS
<i>Relay Node</i>	A Mobile or Seed involved in relaying information between two other Nodes.

2. RELAYS

Relays add flexibility to a communication system. The figure below illustrates a range of options from simple one hop relays to ODMA which is an intelligent adaptive multi-hop system supporting full mobility of callers and relays.

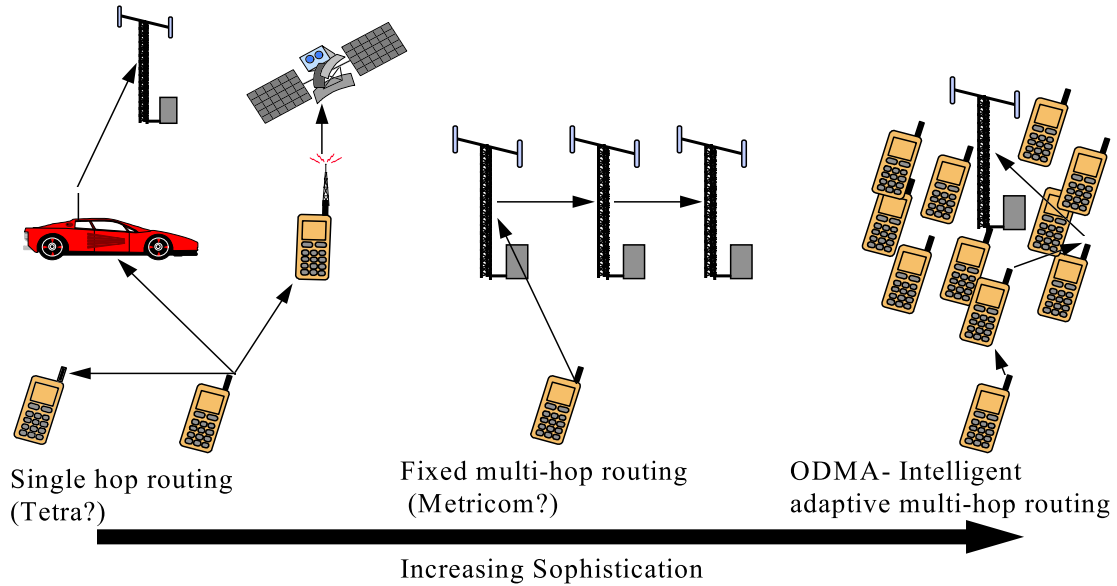


Figure 1 Relaying Options

All the options shown above are possible providing that from the outset the UTRA can support the direct transfer of information from one MS to another. Potential benefits of relaying include;

- Extension of high data rate coverage (144-384kbps)
- Reduction of TX power
- Overcoming dead-spots
- Relaying to satellite system
- Relaying to a vehicle
- Directly linking terminals (private and uncoordinated systems, home BTS etc.)

The above list is by no means exhaustive and the real motivation for relaying will only become apparent as the UTRA standard develops, however there appears sufficient justification to support relaying within WCDMA given the following pre-conditions;

- Relaying must not degrade the QoS of a UMTS cell
- Relaying must not add significant cost or complexity to a UMTS terminal
- Relaying can be enabled or disabled by an operator

2.1 WCDMA + ODMA Scenario

Figure 1 shows a WCDMA cell using an ODMA enhancement. Relaying is used to route packet data services to and from mobiles close to the WCDMA BTS - using a separate unpaired spectrum band. The relay nodes in range of the BTS will toggle between ODMA and WCDMA modes. Relaying extends the range of the high rate data services and can be used to provide coverage in dead spots.

The final hop to the BTS uses the WCDMA slotted mode. In this way relaying can bring concentrated traffic near to the WCDMA BTS which can then work in a spectrally efficient manner over a short range.

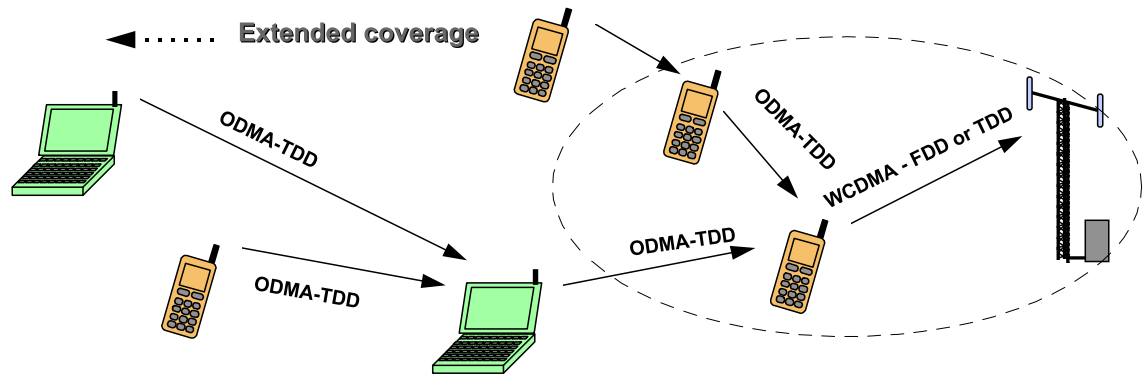


Figure 1 Scenario for WCDMA with ODMA enhancement

3. AN OVERVIEW OF ODMA

The Principle:

Opportunity Driven Multiple Access is a mechanism for maximising the potential for effective communication. This is achieved by distributing intelligence within communicating nodes and providing multiple communication paths between them. The intelligent nodes measure and evaluate their communications options and adapt to exploit the optimum opportunity.

The Practice:

ODMA is an intelligent protocol that sits upon a radio sub-system that supports relaying. The protocol breaks difficult radio paths into a sequence of shorter hops which enables lower transmit powers or higher data rates to be used. It is the goal of the protocol to chose the least cost route through the relaying system when the relays are moving and the radio paths are dynamically changing.

3.1 Multi-hop Transmissions

The transmission of information over a radio channel is subject to some fundamental rules e.g. it becomes more difficult the higher the data rate and the longer the distance. Difficulty maps to a requirement for higher transmitted powers which cause practical problems for mobile equipment and have an associated interference effect which limits the number of possible simultaneous transmissions (capacity). As high data rates are encouraged in UMTS that only leaves the distance aspect to consider.

Relaying is one of the enhancements WCDMA may use to offset the difficulties of high data rate transmission over significant distances.

3.2 Relaying v Direct Transmission

It is not difficult to identify a potential benefit from relaying rather than using direct transmission. Consider the vehicular simulation scenario of UMTS 04.02. The path loss is given by

$$\text{Loss (dB)} = 127 + 37.6\text{LOG}(D)$$

[where D is in km]

Figure 2 below shows the benefits of breaking a long path into a number of shorter hops . It plots effective pathloss for a 1km transmission against the number of relay hops (0 = direct). (Effective pathloss is the loss between hops multiplied by the number of hops)

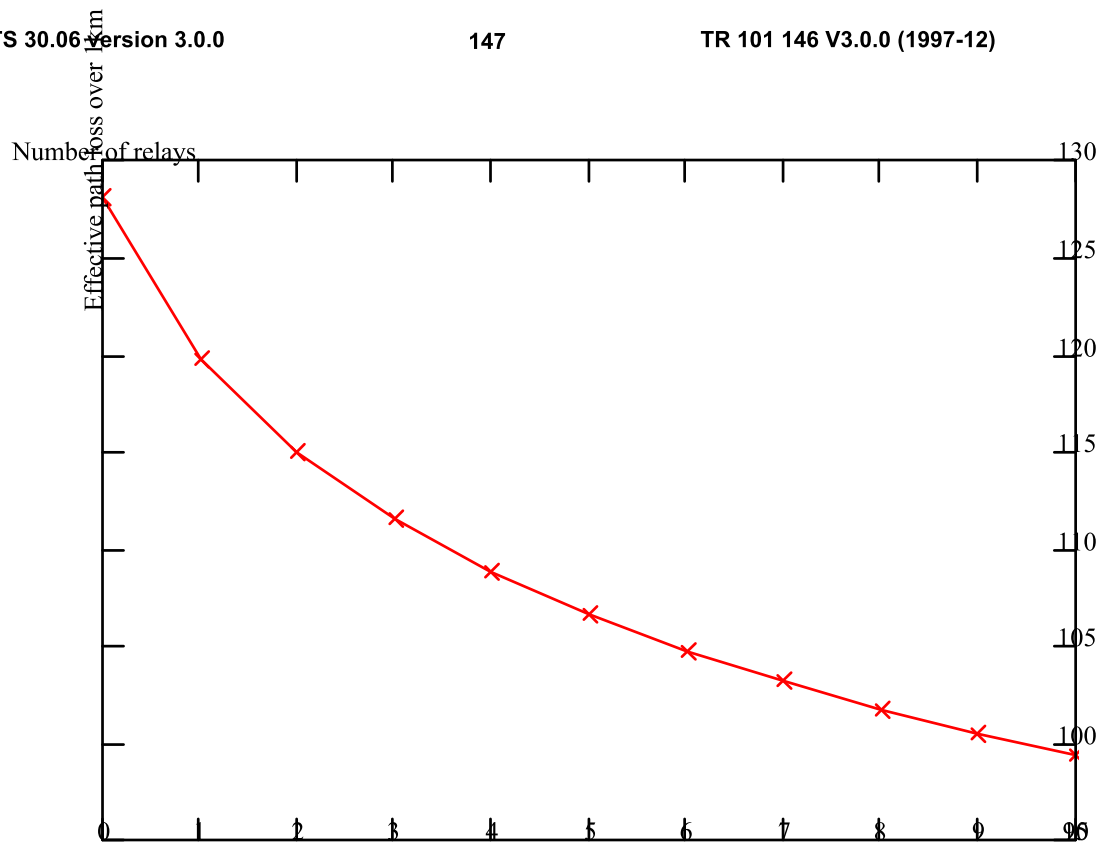


Figure 2 Effective Pathloss v Number of Relays

The graph shows benefits in the range of 10-30dB and that just 2 intermediate relays give a +12dB benefit.

3.3 Relaying to Avoid Shadowing

Radio channels are more complicated than the previous example suggest and show considerable temporal variation of shadow(slow) fading. This fading makes it hard to predefine an optimum route as the shortest paths may be heavily attenuated. However an intelligent relay can make the best local choice of route.

Consider the situation shown in Figure 3 - it is possible to use a number of paths to reach the BTS but the least cost route is to relay around the buildings. To put this into perspective @ 2GHz it is possible to experience 30dB fluctuations around "Manhattan" street corners. Combine this with fast fading variations and burst noise/interference then the ability to identify least cost routing becomes even more desirable.

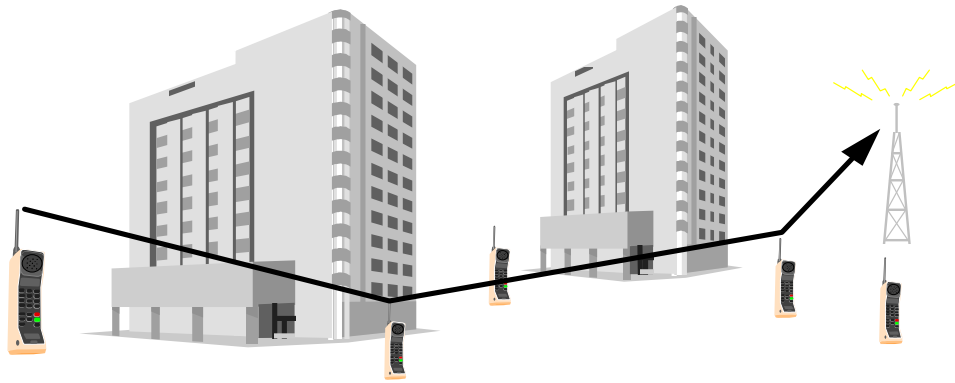


Figure 3 Relaying to Avoid Shadowing

Even if the complexities of real scenarios are ignored and the simple log normal variation model of UMTS 04.02 is used then a gain can be extracted by being allowed to chose the best of several routes.

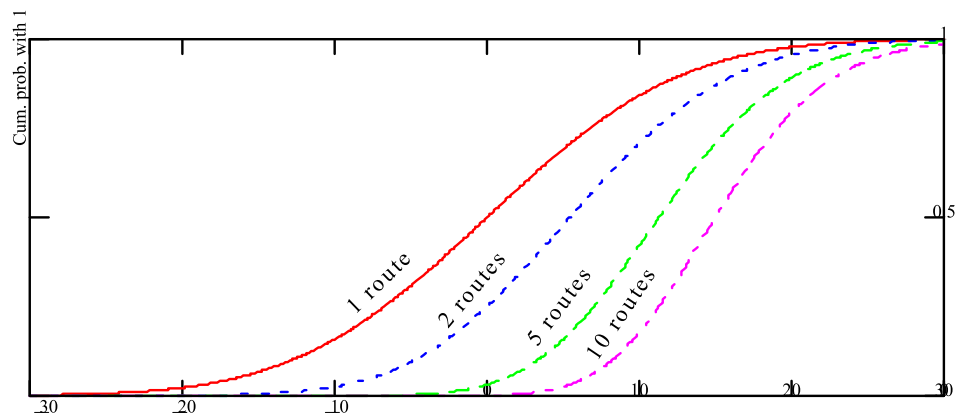


Figure 4 Benefits of Path Selection - Space Diversity

Figure 4 shows the probability of signal loss for a single path but also for the cases where you can chose the best from a number of paths e.g. @ a probability of 0.5 there is a 10dB benefit in being able to chose 1 from 10 paths.

3.4 Radio Resource Re-use

To relay information requires the use of radio resources such as codes. In a conventional structure resources are used once per cell however in ODMA the resources can be used many times within the basic cell area. This is because transmissions are lower power and so interference has only localised effect.

Figure 5 shows just 2 resources being re-used several times along a relay route and elsewhere in the cell - if the transmission circles of a single resource do not overlap interference is avoided.

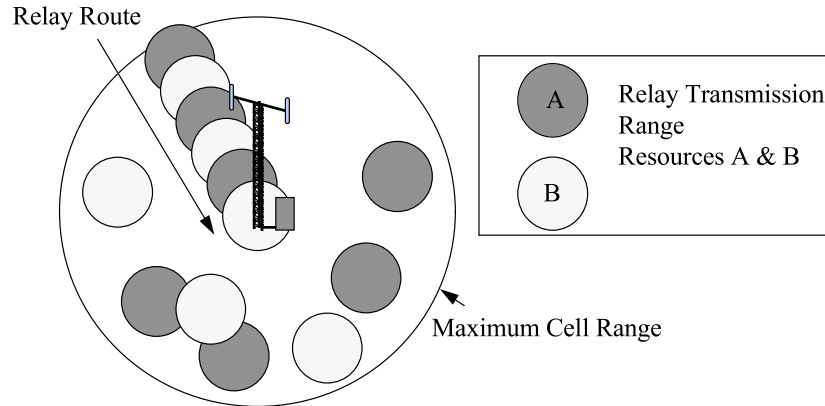


Figure 5 Re-using Resources Within a Cell Area

3.5 Potential For Capacity Gain

The potential for reducing TX power and extending the range of high data rate coverage is an obvious consideration for a relaying solution however it may be less clear that there is potential for increasing capacity. Figure 6 shows a scenario with 3 cells - normally they would be planned to avoid gaps between coverage areas. The resulting overlap will create intercell interference which ultimately reduces capacity.

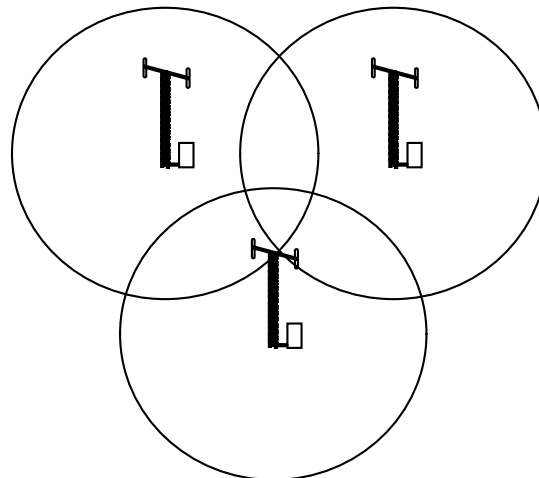


Figure 6 Normal Overlapping Cell Coverage

If the cell areas are restricted so that they do not overlap they become more spectrally efficient (spot coverage) but coverage is poor. Relaying would then be used to fill in the coverage gaps. (This would also be a useful technique at country borders).

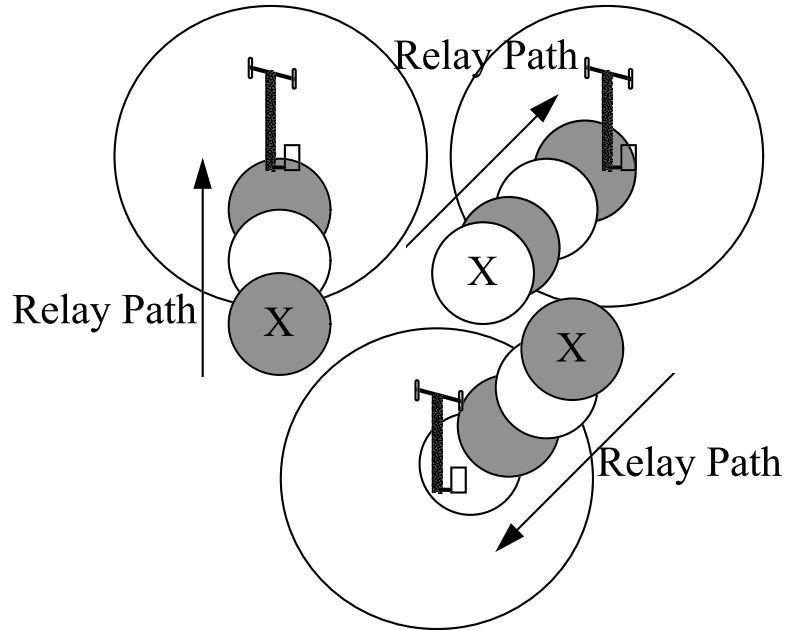


Figure 7 Discontinuous Cell Coverage

The above example does not imply that only a single relay stream can be brought to the vicinity of a BTS. For example there could be multiple ODMA nodes or “data buckets” distributed around the BTS each collecting and distributing significant amounts of traffic (as shown in

Figure 8). In this case it is the final hop to the BTS that becomes critical and so the high efficiency of WCDMA is of great benefit especially if relaying has reduced the level of intercell interference.



Figure 8 Cluster of ODMA Nodes around WCDMA BTS

4. OVERVIEW OF THE ODMA PROTOCOL

ODMA supports packet data transfer between an origin and destination via a network of intermediate relay nodes (fixed or mobile). The technology is characterised by a TDD mode which enables each node to receive other node's transmissions and build a connectivity table at each node. This table is subsequently used to route packets across a network in a dynamic manner without incurring a significant routing overhead.

The ODMA logical channel map in Figure 9 comprises two main types of channel:

- The first type of channel is the *calling channel (CCH)*, used to transfer system overhead information and limited amounts of data, where each CCH is distinguished by different modem rates and RF carriers to minimise interference.
- The second type of channel is the *data channel (DCH)*, used to transfer larger volumes of data and each DCH is associated with a specific CCH.

Note, Figure 9 is an illustration only. In practice, the logical channel structure may comprise several CCHs, each with up to N associated data channels.

Logical Channels in ODMA

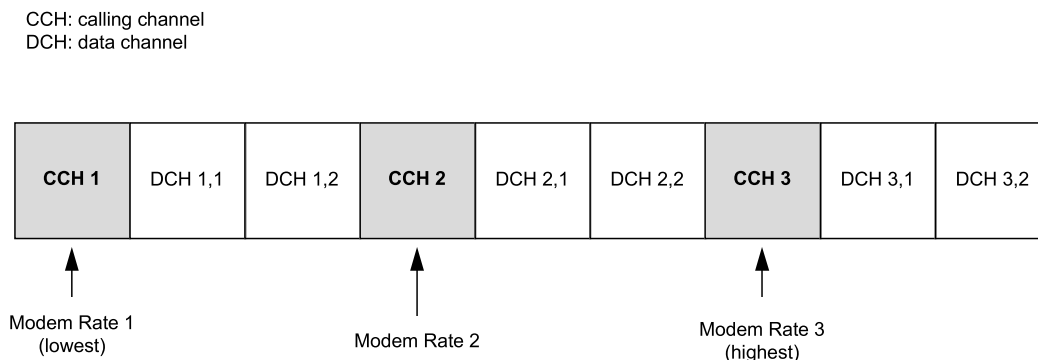


Figure 9. Logical Channels in ODMA.

This document summarises the key protocol features of ODMA which permit calls to be made via several intermediate relay nodes using the logical channel structure in Figure 9. Section 2 discusses the concept of probing on the CCH, a mechanism used by ODMA nodes to detect neighbours which may be used as relays during a call. In addition to supporting the probing function, the CCH may also be used to transfer limited amounts of data and in Section 3, methods of transferring data on the CCH and DCH is described in some detail. Finally, Section 4 details the innovative routing concept which is used to establish network-wide connectivity.

4.1 Idle Mode Functions

4.1.1 Probing for Neighbours

Probing is a mechanism used to indicate mobile activity in the ODMA network. When a mobile station, MS_{new} , is switched on for the first time it has no information about its surroundings. In this case the mobile will camp on one of the predefined system calling CCHs in idle mode which are used by all mobile stations to receive and broadcast system overhead information and data. With no system information stored in memory, MS_{new} will begin a probing session, where the mobile initially camps on a CCH and periodically *broadcasts* a probe packet. The broadcast probe includes the current neighbour list for MS_{new} , which will initially be empty. If a mobile station, MS_a , receives the broadcast packet it will register MS_{new} as a neighbour and send an *addressed* probe in response. The response probe is transmitted at random to avoid contention with other mobiles and typically one response is sent for every n broadcast probes received from a particular MS.

The next time MS_{new} transmits a broadcast probe the neighbour list will have one new entry, MS_a , and an associated quality indicator (a weighted factor based on the received signal strength of the response probe). It is through this basic mechanism that each mobile builds a neighbour list.

4.1.2 Calling Channel Adaptation

The probe-response mechanism enables each MS to build a neighbour list which should contain at least 5 mobiles. In the initial state when an MS is first switched on and the neighbour list is empty, the MS will transmit probes on the CCH which has the highest modem data rate and at the minimum transmit power in order to minimise interference with other mobiles.

Each time a mobile receives a response to a broadcast probe, the responding mobile is included as a neighbour. If the required number of neighbours is not met within time, T_{adapt} , the MS will increase its transmit power by x dB and reset T_{adapt} . The MS will continue to increase the broadcast probe transmit power until it achieves the required number of neighbours. If the maximum transmit power is reached before this condition is satisfied, the MS will switch to a lower rate CCH, defined as the Previous CCH and will stay at the maximum transmit power. The CCH data rate will continue to decrease, each time resetting T_{adapt} , until the MS achieves the required number of neighbours.

Conversely, if the number of mobiles in the neighbour list exceeds the required number, the CCH rate is incremented to the Next CCH. The CCH rate will continue to increase until the required number of neighbours is within acceptable bounds. If the MS reaches the highest CCH and the number of neighbours is still excessive the MS will start to drop the transmit power. Each time the CCH state is changed (i.e. the CCH or broadcast probe transmit power), T_{adapt} is reset.

4.1.3 Neighbours on Adjacent Calling Channels

The CCH adaption algorithm dictates that as the number of neighbours increases in a local area, mobiles will begin to move to higher rate CCHs. This CCH migration implies that distant or widely separated mobiles will have fewer neighbours and will camp on lower rate CCHs, resulting in non-contiguous connectivity. To overcome this problem, the MS in idle mode periodically cycles through all the CCHs and listens for broadcast probes. If a broadcast probe is received, the MS will send an addressed response so that the appropriate neighbour lists can be updated.

Two timers are used to govern the checking process. The first timer is, $Check_timer_1$, which is initiated when a mobile arrives on a new CCH and is proportional to the CCH data rate. When $Check_timer_1$ expires for the first time, the Check Channel status will be null and the MS will set the $Check_Channel$ to the highest rate CCH. On starting the checking process a second timer, $Check_timer_2$ (much less than $Check_timer_1$), is initiated and when this timer expires the MS sets the Check Channel status to the next lowest CCH and returns to the Current CCH, resetting $Check_timer_1$. When $Check_timer_1$ expires for the second time, the Check Channel status is no longer null and the MS continues the check cycle until $Check_timer_2$ expires, at which point the Check Channel status is updated and the MS returns to the Current CCH, resetting $Check_timer_1$. This cycle repeats, skipping the Current CCH, until the Previous CCH is reached and the MS automatically returns to the Current CCH.

Since $Check_timer_2$ is also proportional to the Current CCH modem rate, it takes a relatively short time to check the higher rate channels. However as the cycle progresses the MS will spend longer on each channel, which is why the checking terminates when the Check Channel reaches the Previous CCH.

The checking cycle is illustrated in Figure 10

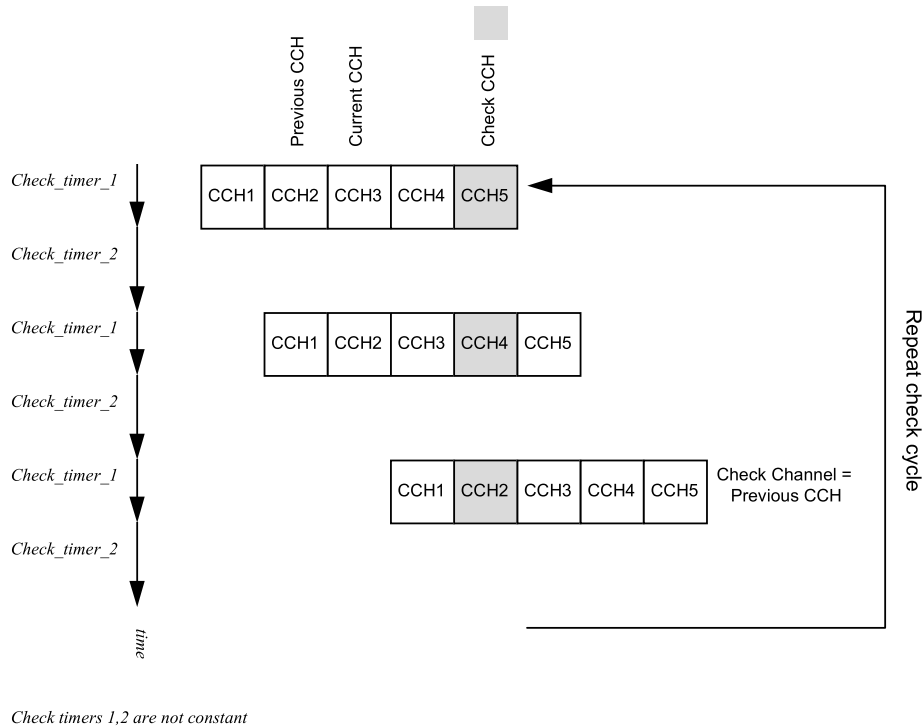


Figure 10. Check channel cycle.

4.2 Transmitting Data

Data may be transmitted on either the CCH or on a dedicated DCH, depending on the volume of data to be sent.

4.2.1 Transmitting Data on the CCH

In addition to responding to broadcast probes, addressed probes may also be used to transmit small amounts of data on the CCH. When an MS has data to send it may transmit an addressed probe packet on the CCH at an interval proportional to the CCH modem rate, R_{CCH} , and is defined by *Probe_timer_1*. This interval also defines the broadcast probe interval, *Probe_timer_2*, which is typically five times longer than *Probe_timer_1*. When an addressed node receives a probe packet with an acceptable error it transmits an acknowledgement immediately in an addressed response packet, in accordance with the ODMA Layer 2 radio link protocol (RLP).

Every time an MS transmits an addressed probe containing data on the CCH, it may be received, but not acknowledged, by third party neighbour mobiles, and provides an implicit indication of activity. In this instance broadcast probes are not necessary and *Probe_timer_2* is reset after every addressed probe transmission. Only when an MS has no data to send is it necessary to transmit a broadcast probe every *Probe_timer_2* seconds to register its active status with its neighbours.

In order to avoid overlapping packet transmissions the length of the packet may not exceed the probe timer interval, *Probe_timer_1*. The relationship between the different probe timers is illustrated in Figure 11.

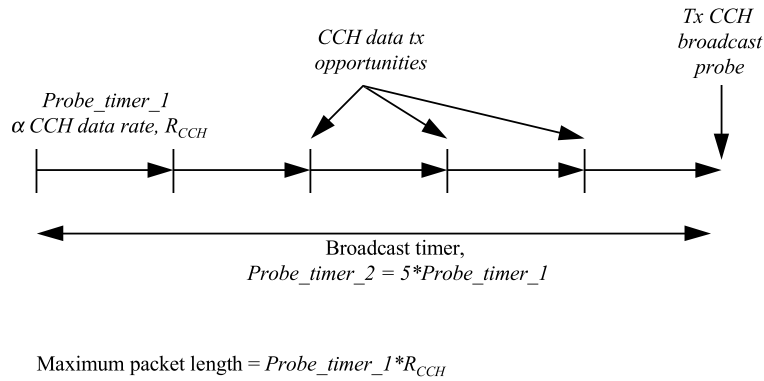


Figure 11. CCH Timer Relationships.

4.2.2 Transmitting Data on a DCH

Clearly, if all mobiles were to transmit a lot of data on the CCH, the channel would become heavily congested and the throughput would decrease. Each CCH therefore has an associated set of DCHs which are used to transfer larger volumes of data between ODMA nodes. In this case either the first addressed data probe sent on the CCH or the corresponding response packet may indicate a DCH in the header field on which subsequent packets will be transmitted. Data exchanges will continue on the data channel until:

- no more data needs to be transmitted, or,
- the data channel timer, T_{data} , expires.

In a lengthy data transfer session the MS will still need to maintain the current status of its neighbours. The data channel timer, T_{data} , ensures that the MS will periodically revert back to the CCH and continue data exchanges on the CCH. At this stage a new DCH may be requested and the cycle repeats until the session is completed.

4.3 Routing and Connectivity

Sections 2 and 3 have described the core mechanisms which enable ODMA nodes (mobiles or fixed units) to derive neighbour list information and relay data. This section will explain how packets are routed and connectivity between two remote nodes is achieved. The ODMA packet structure, described below in Figure 13, is designed to enable nodes to listen to neighbour broadcasts or data transmissions and derive the required connectivity information.

The packet header contains physical layer characteristics, such as transmit powers local modem noise levels and the packet payload encapsulates either data segments, in the case of a data packet, or neighbour list information, in the case of a broadcast probe.

Two levels of connectivity may be considered in ODMA:

- *local connectivity*, which enables a node to select an appropriate Receiving ID for a single relay hop and,
- *end-to-end connectivity*, which enables a node to determine the final Destination ID field for a data segment in a call session.

ODMA Packet Structures

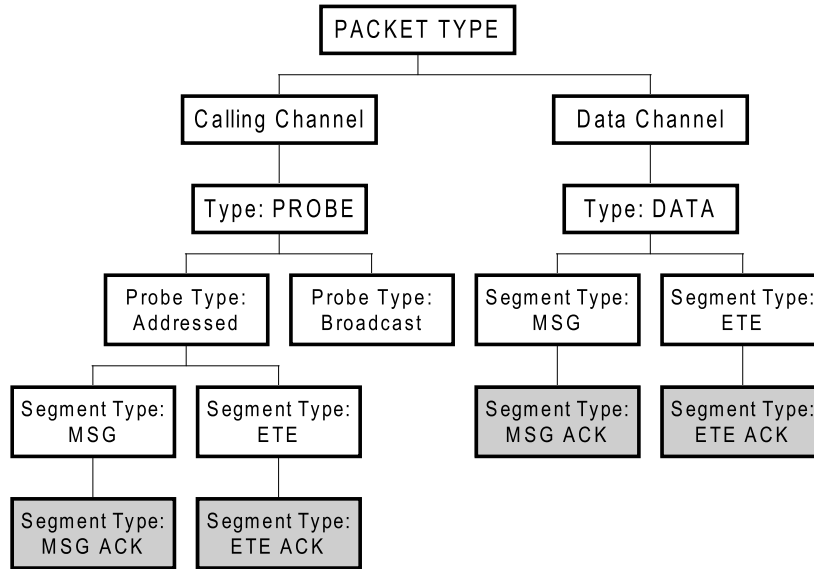


Figure 12 ODMA Packet Structures

Packet Header Information	
Sending ID	The ID of the transmitting MS
Receiving ID	The ID of the receiving MS
Transmit power	The mobile transmit power
Local path loss	The path loss between the transmitting MS and addressed MS (addressed probes only)
Background RSSI	The noise level at the current modem
Background RSSI + 1	The noise level at the next highest rate modem
Background RSSI -1	The noise level at the next lowest rate modem
Requested Rx/Tx channel	Required RF channel when transmitting MS wants to move to a dedicated TCH.

Data Segment Header Information	
Segment type	i.e. MSG, MSG ACK, ETE, ETE ACK
Origin ID	The originating MS
Destination ID	The destination MS
TOC	Time of segment creation
TTD	Time to die
Time Elapsed	Relative segment life-time in the network
Message number	The message number, segment type and Origin ID uniquely define a message segment in the system.

Figure 13. Packet Header Structures in ODMA.

4.3.1 Local Connectivity

Each packet comprises a header section and a payload section. In the case of a broadcast probe transmitted on a CCH, the payload comprises a neighbour list and receive quality indicator. On receiving a broadcast probe with a populated neighbour list a node can derive connectivity up to two hops away. For example, MS_0 in Figure 14 receives broadcast probes from mobiles in tier 1, whose neighbours also reside in tier 2. The tier two nodes are not classed as neighbours, since they cannot be received directly, but may be included in the MS_0 routing table.

The probing mechanism therefore enables an MS to populate the Sending ID and Receiving ID fields in the packet header to relay data over a single hop and define the end-to-end (ETE) connectivity if the Destination ID is in the routing table.

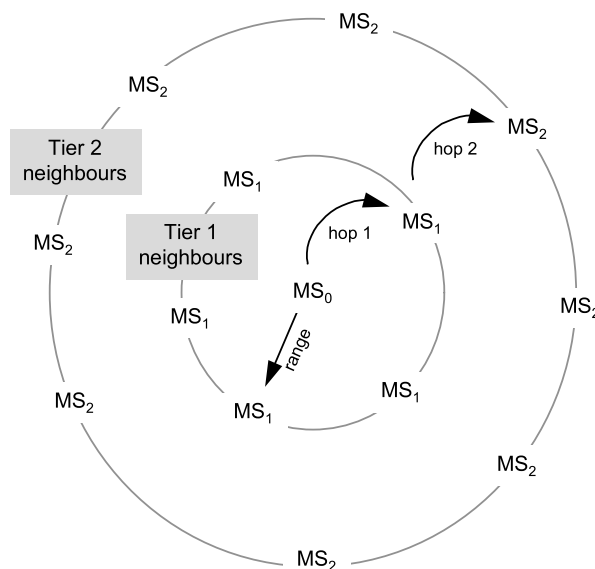


Figure 14. Localised connectivity through probing.

4.3.2 Connectivity Metrics

Within a local connectivity area, defined by the current neighbour list information, a mobile could select one of several relays which may be used to route a packet towards a final destination. Clearly, a choice needs to be made to determine which mobile would represent the best connection for a single

hop. Whenever an MS receives a packet from a neighbour, the header provides sufficient information to perform a basic link budget assessment, which determines the transmit power required to reach a mobile with a sufficient S/N.

Connectivity beyond a local area is derived from layer 2 segment header information. The Origin ID and Destination ID fields provide new entries in the routing table and an ETE segment indicates connectivity with a final destination. The Time-of-creation (TOC) and Time Elapsed fields show the relative time at which a segment was created and how long it has been in the network. The Time Elapsed field is incremented at each relay node and compared with the TOC to determine the delay. Using these fields a node can monitor a packet being transmitted between two other nodes and derive the packet delay. If a segment does not reach its destination within a specified time, defined by the TTD, it is deleted from the transmission queue.

In summary the minimum transmit power (for a required S/N) and network delay are the two main parameters which indicate connectivity quality in the ODMA routing algorithm.

4.3.3 End-to-End Connectivity

In a non-cellular environment, if a mobile wants to initiate an ODMA call with a node which is not listed in the routing table, the MS creates a Destination ID and sends a *router message*, which is a very small, high priority message, routed towards nodes with good connectivity and away from the origin, flooding the immediate local area within the network. The router message will only flood to mobiles within a limited region restricted by a Time To Die field in the router message.

N.B. [In a WCDMA cellular environment all traffic is to or from a Gateway/BTS, the majority of mobiles will always know a route to the Gateway/BTS and since the Gateway/BTS can page them directly without relaying it can request them to initiate a relaying call and so does not have to find a route to the mobile. Once the gateway has received a message from the mobile via relays in response to a page it can then send data back down the same route to the mobile. Therefore router messages may not be required or used very rarely with flooding only over small localised areas.]

If the Destination ID receives the router message it responds via the same route with an ETE acknowledgement which also has a high priority. If the router message does not reach the Destination ID within a given time, specified by the time to die TTD field, another router message is sent, this time via two well connected nodes.

The ETE is sent on a chain of CCHs to acknowledge connectivity and is also received by third party mobiles using the same CCHs but not involved in the call directly. On receiving an ETE, mobiles are able to update their routing tables to include nodes which lie outside their local connectivity area.

Consider the example in Figure 15. ODMA could be considered as a set of overlapping local connectivity areas, A, B, C, D, containing mobiles $A=\{1,2,3\}$, $B=\{3,4,5,6\}$, $C=\{6,7,8,9\}$ and $D=\{9,10\}$, where mobiles within the same area can receive each others transmissions. If MS_1 wants to communicate with MS_{10} , it needs to send a router message across the network and the corresponding ETE is sent on a reciprocal path. On the outbound and return paths, the router and ETE messages are also received by MS_4 and MS_8 , allowing MS_1 and MS_{10} to be entered into each mobile's routing table. When a subsequent outbound packet reaches MS_3 for the second time, MS_3 will assess the connectivity between its neighbours and may conclude (from the neighbour list information) that MS_4 provides a better connection to MS_6 , which has been noted to have connectivity to MS_{10} . This mechanism implies that within each local area call connectivity changes dynamically depending on the link budget and network delay.

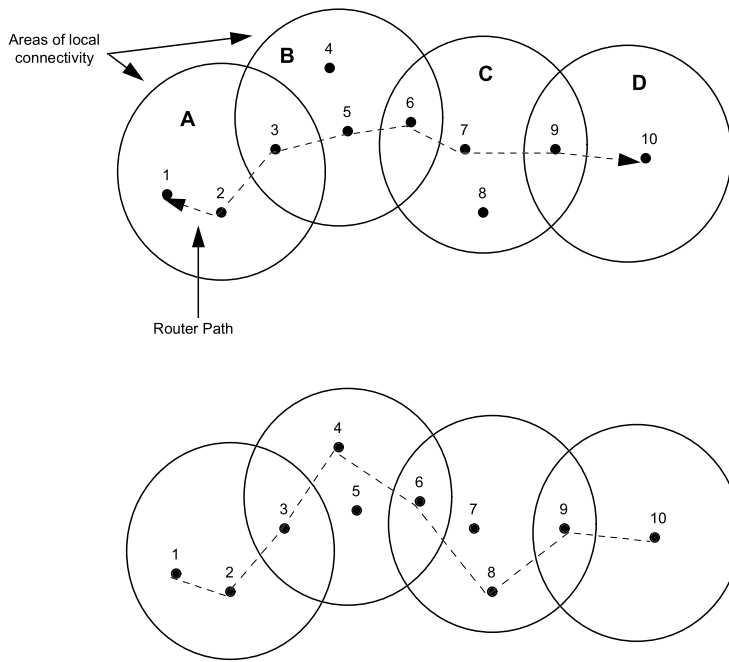


Figure 15. ETE connectivity in ODMA.

When the originating mobile receives the ETE, connectivity is established and the data transfer can proceed according to the Layer 2 protocol, illustrated in Figure 16.

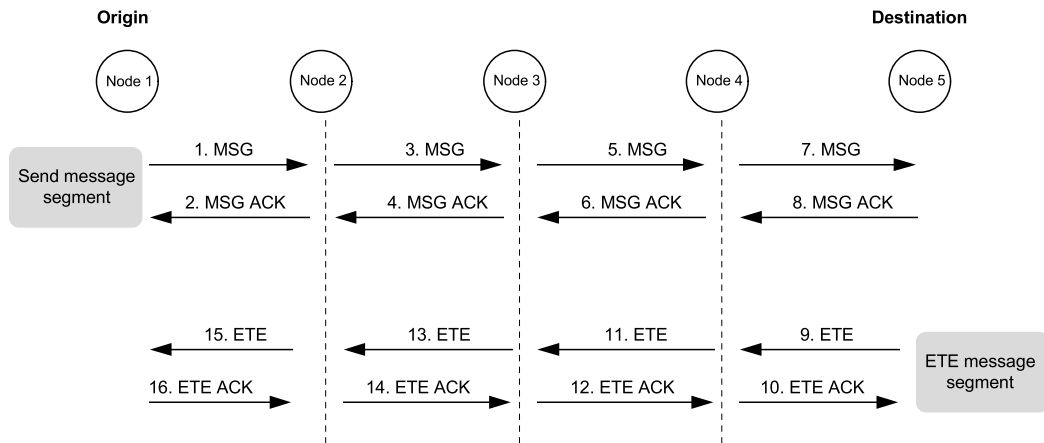


Figure 16. ODMA Layer 2 RLP.

5. SIMULATIONS

Within the Epsilon concept group simulations were performed on the ODMA technology. For this purpose a system simulator tool was created such that the environments, traffic and mobility models of UMTS 04.02 could be supported. The simulated ODMA nodes were software kernels taken from a prototype packet radio system in South Africa which is based on the ODMA technology. Simulations using this tool should therefore be close to reality as the simulated nodes are themselves deciding on the best relay paths, the power levels, overall routing etc. A disadvantage of this approach is that simulations have taken a long time to run and the number of simulated nodes has been limited. As a consequence it has been necessary to concentrate on a small subset of simulation tests relevant to ODMA data relaying i.e. LCD 384kbps. The LCD model was used as it was considered a better measure of performance than UDD which was more open to different interpretations.

A representative link level was used during the simulations but this was not WCDMA. However it is expected that future results using WCDMA would achieve much better results.

Most of the simulations concentrated on extended coverage scenarios using subscriber relay but some initial work was carried out on capacity for a combined ODMA/cellular solution where traffic is concentrated at a number of nodes close to the BTS.

Where subscriber relay is assumed only 1% of the mobiles believed to be within a coverage area are assumed available as relays. (User density estimate based on figures in early versions of UMTS 04.02).

The very wide area coverage simulations were not to prove that such areas should be covered by a single BTS but rather to show the flexibility of systems that support relaying.

5.1 Indoor office (x60) LCD 384kbps Coverage

Figure 17 shows a distribution of packet delays for communications within a 60 office indoor environment using a single BTS and subscriber relay. It can be seen that in general delays are within the 300ms LCD bearer limit and that the mobile TX power during a call is very low (115uW)

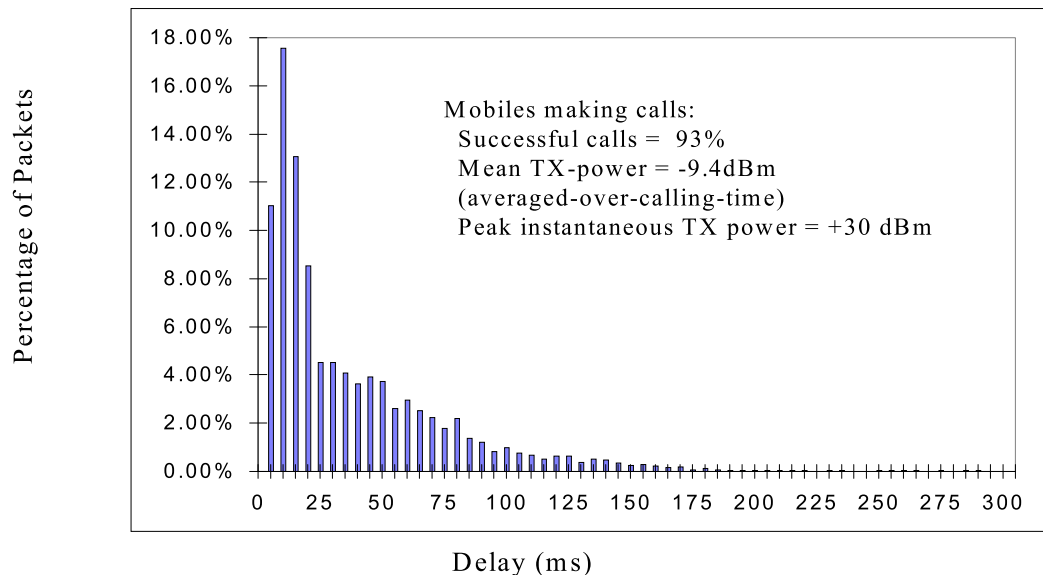


Figure 17 Packet Delay Distribution for Indoor Office (x60) LCD 384kbps Coverage

5.2 Manhattan 10x10 Blocks LCD 384kbps Coverage

Figure 18 shows distribution of packet delays for LCD 384kbps over a 10x10 block of Manhattan. There is more of a delay variation with respect to Indoor attributable to the more difficult environment e.g. corner effects and building loss. The power during a call is also greater (49mW) which suggests fewer or more difficult radio paths.

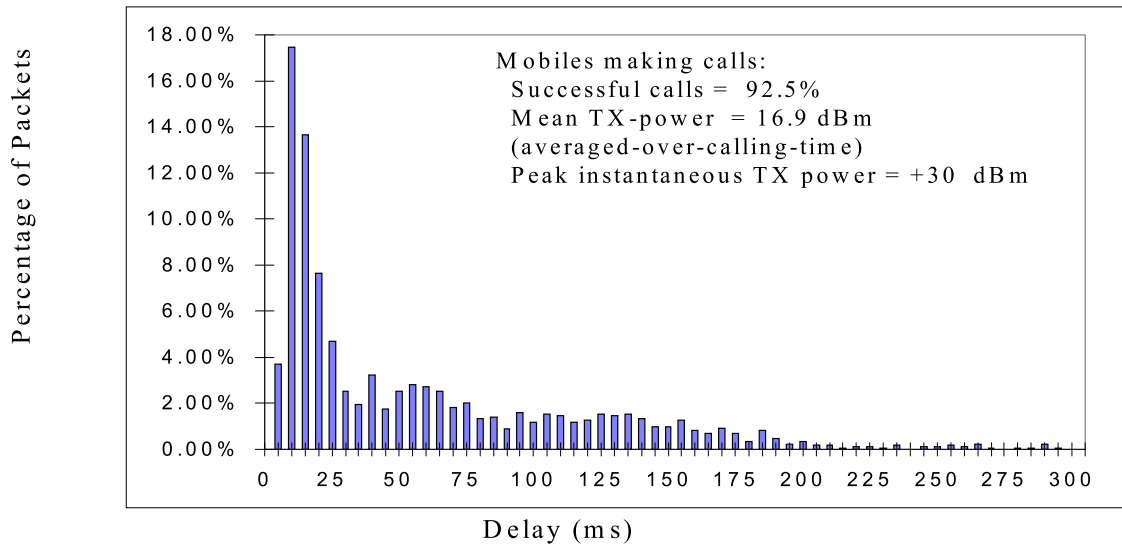


Figure 18 Packet Delay Distribution for Manhattan (10x10) LCD 384kbps Coverage

5.3 Vehicular - 6km x 6km LCD 384kbps Coverage

Figure 19 shows distribution of packet delays for LCD 384kbps over a 6km x 6km vehicular coverage area. There is less delay variation with respect to Manhattan attributable to having less relay hops with a corresponding increased TX power (323mW).

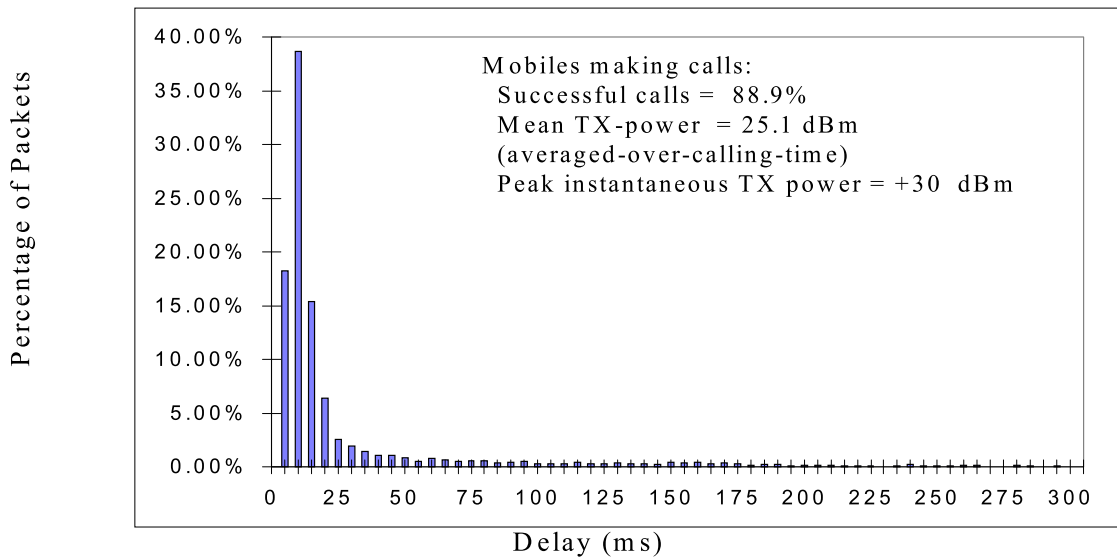


Figure 19 Packet Delay Distribution for Vehicular 6km x 6km LCD 384kbps Coverage

5.4 Manhattan 3x3 Blocks LCD 384kbps Capacity

Figure 20 shows distribution of packet delays for LCD 384kbps over a 3x3 block of Manhattan using 8 WCDMA/ODMA nodes close to the BTS to concentrate traffic. For the spectrum utilised the efficiency of this group of 8 is 860kbps/MHz. This is an interesting initial result which can be improved but the link between the interface between the ODMA layer and the WCDMA cell requires more detailed investigation which has not been possible within the given timescales.

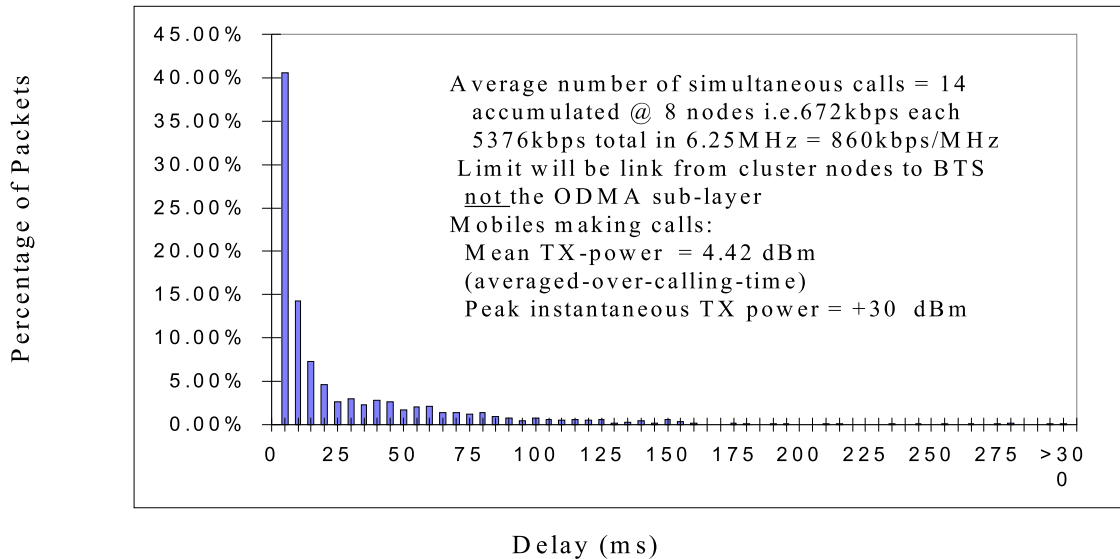


Figure 20 Packet Delay Distribution for Manhattan 3x3 Block LCD 384kbps Capacity

6. WCDMA SUPPORT FOR RELAYING

This section presents the findings from joint Alpha/Epsilon feasibility study which considered how the radio sub-blocks within the WCDMA mobile could support relaying.

WCDMA communication in ODMA mode implies MS-to-MS communication. This, in turn, implies MS reception and transmission on the same frequency band, i.e. TDD operation.

TDD is already included as a key feature of the WCDMA proposal of the concept group Alpha and only a very limited amount of additional features have to be added to a WCDMA terminal in order to support relaying as will be discussed below.

For MS-to-MS communication, the transmit and receive spreading/modulation schemes of the mobile stations should obviously be the same. This is currently not the case for the Alpha concept where the mobile station uses IQ-multiplex of the DPCCH and DPDCH followed by dual-channel QPSK modulation. For the downlink, i.e. the signal received by the mobile station uses time multiplex of the DPCCH and DPDCH followed by ordinary QPSK modulation. It is recommended that, for the WCDMA/ODMA mode, MS-to-MS communication will use the downlink scheme of the Alpha concept. Such an approach will have an only marginal impact on the complexity of the mobile-station transmitter as QPSK can be seen as a special case of dual-channel QPSK.

In ODMA mode, a mobile terminal will initiate transmission with a random-access burst, identical to the ordinary random-access burst of the Alpha RACH. The target MS will detect this random-access burst in a similar way as the BS detects the RACH. This may indicate the need to add a relatively complex RACH detector in the ODMA terminal. However, the main component of the RACH detector (see figure X) is a matched filter identical to the matched filter used for cell search. Even the filter parameters can be the same. The main difference is the addition of the symbol-sampled preamble filter in the case of a RACH detector. However, this is very similar to the slot-wise accumulation of matched-filter outputs in the case of the cell-search. It may even be argued of the preamble of the RACH is actually needed for WCDMA/ODMA communication. The preamble is included in the Alpha concept to support the reception of multiple RACH simultaneously. It is not yet fully clear of that functionality will be needed in the ODMA access-burst detector.

Consequently, only marginal hardware modifications need to be added to a WCDMA/TDD terminal in order to support ODMA communication

The following block diagrams show a breakdown of the WCDMA receiver building blocks which must be considered in order to support relaying.

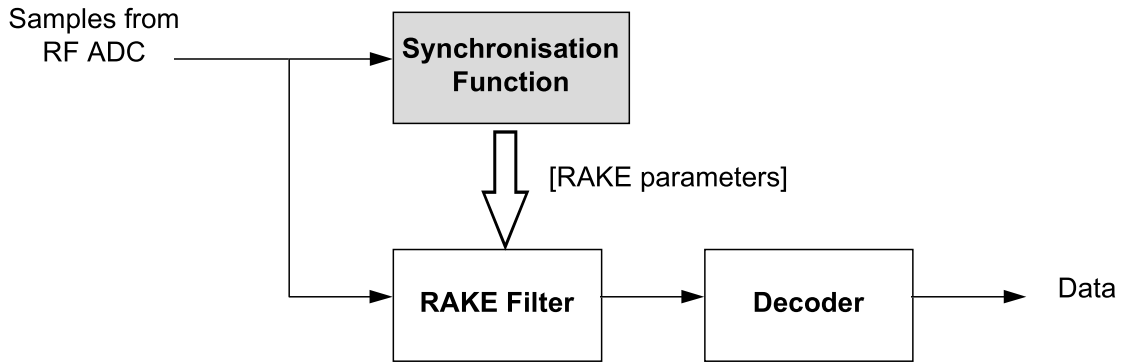


Figure 21 WCDMA Receiver

Figure 21 shows a block diagram of a typical WCDMA receiver. The synchronisation function must be modified as it is assumed that chip and symbol synchronisation cannot be obtained from BTS broadcasts when in ODMA mode (although some basic system time sync is possible from toggling to WCDMA mode). This block is expanded in Figure 22

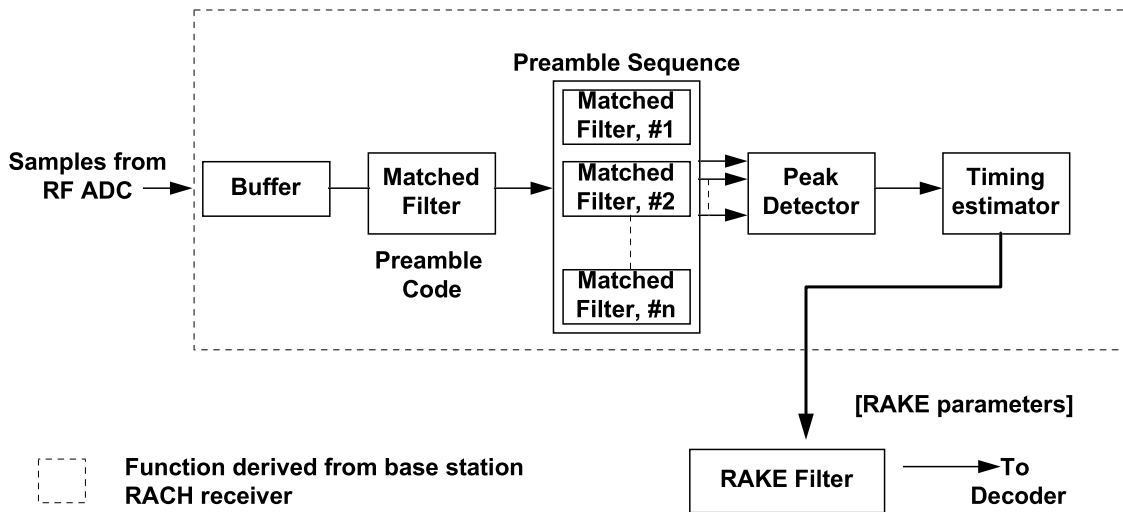


Figure 22 Synchronisation Function

The dotted box indicates functionality derived from the BTS design for dealing with RACH transmissions. RACH transmissions are asynchronous and must be tolerant to collisions and Near Far effects (meets ODMA criteria). Basically matched filters are used to synchronise on a transmission by transmission basis .

The first matched filters looks for a PN sequence common to all preambles. The filter hardware already exists within a WCDMA MS in the form of a BTS searcher. The matched filters for finding particular preambles would need to be added but these are much simpler as they are clocked at a slow rate. The remaining blocks of Figure 22 are also present in the MS and the matched filters are shown below in Figure 23

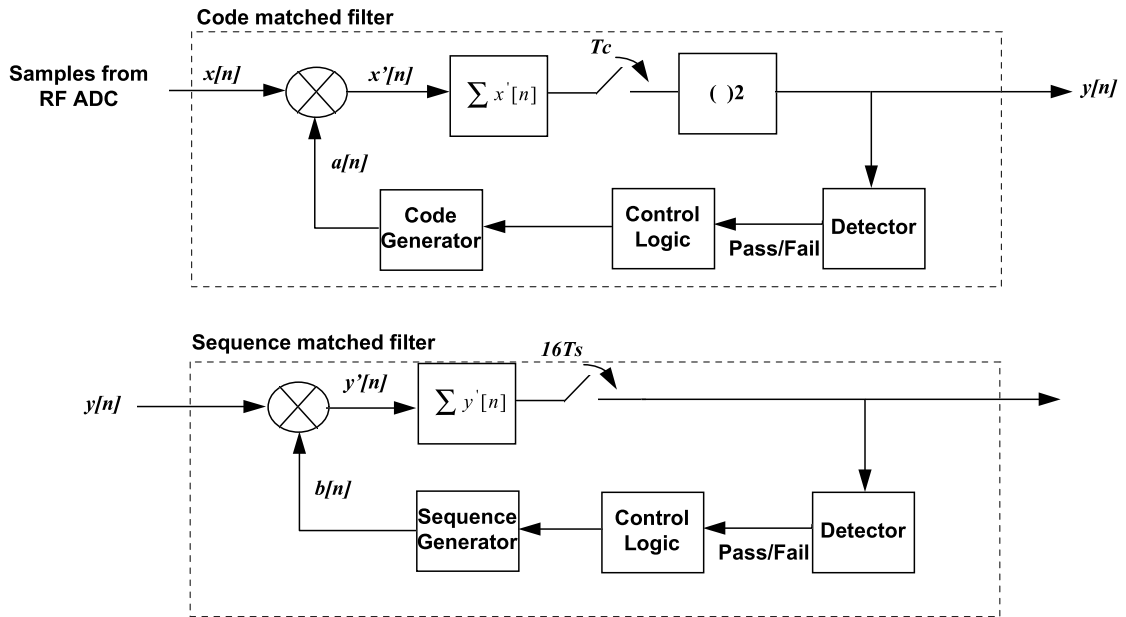


Figure 23 Receiver Matched Filters

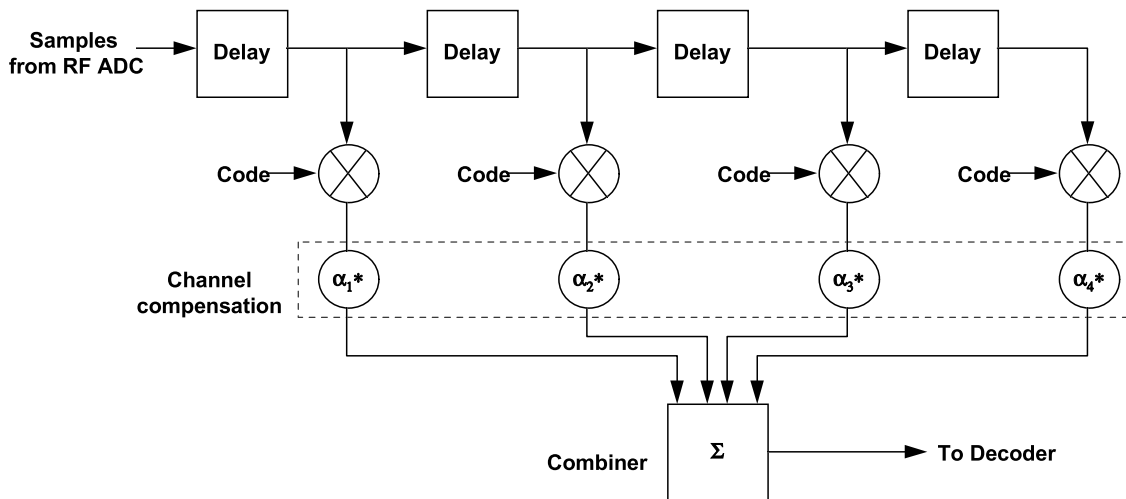


Figure 24 WCDMA Rake Receiver

A typical WCDMA rake receiver is shown in Figure 24 and whilst it requires no significant modification it must be used with care in a relaying receiver. For example if there are many preamble codes then it is unlikely that MSs will attempt to re-use the same one within a local area and so the rake fingers will have multipath delayed versions of the desired signal which can be combined using MRC. Alternatively if there are few preambles, perhaps just one then there will be interfering transmissions on the same code. The fingers of the Rake receiver may have signals from a number of sources rather than multipath from just one so MRC would not be appropriate. In this case it would be better to select a single path. This would be justified for many relaying cases when short low delay spread paths are used.

6.1 Benefits of WCDMA to ODMA implementation

For the ODMA communication with basically random transmission of packets, it is very difficult to rely on interference avoiding techniques (interference occurs on different time-slots and carriers for different packets). Consequently it is important to use a transmission scheme that is as robust to interference as possible. In this way, parallel packet transmissions, also at relatively nearby links will not cause fatal

collisions. WCDMA gives such a high robustness towards interference and does thus provides a good basis for ODMA:

6.2 Cost/complexity

As stated earlier the initial feasibility study suggests that only marginal hardware modifications need to be added to a WCDMA/TDD terminal in order to support ODMA communication

7. CALL SET-UP PROCEDURES FOR ODMA IN A WCDMA CELL.

Within a WCDMA cell that supports ODMA we will consider that all mobiles have the same basic functionality i.e.; they can time multiplex between WCDMA FDD mode and ODMA TDD mode. ODMA traffic will be carried in a separate unpaired spectrum band but the last relay hop to the BTS will use WCDMA/FDD.

Within the cell there are several MS roles e.g.;

- 1) Mobile originator/terminator
- 2) Active relay
- 3) Sleeping relay
- 4) ODMA/WCDMA gateway (last hop)

All the mobiles can receive broadcast information from the BTS and thereby establish basic system timing synchronism.

ODMA requires a background probing activity to determine the location of near neighbours which may act as future relays. If this is allowed to occur at any time the MSs must RX continuously which may reduce battery life. To avoid this, a low duty cycle probing window is used i.e. the sleeping MSs wake up periodically to send and receive probes (e.g. every minute) and then go back to sleep. The window could be of the order of 0.5 seconds long.

The BTS has the capability to send a wakeup page to all the MSs via the WCDMA/FDD cell.

A Sleeping MS that is then paged awake will stay active whilst it can detect local ODMA transmissions. If it has not participated in such communication for a timeout period it will fall asleep. Similarly it may decide to sleep after a long period of activity

When a MO wishes to start a call it makes a conventional RACH access to the WCDMA/FDD BTS. A conventional authentication/call setup will take place but during the negotiation of resource it will be decided to use ODMA mode. Firstly the BTS will send a broadcast wakeup page to the MS relays. The BTS will then ask the MO to send a message to it via ODMA relaying which it then acknowledges. The initial route for these messages will be based on knowledge acquired from the background probing. The transmissions will be monitored by relays not directly involved in the link. These relays then determine connectivity routes between the MO and BTS and are available to make further transmissions more optimum and reliable. Other mobiles will fall asleep using the page-awake rules. A similar procedure is used for MT calls.

7.1 ODMA/WCDMA Gateway - Last Hop to BTS

The last MS in the relay chain will have direct connectivity to the BTS over a short high rate link. The MS will require 2 buffers i.e.; to fill from ODMA and empty via WCDMA and vice versa. For example in the case of significant DL traffic the buffer will be filled by a WCDMA call and at a defined threshold the MS will switch to ODMA mode until the buffer is emptied. Similarly for an UL case ODMA will fill the buffer until a threshold is reached after which a WCDMA call empties the buffer into the BTS. If an ODMA relay is not available as in WCDMA mode traffic is either backed up toward the source or an alternative last hop MS is chosen.

8. BENEFITS OF ODMA TO WCDMA W.R.T. HIGH LEVEL REQUIREMENTS

The potential benefits of ODMA as a WCDMA enhancement are listed below with respect to the UTRA high level requirements.

Key Requirements	Description
	Bearer capabilities
Maximum User Bit Rates	<p>The UTRA should support a range of maximum user bit rates that depend upon a users current environment as follows:</p> <p>Rural Outdoor¹: at least 144 kbit/s (goal to achieve 384 kbit/s), maximum speed: 500 km/h</p> <p>Suburban Outdoor²: at least 384 kbps (goal to achieve 512 kbit/s), maximum speed: 120 km/h</p> <p>Indoor/Low range outdoor³: at least 2Mbps, maximum speed: 10 km/h</p> <p>It is desirable that the definition of UTRA should allow evolution to higher bit rates.</p> <p><i>The maximum user bit rate for packet services in the given environments are determined by the assumptions on channel models and maximum range. If relaying is supported then these assumptions change as communication proceeds via a number of relay hops which are normally low range, low mobility and often LOS. Therefore relaying enables high rate transmissions in all environments.</i></p> <p><i>Where high rate transmission was already possible, relaying will lower the required transmitted power.</i></p>

¹ The specified bit rate will be available throughout the operator's service area, with the possibility of large cells

² The specified bit rate will be available with complete coverage of a suburban or urban area, using microcells or smaller macrocells

³ The specified bit rate will be available indoors and localised coverage outdoors.

Flexibility	<p>Negotiation of bearer service attributes (bearer type, bit rate, delay, BER, up/down link symmetry, protection including none or unequal protection), parallel bearer services (service mix), real-time / non-real-time communication modes, adaptation of bearer service bit rate</p> <p>Circuit and packet oriented bearers</p> <p>Supports scheduling (and pre-emption) of bearers (including control bearers) according to priority</p> <p>Adaptivity of link to quality, traffic and network load, and radio conditions (in order to optimise the link in different environments).</p> <p>Wide range of bit rates should be supported with sufficient granularity</p> <p>Variable bit rate real time capabilities should be provided.</p> <p>Bearer services appropriate for speech shall be provided.</p> <p><i>WCDMA is a flexible and adaptive air interface technology and relaying further enhances these capabilities for packet services. Using ODMA you not only have the opportunity to perform optimum link adaption but you may have a number of different links (relay paths) from which to select the best and thereby bypass heavy shadowing effects. ODMA adds link diversity to WCDMA.</i></p> <p><i>When a MS uses a relay it is effectively replacing it's own transmission limitations with that of a neighbour who is better situated or more able to communicate. For example a low power handportable MS could relay to a vehicle in order to exploit the more powerful transmitter and better antenna to reach a distant BTS or satellite. In these examples the single hop relay means that low delay speech can be supported as well as data services. For the satellite case this gives the option of indoor coverage using a simple UMTS handset..</i></p>
Handover	<p>Provide seamless (to user) handover between cells of one operator.</p> <p>The UTRA should not prevent seamless HO between different operators or access networks.</p> <p>Efficient handover between UMTS and 2nd generation systems, e.g. GSM, should be possible.</p>

	OPERATIONAL REQUIREMENTS
Compatibility with services provided by present Core Transport Networks	ATM bearer services GSM services IP (internet protocol) based services B/N-ISDN services
Radio Access Network Planning	If radio resource planning is required, automatic planning shall be supported.
Public network operators	It shall be possible to guarantee pre-determined levels of quality-of-service and quality to public UMTS network operators, in the presence of other authorised UMTS users.

<p>Private and residential operators</p>	<p>The radio access scheme should be suitable for low cost applications where range, mobility and user speed may be limited.</p> <p>Multiple unsynchronised systems should be able to successfully coexist in the same environment.</p> <p>It should be possible to install basestations without co-ordination.</p> <p>Frequency planning should not be needed.</p> <p><i>Private and residential systems are particularly appropriate for relaying and ODMA.</i></p> <p><i>As ODMA relays do not own dedicated radio resource but share it in an asynchronous fashion with neighbouring nodes they are tolerant to spectrum sharing.</i></p> <p><i>For example ODMA could be used in the same spectrum band within adjacent buildings. This is particularly true as relaying avoids higher power transmissions at the building edge - in fact the highest average transmission powers can be concentrated at the centre of the cell/building. ODMA can be considered as a wireless distributed antenna.</i></p> <p><i>In private companies another option is possible. A MS can exchange signalling with a BTS for call set-up authentication/encryption/user profiles etc. but the data content of the intracompany calls could be transmitted direct MS-MS or via MS relays. The capacity of such a system may be great and can be considered analogous to having a great many BTSs within a given area. In this scenario the delay of relayed calls is also very low and would be appropriate for speech as well as higher rate data services.</i></p> <p><i>In a residential property there maybe a requirement for the UMTS MS to act as a low power cordless phone. The ODMA protocol has a probing mechanism to determine its near neighbours so that if the cordless BTS supported ODMA a MS could detect that it was "at home". The MS could then communicate directly to the BTS using the ODMA band without affecting the Operator's paired spectrum. The direct link would be low delay and suitable for speech as well as higher rate data services.</i></p>
-------------------------------------------------	----------------------------------------------------------------------------------------------------------------------------------------------------------------------------------------------------------------------------------------------------------------------------------------------------------------------------------------------------------------------------------------------------------------------------------------------------------------------------------------------------------------------------------------------------------------------------------------------------------------------------------------------------------------------------------------------------------------------------------------------------------------------------------------------------------------------------------------------------------------------------------------------------------------------------------------------------------------------------------------------------------------------------------------------------------------------------------------------------------------------------------------------------------------------------------------------------------------------------------------------------------------------------------------------------------------------------------------------------------------------------------------------------------------------------------------------------------------------------------------------------------------------------------------------------------------------------------------------------------------------------------------------------------------------------------------------------------------------------------------------------------------------------------------------------------------------------------------------------------------------------------------------------------------------------------------------------------------------------------------------------------------------------------------------------------------------------

EFFICIENT SPECTRUM USAGE	
Spectrum efficiency	<p>High spectrum efficiency for typical mixtures of different bearer services. Spectrum efficiency at least as good as GSM for low bit rate speech. <i>Spectrum efficiency is limited by intercell and intracell interference. Intercell interference can be caused by a mobile on the edge of a cell transmitting at high power to reach it's BTS. The transmissions will interfere with neighbouring cells whose coverage will have been planned to ensure there are no gaps between them. WCDMA counteracts intercell interference by using SHO but this is not used for packet services. Another approach is possible with relaying. Plan the WCDMA cells so that there are coverage gaps for high rate packet services (not necessarily speech). A BTS can then only serve MSs at short range which implies low transmission power and a long distance to the neighbour BTS. Serving these few MSs will be spectrally efficient as there would be simple low loss radio channels, with very little intercell interference. The coverage gaps would be filled in by ODMA relaying which would route traffic to and from the close range or optimally placed MSs. This technique may also be applicable to reduce intercell interference at country borders. Another factor which affects spectral efficiency is the protection methods to ensure reliable transmission in difficult environments which may have high error rates and long delay spreads. WCDMA provides rugged protection methods for these environments but because relaying shortens and simplifies the communication paths less protection may be required. [It should be noted that within a cell area an ODMA sublayer using subscriber relay would re-use the radio resources many times as each re-transmission is of such low power that they will only effect a small percentage of the cell area.]</i></p>
Variable Asymmetry of Total Band Usage	<p>variable division of radio resource between uplink and down link resources from a common pool (NB: This division could be in either frequency, time, or code domains)</p> <p><i>Relaying will be supported in a TDD mode within a separate section of spectrum. Within this spectrum, complete asymmetry is supported with no requirement for a predefined UL/DL split of any kind.. However as relaying is part of a hybrid WCDMA solution the relay spectrum may logically be considered as adding to the WCDMA DL or UL thereby considerably increasing support for variable asymmetry when dealing with packet services.</i></p>
Spectrum Utilisation	<p>Allow multiple operators to use the band allocated to UMTS without co-ordination.⁴</p> <p>It should be possible to operate the UTRA in any suitable frequency band that becomes available such as first & second generation system's bands</p>

⁴ NOTE: the feasibility of spectrum sharing requires further study.

Coverage / Capacity	<p>The system should be flexible to support a variety of initial coverage/capacity configurations and facilitate coverage/capacity evolution Flexible use of various cell types and relations between cells (e.g. indoor cells, hierarchical cells) within a geographical area without undue waste of radio resources.</p> <p>Ability to support cost effective coverage in rural areas</p> <p><i>A major feature of relaying is the prospect to extend service coverage either by extending high data rate services or by relaying from deadspots into coverage. It would be a means to limit the required number of BTS sites to achieve coverage whilst maintaining the customer perceived QoS. Relaying has potential may to combat intercell interference which would allow BTS equipment to achieve greater capacity.</i></p> <p><i>If relaying is used to help initial rollout then it may be necessary to deploy Seeds (operator deployed-powered relaying mobiles). As the number of subscribers increase the Seeds will no longer be necessary .Ultimately more BTS resources will be added to cope with high capacity demands.</i></p>
	Complexity/cost
Mobile Terminal viability	<p>Handportable and PCM-CIA card sized UMTS terminals should be viable in terms of size, weight, operating time, range, effective radiated power and cost.</p> <p><i>A WCDMA MS should readily support relaying as it already contains the required radio block functionality.</i></p>
Network complexity and cost	<p>The development and equipment cost should be kept at a reasonable level, taking into account the cost of cell sites, the associated network connections , signalling load and traffic overhead (e.g. due to handovers).</p> <p><i>Relaying would make use of the equipment proposed for WCDMA and by extending the range of the high rate data services it would require less BTSs for a given coverage area.</i></p>
Mobile station types	<p>It should be possible to provide a variety of mobile station types of varying complexity, cost and capabilities in order to satisfy the needs of different types of users.</p> <p><i>For a relay system to work well there must be as many relay nodes as possible. It is therefore a goal to support relaying in all mobiles - as it is believed that little extra cost or complexity is implied.</i></p> <p><i>It is accepted that the lowest cost mobiles will have limited ability for relaying high rate packet services.</i></p>
	Requirements from bodies outside SMG
Alignment with IMT 2000	<p>UTRA shall meet at least the technical requirements for submission as a candidate technology for IMT 2000 (FPLMTS)</p> <p><i>WCDMA meets these requirements but the development of relaying options could give the European solution an advantage over other world standards</i></p>

Minimum bandwidth allocation	<p>It should be possible to deploy and operate a network in a limited bandwidth</p> <p><i>The relaying sub-layer requires a single separate spectrum band (unpaired) which is used throughout the network. The smallest allocation unit for WCDMA is one 5MHz carrier which can support fairly high data rates if intercell interference is controlled</i></p> <p><i>The band maybe taken from an operator's own spectrum but there are advantages in having an additional default band, e.g. the UMTS spectrum allocated in each country to unlicensed use which can be used on a low power sharing basis.</i></p>
Electro-Magnetic Compatibility (EMC)	<p>The peak and average power and envelope variations have to be such that the degree of interference caused to other equipment is not higher than in today's systems.</p> <p><i>The relaying system will strive to localise the effects of any transmission by minimising the transmitted power of a call.</i></p>
RF Radiation Effects	<p>UMTS shall be operative at RF emission power levels which are in line with the recommendations related to electromagnetic radiation.</p>
Security	<p>The UMTS radio interface should be able to accommodate at least the same level of protection as the GSM radio interface does.</p> <p><i>A security review of ODMA has shown that the potential attacks are very similar to those for GSM. Providing GSM like authentication and end-to-end payload encryption are carried out then the level of protection is comparable.</i></p>
Coexistence with other systems	<p>The UMTS Terrestrial Radio Access should be capable to co-exist with other systems within the same or neighbouring band depending on systems and regulations</p>
	<p>Multimode implementation capabilities</p>
	<p>It should be possible to implement dual mode UMTS/GSM terminals cost effectively.</p>

9. SUMMARY

The use of relaying will add interesting new functionality and flexibility to a WCDMA UTRA and every effort should be made to ensure it is included in the standard especially as initial investigations suggest that the required functionality has negligible impact on mobile terminal cost or complexity.

As discussed in section 6 the properties of WCDMA are particularly advantageous to the use of advanced relaying protocols such as ODMA.

The ODMA/WCDMA combination should be further investigated as simulation results obtained during the ETSI evaluation process have demonstrated the potential for significant coverage and capacity enhancements.

10. ASSOCIATED DOCUMENTS

List of associated documents currently available from the Epsilon Group;

TD number	Title	Source
E-1/97	Agenda & material for discussion	Chairman
E-2/97	Mailing list & document handling	Secretary
E-2/97Rev1	Mailing list & document handling	Secretary
E-3/97	Radio Interface Structure	Chairman
E-4/97	Report of the 1 st ODMA Concept Group meeting	Secretary
E-5/97	Outline of the Technical Discussion	Chairman
E-6/97	Low-cost, low-power terminals for basic services	Motorola
E-7/97	Concept Group ϵ - ODMA - Report	Chairman
E-8/97	ODMA/CTDMA - Initial Discussions on Convergence	Vodafone Ltd Swiss Telecom PTT
E-9/97	Towards a Consistent Interpretation of ETR SMG- 50402	Vodafone Ltd
E-10/97	Notes on the Simulation of ODMA	Vodafone Ltd
E-11/97	Operator's Key Questions to the UTRA Concept Groups	T-Mobil, MMO, TIM, CSELT, FranceTelecom/CNET, Vodafone, Telia, BT, Telecom Finland, Swiss Telecom PTT, KPN, Cellnet, Omnitel
E-12/97	Outline of Evaluation Activities for Concept e - ODMA	Chairman
E- 12/97Rev1	Outline of Evaluation Activities for Concept e - ODMA	Chairman
E-13/97	Salbu Patent - "Adaptive Communication System"	Salbu
E-14/97	Investigation into Average and Instantaneous BER Performance of a $\pi/4$ QPSK on UMTS Channels	LGI
E-15/97	Average BER Performance on UMTS Channels with Paket Transmission considering $\pi/4$ QPSK and TCM8 PSK modulation	Kings College

E-16/97	Concept Group ϵ meeting report/presentation	Chairman
E-17/97	Answers to Operator Interest Group Questions	Chairman
E-18/97	WB-TDMA/CDMA/ODMA Feasibility Study	Siemens/Vodafone/Salbu
E-19/97	Initial Results from ODMA Simulations	Vodafone
E-20/97	ODMA - Opportunity Driven Multiple Access	Vodafone & Salbu
E-21/97	Characteristics of Opportunity Driven Multiple Access	Vodafone & Salbu
E-22/97	ODMA - System Gain from Fast Fading	Vodafone & Salbu
E-23/97	Q&A Session Report	Chairman
E-24/97	Questions to Concept Epsilon - ODMA	Chairman
E-25/97	Concept Group ϵ Report (SMG2 UMTS Ad Hoc #4)	Chairman
E-26/97	ODMA Annex to Alpha Evaluation Report	Chairman
E-27/97	ODMA Annex to Delta Evaluation Report	Chairman

Annex B:

Concept Group Beta β - Orthogonal Frequency Division Multiple Access (OFDMA)

This report contained in this annex was prepared during the evaluation work of SMG2 as a possible basis for the UTRA standard. It is published on the understanding that the full details of the contents have not necessarily been reviewed by, or agreed by, ETSI SMG or SMG2.

ETSI SMG#24
894/97
Madrid, Spain
December 15th-19th, 1997

Tdoc SMG

Source : **SMG2**

Subject : Summary of the concept description of the Beta concept

Allocation : Agenda Item **4.1**

1. Introduction

This documents outlines the basic system characteristic of OFDMA which is proposed for UTRA selection. It describes the basic concept behind the OFDMA proposal and its advantages and features which is the most advanced of its kind present today.

The OFDMA supports the RTT structure which includes physical as well as network protocol layers (Layer 1, 2, 3) and efficient Radio Resource Management mechanisms.

The OFDMA concept is unique in its approach to resolve the problem of interference averaging, combat multipath effect efficiently and increase capacity and spectral efficiency which are of a magnitude higher than any 2nd generation system available commercially today.

One of the main features of the proposed air-interface, OFDMA, is its flexibility in terms of operational matters, allocation of bandslot in a manner has not seen before, and also its service allocation flexibility (mix service in one cell). It also provides the best guard band requirements of any system under study, of order of KHz rather than MHz. In OFDMA, the minimum guard band is 200 KHz.

The system structured in such a way which is backward compatible with the existing 2nd generation systems.

The implementation of low cost dual mode/band terminal is realistic.

2. Key technical characteristic of the basic system

The following table summarises the key technical parameters and characteristics of the OFDMA UTRA proposal.

Multiple Access Scheme	SFH-TDMA and OFDM (BDMA)
Duplex Method	FDD (and TDD)
OFDM carrier spacing	100kHz/24 = 4.17kHz
OFDM symbol duration	240µs
Modulation time/Guard time	278µs/38µs
Timeslot Length	288µs
Bandslot Width (Minimum BW)	100kHz (24 subcarriers)
Data frame length	4.615ms (16 slot/frame)
Bandwidth	100kHz, 200kHz, 400kHz, 800kHz, 1.6MHz (flexible)
Frequency Hopping	1 (hop/burst) = 867 hop/s (no hopping option)
Channel Coding	Convolution coding, rate 1/3-2/3, Optional outer RS coding (rate: 4/5)
Interleave	typical 18.46ms for speech
Subcarrier modulation scheme	Frequency Domain DQPSK, Frequency Domain D8PSK, Coherent modulation schemes are supported
Bit rates	typical 11.6kB/s per timeslot/bandslot (coding=1/3)
Frequency Reuse	1 (fractional load=30%), 3 (load=100%)
Maximum use bitrate	no limitation (depends on system BW)
Power Control	Open loop & closed loop
Power Control step, period	1dB, 1.153ms/control
Frequency deployment step	100kHz
Services	Connection oriented and packet oriented services are supported
Handover	Hard handover, Soft handover not required
GSM backwards compatibility	Time and frequency structure is compatible to GSM

3. Performance Enhancing Features

The flexibility of the OFDM proposal (only the time and frequency grid structure has to be defined) allows the adoption of many performance enhancing features. Some of them are:

- Transmitter Diversity
To increase decrease signal fluctuation by fast fading Tx antenna diversity is supported, a simmlar effect can be achieved by transmission of the same signal twice with a small delay from the same antenna (BS needs only single antenna).
- Adaptive Antennas
The concept supports adaptive antennas (smat antennas) to support SDMA (spatial division multiple access) to increase range, coverage and capacity.
- Advanced Modulation/Coding Schemes
New modulation schemes can be applied (adaptive modulation) on the subcarrier domain (actual C/I based). Improved coding schemes (e.g. Turbo coding) can also be used.
- Multi user detection/Interference cancellation
Is supported in synchronous networks
- Dynamic Channel allocation
Advance DCA scheme can be applied to avoid the interference and maximises the capacity.
- Bandwidth expansion
Higher bandwidth allocation to support higher data rate beyond 2 Mb/s.

4. System Description

The OFDMA concept utilises OFDM modulation which has excellent performance in all multipath radio channels. A variable number of subcarriers is assigned to a user according to the required service. Additionally the number of timeslots is adjusted according to the required service. Variable bandwidth (frequency) and TDMA hopping pattern are supported, to achieve frequency, interference, and time diversity. The time and frequency structure is compatible to GSM.

FDD and TDD modes are supported.

The basic concept is depicted in Figure 1.

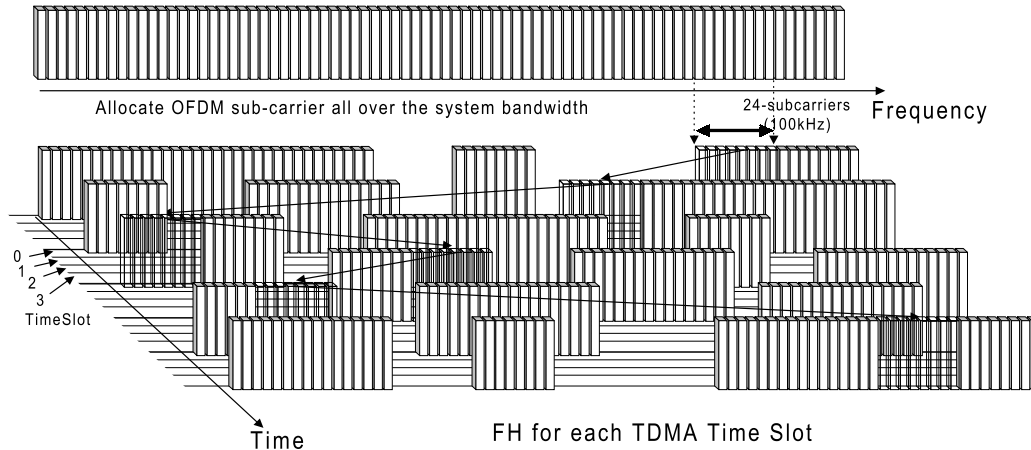


Figure 1: OFDMA Outline (SFH-TDMA)

The TDMA structure is aligned with GSM, one timeslot is $288.46\mu\text{s}$ (half of GSM timeslot). To support a wide variety of services flexible TDMA structures are supported in the FH pattern generator, the basic frame length is equivalent to the GSM frame length of 4.6ms.

Figure 2 shows the mapping of subcarriers into bandslots. One bandslots consist of 24 subcarriers (=100kHz) which is half of the GSM channel bandwidth.

Logical Channel are defined in the OFDMA concept:

Initial Acquisition Channel (IACH for initial time and frequency acquisition), Broadcast channel (BCCH) and Random Access Channel (RACH), Paging Channel (PCH).

Dedicated Control Channels (DCCH), Access Grant Channel (AGCH) and traffic channels are prepared.

Efficient quality based power control is achieved in the up- and downlink in order to minimise interference and maintain the link quality in the multipath environment.

A frequency reuse of 1 is supported which simplifies cell planning, the overall system shows soft capacity (allows capacity enhancement). Uncoordinated operation of base stations is supported.

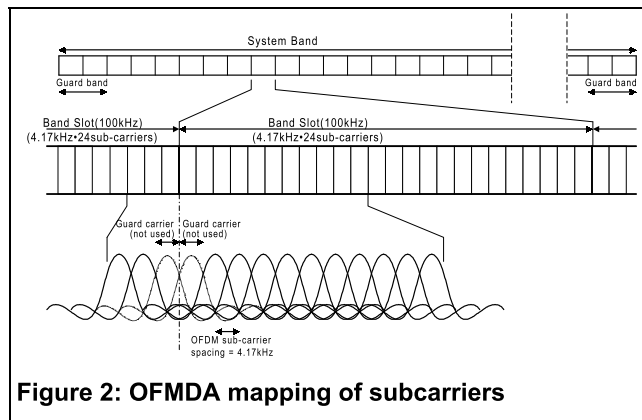


Figure 2: OFDMA mapping of subcarriers

The OFDM concept is optimised for efficient transmission of variable bitrates for connection oriented and packet oriented services.
 The following diagram depicts the harmonised utilisation of the proposed (OFDMA) RTT basic resources for common operation in different environments.

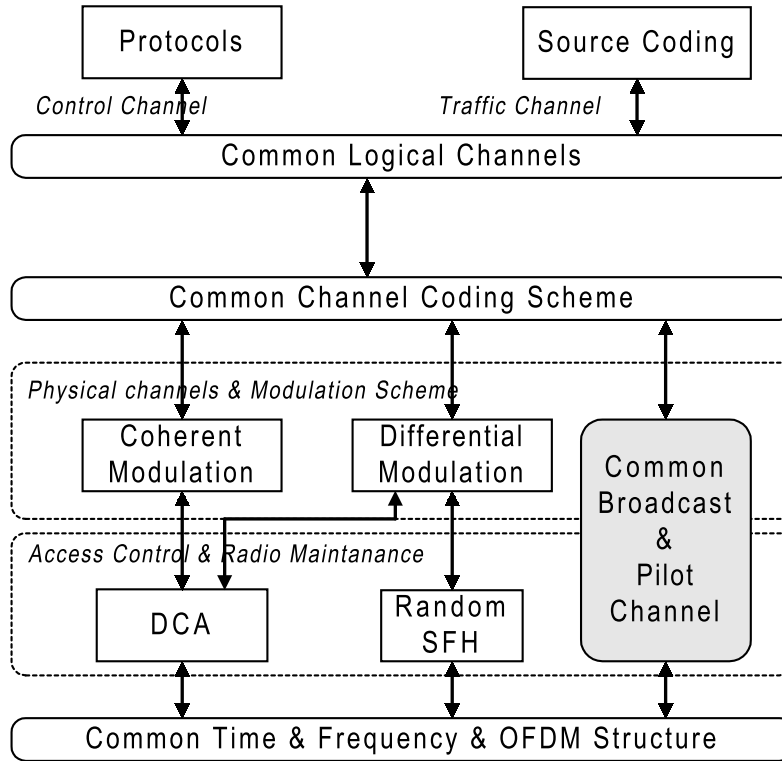


Figure 3: Harmonised RTT platform

5. Summary and main system features

The following summary shows the key advantages of the OFDMA UTRA proposal.

- Single core PHY layer minimising hardware costs with 2 software driven MAC options
- SFH TDMA based MAC for majority of UMTS services
- TDD DCA MAC for unpaired spectrum allocations, asymmetrical services & unlicensed usage
- Adaptive Modulation schemes for different channels
- Robustness against multi-path and Doppler spread
- Low computational overheads
- Simple low cost low-bit rate only terminals feasible
- Straightforward and efficient high bit rate support
- Small guard band requirements ~ 100 kHz
- High Spectral Efficiency achievable - 2 Mbits/s in 1.6 MHz feasible
- No frequency planning is required - effective re-use factor of ~1
- GSM Backwards Compatibility
- Minimum Bandwidth Requirements for system deployment only 1.6 MHz (or less) and deployment possible in steps of 100kHz
- Standard TDMA cellular planning and system enhancement techniques (smart antennas, hierarchical cell structures) can be supported
- Support of connection and packet oriented services
- Hard Handover, no soft handover required

ETSI SMG#24
Madrid, Spain
December 15th-19th, 1997

Tdoc SMG 895/97

Source : SMG2

Subject : Summary of the concept evaluation of the Beta concept

Allocation : Agenda Item **4.1 UTRA**

1. Introduction

This document describes evaluation summary the OFDMA concept based on the High Level Requirements for UTRA. Boxed text from ETR 04-01 has been included for reference.

This document does not outline the detail results, however, the full description of the system and results achieved can be found in the evaluation document.

2. Maximum user bit rate

The UTRA should support a range of maximum user bit rates that depend upon a users current environment as follows:

Rural Outdoor: at least 144 kbit/s (goal to achieve 384 kbit/s), maximum speed: 500 km/h

Suburban Outdoor: at least 384 kbps (goal to achieve 512 kbit/s), maximum speed: 120 km/h

Indoor/Low range outdoor: at least 2Mbps, maximum speed: 10 km/h

It is desirable that the definition of UTRA should allow evolution to higher bit rates.

- Rural Outdoor: 144kbps will be available throughout the operator's service area. The radio interface can tolerate the Doppler spread and rapidly changing channel characteristics associated with high speed vehicles (up to at least 1500 km/h).

- Suburban Outdoor: 384kbps rate will be available with complete coverage of a suburban or urban area

- Indoor/Low range outdoor: >2Mbps will be available indoors and over localised coverage outdoors

3. Flexibility

Negotiation of bearer service attributes (bearer type, bit rate, delay, BER, up/down link symmetry, protection including none or unequal protection),

parallel bearer services (service mix), real-time / non-real-time communication modes, adaptation of bearer service bit rate

Circuit switched and packet oriented bearers

Supports scheduling (and pre-emption) of bearers (including control bearers) according to priority

Adaptivity of link to quality, traffic and network load, and radio conditions (in order to optimise the link in different environments).

Wide range of bit rates should be supported with sufficient granularity

Variable bit rate real time capabilities should be provided.

Bearer services appropriate for speech shall be provided.

The OFDMA concept can provide variety of bearer services with the necessary attributes. i.e. different connection modes, symmetry, communication configuration, information transfer rate, delay variation, maximum transfer delay, maximum bit error rate, error characteristics.

The OFDMA concept is best suited to flexible operation and support of different bearer services in different radio environments. The OFDMA uses enhancing features to dynamically maintain the quality of the connection under different propagation and interference conditions by adjusting transmission band slot and number of time slots allocated.

Bit rate granularity is achieved primarily by allocating different numbers of transmission slots, but this can be supplemented if necessary by adjusting channel coding rates.

Parallel bearers can be transmitted independently, or where appropriate by multiplexing together into a single channel.

Circuit switched and packet oriented services are supported efficiently by Real-Time and Non-Real-Time bearer concepts.

Variable rate data services are supported by dynamically changing the resources and their allocation.

Bearers optimised for speech are available.

The bearer service attributes can be configured as required on initiation of a service, and changed dynamically if required.

4. Minimum bearer capabilities

The following table shows the potential combinations for the most important characterisation attributes (based on ETR-04-01).

Operating environment	Real Time/Constant Delay		Non Real Time/Variable Delay	
	Peak Bit Rate (note 6)	BER / Max Transfer Delay (note 1)	Peak Bit Rate	BER / Max Transfer Delay (note 2)
Rural outdoor (terminal speed up to 500 km/h)	at least 144 kbit/s granularity 13kb/s (note 3)	delay 20 - 300 ms BER 10^{-3} - 10^{-7}	at least 144 kbit/s	BER = 10^{-5} to 10^{-8} Max Transfer Delay 150 ms or more
Urban/ Suburban outdoor (Terminal speed up to 120 km/h)	at least 384 kbit/s granularity 74kb/s (note 4)	delay 20 - 300 ms BER 10^{-3} - 10^{-7}	at least 384 kbit/s	BER = 10^{-5} to 10^{-8} Max Transfer Delay 150 ms or more
Indoor/ Low range outdoor (Terminal speed up to 10 km/h)	2 Mbit/s granularity 150kb/s (note 5)	delay 20 - 300 ms BER 10^{-3} - 10^{-7}	2 Mbit/s	BER = 10^{-5} to 10^{-8} Max Transfer Delay 150 ms or more

Table 1: Minimum bearer capabilities for UMTS

Speech bearers are supported in all operating environments.

Note 1: The minimum achievable transmission delay is less than 20ms. For a given BER operation at lower C/I is possible by extending the interleaving depth. The detailed performance trade-offs between delay and BER (via choice of modulation, coding and interleaving) require further study.

Note 2: The delivery time for NRT/variable delay bearers depends on factors such as operating environment and traffic loading. Delivery times of the order of 150ms with BER in the stated range can be provided (using Type II soft combining ARQ).

Note 3: The indicated granularity is based on BOQAM with a single 1/64 slot allocation and 1/2 rate coding

Note 4: The indicated granularity is based on BOQAM with a single 1/16 slot allocation and 1/2 rate coding

Note 5: The indicated granularity is based on QOQAM with a single 1/16 slot allocation and 1/2 rate coding

Note 6: Finer granularity can be provided by variation of channel coding rate.

5. Service traffic parameters

The OFDMA supports 1-frequency reuse without the need for soft handover, which can support the use of UMTS in various environments with a range of traffic densities and a variety of traffic mixes in most economical manner.

6. Evolution and modularity

The OFDMA concept is service independent, and very flexible in resource management and allocation which is utilised in the implementation of UMTS in phases with enhancements for increasing functionality (for example making use of different modulation and coding technology).

With flexible resource allocation, the OFDMA concept is most suitable for the support of the requirements of an open modular architecture.

7. Handover

Provide seamless (to user) handover between cells of one operator.
 The UTRA should not prevent seamless HO between different operators or access networks.
 Efficient handover between UMTS and 2nd generation systems, e.g. GSM, should be possible.

7.1. Overall handover requirements

Efficient seamless (mobile assisted) handovers can be provided in networks and between TDD and FDD systems.

The OFDMA supports Network handover, Mobile Assisted handover, Forward and MSC assisted handovers.

Handover to second generation systems can be supported by use of an idle frame allowing measurements of signal strengths from alternative base stations.

7.2. Handover requirements with respect to the radio operating environments

The OFDMA radio interface allows handovers within a network, between different environments and between networks run by different operators.

8. Operational requirements

8.1. Compatibility with services provided by present core networks

ATM bearer services

GSM services

IP (Internet Protocol) based services

ISDN services

Flexible RT and NRT bearers with a range of bit rates etc., allow current core network services to be supported.

8.2. Operating environments

OFDMA does not restrict the operational scenario for UMTS, in, for example, international operation across various radio operating environments, across multiple operators and across different regulatory regimes. Further, a range of different MS types (e.g. speech only, high bit rate data), and a variety of services with a range of bit rates are possible.

8.3. Support of multiple radio operating environments

OFDMA can support the requirements of all the specified radio operating environments.

8.4. Radio Access network planning

If radio resource planning is required automatic planning shall be supported

With the flexible resource allocation, the network planning is not as sensitive as in case of GSM.

DCA can be used to re-configure the use of assigned frequency blocks in response to changing traffic.

The OFDMA has the most flexible Frequency Hopping approach "Magic Carpet" which is best utilised in frequency and allocation of resources in different region..

8.5. Public, Private and residential operators

It shall be possible to guarantee pre-determined levels of quality-of-service to public UMTS network operators in the presence of other authorised UMTS users.

The radio access scheme should be suitable for low cost applications where range, mobility and user speed may be limited.
 Multiple unsynchronised systems should be able to successfully coexist in the same environment.
 It should be possible to install basestations without co-ordination.
 Frequency planning should not be needed.

Due to good commonality and flexible resource allocation and advance frequency hopping public, private and residential operation is supported. This include support of unsynchronised multiple system with the usage of DCA.
 Low cost terminals with a restricted set of functionality can be implemented. For example, limited bit rate, power output for private cordless telephone applications.

9. Efficient Spectrum Usage

9.1. Spectral Efficiency

High spectrum efficiency for typical mixtures of different bearer services
 Spectrum efficiency at least as good as GSM for low bit rate speech

The spectral efficiency is considered in detail in evaluation report.
 The results shows that for all service spectrum efficiency is achieved and in all cases greater efficiency than GSM.

9.2. Variable asymmetry of total band usage

Variable division of radio resource between uplink and down link resources from a common pool (NB: This division could be in either frequency, time, or code domains)

Thanks to OFDM, the variable asymmetric band usage is most efficient in OFDMA concept.

9.3. Spectrum utilisation

Allow multiple operators to use the band allocated to UMTS without co-ordination.
 It should be possible to operate the UTRA in any suitable frequency band that becomes available such as first & second generation system's bands

Spectrum sharing requires further study (as noted in ETR 04-01)

OFDMA can be deployed for some applications using a single as little as 800 KHz - 1.6MHz bandwidth (e.g. isolated cell). A small network could be deployed in as little as 3.2MHz. OFDMA spectrum utilisation is most efficient with minimum Guard Band requirements.

9.4. Coverage/capacity

The system should be flexible to support a variety of initial coverage/capacity configurations and facilitate coverage/capacity evolution
 Flexible use of various cell types and relations between cells (e.g. indoor cells, hierarchical cells) within a geographical area without undue waste of radio resources.
 Ability to support cost effective coverage in rural areas

9.4.1. Development and implementation risk

The OFDMA is the most flexible UTRA concept known today, which supports variety of initial coverage and capacity most effectively with the available resources.

9.4.2. Flexibility of radio network design

9.4.2.1. Cell size flexibility

The OFDMA transmission bursts are designed to cover a wide range of channel conditions. This allows operation in picocells, microcells and macrocells. Hierarchical Cell Structures are supported.

9.4.2.2. Cell location flexibility

The Interference Averaging concept means that the system performance is not critically sensitive to base station location

9.4.2.3. Synchronisation

Time synchronisation between different UMTS networks is desirable to optimise spectrum efficiency For both FDD and TDD), but is not essential. Pseudo synchronisation is desirable in TDD mode.

9.4.2.4. Very large cell sizes

Very large cell sizes can be supported (for example by increasing the number of slots allocated to the bearer). Details of other techniques which could be employed, such as adaptive antennas, RF repeater stations or remote antennas are for further study.

9.4.2.5. Evolution requirements

9.4.2.5.1. Coverage evolution

The OFDMA with flexible resource allocation is most efficient in evolution coverage.

9.4.2.5.2. Capacity evolution

Similarly, a minimum of planning is needed in order to install new cells to increase system capacity in areas where coverage is already provided.

10. Complexity / cost

10.1. Mobile Terminal viability

Handportable and PCMCIA card sized UMTS terminals should be viable in terms of size, weight, operating time, range, effective radiated power and cost.

Due to low complexity of OFDMA and low MIPS, the cost of terminal is extremely low. Low cost terminals (speech only) is most feasible in OFDMA concept.

10.2. Network complexity and cost

The development and equipment cost should be kept at a reasonable level, taking into account the cost of cell sites, the associated network connections, signalling load and traffic overhead (e.g. due to handovers).

OFDMA provides a single radio interface concept which can be adapted to all operating environments.

10.3. Mobile station types

It should be possible to provide a variety of mobile station types of varying complexity, cost and capabilities in order to satisfy the needs of different types of users.

Mobile stations can easily be implemented with various complexity/cost/capability trade-offs. For example, low data rate terminals for both GSM and UMTS (multiband/mode) is most economical in OFDMA.

11. Requirements from bodies outside SMG

11.1. Alignment with IMT 2000

UTRA shall meet at least the technical requirements for submission as a candidate technology for IMT 2000 (FPLMTS).

These requirements are fulfilled.

11.2. Minimum bandwidth allocation

It should be possible to deploy and operate a network in a limited bandwidth

The minimum bandwidth for small cell is 1.6 MHz.
The minimum system bandwidth is 5 MHz.

11.3. Electromagnetic compatibility

The peak and average power and envelope variations have to be such that the degree of interference caused to other equipment is not higher than in today's systems.

The peak power and envelope variations can be constrained so that interference is expected to be less severe than (or at least comparable) with GSM

11.4. RF Radiation effects

UMTS shall be operative at RF emission power levels which are in line with the recommendations related to electromagnetic radiation.

Details of emission levels are for further study.
For ease of implementation, a maximum transmitter output power of around 1W peak is considered desirable for hand portable units.

12. Security

The UMTS radio interface should be able to accommodate at least the same level of protection as the GSM radio interface does.

At least supports the same level Security as in GSM, however these issues are for further study in SMG2.

13. CO-existence with other systems

The UMTS Terrestrial Radio Access should be capable to CO-exist with other systems within the same or neighbouring band depending on systems and regulations

Coexistence with other system in OFDMA is most efficient due to low Guard band requirements and most efficient spectrum utilisation. The OFDMA produces the minimum co., and adjacent channel interference.

14. Multimode terminal capability

It should be possible to implement dual mode UMTS/GSM terminals cost effectively.

With backward compatibility with GSM system, multimode terminal is most efficiently implemented and it is the most cost effective terminal.

ETSI SMG#24
Madrid, Spain
December 15th-19th, 1997

Tdoc SMG 896/97

Source: SMG2
Agenda Item: 4.1 UTRA
Subject: Evaluation Document SMG2 - Beta Concept

Concept Group Beta
OFDMA (Orthogonal Frequency Division Multiplex Access)
System Description Performance Evaluation

Disclaimer:

“This document was prepared during the evaluation work of SMG2 as a possible basis for the UTRA standard. It is provided to SMG on the understanding that the full details of the contents have not necessarily been reviewed by, or agreed by, SMG2.”

OFDMA Evaluation Report

The Multiple Access Scheme Proposal for the UMTS Terrestrial Radio Air Interface (UTRA)

Part 1 System Description Performance Evaluation

Summary:

This document describes in detail the OFDMA (Orthogonal Frequency Division Multiple Access) radio interface. This system is proposed for the radio interface for the third generation system (UMTS) in Europe. In addition, results are provided for both link and system level simulations.

The Evaluation Report consist of 3 parts:

- Part 1: System Description and Performance evaluation
- Part 2: Link Budget Templates and Technology Description Template
- Part 3: Frequently Asked Questions

Table of Contents

1. OFDMA System Description	193
2. OFDMA System Features	194
3. OFDMA Logical Channels	195
3.1 Common Control Channels	195
3.1.1 IACH (DL)	195
3.1.2 BCCH (DL)	195
3.1.3 RACH (Random Access Channel) Physical Structure	196
3.1.4 PCH(DL)	197
3.2 Dedicated Channels	197
4. OFDMA Resource Allocation/Physical Channel	198
4.1 Time and Frequency Parameters	198
4.2 Multiple Access (Physical Channel Assignment)	199
4.3 Un-modulated Guard Carriers	199
4.4 Antenna Diversity	200
5. Radio Functions	201
5.1 Channel Coding	201
5.1.1 Convolutional Encoding	201
5.1.2 Reed Solomon Coding and Concatenated Coding	201
5.1.3 Turbo Coding	201
5.2 Interleaving	201
5.3 Modulation and Demodulation Schemes	201
5.3.1 Coherent Modulation	201
5.3.2 Differential Modulation	202
5.4 Random Phase Shift Technique (RPS)	203
5.5 Random Orthogonal Transform (ROT)	203
5.5.1 Transmitter Procedures	204
5.5.2 Receiver Procedures	204
5.6 Time and Frequency Synchronisation	204
5.6.1 Initial Modulation Timing Synchronisation (Downlink)	205
5.6.2 Initial Modulation Timing Synchronisation (Uplink)	206
5.6.3 Modulation Timing Tracking (Uplink & Downlink)	206
5.6.4 Initial Frequency Offset Synchronisation	207
5.6.5 Frequency Offset Tracking	207
5.6.6 Synchronisation Accuracy	207
5.7 PA Linearity	208
5.7.1 Interference to the Adjacent Band Signal	208
5.7.2 Reduction of OFDM Peaks	209
5.7.3 Real PA Nonlinearity Measurements	209
5.7.4 OFDMA receiver complexity (baseband)	211
6. Radio Maintenance Control	212
6.1 Timing Advance	212
6.2 Handover	212
6.2.1 Base Station Originated Hand Over	212
6.2.2 Mobile Assisted Hand Over (MAHO)	212
6.2.3 Forward Hand Over	213
6.2.4 MSC Initiated Handover	214
6.2.5 HCS and GSM handover	214
6.3 Power Control	215
7. Protocols	216
7.1 Protocol Architecture	216
7.2 Random Frequency Hopping Operation	216
7.3 Dynamic Channel Allocation (Fast DCA)	217
7.4 Dynamic Channel Allocation (Simple DCA)	219
8. System Deployment Aspects	220
8.1 System Guard	220
8.2 Phased Deployment Model	220

8.3 Commonality Aspects	221
8.4 Deployment Options	221
8.5 Adaptive/Smart Antenna	222
9. Simulation Description	223
9.1 Link Level Simulation Description (Differential Operation)	223
9.1.1 Speech Services	223
9.1.2 LCD Services	224
9.1.3 UDD Services	224
9.2 Link Level Simulation Description (Coherent Operation).....	224
9.3 System Level Simulation Description (Differential Operation)	224
9.3.1 Speech Services	224
9.3.2 LCD Services	224
9.3.3 UDD Services	224
10. Link Level Results (Differential Operation)	226
10.1 Speech.....	226
10.2 LCD 144 Simulation.....	227
10.3 LCD 384 Simulation.....	228
10.4 UDD 144, 384 Link Level Simulation	229
10.4.1 Mode A.....	229
10.4.2 Mode B.....	232
10.5 UDD 2048 Simulation	235
10.5.1 Mode B.....	235
11. Link Level Results (Coherent Operation).....	237
12. System Simulation Results (Differential Operation).....	239
12.1 Simulation Conditions	239
12.1.1 Overview of System Level Simulation.....	239
12.1.2 Statistical calculations	241
12.1.3 Pathloss calculation	242
12.1.4 Fading calculation	242
12.1.5 Neighbour BS Information.....	242
12.1.6 Interference Restriction.....	242
12.1.7 Traffic Management.....	243
12.1.8 MS Mobility.....	243
12.1.9 Handoff	243
12.1.10 Power Control	243
12.2 System Level Simulation Results (Speech).....	243
12.2.1 Outdoor to Indoor and Pedestrian A	244
12.2.2 Vehicular A.....	245
12.2.3 Indoor Office A	246
12.2.4 Speech System Level Simulation (Summary).....	248
12.3 System Level Simulation Results (LCD 384).....	248
12.3.1 Vehicular A.....	248
12.4 System Level Simulation Results (UDD384)	251
12.4.1 Outdoor to Indoor and Pedestrian A	251
12.5 System Level Simulation Results (UDD2048)	251
12.5.1 Indoor Office A	251
12.6 System Level Simulation Results (50%speech+50%UDD384).....	252
12.6.1 Indoor Office A	252
13. Conclusion	253
14. Annex.....	254
15. Annex.....	254
15.1 System Level Simulation Updates	254
15.1.1 Vehicular A - LCD 384	254
15.1.2 Speech.....	254
15.1.3 UDD 384 - Pedestrian A	255
15.2 Abbreviations	258
15.3 References	258

1. OFDMA System Description

The most important aspects of the physical layer are the time/frequency structure and the OFDM parameters. The following table summarises the common parameters and key technical characteristics of the OFDMA air-interface.

Table 1: Physical Parameters

	Parameter	Value
1	Sub-carrier spacing f_{sc} [Hz]	$100[\text{kHz}]/24 = 4.1666[\text{kHz}]$
2	Effective modulation period T_M [sec]	$1/f_{sc} = 240[\mu\text{s}]$
3	Number of sub-carrier per band slot	24 sub-carriers (100[kHz])
4	Modulation period	$60[\text{ms}]/13/16 = 288.46[\mu\text{s}]$ (Half of GSM time slot)
5	Time slot length T_{TS} [sec]	$60[\text{ms}]/13/16 = 288.46[\mu\text{s}]$ (Same as Modulation period)
6	Tx window shape	Full cosine roll off (Tukey)
7	Ramp period T_R [sec]	$10[\mu\text{s}]$
8	Pre-Guard time T_{G1} [sec]	$38-a[\mu\text{s}]$
9	Post-Guard time T_{G2} [sec]	$a[\mu\text{s}]$ <i>Proposal $a=8.0\mu\text{s}$</i>
10	Modulation unit	Consists of 1 band slot and 1 time slot
11	Modulation block	4 time slots and 1 band slot

2. OFDMA System Features

The following summary shows some advantages of the OFDMA UTRA proposal.

- Single core PHY layer minimizing hardware costs with 2 software driven MAC options
- SFH TDMA based MAC for majority of UMTS services
- TDD DCA MAC for unpaired spectrum allocations, asymmetrical services & unlicensed usage
- Adaptive Modulation schemes for different channels
- Robustness against multi-path and Doppler spread
- Low computational overheads
- Simple low cost low-bit rate only terminals feasible
- Straightforward and efficient high bit rate support
- Small guard band requirements ~ 100 kHz
- High Spectral Efficiency achievable - 2 Mbits/s in 1.6 MHz feasible
- No frequency planning option available - effective re-use factor of ~1
- GSM Backwards Compatibility
- Minimum Bandwidth Requirements for system deployment only 1.6 MHz (or less) and deployment possible in steps of 100kHz
- Standard TDMA cellular planning and system enhancement techniques (smart antennas, hierarchical cell structures) can be supported

3. OFDMA Logical Channels

OFDMA logical channel will follow the standards set in ITU and ETSI. In this section the logical channels for the OFDMA system are defined.

3.1 Common Control Channels

3.1.1 IACH (DL)

The IACH is the initial acquisition channel used for time and frequency synchronisation. In addition the IACH channel conveys information about the allocation of the BCCH channels. The IACH channel is a knowledge enclosed reference operation (KERO) burst (Figure 2) which includes 11 pilot symbols in order to ease detection. A KERO detector consists of a comb filter and correlator (Figure 3). IACH carries a 15 bit random sequence seed and can also be used for neighbour cell search for Mobile Assisted Hand Over (MAHO).

3.1.2 BCCH (DL)

The Broadcast Control Channel is a point-to-multipoint channel providing cell specific system information. The burst type of BCCH is a normal differential burst (Frequency Domain Differential Encoded). BCCH's information is convolutionally encoded ($R = 1/3$) and interleaved (block interleaving) over 64 BCCH bursts.

Allocation of IACH and BCCH bursts

Figure 1 shows IACH and BCCH allocation in the time and frequency domains. IACH bursts are allocated every 16 band slots (fixed at every 1.6 MHz).

The IACH burst carries a 15 bit random sequence seed which is updated. This random sequence is split into three parts R1, R2 and R3 each consisting of 5 bits. R1 and R2 dictate which bandslot a BCCH burst will be allocated. The first BCCH burst after the IACH burst is allocated 3 timeslots later and R1 bandslots higher. The second BCCH burst is allocated 6 timeslots later and R2 bandslots higher. The third part of the random number, R3, dictates when the IACH burst will be transmitted. The next IACH burst is transmitted at $64 + R3$ timeslots later on the same bandslot.

If system band is wider than 1.6[MHz] the same structure and contents of IACH and BCCH will be transmitted at 9 timeslots later on a 1.6[MHz] higher band. This ensures reception of the IACH and BCCH bursts.

All the base stations transmit IACH and BCCH bursts using the same scheme. The random numbers (R1, R2, R3) are independent and therefore there is a low probability ($3/16BS/64TS = 0.3[\%]$) of collision.

No specific frequency channels are allocated for IACH and BCCH and therefore no management is required when using the same band in each cell. IACH and BCCH are also transmitted independently from the other channels (TCHs, etc.). When IACH and BCCH transmit at the same time and same bandslot as an active channel, the active channel is punctured.

MS actions

After the initial MS power on, the MS tunes to the bandslot which may transmit IACH channel (every 1.6[MHz]) and sets KERO detector active. If no signal is received, it is concluded that the system is not operated in the frequency band or the location is out of service area.

If the system is operated, KERO detector will detect all IACHs transmitted by BSs which are located close to the MS.

MS select BS with the highest IACH signal , decodes 15 bits random seed in the IACH.

Now the MS can tune to the BCCH.

Once IACH is detected, MS will not loose the position of future IACH and BCCH because the locations can be calculated uniquely by updating random number.

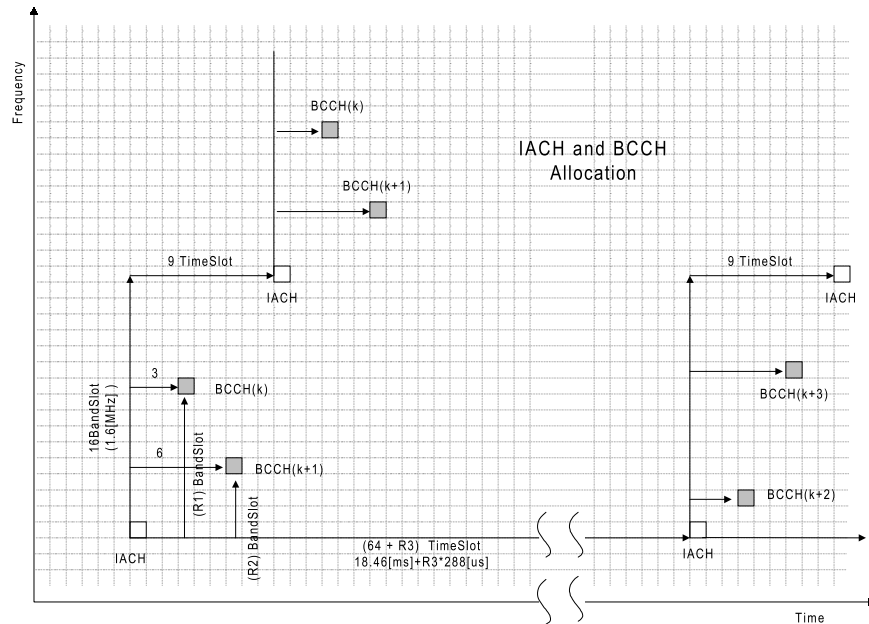


Figure 1: Location of IACH and BCCH channels

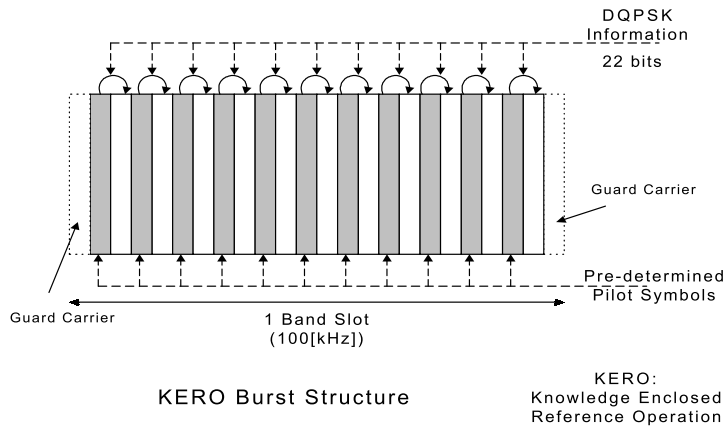


Figure 2: KERO burst structure

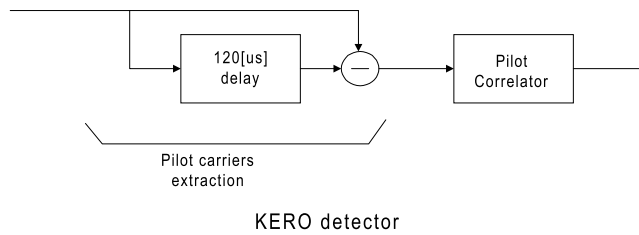


Figure 3: KERO detector

3.1.3 RACH (Random Access Channel) Physical Structure

The Random Access Channel is an uplink channel, carrying the information from the mobile station.

RACH burst

KERO burst (Figure 2) is also used for the RACH burst which can be detected by KERO

detector in the BS. RACH carries a Random Access Number (RAN) which consists of 7 bits related to the Mobile Station Identification (MSID) number.

Allocation and Power Control of RACH

Two continuous time slots are prepared for the RACH burst, because propagation delay is unknown before communication starts between MS and BS. The RACH burst will be transmitted at the same power which was estimated as the down link signal strength (Open Loop Power Control) based on the received IACH and BCCH information.

MS and BS actions

MS measures RSSI and calculates adequate transmit power.

MS transmit RACH burst at calculated power and timing where a propagation delay of 0[μ s] is assumed.

BS detects RACH using KERO detector and then decodes the RAN.

If detection and decoding was done successfully, BS reports back the RAN and time alignment value and location of DCCH (Dedicated Control Channel) through AGCH (Access Grant Channel) to the MS.

MS listens to AGCH, if the RAN corresponds to the RAN of the mobile, assignment of DCCH can be confirmed.

If the RAN is not detected, MS will transmit RACH again.

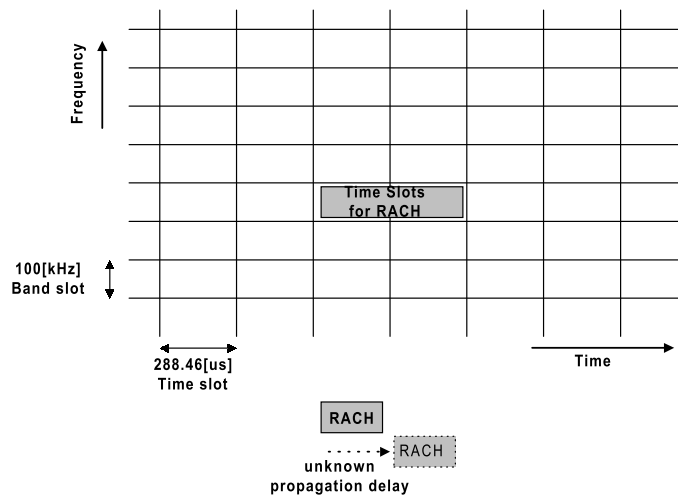


Figure 4: RACH Structure

3.1.4 PCH(DL)

The Paging Channel is a downlink channel that is used to carry information to a mobile station. It can also be used for location update of mobile stations.

3.2 Dedicated Channels

DCCH (DL & UL)

The dedicated control channels are bi-directional and are used to carry control information to and from the mobile station to the network.

TCH (DL & UL)

The traffic channels are bi-directional or unidirectional channels which are used to carry the user information (Speech, data) between the network and mobile station.

AGCH

The Access Grant Channel reports TCH allocations and timing advance information for specific MSs.

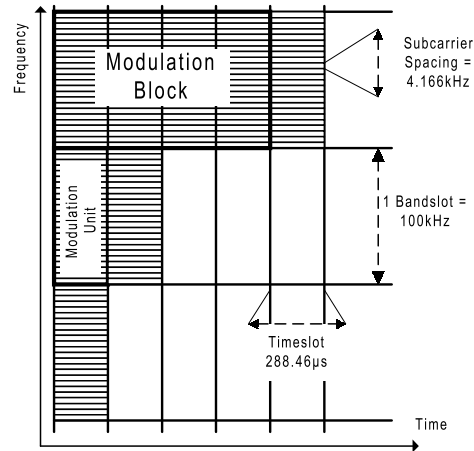
4. OFDMA Resource Allocation/Physical Channel

4.1 Time and Frequency Parameters

The OFDMA air-interface utilises a time and frequency grid for basic physical channel structure.

Figure 5 shows the modulation blocks in the time and frequency grid. The resources (time and frequency) are allocated based on the type of services, operational environment/scenarios (i.e. give more flexibility). There are four mode of resource allocations:-

- a) 1 x time slot + 1 x band slot
- b) n x time slots + 1 x band slot
- c) 1 x time slot + n x band slots
- d) n x time slots + n x band slots



The TDMA frame structure is shown in Figure 6. Each frame is of length 4.615 ms which is divided into 4 sub-frames of length 1.1534 ms. A sub-frame contains 4 time slots of duration 288.46 μs.

The timeslot contains a guard period, power control information and data. Every OFDM symbol is mapped onto one time slot.

Figure 5: Time and frequency grid

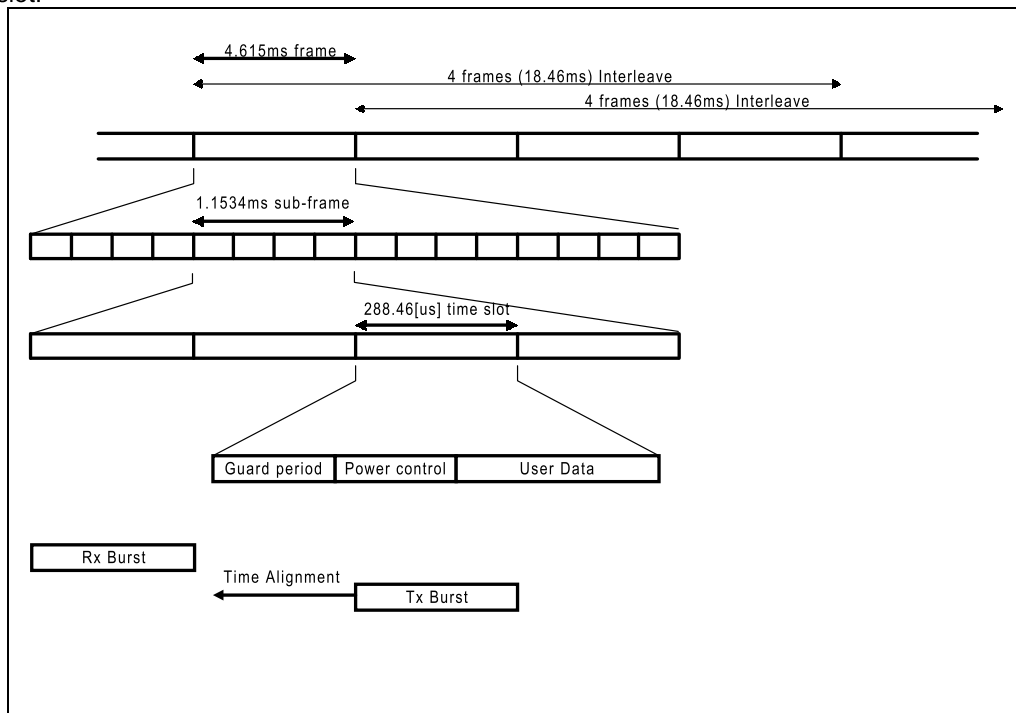


Figure 6: Frame (TDMA) Structure

The Guard time is applied to be robust against very long multi-path delay. Tx windowing shape is full cosine roll off (Tukey window), this reduces adjacent band emissions effectively. Figure 7 shows the shape of the modulation unit.

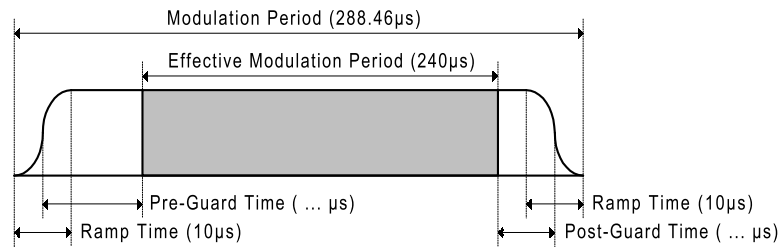


Figure 7: OFDM Modulation Burst

The whole system frequency band is divided into small blocks (bandslots) with a fixed number of subcarriers. To maintain compatibility with GSM a bandslot of 100kHz is chosen which consists of 24 subcarriers. Therefore the subcarrier spacing is $\frac{100}{24} [kHz] = 4.167 [kHz]$.

In each bandslot the two subcarriers at the edge of the bandslot are left unmodulated to relax receiver blocking requirements. In addition, the interference of two adjacent blocks of subcarriers is reduced, which may occur when their orthogonality is compromised due to non-linear PA effects.

Adjacent bandslots can be concatenated to allow transmission of wideband services.

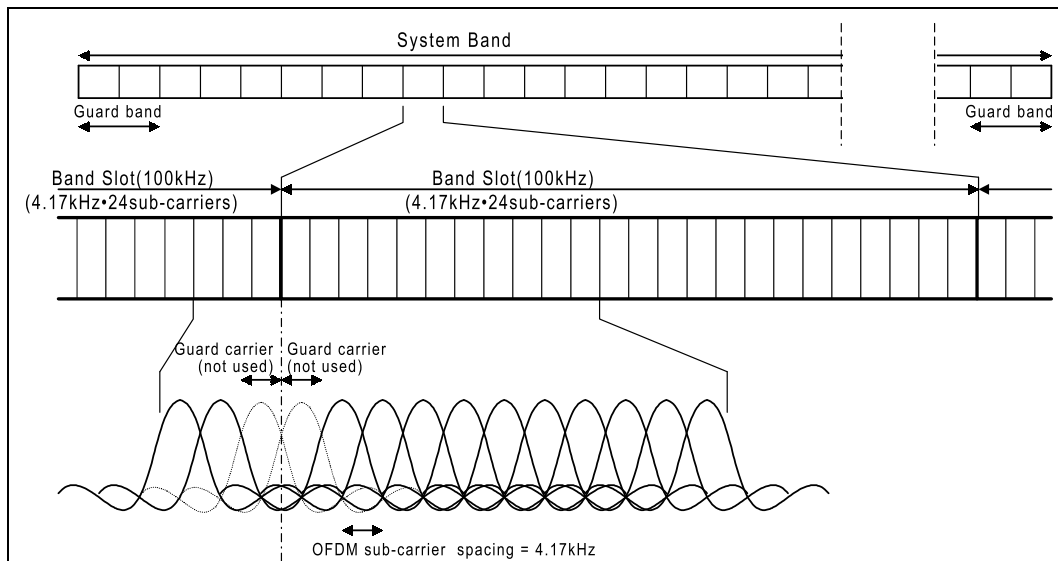


Figure 8: BDMA Frequency Structure

4.2 Multiple Access (Physical Channel Assignment)

The OFDMA utilises the time division multiple access with the aid of slow and fast dynamic channel allocation. Additionally frequency division multiple access (FDMA) is used with variable bandwidth.

4.3 Un-modulated Guard Carriers

In order to reduce adjacent channel emissions and facilitate easy bandslot separation one subcarrier at the edge of the bandslot is left unmodulated.

Figure 9 depicts the scheme.

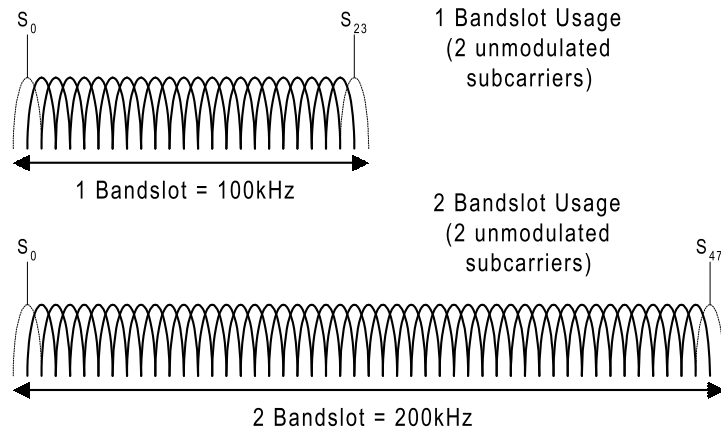


Figure 9 : Guard Carrier Allocation

4.4 Antenna Diversity

Receiver antenna diversity is utilised at the BS and the MS. Maximum ratio combining (MRC) is used to combine the two separate baseband signals after demodulation and is used with confidence weighting to form the received soft decision bits.

5. Radio Functions

5.1 Channel Coding

5.1.1 Convolutional Encoding

Convolutional encoding and soft decision Viterbi decoding is utilised for the basic data transmission. The objective of this coding is to achieve good quality in the tough mobile radio channel. A constraint length of 7 together with variable coderates in the range of 1/4 to 3/4 (according to channel characteristics and modulation scheme) are proposed. Fine tuning of the bit rates is achieved by puncturing during the interleaving and mapping of modulation symbols onto OFDM subcarriers.

Table 2: Basic Code Rates

Constraint length K	Coding rate R
K = 7	R = 1/4
K = 7	R = 1/3
K = 7	R = 1/2
K = 7	R = 3/4 (punctured 1/2)

5.1.2 Reed Solomon Coding and Concatenated Coding

To achieve very low bit error rates (e.g. 10e-6) for video encoding or data transmission Reed Solomon encoding is effective. This coding will be concatenated with an inner convolutional encoder.

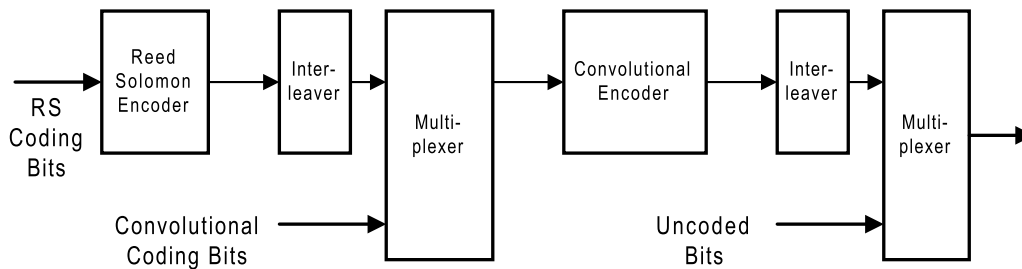


Figure 10: Encoder Structure

5.1.3 Turbo Coding

[For Further Study]

5.2 Interleaving

Interleaving is utilised so the channel coding performs well in the presence of burst errors caused by the fading channel. Interleaving length depends on the service related specified delay constraint.

5.3 Modulation and Demodulation Schemes

5.3.1 Coherent Modulation

While differential detection is the simplest to implement, the advantages of coherent detection over differential detection are a gain of about 2 dB in signal-to-noise ratio and the possibility to do higher order QAM, such as 16-QAM. Disadvantages are a more complex implementation and the presence of extra pilot symbols. Efficient pilot patterns and channel estimation techniques have been described in [SMG2 TD 116/96, 'A conceptual study of OFDM-based multiple access schemes', Telia Research, 22 May 1996]. In the case of indoor use, the relative delay spread and Doppler bandwidth are so small that a simplified scheme is possible, which uses a pilot pattern as depicted in the following figure. Only one out of every 16 subcarriers is a pilot, so the training overhead is 6.25%. In the receiver, reference values for each subcarrier can be obtained by simply averaging the 4 closest pilots. This procedure was used in the evaluation of the indoor scenario.

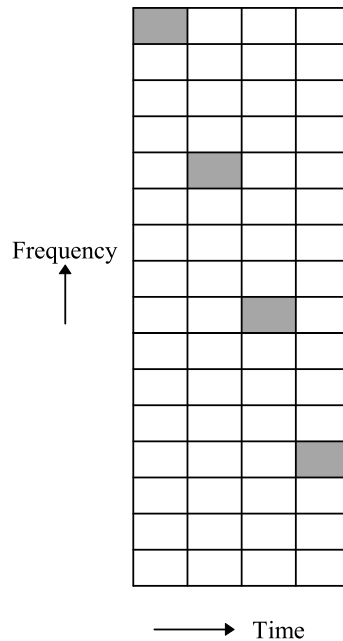


Figure 11: Time and frequency grid showing OFDM pilot symbols

5.3.2 Differential Modulation

Differential modulation will facilitate easy implementation and stable processing. The proposed schemes are differential QPSK and differential 8PSK. 8PSK combined with a lower coding rate will accommodate the highest data rate requirements in the UMTS.

The modulation scheme is Frequency Domain Differential Encoding (e.g. FD-DQPSK, FD-D8PSK).

Each bandslot contains its own reference symbol.

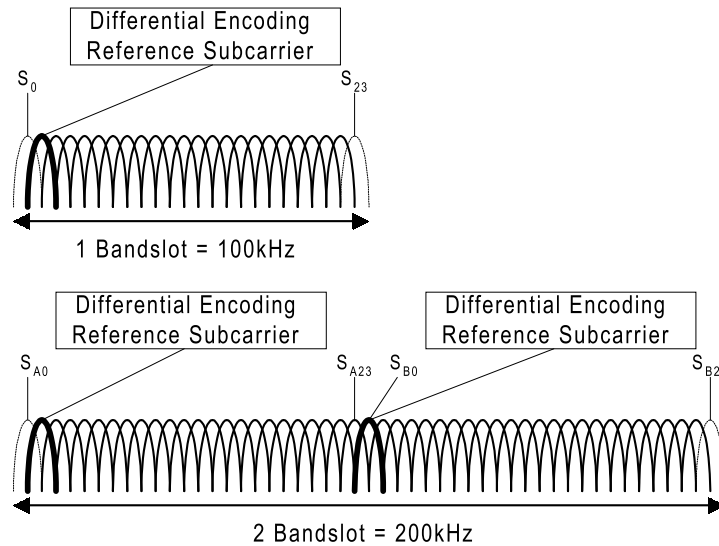


Figure 12: Reference Subcarrier Allocation

5.4 Random Phase Shift Technique (RPS)

This technique helps to 'randomise' interference and enables the differential detector to distinguish 'desired' signal from interfering signal. Receiver structures have been developed to estimate the received $\frac{S}{(N+I)}$ and apply this information as confidence weights to the soft decision demodulated bits before Viterbi decoding.

A random phase sequence is applied to the differential M-ary PSK symbols after differential encoding before IFFT.

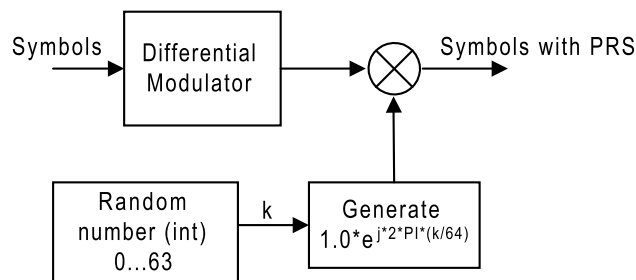


Figure 13: Random Phase Shift Technique

The random sequence is different for different cells and unique within the cell (the possibility to use different sequences within one cell is also possible). The receiver can perform an de-rotation (cross-correlation) of the received RP-shifted symbols with the know RPS sequence to recover the original sequence. This technique is applied to all communications after the initial communication set-up phase.

5.5 Random Orthogonal Transform (ROT)

The Random Orthogonal Transform (ROT) technique is an enhancement of the RPS technique to randomise interference in order to improve the demodulation process. It is based

on small matrix transformation in the transmitter and receiver. The following section describes briefly this technique.

5.5.1 Transmitter Procedures

The adjacent symbols (already differentially encoded) are named x_0 and x_1 , the resulting symbols are named y_0 and y_1 .

For simplification we define: $rot(\vartheta) = e^{j2\pi\vartheta}$

We perform the following calculation to obtain the resulting symbols y_0 and y_1 :

$$\begin{aligned} y_0 &= \frac{1}{\sqrt{2}}(x_0 + x_1) \cdot rot(\Theta_0) \\ y_1 &= \frac{1}{\sqrt{2}}(x_0 - x_1) \cdot rot(\Theta_1) \end{aligned} \quad \text{or} \quad \begin{pmatrix} y_0 \\ y_1 \end{pmatrix} = \begin{pmatrix} \frac{1}{\sqrt{2}} rot(\Theta_0) & \frac{1}{\sqrt{2}} rot(\Theta_0) \\ \frac{1}{\sqrt{2}} rot(\Theta_1) & -\frac{1}{\sqrt{2}} rot(\Theta_1) \end{pmatrix} \begin{pmatrix} x_0 \\ x_1 \end{pmatrix}$$

With the definition of the transformation matrix R : $R = \frac{1}{\sqrt{2}} \begin{pmatrix} rot(\Theta_0) & rot(\Theta_0) \\ rot(\Theta_1) & -rot(\Theta_1) \end{pmatrix}$

The matrix transformation we perform can be written as: $\begin{bmatrix} y_0 \\ y_1 \end{bmatrix} = R \cdot \begin{bmatrix} x_0 \\ x_1 \end{bmatrix}$

5.5.2 Receiver Procedures

In order to demodulate the incoming signal correctly the receiver performs the inverse operation.

The used Matrix in the receiver is called R^{-1} with:

$$R^{-1} = \frac{1}{\sqrt{2}} \begin{pmatrix} rot(-\Theta_0) & rot(-\Theta_1) \\ rot(-\Theta_0) & -rot(-\Theta_1) \end{pmatrix}$$

We can also write:

$$z_0 = \frac{1}{\sqrt{2}}(y_0 \cdot rot(-\Theta_0) + y_1 \cdot rot(-\Theta_1)) = \frac{1}{2}(x_0 + x_1) + \frac{1}{2}(x_0 - x_1) = x_0$$

$$z_1 = \frac{1}{\sqrt{2}}(y_0 \cdot rot(-\Theta_0) - y_1 \cdot rot(-\Theta_1)) = \frac{1}{2}(x_0 + x_1) + \frac{1}{2}(-x_0 + x_1) = x_1$$

Using the described matrix operation the original information symbols can be correctly recovered and the interfering signal can be efficiently randomised.

5.6 Time and Frequency Synchronisation

Synchronisation is an essential issue for the OFDMA system. The following aspects are considered for uplink and downlink: Initial modulation timing synchronisation, modulation timing tracking, initial frequency offset synchronisation and frequency tracking.

The special structure of the OFDMA system which separates users in time and frequency (bandslots) simplifies the accuracy requirements for synchronisation compared to other OFDM systems. The OFDMA scheme provides good synchronisation performance compared to single carrier modulation, the basis is the guard time which is required to mitigate multipath effects.

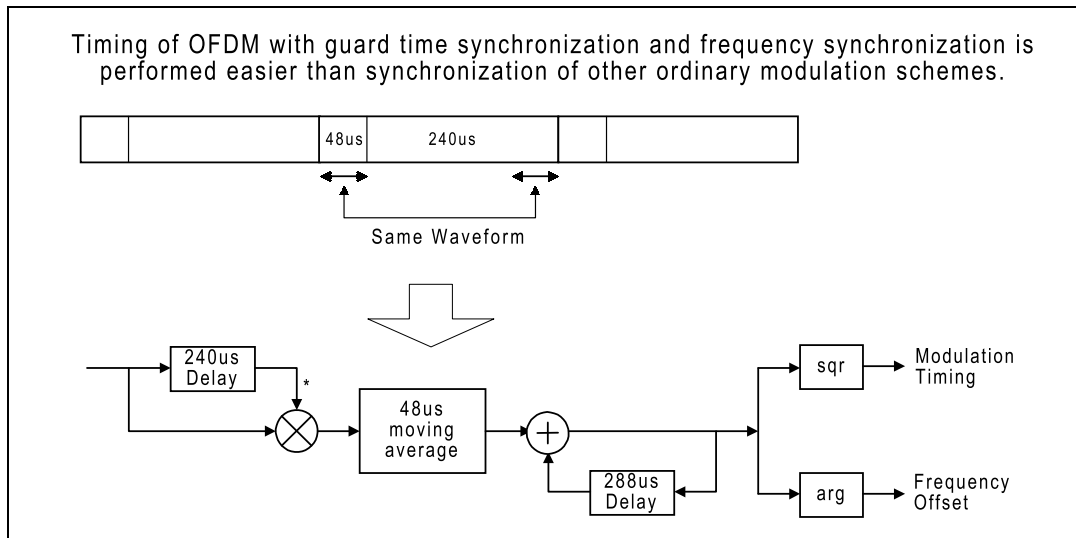


Figure 14: Synchronisation (Schematic)

5.6.1 Initial Modulation Timing Synchronisation (Downlink)

Initial timing synchronisation is required to adjust the MS internal timing to the basestations time frame. After switching on, the mobile station monitors the IACH channel and the BCCH channel.

The modulation burst in the OFMDA system consists of an OFDM symbol with an additional cyclic extension (copy of a portion of the time signal). In the receiver the structure of the burst can be detected by autocorrelation of the time domain signal. Using multiple bursts for the correlation (averaging) the accuracy of the timeslot structure in tough radio environments with low S/N, low C/I and fading channels can be improved. Once the timeslot structure is detected an additional detection of the systems frame structure can be achieved.

The initial, still undetected frequency offset does not significantly degrade the performance of the correlation algorithm.

The correlation equation is $p(k) = \sum_1^K s^*(k) \cdot s(k - T_{OFDM})$ where p(k) is the complex

correlation value and is the summation over the available guard samples. $T_{OFDM} = \frac{1}{f_{SC}}$. where

f_{SC} is the subcarrier spacing. If the samples are equal (copy) the correlation value is high, in other regions (the OFDM signal is almost noise like) the correlation values are low.

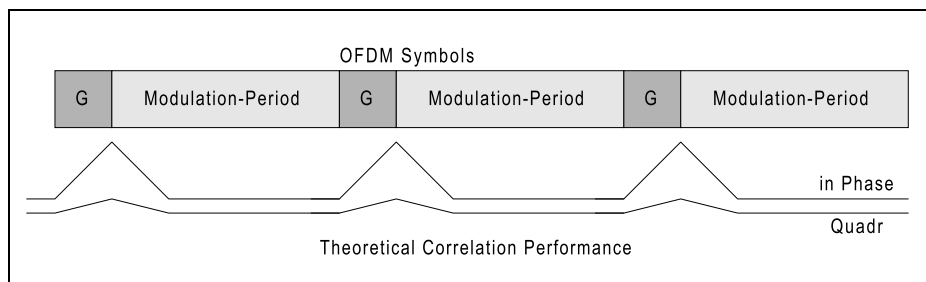


Figure 15: Theoretical Time Synchronisation Performance (Correlation)

The theoretical behaviour of the correlation based timing detection (synchronisation) is depicted in Figure 15, the figure shows also the effect of a frequency offset (small peaks in the q-path).

Figure 16 shows the performance in the Vehicular channel B model. The S/N ratio was 5.0 dB with no interference and no frequency offset. Summation over multiple slots gives superior accurate timing detection.

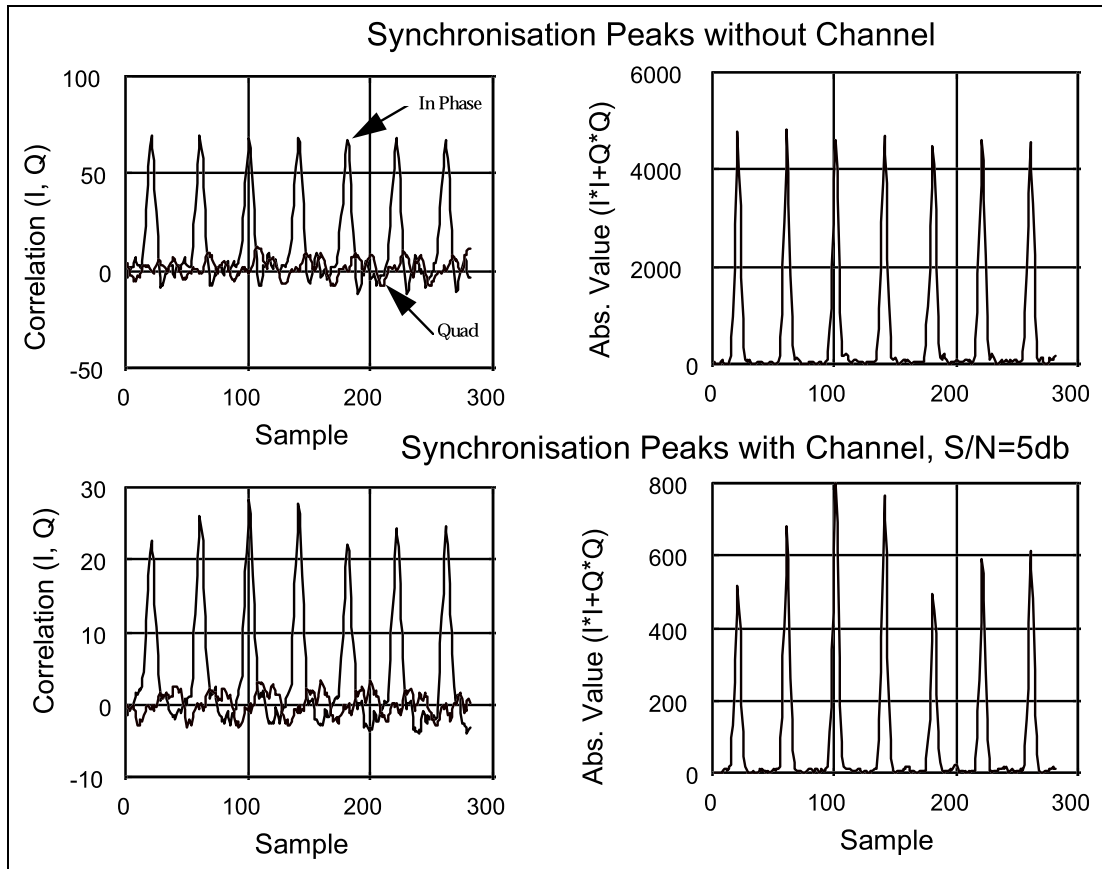


Figure 16: Time Synchronisation in typical fading channel environment

5.6.2 Initial Modulation Timing Synchronisation (Uplink)

After the mobile has detected the basestations timing it sends a RACH to the basestation. The BS measures the time offset for the received RACH and sends back the necessary timing advance to the MS (very similar to GSM). In the frame structure of the OFDMA system reserved slots for reception of RACH exist.

5.6.3 Modulation Timing Tracking (Uplink & Downlink)

Due to the time and frequency structure of the OFDMA system the timing tracking is less critical compared to other OFDM systems where users are interleaved in the frequency domain. The basestation can measure the position of the received OFDM burst within the allocated slot for each MS individually and send the according timing alignment information back to the mobile station.

Additionally, timing information can be refined after the transformation in the subcarrier domain.

In the mobile station the timing information is obtained and adjusted by the above mentioned correlation algorithm. Accurate timing information is required to determine the position of the 'useful' data samples within each burst so the FFT-window can be placed correctly. The guard samples relax the requirement for accurate timing because the position of the FFT window can be shifted within the guard time without performance degradation. Additional timing offset

correction can be performed to cope with the FFT window misplacements.

5.6.4 Initial Frequency Offset Synchronisation

After initial timing synchronisation of the mobile station, the frequency offset can be measured by phase comparison of the (ideally) equal time samples within each burst. Equal samples are placed in the guard interval of the OFDM burst. A phase rotation indicates an frequency offset. Using this technique a range of $-\frac{1}{2}f_{sc} \leq fo \leq +\frac{1}{2}f_{sc}$ can be detected. The initial offset will however extends this range and is detected using the specially designed symbols in the IACH channel.

5.6.5 Frequency Offset Tracking

After initial frequency synchronisation of the mobile station a frequency tracking algorithm calculates the offset within the range of $-\frac{1}{2}f_{sc} \leq fo \leq +\frac{1}{2}f_{sc}$. The offset information is fed back into the VC-TCXO of the down-converters. Our simulations compared different frequency tracking algorithms with realistic models of the VC-TCXO drift behaviour.

5.6.6 Synchronisation Accuracy

The proposed synchronisation acquisition and tracking algorithm is independent of the modulation scheme (coherent-non coherent, differential or coherent) and shows sufficient performance.

Therefore the same schematic applies to the coherent and non-coherent reception type of operation, no variations are necessary.

For coherent 16-QAM reception further processing in the frequency (subcarrier domain) is possible to further improve the performance. Frequency domain time tracking (or combined time-domain frequency-domain tracking algorithms) could be based on observing phase shifts of the known pilots within the time-frequency grid on the subcarrier domain which is very simple.

Some more explanations:

In the downlink only an IACH is multiplexed in order to allow fast and precise initial timing and frequency synchronisation. In the actual 'communication mode' the timing and frequency tracking is performed using the proposed, correlation based, synchronisation algorithm. In the uplink the rough timing offset is detected by the base station by measuring the arrival time of the RACH burst. This gives an initial time-advance value which is reported back to the mobile. During the communication the arrival time of the burst is detected by the base station using the proposed tracking algorithm (same as in the downlink) or an tracking algorithm in the frequency (subcarrier) domain, based on the detected constellation rotation.

The rotation can be explained by the Fourier transform equation:

$$F(g(t - t_0)) = F(g(t))e^{-j\omega t_0}.$$

Both algorithms can also be combined. The alignment values are calculated regularly and reported to the MS. Accuracy requirements are relaxed because the design of the burst allows some overlapping arrival (another advancing feature of the raised cosine pulse shaping besides the reduction of out-of-band emission). Additionally the guard time helps to compensate timing misalignments.

The current burst design proposes a guard interval at the front and an additional guard interval at the back of the OFDM symbol, therefore an timing inaccuracy of $\pm 10\mu\text{s}$ can be handled without any performance degradation. The resulting frequency domain constellation rotation, caused by timing misadjustments can easily be compensated after the FFT.

Summary: *Timing misalignments in the range of $\pm 10\mu\text{s}$ can be allowed without performance degradation. Furthermore, timing errors of $-20\mu\text{s} \dots +15\mu\text{s}$ can be allowed with negligible performance degradation.*

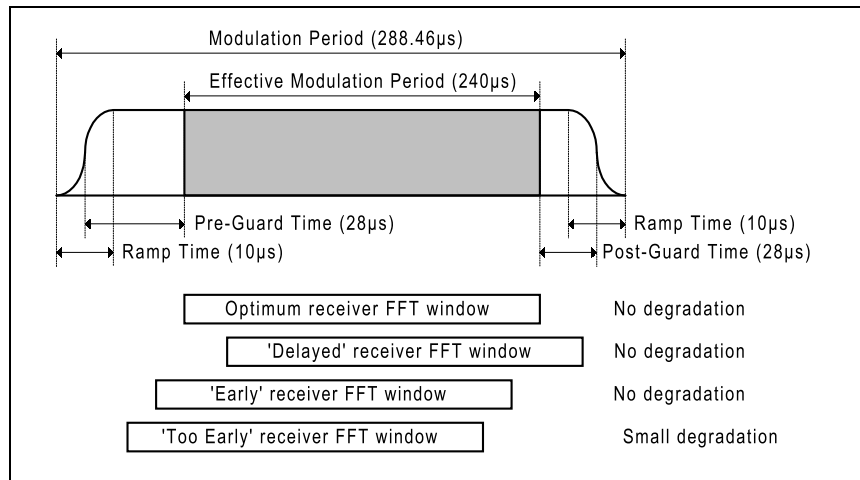


Figure 17: OFDMA burst and synchronisation requirements

5.7 PA Linearity

The envelope of the OFDM signal has a large variance. The complex envelope is approximated by a complex Gaussian distribution. The peak is extremely high, this generates problems for the physical realisation of the amplifiers (A linear-amplifier is expensive, especially for a (low-cost) hand portable terminal transmitters).

Simulations were therefore conducted to examine the power spectrum produced by a non-linear amplifier when transmitting an OFDM signal. The results are shown in Figure 18. These results are shown for different values of output back off (OBO) and are compared to GMSK and QPSK. The model for the amplifier includes the AM-AM and AM-PM distortions. (These distortions were taken from a real device.) The results show that for a reasonable value of OBO the power spectrum produced by the OFDM signal is comparable to other modulation schemes.

5.7.1 Interference to the Adjacent Band Signal

In the OFDMA system, the output power of each user is limited and controlled by a precise power control. Additionally, by back-off adjustment, the power spectrum density of distortion into adjacent band is at least 20dB lower than the signal power spectrum density.

In a typical environment, operation at maximum output power will be a rare case. In OFDMA, designed for operation under low S/N, the influence to adjacent bands is therefore expected to be small.

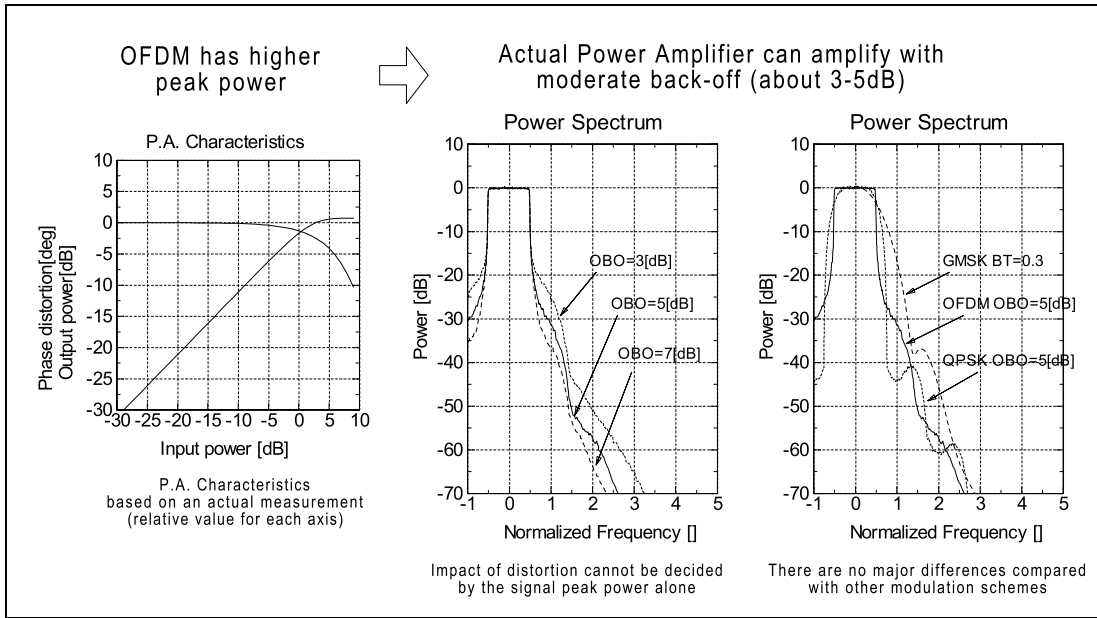


Figure 18: Comparison of OFDM, GMSK and OFDM with non-linear PA

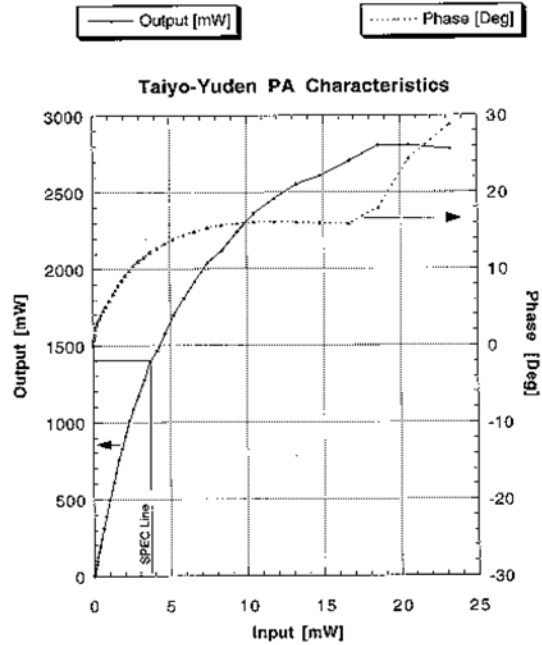
5.7.2 Reduction of OFDM Peaks

Several techniques are known to reduce the Peak-to-Average-Power (PAPR) of the OFDM signal. The PAPR can be expressed as $PAPR = 10 \cdot \log(N)$ where N is the number of subcarriers. The distribution shows that the probability of a high peak is very low. The OFDMA system is designed to operate without any means to reduce the PAPR, but means to reduce the PAPR are considered as an option. Some well known techniques are: Special Coding, Soft-Clipping Windowing and Partial Transmit Sequences (see *Mueller97*).

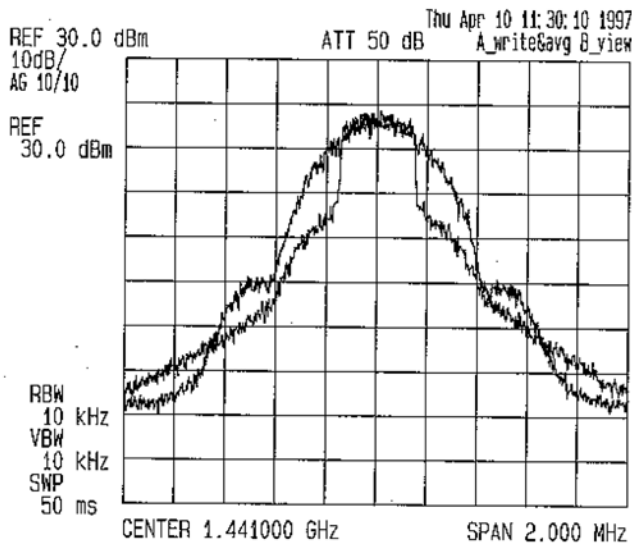
5.7.3 Real PA Nonlinearity Measurements

We measured the non-linear PA effects on currently available off-the-shelf PA for the Japanese PDC system (1.5GHz). The PA are used in handsets (cheap) and are not optimised for OFDM signals. The graph shows the AM-AM and AM-PM conversion characteristics. The graph shows the AM-AM and AM-PM conversion characteristics. We used this amplifier and compared the non-linear effects for different modulation schemes (OFDM, GMSK, OQPSK,...).

Please note that the input-output characteristics is in the linear (not dB) scale.



The following figure shows the result of an actual measurement. We compare the spectrum of an OFDM signal (46 subcarriers) at an Output Back Off (OBO) of 3dB with an GMSK



spectrum. The PA efficiency is shown in Table 3. The efficiency is 43.3% for the OFDM signal and 66% for the GMSK signal. The spectrum shapes are almost equal.

The conclusion is that OFDM signals, amplified with a small back off (3dB) have a comparable spectrum with GMSK signal. In addition the OFDM signal has a much smaller adjacent channel spurious emission.

Other measurement show similar result, the amplification of OFDM signals is not more critical compared to amplification of

other signals using other modulation schemes.

Table 3: Power Efficiency

Modulation Scheme	O.B.O.[dB]	power efficiency
GMSK	0[dB](saturated)	66.0[%]

OFDM	3.0[dB]	43.3[%]
------	---------	---------

5.7.4 OFDMA receiver complexity (baseband)

The main complexity of the signal processing elements for the OFDMA receiver is the FFT. (This is ignoring the processing needed for channel decoding. To calculate the number of operations needed for the FFT, the analysis presented by McDonnell and Wilkinson [1] is used.

The size of the FFT needed at the receiver depends on the service required (scalability). For the case of the low data rate service (speech), only a 32 point FFT is required. This is sufficient for one band slot with 24 carriers and DQPSK modulation. For the highest data rate service (2 Mbit/s) we shall assume a bandwidth of 1.6 MHz and 8-DPSK modulation. This service requires a 512 point FFT.

The total number of real multiplications for an FFT is given by McDonnell¹

$$2F \log_2 F$$

where F is the size of the FFT. At the receiver an FFT has to be performed at the same rate as the time slot duration (288.46 μ s). For speech only every fourth time slot is used so we shall derive an average and peak multiplications per second figure.

For speech therefore,

$$\text{Peak no. of real multiplications per second} = 2 \times 32 \times 5 \times (1.0 / 288.46 \times 10^{-6}) = 1.109 \times 10^6$$

$$\text{Average no. of real multiplications per second (1 FFT operation per frame)} = 277.33 \times 10^3$$

For one frame (4*288.46 μ s=1.154ms) 2 IFFT operations (diversity reception) and 1 FFT (TX burst construction) are required. This results in 3*0.27733MOPS = 0.832 MOPS.

For the highest data rate (2 Mbit/s) service every 7 out of 8 time slots are used.

$$\text{Peak no. of real multiplications per second} = 2 \times 512 \times 9 \times (1.0 / 288.46 \times 10^{-6}) = 31.94 \times 10^6$$

For one frame (8*288.46 μ s=2.307ms) 7*2 IFFT operations (7 used timeslots and 2 diversity reception) and 7 FFT (TX burst construction) are required.

This results in 3*(7/8)*31.94 MOPS = 83.9 MOPS.

This number can be reduced if only one Rx branch is used in the indoor environment (better C/I condition expected as compared to outdoor).

It is also important to note that the main processing element of the OFDMA receiver is a readily available FFT.

The following table summarizes the complexity of the FFT/IFFT processing. Please note the table gives 'peak' processing requirement which have to be divided by the actual used timeslots in the given TDMA structure.

Bandwidth (kHz)	Subcarrier Number / FFT Size	Peak MOPS per single FFT / Peak MOPS: 2*RX, 1*TX
100	24 (32)	1.11 (3.3)
200	48 (64)	2.66 (7.98)
400	96 (128)	6.21 (18.6)
800	192 (256)	14.2 (42.6)
1600	384 (512)	31.95 (95.84)

¹ J.T.E. McDonnell, T. A. Wilkinson, "Comparison of computation complexity of adaptive equaliser and OFDM for indoor wireless networks", *Proceedings IEEE Personal Indoor Mobile Radio Conference (PIMRC) 1996*, pp. 1088-1091

6. Radio Maintenance Control

6.1 Timing Advance

The timing advance technique is required for OFDM based systems in order to maintain orthogonality of all of the up link signals. The accuracy requirements are similar to GSM, +/- 10µs are tolerable without performance degradation.

6.2 Handover

The exact algorithm and parameters used for handover are highly dependent on operational environment and network operators preferences. The standard handover algorithm is the base station originated handover with mobile assistance. However forward handover and MSC initiated handover are also supported.

6.2.1 Base Station Originated Hand Over

The following, lists the steps of a base station originated hand over.

When the mobile station X (MS-X) connected to base station A (BS-A) reports that it has detected the surrounding base station B (BS-B) :

1. BS-A asks BS-B to observe MS-X and inform BS-B about the hopping pattern of the MS-X.
2. BS-B sets its signal detector for detecting MS-X up link signal.
3. BS-A reports to MS-X detailed information of BS-B's and asks BS-B to prepare a handover of MS-X to BS-B. The following information is given:
 - Propagation delay between the two base stations D(A,B)
 - The estimated propagation delay between BS-B and MS-X called Tpd (BS-B, MS-X)
 - The random phase shift pattern of BS-B.
 - New hopping pattern and initial time and frequency slot of BS-B.
4. MS-X will receive BS-B's IACH to confirm the arrival time difference between BS-A and BS-B.
5. BS-B also measures the RSSI of MS-x's up link signal and compares the RSSI with the RSSI of the MSs connected to BS-B (RSSIref). When MS-X's RSSI exceed the RSSIref.

BS-B asks BS-A to hand over MS-X.
 BS-A informs MS-X to hand over to BS-B.
 MS-X will change the connection from BS-A to BS-B.

6.2.2 Mobile Assisted Hand Over (MAHO)

The following procedure outlines the MAHO scheme.

1. Each base station can inform the connected MSs about information of the surrounding BS's including IACH information and the propagation delay between the base stations D(A,B) as described above during the ordinary connection (using control channels).
2. The mobile station can predict the IACH position of the surrounding BS's (bandslot and timeslot).
3. When the timeslot of the IACH occurs which the MS needs the MS will puncture both Rx and Tx traffic channels and use the idle time (at least 4 time slots) to pick up the target IACH.
4. The required hopping puncturing will be less than 6[%] of the data and the punctured hops

will be treated as erased bursts, the soft decision bits will be set to zero (no information). Using the proposed interleaving and coding schemes causes negligible degradation.

5. The MS activates the KERO detector active and tries to decode the IACH.
6. When the MS detects and decodes the IACH, it reports back to its own connecting BS about the successful detection of the IACH BS he detected the IACH.

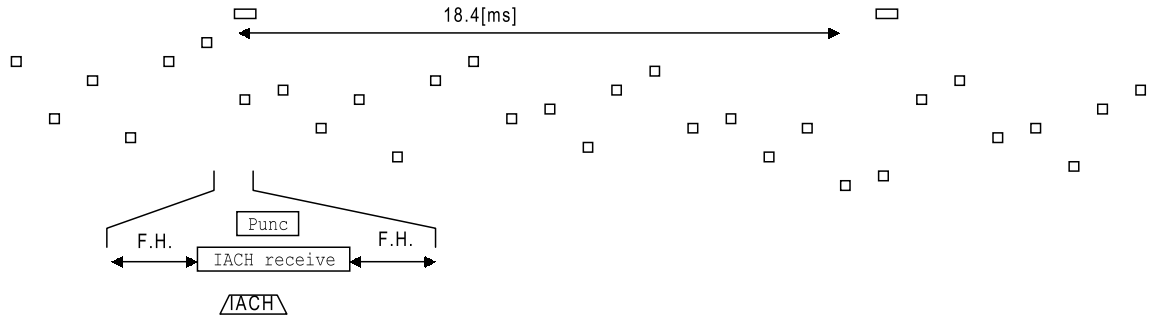


Figure 19 Puncturing Scheme (1 of 4 Time slot usage)

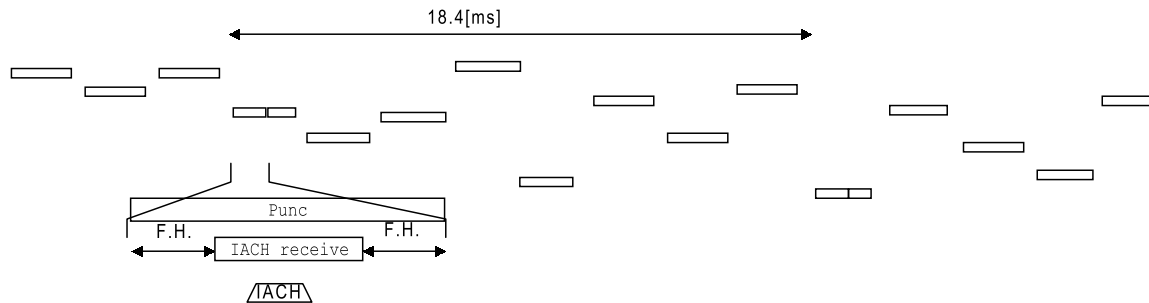


Figure 20 Puncturing Scheme (7 of 8 time slot usage)

6.2.3 Forward Hand Over

Forward hand over can be achieved easily.

The following description is based on the assumption that MS-X is handed over from BS-A to BS-B.

- Even after the hand over, BS-A transmits control data and dummy data instead of traffic data continuously to the receiving MS-X.
- MS will keep previous connection(BS-A) status information such as frame timing ,hopping pattern and so on.
- If the MS fails to hand over to BS-B, it can go back to the previous connection with BS-A.
- When BS-A detect MS-X's signal again, it re-establishes the connection to MS-X.
- An alternative solution exists:

If the network has enough capacity, The MSC can provide traffic data to BS-A also after the handover to BS-B.

MS-X can connect to both BS's like soft handover and switch connection between both basestations based o the received signal quality.

Another possibility in order to avoid slot puncturing is to increase the TDMA scheme during the forward handover phase (e.g. 8-TDMA ,16-TDMA) in order to prepare enough time for the hopping synthesiser to follow the two independent hopping schemes of the connected basestations.

6.2.4 MSC Initiated Handover

MSC initiated handover is supported even for unsynchronised base stations. We assume the channel encoder and decoder is placed at the MSC. Each base stations has modulation and demodulation units. The exact hand over timing is determined by the MSC and informed to both base stations and also to the target MS. The delivery of the down link data will be switched between the two base stations on a slot base (downlink hopping data) without any break (seamless). The uplink data (slot by slot) will be gathered by the MSC. The MS will receive and transmit continuously during hand over. Timing adjustment will be achieved by slot puncturing.

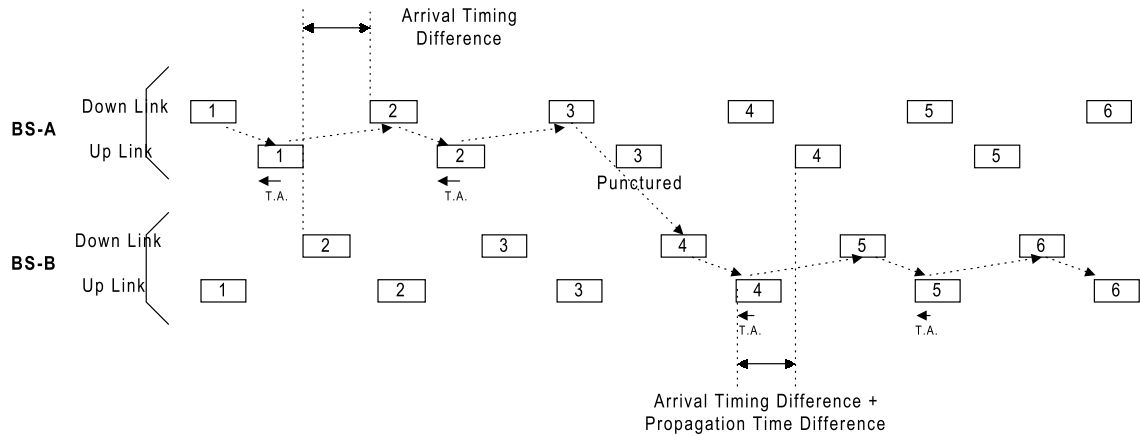


Figure 21 MSC Puncturing Scheme

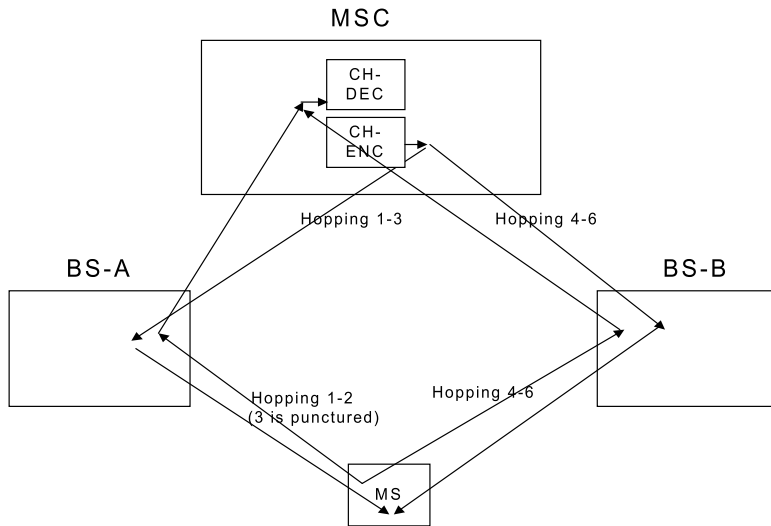


Figure 22 MSC handover

6.2.5 HCS and GSM handover

OFDMA also supports handover for the HCS cell structure and handover from the OFDMA system to the GSM system. For a HCS handover a possible handover procedure is given by,

- 1) Base station informs mobile station if HCS is operated in the area.
- 2) If HCS is operated, mobile station will monitor the different cell structures using the idle time of the TDMA scheme and hopping capability.
- 3) If mobile station detects different

It is very clear that a handover can easily be achieved between UMTS and GSM due to the following points:

- 288.46 μ s OFDMA time slot is exactly half of the GSM time slot.
- 100 kHz channel spacing is exactly half of GSM channel spacing.
- OFDMA can handle 200 kHz bandwidth signal which is exactly same as GSM.
- Both systems are frequency hopping TDMA systems.

6.3 Power Control

Power control in the uplink removes the unevenness of received signal strength at the base station side and decreases the total power to the limit to support the specified QoS (e.g. B.E.R.). At the base station the signal of each mobile station is orthogonal to all other user in the same cell, but a highly unbalanced received signal power results in interference to adjacent cells.

The accuracy is less critical than CDMA because with OFDMA orthogonality is always provided within one cell. However, a precise power control not only improves the transmission performance but also minimises the interference to other cells and therefore increases the overall capacity.

The OFDMA concept allows a variety of different power control schemes to adapt the power to the required link quality. Both closed loop and open loop power control are implemented. Based on quality parameters, measured on a slot-by-slot basis, the power is adjusted in the mobile as well as in the base station transmitter. Each receiver measures the quality of the received burst (C/I ratio) and transmits in the next burst a request to the opposite transmitter to increase, keep or decrease the power level in steps of 1dB. For the fastest power control mode one subcarrier is dedicated to carry power control information, the power is then adjusted on a frame-by-frame basis (each 1.152ms).

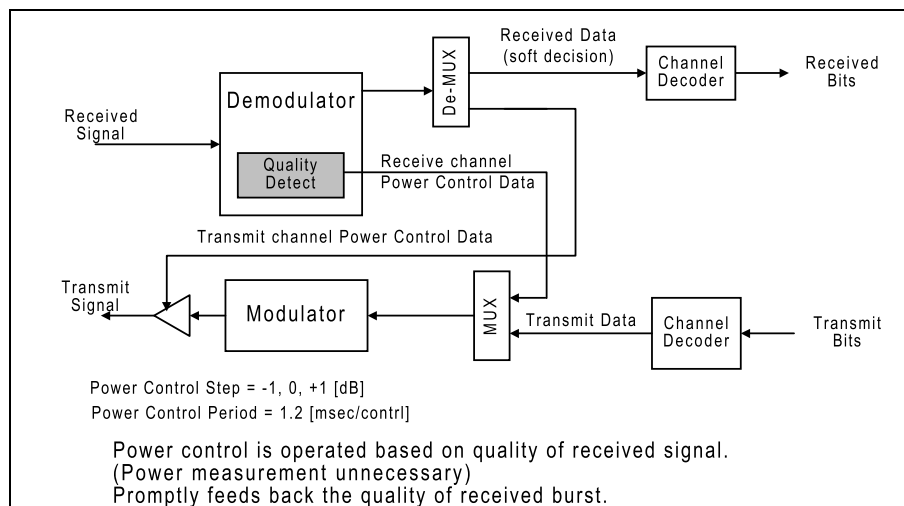


Figure 23: Operation of Power Control

7. Protocols

7.1 Protocol Architecture

The access control is divided into traditional sub-layers.

Table 4: Protocol OSI Layer Structure

Link Layer Control		
Layer 4-7		
Layer 3		
Layer 2	Link Layer Control (LLC)	Control for retransmission of the packet.
	Radio Link Control (RLC)	Divide the LLC frame into several small RLC blocks and retransmit selective parts of erroneous blocks
	MAC	Assign the RLC blocks on one or several TCH and handles the access to the radio media resources.
Layer 1		

MAC layer will be separated according to each multiple access scheme described in the above section.

7.2 Random Frequency Hopping Operation

Frequency hopping is very effective to achieve frequency diversity and interference diversity. Frequency diversity is useful to average the frequency selective channel properties (fading dips). Interference diversity is one of the important techniques used in the OFDMA proposal and has been shown to improve capacity in slow frequency hopping TDMA systems (see *Olofsson95*).

The random hopping pattern is designed to be orthogonal within one cell (no collisions in the time-frequency grid) and random between cells (this causes co-channel interference).

The frequency hopping pattern has to fulfil certain requirements:

- Orthogonality within one cell
- Support of a variety of services by assigning different bandwidth (number of band slots)
- Support of a variety of services by assigning time slots (number of time slots)
- Support of a couple of timeslot structures (4-TDMA, 8-TDMA, 16-TDMA) within the pattern.

The hopping pattern is generated at the base station according to the expected service and traffic requirement and assigned to the cell. This assignment can be modified due to changes in the traffic characteristics. The base station can then support a set of services and a certain number of users for each service.

Summary:

- The random hopping pattern uses the 'frequency' resource as efficiently as possible.
- The System Guard band is extremely small compared to other systems (WB-single carrier, CDMA and traditional WB-OFDM with fixed BW).
- The hopping pattern is orthogonal within one cell (no collisions in the time-frequency grid).
- The hopping pattern supports all required services by assigning different number of band and timeslots.

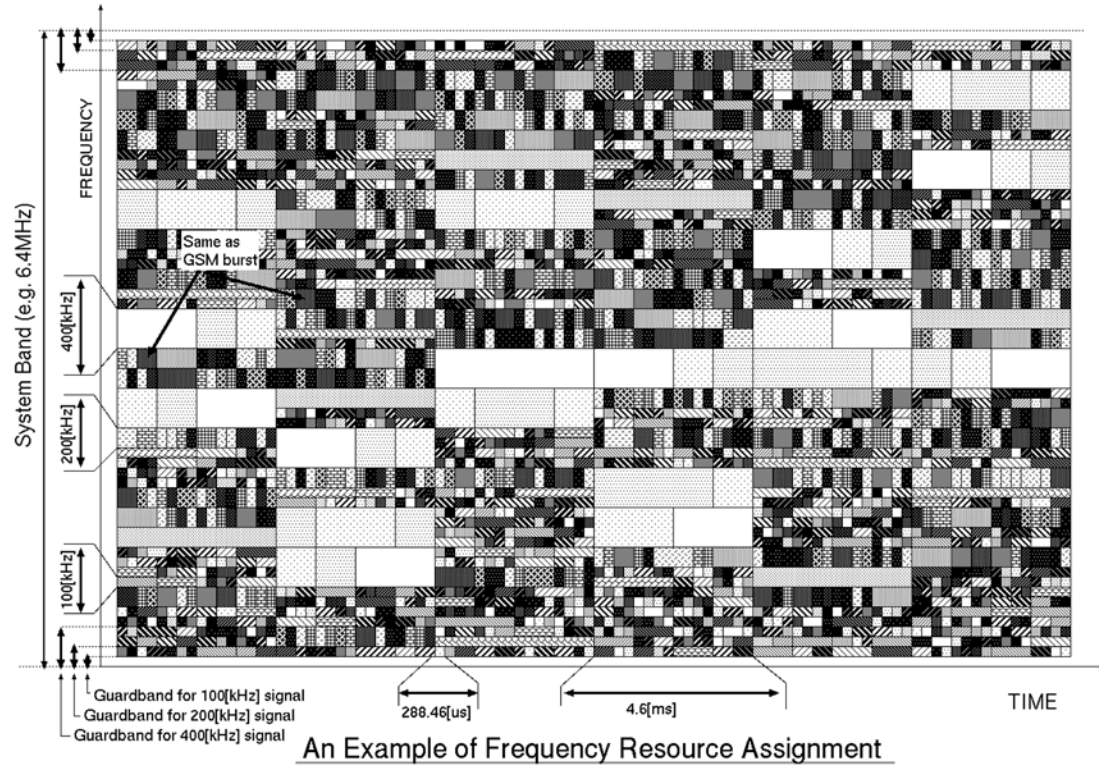


Figure 24: Frequency Hopping Pattern

7.3 Dynamic Channel Allocation (Fast DCA)

Besides FH hopping mode, the system can also be operated in Time division duplex (TDD) Mode. Unlike the FH mode, the TDD mode does not separate the spectrum in an uplink and a downlink. Instead, it assigns band slots individually to uplink or downlink connections. In TDD mode, a Dynamic Channel Allocation algorithm is employed to avoid (rather than to average) excessive interference.

The TDD mode is intended for pico-cellular, indoor use. The indoor environment is characterised by:

- Short radio propagation delays (100 m is traversed in 0.3ms, or 0.1% of the symbol duration).
- Reduced near-far effect, because of greater proximity of transmitters and receivers.
- Greater demand for high rate services, reducing the interference averaging advantage of Frequency Hopping mode.
- High speed data traffic is often asymmetric, prompting flexible division of bandwidth between uplink and downlink.
- Less severe propagation conditions than those outdoor. Mobility-induced Doppler spread and delay spread are both lower.

The Physical layer can be identical to the outdoor radio. Both coherent and differential detection can be applied. For coherent detection, dedicated indoor devices can make use of simplified channel estimation techniques (see section 6.3.1) for coherent detection, since Doppler spread is negligible.

The TDD mode of operation relies on the following principles

- In every frame, a Base Station transmits a Frame Map (FM). The Frame Map contains
 - band slot allocations for the next frame. Band slots can be allocated to
 - the base station for downlink transmission to a single terminal.
 - the base station for downlink transmission to all terminals (broadcast).
 - a single terminal for an uplink transmission.
 - all (or a group of) terminals for contention based access.
 - Transmit power assignments for MTs.
 - Acknowledgements for contention traffic received in the previous frame.
 - Slots are allocated on a connection basis, so that connection-dependent QoS can be provisioned.
 - Control data and user data are transmitted on different connections.
- Terminals can transmit requests for band slots in contention slots designated by the BS in the FM.
- Terminals can also piggyback requests onto uplink transmissions, which provides contention free access, particularly under heavy traffic conditions.
- The base station performs interference measurements in all band slots, except at the time slots in which it is transmitting. This information is used by the band slot allocation algorithm, to assign uplink transmissions to slots with minimal interference. Note that an uplink transmission in a interference free (as measured by the BS) slot may interfere with a simultaneous uplink transmission at a neighbouring base station.
- No simultaneous uplink and downlink transmissions may be scheduled within a cell. Therefore, the blindness of the BS in slots in which it is transmitting, does not reduce capacity.
- Terminals piggyback interference measurement information onto uplink packets. In addition, the BS can query an MS to transmit interference measurement data on an uplink control channel.
- Quality monitoring of active connections is used by BSs and MSs to detect the necessity of a slot reallocation (intra-cell and inter-cell handoff).
- Synchronisation of base stations is not required. It is an option which reduces slot overlap and hence increases system capacity.
- The frame duration has a fixed value of 16 symbols, as in the mode FH channel structure. Alternative values are possible in TDD mode, but the Frame duration must be the identical for all base stations in the network.
- System bandwidth. For the indoor scenario with 30 MHz of available bandwidth, the system bandwidth can in principle be as large as 30MHz for maximal trunking gain.
- Rate $\frac{1}{2}$ convolutional coding is used with up to 24 bits of user data per band slot.

Frame Formats

The frame layout is entirely decided by the DCA algorithm. Like the FH algorithm, the DCA algorithm is distributed and does not rely on communication via the infrastructure. Also, as the FH algorithm it is not part of the system specification, the algorithm may be vendor specific, allowing competitive positioning within a standardised system.

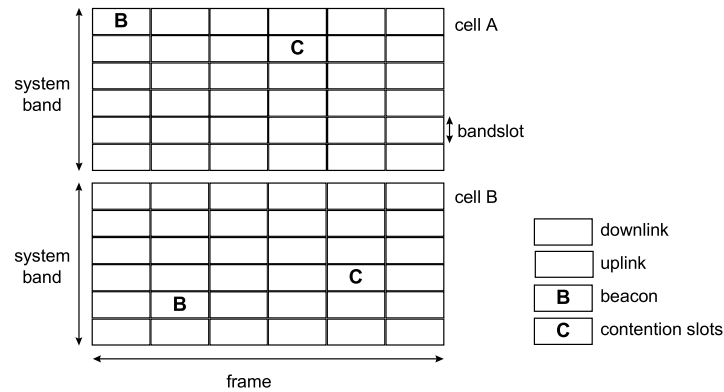


Figure 25: Example of Frame Layout

An example of a frame layout is shown in Figure 25. The figure is purely illustrative. The frame duration and system bandwidth have unrealistically small values. Also the packets, such as the FM and user data packets will occupy more than 1 band slot in practice.

In general the applied DCA algorithm must strive to reduce intra and inter cell interference. Constant bit rate traffic causes long term interference which is highly predictive of the interference in the next slot. If traffic is bursty, the predictive value of interference measurements is limited. Since a BS is not aware whether band slots in neighbouring cells are allocated to circuit mode or packet mode connections, BSs and MSs shall average measurements over longer periods of time. Busy slots (high average interference level) shall be avoided for any transmission. Quiet slots (low average interference level) shall be assigned to constant bit rate connections, or to the guaranteed part of a variable bit rate connection. Slots with medium average interference shall be assigned to connections with bursty traffic, which use contention mode access.

Initial association does not differ from the procedure in FH mode. When joining the Base Station, the Mobile Station uses the KERO detection algorithm to detect the location of the IACH, and hence the BCCH. The BCCH is used to relay the location of the FM in the current frame to the MS. Once the FM is located it can be tracked since it will advertise when it is moved to a different location. The uplink synchronisation phase be avoided, since no timing advance is required —uplink transmissions can simply be synchronised to the downlink. The small propagation delay is easily absorbed in the symbol guard time, which is dimensioned for outdoor delay spreads.

7.4 Dynamic Channel Allocation (Simple DCA)

Simple DCA assigns a fixed resource (bandslots and timeslots) to a communication during the set-up phase. This assignment is kept for the whole duration of the communication. This scheme is very simple but can not react on varying interference or channel conditions compared to fast DCA where the 'actual best' channel (= timeslot & bandslot combination) is used for transmission. This scheme has a lower performance than the fast DCA operation but can be used for simple (uncoordinated) systems like cordless telephony.

[For Further Study]

8. System Deployment Aspects

8.1 System Guard

The multirate concept of the OFDMA is the assignment of multiple time-slots and multiple band-slots. Wide band signals in any system have the disadvantage of the requirement for a wider guard band. This is a limiting factor for every system using wide band signals. The system guard band depends on the spectrum mask to separate different systems. With a wide band signal a larger system guard band has to be prepared compared to narrow band systems.

This considerations are also valid for OFDMA. To reduce this overhead frequency hopping patterns were developed which avoid the allocation of wideband signals close to the edge of the system band. Narrow band signals (e.g. voice, low-rate data) can be positioned close to the edge of the system band. This gives an additional increment of the system resources usage.

A system using only wide-band carriers has to have a much larger guard band (reduced efficiency of the systems resource allocation).

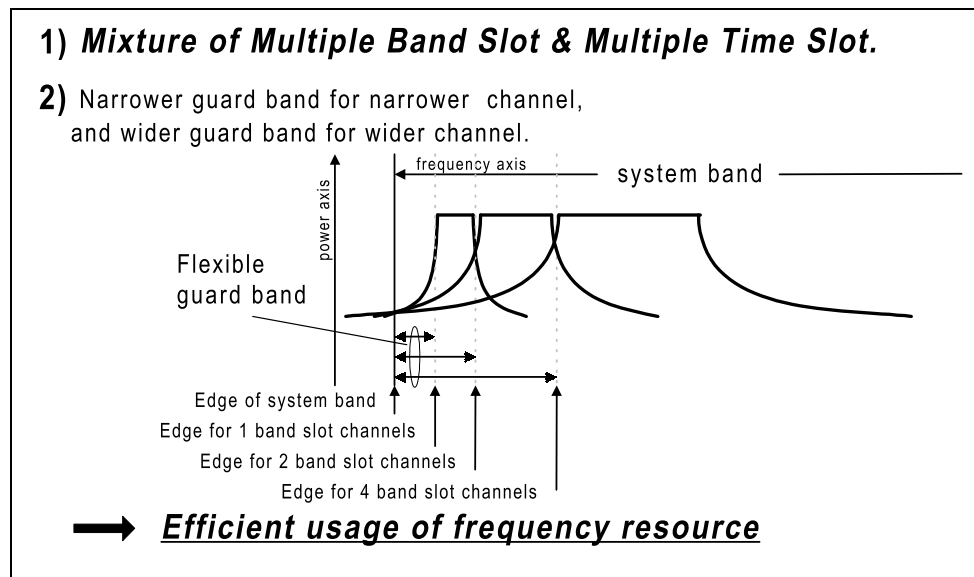


Figure 26: Flexible OFDMA Structure

8.2 Phased Deployment Model

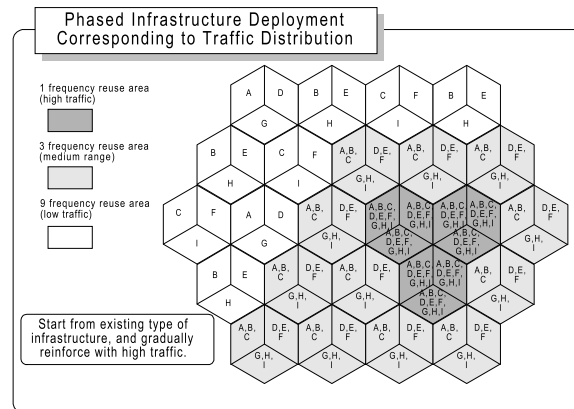
A phased introduction is very effective to reduce the roll-out cost of the UMTS system. Starting with deployment scenarios to support the initial low density penetration of UMTS the system can be extended in steps according to the demanded traffic.

An example:

- Initial stage:
9-Frequency reuse, which is the same as used in current GSM system has a large margin of CIR and link budget. The OFDMA system supports as much as possible the backwards compatibility to GSM including aspects of the air-interface. Therefore the investment and resources used in the GSM system can be re-used.

- Second stage:
When the penetration of UMTS subscribers increases, a reduction of the reuse factor to 3 is possible which still has some margin for stable and safe operation.
- Third stage:
When traffic grows in very high traffic areas, 1 frequency reuse operation will be implemented. Enhanced infrastructure will be needed, but only in high traffic areas.

In the case of a CDMA system, 1-frequency reuse operation and soft hand over is a mandatory requirement even in the introduction phase of UMTS or very low traffic density area. This increases initial investments and operating costs compared to OFDMA.



8.3 Commonality Aspects

Commonality is an important high level requirement for UMTS. Commonality means the support of cellular (co-ordinated systems) and also cordless (uncoordinated systems) communication with the same terminal. The OFDMA system can efficiently support all operating environments including uncoordinated systems (like cordless telephony). Another aspect of commonality is the operation in different radio environments. The OFDMA system can operate in any radio propagation environment (pico cells, micro cells, macro cells) and can easily support hierarchical cell structures without modifications of the burst structure.

The support of various data-rates required for UMTS (up to 2Mbps) is also very important. The supported data-rate depends on the number of allocated time and bandslots for one communication link. Different classes of terminals can therefore be defined providing the end user with a cost efficient solution. These classes could include a very cheap low-end terminals (e.g. supporting speech and data services up to 64kbps) a medium terminal (up to 384kbps) and a high-end terminal (up to 2Mbps).

8.4 Deployment Options

The OFDMA proposal offers operators and users a full range of deployment options. For traditional licensed outdoor cellular operation, including the improved UMTS higher bit rate services, OFDMA offers the Random Slow frequency Hopping MAC (see section 7.2). This MAC can be configured to eliminate the need for deliberate frequency planning (effective frequency re-use pattern of 1) if required and still provide performance (in terms of user capacity) comparable to other technologies. In addition, traditional TDMA system cellular system planning and enhancement techniques, such as cell sectorisation, hierarchical cell structures and adaptive/smart antennas (see section 8.5) can be applied to dramatically boost capacity further.

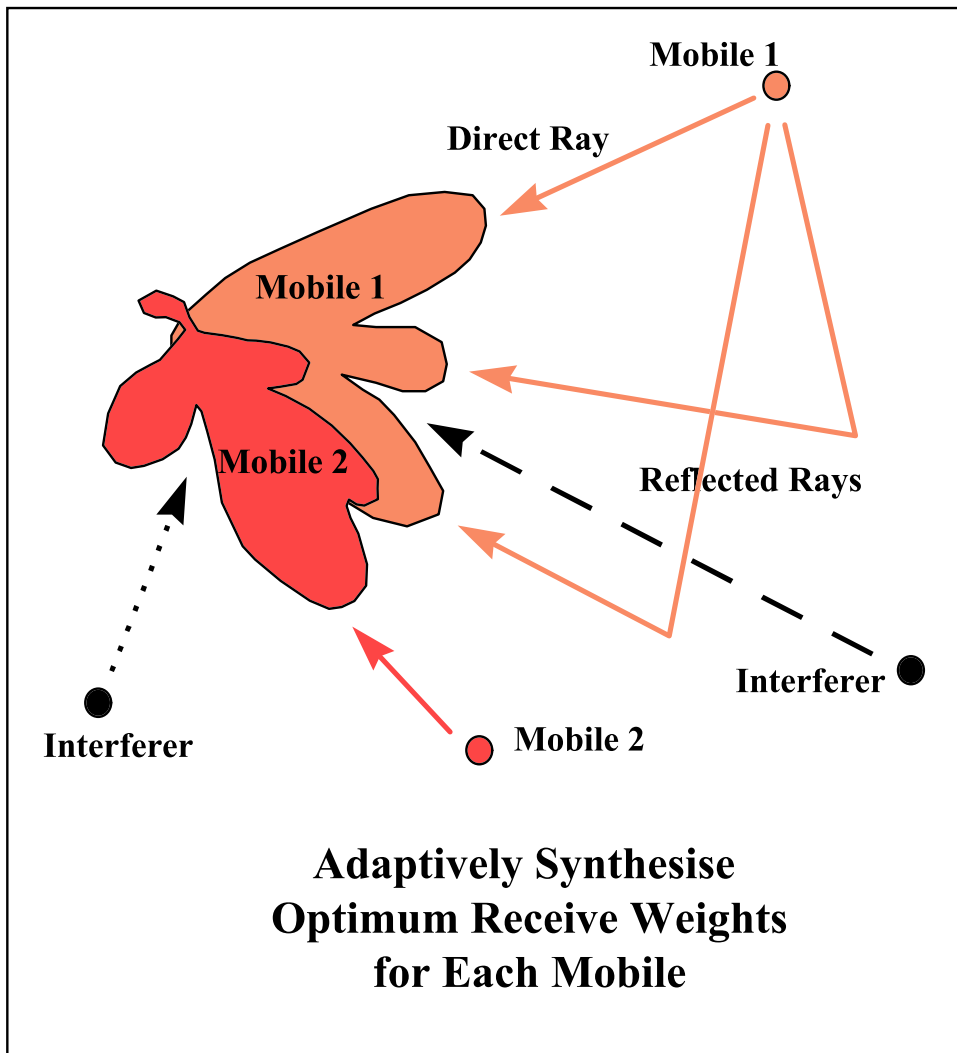
For unlicensed usage and use in allocations of unpaired spectrum, i.e. in indoor office WLAN style environments, the OFDMA DCA-TDD MAC option (see section 7.3) would be applied. This is being especially developed to impose no restrictions on adjacent base stations physical locations or synchronisation and to allow truly asymmetrical services.

Having a modulation scheme based on narrowband OFDM sub-carriers, provides this proposal with a degree of freedom in the frequency domain that other proposals cannot match. For instance, for the SFH MAC option, if an operator requires a more capacity on the downlink than the uplink, then it is possible to increase or decrease either the uplink or downlink spectrum allocation in increments of one bandslot (100kHz) down due a minimum bandwidth per link of 800 kHz (with a modified BCCH channel). This capability to accommodate OFDMA within relatively narrow portions of spectrum, is advantageous to operators who desire asymmetric capacity between their up and down links and also to

operators who wish to re-farm existing frequency allocations to this technology.

8.5 Adaptive/Smart Antenna

Adaptive antennas reduce the amount of co-channel interference, enabling operators to employ tighter frequency re-use thus increasing the network capacity. Conservative estimates suggest that an existing system designed with a frequency re-use plan of 4/3 could have its frequency plan tightened to 1/3 giving a potential factor of two improvement in capacity. Interference reduction is achieved by using the principle of spatial filtering. Complex algorithms are used to adapt the antenna radiation pattern in order to maximise the signal-to-interference-and-noise (SINR) ratio and doing so "nulls" are created in the direction of interfering signals. This adaptation is performed on a per timeslot (or bandslot) basis (see figure below). The base station is able to constructively combine the multipath signals from the wanted mobile while "nulling out" those signals originating from interfering mobiles.



9. Simulation Description

Performance evaluation of the OFDMA concept group has been carried out by simulation according to ETR-0402. The following simulation scenarios were considered during the first phase of simulations.

The two operational styles of the OFDMA proposal (using SFH and differential detection or coherent reception in combination with DCA) have been analysed.

For the first operation style (differential reception and SFH) the following scenarios were simulated.

Environment	Propagation Model	Service Mixture	Cell Type	Link Level	System Level
Vehicular 120km/h	Vehicular A	UDD 144 Speech LCD 144 LCD 384	Macro	Yes Yes Yes Yes	No Yes No Yes
Outdoor to Indoor and Pedestrian 3km/h	Outdoor to Indoor and Pedestrian A	UDD 384 Speech LCD 144 UDD 2048	Micro	Yes Yes Yes Yes	Yes Yes No No
Indoor Office 3km/h	Indoor Office A	UDD 2048 Speech LCD 384 50% speech + 50% UDD 384	Pico	Yes Yes Yes No	Yes Yes No No

For the second operation style (coherent reception) the following scenarios were simulated.

Environment	Propagation Model	Service Mixture	Cell Type	Link Level	System Level
Indoor Office 3km/h	Indoor Office A		Pico	Yes	No

9.1 Link Level Simulation Description (Differential Operation)

The required E_b/N_0 figures presented here represent the values needed in the receiver to support the corresponding BER values including all necessary overheads (control channels, PC information). Energy from common broadcast channels are not included.

Both uplink and downlink assume antenna diversity. E_b/N_0 values are all ratio of a bit energy ($E_b[J/bit]$) which is actually fed into the receiver versus noise density ($N_0[J]$) without power control at transmitter side.

9.1.1 Speech Services

The speech service simulations assume a hypothetical 8kbps speech codec with a user BER requirement of 10^{-3} . Interleaving is achieved over 4 GSM frames (18.48ms) which satisfies the UMTS requirements of one-way delay below 20ms. Larger inter-frame interleaving can be applied if the delay constraints are relaxed, this improves performance especially in low speed scenarios. A convolutional code of rate 1/3 and constraint length of 7 was used for up and downlink. The Modulation scheme is (FD)DQPSK. The implementation of the CC does not require tail bits.

Speech channel (User data): 148 bits (per 18.46ms), 16 CRC bits (per 18.46ms).
(Control): 16 PC bits(per 18.46ms), 49 general (per 18.46ms)

9.1.2 LCD Services

The required BER can be achieved using concatenated codes. Interleaving is achieved over 8 frames (interleaver delay $8 \times 18.46\text{ms} = 147\text{ms}$). The outer code is a Reed-Solomon code with a small size and efficient coding rate considering actual implementation. RS code parameters are: GF(255), $(n,k) = (40,36)$ or $(80,72)$ ($R = 0.9$). The RS interleaver length is 144ms.

The 'user' satisfaction' criteria are according to 0402, which includes blocking, quality and dropping.

The quality threshold is a BER of 10^{-6} for 95% of the time. Dropping will occur if the duration of a BER $> 10^{-6}$ is longer than 26s for LCD 384.

- LCD 144:
 - Time slot usage is 7 of 8 time slots and remaining 1 slot if for frequency hopping. 4 band slots (400[kHz] BW) are used.
 - Modulation scheme is (FD)DQPSK
 - Convolutional coding rate is $R = 1/3$
 - Link level bit rate is a little bit too high (163[kbps]) which can be modified to 144[kbps] by repetition.
- LCD 384
 - Time slot usage is 7 of 8 time slots and remaining 1 slot if for frequency hopping.
 - 8 band slots (800[kHz] BW) are used.
 - Modulation scheme is (FD)DQPSK
 - Convolutional coding rate is approximately $R = 1/2.5$ by puncturing technique to match the 384[kbps]

9.1.3 UDD Services

UDD144, UDD384 and UDD2048 link level simulations have been performed according to ETR0402.

9.2 Link Level Simulation Description (Coherent Operation)

Indoor link level simulations were performed for packets of 14400 bits (6 blocks of 4 symbols for coherent, 24 symbols for differential). No antenna diversity was used. Bit and packet error ratios were obtained by averaging over 1000 independent channels. QPSK with rate $\frac{1}{2}$ coding was used (constraint length 7).

The BER versus E_b/N_o figures are derived with and without power control. Using power control the results show 10 dB better values compared to the average required E_b/N_o in the case of no power control (at BER of 10^{-3}).

9.3 System Level Simulation Description (Differential Operation)

The simulations were carried out according to the system deployment scenarios, mobility models and user satisfaction criteria's of ETR-0402.

9.3.1 Speech Services

For speech (circuit switched service), the performance has been evaluated have been evaluated using dynamic system simulations. Speech is considered using 50% voice activity.

9.3.2 LCD Services

Circuit switched LCD services have been evaluated using dynamic system simulations. The 'user' satisfaction' criteria are according to 0402, which includes blocking, quality and dropping.

The quality threshold is a BER of 10^{-6} for 95% of the time. Dropping will occur if the duration of a BER $> 10^{-6}$ is longer than 26s for LCD 384.

9.3.3 UDD Services

UDD services were simulated according to 0402. The 'user' satisfaction criteria is set according to the latest definition contained in document SMG G18/97. This stipulates that the throughput of a satisfied user is 10% of the average bit rate stated in 0402. No user are

dropped during the duration of the call.

10. Link Level Results (Differential Operation)

In this section link level results are presented using the channel characteristics given in the 0402 document. E_b/N_0 values are all ratio of a bit energy (E_b [J/bit]) which is actually fed into the receiver versus noise density (N_0 [J]) without power control at transmitter side. All link level simulations apply antenna diversity (2 antennas) with frequency hopping around 12.8MHz.

10.1 Speech

The simulation parameters for speech are shown in Table 5. The BER results are shown in Figure 27. The E_b/N_0 values presented in Figure 27 include all the overheads needed for control channels.

Table 5 - Simulation parameters for speech

Environment	(O)	(P)	(V)
Delay profile	Office A	Pedestrian A	Vehicular A
Mobile speed	3[km/h]	3[km/h]	120[km/h]
UL/DL	both	both	both
Antenna diversity	2 branches	2 branches	2 branches
Link level bit rate [kbps]	12.1[kbps]	12.1[kbps]	12.1[kbps]
Information bit rate [kbps]	8[kbps]	8[kbps]	8[kbps]
Modulation	FDDQPSK	FDDQPSK	FDDQPSK
Convolutional coding	K = 7, R = 1/3	K = 7, R = 1/3	K = 7, R = 1/3
Interleaver length (CC)	18.4[ms](16hop)	18.4[ms](16hop)	18.4[ms](16hop)
RS coding	No	No	No
Interleaver length (RS)	N/A	N/A	N/A
Time slot usage	1(1/4)	1(1/4)	1(1/4)
Band slot usage	1(100[kHz])	1(100[kHz])	1(100[kHz])
Frequency hopping bandwidth	12.8[MHz]	12.8[MHz]	12.8[MHz]
Power Control	No	No	No
Required. Average .received E_b/N_0 [dB] @BER= 10^{-3}	10.0[dB]	11.2[dB]	5.6[dB]

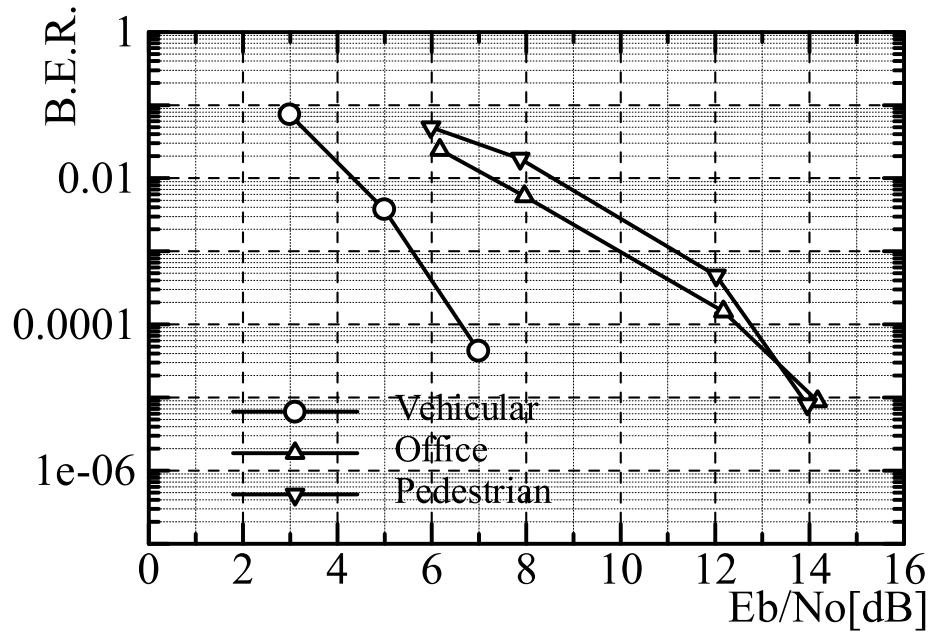


Figure 27: Eb/No vs BER (SPEECH)

10.2 LCD 144 Simulation

The simulation parameters for LCD 144 are shown in Table 6. In order to achieve the low bit error rates required RS error coding is applied. The details of the RS coding is shown in Table 6. The BER results are shown in Figure 28.

Table 6: Simulation parameters for LCD 144

Environment	(O)	(P)	(V)
Delay profile	Office A	Pedestrian A	Vehicular A
Mobile speed	3[km/h]	3[km/h]	120[km/h]
UL/DL	both	both	both
Antenna diversity	2 branches	2 branches	2 branches
Link level bit rate [kbps]	163[kbps]	163[kbps]	163[kbps]
Information bit rate [kbps]	144[kbps]	144[kbps]	144[kbps]
Modulation	FDDQPSK	FDDQPSK	FDDQPSK
Convolutional coding	K = 7, R = 1/3	K = 7, R = 1/3	K = 7, R = 1/3
Interleaver length (CC)	147.2[ms] (64hop)	147.2[ms] (64hop)	147.2[ms] (64hop)
RS coding	GF(255)(40,36)	GF(255)(40,36)	GF(255)(40,36)
Interleaver length (RS)	144[ms]	144[ms]	144[ms]
Time slot usage	7(7/8)	7(7/8)	7(7/8)
Band slot usage	4(400[kHz])	4(400[kHz])	4(400[kHz])
Frequency hopping bandwidth	12.8[MHz]	12.8[MHz]	12.8[MHz]
Power control	No	No	No
Required. Average .received Eb/No[dB] @BER=10 ⁻⁶		10.0[dB]	5.9[dB]

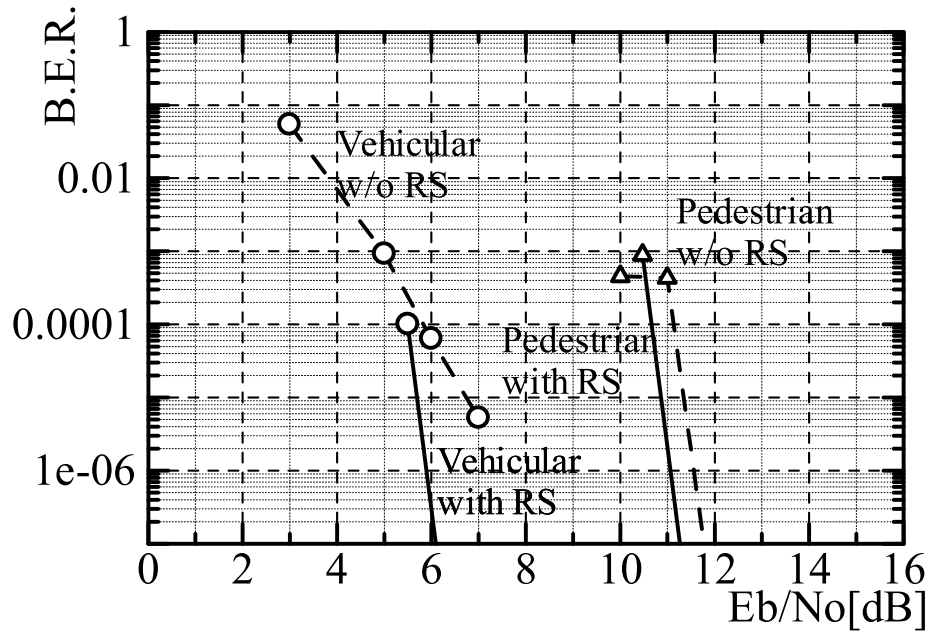


Figure 28: Eb/No vs BER (LCD 144)

10.3 LCD 384 Simulation

The simulation parameters for LCD 384 are shown in Table 7. In order to achieve the low bit error rates required RS error coding is applied. The details of the RS coding is shown in Table 7. The BER results are shown in Figure 29.

Table 7: Link Level Simulation parameters for LCD 384

Environment	(O)	(P)	(V)
Delay profile	Office A	Pedestrian A	Vehicular A
Mobile speed	3[km/h]	3[km/h]	120[km/h]
UL/DL	both	both	both
Antenna diversity	2 branches	2 branches	2 branches
Link level bit rate [kbps]	396[kbps]	396[kbps]	396[kbps]
Information bit rate [kbps]	384[kbps]	384[kbps]	384[kbps]
Modulation	FDDQPSK	FDDQPSK	FDDQPSK
Convolutional coding	K = 7, R = 1/2.5	K = 7, R = 1/2.5	K = 7, R = 1/2.5
Interleaver length (CC)	147.2[ms] (64hop)	147.2[ms] (64hop)	147.2[ms] (64hop)
RS Coding	GF(255)(40,36)	GF(255)(40,36)	GF(255)(80,72)
Interleaver length (RS)	144[ms]	144[ms]	144[ms]
Time slot usage	7(7/8)	7(7/8)	7(7/8)
Band slot usage	8(800[kHz])	8(800[kHz])	8(800[kHz])
Frequency hopping bandwidth	12.8[MHz]	12.8[MHz]	12.8[MHz]
Power control	No	No	No
Required. Average .received Eb/No[dB] @BER=10 ⁻⁶	11.3[dB]		5.8[dB]

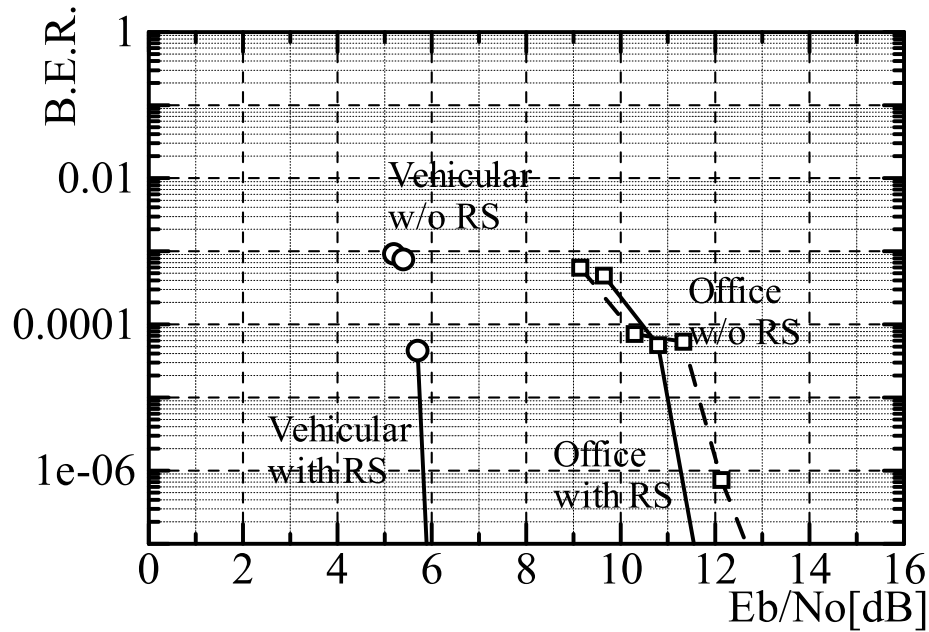


Figure 29: Eb/No vs BER (LCD384)

10.4 UDD 144, 384 Link Level Simulation

For implementing UDD services two modes were investigated. The first of these, mode A, is an LCD type interleaving coding method which uses an interleaver depth of 16. CRC bits are then added to the packet. No RS coding is used. The parameters of Mode A are seen in Table 8 and Table 9.

Mode B uses a block coding method in which each packet contains both CRC and RS code bits. The parameters of Mode A are seen in Table 10.

10.4.1 Mode A

Table 8: Simulation parameters for UUD384 Mode A

Environment	(O)	(P)	(V)
Delay profile	Office A	Pedestrian A	Vehicular A
Mobile speed	3[km/h]	3[km/h]	120[km/h]
UL/DL	both	both	both
Antenna diversity	2 branches	2 branches	2 branches
Link level bit rate [kbps]	1.27[Mbps]	1.27[Mbps]	1.27[Mbps]
Information bit rate [kbps]	416[kbps]	416[kbps]	416[kbps]
Modulation	FDDQPSK	FDDQPSK	FDDQPSK
Convolutional coding	K = 7, R = 1/3	K = 7, R = 1/3	K = 7, R = 1/3
Interleaver length (CC)	18.4[ms] (16hop)	18.4[ms] (16hop)	18.4[ms] (16hop)
Data block	320[bits]	320[bits]	320[bits]
CRC	16[bits]	16[bits]	16[bits]
RS coding	N/A	N/A	N/A
Interleaver length (RS)	N/A	N/A	N/A

Time slot usage	3(3/4)	3(3/4)	3(3/4)
Band slot usage	8(800[kHz])	8(800[kHz])	8(800[kHz])
Frequency hopping bandwidth	12.8[MHz]	12.8[MHz]	12.8[MHz]
Power control	No	No	No
Required. Average .received Eb/No[dB] @BLER=10 ⁻¹	7.0[dB]	7.8[dB]	5.2[dB]

Table 9: Simulation parameters for UUD144 Mode A

Environment	(O)	(P)	(V)
Delay profile	Office A	Pedestrian A	Vehicular A
Mobile speed	3[km/h]	3[km/h]	120[km/h]
UL/DL	both	both	both
Antenna diversity	2 branches	2 branches	2 branches
Link level bit rate [kbps]	637[kbps]	637[kbps]	637[kbps]
Information bit rate [kbps]	208[kbps]	208[kbps]	208[kbps]
Modulation	FDDQPSK	FDDQPSK	FDDQPSK
Convolutional coding	K = 7, R = 1/3	K = 7, R = 1/3	K = 7, R = 1/3
Interleaver length (CC)	18.4[ms] (16hop)	18.4[ms] (16hop)	18.4[ms] (16hop)
Data block	320[bits]	320[bits]	320[bits]
CRC	16[bits]	16[bits]	16[bits]
RS coding	N/A	N/A	N/A
Interleaver length (RS)	N/A	N/A	N/A
Time slot usage	3(3/4)	3(3/4)	3(3/4)
Band slot usage	4(400[kHz])	4(400[kHz])	4(400[kHz])
Frequency hopping bandwidth	12.8[MHz]	12.8[MHz]	12.8[MHz]
Power control	No	No	No
Required. Average .received Eb/No[dB] @BLER=10 ⁻¹	7.0[dB]	7.8[dB]	5.2[dB]

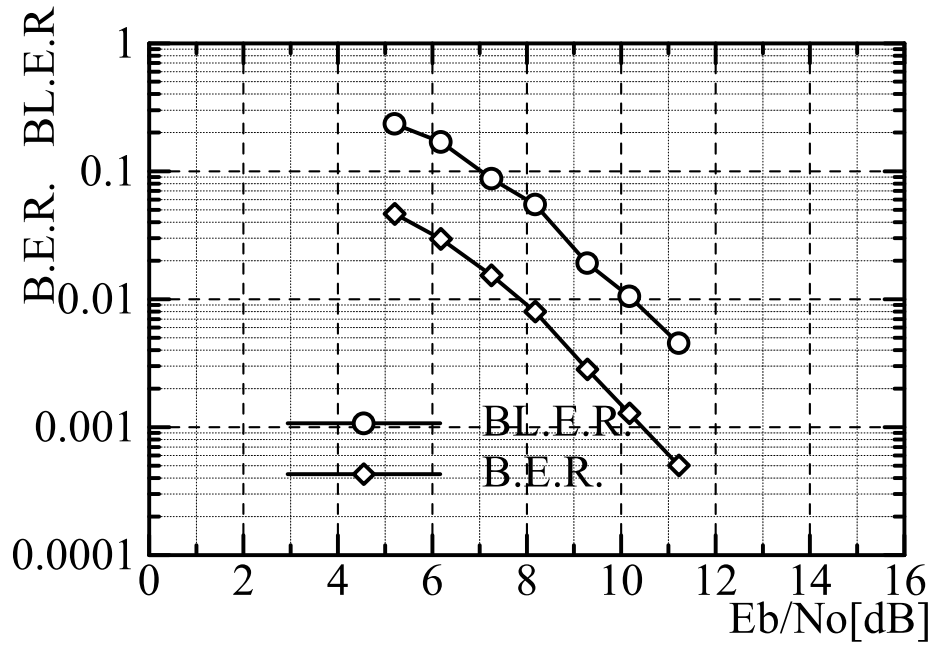


Figure 30 E_b/N_0 vs BL.E.R. (Mode A, Office)

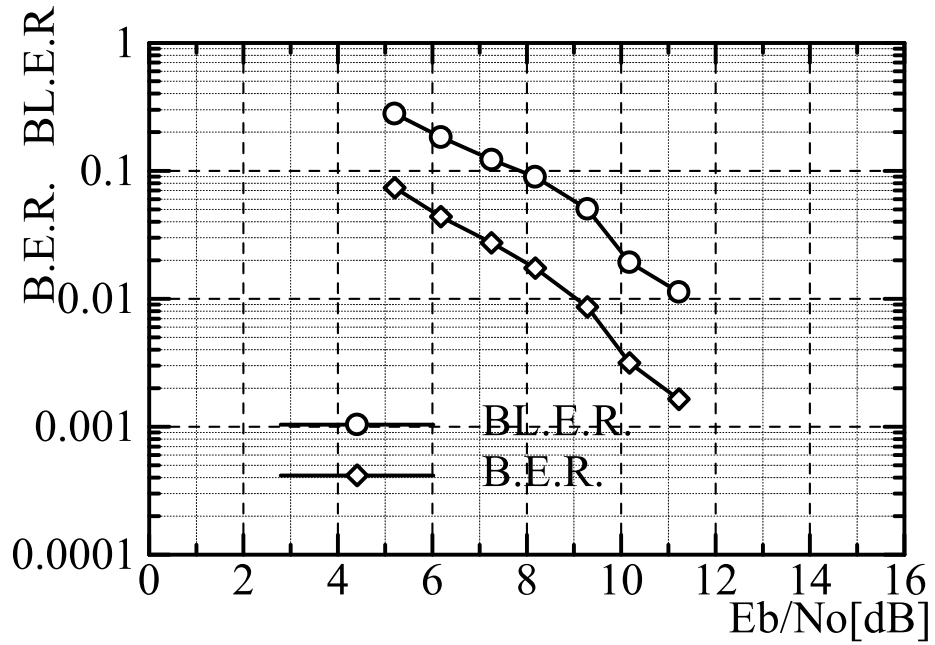


Figure 31 E_b/N_0 vs BL.E.R. (Mode A, Pedestrian)

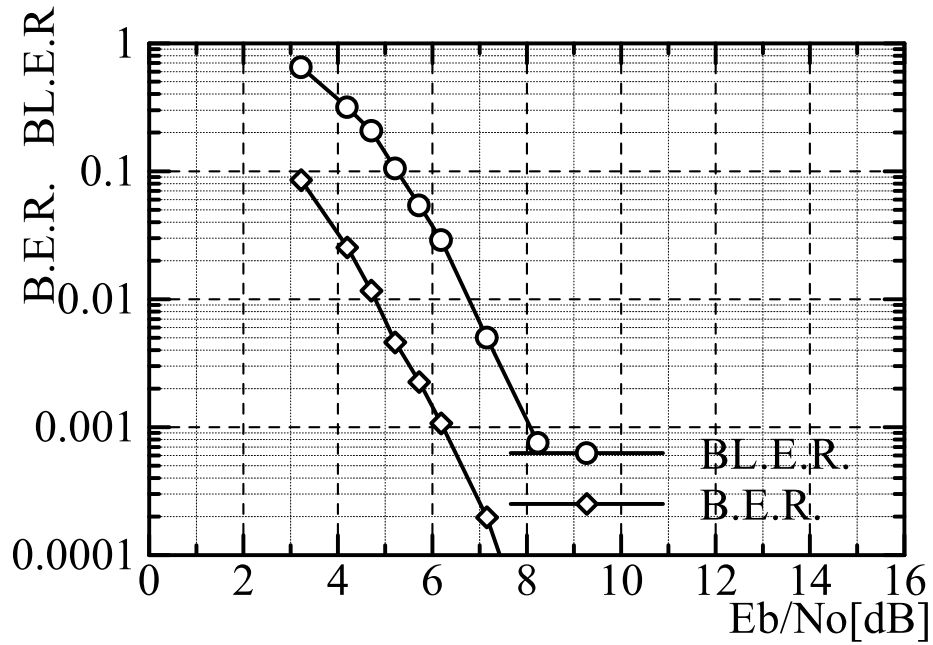


Figure 32 E_b/N_0 vs BL.E.R. (Mode A, Vehicular)

10.4.2 Mode B

Table 10: Simulation parameters for UUD384 Mode B

Environment	(O)	(P)	(V)
Delay profile	Office A	Pedestrian A	Vehicular A
Mobile speed	3[km/h]	3[km/h]	120[km/h]
UL/DL	both	both	both
Antenna diversity	2 branches	2 branches	2 branches
Link level bit rate [kbps]	637[kbps]	637[kbps]	637[kbps]
Information bit rate [kbps]	416[kbps]	416[kbps]	416[kbps]
Modulation	FDDQPSK	FDDQPSK	FDDQPSK
Convolutional coding	K = 7, R = 1/2	K = 7, R = 1/2	K = 7, R = 1/2
Interleaver length (CC)	1.15[ms]	1.15[ms]	1.15[ms]
Data block	480[bits]	480[bits]	480[bits]
CRC	16[bits]	16[bits]	16[bits]
RS coding	N/A	N/A	N/A
Interleaver length (RS)	N/A	N/A	N/A
Time slot usage	4	4	4
Band slot usage	4(400[kHz])	4(400[kHz])	4(400[kHz])
Frequency hopping bandwidth	No FH	No FH	No FH
Power control	No	No	No
Required. Average .received E_b/N_0 [dB] @BER= 10^{-1}	7.8[dB]	8.5[dB]	8.8[dB]

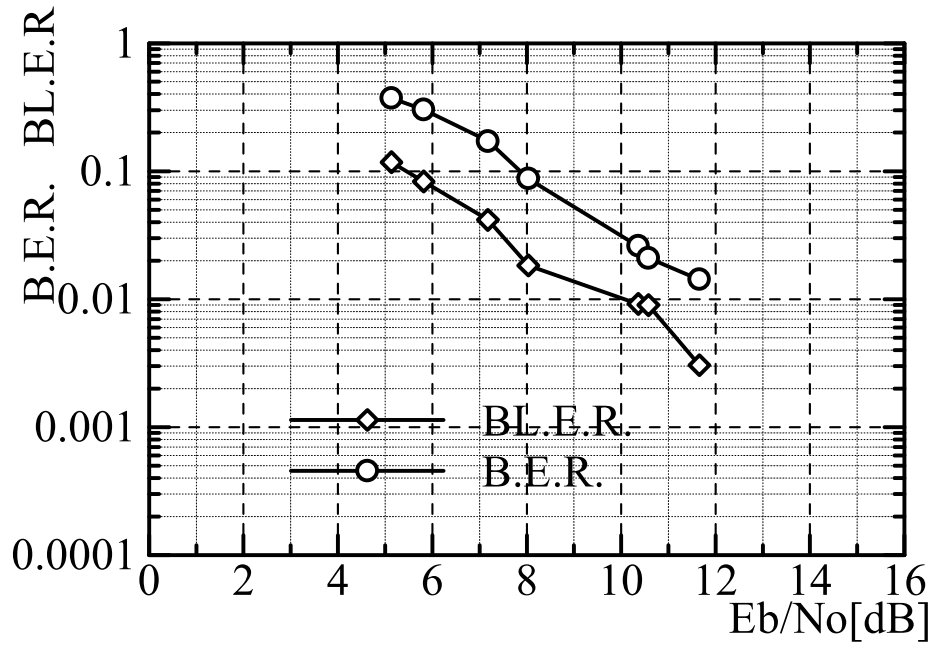


Figure 33 E_b/N_0 vs BL.E.R. (Mode B, Office)

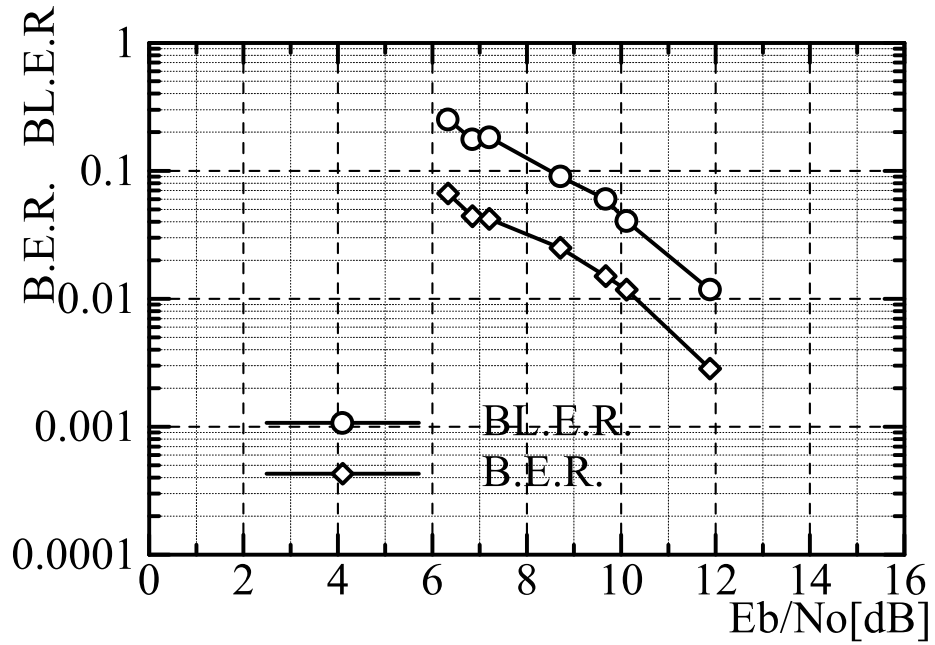


Figure 34 (Mode B, Office)

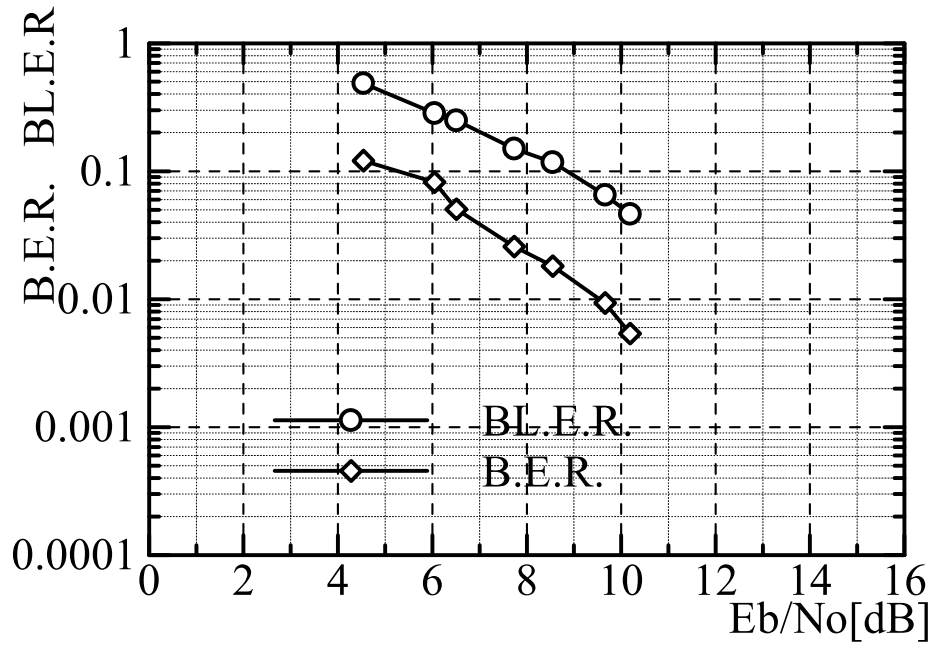


Figure 35 E_b/N_0 vs B.L.E.R. (Mode B, Vehicular)

10.5 UDD 2048 Simulation

10.5.1 Mode B

Table 11: Simulation parameters for UUD2048 Mode B

Environment	(O)	(P)
Delay profile	Office A	Pedestrian A
Mobile speed	3[km/h]	3[km/h]
UL/DL	both	both
Antenna diversity	2 branches	2 branches
Link level bit rate [kbps]	3.82[Mbps]	3.82[Mbps]
Information bit rate [kbps]	2.218[Mbps]	2.218[Mbps]
Modulation	FDD8PSK	FDD8PSK
Convolutional coding	K = 7, R = 1/2	K = 7, R = 1/2
Interleaver length (CC)	288[us]	288[us]
Data block	320[bits]	320[bits]
CRC	16[bits]	16[bits]
RS coding	N/A	N/A
Interleaver length (RS)	N/A	N/A
Time slot usage	2 blocks per Time Slot	2 blocks per Time Slot
Band slot usage	16(1.6[MHz])	16(1.6[MHz])
Frequency hopping bandwidth	No FH	No FH
Power control	No	No
Required. Average .received Eb/No[dB] @BER=10 ⁻¹	10.3[dB]	10.3[dB]

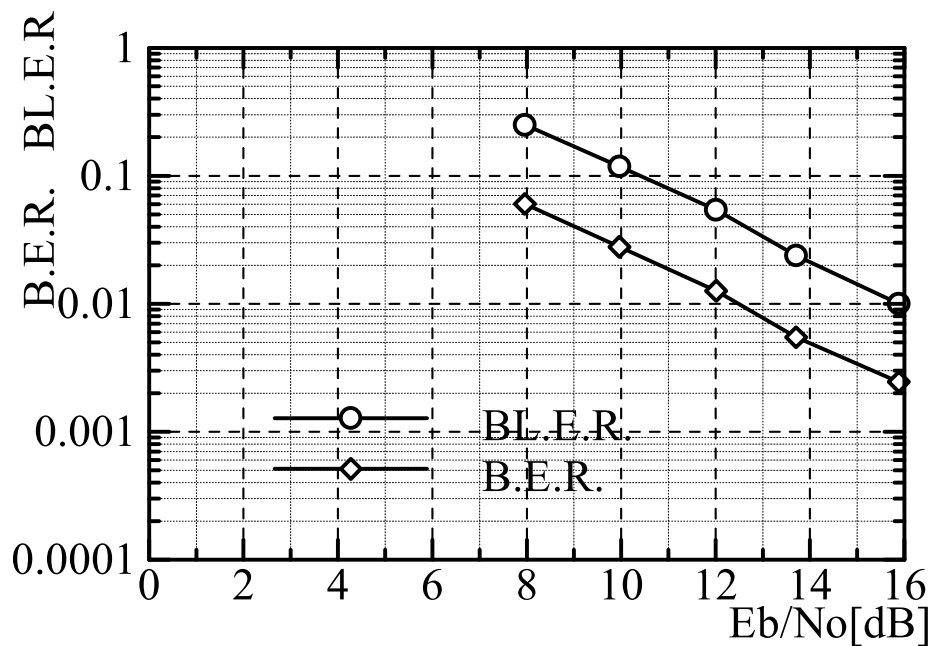


Figure 36 Eb/No vs B.L.E.R. (UUD2048, Office)

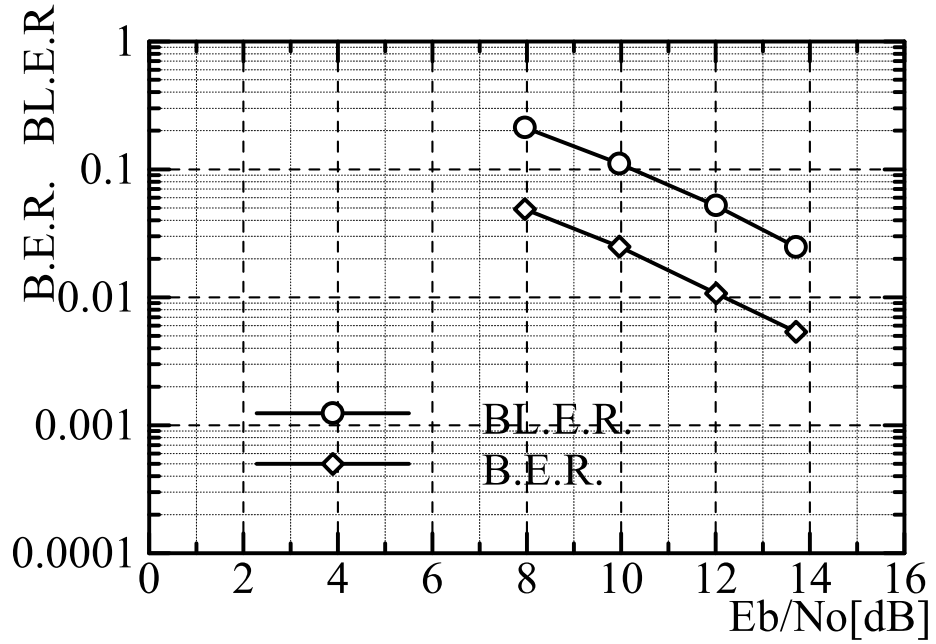


Figure 37 Eb/No vs BL.E.R. (UUD2048, Pedestrian)

11. Link Level Results (Coherent Operation)

For the coherent operation mode the Indoor scenario was considered first. Indoor link level simulations were performed for packets of 14400 bits (6 blocks of 4 symbols for coherent, 24 symbols for differential). No antenna diversity was used. Bit and packet error ratios were obtained by averaging over 1000 independent channels, according to the indoor model A. For the highest data rate, each OFDM symbol has 600 subcarriers, so the data rate is 2.08 Mbps. The total number of subcarriers is 3600 in a bandwidth of 15 MHz. QPSK with rate $\frac{1}{2}$ coding was used (constraint length 7).

Figure 38 shows bit and packet error ratios versus E_b/N_o without power control. Figure 39 shows the same results with power control. In this case, the results are much better because E_b/N_o is now constant for each packet. For a BER of 10^{-3} , for instance, about 5.5 dB E_b/N_o is required for coherent detection, which is about 10 dB better than the average required E_b/N_o in the case of no power control. However, it should be noted that this improvement holds for the mean E_b/N_o at the input of the receiver. E_b/N_o does not include any increase in the average transmit power, which will be present in the case of power control.

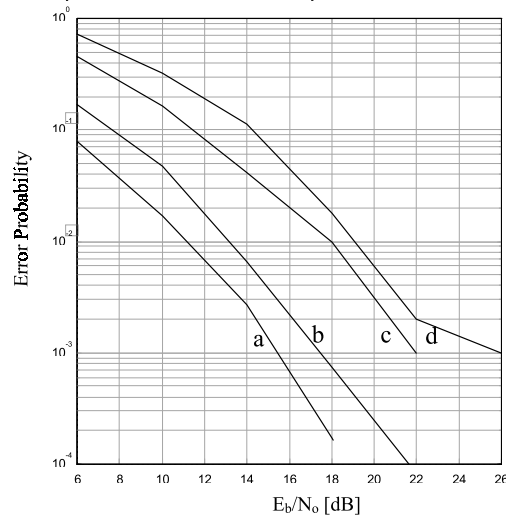


Figure 38: a) BER for coherent detection, b) BER for differential detection in the frequency domain, c) Packet Error Ratio (PER) for coherent detection, d) PER for differential detection.

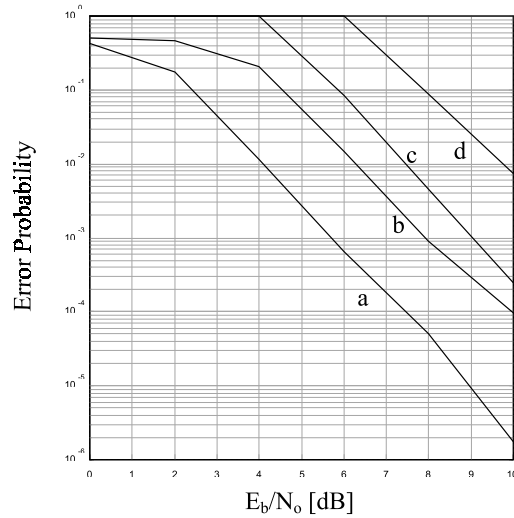


Figure 39: BER and PER for perfect power control, a) BER for coherent detection, b) BER for differential detection, c) PER for coherent detection, d) PER for differential detection

The 5 Hz Doppler in the indoor channel model A has no effect at all, because the packets are too small to benefit from time diversity. Even for circuit switched data, the maximum interleaving time is too short to get a significant improvement. So, the BER plots apply to any rate, provided that a proper interleaving in frequency is done such that the system benefits from the full frequency diversity.

12. System Simulation Results (Differential Operation)

The simulations were carried out according to the system deployment scenarios, mobility models and user satisfaction criteria of ETR-0402. Evaluation results were conducted by simulation with assumptions based on ETR-0402. The details of the simulation conditions are described before presenting the results. Results for circuit switched traffic and packet traffic are presented. Further results will be presented at a later date.

12.1 Simulation Conditions

12.1.1 Overview of System Level Simulation

The structure of the system level simulation is shown in Figure 40.

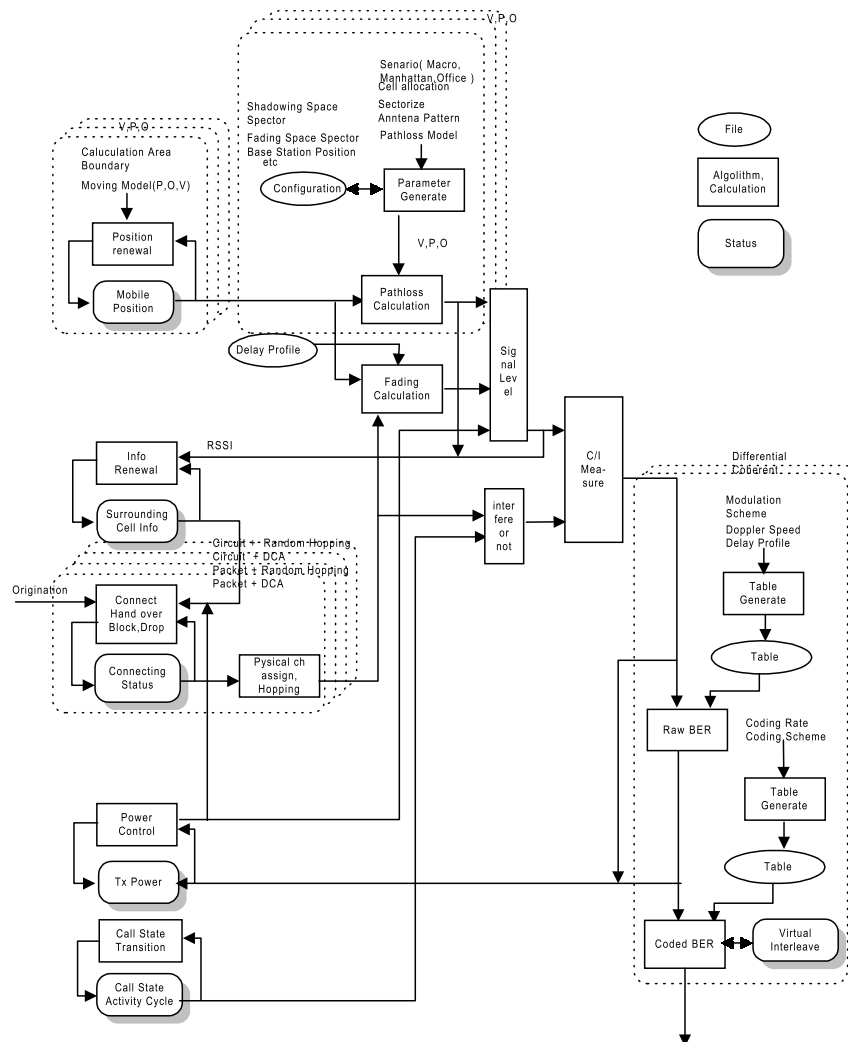


Figure 40: Structure of System Level Simulation

In the system level simulation, the coded BER is calculated by using a look up table. The

$C/(I+N)$ for each slot is collected, and the raw BER is found. (The raw BER are calculated values for all slots within one interleaver frame.) The mean raw BER is then calculated, and finally, the coded BER is calculate by mean raw BER using another look up table. These look up tables are created by the link level simulation. The impact of the channel impulse response model is taken into account for each look up table for each specific evaluation environment. For diversity antenna reception, we collect the raw BER value for each branch, and calculate the mean raw BER.

In actual operation, a cross interleaver will be implemented to reduce transmission delays. However for the system level simulations a cross interleaver is not used to simplify simulations. This does not influence the performance. Interleaving is achieved over 18.46msec (speech service). Currently, only co-channel interference from other cells is taken account, and the interference caused by adjacent channel spurious emission is ignored. For speech services, OFDMA uses a 4 TDMA structure with channel spacing of 100kHz. For a 15MHz system bandwidth the OFDMA system has 600 (15000kHz / 100kHz * 4 TDMA) logical channels. To reduce the simulation time only 1 time slot was simulated. The performance in the other slots was assumed to be the same. In addition, a system bandwidth of only 3.2 MHz was used in order to reduce the number of logical channels and shorten the simulation time. Evaluation with 3.2 MHz bandwidth (32 logical channel per cell) was regarded as reliable enough to measure the precise interference distribution/density.

32 logical channel per cell is however too small to achieve the required trunking efficiency. For a 90% system load which corresponds to 600 logical channel per cell, all of the system traffic can be accommodated without blocking. By evaluating the same load of the system which has only 32 logical channel per cell, the system will block about 8% of the users (see Figure 41). To compensate for this the blocked user rate is calculated by simulating the exact blocked user rate assuming 600 logical channel by using another look up table.

Figure 42 shows the results for satisfied users versus system load for 3.2 MHz and 32 channels and Figure 43 shows percentage of blocked users versus accommodated load for the same conditions. By using the look up table the results for 600 channels in 15 MHz are shown in Figure 44. It can therefore be seen that blocking does not occur at a load of 135kbps/MHz/cell. For a speech service with 15MHz system bandwidth, blocking can therefore be ignored. Additionally, at 32 channels per cell case, it is impossible to achieve a load of greater than 135 kbps/MHz/cell.

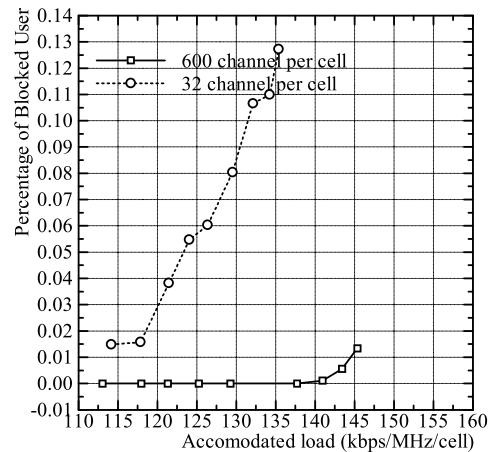


Figure 41: Blocking versus Load

It can be seen that at a load of 135 kbps/MHz/cell, blocking does not occur. For a speech service with 15 MHz system bandwidth, blocking can therefore be ignored. Additionally, in the 32 channels per cell case, it is impossible to achieve a load of greater than 135 kbps/MHz/cell.

The system level simulation used a simulation time of only 120s to collect the statistical values for the evaluation of the speech service scenario. Ideally, a longer time is needed, and results with a longer time will be provided before December.

For each environment (Pedestrian/Vehicular), quality statistical values are only measured on marked BS which are allocated in the middle of the assumed service area. For evaluation of the pedestrian environment, 66 base stations are needed to cover the whole of the service area, including 6 marked BS. For evaluation of the vehicular environment, 21 base stations are needed to cover the service area, including 3 marked BS.

12.1.2 Statistical calculations

1) System load

The system load is calculated in the whole service area using the equation in document ETR 0402. The calculated system load does not include blocked users.

1. Number of handoffs per call

This value is also calculated for the whole of the service area, by counting all handoff execution and number of total calls generated during the observation duration.

2. Blocked users

Blocked users are only collected at marked BS, although blocking occurs at other base stations. Each new MS attempts to connect to the BS which has the lowest pathloss and long term fading. Blocking occurs when there is a shortage of channels (no more logical channels available at this BS).

3. Dropped users

Dropped users are only collected at marked BS, though dropping might occur at other base stations, as described in ETR-0402. Connections will drop according to conditions described in ETR 0402.

4. Not satisfied users

Not satisfied users are calculated according to conditions described in ETR-0402.

At every 0.5 seconds, the BER is collected at every connection within the service area. The quality statistical calculation is also performed at every MS which are connected to the marked BS. (If a MS was originally connected to a 'marked BS' as is disconnected during this period it is not included.)

5. Total BER

ETR-0402 does not require to submit this quality statistical value, but it has been calculated as reference. This value is collected for the whole of the service area.

12.1.3 Pathloss calculation

According to ETR-0402, mobiles position should be updated at every shadowing decorrelation length. As OFDMA operates fast power control, discrete mobility of MS is not acceptable for precise evaluation. Samples of long term fading value are therefore collected at every decorrelation length and interpolation performed for calculating long term fading for every point between the discrete samples of the long term fading.

12.1.4 Fading calculation

Fading is created according to the channel impulse response model described in section B.1.4.2 of ETR-0402. The total number of fading spectors is set to 16. The fading envelope is calculated for each diversity antenna branch. The distance between diversity antenna is set as 7.5cm (at MS).

12.1.5 Neighbour BS Information

All BS inside the system area have a priori knowledge of neighbour BS. This information is used for cell search and handoff.

12.1.6 Interference Restriction

This procedure reduces the simulation time. To be precise the co-channel interference power should be collected from all cells. However, the total interference power is dominated by a couple of relatively large interferes. For instance, a -20dB interference from 1 MS is much larger than the sum of -40dB interference from 10 or more MS. In the simulation therefore, the interference power is calculated by restricting the source of interference as follows.

$L1$ [dB] is defined as the pathloss between MS being considered and its connected BS. This base station is named B_{sa} .

$L2$ [dB] is defined as the pathloss between MS and other cell's BS. These basestations are named B_{Sx} .

1) If $L1 + \text{Threshold} < L2$,

To B_{Sx} , up link interference from this MS should be omitted.

To this MS, down link interference from B_{Sx} should be omitted.

Threshold is set to 35[dB].

Each MS will therefore search all interference candidates from the BS and check to see it is visible from the MS location. If candidate is not treated as visible, then this MS will ignore it when calculating interference.

This procedure is done at every update of the MS position.

For uplink the same procedure is used.

12.1.7 Traffic Management

Circuit switched traffic is expressed by the Poisson process with additional minimum call duration, according to ETR-0402. Each call is generated after calculated interval from previous call generation. Calls will be terminated when call termination timer is expired, or when call is forced to be dropped. Dropped calls occur according to condition described in ETR-0402. At system level simulation, 1 MS is used for initialisation and the number of communicating MS increases rapidly during the first 10 seconds. The total traffic then reaches input load with some variation according to Poisson process.

If activity factor is 100%, then ON state will last until call termination. If activity factor is not 100%, then another call state will be selected at each state of timer expiration. ON state and OFF state timer are set according to description in ETR-0402. During the OFF duration, ACCH is transmitted with a lower bit rate (1/4 or 1/8 compared to continuous TCH transmission) to maintain power control. In the current system level simulation no information is transmitted during the 'OFF' state to simplify simulations.

12.1.8 MS Mobility

MS mobility is implemented according to ETR-0402 except the frequency of the location updates. As described above, the MS location is updated more frequently than the long term fading decorrelation length. The MS location is updated at every 1.15msec which is 1 TDMA frame duration. If the MS moves outside the service area for the vehicular case, the MS is forced to go back in the opposite direction to stay in the service area. In the case of pedestrian, every MS is located in the centre of the street.

12.1.9 Handoff

Handoff is triggered by a simple pathloss comparison which does not include fading attenuation. The MS attempts to connect to the closest BS during handover. Handoff check is initiated every 73.6 msec. If the BS which the MS attempts to create a connection, does not have vacant channel, handoff will fail, and this MS will stay connected to the previous BS.

12.1.10 Power Control

Power control is achieved for every slot by returned power control command. Power control command is returned to transmitter without errors, as ETR-0402 requires to evaluate up/down link separately. Power control step is set to 1dB. Power control command is reflected to exact transmission with some time lag. In case of 4 TDMA structure, returned power control command is reflected 3 TDMA frames later.

In the case of the multi slot usage for higher bit rate transmission, the power control command will be achieved uniquely for 1 time slot unit. Power control command is decided by mean quality among received 1 time slot unit.

12.2 System Level Simulation Results (Speech)

Speech service system capacity (circuit switched service) has been evaluated using dynamic system simulations. A voice activity of 50% is considered.

12.2.1 Outdoor to Indoor and Pedestrian A

The following figures show the speech service spectrum efficiency for an outdoor to Indoor and pedestrian A environment. Figure 42 shows the satisfied user rate versus system load using the described system level simulation.

As explained before, this evaluation is based on system band width of 3.2MHz, considering 15MHz bandwidth we can eliminate all blocked users from the 'unsatisfied users'. Using the full bandwidth of 15MHz the accommodated load is smaller than 135kbps/MHz/cell, so the actual rate of blocked users is 0% (considering Figure 43 which shows blocked user rate versus system load at 3.2Mhz).

Finally Figure 44 shows the final system level simulation results assuming 15MHz system bandwidth (satisfied user rate versus system load). No dropping was observed at all evaluated system loads, the mean number of handoff procedures per user is 2.7.

It should be noted that OFDMA has the ability to accommodate more than the presented load figures because all plots in Figure 44 show a satisfied user rate above 98%. As described before, we could not measure quality statistics at higher load (occurrence of blocking).

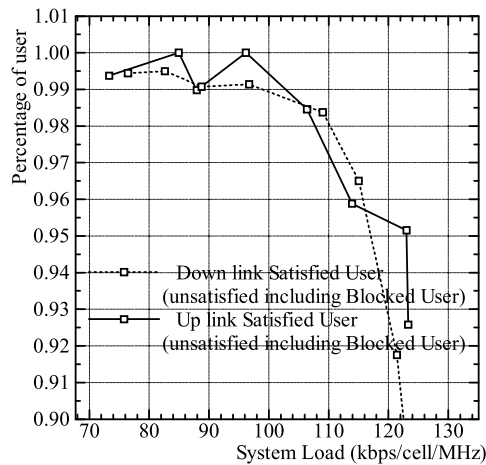


Figure 42: System Bandwidth 3.2MHz

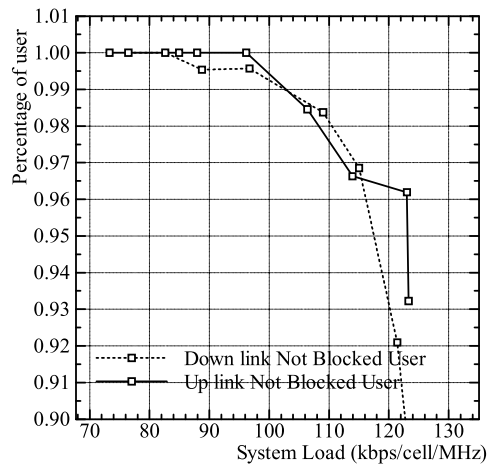


Figure 43: System Bandwidth 3.2MHz

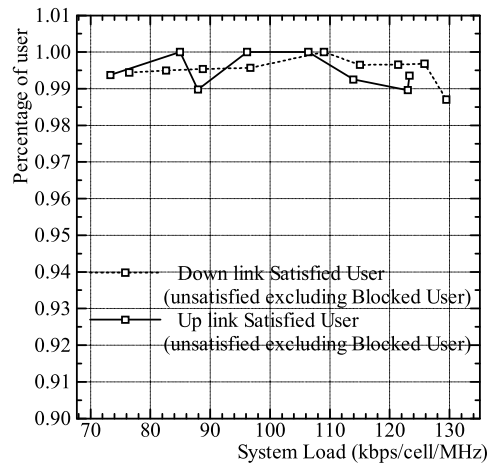


Figure 44: System Bandwidth 15MHz

12.2.2 Vehicular A

The following figures show the spectrum efficiency for a speech service scenario at Vehicular A environment. Figure 46 shows the satisfied user rate versus system load evaluated by dynamic system level simulation. Figure 45 shows the blocked user rate versus system load and Figure 47 finally gives the system level simulation results assuming 15MHz system bandwidth (here again the assumption of no blocking with a system bandwidth of 15MHz is valid). No dropped users were observed at all evaluated system loads, the mean number of handoff procedures per user is 3.3.

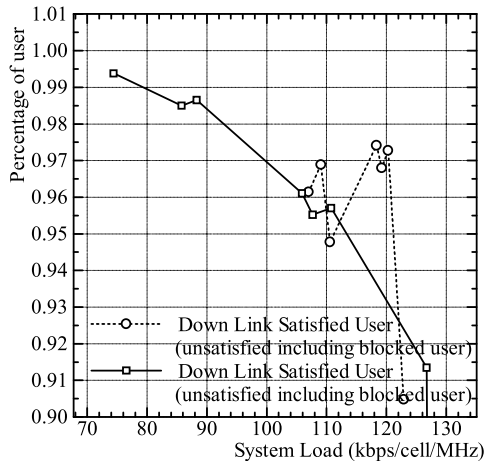


Figure 46: System Bandwidth 3.2MHz

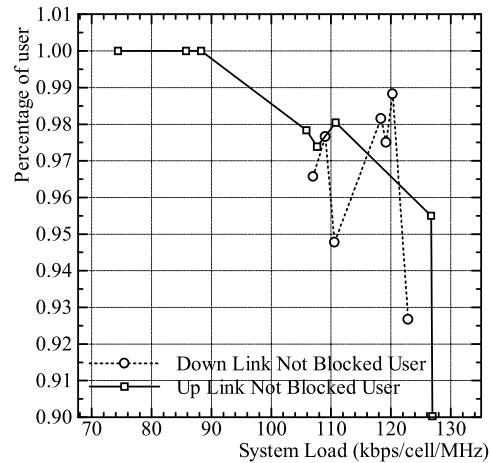


Figure 45: System Bandwidth 3.2MHz

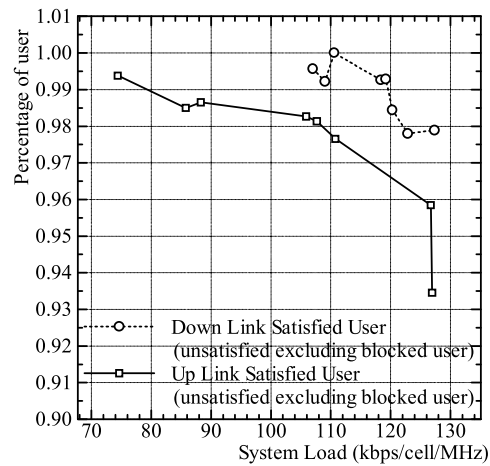


Figure 47: System Bandwidth 15MHz

12.2.3 Indoor Office A

The following figures show the spectrum efficiency for a speech service scenario for the indoor office A environment. Figure 48 shows the satisfied user rate versus system load evaluated by the dynamic system level simulation. Figure 44 shows the blocked user rate versus system load and Figure 50 gives the system level bandwidth of 15MHz is valid). No dropped users were observed at all evaluated system loads. The simulation results assuming 15MHz system bandwidth (here again the assumption of no blocking with a system summarised results are shown in Table 12.

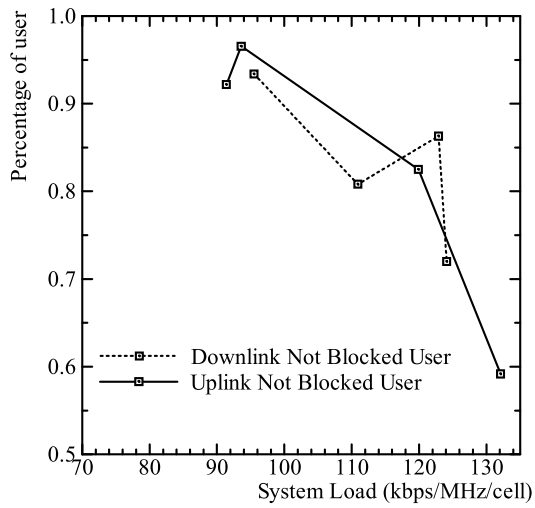
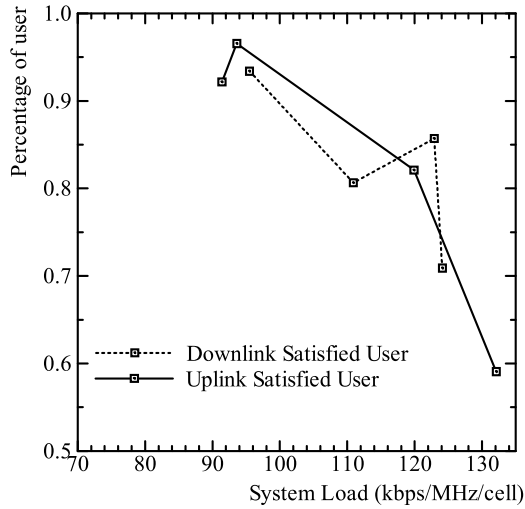


Figure 48 System Bandwidth 3.2 MHz

Figure 49 System Bandwidth 3.2 MHz

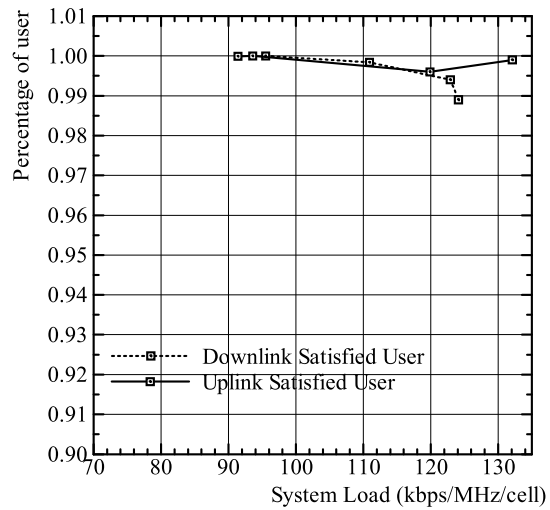


Figure 50 System Bandwidth 15 MHz

12.2.4 Speech System Level Simulation (Summary)

Table 12 summarises the system level simulation results for speech services according to ETR0402.

Table 12: Speech System Level Simulation Summary

Service	Environment	Cell Capacity (#User/MHz/Cell) (UL/DL)	Spectrum Efficiency (kbps/MHz/Cell) (UL/DL)	Mean BER (UL/DL)
Speech (8kbps, 50% VA)	Indoor Office A	33.0 / 31.0	132 / 124	6.5e-5 / 4.0e-5
	Outdoor to Indoor and Pedestrian A	30.75 / 32.25	123 / 129	5.8e-5 / 2.2e-5
	Vehicular A	27.0 / 30.5	108 / 122	2.1e-4 / 3.7e-4

For speech services the BDMA system requires only a very small guard band (e.g. 200kHz or 400kHz on each side) to full fill adjacent system spurious emission requirements. Therefore the results we presented should be normalised by a factor of $(15-2*0.4)/15=0.95$.

12.3 System Level Simulation Results (LCD 384)

12.3.1 Vehicular A

The following figures show results of the spectrum efficiency simulation of LCD 384kbps services for the Vehicular A environment. For LCD 384kbps service system level simulation, we assume 13.6MHz system bandwidth and the rest of 1.4 MHz as guard band. LCD 384kbps service requires 800kHz bandwidth (8 bandslots) per connection, in total 17 carriers are available to operate LCD 384 services using 13.6MHz.

Two scenarios were simulated, the first simulation uses the maximum transmit power specified in the link budget template(see Table 1.3 in ETR-0402), and the second simulation uses optimised transmitter power² for the OFDMA SRTT.

Table 13: LCD 384 Concept Optimising Parameters

		Downlink	Uplink
Test Environment		Vehicular A	Vehicular A
Test Service		LCD 384	LCD 384
Concept Optimising Parameters			
Max. TX power per Traffic Channel	[dBm]	45.0	33.0
Average TX power per Traffic Channel	[dBm]	44.4	32.4
TX antenna gain	[dBi]	17	2

² For the down-link the maximum TX power per band-time slot is the same TX power specified in ETR-0402 to support voice services (36.0dBm), therefore no modification in the BS transmitter is necessary to operate a LCD 384kBps service.
For the up-link the maximum TX power of the MS is the same as defined in the GSM specifications (2 W) which is a realistic assumption.

RX antenna gain	[dBi]	2	17
-----------------	-------	---	----

Figure 51 shows the satisfied user rate versus system load and Figure 52 shows the dropped user rate versus system load. No blocking was observed at the simulated system load values. These results are achieved using the specified (ETR0402) maximum transmitter power. We emphasise that because of the fundamental transmitter power shortage, there is no possibility to accommodate a certain amount of users under the (non optimised) conditions described in ETR-0402. We believe this problem is not limited to the OFDMA SRTT. No information can be received if the received Eb/No is smaller than the required Eb/No, this is valid for any radio access scheme.

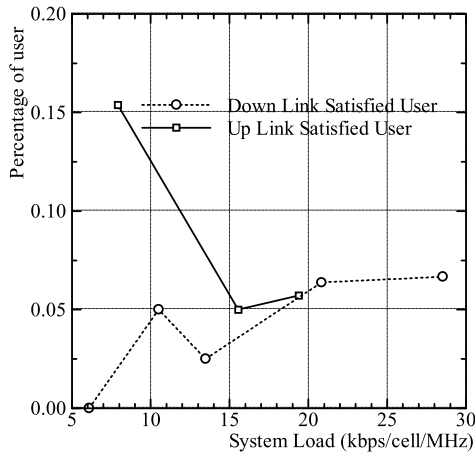


Figure 51: Satisfied User Rate

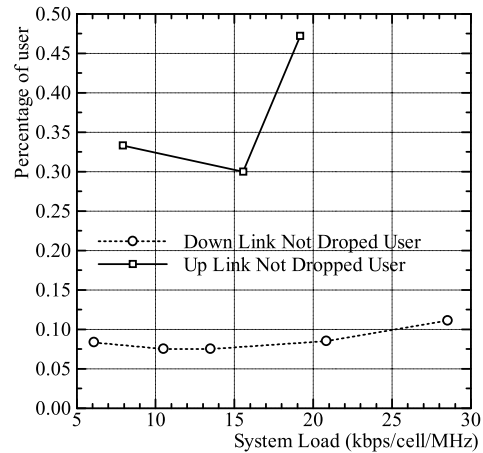


Figure 52: Not Dropped User Rate

Figure 53 shows the satisfied user rate versus system load, and Figure 54 shows blocked user rate versus system load. No dropping was observed at each simulated system load. These results are based on the optimised transmitter power assumption.

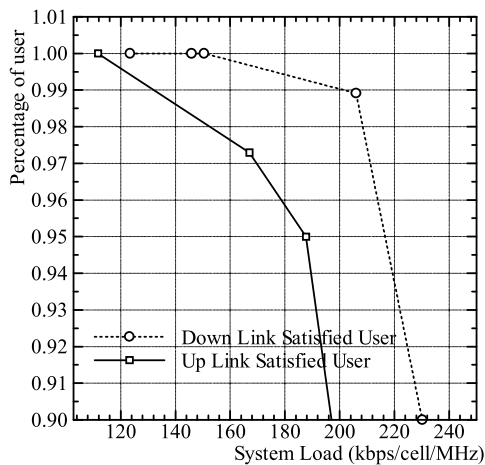


Figure 53: Satisfied User Rate

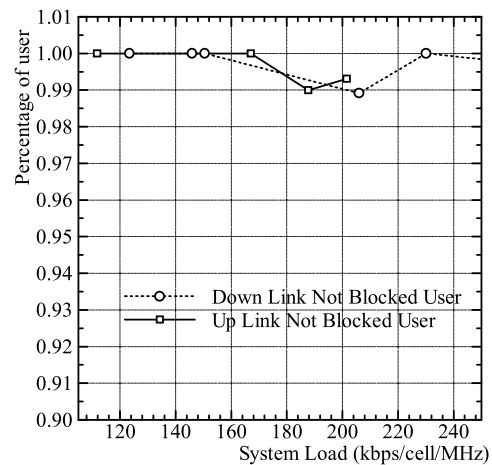


Figure 54: Not blocked User Rate

The following table summarises the results for LCD 384 services.

Table 14: LCD 384 System Level Simulation Summary

Service	Environment	Cell Capacity (#User/MHz/Cell) (UL/DL)	Spectrum Efficiency (kbps/MHz/Cell) (UL/DL)	Mean BER (UL/DL)
LCD 384kbps (with specified transmitter power)	Indoor Office A	T.B.D. / T.B.D.	T.B.D. / T.B.D.	T.B.D. / T.B.D.
	Outdoor to Indoor and Pedestrian A	T.B.D. / T.B.D.	T.B.D. / T.B.D.	T.B.D. / T.B.D.
	Vehicular A	/	None / None	not measured
LCD 384kbps (with optimised transmitter power)	Indoor Office A	T.B.D. / T.B.D.	T.B.D. / T.B.D.	T.B.D. / T.B.D.
	Outdoor to Indoor and Pedestrian A	T.B.D. / T.B.D.	T.B.D. / T.B.D.	T.B.D. / T.B.D.
	Vehicular A	/	152 / 208	not measured

For 800kHz services like LCD 384kbps, the BDMA system requires approximately 700-800kHz guard band to fulfil adjacent system spurious emission requirements. Therefore the results we presented should be normalised by a factor of $(15-2*0.7)/15=0.91$

12.4 System Level Simulation Results (UDD384)

System level simulations were conducted for the UDD384 packet services. The simulations were conducted in accordance with 0402 and SMG2 G18/97. A satisfied user is therefore defined as one in which a throughput of 10 % of the target bit rate can be maintained. Calls with packet services are never dropped. In a similar way to the circuit switched services a look up table is used to derive the block (or packet) error rate from the raw BER.

12.4.1 Outdoor to Indoor and Pedestrian A

System results for the UDD 384 services (Mode B) are shown in Figure 55 for the uplink and downlink. These results are for a system bandwidth of 3.2 MHz. The results are therefore likely to increase for the case of 15 MHz due to the availability of more channels and consequent decrease in blocking. The results are summarised in Table 15.

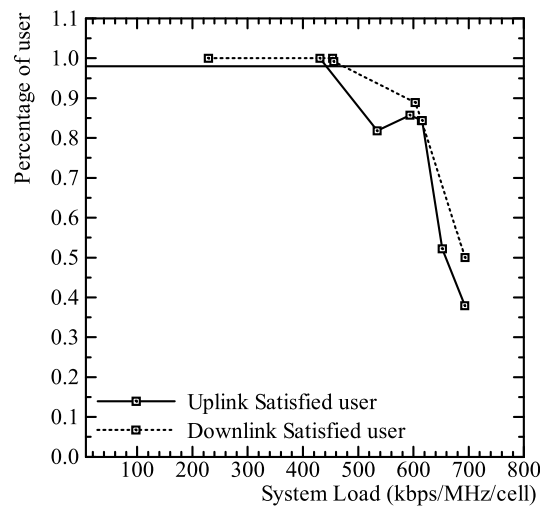


Figure 55 System Bandwidth 3.2 MHz

Table 15 UDD 384 Pedestrian Simulation Summary

	Environment	Cell Capacity (#User/MHz/Cell) (UL/DL)	Spectrum Efficiency (kbps/MHz/Cell) (UL/DL)
UDD384 (10%)	Outdoor to Indoor and Pedestrian A		440 / 465

12.5 System Level Simulation Results (UDD2048)

12.5.1 Indoor Office A

Preliminary results for the UDD 2048 services (Mode B) are shown in Figure 56 for the uplink and downlink. It is important to note that these are preliminary results and that the system parameters have not yet been optimised to yield the best performance. These results are for a system bandwidth of 15 MHz and a system with only one floor. The results are summarised in Table 16.

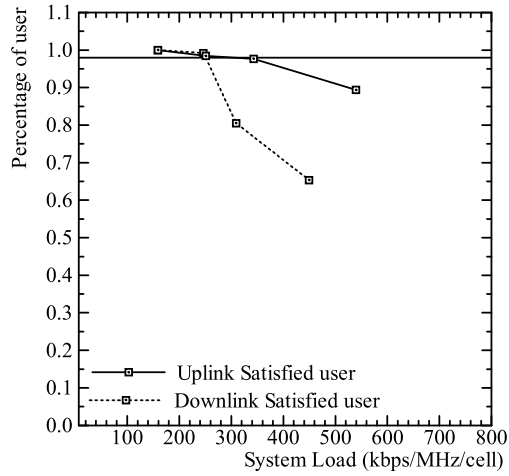


Figure 56 System Bandwidth 15 MHz

Table 16 UDD 2048 Indoor Simulation Summary

	Environment	Cell Capacity (#User/MHz/Cell) (UL/DL)	Spectrum Efficiency (kbps/MHz/Cell) (UL/DL)
UDD2048 (10%)	Indoor		240 / 240

12.6 System Level Simulation Results (50%speech+50%UDD384)

12.6.1 Indoor Office A

These simulations are in progress and results will be submitted shortly.

13. Conclusion

In this evaluation report we have provided a description of the basic functional blocks that make up the OFDMA system. From this description it should be clear that the OFDMA proposal can be considered as a hybrid OFDM-TDMA scheme.

- The benefits of using OFDM as the underlying modulation scheme, is that it greatly reduces the required hardware complexity and provides a degree of flexibility in the frequency domain that enables two MACs to be supported by the same basic PHY layer. This inherent frequency flexibility provides operators with frequency deployment options that allows the support of asymmetric up and down links as well as smaller re-farmed portions of spectrum.
- The benefits of the two software driven TDMA style MACs allow the OFDMA proposal to realistically provide the full complement of UMTS services (including unlicensed operation & high bit-rate support) in a spectrally efficient manner with relatively low complexity terminals.
- Both MACs have been deliberately designed to share the same basic TDMA framing structure of GSM, making the possibility of dual mode UMTS/GSM terminals/core networks that much more realistic.
- In addition to this ability to co-exist and work with existing 2nd generation networks, we believe that OFDMA also has the flexibility to expand its horizons for later developments of UMTS.
- Enhancement techniques already available and proven for TDMA system can be applied to OFDMA easily (e.g. HCS, directional antennas).

In the near future we intend to release further results showing the system capacity for packet data transfer services. We also have work under way to develop a hardware testbed. In the meantime, we look forward to your comments and questions.

14. Annex

15. Annex

15.1 System Level Simulation Updates

During the preparation of the evaluation report new results with longer simulation time were carried out for the system level simulation. This annex contains the latest results achieved.

15.1.1 Vehicular A - LCD 384

This section contains new simulation results for the LCD 384 service in the Vehicular A environment, the corresponding chapter is 12.3.1.

Figure 57 shows the downlink system performance for the LCD 384 service in Vehicular A environment with different simulation times. It can be seen that the results produced by the 1200 second simulation produce higher system load figure than those with the 120 second simulation.

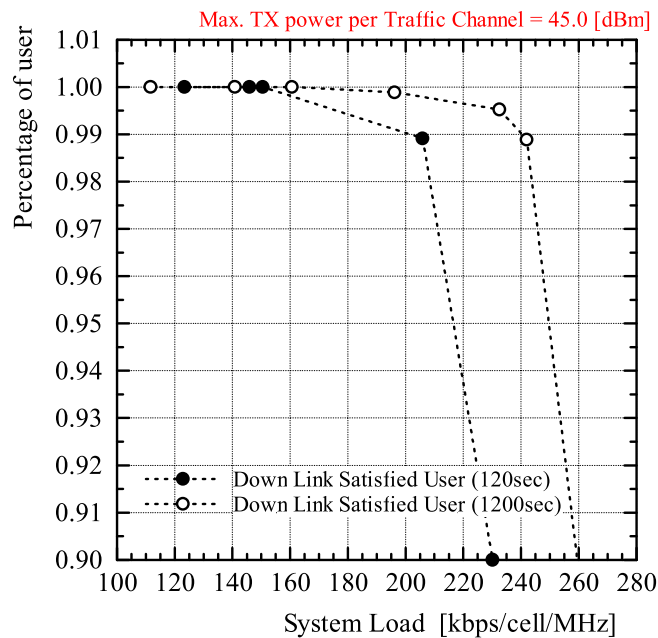


Figure 57 Downlink simulation system performance with different simulation time

15.1.2 Speech

This section contains new simulation results for the speech service in the Vehicular A environment, the corresponding chapter is 12.2.2.

Figure 58 shows the system performance of the speech service with 15 MHz bandwidth, Vehicular A environment and 480 seconds observation time. The call duration has also been reduced to 40 seconds.

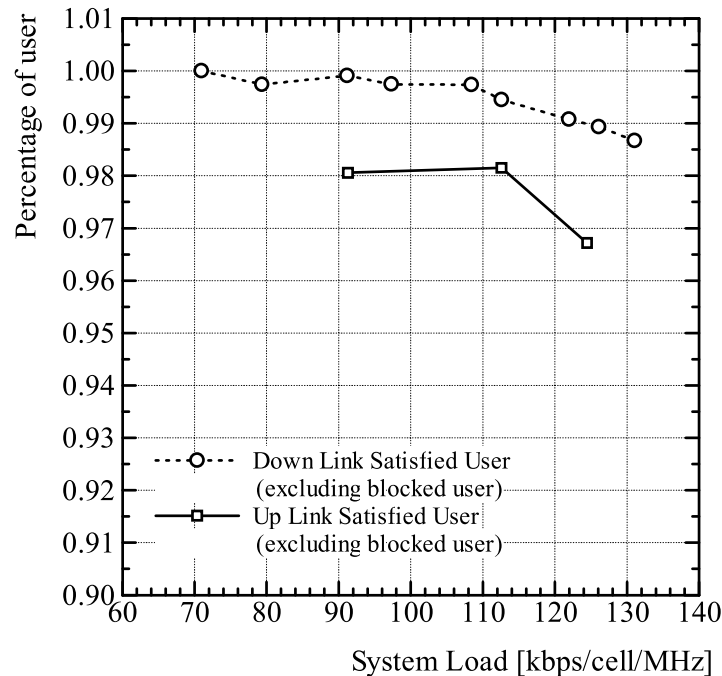


Figure 58 System load performance (Speech) with longer observation time (480 s)

As can be seen from these results the longer simulation time causes a smoother load curve to be produced due to the improved statistics of the simulation results. What is more important, however, is that system load for 98 % satisfied user is higher (increase of 10%) for the longer simulation time. This indicates that the results shown in the Evaluation report are pessimistic.

15.1.3 UDD 384 - Pedestrian A

This section contains new simulation results for the UDD384 service in the Pedestrian/Indoor to Outdoor environment, the corresponding chapter is 12.4.1.

These are initial results for the downlink for mode A of UDD services.

The simulation has not terminated at the 98% user satisfaction, but the performance of mode A is better than for mode B.

The PDF graphs shown in Figure 61, Figure 62, Figure 63 are shown for three different loads 420, 290 and 155 kbit/s respectively. The two vertical lines indicate the PDF at 10 % of the target bit rate (38.4 kbit/s) and 100 % of the target bit rate (384 kbit/s).

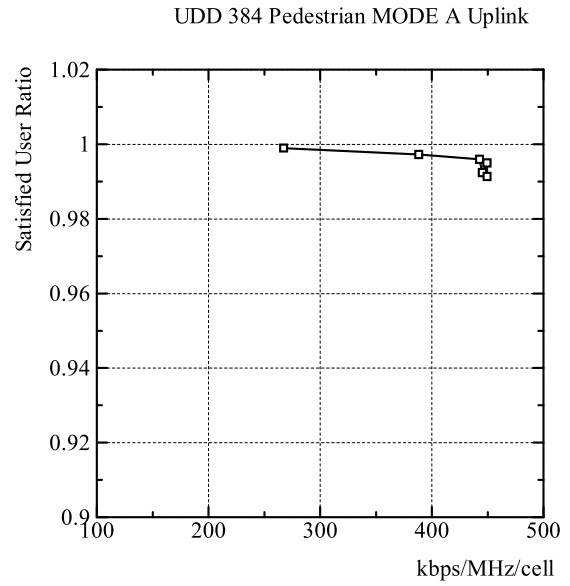
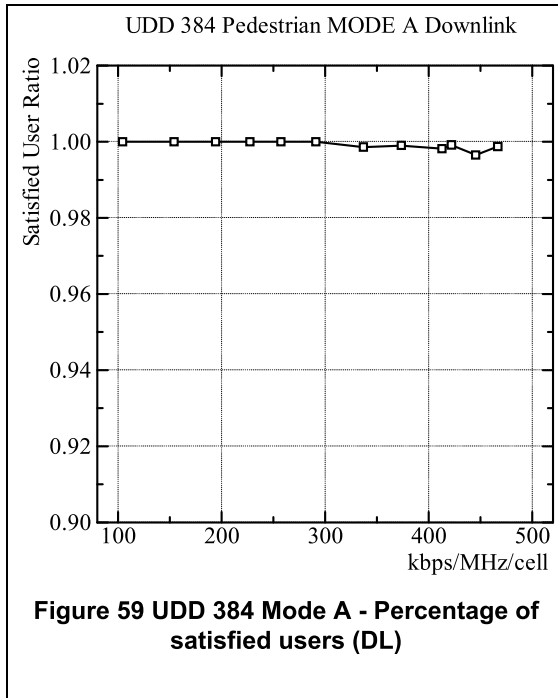
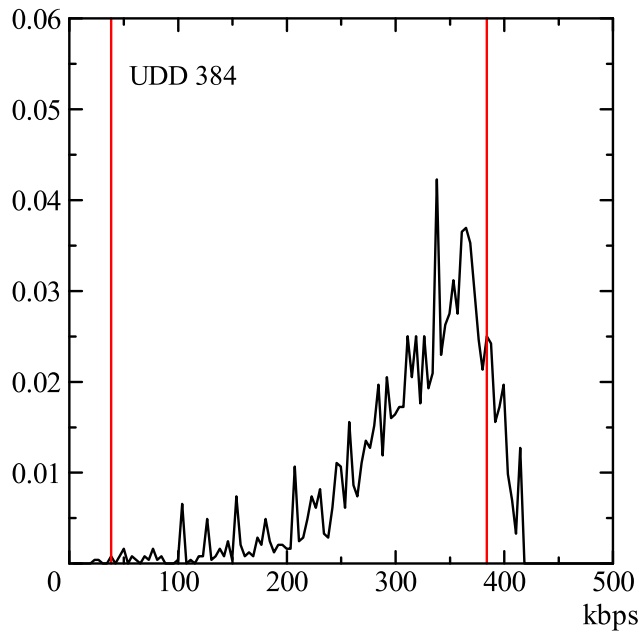
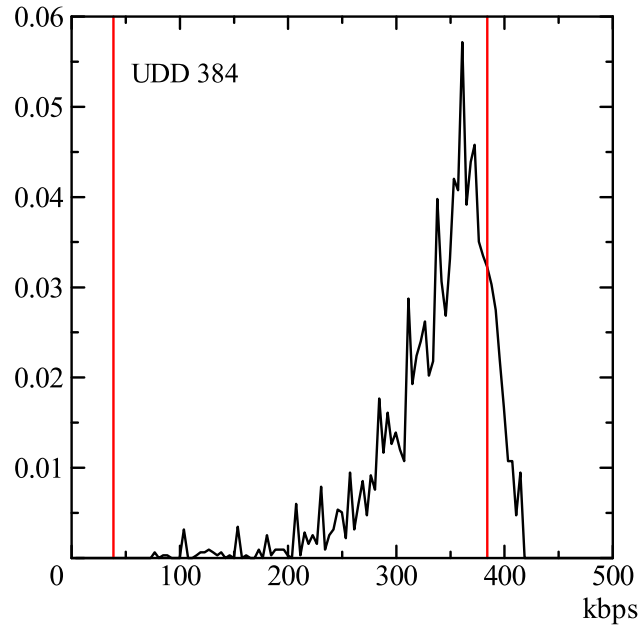


Figure 60: UDD 384 Mode A - Percentage of satisfied users (UL)



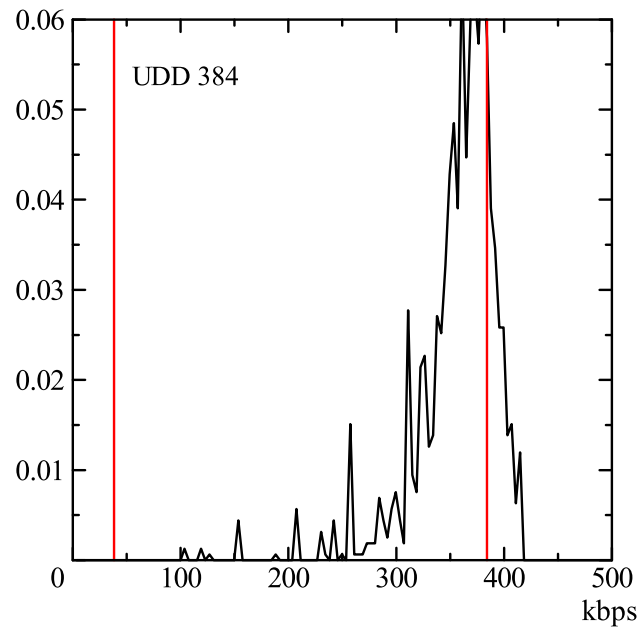
420kbps/MHz/cell

Figure 61 - PDF of mean bit rate at system load of 420 kbit/s/MHz/cell



290kbps/MHz/cell

Figure 62 PDF of mean bit rate for system load of 290 kbit/s/MHz/Cell



155kbps/MHz/cell

Figure 63 PDF of mean bit rate for system load of 155 kbit/s/MHz/Cell

15.2 Abbreviations

BCCH	Broadcast control channel
CDMA	Code Division Multiple Access
DCA	Dynamic channel assignment
DCCH	Dedicated control channel
DL	Downlink
IACH	Initial acquisition channel
KERO	Knowledge enclosed reference operation
MRC	Maximal ratio combining
OBO	Output Back Off
OFDMA	Orthogonal Frequency Multiple Access
QPSK	Quadrature Phase Shift Keying
RACH	Random access channel
ROT	Random orthogonal transform
RPS	Random phase shift
SFH	Slow Frequency Hopping
TDMA	Time Division Multiple Access
UL	Uplink
UMTS	Universal Mobile Telephone System

15.3 References

- [SMG50402]** ETR/SMG-50402 Version 0.9.5.
ETSI draft specification of the Selection procedure for the choice of radio transmission technologies of the Universal Mobile Telecommunication System (UMTS).
- [Mueller97]** Mueller S., Baeuml R., Fischer R., Huber B; 'OFMD with reduced Peak-to-Average Power Ratio by Multiple Signal Representation; Annals of Telecommunications; Vol. 52; No. 1-2; pp. 58-67, February 1997.
- [Olofsson95]** Olofsson H., Naslund J., Sköld J.; 'Interference Diversity Gain in Frequency Hopping GSM'; Proceedings IEEE Vehicular Technology Conference (VTC); Chicago; pp. 102-106; June 1995
- [Pauli97]** Pauli M., Kuchenbecker H.P.; 'Minimisation of the intermodulation distortion of a nonlinearity amplified OFDM signal'; Wireless Personal Communications; Vol. 4; No. 1; pp. 93-101; January 1997,.

OFDMA Evaluation Report

The Multiple Access Scheme Proposal for the UMTS Terrestrial Radio Air Interface (UTRA)

Part 2

Link Budget and Technology Description Template

Introduction:

This document contains the link budgets for speech, LCD 144 and LCD384.

For Speech also the new test cases of Vehicular B channel model and MS speed of 250km/h has been tested with excellent performance.

The second part of this document contains the technology description template for the OFDMA system (according to ETR30.03).

Table of Content

1. Link Budget Templates.....	260
1.1 Link Budget Speech.....	260
1.2 Link Budget LCD144	262
1.3 Link Budget LCD384	263
1.4 Link Budget UDD144	264
1.5 Link Budget UDD384	265
1.6 Link Budget UDD2048	266
2. Technology Description Template.....	267

1. Link Budget Templates

1.1 Link Budget Speech

Test environment		(O)		(P)		(V) Vehicular A 120[km/h]	
Item		Down Link	Up Link	Down Link	Up Link	Down Link	Up Link
Test service		SP	SP	SP	SP	SP	SP
Ave. Tx Power per traffic Ch	[dBm]	10.0	4.0	20.0	14.0	30.0	24.0
(a1) Max Tx Power per traffic Ch	[dBm]	16.0	10.0	26.0	20.0	36.0	30.0
(a2) Max Total Tx Power	[dBm]	16.0	10.0	26.0	20.0	36.0	30.0
(b) Cable, connector, and combiner losses	[dB]	2	0	2	0	2	0
(c) Transmitter Antenna gain	[dBi]	2	0	10	0	13	0
(d1) Tx e.i.r.p. per traffic ch=(a1-b+c)	[dBm]	16.0	10.0	34.0	20.0	47.0	30.0
(d2) Total Tx e.i.r.p. = (a2-b+c)	[dBm]	16.0	10.0	34.0	20.0	47.0	30.0
(e) Receiver Antenna Gain	[dBi]	0	2	0	10	0	13
(f) Cable and Connector Losses	[dB]	0	2	0	2	0	2
(g) Receiver Noise Figure	[dB]	5	5	5	5	5	5
(h) Thermal Noise Density	[dBm/Hz]	-174	-174	-174	-174	-174	-174
(i) Receiver Interference Density	[dBm/Hz]	-Infy	-Infy	-Infy	-Infy	-Infy	-Infy
(j) total effective noise plus interference	[dBm/Hz]	-169	-169	-169	-169	-169	-169
(k) Information Rate (10 log (Rb))	[dBHz]	45.05	45.05	45.05	45.05	45.05	45.05
		8.0[kbps] x 4					
(l) Required Eb/(No+lo) with no power control	[dB]	10.0	10.0	11.2	11.2	5.6	5.6
		including diversity gain					
(m) Receiver sensitivity = (j + k + l)	[dB]	-	-	-	-	-	-
		113.95	113.95	111.75	111.75	118.35	118.35
(n) Hand-off gain	[dB]	5.9	5.9	4.7	4.7	4.7	4.7
(o) Explicit diversity gain	[dB]	0	0	0	0	0	0
		included in req.Eb/No					
(o') Other gain	[dB]	0	0	0	0	0	0
(p) Log-normal fade margin	[dB]	15.4	15.4	11.3	11.3	11.3	11.3
(q) Maximum path loss = {d1-m+(e-f)+o+n+o' -p}	[dB]	120.35	114.45	140.15	134.15	158.75	152.75
(r) Maximum Range	[m]	600.25	381.65	635.33	449.77	6514	4511

$$(O) \quad L(R[m]) = 37 + 30\log(R[m]) \text{ [dB]}$$

$$(P) \quad L(R[km]) = 148.03 + 40\log(R[km]) \text{ [dB]}$$

$$(V) \quad L(R[km]) = 128.15 + 37.6\log(R[km]) \text{ [dB]}$$

Test environment		(O)		(P)		(V) Vehicular B 250[km/h]	
Item		Down Link	Up Link	Down Link	Up Link	Down Link	Up Link
Test service		SP	SP	SP	SP	SP	SP
Ave. Tx Power per traffic Ch	[dBm]	10.0	4.0	20.0	14.0	30.0	24.0
(a1) Max Tx Power per traffic Ch	[dBm]	16.0	10.0	26.0	20.0	36.0	30.0
(a2) Max Total Tx Power	[dBm]	16.0	10.0	26.0	20.0	36.0	30.0
(b) Cable, connector, and combiner losses	[dB]	2	0	2	0	2	0
(c) Transmitter Antenna gain	[dBi]	2	0	10	0	13	0
(d1) Tx e.i.r.p. per traffic ch=(a1-b+c)	[dBm]	16.0	10.0	34.0	20.0	47.0	30.0
(d2) Total Tx e.i.r.p. = (a2-b+c)	[dBm]	16.0	10.0	34.0	20.0	47.0	30.0
(e) Receiver Antenna Gain	[dBi]	0	2	0	10	0	13
(f) Cable and Connector Losses	[dB]	0	2	0	2	0	2
(g) Receiver Noise Figure	[dB]	5	5	5	5	5	5
(h) Thermal Noise Density	[dBm/Hz]	-174	-174	-174	-174	-174	-174
(i) Receiver Interference Density	[dBm/Hz]	-Infy	-Infy	-Infy	-Infy	-Infy	-Infy
(j) total effective noise plus interference	[dBm/Hz]	-169	-169	-169	-169	-169	-169
(k) Information Rate (10 log (Rb))	[dBHz]	45.05	45.05	45.05	45.05	45.05	45.05
(l) Required Eb/(No+Io) with no power control	[dB]	8.0[kbps] x 4				5.7	5.7
(m) Receiver sensitivity = (j + k + l)	[dB]	including diversity gain				- 118.45	- 118.45
(n) Hand-off gain	[dB]	5.9	5.9	4.7	4.7	4.7	4.7
(o) Explicit diversity gain	[dB]	0	0	0	0	0	0
(o') Other gain	[dB]	included in req.Eb/No				0	0
(p) Log-normal fade margin	[dB]	15.4	15.4	11.3	11.3	11.3	11.3
(q) Maximum path loss = {d1-m+(e-f)+o+n+o' -p}	[dB]					158.85	152.85
(r) Maximum Range	[m]					6553	4538

- (O) $L(R[m]) = 37 + 30\log(R[m])$ [dB]
(P) $L(R[km]) = 148.03 + 40\log(R[km])$ [dB]
(V) $L(R[km]) = 128.15 + 37.6\log(R[km])$ [dB]

1.2 Link Budget LCD144

Test environment		(O)		(P)		(V)	
Item		Down Link	Up Link	Down Link	Up Link	Down Link	Up Link
Test service		LC144	LC144	LC144	LC144	LC144	LC144
Ave. Tx Power per traffic Ch	[dBm]	10.0	4.0	20.0	14.0	30.0	24.0
(a1) Max Tx Power per traffic Ch	[dBm]	10.6	4.6	20.6	14.6	30.6	24.6
(a2) Max Total Tx Power	[dBm]	10.6	4.6	20.6	14.6	30.6	24.6
(b) Cable, connector, and combiner losses	[dB]	2	0	2	0	2	0
(c) Transmitter Antenna gain	[dBi]	2	0	10	0	13	0
(d1) Tx e.i.r.p. per traffic ch=(a1-b+c)	[dBm]	10.6	4.6	28.6	14.6	41.6	24.6
(d2) Total Tx e.i.r.p. = (a2-b+c)	[dBm]	10.6	4.6	28.6	14.6	41.6	24.6
(e) Receiver Antenna Gain	[dBi]	0	2	0	10	0	13
(f) Cable and Connector Losses	[dB]	0	2	0	2	0	2
(g) Receiver Noise Figure	[dB]	5	5	5	5	5	5
(h) Thermal Noise Density	[dBm/Hz]	-174	-174	-174	-174	-174	-174
(i) Receiver Interference Density	[dBm/Hz]	-Infy	-Infy	-Infy	-Infy	-Infy	-Infy
(j) total effective noise plus interference	[dBm/Hz]	-169	-169	-169	-169	-169	-169
(k) Information Rate (10 log (Rb))	[dBHz]	52.2	52.2	52.2	52.2	52.2	52.2
		144[kbps] x (8/7)					
(l) Required Eb/(No+lo) with no power control	[dB]			10.0	10.0	5.9	5.9
		including diversity gain					
(m) Receiver sensitivity = (j + k + l)	[dB]			-106.8	-106.8	-110.9	-110.9
(n) Hand-off gain	[dB]	5.9	5.9	4.7	4.7	4.7	4.7
(o) Explicit diversity gain	[dB]	0	0	0	0	0	0
		included in req.Eb/No					
(o') Other gain	[dB]	0	0	0	0	0	0
(p) Log-normal fade margin	[dB]	15.4	15.4	11.3	11.3	11.3	11.3
(q) Maximum path loss = {d1-m+(e-f)+o+n+o' -p}	[dB]			136.8	130.7	145.9	139.9
(r) Maximum Range	[m]			524	369	2965	2054

- (O) $L(R[m]) = 37 + 30\log(R[m])$ [dB]
(P) $L(R[km]) = 148.03 + 40\log(R[km])$ [dB]
(V) $L(R[km]) = 128.15 + 37.6\log(R[km])$ [dB]

1.3 Link Budget LCD384

Test environment		(O)		(P)		(V)	
Item		Down Link	Up Link	Down Link	Up Link	Down Link	Up Link
Test service		LC384	LC384	LC384	LC384	LC384	LC384
Ave. Tx Power per traffic Ch	[dBm]	10.0	4.0	20.0	14.0	30.0	24.0
(a1) Max Tx Power per traffic Ch	[dBm]	10.6	4.6	20.6	14.6	30.6	24.6
(a2) Max Total Tx Power	[dBm]	10.6	4.6	20.6	14.6	30.6	24.6
(b) Cable, connector, and combiner losses	[dB]	2	0	2	0	2	0
(c) Transmitter Antenna gain	[dBi]	2	0	10	0	13	0
(d1) Tx e.i.r.p. per traffic ch=(a1-b+c)	[dBm]	10.6	4.6	28.6	14.6	41.6	24.6
(d2) Total Tx e.i.r.p. = (a2-b+c)	[dBm]	10.6	4.6	28.6	14.6	41.6	24.6
(e) Receiver Antenna Gain	[dBi]	0	2	0	10	0	13
(f) Cable and Connector Losses	[dB]	0	2	0	2	0	2
(g) Receiver Noise Figure	[dB]	5	5	5	5	5	5
(h) Thermal Noise Density	[dBm/Hz]	-174	-174	-174	-174	-174	-174
(i) Receiver Interference Density	[dBm/Hz]	-Infy	-Infy	-Infy	-Infy	-Infy	-Infy
(j) total effective noise plus interference	[dBm/Hz]	-169	-169	-169	-169	-169	-169
(k) Information Rate (10 log (Rb))	[dBHz]	56.4	56.4	56.4	56.4	56.4	56.4
(l) Required Eb/(No+Io)	[dB]	11.3	11.3	384 [kbps] x (8/7)		5.8	5.8
(m) Receiver sensitivity = (j + k + l)	[dB]	-101.3	-101.3	including diversity gain		-106.8	-106.8
(n) Hand-off gain	[dB]	5.9	5.9	4.7	4.7	4.7	4.7
(o) Explicit diversity gain	[dB]	0	0	0	0	0	0
(o') Other gain	[dB]	0	0	0	0	0	0
(p) Log-normal fade margin	[dB]	15.4	15.4	11.3	11.3	11.3	11.3
(q) Maximum path loss = {d1-m+(e-f)+o+n+o' -p}	[dB]	102.4	96.4			141.8	135.8
(r) Maximum Range	[m]	151.4	95.5			2307	1598

- (O) $L(R[m]) = 37 + 30\log(R[m])$ [dB]
(P) $L(R[km]) = 148.03 + 40\log(R[km])$ [dB]
(V) $L(R[km]) = 128.15 + 37.6\log(R[km])$ [dB]

1.4 Link Budget UDD144

Test environment		(O)		(P)		(V)	
Item		Down Link	Up Link	Down Link	Up Link	Down Link	Up Link
Test service		UD144	UD144	UD144	UD144	UD144	UD144
Ave. Tx Power per traffic Ch	[dBm]	10.0	4.0	20.0	14.0	30.0	24.0
(a1) Max Tx Power per traffic Ch	[dBm]	10.6	4.6	20.6	14.6	30.6	24.6
(a2) Max Total Tx Power	[dBm]	10.6	4.6	20.6	14.6	30.6	24.6
(b) Cable, connector, and combiner losses	[dB]	2	0	2	0	2	0
(c) Transmitter Antenna gain	[dBi]	2	0	10	0	13	0
(d1) Tx e.i.r.p. per traffic ch=(a1-b+c)	[dBm]	10.6	4.6	28.6	14.6	41.6	24.6
(d2) Total Tx e.i.r.p. = (a2-b+c)	[dBm]	10.6	4.6	28.6	14.6	41.6	24.6
(e) Receiver Antenna Gain	[dBi]	0	2	0	10	0	13
(f) Cable and Connector Losses	[dB]	0	2	0	2	0	2
(g) Receiver Noise Figure	[dB]	5	5	5	5	5	5
(h) Thermal Noise Density	[dBm/Hz]	-174	-174	-174	-174	-174	-174
(i) Receiver Interference Density	[dBm/Hz]	-Infy	-Infy	-Infy	-Infy	-Infy	-Infy
(j) total effective noise plus interference	[dBm/Hz]	-169	-169	-169	-169	-169	-169
(k) Information Rate (10 log (Rb))	[dBHz]	53.2	53.2	53.2	53.2	53.2	53.2
		277.3 [kbps] x (3/4)					
(l) Required Eb/(No+Io)	[dB]	7.0	7.0	7.8	7.8	5.2	5.2
		including diversity gain					
(m) Receiver sensitivity = (j + k + l)	[dB]	-108.8	-108.8	-108.0	-108.0	-110.6	-110.6
(n) Hand-off gain	[dB]	5.9	5.9	4.7	4.7	4.7	4.7
(o) Explicit diversity gain	[dB]	0	0	0	0	0	0
		included in req.Eb/No					
(o') Other gain	[dB]	0	0	0	0	0	0
(p) Log-normal fade margin	[dB]	15.4	15.4	11.3	11.3	11.3	11.3
(q) Maximum path loss = {d1-m+(e-f)+o+n+o' -p}	[dB]	109.9	103.9	130.0	124.0	145.6	139.6
(r) Maximum Range	[m]	269	170	350	250	2911	2016

- (O) $L(R[m]) = 37 + 30\log(R[m])$ [dB]
(P) $L(R[km]) = 148.03 + 40\log(R[km])$ [dB]
(V) $L(R[km]) = 128.15 + 37.6\log(R[km])$ [dB]

1.5 Link Budget UDD384

Test environment Item		(O)		(P)		(V)	
		Down Link	Up Link	Down Link	Up Link	Down Link	Up Link
Test service		UD384	UD384	UD384	UD384	UD384	UD384
Ave. Tx Power per traffic Ch	[dBm]	10.0	4.0	20.0	14.0	30.0	24.0
(a1) Max Tx Power per traffic Ch	[dBm]	10.6	4.6	20.6	14.6	30.6	24.6
(a2) Max Total Tx Power	[dBm]	10.6	4.6	20.6	14.6	30.6	24.6
(b) Cable, connector, and combiner losses	[dB]	2	0	2	0	2	0
(c) Transmitter Antenna gain	[dBi]	2	0	10	0	13	0
(d1) Tx e.i.r.p. per traffic ch=(a1-b+c)	[dBm]	10.6	4.6	28.6	14.6	41.6	24.6
(d2) Total Tx e.i.r.p. = (a2-b+c)	[dBm]	10.6	4.6	28.6	14.6	41.6	24.6
(e) Receiver Antenna Gain	[dBi]	0	2	0	10	0	13
(f) Cable and Connector Losses	[dB]	0	2	0	2	0	2
(g) Receiver Noise Figure	[dB]	5	5	5	5	5	5
(h) Thermal Noise Density	[dBm/Hz]	-174	-174	-174	-174	-174	-174
(i) Receiver Interference Density	[dBm/Hz]	-Infy	-Infy	-Infy	-Infy	-Infy	-Infy
(j) total effective noise plus interference	[dBm/Hz]	-169	-169	-169	-169	-169	-169
(k) Information Rate (10 log (Rb))	[dBHz]	56.2	56.2	56.2	56.2	56.2	56.2
(k)		554.6 [kbps] x (3/4)					
(l) Required Eb/(No+Io)	[dB]	7.0	7.0	7.8	7.8	5.2	5.2
		including diversity gain					
(m) Receiver sensitivity = (j + k + l)	[dB]	-111.8	-111.8	-111.0	-111.0	-113.6	-113.6
(n) Hand-off gain	[dB]	5.9	5.9	4.7	4.7	4.7	4.7
(o) Explicit diversity gain	[dB]	0	0	0	0	0	0
		included in req.Eb/No					
(o') Other gain	[dB]	0	0	0	0	0	0
(p) Log-normal fade margin	[dB]	15.4	15.4	11.3	11.3	11.3	11.3
(q) Maximum path loss = {d1-m+(e-f)+o+n+o' -p}	[dB]	106.9	100.9	127.0	121.0	142.6	136.6
(r) Maximum Range	[m]	214	135	298	211	2423	1677

- (O) $L(R[m]) = 37 + 30\log(R[m])$ [dB]
(P) $L(R[km]) = 148.03 + 40\log(R[km])$ [dB]
(V) $L(R[km]) = 128.15 + 37.6\log(R[km])$ [dB]

1.6 Link Budget UDD2048

Test environment Item		(O)		(P)		(V)	
		Down Link	Up Link	Down Link	Up Link	Down Link	Up Link
Test service		U2048	U2048	U2048	U2048	U2048	U2048
Ave. Tx Power per traffic Ch	[dBm]	10.0	4.0	20.0	14.0	30.0	24.0
(a1) Max Tx Power per traffic Ch	[dBm]	10.6	4.6	20.6	14.6	30.6	24.6
(a2) Max Total Tx Power	[dBm]	10.6	4.6	20.6	14.6	30.6	24.6
(b) Cable, connector, and combiner losses	[dB]	2	0	2	0	2	0
(c) Transmitter Antenna gain	[dBi]	2	0	10	0	13	0
(d1) Tx e.i.r.p. per traffic ch=(a1-b+c)	[dBm]	10.6	4.6	28.6	14.6	41.6	24.6
(d2) Total Tx e.i.r.p. = (a2-b+c)	[dBm]	10.6	4.6	28.6	14.6	41.6	24.6
(e) Receiver Antenna Gain	[dBi]	0	2	0	10	0	13
(f) Cable and Connector Losses	[dB]	0	2	0	2	0	2
(g) Receiver Noise Figure	[dB]	5	5	5	5	5	5
(h) Thermal Noise Density	[dBm/Hz]	-174	-174	-174	-174	-174	-174
(i) Receiver Interference Density	[dBm/Hz]	-Infy	-Infy	-Infy	-Infy	-Infy	-Infy
(j) total effective noise plus interference	[dBm/Hz]	-169	-169	-169	-169	-169	-169
(k) Information Rate (10 log (Rb))	[dBHz]	63.4	63.4	63.4	63.4	63.4	63.4
(k)		2.21 [Mbps]					
(l) Required Eb/(No+Io)	[dB]	10.3	10.3	10.3	10.3		
		including diversity gain					
(m) Receiver sensitivity = (j + k + l)	[dB]	-95.3	-95.3	-95.3	-95.3		
(n) Hand-off gain	[dB]	5.9	5.9	4.7	4.7	4.7	4.7
(o) Explicit diversity gain	[dB]	0	0	0	0	0	0
		included in req.Eb/No					
(o') Other gain	[dB]	0	0	0	0	0	0
(p) Log-normal fade margin	[dB]	15.4	15.4	11.3	11.3	11.3	11.3
(q) Maximum path loss = {d1-m+(e-f)+o+n+o' -p}	[dB]	96.4	90.4	117.3	111.3		
(r) Maximum Range	[m]	95.5	60.3	170	120		

- (O) $L(R[m]) = 37 + 30\log(R[m])$ [dB]
(P) $L(R[km]) = 148.03 + 40\log(R[km])$ [dB]
(V) $L(R[km]) = 128.15 + 37.6\log(R[km])$ [dB]

2. Technology Description Template

A1.1	Test environment support	
A1.1.1	In what test environments will the SRTT operate?	Office/Pedestrian/Vehicular
A1.1.2	If the SRTT supports more than one test environment, what test environment does this technology description template address?	Office/Pedestrian/Vehicular
A1.1.3	Does the SRTT include any features in support of FWA application? Provide detail about the impact of those features on the technical parameters provided in this template, stating whether the technical parameters provided apply for mobile as well as for FWA applications.	FWA is supported
A1.2	Technical parameters Note: Parameters for both forward link and reverse link should be described separately, if necessary.	
A1.2.1	What is the minimum frequency band required to deploy the system (MHz)?	3.2[MHz] = 1.6[MHz]*2(FDD)
A1.2.2	What is the duplex method: TDD or FDD?	FDD TDD is supported
A1.2.2.1	What is the minimum up/down frequency separation for FDD?	[TBD ex. 30[MHz]]
A1.2.2.2	What is requirement of transmit/receive isolation? Does the proposal require a duplexer in either the mobile station (MS) or BS?	MS using 1 time slots Not Required
		MS using multi time slots Required
		BS Required
A1.2.3	Does the SRTT allow asymmetric transmission to use the available spectrum? Characterize.	Asymmetric duplex duty of TDD Asymmetric duplex band width og FDD
A1.2.4	What is the RF channel spacing (kHz)? In addition, does the SRTT use an interleaved frequency plan? Note:.....	100[kHz] No interleave.
A1.2.5	What is the bandwidth per duplex RF channel (MHz) measured at the 3 dB down points? It is given by (bandwidth per RF channel) x (1 for TDD and 2 for FDD). Provide detail.	200[kHz]
A1.2.5.1	Does the proposal offer multiple or variable RF channel bandwidth capability? If so, are multiple bandwidths or variable bandwidths provided for the purposes of compensating the transmission medium for impairments but intended to be feature transparent to the end user?	Yes. Variable bandwidth scheme named BDMA BDMA is Band Division Multiple Access which use very wide band OFDM signal and share the block of sub-carriers (24 * 4.16[kHz] = 100[kHz])
A1.2.6	What is the RF channel bit rate (kbps)?	159[kbps] /100[kHz] (DQPSK) 2*(QPSK)*23 (24-1(differential))/288.46[us] 239[kbps]/100[kHz] (D8PSK)
		Note: The maximum modulation rate of RF (after channel encoding, adding of in-band control signalling and any overhead signalling) possible to transmit carrier over an RF channel, i.e. independent of access technology and of modulation schemes.

A1.2.7	Frame Structure: Describe the frame structure to give sufficient information such as:	
	- frame length	1.15[ms]
	- the number of time slots per frame	4[time slot/frame]
	- guard time or the number of guard bits	Tu=288.46[us/time slot] Tm=240[us] for OFDM modulation length Tg=48.46[us] for guard time
	- user information bit rate for each time slot	
	- channel bit rate (after channel coding)	
	- channel symbol rate (after modulation)	fsym = 1/Tu = 3.467[ksym/s]
	-associated control channel (ACCH) bit rate	
	- power control bit rate.	2[bit/time slot]
	Note 1: Channel coding may include forward error correction (FEC), cyclic redundancy checking (CRC), ACCH, power control bits and guard bits. Provide detail.	
	Note 2: Describe the frame structure for forward link and reverse link, respectively.	
	Note 3: Describe the frame structure for each user information rate.	
A1.2.8	Does the SRTT use frequency hopping? If so, characterize and explain particularly the impact (e.g. improvements) on system performance.	Yes. Frequency Diversity Effect. Interference Diversity Effect. Operation without FH is also possible e.g. DCA operation
A1.2.8.1	What is the hopping rate?	866.7[hop/sec] (1 [hop/frame])
A1.2.8.2	What is the number of the hopping frequency sets?	Depend on Assigned frequency band (ex. 200[frequency/20MHz])
A1.2.8.3	Are BSs synchronised or non-synchronised?	Synchronisation is not required. (preferred)
A1.2.9	Does the SRTT use a spreading scheme?	No.
A1.2.9.1	What is the chip rate (Mchip/s)? Rate at input to modulator.	N/A
A1.2.9.2	What is the processing gain? 10 log (Chip rate / Information rate).	N/A
A1.2.9.3	Explain the uplink and downlink code structures and provide the details about the types (e.g. personal numbering (PN) code, Walsh code) and purposes (e.g. spreading, identification, etc.) of the codes.	N/A
A1.2.10	Which access technology does the proposal use: TDMA, FDMA, CDMA, hybrid, or a new technology? In the case of CDMA, which type of CDMA is used: Frequency Hopping (FH) or Direct Sequence (DS) or hybrid? Characterize.	Hybrid SFH-TDMA and BDMA(FDMA) BDMA is Band Division Multiple Access which use very wide band OFDM signal and share the block of sub-carriers (24 * 4.16[kHz] =100[kHz]) for each user.
A1.2.11	What is the baseband modulation technique? If both the data modulation and spreading modulation are required, describe in detail.	Frequency Domain DPSK (DQPSK,D8PSK)

	What is the peak to average power ratio after baseband filtering (dB)?	10log(N)[dB] N is number of sub-carriers
A1.2.12	What are the channel coding (error handling) rate and form for both the forward and reverse links? E.g., does the SRTT adopt: - FEC or other schemes? - unequal error protection? Provide details. - soft decision decoding or hard decision decoding? Provide details. - iterative decoding (e.g. turbo codes)? Provide details. - Other schemes?	K=7,R=3/4-1/3 Convolutional encoding Soft decision Viterbi Decoding Reed-Solomon code for data (R=0.8-0.9)
A1.2.13	What is the bit interleaving scheme? Provide detailed description for both uplink and downlink.	4.615[ms] data-frame data is encoded. 4 frame coded bits are buffered. 4 hopping burst is generated by using 4 frame coded bits. As a result, 18.46[ms/interleave] or 16[hop/interleave] is achieved. Longer interleave size is available
A1.2.14	Describe the approach taken for the receivers (MS and BS) to cope with multipath propagation effects (e.g. via equaliser, RAKE receiver, etc.).	Not using equaliser or RAKE receiver OFDM is robust against multipath propagation.
A1.2.14.1	Describe the robustness to intersymbol interference and the specific delay spread profiles that are best or worst for the proposal.	ISI (inter symbol interference is very small using OFDM) ITU TG8/1 Vehicular C (rms delay spread 12[us], max delay is 55[us])
A1.2.14.2	Can rapidly changing delay spread profile be accommodated? Describe.	Yes. No impact.
A1.2.15	What is the adjacent channel protection ratio? Note: In order to maintain robustness to adjacent channel interference, the SRTT should have some receiver characteristics that can withstand higher power adjacent channel interference. Specify the maximum allowed relative level of adjacent RF channel power in dBc. Provide detail how this figure is assumed.	10[dBc] Adjacent channel spurious emission will be less than -17[dB] , and required C/I is more than 5[dB]. Basically, adjacent band signal will not exceed 0[dB], because all transmit signal should be power controlled. Moreover, -17[dB] is worst and rare case which occurs at when transmit power is maximum in power control operation. Frequency Hopping will provide risk diversity and it is also available to adjacent band interference.
A1.2.16	Power classes	
A1.2.16.1	Mobile terminal emitted power: What is the radiated antenna power measured at the antenna? For terrestrial component, give (in dBm). For satellite component, the mobile terminal emitted power should be given in e.i.r.p. (effective isotropic radiated power) (in dBm).	
A1.2.16.1.1	What is the maximum peak power transmitted while in active or busy state?	OFDM signal has high peak. Maximum peak transmit power is required 3[dB] higher than average power within the burst with allowable distortion. Burst average power is calculated by 4 times of time average power described in next section.

A1.2.16.1.2	What is the time average power transmitted while in active or busy state? Provide detailed explanation used to calculate this time average power.	(O)	4 [dBm]
		(P)	14 [dBm]
		(V)	24[dBm]
A1.2.16.2	Base station transmit power per RF carrier for terrestrial component		
A1.2.16.2.1	What is the maximum peak transmitted power per RF carrier radiated from antenna?	OFDM signal has high peak. Maximum peak transmit power is required 9[dB] higher than time average power described in next section with allowable distortion. (BS will amplify all of users with one or several amplifiers)	
A1.2.16.2.2	What is the average transmitted power per RF carrier radiated from antenna?	(O)	10 [dBm]
		(P)	24 [dBm]
		(V)	30[dBm]
A1.2.17	What is the maximum number of voice channels available per RF channel that can be supported at one BS with 1 RF channel (TDD systems) or 1 duplex RF channel pair (FDD systems), while still meeting ITU-T G.726 performance requirements?	4 [voice channels/100kHz band slot]	
A1.2.18	Variable bit rate capabilities: Describe the ways the proposal is able to handle variable baseband transmission rates. For example, does the SRTT use: -adaptive source and channel coding as a function of RF signal quality? -variable data rate as a function of user application? -variable voice/data channel utilization as a function of traffic mix requirements? Characterize how the bit rate modification is performed. In addition, what are the advantages of your system proposal associated with variable bit rate capabilities?	Multi time slot scheme (from 1 to 4 time slots) Multi band slot scheme (Variable bandwidth transmission) (from 1 to whole of available band slot) Multi coding rate. Convolutional coding R=3/4-1/3 BCH for data	
A1.2.18.1	What are the user information bit rates in each variable bit rate mode?	11.5[kbps] (1 time slot x 1 band slot) $x[\text{kbps}] = N(\text{time slot}) * (M(\text{band slot}) * 23 - 3)$ $* 16 / 18.46[\text{ms}] * 2 * R(\text{coding rate}) -$ 0.6[kbps](control channel) Half or quarter rate is available	
A1.2.19	What kind of voice coding scheme or CODEC is assumed to be used in proposed SRTT? If the existing specific voice coding scheme or CODEC is to be used, give the name of it. If a special voice coding scheme or CODEC (e.g. those not standardized in standardization bodies such as ITU) is indispensable for the proposed SRTT, provide detail, e.g. scheme, algorithm, coding rates, coding delays and the number of stochastic code books.	8[kbps] is for normal Supporting 4[kbps] is better. Supporting 16[kbps], 32[kbps] is better	
A1.2.19.1	Does the proposal offer multiple voice coding rate capability? Provide detail.	SRTT offers multiple voice coding rate capability	

A1.2.20	Data services: Are there particular aspects of the proposed technologies which are applicable for the provision of circuit-switched, packet-switched or other data services like asymmetric data services? For each service class (A, B, C and D) a description of SRTT services should be provided, at least in terms of bit rate, delay and BER/frame error rate (FER).		
<p>Note 1: See Recommendation ITU-R M.[FPLMTS.TMLG] for the definition of:</p> <ul style="list-style-type: none"> - "circuit transfer mode" - "packet transfer mode" - "connectionless service" <p>and for the aid of understanding "circuit switched" and "packet switched" data services.</p> <p>Note 2: See ITU-T Recommendation I.362 for details about the service classes A, B, C and D.</p>			
A1.2.20.1	For delay constrained, connection oriented. (Class A)		
A1.2.20.2	For delay constrained, connection oriented, variable bit rate (Class B)		
A1.2.20.3	For delay unconstrained, connection oriented. (Class C)		
A1.2.20.4	For delay unconstrained, connectionless. (Class D)		
A1.2.21	Simultaneous voice/data services: Is the proposal capable of providing multiple user services simultaneously with appropriate channel capacity assignment?	Yes.	
<p>Note: The following describes the different techniques that are inherent or improve to a great extent the technology described above to be presented.</p> <p>Description for both BS and MS are required in attributes from A1.2.22 through A1.2.23.2.</p>			
A1.2.22	Power control characteristics: Is a power control scheme included in the proposal? Characterize the impact (e.g. improvements) of supported power control schemes on system performance.	<p>Yes.</p> <p>Decrease power consumption of the terminal.</p> <p>Decrease adjacent band interference.</p> <p>Decrease co-channel interference to other communications.</p> <p>Increase system capacity approximately twice.</p>	
A1.2.22.1	What is the power control step size in dB?	+1.0,0.0,-1.0[dB]	
A1.2.22.2	What are the number of power control cycles per second?	<p>every time burst.</p> <p>866[control/s]</p>	
A1.2.22.3	What is the power control dynamic range in dB?	Up link	80[dB]
		Down link	20[dB]
A1.2.22.4	What is the minimum transmit power level with power control?	20[nW] in up link	
A1.2.22.5	What is the residual power variation after power control when SRTT is operating? Provide details about the circumstances (e.g. in terms of system characteristics, environment, deployment, MS-speed, etc.) under which this residual power variation appears and which impact it has on the system performance.	<p>Standard deviation of variation which is approximated by log-normal distribution is few decibel.</p> <p>Major impact on the system will not appear.</p>	
A1.2.23	Diversity combining in MS and BS: Are diversity combining schemes incorporated in the design of the SRTT?	Yes.	

A1.2.23.1	Describe the diversity techniques applied in the MS and at the BS, including micro diversity and macro diversity, characterizing the type of diversity used, for example:	Time diversity effect by 18.4[ms] interleaving Frequency diversity effect by FH 2 branch antenna diversity
	<ul style="list-style-type: none"> -time diversity : repetition, RAKE-receiver, etc., - space diversity : multiple sectors, multiple satellite, etc., - frequency diversity : FH, wideband transmission, etc., - code diversity : multiple PN codes, multiple FH code, etc., - other scheme 	
	<p>Characterize the diversity combining algorithm, for example, switch diversity, maximal ratio combining, equal gain combining. Additionally, provide supporting values for the number of receivers (or demodulators) per cell per mobile user. State the dB of performance improvement introduced by the use of diversity.</p> <p>For the MS: what is the minimum number of RF receivers (or demodulators) per mobile unit and what is the minimum number of antennas per mobile unit required for the purpose of diversity reception?</p> <p>These numbers should be consistent to that assumed in the link budget template of Annex 2 and that assumed in the calculation of the "capacity" defined at A1.3.1.5.</p>	<p>Combining method of all diversity scheme is maximum ratio combining (MRC) at the input of Viterbi decoder.</p> <p>2 branch space antenna diversity requires</p> <ul style="list-style-type: none"> 2 antennas 2 receivers 2 demodulators <p>but demodulator will be reused for each branch of signal except memory ,Viterbi decoder and channel decoder require 1 unit respectively.</p>
A1.2.23.2	What is the degree of improvement expected in dB? Also indicate the assumed conditions such as BER and FER.	Total gain is 10[dB] including 3[dB] by 2 branch at BER=0.1[%].
A1.2.24	Handover/Automatic Radio Link Transfer (ALT): Do the radio transmission technologies support handover?	Yes.
	Characterize the type of handover strategy (or strategies) which may be supported, e.g. MS assisted handover. Give explanations on potential advantages, e.g. possible choice of handover algorithms. Provide evidence whenever possible.	Mobile Assisted Hand Over.
A1.2.24.1	What is the break duration (sec) when a handover is executed? In this evaluation, a detailed description of the impact of the handover on the service performance should also be given. Explain how the estimate was derived.	0[s] Applying coded-bit level hand over through the MSC Information bits are connected with each base station by coding and interleaving.
A1.2.24.2	For the proposed SRTT, can handover cope with rapid decrease in signal strength (e.g. street corner effect)?Give a detailed description of	Basically, hand over will be detected not decreasing the received power at connecting base stations but increasing the received power at other base stations which are candidates for hand over. MAHO will be effective to select the candidate base station for hand over.
	- the way the handover detected, initiated and executed,	Received signal strength will be detected and initiated by surrounding BS
	- how long each of this action lasts (minimum/maximum time in msec),	Under Investigation
	- the time-out periods for these actions.	TBD

A1.2.25	Characterize how the proposed SRTT reacts to the system deployment (e.g. necessity to add new cells and/or new carriers) particularly in terms of frequency planning.	Frequency planning is not required in 1 frequency reuse or 3 sector frequency (1 site) reuse. N frequency reuse case, frequency planning is necessary.
A1.2.26	Sharing frequency band capabilities: To what degree is the proposal able to deal with spectrum sharing among UMTS systems as well as with all other systems:	
	- spectrum sharing between operators	Use different band with adequate guard band between each operator's bands. Guard band is 100[kHz]
	- spectrum sharing between terrestrial and satellite UMTS systems	Same as the above
	- spectrum sharing between UMTS and non-UMTS systems	same as the above.
	- spectrum sharing between private and public UMTS operator.	same as the above.
	- other sharing schemes.	
A1.2.27	Dynamic channel allocation: Characterize the Dynamic Channel Allocation (DCA) schemes which may be supported and characterize their impact on system performance (e.g. in terms of adaptability to varying interference conditions, adaptability to varying traffic conditions, capability to avoid frequency planning, impact on the reuse distance, etc.).	In case of not applying FH, DCA is used. Detecting no interference frequency band and assign users to the band ,like DECT or PHS.
A1.2.28	Mixed cell architecture: How well does the SRTT accommodate mixed cell architectures (pico, micro and macrocells)? Does the proposal provide pico, micro and macro cell user service in a single licensed spectrum assignment, with handoff as required between them? (terrestrial component only)	Using different frequency bands. Hand over is possible.
	Note: Cell definitions are as follows: pico - cell hex radius (r) < 100 m micro - 100 m < (r) < 1000 m macro - (r) > 1000 m	
A1.2.29	Describe any battery saver / intermittent reception capability.	
A1.2.29.1	Ability of the MS to conserve standby battery power: Provide details about how the proposal conserves standby battery power.	Intermittent reception can be possible.
A1.2.30	Signalling transmission scheme: If the proposed system will use SRTTs for signalling transmission different from those for user data transmission, describe the details of the signalling transmission scheme over the radio interface between terminals and base (satellite) stations.	Using 2 time slots, because time alignment value is unknown before communicating between BS and MS
A1.2.30.1	Describe the different signalling transfer schemes which may be supported, e.g. in connection with a call, outside a call. Does the SRTT support: - new techniques? Characterize. - signalling enhancements for the delivery of multimedia services? Characterize.	Basic formation of signal is same but reduce the information bits and ensure correct receiving.

A1.2.31	Does the SRTT support a Bandwidth on Demand (BOD) capability? BOD refers specifically to the ability of an end-user to request multi-bearer services. Typically, this is given as the capacity in the form of bits per second of throughput. Multi-bearer services can be implemented by using such technologies as multi-carrier, multi-time slot or multi-codes. If so, characterize these capabilities. Note: BOD does not refer to the self-adaptive feature of the radio channel to cope with changes in the transmission quality (see A1.2.5.1).	If higher rate is demanded, more sub-carriers can be assigned. Multi-time slot is also available
A1.2.32	Does the SRTT support channel aggregation capability to achieve higher user bit rates?	Yes. TDMA scheme has no limit of system bandwidth and user bit rate. (If frequency resource and device are available)
A1.3	Expected performances	
A1.3.1	for terrestrial test environment only	
A1.3.1.1	What is the achievable BER floor level (for voice)?	Almost 0[%]
	Note: The BER floor level is evaluated under the BER measuring conditions defined in Annex 2 using the data rates indicated in section 1 of Annex 2.	
A1.3.1.2	What is the achievable BER floor level (for data)?	Almost 0[%]
	Note: The BER floor level is evaluated under the measuring conditions defined in Annex 2 using the data rates indicated in section 1 of Annex 2.	
A1.3.1.3	What is the maximum tolerable delay spread (in nsec) to maintain the voice and data service quality requirements?	12000[ns] (Old ITU TG8/1 Vehicular C model)
	Note: The BER is an error floor level measured with the Doppler shift given in the BER measuring conditions of Annex 2.	
A1.3.1.4	What is the maximum tolerable Doppler shift (in Hz) to maintain the voice and data service quality requirements?	At least 1000[Hz]
	Note: The BER is an error floor level measured with the delay spread given in the BER measuring conditions of Annex 2.	
A1.3.1.5	Capacity: The capacity of the radio transmission technology has to be evaluated assuming the deployment models described in Annex 2 and technical parameters from A1.2.22 through A1.2.23.2.	

<p>A1.3.1.5.1</p>	<p>What is the voice traffic capacity per cell (not per sector): Provide the total traffic that can be supported by a single cell in Erlangs/MHz/cell in a total available assigned non-contiguous bandwidth of 30 MHz (15 MHz forward/15 MHz reverse) for FDD mode or contiguous bandwidth of 30 MHz for TDD mode. Provide capacities for all penetration values defined in the deployment model for the test environment in Annex 2. The procedure to obtain this value is described in Annex 2. The capacity supported by not a standalone cell but a single cell within contiguous service area should be obtained here.</p>	<p>See system level simulation results</p>

A1.3.1.5.2	<p>What is the information capacity per cell (not per sector): Provide the total number of user-channel information bits which can be supported by a single cell in Mbps/MHz/cell in a total available assigned non-contiguous bandwidth of 30 MHz (15 MHz forward/15 MHz reverse) for FDD mode or contiguous bandwidth of 30 MHz for TDD mode. Provide capacities for all penetration values defined in the deployment model for the test environment in Annex 2. The procedure to obtain this value is described in Annex 2. The capacity supported by not a standalone cell but a single cell within contiguous service area should be obtained here.</p>	See system level simulation results
A1.3.1.6	<p>Does the SRTT support sectorization? If yes, provide for each sectorization scheme and the total number of user-channel information bits which can be supported by a single site in Mbps/MHz (and the number of sectors) in a total available assigned non-contiguous bandwidth of 30 MHz (15 MHz forward/15 MHz reverse) in FDD mode or contiguous bandwidth of 30 MHz in TDD mode.</p>	<p>Yes. 3 , 6 sectors per cell is effective to increase capacity</p>
A1.3.1.7	<p>Coverage efficiency: The coverage efficiency of the radio transmission technology has to be evaluated assuming the deployment models described in Annex 2.</p>	
A1.3.1.7.1	<p>What is the base site coverage efficiency in km²/site for the lowest traffic loading in the voice only deployment model? Lowest traffic loading means the lowest penetration case described in Annex 2.</p>	See Link budget Template
A1.3.1.7.2	<p>What is the base site coverage efficiency in km²/site for the lowest traffic loading in the data only deployment model? Lowest traffic loading means the lowest penetration case described in Annex 2.</p>	See Link budget Template

A1.3.3	Maximum user bit rate (for data): Specify the maximum user bit rate (kbps) available in the deployment models described in Annex 2.	At least 2048[kbps]
A1.3.4	What is the maximum range in metres between a user terminal and a BS (prior to hand-off, relay, etc.) under nominal traffic loading and link impairments as defined in Annex 2?	See Link budget Template
A1.3.5	Describe the capability for the use of repeaters.	Possible
A1.3.6	Antenna Systems: Fully describe the antenna systems that can be used and/or have to be used; characterize their impacts on systems performance, (terrestrial only);	-Conventional antenna system (2 branch antenna diversity) -Tx diversity antenna system is available Each transmit burst is transmitted from different antenna which are placed like conventional diversity antenna -Switched beam antenna will be supported. It improve link margin and capacity.
	e.g., does the SRTT have the capability for the use of: - Remote antennas: Describe whether and how remote antenna systems can be used to extend coverage to low traffic density areas. - Distributed antennas: Describe whether and how distributed antenna designs are used, and in which UMTS test environments. - Smart antennas (e.g., switched beam, adaptive, etc.): Describe how smart antennas can be used and what is their impact on system performance. - Other antenna systems.	
A1.3.7	Delay (for voice)	
A1.3.7.1	What is the radio transmission processing delay due to the overall process of channel coding, bit interleaving, framing, etc., not including source coding?	data is interleaved over 18.4[ms]
	This is given as transmitter delay from the input of the channel coder to the antenna plus the receiver delay from the antenna to the output of the channel decoder. Provide this information for each service being provided. In addition, a detailed description of how this parameter was calculated is required for both the uplink and the downlink.	
A1.3.7.2	What is the total estimated round trip delay in msec to include both the processing delay, propagation delay (terrestrial only) and VOCODER delay? Give the estimated delay associated with each of the key attributes described in Figure 1 of Annex 3 that make up the total delay provided.	[Voice codec has not been defined yet]
A1.3.7.3	Does the proposed SRTT need echo control?	[Voice codec has not been defined yet]
A1.3.9	Description of the ability to sustain quality under certain extreme conditions.	

A1.3.9.1	System overload (terrestrial only): Characterize system behaviour and performance in such conditions for each test services in Annex 2, including potential impact on adjacent cells. Describe the effect on system performance in terms of blocking grade of service for the cases that the load on a particular cell is 125%, 150%, 175%, and 200% of full load.	Graceful degradation
	Also describe the effect of blocking on the immediate adjacent cells. Voice service is to be considered here. Full load means a traffic loading which results in 1% call blocking with the BER of 10^{-3} maintained.	Under Investigation
A1.3.9.2	Hardware failures: Characterize system behaviour and performance in such conditions. Provide detailed explanation on any calculation.	Hardware failures must be detected by MS itself. If it is detected, MS must not transmit any more.
A1.3.9.3	Interference immunity: Characterize system immunity or protection mechanisms against interference. What is the interference detection method? What is the interference avoidance method?	Narrow band interference can be erased every Band slot(100[kHz]) frequency hopping can distribute risks caused by interference.
A1.3.10	Characterize the adaptability of the proposed SRTT to different and/or time-varying conditions (e.g. propagation, traffic, etc.) that are not considered in the above attributes of the section A1.3.	Insensitive against different and/or time-varying conditions
A1.4	Technology design constraints	
A1.4.1	Frequency stability: Provide transmission frequency stability (not oscillator stability) requirements of the carrier (include long term - 1 year - frequency stability requirements in ppm).	
A1.4.1.1	For Base station transmission (terrestrial component only)	0.02[ppm]
A1.4.1.2	For Mobile station transmission	MS Tx signal should track receiving signal frequency (0.1[ppm])
A1.4.2	Out-of-band and spurious emissions: Specify the expected levels of base or satellite and mobile transmitter emissions outside the operating channel, as a function of frequency offset.	See Evaluation Report
A1.4.3	Synchronisation requirements: Describe SRTT's timing requirements, e.g.	
	- Is BS-to-BS or satellite land earth station (LES)-to-LES synchronisation required? Provide precise information, the type of synchronisation, i.e., synchronisation of carrier frequency, bit clock, spreading code or frame, and their accuracy.	Synchronization is not required but preferred for easier operation.
	- Is BS-to-network synchronisation required? (terrestrial only)	TBD
	- State short-term frequency and timing accuracy of BS (or LES) transmit signal.	TBD
	- State source of external system reference and the accuracy required, if used at BS (or LES) (for example: derived from wireline network, or GPS receiver).	Both wire line and GPS available for synchronous operation.
	- State free run accuracy of MS frequency and timing reference clock.	+2[ppm]
	- State base-to-base bit time alignment requirement over a 24 hour period, in microseconds.	TBD

	-For private systems: Can multiple un-synchronized systems coexist in the same environment?	Multiple un-synchronized systems can coexist	
A1.4.4	Timing jitter: For BS (or LES) and MS give: - the maximum jitter on the transmit signal, - the maximum jitter tolerated on the received signal. Timing jitter is defined as r.m.s. value of the time variance normalized by symbol duration.	MS BS	T.B.D.[us] on the transmit signal,
			T.B.D.[us] tolerated on the received signal
A1.4.5	Frequency synthesizer: What is the required step size, switched speed and frequency range of the frequency synthesizer of MSs?	Step size = 100[kHz] or 200[kHz] switched speed = 288[us] frequency range depends on system band width	
A1.4.6.1	Describe the special requirements on the fixed networks for the handover procedure. Provide handover procedure to be employed in proposed SRTT in detail.	No	
A1.4.7	Fixed network feature transparency		
A1.4.7.1	Which service(s) of the standard set of ISDN bearer services can the proposed SRTT pass to users without fixed network modification.		
A1.4.8	Characterize any radio resource control capabilities that exist for the provision of roaming between a private (e.g., closed user group) and a public IMT-UMTS operating environment.		
A1.4.9	Describe the estimated fixed signalling overhead (e.g., broadcast control channel, power control messaging). Express this information as a percentage of the spectrum which is used for fixed signalling. Provide detailed explanation on your calculations.		
A1.4.10	Characterize the linear and broadband transmitter requirements for BS and MS. (terrestrial only)	BS requires linear amplifier, and broadband transmitter is available. MS requires almost linear amplifier (Keeping 3[dB] output back off)	
A1.4.11	Are linear receivers required? Characterize the linearity requirements for the receivers for BS and MS. (terrestrial only)	Yes. Same as GSM	
A1.4.12	Specify the required dynamic range of receiver. (terrestrial only)	80[dB]	

A1.4.13	<p>What are the signal processing estimates for both the hand-portable and the BS?</p> <ul style="list-style-type: none"> - MOPS (Millions of Operations Per Second) value of parts processed by DSP - gate counts excluding DSP - ROM size requirements for DSP and gate counts in Kbytes - RAM size requirements for DSP and gate counts in Kbytes 	MS	<p>In case of minimum bit rate 10[kbps]</p> <p>Diversity Demodulator(including FFT)</p> <ul style="list-style-type: none"> ⇒ 0.608[M complexMAC/s] ⇒ 128[complex word memory] ⇒ 8 [ROM] ⇒ K = 7 Viterbi decoder <p>Modulator(including FFT)</p> <ul style="list-style-type: none"> ⇒ 0.134[M complexMAC/s] ⇒ 64[complex ord memory] ⇒ 8[ROM]
	BS	almost same as MS	
<p>Note 1: At a minimum the evaluation should review the signal processing estimates (MOPS, memory requirements, gate counts) required for demodulation, equalization, channel coding, error correction, diversity processing (including RAKE receivers), adaptive antenna array processing, modulation, A-D and D-A converters and multiplexing as well as some IF and baseband filtering. For new technologies, there may be additional or alternative requirements (such as FFTs etc.).</p> <p>Note 2: The signal processing estimates should be declared with the estimated condition such as assumed services, user bit rate and etc.</p>			
A1.4.15	Characterize the frequency planning requirements:		
	<ul style="list-style-type: none"> - Frequency reuse pattern: given the required C/I and the proposed technologies, specify the frequency cell reuse pattern (e.g. 3-cell, 7-cell, etc.) and, for terrestrial systems, the sectorization schemes assumed; 	<p>req.C/I = 5[dB] with Interference diversity</p> <p>1 frequency reuse with adequate system load</p> <p>3 frequency reuse with full load.</p> <p>9 frequency reuse for noise limited operation at low traffic and large cell.</p>	
	<ul style="list-style-type: none"> - Characterize the frequency management between different cell layers; 	by using different band	
	<ul style="list-style-type: none"> - Does the SRTT use an interleaved frequency plan? 	No.	
	<ul style="list-style-type: none"> - Are there any frequency channels with particular planning requirements? 	No.	
	<ul style="list-style-type: none"> -Can the SRTT support self planning technique? 	Not required.	
	<ul style="list-style-type: none"> - All other relevant requirements. 	Nothing	
<p>Note: The use of the second adjacent channel instead of the adjacent channel at a neighbouring cluster cell is called "interleaved frequency planning". If a proponent is going to employ an interleaved frequency plan, the proponent should state so in A1.2.4 and complete A1.2.15 with the protection ratio for both the adjacent and second adjacent channel.</p>			
A1.4.16	Describe the capability of the proposed SRTT to facilitate the evolution of existing radio transmission technologies used in mobile telecommunication systems migrate toward this SRTT. Provide detail any impact and constraint on evolution.	This system can be implemented from minimum service (e.g. voice) to high grade service gradually . Existing network can be used at the moment.	

A1.4.16.1	Does the SRTT support backwards compatibility into GSM/DCS in terms of easy dual mode terminal implementation , spectrum co-existence and handover between UMTS and GSM/DCS?	Time slot length is exactly half of GSM/DCS frame length is exactly 1/8 of GSM/DCS Channel spacing is exactly half of GSM/DCS SRTT already has frequency hopping capability This also enables MAHO between UMTS and GSM/DCS.
A1.4.17	Are there any special requirements for base site implementation? Are there any features which simplify implementation of base sites? (terrestrial only)	No.
A1.5	Information required for terrestrial link budget template Proponents should fulfil the link budget template given in Table 1.3 of Annex 2 and answer the following questions.	
A1.5.1	What is the BS noise figure (dB)?	See Link budget template
A1.5.2	What is the MS noise figure (dB)?	
A1.5.3	What is the BS antenna gain (dBi)?	
A1.5.4	What is the MS antenna gain (dBi)?	
A1.5.5	What is the cable, connector and combiner losses (dB)?	
A1.5.5	What are the number of traffic channels per RF carrier?	
A1.5.6	What is the SRTT operating point (BER/FER) for the required E_b/N_0 in the link budget template?	
A1.5.7	What is the ratio of intra-sector interference to sum of intra-sector interference and inter-sector interference within a cell (dB)?	
A1.5.8	What is the ratio of in-cell interference to total interference (dB)?	
A1.5.9	What is the occupied bandwidth (99%) (Hz)?	
A1.5.10	What is the information rate (dBHz)?	

OFDMA Evaluation Report

The Multiple Access Scheme Proposal for the UMTS Terrestrial Radio Air Interface (UTRA)

Part 3

OFDMA Concept – Frequently asked Questions (FAQ)

Summary:

This document describes details which were requested in many questions to the Beta Concept Group.

The covered areas are:

- SFH/TDMA operation performance versus doppler frequency
- SFH/TDMA operation performance versus hopping bandwidth
- Fast Fourier Transform (FFT/IFFT) complexity as main element of the OFDMA system
- Feasibility and importance of antenna diversity reception system in hand-portable Mobile Station
- Detailed Handover procedures
- Additional Information on Time and Frequency Synchronisation
- Power Amplifier Requirements
- Multiband Reception and Filter Requirements
- Frequency Hopping Feasibility

Table of Contents

1. BER Performance versus Doppler Frequency.....	284
2. Hopping Bandwidth versus B.E.R.	285
3. OFDMA receiver complexity	286
4. Antenna Diversity Reception in hand-portable Mobile Station	288
5. Hand Over Scheme of the OFDMA System	293
5.1 Overview of Hand Over	293
5.2 Synchronisation	293
5.2.1 Pseudo Synchronisation System	293
5.2.2 Unsynchronised System	294
5.3 Mobile Assisted Hand Over (MAHO)	294
5.4 Base Station Originated Hand Over	295
5.5 Forward Hand Over	296
5.6 MCS Initiated Hand Over.....	296
6. Time and Frequency Synchronisation	298
7. Power Amplifier Requirements	299
8. Multiband Reception and Filter Requirements.....	300
9. Frequency Hopping Feasibility.....	301

1. BER Performance versus Doppler Frequency

The SFH/TDMA operation (originally proposed BDMA system by SONY) achieves very good frequency diversity by means of frequency hopping and very good time diversity by interleaving and coding.

Both techniques will dramatically reduce the required received E_b/N_0 and strongly improve link margin.

In order to investigate the performance of the OFDMA proposal in high speed scenarios we simulated the required received E_b/N_0 versus the doppler frequency in link level simulations. Table 1 shows simulation parameters. Figure 1 shows the required E_b/N_0 value versus B.E.R. and Figure 2 shows the maximum Doppler frequency versus the required E_b/N_0 value to achieve the target B.E.R. of $10e-3$.

Figure 2 clearly shows that the BDMA system with the selected parameters (guard time, subcarrier spacing, ...) has a good balance to achieve low required E_b/N_0 values in the wide range of maximum Doppler frequencies. It is surprising that for very fast moving MS ($f_D=1000$ [Hz] , speed is 500 [km/h] @ 2 [GHz]) the system can achieve a high quality transmission without special techniques (e.g. equalisation).

Table 1: Simulation Parameter

Delay Model	Vehicular A
Antenna Diversity	2 Branch
Hopping Bandwidth	12.8[MHz]
Application	Speech (12kbps incl. overhead)
Correlation between antennas	0.0

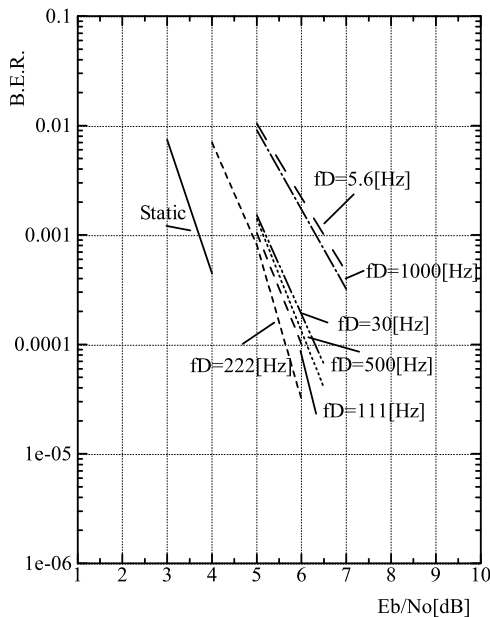


Figure 1: B.E.R. versus speed (doppler) for speech service

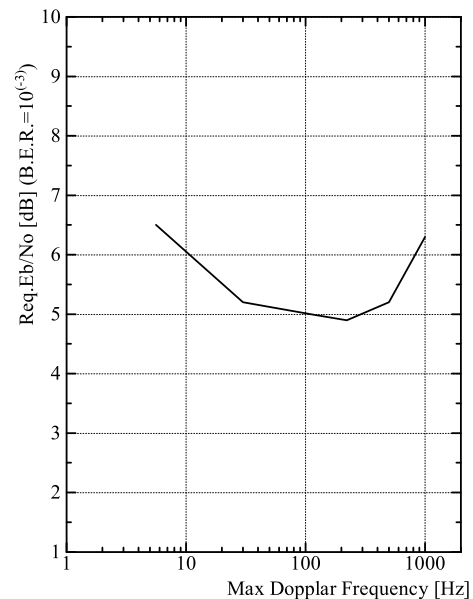


Figure 2: Required E_b/N_0 versus speed (doppler frequency)

2. Hopping Bandwidth versus B.E.R.

The support of hierarchical cell structures is an important UMTS requirement. In this case each cell layer has a limited bandwidth.(e.g. 5[MHz]). Originally the BDMA system achieves very good frequency diversity within higher bandwidths (e.g. 12.8[MHz]). Now we simulated the transmission performance using a limited bandwidth to confirm the performance of frequency hopping.

Table 2 shows the used simulation parameters, Figure 4 shows the E_b/N_0 versus B.E.R. for slow moving mobile station (MS) and fast moving MS. Figure 3 shows hopping bandwidth versus required E_b/N_0 value to achieve a target B.E.R. of 10^{-3} .

This simulation confirms that for fast moving MS the dominant factor of performance improvement is caused by the time diversity effect (time domain interleaving) and we cannot evaluate the effect of hopping bandwidth limitation. In case of slow moving MS the performance improves with wider hopping bandwidth.

It is also obvious that a bandwidth of 5[MHz] is already enough to achieve very low required E_b/N_0 values (effect of frequency diversity).

Table 2 Simulation Parameter

Delay Model	Vehicular A
Application	Speech (12kbps incl. overhead)
Antenna Diversity	2 Branch
Correlation between antennas	0.0
Max Doppler Frequency	5.6[Hz] , 222[Hz]

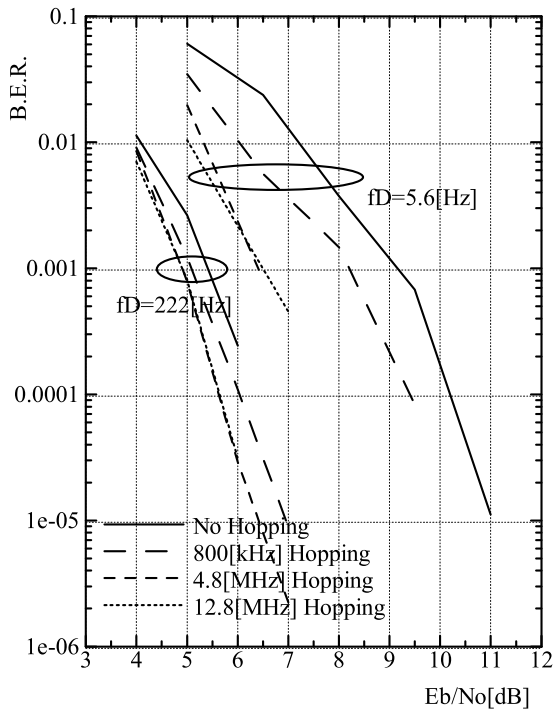


Figure 4: BER versus E_b/N_0

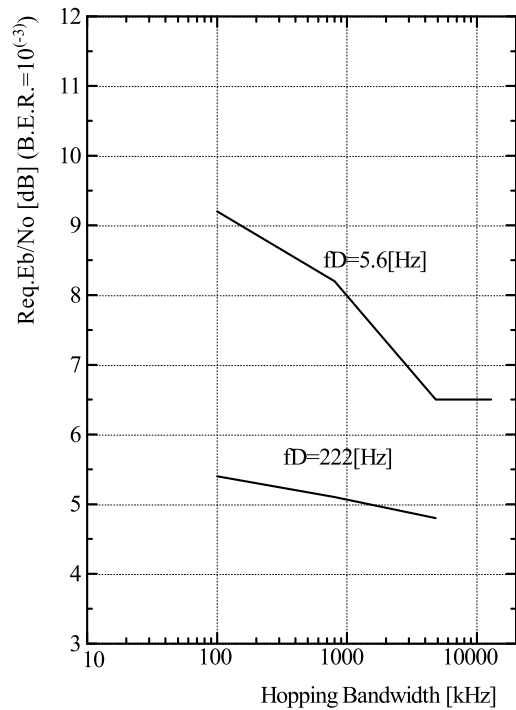


Figure 3: Required E_b/N_0 versus Hopping Bandwidth

3. OFDMA receiver complexity

The main complexity of the signal processing elements for the OFDMA receiver is the FFT. (This is ignoring the processing needed for channel decoding. To calculate the number of operations needed for the FFT, the analysis presented by McDonnell and Wilkinson [1] is used.

The size of the FFT needed at the receiver depends on the service required (scalability). For the case of the low data rate service (speech), only a 32 point FFT is required. This is sufficient for one band slot with 24 carriers and DQPSK modulation. For the highest data rate service (2 Mbit/s) we shall assume a bandwidth of 1.6 MHz and 8-DPSK modulation. This service requires a 512 point FFT.

The total number of real multiplications for an FFT is given by [1]

$$2F \log_2 F$$

where F is the size of the FFT. At the receiver an FFT has to be performed at the same rate as the time slot duration (288.46 μ s). For speech only every fourth time slot is used so we shall derive an average and peak multiplications per second figure.

For speech therefore,

$$\text{Peak no. of real multiplications per second} = 2 \times 32 \times 5 \times (1.0 / 288.46 \times 10^{-6}) = 1.109 \times 10^6$$

$$\text{Average no. of real multiplications per second (1 FFT operation per frame)} = 277.33 \times 10^3$$

For one frame (4*288.46 μ s=1.154ms) 2 IFFT operations (diversity reception) and 1 FFT (TX burst construction) are required. This results in 3*0.27733MOPS = 0.832 MOPS.

For the highest data rate (2 Mbit/s) service every 7 out of 8 time slots are used.

$$\text{Peak no. of real multiplications per second} = 2 \times 512 \times 9 \times (1.0 / 288.46 \times 10^{-6}) = 31.94 \times 10^6$$

For one frame (8*288.46 μ s=2.307ms) 7*2 IFFT operations (7 used timeslots and 2 diversity reception) and 7 FFT (TX burst construction) are required.

This results in 3*(7/8)*31.94 MOPS = 83.9 MOPS.

This number can be reduced if only one Rx branch is used in the indoor environment (better C/I condition expected as compared to outdoor).

It is also important to note that the main processing element of the OFDMA receiver is a readily available FFT.

The following table summarizes the complexity of the FFT/IFFT processing. Please note the table gives 'peak' processing requirement which have to be divided by the actual used timeslots in the given TDMA structure.

Bandwidth (kHz)	Subcarrier Number / FFT Size	Peak MOPS per single FFT / Peak MOPS: 2*RX, 1*TX
100	24 (32)	1.11 (3.3)
200	48 (64)	2.66 (7.98)
400	96 (128)	6.21 (18.6)
800	192 (256)	14.2 (42.6)
1600	384 (512)	31.95 (95.84)

Conclusions

It can be concluded that the complexity of the OFDMA depends upon the service required (almost linear complexity (MOPS) versus supported data rate). This offers benefits in terms of terminal cost and standby time for a given level of service. Even for the highest data rate service the complexity of the receiver is reasonable.

References

- [1] J.T.E. McDonnell, T.A. Wilkinson, "Comparison of computation complexity of adaptive equaliser and OFDM for indoor wireless networks", *Proceedings IEEE Personal Indoor Mobile Radio Conference (PIMRC) 1996*, pp. 1088-1091

4. Antenna Diversity Reception in hand-portable Mobile Station

It was often claimed that antenna diversity is not feasible and not effective (correlation) in a hand-portable mobile station (MS). In this report we will present information on the feasibility and effectiveness of antenna diversity reception in a small (hand-held) MS.

We present actual field test measurement results to prove the simulations.

Actual Measurement Result of Diversity Antennas of Mobile Station

SONY has much experience in the development of diversity antennas for hand-portable mobile stations (MS). As an example we present the measurement results for an PDC 1.5GHz handheld MS. The terminal TH241 for the PDC (Personal Digital Cellular) system was developed already 5 years ago. The following graph shows the layout.

The MS achieves antenna diversity by means of an conventional rod antenna and a second planar patch antenna (see Figure 5).

The used antenna diversity system for the hand-portable mobile station shows a good characteristics (low correlation) the measurement results (based on field test with the equipment) shows the effectiveness.

The following figures show the antenna pattern for both antennas.

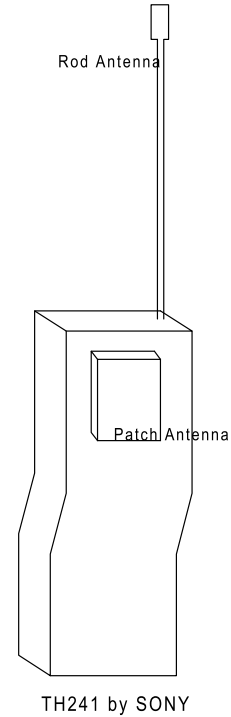


Figure 5: TH 241 SONY PDC MS

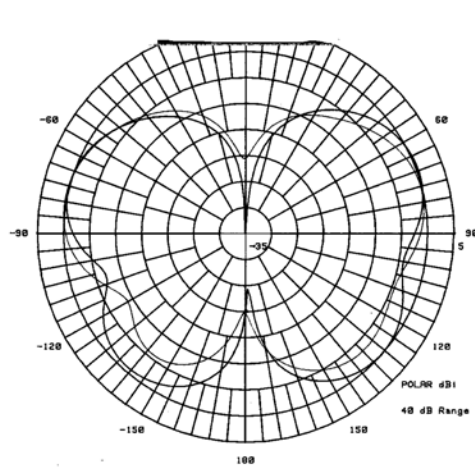


Figure 6: Antenna Pattern (Rod)

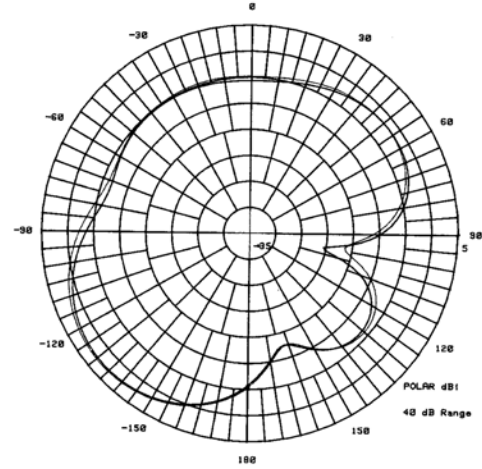


Figure 7: Antenna Pattern (Patch)

The RSSI versus time was measured for different vehicular speeds (10[km/h] and 80[km/h] respectively). The full line shows the RSSI of the Rod antenna and the dotted line is the RSSI of the Patch antenna (Figure 8 and Figure 9...).

It is obvious that both antennas have almost the same effective gain the correlation is very small.

The actual measured correlation value is only 0.2!! (see Table 3).

Table 3: Measured Correlation Value for Antenna Diversity

Vehicular Speed	Correlation between antennas
10[km/h]	0.18
80[km/h]	0.22

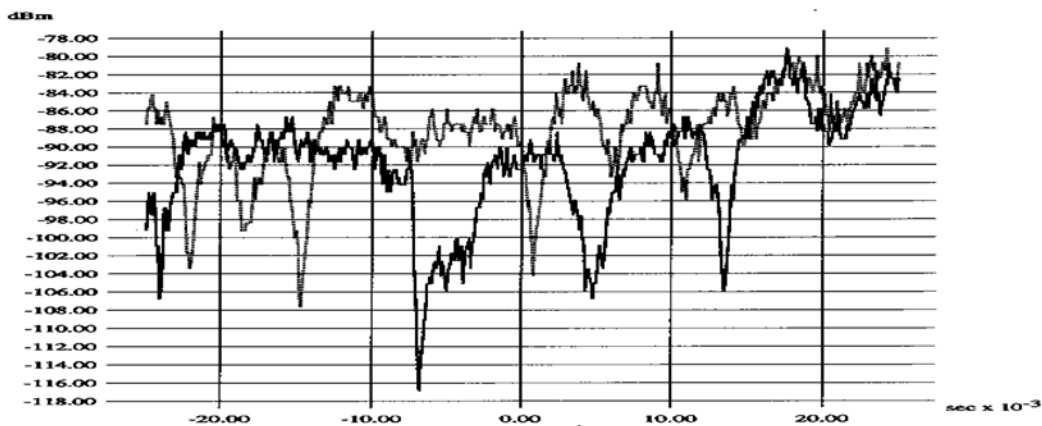


Figure 8: RSSI of Both Antennas (Vehicular speed = 80[km/h])

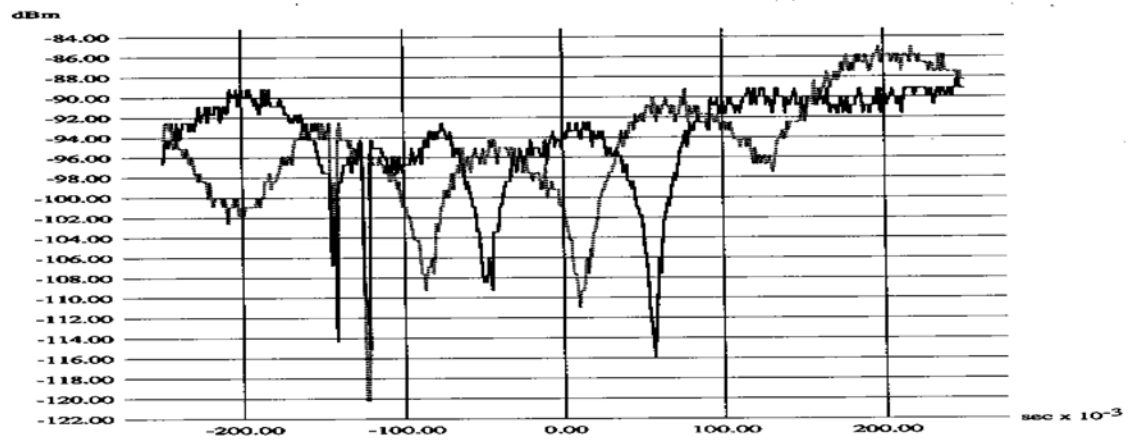


Figure 9: RSSI of Both Antennas (Vehicular Speed = 10[km/h])

Importance of Antenna Diversity Reception

The basestation Tx power in typical operation can be larger compared to MS Tx power and this will achieve good results in the link budget. However, the capacity will not be improved by Tx power much because the capacity is mainly determined by the systems capability to accommodate co-channel interference.

As seen in the DS-CDMA results, the down link capacity is small. In general (g.e. for speech service) the same capacity is necessary both in up link and and down link. This means that the capacity of DS-CDMA is limited by the down link capacity.

Compared with OFDMA assuming the above mentioned realistic and very effective antenna diversity reception we believe the **capacity of the OFDMA system can be 3 times larger**.

Table 4 Capacity Comparison

W-CDMA down link capacity in vehicular environment	44[kbps/MHz/cell]
OFDMA down link capacity in vehicular environment	122[kbps/MHz/Cell]

Comparison between with and without antenna diversity(Simulation)

To evaluate the performance with and without Rx antenna diversity the following simulation was carried out.

The simulation parameters are shown in Table 5, Figure 10 shows the B.E.R. versus E_B/N_0 .

3.3dB improvement was achieved by the usage of an antenna diversity reception.

Table 5: Simulation Parameter

Delay Model	Vehicular A
Max Doppler Spread	222[Hz]
Application	Speech (12kbps incl. overhead)
Correlation between antennas	0.0

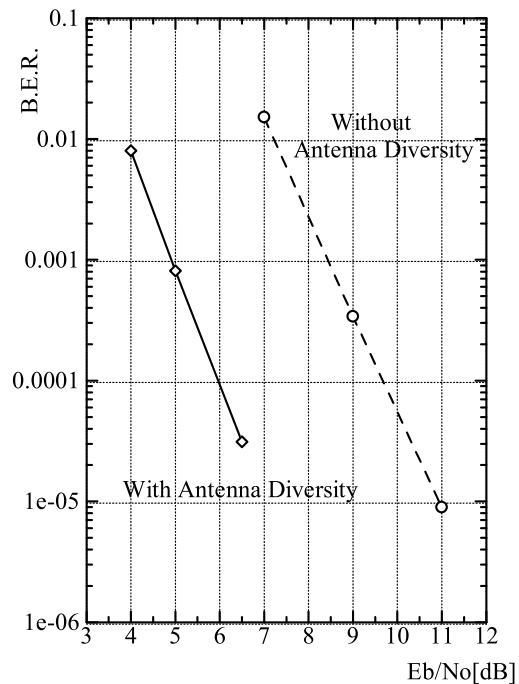


Figure 10: B.E.R. vs E_B/N_0

Conclusion

Antenna diversity reception is very effective, realistic and be implemented at reasonable cost today.

There is no reason to remove it and for future high capacity systems (UMTS) we should make the best effort to develop even better antenna diversity reception systems as available now.

5. Hand Over Scheme of the OFDMA System

Handover is very important and the details should be presented. In this chapter we present the handover schemes we propose for the OFDMA system. This chapter contains information mainly related to the SFH/TDMA operation of the OFDMA based UTRA proposal.

5.1 Overview of Hand Over

The handover scheme of the OFDMA proposal is based on Base Station Originated Hand Over.

The following lines show the outline of the hand over procedure:

1. Mobile station (X) listens to the surrounding base stations. After identifying it reports the IDs of the nearest base stations (B,C,D..) to the connecting base station (A), this scheme is called Mobile Assisted Hand Over (MAHO)
2. BS-A asks BS-B,C,D... to observe MS-X (hopping pattern is reported to surrounding BS-B,C,D..)
3. BS-B,C,D.. detect MS-X's receive signal strength (interference to BS-B,C,D,...).
4. If BS-B detects that MS-X's RSSI becomes higher than normal connecting user of BS-B, BS-B asks BS-A to hand over the MS-X. (Base Station Originated Hand Over)

5.2 Synchronisation

Synchronisation is not required in the BDMA system, however synchronisation provides many advantages in other aspects. Synchronisation can be provided by, for example, GPS system which is well known and adopted for many systems (even by the IS-95 DS-CDMA system).

5.2.1 Pseudo Synchronisation System

The following scheme is proposed in the non-synchronised BDMA system to achieve pseudo-synchronisation.

1. Each base station has enough precise timing reference (e.g. 0.1[ppm], this means 1[μ s] synchronisation slip will occur during 10[s])
2. Propagation delay between BS-A and MS-X connected to BS-A ($T_{pd}(A,X)$) can be measured by their closed loop timing advance measurement/adjustment.
3. The Timing Difference (Framing) between the basestations BS-A and BS-B is assumed to be initially known ($D(A,B)$).
4. MS-X listens to IACH from BS-B and measures arrival time difference between BS-A and BS-B. Arrival time difference represents the time $T = (D(A,B) + T_{pd}(B,X) - T_{pd}(A,X))$
5. The system can estimate the propagation delay between BS-B and MS-X ($T_{pd}(B,X) = T - D(A,B) - T_{pd}(A,X)$) without the need for an active traffic connection between BS-B and MS-X.
6. If MS-X is handed over to BS-B, the precise $T_{pd}(B,X)$ can be measured and used to update the $D(A,B)$

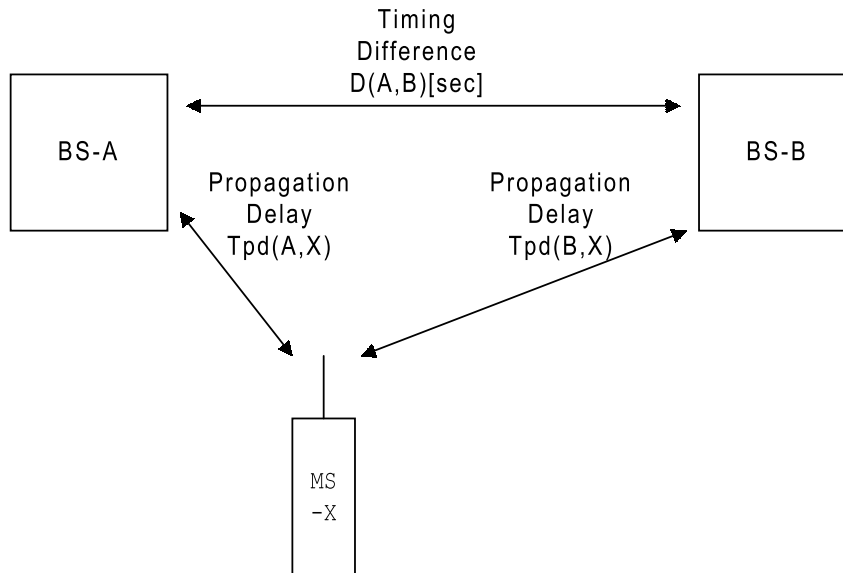


Figure 11: Pseudo Synchronisation

Alternative method

To measure the $D(A,B)$, another possibility is to use a GPS receiver at each basestation. The GPS signal is used to measure the timing difference (framing) between the basetations. The difference is reported to each of the basestations but still the basestations are not synchronised.

5.2.2 Unsynchronised System

Completely non-synchronized system will be supported. When the mobile station performs a hand over the mobile station releases the previous connection and acquires the synchronisation of the new base station and connects.

This rough hand over scheme is not suitable for tight frequency reuse operation (e.g. 1 frequency reuse) and will cause some break duration.

5.3 Mobile Assisted Hand Over (MAHO)

The following procedure outlines the MAHO scheme.

1. Each base station can inform the connected MSs about information of the surrounding BS's including IACH information and the propagation delay between the basestations $D(A,B)$ as described above during the ordinary connection (using control channels).
2. the mobile station can predict the IACH position of the surrounding BS's (bandslot and timeslot).
3. When the the timeslot of the IACH comes which the MS wants to pick up the MS will puncture both Rx and Tx hop and uses the idle time (at least 4 time slots) to pick up the target IACH.
4. The required hopping puncturing will be less than 6[%] of the data and the punctured hops will be treated as erased bursts, the soft decision bits will be set to zero (no information). Using the proposed interleaving and coding schemes this will cause niglegible degradation.
5. The MS activates the KERO detector active and tries to decode the IACH.
6. When the MS detects and decoded the IACH, it reports back to its own, connecting BS about the succesfull detection of the IACH BS he detected the IACH.

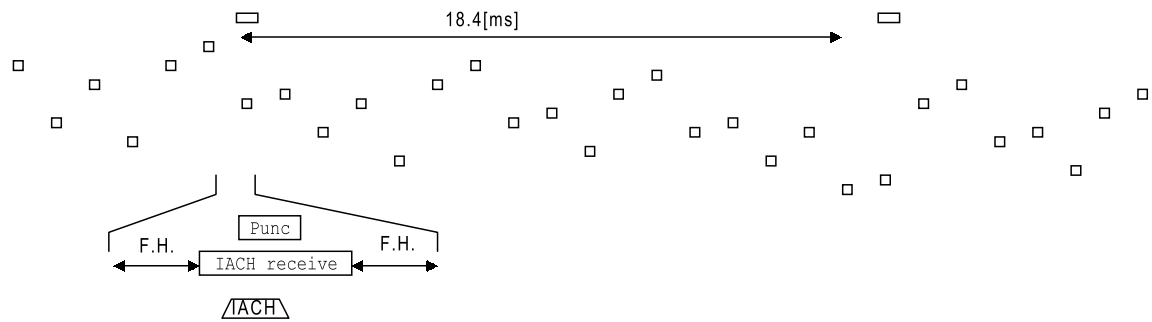


Figure 12 Puncturing Scheme (1 of 4 time slot usage)

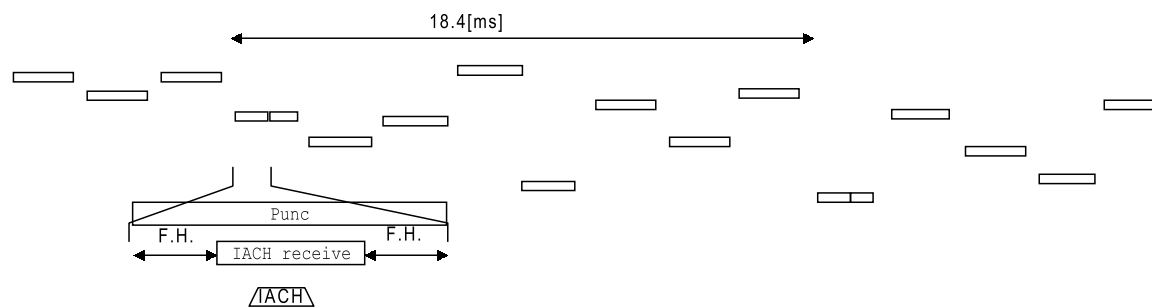


Figure 13 Puncturing Scheme (7 of 8 time slot usage)

5.4 Base Station Originated Hand Over

The following list shows the steps of a base station originated hand over.

1. When the MS (MS-X) connected to BS-A reports to the BS-A that it has detected the surrounding BS (BS-B),
2. BS-A asks BS-B to observe MS-X and inform BS-B about the hopping pattern of the MS-X.
3. BS-B sets its signal detector for detecting MS-X up link signal.
4. BS-A reports to MS-X detailed information of BS-B's and asks BS-B to prepare a handover of MS-X to BS-B.
The following information is given:
 - Propagation delay between the two basestations $D(A,B)$
 - The estimated propagation delay between BS-B and MS-X called $Tpd(BS-B, MS-X)$
 - The random phase shift pattern of BS-B.
 - New hopping pattern and initial time and frequency slot of BS-B.
5. MS-X will receive BS-B's IACH to confirm the arrival time difference between BS-A and BS-B.
6. BS-B also measures the RSSI of MS-x's up link signal and compares the RSSI with the RSSI of the MSs connected to BS-B ($RSSI_{ref}$).
7. When MS-X's RSSI exceed the $RSSI_{ref}$, BS-B asks BS-A to hand over MS-X.
8. BS-A informs MS-X to hand over to BS-B.

9. MS-X will change the connection from BS-A to BS-B.

5.5 Forward Hand Over

Forward hand over can be achieved easily.

The following description is based on the assumption that MS-X is handed over from BS-A to BS-B.

- Even after the hand over, BS-A transmit control data and dummy data instead of traffic data continuously to the receiving MS-X.
- MS will keep previous connection(BS-A) status information such as frame timing ,hopping pattern and so on.
- If the MS fails to hand over to BS-B, it can go back to the previous connection with BS-A.
- When BS-A detect MS-X's signal again, it re-establishes the connection to MS-X.
- An alternative solution exists:

If the network has enough capacity, The MSC can provide traffic data to BS-A also after the handover to BS-B.

MS-X can connect to both BS's like soft handover and switch connection between both basestations based o the received signal quality.

Another possibility in order to avoid slot puncturing is to increase the TDMA scheme during the forward handover phase (e.g. 8-TDMA ,16-TDMA) in order to prepare enough time for the hopping synthesiser to follow the two independent hopping schemes of the connected basestations.

5.6 MCS Initiated Hand Over

Seemless MCS initiated is supported even for unsynchronised basestations.

We assume the channel encoder and decoder is placed at the MSC. Each base stations has modulation and demodulation units.

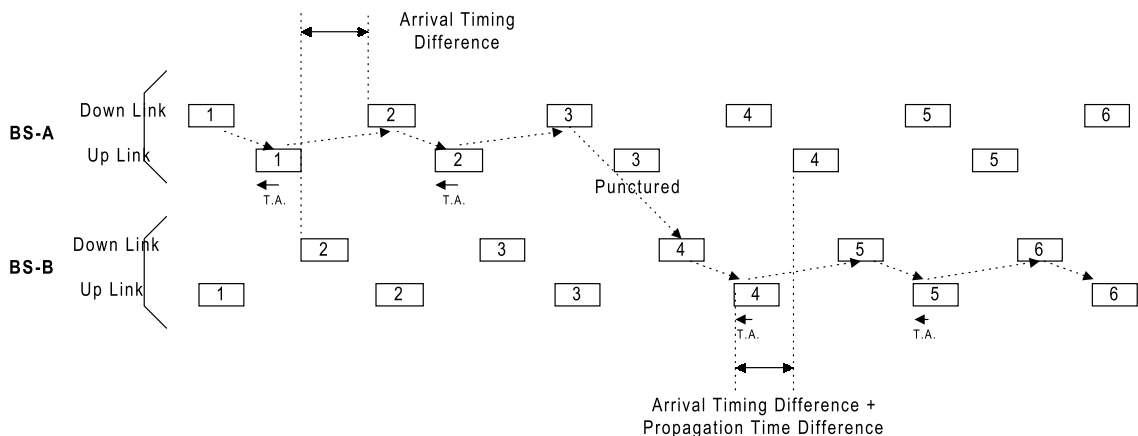
The exact hand over timing is determined by the MSC and informed to both basestations and also to the target MS

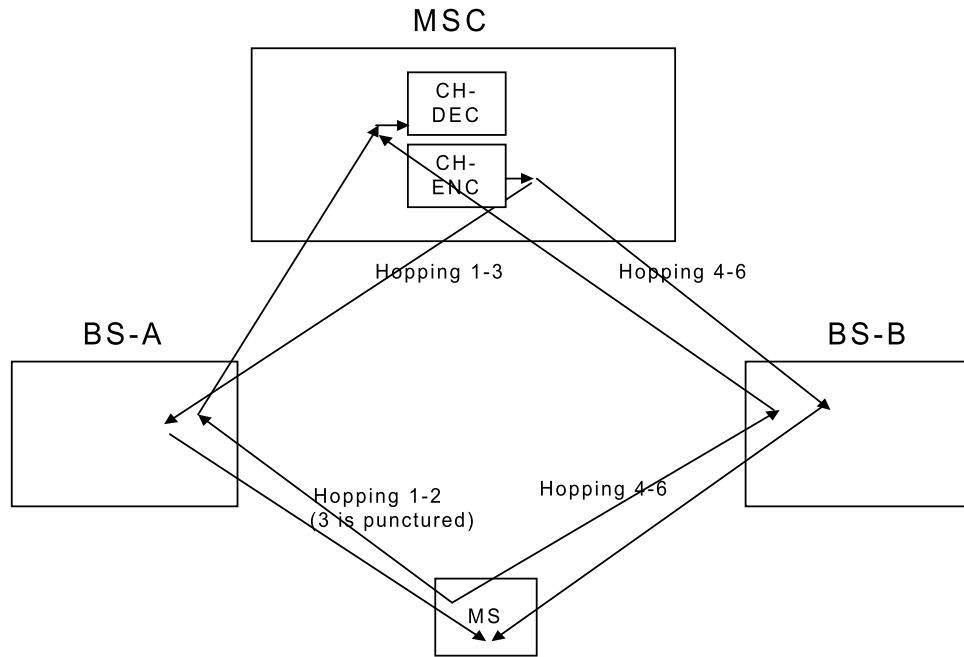
The delivery of the down link data will be switched between the two basestations on a slot base (downlink hopping data) without any break (seemless).

The uplink data (slot by slot) will be gathered by the MSC.

The MS will receive and transmit continuously during hand over.

Timing adjustment will be achieved by slot puncturing.





6. Time and Frequency Synchronisation

The proposed synchronisation acquisition and tracking algorithm is independent of the modulation scheme (coherent-non coherent, differential or coherent) and shows sufficient performance.

Therefore the same schematic applies to the coherent and non-coherent reception type of operation, no variations are necessary.

For coherent 16-QAM reception further processing in the frequency (subcarrier domain) is possible to further improve the performance. Frequency domain time tracking (or combined time-domain frequency-domain tracking algorithms) could be based on observing phase shifts of the known pilots within the time-frequency grid on the subcarrier domain which is very simple.

Some more explanations:

In the downlink only an IACH is multiplexed in order to allow fast and precise initial timing and frequency synchronisation. In the actual 'communication mode' the timing and frequency tracking is performed using the proposed, correlation based, synchronisation algorithm. In the uplink the rough timing offset is detected by the base station by measuring the arrival time of the RACH burst. This gives an initial time-advance value which is reported back to the mobile. During the communication the arrival time of the burst is detected by the base station using the proposed tracking algorithm (same as in the downlink) or an tracking algorithm in the frequency (subcarrier) domain, based on the detected constellation rotation.

The rotation can be explained by the Fourier transform equation:

$$F(g(t - t_0)) = F(g(t))e^{-j\omega t_0}$$

Both algorithms can also be combined. The alignment values are calculated regularly and reported to the MS. Accuracy requirements are relaxed because the design of the burst allows some overlapping arrival (another advancing feature of the raised cosine pulse shaping besides the reduction of out-of-band emission). Additionally the guard time helps to compensate timing misalignments.

The current burst design proposes a guard interval at the front and an additional guard interval at the back of the OFDM symbol, therefore an timing inaccuracy of $\pm 10\mu\text{s}$ can be handled without any performance degradation. The resulting frequency domain constellation rotation, caused by timing misadjustments can easily be compensated after the FFT.

Summary: *Timing misalignments in the range of $\pm 10\mu\text{s}$ can be allowed without performance degradation. Furthermore, timing errors of $-20\mu\text{s} \dots +15\mu\text{s}$ can be allowed with negligible performance degradation.*

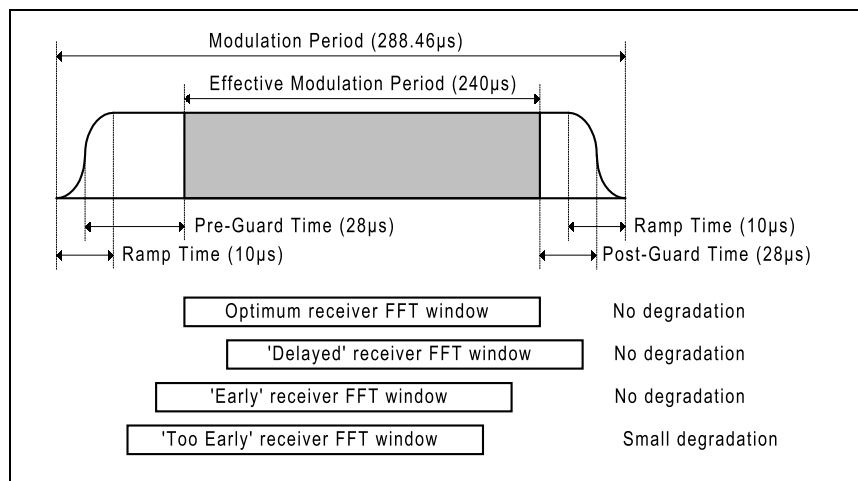


Figure 14: OFMDA burst and synchronisation requirements

7. Power Amplifier Requirements

The back-off requirement for larger number of subcarriers (e.g. 384 subcarriers for 1.6MHz operation) is the same as for small number of subcarriers as the statistics is the same. Further details can also be found in Tdoc B11/97 (Author: Lucent Technologies) which describes the effect of limiting the dynamic range of the OFDM signal to 3-5dB in order to reduce the out-of-band spurious emission and maintain a high power efficiency. The PA back-off is also independent from the modulation scheme (QPSK, 8PSK) and the interference detection schemes proposed (Random Phase Shift and Random Orthogonal Transform).

The adjacent channel interference is guaranteed to be below -17[dB] using readily available cheap MS power amplifiers with reasonable back-off (3dB). Comparing the adjacent channel interference with the co-channel interference level (from -3[dB] to -5[dB]), the adjacent channel interference which level is guaranteed to be below -17[dB] is negligible. Details can be found in the evaluation report, chapter 7.2 (SMG2 Tdoc 299/97).

Non-linear behavior of the PA is a really rare case in the OFDMA system and only happens if full power operation is required (e.g. Tx power is 30dBm), considering a uniform distribution of mobile stations within a cell only a very small number of MS (et the border of the cell) have to transmit at high power. In reality around 80% (or more) of the MS operate in the linear region of the PA where OFDM with the proposed shaping (raised cosine ramping) shows an almost perfect rectangular spectrum shape.

Considering system operation the interference diversity is also very effective considering neighbouring bandslot interference.

The 3dB back-off mentioned in the evaluation report is referenced to the saturation output power (not 1dB compression point).

8. Multiband Reception and Filter Requirements

The multiband concept we propose does not imply the need for sharp cut-off filters at the IF in the MS.

Generally speaking the filter requirements are less tough as in already existing systems (we refer to IS-95). Some details can be presented:

- The downlink power dynamic range is limited to 17-20dB in the actual implementation. This helps to avoid too high power imbalance of the used bandslot compared to the two adjacent bandslots.
- Interference diversity is also very effective considering neighbouring bandslot interference.
- The mobile controls the average power of the received burst according to the target SIR for the actual communication. Therefore the power of the bursts is adjusted according to the average interference condition and the target SIR.
- Small oversampling (already used for the FFT/IFFT operation) allows relaxed filter shape specifications. An example is given for better understanding. For reference also the filtering requirements of IS-95 are given which are much more severe and can be implemented cheap already today.

For the presented OFDMA example we use 24 subcarriers per bandslot, the minimum FFT required to process 24 subcarriers is 32. This implies an oversampling ratio of $(32/24)=1.33$ of the ADC before delivery of the samples to the FFT unit. The oversampling also reduces the cut-off requirements of the analogue filtering before ADC.

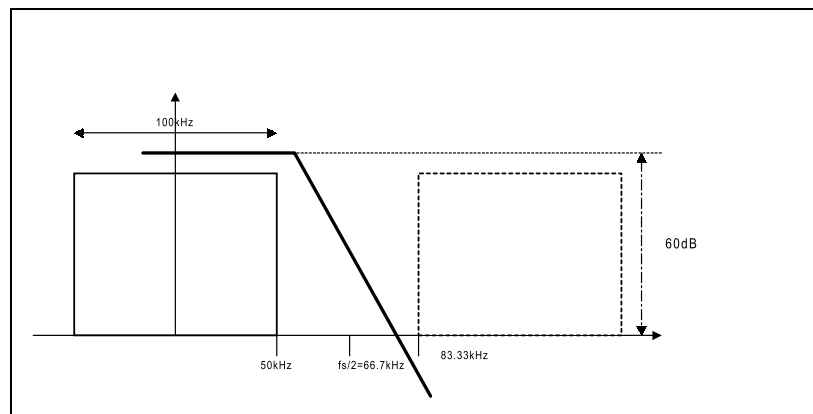


Figure 15: OFDMA filter requirements

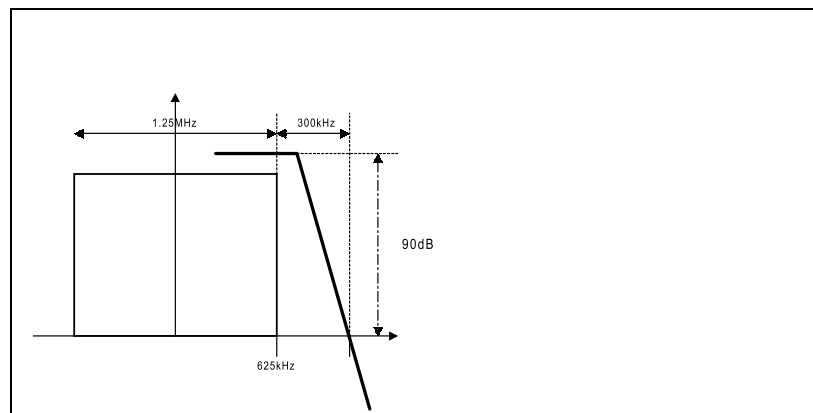


Figure 16: IS-95 filter requirements (for reference)

9. Frequency Hopping Feasibility

The OFDMA uses 4 time faster hopping than GSM. We present an example for speech. For speech a 4-TDMA scheme is used, this scheme still allows simple implementation of the hopping synthesiser (acquisition time, frequency stepping, phase noise, spurious,).

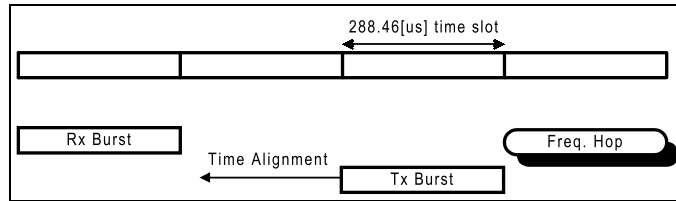


Figure 17: 4-TDMA frame and frequency hopping

In the 4-TDMA still 288µs are available for achieving the frequency hopping with accurate tuning and settling.

Actual hardware measurements using available synthesisers (g.e. fractional-N synthesisers) shows enough performance to support the 4-times faster hopping as compared to GSM.

Also within ACTS hopping synthesisers are developed to achieve very promising figures (e.g. 25µs acquisition time, 1kHz frequency stepping), actually developed prototype HW achieves already 80µs acquisition time and meets 1kHz frequency stepping and other requirements (see ACTS 97 proceedings, Aalborg, Denmark, pg.459-463, 'A High Resolution Synthesizer for SW Radio', W. Rebenak, D. Peris, Thomson-CSF Communications).

Number of required hopping synthesizers

At least for single timeslot operation (4-TDMA) and for multiple bandslot operation schemes using a single timeslot (e.g. 8 bandslots and 16 bandslots) only one frequency synthesiser is necessary to generate the frequency hopping. Especially speech (using single timeslot and single bandslot) and low rate data terminals (e.g. supporting LCD64 using multiple bandslots) can be implemented at low cost with a single synthesiser.

For higher data rate transmission reception and transmission is needed at the same time (e.g. using 7 timeslots in a 8-TDMA scheme) and two independent synthesisers are necessary for the reception and transmission. But for higher data rates a higher complexity of the MS should be allowed.

Only for clarification, the proposed RX diversity scheme is not correlated to the usage of multiple frequency synthesisers.

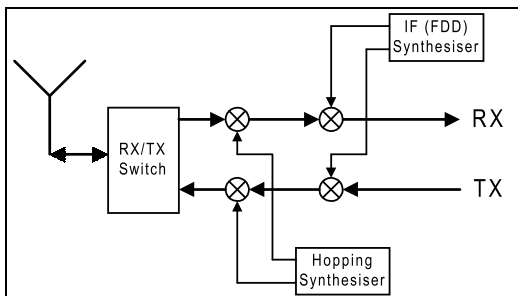


Figure 19: Simple (low data rate) Rx/Tx layout with one hopping synthesiser

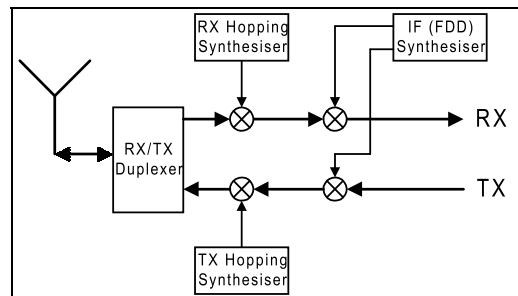


Figure 18: Advanced (high data rate) Rx/Tx layout with two hopping synthesiser

Annex C:

Concept Group Gamma γ - Wideband TDMA (WB-TDMA)

This report contained in this annex was prepared during the evaluation work of SMG2 as a possible basis for the UTRA standard. It is published on the understanding that the full details of the contents have not necessarily been reviewed by, or agreed by, ETSI SMG or SMG2.

ETSI SMG#24

TDoc SMG 900 / 97

Madrid, Spain

Agenda item 4.1: UTRA

December 15-19, 1997

Source: SMG2

**Concept Group Gamma -
WB-TDMA:
System Description Summary**

Concept Group Gamma: System Description Summary

1 Introduction

The WB-TDMA concept described here constitutes a candidate Radio Transmission Technology (RTT) which includes the physical carrier structure, the radio dependent protocol layers from layer 1 to layer 3 as well as the related radio resource management algorithms. The flexibility and efficiency is provided by sophisticated multiple access means, which include adaptive mechanisms to optimise the performance of the physical layer. Further, it is not the efficient protocols or the physical layer techniques alone, which will provide an advanced radio transmission solution, rather the complete radio interface including effective radio resource management algorithms. These aspects have been fully considered as part of the work of the Gamma concept group.

The present document summarises the main system features. More detailed information can be found in the Gamma Group Evaluation Document (ETSI SMG2#24, Tdoc SMG2 365/97).

2 Key Technical Characteristics of the Basic System

Main MA parameters	WB-TDMA
Multiple access method	TDMA
Duplexing method	FDD and TDD
Channel spacing	1.6 MHz
Carrier bit rate	2.6 Mbit/s / 5.2 Mbit/s
Physical layer structure	
Time slot structure	16 or 64 slots/TDMA frame
Frame length	4.615 ms
Multirate concept	Multislot
FEC codes	Rate Compatible Punctured Convolutional codes, Turbo Codes, Reed Solomon codes
ARQ scheme	Type II hybrid ARQ
Interleaving	Inter-slot and intra-slot interleaving
Modulation	B-OQAM / Q-OQAM
Pulse shaping	Root Raised Cosine, roll-off = 0.35

Detection	Coherent, based on midamble
-----------	-----------------------------

3 Performance Enhancing Features

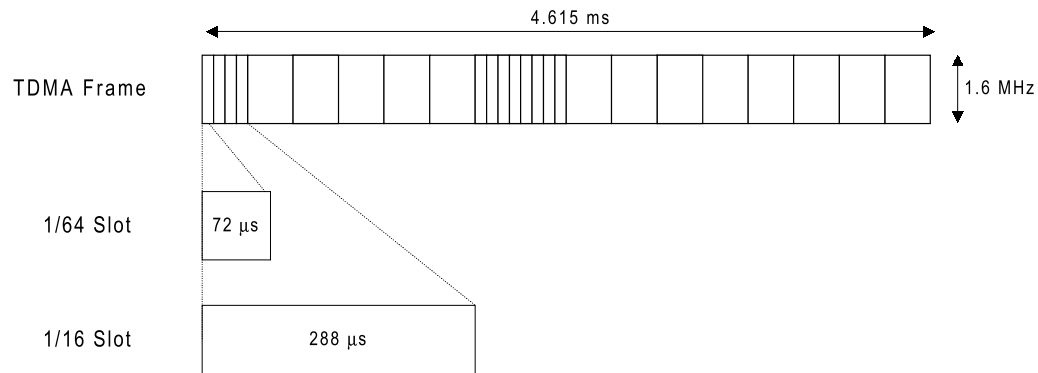
Feature	Description	Comments
Frequency diversity	Frequency hopping per frame or slot	Also provides interference diversity
Time diversity	Time hopping within frame	Provides interference diversity without increasing total bandwidth
Path diversity	Antenna diversity	BS antenna diversity assumed MS antenna diversity expected for high rate terminals.
Burst structure	Additional burst formats	Multiplexed burst for downlink efficiency Bursts optimised for specific conditions (eg large delay spreads)
Modulation	Flexible modulation format	Any modulation/coding scheme meeting emission mask (including OFDM) can be used within a flexible burst structure
Bandwidth	Multi-band structure	Supports larger cells (narrow band) or higher bit rates (wide band)
Power control	Slow power control	50 dB dynamic range Fast power control could be used if frequency hopping is not viable (eg single carrier)
Handover	Mobile assisted hard handover	Inter-frequency handover supported Soft handover (i.e. two simultaneous connections) is possible
Interference cancellation	Joint detection	Optional feature suited to suppression of small number of dominant interferers
Interference reduction	Directional antennas	Cell sectorisation is supported Adaptive antenna techniques could be applied.
Channel allocation	Slow and fast DCA supported	Allows interference avoidance

The features in the above table are not essential to the operation of WB-TDMA, but are generally considered highly desirable.

In addition, Link Adaptation in response to changes in channel conditions is considered essential for achieving high spectral efficiency.

4 System Description

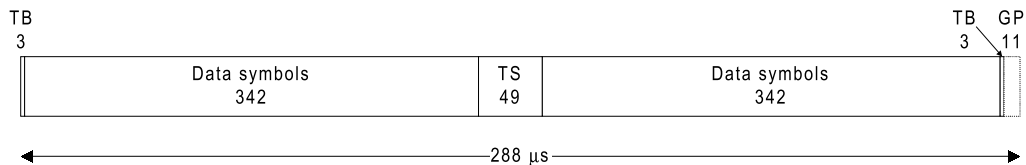
The frame duration is chosen to be 4.615ms for compatibility with GSM. A similar multi-frame structure to GSM could also be adopted.



FDD frame structure of WB-TDMA.

The frame is divided into slots of relative size 1/16 and 1/64. The same frame duration is applied in both FDD and TDD modes, except that in TDD mode an adjustable switching point determines the fraction of capacity devoted to uplink and downlink.

A number of different transmission bursts are defined for WB-TDMA. As an example, the diagram below shows a data burst for a 1/16th slot.



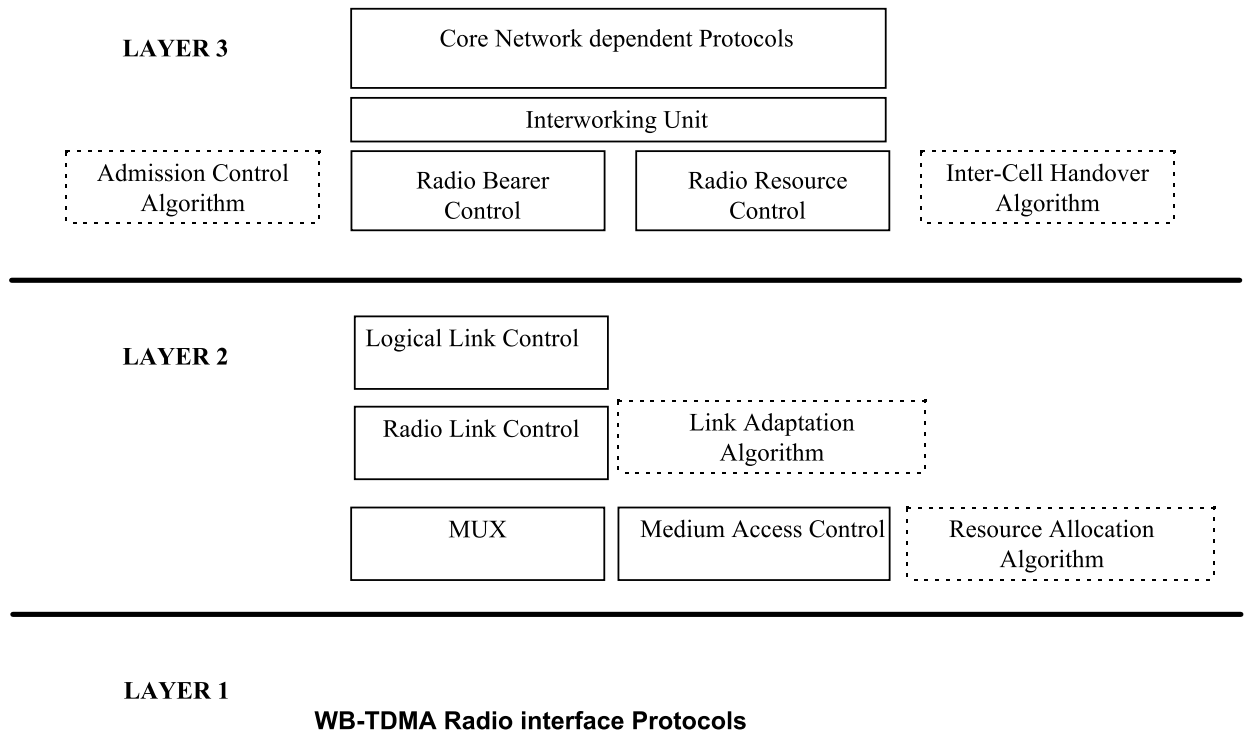
Data burst structure. TB=tail symbols, TS=training sequence and GP= guard period.

The basic modulation scheme is Binary Offset Quadrature Amplitude Modulation (B-OQAM) with a symbol rate of 2.6Msymbols/s. For higher bit rates Quaternary-OQAM is used. The corresponding carrier spacing is 1.6MHz.

Different user bit rates can be achieved by allocating different numbers of slots.

Examples of service mappings for WB-TDMA

Required user bit rate (kbits/s)	Code rate	Slot type	Burst type	Modulation	Number of basic physical channels per frame
8	0.5	1/64	Nonspread Speech 2	BOQAM	0.5
64	0.5	1/64	Nonspread Speech 2	BOQAM	4
144	0.5	1/16	Nonspread Data	BOQAM	2
384	0.5	1/16	Nonspread Data	BOQAM	5
1024	0.5	1/16	Nonspread Data	BOQAM	14
2048	0.5	1/16	Nonspread Data	QQQAM	14



The above diagram represents the layer structure and the protocols and algorithms of the WB-TDMA radio interface. Algorithms are represented in dashed boxes. For example, link adaptation is applied in response to different channel conditions by adjusting the code rate, making it possible to achieve a given quality of service independently of the C/I.

5 Summary

The WB-TDMA concept has been developed as a cost-effective flexible platform for implementation of the UTRA, which can easily adapt to a variety of operating environments and application requirements. It offers a high degree of backwards compatibility with GSM, while at the same time is "future proof" because it allows enhancement by application of technological developments. WB-TDMA could also be used in combination with other techniques, for example as a complement to CDMA for provision of high bit rates over short ranges.

ETSI SMG#24

TDoc SMG 901 / 97

Madrid, Spain

Agenda item 4.1: UTRA

December 15-19, 1997

Source: SMG2

Concept Group Gamma -

WB-TDMA:

Evaluation Summary

Concept Group Gamma: Evaluation Summary**1 Introduction**

The performance of the WB-TDMA concept has been evaluated in detail within the Gamma group. Results of link level and system level spectrum efficiency simulations are given in the Gamma Group Evaluation Document (ETSI SMG2#24, Tdoc SMG2 365/97). This also contains in Annex the Technologies Description Template, answers to questions from operators, and analytical results for spectrum efficiency.

Specific aspects which have been considered in the development of the WB-TDMA concept are:

- Support of high bit rates with a relatively simple terminal
- Effective support of non-real-time traffic with fast variations in data rate and packet size
- Support of TDD mode with data rates fulfilling the UMTS requirements
- Possibility to implement simple low bit rate terminals
- Narrow spectrum and low interference to adjacent carriers
- Flexibility for introduction of enhancements

2 Fulfilment of the High Level Requirements

This section describes how the WB-TDMA concept meets the High Level Requirements for UTRA.

2.1 Bearer capabilities**2.1.1 Maximum user bit rate**

- **Rural Outdoor:** 144kbps will be available throughout the operator's service area. The radio interface can tolerate the Doppler spread and rapidly changing channel characteristics associated with high speed vehicles (up to at least 1500km/h with 1/64 slot bursts). The maximum cell size depends on propagation conditions, but is comparable with GSM at 1800MHz (assuming similar requirements for bearer capabilities and quality of service).
- **Suburban Outdoor:** 384kbps rate will be available with complete coverage of a suburban or urban area
- **Indoor/Low range outdoor:** 2Mbps will be available indoors and over localised coverage outdoors

The maximum practical bit rate which can be provided depends on factors such as the operating environment, required quality of service, traffic loading and proximity of the mobile to the base station. However, the radio interface can support rates up to around 1Mbps for Rural and Suburban Outdoor, and 4Mbps over short ranges.

2.1.1.1 Bearer Service Attributes

The WB-TDMA concept can provide bearers with the necessary attributes. i.e. different connection modes, symmetry, communication configuration, information transfer rate, delay variation, maximum transfer delay, maximum bit error rate, error characteristics.

2.1.2 Flexibility

The WB-TDMA concept provides flexibility of bearer service attributes by use of a number of different transmission bursts optimised for different bit rates in different radio environments. The Link Adaptation mechanism can be used to dynamically maintain the quality of the connection under changes in propagation and interference conditions by adjusting transmission format and number of slots allocated. Bit rate granularity is achieved primarily by allocating different numbers of transmission slots, but this can be supplemented if necessary by adjusting channel coding rates. Parallel bearers can be transmitted independently, or where appropriate by multiplexing together into a single channel. Circuit switched and packet oriented services are supported efficiently by Real-Time and Non-Real-Time bearer concepts. Variable rate data services are supported by dynamically changing the capacity allocation. Scheduling of bearers is allowed, but could be the subject of further study. The bearer service attributes can be configured as required on initiation of a service, and changed dynamically if required.

2.1.2.1. Minimum bearer capabilities

Bearers optimised for speech are supported in all operating environments. The BER requirements for RT data services are met by concatenated coding. The transmission delay depends on the interleaving depth, but the minimum value can be less than 20ms (one way). Packet delivery times of the order of 150ms can be provided (using Type II soft combining ARQ). The detailed performance trade-offs between delay and BER (via choice of modulation, coding and interleaving) require further study.

2.1.2.2 Service traffic parameters

Since WB-TDMA provides Link Adaptation as a fundamental feature it can support the use of UMTS in various environments with a range of traffic densities range and a variety of traffic mixes in an economical way.

2.1.2.3 Performance

Details of performance are given in the Gamma Group evaluation document:

2.1.3 Configuration management

WB-TDMA will allow the definition of configuration management features.

2.1.4 Evolution and modularity

The WB-TDMA concept is service independent, and is defined so that UMTS can be implemented in phases with enhancements for increasing functionality (for example making use of different modulation and coding technology). The requirement for backwards compatibility can be met by provision of a negotiation mechanism to agree on supported capabilities between mobiles and infrastructure. The WB-TDMA concept is consistent with the requirements of an open modular architecture and implementation of software downloading of radio interface features. However these aspects require further development.

2.1.5 Handover

2.1.5.1 Overall handover requirements

Efficient seamless (mobile assisted) handovers can be provided in networks with synchronised base stations and between TDD and FDD systems. Seamless handover

between unsynchronised systems is for further study. The signalling load arising from handovers is dependent on scenario, but is not expected to be significant. The level of security is not affected by handovers. Handover to second generation systems can be well supported by use of an idle frame allowing measurements of signal strengths from alternative base stations. The choice of frame structure allows synchronisation of UTRA with GSM sharing the same cell sites which simplifies handover in this case.

2.1.5.2 Handover requirements with respect to the radio operating environments

The WB-TDMA radio interface allows handovers within a network, between different environments and between networks run by different operators.

2.2 Operational requirements

2.2.1 Compatibility with services provided by present core networks

Flexible RT and NRT bearers with a range of bit rates etc., allow current core network services to be supported.

2.2.2 Operating environments

WB-TDMA does not restrict the operational scenario for UMTS, in, for example, international operation across various radio operating environments, across multiple operators and across different regulatory regimes. Further, a range of different MS types (e.g. speech only, high bit rate data), and a variety of services with a range of bit rates are possible. WB-TDMA can support fixed wireless access, but performance in this application is for further study.

2.2.2.1 Support of multiple radio operating environments

WB-TDMA can support the requirements of all the specified radio operating environments.

2.2.2.2 Support of multiple equipment vendors

Minimum specification levels to ensure inter-operability are for further study.

2.2.3 Radio Access network planning

The Interference Averaging feature means that network planning is not as sensitive as in GSM. Link Adaptation ensures that minimal C/I planning is required. DCA can be used to re-configure the use of assigned frequency blocks in response to changing traffic. UMTS terminals using WB-TDMA will almost certainly incorporate frequency agility capability to support frequency hopping. This could facilitate the use over non-overlapping allocations across regions or countries (unless other hardware restrictions apply).

2.2.4 Public, Private and residential operators

2.2.4.1 Public UMTS operators

The ability to guarantee pre-determined levels of quality for public operators is likely to require separate frequency allocations for each operator.

2.2.4.2 Private UMTS operators

WB-TDMA is inherently resistant to interference and therefore is suitable for uncoordinated deployment. The Bunch concept allows installation of base-station clusters without any cell planning or co-ordination with other Bunches and co-ordination is automatically provided within a Bunch. DCA can further be used to avoid interference.

2.2.4.3 Residential UMTS operators

Residential systems can be deployed in the same way as private systems.

2.3 Efficient spectrum usage

2.3.1 Spectral Efficiency

High spectral efficiency is achieved, and is better than GSM for comparable services. More detailed results are given in the Gamma Group evaluation document.

2.3.2 Variable asymmetry of total band usage

In an unpaired frequency allocation, TDD provides flexibility by adapting the uplink/downlink duty cycle. With paired frequency allocation, asymmetric traffic with pure FDD is likely lead to under utilisation of one or other of the band pairs. In this case TDD in the under used band would be an efficient solution.

2.3.3 Spectrum utilisation

WB-TDMA can be deployed using for some applications using a single 1.6MHz carrier (e.g. isolated cell). A small network could be deployed in as little as 5MHz. The concept is not critically sensitive to choice of carrier frequency.

2.3.4 Coverage/capacity

2.3.4.1 Development and implementation risk

The WB-TDMA concept is a natural extension to proven technology (i.e. GSM) so unknown factors in development and implementation risks are minimised.

2.3.4.2 Flexibility of radio network design

The WB-TDMA transmission bursts are designed to cover a wide range of channel conditions. This allows operation in picocells, microcells and macrocells. Hierarchical Cell Structures are supported. The Interference Averaging concept means that the system performance is not critically sensitive to base station location

2.3.4.3 Synchronisation

Time synchronisation between different UMTS networks is desirable to optimise spectrum efficiency For both FDD and TDD), but is not essential.

2.3.4.4 Repeaters and relays

Repeaters and vehicles with mobile BS can be supported in principle, but the details are for further study.

2.3.5 Very large cell sizes

Very large cell sizes can be supported (for example by increasing the number of slots allocated to the bearer). Details of other techniques which could be employed, such as adaptive antennas, RF repeater stations or remote antennas are for further study.

2.3.6 Evolution requirements

2.3.6.1 Coverage evolution

The WB-TDMA concept supports:

- contiguous coverage (traditional cellular approach);
- island coverage (Bunch concept);
- spot coverage (isolated cell).

Since performance is not sensitive to base station deployment, a minimum of planning is required in order to install new cells to extend system coverage. Initial calculations indicate that since maximum range can be comparable to GSM at 1800MHz, reusing existing cell-sites is possible to achieve fast roll-out.

2.3.6.2 Capacity evolution

Similarly, a minimum of planning is needed in order to install new cells to increase system capacity in areas where coverage is already provided. WB-TDMA supports techniques for capacity improvement, such as the use of adaptive antenna, but these are not essential.

2.4 Complexity / cost

2.4.1 Mobile Terminal viability

WB-TDMA is not inherently complex. Low bit rate terminals will not require a duplexer. Low complexity equaliser techniques (eg DFE) are viable in low delay spread environments. Simulation studies show that frequency hopping combined with channel coding allow operation with high delay spreads.

2.4.2 Network complexity and cost

WB-TDMA provides a single radio interface concept which can be adapted to all operating environments. All the operating options within WB-TDMA are based on a common approach, in order to minimise implementation complexity. A layered approaches is has been followed in the development of the radio interface.

2.4.3 Mobile station types

Low cost terminals with a restricted set of functionality can be implemented. For example, limited bit rate, power output or multipath equalisation capability could be appropriate for private cordless telephone applications. Low rate terminals can operate without the need for duplex filters.

2.5 Requirements from bodies outside SMG

2.5.1 Alignment with IMT 2000

WB-TDMA meets at the technical requirements for submission as a candidate technology for IMT 2000 (FPLMTS) for all the terrestrial operating environments.

2.5.2 Minimum bandwidth allocation

WB-TDMA can be deployed using for some applications using a single 1.6MHz carrier (e.g. isolated cell). A small network could be deployed in as little as 5MHz (excluding guard bands). However, larger bandwidths will be required to achieve good trunking efficiency for high bit rate services.

2.5.3 Electromagnetic compatibility

The peak power and envelope variations can be constrained so that interference is expected to be less severe than (or at least comparable with) GSM

2.5.4 RF Radiation effects

WB-TDMA can operate at RF emission power levels which are in line with the recommendations related to electromagnetic radiation. For ease of implementation, a maximum transmitter output power of around 1W peak is considered desirable for hand portable units.

2.5.5 Security

WB-TDMA should be able to accommodate at least the same level of protection as GSM..

2.5.6 Co-existence with other systems

WB-TDMA is not inherently sensitive to co- or adjacent channel interference. It also does not produce high levels of adjacent channel interference. The exact guard band requirements depend on the deployment assumptions, but with a 1.6MHz signal bandwidth, are not large.

2.6 Multimode terminal capability

WB-TDMA shares aspects of TDMA with GSM, including related frame structures. This is beneficial for implementation of dual mode terminals.

2.7 Services supported by the radio interface

Detailed mechanisms for support of user position location are for further study.

**ETSI SMG
Meeting no 24
Madrid, Spain
15 - 19 December 1997**

Tdoc SMG 902/97

Title: Wideband TDMA Evaluation Document v 3.0

Source: SMG2

**Concept Group Gamma -
Wideband TDMA**

EVALUATION DOCUMENT

v 3.0

<p>This document was prepared during the evaluation work of SMG2 as a possible basis for the UTRA standard. It is provided to SMG on the understanding that the full details of the contents have not necessarily been reviewed by, or agreed by, SMG2.</p>

Executive Summary

Concept group Gamma was set up to define a Wideband TDMA based concept as a proposal for UTRA. The outcome of the definition and evaluation is presented in this document.

The WB-TDMA concept described hereafter constitutes a candidate Radio Transmission Technology (RTT) covering the physical carrier structure, the radio dependent protocol layers from layer 1 to layer 3 as well as the related radio resource management algorithms. The flexibility and efficiency of the WB-TDMA based radio interface is provided with the sophisticated multiple access means, which include variable mechanisms to get efficiency out of the physical layer. Further on, it is not the efficient protocols or the physical layer techniques alone, which will provide advanced radio transmission solutions. Rather it is the complete radio interface with effective protocols, flexible physical structure and effective radio resource management algorithms that will provide the platform of the Radio Transmission Technology.

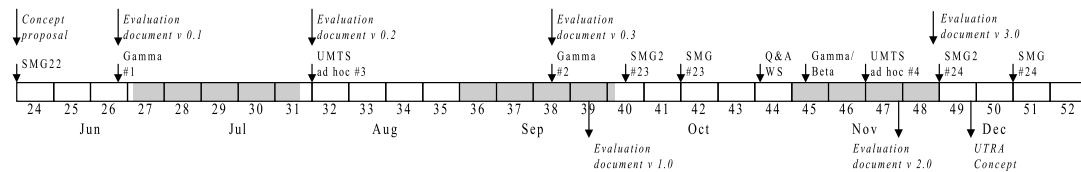


Figure 1-1 Gamma group evaluation document time schedule

Gamma group has followed in its work open and progressive approach (Figure 1-1). Participation in the concept groups work and technical contributions have been received from major manufacturers in Europe: Alcatel, Frames project (Ericsson, Nokia, Siemens), Motorola and Philips as well as from France Télécom. Group has held three meetings and met during SMG2 and SMG2 UMTS ad hoc meetings.

The basic building blocks for the concept are described in detail in the following documents:

Layer 1 - WB-TDMA Evaluation document v 3.0 - Tdoc SGM2 365/97 (This document)

Layer 2 - Radio Protocols for WB-TDMA - Tdoc SMG2 Gamma 19/97

RRM - Radio Resource Management for WB-TDMA - Tdoc SMG2 Gamma 15/97

These documents give quite detailed picture of the concept. Further work is needed to provide detailed description of items that are still on generic level in these documents.

The evaluation work is presented also in this document in form of link and system level simulation results. The studied cases are listed in Table 1.

Table 1 Evaluated services

Priority	Environment	Service mixture	Propagation model	Cell coverage	Link level	System level
1.1	Outdoor to Indoor and Pedestrian 3 km/h	UDD 384	Outdoor to Indoor and Pedestrian A	Microcell	completed	completed
1.2		Speech			completed	completed
1.3		LCD 144 kbit/s			completed	(not required)
1.5		UDD 2048			completed	(not required)
extra		UDD 144			completed	
2.1	Indoor 3 km/h	UDD 2048	Indoor A	Picocell	completed	completed
2.2		Speech			completed	(not required)
2.3		LCD 384 kbit/s			completed	(not required)
2.4		50 % speech + 50 % UDD 384			(not required)	preliminary
extra		UDD 2048 with walls			(not required)	completed
extra		UDD 144		completed		
extra		UDD 384		completed		
3.1	Vehicular 120 km/h	UDD 144	Vehicular A	Macrocell	completed	(not required)
3.2		Speech			completed	completed
3.3		LCD 384 kbit/s			completed	completed
extra		UDD 384			completed	completed
extra		UDD 2048		completed		
extra	Vehicular	Speech	Vehicular B		completed	(not req)
extra	120 km/h	UDD 144			completed	
extra		UDD 384			completed	

4 extra extra	Vehicular 250 km/h	Speech UDD 144 UDD 384	Vehicular B		completed completed completed	(not req)
---------------------	------------------------------	-------------------------------------	--------------------	--	--------------------------------------------	-----------

Concept group Gamma officials are:

Chairman Riku Pirhonen Nokia riku.pirhonen@research.nokia.com

Vice-chairman Frédéric Gourgue Alcatel frederic.gourgue@vz.cit.alcatel.fr

Secretary Patrick Blanc France Télécom / CNET patrick.blanc@issy.cnet.fr

Concept group has an e-mail distribution list: smg2gamma@list.etsi.fr.

1. Introduction	326
1.1 Contents	326
1.2 Layered structure of the Radio Interface	326
2. Logical channels	328
2.1 Control Channels	328
2.1.1 Dedicated Control Channels	328
2.1.2 Common Control Channels	328
2.2 Traffic Channels	329
2.3 Usage of the Dedicated and Common Control Channels	329
2.4 Mapping of Logical Channels to Physical Channels	329
2.4.1 Control Channels	329
2.4.1.1 Dedicated Control Channels	329
2.4.1.2 Common Control Channels	329
2.4.2 Traffic Channels	330
2.4.3 Channel Combinations	330
2.5 Cell access and synchronisation (BCCH)	331
2.5.1 Initial synchronisation	331
2.5.2 Neighbour monitoring	332
2.5.3 Handover between WB-TDMA and GSM	333
3. Physical channels	334
3.1 Multiframe	334
3.2 Multi-band concept	335
3.2.1 Definition	335
3.3 FDD and TDD frames	335
3.3.1 FDD frame	335
3.3.2 TDD frame	336
3.3.3 Time slots	336
3.4 Bursts	337
3.4.1 Traffic bursts for the 1.6 MHz carrier	337
3.4.1.1 Data burst	337
3.4.1.2 Speech bursts 1 and 2	337
3.4.1.3 Multiplexed Burst	338
3.4.1.4 Flexible Burst	339
3.4.2 Traffic bursts for the 200 kHz carrier	339
3.4.2.1 1/8 burst	340
3.4.2.2 1/16 burst	340
3.4.3 Synchronisation bursts	341
3.4.3.1 Frequency correction burst	341
3.4.3.2 Synchronisation burst	341
3.4.4 Access burst	342
3.4.5 Training Adaptation	344
3.5 Modulation	344
3.5.1 Data modulation	344
3.5.1.1 Symbol rate	344
3.5.1.2 Mapping of bits onto signal point constellation	344
3.5.1.3 Pulse shape filtering	345
3.5.2 Other modulation schemes	346

3.6 Examples of gross bit rates and service mappings	346
3.6.1 Gross bit rates of WB-TDMA bursts	346
3.6.2 Service mappings with WB-TDMA bursts	347
3.6.3 Multirate concept with flexible bursts	347
4. Layer 2 Radio Protocols	348
4.1 Overview of layer 2	348
4.2 The LLC sub-layer	349
4.3 The RLC/MAC sub-layer	349
4.3.1 RLC	350
4.3.1.1 Functions of RLC	350
4.3.1.2 RLC Protocol	350
4.3.2 MAC	351
4.3.2.1 Signalling procedures for data transfer	351
4.3.2.2 Signalling Procedures for Cell Management	357
4.3.2.3 Signalling Procedures for Controlling the Radio Link	357
5. Radio resource management	359
5.1 Introduction	359
5.2 Overview of the RRM scheme	359
5.3 Application of RRM techniques	360
5.3.1 Time and Frequency Hopping	360
5.3.2 Power Control	360
5.3.3 Link Adaptation	360
5.3.3.1 Link Adaptation for RT services	360
5.3.3.2 Link Adaptation for NRT services	361
5.3.4 Quality Loop	361
5.3.5 Slow Dynamic Channel Allocation	361
5.3.6 Fast Dynamic Channel Allocation	362
5.3.7 Admission and Load Control	362
5.3.8 Inter-cell Handover initiation	362
5.3.9 Interactions between the RRM algorithms	363
5.3.10 Operation in TDD mode	364
5.3.11 Bunch concept	364
5.3.11.1 Overview of algorithms	365
5.3.12 Frequency management for the multi-band concept	366
5.3.12.1 Frequency split	366
5.3.12.2 Frequency hopping algorithm	367
5.3.12.3 Resource allocation algorithm	368
5.3.12.4 Analysis of the multi-band system concept	368
5.4 Conclusion of the RRM techniques	370
6. Enhancements	371
6.1 Utilisation of the reciprocal channel for TDD operation	371
6.2 Adaptive antennas (AA)	371
6.3 Antenna diversity	371
6.4 Inter-cell interference suppression	371
6.5 Joint demodulation of co-channel signals	372
6.6 Improved Modulation and channel coding	372
6.7 Fast power control (frame-by-frame)	373

7. Simulations	374
7.1 Simulation cases	374
7.2 Introduction	374
7.3 Validation of simulation chains	375
7.4 Required E_b/N_0's and C/I's	376
7.4.1 Speech	376
7.4.2 UDD	376
7.5 E_b/N_0 simulation results	378
7.5.1 Speech	378
7.5.1.1 Speech in ITU Indoor_A	378
7.5.1.2 Speech in ITU Micro_A	379
7.5.1.3 Speech in ITU Vehicular_A	380
7.5.1.4 Speech in ITU Vehicular_B	381
7.5.2 LCD	382
7.5.2.1 LCD 144 in ITU Micro_A	382
7.5.3 UDD	383
7.5.3.1 UDD in ITU Indoor_A	383
7.5.3.2 UDD in ITU Micro_A	385
7.5.3.3 UDD in ITU Vehicular_A	387
7.5.3.4 UDD in ITU Vehicular_B	389
7.6 C/I simulation results	391
7.6.1 Speech	391
7.6.1.1 Speech in ITU Indoor_A	391
7.6.1.2 Speech in ITU Micro_A	392
7.6.1.3 Speech in ITU Vehicular_A	393
7.6.1.4 Speech in ITU Vehicular_B	394
7.6.2 LCD	394
7.6.2.1 LCD 384 in ITU Indoor_A	394
7.6.2.2 LCD 144 in ITU Micro_A	395
7.6.2.3 LCD 384 in ITU Vehicular_A	395
7.6.3 UDD	396
7.6.3.1 UDD in ITU Indoor_A	396
7.6.3.2 UDD in ITU Micro_A	398
7.6.3.3 UDD in ITU Vehicular_A	401
7.6.3.4 UDD in ITU Vehicular_B	404
7.6.4 Coverage Analysis	405
7.6.5 Discussion	406
7.6.6 References	406
7.7 System Level Simulations	407
7.7.1 Introduction	407
7.7.2 Basic assumptions	407
7.7.2.1 General models	407
7.7.2.2 Channel allocation	407
7.7.2.3 Frequency and time hopping	407
7.7.2.4 Power control	407
7.7.2.5 Handover	408
7.7.2.6 Link Adaptation	408
7.7.2.7 Type II hybrid ARQ	408
7.7.2.8 DTX	408
7.7.2.9 Modulation adaptation	408
7.7.2.10 Frequency Planning	408
7.7.2.11 Interface between system and link level simulation	408
7.7.3 Results	409
7.7.3.1 Micro cell	410

7.7.3.2 Indoor	411
7.7.3.3 Macro cell	414
7.7.4 Discussion	414
7.8 REFERENCES	415
8. High Level Requirements	416
8.1 Bearer capabilities	416
8.1.1 Maximum user bit rate	416
8.1.1.1 Bearer Service Attributes	416
8.1.2 Flexibility	417
8.1.2.1 Minimum bearer capabilities	417
8.1.2.2 Service traffic parameters	418
8.1.2.3 Performance	418
8.1.3 Configuration management	419
8.1.4 Evolution and modularity	419
8.1.5 Handover	419
8.1.5.1 Overall handover requirements	419
8.1.5.2 Handover requirements with respect to the radio operating environments	419
8.2 Operational requirements	419
8.2.1 Compatibility with services provided by present core networks	419
8.2.2 Operating environments	420
8.2.2.1 Support of multiple radio operating environments	420
8.2.2.2 Support of multiple equipment vendors	420
8.2.3 Radio Access network planning	420
8.2.4 Public, Private and residential operators	420
8.2.4.1 Public UMTS operators	420
8.2.4.2 Private UMTS operators	421
8.2.4.3 Residential UMTS operators	421
8.3 Efficient spectrum usage	421
8.3.1 Spectral Efficiency	421
8.3.2 Variable asymmetry of total band usage	421
8.3.3 Spectrum utilisation	421
8.3.4 Coverage/capacity	422
8.3.4.1 Development and implementation risk	422
8.3.4.2 Flexibility of radio network design	422
8.3.4.3 Synchronisation	422
8.3.4.4 Repeaters and relays	422
8.3.4.5 Very large cell sizes	422
8.3.4.6 Evolution requirements	422
8.4 Complexity / cost	423
8.4.1 Mobile Terminal viability	423
8.4.2 Network complexity and cost	423
8.4.3 Mobile station types	423
8.5 Requirements from bodies outside SMG	424
8.5.1 Alignment with IMT 2000	424
8.5.2 Minimum bandwidth allocation	424
8.5.3 Electromagnetic compatibility	424
8.5.4 RF Radiation effects	424
8.5.5 Security	424
8.5.6 Co-existence with other systems	424
8.6 Multimode terminal capability	425
8.7 Services supported by the radio interface	425
8.7.1 Location service	425
9. Conclusions	426

10. Annex 1 (ETR04.02)	427
11. Annex 2 : Operators Questions List	450
11.1 Guard band	450
11.1.1 Principle of the analysis	450
11.1.1.1 Spurious Emissions of the mobiles	451
11.1.1.2 BTS receiver characteristics	451
11.1.2 Considered environments and minimum coupling losses	451
11.1.2.1 Indoor Office	452
11.1.2.2 Outdoor to Indoor and Pedestrian	452
11.1.2.3 Vehicular	452
11.1.3 Synthesis	452
11.1.3.1 Colocated base stations	452
11.1.3.2 Non-colocated base stations	453
11.2 Spectrum requirements	455
11.3 GSM backwards compatibility	455
11.4 Macro diversity (or soft handover)	456
11.5 Support of asymmetric traffic	457
11.6 Operational requirements	458
11.7 Signalling overhead	459
11.8 MAC (Medium Access Control) procedure	461
11.9 System architecture requirements	463
11.10 Radio network planning	463
12. Annex 3 : Spectrum Efficiency Results Using an Analytical Model	465
12.1 Analytical Method	465
12.1.1 Analysis Approach	465
12.1.1.1 General Downlink Interference Model	465
12.1.1.2 Handover to adjacent cells	469
12.1.2 Effect of Link Parameters	470
12.1.2.1 Adaptive Modulation	470
12.1.2.2 Fractional Loading	471
12.1.2.3 Power Control	471
12.1.3 Blocking and Trunking Efficiency	471
12.1.4 Successful Call Criteria	472
12.1.4.1 Voice Calls	473
12.1.5 System Capacity	474
12.1.5.1 Stationary Terminals	474
12.1.5.2 Moving terminals	474
12.1.6 Procedure for Generation of Results	474
12.2 GSM Spectrum Efficiency	476
12.2.1 GSM Link Level Performance	476
12.2.2 Available GSM channels	476
12.2.3 Deployment Results - Indoor Environment	477
12.2.4 Deployment Results - Outdoor environment	477
12.2.5 Conclusions	478
12.3 Spectrum Efficiency of W-TDMA	480
12.3.1 Deployment Results - Pedestrian Environment	480
12.3.1.1 Speech	480
12.3.1.2 LCD 144	480
12.3.2 Deployment Results - Vehicular Environment	481

12.3.2.1 Speech	481
12.3.2.2 LCD384	482
12.3.3 Deployment Results - Indoor Environment	483
12.3.3.1 Speech	483
12.3.3.2 LCD384	484
12.4 Summary of Results	485

Glossary of abbreviations used in:

AC	Admission Control
ARQ	Automatic Repeat reQuest
BS	Base station
(D)CA	(Dynamic) Channel Allocation
DL	Downlink (forward link)
TDMA	Time Division Multiple Access
FDD	Frequency Division Duplexing
FEC	Forward Error Correction
FH	Frequency Hopping
FMA	Frames Multiple Access
HCS	Hierarchical Cell Structure
HO	Handover
IA	Interference Averaging
JD	Joint Detection
LA	Link Adaptation
LC	Load Control
Mbps	Mega bits per second
MS	Mobile Station
NRT	Non Real Time
PC	Power Control
QL	Quality Loop
RNC	Radio Network Controller
RRM	Radio Resource Management
RT	Real Time
TDD	Time Division Duplexing
TH	Time Hopping
TX	transmission
UL	Uplink (reverse link)

1. Introduction

Concept group Gamma was set up to define a Wideband TDMA based concept as a proposal for UTRA. The current outcome of the definition and evaluation is presented in this document.

1.1 Contents

In chapters 2 - 5 this document describes the WB-TDMA concept basic building blocks. Chapter 2 introduces the different logical channels and Chapter 3 the physical channels (layer 1). Further, the Logical Link Control (LLC), Radio Link Control (RLC) and Medium Access Control (MAC) are described in Chapter 4. Chapter 5 describes Radio Resource Management (RRM), the radio resource related part of the management plane.

Most of this document describes and evaluates the very basic WB-TDMA. However, there are several attractive and innovative possibilities foreseen to enhance the performance of the scheme. The Chapter 6 will describe some ideas about the possible enhancements.

Evaluation of the concept is based on extensive simulation campaign. Simulations have been completed and the results of these link and system level simulations are reported in chapter 7.

An essential part of any concept is its capability to fulfil the High Level Requirements set by ETSI SMG2. Chapter 8 discusses the presented concept and compares it to the high level requirements. Conclusions are presented in chapter 9.

1.2 Layered structure of the Radio Interface

The WB-TDMA building blocks described in chapter 3 - 5 can be reviewed with the help of the layered structure of the Radio Interface shown in *Figure 1-1* below.

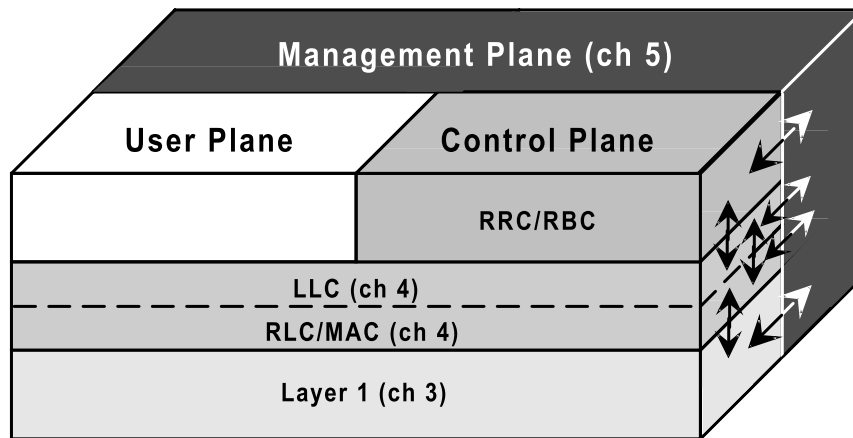


Figure 1-1 *The Layered Structure of WB-TDMA Radio Interface*

The radio interface comprises layered structure with Management, Control and User planes in the GRAN MT and in the GRAN BSS. The management plane extends as a uniform set of functionalities over all the layers and over the control and user planes. The functional entities in the management plane can handle both the inter-layer actions between any of the layers (not only the adjacent layers) and actions targeted to the control and the user planes.

The physical layer (L1) has no division between the control and the user planes.

Table 1-1 Layer 1 of the Evaluated WB-TDMA scheme

Main MA parameters	WB-TDMA
Multiple access method	TDMA
Duplexing method	FDD and TDD
Channel spacing	1.6 MHz
Carrier bit rate	2.6 Mbit/s / 5.2 Mbit/s
Physical layer structure	
Time slot structure	16 or 64 slots/TDMA frame Flexible frame structure
Frame length	4.615 ms
Multirate concept	Multislot, flexible bursts
FEC codes	Rate Compatible Punctured Convolutional codes, Turbo Codes
ARQ scheme	Type II hybrid ARQ
Interleaving	Inter-slot and intra-slot interleaving
Modulation	Adaptive B-OQAM / Q-OQAM
Pulse shaping	Root Raised Cosine, roll-off = 0.35
Detection	Coherent, based on midamble
Additional diversity means	Frequency hopping per frame or slot, Time hopping, Antenna diversity
Other RTT features	
Power control	Slow power control, 50 dB dynamic range
Handover	Mobile assisted hard handover Soft handover possible
IF handover	Mobile assisted hard handover Soft handover possible
Interference reduction	Joint detection optional
Channel allocation	Slow and fast DCA supported

The radio link layer (L2) has two sublayers, the LLC sublayer and the RLC/MAC sublayer. The control plane and the user plane are not separated in the LLC sublayer as it offers common Service Access Points (SAP) to access its transport mechanisms. The LLC provides the only service access points of the radio interface for the higher layers. The LLC is intended for both layer 3 signalling and for data transport. The transport mechanisms are provided in either HDLC-mode or minimum mode. The HDLC-mode has error detection, error correction, flow control and segmentation capabilities, whereas minimum mode has only the smallest subset of these.

The RLC/MAC sublayer will offer compact message structures to enable efficient and flexible communication between the peer-to-peer entities over the air interface. The RLC-messages can carry either control or user data messages or both of them in a specified way. The MAC will transport control messages between its peer-to-peer entities. MAC operates in the control plane, as it controls the RLC task to transport Service Data Units (SDU) of the higher layers. State machines for L2 will mostly be the same for the control and the user planes.

The radio network layer (L3) operates in the control plane. It comprises of Radio Bearer Control and Radio Resource Control sublayers. The RNL uses a Service Access Point of the LLC-sublayer to transport its messages between the peer-to-peer entities over the air interface. The RBC protocol has different entities for each radio bearer and it handles procedures for the set-up, negotiation and release of the radio bearers. The RRC protocol handles procedures, which are not directly related to a single bearer, but control the common parameters by e.g. system information, paging, measurement reports, signalling for the algorithms and handover functionality.

User data in this document refers to any data from the user plane of layer 3 or any data from the higher layers. These messages will originate and terminate in the Core Network or in the Mobile Terminal.

2. Logical channels

The purpose of this chapter is to describe the logical channels required for data transfer on UMTS WB-TDMA radio interface. All logical channels are unidirectional.

2.1 Control Channels

Control channels are intended to carry L3 and MAC signalling data.

2.1.1 Dedicated Control Channels

Dedicated Control Channels (DCCH) are point-to-point control channels that carry connection oriented messages.

1. Fast Associated Control Channel (FACCH) is a point-to-point channel in the uplink or downlink direction. The allocation of a FACCH is linked to the allocation of a TCH. FACCH is used for the RLC/MAC layer messages, e.g. capacity allocations or link control messages.
2. Stand-alone DCCH (SDCCH) is a point-to-point channel in the uplink or downlink direction. The allocation of a SDCCH is not linked to the allocation of a TCH. SDCCH is used for the RLC/MAC layer messages.

2.1.2 Common Control Channels

Common Control Channels (CCCH) are point-to-multipoint control channels that carry connectionless or connection oriented messages.

1. Broadcast Control Channel (BCCH) is a point-to-multipoint control channel in the downlink direction. A BCCH is intended to broadcast a L3 and MAC signalling data.
2. Paging Channel (PCH) is a point-to-multipoint control channel in the downlink direction. A PCH is intended to broadcast L3 paging messages. The BS-MAC is responsible for ordering transmission on PCH according to L3 paging group information and retransmission requirements.
3. Random Access Channel for short access bursts (S-RACH) is a shared uplink channel and it is used for the messages transmitted in an access burst, e.g. Access Request message.
4. Random Access Channel for normal bursts (N-RACH) is a shared uplink channel and it is used for the messages transmitted in a normal burst, e.g. Capacity Request message and messages related to link adaptation.
5. Forward Access Channel (FACH) is a point-to-multipoint channel in the downlink direction. A FACH is used for transmitting MAC messages to MSs.
6. Uplink Acknowledgement Channel (UACH) is a point-to-point uplink channel which is used by the MSs to acknowledge the reception of message received in the FACH.
7. Forward Order Channel (FOCH) is a point-to-point channel in the uplink direction. A FOCH is used for NRT unit transmission requests for downlink NRT data transfer.
8. NRT Control Channel for downlink traffic (DNCCH) is a point-to-multipoint channel in the downlink direction. A DNCCH is used for broadcasting physical channel allocations and FO scheduling for downlink NRT data transfer. MSs with downlink reservation ID (RID) are expected to listen to DNCCH.
9. NRT Control Channel for uplink traffic (UNCCH) is a point-to-multipoint channel in the downlink direction. A UNCCH is used for broadcasting physical channel allocations and data unit transmission requests for uplink NRT data transfer. MSs with uplink reservation ID (RID) are expected to listen to UNCCH.
10. Public Power Control Channel (PWCCCH) is a point-to-multipoint channel in the downlink direction. A PWCCCH is used for broadcasting fast power control commands for each allocated timeslot.
11. Frequency Correction Channel (FCCH) is a point-to-multipoint downlink channel that is used by the mobile station to correct its frequency standard to coincide with the frequency standard of the BS.

12. Synchronisation channel (SCH) is a point-to-multipoint downlink channel that is used by the mobile station to synchronise with the TDMA multiframe structure of the BS.

2.2 Traffic Channels

A Traffic Channel (TCH) is used for L3 signalling data and user data transfer.

2.3 Usage of the Dedicated and Common Control Channels

For those messages which can be transmitted on CCCH (N-RACH in uplink, FACH in downlink, UACH always for acknowledging messages transmitted on FACH) or DCCH (SDCCH which allocated capacity or FACCH which uses capacity stolen from TCH) logical channel is selected by MAC.

Guidelines for selecting the logical channel are following:

- If there is one or few MAC messages waiting for transmission, FACCH and CCCH are preferred to SDCCH.
- If the MS has allocation for a bearer and if the bearer parameters are such that stealing will not cause significant decrease to QoS, transmission on FACCH is preferred to CCCH.
- SDCCH capacity is allocated when several MAC messages need to be transmitted e.g. during the handover.

2.4 Mapping of Logical Channels to Physical Channels

The purpose of this chapter is to describe the physical resource requirements for the logical channels specified in the previous chapter. Mapping of the control messages onto spread channels is ffs.

2.4.1 Control Channels

2.4.1.1 Dedicated Control Channels

1. Fast Associated Control Channel (FACCH) is mapped to TCH by stealing capacity allocated for a bearer service. FACCH can be mapped on any TCH allocated for the same MAC-identifier to which the MAC message is addressed to.

Multiplexing and demultiplexing of FACCH on/from the traffic channels is done on burst by burst basis by altering between normal and FACCH training sequence. Stolen capacity causes predefined transmission format change to the burst by introducing a puncturing pattern to the transmitted data.

2. Stand-alone Dedicated Control Channel (SDCCH) is mapped to the physical channels according to channel allocation messages.

2.4.1.2 Common Control Channels

1. Broadcast Control Channel (BCCH)
2. Paging Channel (PCH) is interleaved over two to four 1/64 timeslots.
3. Random Access Channel for short access bursts (S-RACH) mapping is derived from cell broadcast. S-RACH is mapped to 1/64 (microcells) or 1/16 (macrocells) timeslots. 1/64 timeslot S-RACH allocation is not mandatory in a cell, in the microcells S-RACH can be mapped to the same physical channel with N-RACH.
4. Random Access Channel for normal bursts (N-RACH) capacity can be dynamically changed and it is derived from cell broadcast. If S-RACH is mapped to the same physical channel with N-RACH, both normal and access bursts are expected. Additional N-RACHs can be dynamically allocated and Control Capacity Allocation can be used to indicate selected MSs the new location of N-RACH. N-RACH is mapped to 1/64 timeslots.
5. Forward Access Channel (FACH) capacity can be dynamically changed and it follows a predefined rule derived from cell broadcast. Additional FACHs can be dynamically allocated and Control

Capacity Allocation can be used to indicate selected MSs the new location of FACH. FACH is mapped to 1/64 timeslots.

6. Uplink Acknowledgement Channel (UACH) allocation is linked to the allocation of FACH. UACH is also mapped to 1/64 timeslots.
7. Several Forward Order Channels (FOCH) may share the same physical resource. FO is interleaved into two 1/64 timeslots over two subsequent TDMA-frames. The FOCH scheduling is broadcast on the DNCCH.
8. Each NRT Control Channel for downlink traffic (DNCCH) message is mapped over two 1/64 timeslots in subsequent TDMA-frames.
9. Each NRT Control Channel for uplink traffic (UNCCH) message is mapped over two 1/64 timeslots in subsequent TDMA-frames.
10. PWCCH
11. Frequency Correction Channel (FCCH). The frequency correction burst is sent in one 1/64 slot.
12. Synchronisation Channel (SCH). The synchronisation burst can be sent in one 1/64 slot or in one 1/16 slot.

2.4.2 Traffic Channels

A Traffic Channel (TCH) is mapped to the physical channels according to channel allocation messages.

2.4.3 Channel Combinations

At a given moment, a MS accesses only a limited number of the logical channels. One of the following combinations is always accessed:

1. BCCH
2. BCCH + PCH + S-RACH + AGCH
3. BCCH + FACH + UACH + S/N-RACH
4. S/N-RACH + FACH + UACH

Combination 1. is normally used only in the phase when the physical connection is not set.

Combination 2. is used when a MS has no established bearers and is actively listening to the paging messages.

Combination 3. is used after initial access procedure when a MS has established initial bearer.

Combinations 1.- 3. can be accessed on the first RF carrier.

Combination 4. can be used if MS is informed about broadcast information changes via dedicated control channels. If this channel combination should be used, MS is informed about the control channel location which can be on any RF carrier.

In addition to combination 3 and 4 any of the following combinations can be added:

5. SDCCH
6. TCH + FACCH
7. DNCCH + FOCH
8. UNCCH
9. TCH
10. PWCCH

Combinations 5. and 6. are used if a dedicated control channel is needed.

Combination 7. is used by an MS with downlink reservation ID. RF carrier of the DNCCH and downlink transmission is indicated in the NRT-CA message.

Combination 8. is used by an MS with uplink reservation ID. RF carrier of the UNCCCH and uplink transmission is indicated in the NRT-CA message.

Combination 9. is used if a traffic channel is needed.

Combination 10. is listened by a MS on every RF carrier where MS has uplink transmission resource and hence MS having uplink allocations on several RF carriers has to listen to several PWCCCHs.

2.5 Cell access and synchronisation (BCCH)

When the power is switched on in a MS, it must be able to find the network and then to synchronise with it. During active call mobile must be able to monitor neighbouring cells and when needed to synchronise with them. In a wideband TDMA system, the introduction of GSM like beacon is seen to have a number of disadvantages:

- continuous beacon signal with fixed power causes unnecessary interference and thus decreases network capacity,
- beacon carrier can not have frequency hopping, which gives rise for an additional frequency planning.

Two potential solutions to overcome or diminish the problem indicated above are

- 1) Discontinuous wideband BCCH (1.6 MHz)
- 2) Continuous narrowband BCCH (200 kHz)

To enable the design of the single bandwidth terminal for *WB-TDMA* it might be desirable to select the first alternative. In the following, the discontinuous wideband BCCH is described in more detail.

2.5.1 Initial synchronisation

When the power is switched on, the mobile starts scanning frequencies. When it finds a 'strong' frequency, it begins to listen to it.

In every cell, there is one so called beacon frequency which includes BCCH timeslots. The BCCH multiframe structure follows a period of 51 frames. The multiframe includes five frequency synchronisation (FCCH) and five synchronisation (SCH) bursts as described in *Figure 2-1*. FCCH includes only constant sine-transmission and is used for frequency synchronisation. SCH includes a long training sequence for time synchronisation. SCH also includes base station identity code (BSIC) and frame number which gives the frame synchronisation.

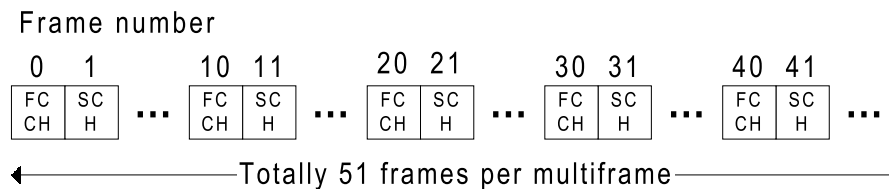


Figure 2-1 GSM multiframe for BCCH-timeslot

If a MS finds a FCCH burst it stays on that frequency, otherwise it must seek another strong frequency. The mobile receives several FCCHs and tunes its frequency oscillator. After that it is able to receive SCH and thus reach the time and frame synchronisation.

It would be beneficial if also the BCCH carrier could have frequency hopping. However, to make the initial synchronisation fast it is necessary that FCCH and SCH slots remain in a fixed frequency while the other slots of the BCCH carrier may hop. This requires an additional procedure called frequency hopping synchronisation here. A MS will learn the hopping pattern while listening to several SCH bursts that include information about the frequency hopping pattern. In the following, the overall initial synchronisation is summarised:

1. Find a strong frequency by power measurements
2. Frequency synchronisation (FCCH)

3. Time and frame synchronisation (SCH)
4. Frequency hopping synchronisation (several SCHs)

2.5.2 Neighbour monitoring

In GSM, the neighbour monitoring is based on the constant reference power transmitted on the beacon carrier. This carrier can not benefit from improvements like power control or DTX. In fact, if there is nothing to be transmitted in beacon carrier, then there must be transmitted bursts which do not contain any information (dummy-burst).

In WB-TDMA, constant power beacon carrier should be avoided due to the wider bandwidth and smaller number of carriers. However, accurate monitoring requires that the power to be measured is known. A solution is a non-continuous beacon signal which is transmitted short pre-determined time during each frame. To be able to make accurate measurements the mobile must know when this beacon signal is transmitted. Therefore, synchronous network is preferred although it is not required. Still, one has to be careful when transmitting the beacon signal in the pre-determined and fixed timeslot because some mobiles are not able to measure it. This can be avoided if beacon signal transmission would use time hopping according to the pre-determined pseudo-random sequence. These sequences should be different in neighbouring cells. Alternatively, the traffic channels of the MS can be rearranged to make these measurements available.

Figure 2-2 shows an example about a beacon signal which is defined as a transmission of known power in beacon frequency. In each frame, one 1/16 time slot, selected according to the pre-determined pseudo random sequence, can be transmitted with the known power. This means that if there is not an active user in a slot, then dummy burst must be used. In the case of an active user, the transmission power in that particular slot is replaced by the power of beacon signal. In each frame, the beacon signal lasts pre-determined time (e.g. multiple of 72 μ s). This value has to be set in such a way that all mobiles that may do handover to the cell can make measurements.

In each base station, there is a neighbour list, which contains all necessary information about beacon signal (frequency, transmitted signal power, the length of measurement window, pseudo-random sequence and the start of that sequence).

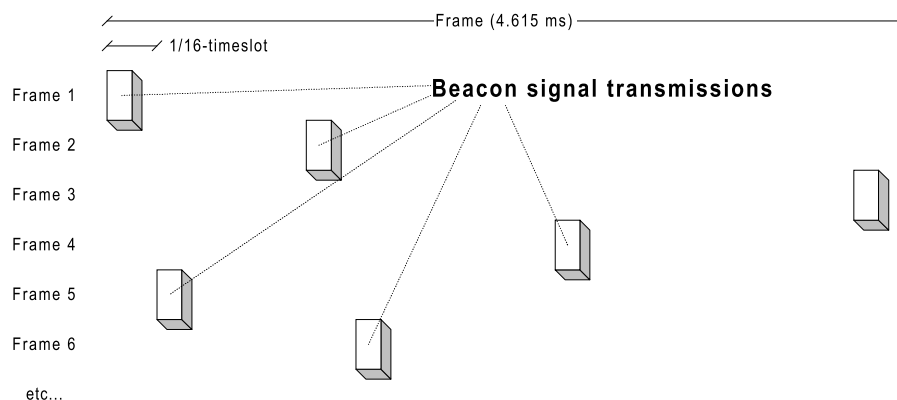


Figure 2-2 An example about beacon signal.

In cells, having only one transceiver and applying frequency hopping, the beacon signal is transmitted only when the beacon frequency is used (*Figure 2-3*). Because the beacon frequency is used relatively infrequently, the transmission of the beacon signal must last longer time to guarantee the possibility to measure it.

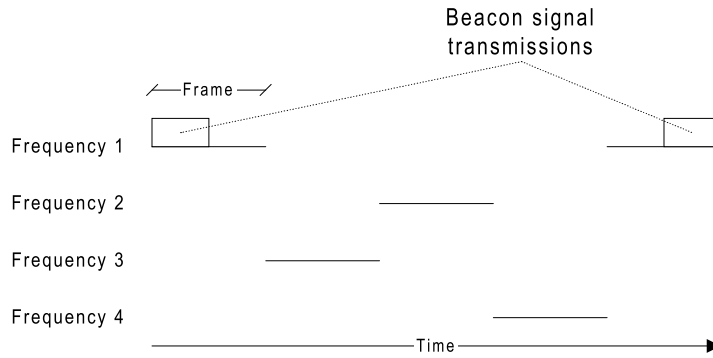


Figure 2-3 Beacon signal transmission in frequency hopping BTS with one transceiver.

2.5.3 Handover between WB-TDMA and GSM

Compatible multiframe structures of WB-TDMA and GSM make synchronisation of a MS to both systems feasible. This makes seamless handover for RT bearer services possible, and enables lossless handover for those NRT bearer services which can be established in both systems. It is preferable that WB-TDMA base station would maintain a neighbour list containing also the nearest GSM neighbours and vice versa. Then, a WB-TDMA mobile station could pre-synchronise with the strongest GSM neighbour cells and finally decide and execute the handover to GSM. The corresponding procedure can be applied to handover from GSM to WB-TDMA.

3. Physical channels

WB-TDMA can operate in FDD mode and in TDD mode. The channel spacing of WB-TDMA is 1.6 MHz both in FDD and in TDD mode. The basic physical channel of WB-TDMA is a certain time slot on a certain carrier frequency. In the following, an overview about the multiframe, unit frame and time slot structure is given. The last subsection defines the modulation method. The Wideband TDMA concept can be used in conjunction with other techniques. For example, a system with a TDMA downlink and CDMA uplink could be viable.

In order to efficiently cope with all radio environments and all services, a multi-band system concept is proposed and presented in section 3.2. A limited number of bandwidths are actually being considered in the evaluation, and the exact definition of these bandwidths might need to be reviewed at a later stage.

3.1 Multiframe

The requirements for the multiframe structure come from two major directions. First, it is required that seamless handovers between WB-TDMA and GSM can be made. This implies a GSM like multiframe structure that can be further improved by taking into account the identified deficiencies in GSM. Secondly, the control requirements from the packet access protocol (RLC/MAC) have to be incorporated into the multiframe structure. One candidate multiframe structure is presented in *Figure 3-1*. The contents of the control channel cluster indicated in the figure is dependent on the higher layer protocols, too.

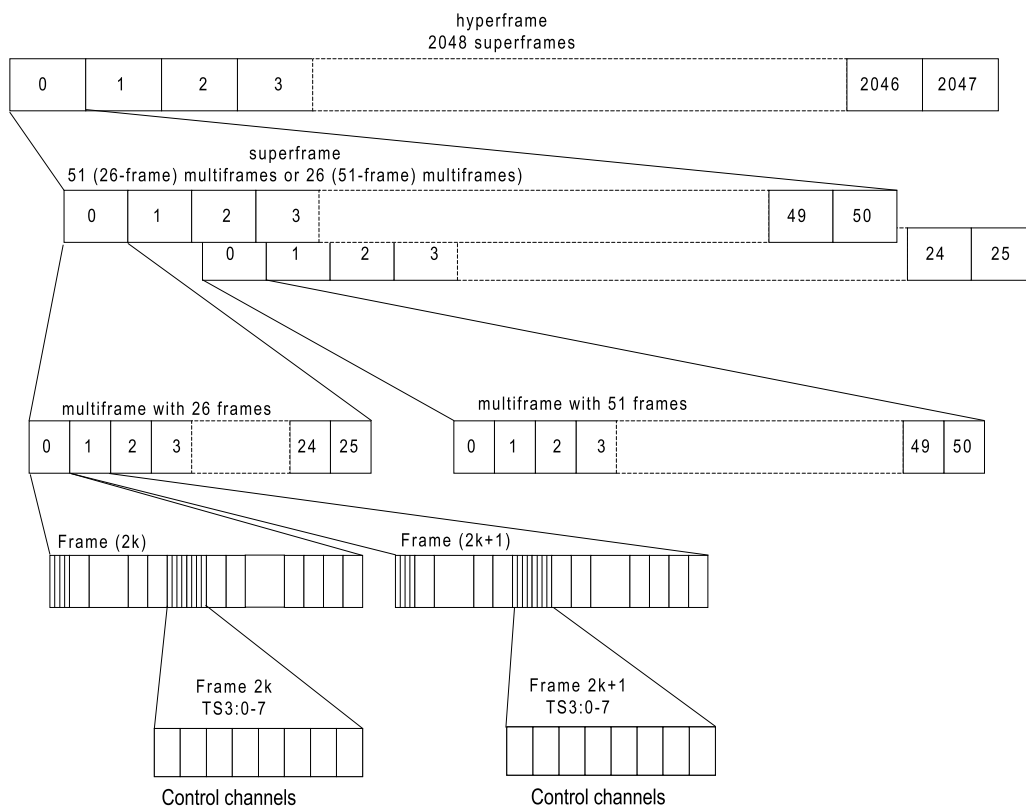


Figure 3-1 A candidate multiframe structure that aims to provide compatibility with the GSM multiframe structure in order to make handovers between WB-TDMA and GSM possible.

3.2 Multi-band concept

3.2.1 Definition

With TDMA systems, it is difficult to handle efficiently all radio environments (delay spread) and the wide range of UMTS bit rates using a single carrier bandwidth. For instance the 1.6 MHz bandwidth may not be optimal for low bit rate services in large cells (with large delay spread). Therefore a multi-band system concept is introduced in order to solve this issue.

The TDMA multi-band system concept may use different bandwidths defined as :

$$BW = 2^n \times 100 \text{ kHz}, n \text{ from } 1 \text{ to a maximum value } M \text{ to be defined}$$

In order to be compatible with GSM, a basic carrier spacing of 200 kHz is chosen.

A TDMA multi-band system is illustrated on Figure 3-2 below, where the system can exploit 200, 400, 800, 1600 and 3200 kHz bands. However, in the current phase, only two carriers bandwidths are further studied, i.e. 200 kHz and 1600 kHz. The support of 3200 kHz could be considered in a later stage in order to support high bit rates with binary modulation, as well as the support of intermediate carrier bandwidths.

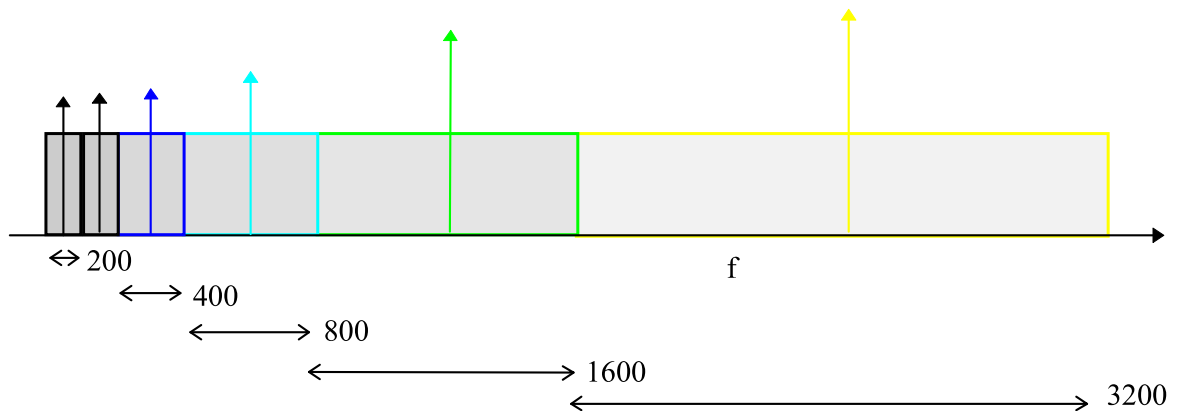


Figure 3-2 :- Multi-band TDMA system concept

It is pointed out that adjacent carriers might be used in the same cell, with different carrier bandwidths. A high adjacent channel protection will therefore be needed in order to avoid interference from adjacent channels, especially when different bandwidths are in use.

3.3 FDD and TDD frames

In the following sections, a unit frame structure is presented separately for FDD and TDD modes.

3.3.1 FDD frame

The unit FDD frame is presented in Figure 3-3. The length of the FDD frame is 4.615 ms which is 12000 symbol periods.

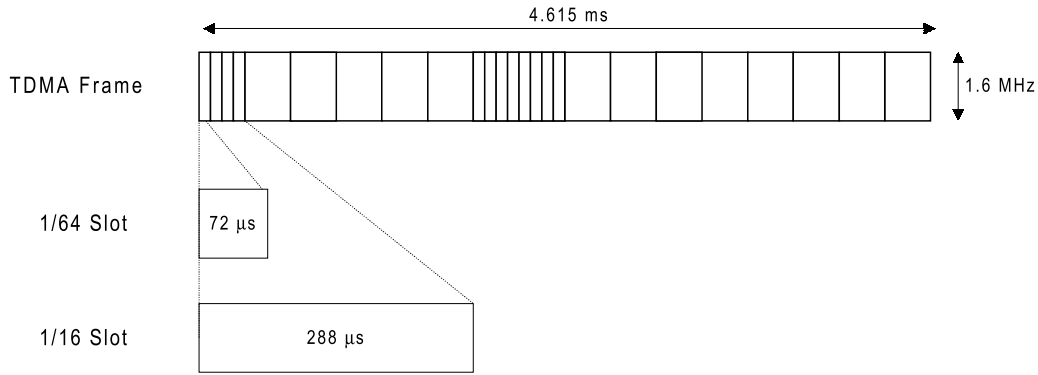


Figure 3-3 The unit FDD frame structure of WB-TDMA. WB-TDMA without spreading uses 1/64 and 1/16 slots.

3.3.2 TDD frame

The TDD frame is of the same length as the FDD frame but it is divided into downlink and uplink parts (Figure 3-4). The switching point between uplink and downlink can be moved in the TDD frame to adopt asymmetric traffic. The minimum length of uplink and downlink parts is one eighth of the frame length (577 μs).

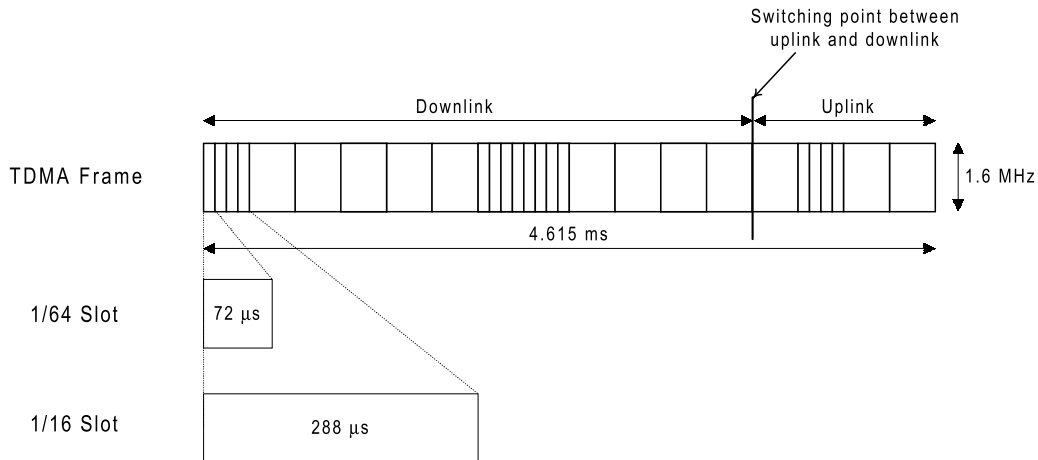


Figure 3-4 The unit TDD frame structure of WB-TDMA..

In the TDD frame structure, it is assumed that the same mobile station is not receiving in the last slot of the downlink part and transmitting in the first slot of the uplink part.

3.3.3 Time slots

The TDMA frame is subdivided into time slots. Two different types of time slots are presented for WB-TDMA in Figure 3-3 and in Table 3-1 : 1/64 time slot and 1/16 time slot. In a 1/64 time slot there are 187.5 symbol periods and in a 1/16 time slot 750 symbol periods.

Table 3-1 : Time slot lengths in seconds and in symbol periods.

Time slot type	Length in seconds	Length in symbol periods (SP)
1/64 time slot	72 μs	187.5 SP
1/16 time slot	288 μs	750 SP

A TDMA frame of length 4.615 ms can consist of

- 64 1/64 time slots of length 72 μ s (15/208 ms) or
- 16 1/16 time slots of length 288 μ s (15/52 ms) or
- any mix of these time slots of different lengths fitting together in the TDMA frame.

The 1/64 slot can be used for every service from low rate speech and data to high rate data services. The 1/16 slot is to be used for medium to high rate data services.

The physical content of the time slots are the bursts of corresponding length as described in Section 3.4.

3.4 Bursts

3.4.1 Traffic bursts for the 1.6 MHz carrier

Three types of traffic bursts are defined for WB-TDMA: the Speech burst 1 (S1), the Speech burst 2 (S2) and the Data burst (D). In addition, multiplexed burst (MB) and flexible burst (FB) are introduced into the WB-TDMA concept.

3.4.1.1 Data burst

The Data burst uses 1/16 time slot. It consists of two tail symbol fields, two data symbol fields, training sequence field and guard period (*Figure 3-5*). The use of individual symbols is defined in *Table 3-2*.

The payload of the Data burst (number of data symbols) is 684 symbols. The training sequence is located in the middle of the burst so that none of the data symbols is too far from it. This improves the channel estimate compared to the use of the preamble type training sequence. Burst tail symbols are defined to have fixed value (e.g. 0's) in order to make different detection methods possible. In the end of the burst there is the guard period of 11 symbol periods. The guard period is a protection interval between bursts for time alignment uncertainty, time dispersion and power ramping.

Data burst can be used for all services from medium rate data (64 kbps) to high rate data up to 2 Mbit/s.

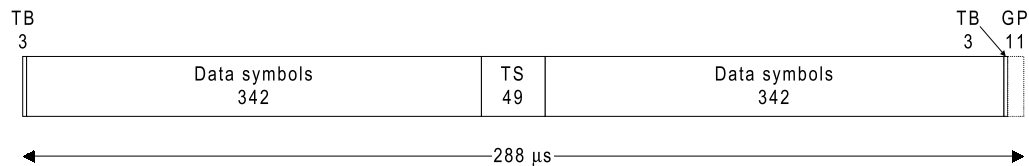


Figure 3-5 Burst structure of the Data burst. TB stands for burst tail symbol, TS for training sequence and GP for guard period.

Table 3-2 : The contents of the Data burst fields and the use of individual symbols

Symbol number (SN)	Length of field	Contents of field
0-2	3	Tail symbols
3-344	342	Data symbols
345-393	49	Training sequence
394-735	342	Data symbols
736-738	3	Tail symbols
739-749	11	Guard period

3.4.1.2 Speech bursts 1 and 2

The Speech bursts use 1/64 time slot. There are two types of Speech bursts that differ in the length of the training sequence. The training sequence of the Speech burst 1 is 49 symbol periods long whereas

the training sequence of the Speech burst 2 is 27 symbol periods long. Thus the Speech burst 1 provides better channel estimate and allows for longer multipath delays than the Speech burst 2 by sacrificing some of the burst payload.

The Speech bursts 1 and 2 consist of two tail symbol fields, two data symbol fields, training sequence field and guard period (*Figure 3-6* and *Figure 3-7*). The payloads (number of data symbols) of the Speech bursts 1 and 2 are 122 symbols and 144 symbols, respectively. The use of the individual symbols is defined in *Table 3-3* and *Table 3-4*.

Both burst formats (Speech 1 and 2) can be used for all services from speech to high rate data up to 2 Mbit/s.

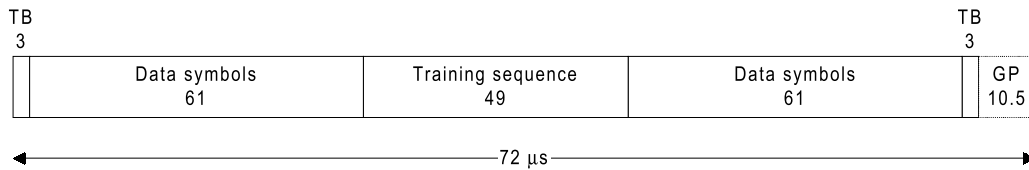


Figure 3-6 Burst structure of the Speech burst 1. TB stands for burst tail bit and GP for guard period.

Table 3-3 : The contents of the Speech burst 1 fields and the use of individual symbols.

Symbol number (SN)	Length of field	Contents of field
0-2	3	Tail symbols
3-63	61	Data symbols
64-112	49	Training sequence
113-173	61	Data symbols
174-176	3	Tail symbols
177-187	10.5	Guard period

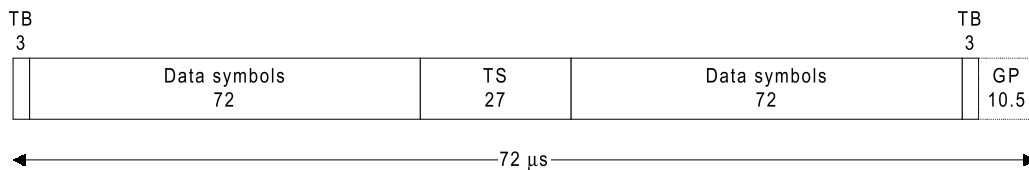


Figure 3-7 Burst structure of the Speech burst 2. TB stands for burst tail bit, TS for training sequence and GP for guard period.

Table 3-4 : The contents of the Speech burst 2 fields and the use of individual symbols.

Symbol number (SN)	Length of field	Contents of field
0-2	3	Tail symbols
3-74	72	Data symbols
75-101	27	Training sequence
102-173	72	Data symbols
174-176	3	Tail symbols
177-187	10.5	Guard period

3.4.1.3 Multiplexed Burst

The Multiplexed Burst is defined to occupy an integer number of adjacent 1/16 time slots, and is intended for use on the downlink. It is divided into a header and a body (*Figure 3-8*). The header contains an indication of which users have data in the body, and on the location and format of this data. The header is comprised of one or more of defined bursts (e.g. Speech Burst 1) while the body contains any number of flexible bursts.

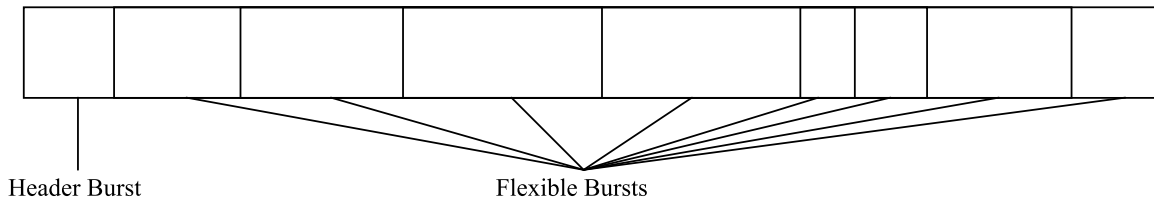


Figure 3-8 Multiplexed burst

The header may be reduced in size or eliminated, if sufficient information can be provided to the mobiles with reasonable efficiency using signalling defined for link adaptation mechanisms (cf., 5.3.3).

3.4.1.4 Flexible Burst

The allowed format(s) of flexible bursts (including modulation and coding scheme) are agreed between the mobile and base on call set up, or via a signalling channel. As an example (Figure 3-9) we consider a burst of a similar structure to the Data burst, but with a variable number of data symbols (ND) and variable length of training sequence (NT).

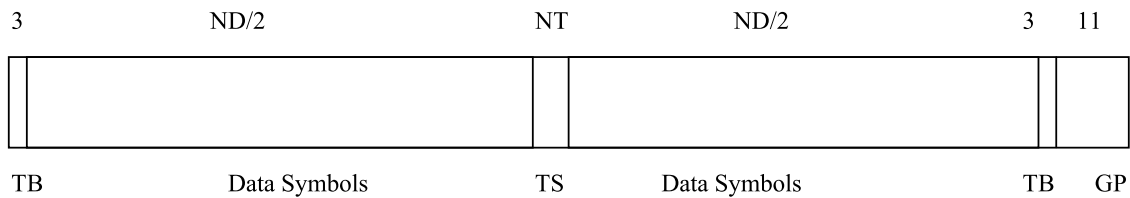


Figure 3-9 Structure of Flexible Burst

Table 3-5 : Contents of Flexible Burst

Symbol Number	Length of field	Contents of field
0 - 2	3	Tail symbols
3 - (2+ND/2)	ND/2	Data symbols
(3+ND/2) - (2+ND/2+TS)	NT	Training sequence
(3+ND/2+TS) - (2+ND+TS)	ND/2	Data symbols
(3+ND+TS) - (5+ND+TS)	3	Tail symbols
(6+ND+TS) - (16+ND+TS)	11	Guard period

Note that it may be possible to significantly reduce the guard period, which in the downlink would only be required to accommodate power ramping.“

3.4.2 Traffic bursts for the 200 kHz carrier

The 200 kHz is first being defined to support low bit rate services (speech) in large cells, but could be extended for the support of higher bit rates using quaternary modulation. Two types of bursts are defined for the 200 kHz carrier : the 1/8 burst and the 1/16 burst.

3.4.2.1 1/8 burst

The 1/8 burst is very similar to the GSM, which eases compatibility with GSM. A smaller guard time is proposed, taking into consideration progress in technology of power amplifiers.

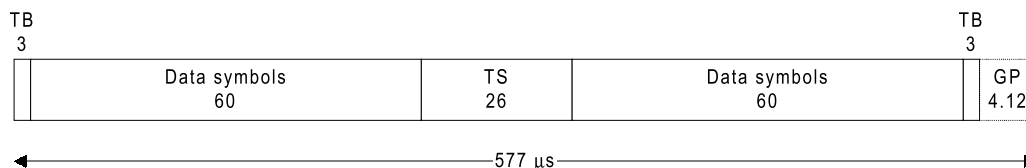


Figure 3-10 : Burst structure of the 1/8 burst for 200 kHz carrier. TB stands for burst tail bit, TS for training sequence and GP for guard period.

Table 3-6 : The contents of the 1/8 burst for 200 kHz fields and the use of individual symbols.

Symbol number (SN)	Length of field	Contents of field
0-2	3	Tail symbols
3-62	60	Data symbols
63-88	26	Training sequence
89-148	60	Data symbols
149-152	3	Tail symbols
153-157	4.12	Guard period

3.4.2.2 1/16 burst

A 1/16 burst is proposed in order to improve the frequency diversity gain provided by frequency hopping. Indeed, for the same bit rate, instead of using a 1/8 slot, a mobile can use two 1/16 slots and hop inside the frame. The 1/16 slot also permits to offer lower bit rate services that could be useful for very low bit rate data or speech in some cases.

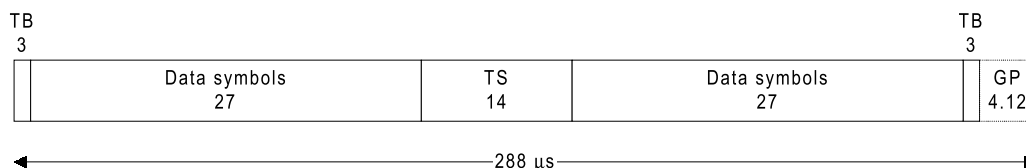


Figure 3-11 : Burst structure of the 1/16 burst for 200 kHz carrier. TB stands for burst tail bit, TS for training sequence and GP for guard period.

Table 3-7 : The contents of the 1/16 burst for 200 kHz carrier fields and the use of individual symbols.

Symbol number (SN)	Length of field	Contents of field
0-2	3	Tail symbols
3-29	27	Data symbols
30-43	14	Training sequence
44-70	27	Data symbols
71-73	3	Tail symbols
74-78	4.12	Guard period

The concept of multiplexed burst or flexible burst could be applied as well to the 200 kHz carrier, although details have not been developed yet.

3.4.3 Synchronisation bursts

Three different bursts are defined for synchronisation purposes: one frequency correction burst and two different synchronisation bursts. The actual synchronisation procedure is defined in Section 2.3.

3.4.3.1 Frequency correction burst

To enable the MS to synchronise to the BS carrier frequency the Frequency correction burst is used. This burst is used only in the downlink. The Frequency correction burst is sent using a 1/64-slot. It is for further study whether the longer burst (1/16-slot) for frequency correction is needed. *Figure 3-12* and *Table 3-8* show the 1/64-slot Frequency correction burst.

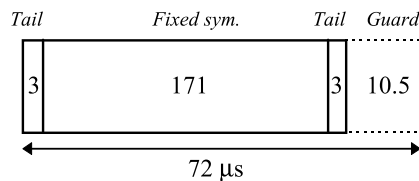


Figure 3-12 The Frequency correction burst.

Table 3-8: The contents of the Frequency correction burst

Symbol number (SN)	Length of field	Contents of field
0-2	3	Tail symbols
3-173	171	Fixed symbols
174-176	3	Tail symbols
177-186.5	10.5	Guard symbols

The fixed bits in the burst are all 0's. This gives that the transmitted signal is equivalent to an unmodulated carrier with an offset of approximately 651 kHz from the carrier frequency, which can be seen from the following equation ($\pi/2$ -rotation for each symbol):

$$f_{\text{offset}} = \frac{1}{4 \cdot T_{\text{sym}}} \approx 651 \text{ kHz} \quad (3-1)$$

3.4.3.2 Synchronisation burst

To enable the MS to synchronise to the BTS TDMA structure, the Synchronisation burst is used. This burst is used only in the downlink. *Figure 3-13* and *Table 3-9* show the 1/16-slot Synchronisation burst and *Figure 3-14* and *Table 3-10* show the 1/64-slot Synchronisation burst. In the data fields these bursts carry information about the TDMA structure. These bursts have a significantly longer training sequence than the traffic bursts. The length of the data field for the 1/16-slot burst is probably unnecessary long, but on the other hand a longer training sequence would probably not be needed. The question is if the length of the training sequence field for the 1/64-slot burst is long enough and also if the data fields are long enough. If they are sufficiently long, probably only the 1/64-slot burst is needed.

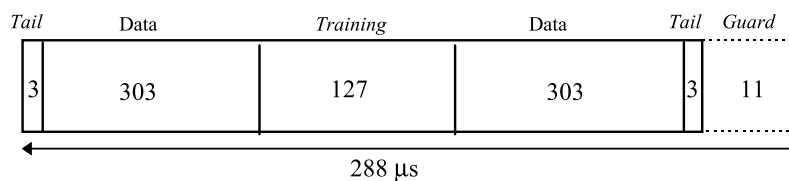


Figure 3-13 The 1/16-slot Synchronisation burst.

Table 3-9 : The contents of the 1/16-slot Synchronisation burst.

Symbol number (SN)	Length of field	Contents of field
0-2	3	Tail symbols
3-305	303	Data symbols
306-432	127	Training sequence
433-735	303	Data symbols
736-738	3	Tail symbols
739-749	11	Guard period

Training sequence for the 1/16-slot Synchronisation burst:

TS = (11111110111011101111010001011001011111000100000011
 00110110001110011101011100001001100000101010111010
 01001010011110010001101010000)

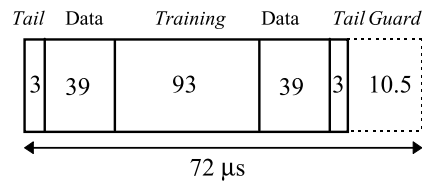


Figure 3-14 The 1/64-slot Synchronisation burst

Table 3-10 : The contents of the 1/64-slot Synchronisation burst.

Symbol number (SN)	Length of field	Contents of field
0-2	3	Tail symbols
3-41	39	Data symbols
42-134	93	Training sequence
135-173	39	Data symbols
174-176	3	Tail symbols
177-186.5	10.5	Guard period

Training sequence for the 1/64-slot Synchronisation burst:

TS = (0010100101111101010100001011011110011100101011001
 1000001101101011101000110010001000001001001)

The 1/64-burst Synchronisation burst consists of 25 information symbols, 10 parity symbols and 4 tail symbols. The 78 data symbols are obtained by a convolutional code of rate 1/2.

3.4.4 Access burst

The Access burst is used for initial random access and after/for handover. The modulation is BOQAM. Since timing advance is not known at initial random access and handover, a longer guard period is needed for the Access burst than for traffic bursts. The length of the guard period, t_{guard} , limits the maximum radius, r_{max} , of the cell, which can be seen in the equation below.

$$r_{max} = \frac{c \cdot t_{guard}}{2} \tag{3-2}$$

where c is the speed of light.

In Table 3-11 one can find the maximum cell radius for the two bursts. As can be seen, the 1/16-slot Access burst, the guard of which is set to 625 symbols, can handle cells with radius up to 36 km, while the 1/64-slot Access burst, the guard of which is set to 98.5 symbols, can handle cells with 5 km radius.

Table 3-11 : Maximum cell radius for the two access bursts.

Slot type	Slot length [ms]	t_{guard} [ms]	r_{max} [km]
1/16	288	240	36
1/64	72	33	5

Figure 3-15 and Table 3-12 show the 1/16-slot Access burst and Figure 3-16 and Table 3-13 show the 1/64-slot Access burst.

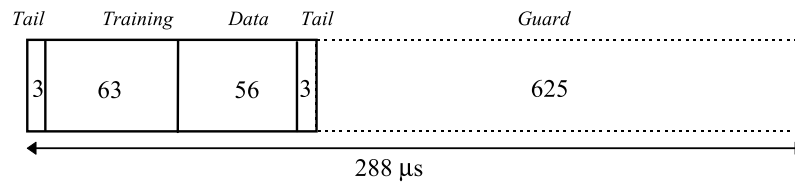


Figure 3-15 The 1/16-slot Access burst.

Table 3-12 : The contents of the 1/16-slot Access burst.

Symbol number (SN)	Length of field	Contents of field
0-2	3	Tail symbols
3-65	63	Training sequence
66-121	56	Data symbols
122-124	3	Tail symbols
125-749	625	Guard symbols

Training sequence for the 1/16-slot Access burst:

TS = (1111100000100001100010100111101000111001001011011
10110011010101)

The 1/16-burst Access burst consists of 18 information symbols, 6 parity symbols and 4 tail symbols. The 56 data symbols are obtained by a convolutional code of rate 1/2.

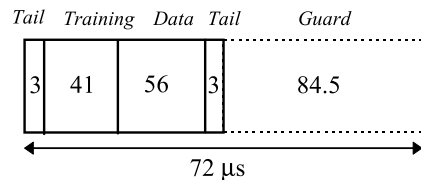


Figure 3-16 The 1/64-slot Access burst.

Table 3-13 : The contents of the 1/64-slot Access burst

Symbol number (SN)	Length of field	Contents of field
0-2	3	Tail symbols
9-43	41	Training sequence
44-99	56	Data symbols
100-102	3	Tail symbols
103-186.5	84.5	Guard symbols

The training sequence for the 1/64-slot Access burst is:

$$TS = (0100101101111111001100110101010001111000)$$

The 1/64-slot Access burst consists of 18 information symbols, 6 parity symbols and 4 tail symbols. The 56 data symbols are obtained by a convolutional code of rate $\frac{1}{2}$.

3.4.5 Training Adaptation

It is desirable to be able to adapt the duration of the training sequence to transmission conditions. For example, longer training sequences may be needed for channels with large delay spreads, or for low C/I. This can be done within the definition of the Flexible Burst in Chapter 3.4.1.4. Also the Flexible Burst allows the frequency of training sequences can be altered to optimise the trade-off between training overhead and throughput, by allowing more frequent channel measurements for environments with fast moving terminals and less frequent measurements for slow moving mobiles.

The set of defined uplink and downlink transmission bursts could also be extended. To avoid additional overhead from longer training sequences, bursts intended for low bit rate bearers could be designed specifically for use in alternate frames (or even less frequently). As an example, a 1/32 slot burst could be used every other frame instead of a 1/64 slot every frame.

Training adaptation can be supported as part of link adaptation and also needs appropriate channel measurements, for example of channel quality and delay spread.

3.5 Modulation

The basic modulation parameters including pulse shaping are summarised in Table 3-14.

Table 3-14 : Basic modulation parameters

Carrier symbol rate	2.6 MSymbol/s
Carrier spacing	1.6 MHz
Data modulation	Binary Offset QAM Quaternary Offset QAM
Pulse shaping	Root Raised Cosine (roll-off 0.35)

3.5.1 Data modulation

In this section, symbol rates and durations are defined, the mapping of bits onto signal point constellation is shown and the pulse shaping is defined.

3.5.1.1 Symbol rate

The symbol rate and symbol duration are shown in Table 3-15.

Table 3-15 : Summary of symbol rates and durations

	Symbol rate	Symbol duration
WB-TDMA	2.6 Msymbol/s	0.384 μ s

3.5.1.2 Mapping of bits onto signal point constellation

In WB-TDMA the data modulation is either Binary Offset QAM (BOQAM), which is sometimes also referred to as Offset QPSK (OQPSK), or Quaternary Offset QAM (QOQAM), which is sometimes also referred to as Offset 16QAM.

Offset QAM may in general be expressed as:

$$s(t) = \left[\sum_k a_{2k} h(t - 2kT) \right] \cos(\omega_c t) - \left[\sum_k a_{2k+1} h(t - (2k + 1)T) \right] \sin(\omega_c t), \tag{3-3}$$

where $\omega_c = 2\pi f_c$, f_c is the carrier frequency, $1/T$ is the symbol rate ($T = T_b$ for Binary Offset QAM and $T = 2T_b$ for Quaternary Offset QAM), a_k is the k th data symbol taking on values of ± 1 for Binary Offset QAM and ± 1 and ± 3 for Quaternary Offset QAM and $h(t)$ is the impulse response of the shaping filter. The difference between Offset QAM and conventional QAM is the delay of T (half a symbol period for QAM) in the quadrature branch. This time shift prevents zero-crossing signal transitions, as shown in *Figure 3-17* and *Figure 3-18*. This improves the Peak-to-Average Power Ratio, which makes Offset QAM more suitable for using with non-linear amplifiers.

The complex envelope of an Offset QAM signal is

$$\begin{aligned} u(t) &= \sum_k [a_{2k} h(t - 2kT) + j a_{2k+1} h(t - (2k + 1)T)] \\ &= \sum_k j^{(k \bmod 2)} a_k h(t - kT) \end{aligned} \tag{3-4}$$

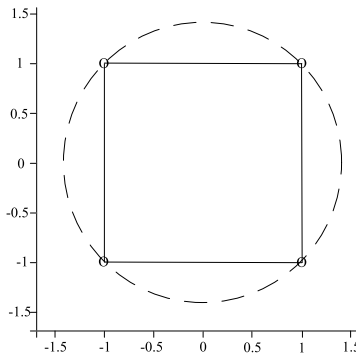


Figure 3-17 Signal point constellation for BOQAM with rectangular pulse shaping (O, —) and GMSK (----).

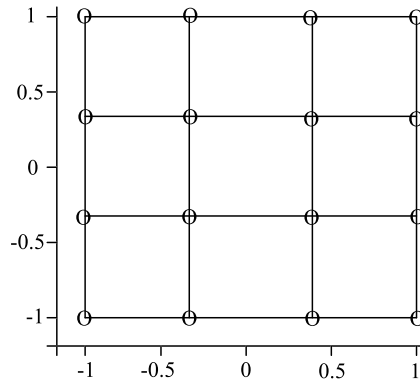


Figure 3-18 Signal point constellation for QOQAM with rectangular pulse shaping (O, —)

3.5.1.3 Pulse shape filtering

In WB-TDMA, the pulse shaping filter has square root raised cosine spectrum with impulse response given by:

$$h(t) = \sqrt{\frac{E}{2T}} \frac{1}{\pi t / 2T} \left[\frac{\sin \pi(1 - \alpha)t / 2T + 4\alpha t / 2T \cos \pi(1 + \alpha)t / 2T}{1 - (4\alpha t / 2T)^2} \right], \tag{3-3}$$

which is uniquely defined by the roll-off factor α . Here, the value 0.35 is chosen for the roll-off factor α . E is the energy of the pulse $h(t)$ (usually normalised to 1). The impulse response $h(t)$ and the energy density spectrum of $h(t)$ with the roll-off factor $\alpha = 0.35$ are depicted in *Figure 3-19*.

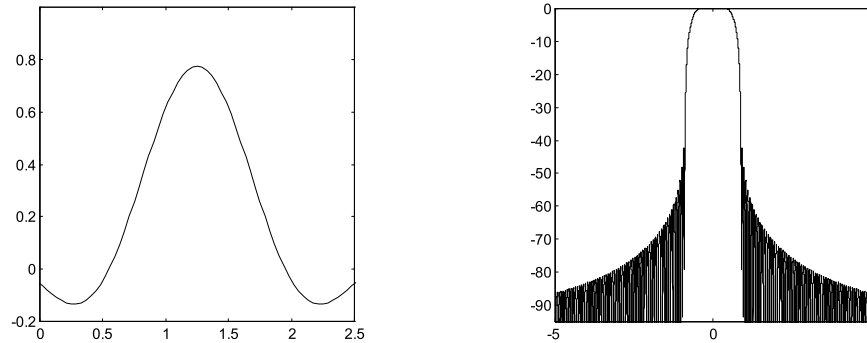


Figure 3-19 Binary Offset QAM basic impulse $h(t)$ and the corresponding energy density spectrum of $h(t)$ with the roll-off factor $\alpha=0.35$ for a symbol duration $0.38 \mu\text{s}$ ($1/2.6 \text{ Msymbol/s}$).

3.5.2 Other modulation schemes

To allow maximum flexibility any modulation scheme supported by both base and mobile is allowed (including spreading). However, it must meet any relevant requirements on emission spectrum such as adjacent channel radiation. The modulations studied by FRAMES are a good basis for evaluating performance.

3.6 Examples of gross bit rates and service mappings

This chapter presents the gross bit rates of WB-TDMA, some examples how the burst can be used to provide different data rates and how flexible bursts can be used in multirate services.

3.6.1 Gross bit rates of WB-TDMA bursts

Table 3-16 : Gross bit rates of different burst types of WB-TDMA

Slot type	Burst type	Modulation	Gross bit rate per single slot (kbit/s)	Total gross bit rate (using all slots) (Mbit/s)
1/64	Speech 1	BOQAM	26.4	1.69
1/64	Speech 1	QOQAM	52.8	3.38
1/64	Speech 2	BOQAM	31.2	2.00
1/64	Speech 2	QOQAM	62.4	4.00
1/16	Data	BOQAM	148.2	2.37
1/16	Data	QOQAM	296.4	4.74

3.6.2 Service mappings with WB-TDMA bursts

Table 3-17 : Examples of service mappings for WB-TDMA

Required user bit rate (kbits/s)	Code rate	Slot type	Burst type	Modulation	Number of basic physical channels per frame
8	0.5	1/64	Speech 2	BOQAM	0.5
64	0.5	1/64	Speech 2	BOQAM	4
144	0.5	1/16	Data	BOQAM	2
384	0.5	1/16	Data	BOQAM	5
1024	0.5	1/16	Data	BOQAM	14
2048	0.5	1/16	Data	QOQAM	14

3.6.3 Multirate concept with flexible bursts

The bit rate requirements for different applications could be met by using different modulation and coding schemes, as well as by allocation of a variable number of transmission slots. In the Adaptive Modulation concept the selection of the modulation and coding scheme is determined by the C/I at the mobile and the bit rate varied by adapting the slot duration.

As an example, the payload requirements for an 8kbps speech codec would vary from 40 symbols per frame (with Q-OQAM and 1/2 rate coding) to 120 symbols per frame (with B-OQAM and 1/3 rate coding). This assumes that 200 frames per second are used out of the available 216.68 frames per second (as in GSM). Therefore, using the Flexible Burst, and assuming training sequences of 27 symbols and 49 symbols respectively, the corresponding range of burst durations would be from 84 symbols to 186 symbols. The latter figure is almost the same as for the speech bursts.

Speech is considered to be a discontinuous data source, with a typical occupancy of 50%. Therefore efficient use of transmission capacity is achieved by multiplexing a number of such traffic channels into a Multiplexed Burst.

4. Layer 2 Radio Protocols

The following Figure 4-1 represents the layer structure and the protocols and algorithms of the WB-TDMA radio interface. Algorithms are represented in dashed boxes.

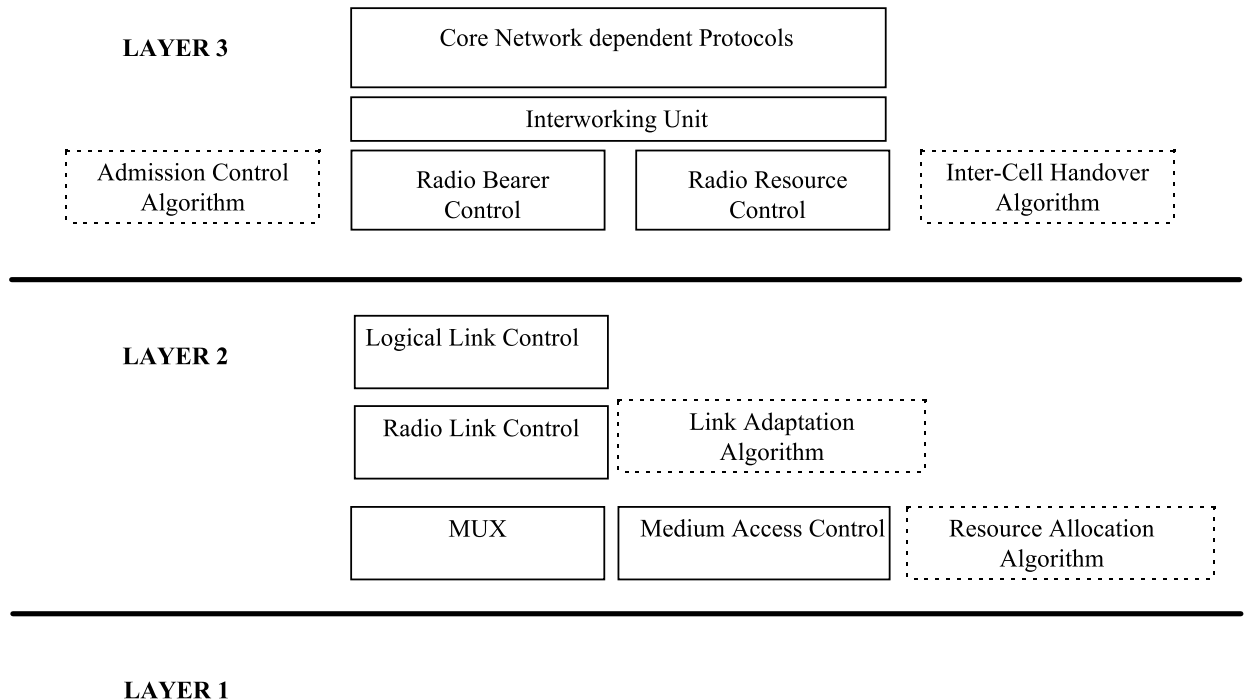


Figure 4-1. WB-TDMA Radio interface

4.1 Overview of layer 2

The overall function of layer 2 is to realise radio bearers for layer 3 with respect to their QoS objectives. The first radio bearer, called the initial radio bearer, is mainly used to transport radio network layer (RNL) signalling, plus possibly messages destined to core network dependent control protocols. Other radio bearers are used to transport user data and network signalling. The initial radio bearer shall be maintained as long as other radio bearers have data to transfer. It is the last one to be released.

The set-up procedure for the initial radio bearer is triggered by layer 3 either after the reception of a paging message or because the MS wants to establish a connection to the fixed part of the core network. The set-up request is sent on a common uplink channel. The network allocates, in return, a MAC level identity to the MS. The procedure deals with collision and layer 3 solves contention between mobiles in order to guarantee that the MAC level identity is allocated to one and only one mobile. The MAC level identity is kept as long as the initial radio bearer is maintained. It is valid inside a given cell and has to be exchanged at each intercell handover.

The messages used to establish other radio bearers are layer 3 messages that are transported on the initial radio bearer.

Layer 2 is structured into two sub-layers (Figure 4-2) : the Logical Link Control (LLC) and the Radio Link Control / Medium Access Control (RLC/MAC) sub-layers. Service access points (SAP) are marked with dark dots. The RLC/MAC sub-layer has an internal structure. Therefore layer 2 is in fact composed of three types of protocol entities :

The LLC and RLC entities are created in association with a radio bearer and their function is to guarantee the negotiated QoS for the radio bearer.

The mobile MAC and network MAC entities are shared by all the radio bearers in one MS or one BS, respectively, and their main task is to dynamically split the radio resource between the bearers.

The reason why RLC and MAC are considered as belonging to the same sub-layer is that both entities have direct access to the physical layer and the LLC sub-layer.

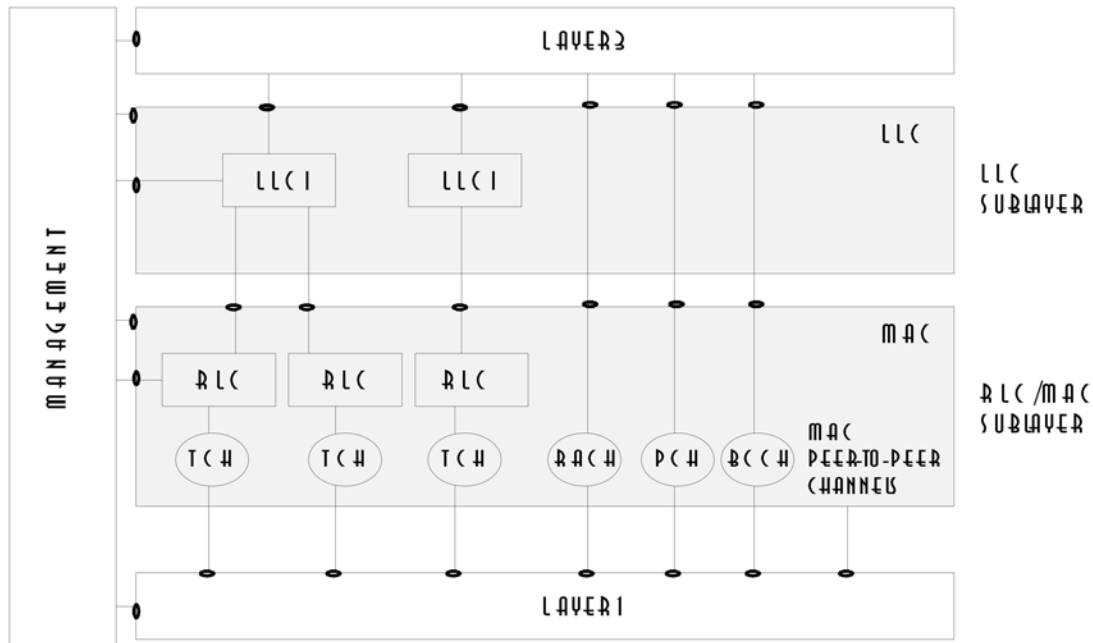


Figure 4-2. Layer 2 internal structure

The Layer 2 protocols are described in detail in the Gamma concept group document Tdoc SMG2 G19/97, Radio Protocols for WB-TDMA.

4.2 The LLC sub-layer

The current working assumption is that the LLC protocol is located at the radio network controller (RNC) and in the MS.

The LLC sub-layer controls the data flow at layer 2 - layer 3 interface and transports it across the radio interface with error detection and correction levels appropriate to the QoS of the bearers. It expects from RLC/MAC a stable QoS level. Its control mechanisms are not designed to cater with radio fluctuations.

A pair of LLC entities (one in the MS and one in the network) is either associated to one single radio bearer or to a pair of radio bearers (one up-link and one down-link). The way the entities operate depends on the required QoS for the associated radio bearer or radio bearer couple. There are two operating modes :

HDLC mode. The transfer can be acknowledged or unacknowledged. In the acknowledged case, a backward signalling link is necessary to transport the acknowledgements and retransmission commands. This signalling link can either be dedicated or combined with layer 3 data. Independent data links with different priorities may be handled by peer LLC entities.

Minimum mode. The LLC sub-layer is completely transparent to the data. It mainly relays the data to the lower or to the upper layer.

4.3 The RLC/MAC sub-layer

Although RLC/MAC has been defined as one layer which has one interface to the physical layer and one interface to the LLC layer, functions of the RLC part and the MAC part can be separated.

4.3.1 RLC

4.3.1.1 Functions of RLC

Two RLC entities (one in the MS and one in the network) are created by the management plane at each establishment of a radio bearer. These entities handle the service data units (SDU) coming from the LLC entities associated with the bearer. Their operating parameters are selected as a function of the QoS to be provided. A first task of RLC entities is to segment the SDU coming from LLC. A second task is to meet the QoS objectives that were assigned to them. For this purpose, they have elaborate control mechanisms at their disposal in order to deal with radio link quality fluctuations.

4.3.1.2 RLC Protocol

RLC entities are located both in mobile stations and in the network. The current working assumption is that the network RLCs are located in the base station. It has two operating modes, the first one to cater for real time (RT) transmissions and the second one to cater for non real time (NRT) transmissions. The RT mode uses power control and link adaptation mechanisms. The NRT mode uses power control and retransmission procedures (link adaptation for NRT services is realised with type-II hybrid ARQ, i.e. retransmission).

In the RT mode, the source RLC entity :

- Uses for the bearer a set of transmission formats (channel coding, interleaving, modulation) agreed at bearer set-up by layer 3.
- Has a dynamic set of traffic channels (TCH). This set can be reduced or increased through a request of the link adaptation algorithm to the local MAC entity (residing on the same side of the radio interface). Request may be done because e.g. there are traffic variations.
- Is in charge of splitting the LLC flow between the set of traffic channels (TCH). The transmission format is selected separately for each TCH. RLC segments the LLC data into RLC-protocol data units (PDU) in accordance with the chosen transmission format, optionally computes a CRC, and then delivers the PDU to the physical layer for transmission.
- In the RT mode, the sink RLC entity :
- Has a dynamic set of traffic channels (TCH) (the same as the one of the source RLC). This set can be reduced or increased through a request of the link adaptation algorithm to the local MAC entity. Request may be done because e.g. there are radio condition variations.
- Checks the CRC, if there is one, and discards the PDU if it is corrupted. Depending on the type of radio bearer the RLC entity is associated to, a corrupted PDU is either discarded or passed to LLC with a bad CRC indication.
- Assembles received PDUs and delivers the resulting SDU to LLC.

In the NRT mode, the source RLC :

- Uses the transmission format agreed at bearer set-up by layer 3.
- Indicates to local MAC the data amount which is to be transmitted. The peer RLCs deduce from the data amount and the agreed transmission format the adapted segmentation.
- Delivers PDUs to layer 1 when authorised by MAC, i.e. when resources are allocated to the radio bearer by the network.
- In the NRT mode, the sink RLC :
- Checks the CRC and alerts MAC when a PDU is received corrupted. It shall be noted that the role of RLC in the retransmission procedure is very limited. It only checks the CRC. All the signalling is handled by MAC entities.
- Assembles the correct PDUs and delivers SDU to LLC.

4.3.2 MAC

MAC entities are located both in mobile stations and in the network. They are respectively referred to as MS-MAC and BS-MAC (although it can be located in the RNC as well) in the following.

There is permanently one and only one MS-MAC entity per mobile. This entity is a state machine with two main states, the idle state when the mobile station is idle and the MS-MAC-Operation state once the mobile has established an initial radio bearer. In the idle state, the MS-MAC has received network and cell information broadcast on the BCCH. This information is used to make cell selection and points to the other common control channels used by MAC (PCH, RACH and FACH). MS-MAC listens to PCH where paging messages are received.

After a successful initial access procedure, MS-MAC enters the MS-MAC-Operation state. In this state, MS-MAC manages timing advance, power control and radio resources for the mobile station.

Timing advance management is used to align a mobile's transmission timing so that it closely matches the slot boundaries of the serving base station, compensating for transmission path delay. Transmission power levels are controlled in both directions. The control is made for each radio bearer with an option to adjust the power levels for each physical channel separately.

Radio resource management consists of allocating, exchanging and releasing physical channels to the radio bearer:

For RT radio bearers, the allocation mechanism is of circuit switched type, i.e. the physical channel allocation is valid up to the execution of a release procedure.

For NRT radio bearers, the allocation mechanism is of packet switched type, i.e. the allocation is only valid during an allocation period. This mechanism allows quick adaptation to load conditions because resources are not allocated for an indeterminate period of time. Furthermore, the MAC entities handle retransmission signalling when an RLC-PDU is received with a corrupted CRC.

There is permanently one BS-MAC entity per cell in the network. It broadcast information on the BCCH for the mobile stations which are in the idle state. It transmits paging messages on the PCH. It finally manages timing advance, power control and resources of all the radio bearers in the cell.

Peer MAC entities co-operate through the exchange of MAC messages. These messages do not encapsulate SDU from upper layers. Data primitives coming from or destined to upper layers are moved directly between layer 1 and the corresponding RLC. A CRC (Cyclic Redundancy Code) field is always part of a MAC message to enable the destination entity to check message validity. Messages and procedures used for radio resource management are detailed in 4.3.2.1 and 4.3.2.1.2. Messages and procedures used for NRT retransmission are presented in 4.3.2.1.2.1 to 4.3.2.1.2.2.

4.3.2.1 Signalling procedures for data transfer

4.3.2.1.1 RT operating mode

The important characteristic of the RT operating mode is that it allocates physical channels for an indeterminate period of time. A release procedure is necessary to liberate the resource. Several radio bearers cannot be multiplexed on one TCH. MAC uses an addressing scheme that allows the TCH to have a very precise granularity so that multiplexing is not necessary (one TCH is mapped onto one physical channel. This mapping can be in each TDMA frame, every second TDMA frame, every fourth TDMA frame, ..., up to every 128th TDMA frame).

4.3.2.1.1.1 Network initiated procedures

The network initiated procedures respond to radio condition variations for uplink radio bearers and bit rate variations for downlink radio bearers.

There are three types of commands : the allocation of a physical channel, the exchange of a physical channel for another one, the de-allocation of a physical channel. Whenever, for example, a network RLC asks the network MAC entity for more resources, the network MAC alerts the peer MAC with an "RT Capacity Allocation" message (*Figure 4-3*). This message indicates the concerned radio bearer and the physical channel allocated. It is acknowledged by an "RT Capacity Allocation Acknowledgement"

message. The “RT Capacity Change” and “RT Capacity Deallocation” messages and their associated acknowledgements are used to exchange and liberate physical channels.

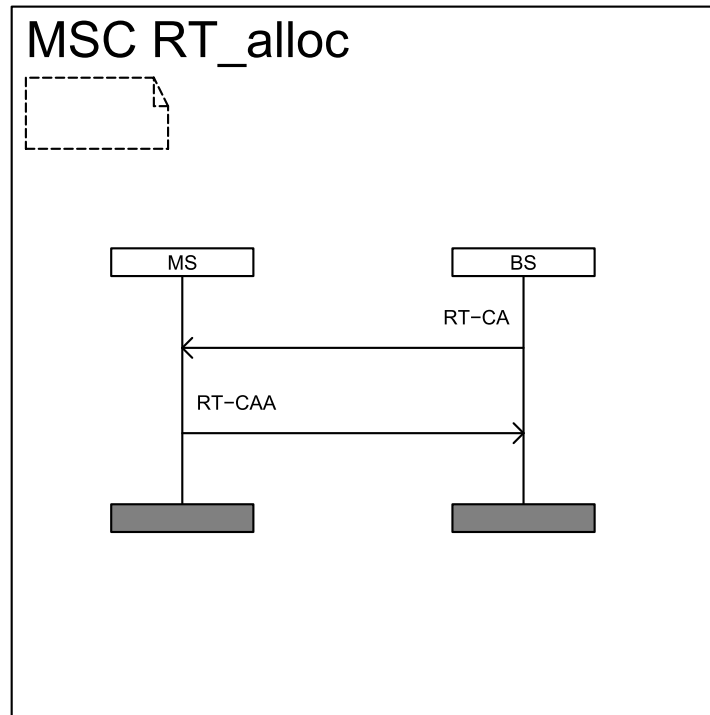


Figure 4-3. Network initiated RT allocation

4.3.2.1.1.2 Mobile initiated procedures

The mobile initiated procedures are due to radio condition variations for downlink radio bearers and bit rate variations for uplink radio bearers.

Whenever a mobile RLC requests a resource change from its MAC entity, it interprets the request into an “RT Capacity Request” MAC message (Figure 4-4). This message indicates the concerned radio bearer and the amount of resources needed. The capacity allocation procedure is similar for a mobile initiated procedure as described in Network initiated procedures. However, the channel allocation is initiated by the RT-CR message and not by the network RLC request.

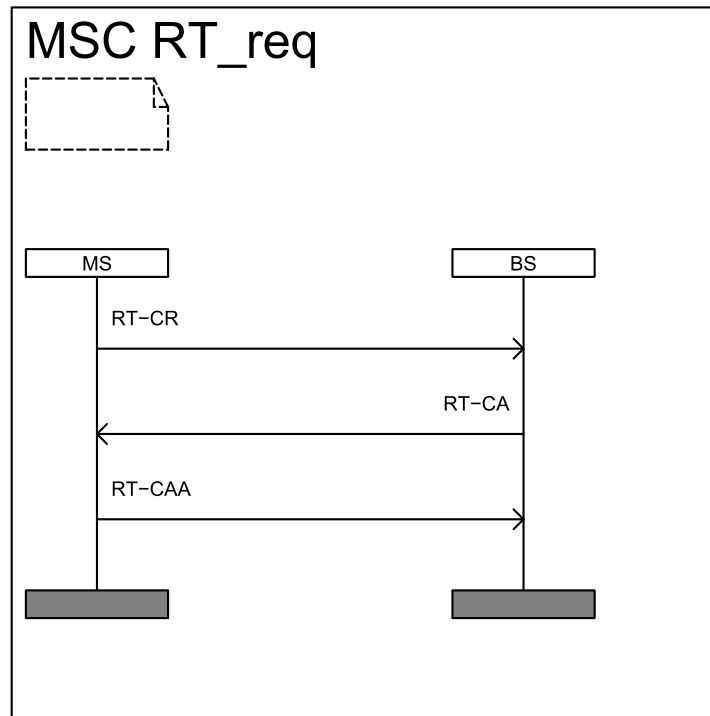


Figure 4-4. Mobile initiated RT allocation

4.3.2.1.2 NRT operating mode

In NRT operating mode, resource allocation algorithm (in the network) knows the amount of data to transmit. Two NRT schemes are supported, the resource allocation algorithm being the one to decide which scheme is the more appropriate to the NRT radio bearer. In both schemes, the TCHs are allocated only allocation period by allocation period.

In the Scheduled Allocation NRT, only TCHs mapped on 1/16th physical channels are used and the allocation period is fixed to be two TDMA-frames. Two frames is considered to be a reasonable compromise between the flexibility of the NRT service (the acceptable load limit of a cell is affected by the ability of NRT-services to give way to RT-services, when required) and the control overhead and signalling error-rate involved. Two frames gives some interleaving gain, results in reasonable message size and is still very flexible. An NRT unit designates the two 1/16 bursts associated with a TCH during one allocation period. Because the network has to announce for each allocation period the TCHs splitting between the different NRT bearers, each active RLC is allocated a short identity (denoted RID) at the beginning of its source activity. This identity is valid until released by BS-MAC. In case of bad reception, the retransmission procedure allows a selective reject on a NRT unit per NRT unit.

In the second scheme, referred to as Immediate Allocation NRT, TCHs mapped on all types of physical channels (1/8th, 1/16th, 1/32th) can be allocated and the allocation period length is variable (2-32 TDMA frames). Allocations are announced for each TCH separately and associated an allocation identity. In case of bad reception, the retransmission procedure allows an independent retransmission of the different allocations.

4.3.2.1.2.1 Scheduled Allocation NRT procedures

When the source of a downlink bearer activates, and BS-MAC decides to use scheduled allocation NRT capacity, the network MAC sends a "Scheduled Allocation NRT Capacity Allocation" message to the concerned mobile that indicates the bearer reference, and the RID (Figure 4-5). The message points as well to a pair of logical channels (downlink NRT control channel (DNCCH), forward order channel (FOCH)). The mobile acknowledges the SA NRT-CA with an "SA NRT Capacity Allocation Acknowledgement" message.

The mobile MAC entity is required to listen to the DNCCH. The splitting of physical channels between the RIDs is announced for each allocation period in a “Downlink NRT Control” message on the DNCCH (Figure 4-5). The mobiles indicate the list of NRT units that should be sent by BS in a “Forward Order” message. This message is sent on the FOCH, a common channel shared by several mobiles. The scheduling of FOCH usage is announced on the DNCCH.

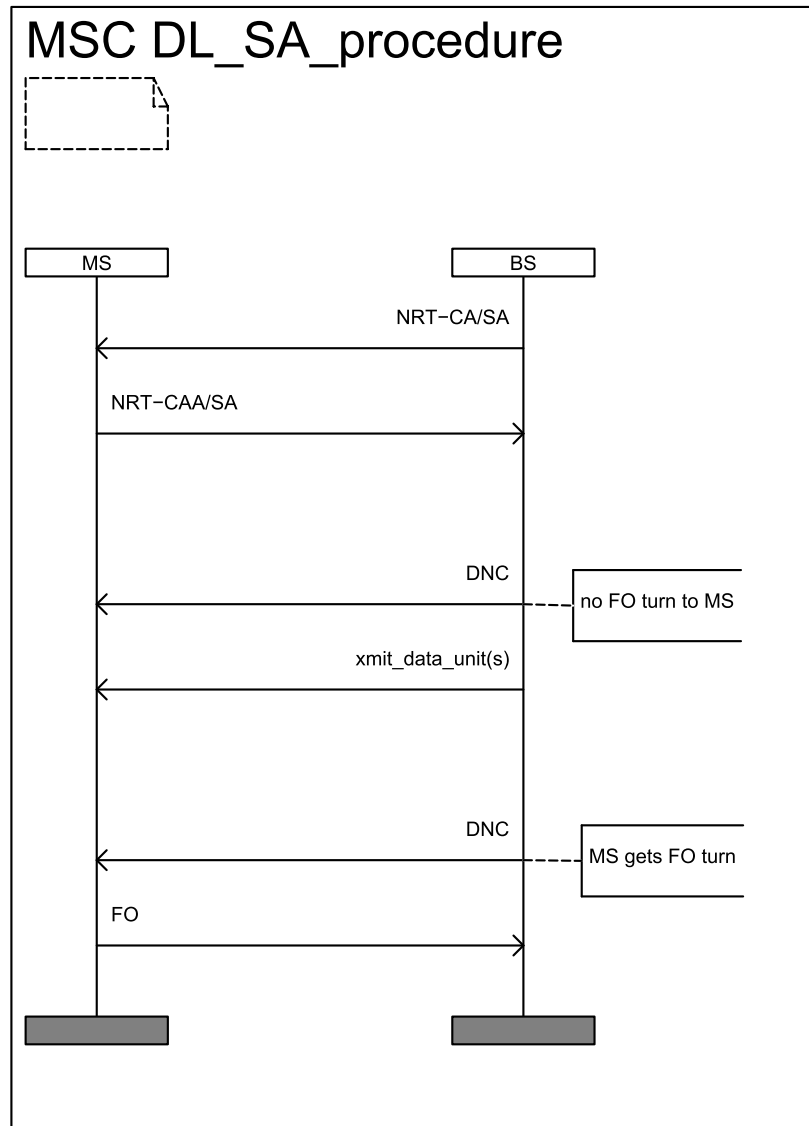


Figure 4-5. Downlink Scheduled Allocation transmission

When the source of an uplink bearer activates, the mobile MAC sends an “NRT Capacity Request” message to the network that indicates the bearer reference and the amount of data to transmit (Figure 4-6). If BS MAC decides to use scheduled allocation NRT capacity, it allocates in return an RID and announces the granted data amount in an “SA NRT Capacity Allocation” message. The message also points to an uplink NRT control channel (UNCCH). Finally the mobile sends an acknowledgement with an “NRT Capacity Allocation Acknowledgement” message.

The splitting of physical channels between RIDs for each allocation period is announced by the BS-MAC in an “Uplink NRT Control” message on the UNCCH (Figure 4-6). The Uplink NRT control message also indicates the NRT units that should be sent in the allocated physical channels.

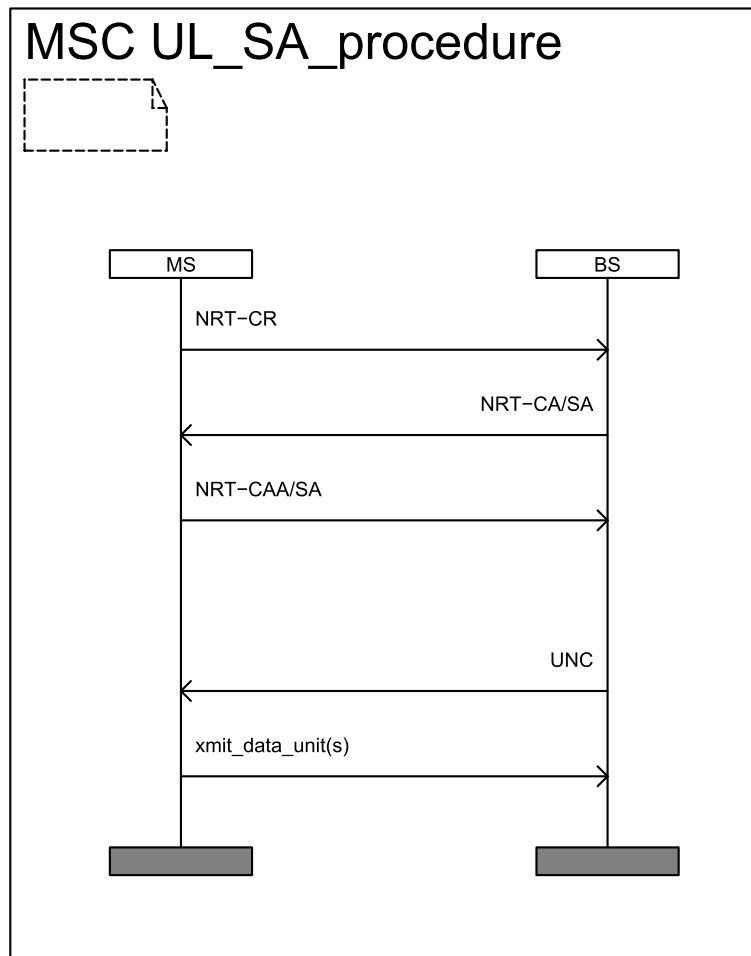


Figure 4-6. Uplink Scheduled Allocation transmission

The Scheduled Allocation NRT signalling allows the use of different retransmission schemes. Since, in any case, all NRT data is ordered by the receiver, the algorithms by which the orders are made are not required to be the same for all MSs. A more or less sophisticated retransmission scheme can be applied by the receiver. The most simple ARQ algorithm could be the normal type 1 ARQ where RLC-CRC is checked and according to the result the PDU is either accepted or discarded and requested to be retransmitted.

Good efficiency is however assumed to be achieved with following kind of type II hybrid ARQ scheme. An RLC-PDU is coded in a way that by transmitting a first part of it, it is already possible to decode the data. If the decoding is not successful then the rest of the coded data (containing redundancy to the first part) is transmitted. If the PDU decoding is not successful after having transmitted all of the data then some data units, preferably the ones with the lowest reception quality, are requested to be retransmitted until the decoding is successful.

4.3.2.1.2.2 Immediate Allocation NRT procedures

Whether the Immediate Allocation is initiated by a BS-RLC request or after reception of an MS-MAC NRT Capacity request the procedure is almost the same. First BS-MAC sends an «Immediate Allocation NRT Capacity Allocation» message containing MAC-ID, Bearer-ID, Physical channel address, the length of the allocation period and an allocation identifier (*Figure 4-7* and *Figure 4-8*). Then the transmitting side transmits the NRT data accordingly. In the case of downlink transmission the MS MAC acknowledges the received data if the decoding of it was successful. In case of an uplink transmission, the BS MAC is informed by the local RLC whether the decoding was successful or not. For both transmission directions, if the decoding is not successful the BS-MAC sends an IA NRT-CA

message with the same allocation identifier and the transmitter retransmits the data. This procedure is repeated until the decoding is found to be successful.

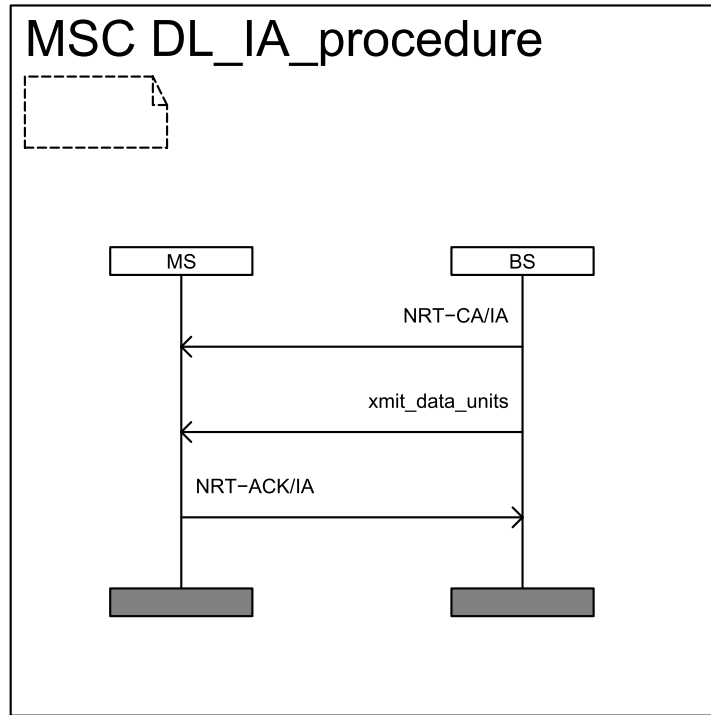


Figure 4-7. Downlink Immediate Allocation transmission

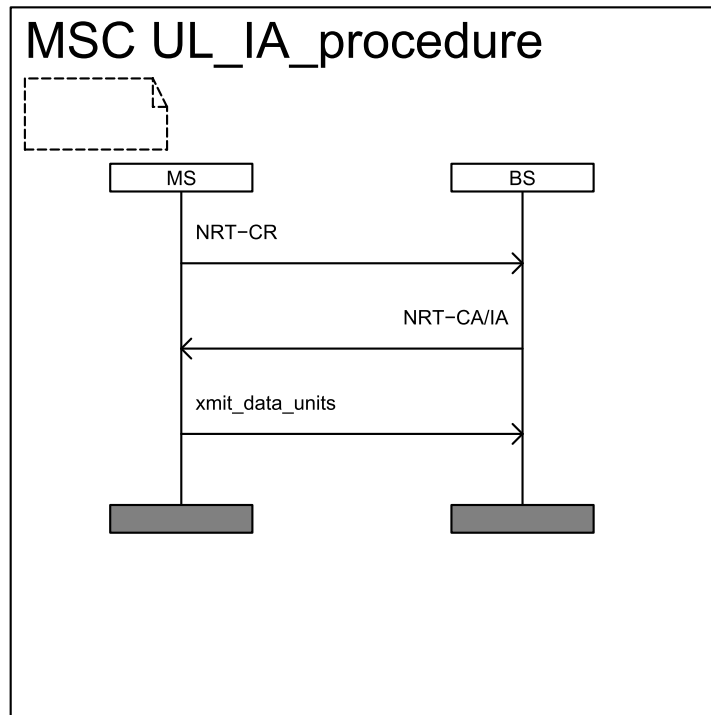


Figure 4-8. Uplink Immediate Allocation transmission

4.3.2.2 Signalling Procedures for Cell Management

Note: In the following the MAC entity controlling the area of one cell (i.e. the area covered by one BS) is called BS-MAC. This MAC entity can be physically located in the RNC as well.

4.3.2.2.1 Overview

RLC/MAC layer signalling procedures for cell management provide functions for control channel allocation and the transmission of cell system information.

4.3.2.2.2 Control Channel Management

4.3.2.2.2.1 Control Channel Capacity Allocation

A CTRL-Capacity Allocation (CTRL-CA) message is used by the BS-MAC to allocate uplink or downlink SDCCH or to inform the MS about a new location of FACH (forward access channel) or N-RACH (random access channel for normal bursts).

The CTRL-Capacity Allocation Acknowledgement (CTRL-CAA) message is used by the MS to acknowledge the CTRL-Capacity Allocation.

If a CTRL-CAA is not received by the BS in a predefined time the status of the allocation must be solved by CTRL-CA or CTRL-Capacity Deallocation (CTRL-CD) signalling until the CTRL-CAA/CTRL-CDA has been received.

The procedure is similar as illustrated in Figure 4-3.

4.3.2.2.3 System Information Broadcasts

L2 and L3 parameters to be transmitted on BCCH are ffs.

4.3.2.2.4 Paging of the MSs

A paging message is transmitted by the network to page one or more MSs. The number of MSs that can be paged at a time depends on the way in which the mobiles are addressed.

4.3.2.2.5 Handover Signalling

There are several handover procedures proposed for WB-TDMA. It is assumed that all bearers allocated to a mobile must be served by a single cell. Therefore, all bearers are handed over simultaneously. In addition to the normal signalling procedures layer 2 is expected to provide data flow suspension and resumption during the handover and handover access signalling to the new cell. Details of the WB-TDMA handover are ffs.

4.3.2.3 Signalling Procedures for Controlling the Radio Link

MAC provides signalling procedures for timing advance, power control and measurement reporting.

4.3.2.3.1 Timing Advance Adjustment

MS has to transmit something periodically to provide BS information needed to maintain the TA. If the MS has nothing to transmit then a specific Timing Advance Probe (TAP) message can be sent.

In order to administer dynamic channel assignment on behalf of MS supporting multiple bearers, a BS-MAC must maintain a record of which physical channels are allocated for transmit and receive to each MS for all of its bearers. This record can be used as a basis for combining the time alignment measurements (made by layer 1) for all of a MS bearers to form a single estimate of time correction for the MS. Consequently, the BS-MAC (or a process associated with BS-MAC) will continuously monitor a MSs timing alignment based on measurements reported by layer 1.

If needed, the BS-MAC transmits a Timing Adjustment Correction (TAC) message which contains TA correction to be applied to all transmitted bursts. TAC message can be transmitted on common control

channel (FACH) or dedicated control channel (SDCCH or FACCH). TAC message is not acknowledged by the MS-MAC.

The MS may stop the transmission of TA probes and then the MS will lose the time alignment. Such an MS willing again to start transmission to the BS has to send a TAP message in an access burst on S-RACH. As a response to the probe the BS will transmit TAC message.

It is ffs. whether BS could initiate transmission of the TAP by sending a polling message on FACH. A TAP message could be transmitted on UACH as a response to this polling message.

4.3.2.3.2 Power Control

For slow power control the Power Control (PC) message can be transmitted on FACH, N-RACH or on any DCCH.

For the optional fast power control the use of FACCH, SDCCH and FACH is inappropriate for the transfer of power level reports. Instead, a Public power control channel PWCCH is adopted. This requires one 1/64 timeslot per frame and indicates the differential power setting to be applied. It has the advantage that it can support unidirectional bearers or bearers operating DTX but has the disadvantage that mobiles are required to be able to monitor a broadcast every frame.

The details of the power control can be found in document SMG2 Gamma 15/97.

4.3.2.3.3 Measurement Reporting

The required signalling procedures depend on the RRM algorithms. It is possible that all measurements are transmitted over the radio interface in the L3 messages, and that the contents of the measurement report is distributed to the relevant algorithms by L3.

4.3.2.3.4 Radio Link Failure

The time-out procedure for the radio link failure is for ffs.

4.3.2.3.5 Adaptive Antennas

When adaptive antennas are used MS has to transmit something to provide BS information needed to estimate the location of the MS. If the MS has nothing to transmit then a specific probe (e.g. Timing Advance Probe message) can be sent.

Logical channels specified for RLC/MAC support use of adaptive antennas, except BCCH, PCH, DNCCH, UNCCH and PWCCH. These channels are broadcast simultaneously to several MSs. Logical channels are described in chapter 2.

The detailed requirements of adaptive antennas are for ffs.

5. Radio resource management

5.1 Introduction

For WB-TDMA, FRAMES has chosen to study two RRM concepts : a decentralised solution with emphasis on interference diversity strategy, the so called '*interference averaging*' concept, and a centralised solution with the emphasis on interference minimisation strategy, the so called '*bunch*' concept. On a scale where each system is characterised by its grade of centralisation these two solutions take place on the two opposite ends of the scale. If both solutions can be supported in terms of the measurements and signalling provided in the system, it is likely that a wide variety of solutions situated on an intermediate position on this scale can be supported and deployed, responding to the requirements of future operators.. The Interference Averaging concept does not require central management of radio resources for interference minimisation reasons but is rather based on. frequency- and time-hopping to reach a common averaged interference level. On the contrary, the bunch concept assumes that a limited number of Remote Antenna Units are connected to a central unit. To reach a minimisation of intra-bunch interference the knowledge of all allocated resources, transmitter powers and path gains together with synchronisation between the cells is required. Inter-bunch interference is dealt with frequency and time hopping.

The Interference Averaging concept is proposed to be used in all kinds of environments and the bunch concept as an option for areas with high traffic. Both concepts are being further investigated. However, these concepts are just examples of a wide range of RRM schemes that can be supported with the signalling designed for these concepts.

In the following, a short description of the algorithms of the IA concept and an overview of the Bunch concept is given. The Radio Resource Management schemes are described in more detail in the Gamma Concept group document Tdoc SMG2 G15/97, Radio Resource Management for WB-TDMA.

5.2 Overview of the RRM scheme

The main idea of the proposed set of Radio Resource Management (RRM) algorithms is to ensure the existence of a simple, robust and credible scheme for the FMA mode 1 without spreading. The cornerstone of the presented scheme is interference averaging. To achieve this frequency and time hopping (FH/TH) with a low re-use is proposed. Due to the interference averaging, all the used channels of a given cell in the system experience almost equal interference conditions. This simplifies greatly the RRM algorithms used. The intention is to prove by simulation that this scheme although suboptimal is very good. Also due the robustness of the proposed scheme it can in reality prove to be superior to many so-called 'optimal' schemes. The algorithms presented include Power Control (PC), Link Adaptation (LA), Quality Loop (QL), Automatic Repeat reQuest (ARQ), Admission Control (AC), Channel Allocation (CA) and Handover (HO).

The traffic to be handled can be divided into two classes, i.e. non-real-time (NRT) and real time (RT) traffic. For RT traffic a very simple Admission Control algorithm is applied. The Admission Control is based on a highest allowed fractional loading per cell (e.g. 25% to 70% of the allocated spectrum can be used for RT traffic in one cell). The value of the highest allowed fractional loading can be selected by the operator. The Power Control for RT traffic is C based (or RSSI based). C/I-based Power Control will be studied in the future. This is in conjunction with the higher allowed transmission power (as compared to NRT traffic) and the LA scheme ensures the quality of the RT traffic. The LA scheme for RT traffic is based on the adjustment of the gross bit rate of a bearer. The Handover for RT is based on a simple pathloss or C/I criteria.

For NRT traffic no Load Control beyond the natural hard limit provided by the number of channels is applied. This is due to the fact, that simulations have shown that for NRT traffic the best spectral efficiency is obtained with re-use 1 and a fractional load, i.e., a load of less than 100% full load. Power Control is C-based with a relatively low dynamic range. The ARQ process replaces both coding adaptation and fast C/I-based Power Control. This is due to the fact the ARQ algorithm is of type II (i.e. the ARQ algorithm increases the coding rate with the number of re-transmissions). The Handover for NRT traffic is based on the offered capacity from the candidate cells.

The proposed solutions may seem deceptively simple at first, but preliminary simulations have shown that they are very effective. They are also extremely adaptive regarding to the JD/IC and adaptive

antenna techniques. Also the robustness of the proposed scheme ensures that the operator can deploy capacity easily whenever and wherever needed.

5.3 Application of RRM techniques

5.3.1 Time and Frequency Hopping

In the proposed system, time and frequency hopping techniques with hopping unit 1/16 slot are used. The characteristics of the MSs set the main constraints to the time and frequency hopping sequences. E.g. some of the WB-TDMA terminals may have only one receiver and they must have enough time between reception and transmission (as in GSM). In a system exploiting all hopping dimensions this kind of low end MSs can use only low bit rate services. In an isolated system, where hopping can be reduced, these MSs can use high bit rate services. The hopping sequences are for further study.

5.3.2 Power Control

The main purpose of Power Control is to adjust transmitter power levels in such a way that sufficient signal strengths are sustained at the receivers and power levels are minimised.

In the proposed system the Power Control algorithms are slightly different for the uplink and the downlink. C based Δ -modulation PC (i.e. PC commands are of the form step up or step down) is utilised in the uplink direction. The length of the control period can be e.g. 5-500 ms. For short control periods the step size is very small (for NRT traffic) and for long control periods it is larger (for RT traffic). The maximum allowed transmission powers may be different for RT and NRT services due to strict delay requirements of RT services. The initial power request is set based on the pathloss estimate to the serving BS. In the downlink direction the Power Control is also C based but it is slower. The length of the control period can be e.g. 100-500 ms.

Pathloss based PC has been selected for the first version of the proposed system, C/I-based Power Control is an item for further study.

5.3.3 Link Adaptation

The scope of LA is to dynamically adapt the transmission mode to the channel conditions so that the BER and delay requirements are met with a minimum system capacity (backward Link Adaptation). In addition to this, requests for more and less capacity are made based on the source rate changes (forward Link Adaptation). In the former case, the receiving end makes the request to BS and in the latter case the transmitting end makes the request to BS. The Link Adaptation functions by changing the number of slots allocated to the bearer.

At the bearer set-up a subset of all possible transmission modes is selected to be used. In this set-up procedure e.g. the MS's capability to use different codings and modulations is taken into account. The coding schemes can be expressed with rather coarse grid because puncturing is assumed to be used for the fine tuning. The transmission mode pool should be big enough to allow flexibility. It contains information about coding rate, coding type (e.g. convolutional, block, turbo, repetition), modulation (lower order or higher order modulation), interleaving depth/time, interleaving type (per channel / per bearer) and burst types.

For RT bearers the only channel coding and modulation will be adapted when a bearer exists. Interleaving and burst type are selected at the bearer set-up or during the HO. Interleaving is assumed to be performed over all slots of one RT bearer. For NRT bearers ARQ and modulation changes are used.

5.3.3.1 Link Adaptation for RT services

The Link Adaptation for RT is based on a quality function Q of the C/I of the received bursts over each interleaving period. The measurements of one bearer are averaged over all used frequencies and time slots. The LA algorithm decreases and increases the number of channels based on the quality Q and some threshold values. Link Adaptation is performed after each received interleaving period. LA signalling is not needed very often and it is preferably packet based.

In case of video service or other variable rate service, the adaptation to the source bit rate i.e. forward Link Adaptation, is necessary. Then the requested capacity is determined using the current coding and

modulation. The possible extra space, due to the granularity of the slot size, is filled with additional coding (/ the lack of space is compensated with reduced coding) which is spread equally to all the slots of the bearer by puncturing or repetition. When a new channel is requested it takes some time before it is available if it can be allowed at all. This should be taken into account when making requests. The problem could be solved by requesting excess capacity.

5.3.3.2 Link Adaptation for NRT services

A combination of Automatic Repeat reQuests (ARQ) and Forward Error Correction (FEC), called as a hybrid-ARQ, can provide very low bit-error-rates. In this RRM scheme a type II hybrid-ARQ process, optimised especially for fading environment and WB-TDMA, is used as a main Link Adaptation technique for NRT bearers. Thus the network is insensitive to planning errors. Also the need for fast Power Control is removed by the ARQ scheme. The proposed ARQ scheme is expected to increase the capacity of the network. For more details about hybrid-ARQ, see chapter x.

In addition to ARQ, the modulation changes can be utilised in NRT services. A change to higher order modulation could be made then the function Q is over some threshold value and vice versa. The higher order modulation provides a higher bit rate but it is more sensitive to time dispersion, so this LA algorithm should be used only in small cell environments.

5.3.4 Quality Loop

The goal of the Quality Loop of the LA algorithm is to adjust the LA parameters to be such that the quality experienced by the bearer is sufficient. These parameters can either be set by the operator or they can be adaptive. In this version of the system the adaptive version is not covered. It will be a subject of future studies.

5.3.5 Slow Dynamic Channel Allocation

As described earlier each BS can use any frequency in the Interference Averaging concept. This also holds with the optional slow DCA scheme for a single HCS layer case presented here. Slow DCA has two phases called *slot prioritising* and *allocation of slots*.

Example: Consider an operator having 8 frequencies ($8 \times 1.6 \text{ MHz} = 12.8 \text{ MHz}$) to each direction. This equals to 512 1/64 slots to each direction. The frequency prioritising would prioritise the slots for each BS in the following manner. Each BS will get:

- 1) 64 most preferred slots
- 2) 64 second most preferred slots
- 3) 128 third most preferred slots
- 4) 256 fourth most preferred slots

Prioritising over BSs is done so that if all the BSs used only their the most preferred slots, the network would have reuse pattern 8. If all BS used their most and second most preferred slots the network would have reuse pattern 4. If all BS used their most, second most and third most preferred slots, the network would have reuse pattern 2. Naturally if all BS used all their slots, the network would have reuse pattern 1.

The allocation of slots is done independently in each BS. Each BS checks the amount of requested resources and 'activates' the needed amount of slots.

Example (cont.): Each BS can activate either 64 , 128, 256 or 512 slots.

All traffic slots will then hop randomly in time within the activated slots and the cyclic frequency hopping is used over the whole spectrum to get more channel diversity. Thus in case of effective reuse 1 this slow DCA will converge to default Interference Averaging concept with no frequency planning. If the slow DCA were done manually during the network set-up and network enhancements (frequency planning), there would be no need for additional signalling nor measurements.

5.3.6 Fast Dynamic Channel Allocation

The scope of the (fast Dynamic) Channel Allocation algorithm is to keep the record of the channel usage and select channels for the new and existing bearers. The CA algorithm searches a feasible allocation based on priority and fragmentation criteria and the capabilities of the MSs. The priority list should take into account users i.e. relations between bearers. Fragmentation should be avoided because the shorter bursts cause more signalling and overhead. Also TDD option may set some constraints to the allocation. Apart from these conditions, the appointed or released channel is chosen from the set of free channels randomly, because of the averaging techniques used.

The channels are allocated to the RT bearers simply according to their priorities. The NRT services are treated as 'best effort'. This means that the slots are first given to the RT bearers and the rest of the slots is available for NRT bearers. The slots are allocated to the NRT bearers according to their priorities. A NRT bearer has a high priority if it has a lot of data to transmit and vice versa. NRT bearers having difficulty of sustaining the agreed minimum bit rate are prioritised over other NRT bearers. The signalling load may become too heavy if very many NRT bearers are active at the same time so the number of simultaneous NRT bearers is limited.

5.3.7 Admission and Load Control

The purpose of Load Control is to maximise the achieved bit rate over the network by adjusting the number of slots of controllable rate bearers. In the proposed system no Load Control is applied. All the available slots are filled with data of NRT bearers. The Channel Allocation algorithm allocates the channels in a 'fair' manner.

The purpose of Admission Control is to ensure that the bearer requesting access into the system can be granted its QoS requirements without compromising the QoS requirements of the bearers already in the system. Admission Control is based on the amount of available slots in the given cell. The number of slots a bearer will use is estimated in both directions. In the uplink direction this estimation is simple, since the interference conditions are equal for all slots. In the downlink direction the estimation is done by the mobile. This Admission Control is performed in both directions of the incoming bearer.

For RT traffic a very simple Admission Control algorithm is applied. The Admission Control is based on a highest allowed fractional loading per cell (e.g. 25% to 70% of the allocated spectrum can be used for RT traffic in one cell). The value of the highest allowed fractional loading can be selected by the operator.

For NRT traffic no Load Control beyond the natural hard limit provided by the number of channels is applied. This is due to the fact, that simulations have shown that for NRT traffic the best spectral efficiency is obtained with re-use 1 and a fractional load, less than the 100% full load.

5.3.8 Inter-cell Handover initiation

The proposed Handover is a C/I based algorithm that requires frequency hopping and prefers also time hopping. This algorithm tries to select the BS that can provide best quality (C/I) to be the serving BS. Quality is estimated separately for each candidate BS before the actual Handover is initiated. For fast mobiles a macro cell connection is preferred.

All the BSs continuously calculate quantity which is a function of its own transmission power. The MSs measure pathlosses to candidate BSs and report them to the serving BS. This information is forwarded to the RNC (Radio Network Controller) where the Handover initiation decision is made. Also MS initiated HO is possible if the same information is signalled to the MS.

From this data, the average C/I an MS would experience in the new cell is estimated first. Then for each BS a loading factor that estimates the number of slots available for the MS is calculated. The loading factor is calculated separately for RT and NRT services and for both directions. The weighting factor combines the information about the expected C/I and the loading and it is calculated for each candidate BS. If the system load is asymmetric then the uplink and downlink can be weighted separately so that the more critical direction has higher influence on the decision. If the weighting factor of a BS is handover margin higher than the weighting factor of the serving BS, it is selected. If a user operates with a mixture of RT and NRT services the condition causes the MS to prefer the BS with high expected C/I, high number of available slots for NRT and a feasible number of slots for RT.

If the Handover is wanted to perform purely on pathloss basis then the RNC uses pathloss information provided by the MS instead of the above calculations for Handover decision.

5.3.9 Interactions between the RRM algorithms

Both the up- and downlink PC algorithms and the fast Dynamic Channel Allocation algorithm are located in the BS. The downlink PC may optionally locate in the MS. The up- and downlink LA and the Quality Loop (for further study) algorithms are located in the BS and MS respectively. The network initiated Handover, Admission Control and the slow DCA (for further study) are carried out in the RNC. The MS initiated HO is, naturally, performed in the MS.

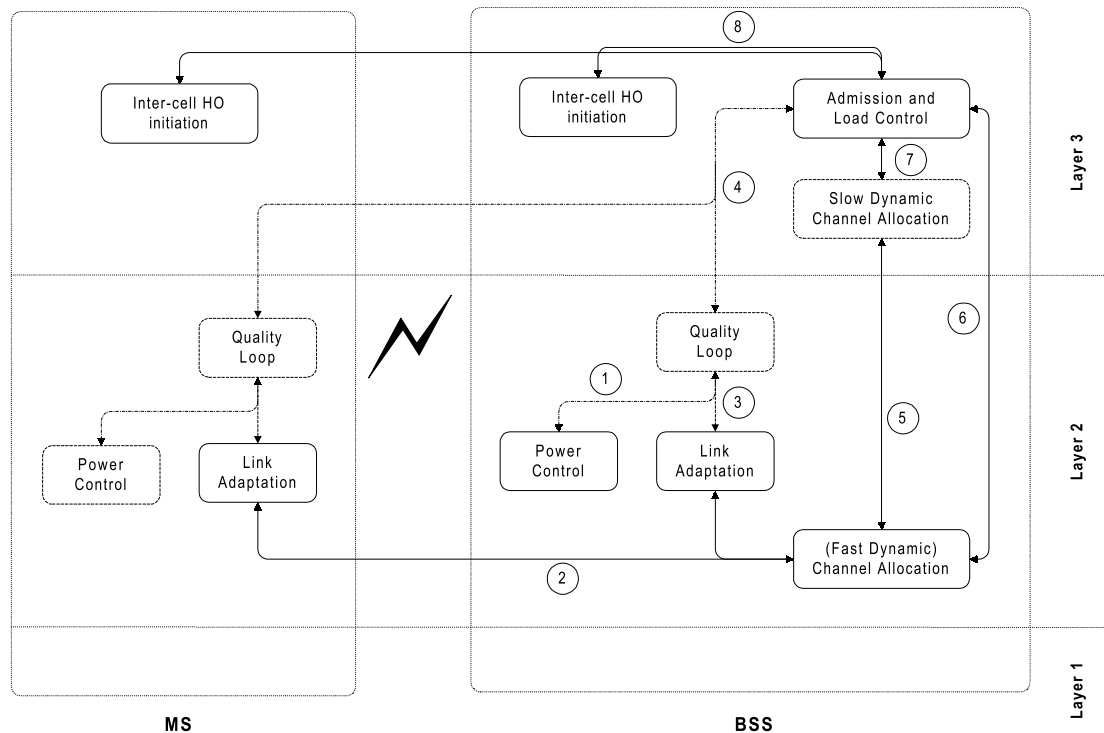


Figure 5-1. Interactions between algorithms.

1. QL \Leftrightarrow PC

The Power Control is C-based and for this kind of PC no Quality Loop is needed. The QL could be needed for C/I based PC which is for further study (if both LA and PC were C/I based then the Quality Loop would take care of the interaction between them).

2. LA \Leftrightarrow fast DCA

For RT bearers the Link Adaptation functions by changing the number of slots allocated to the bearer. When adapting to the channel conditions the receiving end makes the request to the BS Channel Allocation algorithm and when adapting to the source rate the transmitting end makes the request to the BS Channel Allocation algorithm. The Link Adaptation for NRT bearers is realised by ARQ.

3. QL \Leftrightarrow LA

The Quality Loop adjusts the LA parameters so that the quality experienced by the bearer is sufficient. The QL is needed only for RT bearers. In this version of the system the adaptive version is not covered and it will be the subject of future studies.

4. QL \Leftrightarrow AC & LC

The Admission or Load Control may set limits to the C/I target determined by the Quality Loop. This is for further study.

5. slow DCA \Leftrightarrow fast DCA

The slow DCA determines, in the long term, the channels which the fast DCA can allocate to the bearers.

6./7. AC & LC \Leftrightarrow slow / fast DCA

The Admission and Load Control algorithms get load and other statistics from the Slow and Fast DCA algorithms. The DCA algorithms get limits to the allocations.

8. inter-cell HO initiation \Leftrightarrow AC & LC

In the presented C/I based HO algorithm, the loading have an effect on the priorities of the HO candidate cells. If the HO initiation is pathloss based then it has to be separately checked whether the call can be admitted to the desired cell or not.

5.3.10 Operation in TDD mode

It is very important for the TDMA UMTS system to be able to function in a TDD mode. This includes asymmetric allocation of capacity in the uplink and downlink directions of transfer. This item is for further study.

5.3.11 Bunch concept

Generally in order to control more complex systems like pico- and micro cell environments and exploit the trunking gain, a possibility is to increase the degree of centralisation of the system: the more knowledge the central unit has on the system, the better it can adapt the system to its new situation and optimise the engaged resources. The price for this gain in the co-ordination is on the other hand an increase of the needed information (i.e., signalling and measurements) transfer and important computation resources in the central unit .

In small areas a solution to combine the needs of the coverage with a higher centralisation may be the use of remote antennas. That is the main idea of the 'bunch' concept A bunch consists of a limited number of Remote Antenna Units (RAUs) that are connected to a functional entity named Central Unit (CU). All intelligence as well as a significant part of the signal processing are located in the CU. The RAUs are simple antenna units capable of transmitting and receiving user signals as well as performing measurements ordered by the CU (Figure 5-2). A bunch can cover for instance a group of streets, a building or even a building floor.

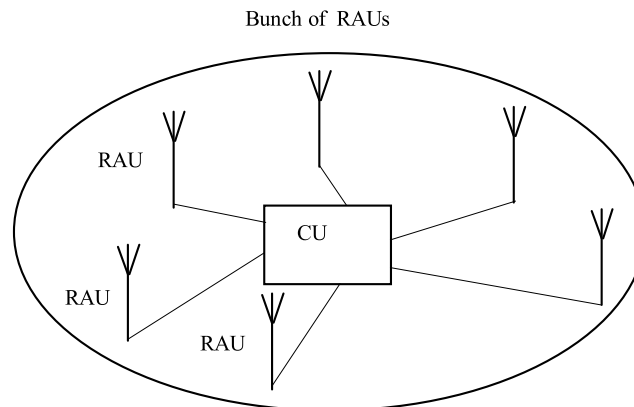


Figure 5-2: A bunch consists of a Central Unit (CU) and a number of Remote Antenna Units (RAU)

It is assumed that the RAUs within a bunch are slot and frame synchronised. The relatively short distances between the RAUs and the CU make it feasible to use a high-speed access network and to achieve synchronisation. It should also be possible to exchange information between bunches, but on much lower bandwidth. The advantage of bunches is that they have the potential to offer a high capacity and thus they are ideally suited to hot spot areas. The CU has knowledge about all allocated resources, transmitter powers and path gains in the bunch, and can adaptively allocate resources to the RAUs according to the current need. This results in a very efficient resource utilisation within the bunch. Also, by having a “pool” of resources in the CU, we gain in trunking efficiency. An important requirement is that it should be possible to assign resources to RAUs on a slot by slot basis (i.e., individual slots of the same carrier frequency can be assigned to different RAUs). The price for the high capacity is increased algorithm complexity and signalling load.

Bunches are well suited for hot spot applications. In areas with a low capacity demand however, traditional macro cells will probably be used. Hence, bunches must be able to coexist with macro cells as well as with other bunches. Bunches are well suited as the lowest layer in a Hierarchical Cell Structures network (HCS). Figure 5-3 shows a potential scenario, with macro and micro cells, one outdoor bunch and two indoor bunches (each covering a building floor).

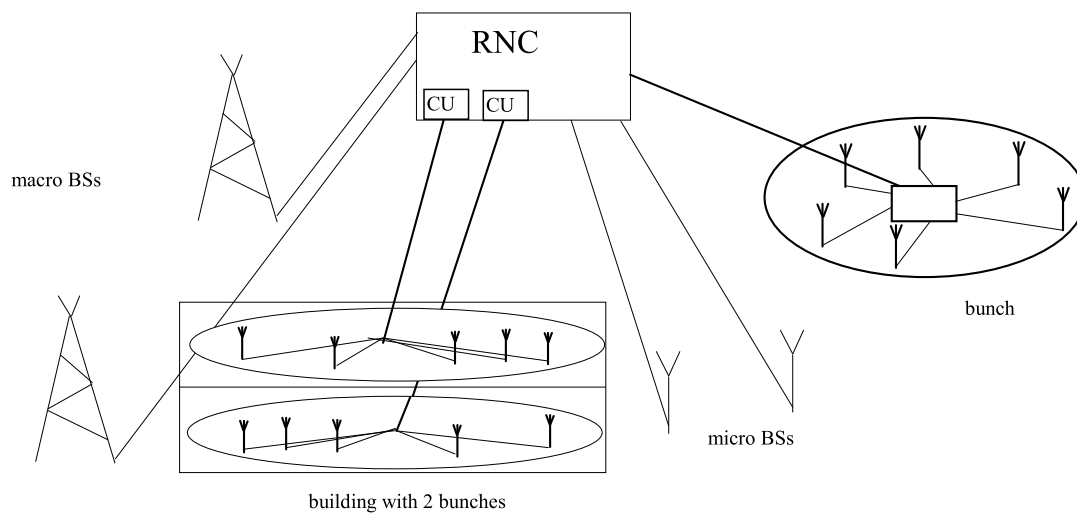


Figure 5-3: A scenario with several bunches, microcells and macrocells

In the figure the bunches, the micro BS and the macro BS are controlled by a central unit, here denoted RNC (Radio Network Controller). However it should be noted that the Central Unit is only defined from a functional point of view. That means that the different functional CUs may be physically contained in the RNC as long as the requirements put to the physical links between RNC and RAUs are met.

5.3.11.1 Overview of algorithms

There will be two types of interference in the system: intra- and inter-bunch interference. Within a bunch, the synchronism and the centralised approach make it possible to avoid most of the interference by means of sophisticated radio network algorithms. The inter-bunch interference, i.e. from outside the bunch, also needs to be considered. Note that the inter-bunch interference is not only the interference from other bunches but also from cells in other HCS layers.

In this centralised concept, the RRM domains (such as LA and PC) are linked closely together and can not easily be handled separately.

5.3.11.1.1 Inter-bunch algorithms

Between bunches, or between bunches and BSs, random frequency and time hopping can be used to average out the inter-bunch interference, in the same way as between cells in the Interference Averaging concept. All bunches should have individual hopping patterns with low inter-bunch correlation. Using

this scheme, we hope to be able to utilise all the operator's frequencies within all bunches (reuse 1 on a bunch level). However, in some scenarios it might be necessary to increase the reuse factor. For example, if the bunch is part of a HCS network, the downlink interference on the bunch from the surrounding macro BSs is likely to be high. Particularly if the bunch uses lower transmit powers than the surrounding network, the situation can be very severe. Therefore, it might become necessary to divide the frequency spectrum so that the bunch uses different frequencies than the nearby macro BSs. Then, frequency and time hopping can only be performed on the part of the spectrum allocated to the bunch or BS. And as soon as frequency planning is needed, there is a need for a slow DCA or similar algorithm that automates this task.

5.3.11.1.2 Intra-bunch algorithms

Also within a bunch, frequency hopping can be used to achieve frequency diversity. The intra-bunch interference is not affected because the hopping is controlled by the CU so that all transmitters maintain the same relative positions in the frequency/time matrix. This means that all transmitters in the bunch hop synchronously, using the same hopping sequence. The resulting constant intra-bunch interference enables the use of algorithms such as fast DCA.

We have integrated all the intra-bunch radio resource management algorithms like channel assignment, link adaptation, power control and handover into a structure that we call Generic Intra-bunch Resource Manager (GIRM). The reason for this is that we believe that the system can be made more efficient if the different algorithms co-operate more tightly than in conventional systems. The intra-bunch algorithms in the bunch concept are highly dependent on each other and thus, they can not be viewed as separate entities. The GIRM consists of a priority queue for requests, one block for allocation of new resources (GA), one for de-allocation of resources (GD), a measurement unit (MMT), a power control entity (PC) which is partly included in the GA and GD. The link adaptation and intra-bunch handover do not have separate blocks because these functions are included in the GA and GD which will be described later.

In some cases, channels can be changed without changing RAU and RAU can be changed without changing channels. This offers the possibility to have MSs in macro diversity (connected to several RAUs at the same time) whenever it is considered appropriate. A natural macro diversity application is "make-before-break" handover, i.e. the MS can be connected to the new RAU before it leaves the old RAU. Another example is a bunch subject to severe interference from outside the bunch. Then, macro diversity could be used to increase the carrier signal strength (C) to improve the MSs' C/I ratio.

5.3.12 Frequency management for the multi-band concept

5.3.12.1 Frequency split

In case the system works with several carrier bandwidths, as described in the multi-band concept, a specific frequency management structure is proposed.

Within one cell layer, the total bandwidth allocated to an operator is split into several blocks corresponding to the different carrier bandwidths in use. This arrangement allows to have equal bit rate services in the same part of the total bandwidth and should thus reduce some interference issues between services having different bit rates.

Figure 5.4 shows an example of this structure with a total bandwidth of 8 MHz. The total bandwidth is split into 5 band of 1.6 MHz. Each block of 1.6 MHz is split in bands of 200, 400 or 800 kHz.

The resource split will depend on the service needs. Therefore it should be possible to change it dynamically during the day according to the traffic share between different services. This strategy avoids to allocate important spectrum bandwidth for high bit rate during peak hours for instance.

The resource split must be the same in all cells of the area. In that way, we make sure that a service is always available in the area and we avoid interference between services using different bit rates.

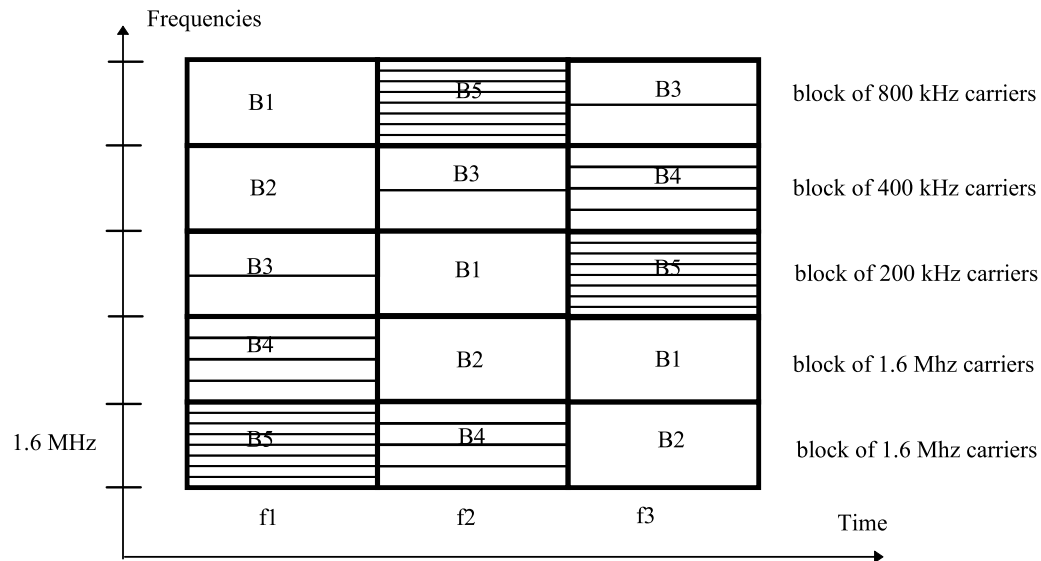


Figure 5-4 : example of bandwidth structure for one cell layer

5.3.12.2 Frequency hopping algorithm

Frame by frame frequency hopping can be used with that structure in order to have frequency and interference diversity. Hopping sequence must take into account the frequency structure. It is proposed to use a two-steps frequency hopping algorithm as described below :

The first step is a frequency hopping on the blocks. This hopping sequence is a pseudo-random hopping (we proposed to take the GSM pseudo-random hopping algorithm). In order to keep the same spectrum split for all cells of a given area, the hopping sequence should be the same for each cell of the area. This first step is used in order to have frequency diversity.

The second step is a frequency hopping on sub-bands inside each block. For each block split into sub-bands, a new pseudo-random hopping is applied. This hopping sequence is different for each cell and each block in order to have frequency and interference diversity.

The two steps of the algorithm are independent and the hopping sequences associated also. The second step is optional, and is applied only if the block is split into sub-bands. This algorithm is general enough to be applied by the mobile or the base station. Furthermore, it is flexible enough to support dynamic change of the spectrum split.

For the application of the frequency hopping algorithm, the following parameters are defined and have to be known :

- BlockNb : Number of blocks in the frequency band
- Pmax : Index of the widest carrier bandwidth in the blocks ($BW = 2^{P_{max}} \times 100$ kHz)
- P : Index of the carrier bandwidth being used ($BW = 2^P \times 100$ kHz)

The following parameters need also to be known to the mobile or base station when using frequency hopping.

- f : Carrier centre frequency
- Fmin : Minimal frequency of the total bandwidth
- Df : Carrier bandwidth of the elementary carrier (200 kHz)

The term *Random(N)* represents a GSM hopping sequence on N frequencies, with associated parameters HSN and MAIO. For the first step, parameters (HSN, MAIO) are identical for all cells

within a given area (no interferer diversity). For the second step, a set of parameters (HSN, MAIO^o is associated with each cell.

The following formulas are applied to obtain the new frequency based on the current one :

- first step, pseudo-random hopping on BlockNb blocks :

$$f_{nb} = \left[\frac{f - F_{\min}}{Df} + \text{Random}(\text{BlockNb}) \times 2^{p_{\max}} \right] \text{mod}(\text{BlockNb} \times 2^{p_{\max}})$$

$$f_{new} = F_{\min} + f_{nb} \times Df$$

- second step, pseudo-random hopping within one block, used only if carrier bandwidth in the block is smaller than Pmax :

if (P < Pmax)

{

$$f_{\min} = F_{\min} + \left[\left(\text{int} \right) \frac{f_{nb}}{2^{p_{\max}}} \right] \times 2^{p_{\max}} \times Df$$

$$f_{new} = f_{\min} + \left[\left(\frac{f_{nb} \times Df - f_{\min}}{Df} + \text{Random}(2^{p_{\max}-p}) \times 2^p \right) \text{mod}(2^{p_{\max}}) \right] \times Df$$

}

5.3.12.3 Resource allocation algorithm

The resource allocation algorithm needs to be adapted to the multi-band concept, in order to allocate resources, according to the required bit rate and the frequency arrangement.

The algorithm could also have some interaction with the dynamic channel algorithm based on segregation mechanisms, if it is used.

The adaptation of the resource allocation algorithm is currently under study.

5.3.12.4 Analysis of the multi-band system concept

The multi-band system concept has been introduced in section 3.2 as an alternative to the single carrier bandwidth system. Pros and cons of this concept are analysed here to help in the selection of this option.

5.3.12.4.1 Bit rate range for each carrier bandwidth

Each carrier type can support a given range of bit rates. The range of a carrier type is based on the bit rate service supported by one slot and the maximal permitted number of slots allocated on this carrier. An allocation from 1 to Nmax-1 slots per carrier is recommended in order to keep at least one slot for the BCCH channel monitoring process.

The figure 5.5 shows the bit rate range for each carrier type. If we consider a certain bit rate, this figure shows which carrier type can support this bit rate. The resource allocation strategy may favour either the allocation of a few slots on a wide bandwidth or the allocation of a lot of slots on smaller bands.

For example, the 200 kHz band can support 11,7 kbits/s up to 182 kbits/s gross bit rate. The first one is obtained by using one 1/16 slot in a frame, and the last one is obtained by using 7 1/8 slots in a frame.

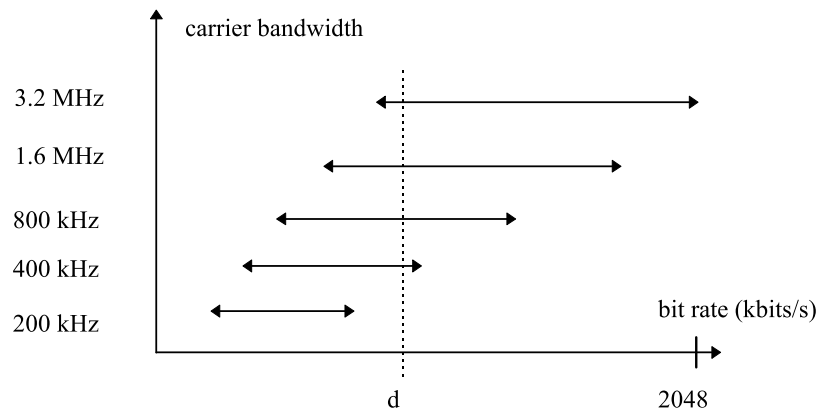


Figure 5-5 : bit rate range for each carrier type

5.3.12.4.2 Pros and cons for the multi-band concept

The following advantages have been identified for the multi-band concept :

- This concept permits to optimise the TDMA transmission scheme for all envisaged bit rates and environments. Such an optimisation is not feasible with a single bandwidth.
- With this concept, low bit rate terminals may only use small bandwidth option, thus reducing complexity and cost. This multi-band concept allows to propose several mobile terminals, according to the offered services. Thus, a very cheap terminal could be proposed for speech services and some low bit rate data services.
- Migration from GSM to UMTS will be easy with this approach, since 200 kHz bands could be used with GSM modulation.
- The handover between Multi-band TDMA and GSM may be very easy if the control channels are mapped on 200 kHz frequencies. Indeed, this allows to listen transparently to GSM or Multi-band TDMA beacon frequencies.
- The flexibility of the frequency structure will allow to dynamically adapt the configuration according to traffic needs.
- The multiband concept need less overhead (due to guard time and training period), compared to the wideband TDMA burst structure.

However the following problems have also been identified and would need further studies :

- The multi-band concept implies that a mobile terminal can be configured with several carrier bandwidths, depending on the carrier type in use.
- In the base station, for an efficient adaptation to traffic needs, it should be possible to dynamically change the frequency split between the different carrier types, without any change in the number of TxRx. Therefore, these TxRx should be able to transmit using a single 1.6 MHz carrier or using 8 200 kHz carriers (with different mobiles). This requirement puts high constraints on RF parts in base station that need to be evaluated.
- The resource allocation mechanisms will be slightly more complex than in the case of a single carrier bandwidth for an optimal use of radio resources.
- Interference between adjacent channels of different bandwidth may occur and this will also need further studies.

5.3.12.4.3 Provisional conclusion

From a pure performance point of view, the multi-band system concept seems to provide interesting improvement compared to the single bandwidth system. However more detailed evaluation results are needed to estimate the trade-off between performance and complexity/cost. Also this concept could be used as an option according to the expected environment and services.

Finally, the exact definition of carrier bandwidth and frames structure might need to be reviewed at a later stage, whenever this concept is retained for UTRA.

5.4 Conclusion of the RRM techniques

The IA concept is proposed to be the basic RRM scheme and the Bunch concept may be used in some areas where the traffic load is high. However, these concepts are just examples of a wide range of RRM schemes that can be supported with the flexible signalling designed for these concepts. E.g. the Power Control strategy ensures the possibility to use slow, fast or packet based Power Control. The PC criteria can also be changed (according to quality, RSSI etc.). Different RRM strategies can then utilise the most suitable PC strategy. Also different services may utilise different PC strategies. Further, the Quality Loop can adapt the target of the C/I based LA or PC or both.

6. Enhancements

The simulation results of WB-TDMA are shown in Chapter 7. These performance results can be improved in a number of ways. A few possible enhancements are discussed in this chapter.

6.1 *Utilisation of the reciprocal channel for TDD operation*

In TDD operation the fast fading is the same both in uplink and downlink if the Doppler frequency is sufficiently lower than the frame frequency. This reciprocal channel can be utilised for

- open loop control
- transmission diversity

6.2 *Adaptive antennas (AA)*

The well-known advantages of adaptive antennas system are following

- improved range
- improved spectrum efficiency
- improved quality

Without doubt, the amount improvement which AA techniques provide, depends on the antenna array complexity. As AA techniques are often more powerful when used in the receiver side, the possibility of implementing a small antenna array in the mobile receiver is of interesting alternative in the WB-TDMA system to balance the up- and downlink performances.

The WB-TDMA system is designed to well support the usage of adaptive antennas. For example, appropriate training sequences with good cross-correlation are selected to optimise the usage of AA techniques for interference cancellation. The implementation of BCCH in the system taking advantage of AA techniques requires also careful system design as BCCH by its omni-directional nature makes it difficult to support adaptive antennas. In Sec. 2.5, the discontinuous BCCH on WB-carrier allows to use AA techniques in the TCH channels located on the same carrier with BCCH carrier and range extension for BCCH can be achieved by adding sufficient amount of redundancy on BCCH information. The other alternative, 200 kHz continuous BCCH has a better range inherently as a consequence of its narrower bandwidth.

Interference cancellation by using digital antenna array implemented in the receiver is a very powerful technique against co-channel interference as well as other spatially distributed interferences such as adjacent channel interference. The system requirements for AA-IC-receiver are not as stringent as for the JD-receiver. For example, AA-IC-receiver do not strictly require synchronous system. A drawback of asynchronism is that the interference is not the same over a burst which leads to gradual performance loss if the interference cannot be estimated separately for the both ends of a burst. In the synchronous system, the optimisation of training sequence cross-correlation properties is of key importance.

6.3 *Antenna diversity*

All capacity results shown in this document are for downlink without antenna diversity. Since antenna diversity could be applied in the uplink, a considerable improvement could be expected compared to these downlink results.

6.4 *Inter-cell interference suppression*

At least two types of interference cancellation techniques are applicable in WB-TDMA system: joint demodulation of co-channel signals and adaptive antennas. Interference cancellation (IC) is referred technique which implemented in the receiver to suppress the interference which is present in the receiver. This can be done in real time by post-processing the burst in the receiver memory.

The advantages of co-channel inter-cell interference suppression in WB-TDMA are as follows

- improved spectrum efficiency (lower reuse, or saved air interface time)

- easier cell deployment
- improved quality
- make the receivers operation more reliable in the case of sudden interference changes

The first bullet refers to the capacity increase resulting from the receivers' improved susceptibility with co-channel interference. A way to gain the capacity is to design the network with lower reuse when IC-receivers are used. Another way not requiring lowering the reuse factor, is to take advantage of the saved air time as the IC-receiver copes with less channel coding and/or retransmission.

The second bullet implies the possibility to rely on IC as a method to equalise the location dependent interference level changes. An example of such case is a street micro-cellular system where street crossings suffer from a higher interference level. Already, fast link adaptation is specified in WB-TDMA system to tackle the same problem, but at the expense of extra radio resources.

The third bullet, implies the possibility to provide a better service quality for a user having receiver with IC-capability. For example, a user with IC-receiver may be granted with a higher service bit rate as it can cope with less channel coding.

The fourth bullet emphasises the fact that interference cancellation can be thought as real-time adaptation as it removes the interference which already were present in the receiver. If the receiver can adapt the sudden interference level changes, it helps e.g. to avoid call drop outs or extra time can be obtained to perform handover to a new base station or channel.

6.5 Joint demodulation of co-channel signals

In TDMA systems, as the number of nearby co-channel signals is few and the signals have independent propagation paths, there is a high probability for the existence of a dominant interfering signal (DI) in the receiver. The probability of DI is further increased by DTX, fractional loading and cell sectorisation. Joint demodulation of desired signal and DI provides substantial interference suppression gain and, moreover, makes it feasible to implement a receiver with reasonable complexity.

The receiver can be divided into two parts: joint channel estimator and detector. From the detector complexity and structure point of view, detection of two independent Bin OQAM signals simultaneously is identical to the detection of a single Quat-OQAM signal. Therefore, as Quat-OQAM is supported anyway by WB-TDMA receiver, the support of IC for Bin-OQAM signals do not require major changes in the demodulator. The practical limitations of receiver complexity limits the operational environment of the JD-receiver as for Quat-OQAM modulation

To support joint channel estimation and DI identification, base stations need to be synchronised to make training sequences from co-channels overlap with each other and training sequences with good cross-correlation properties need to be used.

6.6 Improved Modulation and channel coding

In principle the W-TDMA concept can support any modulation scheme meeting the emission mask requirements. This will allow the use of higher order modulations to support even higher bit rate connections over short ranges (e.g., within a single room). It will also allow alternative methods of combating multipath, such as OFDM.

Similarly, the use of different channel coding algorithms need not be restricted. By optimised the channel coding the link levels performance and system capacities can be improved. The following items are examples for improving the channel coding.

- optimised puncturing
- Turbo codes
- longer constraint lengths, now $K=5$ for convolutional codes and $K=3$ for Turbo codes
- Interleaving depth can be adjusted to optimise trade off between bearer C/I requirement and delay

Finally, the multi-band concept could be extended to consider wider bandwidths, which would allow higher bit rates to be supported. Available spectrum is likely to be a constraint on evolution in this direction.

6.7 Fast power control (frame-by-frame)

Fast power control (frame-by-frame) could be used to improve the performance in case where frequency hopping cannot be applied. Such case is e.g. if the operator has only one carrier available.

7. Simulations

7.1 Simulation cases

Table 1. Simulation cases

Priority	Environment	Service	Propagation model	Cell coverage	Link level	System level
1.1	Outdoor to Indoor and Pedestrian 3 km/h	UDD 384	Outdoor to Indoor and Pedestrian A	Microcell	X	X
1.2		Speech			X	X
1.3		LCD 144 kbit/s			X	
1.5		UDD 2048			X	
2.1	Indoor 3 km/h	UDD 2048	Indoor A	Picocell	X	X
2.2		Speech			X	
2.3		LCD 384 kbit/s			X	
2.4		50 % speech + 50 % UDD 384				X
3.1	Vehicular 120 km/h	UDD 144	Vehicular A	Macrocell	X	
3.2		Speech			X	X
3.3		LCD 384 kbit/s			X	X

Table 2. Description of simulation cases

Test environments	Indoor Office	Outdoor to Indoor and Pedestrian	Vehicular 120 km/h	Vehicular 500 km/h
Test services	bit rates (values) BER Channel activity	bit rates (values) BER Channel activity	bit rates (values) BER Channel activity	bit rates (values) BER Channel activity
Representative low delay data bearer for speech*¹	8 kbps $\leq 10^{-3}$ 20 ms 50%	8 kbps $\leq 10^{-3}$ 20 ms 50%	8 kbps $\leq 10^{-3}$ 20 ms 50%	8 kbps $\leq 10^{-3}$ 20 ms 50%
LDD Data (circuit- switched, low delay)*¹	144-384-2048 kbps $\leq 10^{-6}$ 50 ms 100%	64 - 144 - 384 kbps $\leq 10^{-6}$ 50 ms 100%	32 - 144 - 384 kbps $\leq 10^{-6}$ 50 ms 100%	32 -- 144 kbps $\leq 10^{-6}$ 50 ms 100%
LCD Data (circuit- switched, long delay constrained)*¹	144-384-2048 kbps $\leq 10^{-6}$ 300 ms 100%	64 - 144 - 384 kbps $\leq 10^{-6}$ 300 ms 100%	32 - 144 - 384 kbps $\leq 10^{-6}$ 300 ms 100%	32 - - 144 kbps $\leq 10^{-6}$ 300 ms 100%
UDD Data (packet) Connection-less information types	See section 1.2.2	See section 1.2.2	See section 1.2.2	See section 1.2.2

*¹ Proponents must indicate the achieved one-way delay (excluding propagation delay, delay due to speech framing and processing delay of voice channel coding) for all the test services.

Note : For LDD services, a BER threshold of 10^{-4} will be considered for the initial comparison phase of the different concepts in order to reduce simulation times. The BER threshold of 10^{-6} will be considered in the optimization phase.

7.2 Introduction

This document presents link level simulation results of FMA1 without spreading (WB-TDMA). The results are obtained with COSSAP. Both non-real time service results with ARQ and real time service results with FEC are presented. For Real time (RT) services the interference averaging concept relies heavily on the link adaptation. Therefore a few link adaptation options are presented for RT services. For providing input to system simulations the link level simulations are run against one co-channel interferer and for range calculations against Gaussian noise. These results are valid both for FDD and

TDD operation. In TDD operation, however, these results could be improved by utilising the reciprocal channel for e.g. open loop control and transmission diversity.

The results in this document are shown against average(C)/average(I). The interface between link and system level simulations does not directly utilise these curves but the burst-by-burst collected information. For more information about the interface see the following chapter and [16]

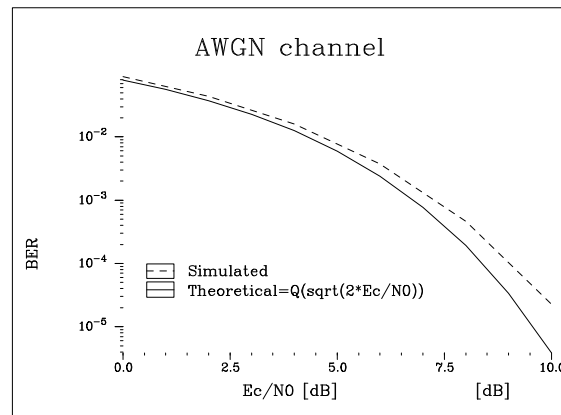
The basic assumptions and technical choices of the link level simulations are shown in Table 7-1.

Table 7-1. Link level assumptions and technical choices

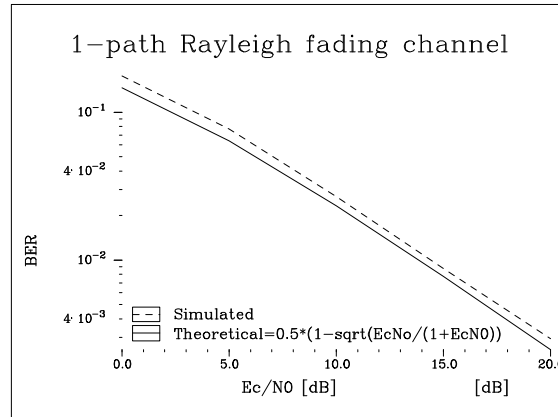
Channel estimator	Correlator, delay search window of 3 symbols, independent estimation from burst-to-burst
Equaliser	Soft Output Viterbi Algorithm (SOVA)
Number of equaliser taps	ITU Indoor A: 3 taps ITU Outdoor to indoor A: 3 taps ITU Vehicular A/B: 5 taps
Modulation	Bin-O-QAM Quat-O-QAM
Channel coding	Convolutional codes, $K=5$, $K=9$ Turbo codes, $K=3$ + puncturing / repetition for rate matching Concatenated code for LCD 144 and LCD 384: Reed-Solomon (500,400) or Reed-Solomon (210,168) + Convolutional code ($K=9$)
Power control	Slow power control, not modelled in link level
Interference modelling	One co-channel interferer (for capacity) Gaussian noise (for range)
Antenna diversity	In uplink, not in downlink
Frequency hopping	Frame-by-frame hopping or slot-by-slot hopping Uncorrelated frequencies
Time hopping	Included in link level frequency hopping for interference diversity, not separately modelled in link level

7.3 Validation of simulation chains

The link level COSSAP simulation chains of FMA1 without spreading has been validated by comparing the simulation results in non-fading AWGN channel and in 1-path Rayleigh fading channel to the theoretical BER-curves. The results are shown in the figure below.



Simulated results compared to theoretical value in AWGN channel
(overhead due to training sequence and tail bits is not to be taken into account in E_c/N_0)



Simulated results compared to theoretical value in 1-path Rayleigh fading channel

The simulated results are a little worse than theoretical values as expected. This is due to the non-ideal channel estimation.

7.4 Required E_b/N_0 's and C/I's

7.4.1 Speech

Required E_b/N_0 (dB) for speech	1 slot/frame UL/DL	2 slots/frame UL/DL	4 slots/frame UL/DL	6 slots/frame UL/DL
Indoor_A 3 km/h	6.9 / 12.4	5.5 / 9.8	5.6 / 8.6	5.9 / 8.4
Micro_A 3 km/h	6.9 / 12.2	5.7 / 9.7	5.6 / 8.7	5.9 / 8.6
Vehicular_A 120 km/h	6.6 / 11.6	6.2 / 9.6	6.2 / 8.9	6.6 / 8.7
Vehicular_B 120 km/h	8.6 / 18.8	7.1 / 11.2	6.9 / 9.7	7.1 / 9.5
Vehicular_B 250 km/h	8.6 / 19.6	7.1 / 11.7	6.9 / 10.1	7.2 / 9.5

Required C/I (dB) for speech	1 slot/frame UL/DL	2 slots/frame UL/DL	4 slots/frame UL/DL	6 slots/frame UL/DL
Indoor_A 3 km/h	2.0 / 7.5	-2.9 / 1.7	-6.8 / -2.8	-9.0 / -5.1
Micro_A 3 km/h	1.8 / 7.9	-3.1 / 1.7	-6.8 / -3.2	-8.7 / -5.3
Vehicular_A 120 km/h	2.0 / 7.7	-1.9 / 2.2	-5.3 / -1.9	-7.0 / -4.1
Vehicular_B 120 km/h	3.9 / 13.0	-0.7 / 4.2	-4.7 / -0.9	-6.3 / -3.2
Vehicular_B 250 km/h	4.0 / 15.0	-0.7 / 4.6	-4.6 / -0.8	-6.4 / -3.0

7.4.2 UDD

Required E_b/N_0 (dB) for UDD 144	2 slot/frame UL/DL	4 slots/frame UL/DL
Indoor_A 3 km/h	2.7 / 6.3	2.3 / 4.9
Micro_A 3 km/h	2.8 / 6.2	2.1 / 4.9

Vehicular_A 120 km/h	4.0 / 8.1	3.2 / 6.2
Vehicular_B 120 km/h	- / 11.0	- / 7.2
Vehicular_B 250 km/h	5.2 / 11.3	3.7 / 7.1

Required C/I (dB) for UDD 144	2 slot/frame UL/DL	4 slots/frame UL/DL	8 slots/frame UL/DL
Indoor_A 3 km/h	-1.6 / 2.1	-6.5 / -3.8	- / -
Micro_A 3 km/h	-1.5 / 2.3	-6.2 / -3.7	- / -8.0
Vehicular_A 120 km/h	0.9 / 4.7	-3.4 / -1.1	- / -5.1
Vehicular_B 120 km/h	- / 8.7	- / 0.8	- / -3.7
Vehicular_B 250 km/h	2.7 / 8.9	-2.5 / 0.6	-5.6 / -3.7

Required E_b/N_0 (dB) for UDD 384	8 slots/frame UL/DL	16 slots/frame UL/DL
Indoor_A 3 km/h	2.1 / 5.1	2.4 / 4.9
Micro_A 3 km/h	2.0 / 5.2	2.3 / 4.9
Vehicular_A 120 km/h	3.4 / 6.6	3.4 / 6.2
Vehicular_B 120 km/h	- / 8.0	- / 6.9
Vehicular_B 250 km/h	4.1 / 7.9	3.8 / 6.6

Required C/I (dB) for UDD 384	8 slots/frame UL/DL	12 slots/frame UL/DL	16 slots/frame UL/DL
Indoor_A 3 km/h	-4.6 / -1.8	- / -	- / -
Micro_A 3 km/h	-4.6 / -1.5	- / -	- / -6.5
Vehicular_A 120 km/h	-1.8 / 1.0	-3.8 / -1.8	- / -2.9
Vehicular_B 120 km/h	- / 2.8	- / -0.3	- / -2.0
Vehicular_B 250 km/h	-0.7 / 3.0	-4.3 / -0.3	-3.1 / -2.1

Required E_b/N_0 (dB) for UDD 2048	16 slots/frame UL/DL
Indoor_A 3 km/h	4.6 / 7.0 (Quat!)
Micro_A 3 km/h	4.4 / 7.6 (Quat!)
Vehicular_A 120 km/h	12.7 / 16.9

Vehicular_B 120 km/h	not possible
Vehicular_B 250 km/h	- / -

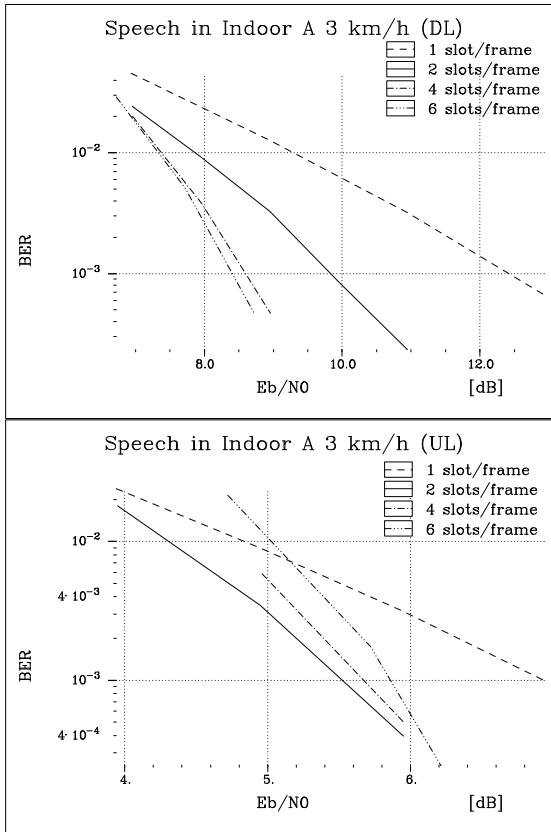
Required C/I (dB) for UDD 2048	16 slots/frame UL/DL
Indoor_A 3 km/h	4.2 / 7.6 (Quat!)
Micro_A 3 km/h	4.3 / 8.2 (Quat!)
Vehicular_A 120 km/h	12.2 / 17.6
Vehicular_B 120 km/h	not possible
Vehicular_B 250 km/h	not possible

7.5 E_b/N_0 simulation results

7.5.1 Speech

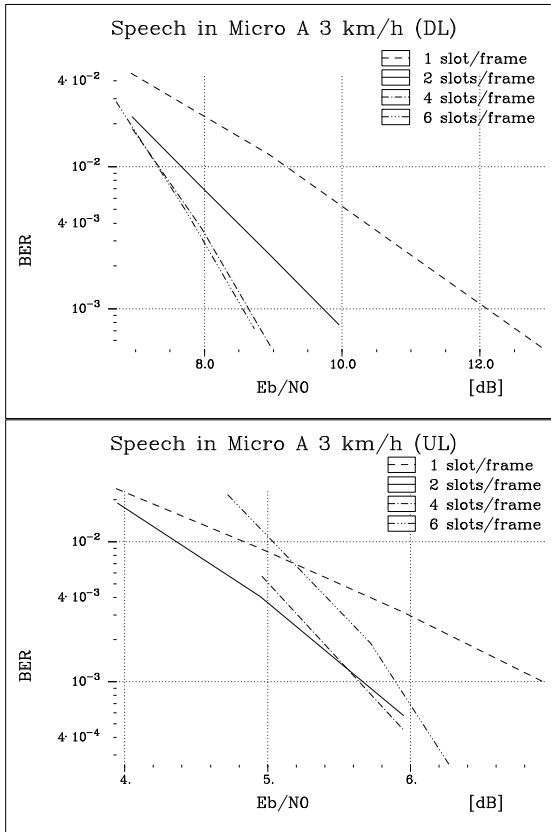
7.5.1.1 Speech in ITU Indoor_A

Parameters	Value(s)
Slot size	1/64
Modulation(s)	Bin-O-QAM
Number of slots used per frame	1, 2, 4, 6
Uncoded data block	150
Coding rate	0.26, 0.13, 0.07, 0.05
Basic code	CC(1,2,9)
Interleaving depth	Over 4 frames
Puncturing	Yes
Frequency hopping	Yes
Mobile speed	3 km/h
Antenna diversity	DL: No, UL: Yes



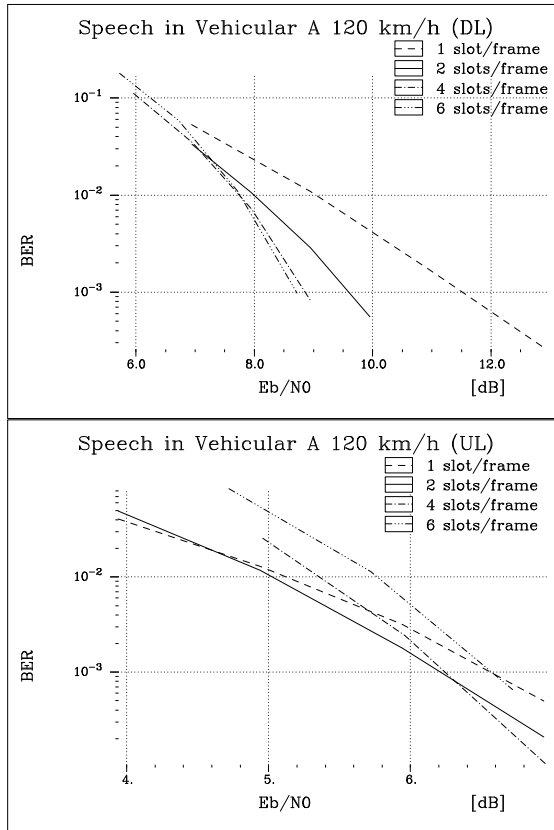
7.5.1.2 Speech in ITU Micro_A

Parameters	Value(s)
Slot size	1/64
Modulation(s)	Bin-O-QAM
Number of slots used per frame	1, 2, 4, 6
Uncoded data block	150
Coding rate	0.26, 0.13, 0.07, 0.05
Basic code	CC(1,2,9)
Interleaving depth	Over 4 frames
Puncturing	Yes
Frequency hopping	Yes
Mobile speed	3 km/h
Antenna diversity	DL: No, UL: Yes



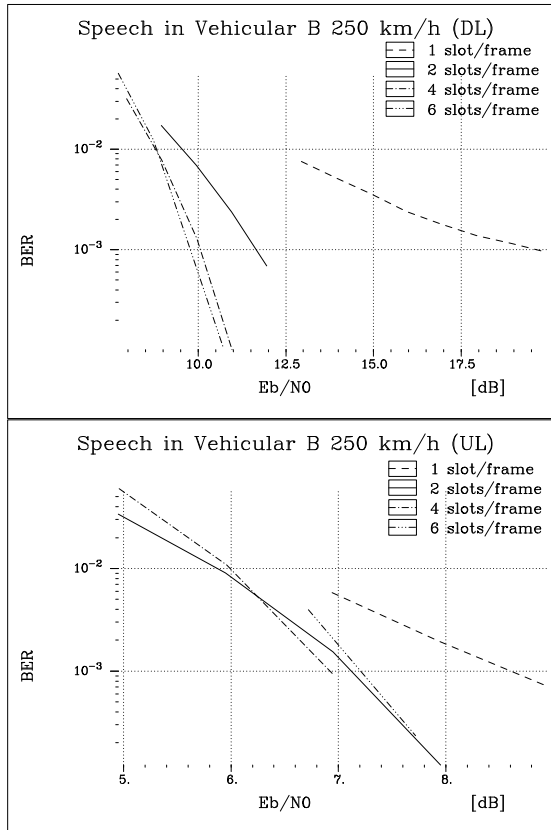
7.5.1.3 Speech in ITU Vehicular_A

Parameters	Value(s)
Slot size	1/64
Modulation(s)	Bin-O-QAM
Number of slots used per frame	1, 2, 4, 6
Uncoded data block	150
Coding rate	0.26, 0.13, 0.07, 0.05
Basic code	CC(1,4,9)
Interleaving depth	Over 4 frames
Puncturing	Yes
Frequency hopping	Slot-by-slot
Mobile speed	120 km/h
Antenna diversity	DL: No, UL: Yes



7.5.1.4 Speech in ITU Vehicular_B

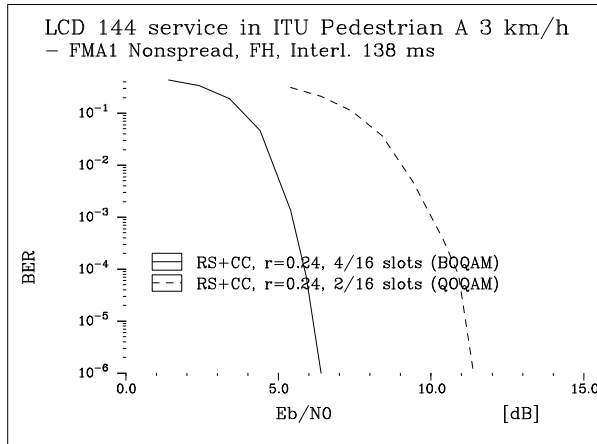
Parameters	Value(s)
Slot size	1/64
Modulation(s)	Bin-O-QAM
Number of slots used per frame	1, 2, 4, 6
Uncoded data block	150
Coding rate	0.26, 0.13, 0.07, 0.05
Basic code	CC(1,4,9)
Interleaving depth	Over 4 frames
Puncturing	Yes
Frequency hopping	Slot-by-slot
Mobile speed	250 km/h
Antenna diversity	DL: No, UL: Yes



7.5.2 LCD

7.5.2.1 LCD 144 in ITU Micro_A

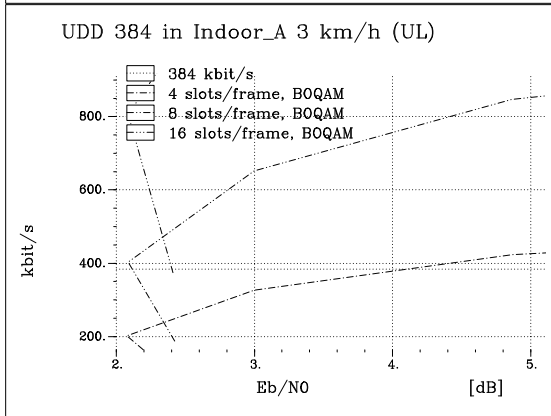
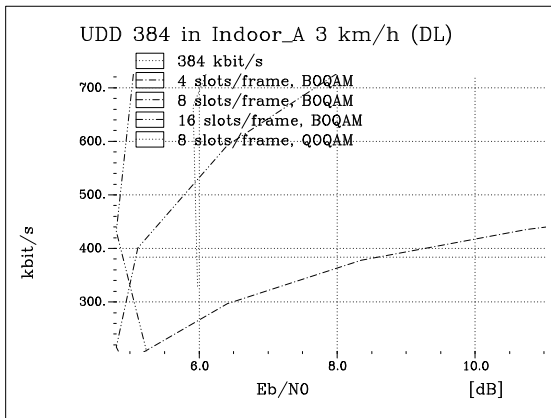
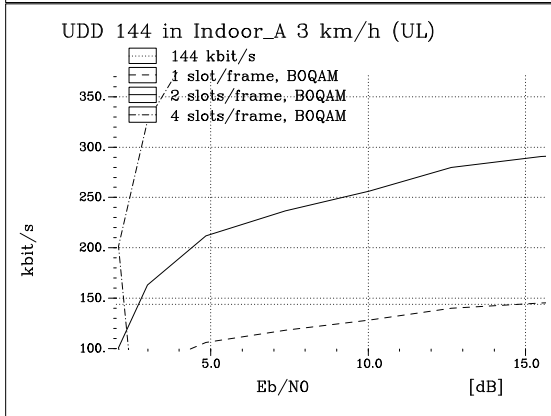
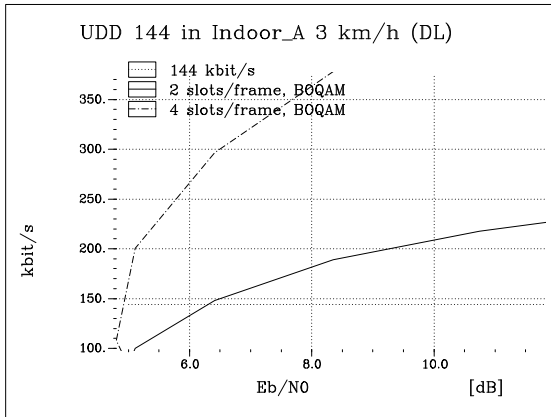
Parameters	Value(s)
Slot size	1/16
Modulation(s)	Quat-O-QAM, Bin-O-QAM
Number of slots used per frame	2,4
User bitrate	145.6 kbit/s
Coding rate	0.24
Basic code	CC(1,2,5), RS-code
Interleaving depth	Over 30 frames
Puncturing	Yes
Frequency hopping	Slot-by-slot
Mobile speed	3 km/h
Antenna diversity	No

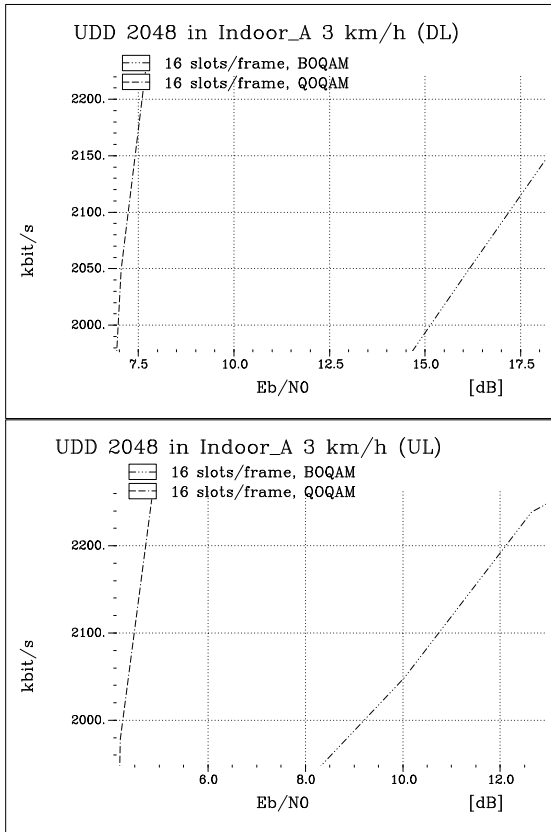


7.5.3 UDD

7.5.3.1 UDD in ITU Indoor_A

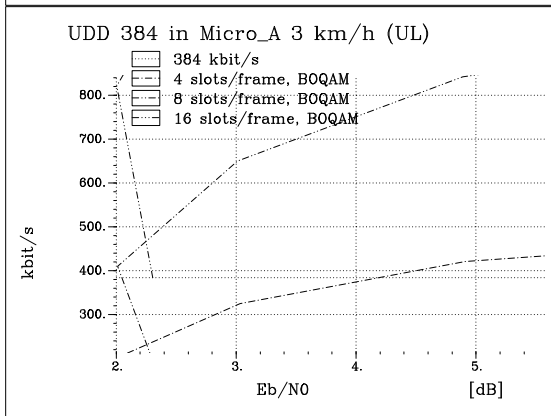
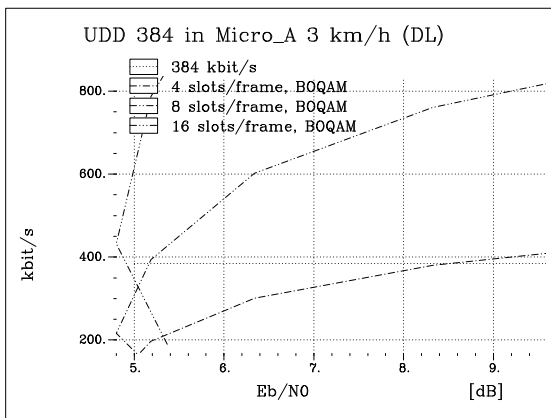
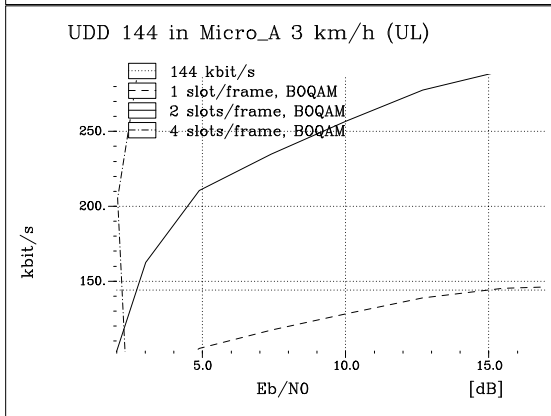
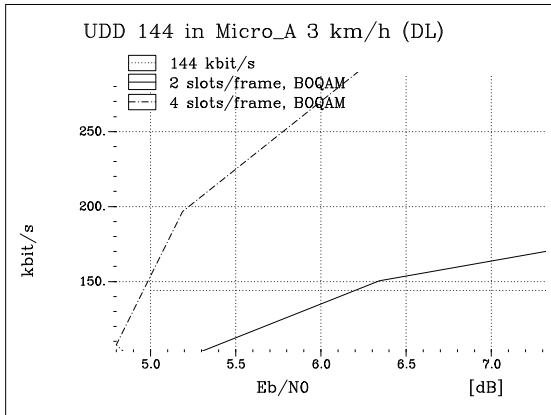
Parameters	Value(s)
Slot size	1/16
Modulation(s)	Bin-O-QAM and Quat-O-QAM
Number of slots used per frame	2, 4, 8, 16
Uncoded data block	2726
Coding rate	Variable
Basic code	CC(1,29)
Interleaving depth	Over 4 or 8 bursts
Puncturing	Via hybrid-ARQ
Frequency hopping	Slot-by-slot
Mobile speed	3 km/h
Antenna diversity	UL: Yes, DL: No

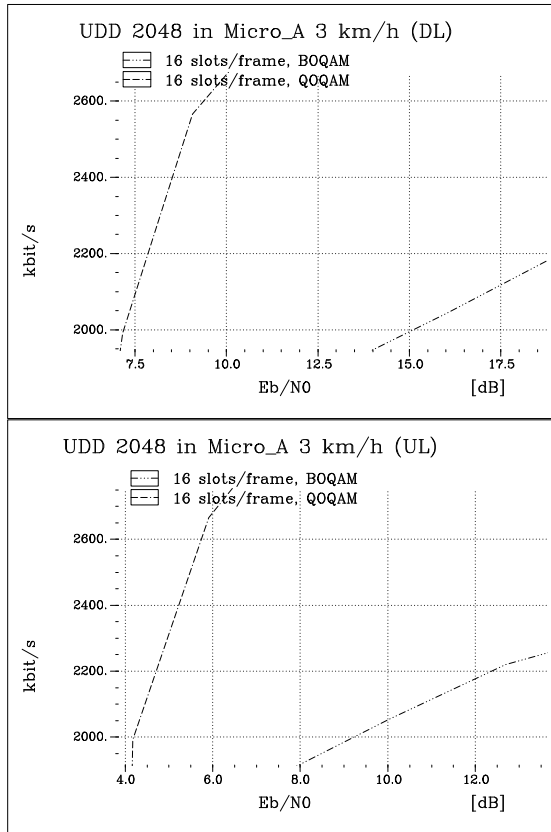




7.5.3.2 UDD in ITU Micro_A

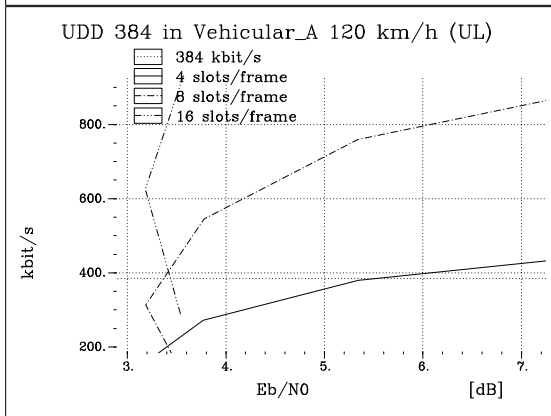
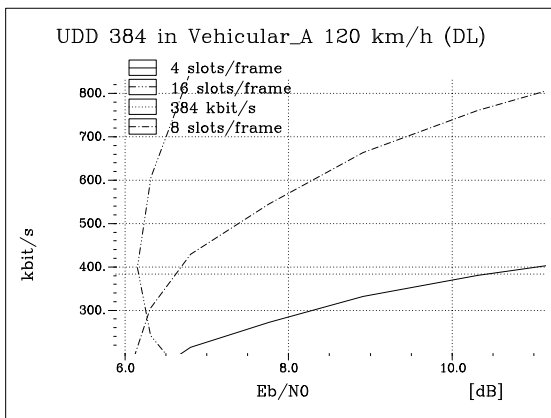
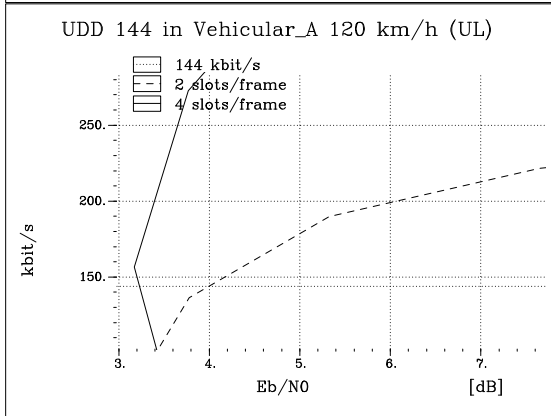
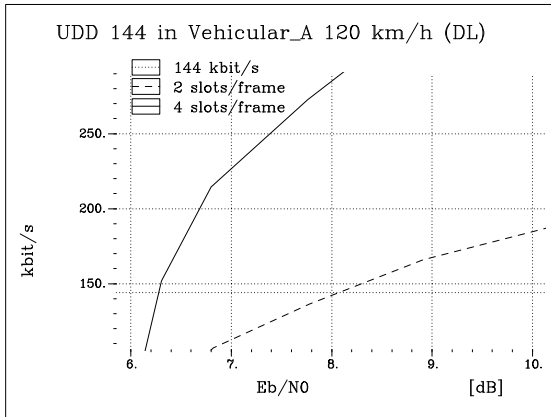
Parameters	Value(s)
Slot size	1/16
Modulation(s)	Bin-O-QAM and Quat-O-QAM
Number of slots used per frame	2, 4, 8, 16
Uncoded data block	2726
Coding rate	Variable
Basic code	CC(1,29)
Interleaving depth	Over 4 or 8 bursts
Puncturing	Via hybrid-ARQ
Frequency hopping	Slot-by-slot
Mobile speed	3 km/h
Antenna diversity	UL: Yes, DL: No

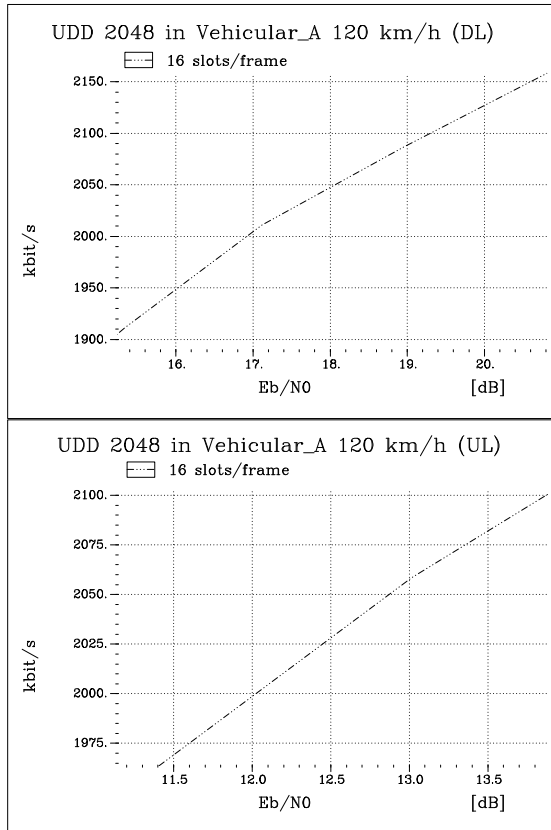




7.5.3.3 UDD in ITU Vehicular_A

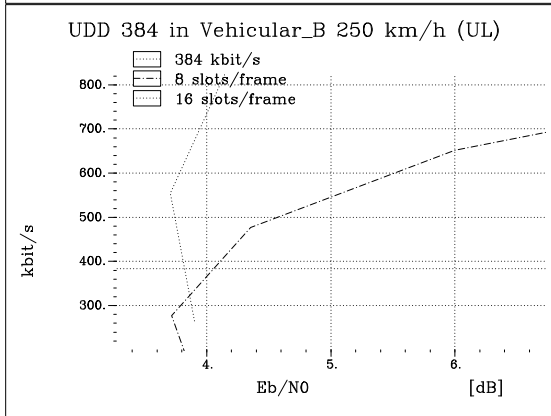
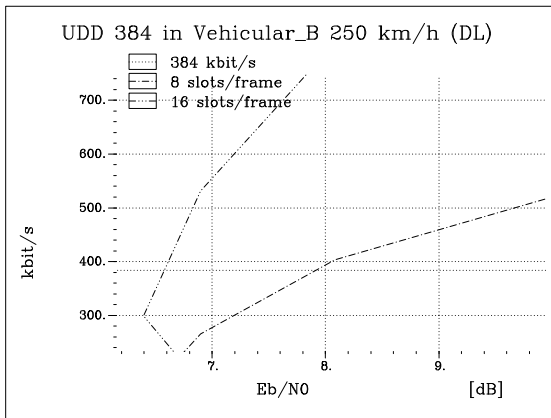
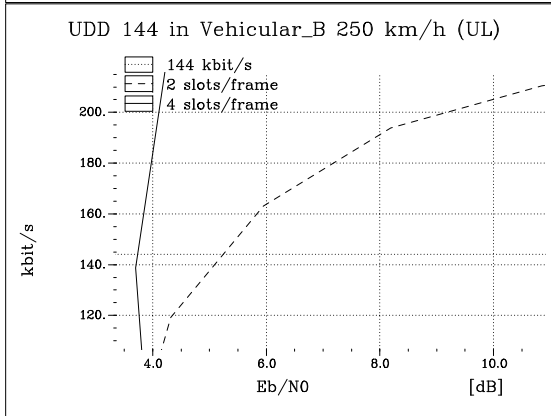
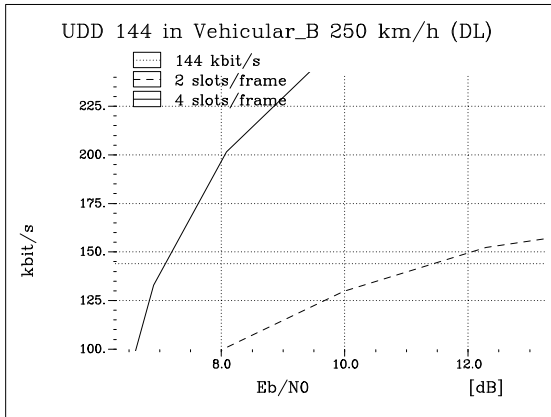
Parameters	Value(s)
Slot size	1/16
Modulation(s)	Bin-O-QAM
Number of slots used per frame	2, 4, 8, 16
Uncoded data block	2726
Coding rate	Variable
Basic code	CC(1,2,9)
Interleaving depth	Over 8 bursts
Puncturing	Via hybrid-ARQ
Frequency hopping	Slot-by-slot
Mobile speed	120 km/h
Antenna diversity	UL: Yes, DL: No





7.5.3.4 UDD in ITU Vehicular_B

Parameters	Value(s)
Slot size	1/16
Modulation(s)	Bin-O-QAM
Number of slots used per frame	2, 4, 8, 16
Uncoded data block	2726
Coding rate	Variable
Basic code	CC(1,2,9)
Interleaving depth	Over 8 bursts
Puncturing	Via hybrid-ARQ
Frequency hopping	Slot-by-slot
Mobile speed	250 km/h
Antenna diversity	UL: Yes, DL: No

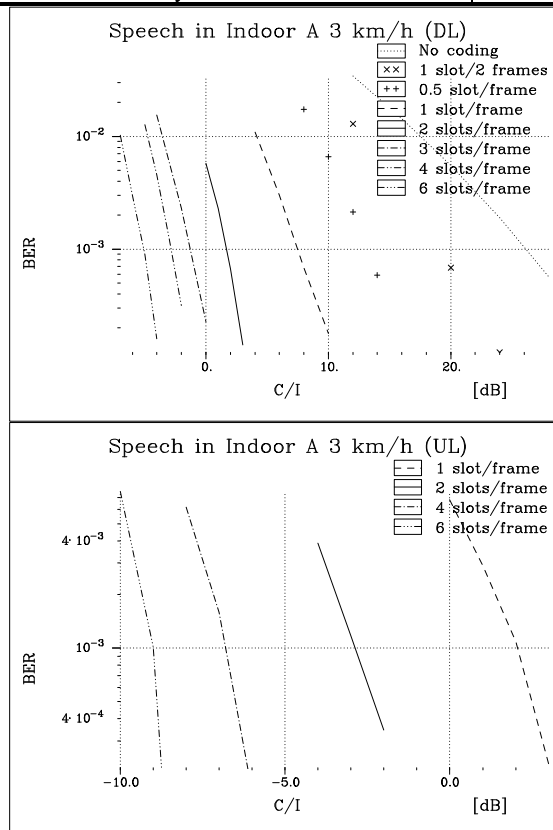


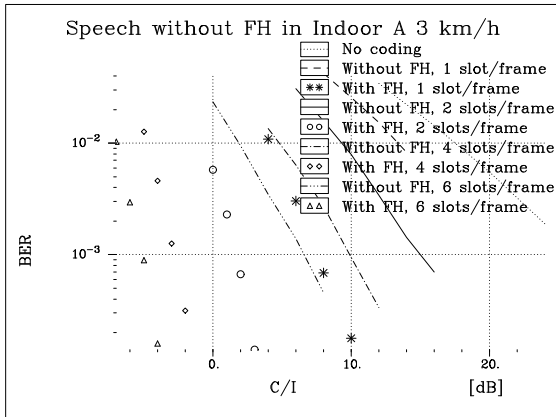
7.6 C/I simulation results

7.6.1 Speech

7.6.1.1 Speech in ITU Indoor_A

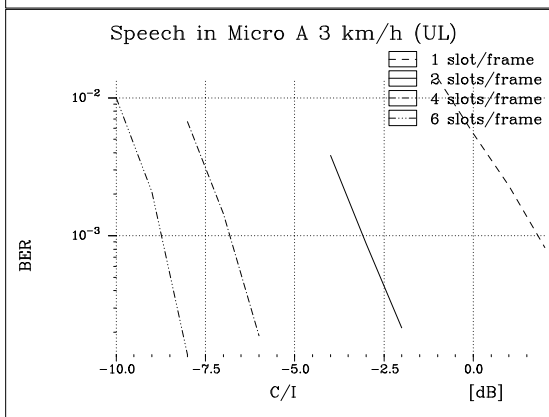
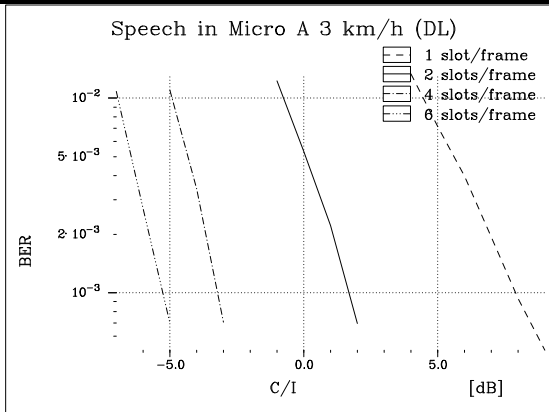
Parameters	Value(s)
Slot size	1/64
Modulation(s)	Bin-O-QAM
Number of slots used per frame	1, 2, 4, 6
Uncoded data block	150
Coding rate	0.26, 0.13, 0.07, 0.05
Basic code	CC(1,2,9)
Interleaving depth	Over 4 frames
Puncturing	Yes
Frequency hopping	Slot-by-slot
Mobile speed	3 km/h
Antenna diversity	UL: Yes, DL: No





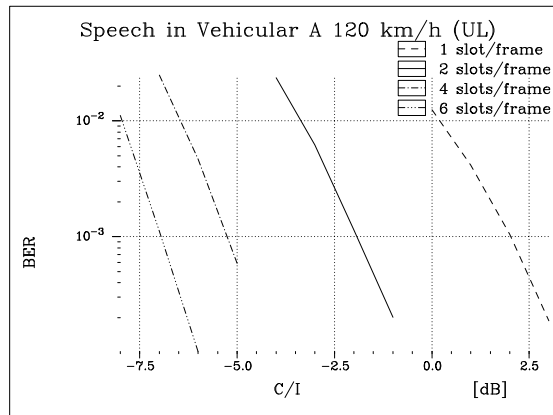
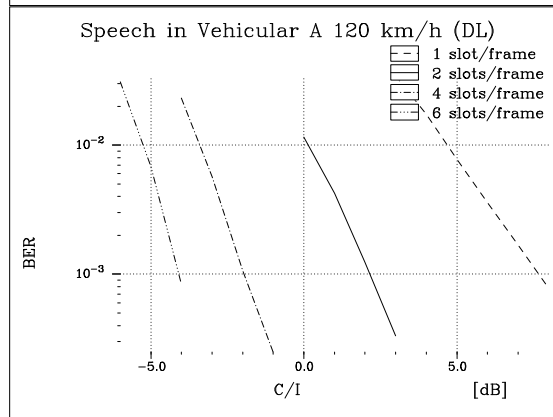
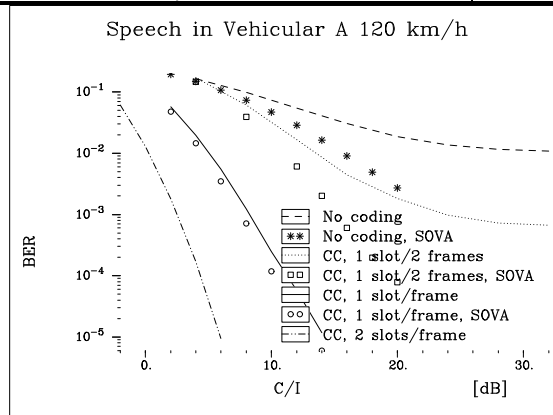
7.6.1.2 Speech in ITU Micro_A

Parameters	Value(s)
Slot size	1/64
Modulation(s)	Bin-O-QAM
Number of slots used per frame	1, 2, 4, 6
Uncoded data block	150
Coding rate	0.26, 0.13, 0.07, 0.05
Basic code	CC(1,2,9)
Interleaving depth	Over 4 frames
Puncturing	Yes
Frequency hopping	Slot-by-slot
Mobile speed	3 km/h
Antenna diversity	UL: Yes, DL: No



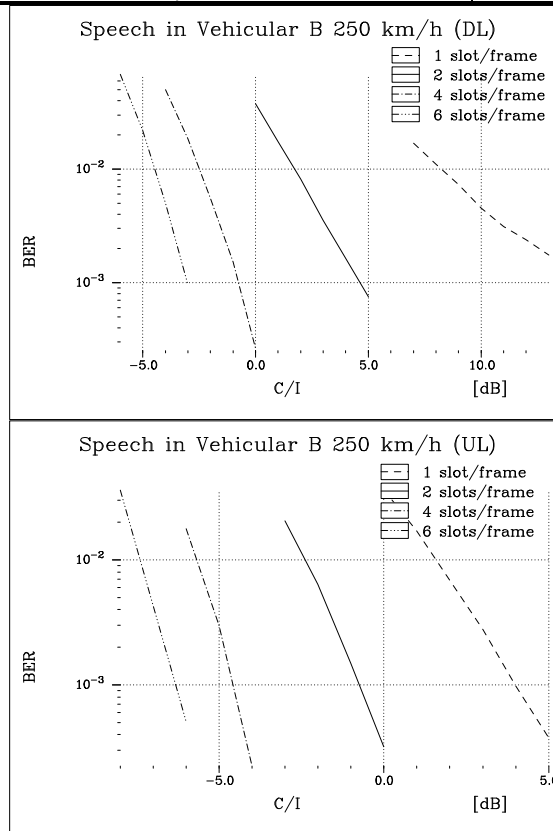
7.6.1.3 *Speech in ITU Vehicular_A*

Parameters	Value(s)
Slot size	1/64
Modulation(s)	Bin-O-QAM
Number of slots used per frame	1, 2, 3, 4, 6
Uncoded data block	150
Coding rate	0.26, 0.13, 0.09, 0.07, 0.05
Basic code	CC(1,2,5), CC(1,2,9)
Interleaving depth	Over 4 frames
Puncturing	Yes
Frequency hopping	Slot-by-slot
Mobile speed	120 km/h
Antenna diversity	UL: Yes, DL: No



7.6.1.4 Speech in ITU Vehicular_B

Parameters	Value(s)
Slot size	1/64
Modulation(s)	Bin-O-QAM
Number of slots used per frame	1, 2, 4, 6
Uncoded data block	150
Coding rate	0.26, 0.13, 0.07, 0.05
Basic code	CC(1,2,9)
Interleaving depth	Over 4 frames
Puncturing	Yes
Frequency hopping	Slot-by-slot
Mobile speed	250 km/h
Antenna diversity	DL: No, UL: Yes

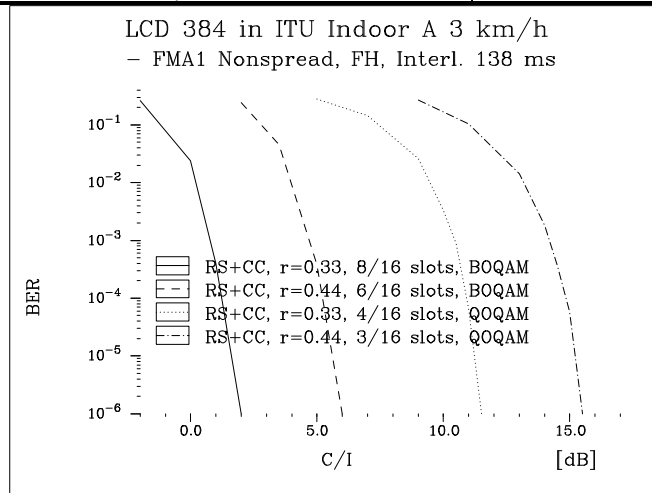


7.6.2 LCD

7.6.2.1 LCD 384 in ITU Indoor_A

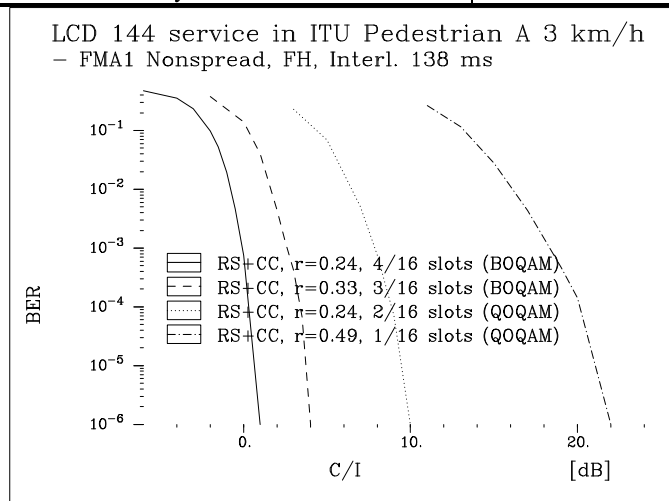
Parameters	Value(s)
Slot size	1/16
Modulation(s)	Quat-O-QAM, Bin-O-QAM
Number of slots used per frame	3, 4, 6, 8
User bitrate	390 kbit/s
Coding rate	0.33, 0.44
Basic code	CC(1,2,5), CC(1,3,5), RS-code
Interleaving depth	Over 30 frames
Puncturing	Yes
Frequency hopping	Slot-by-slot

Mobile speed	3 km/h
Antenna diversity	No



7.6.2.2 LCD 144 in ITU Micro_A

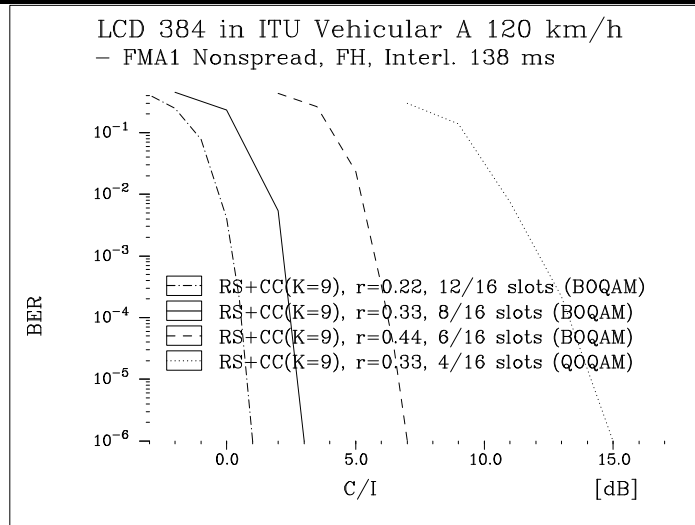
Parameters	Value(s)
Slot size	1/16
Modulation(s)	Quat-O-QAM, Bin-O-QAM
Number of slots used per frame	1, 2, 3, 4
User bitrate	145.6 kbit/s
Coding rate	0.24, 0.33, 0.49
Basic code	CC(1,2,5), CC(1,3,5), CC(1,4,5), RS-code
Interleaving depth	Over 30 frames
Puncturing	Yes
Frequency hopping	Slot-by-slot
Mobile speed	3 km/h
Antenna diversity	No



7.6.2.3 LCD 384 in ITU Vehicular_A

Parameters	Value(s)
Slot size	1/16
Modulation(s)	Quat-O-QAM, Bin-O-QAM

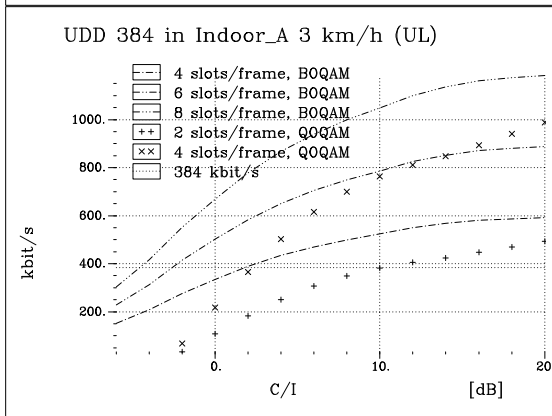
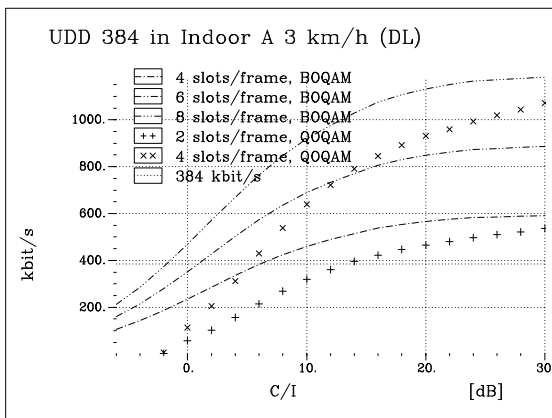
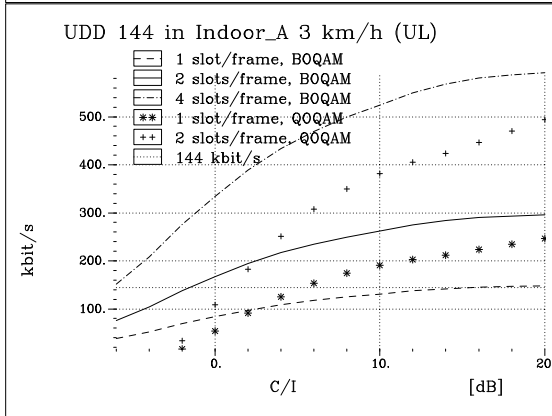
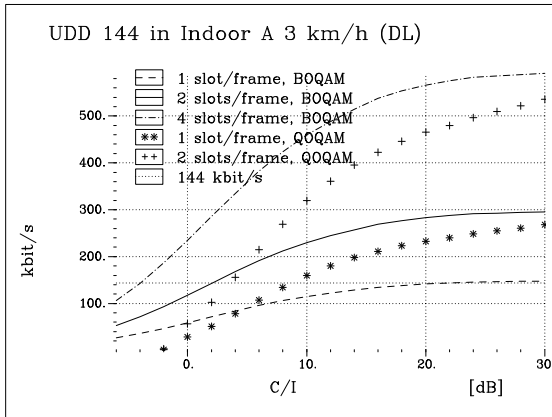
Number of slots used per frame	4, 6, 8, 12
User bitrate	390 kbit/s
Coding rate	0.22, 0.33, 0.44
Basic code	CC(1,2,5), CC(1,3,5), CC(1,4,5), RS-code
Interleaving depth	Over 30 frames
Puncturing	Yes
Frequency hopping	Slot-by-slot
Mobile speed	120 km/h
Antenna diversity	No

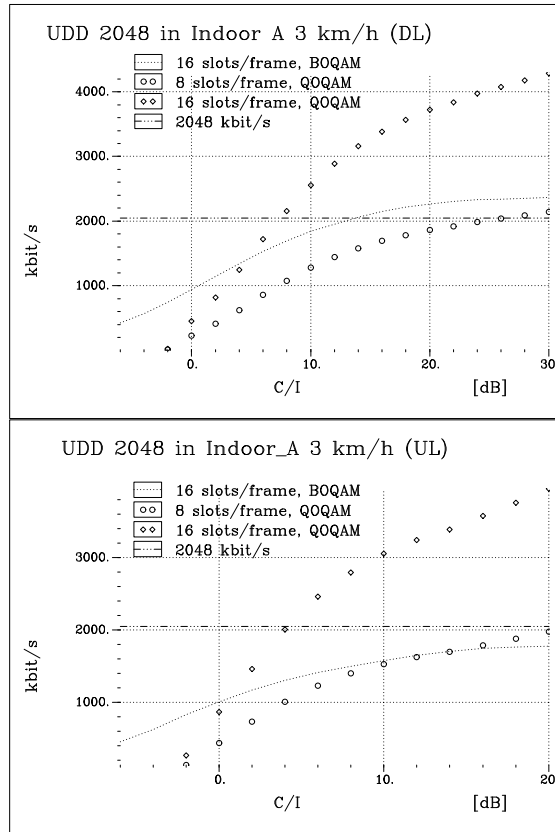


7.6.3 UDD

7.6.3.1 UDD in ITU Indoor_A

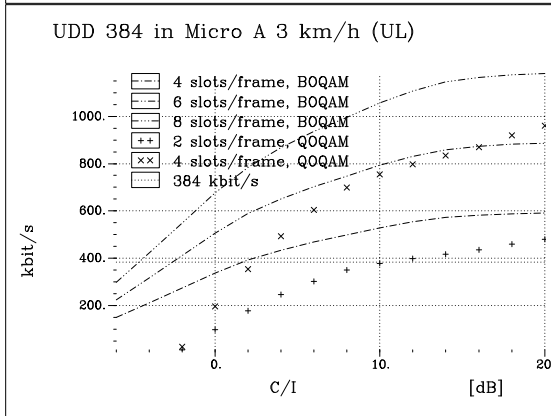
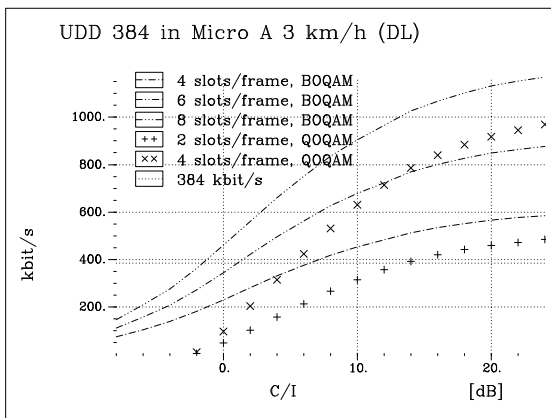
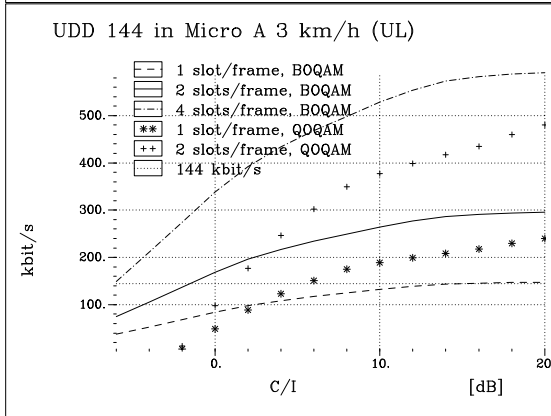
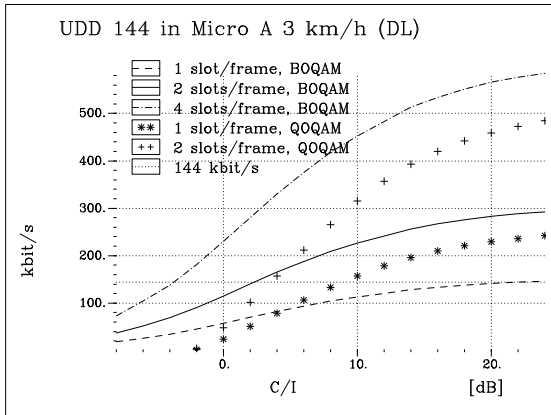
Parameters	Value(s)
Slot size	1/16
Modulation(s)	Bin-O-QAM and Quat-O-QAM
Number of slots used per frame	1, 2, 4, 6, 8, 16
Uncoded data block	2726
Coding rate	Variable
Basic code	CC(1,2,9)
Interleaving depth	Over eighth bursts
Puncturing	Via hybrid-ARQ
Frequency hopping	Slot-by-slot
Mobile speed	3 km/h
Antenna diversity	UL: Yes, DL: No

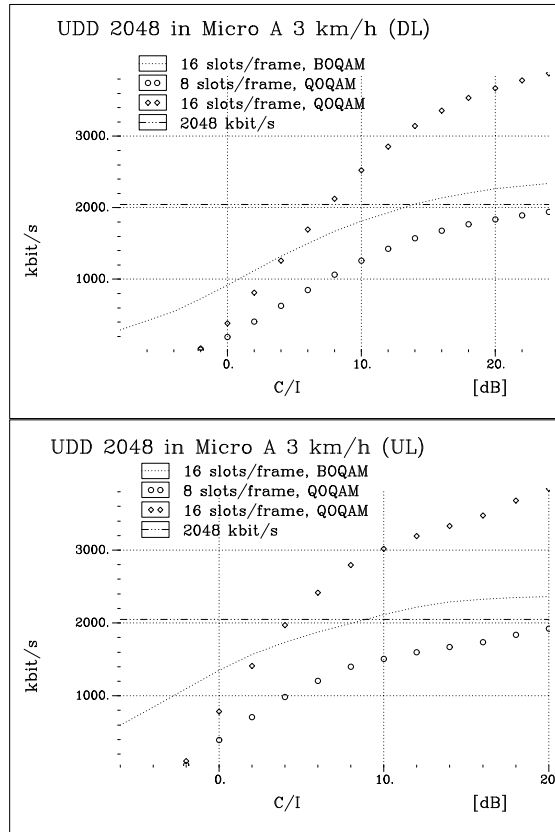




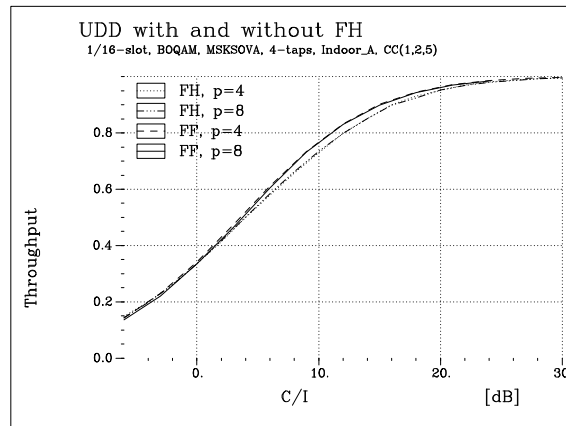
7.6.3.2 UDD in ITU Micro_A

Parameters	Value(s)
Slot size	1/16
Modulation(s)	Bin-O-QAM and Quat-O-QAM
Number of slots used per frame	1, 2, 4, 6, 8, 16
Uncoded data block	2726
Coding rate	Variable
Basic code	CC(1,2,9)
Interleaving depth	Over 8 bursts
Puncturing	Via hybrid-ARQ
Frequency hopping	Slot-by-slot
Mobile speed	3 km/h
Antenna diversity	UL: Yes, DL: No





Effect of frequency hopping can be illustrated by following simulations. In the sense of the throughput frequency hopping decreases the performance about 0.7 dB.



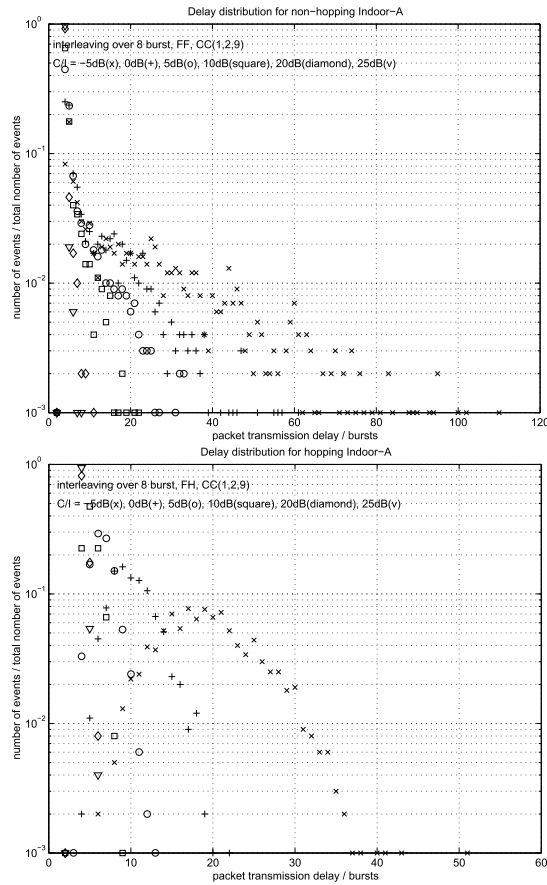
ARQ with (FH) and without (FF) frequency hopping.

However the throughput is not the only measure for packet service quality. It is also beneficial that ARQ-scheme does not produce very high occasional delay. In this sense frequency hopping improves the performance and it also helps to average the interference caused to other users.

Without frequency hopping there occasionally are longer delays for individual packets. However, because the average delays in these two cases are about the same, there are also low delays in the non-hopping case.

In indoor_A channel delays over 10 bursts (~46 ms) were not present if C/I was over 10 dB. With C/I = 0 dB the maximum delay is measured to be 20 bursts (less than 100 ms). Without frequency hopping maximum delays at C/I of 10 dB can exceed 20 bursts and with C/I = 0 dB maximum delays can exceed

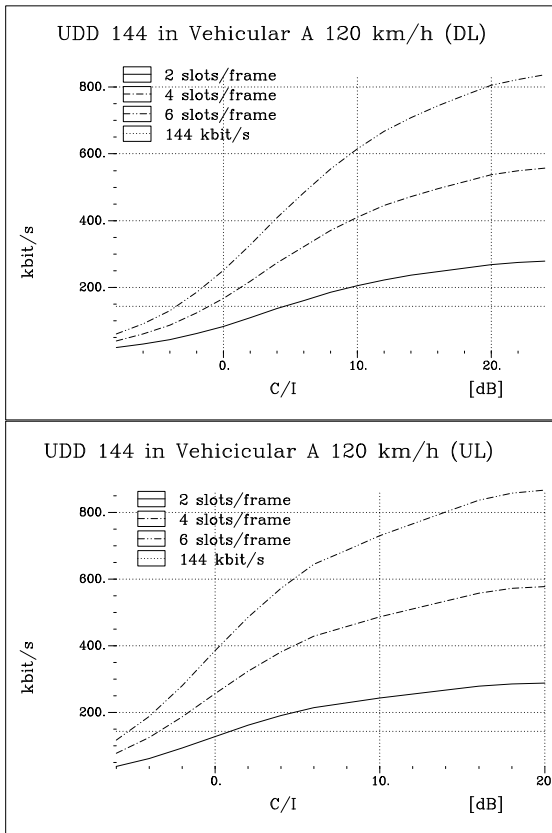
60 bursts (~ 280 ms). In the non-hopping case the delay distribution has longer tail than in the hopping case.

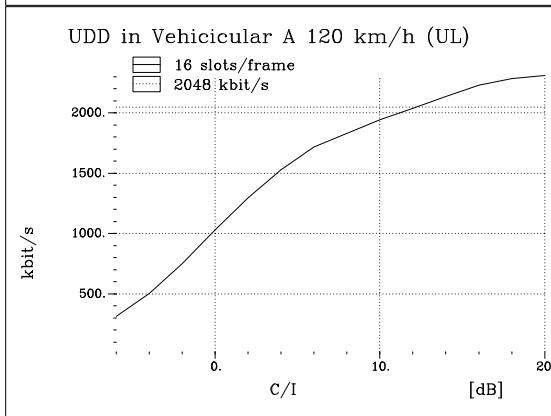
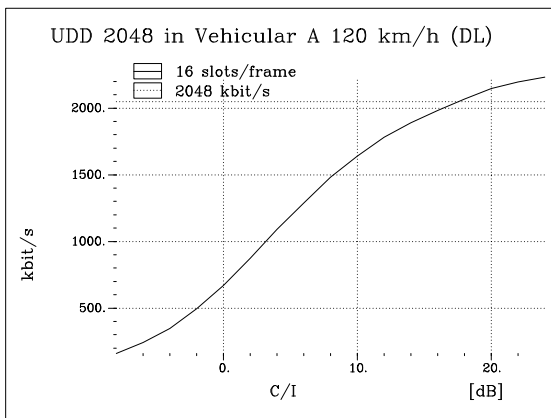
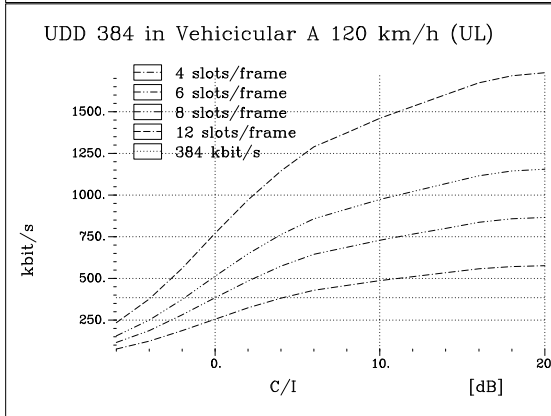
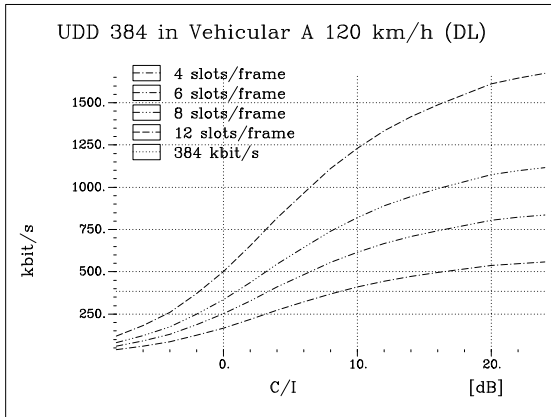


Delay distribution for non-hopping and hopping UDD

7.6.3.3 UDD in ITU Vehicular_A

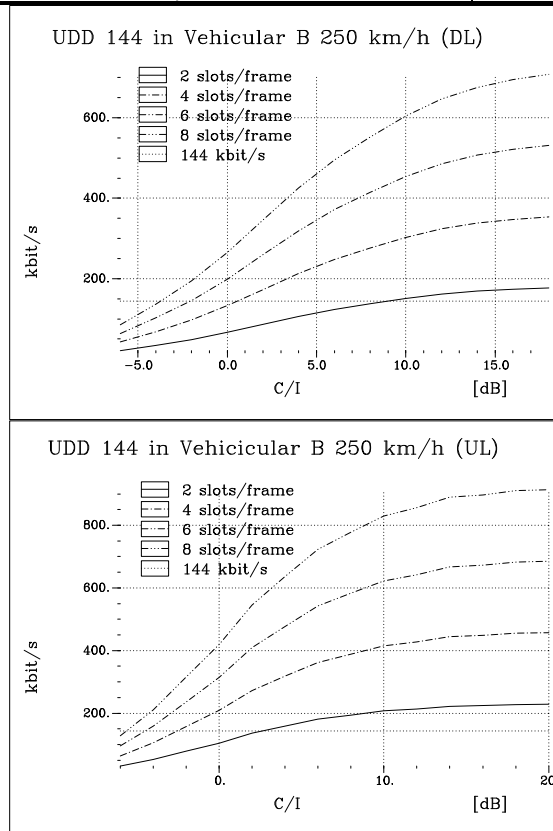
Parameters	Value(s)
Slot size	1/16
Modulation(s)	Bin-O-QAM and Quat-O-QAM
Number of slots used per frame	2, 4, 6, 8, 12, 16
Uncoded data block	2726
Coding rate	Variable
Basic code	CC(1,2,9)
Interleaving depth	Over 8 bursts
Puncturing	Via hybrid-ARQ
Frequency hopping	Slot-by-slot
Mobile speed	120 km/h
Antenna diversity	UL: Yes, DL: No

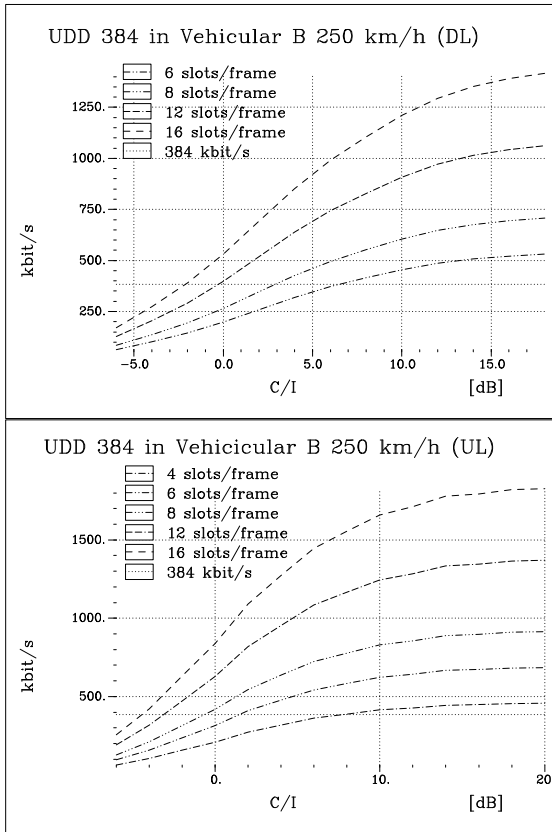




7.6.3.4 UDD in ITU Vehicular_B

Parameters	Value(s)
Slot size	1/16
Modulation(s)	Bin-O-QAM and Quat-O-QAM
Number of slots used per frame	2, 4, 6, 8, 12, 16
Uncoded data block	2726
Coding rate	Variable
Basic code	CC(1,2,9)
Interleaving depth	Over 8 bursts
Puncturing	Via hybrid-ARQ
Frequency hopping	Slot-by-slot
Mobile speed	250 km/h
Antenna diversity	UL: Yes, DL: No





7.6.4 Coverage Analysis

The coverage of WB-TDMA is analysed in the table below and compared to the range of GSM900 and GSM1800. This analysis is based on the WB-TDMA link level simulation against Gaussian noise.

Table 7-2 : WB-TDMA coverage calculations for speech service

WB-TDMA coverage analysis for speech service											
		WB-TDMA		WB-TDMA		WB-TDMA		GSM1800		GSM900	
		Downlink	Uplink	Downlink	Uplink	Downlink	Uplink	Downlink	Uplink	Downlink	Uplink
Test environment		Indoor	Indoor	Pedestr.	Pedestr.	Vehicular	Vehicular	Vehicular	Vehicular	Vehicular	Vehicular
Multipath channel class		A	A	A	A	A	A				
Test service		Speech	Speech	Speech	Speech	Speech	Speech	Speech	Speech	Speech	Speech
Number of slots used / frame		6	6	6	6	6	6	1	1	1	1
Total number of slots / frame		64	64	64	64	64	64	8	8	8	8
Bit rate	bit/s	8000,00	8000,00	8000,00	8000,00	8000,00	8000,00	13000,00	13000,00	13000,00	13000,00
Maximum peak power limitation	dBm		30,00		30,00		30,00		30,00		33,00
Average TX power per traffic ch. (ETR0402)	dBm	10,00	4,00	20,00	14,00	30,00	24,00	30,00	24,00	30,00	24,00
Maximum TX power per traffic ch.	dBm	20,28	14,28	30,28	24,28	40,28	30,00	39,03	30,00	39,03	33,00
Average TX power per traffic ch. (real)	dBm	10,00	4,00	20,00	14,00	30,00	19,72	30,00	20,97	30,00	23,97
Maximum total TX power	dBm	20,28	14,28	30,28	24,28	40,28	30,00	39,03	30,00	39,03	33,00
Cable, conn. and combiner losses	dB	2,00	0,00	2,00	0,00	2,00	0,00	2,00	0,00	2,00	0,00
TX antenna gain	dBi	2,00	0,00	10,00	0,00	13,00	0,00	13,00	0,00	13,00	0,00
TX EIRP per traffic channel	dBm	20,28	14,28	38,28	24,28	51,28	30,00	50,03	30,00	50,03	33,00
Total TX EIRP	dBm	20,28	14,28	38,28	24,28	51,28	30,00	50,03	30,00	50,03	33,00
RX antenna gain	dBi	0,00	2,00	0,00	10,00	0,00	13,00	0,00	13,00	0,00	13,00
Cable and connector losses	dB	0,00	2,00	0,00	2,00	0,00	2,00	0,00	2,00	0,00	2,00
Receiver noise figure	dB	5,00	5,00	5,00	5,00	5,00	5,00	5,00	5,00	5,00	5,00
Thermal noise density	dBm/Hz	-174,00	-174,00	-174,00	-174,00	-174,00	-174,00	-174,00	-174,00	-174,00	-174,00
RX interference density	dBm/Hz	-1000,00	-1000,00	-1000,00	-1000,00	-1000,00	-1000,00	-1000,00	-1000,00	-1000,00	-1000,00
Total effect. noise + interf. density	dBm/Hz	-169,00	-169,00	-169,00	-169,00	-169,00	-169,00	-169,00	-169,00	-169,00	-169,00
Information rate (during tx)	dBHz	49,31	49,31	49,31	49,31	49,31	49,31	50,17	50,17	50,17	50,17
Required Eb/(No+I _o)	dB	8,40	5,90	8,60	5,90	8,70	6,60	12,00	12,00	12,00	12,00
RX sensitivity	dB	-111,29	-113,79	-111,09	-113,79	-110,99	-113,09	-106,83	-106,83	-106,83	-106,83
Handoff gain	dB	4,10	4,10	3,00	3,00	3,00	3,00	3,00	3,00	3,00	3,00
Explicit diversity gain	dB	0,00	0,00	0,00	0,00	0,00	0,00	0,00	4,50	0,00	4,50
Other gain	dB	0,00	0,00	0,00	0,00	0,00	0,00	0,00	0,00	0,00	0,00
Log-normal fade margin	dB	15,40	15,40	11,30	11,30	11,30	11,30	11,30	11,30	11,30	11,30
Maximum path loss	dB	120,27	116,77	141,07	137,77	153,97	145,79	148,56	144,03	148,56	147,03
Maximum range	m	596,54	456,01	669,85	553,96	4875,37	2954,25	3500,77	2652,54	5374,45	4893,49

The maximum range of WB-TDMA for speech service is longer than the range of GSM1800 speech service.

It should be noticed that the coverage analysis for speech service is based on 6 slot transmission. Those other 58 slots in a TDMA frame in that carrier can be used to support other users and this does not affect the range of the 6-slot user. For example, if other users take 1 slot/frame on average, 58 other users can be supported with one 1.6 MHz carrier while still providing the maximum range for one user. If this WB-TDMA scheme is compared to other proposals with e.g. 5 MHz bandwidth, then total of 3 WB-TDMA carriers can be used at the same bandwidth to support even a higher number of users while providing the maximum range. This implies that the intra-cell interference does not reduce the coverage area of WB-TDMA and the coverage of cellular WB-TDMA network is fairly insensitive to the traffic load.

It should also be noticed that the average transmission power in Vehicular environment is 4.3 dB lower than the maximum average power given in ETR0402. This is due to the limitation set on the MS peak power. The lower average power also implies lower power consumption of the mobile station power amplifier at the cell edge.

The handoff gain in the table above is an estimated figure which should be verified by simulations. The current assumption is that the hard handoff gain is 2.0 dB lower than the soft handoff gain in the alpha group assumptions. In case of a single cell the handoff gain would be 0.0 dB in both concept groups.

7.6.5 Discussion

These simulations have been done with FDD assumption. To some extent these results can be generalised to show the performance for TDD mode. Detailed TDD simulations would be needed to evaluate the TDD specific features such as flexibility for resource allocation in up- and downlink and utilisation of asymmetric spectrum allocations.

7.6.6 References

- [1] ETSI SMG2 UMTS ad hoc #3 TDoc 73, Rennes, 1997.
- [2] ETR0402 "Selection procedure for the choice of radio technologies of UMTS"

7.7 System Level Simulations

7.7.1 Introduction

This chapter describes the executed system level simulations and the assumptions used in them. The simulated system is WB-TDMA utilizing the Interference Averaging (IA) concept. The main features of the IA-concept are frequency hopping on the whole operator bandwidth, time hopping, link adaptation, type II hybrid ARQ and quality based Handover (HO). Frequency Hopping (FH) and Time Hopping (TH) provide interference averaging and Link Adaptation (LA) provides interference diversity which are the cornerstones of the scheme.

7.7.2 Basic assumptions

Only the *downlink* direction is considered. It is expected that downlink will be the capacity limiting direction. Advanced receiver techniques such as antenna diversity can be used in the uplink to make its capacity exceed that of the downlink. Additionally, the locations of the interfering transmitters (mobile stations) will also change providing more interference diversity gain through FH and TH in the uplink. Hence the lower limit for performance is presented.

In the following the major assumptions that have effect on the performance are presented.

7.7.2.1 General models

All test environments, propagation models, mobility models and quality of service (QoS) criteria for Real Time (RT) and Non real time users are modeled according to [1]. In addition if a user receives all requested bits within 150 ms the user is regarded as a satisfied user.

7.7.2.2 Channel allocation

Channels are allocated frame by frame independently in each BTS. RT services are prioritized over NRT services. Channel allocation for RT services is based on 'first come first served' principle. Within NRT services users having difficulties to maintain the minimum bit rate and NRT users with lowest transmitted power per slot are prioritized over the rest of the NRT users.

For channel allocation, a channel matrix for each BTS is defined. It contains $f \times t$ slots, where f is the amount of frequencies available for the BTS and t is the amount of slots in one FMA1 frame. A channel separation of 1.6 MHz is used, thus the maximum size for the channel matrix is nine frequencies and 64 or 16 time slots for 1/64 and 1/16 slots structures respectively. However, to speed up simulations with some simulation cases less frequencies and/or time slots have been used. The amount of used frequencies and time slots in each simulation case are indicated together with the simulation results. Use of less frequencies and time slots (smaller channel matrix) in the simulation than the maximum number available on the band causes less diversity and more blocking, thus this is a pessimistic assumption and worse performance is obtained.

7.7.2.3 Frequency and time hopping

Random uncorrelated memoryless frequency hopping is applied. The random hopping introduces interference diversity, uncorrelated means that the channel fading of different frequencies are uncorrelated, memoryless means that each frequency has the same probability to be chosen regardless of the previously used frequencies. As an example; if nine frequencies are used in a BTS, there is 1/9 probability that two consecutive slots of one particular connection use same frequency. For time hopping there are no restrictions which time slots a terminal can use. User carrier and interfering carrier are slot synchronized but this is not utilized in the simulations, e.g. by joint detection.

7.7.2.4 Power control

Slow pathloss based power control is applied. The dynamic range of the power control is 30 dB or less. The dynamic range for each simulation case is given in chapter 3.

7.7.2.5 Handover

Simple pathloss based handover with hand over margin of 3 dB is used, i.e., handover is performed to a new base station if the pathloss to the new base station is 3 dB lower than to the serving base station. In indoor simulations, HO to a BTS in a different floor is prohibited. Taking into account very high standard deviation (12 dB) for indoor slow fading, this probably has a negative effect to the capacity.

7.7.2.6 Link Adaptation

For RT users quality based link adaptation is used. The channel coding rate is increased when the connection experiences a bad frame and if the serving BTS has extra radio resources available. Amount of channel coding will be decreased if less channel coding would have continuously been sufficient for certain amount of frames. If needed, LA can be done at the beginning of an interleaving period.

For NRT the link adaptation is performed with type II hybrid ARQ, thus the coding rate depends on the amount of retransmissions. The modulation is kept constant over the whole simulation.

7.7.2.7 Type II hybrid ARQ

In the used ARQ scheme user data is coded with $\frac{1}{2}$ -rate convolution code and interleaved over 4 bursts. The interleaving is done in a such way that decoding is possible after two of four bursts have been received. Thus the effective coding rate is one. If the decoding is not successful third burst is sent and decoding is redone. After third burst the coding rate is $\frac{2}{3}$. If the decoding is still not successful fourth burst is sent and decoding is done again, now with the coding rate of $\frac{1}{2}$. If the decoding is still not successful, the burst with the lowest $C/(I+N)$ value is resent and the original burst and the retransmitted burst are combined by adding their $C/(I+N)$ values (maximal ratio combining). This repetition coding is repeated until the decoding is successful.

7.7.2.8 DTX

Radio resources of speech user are released during the DTX period. If there are no resources available after the DTX period bit error rate of 0.5 is applied until resources are allocated or the user is dropped.

7.7.2.9 Modulation adaptation

Simple modulation adaptation algorithm is used for UDD services. Preferred modulation is Q-O-QAM but B-O-QAM is used for small packets.

7.7.2.10 Frequency Planning

A characteristic feature of the simulated IA concept is very simple frequency planning with frequency re-use 1. Thus all the frequencies can be used at each base station. Through fractional loading the load in each cell is always less than 100%. Due to fixed antenna pattern in [1], reuse 1/3 is used in vehicular environment (macro).

7.7.2.11 Interface between system and link level simulation

Link level simulation and system level simulations are connected to each other by using the actual value interface [2]. The actual value interface makes it possible to simulate fast radio resource algorithms on the system level. The actual value interface also increases the simulation realism considerably.

The actual value interface is a novel way to connect link and system level simulations. In the actual value approach the link level simulation data e.g. bit errors are measured for every burst or frame. This means however, that possible de-interleaving and decoding has to be considered on the system level. The performance of receiver algorithms, such as decoding, are not measured or analyzed in the system level simulations, but their performance is considered on the link level. The effect of receiver algorithms is seen in the link level results that are given as inputs to the system level simulation.

If the system level simulation is done with an actual value interface, fast fading has to be taken into account in addition to slow fading and pathloss. With the average value interface fast fading was neglected, since the input from the link level and correspondingly the channel was averaged over a long

period (and the fast fading characteristics were included on the link level). With the actual value interface, non-averaged link level simulations are used. Thus fast fading has to be considered on the system level. The same kind of correlated fading process is used both in link- and system level simulations, modeled as Rayleigh, with a certain Doppler frequency.

The strength of an actual value interface, compared to the average value interface, is that all the radio resource management algorithms can be simulated on the system level accurately since the simulation resolution is as accurate as the resolution of the mentioned algorithms. The actual value interface enables possible gain or loss of frequency hopping, ARQ and link adaptation algorithms. If frequency hopping was simulated on the link level and the average value interface was used, interference diversity gain could not be modeled. This is because in the link level simulations only interfering user(s) operating with the same frequency as the observed user can be considered. Correspondingly, if ARQ was simulated on the link level, the varying interference conditions that have their impacts to ARQ performance could not be taken into account. Link adaptation can be simulated thoroughly only on the system level since adaptation decisions depend only on the changing interference conditions. If the link adaptation algorithm was fast the average value interface could not be used.

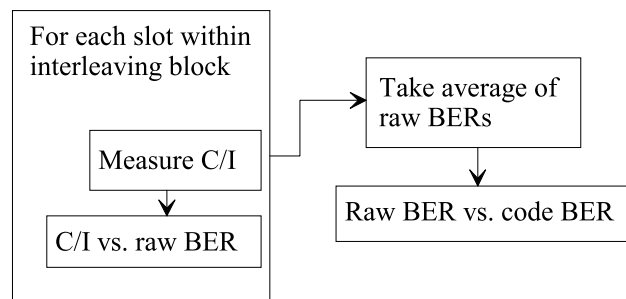


Figure 1. Block diagram of interface for RT bearers.

The selected interface for FMA1 is similar as presented in [3]. In [3], however, no fast fading is used in system level. An actual value interface for GSM is presented in [4] to take into account interference and frequency diversity. The accuracy of this interface has been tested in [4] also with different number of hopping frequencies available.

In the method presented here, link level simulation results are collected on a burst-by-burst basis, i.e. C/I and BER values are collected for each burst and coded BER/FER values for each interleaving period. E.g. if the target service has interleaving over 4 bursts, then C/I values for 4 bursts are observed directly from the fading channel and BER/FER of the coding block is measured over the interleaving period. In the link level simulation raw BER (BER before decoding and de-interleaving) versus C/I ratio is measured for each burst within the interleaving block. In the system level the C/I ratio is measured for each burst within the interleaving block and is mapped to raw BER by using a *raw BER vs. C/I curve* from the link level. De-interleaving is modeled so that the average raw BER within the interleaving block is calculated. Further, decoding is modeled by mapping the de-interleaved raw BER to the coded BER/FER by using the measured *mean raw BER vs. coded BER/FER curve*. The actual value interface for FMA1 is depicted in Figure 1, C/I vs. raw BER curve in Figure 2a and mean raw BER vs. coded BER curve in Figure 2b.

7.7.3 Results

Simulation results are collected to Table 1. Detailed description of the simulations carried out are presented in the following chapters.

Table 1. Summary of the system simulations results

Environment	Service	Capacity [kbps/MHz/cell]	Notes
Outdoor to indoor	UDD384	811	

pedestrian			
	Speech	190	
Indoor	UDD2048	332	
	Mixed	60	<i>Preliminary result</i>
Indoor‘with walls’	UDD2048	743	<i>Wall attenuation 5 dB</i>
Vehicular	Speech	55	
	LCD384	113	

7.7.3.1 Micro cell

7.7.3.1.1 UDD384

The simulated Spectrum efficiency is **811 kbps/MHz/cell**. Of all sessions 99.7% fulfill all quality criteria. Dropping is the major reason for not fulfilling all quality criteria, the bad quality criterion has not any practical effects.

The average active session throughput is 405 kbps and 46 % of the sessions have active session throughput 384 kbps or higher. The respective ratios for 512 kbps, 1Mbps and 2Mbps are 24%, 3.1% and 0.25%. Thus higher bit rate are also possible in outdoor to indoor pedestrian environment. The distribution of active session throughputs can be seen in Figure 1. Reuse 1 is used with fractional load of 79%. In Figure 2 histogram for needed transmissions per a hybrid II ARQ packet is presented.

With micro cell UDD384 simulations the channel matrix is 16 time slots x 5 frequencies due to simulation complexity reasons (9 frequencies could have been used). Thus channel diversity gain and specially the statistical multiplexing gain is reduced. The preferred modulation is Q-O-QAM, but the modulation is switched to B-O-QAM if offer traffic does not require Q-O-QAM. If less bits that can be transmitted in one radio packet are sent, the radio packet is filled with dummy bits. These overhead dummy bits are not included into spectrum efficiency nor into active session throughput. The dynamic range for the power control is 30 dB.

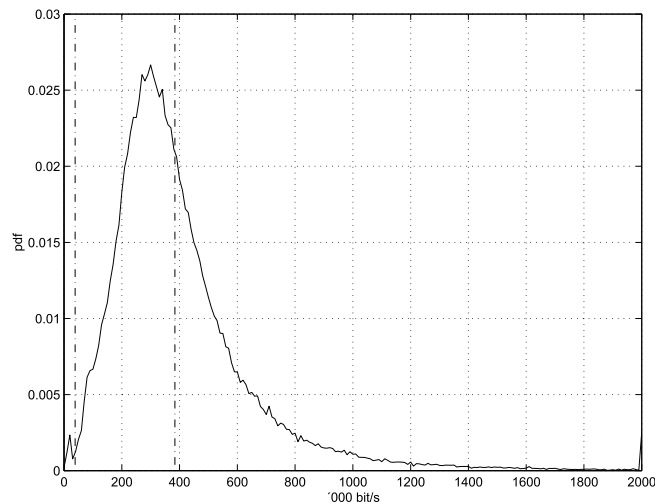


Figure 1. Histogram for session throughputs

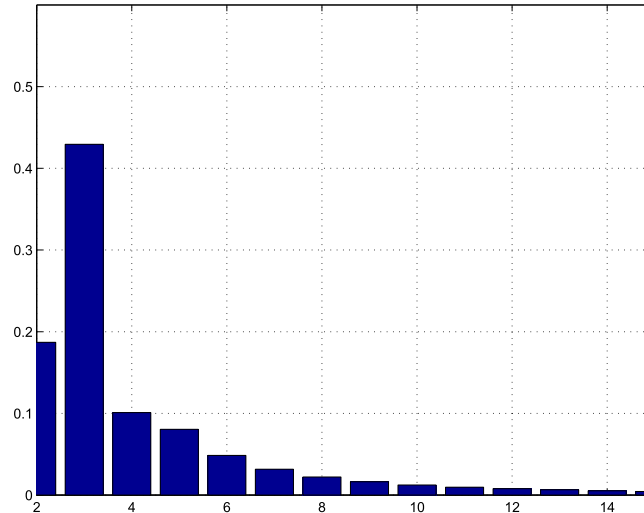


Figure 2. Histogram for needed transmissions per hybrid II ARQ packet. Both Q-O-QAM and B-O-QAM packet are included.

7.7.3.1.2 Speech

The simulated capacity is **190 kbps/MHz/cell**. Then the blocking and dropping are ca. 0 and bad quality is ca. 2 %. Thus quality requirements are fulfilled with that loading. An user uses in average 1.12 slots per frame when it is active. The developed fractional cell loading was 65 % in the six middle cells. The used power dynamics was 30 dB.

With micro cell speech simulations the matrix was 16 time slots x 9 frequencies. In reality the number of time slots would be 64. Only 16 time slots were used in order to reduce simulation time. Thus less diversity is obtained and more blocking happens which leads to that the simulated capacity becomes lower than with the full channel matrix.

7.7.3.2 Indoor

7.7.3.2.1 UDD2048

The simulated spectrum efficiency is **332 kbps/MHz/cell**. Of all sessions 98.4 % fulfill quality criteria. If all bits user requests during a session are received correctly within 150 ms, the user is regarded as satisfied user independent of active bit rate. Insufficient active session throughput is the limiting reason for most sessions not fulfilling the performance criteria.

The average active session throughput is 713 kbps and 0.4 % of the sessions have active session throughput 2048 kbps or higher. If offered load is reduced the average active session throughput and ratio of the users having active session throughput 2048 kbps or higher increases. Reuse 1 is used with fractional load of 48%. The distribution of active session throughputs can be seen in Figure 3. In Figure 4 histogram for needed transmissions per a hybrid II ARQ packet is presented.

With pico cell UDD2048 simulations the channel matrix was 16 time slots x 9 frequencies. The preferred modulation is Q-O-QAM, but the modulation is switched to B-O-QAM if offer traffic does not require Q-O-QAM. If the BTS buffer has less bits that can be transmitted in a one radio packet, the radio packet is filled with dummy bits. These overhead dummy bits are not included into spectrum efficiency nor into active session throughput. The dynamic range of the power control is 30 dB.

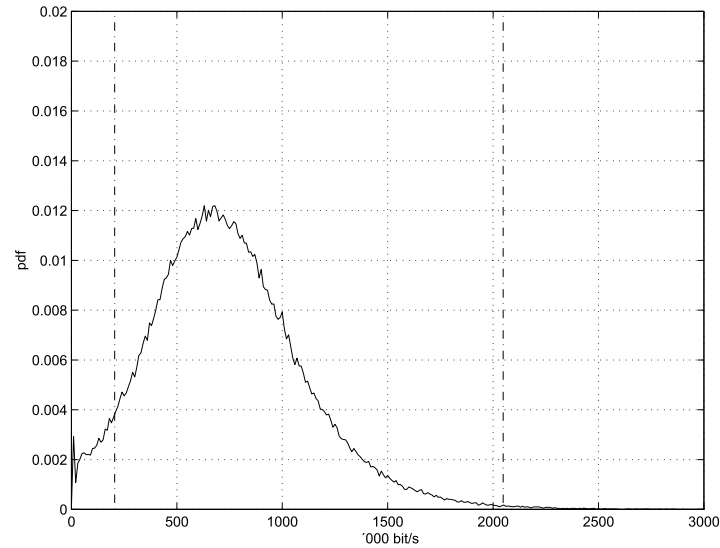


Figure 3. Histogram for session throughputs.

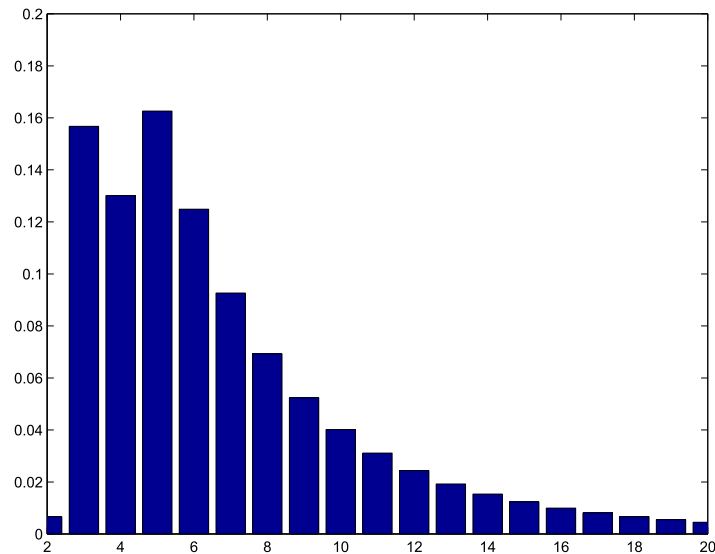


Figure 4. Histogram for needed transmissions per hybrid II ARQ packet. Both Q-O-QAM and B-O-QAM packet are included.

7.7.3.2.2 Mixed

The simulated spectrum efficiency is **60 kbps/MHz/cell**. Of all speech user 99 % and 99.8% of all NRT384 sessions fulfill quality criteria. Thus the presented result is *very preliminary* result. With mixed speech and UDD384 simulation channel matrix of 9 frequencies and 16 times slots is used. According to ETSI definitions 50% of the ongoing users are speech users and the other 50 % are UDD384 users. Taking into account that the mean holding time for UDD384 users depends on the network load, the analytical birth processes can not be derived. Instead one birth process is used for both services and the probability of the service of the new user depends on the ratio of speech and UDD384 users.

7.7.3.2.3 Indoor with walls

Indoor model defined in [1] has hardly any isolation between cells in same floor. Therefore additional simulations with walls are carried out. UDD2048 simulation with walls is otherwise identical to

UDD2048 simulation without walls presented in this paper, expect it has additional wall attenuation of 5 dB and standard deviation of slow fading is reduced from 12 dB to 4 dB.

The simulated spectrum efficiency is **743 kbps/MHz/cell**. Of all sessions 98.7 % fulfill quality criteria. If all bits user requests during a session are received correctly within 150 ms, the user is regarded as satisfied user independent of active bit rate. Insufficient active session throughput is the limiting reason for most sessions not fulfilling the performance criteria.

The average active session throughput is 692 kbps and 0.4 % of the sessions have active session throughput 2048 kbps or higher. If offered load is reduced the average active session throughput and ratio of the users having active session throughput 2048 kbps or higher increases. Reuse 1 is used with fractional load of 86 %. The distribution of active session throughputs can be seen in Figure 5. In Figure 6 histogram for needed transmissions per a hybrid II ARQ packet is presented.

With pico cell UDD2048 simulations the channel matrix was 16 time slots x 8 frequencies. The preferred modulation is Q-O-QAM, but the modulation is switched to B-O-QAM if offer traffic does not require Q-O-QAM. If the BTS buffer has less bits that can be transmitted in a one radio packet, the radio packet is filled with dummy bits. These overhead dummy bits are not included into spectrum efficiency nor into active session throughput. The dynamic range of the power control is 30 dB.

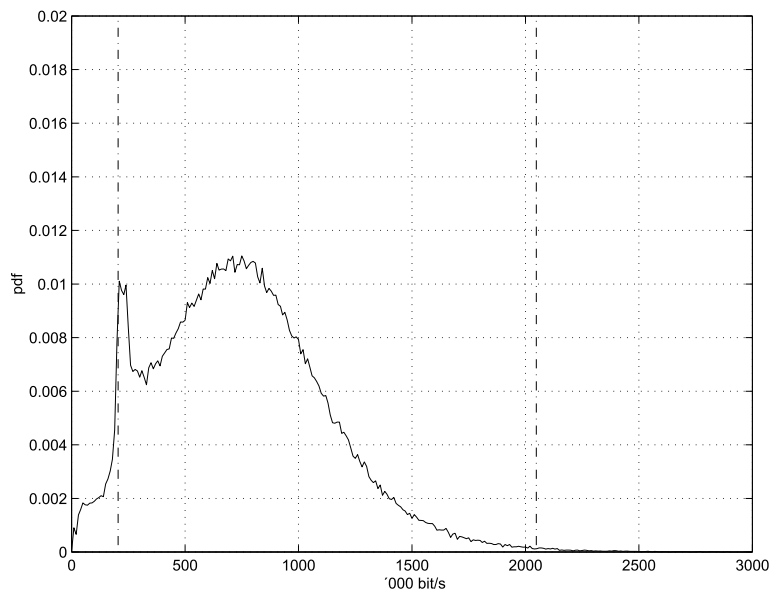


Figure 5. Histogram for session throughputs.

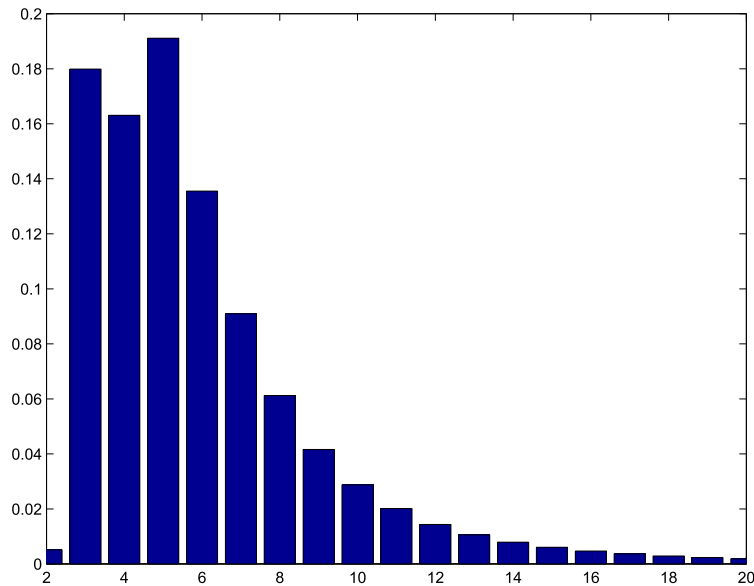


Figure 6. Histogram for needed transmissions per hybrid II ARQ packet. Both Q-O-QAM and B-O-QAM packet are included.

7.7.3.3 Macro cell

7.7.3.3.1 Speech

The simulated capacity is **55 kbps/MHz/cell**. Then the blocking and dropping is less than 1 % and bad quality is less than 1 %. Thus quality requirements are fulfilled with that loading. An user uses in average 1.48 slots per frame when it is active. The average fractional cell loading was 72 % in the middle cells. The used power dynamics was 10 dB.

With macro cell speech simulations the matrix was 16 time slots x 3 frequencies, which indicates reuse 1/3. In reality the number of time slots would be 64. Only 16 time slots is used in order to reduce simulation time. Thus less diversity is obtained and more blocking happens which leads to that the simulated capacity becomes lower than with the full channel matrix.

7.7.3.3.2 LCD384

The simulated capacity is **113 kbps/MHz/cell**. In this simulation 98,1% of all users are satisfied, thus quality requirements are fulfilled with this loading. The used modulation is B-O-QAM and available link adaptation modes are 6/16, 8/16 and 12/16. With macro cell LCD384 simulations the matrix is 16 time slots x 9 frequencies, which indicates reuse 1/1. The average fractional cell loading is ca. 28 % in the middle cells. During the simulation, the ratio link adaptation modes (6/16, 8/16 and 12/16) were 11%, 36% and 52%, respectively.

7.7.4 Discussion

System simulation results for WB-TDMA are shown. The used RRM scheme is based on the interference averaging principle. In order to study the effects of fast algorithms such as ARQ and Frequency hopping, the interface between link and system level results is implemented according to [2].

The results present a lower bound case due to several reasons: downlink results are presented, all the possible enhancements by the interference averaging radio resource management algorithms are not implemented and network parameter optimization is not completed.

These simulations have been done with FDD assumption. To some extent these results can be generalized to show the trends also for the TDD mode. Detailed TDD simulations would be needed to evaluate the TDD specific features such as flexibility for resource allocation in up- and downlink and

utilization of asymmetric spectrum allocations. Also the link level results for TDD may be enhanced due to algorithms that make use of reciprocity of the channel.

The future improvements to be tested include several things. Among these are interference cancellation, antenna diversity, the application of ARQ to LCD data, better coding schemes (e.g. increased constraint length, optimal puncturing and concatenated codes), optimized mapping of user data into packets, fast power control and channel allocation to cells.

Future work will include the estimation of signaling overhead and degradation of the obtained capacity due to signaling. The estimated signaling load is less than 10 % of the capacity. **This load has not been subtracted from the presented capacity figures.**

The obtained simulation results show high capacity for the WB-TDMA system especially for UDD services. Main conclusions are:

- WB-TDMA with interference averaging is very promising alternative especially for non delay sensitive packet services.
- High capacities can be provided without extensive frequency and network management
- Since WB-TDMA has hardly any intra cell interference and reuse 1 can be applied, additional inter cell interference management and reduction techniques, such as adaptive antennas, joint detection and cell planning can still increase the capacity.
- For RT services the possible gains of faster quality based power control should be investigated.

7.8 REFERENCES

- [1] UMTS 30.03 v3.0.0 "Selection procedure for the choice of radio technologies of UMTS", Annex 2
- [2] ETSI SMG2 UMTS ad hoc #3 TDoc 73, Rennes, 1997.
- [3] ETSI SMG2 Gamma Concept Group, TDoc G18/97, Sollentuna, 1997.
- [4] ETSI SMG2 Gamma Concept Group, TDoc /97, Bad Salzderfurth, 1997.

8. High Level Requirements

This section describes how the W-TDMA concept meets the High Level Requirements for UTRA. Boxed text from ETR 04-01 has been included for reference.

Some issues are identified for further study by Gamma Group. Others may be more appropriate for consideration by SMG2 during later stages of UMTS standardisation.

8.1 Bearer capabilities

8.1.1 Maximum user bit rate

The UTRA should support a range of maximum user bit rates that depend upon a users current environment as follows:

Rural Outdoor: at least 144 kbit/s (goal to achieve 384 kbit/s), maximum speed: 500 km/h

Suburban Outdoor: at least 384 kbps (goal to achieve 512 kbit/s), maximum speed: 120 km/h

Indoor/Low range outdoor: at least 2Mbps, maximum speed: 10 km/h

It is desirable that the definition of UTRA should allow evolution to higher bit rates.

- Rural Outdoor: 144kbps will be available throughout the operator's service area. The radio interface can tolerate the Doppler spread and rapidly changing channel characteristics associated with high speed vehicles (up to at least 1500km/h with 1/64 slot bursts). The maximum cell size depends on propagation conditions, but is comparable with GSM (assuming similar requirements for bearer capabilities and quality of service).

- Suburban Outdoor: 384kbps rate will be available with complete coverage of a suburban or urban area

- Indoor/Low range outdoor: 2Mbps will be available indoors and over localised coverage outdoors

The maximum practical bit rate which can be provided depends on factors such as the operating environment, required quality of service, traffic loading and proximity of mobile to base station.. However, the radio interface can support rates up to around 1Mbps for Rural and Suburban Outdoor, and 4Mbps over short ranges.

8.1.1.1 Bearer Service Attributes

The W-TDMA concept can provide bearers with the necessary attributes. i.e. different connection modes, symmetry, communication configuration, information transfer rate, delay variation, maximum transfer delay, maximum bit error rate, error characteristics.

8.1.2 Flexibility

Negotiation of bearer service attributes (bearer type, bit rate, delay, BER, up/down link symmetry, protection including none or unequal protection),

parallel bearer services (service mix), real-time / non-real-time communication modes, adaptation of bearer service bit rate

Circuit switched and packet oriented bearers

Supports scheduling (and pre-emption) of bearers (including control bearers) according to priority

Adaptivity of link to quality, traffic and network load, and radio conditions (in order to optimise the link in different environments).

Wide range of bit rates should be supported with sufficient granularity

Variable bit rate real time capabilities should be provided.

Bearer services appropriate for speech shall be provided.

The W-TDMA concept provides flexibility of bearer service attributes by use of a number of different transmission bursts optimised for different bit rates in different radio environments. The Link Adaptation mechanism can be used to dynamically maintain the quality of the connection under changes in propagation and interference conditions by adjusting transmission format and number of slots allocated.

Bit rate granularity is achieved primarily by allocating different numbers of transmission slots, but this can be supplemented if necessary by adjusting channel coding rates.

Parallel bearers can be transmitted independently, or where appropriate by multiplexing together into a single channel.

Circuit switched and packet oriented services are supported efficiently by Real-Time and Non-Real-Time bearer concepts.

Variable rate data services are supported by dynamically changing the capacity allocation.

Scheduling of bearers is allowed, but could be the subject of further study by SMG2.

Bearers optimised for speech are available.

The bearer service attributes can be configured as required on initiation of a service, and changed dynamically if required.

8.1.2.1 *Minimum bearer capabilities*

The following table shows the potential combinations for the most important characterisation attributes (based on ETR-04-01).

	Real Time/Constant Delay		Non Real Time/Variable Delay	
Operating environment	Peak Bit Rate (note 6)	BER / Max Transfer Delay (note 1)	Peak Bit Rate	BER / Max Transfer Delay (note 2)
Rural outdoor (terminal speed up to 500 km/h)	at least 144 kbit/s granularity 13kb/s (note 3)	delay 20 - 300 ms BER 10^{-3} - 10^{-7}	at least 144 kbit/s	BER = 10^{-5} to 10^{-8} Max Transfer Delay 150 ms or more
Urban/ Suburban outdoor (Terminal speed up to 120 km/h)	at least 384 kbit/s granularity 74kb/s (note 4)	delay 20 - 300 ms BER 10^{-3} - 10^{-7}	at least 384 kbit/s	BER = 10^{-5} to 10^{-8} Max Transfer Delay 150 ms or more
Indoor/ Low range outdoor (Terminal speed up to 10 km/h)	2 Mbit/s granularity 150kb/s (note 5)	delay 20 - 300 ms BER 10^{-3} - 10^{-7}	2 Mbit/s	BER = 10^{-5} to 10^{-8} Max Transfer Delay 150 ms or more

Table 1: Minimum bearer capabilities for UMTS

Speech bearers are supported in all operating environments.

- Note 1: The minimum achievable transmission delay is less than 20ms. For a given BER operation at lower C/I is possible by extending the interleaving depth. The detailed performance trade-offs between delay and BER (via choice of modulation, coding and interleaving) require further study.
- Note 2: The delivery time for NRT/variable delay bearers depends on factors such as operating environment and traffic loading. Delivery times of the order of 150ms with BER in the stated range can be provided (using Type II soft combining ARQ).
- Note 3: The indicated granularity is based on BOQAM with a single 1/64 slot allocation and 1/2 rate coding
- Note 4: The indicated granularity is based on BOQAM with a single 1/16 slot allocation and 1/2 rate coding
- Note 5: The indicated granularity is based on QOQAM with a single 1/16 slot allocation and 1/2 rate coding
- Note 6: Finer granularity can be provided by variation of channel coding rate.

8.1.2.2 Service traffic parameters

Since W-TDMA provides Link Adaptation as a fundamental feature it can support the use of UMTS in various environments with a range of traffic densities range and a variety of traffic mixes in an economical way.

8.1.2.3 Performance

Details of performance are given elsewhere in this evaluation document:

8.1.3 Configuration management

W-TDMA will allow the definition of configuration management features.

8.1.4 Evolution and modularity

The W-TDMA concept is service independent, and is defined so that UMTS can be implemented in phases with enhancements for increasing functionality (for example making use of different modulation and coding technology). The requirement for backwards compatibility can be met by provision of a negotiation mechanism to agree on supported capabilities between mobiles and infrastructure.

The W-TDMA concept is consistent with the requirements of an open modular architecture and implementation of software downloading of radio interface features. However these aspects require further development within SMG2.

8.1.5 Handover

Provide seamless (to user) handover between cells of one operator.

The UTRA should not prevent seamless HO between different operators or access networks.

Efficient handover between UMTS and 2nd generation systems, e.g. GSM, should be possible.

8.1.5.1 Overall handover requirements

Efficient seamless (mobile assisted) handovers can be provided in networks with synchronised base stations and between TDD and FDD systems. Seamless handover between unsynchronised systems, is for further study by Gamma Group.

Signalling load from handovers is not expected to be significant but is dependent on scenario, and could be the subject of further study by Gamma Group.

The level of security is not be affected by handovers. Security in general is ffor further study in SMG2.

Handover to second generation systems can be supported by use of an idle frame allowing measurements of signal strengths from alternative base stations.

The choice of frame structure allows synchronisation of UTRA with GSM sharing the same cell sites which simplifies handover in this case.

8.1.5.2 Handover requirements with respect to the radio operating environments

The W-TDMA radio interface allows handovers within a network, between different environments and between networks run by different operators.

8.2 Operational requirements

8.2.1 Compatibility with services provided by present core networks

ATM bearer services
GSM services
IP (Internet Protocol) based services
ISDN services

Flexible RT and NRT bearers with a range of bit rates etc., allow current core network services to be supported.

8.2.2 Operating environments

W-TDMA does not restrict the operational scenario for UMTS, in, for example, international operation across various radio operating environments, across multiple operators and across different regulatory regimes. Further, a range of different MS types (e.g. speech only, high bit rate data), and a variety of services with a range of bit rates are possible.

W-TDMA can support fixed wireless access, but performance in this application is for further study in SMG2.

8.2.2.1 Support of multiple radio operating environments

W-TDMA can support the requirements of all the specified radio operating environments.

8.2.2.2 Support of multiple equipment vendors

Minimum specification levels to ensure inter-operability are for further study.

8.2.3 Radio Access network planning

If radio resource planning is required automatic planning shall be supported

The Interference Averaging feature means that network planning is not as sensitive as in GSM. Detailed planning procedures are for further study in SMG2.

DCA can be used to re-configure the use of assigned frequency blocks in response to changing traffic.

UMTS terminals using W-TDMA will almost certainly incorporate frequency agility capability to support frequency hopping. This could facilitate the use over non-overlapping allocations across regions or countries (unless other hardware restrictions apply).

8.2.4 Public, Private and residential operators

It shall be possible to guarantee pre-determined levels of quality-of-service to public UMTS network operators in the presence of other authorised UMTS users.

The radio access scheme should be suitable for low cost applications where range, mobility and user speed may be limited.

Multiple unsynchronised systems should be able to successfully coexist in the same environment.

It should be possible to install basestations without co-ordination.

Frequency planning should not be needed.

Low cost terminals with a restricted set of functionality can be implemented. For example, limited bit rate, power output or multipath equalisation capability could be appropriate for private cordless telephone applications.

8.2.4.1 Public UMTS operators

The ability to guarantee pre-determined levels of quality for public operators is likely to require separate frequency allocations for each operator. The possibility of public operators sharing part of the spectrum is for further study in Gamma Group/SMG2.

8.2.4.2 *Private UMTS operators*

The Bunch concept is suitable for Private UMTS operators who may wish to operate clusters of base stations within a restricted area. A Bunch can be installed without any cell planning or co-ordination with other Bunches (by using Interference Averaging), and its co-ordination is automatically provided within a Bunch.

8.2.4.3 *Residential UMTS operators*

Residential systems can be deployed in the same way as private systems, except that in the limiting case there may be only one base and one mobile in the system.

8.3 *Efficient spectrum usage*

8.3.1 Spectral Efficiency

High spectrum efficiency for typical mixtures of different bearer services
Spectrum efficiency at least as good as GSM for low bit rate speech

The spectral efficiency is considered in detail elsewhere in this report.

Preliminary results indicate that speech and data services can be provided more efficiently than in GSM.

8.3.2 Variable asymmetry of total band usage

Variable division of radio resource between uplink and down link resources from a common pool (NB: This division could be in either frequency, time, or code domains)

In an unpaired frequency allocation, TDD provides flexibility by adapting the uplink/downlink duty cycle. With paired frequency allocation, asymmetric traffic with pure FDD is likely to lead to under utilisation of one or other of the band pairs. In this case TDD in the under used band would be an efficient solution. Detailed performance and consideration of other approaches is for further study in Gamma Group.

8.3.3 Spectrum utilisation

Allow multiple operators to use the band allocated to UMTS without co-ordination.
It should be possible to operate the UTRA in any suitable frequency band that becomes available such as first & second generation system's bands

Spectrum sharing requires further study (as noted in ETR 04-01)

W-TDMA can be deployed using for some applications using a single 1.6MHz carrier (e.g. isolated cell). A small network could be deployed in as little as 5MHz (excluding guard bands). Therefore, since the concept is not critically sensitive to choice of carrier frequency this enhances the viability of deployment in any available band.

8.3.4 Coverage/capacity

The system should be flexible to support a variety of initial coverage/capacity configurations and facilitate coverage/capacity evolution

Flexible use of various cell types and relations between cells (e.g. indoor cells, hierarchical cells) within a geographical area without undue waste of radio resources.

Ability to support cost effective coverage in rural areas

8.3.4.1 *Development and implementation risk*

The W-TDMA concept is a natural extension to proven technology so unknown factors in development and implementation risks are minimised.

8.3.4.2 *Flexibility of radio network design*

8.3.4.2.1 Cell size flexibility

The W-TDMA transmission bursts are designed to cover a wide range of channel conditions. This allows operation in picocells, microcells and macrocells. Hierarchical Cell Structures are supported.

8.3.4.2.2 Cell location flexibility

The Interference Averaging concept means that the system performance is not critically sensitive to base station location

8.3.4.3 *Synchronisation*

Time synchronisation between different UMTS networks is desirable to optimise spectrum efficiency (for both FDD and TDD), but is not essential.

8.3.4.4 *Repeaters and relays*

Repeaters can be supported in principle, but the details are for further study in SMG2.

8.3.4.4.1 Vehicle with mobile BS operating environment

A vehicle with mobile BS can be supported in principle, but the details are for further study in SMG2.

8.3.4.5 *Very large cell sizes*

Very large cell sizes can be supported (for example by increasing the number of slots allocated to the bearer). Details of other techniques which could be employed, such as adaptive antennas, RF repeater stations or remote antennas are for further study.

The implications of frequency conversion of the RF carrier within a RF repeater are for further study in Gamma Group/SMG2.

8.3.4.6 *Evolution requirements*

8.3.4.6.1 Coverage evolution

The W-TDMA concept supports:

- contiguous coverage (traditional cellular approach);
- island coverage (Bunch concept);

- spot coverage (isolated cell).

Since performance is not sensitive to base station deployment, a minimum of planning is required in order to install new cells to extend system coverage. Initial calculations indicate that since maximum range (for voice) can be comparable to GSM, reusing cellsites is possible to achieve fast roll-out.

8.3.4.6.2 Capacity evolution

Similarly, a minimum of planning is needed in order to install new cells to increase system capacity in areas where coverage is already provided.

W-TDMA supports techniques for capacity improvement, such as the use of adaptive antenna, but these are not essential.

8.4 Complexity / cost

8.4.1 Mobile Terminal viability

Handportable and PCMCIA card sized UMTS terminals should be viable in terms of size, weight, operating time, range, effective radiated power and cost.

W-TDMA is not inherently complex. Detailed complexity and other Implementation issues are for further study in Gamma Group.

8.4.2 Network complexity and cost

The development and equipment cost should be kept at a reasonable level, taking into account the cost of cell sites, the associated network connections, signalling load and traffic overhead (e.g. due to handovers).

W-TDMA provides a single radio interface concept which can be adapted to all operating environments.

All the operating options within W-TDMA are based on a common approach, in order to minimise implementation complexity.

A layered approach has been followed in the development of the radio interface.

Detailed evaluation of various costs (e.g. migration from 2nd generation systems) is for further study in SMG2.

8.4.3 Mobile station types

It should be possible to provide a variety of mobile station types of varying complexity, cost and capabilities in order to satisfy the needs of different types of users.

Mobile stations can easily be implemented with various complexity/cost/capability trade-offs. For example, low rate terminals may not need to be capable of transmitting/receiving all possible multi-slot options. It should be possible to avoid the need for duplex filters if sufficient performance can be obtained without simultaneous transmission and reception.

8.5 Requirements from bodies outside SMG

8.5.1 Alignment with IMT 2000

UTRA shall meet at least the technical requirements for submission as a candidate technology for IMT 2000 (FPLMTS).

These requirements are met.

8.5.2 Minimum bandwidth allocation

It should be possible to deploy and operate a network in a limited bandwidth

See section 3.2 and Annex 2.

8.5.3 Electromagnetic compatibility

The peak and average power and envelope variations have to be such that the degree of interference caused to other equipment is not higher than in today's systems.

The peak power and envelope variations can be constrained so that interference is expected to be less severe than (or at least comparable) with GSM

8.5.4 RF Radiation effects

UMTS shall be operative at RF emission power levels which are in line with the recommendations related to electromagnetic radiation.

Details of emission levels are for further study.

For ease of implementation, a maximum transmitter output power of around 1W peak is considered desirable for hand portable units.

8.5.5 Security

The UMTS radio interface should be able to accommodate at least the same level of protection as the GSM radio interface does.

Security issues are for further study in SMG2.

8.5.6 Co-existence with other systems

The UMTS Terrestrial Radio Access should be capable to co-exist with other systems within the same or neighbouring band depending on systems and regulations

W-TDMA is not inherently sensitive to co- or adjacent channel interference. It also does not produce high levels of adjacent channel interference.

Issues such as use of other systems in adjacent or the same band require further study in SMG2.

8.6 Multimode terminal capability

It should be possible to implement dual mode UMTS/GSM terminals cost effectively.

W-TDMA shares aspects of TDMA with GSM, including related frame structures. This is beneficial for implementation of dual mode terminals.

8.7 Services supported by the radio interface

8.7.1 Location service

The detailed mechanism for support of user position location is for further study in SMG2. Since users are orthogonal in time domain in WB-TDMA, implementing position location with observed time difference can be done.

9. Conclusions

This draft evaluation document presents the Wideband TDMA concept and the evaluation work. The report has been prepared by the SMG2 Concept Group Gamma (WB-TDMA).

The Radio Transmission Technology (RTT) building blocks for the WB-TDMA are described in chapters for Logical Channels, Physical Channels, Layer 2 Radio Protocols and Radio Resource Management. Advanced TDMA features which can be used to enhance the performance of the WB-TDMA scheme are described. More detailed descriptions of the Layer 2 protocols and RRM schemes can be found in Tdocs SMG2 Gamma 19 and 15 respectively.

Evaluation for the services as described in Tdoc SMG2 258/97 has been done on link and system layer according to the table below.

Priority	Environment	Service mixture	Propagation model	Cell coverage	Link level	System level
1.1 1.2 1.3 1.5 extra	Outdoor to Indoor and Pedestrian 3 km/h	UDD 384 Speech LCD 144 kbit/s UDD 2048 UDD 144	Outdoor to Indoor and Pedestrian A	Microcell	completed completed completed completed completed	completed completed (not required) (not required)
2.1 2.2 2.3 2.4 extra extra extra	Indoor 3 km/h	UDD 2048 Speech LCD 384 kbit/s 50 % speech + 50 % UDD 384 UDD 2048 with walls UDD 144 UDD 384	Indoor A	Picocell	completed completed completed (not required) (not required) completed completed	completed (not required) (not required) preliminary completed
3.1 3.2 3.3 extra extra	Vehicular 120 km/h	UDD 144 Speech LCD 384 kbit/s UDD 384 UDD 2048	Vehicular A	Macrocell	completed completed completed completed completed	(not required) completed completed
extra extra extra	Vehicular 120 km/h	Speech UDD 144 UDD 384	Vehicular B		completed completed completed	(not req)
4 extra extra	Vehicular 250 km/h	Speech UDD 144 UDD 384	Vehicular B		completed completed completed	(not req)

Considerations how the WB-TDMA concept fulfils the SMG2 high level requirements have also been included (see chapter 8).

Specific aspects that have been considered during development of the WB-TDMA concept are:

- Support of high bit rates with relatively simple terminal
- Effective support of non-real-time traffic with fast variations in data rate and packet size
- Support of TDD mode with data rates fulfilling the UMTS requirements
- Possibility to implement simple terminals for low bit rate use
- Narrow spectrum and low interference to adjacent carriers
- Flexibility for introduction of enhancements

10. Annex 1 (ETR04.02)

Technologies Description Template

	A1.1	Test environment support
ti	A1.1.1	In what test environments will the SRTT operate ? <i>All test environments described in Section 1.1 of annex 2.</i>
td	A1.1.2	If the SRTT supports more than one test environment, what test environment does this technology description template address ? <i>This template considers all the environments.</i>
	A1.1.3	Does the SRTT include any feature in support of FWA application ? Provide detail about impact of those features on the technical parameters provided in this template, stating whether the technical parameters provided apply for mobile as well as for FWA applications. <i>No additional feature is required to support FWA.</i>
	A1.2	Technical parameters Note : Parameters for both forward link and reverse link should be described separately, if necessary.
ti	A1.2.1	What is the minimum frequency band required to deploy the system (MHz) ? <i>Minimum value depends on the application, the load of the network, the QoS and the user traffic model. A 2 Mbit/s is possible in an isolated cell from 1.6 MHz in TDD mode and small cellular networks are possible from 2x4.8MHz.</i>
ti	A1.2.2	What is the duplex method : TDD or FDD <i>Both FDD and TDD options are proposed. The TDD option allows to support asymmetric traffic.</i>
ti	A1.2.2.1	What is the minimum up/down frequency separation for FDD ? <i>Based on DCS1800 assumptions, a sensible value seems to be the uplink or downlink bandwidth plus 10 MHz to make the duplexer feasible.</i>
ti	A1.2.2.2	What is requirement of transmit/receive isolation ? Does the proposal require a duplexer in either the mobile or base station. <i>In FDD mode low rate terminals can operate with non-overlapping transmission and reception time slots and in this case a duplexer is not required..</i>

ti	A1.2.3	<p>Does the SRTT allow asymmetric transmission to use the available spectrum ? Characterize.</p> <p><i>Asymmetric service is possible both in the FDD and TDD modes.</i></p> <p><i>It can be done easily in FDD, especially by taking profit of the unpaired frequency band, by allocating a low bit rate carrier for the uplink from the “paired” band and a high bit rate carrier from the « unpaired » band. The unused pair of the low bit rate carrier can be used for asymmetric services within the symmetric band. TDMA makes this allocation scheme reasonable to implement.</i></p> <p><i>TDD asymmetry could be achieved by ‘traditional’ means by allocation a fixed amount of slots through the whole operator’s TDD spectrum for both directions.</i></p> <p><i>However, due to the uncertainty concerning traffic profiles in different environments this approach does not seem to be very attractive. One idea in the usage of the TDD band is to allocate asymmetric capacity on an individual basis i.e. the frequency band would not be divided into purely uplink and downlink channels in the time domain but rather in a dynamic manner enabling the usage of all channels in frequency and time domain for both directions. These scheme is possible both by using RNC controlled Channel Allocation which enables fast handovers in the frequency and time domain or by Interference Averaging between different cells.</i></p> <p><i>The described scheme would lead to minimum frequency planning. The operator does not have to put fixed percentage of the overall system capacity to up- or downlink traffic.</i></p>
ti	A1.2.4	<p>What is the RF channel spacing (kHz) ? In addition, does the SRTT use interleaved frequency allocation ?</p> <p><i>The channel spacing is 1.6 MHz, both in FDD and TDD modes. Interleaved frequency allocation is not assumed.</i></p> <p>Note : Interleaved frequency allocation ; allocating the 2nd adjacent channel instead of adjacent channel at neighboring cluster cell is so called « interleaved frequency allocation ». If a proponent is going to employ this allocation type, proponent should be stated at A1.2.4 and fill A1.2.15 of protection ratio for both of adjacent and 2nd adjacent channel.</p>
ti	A1.2.5	<p>What is the bandwidth per duplex RF channel (MHz) measured at the 3 dB down points ?</p> <p>It is given by (bandwidth per RF channel) x (1 for TDD and 2 for FDD). Please provide detail.</p> <p><i>The 3 dB bandwidth of the duplex RF channel is around 1.1 MHz in TDD mode (the exact value depending on the linearity requirements of the power amplifier which is not defined yet), while it is twice this value for the FDD mode.</i></p>

	A1.2.5.1	<p>Does the proposal offer multiple or variable RF channel bandwidth capability ? If so, are multiple bandwidths or variable bandwidths provided for the purposes of compensating the transmission medium for impairments but intended to be feature transparent to the end user ?</p> <p><i>As far as traffic is concerned, a single bandwidth of 1.6 MHz is assumed per channel.</i></p> <p><i>A beacon channel (BCCH) is anticipated in addition and two options are considered to prevent the permanent broadcast of a high power signal with negative impact on the reuse pattern :</i></p> <p><i>1/ discontinuous transmission of the BCCH, the bandwidth would remain 1.6 MHz</i></p> <p><i>2/ continuous transmission of a narrowband signal (200 kHz). In that case, two channel bandwidths would exist in the system.</i></p>
ti	A1.2.6	<p>What is the RF channel bit rate (kbps) ? .</p> <p>The maximum modulation rate of RF (after channel encoding, adding of in-band control signaling and any overhead signaling) possible to transmit carrier over an RF channel, i.e. independent of access technology and of modulation schemes.</p> <p><i>It is either 2.6 or 5.2 Mbit/s with the considered modulations presented below in section A1.2.11. It must be in addition mentionned that the W-TDMA concept can support any modulation scheme meeting the emission mask requirements. This will allow the use of higher order modulations to support even higher bit rate connections over short ranges (eg within a single room). It will also allow alternative methods of combatting multipath, such as OFDM. Similarly, the use of different channel coding algorithms need not be restricted.</i></p>

ti	A1.2.7	<p>Frame Structure : Describe the frame structure to give sufficient information such as ;</p> <ul style="list-style-type: none"> - frame length <p><i>The frame length is 4.615 ms</i></p> <ul style="list-style-type: none"> - the number of time slots per frame <p><i>There are 2 standard timeslot lengths :</i></p> <ul style="list-style-type: none"> • <i>those of 72 ms, occupying a 64th of the frame length</i> • <i>those of 288 ms, occupying a 16th of the frame length</i> • <i>other values, within the scope of the so-called "flexible burst" introduced below are possible.</i> <p><i>Any combination of these timeslot fitting the length of the TDMA frame is possible, including a frame of 64 short time slots and a frame of 16 long time slots.</i></p> <ul style="list-style-type: none"> - guard time or the number of guard bits <p><i>There are usually 10.5 to 11 guard symbols per burst, the length of each symbol being 0.384 ms. Three exceptions must be noticed :</i></p> <ul style="list-style-type: none"> • <i>the 1/16th frame access burst with a guard period of 625 symbols,</i> • <i>the 1/64th frame access burst with a guard period of 84,5 symbols</i> <ul style="list-style-type: none"> - user information bit rate for each time slot <p><i>It depend on the type of burst as described below :</i></p> <ul style="list-style-type: none"> • <i>Data bursts, the payload is 684 symbols, resulting in roughly 296 kbit/s for the BOQAM modulation and 593 kbit/s for the QOQAM modulation.</i> • <i>Speech burst 1, the payload is 122 symbols, resulting in roughly 53 kbit/s for the BOQAM modulation and 106 kbit/s for the QOQAM modulation.</i> • <i>Speech burst 2, the payload is 122 symbols, resulting in roughly 53 kbit/s for the BOQAM modulation and 106 kbit/s for the QOQAM modulation.</i> • <i>1/16th-frame synchronisation burst, the payload is 606 symbols, resulting in roughly 263 kbit/s for the BOQAM modulation and 525 kbit/s for the QOQAM modulation.</i> • <i>1/64th-frame synchronisation burst, the payload is 78 symbols, resulting in roughly 34 kbit/s for the BOQAM modulation and 68 kbit/s for the QOQAM modulation.</i> • <i>Access bursts, the payload is 56 symbols, resulting in roughly 24 kbit/s for the BOQAM modulation and 49 kbit/s for the QOQAM modulation.</i> • <i>In addition, a flexible burst was introduced. The length of its different fields (tail, data symbols, training sequence and guard period) is agreed between the mobile and the base station at call setup or whenever required during a call. The actual bit rate is obviously dependant of the actual field lengths.</i> <p><i>A multiplexed burst was defined, it is a combination of data sequences with a header describing its structure. It occupy an integer number of adjacent 1/16 timeslots, and is intended for use on the downlink.</i></p> <ul style="list-style-type: none"> - channel bit rate (after channel coding) <p><i>5.2 or 10.4 Mbit/s</i></p> <ul style="list-style-type: none"> - channel symbol rate (after modulation) <p><i>2.6 Msymb/s</i></p> <ul style="list-style-type: none"> - associated control channel (ACCH) bit rate <p><i>The rate is dynamically adjustable. It is too early to indicate its effective use.</i></p> <ul style="list-style-type: none"> - power control bit rate. <p><i>It was estimated to 0.007% of the channel capacity per mobile</i></p>
----	--------	--------------------------------------------------------------------------------------------------------------------------------------------------------------------------------------------------------------------------------------------------------------------------------------------------------------------------------------------------------------------------------------------------------------------------------------------------------------------------------------------------------------------------------------------------------------------------------------------------------------------------------------------------------------------------------------------------------------------------------------------------------------------------------------------------------------------------------------------------------------------------------------------------------------------------------------------------------------------------------------------------------------------------------------------------------------------------------------------------------------------------------------------------------------------------------------------------------------------------------------------------------------------------------------------------------------------------------------------------------------------------------------------------------------------------------------------------------------------------------------------------------------------------------------------------------------------------------------------------------------------------------------------------------------------------------------------------------------------------------------------------------------------------------------------------------------------------------------------------------------------------------------------------------------------------------------------------------------------------------------------------------------------------------------------------------------------------------------------------------------------------------------------------------------------------------------------------------------------------------------------------------------------------------------------------------------------------------------------------------------------------------------------------------------------------------------------------------------------------------------------------------------------------------------------------------------------------------------------------------------------------------------------------------------------------------------------------------------------------------------------------------------------------------------------------------------------------------------------------------------------------------------------------------------------------------------------------------------------------------------------------------------------------------------------------------------------------------------------------------------------------------------------------------------------------------------------------------------------------------------------------------------------------------------------------------------------------------------------------------------------------------------------------------------------------------------------------------------------------------------------------------------------------------------------------------------------------------------------------------------------------------------------------------------------------------------------------------------------------------------

ti	A1.2.8	<p>Does the SRTT use frequency hopping ? If so characterize and explain particularly the impact (e.g. improvements) on system performance.</p> <p><i>Frequency hopping is an option of the system to improve performances when sufficient spectrum is available to the operator.</i></p> <p><i>The advantages are twofolds :</i></p> <ul style="list-style-type: none"> - <i>better performances for low-velocity mobiles, as frequency hopping allows terminal to escape from a faded frequency,</i> - <i>interference diversity, it might allow a reuse factor of 1 if sufficient frequency is available.</i>
td	A1.2.8.1	<p>What is the hopping rate ?</p> <p><i>It is the frame rate, that is to say 216 Hz (unless the timeslot rate, 1387 Hz, is felt preferable for multislot allocation).</i></p>
td	A1.2.8.2	<p>What is the number of the hopping frequency sets ?</p> <p><i>To be Completed.</i></p>
ti	A1.2.8.3	<p>Are base stations synchronized or non-synchronized ?</p> <p><i>Base stations are normally non-synchronized. A synchronised mode might however be considered to ease monitoring of adjacent cells when discontinuous BCCH is used.</i></p>
ti	A1.2.9	<p>Does the SRTT use spreading scheme ?</p> <p><i>No</i></p>
td	A1.2.9.1	<p>What is the chip rate (Mchip/s) : Rate at input to modulator.</p> <p><i>Not applicable to TDMA.</i></p>
td	A1.2.9.2	<p>What is the processing gain : $10 \log (\text{Chip rate} / \text{Information rate})$.</p> <p><i>Not applicable to this SRTT.</i></p>
td	A1.2.9.3	<p>Explain the uplink and downlink code structures and provide the details about the types (e.g. PN code, Walsh code) and purposes (e.g. spreading, identification, etc.) of the codes.</p> <p><i>Not applicable to this SRTT.</i></p>
ti	A1.2.10	<p>Which access technology does the proposal use : TDMA, FDMA, CDMA , hybrid, or a new technology ?</p> <p><i>FDMA / TDMA.</i></p> <p>In the case of CDMA which type of CDMA is used : Frequency Hopping (FH) or Direct Sequence (DS) or hybrid ? Characterize.</p> <p><i>Not applicable to this SRTT.</i></p>
ti	A1.2.11	<p>What is the baseband modulation technique ? If both the data modulation and spreading modulation are required, please describe detail.</p> <p><i>Two modulations are considered, depending on the bit-rate and the environment : Binary Offset QAM (B-OQAM) and Quaternary Offset QAM (Q-OQAM) with a rolloff of 0.35.</i></p> <p>What is the peak to average power ratio after baseband filtering (dB) ?</p> <p><i>To be completed.</i></p>

ti	A1.2.12	<p>What are the channel coding (error handling) rate and form for both the forward and reverse links ? e.g.</p> <p>- Does the SRTT adopt FEC (Forward Error Correction) or other schemes ?</p> <p><i>Circuit switched services can be protected by convolutional or turbo codes. Convolutional codes can be punctured to efficiently achieve adaptive coding rate.</i></p> <p><i>Packet services can be protected by ARQ schemes.</i></p> <p>- Does the SRTT adopt unequal error protection ? Please provide details.</p> <p><i>This is not considered but can be supported.</i></p> <p>- Does the SRTT adopt soft decision decoding or hard decision decoding ? Please provide details.</p> <p><i>Soft decision decoding is adopted to take profit of the several dB of gain achievable by Viterbi decoding of convolutional codes.</i></p> <p>- Does the SRTT adopt iterative decoding (e.g. turbo codes) ? Please provide details.</p> <p><i>Iterative decoding is considered for Turbo codes. The number of iteration is still opened.</i></p> <p>- Other schemes.</p>
ti	A1.2.13	<p>What is the bit interleaving scheme ? Provide detailed description for both up link and down link.</p> <p><i>Interslot interleaving is provided whenever possible. The interleaving depth can be adjusted to optimise trade-off between bearer C/I requirement and delay.</i></p>
ti	A1.2.14	<p>Describe the taken approach for the receivers (MS and BS) to cope with multipath propagation effects (e.g. via equalizer, RAKE receiver, etc.).</p> <p><i>An equalizer is assumed to combat multipath propagation. Training sequences have been inserted in bursts for that purpose.</i></p>
ti	A1.2.14.1	<p>Describe the robustness to intersymbol interference and the specific delay spread profiles that are best or worst for the proposal.</p> <p><i>Large delay spreads can be tolerated by definition of bursts with long enough training sequences.</i></p> <p><i>If there is residual ISI after equalizer, it is handled by link adaptation and ARQ.</i></p> <p><i>Performance degradation is graceful as delay spread increases. Also Vehicular B channel can be supported with a small degradation in performance with the current burst structure. With longer training sequences and flexible burst structure the performance could be improved.</i></p>
ti	A1.2.14.2	<p>Can rapidly changing delay spread profile be accommodated ? Please describe.</p> <p><i>Simulations show that there is no degradation for 1/64 slot up to 500 km/h. The question is still opened for other slots.</i></p>
ti	A1.2.15	<p>What is the Adjacent channel protection ratio ?</p> <p><i>To be completed.</i></p> <p>In order to maintain robustness to adjacent channel interference, the SRTT should have some receiver characteristics that can withstand higher power adjacent channel interference. Specify the maximum allowed relative level of adjacent RF channel power in dBc. Please provide detail how this figure is assumed.</p> <p><i>To be Completed.</i></p>

	A1.2.16	Power classes <i>To be completed.</i>
ti	A1.2.16.1	Mobile terminal emitted power : What is the radiated antenna power measured at the antenna ? For terrestrial component, please give (in dBm). For satellite component, the mobile terminal emitted power should be given in EIRP (dBm). <i>To be completed</i>
ti	A1.2.16.1 .1	What is the maximum peak power transmitted while in active or busy state ? <i>A peak power limit of 1W is assumed for hand portables.</i>
ti	A1.2.16.1 .2	What is the time average power transmitted while in active or busy state ? Provide detailed explanation used to calculate this time average power. <i>The average power of MS depends on power control settings and number of timeslots used..</i>
ti	A1.2.16.2	Base station transmit power per RF carrier for terrestrial component <i>To be completed.</i>
ti	A1.2.16.2 .1	What is the maximum peak transmitted power per RF carrier radiated from antenna ? <i>To be completed.</i>
ti	A1.2.16.2 .2	What is the average transmitted power per RF carrier radiated from antenna ? <i>To be completed.</i>
ti	A1.2.17	What is the maximum number of voice channels available per RF channel that can be supported at one base station with 1 RF channel (TDD systems) or 1 duplex RF channel pair (FDD systems), while still meeting G.726 performance requirements ? <i>64 channels can be supported per carrier of 1.6 MHz. It is however not possible at that level to precise whether G.726 performance requirements are met.</i>

ti	A1.2.18	<p>Variable bit rate capabilities : Describe the ways the proposal is able to handle variable base band transmission rates. For example, does the SRTT use :</p> <ul style="list-style-type: none"> -adaptive source and channel coding as a function of RF signal quality -variable data rate as a function of user application -variable voice/data channel utilization as a function of traffic mix requirements ? <p>Characterize how the bit rate modification is performed. In addition, what are the advantages of your system proposal associated with variable bit rate capabilities ?</p> <p><i>The Radio Link Control/Medium Access Control (RLC/MAC) protocol supports two types of bearers, real time (RT) and non real time (NRT) bearers. The RT operation mode is used for the radio bearers which have strict delay constraints and quality is mainly fulfilled by power control and forward error corrections. The NRT operation mode is used for radio bearers with low delay requirements which allow backward error correction.</i></p> <p><i>RLC/MAC layer protocol provides fast resource allocations for real time (RT) and non real time (NRT) services supporting also variable bit rates and multibearer connections. For RT services QoS is fulfilled by means of dynamic link adaptation and for NRT services QoS can be maintained by effective ARQ. Radio resources are allocated for a common pool for all bearers thus enabling immediate adaptation to any kind of traffic mix within the available resources. All bearers are controlled independently.</i></p> <p><i>In the RT mode, the RLC entities request resources for the radio bearer due to radio condition variations and the bit rate variations. RLC resource requests are directed to MAC, which is responsible for the channel allocation signalling. Mobile initiated resource requests are transmitted on the dedicated control channel (DCCH) or random access channel (RACH). Channel allocations are transmitted on downlink DCCH or transmitted on the common control channel (CCCH). Fast associated control channel (FACCH) is a dedicated channel which uses capacity stolen from a bearer allocated to the MS. For a few occasional messages this is the preferred signalling channel. If FACCH can not be used, signalling can be transmitted on CCCH. The link adaptation is possible with appr. 9 ms intervals.</i></p> <p><i>In the NRT mode, the RLC entities request resources for certain amount of data. For high bitrates 1/16 timeslot traffic channels are allocated for 9 ms allocation period (2 TDMA frames) at a time. Two frames gives some interleaving gain and is still very flexible. Channel allocations are announced on the NRT control channel (NCCH) and in order to avoid transmission of long identities there, a short reservation identity is allocated for the radio bearer. This identity is valid until the requested data is transmitted and during that time the mobile is obliged to listen to the NCCH. Traffic channels allocated for one reservation identity during one allocation period may vary from 0 to 14 timeslots, and the achieved bit rate may vary from 0 to 2 Mbit/s. For lower bitrates and infrequent transmissions the reservation is made from 1/16 or 1/64 timeslot traffic channels and reservation is valid for indicated time period.</i></p> <p><i>The MAC is also responsible for ARQ signalling. CRC and reception quality based type II soft combining ARQ is expected to provide best efficiency.</i></p>
----	---------	-----------------------------------------------------------------------------------------------------------------------------------------------------------------------------------------------------------------------------------------------------------------------------------------------------------------------------------------------------------------------------------------------------------------------------------------------------------------------------------------------------------------------------------------------------------------------------------------------------------------------------------------------------------------------------------------------------------------------------------------------------------------------------------------------------------------------------------------------------------------------------------------------------------------------------------------------------------------------------------------------------------------------------------------------------------------------------------------------------------------------------------------------------------------------------------------------------------------------------------------------------------------------------------------------------------------------------------------------------------------------------------------------------------------------------------------------------------------------------------------------------------------------------------------------------------------------------------------------------------------------------------------------------------------------------------------------------------------------------------------------------------------------------------------------------------------------------------------------------------------------------------------------------------------------------------------------------------------------------------------------------------------------------------------------------------------------------------------------------------------------------------------------------------------------------------------------------------------------------------------------------------------------------------------------------------------------------------------------------------------------------------------------------------------------------------------------------------------------------------------------------------------------------------------------------------------------------------------------------------------------------------------------------------------------------------------------------------------------------------------------------------------------------------------------------------------------------------------------------------------------------------------------------------------------------------------------------------------------------------------------------------------------------------------------------------------------------------------------------------------------------------------------------------------------------------------------------------------------------------------------------------------------------------------------------------------------------------------------------------------------------------------------------------------------------------------------------------------------------------------------------------------------------------------------------------------------------------------------------------------------

td	A1.2.18.1	<p>What are the user information bit rates in each variable bit rate mode ?</p> <p><i>Basically the protocol is capable of supporting any bitrate restricted by the granularity of channel allocations. Currently the transmission capacity allocation granularity to RT a service is of order 200 bit/s and the smallest allocable packet size for NRT bearer is of order 250 bits (both figures are gross rates thus including channel coding).</i></p> <p><i>For practical reasons it is considered currently to limit the set of possible bitrates for each RT bearer to a set of 16 alternatives, which can be freely selected to each bearer separately taking into account the above mentioned granularity. The bearer can change between these agreed bitrates dynamically during transmission. For all NRT bearers all packet sizes starting from 250 bits are available..</i></p>
ti	A1.2.19 *	<p>What kind of voice coding scheme or CODEC is assumed to be used in proposed SRTT ? If the existing specific voice coding scheme or CODEC is to be used, give the name of it. If a special voice coding scheme or CODEC (e.g. those not standardised in standardisation bodies such as ITU) is indispensable for the proposed SRTT, provide detail, e.g. scheme, algorithm, coding rates, coding delays and the number of stochastic code books.</p>
ti	A1.2.19.1	<p>Does the proposal offer multiple voice coding rate capability ? Please provide detail.</p> <p><i>The protocol for resource allocation handles multiple voice coding rates similarly as any other variable bitrate services. The realisation of multiple source coding rates is however out of the scope of the radio interface.</i></p>
ti	A1.2.20	<p>Data services : Are there particular aspects of the proposed technologies which are applicable for the provision of circuit-switched, packet-switched or other data services like asymmetric data services ? For each service class (A, B, C and D) a description of SRTT services should be provided, at least in terms of bit rate, delay and BER/FER.</p> <p><i>TDD mode is of particular interest for asymmetric data service. The ratio of the channel allocated to uplink and downlink can be dynamically changed as a function of the traffic need.</i></p> <p>Note 1 : See [draft new] Recommendation [FPLMTS.TMLG] for the definition of</p> <ul style="list-style-type: none"> - “circuit transfer mode” - “packet transfer mode” - “connectionless service” <p>and for the aid of understanding “circuit switched” and “packet switched” data services</p> <p>Note 2 : See ITU-T Recommendation I.362 for details about the service classes A, B, C and D</p>
ti	A1.2.20.1	<p>For delay constrained, connection oriented. (Class A)</p> <p><i>The proposal support delay constrained connection oriented service by variable bitrate Real Time bearer, the delay constrain of which may be set to an arbitrary value (4,6 ms granularity) and which may have arbitrary bit rate variation (>250 bit/s granularity). (See A.1.2.18).</i></p>
ti	A1.2.20.2	<p>For delay constrained, connection oriented, variable bit rate (Class B)</p> <p><i>The proposal support delay constrained connection oriented service by variable bitrate Real Time bearer, the delay constrain of which may be set to an arbitrary value (4,6 ms granularity) and which may have arbitrary bit rate variation (>250 bit/s granularity). (See A.1.2.18).</i></p>

ti	A1.2.20.3	For delay unconstrained, connection oriented. (Class C) <i>The proposed concept is capable to reliable transmission of data in any packet size with guaranteed almost arbitrary quality and unconstrained delay. Also tradeoff on the quality target and the delay requirement target can be handled. (See A.1.2.18).</i>
ti	A1.2.20.4	For delay unconstrained, connectionless. (Class D) <i>To be Completed.</i>
ti	A1.2.21	Simultaneous voice/data services : Is the proposal capable of providing multiple user services simultaneously with appropriate channel capacity assignment ? <i>Multiple timeslot allocation can provide simultaneous voice/data service.</i>
		Note : The followings describe the different techniques that are inherent or improve to a great extent the technology described above to be presented : Description for both BS and MS are required in attributes from A2..22 through A1.2.23.2.
ti	A1.2.22	Power control characteristics : Is power control scheme included in the proposal ? Characterise the impact (e.g. improvements) of supported power control schemes on system performance. <i>The scheme includes two power control options.</i> <i>1) Slow power control by dedicated power control messages</i> <i>-Slow power control is applicable for both uplink and downlink power control. The concept provides messages enabling both bearer specific and MS specific power control. The power control interval of this scheme can be arbitrary (>4.615 ms) or can be applied only on demand. The needed amount of power control signalling is highly dependent on the system design, i.e. how large interference variations the system is able to handle.'</i> <i>2) Public Power control for uplink</i> <i>-This option enables controlling the power of each physical channel separately with 4,6 ms interval. This method is only applicable for controlling the uplink powers..</i>
td	A1.2.22.1	What is the power control step size in dB ? <i>A step size of 0.5 dB to 4.0 dB is considered.</i>
td	A1.2.22.2	What are the number of power control cycles per second ? <i>Adjustable for each MS separately and can be dynamically varied during connection. See A.1.2.22.</i>
td	A1.2.22.3	What is the power control dynamic range in dB ? <i>A slow power control scheme is considered, with a dynamic range of 50 dB.</i>
td	A1.2.22.4	What is the minimum transmit power level with power control ? <i>To be Completed.</i>
td	A1.2.22.5	What is the residual power variation after power control when SRTT is operating ? Please provide details about the circumstances (e.g. in terms of system characteristics, environment, deployment, MS-speed, etc.) under which this residual power variation appears and which impact it has on the system performance. <i>To be Completed.</i>

ti	A1.2.23	<p>Diversity combining in mobile station and base station : Are diversity combining schemes incorporated in the design of the SRTT ?</p> <p><i>Frequency and time diversity are considered both at the base station and at the mobile, through frequency hopping, interleaving and possibly timeslot hopping.</i></p> <p><i>Antenna diversity combining is possible and considered at the base station. It is possible but not considered at the mobile station.</i></p>
td	A1.2.23.1	<p>Describe the diversity techniques applied in the mobile station and at the base station , including micro diversity and macro diversity, characterizing the type of diversity used, for example :</p> <ul style="list-style-type: none"> - time diversity : repetition, RAKE-receiver, etc., - space diversity : multiple sectors, multiple satellite, etc., - frequency diversity : FH, wideband transmission, etc., - code diversity : multiple PN codes, multiple FH code, etc., - other scheme. <p><i>Frequency and time hopping are considered.</i></p> <p>Characterize the diversity combining algorithm, for example, switch diversity, maximal ratio combining, equal gain combining. Additionally, provide supporting values for the number of receivers (or demodulators) per cell per mobile user. State the dB of performance improvement introduced by the use of diversity.</p> <p>For the mobile station : what is the minimum number of RF receivers (or demodulators) per mobile unit and what is the minimum number of antennas per mobile unit required for the purpose of diversity reception ?</p> <p><i>One RF receiver and one antenna are considered at the mobile unit.</i></p> <p>These numbers should be consistent to that assumed in the link budget template in Annex 2 and that assumed in the calculation of the “capacity” defined at A1.3.1.5.</p>
td	A1.2.23.2	<p>What is the degree of improvement expected in dB ? Please also indicate the assumed condition such as BER and FER.</p> <p><i>To be Completed.</i></p>
ti	A1.2.24	<p>Handover/Automatic Radio Link Transfer (ALT) : Do the radio transmission technologies support handover ?</p> <p>Characterize the type of handover strategy (or strategies) which may be supported, e.g. mobile station assisted handover. Give explanations on potential advantages, e.g. possible choice of handover algorithms. Provide evidence whenever possible.</p> <p><i>Mobile assistd, seamless handover is considered.</i></p>
td	A1.2.24.1	<p>What is the break duration (sec) when a handover is executed ? In this evaluation, a detailed description of the impact of the handover on the service performance should also be given. Explain how the estimate derived.</p> <p><i>Seamless handover is considered</i></p>

td	A1.2.24.2	<p>For the proposed SRTT, can handover cope with rapid decrease in signal strength (e.g. street corner effect) ?</p> <p>Give a detailed description of</p> <ul style="list-style-type: none"> - the way the handover detected, initiated and executed, - how long each of this action lasts (minimum/maximum time in msec), - the timeout periods for these actions. <p><i>To be Completed.</i></p>
ti	A1.2.25	<p>Characterize how does the proposed SRTT react to the system deployment in terms of the evolution of coverage and capacity (e.g. necessity to add new cells and/or new carriers) :</p> <ul style="list-style-type: none"> - in terms of frequency planning - in terms of the evolution of adaptive antenna technology using mobile identity codes (e.g. sufficient number of channel sounding codes in a TDMA type of system) - other relevant aspects <p><i>To be Completed.</i></p>
ti	A1.2.26	<p>Sharing frequency band capabilities : To what degree is the proposal able to deal with spectrum sharing among UMTS systems as well as with all other systems :</p> <ul style="list-style-type: none"> - spectrum sharing between operators - spectrum sharing between terrestrial and satellite UMTS systems - spectrum sharing between UMTS and non-UMTS systems - spectrum sharing between private and public UMTS operators - other sharing schemes. <p><i>To be Completed.</i></p>
ti	A1.2.27	<p>Dynamic channel allocation : Characterize the DCA schemes which may be supported and characterize their impact on system performance (e.g. in terms of adaptability to varying interference conditions, adaptability to varying traffic conditions, capability to avoid frequency planning, impact on the reuse distance, etc.)</p> <p><i>See section 5.3.</i></p>
ti	A1.2.28	<p>Mixed cell architecture : How well do the technologies accommodate mixed cell architectures (pico, micro and macrocells) ? Does the proposal provide pico, micro and macro cell user service in a single licensed spectrum assignment, with handoff as required between them ? (terrestrial component only)</p> <p><i>To be Completed.</i></p> <p>Note : Cell definitions are as follows :</p> <p style="padding-left: 40px;">pico - cell hex radius \leq 100 m</p> <p style="padding-left: 40px;">micro - $100 \text{ m} < \leq$ 1000 m</p> <p style="padding-left: 40px;">macro - \leq 1000 m</p>
ti	A1.2.29	<p>Describe any battery saver / intermittent reception capability</p> <p><i>To be Completed.</i></p>

td	A1.2.29.1	Ability of the mobile station to conserve standby battery power : Please provide details about how the proposal conserve standby battery power. <i>To be Completed.</i>
td	A1.2.30	Signaling transmission scheme : If the proposed system will use radio transmission technologies for signaling transmission different from those for user data transmission, describe details of signaling transmission scheme over the radio interface between terminals and base (satellite) stations. <i>The same transmission scheme is anticipated for data and signaling.</i>
td	A1.2.30.1	Describe the different signaling transfer schemes which may be supported, e.g. in connection with a call, outside a call. Does the SRTT support new techniques ? Characterise. Does the SRTT support signalling enhancements for the delivery of multimedia services ? Characterise. <i>See section 4.</i>
ti	A1.2.31	Does the SRTT support a Bandwidth on Demand (BOD) capability ? Bandwidth on Demand refers specifically to the ability of an end-user to request multi-bearer services. Typically this is given as the capacity in the form of bits per second of throughput. Multi bearer services can be implemented by using such technologies as multi carrier, multi time slot or multi codes. If so, characterise these capabilities. <i>BOD can be accommodated by multi time slot allocation.</i> Note : BOD does not refer to the self-adaptive feature of the radio channel to cope with changes in the transmission quality (see A1.2.5.1).
ti	A1.2.32	Does the SRTT support channel aggregation capability to achieve higher user bit rates ? <i>Not considered.</i>
	A1.3	Expected Performances
	A1.3.1	for terrestrial test environment only <i>See section 7.</i>
ti	A1.3.1.1	What is the achievable BER floor level (for voice) ? Note : BER floor level under BER measuring condition defined in Annex 2 using the data rates indicated in section 1 of Annex 2. <i>See section 7</i>
ti	A1.3.1.2	What is the achievable BER floor level (for data) ? Note : BER floor level under BER measuring condition defined in Annex 2 using the data rates indicated in section 1 of Annex 2. <i>See section 7</i>
ti	A1.3.1.3	What is the maximum tolerable delay spread (in nsec) to maintain the voice and data service quality requirements ? Note : The BER is an error floor level measured with the Doppler shift given in the BER measuring conditions of ANNEX 2. <i>See section 7</i>

ti	A1.3.1.4	<p>What is the maximum tolerable doppler shift (in Hz) to maintain the voice and data service quality requirements ?</p> <p>Note : The BER is an error floor level measured with the delay spread given in the BER measuring conditions of ANNEX 2.</p> <p><i>See section 7</i></p>
ti	A1.3.1.5	<p>Capacity : The capacity of the radio transmission technology has to be evaluated assuming the deployment models described in ANNEX 2 and technical parameters from A1.2.22 through A1.2.23.2.</p> <p><i>See section 7.7</i></p>
ti	A1.3.1.5.1	<p>What is the voice traffic capacity per cell (not per sector) : Provide the total traffic that can be supported by a single cell in Erlangs/MHz/cell in a total available assigned non-contiguous bandwidth of 30 MHz (15 MHz forward/15 MHz reverse) for FDD mode or contiguous bandwidth of 30 MHz for TDD mode. Provide capacities considering the model for the test environment in ANNEX 2. The procedure to obtain this value is described in ANNEX 2. The capacity supported by not a standalone cell but a single cell within contiguous service area should be obtained here.</p> <p><i>See section 7.7.</i></p>
ti	A1.3.1.5.2	<p>What is the information capacity per cell (not per sector) : Provide the total number of user-channel information bits which can be supported by a single cell in Mbps/MHz/cell in a total available assigned non-contiguous bandwidth of 30 MHz (15 MHz forward / 15 MHz reverse) for FDD mode or contiguous bandwidth of 30 MHz for TDD mode. Provide capacities considering the model for the test environment in ANNEX 2. The procedure to obtain this value is described in ANNEX 2. The capacity supported by not a standalone cell but a single cell within contiguous service area should be obtained here.</p> <p><i>See section 7.7</i></p>
ti	A1.3.1.6	<p>Does the SRTT support sectorization ? If yes, provide for each sectorization scheme and the total number of user-channel information bits which can be supported by a single site in Mbps/MHz (and the number of sectors) in a total available assigned non-contiguous bandwidth of 30 MHz (15 MHz forward/15 MHz reverse) in FDD mode or contiguous bandwidth of 30 MHz in TDD mode.</p> <p><i>The SRTT supports sectorization.</i></p>
ti	A1.3.1.7	<p>Coverage efficiency : The coverage efficiency of the radio transmission technology has to be evaluated assuming the deployment models described in ANNEX 2.</p> <p><i>See annex 2.</i></p>
ti	A1.3.1.7.1	<p>What is the base site coverage efficiency in Km²/site for the lowest traffic loading in the voice only deployment model ? Lowest traffic loading means the lowest penetration case described in ANNEX 2.</p> <p><i>To be Completed.</i></p>
ti	A1.3.1.7.2	<p>What is the base site coverage efficiency in Km²/site for the lowest traffic loading in the data only deployment model ? Lowest traffic loading means the lowest penetration case described in ANNEX 2.</p> <p><i>To be Completed.</i></p>
	A1.3.2 *	<p>for satellite test environment only</p> <p><i>Not applicable to this phase of the study of the SRTT</i></p>

ti	A1.3.2.1 *	What is the required C/No to achieve objective performance defined in ANNEX 2 ?
ti	A1.3.2.2 *	What are the Doppler compensation method and residual Doppler shift after compensation ?
ti	A1.3.2.3 *	Capacity : The spectrum efficiency of the radio transmission technology has to be evaluated assuming the deployment models described in ANNEX 2.
ti	A1.3.2.3.1 *	What is the voice information capacity per required RF bandwidth (bits/sec/Hz) ?
ti	A1.3.2.3.2 *	What is the voice plus data information capacity per required RF bandwidth (bits/sec/Hz) ?
ti	A1.3.2.4 *	Normalized power efficiency : The power efficiency of the radio transmission technology has to be evaluated assuming the deployment models described in ANNEX 2.
ti	A1.3.2.4.1 *	What is the supported information bit rate per required carrier power-to-noise density ratio for the given channel performance under the given interference conditions for voice ?
ti	A1.3.2.4.2 *	What is the supported information bit rate per required carrier power-to-noise density ratio for the given channel performance under the given interference conditions for voice plus data ?
ti	A1.3.3	Maximum user bit rate (for data) : Specify the maximum user bit rate (kbps) available in the deployment models described in ANNEX 2. <i>See section 8</i>
ti	A1.3.4	What is the maximum range in meters between a user terminal and a base station (prior to hand-off, relay, etc.) under nominal traffic loading and link impairments as defined in Annex 2 ? <i>Maximum distance is a function of the sensitivity and of the peak EIRP of the base station and of the mobile. They are not known yet. The only known limit is due to the guard period of the access burst which set the upper cell radius to 36 km.</i>
ti	A1.3.5	Describe the capability for the use of repeaters <i>To be Completed.</i>
ti	A1.3.6	Antenna Systems : Fully describe the antenna systems that can be used and/or have to be used ; characterize their impacts on systems performance, (terrestrial only) e.g. : - Does the SRTT have the capability for the use of remote antennas : Describe whether and how remote antenna systems can be used to extend coverage to low traffic density areas. <i>To be Completed.</i> - Does the SRTT have the capability for the use of distributed antennas : Describe whether and how distributed antenna designs are used, and in which UMTS test environments. <i>To be Completed.</i> - Does the SRTT have the capability for the use of smart antennas (e.g. switched beam, adaptive, etc.) : Describe how smart antennas can be used and what is their impact on system performance. <i>To be Completed.</i> - Other antenna systems. <i>To be Completed.</i>

	A1.3.7	Delay (for voice)												
ti	A1.3.7.1	<p>What is the radio transmission processing delay due to the overall process of channel coding, bit interleaving, framing, etc., not including source coding ? This is given as transmitter delay from the input of the channel coder to the antenna plus the receiver delay from the antenna to the output of the channel decoder. Provide this information for each service being provided. In addition, a detailed description of how this parameter was calculated is required for both the up-link and the down-link.</p> <p><i>In general an exact value for the end-to-end delay depends on the frame duration of the speech codec, interleaving depth and other assumptions. Therefore such values should be carefully interpreted. As a preliminary statement, the W-TDMA concept allows the following delay values :</i></p> <table border="1"> <thead> <tr> <th><i>Speech Frame duration Delay</i></th> <th><i>Interleaving depth (Frames)</i></th> <th><i>Total delay (incl. Codec)</i></th> <th><i>Radio Transmission Delay (subtracting Codec delay)</i></th> </tr> </thead> <tbody> <tr> <td><i>10 ms</i></td> <td><i>2</i></td> <td><i>23.075 ms</i></td> <td><i>13.075 ms</i></td> </tr> <tr> <td><i>20 ms</i></td> <td><i>4</i></td> <td><i>41.535 ms</i></td> <td><i>21.535 ms</i></td> </tr> </tbody> </table> <p><i>The first example provides for voice transmission with a low-delay reasonably comparable with current fixed networks, and with minimal echo cancellation performance requirements. The second example represents more typical operating conditions where additional interleaving is applied to improve robustness.</i></p> <p><i>Processing delay has not been included in the above figures, since it will depend on the capabilities of the hardware. More detailed evaluation of this aspect is required.</i></p>	<i>Speech Frame duration Delay</i>	<i>Interleaving depth (Frames)</i>	<i>Total delay (incl. Codec)</i>	<i>Radio Transmission Delay (subtracting Codec delay)</i>	<i>10 ms</i>	<i>2</i>	<i>23.075 ms</i>	<i>13.075 ms</i>	<i>20 ms</i>	<i>4</i>	<i>41.535 ms</i>	<i>21.535 ms</i>
<i>Speech Frame duration Delay</i>	<i>Interleaving depth (Frames)</i>	<i>Total delay (incl. Codec)</i>	<i>Radio Transmission Delay (subtracting Codec delay)</i>											
<i>10 ms</i>	<i>2</i>	<i>23.075 ms</i>	<i>13.075 ms</i>											
<i>20 ms</i>	<i>4</i>	<i>41.535 ms</i>	<i>21.535 ms</i>											
ti	A1.3.7.2	<p>What is the total estimated round trip delay in msec to include both the processing delay, propagation delay (terrestrial only) and vocoder delay ? Give the estimated delay associated with each of the key attributes described in Figure 1 of Annex 3 that make up the total delay provided.</p> <p><i>To be Completed.</i></p>												
ti	A1.3.7.3 *	Does the proposed SRTT need echo control ?												
ti	A1.3.8 *	<p>What is the MOS level for the proposed codec for the relevant test environments given in Annex 2 ? Specify its absolute MOS value and its relative value with respect to the MOS value of G.711(64k PCM) and G.726 (32k ADPCM).</p> <p>Note : If a special voice coding algorithm is indispensable for the proposed SRTT, the proponent should declare detail with its performance of the codec such as MOS level. (See A1.2.19)</p>												
ti	A1.3.9	<p>Description on the ability to sustain quality under certain extreme conditions.</p> <p><i>To be Completed.</i></p>												

ti	A1.3.9.1	System overload (terrestrial only) : Characterize system behavior and performance in such conditions for each test services in Annex 2, including potential impact on adjacent cells. Describe the effect on system performance in terms of blocking grade of service for the cases that the load on a particular cell is 125%, 150%, 175%, and 200% of full load. Also describe the effect of blocking on the immediate adjacent cells. Voice service is to be considered here. Full load means a traffic loading which results in 1% call blocking with the BER of 10^{-3} maintained. <i>To be Completed.</i>
ti	A1.3.9.2	Hardware failures : Characterize system behavior and performance in such conditions. Provide detailed explanation on any calculation. <i>To be Completed.</i>
ti	A1.3.9.3	Interference immunity : Characterize system immunity or protection mechanisms against interference. What is the interference detection method ? What is the interference avoidance method ? <i>Interference averaging is achieved by time and frequency hopping. Interference is avoided by DCA.</i>
ti	A1.3.10	Characterize the adaptability of the proposed SRTT to different and/or time varying conditions (e.g. propagation, traffic, etc.) that are not considered in the above attributes of the section A1.3. <i>Link adaptation maintains quality of service under different conditions.</i>
	A1.4	Technology Design Constraints
ti	A1.4.1	Frequency stability : Provide transmission frequency stability (not oscillator stability) requirements of the carrier (include long term - 1 year - frequency stability requirements in ppm).
ti	A1.4.1.1	For Base station transmission (terrestrial component only) <i>To be Completed.</i>
ti	A1.4.1.2	For Mobile station transmission <i>To be Completed.</i>
ti	A1.4.2	Out of band and spurious emissions : Specify the expected levels of base or satellite and mobile transmitter emissions outside the operating channel, as a function of frequency offset. <i>To be Completed.</i>

ti	A1.4.3	<p>Synchronisation requirements : Describe SRTT's timing requirements , e.g.</p> <ul style="list-style-type: none"> - Is base station-to-base station or satellite LES-to-LES synchronisation required ? Provide precise information, the type of synchronisation, i.e., synchronisation of carrier frequency, bit clock, spreading code or frame, and their accuracy. <p><i>Synchronisation is not required at base station level when BCCH is permanently broadcast. In this environment, mobiles can acquire the synchronisation of adjacent cells even within a call. Synchronisation might on the other end be required when non-constant BCCH is adopted.</i></p> <ul style="list-style-type: none"> - Is base station-to-network synchronisation required ? (terrestrial only) <p><i>BS synchronisation is not required, but improves spectrum efficiency.</i></p> <ul style="list-style-type: none"> - State short-term frequency and timing accuracy of base station (or LES) transmit signal. <p><i>To be Completed.</i></p> <ul style="list-style-type: none"> - State source of external system reference and the accuracy required, if used at base station (or LES)(for example : derived from wireline network, or GPS receiver). <p><i>Implementation dependant [to be confirmed].</i></p> <ul style="list-style-type: none"> - State free run accuracy of mobile station frequency and timing reference clock. <p><i>To be Completed.</i></p> <ul style="list-style-type: none"> - State base-to-base bit time alignment requirement over a 24 hour period, in microseconds. <p><i>To be Completed.</i></p> <ul style="list-style-type: none"> - For private systems : can multiple unsynchronized systems coexist in the same environment ? <p><i>Yes.</i></p>
ti	A1.4.4	<p>Timing jitter : For base (or LES) and mobile station give :</p> <ul style="list-style-type: none"> - the maximum jitter on the transmit signal, <p><i>To be Completed.</i></p> <ul style="list-style-type: none"> - the maximum jitter tolerated on the received signal. <p><i>To be Completed.</i></p> <p>Timing jitter is defined as RMS value of the time variance normalized by symbol duration.</p>
ti	A1.4.5	<p>Frequency synthesizer : What is the required step size, switched speed and frequency range of the frequency synthesizer of mobile stations ?</p> <p><i>The step size should be equal to the channel raster which is expected to be 200 KHz. The switched speed should correspond to the shortest possible burst (time for the transceiver to switch between transmit and receive state), that is to say 72 ms.</i></p>
ti	A1.4.6*	<p>Does the proposed system require capabilities of fixed networks not generally available today ?</p>
td	A1.4.6.1	<p>Describe the special requirements on the fixed networks for the handover procedure. Provide handover procedure to be employed in proposed SRTT in detail.</p> <p><i>See section 5.3.</i></p>
ti	A1.4.7	<p>Fixed network Feature Transparency</p>

ti	A1.4.7.1*	Which service(s) of the standard set of ISDN bearer services can the proposed SRTT pass to users without fixed network modification.
ti	A1.4.8	Characterize any radio resource control capabilities that exist for the provision of roaming between a private (e.g., closed user group) and a public UMTS operating environment. <i>To be Completed.</i>
ti	A1.4.9	Describe the estimated fixed signaling overhead (e.g., broadcast control channel, power control messaging). Express this information as a percentage of the spectrum which is used for fixed signaling. Provide detailed explanation on your calculations. <i>To be Completed.</i>
ti	A1.4.10	Characterize the linear and broadband transmitter requirements for base and mobile station. (terrestrial only) <i>To be Completed.</i>
ti	A1.4.11	Are linear receivers required ? Characterize the linearity requirements for the receivers for base and mobile station. (terrestrial only) <i>To be Completed.</i>
ti	A1.4.12	Specify the required dynamic range of receiver. (terrestrial only) <i>To be Completed.</i>

ti	A1.4.13	<p>What are the signal processing estimates for both the handportable and the base station ?</p> <p>- MOPS (Mega Operation Per Second) value of parts processed by DSP</p> <p><i>Signal processing requirements of WB-TDMA equalizer.</i></p> <p><i>The complexity of the 5-tap MLSE (SOVA=Soft Output Viterbi Equalizer) per detected symbol is about the same as the complexity of the current GSM equalizer. This SOVA equalizer as well as DFE (Decision Feedback Equalizer) has been used in the link level simulations. The number of real multiplications for SOVA are shown below:</i></p> <p><i>Speech service, 1 slot (1/64)/frame, Bin-O-QAM, 5-tap MLSE, 4.8e6 real multiplications/second</i></p> <p><i>144 kbit/s, 2 slots (1/16)/frame, Bin-O-QAM, 5-tap MLSE, 48e6 real multiplications/second</i></p> <p><i>1 Mbit/s, 12 slots (1/16)/frame, Bin-O-QAM, 5-tap MLSE, 290e6 real multiplications/second</i></p> <p><i>2 Mbit/s, 12 slots (1/16)/frame, Quat-O-QAM, 3-tap MLSE, 630e6 real multiplications/second</i></p> <p><i>The corresponding figures for DFE are as follows:</i></p> <p><i>Speech: 0.6e6 real multiplications/second</i></p> <p><i>144 kbit/s: 6.0e6 real multiplications/second 1 Mbit/s: 36e6 real multiplications/second</i></p> <p><i>2 Mbit/s: 28e6 real multiplications/second</i></p> <p><i>The complexity of the DFE equalizer is much lower than the complexity of MLSE equalizer. This also implies that the remaining intersymbol interference with 5-tap MLSE equalizer could be cancelled with decision feedback part with only a minor increase in receiver complexity.</i></p> <p>- gate counts excluding DSP</p> <p><i>To be Completed.</i></p> <p>- ROM size requirements for DSP and gate counts in kByte</p> <p><i>To be Completed.</i></p> <p>- RAM size requirements for DSP and gate counts in kByte</p> <p><i>To be Completed.</i></p> <p>Note 1 : At a minimum the evaluation should review the signal processing estimates (MOPS, memory requirements, gate counts) required for demodulation, equalization, channel coding, error correction, diversity processing (including RAKE receivers), adaptive antenna array processing, modulation, A-D and D-A converters and multiplexing as well as some IF and baseband filtering. For new technologies, there may be additional or alternative requirements (such as FFTs etc.).</p> <p>Note 2 : The signal processing estimates should be declared with the estimated condition such as assumed services, user bit rate and etc.</p>
ti	A1.4.14*	<p>Dropped calls : Describe how the SRTT handles dropped calls. Does the proposed SRTT utilize a transparent reconnect procedure - that is, the same as that employed for handoff ?</p>

ti	A1.4.15	<p>Characterize the frequency planning requirements :</p> <ul style="list-style-type: none"> - Frequency reuse pattern : given the required C/I and the proposed technologies, specify the frequency cell reuse pattern (e.g. 3-cell, 7-cell, etc.) and, for terrestrial systems, the sectorization schemes assumed ; <p><i>Re-use 1 is supported</i></p> <ul style="list-style-type: none"> - Characterize the frequency management between different cell layers ; <p><i>To be Completed.</i></p> <ul style="list-style-type: none"> - Does the SRTT use interleaved frequency allocation ? <p><i>No.</i></p> <ul style="list-style-type: none"> - Are there any frequency channels with particular planning requirements ? <p><i>No.</i></p> <ul style="list-style-type: none"> - Can the SRTT support self planning techniques ? <p><i>Yes.</i></p> <ul style="list-style-type: none"> - All other relevant requirements <p>Note : Interleaved frequency allocation is to allocate the 2nd adjacent channel instead of adjacent channel at neighboring cluster cell.</p>
ti	A1.4.16	<p>Describe the capability of the proposed SRTT to facilitate the evolution of existing radio transmission technologies used in mobile telecommunication systems migrate toward this SRTT. Provide detail any impact and constraint on evolution.</p> <p><i>The frame structure is compatible with the one of GSM, which makes the synchronisation of a MS to both systems feasible. As a result, a seamless inter-system handover is possible. An UMTS base station should maintain a list of GSM base station in the vicinity so that a MS operating in UMTS-mode can pre-synchronise with the strongest GSM base station in case an inter-system handover is required. The corresponding procedure can be applied in the reverse direction.</i></p>
ti	A1.4.16.1	<p>Does the SRTT support backwards compatibility into GSM/DCS in terms of easy dual mode terminal implementation, spectrum co-existence and handover between UMTS and GSM/DCS ?</p> <p><i>cf question A1.4.16</i></p>
ti	A1.4.17	<p>Are there any special requirements for base site implementation ? Are there any features which simplify implementation of base sites ? (terrestrial only)</p> <p><i>To be Completed.</i></p>
ti	A1.5	<p>Information required for terrestrial link budget template : Proponents should fulfill the link budget template given in Table 1.3 of Annex 2 and answer the following questions.</p> <p><i>To be Completed.</i></p>
ti	A1.5.1	<p>What is the base station noise figure (dB) ?</p> <p><i>The actual figure is implementation dependant. The minimum requirement is TBC.</i></p>
ti	A1.5.2	<p>What is the mobile station noise figure (dB) ?</p> <p><i>The actual figure is implementation dependant. The minimum requirement is TBC.</i></p>

ti	A1.5.3	What is the base station antenna gain (dBi) ? <i>This is implementation dependant. For sectorised envirnment, figures of 18 dBi can be considered.</i>
ti	A1.5.4	What is the mobile station antenna gain (dBi) ? <i>To be Completed.</i>
ti	A1.5.5	What is the cable, connector and combiner losses (dB) ? <i>To be Completed.</i>
ti	A1.5.5	What are the number of traffic channels per RF carrier ? <i>To be completed</i>
ti	A1.5.6	What is the SRTT operating point (BER/FER) for the required E_b/N_0 in the link budget template ? <i>To be Completed.</i>
ti	A1.5.7	What is the ratio of intra-sector interference to sum of intra-sector interference and inter-sector interference within a cell (dB) ? <i>To be Completed.</i>
ti	A1.5.8	What is the ratio of in-cell interference to total interference (dB) ? <i>To be Completed.</i>
ti	A1.5.9	What is the occupied bandwidth (99%) (Hz) ? <i>To be Completed.</i>
ti	A1.5.10	What is the information rate (dBHz) ? <i>To be Completed.</i>
	A1.6 *	Satellite System Configuration (applicable to satellite component only) : Configuration details in this sub-section are not to be considered as variables. They are for information only. <i>Not applicable to this SRTT.</i>
	A1.6.1 *	Configuration of satellite constellation
	A1.6.1.1 *	GSO, HEO, MEO, LEO or combination ?
	A1.6.1.2 *	What is the range of height where satellites are in active communication ?
	A1.6.1.3 *	What is the orbit inclination angle ?
	A1.6.1.4 *	What are the number of orbit planes ?
	A1.6.1.5 *	What are the number of satellites per orbit plane ?
	A1.6.2 *	What is the configuration of spot beams/cell layout pattern ?
	A1.6.3 *	What is the frequency reuse plan among spot beams ?
	A1.6.4 *	What is the service link G/T of satellite beam (average, minimum) ?

A1.6.5 *	What is the service link saturation EIRP of each beam (average, minimum), when configured to support 'Hot spot' ?
A1.6.6 *	What is the service link total saturation EIRP per satellite ?
A1.6.7 *	Satellite e.i.r.p. (effective isotropic radiated power) per RF carrier for satellite component
A1.6.7.1 *	What is the maximum peak e.i.r.p. transmitted per RF carrier ?
A1.6.7.2 *	What is the average e.i.r.p. transmitted per RF carrier ?
A1.6.8 *	What is the feeder link information ?
A1.6.9 *	What is the slot timing adjustment method (mainly applicable to TDMA system) ?
A1.6.10 *	What is the satellite diversity method, if applicable ?

11. Annex 2 : Operators Questions List

The question of operators following the SMG2 UMTS ad hoc meeting in Rennes, August 5-8 were reviewed and resulted in the following comments.

11.1 Guard band

1.1 What is the required guard band between two UMTS operators? Give assumptions made on transmission masks and minimum coupling loss factor to carry out your analysis.

We consider two mobiles belonging to two different networks located in adjacent bands. We analyse how they can interfere first when their serving base stations are co-localised, then when they are not. This correspond to the following schemes :

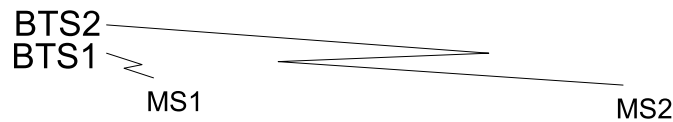


Figure 1 : Near-far effect for colocalised base stations

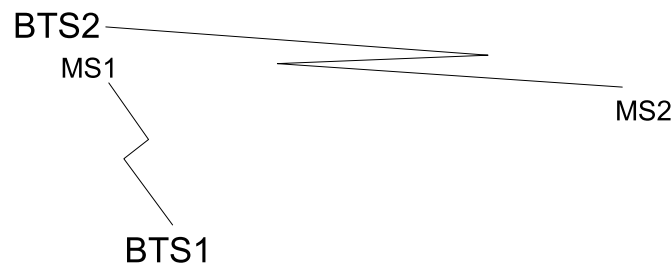


Figure 2 : Near-far effect for non-colocalised base stations

11.1.1 Principle of the analysis

We only consider the worst case for which MS1 is at the shortest possible distance considered and MS2 is at the cell edge. Both mobiles are in addition assumed to transmit during the same timeslot (or at least during overlapping timeslots : BTS synchronisation is not assumed and frames are *a priori* not aligned).

We indicate in the next two sub-sections the criterias allowing to determine whether a guard band is required or not. We define in the following section the considered environments and we derive the minimum path losses. The last section is a synthesis in the various environments presented. The lower and higher considered signal levels will be derived for the colocalised and non-colocalised cases, the opportunity of a guard band is in each case derived; the impact of time and frequency hopping is then mentioned.

The guardband requirements are derived from interference-limited scenarios. It must be pointed out that it leads to pessimistic results as the immunity brought by timeslot hopping, frequency hopping and link adaptation together with frequency reuse one and fractional loading¹ have not been considered in detail yet. This is for further study.

¹ Interference averaging through frequency reuse one and fractional loading is described in section 5.2 of the WB-TDMA evaluation document version 1.0 c.

11.1.1.1 *Spurious Emissions of the mobiles*

The receiver of BTS2 can be affected by the spurious emissions of MS1 which can result from the power spectra of the modulation affected by the non-linearities of the power amplifier, the power ramping at the beginning and the end of the burst and the wideband noise of the local oscillator. The first effect is considered as dominant and is the only one considered in this preliminary study. According to initial simulations, the spurious level at the output of a conservative power amplifier is at about -25 dBc in the first adjacent channel and about -45 dBc in the second adjacent channel. It should be possible to improve these figures, this is left for further studies.

Simulations indicate that MS2 can be satisfactorily received from a $C/(I+N)$ of roughly 7 dB (out of any margin). This can be achieved without guard band if :

- $RX_Power(MS1, BTS2) - 25 \text{ dB} < RX_Power(MS2, BTS2) - 7$,
- where $RX_Power(MS, BTS)$ is the power at which the MS is received by the BTS.

The power at which the interferer is received in the first adjacent channel must thus be at most 18 dB (25 - 7) above the power of the signal of the served mobile. Using the notation of GSM 05.05, we must have $C/Ia1$ of at least -18 dB.

(1)

A similar approach for the second adjacent channel result in a $C/Ia2$ of at least -38 dB. (2)

The guardband required between two un-coordinated UMTS systems is function of the $C/Ia1$ and $C/Ia2$ that can be provided in the considered environment.

11.1.1.2 *BTS receiver characteristics*

The receiver of the BTS can in addition be affected by a strong transmitter in an adjacent band due to the non-linearities of its LNA, the limited selectivity of its filters and to the wideband noise of its local oscillator causing a reciprocal mixing and resulting in some of the power in the adjacent bands to alias onto the useful signal.

We consider that the spurious emissions of the mobile in the adjacent bands are more constraining than the limitations of the receiver. Our analysis will thus focus on criteria (1) and (2) given in the previous section.

11.1.2 **Considered environments and minimum coupling losses**

The minimum coupling loss between MSs and the BTS depends on the environment. We consider below the models of path losses defined in annex 2 of 04.02, namely :

- Indoor office,
- Outdoor to indoor and Pedestrian,
- vehicular.

For simplification, we do not mix the environments in the analysis (it means that the path losses of both mobiles are assumed to be modelled by the same law).

We derive below the minimum and maximum coupling losses, from which we derive the highest possible power dynamic at the input of the base station, both for the collocated and non-collocated scenarios. These values are compared to the criteria (1) and (2) given above. The impact of time and frequency hopping is then considered.

The antenna gain of the mobile is in addition always 0 dBi and the minimum output power is assumed to be -10 dBm. The maximum output power is environment dependant; the assumed values is indicated in each case in section 3.

11.1.2.1 Indoor Office

We assume the minimum distance between a mobile and the base station antenna to be 1 metre in Indoor office. This results in a minimum path loss of 38.5 dB (we had to consider the free path loss as it gave a greater figure than the formula of section 1.4.1.1 of annex 2).

Considering a BTS antenna gain of 5 dBi and 2 dB of feeder loss, we derive a minimum coupling loss of 35.5 dB.

11.1.2.2 Outdoor to Indoor and Pedestrian

We assume the minimum distance between a mobile and the base station to be 6 metres. This results in a minimum path loss of 54 dB, considering again the free path loss propagation.

We now consider an antenna gain of 9 dBi and a feeder loss of 4 dB to derive a minimum coupling loss of 49 dB.

11.1.2.3 Vehicular

The antenna is assumed to be 25 metres above the ground level (following the assumption of annex 2 of 04.02, section 1.4.1.3 and assuming that the roof level is 10 metres above the ground). We assume that the minimum distance between the base station and the mobile is 100 metres (this is roughly the distance corresponding to the minimum coupling loss in line of sight considering the vertical beam pattern of the antenna). Under these assumptions, the minimum path loss is 90.5 dB.

Considering an antenna gain of 18 dBi and a feeder loss of 6 dB, we derive a minimum coupling loss of 78.5 dB.

11.1.3 Synthesis

We first determine the highest signal level received by the base station for each considered environment from the minimum coupling loss derived in section 2 and the assumed mobile transmit power.

The lowest admissible signal power is then stated for the considered environment by taking 10 dB over the BTS sensitivity for interference margin (cf. GSM rec. 05.50, Annex A) plus some shadowing margin (we provisionnaly take the C/I log-normal standard deviation assumed in annex 2 of 04.02 for the considered environment).

The figures obtain allow to see from criteria (1) and (2) whether a guard band is required.

11.1.3.1 Colocated base stations

We consider that the power control will work in a similar way for the two base stations : when the path loss between a mobile falls behind some threshold the serving base station orders the mobile to decrease its output power. As a consequence the mobile the closest from the base station, MS1 in our model, broadcasts with its smallest possible power which is -10 dBm with our assumptions.

Let determine the power dynamic range to determine the need of a guard band, considering that a correct demodulation of MS2 requires a C/I of at least 7 dB² :

² Operation at lower C/I is possible with link adaptation *ie* use of more transmission slots.

Environment	Indoor Office	Indoor to Outdoor and Pedestrian	Vehicular
MS1 TX power	-10 dBm		
Minimum coupling loss	35.5 dB	49 dB	78.5 dB
MS1 RX power per BTS2	-45.5 dBm	-59 dBm	-88.5 dBm
spurious level in 1st adjacent channel	-70.5 dBm	-84 dBm	-113.5 dBm
Required signal level from MS2 at BTS2 to avoid guard band.	-63.5 dBm	-77 dBm	-106.5 dBm
Spurious level in 2nd adjacent channel	-90.5 dBm	-104 dBm	-123.5 dBm
Required signal level from MS2 at BTS2 with one channel guardband (1.6 MHz).	-83.5 dBm	-97 dBm	(-126.5 dBm)
BTS reference sensitivity	-113 dBm		
log-normal shadowing margin	12 dB	10 dB (outdoor) 12 dB (Indoor)	10 dB
interference margin	10 dB	10 dB	10 dB
BTS sensitivity with interference and lognormal margins	-91 dBm	-93 dBm (Outdoor) -91 dBm (Indoor)	-93 dBm

It appears that in **vehicular environment** two UMTS systems can comfortably operate without guard band.

In Indoor to Outdoor environment and Indoor Office, a desensitization might be observed without guard band. It is however possible to mitigate it through time and frequency hopping that should make very rare the conjunction of :

- the worst case shown on figure 1,
- the two mobiles transmitting on overlapping timeslots (although the probability of this event increases with the bit rate).

As a result **Indoor to Outdoor and Pedestrian** can be considered as being feasible without guard band. In the case that frequency hopping and timeslot hopping are not used, it is possible to adopt some guard band. We can see from the table above that a guard band of 1.6 MHz offers a protection which is superior by 4 to 6 dB to what is required. A guard band of 1 to 1.4 MHz should be sufficient to provide the required isolation.

A guard band of 1.6 MHz could be required for **Indoor Office**. Alternatively an indoor base station might be defined. It would be characterised by an admissible input power range shifted by 20 to 25 dB as compared to a standard W-TDMA base station, following the approach that conducted to the definition of the microBTSs M1 to M3 for GSM.

11.1.3.2 Non-colocated base stations

The reference situation is now described by Figure 2. The two base stations are now far away and MS1 can come in the vicinity of BTS2 while broadcasting at full power. We take for this peak transmit power the value indicated in the table given under section 3.3 of the "Response to the Operator's key questions to the UTRA concept groups", Tdoc SMG2/G23/97.

Let determine the power dynamic range to determine the need for a guard band in each of the considered environments.

Environment	Indoor Office	Indoor to Outdoor and Pedestrian	Vehicular
MS1 TX power	14 dBm	24 dBm	30 dBm
Minimum coupling loss	35.5 dB	49 dB	78.5 dB
MS1 RX power per BTS2	-21.5 dBm	-25 dBm	-48.5 dBm
Spurious level in first adjacent channel	-46.5 dBm	-50 dBm	-73.5 dBm
Required signal level from MS2 at BTS2 to avoid guard band	-39.5 dBm	-43 dBm	-66.5 dBm
Spurious level in second adjacent channel	-66.5 dBm	-70 dBm	-93.5 dBm
Required signal level from MS2 at BTS2 with one channel guardband (1.6 MHz)	-59.5 dBm	-63 dBm	-86.5 dBm
BTS reference sensitivity	-113 dBm		
Lognormal shadowing margin	12 dB	10 dB (outdoor) 12 dB (Indoor)	10 dB
Interference margin	10 dB	10 dB	10 dB
BTS sensitivity with interference and C/I margins	-91 dBm	-93 dBm (Outdoor) -91 dBm (Indoor)	-93 dBm

It appears that each environment meets some desensitization, even with a guard band of 1.6 MHz. It can again be combatted by frequency and timeslot hopping.

The most critical case of Indoor office can again be delt with by the definition of a specific classes of indoor base station.

It must however be reminded that the probability of occurrence of scenarios conducting to these desensitizations is very low as they only happen when :

- one interfering mobile is very close to the jammed base station,
- this mobile tranmits at full power,
- the timeslots during which it transmits are overlapping timeslots of a mobile received close to the BTS sensitivity.

1.2 What is the required guard band between UMTS and other systems (in particular, with respect to GSM900, GSM1800, GSM1900, personal satellite communication systems, such as ICO, Iridium and Globalstar)?

The required guard band between a W-TDMA and a GSM system located in adjacent bands is governed by the level of out-of-band emissions generated by each system.

W-TDMA presents some immunity against a GSM interferer because of its larger bandwidth. A guardband of probably 200, eventually 400 kHz might be required.

The guardband required to avoid serious disturbances caused by UMTS on GSM was not simulated yet. We can however anticipate (as a first approximation) from the analysis conducted in section 1.1 that the colocated scenario is much more comfortable. It would correspond to the situation of a GSM operator starting to deploy an UMTS network from the site use from its GSM base stations.

11.2 Spectrum requirements

2.1 *What is the minimum frequency bandwidth required for supporting 2 Mbit/s of user bit rate in each cell, indoor and low range outdoor, simultaneously, (i.e. an user bit rate of 2 Mbit/s/cell), in uplink and downlink respectively?*

[What is the minimum required bandwidth for operating a network in an indoor and low range outdoor environment, each cell of which provides a circuit switched service of 2 Mbit/s user bit rate for one user in uplink and downlink respectively?]

The required bandwidth depends on many things, however, two main issues are:

1. the amount of isolation between cells, on the other words, how interference limited the networks is
2. what kind of bearer distribution is assumed to generate the required 2 Mbits/s/cell

According to system simulations made so far, in a quite isolated environment, Outdoor to Indoor and Pedestrian with UDD384 bearers, the spectrum efficiency is 590 kb/s/MHz/cell, thus the required bandwidth for 2 Mb/s/cell is 3.4 MHz.

On the other hand, in the Indoor Office environment defined by 04.02 (hardly any isolation between cells, no walls and very high slow fading), the spectrum efficiency for UDD2048 is ca. 100 kb/s/MHz/cell. Thus the implied bandwidth for 2 Mb/s/cell would be 20 MHz. This reference environment is however not realistic in most of the cases and results in a too pessimistic spectrum efficiency. A more accurate approach would take walls and a more realistic attenuation factor into account.

The required bandwidth can in addition be reduced by introducing:

Modulation adaptation (see TDoc 15/97, pp 32-33)

Channel allocation to the cells (see TDoc 15/97, pp 42)

Quality based handover (see TDoc 15/97, pp 37-39)

In one cell case where all users are close to BTS, the required bandwidth is 0.67 MHz.

2.2 *What is the minimum required bandwidth and cluster size to deploy and operate a complete network providing a 2 Mbit/s real time service in the indoor environment and, in the same area and at the same time, a 384 kbit/s real time service in the pedestrian environment and a 144 kbit/s real time service in the vehicular environment (characterized by high mobility)? Please comment on the number of users this bandwidth would support at each rate/environment, and how the bandwidth increases when the number of users grows.*

To answer this important question, hierarchical cell structures (HCS) system simulations must be performed. The HCS simulations are for further study.

2.3 *How does the proposed UTRA concept support spectrum re-farming and what is the minimum bandwidth required?*

This question shall be answered altogether with question 1.2.

11.3 GSM backwards compatibility

3.1 *Which concept for handover from UMTS to GSM and vice versa is used in the UTRA proposal? Which data services, besides speech, can be handed over between UMTS and GSM?*

Target is to provide full compatibility at radio interface between WB-TDMA and GSM, some adaptation are required if used service is not available in the target system. This could be handled prior or during the handover.

A description of the mechanisms allowing the handover between the two systems is given in the Evaluation Document (it appears in section 2.5.3 in the version 0.3 of this document).

3.2 How will a UMTS/GSM dual mode terminal be implemented? What are the differences in terms of complexity and cost between a UMTS/GSM dual mode speech terminal and a GSM speech terminal?

Nokia indicated that the difference of cost between a GSM speech terminal and a UMTS/GSM dual mode speech terminal was similar (difference of the order of 10%).

3.3 Does the proposed UTRA concept have any limitations for the reuse of the GSM cell sites, e.g. limitations due to maximum cell size in an environment?

As shown in the table below, the maximum range of WB-TDMA for speech service is longer than the range of GSM1800. So, cell site reuse is possible.

It should be noticed that the coverage analysis for speech service is based on 6 slot transmission. Those other 58 slots in a TDMA frame in that carrier can be used to support other users and this does not affect the range of the 6-slot user. For example, if other users take 1 slot/frame on average, 58 other users can be supported with one 1.6 MHz carrier while still providing the maximum range for one user. If this WB-TDMA scheme is compared to other proposals with e.g. 5 MHz bandwidth, then total of 3 WB-TDMA carriers can be used at the same bandwidth to support even a higher number of users while providing the maximum range.

It should also be noticed that the average transmission power in Vehicular environment is 4.3 dB lower than the maximum average power given in ETR0402. This is due to limitation set on the MS peak power. The lower average power also implies lower power consumption of the mobile station power amplifier at the cell edge.

WB-TDMA coverage analysis for speech service											
		WB-TDMA		WB-TDMA		WB-TDMA		GSM1800		GSM900	
		Downlink	Uplink	Downlink	Uplink	Downlink	Uplink	Downlink	Uplink	Downlink	Uplink
Test environment		Indoor	Indoor	Pedestr.	Pedestr.	Vehicular	Vehicular	Vehicular	Vehicular	Vehicular	Vehicular
Multipath channel class		A	A	A	A	A	A				
Test service		Speech	Speech	Speech	Speech	Speech	Speech	Speech	Speech	Speech	Speech
Number of slots used / frame		6	6	6	6	6	6	1	1	1	1
Total number of slots / frame		64	64	64	64	64	64	8	8	8	8
Bit rate	bit/s	8000,00	8000,00	8000,00	8000,00	8000,00	8000,00	13000,00	13000,00	13000,00	13000,00
Maximum peak power limitation	dBm		30,00		30,00		30,00		30,00		33,00
Average TX power per traffic ch. (ETR0402)	dBm	10,00	4,00	20,00	14,00	30,00	24,00	30,00	24,00	30,00	24,00
Maximum TX power per traffic ch.	dBm	20,28	14,28	30,28	24,28	40,28	30,00	39,03	30,00	39,03	33,00
Average TX power per traffic ch. (real)	dBm	10,00	4,00	20,00	14,00	30,00	19,72	30,00	20,97	30,00	23,97
Maximum total TX power	dBm	20,28	14,28	30,28	24,28	40,28	30,00	39,03	30,00	39,03	33,00
Cable, conn. and combiner losses	dB	2,00	0,00	2,00	0,00	2,00	0,00	2,00	0,00	2,00	0,00
TX antenna gain	dBi	2,00	0,00	10,00	0,00	13,00	0,00	13,00	0,00	13,00	0,00
TX EIRP per traffic channel	dBm	20,28	14,28	38,28	24,28	51,28	30,00	50,03	30,00	50,03	33,00
Total TX EIRP	dBm	20,28	14,28	38,28	24,28	51,28	30,00	50,03	30,00	50,03	33,00
RX antenna gain	dBi	0,00	2,00	0,00	10,00	0,00	13,00	0,00	13,00	0,00	13,00
Cable and connector losses	dB	0,00	2,00	0,00	2,00	0,00	2,00	0,00	2,00	0,00	2,00
Receiver noise figure	dB	5,00	5,00	5,00	5,00	5,00	5,00	5,00	5,00	5,00	5,00
Thermal noise density	dBm/Hz	-174,00	-174,00	-174,00	-174,00	-174,00	-174,00	-174,00	-174,00	-174,00	-174,00
RX interference density	dBm/Hz	-1000,00	-1000,00	-1000,00	-1000,00	-1000,00	-1000,00	-1000,00	-1000,00	-1000,00	-1000,00
Total effect. noise + interf. density	dBm/Hz	-169,00	-169,00	-169,00	-169,00	-169,00	-169,00	-169,00	-169,00	-169,00	-169,00
Information rate (during tx)	dB/Hz	49,31	49,31	49,31	49,31	49,31	49,31	50,17	50,17	50,17	50,17
Required Eb/(No+Io)	dB	8,40	5,90	8,60	5,90	8,70	6,60	12,00	12,00	12,00	12,00
RX sensitivity	dB	-111,29	-113,79	-111,09	-113,79	-110,99	-113,09	-106,83	-106,83	-106,83	-106,83
Handoff gain	dB	4,10	4,10	3,00	3,00	3,00	3,00	3,00	3,00	3,00	3,00
Explicit diversity gain	dB	0,00	0,00	0,00	0,00	0,00	0,00	0,00	4,50	0,00	4,50
Other gain	dB	0,00	0,00	0,00	0,00	0,00	0,00	0,00	0,00	0,00	0,00
Log-normal fade margin	dB	15,40	15,40	11,30	11,30	11,30	11,30	11,30	11,30	11,30	11,30
Maximum path loss	dB	120,27	116,77	141,07	137,77	153,97	145,79	148,56	144,03	148,56	147,03
Maximum range	m	596,54	456,01	669,85	553,96	4875,37	2954,25	3500,77	2652,54	5374,45	4893,49

3.4 Is it possible to operate and manage the UTRA concept with a GSM operation and management system? If not, please indicate the expected differences.

Due to backward compatibility WB-TDMA can in principle be operated through GSM O&M system. However, the goal for WB-TDMA has been easier network deployment e.g. with help of the Interference Averaging scheme (see document WB-TDMA Radio Resource Management). Therefore such a heavy O&M system as in GSM is not expected to be required.

11.4 Macro diversity (or soft handover)

If macro diversity (or soft handover) is used in the proposed UTRA concept, please answer the following questions:

Use of Macro diversity / soft HO is not required by the concept.

11.5 Support of asymmetric traffic

5.1 What is the concept for supporting asymmetric traffic between uplink and downlink and how do you propose to use the unpaired frequency bands?

Asymmetric traffic can be supported by TDD or by allocating different service bit rates for uplink and downlink respectively in FDD. This can be done easily, as an example, by allocating a low bit rate carrier for the uplink from the "paired" band and a high bit rate carrier from the unpaired band. The unused pair of the low bit rate carrier can be used for asymmetric services within the symmetric band. TDMA makes this allocation scheme reasonable to implement.

TDD asymmetry could be achieved by 'traditional' means by allocation a fixed amount of slots through the whole operator's TDD spectrum for both directions.

However, due to the uncertainty concerning traffic profiles in different environments this approach does not seem to be very attractive. One idea in the usage of the TDD band is to allocate asymmetric capacity on an individual basis i.e. the frequency band would not be divided into purely uplink and downlink channels in the time domain but rather in a dynamic manner enabling the usage of all channels in frequency and time domain for both directions. These scheme is possible both by using RNC controlled Channel Allocation which enables fast handovers in the frequency and time domain or by Interference Averaging between different cells.

The described scheme would lead to minimum frequency planning. The operator does not have to put fixed percentage of the overall system capacity to up- or downlink traffic.

5.2 If TDD mode is supported, what are the requirements for synchronization and how stringent are they? Would the use of TDD lower the range of the cell and by how much? Is TDD-FDD handover supported?

Synchronisation is not required but optionally used. Synchronization results to some system performance gain. There are possibilities to use either over the air synchronisation mechanisms (even between uncoordinated systems) or transmission based synchronisation within one system.

The dynamically allocated spectrum available to a particular operator could be based - in addition to other factors - on usage of synchronisation. This scheme would benefit operators who use synchronisation i.e. the ones who utilize the spectrum more efficiently.

1) Synchronisation could improve spectrum efficiency of a system in a certain geographical area and the synchronisation issue is thus related to capacity of a system owned by a single operator.

2) The operator should have the option either to use or not to use synchronised BSSs in its designated frequency band ruled by the inter operator DCA scheme.

If TDD base stations are synchronized the accuracy of the synchronization should be better than the length of the guard period between bursts. i.e. $< 4 \mu\text{s}$, in order to have full advantage of the synchronization. It may also be possible to operate WB-TDMA / TDD network with asynchronous base stations by applying interference averaging to the interference between uplink and downlink. The asynchronous operation is for further study.

TDD provides the same range as FDD.

TDD-FDD handover is supported. This is considered very important in dualmode (FDD-TDD) usage enabling application transparency in both modes

5.3 Does your concept support the use of 75% of an operator's total available spectrum in the downlink and 25% in the uplink? And the other way around (25% for the uplink and 75% for the uplink)? If so, please explain how it can be practically achieved and any implementation constraints that could be found.

If the operators spectrum is unpaired (or spectrum pairs are considered separately), then the TDD option can dynamically adapt to any degree of traffic asymmetry. If the spectrum is paired (on an equal basis), then asymmetric FDD traffic will leave one of the band pairs under used. Additional capacity

could be provided by operating in TDD mode in that part of the spectrum. Interference between TDD and FFD systems in the same band would be mitigated by the interference averaging concept, but this needs further study.

11.6 Operational requirements

6.1 Does the proposed UTRA concept support hierarchical cell structure (HCS) and if so how are single/multi-frequency handovers performed? If HCS is not used, how does the proposed UTRA concept deal with fast moving mobiles in micro cells?

Hierarchical Cell Structure are supported. Operation is similar to what is offered by GSM today.

6.2 How does the proposed UTRA concept handle rapidly varying traffic distribution over short distances (as described in Tdoc SMG2 UMTS 70/97)?

Rapidly varying traffic distribution can be handled by the MAC layer that can react quite rapidly. Interference averaging scheme also simplifies this management.

High traffic densities can be handled, in the limiting case by utilising all the radio resource in one cell. In this case transmission is likely to be noise limited rather than interference limited and the maximum traffic capacity will be correspondingly high (e.g. 1 to 3Mbps/MHz/Cell depending on the environment).

6.3 Are the data rates limited by the operator's willingness to build cell sites, or are there any other technical limitations? I.e., can an operator implement a high bit rate service wherever he wants to or are there any limitations that could make such a deployment technically impossible, e.g., power limitation in the mobile at very high data rates?

Within the constraints of coverage and traffic capacity, bit rates are not constrained except by the available modulation schemes. In the anticipated deployment scenarios power limitations in the mobile are not expected to be a major practical constraint. Large delay spreads can be tolerated by definition of bursts with long enough training sequences.

If there is residual ISI after equalizer, it is handled by link adaptation and ARQ. Performance degradation is graceful as delay spread increases. Also Vehicular B channel can be supported with a small degradation in performance with the current burst structure. With longer training sequences and flexible burst structure the performance could be improved.

6.4 Does your concept allow evolution to higher bit rates than those defined at present? If so, and assuming that spectrum is available, what is the limiting factor (other than range) in your concept to increase those rates? What changes would be required in the system?

Highest possible bitrate is around 4 Mbit/s by allocating all the timeslots of a carrier to the same mobile.

6.5 What is the maximum delay spread that can be handled in the test environments? Evaluate therefore the maximal bit rates that can be supported in each test environment and give the performance degradation as a function of the delay spread.

The maximum delay spread that can be handled is linked to the size of the training sequence. The answer is similar to that of question 6.3 : long delay spreads can be addressed by flexible bursts

Maximum bit rates available with the bursts defined today are approximately:

Indoor, Outdoor to Indoor: more than 4 Mbit/s

Vehicular A: 2 Mbit/s

Vehicular B: 1 Mbit/s

6.6 What strategy does your concept adopt to operate in different environments (e.g. business indoor, urban vehicular outdoor, rural outdoor, fixed outdoor)? Do any parameters need being changed depending on environment? If so, please specify which ones and an estimation of values for different environments, as well as how handover will be performed between them. Please consider the case of

public and residential operators also as different environments and answer the above questions accordingly.

To be completed.

6.7 What is the system performances degradation due to implementation imperfections? In particular, what is the capacity loss due to inhomogeneous traffic distribution and none ideal cell site planning, e. g. cell site not at the traffic center, in comparison with the capacity for a homogenous traffic distribution and an ideal cell site planning?

The interference averaging concept enables some possibilities to combat imperfect network planning: The slow DCA within the interference averaging concept implies that all carrier frequencies are available in *every* cell (i.e. 576 slots in case of 2x15 MHz). Then each cell has 64 most preferred slots, 64 second preferred slots, 64 third preferred slots, etc. If all cells activate only the 64 most preferred slots a reuse of 9 is obtained. If all cells activate all slots a reuse of 1 is obtained.

Probably a reuse of 1 is not the scenario that a real system would face, but a mixture of different reuses in different areas - depending on traffic load. So, when an imperfect planning has occurred, then some slots have to be de-activated in some cell(s) and activated in some other cell(s).

However, if there is no cell site at the hot spot this doesn't help...

The interference generated by the imperfect cell planning would in the interference averaging concept be averaged over the cells that use the same set of active slots.

Further, the MAC layer is also adaptive, for instance priority is given to delay-sensitive services.

Finally, it is however not possible to fully answer this question today. An exact figure of capacity loss would require simulations based on a defined model of the imperfection (user distribution, etc...).

6.8 How does the proposed UTRA concept support uncoordinated operation of independent licensed (cellular, public) networks in adjacent frequency bands and within the same frequency band? How is the co-existence of licensed and unlicensed networks supported?

Uncoordinated operation is possible both for FDD and TDD mode, with possibly a guard band in-between (this will be addressed with the answer to question 1.1).

FDD mode does not support spectrum sharing. This issue is for further study in TDD mode.

6.9 If the UTRA concept requires synchronized base stations, what is the synchronisation accuracy requirement, and how will it be provided?

BS synchronisation is not required, except for the bunch approach (cf. WB-TDMA Evaluation document, section 5.3.11 in version 0.3) , accuracy is in this last case of the order of guard period length.

11.7 Signalling overhead

7.1 What percentage overhead (such as power control, synchronization, handover procedures, support of asymmetric traffic etc.) is required for signalling (both circuit and packet switched services)?

Proposed WB-TDMA UTRA concept is based on dynamic allocation of signalling resources, so all overhead caused by signalling is highly dependent on the cell load, traffic type, chosen RRM scheme etc. Almost all of the layer 2 information can be transmitted through one common set of logical channels (including both common and dedicated options) so the multiplexing gain is maximized, since the capacity for each message type does not to be separately estimated. Almost all RLC/MAC messages can be transmitted also without any overhead by stealing capacity from a suitable traffic bearer. Selection of the logical channel to be used can be done separately for each message.

In the following one possible example using only common control channels is considered. The percentage values are estimated based on the assumption that each cell would have allocatable capacity comparable to one complete 1.6 MHz WB-TDMA carrier. It is also assumed that the control signalling has the same modulation and coding overhead than the user data.

Power control

DL power is controlled by MS specific power control messages. Assuming the adjustment frequency to be 1 second the signalling requirement is 0,007% of UL capacity for each MS. Downlink powers can be controlled also separately for each bearer, but assuming on average one RT bearer for each MS the value is the same). Assuming 50 active MS's in each cell the resulting signalling overhead is 0,4 % from DL.

UL power is assumed to be either controlled similarly but twice as often as the DL power resulting into 0,014% of the DL capacity for each MS. (50 MSs require 0,8 % of DL capacity)

Alternatively UL power can be controlled separately for each slot frame by frame (200 Hz) which requires 1,5 % of DL capacity regardless of the amount of MS's.

Timing Advance

Average adjustment frequency for MS is assumed to be 0,5 s. This requires approximately 0,014% of DL capacity for each active MS. Assuming 50 MSs the resulting signalling overhead is 0,8 %)

L1, L2 and L3 BROADCAST INFORMATION

Synchronisation, pagings and other cell broadcasts require approximately 1,5 % of the primary DL carrier. (In case of multiple carriers in each cell the additional carriers would have much smaller overhead)

Measurements

Amount of measurements for link quality is highly dependent on the chosen RRM scheme. E.g. the interference averaged concept does not require any link quality measurement signalling for link adaptation purposes. Neighbour cell measurements can also be transmitted over the air only on demand basis, i.e. when there is a need for a HO.

Real Time Services

If bitrate and link quality remain constant no additional control signalling is required for RT bearers. Real time traffic (Circuit switched services) require signalling capacity only for channel allocations/deallocations and for link adaptation. Assuming an average signalling interval of 200 ms:s the capacity requirement for each RT bearer is 0,03% of the DL and UL capacity. Assuming 50 RT bearers in each cell the resulting overhead is 1,5% from both UL and DL.

Non Real Time Services

Scheduled allocation procedure require constant signalling capacity regardless of the amount of active NRT connections.

Scheduled allocation procedure for DL data transfer requires appr. 1,5 % of the DL capacity and appr 1,5 % of the UL capacity. Uplink data transfer requires appr.1,5 % of the DL capacity and nothing from uplink.

One possible frame configuration:

Note! This is only one possible realisation of the logical channels. This is not by any means a minimum requirement for the protocol.

DL

- One 1/64 slot for L1, L2 and L3 broadcast information (incl pagings)
- One 1/64 slot for DL MAC messages (~200 messages/s)

Results to 3 % of DL capacity

UL

- One 1/64 slot for Random Access CHannels (~ 50 messages/s)
- One 1/64th slot for Uplink Acknowledgment channel (~200 messages/s)

Results to 3 % of UL capacity

If active Scheduled NRT transmission exists in DL additionally:

- DL: one 1/64th slot for Downlink NRT control (Enables maximum throughput)
- UL: one 1/64th slot for Ddownlink NRT control (The Forward Order Channel)

Results to 1,5 % of both UL and DL capacity

If active Scheduled NRTtransmission exists in UL additionally:

- DL: one 1/64th slot for Uplink NRT Control CHannel (Enables maximum throughput)

Results to 1,5 % of DL capacity

The complete set of control channels allowing all kind of traffic simultaneously results into 6 % of DL capacity and 4,5 % of uplink capacity.

7.2 For packet switched services, does the proposed UTRA concept require transmission of control information (power control, timing advance information etc.) even when no packets need to be transmitted?

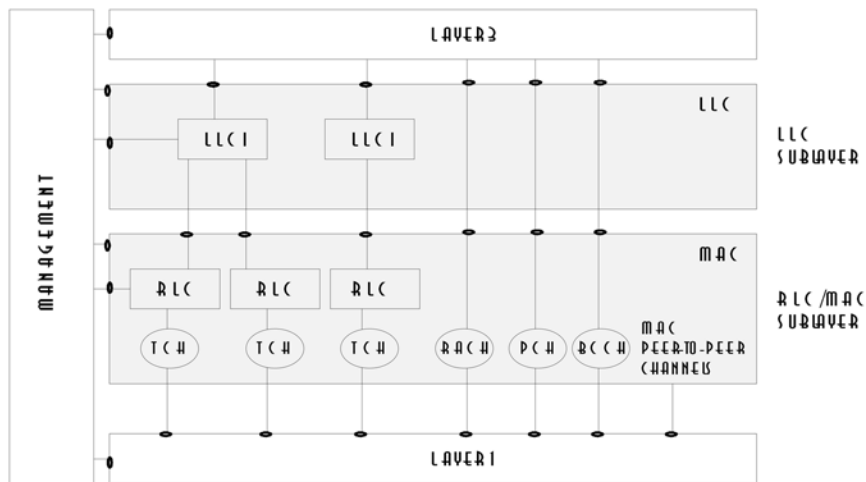
MSs having packet switched services require to have timing advance only when transmitting/receiving data. When no data is transmitted the timing advance signalling can be stopped. Nothing, however, prevents from maintaining the timing advance also when nothing is transmitted resulting into faster access to the radio resources at arrival of a new packet. (The access time saving is at least 10 milliseconds.)

Power control nor any other control messages related to 'packet protocol' are not required during the transmission breaks.

11.8 MAC (Medium Access Control) procedure

81 What protocols are implemented for access contention, what is the strategy for resource allocation (slow and fast allocation, handling of mixed services, support of variable bit rate services and multimedia services), is there any functionality for adaptation to the radio environment or link quality, what protocols are implemented for packet switched services (including ARQ) ?

RLC/MAC layer protocol provides fast resource allocations for real time (RT) and non real time (NRT) services supporting also variable bit rates and multibearer connections. For RT services QoS is fulfilled by means of dynamic link adaptation and for NRT services QoS can be maintained by effective ARQ.



The Radio Link Control/Medium Access Control (RLC/MAC) protocol supports two types of bearers, real time (RT) and non real time (NRT) bearers. The RT operation mode is used for the radio bearers which have strict delay constrains and quality is mainly fulfilled by power control and forward error

corrections. The NRT operation mode is used for radio bearers with low delay requirements which allow backward error correction.

Functionalities of the RLC part and MAC part of the RLC/MAC protocol can be separated, even though both RLC and MAC have direct access to the physical layer and both parts provide services to the upper interface.

RLC entity is created in the MS and in the BS in association with each unidirectional radio bearer and its function is to guarantee the negotiated QoS for the radio bearer. A link adaptation algorithm within the RLC selects transmission format for the RT bearer service according to bearer QoS requirements and link quality. Transmission format is defined by coding, interleaving depth and modulation. On the transmitting side RLC handles the service data units (SDU) coming from the upper entity associated to the radio bearer. The RLC segments data into RLC protocol data units (RLC-PDU) according to the transmission format and forwards RLC-PDUs to the layer 1. On the receiving side RLC checks the CRC, if there is one, and possibly discards corrupted PDUs. Result of the CRC-check can be used in the ARQ procedure. RLC assembles the received PDUs and delivers the SDU to upper layer.

A channel allocation algorithm is located within the BSS side MAC entity. The MAC is responsible for the allocating, exchanging and releasing physical channels for the radio bearer. Peer-to-peer MAC messages between BSS side and mobile station are transmitted on the logical channels dedicated for MAC signalling. The MAC is not crossed by data flows coming from or destined to upper layers, that is the task of RLCs.

For RT radio bearers the MAC provides a resource allocation mechanism which allows a circuit switched type of reservation, i.e. the channel allocation is valid until the execution of a release procedure. For NRT radio bearers MAC provides a reservation mechanism, in which the reservation is valid only a certain allocation period. Fast allocation and release procedures for both RT and NRT bearers allow co-existence of these modes and guarantee efficient use of radio resources.

In the RT mode, the RLC entities request resources for the radio bearer due to radio condition variations and the bit rate variations. RLC resource requests are directed to MAC, which is responsible for the channel allocation signalling. Mobile initiated resource requests are transmitted on the dedicated control channel (DCCH) or random access channel (RACH). Channel allocations are transmitted on downlink DCCH or transmitted on the common control channel (CCCH). Fast associated control channel (FACCH) is a dedicated channel which uses capacity stolen from a bearer allocated to the MS. For a few occasional messages this is the preferred signalling channel. If FACCH can not be used, signalling can be transmitted on CCCH.

In the NRT mode, the RLC entities request resources for certain amount of data. For high bitrates 1/16 timeslot traffic channels are allocated for 9 ms allocation period (2 TDMA frames) at a time. Two frames gives some interleaving gain and is still very flexible. Channel allocations are announced on the NRT control channel (NCCH) and in order to avoid transmission of long identities there, a short reservation identity is allocated for the radio bearer. This identity is valid until the requested data is transmitted and during that time the mobile is obliged to listen to the NCCH. Traffic channels allocated for one reservation identity during one allocation period may vary from 0 to 14 timeslots, and the achieved bit rate may vary from 0 to 2 Mbit/s. For lower bitrates and infrequent transmissions the reservation is made from 1/16 or 1/64 timeslot traffic channels and reservation is valid for indicated time period.

The MAC is also responsible for ARQ signalling. CRC and reception quality based type II soft combining ARQ is expected to provide best efficiency.

8.2 Does your concept intend to treat circuit and packet oriented bearers as two separate entities or will a single type of bearer (e.g. packet) be used and both types of services be carried over the same bearer (e.g. support of connection oriented real time and delay constrained services over packet, similar to the way ATM operates)?

The same radio resources are shared by RT radio bearers and NRT radio bearers, but since they have fundamentally different QoS requirements they require different resource allocation procedures. For RT radio bearers the channel allocation is valid until execution of a release procedure (semi-circuit switched allocation). However, RT allocation and release procedures are very fast and they can be used to adapt resource assignments to RT variable bitrate data flows. For NRT radio bearers the reservation is valid only a certain allocation period (packet switched allocation). Short allocation period for NRT

users guarantees that in the changing load conditions the resources can be reallocated to other users, e.g. RT users, after one allocation period.

See also 8.1.

11.9 System architecture requirements

9.1 What are the system architecture requirements of the proposed UTRA concept?

System architecture is similar to that of GSM.

9.2 If macro diversity is used, at which level are macro diversity combiners needed? Are transmission links between base station controllers required?

Macro diversity is not assumed in the WB-TDMA proposal.

11.10 Radio network planning

10.1 What radio resource planning techniques are required? Is it necessary to plan handover in a UMTS network and how can it be planned?

Purpose is to minimize the need for network planning. Thanks to Interference Averaging, network planning is not as sensitive as in GSM : non optimal planning should result in less degradation than in GSM.

10.2 How can an operator do the coverage and capacity planning for a mixture of services?

Coverage and capacity planning for a mixture of services is expected to needs as in GSM a network planning tool, but exact procedure is not known today.

10.3 What solutions could be implemented to expand coverage and/or capacity? In particular, how does the UTRA concept support adaptive antenna?

Solution to increase the capacity are described in the Evaluation Document (section Further Enhancements).

10.4 Does coverage reduce with increasing traffic? If so indicate the relevant relationship and how to plan for coverage.

There is no INTRA-CELL interference in a TDMA system, thus the coverage reduction is much smaller compared to the system with intra-cell interference. In case of a single cell, no coverage reduction is due to traffic load. See also answer of 3.3.

10.5 Are there built-in functionalities to aid the monitoring and optimization of the radio interface performance and quality?

Metrics can be made available to monitor and optimize the radio interface performance and quality, for instance amount of handovers, number of ARQ, feedback from link adaptation. Quality is guaranteed in realtime traffic by link adaptation and FEC and in non-realtime traffic with ARQ.

10.6 Assuming 144 kbps coverage, what is the foreseen base station density relative to that of GSM 900 (full rate speech) in urban and rural environments?

The range for 144 kbit/s of WB-TDMA in Vehicular channel is 2.1 km. The range for speech of GSM900 is 4.9 km. See the range calculation below. So, the range of WB-TDMA 144 kbit/s is 43 % of the range of GSM900 speech. Thus, the coverage area of WB-TDMA 144 kbit/s is 18 % of the coverage area of GSM900 speech. The base station density is therefore about 5.4 (=1/0.18) times higher than in GSM900 speech..

It must be pointed out however that base-station density requirements in GSM differ significantly for speech and data (particularly if requirement is BER=1.e-6).

WB-TDMA coverage analysis for 144 kbit/s packet service											
		WB-TDMA		WB-TDMA		WB-TDMA		GSM1800		GSM900	
		Downlink	Uplink	Downlink	Uplink	Downlink	Uplink	Downlink	Uplink	Downlink	Uplink
Test environment		Indoor	Indoor	Pedestr.	Pedestr.	Vehicular	Vehicular	Vehicular	Vehicular	Vehicular	Vehicular
Multipath channel class		A	A	A	A	A	A	Speech	Speech	Speech	Speech
Test service		UDD144	UDD144	UDD144	UDD144	UDD144	UDD144	Speech	Speech	Speech	Speech
Number of slots used / frame		2	2	2	2	4	4	1	1	1	1
Total number of slots / frame		16	16	16	16	16	16	8	8	8	8
Bit rate	kbit/s	144,00	144,00	144,00	144,00	144,00	144,00	13,00	13,00	13,00	13,00
Maximum peak power limitation	dBm		30,00		30,00		30,00		30,00		33,00
Average TX power per traffic ch. (ETR0402)	dBm	10,00	4,00	20,00	14,00	30,00	24,00	30,00	24,00	30,00	24,00
Maximum TX power per traffic ch.	dBm	19,03	13,03	29,03	23,03	36,02	30,00	39,03	30,00	39,03	33,00
Average TX power per traffic ch. (real)	dBm	10,00	4,00	20,00	14,00	30,00	23,98	30,00	20,97	30,00	23,97
Maximum total TX power	dBm	19,03	13,03	29,03	23,03	36,02	30,00	39,03	30,00	39,03	33,00
Cable, conn. and combiner losses	dB	2,00	0,00	2,00	0,00	2,00	0,00	2,00	0,00	2,00	0,00
TX antenna gain	dBi	2,00	0,00	10,00	0,00	13,00	0,00	13,00	0,00	13,00	0,00
TX EIRP per traffic channel	dBm	19,03	13,03	37,03	23,03	47,02	30,00	50,03	30,00	50,03	33,00
Total TX EIRP	dBm	19,03	13,03	37,03	23,03	47,02	30,00	50,03	30,00	50,03	33,00
RX antenna gain	dBi	0,00	2,00	0,00	10,00	0,00	13,00	0,00	13,00	0,00	13,00
Cable and connector losses	dB	0,00	2,00	0,00	2,00	0,00	2,00	0,00	2,00	0,00	2,00
Receiver noise figure	dB	5,00	5,00	5,00	5,00	5,00	5,00	5,00	5,00	5,00	5,00
Thermal noise density	dBm/Hz	-174,00	-174,00	-174,00	-174,00	-174,00	-174,00	-174,00	-174,00	-174,00	-174,00
RX interference density	dBm/Hz	-1000,00	-1000,00	-1000,00	-1000,00	-1000,00	-1000,00	-1000,00	-1000,00	-1000,00	-1000,00
Total effect. noise + interf. density	dBm/Hz	-169,00	-169,00	-169,00	-169,00	-169,00	-169,00	-169,00	-169,00	-169,00	-169,00
Information rate (during tx)	dBHz	60,61	60,61	60,61	60,61	57,60	57,60	50,17	50,17	50,17	50,17
Required Eb/(No+Io) (taken from C/I results)	dB	6,30	2,70	6,20	2,80	8,10	4,00	12,00	12,00	12,00	12,00
RX sensitivity	dB	-102,09	-105,69	-102,19	-105,59	-103,30	-107,40	-106,83	-106,83	-106,83	-106,83
Handoff gain	dB	4,10	4,10	3,00	3,00	3,00	3,00	3,00	3,00	3,00	3,00
Explicit diversity gain	dB	0,00	0,00	0,00	0,00	0,00	0,00	0,00	4,50	0,00	4,50
Other gain	dB	0,00	0,00	0,00	0,00	0,00	0,00	0,00	0,00	0,00	0,00
Log-normal fade margin	dB	15,40	15,40	11,30	11,30	11,30	11,30	11,30	11,30	11,30	11,30
Maximum path loss	dB	109,82	107,42	130,92	128,32	142,02	140,10	148,56	144,03	148,56	147,03
Maximum range	m	267,43	222,44	373,39	321,48	2344,86	2084,67	3500,77	2652,54	5374,45	4893,49

12. Annex 3 : Spectrum Efficiency Results Using an Analytical Model

12.1 Analytical Method

12.1.1 Analysis Approach

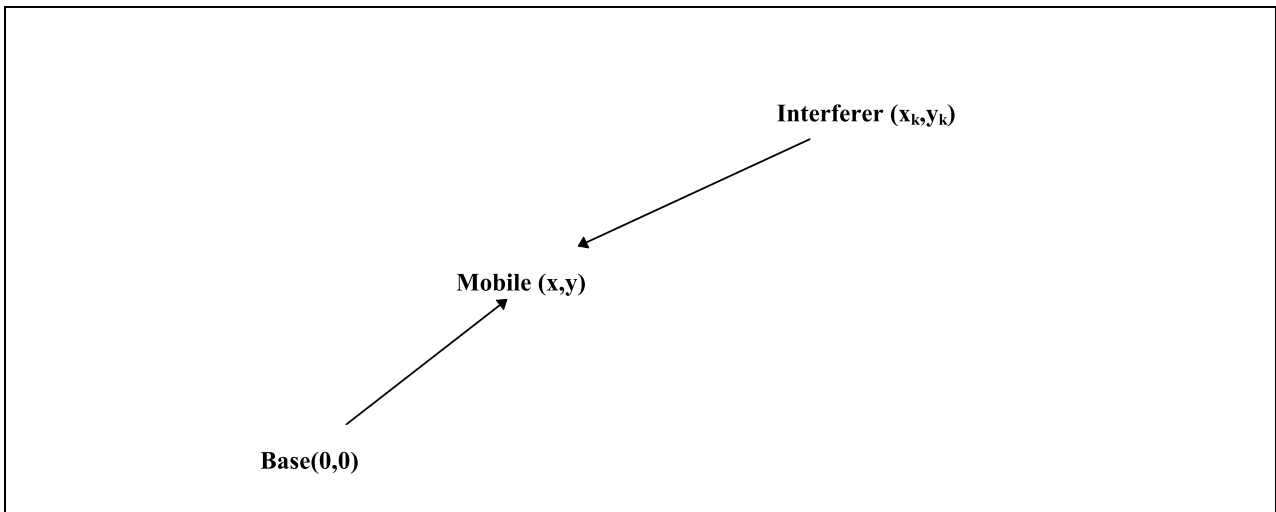
This section describes an analytical method for evaluating the performance of cellular mobile radio systems, in terms of spectral efficiency. It is intended that the results obtained using this method should be considered in support of more detailed simulation results presented elsewhere in the W-TDMA Evaluation Document

Link level simulation results (in the form of minimum carrier to interference ratio to meet BER performance requirements) are used to estimate the system capacity.

A number of simplifications have necessarily been introduced, including more analytically tractable deployment models than the simulation scenarios in UMTS 30.03. Therefore the results generated using this approach are probably best considered for illustrative purposes, and comparing options for UTRA, rather than in terms of absolute capacity.

12.1.1.1 General Downlink Interference Model

Figure 6 Downlink Interference



Here we consider the signal and interference powers in the downlink direction. In order to make the analysis viable, a number of simplifications and approximations are made. The interference limited case is studied, neglecting thermal noise. Adjacent channel interference is neglected.

The Mobile at position (x,y) receives a signal $C(x,y)$ from the Base at $(0,0)$ and interference, potentially from a number of sources $I(x_k, y_k)$, in this case other base stations. If the power transmitted by the wanted base station is P , and the path loss is L , with slow fading (Shadowing) L_s and fast fading (Rayleigh) L_f , then the signal and the sum of interference powers can be computed from Equation 1.

Equation 1

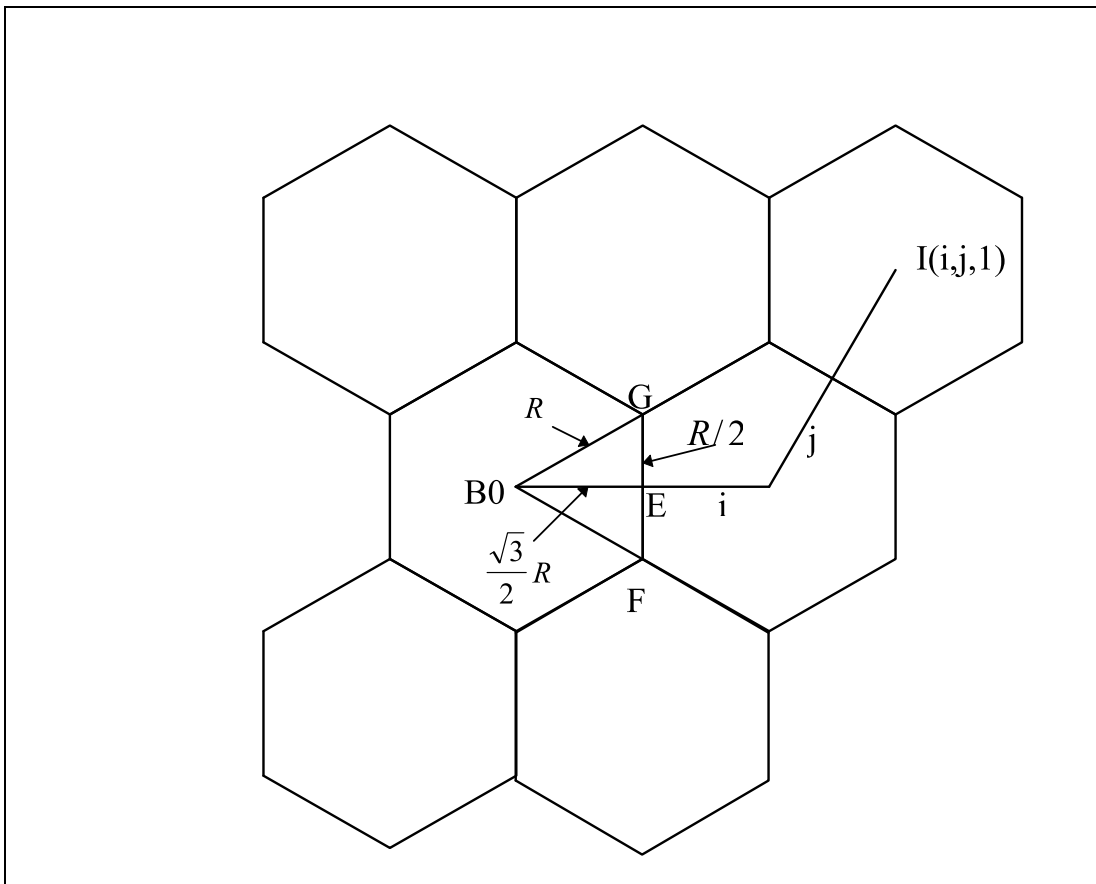
$$C(x,y) = \frac{P}{L_s L_f L(x,y)}$$

$$L(x,y) = (x^2 + y^2)^{\alpha/2}$$

$$I(x,y) = \sum_k \frac{P_k}{L_{sk} L_{fk} ((x - x_k)^2 + (y - y_k)^2)^{\alpha/2}}$$

In general the locations of the interferers will depend on the cluster size. The cluster arrangement can be defined by parameters i, j such that the cluster size is given by $i^2 + j^2$. Then the location of interferers is as shown in Figure 7.

Figure 7: Geometry of interferers



The co-ordinates of the first eighteen interferers are given by Equation 2.

Equation 2

$$\begin{aligned}
 k = 1 \quad & x(i, j, k) = i\sqrt{3}R + j\sqrt{3}R / 2 \\
 & y(i, j, k) = j3R / 2 \\
 k = 2, \dots, 6 \quad & x(i, j, k) = x(i, j, 1) \cos((k-1)\pi/3) + y(i, j, 1) \sin((k-1)\pi/3) \\
 & y(i, j, k) = y(i, j, 1) \cos((k-1)\pi/3) - x(i, j, 1) \sin((k-1)\pi/3) \\
 k = 7 \quad & x(i, j, k) = 2x(i, j, 1) \\
 & y(i, j, k) = 2y(i, j, 1) \\
 k = 8, \dots, 18 \quad & x(i, j, k) = x(i, j, 7) \cos((k-7)\pi/6) + y(i, j, 7) \sin((k-7)\pi/6) \\
 & y(i, j, k) = y(i, j, 7) \cos((k-7)\pi/6) - x(i, j, 7) \sin((k-7)\pi/6)
 \end{aligned}$$

The first six interferers are distributed in a circle around the base station in question. The next twelve form a circle at twice that distance. In practice, the contribution from the second circle can often be neglected.

As an approximation we consider only the six nearest interferers (i.e. those in the first “ring”), and neglect the effect of fast fading (i.e. broad band transmission). Then signal and interference powers are given by Equation 3

Equation 3

$$\begin{aligned}
 C(x, y) &= \frac{P}{L_s (x^2 + y^2)^{\alpha/2}} \\
 I(x, y) &= \sum_{k=1}^6 \frac{P_k}{L_s(k) \left((x - x(i, j, k))^2 + (y - y(i, j, k))^2 \right)^{\alpha/2}}
 \end{aligned}$$

The analysis is greatly simplified if we assume that all base stations continuously transmit the same power, such that $P=P_k$. This is reasonably valid for a fully loaded system without power control.

The usual model for L_s is a log normal distributed random variable with zero mean and a standard deviation σ_s . As a further approximation we assume that $I(x, y)$ is also log normally distributed with a mean value equal to the sum of the interference powers, and with the same variance. The signal to interference ratio (in dB) can then be written as in Equation 4.

Equation 4

$$SIR(x, y) = L_{eff} + 10 \log_{10} \left(\frac{\sum_{k=1}^6 \left((x - x(i, j, k))^2 + (y - y(i, j, k))^2 \right)^{\alpha/2}}{(x^2 + y^2)^{\alpha/2}} \right)$$

Here the variable L_{eff} is the effective slow fading (shadowing) distribution. If the shadowing fading is uncorrelated for signals from the different base stations to the mobile, the effective variance is doubled and the standard deviation of L_{eff} will be $\sqrt{2}\sigma_s$ (dB), with a mean of zero.

We can now compute the signal to interference ratio for a mobile at any location. However, because of the symmetry of the cell layout we only need to consider the triangular region B0 F G in Figure 7.

If T_{SIR} is the minimum required signal to interference ratio for a communication channel, then the probability of achieving coverage is the probability that SIR is higher than this value. Equivalently the probability of an Outage is also given by the average probability that the SIR is less than some threshold T_{SIR} as in Equation 5.

Equation 5

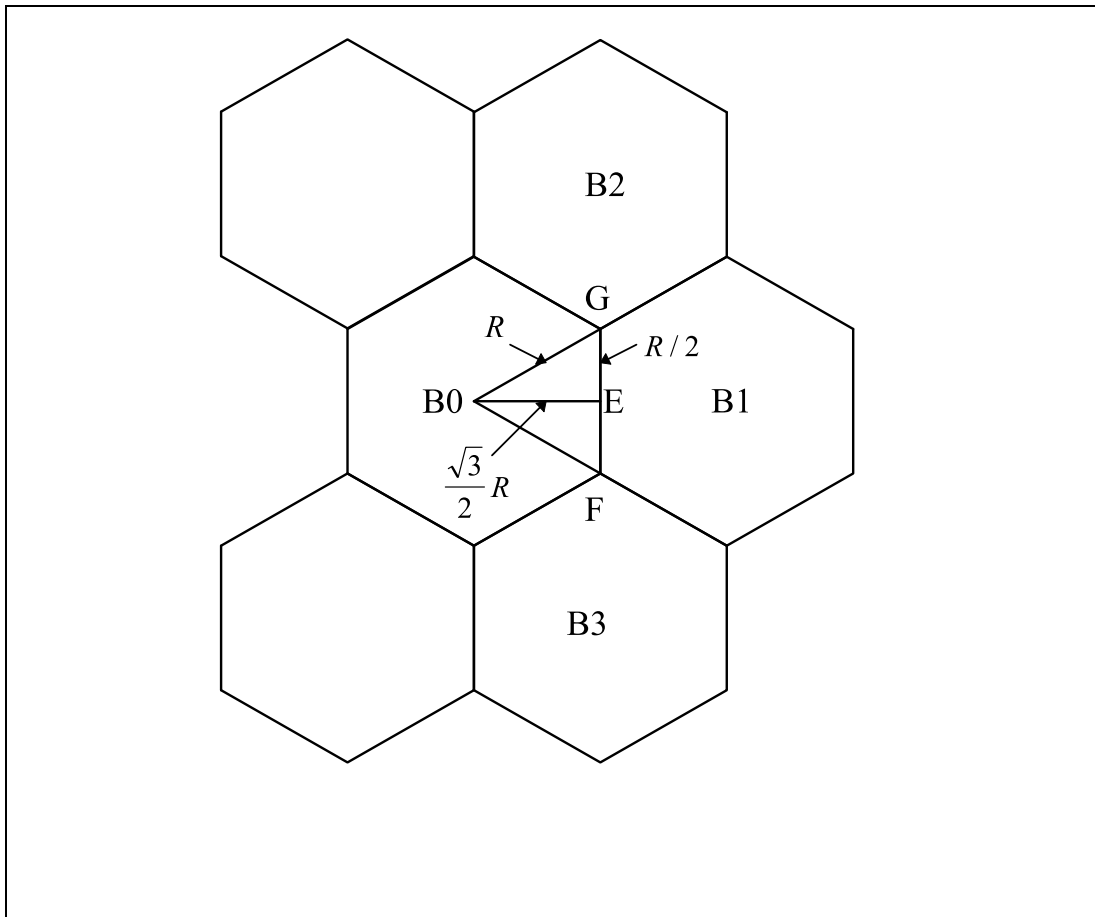
$$P_{\text{out}}(0) = \langle P(\text{SIR} < T_{\text{SIR}}) \rangle = \frac{\int_{x=0}^{x=R\sqrt{3}/2} \int_{y=-x/\sqrt{3}}^{y=x/\sqrt{3}} P(\text{SIR}(x,y) < T_{\text{SIR}}) dy dx}{\sqrt{3}R^2 / 4}$$

We note that $P(\text{SIR}(x,y) < T_{\text{SIR}})$ is obtained from the cumulative distribution of a Gaussian PDF with mean given by Equation 4 and standard deviation $\sqrt{2}\sigma_s$.

12.1.1.2 Handover to adjacent cells

Now we consider the possibility of handover for mobiles within the (area BOGF) to one of the three

Figure 8: Geometry of handover to adjacent cells



nearest neighbouring cells (B1,B2 or B3). In practice handovers could be made to other cells but it is assumed that this is a relatively unlikely event.

The probability of an outage with respect to a given base station (i.e. B1,B2 or B3) can be determine by substituting the co-ordinates (x,y) in Equation 5 with transformed co-ordinates (see Equation 6) relative to the selected base station. The resulting expression is given in Equation 7.

Equation 6

$$\begin{aligned}
 x_1 &= x - R\sqrt{3} \\
 y_1 &= y \\
 x_2 &= x - R\sqrt{3}/2 \\
 y_2 &= y - 3R/2 \\
 x_3 &= x - R\sqrt{3}/2 \\
 y_3 &= 3R/2 - y
 \end{aligned}$$

Equation 7

$$P_{out}(n) = \left\langle P(SIR < T_{SIR}) \right\rangle = \frac{\int_{x=0}^{x=R\sqrt{3}/2} \int_{y=-x/\sqrt{3}}^{y=x/\sqrt{3}} P(SIR(x_n, y_n) < T_{SIR}) dy dx}{\sqrt{3}R^2 / 4}$$

We assume that a handover is attempted if adequate SIR is not achieved with the current base station. If we also assume that this can occur quickly enough to avoid loss of communication during the handover process, then the total outage probability is given by Equation 8.

Equation 8

$$P_{out_total} = \prod_{n=0}^N P_{out}(n)$$

Where N is the total number of base-stations considered for handover.

The use of Equation 8 implies that the probabilities of handovers being possible to adjacent cells are independent, and also independent of the SIR for the current base station. This is a reasonable assumption for different carrier frequencies in the adjacent cells, but a relatively pessimistic assumption if any of the frequencies are the same. This occurs with cluster sizes 1 and 3. For cluster size 3 two of the adjacent cells will use the same frequency, but due to the geometrical arrangement a high probability of handover to one implies a lower probability to the other. Therefore Equation 8 remains a good approximation.

The case of adjacent cell re-use (with or without fractional loading) necessitates minor modification to the equations for handover. Firstly handover probabilities are now correlated. For example if the signal from the base in the current cell is weak, this increases the chance of a handover being possible to an adjacent cell, since the interference level for that cell is reduced. Therefore, when considering handover, the C/I ratio for the adjacent cells is computed without the contribution of an interference component from the current cell. In addition, handovers are only considered possible for cases where the required C/I ratio is less than 0dB.

12.1.2 Effect of Link Parameters

12.1.2.1 Adaptive Modulation

In general the principle of adaptive modulation requires that more than one modulation/channel coding scheme is available (AM1, AM2...AMm). Each scheme will have an associated SIR threshold (T_{SIR}) for satisfactory operation (eg to meet BER requirement). At any given time the most bandwidth efficient option is selected, consistent with current SIR and BER requirement. This adaptation should happen quickly enough that the connection is not lost.

Table 3 Adaptive Modulation with three options

Modulation Scheme	Relative radio resource required	Required SIR	Outage probability without adaptation	Average fraction of time in cell coverage	Average fraction of radio resource used
No coverage				P_1	
AM1	R_1	T_{SIR1}	P_1	$P_2 - P_1$	$R_1(P_2 - P_1)/R$
AM2	R_2	T_{SIR2}	P_2	$P_3 - P_2$	$R_2(P_3 - P_2)/R$
AM3	R_3	T_{SIR3}	P_3	$1 - P_3$	$R_3(1 - P_3)/R$

Note: $R = R_1(P_2 - P_1) + R_2(P_3 - P_2) + R_3(1 - P_3)$

For a given cluster size, the value of P_{out_total} will increase monotonically with SIR threshold. Therefore the limiting outage probability for an adaptive modulation scheme is determined by the modulation with

the lowest SIR threshold. Thus for three modulation schemes such that $T_{SIR1} < T_{SIR2} < T_{SIR3}$, the fraction of time that each is used is given in Table 3

The fractional allocation of radio resource can be found from the resource required by each modulation scheme and the probability that it is used.

For the moment it is assumed that the coding/modulation scheme is selected according to C/I.

12.1.2.2 Fractional Loading

The effect of fractional loading is particularly relevant when considering frequency re-use in the adjacent cell.

With effective frequency/time hopping the effect of fractional loading can be approximated by reducing the effective interference power by the loading factor.

This adjustment can be implemented in the analysis by reducing the SIR threshold T_{SIR} by an appropriate amount. Usually this will not be large. For example with a typical loading level of 63%, and assuming a linear relation between loading and average interference power, the correction amounts to about 2dB.

12.1.2.3 Power Control

If link adaptation is used, this in general limits the power control dynamic range, since the C/I requirements of the different modulation/coding schemes typically differ by only a few dB. The effect of power control can be approximated by reducing the effective interference level (as for fractional loading). If the power distribution is uniform (for a given coding/modulation option) then the average interference reduction will be then typically be less than 3dB. This can be implemented in the analysis by reducing the SIR threshold T_{SIR} by an appropriate amount.

For the moment we assume that power level is set according to C/I.

12.1.3 Blocking and Trunking Efficiency

Blocking must be considered as it is a major limiting factor on efficiency, and leads to low trunking efficiency when only a small number of communication channels are available. Traffic calls are assumed to originate uniformly within the cell and their arrival can be modelled by the Poisson probability distribution:

Equation 9

$$p_k = \frac{(\lambda t)^k}{k!} \exp(-\lambda t)$$

Here p_k is the probability of k calls arriving in a time interval t , and λ is the mean arrival rate of calls.

For the Poisson call model, if blocked calls are cleared (i.e. rejected), then the Erlang B formula for the fraction of blocked calls is appropriate.

Equation 10

$$E(A, N) = \frac{A^N / N!}{\sum_{i=0}^N A^i / i!}$$

Here A is the offered traffic in erlangs where $A = \lambda\mu$ and μ is the mean call duration. N is the number of channels available.

We do not give a special consideration to handovers, under the assumption that handovers into the cell and out of it occur at equal rates.

In the case of adaptive modulation, we could consider blocking in the case of mixed traffic, where calls can require the use of different amounts of transmission capacity (i.e. different numbers of channels). This problem has been studied by Kaufman (IEEE Transactions on Communications, Vol COM-29, No 10, pp1474-1481, 1981).

A simpler approach, which will be valid for a large number of channels, is to assume that the traffic can be adequately represented by assuming that all calls use the average number of channels.

12.1.4 Successful Call Criteria

The criteria adopted for UMTS evaluation indicate that for a satisfied user the following conditions apply:

- The call should not be blocked on arrival.
- The error rate should be less than the required quality threshold (10^{-3} or 10^{-6}) for 95% of the call.
- The call should not be dropped.

For the moment we assume that the dropping criterion is much less stringent than the error rate criterion.

Blocking is considered in Section Blocking and Trunking Efficiency

Now, a call will have failed if the error rate exceeds the required threshold for more than the given fraction of the call (Q). Let us define the probability of the transmission being corrupted for a given (short) interval of time as $p_{corrupt}$. Then the probability of the call failing is the probability that the ratio of corrupted to uncorrupted intervals exceeds the required threshold. Considering a call of duration d time intervals, the failure probability is given by

Equation 11

$$p_{fail}(d, Q) = 1 - \sum_{k=0}^{d/Q} \frac{d}{(d-k)!k!} p_{corrupt}^k (1 - p_{corrupt})^{d-k}$$

where d/Q is the maximum allowed number of corrupted time intervals during a call (which should be truncated to an integer value). In practice the calls have some duration distribution. In the case of a Poisson distribution with mean value D the average probability of failure is given by

Equation 12

$$p_{fail_av}(D, Q) = \sum_{d=0}^{d=\infty} p_{fail}(d, Q) P(D, d).$$

Where

$$P(D, d) = \frac{D^d e^{-D}}{d!}$$

In practice the summation is accurate enough with an upper limit of about $2D$, and for the purposes of this paper, where the allowed number of corrupted durations is much greater than one, using the mean call duration in Equation 11 is a reasonable approximation. We note that for a time interval of 0.5 second (the resolution suggested in UMTS 30.03), an average call duration of 120secs gives $D=240$. For a quality threshold $Q=0.05$, an average call failure probability of 0.01 is achieved for a corruption probability of 0.0242 using Equation 12, and 0.0257 using the approximation of average call duration substituted in Equation 11.

This result can be interpreted as implying that more than 99% of calls will be satisfactory if the probability is less than about 0.02 of a short section of a call having an error rate greater than the allowed threshold.

12.1.4.1 Voice Calls

Voice activity can be exploited to increase system capacity. If free resources can be re-allocated quickly enough, then it might be supposed that the effective number of available channels is increased in direct proportion to the inactivity factor. However, there will be a necessary signalling overhead, and on-going speech calls which become active and find insufficient resources available will become corrupted.

The following analysis for one carrier considers both to the case of free allocation of active speech calls to any transmission available slot(s), and to the case where speech calls are multiplexed together into a single burst. We also extend this to consider the case where a number of carriers are available, but a call remains assigned to the same carrier.

A voice call must remain sufficiently uncorrupted by “multiplex blocking” to remain acceptable. If the number of active calls exceeds the number of available slots, the information for some calls will be lost. If we assume that the affected calls are selected at random from the currently active calls, then with M channels available and N calls in progress (such that M<N), the average probability that a call will be corrupted during a short time interval is given by Equation 13.

Equation 13

$$P_{\text{corrupt}}(N, M) = \frac{1}{N} \sum_{i=M+1}^N (i - M) \frac{N!}{(N - i)! i!} p_a^i (1 - p_a)^{N-i}$$

Where p_a is the probability of the call being active.

The probability of the call failing can be derived by combining Equation 11 with Equation 13.

Now combining the probability that a call will be blocked on admission to the system (using Equation 10), and the probability that it will be lost due to insufficient slots (for any number of calls in progress), the average probability of losing a call is given approximately by Equation 14.

Equation 14

$$P_{\text{loss}}(A, N, M, N_{\text{max}}) \approx E(A, N_{\text{max}}) + \sum_{n=1}^{N_{\text{max}}} p_{\text{fail}}(N, M) E(A, n)$$

where N_{max} is the maximum number of calls allowed to be admitted at any one time.

We can further consider the case where more than one multiplex burst is used (eg on different carriers). In this case, if the calls are initially distributed as evenly as possible among the available carriers, then the average probability of call loss is derived from the probabilities of loss for each carrier.

Equation 15

$$P_{\text{loss}}(A, N, N_{\text{max}}, C) \approx E(A, N_{\text{max}}) + \sum_{n=1}^{N_{\text{max}}} E(A, n) \left(\frac{\sum_{c=1}^C \text{Floor}((n + c - 1) / C) p_{\text{fail}}(\text{Floor}((n + c - 1) / C), M_c)}{n} \right)$$

Where C is the number of carriers, M_c is the number of channels available in the cth carrier. The function Floor(x) returns the largest integer less than or equal to x. Normally M_c would have the same value for each carrier.

The analysis has not so far been extended to consider the case of mixed traffic (different slot allocations) in combination with voice activity, except using the approximation mentioned in Section Blocking and Trunking Efficiency.

12.1.5 System Capacity

12.1.5.1 Stationary Terminals

For stationary terminals, in the simplest case, the fraction of unsatisfied users is the sum of the probabilities of unsatisfactory coverage (using Equation 8) and blocking (using Equation 10). Thus the maximum traffic load can be found for which the number of satisfied users is sufficient.

For mixed traffic or where the calls can use different amounts of radio resource, approximate blocking results can be found by assuming that each call uses the average amount of radio resource. For voice traffic with some activity factor, the probability of a satisfactory call is given by Equation 14 or Equation 15 for the multi-carrier case.

A slightly pessimistic approximation to the results from Equation 15 is obtained by considering the capacity available with a single carrier for 100% activity, dividing by the “inactivity factor” and multiplying by the total number of carriers.

In principle the SIR threshold should be adjusted in Equation 7 to account for fractional loading and power control. Then for typical conditions of 63% fractional loading, and 3dB power control adjustment, a total correction factor of zero will ensure that less than 1% of calls are dropped with a C/I measurement error of 2dB, and 0.1% with an error of 1.5dB.

12.1.5.2 Moving terminals

Further development of the above analysis is required for moving terminals.

If link adaptation and power control are fast enough to track changes in shadowing fading, then the main impact of terminal movement will be due to outages where the C/I falls below the minimum possible operating level. For fast moving terminals (or long enough calls) it is reasonable to assume that the C/I conditions for short segments of the call are statistically independent. This allows the use of the analysis in Section Successful Call Criteria. Therefore for a 1% probability of an unsatisfied user (due to BER), the outage probability for the most robust modulation/coding scheme must be less than about 0.025.

This would appear to give moving terminals a small advantage in call quality. However, there may be other practical factors which reduce this advantage (eg speed of link adaptation, Doppler effects, handover failure).

Therefore results presented here are for stationary users.

12.1.6 Procedure for Generation of Results

In a given radio environment the signal to interference ratio required to achieve an acceptable BER is obtained from Link Level simulations for different modulation and coding schemes.

Reasonable targets are to allow 1% loss of calls due insufficient quality or outage and 1% blocking, with a maximum allowed total of 2%.

In order to evaluate the capacity obtained for Adaptive Modulation the steps, carried out for each radio propagation model, are as follows:

- Select the set of modulation/coding schemes to be considered
- Obtain operating SIR for each modulation/coding scheme, and make probability of outage for each modulation/coding scheme for a range of cluster sizes.
- Set SIR threshold with corrections for power control and fractional loading if appropriate. Any correction for fractional loading may need to be reconsidered after the total capacity is determined.
- Select the smallest cluster size for which the required outage probability is obtained with the most robust available modulation scheme (i.e. outage probabilities of about 0.01 and 0.025 for stationary and moving terminals respectively).
- Obtain the maximum percentage of time that each modulation/coding scheme can be used, consistent with maintaining coverage.

- Compute the maximum possible blocking rate such that sufficient users remain satisfied (considering the achievable outage probability).
- Compute the maximum traffic loading at which the blocking rate criterion is met (using a mixed traffic model, with appropriate percentages of time and the radio resource required for a channel transmitted using each modulation scheme, or an approximation)

The analysis can be repeated with different modulation/coding schemes and possibly different cluster sizes. One assumption which may be necessary is that the multiple radio carriers are considered as a single resource.

12.2 GSM Spectrum Efficiency

Comparison of the spectral efficiency of GSM with that of UMTS concepts seems to be of great interest in SMG2. However, such comparisons should be made using similar assumptions, bearer characteristics and quality of service. This document presents initial results for the downlink spectrum efficiency of GSM obtained for scenarios suitable for comparison with UMTS, and based on quality of service criteria compatible with those given in UMTS 30.03

The system is assumed to be interference limited, with all interfering base stations transmitting equal power. Downlink power control and fractional loading effects due to DTX are also considered. The model for stationary users is assumed.

12.2.1 GSM Link Level Performance

Performance requirements for GSM are given in pr ETS 300 577 (GSM 5.05 ver 4.19.0).

Since the UMTS bearers so far considered for evaluation all assume uniform error protection, this makes direct comparison with GSM speech services difficult. Therefore it is proposed that the comparison is based on the performance of the GSM data services.

The reference value for C/I is 9dB. For the TCH/F9.6 and H4.8 services, the maximum allowed BER under the reference conditions is as follows:

Test Condition	BER
TU3, No FH	8%
TU3, ideal FH	0.3%
TU50, No FH	0.8%
TU50, ideal FH	0.3%
RA250, No FH	0.2%

The radio channels assumed for GSM are not very close to those to be used in the UMTS evaluation. However, there is reasonable similarity between the RA channel and the Outdoor to indoor channel A and Indoor channel B, and between the TU channel and Outdoor to indoor channel B and Vehicular channel A.

Based on the above it seems reasonable to suppose, as a starting assumption, that GSM can achieve a BER of 0.1% (required for speech) with $C/I=10$ dB, and 0.0001% (required for data) with $C/I=12$ dB (approx.), provided frequency hopping approaching the ideal is used. We can approximate the effect of DTX with 50% voice activity by reducing the effective C/I requirement by 3dB, since the average interference power is reduced by a factor of two. An additional reduction of 3dB is included for power control. This assumes sufficient interferer diversity is achieved by frequency hopping.

The TCH/F9.6 bit rate is close enough to the nominal 8kbps assumed for speech in UMTS to make such a comparison reasonable.

All the spectrum efficiency results given below are under the assumption of 9.6kbps throughput per channel.

12.2.2 Available GSM channels

In 15MHz bandwidth, as proposed for UTRA evaluation, there is room for up to 75 carriers with 200kHz spacing (assuming no guard bands). Each of these can support a maximum of 8 voice or 9.6kbps data calls. Therefore the maximum number of channels available is 600.

With cluster sizes larger than one the number of carriers per cell is reduced accordingly.

12.2.3 Deployment Results - Indoor Environment

In the indoor environment, the propagation exponent is 3, and the standard deviation of log-normal shadowing is 12dB. An un-sectored cell is appropriate.

Under these conditions the probability of outage for “Voice” (10dB C/I) and “Data” (12dB C/I) are given for some typical cluster sizes.

Table 4 Outage probability in indoor environment

Cluster Size	Outage Probability - Voice	Outage Probability - Voice (DTX+Power Control)	Outage Probability - Data
3	0.155	0.060	0.20
4	0.110	0.037	0.147
7	0.054	0.0148	0.077
9	0.038	0.0094	0.056
12	0.025	0.0055	0.038
13	0.022	0.0046	0.038
19	0.0117	0.0021	0.0190

It is clear that for voice with DTX and power control, a cluster size of 7 is sufficient to satisfy 98% of users. This gives $75/7=10$ carriers per cell. A cluster size of 19 is needed for the other options. The spectrum efficiency can now be calculated under the maximum traffic condition where the sum of the blocking and outage probabilities is 0.02.

Table 5: GSM Spectrum Efficiency in indoor environment

	Voice	Voice (DTX+Power Control)	Data (9.6kbs)
Cluster size	19	7	19
Carriers per cell	3	10	3
Channels per cell	24	80	24
Total spectrum used (MHz)	11.4	14.0	11.4
Outage probability	0.0117	0.0148	0.0190
Maximum blocking probability	0.0083	0.0052	0.001
Maximum traffic per cell (Erlangs)	15.0	62.8	12.2
Spectrum Efficiency (Erlang/MHz/cell)	1.32	4.48	0.93
Spectrum Efficiency (kbps/MHz/cell)	12.7	21.5	8.9

12.2.4 Deployment Results - Outdoor environment

In the outdoor environment, the propagation exponent is 4 (depending on antenna configuration), and the standard deviation of log-normal shadowing is 10dB. The results here are given for omni-directional antennas.

Under these conditions the probability of outage for “Voice” (10dB C/I) and “Data” (12dB C/I) is given for some typical cluster sizes.

Table 6: Outage Probability in outdoor environment

Cluster Size	Outage Probability - Voice	Outage Probability - Voice (DTX+Power Control)	Outage Probability - Data
3	0.087	0.023	0.123
4	0.044	0.0091	0.068
7	0.0101	0.00130	0.0180
9	0.0047	0.00048	0.0088
12	0.00178	0.00054	0.0037
13	0.00135	0.000099	0.0028
19	0.00031	0.0000166	0.00073

In the case of Voice with DTX and power control, a cluster size of 4 is needed to meet the requirement that 98% of users must be satisfied. This means that there would be $75/4 = 18$ carriers available per cell, giving 144 voice channels per cell. In the other cases the cluster size is 7, giving 80 channels per cell.

The spectrum efficiency can now be calculated

Table 7: GSM Spectrum Efficiency in outdoor environment

	Voice	Voice (DTX+Power Control)	Data (9.6kbs)
Cluster size	7	4	7
Carriers per cell	10	18	10
Channels per cell	80	144	80
Total spectrum used (MHz)	14	14.4	14
Outage probability	0.0101	0.0091	0.018
Maximum blocking probability	0.0099	0.0109	0.002
Maximum traffic per cell (Erlangs)	65	126	60
Spectrum Efficiency (Erlang/MHz/cell)	4.6	8.8	4.3
Spectrum Efficiency (kbps/MHz/cell)	44	42	41

For sectored cells the efficiency should be similar to the above values.

12.2.5 Conclusions

Making some reasonable assumptions the spectrum efficiency has been obtained for GSM in a way which allows comparisons to be made with the voice bearer currently being evaluated for UTRA. Spectrum efficiency has also been calculated for the GSM data services using a quality criterion which is similar to that used in UMTS evaluation.

The results presented here clearly show that:

- The radio environment, and particularly the propagation model, has a major effect on spectral efficiency (typically by a factor of more than two between indoor and outdoor environments).
- Minimising the cluster size while maintaining low enough outage probability is essential in maximising spectrum efficiency.
- Any measures to reduce interference levels such as DTX, fractional loading and power control will significantly improve spectral efficiency (at least in terms of Erlangs).

It is interesting to compare the results here with those produced by Wigard et al (Capacity of a GSM Network with Fractional Loading and Random Frequency Hopping, 7th IEEE International Symposium on Personal, Indoor and Mobile Radio Communications, p723-72, Taiwan, October 1996). Although some assumptions were rather different (eg propagation exponent of 3.5, and lower quality thresholds), the capacity for cluster size of 4 was about 8.3 Erlang/MHz/Cell compared with the 8.8 Erlang/MHz/Cell here.

These results are also similar to those for the GSM reference model proposed for comparison with UMTS (Tdoc SMG2 UMTS 122/97) estimates the efficiency as 2.35 Erlang/MHz/Cell and 30.55kbps/MHz/Cell, but with sectorized cells and without frequency hopping or DTX.

12.3 Spectrum Efficiency of W-TDMA

Results are presented here for the downlink spectrum efficiency of the W-TDMA concept for various deployment options. The model for stationary users is adopted, but similar results would be obtained assuming moving terminals. It is assumed that there is a 3dB improvement in average C/I from the use of power control, and an additional 2dB improvement for fractional loading (nominally of 63%) in the case of adjacent cell frequency re-use.

Results are given for omni-directional antennas and hexagonal cell layout. Cluster sizes of 1 and 3 are considered.

In 15MHz bandwidth up to nine 1.6MHz carriers are available (occupying a total bandwidth of 14.4MHz). It is assumed that new calls can be allocated to any available radio resources. In the case of speech calls with 50% activity factor it is assumed that a call remains on the initially allocated carrier. This may be pessimistic, since inter-frequency handovers are allowed. In general it is assumed for data calls that radio resources are effectively pooled (i.e. a call can be transferred to a new carrier as required to optimise slot allocations).

Admission control is assumed to operate such that the call is blocked if insufficient resources are available in that cell. The possibility of serving the call from a nearby cell is not considered. This seems a pessimistic assumption.

Signalling capacity equivalent to 1/16 of a frame on every carrier is assumed to be fully occupied (eg for link adaptation and power control), and this is included in the spectrum efficiency calculation.

12.3.1 Deployment Results - Pedestrian Environment

In the Pedestrian Environment the propagation exponent is 4, and the standard deviation of log-normal shadowing is 10dB. Simulations carried out for the Outdoor to Indoor case, with a standard deviation of shadowing of 12dB gave similar results to those below.

12.3.1.1 Speech

In this case 64 slots per frame are available. It is assumed that 4 are used for signalling. Single frequency re-use can be supported. Fractional loading and power control are assumed, and the fraction of the time each modulation/coding scheme is used is shown.

Table 8: Modulation/coding schemes (Speech, Pedestrian A)

Number of slots per frame	Modulation	C/I (dB)	Fraction of time used
3	B-OQAM	-1.4	0.237
2	B-OQAM	2.8	0.103
1	B-OQAM	7.6	0.248
1 in 2 frames	B-OQAM	18.2	0.398

The average number of slots per user channel is 1.36. The effective number of channels per carrier is therefore 43. Coverage with sufficient quality of service is achieved for 99.4% of users. Allowing a blocking probability of 0.006 this gives a total capacity of 356 Erlangs/Cell. Considering the extra slots available with 50% voice activity, this increases to 546 Erlangs/Cell, equivalent to 71% fractional loading. This gives 152kbps/MHz/Cell.

These results may be pessimistic, since the blocking and bad quality calculation is carried out per carrier. In practice new calls can be allocated to any carrier with unused slots, increasing the trunking efficiency.

12.3.1.2 LCD 144

In this case there are 16 slots per carrier, with an average of one slot allocated to signalling. Two cluster sizes are considered.

Table 9: Modulation/coding schemes (LCD 144, Pedestrian A)

Number of slots per frame	Modulation	C/I (dB)	Fraction of time used (Schema A, re-use=1)	Fraction of time used (Scheme B, re-use=3)
8	B-OQAM	-2.0 (est)	0.205	-
4	B-OQAM	1.0	0.059	-
3	B-OQAM	4.0	0.134	0.038
2	Q-OQAM	10.0	0.275	0.262
1	Q-OQAM	22.0	0.316	0.690

With re-use pattern 3 the average number of slots per channel is 1.33, which gives 11 effective channels per carrier, and a capacity of 23 Erlangs per cell or 230kbps/MHz/Cell with a fractional loading of 70%. With adjacent cell re-use the average number of slots is 3.1, which gives 4 effective channels per carrier, and a capacity of 25 Erlangs per cell or 250kbps/MHz/Cell with fractional loading of 60%.

These figures may be optimistic since the number of effective channels per carrier is small, which may lead to significant additional blocking.

With re-use factor 1, it appears is necessary to use a larger number of slots (eg 8) per channel to achieve sufficient coverage. Smaller slot allocations are sufficient for re-use factor 3.

12.3.2 Deployment Results - Vehicular Environment

In UMTS 30.03 the vehicular environment specifies sectorized cells. The results here are presented for omni-directional antennas. The capacity figures per cell (i.e. per sector) should be similar for sectorized cells. The standard deviation of shadowing was 10dB, with a propagation exponent assumed to be 4.

12.3.2.1 Speech

Here we consider as examples two possible schemes;

A: Single frequency re-use with link adaptation options of 1, 2, 4 and 6 slots per channel

B: Cluster size of 3 with 1/4, 1/2, 1 and 2 slot option.

For scheme A the C/I the offset for power control and fractional loading is 5dB. For scheme B only a 3dB offset for power control is applied. In scheme B the 1/2 and 1/4 slot options require the use of a multiplexed burst.

Table 10: Modulation/coding schemes (Speech, Vehicular A)

Number of slots per frame	Modulation	C/I (dB)	Fraction of time used (Scheme A, re-use=1)	Fraction of time used (Scheme B, re-use=3)
6	B-OQAM	-4.1	0.006	-
4	B-OQAM	-1.9	0.227	-
2	B-OQAM	2.2	0.121	0.022
1	B-OQAM	7.7	0.644	0.056
1/2	B-OQAM	12.8	-	0.258
1/4	Q-OQAM	23 (est)	-	0.658

For comparison we also consider Scheme A in the Vehicular B channel.

Table 11: Modulation/coding schemes (Speech, Vehicular B)

Number of slots per frame	Modulation	C/I (dB)	Fraction of time used (Scheme A, re-use=1)
6	B-OQAM	--3.2	0.008
4	B-OQAM	-0.9	0.263
2	B-OQAM	4.2	0.202
1	B-OQAM	13.0	0.519

Table 12 Spectral Efficiency (Speech, Vehicular A)

Scheme	Cluster size	Average number of slots per channel	Spectrum Efficiency (Erlang/Cell)	Spectrum Efficiency (kbps/MHz/cell)	Fractional loading (%)
A (Veh A)	1	1.83	411	114	72
A (Veh B)	1	2.02	357	99	69
B	3	0.39	815	226	89

If can be seen that with Scheme A in re-use factor 1 the spectral efficiency is reduced by about 13% in the Vehicular B environment. This reduction might be larger with Scheme B, since shorter slot allocations would typically be used.

12.3.2.2 LCD384

In this case we consider 16 slots in a frame, and a 384kbps circuit switched bearer with a 3 frequency re-use pattern.

Table 13: Modulation/coding schemes (LCD 384, Vehicular A)

Number of slots per frame	Modulation	C/I (dB)	Fraction of time used (Cluster size=3)
8	B-OQAM	3.0	0.015
6	B-OQAM	7.0	0.100
4	Q-OQAM	15.0	0.097

3	Q-OQAM	19 (est)	0.780
---	--------	----------	-------

The average number of slots per channel is 3.4, giving 4 channels per carrier. The spectrum efficiency is 6.1 Erlangs/Cell or 163kbps/MHz/Cell. The average fractional loading is 49%. Clearly the small number of available channels limits the trunking efficiency.

In this case the use of even shorter slot allocations appears advantageous.

Single frequency re-use would probably be viable (eg by introducing a 12 or 16 slot mode), but at a low fractional loading level.

12.3.3 Deployment Results - Indoor Environment

The deployment model in UMTS 30.03 specifies a rectangular geometry for the base-stations. Here we consider a conventional hexagonal deployment. This is expected to give somewhat higher spectral efficiency. The standard deviation of shadowing is 12dB with a propagation exponent of 3.

12.3.3.1 Speech

We consider two options with re-use factor 1.

Table 14 Modulation/coding schemes (Speech, Indoor A)

Number of slots per frame	Modulation	C/I (dB)	Fraction of time used (Scheme A re-use 1)	Fraction of time used (Scheme B re-use 1)
6	B-OQAM	-5.1	0.008	0.008
4	B-OQAM	-2.8	0.009	0.009
3	B-OQAM	-1.0	0.290	0.290
2	B-OQAM	1.7	0.121	0.121
1	B-OQAM	7.5	0.246	0.128
1 in 2 frames	B-OQAM	19.2	0.316	-
1/2	B-OQAM	13.4		0.203
1/4	Q-OQAM	24 (est)		0.231

Table 15 Spectrum Efficiency (Speech, Indoor A)

Scheme	Cluster size	Average number of slots per channel	Spectrum Efficiency (Erlang/Cell)	Spectrum Efficiency (kbps/MHz/cell)	Fractional loading (%)
A	1	1.60	475	132	72
B	1	1.48	506	141	71

It can be seen that the use of 1/4 and 1/2 slot options in Scheme B gives slightly higher efficiency. This would require the use of a multiplexed burst.

12.3.3.2 LCD384*Table 16: Modulation/coding schemes (LCD 384, Indoor A)*

Number of slots per frame	Modulation	C/I (dB)	Fraction of time used (re-use=3)
16	B-OQAM	-1 (est)	0.011
8	B-OQAM	2.0	0.028
6	B-OQAM	6.0	0.076
4	Q-OQAM	11.5	0.086
3	Q-OQAM	15.5	0.788

A 16 slot mode is needed to ensure coverage with re-use factor 3. The average number of slots per channel is 3.5, giving 12 channels per carrier. The Spectrum Efficiency is 5.8 Erlangs/Cell or 155kbps/MHz/Cell, with an average fractional loading of 49%. Clearly the small number of available channels limits the trunking efficiency.

12.4 Summary of Results

Environment	Service	Re-use factor	Spectral Efficiency (Erlangs/MHz/Cell)	Spectral Efficiency (kbps/MHz/Cell)
Pedestrian A	Speech	1	38	152
Pedestrian A	LCD144	1	1.60	230
Pedestrian A	LCD144	3	1.74	250
Vehicular A	Speech	1	29	114
Vehicular A	Speech	3	57	226
Vehicular B	Speech	1	25	99
Vehicular A	LCD384	3	0.42	163
Indoor A	Speech	1	3.5	141
Indoor A	LCD384	3	0.40	155

The results shown above were obtained using the analytical method outlined earlier. The main simplifying assumptions are that the users are stationary, the system is noise limited, and that omnidirectional antennas are deployed in hexagonal cells. This means that the modelling of the Pedestrian environment is compatible with the requirements of UMTS 30.03. The results in the other environments should be considered as indicative only.

Annex D:

Concept Group Delta δ - Wideband TDMA/CDMA

This report contained in this annex was prepared during the evaluation work of SMG2 as a possible basis for the UTRA standard. It is published on the understanding that the full details of the contents have not necessarily been reviewed by, or agreed by, ETSI SMG or SMG2.

**ETSI SMG#24
Madrid, Spain
December 15-19, 1997
Source: SMG2**

TDoc SMG 897 / 97

**Concept Group Delta WB-TDMA/CDMA:
System Description Summary**

Introduction

In the procedure to define the UMTS Terrestrial Radio Access (UTRA), the WB-TDMA/CDMA concept group developed and evaluated a multiple access concept based on frequency, time, and code division.

The WB-TDMA/CDMA design rationale is as follows:

- **CDMA component:** To offer interferer diversity, to provide fine granularity of user data rates without high peak to mean powers.
- **TDMA component based on GSM timing structure:** To build UTRA directly on top of proven GSM technology, to ensure easy handover between GSM and UMTS, to reduce the number of codes to be processed at the same time and hence make multi-user detection feasible from day 1 of UMTS. To take advantage of orthogonal partitioning of radio resources to avoid instability.
- **Benefit from near-far resistant multi user-detection (MUD):** Cancellation of intra cell interference, to achieve stability without fast and accurate power control. To avoid soft handover.
- **Wideband carrier:** To support high user bit rates required in UMTS, and to take advantage of frequency diversity.

Key technical characteristics of the basic system

Table 1 - WB-TDMA/CDMA key technical characteristics

Multiple Access Method	TDMA and CDMA (FDMA inherent)
Duplex Method	FDD and TDD
Channel Spacing	1.6 MHz
Carrier chip / bit rate	2.167 Mchip/s
Time slot structure	8 slots / TDMA frame
Spreading	Orthogonal, 16 chips/symbol
Frame length	4.615ms
Multi-rate concept	multi-slot and multi-code
FEC codes	R = 1/8 . . . 1 (convolutional, punctured)
Interleaving	inter-slot interleaving
Modulation	QPSK / 16QAM
Burst types	2 different burst types: - burst 1: for long delay spread environments - burst 2: for short delay spread environments
Pulse shaping	GMSK basic impulse $C_0(t)$
Detection	coherent, based on midamble
Power control	slow
Handover / IF handover	mobile assisted hard handover
Channel allocation	slow and fast DCA supported
Intracell interference	suppressed by joint detection
Intercell interference	like in other clustered systems

Performance enhancing features (according to network operator choice)

- BTS antenna hopping,
- frequency hopping,
- directive and/or adaptive antennas,
- time slot hopping,
- cell synchronization,
- interference based DCA,
- faster power control (for slow moving mobiles),
- quality based power control,
- co-channel multi-user detection (synchronized cells),
- relaying and advanced relay protocols such as ODMA.

As in GSM: In order to ensure that frequency hopping can be utilized in an operating system at any time, the frequency hopping capability shall be mandatory in all mobile terminals.

In addition, future enhancements of UTRA could include performance improving features which could take advantage of software configurable mobile station concepts, e.g. Turbo codes and improved link adaptation.

WB-TDMA/CDMA Support for Relaying and ODMA: A feasibility study conducted by the Delta and Epsilon concept groups concluded that WB-TDMA/CDMA can support relaying and the ODMA protocol with negligible increase in mobile complexity or cost. The ODMA protocol breaks difficult radio paths into a sequence of shorter hops which enables lower transmit powers or higher data rates to be used. It is the goal of the protocol to choose the least cost route through the relaying system when the relays are moving and the radio paths are dynamically changing. Simulations have shown that relaying has the potential to improve coverage and flexibility and may also increase capacity by lowering transmission powers and associated intercell interference. Further details are provided in part 6 of the WB-TDMA/CDMA Evaluation Report.

System description

Figure 1 depicts the multiple access of WB-TDMA/CDMA. For comparison reasons the multiple access of GSM is depicted in Figure 1, too. In WB-TDMA/CDMA up to 8 traffic channels (TCH) are supported in a time slot and a frequency band of width 1.6 MHz. However, the number of 8 traffic channels (CDMA codes) is not sharp. It is also feasible to assign 9 or even more CDMA codes within a time slot. The traffic channels are separated at the receiver based on TCH specific CDMA codes. As can be seen from Figure 1 in both WB-TDMA/CDMA and GSM a TDMA frame consists of 8 time slots. The duration of the TDMA frame as well as time slots is exactly the same for both GSM and WB-TDMA/CDMA. This identical frame and time slot structure allows to build WB-TDMA/CDMA easily on top of proven GSM technology and ensures an easy handover between GSM and UMTS.

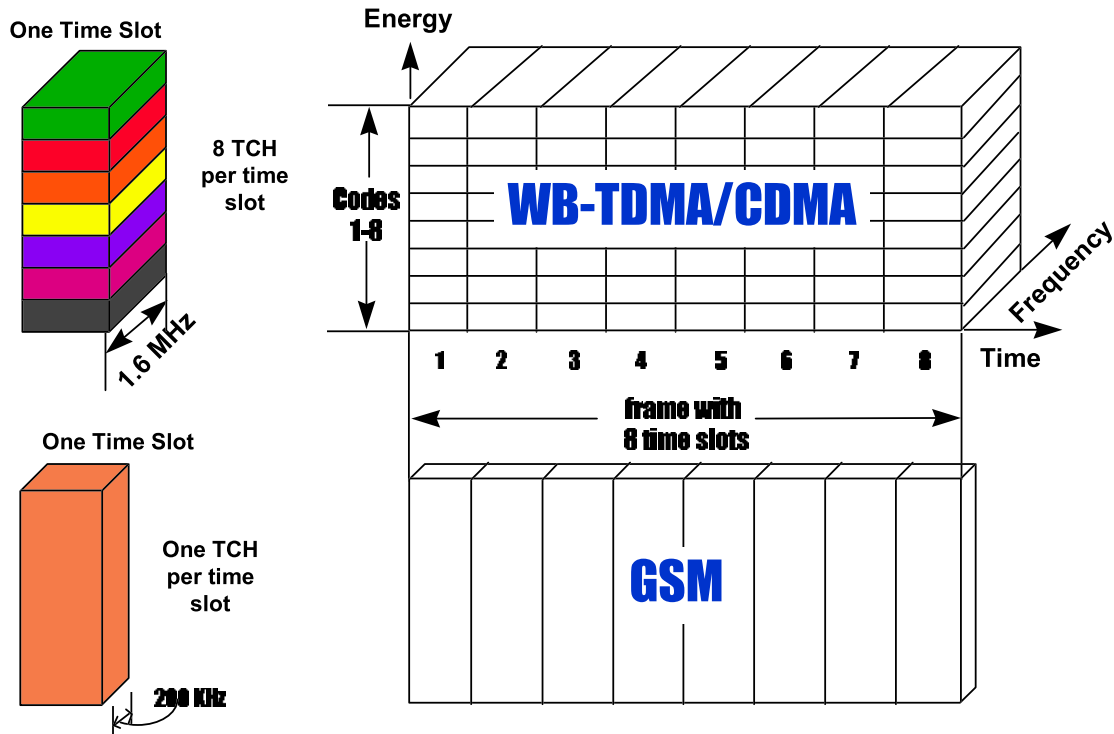


Figure 1: Multiple access of WB-TDMA/CDMA and GSM

In Figure 2 the uplink, i.e. the link from K (e.g. equal to 8) mobiles to the base station, of WB-TDMA/CDMA is depicted. At the mobile k ($k = 1, \dots, K$) the data of the traffic channel k is spread with the traffic channel specific CDMA code k . After spreading, the data of the traffic channel k is put into 2 data blocks. As in GSM a WB-TDMA/CDMA transmitted burst consists of 2 data blocks and a midamble which is used for channel estimation. At the base station the received signal is the superposition of the bursts transmitted from all K mobiles. At the base station receiver, first the different channels are estimated. This channel estimation uses as input the midambles assigned to the K mobiles. Input for joint detection are the estimated K radio channels as well as the K CDMA codes assigned to the K traffic channels. Then, in a single step multi-user / joint detection (JD) of data belonging to all K traffic channels is performed. Intersymbol interference (ISI) and cross interference between data symbols of different traffic channels are eliminated. Due to the joint detection the requirements on uplink power control are quite relaxed and the benefits of CDMA without the intra-cell interference can be utilized. Furthermore, soft handover, which means additional infrastructure costs, is not needed.

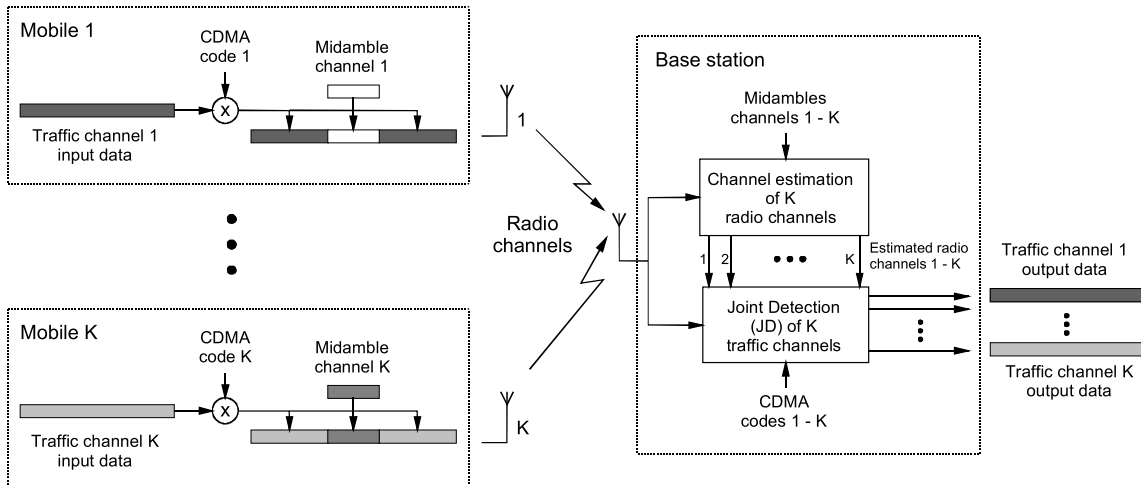


Figure 2: Uplink of WB-TDMA/CDMA

In the WB-TDMA/CDMA proposal user data rates from 8kbit/s up to 2Mbit/s with fine granularity can be adapted by

- assigning to a single user up to 8 time slots (multi-slot option),
- assigning to a single user up to 8 CDMA codes per time slot (multi-code option),
- adapting FEC coding rate (convolutional, punctured),
- adapting order of modulation (16QAM or QPSK).

For 16QAM data modulation the flexibility of data rates that can be provided to a single user is depicted in Figure 3. In Figure 3 the user data rate per CDMA code and per time slot is 32kbit/s.

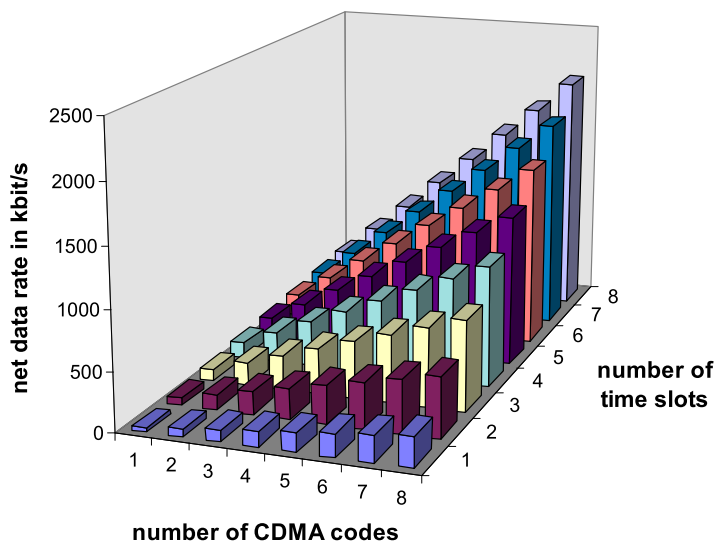


Figure 3: Flexibility of data rates in WB-TDMA/CDMA

Summary

The concept group delta WB-TDMA/CDMA proposal fulfills the UMTS requirements described in ETR 0401.

The main features can be summarized as follows:

- Support of hierarchical cell structures.
- Flexibility of user data rates by assigning different number of CDMA codes and time slots, adaptation of FEC code rate and used modulation type.
- Due to the moderate carrier bandwidth gradual introduction of UMTS islands on top of GSM networks is feasible.
- Stability of power control schemes guaranteed thanks to Multi User Detection.
- The WB-TDMA/CDMA proposal is an evolution towards wideband of the field proven GSM technology, i.e. keeping the same timing structure, and thus guarantees the robustness of the future UMTS system.
- Soft handover is not needed.
- Supports seamless handover between GSM and UMTS.
- The WB-TDMA/CDMA air interface used in unregulated frequency allocation for residential and business applications allows the use of uncoordinated systems through DCA techniques used in existing cordless systems.
- Some future enhancements are already foreseen to be introduced: adaptive antennas, new channel coding schemes, new receiver technologies, and ODMA.

**ETSI SMG#24
Madrid, Spain
December 15-19, 1997
Source: SMG2**

TDoc SMG2 898 / 97

Concept Group Delta WB-TDMA/CDMA: Evaluation Summary

Introduction

In the procedure to define the UMTS Terrestrial Radio Access (UTRA), the WB-TDMA/CDMA concept group developed and evaluated a multiple access concept based on frequency, time, and code division.

The WB-TDMA/CDMA design rationale is as follows:

- **CDMA component:** To offer interference diversity, to provide fine granularity of user data rates without high peak to mean powers.
- **TDMA component based on GSM timing structure:** To build UTRA directly on top of proven GSM technology, to ensure easy handover between GSM and UMTS, to reduce the number of codes to be processed at the same time and hence make multi-user detection feasible from day 1 of UMTS. To take advantage of orthogonal partitioning of radio resources to avoid instability.
- **Benefit from near-far resistant multi user-detection (MUD):** Cancellation of intra cell interference, to achieve stability without fast and accurate power control, to avoid soft handover.
- **Wideband carrier:** To support high user bit rates required in UMTS, and to take advantage of frequency diversity.

This document contains a brief summary how the concept group delta WB-TDMA/CDMA fulfills the high level requirements.

Please note, that part 6 of the evaluation report includes an addition to this summary showing how the OFDMA enhancement can help to fulfill and exceed the high level requirements.

maximum user bit rates

- rural area: at least 144kbps (goal to achieve 384kbps), maximum speed is 500km/h
- suburban outdoor: at least 384kbps (goal to achieve 512kbps), maximum speed is 120km/h
- indoor/low range outdoor: at least 2Mbps, maximum speed is 10 km/h
- it is desirable that the definition of the UMTS air interface should allow evolution to higher bit rates

Bit rates as requested in the high level requirements are well supported.

Real time 144kbps:

- allocating 1 code in each of the 8 time slots to a user (LCD 144a), QPSK,
- allocating 9 codes in 1 of the 8 time slots to a user (LCD 144b), QPSK,
- allocating 3 codes in 4 of the 8 time slots to a user (LCD 144c), QPSK.

Real time 384kbps:

- allocating 3 codes in each of the 8 time slots to a user (LCD 384a), QPSK,
- allocating 9 codes in 3 of the 8 time slots to a user (LCD 384b), QPSK.

Real time 2Mbps:

- 9 codes are allocated in each of the 8 time slots to a user (LCD 2048), 16QAM.

Evolution to higher bit rates supported by e.g. higher RF bandwidth and/or higher order modulation.

flexibility

- negotiation of bearer service attributes
- parallel bearer services (service mix), real-time/non-real-time communication modes
- adaptation of bearer service bit rate
- circuit and packet oriented bearers
- supports scheduling of bearers according to priority
- adaptation of link to quality, traffic and network load, and radio conditions
- wide range of bit rates should be supported with sufficient granularity

- variable bit rate real time capabilities should be provided
- bearer services appropriate for speech shall be provided

High range of variability of user bit rates and bearer services due to

- *pooling of time slots, pooling of CDMA codes,*
 - *variation of modulation scheme,*
 - *variation of FEC code rate, optimized combination of block and convolutional codes (outer and inner code)*
-

handover

- provide seamless handover between cells of one operator
- seamless handover between different operators or access network should not be prevented
- efficient handover between UMTS and 2nd generation systems, e.g. GSM, should be possible

Seamless and efficient HO between both systems will be possible due to the same timing and frame structure in WB-TDMA/CDMA and GSM.

Soft handover is not used, thus HO between different operators or access networks has no performance loss.

compatibility with services provided by present core transport networks

- ATM bearer services
- GSM services
- IP based services
- B/N-ISDN services

Wide range of bearer classes will provide an efficient means of transport for core network services (ATM, GSM, IP, B/N-ISDN) over the radio interface.

radio access planning

- if radio resource planning is required, automatic planning should be supported

Radio resource planning for following items is necessary:

- *Coverage, power, and frequency planning,*
- *planning of PICH (beacon frequency) and spreading codes.*

Planning for the items listed above can be done in an automatic way.

public network operators

- it shall be possible to guarantee pre-determined levels of quality-of-service and quality to public UMTS network operators, in the presence of other authorized UMTS users

UMTS public operators (terrestrial as well as satellite) require dedicated frequency bands with appropriate guard bands.

The guaranteed pre-determined levels of QoS are met for:

- *RT bearers with link adaptation (order of modulation, FEC code rate, optimized combination of block and convolutional codes (outer and inner code), number of physical channels used, etc.),*
- *NRT bearers with ARQ.*

Network robustness is ensured by partitioning of radio resources.

private and residential operators

- the radio access scheme should be suitable for low cost applications where range, mobility and user speed may be limited
- multiple non synchronized systems should be able to successfully coexist in the same environment
- it should be possible to install base stations without co-ordination
- frequency planning should not be needed

It is recommended that private and public UMTS systems keep a separate frequency band.

Operating public and private systems in the same frequency band is possible by limiting the private systems' TX power and using DCA.

Operation in unpaired spectrum for unlicensed use possible due to inherent TDD capability.

TDD allows for simple low cost applications, where the radio resource is divided into independent units with fine granularity and thus, uncoordinated systems can coexist in the same geographical area using DCA.

spectrum efficiency

- high spectrum efficiency for typical mixtures of different bearer services
- spectrum efficiency at least as good as GSM for low bit rate speech

These requirements are very well supported by the WB-TDMA/CDMA proposal. For more details refer to part 4 of the evaluation report. Spectrum efficiency for speech is better than in GSM.

variable asymmetry of total band usage

- variable division of radio resource between uplink and downlink resources from a common pool

FDD:

- *Overall traffic asymmetry requires larger downlink than uplink spectrum,*
- *single user traffic asymmetry is provided with assignment of different number of time slots and CDMA codes in uplink and downlink, respectively.*

TDD:

- *In the TDMA frame the switching point between uplink and downlink can be adapted dynamically,*
- *switching point dynamically set per cell,*
- *overall traffic asymmetry is supported in paired symmetric frequency bands.*

Combination of FDD and TDD is possible.

spectrum utilization

- allow multiple operators to use the band allocated to UMTS without coordination
- it should be possible to operate the UMTS in any suitable frequency band that becomes available such as first & second generation systems bands

It is recommended that private and public UMTS systems keep a separate frequency band.

Operating public and private systems in the same frequency band is possible by limiting the private systems' TX power and using DCA.

Private and residential operators can use the same frequency band.

Operation in unpaired spectrum for unlicensed use possible due to inherent TDD capability.

The minimum required spectrum for re-farming is 3 x 1.6 MHz (reuse 3) + appropriate guard band.

Hot spot re-farming is possible with 1.6 MHz (single carrier) + appropriate guardband..

Relatively small carrier bandwidth which is an integer multiple of 200 kHz yields good re-farming granularity.

coverage, capacity

- the system should be flexible to support a variety of initial coverage/capacity configurations and facilitate coverage/capacity evolution
- flexible use of various cell types and relations between cells within a geographical area without undue waste of radio resources
- ability to support cost effective coverage in rural areas

Coverage / capacity evolution is possible due to adaptive antennas and DCA.

HCS is fully supported with at least 3 layers due to moderate bandwidth of the carriers.

Adaptation of frequency separated cell layers together with slow DCA are options to improve the capacity gains due to HCS.

mobile terminal viability

- hand-portable and PCM-CIA card sized UMTS terminals should be viable in terms of size, weight, operating time, range, effective radiated power and cost

RF linearity requirements are slightly higher as GSM today.

Required signal processing for joint detection is such that low cost terminals will be feasible day 1 when UMTS is introduced.

network complexity and cost

- the development and equipment cost should be kept at a reasonable level, taking into account the cost of cell sites, the associated network connections, signaling load and traffic overhead

Soft handover is not used, thus additional traffic and operating cost in the fixed network due to soft handover is avoided.

Smooth transition path for GSM networks is possible.

High TRX efficiency allows for small BTS.

If WB-TDMA/CDMA will be a world-wide standard, it is expected that the cost of base stations and associated equipment will benefit from a larger market. Interoperability between operators not only in Europe will also be much simpler since the core network will be based on GSM.

mobile station types

- it should be possible to provide a variety of mobile station types of varying complexity, cost and capabilities in order to satisfy the needs of different types of users

Low cost speech terminal:

1 time slot with only a 1 code capability in the uplink, and up to full code capability in the downlink for optional data applications.

Low cost terminal:

1 time slot with full code capability in the uplink and downlink for NRT services only.

Enhanced MS:

Duplex operation in every time slot and simultaneously monitoring of the surroundings

A duplexer is not needed below a certain level of time slot aggregation

Refer to the high level requirement mobile terminal variability, too.

alignment with IMT2000 (FPLMTS)

- UMTS radio interface shall meet at least the technical requirements for submission as a candidate technology for IMT2000

As WB-TDMA/CDMA meets the UTRA requirements, it can be submitted as IMT-2000 proposal.

minimum bandwidth allocation

- it should be possible to deploy and operate a network in a limited bandwidth

Uncoordinated operation of different UMTS operators within one frequency band requires appropriate guardbands between frequency allocations of each operator. The size of the necessary guardband is derived from the isolation between uncoordinated BTSs and MSs according to different scenarios considered in SMG2.

The minimum required spectrum for UMTS operators is 3×1.6 MHz (reuse 3) + guardband.

electromagnetic compatibility

- the peak and average power and envelope variations have to be such that the degree of interference caused to other equipment is not higher than in today's systems

The burst transmission due to the TDMA component is expected to cause similar EMC issues as in GSM.

In case of multi-code and / or 16QAM modulation additional envelope variations occur. However, it is expected that this can be tolerated, and EMC will not be degraded seriously.

RF radiation effects

- UMTS radio interface shall be operative at RF emission power levels which are in line with the recommendations related to electromagnetic radiation

In principal the average power levels of different mobile types are independent of SRTT.

The power levels of different mobile types can be specified such that recommendations are fulfilled.

security

- UMTS radio interface should be able to accommodate at least the same level of protection as the GSM radio interface does

This requirement is in principal independent from SRTT. Thus, the WB-TDMA/CDMA air interface can be specified such that level of protection is at least as that of the GSM radio interface.

coexistence with other systems

- the UMTS radio interface should be capable to coexist with other systems within the same frequency band.

Refer to explanations given for public, private and residential operators, as well as spectrum utilization.

dual mode

- it should be possible to implement dual mode UMTS/GSM terminals cost effectively

Harmonized approach between WB-TDMA/CDMA and GSM with respect to clocking, carrier spacing and frame structure.

For dual mode terminals additional GSM RX RF, and IF filters are required.

MLSE function in GSM can be realized by Joint Detection (JD) hardware.

No additional digital hardware for MLSE function in GSM is needed.

**ETSI SMG2#24
97**

Tdoc SMG 899 /

Madrid, Spain

December 15th-19th, 1997

Source: SMG2

Agenda Item: 4.1 UTRA

Subject: Evaluation Document Cover Sheet for:

**Concept Group Delta
WB-TDMA/CDMA
System Description Performance Evaluation**

Disclaimer:

“This document was prepared during the evaluation work of SMG2 as a possible basis for the UTRA standard. It is provided to SMG on the understanding that the full details of the contents have not necessarily been reviewed by, or agreed by, SMG2.”

ETSI SMG2#24

TDoc SMG2 368 / 97

Cork, Ireland

December 1-5, 1997

**Concept Group Delta
Wideband TDMA/CDMA**

**Evaluation Report - Part 1
V 2.0 b**

Table of Contents

1 INTRODUCTION	504
1.1 Contact Persons	504
2 ABBREVIATIONS	505
3 LOGICAL CHANNELS	507
3.1 Traffic channels	507
3.2 Control channels	507
3.2.1 Dedicated Control Channels	507
3.2.2 Common Control Channels	507
3.3 Mapping of Logical Channels to Physical Channels	508
3.3.1 Traffic Channels	508
3.3.2 Control Channels	508
4 PHYSICAL CHANNEL STRUCTURE	513
4.1 Multiframe	513
4.2 Frame Structure	514
4.2.1 Time slots	514
4.2.2 FDD frame	514
4.2.3 TDD frame	514
4.2.4 Spreading codes	515
4.3 Bursts	515
4.3.1 Traffic bursts	515
4.3.2 Access Bursts	516
4.3.3 Pilot burst	517
4.4 Modulation	517
4.4.1 Data modulation	518
4.4.2 Spreading modulation	520
4.4.3 Training sequences for spread bursts	522
4.5 Examples of gross bit rates and service mappings	526
5 RESOURCE ALLOCATION, VARIABLE DATA RATES	528
5.1 The RLC/MAC sub-layer	528
5.2 RT operating mode	529
5.2.1 Real Time Transmission	529
5.3 NRT operating mode	529
5.3.1 Scheduled Allocation Down-link transmission	530
5.3.2 Scheduled Allocation, Up-link transmission	530
5.3.3 Immediate Allocation	531

6 RADIO RESOURCE MANAGEMENT	532
6.1 General	532
6.1.1 Supported services and environments	532
6.1.2 Mobile station classes	532
6.2 Channel allocation	533
6.2.1 Channel allocation to cells	533
6.2.2 Fast channel allocation	533
6.3 Link Quality Control	535
6.4 Power Control	536
6.5 Admission Control	536
6.6 Handover	537
6.6.1 General	537
6.6.2 HO scheme for RT bearer services	538
6.6.3 HO scheme for NRT bearer services	541
6.7 Handover in TDD mode	542
6.7.1 Handover between FDD and TDD	542
6.8 Handover between WB-TDMA/CDMA and GSM	542

1 Introduction

In the procedure to define the UMTS Terrestrial Radio Access (UTRA), the wideband TDMA/CDMA concept group develops and evaluates a multiple access concept based on time, frequency and code division. This group basically includes the FRAMES Multiple Access Mode 1 (FMA1) with spreading proposal.

Intention of this document is to present detailed technical data and evaluation results for the concept discussed in this group.

The final version 2.0 b of the evaluation report contains 6 parts:

- Part 1: Description of the proposal
- Part 2: Mixed services in Wideband TDMA/CDMA
- Part 3: Link level simulation results
- Part 4: System level simulation results
- Part 5: Template according UMTS 30.03, annex 1
- Part 6: Support for Relaying and ODMA

1.1 Contact Persons

Address	Name	Phone / Fax / E-mail
Chairman		
Siemens AG	Markus Nasshan	Phone : +49 2871 91 2746
PN KE TI 21		Fax : +49 2871 91 3387
Kaiser-Wilhelm-Str. 56		E-mail : markus.nasshan@pn.siemens.de
D-46393 Bocholt		
Germany		
Secretary		
Mannesmann Mobilfunk	Volker Höhn	Phone : +49 211 533 3637
Am Seestern 1		Fax : +49 211 533 2834
D-40547 Düsseldorf		E-mail : volker.hoehn@D2privat.de
Germany		

2 Abbreviations

16QAM	16-ary Quadrature Amplitude Modulation
ARQ	Automatic Repeat on Request
BCCH	Broadcast Control Channel
BER	Bit Error Rate
BPSK	Binary Phase Shift Keying
BS	Base Station
BSS	Base Station Subsystem
CA	Capacity Allocation
CAA	Capacity Allocation Acknowledgement
CBR	Constant Bit Rate
CCCH	Common Control Channel
CD	Capacity Deallocation
CDA	Capacity Deallocation Acknowledgement
CDMA	Code Division Multiple Access
CTDMA	Code Time Division Multiple Access
CRC	Cyclic Redundancy Check
CU	Central Unit
CUCH	Common Uplink Channel
DCA	Dynamic Channel Allocation
DCCH	Dedicated Control Channel
DL	Downlink
DS	Direct Sequence
DTX	Discontinuous Transmission
DU	Data Units
FACCH	Forward Associated Control Channel
FACH	Forward Access Channel
FCCH	Frequency Correction Channel
FCH	Frame Control Header
FDD	Frequency Division Duplex
FDMA	Frequency Division Multiple Access
FEC	Forward Error Control
FER	Frame Error Rate
FMA1	FRAMES Multiple Access Mode 1
FO	Forward Order
FOCH	Forward Order Channel
FRAMES	Future Radio wideband Multiple Access
FWA	Fixed Wireless Access
GMSK	Gaussian Minimum Shift Keying
HCS	Hierarchical Cell Structure
IA	Interference Averaged
JD	Joint Detection
L1	Layer 1
L2	Layer 2
LLC	Logical Link Control
MA	Multiple Access

MAC	Medium Access Control
MAHO	Mobile Assisted Handover
MOHO	Mobile Originated Handover
MS	Mobile Station
NRT	Non-Real Time
PC	Power Control
PCH	Paging Channel
PICH	Pilot Channel
POTS	Plain Old Telephone Service
PWCCH	Public Power Control Channel
QAM	Quadrature Amplitude Modulation
QOQAM	Quaternary Offset Quadrature Amplitude Modulation
QoS	Quality of Service
QPSK	Quaternary Phase Shift Keying
RACH	Random Access Channel
RAU	Remote Antenna Units
RF	Radio Frequency
RLC	Radio Link Control
RRC	Radio Resource Control
RRM	Radio Resource Management
RT	Real Time
SCH	Synchronization Channel
SDCCH	Stand-alone Dedicated Control Channel
TCH	Traffic channel
TDD	Time Division Duplex
TDMA	Time Division Multiple Access
UACH	Uplink Acknowledgement Channel
UL	Uplink
UMTS	Universal Mobile Telecommunications System
VBR	Variable Bit Rate

3 Logical channels

This chapter describes the logical channels required for data transfer. Logical channels are unidirectional and can be divided into two categories:

- Traffic channels and
- Control channels

3.1 Traffic channels

A traffic channel (TCH) is used for transferring user data and / or layer 3 signalling data.

3.2 Control channels

Control channels carry layer 3 and MAC signalling data and they are also needed for the initial synchronization of the mobile station. Control channels can be further divided into:

- Dedicated control channels and
- Common control channels.

3.2.1 Dedicated Control Channels

Dedicated Control Channels (DCCH) are point-to-point control channels that carry connection oriented messages.

1. Associated Control Channel (ACCH) is a point-to-point channel in the uplink or downlink direction. The allocation of an ACCH is linked to the allocation of a TCH. The ACCH is used for RLC/MAC layer messages, e.g. capacity allocations or link control messages.
2. Stand-alone DCCH (SDCCH) is a point-to-point channel in the uplink or downlink direction. The allocation of an SDCCH is not linked to the allocation of a TCH, MAC may or may not allocate SDCCH capacity to an MS dependent upon circumstances. An SDCCH is used for the transfer of layer 3 and RLC/MAC layer messages.

3.2.2 Common Control Channels

Common Control Channels (CCCH) are point-to-multipoint or point-to-point control channels that carry connectionless or connection oriented messages.

PICH Pilot Channel is a point-to-multipoint channel in the downlink direction. The PICH is used for power measurements and initial frequency and time slot synchronization by the mobile stations.

BCCH Broadcast Control Channel is a point-to-multipoint control channel in the downlink direction. The BCCH is used for the broadcast of layer 3 and MAC information that describes the cell.

PCH Paging Channel is a point-to-multipoint control channel in the downlink direction. The PCH is used for the broadcast of layer 3 paging messages.

RACH Random Access Channel is a contention access uplink channel that can be used by MS to signal a number of messages, e.g. capacity request messages and access request messages. The RACH may be segmented into two components, one for use by MS that have time alignment with the cell (this component makes use of a normal burst (not access burst) and is therefore called N-RACH) and one for use by MS that do not have time alignment with

the cell (this component uses a short access burst and is called S-RACH. There exists two types of such access bursts, depending on the cell size).

FACH Forward Access Channel is a point-to-multipoint channel in the downlink direction that is used to transfer MAC related signalling (e.g. capacity allocations).

UACH Uplink Assigned Channel is a point-to-point uplink channel that is temporarily assigned to an MS either for the acknowledging of certain MAC messages or for data unit transmission requests for downlink NRT data transfer.

SCH Synchronization channel is a point-to-multipoint downlink channel that is used by the mobile station to synchronize with the TDMA multiframe structure of the BS.

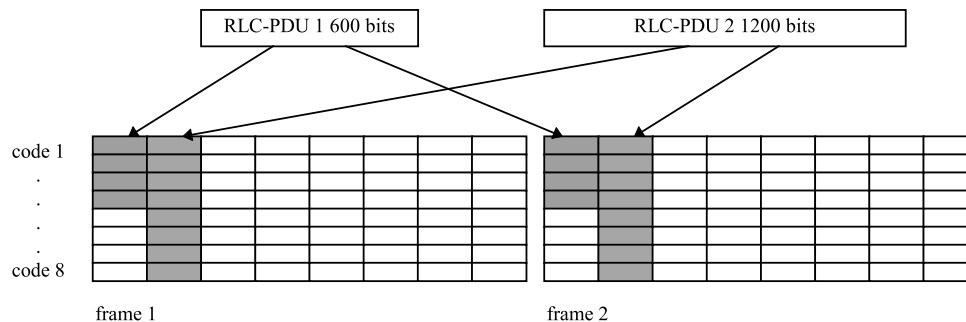
3.3 Mapping of Logical Channels to Physical Channels

This section describes the way in which logical channels are mapped onto physical resources. Details on the multiframe structure are given in section 4.1.

In the sequel, we use the terms physical channel and resource unit; a physical channel is defined as the association of one time slot and one frequency (or set of frequencies + hopping sequence when slow frequency hopping is used). A resource unit is that part of a physical channel that is associated with one spreading code. A physical channel therefore comprises up to m resource units where m is the maximum number of available codes in one time slot.

3.3.1 Traffic Channels

A traffic channel is allocated one or more sets of slots/codes within a frame together with an interleaving interval. Each set of slots and codes over an interleaving interval maps to a data unit and a data unit can correspond to an FEC code block and RLC protocol data unit. This is illustrated by the following diagram:



For RT allocation, a traffic channel is mapped onto one or more resource units over an indeterminate period of time. A release procedure is necessary to liberate the resource. The mapping of a TCH on slots and codes can be each TDMA frame, every second TDMA frame, every fourth TDMA frame,...up to every 64th TDMA frame.

For NRT allocation, the mapping of the traffic channel onto resource units is valid only for a so-called allocation period.

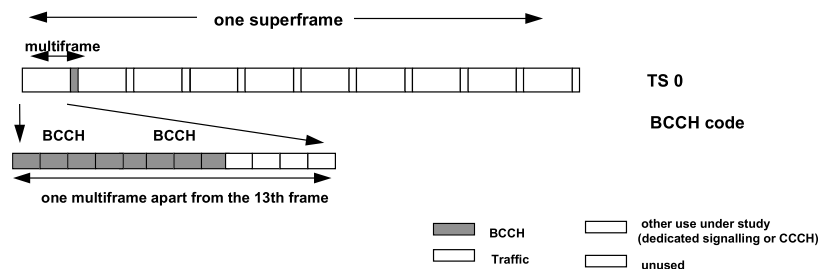
3.3.2 Control Channels

The Pilot Channel PICH is transmitted at a constant power by the BS on the BCCH carrier. In FDD mode, it is transmitted continuously (on all time slots per frame). In TDD mode, it is transmitted only during the downlink time slots. The PICH is used by the mobile stations to perform power measurements (for cell (re-)selection and mobile assisted handover) and to acquire initial frequency and time slot synchronization (time slot boundary).

The Pilot Channel is based on a long chip-sequence hidden under the data channels by large spreading; the transmitted power of the PICH is expected to be 16 dB below the highest allowed power of any downlink data channel. The long chip sequence used for synchronization matches the time-slot length of 1250 chips. Eight orthogonal sequences are defined. They are allocated on a base station basis to control the risk of interference between close cells sharing the same frequency.

At power up or during the monitoring of adjacent cells, the mobile station scans for one of the eight possible sequences over windows of 2×1250 chips to determine the time and frequency synchronization. The result of the autocorrelation is a good estimate of the received power level. It must be pointed out that the eight sequences can be simultaneously analysed, which may allow the mobile station, from the same set of samples, to get power measurements and synchronization from several base stations sharing the same BCCH frequency.

The Broadcast Control Channel BCCH is mapped onto a predefined time-slot (e.g. time-slot 0) and predefined spreading code, hereafter called BCCH spreading code. The BCCH logical channel may occupy partly or fully the corresponding resource unit, apart from the 13th frames carrying SCH, dedicated signaling or idle frames, as explained later. This is illustrated in the figure below. Additional resource units located anywhere in terms of slot or frequency may carry additional BCCHs. The exact position of these additional channels is indicated in the “primary” BCCH (e.g. on TS 0).



Mapping of the BCCH logical channel

The Paging Channel PCH can be mapped on any combination of time slots and codes on the BCCH carrier, and it can occupy partly or fully the corresponding resource units, apart from the 13th frames carrying SCH or dedicated signalling. In case other frequencies carry additional BCCH, they can also carry additional PCH. The exact location of the PCH is indicated on the BCCH. Of course, the chosen location must allow efficient DRX. One possibility is to map PCH on TS 0 of the BCCH carrier and on the BCCH spreading code (BCCH and PCH thus sharing the same resource unit).

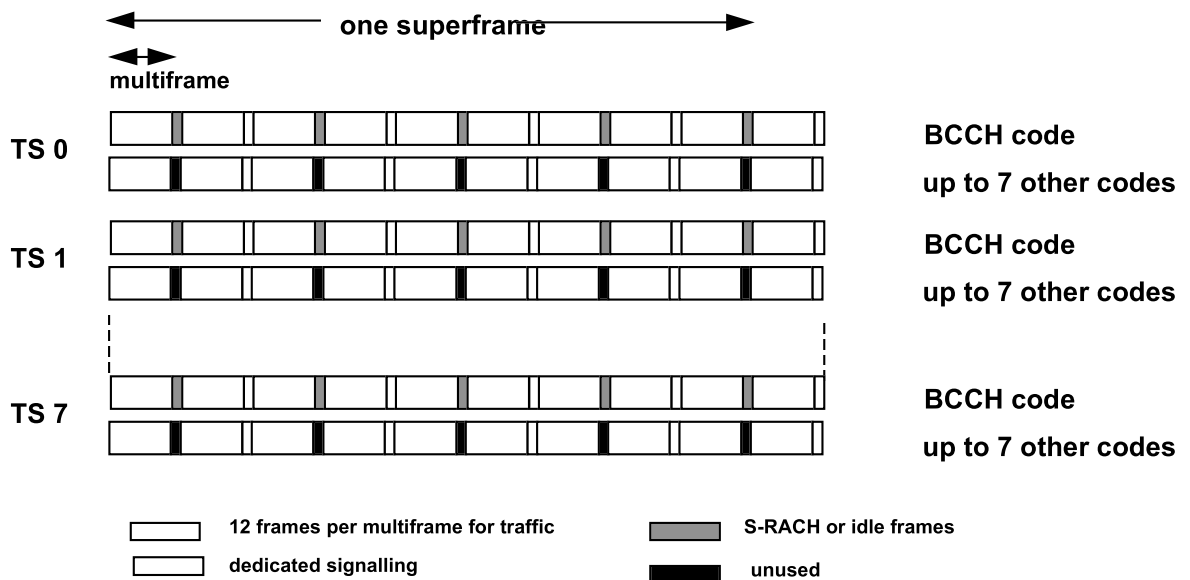
The Random Access Channel RACH (both N-RACH and S-RACH) has an interleaving period of one frame and each transmission occupies only one burst.

The N-RACH is an uplink contention access signalling channel for MS being time-aligned that is used to transfer MAC related signalling to the network (e.g. capacity requests). It can be mapped on any resource unit and it can occupy it partly or fully, apart from the 13th frames. Its location can be

indicated on the BCCH or on the FACH. The total N-RACH capacity may be subdivided amongst a number of access groups.

The S-RACH is used by a mobile station that needs to access the network without knowing its timing advance (either on initial access or for handover access in the case of asynchronous handovers). Characteristics of the joint detection impose that S-RACH bursts are not transmitted simultaneously to traffic bursts. A fixed (basic) mapping on the multiframe structure can be used, whereby the S-RACH are mapped on some of the 13th frames on each time slot and on each carrier; as an example, the S-RACH can be mapped on 5 multiframes out of the 9 multiframes of a superframe, as shown in the next figure. This mapping applies both to FDD and TDD modes, but, in TDD, only the uplink time slots can be used.

Of course, other dynamic or extended mappings are possible; for example, in order to increase the S-RACH capacity, time slots of the 12 first frames of the multiframe may be partly or fully allocated in the uplink for random access opportunities.



Mapping of the basic S-RACH on all time-slots and all carriers for the fixed mapping case

Since transmitting random accesses and monitoring neighbouring cells can be considered as two mutually exclusive actions, the 13th uplink frames reserved for S-RACH in the fixed mapping case are also the “idle” frames. The corresponding downlink frames are also idle.

The Forward Access Channel FACH can be mapped on any combination/fraction of downlink resource units. Again, the 13th frames cannot be used for the FACH. The FACH can be segmented into a number of parallel channels each serving a group of MS if required.

The Uplink Assigned Channel UACH can be allocated any resource unit on the uplink (not on the 13th frames), but the allocation is made for the transfer of only one message (e.g. acknowledgement or forward order message).

The **Synchronization Channel SCH** uses the synchronization burst format. The exact burst format is still under study. However in principle it must fulfil the same role as the synchronization burst in GSM. This burst carries the base station identification and the frame number, in order to locate the frame within the multiframe and superframe. The channel coding is such that a single burst carries the whole information. There is no interleaving between bursts.

The SCH channel is mapped as a minimum onto the BCCH carrier but may also be mapped on any carrier, not only the carrier on which the pilot channel is transmitted.

If Y and W are non zero positive integers, the SCH channel can be found Y times per superframe (where the superframe comprises Y+4W multiframes as described in section 4.1) on any of the 8 time-slots (TS=0 to 7). The SCH occupies part of the "signalling" frames positions, i.e the 13th frames positions.

An example of superframe comprising 9 multiframes is obtained with Y = 1 and W = 2; in that case, the SCH appears once per superframe for any time slot of the BCCH carrier. Hence for the time-slot number TS, the SCH should appear at the frame with number $FN = \{ (TS+1)*13 \} \text{ mod } (13*9)$. In effect this means that an SCH slot appears every 13 frames in one time-slot, apart from the end of the superframe that exhibits a gap of 26 frames without SCH. Most of the time, an SCH appears roughly every 60ms. This scheme applies both to FDD and TDD modes, but in TDD mode, only the downlink time slots can be used.

When the SCH is transmitted, nothing else is transmitted in the same time slot on the remaining available spreading codes. The absence of transmission of traffic burst on the BCCH carrier on frames with synchronization bursts is due to some characteristics of the joint detection. The mapping of the SCH is illustrated in Figure 3-1.

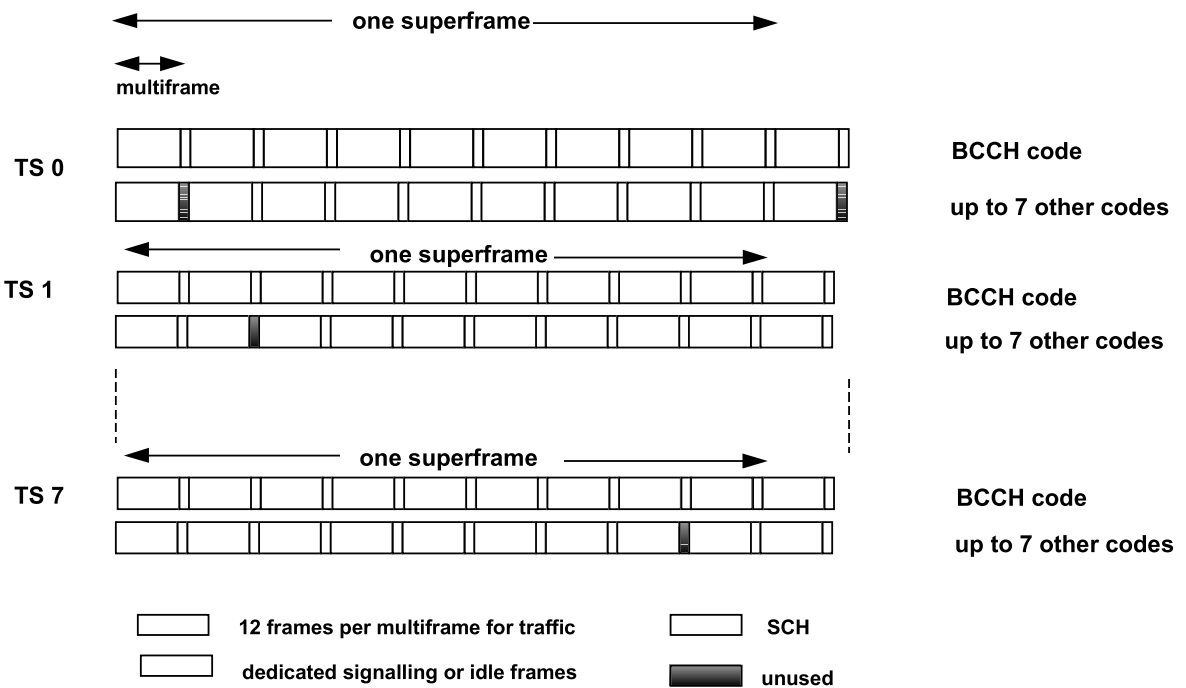


Figure 3-1: Mapping of the SCH channel

The **Associated Control Channel ACCH** is mapped, either on the 13th frames that are not idle or used for SCH or S-RACH signalling, or by stealing capacity allocated to a TCH for a bearer service. In case of stealing, the ACCH can steal capacity from any TCH allocated for the same MAC identifier to which the MAC message is addressed.

The Stand-alone Dedicated Control Channel SDCCH can be mapped on any resource unit and can occupy it partly or fully, apart from the 13th frames. The allocation is usually made for a relatively short period of time.

4 Physical channel structure

TD/CDMA can operate in FDD mode and in TDD mode. The channel spacing of TD/CDMA is 1.6 MHz both in FDD and in TDD mode. The basic physical channel of TD/CDMA is a certain time slot and one spreading code on a certain carrier frequency (code physical channel). In the following, an overview about the multiframe, unit frame, time slot and code structure is given. Then, the modulation method is defined. Finally, an example of service mappings to physical channels is given.

4.1 Multiframe

The requirements for the multiframe structure come from two major directions. First, it is required that seamless handovers between TD/CDMA and GSM can be made. This implies a GSM like multiframe structure that can be further improved by taking into account the identified deficiencies in GSM. Secondly, the control requirements from the packet access protocol (RLC/MAC) have to be incorporated into the multiframe structure. One candidate multiframe structure is proposed next and shown in *Figure 4-1*.

In the proposed structure, all resource units (all carriers, all time-slots, all the codes per time-slot) use a 13-frame multiframe. If a resource unit is allocated to a traffic channel, 12 out of 13 frames (both in up and downlink) carry the user information, the remaining frame being used either for dedicated (ACCH), common control signalling (SCH or S-RACH) or monitoring. This is illustrated in *Figure 4-1* where the "signalling" frame corresponds in a static way to the 13th frame. Dynamic mapping of the "signalling" frame may be investigated later.

Also the resource unit(s) carrying the BCCH carrier use that 13 frame multiframe. This is analogous to the GSM 26 frame multiframe, where half of the 13th frame are used for the SACCH and half for the monitoring (idle frame).

The mapping of logical channels onto that multiframe structure is given in section 3.3.

A superframe comprises several, say X , multiframes. As an example we chose a superframe made of $X=9$ multiframes, hence 117 frames, as illustrated in *Figure 4-1*. In general X should be equal to $Y+4W$, where Y and W are non zero positive integers; the example of *Figure 4-1* corresponds to $Y = 1$ and $W = 2$.

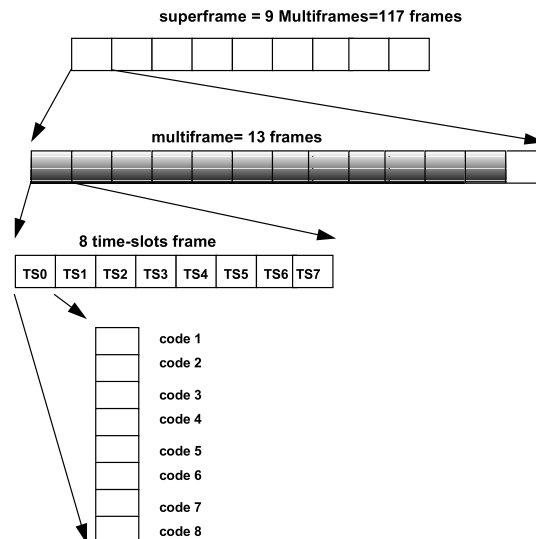


Figure 4-1 A candidate multiframe structure that aims to provide compatibility with the GSM multiframe structure in order to make handovers between TD/CDMA and GSM possible.

4.2 Frame Structure

In the following sections, a unit frame structure is outlined.

4.2.1 Time slots

The TDMA frame is subdivided into eight time slots of 577 μ s duration each. This interval corresponds to 1250 chip periods. The physical content of the time slots are the bursts of corresponding length as described in Section 4.3.

4.2.2 FDD frame

The unit FDD frame is presented in Figure 4-2. The length of the FDD frame is 4.615 ms which is 10000 chip periods.

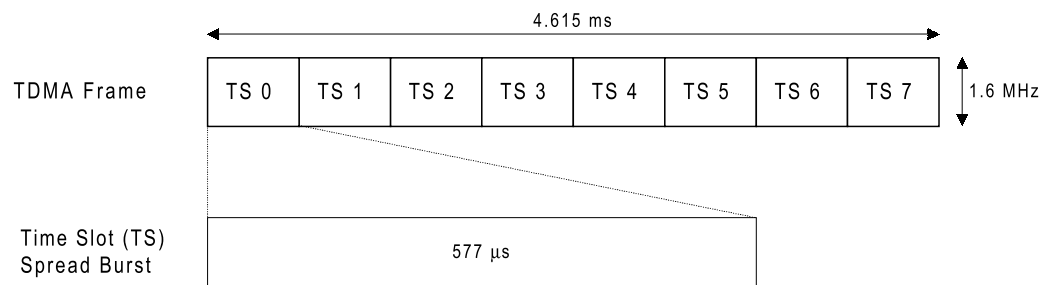


Figure 4-2 The unit FDD frame structure of WB-TDMA/CDMA.

4.2.3 TDD frame

The TDD frame is of the same length as the FDD frame but it is divided into downlink and uplink parts (Figure 4-3). The switching point between uplink and downlink can be moved in the TDD frame to adopt asymmetric traffic. The minimum length of uplink and downlink parts is one eighth of the frame length (577 μ s).

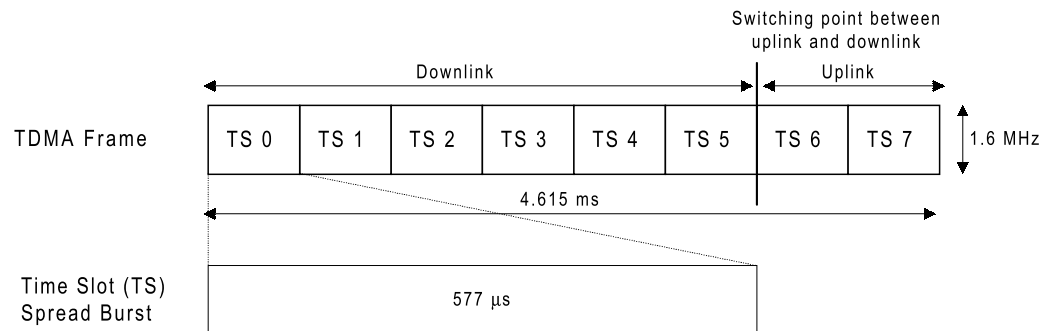


Figure 4-3 The unit TDD frame structure of WB-TDMA/CDMA.

In the TDD frame structure, it is assumed that the same mobile station is not receiving in the last slot of the downlink part and transmitting in the first slot of the uplink part.

4.2.4 Spreading codes

Within each time slot of length 577 μ s, an additional separation of user signals by spreading codes is used. This means that within one time slot of length 577 μ s, more than one burst of corresponding length as described in Section 4.3 can be transmitted. These multiple bursts within the same time slot can be allocated to different users or partly or all to one and the same user. For the multiple bursts within the same time slot, different spreading codes are used to allow the distinction of the multiple bursts.

The spread bursts as described in Section 4.3 are designed in such a way that up to 8 bursts can be transmitted within one time slot in case the bursts are allocated to different users in the uplink. In the downlink as well as in case all bursts within one time slot are allocated to one and the same user in the uplink, also more than 8 bursts (e.g. 9 or 10) can be transmitted within one time slot. By the transmission of multiple bursts within one time slot, small bit rate granularity and high bit rate flexibility are achieved, thus allowing the implementation of the whole service range from low to high bit rates.

4.3 Bursts

4.3.1 Traffic bursts

Two types of traffic bursts are defined: the Spread Speech/Data burst 1 (S1) and the Spread Speech/Data burst 2 (S2). The Speech/Data bursts 1 and 2 consist of two data symbol fields, training sequence field and guard period (Figure 4-4 and Figure 4-5). The training sequence length of the Spread Speech/Data burst 1 is 296 chip periods long whereas the training sequence length of the Spread Speech/Data burst 2 is 107 chip periods long. A set of training sequences is defined in Section 4.4.3.

Both burst formats can be used for all services from speech to high rate data up to 2 Mbit/s. The midamble length of the Spread Speech/Data burst 1 is suited for estimating the different uplink channel impulse responses of 8 users within the same time slot with a time dispersion of up to about 15 μ s. If the number of users is reduced, the tolerable time dispersion is increased. For instance, the midamble length of the Spread Speech /Data burst 1 is also suited for estimating the different uplink channel impulse responses of 4 users within the same time slot with a time dispersion of up to about 25.5 μ s. The midamble length of the Spread Speech/Data burst 1 is also suited for estimating the downlink channel impulse response with a time dispersion of 53.5 μ s, independent of the number of active users; furthermore, for estimating the uplink channel impulse response with a time dispersion of up to about 53.5 μ s in case all bursts within a slot are allocated to one and the same user. However, in this case some symbols of the data symbol field following the midamble might have to be punctured in order to increase the guard interval. The midamble length of the Spread Speech/Data burst 2 is suited for estimating the different uplink channel impulse responses of 8 users within the same time slot with a time dispersion of about 5.5 μ s; furthermore, for estimating the downlink channel impulse response with a time dispersion of up to about 15 μ s and higher, independent of the number of active users; furthermore, for estimating the uplink channel impulse response with a time dispersion of up to about 15 μ s and higher in case all bursts within a slot are allocated to one and the same user.

Thus, the Spread Speech/Data burst 1 can be used for

- uplink, up to 8 different users per time slot, channel time dispersion of up to about 15 μ s, all services from speech up to 2 Mbit/s,
- uplink, in case the bursts within a time slot are allocated to up to 4 different users, channel time dispersion of up to about 25.5 μ s, all services from speech up to 2 Mbit/s, (example)
- downlink, independent of the number of active users, channel time dispersion of up to 53.5 μ s, all services from speech up to 2 Mbit/s,
- uplink, in case all bursts within a slot are allocated to one and the same user, channel time dispersion of up to 53.5 μ s, all services from speech up to 2 Mbit/s.

The Spread Speech/Data burst 2 can be used for

- uplink, up to 8 different users per time slot, channel time dispersion of up to about 5.5 μ s, all services from speech up to 2 Mbit/s,
- downlink, independent of the number of active users, channel time dispersion of up to 15 μ s and higher, all services from speech up to 2 Mbit/s,
- uplink, in case all bursts within a slot are allocated to one and the same user, channel time dispersion of up to 15 μ s and higher, all services from speech up to 2 Mbit/s.

Concerning the use of the different bursts, confer also Section 4.4.3.

The payloads (number of data symbols) of the Spread Speech/Data bursts 1 and 2 are 56 symbols and 68 symbols, respectively. The use of the individual symbols is defined in Table 4-1 and Table 4-2.

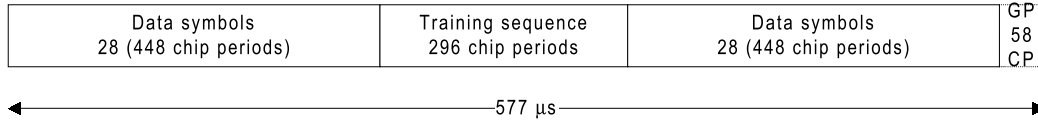


Figure 4-4 Burst structure of the Spread Speech/Data burst 1. GP stands for guard period and CP for chip periods.

Table 4-1 The contents of the Spread Speech/Data burst 1 fields and the use of individual chips.

Chip number (CN)	Length of field in chips	Length of field in symbols	Contents of field
0-447	448	28	Data symbols
448-743	296	-	Training sequence
744-1191	448	28	Data symbols
1192-1249	58	-	Guard period

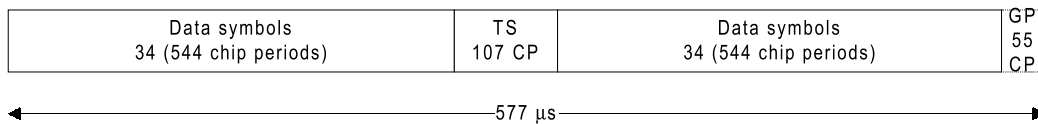


Figure 4-5 Burst structure of the Spread Speech/Data burst 2. TS stands for training sequence, GP for guard period and CP for chip periods.

Table 4-2 The contents of the Spread Speech/Data burst 2 fields and the use of individual chips.

Chip number (CN)	Length of field in chips	Length of field in symbols	Contents of field
0-543	544	34	Data symbols
544-650	107	-	Training sequence
651-1194	544	34	Data symbols
1195-1249	55	-	Guard period

4.3.2 Access Bursts

Two proposals of RACH bursts are presented below, allowing either to maximise the admissible delay spread by putting a long guard period at the end of the burst, either to maximise the capacity of the access channel in low delay spread environments by multiplying by two the number of admissible RACH in a timeslot.

Two bursts are defined, a short one with a length of 625 chips (288.5 ms) and a long one of 1250 chips (577 ms). Their structure is precised by the two figures below :

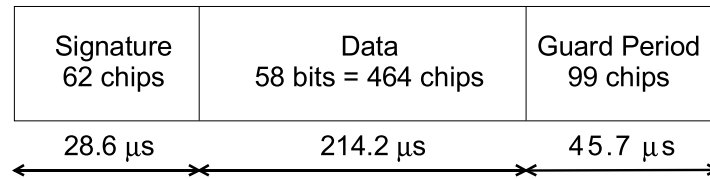


Figure 1 : Short access burst

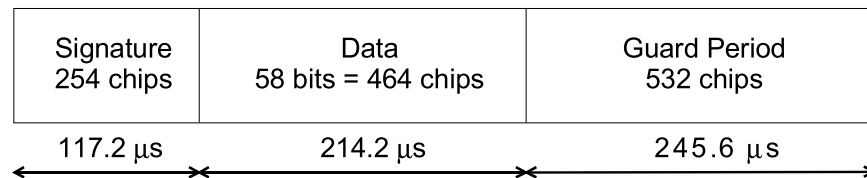


Figure 2 : Long access burst

The long burst exactly matches the timeslot length. The guard period is sufficiently long to allow for a cell radius of 35 km offering in addition 11.7 μ s of tolerance for delay spread and imperfect mobile synchronisation.

The short burst is a half of the timeslot length so that a timeslot allocated for access can be subdivided in two, this scheme doubles the number of access channels in areas with a low-delay spread, typically the indoor environment.

The base station indicates in the BCCH the expected kind of access burst.

These bursts are defined so that the random access channel offers the highest possible throughput by allowing to resolve whenever possible the concurrent accesses and otherwise to pick up the best signals while ignoring the others. For this reason the access burst carries enough information :

- to statistically allow a discrimination between several mobiles simultaneously attempting an access, consequently allowing to unambiguously inform each of them when its message was correctly decoded and in this case which was the channel allocated;
- for the mobile to give indication of the requested service, to allow a direct channel allocation without extra exchanges on a dedicated physical channel that would result in a delayed call establishment.

4.3.3 Pilot burst

The pilot burst is made of 1250 chips in order to exactly match the timeslot duration.

4.4 Modulation

In this chapter, there has been made a separation between the data modulation and the spreading modulation. The data modulation is defined in Section 4.4.1 and the spreading modulation in Section 4.4.2. The basic modulation parameters including pulse shaping are summarized in Table 4-3.

Table 4-3 Basic modulation parameters

Carrier symbol/chip rate	2.167 Mchip/s
Carrier spacing	1.6 MHz
Data modulation	QPSK 16QAM
Spreading modulation	Linearised GMSK
Spreading characteristics	Orthogonal 16 chips/symbol

4.4.1 Data modulation

In this section, symbol rates and durations are defined and the mapping of bits onto signal point constellation is shown.

4.4.1.1 Symbol rate

The symbol rates and symbol durations are summarized in Table 4-4.

Table 4-4 Summary of WB symbol rates and durations.

Symbol rate	Symbol duration
135.41 ksymbol/s	7.384 μ s

4.4.1.2 Mapping of bits onto signal point constellation

In WB-TDMA/CDMA a certain number K of CDMA codes can be assigned to either a single user or to different users who are simultaneously transmitting bursts in the same time slot and in the same frequency band of width B equal to 1.6 MHz. The maximum possible number of CDMA codes, which is smaller or equal to 16, depends on the actual interference situation and the service requirements. In Section 4.3.1 the bodies of such spread bursts associated with a particular user are shown. Each user burst has 2 data carrying parts termed data blocks

$$\underline{\mathbf{d}}^{(k,i)} = (\underline{d}_1^{(k,i)}, \underline{d}_2^{(k,i)}, \dots, \underline{d}_N^{(k,i)})^T, \quad i = 1, 2, \quad k = 1, \dots, K. \quad (4-1)$$

Data block $\underline{\mathbf{d}}^{(k,1)}$ is transmitted before the midamble and data block $\underline{\mathbf{d}}^{(k,2)}$ after the midamble. Each of the N data symbols $\underline{d}_n^{(k,i)}$, $i=1, 2$, $k=1, \dots, K$, $n=1, \dots, N$, of (4-1) of a data block has the symbol duration T_S .

The data modulation is either QPSK or 16QAM. In the case of QPSK modulation the data symbols $\underline{d}_n^{(k,i)}$ are generated from 2 interleaved and encoded data bits

$$b_{l,n}^{(k,i)} \in \{0,1\}, \quad l=1,2, \quad n=1, \dots, N, \quad k=1, \dots, K, \quad i=1, 2, \quad (4-2)$$

using the equation

$$\operatorname{Re}\{\underline{d}_n^{(k,i)}\} = \frac{1}{\sqrt{2}}(2b_{1,n}^{(k,i)} - 1), \quad (4-3)$$

$$\operatorname{Im}\{\underline{d}_n^{(k,i)}\} = \frac{1}{\sqrt{2}}(2b_{2,n}^{(k,i)} - 1), \quad n=1, \dots, N, \quad k=1, \dots, K, \quad i=1, 2.$$

Equation (4-3) corresponds to a QPSK modulation of the interleaved and encoded data bits $b_{l,n}^{(k,i)}$ of (4-2). In the case of 16QAM modulation data symbols $\underline{d}_n^{(k,i)}$ are generated from 4 interleaved and encoded data bits

$$b_{l,n}^{(k,i)} \in \{0,1\}, \quad l=1, \dots, 4, \quad n=1, \dots, N, \quad k=1, \dots, K, \quad i=1, 2. \quad (4-4)$$

The applied signal point constellation for 16QAM is depicted in Figure 4-6. The mapping of interleaved and encoded data bits $b_{l,n}^{(k,i)}$ of (4-4) to the signal point constellation of 16QAM according to Figure 4-6 is listed in Table 4-5.

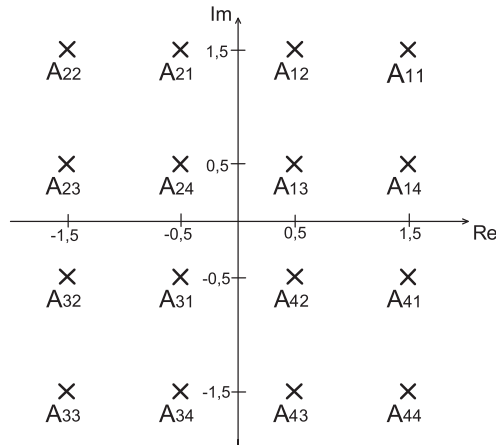


Figure 4-6 Signal point constellation for 16QAM

Table 4-5 Mapping of input bits $b_{l,n}^{(k,i)}$ to the 16QAM signal point constellation

Input bits $b_{l,n}^{(k,i)}$, $l=1,\dots,4$	Mapped on $d_n^{(k,i)}=A_{ij}$
0000	$A_{13} = 0,5 + j 0,5$
0001	$A_{12} = 0,5 + j 1,5$
0010	$A_{14} = 1,5 + j 0,5$
0011	$A_{11} = 1,5 + j 1,5$
0100	$A_{42} = 0,5 - j 0,5$
0101	$A_{43} = 0,5 - j 1,5$
0110	$A_{41} = 1,5 - j 0,5$
0111	$A_{44} = 1,5 - j 1,5$
1000	$A_{24} = -0,5 + j 0,5$
1001	$A_{21} = -0,5 + j 1,5$
1010	$A_{23} = -1,5 + j 0,5$
1011	$A_{22} = -1,5 + j 1,5$
1100	$A_{31} = -0,5 - j 0,5$
1101	$A_{34} = -0,5 - j 1,5$
1110	$A_{32} = -1,5 - j 0,5$
1111	$A_{33} = -1,5 - j 1,5$

4.4.1.3 Pulse shape filtering

The pulse shape filtering is applied to each chip at the transmitter. In this context the term chip represents a single element $c_q^{(k)}$, $q=1,\dots,Q$, $k=1,\dots,K$, of a CDMA code $c^{(k)}$, $k=1,\dots,K$, see also Section 4.4.2.2. The impulse response of the above mentioned chip impulse filter shall be the GMSK main

impulse $C_0(t)$ of duration five times the chip duration T_C and time bandwidth product 0.3. The GMSK main impulse $C_0(t)$ is defined as

$$C_0(t) = \begin{cases} S(t) \prod_{i=1}^3 S(t+iT_C), & \text{for } 0 \leq t \leq 5T_C \\ 0, & \text{else} \end{cases} \quad (4-5)$$

with

$$S(t) = \begin{cases} \sin\left(\pi \int_0^t g(t') dt'\right), & \text{for } 0 \leq t \leq 4T_C \\ \sin\left(\frac{\pi}{2} - \pi \int_0^{t-4T_C} g(t') dt'\right), & \text{for } 4T_C < t \leq 8T_C \\ 0, & \text{else} \end{cases} \quad (4-6)$$

and

$$g(t) = \frac{1}{2T_C} \left[\operatorname{erfc}\left(2\pi \cdot 0.3 \frac{t-5T_C/2}{T_C \sqrt{\log_e(2)}}\right) - \operatorname{erfc}\left(2\pi \cdot 0.3 \frac{t-3T_C/2}{T_C \sqrt{\log_e(2)}}\right) \right] \quad (4-7)$$

In equation (4-7) above

$$\operatorname{erfc}(z) = \frac{1}{\sqrt{2\pi}} \int_z^{+\infty} e^{-\zeta^2/2} d\zeta \quad (4-8)$$

denotes the complementary error function. The impulse response $C_0(t)$ according to (4-5) and the energy density spectrum $\phi_{C_0}(f)$ of $C_0(t)$ are depicted in Figure 4-7.

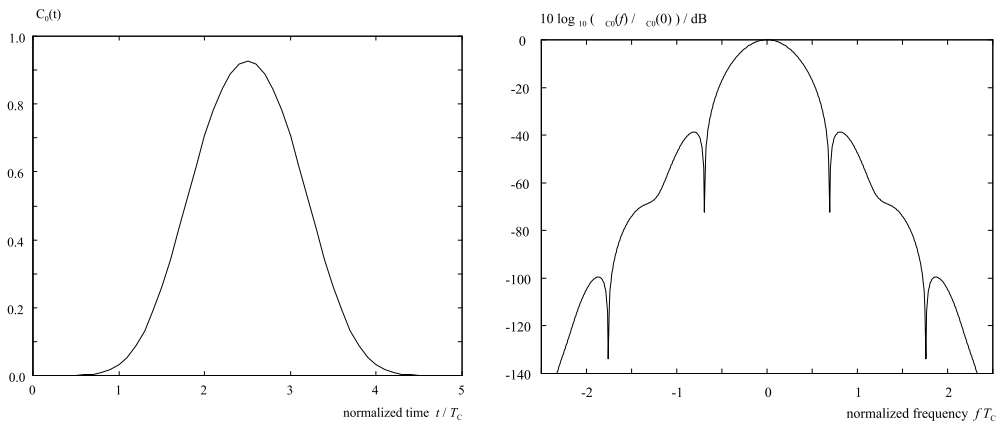


Figure 4-7 GMSK basic impulse $C_0(t)$ and the corresponding energy density spectrum $\phi_{C_0}(f)$ of $C_0(t)$

4.4.2 Spreading modulation

4.4.2.1 Basic spreading parameters

Each data symbol $d_n^{(k,j)}$ of (4-1) is spread with a CDMA code $\underline{c}^{(k)}$ of length

$$Q = 16. \quad (4-9)$$

Hence, the spreading factor is equal to Q according to (4-9). With Table 4-4 and (4-9) the chip duration is equal to

$$T_C = \frac{T_S}{Q} = 0.461 \mu\text{s}. \quad (4-10)$$

4.4.2.2 CDMA codes

The elements $c_q^{(k)}$, $q=1,\dots,Q$, $k=1,\dots,K$, of the CDMA codes $c^{(k)}$, $k=1,\dots,K$, shall be taken from the complex set

$$V_c = \{1, j, -1, -j\}. \tag{4-11}$$

In equation (4-11) the letter j denotes the imaginary unit. The CDMA codes $c^{(k)}$ are generated from binary CDMA codes $a^{(k)}$ with elements $a_q^{(k)}$, $q=1,\dots,Q$, $k=1,\dots,K$, using the relation

$$c_q^{(k)} = (j)^q \cdot a_q^{(k)}, a_q^{(k)} \in \{1, -1\}, q=1,\dots,Q, k=1,\dots,K. \tag{4-12}$$

Hence, the elements $c_q^{(k)}$ of the CDMA codes $c^{(k)}$ are alternating real and imaginary. Table 4-6 lists binary CDMA codes which can be used for $a^{(k)}$, $k=1,\dots,K$, in equation (4-12). These 16 orthogonal binary CDMA codes are generated based on Walsh-Hadamard codes followed by a multiplication with a Pseudo Random (PN) sequence. Typically K is smaller than 16 and therefore in equation (4-12) less than 16 binary CDMA codes are needed. Hence, the binary CDMA codes of Table 4-6 with the smallest code numbers shall be used in practice. The CDMA codes given in Table 4-6 are one example. Other sets of 16 CDMA codes can be generated by multiplying the 16 orthogonal binary Walsh-Hadamard CDMA codes with other PN sequences. In this way, different sets of binary CDMA codes can be used in different cells.

Table 4-6 16 Binary CDMA codes

Code 1	$(-1 -1 1 1 1 -1 1 -1 1 -1 1 -1 1 -1 -1 -1)^T$
Code 2	$(-1 -1 1 1 1 -1 1 -1 -1 1 -1 1 1 1 1 1)^T$
Code 3	$(-1 -1 1 1 -1 1 -1 1 -1 1 1 -1 -1 -1 -1)^T$
Code 4	$(-1 -1 1 1 -1 1 -1 1 1 -1 1 -1 1 1 1)^T$
Code 5	$(-1 -1 -1 -1 -1 1 1 -1 1 -1 -1 1 -1 1 -1)^T$
Code 6	$(-1 -1 -1 -1 -1 1 1 -1 -1 1 1 -1 1 -1 1)^T$
Code 7	$(-1 -1 -1 -1 1 -1 -1 1 -1 1 1 -1 -1 1 -1)^T$
Code 8	$(-1 -1 -1 -1 1 -1 -1 1 1 -1 -1 1 1 -1 1)^T$
Code 9	$(-1 1 -1 1 1 1 -1 -1 1 1 -1 -1 1 1 1)^T$
Code 10	$(-1 1 -1 1 1 1 -1 -1 -1 1 1 1 -1 -1 1)^T$
Code 11	$(-1 1 -1 1 -1 -1 1 1 -1 -1 1 1 1 1 1)^T$
Code 12	$(-1 1 -1 1 -1 -1 1 1 1 -1 -1 -1 -1 -1 1)^T$
Code 13	$(-1 1 1 -1 -1 -1 -1 -1 1 1 1 1 -1 -1 -1)^T$
Code 14	$(-1 1 1 -1 -1 -1 -1 -1 -1 -1 -1 1 1 1 1)^T$
Code 15	$(-1 1 1 -1 1 1 1 1 -1 -1 -1 -1 -1 1 -1)^T$
Code 16	$(-1 1 1 -1 1 1 1 1 1 1 1 1 1 1 -1)^T$

4.4.2.3 Spread signal of data symbols and data blocks

With the chip impulse filter $C_0(t)$ of (4-5) the spread signal $d_n^{(k,i)}(t)$ belonging to an arbitrary data symbol $d_n^{(k,i)}$ can be expressed as

$$d_n^{(k,i)}(t - T_0) = d_n^{(k,i)} \sum_{q=1}^Q c_q^{(k)} \cdot C_o(t - (q-1)T_c) = d_n^{(k,i)} \sum_{q=1}^Q (j)^q \cdot a_q^{(k)} \cdot C_o(t - (q-1)T_c). \tag{4-13}$$

In equation (4-13) T_0 denotes an arbitrary time shift. The transmitted signal belonging to the data block $d^{(k,1)}$ of (4-1) transmitted before the midamble is

$$\underline{d}_n^{(k,1)}(t) = \sum_{n=1}^N \underline{d}_n^{(k,1)} \sum_{q=1}^Q \underline{c}_q^{(k)} \cdot C_o(t - (q-1)T_c - nT_c) \quad (4-14)$$

and for the data block $\underline{d}^{(k,2)}$ of (4-1) transmitted after the midamble

$$\underline{d}_n^{(k,2)}(t) = \sum_{n=1}^N \underline{d}_n^{(k,2)} \sum_{q=1}^Q \underline{c}_q^{(k)} \cdot C_o(t - (q-1)T_c - nT_c - NQT_c - L_m T_c). \quad (4-15)$$

4.4.3 Training sequences for spread bursts

Section 4.3.1 contains a description of the spread speech/data bursts. The spread speech/data bursts contain L_m midamble chips which also termed midamble elements. The L_m elements $\underline{m}_i^{(k)}$, $i=1, \dots, L_m$, $k=1, \dots, K$, of the midamble codes $\underline{\mathbf{m}}^{(k)}$, $k=1, \dots, K$, of the K users are taken from the complex set

$$\underline{\mathbf{v}}_m = \{1, j, -1, -j\}. \quad (4-16)$$

The elements $\underline{m}_i^{(k)}$ of the complex midamble codes $\underline{\mathbf{m}}^{(k)}$ fulfill the relation

$$\underline{m}_i^{(k)} = (j)^i \cdot m_i^{(k)}, m_i^{(k)} \in \{1, -1\}, i = 1, \dots, L_m, k = 1, \dots, K. \quad (4-17)$$

Hence, the elements $\underline{m}_i^{(k)}$ of the complex midamble codes $\underline{\mathbf{m}}^{(k)}$ of the K users are alternating real and imaginary.

With W being the number of taps of the impulse response of the mobile radio channels, the L_m binary elements $m_i^{(k)}$, $i = 1, \dots, L_m$, $k = 1, \dots, K$, of (4-17) for the complex midambles $\underline{\mathbf{m}}^{(k)}$, $k=1, \dots, K$, of the K users are generated according to Steiner's method [2] from a single periodic basic code

$$\mathbf{m} = (m_1, m_2, \dots, m_{L_m + (K-1)W})^T, m_i \in \{1, -1\}, i = 1, \dots, (L_m + (K-1)W). \quad (4-18)$$

The elements m_i , $i = 1, \dots, (L_m + (K-1)W)$, of (4-18) fulfill the relation

$$m_i = m_{i-P}, i = (P+1), \dots, (L_m + (K-1)W). \quad (4-19)$$

The P elements m_i , $i = 1, \dots, P$, of one period of \mathbf{m} according to (4-18) are contained in the vector

$$\mathbf{m}_p = (m_1, m_2, \dots, m_p)^T. \quad (4-20)$$

With \mathbf{m} according to (4-18) the L_m binary elements $m_i^{(k)}$, $i = 1, \dots, L_m$, $k = 1, \dots, K$, of (4-17) for the midambles of the K users are generated based on Steiner's formula

$$m_i^{(k)} = m_{i+(k-1)W}, i = 1, \dots, L_m, k = 1, \dots, K. \quad (4-21)$$

In the following the term a midamble code set or a midamble code family denotes K specific midamble codes $\underline{\mathbf{m}}^{(k)}$, $k=1, \dots, K$. Different midamble code sets $\underline{\mathbf{m}}^{(k)}$, $k=1, \dots, K$, are in the following specified based on different periods \mathbf{m}_p according (4-20).

In adjacent cells of the cellular mobile radio system, different midamble codes sets $\underline{\mathbf{m}}^{(k)}$, $k=1, \dots, K$, should be used to guarantee a proper channel estimation.

As mentioned above a single midamble code set $\underline{\mathbf{m}}^{(k)}$, $k=1, \dots, K$, consisting of K midamble codes is based on a single period \mathbf{m}_p according to (4-20).

In the following several periods \mathbf{m}_p according (4-20) which should be used to generate different midamble code sets $\underline{\mathbf{m}}^{(k)}$, $k=1, \dots, K$, will be listed in tables in a hexadecimal representation. As shown in Table 4-7 always 4 binary elements m_i are mapped on a single hexagonal digit.

Table 4-7 Mapping of 4 binary elements m_i on a single hexagonal digits

4 binary elements m_i	mapped on hexagonal digit
-1 -1 -1 -1	0
-1 -1 -1 1	1
-1 -1 1 -1	2
-1 -1 1 1	3
-1 1 -1 -1	4
-1 1 -1 1	5
-1 1 1 -1	6
-1 1 1 1	7
1 -1 -1 -1	8
1 -1 -1 1	9
1 -1 1 -1	A
1 -1 1 1	B
1 1 -1 -1	C
1 1 -1 1	D
1 1 1 -1	E
1 1 1 1	F

The mean degradations [2, equation (38)] which serve as a quality information of the periods \mathbf{m}_p according to (4-20) and hence of the specified midamble code sets $\mathbf{m}^{(k)}$, $k=1, \dots, K$, will be also given.

The spread speech/data burst 1 described in Section 4.3.1 contains L_m equal to 296 midamble chips and can be used for different cases that are given in Table 4-8. In case 1.1, K equals 8, W equals 33, and P equals 264. Note: *In case 1.4, some symbols of the data symbol field following the midamble might have to be punctured in order to increase the guard interval.*

Table 4-9 contains periods \mathbf{m}_p according (4-20) for case 1.1.

Table 4-8 Summary of the cases for which the different burst types and training sequences can be used.

Case number	Spread speech/ data burst number	Link direction	Number of different users per time slot	Channel time dispersion	Training sequences given in Table
1.1	1	uplink	up to 8	up to 15 μ s	Table 4-9
1.2	1	uplink	up to 4	up to 25.5 μ s	Table 4-10
1.3	1	downlink	independent; for all numbers	up to 25.5 μ s	Table 4-10
1.4	1	uplink	all bursts in the same time slot allocated to one and the same user	up to 53.5 μ s	Table 4-11
		downlink	independent; for all numbers		
2.1	2	uplink	up to 8	up to 5.5 μ s	Table 4-12
2.2	2	uplink	all bursts in the same time slot allocated to one and the same user	up to 15 μ s	Table 4-13
		downlink	independent; for all numbers		

Note: In case 1.4, some symbols of the data symbol field following the midamble might have to be punctured in order to increase the guard interval.

Table 4-9 Periods m_p according (4-20) for case 1.1 (confer Table 4-8).

Periods m_p of length $P=264$	Degradation in dB, ([2], equation (38))
B257 133D 209C B1E3 D538 80A1 3ACC 53EB 12C6 D826 1547 0344 85FF 5BA0 F4CD F495 73	0.6859
B635 B3B3 4056 AEED E2AD 3797 1F00 6603 A8D3 87A9 EEED 0B8C 0241 A920 1ED4 2306 75	0.9418
89A7 3444 A1D4 210C C049 51F3 FF92 7107 5962 0993 85A9 5EB4 BE7C 3B81 47F7 3D94 CA	0.8557
E5E2 760D 86D0 C3C7 1BC8 E95F 70C6 91C8 8089 274D 0680 3FF9 58FD 92A8 4D4A 22BA CE	0.9151
0F02 97EA FBD4 1D57 A464 310C 9DAA 11D9 2981 903A EC7C 8924 BC14 77B7 7858 C6C1 94	0.8418
40A3 F18E 46AD 3640 C074 822A B3B3 0ACB 5938 FE32 DE16 58A6 9141 3953 F281 1860 EF	0.8734
20E8 34F0 14D6 6F40 722B 5BFF 4E30 FCC4 8319 C883 1176 FCAA 4BD2 8526 8678 A236 98	0.8950
DC3D 5503 7D2E 907F 3329 C511 CB81 880E BD06 4700 18CF D7CF 097A 4889 29CB 4792 72	0.7378

In case 1.2, K equals 4, W equals 57, and P equals 240. In case 1.3, K equals 1, W equals 57, and P equals 240. Table 4-10 contains periods m_p according (4-20) for case 1.2, and case 1.3.

Table 4-10 Periods m_p according (4-20) for case 1.2, and case 1.3 (confer Table 4-8).

Periods of length $P=240$	Degradation in dB
4976 A5B5 1842 319F CB04 7165 6C2F 4864 2E16 031C B44C FABF 66E6 85EE	0.8727

1157	
FCC6 F0AB 7C19 06B3 416B C630 9884 ACC5 64D1 97A0 BED7 C38C 5EE9 9B60 20AA	0.7906
17F0 C80A 15DC 3080 64C1 C4F0 757B 4C7B B8E4 9474 4DCE F593 6894 8B82 337A	0.9248
A81B 226A 8711 0E90 F8A1 1A0F DAD1 AF86 F646 030D BC85 5FE4 835A DC73 D858	0.7545
040C D19E 7323 5E86 4C3F 90C7 D55D AC4A 2CCF 13C0 EEC2 416A 7BCB 9410 281F	0.9321
0B14 545B 86A1 30EC 8422 07F5 A7A6 CFA2 7633 D50F 4B86 3FC0 64D0 8133 D971	0.6956
2DFA 5B21 ABC4 CFE1 C721 BC28 92A3 C62F E04D 5B01 C1A2 0843 5F33 220F B72A	0.8549
8010 9103 DF94 AADC 30EC 0928 0E67 E75C 9D05 9F0C B4FE 4510 56B2 CD41 3E18	0.9306

In case 1.4, K equals 1, W equals 117, and P equals 180. Table 4-11 contains periods \mathbf{m}_p according (2-29) for case 1.4.

Table 4-11 Periods \mathbf{m}_p according (2-29) for and case 1.4 (confer Table 4-8).

Periods of length $P=180$	Degradation in dB
058B 8AFD FE2C D161 077A 1DC1 D671 C6B3 2044 C5A5 809C D	0.7695
100C 5454 2A87 0947 7921 F46F C192 65B3 8529 289F 9B2B 7	0.6636
C267 E0ED 37AA B8B4 037F 8527 1A39 60B5 4CFB 1A20 8424 E	0.8443
EF0F 9477 0104 E4A4 37A2 316A 78E0 93FD EB9A 3112 0993 2	0.9377
C3F3 0E95 EAE9 8119 FB2D C6C5 8597 44F7 0938 2584 4152 4	0.8699
D027 D317 C521 9C59 664C BD8F C129 17B7 D7A2 A318 01A5 8	0.7816
0A44 9557 AF3F 7095 7762 C473 23F9 8678 2419 0DE1 E025 A	0.9472
8656 5F14 95C9 AC17 BD83 8E99 83E2 1444 533E 038D BB50 1	0.9198

The spread speech/data burst 2 described in section 4.3.1 contains L_m equal to 107 midamble chips and can be used for different cases given in Table 4-8. In case 2.1, K equals 8, W equals 12, and P equals 96. Table 4-12 contains periods \mathbf{m}_p according (4-20) for case 2.1.

Table 4-12 Periods \mathbf{m}_p according (4-20) for case 2.1 (confer Table 4-8).

Periods of length $P=96$	Degradation in dB
48A7 4F42 2A78 3A80 1CB6 736E	0.6842
C4C0 03AA 09A1 FADC D462 9E62	0.8320
5821 EBEE 07A6 91C0 8929 4CC1	0.6881
98CD 3057 C349 3F57 9686 810A	0.9026
9440 AF0C 9BD0 386A B9B6 13BC	0.7971

B5F5 24D0 3BE3 0682 A118 89A2	0.7828
52C4 9D1C 9C41 6588 30AC F43F	0.9496
1F4A A362 484D F488 04E3 2BE3	0.7626

In case 2.2, K equals 1, W equals 32, and P equals 76. Table 4-13 contains periods \mathbf{m}_p according (4-20) for case 2.2.

Table 4-13 Periods \mathbf{m}_p according (2-29) case 2.2 (confer Table 4-8).

Periods of length $P=76$	Degradation in dB
3731 7058 77C9 1EA2 414	0.5825
A599 C7C8 69D1 5F25 002	0.9177
88E9 A25E F158 0A48 C38	0.7769
88E9 A25E F158 0A48 C38	0.7769
0E95 0137 90D1 172E 6B7	0.6832
EE96 C227 8186 3952 07E	0.7473
E05E 99A5 5D38 1849 0DE	0.9156
88E9 A25E F158 0A48 C38	0.7769

In the case of the downlink, $2K$ data blocks are transmitted in a burst simultaneously. Also in the uplink, if K' greater than one CDMA code are assigned to a single user, $2K'$ data blocks are transmitted in a burst simultaneously by this user. This is the so called multi-code uplink situation. In the downlink and the multi-code uplink, the mean power used to transmit the midambles on the one hand and the $2K$ (or $2K'$) data blocks on the other hand shall be equal. This shall be achieved by multiplying the midamble codes $\mathbf{m}^{(k)}$, $k=1, \dots, K$, with a proper real factor to achieve an attenuation or an amplification.

4.5 Examples of gross bit rates and service mappings

This chapter presents the gross bit rates of WB-TDMA/CDMA and some examples how the burst can be used to provide different data rates.

Table 4-14 Gross bit rates of different burst types of WB-TDMA/CDMA

Burst type	Modulation	Gross bit rate per single slot (kbit/s)	Total gross bit rate (using all slots) (Mbit/s)
Spread Speech/Data 1	QPSK	24.3	1.55
Spread Speech/Data 1	16QAM	48.6	3.11
Spread Speech/Data 2	QPSK	29.5	1.89
Spread Speech/Data 2	16QAM	59.0	3.77

Note In gross bit rates per slot, no overhead due to possible idle slots or associated control channels is included.

A service requiring a certain bit rate can be accomplished by using a combination of time slots and codes. In Table 4-15 the user bit rates of specific interest are listed. Further, examples of how these rates could be mapped onto time and code slots in the WB-TDMA/CDMA case are also given.

Table 4-15 Examples of service mappings for WB-TDMA/CDMA.

required user bit rate (kbit/s)	code rate	burst type	modulation	number of basic physical channels (code/time slot) per frame
8	0.66	<i>spread speech/data burst 1</i>	<i>QPSK</i>	0.5
	0.54	<i>spread speech/data burst 2</i>		
64	0.66	<i>spread speech/data burst 1</i>	<i>QPSK</i>	4
	0.54	<i>spread speech/data burst 2</i>		
144	0.66	<i>spread speech/data burst 1</i>	<i>QPSK</i>	9
	0.54	<i>spread speech/data burst 2</i>		
384	0.66	<i>spread speech/data burst 1</i>	<i>QPSK</i>	24
	0.54	<i>spread speech/data burst 2</i>		
1024	0.66	<i>spread speech/data burst 1</i>	<i>QPSK</i>	64
	0.54	<i>spread speech/data burst 2</i>		
2048	0.66	<i>spread speech/data burst 1</i>	<i>16QAM</i>	64
	0.54	<i>spread speech/data burst 2</i>		

5 Resource allocation, variable data rates

The following figure represents the layer structure and the protocols and algorithms of the UMTS TD/CDMA radio interface. Algorithms are represented in dashed boxes.

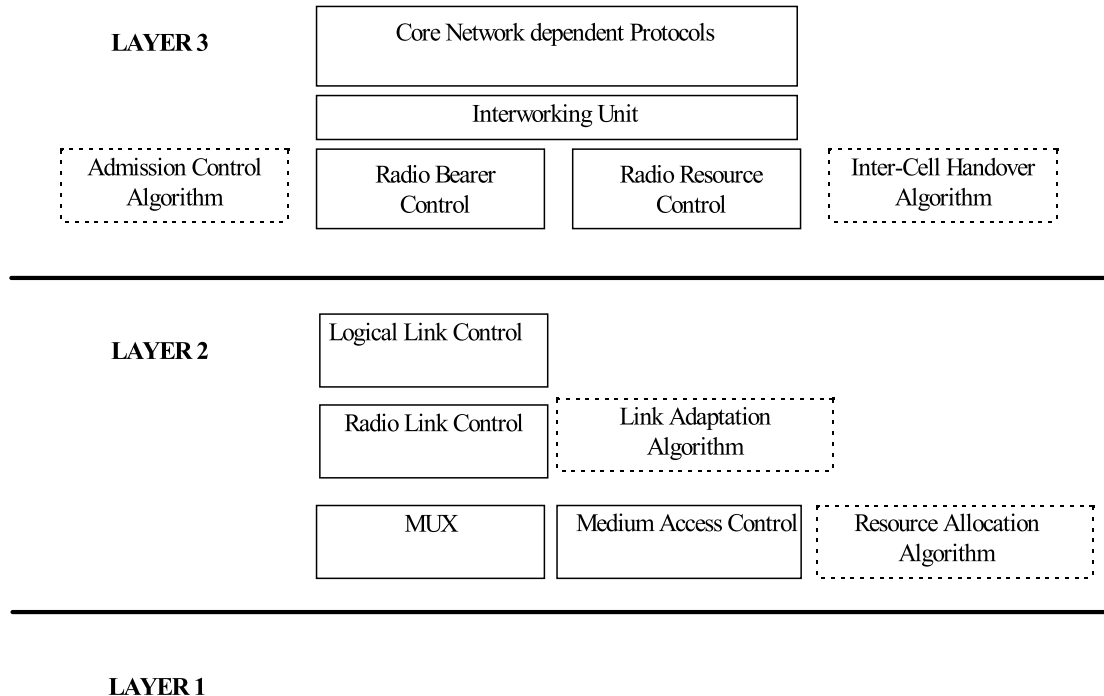


Figure -15-1 UMTS TD/CDMA Radio interface

5.1 The RLC/MAC sub-layer

RLC functions of the RLC/MAC protocol are bearer specific and RLC entities for each bearer are created during bearer setup. The RLC entity is unidirectional, so that an unidirectional bearer is represented by 2 RLC entities, one on the network side and one in the MS, while a bi-directional bearer is represented by 4 RLC entities, 2 on the network side and 2 in the MS. These entities deal with link adaptation (both traffic and radio condition adaptation).

The MAC entity is common to all bearers in a cell, i.e. all RLC functions are served by a single MAC protocol. The MAC protocol locates in the BS the MAC entity and in the MS the MAC entity.

There are two MAC/ RLC operating modes, one called Real Time (RT) and the other called Non Real Time (NRT). The former is used for radio bearers which have severe delay variation constraints and the quality is mainly fulfilled by forward error correction and power control. The latter is used for radio bearers with relaxed delay variations that allow use of backward error correction. The resource allocation and release mechanisms for the two operating modes are described in the following.

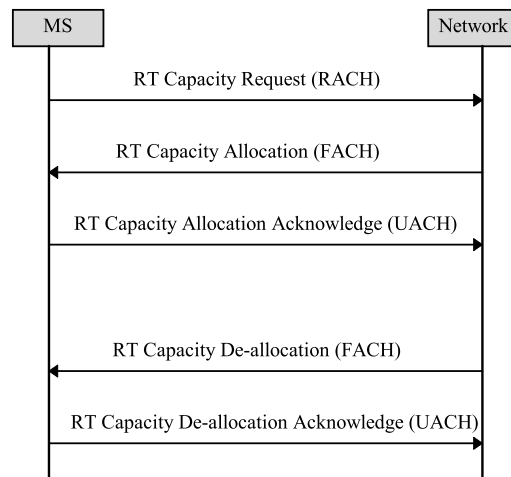
Key benefits of the developed RLC/MAC protocol are

- fast allocation and release of resources -> efficient access to radio resources
- optimized co-existence of RT and NRT operating modes
- supports an efficient Type II Hybrid ARQ scheme for NRT services.

5.2 RT operating mode

Capacity for RT services is allocated in a circuit switched manner i.e. the capacity is allocated for a bearer until a specific release procedure is executed. The MAC resource allocation function can administer resources in the RT mode in a number of ways: for example, at set-up it could allocate the bearer the maximum resources that the call requires, and the call retains exclusive use of those resources throughout its duration even if only a fraction are used for most of the time. Alternatively, the maximum resources can be allocated but those which are not used can be released for use by NRT services when not required. A delay will result whilst allocated resources are recovered but blocking will not occur. Thirdly, resources need only be allocated when required and when released are added to the general resource pool. The RT signalling procedures of the proposed scheme are capable of supporting all these options.

5.2.1 Real Time Transmission



For dynamic allocation, whenever a BSS RLC detects that its radio bearer needs more resources than it currently has, it requests resources from MAC. BS MAC sends a Capacity Allocation (CA) message to the MS MAC. The CA message is transmitted on the downlink MAC signalling channel (FACH) and contains the MS and bearer identifiers and the parameters (slot-code set(s)) that identify the additional channel. The CA message is acknowledged by the MS with a Capacity Allocation Acknowledgement (CAA) message which is transmitted on the random access channel for MAC related signalling (N-RACH) or a channel temporarily assigned to the MS for the acknowledgement (UACH).

Whenever a BSS RLC detects that the bearer has too many resources allocated, RLC can request MAC to decrease its resources. A Capacity De-allocation (CD) message is transmitted to the MS on the FACH and is acknowledged by a Capacity De-allocation Acknowledgement (CDA) sent on the N-RACH or UACH.

The resource allocation de-allocation procedure is the same for MS initiated changes, but the CA-CAA message exchange is initiated by the MS MAC transmitting a Capacity Request (CR) message on the N-RACH indicating the revised capacity requirements. Each of the above messages may also be transmitted on an ACCH or SDCCH should the channel be available.

5.3 NRT operating mode

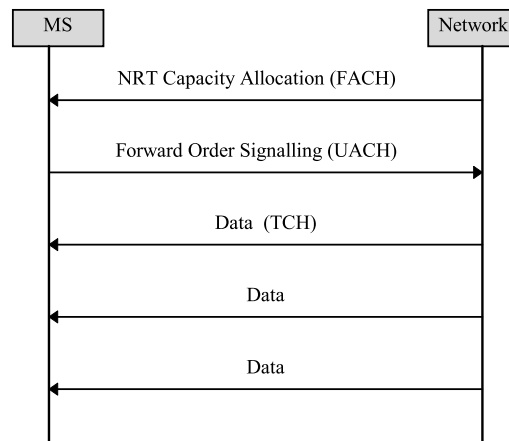
Capacity allocation for an NRT bearer is made for relatively short periods of time and the resource is automatically released at the end of the allocation period. Two NRT schemes are supported, the resource allocation scheme decides which one is the most appropriate for each case.

In the first scheme, referred to as Scheduled Allocation, type II ARQ and/or soft combining is used. Consequently data to be transmitted is scheduled by the forward order principle i.e. the receiving side identifies what data is to be transmitted in each allocation of resources.

In the second scheme, referred to as Immediate Allocation, use is made of type I selective retransmission ARQ. In this case the transmitting end selects what is to be sent and the receiving end acknowledges, requesting retransmission of what has been missed.

In both cases the BSS MAC makes allocations of NRT resources to MS for uplink or downlink data transmission. These allocations are made for relatively short periods of time specified by the MAC resource allocation process at the time of allocation. Allocations take the form of sets of slots/codes. Each set, over an interleaving period, represents an ARQ retransmission unit. (data unit). For most of the implementation that are being considered a retransmission unit is also the same as a FEC coding block. The allocation period is equivalent to one or more interleaving periods.

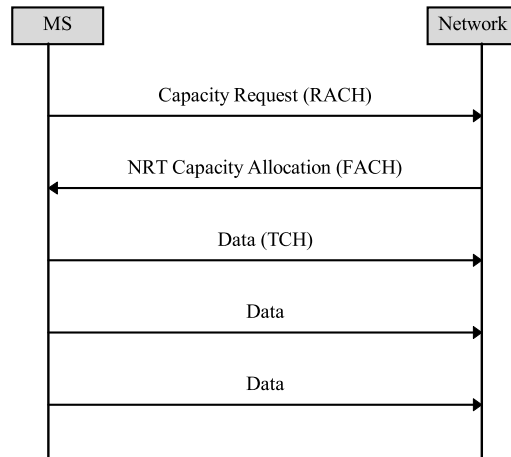
5.3.1 Scheduled Allocation Down-link transmission



Whenever a down link NRT radio bearer BSS RLC entity needs to transfer data, it indicates the amount of data to the BSS MAC entity. The MAC will make one or more NRT resource allocations to transfer this data. The allocations will be signalled to the destination MS MAC by Capacity Allocation (CA) messages transmitted on the FACH. The CA messages will contain the slot/code sets, interleaving period and allocation period for the data transfer together with a similar, but smaller, resource allocation for a UACH channel to be used by the MS for forward order signalling.

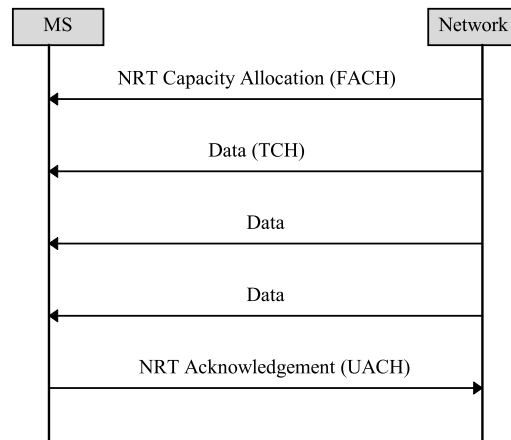
The MS will identify the data units that are to be transmitted (or re-transmitted for soft or type II combining) in the Forward Order message sent on a UACH after which the BSS will transmit the data to the MS.

5.3.2 Scheduled Allocation, Up-link transmission



Whenever the MS RLC entity of an up-link radio bearer needs to transfer data, it indicates the quantity of data to the MS MAC entity. The MAC then sends a Capacity Request (CR) message to the BSS MAC using the RACH signalling channel. The BSS MAC will respond with one or more Capacity Allocation messages transmitted on the FACH. In addition to the allocation of capacity for data transfer, the capacity allocation will indicate which data units are to be transmitted (or re-transmitted for soft or type II combining). The MS will respond to each allocation by transmitting the requested data units in the allocated slots using the allocated codes.

5.3.3 Immediate Allocation



Whether the Immediate Allocation is initiated by a BS-RLC request or after reception of an MS-MAC NRT Capacity Request, the procedure is almost the same. The BS-MAC sends a Capacity Allocation message to the MS indicating the slot/code sets, interleaving period and allocation time for data transfer. In the case of down-link data transfer the allocation will also specify UACH resources for acknowledgement signalling. Then the transmitting side transmits the data in the specified capacity. The receiving end sends an NRT Acknowledgement message when the allocation period is complete, in the uplink direction on the UACH and in the downlink direction on the FACH channel.

6 Radio Resource Management

6.1 General

For WB-TDMA/CDMA the radio resource management concept covers the following topics:

- Channel allocation
- Link Quality control
- Power control
- Admission Control
- Handover

Since UMTS requires the support of various services (in the range from 8 kbps up to 2 Mbps, RT and NRT; symmetric and asymmetric) in various environments the radio resource management concept being developed for WB-TDMA/CDMA must be capable to fulfil those key requirements. Additionally, constraints arising from the MS capabilities have to be taken into account.

6.1.1 Supported services and environments

According to [1] the following key requirements must be fulfilled regarding supported services in specific environments:

- Rural Outdoor: at least 144 kbps, maximum speed: 500 km/h
- Suburban Outdoor: at least 384 kbps, maximum speed: 120 km/h
- Indoor/Low range outdoor: at least 2 Mbps, maximum speed: 10 km/h
- Negotiation of bearer service attributes (bearer type, bit rate, delay, BER, up/down link symmetry, protection including none or unequal protection)
- Parallel bearer services (service mix), real-time (RT) / non-real-time (NRT) communication modes
- Circuit switched and packet oriented bearers
- Supports scheduling (and pre-emption) of bearers (including control bearers) according to priority
- Adaptivity of link to quality, traffic and network load, and radio conditions (in order to optimise the link in different environments).
- Wide range of bit rates should be supported with sufficient granularity
- Variable bit rate real time capabilities should be provided.
- Bearer services appropriate for speech shall be provided.

6.1.2 Mobile station classes

The number of the mobile classes has to be limited for practical reasons, avoiding the complexity actually reached for example in the GPRS. Since technical, economical and marketing issues will be the dominating factors determining the number of different mobile station classes it is difficult find a realistic scenario.

However, from radio resource management point of view the following mobile station classes are assumed as realistic:

- **simple speech MS:** half duplex operation within any timeslot; single timeslot both for UL and DL; half duplex multicode (DL: multicode; UL: single code)
This MS provides similar capabilities as a basic GSM MS for both RT and NRT services.
- **simple MS:** half duplex operation within any timeslot; single timeslot both for UL and DL; duplex multicode (DL: multicode; UL: multicode)
This MS is capable to support RT speech and NRT 'best effort' services up to a data rate of ≤ 144 kbps
- **enhanced MS:** full duplex operation within any timeslot; capability to retune frequency every timeslot; multislot capability; duplex multicode (DL: multicode; UL: multicode)
This MS is capable to support all services up to the maximum data rate of 2 Mbps (RT and NRT).

Additionally, if the market demands a MS class with service capabilities situated between the simple MS and enhanced MS, the following MS class can be introduced:

- **medium MS:** half duplex operation within any timeslot; capability to retune frequency every timeslot; restricted multislot capability ($UL + DL \leq 5 TS$); duplex multicode (DL: multicode; UL: multicode)

It is emphasised that regardless from the actual MS class each MS is capable to perform joint detection of up to 12 different codes within one timeslot to ensure that even the 'simple speech MS' is capable to detect the allocated codes in the DL. Therefore, the MS capabilities have mainly an impact on the multislot operation capability which is similar to all TDMA based systems.

Additionally, the MS may have the following capabilities:

- dual mode (WB-TDMA/CDMA - GSM)
- antenna diversity

6.2 Channel allocation

For WB-TDMA/CDMA, a physical channel is characterised by its frequency bin, time slot, and spreading code as explained in the chapter on the physical channel structure

Channel allocation covers both:

- channel allocation to cells
- channel allocation to bearer services (fast channel allocation)

6.2.1 Channel allocation to cells

By default, separation of channels between cells is performed in the frequency and code domain, i.e.:

- carrier frequencies are allocated to one cell. Using FDD, a separate bandwidth is allocated for up- and downlink.
- A set of 16 orthogonal Walsh-codes is assigned to each cell multiplied with a cell-specific scrambling sequence of length 16. This code set is used in all timeslots of all carriers within the cell. Since this results in a sufficient number of available code sets a fixed allocation scheme can be applied resulting in a static allocation of one code set to a cell.

For initial deployment of WB-TDMA/CDMA fixed channel allocation is required.

WB-TDMA/CDMA doesn't prevent the use of dynamic channel allocation techniques. Separation can be made both in the frequency and time domain. The type of dynamic channel allocation technique and the achievable gain is for further study.

6.2.2 Fast channel allocation

Fast channel allocation refers to the allocation of one or multiple physical channels to any bearer service. All bearer services capabilities for UMTS outlined in [1] are supported for the listed propagation environments (pico-, micro-, and macro-cells).

The following principles hold for fast channel allocation:

1. The basic resource unit (RU) used for channel allocation is one code / timeslot / frequency
2. Multirate services are achieved by pooling of resource units. This can be made both in the code domain (pooling of multiple codes within one timeslot = **multicode** operation) and time domain (pooling of multiple timeslots within one frame = **multislot** operation). Additionally, any combination of both is possible. For the 'enhanced MS', any arbitrary distribution of the allocated

- resources in the code / time domain on one carrier is possible. For the simple MS, only the time domain is restricted to one timeslot.
3. For UL, at maximum 8 different users per timeslot are allowed; for DL, at maximum 12 different users are possible
 4. For UL and DL, up to 12 codes can be active in one timeslot simultaneously. However, at maximum 8 codes per timeslot can be allocated to one user.
 5. Every MS belonging to any MS class is capable to perform in the DL joint detection of up to 12 codes per timeslot. In the UL, except of the 'simple speech MS' each other has the full multicode capability. Therefore, the MS capabilities have only an impact on the multislots allocation which is common for all TDMA-based systems. As a consequence from the MS capabilities point of view, the channel allocation is restricted in the time domain only, whereas in the code domain the full flexibility is provided.
 6. Channel allocation discriminates both RT and NRT bearer services:
 - RT services: Channels remain allocated for the whole duration the bearer service is established ('circuit-oriented'). The allocated channels may change because of a channel reallocation procedure.
 - NRT services: Channels are allocated for the period of the transmission of a dedicated data packet only ('packet-oriented'). Channel allocation is performed using 'best effort strategy', i.e. resources available for NRT services are distributed to all admitted NRT services with pending transmission requests. The number of channels allocated for any NRT service is variable and depends at least on the number of current available resources and the number of NRT services attempting for packet transmission simultaneously. Additionally, prioritisation of admitted NRT services is possible.
 7. Mixed allocation of RT and NRT services is possible. The channel allocation scheme takes the different C/I requirements of RT and NRT services into account by maintaining resource pools for RT and NRT services. The partitioning of the resource pools is dynamic and gives the operator the flexibility to optimise the system regarding a preferred service profile.
 8. For symmetric RT services a time shift between DL and UL of 3 timeslots is made (as for GSM) thus preventing the need of a duplex operation for the simple MS.
 9. In case of asymmetric RT bearer services for the 'enhanced MS' channel allocation is made for uplink and downlink independently. For NRT services, channel allocation for up- and downlink is made independently for all MS classes.
 10. In case of DTX for speech services, the resources remain allocated during the silent period although no signal is transmitted. Therefore, DTX operation improves the interference (inter- and intracell) level.
 11. To utilise the mandatory multicode capability of all MS classes the channel allocation scheme prefers the multicode option, i.e. the number of allocated timeslots for any bearer service is minimised by allocating as many codes per timeslot as possible. The number of codes used by one bearer service within one timeslot is a power of 2, i.e. 1,2,4 or 8
 12. In case of high rate RT services (i.e. services requiring multiple resource units) a 'channel reshuffling procedure' is required to prevent a fragmentation of the allocated codes over to many timeslots. This is achieved by freeing the least loaded timeslots (timeslots with minimum used codes) by performing a channel reallocation procedure.
 13. The bursty nature of NRT services and the channel allocation according 'best effort' achieves high statistical gain thus avoiding the need of the reshuffling procedure for multi-rate NRT services
 14. The required effort for channel reshuffling is reasonable because:
 - the expected long duration of multi-rate RT bearer services (e.g. video conference) lowers the expected rate of channel reshuffling. Further, due to their high resource consumption the number of multi-rate RT bearer services is limited by admission control
 - number of allocated codes per timeslot per bearer service are powers of 2, thus decreasing the reshuffling rate if timeslots are partly filled with used codes

6.3 Link Quality Control

Link Quality Control is in charge to provide measures to maintain the bearer service QoS parameters taking the radio environment condition (i.e., interference level) into account.

For WB-TDMA/CDMA this implies the selection of the following transmission parameters according to the current radio environment condition:

- channel coding
- interleaving depth
- burst type
- modulation

The selection of the transmission parameters and the required data rate of the bearer service directly determines the required number of resource units. In case of bearer services requiring multiple resource units the selection of the transmission parameters is equal for all allocated resources.

Some of the parameters are dependent from the system deployment and the required bearer service and remain static:

1. The burst type is cell dependent (i.e., all MS within the cell use the same burst type) and is determined during system deployment.
2. 16QAM modulation is used for 2 Mbps services only; the remaining services use QPSK. Nevertheless, a mix of QPSK and 16QAM within one cell is possible. The higher C/I requirements of 16QAM are maintained by link quality control.
3. For RT (speech, LCD, LDD) services, the interleaving depth is determined during call set-up and remains fixed for the whole call duration. To prevent long time intervals for channel allocation, the interleaving depth should not exceed 16 TDMA frames.

Since the radio environment conditions vary in time and space, link quality control has to take this into account when maintaining the bearer service QoS. The basic measure for maintaining the link quality is using power control.

Additionally, dependent from the type of bearer service the following additional measures are provided:

- for multi rate RT services, link adaptation can be performed
- for NRT services, an ARQ mechanism is used

Link adaptation for RT services means the adaptation of the channel coding according to a quality criteria derived from the C/I values of all received bursts over each interleaving period. The measurements of one bearer are averaged over all used codes, timeslots and frequencies (if frequency hopping is applied). Since the adaptation of the channel coding results in an increase or decrease of the number allocated resources the use of link adaptation for multi rate RT bearer services results in additional capacity gain since it allows to adapt the resource requirements on the current interference level. Link adaptation can be performed after each interleaving period. If additional resources are allocated (or released in case of less channel coding) the number of these resources is always 1, 2, 4, 8 or a higher power of 2 to avoid resource fragmentation.

For NRT services, an ARQ mechanism is used instead of link adaptation. Two ARQ types are foreseen:

- ARQ type 1: selective re-transmission of the disturbed data block
- ARQ type 2: ARQ mode uses hybrid coding, soft combining and reception quality estimates

The first option is being preferred for a small packets whereas the second is preferred for high rate NRT services transmitting large packets. Since the ARQ scheme is basically a data link layer protocol feature, please refer to chapter 5.

6.4 Power Control

Power control is applied for WB-TDMA/CDMA to limit the interference level within the system thus reducing the intercell interference level and to reduce the power consumption in the MS.

As mandatory power control scheme, a slow C-level based power control scheme (similar to GSM) is used both for up- and downlink. Power control is made individually for each resource unit (code) with the following characteristics:

	Uplink	Downlink
Dynamic range	80 dB	30 dB
Power control rate	variable; 2-200 cycles / second	variable; 2-200 cycles / second
Step size	2 dB	2 dB
Remarks	None	within one timeslot the powers of all active codes are balanced to be within a range of 20 dB

- All codes within one timeslot allocated to the same bearer service use the same transmission power.
- For RT services, a closed loop power control is used
- For NRT services, an open loop power control is used
- The initial power value is based on the pathloss estimate to the serving BS
- In case of one user with simultaneous RT and NRT bearer service, the closed loop power control is used both for RT and NRT bearer service. However, depending on the current services different power levels are used.

Optional enhancements concerning power control for further study:

- Introduction of quality based power control
- Introduction of fast power control

6.5 Admission Control

Admission Control decides whether a user respectively a bearer service requested by a user is to be admitted into the system during bearer setup, bearer re-negotiation or handover decision procedure. Due to the different bearer services to be supported and the limited available bandwidth admission control is vital for a successful system deployment.

The decision is at least based on the following information maintained by admission control:

- available resources in the system (cell or group of cells)
- established bearer services including their QoS attributes
- 'system load' defined by number of resources already occupied
- Capabilities of admitted MS

One of the paramount requirements towards admission control is to provide the operator the flexibility to optimise the system load to his specific needs, e.g. one operator focuses on a maximum number of admitted NRT users whereas another one focuses on a maximum quality for admitted RT users. This flexibility can be provided by introducing bearer priorities or bearer pricing schemes.

At least the following simple rules can be applied from admission control:

1. Within a system, the percentage of admitted realtime services is restricted to a specific 'fractional load' of the overall available capacity to provide capacity used for link adaptation and handover.
2. Concerning admission of NRT services, as long as they don't require a sustainable data rate they are admitted according to best effort

6.6 Handover

6.6.1 General

In general sense, handover (HO) is considered as the change of physical channels (both at the radio interface and within the fixed part of the access network) allocated to a call while maintaining this call. Within the scope of this chapter HO procedures are restricted to the procedures executed at the radio interface for intercell handover i.e., handover between different cells belonging either to the same or different cell layers (HCS). The intracell handover (HO within a cell) can be defined as channel reallocation and is therefore within the scope of channel assignment (or channel allocation) procedure. Further, the procedures within the fixed part of the access network are not treated in this chapter.

6.6.1.1 Key requirements

The purpose of intercell HO is to maintain a call while the user is crossing a cell border. Also measures from Radio Resource Management (e.g. directed retry) and O&M (e.g. Pre-emption) may trigger intercell HO.

The following key requirements on intercell HO are defined in [1]:

1. Provide seamless handover between cells of one operator. Non-seamless handover should be provided when seamless handover is not feasible
2. Efficient handover between UMTS and 2nd generation systems, e.g. GSM, should be supported, if the 2nd generation systems support these bearer services.
3. The UTRA should not prevent seamless handover between different operators or access networks

6.6.1.2 Assumptions

1. If parallel bearer services are established on a single mobile terminal they are being served by the same cell. Consequently, a handover is performed for all these bearer services simultaneously.
2. For WB-TDMA/CDMA, only hard handover is mandatory. Soft handover (macro diversity) is not necessary. However, the proposal doesn't prevent the use of soft handover.
3. Since mobile assisted handover is assumed, the following requirements arise:
 - to allow path loss measurements within each cell a continuous pilot signal is transmitted with a constant transmission power
 - to allow pre-synchronisation to any cell to perform cell identification a broadcast signal containing synchronisation information is transmitted with a constant transmission power
 - within each cell broadcast information is sent also being used for the unambiguous identification of the cell.

The proposed WB-TDMA/CDMA BCCH structure (refer to chapter 3.3.2) meets above requirements

4. Several MS classes are supported which are characterised by the number of RX/TX units, the synthesiser (s) tuning speed and the provision of duplexer units. For the enhanced MS no specific restrictions concerning handover procedures exist. However, in order to provide a handover scheme also being supported from less complex MS the following assumptions are made:
 - The simple MS is able to execute measurements at least in one time slot in the frame while it is neither receiving nor transmitting traffic
 - While the MS is being active in either WB-TDMA/CDMA or GSM mode measurements on beacon frequencies of both GSM and WB-TDMA/CDMA are possible. It is assumed that the simple MS cannot perform these measurements in parallel (simultaneously at any time instant). For more complex MS classes these restriction may not hold.
5. To allow neighbour cell identification for the simple MS 'idle' periods are provided
6. HO scheme does not mandatory require synchronised cells. However, HO between synchronised cells is an option.

6.6.1.3 Discrimination NRT <-> RT bearer services

For the HO procedure the discrimination between real-time (RT) and non-real-time (NRT) bearer services is possible due to the different requirements on the HO procedure:

- RT bearer services have stringent delay requirements but have more relaxed BER requirements. Since the HO shall be seamless, i.e. not noticeable for the user, the handover procedure should cause no extra delay. A seamless handover for RT services does not imply the need of a lossless handover.
- NRT bearer services have very low (possibly unconstrained) delay requirements but stringent BER requirements. Concerning HO of NRT services, the HO shall be lossless i.e., no data loss at expense of a possible increase of delay.

6.6.2 HO scheme for RT bearer services

The basic HO scheme is similar to GSM i.e., the basic scheme is a mobile assisted, network evaluated and decided, hard handover using backward signalling. Nevertheless, improvements are introduced to consider the corner effect, HCS and UMTS specific traffic / service requirements. Furthermore, to support a seamless HO for various RT services, an accelerated HO access is suggested.

Mobile evaluated handover with background network control also offers possibilities for faster HO decision and therefore is not excluded principally but left for further study, since it leads to extra downlink signalling overhead due to additional broadcast information to control the HO evaluation algorithm in the MS, and to less flexible HO evaluation algorithm selection due to the necessity of modifications in the MS.

6.6.2.1 HO criteria

HO initiation and decision shall be performed on the following non-exhaustive criteria list:

1. Receive level of serving cell and neighbour cells
2. Receive quality of traffic and /or signalling channel of serving cell
3. MS-BS distance
4. MS mobility (estimation of MS speed and direction)
5. MS power budget
6. traffic reasons (overload handling)
7. Type of bearer service
8. Cell priority

The introduction of a C/I based HO criteria is an option for further study

6.6.2.2 HO Phases

6.6.2.2.1 Measurement phase

Measurements performed by MS:

1. Receive level of downlink traffic channels of serving cell and pilot channel (PICH, refer to chapter 3.3.2) of neighbour cells used for pathloss estimation. PICH measurements are performed in the period between TX and RX.
2. Receive quality of downlink traffic and signalling channels of serving cell
3. MS mobility (estimation of MS speed using time thresholds)
4. Observed time difference between serving and candidate cells for timing advance estimation ('pseudo-synchronous' handover)

The measurements are pre-processed and transmitted periodically to the network. Additionally, the MS can transmit measurements instantaneously on certain events (e.g., fast signal strength decay due to the corner effect) or if ordered by the network requesting extra measurement reports.

Further, measurement pre-processing allows trend analysis to detect an 'Emergency HO condition' resulting in an accelerated handover procedure.

Frame synchronisation and cell identification is obtained from the SCH (refer to chapter 3.3.2) which is detected in the period between TX and RX. Since the PICH provides an implicit cell identification after initial neighbour cell SCH detection the PICH is sufficient for neighbour cell identification.

Measurements performed by BS:

1. Receive quality of uplink traffic and signalling channels
2. Interference level on idle channels

Further, the BS maintains up-to-date information about the difference between its own and neighbour cells' timing ('pseudo-synchronous' handover) and about the load situation.

In case of urban areas, the BS maintains information concerning the estimated MS speed and direction allowing the network to prepare a handover to specific cell(s) to mitigate the corner effect ('Emergency HO').

6.6.2.2.2 HO initiation phase

Here we distinguish between HO initiation in a single layer and between layers in HCS.

6.6.2.2.2.1 HO initiation in single layer structures

A handover is initiated if one of the following condition is fulfilled with decreasing priority:

1. 'Emergency HO condition', i.e. the rapid decay of signal strength due to corner effect. Detection of this condition is possible both through signal strength measurements (performed by MS) and through estimation of MS speed and direction allowing the network to prepare a handover to a specific cell (or cells).
2. Receive quality of traffic and /or signalling channel of serving cell falls below a specific threshold and cannot be mitigated by means of link quality control. Both up- and downlink shall be handled separately (e.g., by introducing weight factors) to consider asymmetric bearer services.
3. Receive level of serving cell falls below a specific threshold
4. MS-BS distance exceeds a specific threshold
5. Power budget exceeds hysteresis margin.
6. Network initiated HO due to traffic reasons (overload handling)

6.6.2.2.2 HO initiation in HCS

In addition to the intra layer HO initiation conditions listed above the following conditions initiate inter layer HO

- MS mobility recommends inter layer HO (e.g., microcell -> macrocell)
- Sufficient level HO, i.e. if a cell of a subordinate layer is received with sufficient RX level, an inter layer HO to this subordinate cell is initiated. Thus, as long as no other constraints hold, the traffic is concentrated in the lower layers.
- Priority level assigned to cells; the priority is service and operator dependent

6.6.2.2.3 HO decision phase

In the basic scheme HO decision is performed in the network only. HO decision is based on:

- radio related criteria
- traffic and service related criteria

For the first case, from the HO candidates the target cell is selected with:

- minimum path loss
- best C/I estimate

For traffic / service related HO decision the following criteria must be considered:

1. Candidate cell supports the type of bearer service the handover decision is pending.
2. Load situation in candidate cells
3. Bearer service priority (if HO for multiple bearer services is pending and the target cell is only capable to serve a subset)

For both radio and traffic / service related decision the cell priority (in HCS environment) is considered.

6.6.2.2.4 HO execution phase

As basic scheme, hard backward handover is assumed. Concerning handover access two options are foreseen:

- handover access with known timing advance ('pseudo-synchronous' handover), being the standard case
- handover access without known timing advance ('asynchronous' handover), in the (seldom) case of unknown timing relation between the old and new serving base station.

As soon as the HO decision has been made the network sends a handover command to the MS providing the new serving cell and the identities of the allocated physical channels in the new serving cell. An optional bearer re-negotiation has to take place if the new serving cell cannot support the bearer service agreed at call establishment.

As soon as the MS has received the HO command comprising the target cell, the traffic channels and the type of handover (asynchronous/pseudo-synchronous), it performs a HO access on the new serving cell:

- In case of a pseudo-synchronous handover the handover access is made on the new traffic channel since the timing advance is known. Thus, the break duration (time interval between release of old traffic channels and establishment of the new ones in the target cell) is minimised.

- In case of an asynchronous handover (which is the rare case) the handover access is performed on a dedicated random access channel to obtain time alignment from the BS before switching to the new traffic channels.

If the access to the target cell was not successful the MS returns to the old serving cell. If this is no longer possible due to rapid signal decay (e.g., corner effect) it shall be possible to make an emergency HO access to a cell which has been indicated by the network as 'Emergency HO cell'. This is an example for a forward HO to a cell (or limited number of cells) which have been prepared by the network for this accelerated handover. However, the detailed procedure of this handover scheme is for further study.

6.6.3 HO scheme for NRT bearer services

NRT bearer services require a lossless HO. Thus, break duration time is of minor importance whereas an ARQ protocol on higher network layers guarantees a lossless data transfer. Since the data of NRT bearer services is transferred in a packet oriented mode over the air interface similarities to GPRS arise: Handover is performed in-between the transmission of data packets. For data rates supported by GPRS a handover of a WB-TDMA/CDMA NRT bearer service to GPRS and vice versa is supported. In general, a HO for packet data services is more like a cell selection than a traditional HO.

In case a MS has allocated RT and NRT services at a time by default the handover for the RT service is prioritised over the NRT service, i.e. the NRT services follow the RT services into the new cell. Nevertheless, other HO strategies are possible, i.e. due to priority of the bearer services.

In case an MS only uses NRT services, a forward mobile evaluated (MEHO) handover with background control from the network utilising broadcast HO parameters is proposed. For enabling the network to control NRT HO immediately, we also consider a mobile assisted, network evaluated handover as option for further study.

6.6.3.1 HO Criteria

HO initiation shall be performed on the following criteria:

1. receive level of pilot channel (PICH) of serving cell and of neighbour cells
2. receive quality of traffic and/or signalling channel of serving cell based on BER or ARQ repeat counters
3. MS mobility
4. routing area hysteresis
5. network initiation due to traffic constraints

6.6.3.2 HO Phases

6.6.3.2.1 Measurement phase

Measurements performed by MS:

1. The MS measures receive level of serving cell and neighbour cells on the pilot channel. Additionally, the MS synchronises onto and decodes the neighbour SCH's. Thus, a unique identification of candidate neighbour cells is possible during and in-between packet data transfer.
2. Receive quality of downlink traffic and signalling channels of serving cell can be measured in terms of BER, receive quality of up- and downlink traffic channels can be estimated by ARQ repeat counters.
3. MS mobility can be estimated by time thresholds

6.6.3.2.2 Cell (Re-)Selection

A cell re-selection is initiated by MS if a packet transmission has ended and if one of the following conditions is fulfilled with decreasing priority:

1. receive level of pilot channel of the serving cell falls below a certain threshold

2. receive quality of the serving cell falls below a certain threshold

The selection of a new cell depends on

1. pathloss criterion fulfilled
2. MS mobility
3. cell priority
4. routing area

The HO (Cell selection resp.) is a forward type of handover, i.e. signalling channels are established in the new cell before the next data packet starts.

Optionally, the network has the possibility to command an MS to perform a cell re-selection to a specific cell, e.g. for load regulation conditions. This command overwrites MS decisions.

6.7 Handover in TDD mode

If WB-TDMA/CDMA uses TDD operation the TDMA frame (8 time-slot frame) is divided between uplink and downlink transmission. WB-TDMA/CDMA supports the TDD operation with cell by cell basis configuration of the distribution between up- and downlink taking advantage of asymmetric bearer services.

The handover scheme described in the previous section is also suitable for the TDD operation. Since the TDD operation requires locally synchronised cells the MS is capable to perform neighbour cell measurements and identification. If in TDD mode the channel allocation algorithm considers to provide a sufficient measurement window for the simple MS.

6.7.1 Handover between FDD and TDD

Regarding the FDD/TDD handover, a MAHO can still be used through the monitoring of the neighbour cells as described in the previous section. For a MS in FDD mode, and by using the idle period between reception and transmission of a burst, a MS can then always monitor a TDD pilot channel every frame provided that the TDD cell has at least 3 TS dedicated to the downlink, which should be true given the downlink biased nature of transmissions which is envisaged in TDD mode. The idle frame allows to acquire the TDD frame synchronisation. The handover itself can be optimised through the use of pseudo-synchronisation information, so that the MS knows the relative timing of the TDD cell. Otherwise an asynchronous handover is performed. The TDD to FDD handover follows similar principles and is even easier since in FDD mode the pilot channel is transmitted in all timeslots in every frame and the SCH is transmitted more frequently.

FDD/TDD handovers can then be achieved with simple MS with only one synthesiser and no duplexer. This has the potential for a seamless operation between the TDD and the FDD mode.

6.8 Handover between WB-TDMA/CDMA and GSM

Compatible multiframe structures of WB-TDMA/CDMA and GSM make synchronisation of a MS to both systems feasible. Indeed, the mapping of the traffic slots in the WB-TDMA/CDMA multiframe structure (= 13 frames) is identical to the mapping in GSM. Idle frames may therefore be used to track GSM SCH and the monitoring window between transmit and receive may be used to perform GSM BCCH carrier power measurements

Therefore, efficient handover between WB-TDMA/CDMA and GSM is possible under the prerequisite that a WB-TDMA/CDMA base station would maintain a neighbour list containing also the nearest GSM neighbours and vice versa.

Thus, in case of a handover from WB-TDMA/CDMA to GSM a UMTS mobile station being active in UMTS mode could perform GSM neighbour cell measurements and could presynchronise with the strongest GSM neighbour cells for cell identification.

If in the WB-TDMA/CDMA access network the condition to perform a HO to the GSM cell is detected, in interworking with the GSM network it is decided whether a handover of the bearer service is possible (service is supported from GSM network) or not. In the latter case, a bearer re-negotiation might be performed to adapt the bearer QoS to the GSM network capabilities. If the handover to the GSM network is possible, the handover execution is performed similar to the known GSM inter-MSC HO procedure.

In case of a handover from GSM to WB-TDMA/CDMA, the UMTS mobile station being active in GSM mode uses the monitoring window between transmission and reception and the GSM 'idle' frame to perform the WB-TDMA/CDMA pilot channel measurements and uses the WB-TDMA/CDMA SCH to obtain frame synchronisation and cell identification.

If in the GSM network the condition to perform a HO to the WB-TDMA/CDMA cell is detected, in interworking with the WB-TDMA/CDMA network it is decided whether a handover of the bearer service is possible or not. If the handover to the WB-TDMA/CDMA network is possible, the handover execution is performed similar to the known GSM inter-MSC HO procedure.

References:

- [1] ETR (04-01): 'Requirements for the UMTS Terrestrial Radio Access System', Vers. 2.6.1
- [2] B. Steiner; P. Jung: Uplink channel estimation in synchronous CDMA mobile radio systems with joint detection. The fourth International Symposium on Personal, Indoor and Mobile Radio Communications (PIMRC'93), Yokohama, Japan, September 8-11, 1993.

**ETSI SMG2#24
97**

Tdoc SMG 899 /

Madrid, Spain

December 15th-19th, 1997

Source: SMG2

Agenda Item: 4.1 UTRA

Subject: Evaluation Document Cover Sheet for:

**Concept Group Delta
WB-TDMA/CDMA
System Description Performance Evaluation**

Disclaimer:

“This document was prepared during the evaluation work of SMG2 as a possible basis for the UTRA standard. It is provided to SMG on the understanding that the full details of the contents have not necessarily been reviewed by, or agreed by, SMG2.”

ETSI SMG2#24

TDoc SMG2 368 / 97

Cork, Ireland

December 1-5, 1997

**Concept Group Delta
Wideband TDMA/CDMA**

**Evaluation Report - Part 2
V 2.0 b**

Table of Contents

1. INTRODUCTION	548
2. SERVICES ASPECTS	548
2.1 Two important questions	548
2.2 Standard service deployment (SSD) approach	548
2.3 Adaptive service deployment (ASD) approach	550
3. EXAMPLES OF MAPPING OF BEARER SERVICES ON PHYSICAL CHANNELS	551
3.1 Overview	551
3.2 Low user bit rate services	552
3.2.1 Speech service	552
3.3 Mixed services	557
3.3.1 50% speech + 50% UDD 8	557
3.3.2 50% speech + 50% UDD 384	559
3.3.3 50% speech + 50% UDD 2048	560

1. Introduction

In this part of the evaluation report mixed services for WB-TDMA/CDMA are considered. The report focuses on the following items:

- Service aspects for mixed services
- Variable bit rates in WB-TDMA/CDMA
- Realization of different service classes
- Visualization of mixed services

The system parameters used in this part 2 of the evaluation report are not necessarily identical with the system parameters used in the other parts of the evaluation report. Hence, all information contained in this part of the report shall only demonstrate the ability of WB-TDMA/CDMA to support mixed services and shall not be understood as a final specification.

2. Services aspects

2.1 *Two important questions*

In the following, the services aspects with particular respect to mixed services scenarios of WB-TDMA/CDMA are considered. First, the following two important questions must be answered:

- How can services with varying quality of service (QoS) criteria be used by various users when simultaneously maintaining a preferably high spectral efficiency?
- How can different services with different QoS criteria be used by a particular user?

Both questions must be jointly addressed when dealing with services aspects. Essentially, the two questions address the same problem, namely radio resource management. In this section, we address possible answers to these questions.

2.2 *Standard service deployment (SSD) approach*

A conservative answer is based on a fixed network planning approach which is presently deployed in second generation networks for speech and low data rate transmission. This approach is termed standard service deployment (SSD) approach. The network planning sets out from that particular service which is mostly used. This service will be termed the standard service in what follows. This service is of highest economical interest to the network operators and service providers because it will make up for the largest part of their revenue. All parameters of the standard service, including the link level parameters, are chosen in such a way that a highest possible spectral efficiency is assumed when solely using this standard service.

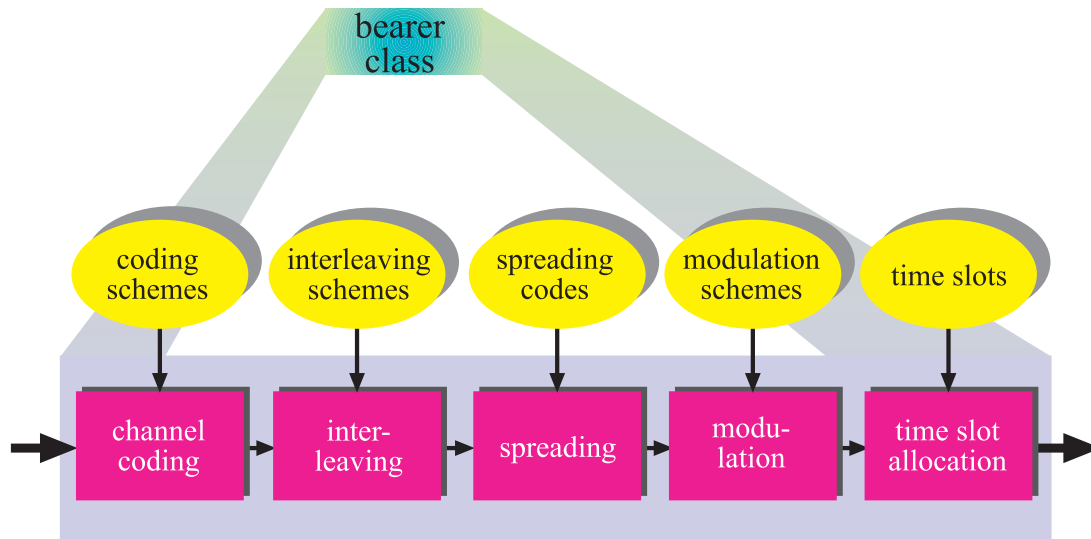


Figure 2.1 Bearer class

The standard service is provided by using a particular bearer class. *Figure 2.1* illustrates the link level parameters which belong to such a bearer class which can be provided by WB-TDMA/CDMA. First, the coding scheme is selected from a toolset of various coding schemes which comprises e.g. turbo codes, conventional convolutional codes, block codes such as Reed-Solomon codes etc. These coding schemes are parametrized when selected for a particular service. The selection is based on the desired QoS criterion, in particular by the desired bit error ratio or the desired packet loss ratio in the case of packet services. For instance, the code rate of the overall coding scheme, possible repetition and puncturing schemes, the constraint length of convolutional codes and the possible concatenation of schemes is set. Since the coded data are interleaved, the interleaving scheme is chosen from the interleaving schemes toolset which comprises for instance block and convolutional interleaving. Like in the case of the channel coding, the choice of the interleaving is based on the QoS criteria, in particular the delay criteria. In the case of unconstrained delay services, the choice of the interleaving is based on the desired throughput criterion. To facilitate an easy adaptation of the throughput to the time varying channel conditions, the interleaving depth can be chosen adaptively with respect to the actual correlation time of the channel. In this case, an on-the-fly optimization of the spectral efficiency is possible. Then, the spreading codes to be used in the spreading modulation are set. Afterwards, the modulation scheme to be used for data modulation, e.g. QPSK or 16QAM, is set together with the modulation scheme for spreading. The latter modulation scheme is based on binary continuous phase modulation (CPM). In WB-TDMA/CDMA GMSK is used.

A particular frequency reuse scheme with a given cluster order r is associated with this choice. The cluster order r designates the number of cells per cluster and is sometimes also called cluster size or frequency reuse factor. All other services which can now be seen as supplementary services must be deployed in the same cluster order r . All parameters of these supplementary services, including the link level parameters, have to be chosen to comply with the constraints defined by the deployment of the standard service. This conservative SSD approach is not optimal with respect to a joint high spectral efficiency. However, this conservative SSD approach enables second generation network operators a backward compatibility with their existing networks. Since the conservative SSD approach does not call for a flexible adaptation of the network, taking system load, environment and user requests into account, the signaling overhead required for supporting a variety of services can be kept small. WB-TDMA/CDMA is capable of supporting this conservative SSD approach.

The SSD approach allows the utilization of different services with varying QoS criteria by various users when simultaneously maintaining a rather high spectral efficiency. The rather high spectral efficiency will be achieved owing to the fact that the network planning has been done with respect to the standard service. Also, different services with different QoS criteria can be used by a particular user with high spectral efficiency.

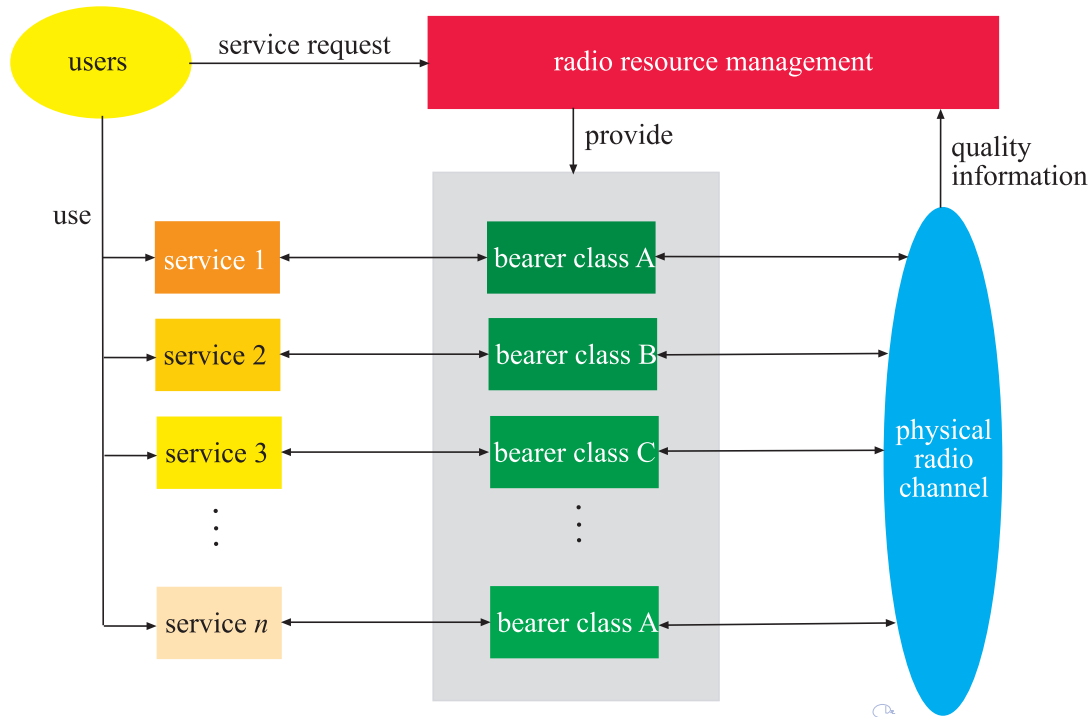


Figure 2.2 Generic radio resource allocation for ASD

2.3 Adaptive service deployment (ASD) approach

To facilitate an improved joint spectral efficiency, an adaptive service deployment (ASD) approach can be used. The ASD approach uses a hybrid channel allocation (HCA) scheme which overcomes the weaknesses of fixed channel allocation (FCA), widely deployed in second generation cellular systems, and of dynamic channel allocation (DCA), which is used in e.g. the Digital Enhanced Cordless Telecommunications (DECT) system. The FCA part of the HCA scheme uses a classical frequency planning similar to the one addressed in Sect. 2.2. Simulations have shown that a cluster order r of three provides a very stable radio network with a high spectral efficiency for most service cases. Therefore, cluster order r equal to three is proposed for WB-TDMA/CDMA.

In order to enable the network to deploy the available resources as efficiently as possible, the DCA part of the aforementioned HCA scheme is based on link quality measurements. This will be outlined in what follows. The choice of the parameters of a bearer class, in particular of the link level parameters shown in Figure 2.1, is based on a variety of measurement results of so-called quality parameters, such as measured distance between mobiles and base transceiver stations, measured signal-to-noise ratio or carrier-to-interference ratio at the detector inputs, measured duration of the channel impulse response, estimated bit error ratio, and measured mobile speeds. Setting out from these measurement results, the base station controller allocates the radio resources for each of the requested services and for each mobile user in an adaptive fashion. This approach facilitates the on-the-fly maximization of the spectral efficiency.

Figure 2.2 illustrates the radio resource allocation for WB-TDMA/CDMA in a generic way. The users wish to access a variety of services 1 to n . Therefore, random access requests are transmitted to the base transceiver stations which direct these requests to the base station controller. In addition, signaling between base transceiver stations and mobiles facilitates the measurement of the aforementioned quality parameters. This quality information is directly related to the physical radio channel. Based on the requests for service utilization by the users and the available quality information, the base station controllers decide on the granting of the requested accesses based on the availability of the services in both the network and the environment. Furthermore, the parameters of the bearer classes are negotiated.

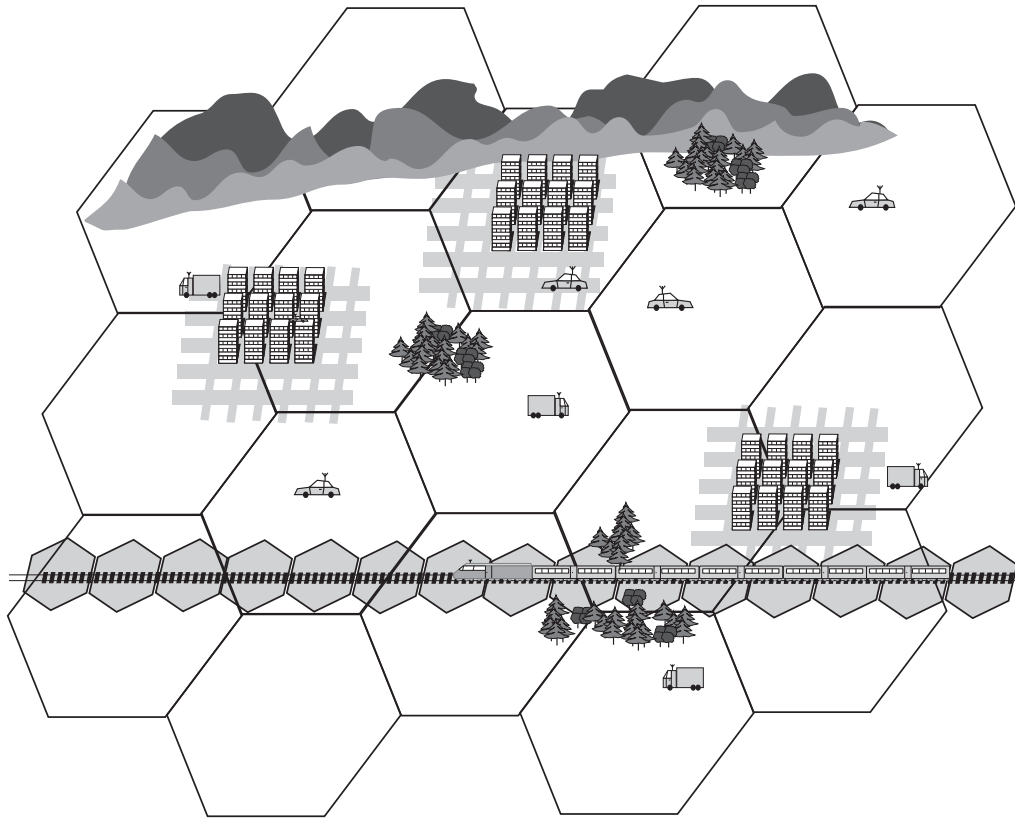


Figure 2.3 Part of a hierarchical cell structures (HCS) environment

The ASD approach can be further extended when considering hierarchical cell structures (HCS). Different services classes which are associated with different bearer classes can be provided in different cell layers. This allows for an additional means of optimization of the network structure. By setting out from the measurement results of the quality parameters addressed before, the allocation of users to the different hierarchies in the HCS environment is done. The HCA based resource allocation will then be done within each cell layer.

In *Figure 2.3*, a part of a HCS environment is depicted. The lowest hierarchy is presented by a network of macro cells which are assumed to be hexagonal. Within the macro cells, Manhattan grid like micro cellular structures are located. Within buildings, pico cells can be used. Furthermore, special small macro cells are used to provide service to e.g. high speed trains or motorways. The ASD approach supports seamless handover between different cell layers and within the cell layers. The handover is based on the measurement results of the aforementioned quality parameters.

The ASD approach allows the utilization of different services with varying QoS criteria by various users when simultaneously maintaining a high spectral efficiency. Also, different services with different QoS criteria can be used by a particular user with high spectral efficiency.

3. Examples of mapping of bearer services on physical channels

3.1 Overview

In the case of WB-TDMA/CDMA, the total number of available basic physical channels per TDMA frame is given by the maximum number of time slots which is 8 and the maximum number of CDMA codes per time slot which is 8 in case the different codes within one time slot are allocated to different users in the uplink and which is 12 in the downlink and 9 in case the different codes within one time slot are allocated to one and the same user in the up- and downlink. The total number of basic physical

channels can be achieved by different combinations of numbers of codes and numbers of time slots when taking into account the maximum numbers mentioned before.

The service classes given in the following represent only a selection of all possibilities which are conceivable. Further adaptations of the services can be made based on the aforementioned environmental conditions and actual network capabilities.

3.2 Low user bit rate services

3.2.1 Speech service

The speech service with a user data rate of 8 kbit/s is transmitted by using the spread speech/data bursts of FMA1. In macro cellular environments, the burst 1 is used whereas in micro and pico cellular environments, the burst type 2 is used. To provide an 8 kbit/s service, 150 user bits per four frames of length 4.615 ms have to be transmitted over the air interface. This block size of 150 user bits is regarded as the basic input block size for the speech service in what follows. In layer 2, up to 5 % (7 to 8 bits) overhead can be added for signaling purposes.

In this section, three different possibilities of service mapping for the speech service are given. This mapping can be used in different environments and different transmission conditions.

3.2.1.1 Macro cellular environment with bad E_b/N_0 conditions

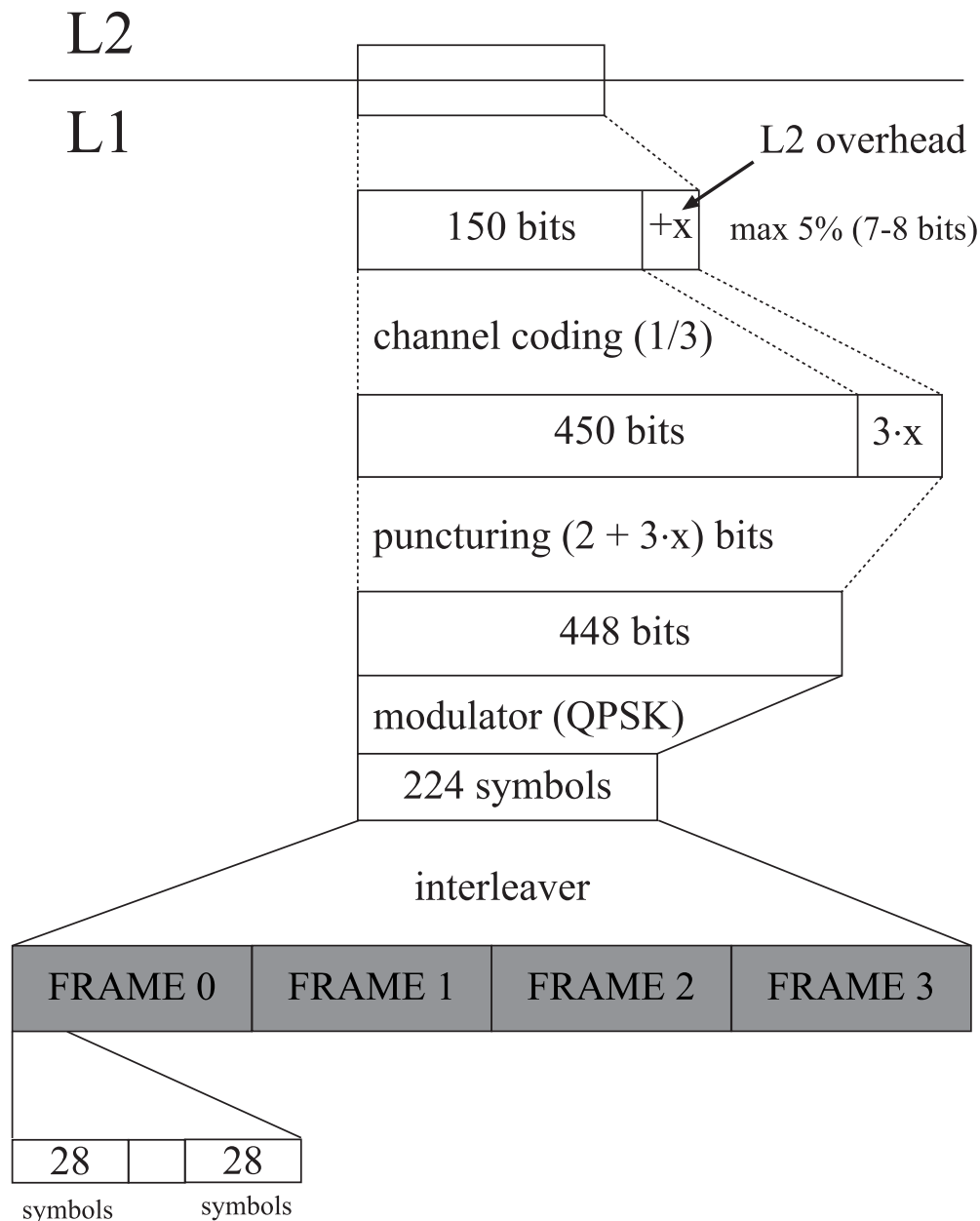


Figure 3.1 Speech service mapping for macro cellular environments with bad E_b/N_0 conditions

The speech service mapping for macro cellular environments with bad E_b/N_0 conditions is depicted in Figure 3.1. This mapping is used in large macro cells, like in rural areas. 64 speech channels are provided per carrier. By using a channel coding rate of $R = 1/3$, a very low E_b/N_0 is required to achieve the QoS requirements.

First, the data from layer 2 (150 bits + x bits L2 overhead) are encoded with code rate $R_c = 1/3$. Then $2 \text{ bit} + 3x \text{ bit}$ are punctured to get an output block size of 448 encoded bits. These 448 encoded bits are mapped onto 224 QPSK symbols. These 224 QPSK symbols are then interleaved and distributed over four TDMA frames. In each used frame, only one slot and one code is used to transmit 56 symbols per frame making up a total number of 4 basic physical channels.

3.2.1.2 Macro cellular environment with better E_b/N_0 conditions

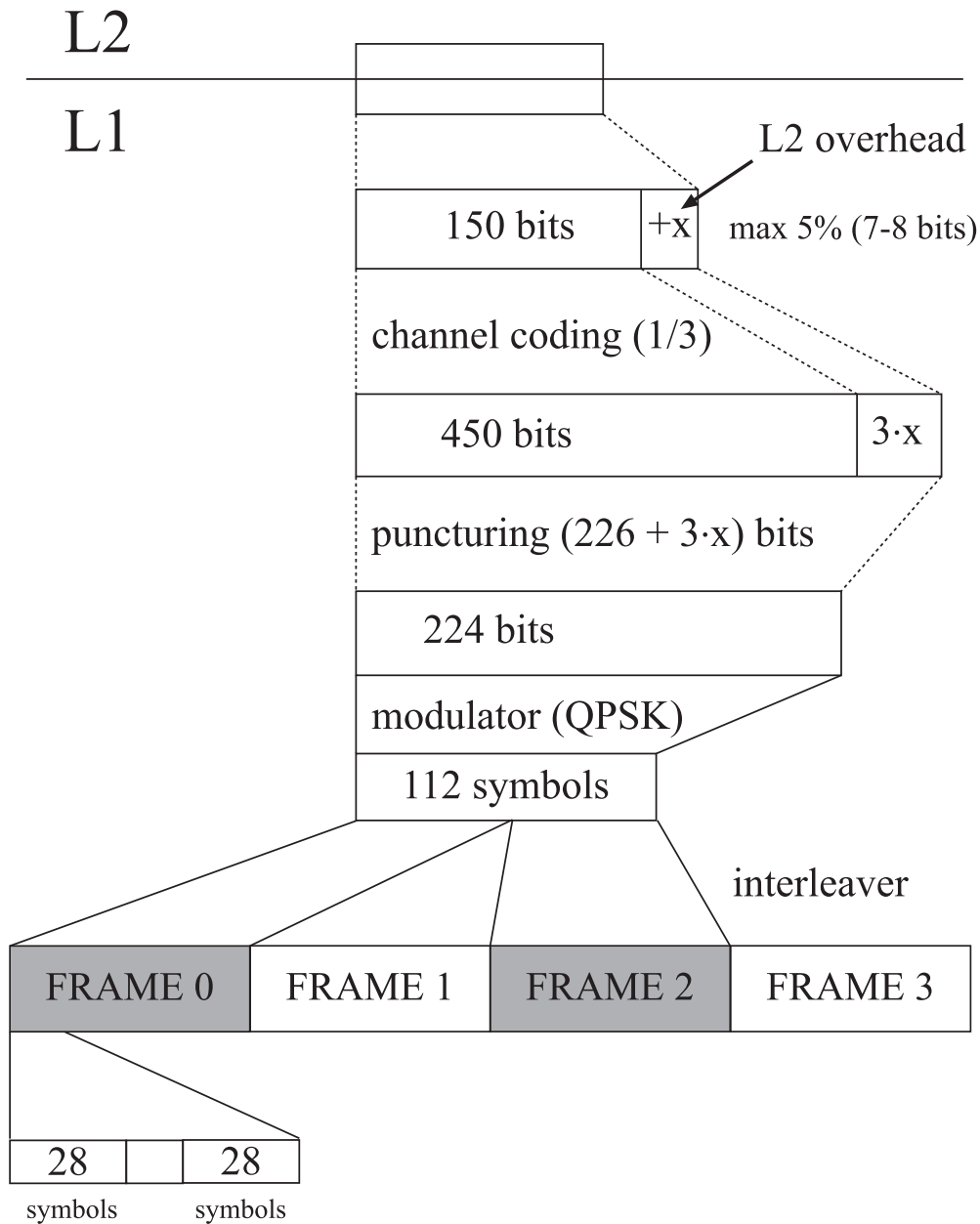


Figure 3.2 Speech service for macro cellular environment with better E_b/N_0 conditions

For better E_b/N_0 conditions, a higher code rate of approx. $R_c = 2/3$ can be used. As in macro cellular environments with bad E_b/N_0 conditions, the spread speech/data burst 1 is deployed. In Figure 3.2, the mapping for macro cellular environments with normal E_b/N_0 conditions is depicted. By using this mapping, 128 speech channels of 8kbit/s can be provided on each carrier. This mapping is used in small macro cells with high traffic density like in urban environments.

First, the data from layer 2 is encoded with rate $R_c = 1/3$. After puncturing $(226 + 3x)$ encoded bits, 224 encoded bits are passed on to the bit to symbol mapper which generates 112 QPSK symbols. The

interleaver distributes the 112 QPSK symbols over two out of four frames. Hence, only 2 basic physical channels are utilized.

3.2.1.3 Micro and pico cellular environments

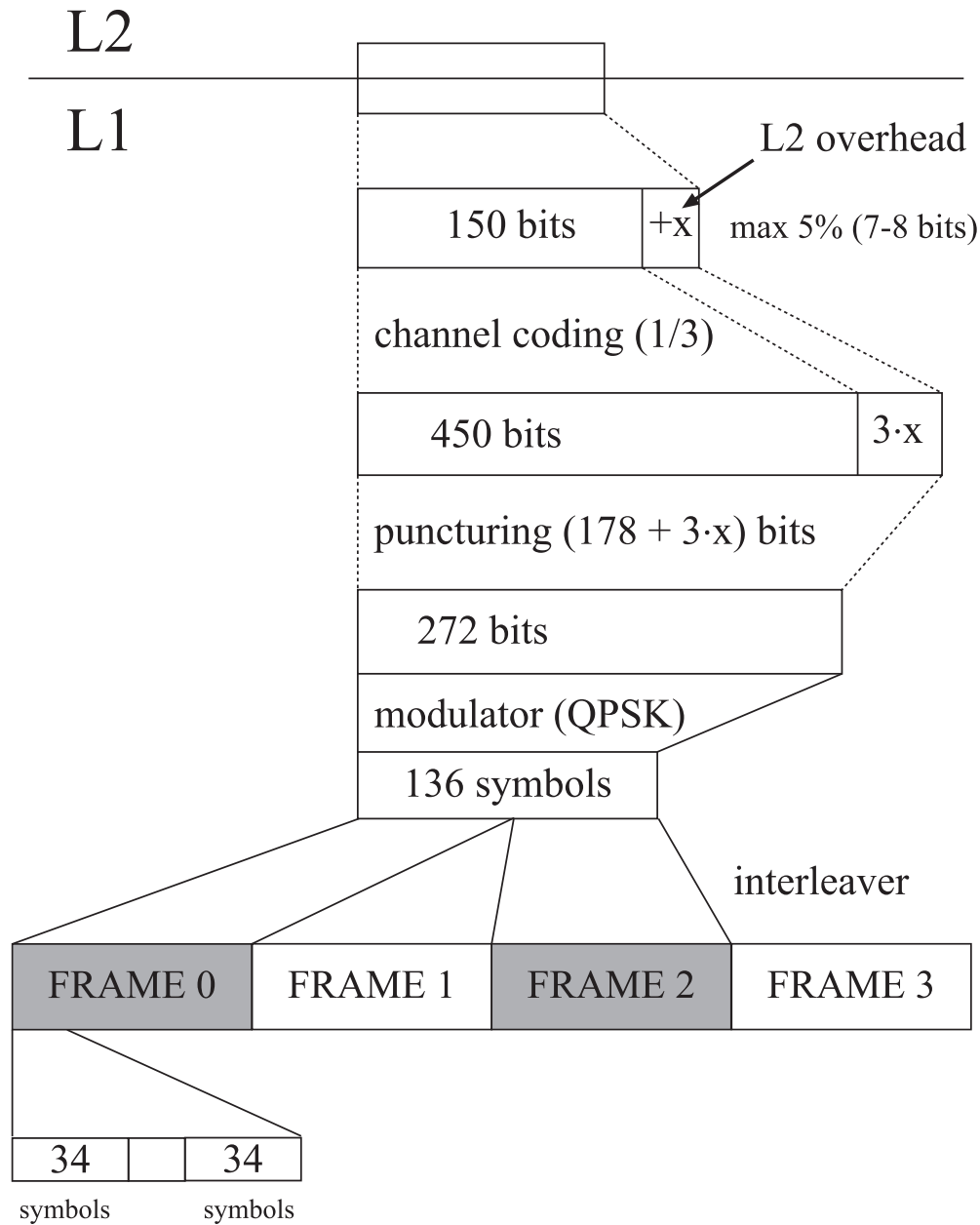


Figure 3.3 Speech service mapping for micro and pico cellular environments

In micro and pico cellular environments, the spread speech/data burst 2 with 68 symbols per time slot and code can be used. In Figure 3.3, the mapping for these environments is shown.

The data from layer 2 is encoded with code rate $R_c = 1/3$. After puncturing ($178 + 3x$) encoded bits, 272 encoded bits are passed on to the bit to symbol mapper which generates 136 QPSK symbols. The interleaver distributes the 136 QPSK symbols over two out of four frames. Hence, only 2 basic physical channels are utilized.

3.2.1.4 GSM type speech service

Another possibility of providing speech service is a modified interleaving which allows a better exploitation of time diversity. In what follows, a service will be described which is intended for deployment in macro cellular environments with bad E_b/N_0 conditions, cf. *Figure 3.4*.

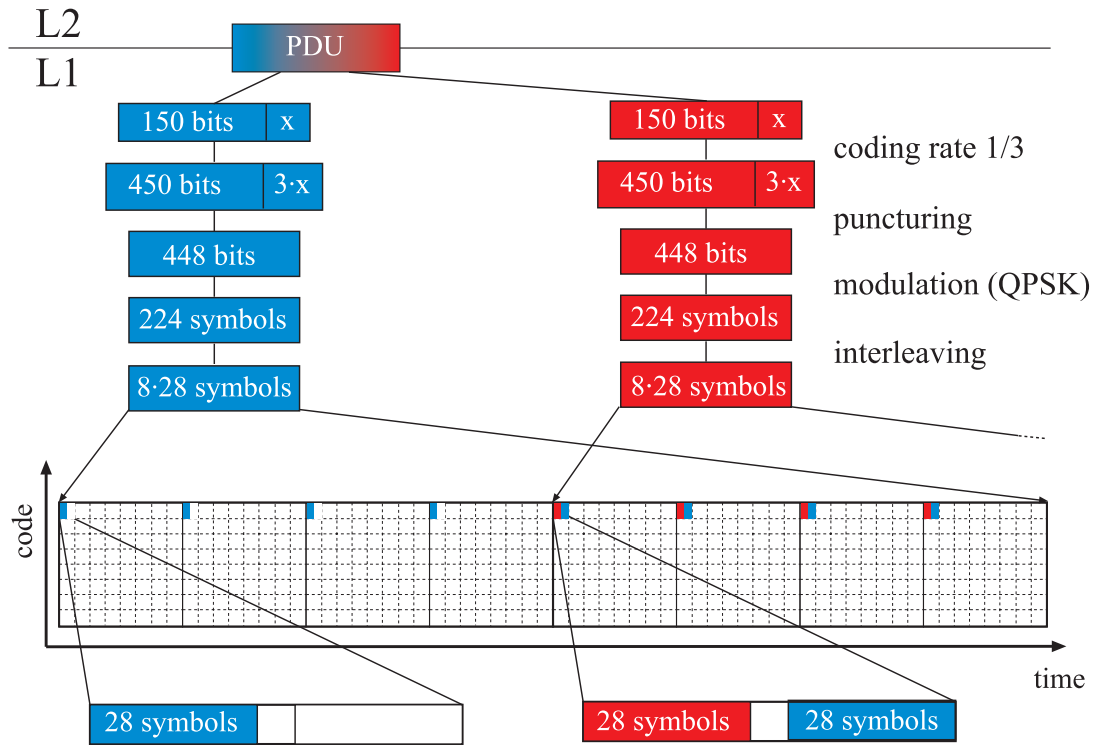


Figure 3.4 Speech service mapping for micro and pico cellular environments

64 speech channels are provided per carrier. By using a channel coding rate of $R_c = 1/3$, a very low E_b/N_0 is required to achieve the QoS requirements. The mapping shall be described by considering two consecutive PDU's from layer 2. The PDU's are distinguished by their color in *Figure 3.4*, the first one being depicted in blue, the second one in red. First, the two PDU's from layer 2, each containing 150 bits + x bits L2 overhead, are encoded with code rate $R_c = 1/3$. Then, in each PDU, 2 bit + 3x bit are punctured to generate an output block size of 448 encoded bits. These 448 encoded bits are mapped onto 224 QPSK symbols. The 224 QPSK symbols are then interleaved with the same procedure used in GSM.

The mapping of the 224 QPSK symbols per PDU will be described by setting out from the left, i.e. the blue, PDU. In *Figure 3.4*, the slots available in eight consecutive TDMA frames are explicitly shown. Each TDMA frame consists of eight time slots and eight CDMA codes per time slot. The time slots are distinguished by their allocation with respect to the time axis whereas the CDMA codes are distinguished by their allocation with respect to the code axis. We denote upper left slot per TDMA frame slot 1 and the lower right shall be referred to as slot 64. Without loss of generality, only slot 1 is considered. In each slot, a burst is transmitted consisting of two burst halves comprising 28 QPSK symbols each.

The 224 QPSK symbols are allocated to eight groups of 28 QPSK symbols each. Each group of 28 QPSK symbols is then mapped onto a burst half. The first four groups of 28 QPSK symbols are allocated to the first burst halves of four bursts whereas the second four groups of 28 QPSK symbols are mapped onto the second burst halves. Meanwhile, the first four groups of 28 QPSK symbols associated with the following PDU, depicted in red, are mapped onto the first burst halves of the latter four bursts.

3.3 Mixed services

In the following a set of possible mixed service scenarios will be discussed with respect to a user deploying two different services simultaneously and in regard of the radio network offering a service mix.

3.3.1 50% speech + 50% UDD 8

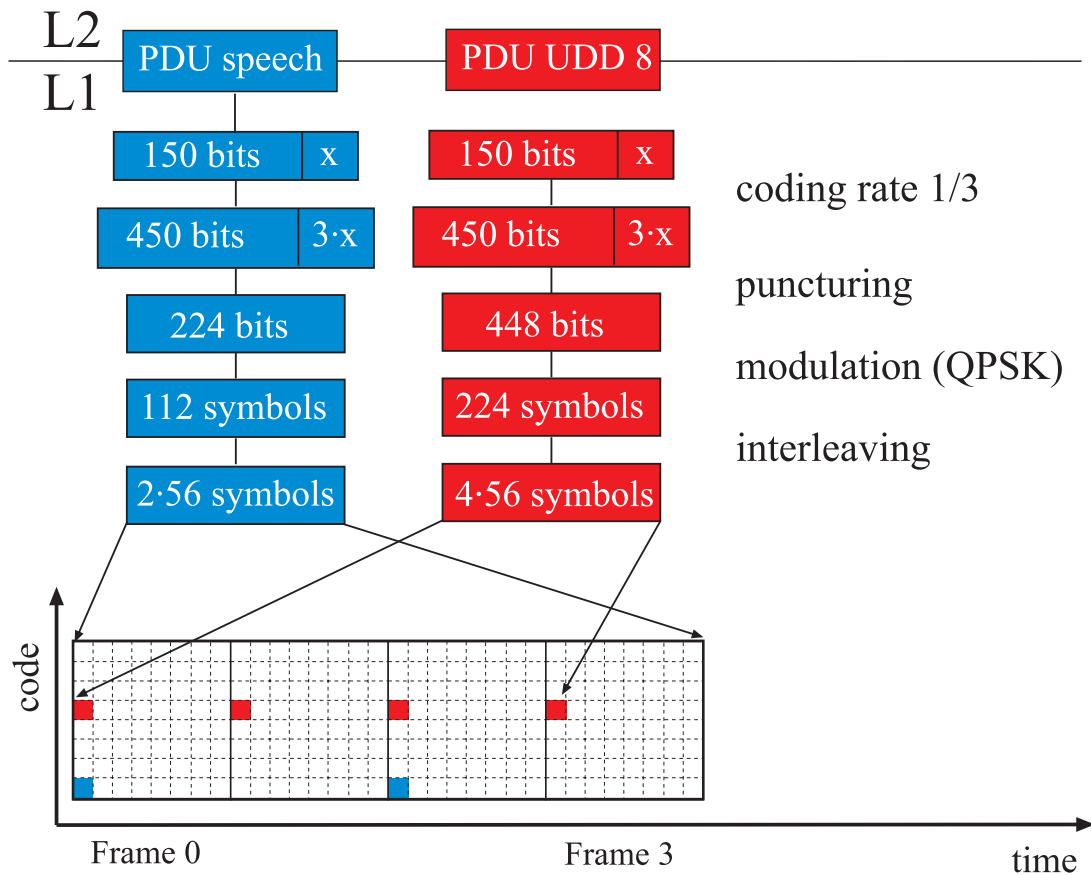


Figure 3.5 50% speech + 50% UDD 8 (short UDD 8 packets)

Assume that one Erl is related to a simultaneous connection consisting of speech and UDD 8. In this case, between 32 and 64 Erl can be offered. Thus, a maximum of 64 simultaneous connections are supported per cell and carrier. This is also the case when each user simultaneously entertains a speech and a UDD 8 connection.

Assume that a user only uses one type of service, be it speech or UDD 8. In this case between 32 and 64 speech users can coexist with between 32 and 64 UDD 8 users.

Figure 3.5 shows one possibility of implementing the services for the case of short UDD 8 packets containing 150 bits each. The service mix is based on the speech service described in Figure 3.2. The short UDD 8 service uses a block size of 150 bits and a coding rate of 1/3. After addition of the layer 2 overhead and puncturing the 448 bits are mapped onto 224 symbols interleaved and distributed over 4 TDMA frames. The mapping of the speech and the UDD 8 PDU's is depicted in Figure 3.5 over four successive TDMA frames. For the purpose of distinguishing the two types of PDU's, the speech PDU is shown in blue color whereas the UDD 8 PDU is red.

The speech service only requires two slots out of the $4 \cdot 64 = 256$ slots available in the four TDMA frames. Assume that within each TDMA frame slot #1 is located in the upper left edge, slot #8 is located in the lower left edge, cf. *Figure 3.5*. To allow the exploitation of time diversity, only slots of every second TDMA frame are used for this speech service. Without loss of generality, slot #8 of TDMA frame 1 and 3 are used for the speech service.

The chosen UDD 8 service requires allocation of a single slot in every consecutive TDMA frame. Without loss of generality, slot #4 of every TDMA frame is used, cf. *Figure 3.5*.

Hence, only two out of 64 slots of TDMA frames 1 and 3 and only one slot of TDMA frames 2 and 4 are used. All other slots are still available for other services. Hence, 32 Erl of (50% speech + 50% UDD 8) service mix can be supported per carrier as illustrated in *Figure 3.5*.

In this case, still 32 slots of TDMA frame 2 and 32 slots of TDMA frame 4 are not allocated. These slots could then still be allocated to 32 more users of speech service.

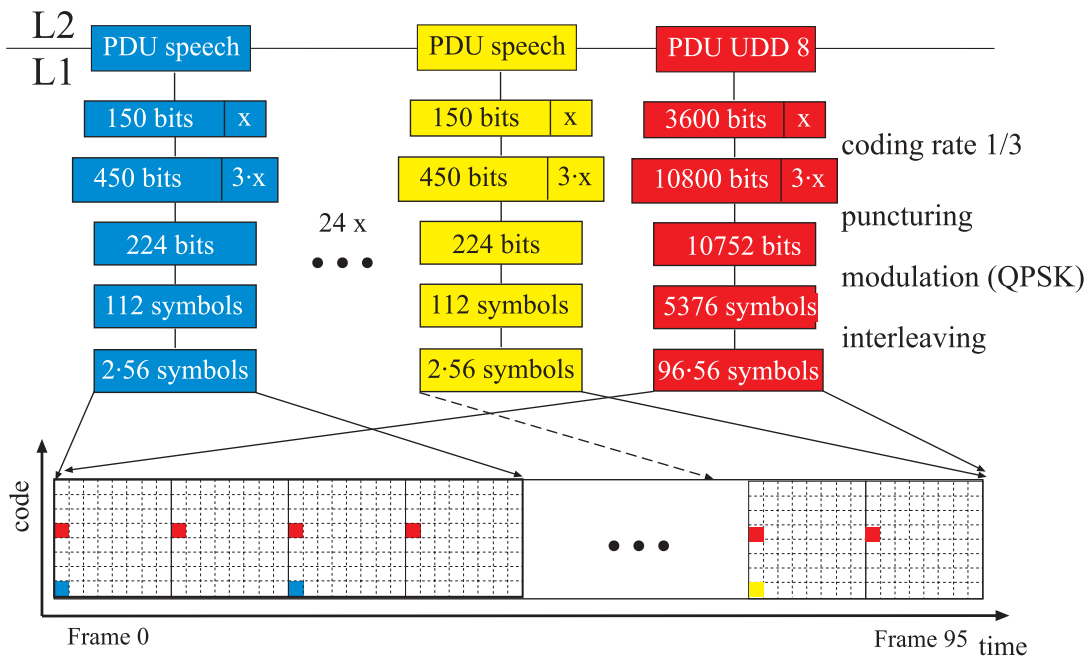


Figure 3.6 50% speech + 50% UDD 8 (long UDD 8 packets)

Figure 3.6 shows another possibility of implementing the services for the case of long UDD 8 packets containing 3600 bits each. The service mix is based on the same speech service and the long UDD 8 service.

The long UDD 8 service uses a block size of 3600 bits and a coding rate of 1/3. After addition of the layer 2 overhead and puncturing the 10752 bits are mapped onto 5376 symbols interleaved and distributed over 96 TDMA frames.

Twenty-four consecutive speech PDU's each containing 150 bits and one UDD 8 PDU with 3600 bits are considered in *Figure 3.6*. The information contained in all these PDU's is distributed over 96 consecutive TDMA frames. Similar to *Figure 3.5*, only every second TDMA frame is required for the deployed speech service. Therefore, slot #8 of every odd numbered TDMA frame is used for speech service. To facilitate the UDD 8 service, slot #4 of every consecutive TDMA frame is used.

According to *Figure 3.6*, 32 Erl of (50% speech + 50% UDD 8) service mix can be supported. Furthermore, 32 slots of every even numbered TDMA frame are unused allowing for the support of e.g. up to 32 Erl of speech service No. 2 of *Figure 3.6*.

3.3.2 50% speech + 50% UDD 384

Assume that one Erl is related to a simultaneous connection consisting of speech and UDD 384. In this case, between 1 and 2 Erl can be offered per carrier. Thus, a maximum of 2 simultaneous connections are supported per carrier. This is also the case when each user simultaneously entertains a speech and a UDD 384 connection.

Assume that a user only uses one type of service, be it speech or UDD 384. In this case between 1 and 2 speech users can coexist with between 1 and 2 UDD384 users.

Figure 3.7 illustrates a possible implementation of the service mix for the case of UDD 384 packets containing 12•3600 bits each.

The service mix is based on the speech service described in Figure 3.3. The UDD 384 service uses 12 blocks each with a size of 3600 bits and a coding rate of 1/3. After addition of the layer 2 overhead and puncturing the 6528 bits are mapped onto 3264 symbols interleaved and distributed over 24 TDMA frames. In this case, 2 Erl of (50% speech + 50% UDD 384) service mix can be supported per carrier. In the following, one Erl of this service mix will be described by using Figure 3.7.

Figure 3.7 shows six consecutive speech PDU's of 150 bits each and twelve consecutive UDD 384 PDU's containing 3600 bits each. All these PDU's must be distributed and transmitted in 24 successive TDMA frames as shown in Figure 3.7.

With the considered speech service one slot of every second TDMA frame must be used. In our case slot #8 of the odd numbered TDMA frames is allocated to speech transmission. To support UDD 384, slots #9...#16, #33...#40, and #57...#64 of each TDMA frame are used for UDD 384 related traffic.

After allocating further resources to a second Erl of the (50% speech + 50% UDD 384) service mix, still 15 slots of each odd numbered and 16 slots of each even numbered TDMA frame are unallocated. In these slots, up to 31 Erl of extra speech service could be provided.

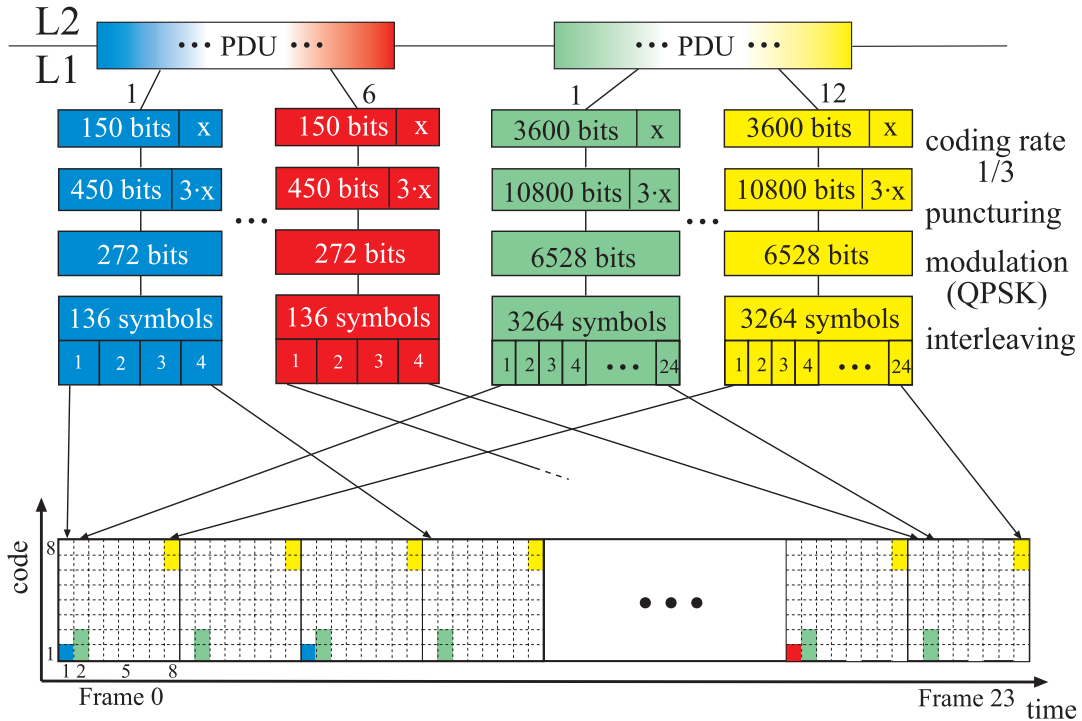


Figure 3.7 50% speech + 50% UDD 384

3.3.3 50% speech + 50% UDD 2048

Assume that one Erl is related to a simultaneous connection consisting of speech and UDD 2048. In this case, 1 Erl can be offered per carrier. This is also the case when a user simultaneously entertains a speech and a UDD 2048 connection.

Now, assume that a user only uses one type of service, be it speech or UDD 2048. In this case 1 speech user can coexist with 1 UDD 2048 user.

Figure 3.8 illustrates a possible implementation of the service mix for the case of UDD 2048 packets containing 128·3600 bits each and the same speech service as above. In this case, 1 Erl of (50% speech + 50% UDD 2048) service mix can be supported.

In Figure 3.8, 48 consecutive TDMA frames with 64 slots each are shown. Furthermore, twelve successive speech PDU's of 150 bits each are considered. To implement the speech service a single slot is required every second TDMA frame. Without loss of generality, slot #8 is utilized for speech transmission in each odd numbered TDMA frame.

According to Figure 3.8, slots #9...#64 of every TDMA frame are used for implementing the UDD 2048 service. 128 consecutive UDD 2048 PDU's with 3600 bits each are considered. One possible way of distributing the information contained in these PDU's over the 48 TDMA frames is indicated in Figure 3.8.

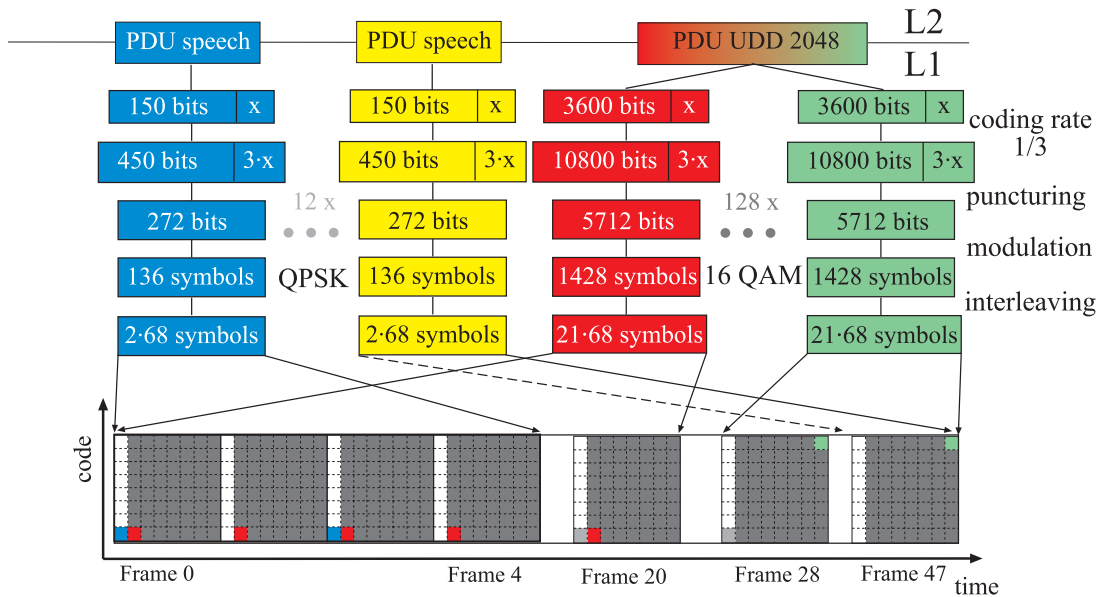


Figure 3.8 50% speech + 50% UDD 2048

In the odd numbered TDMA frames, slots #1...#7 are unused whereas slots #1...#8 of the even numbered TDMA frames are unallocated. Hence, up to 15 Erl of extra speech service could be provided per carrier.

ETSI SMG2#24
97
Madrid, Spain
December 15th-19th, 1997

Tdoc SMG 899 /

Source: SMG2
Agenda Item: 4.1 UTRA
Subject: Evaluation Document Cover Sheet for:

Concept Group Delta
WB-TDMA/CDMA
System Description Performance Evaluation

Disclaimer:

“This document was prepared during the evaluation work of SMG2 as a possible basis for the UTRA standard. It is provided to SMG on the understanding that the full details of the contents have not necessarily been reviewed by, or agreed by, SMG2.”

**ETSI SMG2#24
Cork, Ireland
December 1-5, 1997**

TDoc SMG2 368 / 97

**Concept Group Delta
Wideband TDMA/CDMA**

**Evaluation Report - Part 3
V 2.0 b**

Table of contents

1 EVALUATION RESULTS	564
1.1 Introduction	564
1.2 Abbreviations	564
1.3 Link level simulations	565
1.3.1 Speech service	566
1.3.2 LCD services	568
1.3.3 UDD services	571
1.4 Possible improvements	573

Compared to the previous version of this report, the following improvements are included in this version:

- the minimum mean square error equalizer instead of the zero forcing equalizer has been used for joint detection, which leads to a performance improvement at the same computational complexity,
- in some cases, burst type 1 instead of 2 has been used, leading to a better performance,
- the channel estimation has been optimized,
- the receive filter has been optimized.

1 Evaluation results

1.1 Introduction

As a part of the work carried out by the ETSI/SMG2 concept group Delta, Wideband TDMA/CDMA, a performance evaluation of TD/CDMA is carried out by means of simulations.

The SMG2 document UMTS TR 30.03 [1] describes how this evaluation is to be made. It lists a large number of environments and services to be tested. In Tdoc SMG2 260/97 [2] and Tdoc SMG2 329/97 [5], a subset of all these test cases are listed as prioritised. Simulation results obtained so far are for these prioritised test cases. The prioritised simulation cases from Tdoc 260/97 and Tdoc 329/97 are shown in Table 1-1. In addition, a 2 Mbit/s circuit switched service is investigated in the Pedestrian environment.

Table 1-1. Required simulations according to Tdoc 260/97 and Tdoc 329/97

Environment	Service mixture	Propagation model	Cell type	Link level	System level
Outdoor to indoor and pedestrian A 3 km/h	UDD 384 Speech LCD 144 UDD 2048	Outdoor to indoor and pedestrian A	Micro	X X X X	X X
Indoor office A 3 km/h	UDD 2048 Speech LCD 384 50% speech + 50% UDD 384	Indoor office A	Pico	X X X	X X
Vehicular A 120 km/h	UDD 144 Speech LCD 384	Vehicular A	Macro	X X X	X X X

importance	Environment	Service mixture	Propagation model	Cell type	Link level	System level
mandatory	vehicular 250 km/h	speech	Vehicular B	macro	X	
optional	vehicular 120 km/h	speech	Vehicular B	macro	X	
optional	vehicular 120 km/h	50% speech + 50% UDD 384	Vehicular A	macro	X	X
optional	indoor 3 km/h	LCD 2048	Indoor A	pico	X	X

In this chapter, link level simulation results for TD/CDMA for the services in Table 1-1 and for the 2 Mbit/s circuit switched service in the Pedestrian environment are shown.

1.2 Abbreviations

ARQ	automatic repeat request
BER	bit error rate
BLER	block error rate
BS	base station
CDMA	code division multiple access
CRC	cyclic redundancy check
DL	downlink
FDD	frequency division duplex
FEC	forward error correction
GMSK	Gaussian minimum shift keying
LCD	long constrained delay
MMSE	minimum mean square error
MS	mobile station
QPSK	quaternary phase shift keying

TDD	time division duplex
TDMA	time division multiple access
TS	time slot
UDD	unconstrained delay data
UL	uplink
ZF	zero forcing
16QAM	16ary quadrature amplitude modulation

1.3 Link level simulations

In the following, link level simulation results for TD/CDMA are presented. The results are valid for both FDD and TDD operation. However, in TDD operation the results can be further improved by making use of the reciprocal channel for e.g. open loop control and pre-equalization.

The circuit switched services, i.e., speech and LCD services, cf. Table 1-1, are implemented with forward error correction (FEC) and the packet services, i.e., UDD services, use automatic repeat request (ARQ) together with FEC. The basic assumptions and technical choices for the link level simulations are summarized in Table 1-2.

Table 1-2 Basic assumptions and technical choices for the link level simulations

carrier frequency	2 GHz
carrier spacing	1.6 MHz
duration of a TDMA frame	4.615 ms
duration of a time slot	577 μ s
data modulation	QPSK; 16QAM
spreading modulation	linearized GMSK
number of chips per symbol	16
chip duration	0.4615 μ s
channel coding	convolutional coding + puncturing for rate matching
interleaving	block interleaving
data detection	joint detector: minimum mean square error block linear equalizer [3] if not mentioned otherwise
channel estimation	joint channel estimator according to [4] based on correlation; independent channel estimation from burst to burst
power control	slow power control, not modelled in the link level
frequency hopping	frame-by-frame

In the simulations, all intracell interferers are modelled completely with their whole transmission and reception chains. Intercell interference is modelled as white Gaussian noise. In the following, bit error rates (BER) are shown as a function of the average E_b/N_0 in dB (E_b is the energy per bit and N_0 is the one-sided spectral noise density) with the intracell interference, i.e., the number K of active users per time slot as a parameter. The relation between the E_b/N_0 and the carrier to interference ratio C/I , with C denoting the carrier power per CDMA code and with I denoting the intercell interference power, is given by

$$\frac{C}{I} = \frac{E_b}{N_0} \cdot \frac{R_c \cdot \log_2 M}{B \cdot Q \cdot T_c} \quad (1-1)$$

with

R_c	the rate of the channel encoder (depends on the service),
M	the size of the data symbol alphabet (4 for QPSK, 16 for 16QAM),
B	the user bandwidth (1.6 MHz),
Q	the number of chips per symbol (16) and
T_c	the chip duration (0.4615 μ s).

The expression $\log_2 M$ is the number of bits per data symbol and $Q \cdot T_c / \log_2 M$ is the bit duration at the output of the encoder. One net information bit is transmitted in a duration of $Q \cdot T_c / (R_c \cdot \log_2 M)$. Therefore, (1-1) is equivalent to $C/I = (E_b/T_b)/(N_0 \cdot B)$, i.e., $C = E_b/T_b$ and $I = N_0 \cdot B$ with T_b the duration of a net information bit. The carrier to interference ratio per user is K_c times the carrier to interference ratio per CDMA code, with K_c denoting the number of CDMA codes per time slot per user.

Compared to the previous version of this report, the following improvements are included in this version:

- The minimum mean square error equalizer instead of the zero forcing equalizer has been used for joint detection, which leads to a performance improvement at the same computational complexity.
- In some cases, burst type 1 instead of 2 has been used, leading to a better performance.
- The channel estimation has been optimized by weighting the estimated taps by their reliability.
- The receive filter has been optimized. A receive filter matched to the linearized GMSK pulse has been introduced.

1.3.1 Speech service

In this section, link level simulation results for the speech service are given. The system parameters for implementing the speech service are summarized in Table 1-3.

Table 1-3 System parameters for the speech service

service	speech, 8 kbit/s, 20 ms delay
user bit rate	8.234 kbit/s
number of time slots per frame per user	1
number of codes per time slot per user	1
burst type	spread speech/data burst 1 for the uplink and for Vehicular B downlink; spread speech/data burst 2 for the downlink except for Vehicular B
bits per basic physical channel	112 for the spread speech/data burst 1; 136 for the spread speech/data burst 2
data modulation	QPSK
convolutional code rate	0.34 for the spread speech/data burst 1; 0.28 for the spread speech/data burst 2
interleaving depth	4 frames = 4 bursts
user block size	152 bits
frequency hopping	no frequency hopping for Vehicular, frame-by-frame hopping for Pedestrian and Indoor if not mentioned otherwise
antenna diversity	uplink: yes (2 branches), downlink: no

The required values for E_b/N_0 and C/I in order not to exceed a BER of 10^{-3} as defined for the speech service are summarized in Table 1-4. The values of C/I are obtained from the values of E_b/N_0 according to (1-1) by subtracting 13.2 dB for the spread speech/data burst 2 and by subtracting 12.4 dB for the spread speech/data burst 1.

All the simulations have been performed with an equalizer which is not adaptive, i.e., which does not adapt to the time variations within one burst. By using an adaptive equalizer, the performance for the high speed cases can be improved. In all the simulation cases given in Table 1-4, no power control has been performed. For Pedestrian and Indoor environment, frequency hopping has been used if not

mentioned otherwise. For the Vehicular B channel, the midamble has been used which is designed for a maximum excess delay of the channel of 15 μ s although the excess delay of the channel impulse response is 20 μ s. The reason for this choice is that the power of the taps with long delay spread are rather weak in the Vehicular B channel.

In the following, the possible reduction of the required values for E_b/N_0 and C/I in order not to exceed a BER of 10^{-3} in the case of low mobile velocities by using an enhanced power control instead of frequency hopping is investigated theoretically. For the Indoor case with $K = 4$ active users, the effect of an enhanced power control has been investigated exemplarily. In a first, idealized investigation, the actual power is estimated for each burst and then the transmit power of the next burst is adjusted according to the power estimate obtained in the last burst. In the simulations, real noisy power estimation is performed. The transmit power in the next burst is adjusted based on the unquantized power estimate obtained from the previous burst, which will give an upper bound of the gain that can be achieved by enhanced power control. This upper bound is equal to 5 dB. In a second investigation, the actual power is also estimated by real noisy power estimation for each burst. Based on this estimate, the transmit power in the next burst is either increased or decreased by a fixed step size of 2 dB. The gain achievable is 2.5 dB as compared to the case of using frequency hopping. The purpose of these investigations is to show the basic potential of an enhanced power control.

Table 1-4 Required values for E_b/N_0 and C/I for the speech service

Speech 8 kbit/s $K_c = 1$	$10 \log_{10} (E_b/N_0)$ in dB @ BER = 10^{-3}			$10 \log_{10} (C/I)$ in dB @ BER = 10^{-3}		
	K = 1 UL / DL	K = 4 UL / DL	K = 8 UL / DL	K = 1 UL / DL	K = 4 UL / DL	K = 8 UL / DL
Vehicular A, 120 km/h	4.2 / -	4.6 / 7.9	5.1 / 8.7	-8.2 / -	-7.8 / -5.3	-7.3 / -4.5
Outdoor to Indoor and Pedestrian A, 3 km/h	5.2 / - without FH: 10.3 / -	5.4 / 9.8	5.6 / 10.2	-7.2 / - without FH: -2.1 / -	-7.0 / -3.4	-6.8 / -3.0
Indoor A, 3 km/h	5.3 / - without FH: 11.4 / -	5.4 / 9.8	5.7 / 10.3	-7.1 / - without FH: -1.0 / -	-7.0 / -3.4	-6.7 / -2.9
Vehicular B, 120 km/h	4.3 / -	4.9 / 8.2	5.3 / 9.4	-8.1 / -	-7.5 / -5.0	-7.1 / -3.8
Vehicular B, 250 km/h	5.4 / -	5.9 / 9.3	6.5 / 10.8	-7.0 / -	-6.5 / -3.9	-5.9 / -2.4

K_c = number of codes per time slot per user, K = number of users per time slot, UL/DL = uplink/downlink, FH = frequency hopping

Corresponding bit error rate curves are shown in Figure 1-2 to Figure 1-6, where the coded BER (userBER) is depicted versus the E_b/N_0 .

In Figure 1-1, the dependence of the required values for E_b/N_0 for speech 8 kbit/s in order not to exceed a BER of 10^{-3} as a function of the number K of active users per time slot for Indoor A, Pedestrian A and Vehicular A in the downlink is depicted. Values of K between 1 and 12 are considered. There is a slight degradation with increasing number K of active users per time slot. This is due to the increase of intracell interference with increasing K . The degradation is less for the Indoor and Pedestrian channels which have less multipaths than for the Vehicular channel with more multipaths. When the number K of users approaches the spreading factor of 16, the degradation increases.

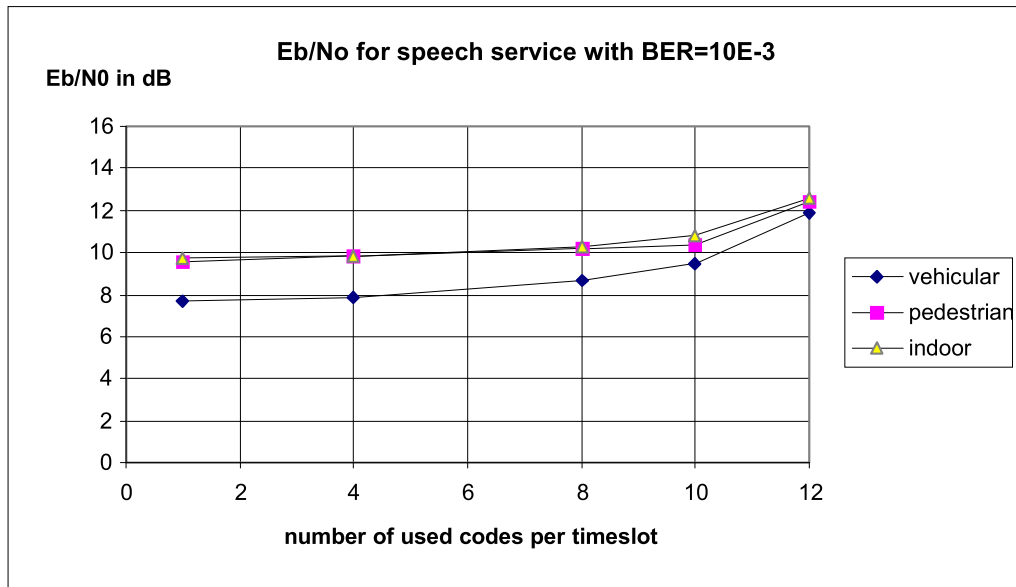


Figure 1-1. Dependence of the required values for E_b/N_0 for speech 8 kbit/s in order not to exceed a BER of 10^{-3} as a function of the number K of active users per time slot in the downlink for Indoor A, Pedestrian A and Vehicular A

1.3.2 LCD services

In this section, link level simulation results for the LCD services are given. The system parameters for implementing the LCD 144 kbit/s service are summarized in Table 1-5 and for implementing the LCD 384 kbit/s service in Table 1-6. Furthermore, an LCD 2048 kbit/s service is investigated, for which the system parameters are given in Table 1-7. For the LCD 144 kbit/s service, three alternatives are considered:

- allocating 1 code in each of the 8 time slots to a user (LCD 144a),
- allocating 9 codes in 1 of the 8 time slots to a user (LCD 144b),
- allocating 3 codes in 4 of the 8 time slots to a user (LCD 144c).

For the LCD 384 kbit/s service, two alternatives are considered:

- allocating 3 codes in each of the 8 time slots to a user (LCD 384a),
- allocating 9 codes in 3 of the 8 time slots to a user (LCD 384b).

For the LCD 2048 kbit/s service, 9 codes are allocated in each of the 8 time slots to a user (LCD 2048).

Table 1-5 System parameters for the LCD 144 kbit/s service

service	LCD, 144 kbit/s, 300 ms delay		
	LCD 144a	LCD 144b	LCD 144c
user bit rate	149.1 kbit/s	144.0 kbit/s	144.0 kbit/s
number of time slots per frame per user	8	1	4
number of codes per time slot per user	1	9	3
burst type	spread speech/data burst 2		
bits per basic physical channel	136		
data modulation	QPSK		
convolutional code rate (inner code)	0.63	0.66	0.50
Reed Solomon code rate (outer code)	-	200/245	150/183
total code rate	0.63	0.54	0.41
interleaving depth	64 frames = 64 bursts	65 frames = 65 bursts	65 frames = 65 bursts
user block size	5504 bits	4800	3600 bits
frequency hopping	frame-by-frame hopping for Pedestrian if not mentioned otherwise	frame-by-frame hopping for Pedestrian	frame-by-frame hopping for Pedestrian
antenna diversity	uplink: yes (2 branches), downlink: no		

Table 1-6 System parameters for the LCD 384 kbit/s service

service	LCD, 384 kbit/s, 300 ms delay	
	LCD 384a	LCD 384b
user bit rate	384.0 kbit/s	384.5 kbit/s
number of time slots per frame per user	8	3
number of codes per time slot per user	3	9
burst type	spread speech/data burst 2	
bits per basic physical channel	136	
data modulation	QPSK	
convolutional code rate (inner code)	0.66	0.49
Reed Solomon code rate (outer code)	200/245	178/183
total code rate	0.54	0.48
interleaving depth	65 frames = 65 bursts	65 frames = 65 bursts
user block size	4800 bits	4272 bits
frequency hopping	no frequency hopping for Vehicular, frame-by-frame hopping for Indoor	
antenna diversity	uplink: yes (2 branches), downlink: no	

Table 1-7 System parameters for the LCD 2048 kbit/s service

service	LCD, 2048 kbit/s, 300 ms delay
	user bit rate
number of time slots per frame per user	8
number of codes per time slot per user	9
burst type	spread speech/data burst 2
bits per basic physical channel	136
data modulation	16QAM
convolutional code rate (inner code)	0.50
Reed Solomon code rate (outer code)	178/184
total code rate	0.48
interleaving depth	65 frames = 65 bursts
user block size	8544 bits
frequency hopping	frame-by-frame hopping
antenna diversity	uplink: yes (2 branches), downlink: no

To reach the BER requirement of 10^{-6} , the LCD services (except for LCD 144a) use a concatenated coding scheme with an inner convolutional code and an outer Reed Solomon code. In the results given here, the BER at the output of the inner convolutional decoder is shown. It is expected that a BER of about 10^{-4} at the output of the inner convolutional decoder will lead to a BER of 10^{-6} at the output of the outer Reed Solomon decoder. The results valid for the output of the Reed Solomon decoder are not yet available due to the extremely long simulation times to measure a BER of 10^{-6} with sufficient accuracy. The required values for E_b/N_0 and C/I in order not to exceed a BER of 10^{-4} at the output of the inner convolutional decoder are summarized in Table 1-8 for LCD 144 kbit/s, in Table 1-9 for LCD 384 kbit/s and in Table 1-10 for LCD 2048 kbit/s. The values of C/I are obtained from the values of E_b/N_0 according to (1-1) by subtracting 9.7 dB for LCD 144a, 10.4 dB for LCD 144b, 11.6 dB for LCD 144 c, 10.4 dB for LCD 384a, 10.9 dB for LCD 384b and 7.9 dB for LCD 2048. The required E_b/N_0 and C/I values for the downlink can be considerably reduced by using antenna diversity also in the downlink. This would be a reasonable assumption for those applications which are executed e.g. on a laptop.

Table 1-8 Required values for E_b/N_0 and C/I for the LCD 144 kbit/s service

LCD 144 a $K_c = 1$	10 log ₁₀ (Eb/N0) in dB @ BER = 10 ⁻⁴ CC			10 log ₁₀ (C/I) in dB @ BER = 10 ⁻⁴ CC		
	K = 1 UL / DL	K = 4 UL / DL	K = 8 UL / DL	K = 1 UL / DL	K = 4 UL / DL	K = 8 UL / DL
Outdoor to Indoor and Pedestrian A, 3 km/h	3.7 / - without FH: 7.9 / -	4.0 / 7.4	4.8 / 7.5	-6.0 / - without FH: -1.8 / -	-5.7 / -2.3	-4.9 / -2.2

LCD 144 b $K_c = 9$	10 log ₁₀ (Eb/N0) in dB @ BER = 10 ⁻⁴ CC, i.e. @ BER ≈ 10 ⁻⁶ RS K = 1 UL / DL		10 log ₁₀ (C/I) in dB @ BER = 10 ⁻⁴ CC, i.e. @ BER ≈ 10 ⁻⁶ RS K = 1 UL / DL	
	Outdoor to Indoor and Pedestrian A, 3 km/h	4.1 / 9.1		-6.3 / -1.3

LCD 144 c $K_c = 3$	10 log ₁₀ (Eb/N0) in dB @ BER = 10 ⁻⁴ CC, i.e. @ BER ≈ 10 ⁻⁶ RS			10 log ₁₀ (C/I) in dB @ BER = 10 ⁻⁴ CC, i.e. @ BER ≈ 10 ⁻⁶ RS		
	K = 1 UL / DL	K = 2 UL / DL	K = 3 UL / DL	K = 1 UL / DL	K = 2 UL / DL	K = 3 UL / DL
Outdoor to Indoor and Pedestrian A, 3 km/h	2.2 / -	2.4 / 6.0	2.6 / 7.6	-9.4 / -	-9.2 / -5.6	-9.0 / -4.0

K_c = number of codes per time slot per user, K = number of users per time slot, UL/DL = uplink/downlink, CC = at the output of the inner convolutional decoder, RS = at the output of the outer Reed Solomon decoder

Table 1-9 Required values for E_b/N_0 and C/I for the LCD 384 kbit/s service

LCD 384 a $K_c = 3$	10 log ₁₀ (Eb/N0) in dB @ BER = 10 ⁻⁴ CC, i.e. @ BER ≈ 10 ⁻⁶ RS			10 log ₁₀ (C/I) in dB @ BER = 10 ⁻⁴ CC, i.e. @ BER ≈ 10 ⁻⁶ RS		
	K = 1	K = 2	K = 3	K = 1	K = 2	K = 3
	UL / DL	UL / DL	UL / DL	UL / DL	UL / DL	UL / DL
Vehicular A, 120 km/h	3.2 / -	3.5 / 8.8	5.0 / 9.8	-7.2 / -	-6.9 / -1.6	-5.4 / -0.6
Indoor Office A, 3 km/h	2.7 / -	2.9 / 7.2	3.9 / 9.1	-7.7 / -	-7.5 / -3.2	-6.5 / -1.3

LCD 384 b $K_c = 9$	10 log ₁₀ (Eb/N0) in dB @ BER = 10 ⁻⁴ CC, i.e. @ BER ≈ 10 ⁻⁶ RS		10 log ₁₀ (C/I) in dB @ BER = 10 ⁻⁴ CC, i.e. @ BER ≈ 10 ⁻⁶ RS	
	K = 1		K = 1	
	UL / DL		UL / DL	
Vehicular A, 120 km/h	3.6 / 9.3		-7.3 / -1.6	
Indoor Office A, 3 km/h	2.7 / 7.4		-8.2 / -3.5	

K_c = number of codes per time slot per user, K = number of users per time slot, UL/DL = uplink/downlink, CC = at the output of the inner convolutional decoder, RS = at the output of the outer Reed Solomon decoder

Table 1-10 Required values for E_b/N_0 and C/I for the LCD 2048 kbit/s service

LCD 2048 $K_c = 9$	10 log ₁₀ (Eb/N0) in dB @ BER = 10 ⁻⁴ CC, i.e. @ BER ≈ 10 ⁻⁶ RS		10 log ₁₀ (C/I) in dB @ BER = 10 ⁻⁴ CC, i.e. @ BER ≈ 10 ⁻⁶ RS	
	K = 1		K = 1	
	UL / DL		UL / DL	
Outdoor to Indoor and Pedestrian A, 3 km/h	6.7 / 11.1		-1.2 / 3.2	
Indoor Office A, 3 km/h	6.9 / 10.9		-1.0 / 3.0	

K_c = number of codes per time slot per user, K = number of users per time slot, UL/DL = uplink/downlink, CC = at the output of the inner convolutional decoder, RS = at the output of the outer Reed Solomon decoder

Corresponding error rate curves are shown in Figure 1-7 to Figure 1-9 for the LCD 144 kbit/s service, in Figure 1-10 to Figure 1-13 for the LCD 384 kbit/s service and in Figure 1-14 to Figure 1-15 for the LCD 2048 kbit/s service. In these figures, the coded BER at the output of the inner convolutional decoder (ccBER) is depicted.

1.3.3 UDD services

In this section, link level simulation results for the UDD services are given. The UDD services are implemented by using a type II hybrid ARQ scheme. This ARQ scheme is explained in the following for improving the code rate from one transmission to the next from 1 to 2/3 to 1/2 to 1/3 and to 1/4. Some of these steps can also be omitted, for instance the 1/3 and 1/4 code rate can be omitted or for instance the 2/3 code rate can be omitted. In the used ARQ scheme, the user data is encoded with a 1/4 rate convolutional code and interleaved over 8 bursts. Rate compatible punctured convolutional (RCPC) codes are used [6]. The coding and interleaving are done in such a way that decoding is possible after two of eight bursts have been received. Thus, the effective code rate is 1 after the reception of these two bursts and the packets to be transmitted are divided into blocks of 2x136-8 bits =

264 bits each in the case of QPSK (528 bits in the case of 16QAM), which constitutes the user block including data, CRC, block number, and encoder tail. If the decoding is not successful, the third burst is sent and decoding is reattempted. After the third burst, the code rate is 2/3. If the decoding is still not successful, the fourth burst is sent and decoding is done again, now with the code rate of 1/2. Then, two more bursts are sent, leading to a code rate of 1/3 and two further bursts, leading to a code rate 1/4. If the decoding is not successful, the burst with the lowest signal to noise-and-interference value is resent and the original burst and the retransmitted burst are combined by maximum ratio combining. This repetition coding is repeated until the decoding is successful. The system parameters for implementing the UDD services are summarized in Table 1-11. Both code pooling and time slot pooling are considered.

Table 1-11 System parameters for the UDD services

service	UDD, 144 kbit/s, 384 kbit/s and 2048 kbit/s, no delay constraint
user bit rate	variable
number of time slots per frame per user	variable, 1 to 8
number of codes per time slot per user	variable, 1 to 9
burst type	spread speech/data burst 2
bits per basic physical channel	136 for QPSK, 272 for 16QAM
data modulation	QPSK or 16QAM
data detection	joint detector: zero forcing block linear equalizer [3]
convolutional code rate (inner code)	variable, 1, 2/3, 1/2, 1/3, 1/4
interleaving depth	2, 3, 4, 6, 8 frames = 2, 3, 4, 6, 8 bursts
user block size	264 bits for QPSK, 528 bits for 16QAM
frequency hopping	no frequency hopping for Vehicular, frame-by-frame hopping for Pedestrian and Indoor
antenna diversity	yes (2 branches)

In the link level simulations, an ideal CRC (cyclic redundancy check) is modelled. The effects of ARQ are included in the system level simulations. The aim of the link-level simulations is to find the required E_b/N_0 values to achieve certain BERs and BLERs. The following alternatives have been simulated as being extreme cases:

- allocating 1 code in 1, 2, ... 8 time slots to a user in the uplink, with 1 user being active per time slot,
- allocating 9 codes in 1, 2, ... 8 time slots to a user in the uplink, with 1 user being active per time slot,
- allocating 1 code in 1, 2, ... 8 time slots to a user in the downlink, with 4 users being active per time slot,
- allocating 9 codes in 1, 2, ... 8 time slots to a user in the downlink, with 1 user being active per time slot.

These cases are extreme cases with respect to code pooling. The performance when pooling other numbers of codes is inbetween the extreme cases given here. Since it is likely that these applications will be executed on a laptop, antenna diversity in the downlink is also included in the results.

Based on a throughput analysis, the bit rates achievable depending on the average C/I are determined. The achievable bit rates are determined by taking into account the necessary retransmissions due to block errors and the related decrease of the effective information bit rate. The considered ARQ scheme is improving the code rate from one transmission to the next from 1 to 2/3 to 1/2 to 1/3 and to 1/4. The results including the code rate 2/3 are better compared to the case when omitting the code rate 2/3.

The required C/I values in order to achieve the required nominal bit rate are summarized in Table 1-12 for UDD 144 kbit/s, in Table 1-13 for UDD 384 kbit/s and in Table 1-14 for UDD 2048 kbit/s.

Table 1-12 Required value for C/I for the UDD 144 kbit/s service, code rates 1, 2/3, 1/2, 1/3 and 1/4

UDD 144	10 log ₁₀ (C/I) in dB @ 144 kbit/s		
	K _c = 9, K = 1, TS = 1, QPSK UL and DL	K _c = 1, K = 1, TS = 8, QPSK UL	K _c = 1, K = 4, TS = 8, QPSK DL
Vehicular A, 120 km/h	-7.9	-6.7	-7.4

K_c = number of codes per time slot per user, K = number of users per time slot, UL/DL = uplink/downlink, TS = number of time slots per user

Table 1-13 Required value for C/I for the UDD 384 kbit/s service, code rates 1, 2/3, 1/2, 1/3 and 1/4

UDD 384	10 log ₁₀ (C/I) in dB @ 384 kbit/s		
	K _c = 9, K = 1, TS = 3, QPSK UL and DL	K _c = 9, K = 1, TS = 2, QPSK UL and DL	K _c = 9, K = 1, TS = 2, 16QAM UL and DL
Outdoor to Indoor and Pedestrian A, 3 km/h	<-9.0	-4.6	-5.6

K_c = number of codes per time slot per user, K = number of users per time slot, UL/DL = uplink/downlink, TS = number of time slots per user

Table 1-14 Required value for C/I for the UDD 2048 kbit/s service, code rates 1, 2/3, 1/2, 1/3 and 1/4

UDD 2048	10 log ₁₀ (C/I) in dB @ 2048 kbit/s K _c = 9, K = 1, TS = 8, 16QAM UL and DL
	Outdoor to Indoor and Pedestrian A, 3 km/h
Indoor Office A, 3 km/h	-3.9

K_c = number of codes per time slot per user, K = number of users per time slot, UL/DL = uplink/downlink, TS = number of time slots per user

Corresponding bit rate curves are shown in Figure 1-16 to Figure 1-18 for the UDD 144 kbit/s service, in Figure 1-19 to Figure 1-21 for the UDD 384 kbit/s service and in Figure 1-22 to Figure 1-23 for the UDD 2048 kbit/s service. In these figures, the achievable bit rate is depicted versus the average C/I.

1.4 Possible improvements

The link level simulation results shown in this document can be improved for example in the following ways:

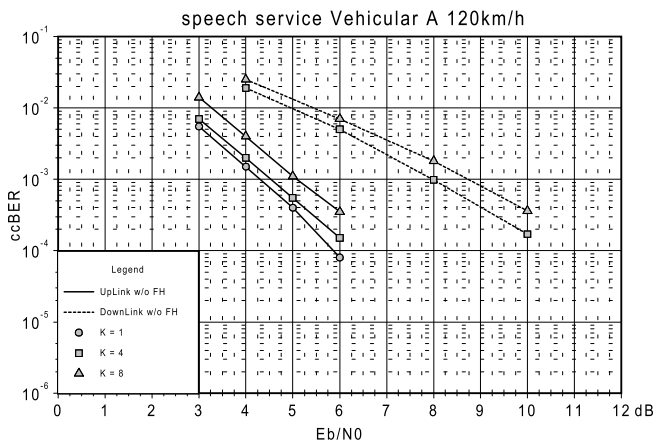
- enhanced power control (e.g. frame-by-frame) for low velocities, for instance for the Indoor and Pedestrian test cases with 3 km/h; an exemplary test has shown a gain of 2.5 dB, cf. the section on the speech service, when using enhanced power control instead of frequency hopping,
- shared slots in the downlink for increasing diversity,
- modification of the FEC scheme in the case of 16 QAM so that the 4 bits forming a 16QAM symbol are equally protected,
- improved CDMA codes,

- use of better joint detection algorithms, e.g. decision feedback equalizers [3], which require essentially the same computational complexity as the minimum mean square error and zero forcing block linear equalizers used in the simulations,
- joint detection or interference cancellation process including the strongest intercell interferers,
- improved channel estimation, e.g., based not only on the midamble portions, but also on the data-carrying part of the burst or based on more than one burst, especially for low velocities,
- improved channel coding, e.g., optimized puncturing pattern, better coding schemes as for instance Turbo codes, concatenated codes for low BER,
- utilization of the reciprocal channel in the case of TDD operation for e.g. open loop control and pre-equalization.

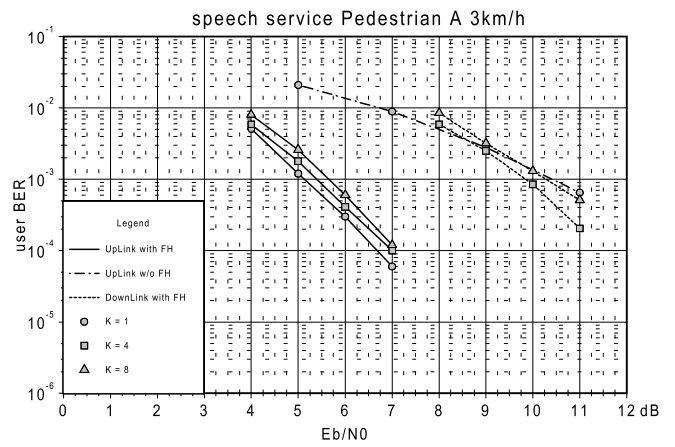
References

- [1] UMTS TR 30.03, "Universal Mobile Telecommunications System (UMTS); Selection procedures for the choice of radio transmission technologies of the UMTS," version 3.0.0.
- [2] ETSI/SMG2 Tdoc 260/97, "Common Workplan of SMG2 UTRA Concept Groups".
- [3] A. Klein, G. K. Kaleh, and P. W. Baier, "Zero forcing and minimum mean-square-error equalization for multiuser detection in code-division multiple-access channels," *IEEE Transactions on Vehicular Technology*, vol. 45, May 1996, pp. 276-287.
- [4] B. Steiner and P. W. Baier, "Low cost channel estimation in the uplink receiver of CDMA mobile radio systems," *Frequenz*, vol. 47, Nov./Dez. 1993, pp. 292-298.
- [5] ETSI/SMG2 Tdoc 329/97, "Next simulation test cases".
- [6] P. Frenger, P. Orten, T. Ottosson, and A. Svensson, "Rate matching in multichannel systems using RCPC-codes," in *Proc. IEEE Vehicular Technology Conference*, Arizona, 1997, pp. 354-357.

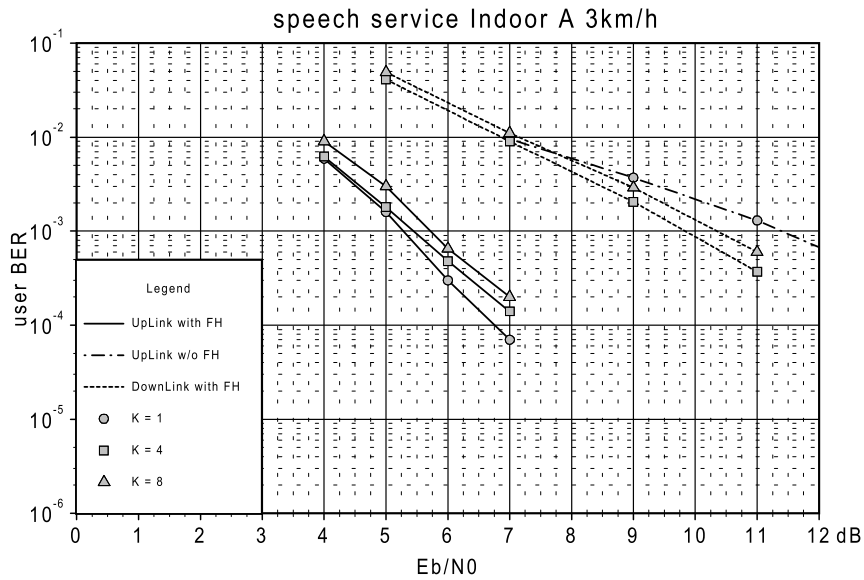
**Figure 1-2 Speech UL and DL Vehicular A 120 km/h,
1, 4 and 8 Users per TS, 1 Code and 1 TS per user**



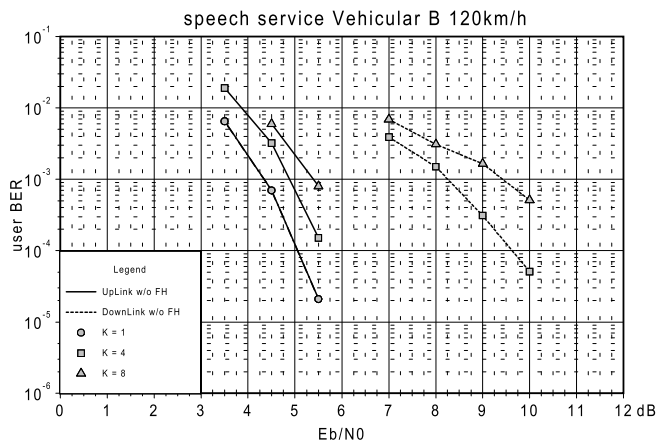
**Figure 1-3 Speech UL and DL Pedestrian A 3 km/h,
1, 4 and 8 Users per TS, 1 Code and 1 TS per user**



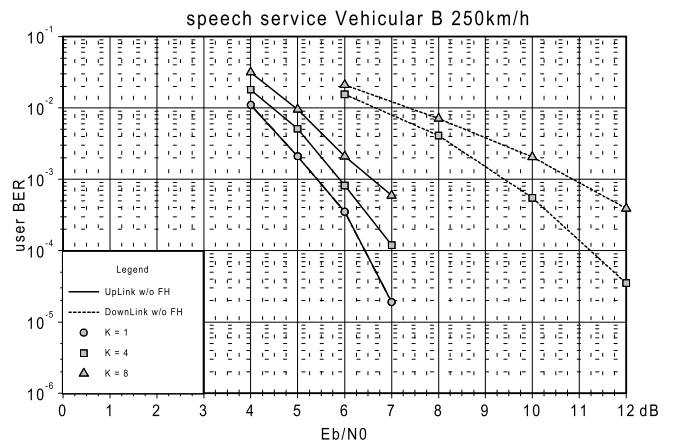
**Figure 1-4 Speech UL and DL Indoor 3 km/h,
1, 4 and 8 Users per TS, 1 Code and 1 TS per user**



**Figure 1-5 Speech UL and DL Vehicular B 120 km/h,
1, 4 and 8 Users per TS, 1 Code and 1 TS per user**

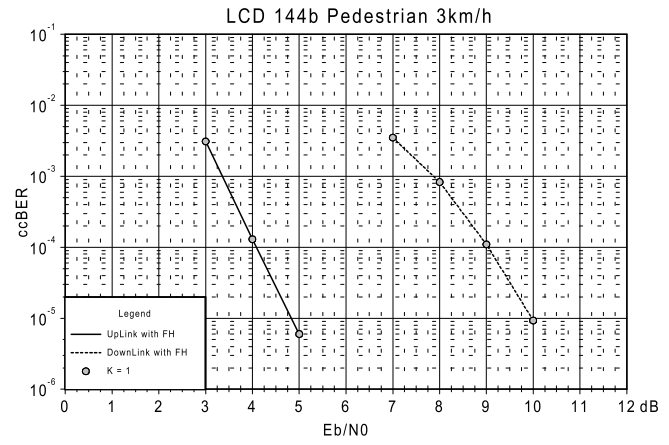
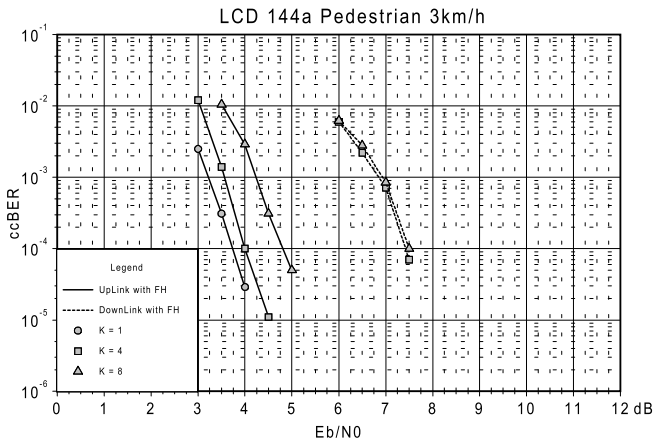


**Figure 1-6 Speech UL and DL Vehicular B 250 km/h,
1, 4 and 8 Users per TS, 1 Code and 1 TS per user**



**Figure 1-7 LCD 144 a UL and DL Pedestrian 3 km/h,
1, 4 and 8 Users per TS, 1 Code and 8 TS per user**

**Figure 1-8 LCD 144 b UL and DL Pedestrian 3 km/h,
1 User per TS, 9 Codes and 1 TS per user**



**Figure 1-9 LCD 144 c UL and DL Pedestrian 3 km/h,
1, 2 and 3 Users per TS, 3 Codes and 4 TS per user**

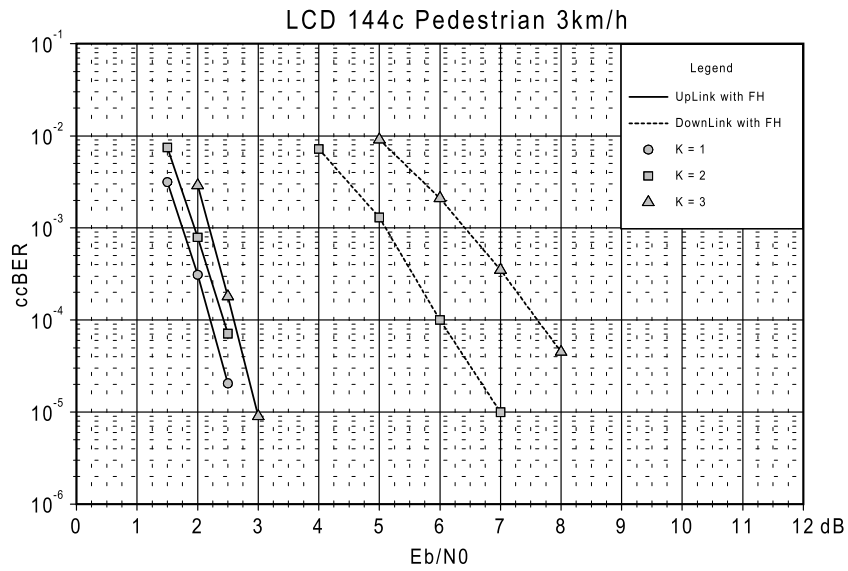


Figure 1-10 LCD 384 a UL and DL Vehicular 120 km/h, 1, 2 and 3 Users per TS, 3 Codes and 8 TS per user

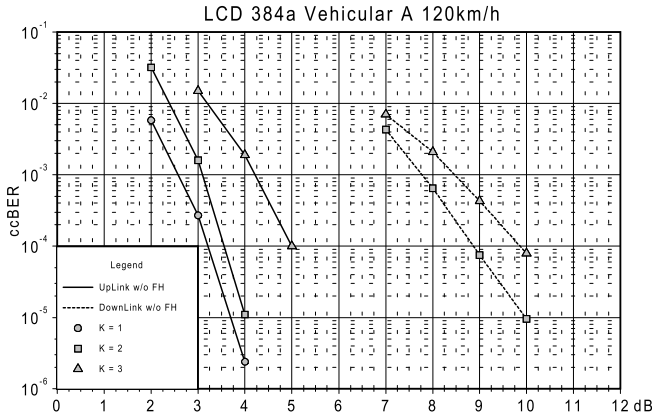


Figure 1-11 LCD 384 a UL and DL Indoor 3 km/h, 1, 2 and 3 Users per TS, 3 Codes and 8 TS per user

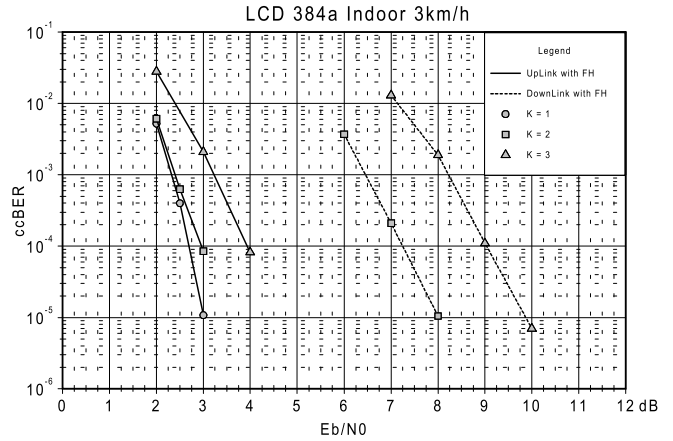


Figure 1-12 LCD 384 b UL and DL Vehicular 120 km/h, 1 User per TS, 9 Codes and 3 TS per user

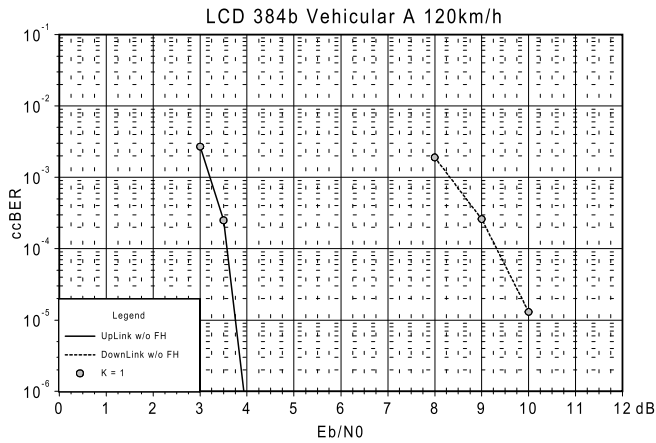


Figure 1-13 LCD 384 b UL and DL Indoor 3 km/h, 1 User per TS, 9 Codes and 3 TS per user

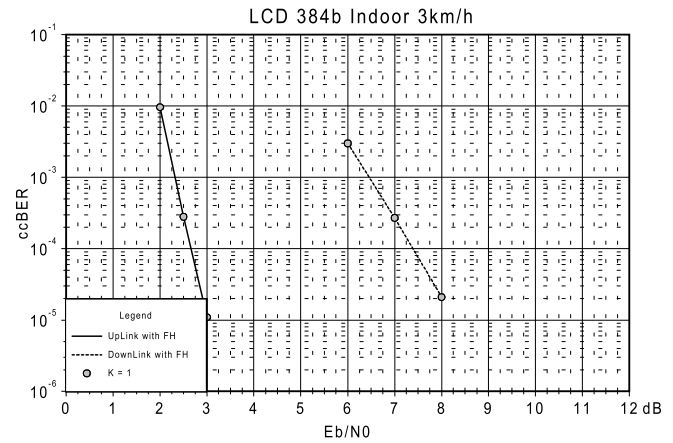


Figure 1-14 LCD 2048 UL and DL Pedestrian 3 km/h, 1 User per TS, 9 Codes and 8 TS per user

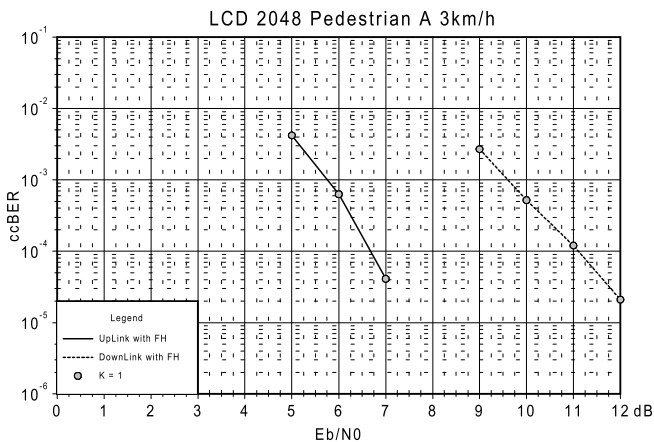
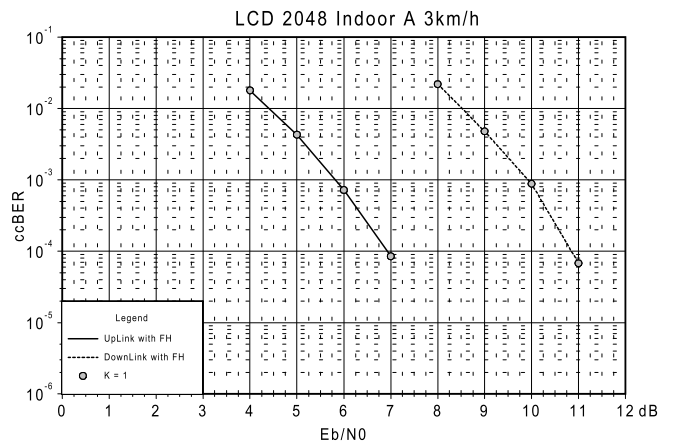


Figure 1-15 LCD 2048 UL and DL Indoor 3 km/h, 1 User per TS, 9 Codes and 8 TS per user



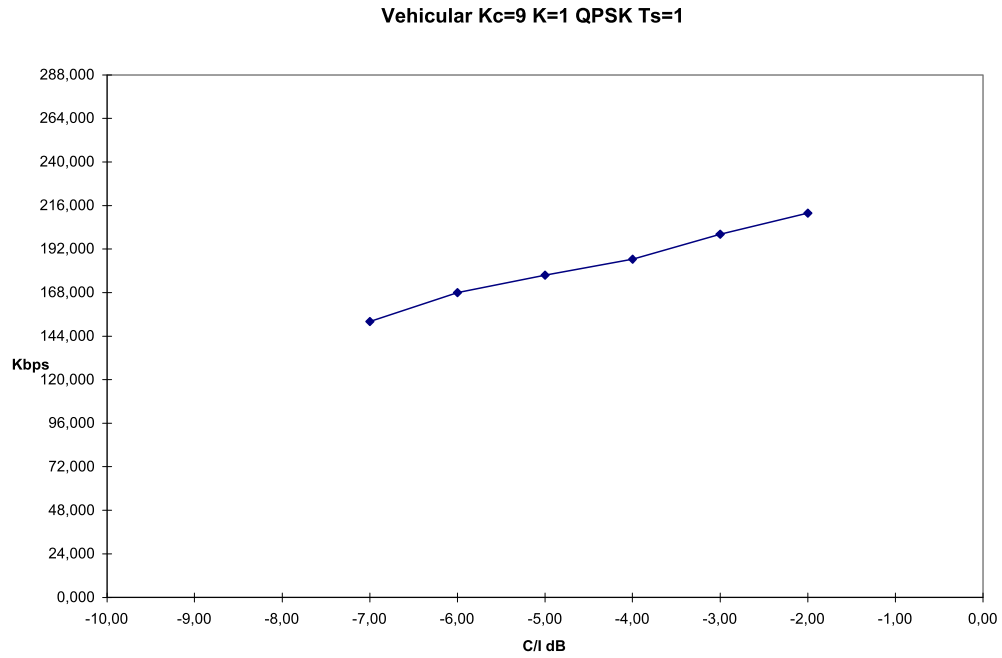


Figure 1-16 UDD 144 kbit/s UL and DL Vehicular 120 km/h, 1 User per TS, 9 Codes and 1 TS per user, QPSK, code rates 1, 2/3, 1/2, 1/3 and 1/4

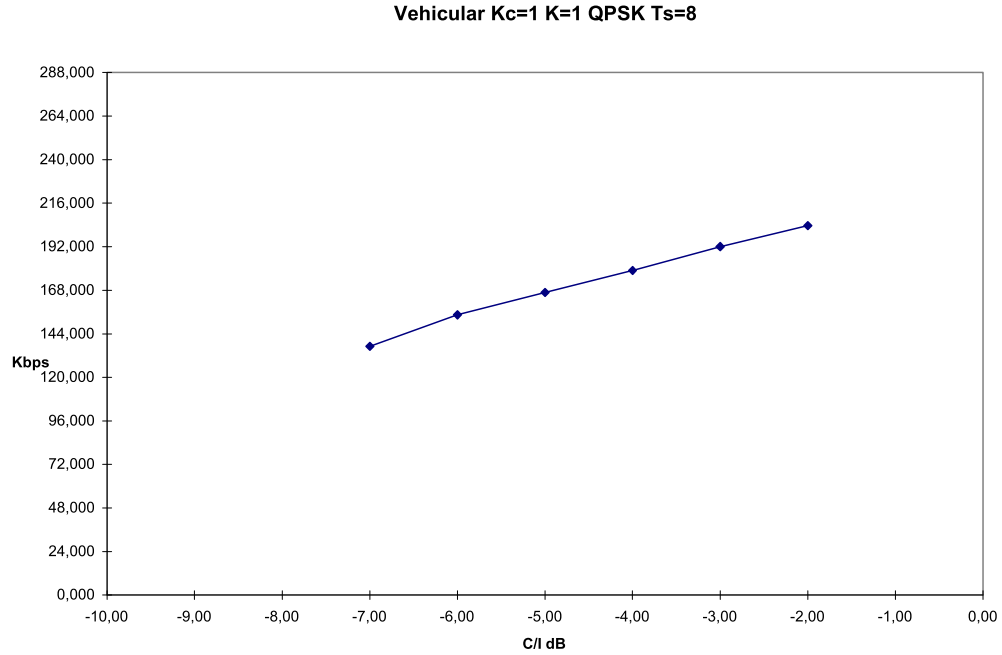


Figure 1-17 UDD 144 kbit/s UL Vehicular 120 km/h, 1 User per TS, 1 Code and 8 TS per user, QPSK, code rates 1, 2/3, 1/2, 1/3 and 1/4

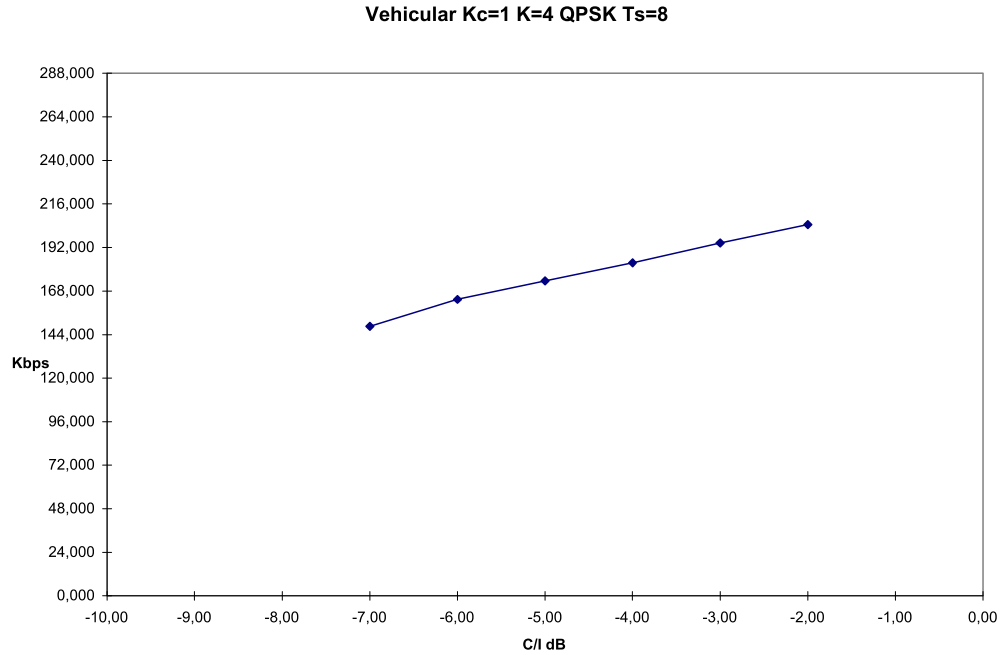


Figure 1-18 UDD 144 kbit/s UL Vehicular 120 km/h, 4 Users per TS, 1 Code and 8 TS per user, QPSK, code rates 1, 2/3, 1/2, 1/3 and 1/4

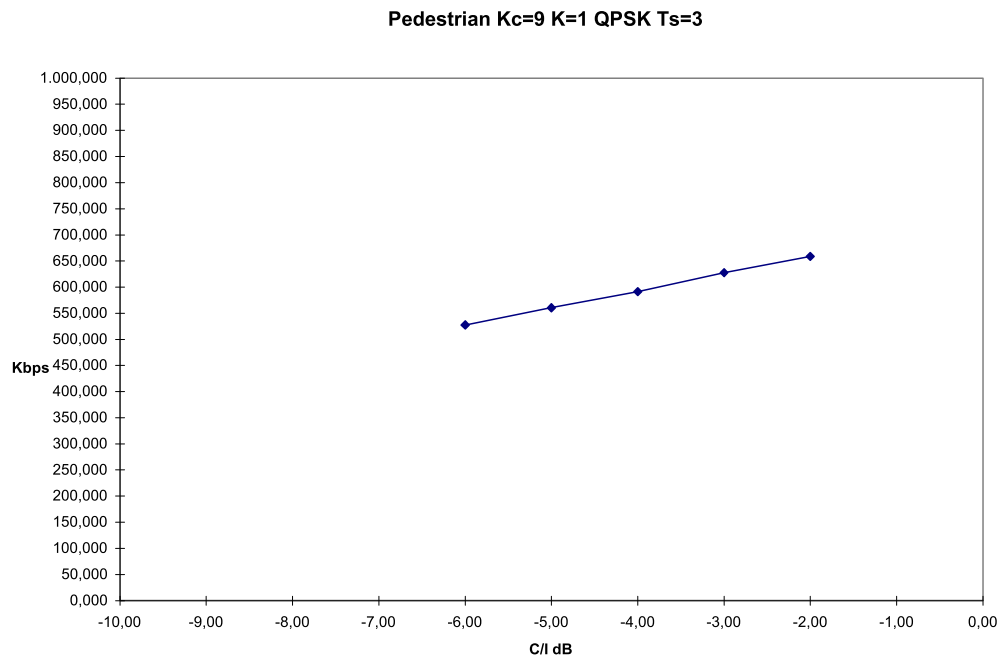


Figure 1-19 UDD 384 kbit/s UL and DL Pedestrian 3 km/h, 1 User per TS, 9 Codes and 3 TS per user, QPSK, code rates 1, 2/3, 1/2, 1/3 and 1/4

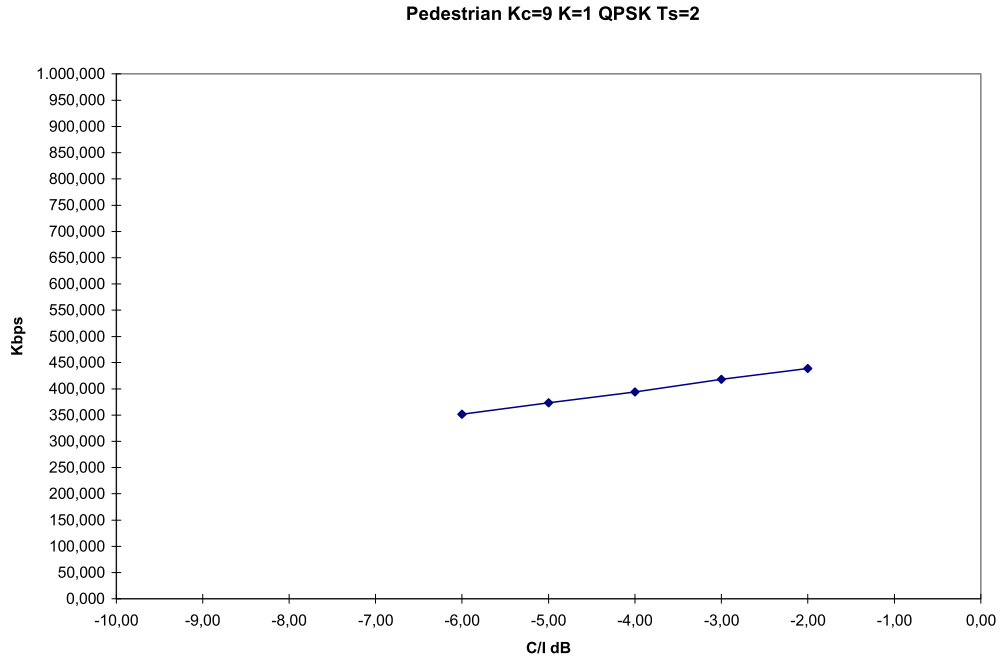


Figure 1-20 UDD 384 kbit/s UL and DL Pedestrian 3 km/h, 1 User per TS, 9 Codes and 2 TS per user, QPSK, code rates 1, 2/3, 1/2, 1/3 and 1/4

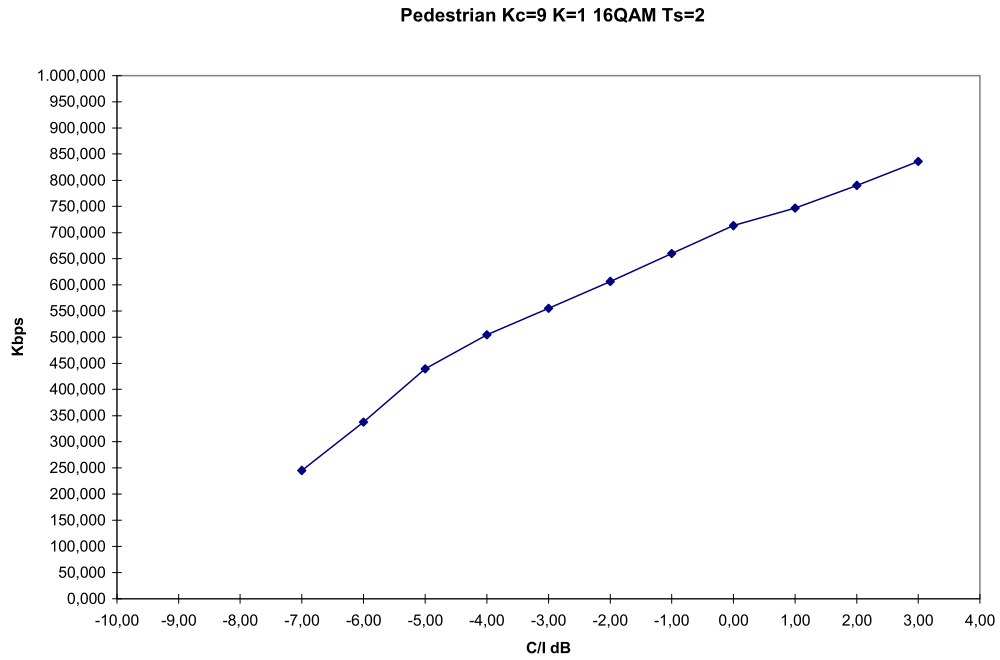


Figure 1-21 UDD 384 kbit/s UL and DL Pedestrian 3 km/h, 1 User per TS, 9 Codes and 2 TS per user, 16QAM, code rates 1, 2/3, 1/2, 1/3 and 1/4

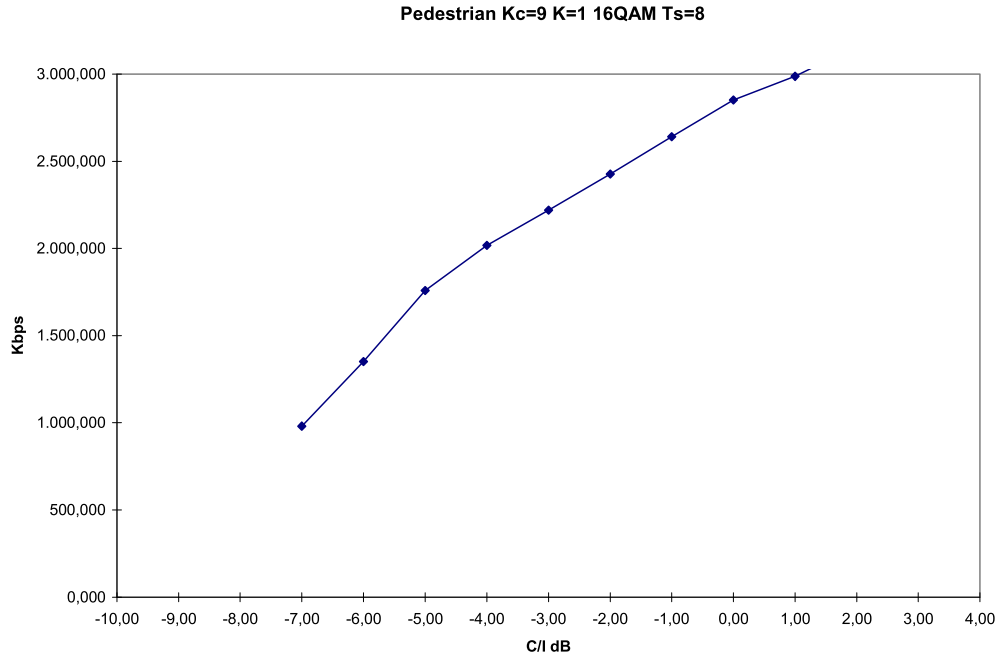


Figure 1-22 UDD 2048 kbit/s UL and DL Pedestrian 3 km/h, 1 User per TS, 9 Codes and 8 TS per user, 16QAM, code rates 1, 2/3, 1/2, 1/3 and 1/4

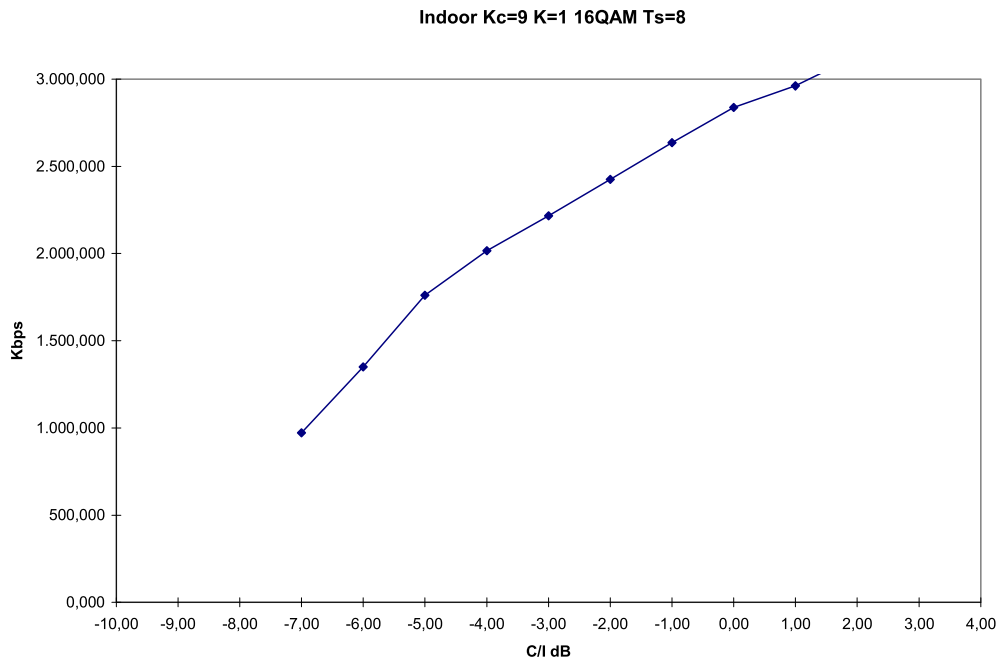


Figure 1-23 UDD 2048 kbit/s UL and DL Indoor 3 km/h, 1 User per TS, 9 Codes and 8 TS per user, 16QAM, code rates 1, 2/3, 1/2, 1/3 and 1/4

ETSI SMG2#24
97
Madrid, Spain
December 15th-19th, 1997

Tdoc SMG 899 /

Source: SMG2
Agenda Item: 4.1 UTRA
Subject: Evaluation Document Cover Sheet for:

Concept Group Delta
WB-TDMA/CDMA
System Description Performance Evaluation

Disclaimer:

“This document was prepared during the evaluation work of SMG2 as a possible basis for the UTRA standard. It is provided to SMG on the understanding that the full details of the contents have not necessarily been reviewed by, or agreed by, SMG2.”

**ETSI SMG2#24
Cork, Ireland
December 1-5, 1997**

TDoc SMG2 368 / 97

**Concept Group Delta
Wideband TDMA/CDMA**

**Evaluation Report - Part 4
V 2.0 b**

System Level Simulations

General

This section describes the TDMA/CDMA system level simulations. The TDMA/CDMA approach has 3 dimensions: frequency, time and code dimension.

In general, only the *downlink* direction is considered. It was found that the downlink is limiting the system capacity, since for example antenna diversity can be used in the uplink to improve the soft blocking limit significantly.

The simulation results presented in this document rely on statistics gathered from about 5000 calls in the reference cells.

Used Models

All test environments including network structure, cell shape, antenna pattern, propagation models (path loss and shadowing, channel model), mobility models, traffic models and quality of service (QoS) criteria for Real Time (RT) users are modeled according to [1].

Traffic and quality of service (QoS) criteria for Non Real Time (RT) users is modeled according to [3].

In the macro environment a re-use pattern 1/3 is used. Statistics is collected within the central cluster surrounded by 3 interferer rings.

In the micro environment a re-use scheme of 1 and 3 is used within the Manhattan grid structure given in [1]. Statistics is gathered from the 6 cells according to [1].

For the results (given in table 1) in the pico environment a re-use scheme of 1 and 3 is used within the indoor office model given in [1]. Statistics is gathered from the 6 cells in the middle floor according to [1]. A clustered system for the mixed service in indoor environment is currently under investigation.

Resource Allocation

A resource unit (RU) in TDMA/CDMA is a triple consisting of frequency channel, time slot and code. For services that require more than one RU:

- a number of codes (multi-code), or
- a number of time-slots (multi-slot), or
- a combination of both (mixed allocation)

may be allocated.

For RT services the resources are allocated at session setup and are kept unchanged till session end. On intercell handover the same type of resource is allocated in the new cell.

For NRT services the allocation and de-allocation is done on block level driven by the number of data a user has in the buffer.

The resource allocation tries to distribute the allocated codes homogeneously over all frequencies and timeslots, i.e. it is searched for the time slot with minimum number of codes.

Frequency and Time Hopping

The simulator is capable of simulating both frequency and time hopping by using quasi-random hopping-sequences. The number of hopping frequencies corresponds to the number of carriers within a cell (e.g. 3 for the 1/3 cluster in macro environment). Frequency hopping is performed on a frame by frame basis. The presented simulation results have been produced without time hopping. Simulation results without any hopping are presented as well.

It should be noted, since resource allocation for non real time services is performed on a block basis the effect of frequency hopping is irrelevant for that type of service.

Power Control

Slow (0.5 sec control interval) level based power control is used with a dynamic range of 20 dB in the downlink and 70 dB in the uplink. No fast PC is used within the presented TDMA/CDMA simulation results.

Handover

The handover is based on GSM-like power budget (path loss difference between serving and neighbour cells) with a handover margin of 3 dB.

Link Adaptation

Link adaptation has not been used yet explicitly within the simulations. However, it may be applied in TDMA/CDMA to improve spectrum efficiency.

ARQ

For NRT services the first transmission of a block is done nearly uncoded. If the first transmission fails a second transmission contains the coding bits in a way that all blocks of the first and second transmission together result in a higher coding rate.

If the second transmission also fails the worst (raw-BER) burst is retransmitted and a maximum ratio combining is done between the original and the retransmitted burst. The code rate is not increased in this step. For all further retransmissions this maximum ratio combining is used.

If the number of retransmissions exceeds a given threshold (10 - 20) the session is dropped.

DTX

For speech services voice activity detection (VAD) and discontinuous transmission (DTX) is used with an activity factor of 0.5 and mean speech (activity) periods of 3 seconds according to [1]. During the silent periods the transmit power is switched off, but the channels are not released, i.e. DTX is used to reduce interference and thereby to relieve the soft blocking limit.

Interface between System and Link Level Simulation

Link level simulations are done with fast (multipath) fading and the result is the BER-CIR relationship.

In a system with frequency / time hopping and resource allocation on block level, system simulations based on an average value interface result in a very low accuracy. This is why an actual value interface (AVI) has been used in the system level simulator to produce the results presented in this document.

Within the system level simulations fast fading has been taken into account to calculate the actual values of CIR experienced on each burst.

Due to the code dimension in TDMA/CDMA the CIR values are distinguished between intercell CIR_{inter} and intracell CIR_{intra} .

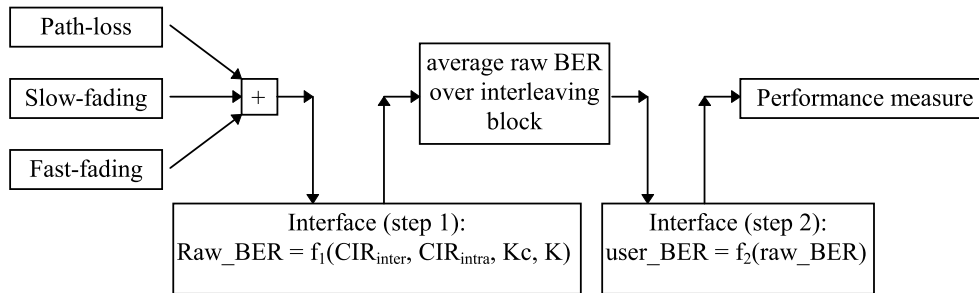
The CIR_{inter} is the ratio between the wanted signal in the reference cell and the sum of interfering signals from all other cells at the same frequency and time slot.

The CIR_{intra} is the ratio between the wanted signal in the reference cell and the sum of the signals from all other users in the same cell at the same frequency and time-slot. Simulations have shown that the impact of the intracell interference is negligible (due to joint detection).

Within the AVI the burst CIR values are mapped on a raw BER on a burst. Beside on the CIR_{intra} and CIR_{inter} the raw BER also depends upon

- the number of codes K_C per user used with a certain service (code pooling)
- the number of users K per time slot.

Depending on the interleaving depth assumed for each service, the average raw BER on a corresponding number of bursts constituting one block is calculated and subsequently mapped on a user BER value of the received block.



Actual Value Interface at system level

For ARQ there is an additional interface function that gives the relationship between raw BER and BLER (block erasure rate).

Results

The simulation results are summarized in Table 1. The variation in the values compared with the corresponding ones given in Table 1 of the Evaluation Report - Part 4 Version 1.0 is due to corresponding improvements on link level which are presented in Evaluation Report - Part 3 Version 2.0b. Furthermore the table has been updated with cluster 3 results for UDD and pedestrian speech services. More detailed description of the simulations carried out is presented in the following chapters.

Table 1: Summary of the system simulations results

Environment	Service	Cluster	Number of time slots	Number of codes	FH	Downlink Antenna diversity	Average TXPWR [dBm]	Spectrum Efficiency [kbps/MHz/cell]
							DL / UL	
Vehicular	Speech	1/3	1	1	yes	no	30 / 24	72
			1	1	no	no		68
	LCD384	1/3	8	3	no	no	37 / 31	129
			8	3	no	yes		176
			8	3	no	-		176 (UL)
			8	3	no	no		-
Outdoor to indoor pedestrian	UDD384	1	(*)	(*)	-	yes	20 / 14	812
		3	(*)	(*)	-	yes	20 / 14	387
	Speech	3	1	1	yes	no	20 / 14	75
		3	1	1	no	no		73
Indoor office	service mix - speech & - UDD384	1			yes	no, yes	10 / 4	110
					no	no, yes		104
	UDD2048	1	(*)	(*)	-	yes	10 / 4	405
		1	(*)	(*)	-	no		170
		3	(*)	(*)	-	yes		195
		3	(*)	(*)	-	no		132

- (*) ... not relevant since RU allocation is done dynamically
 - ... not relevant for UDD

Vehicular Environment

In the vehicular macro cell environment a cluster 1/3 is used for all services. This means that each frequency is used at each site, but the whole spectrum is divided into 3 subgroups which are allocated to the three sectors (cells), i.e. there are 3 radio frequencies allocated to each cell. Spectrum efficiency values presented below are related to one cell. The load per site is obtained by multiplying these values by 3.

The figures in table 1 are based on 14.4 MHz spectrum (9 carrier) without guard bands.

Speech

For the speech service the maximum number of codes per time slot is 12 (cf. delta evaluation report part 3). Applying frequency hopping, the percentage of satisfied users is 99% (downlink result) for a simulated load of 72 kbps/MHz/cell. Hard blocking (no channel available) is 0.98%. Switching off frequency hopping, the spectrum efficiency is marginally reduced to 68 kbps/MHz/cell. The figure for a minimum spectrum usage of 1 carrier per cell decreases slightly to 67 kbps/MHz/cell.

LCD384

System level simulations have been carried out for the LCD option using 8 time slots and 3 codes (denoted by LCD384a in the link level simulations). Up to 4 users (i.e. $4 \times 3 = 12$ codes) can be served on one carrier, i.e. there are 12 logical channels per sector for LCD services.

Simulations have been performed with and without hopping. However, the results do not differ significantly (less than 5%). Therefore only the **no** hopping results are presented.

The presented numbers are achieved by increasing the average power by 7 dB to 31 dBm (UL) and 37 dBm (DL) average power (which is equal to the peak peak power since all time slots are used by the LCD384 service). When using the prescribed average power levels of 24 dBm / 30 dBm, the maximum cell range is about 1.8 km as presented in the link budget templates of the delta group. Obviously for a required cell radius of 2 km no reasonable capacity figures can be provided.

For 3 carriers per cell the hard blocking limit derived by Erlang-B formula (at 2% blocking) is 176 kbps/MHz/cell.

For a minimum spectrum of 1 carrier per cell the hard blocking limit is at 87 kbps/MHz/cell.

Environment: Outdoor to Indoor Pedestrian

In the micro cell environment a cluster 3 is used for all services. The figures in table 1 are based on 14.4 MHz spectrum (9 carrier) without guard bands.

In addition to cluster 3, results on cluster 1 are provided for UDD384.

UDD384

For the UDD services resources are allocated on demand, i.e. depending on the current packet size. In the TDMA/CDMA system the possible resource allocation granularity is 1 code. To speed up simulations a resource allocation granularity of 1 time slot for cluster 1 and $\frac{1}{2}$ time slot (4 codes) for cluster 3 has been used within the simulations. From the point of view of the traffic model (usage of resource units) and interference averaging this is a pessimistic assumption. The maximum number of allocated resources are 2 slots x 9 codes (cluster 1) and 2 slots x 4 codes (cluster 3).

Speech

For the speech service the maximum number of codes per time slot is 12 (cf. delta evaluation report part 3). Simulations have been performed with and without hopping. However, the results do not differ significantly (less than 10%). This is due to the following facts:

- hopping randomly over 3 frequencies (per cells) gives an average usage of 2 different frequencies within the interleaving depth of 4, hence the gain from frequency diversity is small;
- on the other hand in a re-use scheme of 3 the interference is very low except for a small area on the crossings; hence the gain from interference diversity is small as well;
- furthermore in the micro environment there is a high coherence bandwidth.

Environment: Indoor

The figures in table 1 are based on 14.4 MHz spectrum (9 carrier) without guard bands.

UDD2048

For the UDD services resources are allocated on demand, i.e. depending on the current packet size. In the TDMA/CDMA system the possible resource allocation granularity is 1 code. To speed up simulations a resource allocation granularity of 1 time slot has been used within the simulations (exception: for the cluster 3 with AD a granularity of $\frac{1}{2}$ timeslot has been used). From the point of view of the traffic model (usage of resource units) and interference averaging this is a pessimistic assumption. The maximum number of allocated resources is 8 slots x 9 codes (4 codes for the cluster 3 with AD).

Results are presented for both cluster 1 and 3.

Mixed Speech and UDD384

For this case a resource allocation granularity of 1 code has been used within the simulations. At the moment results are available for cluster 1 only. Results for cluster 3 will be available in 2 weeks. However first estimations show that the figures for cluster 3 are nearly the same as for cluster 1. Simulations have been performed with and without frequency hopping. However, the results do not differ significantly (less than 5%). This is due to the following facts:

- the UDD services provide inherently interference averaging since resource allocation is done at block level.
- furthermore in the pico environment there is even a higher coherence bandwidth than in micro.

Summary

Simulation results concerning spectrum efficiency of TDMA/CDMA have been presented for real time and non real time services. The presented values do not include the impact of signaling which however is estimated to be about 10%.

On the other hand there are some options which may significantly improve the spectrum efficiency values:

- link adaptation
- fast power control
- power control based on quality
- time slot hopping
- smart antennas
- floating carrier.

These options and the corresponding tradeoff between capacity increase and complexity issues are under investigation.

References

- [1] UMTS TR 30.03 “Selection procedure for the choice of radio transmission technologies of the UMTS”, Annex 2
- [2] ETSI SMG2 UMTS ad hoc #3 TDoc 73, Rennes, 1997.
- [3] CR on UMTS: 30.03 A002, Oct. 1997

**ETSI SMG2#24
97**

Tdoc SMG 899 /

Madrid, Spain

December 15th-19th, 1997

Source: SMG2

Agenda Item: 4.1 UTRA

Subject: Evaluation Document Cover Sheet for:

**Concept Group Delta
WB-TDMA/CDMA
System Description Performance Evaluation**

Disclaimer:

“This document was prepared during the evaluation work of SMG2 as a possible basis for the UTRA standard. It is provided to SMG on the understanding that the full details of the contents have not necessarily been reviewed by, or agreed by, SMG2.”

ETSI SMG2#24

TDoc SMG2 368 / 97

Cork, Ireland

December 1-5, 1997

**Concept Group Delta
Wideband TDMA/CDMA**

**Evaluation Report - Part 5
V 2.0 b**

Table of Contents

1 ETR 0402 ANNEX 1 TEMPLATE.....	594
2 DETAILED EXPLANATION OF TEMPLATE	622
2.1 RAPID CHANGING DELAY SPREAD - A1.2.14.2	622
2.1.1 <i>Varying tap coefficients vs. varying delay spread profile:</i>	622
2.1.2 <i>Classification of speeds and required action:</i>	622
2.1.3 <i>Adaptation Procedure</i>	623
2.2 MIGRATION - A1.4.16	624
2.2.1 <i>Dual mode terminal implementation</i>	624
2.2.2 <i>Spectrum co-existence</i>	625
2.2.3 <i>Handover between UMTS and GSM900/1800</i>	625
2.2.4 <i>Other evolution aspects</i>	626
2.3 SMART ANTENNAS - A1.3.6.....	626
2.3.1 <i>Diversity antennas</i>	626
2.3.2 <i>Sector antennas</i>	628
2.3.3 <i>Adaptive antenna arrays</i>	628
2.3.4 <i>Impact on System Performance</i>	629
2.4 LINK BUDGET CALCULATIONS - A1.5.....	629
3 REFERENCES	648

1 ETR 0402 Annex 1 Template

A1.1	Test environment support
A1.1.1	<p>In what test environments will the SRTT operate?</p> <ul style="list-style-type: none"> • indoor office • outdoor to indoor and pedestrian • vehicular • mixed
A1.1.2	<p>If the SRTT supports more than one test environment, what test environment does this technology description template address?</p> <p>Template addresses all test environments unless mentioned explicitly.</p>
A1.1.3	<p>Does the SRTT include any feature in support of FWA application ? Provide detail about impact of those features on the technical parameters provided in this template, stating whether the technical parameters provided apply for mobile as well as for FWA applications.</p> <p>For the FWA application low one-way delay values are required. By switching off the interleaving function and using a time slot instead of code slot aggregation strategy the TDMA framing delay is reduced to negligible values.</p> <p>Next to delay, fully transparent POTS 3.1 kHz audio channel provision and efficient resource usage have to use the feature of in-call bearer mode modification (cf. A1.2.18) from e.g. 16 to 64 kbps (and bypassing speech compression circuits) if e.g. a modem/fax signal is detected.</p> <p>The feasibility of HCS (cf. A1.2.28) in a limited spectrum (also due to the good carrier granularity) is of benefit for FWA because the directive subscriber antennas have not to be redirected if new closer cell sites are added for capacity improvement.</p> <p>The stationarity and the antenna gain of the FWA terminal provide an excess link margin with respect to mobile terminals. Furthermore, the directivity of the FWA subscriber terminals reduces intercell interference considerably. With this SRTT these facts can be exploited for the benefit of the operator in several ways while accommodating mobile and FWA terminals with the same infrastructure:</p> <ul style="list-style-type: none"> • 16 QAM modulation can be used in order to increase capacity and maximum data rates also in the outdoor environments. This is enabled without penalty by the TDMA component and the joint detection algorithm for the CDMA component which allow for good orthogonalization of basic channels within a cell. 16QAM and QPSK modulation schemes can be mixed even in the same time slot of the same carrier (since the joint detection algorithm is transparent to these modulation schemes) yielding maximum flexibility and trunking gain. • At a given data rate the maximum range can be increased for the FWA terminals. • The reduced intercell interference is converted into increased capacity using the fractional loading, link adaptation and interference averaging strategies which are part of this SRTT's radio resource management. <p>Note: POTS is short cut for Plain Old Telephone Service</p>
A1.2	<p>Technical parameters</p> <p>Note : Parameters for both forward link and reverse link should be described separately, if necessary.</p>
A1.2.1	<p>What is the minimum frequency band required to deploy the system (MHz)?</p> <p><i>Editor's note: Changed after discussion in plenary:</i></p> <p>The minimum frequency band required for UMTS operators to deploy the system is 3 x 1.6 MHz (reuse 3) + appropriate guard band.</p>
A1.2.2	<p>What is the duplex method: TDD or FDD?</p> <p>Both TDD and FDD, refer to part 1 of the evaluation report.</p>

A1.2.2.1	<p>What is the minimum up/down frequency separation for FDD?</p> <p>Assuming ideal filters, the minimum up/down frequency separation for FDD could be zero. However, in practice, the minimum up/down frequency separation for FDD is basically depended on the duplexer technology available in 2002. Based on today's technology a minimum up/down frequency separation of e.g. 45MHz as in GSM is feasible with reasonable cost.</p>
A1.2.2.2	<p>What is requirement of transmit/receive isolation? Does the proposal require a duplexer in either the mobile or base station.</p> <p>Duplexer for base station implementation can be used. For mobile terminals a duplexer is not needed below a certain level of time slot aggregation (2-3 time slots). For example, mobile terminals using up to 2 time slots with up to 8 CDMA codes each, i.e. mobile terminals having a data rate of up to 256kbps, do not need a duplexer.</p>
A1.2.3	<p>Does the SRTT allow asymmetric transmission to use the available spectrum? Characterize.</p> <p>Yes,</p> <ul style="list-style-type: none"> • if system operates in TDD mode, the switching point between uplink and downlink can be moved in the TDD frame to adopt asymmetric traffic, refer to part 1 of the evaluation report. • if system operates in FDD mode, different number of time slots and CDMA codes are used between uplink and downlink.
A1.2.4	<p>What is the RF channel spacing (kHz)? In addition, does the SRTT use interleaved frequency allocation?</p> <p>Note: Interleaved frequency allocation; allocating the 2nd adjacent channel instead of adjacent channel at neighboring cluster cell is so called "interleaved frequency allocation". If a proponent is going to employ this allocation type, proponent should be stated at A1.2.4 and fill A1.2.15 of protection ratio for both of adjacent and 2nd adjacent channel.</p> <p>RF channel spacing is 1600kHz. Interleaved frequency allocation is not used.</p>
A1.2.5	<p>What is the bandwidth per duplex RF channel (MHz) measured at the 3 dB down points? It is given by (bandwidth per RF channel) x (1 for TDD and 2 for FDD). Please provide detail.</p> <p>TDD: $2 \times 0.45 \times 1/T_c = 0.975$ MHz</p> <p>FDD: $2 \times 2 \times 0.45 \times 1/T_c = 1.95$ MHz</p> <p>Note: For the spectrum of the transmitted signals, refer to part 1 of the evaluation report.</p>
A1.2.5.1	<p>Does the proposal offer multiple or variable RF channel bandwidth capability? If so, are multiple bandwidths or variable bandwidths provided for the purposes of compensating the transmission medium for impairments but intended to be feature transparent to the end user?</p> <p>1 RF channel of bandwidth 1.6 MHz is used.</p> <p>However, for 2 Mbit/s services an RF channel bandwidth of 2×1.6 MHz = 3.2 MHz together with a QPSK data modulation is an option.</p>
A1.2.6	<p>What is the RF channel bit rate (kbps)? .</p> <p>The maximum modulation rate of RF (after channel encoding, adding of in-band control signaling and any overhead signaling) possible to transmit carrier over an RF channel, i.e. independent of access technology and of modulation schemes.</p> <p>QPSK: RF channel bit rate per CDMA code / time slot is 270.83kbps. ($2 \times 1/T_s$)</p> <p>16QAM: RF channel bit rate per CDMA code / time slot is 541.67kbps. ($4 \times 1/T_s$)</p>

A1.2.7	<p>Frame Structure : Describe the frame structure to give sufficient information such as;</p> <ul style="list-style-type: none"> - frame length: 4.615ms - the number of time slots per frame: 8 - guard time or the number of guard bits: 25.4μs and 26.77μs, respectively - user information bit rate for each time slot / CDMA code: 16kbps (QPSK) or 32kbps (16QAM) - channel bit rate (after channel coding): 270.83kbps (QPSK) or 541.67kbps (16QAM) - channel symbol rate (after modulation): 135.41 ksymbols/s - associated control channel (ACCH) bit rate: For further study. - power control bit rate: Confer A1.2.22. <p>Note 1: Channel coding may include FEC, CRC, ACCH, power control bits and guard bits. Provide detail.</p> <p>Note 2: Describe the frame structure for forward link and reverse link, respectively.</p> <p>Note 3: Describe the frame structure for each user information rate.</p>
A1.2.8	<p>Does the SRTT use frequency hopping? If so characterize and explain particularly the impact (e.g. improvements) on system performance.</p> <p>Frequency hopping is an option especially for indoor office and outdoor to indoor and pedestrian test environments. The improvements on the link level performance is for low speeds in indoor office and outdoor to indoor and pedestrian test environments in the order of 5dB with respect to the required Eb/N0 to achieve a certain QoS to mitigate the impact of Rayleigh. In vehicular test environments the improvements on the link level performance is rather low (i.e. below 1dB), especially for speeds around 120km/h. A further advantage of frequency hopping is interference diversity.</p>
A1.2.8.1	<p>What is the hopping rate?</p> <p>Frequency hopping is applied from burst to burst. Highest hopping rate is required in multi-slot option if 2 consecutive bursts are assigned to a single user. In this case the hopping rate is 1733.1 hops per second.</p>
A1.2.8.2	<p>What is the number of the hopping frequency sets?</p> <p>The number of frequency hopping sets is dependent on the available spectrum resource. For a cell several carrier frequencies have to be allocated, i.e. also for a minimum configuration in a 1/3 cluster with a single TRX equipment at least 2 carrier frequencies should be allocated. The hopping gain in the FMA1 with spreading proposal is lower compared to today's narrowband systems due to the higher bandwidth. The carrier bandwidth of 1.6 MHz reduces already the effects of Rayleigh fading. However for interference averaging reasons frequency hopping will show some benefits. The number of frequency hopping sets can be derived by taking the total BW allocated to an operator, divided by the cluster size. Taking the integer part of the result, the number of frequencies in a hopping set is defined. The number of hopping sets corresponds with the cluster size, in the WB-TDMA/CDMA proposal we recommend a 1/3 cluster. The frequencies contained in a hopping frequency set, shall not be grouped together. A set is best, when the typical distance between two frequencies is as large as possible, to achieve a good decorrelation from burst to burst.</p> <p>Furthermore there is a high degree of flexibility in configuring hopping sequences.</p>
A1.2.8.3	<p>Are base stations synchronized or non-synchronized?</p> <p>It is not required that base stations are synchronized. All simulation results presented are based on unsynchronized base stations. However, a performance improvement might be achieved by synchronized base stations especially in small cells.</p>
A1.2.9	<p>Does the SRTT use spreading scheme?</p> <p>Yes, in addition to a basic TDMA structure.</p>

A1.2.9.1	<p>What is the chip rate (Mchip/s): Rate at input to modulator.</p> <p>2.167 Mchips/s.</p>
A1.2.9.2	<p>What is the processing gain: $10 \log(\text{Chip rate} / \text{Information rate})$.</p> <p>$PG = 10\log(16)=12\text{dB}$</p>
A1.2.9.3	<p>Explain the uplink and downlink code structures and provide the details about the types (e.g. PN code, Walsh code) and purposes (e.g. spreading, identification, etc.) of the codes.</p> <p>Orthogonal CDMA codes for spreading within a time slot are used based on binary Walsh-Hadamard codes followed by a multiplication with a Pseudo Random (PN) sequence. For more details refer to part 1 of the evaluation report.</p>
A1.2.10	<p>Which access technology does the proposal use: TDMA, FDMA, CDMA, hybrid, or a new technology?</p> <p>In the case of CDMA which type of CDMA is used: Frequency Hopping (FH) or Direct Sequence (DS) or hybrid? Characterize.</p> <p>Combination of TDMA/CDMA is used. FDMA is inherent. Basic principle of this proposal is the suppression / cancellation of intracell interference. Slow frequency hopping per frames is an option, cf. A1.2.8.</p>
A1.2.11	<p>What is the base band modulation technique? If both the data modulation and spreading modulation are required, please describe detail.</p> <p>What is the peak to average power ratio after base band filtering (dB)?</p> <p>Spreading modulation is linearized GMSK. Data modulation is QPSK or 16QAM (2Mbps). For details, refer to part 1 or the evaluation report.</p> <p>For QPSK data modulation PAR is 3dB. For 16QAM data modulation PAR is 5dB. For more details refer to SMG2 TDoc UMTS 64/97.</p>
A1.2.12	<p>What are the channel coding (error handling) rate and form for both the forward and reverse links? E.g.</p> <ul style="list-style-type: none"> - Does the SRTT adopt FEC (Forward Error Correction) or other schemes? - Does the SRTT adopt unequal error protection? Please provide details. - Does the SRTT adopt soft decision decoding or hard decision decoding? Please provide details. - Does the SRTT adopt iterative decoding (e.g. turbo codes)? Please provide details. - Other schemes. <ul style="list-style-type: none"> • For speech and circuit switched data services FEC is applied. • Either a convolutional code or a combination of a convolutional code and a Reed Solomon code is used. • The type of code (convolutional, Reed Solomon or combination) is dependent on the required quality of service and / or the propagation environment. • The code rate varies from 0.25 up to 1, again depending on the required quality of service and/or the propagation environment. • Turbo codes are an option for data services. • For non real time packet data services a type II hybrid ARQ/FEC protocol is used. The FEC is based on nested convolutional codes with rates 0.25 up to 1. • Soft decision decoding is always used. Furthermore, estimated channel state information is used in the decoders. <p>For some examples refer to the simulation chapter contained in this report.</p> <p>The proposal is flexible to change the type of FEC/error handling and their parameters to fulfill the requirements of further, new services.</p>

A1.2.13	<p>What is the bit interleaving scheme? Provide detailed description for both up link and down link.</p> <ul style="list-style-type: none"> • 2 stage interleaving is used. • 1st : Interleaving of bits over bursts transmitted in different frames is applied. • 2nd : Interleaving of bits transmitted in a single burst is applied. • Number of frames used for the 1st interleaving stage depends on the delay requirements. • For speech services the number of frames for the first interleaving stage is e.g. 4 which results in a delay of less than 20 ms. • For circuit switched data services the number of frames for the 1st interleaving stage is e.g. 65 which results in a delay of less than 300 ms. • For non real time packet services using the type II hybrid ARQ/FEC protocol the number of frames for the 1st interleaving stage is e.g. 2. • The 2nd stage interleaving shall pair a bit close to the midamble and a bit distant from the midamble to improve the performance. <p>The proposal is flexible to change the type of interleaving and their parameters to fulfill the requirements of further services.</p>
A1.2.14	<p>Describe the taken approach for the receivers (MS and BS) to cope with multipath propagation effects (e.g. via equalizer, RAKE receiver, etc.).</p> <p>Joint detection of data belonging to different CDMA codes is performed based on equalizers. The following equalizers are suited in both MS and BS to perform the joint detection and to cope with multipath propagation effects:</p> <ul style="list-style-type: none"> • Zero Forcing Block Linear Equalizer (ZF-BLE) • Zero Forcing Block Decision Feedback Equalizer (ZF-BDFE) • Minimum Mean Square Error Block Linear Equalizer (MMSE-BLE) • Minimum Mean Square Error Block Decision Feedback Equalizer (MMSE-BDFE) <p>The above mentioned equalizers are described in detail in:</p> <ol style="list-style-type: none"> 1. Klein, A.; Baier, P.W.: Linear unbiased data estimation in mobile radio systems applying CDMA. IEEE Journal on Selected Areas in Communications, Vol. 11 (1993), pp. 1058-1066. 2. Klein, A; Kaleh, G.K.; Baier, P.W.: Equalizers for multi-user detection in code division multiple access mobile radio systems. Proceedings of the 44th IEEE Vehicular Technology Conference VTC'94, Stockholm (1994), pp. 762-766. 3. Jung, P; Blanz, J.J.: Joint detection with coherent receiver antenna diversity in CDMA mobile radio systems. IEEE Transactions on Vehicular Technology, Vol. VT-44 (1995), pp. 76-88.
A1.2.14.1	<p>Describe the robustness to intersymbol interference and the specific delay spread profiles that are best or worst for the proposal.</p> <p>Intersymbol interferences are eliminated in the data detection process due to the application of the equalizers listed in A1.2.14.</p> <p>Radio channel with very low delay spread are worst for the proposal. However, a significant performance improvement will be achieved (for low speeds of the mobile terminals) if a simple power control scheme is applied. Furthermore, frequency hopping is a powerful countermeasure to cope with these channels.</p> <p>Channels with large delay spread profiles (excess delays of up to 12μs) are best for the proposal due to multipath diversity.</p>

A1.2.14.2	<p>Can rapidly changing delay spread profile be accommodated? Please describe.</p> <p>Yes. Adaptation of model tap coefficients during each half-burst is required. Very fast adaptation for very high speeds may cause stability problems, however. In consequence, additional precautions may become necessary that may seem exaggerated for low speeds. For further details see 2.1.1.</p>
A1.2.15	<p>What is the Adjacent channel protection ratio?</p> <p>In order to maintain robustness to adjacent channel interference, the SRTT should have some receiver characteristics that can withstand higher power adjacent channel interference. Specify the maximum allowed relative level of adjacent RF channel power in dBc. Please provide detail how this figure is assumed.</p> <p>15dBc. This figure is the fractional out of band power for an RF bandwidth of 1.6MHz.</p> <p>The system can withstand an adjacent power of 15dBc. There is no remarkable IF filter suppression support to be assumed, due to the close vicinity to the pass band. Therefore, the resistance is dictated by the spectrum roll off characteristic only. The maximum permitted power level in the adjacent channel is permitted to be 17dB higher than the wanted signal. This is valid for speech in the worse case szenario.</p>
A1.2.16	<p>Power classes</p> <p>Details provided in A1.2.26 on the power classes (average and peak power) are subject of system specification and do basically not depend on the air interface proposal. Hence, all values given in A1.2.16 shall discussed after milestone M2.</p>
A1.2.16.1	<p>Mobile terminal emitted power: What is the radiated antenna power measured at the antenna? For terrestrial component, please give (in dBm).</p> <p>At the input of the MS antenna a max. power of 33 dBm can be fed in. This is valid for all services due to EMC restrictions and biological effects.</p>
A1.2.16.1.1	<p>What is the maximum peak power transmitted while in active or busy state?</p> <p>The maximum peak power in active state is 33 dBm.</p>
A1.2.16.1.2	<p>What is the time average power transmitted while in active or busy state? Provide detailed explanation used to calculate this time average power.</p> <p>The average power in active state is min. 24 dBm and max. 33 dBm. The average power is related to the number of Time slots occupied by the MS and the number of idle slots. The ratio between active slots and the frame length gives the average power. This is the usual definition for TDMA structured proposals. If a MS is only active on one time slot, the peak power can be averaged over the complete Frame. I.e. in the structure of the proposal with the frame structure of 8 bursts, the average power is 9 dB lower than the peak power, if only one burst is active. The other extreme is a MS which is active on all bursts, than the average power is 33 dBm. However, the concept support different power classes which are for further study.</p>
A1.2.16.2	<p>Base station transmit power per RF carrier for terrestrial component</p> <p>The Base station (BTS) output power must be sufficient to balance the budget with the MS. Assuming same reference sensitivities and antenna gains for RX and TX, the only difference in the budget is caused by the diversity gain of the BTS. We take a typical figure of 4 dB as the best case diversity gain. I. e. that for a MS transmitting with 33 dBm, the BTS has to respond with at least 37 dBm. This power is the power fed to the antenna socket, not taking into account any feeder losses or combiner losses. Depending on the combining technique and the feeder losses, the PA in the BTS has to provide a higher power to compensate the losses. To support 8 independent mobile stations within one time slot and frequency band the maximum BTS PA peak power increases to 46dBm.</p>
A1.2.16.2.1	<p>What is the maximum peak transmitted power per RF carrier radiated from antenna?</p> <p>The max. peak power per RF carrier fed to the antenna socket is about 46 dBm. To derive to radiated power the antenna in dBi has to be added to the peak power.</p>

A1.2.16.2. 2	<p>What is the average transmitted power per RF carrier radiated from antenna?</p> <p>The min. average power is 28 dBm, and the max. 46 dBm per carrier. This follows the definition used in A 1.2.16.1.2.</p>
A1.2.17	<p>What is the maximum number of voice channels available per RF channel that can be supported at one base station with 1 RF channel (TDD systems) or 1 duplex RF channel pair (FDD systems), while still meeting G.726 performance requirements?</p> <p>TDD: 64 voice channels (half rate transmission, 8kbps)</p> <p>FDD: 128 voiced channels (half rate transmission, 8kbps)</p>
A1.2.18	<p>Variable bit rate capabilities: Describe the ways the proposal is able to handle variable base band transmission rates. For example, does the SRTT use:</p> <ul style="list-style-type: none"> -adaptive source and channel coding as a function of RF signal quality -variable data rate as a function of user application -variable voice/data channel utilization as a function of traffic mix requirements? <p>Characterize how the bit rate modification is performed. In addition, what are the advantages of your system proposal associated with variable bit rate capabilities?</p> <p>The proposal is able to handle variable bit rates in a flexible and efficient way for</p> <ul style="list-style-type: none"> • Voice: The standard mode of operation are the gross rates of 24.3 kbps and 29.5 kbps, respectively. Furthermore, the proposal provides a high capacity mode, where 2 users share one time slot. Even for this rate the UMTS performance requirement for speech quality - G.726 (ADPCM) - is be met. The modes can be adapted dynamically to the RF signal quality, the traffic load and the user application, e. g. once per second. The concept of the Adaptive Multirate Codec currently developed in SMG11 is very well suited for this concept since it is based on 2 transmission rates that fit exactly into the two modes provided by the proposal. • Data: Variable bit rates between 8kbps and 2 Mbps can be provided by using a combination of time slots and codes. Furthermore, variable data rates are supported by different bust types and channel coding. In order to ensure maximum throughput, the error protection of the user data has to be adapted to the channel conditions. By doing this, the nominal data rate over the air interface might be reduced, but the throughput is optimized due to the lack of errors and frame repetitions. The special joint detection receiver used in this proposal gives excellent support for such adaptation algorithms. It provides optimum estimates of all interfering signals as a basis for channel adaptation. • Voice/data: The same that was said about voice and data separately holds for variable voice/data. The data rates can be chosen separately or combined, e. g. as data + voice service within one channel. In any case the data rates are variable and can be adapted to the user needs.
A1.2.18.1	<p>What are the user information bit rates in each variable bit rate mode?</p> <p>It is proposed to make a distinction between voice and data rates because of the different requirements of these services. However the rates for data can be applied to voice as well by losing some of the efficiency of e. g. unequal error protection.</p> <ul style="list-style-type: none"> • Voice: The user information bit rate for voice could be 4 - 16 kbps. The former is a high capacity robust mode and 6-7 kbps appears to be the lowest rate for attaining the required G.726 quality. The latter at 16 kbps could be used for wireline quality with strong background noise or wideband applications. The exact bit rates depend on the speech codec used. • Data: The user information bit rates could be below 8kbps, or could be 64, 144, 384, 1024, and 2048 kbps, respectively. The data rate granularity is in the order of 8, 16 and 32 kbps, respectively. These are only examples. In practice also any other bit rates within this range can be supported with a high degree of flexibility.

A1.2.19.1	<p>Does the proposal offer multiple voice coding rate capability? Please provide detail.</p> <p>The proposal offers multiple voice coding rate capability.</p> <p>It is very important to guarantee constant speech quality under a variety of channel conditions. The joint detection (JD) receiver used in this proposal provides exact information on all the intracell interfering signals within a time slot. This information can be used to adapt the error protection to the channel conditions and allowing optimal quality and robustness against errors. The adaptation is done by means of using the proper burst type as well as the proper channel coding scheme. Both can be adapted dynamically and seamless within a call. Unequal error protection is used for high efficiency.</p> <p>The bit rate could vary between 4kbps and 16 kbps for standard voice services depending on the speech codec (Details of voice coding still to be defined). It can be adapted to the quality desired and to the resources available on the air interface, respectively. The transition between the various rates is seamless. A DTX mode with low data rate can be offered in addition to the a. m. coding rates</p> <p>The delay can be varied by using different voice coding modes.</p>
A1.2.20	<p>Data services: Are there particular aspects of the proposed technologies which are applicable for the provision of circuit-switched, packet-switched or other data services like asymmetric data services? For each service class (A, B, C and D) a description of SRTT services should be provided, at least in terms of bit rate, delay and BER/FER.</p> <p>Note 1: See [draft new] Recommendation [FPLMTS.TMLG] for the definition of</p> <ul style="list-style-type: none"> - “circuit transfer mode” - “packet transfer mode” - “connectionless service” <p>and for the aid of understanding “circuit switched” and “packet switched” data services</p> <p>Note 2: See ITU-T Recommendation I.362 for details about the service classes A, B, C and D</p> <p>The SRTT provides a high flexibility due to a separation of the radio resource units in the frequency, time and code domain. The smallest resource unit to be allocated is one code within one time slot within one frequency. This results in 64 resource units available on one frequency which can be allocated independently. However, by using half bursts resource units with lower corresponding bit rate can be generated. In this also more than 64 resource units are available.</p> <p>Thus, by pooling of resource units bearer services at the radio interface with various data rates can be achieved. Further, by variation of the coding rate and interleaving depth various BER and delay requirements can be met.</p> <p>For each service class dedicated bearer services at the radio interface are defined allowing an unambiguous mapping between each other.</p> <p>Because of possible reallocation on TDMA-frame basis, a high flexibility concerning variable bit rate services is achieved.</p> <p>The bearer services at the radio interface are separated into low delay data (LDD), long constrained delay (LCD) and unconstrained delay data (UDD) bearer services. The LDD bearer is characterized by stringent delay (and stringent delay variation) requirements. In contrary, the LCD bearer is characterized by less stringent delay (and delay variation) requirements but high BER requirements. Both LDD and LCD bearers can have a constant or variable bit rate. Finally, the UDD bearer is characterized by unconstrained delay requirements.</p> <p>The following mapping is performed:</p> <ul style="list-style-type: none"> • class A: LDD • class B: LDD-VBR • class C: LCD • class D: UDD

A1.2.20.1	<p>For delay constrained, connection oriented. (Class A)</p> <p>The following non-comprehensive list gives some example supported LDD services:</p> <ul style="list-style-type: none"> • 8 kbit/s; Delay 20 ms; BER < 10⁻³ • 144 kbit/s; Delay 50 ms; BER < 10⁻⁶ • 384 kbit/s; Delay 50 ms; BER < 10⁻⁶
A1.2.20.2	<p>For delay constrained, connection oriented, variable bit rate (Class B)</p> <p>The following non-comprehensive list gives some example supported LDD-VBR services:</p> <ul style="list-style-type: none"> • Peak data rate 64 kbit/s; Delay 50 ms; BER < 10⁻⁶; Granularity: 16 kbit/s • Peak data rate 144 kbit/s; Delay 50 ms; BER < 10⁻⁶; Granularity: 16 kbit/s • Peak data rate 384 kbit/s; Delay 50 ms; BER < 10⁻⁶; Granularity: 16 kbit/s • Peak data rate 2048 kbit/s; Delay 50 ms; BER < 10⁻⁴; Granularity: 32 kbit/s
A1.2.20.3	<p>For delay unconstrained, connection oriented. (Class C)</p> <p>The following non-comprehensive list gives some example supported LCD services:</p> <ul style="list-style-type: none"> • 64 kbit/s; Delay 300 ms; BER < 10⁻⁶ • 144 kbit/s; Delay 300 ms; BER < 10⁻⁶ • 384 kbit/s; Delay 300 ms; BER < 10⁻⁶ • 2048 kbit/s; Delay 300 ms; BER < 10⁻⁶
A1.2.20.4	<p>For delay unconstrained, connectionless. (Class D)</p> <p>The following non-comprehensive list gives some example supported UDD services:</p> <ul style="list-style-type: none"> • 64 kbit/s; Delay unconstrained; BER < 10⁻⁸ • 144 kbit/s; Delay unconstrained; BER < 10⁻⁸ • 384 kbit/s; Delay unconstrained; BER < 10⁻⁸ • 2048 kbit/s; Delay unconstrained; BER < 10⁻⁸
A1.2.21	<p>Simultaneous voice/data services: Is the proposal capable of providing multiple user services simultaneously with appropriate channel capacity assignment</p> <p>Note : The followings describe the different techniques that are inherent or improve to a great extent the technology described above to be presented:</p> <p>Description for both BS and MS are required in attributes from A2..22 through A1.2.23.2.</p> <p>The proposal is capable of providing multiple services simultaneously with appropriate channel capacity assignment. For more details refer to radio resource allocation, radio resource management, MAC etc in part 1 of the evaluation report.</p>
A1.2.22	<p>Power control characteristics: Is power control scheme included in the proposal? Characterize the impact (e.g. improvements) of supported power control schemes on system performance.</p> <p>Power control is applied for the uplink and the downlink. A slow power control scheme can be used, similar to the GSM power control scheme, taking into account link quality and radio signal strength. However, a faster power control maybe used to improve system performance especially in indoor environments. The applied power control scheme reduces the intercell interference and hence increases spectral efficiency or capacity. However, the power control also reduces the impact of intracell interference which suppression by joint detection (JD).</p>
A1.2.22.1	<p>What is the power control step size in dB?</p> <p>The nominal power control step size granularity is 2dB. By means of protocol commands multiples of the power control granularity step size can be generated.</p>

A1.2.22.2	<p>What are the number of power control cycles per second?</p> <p>Depending on the required service and the deployed environment the number of power control cycles per seconds may vary between 2 and 200.</p>
A1.2.22.3	<p>What is the power control dynamic range in dB?</p> <p>The power control dynamic range is 80 dB for mobiles and 30 dB for base stations.</p>
A1.2.22.4	<p>What is the minimum transmit power level with power control?</p> <p>The minimum transmit power level is dependent upon the actual mobile class considered. For a 1Watt mobile the minimum transmit power level is -40dBm.</p>
A1.2.22.5	<p>What is the residual power variation after power control when SRTT is operating? Please provide details about the circumstances (e.g. in terms of system characteristics, environment, deployment, MS-speed, etc.) under which this residual power variation appears and which impact it has on the system performance.</p> <p>The residual power variation is less than 0.3dB rms during a burst.</p>
A1.2.23	<p>Diversity combining in mobile station and base station: Are diversity combining schemes incorporated in the design of the SRTT?</p> <p>Yes, see details below.</p>
A1.2.23.1	<p>Describe the diversity techniques applied in the mobile station and at the base station, including micro diversity and macro diversity, characterizing the type of diversity used, for example:</p> <ul style="list-style-type: none"> - time diversity : repetition, RAKE-receiver, etc., - space diversity : multiple sectors, multiple satellite, etc., - frequency diversity : FH, wide-band transmission, etc., - code diversity : multiple PN codes, multiple FH code, etc., - other scheme. <p>Characterize the diversity combining algorithm, for example, switch diversity, maximal ratio combining, equal gain combining. Additionally, provide supporting values for the number of receivers (or demodulators) per cell per mobile user. State the dB of performance improvement introduced by the use of diversity.</p> <p>For the mobile station: what is the minimum number of RF receivers (or demodulators) per mobile unit and what is the minimum number of antennas per mobile unit required for the purpose of diversity reception?</p> <p>These numbers should be consistent to that assumed in the link budget template in Annex 2 and that assumed in the calculation of the “capacity” defined at A1.3.1.5.</p> <p>MS and BS:</p> <ul style="list-style-type: none"> • Frequency diversity due to CDMA-spreading, and frequency hopping (based on time slots or TDMA frames, option). • Time diversity due to interleaving and FEC coding. • Interferer diversity due to CDMA-spreading, frequency hopping (option) and time slot hopping (using slots with different numbers in consecutive TDMA frames, option). <p>Additional diversity in BS:</p> <ul style="list-style-type: none"> • Antenna diversity using maximal ratio pre-detection combining. • Space diversity using sectorized antennas (option). <p>MS: The number of receivers (or demodulators) is 1. The number of used antennas is 1.</p> <p>BS: In case of 8 CDMA codes assigned to 8 different mobile stations the number of receivers (or demodulators) per cell and per mobile is 1/8. Hence, only 1 receiver is required for 8 mobiles.</p>

A1.2.23.2	<p>What is the degree of improvement expected in dB? Please also indicate the assumed condition such as BER and FER.</p> <p>The gains achievable by the different types of diversity depend on the characteristics of the mobile radio channel, the interference situation, and the combination of types of diversity used in the system. The dependence on the combination means that, e.g. when introducing an additional type of diversity in a system which provides only small diversity, the gain achievable by this additional type of diversity is larger as compared with the case of introducing the same additional type of diversity in a system which already provides large diversity. Hence, diversity gain due to single features cannot be added to get overall diversity gain.</p> <p>For further details confer to the simulation results (link and system level) and the paper Klein, A.; Steiner, B.; Steil, A.: Known and novel diversity approaches as a powerful means to enhance the performance of cellular mobile radio systems. IEEE Journal on Selected Areas in Communications, Vol. 14, No. 10, pp. 1784-1795, December 1996.</p>
A1.2.24	<p>Handover/Automatic Radio Link Transfer (ALT) : Do the radio transmission technologies support handover?</p> <p>Characterize the type of handover strategy (or strategies) which may be supported, e.g. mobile station assisted handover. Give explanations on potential advantages, e.g. possible choice of handover algorithms. Provide evidence whenever possible.</p> <p>WB-TDMA/CDMA supports HO as required in SMG2 ETR (04-01). Discrimination is made between HO for real time (RT) and non-real time (NRT) services.</p> <p>For RT, the basic HO scheme is similar to GSM i.e., the basic scheme is a mobile assisted, network evaluated and decided hard handover using backward signalling. Further, appropriate measures are provided to accelerate the HO procedure, e.g. in case of a corner effect</p> <p>For NRT, the basic HO scheme is similar to GPRS for GSM i.e., the basic scheme is a mobile evaluated and decided (with background network control) hard handover using forward signalling (cell reselection).</p> <p>Detailed description refer to part 1 of the evaluation report.</p> <p>Potential advantages:</p> <ul style="list-style-type: none"> • Seamless HO for RT, lossless HO for NRT bearer services • High grade of compatibility to GSM to support efficient HO between WB-TDMA/CDMA and GSM • Agreed bearer service is maintained during HO as far as possible; if the target cell cannot maintain the service (capacity/service offer reasons) bearer re-negotiation is performed to prevent a drop of the bearer service • HO applicable for different cell size (pico,micro,macro) and hierarchical cell structures • network evaluated handover allows high flexibility of the used HO algorithms, e.g. operator specific solutions are possible • 'Emergency HO' scheme to mitigate the corner effect <p>HO scheme also applicable for simple MS</p>

A1.2.24.1	<p>What is the break duration (sec) when a handover is executed? In this evaluation, a detailed description of the impact of the handover on the service performance should also be given. Explain how the estimate derived.</p> <p>For WB-TDMA/CDMA break duration is the time interval between release of the traffic and signalling channels of the old cell and the successful establishment of these in the new target cell.</p> <p>This time is mainly dependent on the access procedure to the target cell. Since by default the 'pseudo-synchronous' handover is performed i.e., the MS performs HO access onto the traffic channels in the new cell with known timing advance the break duration is much shorter in comparison to GSM.</p> <p>Impact of HO on service performance:</p> <ul style="list-style-type: none"> • RT Speech: since the break duration is shorter than GSM, seamless HO is achieved • other RT services: highly dependent on source coding; no general statement possible <p>NRT services: ARQ mechanism ensures lossless HO</p>
A1.2.24.2	<p>For the proposed SRTT, can handover cope with rapid decrease in signal strength (e.g. street corner effect)?</p> <p>Give a detailed description of</p> <ul style="list-style-type: none"> - the way the handover detected, initiated and executed, - how long each of this action lasts (minimum/maximum time in msec), - the timeout periods for these actions. <p>The 'Emergency HO' scheme is dedicated to mitigate the corner effect for RT bearer services</p> <p>1.) Detection and initiation of 'Emergency HO condition':</p> <ul style="list-style-type: none"> • measurement pre-processing comprises trend analysis (MS and BS) • Shorter HO window size in combination with higher thresholds • After detection of 'Emergency HO condition' immediate event notification in the network <p>2.) Decision:</p> <ul style="list-style-type: none"> • accelerated HO decision: HO candidate cell set is reduced to 'Emergency HO cell' subset; this subset is predefined and known both in the network and in the MS (via broadcast information). In HCS this subset may comprise cell(s) of a super-ordinate layer <p>3.) Execution:</p> <ul style="list-style-type: none"> • default HO execution procedure: HO command send to MS by the old cell using backward signalling; MS performs 'pseudo-synchronous' handover to 'Emergency HO cell' <p>if backward signalling is no longer possible (connection loss to old BS) or if the HO command is lost (detected by timeout), the MS performs forward HO to 'Emergency HO cell'</p>

A1.2.25	<p>Characterize how does the proposed SRTT react to the system deployment in terms of the evolution of coverage and capacity (e.g. necessity to add new cells and/or new carriers):</p> <ul style="list-style-type: none">- in terms of frequency planning- in terms of the evolution of adaptive antenna technology using mobile identity codes (e.g. sufficient number of channel sounding codes in a TDMA type of system)- other relevant aspects <p>By using adaptive antennas, the coverage and capacity of WB-TDMA/CDMA can be improved significantly, cf. A1.3.6. These coverage improvements can be used to increase the cell size (range extension). Capacity improvements can be achieved by reducing the cluster size, i.e., the number of cells per cluster, or by using 16 QAM instead of the QPSK data modulation.</p> <p>The cluster size may be reduced until all available frequencies are used in every cell (cluster size one). Alternatively or to increase the number of available resources even further, each cell may be sectorized, e.g., into three sectors. Furthermore, each sector may be covered by an adaptive antenna array. Different frequency groups or (alternatively) the same frequency groups may be used in different sectors of a cell. If the same frequencies are used in every sector (which provides the highest capacity), different (spreading) code families must be employed in each sector to separate the co-channel users. In this case, up to $3 \times K = 24$ co-channel users can be served in every cell, assuming that the cells are sectorized into three sectors.</p> <p>For further information refer to A1.4.15.</p>
---------	-------------------------------------------------------------------------------------------------------------------------------------------------------------------------------------------------------------------------------------------------------------------------------------------------------------------------------------------------------------------------------------------------------------------------------------------------------------------------------------------------------------------------------------------------------------------------------------------------------------------------------------------------------------------------------------------------------------------------------------------------------------------------------------------------------------------------------------------------------------------------------------------------------------------------------------------------------------------------------------------------------------------------------------------------------------------------------------------------------------------------------------------------------------------------------------------------------------------------------------------------------------------------------------------------------------------------------------------------------------------------------------------------------------------------------------------------------------------------------------------------------------------------------------------------------------------------------------------------------------------------------------------------------------------------------------------------------------------------------

A1.2.26	<p>Sharing frequency band capabilities: To what degree is the proposal able to deal with spectrum sharing among UMTS systems as well as with all other systems:</p> <ul style="list-style-type: none"> - spectrum sharing between operators - spectrum sharing between terrestrial and satellite UMTS systems - spectrum sharing between UMTS and non-UMTS systems - spectrum sharing between private and public UMTS operators - other sharing schemes. <p>- The proposal is designed that within the total spectrum several operators can operate their system in an uncoordinated manner. This assumes that each of these operators have a dedicated band of operation including guard bands between operators. Due to the fact that possible sharing scenarios are not yet specified it is not easy to say how far the operators require a guard band between their systems. The definition of the RF parameters requires the set up of system scenarios to analyze the impact of MS to MS, BS to MS and MS to BS interference in different environments. By means of these scenarios, the RF limits can be defined to ensure proper operation.</p> <p>- The proposal is able to co-exist with the satellite UMTS system, as far a certain guard band is kept between the carriers. The UMTS satellite systems can utilize both, a TDMA and a CDMA structure. Depending on this, the spectrum roll off is defined. Due to the fact, that the current UMTS satellite specification allows an operation of a carrier on the band edge (!), the UMTS satellite carrier pollutes into the UMTS band. This can require to keep several carriers on the band edge free. This is dependent on the local spectrum allocation and the used satellite transmission technique.</p> <p>The WB-TDMA/CDMA proposal will typically require one carrier guard band, to protect a UMTS satellite system. But this has to be cross-checked with transmission parameters of the adjacent system. It has to be noted that the co-existence of UMTS and Satellite UMTS has to be treated like an in-band interference situation, due to the fact that the spectrum allocation does not provide any guard space.</p> <ul style="list-style-type: none"> - spectrum sharing between UMTS and non-UMTS systems <p>Here we have to distinguish between the case that the non UMTS system is allocated out of the UMTS band, and secondly inside the UMTS band.</p> <p>Systems outside the UMTS band are protected by the fact, that min. guard bands can be expected between the systems. Further more both systems have to fulfill out of band spectrum requirements which are usually in line with CEPT requirements to ensure the uncoordinated operation of systems within one area. If there are insufficient guard bands allocated, system scenarios have to be used to define other measures, like the reduction of power for corner carriers. This is very much depending on the transmission technique used by the non UMTS system. The system scenarios have to be used to identify interference sources and victims. If this is analyzed special measures can be defined.</p> <p>Non UMTS systems which are operated inside the UMTS band will require a certain guard band to the UMTS systems. To evaluate these guard bands, again system scenarios have to be made. This is very much depending on the transmission technique used by the non UMTS system. The system scenarios have to be used to identify interference sources and victims. If this is analyzed special measures can be defined.</p> <ul style="list-style-type: none"> - spectrum sharing between private and public operators <p>Private operators can be wireless PBXs running in a companies plant, and cordless type devices in residential applications. If for the private use a part of the spectrum is reserved, like the spectrum portion of a public operator, the coexistence is the same like between two public operators. I.e. the private equipment can be designed with the same RF parameters as for the public use. If the private equipment is used in the same spectrum portion of a public operator, both the public and the private systems will suffer by interference. This effect can be limited by modifying e.g. the RF parameters of the private systems by reducing TX powers to the minimum required level to maintain the link quality of the private system. Such measures will reduce the interference between private and public operation. However it will remain a capacity and performance quality degradation for both operator types. For an optimized use of the spectrum, we recommend to keep a separate spectrum for this applications.</p>
---------	--------------------------------------------------------------------------------------------------------------------------------------------------------------------------------------------------------------------------------------------------------------------------------------------------------------------------------------------------------------------------------------------------------------------------------------------------------------------------------------------------------------------------------------------------------------------------------------------------------------------------------------------------------------------------------------------------------------------------------------------------------------------------------------------------------------------------------------------------------------------------------------------------------------------------------------------------------------------------------------------------------------------------------------------------------------------------------------------------------------------------------------------------------------------------------------------------------------------------------------------------------------------------------------------------------------------------------------------------------------------------------------------------------------------------------------------------------------------------------------------------------------------------------------------------------------------------------------------------------------------------------------------------------------------------------------------------------------------------------------------------------------------------------------------------------------------------------------------------------------------------------------------------------------------------------------------------------------------------------------------------------------------------------------------------------------------------------------------------------------------------------------------------------------------------------------------------------------------------------------------------------------------------------------------------------------------------------------------------------------------------------------------------------------------------------------------------------------------------------------------------------------------------------------------------------------------------------------------------------------------------------------------------------------------------------------------------------------------------------------------------------------------------------------------------------------------------------------------------------------------------------------------------------------------------------------------------------------------------------------------------------------------------------------------------------------------------------------------------------------------------------------------------------------------------------------------------------------------------------------------------------------------------------------------------------------------------------------------------------------------------------------------------------------------------------------------------------------------------------------------------------------------------------------------------------------------------------------------------------------------------------------------------------------------------------------------------------------------------------------------------------------------------------------------------------------------------------------------------------------------------------------------------------------------------------------------------------------------------------------------------------------------------------------------------------------------------------------------------------------------------------------------------------------------------------------------------------------------------------------------------------------------------------------------------------------------------------------------------------------------------------------------------------------------------------------------------------------------------------------------------------------------------------------------------------------------------------------------------------------------------------------------------------------------------------------------------------------------------------------------------------------------------------------------------------------------------------------

A1.2.27	<p>Dynamic channel allocation: Characterize the DCA schemes which may be supported and characterize their impact on system performance (e.g. in terms of adaptability to varying interference conditions, adaptability to varying traffic conditions, capability to avoid frequency planning, impact on the reuse distance, etc.)</p> <p>WB-TDMA/CDMA facilitates the application of a variety of dynamic channel allocation (DCA) strategies, where the allocation of channels depends on the current traffic load and/or the current interference conditions. All bearer capabilities for UMTS outlined in ETR 04-01 are supported for the listed propagation environments (pico-, micro-, and macro-cells). To achieve maximum flexibility, the DCA algorithms treat uplink and downlink independently from each other. Of course, the MS capabilities have to be taken into account.</p> <p>In general, two types of DCA can be distinguished. Allocation of carrier frequencies to cells is often referred to as <i>slow DCA</i>, whereas the allocation of a channel to a certain call is called <i>fast DCA</i>. In WB-TDMA/CDMA, a channel is characterized by its frequency, time slot, and spreading code as explained in the chapter on the physical channel structure. If frequency hopping is used, the carrier frequencies can be considered as equal from an interference point of view. The interference on different slots in the time frame, however, may still be different. Therefore, a DCA algorithm that allocates the least interfered slots to ongoing calls results in a considerable gain in quality and/or capacity. If synchronized base stations are used, advanced combinations of fast and slow DCA can be implemented.</p>
A1.2.28	<p>Mixed cell architecture: How well do the technologies accommodate mixed cell architectures (pico, micro and macro cells)? Does the proposal provide pico, micro and macro cell user service in a single licensed spectrum assignment, with handoff as required between them? (terrestrial component only)</p> <p>Note: Cell definitions are as follows:</p> <p style="padding-left: 40px;">pico - cell hex radius $(r) < 100$ m micro - $100 \text{ m} < (r) < 1000$ m macro - $(r) > 1000$ m</p> <p>The proposal fully supports the hierarchical cell structure with at least 3 layers. Due to the moderate bandwidth of the carrier the separation between the different layers can be easily realized on the basis of frequency sharing between layers. That means that the available frequency band has to be grouped in sub-bands of several carriers allocated each to a layer. However the borders of the sub-bands will be kept flexible and the bandwidth allocation will be managed by the slow dynamic channel allocation in order to adapt the capacity of each layer to the slow trend of the traffic in the covered area and meet the loss of trunking efficiency resulting of a fixed allocation.</p> <p>In the case a limited number of cells covering a defined area is kept synchronous a layer separation on a time slot basis is also possible in this area. However this option still requires more investigations and is for further study.</p> <p>A requirement of HCS is to modify the usual handover algorithms due to signal strength and quality by introducing new parameters in order to ensure a re-partition of the mobiles in the best appropriate layer from a system point of view, even if another cell in another layer is offering equal or even better radio propagation conditions. Also the controlled transition from a layer to another lower or higher hierarchical layer has to be ensured. For this aim the handover algorithms take into account the following criteria:</p> <ul style="list-style-type: none"> • the speed of the mobile: fast moving mobiles are served in the micro or macro-cell layer. • the required service: very high bit rate services are expected to be served by the pico cell layer. • the priority and the type of each cell: As far as possible the mobile is kept in the lowest layer and handover is performed between cells belonging to the same hierarchical layer. However the assigned cell priority level offers the operator the means for a fine tuning of the traffic distribution in the network. The case of very fast signal degradation is coped by the emergency handover scheme.

A1.2.29	<p>Describe any battery saver / intermittent reception capability</p> <ul style="list-style-type: none"> • power control • discontinuous transmission (DTX) for voice and packet transmission for data • discontinuous reception
A1.2.29.1	<p>Ability of the mobile station to conserve standby battery power: Please provide details about how the proposal conserve standby battery power.</p> <ul style="list-style-type: none"> • Transmitter: During stand-by the transmitter part of the MS can be switched off completely. This is due to the TD principle, which does not require uplink power control for an MS during standby periods. • Receiver: For approx. 93 % of the time the receive part of the portable can be shut down. Only control channels are active in downlink direction. Within these control channels information to the MS is transmitted at certain pre-defined points in time only (similar to GSM). The receive part of a MS needs to be active for approx. 7% of the time for paging and cell broadcast messages as well as cell monitoring.
A1.2.31	<p>Does the SRTT support a Bandwidth on Demand (BOD) capability? Bandwidth on Demand refers specifically to the ability of an end-user to request multi-bearer services. Typically this is given as the capacity in the form of bits per second of throughput. Multi bearer services can be implemented by using such technologies as multi-carrier, multi-time slot or multi-codes. If so, characterize these capabilities.</p> <p>Note: BOD does not refer to the self-adaptive feature of the radio channel to cope with changes in the transmission quality (see A1.2.5.1).</p> <p>BOD (variable data rate) capability is fully supported due to the flexible radio interface with data rates from 8 kbps until 2 Mbps with small granularity. This is achieved by multi-code option (assigning more than one CDMA code to a single user), multi-slot option (assigning more than one time slot in a TDMA frame to a single user), and the order of modulation (QPSK, 16QAM).</p>
A1.2.32	<p>Does the SRTT support channel aggregation capability to achieve higher user bit rates?</p> <p>Yes, see A1.2.31, multi-code, multi-slot and order of modulation.</p>
A1.3	Expected Performances
A1.3.1	for terrestrial test environment only
A1.3.1.1	<p>What is the achievable BER floor level (for voice)?</p> <p>Note: BER floor level under BER measuring condition defined in Annex 2 using the data rates indicated in section 1 of Annex 2.</p> <p>BER floor is $< 10^{-6}$.</p>
A1.3.1.2	<p>What is the achievable BER floor level (for data)?</p> <p>Note: BER floor level under BER measuring condition defined in Annex 2 using the data rates indicated in section 1 of Annex 2.</p> <p>BER floor is $< 10^{-6}$.</p>

A1.3.1.3	<p>What is the maximum tolerable delay spread (in nsec) to maintain the voice and data service quality requirements?</p> <p>Note: The BER is an error floor level measured with the Doppler shift given in the BER measuring conditions of ANNEX</p> <p>Up to an excess delay of about 53 500 ns</p> <p>This is valid in case of the uplink if all bursts within a time slot are allocated to one and the same user or it is valid for the downlink in general.</p> <p>However, for excess delays of 53 500 ns some symbols of the data symbol field following the midamble might have to be punctured in order to increase the guard interval. For more details refer to part 1 of the evaluation report.</p>
A1.3.1.4	<p>What is the maximum tolerable doppler shift (in Hz) to maintain the voice and data service quality requirements?</p> <p>Note: The BER is an error floor level measured with the delay spread given in the BER measuring conditions of ANNEX 2.</p> <p>Refer to link level simulation results in part 3 of the evaluation report.</p>
A1.3.1.5	<p>Capacity: The capacity of the radio transmission technology has to be evaluated assuming the deployment models described in ANNEX 2 and technical parameters from A1.2.22 through A1.2.23.2.</p>
A1.3.1.5.1	<p>What is the voice traffic capacity per cell (not per sector): Provide the total traffic that can be supported by a single cell in Erlangs/MHz/cell in a total available assigned non-contiguous bandwidth of 30 MHz (15 MHz forward/15 MHz reverse) for FDD mode or contiguous bandwidth of 30 MHz for TDD mode. Provide capacities considering the model for the test environment in ANNEX 2. The procedure to obtain this value is described in ANNEX 2. The capacity supported by not a standalone cell but a single cell within contiguous service area should be obtained here.</p> <p>Refer to part 4 of the evaluation report.</p>
A1.3.1.5.2	<p>What is the information capacity per cell (not per sector): Provide the total number of user-channel information bits which can be supported by a single cell in Mbps/MHz/cell in a total available assigned non-contiguous bandwidth of 30 MHz (15 MHz forward / 15 MHz reverse) for FDD mode or contiguous bandwidth of 30 MHz for TDD mode. Provide capacities considering the model for the test environment in ANNEX 2. The procedure to obtain this value is described in ANNEX 2. The capacity supported by not a standalone cell but a single cell within contiguous service area should be obtained here.</p> <p>Refer to part 4 of the evaluation report.</p>
A1.3.1.6	<p>Does the SRTT support sectorization? If yes, provide for each sectorization scheme and the total number of user-channel information bits which can be supported by a single site in Mbps/MHz (and the number of sectors) in a total available assigned non-contiguous bandwidth of 30 MHz (15 MHz forward/15 MHz reverse) in FDD mode or contiguous bandwidth of 30 MHz in TDD mode.</p> <p>Sectorization is supported. For more details refer to part 4 of the evaluation report.</p>
A1.3.1.7	<p>Coverage efficiency : The coverage efficiency of the radio transmission technology has to be evaluated assuming the deployment models described in ANNEX 2.</p>
A1.3.1.7.1	<p>What is the base site coverage efficiency in Km^2/site for the lowest traffic loading in the voice only deployment model? Lowest traffic loading means the lowest penetration case described in ANNEX 2.</p> <p>The base station density represents a figure to get the minimum required number of base stations for an area. I.e. the minimum number of base stations is derived by the noise limitation of the cell, and not by interference or capacity. E.g. assume a range for a 8kbps voice service of 4.4 km (which is quite close to the values presented in the link budget calculations). To calculate the area of one sector the formula given in section 1.6.1 of 0402 is used. It is assumed that one BTS site has 3 sectors. The corresponding base station density is 0.0265 base stations per square km for this service.</p>

A1.3.1.7.2	<p>What is the base site coverage efficiency in Km^2/site for the lowest traffic loading in the data only deployment model? Lowest traffic loading means the lowest penetration case described in ANNEX 2.</p> <p>Further input required, see also A1.3.1.7.1.</p>
A1.3.3	<p>Maximum user bit rate (for data): Specify the maximum user bit rate (kbps) available in the deployment models described in ANNEX 2.</p> <p>Indoor office: 2048 kbps</p> <p>Outdoor to indoor and pedestrian: 2048 kbps</p> <p>Vehicular: 1048 kbps</p>
A1.3.4	<p>What is the maximum range in meters between a user terminal and a base station (prior to hand-off, relay, etc.) under nominal traffic loading and link impairments as defined in Annex 2?</p> <p>Refer to section 2.4.</p>
A1.3.5	<p>Describe the capability for the use of repeaters</p> <p>The proposal supports the use of repeaters. Repeaters are units receiving signals on UMTS carriers and transmitting the same information content on the same frequency with increased power. This does the repeater for up and downlink. The repeater does not take any action on signaling etc., and needs therefore only a main power connection and the antennas. Repeaters can be used in rural areas for enhancing cells with low traffic density. Or repeaters can be used in urban areas to improve the indoor coverage on certain areas. The transmission via the repeater has to fulfill a certain linearity in case of band repetition due to multi carrier transmission. Usually there is a radio channel between MS and BTS. In the repeater this results in a chain of radio channel, repeater, and radio channel. The total delay time of the repeater shall be fix, it was to be checked case by case, that the enhanced cell range, together with the repeater delay does not exceed the max. guard period time of the RACH.</p> <p>The use of repeaters for this proposal requires the same level of planning activities like for repeaters in second generation TDMA systems. Repeaters are seen as an appropriate measure to enhance cell ranges in low traffic areas.</p>

A1.3.6	<p>Antenna Systems: Fully describe the antenna systems that can be used and/or have to be used; characterize their impacts on systems performance, (terrestrial only) e.g.:</p> <ul style="list-style-type: none"> - Does the SRTT have the capability for the use of remote antennas: Describe whether and how remote antenna systems can be used to extend coverage to low traffic density areas. - Does the SRTT have the capability for the use of distributed antennas: Describe whether and how distributed antenna designs are used, and in which UMTS test environments. - Does the SRTT have the capability for the use of smart antennas (e.g. switched beam, adaptive, etc.): Describe how smart antennas can be used and what is their impact on system performance. - Other antenna systems. <p>WB-TDMA/CDMA does not require the use of smart antennas. But the resulting signal-to-interference-plus-noise-ratio (SINR) can be improved significantly by incorporating various smart antenna concepts at the base station on the uplink as well as the downlink. These SINR gains may be exploited</p> <ul style="list-style-type: none"> • to increase the capacity (mainly in urban areas), e.g., by reducing the cluster size, i.e., the number of cells per cluster, or by using 16 QAM instead of the QPSK data modulation, • to increase the coverage (mainly in rural areas), e.g., by increasing the cell size (range extension), • to increase the quality, • to decrease the delay spread, • to reduce the transmission powers, <p>or a combination thereof. In Section 2.3 three different smart antenna concepts, namely</p> <ul style="list-style-type: none"> • diversity antennas, • sector antennas, • and adaptive antenna arrays, <p>and show how these smart antenna concepts can be incorporated into the joint detection (JD) processes used in WB-TDMA/CDMA. With 8 antenna elements, improvements of the spectral efficiency by a factor of three to more than five have been achieved for WB-TDMA/CDMA, depending on the chosen channel model and the employed smart antenna concept.</p> <p>As opposed to GSM, the gains in capacity and range achieved by using smart antennas can be realized for all traffic channels, since the control channels that have to be broadcasted in an omnidirectional fashion are transmitted on a separate GSM-like 200 kHz carrier. To decrease the required cluster size of this broadcast control channel, unnecessary information is removed and the coding is increased with respect to GSM.</p> <p>For further details on smart antennas see section 2.3.</p>
--------	-------------------------------------------------------------------------------------------------------------------------------------------------------------------------------------------------------------------------------------------------------------------------------------------------------------------------------------------------------------------------------------------------------------------------------------------------------------------------------------------------------------------------------------------------------------------------------------------------------------------------------------------------------------------------------------------------------------------------------------------------------------------------------------------------------------------------------------------------------------------------------------------------------------------------------------------------------------------------------------------------------------------------------------------------------------------------------------------------------------------------------------------------------------------------------------------------------------------------------------------------------------------------------------------------------------------------------------------------------------------------------------------------------------------------------------------------------------------------------------------------------------------------------------------------------------------------------------------------------------------------------------------------------------------------------------------------------------------------------------------------------------------------------------------------------------------------------------------------------------------------------------------------------------------------------------------------------------------------------------------------------------------------------------------------------------------------------------------------------------------------------------------------------------------------------------------------------------------------------------------------------------------------------------------------------------------------------------------------------------------------------------------------------------------------------------------------------------------------------------------------------------------------------------------------------------------------------------------------------------------------------------------------------------------------------------------------------------------------------------------------------------------------------------

A1.3.6 (continued)	<p>The proposal supports the use of remote antennas. The antenna can be remoted by an RF feeder, or by another media. The question is how far remotization can be used for range extensions. Therefore an extension on the RF feeder line is not appropriate, due to the high insertion losses of the cable. Remotization of the antennas requires, that together with the antenna a part of the RF front end is remoted. How the function split between the central unit and the RF-front end is made, depends on the applications and the restrictions dictated by the available land-line bandwidth.</p> <p>One option is to use macro diversity schemes, and to combine the receiver data in the central unit. To achieve the best gain by such a combining, it is necessary for the combining unit to receive as much as possible raw information of the receivers. The disadvantage is, that the required bandwidths to interconnect the remote units to the central units are large. However, this technique improves the area of reliable coverage, and the BTS density is allowed to be more sparse as in other cases.</p> <p>But macro diversity requires that the measure is used throughout a larger area to gain from. For a simple enlarging of a cell it is sufficient to remote one RF front end. This remotization requires only a lower bandwidth, because it is possible to remote more signal processing and sending only the net data via the land-line. The land-line media may be copper or fiber, depending on the bandwidth requirements and the availability. The interface between central and remote unit will be a proprietary one, to have the full flexibility to optimize in terms of applications and internal function splits.</p> <p>The remotized unit can be operated on an own frequency, or does the frequency share with a transceiver in the central unit. This sharing can be done by allocating dedicated time slots to one transceiver and other times lots to the other receiver. This will cause intracell handovers between the time slots, when a MS moves from one service area to the other.</p> <p>The other option is to transmit and receive simultaneously, but instead with macro diversity schemes, the central unit decides simply which one of the base band signals shall be used, e.g. on a frame by frame basis. This does not require any extra land-line bandwidth. The proposal shows excellent performance in handling long delay spreads. Therefore, the MS does treat the sum of both signals as a single signal with long excess delay. However, this is not critical due to the power distribution versus delay.</p> <p>Does the RTT have the capability for the use of distributed antennas: Describe whether and how distributed antennas are used, and in which UMTS test environments.</p> <p>The proposal supports the use of distributed antennas on the same degree as it is feasible to do it with second generation TDMA systems. This option is useful to improve the indoor coverage, or to ensure urban outdoor coverage, whilst operating with very low antenna heights. All receive and transmit signals are combined onto their feeder cables. Instead of connecting the feeder cables to a single antenna, a splitter is used to distribute onto different antennas. By using the RF layer as the transport mechanism on the cables, the insertion loss of coax feeder cable will limit the remotization ranges to only some hundred meters. The splitter devices have of course to fulfill some linearity requirements to avoid unwanted intermodulations</p>
A1.3.7	Delay (for voice)
A1.3.7.1	<p>What is the radio transmission processing delay due to the overall process of channel coding, bit interleaving, framing, etc., not including source coding? This is given as transmitter delay from the input of the channel coder to the antenna plus the receiver delay from the antenna to the output of the channel decoder. Provide this information for each service being provided. In addition, a detailed description of how this parameter was calculated is required for both the up-link and the down-link.</p> <p>The delay for voice service A (every second time slot) and voice service B (every time slot) is:</p> <p>Downlink: 19.1 ms consisting of channel coding 0.5 ms (implementation dependent) + margin 0.6 ms + interleaving 18 ms</p> <p>Uplink: 5 ms consisting of joint detection receiver 3 ms + channel decoding 1.0 ms + margin 1.0 ms. In the uplink case the delay due to interleaving is associated with the mobile station.</p> <p>The numbers refer to the delay to be expected in the BTS, based on interleaving over 4 blocks and state-of-the-art hardware implementation. The increased processing delays for uplink are due to the higher complexity of the joint detector and the channel decoder. In downlink there is no joint detection considered and there is only channel encoding.</p>

A1.3.9.3	<p>Interference immunity: Characterize system immunity or protection mechanisms against interference. What is the interference detection method? What is the interference avoidance method?</p> <p>Interference immunity: The system has different methods of interference detection and elimination. Intracell interference - as typical for all CDMA operation - is eliminated by Joint Detection (JD), a special kind of multi user detection. The strongest interferer of an adjacent cell can be included to JD as an option. Methods for the reduction of the impact of interference are intracell and intercell handover, as performed by interference detecting means like MAHO and additional soft decision criteria in MS and BS.</p>
A1.3.10	<p>Characterize the adaptability of the proposed SRTT to different and/or time varying conditions (e.g. propagation, traffic, etc.) that are not considered in the above attributes of the section A1.3.</p> <p>Time varying conditions are required due to traffic fluctuations. The sectorised arrangement of BTSs with frequency sharing 1/3 between the sectors allow to switch unequal channel distributions - up to all TDMA time slots - to each one of the sectors. By this DCA capability the capacity within one sector can be increased - depending on demand - by a factor of three (dynamic hot spots capability) without requiring additional BTS equipment.</p> <p>Furthermore, WB-TDMA/CDMA is able to utilize measures like directed retry and handover due to traffic load as it is used in GSM today. HCS is also a good measure to cope with traffic variations.</p>
A1.4	Technology Design Constraints
A1.4.1	Frequency stability: Provide transmission frequency stability (not oscillator stability) requirements of the carrier (include long term - 1 year - frequency stability requirements in ppm).
A1.4.1.1	<p>For Base station transmission (terrestrial component only)</p> <ul style="list-style-type: none"> - Long term stability: $\leq \pm 5 \cdot 10^{-8}$/ year - Temperature stability (-10 to + 70 °C): $\pm 2 \cdot 10^{-8}$ - Controlled short term stability: $\pm 1 \cdot 10^{-9}$ = steps of AFC to network reference. - Medium and long term stability: = stability of network reference by AFC.
A1.4.1.2	<p>For Mobile station transmission</p> <ul style="list-style-type: none"> - Long term stability: $\leq \pm 2.5 \cdot 10^{-6}$/ year - Temperature stability (-10 to + 70 °C): $\pm 2 \cdot 10^{-6}$ - Controlled short term stability: $\pm 1 \cdot 10^{-7}$ = step width of AFC to BTS reference. - Medium and long term stability: = stability of BTS reference by AFC.
A1.4.2	<p>Out of band and spurious emissions: Specify the expected levels of base or satellite and mobile transmitter emissions outside the operating channel, as a function of frequency offset.</p> <p>Out of band spurious emissions (30 MHz to 4 GHz; measurem.-Bw. according to GSM):</p> <ul style="list-style-type: none"> - $\Delta f \geq 2$ MHz to ≤ 30 MHz: = no more than -36 dBm; Bw 30 to 1000 kHz - $\Delta f \geq 30$ MHz to ≤ 1GHz: = no more than -36 dBm; Bw 3000kHz - $\Delta f \geq 1$ GHz to 12.75 GHz: = no more than -30 dBm

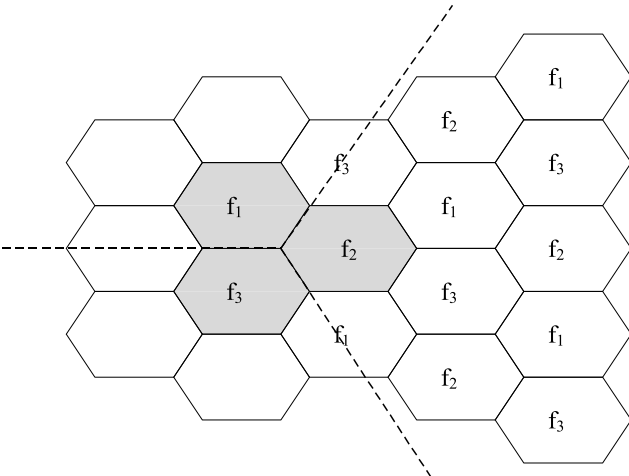
A1.4.3	<p>Synchronization requirements: Describe SRTT's timing requirements , e.g.</p> <ul style="list-style-type: none"> - Is base station-to-base station or satellite LES-to-LES synchronization required? Provide precise information, the type of synchronization, i.e., synchronization of carrier frequency, bit clock, spreading code or frame, and their accuracy. - Is base station-to-network synchronization required? (terrestrial only) - State short-term frequency and timing accuracy of base station (or LES) transmit signal. - State source of external system reference and the accuracy required, if used at base station (or LES)(for example: derived from wire-line network, or GPS receiver). - State free run accuracy of mobile station frequency and timing reference clock. - State base-to-base bit time alignment requirement over a 24 hour period, in microseconds. - For private systems: can multiple unsynchronized systems coexist in the same environment? - Base station to base station synchronization is not required. The system is designed for asynchronous operation. - If of advantage or required, synchronized operation is possible, either with system internal means (like the German C-450 network) or via GPS. Accuracy $\approx 1\mu\text{s}$. - BTS synchronization to the network is useful like in GSM (for stability refer to A.1.4.1) - Source stability of external reference frequency = $\pm 2 \cdot 10^{-8}$ - Free run accuracy of mobile station and derived timing reference clock = $\pm 2.5 \cdot 10^{-6}$ - Base to base bit time alignment over 24 hour = 200 μs. - Multiple unsynchronized systems can coexist in the same radio environment.
A1.4.4	<p>Timing jitter : For base (or LES) and mobile station give:</p> <ul style="list-style-type: none"> - the maximum jitter on the transmit signal, - the maximum jitter tolerated on the received signal. <p>Timing jitter is defined as RMS value of the time variance normalized by symbol duration.</p> <ul style="list-style-type: none"> - The maximum jitter on the transmit signal is 5 % rms. - The maximum jitter on the receive signal is 20 % rms.
A1.4.5	<p>Frequency synthesizer: What is the required step size, switched speed and frequency range of the frequency synthesizer of mobile stations?</p> <ul style="list-style-type: none"> - Required step size is any integer fraction of 0.8 MHz (0.2 MHz = GSM is admissible). - Switching time for 5 degree phase error = 500 μs (for simple speech terminals). - Frequency range ≈ 2 GHz, switching bandwidth to be defined by spectrum assignment.
A1.4.6.1	<p>Describe the special requirements on the fixed networks for the handover procedure. Provide handover procedure to be employed in proposed SRTT in detail.</p> <p>Because no soft handover is required, no special requirements on the fixed network arise. In principle improved GSM procedures are used.</p>

A1.4.8	<p>Characterize any radio resource control capabilities that exist for the provision of roaming between a private (e.g., closed user group) and a public UMTS operating environment.</p> <p>The specific requirements for private systems as well as residential applications are very efficiently fulfilled by the WB-TDMA/CDMA proposal. Private systems include the whole range of applications from large multicell wireless PBXs to small single cell cordless telephones connected to the analogue or the ISDN PSTNs.</p> <p>The fundamental requirement is coexistence of independent systems without any need for co-ordination, planning or common control</p> <p>Coexistence in the same environment means that uncoordinated systems located in the same geographical area have to share the same frequency band. Successful coexistence means that the individual systems can efficiently cope with cross-interference between the independent running systems.</p> <p>The basic conditions to meet this target are:</p> <ul style="list-style-type: none"> • A resource division structure that requires no co-ordination or synchronization of the different systems and limits the cross-interference generated by one system to only very few other systems. • A Dynamic Channel Allocation (DCA) procedure including fast seamless handover between different channels that guarantees fast resource allocation, efficient use of the available spectrum (no need to split into up- and downlink parts) and a stable operation of the systems. • A simple and fast method to detect the less interfered available portion of capacity. • An early collision detection that allows the initiation of a handover well before the whole data stream becomes corrupted. <p>The WB-TDMA/CDMA proposal fulfills all the above requirements. By the proposed TD-structure in combination with the moderate bandwidth of 1.6 MHz a 20 MHz wide frequency band for example will be divided into 80 to 96 separated blocks (depending on the required guard bands to adjacent services). Every block is defined by its time interval and its carrier frequency. Every block has a limited capacity of about 125/250 kbps. Assuming a well-designed DCA and an increasing demand on traffic or data rate for UMTS applications, this capacity in most cases will be allocated to one small system. The only interference from other systems will be from systems using adjacent frequency bands or adjacent time slots.</p> <p>The problem of sliding collisions due to unsynchronized systems can be solved by proper implementations allowing to detect increasing data corruption at the beginning or the end of every burst.</p> <p>Escaping from an interferer by seamless handing over to less interfered channels, requires the detection of suitable resources and the set-up of a second link in parallel to the running connection. In WB-TDMA/CDMA this can be done for low and medium data rates without the need for a second transmitter hardware.</p>
A1.4.9	<p>Describe the estimated fixed signaling overhead (e.g., broadcast control channel, power control messaging). Express this information as a percentage of the spectrum which is used for fixed signaling. Provide detailed explanation on your calculations.</p> <p>This is mainly dependent on layer 2 and 3 algorithms. Further details will be elaborated between milestone M2 and M3.</p>
A1.4.10	<p>Characterize the linear and broadband transmitter requirements for base and mobile station. (terrestrial only)</p> <p>Compared to current existing 2nd generation systems (e.g. GSM) different modulation schemes and the multi code option are used in this proposal. Furthermore, on an RF frequency more than one subscriber will be transmitted. This will lead to higher linearity requirements due to additional amplitude modulation. However, in case of the base station these requirements can be fulfilled with existing of the shelf equipment.</p>

A1.4.11	<p>Are linear receivers required? Characterize the linearity requirements for the receivers for base and mobile station. (terrestrial only)</p> <p>The linearity requirements of the BS/MS receiver are heavily dependent on the system scenarios, which have to be set up. However, it is expected that these requirements will be only slightly higher compared to GSM today.</p>																						
A1.4.12	<p>Specify the required dynamic range of receiver. (terrestrial only)</p> <p>- Dynamic range of the receiver with AGC = 80 dB</p>																						
A1.4.13	<p>What are the signal processing estimates for both the handportable and the base station?</p> <ul style="list-style-type: none"> - MOPS (Mega Operation Per Second) value of parts processed by DSP - gate counts excluding DSP - ROM size requirements for DSP and gate counts in kByte - RAM size requirements for DSP and gate counts in kByte <p>The major issue of signal processing is the number of required real multiplications per second for joint (data) detection and channel estimation. The signal processing expense differs for the spread burst 1, spread burst 2, and for the total number of active CDMA codes within a time slot and a frequency band.</p> <p>In the following the number of real multiplications per second for joint detection and channel estimation are given for different numbers of active CDMA codes. The signal processing for one of the 8 time slots is considered. The signal processing expense for joint detection is independent whether QPSK or 16QAM modulation is used. For joint detection the Zero Forcing Block Linear Equalizer (ZF-BLE) has been considered, see A1.2.14. Channel estimation is considered as described in [3,8].</p> <p>Spread burst 1:</p> <p style="padding-left: 40px;">joint detection:</p> <table style="margin-left: 80px; border: none;"> <tr> <td style="padding-right: 20px;">1 CDMA code active:</td> <td style="text-align: right;">$3.4 \cdot 10^6$ real mult./second</td> </tr> <tr> <td colspan="2" style="padding-left: 40px;">data rate: 16kbps (QPSK) or 32kbps (16QAM)</td> </tr> <tr> <td>4 CDMA codes active:</td> <td style="text-align: right;">$21.15 \cdot 10^6$ real mult./second</td> </tr> <tr> <td colspan="2" style="padding-left: 40px;">data rate: 64kbps (QPSK) or 128kbps (16QAM)</td> </tr> <tr> <td>8 CDMA codes active:</td> <td style="text-align: right;">$60.6 \cdot 10^6$ real mult./second</td> </tr> <tr> <td colspan="2" style="padding-left: 40px;">data rate: 128kbps (QPSK) or 256kbps (16QAM)</td> </tr> <tr> <td>channel estimation (8 channels of up to 15μs):</td> <td style="text-align: right;">$12.8 \cdot 10^6$ real mult./second</td> </tr> </table> <p>spread burst 2 :</p> <p>(data rates as for spread burst 1)</p> <p style="padding-left: 40px;">joint detection:</p> <table style="margin-left: 80px; border: none;"> <tr> <td style="padding-right: 20px;">1 CDMA code active:</td> <td style="text-align: right;">$2.7 \cdot 10^6$ real mult./second</td> </tr> <tr> <td>4 CDMA codes active:</td> <td style="text-align: right;">$15.6 \cdot 10^6$ real mult./second</td> </tr> <tr> <td>8 CDMA codes active:</td> <td style="text-align: right;">$43.0 \cdot 10^6$ real mult./second</td> </tr> <tr> <td>channel estimation (8 channels of up to 5.5μs):</td> <td style="text-align: right;">$3.3 \cdot 10^6$ real mult./second</td> </tr> </table> <p>RAM and ROM size requirements for implementation are quite relaxed since the matrices considered for channel estimation and joint detection are extremely sparse. Joint detection and channel estimation do not necessarily have to be implemented with a DSP. A optimized implementation might use dedicated hardware of certain parts of the algorithms.</p>	1 CDMA code active:	$3.4 \cdot 10^6$ real mult./second	data rate: 16kbps (QPSK) or 32kbps (16QAM)		4 CDMA codes active:	$21.15 \cdot 10^6$ real mult./second	data rate: 64kbps (QPSK) or 128kbps (16QAM)		8 CDMA codes active:	$60.6 \cdot 10^6$ real mult./second	data rate: 128kbps (QPSK) or 256kbps (16QAM)		channel estimation (8 channels of up to 15 μ s):	$12.8 \cdot 10^6$ real mult./second	1 CDMA code active:	$2.7 \cdot 10^6$ real mult./second	4 CDMA codes active:	$15.6 \cdot 10^6$ real mult./second	8 CDMA codes active:	$43.0 \cdot 10^6$ real mult./second	channel estimation (8 channels of up to 5.5 μ s):	$3.3 \cdot 10^6$ real mult./second
1 CDMA code active:	$3.4 \cdot 10^6$ real mult./second																						
data rate: 16kbps (QPSK) or 32kbps (16QAM)																							
4 CDMA codes active:	$21.15 \cdot 10^6$ real mult./second																						
data rate: 64kbps (QPSK) or 128kbps (16QAM)																							
8 CDMA codes active:	$60.6 \cdot 10^6$ real mult./second																						
data rate: 128kbps (QPSK) or 256kbps (16QAM)																							
channel estimation (8 channels of up to 15 μ s):	$12.8 \cdot 10^6$ real mult./second																						
1 CDMA code active:	$2.7 \cdot 10^6$ real mult./second																						
4 CDMA codes active:	$15.6 \cdot 10^6$ real mult./second																						
8 CDMA codes active:	$43.0 \cdot 10^6$ real mult./second																						
channel estimation (8 channels of up to 5.5 μ s):	$3.3 \cdot 10^6$ real mult./second																						

A1.4.15	<p>Characterize the frequency planning requirements:</p> <ul style="list-style-type: none"> - Frequency reuse pattern: given the required C/I and the proposed technologies, specify the frequency cell reuse pattern (e.g. 3-cell, 7-cell, etc.) and, for terrestrial systems, the sectorization schemes assumed; - Characterize the frequency management between different cell layers; - Does the SRTT use interleaved frequency allocation? - Are there any frequency channels with particular planning requirements? - Can the SRTT support self planning techniques? - All other relevant requirements <p>Note: Interleaved frequency allocation is to allocate the 2nd adjacent channel instead of adjacent channel at neighboring cluster cell.</p> <p>a.) Frequency re-use pattern and sectorization scheme:</p> <p>As can be seen from the detailed results of the link level simulations the required C/I to operate the system is significantly lower than for GSM (even if one takes into account that there up to 8 times as much interferers per time slot as for GSM); e.g. for speech the required C/I was found to be about -5 dB for the uplink and -3.0 ... -2.0 dB for the downlink for all environments. Hence, a smaller cluster size as for GSM is expected. The exact figures for the cluster size obviously depend upon the required grade of service. However, simulation results show that an omni cell cluster 3 is appropriate to operate the system, at least under fractional loading conditions. By using a sectorized clover leaf network of cluster 1/3 the threefold capacity per site can be achieved at nearly the same grade of service.</p> <p>b.) Frequency management between different layers:</p> <p>For isolated hot spot micro cells and indoor pico cells it is expected to re-use frequencies from the macro layer. In this case the frequency planning tool has to take into account interference between different cell layers. For contiguous micro cell coverage within a hierarchical cell structure separate frequencies should be assigned to different layers.</p> <p>By using channel segregation, a dynamic separation between frequencies of different layers may be achieved.</p> <p>c.) Interleaved frequency allocation:</p> <p>Due to interference averaging, low values for the required C/I and an adjacent channel suppression of 15 dBc, it is possible to use adjacent frequencies in adjacent cells, hence no interleaved frequency allocation is used. However, adjacent frequencies within one cell should be avoided.</p> <p>d.) Are there any frequency channel with special planning requirements?</p> <p>No.</p> <p>e.) Can the SRTT support self planning techniques?</p> <p>Based on link quality measurements, priority levels can be assigned to each RF carrier in each cell. By this method a self planning by channel segregation is possible which also may be used for separating the frequency resources between different cell layers. Additional measurements by the MS - as discussed for future GSM phases - can be foreseen from the beginning for FMA 1 with spreading to support these self planning techniques.</p> <p>f.) All other relevant requirements?</p> <p>None.</p>
---------	--------------------------------------------------------------------------------------------------------------------------------------------------------------------------------------------------------------------------------------------------------------------------------------------------------------------------------------------------------------------------------------------------------------------------------------------------------------------------------------------------------------------------------------------------------------------------------------------------------------------------------------------------------------------------------------------------------------------------------------------------------------------------------------------------------------------------------------------------------------------------------------------------------------------------------------------------------------------------------------------------------------------------------------------------------------------------------------------------------------------------------------------------------------------------------------------------------------------------------------------------------------------------------------------------------------------------------------------------------------------------------------------------------------------------------------------------------------------------------------------------------------------------------------------------------------------------------------------------------------------------------------------------------------------------------------------------------------------------------------------------------------------------------------------------------------------------------------------------------------------------------------------------------------------------------------------------------------------------------------------------------------------------------------------------------------------------------------------------------------------------------------------------------------------------------------------------------------------------------------------------------------------------------------------------------------------------------------------------------------------------------------------------------------------------------------------------------------------------------------------------------------------------------------------------------------------------------------------------------------------------------------------------------------------------------------------------------------------------------------------------------------------------------------------------------------------------------------------------------------------------------------------------------------------------------------------------------------------------------------------------------------------------------------------------------------------------------------------------------------------------------------------------------------------------------------------------------------------------------------------------------------------------------------------------------------------------------------------------

A1.4.16	<p>Describe the capability of the proposed SRTT to facilitate the evolution of existing radio transmission technologies used in mobile telecommunication systems migrate toward this SRTT. Provide detail any impact and constraint on evolution.</p> <p>One of the basic intentions, which resulted in the WB-TDMA/CDMA proposal, is to facilitate the evolution from GSM900/1800 towards UMTS due to</p> <ul style="list-style-type: none"> • same timing • carrier spacing is multiple of 200kHz • same clock rate as in GSM terminals • therefore, easy support of dual mode terminals • easy support of handover between UMTS and GSM • no softhandover required <p>For further details see section 2.2.</p>
A1.4.16.1	<p>Does the SRTT support backwards compatibility into GSM/DCS in terms of easy dual mode terminal implementation, spectrum co-existence and handover between UMTS and GSM/DCS?</p> <ul style="list-style-type: none"> • Dual mode terminal: 2 duplexers and 2 RF filters are needed. All the other HW units are used for both UMTS or GSM mode. • Spectrum co-existence: GSM900/1800 and WB-TDMA/CDMA links can be active in adjacent frequency channels without a deterioration of the bit error rate, of course with respect to a certain guard band. • Handover: Efficient handover between GSM900/1800 and WB-TDMA/CDMA and vice versa for real time services during a call is possible due to the same timing. For non real time bearer services which can be established in both systems the handover will be lossless.
A1.4.17	<p>Are there any special requirements for base site implementation? Are there any features which simplify implementation of base sites? (terrestrial only)</p> <p>There are no special requirements for base site implementation, as in GSM.</p> <p>Simplificating features are: Due to the high TRX efficiency of 64 channels per receiver and large scale integration techniques high capacity BTS are very small and sheltered. Therefore, no solid buildings are required. BTS may be installed directly to masts, taking advantage of shortest connection to antennas and dropping costs for BTS site implementations.</p>
A1.5	<p>Information required for terrestrial link budget template: Proponents should fulfill the link budget template given in Table 1.3 of Annex 2 and answer the following questions.</p> <p>Link budget templates are given in section 2.4 of this part 5 of the evaluation report.</p>
A1.5.1	<p>What is the base station noise figure (dB)?</p> <p>The BS noise figure is strongly dependent on the BS design. However, noise figures in the range from 4 to 6 dB are realistic for this proposal. However, this information is independent from the air interface proposal.</p>
A1.5.2	<p>What is the mobile station noise figure (dB)?</p> <p>The MS noise figure is strongly dependent on the MS design. However noise figures in the range from 4 to 6 dB are realistic for this proposal. However, this information is independent from the air interface proposal.</p>

<p>A1.5.3</p>	<p>What is the base station antenna gain (dBi)?</p> <p>The BS antenna gain is dependent on the environment where the BS operates, thus outdoor environments allow for higher antenna gain than indoor environments. Suitable antenna gains for the different environments are:</p> <ul style="list-style-type: none"> • Outdoor: 10-18 dBi • Outdoor to Indoor: 8-12 dBi • Indoor: 2-6 dBi <p>However, this information is independent from the air interface proposal.</p>
<p>A1.5.4</p>	<p>What is the mobile station antenna gain (dBi)?</p> <p>The MS antenna gain is limited by the requirement to have a low cost, small sized handheld. Thus the antenna gain for low data rate mobile is expected to be 0 dBi. High data rate mobiles, maybe connected to a notebook, may allow for mobile antenna gain of 3 dBi.</p>
<p>A1.5.5</p>	<p>What is the cable, connector and combiner losses (dB)?</p> <p>For the mobile the cable, connector and combiner losses can be neglected, thus they can be set to zero.</p> <p>For the base station the cable, connector and combiner losses will be smaller compared to a GSM system due to the use of broadband carrier. The broadband carrier results in a large number of basic traffic channels and thereby in a high traffic value. Therefore, there is a much lower need for combining of several carriers as compared to GSM. Thus only a small number of carrier will be combined to one antenna reducing the overall losses to around 2 to 4 dB. However, this information is independent from the air interface proposal.</p>
<p>A1.5.5</p>	<p>What are the number of traffic channels per RF carrier?</p> <p>The total number of traffic channels per RF carrier is 64 (each having a data rate of 16kbps for QPSK and 32kbps for 16QAM), whereas the carrier can be separated into 8 time slots in the TDMA domain and into 8 codes in the CDMA domain.</p>
<p>A1.5.6</p>	<p>What is the SRTT operating point (BER/FER) for the required E_b/N_0 in the link budget template?</p> <p>Refer to section 2.4 of this part 5 of the evaluation report.</p>
<p>A1.5.7</p>	<p>What is the ratio of intra-sector interference to sum of intra-sector interference and inter-sector interference within a cell (dB)?</p> <p>In case of sectorized cells, each sector will use different frequencies (see figure below), thus the inter-sector interference will be zero if only one cell is considered. Intra-sector interference is equal to zero in case of perfect channel estimation due to the joint detection process, that can't be achieved in reality, thus leading to small resulting interference after joint detection within one sector. Regarding one cell the above required ratio becomes 1.</p> <div style="text-align: center;">  <p><i>Three sector cell (grey hatched) with hexagon sectors</i></p> </div>

A1.5.8	<p>What is the ratio of in-cell interference to total interference (dB)?</p> <p>The in-cell interference is completely suppressed in the joint detection process, thus the ratio of in-cell to total interference is theoretically in linear units equal to zero.</p>
A1.5.9	<p>What is the occupied bandwidth (99%) (Hz)?</p> <p>The 99% bandwidth of a 1.6 MHz RF carrier is $2 \text{ MHz} = 2 \cdot 10^6 \text{ Hz}$.</p>
A1.5.10	<p>What is the information rate (dBHz)?</p> <p>The information rate for one traffic channel per user including overhead (midamble, guard time), which is equivalent to allocate one code and one time slot of a carrier, is equal to 270.8 kbps equal to 54.32 dBHz for QPSK and 541.6 kbps equal to 57.32 dBHz for 16QAM.</p>

2 Detailed Explanation of Template

In this chapter detailed explanations are given for issues raised and adequately answered in the template.

2.1 *Rapid changing delay spread - A1.2.14.2*

2.1.1 Varying tap coefficients vs. varying delay spread profile:

High vehicle speeds lead to high Doppler shifts. This is described by the fading of the individual model tap coefficients whose individual delays are fixed in case of a channel (real or simulation model) with many taps. The equalizer also uses an internal channel model. In case of many equally spaced taps in the internal equalizer channel model only the tap coefficients vary but the profile of the internal channel model of the equalizer remains constant, i.e. average tap amplitude and delay with respect to the channel model remain constant. In this case of many equidistant taps the time-variant channel coefficients can be tracked by adaptation algorithms like e.g. LMS or RLS during the bursts starting from the midamble.

2.1.2 Classification of speeds and required action:

The speed / Doppler shift can be classified into the following ranges:

Low: The channel coefficients do not vary considerably during a number of bursts or during the occurrence of several training sequences. In this case the channel estimation from the midamble can be averaged over several bursts for noise reduction. In case of frequency hopping only bursts with the same frequency are considered so that the speed for which this condition is met is much lower than for the case without frequency hopping - especially in case of random frequency hopping.

Medium: The channel coefficients do not vary considerably during one burst or from one training sequence to the next. In this case channel estimation from the midamble once per burst is sufficient to ensure proper detection.

High: The channel coefficients vary considerably during one burst or between one training sequence and the next. In this case adaptation algorithms are required in order to track the time-variant channel coefficients during the burst so as to ensure proper detection.

It is well-known from adaptation theory that adaptation causes noise amplification which worsens with faster adaptation. Just like slowing down the adaptation from once per burst by averaging over a number of bursts reduces the noise before detection, speeding up the adaptation increases the noise before detection. For the adaptation, algorithm noise also includes interference. For the same detection error rate the tolerable input noise (including interference) therefore increases for slower and decreases for faster adaptation. In order to

minimize this effect, additional noise generated internally by poor channel modeling and estimation errors caused by detection errors must be kept low. The following error propagation must be avoided: Detection errors cause wrong adaptation which in turn increases detection errors and so on so that the rest of the half-burst is lost.

The maximum permissible speed is chosen in the adaptation algorithms by a respective choice of the adaptation step size irrespective of the actual speed. This also selects the level of noise amplification and thus the level of reduction in S/N and C/I performance, i.e. of sensitivity and capacity. For GSM and a Viterbi equalizer the performance was observed to decrease only slightly with increased permissible speed up to a certain value, then moderately and finally extremely before instability occurred. The highest adaptation step size with only slight increase can be used as a standard value: Up to this permissible speed performance reduction becomes negligible. For higher speeds detection is still feasible although the required speeding up of the adaptation degrades performance in terms of sensitivity and capacity. The actual values depend on the equalizer type, equalizer implementation and the adaptation profile, however.

2.1.3 Adaptation Procedure

Even without adaptation of the channel coefficients simulations have shown successful reception up to 500 km/h without noise. Obviously, a considerably reduced S/N or C/I performance results from the high speed. With any type of adaptation of channel coefficients during the burst noise enhancement by the adaptation introduces a worsening of C/I or S/N performance with faster adaptation.

For adaptation the half-bursts can be partitioned into small blocks during which the channel coefficients do not vary considerably. The detection uses the channel coefficients estimated during the previous block. The received signal is given by the convolution of codes, individual channels and data signals, followed by a summation over all users and addition of noise. Collecting the codes, the channels and the summation over all users in the overall channel matrix A , as well as all data signals in the data symbol vector d the received signal vector e is given by:

$$e = Ad + n$$

Detection according to e.g. the zero-forcing criterion can now be performed according to

$$\hat{d} = A^+ e$$

where $^+$ denotes the Moore-Penrose pseudo inverse (pinv in Matlab). Another expression for the received signal vector e is found by collecting the codes, the data symbols and the summation over all users in the spread signal matrix G , as well as all channel coefficients in the channel coefficient vector h :

$$e = Gh + n$$

After detection of a block the data symbols are known and the spread signal matrix G can be constructed. Then the channel can be estimated e.g. according to the zero-forcing criterion:

$$\hat{h} = G^+ e$$

This channel estimation is now used for the detection of the next block.

There is always a delay of one block between channel estimation and channel modeling during detection. This adversely affects the stability in case of very fast adaptation required for very high speeds. In order to minimize the delay the blocks need not succeed one another but can be interleaved: For example, the first block is assumed to extend from symbol # 1 to 10, the second block from symbol # 2 to 11, the third from symbol # 3 to 12 and so on. Thus a new estimation for each symbol period is available. In the example symbol 10 now belongs to 10 blocks: from block #1, where it is the last symbol, to block #10, where it is the first

symbol. Thus at the expense of drastically increased complexity 10 separate estimates are available that can be averaged to partially smooth out the noise introduced by the small block length.

In case of interleaving, the timing advance from one block to the next by a number of symbols can also be described by deleting some vector elements at the top of the received signal vector and the symbol vector so that some rows at the top and some columns on the left of the combined channel matrix A are deleted and some rows at the bottom and some columns on the right are added. The fact that most of the combined channel matrix A remains unchanged could be exploited for a reduced-complexity calculation of the pseudo-inverse for the zero forcing criterion or other solutions according to other criteria. Obviously, the details depend on the detector type / optimization criterion like ZF, MMSE, with or without feedback and, furthermore, on the mathematical details of how the specific solution is calculated.

Problems arise for very short blocks in consequence of very high speeds: The channel estimation is not based on specifically optimized midamble codes but on random data symbols so that a much more noisy estimation must be expected. Therefore it is desirable to have a heavily over-determined equation system for channel estimation and thus rather long blocks - in contradiction to the postulation of channels not to vary considerably during blocks.

2.2 Migration - A1.4.16

As GSM will be the major 2nd generation digital technology world-wide at the time of UMTS deployment, the WB-TDMA/CDMA proposal is based on the intention to provide a step by step evolution from GSM towards UMTS.

- The 1st step shall be that UMTS infrastructure equipment is only available in hot-spots whereas the GSM equipment provides the general coverage.
- The 2nd step shall be that the UMTS coverage is improving continuously. GSM base station sites shall be reused for UMTS base stations. UMTS shall be either deployed in the allocated UMTS frequency bands or in reused GSM frequency bands.
- The long term vision (step 3) shall be that the UMTS coverage is better than the GSM coverage and will still improve till general coverage is reached.

As the time schedule of these steps is not known yet, the WB-TDMA/CDMA concept offers optimized solutions for all 3 steps. The following subsections focus on single aspects of the migration strategy.

2.2.1 Dual mode terminal implementation

Two dual mode terminal implementations are possible:

- 1st option: 2 separated units for GSM and UMTS mode are joined together within 1 MS. This enables the subscriber to use the MS within GSM and UMTS mode simultaneously for e.g. different bearers.
- 2nd option: GSM and UMTS mode share the use of the same HW units whenever possible. Thus the MS can only be either in GSM or in UMTS mode. The subscriber can either use GSM or UMTS bearers dependent on the MS mode. When the MS is in GSM mode, the MS can monitor GSM and UMTS frequencies to assist the handover with measurements. When the MS is in UMTS mode, the MS can monitor GSM and UMTS frequencies.

The 2nd option will probably be less expensive than the 1st option. WB-TDMA/CDMA requires for the 2nd option implementation only an additional GSM duplexer and an

additional GSM RX filter on top of the implementation of a single WB-TDMA/CDMA mode terminal. For bit rates within the WB-TDMA/CDMA mode of 144 kbps or higher a second receiver is necessary as well.

2.2.2 Spectrum co-existence

As UMTS provides much higher bit rates than GSM, it is expected that current GSM900/1800 operators might want to deploy UMTS technology to their existing frequency bands. In this case the services for UMTS and GSM might be offered from the same base station site.

Within this scenario, WB-TDMA/CDMA carriers can even be optionally adjacent to GSM900/1800 carriers. In this case the carrier spacing df between WB-TDMA/CDMA and GSM900/1800 links is 1.2 MHz so that the bit error rate does not become worse in any channel (please refer to Figure 2-1).

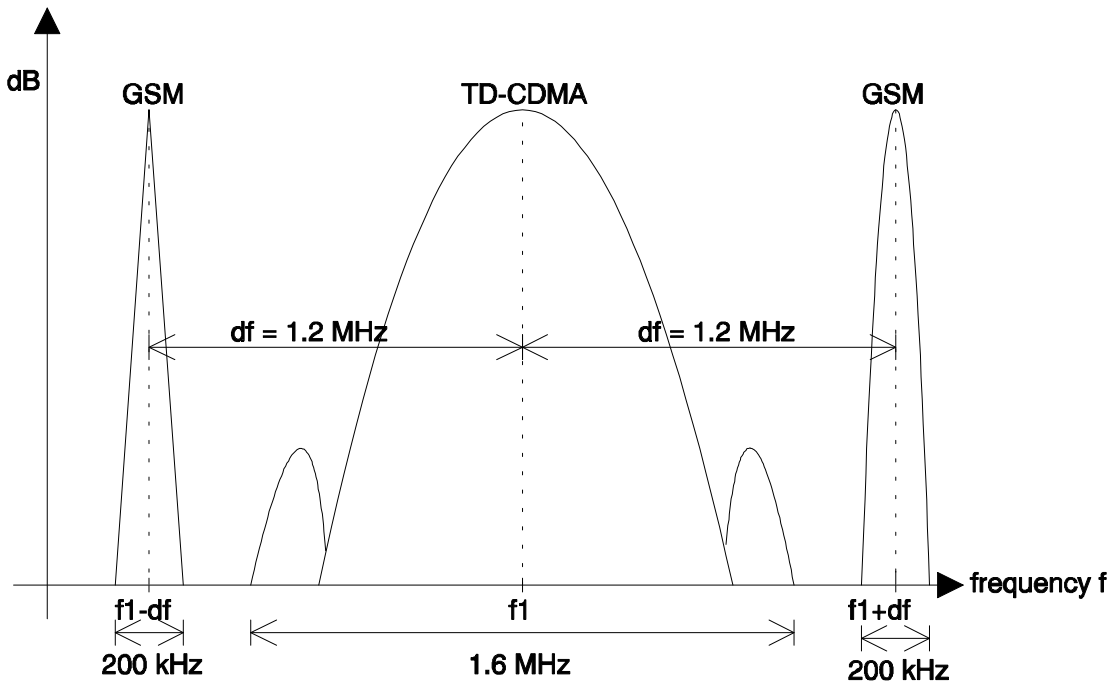


Figure 2-1 WB-TDMA/CDMA and GSM900/1800 carriers use adjacent channels

2.2.3 Handover between UMTS and GSM900/1800

The following item makes handover between UMTS and GSM and vice versa-feasible. For real time bearer services this handover will be efficient; for non real time bearer services which can be established in both systems this handover will be lossless.

- WB-TDMA/CDMA provides a multiframe structure which is compatible to GSM. This makes a synchronization of a MS to both systems feasible.
- The broadcast control channel (BCCH) and the random access channel (RACH) concept for WB-TDMA/CDMA uses a narrowband GSM-like 200 kHz channel -> backwards compatibility is achieved.
- WB-TDMA/CDMA suggests as basic handover scheme to use mobile assisted and network evaluated handover similar to GSM.

- The signaling scheme within the UMTS network concerning handover is compliant to GSM.

2.2.4 Other evolution aspects

- WB-TDMA/CDMA allows the same frequency planning as GSM (except due to smaller cell sizes when used in a higher frequency band). Hierarchical cell layers are feasible. Thus, GSM base station sites can be reused for WB-TDMA/CDMA base stations.
- The code planning within WB-TDMA/CDMA is not critical as there are plenty sets of codes available to be distributed among the adjacent cells.
- As WB-TDMA/CDMA follows the same principles as GSM in many terms, the training of people, reuse of already existing capabilities, etc. is easy.

2.3 Smart antennas - A1.3.6

WB-TDMA/CDMA does not require the use of smart antennas. But the resulting signal-to-interference-plus-noise-ratio (SINR) can be improved significantly by incorporating various smart antenna concepts on the uplink as well as the downlink. These SINR gains may be exploited

- to increase the capacity (mainly in urban areas),
e.g., by reducing the cluster size, i.e., the number of cells per cluster, or by using 16 QAM instead of the QPSK data modulation,
- to increase the coverage (mainly in rural areas),
e.g., by increasing the cell size (range extension) or by improving the edge coverage,
- to increase the link quality,
- to decrease the delay spread,
- to reduce the transmission powers,

or a combination thereof. In the sequel, we present three different smart antenna concepts, namely

- diversity antennas,
- sector antennas,
- and adaptive antenna arrays,

and show how these smart antenna concepts can be incorporated into the joint detection (JD) processes used in WB-TDMA/CDMA.

2.3.1 Diversity antennas

The first approach is the well-known space diversity concept using omnidirectional antennas with rather large distances between each other. The antennas are positioned at locations separated by several (e.g., 10) wavelengths l . Assume that K mobile users (their channels are separated by channel specific spreading codes) are simultaneously active on the same frequency and in the same time slot. On the uplink, a channel estimator estimates the channel impulse responses corresponding to the K connections between a particular diversity antenna and the mobile users according to the maximum likelihood channel estimation algorithm described in [8]. Based on the estimated channel impulse responses and the knowledge of the channel specific spreading codes, joint detection (JD) is performed using the JD algorithms

presented in [9]. On the downlink, the same signals are transmitted by all diversity antennas at the BS, and the receivers at the MS can remain unchanged. Moreover, diversity antennas may also be installed at the MS. Then the channel estimation and JD algorithms are executed as described before. Note that the use of diversity antennas at the MS may also be combined with the use of sector antennas or adaptive antenna arrays at the BS. This holds especially for MS for higher rate services e.g. lap tops.

Diversity antennas cause the radio channels between the BS and the corresponding mobiles to experience more or less independent fading processes. Due to this space diversity, the effective fading depths after combining are reduced. However, depending on the directional properties of the mobile radio channel, it is desirable to separate the antennas by rather large distances to guarantee independent fading processes. A similar effect may also be achieved by using polarization diversity. Notice that space diversity may also be combined with polarization diversity.

2.3.2 Sector antennas

In the second approach, the coverage area of a certain BS is served by a number of different fixed beams. These narrow beams with a predetermined direction can be implemented physically by a number of independent directive antennas (sector antennas) or virtually by adoption of an antenna array and an appropriate signal transform from element- to beamspace (e.g., by a Butler matrix). This signal transform corresponds to a fixed phase feed network (a beamformer) and provides several output ports corresponding to beams with fixed directions.

On the uplink, a channel estimator according to [8] is implemented for each sector antenna. This channel estimator determines the channel impulse responses for connections between the corresponding sector antenna and all users that are assigned to the considered BS. Based on the estimated channel impulse responses and the channel specific spreading sequences, the transmitted data symbols are estimated via JD as explained in [9]. On the downlink, each signal may be transmitted by only one sector antenna. For each mobile, the best sector antenna is determined from the corresponding channel impulse responses estimated on the uplink or another (uplink) performance criterion such as received-signal-strength or BER. This results in enhanced SINR values at the MS (mobile station) receiver. However, this assumes a mobile radio channel which is reciprocal in average.

The use of a set of non-adaptive directional antennas (sector antennas) results in a reduced time dispersion (reduced delay spread) of the observed transmission channels. Depending on the directions of arrival (DOAs) of the dominant wavefronts, a reduction of intercell and intracell interference can be achieved as well. Due to the fixed directivity of the sector antennas, no information about DOAs is necessary to implement the receiver. Nevertheless, if the number of sectors is sufficiently large, the directional inhomogeneity of the mobile radio channel can be exploited. Note that through the addition of a second set of sector antennas, the resulting system can also provide spatial or polarization diversity.

2.3.3 Adaptive antenna arrays

The most flexible and most powerful concept uses adaptive antenna arrays. If two-dimensional array geometries like uniform rectangular arrays are used, one antenna array can cover the whole cell [10]. If a one-dimensional array geometry like a uniform linear array is employed, the cells must be sectorized and a single ULA only covers a sector of approximately -60° to 60° in azimuth.

First the user specific channel impulse responses are estimated for each antenna element independently as illustrated in Figure 2-2. In the depicted example, an antenna array with $K_a = 4$ antenna elements is used. Based on the K_a user specific channel impulse response vectors, the dominant directions of arrival (DOAs) are estimated for each user separately, cf. Figure

2-2. By using high-resolution direction finding schemes, we can estimate up to $K_a - 1$ dominant DOAs per user [4].

Due to their simplicity and their high-resolution capability, ESPRIT-type algorithms are particularly attractive for this task. Here, the DOA estimates are obtained without nonlinear optimization and without the computation or search of any spectral measure [10]. Assume that all antenna elements have identical radiation characteristics (they might be omnidirectional or focused on a particular sector of interest). Furthermore, we use a centrosymmetric array configuration such that Unitary ESPRIT [10] can be used to estimate the dominant DOAs. Unitary ESPRIT retains the simplicity and the high-resolution capability of the original ESPRIT algorithm, but it is formulated in terms of real-valued computations throughout. This yields a substantial reduction of the computational complexity. Moreover, there is an efficient two-dimensional (2-D) extension for 2-D arrays with a dual invariance structure. This 2-D extension, known as 2-D Unitary ESPRIT, is a closed-form algorithm to provide automatically paired azimuth and elevation angle estimates [10].

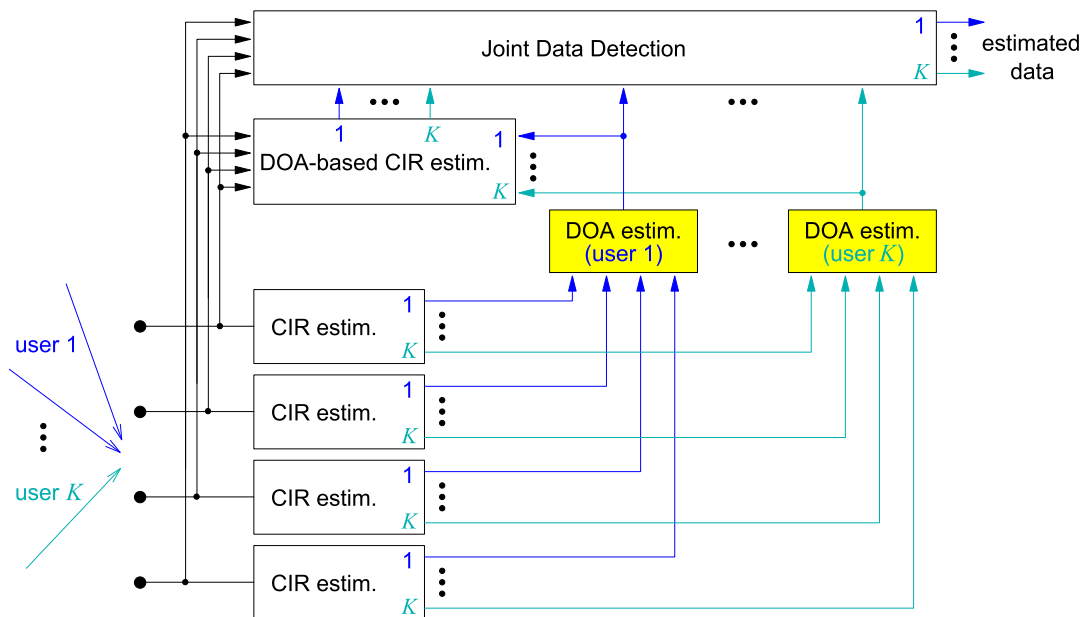


Figure 2-2 Joint detection receiver structure for K simultaneously active users using an adaptive antenna array and direction of arrival (DOA)-based channel impulse response (CIR) estimation. In the depicted example, an antenna array with $K_a = 4$ antenna elements is used.

Using the estimated DOAs, improved DOA-based channel impulse response (CIR) estimates can be obtained for all users, cf. Figure 2-2. Thereby, the number of estimated channel parameters is reduced. The maximum likelihood DOA-based channel estimator and a simplified sub-optimum DOA-based channel estimator are described in [4]. Based on the dominant DOAs of all K users and the corresponding DOA-based channel impulse response vectors, the transmitted data is estimated via joint detection as illustrated in Figure 2-2. Here, the conventional channel impulse response estimates are simply replaced by improved estimates that take into account the dominant DOAs and the corresponding DOA-based channel impulse response vectors.

This DOA-based JD technique can be interpreted as a beamforming block followed by a signal separation part as explained in [5]. The beamformers maximize the signal-to-

interference-plus-noise-ratio at their outputs. In a second step, the outputs of the beamformers corresponding to a particular user are combined according to the maximum ratio combining (MRC) strategy. In a final step, the outputs of the MRCs are fed into an interference cancellation unit, which removes inter symbol interference (ISI) as well as multiple access interference (MAI) originating from users assigned to the considered BS [5].

MAI originating from users in adjacent cells, i.e., inter-cell-interference, can also be taken into account in the joint detection process. To this end, the spatial correlation matrix of the inter-cell interference \mathbf{R}_d needs to be estimated. Then it can be used in the joint detection process to cancel inter-cell-interference as explained in [11] and [5]. The estimation of \mathbf{R}_d could, for instance, be achieved during the duration of the midamble after subtracting the contributions of the midambles of the K active users from the noise-corrupted array measurements.

Taking the estimated DOAs and the corresponding DOA-based channel impulse response (CIR) estimates into account, improves the performance of the (uplink) JD receiver considerably [4]. In FDD systems, the estimated DOAs can be exploited for efficient downlink beamforming [12]. In this FDD case, the antenna array has to be calibrated and its geometry must be known to enable the estimation of the dominant DOAs of all users. This assumes that the radio channel is reciprocal in average. Notice that these requirements do not exist in the TDD case. In a TDD mode, the weights from the uplink beamforming block can simply be used for downlink beamforming as well. However, this is only valid for low mobile speeds.

Notice that there are at most $K = 8$ co-channel users (separated by channel specific spreading codes) such that it is quite unlikely that two of them have the same dominant DOAs. Moreover, this undesirable situation can be avoided completely by employing intelligent channel assignment strategies that take the dominant DOAs into account. The fact that there are only a few co-channel users (separated by channel specific spreading codes) is a significant advantage of WB-TDMA/CDMA.

2.3.4 Impact on System Performance

With 8 antenna elements, improvements of the spectral efficiency by a factor of three to more than five have been achieved for WB-TDMA/CDMA, depending on the chosen channel model and the employed smart antenna concept.

2.4 Link budget calculations - A1.5

In the simulations, all intracell interferers are modelled completely with their whole transmission and reception chains. Intercell interference is modelled as white Gaussian noise.

Equation (1-1) is

$$\frac{C}{I} = \frac{E_b}{N_0} \cdot \frac{R_c \cdot \log_2 M}{B \cdot Q \cdot T_c}$$

with

C/I the carrier to interference ratio C/I ,

C	carrier power per CDMA code,
I	intercell interference power,
E_b	energy per bit,
N_0	one-sided spectral noise density,
R_c	the rate of the channel encoder (depends on the service),
M	the size of the data symbol alphabet (4 for QPSK, 16 for 16QAM),
B	the user bandwidth (1.6 MHz),
Q	the number of chips per symbol (16) and
T_c	the chip duration (0.4615 μ s).

The expression $\log_2 M$ is the number of bits per data symbol and $Q \cdot T_c / \log_2 M$ is the bit duration at the output of the encoder. One net information bit is transmitted in a duration of $Q \cdot T_c / (R_c \cdot \log_2 M)$. Therefore, the equation (1-1) of the evaluation report part 3 is equivalent to $C/I = (E_b/T_b)/(N_0 \cdot B)$, i.e., $C = E_b/T_b$ and $I = N_0 \cdot B$ with T_b the duration of a net information bit. The carrier to interference ratio per user is K_c times the carrier to interference ratio per CDMA code, with K_c denoting the number of CDMA codes per time slot per user.

Example: For speech the coding rate is $R_c = 0.28$ and equation (1-1) becomes:

$$\frac{C}{I} = \frac{E_b}{N_0} \cdot \frac{R_c \cdot \log_2 M}{B \cdot Q \cdot T_c} = \frac{E_b}{N_0} - 13.2 \text{ dB}$$

In the following the link budget templates are calculated according UMTS 30.03. In addition some general information is given to assist in understanding the particular figures used in the template.

The average transmitter power per traffic channel is pre-set by UMTS 30.03. To achieve various data rates one or up to 8 timeslots and/or one or up to 9 codes are assigned to one particular user. Thus if one user is allocated 8 timeslots, the maximum transmitter power is equal to the average transmitter power. On the other hand if one user is allocated one timeslot, the maximum transmitter power is 8 times the average transmitter power.

Several questions are raised on the E_b/N_0 and R_b assumptions, thus some exemplary calculations are performed for clarification:

Assuming QPSK (which is valid for nearly all test cases), the gross bit rate on the air is 270.8 kbps including midamble and guard period, 258.9 kbps including midamble and excluding the guard period and 235.7 kbps excluding midamble and guard period. Since no energy is needed to transmit the guard period, 258.9 kbps is used to determine the information bit rate in the template. All E_b/N_0 values derived by the link level simulations are associated with the energy per bit needed to achieve the corresponding BER/FER. Thus the midamble is excluded in the E_b/N_0 and therefore included in the information rate as explained above. The information bit rate is derived by multiplying 258.9 kbps with the total coding rate used by the service. That means the information rate becomes

- $258.9 \text{ kbps} \cdot 0.28 = 72.5 \text{ kbps}$ for speech, spread speech/data burst 2,
- $258.9 \text{ kbps} \cdot 0.34 = 88 \text{ kbps}$ for speech, spread speech/data burst 1,
- $258.9 \text{ kbps} \cdot 0.63 = 163.1 \text{ kbps}$ for LCD 144 a, spread speech/data burst 2,
- $258.9 \text{ kbps} \cdot 0.54 = 139,8 \text{ kbps}$ for LCD 144 b, spread speech/data burst 2,
- $258.9 \text{ kbps} \cdot 0.41 = 106.1 \text{ kbps}$ for LCD 144 c, spread speech/data burst 2,
- $258.9 \text{ kbps} \cdot 0.54 = 139.8 \text{ kbps}$ for LCD 384 a, spread speech/data burst 2,
- $258.9 \text{ kbps} \cdot 0.48 = 124,3 \text{ kbps}$ for LCD 384 b, spread speech/data burst 2.

In case of 2048 kbps services 16QAM is used, i.e. the gross bit rate on the air is 494.6 kbps (note that the midamble is of constant length for QPSK and 16QAM, thus the bit rate is not exactly doubled). The information rate becomes

- $494.6 \text{ kbps} \cdot 0.48 = 237.4 \text{ kbps}$ for LCD 2048, spread speech/data burst 2, 16 QAM.

As mentioned on the previous page, the E_b/N_0 figures are related to one code. This is referred to by multiplying the information rate with the number of codes used for the particular service.

Link budget templates are provided for:

Environment	Speech	LCD144 kbps	LCD 384 kbps	LCD 2048 kbps
Vehicular	X		a	
Outdoor to Indoor	X	a, b, c		X
Indoor	X		a, b	X

The log-normal fade margin and the handover gain in the subsequent templates are obtained by independent quasi-static simulations. Basis of the simulations is a hexagonal cell structure, where mobiles are randomly distributed over the cell area. Each mobile is subject of fading effects according to the log-normal conditions specified for each test environment (e.g. standard deviation of 10/12 dB for outdoor/indoor environments). Thus the log normal fade margin is determined regarding one single cell. In a multiple hexagonal cell layout one gains from the possibility of maintaining the connection due to several potential serving cells. According to the pre-set conditions for the Link Budget Template, the hand off gain is calculated assuming 50% shadowing correlation. The handover gain depends on the handover margin used in the simulations. To allow for easy comparison of the concept group results, the applied figures are:

Environment	log-normal fade margin	hard hand-off gain
Indoor Office	15,4	5,9
Outdoor to Indoor and Pedestrian	11,3	4,7
Vehicular	11,3	4,7

High range values are achieved in Vehicular environments without frequency hopping. Compared to the case with frequency hopping, in Outdoor to Indoor/Pedestrian and Indoor environments the range is reduced if no frequency hopping is applied. However these environments are expected to be interference limited, thus the range is no critical issue in pico and micro cells.

For the following reason no link budget templates are calculated for UDD services. The proposed Type II Hybrid ARQ scheme allows for retransmission in case of unsuccessful data detection. Therefore no fixed E_b/N_0 or C/I values required to achieve the QoS at the cell border can be defined. However the range of UDD services is larger than the range of the corresponding LCD service due to ARQ retransmissions.

Vehicular Environment:

Table 1: *Speech Service, without Frequency Hopping, MMSE equalizer, spread speech/data burst 2 for Downlink and spread speech/data burst 1 for Uplink*

	Item	Forward Link	Reverse Link	comment
Test Environment	Vehicular			
Test Service	Speech, 8 kbps, 20ms delay	burst2	burst1	
Multipath Channel	Vehicular A			
	average transmitter power per traffic channel [dBm]	30	24	
	max. transmitter power per traffic channel [dBm]	39,03	33,03	1 timeslot used
	max. total transmitter power [dBm]	48,06	33,03	
	cable, connector and combiner losses [dB]	2	0	
	transmitter antenna gain [dBi]	13	0	
	transmitter eirp per traffic channel [dBm]	50,03	33,03	
	total transmitter eirp [dBm]	59,06	33,03	
	receiver antenna gain [dBi]	0	13	
	cable and connector losses [dB]	0	2	
	receiver noise figure [dB]	5	5	
	thermal noise density [dBm/Hz]	-174	-174	
	receiver interference density [dBm/Hz]	-1000	-1000	low interference
	total effective noise plus interference density [dBm/Hz]	-169,00	-169,00	
	information rate Rb [kHz]	72,5	72,5	
	10log(Rb)	48,60	48,60	
	required Eb/(N0+I0) [dB]	7,9	4,2	
	receiver sensitivity [dBm]	-112,50	-116,20	
	hand off gain [dB]	4,7	4,7	
	explicit diversity gain [dB]	0	0	included in Eb/(N0+I0) figure
	other gain [dB]	0	0	
	log-normal fade margin [dB]	11,3	11,3	
	max. path loss [dB]	155,93	153,63	
	max. range [km]	5,497	4,774	

Table 2: LCD 384kbps a Service, without Frequency Hopping, MMSE equalizer, spread speech/data burst 2 for Downlink and Uplink

	Item	Forward Link	Reverse Link	comment
Test Environment	Vehicular			
Test Service	LCD 384 kbps, a			
Multipath Channel	Vehicular A			
	average transmitter power per traffic channel [dBm]	30	24	
	max. transmitter power per traffic channel [dBm]	30,00	24,00	8 timeslots used
	max. total transmitter power [dBm]	34,77	24,00	
	cable, connector and combiner losses [dB]	2	0	
	transmitter antenna gain [dBi]	13	0	
	transmitter eirp per traffic channel [dBm]	41,00	24,00	
	total transmitter eirp [dBm]	45,77	24,00	
	receiver antenna gain [dBi]	0	13	
	cable and connector losses [dB]	0	2	
	receiver noise figure [dB]	5	5	
	thermal noise density [dBm/Hz]	-174	-174	
	receiver interference density [dBm/Hz]	-1000	-1000	low interference
	total effective noise plus interference density [dBm/Hz]	-169,00	-169,00	
	information rate Rb [kHz]	419,4	419,4	3 codes used
	10log(Rb)	56,23	56,23	
	required Eb/(N0+I0) [dB]	8,8	3,2	
	receiver sensitivity [dBm]	-103,97	-109,57	
	hand off gain [dB]	4,7	4,7	
	explicit diversity gain [dB]	0	0	included in Eb/(N0+I0) figure
	other gain [dB]	0	0	
	log-normal fade margin [dB]	11,3	11,3	
	max. path loss [dB]	138,37	137,97	
	max. range [km]	1,876	1,831	

Table 3: LCD 384kbps b Service, without Frequency Hopping, MMSE equalizer, spread speech/data burst 2 for Downlink and Uplink

	Item	Forward Link	Reverse Link	comment
Test Environment	Vehicular			
Test Service	LCD 384 kbps, b			
Multipath Channel	Vehicular A			
	average transmitter power per traffic channel [dBm]	30	24	
	max. transmitter power per traffic channel [dBm]	34,26	28,26	3 timeslots used
	max. total transmitter power [dBm]	34,26	28,26	
	cable, connector and combiner losses [dB]	2	0	
	transmitter antenna gain [dBi]	13	0	
	transmitter eirp per traffic channel [dBm]	45,26	28,26	
	total transmitter eirp [dBm]	45,26	28,26	
	receiver antenna gain [dBi]	0	13	
	cable and connector losses [dB]	0	2	
	receiver noise figure [dB]	5	5	
	thermal noise density [dBm/Hz]	-174	-174	
	receiver interference density [dBm/Hz]	-1000	-1000	low interference
	total effective noise plus interference density [dBm/Hz]	-169,00	-169,00	
	information rate Rb [kHz]	1118,7	1118,7	9 codes used
	10log(Rb)	60,49	60,49	
	required Eb/(N0+I0) [dB]	9,3	3,6	
	receiver sensitivity [dBm]	-99,21	-104,91	
	hand off gain [dB]	4,7	4,7	
	explicit diversity gain [dB]	0	0	included in Eb/(N0+I0) figure
	other gain [dB]	0	0	
	log-normal fade margin [dB]	11,3	11,3	
	max. path loss [dB]	137,87	137,57	
	max. range [km]	1,819	1,786	

Outdoor to Indoor Environment:

Table 4: *Speech Service, with Frequency Hopping, MMSE equalizer, spread speech/data burst 2 for Downlink and spread speech/data burst 1 for Uplink*

Item	Forward Link	Reverse Link	comment
Test Environment	Outdoor to Indoor		
Test Service	burst2	burst1	
Multipath Channel	Pedestrian A		
average transmitter power per traffic channel [dBm]	20	14	
max. transmitter power per traffic channel [dBm]	29,03	23,03	1 timeslot used
max. total transmitter power [dBm]	38,06	23,03	
cable, connector and combiner losses [dB]	2	0	
transmitter antenna gain [dBi]	10	0	
transmitter eirp per traffic channel [dBm]	37,03	23,03	
total transmitter eirp [dBm]	46,06	23,03	
receiver antenna gain [dBi]	0	10	
cable and connector losses [dB]	0	2	
receiver noise figure [dB]	5	5	
thermal noise density [dBm/Hz]	-174	-174	
receiver interference density [dBm/Hz]	-1000	-1000	low interference
total effective noise plus interference density [dBm/Hz]	-169,00	-169,00	
information rate Rb [kHz]	72,5	72,5	1 code used
10log(Rb)	48,60	48,60	
required Eb/(N0+I0) [dB]	9,8	5,2	
receiver sensitivity [dBm]	-110,60	-115,20	
hand off gain [dB]	4,7	4,7	
explicit diversity gain [dB]	0	0	included in Eb/(N0+I0) figure
other gain [dB]	0	0	
log-normal fade margin [dB]	11,3	11,3	
max. path loss [dB]	141,03	139,63	
max. range [km]	0,669	0,618	

Table 5: *Speech Service without Frequency Hopping, MMSE equalizer, spread speech/data burst 1 for Uplink*

	Item	Reverse Link	comment
Test Environment	Outdoor to Indoor		
Test Service	Speech, 8 kbps, 20ms delay	burst1	
Multipath Channel	Pedestrian A		
	average transmitter power per traffic channel [dBm]	14	
	max. transmitter power per traffic channel [dBm]	23,03	1 timeslot used
	max. total transmitter power [dBm]	23,03	
	cable, connector and combiner losses [dB]	0	
	transmitter antenna gain [dBi]	0	
	transmitter eirp per traffic channel [dBm]	23,03	
	total transmitter eirp [dBm]	23,03	
	receiver antenna gain [dBi]	10	
	cable and connector losses [dB]	2	
	receiver noise figure [dB]	5	
	thermal noise density [dBm/Hz]	-174	
	receiver interference density [dBm/Hz]	-1000	low interference
	total effective noise plus interference density [dBm/Hz]	-169,00	
	information rate Rb [kHz]	72,5	1 code used
	10log(Rb)	48,60	
	required Eb/(N0+I0) [dB]	10,3	
	receiver sensitivity [dBm]	-110,10	
	hand off gain [dB]	4,7	
	explicit diversity gain [dB]	0	included in Eb/(N0+I0) figure
	other gain [dB]	0	
	log-normal fade margin [dB]	11,3	
	max. path loss [dB]	134,53	
	max. range [km]	0,460	

Table 6: LCD 144kbps a Service, with Frequency Hopping, MMSE equalizer, spread speech/data burst 2 for Downlink and Uplink

	Item	Forward Link	Reverse Link	comment
Test Environment	Outdoor to Indoor			
Test Service	LCD 144 kbps, a			
Multipath Channel	Pedestrian A			
	average transmitter power per traffic channel [dBm]	20	14	
	max. transmitter power per traffic channel [dBm]	20,00	14,00	8 timeslots used
	max. total transmitter power [dBm]	29,03	14,00	
	cable, connector and combiner losses [dB]	2	0	
	transmitter antenna gain [dBi]	10	0	
	transmitter eirp per traffic channel [dBm]	28,00	14,00	
	total transmitter eirp [dBm]	37,03	14,00	
	receiver antenna gain [dBi]	0	10	
	cable and connector losses [dB]	0	2	
	receiver noise figure [dB]	5	5	
	thermal noise density [dBm/Hz]	-174	-174	
	receiver interference density [dBm/Hz]	-1000	-1000	low interference
	total effective noise plus interference density [dBm/Hz]	-169,00	-169,00	
	information rate Rb [kHz]	163,1	163,1	1 code used
	10log(Rb)	52,12	52,12	
	required Eb/(N0+I0) [dB]	7,4	3,7	
	receiver sensitivity [dBm]	-109,48	-113,18	
	hand off gain [dB]	4,7	4,7	
	explicit diversity gain [dB]	0	0	included in Eb/(N0+I0) figure
	other gain [dB]	0	0	
	log-normal fade margin [dB]	11,3	11,3	
	max. path loss [dB]	130,88	128,58	
	max. range [km]	0,373	0,327	

Table 7: LCD 144kbps a Service, without Frequency Hopping, MMSE equalizer, spread speech/data burst 2 for Uplink

	Item	Reverse Link	comment
Test Environment	Outdoor to Indoor		
Test Service	LCD 144 kbps, a		
Multipath Channel	Pedestrian A		
	average transmitter power per traffic channel [dBm]	14	
	max. transmitter power per traffic channel [dBm]	14,00	8 timeslots used
	max. total transmitter power [dBm]	14,00	
	cable, connector and combiner losses [dB]	0	
	transmitter antenna gain [dBi]	0	
	transmitter eirp per traffic channel [dBm]	14,00	
	total transmitter eirp [dBm]	14,00	
	receiver antenna gain [dBi]	10	
	cable and connector losses [dB]	2	
	receiver noise figure [dB]	5	
	thermal noise density [dBm/Hz]	-174	
	receiver interference density [dBm/Hz]	-1000	low interference
	total effective noise plus interference density [dBm/Hz]	-169,00	
	information rate Rb [kHz]	163,1	1 code used
	10log(Rb)	52,12	
	required Eb/(N0+I0) [dB]	7,9	
	receiver sensitivity [dBm]	-108,98	
	hand off gain [dB]	4,7	
	explicit diversity gain [dB]	0	included in Eb/(N0+I0) figure
	other gain [dB]	0	
	log-normal fade margin [dB]	11,3	
	max. path loss [dB]	124,38	
	max. range [km]	0,257	

Table 8: LCD 144kbps b Service, with Frequency Hopping, MMSE equalizer, spread speech/data burst 2 for Downlink and Uplink

	Item	Forward Link	Reverse Link	comment
Test Environment	Outdoor to Indoor			
Test Service	LCD 144 kbps, b			
Multipath Channel	Pedestrian A			
	average transmitter power per traffic channel [dBm]	20	14	
	max. transmitter power per traffic channel [dBm]	29,03	23,03	1 timeslot used
	max. total transmitter power [dBm]	29,03	23,03	
	cable, connector and combiner losses [dB]	2	0	
	transmitter antenna gain [dBi]	10	0	
	transmitter eirp per traffic channel [dBm]	37,03	23,03	
	total transmitter eirp [dBm]	37,03	23,03	
	receiver antenna gain [dBi]	0	10	
	cable and connector losses [dB]	0	2	
	receiver noise figure [dB]	5	5	
	thermal noise density [dBm/Hz]	-174	-174	
	receiver interference density [dBm/Hz]	-1000	-1000	low interference
	total effective noise plus interference density [dBm/Hz]	-169,00	-169,00	
	information rate Rb [kHz]	1285,2	1285,2	9 codes used
	10log(Rb)	61,09	61,09	
	required Eb/(N0+I0) [dB]	9,1	4,1	
	receiver sensitivity [dBm]	-98,81	-103,81	
	hand off gain [dB]	4,7	4,7	
	explicit diversity gain [dB]	0	0	included in Eb/(N0+I0) figure
	other gain [dB]	0	0	
	log-normal fade margin [dB]	11,3	11,3	
	max. path loss [dB]	129,24	128,24	
	max. range [km]	0,340	0,321	

Table 9: LCD 144kbps c Service, with Frequency Hopping, MMSE equalizer, spread speech/data burst 2 for Downlink and Uplink

	Item	Forward Link	Reverse Link	comment
Test Environment	Outdoor to Indoor			
Test Service	LCD 144 kbps, c			
Multipath Channel	Pedestrian A			
	average transmitter power per traffic channel [dBm]	20	14	
	max. transmitter power per traffic channel [dBm]	23,01	17,01	4 timeslots used
	max. total transmitter power [dBm]	27,78	17,01	
	cable, connector and combiner losses [dB]	2	0	
	transmitter antenna gain [dBi]	10	0	
	transmitter eirp per traffic channel [dBm]	31,01	17,01	
	total transmitter eirp [dBm]	35,78	17,01	
	receiver antenna gain [dBi]	0	10	
	cable and connector losses [dB]	0	2	
	receiver noise figure [dB]	5	5	
	thermal noise density [dBm/Hz]	-174	-174	
	receiver interference density [dBm/Hz]	-1000	-1000	low interference
	total effective noise plus interference density [dBm/Hz]	-169,00	-169,00	
	information rate Rb [kHz]	318,3	318,3	3 codes used
	10log(Rb)	55,03	55,03	
	required Eb/(N0+I0) [dB]	6	2,2	
	receiver sensitivity [dBm]	-107,97	-111,77	
	hand off gain [dB]	4,7	4,7	
	explicit diversity gain [dB]	0	0	included in Eb/(N0+I0) figure
	other gain [dB]	0	0	
	log-normal fade margin [dB]	11,3	11,3	
	max. path loss [dB]	132,38	130,18	
	max. range [km]	0,407	0,359	

Table 10: LCD 2048 Mbps Service, with Frequency Hopping, MMSE equalizer, spread speech/data burst 2 for Downlink and Uplink

	Item	Forward Link	Reverse Link	comment
Test Environment	Outdoor to Indoor			
Test Service	LCD 2048 kbps			
Multipath Channel	Pedestrian A			
	average transmitter power per traffic channel [dBm]	20	14	
	max. transmitter power per traffic channel [dBm]	20,00	14,00	8 timeslots used
	max. total transmitter power [dBm]	20,00	14,00	
	cable, connector and combiner losses [dB]	2	0	
	transmitter antenna gain [dBi]	10	0	
	transmitter eirp per traffic channel [dBm]	28,00	14,00	
	total transmitter eirp [dBm]	28,00	14,00	
	receiver antenna gain [dBi]	0	10	
	cable and connector losses [dB]	0	2	
	receiver noise figure [dB]	5	5	
	thermal noise density [dBm/Hz]	-174	-174	
	receiver interference density [dBm/Hz]	-1000	-1000	low interference
	total effective noise plus interference density [dBm/Hz]	-169,00	-169,00	
	information rate Rb [kHz]	2136,6	2136,6	9 codes used
	10log(Rb)	63,30	63,30	
	required Eb/(N0+I0) [dB]	11,1	6,7	
	receiver sensitivity [dBm]	-94,60	-99,00	
	hand off gain [dB]	4,7	4,7	
	explicit diversity gain [dB]	0	0	included in Eb/(N0+I0) figure
	other gain [dB]	0	0	
	log-normal fade margin [dB]	11,3	11,3	
	max. path loss [dB]	116,00	114,40	
	max. range [km]	0,159	0,145	

Indoor Environment:

Table 11: *Speech Service, with Frequency Hopping, MMSE equalizer, spread speech/data burst 2 for Downlink and spread speech/data burst 1 for Uplink*

	Item	Forward Link	Reverse Link	comment
Test Environment	Indoor			
Test Service	Speech, 8 kbps, 20ms delay	burst2	burst1	
Multipath Channel	Indoor Office A			
	average transmitter power per traffic channel [dBm]	10	4	
	max. transmitter power per traffic channel [dBm]	19,03	13,03	1 timeslot used
	max. total transmitter power [dBm]	28,06	13,03	
	cable, connector and combiner losses [dB]	2	0	
	transmitter antenna gain [dBi]	2	0	
	transmitter eirp per traffic channel [dBm]	19,03	13,03	
	total transmitter eirp [dBm]	28,06	13,03	
	receiver antenna gain [dBi]	0	2	
	cable and connector losses [dB]	0	2	
	receiver noise figure [dB]	5	5	
	thermal noise density [dBm/Hz]	-174	-174	
	receiver interference density [dBm/Hz]	-1000	-1000	low interference
	total effective noise plus interference density [dBm/Hz]	-169,00	-169,00	
	information rate Rb [kHz]	72,5	72,5	1 code used
	10log(Rb)	48,60	48,60	
	required Eb/(N0+I0) [dB]	9,8	5,3	
	receiver sensitivity [dBm]	-110,60	-115,10	
	hand off gain [dB]	5,9	5,9	
	explicit diversity gain [dB]	0	0	included in Eb/(N0+I0) figure
	other gain [dB]	0	0	
	log-normal fade margin [dB]	15,4	15,4	
	max. path loss [dB]	120,13	118,63	
	max. range [m]	590,1	525,9	

Table 12: *Speech Service without Frequency Hopping, MMSE equalizer, spread speech/data burst 1 for Uplink*

	Item	Reverse Link	comment
Test Environment	Indoor		
Test Service	Speech, 8 kbps, 20ms delay		
Multipath Channel	Indoor Office A		
	average transmitter power per traffic channel [dBm]	4	
	max. transmitter power per traffic channel [dBm]	13,03	1 timeslot used
	max. total transmitter power [dBm]	13,03	
	cable, connector and combiner losses [dB]	0	
	transmitter antenna gain [dBi]	0	
	transmitter eirp per traffic channel [dBm]	13,03	
	total transmitter eirp [dBm]	13,03	
	receiver antenna gain [dBi]	2	
	cable and connector losses [dB]	2	
	receiver noise figure [dB]	5	
	thermal noise density [dBm/Hz]	-174	
	receiver interference density [dBm/Hz]	-1000	low interference
	total effective noise plus interference density [dBm/Hz]	-169,00	
	information rate Rb [kHz]	72,5	1 code used
	10log(Rb)	48,60	
	required Eb/(N0+I0) [dB]	11,4	
	receiver sensitivity [dBm]	-109,00	
	hand off gain [dB]	5,9	
	explicit diversity gain [dB]	0	included in Eb/(N0+I0) figure
	other gain [dB]	0	
	log-normal fade margin [dB]	15,4	
	max. path loss [dB]	112,53	
	max. range [m]	329,3	

Table 13: LCD 384kbps a Service, with Frequency Hopping, MMSE equalizer, spread speech/data burst 2 for Downlink and Uplink

	Item	Forward Link	Reverse Link	comment
Test Environment	Indoor			
Test Service	LCD 384, a			
Multipath Channel	Indoor Office A			
	average transmitter power per traffic channel [dBm]	10	4	
	max. transmitter power per traffic channel [dBm]	10,00	4,00	8 timeslots used
	max. total transmitter power [dBm]	14,77	4,00	
	cable, connector and combiner losses [dB]	2	0	
	transmitter antenna gain [dBi]	2	0	
	transmitter eirp per traffic channel [dBm]	10,00	4,00	
	total transmitter eirp [dBm]	14,77	4,00	
	receiver antenna gain [dBi]	0	2	
	cable and connector losses [dB]	0	2	
	receiver noise figure [dB]	5	5	
	thermal noise density [dBm/Hz]	-174	-174	
	receiver interference density [dBm/Hz]	-1000	-1000	low interference
	total effective noise plus interference density [dBm/Hz]	-169,00	-169,00	
	information rate Rb [kHz]	419,4	419,4	3 codes used
	10log(Rb)	56,23	56,23	
	required Eb/(N0+I0) [dB]	7,2	2,7	
	receiver sensitivity [dBm]	-105,57	-110,07	
	hand off gain [dB]	5,9	5,9	
	explicit diversity gain [dB]	0	0	included in Eb/(N0+I0) figure
	other gain [dB]	0	0	
	log-normal fade margin [dB]	15,4	15,4	
	max. path loss [dB]	106,07	104,57	
	max. range [m]	200,66	178,84	

Table 14: LCD 384kbps b Service, with Frequency Hopping, MMSE equalizer, spread speech/data burst 2 for Downlink and Uplink

	Item	Forward Link	Reverse Link	comment
Test Environment	Indoor			
Test Service	LCD 384, b			
Multipath Channel	Indoor Office A			
	average transmitter power per traffic channel [dBm]	10	4	
	max. transmitter power per traffic channel [dBm]	14,26	8,26	3 timeslots used
	max. total transmitter power [dBm]	19,03	8,26	
	cable, connector and combiner losses [dB]	2	0	
	transmitter antenna gain [dBi]	2	0	
	transmitter eirp per traffic channel [dBm]	14,26	8,26	
	total transmitter eirp [dBm]	19,03	8,26	
	receiver antenna gain [dBi]	0	2	
	cable and connector losses [dB]	0	2	
	receiver noise figure [dB]	5	5	
	thermal noise density [dBm/Hz]	-174	-174	
	receiver interference density [dBm/Hz]	-1000	-1000	low interference
	total effective noise plus interference density [dBm/Hz]	-169,00	-169,00	
	information rate Rb [kHz]	1118,7	1118,7	9 codes used
	10log(Rb)	60,49	60,49	
	required Eb/(N0+I0) [dB]	7,4	2,7	
	receiver sensitivity [dBm]	-101,11	-105,81	
	hand off gain [dB]	5,9	5,9	
	explicit diversity gain [dB]	0	0	included in Eb/(N0+I0) figure
	other gain [dB]	0	0	
	log-normal fade margin [dB]	15,4	15,4	
	max. path loss [dB]	105,87	104,57	
	max. range [m]	197,58	178,82	

Table 15: LCD 2048 Mbps Service, with Frequency Hopping, MMSE equalizer, spread speech/data burst 2 for Downlink and Uplink

	Item	Forward Link	Reverse Link	comment
Test Environment	Indoor			
Test Service	LCD 2048			
Multipath Channel	Indoor Office A			
	average transmitter power per traffic channel [dBm]	10	4	
	max. transmitter power per traffic channel [dBm]	10,00	4,00	8 timeslots used
	max. total transmitter power [dBm]	19,03	4,00	
	cable, connector and combiner losses [dB]	2	0	
	transmitter antenna gain [dBi]	2	0	
	transmitter eirp per traffic channel [dBm]	10,00	4,00	
	total transmitter eirp [dBm]	19,03	4,00	
	receiver antenna gain [dBi]	0	2	
	cable and connector losses [dB]	0	2	
	receiver noise figure [dB]	5	5	
	thermal noise density [dBm/Hz]	-174	-174	
	receiver interference density [dBm/Hz]	-1000	-1000	low interference
	total effective noise plus interference density [dBm/Hz]	-169,00	-169,00	
	information rate Rb [kHz]	2136,6	2136,6	9 codes used
	10log(Rb)	63,30	63,30	
	required Eb/(N0+I0) [dB]	10,9	6,9	
	receiver sensitivity [dBm]	-94,80	-98,80	
	hand off gain [dB]	5,9	5,9	
	explicit diversity gain [dB]	0	0	included in Eb/(N0+I0) figure
	other gain [dB]	0	0	
	log-normal fade margin [dB]	15,4	15,4	
	max. path loss [dB]	95,30	93,30	
	max. range [m]	87,79	75,29	

3 References

- [1] Peter Jung, Josef Blanz, Markus Naßhan and Paul Walter Baier, Simulation of the uplink of JD-CDMA mobile radio systems with coherent receiver antenna diversity. *Wireless Personal Communications* 1: 61-89, 1994.
- [2] Peter Jung, Laurent's representation of binary digital continuous phase modulated signals with modulation index $\frac{1}{2}$ revisited. *IEEE Transactions on Communications*, Vol. 42, N0. 2/3/4, February/March/April 1994, pp. 221—224.
- [3] Bernd Steiner, Peter Jung, Uplink channel estimation in synchronous CDMA mobile radio systems with joint detection. *The Fourth International Symposium on Personal, Indoor and Mobile Radio Communications (PIMRC'93)*, pp. 123-127, Yokohama, Japan, September 8-11, 1993.
- [4] A. Papathanassiou, M. Haardt, I. Furió, and J. J. Blanz, Multi-User Direction of Arrival and Channel Estimation for Time-Slotted CDMA with Joint Detection, In Proc. 13th International Conference on Digital Signal Processing (DSP), Santorini, Greece, vol. 1, pp. 375-378, Jul. 1997.
- [5] J. J. Blanz, A. Papathanassiou, M. Haardt, I. Furió, and P. W. Baier, Smart Antennas for Combined DOA and Joint Channel Estimation in Time-Slotted CDMA Mobile Radio Systems with Joint Detection - Part II: Combined DOA and Joint Channel Estimation, *IEEE Transactions on Vehicular Technology*, June 1997, submitted for publication.
- [6] C. Farsakh and J. A. Nossek, Maximizing the Capacity of an SDMA Mobile Radio Systems, In Proc. IEEE/IEE International Conference on Telecommunications (ICT), Melbourne, Australia, pp. 813-818, vol. 2, April 1997.
- [7] Tdoc SMG2 249/97 ETR 04-01 'Requirements for the UMTS Terrestrial Radio Access System'; Vers 2.6.0; May 1997
- [8] Bernd Steiner and Peter Jung, Optimum and suboptimum channel estimation for the uplink of CDMA mobile radio systems with joint detection. *European Transactions on Telecommunications and Related Techniques*, vol. 5 , pp. 39-50, 1994.
- [9] J. J. Blanz, A. Klein, M. Naßhan, and A. Steil, Performance of a cellular hybrid C/TDMA mobile radio systems applying joint detection and coherent receiver antenna diversity. *IEEE Journal on Selected Areas in Communications*, vol. 12, pp. 568-579, 1994.
- [10] M. Haardt, *Efficient One-, Two-, and Multidimensional High-Resolution Array Signal Processing*, Shaker Verlag, Aachen, Germany, ISBN 3-8265-2220-6, 1997.
- [11] J. J. Blanz, A. Papathanassiou, M. Haardt, I. Furió, and P. W. Baier, Smart Antennas for Combined DOA and Joint Channel Estimation in Time-Slotted CDMA Mobile Radio Systems with Joint Detection - Part I: Combined DOA and Joint Channel Estimation, *IEEE Transactions on Vehicular Technology*, June 1997, submitted for publication.
- [12] R. Schmalenberger and J. J. Blanz, Multi Antenna C/I Balancing in the Downlink of Digital Cellular Mobile Radio Systems, In Proc. IEEE 47th Vehicular Technology Conference (VTC), Phoenix, AZ, USA, May 1997.

**ETSI SMG2#24
97**

Tdoc SMG 899 /

Madrid, Spain

December 15th-19th, 1997

Source: SMG2

Agenda Item: 4.1 UTRA

Subject: Evaluation Document Cover Sheet for:

**Concept Group Delta
WB-TDMA/CDMA
System Description Performance Evaluation**

Disclaimer:

“This document was prepared during the evaluation work of SMG2 as a possible basis for the UTRA standard. It is provided to SMG on the understanding that the full details of the contents have not necessarily been reviewed by, or agreed by, SMG2.”

ETSI SMG2#24

TDoc SMG2 368 / 97

Cork, Ireland

December 1-5, 1997

**Concept Group Delta
Wideband TDMA/CDMA**

**Evaluation Report - Part 6
V 2.0 b**

TABLE OF CONTENTS

1. INTRODUCTION	653
1.1 Terminology	653
2. RELAYS	654
2.1 WB-TDMA/CDMA + ODMA Scenario	655
3. AN OVERVIEW OF ODMA	656
3.1 Multi-hop Transmissions	656
3.2 Relaying vs. Direct Transmission	657
3.3 Relaying to Avoid Shadowing	658
3.4 Radio Resource Re-use	659
3.5 Potential For Capacity Gain	659
4. OVERVIEW OF THE ODMA PROTOCOL	661
4.1 Idle Mode Functions	662
4.1.1 Probing for Neighbours	662
4.1.2 Calling Channel Adaptation	662
4.1.3 Neighbours on Adjacent Calling Channels	662
4.2 Transmitting Data	664
4.2.1 Transmitting Data on the CCH	664
4.2.2 Transmitting Data on a DCH	664
4.3 Routing and Connectivity	665
4.3.1 Local Connectivity	666
4.3.2 Connectivity Metrics	667
4.3.3 End-to-End Connectivity	667
5. SIMULATIONS	671
5.1 Indoor office (x60) LCD 384kbps Coverage	672
5.2 Manhattan 10x10 Blocks LCD 384kbps Coverage	672
5.3 Vehicular - 6km x 6km LCD 384kbps Coverage	673
5.4 Manhattan 3x3 Blocks LCD 384kbps Capacity	673
6. CALL SET-UP PROCEDURES FOR ODMA IN A WB-TDMA/CDMA CELL.	674
6.1 ODMA/WB-TDMA/CDMA Gateway - Last Hop to BTS	675

7. WB-TDMA/CDMA SUPPORT FOR RELAYING	676
7.1 Benefits of Using WB-TDMA/CDMA for Relaying	676
7.2 Impact of Relaying on Implementation and Complexity of WB-TDMA/CDMA	676
8. BENEFITS OF ODMA TO WB-TDMA/CDMA W.R.T. HIGH LEVEL REQUIREMENTS	679
9. SUMMARY	687
10. ASSOCIATED DOCUMENTS	687

SUPPORT FOR RELAYING AND ODMA

1. Introduction

WB-TDMA/CDMA satisfies the high level requirements for the UTRA and particular consideration has been given to the future evolution of the system in terms of performance and flexibility. Many advanced features have already been incorporated into the core design but WB-TDMA/CDMA is also a suitable platform for the support of relaying.

Relaying is a widely used technique for radio packet data transmission both in commercial and military systems but it has so far not been widely used in cellular systems. Relaying has the potential to improve coverage and flexibility but may also increase capacity by lowering transmission powers and associated intercell interference.

Within the ETSI SMG2 process for UTRA evaluation, investigation of relay systems was carried out within the Epsilon Concept Group by considering a technology called Opportunity Driven Multiple Access - ODMA. The protocols used in ODMA are very similar to those of a packet radio system currently being trialed in South Africa. System level simulations were carried out in accordance with UMTS 04.02 which showed that very wide area coverage was possible in all environments using a subscriber relay system and that there was potential for increased capacity when used in a cellular hybrid.

A feasibility study was jointly conducted by the Delta and Epsilon concept groups to determine the practicality of supporting relaying using the basic WB-TDMA/CDMA design. The outcome of the study and the general findings from the epsilon evaluation work are recorded in this text and the basic conclusion was that the WB-TDMA/CDMA design was sufficiently flexible to support relaying with negligible increase to the MS complexity or cost. WB-TDMA/CDMA therefore offers the flexibility of simple relaying but also provide a suitable platform for advanced relay protocols such as ODMA.

1.1 Terminology

The definition of terms listed below may help when reading the following text.

<i>Mobile or MS</i>	An ODMA terminal.
<i>Seed</i>	Roughly described as a deliberately placed Mobile that never moves and is always powered on.
<i>Gateway or BTS</i>	A fixed ODMA Node with interfaces to “the network” — the equivalent of a GSM base station.
<i>Node</i>	A Mobile, Seed or Gateway/BTS
<i>Relay Node</i>	A Mobile or Seed involved in relaying information between two other Nodes.

2. Relays

Relays add flexibility to a communication system. The figure below illustrates a range of options from simple one hop relays to ODMA which is an intelligent adaptive multi-hop system supporting full mobility of callers and relays.

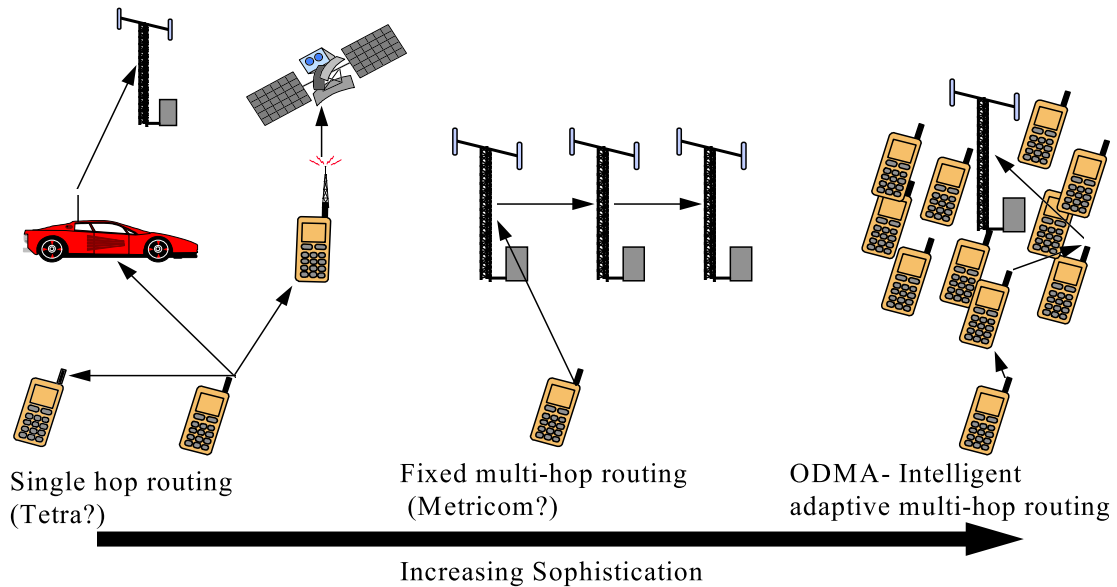


Figure 1 Relaying Options

All the options shown above are possible providing that from the outset the UTRA can support the direct transfer of information from one MS to another. Potential benefits of relaying include;

- ◆ Extension of high data rate coverage (144-384kbps)
- ◆ Reduction of TX power
- ◆ Overcoming dead-spots
- ◆ Relaying to satellite system
- ◆ Relaying to a vehicle
- ◆ Directly linking terminals (private and uncoordinated systems, home BTS etc.)

The above list is by no means exhaustive and the real motivation for relaying will only become apparent as the UTRA standard develops, however there appears sufficient justification to support relaying within WB-TDMA/CDMA given the following pre-conditions;

- ◆ Relaying must not degrade the QoS of a UMTS cell
- ◆ Relaying must not add significant cost or complexity to a UMTS terminal
- ◆ Relaying can be enabled or disabled by an operator

2.1 WB-TDMA/CDMA + ODMA Scenario

Figure 2 shows a WB-TDMA/CDMA cell using an ODMA enhancement. Relaying is used to route packet data services to and from mobiles close to the WB-TDMA/CDMA BTS - using a separate unpaired spectrum band. The relay nodes in range of the BTS will toggle between ODMA and WB-TDMA/CDMA modes. Relaying extends the range of the high rate data services and can be used to provide coverage in dead spots.

The final hop to the BTS uses the WB-TDMA/CDMA slotted mode. In this way relaying can bring concentrated traffic near to the WB-TDMA/CDMA BTS which can then work in a spectrally efficient manner over a short range.

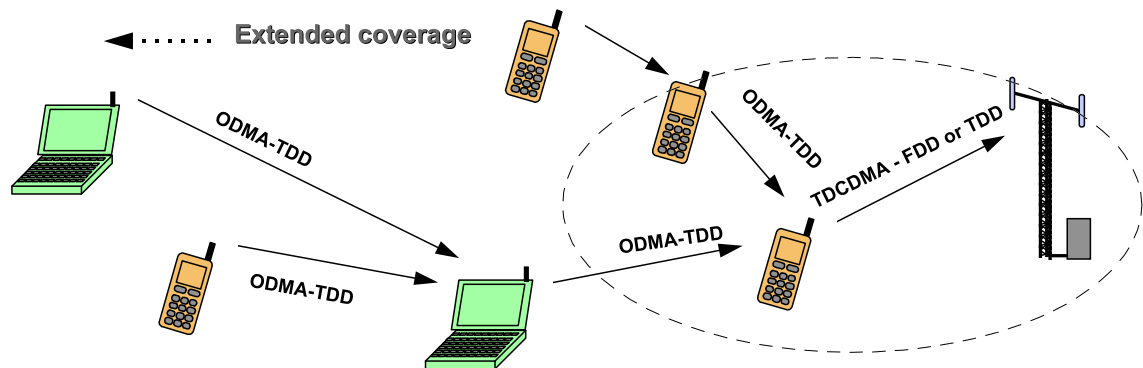


Figure 2 Scenario for WB-TDMA/CDMA with ODMA enhancement

3. An Overview of ODMA

The Principle:

Opportunity Driven Multiple Access is a mechanism for maximising the potential for effective communication. This is achieved by distributing intelligence within communicating nodes and providing multiple communication paths between them. The intelligent nodes measure and evaluate their communications options and adapt to exploit the optimum opportunity.

The Practice:

ODMA is an intelligent protocol that sits upon a radio sub-system that supports relaying. The protocol breaks difficult radio paths into a sequence of shorter hops which enables lower transmit powers or higher data rates to be used. It is the goal of the protocol to choose the least cost route through the relaying system when the relays are moving and the radio paths are dynamically changing.

3.1 Multi-hop Transmissions

The transmission of information over a radio channel is subject to some fundamental rules e.g. it becomes more difficult the higher the data rate and the longer the distance. Difficulty maps to a requirement for higher transmitted powers which cause practical problems for mobile equipment and have an associated interference effect which limits the number of possible simultaneous transmissions (capacity). As high data rates are encouraged in UMTS that only leaves the distance aspect to consider.

Relaying is one of the enhancements WB-TDMA/CDMA may use to offset the difficulties of high data rate transmission over significant distances.

3.2 Relaying vs. Direct Transmission

It is not difficult to identify a potential benefit from relaying rather than using direct transmission. Consider the vehicular simulation scenario of UMTS 04.02. The path loss is given by

$$\text{Loss (dB)} = 127 + 37.6\text{LOG}(D)$$

[where D is in km]

Figure 3 below shows the benefits of breaking a long path into a number of shorter hops . It plots effective pathloss for a 1km transmission against the number of relay hops (0 = direct). (Effective pathloss is the loss between hops)

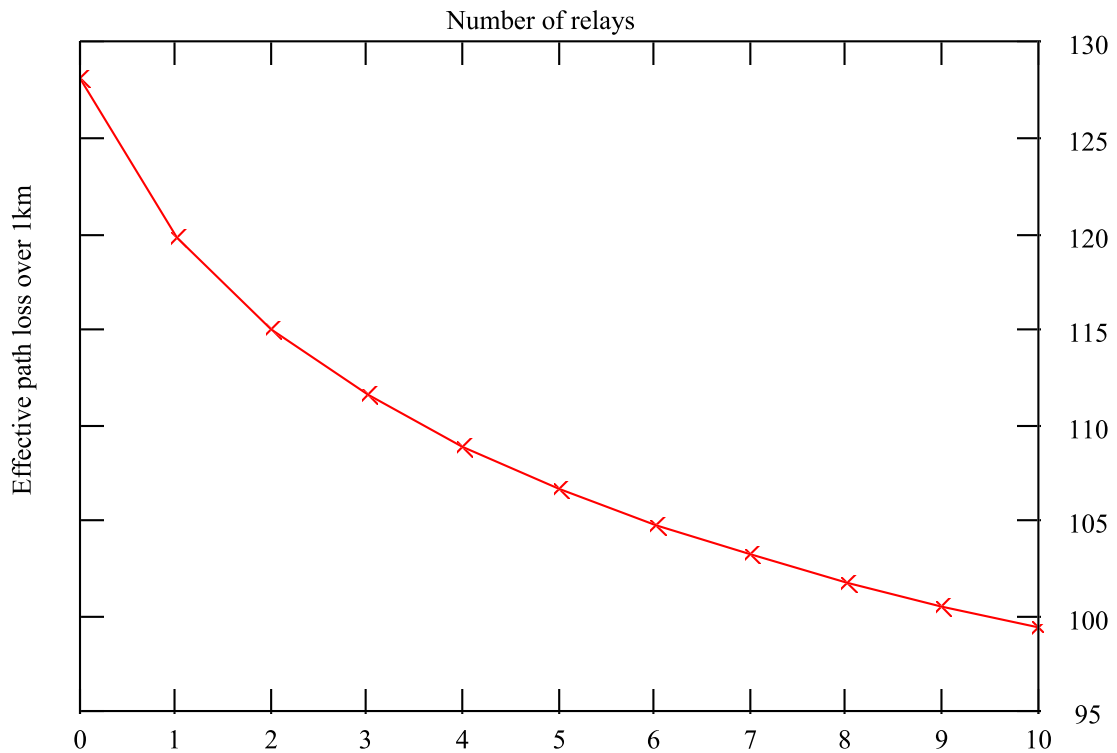


Figure 3 Effective Pathloss v Number of Relays

The graph shows benefits in the range of 10-30dB and that just 2 intermediate relays give a +12dB benefit.

3.3 Relaying to Avoid Shadowing

Radio channels are more complicated than the previous example suggest and show considerable temporal variation of shadow(slow) fading. This fading makes it hard to predefine an optimum route as the shortest paths may be heavily attenuated. However an intelligent relay can make the best local choice of route.

Consider the situation shown in Figure 4 - it is possible to use a number of paths to reach the BTS but the least cost route is to relay around the buildings. To put this into perspective @ 2GHz it is possible to experience 30 dB fluctuations around “Manhattan“ street corners. Combine this with fast fading variations and burst noise/interference then the ability to identify least cost routing becomes even more desirable.

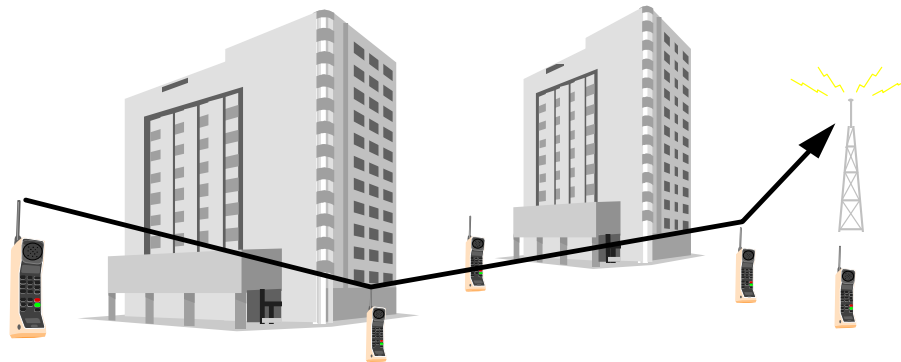


Figure 4 Relaying to Avoid Shadowing

Even if the complexities of real scenarios are ignored and the simple log normal variation model of UMTS 04.02 is used then a gain can be extracted by being allowed to chose the best of several routes.

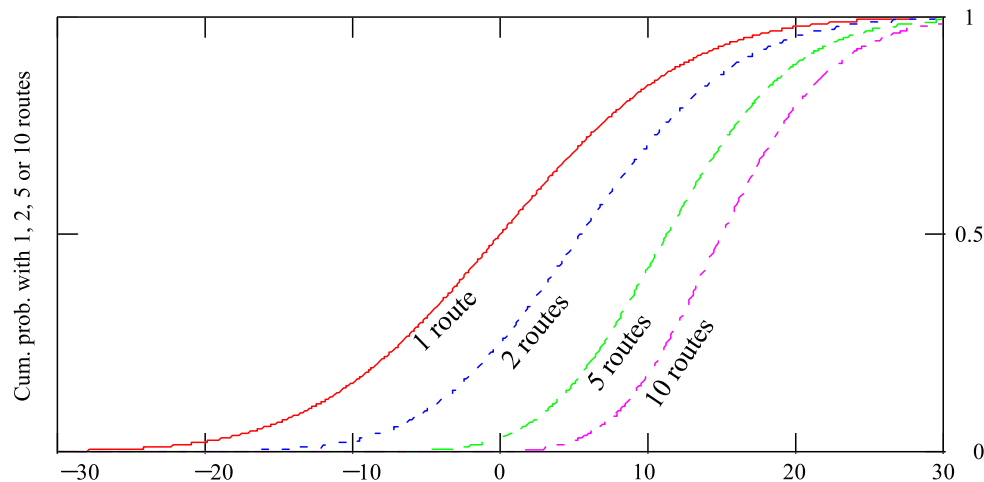


Figure 5 Benefits of Path Selection - Space Diversity

Figure 5 shows the probability of signal loss for a single path but also for the cases where you can chose the best from a number of paths e.g. @ a probability of 0.5 there is a 10dB benefit in being able to choose 1 from 10 paths.

3.4 Radio Resource Re-use

To relay information requires the use of radio resources such as timeslots and codes. In a conventional structure resources are used once per cell however in ODMA the resources can be used many times within the basic cell area. This is because transmissions are lower power and so interference has only localised effect.

Figure 6 shows just 2 resources being re-used several times along a relay route and elsewhere in the cell - if the transmission circles of a single resource do not overlap interference is avoided.

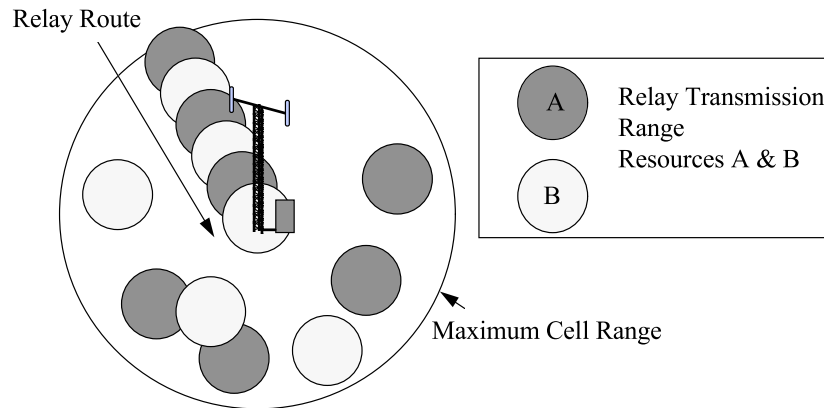


Figure 6 Re-using Resources Within a Cell Area

3.5 Potential For Capacity Gain

The potential for reducing TX power and extending the range of high data rate coverage is an obvious consideration for a relaying solution however it may be less clear that there is potential for increasing capacity. Figure 7 shows a scenario with 3 cells - normally they would be planned to avoid gaps between coverage areas. The resulting overlap will create intercell interference which ultimately reduces capacity.

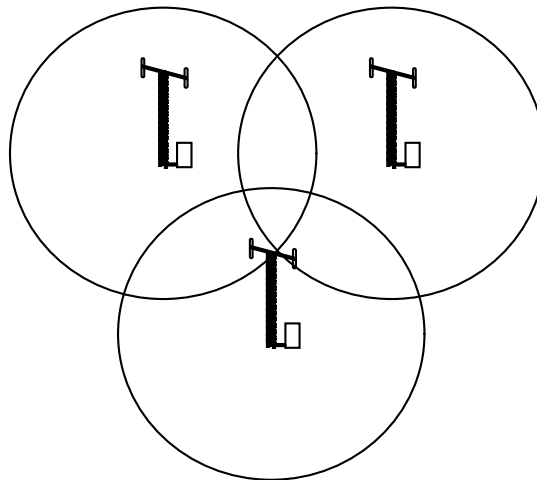


Figure 7 Normal Overlapping Cell Coverage

If the cell areas are restricted so that they do not overlap they become more spectrally efficient (spot coverage) but coverage is poor. Relaying would then be used to fill in the coverage gaps. (This would also be a useful technique at country borders).

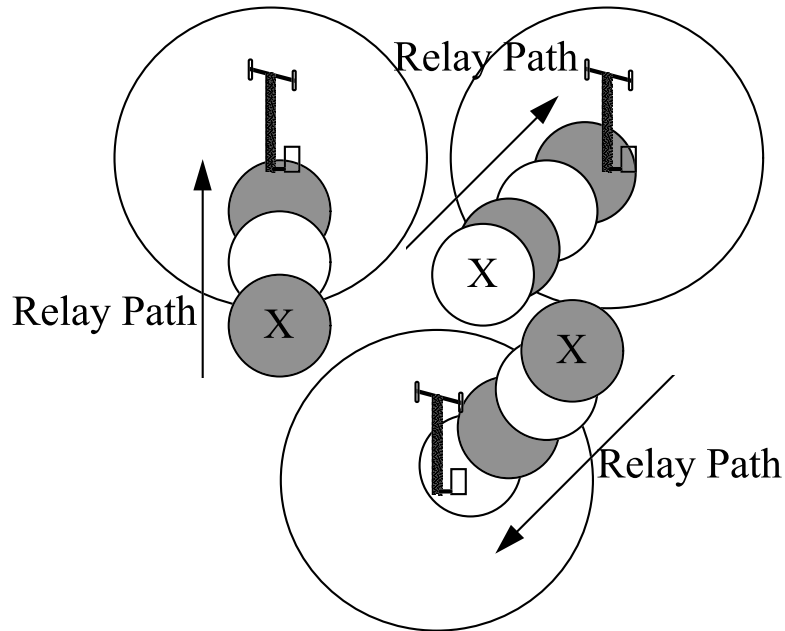


Figure 8 Discontinuous Cell Coverage

The above example does not imply that only a single relay stream can be brought to the vicinity of a BTS. For example there could be multiple ODMA nodes or “data buckets” distributed around the BTS each collecting and distributing significant amounts of traffic (as shown in Figure 9). In this case it is the final hop to the BTS that becomes critical and so the excellent hot spot efficiency of WB-TDMA/CDMA is of great benefit especially if relaying has reduced the level of intercell interference.



Figure 9 Cluster of ODMA Nodes around WB-TDMA/CDMA BTS

4. Overview of the ODMA Protocol

ODMA supports packet data transfer between an origin and destination via a network of intermediate relay nodes (fixed or mobile). The technology is characterised by a TDD mode which enables each node to receive other node's transmissions and build a connectivity table at each node. This table is subsequently used to route packets across a network in a dynamic manner without incurring a significant routing overhead.

The ODMA logical channel map in Figure 10 comprises two main types of channel:

- The first type of channel is the *calling channel (CCH)*, used to transfer system overhead information and limited amounts of data, where each CCH is distinguished by different modem rates and RF carriers to minimise interference.
- The second type of channel is the *data channel (DCH)*, used to transfer larger volumes of data and each DCH is associated with a specific CCH.

Note, Figure 10 is an illustration only. In practice, the logical channel structure may comprise several CCHs, each with up to N associated data channels.

Logical Channels in ODMA

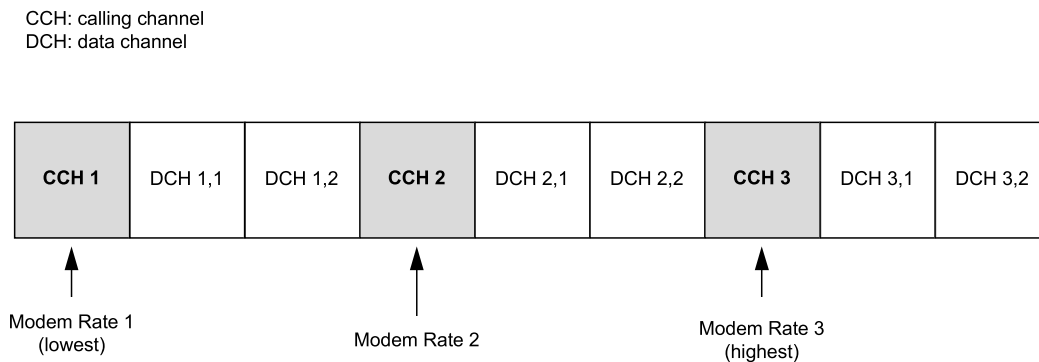


Figure 10. Logical Channels in ODMA.

This document summarises the key protocol features of ODMA which permit calls to be made via several intermediate relay nodes using the logical channel structure in Figure 10. Section 2 discusses the concept of probing on the CCH, a mechanism used by ODMA nodes to detect neighbours which may be used as relays during a call. In addition to supporting the probing function, the CCH may also be used to transfer limited amounts of data and in Section 3, methods of transferring data on the CCH and DCH is described in some detail. Finally, Section 4 details the innovative routing concept which is used to establish network-wide connectivity.

4.1 Idle Mode Functions

4.1.1 Probing for Neighbours

Probing is a mechanism used to indicate mobile activity in the ODMA network. When a mobile station, MS_{new} , is switched on for the first time it has no information about its surroundings. In this case the mobile will camp on one of the predefined system calling CCHs in idle mode which are used by all mobile stations to receive and broadcast system overhead information and data. With no system information stored in memory, MS_{new} will begin a probing session, where the mobile initially camps on a CCH and periodically *broadcasts* a probe packet. The broadcast probe includes the current neighbour list for MS_{new} , which will initially be empty. If a mobile station, MS_a , receives the broadcast packet it will register MS_{new} as a neighbour and send an *addressed* probe in response. The response probe is transmitted at random to avoid contention with other mobiles and typically one response is sent for every n broadcast probes received from a particular MS.

The next time MS_{new} transmits a broadcast probe the neighbour list will have one new entry, MS_a , and an associated quality indicator (a weighted factor based on the received signal strength of the response probe). It is through this basic mechanism that each mobile builds a neighbour list.

4.1.2 Calling Channel Adaptation

The probe-response mechanism enables each MS to build a neighbour list which should contain at least 5 mobiles. In the initial state when an MS is first switched on and the neighbour list is empty, the MS will transmit probes on the CCH which has the highest modem data rate and at the minimum transmit power in order to minimise interference with other mobiles.

Each time a mobile receives a response to a broadcast probe, the responding mobile is included as a neighbour. If the required number of neighbours is not met within time, T_{adapt} , the MS will increase its transmit power by x dB and reset T_{adapt} . The MS will continue to increase the broadcast probe transmit power until it achieves the required number of neighbours. If the maximum transmit power is reached before this condition is satisfied, the MS will switch to a lower rate CCH, defined as the Previous CCH and will stay at the maximum transmit power. The CCH data rate will continue to decrease, each time resetting T_{adapt} , until the MS achieves the required number of neighbours.

Conversely, if the number of mobiles in the neighbour list exceeds the required number, the CCH rate is incremented to the Next CCH. The CCH rate will continue to increase until the required number of neighbours is within acceptable bounds. If the MS reaches the highest CCH and the number of neighbours is still excessive the MS will start to drop the transmit power. Each time the CCH state is changed (i.e. the CCH or broadcast probe transmit power), T_{adapt} is reset.

4.1.3 Neighbours on Adjacent Calling Channels

The CCH adaption algorithm dictates that as the number of neighbours increases in a local area, mobiles will begin to move to higher rate CCHs. This CCH migration

implies that distant or widely separated mobiles will have fewer neighbours and will camp on lower rate CCHs, resulting in non-contiguous connectivity. To overcome this problem, the MS in idle mode periodically cycles through all the CCHs and listens for broadcast probes. If a broadcast probe is received, the MS will send an addressed response so that the appropriate neighbour lists can be updated.

Two timers are used to govern the checking process. The first timer is, *Check_timer_1*, which is initiated when a mobile arrives on a new CCH and is proportional to the CCH data rate. When *Check_timer_1* expires for the first time, the Check Channel status will be null and the MS will set the *Check Channel* to the highest rate CCH. On starting the checking process a second timer, *Check_timer_2* (much less than *Check_timer_1*), is initiated and when this timer expires the MS sets the Check Channel status to the next lowest CCH and returns to the Current CCH, resetting *Check_timer_1*. When *Check_timer_1* expires for the second time, the Check Channel status is no longer null and the MS continues the check cycle until *Check_timer_2* expires, at which point the Check Channel status is updated and the MS returns to the Current CCH, resetting *Check_timer_1*. This cycle repeats, skipping the Current CCH, until the Previous CCH is reached and the MS automatically returns to the Current CCH.

Since *Check_timer_2* is also proportional to the Current CCH modem rate, it takes a relatively short time to check the higher rate channels. However as the cycle progresses the MS will spend longer on each channel, which is why the checking terminates when the Check Channel reaches the Previous CCH.

The checking cycle is illustrated in Figure 11

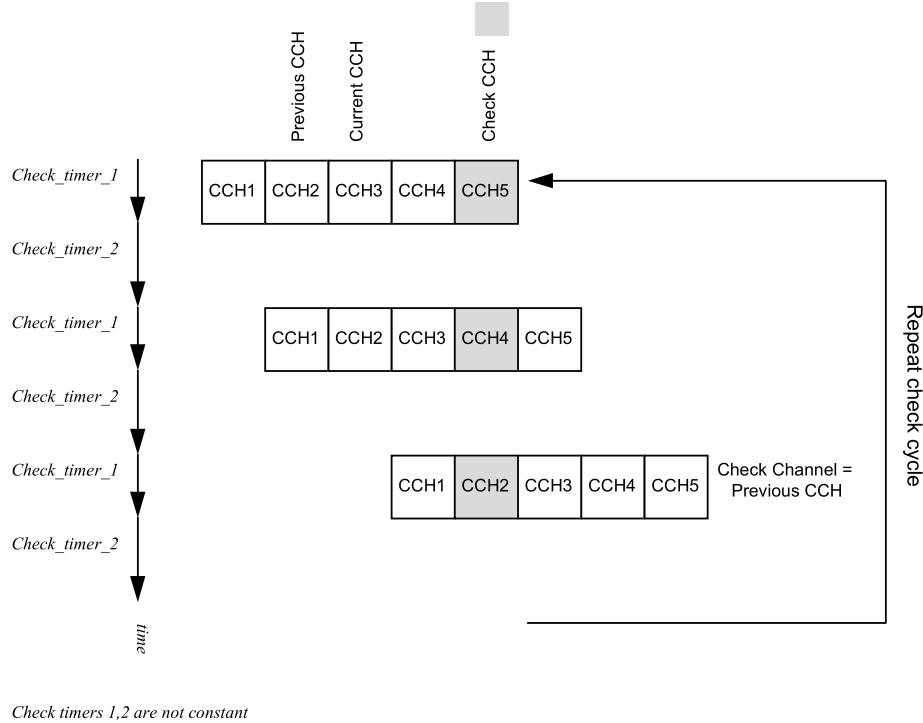


Figure 11. Check channel cycle.

4.2 Transmitting Data

Data may be transmitted on either the CCH or on a dedicated DCH, depending on the volume of data to be sent.

4.2.1 Transmitting Data on the CCH

In addition to responding to broadcast probes, addressed probes may also be used to transmit small amounts of data on the CCH. When an MS has data to send it may transmit an addressed probe packet on the CCH at an interval proportional to the CCH modem rate, R_{CCH} , and is defined by *Probe_timer_1*. This interval also defines the broadcast probe interval, *Probe_timer_2*, which is typically five times longer than *Probe_timer_1*. When an addressed node receives a probe packet with an acceptable error it transmits an acknowledgement immediately in an addressed response packet, in accordance with the ODMA Layer 2 radio link protocol (RLP).

Every time an MS transmits an addressed probe containing data on the CCH, it may be received, but not acknowledged, by third party neighbour mobiles, and provides an implicit indication of activity. In this instance broadcast probes are not necessary and *Probe_timer_2* is reset after every addressed probe transmission. Only when an MS has no data to send is it necessary to transmit a broadcast probe every *Probe_timer_2* seconds to register its active status with its neighbours.

In order to avoid overlapping packet transmissions the length of the packet may not exceed the probe timer interval, *Probe_timer_1*. The relationship between the different probe timers is illustrated in Figure 12.

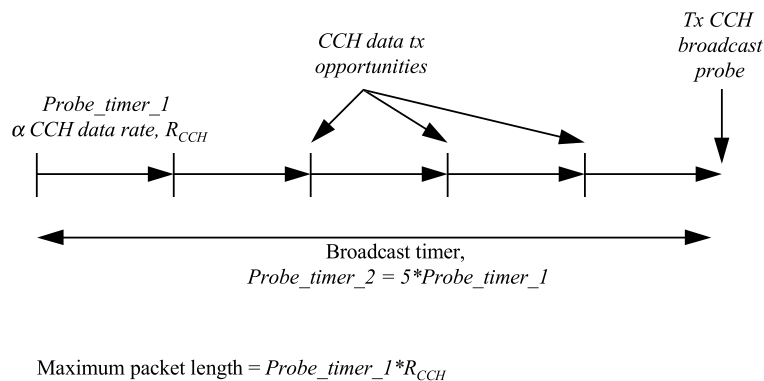


Figure 12. CCH Timer Relationships.

4.2.2 Transmitting Data on a DCH

Clearly, if all mobiles were to transmit a lot of data on the CCH, the channel would become heavily congested and the throughput would decrease. Each CCH therefore has an associated set of DCHs which are used to transfer larger volumes of data between ODMA nodes. In this case either the first addressed data probe sent on the CCH or the corresponding response packet may indicate a DCH in the header field on which subsequent packets will be transmitted. Data exchanges will continue on the data channel until:

- a) no more data needs to be transmitted, or,

b) the data channel timer, T_{data} , expires.

In a lengthy data transfer session the MS will still need to maintain the current status of its neighbours. The data channel timer, T_{data} , ensures that the MS will periodically revert back to the CCH and continue data exchanges on the CCH. At this stage a new DCH may be requested and the cycle repeats until the session is completed.

4.3 Routing and Connectivity

Sections 2 and 3 have described the core mechanisms which enable ODMA nodes (mobiles or fixed units) to derive neighbour list information and relay data. This section will explain how packets are routed and connectivity between two remote nodes is achieved. The ODMA packet structure, described below in Figure 14, is designed to enable nodes to listen to neighbour broadcasts or data transmissions and derive the required connectivity information.

The packet header contains physical layer characteristics, such as transmit powers local modem noise levels and the packet payload encapsulates either data segments, in the case of a data packet, or neighbour list information, in the case of a broadcast probe.

Two levels of connectivity may be considered in ODMA:

- *local connectivity*, which enables a node to select an appropriate Receiving ID for a single relay hop and,
- *end-to-end connectivity*, which enables a node to determine the final Destination ID field for a data segment in a call session.

ODMA Packet Structures

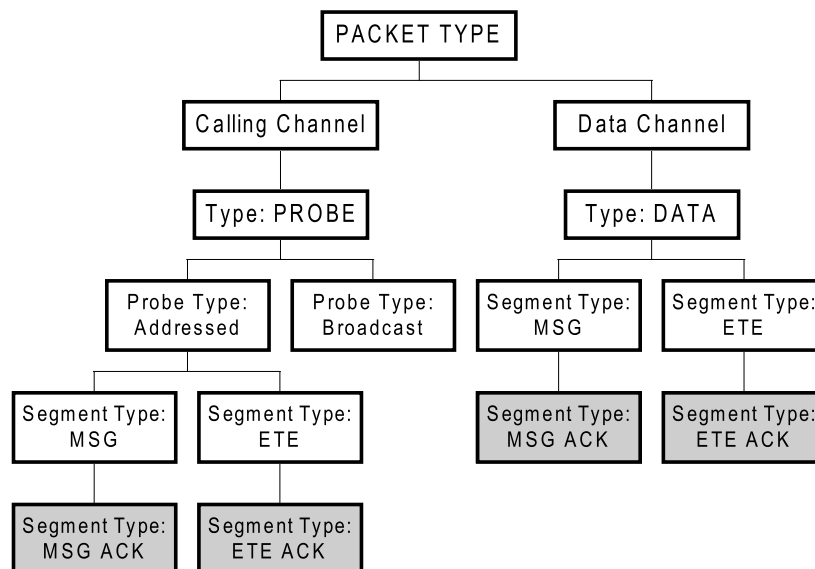


Figure 13 ODMA Packet Structures

Packet Header Information

Sending ID	The ID of the transmitting MS
Receiving ID	The ID of the receiving MS
Transmit power	The mobile transmit power
Local path loss	The path loss between the transmitting MS and addressed MS (addressed probes only)
Background RSSI	The noise level at the current modem
Background RSSI + 1	The noise level at the next highest rate modem
Background RSSI -1	The noise level at the next lowest rate modem
Requested Rx/Tx channel	Required RF channel when transmitting MS wants to move to a dedicated TCH.

Data Segment Header Information

Segment type	i.e. MSG, MSG ACK, ETE, ETE ACK
Origin ID	The originating MS
Destination ID	The destination MS
TOC	Time of segment creation
TTD	Time to die
Time Elapsed	Relative segment life-time in the network
Message number	The message number, segment type and Origin ID uniquely define a message segment in the system.

Figure 14. Packet Header Structures in ODMA.**4.3.1 Local Connectivity**

Each packet comprises a header section and a payload section. In the case of a broadcast probe transmitted on a CCH, the payload comprises a neighbour list and receive quality indicator. On receiving a broadcast probe with a populated neighbour list a node can derive connectivity up to two hops away. For example, MS₀ in Figure 15 receives broadcast probes from mobiles in tier 1, whose neighbours also reside in tier 2. The tier two nodes are not classed as neighbours, since they cannot be received directly, but may be included in the MS₀ routing table.

The probing mechanism therefore enables an MS to populate the Sending ID and Receiving ID fields in the packet header to relay data over a single hop and define the end-to-end (ETE) connectivity if the Destination ID is in the routing table.

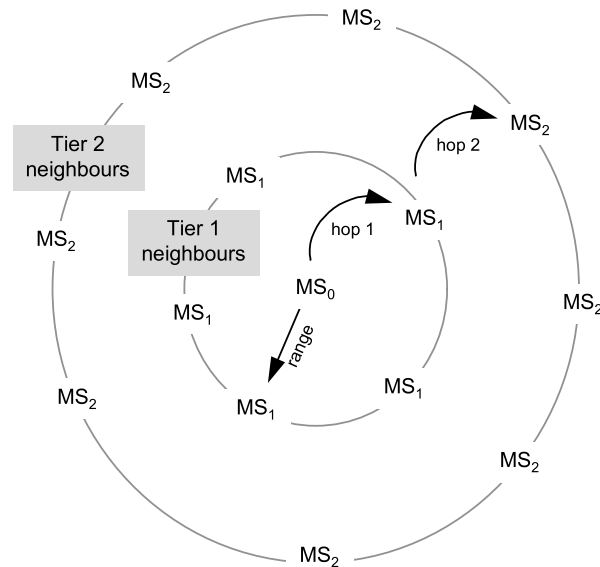


Figure 15. Localised connectivity through probing.

4.3.2 Connectivity Metrics

Within a local connectivity area, defined by the current neighbour list information, a mobile could select one of several relays which may be used to route a packet towards a final destination. Clearly, a choice needs to be made to determine which mobile would represent the best connection for a single hop. Whenever an MS receives a packet from a neighbour, the header provides sufficient information to perform a basic link budget assessment, which determines the transmit power required to reach a mobile with a sufficient S/N.

Connectivity beyond a local area is derived from layer 2 segment header information. The Origin ID and Destination ID fields provide new entries in the routing table and an ETE segment indicates connectivity with a final destination. The Time-of-creation (TOC) and Time Elapsed fields show the relative time at which a segment was created and how long it has been in the network. The Time Elapsed field is incremented at each relay node and compared with the TOC to determine the delay. Using these fields a node can monitor a packet being transmitted between two other nodes and derive the packet delay. If a segment does not reach its destination within a specified time, defined by the TTD, it is deleted from the transmission queue.

In summary the minimum transmit power (for a required S/N) and network delay are the two main parameters which indicate connectivity quality in the ODMA routing algorithm.

4.3.3 End-to-End Connectivity

In a non-cellular environment, if a mobile wants to initiate an ODMA call with a node which is not listed in the routing table, the MS creates a Destination ID and sends a *router message*, which is a very small, high priority message, routed towards nodes with good connectivity and away from the origin, flooding the immediate local

area within the network. The router message will only flood to mobiles within a limited region restricted by a Time To Die field in the router message.

N.B. [In a WB-TDMA/CDMA cellular environment all traffic is to or from a Gateway/BTS, the majority of mobiles will always know a route to the Gateway/BTS and since the Gateway/BTS can page them directly without relaying it can request them to initiate a relaying call and so does not have to find a route to the mobile. Once the gateway has received a message from the mobile via relays in response to a page it can then send data back down the same route to the mobile. Therefore router messages may not be required or used very rarely with flooding only over small localised areas.]

If the Destination ID receives the router message it responds via the same route with an ETE acknowledgement which also has a high priority. If the router message does not reach the Destination ID within a given time, specified by the time to die TTD field, another router message is sent, this time via two well connected nodes.

The ETE is sent on a chain of CCHs to acknowledge connectivity and is also received by third party mobiles using the same CCHs but not involved in the call directly. On receiving an ETE, mobiles are able to update their routing tables to include nodes which lie outside their local connectivity area.

Consider the example in Figure 16. ODMA could be considered as a set of overlapping local connectivity areas, A, B, C, D, containing mobiles $A=\{1,2,3\}$, $B=\{3,4,5,6\}$, $C=\{6,7,8,9\}$ and $D=\{9,10\}$, where mobiles within the same area can receive each others transmissions. If MS_1 wants to communicate with MS_{10} , it needs to send a router message across the network and the corresponding ETE is sent on a reciprocal path. On the outbound and return paths, the router and ETE messages are also received by MS_4 and MS_8 , allowing MS_1 and MS_{10} to be entered into each mobile's routing table. When a subsequent outbound packet reaches MS_3 for the second time, MS_3 will assess the connectivity between its neighbours and may conclude (from the neighbour list information) that MS_4 provides a better connection to MS_6 , which has been noted to have connectivity to MS_{10} . This mechanism implies that within each local area call connectivity changes dynamically depending on the link budget and network delay.

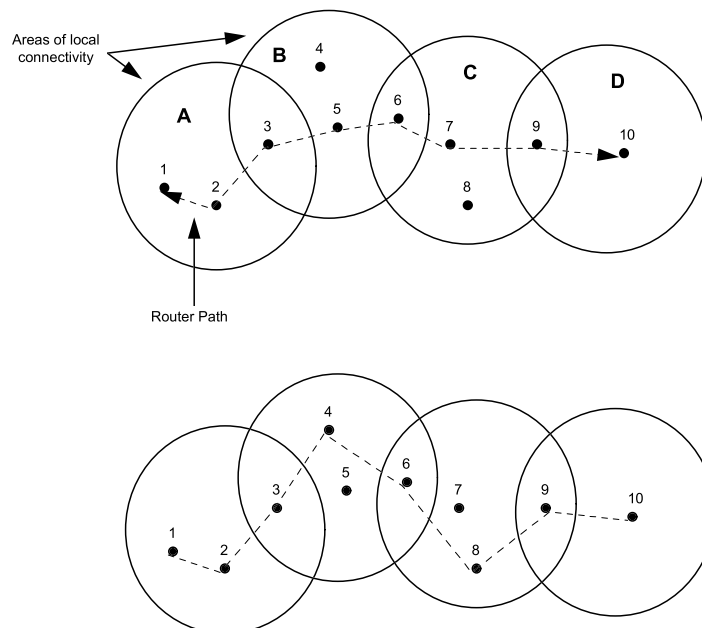


Figure 16. ETE connectivity in ODMA.

When the originating mobile receives the ETE, connectivity is established and the data transfer can proceed according to the Layer 2 protocol, illustrated in Figure 17.

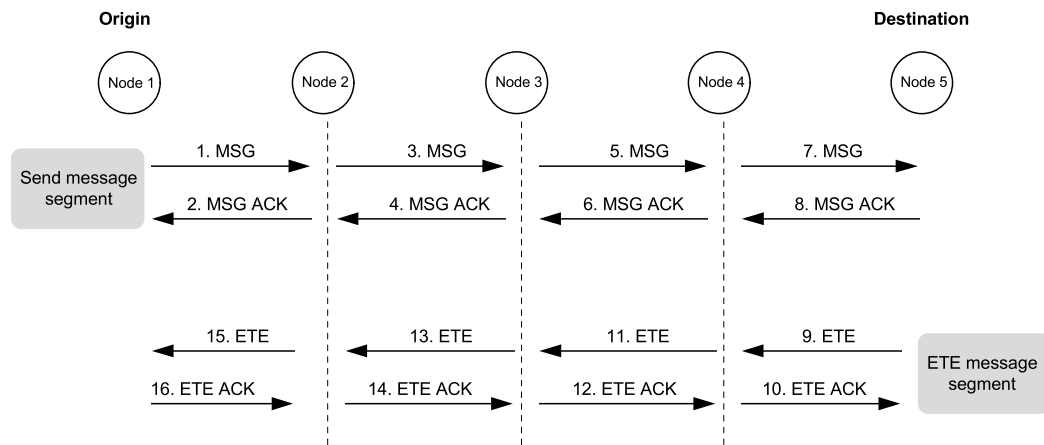


Figure 17. ODMA Layer 2 RLP.

5. Simulations

Within the Epsilon concept group simulations were performed on the ODMA technology. For this purpose a system simulator tool was created such that the environments, traffic and mobility models of UMTS 04.02 could be supported. The simulated ODMA nodes were software kernels taken from a prototype packet radio system in South Africa which is based on the ODMA technology. Simulations using this tool should therefore be close to reality as the simulated nodes are themselves deciding on the best relay paths, the power levels, overall routing etc. A disadvantage of this approach is that simulations have taken a long time to run and the number of simulated nodes has been limited. As a consequence it has been necessary to concentrate on a small subset of simulation tests relevant to ODMA data relaying i.e. LCD 384kbps. The LCD model was used as it was considered a better measure of performance than UDD which was more open to different interpretations.

A representative link level was used during the simulations but this was not WB-TDMA/CDMA. However it is expected that future results using WB-TDMA/CDMA would achieve much better results.

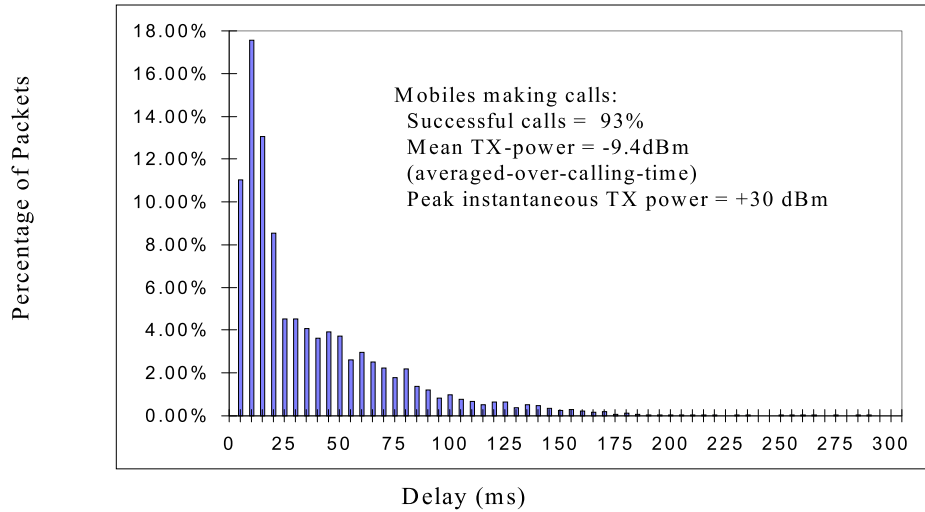
Most of the simulations concentrated on extended coverage scenarios using subscriber relay but some initial work was carried out on capacity for a combined ODMA/cellular solution where traffic is concentrated at a number of nodes close to the BTS.

Where subscriber relay is assumed only 1% of the mobiles believed to be within a coverage area are assumed available as relays. (User density estimate based on figures in early versions of UMTS 04.02).

The very wide area coverage simulations were not to prove that such areas should be covered by a single BTS but rather to show the flexibility of systems that support relaying.

5.1 Indoor office (x60) LCD 384kbps Coverage

Figure 18 shows a distribution of packet delays for communications within a 60 office indoor environment using a single BTS and subscriber relay. It can be seen that in general delays are within the 300ms LCD bearer limit and that the mobile TX power



during a call is very low (115uW)

Figure 18 Packet Delay Distribution for Indoor Office (x60) LCD 384kbps Coverage

5.2 Manhattan 10x10 Blocks LCD 384kbps Coverage

Figure 19 shows distribution of packet delays for LCD 384kbps over a 10x10 block of Manhattan. There is more of a delay variation with respect to Indoor attributable to the more difficult environment e.g. corner effects and building loss. The power during a call is also greater (49mW) which suggests fewer or more difficult radio paths.

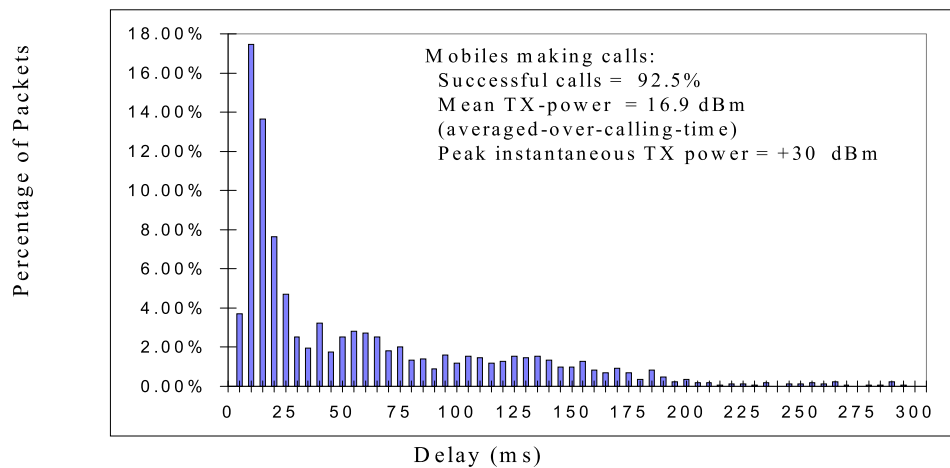
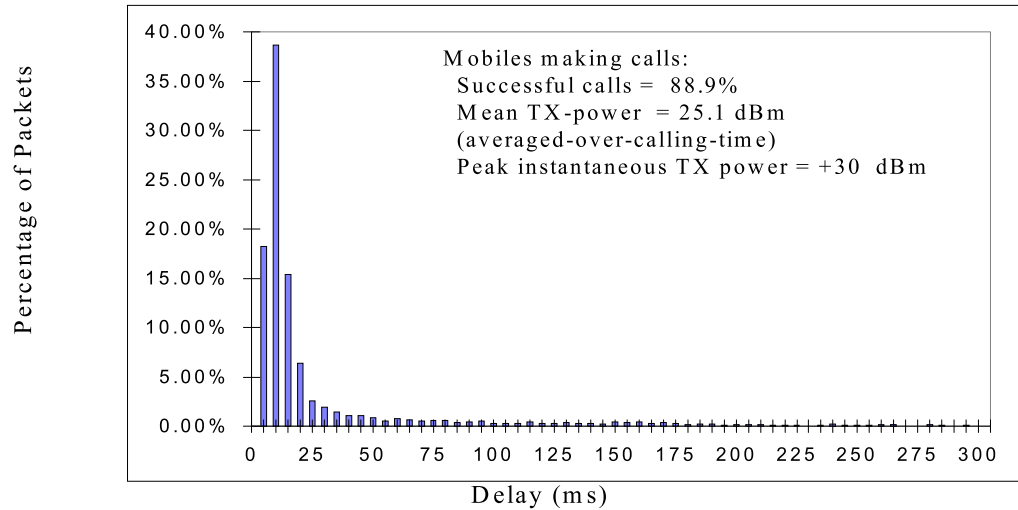


Figure 19 Packet Delay Distribution for Manhattan (10x10) LCD 384kbps Coverage

5.3 Vehicular - 6km x 6km LCD 384kbps Coverage

Figure 20 shows distribution of packet delays for LCD 384kbps over a 6km x 6km vehicular coverage area. There is less delay variation with respect to Manhattan attributable to having less relay hops with a corresponding increased TX power



(323mW).

Figure 20 Packet Delay Distribution for Vehicular 6km x 6km LCD 384kbps Coverage

5.4 Manhattan 3x3 Blocks LCD 384kbps Capacity

Figure 21 shows distribution of packet delays for LCD 384kbps over a 3x3 block of Manhattan using 8 WB-TDMA/CDMA/ODMA nodes close to the BTS to concentrate traffic. For the spectrum utilised the efficiency of this group of 8 is 860kbps/MHz. This is an interesting initial result which can be improved but the link between the interface between the ODMA layer and the WB-TDMA/CDMA cell requires more detailed investigation which has not been possible within the given timescales.

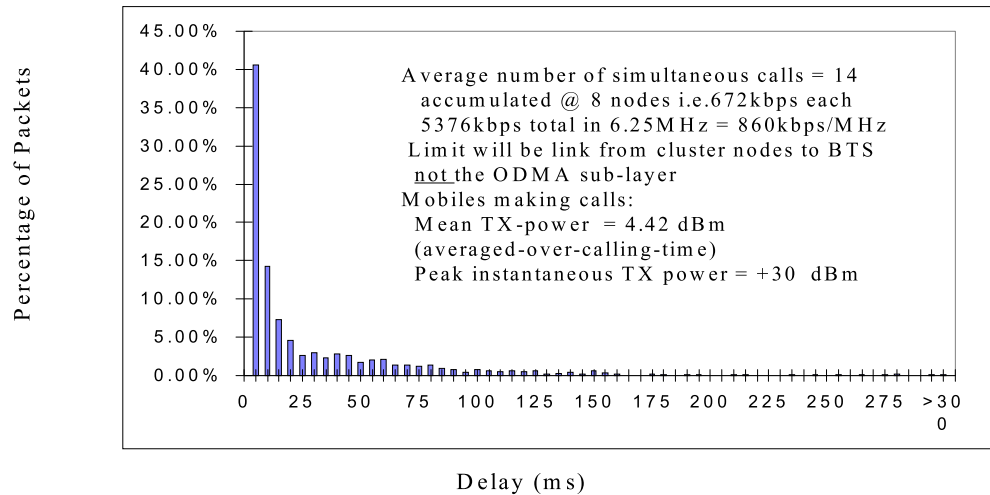


Figure 21 Packet Delay Distribution for Manhattan 3x3 Block LCD 384kbps Capacity

6. Call Set-up Procedures for ODMA in a WB-TDMA/CDMA cell.

Within a WB-TDMA/CDMA cell that supports ODMA we will consider that all mobiles have the same basic functionality i.e.; they can time multiplex between WB-TDMA/CDMA FDD mode and ODMA TDD mode. ODMA traffic will be carried in a separate unpaired spectrum band but the last relay hop to the BTS will use WB-TDMA/CDMA/FDD.

Within the cell there are several MS roles e.g.;

- 1) Mobile originator/terminator (MO / MT)
- 2) Active relay
- 3) Sleeping relay
- 4) ODMA/WB-TDMA/CDMA gateway (last hop)

All the mobiles can receive broadcast information from the BTS and thereby establish basic system timing synchronism.

ODMA requires a background probing activity to determine the location of near neighbours which may act as future relays. If this is allowed to occur at any time the MSs must RX continuously which may reduce battery life. To avoid this, a low duty cycle probing window coordinated by BTS broadcast information is used, i.e. the sleeping MSs wake up periodically to send and receive probes (e.g. every minute) and then go back to sleep. The window could be of the order of 0.5 seconds long.

The BTS has the capability to send a wakeup page to all the MSs via the WB-TDMA/CDMA/FDD cell. A sleeping MS that is then paged awake will stay active whilst it can detect local ODMA transmissions. If it has not participated in such communication for a timeout period it will fall asleep. Similarly it may decide to sleep after a long period of activity

When a MO wishes to start a call it makes a conventional RACH access to the WB-TDMA/CDMA/FDD BTS. A conventional authentication/call setup will take place but during the negotiation of resource it will be decided to use ODMA mode. Firstly the BTS will send a broadcast wakeup page to the MS relays. The BTS will then ask the MO to send a message to it via ODMA relaying which it then acknowledges. The initial route for these messages will be based on knowledge acquired from the background probing. The transmissions will be monitored by relays not directly involved in the link. These relays then determine connectivity routes between the MO and BTS and are available to make further transmissions more optimum and reliable. Other mobiles will fall asleep using the page-awake rules. A similar procedure is used for MT calls.

6.1 ODMA/WB-TDMA/CDMA Gateway - Last Hop to BTS

The last MS in the relay chain will have direct connectivity to the BTS over a short high rate link. The MS will require 2 buffers i.e.; to fill from ODMA and empty via WB-TDMA/CDMA and vice versa. For example in the case of significant DL traffic the buffer will be filled by a WB-TDMA/CDMA call and at a defined threshold the MS will switch to ODMA mode until the buffer is emptied. Similarly for an UL case ODMA will fill the buffer until a threshold is reached after which a WB-TDMA/CDMA call empties the buffer into the BTS. If an ODMA relay is not available as in WB-TDMA/CDMA mode traffic is either backed up toward the source or an alternative last hop MS is chosen.

7. WB-TDMA/CDMA Support for Relaying

This section presents the findings from joint Delta/Epsilon feasibility study which considered the benefits of TD-CDMA for relaying and how and with which additional complexity the radio sub-blocks within the WB-TDMA/CDMA mobile could support relaying.

7.1 Benefits of Using WB-TDMA/CDMA for Relaying

- WB-TDMA/CDMA communication in ODMA mode implies MS-to-MS communication. This, in turn, implies MS reception and transmission on the same frequency band, i.e. TDD operation. TDD is already included as a key feature of the WB-TDMA/CDMA proposal of the concept group Delta and only a very limited amount of additional features have to be added to a WB-TDMA/CDMA terminal in order to support relaying as will be discussed further in the next section.
- Within a given spectrum WB-TDMA/CDMA provides for high granularity of orthogonal basic channels which is beneficial for DCA in an uncoordinated mode of operation context.
- An evolution to higher data rates is supported by means of higher order modulation schemes and larger carrier bandwidth (cf. future enhancements option for WB-TDMA/CDMA).
- WB-TDMA/CDMA features a very high hot spot capacity due to low intracell interference by timeslot orthogonality and joint detection. Thus, use of high order modulation schemes (e.g. 16QAM) can be used to effectively increase cell capacity which would not be possible for CDMA without joint detection techniques.
- Link budget improvement due to static Seeds with directional antennas can be translated into further capacity gains especially for the last hop while coexisting with other mobile users by the same means (e.g. adaption of modulation order).
- The joint detection receiver in mobile terminals provides an efficient means to resolve collisions in a way that the colliding transmission can be resolved and both used, thus increasing the efficiency and delay times in ODMA.

7.2 Impact of Relaying on Implementation and Complexity of WB-TDMA/CDMA

For mobiles supporting both FDD and TDD modes of operation there is negligible impact on hardware with transmissions taking place using the timing context of the serving BTS. As shown in Figure 22 the required receiver components are as for a normal simple WB-TDMA/CDMA mobile.

The full receiver consisting of both monitoring and detection circuit is regularly switched on for reception of normal FDD paging messages originated by the BTS.

During the probing windows (e.g. 0.5 sec every 30 sec) only the monitoring circuit is switched on to listen to probes from neighbouring mobiles. This is performed by evaluating the code active indications from the Channel Estimator circuit. If a code-time slot burst is detected, the detection circuit is switched on to evaluate the data sections of the receive buffer contents (if just one active code is detected this is a

trivial operation, otherwise it can resolve the «collision» and detect all code-time slot burst transmission colliding in one particular time slot). During the wake-up window the same principle is applied.

The monitoring circuit consists of the burst buffer from which the midamble section is extracted and forwarded to the channel estimator. The channel estimator performs on a burst by burst basis a fast correlation with the known midamble sequence. As can be seen in Figure 23 the output of this correlation process is a set of channel estimation vectors for each code, if it is active or not. The code active indication can be obtained from a code's channel estimation by comparing the energy in the channel estimate with a threshold. From this information a power estimation can be derived as well. For short delay spreads introduced by the radio channel a certain jitter in time alignment of more than 5 μ sec in each direction can be tolerated with negligible performance degradation.

The fast correlation is depicted in more detail in Figure 24. It consists of a (fast) discrete Fourier transform of the midamble samples, followed by an element-by-element multiplication with a precomputed and stored "inverse" of the correlation sequence and an inverse FFT. This operation has to be performed once per burst which is monitored.

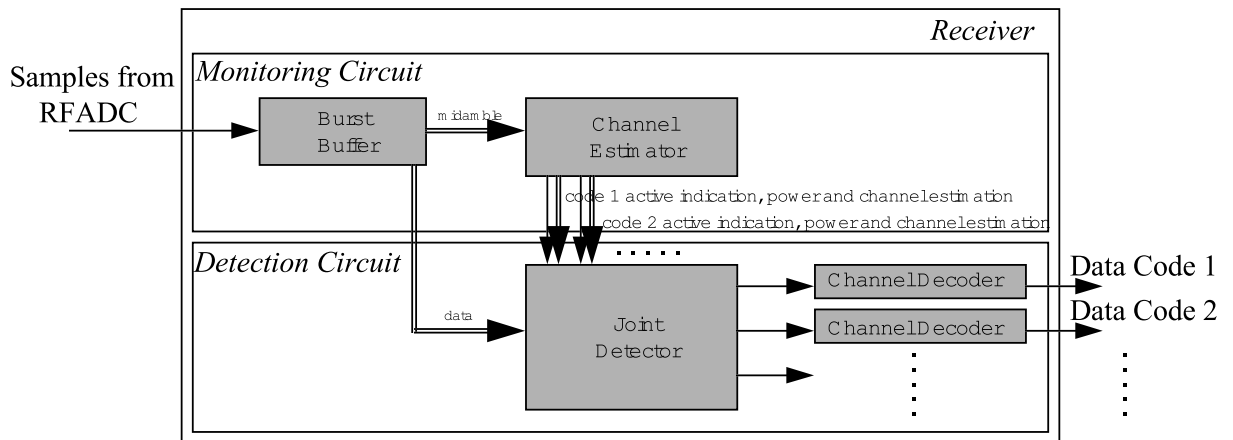


Figure 22 WB-TDMA/CDMA - ODMA Enabled Receiver

The block diagrams illustrate that no additional hardware and DSP functionality is required for a simple WB-TDMA/CDMA mobile in order to support ODMA mode of operation as MO or MT and as relay. Thus, the impact on cost and complexity of the ODMA support in mobile terminals is primarily on the higher layers and thus, considered to be low.

For higher throughputs, e.g. for the last hop and/or fixed seeds, more complex transceiver types e.g. the full featured mobile as well as directional antennas to the base station are helpful, of course.

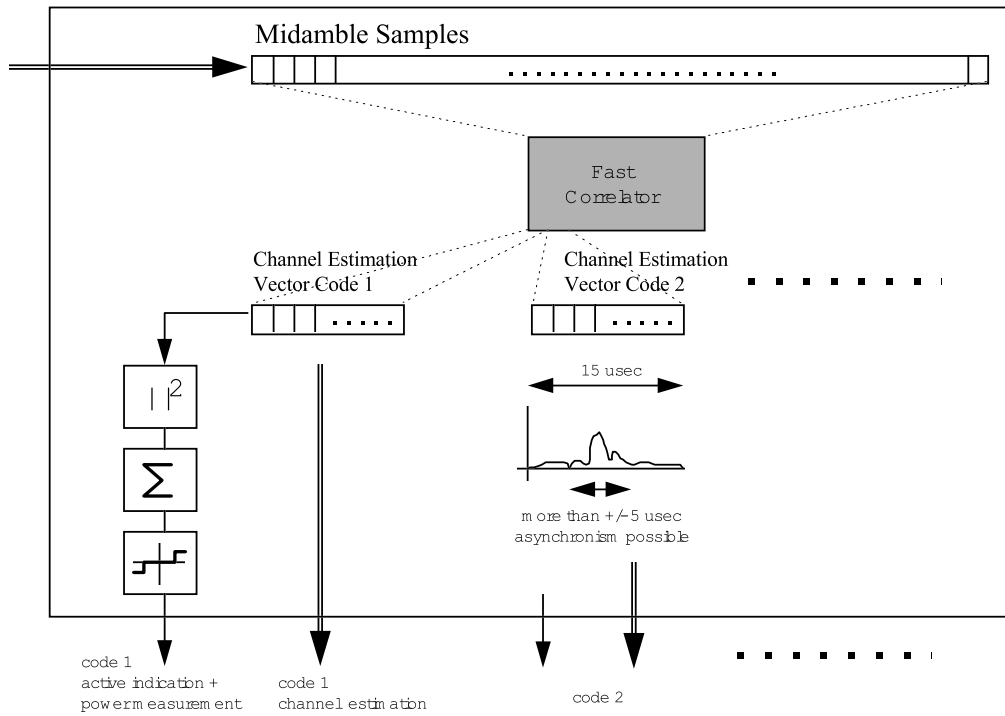


Figure 23 WB-TDMA/CDMA Channel Estimator Function

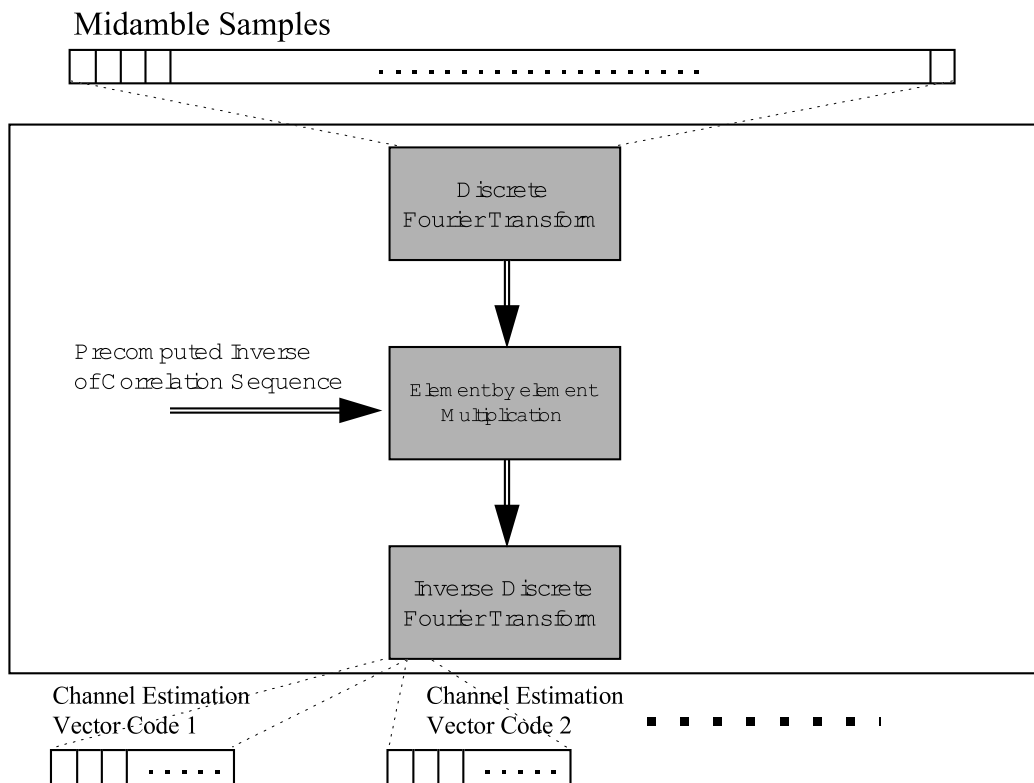


Figure 24 WB-TDMA/CDMA Fast Correlator

8. Benefits of ODMA to WB-TDMA/CDMA w.r.t. High Level Requirements

The potential benefits of ODMA as a WB-TDMA/CDMA enhancement are listed below with respect to the UTRA high level requirements.

Key Requirements	Description
	Bearer capabilities
Maximum User Bit Rates	<p>The UTRA should support a range of maximum user bit rates that depend upon a users current environment as follows:</p> <p>Rural Outdoor¹: at least 144 kbit/s (goal to achieve 384 kbit/s), maximum speed: 500 km/h</p> <p>Suburban Outdoor²: at least 384 kbps (goal to achieve 512 kbit/s), maximum speed: 120 km/h</p> <p>Indoor/Low range outdoor³: at least 2Mbps, maximum speed: 10 km/h</p> <p>It is desirable that the definition of UTRA should allow evolution to higher bit rates.</p> <p><i>The maximum user bit rate for packet services in the given environments are determined by the assumptions on channel models and maximum range. If relaying is supported then these assumptions change as communication proceeds via a number of relay hops which are normally low range, low mobility and often LOS. Therefore relaying enables high rate transmissions in all environments.</i></p> <p><i>Where high rate transmission was already possible, relaying will lower the required transmitted power.</i></p>

¹ The specified bit rate will be available throughout the operator's service area, with the possibility of large cells

² The specified bit rate will be available with complete coverage of a suburban or urban area, using microcells or smaller macrocells

³ The specified bit rate will be available indoors and localised coverage outdoors.

Flexibility	<p>Negotiation of bearer service attributes (bearer type, bit rate, delay, BER, up/down link symmetry, protection including none or unequal protection), parallel bearer services (service mix), real-time / non-real-time communication modes, adaptation of bearer service bit rate</p> <p>Circuit and packet oriented bearers</p> <p>Supports scheduling (and pre-emption) of bearers (including control bearers) according to priority</p> <p>Adaptivity of link to quality, traffic and network load, and radio conditions (in order to optimise the link in different environments).</p> <p>Wide range of bit rates should be supported with sufficient granularity</p> <p>Variable bit rate real time capabilities should be provided.</p> <p>Bearer services appropriate for speech shall be provided.</p> <p><i>WB-TDMA/CDMA is a flexible and adaptive air interface technology and relaying further enhances these capabilities for packet services. Using ODMA you not only have the opportunity to perform optimum link adaption but you may have a number of different links (relay paths) from which to select the best and thereby bypass heavy shadowing effects. ODMA adds link diversity to WB-TDMA/CDMA.</i></p> <p><i>When a MS uses a relay it is effectively replacing its own transmission limitations with that of a neighbour who is better situated or more able to communicate. For example a low power handportable MS could relay to a vehicle in order to exploit the more powerful transmitter and better antenna to reach a distant BTS or satellite. In these examples the single hop relay means that low delay speech can be supported as well as data services.</i></p> <p><i>For the satellite case this gives the option of indoor coverage using a simple UMTS handset.</i></p>
Handover	<p>Provide seamless (to user) handover between cells of one operator.</p> <p>The UTRA should not prevent seamless HO between different operators or access networks.</p> <p>Efficient handover between UMTS and 2nd generation systems, e.g. GSM, should be possible.</p>

	OPERATIONAL REQUIREMENTS
Compatibility with services provided by present Core Transport Networks	ATM bearer services GSM services IP (internet protocol) based services B/N-ISDN services
Radio Access Network Planning	If radio resource planning is required, automatic planning shall be supported.
Public network operators	It shall be possible to guarantee pre-determined levels of quality-of-service and quality to public UMTS network operators, in the presence of other authorised UMTS users.

<p>Private and residential operators</p>	<p>The radio access scheme should be suitable for low cost applications where range, mobility and user speed may be limited.</p> <p>Multiple unsynchronised systems should be able to successfully coexist in the same environment.</p> <p>It should be possible to install basestations without co-ordination.</p> <p>Frequency planning should not be needed.</p> <p><i>Private and residential systems are particularly appropriate for relaying and ODMA.</i></p> <p><i>As ODMA relays do not own dedicated radio resource but share it in an asynchronous fashion with neighbouring nodes. They are tolerant to spectrum sharing.</i></p> <p><i>For example ODMA could be used in the same spectrum band within adjacent buildings. This is particularly true as relaying avoids higher power transmissions at the building edge - in fact the highest average transmission powers can be concentrated at the centre of the cell/building. ODMA can be considered as a wireless distributed antenna.</i></p> <p><i>In private companies another option is possible. A MS can exchange signalling with a BTS for call set-up authentication/encryption/user profiles etc. but the data content of the intracompany calls could be transmitted direct MS-MS or via MS relays. The capacity of such a system may be great and can be considered analogous to having a great many BTSs within a given area. In this scenario the delay of relayed calls is also very low and would be appropriate for speech as well as higher rate data services.</i></p> <p><i>In a residential property there maybe a requirement for the UMTS MS to act as a low power cordless phone. The ODMA protocol has a probing mechanism to determine its near neighbours so that if the cordless BTS supported ODMA a MS could detect that it was "at home". The MS could then communicate directly to the BTS using the ODMA band without affecting the Operator's paired spectrum. The direct link would be low delay and suitable for speech as well as higher rate data services. Thus, ODMA provides the necessary functionalities to operate WB-TDMA/CDMA in a cordless fashion.</i></p>
-------------------------------------------------	------------------------------------------------------------------------------------------------------------------------------------------------------------------------------------------------------------------------------------------------------------------------------------------------------------------------------------------------------------------------------------------------------------------------------------------------------------------------------------------------------------------------------------------------------------------------------------------------------------------------------------------------------------------------------------------------------------------------------------------------------------------------------------------------------------------------------------------------------------------------------------------------------------------------------------------------------------------------------------------------------------------------------------------------------------------------------------------------------------------------------------------------------------------------------------------------------------------------------------------------------------------------------------------------------------------------------------------------------------------------------------------------------------------------------------------------------------------------------------------------------------------------------------------------------------------------------------------------------------------------------------------------------------------------------------------------------------------------------------------------------------------------------------------------------------------------------------------------------------------------------------------------------------------------------------------------------------------------------------------------------------------------------------------------------------------------------------------------------------------------------------------------------------------------------

	EFFICIENT SPECTRUM USAGE
Spectrum efficiency	<p>High spectrum efficiency for typical mixtures of different bearer services.</p> <p>Spectrum efficiency at least as good as GSM for low bit rate speech.</p> <p><i>Spectrum efficiency is limited by intercell and intracell interference.</i></p> <p><i>Intercell interference can be caused by a mobile on the edge of a cell transmitting at high power to reach its BTS. The transmissions will interfere with neighbouring cells whose coverage will have been planned to ensure there are no gaps between them.</i></p> <p><i>Another approach is possible with relaying. Plan the WB-TDMA/CDMA cells so that there are coverage gaps for high rate packet services (not necessarily speech). A BTS can then only serve MSs at short range which implies low transmission power and a long distance to the neighbour BTS. Serving these few MSs will be spectrally efficient as there would be simple low loss radio channels, with very little intercell interference. The coverage gaps would be filled in by ODMA relaying which would route traffic to and from the close range or optimally placed MSs.</i></p> <p><i>This technique may also be applicable to reduce intercell interference at country borders.</i></p> <p><i>Another factor which affects spectral efficiency is the protection methods to ensure reliable transmission in difficult environments which may have high error rates and long delay spreads. WB-TDMA/CDMA provides rugged protection methods for these environments but because relaying shortens and simplifies the communication paths less protection may be required.</i></p> <p><i>[It should be noted that within a cell area an ODMA sublayer using subscriber relay would re-use the radio resources many times as each re-transmission is of such low power that they will only effect a small percentage of the cell area.]</i></p>

Variable Asymmetry of Total Band Usage	<p>variable division of radio resource between uplink and down link resources from a common pool (NB: This division could be in either frequency, time, or code domains)</p> <p><i>Relaying will be supported in a TDD mode within a separate section of spectrum. Within this spectrum, complete asymmetry is supported with no requirement for a predefined UL/DL split of any kind. However as relaying is part of a hybrid WB-TDMA/CDMA solution the relay spectrum may logically be considered as adding to the WB-TDMA/CDMA DL or UL thereby considerably increasing support for variable asymmetry when dealing with packet services.</i></p>
Spectrum Utilisation	<p>Allow multiple operators to use the band allocated to UMTS without co-ordination.⁴</p> <p>It should be possible to operate the UTRA in any suitable frequency band that becomes available such as first & second generation system's bands</p>
Coverage Capacity /	<p>The system should be flexible to support a variety of initial coverage/capacity configurations and facilitate coverage/capacity evolution</p> <p>Flexible use of various cell types and relations between cells (e.g. indoor cells, hierarchical cells) within a geographical area without undue waste of radio resources.</p> <p>Ability to support cost effective coverage in rural areas</p> <p><i>A major feature of relaying is the prospect to extend service coverage either by extending high data rate services or by relaying from deadspots into coverage. It would be a means to limit the required number of BTS sites to achieve coverage whilst maintaining the customer perceived QoS.</i></p> <p><i>Relaying has potential to combat intercell interference which would allow BTS equipment to achieve greater capacity.</i></p> <p><i>If relaying is used to help initial rollout then it may be necessary to deploy Seeds (operator deployed-powered relaying mobiles). As the number of subscribers increase the Seeds will no longer be necessary. Ultimately more BTS resources will be added to cope with high capacity demands.</i></p>
	Complexity/cost
Mobile Terminal viability	<p>Handportable and PCM-CIA card sized UMTS terminals should be viable in terms of size, weight, operating time, range, effective radiated power and cost.</p> <p><i>A WB-TDMA/CDMA MS should readily support relaying as it already contains the required radio block functionality.</i></p>

⁴ NOTE: the feasibility of spectrum sharing requires further study.

Network complexity and cost	<p>The development and equipment cost should be kept at a reasonable level, taking into account the cost of cell sites, the associated network connections, signalling load and traffic overhead (e.g. due to handovers).</p> <p><i>Relaying would make use of the equipment proposed for WB-TDMA/CDMA and by extending the range of the high rate data services it would require less BTSs for a given coverage area.</i></p>
Mobile station types	<p>It should be possible to provide a variety of mobile station types of varying complexity, cost and capabilities in order to satisfy the needs of different types of users.</p> <p><i>For a relay system to work well there must be as many relay nodes as possible. It is therefore a goal to support relaying in all mobiles - as it is believed that little extra cost or complexity is implied.</i></p> <p><i>It is accepted that the lowest cost mobiles will have limited ability for relaying high rate packet services.</i></p>
	Requirements from bodies outside SMG
Alignment with IMT 2000	<p>UTRA shall meet at least the technical requirements for submission as a candidate technology for IMT 2000 (FPLMTS)</p> <p><i>WB-TDMA/CDMA meets these requirements but the development of relaying options could give the European solution an advantage over other candidate technologies.</i></p>
Minimum bandwidth allocation	<p>It should be possible to deploy and operate a network in a limited bandwidth</p> <p><i>The relaying sub-layer requires a single separate spectrum band (unpaired) which is used throughout the network. The smallest allocation unit for WB-TDMA/CDMA is one 1.6MHz carrier which can support high data rates if intercell interference is controlled.</i></p> <p><i>The band maybe taken from an operator's own spectrum but there are advantages in having an additional default band, e.g. the UMTS spectrum allocated in each country to unlicensed use which can be used on a low power sharing basis.</i></p>
Electro-Magnetic Compatibility (EMC)	<p>The peak and average power and envelope variations have to be such that the degree of interference caused to other equipment is not higher than in today's systems.</p> <p><i>The relaying system will strive to localise the effects of any transmission by minimising the transmitted power of a call, thus improving EMC.</i></p>
RF Radiation Effects	<p>UMTS shall be operative at RF emission power levels which are in line with the recommendations related to electromagnetic radiation.</p>

Security	<p>The UMTS radio interface should be able to accommodate at least the same level of protection as the GSM radio interface does.</p> <p><i>A security review of ODMA has shown that the potential attacks are very similar to those for GSM. Providing GSM like authentication and end-to-end payload encryption are carried out then the level of protection is comparable.</i></p>
Coexistence with other systems	<p>The UMTS Terrestrial Radio Access should be capable to co-exist with other systems within the same or neighbouring band depending on systems and regulations</p>
	<p>Multimode implementation capabilities</p>
	<p>It should be possible to implement dual mode UMTS/GSM terminals cost effectively.</p>

9. Summary

The use of relaying will add interesting new functionality and flexibility to a WB-TDMA/CDMA UTRA and every effort should be made to ensure it is included in the standard especially as initial investigations suggest that the required functionality has negligible impact on mobile terminal cost or complexity.

As discussed in section 6 the properties of WB-TDMA/CDMA are particularly advantageous to the use of advanced relaying protocols such as ODMA.

The ODMA/WB-TDMA/CDMA combination should be further investigated as simulation results obtained during the ETSI evaluation process have demonstrated the potential for significant coverage and capacity enhancements.

10. Associated Documents

List of associated documents currently available from the Epsilon Group;

TD number	Title	Source
E-1/97	Agenda & material for discussion	Chairman
E-2/97	Mailing list & document handling	Secretary
E-2/97Rev1	Mailing list & document handling	Secretary
E-3/97	Radio Interface Structure	Chairman
E-4/97	Report of the 1 st ODMA Concept Group meeting	Secretary
E-5/97	Outline of the Technical Discussion	Chairman
E-6/97	Low-cost, low-power terminals for basic services	Motorola
E-7/97	Concept Group e - ODMA - Report	Chairman
E-8/97	ODMA/CTDMA - Initial Discussions on Convergence	Vodafone Ltd Swiss Telecom PTT
E-9/97	Towards a Consistent Interpretation of ETR SMG-50402	Vodafone Ltd
E-10/97	Notes on the Simulation of ODMA	Vodafone Ltd
E-11/97	Operator's Key Questions to the UTRA Concept Groups	T-Mobil, MMO, TIM, CSELT, FranceTelecom/CNET, Vodafone, Telia, BT, Telecom Finland, Swiss Telecom PTT, KPN, Cellnet, Omnitel
E-12/97	Outline of Evaluation Activities for Concept e - ODMA	Chairman
E-12/97Rev1	Outline of Evaluation Activities for Concept e - ODMA	Chairman
E-13/97	Salbu Patent - "Adaptive Communication System"	Salbu
E-14/97	Investigation into Average and Instantaneous BER Performance of a $\pi/4$ QPSK on UMTS Channels	LGI

E-15/97	Average BER Performance on UMTS Channels with Paket Transmission considering $\pi/4$ QPSK and TCM8 PSK modulation	Kings College
E-16/97	Concept Group ϵ meeting report/presentation	Chairman
E-17/97	Answers to Operator Interest Group Questions	Chairman
E-18/97	WB-TDMA/CDMA/ODMA Feasibility Study	Siemens/Vodafone/Salbu
E-19/97	Initial Results from ODMA Simulations	Vodafone
E-20/97	ODMA - Opportunity Driven Multiple Access	Vodafone & Salbu
E-21/97	Characteristics of Opportunity Driven Multiple Access	Vodafone & Salbu
E-22/97	ODMA - System Gain from Fast Fading	Vodafone & Salbu
E-23/97	Q&A Session Report	Chairman
E-24/97	Questions to Concept Epsilon - ODMA	Chairman
E-25/97	Concept Group ϵ Report (SMG2 UMTS Ad Hoc #4)	Chairman
E-26/97	ODMA Annex to Alpha Evaluation Report	Chairman
E-27/97	ODMA Annex to Delta Evaluation Report	Chairman

History

Document history		
V3.0.0	December 1997	Publication