

(19) **United States**

(12) **Patent Application Publication** (10) **Pub. No.: US 2004/0044627 A1**

Russell et al. (43) **Pub. Date: Mar. 4, 2004**

(54) **METHODS, SYSTEMS AND APPARATUSES FOR SECURE TRANSACTIONS**

Publication Classification

(76) Inventors: **David C. Russell**, Portsmouth, VA (US); **Bart A. Singer**, Williamsburg, VA (US)

(51) **Int. Cl.⁷** **H04K 1/00**; H04L 9/00; G06F 17/60

(52) **U.S. Cl.** **705/50**

(57) **ABSTRACT**

The invention is directed towards methods, systems and apparatuses, see FIG. 1, (100) for providing secure and private interactions. The invention provides capability for verifying the identity of a party initiating an electronic interaction with another party through data input module (140) which is verified by the identity verification module (150), which further includes a self-destruct mechanism (153). Embodiments of the invention include secure methods for conducting transactions and for limiting the transfer and distribution of personal data to only those data that are absolutely necessary for the completion of the transactions. The invention facilitates the transfer of additional personal data contingent upon an agreement that appropriately compensates the provider of the personal data.

Correspondence Address:

Kimberly A Chasteen
Williams Mullen
Suite 210
One Old Oyster Point Road
Newport News, VA 23602 (US)

(21) Appl. No.: **10/148,512**

(22) PCT Filed: **Nov. 29, 2000**

(86) PCT No.: **PCT/US00/42323**

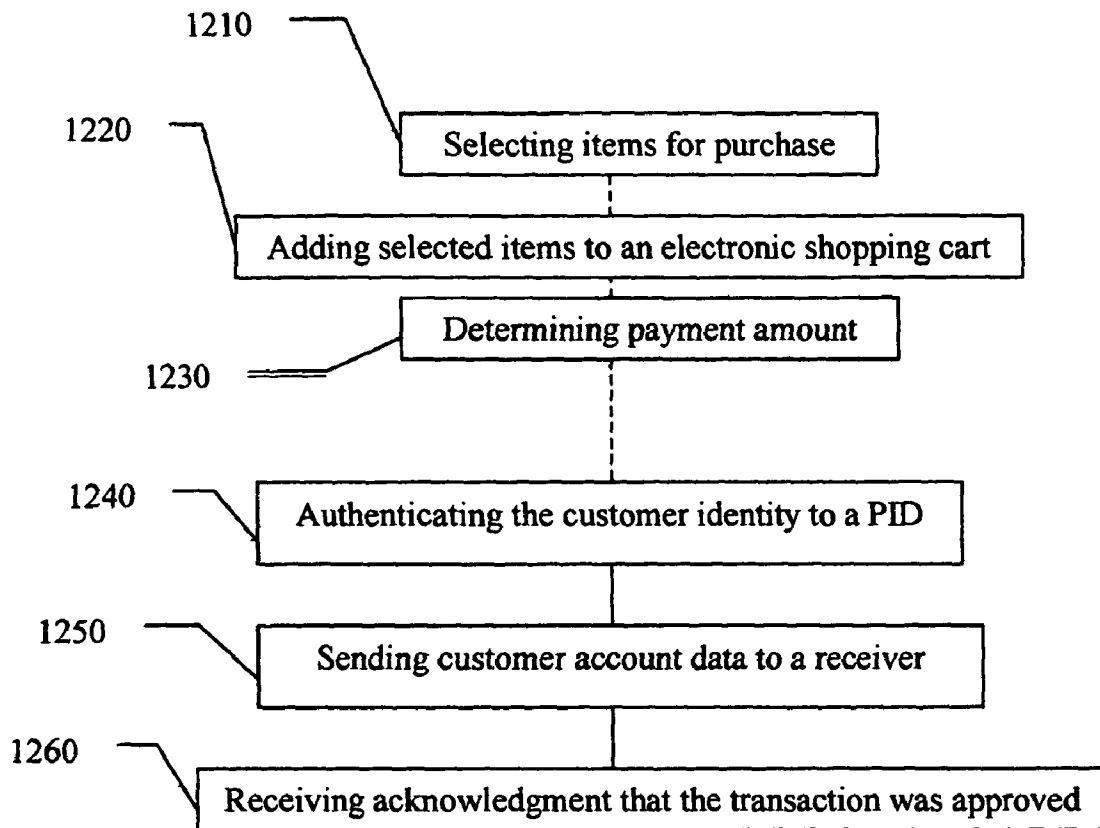

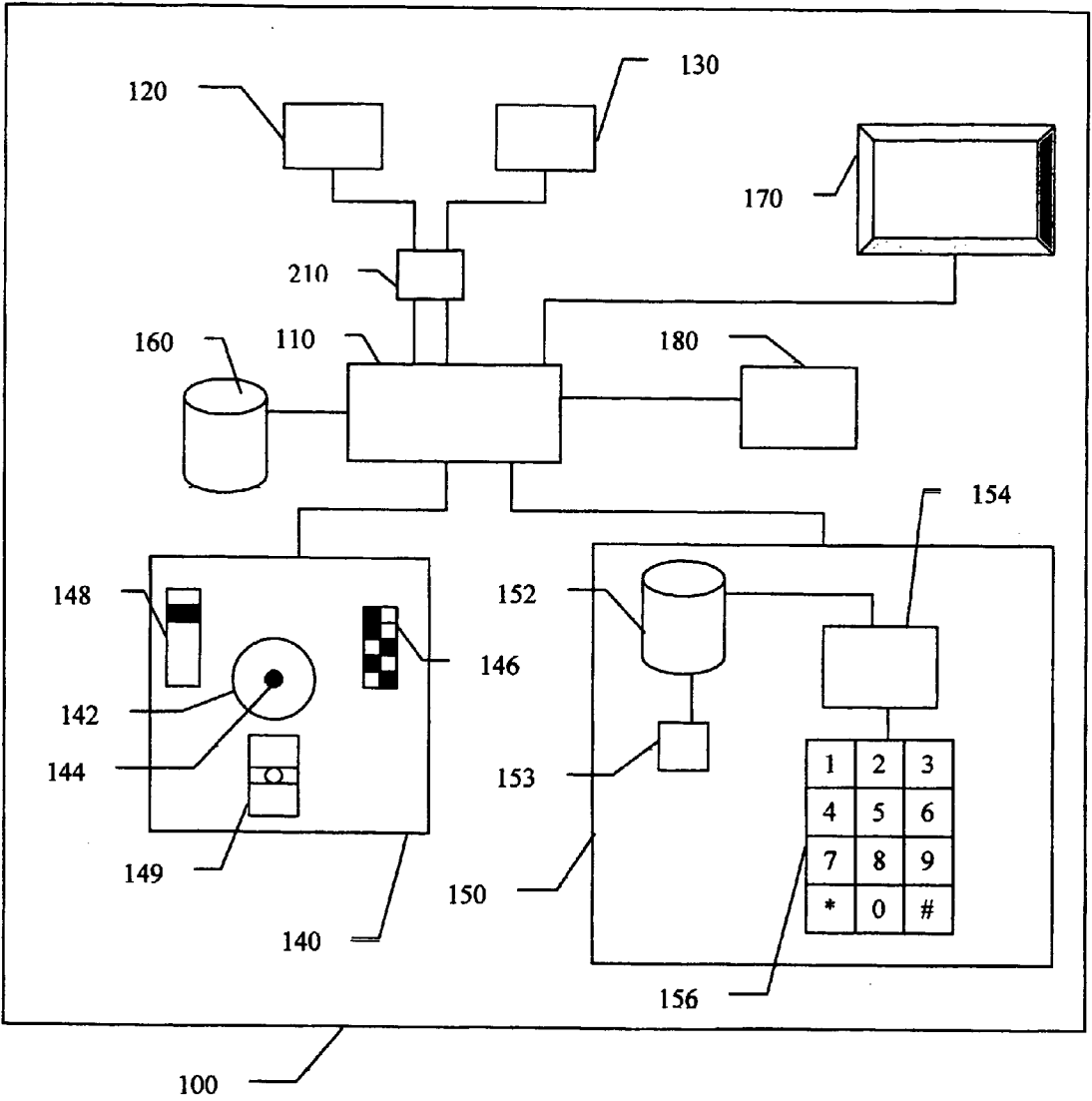

Figure 1

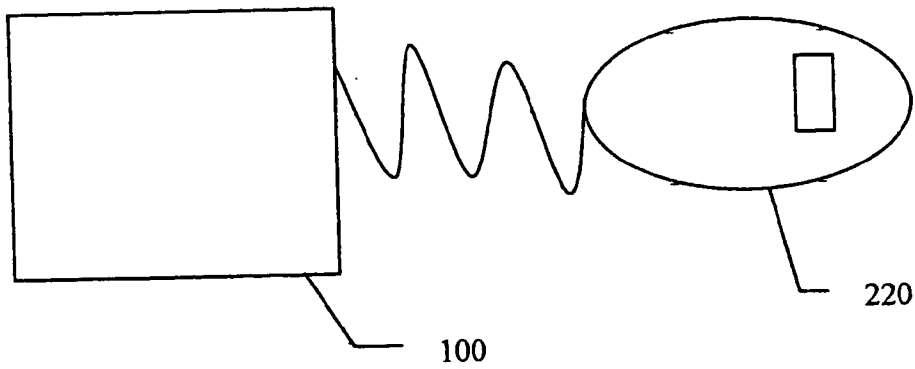

Figure 2A

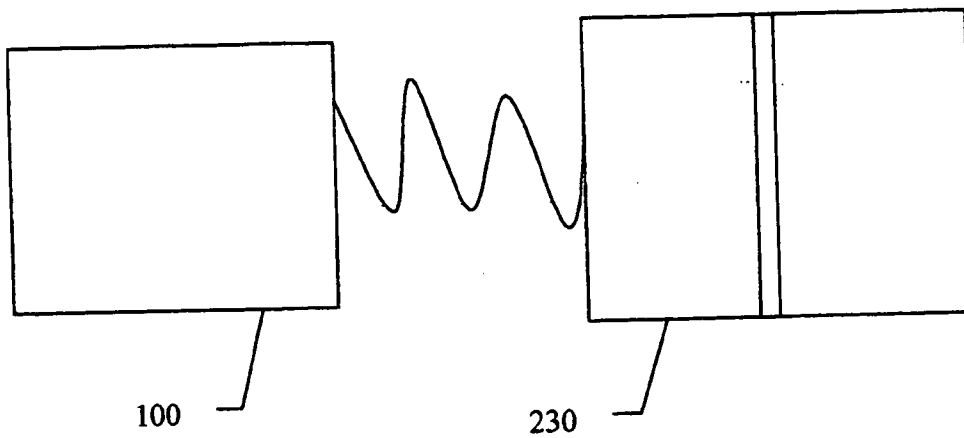

Figure 2B

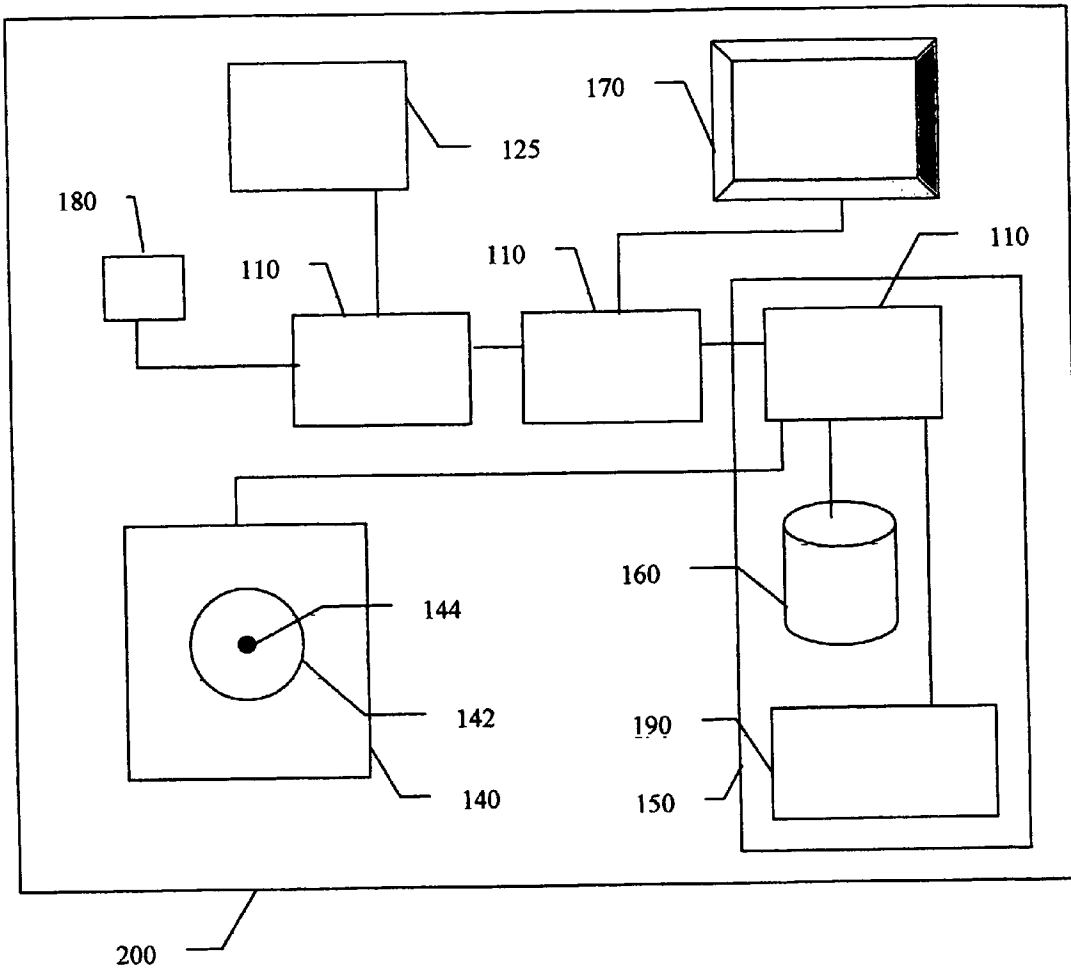

Figure 3

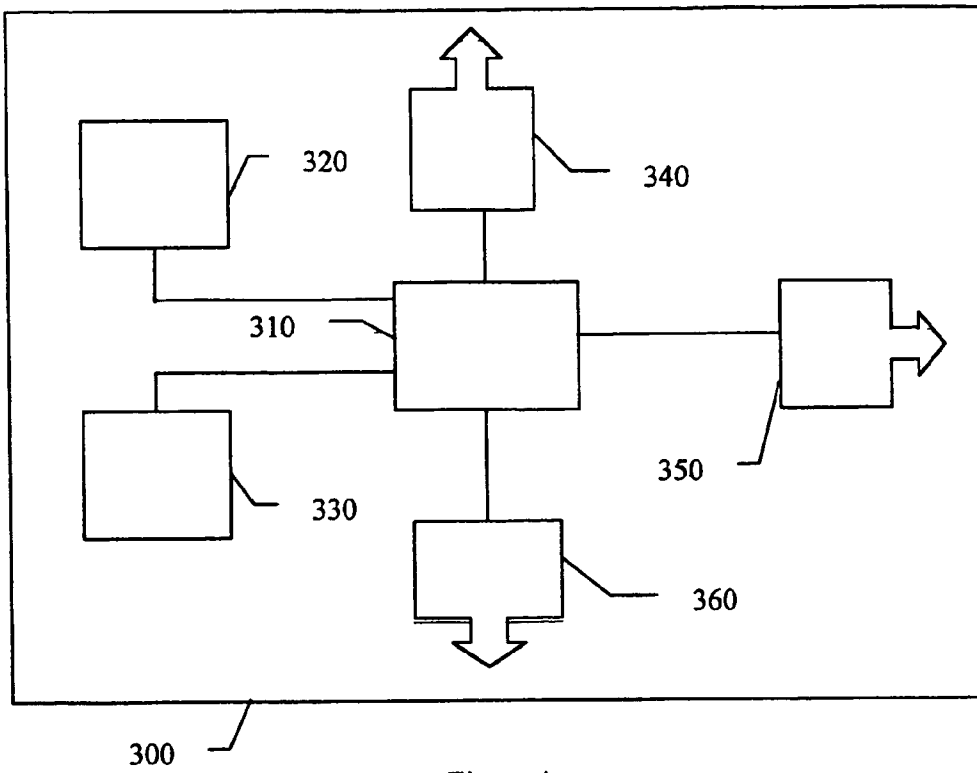

Figure 4

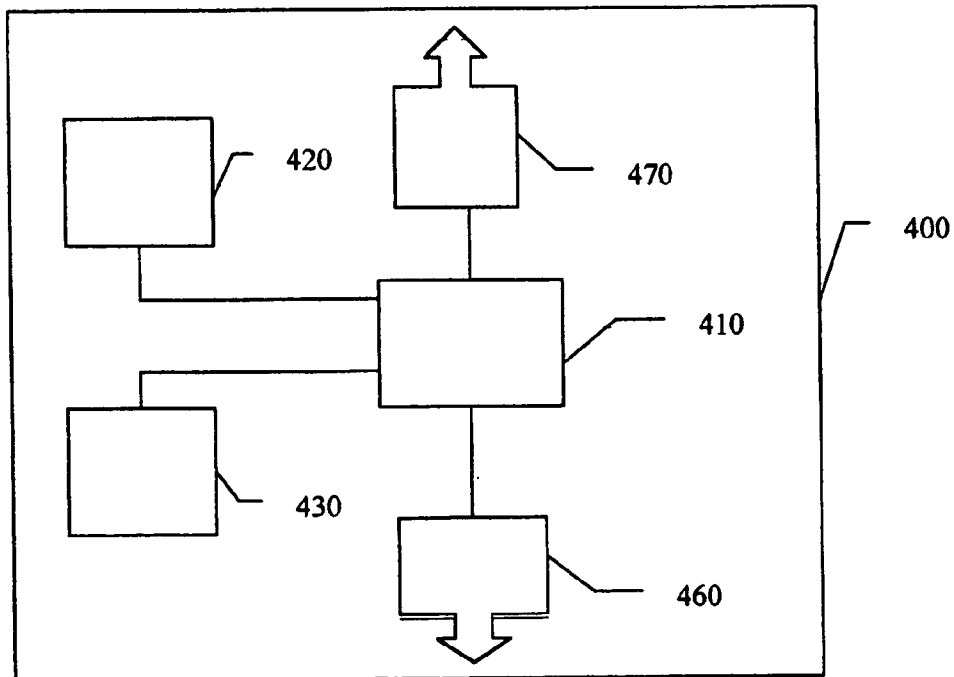

Figure 5

Explore Litigation Insights

Docket Alarm provides insights to develop a more informed litigation strategy and the peace of mind of knowing you're on top of things.

Real-Time Litigation Alerts



Keep your litigation team up-to-date with **real-time alerts** and advanced team management tools built for the enterprise, all while greatly reducing PACER spend.

Our comprehensive service means we can handle Federal, State, and Administrative courts across the country.

Advanced Docket Research



With over 230 million records, Docket Alarm's cloud-native docket research platform finds what other services can't. Coverage includes Federal, State, plus PTAB, TTAB, ITC and NLRB decisions, all in one place.

Identify arguments that have been successful in the past with full text, pinpoint searching. Link to case law cited within any court document via Fastcase.

Analytics At Your Fingertips



Learn what happened the last time a particular judge, opposing counsel or company faced cases similar to yours.

Advanced out-of-the-box PTAB and TTAB analytics are always at your fingertips.

API

Docket Alarm offers a powerful API (application programming interface) to developers that want to integrate case filings into their apps.

LAW FIRMS

Build custom dashboards for your attorneys and clients with live data direct from the court.

Automate many repetitive legal tasks like conflict checks, document management, and marketing.

FINANCIAL INSTITUTIONS

Litigation and bankruptcy checks for companies and debtors.

E-DISCOVERY AND LEGAL VENDORS

Sync your system to PACER to automate legal marketing.