



(12) **United States Patent**
Rowe et al.

(10) **Patent No.:** **US 6,344,848 B1**
(45) **Date of Patent:** **Feb. 5, 2002**

(54) **STYLUS ASSEMBLY**

5,973,677 A * 10/1999 Gibbons 345/179
6,064,374 A * 5/2000 Fukuzaki 345/179

(75) Inventors: **Richard Rowe; Kulbir Sandhu**, both
of San Jose, CA (US)

OTHER PUBLICATIONS

(73) Assignee: **Palm, Inc.**, Santa Clara, CA (US)

Gray, R. et al., "Efficient MC68HC08 programming: reducing cycle count and improving code density", *Dr. Dobbs' Journal*, vol. 20, No. 5, May 1995, pp. 70-75.

(*) Notice: Subject to any disclaimer, the term of this patent is extended or adjusted under 35 U.S.C. 154(b) by 0 days.

Ruley, J. et al., "Handheld-to-Handheld Combat", *Windows Magazine*, No. 811, p. 55, Nov. 1997.

(21) Appl. No.: **09/253,588**

Forbes, J. et al., "Palm PCs get a Big Hand (What's Hot)", *Windows Magazine*, No. 905, p. 96, May 1998.

(22) Filed: **Feb. 19, 1999**

Penwarden, M., "More Muscle for HP's OmniBook", *Windows Magazine*, No. 501, p. 110, Jan. 1994.

(51) **Int. Cl.**⁷ **G09G 5/00**

Feigel, C., "IBM, Motorola preview embedded PowerPCs; 403 and 505 processors combine strong performance with low cost", *Microprocessor Report*, vol. 8, No. 6, pp. 1-5, May 1994.

(52) **U.S. Cl.** **345/179**

Dayton, D., "FRx extends reporting power of Platinum Series", *PC Week*, vol. 8, No. 5, p. 29(2), Feb. 1991.

(58) **Field of Search** 345/179, 180;
178/18-20; 81/181-182, 437-439; 7/160-162,
165, 167

* cited by examiner

(56) **References Cited**

Primary Examiner—Almis R. Jankus

U.S. PATENT DOCUMENTS

(74) *Attorney, Agent, or Firm*—Hickman Palermo Truong & Becker LLP; Van Mahamedi

3,744,034 A	7/1973	Paul	340/172.5
4,860,372 A	8/1989	Kuzunuki et al.	382/13
4,972,496 A	11/1990	Sklarew	382/13
5,018,411 A *	5/1991	La Padura	81/57.5
5,231,381 A	7/1993	Duwaer	340/712
5,305,394 A	4/1994	Tanaka	382/13
5,389,745 A	2/1995	Sakamoto	178/18
5,434,929 A	7/1995	Beermink	382/187
5,444,192 A	8/1995	Shetye et al.	178/18
5,452,371 A	9/1995	Bozinovic et al.	382/187
5,528,743 A	6/1996	Tou et al.	395/148
5,534,892 A	7/1996	Tagawa	345/173
5,615,284 A	3/1997	Rhyne et al.	382/187
5,621,817 A	4/1997	Bozinovic et al.	382/189
5,630,148 A	5/1997	Norris	395/750
5,635,682 A *	6/1997	Cherdack	187/18
5,638,566 A *	6/1997	Wu	7/167
5,698,822 A	12/1997	Haneda et al.	178/18
5,841,901 A	11/1998	Arai et al.	382/187
5,916,278 A *	6/1999	Garcia	7/165

(57) **ABSTRACT**

A stylus assembly adapted to enter data into an electronic device and provide a user with a tool to access the electronic device to maintain and/or repair the electronic device. The stylus assembly includes a stylus body and a stylus point coupled to the stylus body. The stylus point further includes a first end for entering data into an electronic device, such as a personal data assistant, and a second end coupled to the stylus body. A tool is then detachably coupled to one of the stylus body and the second end of the stylus point. When the tool is not accessing the electronic device and the stylus body and the stylus point are coupled together the tool is disposed within the other of the stylus point and the stylus body to which it is not attached.

31 Claims, 7 Drawing Sheets

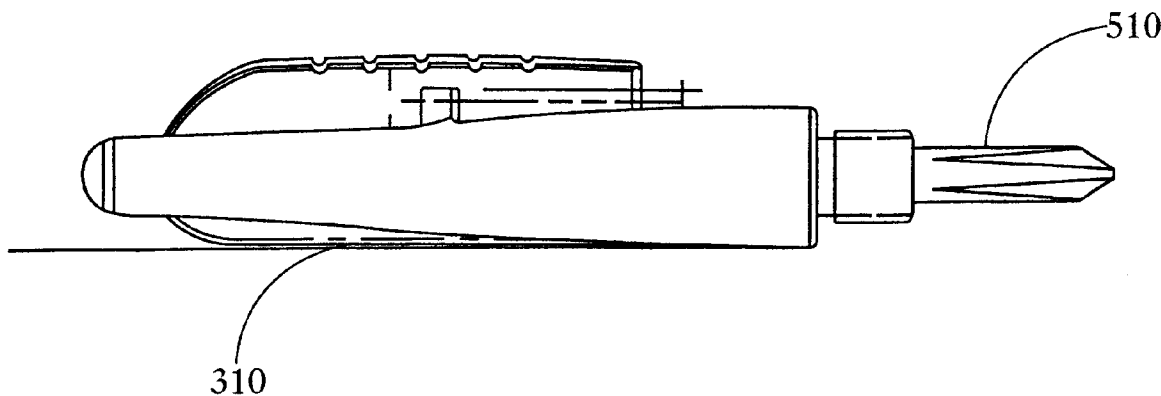

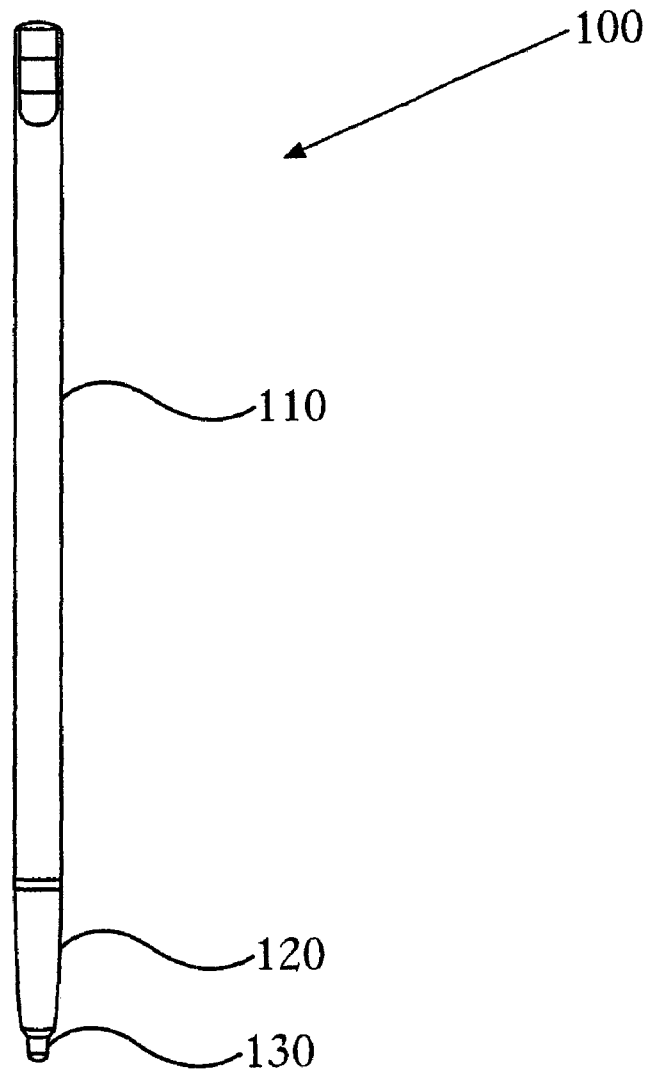

FIGURE 1

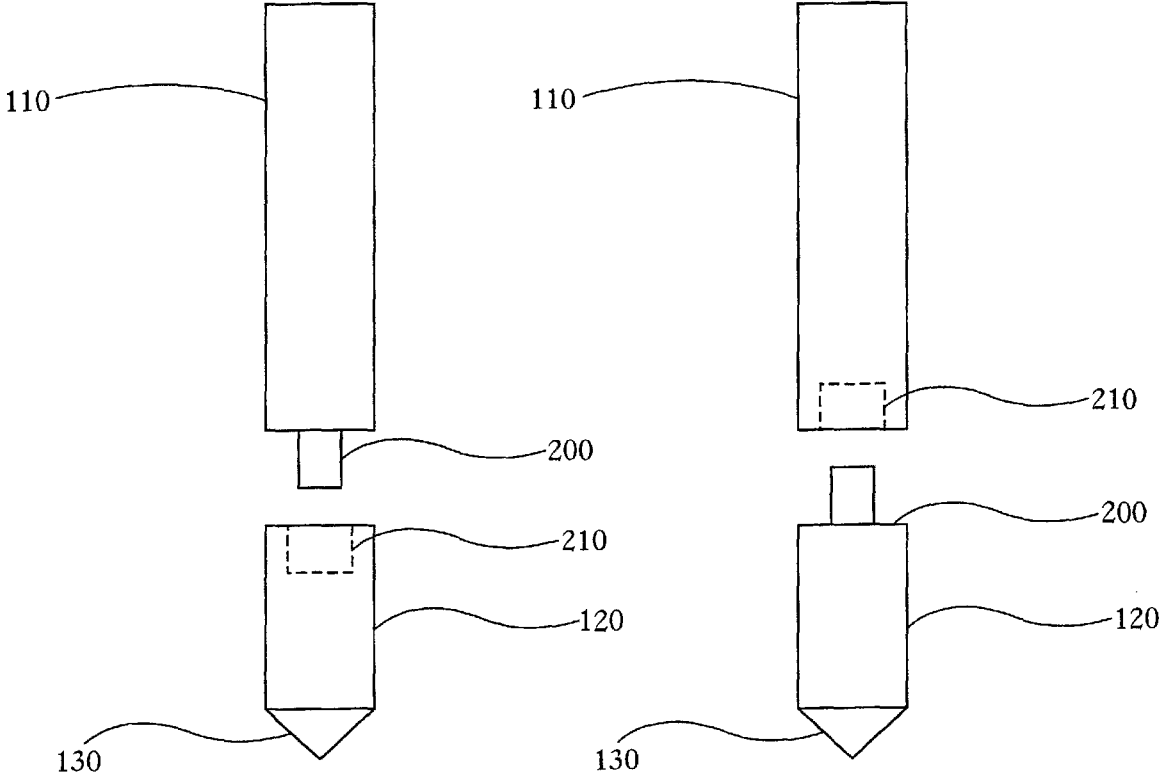

FIGURE 2A

FIGURE 2B

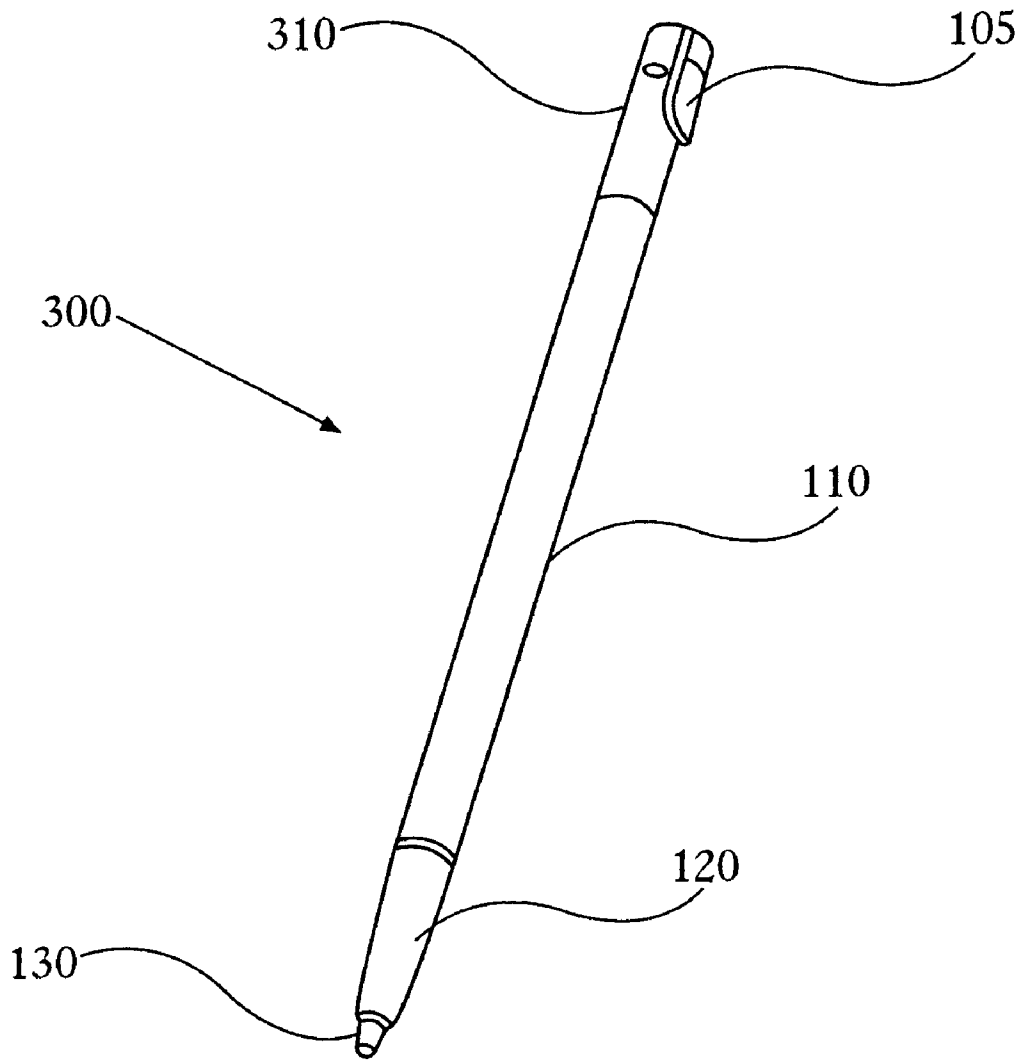

FIGURE 3

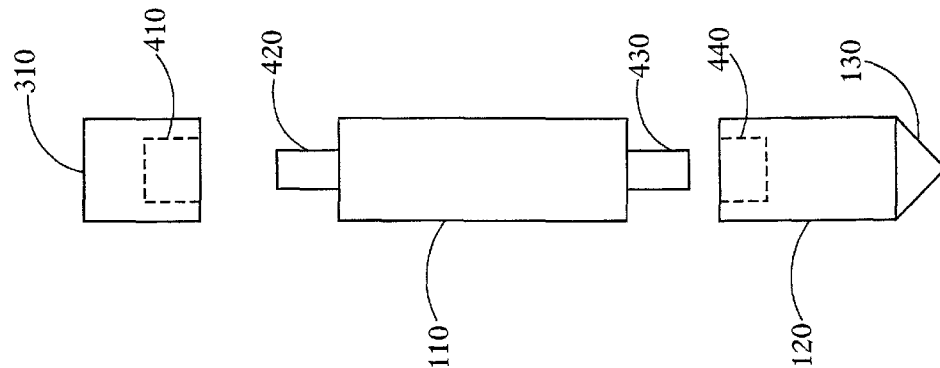

FIGURE 4A

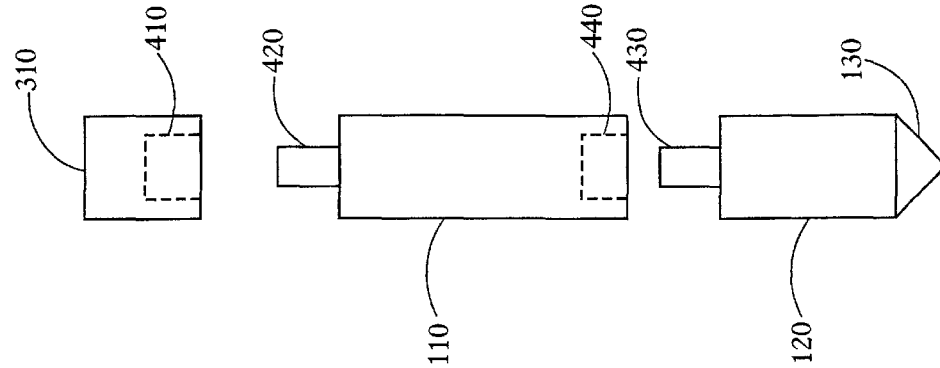

FIGURE 4B

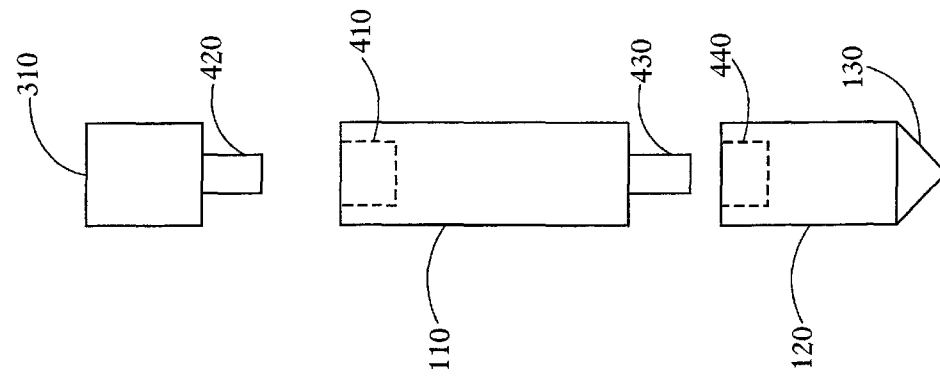

FIGURE 4C

Explore Litigation Insights

Docket Alarm provides insights to develop a more informed litigation strategy and the peace of mind of knowing you're on top of things.

Real-Time Litigation Alerts



Keep your litigation team up-to-date with **real-time alerts** and advanced team management tools built for the enterprise, all while greatly reducing PACER spend.

Our comprehensive service means we can handle Federal, State, and Administrative courts across the country.

Advanced Docket Research



With over 230 million records, Docket Alarm's cloud-native docket research platform finds what other services can't. Coverage includes Federal, State, plus PTAB, TTAB, ITC and NLRB decisions, all in one place.

Identify arguments that have been successful in the past with full text, pinpoint searching. Link to case law cited within any court document via Fastcase.

Analytics At Your Fingertips



Learn what happened the last time a particular judge, opposing counsel or company faced cases similar to yours.

Advanced out-of-the-box PTAB and TTAB analytics are always at your fingertips.

API

Docket Alarm offers a powerful API (application programming interface) to developers that want to integrate case filings into their apps.

LAW FIRMS

Build custom dashboards for your attorneys and clients with live data direct from the court.

Automate many repetitive legal tasks like conflict checks, document management, and marketing.

FINANCIAL INSTITUTIONS

Litigation and bankruptcy checks for companies and debtors.

E-DISCOVERY AND LEGAL VENDORS

Sync your system to PACER to automate legal marketing.