



US006061551A

- [54] **METHOD AND SYSTEM FOR DOWN-CONVERTING ELECTROMAGNETIC SIGNALS**
- [75] Inventors: **David F. Sorrells; Michael J. Bultman**, both of Jacksonville; **Robert W. Cook**, Switzerland; **Richard C. Looke; Charley D. Moses, Jr.**, both of Jacksonville, all of Fla.
- [73] Assignee: **Parkervision, Inc.**, Jacksonville, Fla.
- [21] Appl. No.: **09/176,022**
- [22] Filed: **Oct. 21, 1998**
- [51] Int. Cl.<sup>7</sup> ..... **H01Q 11/12**
- [52] U.S. Cl. .... **455/118; 455/313; 455/323; 455/324**
- [58] **Field of Search** ..... 455/131, 139, 455/142, 182.1, 202, 205, 313, 317, 318, 323, 118, 113, 324; 329/345, 347; 327/9, 91; 702/66, 70
- [56] **References Cited**

U.S. PATENT DOCUMENTS

Re. 35,494	4/1997	Nicollini	327/554
Re. 35,829	6/1998	Sanderford, Jr.	375/200
2,057,613	10/1936	Gardner	250/8
2,241,078	5/1941	Vreeland	179/15
2,270,385	1/1942	Skillman	179/15
2,283,575	5/1942	Roberts	250/6
2,358,152	9/1944	Earp	179/171.5
2,410,350	10/1946	Labin et al.	179/15
2,451,430	10/1948	Barone	250/8
2,462,069	2/1949	Chatterjea et al.	250/17
2,462,181	2/1949	Grosselfinger	250/17
2,472,798	6/1949	Fredendall	178/44
2,497,859	2/1950	Boughtwood et al.	250/8
2,499,279	2/1950	Peterson	332/41
2,802,208	8/1957	Hobbs	343/176
2,985,875	5/1961	Grisdale et al.	343/100
3,023,309	2/1962	Foulkes	250/17
3,069,679	12/1962	Sweeney et al.	343/200
3,104,393	9/1963	Vogelman	343/200
3,114,106	12/1963	McManus	325/56
3,118,117	1/1964	King et al.	332/22

(List continued on next page.)

FOREIGN PATENT DOCUMENTS

0 035 166 A1	2/1981	European Pat. Off.	..... H04B 1/26
0 193 899 B1	9/1986	European Pat. Off.	..... G01S 7/52
0 380 351 A2	8/1990	European Pat. Off.	..... H03H 17/04

(List continued on next page.)

OTHER PUBLICATIONS

- Akers, N.P. et al., "RF sampling gates: a brief review," *IEE Proceedings—A*, vol. 133, Part A, No. 1, Jan. 1986, pp. 45–49.
- Faulkner, Neil D. and Mestre, Enric Vilar, "Subharmonic Sampling for the Measurement of Short-term Stability of Microwave Oscillators," *IEEE Transactions on Instrumentation and measurement*, vol. IM-32, No. 1, Mar. 1983, pp. 208–213.
- Itakura, T., "Effects of the sampling pulse width on the frequency characteristics of a sample-and-hold circuit," *IEE Proceedings—Circuits, Devices and Systems*, Aug. 1994, vol. 141, No. 4, pp. 328–336.

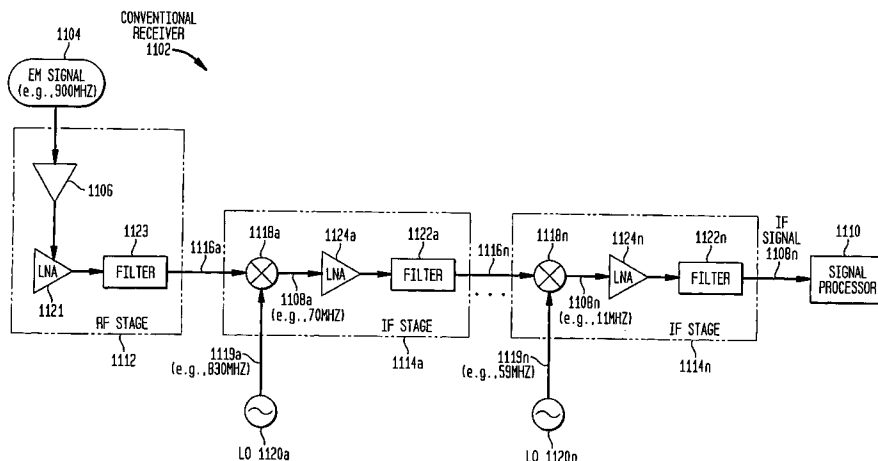
(List continued on next page.)

*Primary Examiner*—Doris H. To  
*Assistant Examiner*—Sam Bhattacharya  
*Attorney, Agent, or Firm*—Sterne, Kessler, Goldstein & Fox P.L.L.C.

[57] **ABSTRACT**

Methods, systems, and apparatuses for down-converting an electromagnetic (EM) signal by aliasing the EM signal are described herein. Briefly stated, such methods, systems, and apparatuses operate by receiving an EM signal and an aliasing signal having an aliasing rate. The EM signal is aliased according to the aliasing signal to down-convert the EM signal. The term aliasing, as used herein, refers to both down-converting an EM signal by under-sampling the EM signal at an aliasing rate, and down-converting an EM signal by transferring energy from the EM signal at the aliasing rate. In an embodiment, the EM signal is down-converted to an intermediate frequency (IF) signal. In another embodiment, the EM signal is down-converted to a demodulated baseband information signal. In another embodiment, the EM signal is a frequency modulated (FM) signal, which is down-converted to a non-FM signal, such as a phase modulated (PM) signal or an amplitude modulated (AM) signal.

204 Claims, 126 Drawing Sheets



## U.S. PATENT DOCUMENTS

3,226,643	12/1965	McNair	325/40	4,591,736	5/1986	Hirao et al.	307/267
3,258,694	6/1966	Shepherd	325/145	4,602,220	7/1986	Kurihara	331/19
3,383,598	5/1968	Sanders	325/163	4,603,300	7/1986	Welles, II et al.	329/50
3,384,822	5/1968	Miyagi	325/30	4,612,464	9/1986	Ishikawa et al.	307/496
3,454,718	7/1969	Perreault	178/66	4,612,518	9/1986	Gans et al.	332/21
3,523,291	8/1970	Pierret	340/347	4,616,191	10/1986	Galani et al.	331/4
3,548,342	12/1970	Maxey	332/9	4,621,217	11/1986	Saxe et al.	315/1
3,555,428	1/1971	Perreault	325/320	4,628,517	12/1986	Schwarz et al.	375/40
3,617,892	11/1971	Hawley et al.	325/145	4,634,998	1/1987	Crawford	331/1 A
3,621,402	11/1971	Gardner	328/37	4,648,021	3/1987	Alberkrack	363/157
3,623,160	11/1971	Giles et al.	340/347 DA	4,651,034	3/1987	Sato	307/556
3,626,417	12/1971	Gilbert	343/203	4,675,882	6/1987	Lillie et al.	375/80
3,629,696	12/1971	Bartelink	324/57 R	4,688,253	8/1987	Gumm	381/7
3,662,268	5/1972	Gans et al.	325/56	4,716,376	12/1987	Daudelin	329/107
3,689,841	9/1972	Bello et al.	325/39	4,716,388	12/1987	Jacobs	333/173
3,714,577	1/1973	Hayes	325/145	4,718,113	1/1988	Rother et al.	455/209
3,717,844	2/1973	Barret et al.	340/5 R	4,726,041	2/1988	Prohaska et al.	375/91
3,735,048	5/1973	Tomsa et al.	179/15 BM	4,733,403	3/1988	Simone	375/103
3,806,811	4/1974	Thompson	325/146	4,734,591	3/1988	Ichitsubo	307/219.1
3,868,601	2/1975	MacAfee	332/45	4,737,969	4/1988	Steel et al.	375/67
3,949,300	4/1976	Sadler	325/31	4,743,858	5/1988	Everard	330/10
3,967,202	6/1976	Batz	325/31	4,745,463	5/1988	Lu	358/23
3,980,945	9/1976	Bickford	325/30	4,751,468	6/1988	Agoston	328/133
3,987,280	10/1976	Bauer	235/150.53	4,757,538	7/1988	Zink	381/7
3,991,277	11/1976	Hirata	179/15 FD	4,768,187	8/1988	Marshall	370/69.1
4,003,002	1/1977	Snijders et al.	332/10	4,769,612	9/1988	Tamakoshi et al.	328/167
4,013,966	3/1977	Campbell	325/363	4,785,463	11/1988	Janc et al.	375/1
4,019,140	4/1977	Swerdlow	322/65	4,791,584	12/1988	Greivenkamp, Jr. et al.	364/525
4,035,732	7/1977	Lohrmann	325/446	4,801,823	1/1989	Yokoyama	307/353
4,047,121	9/1977	Campbell	351/76	4,806,790	2/1989	Sone	307/353
4,066,841	1/1978	Young	178/66 R	4,810,904	3/1989	Crawford	307/353
4,066,919	1/1978	Huntington	307/353	4,810,976	3/1989	Cowley et al.	331/117 R
4,081,748	3/1978	Batz	325/56	4,811,362	3/1989	Yester, Jr. et al.	375/75
4,130,765	12/1978	Arakelian et al.	307/220 R	4,819,252	4/1989	Christopher	375/122
4,130,806	12/1978	Van Gerwen et al.	325/487	4,833,445	5/1989	Buchele	341/118
4,142,155	2/1979	Adachi	325/47	4,862,121	8/1989	Hochschild et al.	333/173
4,170,764	10/1979	Salz et al.	332/17	4,868,654	9/1989	Juri et al.	358/133
4,204,171	5/1980	Sutphin, Jr.	328/167	4,870,659	9/1989	Oishi et al.	375/82
4,210,872	7/1980	Gregorian	330/9	4,871,987	10/1989	Kawase	332/100
4,245,355	1/1981	Pascoe et al.	455/326	4,885,587	12/1989	Wiegand et al.	42/14
4,253,066	2/1981	Fisher et al.	329/50	4,885,756	12/1989	Fontanes et al.	375/82
4,253,069	2/1981	Nossek	330/107	4,888,557	12/1989	Puckette, IV et al.	329/341
4,308,614	12/1981	Fisher et al.	370/119	4,890,302	12/1989	Muilwijk	375/80
4,320,361	3/1982	Kikkert	332/16 R	4,893,316	1/1990	Janc et al.	375/44
4,320,536	3/1982	Dietrich	455/325	4,893,341	1/1990	Gehring	381/7
4,346,477	8/1982	Gordy	455/257	4,894,766	1/1990	De Agro	363/159
4,355,401	10/1982	Ikoma et al.	375/5	4,896,152	1/1990	Tiemann	340/853
4,356,558	10/1982	Owen et al.	364/724	4,902,979	2/1990	Puckette, IV	329/343
4,360,867	11/1982	Gonda	363/158	4,908,579	3/1990	Tawfik et al.	328/167
4,363,132	12/1982	Collin	455/52	4,910,752	3/1990	Yester, Jr. et al.	375/75
4,365,217	12/1982	Berger et al.	333/165	4,914,405	4/1990	Wells	331/25
4,370,572	1/1983	Cosand et al.	307/353	4,920,510	4/1990	Senderowicz et al.	364/825
4,389,579	6/1983	Stein	307/353	4,922,452	5/1990	Larsen et al.	365/45
4,392,255	7/1983	Del Giudice	455/328	4,931,921	6/1990	Anderson	363/163
4,430,629	2/1984	Betzl et al.	333/165	4,944,025	7/1990	Gehring et al.	455/207
4,446,438	5/1984	Chang et al.	328/127	4,955,079	9/1990	Connerney et al.	455/325
4,456,990	6/1984	Fisher et al.	370/119	4,965,467	10/1990	Bilteerijst	307/352
4,472,785	9/1984	Kasuga	364/718	4,967,160	10/1990	Quienvy et al.	328/16
4,479,226	10/1984	Prabhu et al.	375/1	4,970,703	11/1990	Hariharan et al.	367/138
4,481,490	11/1984	Huntley	332/41	4,982,353	1/1991	Jacob et al.	364/724.1
4,481,642	11/1984	Hanson	375/9	4,984,077	1/1991	Uchida	358/140
4,485,488	11/1984	Houdart	455/327	4,995,055	2/1991	Weinberger et al.	375/5
4,504,803	3/1985	Lee et al.	332/31 R	5,005,169	4/1991	Bronder et al.	370/76
4,517,519	5/1985	Mukaiyama	329/126	5,006,810	4/1991	Popescu	328/167
4,517,520	5/1985	Ogawa	329/145	5,010,585	4/1991	Garcia	455/118
4,518,935	5/1985	Van Roermund	333/173	5,014,304	5/1991	Nicollini et al.	379/399
4,521,892	6/1985	Vance et al.	375/88	5,015,963	5/1991	Sutton	329/361
4,563,773	1/1986	Dixon, Jr. et al.	455/327	5,017,924	5/1991	Guiberteau et al.	342/195
4,577,157	3/1986	Reed	329/50	5,020,149	5/1991	Hemmie	455/325
4,583,239	4/1986	Vance	375/94	5,020,154	5/1991	Zierhut	455/608
				5,052,050	9/1991	Collier et al.	455/296
				5,065,409	11/1991	Hughes et al.	375/91

5,091,921	2/1992	Minami .....	375/88	5,463,356	10/1995	Palmer .....	332/117
5,095,533	3/1992	Loper et al. ....	455/245	5,463,357	10/1995	Hobden .....	332/151
5,095,536	3/1992	Loper .....	455/324	5,465,071	11/1995	Kobayashi et al. ....	329/315
5,111,152	5/1992	Makino .....	329/300	5,465,410	11/1995	Hiben et al. ....	455/266
5,113,094	5/1992	Grace et al. ....	307/529	5,465,415	11/1995	Bien .....	455/326
5,113,129	5/1992	Hughes .....	323/316	5,471,162	11/1995	McEwan .....	327/92
5,122,765	6/1992	Pataut .....	332/105	5,479,120	12/1995	McEwan .....	327/91
5,124,592	6/1992	Hagino .....	307/520	5,479,447	12/1995	Chow et al. ....	375/260
5,136,267	8/1992	Cabot .....	333/174	5,483,193	1/1996	Kennedy et al. ....	329/300
5,140,705	8/1992	Kosuga .....	455/318	5,483,549	1/1996	Weinberg et al. ....	375/200
5,150,124	9/1992	Moore et al. ....	342/68	5,483,691	1/1996	Heck et al. ....	455/234.2
5,151,661	9/1992	Caldwell et al. ....	328/14	5,490,173	2/1996	Whikehart et al. ....	375/316
5,159,710	10/1992	Cusdin .....	455/304	5,493,581	2/1996	Young et al. ....	375/350
5,170,414	12/1992	Silvian .....	375/59	5,495,200	2/1996	Kwan et al. ....	327/554
5,172,070	12/1992	Hiraiwa et al. ....	329/304	5,495,202	2/1996	Hsu .....	327/113
5,191,459	3/1993	Thompson et al. ....	359/133	5,495,500	2/1996	Jovanovich et al. ....	375/206
5,204,642	4/1993	Ashgar et al. ....	331/135	5,499,267	3/1996	Ohe et al. ....	375/206
5,212,827	5/1993	Meszko et al. ....	455/219	5,500,758	3/1996	Thompson et al. ....	359/189
5,214,787	5/1993	Karkota, Jr. ....	455/3.2	5,517,688	5/1996	Fajen et al. ....	455/333
5,220,583	6/1993	Solomon .....	375/82	5,519,890	5/1996	Pinckley .....	455/307
5,220,680	6/1993	Lee .....	455/102	5,523,719	6/1996	Longo et al. ....	327/557
5,222,144	6/1993	Whikehart .....	381/15	5,523,726	6/1996	Kroeger et al. ....	332/103
5,230,097	7/1993	Currie et al. ....	455/226.1	5,523,760	6/1996	McEwan .....	342/89
5,239,686	8/1993	Downey .....	455/78	5,539,770	7/1996	Ishigaki .....	375/206
5,241,561	8/1993	Barnard .....	375/1	5,555,453	9/1996	Kajimoto et al. ....	455/266
5,249,203	9/1993	Loper .....	375/97	5,557,642	9/1996	Williams .....	375/316
5,251,218	10/1993	Stone et al. ....	370/120	5,579,341	11/1996	Smith et al. ....	375/267
5,251,232	10/1993	Nonami .....	375/5	5,579,347	11/1996	Lindquist et al. ....	375/346
5,260,970	11/1993	Henry et al. ....	375/10	5,584,068	12/1996	Mohindra .....	455/324
5,263,194	11/1993	Ragan .....	455/316	5,592,131	1/1997	Labreche et al. ....	332/103
5,263,196	11/1993	Jasper .....	455/324	5,602,847	2/1997	Pagano et al. ....	370/484
5,267,023	11/1993	Kawasaki .....	358/23	5,602,868	2/1997	Wilson .....	375/219
5,278,826	1/1994	Murphy et al. ....	370/76	5,604,732	2/1997	Kim et al. ....	370/342
5,282,023	1/1994	Scarpa .....	358/36	5,608,531	3/1997	Honda et al. ....	386/1
5,287,516	2/1994	Schaub .....	375/88	5,610,946	3/1997	Tanaka et al. ....	375/269
5,293,398	3/1994	Hamao et al. ....	375/1	5,617,451	4/1997	Mimura et al. ....	375/340
5,303,417	4/1994	Laws .....	455/314	5,619,538	4/1997	Sempel et al. ....	375/328
5,307,517	4/1994	Rich .....	455/306	5,621,455	4/1997	Rogers et al. ....	348/6
5,315,583	5/1994	Murphy et al. ....	370/18	5,630,227	5/1997	Bella et al. ....	455/324
5,321,852	6/1994	Seong .....	455/182.1	5,640,415	6/1997	Pandula .....	375/202
5,325,204	6/1994	Scarpa .....	348/607	5,640,424	6/1997	Banavong et al. ....	375/316
5,337,014	8/1994	Najle et al. ....	324/613	5,640,428	6/1997	Abe et al. ....	375/334
5,339,054	8/1994	Taguchi .....	332/100	5,640,698	6/1997	Shen et al. ....	455/323
5,339,459	8/1994	Schiltz et al. ....	455/333	5,648,985	7/1997	Bjerede et al. ....	375/219
5,355,114	10/1994	Sutterlin et al. ....	340/310.A	5,650,785	7/1997	Rodal .....	342/357
5,361,408	11/1994	Watanabe et al. ....	455/324	5,663,878	9/1997	Walker .....	363/159
5,369,800	11/1994	Takagi et al. ....	455/59	5,663,986	9/1997	Striffler .....	375/260
5,375,146	12/1994	Chalmers .....	375/103	5,668,836	9/1997	Smith et al. ....	375/316
5,379,040	1/1995	Mizomoto et al. ....	341/143	5,680,078	10/1997	Ariie .....	332/178
5,379,141	1/1995	Thompson et al. ....	359/125	5,680,418	10/1997	Croft et al. ....	375/346
5,388,063	2/1995	Takatori et al. ....	364/724.17	5,689,413	11/1997	Jaramillo et al. ....	363/146
5,390,364	2/1995	Webster et al. ....	455/52.3	5,699,006	12/1997	Zelev et al. ....	327/341
5,400,084	3/1995	Scarpa .....	348/624	5,705,955	1/1998	Freeburg et al. ....	331/14
5,404,127	4/1995	Lee et al. ....	340/310.02	5,710,998	1/1998	Opas .....	455/324
5,410,541	4/1995	Hotto .....	370/76	5,714,910	2/1998	Skoczen et al. ....	331/3
5,412,352	5/1995	Graham .....	332/103	5,715,281	2/1998	Bly et al. ....	375/344
5,416,803	5/1995	Janer .....	375/324	5,721,514	2/1998	Crockett et al. ....	331/3
5,422,913	6/1995	Wilkinson .....	375/347	5,724,002	3/1998	Hulick .....	329/361
5,423,082	6/1995	Cygan et al. ....	455/126	5,724,653	3/1998	Baker et al. ....	455/296
5,428,638	6/1995	Cioffi et al. ....	375/224	5,729,577	3/1998	Chen .....	375/334
5,428,640	6/1995	Townley .....	375/257	5,729,829	3/1998	Talwar et al. ....	455/63
5,434,546	7/1995	Palmer .....	332/151	5,732,333	3/1998	Cox et al. ....	455/126
5,438,692	8/1995	Mohindra .....	455/324	5,736,895	4/1998	Yu et al. ....	327/554
5,444,415	8/1995	Dent et al. ....	329/302	5,737,035	4/1998	Rotzoll .....	348/725
5,444,416	8/1995	Ishikawa et al. ....	329/341	5,742,189	4/1998	Yoshida et al. ....	327/113
5,444,865	8/1995	Heck et al. ....	455/86	5,748,683	5/1998	Smith et al. ....	375/347
5,446,421	8/1995	Kechkaylo .....	332/100	5,760,645	6/1998	Comte et al. ....	329/304
5,446,422	8/1995	Mattila et al. ....	332/103	5,764,087	6/1998	Clark .....	327/105
5,448,602	9/1995	Ohmori et al. ....	375/347	5,767,726	6/1998	Wang .....	327/356
5,451,899	9/1995	Lawton .....	329/302	5,768,118	6/1998	Faulk et al. ....	363/72
5,454,007	9/1995	Dutta .....	375/322	5,771,442	6/1998	Wang et al. ....	455/93
5,454,009	9/1995	Fruit et al. ....	372/202	5,777,692	7/1998	Ghosh .....	348/725

5,777,771	7/1998	Smith	359/180
5,786,844	7/1998	Rogers et al.	348/6
5,793,801	8/1998	Fertner	375/219
5,802,463	9/1998	Zuckerman	455/208
5,809,060	9/1998	Cafarella et al.	375/206
5,818,582	10/1998	Fernandez et al.	356/318
5,825,254	10/1998	Lee	331/25
5,834,985	11/1998	Sundegård	332/100
5,864,754	1/1999	Hotto	455/280
5,881,375	3/1999	Bonds	455/118
5,892,380	4/1999	Quist	327/172
5,894,239	4/1999	Bonaccio et al.	327/176
5,896,562	4/1999	Heinonen	455/76
5,900,747	5/1999	Brauns	327/9
5,901,054	5/1999	Leu et al.	363/41
5,901,187	5/1999	Iinuma	375/347
5,901,344	5/1999	Opas	455/76
5,901,347	5/1999	Chambers et al.	455/234.1
5,901,348	5/1999	Bang et al.	455/254
5,901,349	5/1999	Geugnaud et al.	455/302
5,903,178	5/1999	Miyatsuji et al.	327/308
5,903,187	5/1999	Claverie et al.	329/342
5,903,196	5/1999	Salvi et al.	331/16
5,903,421	5/1999	Furutani et al.	361/58
5,903,553	5/1999	Sakamoto et al.	370/338
5,903,595	5/1999	Suzuki	375/207
5,903,609	5/1999	Kool et al.	375/261
5,903,827	5/1999	Kennan et al.	455/323
5,903,854	5/1999	Abe et al.	455/575
5,905,449	5/1999	Tsubouchi et al.	340/825.69
5,907,149	5/1999	Marckini	235/487
5,907,197	5/1999	Faulk	307/119
5,911,116	6/1999	Nosswitz	455/83
5,911,123	6/1999	Shaffer et al.	455/554
5,914,622	6/1999	Inoue	327/172
5,920,199	7/1999	Sauer	324/678
5,943,370	8/1999	Smith	375/334

## FOREIGN PATENT DOCUMENTS

0 380 351 A3	2/1991	European Pat. Off.	H03H 17/04
0 411 840 A2	2/1991	European Pat. Off.	G01R 33/36
0 411 840 A3	2/1991	European Pat. Off.	G01R 33/36
0 423 718 A2	4/1991	European Pat. Off.	H04N 7/01
0 423 718 A3	4/1991	European Pat. Off.	H04N 7/01
0 486 095 A1	5/1992	European Pat. Off.	H03D 3/00
0 512 748 A2	11/1992	European Pat. Off.	H04N 9/64
0 512 748 A3	11/1992	European Pat. Off.	H04N 9/64
0 548 542 A1	6/1993	European Pat. Off.	H03B 19/14
0 632 288 A2	1/1995	European Pat. Off.	G01S 13/75
0 411 840 B1	10/1995	European Pat. Off.	G01R 33/36
0 696 854 A1	2/1996	European Pat. Off.	H04B 1/26
0 632 288 A3	7/1996	European Pat. Off.	G01S 13/75
0 486 095 B1	2/1997	European Pat. Off.	H03D 3/00
0 782 275 A2	7/1997	European Pat. Off.	H04B 7/02
0 785 635 A1	7/1997	European Pat. Off.	H04B 1/713
0 795 978 A2	9/1997	European Pat. Off.	H04L 5/06
0 837 565 A1	4/1998	European Pat. Off.	H04B 1/69
0 862 274 A1	9/1998	European Pat. Off.	H03M 1/06
0 874 499 A2	10/1998	European Pat. Off.	H04L 25/64
0 512 748 B1	11/1998	European Pat. Off.	H04N 9/64
2 743 231 A1	7/1997	France	H04B 7/12
2-39632	2/1990	Japan	H04B 7/12
2-131629	5/1990	Japan	H04B 7/12
2-276351	11/1990	Japan	H04L 27/22
2 161 344	1/1986	United Kingdom	H04B 7/12
2 215 945	9/1989	United Kingdom	H04L 27/00
WO 80/01633	8/1980	WIPO	H04J 1/08
WO 94/05087	3/1994	WIPO	H03M 1/00
WO 96/02977	2/1996	WIPO	H04B 1/26
WO 96/39750	12/1996	WIPO	H04B 1/26
WO 98/00953	1/1998	WIPO	H04L 27/26
WO 98/24201	6/1998	WIPO	H04H 1/00

## OTHER PUBLICATIONS

- Oppenheim, Alan V. et al., *Signals and Systems*, Prentice-Hall, 1983, pp. 527–562.
- Razavi, B., *RF Microelectronics*, Prentice-Hall, 1998, pp. 147–149.
- Russell, R. and Hoare, L., “Millimeter Wave Phase Locked Oscillators,” *Military Microwaves '78 Conference Proceedings*, 1978, pp. 238–242.
- Vollmer, A., “Complete GPS Receiver Fits on Two Chips,” *Electronic Design*, Jul. 6, 1998, pp. 50, 52, 54 & 56.
- EPO Search Report for App. No. 09/176,022; Completed Mar. 18, 1999, 3 pages.
- Shen et al., “A 900 MHz Integrated Discrete-Time Filtering RF Front-End,” *IEEE International Solid-State Circuits*, 1996, pp. 54–55 and 417.
- Chan, P. et al., “A Highly Linear 1-GHz CMOS Downconversion Mixer,” *European Solid State Circuits Conference*, Seville, Spain, Sep. 22–24, 1993, pp. 210–213.
- Pärssinen, A. et al., “A 2-GHz Subharmonic Sampler for Signal Downconversion,” *IEEE Trans On Microwave Theory and Techniques*, vol. 45, No. 12, Dec. 1997, (7 Pages).
- Thomas, G.B., *Calculus and Analytic Geometry*, Third Edition, Addison-Wesley Publishing, 1960, pp. 119–133.
- Wang, H., “A 1-V Multigigahertz RF Mixer Core in 0.5- $\mu$ m CMOS,” *IEEE*, Jul. 1, 1998, 3 pages.
- Weast, R.C. et al. (Ed.), *Handbook of Mathematical Tables*, Second Edition, The Chemical Rubber Co., 1964, pp. 480–485.
- Groshong, R.A. and Ruscak, S., “Undersampling Techniques Simplify Digital Radio,” *Electronic Design*, May 23, 1991, pp. 67–78.
- Kirsten, J. and Fleming, T., “Undersampling reduces data-acquisition costs for select applications,” *EDN*, Jun. 21, 1990, pp. 217–222, 224, 226–228.
- Aghvami, H. et al., “Land Mobile Satellites Using the Highly Elliptic Orbits—The UK T-SAT Mobile Payload,” *4<sup>th</sup> International Conf. On Satellite Systems for Mobile Communications and Navigation*, Oct. 17–19, 1988, pp. 147–153.
- Al-Ahmad, H.A.M. et al., “Doppler Frequency Correction for a Non-Geostationary Communications Satellite. Techniques for CERS and T-SAT,” *Electronics Division Colloquium on Low Noise Oscillators and Synthesizer*, Jan. 23, 1986, pp. 4/1–4/5.
- Ali, I. et al., “Doppler Characterization for LEO Satellites,” *IEEE Transactions On Communications*, vol. 46, No. 3, Mar. 1998, pp. 309–313.
- Allan, D.W., “Statistics of Atomic Frequency Standards,” *Proc. Of the IEEE Special Issue on Frequency Stability*, Feb. 1966, pp. 221–230.
- Allstot, D.J. et al., “MOS Switched Capacitor Ladder Filters,” *IEEE Journal of Solid-State Circuits*, vol. SC-13, No. 6, Dec. 1978, pp. 806–814.
- Allstot, D.J. and Black, W.C. Jr., “Technological Design Considerations for Monolithic MOS Switched-Capacitor Filtering Systems,” *Proceedings of the IEEE*, vol. 71, No. 8, Aug. 1983, pp. 967–986.
- Alouini, M. et al., “Channel Characterization and Modeling for Ka-Band Very Small Aperture Terminals,” *Proc. Of the IEEE*, vol. 85, No. 6, Jun. 1997, pp. 981–997.



- Andreyev, G.A. and Ogarev, S.A., "Phase Distortions of Keyed Millimeter-Wave Signals in the Case of Propagation in a Turbulent Atmosphere," *Telecommunications and Radio Engineering*, vol. 43, No. 12, Dec. 1988, pp. 87–90.
- Antonetti, A. et al., "Optoelectronic Sampling in the Pico-second Range," *Optics Communications*, vol. 21, No. 2, May 1977, pp. 211–214.
- Austin, J. et al., "Doppler Correction of the Telecommunication Payload Oscillators in the UK T-SAT," *18<sup>th</sup> European Microwave Conference*, Sep. 12–15, 1988, pp. 851–857.
- Auston, D.H., "Picosecond optoelectronic switching and gating in silicon," *Applied Physics Letters*, vol. 26, No. 3, Feb. 1, 1975, pp. 101–103.
- Baher, H., "Transfer Functions for Switched-Capacitor and Wave Digital Filters," *IEEE Transactions on Circuits and Systems*, vol. CAS-33, No. 11, Nov. 1986, pp. 1138–1142.
- Baines, R., "The DSP Bottleneck," *IEEE Communications Magazine*, May 1995, pp. 46–54.
- Banjo, O.P. and Vilar, E., "Binary Error Probabilities on Earth-Space Links Subject to Scintillation Fading," *Electronics Letters*, vol. 21, No. 7, Mar. 28, 1985, pp. 296–297.
- Banjo, O.P. and Vilar, E., "The Dependence of Slant Path Amplitude Scintillations on Various Meteorological Parameters," *Antennas and Propagation (ICAP 87) Part 2: Propagation*, Mar. 30–Apr. 2, 1987, pp. 277–280.
- Banjo, O.P. and Vilar, E., "Measurement and Modeling of Amplitude Scintillations on Low-Elevation Earth-Space Paths and Impact on Communication Systems," *IEEE Transactions On Communications*, vol. COM-34, No. 8, Aug. 1986, pp. 774–780.
- Banjo, O.P. et al., "Tropospheric Amplitude Spectra Due to Absorption and Scattering in Earth-Space Paths," *Antennas and Propagation (ICAP 85)*, Apr. 16–19, 1985, pp. 77–82.
- Basili, P. et al., "Case Study of Intense Scintillation Events on the OTS Path," *IEEE Transactions On Antennas and Propagation*, vol. 38, No. 1, Jan. 1990, pp. 107–113.
- Basili, P. et al., "Observation of High  $C^2$  and Turbulent Path Length on OTS Space-Earth Link," *Electronics Letters*, vol. 24, No. 17, Aug. 18, 1988, pp. 1114–1116.
- Blakey, J.R. et al., "Measurement of Atmospheric Millimetre-Wave Phase Scintillations in an Absorption Region," *Electronics Letters*, vol. 21, No. 11, May 23, 1985, pp. 486–487.
- Burgueño, A. et al., "Influence of rain gauge integration time on the rain rate statistics used in microwave communications," *Annales des Telecommunications*, Sep./Oct. 1988, pp. 522–527.
- Burgueño, A. et al., "Long-Term Joint Statistical Analysis of Duration and Intensity of Rainfall Rate with Application to Microwave Communications," *Antennas and Propagation (ICAP 87) Part 2: Propagation*, Mar. 30–Apr. 2, 1987, pp. 198–201.
- Burgueño, A. et al., "Long Term Statistics of Precipitation Rate Return Periods in the Context of Microwave Communications," *Antennas and Propagation (ICAP 89) Part 2: Propagation*, Apr. 4–7, 1989, pp. 297–301.
- Burgueño, A. et al., "Spectral Analysis of 49 Years of Rainfall Rate and Relation to Fade Dynamics," *IEEE Transactions On Communications*, vol. 38, No. 9, Sep. 1990, pp. 1359–1366.
- Catalan, C. and Vilar, E., "Approach for satellite slant path remote sensing," *Electronics Letters*, vol. 34, No. 12, Jun. 11, 1998, pp. 1238–1239.
- Dewey, R.J. and Collier, C.J., "Multi-Mode Radio Receiver," pp. 3/1–3/5.
- "DSO takes sampling rate to 1 Ghz," *Electronic Engineering*, Mar. 1987, pp. 77, 79.
- Erdi, G. and Henneuse, P.R., "A Precision FET-Less Sample-and-Hold with High Charge-to-Droop Current Ratio," *IEEE Journal of Solid-State Circuits*, vol. SC-13, No. 6, Dec. 1978, pp. 864–873.
- Faulkner, N.D. et al., "Sub-Harmonic Sampling for the Accurate Measurement of Frequency Stability of Microwave Oscillators," *CPEM 82 Digest: Conf. On Precision Electromagnetic Measurements*, 1982, pp. M-10 & M-11.
- Faulkner, N.D. and Vilar, E., "Time Domain Analysis of Frequency Stability Using Non-Zero Dead-Time Counter Techniques," *CPEM 84 Digest Conf. On Precision Electromagnetic Measurements*, 1984, pp. 81–82.
- Filip, M. and Vilar, E., "Optimum Utilization of the Channel Capacity of a Satellite Link in the Presence of Amplitude Scintillations and Rain Attenuation," *IEEE Transactions On Communications*, vol. 38, No. 11, Nov. 1990, pp. 1958–1965.
- Fukahori, K., "A CMOS Narrow-Band Signaling Filter with Q Reduction," *IEEE Journal of Solid-State Circuits*, vol. SC-19, No. 6, Dec. 1984, pp. 926–932.
- Fukuchi, H. and Otsu, Y., "Available time statistics of rain attenuation on earth-space path," *IEE Proceedings-H: Microwaves, Antennas & Propagation*, vol. 135, No. 6, Dec. 1988, pp. 387–390.
- Gibbins, C.J. and Chadha, R., "Millimetre-wave propagation through hydrocarbon flame," *IEE Proceedings-H: Microwaves, Antennas & Propagation*, vol. 134, No. 2, Apr. 1987, pp. 169–173.
- Gilchrist, B. et al., "Sampling hikes performance of frequency synthesizers," *Microwaves & RF*, Jan. 1984, pp. 93–94 and 110.
- Gossard, E.E., "Clear weather meteorological effects on propagation at frequencies above 1 Ghz," *Radio Science*, vol. 16, No. 5, Sep.–Oct. 1981, pp. 589–608.
- Gregorian, R. et al., "Switched-Capacitor Circuit Design," *Proceedings of the IEEE*, vol. 71, No. 8, Aug. 1983, pp. 941–966.
- Grove, W.M., "Sampling for Oscilloscopes and Other RF Systems: Dc through X-Band," *IEEE Transactions On Microwave Theory and Techniques*, Dec. 1966, pp. 629–635.
- Haddon, J. et al., "Measurement of Microwave Scintillations on a Satellite Down-Line at X-Band," *2<sup>nd</sup> Int'l Conf. On Antennas and Propagation Part 2: Propagation*, Apr. 13–16, 1991, pp. 113–117.
- Haddon, J. and Vilar, E., "Scattering Induced Microwave Scintillations from Clear Air and Rain on Earth Space Paths and the Influence of Antenna Aperture," *IEEE Transactions On Antennas and Propagation*, vol. AP-34, No. 5, May 1986, pp. 646–657.
- Hafdallah, H. et al., "2–4 Ghz MESFET Sampler," *Electronics Letters*, vol. 24, No. 3, Feb. 4, 1988, pp. 151–153.
- Herben, M.H.A.J., "Amplitude and Phase Scintillation Measurements on 8–2 km Line-Of-Sight Path at 30 Ghz," *Electronics Letters*, vol. 18, No. 7, Apr. 1, 1982, pp. 287–289.
- Hewitt, A. et al., "An 18 Ghz Wideband LOS Multipath Experiment," *Int'l Conf. On Measurements for Telecommunication Transmission Systems—MTTS 85*, Nov. 27–28, 1985, pp. 112–116.

- Hewitt, A. et al., "An Autoregressive Approach to the Identification of Multipath Ray Parameters from Field Measurements," *IEEE Transactions On Communications*, vol. 37, No. 11, Nov. 1989, pp. 1136–1143.
- Hewitt, A. and Vilar, E., "Selective Fading on LOS Microwave Links: Classical and Spread-Spectrum Measurement Techniques," *IEEE Transactions On Communications*, vol. 36, No. 7, Jul. 1988, pp. 789–796.
- Hospitalier, E., "Instruments for Recording and Observing Rapidly Varying Phenomena," *Science Abstracts*, vol. VII, 1904, pp. 22–23.
- Howard, I.M. and Swansson, N.S., "Demodulating High Frequency Resonance Signals for Bearing Fault Detection," *The Institution of Engineers Australia Communications Conference*, Melbourne Sep. 18–20, 1990, pp. 115–121.
- Hu, X., *A Switched-Current Sample-and-Hold Amplifier for FM Demodulation*, Thesis for Master of Applied Science, Dept. of Electrical and Computer Engineering, University of Toronto, 1995, pp. 1–64.
- Hung et al., "Characterization of Microwave Integrated Circuits Using An Optical Phase-Locking and Sampling System," *IEEE MTT-S Digest*, 1991, pp. 507–510.
- Kaleh, G.K., "A Frequency Diversity Spread Spectrum System for Communication in the Presence of In-band Interference," *1995 IEEE Globecom*, pp.66–70.
- Janssen, J.M.L., "An Experimental 'Stroboscopic' Oscilloscope for Frequencies up to about 50 Mc/s: I. Fundamentals," *Philips Technical Review*, vol. 12, No. 2, Aug. 1950, pp. 52–59.
- Janssen, J.M.L. and Michels, A.J., "An Experimental 'Stroboscopic' Oscilloscope for Frequencies up to about 50 Mc/s: II. Electrical Build-Up," *Philips Technical Review*, vol. 12, No. 3, Sep. 1950, pp. 73–82.
- Jondral, V.F. et al., "Doppler Profiles for Communication Satellites," *Frequenz*, May–Jun. 1996, pp. 111–116.
- Hurst, P.J., "Shifting the Frequency Response of Switched-Capacitor Filters by Nonuniform Sampling," *IEEE Transactions on Circuits and Systems*, vol. 38, No. 1, Jan. 1991, pp. 12–19.
- Karasawa, Y. et al., "A New Prediction Method for Tropospheric Scintillation on Earth-Space Paths," *IEEE Transactions On Antennas and Propagation*, vol. 36, No. 11, Nov. 1988, pp. 1608–1614.
- Lam, W.K. et al., "Measurement of the Phase Noise Characteristics of an Unlocked Communications Channel Identifier," *Proc. Of the 1993 IEEE International Frequency Control Symposium*, Jun. 2–4, 1993, pp. 283–288.
- Lam, W.K. et al., "Wideband sounding of 11.6 Ghz transhorizon channel," *Electronics Letters*, vol. 30, No. 9, Apr. 28, 1994, pp. 738–739.
- Larkin, K.G., "Efficient demodulator for bandpass sampled AM signals," *Electronics Letters*, vol. 32, No. 2, Jan. 18, 1996, pp. 101–102.
- Lau, W.H. et al., "Analysis of the Time Variant Structure of Microwave Line-of-sight Multipath Phenomena," *IEEE Global Telecommunications Conference & Exhibition*, Nov. 28–Dec. 1, 1988, pp. 1707–1711.
- Lau, W.H. et al., "Improved Prony Algorithm to Identify Multipath Components," *Electronics Letters*, vol. 23, No. 20, Sep. 24, 1987, pp. 1059–1060.
- Lesage, P. and Audoin, C. et al., "Effect of Dead-Time on the Estimation of the Two-Sample Variance," *IEEE Transactions On Instrumentation and Measurement*, vol. IM-28, No. 1, Mar. 1979, pp. 6–10.
- Liechti, C.A., "Performance of Dual-Gate GaAs MESFET's as Gain-Controlled Low-Noise Amplifiers and High-Speed Modulators," *IEEE Transactions On Microwave Theory and Techniques*, vol. MTT-23, No. 6, Jun. 1975, pp. 461–469.
- Linnenbrink, T.E. et al., "A One Gigasample Per Second Transient Recorder," *IEEE Transactions On Nuclear Science*, vol. NS-26, No. 4, Aug. 1979, pp. 4443–4449.
- Liou, M.L., "A Tutorial on Computer-Aided Analysis of Switched-Capacitor Circuits," *Proceedings of the IEEE*, vol. 71, No. 8, Aug. 1983, pp. 987–1005.
- Lo, P. et al., "Coherent Automatic Gain Control," *IEE Colloquium on Phase Locked Techniques*, Mar. 26, 1980, pp. 2/1–2/6.
- Lo, P. et al., "Computation of Rain Induced Scintillations on Satellite Down-Links at Microwave Frequencies," *Third Int'l Conf. On Antennas and Propagation (ICAP 83) Part 2: Propagation*, Apr. 12–15, 1983, pp. 127–131.
- Lo, P.S.L.O. et al., "Observations of Amplitude Scintillations on a Low-Elevation Earth-Space Path," *Electronics Letters*, vol. 20, No. 7, Mar. 29, 1984, pp. 307–308.
- Madani, K. and Aithison, C.S., "A 20 Ghz Microwave Sampler," *IEEE Transactions On Microwave Theory and Techniques*, vol. 40, No. 10, Oct. 1992, pp. 1960–1963.
- Marsland, R.A. et al., "130 Ghz GaAs monolithic integrated circuit sampling head," *Appl. Phys. Lett.*, vol. 55, No. 6, Aug. 7, 1989, pp. 592–594.
- Martin, K. and Sedra, A.S., "Switched-Capacitor Building Blocks for Adaptive Systems," *IEEE Transactions on Circuits and Systems*, vol. CAS-28, No. 6, Jun. 1981, pp. 576–584.
- Marzano, F.S. and d'Auria, G., "Model-based Prediction of Amplitude Scintillation Variance Due to Clear-Air Tropospheric Turbulence on Earth-Satellite Microwave Links," *IEEE Transactions On Antennas and Propagation*, vol. 46, No. 10, Oct. 1998, pp. 1506–1518.
- Matricciani, E., "Prediction of fade durations due to rain in satellite communication systems," *Radio Science*, vol. 32, No. 3, May–Jun. 1997, pp. 935–941.
- McQueen, J.G., "The Monitoring of High-Speed Waveforms," *Electronic Engineering*, Oct. 1952, pp. 436–441.
- Merkelo, J. and Hall, R.D., "Broad-Band Thin-Film Signal Sampler," *IEEE Journal of Solid-State Circuits*, vol. SC-7, No. 1, Feb. 1972, pp. 50–54.
- Merlo, U. et al., "Amplitude Scintillation Cycles in a Sirio Satellite-Earth Link," *Electronics Letters*, vol. 21, No. 23, Nov. 7, 1985, pp. 1094–1096.
- Morris, D., "Radio-holographic reflector measurement of the 30-m millimeter radio telescope at 22 Ghz with a cosmic signal source," *Astronomy and Astrophysics*, vol. 203, No. 2, Sep. (II) 1988, pp. 399–406.
- Moulsley, T.J. et al., "The efficient acquisition and processing of propagation statistics," *Journal of the Institution of Electronic and Radio Engineers*, vol. 55, No. 3, Mar. 1985, pp. 97–103.
- Ndzi, D. et al., "Wide-Band Statistical Characterization of an Over-the-Sea Experimental Transhorizon Link," *IEE Colloquium on Radio Communications at Microwave and Millimetre Wave Frequencies*, Dec. 16, 1996, pp. 1/1–1/6.
- Ndzi, D. et al., "Wideband Statistics of Signal Levels and Doppler Spread on an Over-The-Sea Transhorizon Link," *IEE Colloquium on Propagation Characteristics and Related System Techniques for Beyond Line-of-Sight Radio*, Nov. 24, 1997, pp. 9/1–9/6.
- "New zero IF chipset from Philips," *Electronic Engineering*, Sep. 1995, p. 10.

- Ohara, H. et al., "First monolithic PCM filter cuts costs of telecom systems," *Electronic Design*, vol. 27, No. 8, Apr. 12, 1979, (6 pages).
- Ortgies, G., "Experimental Parameters Affecting Amplitude Scintillation Measurements on Satellite Links," *Electronics Letters*, vol. 21, No. 17, Aug. 15, 1985, pp. 771-772.
- Peeters, G. et al., "Evaluation of Statistical Models for Clear-Air Scintillation Prediction Using Olympus Satellite Measurements," *International Journal of Satellite Communications*, vol. 15, No. 2, Mar.-Apr. 1997, pp. 73-88.
- Perrey, A.G. and Schoenwetter, H.K., *NBS Technical Note 1121: A Schottky Diode Bridge Sampling Gate*, May 1980, pp. 1-14.
- Poulton, K. et al., "A 1-GHz 6-bit ADC System," *IEEE Journal of Solid-State Circuits*, vol. SC-22, No. 6, Dec. 1987, pp. 962-969.
- "Project COST 205: Scintillations in Earth-satellite links," *Alta Frequenza: Scientific Review in Electronics*, vol. LIV, No. 3, May-Jun. 1985, pp. 209-211.
- Reeves, R.J.D., "The Recording and Collocation of Waveforms (Part 1)," *Electronic Engineering*, Mar. 1959, pp. 130-137.
- Reeves, R.J.D., "The Recording and Collocation of Waveforms (Part 2)," *Electronic Engineering*, Apr. 1959, pp. 204-212.
- Rein, H.M. and Zahn, M., "Subnanosecond-Pulse Generator with Variable Pulsewidth Using Avalanche Transistors," *Electronics Letters*, vol. 11, No. 1, Jan. 9, 1975, pp. 21-23.
- Riad, S.M. and Nahman, N.S., "Modeling Of The Feed-Through Wideband (DC to 12.4 Ghz) Sampling-Head," *IEEE MTT-S International Microwave Symposium Digest*, Jun. 27-29, 1978, pp. 267-269.
- Rizzoli, V. et al., "Computer-Aided Noise Analysis of MESFET and HEMT Mixers," *IEEE Transactions On Microwave Theory and Techniques*, vol. 37, No. 9, Sep. 1989, pp. 1401-1410.
- Rücker, F. and Dintelmann, F., "Effect of Antenna Size on OTS Signal Scintillations and Their Seasonal Dependence," *Electronics Letters*, vol. 19, No. 24, Nov. 24, 1983, pp. 1032-1034.
- Sabel, L.P., "A DSP Implementation of a Robust Flexible Receiver/Demultiplexer for Broadcast Data Satellite Communications," *The Institution of Engineers Australia Communications Conference*, Melbourne Oct. 16-18, 1990, pp. 218-223.
- Salous, S., "IF digital generation of FMCW waveforms for wideband channel characterization," *IEE Proceedings-I*, vol. 139, No. 3, Jun. 1992, pp. 281-288.
- "Sampling Loops Lock Sources to 23 Ghz," *Microwaves & RF*, Sep. 1990, p. 212.
- Saul, P.H., "A GaAs MESFET Sample and Hold Switch," *5th European Solid State Circuits Conference-ESSCIRC 79*, 1979, pp. 5-7.
- Shen, D. H. et al., "A 900-MHZ RF Front-End with Integrated Discrete-Time Filtering," *IEEE Journal of Solid-State Circuits*, vol. 31, No. 12, Dec. 1996, pp. 1945-1954.
- Shen, X.D., and Vilar, E., "Anomalous transhorizon propagation and meteorological processes of a multilink path," *Radio Science*, vol. 30, No. 5, Sep.-Oct. 1995, pp. 1467-1479.
- Shen, X., and Tawfik, A.N., "Dynamic Behaviour of Radio Channels Due to Trans-Horizon Propagation Mechanisms," *Electronics Letters*, vol. 29, No. 17, Aug. 19, 1993, pp. 1582-1583.
- Shen, X. et al., "Modeling Enhanced Spherical Diffraction and Troposcattering on a Transhorizon Path with aid of the parabolic Equation and Ray Tracing Methods," *IEE Colloquium on Common modeling techniques for electromagnetic wave and acoustic wave propagation*, Mar. 8, 1996, pp. 4/1-47/6.
- Shen, X. and Vilar, E., "Path loss statistics and mechanisms of transhorizon propagation over a sea path," *Electronics Letters*, vol. 32, No. 3, Feb. 1, 1996, pp. 259-261.
- Spillard, C. et al., "X-Band Tropospheric Transhorizon Propagation Under Differing Meteorological Conditions," *Antennas and Propagation (ICAP 89) Part 2: Propagation*, Apr. 4-7, 1989, pp. 451-455.
- Stafford, K.R. et al., "A Complete Monolithic Sample/Hold Amplifier," *IEEE Journal of Solid-State Circuits*, vol. SC-9, No. 6, Dec. 1974, pp. 381-387.
- Staruk, W. Jr. et al., "Pushing HF Data Rates," *Defense Electronics*, May 1985, pp. 211, 213, 215, 217, 220 & 222.
- Stephenson, A.G., "Digitizing multiple RF signals requires an optimum sampling rate," *Electronics*, Mar. 27, 1972, pp. 106-110.
- Sugarman, R., "Sampling Oscilloscope for Statistically Varying Pulses," *The Review of Scientific Instruments*, vol. 28, No. 11, Nov. 1957, pp. 933-938.
- Sylvain, M., "Experimental probing of multipath microwave channels," *Radio Science*, vol. 24, No. 2, Mar.-Apr. 1989, pp. 160-178.
- Takano, T., "Novel GaAs Pet Phase Detector Operable To Ka Band," *IEEE MT-S Digest*, 1984, pp. 381-383.
- Tan, M.A., "Biquadratic Transconductance Switched-Capacitor Filters," *IEEE Transactions On Circuits and Systems-I: Fundamental Theory and Applications*, vol. 40, No. 4, Apr. 1993, pp. 272-275.
- Tanaka, K. et al., "Single Chip Multisystem AM Stereo Decoder IC," *IEEE Transactions On Consumer Electronics*, vol. CE-32, No. 3, Aug. 1986, pp. 482-496.
- Tawfik, A.N., "Amplitude, Duration and Predictability of Long Hop Trans-Horizon X-band Signals Over the Sea," *Electronics Letters*, vol. 28, No. 6, Mar. 12, 1992, pp. 571-572.
- Tawfik, A.N. and Vilar, E., "Correlation of Transhorizon Signal Level Strength with Localized Surface Meteorological Parameters," *8th International Conf. On Antennas and Propagation*, Mar. 30-Apr. 2, 1993, pp. 335-339.
- Tawfik, A.N. and Vilar, E., "Dynamic Structure of a Transhorizon Signal at X-band Over a Sea Path," *Antennas and Propagation (ICAP 89) Part 2: Propagation*, Apr. 4-7, 1989, pp. 446-450.
- Tawfik, A.N. and Vilar, E., "Statistics of Duration and Intensity of Path Loss in a Microwave Transhorizon Sea-Path," *Electronics Letters*, vol. 26, No. 7, Mar. 29, 1990, pp. 474-476.
- Tawfik, A.N. and Vilar, E., "X-Band Transhorizon Measurements of CW Transmissions Over the Sea-Part 1: Path Loss, Duration of Events, and Their Modeling," *IEEE Transactions On Antennas and Propagation*, vol. 41, No. 11, Nov. 1993, pp. 1491-1500.
- Tomassetti, Q., "An Unusual Microwave Mixer," *16th European Microwave Conference*, Sep. 8-12, 1986, pp. 754-759.
- Tortoli, P. et al., "Bidirectional Doppler Signal Analysis Based on a Single RF Sampling Channel," *IEEE Transactions On Ultrasonics, Ferroelectrics, and Frequency Control*, vol. 41, No. 1, Jan. 1984, pp. 1-3.
- Tsividis, Y. and Antognetti, P. (Ed.), *Design of MOS VLSI Circuits for Telecommunications*, p. 304.

- Tsividis, Y., "Principles of Operation and Analysis of Switched-Capacitor Circuits," *Proceedings of the IEEE*, vol. 71, No. 8, Aug. 1983, pp. 926-940.
- Tsurumi, H. and Maeda, T., "Design Study on a Direct Conversion Receiver Front-End for 280 MHz, 900 MHz, and 2.6 Ghz Band radio Communication Systems," *41<sup>st</sup> IEEE Vehicular Technology Conference*, May 19-22, 1991, pp. 457-462.
- Valdamanis, J.A. et al., "Picosecond and Subpicosecond Optoelectronics for Measurements of Future High Speed Electronic Devices," *IEDM Technical Digest*, Dec. 5-7, 1983, pp. 597-600.
- van de Kamp, M.M.J.L., "Asymmetric signal level distribution due to tropospheric scintillation," *Electronics Letters*, vol. 34, No. 11, May 28, 1998, pp. 1145-1146.
- Vasseur, H. and Vanhoenacker, D., "Characterization of tropospheric turbulent layers from radiosonde data," *Electronics Letters*, vol. 34, No. 4, Feb. 19, 1998, pp. 318-319.
- Verdone, R., "Outage Probability Analysis for Short-Range Communication Systems at 60 Ghz in ATT Urban Environments," *IEEE Transactions On Vehicular Technology*, vol. 46, No. 4, Nov. 1997, pp. 1027-1039.
- Vierira-Ribeiro, S.A., *Single-IF DECT Receiver Architecture using a Quadrature Sub-Sampling Band-Pass Sigma-Delta Modulator*, Thesis for Degree of Master's of Engineering, Carleton University, Apr. 1995, pp. 1-180.
- Vilar, E. et al., "A Comprehensive/Selective MM-Wave Satellite Downlink Experiment on Fade Dynamics," *10<sup>th</sup> International Conf. On Antennas and Propagation*, Apr. 14-17, 1997, pp. 2.98-2.101.
- Vilar, E. et al., "A System to Measure LOS Atmospheric Transmittance at 19 Ghz," *Agard Conf. Proc. No. 346: Characteristics of the Lower Atmosphere Influencing Radio Wave Propagation*, Oct. 4-7, 1983, pp. 8-1-8-16.
- Vilar, E. and Smith, H., "A Theoretical and Experimental Study of Angular Scintillations in Earth Space Paths," *IEEE Transactions On Antennas and Propagation*, vol. AP-34, No. 1, Jan. 1986, pp. 2-10.
- Vilar, E. et al., "A Wide Band Transhorizon Experiment at 11.6 Ghz," *8<sup>th</sup> International Conf. On Antennas and Propagation*, Mar. 30-Apr. 2, 1993, pp. 441-445.
- Vilar, E. and Matthew, P.A., "Amplitude Dependence of Frequency in Oscillators," *Electronics Letters*, vol. 8, No. 20, Oct. 5, 1972, pp. 509-511.
- Vilar, E. et al., "An experimental mm-wave receiver system for measuring phase noise due to atmospheric turbulence," *Conf. Proc. 25<sup>th</sup> European Microwave Conference*, 1995, pp. 114-119.
- Vilar, E. and Burgueñ, A., "Analysis and Modeling of Time Intervals Between Rain Rate Exceedances in the Context of Fade Dynamics," *IEEE Transactions on Communications*, vol. 39, No. 9, Sep. 1991, pp. 1306-1312.
- Vilar, E. et al., "Angle of Arrival Fluctuations in High and Low Elevation Earth Space Paths," *Antennas and Propagation (ICAP 85)*, Apr. 16-19, 1985, pp. 83-88.
- Vilar, E., "Antennas and Propagation: A Telecommunications Systems Subject," *Electronics Division Colloquium on Teaching Antennas and Propagation to Undergraduates*, Mar. 8, 1988, (6 Pages).
- Vilar, E. et al., "CERS\*. Millimetre-Wave Beacon Package and Related Payload Doppler Correction Strategies," *Electronics Division Colloquium on CERS-Communications Engineering Research Satellite*, Apr. 10, 1984, pp. 10/1-10/10.
- Vilar, E. and Mouldsley, T.J., "Comment and Reply: Probability Density Function of Amplitude Scintillations," *Electronics Letters*, vol. 21, No. 14, Jul. 4, 1985, pp. 620-622.
- Vilar, E. et al., "Comparison of Rainfall Rate Duration Distributions for ILE-IFE and Barcelona," *Electronics Letters*, vol. 28, No. 20, Sep. 24, 1992, pp. 1922-1924.
- Vilar, E., "Depolarisation and Field Transmittances in Indoor Communications," *Electronics Letters*, vol. 27, No. 9, Apr. 25, 1991, pp. 732-733.
- Vilar, E. and Larsen, J.R., "Elevation Dependence of Amplitude Scintillations on Low Elevation Earth Space Paths," *Antennas and Propagation (ICAP 89) Part 2: Propagation*, Apr. 4-7, 1989, pp. 150-154.
- Vilar, E. et al., "Experimental System and Measurements of Transhorizon Signal Levels at 11 Ghz," *18<sup>th</sup> European Microwave Conference*, Sep. 12-15, 1988, pp. 429-435.
- Vilar, E. and Matthews, P.A., "Importance of Amplitude Scintillations in Millimetric Radio Links," *Conf. Proc. 4<sup>th</sup> European Microwave Conference*, Sep. 10-13, 1974, pp. 202-206.
- Vilar, E. and Haddon, J., "Measurement and Modeling of Scintillation Intensity to Estimate Turbulence Parameters in an Earth-Space Path," *IEEE Transaction On Antennas and Propagation*, vol. AP-32, No. 4, Apr. 1984, pp. 340-346.
- Vilae, E. and Matthew, P.A. "Measurement of Phase Fluctuations on Millimetric Radiowave Propagation," *Electronics Letters*, vol. 7, No. 18, Sep. 9, 1971, pp. 566-568.
- Vilar, E. and Wan, K.W., "Narrow and Wide Band Estimates of Field Strength for Indoor Communications in the Millimetre Band," *Electronics Division Colloquium on Radio-communications in the Range 30-60 Ghz*, Jan. 17, 1991, pp. 5/1-5/8.
- Vilar, E. and Faulkner, N.D., "Phase Noise and Frequency Stability Measurements. Numerical Techniques and Limitations," *Electronics Division Colloquium on Low Noise Oscillators and Synthesizer*, Jan. 23, 1986, (5 Pages).
- Vilar, E. and Senin, S., "Propagation phase noise identified using 40 Ghz satellite downlink," *Electronics Letters*, vol. 33, No. 22, Oct. 23, 1997, pp. 1901-1902.
- Vilar, E. and Wan, K.W., "Narrow and Wide Band Estimates of Field Strength for Indoor Communications in the Millimetre Band," *Electronics Division Colloquium on Radio-communications in the Range 30-60 Ghz*, Jan. 17, 1991, pp. 5/1-5/8.
- Vilar, E. and Haddon, J., "Scintillation Modeling and Measurement—A Tool for Remote-Sensing Slant Paths," *Agard Conf. Proc. No. 332: Propagation Aspects of Frequency Sharing, Interference And System Diversity*, Oct. 18-22, 1982, pp. 27-1-27-13.
- Vilar, E., "Some Limitations on Digital Transmission Through Turbulent Atmosphere," *Int'l Conf. On Satellite Communication Systems Technology*, Apr. 7-10, 1975, pp. 169-187.
- Vilar, E. and Matthews, P.A., "Summary of Scintillation Observations in a 36 Ghz Link Across London," *Int'l Conf. On Antennas and Propagation Part 2: Propagation*, Nov. 28-30, 1978, pp. 36-40.
- Vilar, E. et al., "Wideband Characterization of Scattering Channels," *10<sup>th</sup> International Conf. On Antennas and Propagation*, Apr. 14-17, 1997, pp. 2.353-2.358.
- Voltage and Time Resolution in Digitizing Oscilloscopes: Application Note 348*, Hewlett Packard, Nov. 1986, pp. 1-11.

- Wan, K.W. et al., "A Novel Approach to the Simultaneous Measurement of Phase and Amplitude Noises in Oscillator," *19<sup>th</sup> European Microwave Conference Proceedings*, Sep. 4-7, 1989, pp. 809-813.
- Wan, K.W. et al., "Extended Variances and Autoregressive/Moving Average Algorithm for the Measurement and Synthesis of Oscillator Phase Noise," *Proc. Of the 43<sup>rd</sup> Annual Symposium on Frequency Control*, 1989, pp. 331-335.
- Wan, K.W. et al., "Wideband Transhorizon Channel Sounder at 11 Ghz," *Electronics Division Colloquium on High Bit Rate UHF/SHF Channel Sounders—Technology and Measurement*, Dec. 3, 1993, pp. 3/1-3/5.
- Watson, A.W.D. et al., "Digital Conversion and Signal Processing for High Performance Communications Receivers," pp. 367-373.
- Wiley, R.G., "Approximate FM Demodulation Using Zero Crossings," *IEEE Transactions On Communications*, vol. COM-29, No. 7, Jul. 1981, pp. 1061-1065.
- Worthman, W., "Convergence . . . Again," *RF Design*, Mar. 1999, p. 102.
- Young, I.A. and Hodges, D.A., "MOS Switched-Capacitor Analog Sampled-Data Direct-Form Recursive Filters," *IEEE Journal of Solid-State Circuits*, vol. SC-14, No. 6, Dec. 1979, pp. 1020-1033.
- Dialog File 348 (European Patents) English Language Patent Abstract for EP 35166 A1, published Feb. 18, 1981, (2 Pages).
- Dialog File 347 (JAPIO) English Language Patent Abstract for JP 2-39632, published Feb. 8, 1990, (1 Page).
- Dialog File 347 (JAPIO) English Language Patent Abstract for JP 2-131629, published May 21, 1990, (1 Page).
- Dialog File 347 (JAPIO) English Language Patent Abstract for JP 2-276351, published Nov. 13, 1990, (1 Page).
- Dialog File 348 (European Patents) English Language Patent Abstract for EP 0 785 635 A1, published Dec. 26, 1996, (3 Pages).
- Sasikumar, M. et al., "Active Compensation in the Switched-Capacitor Biquad," *Proceedings of the IEEE*, vol. 71, No. 8, Aug. 1983, pp. 1008-1009.
- Temes, G.C. and Tsvividis, T., "The Special Section on Switched-Capacitor Circuits," *Proceedings of the IEEE*, vol. 71, No. 8, Aug. 1983, pp. 915-916.
- Press Release, "Parkervision, Inc. Announces Fiscal 1993 Results," 2 Pages, Apr. 6, 1994.
- Press Release, "Parkervision, Inc. Announces the Appointment of Michael Baker to the New Position of National Sales Manager," 1 Page, Apr. 7, 1994.
- Press Release, "Parkervision's Cameraman Well-Received By Distance Learning Market," 2 Pages, Apr. 8, 1994.
- Press Release, "Parkervision, Inc. Announces First Quarter Financial Results," 2 Pages, Apr. 26, 1994.
- Press Release, "Parkervision, Inc. Announces The Retirement of William H. Fletcher, Chief Financial Officer," 1 Page, May 11, 1994.
- Press Release, "Parkervision, Inc. Announces New Cameraman System II™ At Infocomm Trade Show," 3 Pages, Jun. 9, 1994.
- Press Release, "Parkervision, Inc. Announces Appointments to its National Sales Force," 2 Pages, Jun. 17, 1994.
- Press Release, "Parkervision, Inc. Announces Second Quarter and Six Months Financial Results," 3 Pages, Aug. 9, 1994.
- Press Release, "Parkervision, Inc. Announces Third Quarter and Nine Months Financial Results," 3 Pages, Oct. 28, 1994.
- Press Release, "Parkervision, Inc. Announces First Significant Dealer Sale of Its Cameraman® System II," 2 Pages, Nov. 7, 1994.
- Press Release, "Parkervision, Inc. Announces Fourth Quarter and Year End Results," 2 Pages, Mar. 1, 1995.
- Press Release, "Parkervision, Inc. Announces Joint Product Developments With VTEL," 2 Pages, Mar. 21, 1995.
- Press Release, "Parkervision, Inc. Announces First Quarter Financial Results," 3 Pages, Apr. 28, 1995.
- Press Release, "Parkervision Wins Top 100 Product Districts' Choice Award," 1 Page, Jun. 29, 1995.
- Press Release, "Parkervision National Sales Manager Next President of USDLA," 1 Page, Jul. 6, 1995.
- Press Release, "Parkervision Granted New Patent," 1 Page, Jul. 21, 1995.
- Press Release, "Parkervision, Inc. Announces Second Quarter and Six Months Financial Results," 2 Pages, Jul. 31, 1995.
- Press Release, "Parkervision, Inc. Expands Its Cameraman System II Product Line," 2 Pages, Sep. 22, 1995.
- Press Release, "Parkervision Announces New Camera Control Technology," 2 Pages, Oct. 25, 1995.
- Press Release, "Parkervision, Inc. Announces Completion of VTEL/Parkervision Joint Product Line," 2 Pages, Oct. 30, 1995.
- Press Release, "Parkervision, Inc. Announces Third Quarter and Nine Months Financial Results," 2 Pages, Oct. 30, 1995.
- Press Release, "Parkervision's Cameraman Personal Locator Camera System Wins Telecon XV Award," 2 Pages, Nov. 1, 1995.
- Press Release, "Parkervision, Inc. Announces Purchase Commitment From VTEL Corporation," 1 Page, Feb. 26, 1996.
- Press Release, "ParkerVision, Inc. Announces Fourth Quarter and Year End Results," 2 Pages, Feb. 27, 1996.
- Press Release, "ParkerVision, Inc. Expands its Product Line," 2 Pages, Mar. 7, 1996.
- Press Release, "ParkerVision Files Patents for its Research of Wireless Technology," 1 Page, Mar. 28, 1996.
- Press Release, "Parkervision, Inc. Announces First Significant Sale of Its Cameraman® Three-Chip System," 2 Pages, Apr. 12, 1996.
- Press Release, "Parkervision, Inc. Introduces New Product Line For Studio Production Marker," 2 Pages, Apr. 15, 1996.
- Press Release, "Parkervision, Inc. Announces Private Placement of 800,000 Shares," 1 Page, Apr. 15, 1996.
- Press Release, "Parkervision, Inc. Announces First Quarter Financial Results," 3 Pages, Apr. 30, 1996.
- Press Release, "ParkerVision's New Studio Product Wins Award," 2 Pages, Jun. 5, 1996.
- Press Release, "Parkervision, Inc. Announces Second Quarter and Six Months Financial Results," 3 Pages, Aug. 1, 1996.
- Press Release, "Parkervision, Inc. Announces Third Quarter and Nine Months Financial Results," 2 Pages, Oct. 29, 1996.
- Press Release, "PictureTel and ParkerVision Sign Reseller Agreement," 2 Pages, Oct. 30, 1996.
- Press Release, "CLI and ParkerVision Bring Enhanced Ease-of-Use to Videoconferencing," 2 Pages, Jan. 20, 1997.
- Press Release, "Parkervision, Inc. Announces Fourth Quarter and Year End Results," 3 Pages, Feb. 27, 1997.
- Press Release, "Parkervision, Inc. Announces First Quarter Financial Results," 3 Pages, Apr. 29, 1997.
- Press Release, "NEC and Parkervision Make Distance Learning Closer," 2 Pages, Jun. 18, 1997.

Press Release, "Parkervision Supplies JPL with Robotic Cameras, Cameraman Shot Director for Mars Mission," 2 Pages, Jul. 8, 1997.

Press Release, "ParkerVision and IBM Join Forces to Create Wireless Computer Peripherals," 2 Pages, Jul. 23, 1997.

Press Release, "ParkerVision, Inc. Announces Second Quarter and Six Months Financial Results," 3 Pages, Jul. 31, 1997.

Press Release, "Parkervision, Inc. Announces Private Placement of 990,000 Shares," 2 Pages, Sep. 8, 1997.

Press Release, "Wal-Mart Chooses Parkervision for Broadcast Production," 2 Pages, Oct. 24, 1997.

Press Release, "Parkervision, Inc. Announces Third Quarter Financial Results," 3 Pages, Oct. 30, 1997.

Press Release, "ParkerVision Announces Breakthrough in Wireless Radio Frequency Technology," 3 Pages, Dec. 10, 1997.

Press Release, "Parkervision, Inc. Announces the Appointment of Joseph F. Skovron to the Position of Vice President, Licensing—Wireless Technologies," 2 Pages, Jan. 9, 1998.

Press Release, "Parkervision Announces Existing Agreement with IBM Terminates—Company Continues with Strategic Focus Announced in December," 2 Pages, Jan. 27, 1998.

Press Release, "Laboratory Tests Verify Parkervision Wireless Technology," 2 Pages, Mar. 3, 1998.

Press Release, "Parkervision, Inc. Announces Fourth Quarter and Year End Financial Results," 3 Pages, Mar. 5, 1998.

Press Release, "Parkervision Awarded Editors' Pick of Show for NAB 98," 2 Pages, Apr. 15, 1998.

Press Release, "Parkervision Announces First Quarter Financial Results," 3 Pages, May 4, 1998.

Press Release, "Parkervision 'DIRECT2DATA' Introduced in Response to Market Demand," 3 Pages, Jul. 9, 1998.

Press Release, "Parkervision Expands Senior Management Team," 2 Pages, Jul. 29, 1998.

Press Release, "Parkervision Announces Second Quarter and Six Month Financial Results," 4 Pages, Jul. 30, 1998.

Press Release, "Parkervision Announces Third Quarter and Nine Month Financial Results," 3 Pages, Oct. 30, 1998.

Press Release, "Questar Infocomm, Inc. Invests \$5 Million in Parkervision Common Stock," 3 Pages, Dec. 2, 1998.

Press Release, "Parkervision Adds Two New Directors," 2 Pages, Mar. 5, 1999.

Press Release, "Parkervision Announces Fourth Quarter and Year End Financial Results," 3 Pages, Mar. 5, 1999.

Press Release, "Joint Marketing Agreement Offers New Automated Production Solution," 2 Pages, Apr. 13, 1999.

Declaration of Michael J. Bultman.

Declaration of Robert W. Cook.

Declaration of Alex Holtz.

Declaration of Richard C. Looke.

Declaration of Charley D. Moses, Jr.

Declaration of Jeffrey L. Parker and David F. Sorrells, with attachment Exhibit 1.

H.E. Rowe, *Signals and Noise in Communication Systems*, D. Van Nostrand Company, Inc., Princeton, New Jersey, 1965, including, for example, Chapter V, Pulse Modulation Systems.

FIG. 1

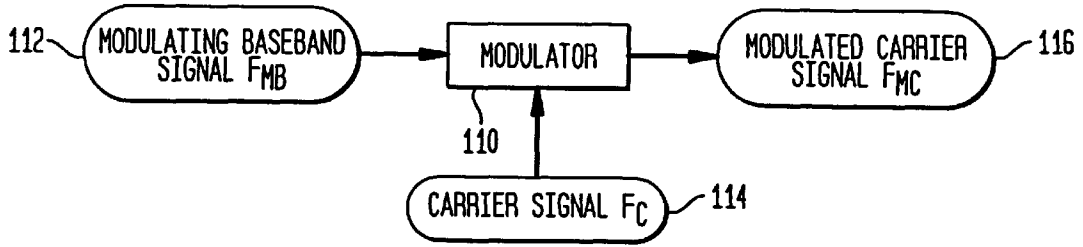


FIG. 2

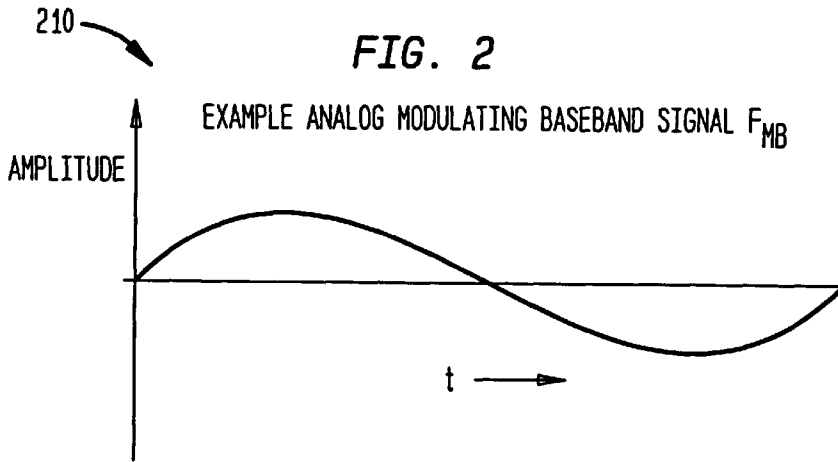


FIG. 3

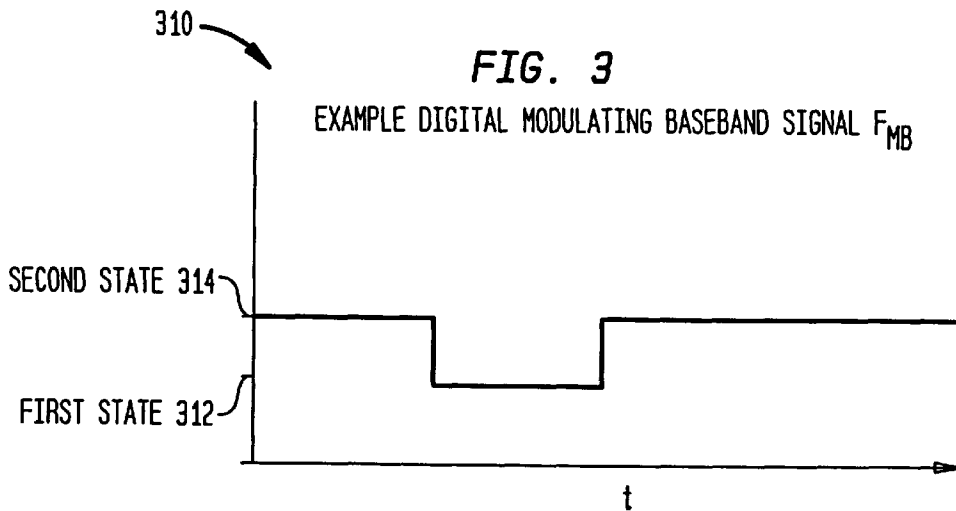
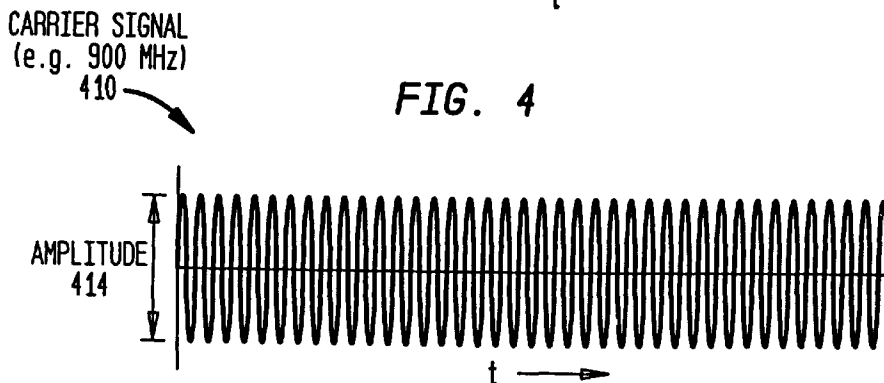
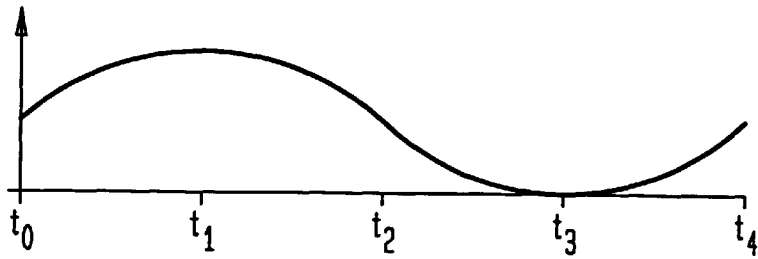


FIG. 4



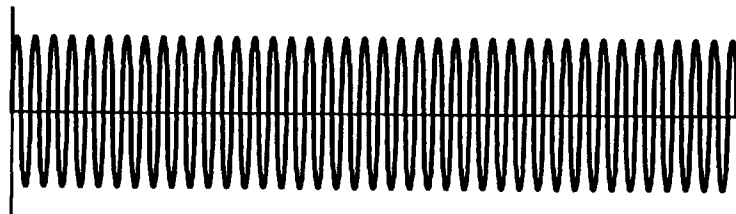
ANALOG  
BASEBAND SIGNAL  
210

FIG. 5A



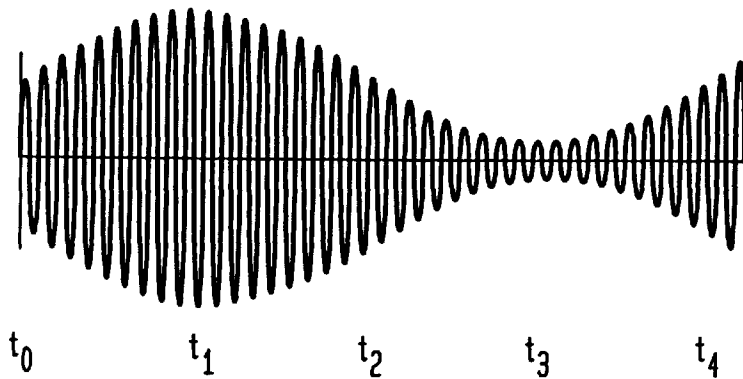
CARRIER SIGNAL  
410

FIG. 5B



AM CARRIER  
SIGNAL  
516

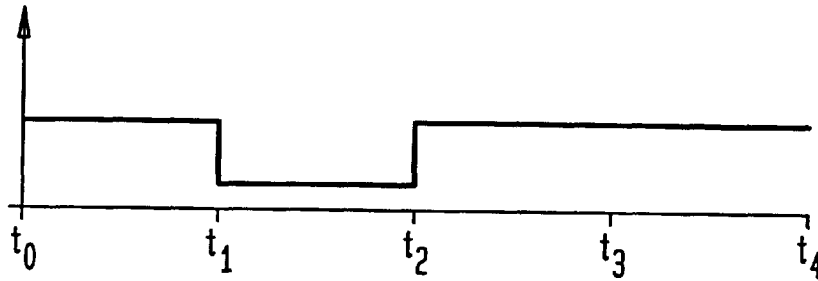
FIG. 5C





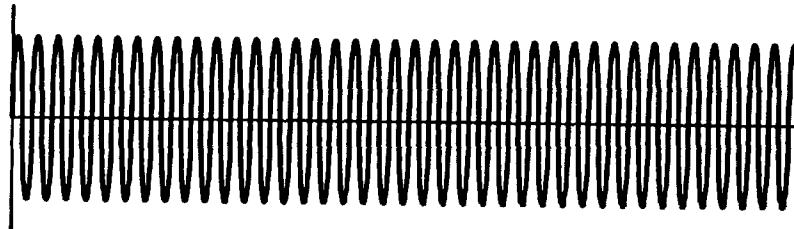
DIGITAL  
BASEBAND SIGNAL  
310

FIG. 6A



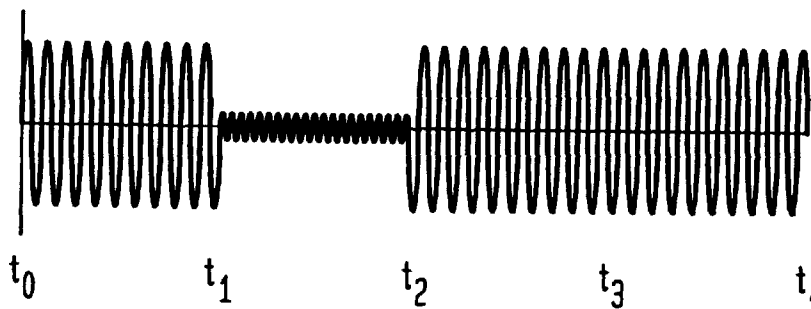
CARRIER SIGNAL  
410

FIG. 6B



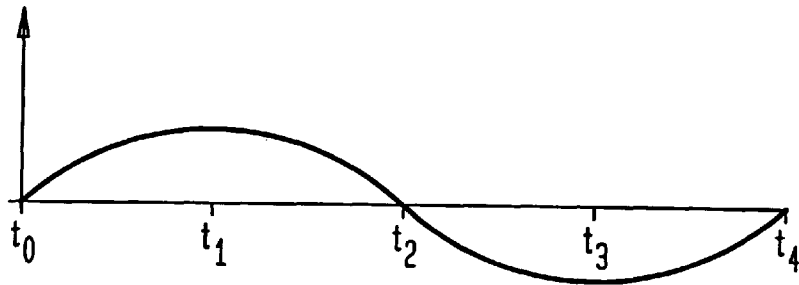
AM CARRIER SIGNAL  
616

FIG. 6C



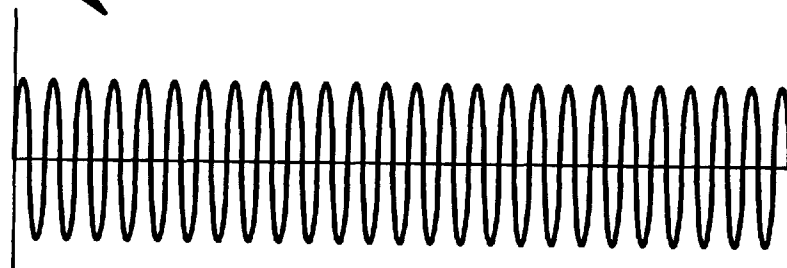
ANALOG  
BASEBAND SIGNAL  
210

FIG. 7A



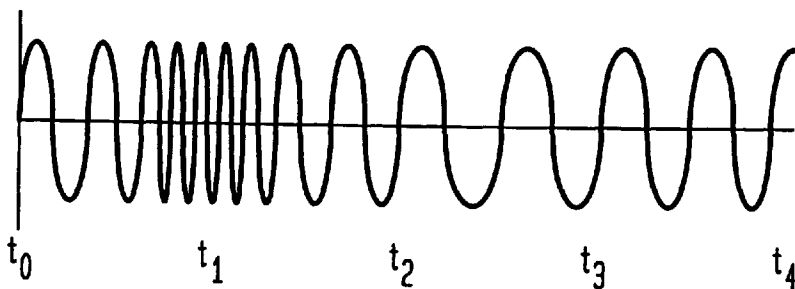
CARRIER SIGNAL  
410

FIG. 7B



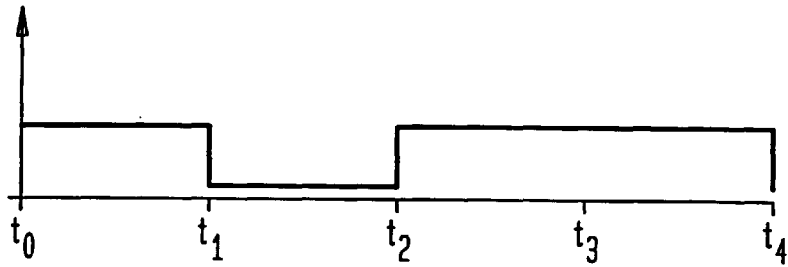
FM CARRIER SIGNAL  
716

FIG. 7C



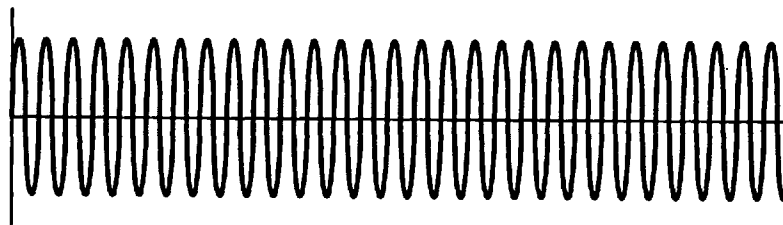
DIGITAL  
BASEBAND SIGNAL  
310

FIG. 8A



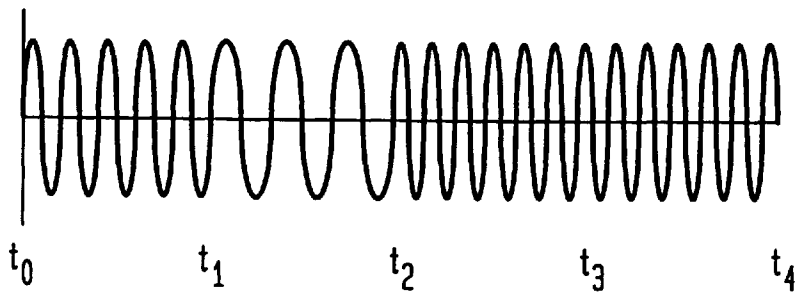
CARRIER SIGNAL  
410

FIG. 8B



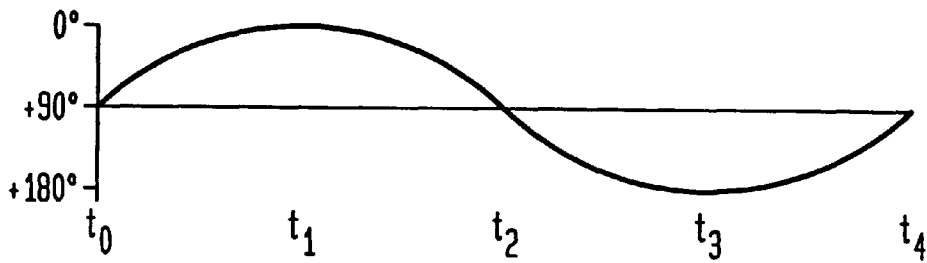
FM CARRIER SIGNAL  
816

FIG. 8C



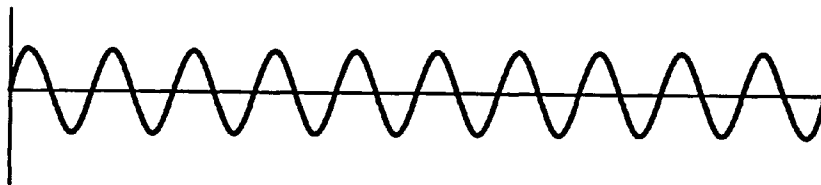
ANALOG  
BASEBAND SIGNAL  
210

FIG. 9A



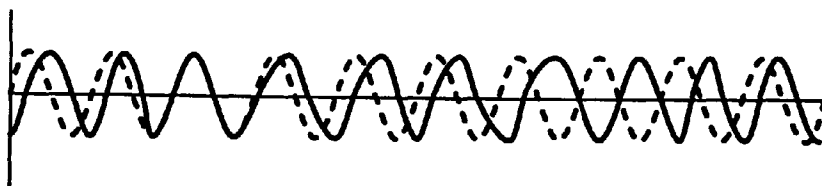
CARRIER SIGNAL  
410

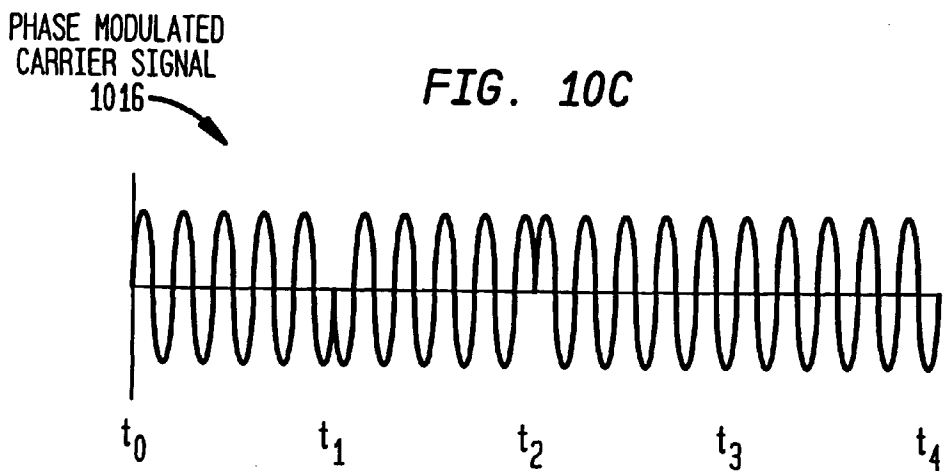
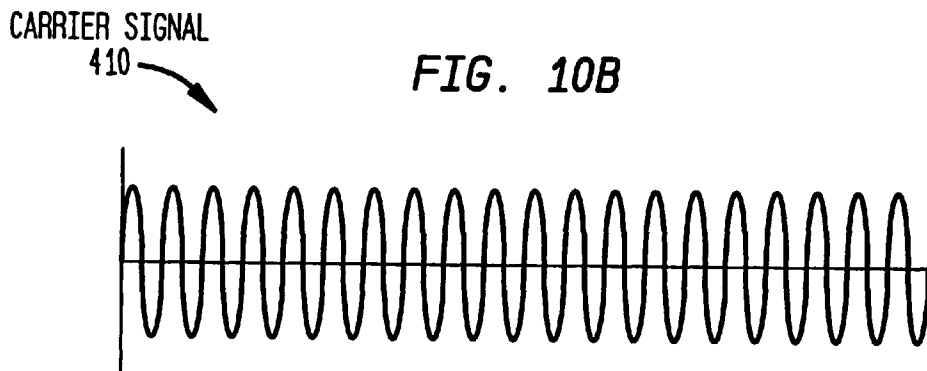
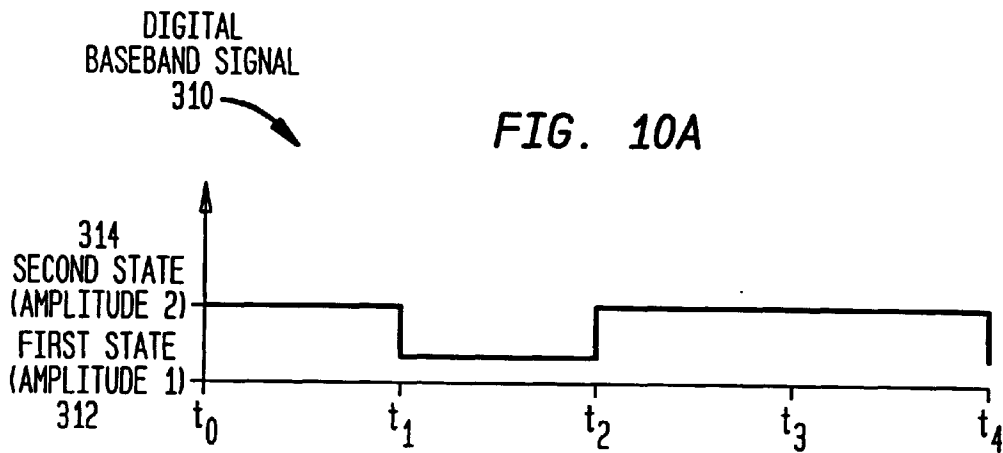
FIG. 9B



PHASE MODULATED  
CARRIER SIGNAL  
916

FIG. 9C





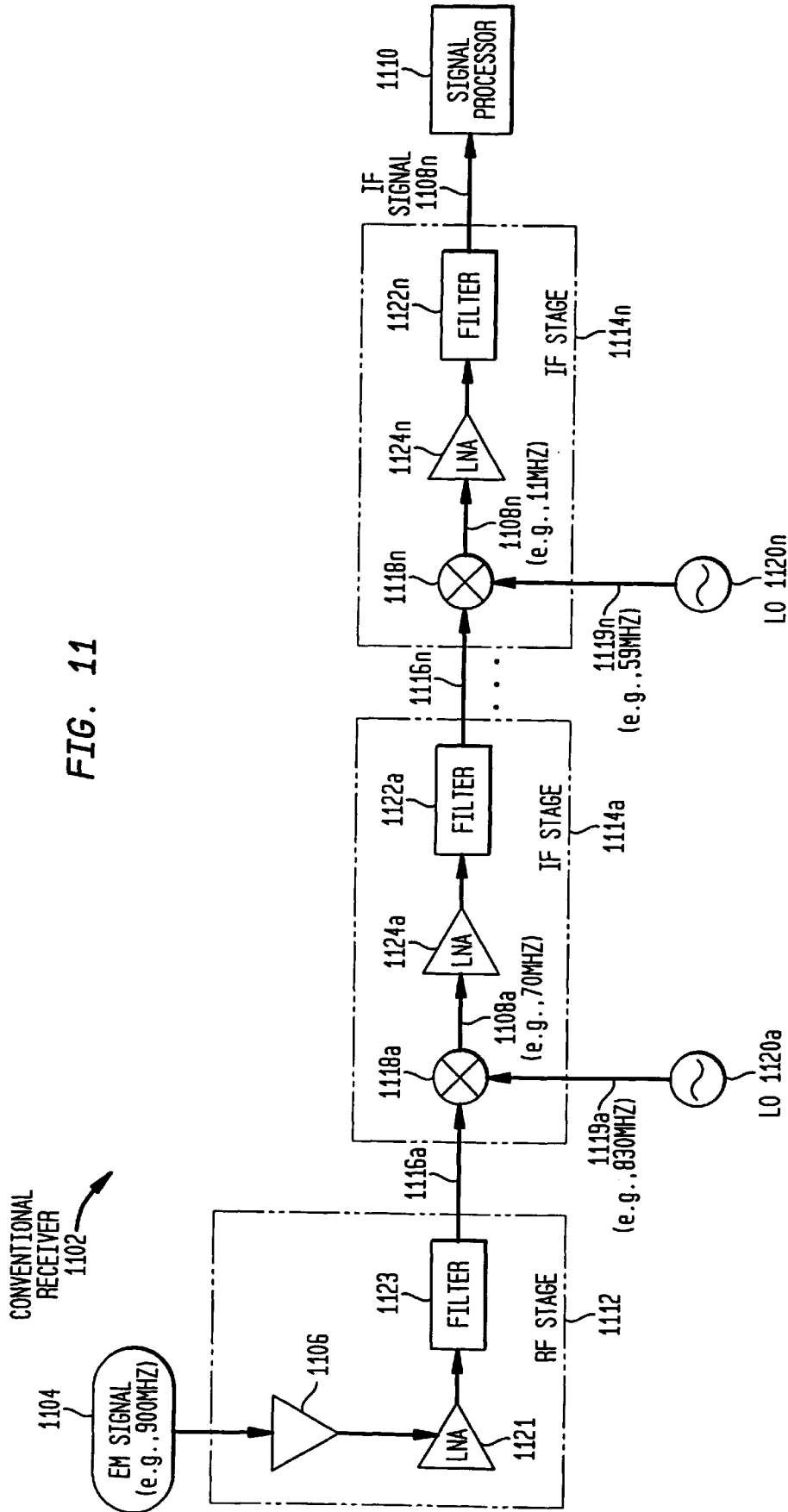


FIG. 12A

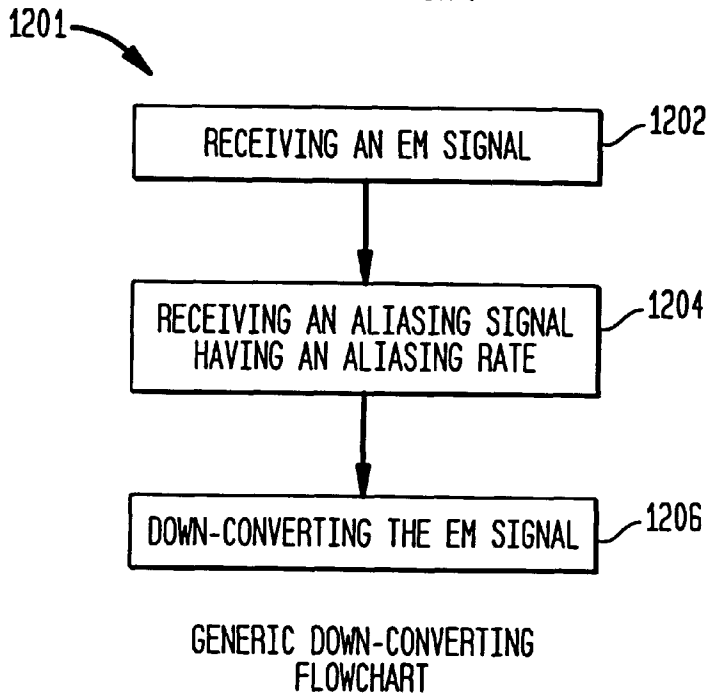


FIG. 12B

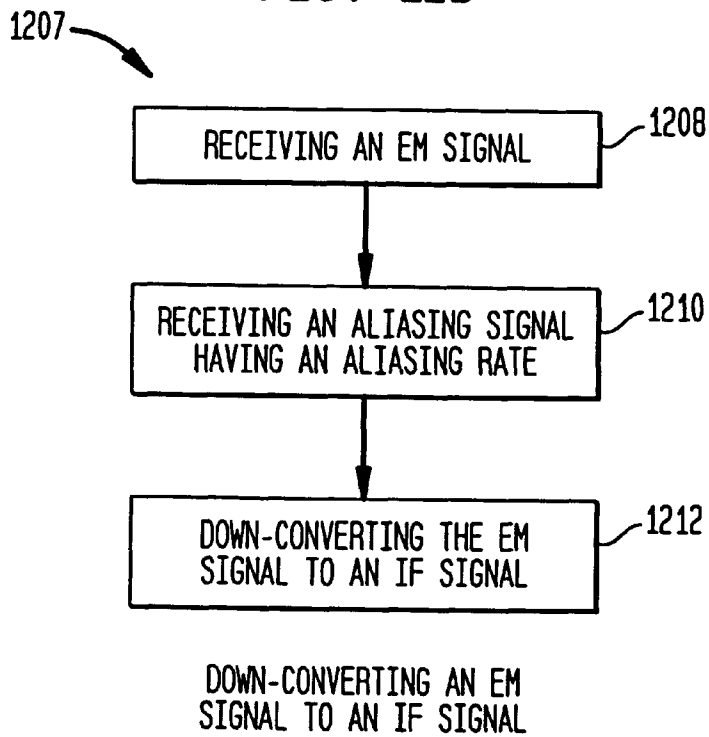
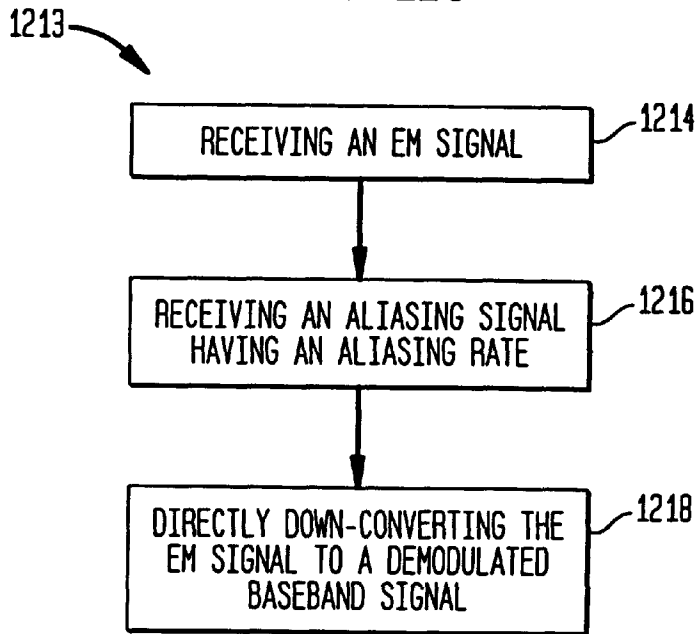
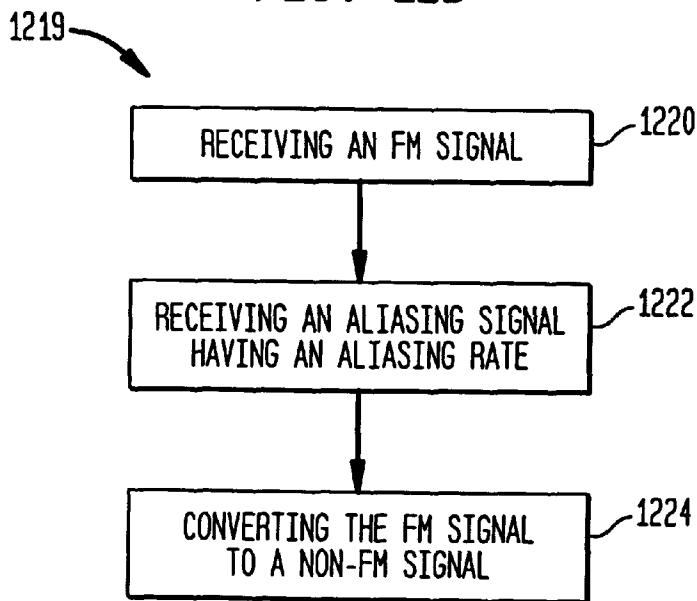


FIG. 12C



DIRECTLY DOWN-CONVERTING AN EM SIGNAL TO A DEMODULATED BASEBAND SIGNAL

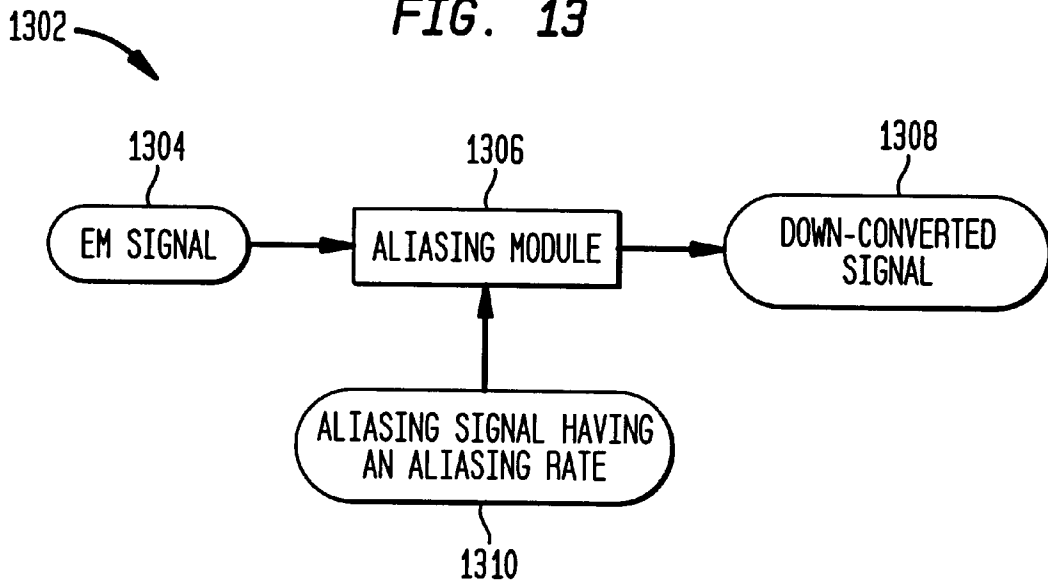
FIG. 12D



MODULATION CONVERSION



FIG. 13



GENERIC DOWN-CONVERTING SYSTEM

FIG. 14A

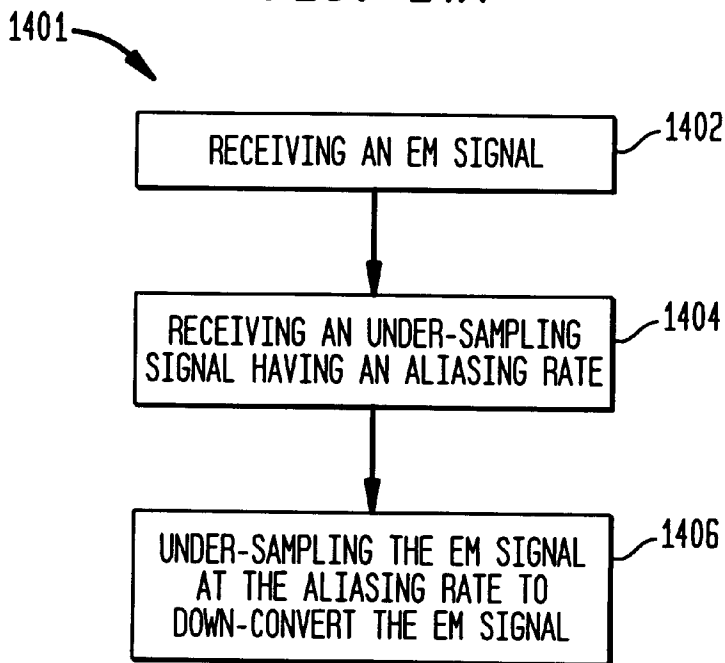


FIG. 14B

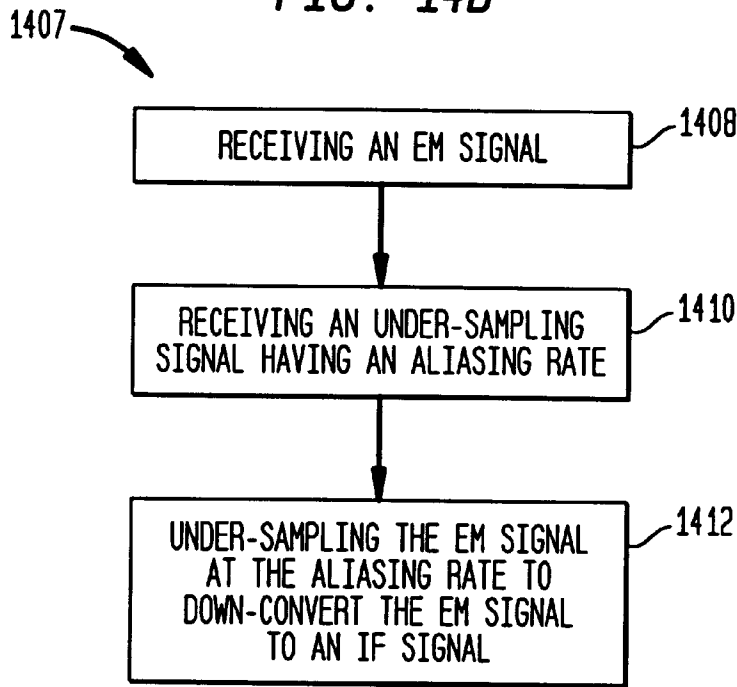
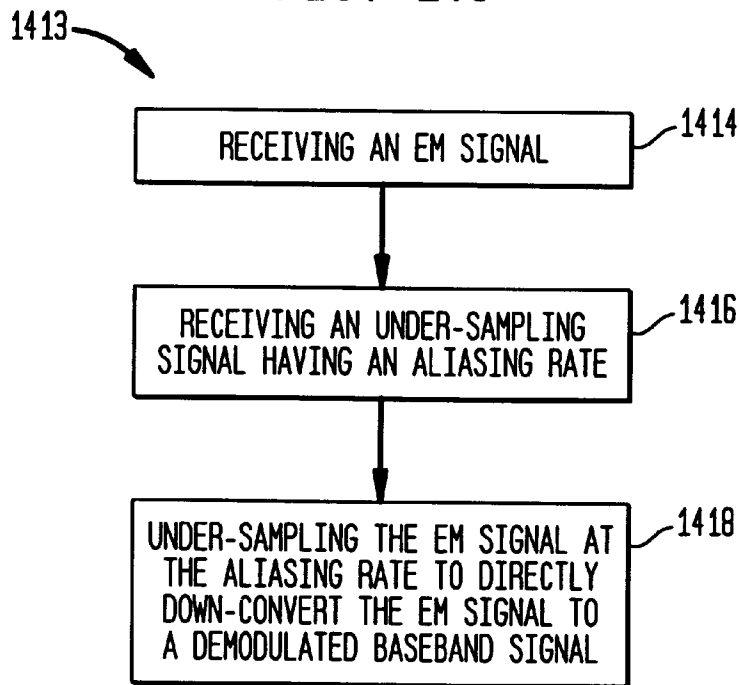


FIG. 14C



**FIG. 14D**

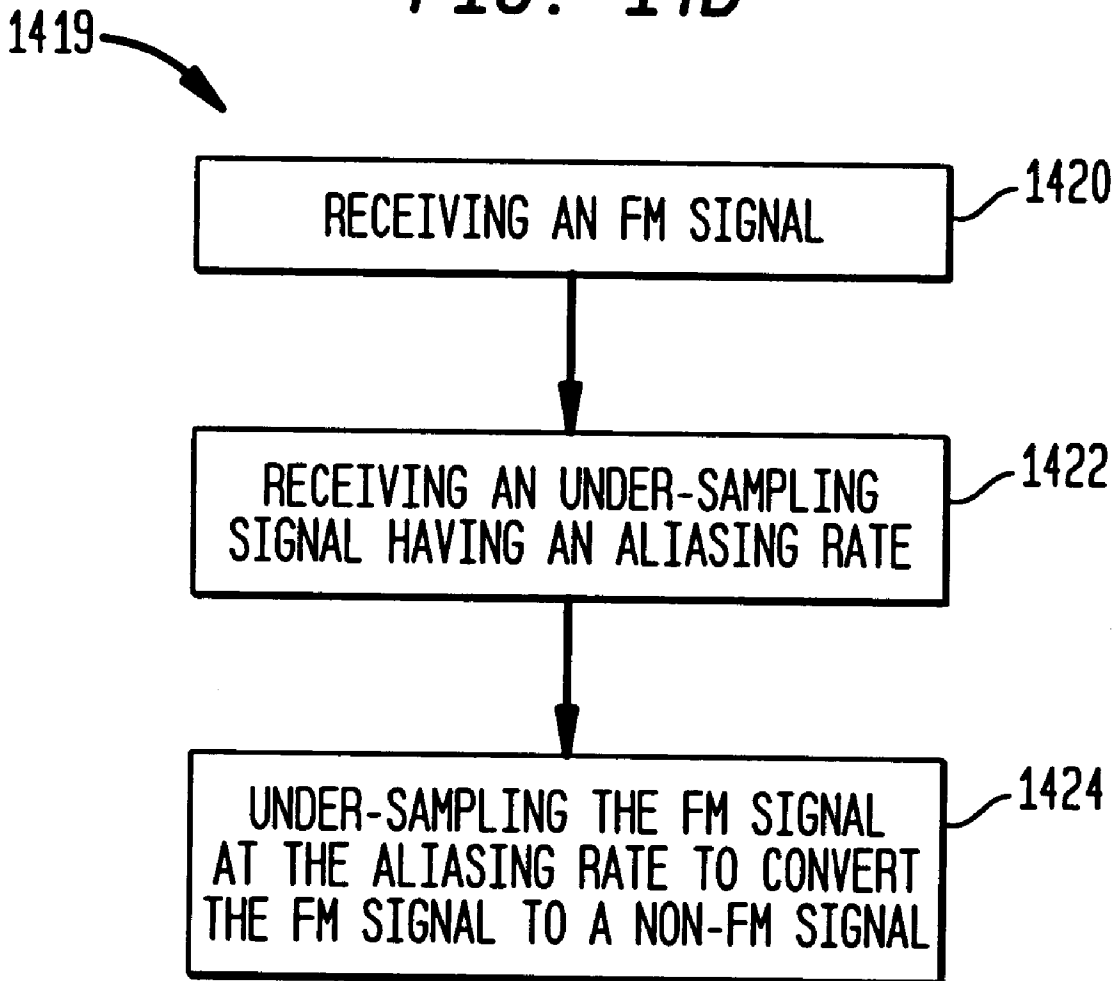


FIG. 15E

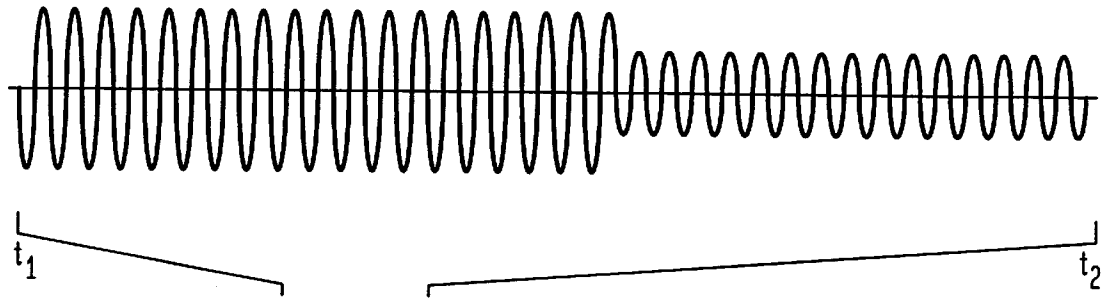


FIG. 15A

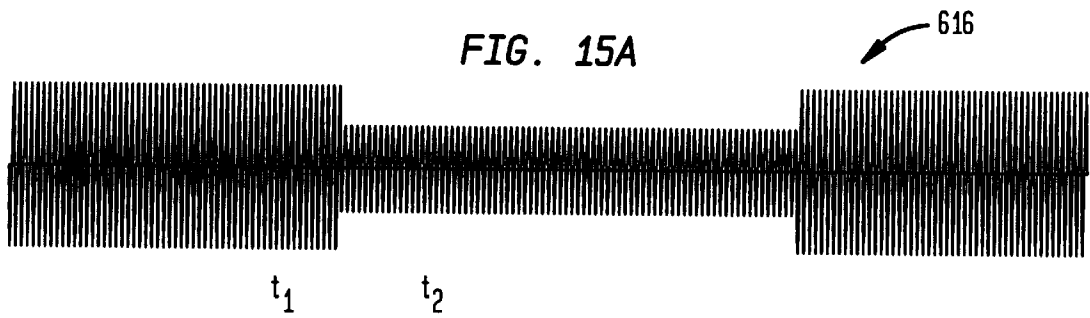


FIG. 15B

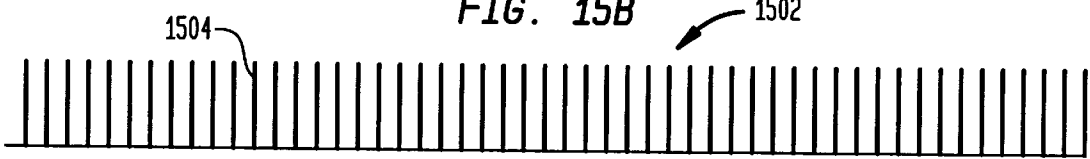


FIG. 15C

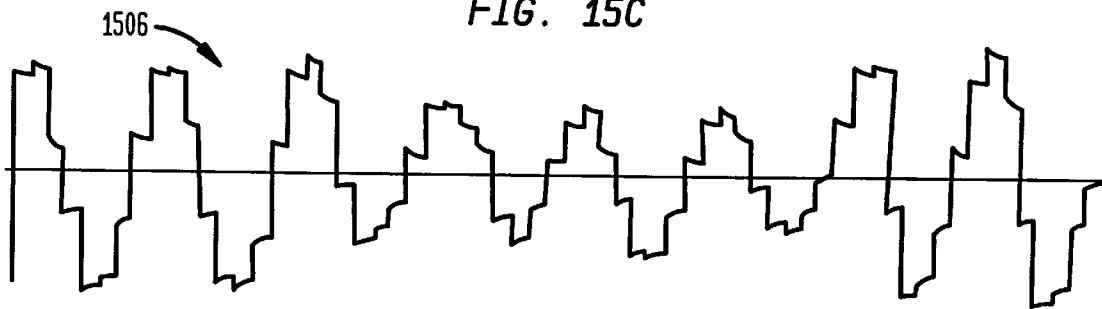


FIG. 15D

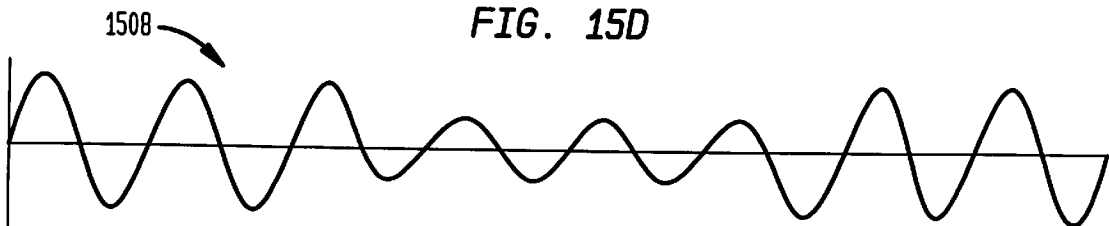


FIG. 16

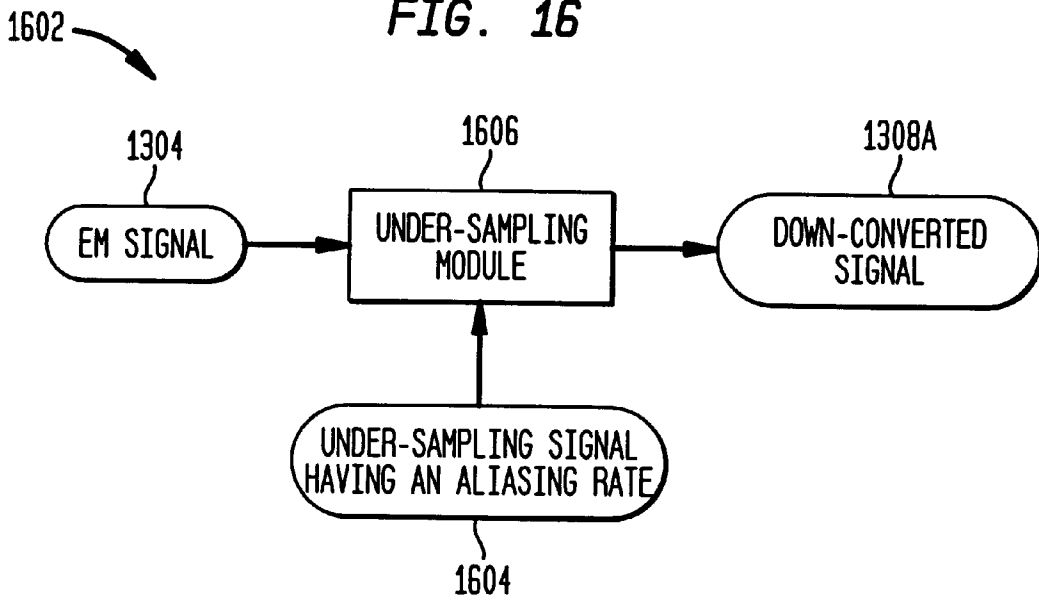
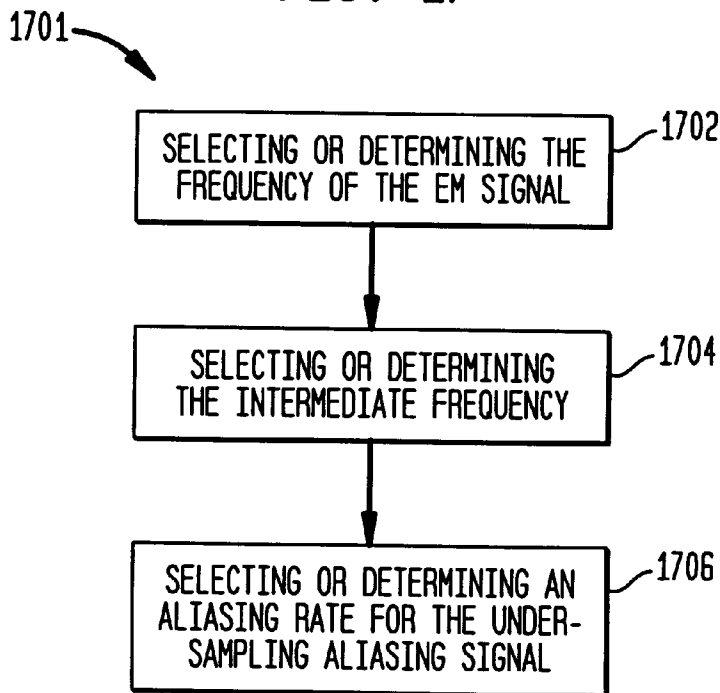
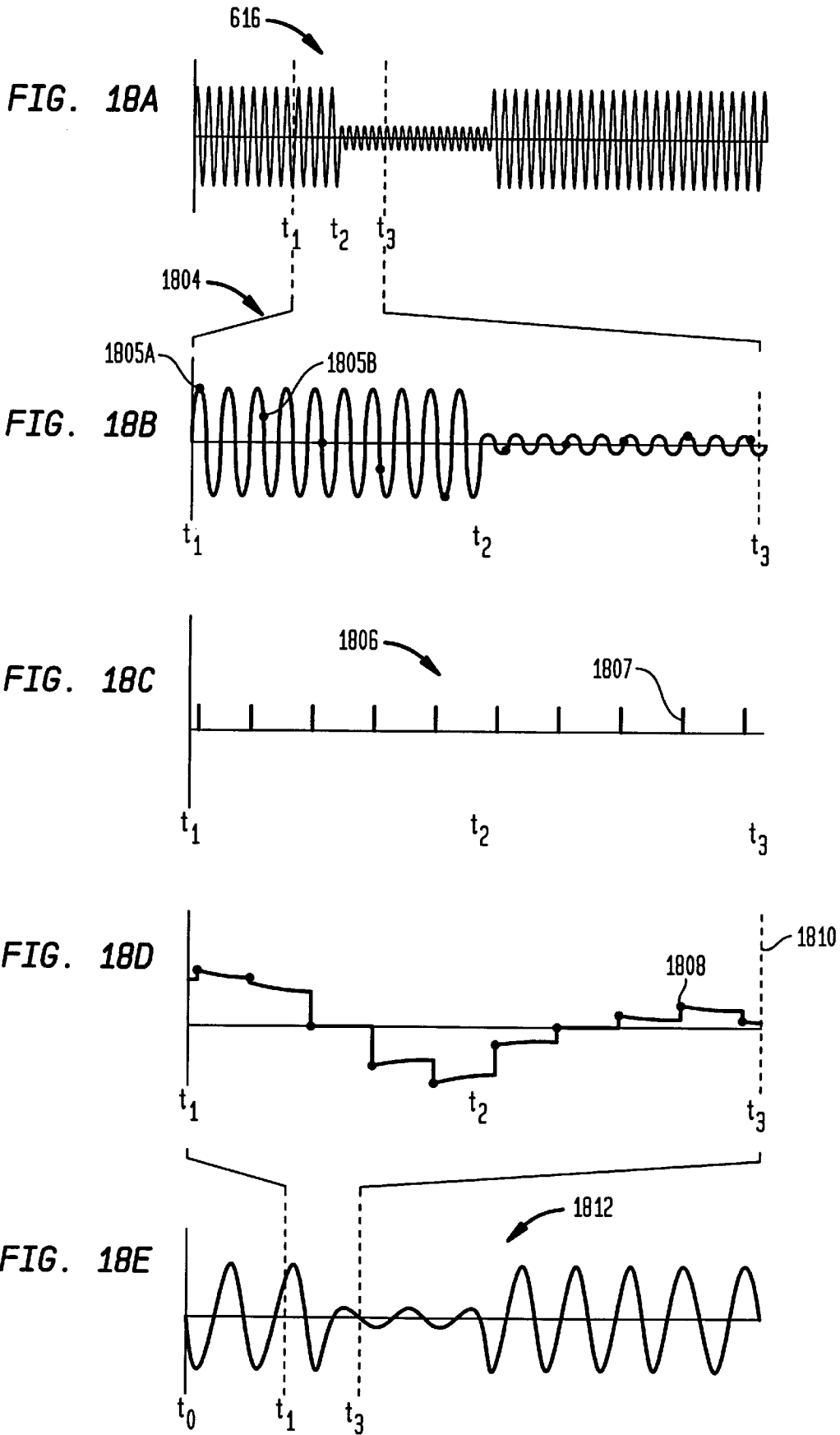
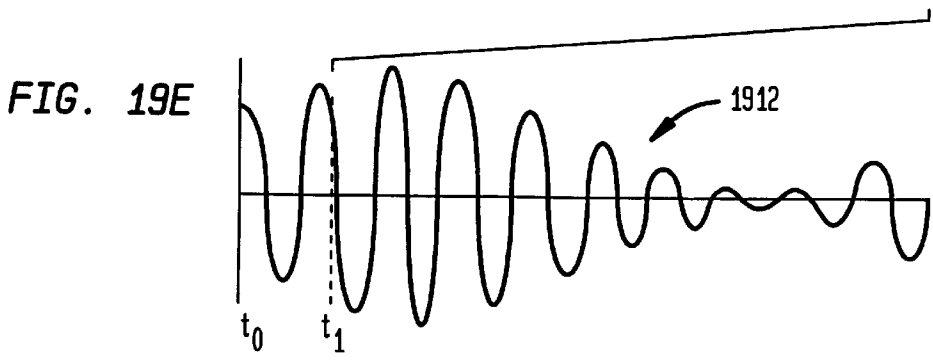
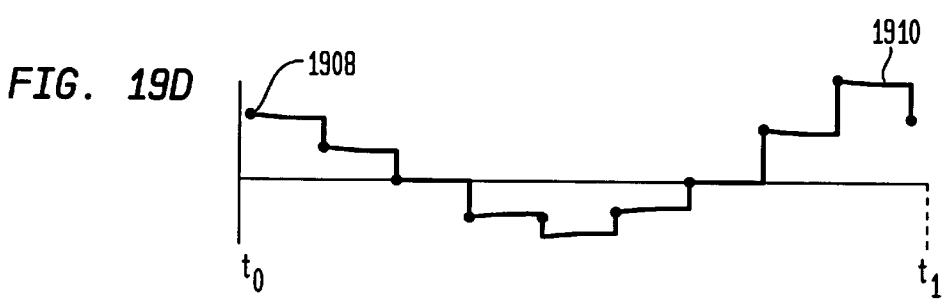
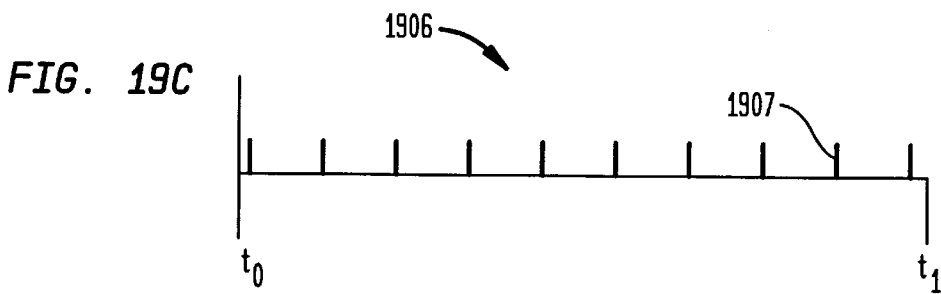
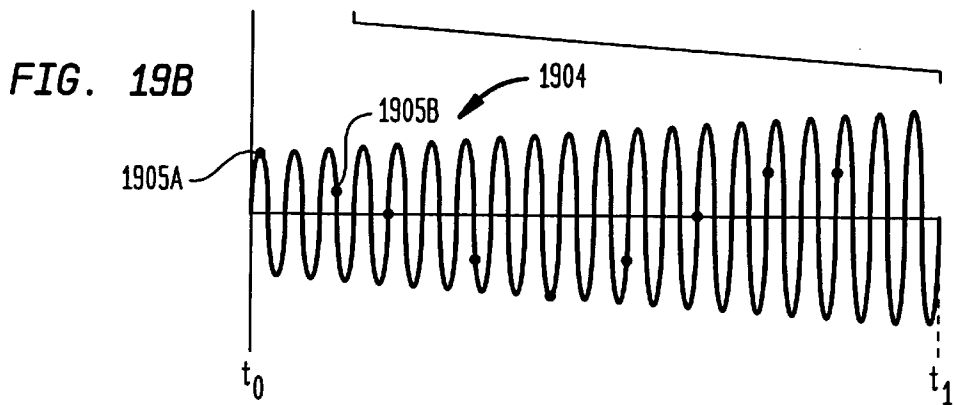
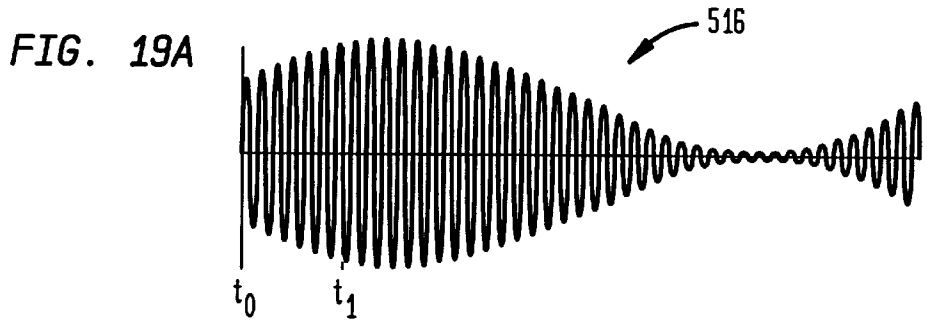


FIG. 17







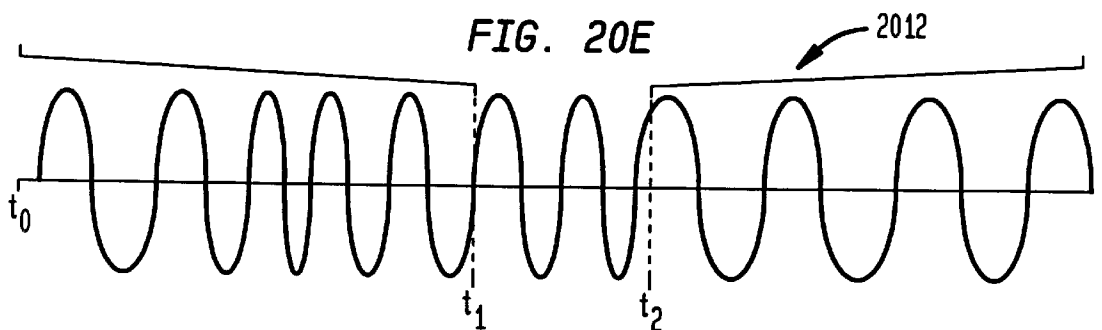
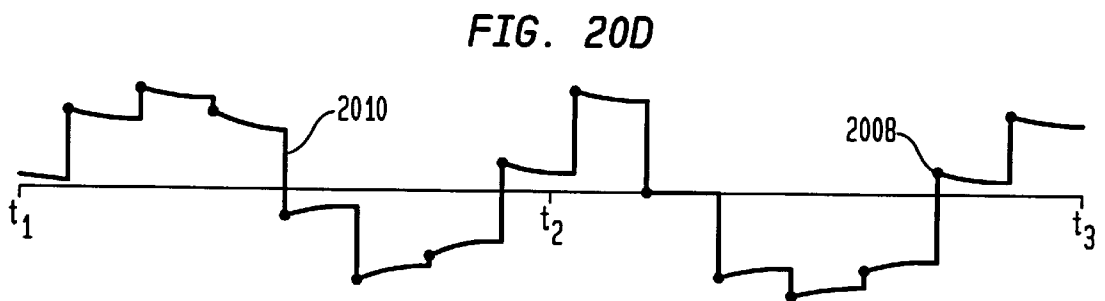
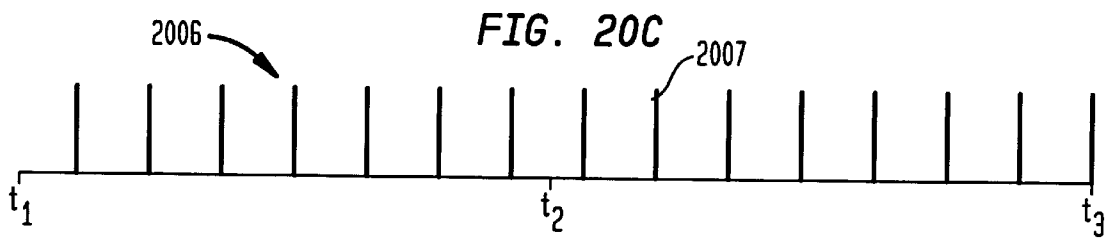
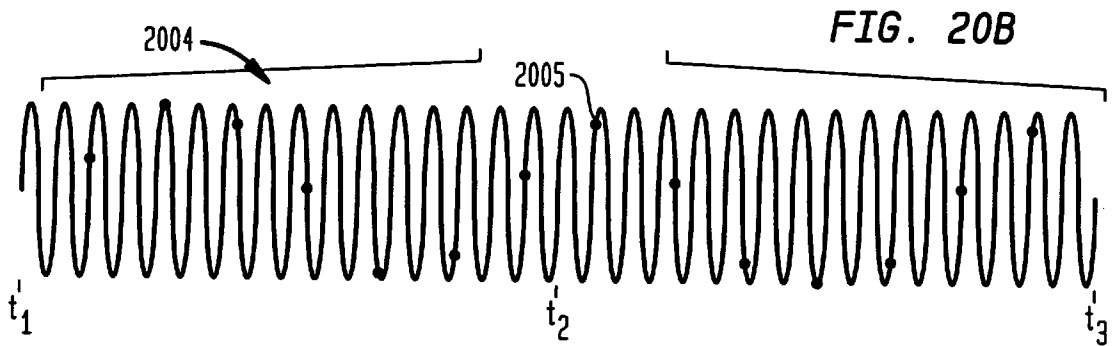
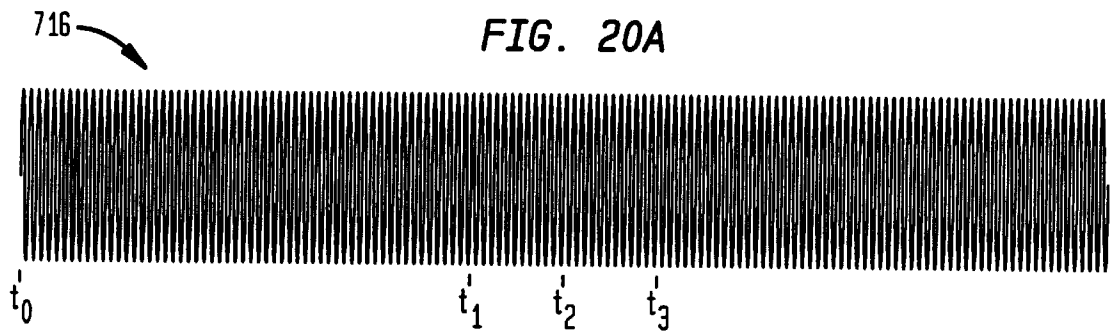




FIG. 21A

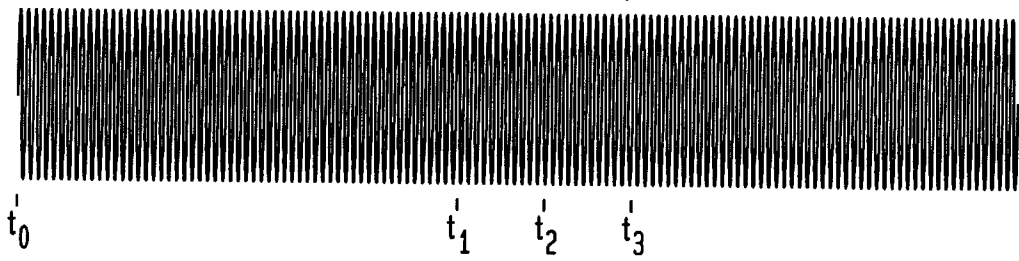


FIG. 21B

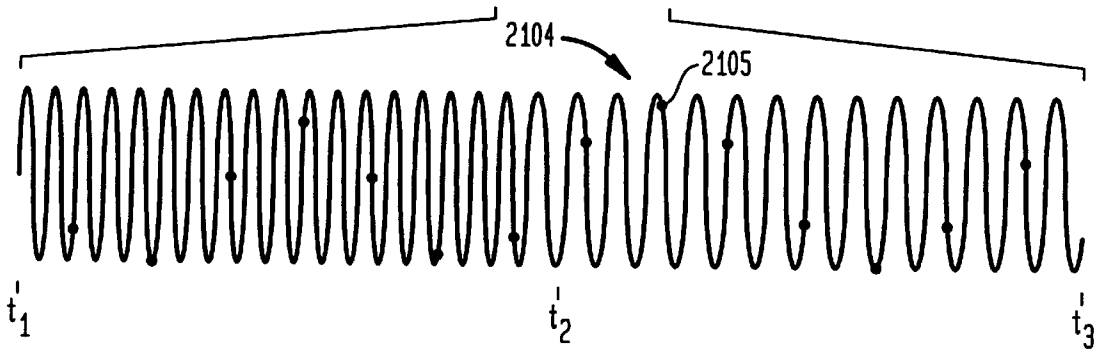


FIG. 21C

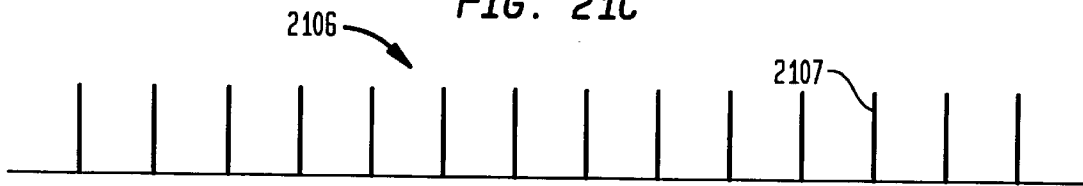


FIG. 21D

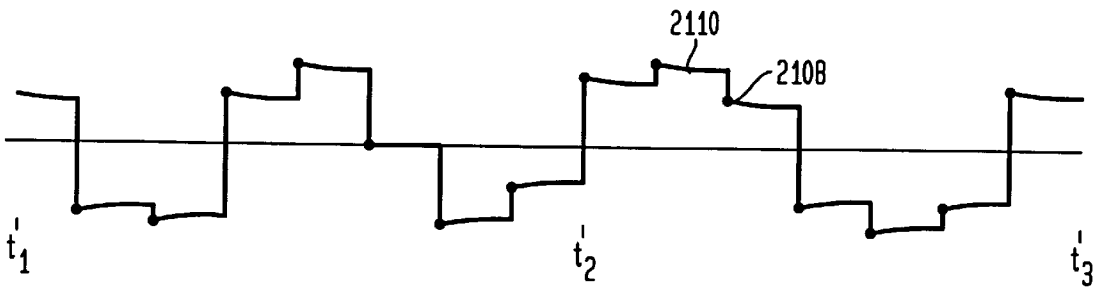


FIG. 21E

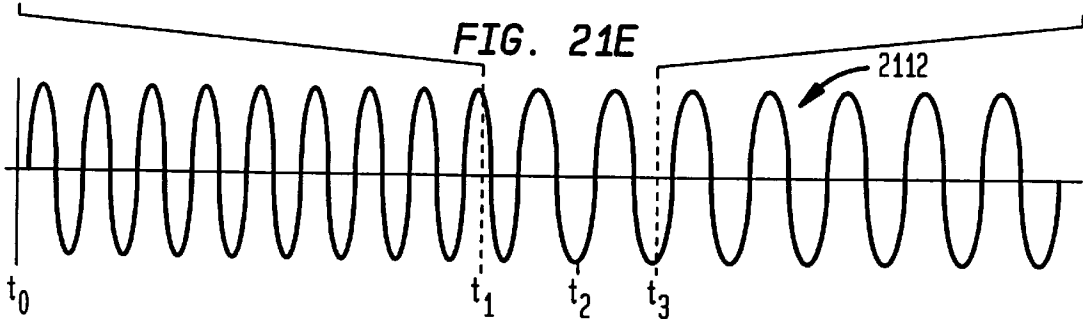


FIG. 22A 1016

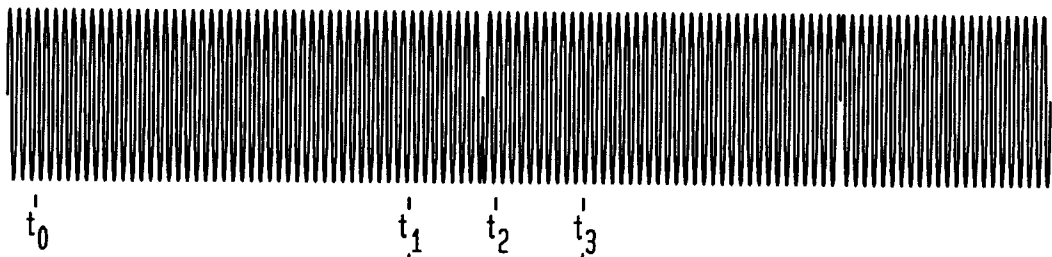


FIG. 22B

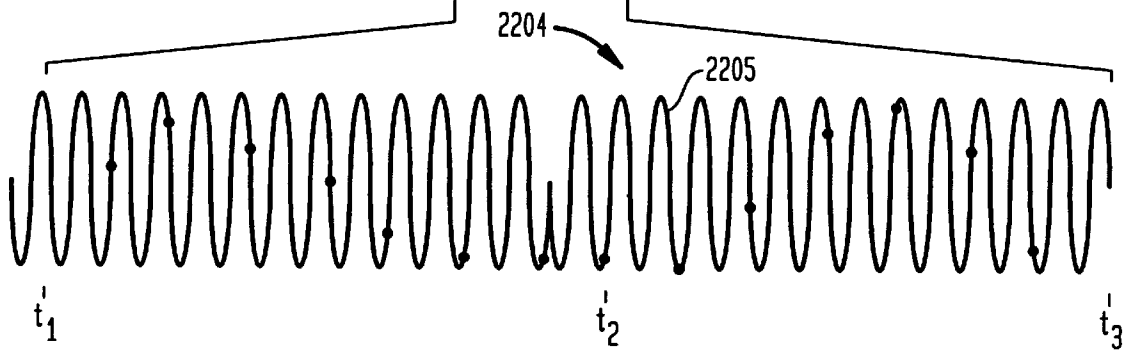


FIG. 22C

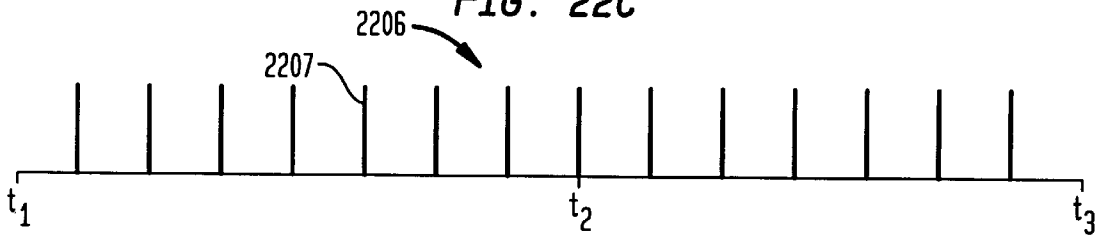


FIG. 22D

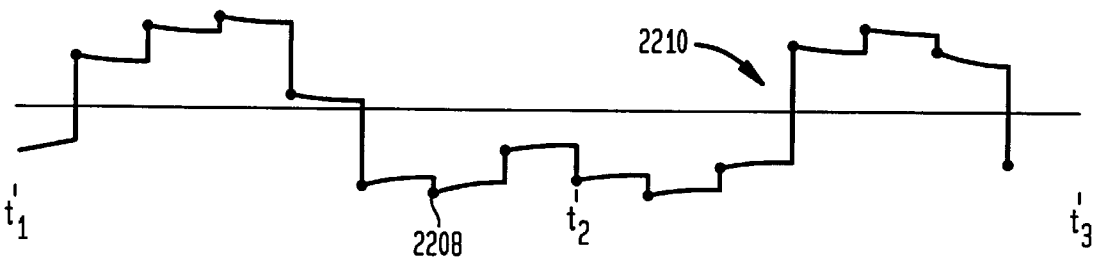


FIG. 22E

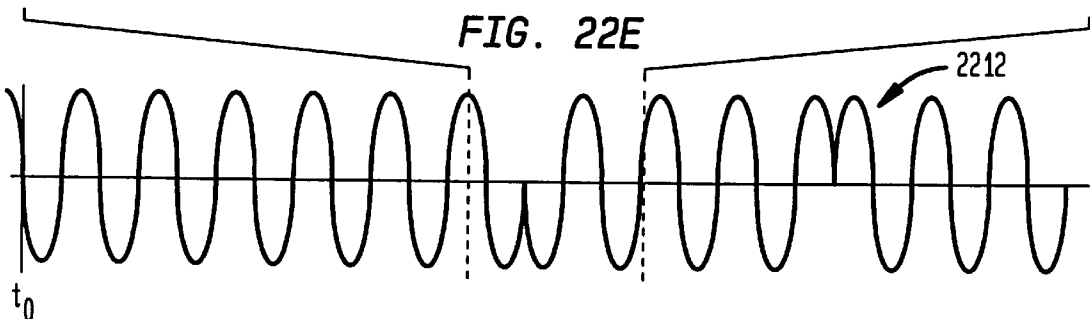


FIG. 23A

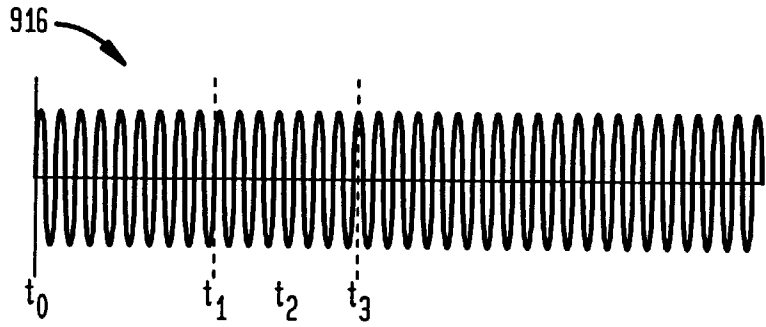


FIG. 23B

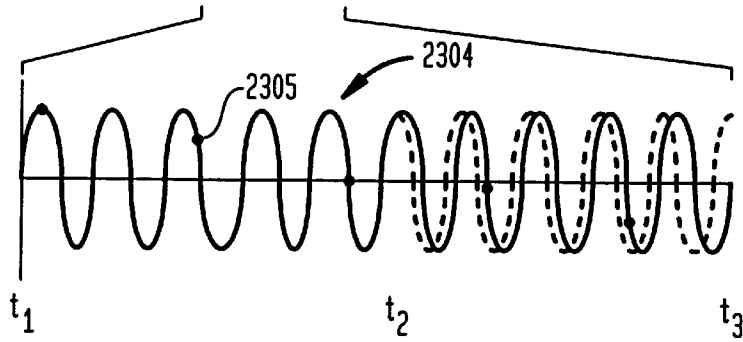


FIG. 23C

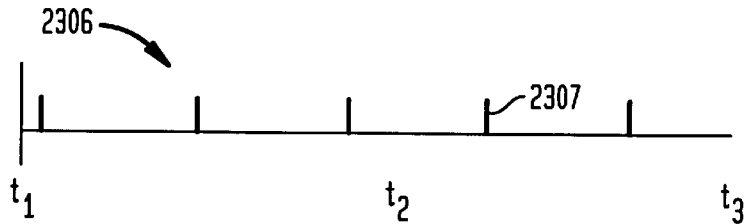


FIG. 23D

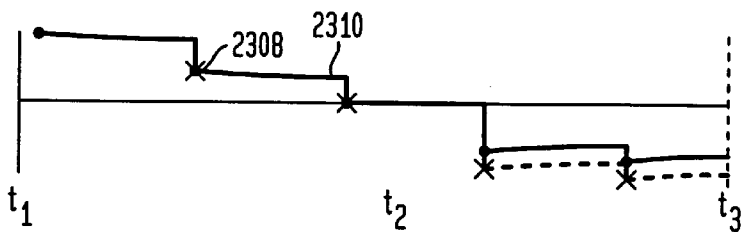


FIG. 23E

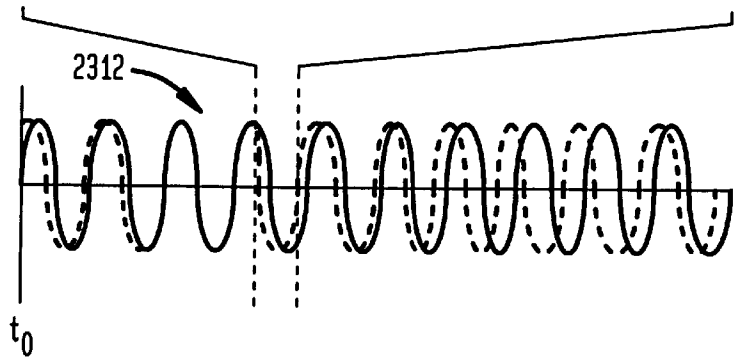


FIG. 24A

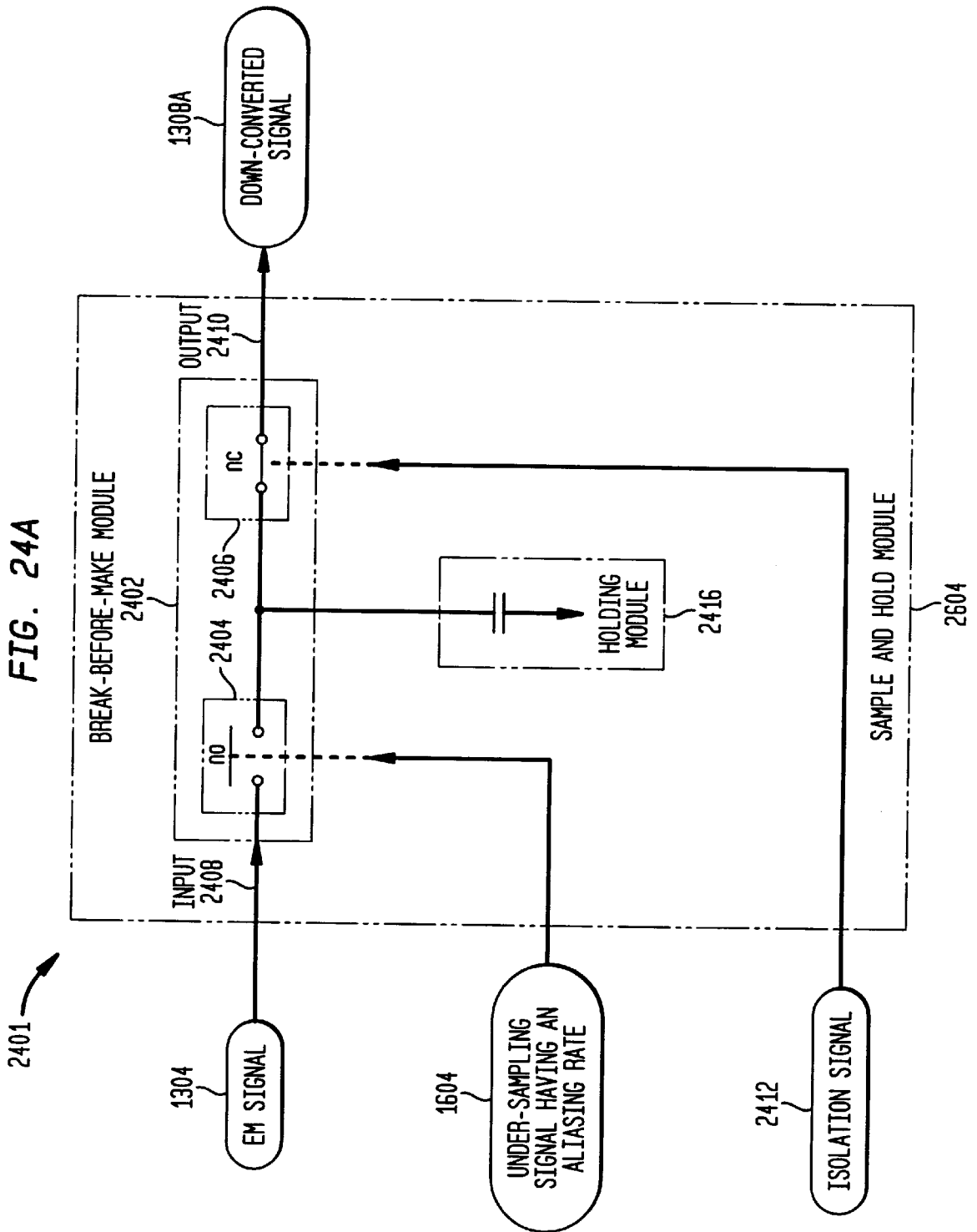


FIG. 24B

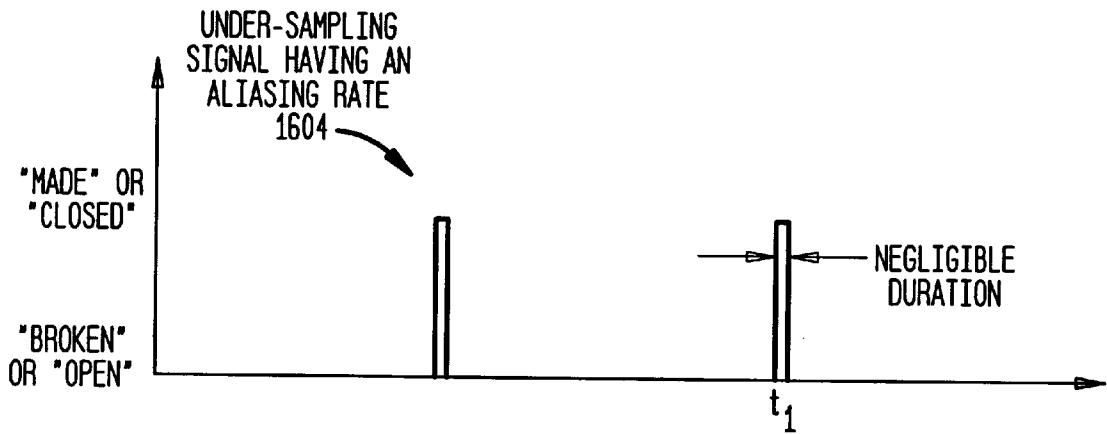
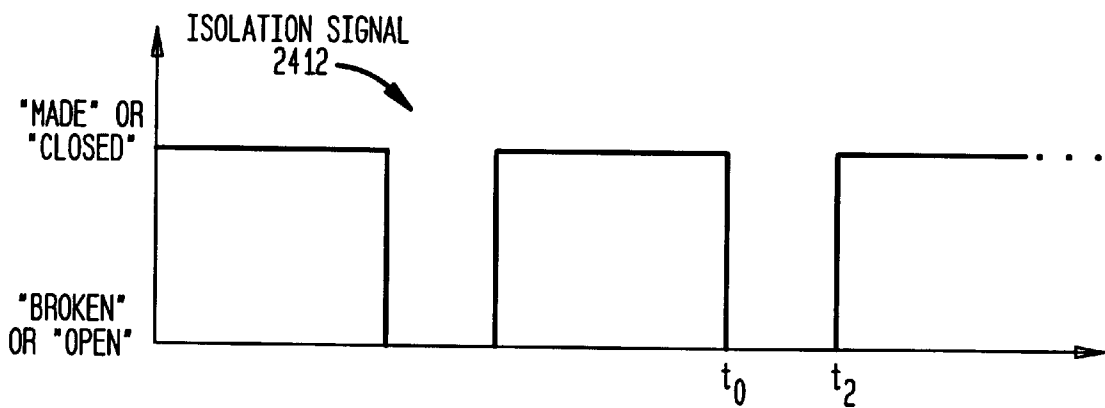
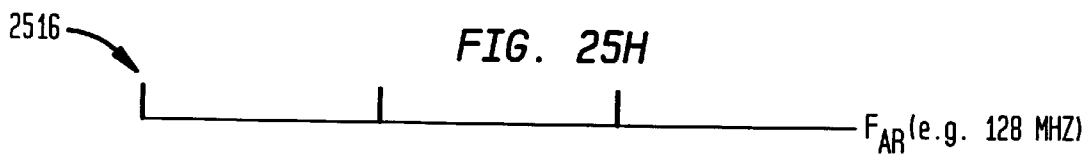
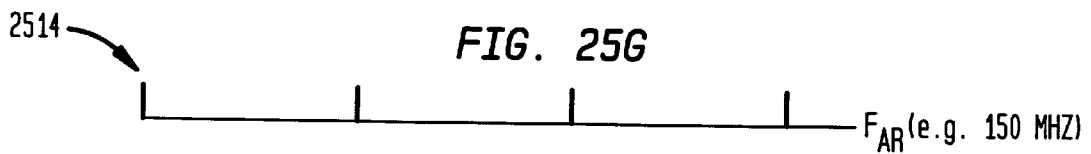
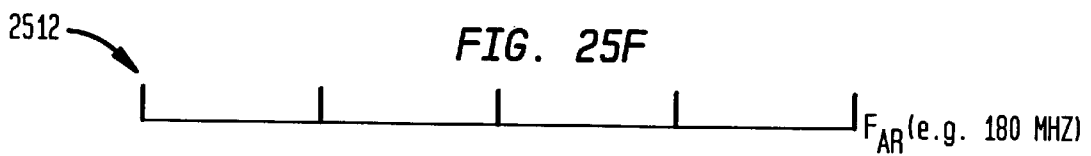
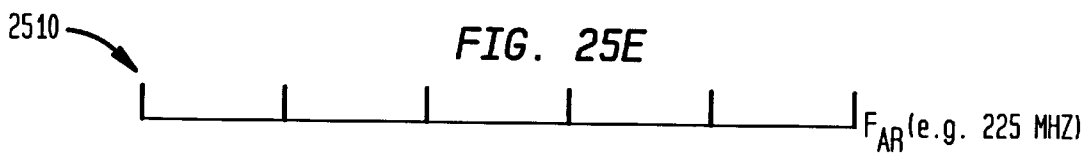
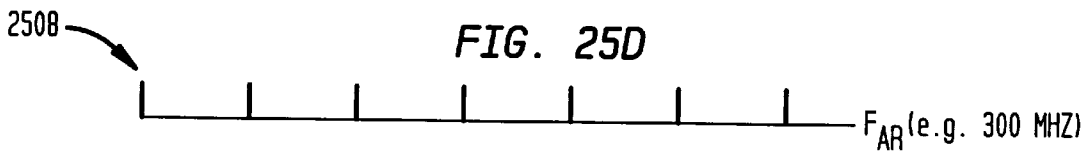
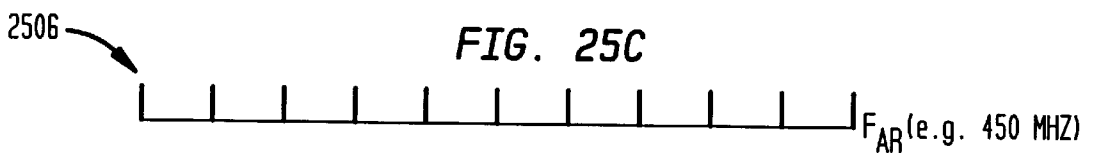
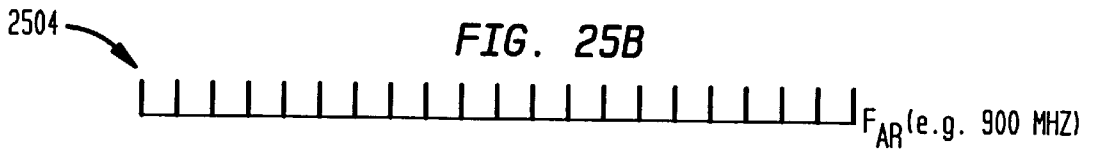
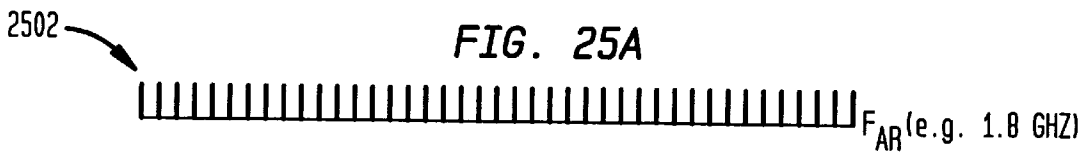


FIG. 24C





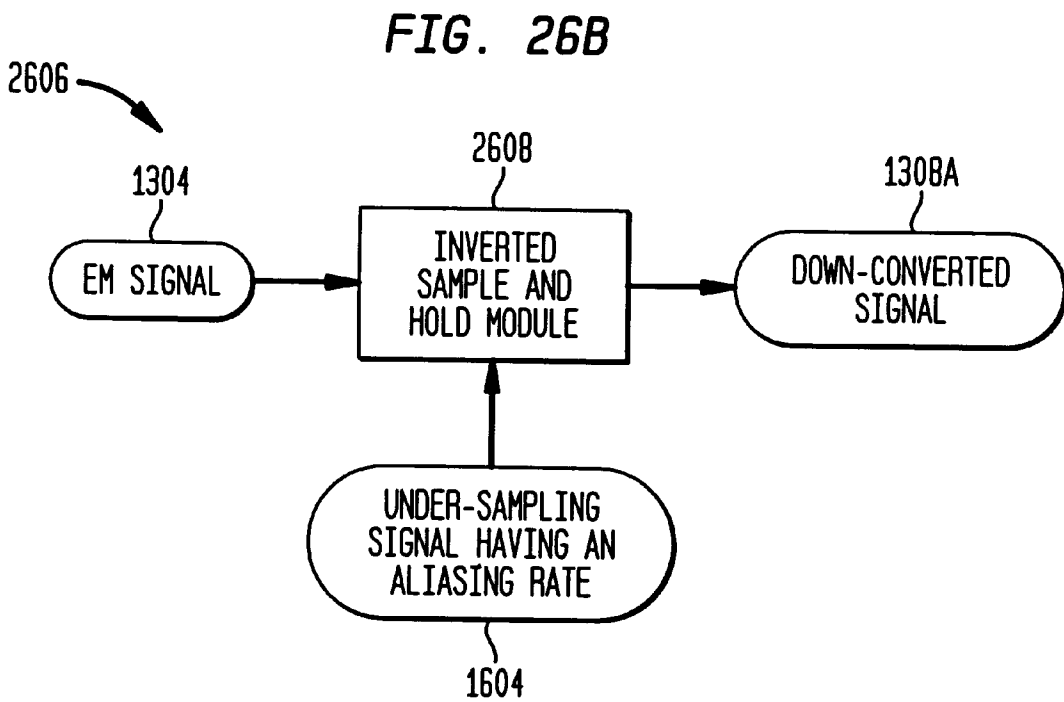
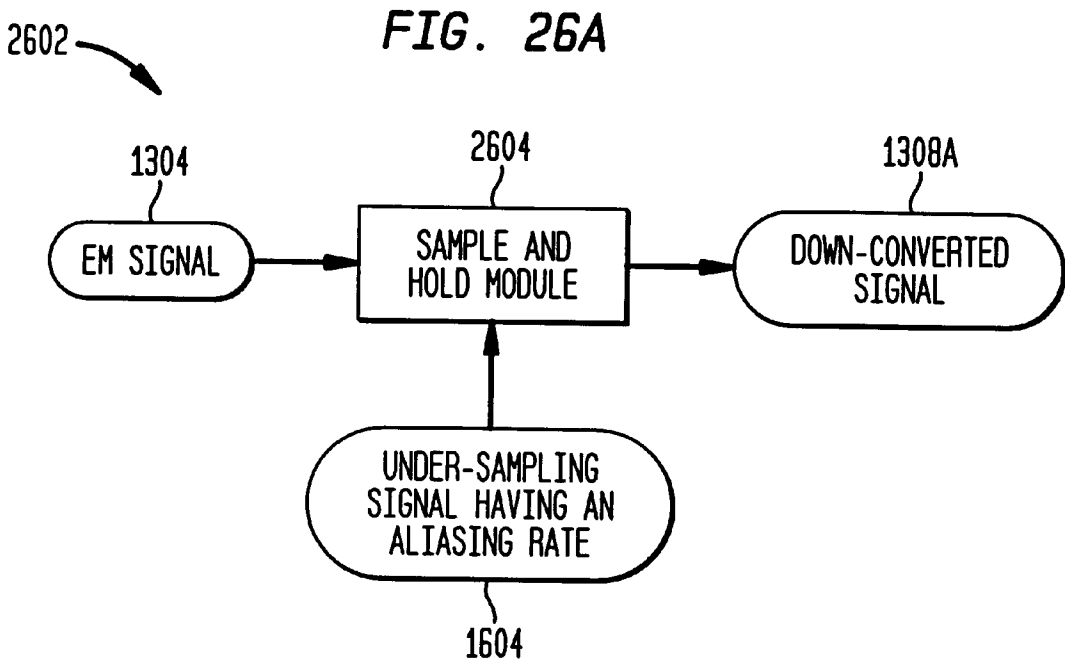


FIG. 27

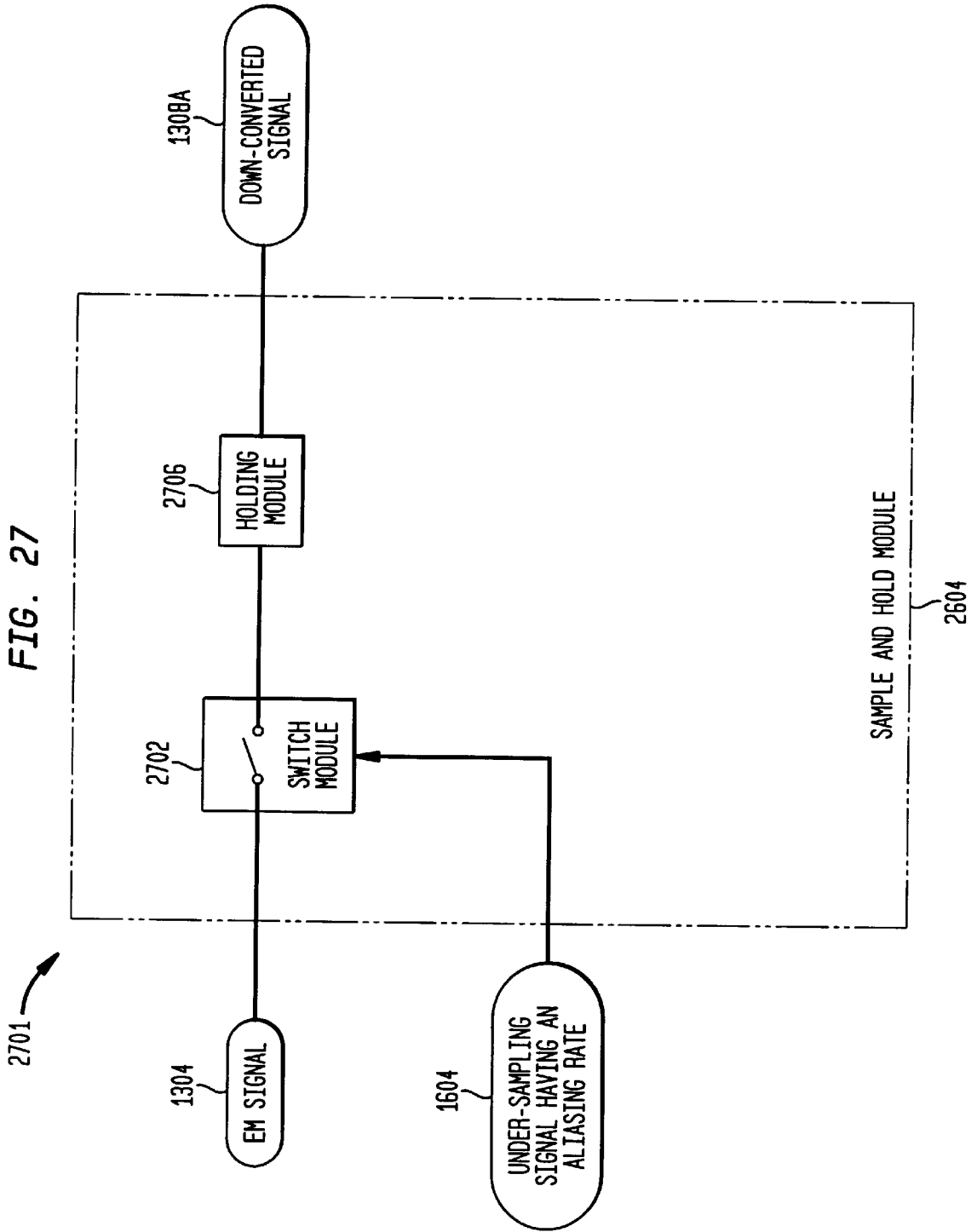




FIG. 28A

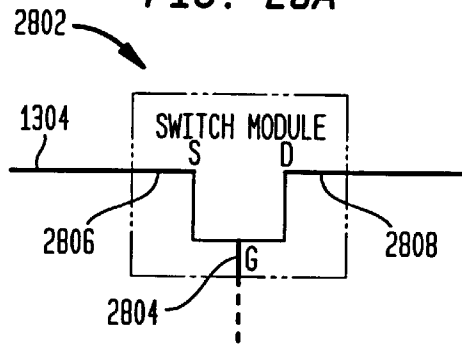


FIG. 28B

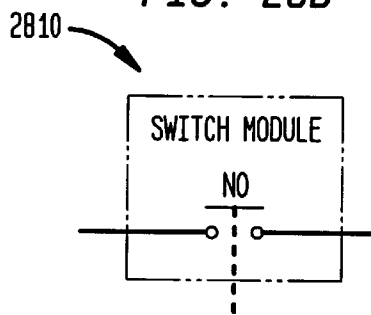


FIG. 28C

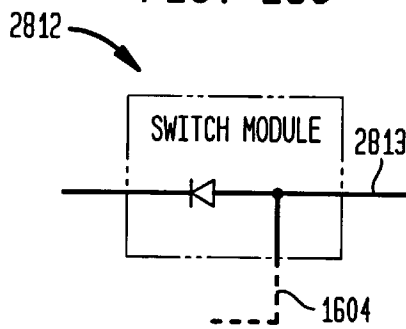


FIG. 28D

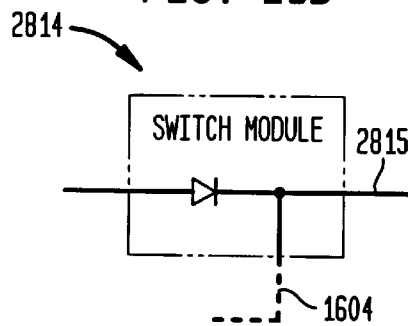


FIG. 29A

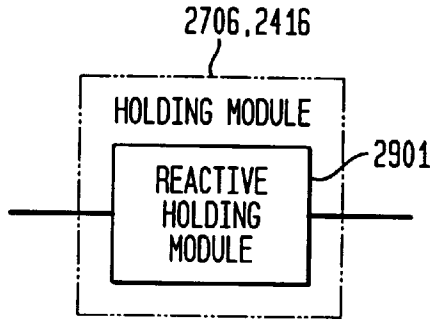


FIG. 29B

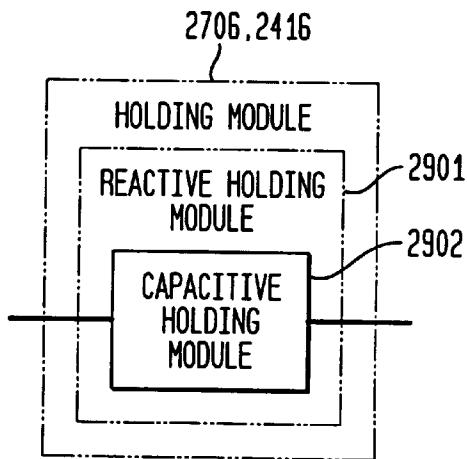


FIG. 29C

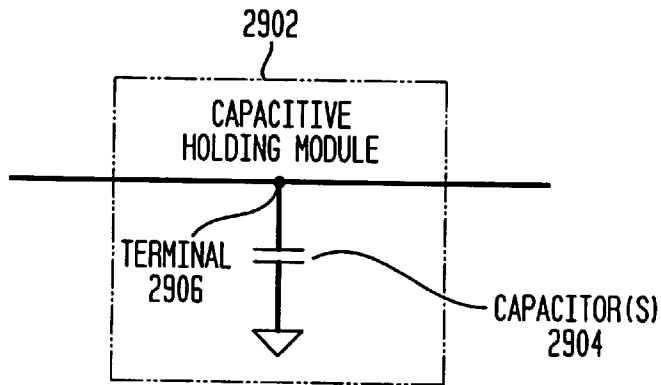


FIG. 29D

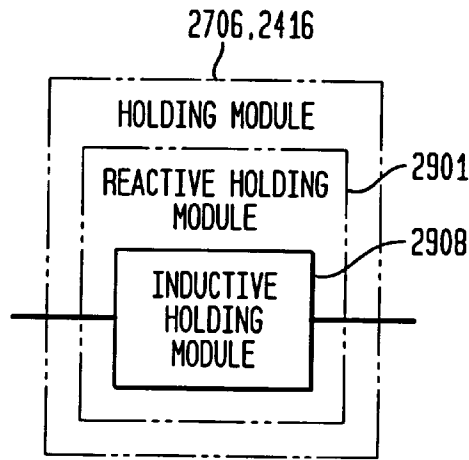


FIG. 29E

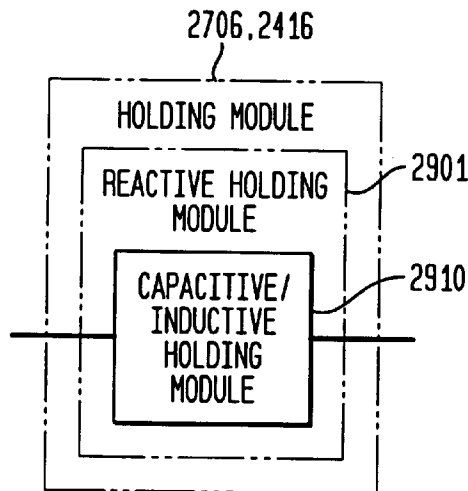


FIG. 29F

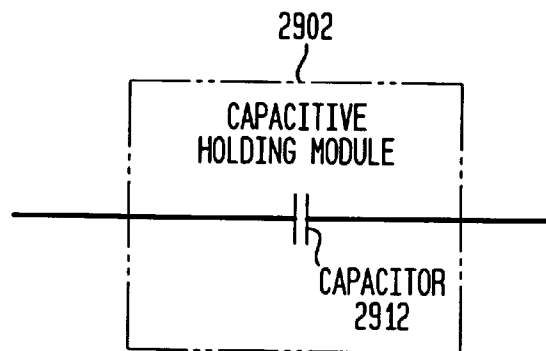


FIG. 29G

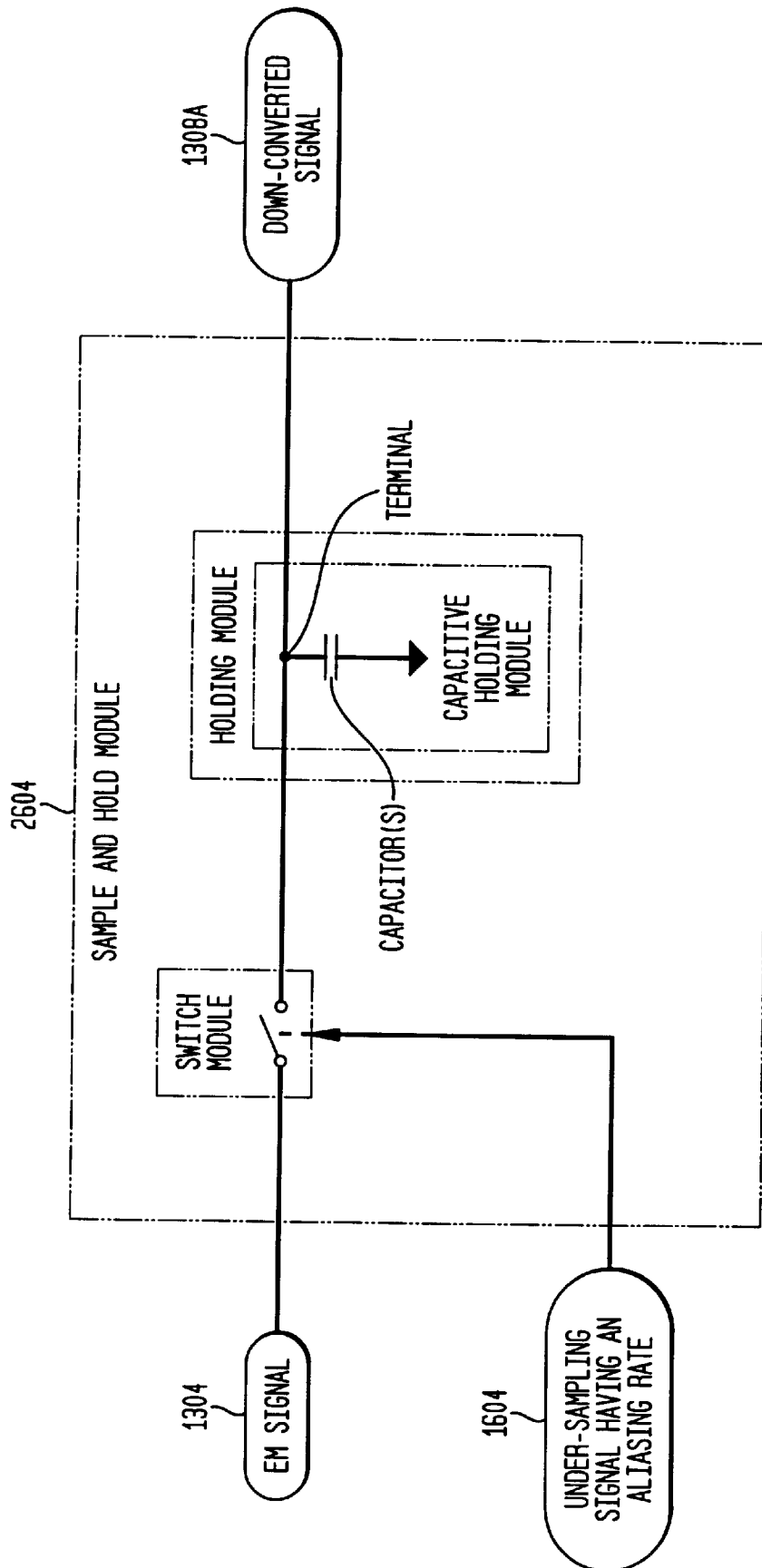
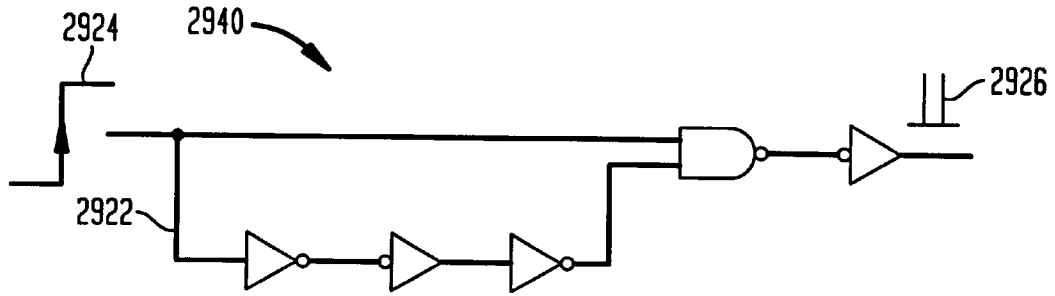
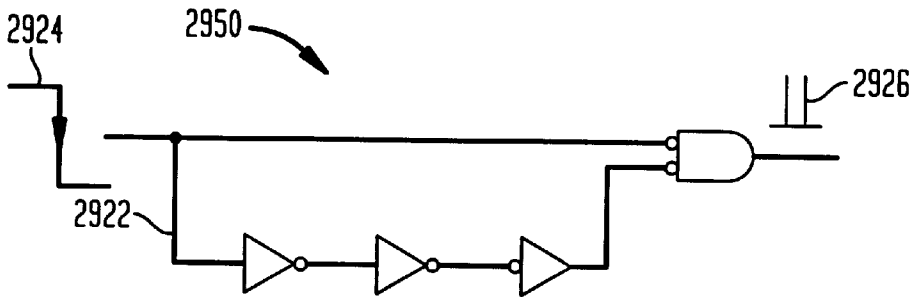


FIG. 29H



A. RISING EDGE PULSE GENERATOR

FIG. 29I



B. FALLING-EDGE PULSE GENERATOR

FIG. 29J

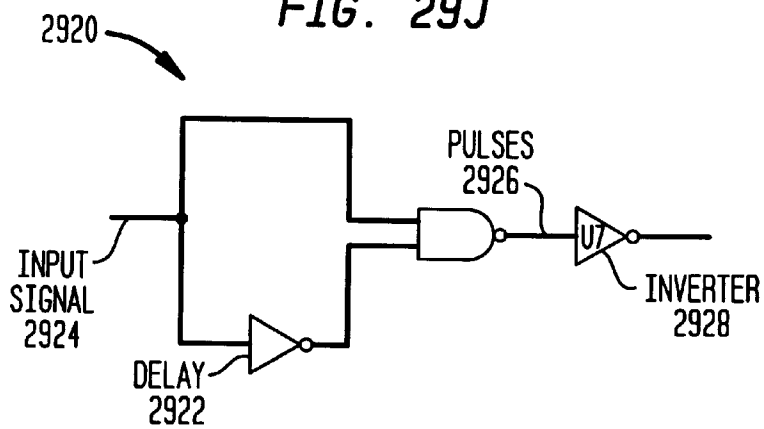


FIG. 29K

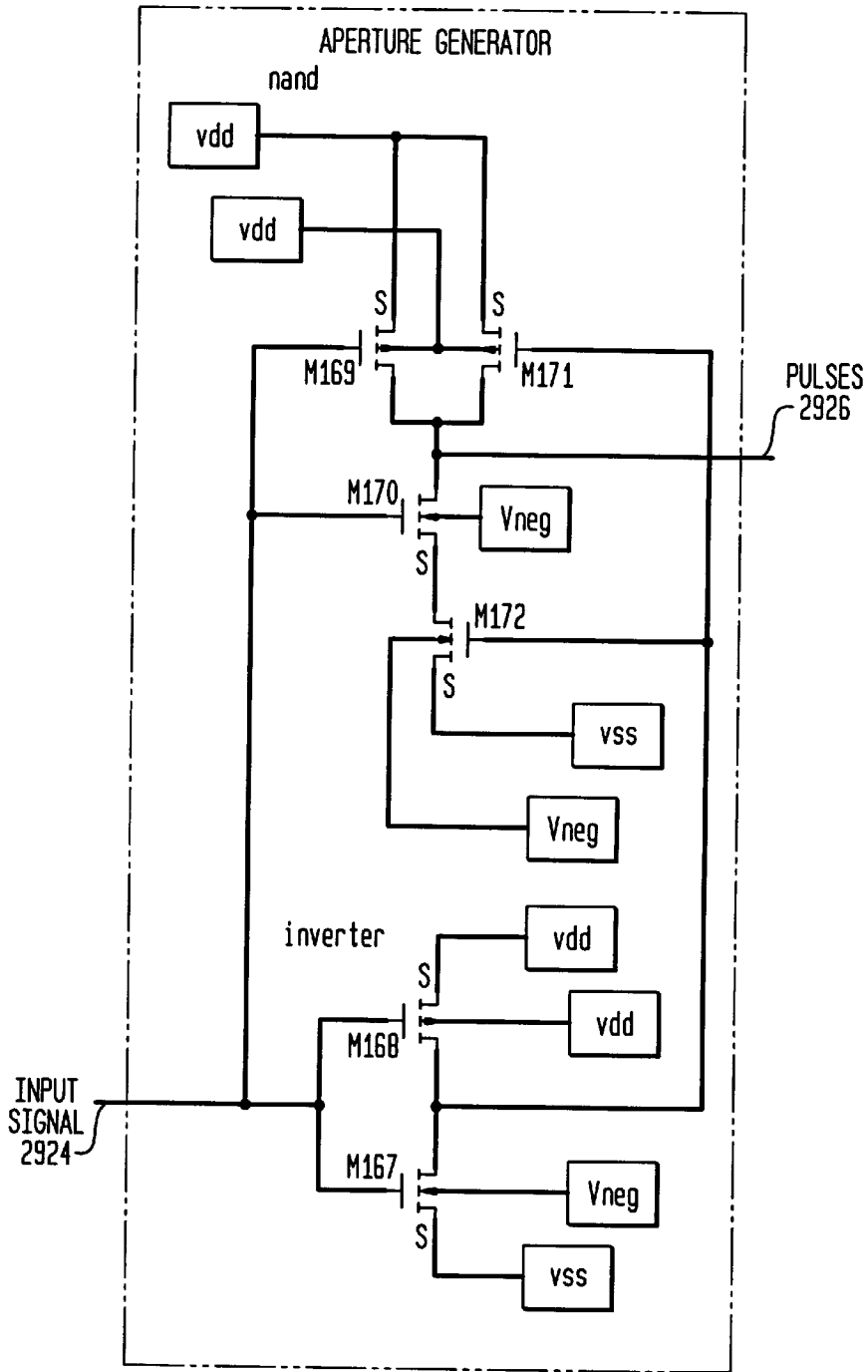
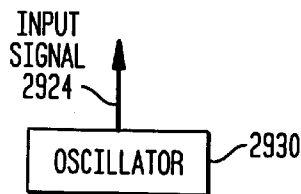


FIG. 29L



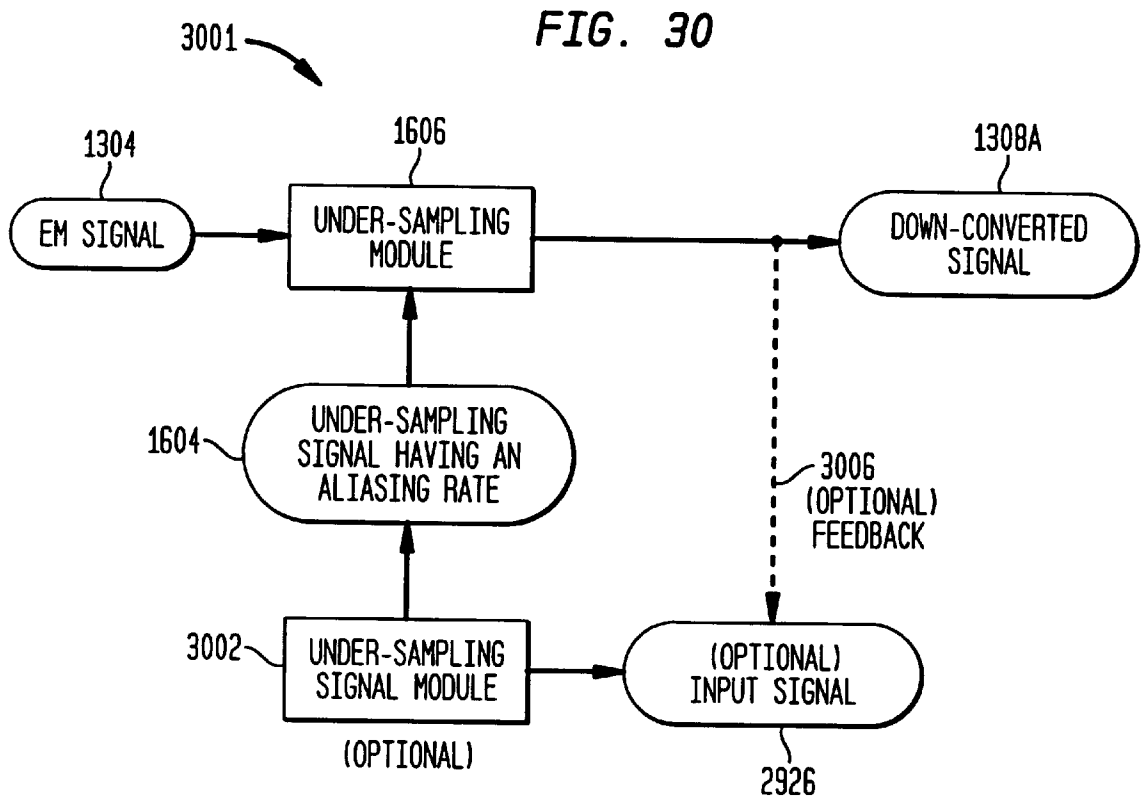


FIG. 31

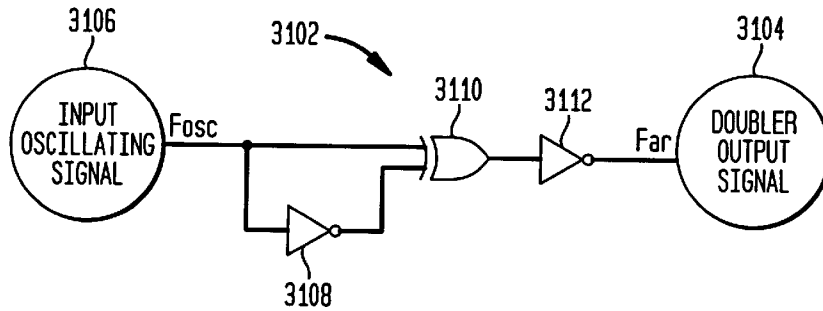


FIG. 32A

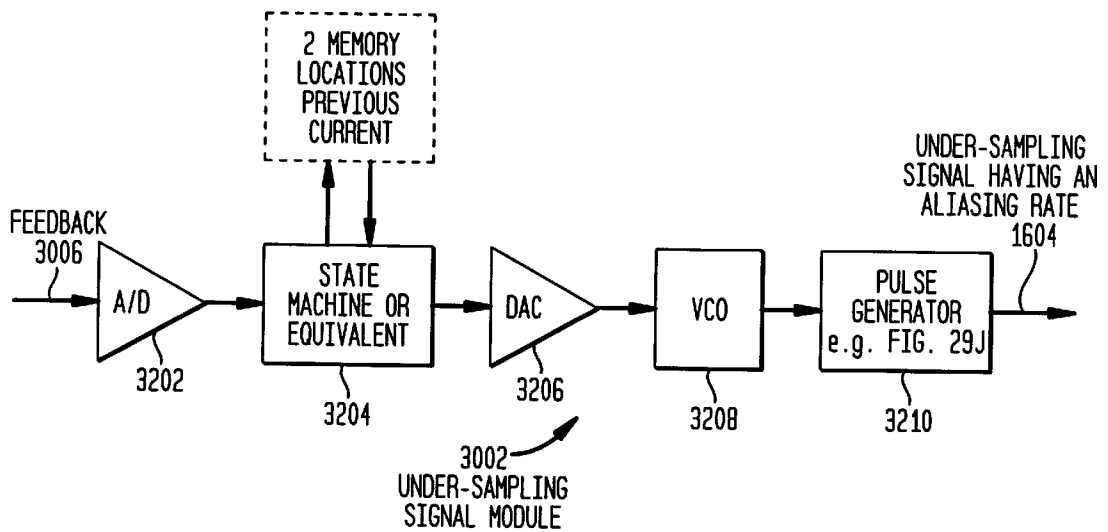
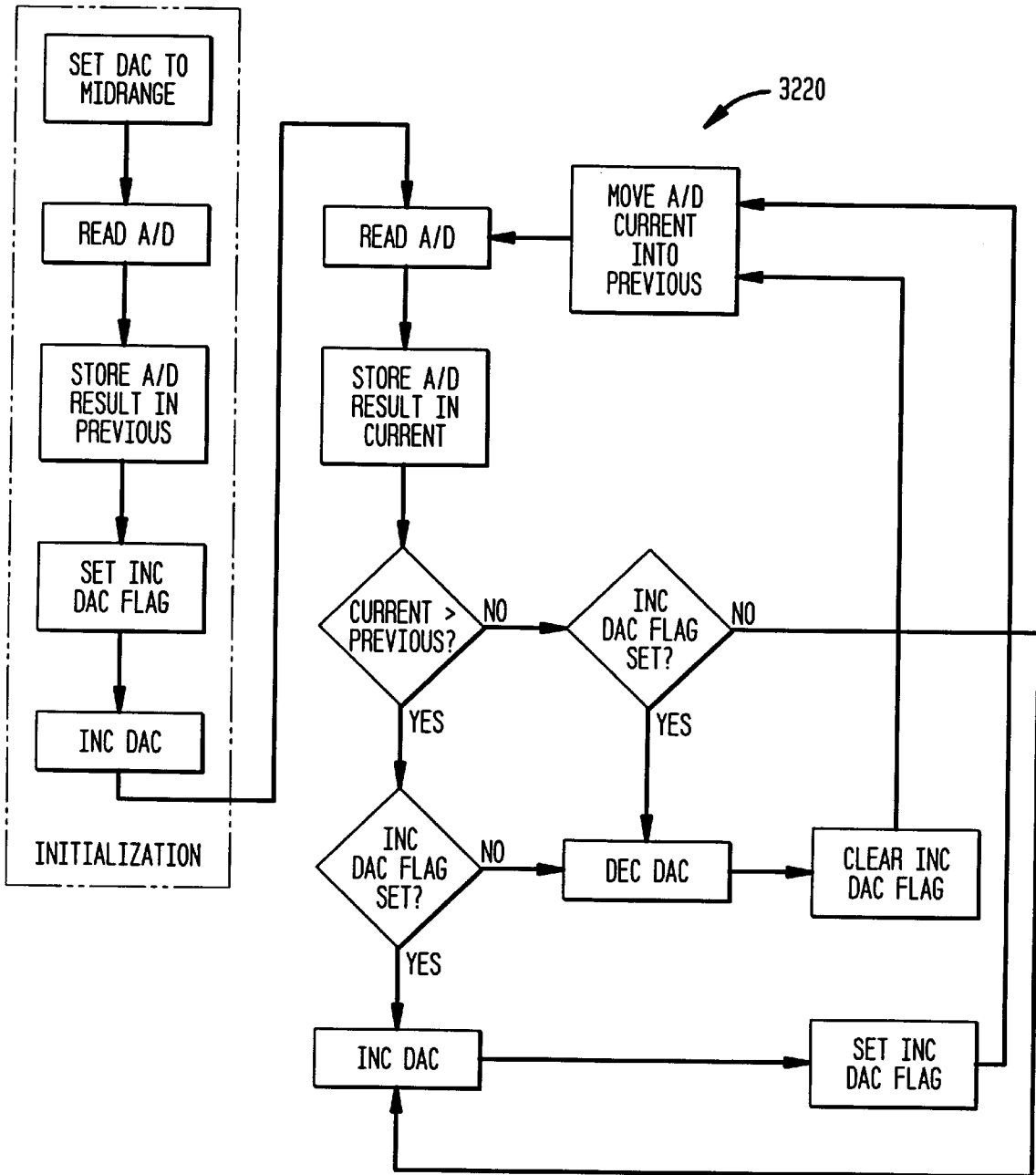


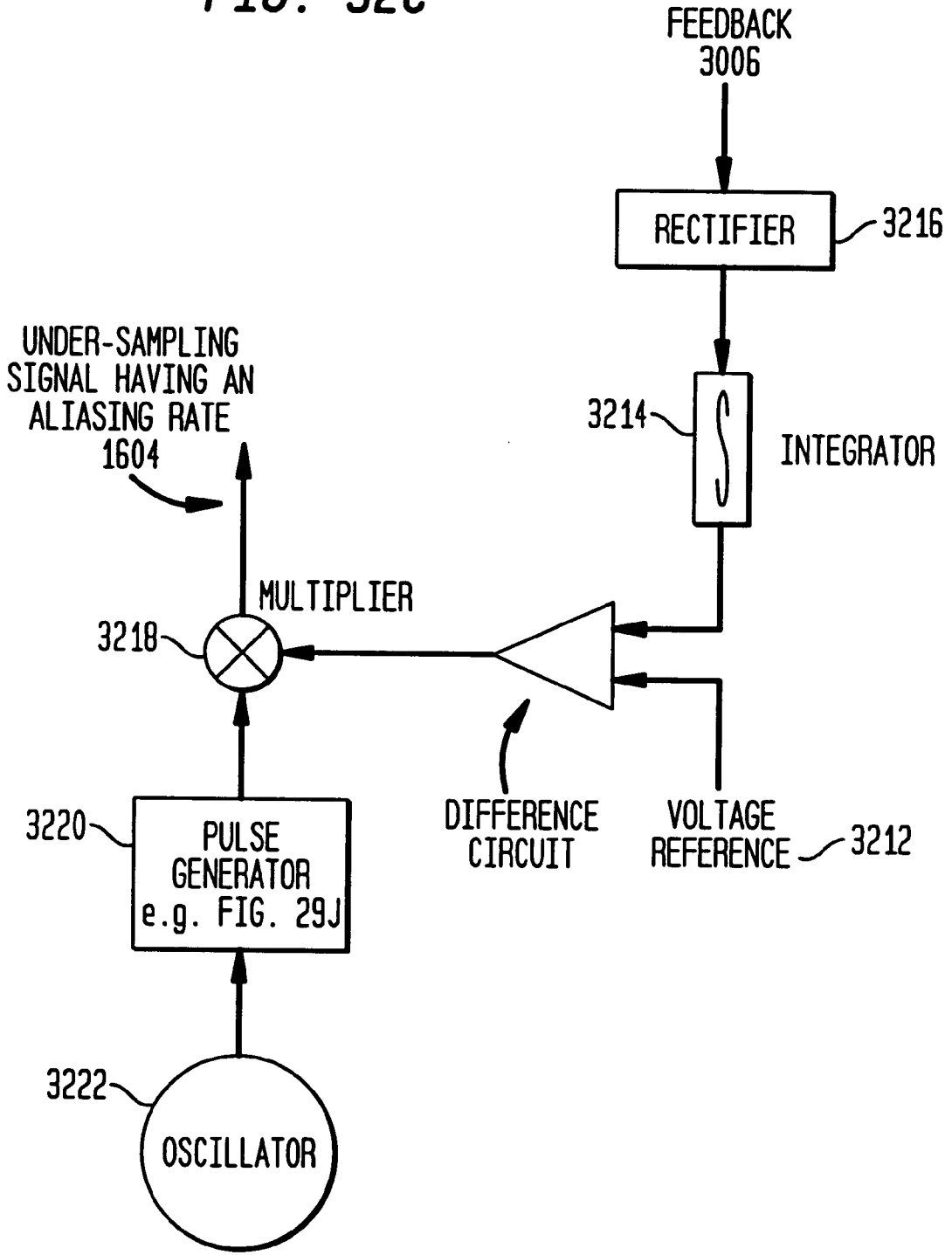


FIG. 32B



STATE MACHINE FLOWCHART

FIG. 32C



ENERGY TRANSFER SIGNAL MODULE 3002

FIG. 33A

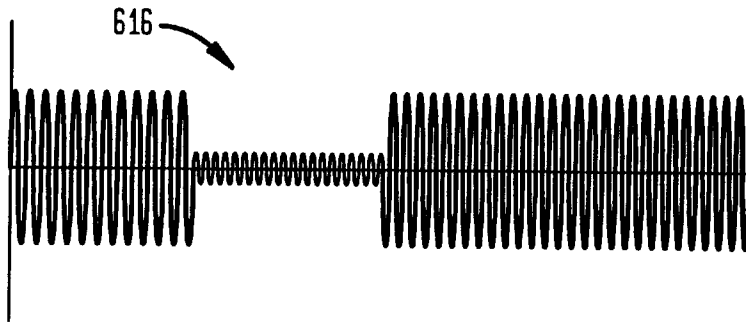


FIG. 33B

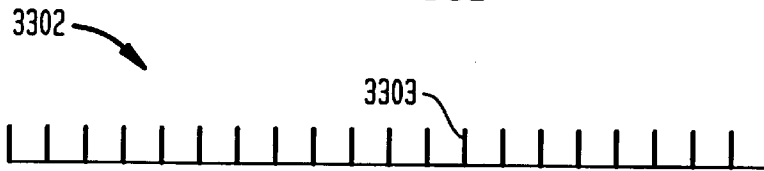


FIG. 33C

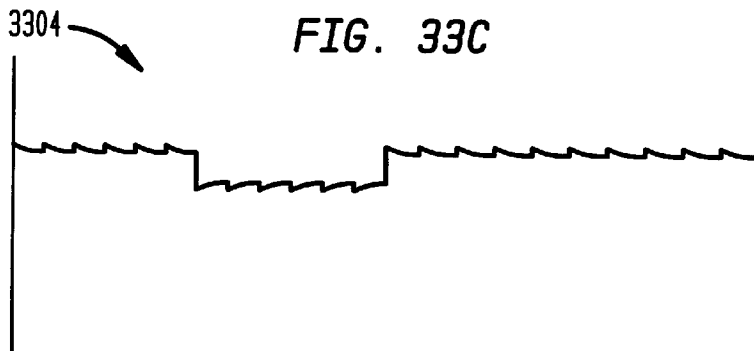
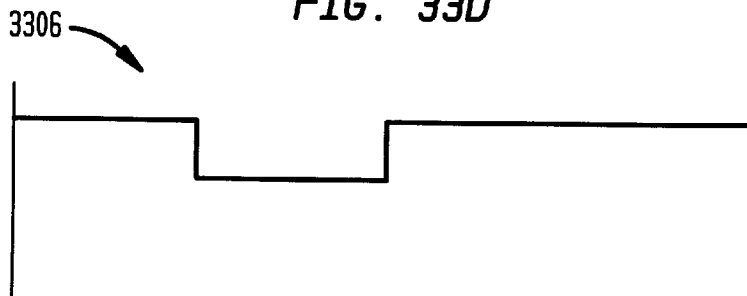


FIG. 33D



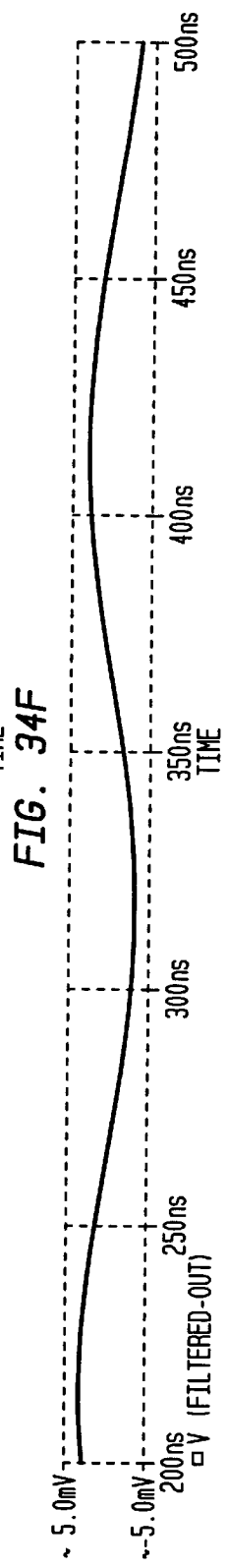
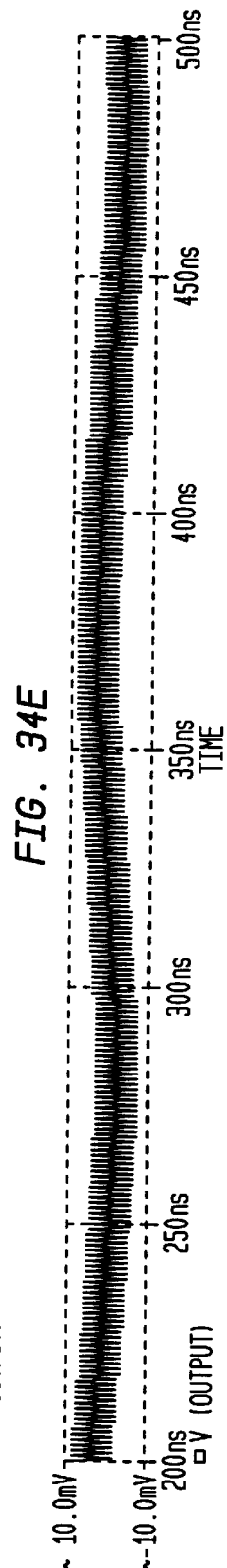
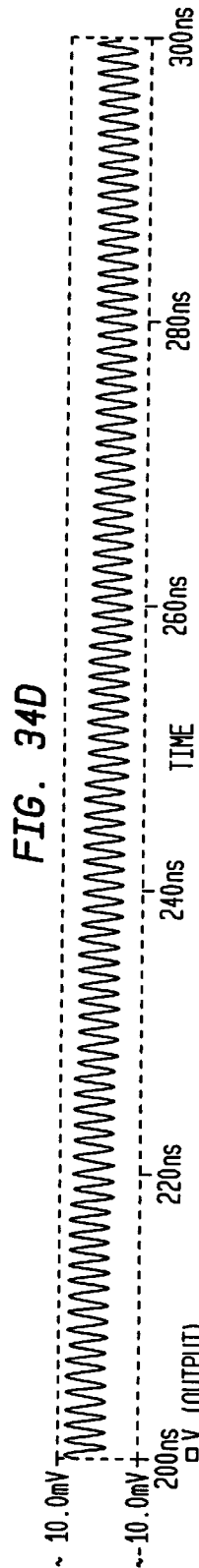
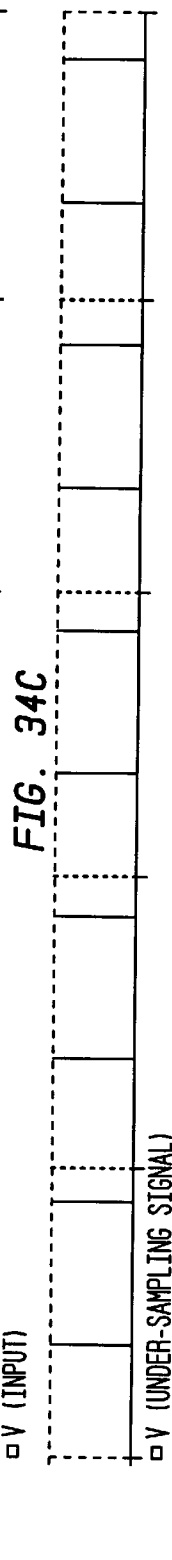
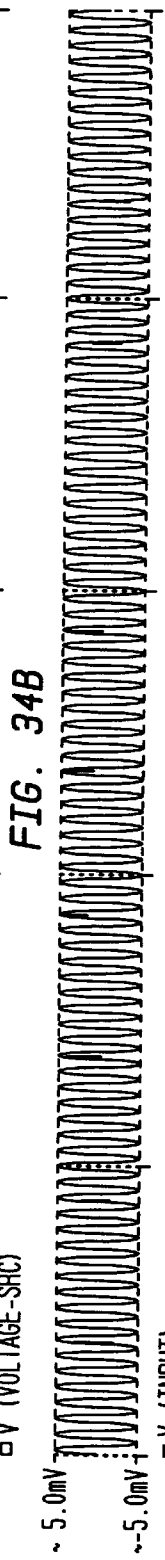
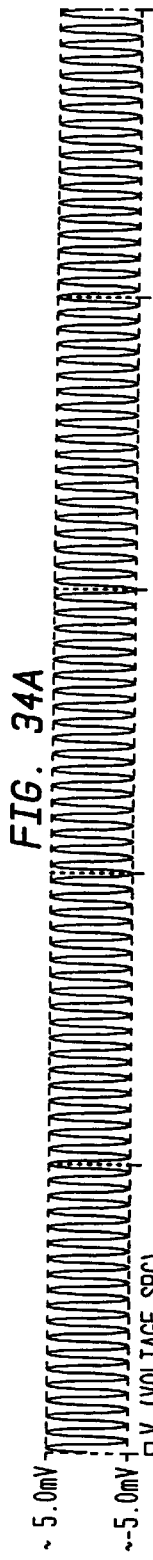


FIG. 35A

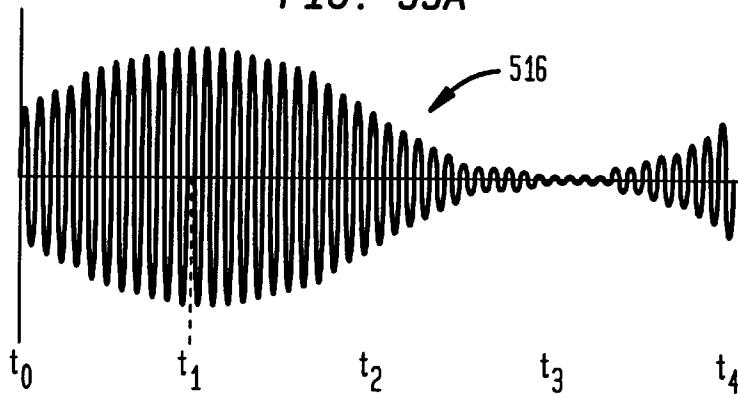


FIG. 35B

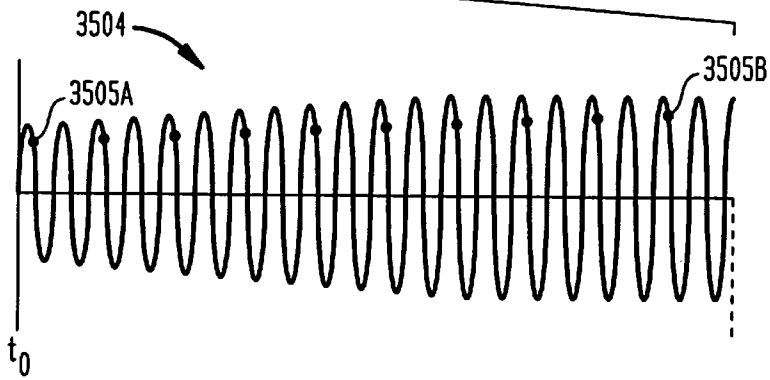


FIG. 35C

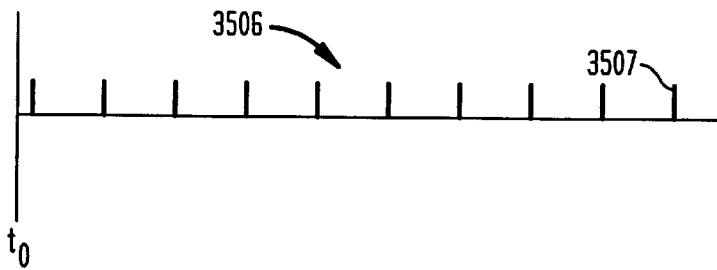


FIG. 35D

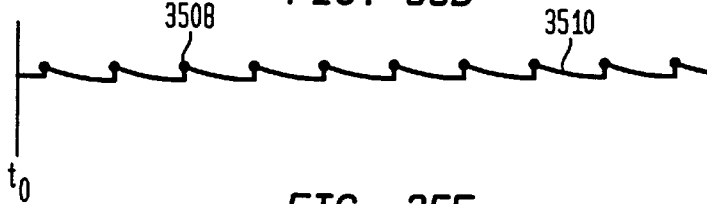


FIG. 35E

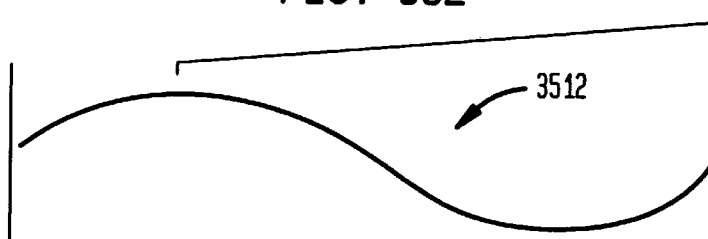


FIG. 36A

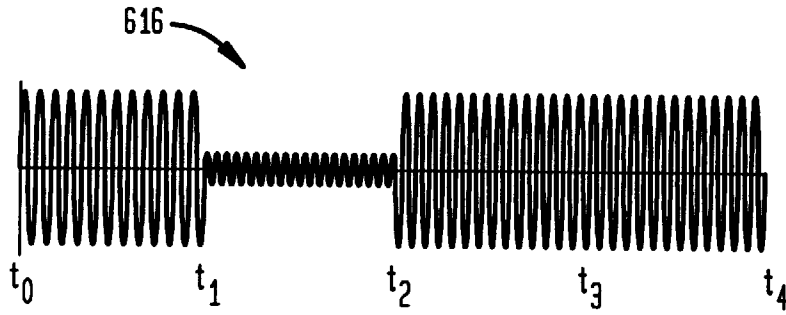


FIG. 36B

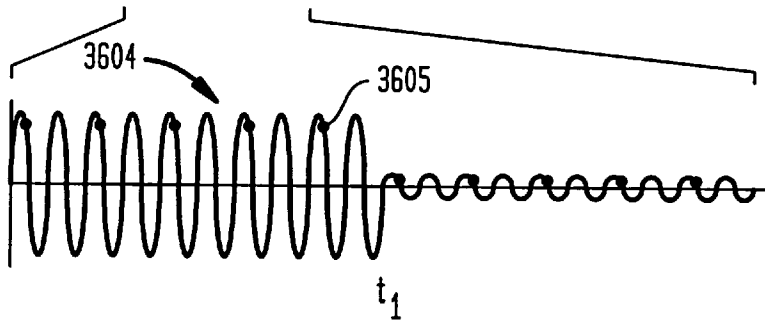


FIG. 36C

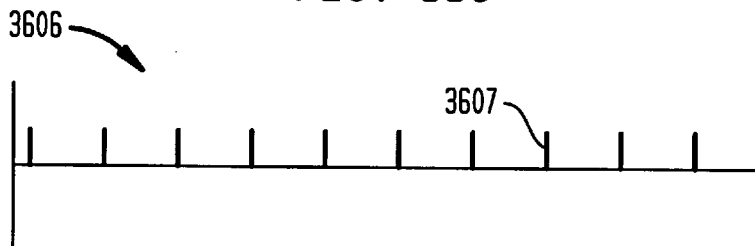


FIG. 36D

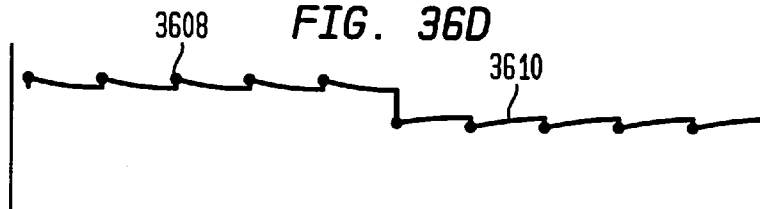
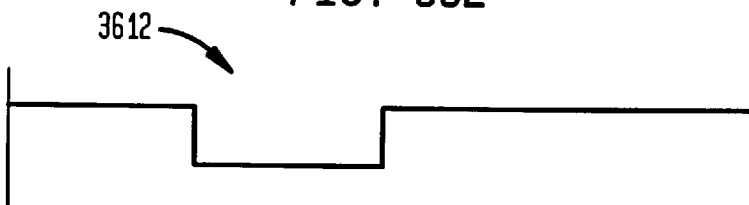
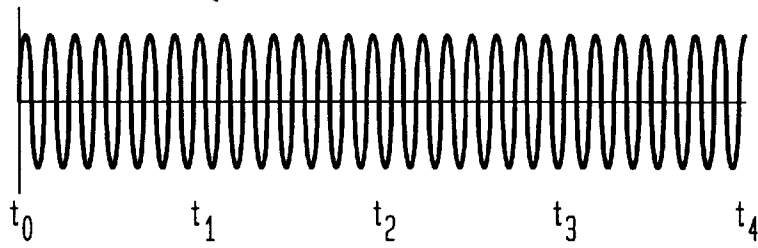


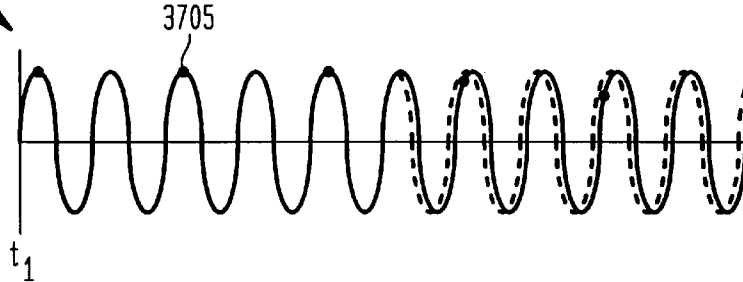
FIG. 36E



916 → **FIG. 37A**



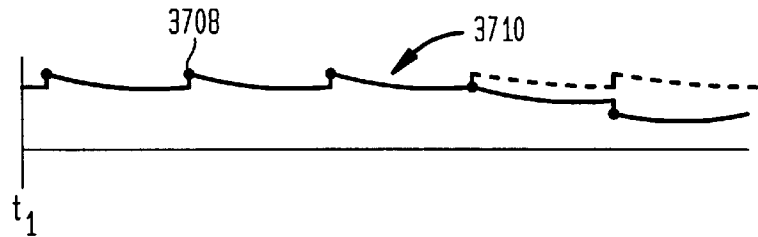
3704 → **FIG. 37B**



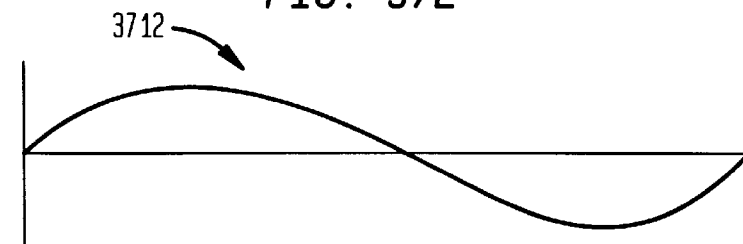
3706 → **FIG. 37C**



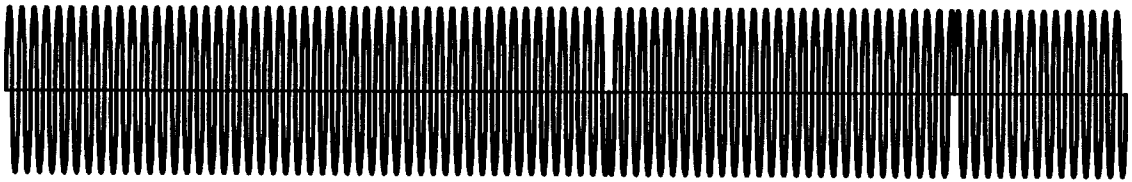
**FIG. 37D**



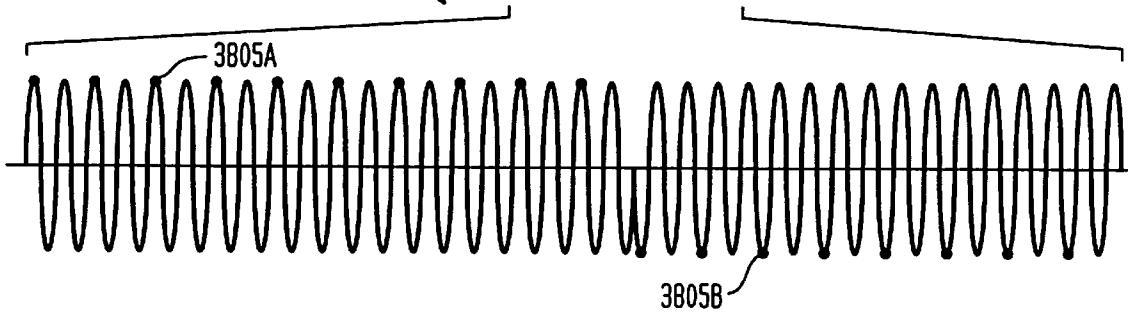
**FIG. 37E**



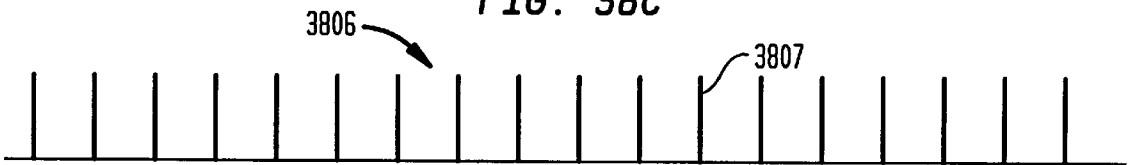
1016 *FIG. 38A*



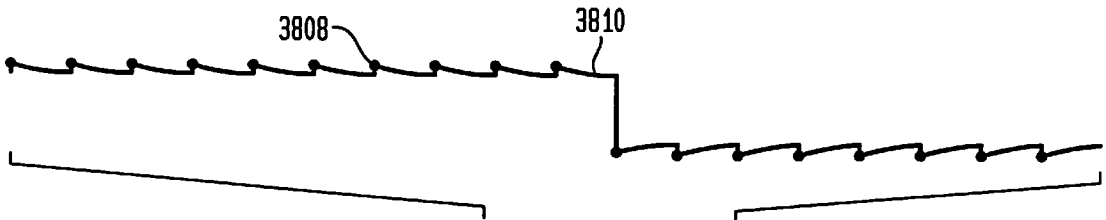
3804 *FIG. 38B*



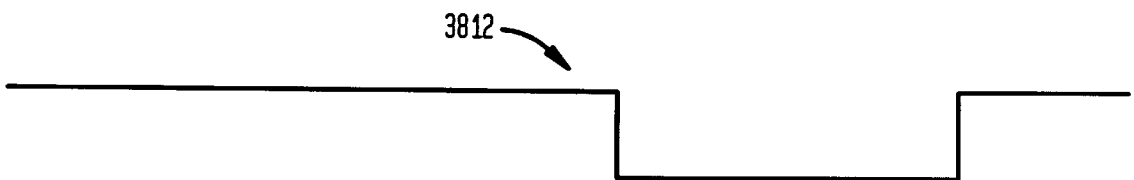
*FIG. 38C*



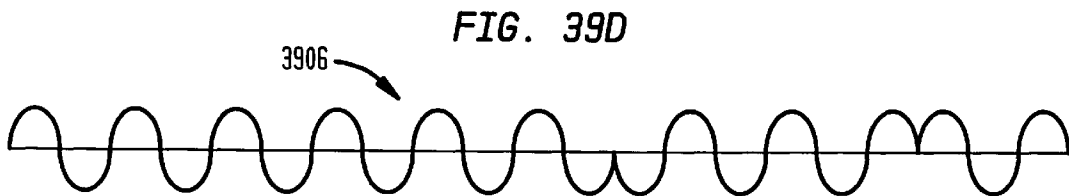
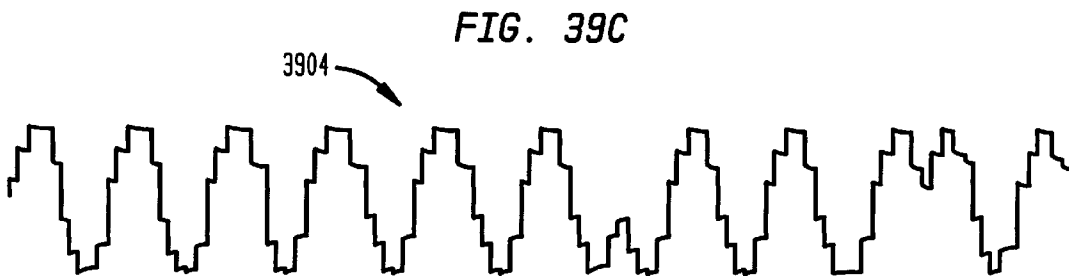
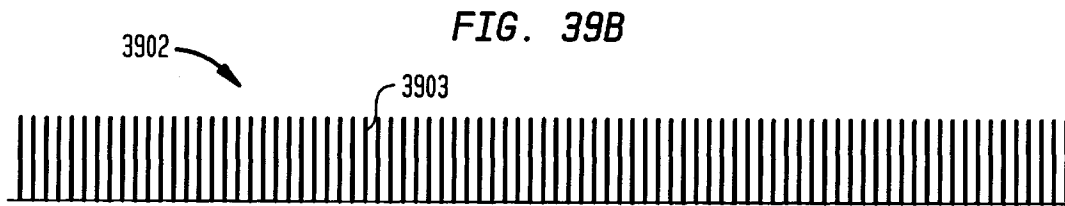
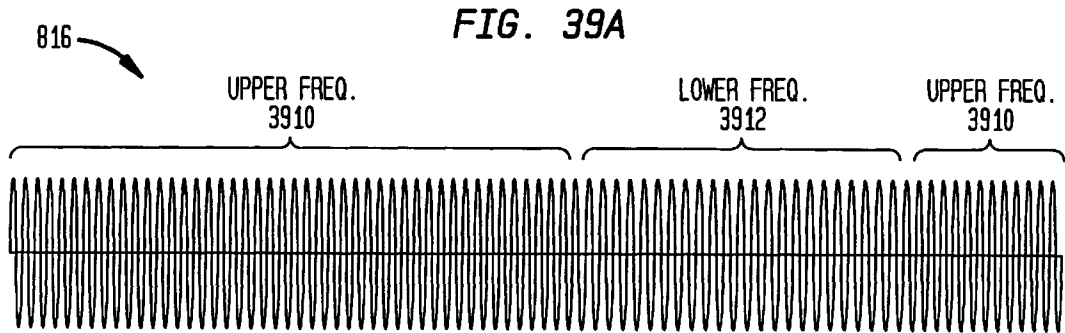
*FIG. 38D*

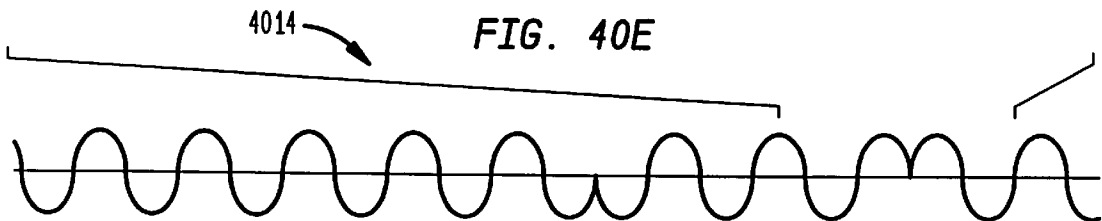
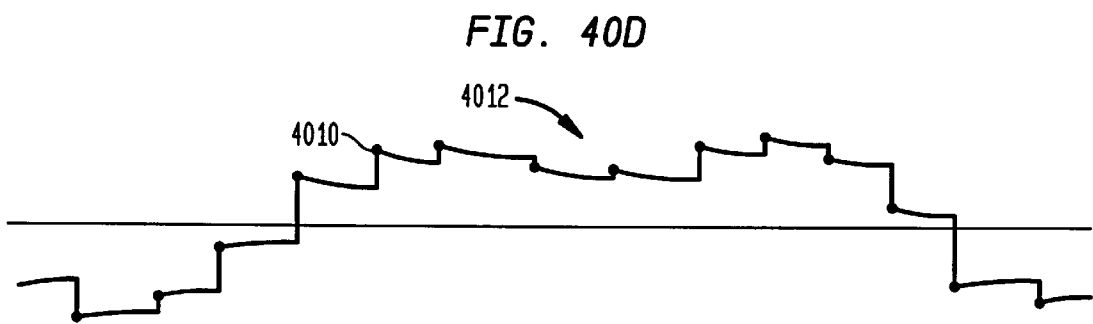
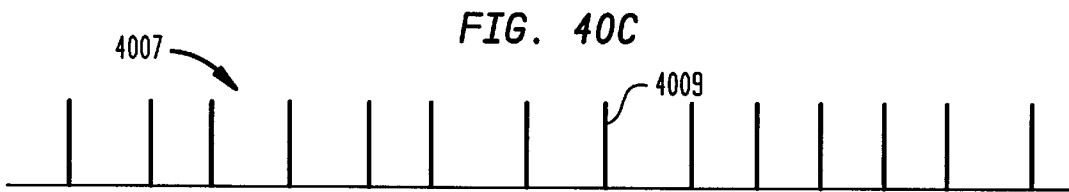
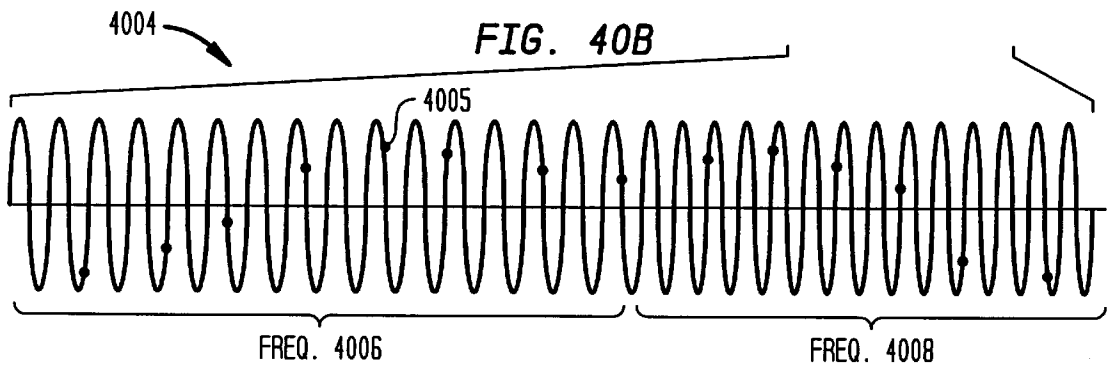
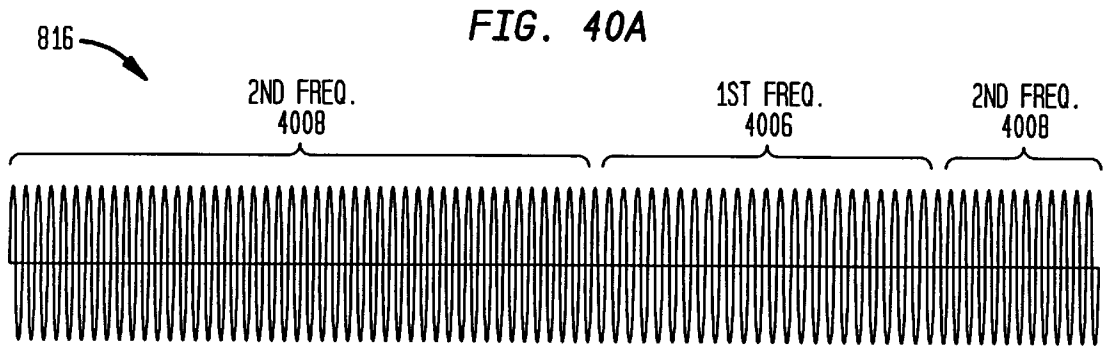


*FIG. 38E*









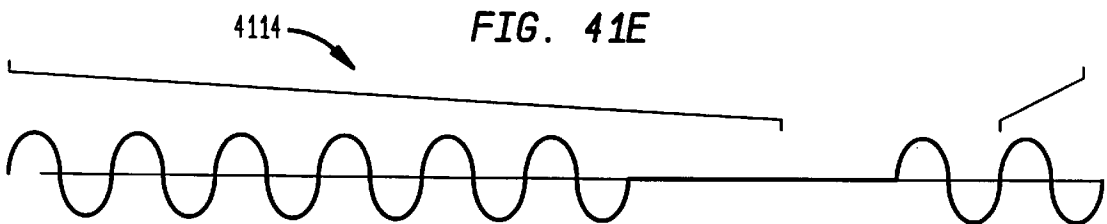
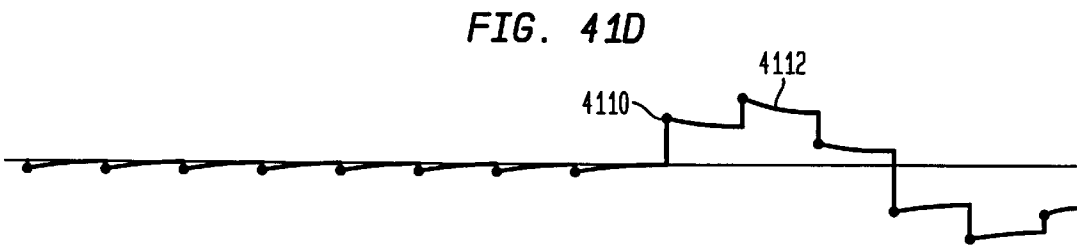
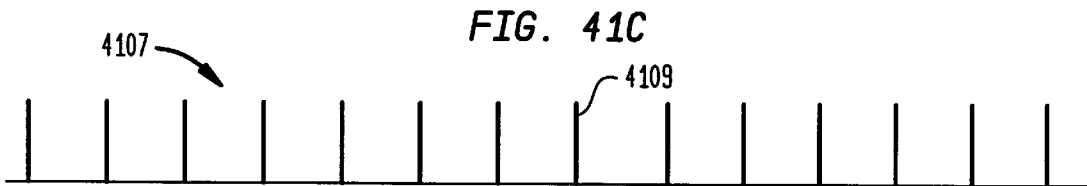
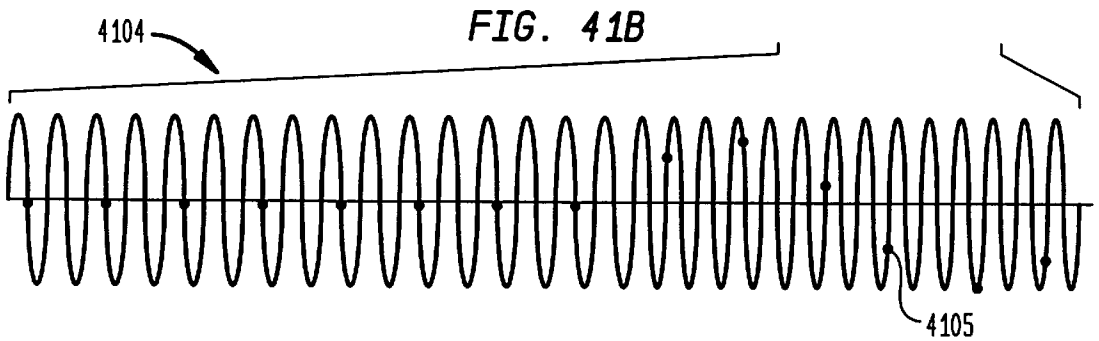
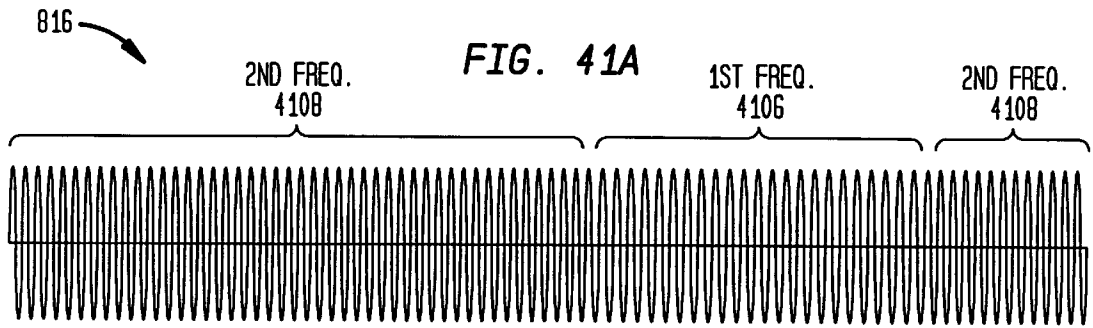


FIG. 42

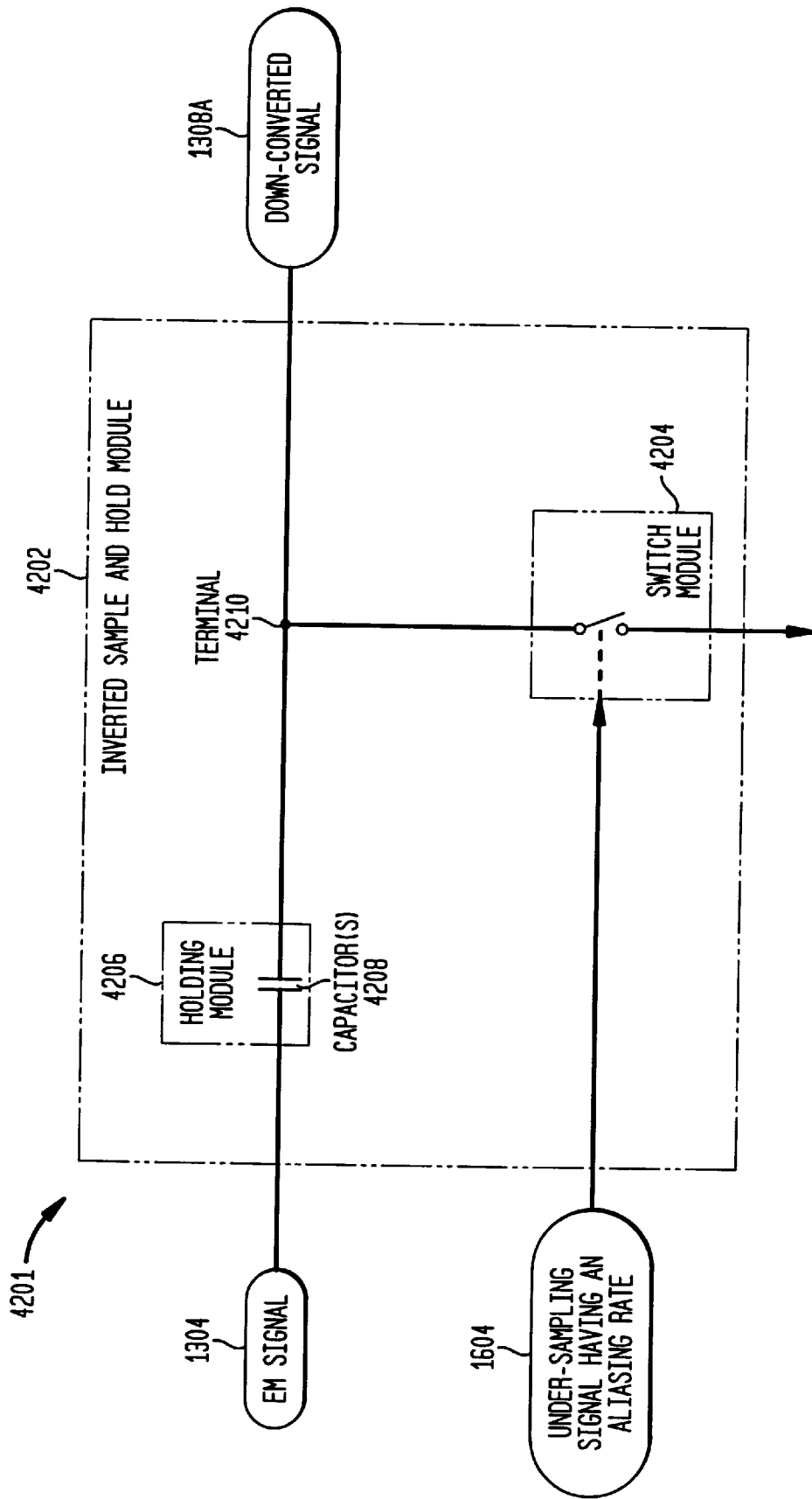


FIG. 43A

3106

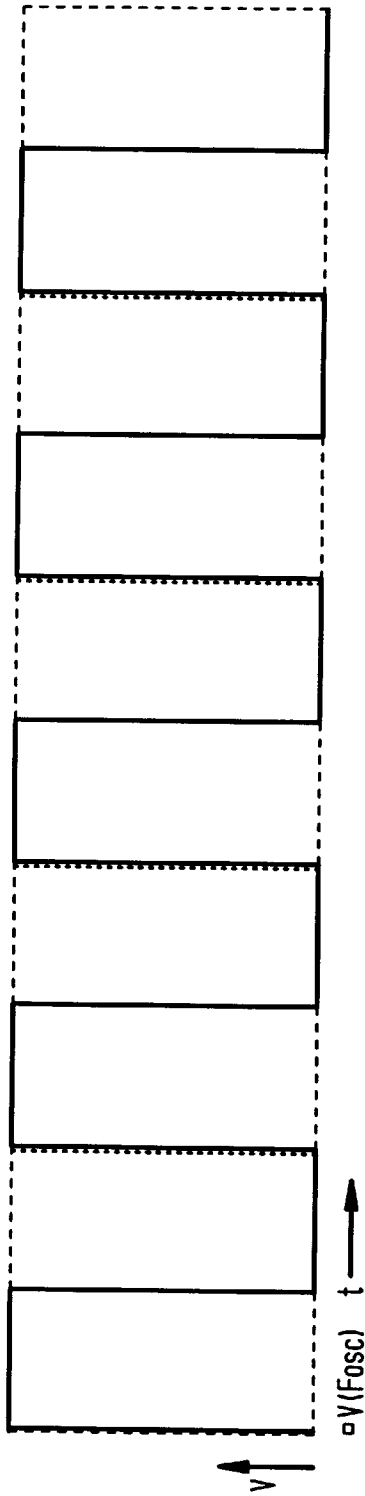
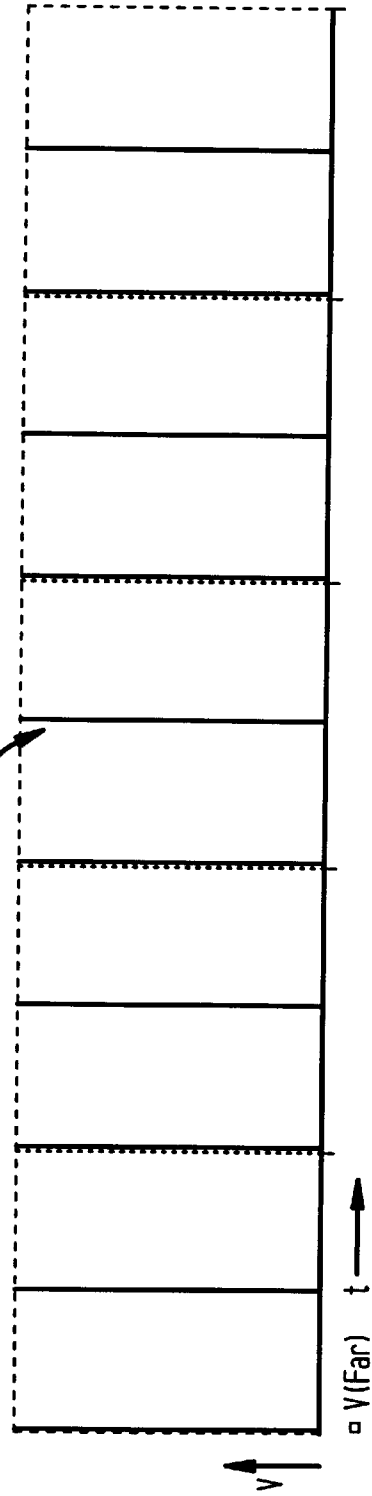
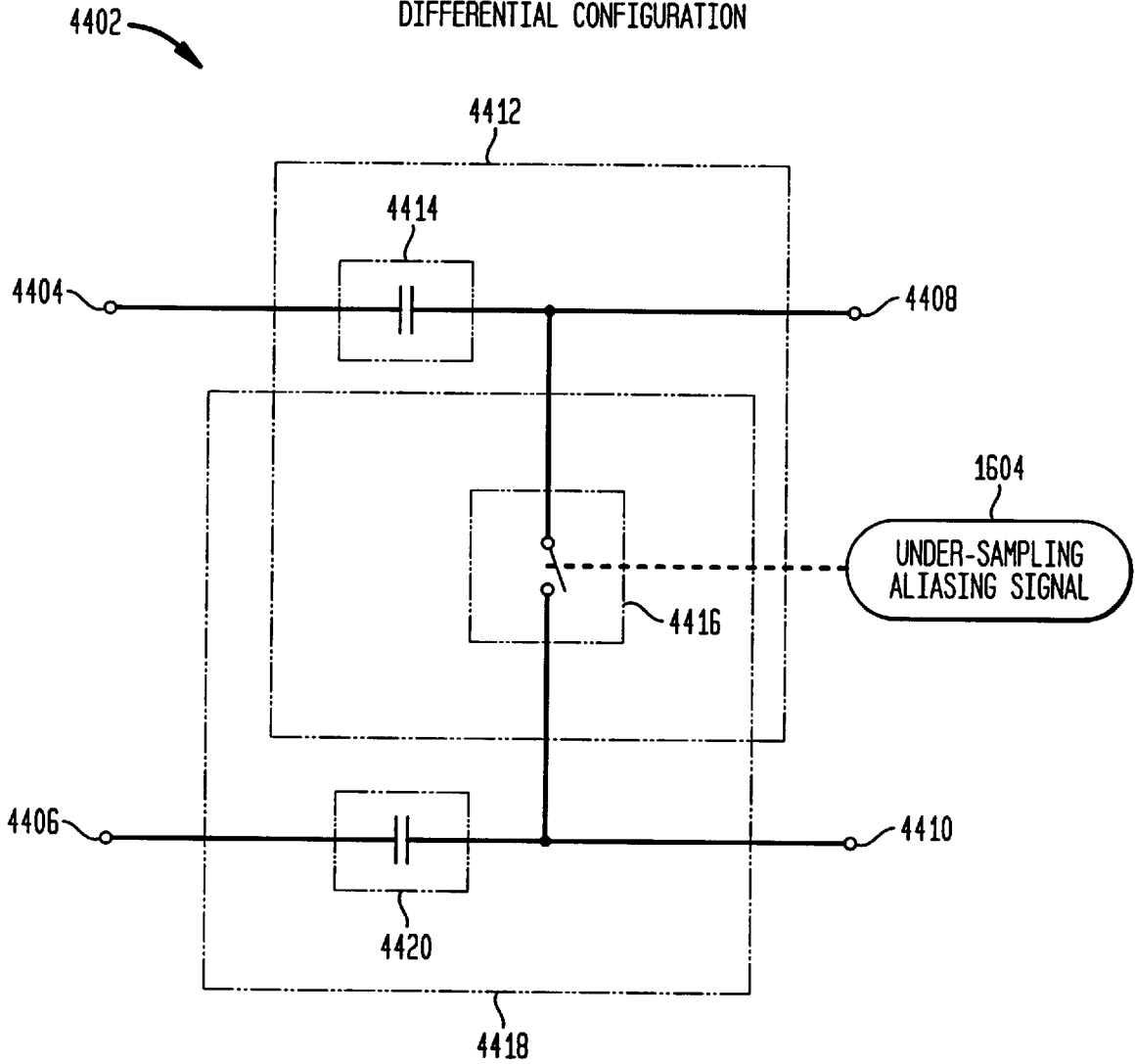


FIG. 43B

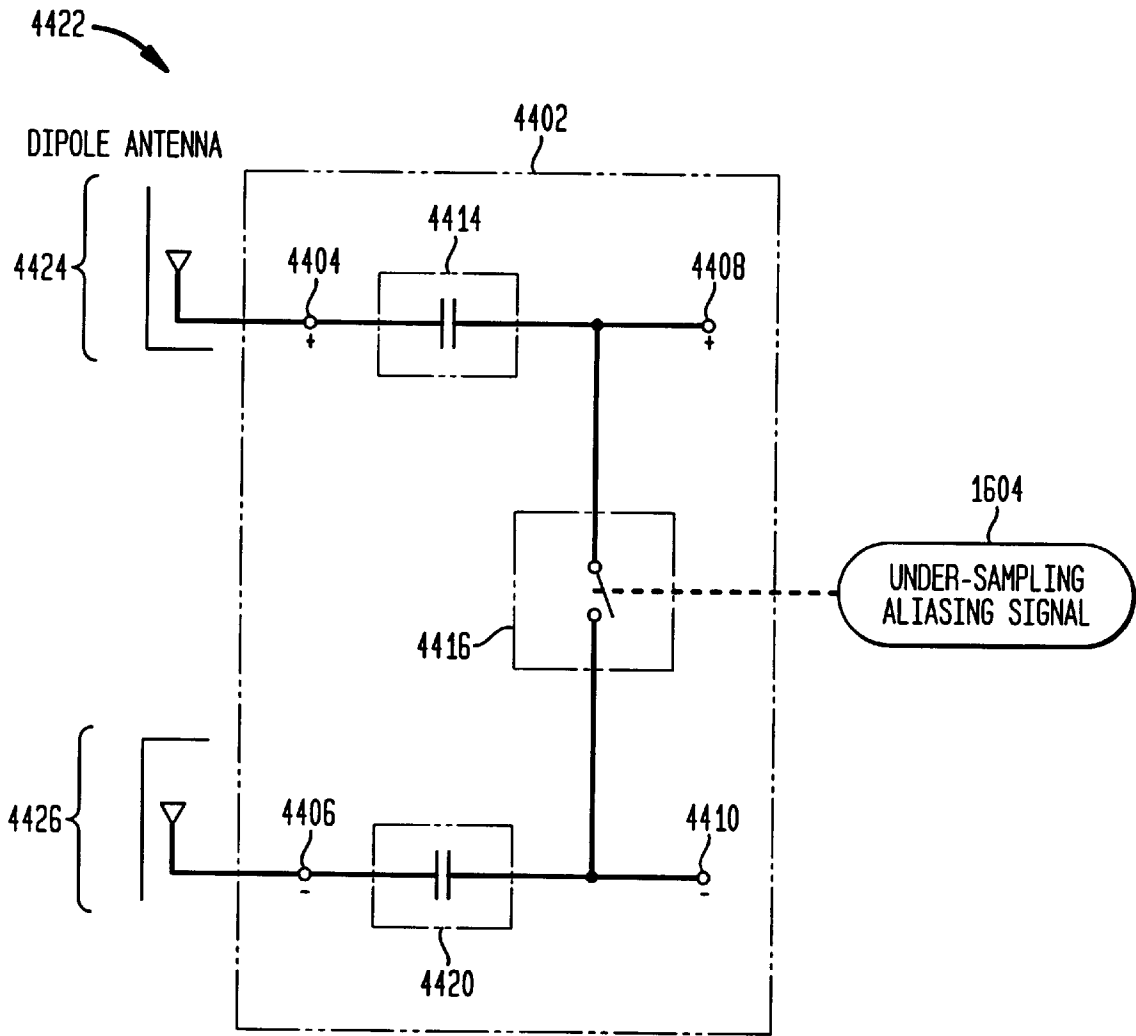
3104



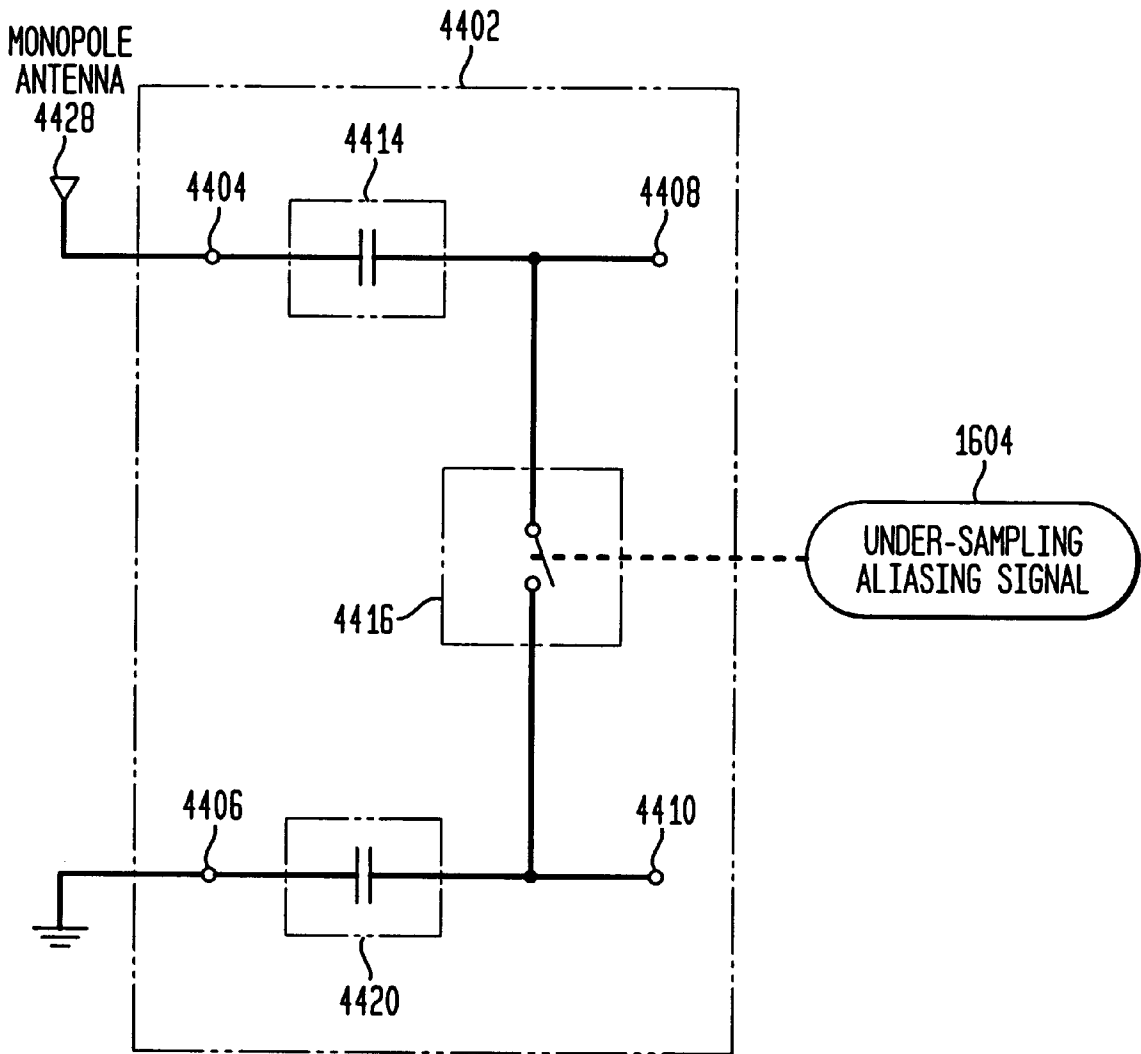
**FIG. 44A**  
DIFFERENTIAL CONFIGURATION



**FIG. 44B**  
DIFFERENTIAL INPUT TO DIFFERENTIAL OUTPUT



**FIG. 44C**  
SINGLE INPUT TO DIFFERENTIAL OUTPUT





**FIG. 44D**  
DIFFERENTIAL INPUT TO SINGLE OUTPUT

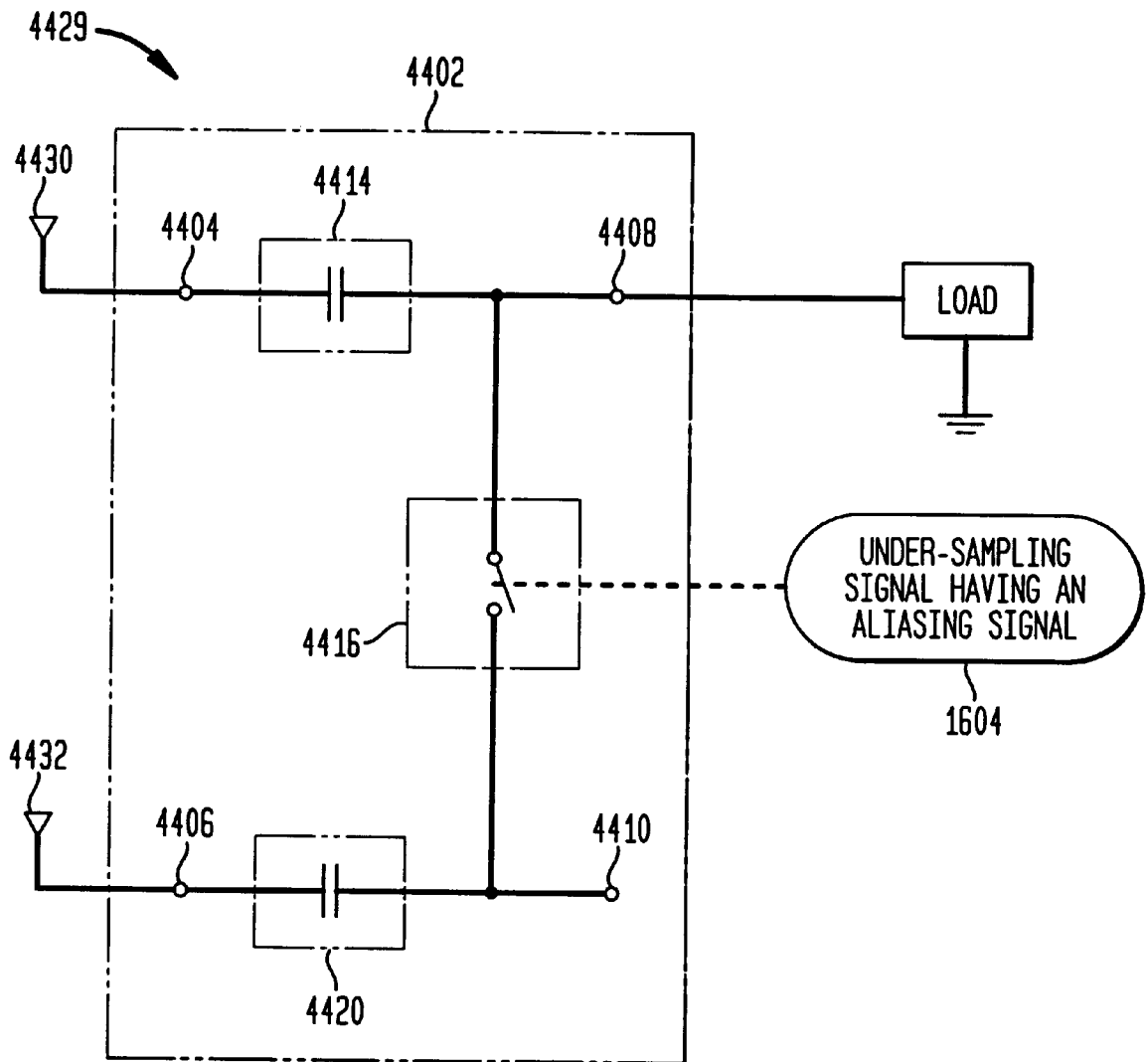


FIG. 44E  
EXAMPLE INPUT/OUTPUT CIRCUITRY

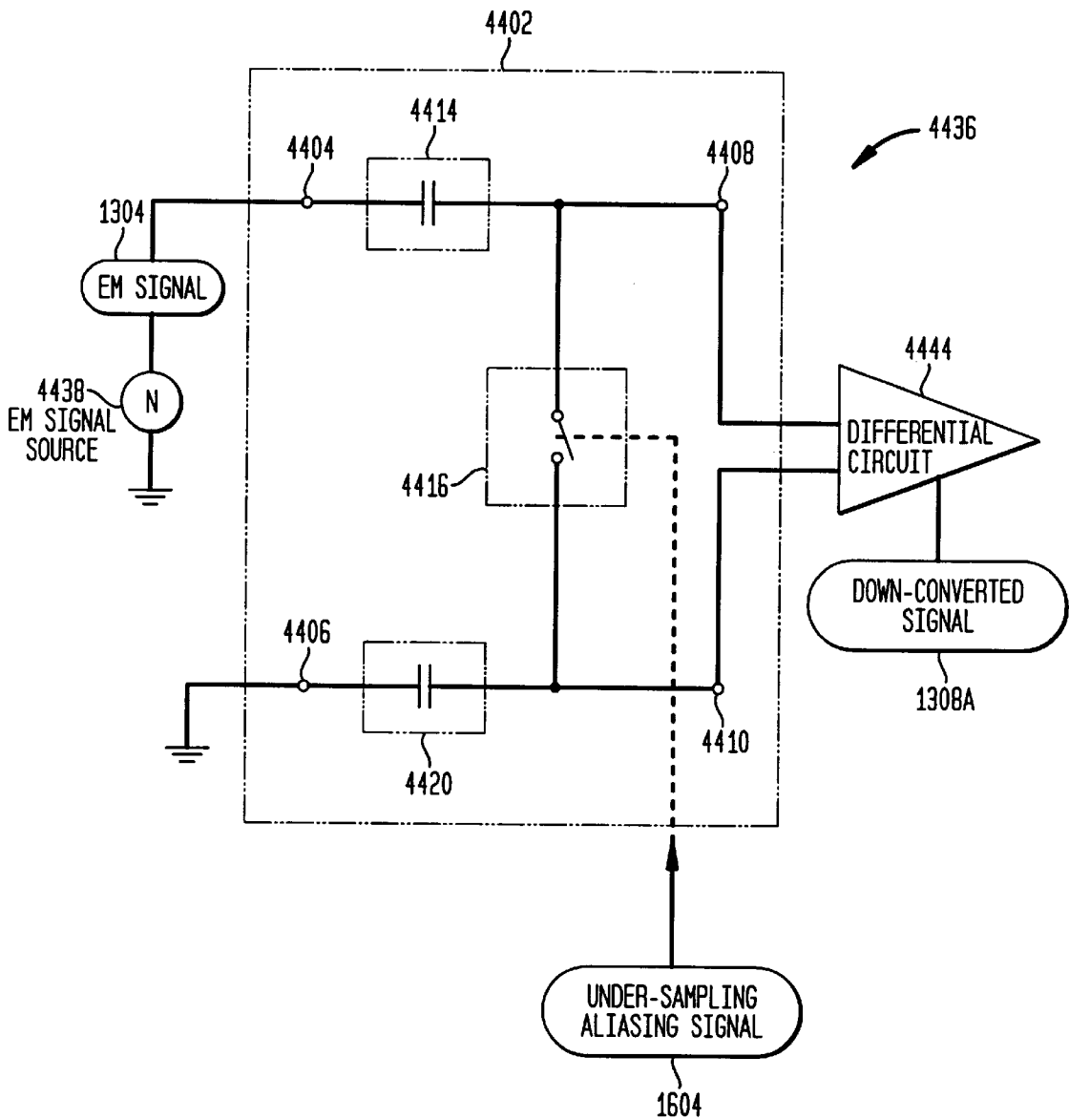


FIG. 45A

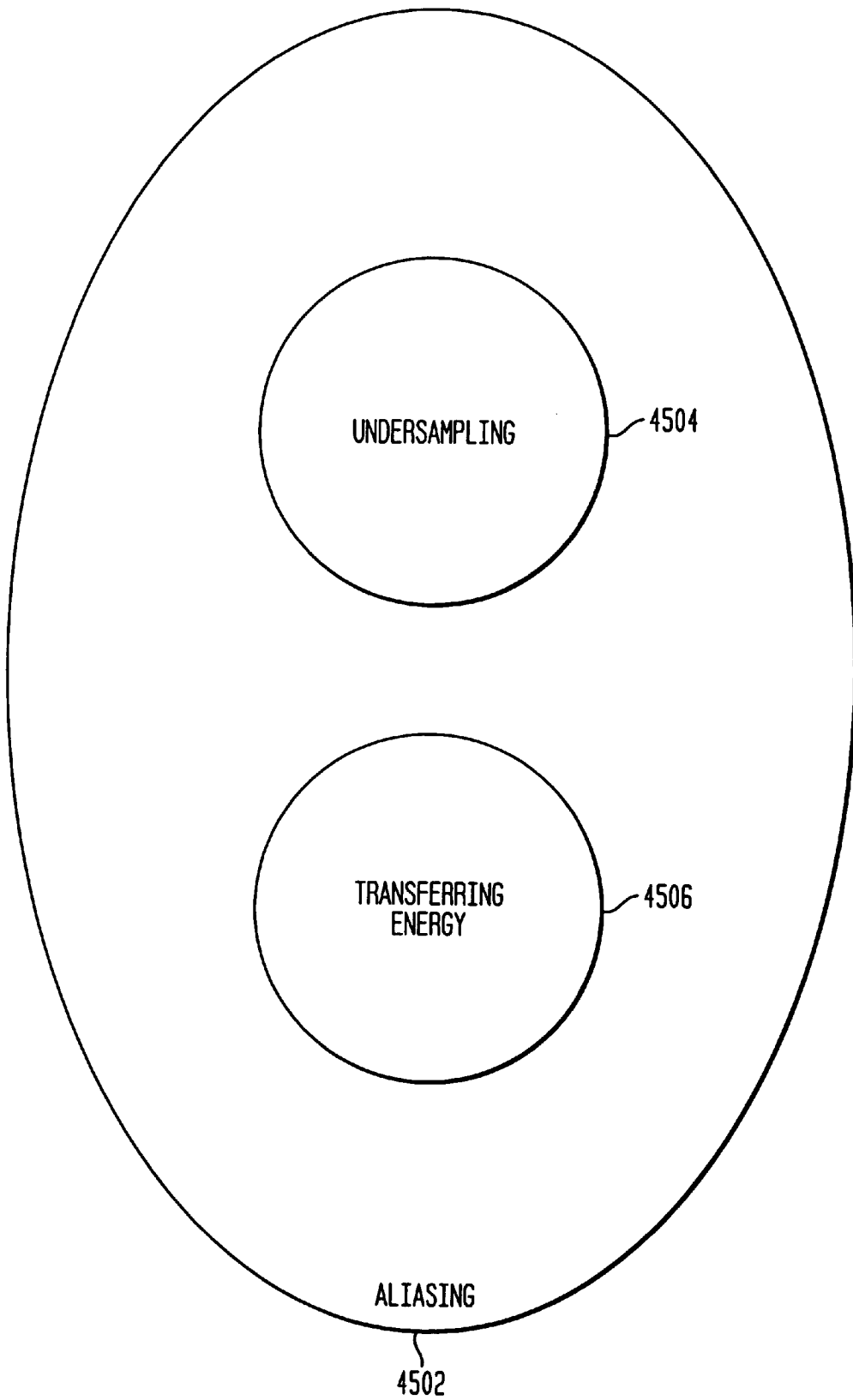


FIG. 45B

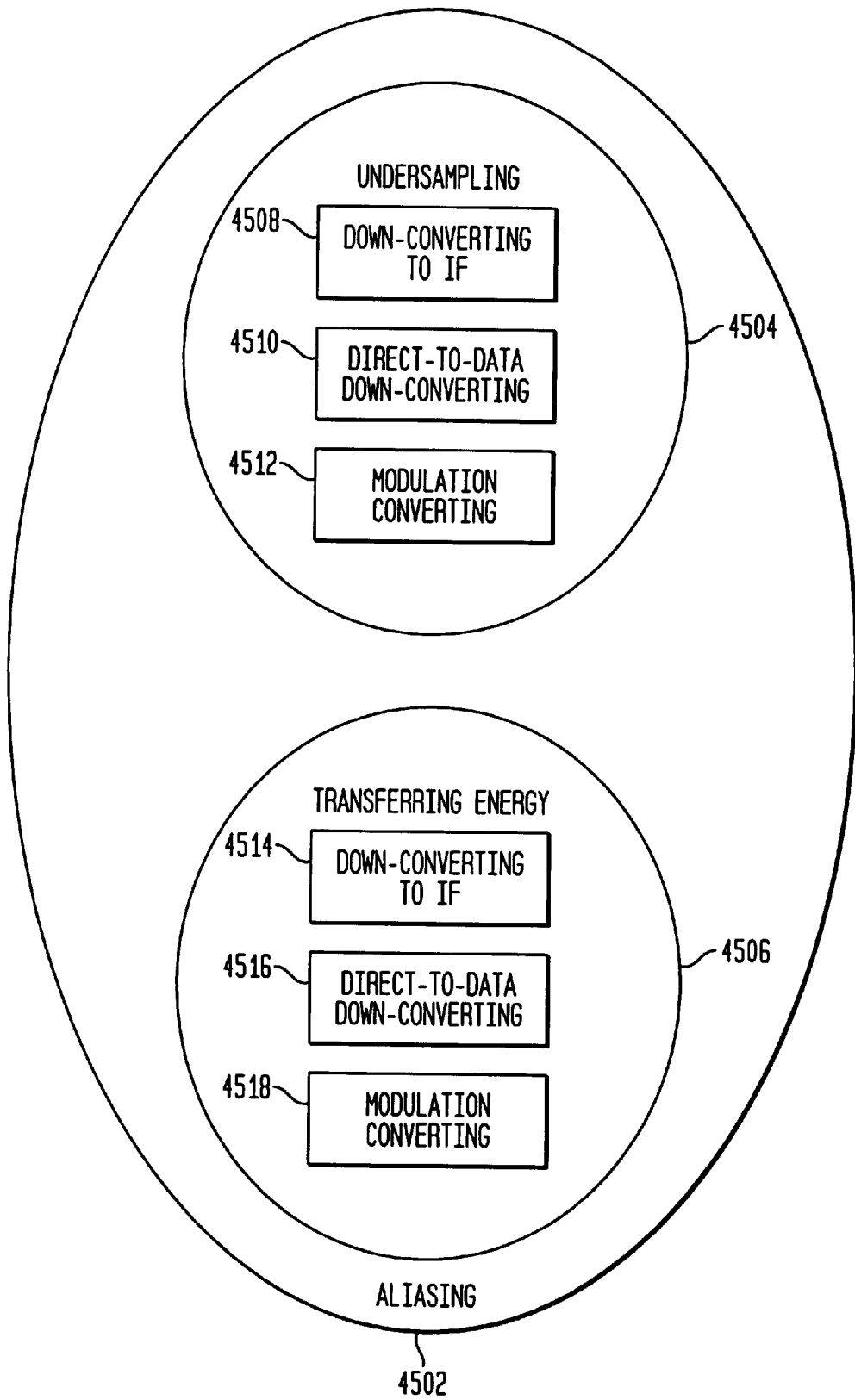


FIG. 46A

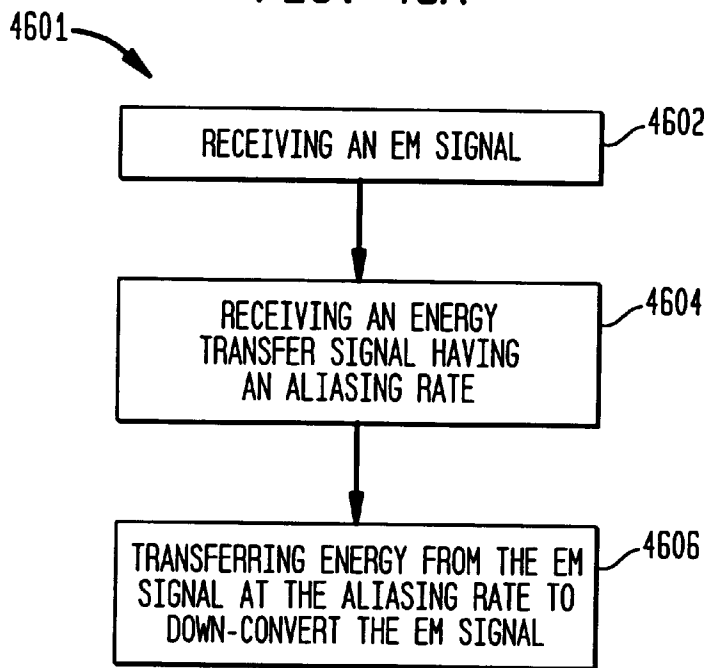


FIG. 46B

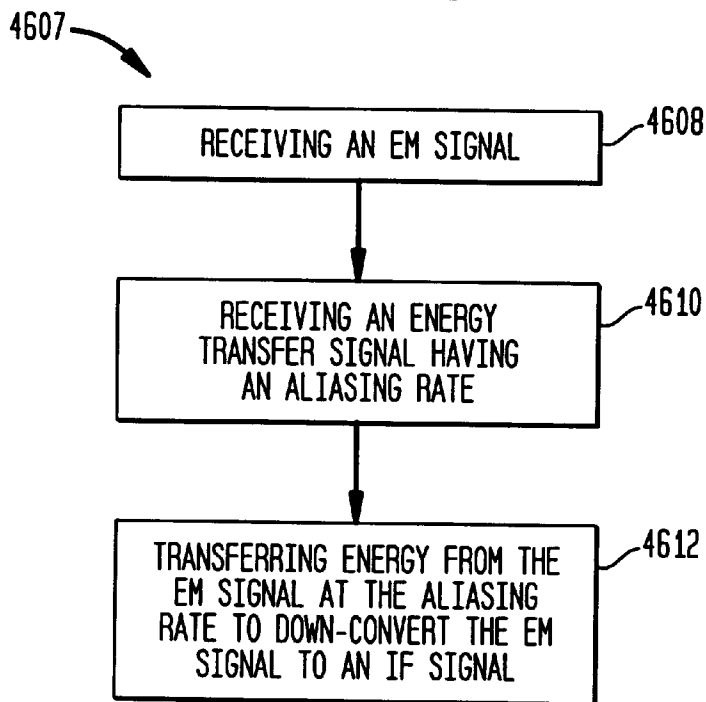


FIG. 46C

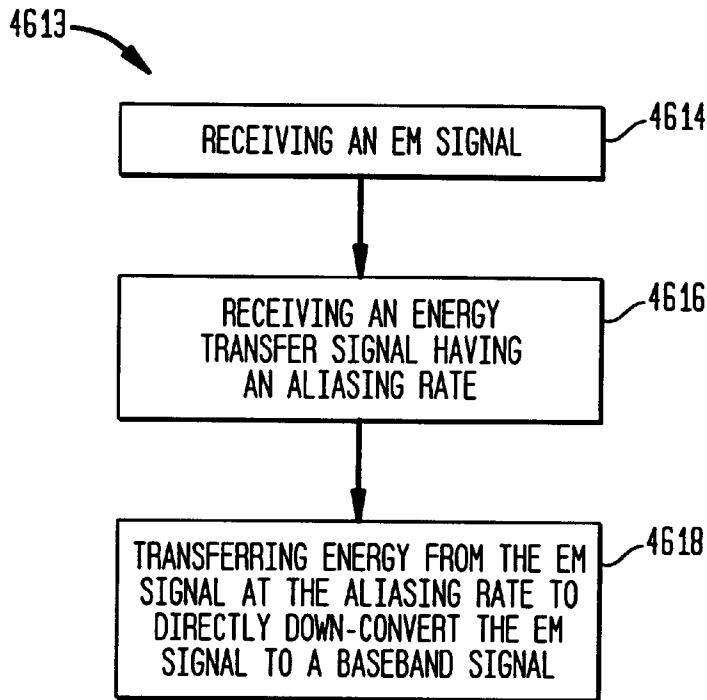


FIG. 46D

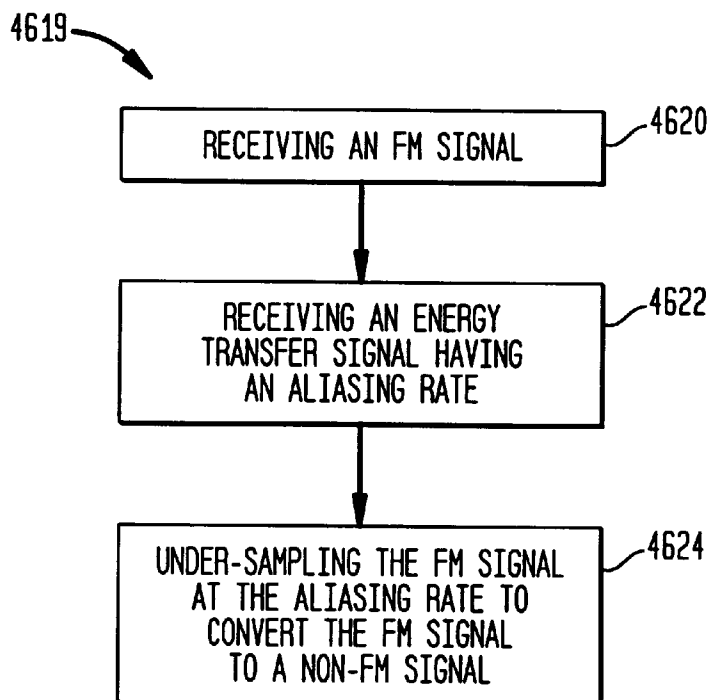
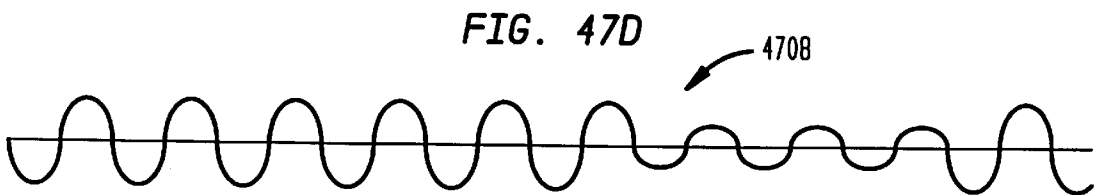
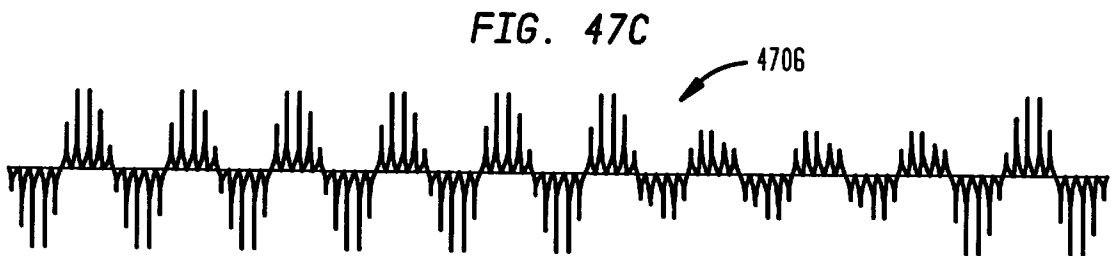
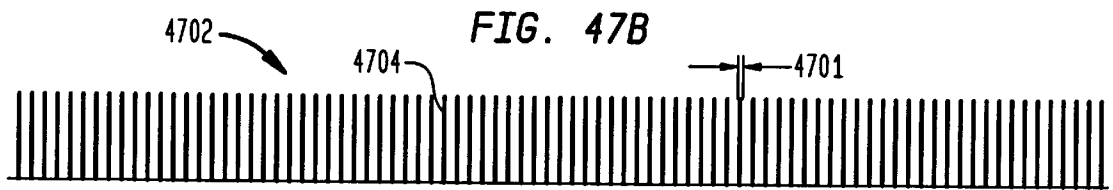
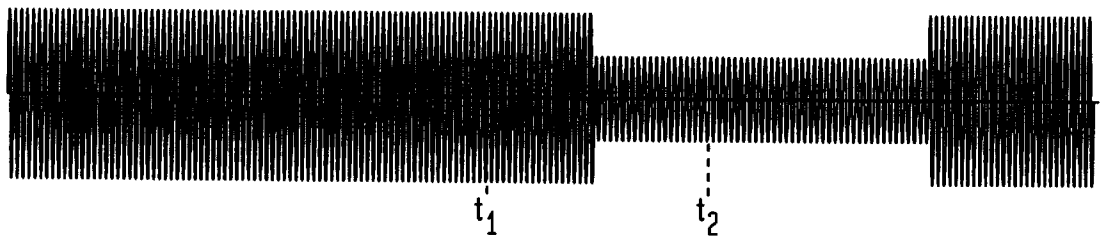
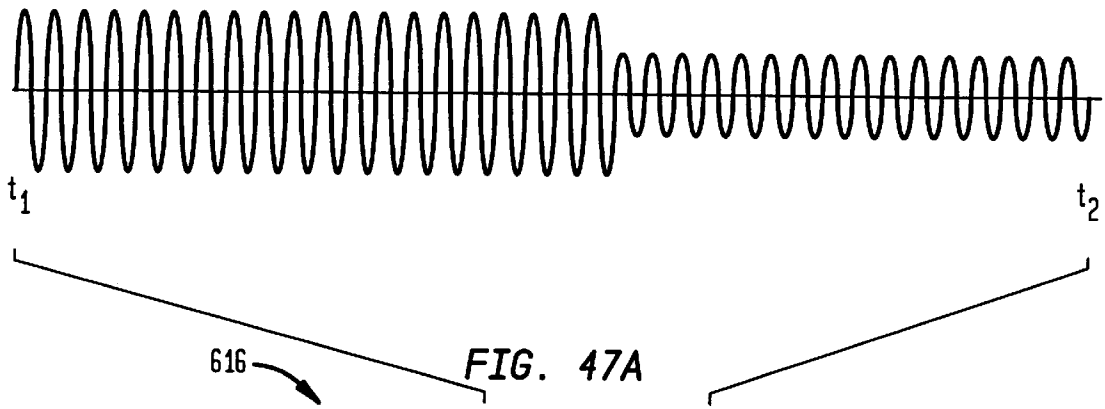
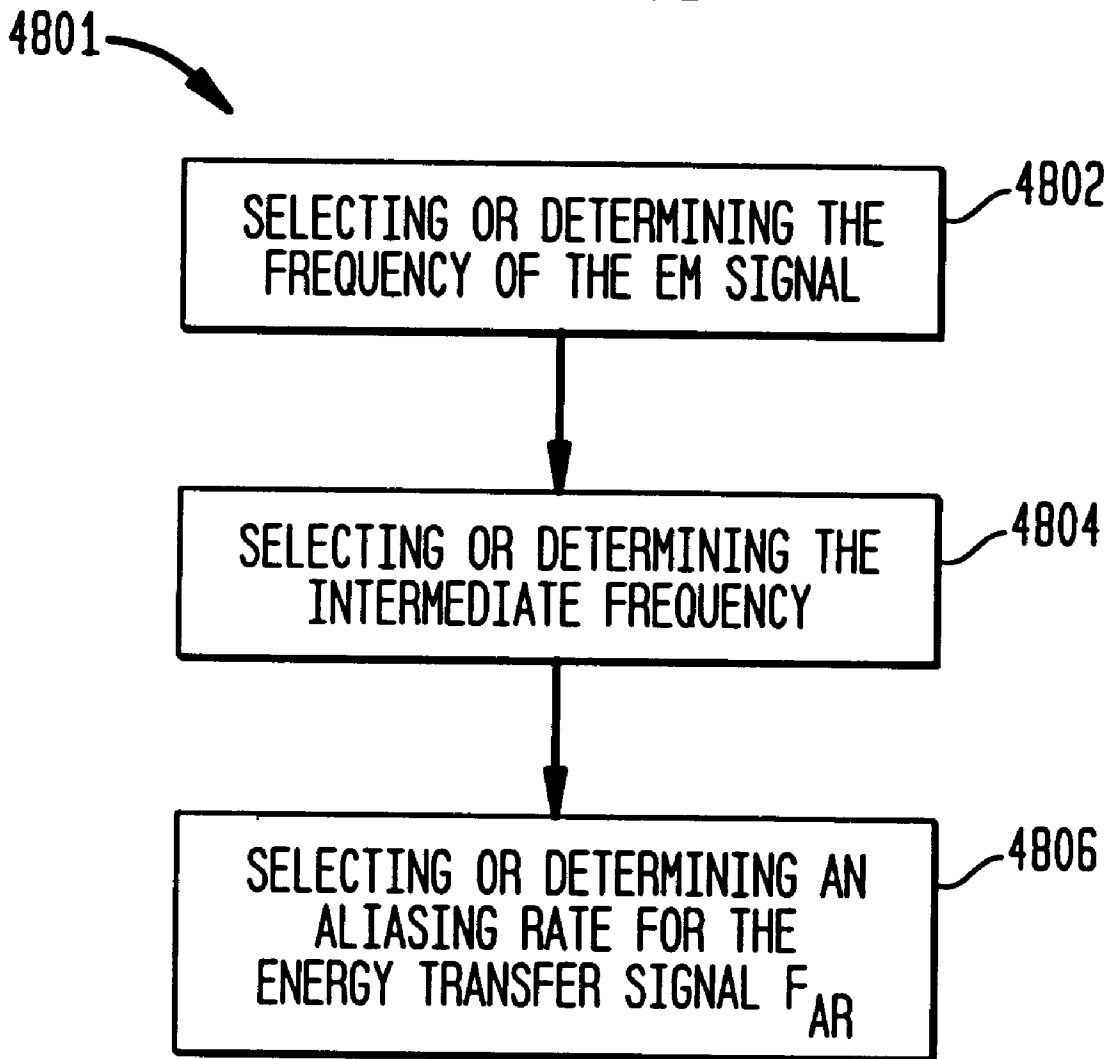


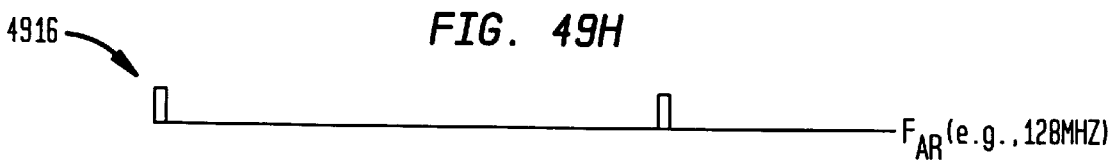
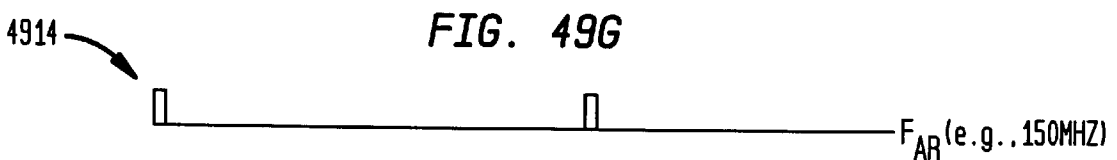
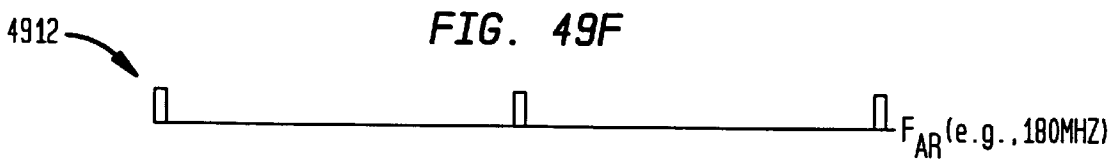
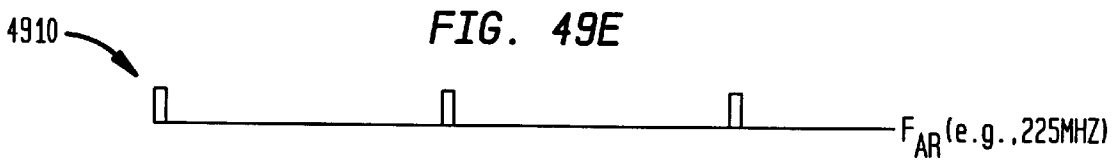
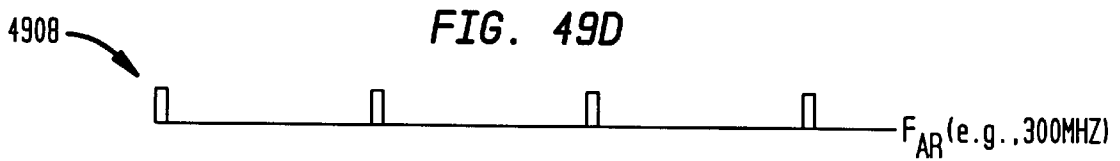
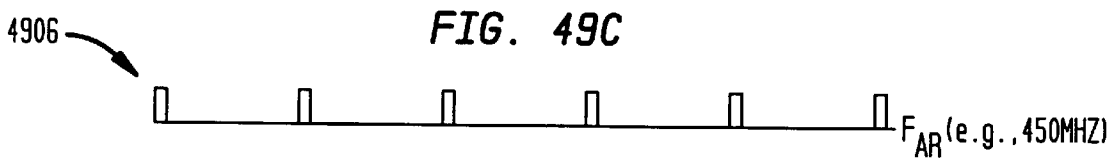
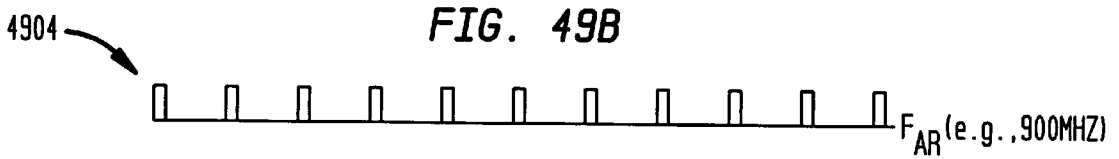
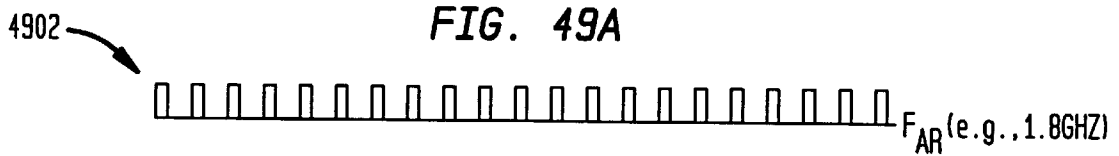
FIG. 47E



**FIG. 48**







516  
(e.g., 901MHz)

FIG. 50A

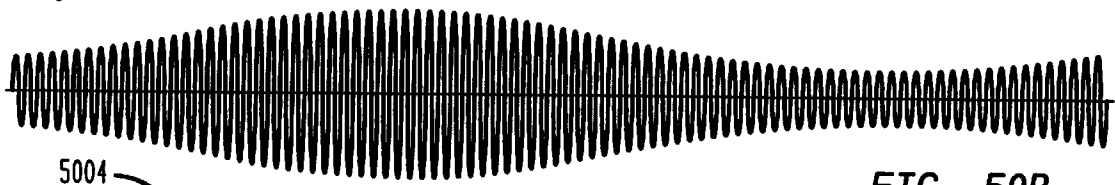
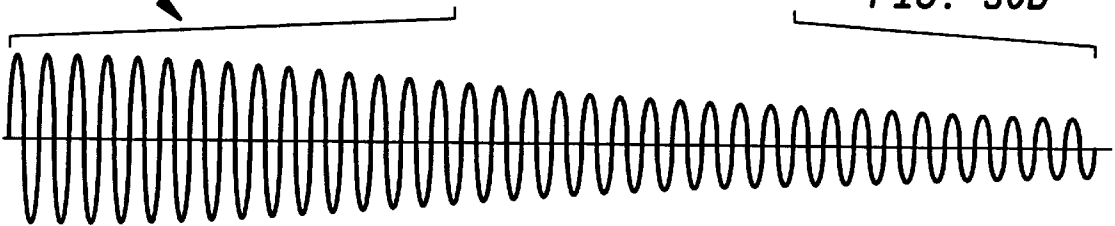
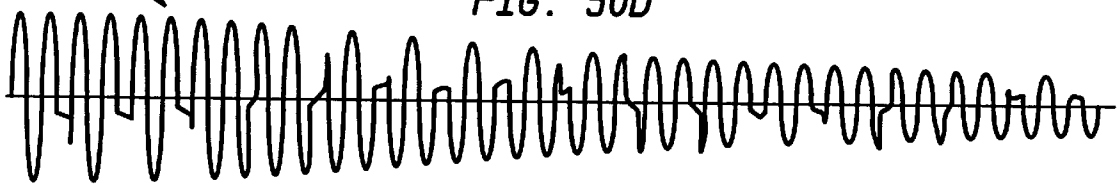


FIG. 50B



5008

FIG. 50D



ENERGY  
TRANSFER SIGNAL  
5006

FIG. 50C

ENERGY TRANSFER PULSES  
5007      APERTURES  
5009

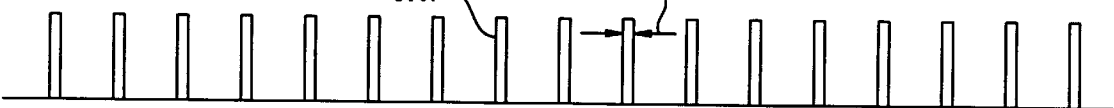
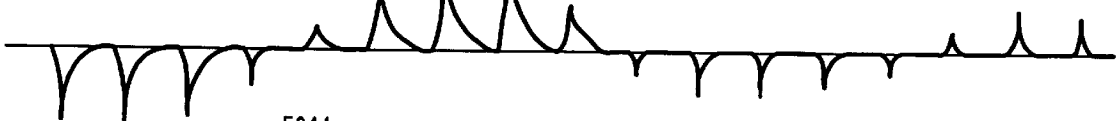


FIG. 50E

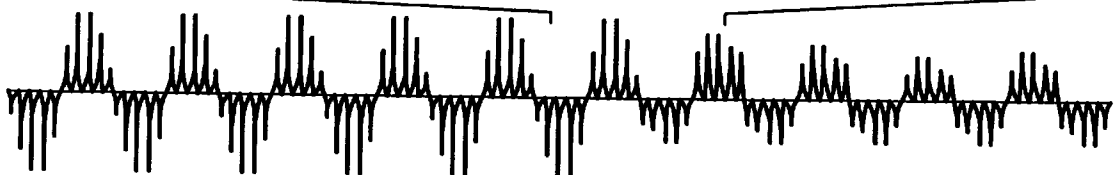
5012

5010A      5010B



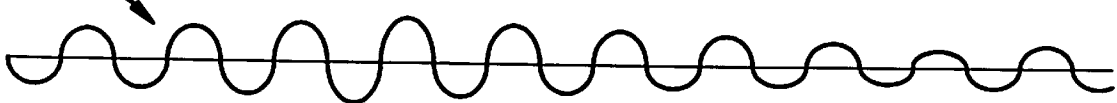
5014

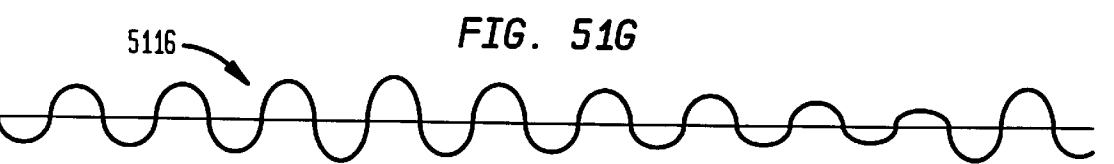
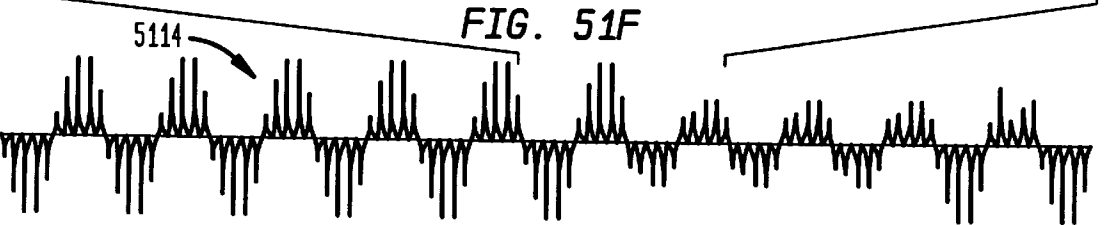
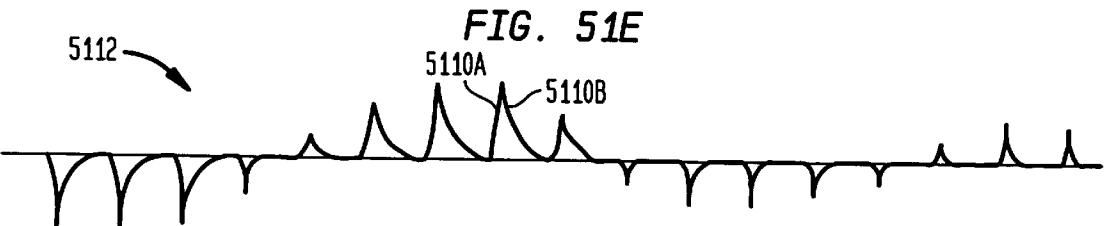
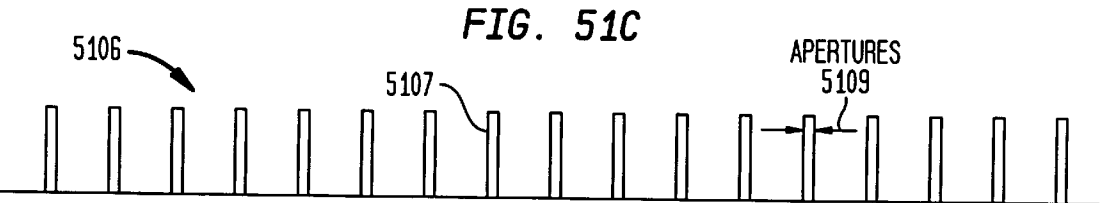
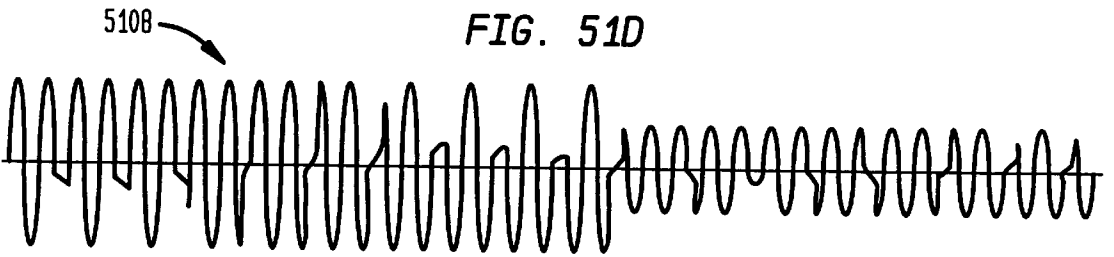
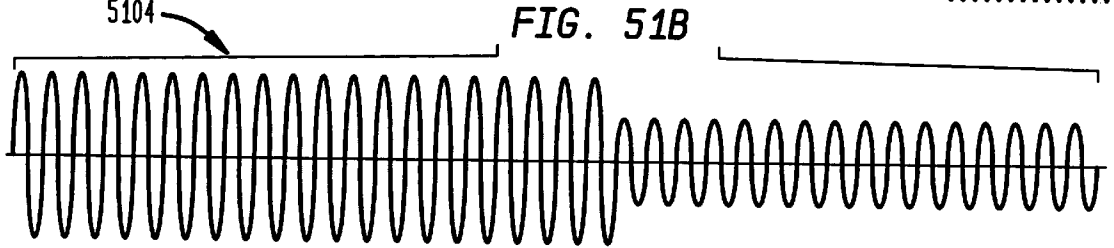
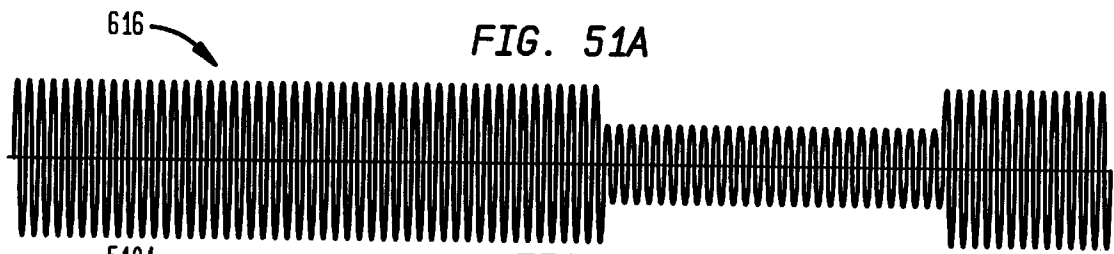
FIG. 50F

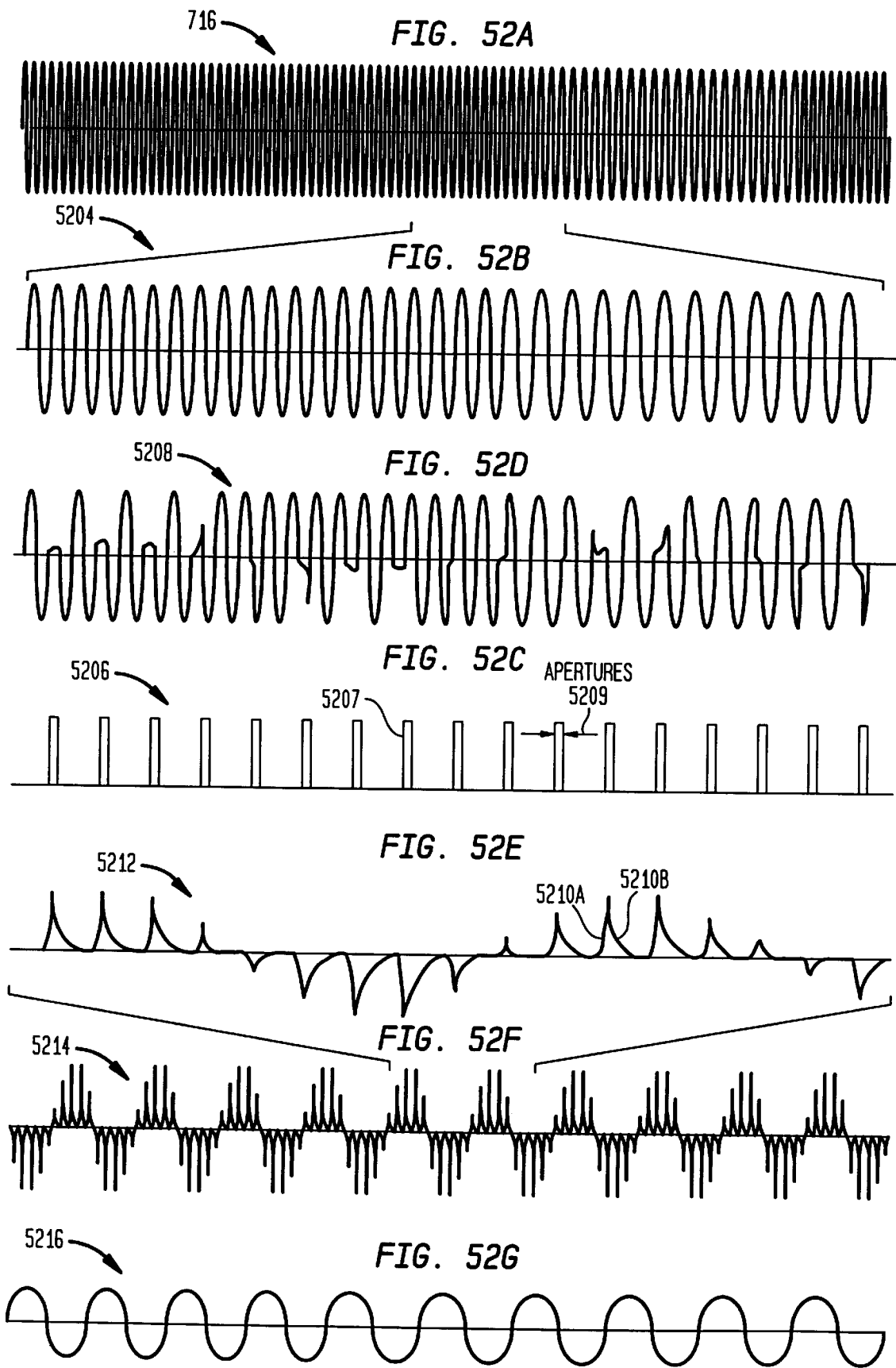


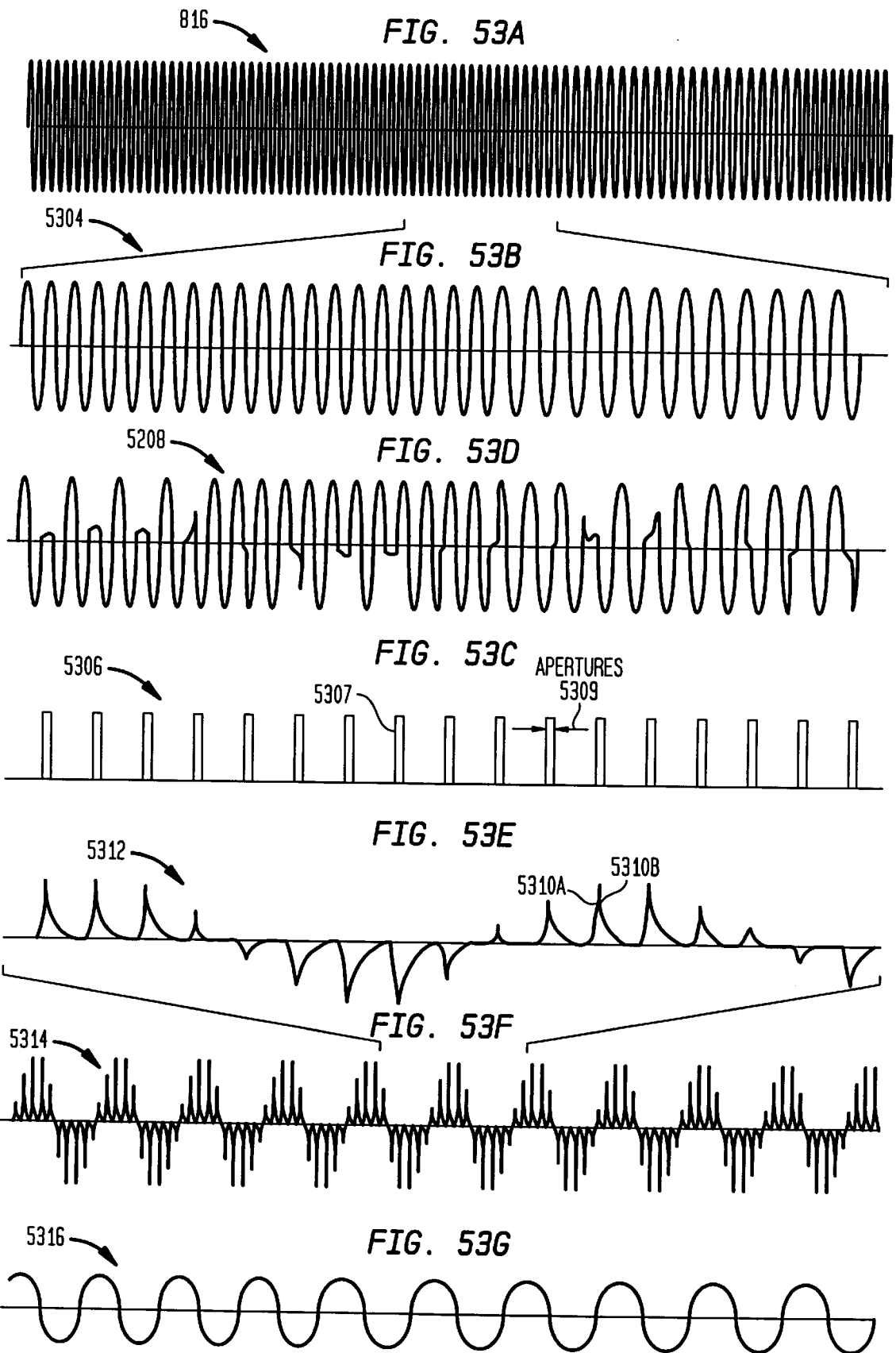
5016

FIG. 50G



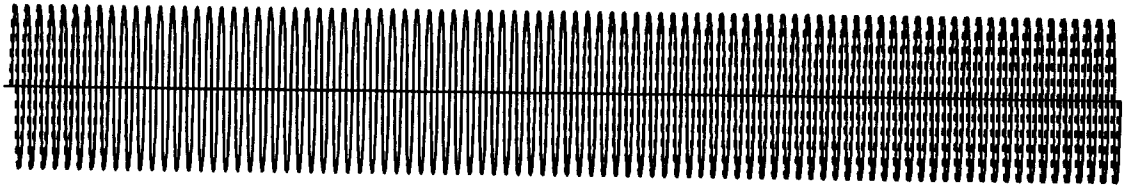






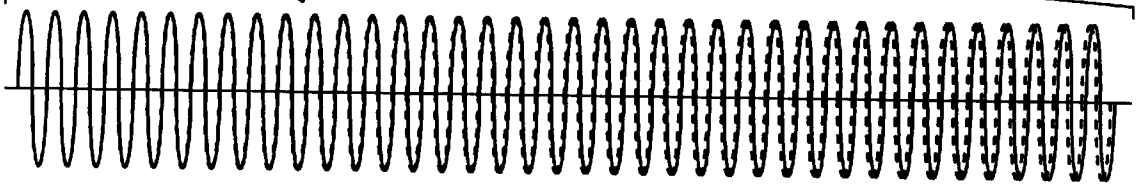
916

FIG. 54A



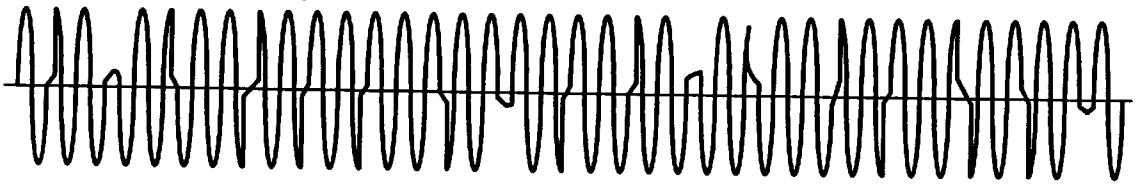
5404

FIG. 54B



5408

FIG. 54D



5406

FIG. 54C

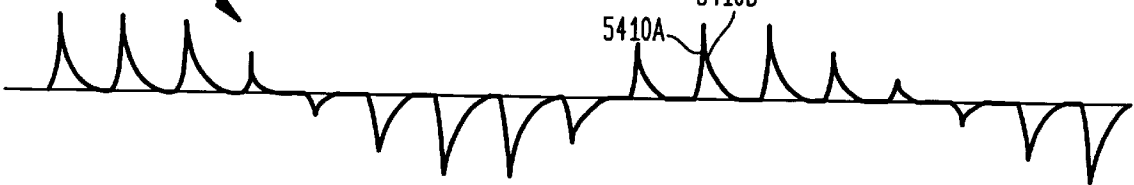
APERTURES  
5409



5412

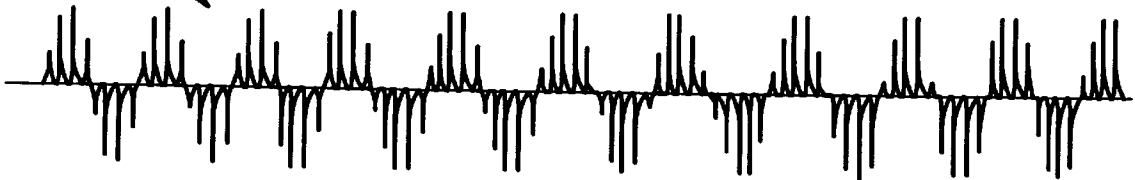
FIG. 54E

5410A  
5410B



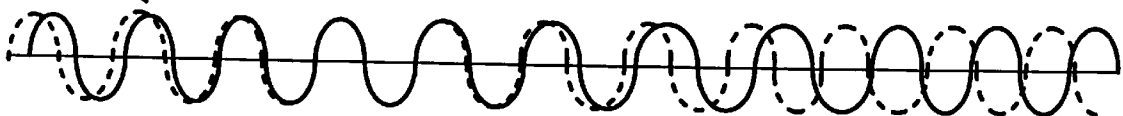
5414

FIG. 54F



5416

FIG. 54G



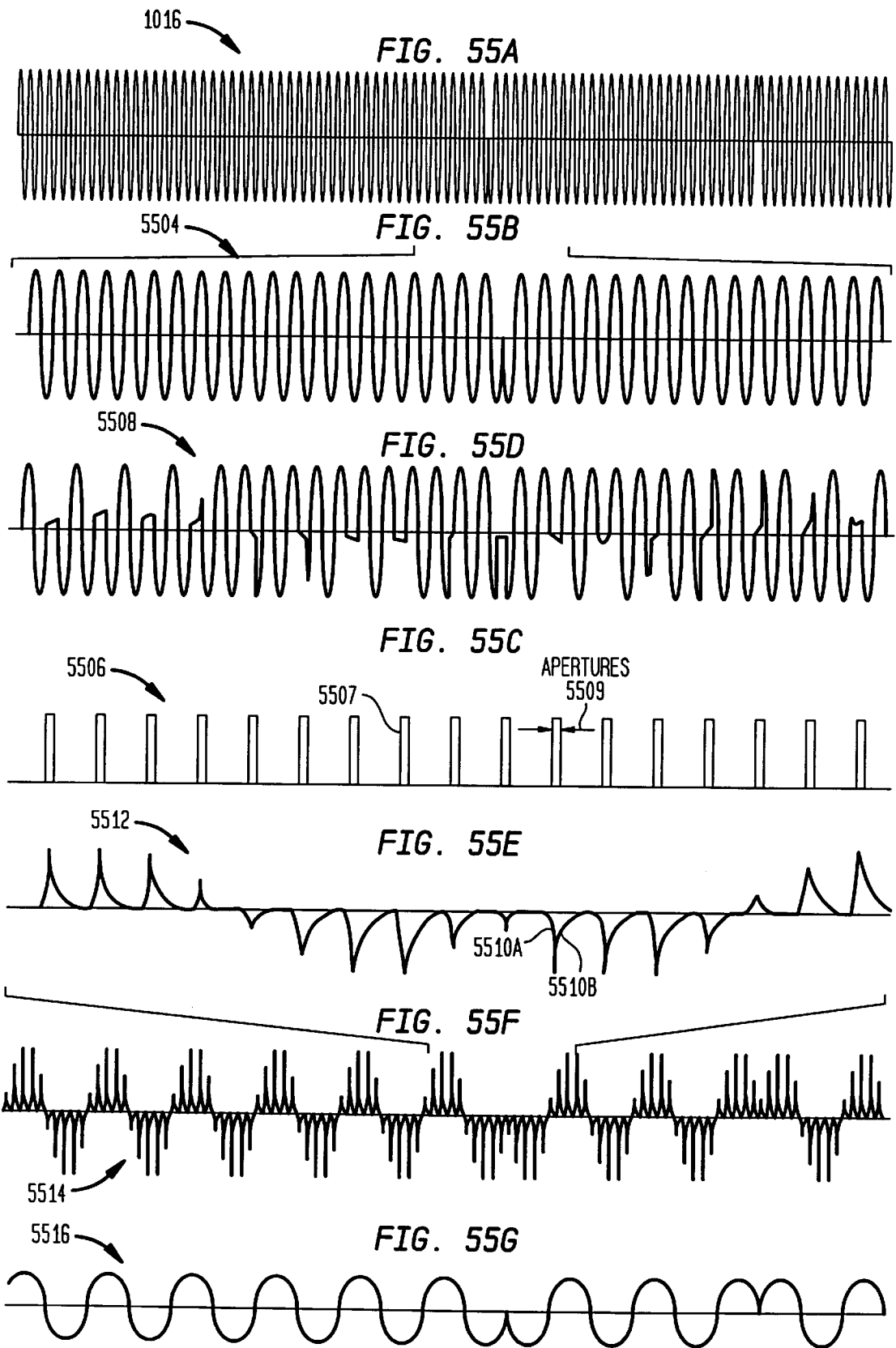


FIG. 56A

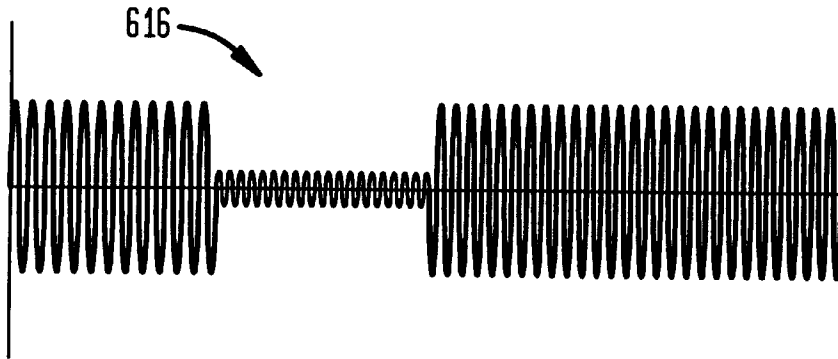


FIG. 56B

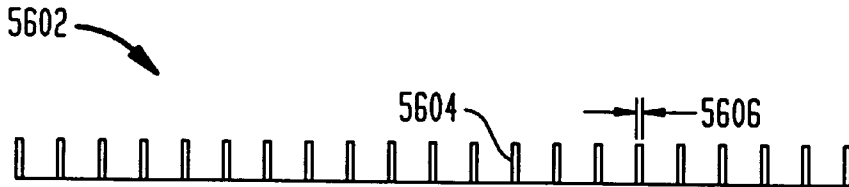


FIG. 56C

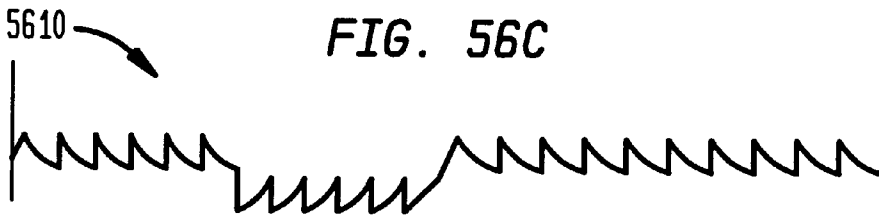
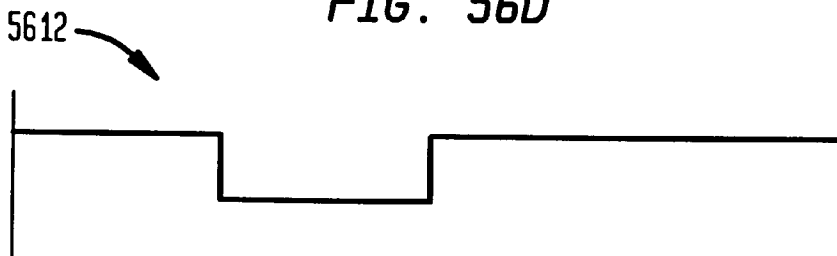
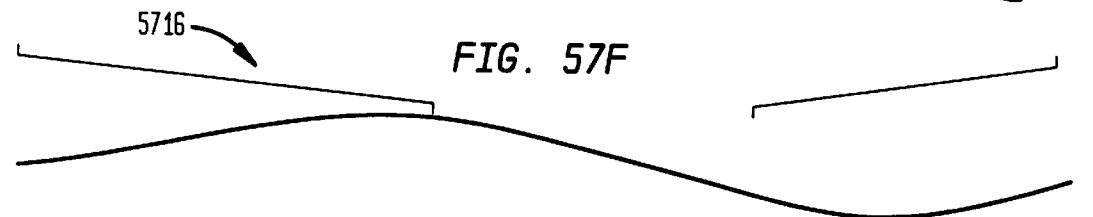
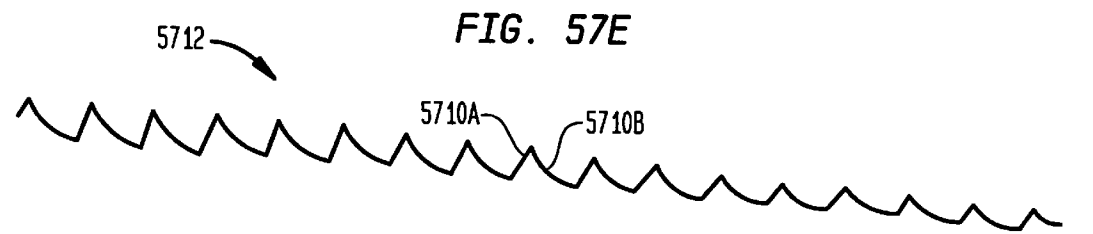
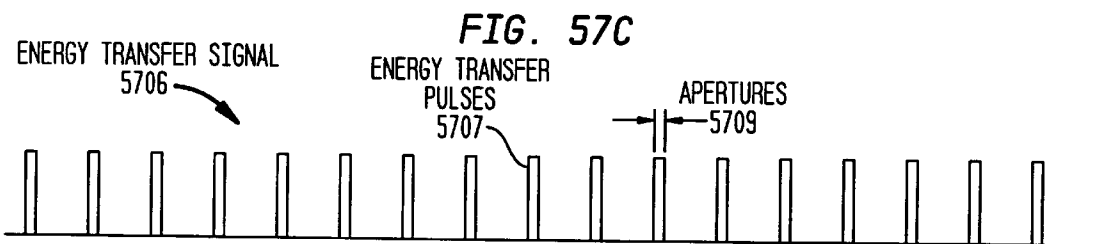
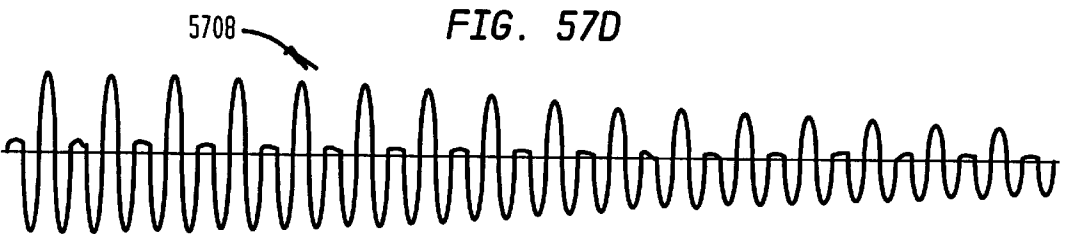
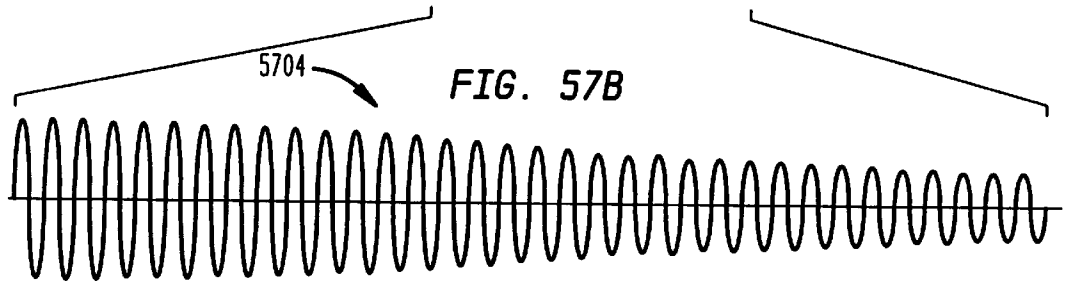
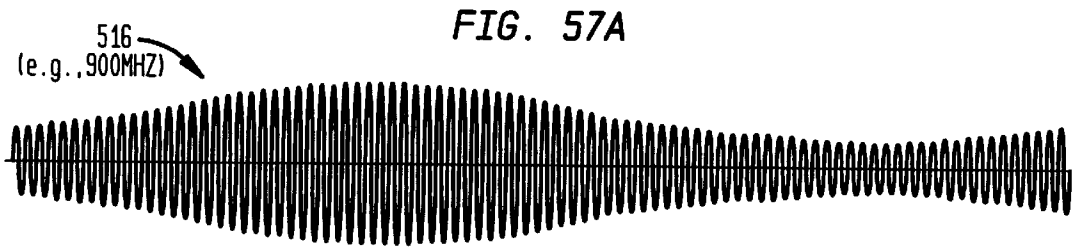
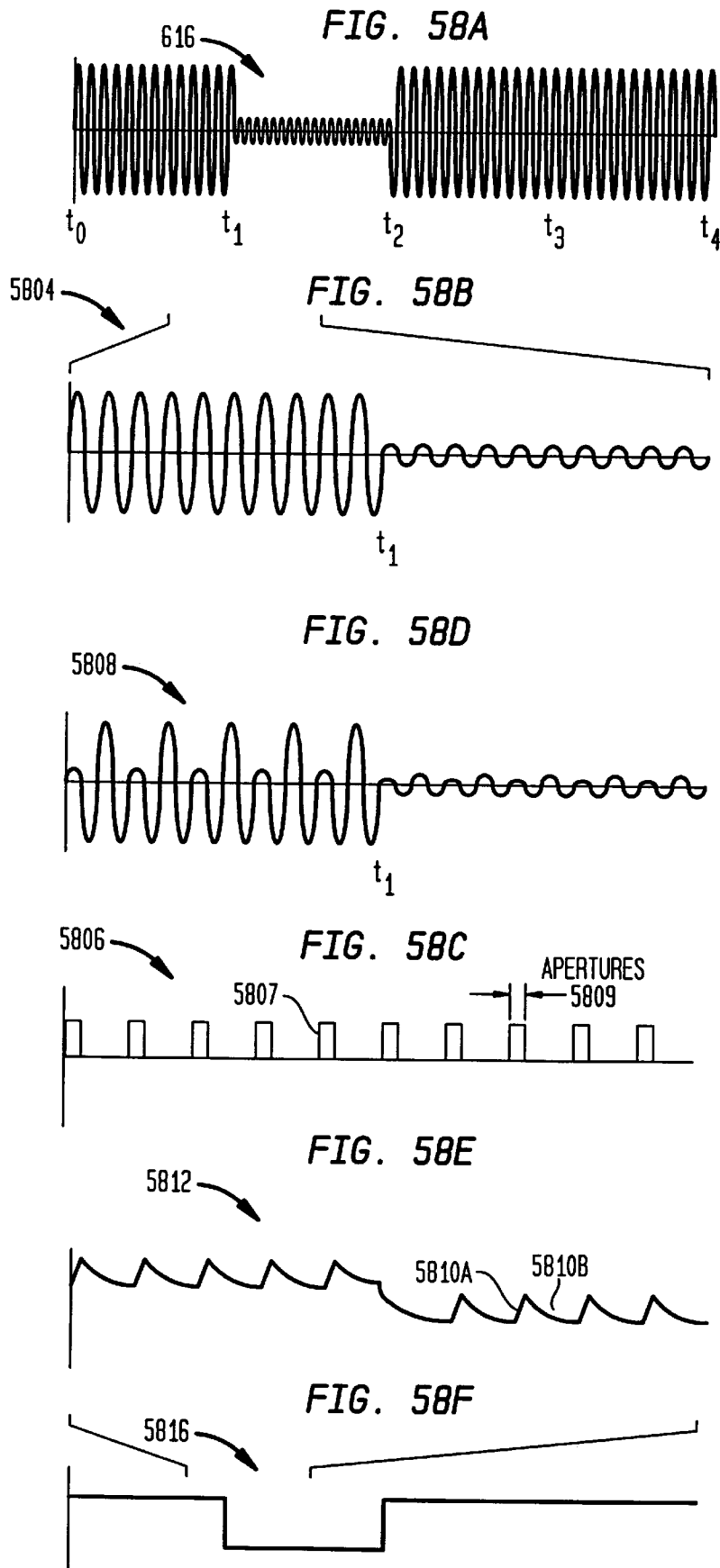


FIG. 56D

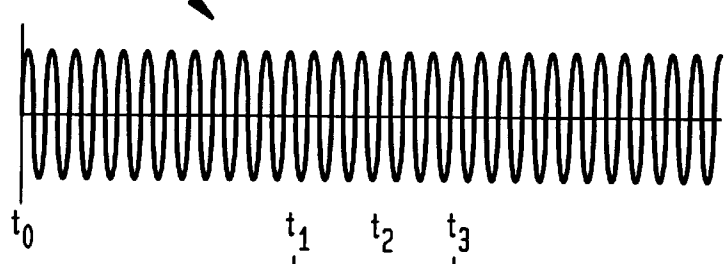




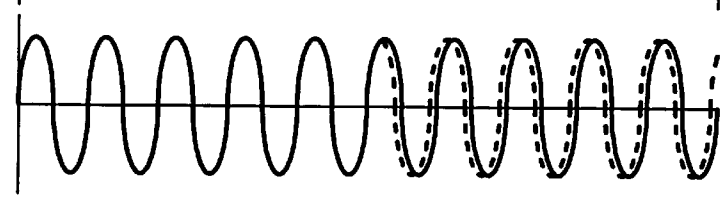




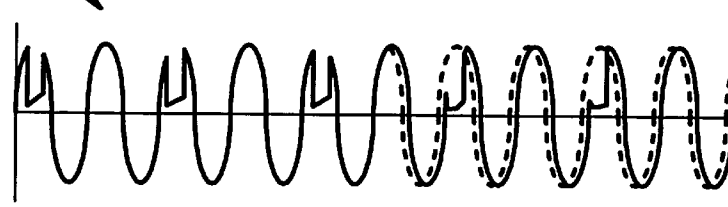
916 **FIG. 59A**



**FIG. 59B**



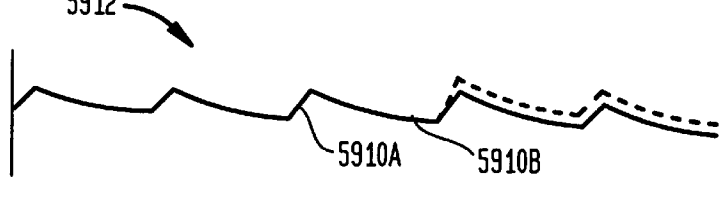
**FIG. 59D**



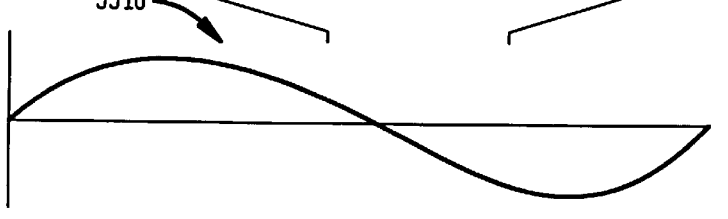
**FIG. 59C**



**FIG. 59E**

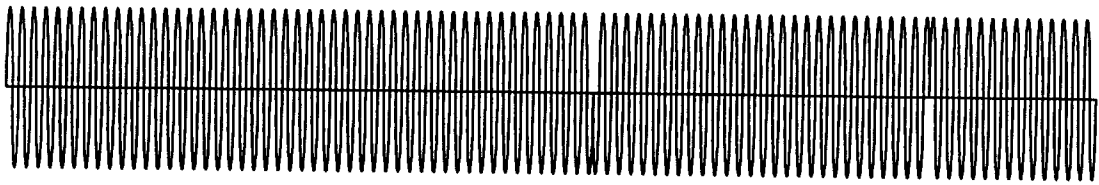


**FIG. 59F**



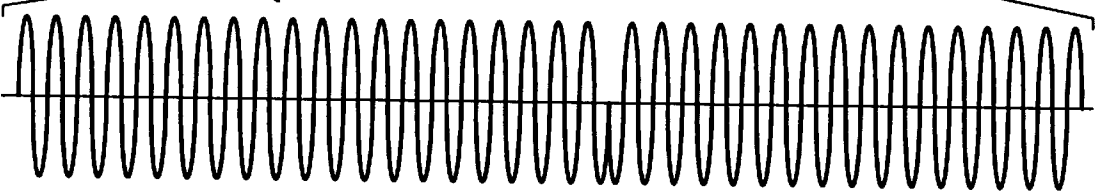
1016

FIG. 60A



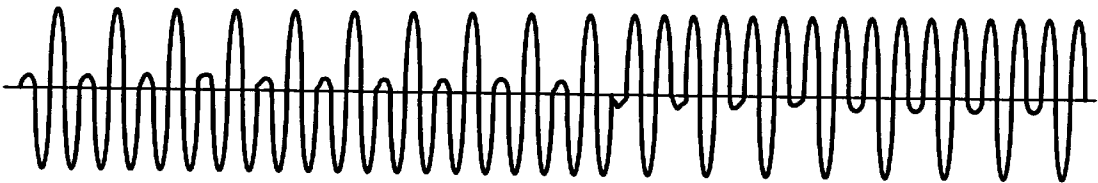
6004

FIG. 60B



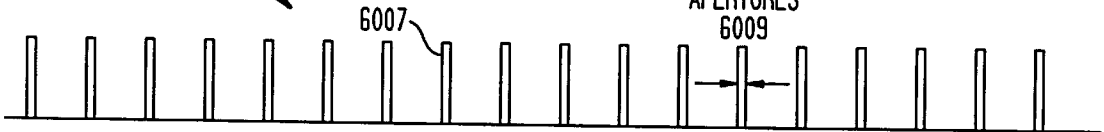
6008

FIG. 60D



6006

FIG. 60C



6012

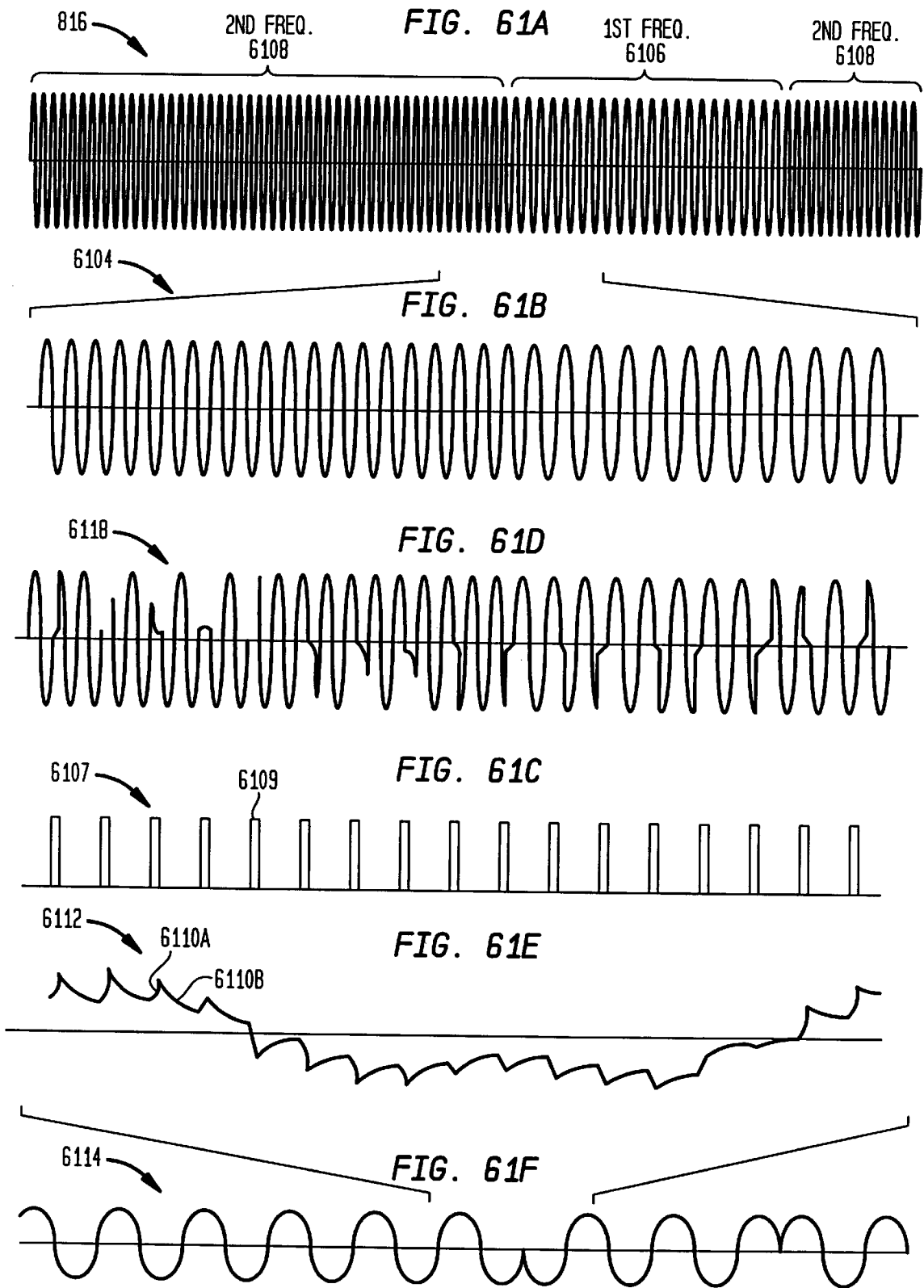
FIG. 60E

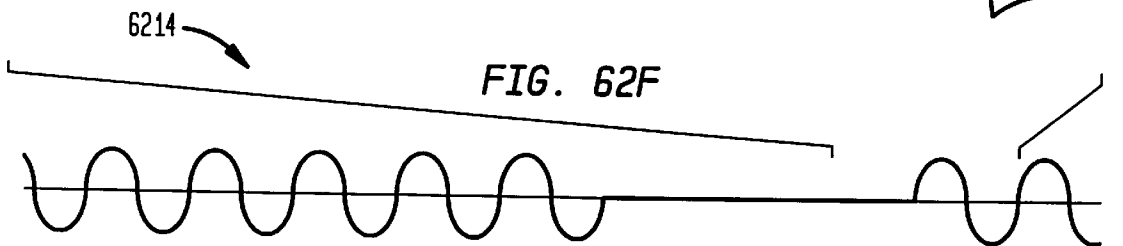
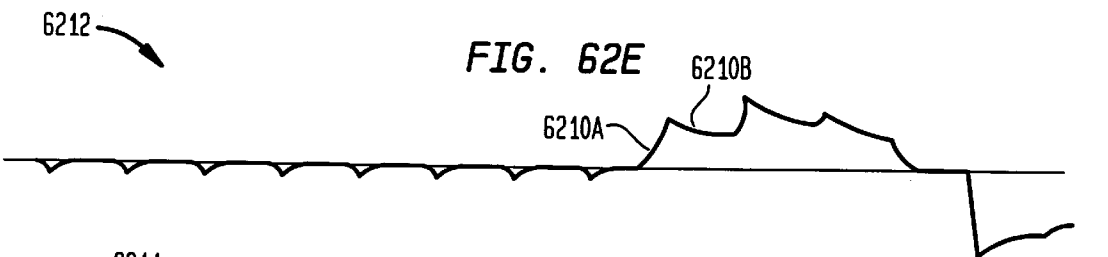
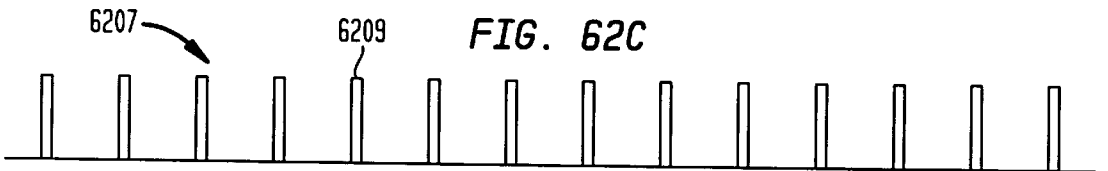
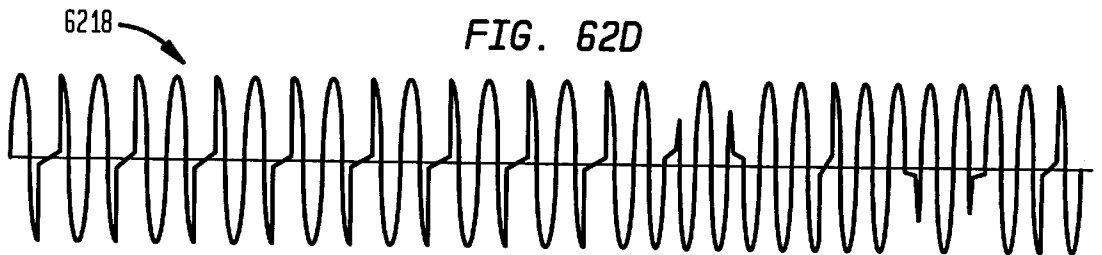
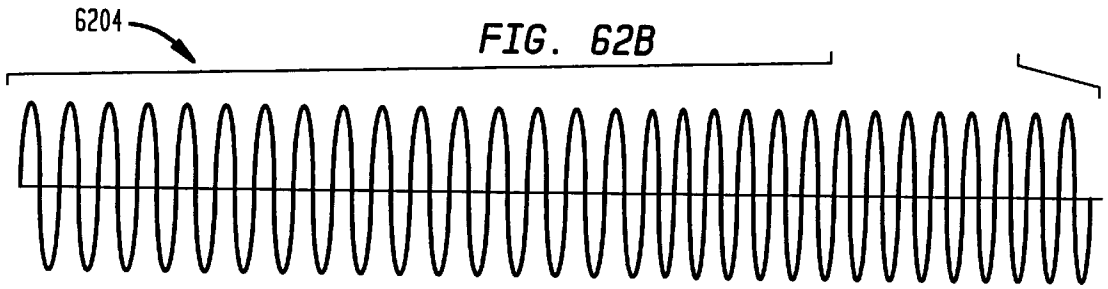
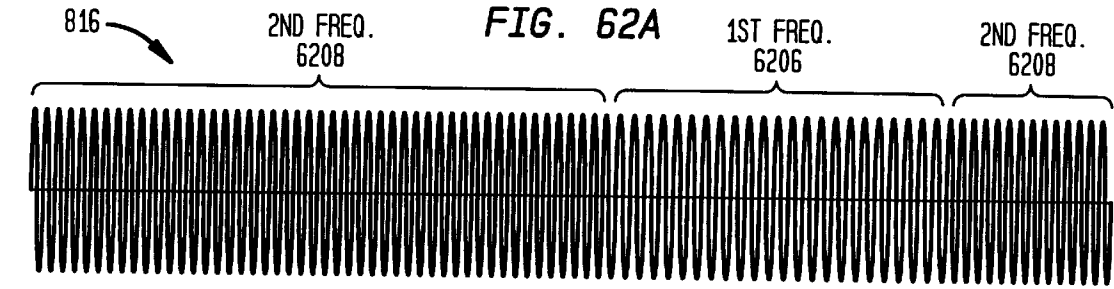


6016

FIG. 60F







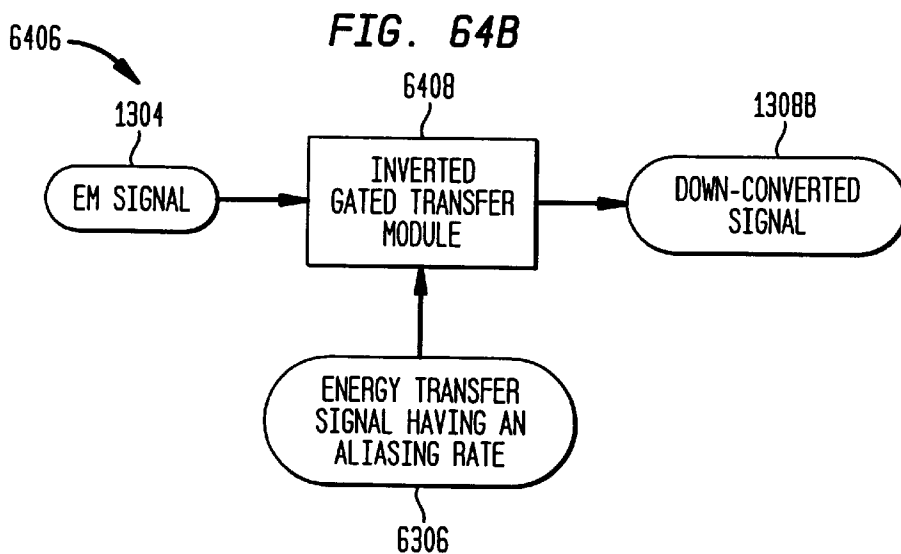
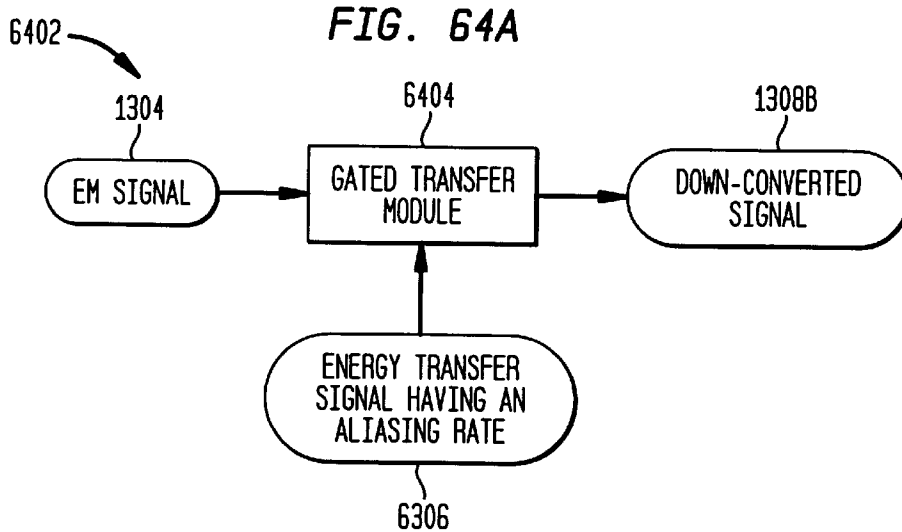
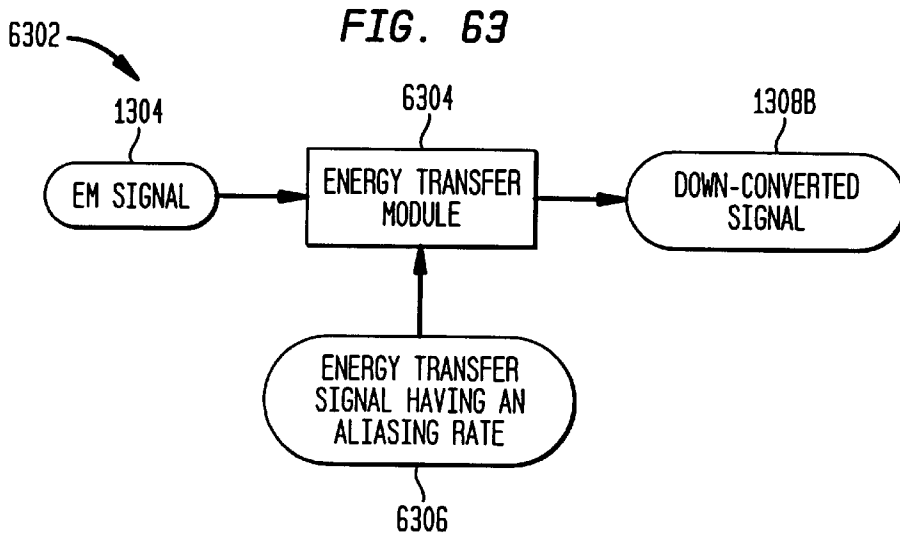


FIG. 65

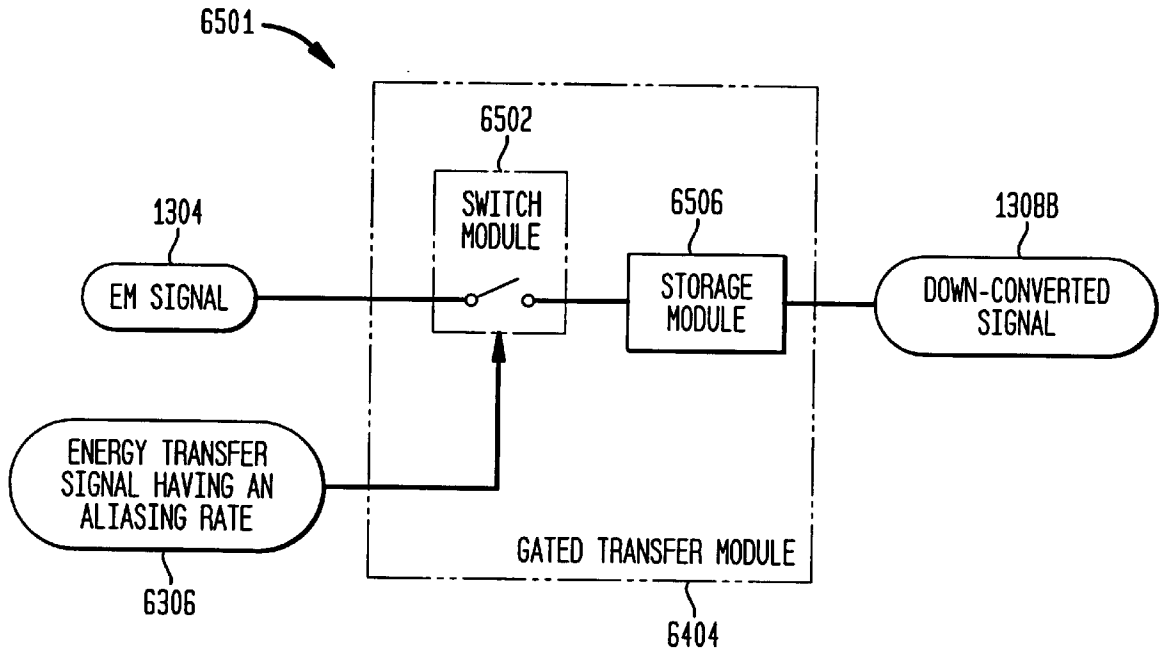


FIG. 66A

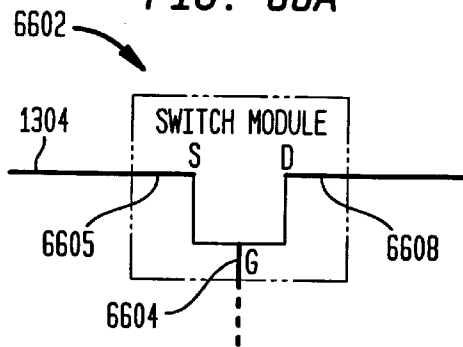
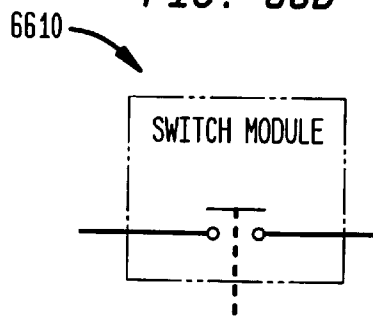
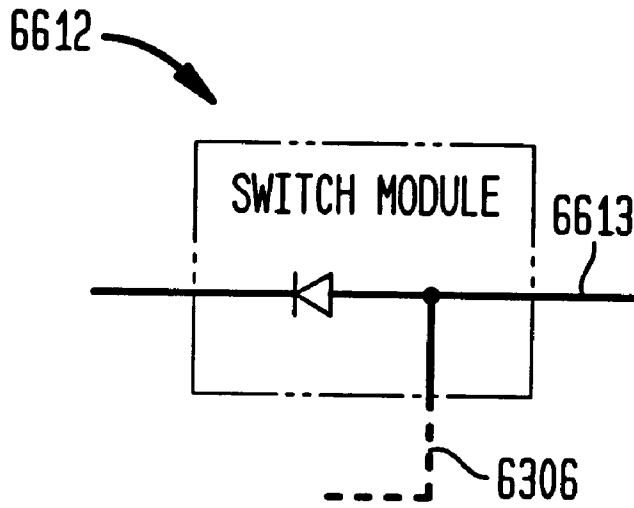


FIG. 66B





**FIG. 66C**



**FIG. 66D**

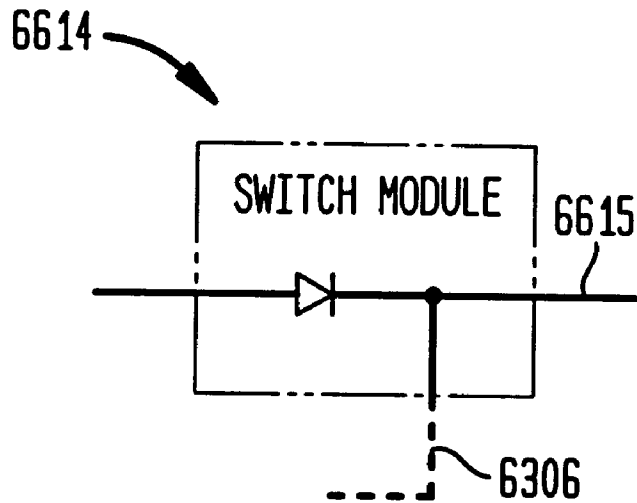


FIG. 67A

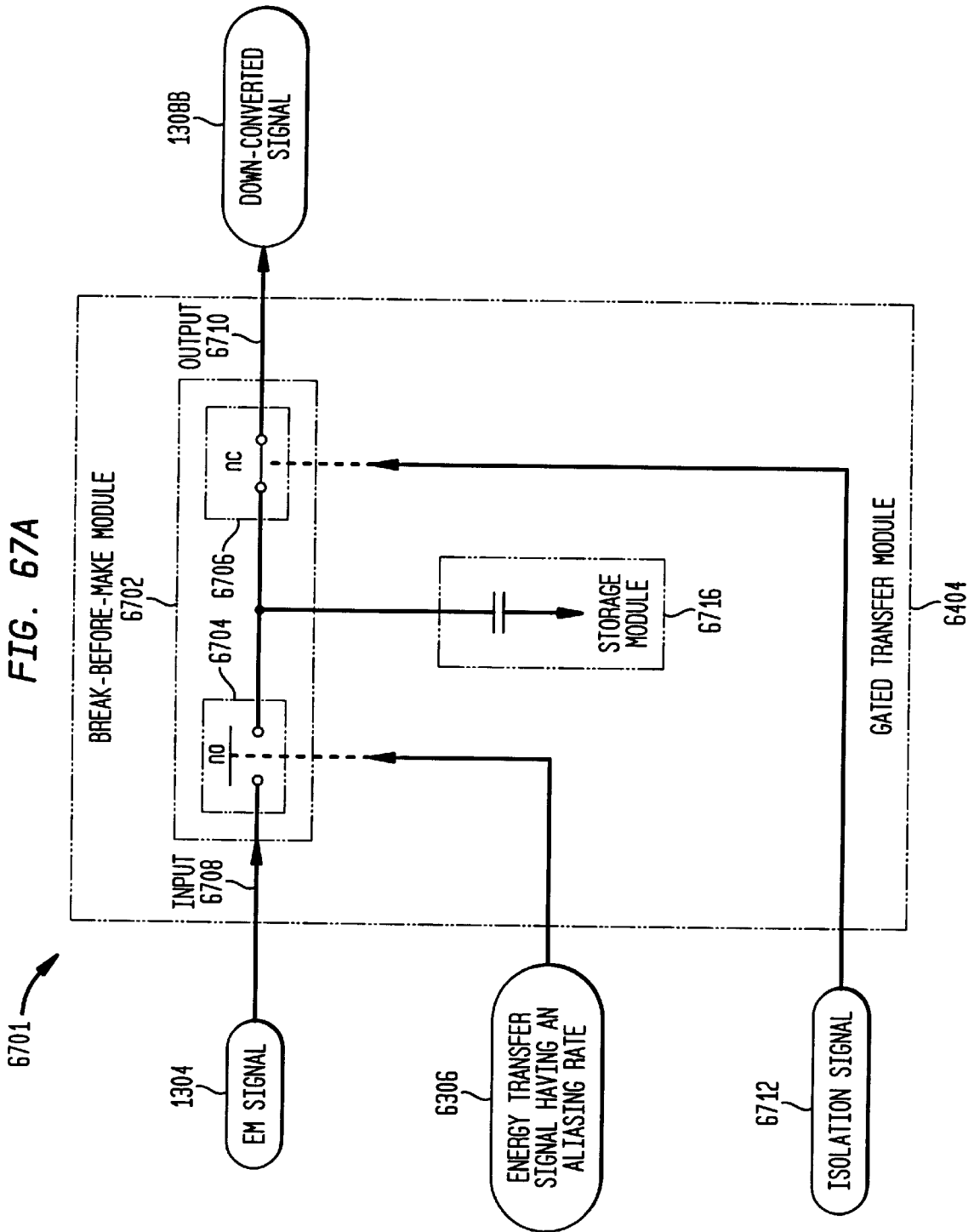


FIG. 67B

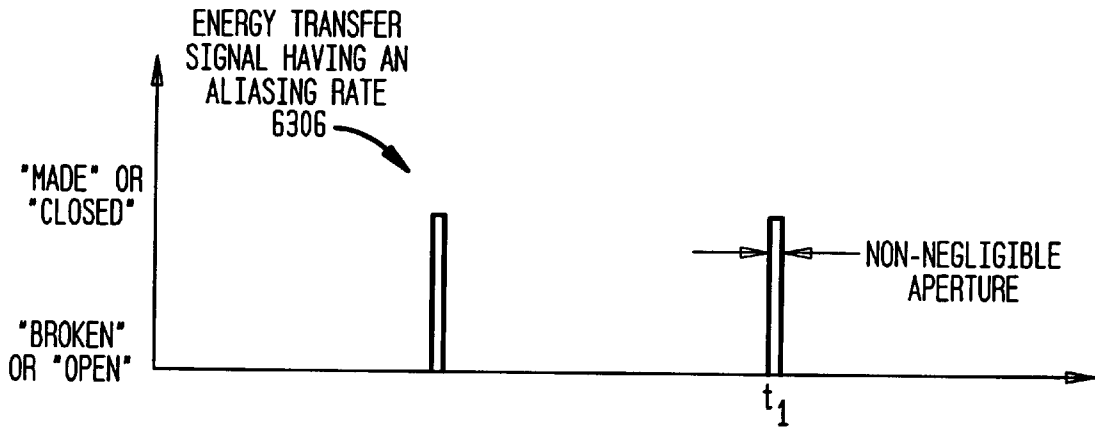


FIG. 67C

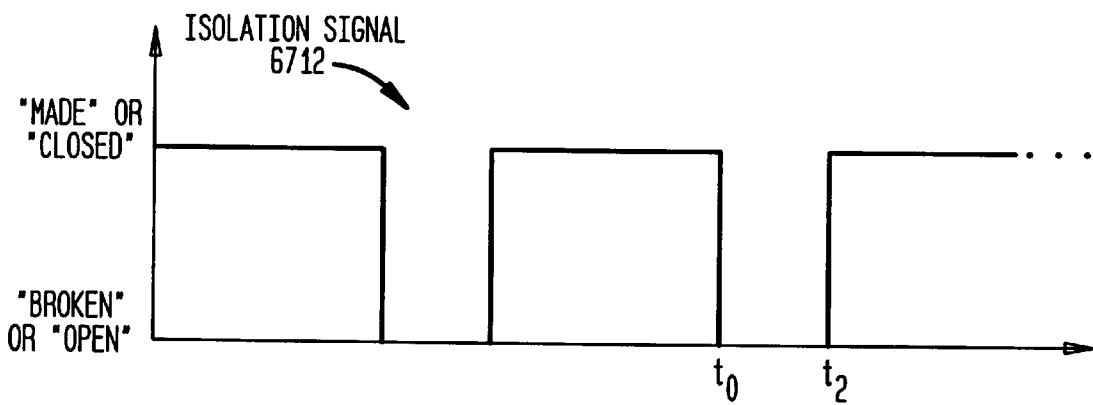


FIG. 68A

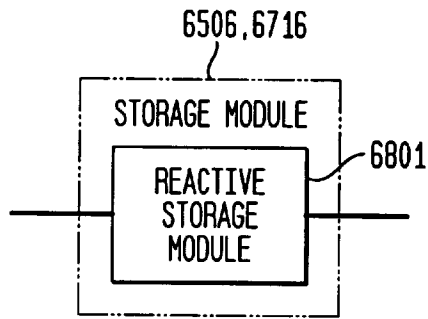


FIG. 68B

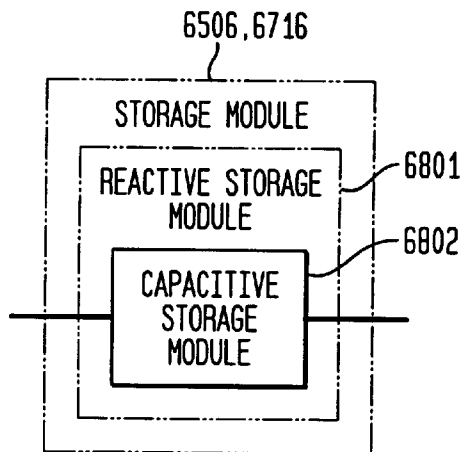


FIG. 68C

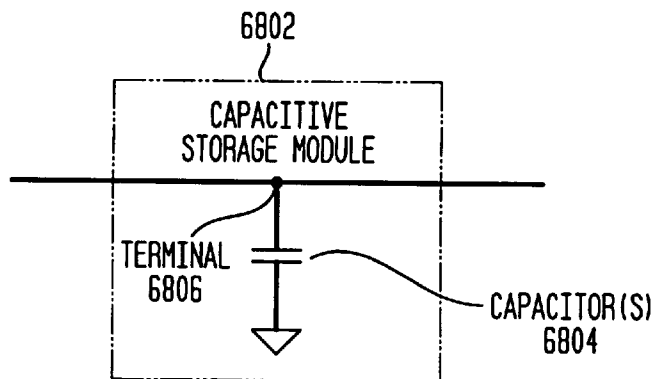


FIG. 68D

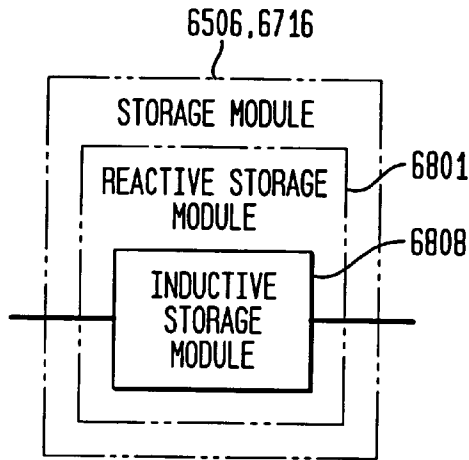


FIG. 68E

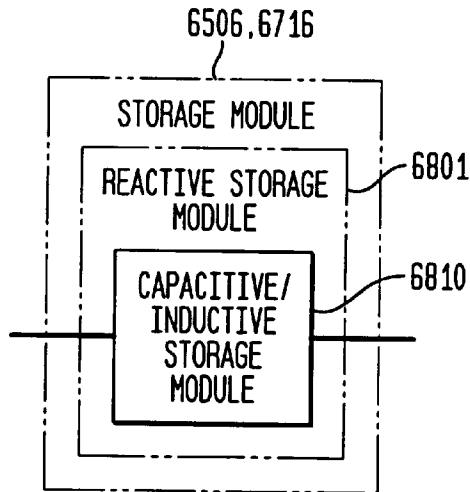


FIG. 68F

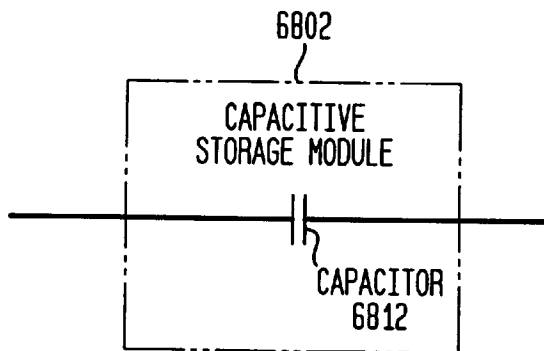


FIG. 686G

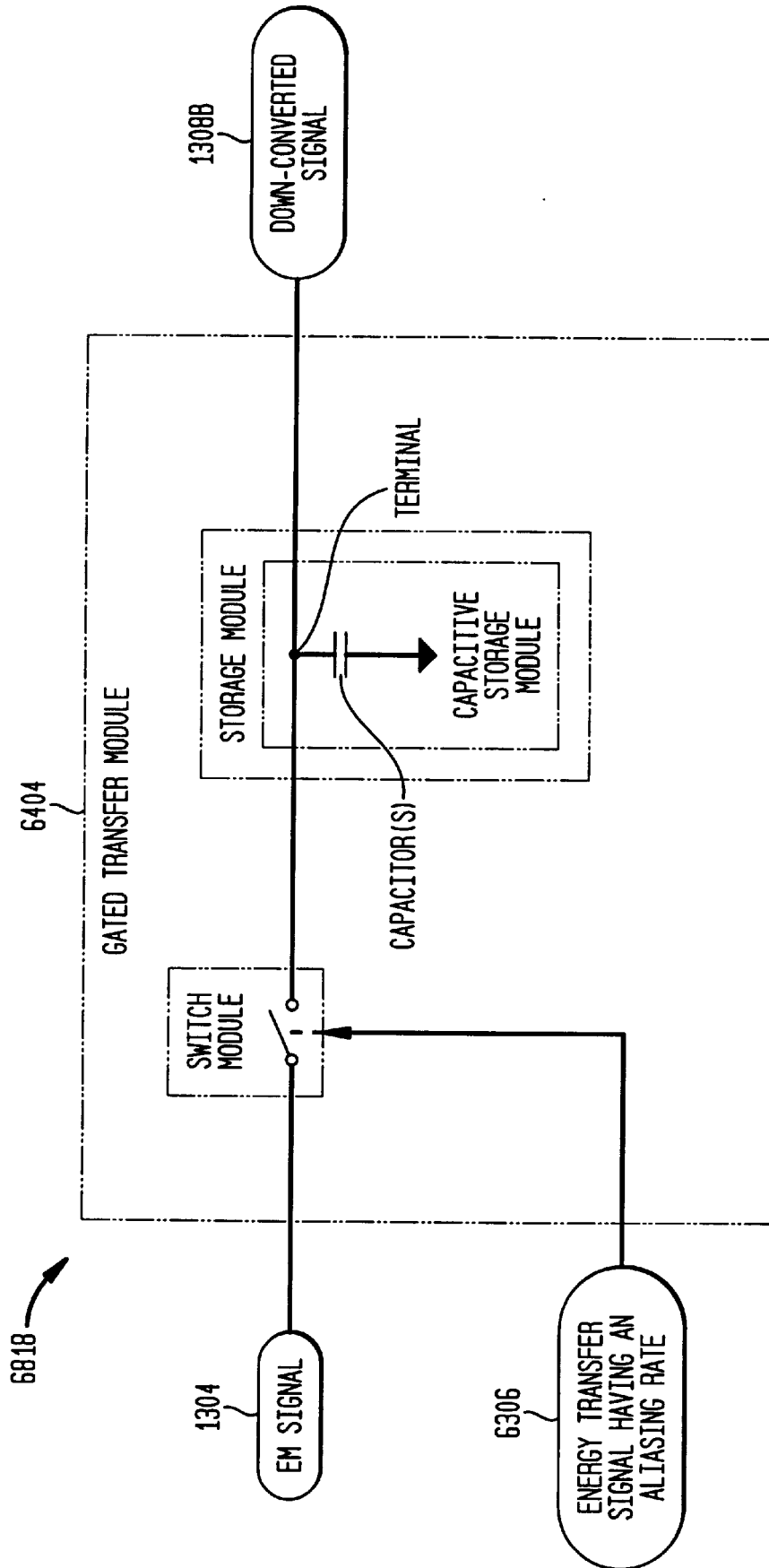


FIG. 68H

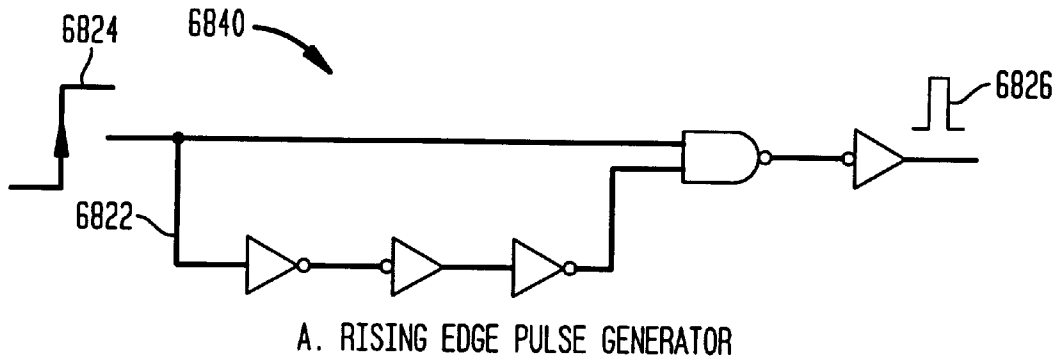


FIG. 68I

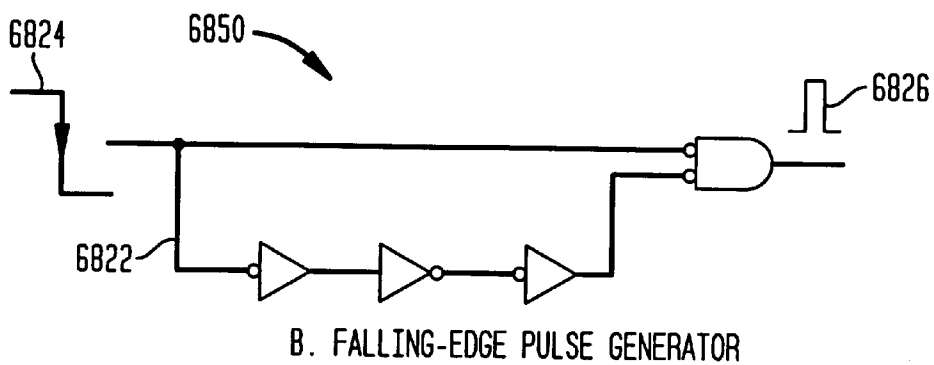


FIG. 68J

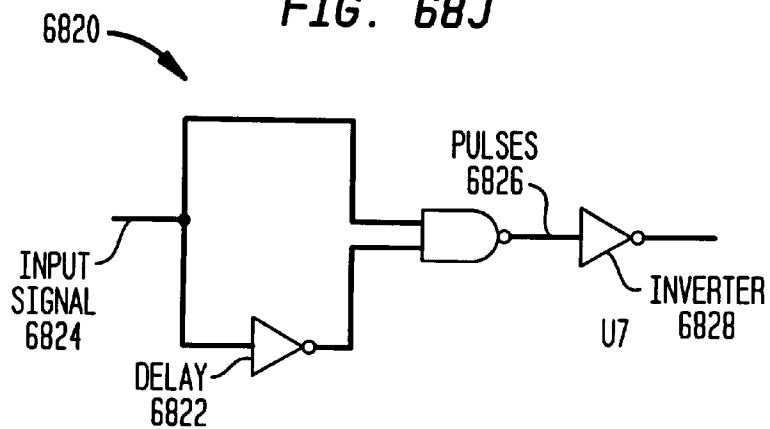


FIG. 68K

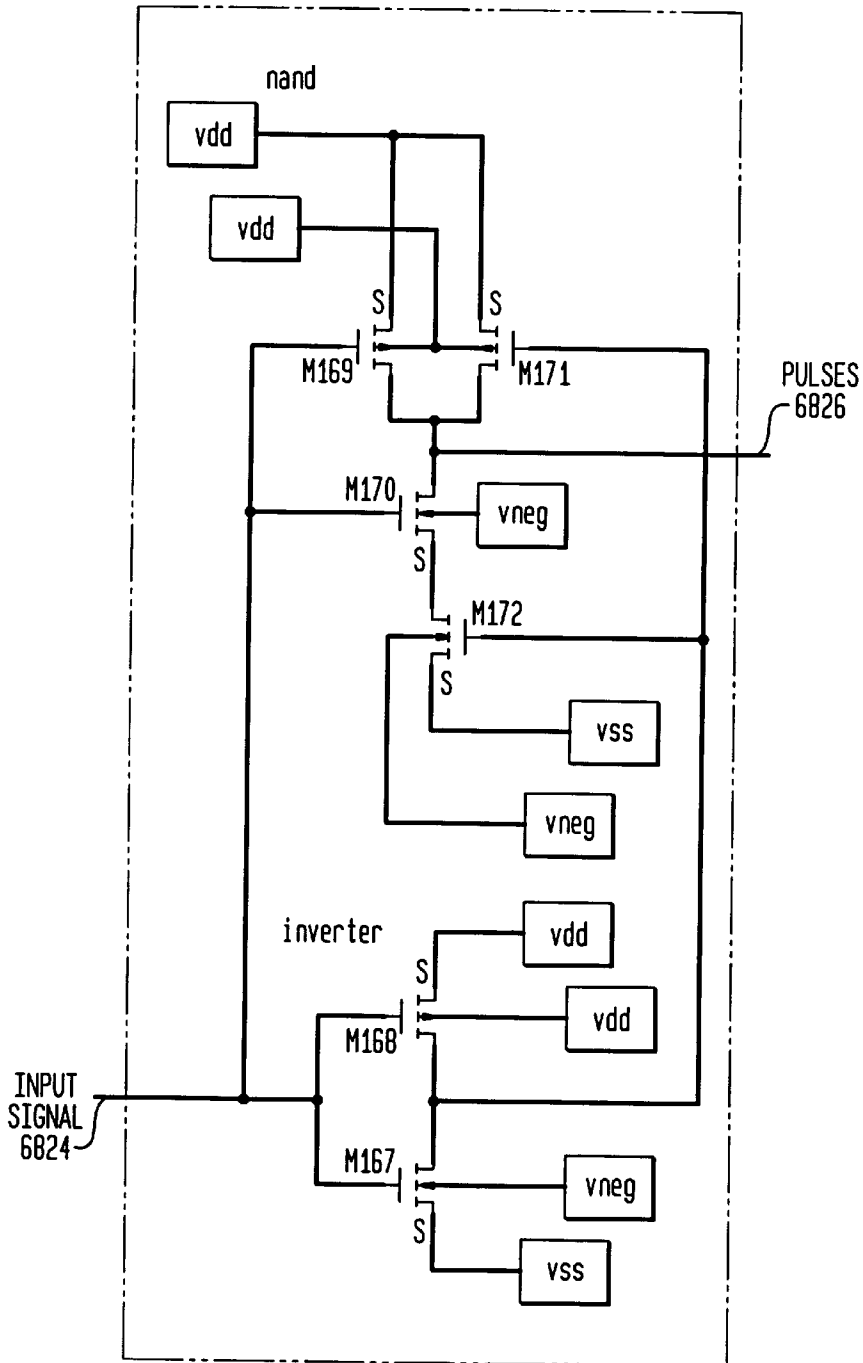


FIG. 68L

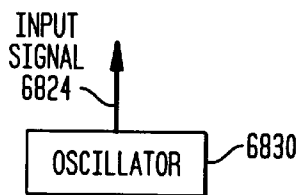




FIG. 69

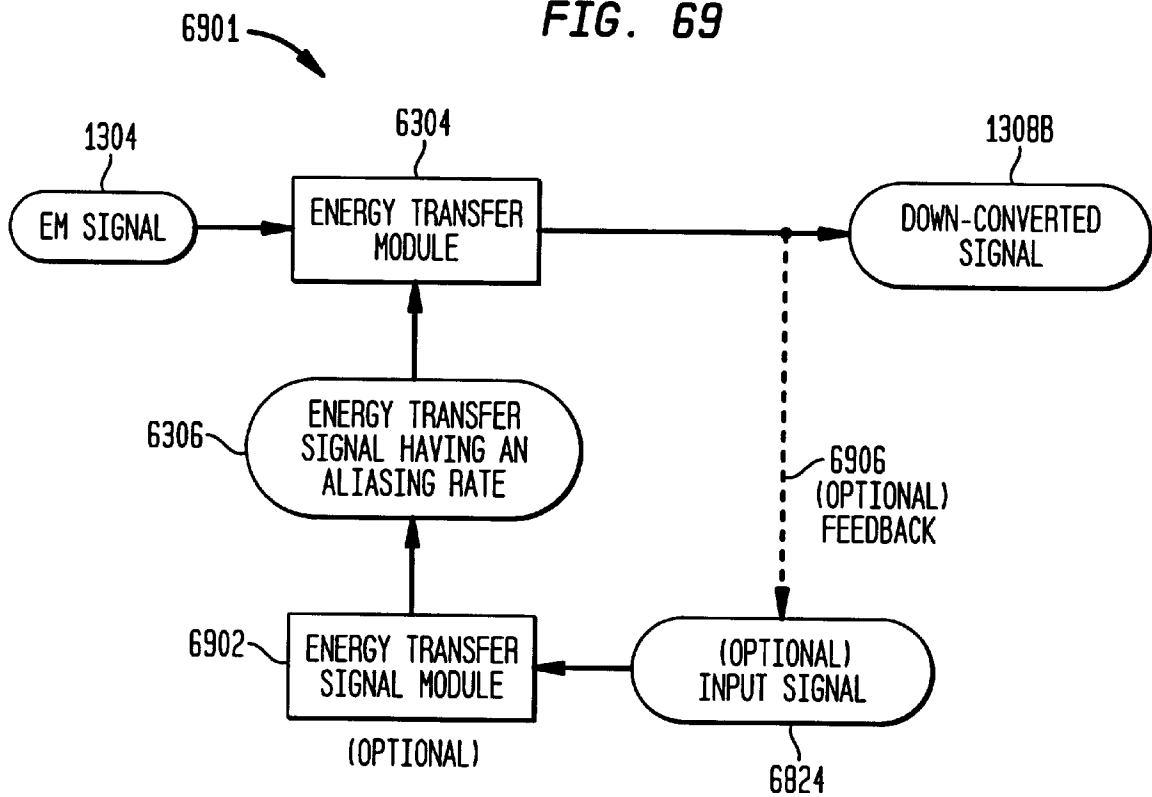


FIG. 70

IMPEDANCE MATCHED ALIASING MODULE

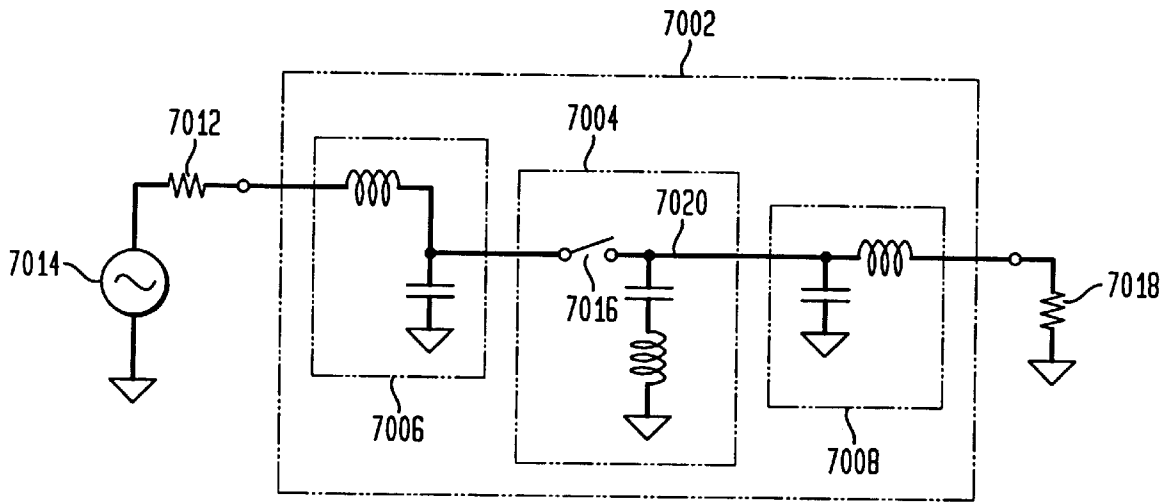


FIG. 71

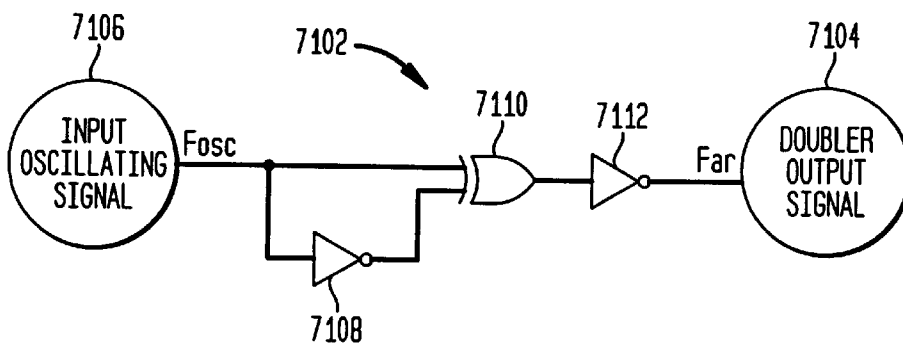


FIG. 72A

7106

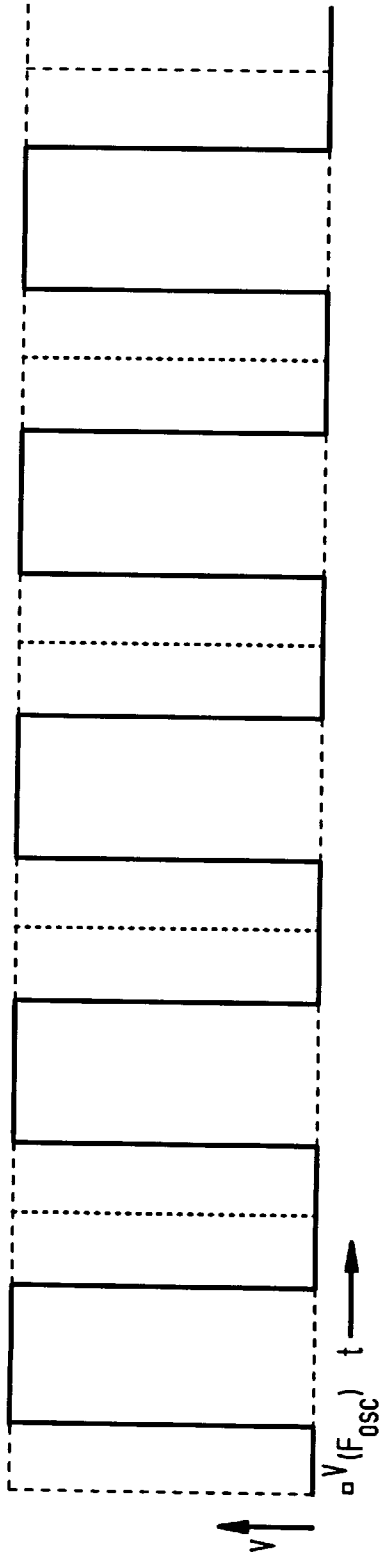
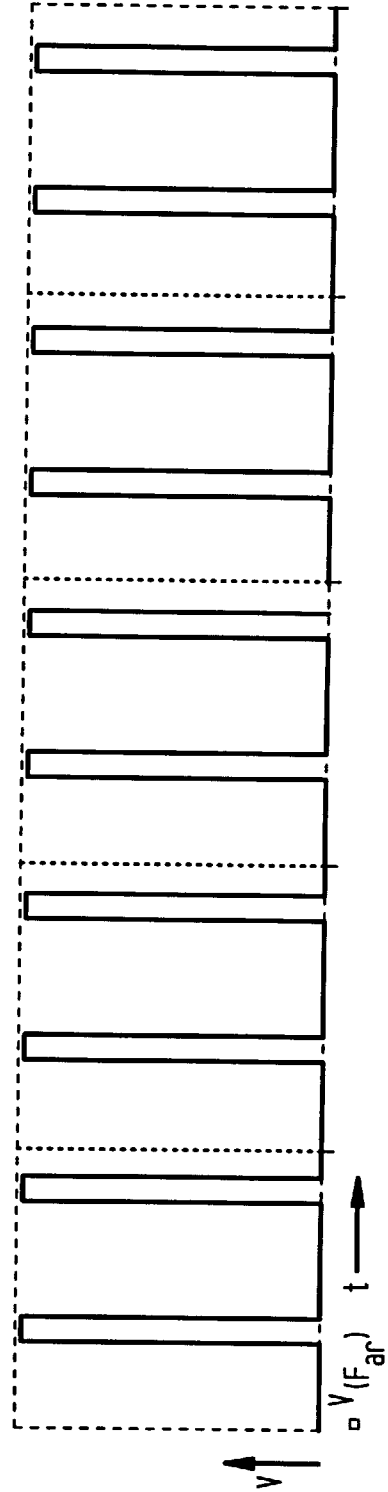
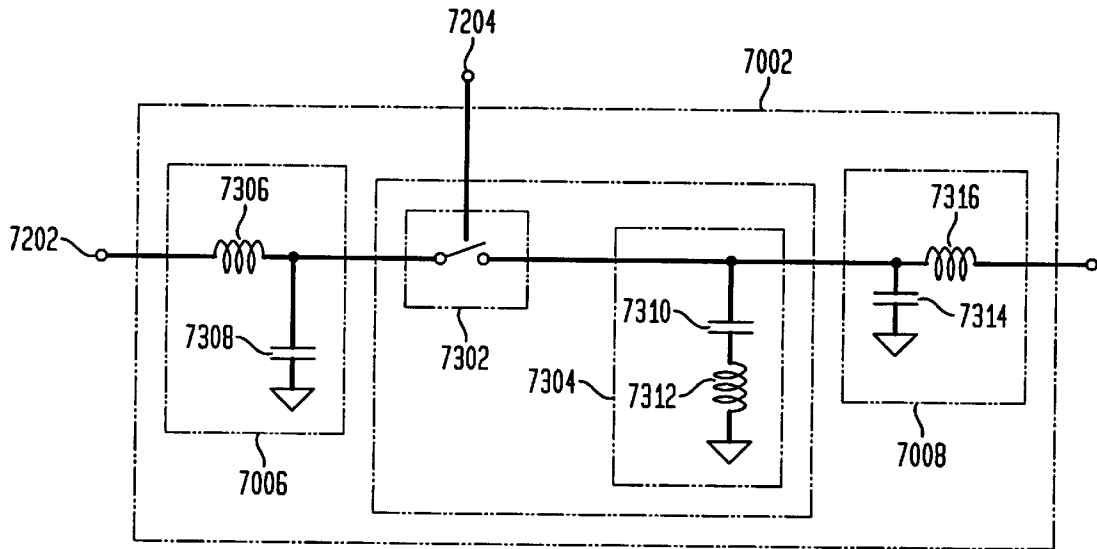


FIG. 72B

7104



**FIG. 73**  
ALIASING MODULE



**FIG. 74**

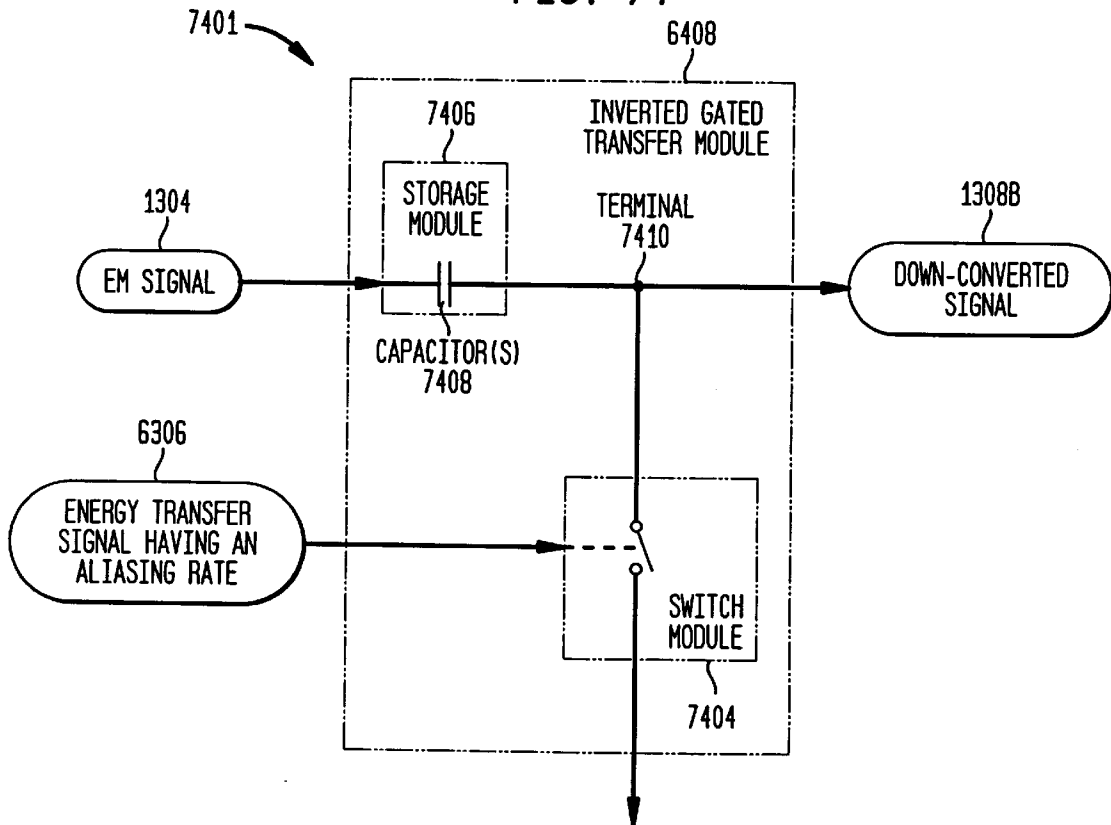


FIG. 75A

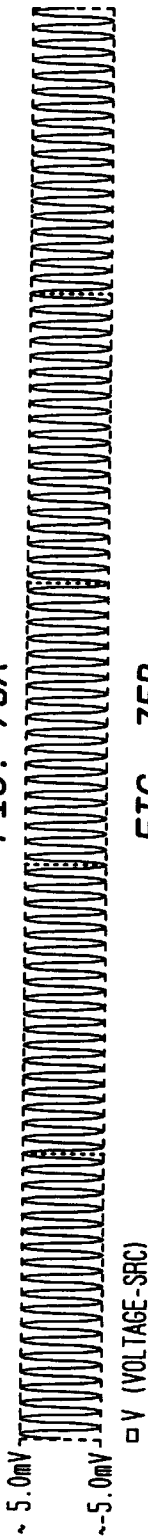


FIG. 75B

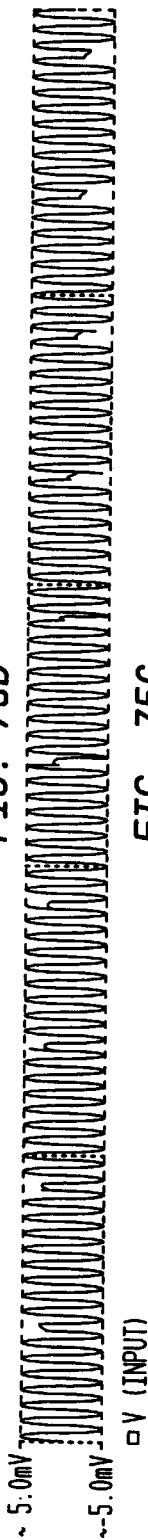


FIG. 75C

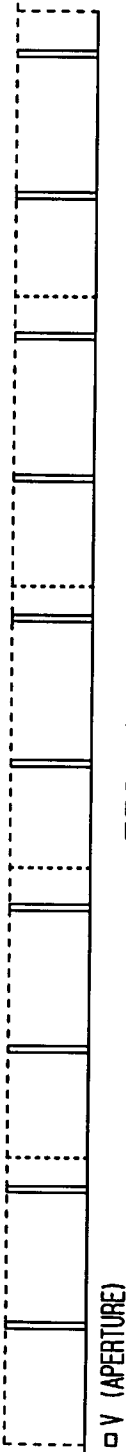


FIG. 75D

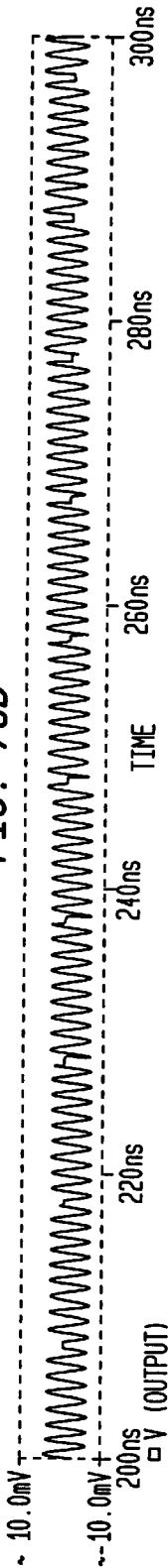


FIG. 75E

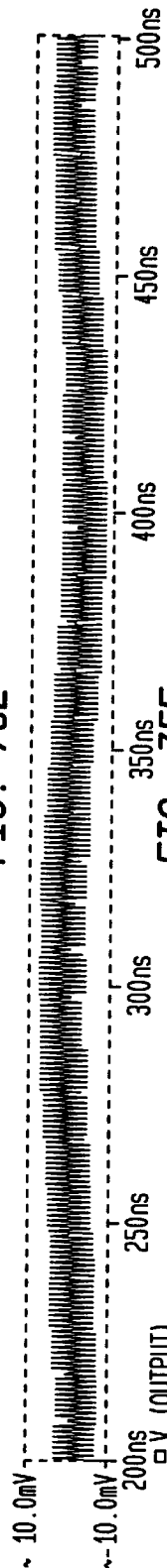
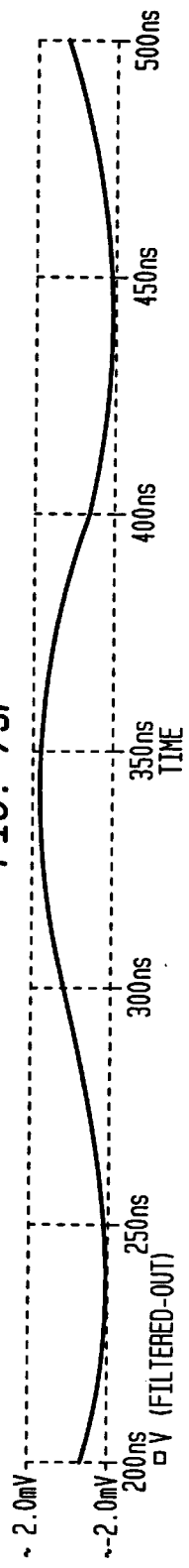
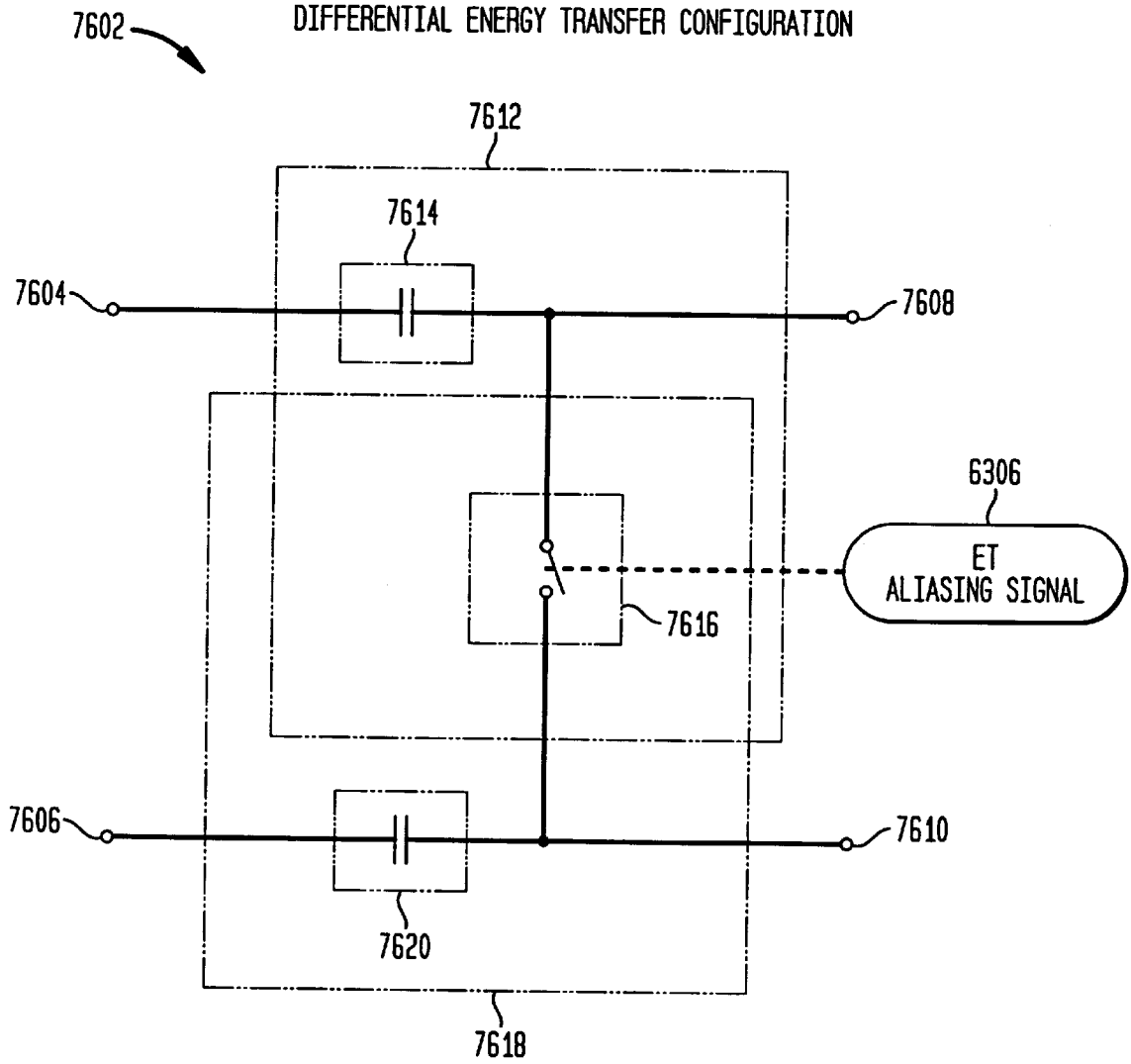


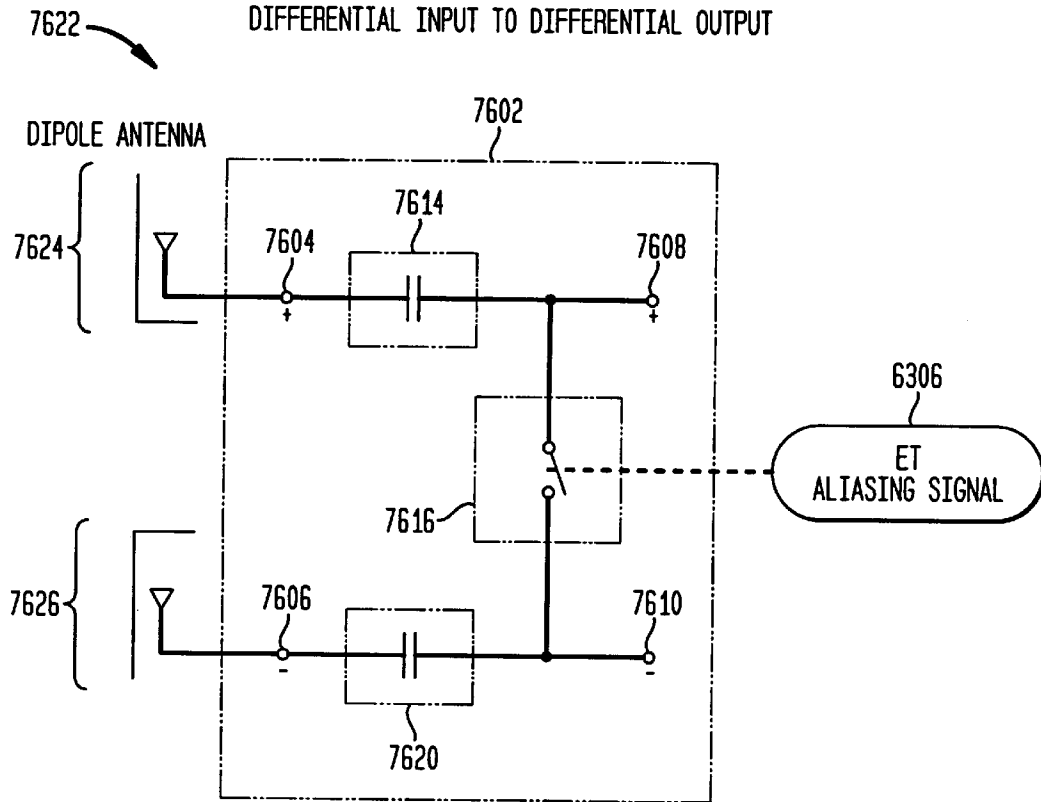
FIG. 75F



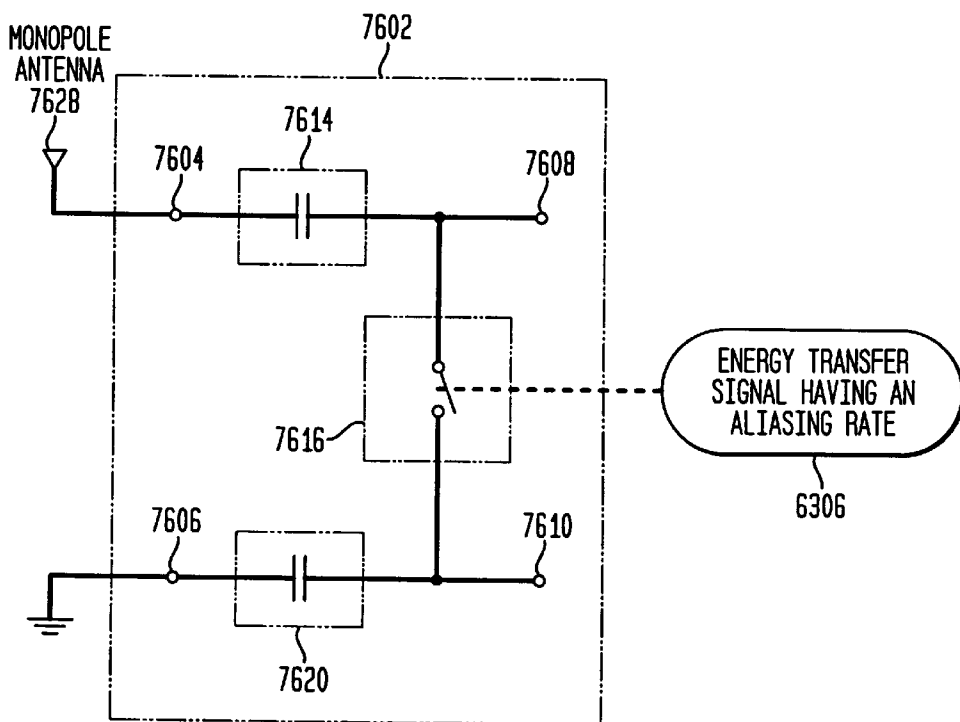
**FIG. 76A**  
DIFFERENTIAL ENERGY TRANSFER CONFIGURATION



**FIG. 76B**  
DIFFERENTIAL INPUT TO DIFFERENTIAL OUTPUT



**FIG. 76C**  
SINGLE INPUT TO DIFFERENTIAL OUTPUT



**FIG. 76D**  
DIFFERENTIAL INPUT TO SINGLE OUTPUT

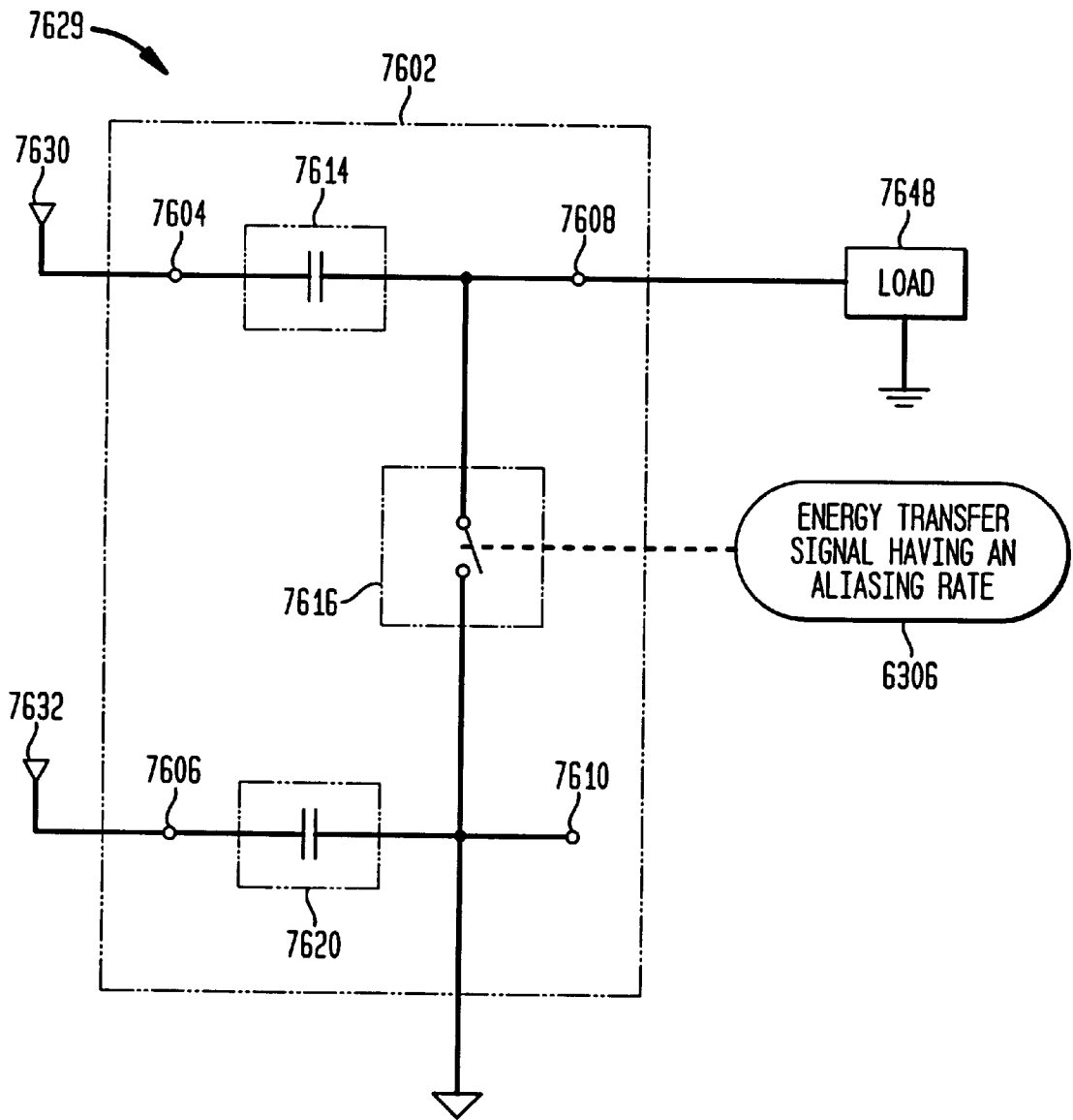




FIG. 76E  
EXAMPLE INPUT/OUTPUT CIRCUITRY

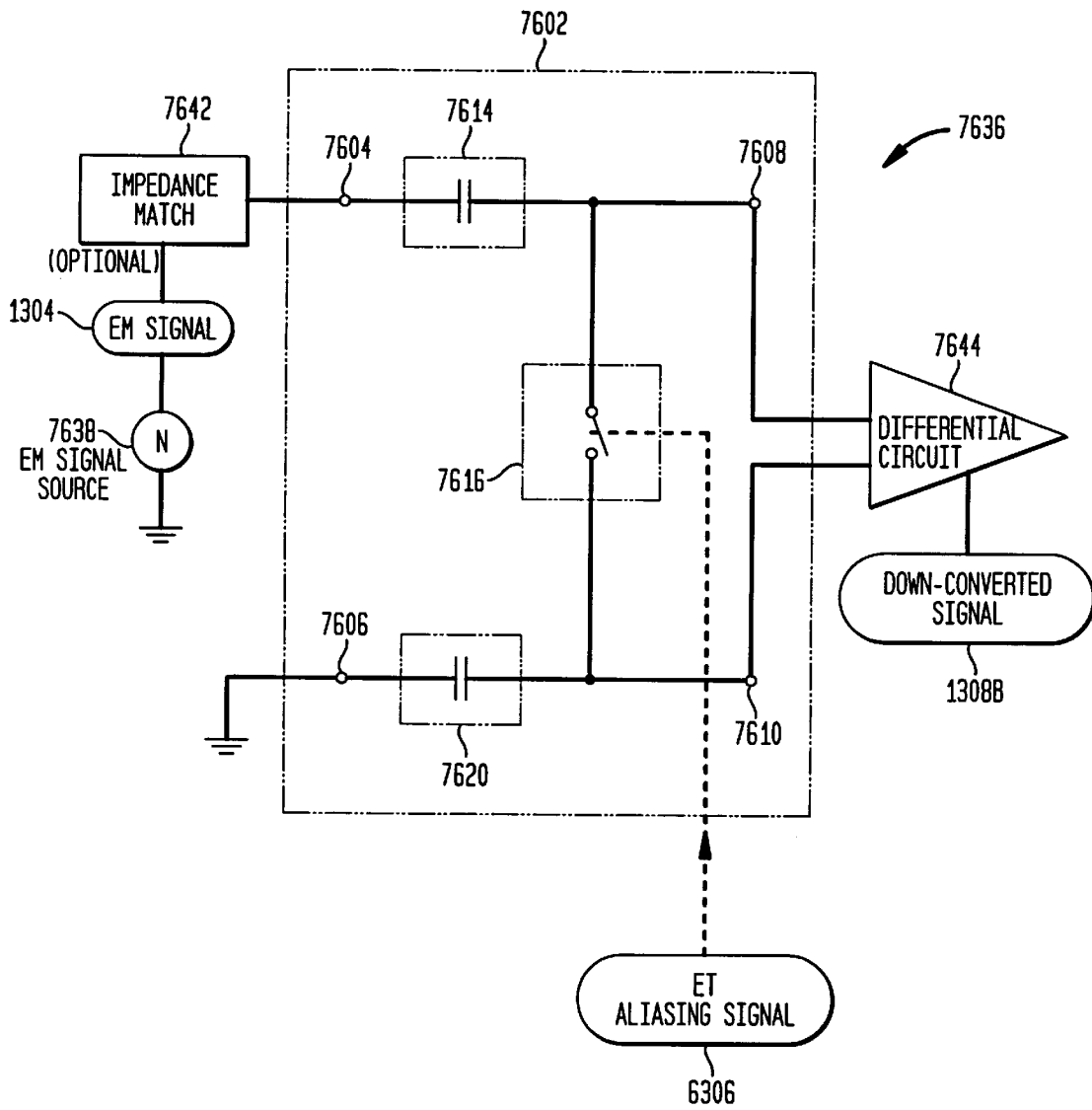


FIG. 77A

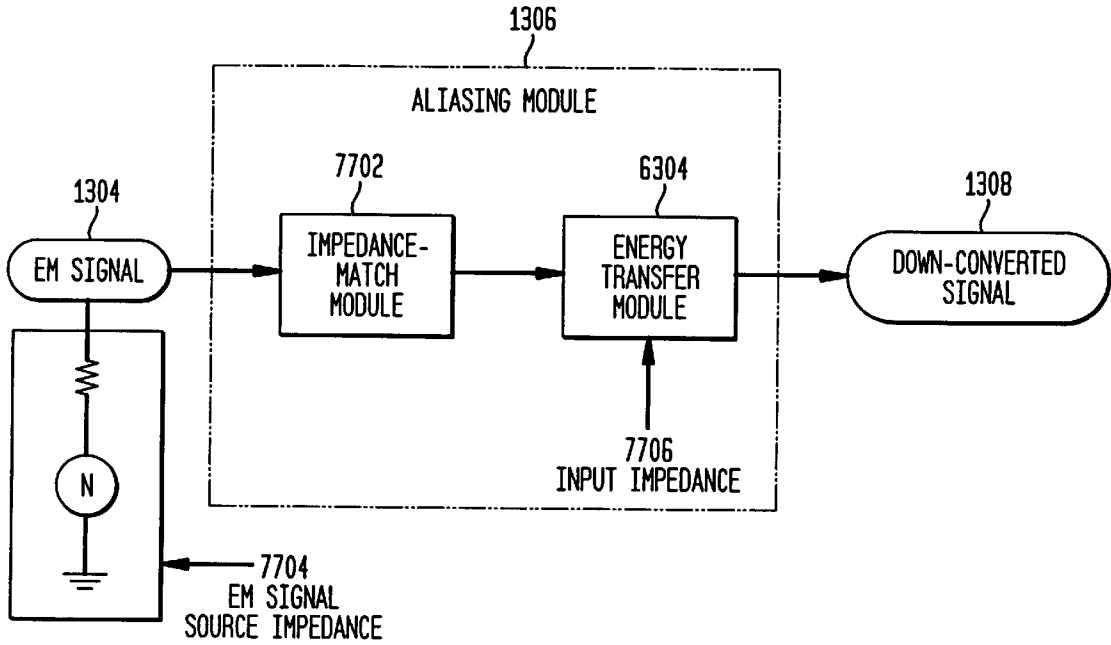


FIG. 77B

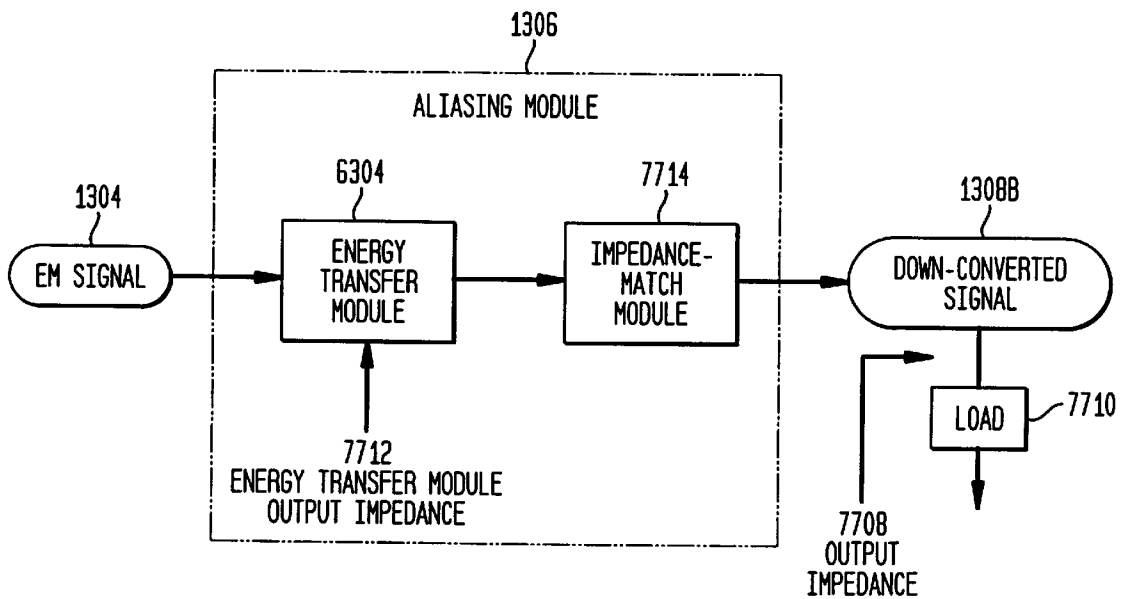


FIG. 77C

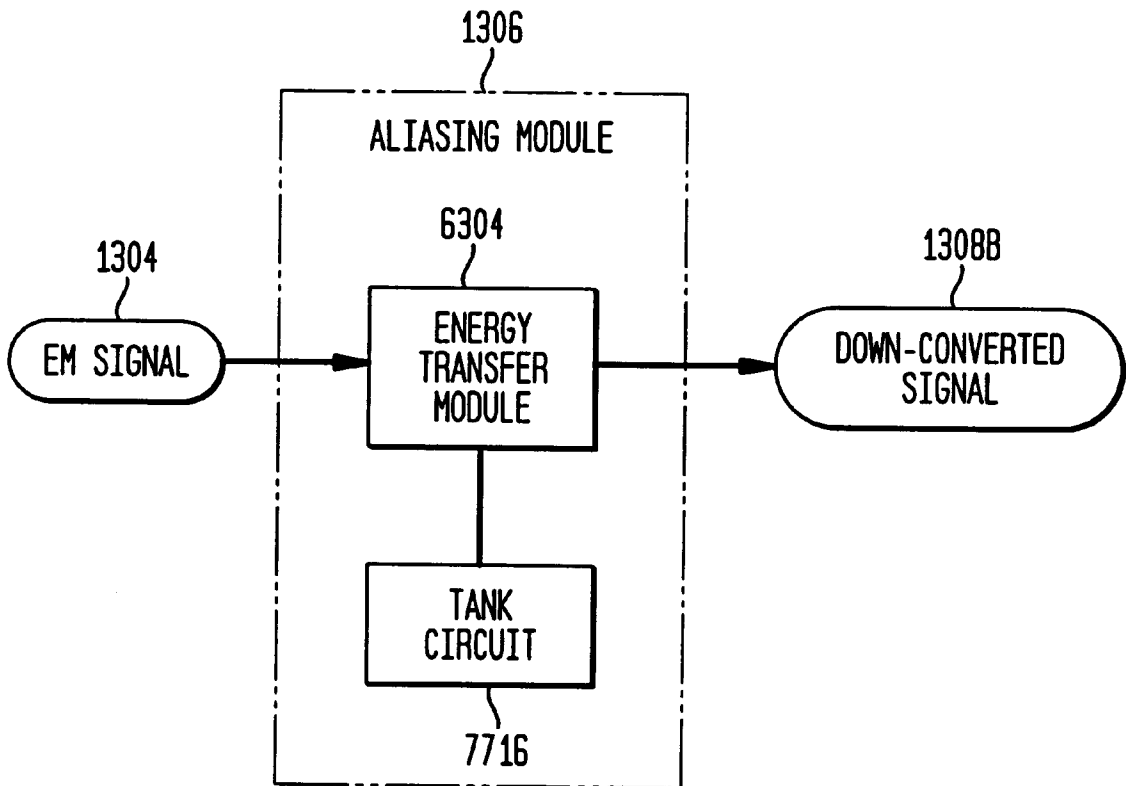


FIG. 78A

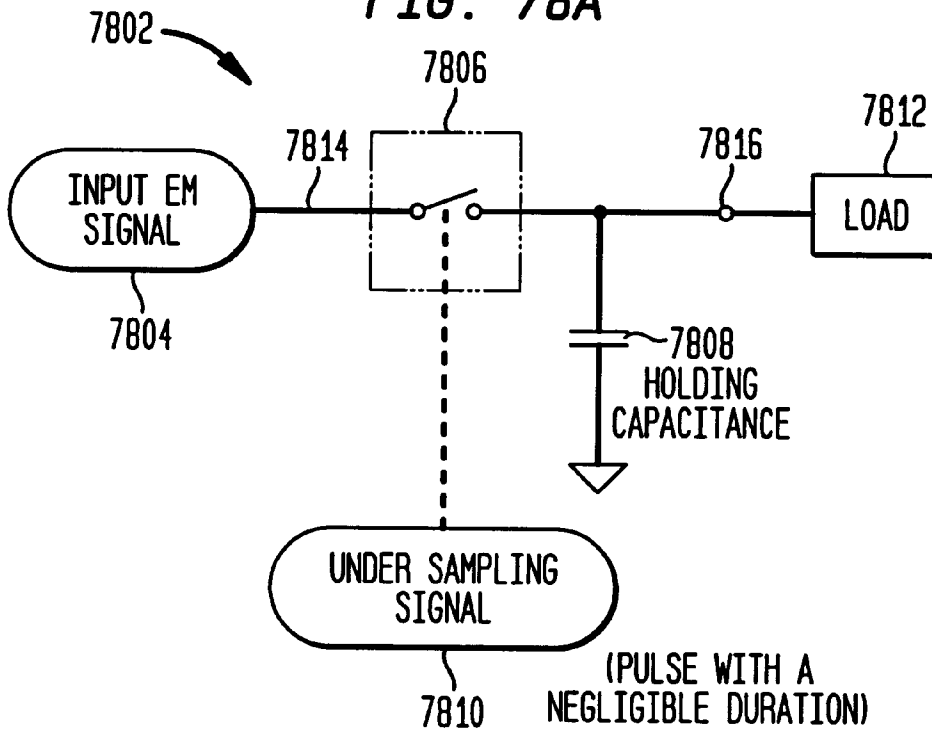
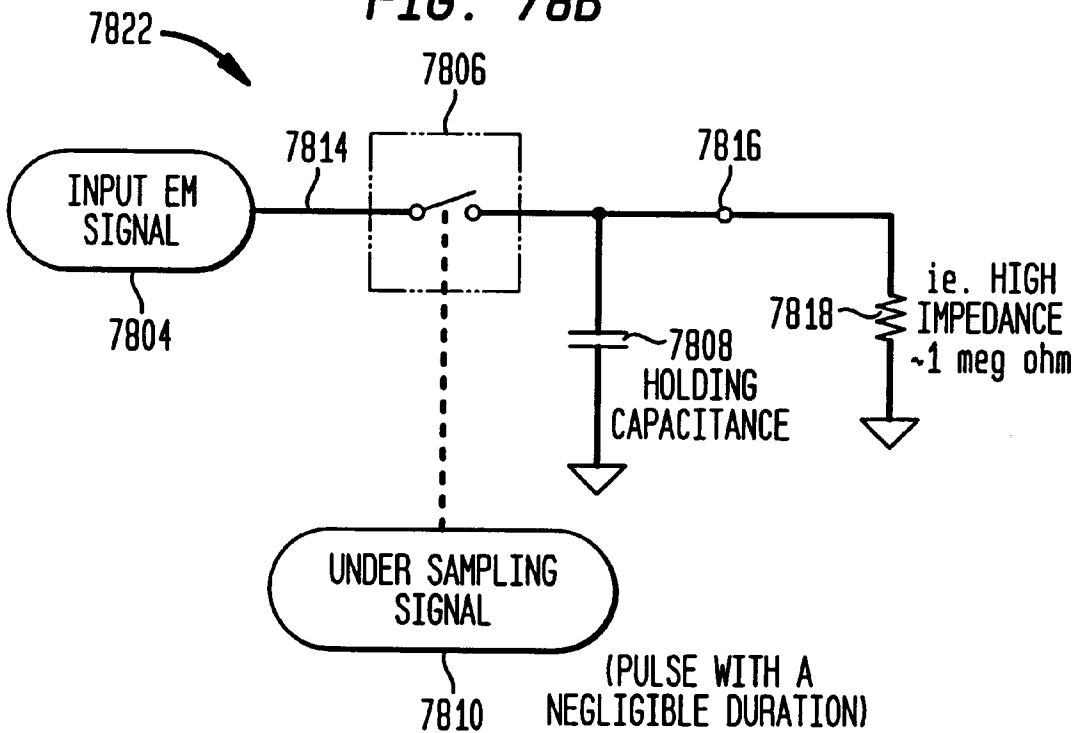


FIG. 78B



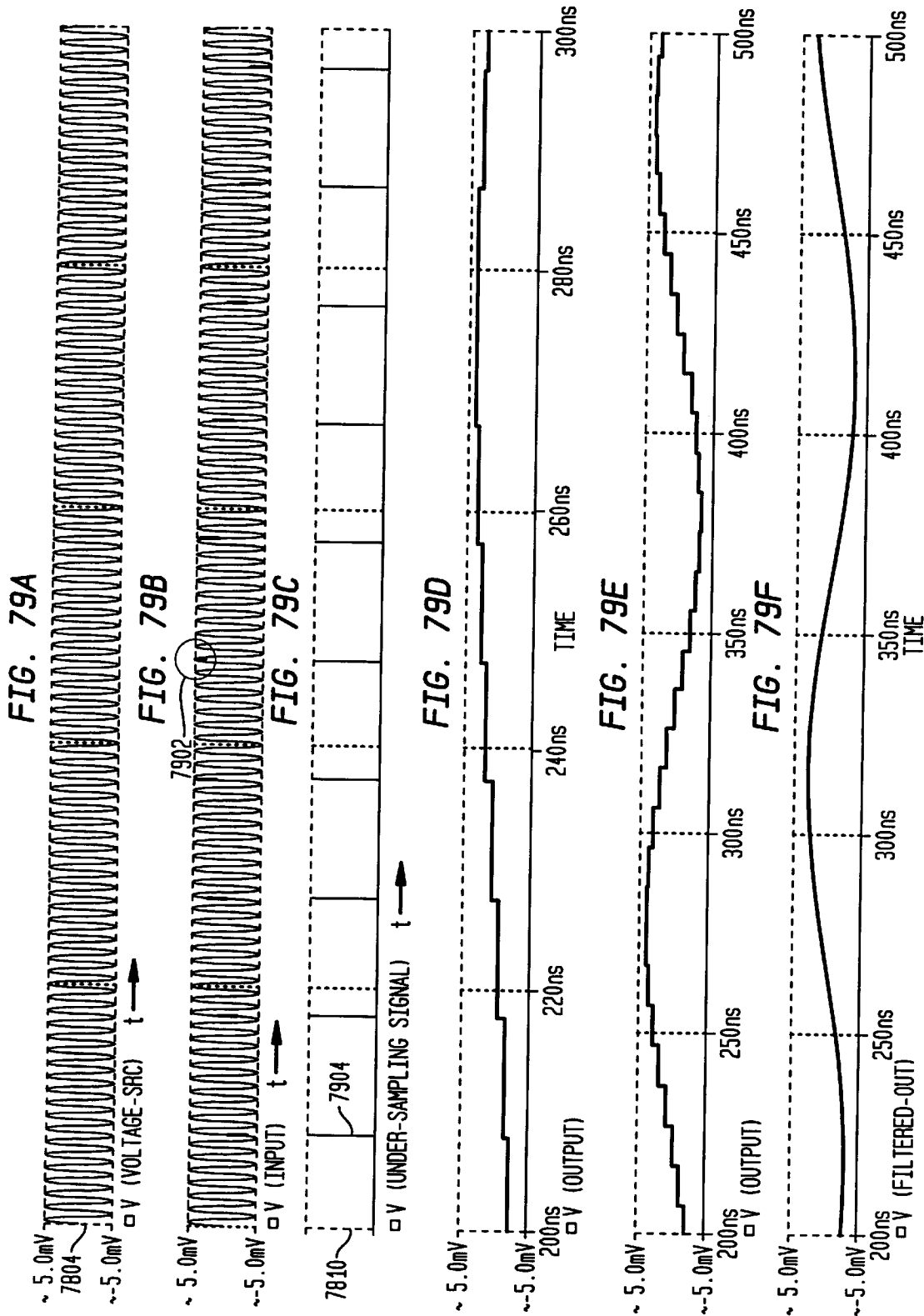


FIG. 80A

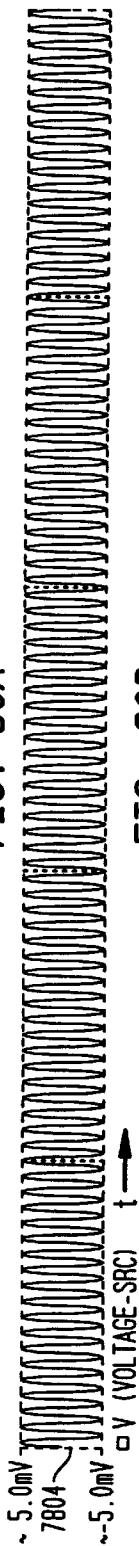


FIG. 80B

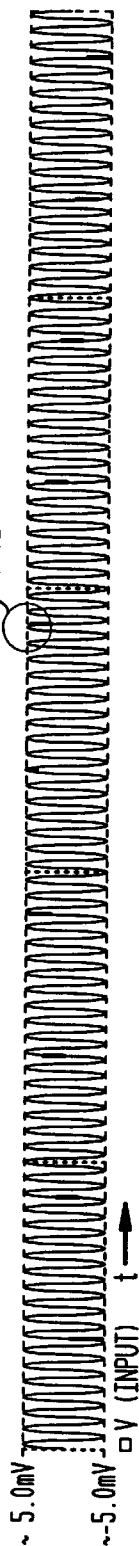


FIG. 80C

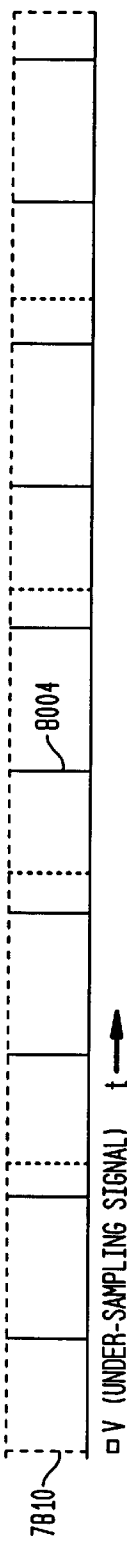


FIG. 80D

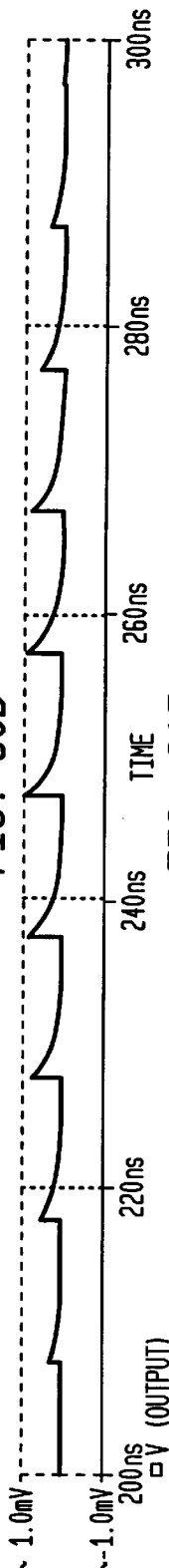


FIG. 80E

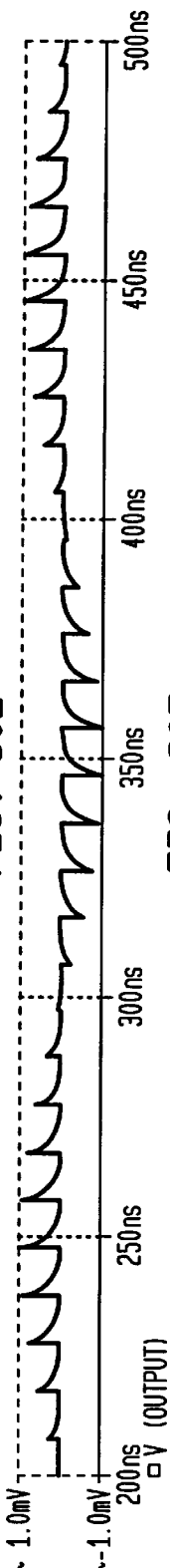


FIG. 80F

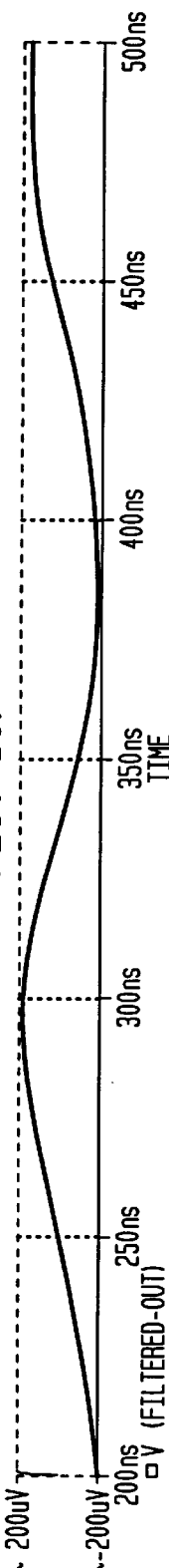


FIG. 81A

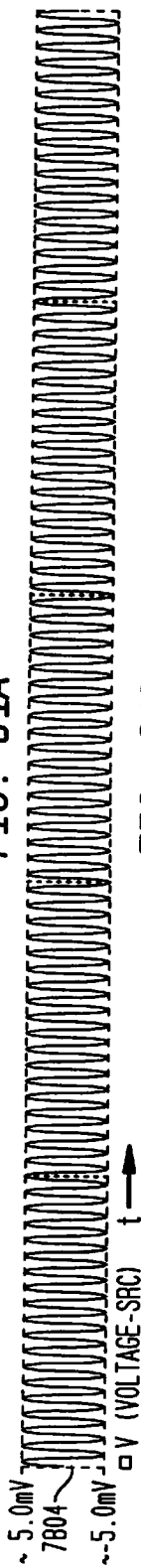


FIG. 81B

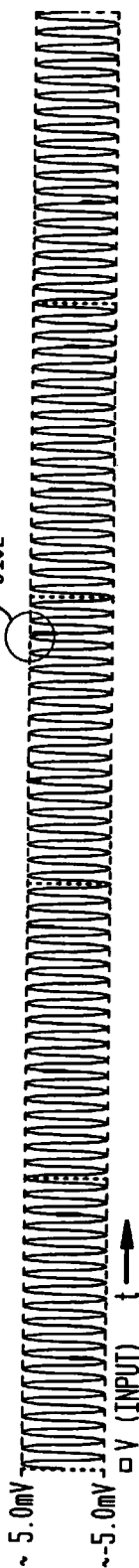


FIG. 81C

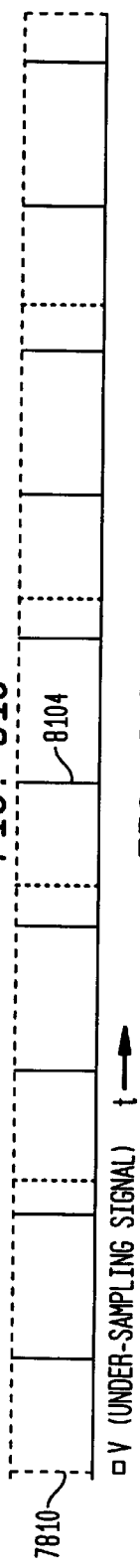


FIG. 81D

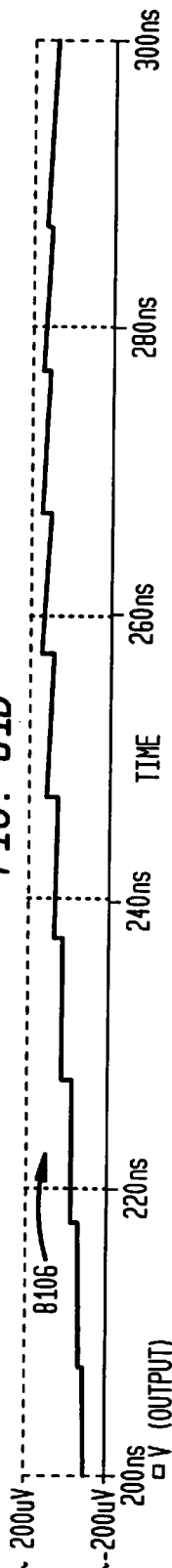


FIG. 81E

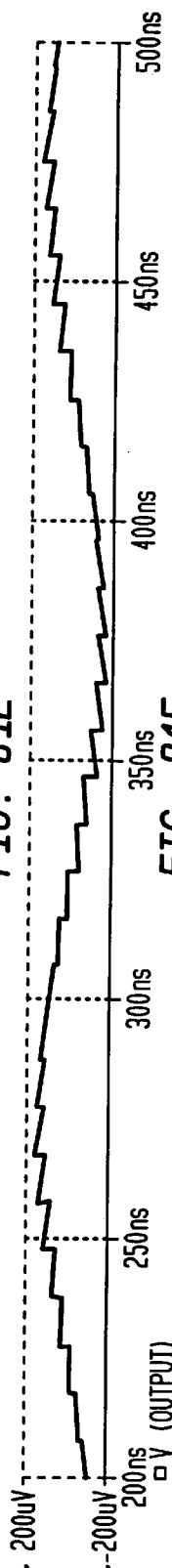
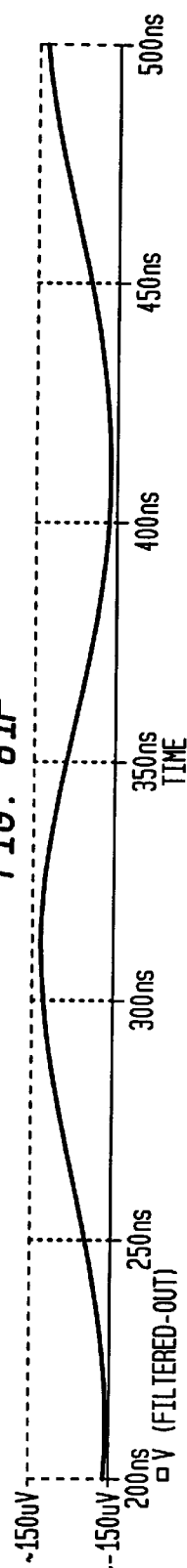


FIG. 81F



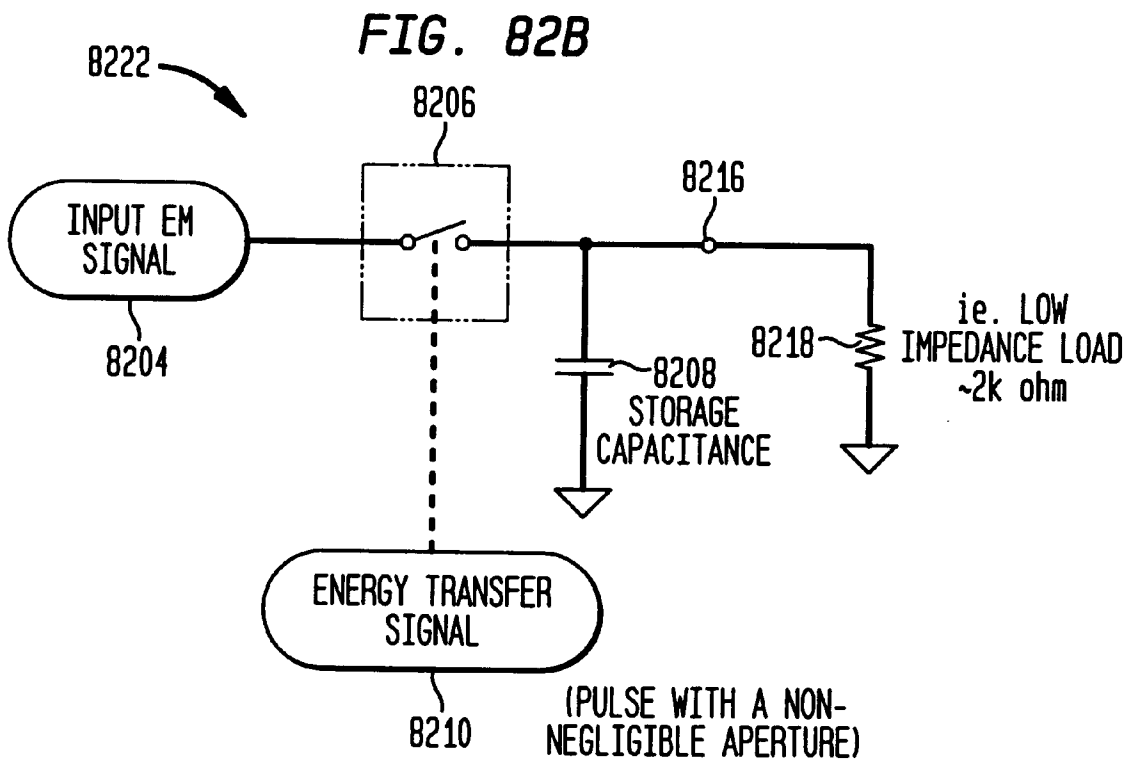
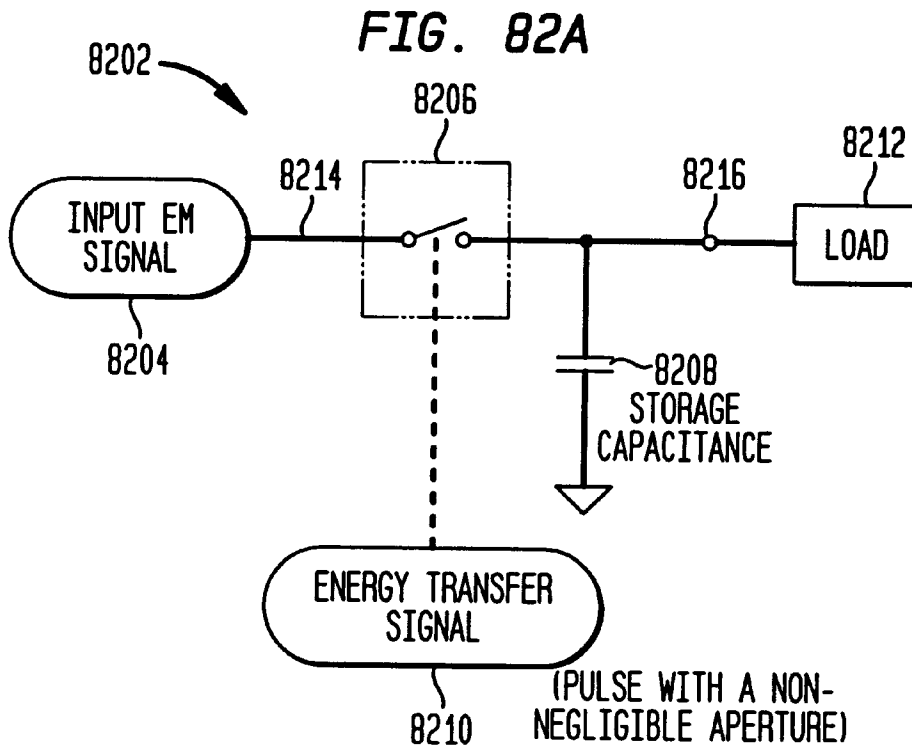




FIG. 83A

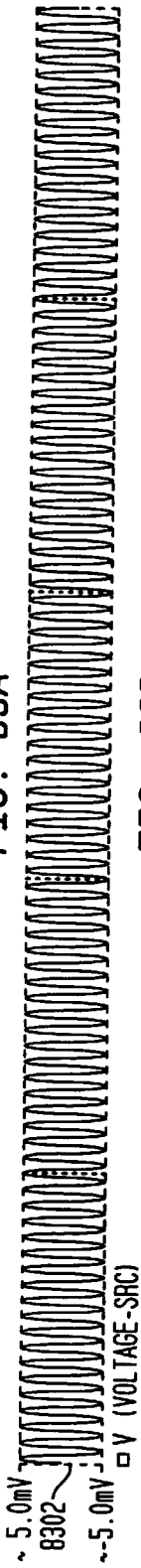


FIG. 83B



FIG. 83C

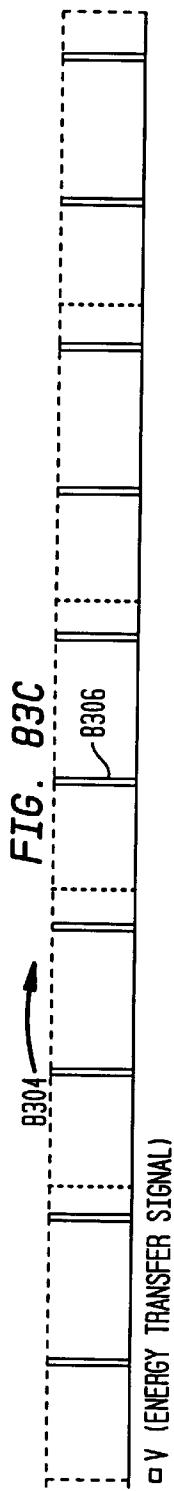


FIG. 83D

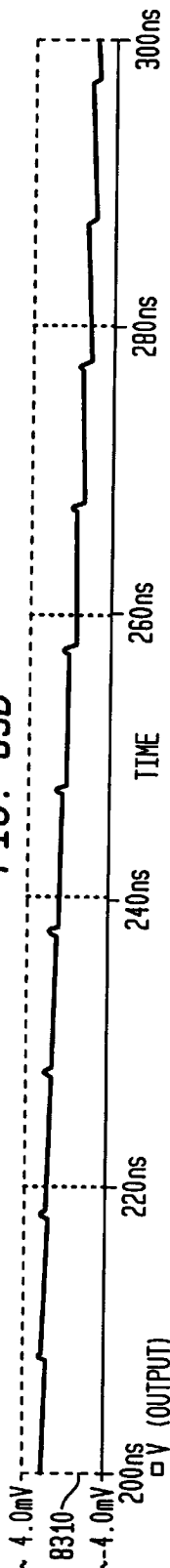


FIG. 83E

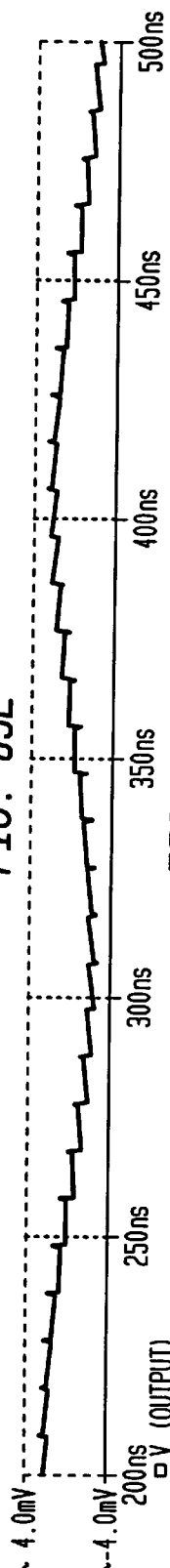


FIG. 83F

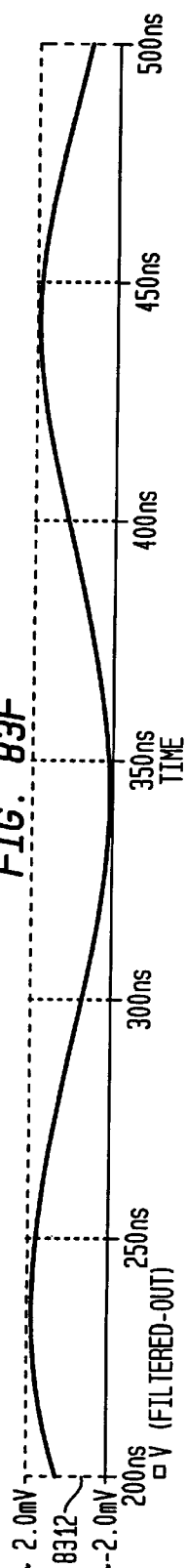


FIG. 84A

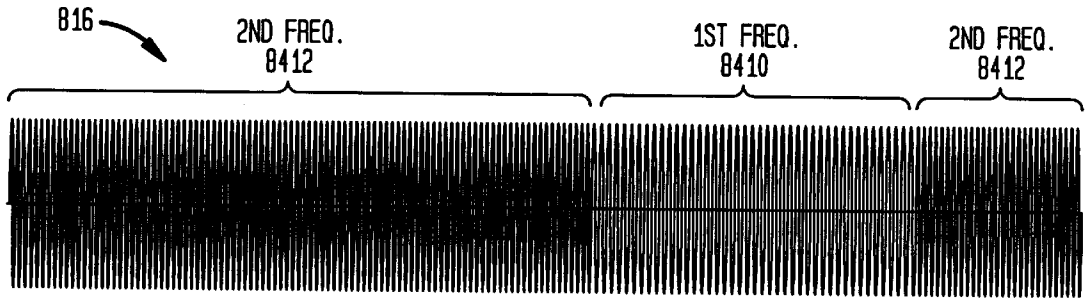


FIG. 84B

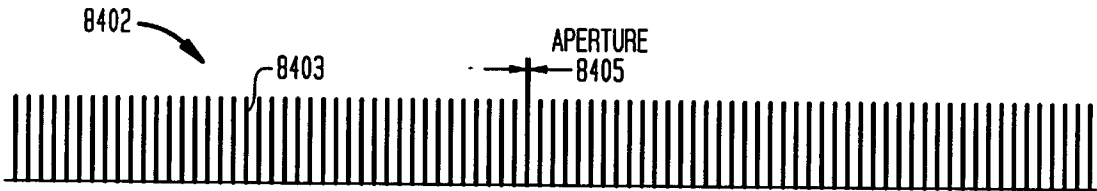


FIG. 84C

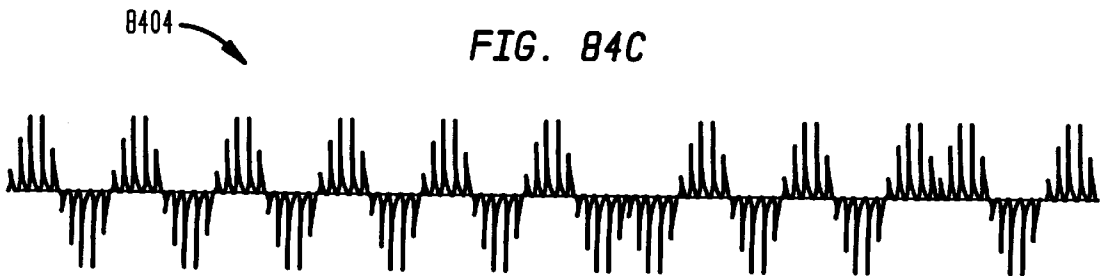


FIG. 84D

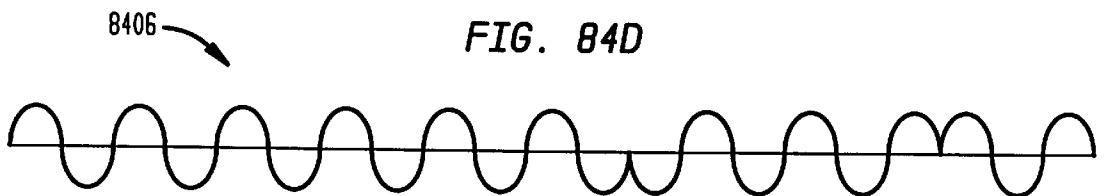


FIG. 85A

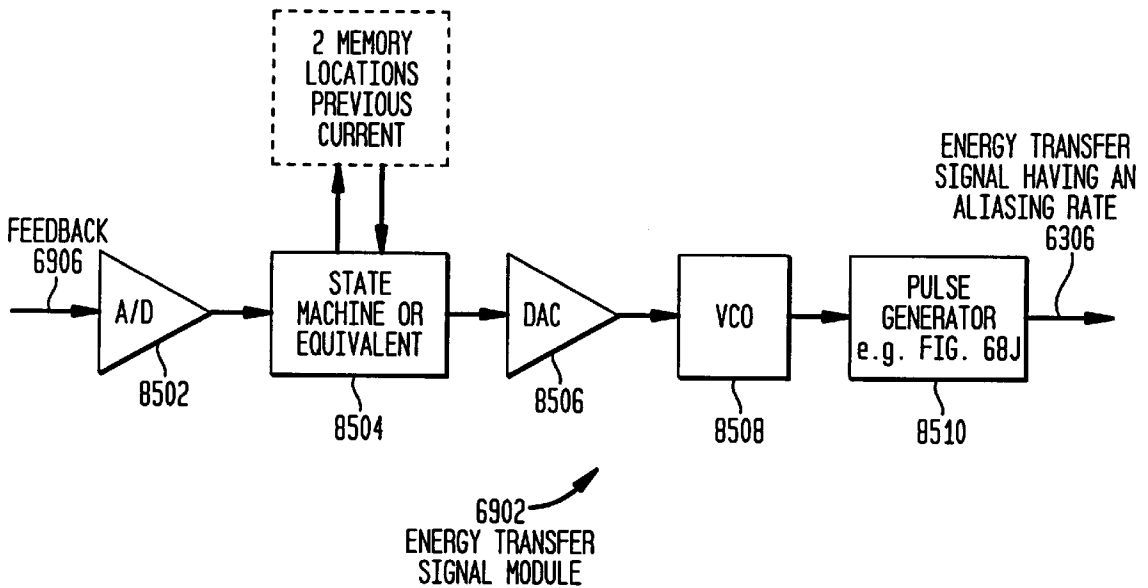


FIG. 85B

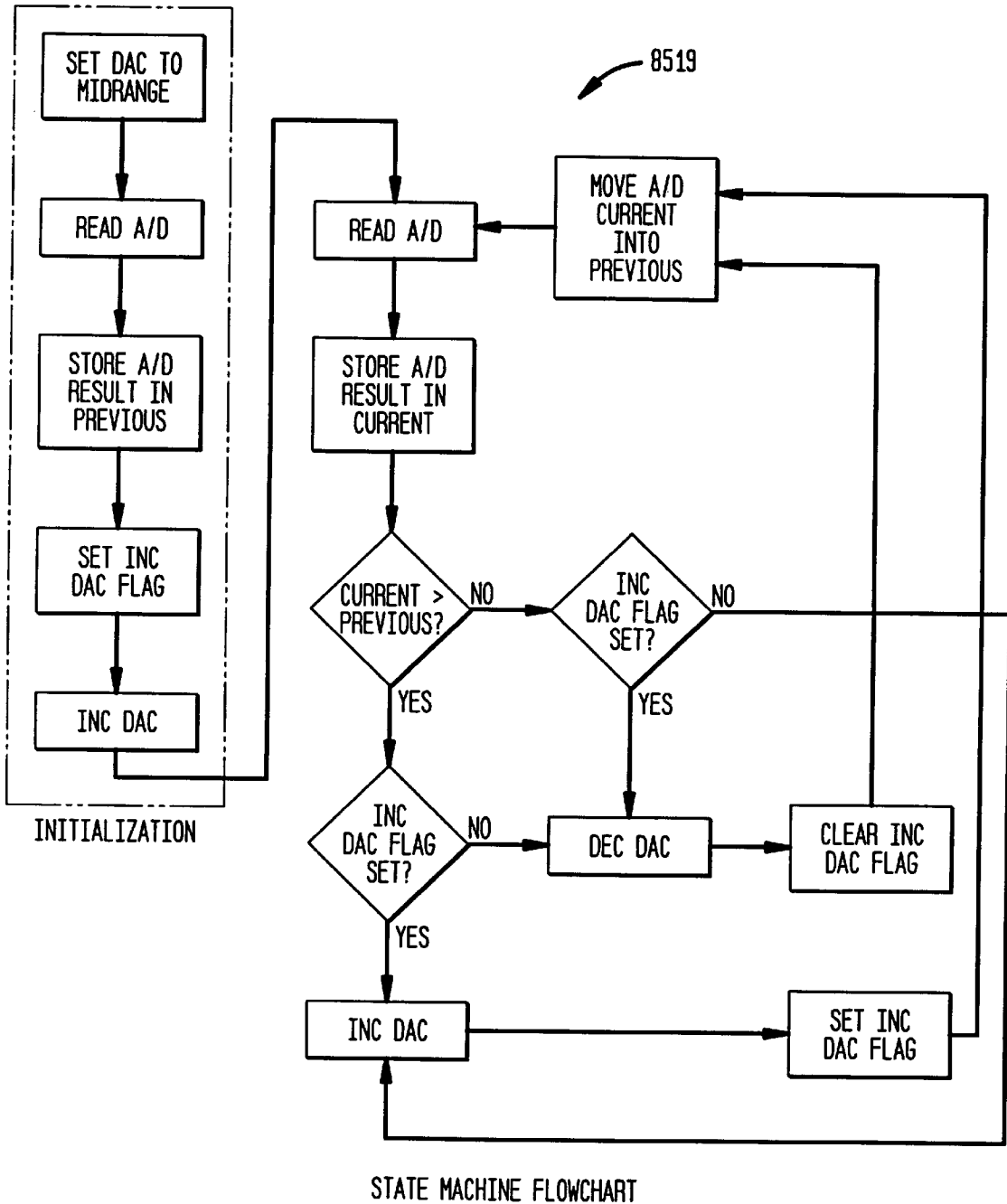
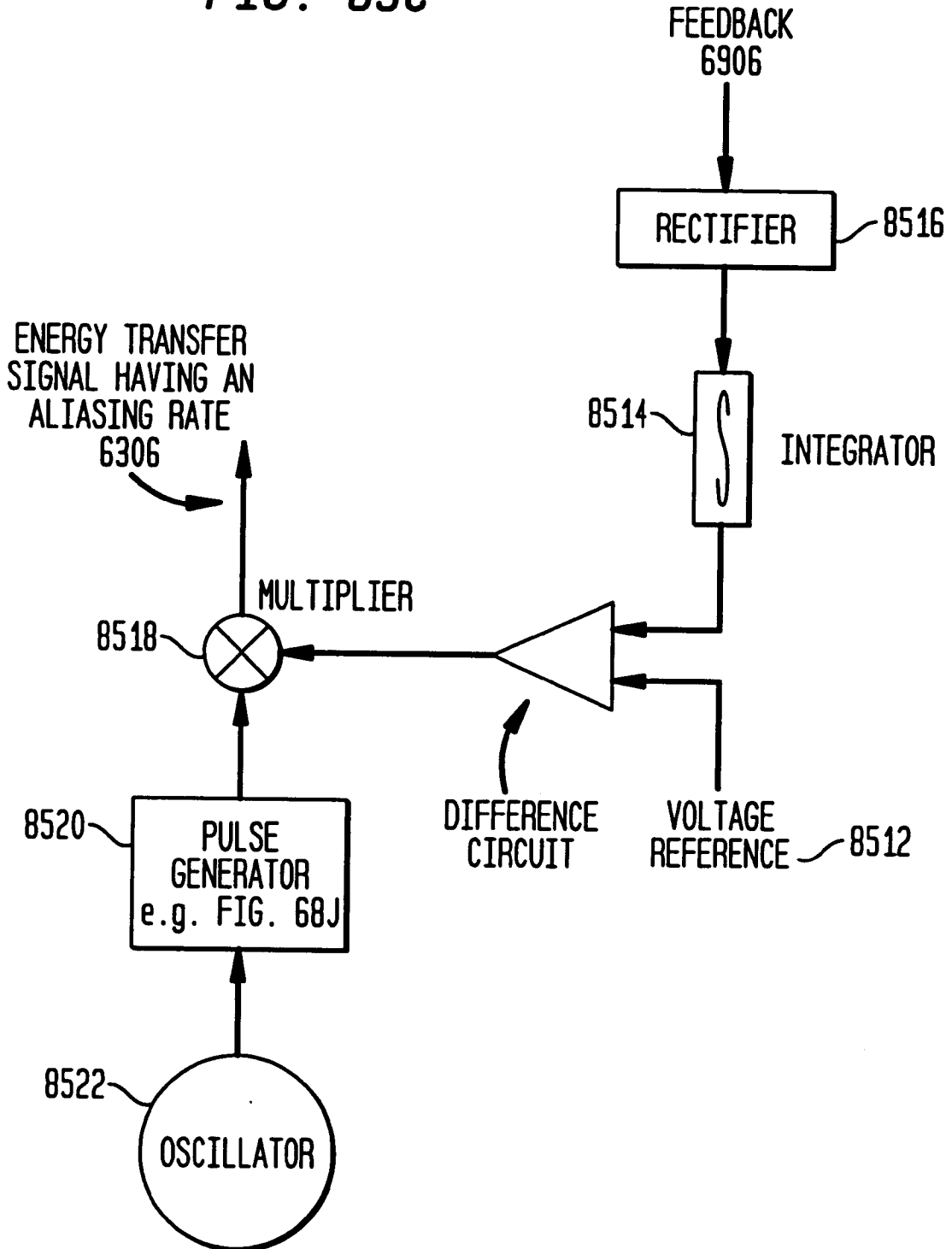


FIG. 85C



ENERGY TRANSFER SIGNAL MODULE 6902

FIG. 86

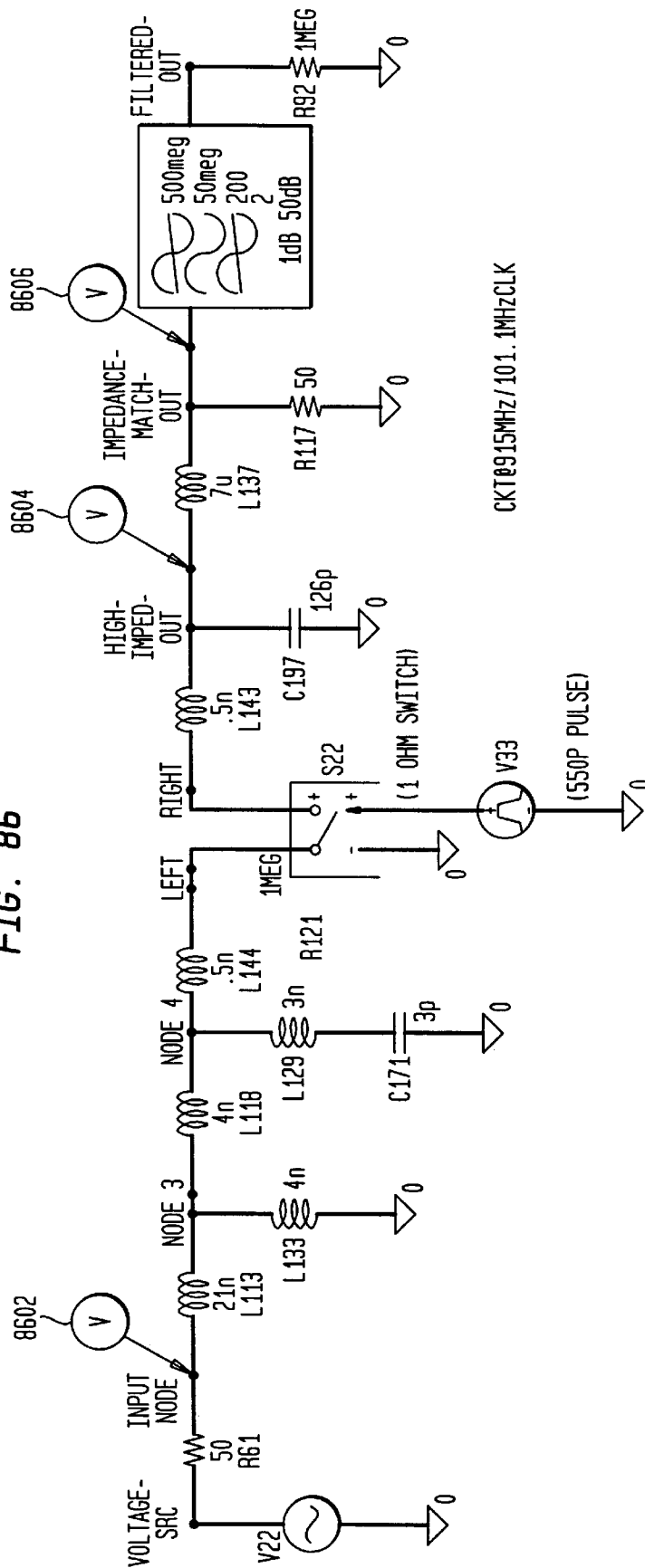
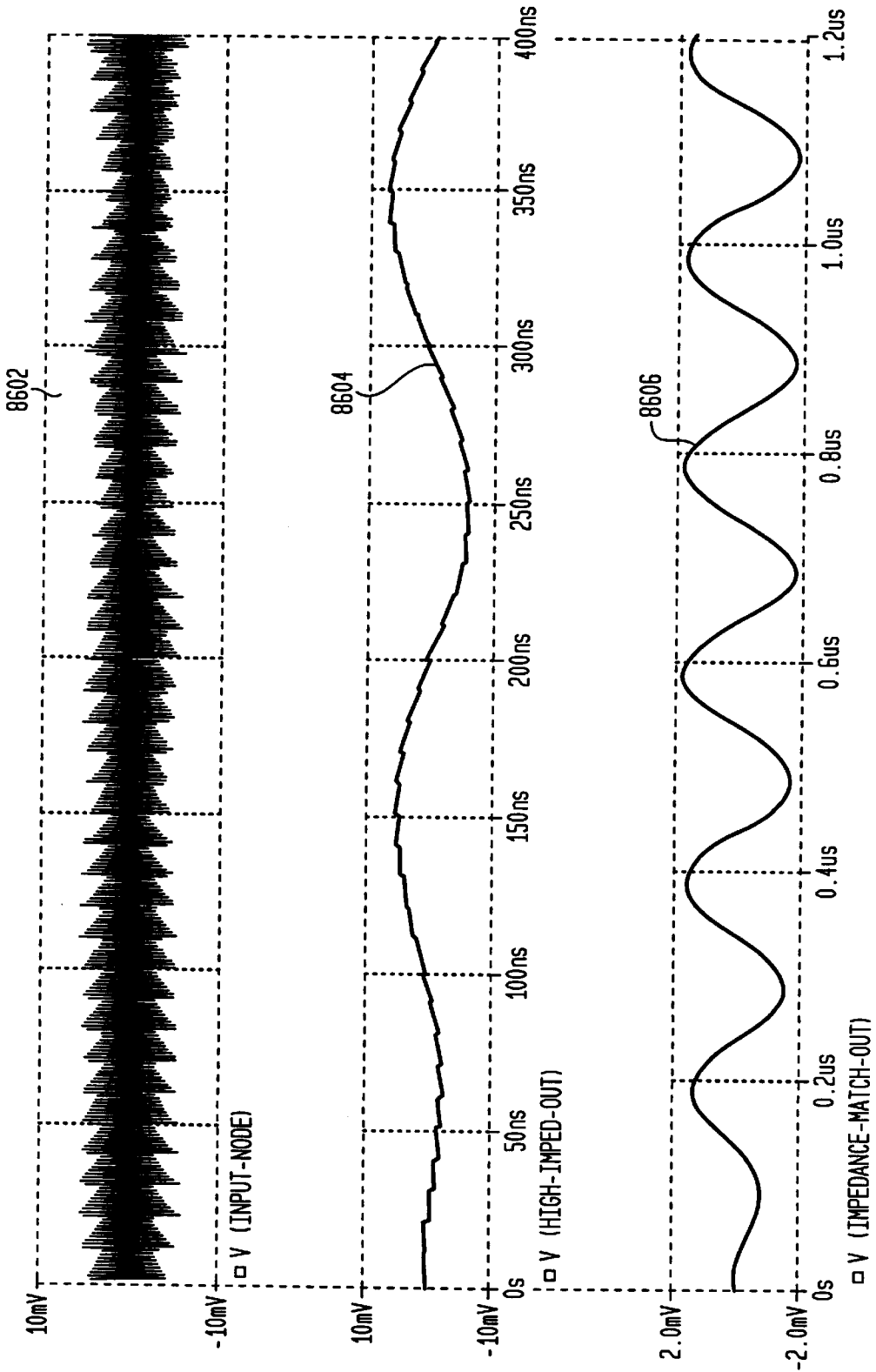


FIG. 87



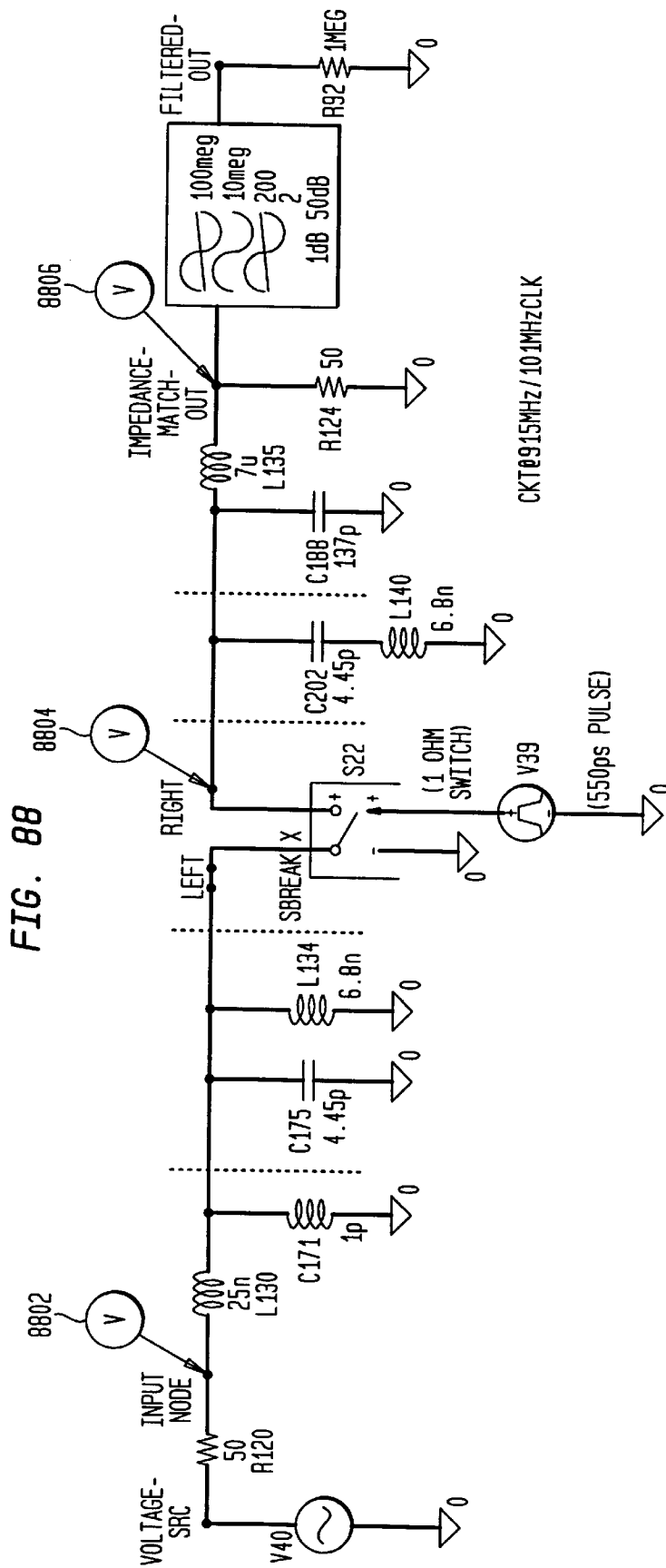




FIG. 89

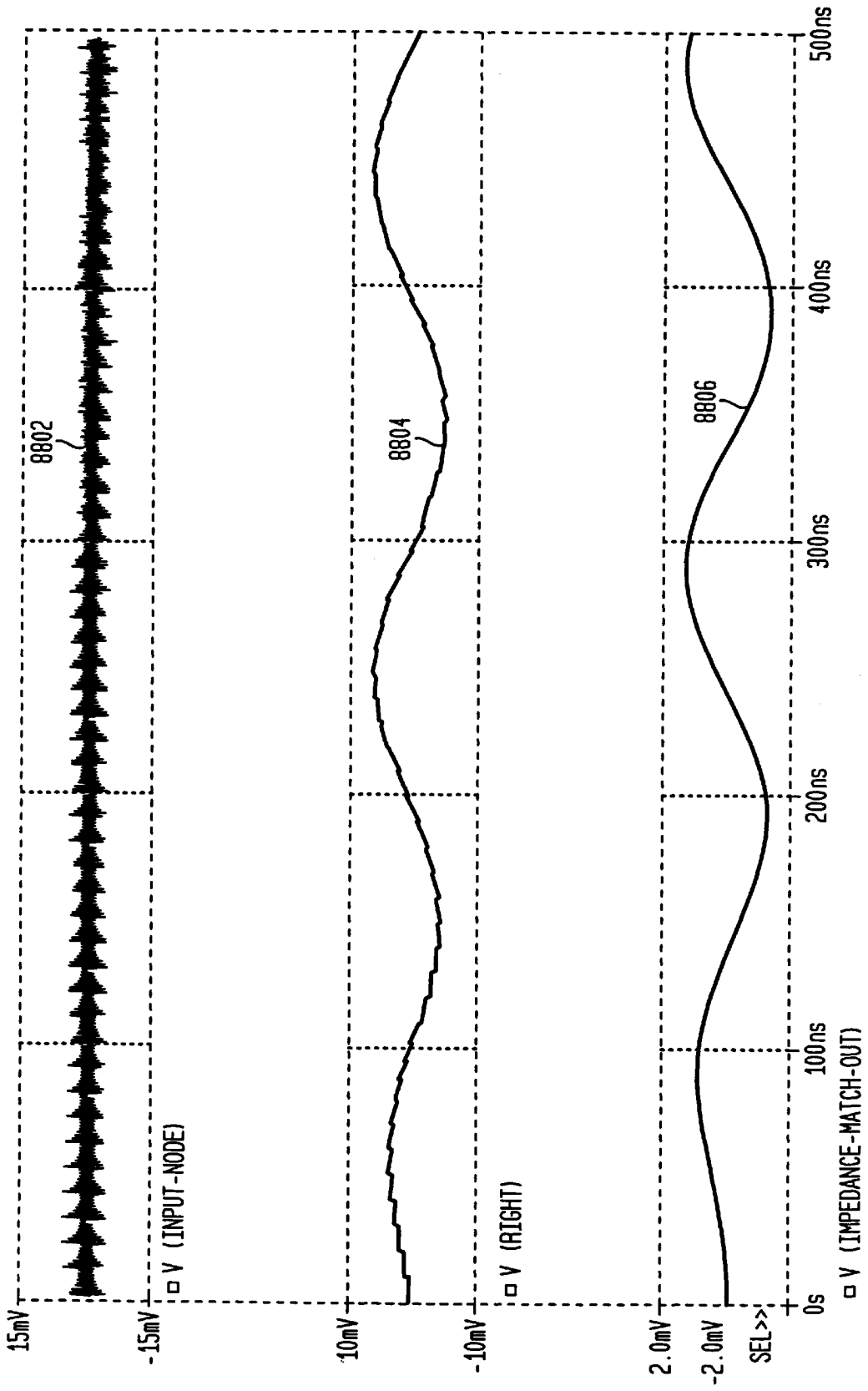


FIG. 90

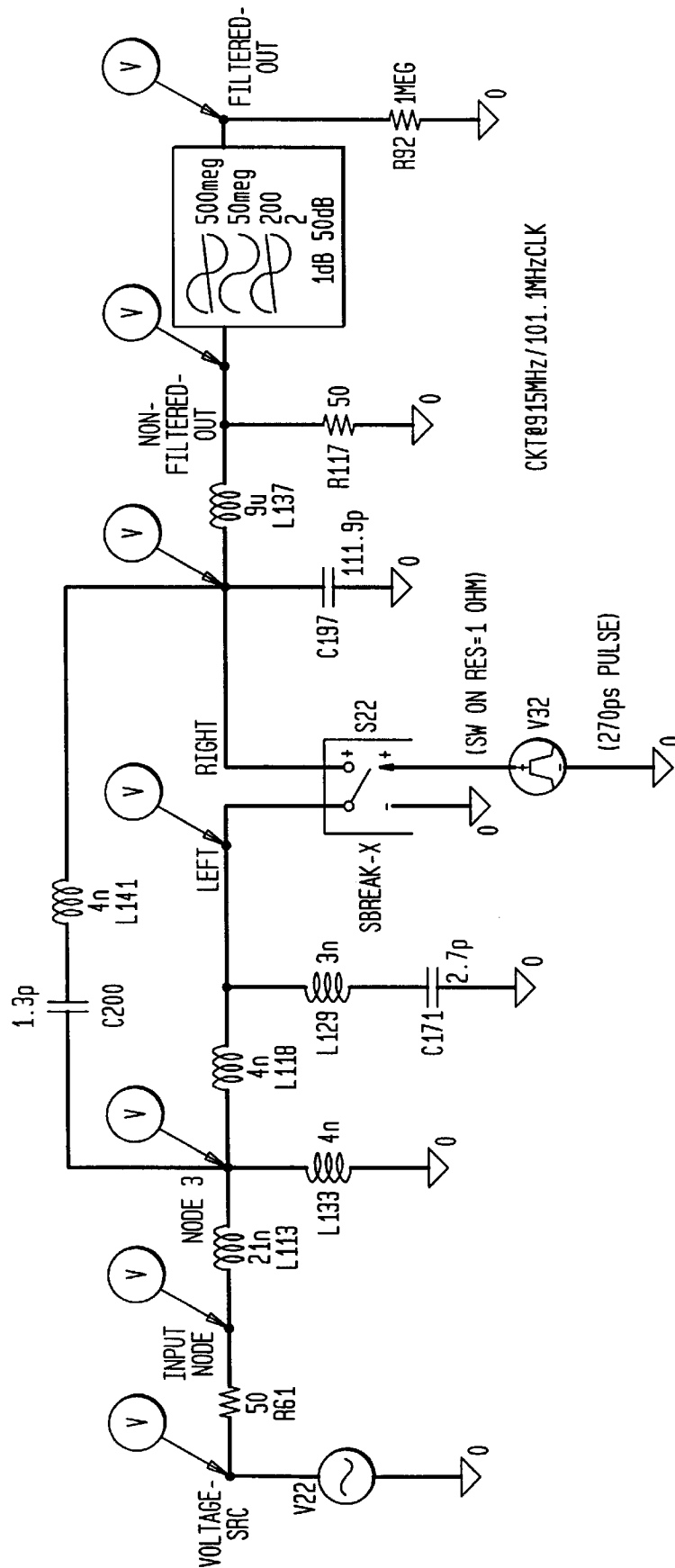
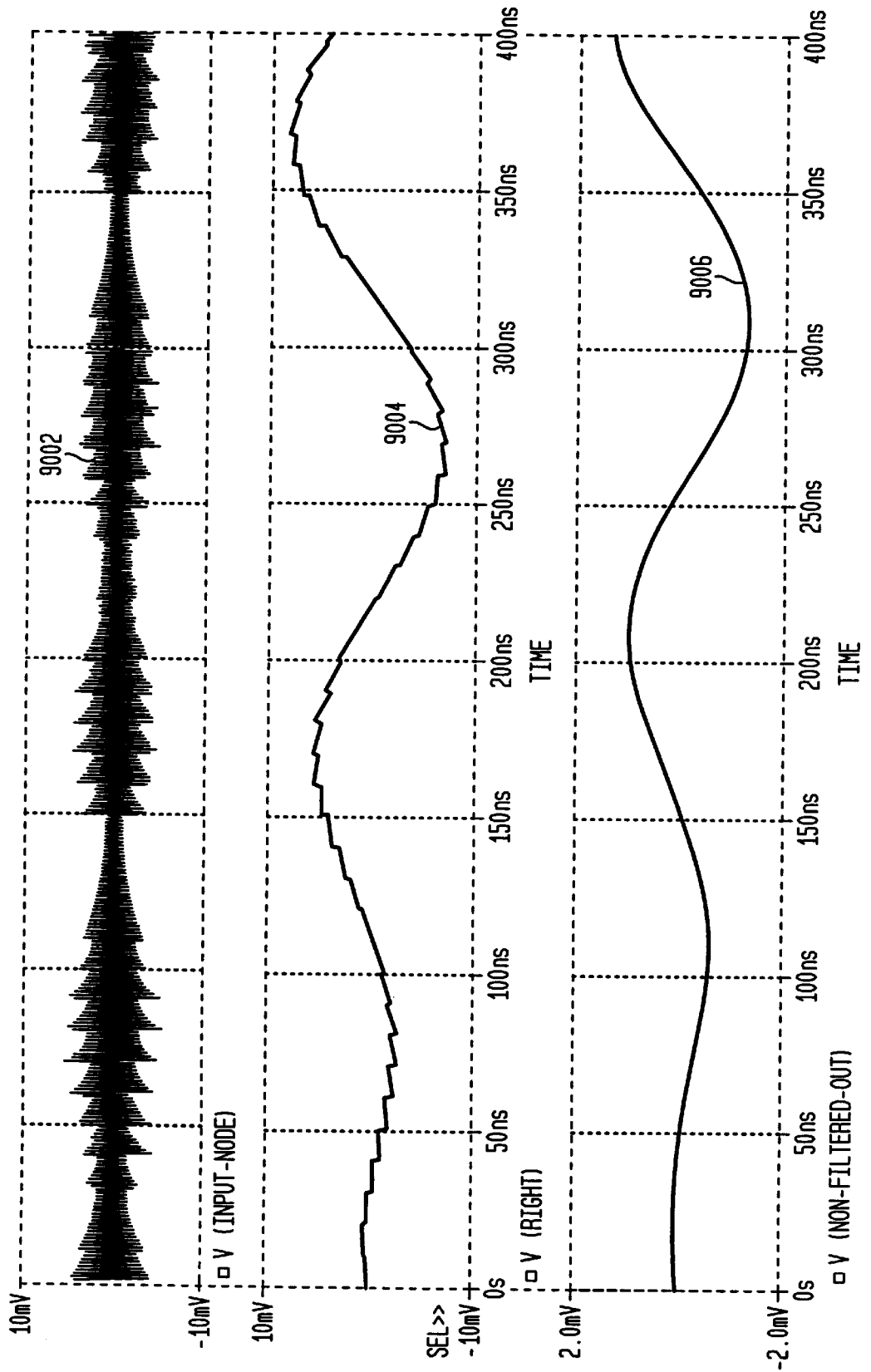


FIG. 91



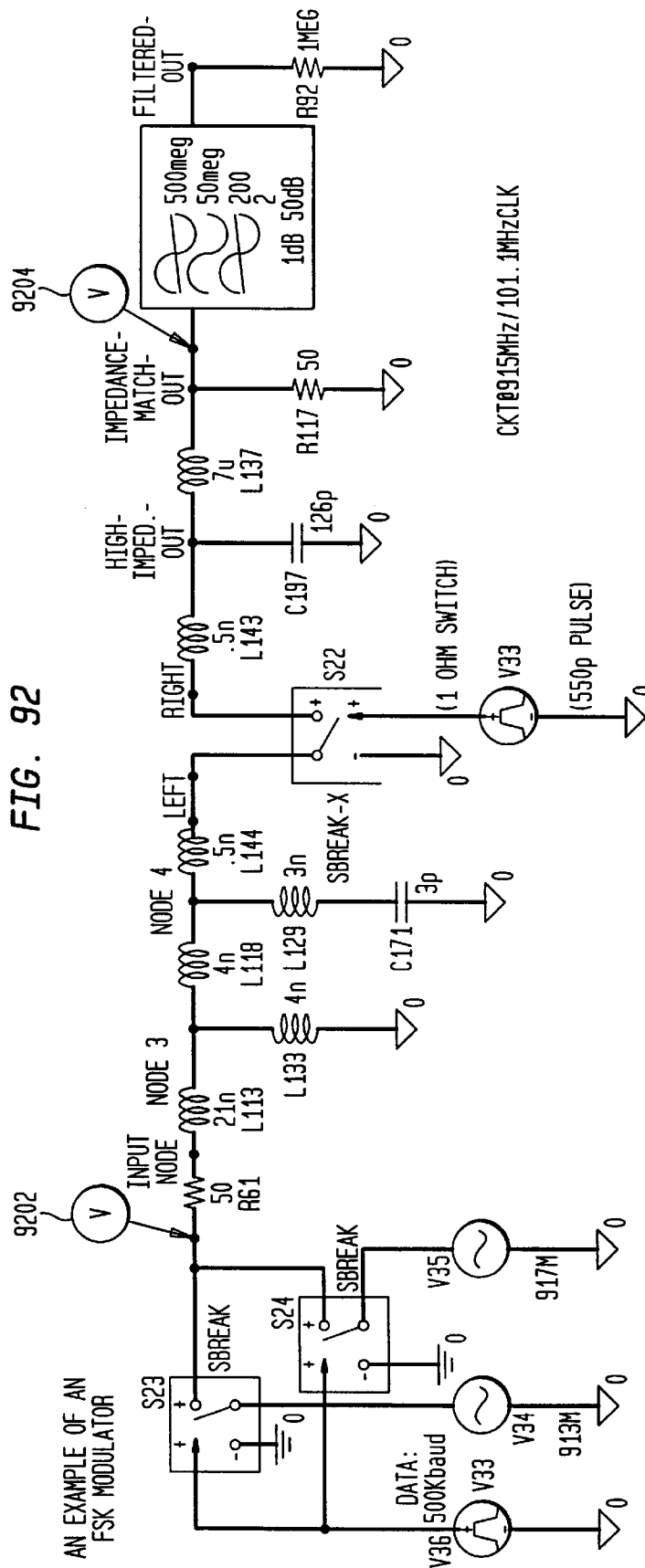


FIG. 93

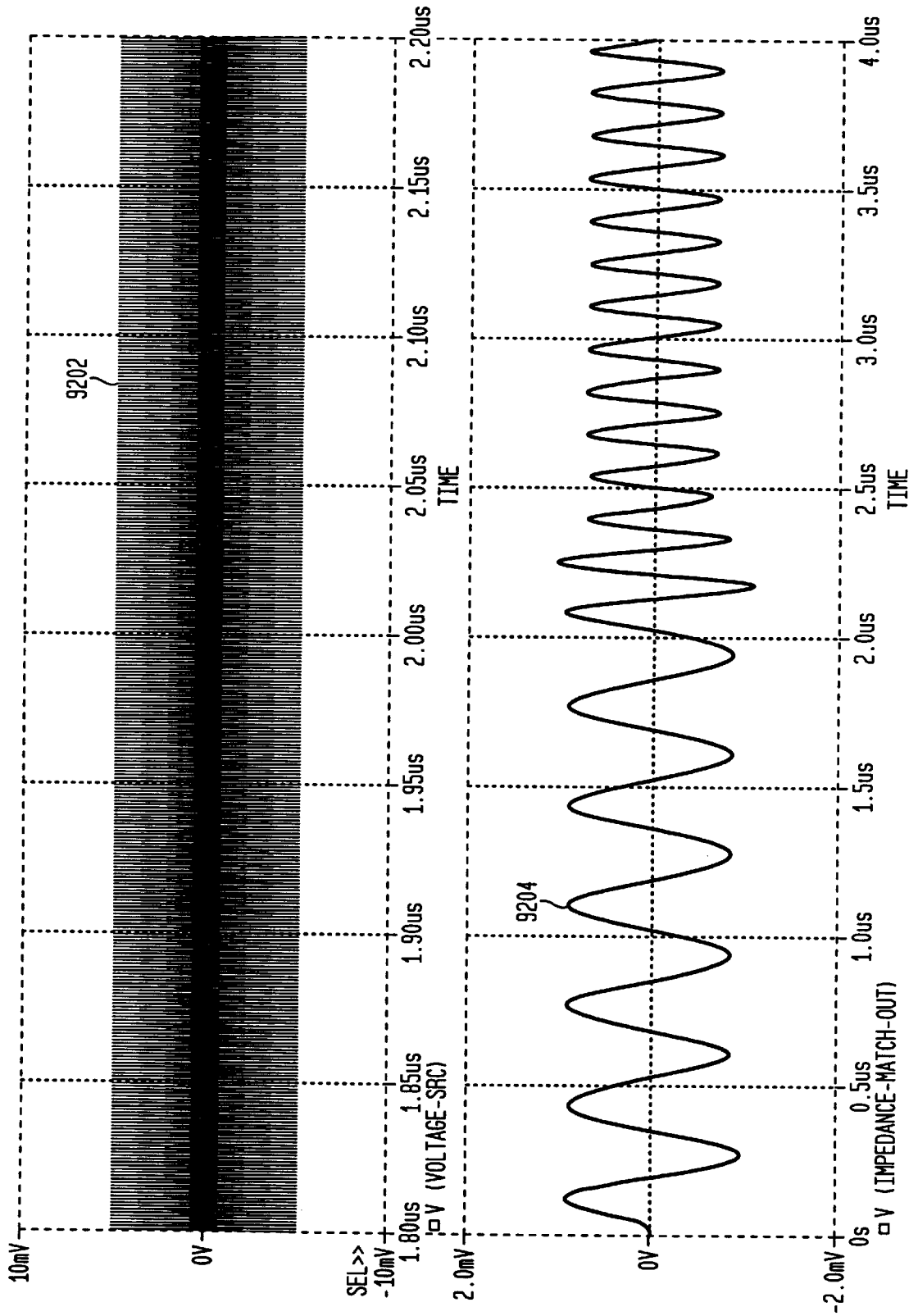


FIG. 94A

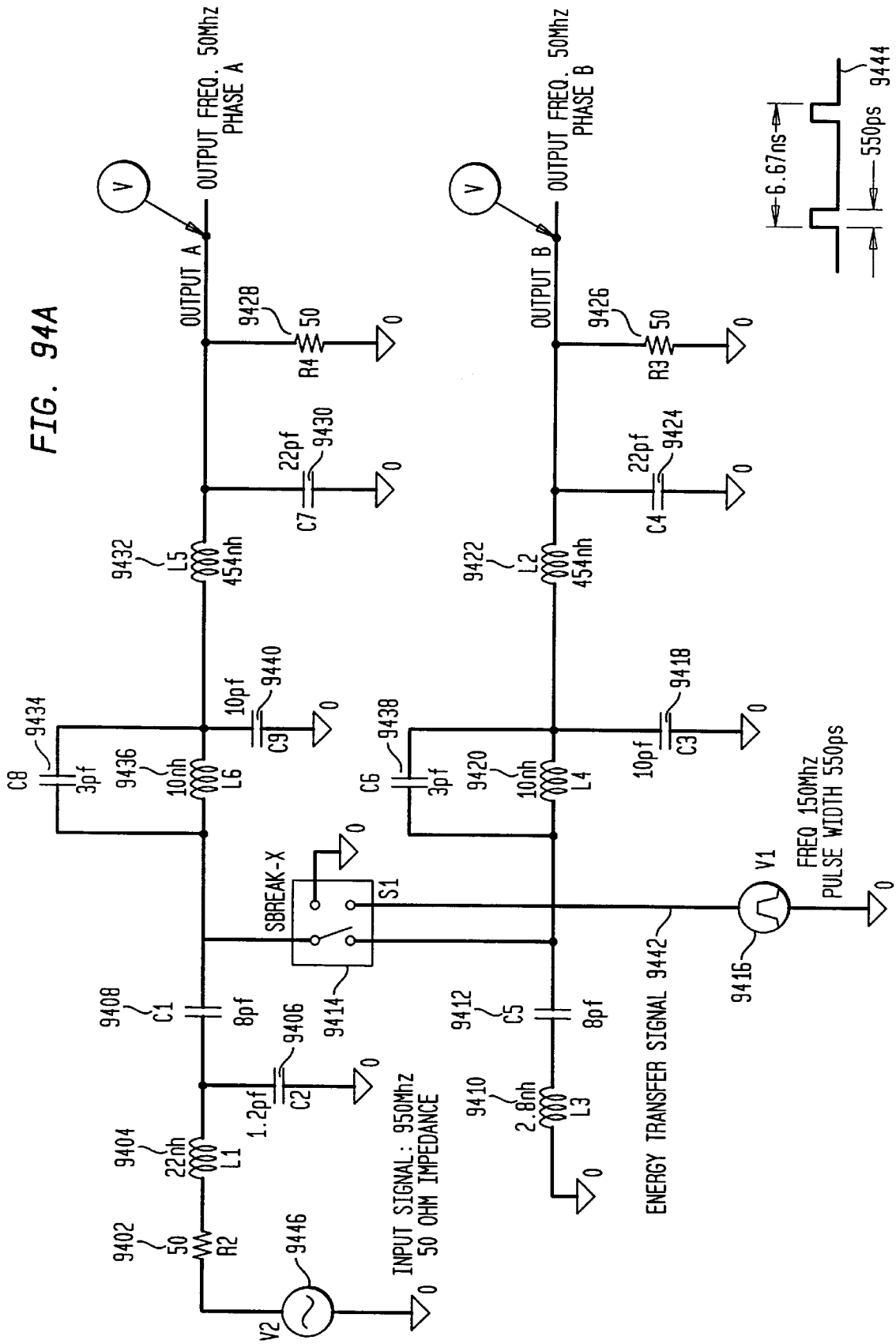


FIG. 94B

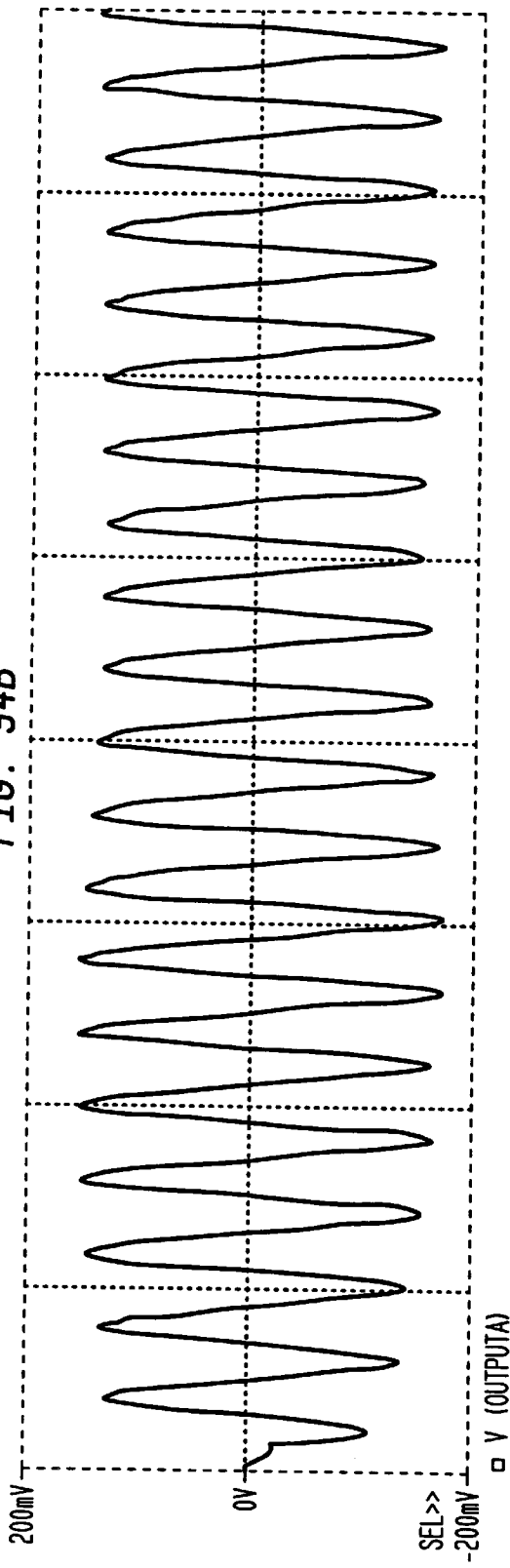


FIG. 94C

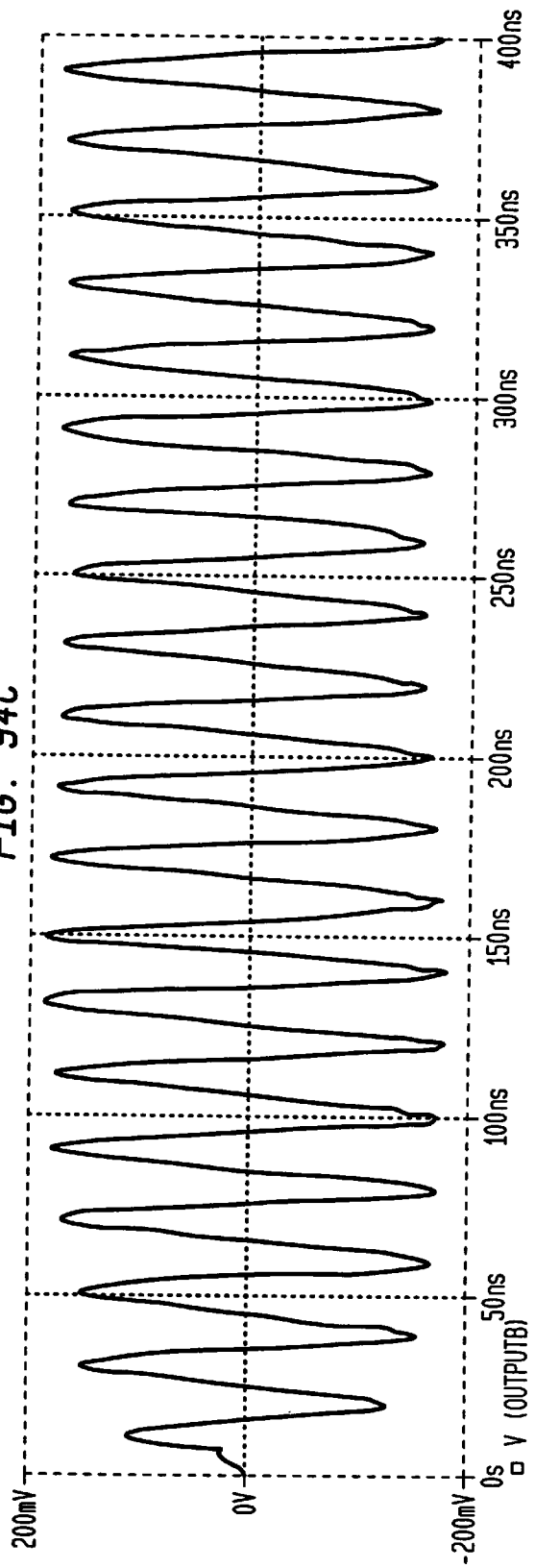


FIG. 95

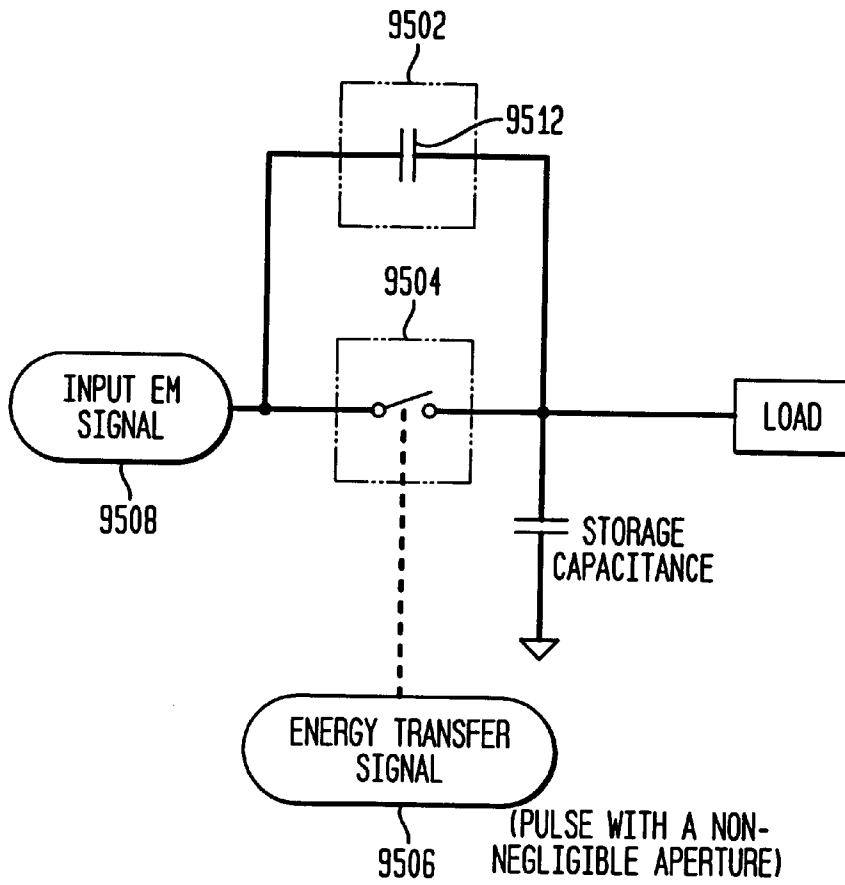


FIG. 96

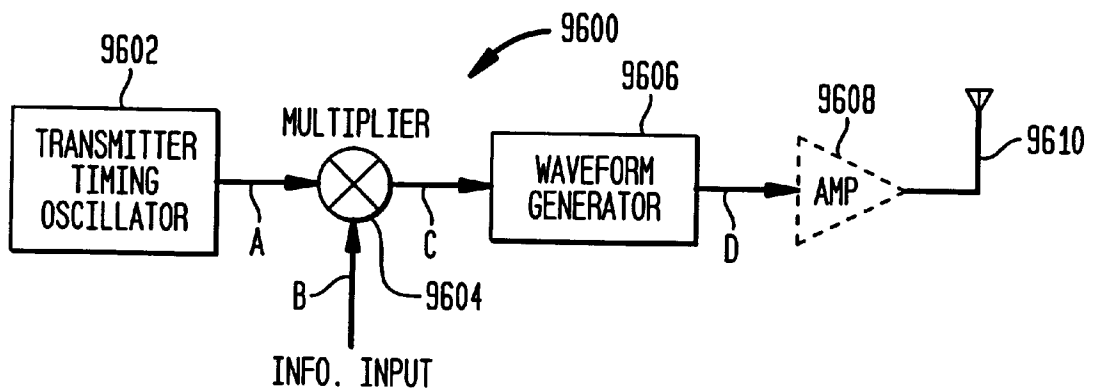




FIG. 97

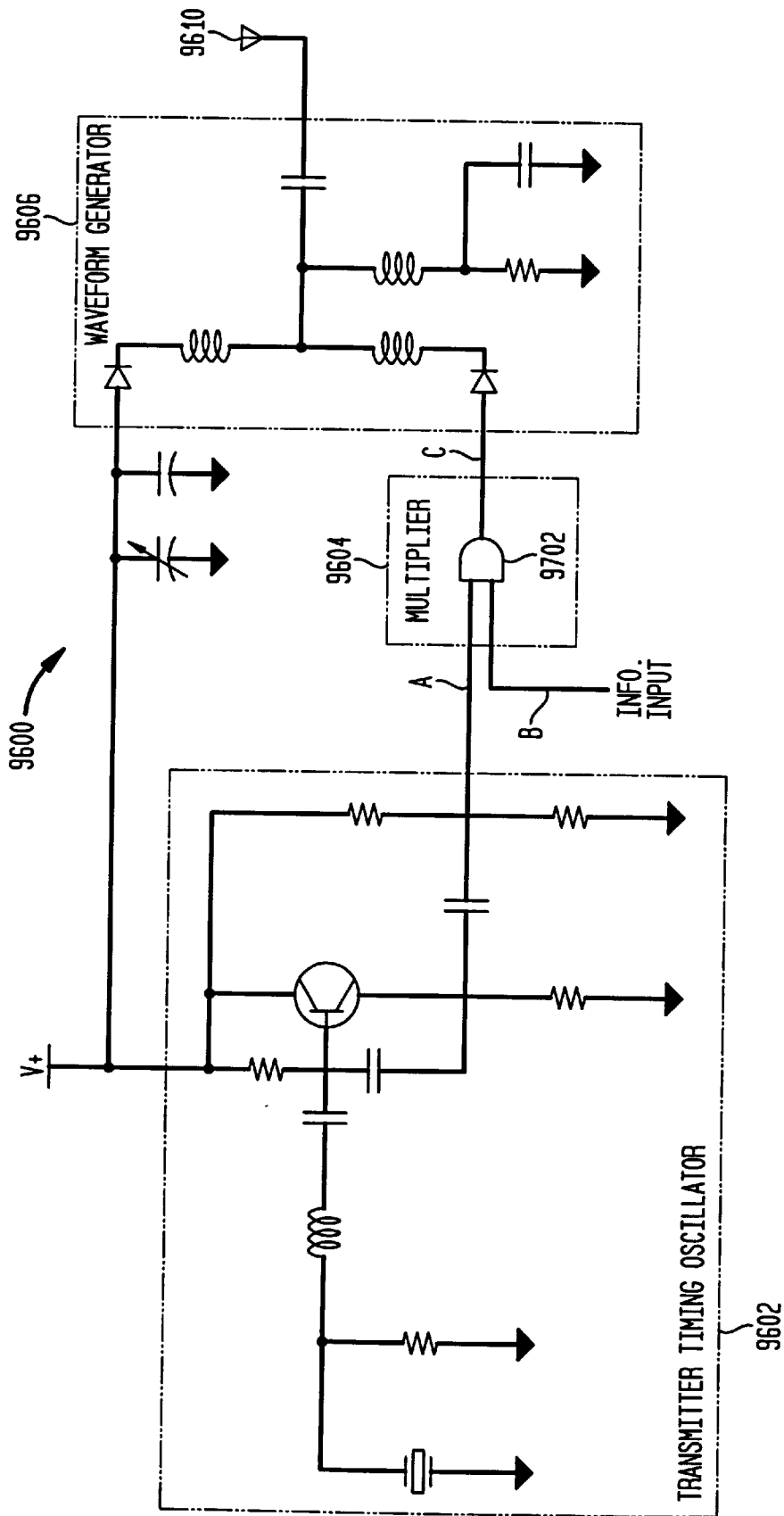


FIG. 98A

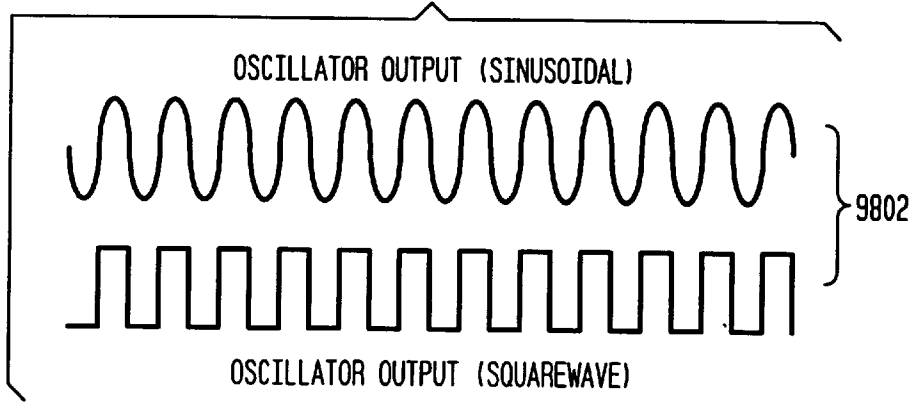


FIG. 98B

INFORMATION INPUT



FIG. 98C

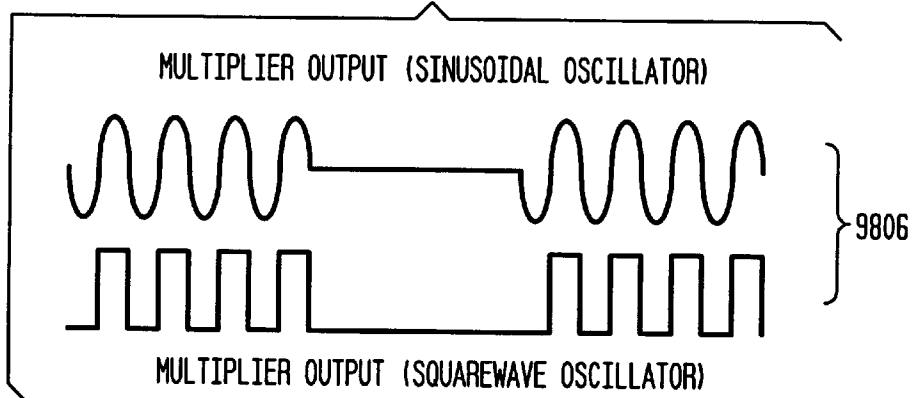


FIG. 98D

WAVEFORM GENERATOR OUTPUT



FIG. 99

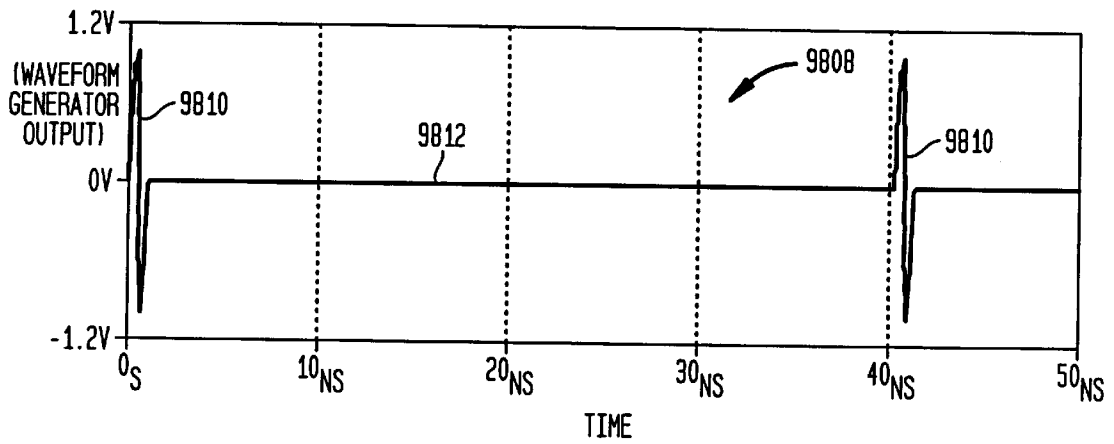


FIG. 100

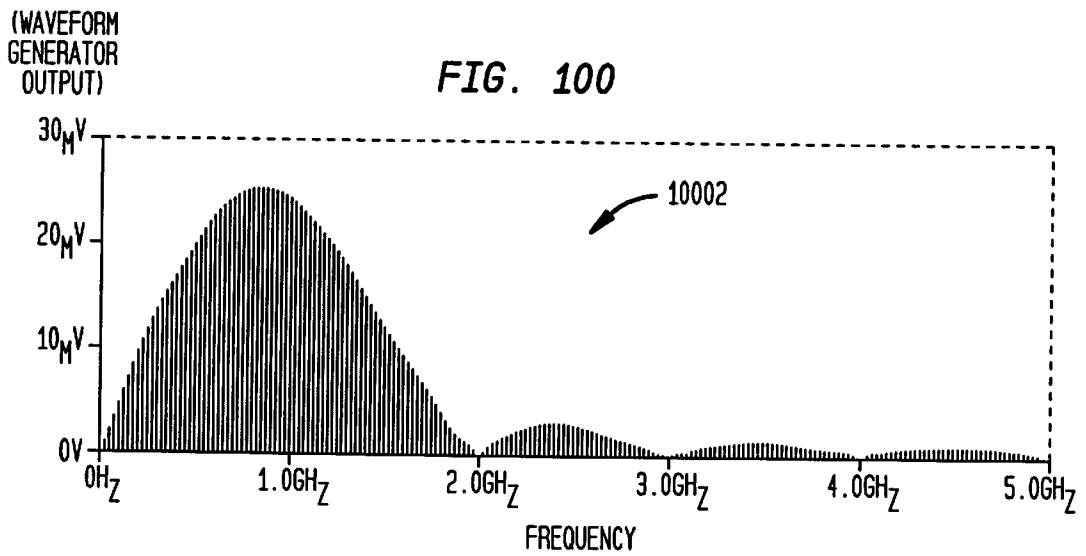
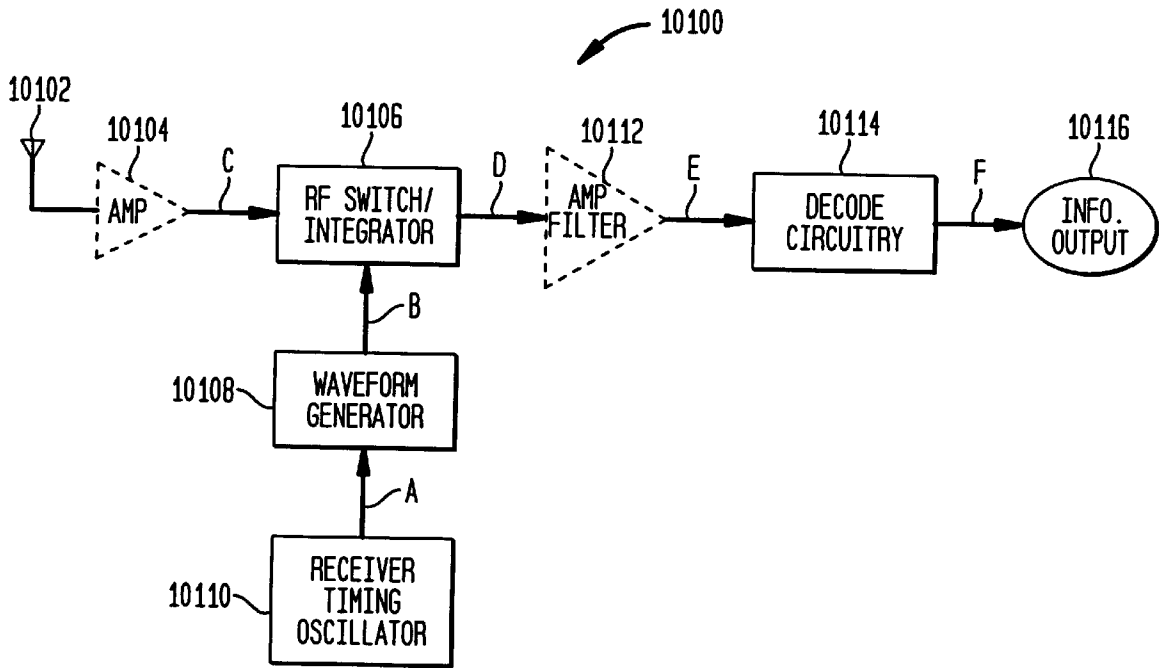


FIG. 101



**FIG. 102A**  
RECEIVER TIMING OSCILLATOR OUTPUT



**FIG. 102B**  
WAVEFORM GENERATOR OUTPUT



**FIG. 102C**  
RF INPUT



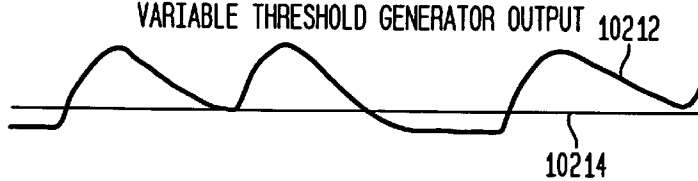
**FIG. 102D**  
RF SWITCH/INTEGRATOR OUTPUT



**FIG. 102E**  
OPTIONAL AMPLIFIER/FILTER OUTPUT



**FIG. 102G**  
RECTIFIER/FILTER OUTPUT  
VARIABLE THRESHOLD GENERATOR OUTPUT



**FIG. 102F**  
INFORMATION OUTPUT



FIG. 103

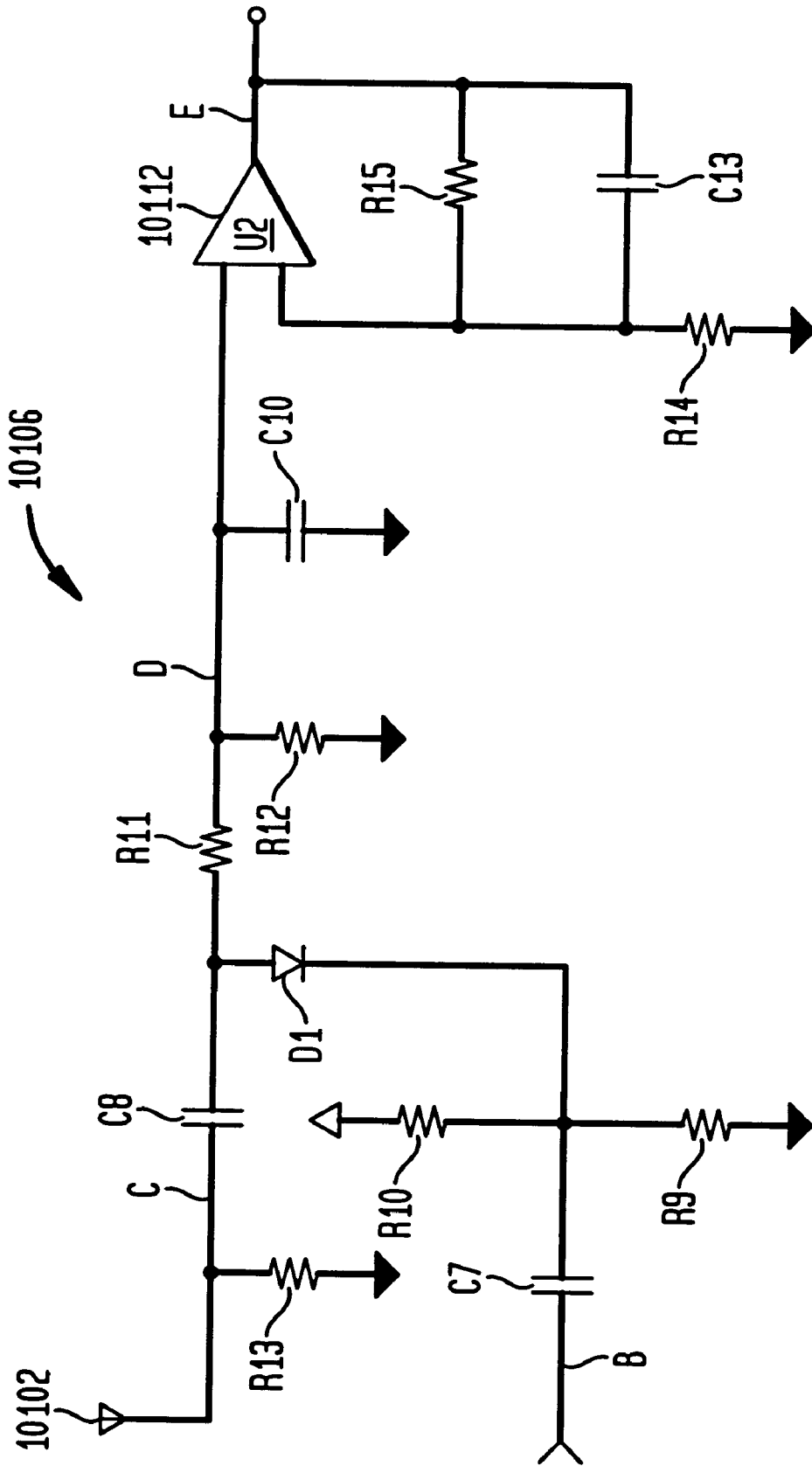


FIG. 104

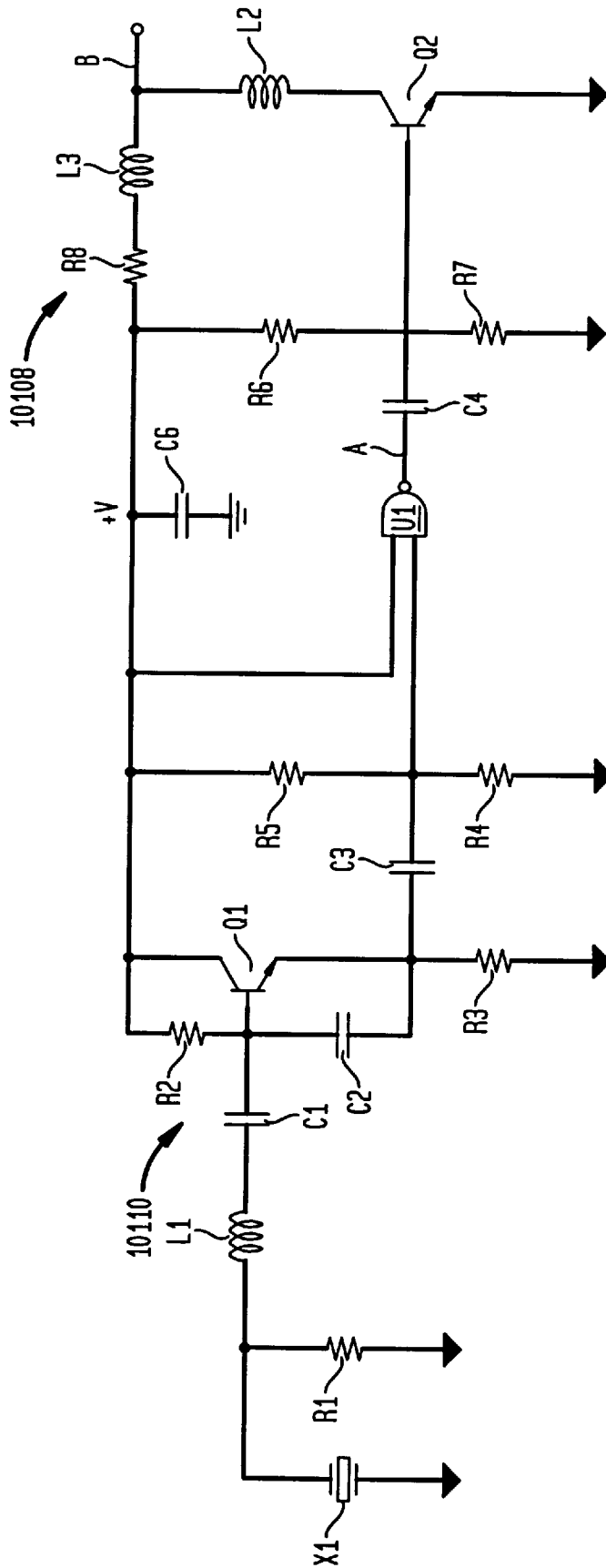


FIG. 105

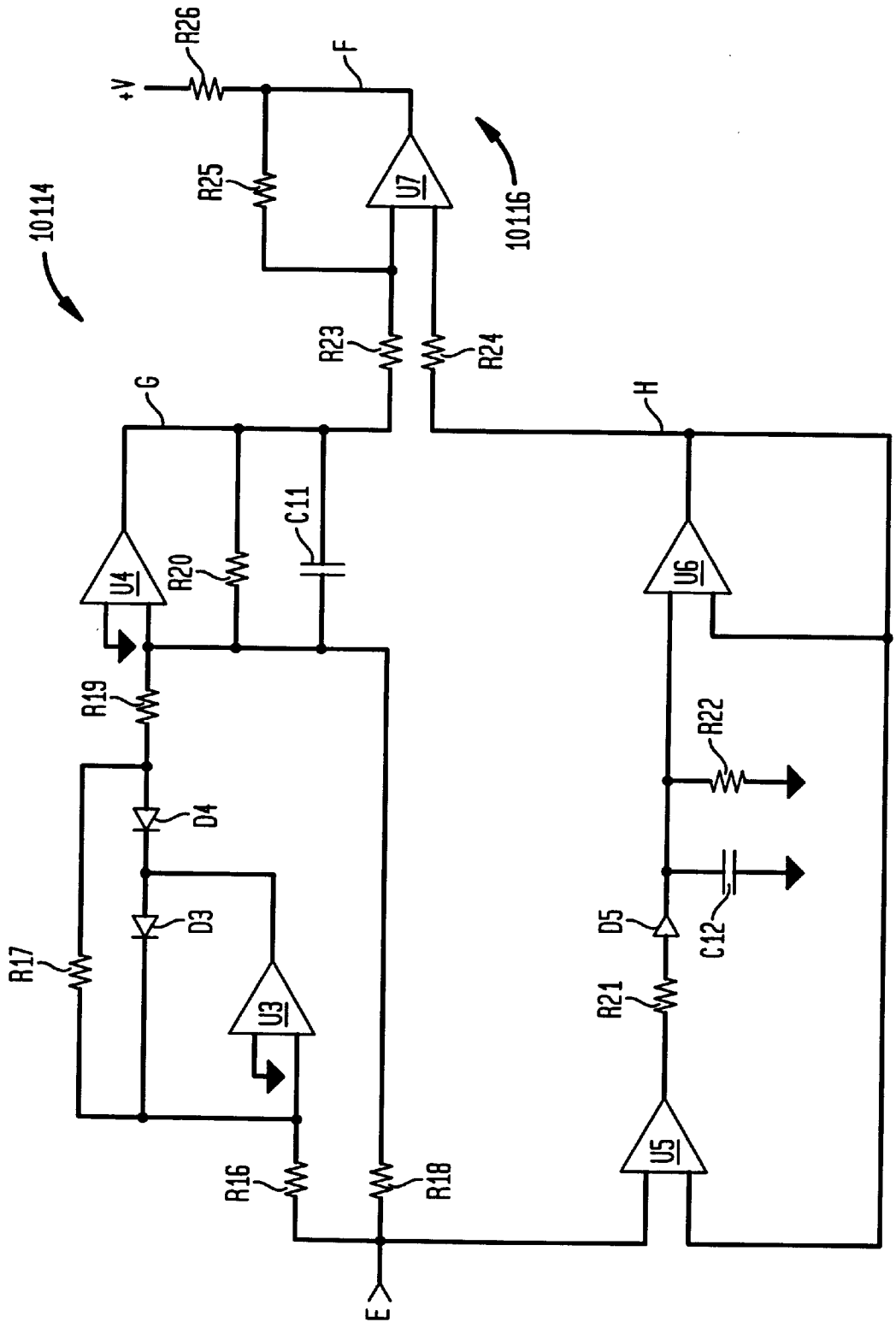




FIG. 106

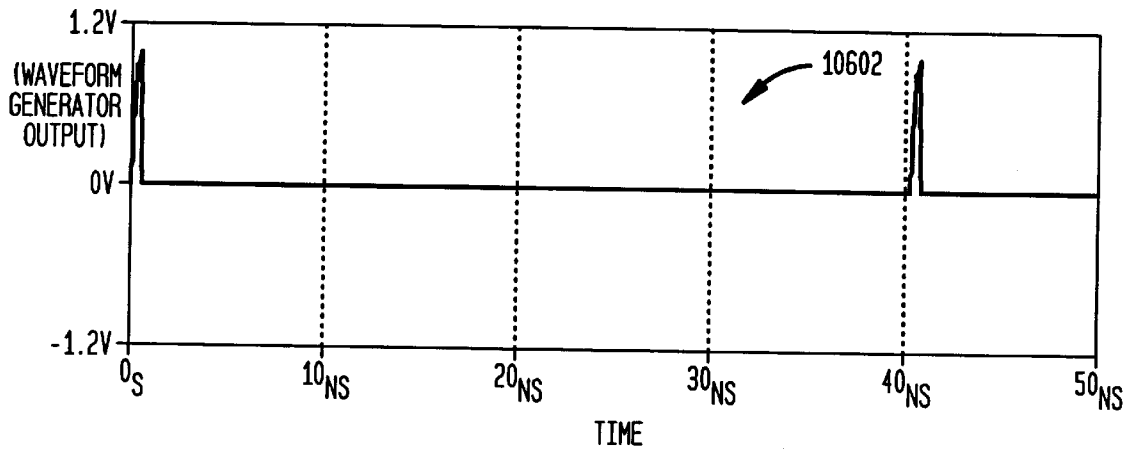


FIG. 107

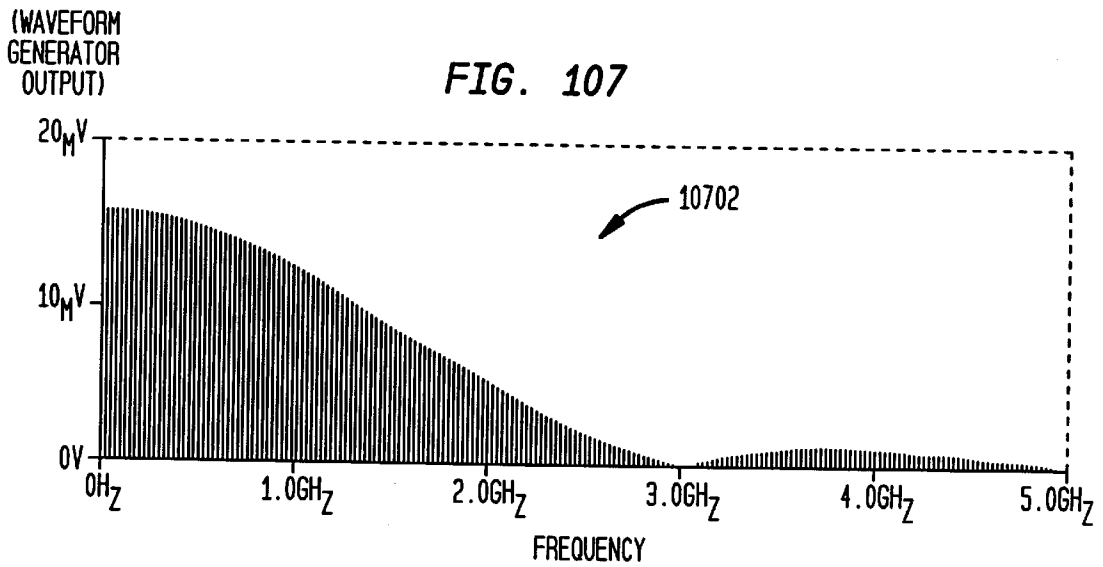


FIG. 108

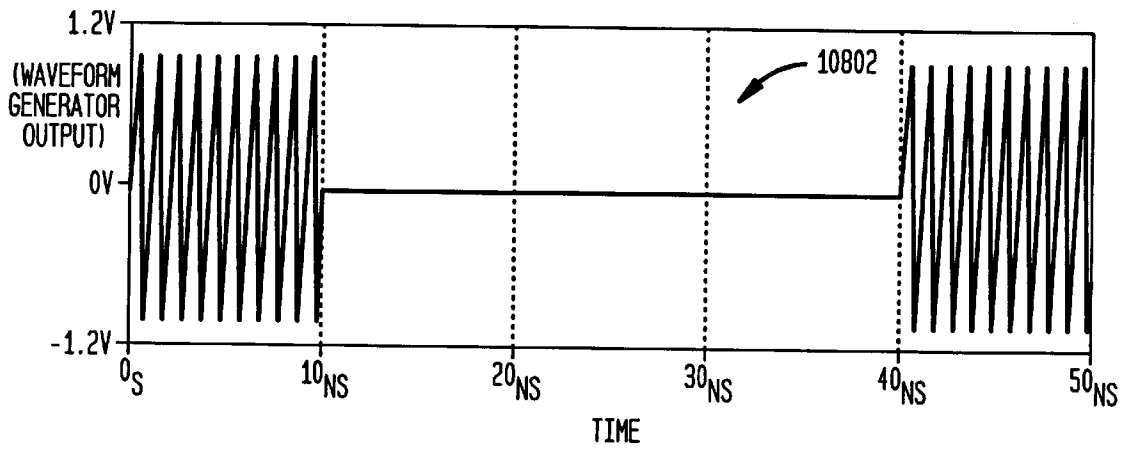


FIG. 109

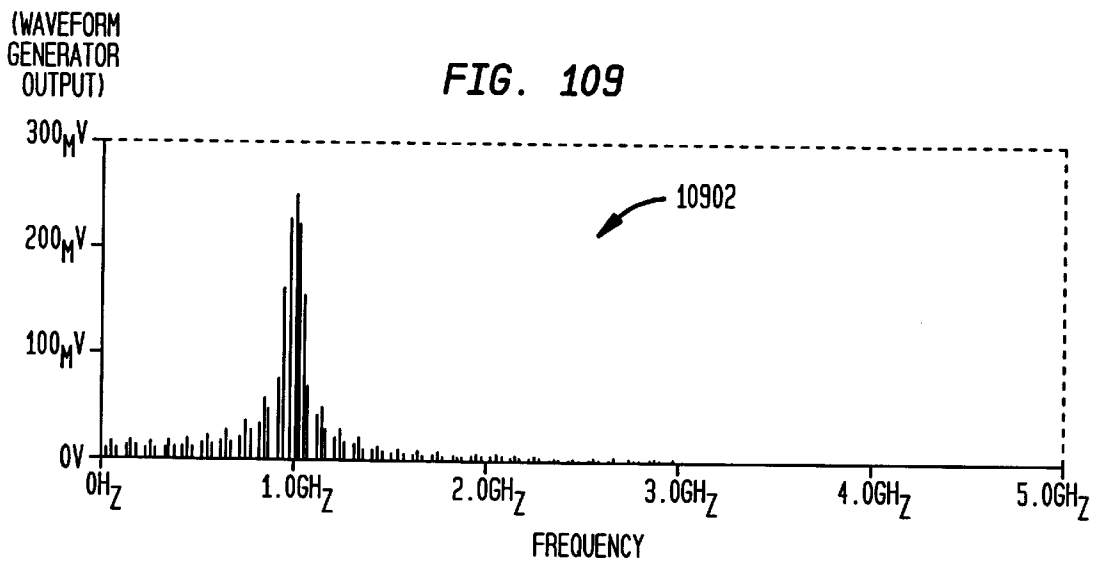


FIG. 110

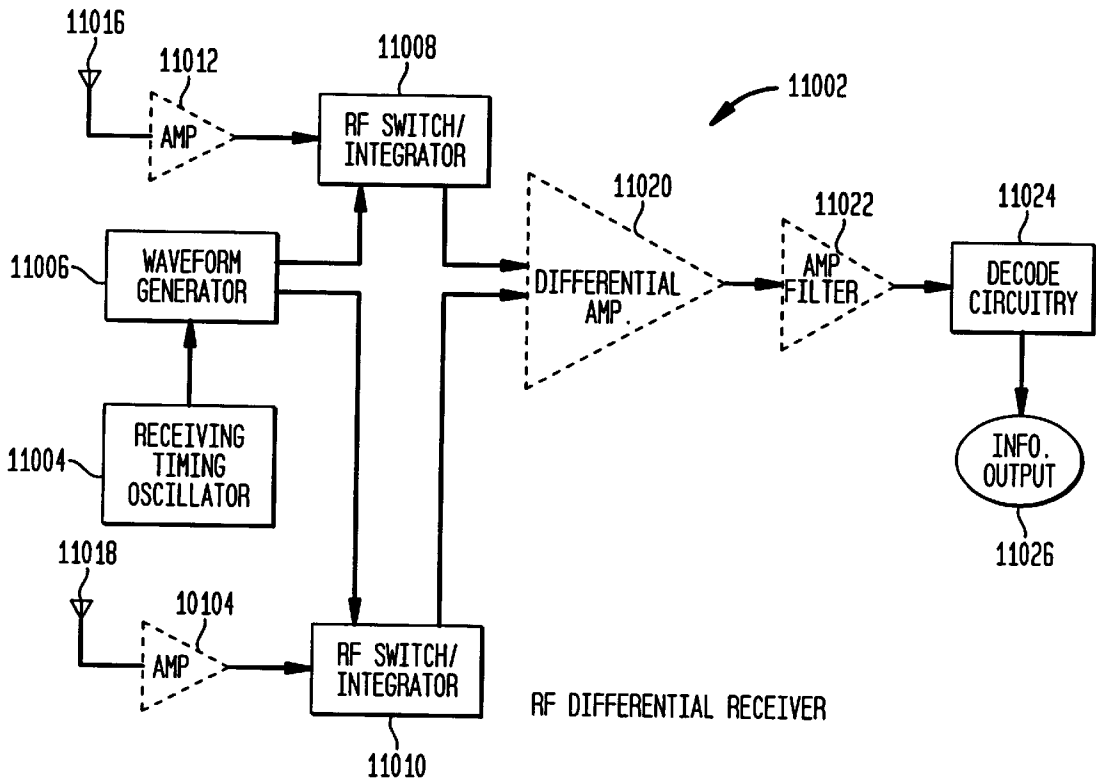


FIG. 111

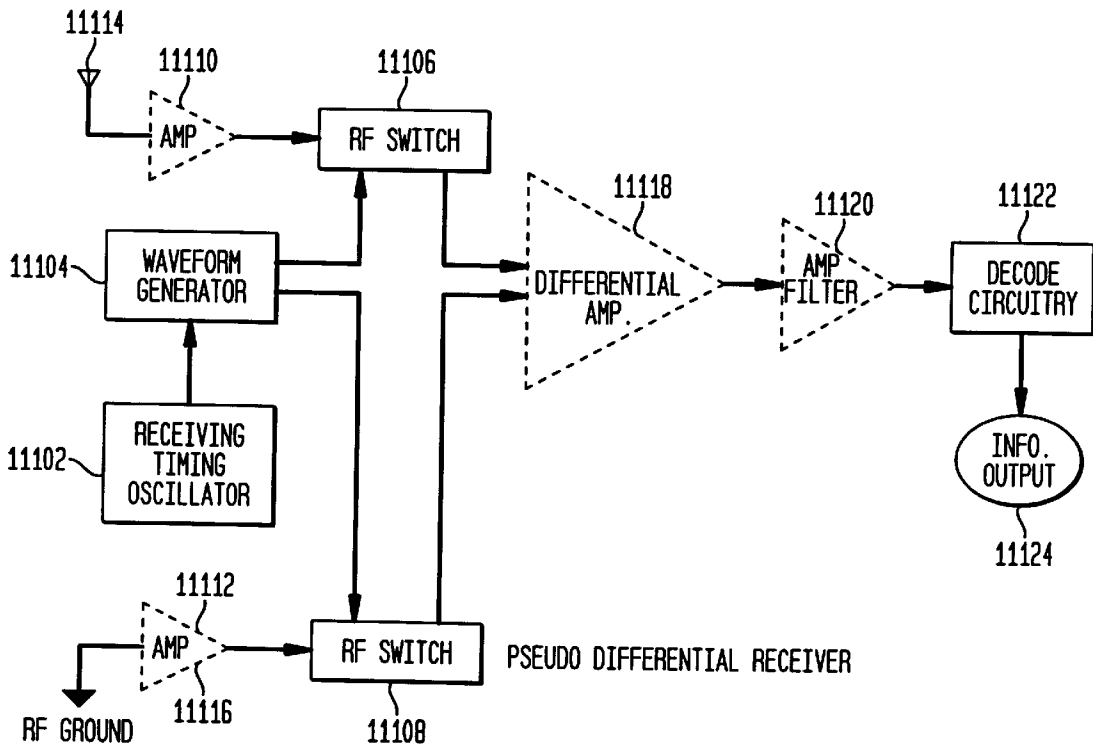


FIG. 112

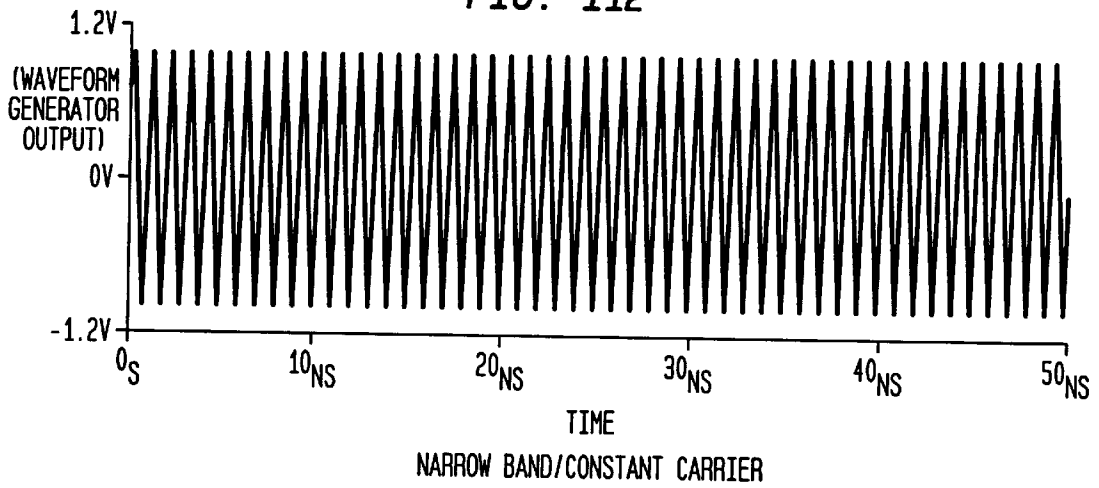
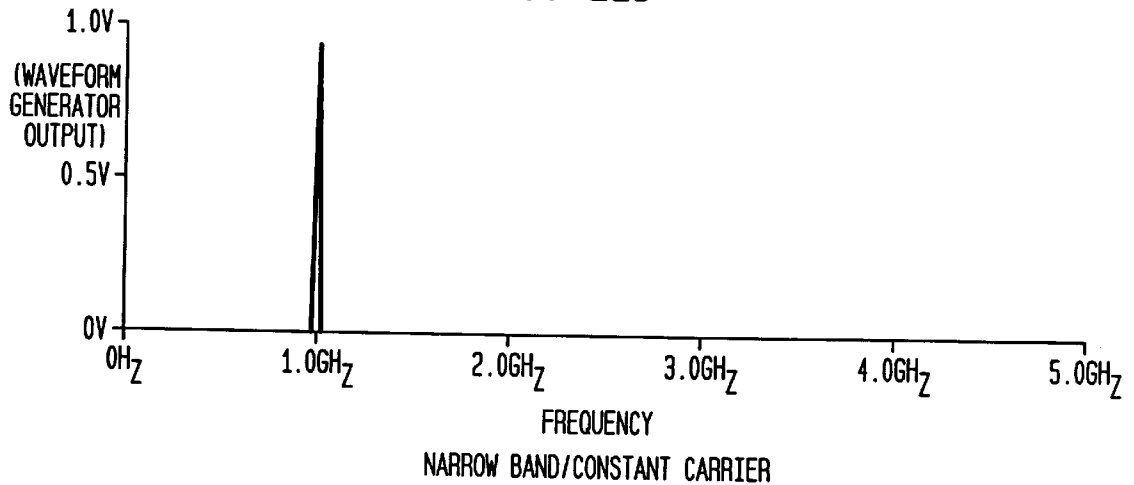


FIG. 113



## METHOD AND SYSTEM FOR DOWN-CONVERTING ELECTROMAGNETIC SIGNALS

### CROSS-REFERENCE TO OTHER APPLICATIONS

The following applications of common assignee are related to the present application, have the same filing date as the present application, and are herein incorporated by reference in their entireties:

“Method and System for Frequency Up-Conversion,” Attorney Docket No. 1744.0020000.

“Method and System for Ensuring Reception of a Communications Signal,” Attorney Docket No. 1744.0030000.

“Integrated Frequency Translation and Selectivity,” Attorney Docket No. 1744.0130000.

“Universal Frequency Translation, and Applications of Same,” Attorney Docket No. 1744.0140000.

### BACKGROUND OF THE INVENTION

#### 1. Field of the Invention

The present invention relates to down-conversion of electromagnetic (EM) signals. More, particularly, the present invention relates to down-conversion of EM signals to intermediate frequency signals, to direct down-conversion of EM modulated carrier signals to demodulated baseband signals, and to conversion of FM signals to non-FM signals. The present invention also relates to under-sampling and to transferring energy at aliasing rates.

#### 2. Related Art

Electromagnetic (EM) information signals (baseband signals) include, but are not limited to, video baseband signals, voice baseband signals, computer baseband signals, etc. Baseband signals include analog baseband signals and digital baseband signals.

It is often beneficial to propagate EM signals at higher frequencies. This is generally true regardless of whether the propagation medium is wire, optic fiber, space, air, liquid, etc.. To enhance efficiency and practicality, such as improved ability to radiate and added ability for multiple channels of baseband signals, up-conversion to a higher frequency is utilized. Conventional up-conversion processes modulate higher frequency carrier signals with baseband signals. Modulation refers to a variety of techniques for impressing information from the baseband signals onto the higher frequency carrier signals. The resultant signals are referred to herein as modulated carrier signals. For example, the amplitude of an AM carrier signal varies in relation to changes in the baseband signal, the frequency of an FM carrier signal varies in relation to changes in the baseband signal, and the phase of a PM carrier signal varies in relation to changes in the baseband signal.

In order to process the information that was in the baseband signal, the information must be extracted, or demodulated, from the modulated carrier signal. However, because conventional signal processing technology is limited in operational speed, conventional signal processing technology cannot easily demodulate a baseband signal from higher frequency modulated carrier signal directly. Instead, higher frequency modulated carrier signals must be down-converted to an intermediate frequency (IF), from where a conventional demodulator can demodulate the baseband signal.

Conventional down-converters include electrical components whose properties are frequency dependent. As a result,

conventional down-converters are designed around specific frequencies or frequency ranges and do not work well outside their designed frequency range.

Conventional down-converters generate unwanted image signals and thus must include filters for filtering the unwanted image signals. However, such filters reduce the power level of the modulated carrier signals. As a result, conventional down-converters include power amplifiers, which require external energy sources.

When a received modulated carrier signal is relatively weak, as in, for example, a radio receiver, conventional down-converters include additional power amplifiers, which require additional external energy.

What is needed includes, without limitation:

an improved method and system for down-converting EM signals;

a method and system for directly down-converting modulated carrier signals to demodulated baseband signals;

a method and system for transferring energy and for augmenting such energy transfer when down-converting EM signals;

a controlled impedance method and system for down-converting an EM signal;

a controlled aperture under-sampling method and system for down-converting an EM signal;

a method and system for down-converting EM signals using a universal down-converter design that can be easily configured for different frequencies;

a method and system for down-converting EM signals using a local oscillator frequency that is substantially lower than the carrier frequency;

a method and system for down-converting EM signals using only one local oscillator;

a method and system for down-converting EM signals that uses fewer filters than conventional down-converters;

a method and system for down-converting EM signals using less power than conventional down-converters;

a method and system for down-converting EM signals that uses less space than conventional down-converters;

a method and system for down-converting EM signals that uses fewer components than conventional down-converters;

a method and system for down-converting EM signals that can be implemented on an integrated circuit (IC); and

a method and system for down-converting EM signals that can also be used as a method and system for up-converting a baseband signal.

### SUMMARY OF THE INVENTION

Briefly stated, the present invention is directed to methods, systems, and apparatuses for down-converting an electromagnetic (EM) signal by aliasing the EM signal, and applications thereof.

Generally, the invention operates by receiving an EM signal. The invention also receives an aliasing signal having an aliasing rate. The invention aliases the EM signal according to the aliasing signal to down-convert the EM signal. The term aliasing, as used herein and as covered by the invention, refers to both down-converting an EM signal by under-sampling the EM signal at an aliasing rate, and down-converting an EM signal by transferring energy from the EM signal at the aliasing rate.

In an embodiment, the invention down-converts the EM signal to an intermediate frequency (IF) signal.

In another embodiment, the invention down-converts the EM signal to a demodulated baseband information signal.

In another embodiment, the EM signal is a frequency modulated (FM) signal, which is down-converted to a non-FM signal, such as a phase modulated (PM) signal or an amplitude modulated (AM) signal.

The invention is applicable to any type of EM signal, including but not limited to, modulated carrier signals (the invention is applicable to any modulation scheme or combination thereof) and unmodulated carrier signals.

Further features and advantages of the invention, as well as the structure and operation of various embodiments of the invention, are described in detail below with reference to the accompanying drawings. It is noted that the invention is not limited to the specific embodiments described herein. Such embodiments are presented herein for illustrative purposes only. Additional embodiments will be apparent to persons skilled in the relevant art(s) based on the teachings contained herein.

The drawing in which an element first appears is typically indicated by the leftmost digit(s) in the corresponding reference number.

#### BRIEF DESCRIPTION OF THE DRAWINGS

The present invention will be described with reference to the accompanying drawings wherein:

FIG. 1 illustrates a structural block diagram of an example modulator;

FIG. 2 illustrates an example analog modulating baseband signal;

FIG. 3 illustrates an example digital modulating baseband signal;

FIG. 4 illustrates an example carrier signal;

FIGS. 5A–5C illustrate example signal diagrams related to amplitude modulation;

FIGS. 6A–6C illustrate example signal diagrams related to amplitude shift keying modulation;

FIGS. 7A–7C illustrate example signal diagrams related to frequency modulation;

FIGS. 8A–8C illustrate example signal diagrams related to frequency shift keying modulation;

FIGS. 9A–9C illustrate example signal diagrams related to phase modulation;

FIGS. 10A–10C illustrate example signal diagrams related to phase shift keying modulation;

FIG. 11 illustrates a structural block diagram of a conventional receiver;

FIGS. 12A–D illustrate various flowcharts for down-converting an EM-signal according to embodiments of the invention;

FIG. 13 illustrates a structural block diagram of an aliasing system according to an embodiment of the invention;

FIGS. 14A–D illustrate various flowcharts for down-converting an EM signal by under-sampling the EM signal according to embodiments of the invention;

FIGS. 15A–E illustrate example signal diagrams associated with flowcharts in FIGS. 14A–D according to embodiments of the invention;

FIG. 16 illustrates a structural block diagram of an under-sampling system according to an embodiment of the invention;

FIG. 17 illustrates a flowchart of an example process for determining an aliasing rate according to an embodiment of the invention;

FIGS. 18A–E illustrate example signal diagrams associated with down-converting a digital AM signal to an intermediate frequency signal by under-sampling according to embodiments of the invention;

FIGS. 19A–E illustrate example signal diagrams associated with down-converting an analog AM signal to an intermediate frequency signal by under-sampling according to embodiments of the invention;

FIGS. 20A–E illustrate example signal diagrams associated with down-converting an analog FM signal to an intermediate frequency signal by under-sampling according to embodiments of the invention;

FIGS. 21A–E illustrate example signal diagrams associated with down-converting a digital FM signal to an intermediate frequency signal by under-sampling according to embodiments of the invention;

FIGS. 22A–E illustrate example signal diagrams associated with down-converting a digital PM signal to an intermediate frequency signal by under-sampling according to embodiments of the invention;

FIGS. 23A–E illustrate example signal diagrams associated with down-converting an analog PM signal to an intermediate frequency signal by under-sampling according to embodiments of the invention;

FIG. 24A illustrates a structural block diagram of a make before break under-sampling system according to an embodiment of the invention;

FIG. 24B illustrates an example timing diagram of an under sampling signal according to an embodiment of the invention;

FIG. 24C illustrates an example timing diagram of an isolation signal according to an embodiment of the invention;

FIGS. 25A–H illustrate example aliasing signals at various aliasing rates according to embodiments of the invention;

FIG. 26A illustrates a structural block diagram of an exemplary sample and hold system according to an embodiment of the invention;

FIG. 26B illustrates a structural block diagram of an exemplary inverted sample and hold system according to an embodiment of the invention;

FIG. 27 illustrates a structural block diagram of sample and hold module according to an embodiment of the invention;

FIGS. 28A–D illustrate example implementations of a switch module according to embodiments of the invention;

FIGS. 29A–F illustrate example implementations of a holding module according to embodiments of the present invention;

FIG. 29G illustrates an integrated under-sampling system according to embodiments of the invention;

FIGS. 29H–K illustrate example implementations of pulse generators according to embodiments of the invention;

FIG. 29L illustrates an example oscillator;

FIG. 30 illustrates a structural block diagram of an under-sampling system with an under-sampling signal optimizer according to embodiments of the invention;

FIG. 31 illustrates a structural block diagram of an under-sampling signal optimizer according to embodiments of the present invention;

FIG. 32A illustrates an example of an under-sampling signal module according to an embodiment of the invention;

FIG. 32B illustrates a flowchart of a state machine operation associated with an under-sampling module according to embodiments of the invention;

FIG. 32C illustrates an example under-sampling module that includes an analog circuit with automatic gain control according to embodiments of the invention;

FIGS. 33A–D illustrate example signal diagrams associated with direct down-conversion of an EM signal to a baseband signal by under-sampling according to embodiments of the present invention;

FIGS. 34A–F illustrate example signal diagrams associated with an inverted sample and hold module according to embodiments of the invention;

FIGS. 35A–E illustrate example signal diagrams associated with directly down-converting an analog AM signal to a demodulated baseband signal by under-sampling according to embodiments of the invention;

FIGS. 36A–E illustrate example signal diagrams associated with down-converting a digital AM signal to a demodulated baseband signal by under-sampling according to embodiments of the invention;

FIGS. 37A–E illustrate example signal diagrams associated with directly down-converting an analog PM signal to a demodulated baseband signal by under-sampling according to embodiments of the invention;

FIGS. 38A–E illustrate example signal diagrams associated with down-converting a digital PM signal to a demodulated baseband signal by under-sampling according to embodiments of the invention;

FIGS. 39A–D illustrate down-converting a FM signal to an FM signal by under-sampling according to embodiments of the invention;

FIGS. 40A–E illustrate down-converting a FSK signal to a PSK signal by under-sampling according to embodiments of the invention;

FIGS. 41A–E illustrate down-converting a FSK signal to an ASK signal by under-sampling according to embodiments of the invention;

FIG. 42 illustrates a structural block diagram of an inverted sample and hold according to an embodiment of the present invention;

FIGS. 43A and B illustrate example waveforms present in the circuit of FIG. 31;

FIG. 44A illustrates a structural block diagram of a differential system according to embodiments of the invention;

FIG. 44B illustrates a structural block diagram of a differential system with a differential input and a differential output according to embodiments of the invention;

FIG. 44C illustrates a structural block diagram of a differential system with a single input and a differential output according to embodiments of the invention;

FIG. 44D illustrates a differential input with a single output according to embodiments of the invention;

FIG. 44E illustrates an example differential input to single output system according to embodiments of the invention;

FIGS. 45A–B illustrate a conceptual illustration of aliasing including under-sampling and energy transfer according to embodiments of the invention;

FIGS. 46A–D illustrate various flowcharts for down-converting an EM signal by transferring energy from the EM signal at an aliasing rate according to embodiments of the invention;

FIGS. 47A–E illustrate example signal diagrams associated with the flowcharts in FIGS. 46A–D according to embodiments of the invention;

FIG. 48 is a flowchart that illustrates an example process for determining an aliasing rate associated with an aliasing signal according to an embodiment of the invention;

FIGS. 49A–H illustrate example energy transfer signals according to embodiments of the invention;

FIGS. 50A–G illustrate example signal diagrams associated with down-converting an analog AM signal to an intermediate frequency by transferring energy at an aliasing rate according to embodiments of the invention;

FIGS. 51A–G illustrate example signal diagrams associated with down-converting a digital AM signal to an intermediate frequency by transferring energy at an aliasing rate according to embodiments of the invention;

FIGS. 52A–G illustrate example signal diagrams associated with down-converting an analog FM signal to an intermediate frequency by transferring energy at an aliasing rate according to embodiments of the invention;

FIGS. 53A–G illustrate example signal diagrams associated with down-converting a digital FM signal to an intermediate frequency by transferring energy at an aliasing rate according to embodiments of the invention;

FIGS. 54A–G illustrate example signal diagrams associated with down-converting an analog PM signal to an intermediate frequency by transferring energy at an aliasing rate according to embodiments of the invention;

FIGS. 55A–G illustrate example signal diagrams associated with down-converting a digital PM signal to an intermediate frequency by transferring energy at an aliasing rate according to embodiments of the invention;

FIGS. 56A–D illustrate an example signal diagram associated with direct down-conversion according to embodiments of the invention;

FIGS. 57A–F illustrate directly down-converting an analog AM signal to a demodulated baseband signal according to embodiments of the invention;

FIGS. 58A–F illustrate directly down-converting a digital AM signal to a demodulated baseband signal according to embodiments of the invention;

FIGS. 59A–F illustrate directly down-converting an analog PM signal to a demodulated baseband signal according to embodiments of the invention;

FIGS. 60A–F illustrate directly down-converting a digital PM signal to a demodulated baseband signal according to embodiments of the invention;

FIGS. 61A–F illustrate down-converting an FM signal to a PM signal according to embodiments of the invention;

FIGS. 62A–F illustrate down-converting an FM signal to an AM signal according to embodiments of the invention;

FIG. 63 illustrates a block diagram of an energy transfer system according to an embodiment of the invention;

FIG. 64A illustrates an exemplary gated transfer system according to an embodiment of the invention;

FIG. 64B illustrates an exemplary inverted gated transfer system according to an embodiment of the invention;

FIG. 65 illustrates an example embodiment of the gated transfer module according to an embodiment of the invention;

FIGS. 66A–D illustrate example implementations of a switch module according to embodiments of the invention;

FIG. 67A illustrates an example embodiment of the gated transfer module as including a break-before-make module according to an embodiment of the invention;

FIG. 67B illustrates an example timing diagram for an energy transfer signal according to an embodiment of the invention;

FIG. 67C illustrates an example timing diagram for an isolation signal according to an embodiment of the invention;

FIGS. 68A–F illustrate example storage modules according to embodiments of the invention;

FIG. 68G illustrates an integrated gated transfer system according to an embodiment of the invention;

FIGS. 68H–K illustrate example aperture generators;

FIG. 68L illustrates an oscillator according to an embodiment of the present invention;

FIG. 69 illustrates an energy transfer system with an optional energy transfer signal module according to an embodiment of the invention;

FIG. 70 illustrates an aliasing module with input and output impedance match according to an embodiment of the invention;

FIG. 71 illustrates an example pulse generator;

FIGS. 72A and B illustrate example waveforms related to the pulse generator of FIG. 71;

FIG. 73 illustrates an example energy transfer module with a switch module and a reactive storage module according to an embodiment of the invention;

FIG. 74 illustrates an example inverted gated transfer module as including a switch module and a storage module according to an embodiment of the invention;

FIGS. 75A–F illustrate an example signal diagrams associated with an inverted gated energy transfer module according to embodiments of the invention;

FIGS. 76A–E illustrate energy transfer modules in configured in various differential configurations according to embodiments of the invention;

FIGS. 77A–C illustrate example impedance matching circuits according to embodiments of the invention;

FIGS. 78A–B illustrate example under-sampling systems according to embodiments of the invention;

FIGS. 79A–F illustrate example timing diagrams for under-sampling systems according to embodiments of the invention;

FIGS. 80A–E illustrate example timing diagrams for an under-sampling system when the load is a relatively low impedance load according to embodiments of the invention;

FIGS. 81A–F illustrate example timing diagrams for an under-sampling system when the holding capacitance has a larger value according to embodiments of the invention;

FIGS. 82A–B illustrate example energy transfer systems according to embodiments of the invention;

FIGS. 83A–F illustrate example timing diagrams for energy transfer systems according to embodiments of the present invention;

FIGS. 84A–D illustrate down-converting an FSK signal to a PSK signal according to embodiments of the present invention;

FIG. 85A illustrates an example energy transfer signal module according to an embodiment of the present invention;

FIG. 85B illustrates a flowchart of state machine operation according to an embodiment of the present invention;

FIG. 85C is an example energy transfer signal module;

FIG. 86 is a schematic diagram of a circuit to down-convert a 915 MHz signal to a 5 MHz signal using a 101.1 MHz clock according to an embodiment of the present invention;

FIG. 87 shows simulation waveforms for the circuit of FIG. 86 according to embodiments of the present invention;

FIG. 88 is a schematic diagram of a circuit to down-convert a 915 MHz signal to a 5 MHz signal using a 101 MHz clock according to an embodiment of the present invention;

FIG. 89 shows simulation waveforms for the circuit of FIG. 88 according to embodiments of the present invention;

FIG. 90 is a schematic diagram of a circuit to down-convert a 915 MHz signal to a 5 MHz signal using a 101.1 MHz clock according to an embodiment of the present invention;

FIG. 91 shows simulation waveforms for the circuit of FIG. 90 according to an embodiment of the present invention;

FIG. 92 shows a schematic of the circuit in FIG. 86 connected to an FSK source that alternates between 913 and 917 MHz at a baud rate of 500 Kbaud according to an embodiment of the present invention;

FIG. 93 shows the original FSK waveform 9202 and the down-converted waveform 9204 at the output of the load impedance match circuit according to an embodiment of the present invention;

FIG. 94A illustrates an example energy transfer system according to an embodiment of the invention;

FIGS. 94B–C illustrate example timing diagrams for the example system of FIG. 94A;

FIG. 95 illustrates an example bypass network according to an embodiment of the invention;

FIGS. 96 and 97 illustrate the amplitude and pulse width modulated transmitter according to embodiments of the present invention;

FIGS. 98A–98D illustrate example signal diagrams associated with the amplitude and pulse width modulated transmitter according to embodiments of the present invention;

FIG. 99 illustrates an example diagram associated with the amplitude and pulse width modulated transmitter according to embodiments of the present invention;

FIG. 100 illustrates an example diagram associated with the amplitude and pulse width modulated transmitter according to embodiments of the present invention;

FIG. 101 shows an embodiment of a receiver block diagram to recover the amplitude or pulse width modulated information;

FIG. 102A–102G illustrate example signal diagrams associated with a waveform generator according to embodiments of the present invention;

FIGS. 103–105 are example schematic diagrams illustrating various circuits employed in the receiver of FIG. A6;

FIGS. 106–109 illustrate time and frequency domain diagrams of alternative transmitter output waveforms;

FIGS. 110 and 111 illustrate differential receivers in accord with embodiments of the present invention; and

FIGS. 112 and 113 illustrate time and frequency domains for a narrow bandwidth/constant carrier signal in accord with an embodiment of the present invention.



---

 Table of Contents
 

---

## I. Introduction

## 1. General Terminology

## 1.1 Modulation

1.1.1 Amplitude Modulation

1.1.2 Frequency Modulation

1.1.3 Phase Modulation

## 1.2 Demodulation

## 2. Overview of the Invention

## 2.1 Aspects of the Invention

## 2.2 Down-Converting by Under-Sampling

2.2.1 Down-Converting to an Intermediate Frequency (IF) Signal

2.2.2 Direct-to-Data Down-Converting

2.2.3 Modulation Conversion

## 2.3 Down-Converting by Transferring Energy

2.3.1 Down-Converting to an Intermediate Frequency (IF) Signal

2.3.2 Direct-to-Data Down-Converting

2.3.3 Modulation Conversion

## 2.4 Determining the Aliasing rate

## 3. Benefits of the Invention Using an Example Conventional Receiver for Comparison

## II. Under-Sampling

## 1. Down-Converting an EM Carrier Signal to an EM Intermediate Signal by Under-Sampling the EM Carrier Signal at the Aliasing Rate

## 1.1 High Level Description

1.1.1 Operational Description

1.1.2 Structural Description

## 1.2 Example Embodiments

## 1.2.1 First Example Embodiment: Amplitude Modulation

1.2.1.1 Operational Description

1.2.1.1.1 Analog AM Carrier Signal

1.2.1.1.2 Digital AM Carrier Signal

1.2.1.2 Structural Description

## 1.2.2 Second Example Embodiment: Frequency Modulation

1.2.2.1 Operational Description

1.2.2.1.1 Analog FM Carrier Signal

1.2.2.1.2 Digital FM Carrier Signal

1.2.2.2 Structural Description

## 1.2.3 Third Example Embodiment: Phase Modulation

1.2.3.1 Operational Description

1.2.3.1.1 Analog PM Carrier Signal

1.2.3.1.2 Digital PM Carrier Signal

1.2.3.2 Structural Description

## 1.2.4 Other Embodiments

## 1.3 Implementation Examples

## 2. Directly Down-Converting an EM Signal to a Baseband Signal (Direct-to-Data)

## 2.1 High Level Description

2.1.1 Operational Description

2.1.2 Structural Description

## 2.2 Example Embodiments

## 2.2.1 First Example Embodiment: Amplitude Modulation

2.2.1.1 Operational Description

2.2.1.1.1 Analog AM Carrier Signal

2.2.1.1.2 Digital AM Carrier Signal

2.2.1.2 Structural Description

## 2.2.2 Second Example Embodiment: Phase Modulation

2.2.2.1 Operational Description

2.2.2.1.1 Analog PM Carrier Signal

2.2.2.1.2 Digital PM Carrier Signal

2.2.2.2 Structural Description

## 2.2.3 Other Embodiments

## 2.3 Implementation Examples

## 3. Modulation Conversion

## 3.1 High Level Description

3.1.1 Operational Description

3.1.2 Structural Description

## 3.2 Example Embodiments

## 3.2.1 First Example Embodiment: Down-Converting an FM Signal to a PM Signal

3.2.1.1 Operational Description

3.2.1.2 Structural Description

## 3.2.2 Second Example Embodiment: Down-Converting an FM Signal to an AM Signal

3.2.2.1 Operational Description

3.2.2.2 Structural Description

## 3.2.3 Other Example Embodiments

## 3.3 Implementation Examples

## 4. Implementation Examples

## 4.1 The Under-Sampling System as a Sample and Hold System

4.1.1 The Sample and Hold System as a Switch Module and a Holding Module

-continued

## Table of Contents

---

4.1.2	The Sample and Hold System as Break-Before-Make Module
4.1.3	Example Implementations of the Switch Module
4.1.4	Example Implementations of the Holding Module
4.1.5	Optional Under-Sampling Signal Module
4.2	The Under-Sampling System as an Inverted Sample and Hold
4.3	Other Implementations
5.	Optional Optimizations of Under-Sampling at an Aliasing Rate
5.1	Doubling the Aliasing Rate ( $F_{AR}$ ) of the Under-Sampling Signal
5.2	Differential Implementations
5.2.1	Differential Input-to-Differential Output
5.2.2	Single input-to-Differential Output
5.2.3	Differential Input-to-Single Output
5.3	Smoothing the Down-Converted Signal
5.4	Load Impedance and Input/Output Buffering
5.5	Modifying the Under-Sampling Signal Utilizing Feedback
III.	Energy Transfer
0.1	Energy Transfer Compared to Under-Sampling
0.1.1	Review of Under-Sampling
0.1.1.1	Effects of Lowering the Impedance of the Load
0.1.1.2	Effects of Increasing the Value of the Holding Capacitance
0.1.2	Introduction to Energy Transfer
1.	Down-Converting an EM Signal to an IF EM Signal by Transferring Energy from the EM Signal at an Aliasing Rate
1.1	High Level Description
1.1.1	Operational Description
1.1.2	Structural Description
1.2	Example Embodiments
1.2.1	First Example Embodiment: Amplitude Modulation
1.2.1.1	Operational Description
1.2.1.1.1	Analog AM Carrier Signal
1.2.1.1.2	Digital AM Carrier Signal
1.2.1.2	Structural Description
1.2.2	Second Example Embodiment: Frequency Modulation
1.2.2.1	Operational Description
1.2.2.1.1	Analog FM Carrier Signal
1.2.2.1.2	Digital FM Carrier Signal
1.2.2.2	Structural Description
1.2.3	Third Example Embodiment: Phase Modulation
1.2.3.1	Operational Description
1.2.3.1.1	Analog PM Carrier Signal
1.2.3.1.2	Digital PM Carrier Signal
1.2.3.2	Structural Description
1.2.4	Other Embodiments
1.3	Implementation Examples
2.	Directly Down-Converting an EM Signal to a Demodulated Baseband Signal by Transferring Energy from the EM Signal
2.1	High Level Description
2.1.1	Operational Description
2.1.2	Structural Description
2.2	Example Embodiments
2.2.1	First Example Embodiment: Amplitude Modulation
2.2.1.1	Operational Description
2.2.1.1.1	Analog AM Carrier Signal
2.2.1.1.2	Digital AM Carrier Signal
2.2.1.2	Structural Description
2.2.2	Second Example Embodiment: Phase Modulation
2.2.2.1	Operational Description
2.2.2.1.1	Analog PM Carrier Signal
2.2.2.1.2	Digital PM Carrier Signal
2.2.2.2	Structural Description
2.2.3	Other Embodiments
2.3	Implementation Examples
3.	Modulation Conversion
3.1	High Level Description
3.1.1	Operational Description
3.1.2	Structural Description
3.2	Example Embodiments
3.2.1	First Example Embodiment: Down-Converting an FM Signal to a PM Signal
3.2.1.1	Operational Description
3.2.1.2	Structural Description
3.2.2	Second Example Embodiment: Down-Converting an FM Signal to an AM Signal
3.2.2.1	Operational Description
3.2.2.2	Structural Description
3.2.3	Other Example Embodiments
3.3	Implementation Examples

-continued

## Table of Contents

---

4.	Implementation Examples
4.1	The Energy Transfer System as a Gated Transfer System
4.1.1	The Gated Transfer System as a Switch Module and a Storage Module
4.1.2	The Gated Transfer System as Break-Before-Make Module
4.1.3	Example Implementations of the Switch Module
4.1.4	Example Implementations of the Storage Module
4.1.5	Optional Energy Transfer Signal Module
4.2	The Energy Transfer System as an Inverted Gated Transfer System
4.2.1	The Inverted Gated Transfer System as a Switch Module and a Storage Module
4.3	Other Implementations
5.	Optional Optimizations of Energy Transfer at an Aliasing Rate
5.1	Doubling the Aliasing Rate ( $F_{AR}$ ) of the Energy Transfer Signal
5.2	Differential Implementations
5.2.1	Differential Input-to-Differential Output
5.2.2	Single Input-to-Differential Output
5.2.3	Differential Input-to-Single Output
5.3	Smoothing the Down-Converted Signal
5.4	Impedance Matching
5.5	Tanks and Resonant Structures
5.6	Optimizing and Adjusting the Non-Negligible Aperture Width/Duration
5.7	Adding a Bypass Network
5.8	Modifying the Energy Transfer Signal Utilizing Feedback
5.9	Other Implementations
6.	Example Energy Transfer Downconverters
IV.	Additional Embodiments
V.	Conclusions

---

### 1. General Terminology

For illustrative purposes, the operation of the invention is often represented by flowcharts, such as flowchart **1201** in FIG. **12A**. It should be understood, however, that the use of flowcharts is for illustrative purposes only, and is not limiting. For example, the invention is not limited to the operational embodiment(s) represented by the flowcharts. Instead, alternative operational embodiments will be apparent to persons skilled in the relevant art(s) based on the discussion contained herein. Also, the use of flowcharts should not be interpreted as limiting the invention to discrete or digital operation. In practice, as will be appreciated by persons skilled in the relevant art(s) based on the herein discussion, the invention can be achieved via discrete or continuous operation, or a combination thereof. Further, the flow of control represented by the flowcharts is provided for illustrative purposes only. As will be appreciated by persons skilled in the relevant art(s), other operational control flows are within the scope and spirit of the present invention. Also, the ordering of steps may differ in various embodiments.

Various terms used in this application are generally described in this section. The description in this section is provided for illustrative and convenience purposes only, and is not limiting. The meaning of these terms will be apparent to persons skilled in the relevant art(s) based on the entirety of the teachings provided herein. These terms may be discussed throughout the specification with additional detail.

The term modulated carrier signal, when used herein, refers to a carrier signal that is modulated by a baseband signal.

The term unmodulated carrier signal, when used herein, refers to a signal having an amplitude that oscillates at a substantially uniform frequency and phase.

The term baseband signal, when used herein, refers to an information signal including, but not limited to, analog information signals, digital information signals and direct current (DC) information signals.

The term carrier signal, when used herein, and unless otherwise specified when used herein, refers to modulated

carrier signals and unmodulated carrier signals, information signals, digital information signals and direct current (DC) information signals.

The term electromagnetic (EM) signal, when used herein, refers to a signal in the EM spectrum. EM spectrum includes all frequencies greater than zero hertz. EM signals generally include waves characterized by variations in electric and magnetic fields. Such waves may be propagated in any medium, both natural and manmade, including but not limited to air, space, wire, cable, liquid, waveguide, micro-strip, strip-line, optical fiber, etc. Unless stated otherwise, all signals discussed herein are EM signals, even when not explicitly designated as such.

The term intermediate frequency (IF) signal, when used herein, refers to an EM signal that is substantially similar to another EM signal except that the IF signal has a lower frequency than the other signal. An IF signal frequency can be any frequency above zero HZ. Unless otherwise stated, the terms lower frequency, intermediate frequency, intermediate and IF are used interchangeably herein.

The term analog signal, when used herein, refers to a signal that is constant or continuously variable, as contrasted to a signal that changes between discrete states.

The term baseband, when used herein, refers to a frequency band occupied by any generic information signal desired for transmission and/or reception.

The term baseband signal, when used herein, refers to any generic information signal desired for transmission and/or reception.

The term carrier frequency, when used herein, refers to the frequency of a carrier signal. Typically, it is the center frequency of a transmission signal that is generally modulated.

The term carrier signal, when used herein, refers to an EM wave having at least one characteristic that may be varied by modulation, that is capable of carrying information via modulation.

The term demodulated baseband signal, when used herein, refers to a signal that results from processing a

modulated signal. In some cases, for example, the demodulated baseband signal results from demodulating an intermediate frequency (IF) modulated signal, which results from down converting a modulated carrier signal. In another case, a signal that results from a combined downconversion and demodulation step.

The term digital signal, when used herein, refers to a signal that changes between discrete states, as contrasted to a signal that is continuous. For example, the voltage of a digital signal may shift between discrete levels.

The term electromagnetic (EM) spectrum, when used herein, refers to a spectrum comprising waves characterized by variations in electric and magnetic fields. Such waves may be propagated in any communication medium, both natural and manmade, including but not limited to air, space, wire, cable, liquid, waveguide, microstrip, stripline, optical fiber, etc. The EM spectrum includes all frequencies greater than zero hertz.

The term electromagnetic (EM) signal, when used herein, refers to a signal in the EM spectrum. Also generally called an EM wave. Unless stated otherwise, all signals discussed herein are EM signals, even when not explicitly designated as such.

The term modulating baseband signal, when used herein, refers to any generic information signal that is used to modulate an oscillating signal, or carrier signal.

#### 1.1 Modulation

It is often beneficial to propagate electromagnetic (EM) signals at higher frequencies. This includes baseband signals, such as digital data information signals and analog information signals. A baseband signal can be up-converted to a higher frequency EM signal by using the baseband signal to modulate a higher frequency carrier signal,  $F_C$ . When used in this manner, such a baseband signal is herein called a modulating baseband signal  $F_{MB}$ .

Modulation imparts changes to the carrier signal  $F_C$  that represent information in the modulating baseband signal  $F_{MB}$ . The changes can be in the form of amplitude changes, frequency changes, phase changes, etc., or any combination thereof. The resultant signal is referred to herein as a modulated carrier signal  $F_{MC}$ . The modulated carrier signal  $F_{MC}$  includes the carrier signal  $F_C$  modulated by the modulating baseband signal,  $F_{MB}$ , as in:

$$F_{MB} \text{ combined with } F_C \rightarrow F_{MC}$$

The modulated carrier signal  $F_{MC}$  oscillates at, or near the frequency of the carrier signal  $F_C$  and can thus be efficiently propagated.

FIG. 1 illustrates an example modulator **110**, wherein the carrier signal  $F_C$  is modulated by the modulating baseband signal  $F_{MB}$ , thereby generating the modulated carrier signal  $F_{MC}$ .

Modulating baseband signal  $F_{MB}$  can be an analog baseband signal, a digital baseband signal, or a combination thereof.

FIG. 2 illustrates the modulating baseband signal  $F_{MB}$  as an exemplary analog modulating baseband signal **210**. The exemplary analog modulating baseband signal **210** can represent any type of analog information including, but not limited to, voice/speech data, music data, video data, etc. The amplitude of analog modulating baseband signal **210** varies in time.

Digital information includes a plurality of discrete states. For ease of explanation, digital information signals are discussed below as having two discrete states. But the invention is not limited to this embodiment.

FIG. 3 illustrates the modulating baseband signal  $F_{MB}$  as an exemplary digital modulating baseband signal **310**. The digital modulating baseband signal **310** can represent any type of digital data including, but not limited to, digital computer information and digitized analog information. The digital modulating baseband signal **310** includes a first state **312** and a second state **314**. In an embodiment, first state **312** represents binary state **0** and second state **314** represents binary state **1**. Alternatively, first state **312** represents binary state **1** and second state **314** represents binary state **0**. Throughout the remainder of this disclosure, the former convention is followed, whereby first state **312** represents binary state zero and second state **314** represents binary state one. But the invention is not limited to this embodiment. First state **312** is thus referred to herein as a low state and second state **314** is referred to herein as a high state.

Digital modulating baseband signal **310** can change between first state **312** and second state **314** at a data rate, or baud rate, measured as bits per second.

Carrier signal  $F_C$  is modulated by the modulating baseband signal  $F_{MB}$ , by any modulation technique, including, but not limited to, amplitude modulation (AM), frequency modulation (FM), phase modulation (PM), etc., or any combination thereof. Examples are provided below for amplitude modulating, frequency modulating, and phase modulating the analog modulating baseband signal **210** and the digital modulating baseband signal **310**, on the carrier signal  $F_C$ . The examples are used to assist in the description of the invention. The invention is not limited to, or by, the examples.

FIG. 4 illustrates the carrier signal  $F_C$  as a carrier signal **410**. In the example of FIG. 4, the carrier signal **410** is illustrated as a 900 MHz carrier signal. Alternatively, the carrier signal **410** can be any other frequency. Example modulation schemes are provided below, using the examples signals from FIGS. 2, 3 and 4.

##### 1.1.1 Amplitude Modulation

In amplitude modulation (AM), the amplitude of the modulated carrier signal  $F_{MC}$  is a function of the amplitude of the modulating baseband signal  $F_{MB}$ . FIGS. 5A–5C illustrate example timing diagrams for amplitude modulating the carrier signal **410** with the analog modulating baseband signal **210**. FIGS. 6A–6C illustrate example timing diagrams for amplitude modulating the carrier signal **410** with the digital modulating baseband signal **310**.

FIG. 5A illustrates the analog modulating baseband signal **210**. FIG. 5B illustrates the carrier signal **410**. FIG. 5C illustrates an analog AM carrier signal **516**, which is generated when the carrier signal **410** is amplitude modulated using the analog modulating baseband signal **210**. As used herein, the term “analog AM carrier signal” is used to indicate that the modulating baseband signal is an analog signal.

The analog AM carrier signal **516** oscillates at the frequency of carrier signal **410**. The amplitude of the analog AM carrier signal **516** tracks the amplitude of analog modulating baseband signal **210**, illustrating that the information contained in the analog modulating baseband signal **210** is retained in the analog AM carrier signal **516**.

FIG. 6A illustrates the digital modulating baseband signal **310**. FIG. 6B illustrates the carrier signal **410**. FIG. 6C illustrates a digital AM carrier signal **616**, which is generated when the carrier signal **410** is amplitude modulated using the digital modulating baseband signal **310**. As used herein, the term “digital AM carrier signal” is used to indicate that the modulating baseband signal is a digital signal.

The digital AM carrier signal **616** oscillates at the frequency of carrier signal **410**. The amplitude of the digital

AM carrier signal **616** tracks the amplitude of digital modulating baseband signal **310**, illustrating that the information contained in the digital modulating baseband signal **310** is retained in the digital AM signal **616**. As the digital modulating baseband signal **310** changes states, the digital AM signal **616** shifts amplitudes. Digital amplitude modulation is often referred to as amplitude shift keying (ASK), and the two terms are used interchangeably throughout the specification.

#### 1.1.2 Frequency Modulation

In frequency modulation (FM), the frequency of the modulated carrier signal  $F_{MC}$  varies as a function of the amplitude of the modulating baseband signal  $F_{MB}$ . FIGS. **7A–7C** illustrate example timing diagrams for frequency modulating the carrier signal **410** with the analog modulating baseband signal **210**. FIGS. **8A–8C** illustrate example timing diagrams for frequency modulating the carrier signal **410** with the digital modulating baseband signal **310**.

FIG. **7A** illustrates the analog modulating baseband signal **210**. FIG. **7B** illustrates the carrier signal **410**. FIG. **7C** illustrates an analog FM carrier signal **716**, which is generated when the carrier signal **410** is frequency modulated using the analog modulating baseband signal **210**. As used herein, the term “analog FM carrier signal” is used to indicate that the modulating baseband signal is an analog signal.

The frequency of the analog FM carrier signal **716** varies as a function of amplitude changes on the analog baseband signal **210**. In the illustrated example, the frequency of the analog FM carrier signal **716** varies in proportion to the amplitude of the analog modulating baseband signal **210**. Thus, at time **t1**, the amplitude of the analog baseband signal **210** and the frequency of the analog FM carrier signal **716** are at maximums. At time **t3**, the amplitude of the analog baseband signal **210** and the frequency of the analog AM carrier signal **716** are at minimums.

The frequency of the analog FM carrier signal **716** is typically centered around the frequency of the carrier signal **410**. Thus, at time **t2**, for example, when the amplitude of the analog baseband signal **210** is at a mid-point, illustrated here as zero volts, the frequency of the analog FM carrier signal **716** is substantially the same as the frequency of the carrier signal **410**.

FIG. **8A** illustrates the digital modulating baseband signal **310**. FIG. **8B** illustrates the carrier signal **410**. FIG. **8C** illustrates a digital FM carrier signal **816**, which is generated when the carrier signal **410** is frequency modulated using the digital baseband signal **310**. As used herein, the term “digital FM carrier signal” is used to indicate that the modulating baseband signal is a digital signal.

The frequency of the digital FM carrier signal **816** varies as a function of amplitude changes on the digital modulating baseband signal **310**. In the illustrated example, the frequency of the digital FM carrier signal **816** varies in proportion to the amplitude of the digital modulating baseband signal **310**. Thus, between times **t0** and **t1**, and between times **t2** and **t4**, when the amplitude of the digital baseband signal **310** is at the higher amplitude second state, the frequency of the digital FM carrier signal **816** is at a maximum. Between times **t1** and **t2**, when the amplitude of the digital baseband signal **310** is at the lower amplitude first state, the frequency of the digital FM carrier signal **816** is at a minimum. Digital frequency modulation is often referred to as frequency shift keying (FSK), and the terms are used interchangeably throughout the specification.

Typically, the frequency of the digital FM carrier signal **816** is centered about the frequency of the carrier signal **410**,

and the maximum and minimum frequencies are equally offset from the center frequency. Other variations can be employed but, for ease of illustration, this convention will be followed herein.

#### 1.1.3 Phase Modulation

In phase modulation (PM), the phase of the modulated carrier signal  $F_{MC}$  varies as a function of the amplitude of the modulating baseband signal  $F_{MB}$ . FIGS. **9A–9C** illustrate example timing diagrams for phase modulating the carrier signal **410** with the analog modulating baseband signal **210**. FIGS. **10A–10C** illustrate example timing diagrams for phase modulating the carrier signal **410** with the digital modulating baseband signal **310**.

FIG. **9A** illustrates the analog modulating baseband signal **210**. FIG. **9B** illustrates the carrier signal **410**. FIG. **9C** illustrates an analog PM carrier signal **916**, which is generated by phase modulating the carrier signal **410** with the analog baseband signal **210**. As used herein, the term “analog PM carrier signal” is used to indicate that the modulating baseband signal is an analog signal.

Generally, the frequency of the analog PM carrier signal **916** is substantially the same as the frequency of carrier signal **410**. But the phase of the analog PM carrier signal **916** varies with amplitude changes on the analog modulating baseband signal **210**. For relative comparison, the carrier signal **410** is illustrated in FIG. **9C** by a dashed line.

The phase of the analog PM carrier signal **916** varies as a function of amplitude changes of the analog baseband signal **210**. In the illustrated example, the phase of the analog PM signal **916** lags by a varying amount as determined by the amplitude of the baseband signal **210**. For example, at time **t1**, when the amplitude of the analog baseband signal **210** is at a maximum, the analog PM carrier signal **916** is in phase with the carrier signal **410**. Between times **t1** and **t3**, when the amplitude of the analog baseband signal **210** decreases to a minimum amplitude, the phase of the analog PM carrier signal **916** lags the phase of the carrier signal **410**, until it reaches a maximum out of phase value at time **t3**. In the illustrated example, the phase change is illustrated as approximately 180 degrees. Any suitable amount of phase change, varied in any manner that is a function of the baseband signal, can be utilized.

FIG. **10A** illustrates the digital modulating baseband signal **310**. FIG. **10B** illustrates the carrier signal **410**. FIG. **10C** illustrates a digital PM carrier signal **1016**, which is generated by phase modulating the carrier signal **410** with the digital baseband signal **310**. As used herein, the term “digital PM carrier signal” is used to indicate that the modulating baseband signal is a digital signal.

The frequency of the digital PM carrier signal **1016** is substantially the same as the frequency of carrier signal **410**. The phase of the digital PM carrier signal **1016** varies as a function of amplitude changes on the digital baseband signal **310**. In the illustrated example, when the digital baseband signal **310** is at the first state **312**, the digital PM carrier signal **1016** is out of phase with the carrier signal **410**. When the digital baseband signal **310** is at the second state **314**, the digital PM carrier signal **1016** is in-phase with the carrier signal **410**. Thus, between times **t1** and **t2**, when the amplitude of the digital baseband signal **310** is at the first state **312**, the digital PM carrier signal **1016** is out of phase with the carrier signal **410**. Between times **t0** and **t1**, and between times **t2** and **t4**, when the amplitude of the digital baseband signal **310** is at the second state **314**, the digital PM carrier signal **1016** is in phase with the carrier signal **410**.

In the illustrated example, the out of phase value between times **t1** and **t3** is illustrated as approximately 180 degrees

out of phase. Any suitable amount of phase change, varied in any manner that is a function of the baseband signal, can be utilized. Digital phase modulation is often referred to as phase shift keying (PSK), and the terms are used interchangeably throughout the specification.

### 1.2 Demodulation

When the modulated carrier signal  $F_{MC}$  is received, it can be demodulated to extract the modulating baseband signal  $F_{MB}$ . Because of the typically high frequency of modulated carrier signal  $F_{MC}$ , however, it is generally impractical to demodulate the baseband signal  $F_{MB}$  directly from the modulated carrier signal  $F_{MC}$ . Instead, the modulated carrier signal  $F_{MC}$  must be down-converted to a lower frequency signal that contains the original modulating baseband signal.

When a modulated carrier signal is down-converted to a lower frequency signal, the lower frequency signal is referred to herein as an intermediate frequency (IF) signal  $F_{IF}$ . The IF signal  $F_{IF}$  oscillates at any frequency, or frequency band, below the frequency of the modulated carrier frequency  $F_{MC}$ . Down-conversion of  $F_{MC}$  to  $F_{IF}$  is illustrated as:

$$F_{MC} \rightarrow F_{IF}$$

After  $F_{MC}$  is down-converted to the IF modulated carrier signal  $F_{IF}$ ,  $F_{IF}$  can be demodulated to a baseband signal  $F_{DMB}$ , as illustrated by:

$$F_{IF} \rightarrow F_{DMB}$$

$F_{DMB}$  is intended to be substantially similar to the modulating baseband signal  $F_{MB}$ , illustrating that the modulating baseband signal  $F_{MB}$  can be substantially recovered.

It will be emphasized throughout the disclosure that the present invention can be, implemented with any type of EM signal, including, but not limited to, modulated carrier signals and unmodulated carrier signals. The above examples of modulated carrier signals are provided for illustrative purposes only. Many variations to the examples are possible. For example, a carrier signal can be modulated with a plurality of the modulation types described above. A carrier signal can also be modulated with a plurality of baseband signals, including analog baseband signals, digital baseband signals, and combinations of both analog and digital baseband signals.

### 2. Overview of the invention

Conventional signal processing techniques follow the Nyquist sampling theorem, which states that, in order to faithfully reproduce a sampled signal, the signal must be sampled at a rate that is greater than twice the frequency of the signal being sampled. When a signal is sampled at less than or equal to twice the frequency of the signal, the signal is said to be under-sampled, or aliased. Conventional signal processing thus teaches away from under-sampling and aliasing, in order to faithfully reproduce a sampled signal.

#### 2.1 Aspects of the Invention

Contrary to conventional wisdom, the present invention is a method and system for down-converting an electromagnetic (EM) signal by aliasing the EM signal. Aliasing is represented generally in FIG. 45A as 4502.

By taking a carrier and aliasing it at an aliasing rate, the invention can down-convert that carrier to lower frequencies. One aspect that can be exploited by this invention is realizing that the carrier is not the item of interest, the lower baseband signal is of interest to reproduce sufficiently. This baseband signal's frequency content, even though its carrier may be aliased, does satisfy the Nyquist criteria and as a result, the baseband information can be sufficiently reproduced.

FIG. 12A depicts a flowchart 1201 that illustrates a method for aliasing an EM signal to generate a down-converted signal. The process begins at step 1202, which includes receiving the EM signal. Step 1204 includes receiving an aliasing signal having an aliasing rate. Step 1206 includes aliasing the EM signal to down-convert the EM signal. The term aliasing, as used herein, refers to both down-converting an EM signal by under-sampling the EM signal at an aliasing rate and to down-converting an EM signal by transferring energy from the EM signal at the aliasing rate. These concepts are described below.

FIG. 13 illustrates a block diagram of a generic aliasing system 1302, which includes an aliasing module 1306. In an embodiment, the aliasing system 1302 operates in accordance with the flowchart 1201. For example, in step 1202, the aliasing module 1306 receives an EM signal 1304. In step 1204, the aliasing module 1306 receives an aliasing signal 1310. In step 1206, the aliasing module 1306 down-converts the EM signal 1304 to a down-converted signal 1308. The generic aliasing system 1302 can also be used to implement any of the flowcharts 1207, 1213 and 1219.

In an embodiment, the invention down-converts the EM signal to an intermediate frequency (IF) signal. FIG. 12B depicts a flowchart 1207 that illustrates a method for under-sampling the EM signal at an aliasing rate to down-convert the EM signal to an IF signal. The process begins at step 1208, which includes receiving an EM signal. Step 1210 includes receiving an aliasing signal having an aliasing rate FAR. Step 1212 includes under-sampling the EM signal at the aliasing rate to down-convert the EM signal to an IF signal.

In another embodiment, the invention down-converts the EM signal to a demodulated baseband information signal. FIG. 12C depicts a flowchart 1213 that illustrates a method for down-converting the EM signal to a demodulated baseband signal. The process begins at step 1214, which includes receiving an EM signal. Step 1216 includes receiving an aliasing signal having an aliasing rate FAR. Step 1218 includes down-converting the EM signal to a demodulated baseband signal. The demodulated baseband signal can be processed without further down-conversion or demodulation.

In another embodiment, the EM signal is a frequency modulated (FM) signal, which is down-converted to a non-FM signal, such as a phase modulated (PM) signal or an amplitude modulated (AM) signal. FIG. 12D depicts a flowchart 1219 that illustrates a method for down-converting the FM signal to a non-FM signal. The process begins at step 1220, which includes receiving an EM signal. Step 1222 includes receiving an aliasing signal having an aliasing rate. Step 1224 includes down-converting the FM signal to a non-FM signal.

The invention down-converts any type of EM signal, including, but not limited to, modulated carrier signals and unmodulated carrier signals. For ease of discussion, the invention is further described herein using modulated carrier signals for examples. Upon reading the disclosure and examples therein, one skilled in the relevant art(s) will understand that the invention can be implemented to down-convert signals other than carrier signals as well. The invention is not limited to the example embodiments described above.

In an embodiment, down-conversion is accomplished by under-sampling an EM signal. This is described generally in Section I.2.2. below and in detail in Section II and its sub-sections. In another embodiment, down-conversion is achieved by transferring non-negligible amounts of energy

from an EM signal. This is described generally in Section I.2.3. below and in detail in Section III.

### 2.2 Down-Converting by Under-Sampling

The term aliasing, as used herein, refers both to down-converting an EM signal by under-sampling the EM signal at an aliasing rate and to down-converting an EM signal by transferring energy from the EM signal at the aliasing rate. Methods for under-sampling an EM signal to down-convert the EM signal are now described at an overview level. FIG. 14A depicts a flowchart 1401 that illustrates a method for under-sampling the EM signal at an aliasing rate to down-convert the EM signal. The process begins at step 1402, which includes receiving an EM signal. Step 1404 includes receiving an under-sampling signal having an aliasing rate. Step 1406 includes under-sampling the EM signal at the aliasing rate to down-convert the EM signal.

Down-converting by under-sampling is illustrated by 4504 in FIG. 45A and is described in greater detail in Section II.

#### 2.2.1 Down-Converting to an Intermediate Frequency (IF) Signal

In an embodiment, an EM signal is under-sampled at an aliasing rate to down-convert the EM signal to a lower, or intermediate frequency (IF) signal. The EM signal can be a modulated carrier signal or an unmodulated carrier signal. In an exemplary example, a modulated carrier signal  $F_{MC}$  is down-converted to an IF signal  $F_{IF}$ .

$$F_{MC} \rightarrow F_{IF}$$

FIG. 14B depicts a flowchart 1407 that illustrates a method for under-sampling the EM signal at an aliasing rate to down-convert the EM signal to an IF signal. The process begins at step 1408, which includes receiving an EM signal. Step 1410 includes receiving an under-sampling signal having an aliasing rate. Step 1412 includes under-sampling the EM signal at the aliasing rate to down-convert the EM signal to an IF signal.

This embodiment is illustrated generally by 4508 in FIG. 45B and is described in Section II.1.

#### 2.2.2 Direct-to-Data Down-Converting

In another embodiment, an EM signal is directly down-converted to a demodulated baseband signal (direct-to-data down-conversion), by under-sampling the EM signal at an aliasing rate. The EM signal can be a modulated EM signal or an unmodulated EM signal. In an exemplary embodiment, the EM signal is the modulated carrier signal  $F_{MC}$ , and is directly down-converted to a demodulated baseband signal  $F_{DMB}$ .

$$F_{MC} \rightarrow F_{DMB}$$

FIG. 14C depicts a flowchart 1413 that illustrates a method for under-sampling the EM signal at an aliasing rate to directly down-convert the EM signal to a demodulated baseband signal. The process begins at step 1414, which includes receiving an EM signal. Step 1416 includes receiving an under-sampling signal having an aliasing rate. Step 1418 includes under-sampling the EM signal at the aliasing rate to directly down-convert the EM signal to a baseband information signal.

This embodiment is illustrated generally by 4510 in FIG. 45B and is described in Section II.2

#### 2.2.3 Modulation Conversion

In another embodiment, a frequency modulated (FM) carrier signal  $F_{FMC}$  is converted to a non-FM signal  $F_{(NON-FM)}$ , by under-sampling the FM carrier signal  $F_{FMC}$ .

$$F_{FMC} \rightarrow F_{(NON-FM)}$$

FIG. 14D depicts a flowchart 1419 that illustrates a method for under-sampling an FM signal to convert it to a non-FM signal. The process begins at step 1420, which includes receiving the FM signal. Step 1422 includes receiving an under-sampling signal having an aliasing rate. Step 1424 includes under-sampling the FM signal at the aliasing rate to convert the FM signal to a non-FM signal. For example, the FM signal can be under-sampled to convert it to a PM signal or an AM signal.

This embodiment is illustrated generally by 4512 in FIG. 45B, and described in Section II.3

### 2.3 Down-Converting by Transferring Energy

The term aliasing, as used herein, refers both to down-converting an EM signal by under-sampling the EM signal at an aliasing rate and to down-converting an EM signal by transferring non-negligible amounts energy from the EM signal at the aliasing rate. Methods for transferring energy from an EM signal to down-convert the EM signal are now described at an overview level. More detailed descriptions are provided in Section III.

FIG. 46A depicts a flowchart 4601 that illustrates a method for transferring energy from the EM signal at an aliasing rate to down-convert the EM signal. The process begins at step 4602, which includes receiving an EM signal. Step 4604 includes receiving an energy transfer signal having an aliasing rate. Step 4606 includes transferring energy from the EM signal at the aliasing rate to down-convert the EM signal.

Down-converting by transferring energy is illustrated by 4506 in FIG. 45A and is described in greater detail in Section III.

#### 2.3.1 Down-Converting to an Intermediate Frequency (IF) Signal

In an embodiment, EM signal is down-converted to a lower, or intermediate frequency (IF) signal, by transferring energy from the EM signal at an aliasing rate. The EM signal can be a modulated carrier signal or an unmodulated carrier signal. In an exemplary example, a modulated carrier signal  $F_{MC}$  is down-converted to an IF signal  $F_{IF}$ .

$$F_{MC} \rightarrow F_{IF}$$

FIG. 46B depicts a flowchart 4607 that illustrates a method for transferring energy from the EM signal at an aliasing rate to down-convert the EM signal to an IF signal. The process begins at step 4608, which includes receiving an EM signal. Step 4610 includes receiving an energy transfer signal having an aliasing rate. Step 4612 includes transferring energy from the EM signal at the aliasing rate to down-convert the EM signal to an IF signal.

This embodiment is illustrated generally by 4514 in FIG. 45B and is described in Section III.1.

#### 2.3.2 Direct-to-Data Down-Converting

In another embodiment, an EM signal is down-converted to a demodulated baseband signal by transferring energy from the EM signal at an aliasing rate. This embodiment is referred to herein as direct-to-data down-conversion. The EM signal can be a modulated EM signal or an unmodulated EM signal. In an exemplary embodiment, the EM signal is the modulated carrier signal  $F_{MC}$ , and is directly down-converted to a demodulated baseband signal  $F_{DMB}$ .

$$F_{MC} \rightarrow F_{DMB}$$

FIG. 46C depicts a flowchart 4613 that illustrates a method for transferring energy from the EM signal at an aliasing rate to directly down-convert the EM signal to a demodulated baseband signal. The process begins at step

**4614**, which includes receiving an EM signal. Step **4616** includes receiving an energy transfer signal having an aliasing rate. Step **4618** includes transferring energy from the EM signal at the aliasing rate to directly down-convert the EM signal to a baseband signal.

This embodiment is illustrated generally by **4516** in FIG. **45B** and is described in Section III.2

### 2.3.3 Modulation Conversion

In another embodiment, a frequency modulated (FM) carrier signal  $F_{MC}$  is converted to a non-FM signal  $F_{(NON-FM)}$ , by transferring energy from the FM carrier signal  $F_{FMC}$  at an aliasing rate.

$$F_{DMC} \rightarrow F_{(NON-FM)}$$

The FM carrier signal  $F_{DMC}$  can be converted to, for example, a phase modulated (PM) signal or an amplitude modulated (AM) signal. FIG. **46D** depicts a flowchart **4619** that illustrates a method for transferring energy from an FM signal to convert it to a non-FM signal. Step **4620** includes receiving the FM signal. Step **4622** includes receiving an energy transfer signal having an aliasing rate. In FIG. **46D**, step **4612** includes transferring energy from the FM signal to convert it to a non-FM signal. For example, energy can be transferred from an FSK signal to convert it to a PSK signal or an ASK signal.

This embodiment is illustrated generally by **4518** in FIG. **45B**, and described in Section III.3

### 2.4 Determining the Aliasing rate

In accordance with the definition of aliasing, the aliasing rate is equal to, or less than, twice the frequency of the EM carrier signal. Preferably, the aliasing rate is much less than the frequency of the carrier signal. The aliasing rate is preferably more than twice the highest frequency component of the modulating baseband signal  $F_{MB}$  that is to be reproduced. The above requirements are illustrated in EQ. (1).

$$2 \cdot F_{MC} \geq F_{AR} > 2 \cdot (\text{Highest Freq. Component of } F_{MB}) \quad \text{EQ. (1)}$$

In other words, by taking a carrier and aliasing it at an aliasing rate, the invention can down-convert that carrier to lower frequencies. One aspect that can be exploited by this invention is that the carrier is not the item of interest; instead the lower baseband signal is of interest to be reproduced sufficiently. The baseband signal's frequency content, even though its carrier may be aliased, satisfies the Nyquist criteria and as a result, the baseband information can be sufficiently reproduced, either as the intermediate modulating carrier signal  $F_{IF}$  or as the demodulated direct-to-data baseband signal  $F_{DMB}$ .

In accordance with the invention, relationships between the frequency of an EM carrier signal, the aliasing rate, and the intermediate frequency of the down-converted signal, are illustrated in EQ. (2).

$$F_C = n \cdot F_{AR} \pm F_{IF} \quad \text{EQ. (2)}$$

Where:

$F_C$  is the frequency of the EM carrier signal that is to be aliased;

$F_{AR}$  is the aliasing rate;

$n$  identifies a harmonic or sub-harmonic of the aliasing rate (generally,  $n=0.5, 1, 2, 3, 4, \dots$ ); and

$F_{IF}$  is the intermediate frequency of the down-converted signal.

Note that as  $(n \cdot F_{AR})$  approaches  $F_C$ ,  $F_{IF}$  approaches zero. This is a special case where an EM signal is directly down-converted to a demodulated baseband signal. This special case is referred to herein as Direct-to-Data down-conversion. Direct-to-Data down-conversion is described in later sections.

High level descriptions, exemplary embodiments and exemplary implementations of the above and other embodiments of the invention are provided in sections below.

### 3. Benefits of the Invention Using an Example Conventional Receiver for Comparison

FIG. **1** illustrates an example conventional receiver system **1102**. The conventional system **1102** is provided both to help the reader to understand the functional differences between conventional systems and the present invention, and to help the reader to understand the benefits of the present invention.

The example conventional receiver system **1102** receives an electromagnetic (EM) signal **1104** via an antenna **1106**. The EM signal **1104** can include a plurality of EM signals such as modulated carrier signals. For example, the EM signal **1104** includes one or more radio frequency (RF) EM signals, such as a 900 MHz modulated carrier signal. Higher frequency RF signals, such as 900 MHz signals, generally cannot be directly processed by conventional signal processors. Instead, higher frequency RF signals are typically down-converted to lower intermediate frequencies (IF) for processing. The receiver system **1102** down-converts the EM signal **1104** to an intermediate frequency (IF) signal **1108n**, which can be provided to a signal processor **1110**. When the EM signal **1104** includes a modulated carrier signal, the signal processor **1110** usually includes a demodulator that demodulates the IF signal **1108n** to a baseband information signal (demodulated baseband signal).

Receiver system **1102** includes an RF stage **1112** and one or more IF stages **1114**. The RF stage **1112** receives the EM signal **1104**. The RF stage **1112** includes the antenna **1106** that receives the EM signal **1104**.

The one or more IF stages **1114a-1114n** down-convert the EM signal **1104** to consecutively lower intermediate frequencies. Each of the one or more IF sections **1114a-1114n** includes a mixer **1118a-1118n** that down-converts an input EM signal **1116** to a lower frequency IF signal **1108**. By cascading the one or more mixers **1118a-1118n**, the EM signal **1104** is incrementally down-converted to a desired IF signal **1108n**.

In operation, each of the one or more mixers **1118** mixes an input EM signal **1116** with a local oscillator (LO) signal **1119**, which is generated by a local oscillator (LO) **1120**. Mixing generates sum and difference signals from the input EM signal **1116** and the LO signal **1119**. For example, mixing an input EM signal **1116a**, having a frequency of 900 MHz, with a LO signal **1119a**, having a frequency of 830 MHz, results in a sum signal, having a frequency of 900 MHz+830 MHz=1.73 GHz, and a difference signal, having a frequency of 900 MHz-830 MHz=70 MHz.

Specifically, in the example of FIG. **11**, the one or more mixers **1118** generate a sum and difference signals for all signal components in the input EM signal **1116**. For example, when the EM signal **1116a** includes a second EM signal, having a frequency of 760 MHz, the mixer **1118a** generates a second sum signal, having a frequency of 760 MHz+830 MHz=1.59 GHz, and a second difference signal, having a frequency of 830 MHz-760 MHz=70 MHz. In this example, therefore, mixing two input EM signals, having frequencies of 900 MHz and 760 MHz, respectively, with an LO signal having a frequency of 830 MHz, results in two IF signals at 70 MHz.

Generally, it is very difficult, if not impossible, to separate the two 70 MHz signals. Instead, one or more filters **1122** and **1123** are provided upstream from each mixer **1118** to filter the unwanted frequencies, also known as image frequencies. The filters **1122** and **1123** can include various filter



topologies and arrangements such as bandpass filters, one or more high pass filters, one or more low pass filters, combinations thereof, etc.

Typically, the one or more mixers **1118** and the one or more filters **1122** and **1123** attenuate or reduce the strength of the EM signal **1104**. For example, a typical mixer reduces the EM signal strength by 8 to 12 dB. A typical filter reduces the EM signal strength by 3 to 6 dB.

As a result, one or more low noise amplifiers (LNAs) **1121** and **1124a–1124n** are provided upstream of the one or more filters **1123** and **1122a–1122n**. The LNAs and filters can be in reversed order. The LNAs compensate for losses in the mixers **1118**, the filters **1122** and **1123**, and other components by increasing the EM signal strength prior to filtering and mixing. Typically, each LNA contributes 15 to 20 dB of amplification.

However, LNAs require substantial power to operate. Higher frequency LNAs require more power than lower frequency LNAs. When the receiver system **1102** is intended to be portable, such as a cellular telephone receiver, for example, the LNAs require a substantial portion of the total power.

At higher frequencies, impedance mismatches between the various stages further reduce the strength of the EM signal **1104**. In order to optimize power transferred through the receiver system **1102**, each component should be impedance matched with adjacent components. Since no two components have the exact same impedance characteristics, even for components that were manufactured with high tolerances, impedance matching must often be individually fine tuned for each receiver system **1102**. As a result, impedance matching in conventional receivers tends to be labor intensive and more art than science. Impedance matching requires a significant amount of added time and expense to both the design and manufacture of conventional receivers. Since many of the components, such as LNA, filters, and impedance matching circuits, are highly frequency dependent, a receiver designed for one application is generally not suitable for other applications. Instead, a new receiver must be designed, which requires new impedance matching circuits between many of the components.

Conventional receiver components are typically positioned over multiple IC substrates instead of on a single IC substrate. This is partly because there is no single substrate that is optimal for both RF, IF, and baseband frequencies. Other factors may include the sheer number of components, their various sizes and different inherent impedance characteristics, etc. Additional signal amplification is often required when going from chip to chip. Implementation over multiple substrates thus involves many costs in addition to the cost of the ICs themselves.

Conventional receivers thus require many components, are difficult and time consuming to design and manufacture, and require substantial external power to maintain sufficient signal levels. Conventional receivers are thus expensive to design, build, and use.

In an embodiment, the present invention is implemented to replace many, if not all, of the components between the antenna **1106** and the signal processor **1110**, with an aliasing module that includes a universal frequency translator (UFT) module. The UFT is able to down-convert a wide range of EM signal frequencies using very few components. The UFT is easy to design and build, and requires very little external power. The UFT design can be easily tailored for different frequencies or frequency ranges. For example, UFT design can be easily impedance matched with relatively little tuning. In a direct-to-data embodiment of the invention,

where an EM signal is directly down-converted to a demodulated baseband signal, the invention also eliminates the need for a demodulator in the signal processor **1110**.

When the invention is implemented in a receiver system, such as the receiver system **1102**, power consumption is significantly reduced and signal to noise ratio is significantly increased.

In an embodiment, the invention can be implemented and tailored for specific applications with easy to calculate and easy to implement impedance matching circuits. As a result, when the invention is implemented as a receiver, such as the receiver **1102**, specialized impedance matching experience is not required.

In conventional receivers, components in the IF sections comprise roughly eighty to ninety percent of the total components of the receivers. The UFT design eliminates the IF section(s) and thus eliminates the roughly eighty to ninety percent of the total components of conventional receivers.

Other advantages of the invention include, but are not limited to:

The invention can be implemented as a receiver with only a single local oscillator;

The invention can be implemented as a receiver with only a single, lower frequency, local oscillator;

The invention can be implemented as a receiver using few filters;

The invention can be implemented as a receiver using unit delay filters;

The invention can be implemented as a receiver that can change frequencies and receive different modulation formats with no hardware changes;

The invention can be also implemented as frequency up-converter in an EM signal transmitter;

The invention can be also implemented as a combination up-converter (transmitter) and down-converter (receiver), referred to herein as a transceiver;

The invention can be implemented as a method and system for ensuring reception of a communications signal, as disclosed in co-pending patent application titled, "Method and System for Ensuring Reception of a Communications Signal," Attorney Docket No. 1744.0030000, incorporated herein by reference in its entirety;

The invention can be implemented in a differential configuration, whereby signal to noise ratios are increased;

A receiver designed in accordance with the invention can be implemented on a single IC substrate, such as a silicon-based IC substrate;

A receiver designed in accordance with the invention and implemented on a single IC substrate, such as a silicon-based IC substrate, can down-convert EM signals from frequencies in the giga Hertz range;

A receiver built in accordance with the invention has a relatively flat response over a wide range of frequencies. For example, in an embodiment, a receiver built in accordance with the invention to operate around 800 MHz has a substantially flat response (i.e., plus or minus a few dB of power) from 100 MHz to 1 GHz. This is referred to herein as a wide-band receiver; and

A receiver built in accordance with the invention can include multiple, user-selectable, Impedance match modules, each designed for a different wide-band of frequencies, which can be used to scan an ultra-wide-band of frequencies.

## II Down-Converting By Under-Sampling

1. Down-Converting an EM Carrier Signal to an EM Intermediate Signal by Under-Sampling the EM Carrier Signal at the Aliasing Rate

In an embodiment, the invention down-converts an EM signal to an IF signal by under-sampling the EM signal. This embodiment is illustrated by **4508** in FIG. **45B**.

This embodiment can be implemented with modulated and unmodulated EM signals. This embodiment is described herein using the modulated carrier signal  $F_{MC}$  in FIG. **1**, as an example. In the example, the modulated carrier signal  $F_{MC}$  is down-converted to an IF signal  $F_{IF}$ . The IF signal  $F_{IF}$  can then be demodulated, with any conventional demodulation technique to obtain a demodulated baseband signal  $F_{DMB}$ . Upon reading the disclosure and examples therein, one skilled in the relevant art(s) will understand that the invention can be implemented to down-convert any EM signal, including but not limited to, modulated carrier signals and unmodulated carrier signals.

The following sections describe example methods for down-converting the modulated carrier signal  $F_{MC}$  to the IF signal  $F_{IF}$ , according to embodiments of the invention. Exemplary structural embodiments for implementing the methods are also described. It should be understood that the invention is not limited to the particular embodiments described below. Equivalents, extensions, variations, deviations, etc., of the following will be apparent to persons skilled in the relevant art(s) based on the teachings contained herein. Such equivalents, extensions, variations, deviations, etc., are within the scope and spirit of the present invention.

The following sections include a high level discussion, example embodiments, and implementation examples.

#### 1.1 High Level Description

This section (including its subsections) provides a high-level description of down-converting an EM signal to an IF signal  $F_{IF}$  according to the invention. In particular, an operational process of under-sampling a modulated carrier signal  $F_{MC}$  to down-convert it to the IF signal  $F_{IF}$ , is described at a high-level. Also, a structural implementation for implementing this process is described at a high-level. This structural implementation is described herein for illustrative purposes, and is not limiting. In particular, the process described in this section can be achieved using any number of structural implementations, one of which is described in this section. The details of such structural implementations will be apparent to persons skilled in the relevant art(s) based on the teachings contained herein.

##### 1.1.1 Operational Description

FIG. **14B** depicts a flowchart **1407** that illustrates an exemplary method for under-sampling an EM signal to down-convert the EM signal to an intermediate signal  $F_{IF}$ . The exemplary method illustrated in the flowchart **1407** is an embodiment of the flowchart **1401** in FIG. **14A**.

Any and all combinations of modulation techniques are valid for this invention. For ease of discussion, the digital AM carrier signal **616** is used to illustrate a high level operational description of the invention. Subsequent sections provide detailed flowcharts and descriptions for AM, FM and PM example embodiments. Upon reading the disclosure and examples therein, one skilled in the relevant art(s) will understand that the invention can be implemented to down-convert any type of EM signal, including any form of modulated carrier signal and unmodulated carrier signals.

The method illustrated in the flowchart **1407** is now described at a high level using the digital AM carrier signal **616** of FIG. **6C**. The digital AM carrier signal **616** is re-illustrated in FIG. **15A** for convenience. FIG. **15E** illustrates a portion **1510** of the AM carrier signal **616**, between time  $t_1$  and  $t_2$ , on an expanded time scale.

The process begins at step **1408**, which includes receiving an EM signal. Step **1408** is represented by the digital AM carrier signal **616**.

Step **1410** includes receiving an under-sampling signal having an aliasing rate  $F_{AR}$ . FIG. **15B** illustrates an example under-sampling signal **1502**, which includes a train of pulses **1504** having negligible apertures that tend toward zero time in duration. The pulses **1504** repeat at the aliasing rate, or pulse repetition rate. Aliasing rates are discussed below.

Step **1412** includes under-sampling the EM signal at the aliasing rate to down-convert the EM signal to the intermediate signal  $F_{IF}$ . When down-converting an EM signal to an IF signal, the frequency or aliasing rate of the pulses **1504** sets the IF.

FIG. **15C** illustrates a stair step AM intermediate signal **1506**, which is generated by the down-conversion process. The AM intermediate signal **1506** is similar to the AM carrier signal **616** except that the AM intermediate signal **1506** has a lower frequency than the AM carrier signal **616**. The AM carrier signal **616** has thus been down-converted to the AM intermediate signal **1506**. The AM intermediate signal **1506** can be generated at any frequency below the frequency of the AM carrier signal **616** by adjusting the aliasing rate.

FIG. **15D** depicts the AM intermediate signal **1506** as a filtered output signal **1508**. In an alternative embodiment, the invention outputs a stair step, non-filtered or partially filtered output signal. The choice between filtered, partially filtered and non-filtered output signals is generally a design choice that depends upon the application of the invention.

The intermediate frequency of the down-converted signal  $F_{IF}$ , which in this example is the AM intermediate signal **1506**, can be determined from EQ. (2), which is reproduced below for convenience.

$$F_C = n F_{AR} \pm F_{IF} \quad \text{EQ (2)}$$

A suitable aliasing rate  $F_{AR}$  can be determined in a variety of ways. An example method for determining the aliasing rate  $F_{AR}$ , is provided below. After reading the description herein, one skilled in the relevant art(s) will understand how to determine appropriate aliasing rates for EM signals, including ones in addition to the modulated carrier signals specifically illustrated herein.

In FIG. **17**, a flowchart **1701** illustrates an example process for determining an aliasing rate  $F_{AR}$ . But a designer may choose, or an application may dictate, that the values be determined in an order that is different than the illustrated order. The process begins at step **1702**, which includes determining, or selecting, the frequency of the EM signal. The frequency of the FM carrier signal **616** can be, for example, 901 MHz.

Step **1704** includes determining, or selecting, the intermediate frequency. This is the frequency to which the EM signal will be down-converted. The intermediate frequency can be determined, or selected, to match a frequency requirement of a down-stream demodulator. The intermediate frequency can be, for example, 1 MHz.

Step **1706** includes determining the aliasing rate or rates that will down-convert the EM signal to the IF specified in step **1704**.

EQ. (2) can be rewritten as EQ. (3):

$$n F_{AR} = F_C \pm F_{IF} \quad \text{EQ. (3)}$$

Which can be rewritten as EQ. (4):

$$n = \frac{F_C \pm F_{IF}}{F_{AR}} \tag{EQ. (4)}$$

or as EQ. (5):

$$F_{AR} = \frac{F_C \pm F_{IF}}{n} \tag{EQ. (5)}$$

( $F_C \pm F_{IF}$ ) can be defined as a difference value  $F_{DIFF}$ , as illustrated in EQ. (6):

$$(F_C \pm F_{IF}) = F_{DIFF} \tag{EQ. (6)}$$

EQ. (4) can be rewritten as EQ. (7):

$$n = \frac{F_{DIFF}}{F_{AR}} \tag{EQ. (7)}$$

From EQ. (7), it can be seen that, for a given n and a constant  $F_{AR}$ ,  $F_{DIFF}$  is constant. For the case of  $F_{DIFF} = F_C - F_{IF}$ , and for a constant  $F_{DIFF}$ , as  $F_C$  increases,  $F_{IF}$  necessarily increases. For the case of  $F_{DIFF} = F_C + F_{IF}$ , and for a constant  $F_{DIFF}$ , as  $F_C$  increases,  $F_{IF}$  necessarily decreases. In the latter case of  $F_{DIFF} = F_C + F_{IF}$ , any phase or frequency changes on  $F_C$  correspond to reversed or inverted phase or frequency changes on  $F_{IF}$ . This is mentioned to teach the reader that if  $F_{DIFF} = F_C + F_{IF}$  is used, the above effect will affect the phase and frequency response of the modulated intermediate signal  $F_{IF}$ .

EQs. (2) through (7) can be solved for any valid n. A suitable n can be determined for any given difference frequency  $F_{DIFF}$  and for any desired aliasing rate  $F_{AR}$  (*Desired*). EQs. (2) through (7) call be utilized to identify a specific harmonic closest to a desired aliasing rate  $F_{AR}$  (*Desired*) that will generate the desired intermediate signal  $F_{IF}$ .

An example is now provided for determining a suitable n for a given difference frequency  $F_{DIFF}$  and for a desired aliasing rate  $F_{AR(Desired)}$ . For ease of illustration, only the case of ( $F_C - F_{IF}$ ) is illustrated in the example below.

$$n = \frac{F_C - F_{IF}}{F_{AR(Desired)}} = \frac{F_{DIFF}}{F_{AR(Desired)}}$$

The desired aliasing rate  $F_{AR(Desired)}$  can be, for example, 140 MHZ. Using the previous examples, where the carrier frequency is 901 MHZ and the IF is 1 MHZ, an initial value of n is determined as:

$$n = \frac{901 \text{ MHZ} - 1 \text{ MHZ}}{140 \text{ MHZ}} = \frac{900}{140} = 6.4$$

The initial value 6.4 can be rounded up or down to the valid nearest n, which was defined above as including (0.5, 1, 2, 3, . . .). In this example, 6.4 is rounded down to 6.0, which is inserted into EQ. (5) for the case of ( $F_C - F_{IF}$ ) =  $F_{DIFF}$ :

$$F_{AR} = \frac{F_C - F_{IF}}{n}$$

$$F_{AR} = \frac{901 \text{ MHZ} - 1 \text{ MHZ}}{6} = \frac{900 \text{ MHZ}}{6} = 150 \text{ MHZ}$$

In other words, under-sampling a 901 MHZ EM carrier signal at 150 MHZ generates an intermediate signal at 1 MHZ. When the under-sampled EM carrier signal is a modulated carrier signal, the intermediate signal will also substantially include the modulation. The modulated intermediate signal can be demodulated through any conventional demodulation technique.

Alternatively, instead of starting from a desired aliasing rate, a list of suitable aliasing rates can be determined from the modified form of EQ. (5), by solving for various values of n. Example solutions are listed below.

$$F_{AR} = \frac{(F_C \cdot F_{IF})}{n} = \frac{F_{DIFF}}{n} = \frac{901 \text{ MHZ} - 1 \text{ MHZ}}{n} = \frac{900 \text{ MHZ}}{n}$$

Solving for n=0.5, 1, 2, 3, 4, 5 and 6:

900 MHZ/0.5=1.8 GHZ (i.e., second harmonic, illustrated in FIG. 25A as 2502);

900 MHZ/1=900 MHZ (i.e., fundamental frequency, illustrated in FIG. 25B as 2504);

900 MHZ/2=450 MHZ (i.e., second sub-harmonic, illustrated in FIG. 25C as 2506);

900 MHZ/3=300 MHZ (i.e., third sub-harmonic, illustrated in FIG. 25D as 2508);

900 MHZ/4=225 MHZ (i.e., fourth sub-harmonic, illustrated in FIG. 25E as 2510);

900 MHZ/5=180 MHZ (i.e., fifth sub-harmonic, illustrated in FIG. 25F as 2512); and

900 MHZ/6=150 MHZ (i.e., sixth sub-harmonic, illustrated in FIG. 25G as 2514).

The steps described above can be performed for the case of ( $F_C + F_{IF}$ ) in a similar fashion. The results can be compared to the results obtained from the case of ( $F_C - F_{IF}$ ) to determine which provides better result for an application.

In an embodiment, the invention down-converts an EM signal to a relatively standard IF in the range of, for example, 100 KHZ to 200 MHZ. In another embodiment, referred to herein as a small off-set implementation, the invention down-converts an EM signal to a relatively low frequency of, for example, less than 100 KHZ. In another embodiment, referred to herein as a large off-set implementation, the invention down-converts an EM signal to a relatively higher IF signal, such as, for example, above 200 MHZ.

The various off-set implementations provide selectivity for different applications. Generally, lower data rate applications can operate at lower intermediate frequencies. But higher intermediate frequencies can allow more information to be supported for a given modulation technique.

In accordance with the invention, a designer picks an optimum information bandwidth for an application and an optimum intermediate frequency to support the baseband signal. The intermediate frequency should be high enough to support the bandwidth of the modulating baseband signal  $F_{MB}$ .

Generally, as the aliasing rate approaches a harmonic or sub-harmonic frequency of the EM signal, the frequency of the down-converted IF signal decreases. Similarly, as the aliasing rate moves away from a harmonic or sub-harmonic frequency of the EM signal, the IF increases.

Aliased frequencies occur above and below every harmonic of the aliasing frequency. In order to avoid mapping

other aliasing frequencies in the band of the aliasing frequency (IF) of interest, the IF of interest is preferably not near one half the aliasing rate.

As described in example implementations below, an aliasing module, including a universal frequency translator (UFT) module built in accordance with the invention, provides a wide range of flexibility in frequency selection and can thus be implemented in a wide range of applications. Conventional systems cannot easily offer, or do not allow, this level of flexibility in frequency selection.

### 1.1.2 Structural Description

FIG. 16 illustrates a block diagram of an under-sampling system 1602 according to an embodiment of the invention. The under-sampling system 1602 is an example embodiment of the generic aliasing system 1302 in FIG. 13. The under-sampling system 1602 includes an under-sampling module 1606. The under-sampling module 1606 receives the EM signal 1304 and an under-sampling signal 1604, which includes under-sampling pulses having negligible apertures that tend towards zero time, occurring at a frequency equal to the aliasing rate  $F_{AR}$ . The under-sampling signal 1604 is an example embodiment of the aliasing signal 1310. The under-sampling module 1606 under-samples the EM signal 1304 at the aliasing rate  $F_{AR}$  of the under-sampling signal 1604. The under-sampling system 1602 outputs a down-converted signal 1308A.

Preferably, the under-sampling module 1606 under-samples the EM signal 1304 to down-convert it to the intermediate signal  $F_{IF}$  in the manner shown in the operational flowchart 1407 of FIG. 14B. But it should be understood that the scope and spirit of the invention includes other structural embodiments for performing the steps of the flowchart 1407. The specifics of the other structural embodiments will be apparent to persons skilled in the relevant art(s) based on the discussion contained herein. In an embodiment, the aliasing rate  $F_{AR}$  of the under-sampling signal 1604 is chosen in the manner discussed in Section II.1.1.1 so that the under-sampling module 1606 under-samples the EM carrier signal 1304 generating the intermediate frequency  $F_{IF}$ .

The operation of the under-sampling system 1602 is now described with reference to the flowchart 1407 and to the timing diagrams in FIGS. 15A–D. In step 1408, the under-sampling module 1606 receives the AM signal 616 (FIG. 15A). In step 1410, the under-sampling module 1606 receives the under-sampling signal 1502 (FIG. 15B). In step 1412, the under-sampling module 1606 under-samples the AM carrier signal 616 at the aliasing rate of the under-sampling signal 1502, or a multiple thereof, to down-convert the AM carrier signal 616 to the intermediate signal 1506 (FIG. 15D).

Example implementations of the under-sampling module 1606 are provided in Sections 4 and 5 below.

### 1.2 Example Embodiments

Various embodiments related to the method(s) and structure(s) described above are presented in this section (and its subsections). These embodiments are described herein for purposes of illustration, and not limitation. The invention is not limited to these embodiments. Alternate embodiments (including equivalents, extensions, variations, deviations, etc., of the embodiments described herein) will be apparent to persons skilled in the relevant art(s) based on the teachings contained herein. The invention is intended and adapted to include such alternate embodiments.

The method for down-converting the EM signal 1304 to the intermediate signal  $F_{IF}$ , illustrated in the flowchart 1407 of FIG. 14B, can be implemented with any type of EM

signal, including unmodulated EM carrier signals and modulated carrier signals including, but not limited to, AM, FM, PM, etc., or any combination thereof. Operation of the flowchart 1407 of FIG. 14B is described below for AM, FM and PM carrier signals. The exemplary descriptions below are intended to facilitate an understanding of the present invention. The present invention is not limited to or by the exemplary embodiments below.

### 1.2.1 First Example Embodiment: Amplitude Modulation

#### 1.2.1.1 Operational Description

Operation of the exemplary process of the flowchart 1407 in FIG. 14B is described below for the analog AM carrier signal 516, illustrated in FIG. 5C, and for the digital AM carrier signal 616, illustrated in FIG. 6C.

#### 1.2.1.1.1 Analog AM Carrier Signal

A process for down-converting the analog AM carrier signal 516 in FIG. 5C to an analog AM intermediate signal is now described with reference to the flowchart 1407 in FIG. 14B. The analog AM carrier signal 516 is re-illustrated in FIG. 19A for convenience. For this example, the analog AM carrier signal 516 oscillates at approximately 901 MHZ. In FIG. 19B, an analog AM carrier signal 1904 illustrates a portion of the analog AM carrier signal 516 on an expanded time scale.

The process begins at step 1408, which includes receiving the EM signal. This is represented by the analog AM carrier signal 516 in FIG. 19A.

Step 1410 includes receiving an under-sampling signal having an aliasing rate  $F_{AR}$ . FIG. 19C illustrates an example under-sampling signal 1906 on approximately the same time scale as FIG. 19B. The under-sampling signal 1906 includes a train of pulses 1907 having negligible apertures that tend towards zero time in duration. The pulses 1907 repeat at the aliasing rate, or pulse repetition rate, which is determined or selected as previously described. Generally, when down-converting to an intermediate signal, the aliasing rate  $F_{AR}$  is substantially equal to a harmonic or, more typically, a sub-harmonic of the difference frequency  $F_{DIFF}$ . For this example, the aliasing rate is approximately 450 MHZ.

Step 1412 includes under-sampling the EM signal at the aliasing rate to down-convert the EM signal to the intermediate signal  $F_{IF}$ . Step 1412 is illustrated in FIG. 19B by under-sample points 1905.

Because a harmonic of the aliasing rate is off-set from the AM carrier signal 516, the under-sample points 1905 “walk through” the analog AM carrier signal 516. In this example, the under-sample points 1905 “walk through” the analog AM carrier signal 516 at approximately a one megahertz rate. In other words, the under-sample points 1905 occur at different locations on subsequent cycles of the AM carrier signal 516. As a result, the under-sample points 1905 capture varying amplitudes of the analog AM signal 516. For example, under-sample point 1905A has a larger amplitude than under-sample point 1905B.

In FIG. 19D, the under-sample points 1905 correlate to voltage points 1908. In an embodiment, the voltage points 1908 form an analog AM intermediate signal 1910. This can be accomplished in many ways. For example, each voltage point 1908 can be held at a relatively constant level until the next voltage point is received. This results in a stair-step output which can be smoothed or filtered if desired, as discussed below.

In FIG. 19E, an AM intermediate signal 1912 represents the AM intermediate signal 1910, after filtering, on a compressed time scale. Although FIG. 19E illustrates the AM intermediate signal 1912 as a filtered output signal, the output signal does not need to be filtered or smoothed to be

within the scope of the invention. Instead, the output signal can be tailored for different applications.

The AM intermediate signal **1912** is substantially similar to the AM carrier signal **516**, except that the AM intermediate signal **1912** is at the 1 MHz intermediate frequency. The AM intermediate signal **1912** can be demodulated through any conventional AM demodulation technique.

The drawings referred to herein illustrate frequency down-conversion in accordance with the invention. For example, the AM intermediate signal **1910** in FIG. **19D** and the AM intermediate signal **1912** in FIG. **19E** illustrate that the AM carrier signal **516** was successfully down-converted to an intermediate signal by retaining enough baseband information for sufficient reconstruction.

#### 1.2.1.1.2 Digital AM Carrier Signal

A process for down-converting the digital AM carrier signal **616** in FIG. **6C** to a digital AM intermediate signal is now described with reference to the flowchart **1407** in FIG. **14B**. The digital AM carrier signal **616** is re-illustrated in FIG. **18A** for convenience. For this example, the digital AM carrier signal **616** oscillates at approximately 901 MHz. In FIG. **18B**, an AM carrier signal **1804** illustrates a portion of the AM signal **616**, from time  $t_0$  to  $t_1$ , on an expanded time scale.

The process begins at step **1408**, which includes receiving an EM signal. This is represented by the AM signal **616** in FIG. **18A**.

Step **1410** includes receiving an under-sampling signal having an aliasing rate  $F_{AR}$ . FIG. **18C** illustrates an example under-sampling signal **1806** on approximately the same time scale as FIG. **18B**. The under-sampling signal **1806** includes a train of pulses **1807** having negligible apertures that tend towards zero time in duration. The pulses **1807** repeat at the aliasing rate, or pulse repetition rate, which is determined or selected as previously described. Generally, when down-converting to an intermediate signal, the aliasing rate  $F_{AR}$  is substantially equal to a harmonic or, more typically, a sub-harmonic of the difference frequency  $F_{DIFF}$ . For this example, the aliasing rate is approximately 450 MHz.

Step **1412** includes under-sampling the EM signal at the aliasing rate to down-convert the EM signal to the intermediate signal  $F_{IF}$ . Step **1412** is illustrated in FIG. **18B** by under-sample points **1805**.

Because a harmonic of the aliasing rate is off-set from the AM carrier signal **616**, the under-sample points **1805** walk through the AM carrier signal **616**. In other words, the under-sample points **1805** occur at different locations of subsequent cycles of the AM signal **616**. As a result, the under-sample points **1805** capture various amplitudes of the AM signal **616**. In this example, the under-sample points **1805** walk through the AM carrier signal **616** at approximately a 1 MHz rate. For example, under-sample point **1805A** has a larger amplitude than under-sample point **1805B**.

In FIG. **18D**, the under-sample points **1805** correlate to voltage points **1808**. In an embodiment, the voltage points **1805** form an AM intermediate signal **1810**. This can be accomplished in many ways. For example, each voltage point **1808** can be held at a relatively constant level until the next voltage point is received. This results in a stair-step output which can be smoothed or filtered if desired, as discussed below.

In FIG. **18E**, an AM intermediate signal **1812** represents the AM intermediate signal **1810**, after filtering, on a compressed time scale. Although FIG. **18E** illustrates the AM intermediate signal **1812** as a filtered output signal, the output signal does not need to be filtered or smoothed to be

within the scope of the invention. Instead, the output signal can be tailored for different applications.

The AM intermediate signal **1812** is substantially similar to the AM carrier signal **616**, except that the AM intermediate signal **1812** is at the 1 MHz intermediate frequency. The AM intermediate signal **1812** can be demodulated through any conventional AM demodulation technique.

The drawings referred to herein illustrate frequency down-conversion in accordance with the invention. For example, the AM intermediate signal **1810** in FIG. **18D** and the AM intermediate signal **1812** in FIG. **18E** illustrate that the AM carrier signal **616** was successfully down-converted to an intermediate signal by retaining enough baseband information for sufficient reconstruction.

#### 1.2.1.2 Structural Description

The operation of the under-sampling system **1602** is now described for the analog AM carrier signal **516**, with reference to the flowchart **1407** and to the timing diagrams of FIGS. **19A–E**. In step **1408**, the under-sampling module **1606** receives the AM carrier signal **516** (FIG. **19A**). In step **1410**, the under-sampling module **1606** receives the under-sampling signal **1906** (FIG. **19C**). In step **1412**, the under-sampling module **1606** under-samples the AM carrier signal **516** at the aliasing rate of the under-sampling signal **1906** to down-convert it to the AM intermediate signal **1912** (FIG. **19E**).

The operation of the under-sampling system **1602** is now described for the digital AM carriers signal **616**, with reference to the flowchart **1407** and to the timing diagrams of FIGS. **18A–E**. In step **1408**, the under-sampling module **1606** receives the AM carrier signal **616** (FIG. **18A**). In step **1410**, the under-sampling module **1606** receives the under-sampling signal **1806** (FIG. **18C**). In step **1412**, the under-sampling module **1606** under-samples the AM carrier signal **616** at the aliasing rate of the under-sampling signal **1806** to down-convert it to the AM intermediate signal **1812** (FIG. **18E**).

Example implementations of the under-sampling module **1606** are provided in Sections 4 and 5 below.

### 1.2.2 Second Example Embodiment: Frequency Modulation

#### 1.2.2.1 Operational Description

Operation of the exemplary process of the flowchart **1407** in FIG. **14B** is described below for the analog FM carrier signal **716**, illustrated in FIG. **7C**, and for the digital FM carrier signal **816**, illustrated in FIG. **8C**.

##### 1.2.2.1.1 Analog FM Carrier Signal

A process for down-converting the analog FM carrier signal **716** to an analog FM intermediate signal is now described with reference to the flowchart **1407** in FIG. **14B**. The analog FM carrier signal **716** is re-illustrated in FIG. **20A** for convenience. For this example, the analog FM carrier signal **716** oscillates at approximately 901 MHz. In FIG. **20B**, an FM carrier signal **2004** illustrates a portion of the analog FM carrier signal **716**, from time  $t_1$  to  $t_3$ , on an expanded time scale.

The process begins at step **1408**, which includes receiving an EM signal. This is represented in FIG. **20A** by the FM carrier signal **716**.

Step **1410** includes receiving an under-sampling signal having an aliasing rate  $F_{AR}$ . FIG. **20C** illustrates an example under-sampling signal **2006** on approximately the same time scale as FIG. **20B**. The under-sampling signal **2006** includes a train of pulses **2007** having negligible apertures that tend towards zero time in duration. The pulses **2007** repeat at the aliasing rate or pulse repetition rate, which is determined or selected as previously described. Generally, when down-converting to an intermediate signal, the aliasing rate  $F_{AR}$  is

substantially equal to a harmonic or, more typically, a sub-harmonic of the difference frequency  $F_{DIFF}$ . For this example, where the FM carrier signal **716** is centered around 901 MHz, the aliasing rate is approximately 450 MHz.

Step **1412** includes under-sampling the EM signal at the aliasing rate to down-convert the EM signal to the intermediate signal  $F_{IF}$ . Step **1412** is illustrated in FIG. **20B** by under-sample points **2005**.

Because a harmonic of the aliasing rate is off-set from the FM carrier signal **716**, the under-sample points **2005** occur at different locations of subsequent cycles of the under-sampled signal **716**. In other words, the under-sample points **2005** walk through the signal **716**. As a result, the under-sample points **2005** capture various amplitudes of the FM carrier signal **716**.

In FIG. **20D**, the under-sample points **2005** correlate to voltage points **2008**. In an embodiment, the voltage points **2005** form an analog FM intermediate signal **2010**. This can be accomplished in many ways. For example, each voltage point **2008** can be held at a relatively constant level until the next voltage point is received. This results in a stair-step output which can be smoothed or filtered if desired, as discussed below.

In FIG. **20E**, an FM intermediate signal **2012** illustrates the FM intermediate signal **2010**, after filtering, on a compressed time scale. Although FIG. **20E** illustrates the FM intermediate signal **2012** as a filtered output signal, the output signal does not need to be filtered or smoothed to be within the scope of the invention. Instead, the output signal can be tailored for different applications.

The FM intermediate signal **2012** is substantially similar to the FM carrier signal **716**, except that the FM intermediate signal **2012** is at the 1 MHz intermediate frequency. The FM intermediate signal **2012** can be demodulated through any conventional FM demodulation technique.

The drawings referred to herein illustrate frequency down-conversion in accordance with the invention. For example, the FM intermediate signal **2010** in FIG. **20D** and the FM intermediate signal **2012** in FIG. **20E** illustrate that the FM carrier signal **716** was successfully down-converted to an intermediate signal by retaining enough baseband information for sufficient reconstruction.

#### 1.2.2.1.2 Digital FM Carrier Signal

A process for down-converting the digital FM carrier signal **816** to a digital FM intermediate signal is now described with reference to the flowchart **1407** in FIG. **14B**. The digital FM carrier signal **816** is re-illustrated in FIG. **21A** for convenience. For this example, the digital FM carrier signal **816** oscillates at approximately 901 MHz. In FIG. **21B**, an FM carrier signal **2104** illustrates a portion of the FM carrier signal **816**, from time  $t1$  to  $t3$ , on an expanded time scale.

The process begins at step **1408**, which includes receiving an EM signal. This is represented in FIG. **21A**, by the FM carrier signal **816**.

Step **1410** includes receiving an under-sampling signal having an aliasing rate  $F_{AR}$ . FIG. **21C** illustrates an example under-sampling signal **2106** on approximately the same time scale as FIG. **21B**. The under-sampling signal **2106** includes a train of pulses **2107** having negligible apertures that tend toward zero time in duration. The pulses **2107** repeat at the aliasing rate, or pulse repetition rate, which is determined or selected as previously described. Generally, when down-converting to an intermediate signal, the aliasing rate  $F_{AR}$  is substantially equal to a harmonic or, more typically, a sub-harmonic of the difference frequency  $F_{DIFF}$ . In this example, where the FM carrier signal **816** is centered around

901 MHz, the aliasing rate is selected as approximately 450 MHz, which is a sub-harmonic of 900 MHz, which is off-set by 1 MHz from the center frequency of the FM carrier signal **816**.

Step **1412** includes under-sampling the EM signal at the aliasing rate to down-convert the EM signal to an intermediate signal  $F_{IF}$ . Step **1412** is illustrated in FIG. **21B** by under-sample points **2105**.

Because a harmonic of the aliasing rate is off-set from the FM carrier signal **816**, the under-sample points **2105** occur at different locations of subsequent cycles of the FM carrier signal **816**. In other words, the under-sample points **2105** walk through the signal **816**. As a result, the under-sample points **2105** capture various amplitudes of the signal **816**.

In FIG. **21D**, the under-sample points **2105** correlate to voltage points **2108**. In an embodiment, the voltage points **2108** form a digital FM intermediate signal **2110**. This can be accomplished in many ways. For example, each voltage point **2108** can be held at a relatively constant level until the next voltage point is received. This results in a stair-step output which can be smoothed or filtered if desired, as described below.

In FIG. **21E**, an FM intermediate signal **2112** represents the FM intermediate signal **2110**, after filtering, on a compressed time scale. Although FIG. **21E** illustrates the FM intermediate signal **2112** as a filtered output signal, the output signal does not need to be filtered or smoothed to be within the scope of the invention. Instead, the output signal can be tailored for different applications.

The FM intermediate signal **2112** is substantially similar to the FM carrier signal **816**, except that the FM intermediate signal **2112** is at the 1 MHz intermediate frequency. The FM intermediate signal **2112** can be demodulated through any conventional FM demodulation technique.

The drawings referred to herein illustrate frequency down-conversion in accordance with the invention. For example, the FM intermediate signal **2110** in FIG. **21D** and the FM intermediate signal **2112** in FIG. **21E** illustrate that the FM carrier signal **816** was successfully down-converted to an intermediate signal by retaining enough baseband information for sufficient reconstruction.

#### 1.2.2.2 Structural Description

The operation of the under-sampling system **1602** is now described for the analog FM carrier signal **716**, with reference to the flowchart **1407** and the timing diagrams of FIGS. **20A–E**. In step **1408**, the under-sampling module **1606** receives the FM carrier signal **716** (FIG. **20A**). In step **1410**, the under-sampling module **1606** receives the under-sampling signal **2006** (FIG. **20C**). In step **1412**, the under-sampling module **1606** under-samples the FM carrier signal **716** at the aliasing rate of the under-sampling signal **2006** to down-convert the FM carrier signal **716** to the FM intermediate signal **2012** (FIG. **20E**).

The operation of the under-sampling system **1602** is now described for the digital FM carrier signal **816**, with reference to the flowchart **1407** and the timing diagrams of FIGS. **21A–E**. In step **1408**, the under-sampling module **1606** receives the FM carrier signal **816** (FIG. **21A**). In step **1410**, the under-sampling module **1606** receives the under-sampling signal **2106** (FIG. **21C**). In step **1412**, the under-sampling module **1606** under-samples the FM carrier signal **816** at the aliasing rate of the under-sampling signal **2106** to down-convert the FM carrier signal **816** to the FM intermediate signal **2112** (FIG. **21E**).

Example implementations of the under-sampling module **1606** are provided in Sections 4 and 5 below.

## 1.2.3 Third Example Embodiment: Phase Modulation

## 1.2.3.1 Operational Description

Operation of the exemplary process of the flowchart 1407 in FIG. 14B is described below for the analog PM carrier signal 916, illustrated in FIG. 9C, and for the digital PM carrier signal 1016, illustrated in FIG. 10C.

## 1.2.3.1.1 Analog PM Carrier Signal

A process for down-converting the analog PM carrier signal 916 to an analog PM intermediate signal is now described with reference to the flowchart 1407 in FIG. 14B. The analog PM carrier signal 916 is re-illustrated in FIG. 23A for convenience. For this example, the analog PM carrier signal 916 oscillates at approximately 901 MHz. In FIG. 23B, a PM carrier signal 2304 illustrates a portion of the analog PM carrier signal 916, from time t1 to t3, on an expanded time scale.

The process of down-converting the PM carrier signal 916 to a PM intermediate signal begins at step 1408, which includes receiving an EM signal. This is represented in FIG. 23A, by the analog PM carrier signal 916.

Step 1410 includes receiving an under-sampling signal having an aliasing rate  $F_{AR}$ . FIG. 23C illustrates an example under-sampling signal 2306 on approximately the same time scale as FIG. 23B. The under-sampling signal 2306 includes a train of pulses 2307 having negligible apertures that tend towards zero time in duration. The pulses 2307 repeat at the aliasing rate, or pulse repetition rate, which is determined or selected as previously described. Generally, when down-converting to an intermediate signal, the aliasing rate  $F_{AR}$  is substantially equal to a harmonic or, more typically, a sub-harmonic of the difference frequency  $F_{DIFF}$ . In this example, the aliasing rate is approximately 450 MHz.

Step 1412 includes under-sampling the EM signal at the aliasing rate to down-convert the EM signal to the intermediate signal  $F_{IF}$ . Step 1412 is illustrated in FIG. 23B by under-sample points 2305.

Because a harmonic of the aliasing rate is off-set from the PM carrier signal 916, the under-sample points 2305 occur at different locations of the subsequent cycles of the PM carrier signal 916. As a result, the under-sample points capture various amplitudes of the PM carrier signal 916.

In FIG. 23D, voltage points 2308 correlate to the under-sample points 2305. In an embodiment, the voltage points 2308 form an analog PM intermediate signal 2310. This can be accomplished in many ways. For example, each voltage point 2308 can be held at a relatively constant level until the next voltage point is received. This results in a stair-step output which can be smoothed or filtered if desired, as described below.

In FIG. 23E, an analog PM intermediate signal 2312 illustrates the analog PM intermediate signal 2310, after filtering, on a compressed time scale. Although FIG. 23E illustrates the PM intermediate signal 2312 as a filtered output signal, the output signal does not need to be filtered or smoothed to be within the scope of the invention. Instead, the output signal can be tailored for different applications.

The analog PM intermediate signal 2312 is substantially similar to the analog PM carrier signal 916, except that the analog PM intermediate signal 2312 is at the 1 MHz intermediate frequency. The analog PM intermediate signal 2312 can be demodulated through any conventional PM demodulation technique.

The drawings referred to herein illustrate frequency down-conversion in accordance with the invention. For example, the analog PM intermediate signal 2310 in FIG. 23D and the analog PM intermediate signal 2312 in FIG. 23E illustrate that the analog PM carrier signal 2316 was

successfully down-converted to an intermediate signal by retaining enough baseband information for sufficient reconstruction.

## 1.2.3.1.2 Digital PM Carrier Signal

A process for down-converting the digital PM carrier signal 1016 to a digital PM intermediate signal is now described with reference to the flowchart 1407 in FIG. 14B. The digital PM carrier signal 1016 is re-illustrated in FIG. 22A for convenience. For this example, the digital PM carrier signal 1016 oscillates at approximately 901 MHz. In FIG. 22B, a PM carrier signal 2204 illustrates a portion of the digital PM carrier signal 1016, from time t1 to t3, on an expanded time scale.

The process begins at step 1408, which includes receiving an EM signal. This is represented in FIG. 22A by the digital PM carrier signal 1016.

Step 1408 includes receiving an under-sampling signal having an aliasing rate  $F_{AR}$ . FIG. 22C illustrates example under-sampling signal 2206 on approximately the same time scale as FIG. 22B. The under-sampling signal 2206 includes a train of pulses 2207 having negligible apertures that tend towards zero time in duration. The pulses 2207 repeat at the aliasing rate, or a pulse repetition rate, which is determined or selected as previously described. Generally, when down-converting to an intermediate signal, the aliasing rate  $F_{AR}$  is substantially equal to a harmonic or, more typically, a sub-harmonic of the difference frequency  $F_{DIFF}$ . In this example, the aliasing rate is approximately 450 MHz.

Step 1412 includes under-sampling the EM signal at the aliasing rate to down-convert the EM signal to an intermediate signal  $F_{IF}$ . Step 1412 is illustrated in FIG. 22B by under-sample points 2205.

Because a harmonic of the aliasing rate is off-set from the PM carrier signal 1016, the under-sample points 2205 occur at different locations of subsequent cycles of the PM carrier signal 1016.

In FIG. 22D, voltage points 2208 correlate to the under-sample points 2205. In an embodiment, the voltage points 2208 form a digital analog PM intermediate signal 2210. This can be accomplished in many ways. For example, each voltage point 2208 can be held at a relatively constant level until the next voltage point is received. This results in a stair-step output which can be smoothed or filtered if desired, as described below.

In FIG. 22E, a digital PM intermediate signal 2212 represents the digital PM intermediate signal 2210 on a compressed time scale. Although FIG. 22E illustrates the PM intermediate signal 2212 as a filtered output signal, the output signal does not need to be filtered or smoothed to be within the scope of the invention. Instead, the output signal can be tailored for different applications.

The digital PM intermediate signal 2212 is substantially similar to the digital PM carrier signal 1016, except that the digital PM intermediate signal 2212 is at the 1 MHz intermediate frequency. The digital PM carrier signal 2212 can be demodulated through any conventional PM demodulation technique.

The drawings referred to herein illustrate frequency down-conversion in accordance with the invention. For example, the digital PM intermediate signal 2210 in FIG. 22D and the digital PM intermediate signal 2212 in FIG. 22E illustrate that the digital PM carrier signal 1016 was successfully down-converted to an intermediate signal by retaining enough baseband information for sufficient reconstruction.

## 1.2.3.2 Structural Description

The operation of the under-sampling system 1602 is now described for the analog PM carrier signal 916, with reference to the flowchart 1407 and the timing diagrams of FIGS. 23A-E. In step 1408, the under-sampling module 1606 receives the PM carrier signal 916 (FIG. 23A). In step 1410, the under-sampling module 1606 receives the under-sampling signal 2306 (FIG. 23C). In step 1412, the under-

sampling module 1606 under-samples the PM carrier signal 916 at the aliasing rate of the under-sampling signal 2306 to down-convert the PM carrier signal 916 to the PM intermediate signal 2312 (FIG. 23E).

The operation of the under-sampling system 1602 is now described for the digital PM carrier signal 1016, with reference to the flowchart 1407 and the timing diagrams of FIGS. 22A–E. In step 1408, the under-sampling module 1606 receives the PM carrier signal 1016 (FIG. 22A). In step 1410, the under-sampling module 1606 receives the under-sampling signal 2206 (FIG. 22C). In step 1412, the under-sampling module 1606 under-samples the PM carrier signal 1016 at the aliasing rate of the under-sampling signal 2206 to down-convert the PM carrier signal 1016 to the PM intermediate signal 2212 (FIG. 22E).

Example implementations of the under-sampling module 1606 are provided in Sections 4 and 5 below.

1.2.4 Other Embodiments

The embodiments described above are provided for purposes of illustration. These embodiments are not intended to limit the invention. Alternate embodiments, differing slightly or substantially from those described herein, will be apparent to persons skilled in the relevant art(s) based on the teachings contained herein. Such alternate embodiments fall within the scope and spirit of the present invention. Example implementations of the under-sampling module 1606 are provided in Sections 4 and 5 below.

### 1.3 Implementation Examples

Exemplary operational and/or structural implementations related to the method(s), structure(s), and/or embodiments described above are presented in Sections 4 and 5 below. The implementations are presented for purposes of illustration, and not limitation. The invention is not limited to the particular implementation examples described therein. Alternate implementations (including equivalents, extensions, variations, deviations, etc., of those described herein) will be apparent to persons skilled in the relevant art(s) based on the teachings contained herein. Such alternate implementations fall within the scope and spirit of the present invention.

## 2. Directly Down-Converting an EM Signal to a Baseband Signal (Direct-to-Data)

In an embodiment, the invention directly down-converts an EM signal to a baseband signal, by under-sampling the EM signal. This embodiment is referred to herein as direct-to-data down-conversion and is illustrated in FIG. 45B as 4510.

This embodiment can be implemented with modulated and unmodulated EM signals. This embodiment is described herein using the modulated carrier signal  $F_{MC}$  in FIG. 1, as an example. In the example, the modulated carrier signal  $F_{MC}$  is directly down-converted to the demodulated baseband signal  $F_{DMB}$ . Upon reading the disclosure and examples therein, one skilled in the relevant art(s) will understand that the invention is applicable to down-convert any EM signal, including but not limited to, modulated carrier signals and unmodulated carrier signals.

The following sections describe example methods for directly down-converting the modulated carrier signal  $F_{MC}$  to the demodulated baseband signal  $F_{DMB}$ . Exemplary structural embodiments for implementing the methods are also described. It should be understood that the invention is not limited to the particular embodiments described below. Equivalents, extensions, variations, deviations, etc., of the following will be apparent to persons skilled in the relevant art(s) based on the teachings contained herein. Such equivalents, extensions, variations, deviations, etc., are within the scope and spirit of the present invention.

The following sections include a high level discussion, example embodiments, and implementation examples.

### 2.1 High Level Description

This section (including its subsections) provides a high-level description of directly down-converting the modulated carrier signal  $F_{MC}$  to the demodulated baseband signal  $F_{DMB}$ , according to the invention. In particular, an operational process of directly down-converting the modulated carrier signal  $F_{MC}$  to the demodulated baseband signal  $F_{DMB}$  is described at a high-level. Also, a structural implementation for implementing this process is described at a high-level. The structural implementation is described herein for illustrative purposes, and is not limiting. In particular, the process described in this section can be achieved using any number of structural implementations, one of which is described in this section. The details of such structural implementations will be apparent to persons skilled in the relevant art(s) based on the teachings contained herein.

#### 2.1.1 Operational Description

FIG. 14C depicts a flowchart 1413 that illustrates an exemplary method for directly down-converting an EM signal to a demodulated baseband signal  $F_{DMB}$ . The exemplary method illustrated in the flowchart 1413 is an embodiment of the flowchart 1401 in FIG. 14A.

Any and all combinations of modulation techniques are valid for this invention. For ease of discussion, the digital AM carrier signal 616 is used to illustrate a high level operational description of the invention. Subsequent sections provide detailed descriptions for AM and PM example embodiments. FM presents special considerations that are dealt with separately in Section II.3, below. Upon reading the disclosure and examples therein, one skilled in the relevant art(s) will understand that the invention can be implemented to down-convert any type of EM signal, including any form of modulated carrier signal and unmodulated carrier signals.

The method illustrated in the flowchart 1413 is now described at a high level using the digital AM carrier signal 616, from FIG. 6C. The digital AM carrier signal 616 is re-illustrated in FIG. 33A for convenience.

The process of the flowchart 1413 begins at step 1414, which includes receiving an EM signal. Step 1414 is represented by the digital AM carrier signal 616 in FIG. 33A.

Step 1416 includes receiving an under-sampling signal having an aliasing rate  $F_{AR}$ . FIG. 33B illustrates an example under-sampling signal 3302 which includes a train of pulses 3303 having negligible apertures that tend towards zero time in duration. The pulses 3303 repeat at the aliasing rate or pulse repetition rate. The aliasing rate is determined in accordance with EQ. (2), reproduced below for convenience.

$$F_C = nF_{AR} \pm F_{IF} \quad \text{EQ. (2)}$$

When directly down-converting an EM signal to baseband (i.e., zero IF), EQ. (2) becomes:

$$F_C = nF_{AR} \quad \text{EQ. (8)}$$

Thus, to directly down-convert the AM signal 616 to a demodulated baseband signal, the aliasing rate is substantially equal to the frequency of the AM signal 616 or to a harmonic or sub-harmonic thereof. Although the aliasing rate is too low to permit reconstruction of higher frequency components of the AM signal 616 (i.e., the carrier frequency), it is high enough to permit substantial reconstruction of the lower frequency modulating baseband signal 310.



Step **1418** includes under-sampling the EM signal at the aliasing rate to directly down-convert it to the demodulated baseband signal  $F_{DMB}$ . FIG. **33C** illustrates a stair step demodulated baseband signal **3304**, which is generated by the direct down-conversion process. The demodulated baseband signal **3304** is similar to the digital modulating baseband signal **310** in FIG. **3**.

FIG. **33D** depicts a filtered demodulated baseband signal **3306**, which can be generated from the stair step demodulated baseband signal **3304**. The invention can thus generate a filtered output signal, a partially filtered output signal, or a relatively unfiltered stair step output signal. The choice between filtered, partially filtered and non-filtered output signals is generally a design choice that depends upon the application of the invention.

#### 2.1.2 Structural Description

FIG. **16** illustrates the block diagram of the under-sampling system **1602** according to an embodiment of the invention. The under-sampling system **1602** is an example embodiment of the generic aliasing system **1302** in FIG. **13**.

In a direct to data embodiment, the frequency of the under-sampling signal **1604** is substantially equal to a harmonic of the EM signal **1304** or, more typically, a sub-harmonic thereof. Preferably, the under-sampling module **1606** under-samples the EM signal **1304** to directly down-convert it to the demodulated baseband signal  $F_{DMB}$ , in the manner shown in the operational flowchart **1413**. But it should be understood that the scope and spirit of the invention includes other structural embodiments for performing the steps of the flowchart **1413**. The specifics of the other structural embodiments will be apparent to persons skilled in the relevant art(s) based on the discussion contained herein.

The operation of the aliasing system **1602** is now described for the digital AM carrier signal **616**, with reference to the flowchart **1413** and to the timing diagrams in FIGS. **33A–D**. In step **1414**, the under-sampling module **1606** receives the AM carrier signal **616** (FIG. **33A**). In step **1416**, the under-sampling module **1606** receives the under-sampling signal **3302** (FIG. **33B**). In step **1418**, the under-sampling module **1606** under-samples the AM carrier signal **616** at the aliasing rate of the under-sampling signal **3302** to directly down-convert the AM carrier signal **616** to the demodulated baseband signal **3304** in FIG. **33C** or the filtered demodulated baseband signal **3306** in FIG. **33D**.

Example implementations of the under-sampling module **1606** are provided in Sections 4 and 5 below.

#### 2.2 Example Embodiments

Various embodiments related to the method(s) and structure(s) described above are presented in this section (and its subsections). These embodiments are described herein for purposes of illustration, and not limitation. The invention is not limited to these embodiments. Alternate embodiments (including equivalents, extensions, variations, deviations, etc., of the embodiments described herein) will be apparent to persons skilled in the relevant art(s) based on the teachings contained herein. The invention is intended and adapted to include such alternate embodiments.

The method for down-converting the EM signal **1304** to the demodulated baseband signal  $F_{DMB}$ , illustrated in the flowchart **1413** of FIG. **14C**, can be implemented with any type EM signal, including modulated carrier signals, including but not limited to, AM, PM, etc., or any combination thereof. Operation of the flowchart **1413** of FIG. **14C** is described below for AM and PM carrier signals. The exemplary descriptions below are intended to facilitate an understanding of the present invention. The present invention is not limited to or by the exemplary embodiments below.

#### 2.2.1 First Example Embodiment: Amplitude Modulation

##### 2.2.1.1 Operational Description

Operation of the exemplary process of the flowchart **1413** in FIG. **14C** is described below for the analog AM carrier signal **516**, illustrated in FIG. **5C** and for the digital AM carrier signal **616**, illustrated in FIG. **6C**.

##### 2.2.1.1.1 Analog AM Carrier Signal

A process for directly down-converting the analog AM carrier signal **516** to a demodulated baseband signal is now described with reference to the flowchart **1413** in FIG. **14C**. The analog AM carrier signal **516** is re-illustrated in **35A** for convenience. For this example, the analog AM carrier signal **516** oscillates at approximately 900 MHz. In FIG. **35B**, an analog AM carrier signal **3504** illustrates a portion of the analog AM carrier signal **516** on an expanded time scale.

The process begins at step **1414**, which includes receiving an EM signal. This is represented by the analog AM carrier signal **516**.

Step **1416** includes receiving an under-sampling signal having an aliasing rate  $F_{AR}$ . FIG. **35C** illustrates an example under-sampling signal **3506** on approximately the same time scale as FIG. **35B**. The under-sampling signal **3506** includes a train of pulses **3507** having negligible apertures that tend towards zero time in duration. The pulses **3507** repeat at the aliasing rate or pulse repetition rate, which is determined or selected as previously described. Generally, when directly down-converting to a demodulated baseband signal, the aliasing rate  $F_{AR}$  is substantially equal to a harmonic or, more typically, a sub-harmonic of the under-sampled signal. In this example, the aliasing rate is approximately 450 MHz.

Step **1418** includes under-sampling the EM signal at the aliasing rate to directly down-convert it to the demodulated baseband signal  $F_{DMB}$ . Step **1418** is illustrated in FIG. **35B** by under-sample points **3505**. Because a harmonic of the aliasing rate is substantially equal to the frequency of the signal **516**, essentially no IF is produced. The only substantial aliased component is the baseband signal.

In FIG. **35D**, voltage points **3508** correlate to the under-sample points **3505**. In an embodiment, the voltage points **3508** form a demodulated baseband signal **3510**. This can be accomplished in many ways. For example, each voltage point **3508** can be held at a relatively constant level until the next voltage point is received. This results in a stair-step output which can be smoothed or filtered if desired, as described below.

In FIG. **35E**, a demodulated baseband signal **3512** represents the demodulated baseband signal **3510**, after filtering, on a compressed time scale. Although FIG. **35E** illustrates the demodulated baseband signal **3512** as a filtered output signal, the output signal does not need to be filtered or smoothed to be within the scope of the invention. Instead, the output signal can be tailored for different applications.

The demodulated baseband signal **3512** is substantially similar to the modulating baseband signal **210**. The demodulated baseband signal **3512** can be processed using any signal processing technique(s) without further down-conversion or demodulation.

The aliasing rate of the under-sampling signal is preferably controlled to optimize the demodulated baseband signal for amplitude output and polarity, as desired.

In the example above, the under-sample points **3505** occur at positive locations of the AM carrier signal **516**. Alternatively, the under-sample points **3505** can occur at other locations including negative points of the analog AM carrier signal **516**. When the under-sample points **3505** occur at negative locations of the AM carrier signal **516**, the resultant demodulated baseband signal is inverted relative to the modulating baseband signal **210**.

The drawings referred to herein illustrate direct to data down-conversion in accordance with the invention. For example, the demodulated baseband signal **3510** in FIG. **35D** and the demodulated baseband signal **3512** in FIG. **35E** illustrate that the AM carrier signal **516** was successfully down-converted to the demodulated baseband signal **3510** by retaining enough baseband information for sufficient reconstruction.

#### 2.2.1.1.2 Digital AM Carrier Signal

A process for directly down-converting the digital AM carrier signal **616** to a demodulated baseband signal is now described with reference to the flowchart **1413** in FIG. **14C**. The digital AM carrier signal **616** is re-illustrated in FIG. **36A** for convenience. For this example, the digital AM carrier signal **616** oscillates at approximately 901 MHz. In FIG. **36B**, a digital AM carrier signal **3604** illustrates a portion of the digital AM carrier signal **616** on an expanded time scale.

The process begins at step **1414**, which includes receiving an EM signal. This is represented by the digital AM carrier signal **616**.

Step **1416** includes receiving an under-sampling signal having an aliasing rate  $F_{AR}$ . FIG. **36C** illustrates an example under-sampling signal **3606** on approximately the same time scale as FIG. **36B**. The under-sampling signal **3606** includes a train of pulses **3607** having negligible apertures that tend towards zero time in duration. The pulses **3607** repeat at the aliasing rate or pulse repetition rate, which is determined or selected as previously described. Generally, when directly down-converting to a demodulated baseband signal, the aliasing rate  $F_{AR}$  is substantially equal to a harmonic or, more typically, a sub-harmonic of the under-sampled signal.

Step **1418** includes under-sampling the EM signal at the aliasing rate to directly down-convert it to the demodulated baseband signal  $F_{DMB}$ . Step **1418** is illustrated in FIG. **36B** by under-sample points **3605**. Because the aliasing rate is substantially equal to the AM carrier signal **616**, or to a harmonic or sub-harmonic thereof, essentially no IF is produced. The only substantial aliased component is the baseband signal.

In FIG. **36D**, voltage points **3608** correlate to the under-sample points **3605**. In an embodiment, the voltage points **3608** form a demodulated baseband signal **3610**. This can be accomplished in many ways. For example, each voltage point **3608** can be held at a relatively constant level until the next voltage point is received. This results in a stair-step output which can be smoothed or filtered if desired, as described below.

In FIG. **36E**, a demodulated baseband signal **3612** represents the demodulated baseband signal **3610**, after filtering, on a compressed time scale. Although FIG. **36E** illustrates the demodulated baseband signal **3612** as a filtered output signal, the output signal does not need to be filtered or smoothed to be within the scope of the invention. Instead, the output signal can be tailored for different applications.

The demodulated baseband signal **3612** is substantially similar to the digital modulating baseband signal **310**. The demodulated analog baseband signal **3612** can be processed using any signal processing technique(s) without further down-conversion or demodulation.

The aliasing rate of the under-sampling signal is preferably controlled to optimize the demodulated baseband signal for amplitude output and polarity, as desired.

In the example above, the under-sample points **3605** occur at positive locations of signal portion **3604**. Alternatively, the under-sample points **3605** can occur at other locations

including negative locations of the signal portion **3604**. When the under-sample points **3605** occur at negative points, the resultant demodulated baseband signal is inverted with respect to the modulating baseband signal **310**.

The drawings referred to herein illustrate frequency down-conversion in accordance with the invention. For example, the demodulated baseband signal **3610** in FIG. **36D** and the demodulated baseband signal **3612** in FIG. **36E** illustrate that the digital AM carrier signal **616** was successfully down-converted to the demodulated baseband signal **3610** by retaining enough baseband information for sufficient reconstruction.

#### 2.2.1.2 Structural Description

The operation of the under-sampling module **1606** is now described for the analog AM carrier signal **516**, with reference to the flowchart **1413** and the timing diagrams of FIGS. **35A–E**. In step **1414**, the under-sampling module **1606** receives the analog AM carrier signal **516** (FIG. **35A**). In step **1416**, the under-sampling module **1606** receives the under-sampling signal **3506** (FIG. **35C**). In step **1418**, the under-sampling module **1606** under-samples the analog AM carrier signal **516** at the aliasing rate of the under-sampling signal **3506** to directly down-convert the AM carrier signal **516** to the demodulated analog baseband signal **3510** in FIG. **35D** or to the filtered demodulated analog baseband signal **3512** in FIG. **35E**.

The operation of the under-sampling system **1602** is now described for the digital AM carrier signal **616**, with reference to the flowchart **1413** and the timing diagrams of FIGS. **36A–E**. In step **1414**, the under-sampling module **1606** receives the digital AM carrier signal **616** (FIG. **36A**). In step **1416**, the under-sampling module **1606** receives the under-sampling signal **3606** (FIG. **36C**). In step **1418**, the under-sampling module **1606** under-samples the digital AM carrier signal **616** at the aliasing rate of the under-sampling signal **3606** to down-convert the digital AM carrier signal **616** to the demodulated digital baseband signal **3610** in FIG. **36D** or to the filtered demodulated digital baseband signal **3612** in FIG. **36E**.

Example implementations of the under-sampling module **1606** are provided in Sections 4 and 5 below.

### 2.2.2 Second Example Embodiment: Phase Modulation

#### 2.2.2.1 Operational Description

Operation of the exemplary process of the flowchart **1413** in FIG. **14C** is described below for the analog PM carrier signal **916**, illustrated in FIG. **9C**, and for the digital PM carrier signal **1016**, illustrated in FIG. **10C**.

##### 2.2.2.1.1 Analog PM Carrier Signal

A process for directly down-converting the analog PM carrier signal **916** to a demodulated baseband signal is now described with reference to the flowchart **1413** in FIG. **14C**. The analog PM carrier signal **916** is re-illustrated in **37A** for convenience. For this example, the analog PM carrier signal **916** oscillates at approximately 900 MHz. In FIG. **37B**, an analog PM carrier signal **3704** illustrates a portion of the analog PM carrier signal **916** on an expanded time scale.

The process begins at step **1414**, which includes receiving an EM signal. This is represented by the analog PM signal **916**.

Step **1416** includes receiving an under-sampling signal having an aliasing rate  $F_{AR}$ . FIG. **37C** illustrates an example under-sampling signal **3706** on approximately the same time scale as FIG. **37B**. The under-sampling signal **3706** includes a train of pulses **3707** having negligible apertures that tend towards zero time in duration. The pulses **3707** repeat at the aliasing rate or pulse repetition rate, which is determined or selected as previously described. Generally, when directly

down-converting to a demodulated baseband signal, the aliasing rate  $F_{AR}$  is substantially equal to a harmonic or, more typically, a sub-harmonic of the under-sampled signal. In this example, the aliasing rate is approximately 450 MHz.

Step 1418 includes under-sampling the analog PM carrier signal 916 at the aliasing rate to directly down-convert it to a demodulated baseband signal. Step 1418 is illustrated in FIG. 37B by under-sample points 3705.

Because a harmonic of the aliasing rate is substantially equal to the frequency of the signal 916, or substantially equal to a harmonic or sub-harmonic thereof, essentially no IF is produced. The only substantial aliased component is the baseband signal.

In FIG. 37D, voltage points 3708 correlate to the under-sample points 3705. In an embodiment, the voltage points 3708 form a demodulated baseband signal 3710. This can be accomplished in many ways. For example, each voltage point 3708 can be held at a relatively constant level until the next voltage point is received. This results in a stair-step output which can be smoothed or filtered if desired, as described below.

In FIG. 37E, a demodulated baseband signal 3712 represents the demodulated baseband signal 3710, after filtering, on a compressed time scale. Although FIG. 37E illustrates the demodulated baseband signal 3712 as a filtered output signal, the output signal does not need to be filtered or smoothed to be within the scope of the invention. Instead, the output signal can be tailored for different applications.

The demodulated baseband signal 3712 is substantially similar to the analog modulating baseband signal 210. The demodulated baseband signal 3712 can be processed without further down-conversion or demodulation.

The aliasing rate of the under-sampling signal is preferably controlled to optimize the demodulated baseband signal for amplitude output and polarity, as desired.

In the example above, the under-sample points 3705 occur at positive locations of the analog PM carrier signal 916. Alternatively, the under-sample points 3705 can occur at other locations include negative points of the analog PM carrier signal 916. When the under-sample points 3705 occur at negative locations of the analog PM carrier signal 916, the resultant demodulated baseband signal is inverted relative to the modulating baseband signal 210.

The drawings referred to herein illustrate direct to data down-conversion in accordance with the invention. For example, the demodulated baseband signal 3710 in FIG. 37D and the demodulated baseband signal 3712 in FIG. 37E illustrate that the analog PM carrier signal 916 was successfully down-converted to the demodulated baseband signal 3710 by retaining enough baseband information for sufficient reconstruction.

#### 2.2.2.1.2 Digital PM Carrier Signal

A process for directly down-converting the digital PM carrier signal 1016 to a demodulated baseband signal is now described with reference to the flowchart 1413 in FIG. 14C. The digital PM carrier signal 1016 is re-illustrated in 38A for convenience. For this example, the digital PM carrier signal 1016 oscillates at approximately 900 MHz. In FIG. 38B, a digital PM carrier signal 3804 illustrates a portion of the digital PM carrier signal 1016 on an expanded time scale.

The process begins at step 1414, which includes receiving an EM signal. This is represented by the digital PM signal 1016.

Step 1416 includes receiving an under-sampling signal having an aliasing rate  $F_{AR}$ . FIG. 38C illustrates an example under-sampling signal 3806 on approximately the same time scale as FIG. 38B. The under-sampling signal 3806 includes

a train of pulses 3807 having negligible apertures that tend towards zero time in duration. The pulses 3807 repeat at the aliasing rate or pulse repetition rate, which is determined or selected as described above. Generally, when directly down-converting to a demodulated baseband signal, the aliasing rate  $F_{AR}$  is substantially equal to a harmonic or, more typically, a sub-harmonic of the under-sampled signal. In this example, the aliasing rate is approximately 450 MHz.

Step 1418 includes under-sampling the digital PM carrier signal 1016 at the aliasing rate to directly down-convert it to a demodulated baseband signal. This is illustrated in FIG. 38B by under-sample points 3705.

Because a harmonic of the aliasing rate is substantially equal to the frequency of the signal 1016, essentially no IF is produced. The only substantial aliased component is the baseband signal.

In FIG. 38D, voltage points 3808 correlate to the under-sample points 3805. In an embodiment, the voltage points 3808 form a demodulated baseband signal 3810. This can be accomplished in many ways. For example, each voltage point 3808 can be held at a relatively constant level until the next voltage point is received. This results in a stair-step output which can be smoothed or filtered if desired, as described below.

In FIG. 38E, a demodulated baseband signal 3812 represents the demodulated baseband signal 3810, after filtering, on a compressed time scale. Although FIG. 38E illustrates the demodulated baseband signal 3812 as a filtered output signal, the output signal does not need to be filtered or smoothed to be within the scope of the invention. Instead, the output signal can be tailored for different applications.

The demodulated baseband signal 3812 is substantially similar to the digital modulating baseband signal 310. The demodulated baseband signal 3812 can be processed without further down-conversion or demodulation.

The aliasing rate of the under-sampling signal is preferably controlled to optimize the demodulated baseband signal for amplitude output and polarity, as desired.

In the example above, the under-sample points 3805 occur at positive locations of the digital PM carrier signal 1016. Alternatively, the under-sample points 3805 can occur at other locations include negative points of the digital PM carrier signal 1016. When the under-sample points 3805 occur at negative locations of the digital PM carrier signal 1016, the resultant demodulated baseband signal is inverted relative to the modulating baseband signal 310.

The drawings referred to herein illustrate frequency down-conversion in accordance with the invention. For example, the demodulated baseband signal 3810 in FIG. 38D and the demodulated baseband signal 3812 in FIG. 38E illustrate that the digital PM carrier signal 1016 was successfully down-converted to the demodulated baseband signal 3810 by retaining enough baseband information for sufficient reconstruction.

#### 2.2.2.2 Structural Description

The operation of the under-sampling system 1602 is now described for the analog PM carrier signal 916, with reference to the flowchart 1413 and the timing diagrams of FIGS. 37A–E. In step 1414, the under-sampling module 1606 receives the analog PM carrier signal 916 (FIG. 37A). In step 1416, the under-sampling module 1606 receives the under-sampling signal 3706 (FIG. 37C). In step 1418, the under-sampling module 1606 under-samples the analog PM carrier signal 916 at the aliasing rate of the under-sampling signal 3706 to down-convert the PM carrier signal 916 to the demodulated analog baseband signal 3710 in FIG. 37D or to the filtered demodulated analog baseband signal 3712 in FIG. 37E.

The operation of the under-sampling system **1602** is now described for the digital PM carrier signal **1016**, with reference to the flowchart **1413** and the timing diagrams of FIGS. **38A–E**. In step **1414**, the under-sampling module **1606** receives the digital PM carrier signal **1016** (FIG. **38A**). In step **1416**, the under-sampling module **1606** receives the under-sampling signal **3806** (FIG. **38C**). In step **1418**, the under-sampling module **1606** under-samples the digital PM carrier signal **1016** at the aliasing rate of the under-sampling signal **3806** to down-convert the digital PM carrier signal **1016** to the demodulated digital baseband signal **3810** in FIG. **38D** or to the filtered demodulated digital baseband signal **3812** in FIG. **38E**.

### 2.2.3 Other Embodiments

The embodiments described above are provided for purposes of illustration. These embodiments are not intended to limit the invention. Alternate embodiments, differing slightly or substantially from those described herein, will be apparent to persons skilled in the relevant art(s) based on the teachings contained herein. Such alternate embodiments fall within the scope and spirit of the present invention.

### 2.3 Implementation Examples

Exemplary operational and/or structural implementations related to the method(s), structure(s), and/or embodiments described above are presented in Sections 4 and 5 below. These implementations are presented for purposes of illustration, and not limitation. The invention is not limited to the particular implementation examples described therein. Alternate implementations (including equivalents, extensions, variations, deviations, etc., of those described herein) will be apparent to persons skilled in the relevant art(s) based on the teachings contained herein. Such alternate implementations fall within the scope and spirit of the present invention.

## 3. Modulation Conversion

In an embodiment, the invention down-converts an FM carrier signal  $F_{FMC}$  to a non-FM signal  $F_{(NON-FM)}$ , by under-sampling the FM carrier signal  $F_{FMC}$ . This embodiment is illustrated in FIG. **45B** as **4512**.

In an example embodiment, the FM carrier signal  $F_{FMC}$  is down-converted to a phase modulated (PM) signal  $F_{PM}$ . In another example embodiment, the FM carrier signal  $F_{FMC}$  is down-converted to an amplitude modulated (AM) signal  $F_{AM}$ . The invention is not limited to these embodiments. The down-converted signal can be demodulated with any conventional demodulation technique to obtain a demodulated baseband signal  $F_{DMB}$ .

The invention can be implemented with any type of FM signal. Exemplary embodiments are provided below for down-converting a frequency shift keying (FSK) signal to a non-FSK signal. FSK is a sub-set of FM, wherein an FM signal shifts or switches between two or more frequencies. FSK is typically used for digital modulating baseband signals, such as the digital modulating baseband signal **310** in FIG. **3**. For example, in FIG. **8**, the digital FM signal **816** is an FSK signal that shifts between an upper frequency and a lower frequency, corresponding to amplitude shifts in the digital modulating baseband signal **310**. The FSK signal **816** is used in example embodiments below.

In a first example embodiment, the FSK signal **816** is under-sampled at an aliasing rate that is based on a mid-point between the upper and lower frequencies of the FSK signal **816**. When the aliasing rate is based on the mid-point, the FSK signal **816** is down-converted to a phase shift keying (PSK) signal. PSK is a sub-set of phase modulation, wherein a PM signal shifts or switches between two or more phases. PSK is typically used for digital modulating base-

band signals. For example, in FIG. **10**, the digital PM signal **1016** is a PSK signal that shifts between two phases. The PSK signal **1016** can be demodulated by any conventional PSK demodulation technique(s).

In a second example embodiment, the FSK signal **816** is under-sampled at an aliasing rate that is based upon either the upper frequency or the lower frequency of the FSK signal **816**. When the aliasing rate is based upon the upper frequency or the lower frequency of the FSK signal **816**, the FSK signal **816** is down-converted to an amplitude shift keying (ASK) signal. ASK is a sub-set of amplitude modulation, wherein an AM signal shifts or switches between two or more amplitudes. ASK is typically used for digital modulating baseband signals. For example, in FIG. **6**, the digital AM signal **616** is an ASK signal that shifts between the first amplitude and the second amplitude. The ASK signal **616** can be demodulated by any conventional ASK demodulation technique(s).

The following sections describe methods for under-sampling an FM carrier signal  $F_{FMC}$  to down-convert it to the non-FM signal  $F_{(NON-FM)}$ . Exemplary structural embodiments for implementing the methods are also described. It should be understood that the invention is not limited to the particular embodiments described below. Equivalents, extensions, variations, deviations, etc., of the following will be apparent to persons skilled in the relevant art(s) based on the teachings contained herein. Such equivalents, extensions, variations, deviations, etc., are within the scope and spirit of the present invention.

The following sections include a high level discussion, example embodiments, and implementation examples.

### 3.1 High Level Description

This section (including its subsections) provides a high-level description of under-sampling the FM carrier signal  $F_{FM}$  to down-convert it to the non-FM signal  $F_{(NON-FM)}$ , according to the invention. In particular, an operational process for down-converting the FM carrier signal  $F_{FM}$  to the non-FM signal  $F_{(NON-FM)}$  is described at a high-level. Also, a structural implementation for implementing this process is described at a high-level. The structural implementation is described herein for illustrative purposes, and is not limiting. In particular, the process described in this section can be achieved using any number of structural implementations, one of which is described in this section. The details of such structural implementations will be apparent to persons skilled in the relevant art(s) based on the teachings contained herein.

#### 3.1.1 Operational Description

FIG. **14D** depicts a flowchart **1419** that illustrates an exemplary method for down-converting the FM carrier signal  $F_{FMC}$  to the non-FM signal  $F_{(NON-FM)}$ . The exemplary method illustrated in the flowchart **1419** is an embodiment of the flowchart **1401** in FIG. **14A**.

Any and all forms of frequency modulation techniques are valid for this invention. For ease of discussion, the digital FM carrier (FSK) signal **816** is used to illustrate a high level operational description of the invention. Subsequent sections provide detailed flowcharts and descriptions for the FSK signal **816**. Upon reading the disclosure and examples therein, one skilled in the relevant art(s) will understand that the invention can be implemented to down-convert any type of FM signal.

The method illustrated in the flowchart **1419** is described below at a high level for down-converting the FSK signal **816** in FIG. **8C** to a FSK signal. The FSK signal **816** is re-illustrated in FIG. **39A** for convenience.

The process of the flowchart **1419** begins at step **1420**, which includes receiving an FM signal. This is represented

by the FSK signal **816**. The FSK signal **816** shifts between an upper frequency **3910** and a lower frequency **3912**. In an exemplary embodiment, the upper frequency **3910** is approximately 901 MHZ and the lower frequency **3912** is approximately 899 MHZ.

Step **1422** includes receiving an under-sampling signal having an aliasing rate  $F_{AR}$ . FIG. **39E** illustrates an example under-sampling signal **3902** which includes a train of pulses **3903** having negligible apertures that tend towards zero time in duration. The pulses **3903** repeat at the aliasing rate or pulse repetition rate.

When down-converting an FM carrier signal  $F_{FMC}$  to a non-FM signal  $F_{(NON-FM)}$ , the aliasing rate is substantially equal to a frequency contained within the FM signal, or substantially equal to a harmonic or sub-harmonic thereof. In this example overview embodiment, where the FSK signal **816** is to be down-converted to a PSK signal, the aliasing rate is based on a mid-point between the upper frequency **3910** and the lower frequency **3912**. For this example, the mid-point is approximately 900 MHZ. In another embodiment described below, where the FSK signal **816** is to be down-converted to an ASK signal, the aliasing rate is based on either the upper frequency **3910** or the lower frequency **3912**, not the mid-point.

Step **1424** includes under-sampling the FM signal  $F_{FMC}$  at the aliasing rate to down-convert the FM carrier signal  $F_{FMC}$  to the non-FM signal  $F_{(NON-FM)}$ . Step **1424** is illustrated in FIG. **39C**, which illustrates a stair step PSK signal **3904**, which is generated by the modulation conversion process.

When the upper frequency **3910** is under-sampled, the PSK signal **3904** has a frequency of approximately 1 MHZ and is used as a phase reference. When the lower frequency **3912** is under-sampled, the PSK signal **3904** has a frequency of 1 MHZ and is phase shifted 180 degrees from the phase reference.

FIG. **39D** depicts a PSK signal **3906**, which is a filtered version of the PSK signal **3904**. The invention can thus generate a filtered output signal, a partially filtered output signal, or a relatively unfiltered stair step output signal. The choice between filtered, partially filtered and non-filtered output signals is generally a design choice that depends upon the application of the invention.

The aliasing rate of the under-sampling signal is preferably controlled to optimize the down-converted signal for amplitude output and polarity, as desired.

Detailed exemplary embodiments for down-converting an FSK signal to a PSK signal and for down-converting an FSK signal to an ASK signal are provided below.

### 3.1.2 Structural Description

FIG. **16** illustrates the block diagram of the under-sampling system **1602** according to an embodiment of the invention. The under-sampling system **1602** includes the under-sampling module **1606**. The under-sampling system **1602** is an example embodiment of the generic aliasing system **1302** in FIG. **13**.

In a modulation conversion embodiment, the EM signal **1304** is an FM carrier signal and the under-sampling module **1606** under-samples the FM carrier signal at a frequency that is substantially equal to a harmonic of a frequency within the FM signal or, more typically, substantially equal to a sub-harmonic of a frequency within the FM signal. Preferably, the under-sampling module **1606** under-samples the FM carrier signal  $F_{FMC}$  to down-convert it to a non-FM signal  $F_{(NON-FM)}$  in the manner shown in the operational flowchart **1419**. But it should be understood that the scope and spirit of the invention includes other structural embodiments for performing the steps of the flowchart **1419**. The specifics of

the other structural embodiments will be apparent to persons skilled in the relevant art(s) based on the discussion contained herein.

The operation of the under-sampling system **1602** shall now be described with reference to the flowchart **1419** and the timing diagrams of FIGS. **39A-39D**. In step **1420**, the under-sampling module **1606** receives the FSK signal **816**. In step **1422**, the under-sampling module **1606** receives the under-sampling signal **3902**. In step **1424**, the under-sampling module **1606** under-samples the FSK signal **816** at the aliasing rate of the under-sampling signal **3902** to down-convert the FSK signal **816** to the PSK signal **3904** or **3906**.

Example implementations of the under-sampling module **1606** are provided in Section 4 below.

### 3.2 Example Embodiments

Various embodiments related to the method(s) and structure(s) described above are presented in this section (and its subsections). These embodiments are described herein for purposes of illustration, and not limitation. The invention is not limited to these embodiments. Alternate embodiments (including equivalents, extensions, variations, deviations, etc., of the embodiments described herein) will be apparent to persons skilled in the relevant art(s) based on the teachings contained herein. The invention is intended and adapted to include such alternate embodiments.

The method for down-converting an FM carrier signal  $F_{FMC}$  to a non-FM signal,  $F_{(NON-FM)}$ , illustrated in the flowchart **1419** of FIG. **14D**, can be implemented with any type of FM carrier signal including, but not limited to, FSK signals. The flowchart **1419** is described in detail below for down-converting an FSK signal to a PSK signal and for down-converting a PSK signal to an ASK signal. The exemplary descriptions below are intended to facilitate an understanding of the present invention. The present invention is not limited to or by the exemplary embodiments below.

#### 3.2.1 First Example Embodiment: Down-Converting an FM Signal to a PM Signal

##### 3.2.1.1 Operational Description

Operation of the exemplary process of the flowchart **1419** in FIG. **14D** is now described for down-converting the FSK signal **816** illustrated in FIG. **8C** to a PSK signal. The FSK signal **816** is re-illustrated in FIG. **40A** for convenience.

The FSK signal **816** shifts between a first frequency **4006** and a second frequency **4008**. In the exemplary embodiment, the first frequency **4006** is lower than the second frequency **4008**. In an alternative embodiment, the first frequency **4006** is higher than the second frequency **4008**. For this example, the first frequency **4006** is approximately 899 MHZ and the second frequency **4008** is approximately 901 MHZ.

FIG. **40B** illustrates an FSK signal portion **4004** that represents a portion of the FSK signal **816** on an expanded time scale.

The process of down-converting the FSK signal **816** to a PSK signal begins at step **1420**, which includes receiving an FM signal. This is represented by the FSK signal **816**.

Step **1422** includes receiving an under-sampling signal having an aliasing rate  $F_{AR}$ . FIG. **40C** illustrates an example under-sampling signal **4007** on approximately the same time scale as FIG. **40B**. The under-sampling signal **4007** includes a train of pulses **4009** having negligible apertures that tend towards zero time in duration. The pulses **4009** repeat at the aliasing rate, which is determined or selected as described above. Generally, when down-converting an FM signal to a non-FM signal, the aliasing rate is substantially equal to a

harmonic or, more typically, a sub-harmonic of a frequency contained within the FM signal.

In this example, where an FSK signal is being down-converted to a PSK signal, the aliasing rate is substantially equal to a harmonic of the mid-point between the frequencies **4006** and **4008** or, more typically, substantially equal to a sub-harmonic of the mid-point between the frequencies **4006** and **4008**. In this example, where the first frequency **4006** is 899 MHz and second frequency **4008** is 901 MHz, the mid-point is approximately 900 MHz. Suitable aliasing rates include 1.8 GHz, 900 MHz, 450 MHz, etc. In this example, the aliasing rate of the under-sampling signal **4008** is approximately 450 MHz.

Step **1424** includes under-sampling the FM signal at the aliasing rate to down-convert it to the non-FM signal  $F_{(NON-FM)}$ . Step **1424** is illustrated in FIG. **40B** by under-sample points **4005**. The under-sample points **4005** occur at the aliasing rate of the pulses **4009**.

In FIG. **40D**, voltage points **4010** correlate to the under-sample points **4005**. In an embodiment, the voltage points **4010** form a PSK signal **4012**. This can be accomplished in many ways. For example, each voltage point **4010** can be held at a relatively constant level until the next voltage point is received. This results in a stair-step output which can be smoothed or filtered if desired, as described below.

When the first frequency **4006** is under-sampled, the PSK signal **4012** has a frequency of approximately 1 MHz and is used as a phase reference. When the second frequency **4008** is under-sampled, the PSK signal **4012** has a frequency of 1 MHz and is phase shifted **180** degrees from the phase reference.

In FIG. **40E**, a PSK signal **4014** illustrates the PSK signal **4012**, after filtering, on a compressed time scale. Although FIG. **40E** illustrates the PSK signal **4012** as a filtered output signal **4014**, the output signal does not need to be filtered or smoothed to be within the scope of the invention. Instead, the output signal can be tailored for different applications. The PSK signal **4014** can be demodulated through any conventional phase demodulation technique.

The aliasing rate of the under-sampling signal is preferably controlled to optimize the down-converted signal for amplitude output and polarity, as desired.

In the example above, the under-sample points **4005** occur at positive locations of the FSK signal **816**. Alternatively, the under-sample points **4005** can occur at other locations including negative points of the FSK signal **816**. When the under-sample points **4005** occur at negative locations of the FSK signal **816**, the resultant PSK signal is inverted relative to the PSK signal **4014**.

The drawings referred to herein illustrate modulation conversion in accordance with the invention. For example, the PSK signal **4014** in FIG. **40E** illustrates that the FSK signal **816** was successfully down-converted to the PSK signal **4012** and **4014** by retaining enough baseband information for sufficient reconstruction.

### 3.2.1.2 Structural Description

The operation of the under-sampling system **1602** is now described for down-converting the FSK signal **816** to a PSK signal, with reference to the flowchart **1419** and to the timing diagrams of FIGS. **40A–E**. In step **1420**, the under-sampling module **1606** receives the FSK signal **816** (FIG. **40A**). In step **1422**, the under-sampling module **1606** receives the under-sampling signal **4007** (FIG. **40C**). In step **1424**, the under-sampling module **1606** under-samples the FSK signal **816** at the aliasing rate of the under-sampling signal **4007** to down-convert the FSK signal **816** to the PSK signal **4012** in FIG. **40D** or the PSK signal **4014** in FIG. **40E**.

3.2.2 Second Example Embodiment: Down-Converting an FM Signal to an AM Signal

### 3.2.2.1 Operational Description

Operation of the exemplary process of FIG. **14D** is now described for down-converting the FSK signal **816**, illustrated in FIG. **8C**, to an ASK signal. The FSK signal **816** is re-illustrated in FIG. **41A** for convenience.

The FSK signal **816** shifts between a first frequency **4106** and a second frequency **4108**. In the exemplary embodiment, the first frequency **4106** is lower than the second frequency **4108**. In an alternative embodiment, the first frequency **4106** is higher than the second frequency **4108**. For this example, the first frequency **4106** is approximately 899 MHz and the second frequency **4108** is approximately 901 MHz.

FIG. **41B** illustrates an FSK signal portion **4104** that represents a portion of the FSK signal **816** on an expanded time scale.

The process of down-converting the FSK signal **816** to an ASK signal begins at step **1420**, which includes receiving an FM signal. This is represented by the FSK signal **816**.

Step **1422** includes receiving an under-sampling signal having an aliasing rate  $F_{AR}$ . FIG. **41C** illustrates an example under-sampling signal **4107** illustrated on approximately the same time scale as FIG. **42B**. The under-sampling signal **4107** includes a train of pulses **4109** having negligible apertures that tend towards zero time in duration. The pulses **4109** repeat at the aliasing rate, or pulse repetition rate. The aliasing rate is determined or selected as described above.

Generally, when down-converting an FM signal to a non-FM signal, the aliasing rate is substantially equal to a harmonic of a frequency within the FM signal or, more typically, to a sub-harmonic of a frequency within the FM signal. When an FSK signal **816** is being down-converted to an ASK signal, the aliasing rate is substantially equal to a harmonic of the first frequency **4106** or the second frequency **4108** or, more typically, substantially equal to a sub-harmonic of the first frequency **4106** or the second frequency **4108**. In this example, where the first frequency **4106** is 899 MHz and the second frequency **4108** is 901 MHz, the aliasing rate can be substantially equal to a harmonic or sub-harmonic of 899 MHz or 901 MHz. In this example the aliasing rate is approximately 449.5 MHz, which is a sub-harmonic of the first frequency **4106**.

Step **1424** includes under-sampling the FM signal at the aliasing rate to down-convert it to a non-FM signal  $F_{(NON-FM)}$ . Step **1424** is illustrated in FIG. **41B** by under-sample points **4105**. The under-sample points **4105** occur at the aliasing rate of the pulses **4109**. When the first frequency **4106** is under-sampled, the aliasing pulses **4109** and the under-sample points **4105** occur at the same location of subsequent cycles of the FSK signal **816**. This generates a relatively constant output level. But when the second frequency **4108** is under-sampled, the aliasing pulses **4109** and the under-sample points **4005** occur at different locations of subsequent cycles of the FSK signal **816**. This generates an oscillating pattern at approximately  $(901 \text{ MHz} - 899 \text{ MHz}) = 2 \text{ MHz}$ .

In FIG. **41D**, voltage points **4110** correlate to the under-sample points **4105**. In an embodiment, the voltage points **4110** form an ASK signal **4112**. This can be accomplished in many ways. For example, each voltage point **4110** can be held at a relatively constant level until the next voltage point is received. This results in a stair-step output which can be smoothed or filtered if desired, as described below.

In FIG. **41E**, an ASK signal **4114** illustrates the ASK signal **4112**, after filtering, on a compressed time scale.

Although FIG. 41E illustrates the ASK signal 4114 as a filtered output signal, the output signal does not need to be filtered or smoothed to be within the scope of the invention. Instead, the output signal can be tailored for different applications. The ASK signal 4114 can be demodulated through any conventional amplitude demodulation technique. When down-converting from FM to AM, the aliasing rate of the under-sampling signal is preferably controlled to optimize the demodulated baseband signal for amplitude output and/or polarity, as desired.

In an alternative embodiment, the aliasing rate is based on the second frequency and the resultant ASK signal is reversed relative to the ASK signal 4114.

The drawings referred to herein illustrate modulation conversion in accordance with the invention. For example, the ASK signal 4114 in FIG. 41E illustrates that the FSK carrier signal 816 was successfully down-converted to the ASK signal 4114 by retaining enough baseband information for sufficient reconstruction.

### 3.2.2.2 Structural Description

The operation of the under-sampling system 1602 is now described for down-converting the FSK signal 816 to an ASK signal, with reference to the flowchart 1419 and to the timing diagrams of FIGS. 41A–E. In step 1420, the under-sampling module 1606 receives the FSK signal 816 (FIG. 41A). In step 1422, the under-sampling module 1606 receives the under-sampling signal 4107 (FIG. 41C). In step 1424, the under-sampling module 1606 under-samples the FSK signal 816 at the aliasing of the under-sampling signal 4107 to down-convert the FSK signal 816 to the ASK signal 4112 of FIG. 41D or the ASK signal 4114 in FIG. 41E.

### 3.2.3 Other Example Embodiments

The embodiments described above are provided for purposes of illustration. These embodiments are not intended to limit the invention. Alternate embodiments, differing slightly or substantially from those described herein, will be apparent to persons skilled in the relevant art(s) based on the teachings contained herein. Such alternate embodiments fall within the scope and spirit of the present invention.

### 3.3 Implementation Examples

Exemplary operational and/or structural implementations related to the method(s), structure(s), and/or embodiments described above are presented in Sections 4 and 5 below. These implementations are presented for purposes of illustration, and not limitation. The invention is not limited to the particular implementation examples described therein. Alternate implementations (including equivalents, extensions, variations, deviations, etc., of those described herein) will be apparent to persons skilled in the relevant art(s) based on the teachings contained herein. Such alternate implementations fall within the scope and spirit of the present invention.

## 4. Implementation Examples

Exemplary operational and/or structural implementations related to the method(s), structure(s), and/or embodiments described in the Sub-Sections above are presented in this section (and its subsections). These implementations are presented herein for purposes of illustration, and not limitation. The invention is not limited to the particular implementation examples described herein. Alternate implementations (including equivalents, extensions, variations, deviations, etc., of those described herein) will be apparent to persons skilled in the relevant art(s) based on the teachings contained herein. Such alternate implementations fall within the scope and spirit of the present invention.

FIG. 13 illustrates a generic aliasing system 1302, including an aliasing module 1306. FIG. 16 illustrates an under-

sampling system 1602, which includes an under-sampling module 1606. The under-sampling module 1606 receives an under-sampling signal 1604 having an aliasing rate  $F_{AR}$ . The under-sampling signal 1604 includes a train of pulses having negligible apertures that tend towards zero time in duration. The pulses repeat at the aliasing rate  $F_{AR}$ . The under-sampling system 1602 is an example implementation of the generic aliasing system 1303. The under-sampling system 1602 outputs a down-converted signal 1308A.

FIG. 26A illustrates an exemplary sample and hold system 2602, which is an exemplary implementation of the under-sampling system 1602. The sample and hold system 2602 is described below.

FIG. 26B illustrates an exemplary inverted sample and hold system 2606, which is an alternative example implementation of the under-sampling system 1602. The inverted sample and hold system 2606 is described below.

### 4.1 The Under-Sampling System as a Sample and Hold System

FIG. 26A is a block diagram of a the sample and hold system 2602, which is an example embodiment of the under-sampling module 1606 in FIG. 16, which is an example embodiment of the generic aliasing module 1306 in FIG. 13.

The sample and hold system 2602 includes a sample and hold module 2604, which receives the EM signal 1304 and the under-sampling signal 1604. The sample and hold module 2604 under-samples the EM signal at the aliasing rate of the under-sampling signal 1604, as described in the sections above with respect to the flowcharts 1401 in FIG. 14A, 1407 in FIG. 14B, 1413 in FIG. 14C and 1419 in FIG. 14D. The under-sampling system 1602 outputs a down-converted signal 1308A.

FIG. 27 illustrates an under-sampling system 2701 as a sample and hold system, which is an example implementation of the under-sampling system 2602. The under-sampling system 2701 includes a switch module 2702 and a holding module 2706. The under-sampling system 2701 is described below.

FIG. 24A illustrates an under-sampling system 2401 as a break before make under-sampling system, which is an alternative implementation of the under-sampling system 2602. The break before make under-sampling system 2401 is described below.

### 4.1.1 The Sample and Hold System as a Switch Module and a Holding Module

FIG. 27 illustrates an exemplary embodiment of the sample and hold module 2604 from FIG. 26A. In the exemplary embodiment, the sample and hold module 2604 includes a switch module 2702, and a holding module 2706.

Preferably, the switch module 2702 and the holding module 2706 under-sample the EM signal 1304 to down-convert it in any of the manners shown in the operation flowcharts 1401, 1407, 1413 and 1419. For example, the sample and hold module 2604 can receive and under-sample any of the modulated carrier signal signals described above, including, but not limited to, the analog AM signal 516, the digital AM signal 616, the analog FM signal 716, the digital FM signal 816, the analog PM signal 916, the digital PM signal 1016, etc., and any combinations thereof.

The switch module 2702 and the holding module 2706 down-convert the EM signal 1304 to an intermediate signal, to a demodulated baseband or to a different modulation scheme, depending upon the aliasing rate.

For example, operation of the switch module 2702 and the holding module 2706 are now described for down-converting the EM signal 1304 to an intermediate signal,



with reference to the flowchart 1407 and the example timing diagrams in FIG. 79A–F.

In step 1408, the switch module 2702 receives the EM signal 1304 (FIG. 79A). In step 1410, the switch module 2702 receives the under-sampling signal 1604 (FIG. 79C). In step 1412, the switch module 2702 and the holding module 2706 cooperate to under-sample the EM signal 1304 and down-convert it to an intermediate signal. More specifically, during step 1412, the switch module 2702 closes during each under-sampling pulse to couple the EM signal 1304 to the holding module 2706. In an embodiment, the switch module 2702 closes on rising edges of the pulses. In an alternative embodiment, the switch module 2702 closes on falling edges of the pulses. When the EM signal 1304 is coupled to the holding module 2706, the amplitude of the EM signal 1304 is captured by the holding module 2706. The holding module 2706 is designed to capture and hold the amplitude of the EM signal 1304 within the short time frame of each negligible aperture pulse. FIG. 79B illustrates the EM signal 1304 after under-sampling.

The holding module 2706 substantially holds or maintains each under-sampled amplitude until a subsequent under-sample. (FIG. 79D). The holding module 2706 outputs the under-sampled amplitudes as the down-converted signal 1308A. The holding module 2706 can output the down-converted signal 1308A as an unfiltered signal, such as a stair step signal (FIG. 79E), as a filtered down-converted signal (FIG. 79F) or as a partially filtered down-converted signal.

#### 4.1.2 The Sample and Hold System as Break-Before-Make Module

FIG. 24A illustrates a break-before-make under-sampling system 2401, which is an alternative implementation of the under-sampling system 2602.

Preferably, the break-before-make under-sampling system 2401 under-samples the EM signal 1304 to down-convert it in any of the manners shown in the operation flowcharts 1401, 1407, 1413 and 1419. For example, the sample and hold module 2604 can receive and under-sample any of the unmodulated or modulated carrier signal signals described above, including, but not limited to, the analog AM signal 516, the digital AM signal 616, the analog FM signal 716, the digital FM signal 816, the analog PM signal 916, the digital PM signal 1016, etc., and combinations thereof.

The break-before-make under-sampling system 2401 down-converts the EM signal 1304 to an intermediate signal, to a demodulated baseband or to a different modulation scheme, depending upon the aliasing rate.

FIG. 24A includes a break-before-make switch 2402. The break-before-make switch 2402 includes a normally open switch 2404 and a normally closed switch 2406. The normally open switch 2404 is controlled by the under-sampling signal 1604, as previously described. The normally closed switch 2406 is controlled by an isolation signal 2412. In an embodiment, the isolation signal 2412 is generated from the under-sampling signal 1604. Alternatively, the under-sampling signal 1604 is generated from the isolation signal 2412. Alternatively, the isolation signal 2412 is generated independently from the under-sampling signal 1604. The break-before-make module 2402 substantially isolates a sample and hold input 2408 from a sample and hold output 2410.

FIG. 24B illustrates an example timing diagram of the under-sampling signal 1604 that controls the normally open switch 2404. FIG. 24C illustrates an example timing diagram of the isolation signal 2412 that controls the normally

closed switch 2406. Operation of the break-before-make module 2402 is described with reference to the example timing diagrams in FIGS. 24B and 24C.

Prior to time  $t_0$ , the normally open switch 2404 and the normally closed switch 2406 are at their normal states.

At time  $t_0$ , the isolation signal 2412 in FIG. 24C opens the normally closed switch 2406. Then, just after time  $t_0$ , the normally open switch 2404 and the normally closed switch 2406 are open and the input 2408 is isolated from the output 2410.

At time  $t_1$ , the under-sampling signal 1604 in FIG. 24B briefly closes the normally open switch 2404. This couples the EM signal 1304 to the holding module 2416.

Prior to  $t_2$ , the under-sampling signal 1604 in FIG. 24B opens the normally open switch 2404. This de-couples the EM signal 1304 from the holding module 2416.

At time  $t_2$ , the isolation signal 2412 in FIG. 24C closes the normally closed switch 2406. This couples the holding module 2416 to the output 2410.

The break-before-make under-sampling system 2401 includes a holding module 2416, which can be similar to the holding module 2706 in FIG. 27. The break-before-make under-sampling system 2401 down-converts the EM signal 1304 in a manner similar to that described with reference to the under-sampling system 2702 in FIG. 27.

#### 4.1.3 Example Implementations of the Switch Module

The switch module 2702 in FIG. 27 and the switch modules 2404 and 2406 in FIG. 24A can be any type of switch device that preferably has a relatively low impedance when closed and a relatively high impedance when open. The switch modules 2702, 2404 and 2406 can be implemented with normally open or normally closed switches. The switch device need not be an ideal switch device. FIG. 28B illustrates the switch modules 2702, 2404 and 2406 as, for example, a switch module 2810.

The switch device 2810 (e.g., switch modules 2702, 2404 and 2406) can be implemented with any type of suitable switch device, including, but not limited to mechanical switch devices and electrical switch devices, optical switch devices, etc., and combinations thereof. Such devices include, but are not limited to transistor switch devices, diode switch devices, relay switch devices, optical switch devices, micro-machine switch devices, etc..

In an embodiment, the switch module 2810 can be implemented as a transistor, such as, for example, a field effect transistor (FET), a bi-polar transistor, or any other suitable circuit switching device.

In FIG. 28A, the switch module 2810 is illustrated as a FET 2802. The FET 2802 can be any type of FET, including, but not limited to, a MOSFET, a JFET, a GaAsFET, etc.. The FET 2802 includes a gate 2804, a source 2806 and a drain 2808. The gate 2804 receives the under-sampling signal 1604 to control the switching action between the source 2806 and the drain 2808. Generally, the source 2806 and the drain 2808 are interchangeable.

It should be understood that the illustration of the switch module 2810 as a FET 2802 in FIG. 28A is for example purposes only. Any device having switching capabilities could be used to implement the switch module 2810 (e.g., switch modules 2702, 2404 and 2406), as will be apparent to persons skilled in the relevant art(s) based on the discussion contained herein.

In FIG. 28C, the switch module 2810 is illustrated as a diode switch 2812, which operates as a two lead device when the under-sampling signal 1604 is coupled to the output 2813.

In FIG. 28D, the switch module 2810 is illustrated as a diode switch 2814, which operates as a two lead device when the under-sampling signal 1604 is coupled to the output 2815.



#### 4.1.4 Example Implementations of the Holding Module

The holding modules **2706** and **2416** preferably captures and holds the amplitude of the original, unaffected, EM signal **1304** within the short time frame of each negligible aperture under-sampling signal pulse.

In an exemplary embodiment, holding modules **2706** and **2416** are implemented as a reactive holding module **2901** in FIG. **29A**, although the invention is not limited to this embodiment. A reactive holding module is a holding module that employs one or more reactive electrical components to preferably quickly charge to the amplitude of the EM signal **1304**. Reactive electrical components include, but are not limited to, capacitors and inductors.

In an embodiment, the holding modules **2706** and **2416** include one or more capacitive holding elements, illustrated in FIG. **29B** as a capacitive holding module **2902**. In FIG. **29C**, the capacitive holding module **2902** is illustrated as one or more capacitors illustrated generally as capacitor(s) **2904**. Recall that the preferred goal of the holding modules **2706** and **2416** is to quickly charge to the amplitude of the EM signal **1304**. In accordance with principles of capacitors, as the negligible aperture of the under-sampling pulses tends to zero time in duration, the capacitive value of the capacitor **2904** can tend towards zero Farads. Example values for the capacitor **2904** can range from tens of pico Farads to fractions of pico Farads. A terminal **2906** serves as an output of the sample and hold module **2604**. The capacitive holding module **2902** provides the under-samples at the terminal **2906**, where they can be measured as a voltage. FIG. **29F** illustrates the capacitive holding module **2902** as including a series capacitor **2912**, which can be utilized in an inverted sample and hold system as described below.

In an alternative embodiment, the holding modules **2706** and **2416** include one or more inductive holding elements, illustrated in FIG. **29D** as an inductive holding module **2908**.

In an alternative embodiment, the holding modules **2706** and **2416** include a combination of one or more capacitive holding elements and one or more inductive holding elements, illustrated in FIG. **29E** as a capacitive/inductive holding module **2910**.

FIG. **29G** illustrates an integrated under-sampling system that can be implemented to down-convert the EM signal **1304** as illustrated in, and described with reference to, FIGS. **79A-F**.

#### 4.1.5 Optional Under-Sampling Signal Module

FIG. **30** illustrates an under-sampling system **3001**, which is an example embodiment of the under-sampling system **1602**. The under-sampling system **3001** includes an optional under-sampling signal module **3002** that can perform any of a variety of functions or combinations of functions, including, but not limited to, generating the under-sampling signal **1604**.

In an embodiment, the optional under-sampling signal module **3002** includes an aperture generator, an example of which is illustrated in FIG. **29J** as an aperture generator **2920**. The aperture generator **2920** generates negligible aperture pulses **2926** from an input signal **2924**. The input signal **2924** can be any type of periodic signal, including, but not limited to, a sinusoid, a square wave, a saw-tooth wave, etc. Systems for generating the input signal **2924** are described below.

The width or aperture of the pulses **2926** is determined by delay through the branch **2922** of the aperture generator **2920**. Generally, as the desired pulse width decreases, the tolerance requirements of the aperture generator **2920** increase. In other words, to generate negligible aperture pulses for a given input EM frequency, the components

utilized in the example aperture generator **2920** require greater reaction times, which are typically obtained with more expensive elements, such as gallium arsenide (GaAs), etc.

The example logic and implementation shown in the aperture generator **2920** are provided for illustrative purposes only, and are not limiting. The actual logic employed can take many forms. The example aperture generator **2920** includes an optional inverter **2928**, which is shown for polarity consistency with other examples provided herein. An example implementation of the aperture generator **2920** is illustrated in FIG. **29K**.

Additional examples of aperture generation logic is provided in FIGS. **29H** and **29I**. FIG. **29H** illustrates a rising edge pulse generator **2940**, which generates pulses **2926** on rising edges of the input signal **2924**. FIG. **29I** illustrates a falling edge pulse generator **2950**, which generates pulses **2926** on falling edges of the input signal **2924**.

In an embodiment, the input signal **2924** is generated externally of the under-sampling signal module **3002**, as illustrated in FIG. **30**. Alternatively, the input signal **2924** is generated internally by the under-sampling signal module **3002**. The input signal **2924** can be generated by an oscillator, as illustrated in FIG. **29L** by an oscillator **2930**. The oscillator **2930** can be internal to the under-sampling signal module **3002** or external to the under-sampling signal module **3002**. The oscillator **2930** can be external to the under-sampling system **3001**.

The type of down-conversion performed by the under-sampling system **3001** depends upon the aliasing rate of the under-sampling signal **1604**, which is determined by the frequency of the pulses **2926**. The frequency of the pulses **2926** is determined by the frequency of the input signal **2924**. For example, when the frequency of the input signal **2924** is substantially equal to a harmonic or a sub-harmonic of the EM signal **1304**, the EM signal **1304** is directly down-converted to baseband (e.g. when the EM signal is an AM signal or a PM signal), or converted from FM to a non-FM signal. When the frequency of the input signal **2924** is substantially equal to a harmonic or a sub-harmonic of a difference frequency, the EM signal **1304** is down-converted to an intermediate signal.

The optional under-sampling signal module **3002** can be implemented in hardware, software firmware, or any combination thereof.

#### 4.2 The Under-Sampling System as an Inverted Sample and Hold

FIG. **26B** illustrates an exemplary inverted sample and hold system **2606**, which is an alternative example implementation of the under-sampling system **1602**.

FIG. **42** illustrates a inverted sample and hold system **4201**, which is an example implementation of the inverted sample and hold system **2606** in FIG. **26B**. The sample and hold system **4201** includes a sample and hold module **4202**, which includes a switch module **4204** and a holding module **4206**. The switch module **4204** can be implemented as described above with reference to FIGS. **28A-D**.

The holding module **4206** can be implemented as described above with reference to FIGS. **29A-F**, for the holding modules **2706** and **2416**. In the illustrated embodiment, the holding module **4206** includes one or more capacitors **4208**. The capacitor(s) **4208** are selected to pass higher frequency components of the EM signal **1304** through to a terminal **4210**, regardless of the state of the switch module **4204**. The capacitor **4202** stores charge from the EM signal **1304** during aliasing pulses of the under-sampling signal **1604** and the signal at the terminal **4210** is

thereafter off-set by an amount related to the charge stored in the capacitor **4206**.

Operation of the inverted sample and hold system **4201** is illustrated in FIGS. **34A–F**. FIG. **34A** illustrates an example EM signal **1304**. FIG. **34B** illustrates the EM signal **1304** after under-sampling. FIG. **34C** illustrates the under-sampling signal **1606**, which includes a train of aliasing pulses having negligible apertures.

FIG. **34D** illustrates an example down-converted signal **1308A**. FIG. **34E** illustrates the down-converted signal **1308A** on a compressed time scale. Since the holding module **4206** is series element, the higher frequencies (e.g., RF) of the EM signal **1304** can be seen on the down-converted signal. This can be filtered as illustrated in FIG. **34F**.

The inverted sample and hold system **4201** can be used to down-convert any type of EM signal, including modulated carrier signals and unmodulated carrier signals, to IF signals and to demodulated baseband signals.

#### 4.3 Other Implementations

The implementations described above are provided for purposes of illustration. These implementations are not intended to limit the invention. Alternate implementations, differing slightly or substantially from those described herein, will be apparent to persons skilled in the relevant art(s) based on the teachings contained herein. Such alternate implementations fall within the scope and spirit of the present invention.

#### 5. Optional Optimizations of Under-Sampling at an Aliasing Rate

The methods and systems described in sections above can be optionally optimized with one or more of the optimization methods or systems described below.

##### 5.1 Doubling the Aliasing Rate (FAR) of the Under-Sampling Signal

In an embodiment, the optional under-sampling signal module **3002** in FIG. **30** includes a pulse generator module that generates aliasing pulses at a multiple of the frequency of the oscillating source, such as twice the frequency of the oscillating source. The input signal **2926** may be any suitable oscillating source.

FIG. **31A** illustrates an example circuit **3102** that generates a doubler output signal **3104** (FIG. **31** and **43B**) that may be used as an under-sampling signal **1604**. The example circuit **3102** generates pulses on rising and falling edges of the input oscillating signal **3106** of FIG. **31B**. Input oscillating signal **3106** is one embodiment of optional input signal **2926**. The circuit **3102** can be implemented as a pulse generator and aliasing rate (FAR) doubler, providing the under-sampling signal **1604** to under-sampling module **1606** in FIG. **30**.

The aliasing rate is twice the frequency of the input oscillating signal  $F_{OSC}$  **3106**, as shown by EQ. (9) below.

$$F_{AR}=2 \cdot F_{OSC} \quad \text{EQ. (9)}$$

The aperture width of the aliasing pulses is determined by the delay through a first inverter **3108** of FIG. **31**. As the delay is increased, the aperture is increased. A second inverter **3112** is shown to maintain polarity consistency with examples described elsewhere. In an alternate embodiment inverter **3112** is omitted. Preferably, the pulses have negligible aperture widths that tend toward zero time. The doubler output signal **3104** may be further conditioned as appropriate to drive a switch module with negligible aperture pulses. The circuit **3102** may be implemented with integrated circuitry, discretely, with equivalent logic circuitry, or with any valid fabrication technology.

#### 5.2 Differential Implementations

The invention can be implemented in a variety of differential configurations. Differential configurations are useful for reducing common mode noise. This can be very useful in receiver systems where common mode interference can be caused by intentional or unintentional radiators such as cellular phones, CB radios, electrical appliances etc. Differential configurations are also useful in reducing any common mode noise due to charge injection of the switch in the switch module or due to the design and layout of the system in which the invention is used. Any spurious signal that is induced in equal magnitude and equal phase in both input leads of the invention will be substantially reduced or eliminated. Some differential configurations, including some of the configurations below, are also useful for increasing the voltage and/or for increasing the power of the down-converted signal **1308A**. While an example of a differential under-sampling module is shown below, the example is shown for the purpose of illustration, not limitation. Alternate embodiments (including equivalents, extensions, variations, deviations, etc.) of the embodiment described herein will be apparent to those skilled in the relevant art based on the teachings contained herein. The invention is intended and adapted to include such alternate embodiments.

FIG. **44A** illustrates an example differential system **4402** that can be included in the under-sampling module **1606**. The differential system **4402** includes an inverted under-sampling design similar to that described with reference to FIG. **42**. The differential system **4402** includes inputs **4404** and **4406** and outputs **4408** and **4410**. The differential system **4402** includes a first inverted sample and hold module **4412**, which includes a holding module **4414** and a switch module **4416**. The differential system **4402** also includes a second inverted sample and hold module **4418**, which includes a holding module **4420** and the switch module **4416**, which it shares in common with sample and hold module **4412**.

One or both of the inputs **4404** and **4406** are coupled to an EM signal source. For example, the inputs can be coupled to an EM signal source, wherein the input voltages at the inputs **4404** and **4406** are substantially equal in amplitude but **180** degrees out of phase with one another. Alternatively, where dual inputs are unavailable, one of the inputs **4404** and **4406** can be coupled to ground.

In operation, when the switch module **4416** is closed, the holding modules **4414** and **4420** are in series and, provided they have similar capacitive values, they charge to equal amplitudes but opposite polarities. When the switch module **4416** is open, the voltage at the output **4408** is relative to the input **4404**, and the voltage at the output **4410** is relative to the voltage at the input **4406**.

Portions of the voltages at the outputs **4408** and **4410** include voltage resulting from charge stored in the holding modules **4414** and **4420**, respectively, when the switch module **4416** was closed. The portions of the voltages at the outputs **4408** and **4410** resulting from the stored charge are generally equal in amplitude to one another but **180** degrees out of phase.

Portions of the voltages at the outputs **4408** and **4410** also include ripple voltage or noise resulting from the switching action of the switch module **4416**. But because the switch module is positioned between the two outputs, the noise introduced by the switch module appears at the outputs **4408** and **4410** as substantially equal and in-phase with one another. As a result, the ripple voltage can be substantially filtered out by inverting the voltage at one of the outputs

4408 or 4410 and adding it to the other remaining output. Additionally, any noise that is impressed with substantially equal amplitude and equal phase onto the input terminals 4404 and 4406 by any other noise sources will tend to be canceled in the same way.

The differential system 4402 is effective when used with a differential front end (inputs) and a differential back end (outputs). It can also be utilized in the following configurations, for example:

- a) A single-input front end and a differential back end; and
- b) A differential front end and single-output back end.

Examples of these system are provided below.

#### 5.2.1 Differential Input-to-Differential Output

FIG. 44B illustrates the differential system 4402 wherein the inputs 4404 and 4406 are coupled to equal and opposite EM signal sources, illustrated here as dipole antennas 4424 and 4426. In this embodiment, when one of the outputs 4408 or 4410 is inverted and added to the other output, the common mode noise due to the switching module 4416 and other common mode noise present at the input terminals 4404 and 4406 tend to substantially cancel out.

#### 5.2.2 Single Input-to-Differential Output

FIG. 44C illustrates the differential system 4402 wherein the input 4404 is coupled to an EM signal source such as a monopole antenna 4428 and the input 4406 is coupled to ground.

FIG. 44E illustrates an example single input to differential output receiver/down-converter system 4436. The system 4436 includes the differential system 4402 wherein the input 4406 is coupled to ground. The input 4404 is coupled to an EM signal source 4438.

The outputs 4408 and 4410 are coupled to a differential circuit 4444 such as a filter, which preferably inverts one of the outputs 4408 or 4410 and adds it to the other output 4408 or 4410. This substantially cancels common mode noise generated by the switch module 4416. The differential circuit 4444 preferably filters the higher frequency components of the EM signal 1304 that pass through the holding modules 4414 and 4420. The resultant filtered signal is output as the down-converted signal 1308A.

#### 5.2.3 Differential Input-to-Single Output

FIG. 44D illustrates the differential system 4402 wherein the inputs 4404 and 4406 are coupled to equal and opposite EM signal sources illustrated here as dipole antennas 4430 and 4432. The output is taken from terminal 4408.

#### 5.3 Smoothing the Down-Converted Signal

The down-converted signal 1308A may be smoothed by filtering as desired. The differential circuit 4444 implemented as a filter in FIG. 44E illustrates but one example. Filtering may be accomplished in any of the described embodiments by hardware, firmware and software implementation as is well known by those skilled in the arts.

#### 5.4 Load Impedance and Input/Output Buffering

Some of the characteristics of the down-converted signal 1308A depend upon characteristics of a load placed on the down-converted signal 1308A. For example, in an embodiment, when the down-converted signal 1308A is coupled to a high impedance load, the charge that is applied to a holding module such as holding module 2706 in FIG. 27 or 2416 in FIG. 24A during a pulse generally remains held by the holding module until the next pulse. This results in a substantially stair-step-like representation of the down-converted signal 1308A as illustrated in FIG. 15C, for example. A high impedance load enables the under-sampling system 1606 to accurately represent the voltage of the original unaffected input signal.

The down-converted signal 1308A can be buffered with a high impedance amplifier, if desired.

Alternatively, or in addition to buffering the down-converted signal 1308A, the input EM signal may be buffered or amplified by a low noise amplifier.

#### 5.5 Modifying the Under-Sampling Signal Utilizing Feedback

FIG. 30 shows an embodiment of a system 3001 which uses down-converted signal 1308A as feedback 3006 to control various characteristics of the under-sampling module 1606 to modify the down-converted signal 1308A.

Generally, the amplitude of the down-converted signal 1308A varies as a function of the frequency and phase differences between the EM signal 1304 and the under-sampling signal 1604. In an embodiment, the down-converted signal 1308A is used as the feedback 3006 to control the frequency and phase relationship between the EM signal 1304 and the under-sampling signal 1604. This can be accomplished using the example block diagram shown in FIG. 32A. The example circuit illustrated in FIG. 32A can be included in the under-sampling signal module 3002. Alternate implementations will be apparent to persons skilled in the relevant art(s) based on the teachings contained herein. Alternate implementations fall within the scope and spirit of the present invention. In this embodiment a state-machine is used for clarity, and is not limiting.

In the example of FIG. 32A, a state machine 3204 reads an analog to digital converter, A/D 3202, and controls a digital to analog converter (DAC) 3206. In an embodiment, the state machine 3204 includes 2 memory locations, Previous and Current, to store and recall the results of reading A/D 3202. In an embodiment, the state machine 3204 utilizes at least one memory flag.

DAC 3206 controls an input to a voltage controlled oscillator, VCO 3208. VCO 3208 controls a frequency input of a pulse generator 3210, which, in an embodiment, is substantially similar to the pulse generator shown in FIG. 29J. The pulse generator 3210 generates the under-sampling signal 1604.

In an embodiment, the state machine 3204 operates in accordance with the state machine flowchart 3220 in FIG. 32B. The result of this operation is to modify the frequency and phase relationship between the under-sampling signal 1604 and the EM signal 1304, to substantially maintain the amplitude of the down-converted signal 1308A at an optimum level.

The amplitude of the down-converted signal 1308A can be made to vary with the amplitude of the under-sampling signal 1604. In an embodiment where Switch Module 2702 is a FET as shown in FIG. 28A, wherein the gate 2804 receives the under-sampling signal 1604, the amplitude of the under-sampling signal 1604 can determine the "on" resistance of the FET, which affects the amplitude of down-converted signal 1308A. Under-sampling signal module 3002, as shown in FIG. 32C, can be an analog circuit that enables an automatic gain control function. Alternate implementations will be apparent to persons skilled in the relevant art(s) based on the teachings contained herein. Alternate implementations fall within the scope and spirit of the present invention.

#### III. Down-Converting by Transferring Energy

The energy transfer embodiments of the invention provide enhanced signal to noise ratios and sensitivity to very small signals, as well as permitting the down-converted signal to drive lower impedance loads unassisted. The energy transfer aspects of the invention are represented generally by 4506 in FIGS. 45A and 45B. Fundamental descriptions of how this is accomplished is presented step by step beginning with a comparison with an under-sampling system.

### 0.1 Energy Transfer Compared to Under-Sampling

Section II above disclosed methods and systems for down-converting an EM signal by under-sampling. The under-sampling systems utilize a sample and hold system controlled by an under-sampling signal. The under-sampling signal includes a train of pulses having negligible apertures that tend towards zero time in duration. The negligible aperture pulses minimize the amount of energy transferred from the EM signal. This protects the under-sampled EM signal from distortion or destruction. The negligible aperture pulses also make the sample and hold system a high impedance system. An advantage of under-sampling is that the high impedance input allows accurate voltage reproduction of the under-sampled EM signal. The methods and systems disclosed in Section II are thus useful for many situations including, but not limited to, monitoring EM signals without distorting or destroying them.

Because the under-sampling systems disclosed in Section II transfer only negligible amounts of energy, they are not suitable for all situations. For example, in radio communications, received radio frequency (RF) signals are typically very weak and must be amplified in order to distinguish them over noise. The negligible amounts of energy transferred by the under-sampling systems disclosed in Section II may not be sufficient to distinguish received RF signals over noise.

In accordance with an aspect of the invention, methods and systems are disclosed below for down-converting EM signals by transferring non-negligible amounts of energy from the EM signals. The resultant down-converted signals have sufficient energy to allow the down-converted signals to be distinguishable from noise. The resultant down-converted signals also have sufficient energy to drive lower impedance circuits without buffering.

Down-converting by transferring energy is introduced below in an incremental fashion to distinguish it from under-sampling. The introduction begins with further descriptions of under-sampling.

#### 0.1.1 Review of Under-Sampling

FIG. 78A illustrates an exemplary under-sampling system 7802 for down-converting an input EM signal 7804. The under-sampling system 7802 includes a switching module 7806 and a holding module shown as a holding capacitance 7808. An under-sampling signal 7810 controls the switch module 7806. The under-sampling signal 7810 includes a train of pulses having negligible pulse widths that tend toward zero time. An example of a negligible pulse width or duration can be in the range of 1–10 psec for under-sampling a 900 MHz signal. Any other suitable negligible pulse duration can be used as well, where accurate reproduction of the original unaffected input signal voltage is desired without substantially affecting the original input signal voltage.

In an under-sampling environment, the holding capacitance 7808 preferably has a small capacitance value. This allows the holding capacitance 7808 to substantially charge to the voltage of the input EM signal 7804 during the negligible apertures of the under-sampling signal pulses. For example, in an embodiment, the holding capacitance 7808 has a value in the range of 1 pF. Other suitable capacitance values can be used to achieve substantially the voltage of the original unaffected input signal. Various capacitances can be employed for certain effects, which are described below.

The under-sampling system is coupled to a load 7812. In FIG. 78B, the load 7812 of FIG. 78A is illustrated as a high impedance load 7818. A high impedance load is one that is relatively insignificant to an output drive impedance of the system for a given output frequency. The high impedance

load 7818 allows the holding capacitance 7808 to substantially maintain the charge accumulated during the under-sampling pulses.

FIGS. 79A–F illustrate example timing diagrams for the under-sampling system 7802. FIG. 79A illustrates an example input EM signal 7804.

FIG. 79C illustrates an example under-sampling signal 7810, including pulses 7904 having negligible apertures that tend towards zero time in duration.

FIG. 79B illustrates the negligible effects to the input EM signal 7804 when under-sampled, as measured at a terminal 7814 of the under-sampling system 7802. In FIG. 79B, negligible distortions 7902 correlate with the pulses of the under-sampling signal 7810. In this embodiment, the negligible distortions 7902 occur at different locations of subsequent cycles of the input EM signal 7804. As a result, the input EM signal will be down-converted. The negligible distortions 7902 represent negligible amounts of energy, in the form of charge that is transferred to the holding capacitance 7808.

When the load 7812 is a high impedance load, the holding capacitance 7808 does not significantly discharge between pulses 7904. As a result, charge that is transferred to the holding capacitance 7808 during a pulse 7904 tends to “hold” the voltage value sampled constant at the terminal 7816 until the next pulse 7904. When voltage of the input EM signal 7804 changes between pulses 7904, the holding capacitance 7808 substantially attains the new voltage and the resultant voltage at the terminal 7816 forms a stair step pattern, as illustrated in FIG. 79D.

FIG. 79E illustrates the stair step voltage of FIG. 79D on a compressed time scale. The stair step voltage illustrated in FIG. 79E can be filtered to produce the signal illustrated in FIG. 79F. The signals illustrated in FIGS. 79D, E, and F have substantially all of the baseband characteristics of the input EM signal 7804 in FIG. 79A, except that the signals illustrated in FIGS. 79D, E, and F have been successfully down-converted.

Note that the voltage level of the down-converted signals illustrated in FIGS. 79E and 79C are substantially close to the voltage level of the input EM signal 7804. The under-sampling system 7802 thus down-converts the input EM signal 7804 with reasonable voltage reproduction, without substantially affecting the input EM signal 7804. But also note that the power available at the output is relatively negligible (e.g.  $V^2/R$ ;  $\sim 5$  mV and 1 MOhm), given the input EM signal 7804 would typically have a driving impedance, in an RF environment, of 50 Ohms (e.g.:  $V^2/R$ ;  $\sim 5$  mV and 50 Ohms).

#### 0.1.1.1 Effects of Lowering the Impedance of the Load

Effects of lowering the impedance of the load 7812 are now described. FIGS. 80A–E illustrate example timing diagrams for the under-sampling system 7802 when the load 7812 is a relatively low impedance load, one that is significant relative to the output drive impedance of the system for a given output frequency.

FIG. 80A illustrates an example input EM signal 7804, which is substantially similar to that illustrated in FIG. 79A.

FIG. 80C illustrates an example under-sampling signal 7810, including pulses 8004 having negligible apertures that tend towards zero time in duration. The example under-sampling signal 7810 illustrated in FIG. 80C is substantially similar to that illustrated in FIGS. 79C.

FIG. 80B illustrates the negligible effects to the input EM signal 7804 when under-sampled, as measured at a terminal 7814 of the under-sampling system 7802. In FIG. 80B, negligible distortions 8002 correlate with the pulses 8004 of

the under-sampling signal **7810** in FIG. **80C**. In this example, the negligible distortions **8002** occur at different locations of subsequent cycles of the input EM signal **7804**. As a result, the input EM signal **7804** will be down-converted. The negligible distortions **8002** represent negligible amounts of energy, in the form of charge that is transferred to the holding capacitance **7808**.

When the load **7812** is a low impedance load, the holding capacitance **7808** is significantly discharged by the load between pulses **8004** (FIG. **80C**). As a result, the holding capacitance **7808** cannot reasonably attain or “hold” the voltage of the original EM input signal **7804**, as was seen in the case of FIG. **79D**. Instead, the charge appears as the output illustrated in FIG. **80D**.

FIG. **80E** illustrates the output from FIG. **80D** on a compressed time scale. The output in FIG. **80E** can be filtered to produce the signal illustrated in FIG. **80F**. The down-converted signal illustrated in FIG. **80F** is substantially similar to the down-converted signal illustrated in FIG. **79F**, except that the signal illustrated in FIG. **80F** is substantially smaller in magnitude than the amplitude of the down-converted signal illustrated in FIG. **79F**. This is because the low impedance of the load **7812** prevents the holding capacitance **7808** from reasonably attaining or “holding” the voltage of the original EM input signal **7804**. As a result, the down-converted signal illustrated in FIG. **80F** cannot provide optimal voltage reproduction, and has relatively negligible power available at the output (e.g.:  $V^2/R$ ;  $\sim 200 \mu V$  and 2 KOhms), given the input EM signal **7804** would typically have a driving impedance, in an RF environment, of 50 Ohms (e.g.:  $V^2/R$ ;  $\sim 5 mV$  and 50 Ohms).

0.1.1.2 Effects of Increasing the Value of the Holding Capacitance  
Effects of increasing the value of the holding capacitance **7808**, while having to drive a low impedance load **7812**, is now described. FIGS. **81A–F** illustrate example timing diagrams for the under-sampling system **7802** when the holding capacitance **7808** has a larger value, in the range of 18 pF for example.

FIG. **81A** illustrates an example input EM signal **7804**, which is substantially similar to that illustrated in FIGS. **79A** and **80A**.

FIG. **81C** illustrates an example under-sampling signal **7810**, including pulses **8104** having negligible apertures that tend towards zero time in duration. The example under-sampling signal **7810** illustrated in FIG. **81C** is substantially similar to that illustrated in FIGS. **79C** and **80C**.

FIG. **81B** illustrates the negligible effects to the input EM signal **7804** when under-sampled, as measured at a terminal **7814** of the under-sampling system **7802**. In FIG. **81B**, negligible distortions **8102** correlate with the pulses **8104** of the under-sampling signal **7810** in FIG. **81C**. Upon close inspection, the negligible distortions **8102** occur at different locations of subsequent cycles of the input EM signal **7804**. As a result, the input EM signal **7804** will be down-converted. The negligible distortions **8102** represent negligible amounts of energy, in the form of charge that is transferred to the holding capacitance **7808**.

FIG. **81D** illustrates the voltage measured at the terminal **7816**, which is a result of the holding capacitance **7808** attempting to attain and “hold” the original input EM signal voltage, but failing to do so, during the negligible apertures of the pulses **8104** illustrated in FIG. **81C**.

Recall that when the load **7812** is a low impedance load, the holding capacitance **7808** is significantly discharged by the load between pulses **8104** (FIG. **81C**), this again is seen in FIGS. **81D** and **E**. As a result, the holding capacitance

**7808** cannot reasonably attain or “hold” the voltage of the original EM input signal **7804**, as was seen in the case of FIG. **79D**. Instead, the charge appears as the output illustrated in FIG. **81D**.

FIG. **81E** illustrates the down-converted signal **8106** on a compressed time scale. Note that the amplitude of the down-converted signal **8106** is significantly less than the amplitude of the down-converted signal illustrated in FIGS. **80D** and **80E**. This is due to the higher capacitive value of the holding capacitance **7808**. Generally, as the capacitive value increases, it requires more charge to increase the voltage for a given aperture. Because of the negligible aperture of the pulses **8104** in FIG. **81C**, there is insufficient time to transfer significant amounts of energy or charge from the input EM signal **7804** to the holding capacitance **7808**. As a result, the amplitudes attained by the holding capacitance **7808** are significantly less than the amplitudes of the down-converted signal illustrated in FIGS. **80D** and **80E**.

In FIGS. **80E** and **80F**, the output signal, non-filtered or filtered, cannot provide optimal voltage reproduction, and has relatively negligible power available at the output (e.g.:  $V^2/R$ ;  $\sim 150 \mu V$  and 2 KOhms), given the input EM signal **7804** would typically have a driving impedance, in an RF environment, of 50 Ohms (e.g.:  $V^2/R$ ;  $\sim 5 mV$  and 50 Ohms).

In summary, under-sampling systems, such as the under-sampling system **7802** illustrated in FIG. **78**, are well suited for down-converting EM signals with relatively accurate voltage reproduction. Also, they have a negligible affect on the original input EM signal. As illustrated above, however, the under-sampling systems, such as the under-sampling system **7802** illustrated in FIG. **78**, are not well suited for transferring energy or for driving lower impedance loads.

0.1.2 Introduction to Energy Transfer  
In an embodiment, the present invention transfers energy from an EM signal by utilizing an energy transfer signal instead of an under-sampling signal. Unlike under-sampling signals that have negligible aperture pulses, the energy transfer signal includes a train of pulses having non-negligible apertures that tend away from zero. This provides more time to transfer energy from an EM input signal. One direct benefit is that the input impedance of the system is reduced so that practical impedance matching circuits can be implemented to further improve energy transfer and thus overall efficiency. The non-negligible transferred energy significantly improves the signal to noise ratio and sensitivity to very small signals, as well as permitting the down-converted signal to drive lower impedance loads unassisted. Signals that especially benefit include low power ones typified by RF signals. One benefit of a non-negligible aperture is that phase noise within the energy transfer signal does not have as drastic of an effect on the down-converted output signal as under-sampling signal phase noise or conventional sampling signal phase noise does on their respective outputs.

FIG. **82A** illustrates an exemplary energy transfer system **8202** for down-converting an input EM signal **8204**. The energy transfer system **8202** includes a switching module **8206** and a storage module illustrated as a storage capacitance **8208**. The terms storage module and storage capacitance, as used herein, are distinguishable from the terms holding module and holding capacitance, respectively. Holding modules and holding capacitances, as used above, identify systems that store negligible amounts of energy from an under-sampled input EM signal with the intent of “holding” a voltage value. Storage modules and storage capacitances, on the other hand, refer to systems that store non-negligible amounts of energy from an input EM signal.

The energy transfer system **8202** receives an energy transfer signal **8210**, which controls the switch module **8206**. The energy transfer signal **8210** includes a train of energy transfer pulses having non-negligible pulse widths that tend away from zero time in duration. The non-negligible pulse widths can be any non-negligible amount. For example, the non-negligible pulse widths can be  $\frac{1}{2}$  of a period of the input EM signal. Alternatively, the non-negligible pulse widths can be any other fraction of a period of the input EM signal, or a multiple of a period plus a fraction. In an example embodiment, the input EM signal is approximately 900 MHz and the non-negligible pulse width is approximately 550 pico seconds. Any other suitable non-negligible pulse duration can be used.

In an energy transfer environment, the storage module, illustrated in FIG. **82** as a storage capacitance **8208**, preferably has the capacity to handle the power being transferred, and to allow it to accept a non-negligible amount of power during a non-negligible aperture period. This allows the storage capacitance **8208** to store energy transferred from the input EM signal **8204**, without substantial concern for accurately reproducing the original, unaffected voltage level of the input EM signal **8204**. For example, in an embodiment, the storage capacitance **8208** has a value in the range of 18 pF. Other suitable capacitance values and storage modules can be used.

One benefit of the energy transfer system **8202** is that, even when the input EM signal **8204** is a very small signal, the energy transfer system **8202** transfers enough energy from the input EM signal **8204** that the input EM signal can be efficiently down-converted.

The energy transfer system **8202** is coupled to a load **8212**. Recall from the overview of under-sampling that loads can be classified as high impedance loads or low impedance loads. A high impedance load is one that is relatively insignificant to an output drive impedance of the system for a given output frequency. A low impedance load is one that is relatively significant. Another benefit of the energy transfer system **8202** is that the non-negligible amounts of transferred energy permit the energy transfer system **8202** to effectively drive loads that would otherwise be classified as low impedance loads in under-sampling systems and conventional sampling systems. In other words, the non-negligible amounts of transferred energy ensure that, even for lower impedance loads, the storage capacitance **8208** accepts and maintains sufficient energy or charge to drive the load **8202**. This is illustrated below in the timing diagrams of FIGS. **83A-F**.

FIGS. **83A-F** illustrate example timing diagrams for the energy transfer system **8202** in FIG. **82**. FIG. **83A** illustrates an example input EM signal **8302**.

FIG. **83C** illustrates an example under-sampling signal **8304**, including energy transfer pulses **8306** having non-negligible apertures that tend away from zero time in duration.

FIG. **83B** illustrates the effects to the input EM signal **8302**, as measured at a terminal **8214** in FIG. **82A**, when non-negligible amounts of energy are transfer from it. In FIG. **83B**, non-negligible distortions **8308** correlate with the energy transfer pulses **8306** in FIG. **83C**. In this example, the non-negligible distortions **8308** occur at different locations of subsequent cycles of the input EM signal **8302**. The non-negligible distortions **8308** represent non-negligible amounts of transferred energy, in the form of charge that is transferred to the storage capacitance **8208** in FIG. **82**.

FIG. **83D** illustrates a down-converted signal **8310** that is formed by energy transferred from the input EM signal **8302**.

FIG. **83E** illustrates the down-converted signal **8310** on a compressed time scale. The down-converted signal **8310** can be filtered to produce the down-converted signal **8312** illustrated in FIG. **83F**. The down-converted signal **8312** is similar to the down-converted signal illustrated in FIG. **79F**, except that the down-converted signal **8312** has substantially more power (e.g.:  $V^2/R$ ; approximately  $\sim 2$  mV and 2K Ohms) than the down-converted signal illustrated in FIG. **79F** (e.g.:  $V^2/R$ ;  $\sim 5$  mV and 1M Ohms). As a result, the down-converted signals **8310** and **8312** can efficiently drive lower impedance loads, given the input EM signal **8204** would typically have a driving impedance, in an RF environment, of 50 Ohms ( $V^2/R$ ;  $\sim 5$  mV and 50 Ohms).

The energy transfer aspects of the invention are represented generally by **4506** in FIGS. **45A** and **45B**.

1. Down-Converting an EM Signal to an IF EM Signal by Transferring Energy from the EM Signal at an Aliasing Rate

In an embodiment, the invention down-converts an EM signal to an IF signal by transferring energy from the EM signal at an aliasing rate. This embodiment is illustrated by **4514** in FIG. **45B**.

This embodiment can be implemented with any type of EM signal, including, but not limited to, modulated carrier signals and unmodulated carrier signals. This embodiment is described herein using the modulated carrier signal  $F_{MC}$  in FIG. **1** as an example. In the example, the modulated carrier signal  $F_{MC}$  is down-converted to an intermediate frequency (IF) signal  $F_{IF}$ . The intermediate frequency signal  $F_{IF}$  can be demodulated to a baseband signal  $F_{DMB}$  using conventional demodulation techniques. Upon reading the disclosure and examples therein, one skilled in the relevant art(s) will understand that the invention can be implemented to down-convert any EM signal, including, but not limited to, modulated carrier signals and unmodulated carrier signals.

The following sections describe methods for down-converting an EM signal to an IF signal  $F_{IF}$  by transferring energy from the EM signal at an aliasing rate. Exemplary structural embodiments for implementing the methods are also described. It should be understood that the invention is not limited to the particular embodiments described below. Equivalents, extensions, variations, deviations, etc., of the following will be apparent to persons skilled in the relevant art(s) based on the teachings contained herein. Such equivalents, extensions, variations, deviations, etc., are within the scope and spirit of the present invention.

The following sections include a high level discussion, example embodiments, and implementation examples.

#### 1.1 High Level Description

This section (including its subsections) provides a high-level description of down-converting an EM signal to an IF signal  $F_{IF}$  by transferring energy, according to the invention. In particular, an operational process of down-converting the modulated carrier signal  $F_{MC}$  to the IF modulated carrier signal  $F_{IF}$ , by transferring energy, is described at a high-level. Also, a structural implementation for implementing this process is described at a high-level. This structural implementation is described herein for illustrative purposes, and is not limiting. In particular, the process described in this section can be achieved using any number of structural implementations, one of which is described in this section. The details of such structural implementations will be apparent to persons skilled in the relevant art(s) based on the teachings contained herein.

##### 1.1.1 Operational Description

FIG. **46B** depicts a flowchart **4607** that illustrates an exemplary method for down-converting an EM signal to an intermediate signal  $F_{IF}$ , by transferring energy from the EM

signal at an aliasing rate. The exemplary method illustrated in the flowchart **4607** is an embodiment of the flowchart **4601** in FIG. **46A**.

Any and all combinations of modulation techniques are valid for this invention. For ease of discussion, the digital AM carrier signal **616** is used to illustrate a high level operational description of the invention. Subsequent sections provide detailed flowcharts and descriptions for AM, FM and PM example embodiments. Upon reading the disclosure and examples therein, one skilled in the relevant art(s) will understand that the invention can be implemented to down-convert any type of EM signal, including any form of modulated carrier signal and unmodulated carrier signals.

The method illustrated in the flowchart **4607** is now described at a high level using the digital AM carrier signal **616** of FIG. **6C**. Subsequent sections provide detailed flowcharts and descriptions for AM, FM and PM example embodiments. Upon reading the disclosure and examples therein, one skilled in the relevant art(s) will understand that the invention can be implemented to down-convert any type of EM signal, including any form of modulated carrier signal and unmodulated carrier signals.

The process begins at step **4608**, which includes receiving an EM signal. Step **4608** is illustrated by the digital AM carrier signal **616**. The digital AM carrier signal **616** of FIG. **6C** is re-illustrated in FIG. **47A** for convenience. FIG. **47E** illustrates a portion of the digital AM carrier signal **616** on an expanded time scale.

Step **4610** includes receiving an energy transfer signal having an aliasing rate  $F_{AR}$ . FIG. **47B** illustrates an example energy transfer signal **4702**. The energy transfer signal **4702** includes a train of energy transfer pulses **4704** having non-negligible apertures **4701** that tend away from zero time duration. Generally, the apertures **4701** can be any time duration other than the period of the EM signal. For example, the apertures **4701** can be greater or less than a period of the EM signal. Thus, the apertures **4701** can be approximately  $1/10, 1/4, 1/2, 3/4$ , etc., or any other fraction of the period of the EM signal. Alternatively, the apertures **4701** can be approximately equal to one or more periods of the EM signal plus  $1/10, 1/4, 1/2, 3/4$ , etc., or any other fraction of a period of the EM signal. The apertures **4701** can be optimized based on one or more of a variety of criteria, as described in sections below.

The energy transfer pulses **4704** repeat at the aliasing rate. A suitable aliasing rate can be determined or selected as described below. Generally, when down-converting an EM signal to an intermediate signal, the aliasing rate is substantially equal to a difference frequency, which is described below, or substantially equal to a harmonic or, more typically, a sub-harmonic of the difference frequency.

Step **4612** includes transferring energy from the EM signal at the aliasing rate to down-convert the EM signal to the intermediate signal  $F_{IF}$ . FIG. **47C** illustrates transferred energy **4706**, which is transferred from the EM signal during the energy transfer pulses **4704**. Because a harmonic of the aliasing rate occurs at an off-set of the frequency of the AM signal **616**, the pulses **4704** “walk-through” the AM signal **616** at the off-set frequency. By “walking through” the AM signal **616**, the transferred energy **4706** forms an AM intermediate signal **4706** that is similar to the AM carrier signal **616**, except that the AM intermediate signal has a lower frequency than the AM carrier signal **616**. The AM carrier signal **616** can be down-converted to any frequency below the AM carrier signal **616** by adjusting the aliasing rate  $F_{AR}$ , as described below.

FIG. **47D** depicts the AM intermediate signal **4706** as a filtered output signal **4708**. In an alternative embodiment,

the invention outputs a stair step, or non-filtered output signal. The choice between filtered, partially filtered and non-filtered output signals is generally a design choice that depends upon the application of the invention.

The intermediate frequency of the down-converted signal  $F_{IF}$ , which, in this example, is the intermediate signal **4706** and **4708**, can be determined from EQ. (2), which is reproduced below for convenience.

$$F_C = n F_{AR} \pm F_{IF} \quad \text{EQ. (2)}$$

A suitable aliasing rate  $F_{AR}$  can be determined in a variety of ways. An example method for determining the aliasing rate  $F_{AR}$ , is provided below. After reading the description herein, one skilled in the relevant art(s) will understand how to determine appropriate aliasing rates for EM signals, including ones in addition to the modulated carrier signals specifically illustrated herein.

In FIG. **48**, a flowchart **4801** illustrates an example process for determining an aliasing rate  $F_{AR}$ . But a designer may choose, or an application may dictate, that the values be determined in an order that is different than the illustrated order. The process begins at step **4802**, which includes determining, or selecting, the frequency of the EM signal. The frequency of the AM carrier signal **616** can be, for example, 901 MHZ.

Step **4804** includes determining, or selecting, the intermediate frequency. This is the frequency to which the EM signal will be down-converted. The intermediate frequency can be determined, or selected, to match a frequency requirement of a down-stream demodulator. The intermediate frequency can be, for example, 1 MHZ.

Step **4806** includes determining the aliasing rate or rates that will down-convert the EM signal to the IF specified in step **4804**.

EQ. (2) can be rewritten as EQ. (3):

$$n F_{AR} = F_C \pm F_{IF} \quad \text{EQ. (3)}$$

Which can be rewritten as EQ. (4):

$$n = \frac{F_C \pm F_{IF}}{F_{AR}} \quad \text{EQ. (4)}$$

or as EQ. (5):

$$F_{AR} = \frac{F_C \pm F_{IF}}{n} \quad \text{EQ. (5)}$$

$(F_C \pm F_{IF})$  can be defined as a difference value  $F_{DIFF}$ , as illustrated in EQ. (6):

$$(F_C \pm F_{IF}) = F_{DIFF} \quad \text{EQ. (6)}$$

EQ. (4) can be rewritten as EQ. (7):

$$n = \frac{F_{DIFF}}{F_{AR}} \quad \text{EQ. (7)}$$

From EQ. (7), it can be seen that, for a given  $n$  and a constant  $F_{AR}$ ,  $F_{DIFF}$  is constant. For the case of  $F_{DIFF} = F_C - F_{IF}$ , and for a constant  $F_{DIFF}$ , as  $F_C$  increases,  $F_{IF}$  necessarily increases. For the case of  $F_{DIFF} = F_C + F_{IF}$ , and for a constant  $F_{DIFF}$ , as  $F_C$  increases,  $F_{IF}$  necessarily decreases. In

the latter case of  $F_{DIFF}=F_C+F_{IF}$ , any phase or frequency changes on  $F_C$  correspond to reversed or inverted phase or frequency changes on  $F_{IF}$ . This is mentioned to teach the reader that if  $F_{DIFF}=F_C+F_{IF}$  is used, the above effect will occur to the phase and frequency response of the modulated intermediate signal  $F_{IF}$ .

EQs. (2) through (7) can be solved for any valid  $n$ . A suitable  $n$  can be determined for any given difference frequency  $F_{DIFF}$  and for any desired aliasing rate  $F_{AR(Desired)}$ . EQs. (2) through (7) can be utilized to identify a specific harmonic closest to a desired aliasing rate  $F_{AR(Desired)}$  that will generate the desired intermediate signal  $F_{IF}$ .

An example is now provided for determining a suitable  $n$  for a given difference frequency  $F_{DIFF}$  and for a desired aliasing rate  $F_{AR(Desired)}$ . For ease of illustration, only the case of  $(F_C-F_{IF})$  is illustrated in the example below.

$$n = \frac{F_C - F_{IF}}{F_{AR(Desired)}} = \frac{F_{DIFF}}{F_{AR(Desired)}}$$

The desired aliasing rate  $F_{AR(Desired)}$  can be, for example, 140 MHz. Using the previous examples, where the carrier frequency is 901 MHz and the IF is 1 MHz, an initial value of  $n$  is determined as:

$$n = \frac{901 \text{ MHz} - 1 \text{ MHz}}{140 \text{ MHz}} = \frac{900}{140} = 6.4$$

The initial value 6.4 can be rounded up or down to the valid nearest  $n$ , which was defined above as including (0.5, 1, 2, 3, . . .). In this example, 6.4 is rounded down to 6.0, which is inserted into EQ. (5) for the case of  $(F_C-F_{IF})=F_{DIFF}$ :

$$F_{AR} = \frac{F_C - F_{IF}}{n}$$

$$F_{AR} = \frac{901 \text{ MHz} - 1 \text{ MHz}}{6} = \frac{900 \text{ MHz}}{6} = 150 \text{ MHz}$$

In other words, transferring energy from a 901 MHz EM carrier signal at 150 MHz generates an intermediate signal at 1 MHz. When the EM carrier signal is a modulated carrier signal, the intermediate signal will also substantially include the modulation. The modulated intermediate signal can be demodulated through any conventional demodulation technique.

Alternatively, instead of starting from a desired aliasing rate, a list of suitable aliasing rates can be determined from the modified form of EQ. (5), by solving for various values of  $n$ . Example solutions are listed below.

$$F_{AR} = \frac{(F_C - F_{IF})}{n} = \frac{F_{DIFF}}{n} = \frac{901 \text{ MHz} - 1 \text{ MHz}}{n} = \frac{900 \text{ MHz}}{n}$$

Solving for  $n=0.5, 1, 2, 3, 4, 5$  and  $6$ :

- 900 MHz/0.5=1.8 GHz (i.e., second harmonic);
- 900 MHz/1=900 MHz (i.e., fundamental frequency);
- 900 MHz/2=450 MHz (i.e., second sub-harmonic);
- 900 MHz/3=300 MHz (i.e., third sub-harmonic);
- 900 MHz/4=225 MHz (i.e., fourth sub-harmonic);
- 900 MHz/5=180 MHz (i.e., fifth sub-harmonic); and
- 900 MHz/6=150 MHz (i.e., sixth sub-harmonic).

The steps described above can be performed for the case of  $(F_C+F_{IF})$  in a similar fashion. The results can be com-

pared to the results obtained from the case of  $(F_C-F_{IF})$  to determine which provides better result for an application.

In an embodiment, the invention down-converts an EM signal to a relatively standard IF in the range of, for example, 100 KHZ to 200 MHZ. In another embodiment, referred to herein as a small off-set implementation, the invention down-converts an EM signal to a relatively low frequency of, for example, less than 100 KHZ. In another embodiment, referred to herein as a large off-set implementation, the invention down-converts an EM signal to a relatively higher IF signal, such as, for example, above 200 MHZ.

The various off-set implementations provide selectivity for different applications. Generally, lower data rate applications can operate at lower intermediate frequencies. But higher intermediate frequencies can allow more information to be supported for a given modulation technique.

In accordance with the invention, a designer picks an optimum information bandwidth for an application and an optimum intermediate frequency to support the baseband signal. The intermediate frequency should be high enough to support the bandwidth of the modulating baseband signal  $F_{MB}$ .

Generally, as the aliasing rate approaches a harmonic or sub-harmonic frequency of the EM signal, the frequency of the down-converted IF signal decreases. Similarly, as the aliasing rate moves away from a harmonic or sub-harmonic frequency of the EM signal, the IF increases.

Aliased frequencies occur above and below every harmonic of the aliasing frequency. In order to avoid mapping other aliasing frequencies in the band of the aliasing frequency (IF) of interest, the IF of interest should not be near one half the aliasing rate.

As described in example implementations below, an aliasing module, including a universal frequency translator (UFT) module built in accordance with the invention provides a wide range of flexibility in frequency selection and can thus be implemented in a wide range of applications. Conventional systems cannot easily offer, or do not allow, this level of flexibility in frequency selection.

#### 1.1.2 Structural Description

FIG. 63 illustrates a block diagram of an energy transfer system 6302 according to an embodiment of the invention. The energy transfer system 6302 is an example embodiment of the generic aliasing system 1302 in FIG. 13. The energy transfer system 6302 includes an energy transfer module 6304. The energy transfer module 6304 receives the EM signal 1304 and an energy transfer signal 6306, which includes a train of energy transfer pulses having non-negligible apertures that tend away from zero time in duration, occurring at a frequency equal to the aliasing rate  $F_{AR}$ . The energy transfer signal 6306 is an example embodiment of the aliasing signal 1310 in FIG. 13. The energy transfer module 6304 transfers energy from the EM signal 1304 at the aliasing rate  $F_{AR}$  of the energy transfer signal 6306.

Preferably, the energy transfer module 6304 transfers energy from the EM signal 1304 to down-convert it to the intermediate signal  $F_{IF}$  in the manner shown in the operational flowchart 4607 of FIG. 46B. But it should be understood that the scope and spirit of the invention includes other structural embodiments for performing the steps of the flowchart 4607. The specifics of the other structural embodiments will be apparent to persons skilled in the relevant art(s) based on the discussion contained herein.

The operation of the energy transfer system 6302 is now described in detail with reference to the flowchart 4607 and to the timing diagrams illustrated in FIGS. 47A-E. In step



4608, the energy transfer module 6304 receives the AM carrier signal 616. In step 4610, the energy transfer module 6304 receives the energy transfer signal 4702. In step 4612, the energy transfer module 6304 transfers energy from the AM carrier signal 616 at the aliasing rate to down-convert the AM carrier signal 616 to the intermediate signal 4706 or 4708.

Example implementations of the energy transfer system 6302 are provided in Sections 4 and 5 below.

### 1.2 Example Embodiments

Various embodiments related to the method(s) and structure(s) described above are presented in this section (and its subsections). These embodiments are described herein for purposes of illustration, and not limitation. The invention is not limited to these embodiments. Alternate embodiments (including equivalents, extensions, variations, deviations, etc., of the embodiments described herein) will be apparent to persons skilled in the relevant art(s) based on the teachings contained herein. The invention is intended and adapted to include such alternate embodiments.

The method for down-converting the EM signal 1304 by transferring energy can be implemented with any type of EM signal, including modulated carrier signals and unmodulated carrier signals. For example, the method of the flowchart 4601 can be implemented to down-convert AM signals, FM signals, PM signals, etc., or any combination thereof. Operation of the flowchart 4601 of FIG. 46A is described below for down-converting AM, FM and PM. The down-conversion descriptions include down-converting to intermediate signals, directly down-converting to demodulated baseband signals, and down-converting FM signals to non-FM signals. The exemplary descriptions below are intended to facilitate an understanding of the present invention. The present invention is not limited to or by the exemplary embodiments below.

#### 1.2.1 First Example Embodiment: Amplitude Modulation

##### 1.2.1.1 Operational Description

Operation of the exemplary process of the flowchart 4607 in FIG. 46B is described below for the analog AM carrier signal 516, illustrated in FIG. 5C, and for the digital AM carrier signal 616, illustrated in FIG. 6C.

##### 1.2.1.1.1 Analog AM Carrier Signal

A process for down-converting the analog AM carrier signal 516 in FIG. 5C to an analog AM intermediate signal is now described for the flowchart 4607 in FIG. 46B. The analog AM carrier signal 516 is re-illustrated in FIG. 50A for convenience. For this example, the analog AM carrier signal 516 oscillates at approximately 901 MHz. In FIG. 50B, an analog AM carrier signal 5004 illustrates a portion of the analog AM carrier signal 516 on an expanded time scale.

The process begins at step 4608, which includes receiving the EM signal. This is represented by the analog AM carrier signal 516.

Step 4610 includes receiving an energy transfer signal having an aliasing rate  $F_{AR}$ . FIG. 50C illustrates an example energy transfer signal 5006 on approximately the same time scale as FIG. 50B. The energy transfer signal 5006 includes a train of energy transfer pulses 5007 having non-negligible apertures 5009 that tend away from zero time in duration. The energy transfer pulses 5007 repeat at the aliasing rate  $F_{AR}$ , which is determined or selected as previously described. Generally, when down-converting to an intermediate signal, the aliasing rate  $F_{AR}$  is substantially equal to a harmonic or, more typically, a sub-harmonic of the difference frequency  $F_{DIFF}$ .

Step 4612 includes transferring energy from the EM signal at the aliasing rate to down-convert the EM signal to

an intermediate signal  $F_{IF}$ . In FIG. 50D, an affected analog AM carrier signal 5008 illustrates effects of transferring energy from the analog AM carrier signal 516 at the aliasing rate  $F_{AR}$ . The affected analog AM carrier signal 5008 is illustrated on substantially the same time scale as FIGS. 50B and 50C.

FIG. 50E illustrates a down-converted AM intermediate signal 5012, which is generated by the down-conversion process. The AM intermediate signal 5012 is illustrated with an arbitrary load impedance. Load impedance optimizations are discussed in Section 5 below.

The down-converted signal 5012 includes portions 5010A, which correlate with the energy transfer pulses 5007 in FIG. 50C, and portions 5010B, which are between the energy transfer pulses 5007. Portions 5010A represent energy transferred from the AM analog signal 516 to a storage device, while simultaneously driving an output load. The portions 5010A occur when a switching module is closed by the energy transfer pulses 5007. Portions 5010B represent energy stored in a storage device continuing to drive the load. Portions 5010B occur when the switching module is opened after energy transfer pulses 5007.

Because a harmonic of the aliasing rate is off-set from the analog AM carrier signal 516, the energy transfer pulses 5007 “walk through” the analog AM carrier signal 516 at the difference frequency  $F_{DIFF}$ . In other words, the energy transfer pulses 5007 occur at different locations of subsequent cycles of the AM carrier signal 516. As a result, the energy transfer pulses 5007 capture varying amounts of energy from the analog AM carrier signal 516, as illustrated by portions 5010A, which provides the AM intermediate signal 5012 with an oscillating frequency  $F_{IF}$ .

In FIG. 50F, an AM intermediate signal 5014 illustrates the AM intermediate signal 5012 on a compressed time scale. In FIG. 50G, an AM intermediate signal 5016 represents a filtered version of the AM intermediate signal 5014. The AM intermediate signal 5016 is substantially similar to the AM carrier signal 516, except that the AM intermediate signal 5016 is at the intermediate frequency. The AM intermediate signal 5016 can be demodulated through any conventional demodulation technique.

The present invention can output the unfiltered AM intermediate signal 5014, the filtered AM intermediate signal 5016, a partially filtered AM intermediate signal, a stair step output signal, etc. The choice between these embodiments is generally a design choice that depends upon the application of the invention.

The signals referred to herein illustrate frequency down-conversion in accordance with the invention. For example, the AM intermediate signals 5014 in FIG. 50F and 5016 in FIG. 50G illustrate that the AM carrier signal 516 was successfully down-converted to an intermediate signal by retaining enough baseband information for sufficient reconstruction.

##### 1.2.1.1.2 Digital AM Carrier Signal

A process for down-converting the digital AM carrier signal 616 to a digital AM intermediate signal is now described for the flowchart 4607 in FIG. 46B. The digital AM carrier signal 616 is re-illustrated in FIG. 51A for convenience. For this example, the digital AM carrier signal 616 oscillates at approximately 901 MHz. In FIG. 51B, a digital AM carrier signal 5104 illustrates a portion of the digital AM carrier signal 616 on an expanded time scale.

The process begins at step 4608, which includes receiving an EM signal. This is represented by the digital AM carrier signal 616.

Step 4610 includes receiving an energy transfer signal having an aliasing rate  $F_{AR}$ . FIG. 51C illustrates an example

energy transfer signal **5106** on substantially the same time scale as FIG. **51B**. The energy transfer signal **5106** includes a train of energy transfer pulses **5107** having non-negligible apertures **5109** that tend away from zero time in duration. The energy transfer pulses **5107** repeat at the aliasing rate, which is determined or selected as previously described. Generally, when down-converting to an intermediate signal, the aliasing rate is substantially equal to a harmonic or, more typically, a sub-harmonic of the difference frequency  $F_{DIFF}$ .

Step **4612** includes transferring energy from the EM signal at the aliasing rate to down-convert the EM signal to the intermediate signal  $F_{IF}$ . In FIG. **51D**, an affected digital AM carrier signal **5108** illustrates effects of transferring energy from the digital AM carrier signal **616** at the aliasing rate  $F_{AR}$ . The affected digital AM carrier signal **5108** is illustrated on substantially the same time scale as FIGS. **51B** and **51C**.

FIG. **51E** illustrates a down-converted AM intermediate signal **5112**, which is generated by the down-conversion process. The AM intermediate signal **5112** is illustrated with an arbitrary load impedance. Load impedance optimizations are discussed in Section 5 below.

The down-converted signal **5112** includes portions **5110A**, which correlate with the energy transfer pulses **5107** in FIG. **51C**, and portions **5110B**, which are between the energy transfer pulses **5107**. Portions **5110A** represent energy transferred from the digital AM carrier signal **616** to a storage device, while simultaneously driving an output load. The portions **5110A** occur when a switching module is closed by the energy transfer pulses **5107**. Portions **5110B** represent energy stored in a storage device continuing to drive the load. Portions **5110B** occur when the switching module is opened after energy transfer pulses **5107**.

Because a harmonic of the aliasing rate is off-set from the frequency of the digital AM carrier signal **616**, the energy transfer pulses **5107** “walk through” the digital AM signal **616** at the difference frequency  $F_{DIFF}$ . In other words, the energy transfer pulse **5107** occur at different locations of subsequent cycles of the digital AM carrier signal **616**. As a result, the energy transfer pulses **5107** capture varying amounts of energy from the digital AM carrier signal **616**, as illustrated by portions **5110**, which provides the AM intermediate signal **5112** with an oscillating frequency  $F_{IF}$ .

In FIG. **51F**, a digital AM intermediate signal **5114** illustrates the AM intermediate signal **5112** on a compressed time scale. In FIG. **51G**, an AM intermediate signal **5116** represents a filtered version of the AM intermediate signal **5114**. The AM intermediate signal **5116** is substantially similar to the AM carrier signal **616**, except that the AM intermediate signal **5116** is at the intermediate frequency. The AM intermediate signal **5116** can be demodulated through any conventional demodulation technique.

The present invention can output the unfiltered AM intermediate signal **5114**, the filtered AM intermediate signal **5116**, a partially filtered AM intermediate signal, a stair step output signal, etc. The choice between these embodiments is generally a design choice that depends upon the application of the invention.

The signals referred to herein illustrate frequency down-conversion in accordance with the invention. For example, the AM intermediate signals **5114** in FIG. **51F** and **5116** in FIG. **51G** illustrate that the AM carrier signal **616** was successfully down-converted to an intermediate signal by retaining enough baseband information for sufficient reconstruction.

#### 1.2.1.2 Structural Description

The operation of the energy transfer system **6302** is now described for the analog AM carrier signal **516**, with refer-

ence to the flowchart **4607** and to the timing diagrams in FIGS. **50A–G**. In step **4608**, the energy transfer module **6304** receives the analog AM carrier signal **516**. In step **4610**, the energy transfer module **6304** receives the energy transfer signal **5006**. In step **4612**, the energy transfer module **6304** transfers energy from the analog AM carrier signal **516** at the aliasing rate of the energy transfer signal **5006**, to down-convert the analog AM carrier signal **516** to the AM intermediate signal **5012**.

The operation of the energy transfer system **6302** is now described for the digital AM carrier signal **616**, with reference to the flowchart **1401** and the timing diagrams in FIGS. **51A–G**. In step **4608**, the energy transfer module **6304** receives the digital AM carrier signal **616**. In step **4610**, the energy transfer module **6304** receives the energy transfer signal **5106**. In step **4612**, the energy transfer module **6304** transfers energy from the digital AM carrier signal **616** at the aliasing rate of the energy transfer signal **5106**, to down-convert the digital AM carrier signal **616** to the AM intermediate signal **5112**.

Example embodiments of the energy transfer module **6304** are disclosed in Sections 4 and 5 below.

### 1.2.2 Second Example Embodiment: Frequency Modulation

#### 1.2.2.1 Operational Description

Operation of the exemplary process of the flowchart **4607** in FIG. **46B** is described below for the analog FM carrier signal **716**, illustrated in FIG. **7C**, and for the digital FM carrier signal **815**, illustrated in FIG. **8C**.

##### 1.2.2.1.1 Analog FM Carrier Signal

A process for down-converting the analog FM carrier signal **716** in FIG. **7C** to an FM intermediate signal is now described for the flowchart **4607** in FIG. **46B**. The analog FM carrier signal **716** is re-illustrated in FIG. **52A** for convenience. For this example, the analog FM carrier signal **716** oscillates around approximately 901 MHz. In FIG. **52B**, an analog FM carrier signal **5204** illustrates a portion of the analog FM carrier signal **716** on an expanded time scale.

The process begins at step **4608**, which includes receiving an EM signal. This is represented by the analog FM carrier signal **716**.

Step **4610** includes receiving an energy transfer signal having an aliasing rate  $F_{AR}$ . FIG. **52C** illustrates an example energy transfer signal **5206** on approximately the same time scale as FIG. **52B**. The energy transfer signal **5206** includes a train of energy transfer pulses **5207** having non-negligible apertures that tend away from zero time in duration. The energy transfer pulses **5207** repeat at the aliasing rate  $F_{AR}$ , which is determined or selected as previously described. Generally, when down-converting to an intermediate signal, the aliasing rate  $F_{AR}$  is substantially equal to a harmonic or, more typically, a sub-harmonic of the difference frequency  $F_{DIFF}$ .

Step **4612** includes transferring energy from the EM signal at the aliasing rate to down-convert the EM signal to an intermediate signal  $F_{IF}$ . In FIG. **52D**, an affected analog FM carrier signal **5208** illustrates effects of transferring energy from the analog FM carrier signal **716** at the aliasing rate  $F_{AR}$ . The affected analog FM carrier signal **5208** is illustrated on substantially the same time scale as FIGS. **52B** and **52C**.

FIG. **52E** illustrates a down-converted FM intermediate signal **5212**, which is generated by the down-conversion process. The FM intermediate signal **5212** is illustrated with an arbitrary load impedance. Load impedance optimizations are discussed in Section 5 below.

The down-converted signal **5212** includes portions **5210A**, which correlate with the energy transfer pulses **5207**

in FIG. 52C, and portions 5210B, which are between the energy transfer pulses 5207. Portions 5210A represent energy transferred from the analog FM carrier signal 716 to a storage device, while simultaneously driving an output load. The portions 5210A occur when a switching module is closed by the energy transfer pulses 5207. Portions 5210B represent energy stored in a storage device continuing to drive the load. Portions 5210B occur when the switching module is opened after energy transfer pulses 5207.

Because a harmonic of the aliasing rate is off-set from the frequency of the analog FM carrier signal 716, the energy transfer pulses 5207 “walk through” the analog FM carrier signal 716 at the difference frequency  $F_{DIFF}$ . In other words, the energy transfer pulse 5207 occur at different locations of subsequent cycles of the analog FM carrier signal 716. As a result, the energy transfer pulses 5207 capture varying amounts of energy from the analog FM carrier signal 716, as illustrated by portions 5210, which provides the FM intermediate signal 5212 with an oscillating frequency  $F_{IF}$ .

In FIG. 52F, an analog FM intermediate signal 5214 illustrates the FM intermediate signal 5212 on a compressed time scale. In FIG. 52G, an FM intermediate signal 5216 represents a filtered version of the FM intermediate signal 5214. The FM intermediate signal 5216 is substantially similar to the analog FM carrier signal 716, except that the FM intermediate signal 5216 is at the intermediate frequency. The FM intermediate signal 5216 can be demodulated through any conventional demodulation technique.

The present invention can output the unfiltered FM intermediate signal 5214, the filtered FM intermediate signal 5216, a partially filtered FM intermediate signal, a stair step output signal, etc. The choice between these embodiments is generally a design choice that depends upon the application of the invention.

The signals referred to herein illustrate frequency down-conversion in accordance with the invention. For example, the FM intermediate signals 5214 in FIG. 52F and 5216 in FIG. 52G illustrate that the FM carrier signal 716 was successfully down-converted to an intermediate signal by retaining enough baseband information for sufficient reconstruction.

#### 1.2.2.1.2 Digital FM Carrier Signal

A process for down-converting the digital FM carrier signal 816 in FIG. 8C is now described for the flowchart 4607 in FIG. 46B. The digital FM carrier signal 816 is re-illustrated in FIG. 53A for convenience. For this example, the digital FM carrier signal 816 oscillates at approximately 901 MHz. In FIG. 53B, a digital FM carrier signal 5304 illustrates a portion of the digital FM carrier signal 816 on an expanded time scale.

The process begins at step 4608, which includes receiving an EM signal. This is represented by the digital FM carrier signal 816.

Step 4610 includes receiving an energy transfer signal having an aliasing rate  $F_{AR}$ . FIG. 53C illustrates an example energy transfer signal 5306 on substantially the same time scale as FIG. 53B. The energy transfer signal 5306 includes a train of energy transfer pulses 5307 having non-negligible apertures 5309 that tend away from zero time in duration. The energy transfer pulses 5307 repeat at the aliasing rate, which is determined or selected as previously described. Generally, when down-converting to an intermediate signal, the aliasing rate  $F_{AR}$  is substantially equal to a harmonic or, more typically, a sub-harmonic of the difference frequency  $F_{DIFF}$ .

Step 4612 includes transferring energy from the EM signal at the aliasing rate to down-convert the EM signal to

the an intermediate signal  $F_{IF}$ . In FIG. 53D, an affected digital FM carrier signal 5308 illustrates effects of transferring energy from the digital FM carrier signal 816 at the aliasing rate  $F_{AR}$ . The affected digital FM carrier signal 5308 is illustrated on substantially the same time scale as FIGS. 53B and 53C.

FIG. 53E illustrates a down-converted FM intermediate signal 5312, which is generated by the down-conversion process. The down-converted signal 5312 includes portions 5310A, which correlate with the energy transfer pulses 5307 in FIG. 53C, and portions 5310B, which are between the energy transfer pulses 5307. Down-converted signal 5312 is illustrated with an arbitrary load impedance. Load impedance optimizations are discussed in Section 5 below.

Portions 5310A represent energy transferred from the digital FM carrier signal 816 to a storage device, while simultaneously driving an output load. The portions 5310A occur when a switching module is closed by the energy transfer pulses 5307.

Portions 5310B represent energy stored in a storage device continuing to drive the load. Portions 5310B occur when the switching module is opened after energy transfer pulses 5307.

Because a harmonic of the aliasing rate is off-set from the frequency of the digital FM carrier signal 816, the energy transfer pulses 5307 “walk through” the digital FM carrier signal 816 at the difference frequency  $F_{DIFF}$ . In other words, the energy transfer pulse 5307 occur at different locations of subsequent cycles of the digital FM carrier signal 816. As a result, the energy transfer pulses 5307 capture varying amounts of energy from the digital FM carrier signal 816, as illustrated by portions 5310, which provides the FM intermediate signal 5312 with an oscillating frequency  $F_{IF}$ .

In FIG. 53F, a digital FM intermediate signal 5314 illustrates the FM intermediate signal 5312 on a compressed time scale. In FIG. 53G, an FM intermediate signal 5316 represents a filtered version of the FM intermediate signal 5314. The FM intermediate signal 5316 is substantially similar to the digital FM carrier signal 816, except that the FM intermediate signal 5316 is at the intermediate frequency. The FM intermediate signal 5316 can be demodulated through any conventional demodulation technique.

The present invention can output the unfiltered FM intermediate signal 5314, the filtered FM intermediate signal 5316, a partially filtered FM intermediate signal, a stair step output signal, etc. The choice between these embodiments is generally a design choice that depends upon the application of the invention.

The signals referred to herein illustrate frequency down-conversion in accordance with the invention. For example, the FM intermediate signals 5314 in FIG. 53F and 5316 in FIG. 53G illustrate that the FM carrier signal 816 was successfully down-converted to an intermediate signal by retaining enough baseband information for sufficient reconstruction.

#### 1.2.2.2 Structural Description

The operation of the energy transfer system 6302 is now described for the analog FM carrier signal 716, with reference to the flowchart 4607 and the timing diagrams in FIGS. 52A–G. In step 4608, the energy transfer module 6304 receives the analog FM carrier signal 716. In step 4610, the energy transfer module 6304 receives the energy transfer signal 5206. In step 4612, the energy transfer module 6304 transfers energy from the analog FM carrier signal 716 at the aliasing rate of the energy transfer signal 5206, to down-convert the analog FM carrier signal 716 to the FM intermediate signal 5212.

The operation of the energy transfer system **6302** is now described for the digital FM carrier signal **816**, with reference to the flowchart **4607** and the timing diagrams in FIGS. **53A–G**. In step **4608**, the energy transfer module **6304** receives the digital FM carrier signal **816**. In step **4610**, the energy transfer module **6304** receives the energy transfer signal **5306**. In step **4612**, the energy transfer module **6304** transfers energy from the digital FM carrier signal **816** at the aliasing rate of the energy transfer signal **5306**, to down-convert the digital FM carrier signal **816** to the FM intermediate signal **5212**.

Example embodiments of the energy transfer module **6304** are disclosed in Sections 4 and 5 below.

### 1.2.3 Third Example Embodiment: Phase Modulation

#### 1.2.3.1 Operational Description

Operation of the exemplary process of the flowchart **4607** in FIG. **46B** is described below for the analog PM carrier signal **916**, illustrated in FIG. **9C**, and for the digital PM carrier signal **1016**, illustrated in FIG. **10C**.

##### 1.2.3.1.1 Analog PM Carrier Signal

A process for down-converting the analog PM carrier signal **916** in FIG. **9C** to an analog PM intermediate signal is now described for the flowchart **4607** in FIG. **46B**. The analog PM carrier signal **916** is re-illustrated in FIG. **54A** for convenience. For this example, the analog PM carrier signal **916** oscillates at approximately 901 MHz. In FIG. **54B**, an analog PM carrier signal **5404** illustrates a portion of the analog PM carrier signal **916** on an expanded time scale.

The process begins at step **4608**, which includes receiving an EM signal. This is represented by the analog PM carrier signal **916**.

Step **4610** includes receiving an energy transfer signal having an aliasing rate  $F_{AR}$ . FIG. **54C** illustrates an example energy transfer signal **5406** on approximately the same time scale as FIG. **54B**. The energy transfer signal **5406** includes a train of energy transfer pulses **5407** having non-negligible apertures that tend away from zero time in duration. The energy transfer pulses **5407** repeat at the aliasing rate, which is determined or selected as previously described. Generally, when down-converting to an intermediate signal, the aliasing rate  $F_{AR}$  is substantially equal to a harmonic or, more typically, a sub-harmonic of the difference frequency  $F_{DIFF}$ .

Step **4612** includes transferring energy from the EM signal at the aliasing rate to down-convert the EM signal to the IF signal  $F_{IF}$ . In FIG. **54D**, an affected analog PM carrier signal **5408** illustrates effects of transferring energy from the analog PM carrier signal **916** at the aliasing rate  $F_{AR}$ . The affected analog PM carrier signal **5408** is illustrated on substantially the same time scale as FIGS. **54B** and **54C**.

FIG. **54E** illustrates a down-converted PM intermediate signal **5412**, which is generated by the down-conversion process. The down-converted PM intermediate signal **5412** includes portions **5410A**, which correlate with the energy transfer pulses **5407** in FIG. **54C**, and portions **5410B**, which are between the energy transfer pulses **5407**. Down-converted signal **5412** is illustrated with an arbitrary load impedance. Load impedance optimizations are discussed in Section 5 below.

Portions **5410A** represent energy transferred from the analog PM carrier signal **916** to a storage device, while simultaneously driving an output load. The portions **5410A** occur when a switching module is closed by the energy transfer pulses **5407**.

Portions **5410B** represent energy stored in a storage device continuing to drive the load. Portions **5410B** occur when the switching module is opened after energy transfer pulses **5407**.

Because a harmonic of the aliasing rate is off-set from the frequency of the analog PM carrier signal **716**, the energy transfer pulses **5407** “walk through” the analog PM carrier signal **916** at the difference frequency  $F_{DIFF}$ . In other words, the energy transfer pulse **5407** occur at different locations of subsequent cycles of the analog PM carrier signal **916**. As a result, the energy transfer pulses **5407** capture varying amounts of energy from the analog PM carrier signal **916**, as illustrated by portions **5410**, which provides the PM intermediate signal **5412** with an oscillating frequency  $F_{IF}$ .

In FIG. **54F**, an analog PM intermediate signal **5414** illustrates the PM intermediate signal **5412** on a compressed time scale. In FIG. **54G**, an PM intermediate signal **5416** represents a filtered version of the PM intermediate signal **5414**. The PM intermediate signal **5416** is substantially similar to the analog PM carrier signal **916**, except that the PM intermediate signal **5416** is at the intermediate frequency. The PM intermediate signal **5416** can be demodulated through any conventional demodulation technique.

The present invention can output the unfiltered PM intermediate signal **5414**, the filtered PM intermediate signal **5416**, a partially filtered PM intermediate signal, a stair step output signal, etc. The choice between these embodiments is generally a design choice that depends upon the application of the invention.

The signals referred to herein illustrate frequency down-conversion in accordance with the invention. For example, the PM intermediate signals **5414** in FIG. **54F** and **5416** in FIG. **54G** illustrate that the PM carrier signal **916** was successfully down-converted to an intermediate signal by retaining enough baseband information for sufficient reconstruction.

##### 1.2.3.1.2 Digital PM Carrier Signal

A process for down-converting the digital PM carrier signal **1016** in FIG. **10C** to a digital PM signal is now described for the flowchart **3607** in FIG. **46B**. The digital PM carrier signal **1016** is re-illustrated in FIG. **55A** for convenience. For this example, the digital PM carrier signal **1016** oscillates at approximately 901 MHz. In FIG. **55B**, a digital PM carrier signal **5504** illustrates a portion of the digital PM carrier signal **1016** on an expanded time scale.

The process begins at step **4608**, which includes receiving an EM signal. This is represented by the digital PM carrier signal **1016**.

Step **4610** includes receiving an energy transfer signal having an aliasing rate  $F_{AR}$ . FIG. **55C** illustrates an example energy transfer signal **5506** on substantially the same time scale as FIG. **55B**. The energy transfer signal **5506** includes a train of energy transfer pulses **5507** having non-negligible apertures **5509** that tend away from zero time in duration. The energy transfer pulses **5507** repeat at an aliasing rate, which is determined or selected as previously described. Generally, when down-converting to an intermediate signal, the aliasing rate  $F_{AR}$  is substantially equal to a harmonic or, more typically, a sub-harmonic of the difference frequency  $F_{DIFF}$ .

Step **4612** includes transferring energy from the EM signal at the aliasing rate to down-convert the EM signal to an intermediate signal  $F_{IF}$ . In FIG. **55D**, an affected digital PM carrier signal **5508** illustrates effects of transferring energy from the digital PM carrier signal **1016** at the aliasing rate  $F_{AR}$ . The affected digital PM carrier signal **5508** is illustrated on substantially the same time scale as FIGS. **55B** and **55C**.

FIG. **55E** illustrates a down-converted PM intermediate signal **5512**, which is generated by the down-conversion process. The down-converted PM intermediate signal **5512**

includes portions **5510A**, which correlate with the energy transfer pulses **5507** in FIG. **55C**, and portions **5510B**, which are between the energy transfer pulses **5507**. Down-converted signal **5512** is illustrated with an arbitrary load impedance. Load impedance optimizations are discussed in Section 5 below.

Portions **5510A** represent energy transferred from the digital PM carrier signal **1016** to a storage device, while simultaneously driving an output load. The portions **5510A** occur when a switching module is closed by the energy transfer pulses **5507**.

Portions **5510B** represent energy stored in a storage device continuing to drive the load. Portions **5510B** occur when the switching module is opened after energy transfer pulses **5507**.

Because a harmonic of the aliasing rate is off-set from the frequency of the digital PM carrier signal **716**, the energy transfer pulses **5507** “walk through” the digital PM carrier signal **1016** at the difference frequency  $F_{DIFF}$ . In other words, the energy transfer pulse **5507** occur at different locations of subsequent cycles of the digital PM carrier signal **1016**. As a result, the energy transfer pulses **5507** capture varying amounts of energy from the digital PM carrier signal **1016**, as illustrated by portions **5510**, which provides the PM intermediate signal **5512** with an oscillating frequency  $F_{IF}$ .

In FIG. **55F**, a digital PM intermediate signal **5514** illustrates the PM intermediate signal **5512** on a compressed time scale. In FIG. **55G**, an PM intermediate signal **5516** represents a filtered version of the PM intermediate signal **5514**. The PM intermediate signal **5516** is substantially similar to the digital PM carrier signal **1016**, except that the PM intermediate signal **5516** is at the intermediate frequency. The PM intermediate signal **5516** can be demodulated through any conventional demodulation technique.

The present invention can output the unfiltered PM intermediate signal **5514**, the filtered PM intermediate signal **5516**, a partially filtered PM intermediate signal, a stair step output signal, etc. The choice between these embodiments is generally a design choice that depends upon the application of the invention.

The signals referred to herein illustrate frequency down-conversion in accordance with the invention. For example, the PM intermediate signals **5514** in FIG. **55F** and **5516** in FIG. **55G** illustrate that the PM carrier signal **1016** was successfully down-converted to an intermediate signal by retaining enough baseband information for sufficient reconstruction.

#### 1.2.3.2 Structural Description

Operation of the energy transfer system **6302** is now described for the analog PM carrier signal **916**, with reference to the flowchart **4607** and the timing diagrams in FIGS. **54A–G**. In step **4608**, the energy transfer module **6304** receives the analog PM carrier signal **916**. In step **4610**, the energy transfer module **6304** receives the energy transfer signal **5406**. In step **4612**, the energy transfer module **6304** transfers energy from the analog PM carrier signal **916** at the aliasing rate of the energy transfer signal **5406**, to down-convert the analog PM carrier signal **916** to the PM intermediate signal **5412**.

Operation of the energy transfer system **6302** is now described for the digital PM carrier signal **1016**, with reference to the flowchart **1401** and the timing diagrams in FIGS. **55A–G**. In step **4608**, the energy transfer module **6304** receives the digital PM carrier signal **1016**. In step **4610**, the energy transfer module **6304** receives the energy transfer signal **5506**. In step **4612**, the energy transfer

module **6304** transfers energy from the digital PM carrier signal **1016** at the aliasing rate of the energy transfer signal **5506**, to down-convert the digital PM carrier signal **1016** to the PM intermediate signal **5512**.

Example embodiments of the energy transfer module **6304** are disclosed in Sections 4 and 5 below.

#### 1.2.4 Other Embodiments

The embodiments described above are provided for purposes of illustration. These embodiments are not intended to limit the invention. Alternate embodiments, differing slightly or substantially from those described herein, will be apparent to persons skilled in the relevant art(s) based on the teachings contained herein. Such alternate embodiments fall within the scope and spirit of the present invention. Example implementations of the energy transfer module **6304** are disclosed in Sections 4 and 5 below.

#### 1.3 Implementation Examples

Exemplary operational and/or structural implementations related to the method(s), structure(s), and/or embodiments described above are presented in Sections 4 and 5 below. These implementations are presented for purposes of illustration, and not limitation. The invention is not limited to the particular implementation examples described therein. Alternate implementations (including equivalents, extensions, variations, deviations, etc., of those described herein) will be apparent to persons skilled in the relevant art(s) based on the teachings contained herein. Such alternate implementations fall within the scope and spirit of the present invention.

#### 2. Directly Down-Converting an EM Signal to an Demodulated Baseband Signal by Transferring Energy from the EM Signal

In an embodiment, the invention directly down-converts an EM signal to a baseband signal, by transferring energy from the EM signal. This embodiment is referred to herein as direct-to-data down-conversion and is illustrated by **4516** in FIG. **45B**.

This embodiment can be implemented with modulated and unmodulated EM signals. This embodiment is described herein using the modulated carrier signal  $F_{MC}$  in FIG. **1**, as an example. In the example, the modulated carrier signal  $F_{MC}$  is directly down-converted to the demodulated baseband signal  $F_{DMB}$ . Upon reading the disclosure and examples therein, one skilled in the relevant art(s) will understand that the invention can be implemented to down-convert any EM signal, including but not limited to, modulated carrier signals and unmodulated carrier signals.

The following sections describe methods for directly down-converting the modulated carrier signal  $F_{MC}$  to the demodulated baseband signal  $F_{DMB}$ . Exemplary structural embodiments for implementing the methods are also described. It should be understood that the invention is not limited to the particular embodiments described below. Equivalents, extensions, variations, deviations, etc., of the following will be apparent to persons skilled in the relevant art(s) based on the teachings contained herein. Such equivalents, extensions, variations, deviations, etc., are within the scope and spirit of the present invention.

The following sections include a high level discussion, example embodiments, and implementation examples.

#### 2.1 High Level Description

This section (including its subsections) provides a high-level description of transferring energy from the modulated carrier signal  $F_{MC}$  to directly down-convert the modulated carrier signal  $F_{MC}$  to the demodulated baseband signal  $F_{DMB}$ , according to the invention. In particular, an operational process of directly down-converting the modulated

carrier signal  $F_{MC}$  to the demodulated baseband signal  $F_{DMB}$  is described at a high-level. Also, a structural implementation for implementing this process is described at a high-level. The structural implementation is described herein for illustrative purposes, and is not limiting. In particular, the process described in this section can be achieved using any number of structural implementations, one of which is described in this section. The details of such structural implementations will be apparent to persons skilled in the relevant art(s) based on the teachings contained herein.

### 2.1.1 Operational Description

FIG. 46C depicts a flowchart 4613 that illustrates an exemplary method for transferring energy from the modulated carrier signal  $F_{MC}$  to directly down-convert the modulated carrier signal  $F_{MC}$  to the demodulated baseband signal  $F_{DMB}$ . The exemplary method illustrated in the flowchart 4613 is an embodiment of the flowchart 4601 in FIG. 46A.

Any and all combinations of modulation techniques are valid for this invention. For ease of discussion, the digital AM carrier signal 616 is used to illustrate a high level operational description of the invention. Subsequent sections provide detailed flowcharts and descriptions for AM and PM example embodiments. FM presents special considerations that are dealt with separately in Section III.3. Upon reading the disclosure and examples therein, one skilled in the relevant art(s) will understand that the invention can be implemented to down-convert any type of EM signal, including any form of modulated carrier signal and unmodulated carrier signals.

The high-level process illustrated in the flowchart 4613 is now described at a high level using the digital AM carrier signal 616, from FIG. 6C. The digital AM carrier signal 616 is re-illustrated in FIG. 56A for convenience.

The process of the flowchart 4613 begins at step 4614, which includes receiving an EM signal. Step 4613 is represented by the digital AM carrier signal 616.

Step 4616 includes receiving an energy transfer signal having an aliasing rate  $F_{AR}$ . FIG. 56B illustrates an example energy transfer signal 5602, which includes a train of energy transfer pulses 5604 having apertures 5606 that are optimized for energy transfer. The optimized apertures 5606 are non-negligible and tend away from zero.

The non-negligible apertures 5606 can be any width other than the period of the EM signal, or a multiple thereof. For example, the non-negligible apertures 5606 can be less than the period of the signal 616 such as,  $1/8$ ,  $1/4$ ,  $1/2$ ,  $3/4$ , etc., of the period of the signal 616. Alternatively, the non-negligible apertures 5606 can be greater than the period of the signal 616. The width and amplitude of the apertures 5606 can be optimized based on one or more of a variety of criteria, as described in sections below.

The energy transfer pulses 5604 repeat at the aliasing rate or pulse repetition rate. The aliasing rate is determined in accordance with EQ. (2), reproduced below for convenience.

$$F_C = nF_{AR} \pm F_{IF} \quad \text{EQ. (2)}$$

When directly down-converting an EM signal to baseband (i.e., zero IF), EQ. (2) becomes:

$$F_C = nF_{AR} \quad \text{EQ. (8)}$$

Thus, to directly down-convert the AM signal 616 to a demodulated baseband signal, the aliasing rate is substantially equal to the frequency of the AM signal 616 or to a

harmonic or sub-harmonic thereof. Although the aliasing rate is too low to permit reconstruction of higher frequency components of the AM signal 616 (i.e., the carrier frequency), it is high enough to permit substantial reconstruction of the lower frequency modulating baseband signal 310.

Step 4618 includes transferring energy from the EM signal at the aliasing rate to directly down-convert the EM signal to a demodulated baseband signal  $F_{DMB}$ . FIG. 56C illustrates a demodulated baseband signal 5610 that is generated by the direct down-conversion process. The demodulated baseband signal 5610 is similar to the digital modulating baseband signal 310 in FIG. 3.

FIG. 56D depicts a filtered demodulated baseband signal 5612, which can be generated from the demodulated baseband signal 5610. The invention can thus generate a filtered output signal, a partially filtered output signal, or a relatively unfiltered output signal. The choice between filtered, partially filtered and non-filtered output signals is generally a design choice that depends upon the application of the invention.

### 2.1.2 Structural Description

In an embodiment, the energy transfer system 6302 transfers energy from any type of EM signal, including modulated carrier signals and unmodulated carrier signal, to directly down-convert the EM signal to a demodulated baseband signal. Preferably, the energy transfer system 6302 transfers energy from the EM signal 1304 to down-convert it to demodulated baseband signal in the manner shown in the operational flowchart 4613. However, it should be understood that the scope and spirit of the invention includes other structural embodiments for performing the steps of the flowchart 4613. The specifics of the other structural embodiments will be apparent to persons skilled in the relevant art(s) based on the discussion contained herein.

Operation of the energy transfer system 6302 is now described in at a high level for the digital AM carrier signal 616, with reference to the flowchart 4613 and the timing diagrams illustrated in FIGS. 56A–D. In step 4614, the energy transfer module 6304 receives the digital AM carrier signal 616. In step 4616, the energy transfer module 6304 receives the energy transfer signal 5602. In step 4618, the energy transfer module 6304 transfers energy from the digital AM carrier signal 616 at the aliasing rate to directly down-convert it to the demodulated baseband signal 5610.

Example implementations of the energy transfer module 6302 are disclosed in Sections 4 and 5 below.

### 2.2 Example Embodiments

Various embodiments related to the method(s) and structure(s) described above are presented in this section (and its subsections). These embodiments are described herein for purposes of illustration, and not limitation. The invention is not limited to these embodiments. Alternate embodiments (including equivalents, extensions, variations, deviations, etc., of the embodiments described herein) will be apparent to persons skilled in the relevant art(s) based on the teachings contained herein. The invention is intended and adapted to include such alternate embodiments.

The method for down-converting the EM signal to the demodulated baseband signal  $F_{DMB}$ , illustrated in the flowchart 4613 of FIG. 46C, can be implemented with various types of modulated carrier signals including, but not limited to, AM, PM, etc., or any combination thereof. The flowchart 4613 of FIG. 46C is described below for AM and PM. The exemplary descriptions below are intended to facilitate an understanding of the present invention. The present invention is not limited to or by the exemplary embodiments below.

### 2.2.1 First Example Embodiment: Amplitude Modulation

#### 2.2.1.1 Operational Description

Operation of the exemplary process of the flowchart **4613** in FIG. **46C** is described below for the analog AM carrier signal **516**, illustrated in FIG. **5C**, and for the digital AM carrier signal **616**, illustrated in FIG. **6C**.

##### 2.2.1.1.1 Analog AM Carrier Signal

A process for directly down-converting the analog AM carrier signal **516** in FIG. **5C** to a demodulated baseband signal is now described with reference to the flowchart **4613** in FIG. **46C**. The analog AM carrier signal **516** is re-illustrated in **57A** for convenience. For this example, the analog AM carrier signal **516** oscillates at approximately 900 MHz. In FIG. **57B**, an analog AM carrier signal portion **5704** illustrates a portion of the analog AM carrier signal **516** on an expanded time scale.

The process begins at step **4614**, which includes receiving an EM signal. This is represented by the analog AM carrier signal **516**.

Step **4616** includes receiving an energy transfer signal having an aliasing rate  $F_{AR}$ . In FIG. **57C**, an example energy transfer signal **5706** is illustrated on approximately the same time scale as FIG. **57B**. The energy transfer signal **5706** includes a train of energy transfer pulses **5707** having non-negligible apertures that tend away from zero time in duration. The energy transfer pulses **5707** repeat at the aliasing rate, which is determined or selected as previously described. Generally, when down-converting an EM signal to a demodulated baseband signal, the aliasing rate  $F_{AR}$  is substantially equal to a harmonic or, more typically, a sub-harmonic of the EM signal.

Step **4618** includes transferring energy from the EM signal at the aliasing rate to directly down-convert the EM signal to the demodulated baseband signal  $F_{DMB}$ . In FIG. **57D**, an affected analog AM carrier signal **5708** illustrates effects of transferring energy from the analog AM carrier signal **516** at the aliasing rate  $F_{AR}$ . The affected analog AM carrier signal **5708** is illustrated on substantially the same time scale as FIGS. **57B** and **57C**.

FIG. **57E** illustrates a demodulated baseband signal **5712**, which is generated by the down-conversion process. Because a harmonic of the aliasing rate is substantially equal to the frequency of the signal **516**, essentially no IF is produced. The only substantial aliased component is the baseband signal. The demodulated baseband signal **5712** is illustrated with an arbitrary load impedance. Load impedance optimizations are discussed in Section 5 below.

The demodulated baseband signal **5712** includes portions **5710A**, which correlate with the energy transfer pulses **5707** in FIG. **57C**, and portions **5710B**, which are between the energy transfer pulses **5707**. Portions **5710A** represent energy transferred from the analog AM carrier signal **516** to a storage device, while simultaneously driving an output load. The portions **5710A** occur when a switching module is closed by the energy transfer pulses **5707**. Portions **5710B** represent energy stored in a storage device continuing to drive the load. Portions **5710B** occur when the switching module is opened after energy transfer pulses **5707**.

In FIG. **57F**, a demodulated baseband signal **5716** represents a filtered version of the demodulated baseband signal **5712**, on a compressed time scale. The demodulated baseband signal **5716** is substantially similar to the modulating baseband signal **210** and can be further processed using any signal processing technique(s) without further down-conversion or demodulation.

The present invention can output the unfiltered demodulated baseband signal **5712**, the filtered demodulated base-

band signal **5716**, a partially filtered demodulated baseband signal, a stair step output signal, etc. The choice between these embodiments is generally a design choice that depends upon the application of the invention.

The aliasing rate of the energy transfer signal is preferably controlled to optimize the demodulated baseband signal for amplitude output and polarity, as desired.

The drawings referred to herein illustrate direct down-conversion in accordance with the invention. For example, the demodulated baseband signals **5712** in FIG. **57E** and **5716** in FIG. **57F** illustrate that the analog AM carrier signal **516** was directly down-converted to a demodulated baseband signal by retaining enough baseband information for sufficient reconstruction.

##### 2.2.1.1.2 Digital AM Carrier Signal

A process for directly down-converting the digital AM carrier signal **616** in FIG. **6C** to a demodulated baseband signal is now described for the flowchart **4613** in FIG. **46C**. The digital AM carrier signal **616** is re-illustrated in **58A** for convenience. For this example, the digital AM carrier signal **616** oscillates at approximately 900 MHz. In FIG. **58B**, a digital AM carrier signal portion **5804** illustrates a portion of the digital AM carrier signal **616** on an expanded time scale.

The process begins at step **4614**, which includes receiving an EM signal. This is represented by the digital AM carrier signal **616**.

Step **4616** includes receiving an energy transfer signal having an aliasing rate  $F_{AR}$ . In FIG. **58C**, an example energy transfer signal **5806** is illustrated on approximately the same time scale as FIG. **58B**. The energy transfer signal **5806** includes a train of energy transfer pulses **5807** having non-negligible apertures that tend away from zero time in duration. The energy transfer pulses **5807** repeat at the aliasing rate, which is determined or selected as previously described. Generally, when directly down-converting an EM signal to a demodulated baseband signal, the aliasing rate  $F_{AR}$  is substantially equal to a harmonic or, more typically, a sub-harmonic of the EM signal.

Step **4618** includes transferring energy from the EM signal at the aliasing rate to directly down-convert the EM signal to the demodulated baseband signal  $F_{DMB}$ . In FIG. **58D**, an affected digital AM carrier signal **5808** illustrates effects of transferring energy from the digital AM carrier signal **616** at the aliasing rate  $F_{AR}$ . The affected digital AM carrier signal **5808** is illustrated on substantially the same time scale as FIGS. **58B** and **58C**.

FIG. **58E** illustrates a demodulated baseband signal **5812**, which is generated by the down-conversion process. Because a harmonic of the aliasing rate is substantially equal to the frequency of the signal **616**, essentially no IF is produced. The only substantial aliased component is the baseband signal. The demodulated baseband signal **5812** is illustrated with an arbitrary load impedance. Load impedance optimizations are discussed in Section 5 below.

The demodulated baseband signal **5812** includes portions **5810A**, which correlate with the energy transfer pulses **5807** in FIG. **58C**, and portions **5810B**, which are between the energy transfer pulses **5807**. Portions **5810A** represent energy transferred from the digital AM carrier signal **616** to a storage device, while simultaneously driving an output load. The portions **5810A** occur when a switching module is closed by the energy transfer pulses **5807**. Portions **5810B** represent energy stored in a storage device continuing to drive the load. Portions **5810B** occur when the switching module is opened after energy transfer pulses **5807**.

In FIG. **58F**, a demodulated baseband signal **5816** represents a filtered version of the demodulated baseband signal



**5812**, on a compressed time scale. The demodulated baseband signal **5816** is substantially similar to the modulating baseband signal **310** and can be further processed using any signal processing technique(s) without further down-conversion or demodulation.

The present invention can output the unfiltered demodulated baseband signal **5812**, the filtered demodulated baseband signal **5816**, a partially filtered demodulated baseband signal, a stair step output signal, etc. The choice between these embodiments is generally a design choice that depends upon the application of the invention.

The aliasing rate of the energy transfer signal is preferably controlled to optimize the down-converted signal for amplitude output and polarity, as desired.

The drawings referred to herein illustrate direct down-conversion in accordance with the invention. For example, the demodulated baseband signals **5812** in FIG. **58E** and **5816** in FIG. **58F** illustrate that the digital AM carrier signal **616** was directly down-converted to a demodulated baseband signal by retaining enough baseband information for sufficient reconstruction.

#### 2.2.1.2 Structural Description

In an embodiment, the energy transfer module **6304** preferably transfers energy from the EM signal to directly down-convert it to a demodulated baseband signal in the manner shown in the operational flowchart **4613**. But it should be understood that the scope and spirit of the invention includes other structural embodiments for performing the steps of the flowchart **1413**. The specifics of the other structural embodiments will be apparent to persons skilled in the relevant art(s) based on the discussion contained herein.

Operation of the energy transfer system **6302** is now described for the digital AM carrier signal **516**, with reference to the flowchart **4613** and the timing diagrams in FIGS. **57A–F**. In step **4612**, the energy transfer module **6404** receives the analog AM carrier signal **516**. In step **4614**, the energy transfer module **6404** receives the energy transfer signal **5706**. In step **4618**, the energy transfer module **6404** transfers energy from the analog AM carrier signal **516** at the aliasing rate of the energy transfer signal **5706**, to directly down-convert the digital AM carrier signal **516** to the demodulated baseband signals **5712** or **5716**.

The operation of the energy transfer system **6402** is now described for the digital AM carrier signal **616**, with reference to the flowchart **4613** and the timing diagrams in FIGS. **58A–F**. In step **4614**, the energy transfer module **6404** receives the digital AM carrier signal **616**. In step **4616**, the energy transfer module **6404** receives the energy transfer signal **5806**. In step **4618**, the energy transfer module **6404** transfers energy from the digital AM carrier signal **616** at the aliasing rate of the energy transfer signal **5806**, to directly down-convert the digital AM carrier signal **616** to the demodulated baseband signals **5812** or **5816**.

Example implementations of the energy transfer module **6302** are disclosed in Sections 4 and 5 below.

#### 2.2.2 Second Example Embodiment: Phase Modulation

##### 2.2.2.1 Operational Description

Operation of the exemplary process of flowchart **4613** in FIG. **46C** is described below for the analog PM carrier signal **916**, illustrated in FIG. **9C** and for the digital PM carrier signal **1016**, illustrated in FIG. **10C**.

##### 2.2.2.1.1 Analog PM Carrier Signal

A process for directly down-converting the analog PM carrier signal **916** to a demodulated baseband signal is now described for the flowchart **4613** in FIG. **46C**. The analog PM carrier signal **916** is re-illustrated in **59A** for convenience. For this example, the analog PM carrier signal **916**

oscillates at approximately 900 MHz. In FIG. **59B**, an analog PM carrier signal portion **5904** illustrates a portion of the analog PM carrier signal **916** on an expanded time scale.

The process begins at step **4614**, which includes receiving an EM signal. This is represented by the analog PM carrier signal **916**.

Step **4616** includes receiving an energy transfer signal having an aliasing rate  $F_{AR}$ . In FIG. **59C**, an example energy transfer signal **5906** is illustrated on approximately the same time scale as FIG. **59B**. The energy transfer signal **5906** includes a train of energy transfer pulses **5907** having non-negligible apertures that tend away from zero time in duration. The energy transfer pulses **5907** repeat at the aliasing rate, which is determined or selected as previously described. Generally, when directly down-converting an EM signal to a demodulated baseband signal, the aliasing rate  $F_{AR}$  is substantially equal to a harmonic or, more typically, a sub-harmonic of the EM signal.

Step **4618** includes transferring energy from the EM signal at the aliasing rate to directly down-convert the EM signal to the demodulated baseband signal  $F_{DMB}$ . In FIG. **59D**, an affected analog PM carrier signal **5908** illustrates effects of transferring energy from the analog PM carrier signal **916** at the aliasing rate  $F_{AR}$ . The affected analog PM carrier signal **5908** is illustrated on substantially the same time scale as FIGS. **59B** and **59C**.

FIG. **59E** illustrates a demodulated baseband signal **5912**, which is generated by the down-conversion process. Because a harmonic of the aliasing rate is substantially equal to the frequency of the signal **516**, essentially no IF is produced. The only substantial aliased component is the baseband signal. The demodulated baseband signal **5912** is illustrated with an arbitrary load impedance. Load impedance optimizations are discussed in Section 5 below.

The demodulated baseband signal **5912** includes portions **5910A**, which correlate with the energy transfer pulses **5907** in FIG. **59C**, and portions **5910B**, which are between the energy transfer pulses **5907**. Portions **5910A** represent energy transferred from the analog PM carrier signal **916** to a storage device, while simultaneously driving an output load. The portions **5910A** occur when a switching module is closed by the energy transfer pulses **5907**. Portions **5910B** represent energy stored in a storage device continuing to drive the load. Portions **5910B** occur when the switching module is opened after energy transfer pulses **5907**.

In FIG. **59F**, a demodulated baseband signal **5916** represents a filtered version of the demodulated baseband signal **5912**, on a compressed time scale. The demodulated baseband signal **5916** is substantially similar to the modulating baseband signal **210** and can be further processed using any signal processing technique(s) without further down-conversion or demodulation. The present invention can output the unfiltered demodulated baseband **5912**, the filtered demodulated baseband signal **5916**, a partially filtered demodulated baseband signal, a stair step output signal, etc. The choice between these embodiments is generally a design choice that depends upon the application of the invention.

The aliasing rate of the energy transfer signal is preferably controlled to optimize the down-converted signal for amplitude output and polarity, as desired.

The drawings referred to herein illustrate direct down-conversion in accordance with the invention. For example, the demodulated baseband signals **5912** in FIG. **59E** and **5916** in FIG. **59F** illustrate that the analog PM carrier signal **916** was successfully down-converted to a demodulated baseband signal by retaining enough baseband information for sufficient reconstruction.



## 1 2.2.2.1.2 Digital PM Carrier Signal

A process for directly down-converting the digital PM carrier signal **1016** in FIG. 6C to a demodulated baseband signal is now described for the flowchart **4613** in FIG. 46C. The digital PM carrier signal **1016** is re-illustrated in **60A** for convenience. For this example, the digital PM carrier signal **1016** oscillates at approximately 900 MHz. In FIG. **60B**, a digital PM carrier signal portion **6004** illustrates a portion of the digital PM carrier signal **1016** on an expanded time scale.

The process begins at step **4614**, which includes receiving an EM signal. This is represented by the digital PM carrier signal **1016**.

Step **4616** includes receiving an energy transfer signal  $F_{AR}$ . In FIG. **60C**, an example energy transfer signal **6006** is illustrated on approximately the same time scale as FIG. **60B**. The energy transfer signal **6006** includes a train of energy transfer pulses **6007** having non-negligible apertures that tend away from zero time in duration. The energy transfer pulses **6007** repeat at the aliasing rate, which is determined or selected as previously described. Generally, when directly down-converting an EM signal to a demodulated baseband signal, the aliasing rate  $F_{AR}$  is substantially equal to a harmonic or, more typically, a sub-harmonic of the EM signal.

MF Step **4618** includes transferring energy from the EM signal at the aliasing rate to directly down-convert the EM signal to the demodulated baseband signal  $F_{DMB}$ . In FIG. **60D**, an affected digital PM carrier signal **6008** illustrates effects of transferring energy from the digital PM carrier signal **1016** at the aliasing rate  $F_{AR}$ . The affected digital PM carrier signal **6008** is illustrated on substantially the same time scale as FIGS. **60B** and **60C**.

FIG. **60E** illustrates a demodulated baseband signal **6012**, which is generated by the down-conversion process. Because a harmonic of the aliasing rate is substantially equal to the frequency of the signal **1016**, essentially no IF is produced. The only substantial aliased component is the baseband signal. The demodulated baseband signal **6012** is illustrated with an arbitrary load impedance. Load impedance optimizations are discussed in Section 5 below.

The demodulated baseband signal **6012** includes portions **6010A**, which correlate with the energy transfer pulses **6007** in FIG. **60C**, and portions **6010B**, which are between the energy transfer pulses **6007**. Portions **6010A** represent energy transferred from the digital PM carrier signal **1016** to a storage device, while simultaneously driving an output load. The portions **6010A** occur when a switching module is closed by the energy transfer pulses **6007**. Portions **601B** represent energy stored in a storage device continuing to drive the load. Portions **6010B** occur when the switching module is opened after energy transfer pulses **6007**.

In FIG. **60F**, a demodulated baseband signal **6016** represents a filtered version of the demodulated baseband signal **6012**, on a compressed time scale. The demodulated baseband signal **6016** is substantially similar to the modulating baseband signal **310** and can be further processed using any signal processing technique(s) without further down-conversion or demodulation.

The present invention can output the unfiltered demodulated baseband signal **6012**, the filtered demodulated baseband signal **6016**, a partially filtered demodulated baseband signal, a stair step output signal, etc. The choice between these embodiments is generally a design choice that depends upon the application of the invention.

The aliasing rate of the energy transfer signal is preferably controlled to optimize the down-converted signal for amplitude output and polarity, as desired.

The drawings referred to herein illustrate direct down-conversion in accordance with the invention. For example, the demodulated baseband signals **6012** in FIG. **60E** and **6016** in FIG. **60F** illustrate that the digital PM carrier signal **1016** was successfully down-converted to a demodulated baseband signal by retaining enough baseband information for sufficient reconstruction.

## 2.2.2.2 Structural Description

In an embodiment, the energy transfer system **6302** preferably transfers energy from an EM signal to directly down-convert it to a demodulated baseband signal in the manner shown in the operational flowchart **4613**. But it should be understood that the scope and spirit of the invention includes other structural embodiments for performing the steps of the flowchart **1413**. The specifics of the other structural embodiments will be apparent to persons skilled in the relevant art(s) based on the discussion contained herein.

Operation of the energy transfer system **6302** is now described for the analog PM carrier signal **916**, with reference to the flowchart **4613** and the timing diagrams in FIGS. **59A–F**. In Step **4614**, the energy transfer module **6304** receives the analog PM carrier signal **916**. In step **4616**, the energy transfer module **6304** receives the energy transfer signal **5906**. In step **4618**, the energy transfer module **6304** transfers energy from the analog PM carrier signal **916** at the aliasing rate of the energy transfer signal **5906**, to directly down-convert the analog PM carrier signal **916** to the demodulated baseband signals **5912** or **5916**.

Operation of the energy transfer system **6302** is now described for the digital PM carrier signal **1016**, with reference to the flowchart **4613** and to the timing diagrams in FIGS. **60A–F**. In step **4614**, the energy transfer module **6404** receives the digital PM carrier signal **1016**. In step **4616**, the energy transfer module **6404** receives the energy transfer signal **6006**. In step **4618**, the energy transfer module **6404** transfers energy from the digital PM carrier signal **1016** at the aliasing rate of the energy transfer signal **6006**, to directly down-convert the digital PM carrier signal **1016** to the demodulated baseband signal **6012** or **6016**.

Example implementations of the energy transfer module **6302** are disclosed in Sections 4 and 5 below.

## 2.2.3 Other Embodiments

The embodiments described above are provided for purposes of illustration. These embodiments are not intended to limit the invention. Alternate embodiments, differing slightly or substantially from those described herein, will be apparent to persons skilled in the relevant art(s) based on the teachings contained herein. Such alternate embodiments fall within the scope and spirit of the present invention. Example implementations of the energy transfer module **6302** are disclosed in Sections 4 and 5 below.

## 2.3 Implementation Examples

Exemplary operational and/or structural implementations related to the method(s), structure(s), and/or embodiments described above are presented in Sections 4 and 5 below. These implementations are presented for purposes of illustration, and not limitation. The invention is not limited to the particular implementation examples described therein. Alternate implementations (including equivalents, extensions, variations, deviations, etc., of those described herein) will be apparent to persons skilled in the relevant art(s) based on the teachings contained herein. Such alternate implementations fall within the scope and spirit of the present invention.

## 3. Modulation Conversion

In an embodiment, the invention down-converts an FM carrier signal  $F_{FMC}$  to a non-FM signal  $F_{(NON-FM)}$ , by

transferring energy from the FM carrier signal  $F_{FMC}$  at an aliasing rate. This embodiment is illustrated in FIG. 45B as 4518.

In an example embodiment, the FM carrier signal  $F_{FMC}$  is down-converted to a phase modulated (PM) signal  $F_{PM}$ . In another example embodiment, the FM carrier signal  $F_{FMC}$  is down-converted to an amplitude modulated (AM) signal  $F_{AM}$ . The down-converted signal can be demodulated with any conventional demodulation technique to obtain a demodulated baseband signal  $F_{DMB}$ .

The invention can be implemented with any type of FM signal. Exemplary embodiments are provided below for down-converting a frequency shift keying (FSK) signal to a non-FSK signal. FSK is a sub-set of FM, wherein an FM signal shifts or switches between two or more frequencies. FSK is typically used for digital modulating baseband signals, such as the digital modulating baseband signal 310 in FIG. 3. For example, in FIG. 8, the digital FM signal 816 is an FSK signal that shifts between an upper frequency and a lower frequency, corresponding to amplitude shifts in the digital modulating baseband signal 310. The FSK signal 816 is used in example embodiments below.

In a first example embodiment, energy is transferred from the FSK signal 816 at an aliasing rate that is based on a mid-point between the upper and lower frequencies of the FSK signal 816. When the aliasing rate is based on the mid-point, the FSK signal 816 is down-converted to a phase shift keying (PSK) signal. PSK is a sub-set of phase modulation, wherein a PM signal shifts or switches between two or more phases. PSK is typically used for digital modulating baseband signals. For example, in FIG. 10, the digital PM signal 1016 is a PSK signal that shifts between two phases. The PSK signal 1016 can be demodulated by any conventional PSK demodulation technique(s).

In a second example embodiment, energy is transferred from the FSK signal 816 at an aliasing rate that is based upon either the upper frequency or the lower frequency of the FSK signal 816. When the aliasing rate is based upon the upper frequency or the lower frequency of the FSK signal 816, the FSK signal 816 is down-converted to an amplitude shift keying (ASK) signal. ASK is a sub-set of amplitude modulation, wherein an AM signal shifts or switches between two or more amplitudes. ASK is typically used for digital modulating baseband signals. For example, in FIG. 6, the digital AM signal 616 is an ASK signal that shifts between the first amplitude and the second amplitude. The ASK signal 616 can be demodulated by any conventional ASK demodulation technique(s).

The following sections describe methods for transferring energy from an FM carrier signal  $F_{FMC}$  to down-convert it to the non-FM signal  $F_{(NON-FM)}$ . Exemplary structural embodiments for implementing the methods are also described. It should be understood that the invention is not limited to the particular embodiments described below. Equivalents, extensions, variations, deviations, etc., of the following will be apparent to persons skilled in the relevant art(s) based on the teachings contained herein. Such equivalents, extensions, variations, deviations, etc., are within the scope and spirit of the present invention.

The following sections include a high level discussion, example embodiments, and implementation examples.

### 3.1 High Level Description

This section (including its subsections) provides a high-level description of transferring energy from the FM carrier signal  $F_{FM}$  to down-convert it to the non-FM signal  $F_{(NON-FM)}$ , according to the invention. In particular, an operational process for down-converting the FM carrier signal  $F_{FM}$  to

the non-FM signal  $F_{(NON-FM)}$  is described at a high-level. Also, a structural implementation for implementing this process is described at a high-level. The structural implementation is described herein for illustrative purposes, and is not limiting. In particular, the process described in this section can be achieved using any number of structural implementations, one of which is described in this section. The details of such structural implementations will be apparent to persons skilled in the relevant art(s) based on the teachings contained herein.

#### 3.1.1 Operational Description

FIG. 46D depicts a flowchart 4619 that illustrates an exemplary method for down-converting the FM carrier signal  $F_{FMC}$  to the non-FM signal  $F_{(NON-FM)}$ . The exemplary method illustrated in the flowchart 4619 is an embodiment of the flowchart 4601 in FIG. 46A.

Any and all forms of frequency modulation techniques are valid for this invention. For ease of discussion, the digital FM carrier (FSK) signal 816 is used to illustrate a high level operational description of the invention. Subsequent sections provide detailed flowcharts and descriptions for the FSK signal 816. Upon reading the disclosure and examples therein, one skilled in the relevant art(s) will understand that the invention can be implemented to down-convert any type of FM signal.

The method illustrated in the flowchart 4619 is described below at a high level for down-converting the FSK signal 816 in FIG. 8C to a PSK signal. The FSK signal 816 is re-illustrated in FIG. 84A for convenience.

The process of the flowchart 4619 begins at step 4620, which includes receiving an FM signal. This is represented by the FSK signal 816. The FSK signal 816 shifts between a first frequency 8410 and a second frequency 8412. The first frequency 8410 can be higher or lower than the second frequency 8412. In an exemplary embodiment, the first frequency 8410 is approximately 899 MHz and the second frequency 8412 is approximately 901 MHz.

Step 4622 includes receiving an energy transfer signal having an aliasing rate  $F_{AR}$ . FIG. 84B illustrates an example energy transfer signal 8402 which includes a train of energy transfer pulses 8403 having non-negligible apertures 8405 that tend away from zero time in duration.

The energy transfer pulses 8403 repeat at the aliasing rate  $F_{AR}$ , which is determined or selected as previously described. Generally, when down-converting an FM carrier signal  $F_{FMC}$  to a non-FM signal  $F_{(NON-FM)}$ , the aliasing rate is substantially equal to a harmonic or, more typically, a sub-harmonic of a frequency within the FM signal. In this example overview embodiment, where the FSK signal 816 is to be down-converted to a PSK signal, the aliasing rate is substantially equal to a harmonic or, more typically, a sub-harmonic of the mid-point between the first frequency 8410 and the second frequency 8412. For the present example, the mid-point is approximately 900 MHz.

Step 4624 includes transferring energy from the FM carrier signal  $F_{FMC}$  at the aliasing rate to down-convert the FM carrier signal  $F_{FMC}$  to the non-FM signal  $F_{(NON-FM)}$ . FIG. 84C illustrates a PSK signal 8404, which is generated by the modulation conversion process.

When the second frequency 8412 is under-sampled, the PSK signal 8404 has a frequency of approximately 1 MHz and is used as a phase reference. When the first frequency 8410 is under-sampled, the PSK signal 8404 has a frequency of 1 MHz and is phase shifted 180 degrees from the phase reference.

FIG. 84D depicts a PSK signal 8406, which is a filtered version of the PSK signal 8404. The invention can thus

generate a filtered output signal, a partially filtered output signal, or a relatively unfiltered stair step output signal. The choice between filtered, partially filtered and non-filtered output signals is generally a design choice that depends upon the application of the invention.

The aliasing rate of the energy transfer signal is preferably controlled to optimize the down-converted signal for amplitude output and polarity, as desired.

Detailed exemplary embodiments for down-converting an FSK signal to a PSK signal and for down-converting an FSK signal to an ASK signal are provided below.

### 3.1.2 Structural Description

FIG. 63 illustrates the energy transfer system 6302 according to an embodiment of the invention. The energy transfer system 6302 includes the energy transfer module 6304. The energy transfer system 6302 is an example embodiment of the generic aliasing system 1302 in FIG. 13.

In a modulation conversion embodiment, the EM signal 1304 is an FM carrier signal  $F_{FMC}$  and the energy transfer module 6304 transfers energy from FM carrier signal at a harmonic or, more typically, a sub-harmonic of a frequency within the FM frequency band. Preferably, the energy transfer module 6304 transfers energy from the FM carrier signal  $F_{FMC}$  to down-convert it to a non-FM signal  $F_{(NON-FM)}$  in the manner shown in the operational flowchart 4619. But it should be understood that the scope and spirit of the invention includes other structural embodiments for performing the steps of the flowchart 4619. The specifics of the other structural embodiments will be apparent to persons skilled in the relevant art(s) based on the discussion contained herein.

The operation of the energy transfer system 6302 shall now be described with reference to the flowchart 4619 and the timing diagrams of FIGS. 84A–84D. In step 4620, the energy transfer module 6304 receives the FSK signal 816. In step 4622, the energy transfer module 6304 receives the energy transfer signal 8402. In step 4624, the energy transfer module 6304 transfers energy from the FSK signal 816 at the aliasing rate of the energy transfer signal 8402 to down-convert the FSK signal 816 to the PSK signal 8404 or 8406.

Example implementations of the energy transfer module 6302 are provided in Section 4 below.

### 3.2 Example Embodiments

Various embodiments related to the method(s) and structure(s) described above are presented in this section (and its subsections). These embodiments are described herein for purposes of illustration, and not limitation. The invention is not limited to these embodiments. Alternate embodiments (including equivalents, extensions, variations, deviations, etc., of the embodiments described herein) will be apparent to persons skilled in the relevant art(s) based on the teachings contained herein. The invention is intended and adapted to include such alternate embodiments.

The method for down-converting an FM carrier signal  $F_{FMC}$  to a non-FM signal,  $F_{(NON-FM)}$ , illustrated in the flowchart 4619 of FIG. 46D, can be implemented with any type of FM carrier signal including, but not limited to, FSK signals. The flowchart 4619 is described in detail below for down-converting an FSK signal to a PSK signal and for down-converting a PSK signal to an ASK signal. The exemplary descriptions below are intended to facilitate an understanding of the present invention. The present invention is not limited to or by the exemplary embodiments below.

#### 3.2.1 First Example Embodiment: Down-Converting an FM Signal to a PM Signal

##### 3.2.1.1 Operational Description

A process for down-converting the FSK signal 816 in FIG. 8C to a PSK signal is now described for the flowchart 4619 in FIG. 46D.

The FSK signal 816 is re-illustrated in FIG. 61A for convenience. The FSK signal 816 shifts between a first frequency 6106 and a second frequency 6108. In the exemplary embodiment, the first frequency 6106 is lower than the second frequency 6108. In an alternative embodiment, the first frequency 6106 is higher than the second frequency 6108. For this example, the first frequency 6106 is approximately 899 MHz and the second frequency 6108 is approximately 901 MHz.

FIG. 61B illustrates an FSK signal portion 6104 that represents a portion of the FSK signal 816 on an expanded time scale.

The process begins at step 4620, which includes receiving an FM signal. This is represented by the FSK signal 816.

Step 4622 includes receiving an energy transfer signal having an aliasing rate  $F_{AR}$ . FIG. 61C illustrates an example energy transfer signal 6107 on approximately the same time scale as FIG. 61B. The energy transfer signal 6107 includes a train of energy transfer pulses 6109 having non-negligible apertures that tend away from zero time in duration. The energy transfer pulses 6109 repeat at the aliasing rate  $F_{AR}$ , which is determined or selected as described above. Generally, when down-converting an FM signal to a non-FM signal, the aliasing rate is substantially equal to a harmonic or, more typically, a sub-harmonic of a frequency within the FM signal.

In this example, where an FSK signal is being down-converted to a PSK signal, the aliasing rate is substantially equal to a harmonic or, more typically, a sub-harmonic, of the mid-point between the frequencies 6106 and 6108. In this example, where the first frequency 6106 is 899 MHz and second frequency 6108 is 901 MHz, the mid-point is approximately 900 MHz. Suitable aliasing rates thus include 1.8 GHz, 900 MHz, 450 MHz, etc.

Step 4624 includes transferring energy from the FM signal at the aliasing rate to down-convert it to the non-FM signal  $F_{(NON-FM)}$ . In FIG. 61D, an affected FSK signal 6118 illustrates effects of transferring energy from the FSK signal 816 at the aliasing rate  $F_{AR}$ . The affected FSK signal 6118 is illustrated on substantially the same time scale as FIGS. 61B and 61C.

FIG. 61E illustrates a PSK signal 6112, which is generated by the modulation conversion process. PSK signal 6112 is illustrated with an arbitrary load impedance. Load impedance optimizations are discussed in Section 5 below.

The PSK signal 6112 includes portions 6110A, which correlate with the energy transfer pulses 6107 in FIG. 61C. The PSK signal 6112 also includes portions 6110B, which are between the energy transfer pulses 6109. Portions 6110A represent energy transferred from the FSK 816 to a storage device, while simultaneously driving an output load. The portions 6110A occur when a switching module is closed by the energy transfer pulses 6109. Portions 6110B represent energy stored in a storage device continuing to drive the load. Portions 6110B occur when the switching module is opened after energy transfer pulses 6107.

In FIG. 61F, a PSK signal 6114 represents a filtered version of the PSK signal 6112, on a compressed time scale. The present invention can output the unfiltered demodulated baseband signal 6112, the filtered demodulated baseband signal 6114, a partially filtered demodulated baseband signal, a stair step output signal, etc. The choice between these embodiments is generally a design choice that depends upon the application of the invention. The PSK signals 6112 and 6114 can be demodulated with a conventional demodulation technique(s).

The aliasing rate of the energy transfer signal is preferably controlled to optimize the down-converted signal for amplitude output and polarity, as desired.

The drawings referred to herein illustrate modulation conversion in accordance with the invention. For example, the PSK signals **6112** in FIG. **61E** and **6114** in FIG. **61F** illustrate that the FSK signal **816** was successfully down-converted to a PSK signal by retaining enough baseband information for sufficient reconstruction.

### 3.2.1.2 Structural Description

The operation of the energy transfer system **1602** is now described for down-converting the FSK signal **816** to a PSK signal, with reference to the flowchart **4619** and to the timing diagrams of FIGS. **61A–E**. In step **4620**, the energy transfer module **1606** receives the FSK signal **816** (FIG. **61A**). In step **4622**, the energy transfer module **1606** receives the energy transfer signal **6107** (FIG. **61C**). In step **4624**, the energy transfer module **1606** transfers energy from the FSK signal **816** at the aliasing rate of the energy transfer signal **6107** to down-convert the FSK signal **816** to the PSK signal **6112** in FIG. **61E** or the PSK signal **6114** in FIG. **61F**.

### 3.2.2 Second Example Embodiment: Down-Converting an FM Signal to an AM Signal

#### 3.2.2.1 Operational Description

A process for down-converting the FSK signal **816** in FIG. **8C** to an ASK signal is now described for the flowchart **4619** in FIG. **46D**.

The FSK signal **816** is re-illustrated in FIG. **62A** for convenience. The FSK signal **816** shifts between a first frequency **6206** and a second frequency **6208**. In the exemplary embodiment, the first frequency **6206** is lower than the second frequency **6208**. In an alternative embodiment, the first frequency **6206** is higher than the second frequency **6208**. For this example, the first frequency **6206** is approximately 899 MHz and the second frequency **6208** is approximately 901 MHz.

FIG. **62B** illustrates an FSK signal portion **6204** that represents a portion of the FSK signal **816** on an expanded time scale.

The process begins at step **4620**, which includes receiving an FM signal. This is represented by the FSK signal **816**.

Step **4622** includes receiving an energy transfer signal having an aliasing rate  $F_{AR}$ . FIG. **62C** illustrates an example energy transfer signal **6207** on approximately the same time scale as FIG. **62B**. The energy transfer signal **6207** includes a train of energy transfer pulses **6209** having non-negligible apertures that tend away from zero time in duration. The energy transfer pulses **6209** repeat at the aliasing rate  $F_{AR}$ , which is determined or selected as described above. Generally, when down-converting an FM signal to a non-FM signal, the aliasing rate is substantially equal to a harmonic or, more typically, a sub-harmonic of a frequency within the FM signal.

In this example, where an FSK signal is being down-converted to an ASK signal, the aliasing rate is substantially equal to a harmonic or, more typically, a sub-harmonic, of either the first frequency **6206** or the second frequency **6208**. In this example, where the first frequency **6206** is 899 MHz and the second frequency **6208** is 901 MHz, the aliasing rate can be substantially equal to a harmonic or sub-harmonic of 899 MHz or 901 MHz.

Step **4624** includes transferring energy from the FM signal at the aliasing rate to down-convert it to the non-FM signal  $F_{(NON-FM)}$ . In FIG. **62D**, an affected FSK signal **6218** illustrates effects of transferring energy from the FSK signal **816** at the aliasing rate  $F_{AR}$ . The affected FSK signal **6218** is illustrated on substantially the same time scale as FIGS. **62B** and **62C**.

FIG. **62E** illustrates an ASK signal **6212**, which is generated by the modulation conversion process. ASK signal

**6212** is illustrated with an arbitrary load impedance. Load impedance optimizations are discussed in Section 5 below.

The ASK signal **6212** includes portions **6210A**, which correlate with the energy transfer pulses **6209** in FIG. **62C**. The ASK signal **6212** also includes portions **6210B**, which are between the energy transfer pulses **6209**. Portions **6210A** represent energy transferred from the FSK **816** to a storage device, while simultaneously driving an output load. Portions **6210A** occur when a switching module is closed by the energy transfer pulses **6207**. Portions **6210B** represent energy stored in a storage device continuing to drive the load. Portions **6210B** occur when the switching module is opened after energy transfer pulses **6207**.

In FIG. **62F**, an ASK signal **6214** represents a filtered version of the ASK signal **6212**, on a compressed time scale. The present invention can output the unfiltered demodulated baseband signal **6212**, the filtered demodulated baseband signal **6214**, a partially filtered demodulated baseband signal, a stair step output signal, etc. The choice between these embodiments is generally a design choice that depends upon the application of the invention. The ASK signals **6212** and **6214** can be demodulated with a conventional demodulation technique(s).

The aliasing rate of the energy transfer signal is preferably controlled to optimize the down-converted signal for amplitude output and/or polarity, as desired.

The drawings referred to herein illustrate modulation conversion in accordance with the invention. For example, the ASK signals **6212** in FIG. **62E** and **6214** in FIG. **62F** illustrate that the FSK signal **816** was successfully down-converted to an ASK signal by retaining enough baseband information for sufficient reconstruction.

### 3.2.2.2 Structural Description

The operation of the energy transfer system **1602** is now described for down-converting the FSK signal **816** to an ASK signal, with reference to the flowchart **4619** and to the timing diagrams of FIGS. **62A–F**. In step **4620**, the energy transfer module **6304** receives the FSK signal **816** (FIG. **62A**). In step **4622**, the energy transfer module **6304** receives the energy transfer signal **6207** (FIG. **62C**). In step **4624**, the energy transfer module **6304** transfers energy from the FSK signal **818** at the aliasing rate of the energy transfer signal **6207** to down-convert the FSK signal **816** to the ASK signal **6212** in FIG. **62E** or the ASK signal **6214** in FIG. **62F**.

#### 3.2.3 Other Example Embodiments

The embodiments described above are provided for purposes of illustration. These embodiments are not intended to limit the invention. Alternate embodiments, differing slightly or substantially from those described herein, will be apparent to persons skilled in the relevant art(s) based on the teachings contained herein. Such alternate embodiments fall within the scope and spirit of the present invention.

Example implementations of the energy transfer module **6302** are disclosed in Sections 4 and 5 below.

### 3.3 Implementation Examples

Exemplary operational and/or structural implementations related to the method(s), structure(s), and/or embodiments described above are presented in Sections 4 and 5 below. These implementations are presented for purposes of illustration, and not limitation. The invention is not limited to the particular implementation examples described therein. Alternate implementations (including equivalents, extensions, variations, deviations, etc., of those described herein) will be apparent to persons skilled in the relevant art(s) based on the teachings contained herein. Such alternate implementations fall within the scope and spirit of the present invention.

#### 4. Implementation Examples

Exemplary operational and/or structural implementations related to the method(s), structure(s), and/or embodiments described above are presented in this section (and its subsections). These implementations are presented herein for purposes of illustration, and not limitation. The invention is not limited to the particular implementation examples described herein. Alternate implementations (including equivalents, extensions, variations, deviations, etc., of those described herein) will be apparent to persons skilled in the relevant art(s) based on the teachings contained herein. Such alternate implementations fall within the scope and spirit of the present invention.

FIG. 63 illustrates an energy transfer system 6302, which is an exemplary embodiment of the generic aliasing system 1302 in FIG. 13. The energy transfer system 6302 includes an energy transfer module 6304, which receives the EM signal 1304 and an energy transfer signal 6306. The energy transfer signal 6306 includes a train of energy transfer pulses having non-negligible apertures that tend away from zero time in duration. The energy transfer pulses repeat at an aliasing rate  $F_{AR}$ .

The energy transfer module 6304 transfers energy from the EM signal 1304 at the aliasing rate of the energy transfer signal 6306, as described in the sections above with respect to the flowcharts 4601 in FIG. 46A, 4607 in FIG. 46B, 4613 in FIG. 46C and 4619 in FIG. 46D. The energy transfer module 6304 outputs a down-converted signal 1308B, which includes non-negligible amounts of energy transferred from the EM signal 1304.

FIG. 64A illustrates an exemplary gated transfer system 6402, which is an example of the energy transfer system 6302. The gated transfer system 6402 includes a gated transfer module 6404, which is described below.

FIG. 64B illustrates an exemplary inverted gated transfer system 6406, which is an alternative example of the energy transfer system 6302. The inverted gated transfer system 6406 includes an inverted gated transfer module 6408, which is described below.

##### 4.1 The Energy Transfer System as a Gated Transfer System

FIG. 64A illustrates the exemplary gated transfer system 6402, which is an exemplary implementation of the energy transfer system 6302. The gated transfer system 6402 includes the gated transfer module 6404, which receives the EM signal 1304 and the energy transfer signal 6306. The energy transfer signal 6306 includes a train of energy transfer pulses having non-negligible apertures that tend away from zero time in duration. The energy transfer pulses repeat at an aliasing rate  $F_{AR}$ .

The gated transfer module 6404 transfers energy from the EM signal 1304 at the aliasing rate of the energy transfer signal 6306, as described in the sections above with respect to the flowcharts 4601 in FIG. 46A, 4607 in FIG. 46B, 4613 in FIG. 46C and 4619 in FIG. 46D. The gated transfer module 6404 outputs the down-converted signal 1308B, which includes non-negligible amounts of energy transferred from the EM signal 1304.

##### 4.1.1 The Gated Transfer System as a Switch Module and a Storage Module

FIG. 65 illustrates an example embodiment of the gated transfer module 6404 as including a switch module 6502 and a storage module 6506. Preferably, the switch module 6502 and the storage module 6506 transfer energy from the EM signal 1304 to down-convert it in any of the manners shown in the operational flowcharts 4601 in FIG. 46A, 4607 in FIG. 46B, 4613 in FIG. 46C and 4619 in FIG. 46D.

For example, operation of the switch module 6502 and the storage module 6506 is now described for down-converting

the EM signal 1304 to an intermediate signal, with reference to the flowchart 4607 and the example timing diagrams in FIG. 83A–F.

In step 4608, the switch module 6502 receives the EM signal 1304 (FIG. 83A). In step 4610, the switch module 6502 receives the energy transfer signal 6306 (FIG. 83C). In step 4612, the switch module 6502 and the storage module 6506 cooperate to transfer energy from the EM signal 1304 and down-convert it to an intermediate signal. More specifically, during step 4612, the switch module 6502 closes during each energy transfer pulse to couple the EM signal 1304 to the storage module 6506. In an embodiment, the switch module 6502 closes on rising edges of the energy transfer pulses. In an alternative embodiment, the switch module 6502 closes on falling edges of the energy transfer pulses. While the EM signal 1304 is coupled to the storage module 6506, non-negligible amounts of energy are transferred from the EM signal 1304 to the storage module 6506. FIG. 83B illustrates the EM signal 1304 after the energy is transferred from it. FIG. 83D illustrates the transferred energy stored in the storage module 6506. The storage module 6506 outputs the transferred energy as the down-converted signal 1308B. The storage module 6506 can output the down-converted signal 1308B as an unfiltered signal such as signal shown in FIG. 83E, or as a filtered down-converted signal (FIG. 83F).

##### 4.1.2 The Gated Transfer System as Break-Before-Make Module

FIG. 67A illustrates an example embodiment of the gated transfer module 6404 as including a break-before-make module 6702 and a storage module 6716. Preferably, the break before make module 6702 and the storage module 6716 transfer energy from the EM signal 1304 to down-convert it in any of the manners shown in the operational flowcharts 4601 in FIG. 46A, 4607 in FIG. 46E, 4613 in FIG. 46C and 4619 in FIG. 46D.

In FIG. 67A, the break-before-make module 6702 includes a normally open switch 6704 and a normally closed switch 6706. The normally open switch 6704 is controlled by the energy transfer signal 6306. The normally closed switch 6706 is controlled by an isolation signal 6712. In an embodiment, the isolation signal 6712 is generated from the energy transfer signal 6306. Alternatively, the energy transfer signal 6306 is generated from the isolation signal 6712. Alternatively, the isolation signal 6712 is generated independently from the energy transfer signal 6306. The break-before-make module 6702 substantially isolates an input 6708 from an output 6710.

FIG. 67B illustrates an example timing diagram of the energy transfer signal 6306, which controls the normally open switch 6704. FIG. 67C illustrates an example timing diagram of the isolation signal 6712, which controls the normally closed switch 6706. Operation of the break-before-make module 6702 is now described with reference to the example timing diagrams in FIGS. 67B and 67C.

Prior to time  $t_0$ , the normally open switch 6704 and the normally closed switch 6706 are at their normal states.

At time  $t_0$ , the isolation signal 6712 in FIG. 67C opens the normally closed switch 6706. Thus, just after time  $t_0$ , the normally open switch 6704 and the normally closed switch 6706 are open and the input 6708 is isolated from the output 6710.

At time  $t_1$ , the energy transfer signal 6306 in FIG. 67B closes the normally open switch 6704 for the non-negligible duration of a pulse. This couples the EM signal 1304 to the storage module 6716.

Prior to  $t_2$ , the energy transfer signal 6306 in FIG. 67B opens the normally open switch 6704. This de-couples the EM signal 1304 from the storage module 6716.

At time  $t_2$ , the isolation signal **6712** in FIG. **67C** closes the normally closed switch **6706**. This couples the storage module **6716** to the output **6710**.

The storage module **6716**, is similar to the storage module **6506** FIG. **65**. The break-before-make gated transfer system **6701** down-converts the EM signal **1304** in a manner similar to that described with reference to the gated transfer system **6501** in FIG. **65**.

#### 4.1.3 Example Implementations of the Switch Module

The switch module **6502** in FIG. **65** and the switch modules **6704** and **6706** in FIG. **67A** can be any type of switch device that preferably has a relatively low impedance when closed and a relatively high impedance when open. The switch modules **6502**, **6704** and **6706** can be implemented with normally open or normally closed switches. The switch modules need not be ideal switch modules.

FIG. **66B** illustrates the switch modules **6502**, **6704** and **6706** as a switch module **6610**. Switch module **6610** can be implemented in either normally open or normally closed architecture. The switch module **6610** (e.g., switch modules **6502**, **6704** and **6706**) can be implemented with any type of suitable switch device, including, but not limited, to mechanical switch devices and electrical switch devices, optical switch devices, etc., and combinations thereof. Such devices include, but are not limited to transistor switch devices, diode switch devices, relay switch devices, optical switch devices, micro-machine switch devices, etc., or combinations thereof.

In an embodiment, the switch module **6610** can be implemented as a transistor, such as, for example, a field effect transistor (FET), a bi-polar transistor, or any other suitable circuit switching device.

In FIG. **66A**, the switch module **6610** is illustrated as a FET **6602**. The FET **6602** can be any type of FET, including, but not limited to, a MOSFET, a JFET, a GaAsFET, etc. The FET **6602** includes a gate **6604**, a source **6606** and a drain **6608**. The gate **6604** receives the energy transfer signal **6306** to control the switching action between the source **6606** and the drain **6608**. In an embodiment, the source **6606** and the drain **6608** are interchangeable.

It should be understood that the illustration of the switch module **6610** as a FET **6602** in FIG. **66A** is for example purposes only. Any device having switching capabilities could be used to implement the switch module **6610** (i.e., switch modules **6502**, **6704** and **6706**), as will be apparent to persons skilled in the relevant art(s) based on the discussion contained herein.

In FIG. **66C**, the switch module **6610** is illustrated as a diode switch **6612**, which operates as a two lead device when the energy transfer signal **6306** is coupled to the output **6613**.

In FIG. **66D**, the switch module **6610** is illustrated as a diode switch **6614**, which operates as a two lead device when the energy transfer signal **6306** is coupled to the output **6615**.

#### 4.1.4 Example Implementations of the Storage Module

The storage modules **6506** and **6716** store non-negligible amounts of energy from the EM signal **1304**. In an exemplary embodiment, the storage modules **6506** and **6716** are implemented as a reactive storage module **6801** in FIG. **68A**, although the invention is not limited to this embodiment. A reactive storage module is a storage module that employs one or more reactive electrical components to store energy transferred from the EM signal **1304**. Reactive electrical components include, but are not limited to, capacitors and inductors.

In an embodiment, the storage modules **6506** and **6716** include one or more capacitive storage elements, illustrated

in FIG. **68B** as a capacitive storage module **6802**. In FIG. **68C**, the capacitive storage module **6802** is illustrated as one or more capacitors illustrated generally as capacitor(s) **6804**.

The goal of the storage modules **6506** and **6716** is to store non-negligible amounts of energy transferred from the EM signal **1304**. Amplitude reproduction of the original, unaffected EM input signal is not necessarily important. In an energy transfer environment, the storage module preferably has the capacity to handle the power being transferred, and to allow it to accept a non-negligible amount of power during a non-negligible aperture period.

A terminal **6806** serves as an output of the capacitive storage module **6802**. The capacitive storage module **6802** provides the stored energy at the terminal **6806**. FIG. **68F** illustrates the capacitive storage module **6802** as including a series capacitor **6812**, which can be utilized in an inverted gated transfer system described below.

In an alternative embodiment, the storage modules **6506** and **6716** include one or more inductive storage elements, illustrated in FIG. **68D** as an inductive storage module **6808**.

In an alternative embodiment, the storage modules **6506** and **6716** include a combination of one or more capacitive storage elements and one or more inductive storage elements, illustrated in FIG. **68E** as a capacitive/inductive storage module **6810**.

FIG. **68G** illustrates an integrated gated transfer system **6818** that can be implemented to down-convert the EM signal **1304** as illustrated in, and described with reference to, FIGS. **83A–F**.

#### 4.1.5 Optional Energy Transfer Signal Module

FIG. **69** illustrates an energy transfer system **6901**, which is an example embodiment of the energy transfer system **6302**. The energy transfer system **6901** includes an optional energy transfer signal module **6902**, which can perform any of a variety of functions or combinations of functions including, but not limited to, generating the energy transfer signal **6306**.

In an embodiment, the optional energy transfer signal module **6902** includes an aperture generator, an example of which is illustrated in FIG. **68J** as an aperture generator **6820**. The aperture generator **6820** generates non-negligible aperture pulses **6826** from an input signal **6824**. The input signal **6824** can be any type of periodic signal, including, but not limited to, a sinusoid, a square wave, a saw-tooth wave, etc. Systems for generating the input signal **6824** are described below.

The width or aperture of the pulses **6826** is determined by delay through the branch **6822** of the aperture generator **6820**. Generally, as the desired pulse width increases, the difficulty in meeting the requirements of the aperture generator **6820** decrease. In other words, to generate non-negligible aperture pulses for a given EM input frequency, the components utilized in the example aperture generator **6820** do not require as fast reaction times as those that are required in an under-sampling system operating with the same EM input frequency.

The example logic and implementation shown in the aperture generator **6820** are provided for illustrative purposes only, and are not limiting. The actual logic employed can take many forms. The example aperture generator **6820** includes an optional inverter **6828**, which is shown for polarity consistency with other examples provided herein.

An example implementation of the aperture generator **6820** is illustrated in FIG. **68K**. Additional examples of aperture generation logic are provided in FIGS. **68H** and **68I**. FIG. **68H** illustrates a rising edge pulse generator **6840**, which generates pulses **6826** on rising edges of the input

signal **6824**. FIG. **68I** illustrates a falling edge pulse generator **6850**, which generates pulses **6826** on falling edges of the input signal **6824**.

In an embodiment, the input signal **6824** is generated externally of the energy transfer signal module **6902**, as illustrated in FIG. **69**. Alternatively, the input signal **6924** is generated internally by the energy transfer signal module **6902**. The input signal **6824** can be generated by an oscillator, as illustrated in FIG. **68L** by an oscillator **6830**. The oscillator **6830** can be internal to the energy transfer signal module **6902** or external to the energy transfer signal module **6902**. The oscillator **6830** can be external to the energy transfer system **6901**. The output of the oscillator **6830** may be any periodic waveform.

The type of down-conversion performed by the energy transfer system **6901** depends upon the aliasing rate of the energy transfer signal **6306**, which is determined by the frequency of the pulses **6826**. The frequency of the pulses **6826** is determined by the frequency of the input signal **6824**. For example, when the frequency of the input signal **6824** is substantially equal to a harmonic or a sub-harmonic of the EM signal **1304**, the EM signal **1304** is directly down-converted to baseband (e.g. when the EM signal is an AM signal or a PM signal), or converted from FM to a non-FM signal. When the frequency of the input signal **6824** is substantially equal to a harmonic or a sub-harmonic of a difference frequency, the EM signal **1304** is down-converted to an intermediate signal.

The optional energy transfer signal module **6902** can be implemented in hardware, software, firmware, or any combination thereof.

#### 4.2 The Energy Transfer System as an Inverted Gated Transfer System

FIG. **64B** illustrates an exemplary inverted gated transfer system **6406**, which is an exemplary implementation of the energy transfer system **6302**. The inverted gated transfer system **6406** includes an inverted gated transfer module **6408**, which receives the EM signal **1304** and the energy transfer signal **6306**. The energy transfer signal **6306** includes a train of energy transfer pulses having non-negligible apertures that tend away from zero time in duration. The energy transfer pulses repeat at an aliasing rate  $F_{AR}$ . The inverted gated transfer module **6408** transfers energy from the EM signal **1304** at the aliasing rate of the energy transfer signal **6306**, as described in the sections above with respect to the flowcharts **4601** in FIG. **46A**, **4607** in FIG. **46B**, **4613** in FIG. **46C** and **4619** in FIG. **46D**. The inverted gated transfer module **6408** outputs the down-converted signal **1308B**, which includes non-negligible amounts of energy transferred from the EM signal **1304**.

##### 4.2.1 The Inverted Gated Transfer System as a Switch Module and a Storage Module

FIG. **74** illustrates an example embodiment of the inverted gated transfer module **6408** as including a switch module **7404** and a storage module **7406**. Preferably, the switch module **7404** and the storage module **7406** transfer energy from the EM signal **1304** to down-convert it in any of the manners shown in the operational flowcharts **4601** in FIG. **46A**, **4607** in FIG. **46B**, **4613** in FIG. **46C** and **4619** in FIG. **46D**.

The switch module **7404** can be implemented as described above with reference to FIGS. **66A–D**. The storage module **7406** can be implemented as described above with reference to FIGS. **68A–F**.

In the illustrated embodiment, the storage module **7206** includes one or more capacitors **7408**. The capacitor(s) **7408** are selected to pass higher frequency components of the EM

signal **1304** through to a terminal **7410**, regardless of the state of the switch module **7404**. The capacitor **7408** stores non-negligible amounts of energy from the EM signal **1304**. Thereafter, the signal at the terminal **7410** is off-set by an amount related to the energy stored in the capacitor **7408**.

Operation of the inverted gated transfer system **7401** is illustrated in FIGS. **75A–F**. FIG. **75A** illustrates the EM signal **1304**. FIG. **75B** illustrates the EM signal **1304** after transferring energy from it. FIG. **75C** illustrates the energy transfer signal **6306**, which includes a train of energy transfer pulses having non-negligible apertures.

FIG. **75D** illustrates an example down-converted signal **1308B**. FIG. **75E** illustrates the down-converted signal **1308B** on a compressed time scale. Since the storage module **7406** is a series element, the higher frequencies (e.g., RF) of the EM signal **1304** can be seen on the down-converted signal. This can be filtered as illustrated in FIG. **75F**.

The inverted gated transfer system **7401** can be used to down-convert any type of EM signal, including modulated carrier signals and unmodulated carrier signals.

#### 4.3 Other Implementations

The implementations described above are provided for purposes of illustration. These implementations are not intended to limit the invention. Alternate implementations, differing slightly or substantially from those described herein, will be apparent to persons skilled in the relevant art(s) based on the teachings contained herein. Such alternate implementations fall within the scope and spirit of the present invention.

#### 5. Optional Optimizations of Energy Transfer at an Aliasing Rate

The methods and systems described in sections above can be optimized with one or more of the optimization methods or systems described below.

##### 5.1 Doubling the Aliasing Rate ( $F_{AR}$ ) of the Energy Transfer Signal

In an embodiment, the optional energy transfer signal module **6902** in FIG. **69** includes a pulse generator module that generates aliasing pulses at twice the frequency of the oscillating source. The input signal **6828** may be any suitable oscillating source.

FIG. **71** illustrates a circuit **7102** that generates a doubler output signal **7104** (FIG. **72B**) that may be used as an energy transfer signal **6306**. The circuit **7102** generates pulses on both rising and falling edges of the input oscillating signal **7106** of FIG. **72A**. The circuit **7102** can be implemented as a pulse generator and aliasing rate ( $F_{AR}$ ) doubler. The doubler output signal **7104** can be used as the energy transfer signal **6306**.

In the example of FIG. **71**, the aliasing rate is twice the frequency of the input oscillating signal  $F_{OSC}$  **7106**, as shown by EQ. (9) below.

$$F_{AR}=2 \cdot F_{OSC} \quad \text{EQ. (9)}$$

The aperture width of the aliasing pulses is determined by the delay through a first inverter **7108** of FIG. **71**. As the delay is increased, the aperture is increased. A second inverter **7112** is shown to maintain polarity consistency with examples described elsewhere. In an alternate embodiment inverter **7112** is omitted. Preferably, the pulses have non-negligible aperture widths that tend away from zero time. The doubler output signal **7104** may be further conditioned is appropriate to drive the switch module with non-negligible aperture pulses. The circuit **7102** may be implemented with integrated circuitry, discretely, with equivalent logic circuitry, or with any valid fabrication technology.



## 5.2 Differential Implementations

The invention can be implemented in a variety of differential configurations. Differential configurations are useful for reducing common mode noise. This can be very useful in receiver systems where common mode interference can be caused by intentional or unintentional radiators such as cellular phones, CB radios, electrical appliances etc. Differential configurations are also useful in reducing any common mode noise due to charge injection of the switch in the switch module or due to the design and layout of the system in which the invention is used. Any spurious signal that is induced in equal magnitude and equal phase in both input leads of the invention will be substantially reduced or eliminated. Some differential configurations, including some of the configurations below, are also useful for increasing the voltage and/or for increasing the power of the down-converted signal **1308B**. While an example of a differential energy transfer module is shown below, the example is shown for the purpose of illustration, not limitation. Alternate embodiments (including equivalents, extensions, variations, deviations etc.) of the embodiment described herein will be apparent to those skilled in the relevant art based on the teachings contained herein. The invention is intended and adapted to include such alternate embodiments.

FIG. **76A** illustrates a differential system **7602** that can be included in the energy transfer module **6304**. The differential system **7602** includes an inverted gated transfer design similar to that described with reference to FIG. **74**. The differential system **7602** includes inputs **7604** and **7606** and outputs **7608** and **7610**. The differential system **7602** includes a first inverted gated transfer module **7612**, which includes a storage module **7614** and a switch module **7616**. The differential system **7602** also includes a second inverted gated transfer module **7618**, which includes a storage module **7620** and a switch module **7616**, which it shares in common with inverted gated transfer module **7612**.

One or both of the inputs **7604** and **7606** are coupled to an EM signal source. For example, the inputs can be coupled to an EM signal source, wherein the input voltages at the inputs **7604** and **7606** are substantially equal in amplitude but 180 degrees out of phase with one another. Alternatively, where dual inputs are unavailable, one of the inputs **7604** and **7606** can be coupled to ground.

In operation, when the switch module **7616** is closed, the storage modules **7614** and **7620** are in series and, provided they have similar capacitive values, accumulate charge of equal magnitude but opposite polarities. When the switch module **7616** is open, the voltage at the output **7608** is relative to the input **7604**, and the voltage at the output **7610** is relative to the voltage at the input **7606**.

Portions of the signals at the outputs **7608** and **7610** include signals resulting from energy stored in the storage modules **7614** and **7620**, respectively, when the switch module **7616** was closed. The portions of the signals at the outputs **7608** and **7610** resulting from the stored charge are generally equal in amplitude to one another but 180 degrees out of phase.

Portions of the signals at the outputs **7608** and **7610** also include ripple voltage or noise resulting from the switching action of the switch module **7616**. But because the switch module is positioned between the two outputs **7608** and **7610**, the noise introduced by the switch module appears at the outputs as substantially equal and in-phase with one another. As a result, the ripple voltage can be substantially canceled out by inverting the signal at one of the outputs **7608** or **7610** and adding it to the other remaining output.

Additionally, any noise that is impressed with equal amplitude and equal phase onto the input terminals **7604** and **7606** by any other noise sources will tend to be canceled in the same way.

The differential system **7602** is most effective when used with a differential front end (inputs) and a differential back end (outputs). It can also be utilized in the following configurations, for example:

- a) A single-input front end and a differential back end; and
- b) A differential front end and a single-output back end.

Examples of these system are provided below.

### 5.2.1 Differential Input-to-Differential Output

FIG. **76B** illustrates the differential system **7602** wherein the inputs **7604** and **7606** are coupled to equal and opposite EM signal sources, illustrated here as dipole antennas **7624** and **7626**. In this embodiment, when one of the outputs **7608** or **7610** is inverted and added to the other output, the common mode noise due to the switching module **7616** and other common mode noise present at the input terminals **7604** and **7606** tend to substantially cancel out.

### 5.2.2 Single Input-to-Differential Output

FIG. **76C** illustrates the differential system **7602** wherein the input **7604** is coupled to an EM signal source such as a monopole antenna **7628** and the input **7606** is coupled to ground. In this configuration, the voltages at the outputs **7608** and **7610** are approximately one half the value of the voltages at the outputs in the implementation illustrated in FIG. **76B**, given all other parameters are equal.

FIG. **76E** illustrates an example single input to differential output receiver/down-converter system **7636**. The system **7636** includes the differential system **7602** wherein the input **7606** is coupled to ground as in FIG. **76C**. The input **7604** is coupled to an EM signal source **7638** through an optional input impedance match **7642**. The EM signal source impedance can be matched with an impedance match system **7642** as described in section 5 below.

The outputs **7608** and **7610** are coupled to a differential circuit **7644** such as a filter, which preferably inverts one of the outputs **7608** or **7610** and adds it to the other output **7608** or **7610**. This substantially cancels common mode noise generated by the switch module **7616**. The differential circuit **7644** preferably filters the higher frequency components of the EM signal **1304** that pass through the storage modules **7614** and **7620**. The resultant filtered signal is output as the down-converted signal **1308B**.

### 5.2.3 Differential Input-to-Single Output

FIG. **76D** illustrates the differential input to single output system **7629** wherein the inputs **7604** and **7606** of the differential system **7602** are coupled to equal and opposite EM signal dipole antennas **7630** and **7632**. In system **7629**, the common mode noise voltages are not canceled as in systems shown above. The output is coupled from terminal **7608** to a load **7648**.

### 5.3 Smoothing the Down-Converted Signal

The down-converted signal **1308B** may be smoothed by filtering as desired. The differential circuit **7644** implemented as a filter in FIG. **76E** illustrates but one example. This may be accomplished in any of the described embodiments by hardware, firmware and software implementation as is well known by those skilled in the arts.

### 5.4 Impedance Matching

The energy transfer module has input and output impedances generally defined by (1) the duty cycle of the switch module, and (2) the impedance of the storage module, at the frequencies of interest (e.g. at the EM input, and intermediate/baseband frequencies).

Starting with an aperture width of approximately  $\frac{1}{2}$  the period of the EM signal being down-converted as a preferred



embodiment, this aperture width (e.g. the “closed time”) can be decreased. As the aperture width is decreased, the characteristic impedance at the input and the output of the energy transfer module increases. Alternatively, as the aperture width increases from  $\frac{1}{2}$  the period of the EM signal being down-converted, the impedance of the energy transfer module decreases.

One of the steps in determining the characteristic input impedance of the energy transfer module could be to measure its value. In an embodiment, the energy transfer module’s characteristic input impedance is 300 ohms. An impedance matching circuit can be utilized to efficiently couple an input EM signal that has a source impedance of, for example, 50 ohms, with the energy transfer module’s impedance of, for example, 300 ohms. Matching these impedances can be accomplished in various manners, including providing the necessary impedance directly or the use of an impedance match circuit as described below.

Referring to FIG. 70, a specific embodiment using an RF signal as an input, assuming that the impedance 7012 is a relatively low impedance of approximately 50 Ohms, for example, and the input impedance 7016 is approximately 300 Ohms, an initial configuration for the input impedance match module 7006 can include an inductor 7306 and a capacitor 7308, configured as shown in FIG. 73. The configuration of the inductor 7306 and the capacitor 7308 is a possible configuration when going from a low impedance to a high impedance. Inductor 7306 and the capacitor 7308 constitute an L match, the calculation of the values which is well known to those skilled in the relevant arts.

The output characteristic impedance can be impedance matched to take into consideration the desired output frequencies. One of the steps in determining the characteristic output impedance of the energy transfer module could be to measure its value. Balancing the very low impedance of the storage module at the input EM frequency, the storage module should have an impedance at the desired output frequencies that is preferably greater than or equal to the load that is intended to be driven (for example, in an embodiment, storage module impedance at a desired 1 MHz output frequency is 2K ohm and the desired load to be driven is 50 ohms). An additional benefit of impedance matching is that filtering of unwanted signals can also be accomplished with the same components.

In an embodiment, the energy transfer module’s characteristic output impedance is 2K ohms. An impedance matching circuit can be utilized to efficiently couple the down-converted signal with an output impedance of, for example, 2K ohms, to a load of, for example, 50 ohms. Matching these impedances can be accomplished in various manners, including providing the necessary load impedance directly or the use of an impedance match circuit as described below.

When matching from a high impedance to a low impedance, a capacitor 7314 and an inductor 7316 can be configured as shown in FIG. 73. The capacitor 7314 and the inductor 7316 constitute an L match, the calculation of the component values being well known to those skilled in the relevant arts.

The configuration of the input impedance match module 7006 and the output impedance match module 7008 are considered to be initial starting points for impedance matching, in accordance with the present invention. In some situations, the initial designs may be suitable without further optimization. In other situations, the initial designs can be optimized in accordance with other various design criteria and considerations.

As other optional optimizing structures and/or components are utilized, their affect on the characteristic imped-

ance of the energy transfer module should be taken into account in the match along with their own original criteria. 5.5 Tanks and Resonant Structures

Tanks and resonant circuits can be used to further optimize the energy transfer characteristics of the invention. An example embodiment is shown in FIG. 94A. Alternate implementations will be apparent to persons skilled in the relevant art(s) based on the teachings contained herein. Alternate implementations fall within the scope and spirit of the present invention. This embodiment takes advantage of the properties of series and parallel (tank) resonant circuits.

A first parallel resonant or tank circuit consists of a capacitor 9438 and an inductor 9420 (tank1). A second tank circuit consists of a capacitor 9434 and an inductor 9436 (tank2). In the illustrated example, the first and second tank circuits resonate at approximately 920 Mhz. At and near resonance, the impedance of these circuits is relatively high. Therefore, in the circuit configuration shown in FIG. 94A, both tank circuits appear as relatively high impedance to the input frequency of 950 Mhz, while simultaneously appearing as relatively low impedance to frequencies in the desired output range of 50 Mhz.

An energy transfer signal 9442 controls a switch 9414. When the energy transfer signal 9442 controls the switch 9414 to open and close, high frequency signal components are not allowed to pass through tank1 or tank 2. However, the lower signal components (50 Mhz in this embodiment) generated by the system are allowed to pass through tank1 and tank2 with little attenuation. The effect of tank1 and tank 2 is to further separate the input and output signals from the same node thereby producing a more stable input and output impedance. Capacitors 9418 and 9440 act to store the 50 Mhz output signal energy between energy transfer pulses.

Further energy transfer optimization is provided by placing an inductor 9410 in series with a storage capacitor 9412 as shown. In the illustrated example, the series resonant frequency of this circuit arrangement is approximately 1 GHz. This circuit increases the energy transfer characteristic of the system. The ratio of the impedance of inductor 9410 and the impedance of the storage capacitor 9412 is preferably kept relatively small so that the majority of the energy available will be transferred to storage capacitor 9412 during operation. Exemplary output signals A and B are illustrated in FIGS. 94B and 94C, respectively.

In FIG. 94A, circuit components 9404 and 9406 form an input impedance match. Circuit components 9432 and 9430 form an output impedance match into a 50 ohm resistor 9428. Circuit components 9422 and 9424 form a second output impedance match into a 50 ohm resistor 9426. Capacitors 9408 and 9412 act as storage capacitors for the embodiment. Voltage source 9446 and resistor 9402 generate a 950 Mhz signal with a 50 ohm output impedance, which are used as the input to the circuit. Circuit element 9416 includes a 150 Mhz oscillator and a pulse generator, which are used to generate the energy transfer signal 9442.

The example tank and resonant structures described above are for illustrative purposes and are not limiting. Alternate configurations can be utilized.

5.6 Optimizing and Adjusting the Non-Negligible Aperture Width/Duration

In an embodiment of the invention, the energy transfer signal 6306 of FIG. 63 is used to vary the input impedance seen by the EM Signal 1304 and to vary the output impedance driving a load. An example of this embodiment is described below using the gated transfer module 6404 shown in FIG. 68G, and in FIG. 82A. The method described below is not limited to the gated transfer module 6404, as it can be applied to all of the embodiments of energy transfer module 6304.

In FIG. 82A, when switch 8206 is closed, the impedance looking into circuit 8202 is substantially the impedance of storage module illustrated as the storage capacitance 8208, in parallel with the impedance of the load 8212. When the switch 8206 is open, the impedance at point 8214 approaches infinity. It follows that the average impedance at point 8214 can be varied from the impedance of the storage module illustrated as the storage capacitance 8208, in parallel with the load 8212, to the highest obtainable impedance when switch 8206 is open, by varying the ratio of the time that switch 8206 is open to the time switch 8206 is closed. Since the switch 8206 is controlled by the energy transfer signal 8210, the impedance at point 8214 can be varied by controlling the aperture width of the energy transfer signal, in conjunction with the aliasing rate.

An example method of altering the energy transfer signal 6306 of FIG. 63 is now described with reference to FIG. 71, where the circuit 7102 receives the input oscillating signal 7106 and outputs a pulse train shown as doubler output signal 7104. The circuit 7102 can be used to generate the energy transfer signal 6306. Example waveforms of 7104 are shown on FIG. 72B.

It can be shown that by varying the delay of the signal propagated by the inverter 7108, the width of the pulses in the doubler output signal 7104 can be varied. Increasing the delay of the signal propagated by inverter 7108, increases the width of the pulses. The signal propagated by inverter 7108 can be delayed by introducing a R/C low pass network in the output of inverter 7108. Other means of altering the delay of the signal propagated by inverter 7108 will be well known to those skilled in the art.

As can now be readily seen from this disclosure; many of the aperture circuits presented, and others, can be modified in the manner described above (e.g. circuits in FIGS. 68 H–K). Modification or selection of the aperture can be done at the design level to remain a fixed value in the circuit, or in an alternative embodiment, may be dynamically adjusted to compensate for, or address, various design goals such as receiving RF signals with enhanced efficiency that are in distinctively different bands of operation, e.g. RF signals at 900 MHz and 1.8 GHz.

### 5.7 Adding a Bypass Network

In an embodiment of the invention, a bypass network is added to improve the efficiency of the energy transfer module. For example, referring to FIG. 95 a bypass network 9502 (shown in this instance as capacitor 9512), is shown bypassing switch module 9504. In this embodiment the bypass network increases the efficiency of the energy transfer module when, for example, less than optimal aperture widths were chosen for a given input frequency on the energy transfer signal 9506. The bypass network 9502 could be of different configurations than shown in FIG. 95. Such an alternate is illustrated in FIG. 90.

### 5.8 Modifying the Energy Transfer Signal Utilizing Feedback

FIG. 69 shows an embodiment of a system 6901 which uses down-converted Signal 1308B as feedback 6906 to control various characteristics of the energy transfer module 6304 to modify the down-converted signal 1308B.

Generally, the amplitude of the down-converted signal 1308B varies as a function of the frequency and phase differences between the EM signal 1304 and the energy transfer signal 6306. In an embodiment, the down-converted signal 1308B is used as the feedback 6906 to control the frequency and phase relationship between the EM signal 1304 and the energy transfer signal 6306. This can be accomplished using the example logic in FIG. 85A. The

example circuit in FIG. 85A can be included in the energy transfer signal module 6902. Alternate implementations will be apparent to persons skilled in the relevant art(s) based on the teachings contained herein. Alternate implementations fall within the scope and spirit of the present invention. In this embodiment a state-machine is used as an example.

In the example of FIG. 85A, a state machine 8504 reads an analog to digital converter, A/D 8502, and controls a digital to analog converter, DAC 8506. In an embodiment, the state machine 8504 includes 2 memory locations, Previous and Current, to store and recall the results of reading A/D 8502. In an embodiment, the state machine 8504 utilizes at least one memory flag.

The DAC 8506 controls an input to a voltage controlled oscillator, VCO 8508. VCO 8508 controls a frequency input of a pulse generator 8510, which, in an embodiment, is substantially similar to the pulse generator shown in FIG. 68J. The pulse generator 8510 generates energy transfer signal 6306.

In an embodiment, the state machine 8504 operates in accordance with a state machine flowchart 8519 in FIG. 85B. The result of this operation is to modify the frequency and phase relationship between the energy transfer signal 6306 and the EM signal 1304, to substantially maintain the amplitude of the down-converted signal 1308B at an optimum level.

The amplitude of the down-converted signal 1308B can be made to vary with the amplitude of the energy transfer signal 6306. In an embodiment where the switch module 6502 is a FET is shown in FIG. 66A, wherein the gate 6604 receives the energy transfer signal 6306, the amplitude of the energy transfer signal 6306 can determine the “on” resistance of the FET, which affects the amplitude of the down-converted signal 1308B. The energy transfer signal module 6902, as shown in FIG. 85C, can be an analog circuit that enables an automatic gain control function. Alternate implementations will be apparent to persons skilled in the relevant art(s) based on the teachings contained herein. Alternate implementations fall within the scope and spirit of the present invention.

### 5.9 Other Implementations

The implementations described above are provided for purposes of illustration. These implementations are not intended to limit the invention. Alternate implementations, differing slightly or substantially from those described herein, will be apparent to persons skilled in the relevant art(s) based on the teachings contained herein. Such alternate implementations fall within the scope and spirit of the present invention.

### 6. Example Energy Transfer Downconverters

Example implementations are described below for illustrative purposes. The invention is not limited to these examples.

FIG. 86 is a schematic diagram of an exemplary circuit to down convert a 915 MHz signal to a 5 MHz signal using a 101.1 MHz clock.

FIG. 87 shows example simulation waveforms for the circuit of FIG. 86. Waveform 8602 is the input to the circuit showing the distortions caused by the switch closure. Waveform 8604 is the unfiltered output at the storage unit. Waveform 8606 is the impedance matched output of the downconverter on a different time scale.

FIG. 88 is a schematic diagram of an exemplary circuit to downconvert a 915 MHz signal to a 5 MHz signal using a 101.1 MHz clock. The circuit has additional tank circuitry to improve conversion efficiency.

FIG. 89 shows example simulation waveforms for the circuit of FIG. 88. Waveform 8802 is the input to the circuit

showing the distortions caused by the switch closure. Waveform **8804** is the unfiltered output at the storage unit. Waveform **8806** is the output of the downconverter after the impedance match circuit.

FIG. **90** is a schematic diagram of an exemplary circuit to downconvert a 915 MHz signal to a 5 MHz signal using a 101.1 MHz clock. The circuit has switch bypass circuitry to improve conversion efficiency.

FIG. **91** shows example simulation waveforms for the circuit of FIG. **90**. Waveform **9002** is the input to the circuit showing the distortions caused by the switch closure. Waveform **9004** is the unfiltered output at the storage unit. Waveform **9006** is the output of the downconverter after the impedance match circuit.

FIG. **92** shows a schematic of the example circuit in FIG. **86** connected to an FSK source that alternates between 913 and 917 MHz, at a baud rate of 500 Kbaud. FIG. **93** shows the original FSK waveform **9202** and the downconverted waveform **9204** at the output of the load impedance match circuit.

#### IV. Additional Embodiments

Additional aspects/embodiments of the invention are considered in this section.

In one embodiment of the present invention there is provided a method of transmitting information between a transmitter and a receiver comprising the steps of transmitting a first series of signals each having a known period from the transmitter at a known first repetition rate; sampling by the receiver each signal in the first series of signals a single time and for a known time interval the sampling of the first series of signals being at a second repetition rate that is a rate different from the first repetition rate by a known amount; and generating by the receiver an output signal indicative of the signal levels sampled in step B and having a period longer than the known period of a transmitted signal.

In another embodiment of the invention there is provided a communication system comprising a transmitter means for transmitting a first series of signals of known period at a known first repetition rate, a receiver means for receiving the first series of signals, the receiver means including sampling means for sampling the signal level of each signal first series of signals for a known time interval at a known second repetition rate, the second repetition rate being different from the first repetition rate by a known amount as established by the receiver means. The receiver means includes first circuit means for generating a first receiver output signal indicative of the signal levels sampled and having a period longer than one signal of the first series of signals. The transmitter means includes an oscillator for generating an oscillator output signal at the first repetition rate, switch means for receiving the oscillator output signal and for selectively passing the oscillator output signal, waveform generating means for receiving the oscillator output signal for generating a waveform generator output signal having a time domain and frequency domain established by the waveform generating means.

The embodiment of the invention described herein involves a single or multi-user communications system that utilizes coherent signals to enhance the system performance over conventional radio frequency schemes while reducing cost and complexity. The design allows direct conversion of radio frequencies into baseband components for processing and provides a high level of rejection for signals that are not related to a known or controlled slew rate between the transmitter and receiver timing oscillators. The system can be designed to take advantage of broadband techniques that further increase its reliability and permit a high user density

within a given area. The technique employed allows the system to be configured as a separate transmitter-receiver pair or a transceiver.

The basic objectives of the present system is to provide a new communication technique that can be applied to both narrow and wide band systems. In its most robust form, all of the advantages of wide band communications are an inherent part of the system and the invention does not require complicated and costly circuitry as found in conventional wide band designs. The communications system utilizes coherent signals to send and receive information and consists of a transmitter and a receiver in its simplest form. The receiver contains circuitry to turn its radio frequency input on and off in a known relationship in time to the transmitted signal. This is accomplished by allowing the transmitter timing oscillator and the receiver timing oscillator to operate at different but known frequencies to create a known slew rate between the oscillators. If the slew rate is small compared to the timing oscillator frequencies, the transmitted waveform will appear stable in time, i.e., coherent (moving at the known slew rate) to the receiver's switched input. The transmitted waveform is the only waveform that will appear stable in time to the receiver and thus the receiver's input can be averaged to achieve the desired level filtering of unwanted signals. This methodology makes the system extremely selective without complicated filters and complex encoding and decoding schemes and allows the direct conversion of radio frequency energy from an antenna or cable to baseband frequencies with a minimum number of standard components further reducing cost and complexity. The transmitted waveform can be a constant carrier (narrowband), a controlled pulse (wideband and ultra-wideband) or a combination of both such as a damped sinusoidal wave and or any arbitrary periodic waveform thus the system can be designed to meet virtually any bandwidth requirement. Simple standard modulation and demodulation techniques such as AM and Pulse Width Modulation can be easily applied to the system.

Depending on the system requirements such as the rate of information transfer, the process gain, and the intended use, there are multiple preferred embodiments of the invention. The embodiment discussed herein will be the amplitude and pulse width modulated system. It is one of the simplest implementations of the technology and has many common components with the subsequent systems. A amplitude modulated transmitter consists of a Transmitter Timing Oscillator, a Multiplier, a Waveform Generator, and an Optional Amplifier. The Transmitter Timing Oscillator frequency can be determined by a number of resonate circuits including an inductor and capacitor, a ceramic resonator, a SAW resonator, or a crystal. The output waveform is sinusoidal, although a squarewave oscillator would produce identical system performance.

The Multiplier component multiplies the Transmitter Timing Oscillator output signal by 0 or 1 or other constants, K1 and K2, to switch the oscillator output on and off to the Waveform Generator. In this embodiment, the information input can be digital data or analog data in the form of pulse width modulation. The Multiplier allows the Transmitter Timing Oscillator output to be present at the Waveform Generator input when the information input is above a predetermined value. In this state the transmitter will produce an output waveform. When the information input is below a predetermined value, there is no input to the Waveform Generator and thus there will be no transmitter output waveform. The output of the Waveform Generator determines the system's bandwidth in the frequency domain

and consequently the number of users, process gain immunity to interference and overall reliability), the level of emissions on any given frequency, and the antenna or cable requirements. The Waveform Generator in this example creates a one cycle pulse output which produces an ultra-wideband signal in the frequency domain. An optional power Amplifier stage boosts the output of the Waveform Generator to a desired power level.

With reference now to the drawings, the amplitude and pulse width modulated transmitter in accord with the present invention is depicted at numeral **9100** in FIGS. **96** and **97**. The Transmitter Timing Oscillator **9602** is a crystal-controlled oscillator operating at a frequency of 25 MHz. Multiplier **9604** includes a two-input NAND gate **9202** controlling the gating of oscillator **9602** output to Waveform Generator **9606**. Waveform Generator **9606** produces a pulse output as depicted at **9808** in FIGS. **98A–98D** and **99**, which produces a frequency spectrum **10002** in FIG. **100**. Amplifier **9608** is optional. The transmitter **9600** output is applied to antenna or cable **9610**, which as understood in the art, may be of various designs as appropriate in the circumstances.

FIGS. **98A–98D**, **99** and **100** illustrate the various signals present in transmitter **9600**. The output of transmitter **9600** in FIG. **98A** may be either a sinusoidal or squarewave signal **9802** that is provided as one input into NAND gate **9702**. Gate **9702** also receives an information signal **9804** in FIG. **98B** which, in the embodiment shown, is digital in form. The output **9806** of Multiplier **9604** can be either sinusoidal or squarewave depending upon the original signal **9802**. Waveform Generator **9606** provides an output of a single cycle impulse signal **9808**. The single cycle impulse **9810** varies in voltage around a static level **9812** and is created at 40 nanoseconds intervals. In the illustrated embodiment, the frequency of transmitter **9602** is 25 MHz and accordingly, one cycle pulses of 1.0 GHz are transmitted every 40 nanoseconds during the total time interval that gate **9702** is “on” and passes the output of transmitter oscillator **9602**.

FIG. **101** shows the preferred embodiment receiver block diagram to recover the amplitude or pulse width modulated information and consists of a Receiver Timing Oscillator **10110**, Waveform Generator **10108**, RF Switch Fixed or Variable Integrator **10106**, Decode Circuit **10114**, two optional Amplifier/Filter stages **10104** and **10112**, antenna or cable input **10102**, and Information Output **10116**. The Receiver Timing Oscillator **10110** frequency can be determined by a number of resonate circuits including an inductor and capacitor, a ceramic resonator, a SAW resonator, or a crystal. As in the case of the transmitter, the oscillator **10110** shown here is a crystal oscillator. The output waveform is a squarewave, although a sinewave oscillator would produce identical system performance. The squarewave timing oscillator output **10202** is shown in FIG. **102A**. The Receiver Timing Oscillator **10110** is designed to operate within a range of frequencies that creates a known range of slew rates relative to the Transmitter Timing Oscillator **9602**. In this embodiment, the Transmitter Timing Oscillator **9602** frequency is 25 MHz and the Receiver Timing Oscillator **10110** outputs between 25.0003 MHz and 25.0012 MHz which creates a +300 to +1200 Hz slew rate.

The Receiver Timing Oscillator **10110** is connected to the Waveform Generator **10108** which shapes the oscillator signal into the appropriate output to control the amount of the time that the RF switch **10106** is on and off. The on-time of the RF switch **10106** should be less than  $\frac{1}{2}$  of a cycle ( $\frac{1}{10}$  of a cycle is preferred) or in the case of a single pulse, no wider than the pulse width of the transmitted waveform or

the signal gain of the system will be reduced. Examples are illustrated in Table A1. Therefore the output of the Waveform Generator **10108** is a pulse of the appropriate width that occurs once per cycle of the receiver timing oscillator **10110**. The output **10204** of the Waveform Generator is shown in FIG. **102B**.

TABLE A1

Transmitted Waveform	Gain Limit on-time	Preferred on-time
Single 1 nanosecond pulse	1 nanosecond	100 picoseconds
1 Gigahertz 1,2,3 . . . etc. cycle	500 picoseconds	50 picoseconds
10 Gigahertz 1,2,3 . . . etc. cycle	50 picoseconds	5 picoseconds

The RF Switch/Integrator **10106** samples the RF signal **10206** shown in FIG. **102C** when the Waveform Generator output **10207** is below a predetermined value. When the Waveform Generator output **10204** is above a predetermined value, the RF Switch **10106** becomes a high impedance node and allows the Integrator to hold the last RF signal sample **10206** until the next cycle of the Waveform Generator **10108** output. The Integrator section of **10106** is designed to charge the Integrator quickly (fast attack) and discharge the Integrator at a controlled rate (slow decay). This embodiment provides unwanted signal rejection and is a factor in determining the baseband frequency response of the system. The sense of the switch control is arbitrary depending on the actual hardware implementation.

In an embodiment of the present invention, the gating or sampling rate of the receiver **10100** is 300 Hz higher than the 25 MHz transmission rate from the transmitter **9600**. Alternatively, the sampling rate could be less than the transmission rate. The difference in repetition rates between the transmitter **9600** and receiver **10100**, the “slew rate,” is 300 Hz and results in a controlled drift of the sampling pulses over the transmitted pulse which thus appears “stable” in time to the receiver **10100**. With reference now to FIGS. **98A–98D** and **102A–102G**, an example is illustrated for a simple case of an output signal **10208** (FIG. **102D**) that is constructed of four samples from four RF input pulses **10206** for ease of explanation. As can be clearly seen, by sampling the RF pulses **10206** passed when the transmitter information signal **9804** (FIG. **98B**) is above a predetermined threshold the signal **10208** is a replica of a signal **10206** but mapped into a different time base. In the case of this example, the new time base has a period four times longer than real time signal. The use of an optional amplifier/filter **10112** results in a further refinement of the signal **10208** which is present in FIG. **102E** as signal **10210**.

Decode Circuitry **10114** extracts the information contained in the transmitted signal and includes a Rectifier that rectifies signal **10208** or **10210** to provide signal **10212** in FIG. **102G**. The Variable Threshold Generator circuitry in circuit **10114** provides a DC threshold signal level **10214** for signal **10210** that is used to determine a high (transmitter output on) or low (transmitter output off) and is shown in FIG. **102G**. The final output signal **10216** in FIG. **102F** is created by an output voltage comparator in circuit **10114** that combines signals **10212** and **10114** such that when the signal **10212** is a higher voltage than signal **10214**, the information output signal goes high. Accordingly, signal **10216** represents, for example, a digital “1” that is now time-based to a 1:4 expansion of the period of an original signal **10206**. While this illustration provides a 4:1 reduction in frequency, it is sometimes desired to provide a reduction of more than 50,000:1; in the preferred embodiment, 100,000:1 or greater

is achieved. This results in a shift directly from RF input frequency to low frequency baseband without the requirement of expensive intermediate circuitry that would have to be used if only a 4:1 conversion was used as a first stage. Table A2 provides information as to the time base conversion and includes examples.

TABLE A2

---

Units  
 $s = 1$     $ps = 1 \cdot 10^{12}$     $ns = 1 \cdot 10^{-9}$     $us = 1 \cdot 10^{-6}$     $MHz = 1 \cdot 10^6$     $KHz = 1 \cdot 10^3$   
Receiver Timing Oscillator Frequency = 25.0003 MHz  
Transmitter Timing Oscillator Frequency = 25 MHz

$$\text{period} = \frac{1}{\text{Transmitter Timing Oscillator Frequency}}$$

period = 40 ns

$$\text{slew rate} = \frac{1}{\frac{\text{Receiver Timing Oscillator Frequency} - \text{Transmitter Timing Oscillator Frequency}}$$

slew rate = 0.003 s

$$\text{time base multiplier} = \frac{\text{slew rate}}{\text{period}} \text{ seconds per nanosecond}$$

time base multiplier =  $8.333 \cdot 10^4$

Example 1:

1 nanosecond translates into 83.33 microseconds  
time base = (1 ns) · time base multiplier  
time base = 83.333 us

Example 2:

2 Gigahertz translates into 24 Kilohertz   2 Gigahertz = 500 picosecond period  
time base = (500 ps) · time base multiplier  
time base = 41.667 us

$$\text{frequency} = \frac{1}{\text{time base}}$$

frequency = 24 KHz

---

FIGS. 106–109 illustrate different pulse output signals 10602 and 10802 and their respective frequency domain at 10702 and 10902. As can be seen from FIGS. 106 and 107, the half-cycle signal 10602 generates a spectrum less subject to interference than the single cycle of FIG. 99 and the 10-cycle pulse of FIG. 108. The various outputs determine

In the illustrated preferred embodiment, the signal 10216 in FIG. 102F has a period of 83.33 usec, a frequency of 12 KHz and it is produced once every 3.3 msec for a 300 Hz slew rate. Stated another way, the system is converting a 1 gigahertz transmitted signal into an 83.33 microsecond signal.

Accordingly, the series of RF pulses 9810 that are transmitted during the presence of an “on” signal at the information input gate 9702 are used to reconstruct the information input signal 9804 by sampling the series of pulses at the receiver 10100. The system is designed to provide an adequate number of RF inputs 10206 to allow for signal reconstruction.

An optional Amplifier/Filter stage or stages 10104 and 10112 may be included to provide additional receiver sensitivity, bandwidth control or signal conditioning for the Decode Circuitry 10114. Choosing an appropriate time base multiplier will result in a signal at the output of the Integrator 10106 that can be amplified and filtered with operational amplifiers rather than RF amplifiers with a resultant simplification of the design process. The signal 10210 in FIG. 102E illustrates the use of Amplifier/Filter 10112 (FIG. 103). The optional RF amplifier 10104 shown as the first stage of the receiver should be included in the design when increased sensitivity and/or additional filtering is required. Example receiver schematics are shown in FIGS. 103–105.

the system’s immunity to interference, the number of users in a given area, and the cable and antenna requirements. FIGS. 99 and 100 illustrate example pulse outputs.

FIGS. 110 and 111 show example differential receiver designs. The theory of operation is similar to the non-differential receiver of FIG. 101 except that the differential technique provides an increased signal to noise ratio by means of common mode rejection. Any signal impressed in phase at both inputs on the differential receiver will attenuated by the differential amplifier shown in FIGS. 110 and 111 and conversely any signal that produces a phase difference between the receiver inputs will be amplified.

FIGS. 112 and 113 illustrate the time and frequency domains of a narrow band/constant carrier signal in contrast to the ultra-wide band signals used in the illustrated embodiment.

#### V. Conclusions

Example embodiments of the methods, systems, and components of the present invention have been described herein. As noted elsewhere, these example embodiments have been described for illustrative purposes only, and are not limiting. Other embodiments are possible and are covered by the invention. Such other embodiments include but are not limited to hardware, software, and software/hardware implementations of the methods, systems, and

components of the invention. Such other embodiments will be apparent to persons skilled in the relevant art(s) based on the teachings contained herein. Thus, the breadth and scope of the present invention should not be limited by any of the above-described exemplary embodiments, but should be defined only in accordance with the following claims and their equivalents.

What is claimed is:

1. A method for down-converting a carrier signal to a lower frequency signal, comprising the steps of:

- (1) receiving a carrier signal;
- (2) transferring non-negligible amounts of energy from the carrier signal, at an aliasing rate that is substantially equal to a frequency of the carrier signal plus or minus frequency of the lower frequency signal, divided by  $n$ , where  $n$  represents a harmonic or sub-harmonic of the carrier signal; and
- (3) generating a lower frequency signal from the transferred energy.

2. The method according to claim 1, wherein step (2) comprises the step of generating an energy transfer signal having the aliasing rate and using the energy transfer signal to transfer the energy from the carrier signal.

3. The method according to claim 2, wherein step (2) further comprises the step of generating a train of pulses having non-negligible apertures that tend away from zero time in duration.

4. The method according to claim 2, wherein step (2) further comprises the step of optimizing a phase of the energy transfer signal.

5. The method according to claim 2, wherein step (2) further comprises the step of optimizing the frequency of the energy transfer signal.

6. The method according to claim 1, wherein step (1) comprises the step of receiving an amplitude modulated carrier signal.

7. The method according to claim 1, wherein step (1) comprises the step of receiving a phase modulated carrier signal.

8. The method according to claim 1, wherein step (1) comprises the step of receiving a carrier signal having a frequency greater than 1 giga Hertz.

9. The method according to claim 1, wherein step (1) comprises the step of receiving a carrier signal having a frequency between 10 mega Hertz and 10 giga Hertz.

10. The method according to claim 1, wherein step (1) comprises the step of receiving the carrier signal through a relatively low input impedance path.

11. The method according to claim 1, wherein step (1) comprises the step of receiving the carrier signal through a relatively efficient power transfer path.

12. The method according to claim 1, wherein step (1) comprises the step of receiving the carrier signal through a substantially impedance matched input path.

13. The method according to claim 1, further comprising the step of:

providing the lower frequency signal directly to a relatively low impedance load.

14. The method according to claim 1, further comprising the step of:

providing the lower frequency signal directly to a load through a relatively efficient power transfer path.

15. The method according to claim 1, further comprising the step of:

providing the lower frequency signal to a load through substantially impedance matched path.

16. The method according to claim 1, wherein step (2) comprises the step of coupling the carrier signal to a reactive storage device at the aliasing rate.

17. The method according to claim 2, wherein step (2) comprises the step of generating the energy transfer signal without synchronizing it with the carrier signal.

18. The method according to claim 2, wherein step (2) comprises the step of generating the energy transfer signal without synchronizing it to a phase of the carrier signal.

19. The method according to claim 2, wherein step (2) comprises the step of generating the energy transfer signal independent of the carrier signal.

20. The method according to claim 2, wherein step (2) comprises the step of generating an asynchronous energy transfer signal having the aliasing rate and using the asynchronous energy transfer signal to transfer the energy from the carrier signal.

21. The method according to claim 20, wherein step (1) comprises the step of receiving the carrier signal through a relatively low input impedance path.

22. The method according to claim 20, wherein step (1) comprises the step of receiving the carrier signal through a relatively efficient power transfer path.

23. An apparatus for down-converting a carrier signal to a lower frequency signal, comprising:

- an energy transfer signal generator;
- a switch module controlled by said energy transfer signal generator; and

a storage module coupled to said switch module; wherein said storage module receives non-negligible amounts of energy transferred from a carrier signal at an aliasing rate that is substantially equal to a frequency of the carrier signal plus or minus a frequency of the lower frequency signal, divided by  $n$  where  $n$  represents a harmonic or sub-harmonic of the carrier signal, wherein a lower frequency signal is generated from the transferred energy.

24. The apparatus according to claim 23, wherein said circuit comprises:

- an input impedance match circuit coupled to an input of said apparatus.

25. The apparatus according to claim 23, wherein said circuit comprises:

- an output impedance match circuit coupled to an output of said apparatus.

26. The apparatus according to claim 23, wherein said switch module is coupled between input of said apparatus and said storage module.

27. The apparatus according to claim 23, wherein said circuit comprises:

- a tank circuit coupled between an input of said apparatus and said switch circuit.

28. The apparatus according to claim 23, wherein said circuit comprises:

- a feed forward circuit in parallel with said switch module.

29. The apparatus according to claim 23, wherein said storage module is coupled between an input of said apparatus and said switch module.

30. The apparatus according to claim 23, wherein said apparatus is tuned for at least on frequency greater than one giga Hertz.

31. The apparatus according to claim 23, wherein said apparatus is tuned for at least on frequency between 10 Mega Hertz and 10 Giga Hertz.

32. The apparatus according to claim 23, wherein said energy transfer signal generator comprises an asynchronous energy transfer signal generator.

33. The method according to claim 1, wherein step (2) comprises the step of gating the carrier signal according to a control signal comprising a stream of pulses, having non-negligible apertures, that repeat at the aliasing rate.

34. The method according to claim 33, wherein step (2) further comprises the step of optimizing the control signal based on the lower frequency signal.

35. The method according to claim 34, wherein step (2) further comprises the step of controlling a frequency relationship between the carrier signal and the control signal.

36. The method according to claim 34, wherein step (2) further comprises the step of controlling a phase relationship between the carrier signal and the control signal.

37. The method according to claim 34, wherein step (2) further comprises the step of controlling a frequency relationship and a phase relationship between the carrier signal and the control signal.

38. The method according to claim 33, wherein step (2) further comprises the step of gating the carrier signal according to an asynchronous control signal comprising a stream of pulses, having non-negligible apertures, that repeat at the aliasing rate.

39. The method according to claim 1, wherein step (2) further comprises the step of gating the carrier signal according to a control signal comprising a stream of pulses, having non-negligible apertures that are equal in duration to approximate half cycles of the carrier signal.

40. The method according to claim 1, wherein step (3) comprises the step of generating a analog lower frequency signal from the transferred energy.

41. The method according to claim 1, wherein step (2) comprises the steps of:

- (a) transferring a non-negligible portion of energy contained in a portion of the carrier signal; and
- (b) repeating step (2)(a) at the aliasing rate.

42. The method according to claim 41, wherein step (2)(a) comprises the step of transferring at least one tenth of one percent of the energy contained in a half period of the carrier signal.

43. The method according to claim 41, wherein step (2)(a) comprises the step of transferring at least one percent of the energy contained in a half period of the carrier signal.

44. The method according to claim 41, wherein step (2)(a) comprises the step of transferring at least ten percent of the energy contained in a half period of the carrier signal.

45. The method according to claim 41, wherein step (2)(a) comprises the step of transferring at least twenty five percent of the energy contained in a half period of the carrier signal.

46. The method according to claim 41, wherein step (2)(a) comprises the step of transferring at least fifty percent of the energy contained in a half period of the carrier signal.

47. The method according to claim 41, wherein step (2)(a) comprises the step of transferring at least seventy five percent of the energy contained in a half period of the carrier signal.

48. The method according to claim 41, wherein step (2)(a) comprises the step of transferring at least eighty percent of the energy contained in a half period of the carrier signal.

49. The method according to claim 41, wherein step (2)(a) comprises the step of transferring at least ninety percent of the energy contained in a half period of the carrier signal.

50. The method according to claim 41, wherein step (3) comprises the step of integrating the transferred energy and generating the lower frequency signal from the integrated energy.

51. The method according to claim 1, wherein step (3) comprises the step of integrating the transferred energy and generating the lower frequency signal from the transferred energy.

52. The method according to claim 1, wherein step (2) comprises the steps of:

- (a) transferring a substantial portion of energy contained in N periods of the carrier signal, wherein N equals A plus B, where A is a positive integer and B is approximately equal to a fraction of an integer; and
- (b) repeating step (2)(a) at the aliasing rate.

53. The method according to claim 52, wherein step (3) comprises the step of integrating the transferred energy and generating the lower frequency signal from the integrated energy.

54. The method according to claim 1, wherein step (2) comprises the step of transferring non-negligible amounts of energy from the carrier signal, at an aliasing rate that is substantially equal to a harmonic or sub-harmonic frequency of the carrier signal.

55. The method according to claim 1, wherein step (1) comprises the step of receiving a modulated carrier signal.

56. The method of claim 55, wherein step (3) comprises the step of generating a lower frequency modulated carrier signal from the transferred energy.

57. The method of claim 55, wherein step (3) comprises the step of generating a demodulated baseband signal from the transferred energy.

58. The method of claim 55, wherein step (1) comprises the step of receiving at least one of an amplitude modulated signal, a frequency modulated signal, and a phase modulated signal.

59. The method of claim 1, wherein step (1) comprises the step of receiving the carrier signal via a communication medium.

60. The method of claim 59, wherein step (1) further comprises the step of receiving the carrier signal via a wire communication medium.

61. The method of claim 1, wherein step (1) comprises the step of receiving an unmodulated carrier signal.

62. The method of claim 1, wherein step (3) comprises the step of generating an intermediate frequency signal from the transferred energy.

63. The method of claim 1, wherein step (3) comprises the step of generating a substantially zero frequency signal from the transferred energy.

64. The method of claim 1, wherein step (2) comprises the step of:

- (a) generating an energy transfer signal comprising a train of pulses, said pulses controlling opening and closing of a switch to transfer energy from the received carrier signal.

65. The method of claim 64, wherein step (2)(a) comprises the step of establishing apertures of said pulses to increase the time that said switch is closed, thereby reducing an impedance of said switch.

66. The method of claim 64, wherein step (2)(a) comprises the step of widening apertures of said pulses of said energy transfer signal by a non-negligible amount that tends away from zero time in duration to extend the time that said switch is closed, thereby increasing energy transferred from said carrier signal.

67. The method of claim 66, wherein step (2)(a) further comprises the step of widening said apertures of said pulses to one of:

- (I) a non-zero fraction of a period of said carrier signal; and
- (II) one or more periods of said carrier signal plus or minus a non-zero fraction of period of said carrier signal.

## 119

68. The method of claim 66, wherein step (2) further comprises the step of transferring sufficient energy from said carrier signal to drive loads without additional buffering or amplification, including high impedance loads and low impedance loads.

69. The method of claim 66, wherein said widening of said apertures of said pulses substantially prevents accurate voltage reproduction of said carrier signal during said apertures.

70. The method of claim 66, wherein step (2) further comprises the step of matching an impedance of said switch to a source impedance, thereby increasing energy transferred from said carrier signal.

71. The method of claim 64, wherein step (2) further comprises the step of matching an impedance of said switch to a load impedance, thereby increasing energy transferred from said carrier signal.

72. The method of claim 64, wherein step (2) further comprises the step of:

coupling said carrier signal to said switch via a resonant circuit, said resonant circuit storing energy from components of said carrier signal while said switch is open, and wherein energy stored in said resonant circuit is discharged via said switch while said switch is closed, thereby increasing energy transfer from said carrier signal.

73. The method of claim 72, wherein said resonant circuit is configured to appear as high impedance to a first range of frequencies including a frequency of said carrier signal, and configured to appear as a low impedance to a second range of frequencies including a frequency of said lower frequency signal, such that passage of components of said carrier signal in said first range of frequencies is impeded through said resonant circuit, and such that passage of components of said carrier signal in said second range of frequencies is not so impeded through said resonant circuit.

74. The method of claim 1, wherein step (2) comprises the step of:

(a) generating an energy transfer signal comprising a train of pulses, said pulses controlling opening and closing of a switch to transfer energy from said carrier signal; wherein step (2)(a) comprises the step of establishing apertures of said pulses to increase the time that said switch is closed, thereby reducing an impedance of said switch;

wherein step (2)(a) comprises the step of widening apertures of said pulses of said energy transfer signal by a non-negligible amount that tends away from zero time in duration to extend the time that said switch is closed, thereby increasing energy transferred from said carrier signal;

wherein said apertures of said pulses of said energy transfer signal are one of:

(I) a non-zero fraction of a period of said carrier signal; and

(II) one or more periods of said carrier signal plus or minus a non-zero fraction of a period of said carrier signal;

wherein energy transferred from said carrier signal is sufficient to drive loads without additional buffering or amplification, including high impedance loads and low impedance loads; and

wherein said widening of said apertures of said pulses substantially prevents accurate voltage reproduction of said carrier signal during said apertures.

75. The method of claim 74, wherein step (2) further comprises the step of:

## 120

matching an impedance of said switch to a source impedance, thereby increasing energy transferred from said carrier signal.

76. The method of claim 74, further comprising the step of:

matching an impedance of said switch to a load impedance, thereby increasing energy transferred from said carrier signal.

77. The method of claim 74, further comprising the step of:

transferring said carrier signal to said switch via a resonant circuit, said resonant circuit storing energy from components of said carrier signal while said switch is open, and wherein energy stored in said resonant circuit is discharged via said switch while said switch is closed thereby increasing energy transfer from said carrier signal.

78. The method of claim 77, wherein said resonant circuit is configured to appear as high impedance to a first range of frequencies including a frequency of said carrier signal, and configured to appear as a low impedance to a second range of frequencies including a frequency of said lower frequency signal, such that passage of components of said carrier signal in said first range of frequencies is impeded through said resonant circuit, and such that passage of components of said carrier signal in said second range of frequencies is not so impeded through said resonant circuit.

79. The method according to claim 1, wherein step (1) comprises the step of receiving a frequency modulated carrier signal.

80. The method according to claim 79, wherein step (3) comprises the step generating an intermediate frequency, frequency modulated signal, from the transferred energy.

81. The method according to claim 79, wherein step (3) comprises the step of generating an intermediate frequency, non-frequency modulated signal, from the transferred energy.

82. The method according to claim 79, wherein step (3) comprises the step of generating an intermediate frequency, amplitude modulated signal, from the transferred energy.

83. The method according to claim 79, wherein step (3) comprises the step of generating an intermediate frequency, phase modulated signal, from the transferred energy.

84. The method according to claim 1, wherein step (2) further comprises the step of generating an asynchronous energy transfer signal having a harmonic substantially equal to a frequency of the carrier signal minus a frequency of the lower frequency signal, and using the asynchronous energy transfer signal to transfer the energy from the carrier signal.

85. The method according to claim 2, wherein step (2) further comprises the step of controlling a sample and hold system with the energy transfer signal.

86. The method according to claim 85, wherein step (2) further comprises the step of using the energy transfer signal to control a switching device that couples the received carrier signal to a storage device.

87. The method according to claim 85, wherein step (3) comprises the step of integrating the transferred energy in the storage device.

88. The method according to claim 2, wherein step (2) further comprises the step of optimizing an amplitude of the energy transfer signal.

89. The method according to claim 3, wherein step (2) further comprises the step of optimizing an amplitude of the pulses.

90. The method according to claim 3, wherein step (2) further comprises the step of optimizing a shape of the pulses.



91. The method according to claim 2, wherein step (2) further comprises the step of optimizing the energy transfer signal based on the lower frequency signal.

92. The method according to claim 3, wherein step (2) further comprises the step of controlling a frequency relationship between the pulses and the carrier signal, based on the lower frequency signal.

93. The method according to claim 3, wherein step (2) further comprises the step of controlling a frequency relationship and a phase relationship between the pulses and the carrier signal, based on the lower frequency signal.

94. The method according to claim 2, wherein step (2) further comprises the step of optimizing an amplitude of the energy transfer signal, based on the lower frequency signal.

95. The method according to claim 3, wherein step (2) further comprises the step of optimizing an amplitude of the pulses, based on the lower frequency signal.

96. The method according to claim 3, wherein step (2) further comprises the step of optimizing a shape of the pulses, based on the lower frequency signal.

97. The method according to claim 3, wherein step (2) further comprises the step of generating the pulses with non-negligible apertures that are equal in duration to approximate half cycles of the carrier signal.

98. The method according to claim 3, wherein step (2) further comprises the step of generating the pulses with non-negligible apertures that are equal in duration to at least one tenth of one percent of approximate half cycles of the carrier signal.

99. The method according to claim 3, wherein step (2) further comprises the step of generating the pulses with non-negligible apertures that are equal in duration to at least one percent of approximate half cycles of the carrier signal.

100. The method according to claim 3, wherein step (2) further comprises the step of generating the pulses with non-negligible apertures that are equal in duration to at least ten percent of approximate half cycles of the carrier signal.

101. The method according to claim 3, wherein step (2) further comprises the step of generating the pulses with non-negligible apertures that are equal in duration to at least twenty five percent of approximate half cycles of the carrier signal.

102. The method according to claim 3, wherein step (2) further comprises the step of generating the pulses with non-negligible apertures that are equal in duration to at least fifty percent of approximate half cycles of the carrier signal.

103. The method according to claim 3, wherein step (2) further comprises the step of generating the pulses with non-negligible apertures that are equal in duration to at least seventy five percent of approximate half cycles of the carrier signal.

104. The method according to claim 3, wherein step (2) further comprises the step of generating the pulses with non-negligible apertures that are equal in duration to at least ninety percent of approximate half cycles of the carrier signal.

105. The method according to claim 3, wherein step (2) further comprises the step of generating the pulses with non-negligible apertures that are equal in duration N cycles of the carrier signal, wherein N equals A plus B, where A is a positive integer and B is a fraction of an integer.

106. The method according to claim 1, wherein step (2) comprises the step of transferring non-negligible amounts of energy relative to energy contained in half cycles of the carrier signal.

107. The method according to claim 1, wherein step (2) further comprises the step of generating a train of pulses having non-negligible apertures relative to a period of the carrier signal.

108. The method according to claim 1, wherein step (3) comprises the step of integrating the transferred energy during apertures.

109. The method according to claim 1, wherein step (2) comprises the step of transferring controlled non-negligible amounts of energy.

110. The method according to claim 1, wherein:

step (2) comprises the step of transferring non-negligible amounts of energy from the carrier signal during aperture periods, which occur at the aliasing rate; and

step (3) comprises the step of integrating the transferred energy over the aperture period and generating the lower frequency signal from the integrated energy.

111. The method according to claim 1, wherein step (2) comprises the step of transferring controlled substantial amounts of energy from the carrier signal at the aliasing rate.

112. The method according to claim 1, wherein:

step (2) comprises the step of transferring controlled substantial amounts of energy from the carrier signal during aperture periods, which occur at the aliasing rate, wherein said transferring of energy substantially prevents accurate voltage reproduction of the carrier signal during the apertures; and

step (3) comprises the step of integrating the transferred energy over the aperture periods; and generating the lower frequency signal from the integrated energy.

113. The method according to claim 1, wherein:

step (2) comprises the step of transferring controlled substantial amounts of energy from the carrier signal during aperture periods, which occur at the aliasing rate, wherein said transferring of energy substantially prevents accurate voltage reproduction of the carrier signal during the apertures; and

step (3) comprises the step of integrating the transferred energy over the aperture periods and generating the lower frequency signal from the integrated energy.

114. The method according to claim 33, wherein step (2) further comprises the step of gating the carrier signal according to a control signal comprising a stream of pulses having non-negligible apertures that are equal in duration to approximate half cycles of the carrier signal and that are substantially aligned with positive half cycles of the carrier signal.

115. The method according to claim 33, wherein step (2) further comprises the step of gating the carrier signal according to a control signal comprising a stream of pulses having non-negligible apertures that are equal in duration to approximate half cycles of the carrier signal and that are substantially aligned with negative half cycles of the carrier signal.

116. The method according to claim 40, wherein step (2) further comprises the step of gating the carrier signal according to a control signal comprising a stream of pulses having non-negligible apertures that are equal in duration to approximate half cycles of the carrier signal and that are not synchronized with the carrier signal.

117. The method according to claim 1, wherein step (2) comprises the steps of:

(a) convolving a portion of a cycle of the carrier with a shaped waveform; and

(b) repeating step (2)(a) at the aliasing rate.

118. The method according to claim 117, wherein step (3) comprises the step of integrating the results of steps (2)(a) and (2)(b) and generating the lower frequency signal from the integrated results.

## 123

119. The method according to claim 118, wherein step (2)(a) comprises the step of convolving the portion of a cycle of the carrier signal with a substantially square waveform.

120. The method of claim 59, wherein step (1) further comprises the step of receiving the carrier signal via a wireless communication medium.

121. The method according to claim 2, wherein step (2) further comprises the step of optimizing an amplitude of the energy transfer signal.

122. The method according to claim 1, wherein step (2) comprises the step of transferring non-negligible amounts of energy from the carrier signal, at the aliasing rate that is substantially equal to a frequency of the carrier signal plus or minus a frequency of the lower frequency signal divided by  $n$ , where  $n$  is equal to 0.5 or any positive integer.

123. The method according to claim 33, wherein step (2) further comprises the step of gating the carrier signal according to a control signal comprising a stream of pulses, having non-negligible apertures that are substantially synchronized with the carrier signal.

124. The method according to claim 33, wherein step (2) further comprises the step of gating the carrier signal according to a control signal comprising a stream of pulses, having non-negligible apertures that are not synchronized with the carrier signal.

125. The method according to claim 1, wherein step (3) comprises the step of generating the lower frequency signal directly from the transferred energy.

126. The method according to claim 1, wherein step (3) comprises the step of generating the lower frequency signal at baseband directly from the transferred energy.

127. The method according to claim 1, wherein step (3) comprises the step of preserving modulation information without the carrier signal.

128. The method according to claim 1, wherein step (3) comprises the step of preserving modulation information without reproducing the carrier signal.

129. The method according to claim 1, wherein step (3) comprises the step of:

(a) controlling the amount of energy transferred from the carrier signal.

130. The method according to claim 129, wherein step (3)(a) comprises the step of controlling an aperture.

131. The method according to claim 130, wherein step (3)(a) further comprises the step of controlling an aperture width.

132. The method according to claim 130, wherein step (3)(a) further comprises the step of controlling an aperture frequency.

133. The method according to claim 130, wherein step (3)(a) further comprises the step of controlling an aperture shape.

134. The method according to claim 129, wherein step (3)(a) comprises the step of controlling energy transfer characteristics.

135. The apparatus according to claim 23, wherein said energy transfer signal generator generates an energy transfer signal comprising a train of pulses having non-negligible apertures that tend away from zero time in duration.

136. The apparatus according to claim 136, wherein said energy transfer signal generator generates the pulses with non-negligible apertures equal in duration to at least one tenth of one percent of approximate half cycles of the carrier signal.

137. The apparatus according to claim 135, wherein said energy transfer signal generator generates the pulses with non-negligible apertures equal in duration to at least one percent of approximate half cycles of the carrier signal.

## 124

138. The apparatus according to claim 135, wherein said energy transfer signal generator generates the pulses with non-negligible apertures equal in duration to at least ten percent of approximate half cycles of the carrier signal.

139. The apparatus according to claim 135, wherein said energy transfer signal generator generates the pulses with non-negligible apertures equal in duration to at least twenty-five percent of approximate half cycles of the carrier signal.

140. The apparatus according to claim 135, wherein said energy transfer signal generator generates the pulses with non-negligible apertures equal in duration to at least fifty percent of approximate half cycles of the carrier signal.

141. The apparatus according to claim 135, wherein said energy transfer signal generator generates the pulses with non-negligible apertures equal in duration to at least seventy-five percent of approximate half cycles of the carrier signal.

142. The apparatus according to claim 135, wherein said energy transfer signal generator generates the pulses with non-negligible apertures equal in duration to at least ninety percent of approximate half cycles of the carrier signal.

143. The apparatus according to claim 135, wherein said energy transfer signal generator generates the pulses with non-negligible apertures equal in duration to approximate half cycles of the carrier signal.

144. The apparatus according to claim 135, wherein said energy transfer signal generator generates the pulses with non-negligible apertures equal in duration of up to ninety percent of a full cycle of the carrier signal.

145. The apparatus according to claim 135, wherein said energy transfer signal generator generates the pulses with non-negligible apertures equal in duration  $N$  cycles of the carrier signal, wherein  $N$  equals  $A$  plus  $B$ , where  $A$  is a positive integer and  $B$  is a fraction of an integer.

146. The apparatus according to claim 135, wherein said energy transfer signal generator optimizes an amplitude of the energy transfer signal.

147. The apparatus according to claim 135, wherein said energy transfer signal generator optimizes an amplitude of the energy transfer signal pulses.

148. The apparatus according to claim 135, wherein said energy transfer signal generator optimizes a shape of the energy transfer signal pulses.

149. The apparatus according to claim 23, further comprising:

a feedback loop that couples an output of said switch module to said energy transfer signal generator.

150. The apparatus according to claim 149, wherein said energy transfer signal generator generates an energy transfer signal comprising a train of pulses having non-negligible apertures that tend away from zero time in duration.

151. The apparatus according to claim 150, wherein said energy transfer signal generator optimizes a frequency of the energy transfer signal based on said feedback loop.

152. The apparatus according to claim 151, wherein said energy transfer signal generator controls a frequency relationship between the carrier signal and the energy transfer signal.

153. The apparatus according to claim 150, wherein said energy transfer signal generator optimizes a phase of the energy transfer signal based on said feedback loop.

154. The apparatus according to claim 153, wherein said energy transfer signal generator controls a phase relationship between the carrier signal and the energy transfer signal.

155. The apparatus according to claim 150, wherein said energy transfer signal generator optimizes a frequency and phase of the energy transfer signal, based on said feedback loop.

## 125

156. The apparatus according to claim 155, wherein said energy transfer signal generator controls a frequency relationship and a phase relationship between the carrier signal and the energy control signal.

157. The apparatus according to claim 150, wherein said energy transfer signal generator optimizes an amplitude of the energy transfer signal based on said feedback loop.

158. The apparatus according to claim 157, wherein said energy transfer signal generator optimizes an amplitude of the energy transfer signal pulses based on said feedback loop.

159. The apparatus according to claim 150, wherein said energy transfer signal generator optimizes a shape of the energy transfer signal pulses based on said feedback loop.

160. The apparatus according to claim 23, wherein said storage device comprises a capacitive storage device sized to store substantial amounts of energy relative to energy contained in approximate half cycles of the carrier signal.

161. The apparatus according to claim 23, wherein said storage device comprises a capacitive storage device sized to store substantial amounts of energy relative to energy contained in a percentage of half cycles of a carrier signal, whereby said capacitive storage device integrates the transferred energy.

162. The apparatus according to claim 26, further comprising at least one of the following:

an input impedance match circuit coupled between said switch module and an apparatus input;

an output impedance match circuit coupled between said storage module and an apparatus output;

a feed forward circuit in parallel with said switch module; and

a tank circuit coupled between said switch circuit and said apparatus input.

163. The apparatus according to claim 23, wherein said switch module is implemented in a complimentary, metal oxide, semi-conductor (C-MOS) material.

164. The apparatus according to claim 23, wherein said switch module and said storage module are implemented in a single integrated circuit.

165. The apparatus according to claim 164, wherein said switch module and said storage module are implemented in a complimentary, metal oxide, semi-conductor (C-MOS) material.

166. The apparatus according to claim 23, wherein said switch module, said storage module and said energy transfer signal generator are implemented in a single integrated circuit.

167. The apparatus according to claim 166, wherein said switch module, said storage module, and said energy transfer signal generator are implemented in a complimentary, metal oxide, semi-conductor (C-MOS) material.

168. The apparatus according to claim 23, wherein said switch module comprises at least two switch devices.

169. The apparatus according to claim 168, wherein said at least two switch devices are configured differentially.

170. The apparatus according to claim 23, wherein said energy transfer signal generator comprises:

a clock generator that generates a clock signal at the aliasing rate; and

an aperture generator that generates pulses having non-negligible apertures, based on the clock signal.

171. The apparatus according to claim 170, wherein said aperture generator generates the pulses with apertures that are non-negligible relative to a period of a carrier signal.

172. The apparatus according to claim 170, wherein said aperture generator generates the pulses with apertures equal to a substantial portion of a half period of the carrier signal.

## 126

173. The apparatus according to claim 170, wherein said clock generator generates the clock signal with rising and falling edges and said aperture generator is configured to generate a pulse for each of said rising edges.

174. The apparatus according to claim 170, wherein said clock generator generates the clock signal with rising and falling edges and said aperture generator generates a pulse for each of said falling edges.

175. The apparatus according to claim 170, wherein said clock generator generates the clock signal with rising and falling edges and said aperture generator generates pulses for each of said rising edges and each of said falling edges.

176. The apparatus according to claim 173, wherein said aperture generator generates multiple pulses for each of said rising edges.

177. The apparatus according to claim 23, further comprising a controllable output impedance.

178. The apparatus according to claim 23, further comprising an output impedance device that substantially sets an output voltage level.

179. The apparatus according to claim 178, wherein said output impedance device substantially sets the output voltage level higher than a voltage level of a received carrier signal.

180. The apparatus according to claim 178, wherein said output impedance device substantially sets the output voltage level lower than a voltage level of a received carrier signal.

181. The apparatus according to claim 178, wherein said output impedance device substantially sets the output voltage level equal to a voltage level of a received carrier signal.

182. The apparatus according to claim 178, wherein said output impedance device substantially sets the output voltage level to approximately two volts peak to peak.

183. The apparatus according to claim 178, wherein said output impedance device substantially sets the output voltage level to approximately three volts peak to peak.

184. The apparatus according to claim 178, wherein said output impedance device substantially sets the output voltage level to approximately four volts peak to peak.

185. The apparatus according to claim 178, wherein said output impedance device substantially sets the output voltage level to approximately five volts peak to peak.

186. The apparatus according to claim 178, wherein said output impedance device substantially sets the output voltage level to approximately eight volts peak to peak.

187. The apparatus according to claim 178, wherein said output impedance device substantially sets the output voltage level to approximately ten volts peak to peak.

188. The apparatus according to claim 23, further comprising a controllable output impedance device that substantially sets an output voltage level.

189. The apparatus according to claim 23, wherein said apparatus generates a lower frequency signal having a voltage level that is higher than a voltage level of an input carrier signal.

190. The apparatus according to claim 23, wherein said apparatus generates a lower frequency signal having a voltage level that is lower than a voltage level of an input carrier signal.

191. The apparatus according to claim 23, wherein said energy transfer signal generator generates an energy transfer signal having the aliasing rate that is substantially equal to a frequency of the carrier signal plus or minus a frequency of the lower frequency signal, divided by n, where n is equal to 0.5 or a positive integer.

192. The apparatus according to claim 23, wherein the aliasing rate is substantially equal to frequency of the carrier

signal divided by n and the lower frequency signal is a baseband signal.

193. The apparatus according to claim 23, wherein the aliasing rate is substantially equal to frequency of the carrier signal divided by n, and the lower frequency signal is a demodulate baseband signal.

194. The apparatus according to claim 23, wherein the aliasing rate is substantially equal to a frequency of the carrier signal divided by n and the lower frequency signal is a zero frequency signal.

195. The apparatus according to claim 23, wherein said storage module receives non-negligible amounts of energy transferred from a carrier signal at an aliasing rate that is substantially equal to a frequency of the carrier signal plus or minus a frequency of the lower frequency signal, divided by n, where n is equal to one of 0.5 or an integer.

196. The apparatus according to claim 23, wherein said energy transfer signal generator generates an energy transfer signal having an aliasing rate that is substantially equal to a frequency of the carrier signal plus or minus a frequency of the lower frequency signal, divided by n, where n represents a harmonic or sub-harmonic of the carrier signal.

197. The apparatus according to claim 23, further comprising a circuit to efficiently transfer power from the carrier signal.

198. The apparatus according to claim 23, wherein said storage module receives and integrates the non-negligible amounts of energy from the carrier signal and generates the lower frequency signal from the integrated energy.

199. The apparatus according to claim 23, wherein said storage module receives and integrates controlled non-negligible amounts of energy transferred from the carrier signal and generates the lower frequency signal from the integrated energy.

200. The apparatus according to claim 23, wherein said storage module receives and integrate controlled non-negligible amounts of energy transferred from a carrier

signal over aperture periods, wherein said storage module generates a lower frequency signal from the integrate transferred energy.

201. The apparatus according to claim 23, wherein said storage module receives and integrate controlled substantial amounts of energy transferred from the carrier signal over aperture periods wherein said storage module generates a lower frequency signal from the integrated energy.

202. The apparatus according to claim 23, wherein said storage module receives and integrate controlled substantial amounts of energy transferred from the carrier signal over aperture periods wherein said storage module generates a lower frequency signal from the integrated energy wherein the transferring of energy substantially prevents accurate voltage reproduction of the carrier signal during the apertures.

203. The apparatus according to claim 23, wherein: said energy transfer signal generator generates an energy transfer signal having an aliasing rate that is substantially equal to a frequency of the carrier signal plus or minus a frequency of the lower frequency signal, divided by n, where n represents a harmonic or sub-harmonic of the carrier signal; and

said storage module receives and integrates controlled substantial amounts of energy transferred from the carrier signal over aperture periods, wherein said storage module generate a lower frequency signal from the integrated energy, wherein the transferring of energy substantially prevents accurate voltage reproduction of the carrier signal during the apertures.

204. The method according to claim 3, wherein step (2) further comprises the step of controlling a phase relationship between the pulses and the carrier signal, based on the lower frequency signal.

\* \* \* \* \*

UNITED STATES PATENT AND TRADEMARK OFFICE  
**CERTIFICATE OF CORRECTION**

PATENT NO. : 6,061,551  
DATED : May 9, 2000  
INVENTOR(S) : Sorrells et al.

Page 1 of 3

It is certified that error appears in the above-identified patent and that said Letters Patent is hereby corrected as shown below:

Column 1,

Line 7, please replace "applications" with -- patents and patent applications --.

Lines 11-18, please replace with the following: "Method and System for Frequency Up-Conversion," Ser. No. 09/176,154, Attorney Docket No. 1744.0020000, now allowed.

"Method and System for Ensuring Reception of a Communications Signal," Ser. No. 09/176,415, Attorney Docket No. 1744.0030000, now U.S. Patent No. 6,061,555, issued May 9, 2000.

"Integrated Frequency Translation and Selectivity," Ser. No. 09/175,966, Attorney Docket No. 1744.0130000, now U.S. Patent No. 6,049,706, issued April 11, 2000.

"Universal Frequency Translation, and Applications of Same," Ser. No. 09/176,027, Attorney Docket No. 1744.0140000, now abandoned. --.

Column 7,

Line 25, please replace "FIG. 74" with -- FIG. 74 --.

Column 8,

Line 54, please replace "FIG. 102A-102G" with -- FIGS. 102A-102G --.

Column 23,

Line 13, please replace " $F_{DMC}$ " with --  $F_{MC}$  --.

Lines 36-37, please replace " $\geq$ " with --  $\geq$  --.

Column 24,

Line 6, please replace "FIG. 1" with -- FIG. 11 --.

Column 26,

Lines 39-42, please replace with -- as disclosed in "Method and System for Ensuring Reception of a Communications Signal," Ser. No. 09/176,415, filed October 21, 1998, Attorney Docket No. 1744.0030000, now U.S. Patent No. 6,061,555, issued May 9, 2000, incorporated herein by reference in its entirety. --.

Column 30,

Line 19, please replace " $F_c \cdot F_{IF}$ " with --  $F_C - F_{IF}$  --.

Column 59,

Line 42, please replace "FIG. 31A" with -- FIG. 31 --.

Column 71,

Line 54, please replace " $F_c \cdot F_{IF}$ " with --  $F_C - F_{IF}$  --.

UNITED STATES PATENT AND TRADEMARK OFFICE  
**CERTIFICATE OF CORRECTION**

PATENT NO. : 6,061,551  
DATED : May 9, 2000  
INVENTOR(S) : Sorrells et al.

Page 2 of 3

It is certified that error appears in the above-identified patent and that said Letters Patent is hereby corrected as shown below:

In the right column on page 8, 25 lines down, please replace "Vilae" with -- Vilar --.  
In the right column on page 8, please replace the reference listed at lines 40-44 with the following reference:

-- Vilar, E. *et al.*, "Scattering and Extinction: Dependence Upon Raindrop Size Distribution in Temperate (Barcelona) and Tropical (Belem) Regions," *10<sup>th</sup> International Conf. On Antennas and Propagation*, April 14-17, 1997, pp. 2.230-2.233. --

Column 89,

Line 25, please delete "MF".

Column 115,

Lines 14-15, please replace "minus frequency" with -- minus a frequency --.

Lines 58, 62, and 66, please replace "providing" with -- (4) providing --.

Line 67, please replace "substantially" with -- a substantially --.

Column 116,

Line 35, please replace "by n where" with -- by n, where --.

Line 47, please replace "between input" with -- between an input --.

Lines 60 and 63, please replace "on" with -- one --.

Column 117,

Line 28, please replace "generating a analog" with -- generating an analog --.

Column 118,

Line 66, please replace "of period" with -- of a period --.

Column 119,

Line 10, please replace "66" with -- 64 --.

Column 120,

Lines 15-16, please replace "closed thereby" with -- closed, thereby --.

Column 121,

Line 34, please replace "ant" with -- at --.

Line 64, please replace "claim 1" with -- claim 3 --.

Column 122,

Line 12, please replace "period" with -- periods --.

Line 53, please replace "40" with -- 33 --.

UNITED STATES PATENT AND TRADEMARK OFFICE  
CERTIFICATE OF CORRECTION

PATENT NO. : 6,061,551  
DATED : May 9, 2000  
INVENTOR(S) : Sorrells et al.

Page 3 of 3

It is certified that error appears in the above-identified patent and that said Letters Patent is hereby corrected as shown below:

Column 123,

Line 13, please replace "signal divided" with -- signal, divided --.

Line 59, please replace "claim 136" with -- claim 135 --.

Column 125,

Line 45, please replace "module and" with -- module, and --.

Column 127,

Line 4, please replace "to frequency" with -- to a frequency --.

Line 6, please replace "demodulate" with -- demodulated --.

Line 36, please replace "integrate" with -- integrates --.

Column 128,

Line 2, please replace "integrate" with -- integrated --.

Line 5, please replace "integrate" with -- integrates --.

Line 7, please replace "periods wherein" with -- periods, wherein --.

Line 10, please replace "integrate" with -- integrates --.

Line 12, please replace "periods wherein" with -- periods, wherein --.

Line 13, please replace "energy wherein" with -- energy, wherein --.

Line 28, please replace "generate" with -- generates --.

Signed and Sealed this

Twenty-second Day of January, 2002

Attest:



Attesting Officer

JAMES E. ROGAN  
Director of the United States Patent and Trademark Office

UNITED STATES PATENT AND TRADEMARK OFFICE  
**CERTIFICATE OF CORRECTION**

PATENT NO. : 6,061,551  
DATED : May 9, 2000  
INVENTOR(S) : Sorrells et al.

Page 1 of 3

It is certified that error appears in the above-identified patent and that said Letters Patent is hereby corrected as shown below:

Drawings.

Please replace Figure 54F, (page 64 of the drawings) with the attached Figure 54F.

Column 5.

Line 40, please insert -- module -- after “hold”.

Column 14.

Lines 29-31, please delete “information signals, digital information signals and direct current (DC) information signals.”.

Column 17.

Line 35, please replace “AM” with -- FM --.

Column 38.

Line 35, please delete “analog”.

Column 41.

Line 24, please replace “thereof Preferably” with -- thereof. Preferably --.

Column 50.

Line 33, please replace “PSK” with -- FSK --.

Column 59.

Line 2, please replace “4206” with -- 4208 --.

Column 80.

Line 2, please replace “716” with -- 916 --.  
Line 36, please replace “3607” with -- 4607 --.

Column 81.

Line 63, please replace “1401” with -- 4607 --.

Column 83.

Line 35, please replace “4613” with -- 4614 --.

Column 87.

Line 29, please replace “1413” with -- 4613 --.



UNITED STATES PATENT AND TRADEMARK OFFICE  
**CERTIFICATE OF CORRECTION**

PATENT NO. : 6,061,551  
DATED : May 9, 2000  
INVENTOR(S) : Sorrells et al.

Page 2 of 3

It is certified that error appears in the above-identified patent and that said Letters Patent is hereby corrected as shown below:

Column 90,

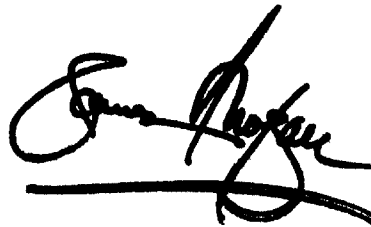
Line 15, please replace "1413" with -- 4613 --.

Column 93,

Line 57, please replace "PSK" with -- FSK --.

Signed and Sealed this

Thirteenth Day of May, 2003

A handwritten signature in black ink, appearing to read "James E. Rogan", written over a horizontal line.

JAMES E. ROGAN  
*Director of the United States Patent and Trademark Office*

