

# Measuring Tilt with Low-g Accelerometers

by: Michelle Clifford and Leticia Gomez  
Sensor Products, Tempe, AZ

## INTRODUCTION

This application note describes how accelerometers are used to measure the tilt of an object. Accelerometers can be used for measuring both dynamic and static measurements of acceleration. Tilt is a static measurement where gravity is the acceleration being measured. Therefore, to achieve the highest degree resolution of a tilt measurement, a low-g, high-sensitivity accelerometer is required. The Freescale MMA6200Q and MMA7260Q series accelerometers are good solutions for XY and XYZ tilt sensing. These devices provide a sensitivity of 800 mV/g in 3.3 V applications. The MMA2260D and MMA1260D are also good solutions for 5 V applications providing a sensitivity of 1200mV/g for X and Z, respectively. All of these accelerometers will experience acceleration in the range of +1g to -1g as the device is tilted from -90 degrees to +90 degrees.

$$1g = 9.8 \text{ m/s}^2$$

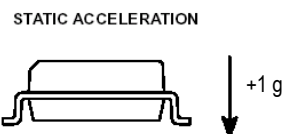

## MODULE

A simple tilt application can be implemented using an 8 or 10-bit microcontroller that has 1 or 2 ADC channels to input the analog output voltage of the accelerometers and general purpose I/O pins for displaying the degrees either on a PC through a communication protocol or on an LCD. See [Figure 1](#) for a typical block diagram. Some applications may not require a display at all. These applications may only require an I/O channel to send a signal for turning on or off a device at a determined angle range.

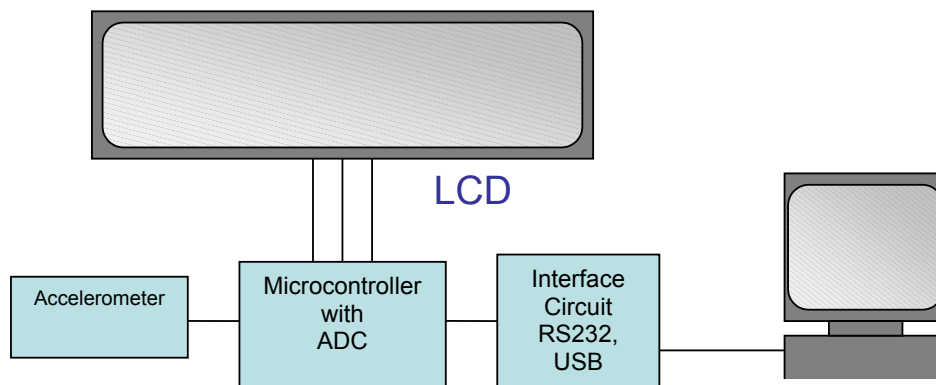

Figure 1. Typical Tilt Application Block Diagram

## MOUNTING CONSIDERATIONS

Device selection depends on the angle of reference and how the device will be mounted in the end application. This will allow you to achieve the highest degree resolution for a given solution due to the nonlinearity of the technology. First, you need to know what the sensing axis is for the accelerometer. See [Figure 2](#) to see where the sensing axes are for the

MMA7260Q. To obtain the most resolution per degree of change, the IC should be mounted with the sensitive axis parallel to the plane of movement where the most sensitivity is desired. For example, if the degree range that an application will be measuring is only 0° to 45° and the PCB will be mounted perpendicular to gravity, then an X-Axis device

would be the best solution. If the degree range was 0° to 45° and the PCB will be mounted perpendicular to gravity, then a Z-Axis device would be the best solution. This is understood more when thinking about the output response signal of the device and the nonlinearity.

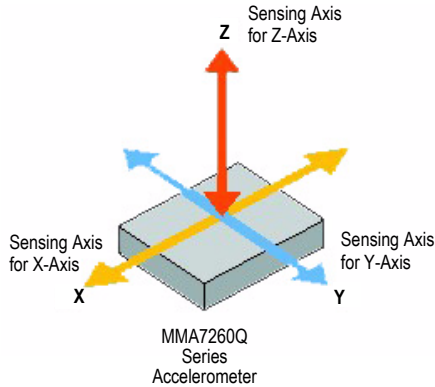

**Figure 2. Sensing Axis for the MMA7260Q Accelerometer With X, Y, and Z-Axis for Sensing Acceleration**

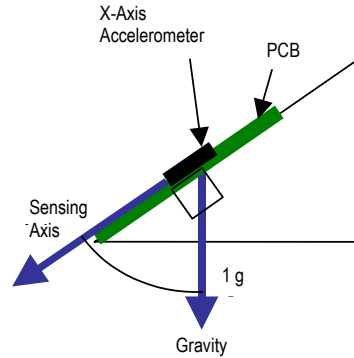

**Figure 3. Gravity Component of a Tilted X-Axis Accelerometer**

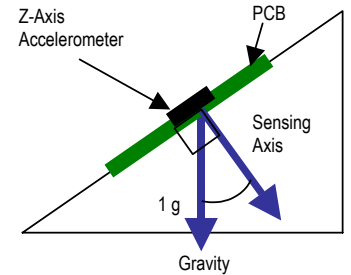
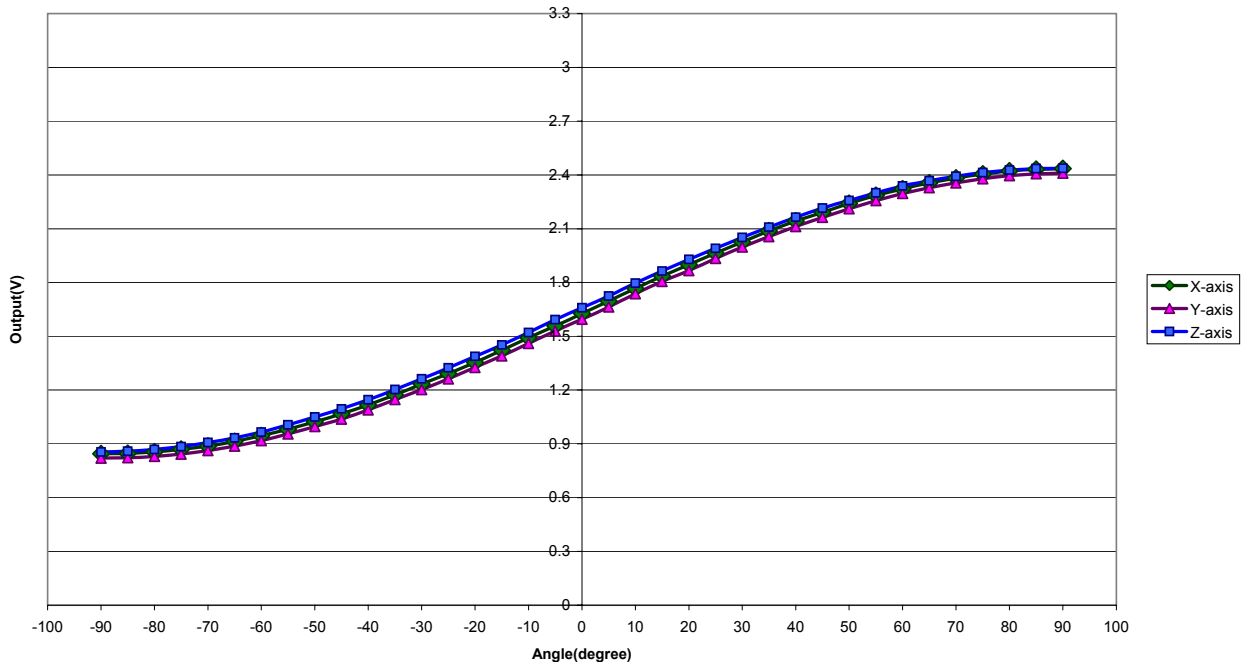

**Figure 4. Gravity Component of a Tilted Z-Axis Accelerometer**

### NONLINEARITY

As seen in Figure 5, the typical output of capacitive, micro-machined accelerometers is more like a sine function. The figure shows the analog output voltage from the accelerometer for degrees of tilt from -90° to +90°. The change in degrees of tilt directly corresponds to a change in the acceleration due to a changing component of gravity acted on the accelerometer. The slope of the curve is actually the sensitivity of the device.

As the device is tilted from 0°, the sensitivity decreases. You see this in the graph as the slope of output voltage decreases for an increasing tilt towards 90°. Because of this nonlinearity, the degree resolution of the application must be determined at 0° and 90° to ensure the lowest resolution is still within the required application resolution. This will be explained more in the following section.



**Figure 5. Typical Nonlinear Output of X, Y, and Z-Axis Accelerometers**

## CALCULATING DEGREE OF TILT

In order to determine the angle of tilt,  $\theta$ , the A/D values from the accelerometer are sampled by the ADC channel on the microcontroller. The acceleration is compared to the zero g offset to determine if it is a positive or negative acceleration, e.g., if value is greater than the offset then the acceleration is seeing a positive acceleration, so the offset is subtracted from the value and the resulting value is then used with a lookup table to determine the corresponding degree of tilt (See [Table 1](#) for a typical 8-bit lookup table), or the value is passed to a tilt algorithm. If the acceleration is negative, then the value is subtracted from the offset to determine the amount of negative acceleration and then passed to the lookup table or algorithm. One solution can measure  $0^\circ$  to  $90^\circ$  of tilt with a single axis accelerometer, or another solution can measure  $360^\circ$  of tilt with two axis configuration (XY, X and Z), or a single axis configuration (e.g. X or Z), where values in two directions are converted to degrees and compared to determine the quadrant that they are in. A tilt solution can be solved by either implementing an arccosine function, an arcsine function, or a look-up table depending on the power of the microcontroller and the accuracy required by the application. For simplicity, we will use the equation:  $\theta = \arcsin(x)$ . The  $\arcsin(y)$  can determine the range from  $0^\circ$  to  $180^\circ$ , but it cannot discriminate the angles in range from  $0^\circ$  to  $360^\circ$ , e.g.  $\arcsin(45^\circ) = \arcsin(135^\circ)$ . However, the sign of x and y can be used to determine which quadrant the angle is in. By this means, we can calculate the angle  $\beta$  in one quadrant ( $0$ - $90^\circ$ ) using  $\arcsin(y)$  and then determine  $\theta$  in the determined quadrant.

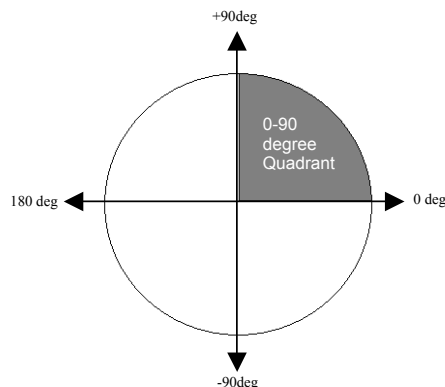

Figure 6. The Quadrants of a 360 Degree Rotation

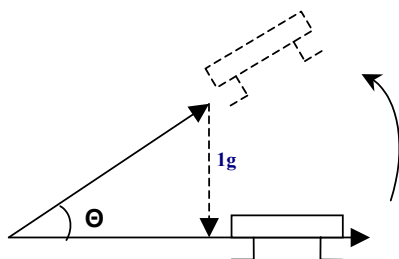

Figure 7. An Example of Tilt in the First Quadrant

$$[1] \quad V_{OUT} = V_{OFFSET} + \left( \frac{\Delta V}{\Delta g} \times 1.0g \times \sin\theta \right)$$

where:  $V_{OUT}$  = Accelerometer Output in Volts  
 $V_{OFF}$  = Accelerometer 0g Offset  
 $\Delta V/\Delta g$  = Sensitivity  
 $1g$  = Earth's Gravity  
 $\theta$  = Angle of Tilt

Solving for the angle:

$$[2] \quad \theta = \arcsin\left(\frac{V_{OUT} - V_{OFFSET}}{\frac{\Delta V}{\Delta g}}\right)$$

This equation can be used with the MMA6260Q as an example:

$$V_{OUT} = 1650mV + 800mV \times \sin\theta$$

Where the angle can be solved by

$$\theta = \arcsin\left(\frac{V_{OUT} - 1650mV}{800mV/g}\right)$$

From this equation, you can see that at  $0^\circ$  the accelerometer output voltage would be 1650mV and at  $90^\circ$  the accelerometer output would be 2450mV.

## INTERFACING TO ADC

### An 8-Bit ADC

An 8-bit ADC cuts 3.3V supply into 255 steps of 12.9mV for each step. Therefore, by taking one ADC reading of the MMA6260Q at 0g ( $0^\circ$  of tilt for an x-axis device) and 1g ( $90^\circ$  of tilt for an x-axis device), would result in the following:

$$0^\circ: 1650mV + 12.9mV = 1662.9mV, \\ \text{which is } 0.92^\circ \text{ resolution}$$

$$90^\circ: 2450mV + 12.9mV = 2462.9mV, \\ \text{which is } 6.51^\circ \text{ resolution}$$

Due to the nonlinearity discussed earlier, you will see that the accelerometer is most sensitive when the sensing axis is closer to  $0^\circ$ , and less sensitive when closer to  $90^\circ$ . Therefore, the system provides a 0.92 degree resolution at the highest sensitivity point ( $0$  degrees), and a 6.51 degree resolution at the lowest sensitivity point ( $90^\circ$ ).

### A 10-Bit ADC

A 10-bit ADC cuts 3.3V supply into 1023 steps of 3.2mV for each step. Therefore, by taking one ADC reading of the MMA6260Q again at 0g ( $0^\circ$  of tilt for an x-axis device), would now result in the following:

$$0^\circ: 1650mV + 3.2mV = 1653.2mV$$

$$90^\circ: 2450mV + 3.2mV = 2453.2mV$$

This results in a 0.229 degree resolution at the highest sensitivity point (0°) and a 3.26 degree resolution at the lowest sensitivity point (90°).

#### A 12-Bit ADC

A 12-bit ADC cuts 3.3V supply into 4095 steps of 0.8mV for each step. Therefore, by taking one ADC reading of the MMA6260Q again at 0g (0° of tilt for an x-axis device), would now result in the following:

$$0^\circ: 1650\text{mV} + 0.8\text{mV} = 1650.8\text{mV}$$

$$90^\circ: 2450\text{mV} + 0.8\text{mV} = 2450.8\text{mV}$$

This results in a 0.057 degree resolution at the highest sensitivity point (0°) and 1.63 degree resolution at the lowest sensitivity point (90°). However, for 0.8mV changes, the noise factor becomes the factor to consider during design. How much noise the system has will depend on how much resolution you can get with a higher bit count.

## TILT APPLICATIONS

There are many applications where tilt measurements are required or will enhance its functionality. In the cell phone market and handheld electronics market, tilt applications can be used for controlling menu options, e-compass compensation, image rotation, or function selection in response to different tilt measurements. In the medical markets, tilt is used for making blood pressure monitors more accurate. They can also be used for feedback for tilting hospital beds or chairs. A tilt controller can also be used for an easier way to control this type of equipment. Accelerometers for tilt measurements can also be designed into a multitude of products, such as game controllers, virtual reality input devices, HDD portable products, computer mouse, cameras, projectors, washing machines, and personal navigation systems.

Table 1. 8-Bit Lookup Table for Determining Degree of Tilt

ADC Bits	Calculated Voltage	g	arcsine	arccos	ADC Bits	Calculated Voltage	g	arcsine	arccos
66	-0.80	-1.00	-87.47	177.47	129	0.01	0.02	0.92	89.08
67	-0.79	-0.98	-79.39	169.39	130	0.03	0.03	1.85	88.15
68	-0.77	-0.97	-75.19	165.19	131	0.04	0.05	2.77	87.23
69	-0.76	-0.95	-71.93	161.93	132	0.05	0.06	3.70	86.30
70	-0.75	-0.93	-69.16	159.16	133	0.06	0.08	4.62	85.38
71	-0.73	-0.92	-66.70	156.70	134	0.08	0.10	5.55	84.45
72	-0.72	-0.90	-64.47	154.47	135	0.09	0.11	6.48	83.52
73	-0.71	-0.89	-62.40	152.40	136	0.10	0.13	7.41	82.59
74	-0.70	-0.87	-60.47	150.47	137	0.12	0.15	8.34	81.66
75	-0.68	-0.85	-58.65	148.65	138	0.13	0.16	9.27	80.73
76	-0.67	-0.84	-56.92	146.92	139	0.14	0.18	10.21	79.79
77	-0.66	-0.82	-55.26	145.26	140	0.15	0.19	11.15	78.85
78	-0.64	-0.81	-53.67	143.67	141	0.17	0.21	12.09	77.91
79	-0.63	-0.79	-52.14	142.14	142	0.18	0.23	13.04	76.96
80	-0.62	-0.77	-50.66	140.66	143	0.19	0.24	13.99	76.01
81	-0.61	-0.76	-49.23	139.23	144	0.21	0.26	14.94	75.06
82	-0.59	-0.74	-47.83	137.83	145	0.22	0.27	15.90	74.10
83	-0.58	-0.73	-46.48	136.48	146	0.23	0.29	16.86	73.14
84	-0.57	-0.71	-45.15	135.15	147	0.24	0.31	17.83	72.17
85	-0.55	-0.69	-43.86	133.86	148	0.26	0.32	18.80	71.20
86	-0.54	-0.68	-42.59	132.59	149	0.27	0.34	19.78	70.22
87	-0.53	-0.66	-41.35	131.35	150	0.28	0.35	20.76	69.24
88	-0.52	-0.64	-40.13	130.13	151	0.30	0.37	21.75	68.25
89	-0.50	-0.63	-38.93	128.93	152	0.31	0.39	22.75	67.25
90	-0.49	-0.61	-37.76	127.76	153	0.32	0.40	23.76	66.24
91	-0.48	-0.60	-36.60	126.60	154	0.34	0.42	24.77	65.23
92	-0.46	-0.58	-35.46	125.46	155	0.35	0.44	25.79	64.21
93	-0.45	-0.56	-34.33	124.33	156	0.36	0.45	26.82	63.18
94	-0.44	-0.55	-33.22	123.22	157	0.37	0.47	27.86	62.14
95	-0.43	-0.53	-32.12	122.12	158	0.39	0.48	28.91	61.09
96	-0.41	-0.52	-31.04	121.04	159	0.40	0.50	29.97	60.03
97	-0.40	-0.50	-29.97	119.97	160	0.41	0.52	31.04	58.96
98	-0.39	-0.48	-28.91	118.91	161	0.43	0.53	32.12	57.88
99	-0.37	-0.47	-27.86	117.86	162	0.44	0.55	33.22	56.78
100	-0.36	-0.45	-26.82	116.82	163	0.45	0.56	34.33	55.67
101	-0.35	-0.44	-25.79	115.79	164	0.46	0.58	35.46	54.54
102	-0.34	-0.42	-24.77	114.77	165	0.48	0.60	36.60	53.40
103	-0.32	-0.40	-23.76	113.76	166	0.49	0.61	37.76	52.24
104	-0.31	-0.39	-22.75	112.75	167	0.50	0.63	38.93	51.07
105	-0.30	-0.37	-21.75	111.75	168	0.52	0.64	40.13	49.87
106	-0.28	-0.35	-20.76	110.76	169	0.53	0.66	41.35	48.65
107	-0.27	-0.34	-19.78	109.78	170	0.54	0.68	42.59	47.41
108	-0.26	-0.32	-18.80	108.80	171	0.55	0.69	43.86	46.14
109	-0.24	-0.31	-17.83	107.83	172	0.57	0.71	45.15	44.85
110	-0.23	-0.29	-16.86	106.86	173	0.58	0.73	46.48	43.52
111	-0.22	-0.27	-15.90	105.90	174	0.59	0.74	47.83	42.17
112	-0.21	-0.26	-14.94	104.94	175	0.61	0.76	49.23	40.77
113	-0.19	-0.24	-13.99	103.99	176	0.62	0.77	50.66	39.34
114	-0.18	-0.23	-13.04	103.04	177	0.63	0.79	52.14	37.86
115	-0.17	-0.21	-12.09	102.09	178	0.64	0.81	53.67	36.33
116	-0.15	-0.19	-11.15	101.15	179	0.66	0.82	55.26	34.74
117	-0.14	-0.18	-10.21	100.21	180	0.67	0.84	56.92	33.08
118	-0.13	-0.16	-9.27	99.27	181	0.68	0.85	58.65	31.35
119	-0.12	-0.15	-8.34	98.34	182	0.70	0.87	60.47	29.53
120	-0.10	-0.13	-7.41	97.41	183	0.71	0.89	62.40	27.60
121	-0.09	-0.11	-6.48	96.48	184	0.72	0.90	64.47	25.53
122	-0.08	-0.10	-5.55	95.55	185	0.73	0.92	66.70	23.30
123	-0.06	-0.08	-4.62	94.62	186	0.75	0.93	69.16	20.84
124	-0.05	-0.06	-3.70	93.70	187	0.76	0.95	71.93	18.07
125	-0.04	-0.05	-2.77	92.77	188	0.77	0.97	75.19	14.81
126	-0.03	-0.03	-1.85	91.85	189	0.79	0.98	79.39	10.61
127	-0.01	-0.02	-0.92	90.92	190	0.80	1.00	87.47	2.53
128	0.00	0.00	0.00	90.00					

# Explore Litigation Insights

Docket Alarm provides insights to develop a more informed litigation strategy and the peace of mind of knowing you're on top of things.

## Real-Time Litigation Alerts



Keep your litigation team up-to-date with **real-time alerts** and advanced team management tools built for the enterprise, all while greatly reducing PACER spend.

Our comprehensive service means we can handle Federal, State, and Administrative courts across the country.

## Advanced Docket Research



With over 230 million records, Docket Alarm's cloud-native docket research platform finds what other services can't. Coverage includes Federal, State, plus PTAB, TTAB, ITC and NLRB decisions, all in one place.

Identify arguments that have been successful in the past with full text, pinpoint searching. Link to case law cited within any court document via Fastcase.

## Analytics At Your Fingertips



Learn what happened the last time a particular judge, opposing counsel or company faced cases similar to yours.

Advanced out-of-the-box PTAB and TTAB analytics are always at your fingertips.

## API

Docket Alarm offers a powerful API (application programming interface) to developers that want to integrate case filings into their apps.

## LAW FIRMS

Build custom dashboards for your attorneys and clients with live data direct from the court.

Automate many repetitive legal tasks like conflict checks, document management, and marketing.

## FINANCIAL INSTITUTIONS

Litigation and bankruptcy checks for companies and debtors.

## E-DISCOVERY AND LEGAL VENDORS

Sync your system to PACER to automate legal marketing.