

\$100
Laptop

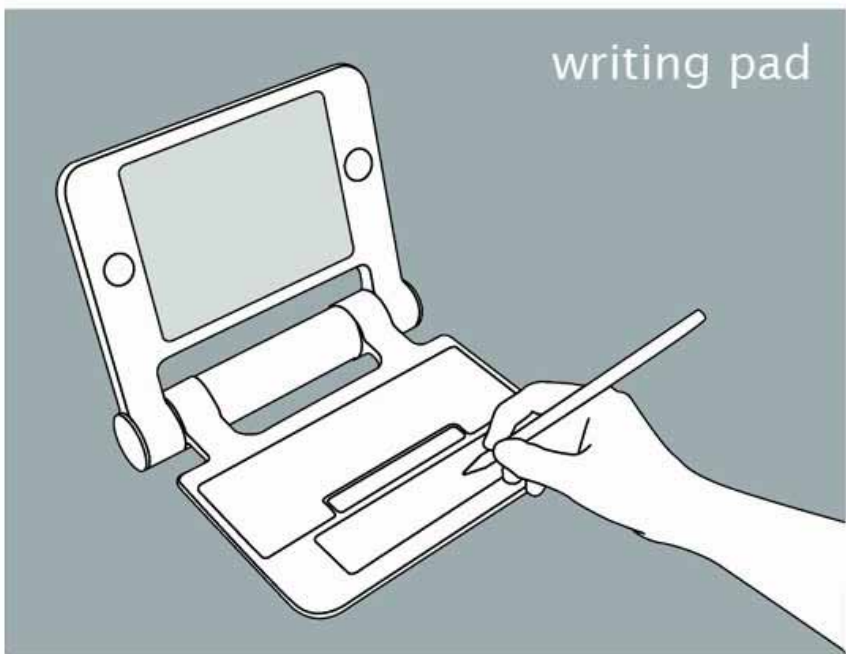

writing pad

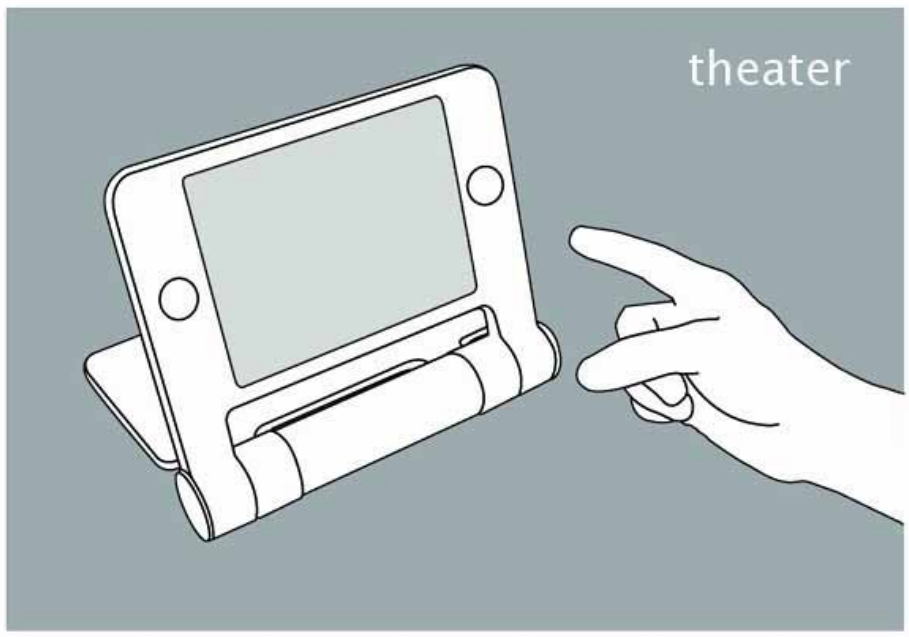

theater

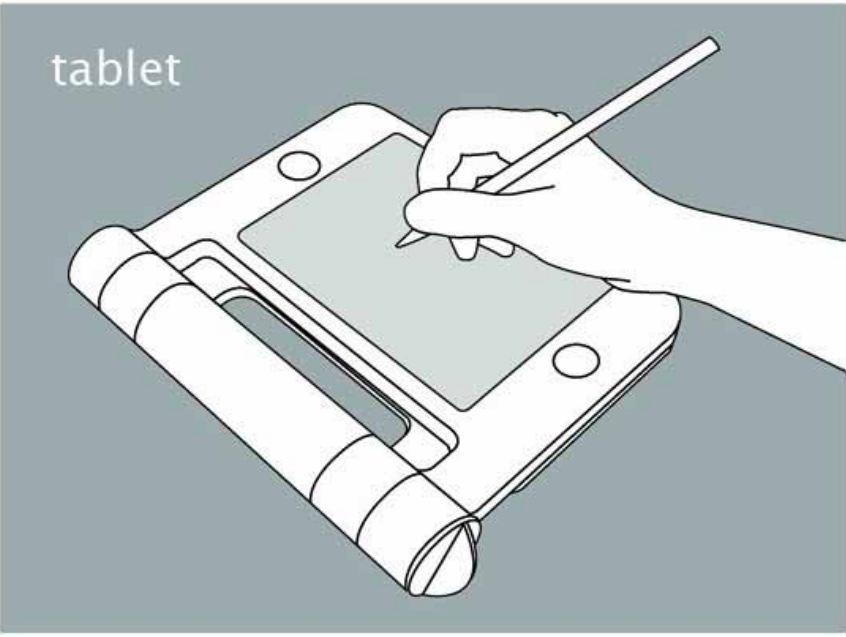

tablet

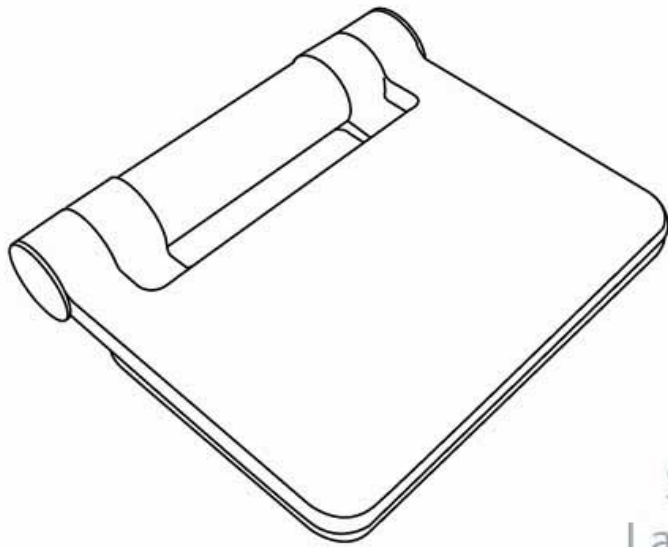

\$100
Laptop

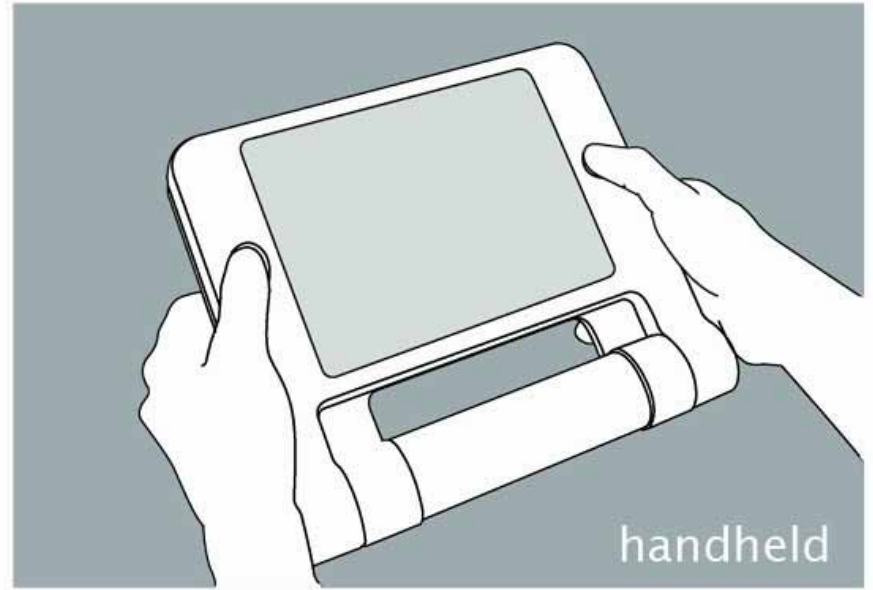

handheld

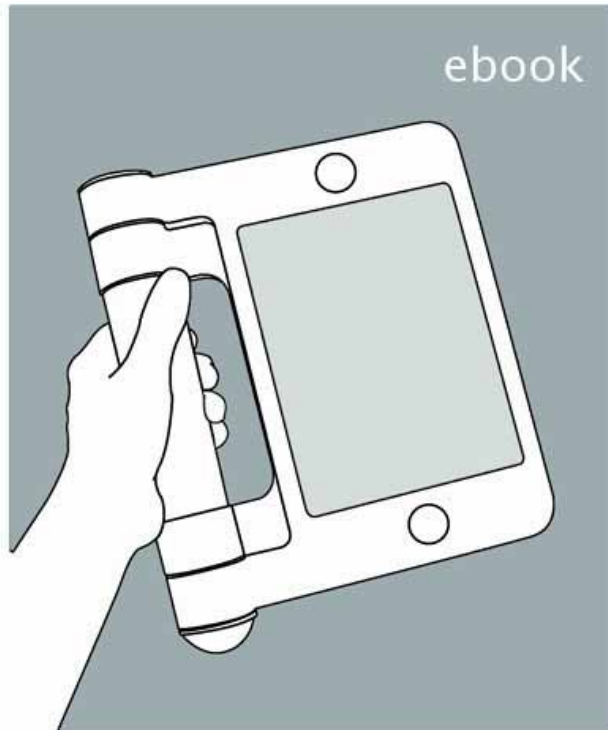

ebook

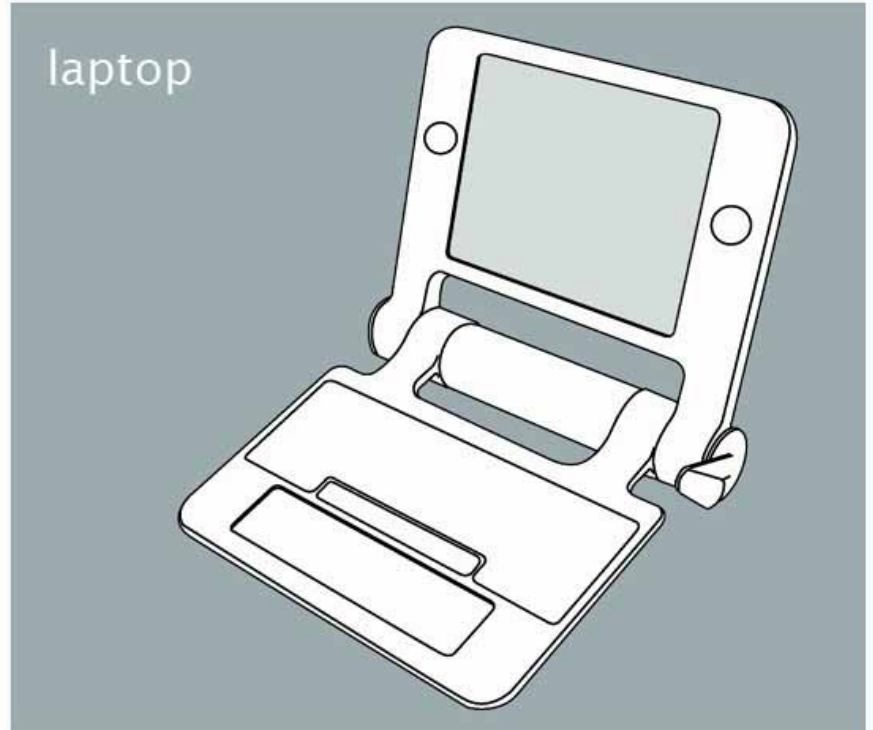

laptop

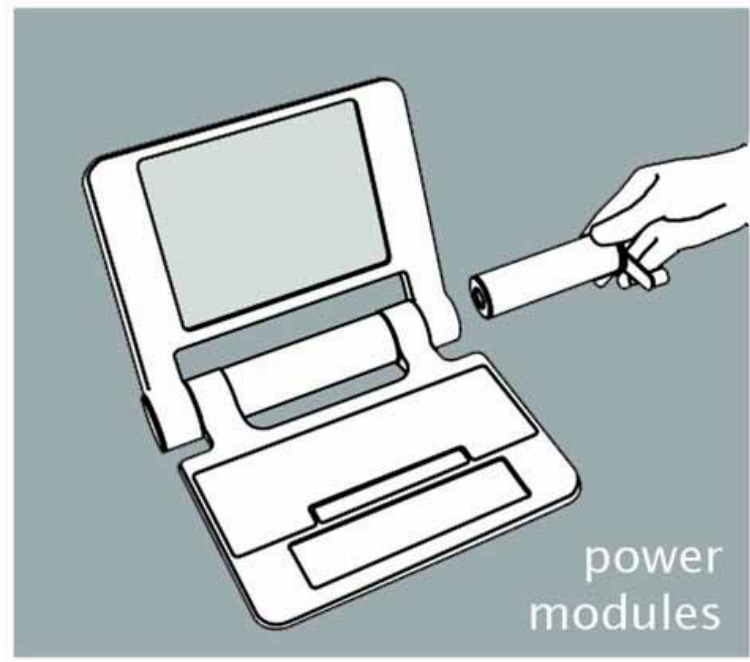
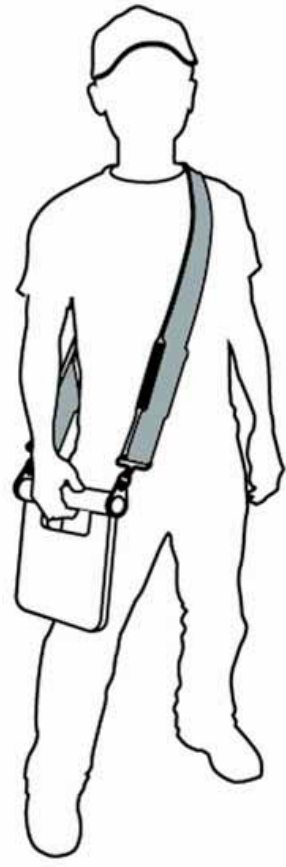

← carrying strap
converts to ...
AC adapter & cord →

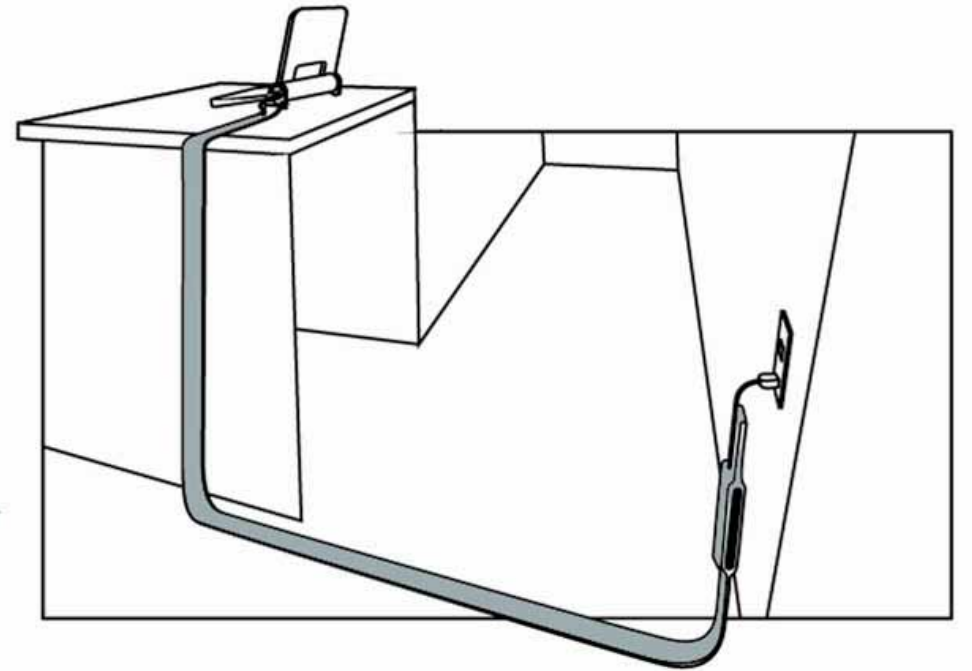



Thursday, September 29th 2005

MIT's \$100 Laptop

by Dark Ride | Sep 29th, 2005 00:55 | [Discuss \(4 Comments\)](#)

This laptop will only be provided to governments of poor countries to give to school children for free.

It will have a 500 MHz processor, 1GB of memory and an innovative dual-mode display that can be used in full-color mode, or in a black-and-white sunlight-readable mode. The display makes the laptop "both an electronic book and a laptop."

One display design being considered is a flat, flexible printed display developed at MIT's Media Lab. Negroponete said the technology can be used to produce displays that cost roughly 10 cents per square inch. "The target is \$12 for a 12-inch display with near-zero power consumption"



The handcrank (right) is to generate electricity



Laptop will come into market in 2006/2007



The laptop has multiple functionalities, different features & different variabilities.

Source: [CNET News](#)



Add your own comment

4 Comments