

(19) **United States**
 (12) **Patent Application Publication**
Koyama

(10) **Pub. No.: US 2003/0197664 A1**
 (43) **Pub. Date: Oct. 23, 2003**

(54) **ELECTRO-OPTICAL DEVICE**
 (75) **Inventor: Jun Koyama, Kanagawa (JP)**

(30) **Foreign Application Priority Data**
 Oct. 26, 1999 (JP) 11-304679
 Nov. 29, 1999 (JP) 11-337003

Correspondence Address:
Edward D. Manzo
Cook, Alex, McFarron, Manzo, Cummings &
Mehler, Ltd.
200 West Adams St., Ste. 2850
Chicago, IL 60606 (US)

Publication Classification
 (51) **Int. Cl.⁷ G09G 3/30**
 (52) **U.S. Cl. 345/76**

(57) **ABSTRACT**

(73) **Assignee: Semiconductor Energy Laboratory Co., Ltd.**

An electro-optical device for performing time division gray scale display and which is capable of arbitrarily setting the amount of time during which light is emitted by EL elements is provided. From among n sustain periods Ts1, . . . , Tsn, the brightness of light emitted by the EL elements during at least one sustain period is set to be always lower than the brightness of light emitted by the EL elements during the other sustain periods, and the sustain periods are extended by the amount that the brightness has dropped. In accordance with the above structure, the sustain periods can be extended by lowering the setting of the brightness of light emitted by the EL elements.

(21) **Appl. No.: 10/435,968**
 (22) **Filed: May 12, 2003**

Related U.S. Application Data

(63) **Continuation of application No. 09/692,713, filed on Oct. 19, 2000, now Pat. No. 6,587,086.**

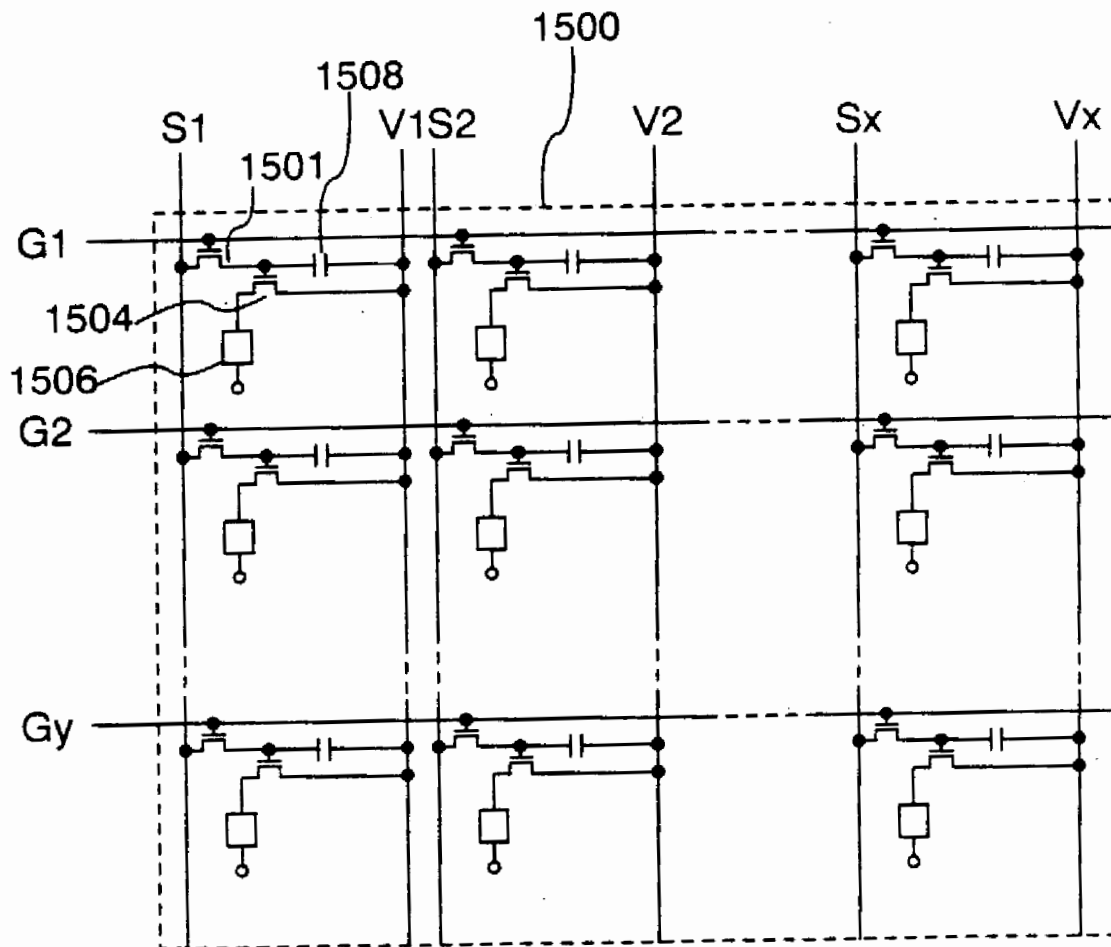

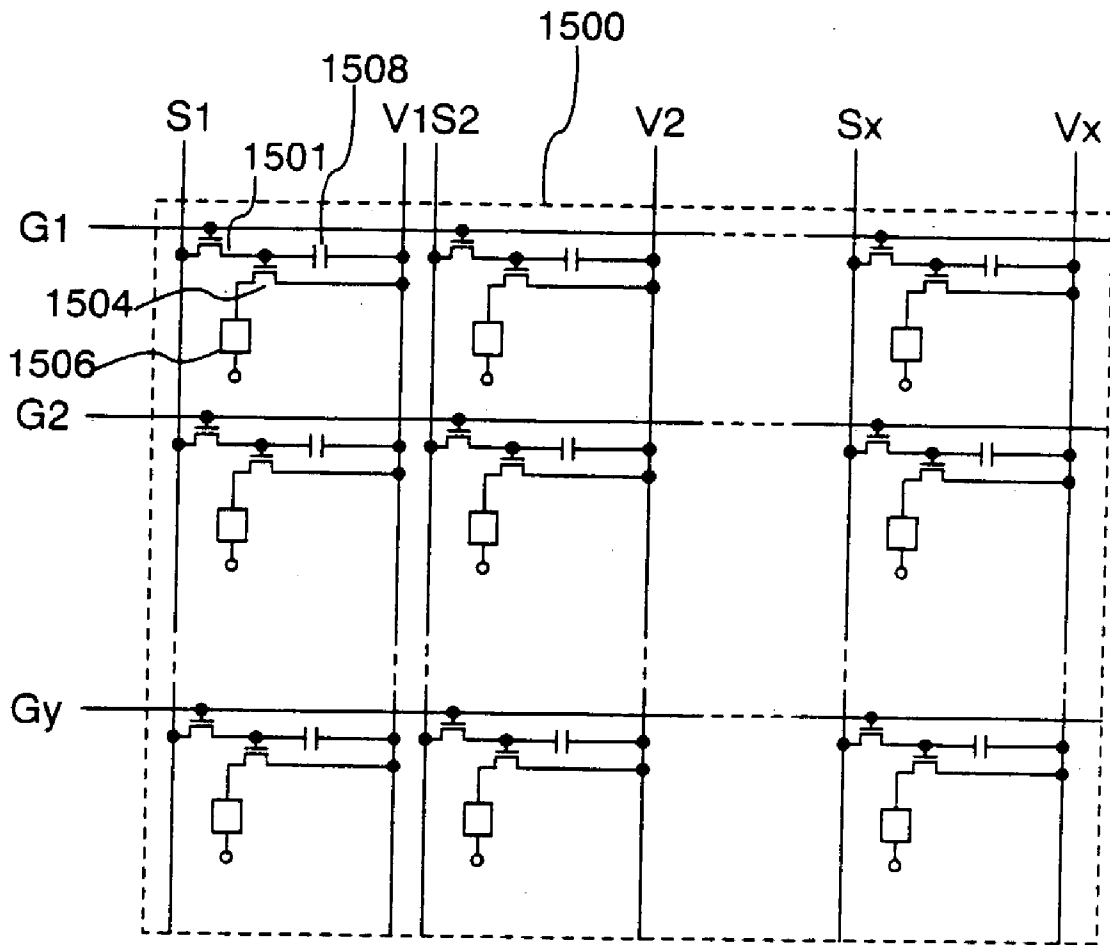

Fig.1

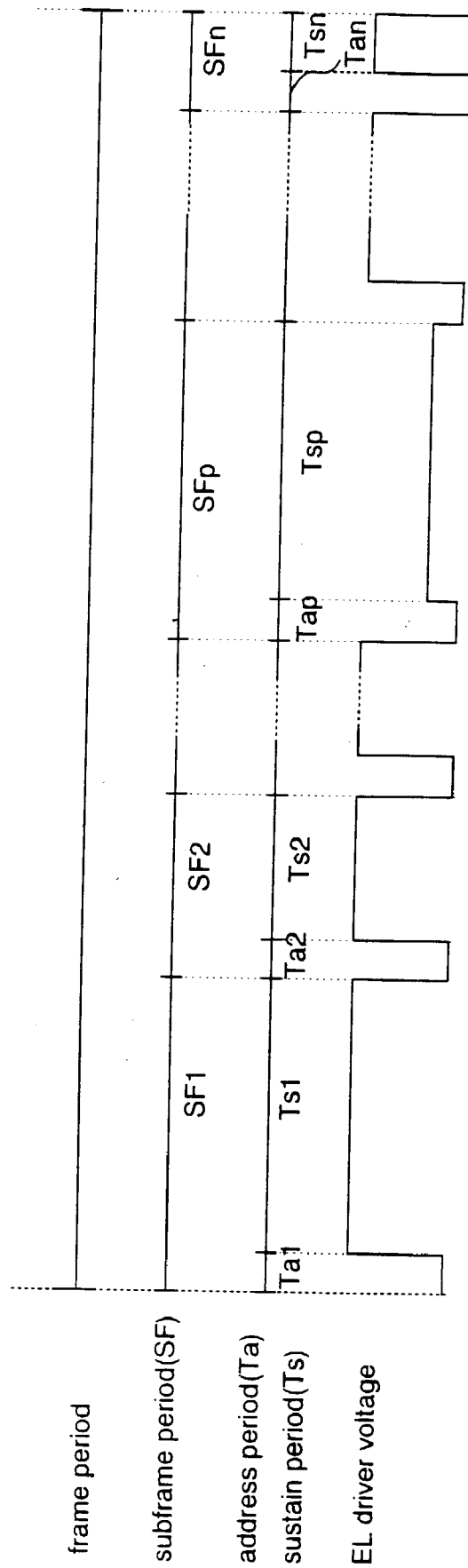

Fig.2

Fig.3A

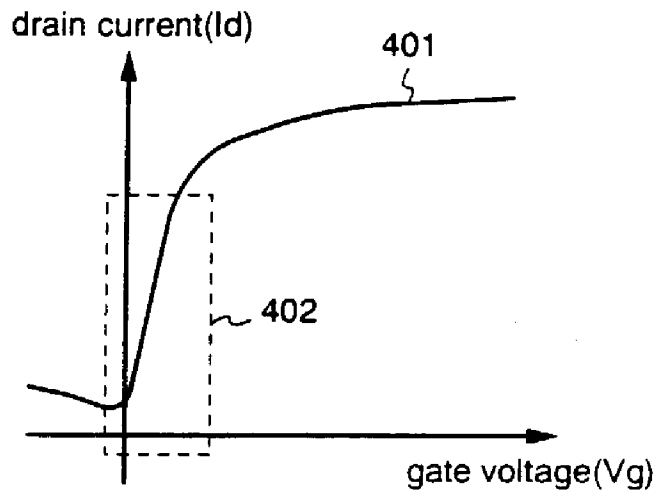
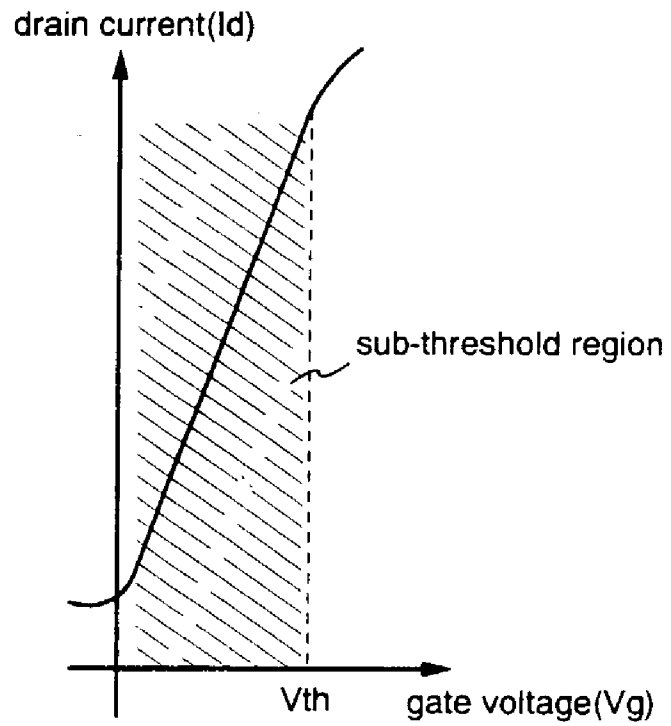

Fig.3B



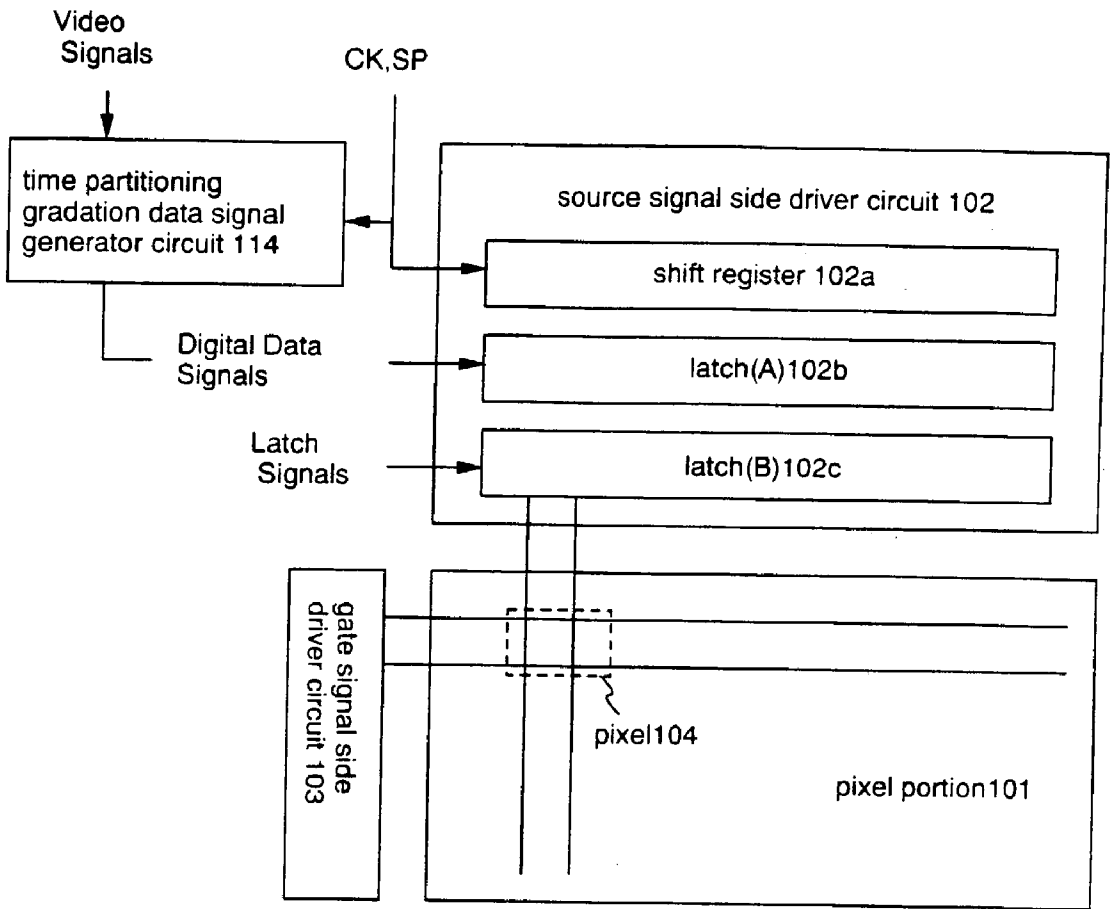

Fig.4A

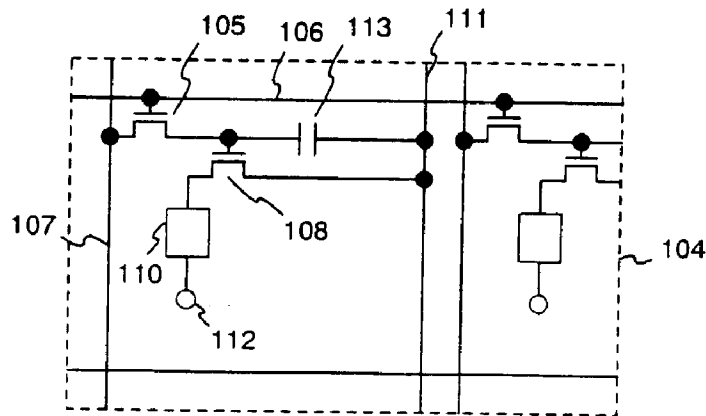

Fig.4B

Explore Litigation Insights

Docket Alarm provides insights to develop a more informed litigation strategy and the peace of mind of knowing you're on top of things.

Real-Time Litigation Alerts



Keep your litigation team up-to-date with **real-time alerts** and advanced team management tools built for the enterprise, all while greatly reducing PACER spend.

Our comprehensive service means we can handle Federal, State, and Administrative courts across the country.

Advanced Docket Research



With over 230 million records, Docket Alarm's cloud-native docket research platform finds what other services can't. Coverage includes Federal, State, plus PTAB, TTAB, ITC and NLRB decisions, all in one place.

Identify arguments that have been successful in the past with full text, pinpoint searching. Link to case law cited within any court document via Fastcase.

Analytics At Your Fingertips



Learn what happened the last time a particular judge, opposing counsel or company faced cases similar to yours.

Advanced out-of-the-box PTAB and TTAB analytics are always at your fingertips.

API

Docket Alarm offers a powerful API (application programming interface) to developers that want to integrate case filings into their apps.

LAW FIRMS

Build custom dashboards for your attorneys and clients with live data direct from the court.

Automate many repetitive legal tasks like conflict checks, document management, and marketing.

FINANCIAL INSTITUTIONS

Litigation and bankruptcy checks for companies and debtors.

E-DISCOVERY AND LEGAL VENDORS

Sync your system to PACER to automate legal marketing.