

INFORMATION DISCLOSURE STATEMENT BY APPLICANT (Not for submission under 37 CFR 1.99)	Application Number		
	Filing Date		
	First Named Inventor	David Astely et al.	
	Art Unit		
	Examiner Name		
	Attorney Docket Number	4015-9600 / P30138-US3	

U.S.PATENTS							Remove
Examiner Initial*	Cite No	Patent Number	Kind Code ¹	Issue Date	Name of Patentee or Applicant of cited Document	Pages, Columns, Lines where Relevant Passages or Relevant Figures Appear	
	1	8265030	B2	2012-09-11	Miki et al.		
	2	8447343	B2	2013-05-21	Gerstenberger et al.		
	3	8472368	B2	2013-06-25	Baldemair et al.		
	4	8634358	B2	2014-01-21	Damnjanovic et al.		
	5	8792830	B2	2014-07-29	Lim et al.		
If you wish to add additional U.S. Patent citation information please click the Add button.							Add
U.S.PATENT APPLICATION PUBLICATIONS							Remove
Examiner Initial*	Cite No	Publication Number	Kind Code ¹	Publication Date	Name of Patentee or Applicant of cited Document	Pages, Columns, Lines where Relevant Passages or Relevant Figures Appear	
	1	20020160784	A1	2002-10-31	Kuwahara et al.		

**INFORMATION DISCLOSURE
STATEMENT BY APPLICANT**
(Not for submission under 37 CFR 1.99)

Application Number		
Filing Date		
First Named Inventor	David Astely et al.	
Art Unit		
Examiner Name		
Attorney Docket Number	4015-9600 / P30138-US3	

2	20100003997	A1	2010-01-07	Koyanagi
3	20100098012	A1	2010-04-22	Bala et al.
4	20100208679	A1	2010-08-19	Papsakellariou et al.
5	20100232373	A1	2010-09-16	Nory et al.
6	20100271970	A1	2010-10-28	Pan et al.
7	20100285809	A1	2010-11-11	Lindstrom et al.
8	20100296389	A1	2010-11-25	Khandekar et al.
9	20100322173	A1	2010-12-23	Marinier et al.
10	20110007695	A1	2011-01-13	Choi et al.
11	20110007699	A1	2011-01-13	Moon et al.
12	20110081913	A1	2011-04-07	Lee et al.

**INFORMATION DISCLOSURE
STATEMENT BY APPLICANT**
(Not for submission under 37 CFR 1.99)

Application Number		
Filing Date		
First Named Inventor	David Astely et al.	
Art Unit		
Examiner Name		
Attorney Docket Number	4015-9600 / P30138-US3	

13	20110081932	A1	2011-04-07	Astely et al.
14	20110243039	A1	2011-10-06	Papasakellariou et al.
15	20110310856	A1	2011-12-22	Hariharan et al.
16	20120020317	A1	2012-01-26	Ishii et al.
17	20120051306	A1	2012-03-01	Chung et al.
18	20120082125	A1	2012-04-05	Huang
19	20120140708	A1	2012-06-07	Choudhury et al.
20	20120314675	A1	2012-12-13	Mujcic
21	20130010721	A1	2013-01-10	Aiba et al.
22	20130003700	A1	2013-01-03	Zhang et al.
23	20130034073	A1	2013-02-07	Aiba et al.

**INFORMATION DISCLOSURE
STATEMENT BY APPLICANT**
(Not for submission under 37 CFR 1.99)

Application Number		
Filing Date		
First Named Inventor	David Astely et al.	
Art Unit		
Examiner Name		
Attorney Docket Number	4015-9600 / P30138-US3	

24	20130136084	A1	2013-05-30	Zhang et al.	
25	20120147847	A1	2012-06-14	Matsumoto et al.	Corresponds to WO2009022474A1

If you wish to add additional U.S. Published Application citation information please click the Add button.

FOREIGN PATENT DOCUMENTS

Examiner Initial*	Cite No	Foreign Document Number ³	Country Code ² i	Kind Code ⁴	Publication Date	Name of Patentee or Applicant of cited Document	Pages, Columns, Lines where Relevant Passages or Relevant Figures Appear	T ⁵
	1	101765208	CN	A	2010-06-30	Huawei Technologies Co., Inc.	Machine Translation Included (in parent case)	
	2	2009022474	WO	A1	2009-02-19	Panasonic Corp.	Corresponds to US2012/0147847A1	

If you wish to add additional Foreign Patent Document citation information please click the Add button

NON-PATENT LITERATURE DOCUMENTS

Examiner Initials*	Cite No	Include name of the author (in CAPITAL LETTERS), title of the article (when appropriate), title of the item (book, magazine, journal, serial, symposium, catalog, etc), date, pages(s), volume-issue number(s), publisher, city and/or country where published.	T ⁵
	1	3RD GENERATION PARTNERSHIP PROJECT, MOTOROLA (source), "Control Signalling Design for Supporting Carrier Aggregation," 3GPP TSG RAN1 #56, R1-090792, Athens, GR, Feb. 9-13, 2009.	
	2	3RD GENERATION PARTNERSHIP PROJECT, ZTE (source), "Uplink Control Channel Design for LTE-Advanced," TSG-RAN WG1 #58, R1-093209, Shenzhen, China, June 25 - Aug. 29, 2009.	
	3	3RD GENERATION PARTNERSHIP PROJECT, NOKIA, NOKIA SIEMENS NETWORKS (source), "L1 Control Signaling with Carrier Aggregation in LTE-Advanced," 3GPP TSG-RAN WG1 Meeting #54bis, R1-083730, Prague, Czech Republic, Sept. 29 - October 3, 2008.	

**INFORMATION DISCLOSURE
STATEMENT BY APPLICANT**
(Not for submission under 37 CFR 1.99)

Application Number		
Filing Date		
First Named Inventor	David Astely et al.	
Art Unit		
Examiner Name		
Attorney Docket Number	4015-9600 / P30138-US3	

4	3RD GENERATION PARTNERSHIP PROJECT, NOKIA SIEMENS NETWORKS, NOKIA (source), "Channelization of SRI and Persistent ACK/NACK on PUCCH," 3GPP TSG RAN WG1 Meeting #52bis, R1-081460, Shenzhen, China, March 31 - April 4, 2008.
5	3RD GENERATION PARTNERSHIP PROJECT, QUALCOMM EUROPE, "Clarifying PUSCH Resource Allocation," 3GPP TSG-RAN WG1 Meeting #54, R1-083181, Jeju, Korea, August 18-22, 2008.
6	NTT DOCOMO, Inc., "UL Layered Control Signal Structure in LTE-Advanced", 3GPP DRAFT RAN WG1 Meeting #54bis; RI-083679 UL LAYERED CONTROL SIGNAL, 3RD GENERATION PARTNERSHIP PROJECT (3GPP), MOBILE COMPETENCE CENTRE ; 650, ROUTE DES LUCIOLES ; F-06921 SOPHIA-ANTIPOLIS CEDEX ; FRANCE, vol. Ran WG1, no. Prague, Czech Republic; 20080929-20081003, 29 September 2008 (2008-09-29), XP050597042, [retrieved on 2008-09-24].
7	ZTE (source), "ACK/NACK Design for LTE-Advanced,"TSG-RAN WG1 #58bis, R1-093821, Miyazaki, Japan, October 12-16, 2009.
8	Infineon Technologies (source), "Clarification of UL DPCCCH slot format information usage in IE 'DTX-DRX information',"3GPP TSG-RAN WG2 Meeting #65, Tdoc R2-091165, Athens, Greece February 9-13, 2009.
9	NTT DocCoMo, Inc. (source), "UL ACK/NACK resource allocation for DL semi-persistent scheduling," 3GPP TSG RAN WG2 #62, R2-082485 (resubmission of R2-081857), Kansas City, Missouri, USA, May 5-9, 2008.

If you wish to add additional non-patent literature document citation information please click the Add button

EXAMINER SIGNATURE

Examiner Signature		Date Considered	
--------------------	--	-----------------	--

*EXAMINER: Initial if reference considered, whether or not citation is in conformance with MPEP 609. Draw line through a citation if not in conformance and not considered. Include copy of this form with next communication to applicant.

¹ See Kind Codes of USPTO Patent Documents at www.USPTO.GOV or MPEP 901.04. ² Enter office that issued the document, by the two-letter code (WIPO Standard ST.3). ³ For Japanese patent documents, the indication of the year of the reign of the Emperor must precede the serial number of the patent document. ⁴ Kind of document by the appropriate symbols as indicated on the document under WIPO Standard ST.16 if possible. ⁵ Applicant is to place a check mark here if English language translation is attached.

INFORMATION DISCLOSURE STATEMENT BY APPLICANT (Not for submission under 37 CFR 1.99)	Application Number		
	Filing Date		
	First Named Inventor	David Astely et al.	
	Art Unit		
	Examiner Name		
	Attorney Docket Number	4015-9600 / P30138-US3	

CERTIFICATION STATEMENT

Please see 37 CFR 1.97 and 1.98 to make the appropriate selection(s):

That each item of information contained in the information disclosure statement was first cited in any communication from a foreign patent office in a counterpart foreign application not more than three months prior to the filing of the information disclosure statement. See 37 CFR 1.97(e)(1).

OR

That no item of information contained in the information disclosure statement was cited in a communication from a foreign patent office in a counterpart foreign application, and, to the knowledge of the person signing the certification after making reasonable inquiry, no item of information contained in the information disclosure statement was known to any individual designated in 37 CFR 1.56(c) more than three months prior to the filing of the information disclosure statement. See 37 CFR 1.97(e)(2).

See attached certification statement.

The fee set forth in 37 CFR 1.17 (p) has been submitted herewith.

A certification statement is not submitted herewith.

SIGNATURE

A signature of the applicant or representative is required in accordance with CFR 1.33, 10.18. Please see CFR 1.4(d) for the form of the signature.

Signature	/Edward M. Roney/	Date (YYYY-MM-DD)	2016-11-14
Name/Print	Edward M. Roney	Registration Number	62048

This collection of information is required by 37 CFR 1.97 and 1.98. The information is required to obtain or retain a benefit by the public which is to file (and by the USPTO to process) an application. Confidentiality is governed by 35 U.S.C. 122 and 37 CFR 1.14. This collection is estimated to take 1 hour to complete, including gathering, preparing and submitting the completed application form to the USPTO. Time will vary depending upon the individual case. Any comments on the amount of time you require to complete this form and/or suggestions for reducing this burden, should be sent to the Chief Information Officer, U.S. Patent and Trademark Office, U.S. Department of Commerce, P.O. Box 1450, Alexandria, VA 22313-1450. **DO NOT SEND FEES OR COMPLETED FORMS TO THIS ADDRESS. SEND TO: Commissioner for Patents, P.O. Box 1450, Alexandria, VA 22313-1450.**

Privacy Act Statement

The Privacy Act of 1974 (P.L. 93-579) requires that you be given certain information in connection with your submission of the attached form related to a patent application or patent. Accordingly, pursuant to the requirements of the Act, please be advised that: (1) the general authority for the collection of this information is 35 U.S.C. 2(b)(2); (2) furnishing of the information solicited is voluntary; and (3) the principal purpose for which the information is used by the U.S. Patent and Trademark Office is to process and/or examine your submission related to a patent application or patent. If you do not furnish the requested information, the U.S. Patent and Trademark Office may not be able to process and/or examine your submission, which may result in termination of proceedings or abandonment of the application or expiration of the patent.

The information provided by you in this form will be subject to the following routine uses:

1. The information on this form will be treated confidentially to the extent allowed under the Freedom of Information Act (5 U.S.C. 552) and the Privacy Act (5 U.S.C. 552a). Records from this system of records may be disclosed to the Department of Justice to determine whether the Freedom of Information Act requires disclosure of these records.
2. A record from this system of records may be disclosed, as a routine use, in the course of presenting evidence to a court, magistrate, or administrative tribunal, including disclosures to opposing counsel in the course of settlement negotiations.
3. A record in this system of records may be disclosed, as a routine use, to a Member of Congress submitting a request involving an individual, to whom the record pertains, when the individual has requested assistance from the Member with respect to the subject matter of the record.
4. A record in this system of records may be disclosed, as a routine use, to a contractor of the Agency having need for the information in order to perform a contract. Recipients of information shall be required to comply with the requirements of the Privacy Act of 1974, as amended, pursuant to 5 U.S.C. 552a(m).
5. A record related to an International Application filed under the Patent Cooperation Treaty in this system of records may be disclosed, as a routine use, to the International Bureau of the World Intellectual Property Organization, pursuant to the Patent Cooperation Treaty.
6. A record in this system of records may be disclosed, as a routine use, to another federal agency for purposes of National Security review (35 U.S.C. 181) and for review pursuant to the Atomic Energy Act (42 U.S.C. 218(c)).
7. A record from this system of records may be disclosed, as a routine use, to the Administrator, General Services, or his/her designee, during an inspection of records conducted by GSA as part of that agency's responsibility to recommend improvements in records management practices and programs, under authority of 44 U.S.C. 2904 and 2906. Such disclosure shall be made in accordance with the GSA regulations governing inspection of records for this purpose, and any other relevant (i.e., GSA or Commerce) directive. Such disclosure shall not be used to make determinations about individuals.
8. A record from this system of records may be disclosed, as a routine use, to the public after either publication of the application pursuant to 35 U.S.C. 122(b) or issuance of a patent pursuant to 35 U.S.C. 151. Further, a record may be disclosed, subject to the limitations of 37 CFR 1.14, as a routine use, to the public if the record was filed in an application which became abandoned or in which the proceedings were terminated and which application is referenced by either a published application, an application open to public inspections or an issued patent.
9. A record from this system of records may be disclosed, as a routine use, to a Federal, State, or local law enforcement agency, if the USPTO becomes aware of a violation or potential violation of law or regulation.

Electronic Patent Application Fee Transmittal

Application Number:				
Filing Date:				
Title of Invention:	PUCCH RESOURCE ALLOCATION FOR CARRIER AGGREGATION IN LTE-ADVANCED			
First Named Inventor/Applicant Name:	David Astely			
Filer:	Edward Milton Roney/Kenyatta Upchurch			
Attorney Docket Number:	4015-9600 / P30138-US3			
Filed as Large Entity				
Filing Fees for Utility under 35 USC 111(a)				
Description	Fee Code	Quantity	Amount	Sub-Total in USD(\$)
Basic Filing:				
UTILITY APPLICATION FILING	1011	1	280	280
UTILITY SEARCH FEE	1111	1	600	600
UTILITY EXAMINATION FEE	1311	1	720	720
Pages:				
Claims:				
CLAIMS IN EXCESS OF 20	1202	10	80	800
INDEPENDENT CLAIMS IN EXCESS OF 3	1201	1	420	420
Miscellaneous-Filing:				

Description	Fee Code	Quantity	Amount	Sub-Total in USD(\$)
LATE FILING FEE FOR OATH OR DECLARATION	1051	1	140	140
Petition:				
Patent-Appeals-and-Interference:				
Post-Allowance-and-Post-Issuance:				
Extension-of-Time:				
Miscellaneous:				
Total in USD (\$)				2960

Electronic Acknowledgement Receipt

EFS ID:	27498244
Application Number:	15350360
International Application Number:	
Confirmation Number:	1120
Title of Invention:	PUCCH RESOURCE ALLOCATION FOR CARRIER AGGREGATION IN LTE-ADVANCED
First Named Inventor/Applicant Name:	David Astely
Customer Number:	24112
Filer:	Edward Milton Roney/Kenyatta Upchurch
Filer Authorized By:	Edward Milton Roney
Attorney Docket Number:	4015-9600 / P30138-US3
Receipt Date:	14-NOV-2016
Filing Date:	
Time Stamp:	13:23:01
Application Type:	Utility under 35 USC 111(a)

Payment information:

Submitted with Payment	yes
Payment Type	EFT
Payment was successfully received in RAM	\$2960
RAM confirmation Number	111416INTEFSW13242301
Deposit Account	
Authorized User	

The Director of the USPTO is hereby authorized to charge indicated fees and credit any overpayment as follows:

File Listing:					
Document Number	Document Description	File Name	File Size(Bytes)/ Message Digest	Multi Part /.zip	Pages (if appl.)
1		P30138_US3_Continuation_Application.pdf	129329 ffb6b7a87c0fa531cc159f540c76d776964213e4	yes	25
Multipart Description/PDF files in .zip description					
Document Description			Start	End	
Specification			1	17	
Claims			18	24	
Abstract			25	25	
Warnings:					
Information:					
2	Drawings-only black and white line drawings	P30138_US3_Drawings.pdf	468129 04d7c7686b30afed29c060495cd6982ee8e344a1	no	12
Warnings:					
Information:					
3	Application Data Sheet	P30138_US3_Application_Data_Sheet.pdf	1823708 7de0a7df9f944a0203ed28bcd2717d92bf5482a	no	10
Warnings:					
Information:					
4	Transmittal Letter	P30138_US3_IDS_Cover_Ltr.pdf	99760 629acd7f5af2420ac3490eb49da5fe9530e4f823	no	1
Warnings:					
Information:					
5	Information Disclosure Statement (IDS) Form (SB08)	P30138_US3_IDS_SB08.pdf	1037454 14f5f3362bd63c73fc1dcdb33a14f8a3b6eb74f2	no	7

Warnings:					
Information:					
6	Fee Worksheet (SB06)	fee-info.pdf	40251	no	2
			f26c552f42badb4a05277adc7675aad71e001c96		
Warnings:					
Information:					
Total Files Size (in bytes):				3598631	
<p>This Acknowledgement Receipt evidences receipt on the noted date by the USPTO of the indicated documents, characterized by the applicant, and including page counts, where applicable. It serves as evidence of receipt similar to a Post Card, as described in MPEP 503.</p> <p><u>New Applications Under 35 U.S.C. 111</u> If a new application is being filed and the application includes the necessary components for a filing date (see 37 CFR 1.53(b)-(d) and MPEP 506), a Filing Receipt (37 CFR 1.54) will be issued in due course and the date shown on this Acknowledgement Receipt will establish the filing date of the application.</p> <p><u>National Stage of an International Application under 35 U.S.C. 371</u> If a timely submission to enter the national stage of an international application is compliant with the conditions of 35 U.S.C. 371 and other applicable requirements a Form PCT/DO/EO/903 indicating acceptance of the application as a national stage submission under 35 U.S.C. 371 will be issued in addition to the Filing Receipt, in due course.</p> <p><u>New International Application Filed with the USPTO as a Receiving Office</u> If a new international application is being filed and the international application includes the necessary components for an international filing date (see PCT Article 11 and MPEP 1810), a Notification of the International Application Number and of the International Filing Date (Form PCT/RO/105) will be issued in due course, subject to prescriptions concerning national security, and the date shown on this Acknowledgement Receipt will establish the international filing date of the application.</p>					

PUCCH RESOURCE ALLOCATION FOR CARRIER AGGREGATION
IN LTE-ADVANCED

RELATED APPLICATION

[0001] This application is a continuation of U.S. Patent Application No. 12/896,993, filed October 4, 2010, now U.S. Patent No. 9,497,004, issued November 15, 2016, claiming the benefit of U.S. Provisional Patent Application 61/248,661, filed October 5, 2009, all of which the contents are hereby incorporated by reference as if fully set forth below.

TECHNICAL FIELD

[0002] The present invention relates generally to carrier aggregation in a mobile communication system and, more particularly, to an efficient resource allocation for the physical uplink control channel for carrier aggregation.

BACKGROUND

[0003] Carrier aggregation is one of the new features being discussed for the next generation of Long Term Evolution (LTE) systems, which is being standardized as part of LTE Release 10 (known as LTE-Advanced). LTE Rel 8 currently supports bandwidths up to 20 MHz. In LTE-Advanced, bandwidths up to 100 MHz will be supported. The very high data rates contemplated for LTE-Advanced will require an expansion of the transmission bandwidth. In order to maintain backward compatibility with LTE Rel-8 user terminals, the available spectrum is divided into Rel-8 compatible chunks called component carriers. Carrier aggregation enables the needed bandwidth expansion by allowing user terminals to transmit data over multiple component carriers comprising up to 100 MHz of spectrum. Carrier aggregation also ensures efficient use of a wide carrier for legacy terminals by making it possible for legacy terminals to be scheduled in all parts of the wideband LTE-Advanced carrier.

[0004] The number of aggregated component carriers, as well as the bandwidth of the individual component carrier, may be different for Uplink (UL) and Downlink (DL). A symmetric configuration refers to the case where the number of component carriers in downlink and uplink is the same. An asymmetric configuration refers to the case where the number of component carriers is different. The number of component carriers

configured for a geographic cell area may be different from the number of component carriers seen by a terminal. A user terminal, for example, may support more downlink component carriers than uplink component carriers, even though in the geographic cell area the same number of uplink and downlink component carriers is offered by the network.

[0005] One consideration for carrier aggregation is how to transmit control signaling from the user terminal on the uplink from the user terminal. Uplink control signaling may include acknowledgement (ACK) signaling for hybrid automatic repeat request (HARQ) protocols, channel state and quality information (CSI, CQI) reporting for downlink scheduling, and scheduling requests (SRs) indicating that the user terminal needs uplink resources for uplink data transmissions. One solution is to transmit the uplink control information on multiple uplink component carriers associated with different downlink component carriers. However, this option is likely to result in higher user terminal power consumption and a dependency on specific user terminal capabilities. It may also create implementation issues due to inter-modulation products, and may lead to generally higher complexity for implementation and testing.

SUMMARY

[0006] The invention provides a signaling mechanism for efficient transmission of control information in a communication system using carrier aggregation. The signaling mechanism allows the transmission, on a single uplink component carrier, of control information associated with downlink transmissions on multiple aggregated downlink component carriers. Semi-statically reserved resources for the transmission of control information on the uplink component carrier may be dynamically shared by user terminals that are assigned multiple downlink component carriers for downlink transmissions. Implicit or explicit resource indication can be used in combination with dynamic resource indication.

[0007] One exemplary embodiment of the invention comprises a method implemented by a base station of receiving control information from user terminals. The method comprises scheduling downlink transmissions to said user terminal on one or more downlink component carriers; if the user terminal is scheduled to receive downlink transmissions on a first single downlink component carrier, receiving control information associated with the downlink transmissions to the user terminal on a first set of radio

resources on an uplink primary component carrier associated with said first downlink component carrier; and if the user terminal is scheduled to receive downlink transmissions on a second single downlink component carrier or multiple downlink component carriers, receiving control information associated with the downlink transmissions to the user terminal on a second set of radio resources on the uplink primary component carrier.

[0008] Another exemplary embodiment of the invention comprises a base station for transmitting data to one or more user terminals. The base station comprises a transmitter to transmit user data on one or more downlink component carriers to a user terminal; and a controller to schedule downlink transmissions to the user terminal. The controller is configured to schedule downlink transmissions to the user terminal on one or more downlink component carriers; if the user terminal is scheduled to receive downlink transmissions on a first single downlink component carrier, receive control information associated with the downlink transmissions to the user terminal on a first set of radio resources on an uplink primary component carrier associated with said first downlink component carrier; and, if the user terminal is scheduled to receive downlink transmissions on a second single downlink component carrier or multiple downlink component carriers, receive control information associated with the downlink transmissions to the user terminal on a second set of radio resources on the uplink primary component carrier..

[0009] Another exemplary embodiment of the invention comprises a method of transmitting control information implemented by a user terminal in a mobile communication network. The method comprises receiving an assignment of radio resources for downlink transmissions from a base station; transmitting control information associated with the downlink transmissions on a first set of radio resources on an uplink component carrier if an assignment of a single downlink component carrier for the downlink transmission is received; and transmitting control information associated with the downlink transmissions on a second set of radio resources on the uplink component carrier if an assignment of multiple downlink component carriers for the downlink transmission is received.

[0010] Another exemplary embodiment of the invention comprises a user terminal configured to send control information associated with downlink transmissions on one or more downlink component carriers. The user terminal comprises a receiver to receive

downlink transmissions from a base station; a transmitter to transmit control information associated with the downlink transmission to a base station; and a controller to select radio resources for transmission of control information associated with the downlink transmissions. The controller is configured to select a first set of radio resources on an uplink component carrier if an assignment of a single downlink component carrier for the downlink transmission is received; and select a second set of radio resources on the uplink component carrier if an assignment of multiple downlink component carriers for the downlink transmission is received.

[0011] Another exemplary embodiment of the invention comprises an alternate method of transmitting control information implemented by a user terminal in a mobile communication network. The method comprises receiving an assignment of radio resources for a downlink transmissions from a base station; transmitting control information associated with the downlink transmission on a first set of radio resources on an uplink component carrier if an assignment of a first downlink component carrier for the downlink transmission is received; and transmitting control information associated with the downlink transmission on a second set of radio resources on the uplink component carrier if an assignment of a second downlink component carrier for the downlink transmission is received.

[0012] Another exemplary embodiment of the invention comprises a user terminal configured to send control information associated with downlink transmissions on one or more downlink component carriers. The user terminal comprises a receiver to receive downlink transmissions from a base station; a transmitter to transmit control information associated with the downlink transmission to a base station; and a controller to select radio resources for transmission of control information associated with the downlink transmission. The controller is configured to select a first set of radio resources on an uplink component carrier if an assignment of a first downlink component carrier for the downlink transmission is received; and select a second set of radio resources on the uplink component carrier if an assignment of a second downlink component carrier for the downlink transmission is received.

BRIEF DESCRIPTION OF THE DRAWINGS

[0013] Fig. 1 illustrates an exemplary OFDM communication system.

[0014] Fig. 2 illustrates an exemplary time-frequency grid for an OFDM system.

- [0015] Fig. 3 illustrates an exemplary time-domain structure for an OFDM system.
- [0016] Fig. 4 illustrates uplink L1/L2 control signaling transmission on PUCCH.
- [0017] Fig. 5 illustrates the PUCCH format 1 using a normal cyclic prefix.
- [0018] Fig. 6 illustrates the PUCCH format 2 using a normal cyclic prefix.
- [0019] Fig. 7 illustrates an exemplary allocation of resource blocks for PUCCH.
- [0020] Fig. 8 illustrates the concept of carrier aggregation.
- [0021] Fig. 9 illustrates an exemplary method implemented by a base station of receiving control information from user terminals scheduled on a single carrier and multiple carriers.
- [0022] Fig. 10 illustrates an exemplary method implemented by a user terminal of signaling control information to a base station.
- [0023] Fig. 11 illustrates another exemplary method implemented by a user terminal of signaling control information to a base station.
- [0024] Fig. 12 illustrates an exemplary base station with a controller for controlling downlink transmissions by the base station to one or more user terminals and associated transmissions of uplink control information by the user terminals
- [0025] Fig. 13 illustrates an exemplary user terminal with a controller for controlling transmission of uplink control information to a base station.

DETAILED DESCRIPTION

[0026] Referring now to the drawings, Fig. 1 illustrates an exemplary mobile communication network 10 for providing wireless communication services to user terminals 100. Three user terminals 100 are shown in Fig. 1. The user terminals 100 may comprise, for example, cellular telephones, personal digital assistants, smart phones, laptop computers, handheld computers, or other devices with wireless communication capabilities. The mobile communication network 10 comprises a plurality of geographic cell areas or sectors 12. Each geographic cell area or sector 12 is served by a base station 20, which is referred to in LTE as a NodeB or Enhanced NodeB (eNodeB). A single base station 20 may provide service in multiple geographic cell areas or sectors 12. The user terminals 100 receive signals from a serving base

station 20 on one or more downlink (DL) channels, and transmit signals to the base station 20 on one or more uplink (UL) channels.

[0027] For illustrative purposes, an exemplary embodiment of the present invention will be described in the context of a Long-Term Evolution (LTE) system. Those skilled in the art will appreciate, however, that the present invention is more generally applicable to other wireless communication systems, including Wideband Code-Division Multiple Access (WCDMA) and WiMax (IEEE 802.16) systems.

[0028] LTE uses Orthogonal Frequency Division Multiplexing (OFDM) in the downlink and Discrete Fourier Transform (DFT) spread OFDM in the uplink. The basic LTE downlink physical resource can be viewed as a time-frequency grid. Fig. 2 illustrates a portion of an exemplary OFDM time-frequency grid 50 for LTE. Generally speaking, the time-frequency grid 50 is divided into one millisecond subframes. Each subframe includes a number of OFDM symbols. For a normal cyclic prefix (CP) length, suitable for use in situations where multipath dispersion is not expected to be extremely severe, a subframe comprises fourteen OFDM symbols. A subframe comprises twelve OFDM symbols if an extended cyclic prefix is used. In the frequency domain, the physical resources are divided into adjacent subcarriers with a spacing of 15 kHz. The number of subcarriers varies according to the allocated system bandwidth. The smallest element of the time-frequency grid 50 is a resource element. A resource element comprises one OFDM subcarrier during one OFDM symbol interval.

[0029] In LTE systems, data is transmitted to the user terminals over a downlink transport channel known as the Physical Downlink Shared Channel (PDSCH). The PDSCH is a time and frequency multiplexed channel shared by a plurality of user terminals. As shown in Fig. 3, the downlink transmissions are organized into 10 ms radio frames. Each radio frame comprises ten equally-sized subframes. For purposes of scheduling users to receive downlink transmissions, the downlink time-frequency resources are allocated in units called resource blocks (RBs). Each resource block spans twelve subcarriers (which may be adjacent or distributed across the frequency spectrum) and one 0.5 ms slot (one half of one subframe). The term "resource block pair" refers to two consecutive resource blocks occupying an entire one millisecond subframe.

[0030] The base station 20 dynamically schedules downlink transmissions to the user terminals based on channel state and quality information (CSI, CQI) reports from the

user terminals on the Physical Uplink Control Channel (PUCCH) or Physical Uplink Shared Channel (PUSCH). The CQI and CSI reports indicate the instantaneous channel conditions as seen by the receiver. In each subframe, the base station 20 transmits downlink control information (DCI) identifying the user terminals that have been scheduled to receive data (hereinafter the scheduled terminals) in the current downlink subframe and the resource blocks on which the data is being transmitted to the scheduled terminals. The DCI is typically transmitted on the Physical Downlink Control Channel (PDCCH) in the first 1, 2, or 3 OFDM symbols in each subframe.

[0031] Hybrid Automatic Repeat Request (HARQ) is used to mitigate errors that occur during transmission of data on the downlink. When the base station 20 indicates that a user terminal 100 is scheduled to receive a transmission on the PDSCH, the user terminal 100 decodes the PDSCH and transmits an acknowledgement (ACK/NACK) message to base station 20 on the PUCCH or PUSCH. The acknowledgement message informs the base station 20 whether the data packet was correctly received by the user terminal 100. The acknowledgement message could be either a positive acknowledgement (ACK) indicating a successful decoding or a negative acknowledgement (NACK) message indicating a decoding failure. Based on the acknowledgement message received from the user terminal 100, base station 20 determines whether to transmit new data (ACK received) or to retransmit the previous data (NACK received).

[0032] For uplink transmissions, the user terminals transmit scheduling requests (SRs) to the base station 20 on the PUCCH when the user terminals have data to send but no valid uplink grant. The base stations 20 allocate uplink resources responsive to the scheduling requests and transmit a scheduling grant to the user terminal 100 on the PDCCH. When the data is received, the base station 20 transmits ACK/NACK signaling to the user terminal 100 on the Physical Hybrid Automatic Repeat Request Indicator Channel (PHICH) to indicate whether the data is received correctly.

[0033] If the user terminal 100 has not been assigned an uplink resource for data transmission, the L1/L2 control information (CQI reports, ACK/NACKs, and SRs) is transmitted in uplink resources (resource blocks) specifically assigned for uplink transmission of L1/L2 control information on the Physical Uplink Control Channel (PUCCH). As illustrated in Fig. 4, these resources are located at the edges of the total available cell bandwidth. Each PUCCH resource comprises of one resource block

(twelve subcarriers) within each of the two slots of an uplink subframe. Frequency hopping is used to provide frequency diversity. The frequency of the resource blocks alternate at the slot boundary, with one resource block at the upper part of the spectrum within the first slot of a subframe and an equally sized resource block at the lower part of the spectrum during the second slot of the subframe, or vice versa. If more resources are needed for the uplink L1/L2 control signaling, e.g., in case of very large overall transmission bandwidth supporting a large number of users, additional resources blocks can be assigned adjacent the previously assigned resource blocks.

[0034] The reasons for locating the PUCCH resources at the edges of the overall available spectrum are two-fold. First, the allocation maximizes the frequency diversity, particularly when frequency hopping is employed. Second, the allocation avoids fragmentation of the uplink spectrum, which would make it impossible to assign very wide transmission bandwidths to a single user terminal 100 and still retain the single-carrier property of the uplink transmission.

[0035] The bandwidth of one resource block during one subframe is too large for the control signaling needs of a single user terminal 100. Therefore, to efficiently exploit the resources set aside for control signaling, multiple user terminals can share the same resource block. This is done by assigning the different terminals different orthogonal phase rotations of a cell-specific length-12 frequency-domain sequence. A linear phase rotation in the frequency domain is equivalent to applying a cyclic shift in the time domain. Thus, although the term “phase rotation” is used herein, the term cyclic shift is sometimes used with an implicit reference to the time domain.

[0036] The resource used by a PUCCH is therefore not only specified in the time-frequency domain by the resource-block pair, but also by the phase rotation applied. Similarly to the case of reference signals, there are up to twelve different phase rotations specified in the LTE standard, providing up to twelve different orthogonal sequences from each cell-specific sequence. However, in the case of frequency-selective channels, not all the twelve phase rotations can be used if orthogonality is to be maintained. Typically, up to six rotations are considered usable in a cell.

[0037] There are two message formats defined for transmission of control information on the PUCCH, each capable of carrying a different number of bits. A user terminal 100 uses PUCCH format 1 to transmit HARQ acknowledgements and scheduling requests. For CQI reporting, the user terminal 100 uses PUCCH format 2.

[0038] Hybrid-ARQ acknowledgements are used to acknowledge the reception of one (or two in case of spatial multiplexing) transport blocks in the downlink. Scheduling requests are used to request resources for uplink data transmission. A scheduling request is transmitted only when the user terminal 100 is requesting resources, otherwise the user terminal 100 stays silent in order to save battery resources and not create unnecessary interference. For scheduling requests, no explicit information bit is transmitted. Instead, the user terminal requests uplink resources by the presence (or absence) of energy on the corresponding PUCCH. Although HARQ acknowledgements and scheduling requests serve different purposes, they share the same PUCCH format. This format is referred to as PUCCH format 1 in the specifications

[0039] Fig. 5 illustrates the structure of a PUCCH format 1 message. The PUCCH format 1 uses the same structure in each of the two slots of a subframe. For transmission of a HARQ acknowledgement, the single HARQ acknowledgement bit is used to generate a BPSK symbol (in case of downlink spatial multiplexing the two acknowledgement bits are used to generate a QPSK symbol). For a scheduling request, on the other hand, the BPSK/QPSK symbol is replaced by a constellation point treated as negative acknowledgement at the base station 20. The modulation symbol is then used to generate the signal to be transmitted in each of the two PUCCH slots.

[0040] A PUCCH format 1 resource, used for either a HARQ acknowledgement or a scheduling request, is represented by a single scalar resource index. From the index, the phase rotation and the orthogonal cover sequence is derived. For HARQ transmission, the resource index to use for transmission of the HARQ acknowledgement is given implicitly by the DCI transmitted on the PDCCH to schedule the downlink transmission to the user terminal 100. Thus, the resources to use for an uplink HARQ acknowledgement vary dynamically and depend on the DCI used to schedule the user terminal 100 in each subframe.

[0041] In addition to dynamic scheduling based on the DCI transmitted by the base station on the PDCCH, it is also possible to semi-persistently schedule a user terminal 100 according to a specific pattern. In this case the configuration information indicating the semi-persistent scheduling pattern includes information on the PUCCH index to use for the HARQ acknowledgements. The configuration information also informs the user terminal 100 which PUCCH resources to use for transmission of scheduling requests.

[0042] The PUCCH resources are split into two parts: a semi-static part and a dynamic part. The semi-static part of the PUCCH resources is used for scheduling requests and HARQ acknowledgements from semi-persistent users. The amount of resources used for the semi-static part of PUCCH 1 resources does not vary dynamically. The dynamic part is used for dynamically scheduled user terminals. As the number of dynamically scheduled terminals varies, the amount of resources used for the dynamic PUCCHs varies.

[0043] Channel-status reports are used to provide the base station 20 with an estimate of the channel conditions as seen by the user terminal 100 in order to aid channel-dependent scheduling. A channel-status report consists of multiple bits per subframe. PUCCH format 1, which is capable of at most two bits of information per subframe, can not be used for this purpose. Transmission of channel-status reports on the PUCCH is instead handled by PUCCH format 2, which is capable of multiple information bits per subframe.

[0044] PUCCH format 2, illustrated for normal cyclic prefix in Fig. 6, is based on a phase rotation of the same cell-specific sequence as format 1. Similarly to format 1, a format 2 resource can be represented by an index from which the phase rotation and other quantities necessary are derived. The PUCCH format 2 resources are semi-statically configured.

[0045] Both PUCCH format 1 and format 2 signaling messages are transmitted on a resource-block pair with one resource block in each slot. The resource-block pair is determined from the PUCCH resource index. Thus, the resource-block number to use in the first and second slot of a subframe can be expressed as

[0046] $RBnumber(i) = f(\text{PUCCH index}, i)$

[0047] where i is the slot number (0 or 1) within the subframe and f a function found in the specification.

[0048] Multiple resource-block pairs can be used to increase the control-signaling capacity. When one resource-block pair is full, the next PUCCH resource index is mapped to the next resource-block pair in sequence. The mapping is done such that PUCCH format 2 (channel-status reports) is transmitted closest to the edges of the uplink cell bandwidth with the semi-static part of PUCCH format 1 next and finally the

dynamic part of PUCCH format 1 in the innermost part of the bandwidth as shown in Fig. 7.

[0049] Three semi-statically parameters are used to determine the resources to use for the different PUCCH formats:

[0050] • $N_{RB}^{(2)}$, provided as part of the system information, controls on which resource-block pair the mapping of PUCCH format 1 starts

[0051] • $N_{PUCCH}^{(1)}$ controls the split between the semi-static and dynamic part of PUCCH format 1

[0052] • $N_{CS}^{(1)}$ controls the mix of format 1 and format 2 in one resource block. In most cases, the configuration is done such that the two PUCCH formats are mapped to separate sets of resource blocks, but there is also a possibility to have the border between format 1 and 2 within a resource block.

[0053] In order to support bandwidths greater than 20MHz, carrier aggregation will be supported in LTE Rel 10. To maintain backward compatibility with Rel 8 user terminals 100, the available spectrum is divided into Rel-8 compatible component carriers (e.g., 20 Mhz component carriers) as shown in Fig. 8. A user terminal 100 can obtain bandwidth up to 100 MHz by transmitting on multiple component carriers. The use of multiple component carriers for data transmission is known as carrier aggregation.

[0054] The number of aggregated component carriers as well as the bandwidth of the individual component carrier may be different for Uplink (UL) and Downlink (DL). A symmetric configuration refers to the case where the number of component carriers in DL and UL are the same. An asymmetric configuration refers to the case where the number of component carriers is different for the UL and DL. The number of component carriers configured for a geographic cell area 12 may be different from the number of component carriers seen by the user terminal 100. A user terminal 100 may, for example, support more DL component carriers than UL component carriers, even though in the geographic cell area 12 the same number of UL and DL component carriers is offered by the network.

[0055] One consideration for carrier aggregation is how to configure the PUCCH for uplink control signaling from the user terminal. One solution is to transmit the uplink control information on multiple control channels on multiple UL component carriers.

However, this option is likely to result in higher user terminal power consumption and a dependency on specific user terminal capabilities. It may also create implementation issues due to inter-modulation products, and may lead to generally higher complexity for implementation and testing.

[0056] According to some embodiments of the present invention, the PUCCH resources on a single uplink component carrier are used to support downlink transmissions on several downlink component carriers. With this approach, a user terminal 100 transmit HARQ signaling associated with downlink transmissions on two or more downlink component carriers on PUCCH resources on a single uplink component carrier. Similarly, a single uplink component carrier may be used to support uplink transmissions on several uplink component carriers. For example, a user terminal 100 may use PUCCH resources on a single uplink component carrier to request uplink resources on multiple uplink component carriers. The uplink component carrier on which PUCCH resources are used to support downlink or uplink transmissions on two or more component carriers is referred to herein as uplink primary component carrier (UL PCC) or uplink associated with the primary cell (PCell).

[0057] For HARQ signaling, a straight-forward approach would be to increase the PUCCH resources on the UL PCC for PUCCH format 1 by a factor of N, where N is the number of aggregated downlink component carriers supported. However, consideration should be given to the typical expected use case. Not all user terminals 100 will be scheduled to receive downlink transmission on multiple downlink component carriers. The number of downlink component carriers used for transmission will be user terminal specific and will vary dynamically as user terminals 100 are scheduled. With bursty data-transmission, the number of user terminals 100 simultaneously assigned resources on several downlink carriers is expected to be rather small. Multiple downlink component carriers are only needed when there are not enough resources on a single component carrier, and there appears to be no benefits from assigning several smaller transport blocks on multiple downlink component carriers for a large number of user terminals 100. Therefore, the design of the ACK/NACK feedback on PUCCH should be optimized for a low number of simultaneous user terminals 100 with assignments on multiple downlink component carrier.

[0058] Considering that the typical use case is a rather small number of user terminals 100 simultaneously assigned resources on multiple downlink component carriers,

increasing the overhead with a factor of N is probably not necessary. Rather, the amount of resources should be chosen in anticipation on the number of user terminals 100 that simultaneously are expected to have assignments on multiple downlink component carriers, which is expected to be scenario and implementation dependent. This could be achieved by configuring a set of uplink resources upon which the currently scheduled user terminal(s) 100 using multiple component carriers transmit the ACK/NACK feedback.

[0059] According to a first approach, a set of shared PUCCH resources of potentially configurable size, in addition to PUCCH resources according to LTE Rel-8, is allocated for HARQ acknowledgements by user terminals 100 which receive downlink assignments on multiple downlink component carriers. The resource set and/or the size of the resource set can be transmitted to the user terminal by Radio Resource Control (RRC) signaling. With this approach, the UL PCC contains PUCCH resources according to LTE Rel-8 for HARQ acknowledgements from user terminals 100 assigned resources for downlink transmission on a single downlink component carrier associated with the UL PCC. The shared PUCCH resource would be used by user terminals 100 which receive resource assignments for downlink transmission on multiple downlink component carriers. There may be some circumstances, such as retransmissions, when the user terminal 100 is assigned resources on a single downlink component carrier that is different from the downlink component carrier associated with the UL PCC. In such a case the shared set of PUCCH resources can also be used for such “cross-carrier” HARQ acknowledgements.

[0060] According to a second approach, a set of shared PUCCH resources of potentially configurable size, in addition to PUCCH resources according to LTE Rel-8, is allocated for HARQ acknowledgements by user terminals 100 which receive downlink assignments on at least one downlink component carrier other than the downlink component carrier having associated Rel- 8 resources on the UL PCC. The resource set and/or the size of the resource set can be transmitted to the user terminal by RRC signaling.

[0061] With either of the above approaches, the set of shared PUCCH resources may be made visible to the user terminal 100 in the same way as for LTE Rel-8 user terminals 100, namely in the form of an association rule between the DL PDCCH CCE and index to PUCCH resource. Thus, from a system perspective, the two sets of

PUCCH resources could overlap or be interleaved. In principle, a user terminal 100 could be configured with semi-static PUCCH resources for HARQ acknowledgements and then use these resources for HARQ acknowledgements in case of multiple DL component carrier assignments. By configuring all the user terminals 100 in the cell to have the same semi-static ACK/NACK resources, such a scheme would allow for assigning at most a single user terminal multiple DL component carrier at the same time. When there is no need for HARQ acknowledgements of multiple carriers, the resource could of course be used for data transmission. The user terminals 100 could select which shared PUCCH resources to use based on component carrier, DL PDDCH CCE, C-RNTI and other parameters. There is though a risk for collisions or scheduling constraints, and to reduce this, one could consider having a dynamic indicator to aid the selection of PUCCH resource. The dynamic indication allows managing the ACK/NACK resources more carefully which is of interest when the amount of resources reserved for HARQ acknowledgements is small and orthogonality is desired.

[0062] In one exemplary embodiment, semi-static PUCCH resources are reserved for user terminals 100 configured with multiple downlink component carriers. The assignment of PUCCH resources can be achieved by implicit indication of actual resource block, e.g., utilizing CCE index, number of the downlink component carriers, RNTI or a combination of these parameters. Alternatively, reserved PUCCH resources can be indicated explicitly via signaling to the user terminal 100 (e.g., RRC signaling), or by a combination of implicit and explicit signaling. Additionally, dynamic indication of PUCCH resources for HARQ acknowledgements can be done by using additional relative or explicit dynamic indication to select actual PUCCH resources out of the set of implicit/explicitly reserved (e.g., semi-statically reserved) resources. For example, the base station 20 may send as a control message or part of a control message, an indicator, referred to herein as an acknowledgement resource indication (ARI), comprising a single bit to indicate that the user terminal 100 should use the next available PUCCH resource or the next cyclically available PUCCH resource from the set of semi-statically reserved PUCCH resources. In some embodiments, the ARI may comprise the entire control message. In other embodiment, the ARI may be included as an information element in a larger control message. Alternatively, the base station 20 can send a multi-bit ARI to indicate the actual PUCCH resource out of the set of semi-statically reserved PUCCH resources.

[0063] There may be at least two different mappings to PUCCH resources on the UL PCC. A first resource mapping may be used for HARQ acknowledgements of downlink transmissions on a single designated downlink component carrier, and a second mapping for HARQ acknowledgements of downlink transmissions on at least one other downlink component carrier. The two mappings may be described by parameters, such as first resource and size of resource set that are configurable by means of higher layer signaling. The user terminal 100 may, based on the detected downlink assignments on one or several downlink component carriers, select one of the two mappings. In a preferred embodiment, the first mapping coincides with the Rel-8 mapping rules for ACK/NACK resources.

[0064] The user terminal 100 may, depending on the detected downlink assignments, and the downlink component carriers on which the downlink assignment was sent, select which mapping to use. Two approaches may be used by the user terminal 100 to select the mapping of radio resources for uplink control signaling. In the first approach, the user terminal 100 selects a first mapping if downlink assignment of a single downlink component carrier is detected and the downlink assignment is sent on the associated downlink component carrier. The user terminal 100 selects a second mapping if it detects at least one downlink assignment for at least one downlink component carrier different from the single associated downlink component carrier (for which there are Rel-8 ACK/NACK resources). In a second approach, the user terminal selects a mapping depending on the number of component carriers it detects for downlink assignments for downlink transmissions.

[0065] Fig. 9 illustrates an exemplary method 50 implemented by a base station 20 in a communication network 10 of receiving uplink control information from a user terminal 100 depending on the assignment of downlink component carriers. The base station 20 schedules the user terminal 100 to receive downlink transmissions on one or more downlink component carriers (block 52). The user terminal 100 may be scheduled to receive downlink transmissions on a single downlink component carrier associated with a primary uplink component carrier. In this case, the base station 20 receives control information associated with the downlink transmissions to the user terminal 100 on a first set of radio resources on the uplink primary component carrier (block 54). Alternatively, the user terminal 100 may be scheduled to receive downlink transmissions on multiple downlink component carriers, or on a single downlink component carrier other than the

downlink component carrier associated with the uplink primary component carrier. In this alternative case, the base station 20 receives uplink control information associated with the downlink transmissions from the user terminal 100 on a second set of radio resources on the uplink component carrier (block 56).

[0066] Fig. 10 illustrates an exemplary method 60 implemented by a user terminal of transmission of uplink control signaling to a base station 20. The user terminal 100 receives a radio resource assignment for a downlink transmission from the base station 20 (block 62). If the user terminal 100 detects assignments of radio resources for a single downlink component carrier, the user terminal 100 transmits, on a first set of radio resources on an uplink primary component carrier, uplink control information associated with the downlink transmissions (block 64). On the other hands, if the user terminal 100 receives assignments for multiple downlink component carriers, the user terminal 100 transmits, on a second set of radio resources on the uplink primary component carrier, uplink control information associated with downlink transmissions (block 66).

[0067] Fig. 11 illustrates another exemplary method 70 implemented by a user terminal 100 of transmission of uplink control signaling to a base station 20. The user terminal 100 receives a radio resource assignment for a downlink transmission from the base station 20 (block 72). If the user terminal 100 detects assignments of radio resources for a first downlink component carrier, the user terminal 100 transmits, on a first set of radio resources on a uplink primary component carrier, uplink control information associated with the downlink transmissions (block 74). On the other hands, if the user terminal 100 receives assignments for a second downlink component carrier, the user terminal 100 transmits, on a second set of radio resources on the primary uplink component carrier, uplink control information associated with downlink transmissions (block 76).

[0068] Fig. 12 illustrates an exemplary base station 20 according to the present invention. The base station 20 comprises a transceiver 22 for communicating with user terminals and processing circuit 32 for processing the signals transmit and received by the transceiver 22. The transceiver 22 includes a transmitter 24 coupled to one or more transmit antennas 28 and receiver 26 coupled to one or more receive antennas 30. The same antenna(s) 28, 30 may be used for both transmission and reception. The processing circuit 32 may be implemented by one or more processors, hardware, firmware or a combination thereof. Typical functions of the processing circuit 32 include modulation and coding of transmitted signals, and the demodulation and decoding of

received signals. The processing circuit 32 also includes a controller 34 for controlling the operation of the base station 20. The controller 34 is responsible for transmission of downlink control information on the PDCCH, and for the processing of uplink control information received on the PUCCH.

[0069] Fig. 13 illustrates a functional block diagram of an exemplary user terminal 100. The user terminal 100 comprises a transceiver 110 and a processing circuit 120. The transceiver 110 comprises a transmitter 112 coupled to one or more transmit antennas 114, and a receiver 116, coupled to one or more receive antennas 118. Those skilled in the art will appreciate that the same antennas may be used for transmission and reception. The processing circuit 120 processes signals transmitted and received by the transceiver 110. The processing circuit 120 comprises one or more processors, hardware, firmware, or a combination thereof. Typical functions of the processing circuit 120 include modulation and coding of transmitted signals, and the demodulation and decoding of received signals. The processing circuit 120 includes a controller 122 for controlling uplink transmissions and the reception of downlink transmissions. The controller 122 generates uplink control information for transmission on the PUCCH, and processes downlink control information received on the PDCCH as previously described.

[0070] The invention provides means for efficient transmission of PUCCH on one component carrier corresponding to multiple downlink component carriers, without creating implementation problems in the user terminal or being over-dimensioned and therefore inefficient.

[0071] The present invention may, of course, be carried out in other specific ways than those herein set forth without departing from the scope and essential characteristics of the invention. The present embodiments are, therefore, to be considered in all respects as illustrative and not restrictive, and all changes coming within the meaning and equivalency range of the appended claims are intended to be embraced therein.

CLAIMS

What is claimed is:

1. A method implemented by a base station of receiving control information from a user terminal, the method comprising:
 - scheduling downlink transmissions to a first user terminal on a single downlink component carrier associated with a primary cell and scheduling downlink transmissions to a second user terminal on multiple downlink component carriers or on a downlink component carrier associated with a non-primary cell;
 - receiving, on a first set of radio resources, control information associated with the downlink transmissions to the first user terminal, wherein the first set of radio resources is reserved for user terminals scheduled to receive downlink transmissions on a single downlink component carrier associated with the primary cell; and
 - receiving, on a second set of radio resources, control information associated with the downlink transmissions to the second user terminal, wherein the second set of radio resources is reserved for user terminals scheduled to receive downlink transmissions on multiple downlink component carriers or on a downlink component carrier associated with a non-primary cell, the first and second sets of radio resources being on a same uplink component carrier associated with the primary cell.
2. The method of claim 1, wherein the first and second sets of radio resources are different.
3. The method of claim 2, wherein the second set of radio resources are additional resources as compared to the first set of radio resources.
4. The method of claim 1, further comprising transmitting control information to the first user terminal to explicitly indicate the first set of radio resources on the uplink component carrier associated with the primary cell.

5. The method of claim 1, further comprising providing the first user terminal with an implicit indication to dynamically assign radio resources in said first set of radio resources.
6. The method of claim 5, wherein the implicit indication is a control channel element (CCE) of a Physical Downlink Control Channel (PDCCH) used for scheduling the first user terminal.
7. The method of claim 1, further comprising transmitting control information to the second user terminal on a downlink component carrier to implicitly or explicitly indicate the second set of radio resources on the uplink component carrier associated with the primary cell.
8. The method of claim 7, wherein at least one of the first and second sets of radio resources is indicated explicitly by an uplink control channel resource index.
9. The method of claim 8, wherein an explicit indication related to the second set of radio resources is transmitted as radio resource control signaling.
10. The method of claim 1, further comprising transmitting, on the single downlink component carrier, an indication to assign radio resources in the second set of radio resources when the second user terminal is scheduled to receive the downlink transmissions on the multiple downlink component carriers or on the downlink component carrier associated with the non-primary cell
11. The method of claim 10, wherein the indication to assign radio resources in said second set of radio resources is an acknowledgement resource indication to dynamically assign radio resources to the second user terminal when the second user terminal is scheduled to receive downlink transmissions on the multiple downlink component carriers or on the downlink component carrier associated with the non-primary cell.
12. The method of claim 11, wherein the acknowledgement resource indication selects radio resources in the second set of radio resources, which is a semi-statically configured set of uplink resources.

13. The method of claim 1, further comprising:
 - receiving control signaling on the second set of radio resources if radio resources on a single downlink component carrier associated with a non-primary cell are assigned for the downlink transmissions.

14. The method of claim 1, further comprising:
 - if the first user terminal is scheduled to receive downlink transmissions on a second single downlink component carrier associated with a non-primary cell, receiving control information associated with the downlink transmissions to the first user terminal on the second set of radio resources on the uplink component carrier associated with the primary cell, wherein the second set of radio resources is reserved for user terminals scheduled to receive downlink transmissions on the second single downlink component carrier.

15. The method of claim 1, wherein the first user equipment is the same as the second user equipment.

16. The method of claim 1, wherein the first user equipment is different from the second user equipment.

17. A base station comprising:

a transmitter to transmit user data on one or more downlink component carriers to a first user terminal and a second user terminal; and

a controller to schedule downlink transmissions to the first user terminal and the second user terminal, the controller configured to:

schedule downlink transmissions to the first user terminal on a single downlink component carrier associated with a primary cell and schedule downlink transmissions to the second user terminal on multiple downlink component carriers or on a downlink component carrier associated with a non-primary cell;

receive, on a first set of radio resources, control information associated with the downlink transmissions to the first user terminal, wherein the first set of radio resources is reserved for user terminals scheduled to receive downlink transmissions on a single downlink component carrier associated with the primary cell; and

receive, on a second set of radio resources, control information associated with the downlink transmissions to the second user terminal, wherein the second set of radio resources is reserved for user terminals scheduled to receive downlink transmissions on multiple downlink component carriers or on a downlink component carrier associated with a non-primary cell, the first and second sets of radio resources being on a same uplink component carrier associated with the primary cell.

18. A method implemented by a user terminal of transmitting control information in a mobile communication network, the method comprising:
- receiving an assignment of radio resources for downlink transmissions from a base station;
 - transmitting, on a first set of radio resources, control information associated with the downlink transmissions responsive to being assigned radio resources on a single downlink component carrier associated with the primary cell for the downlink transmission, wherein the first set of radio resources is reserved for user terminals scheduled to receive downlink transmissions on a single downlink component carrier associated with the primary cell; and
 - transmitting, on a second set of radio resources, control information associated with the downlink transmissions responsive to being assigned radio resources on multiple downlink component carriers or on a downlink component carrier associated with a non-primary cell for the downlink transmission, wherein the second set of radio resources is reserved for user terminals scheduled to receive downlink transmissions on multiple downlink component carriers or on a downlink component carrier associated with a non-primary cell, the first and second sets of radio resources being on a same uplink component carrier associated with the primary cell.
19. The method of claim 18, wherein the first and second sets of radio resources are different.
20. The method of claim 19, wherein the second set of radio resources are additional resources as compared to the first set of radio resources.
21. The method of claim 18, further comprising receiving control information from the base station explicitly indicating the first set of radio resources on the uplink component carrier associated with the primary cell.
22. The method of claim 21, wherein said receiving the control information comprises receiving an uplink control channel resource index explicitly indicating said first set of radio resources.

23. The method of claim 22, wherein an explicit indication relating to the second set of radio resources is received as radio resource control signaling.
24. The method of claim 18, further comprising receiving an implicit indication to dynamically assign radio resources in said first set of radio resources.
25. The method of claim 24, wherein the implicit indication is a control channel element (CCE) of a Physical Downlink Control Channel (PDCCH) on which the assignment of radio resources for downlink transmissions is received.
26. The method of claim 18, further comprising receiving, on the single downlink component carrier, an indication to assign radio resources in the second set of radio resources when the user terminal is scheduled to receive the downlink transmissions on the multiple downlink component carriers or on the downlink component carrier associated with the non-primary cell.
27. The method of claim 26, wherein the indication to assign radio resources in said second set of radio resources is an acknowledgement resource indication to dynamically assign radio resources in when the user terminal is scheduled to receive downlink transmissions on the multiple downlink component carriers or on the downlink component carrier associated with the non-primary cell.
28. The method of claim 27, further comprising selecting radio resources in the second set of radio resources, which is a semi-statically configured set of uplink resources, responsive to the acknowledgement resource indication.
29. The method of claim 18, further comprising:
transmitting control signaling on the second set of radio resources if radio resources on a single downlink component carrier associated with a non-primary cell are assigned for the downlink transmissions.

30. A user terminal for mobile communications, the user terminal comprising:
- a receiver to receive downlink transmissions from a base station;
 - a transmitter to transmit control information associated with the downlink transmission to a base station; and
 - a controller to select radio resources for transmission of control information associated with the downlink transmissions, the controller configured to:
 - select a first set of radio resources responsive to being assigned radio resources on a single downlink component carrier associated with the primary cell for the downlink transmission, wherein the first set of radio resources is reserved for user terminals scheduled to receive downlink transmissions on a single downlink component carrier associated with the primary cell; and
 - select a second set of radio resources responsive to being assigned radio resources on multiple downlink component carriers or on a downlink component carrier associated with a non-primary cell for the downlink transmissions, wherein the second set of radio resources is reserved for user terminals scheduled to receive downlink transmissions on multiple downlink component carriers or on a downlink component carrier associated with a non-primary cell, the first and second sets of radio resources being on a same uplink component carrier associated with the primary cell.

ABSTRACT

Systems and methods of signaling uplink control information in a mobile communication network using carrier aggregation are provided. In one exemplary embodiment, a method may include scheduling downlink transmissions to a first user terminal on a single downlink component carrier (CC) associated with a primary cell and scheduling downlink transmissions to a second user terminal on multiple downlink CCs or on a downlink CC associated with a non-primary cell. Further, the method may include receiving, on a first set of radio resources, control information associated with the downlink transmissions to the first user terminal. In addition, the method may include receiving, on a second set of radio resources, control information associated with the downlink transmissions to the second user terminal.

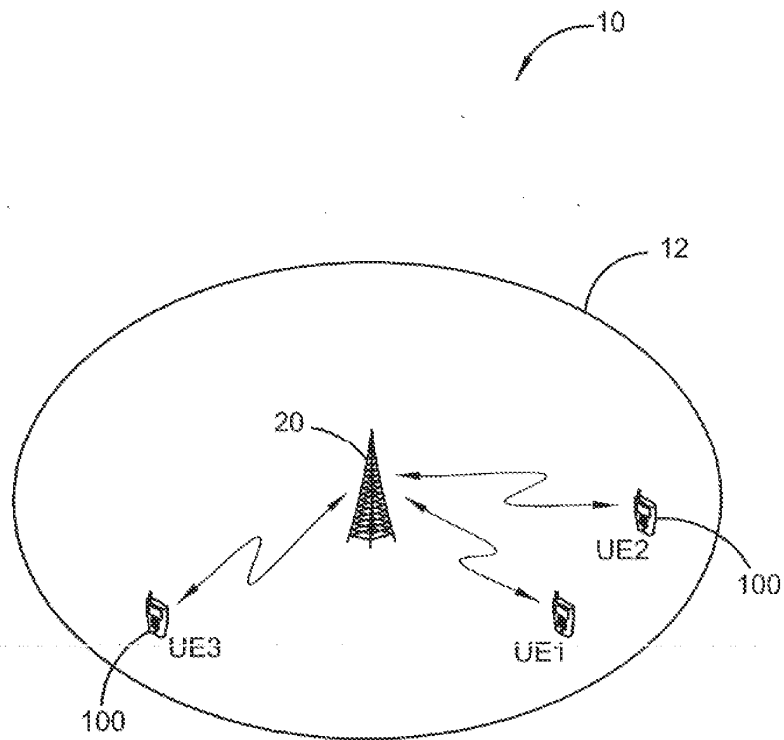

FIG. 1

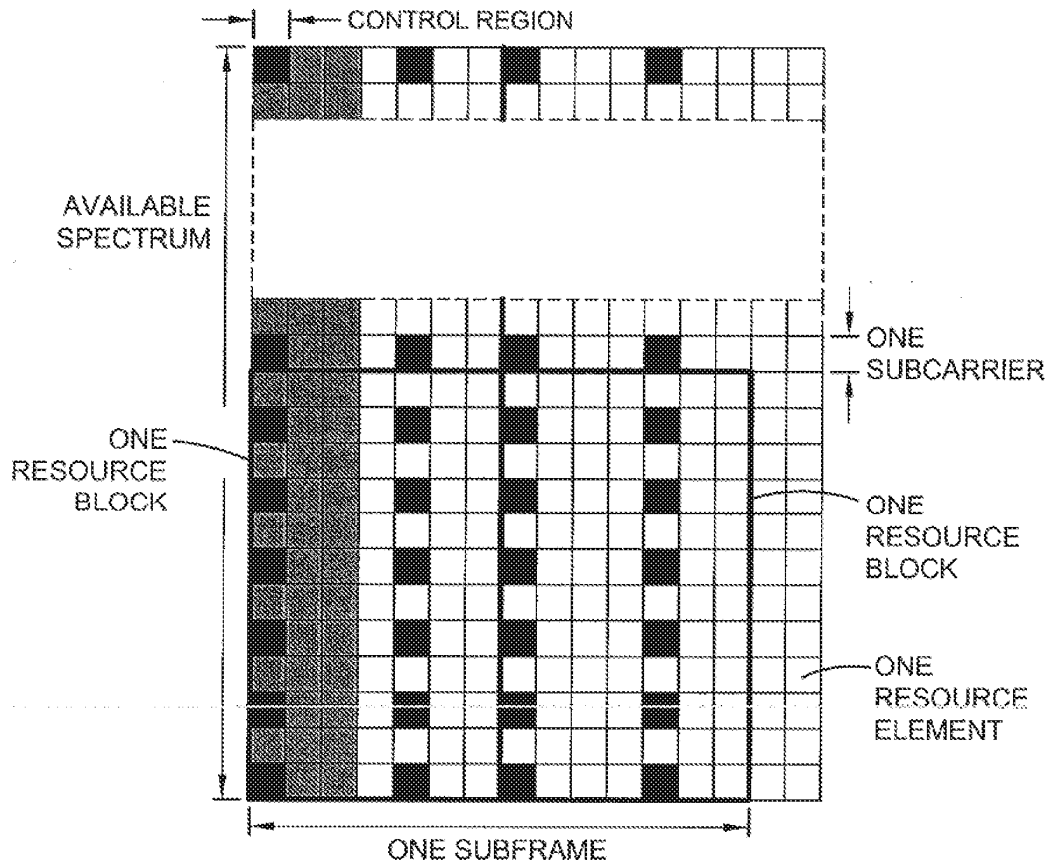

FIG. 2

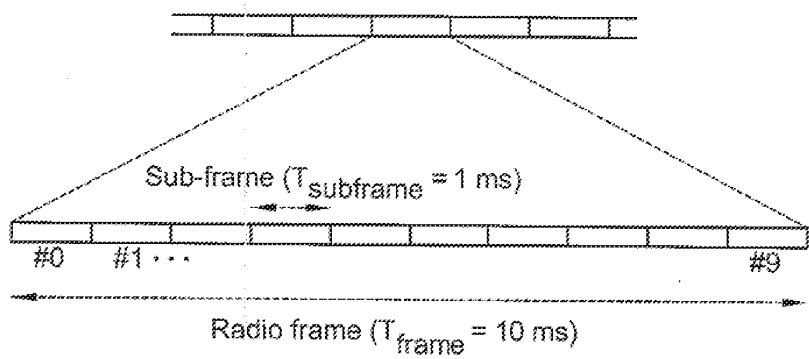

FIG. 3

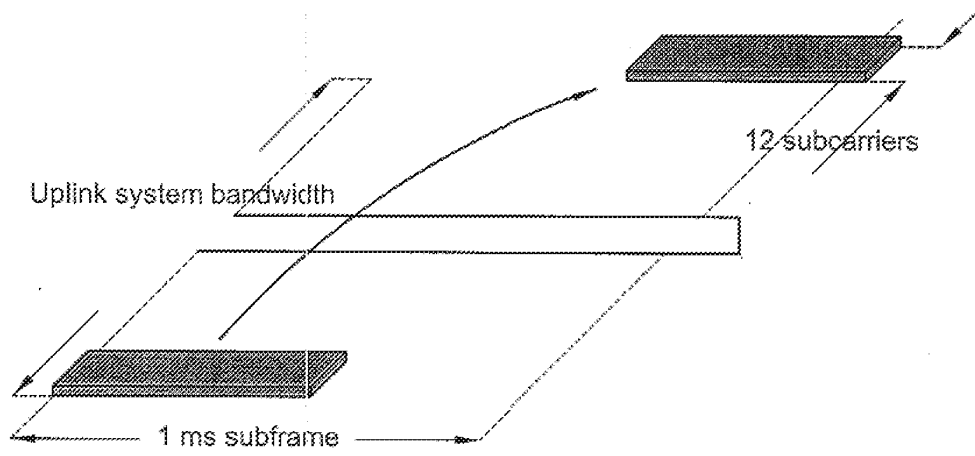

FIG. 4

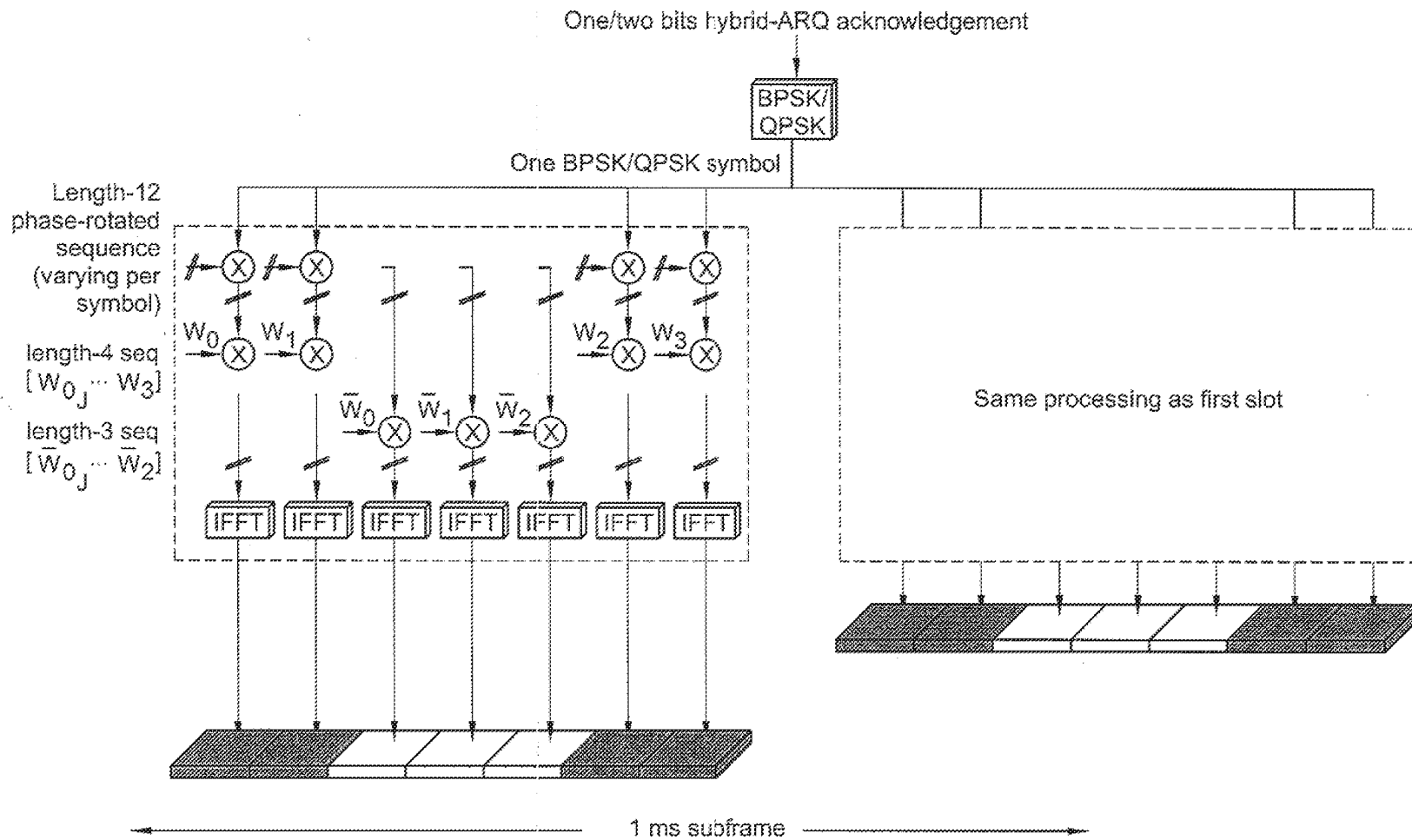

FIG. 5

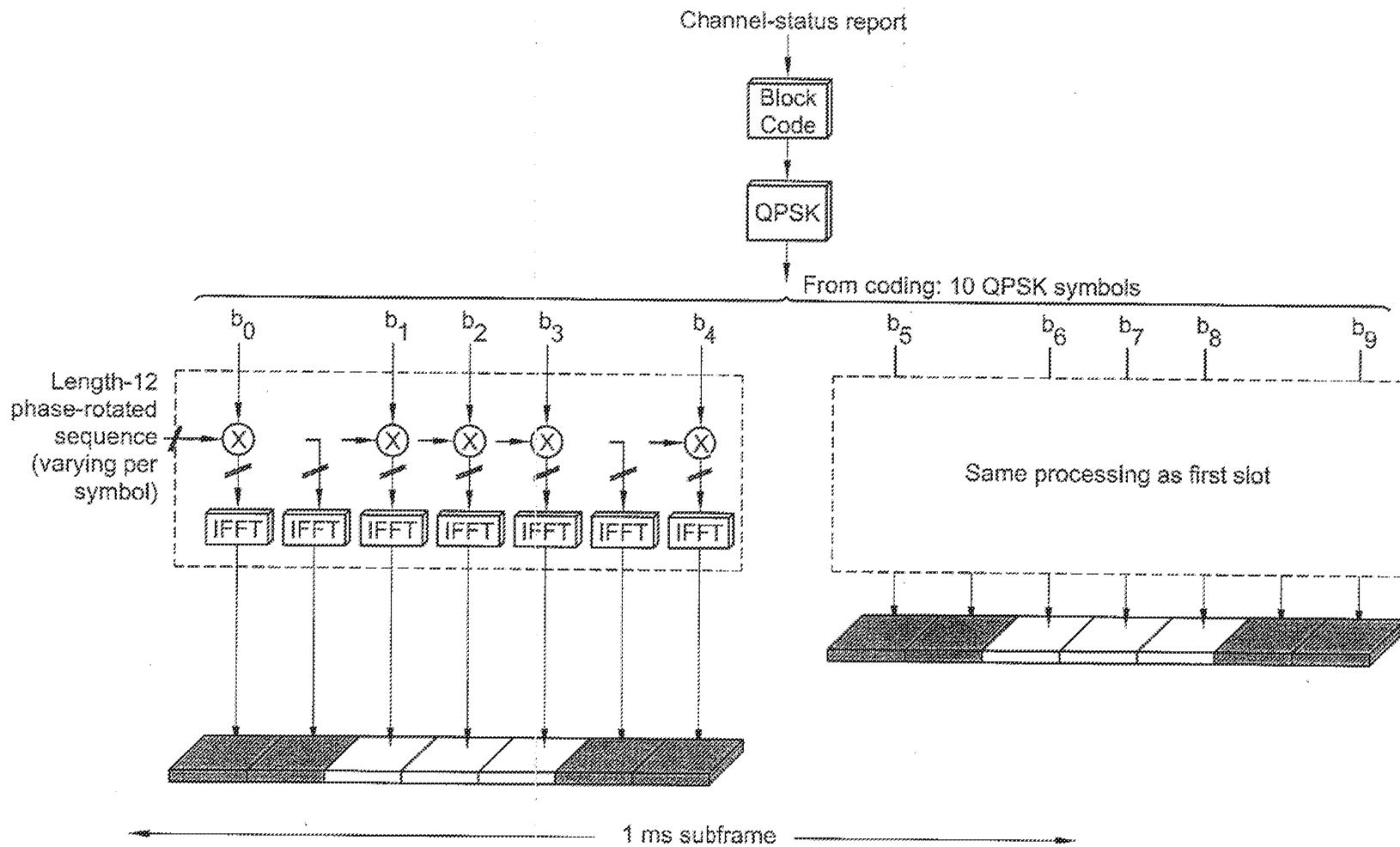
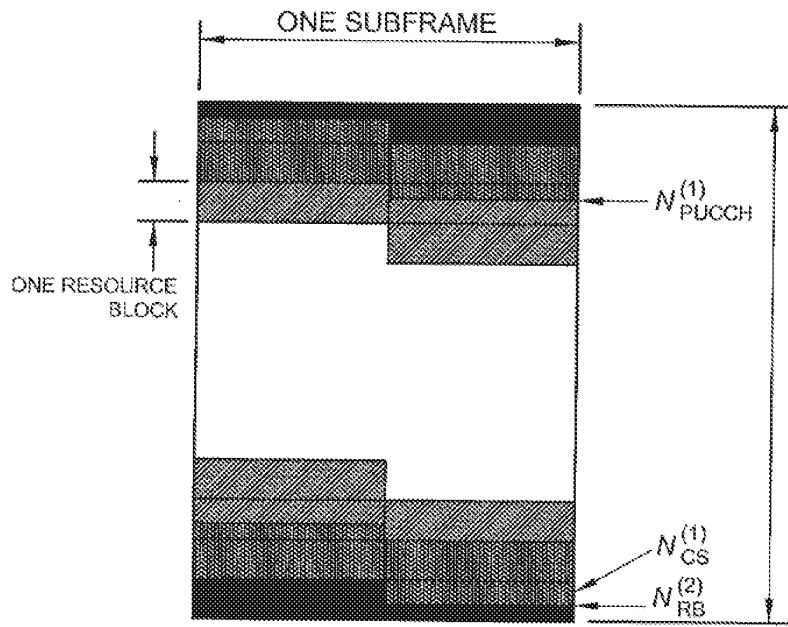

FIG. 6



- PUCCH FORMAT 2
- ▨ PUCCH FORMAT 1 (STATIC PART)
- ▩ PUCCH FORMAT 1 (DYNAMIC PART)

FIG. 7



FIG. 8

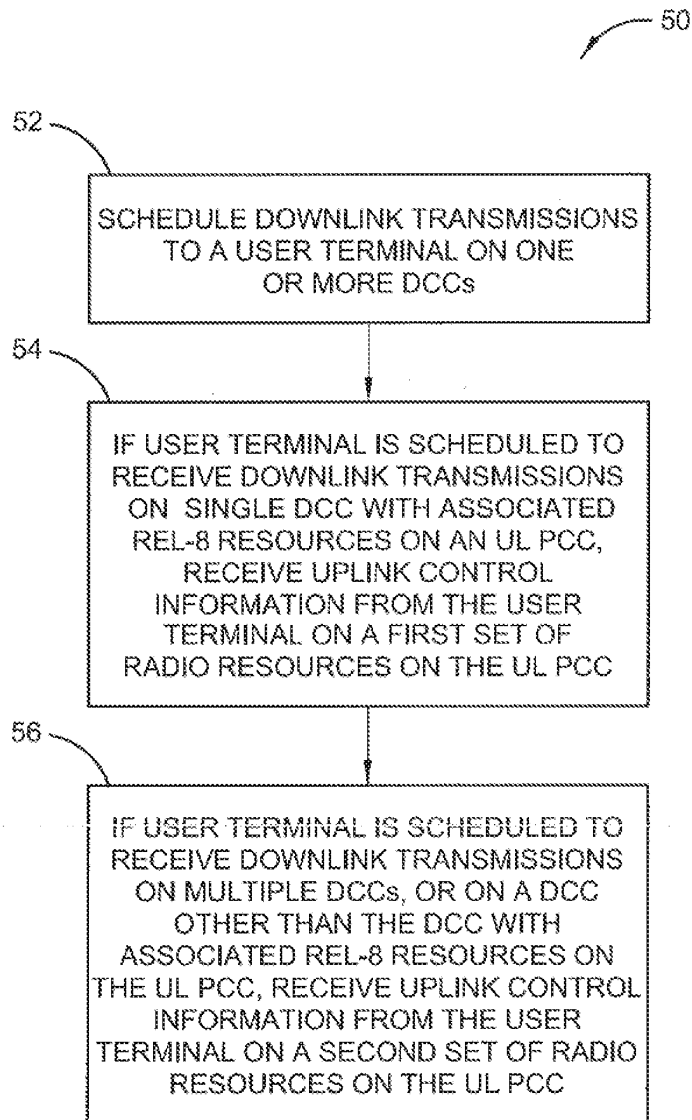

FIG. 9

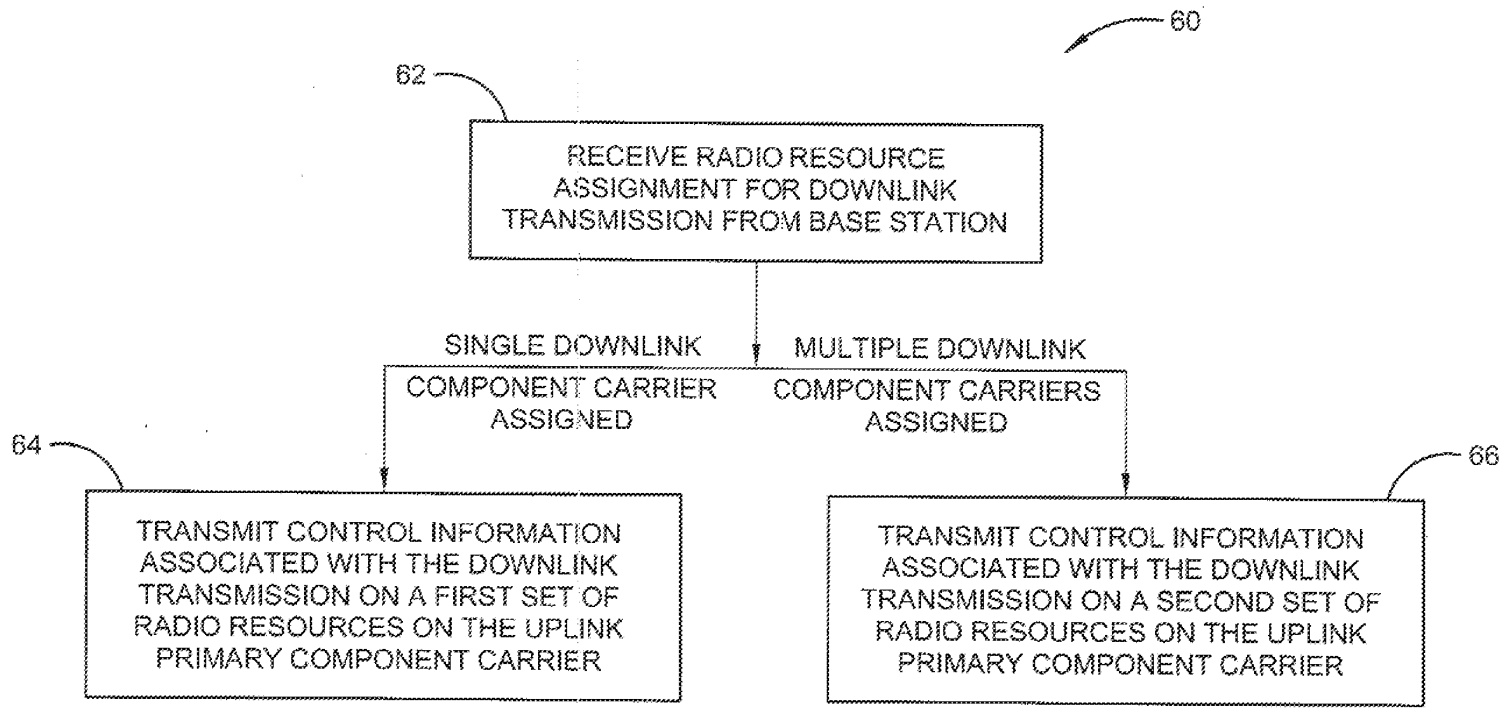

FIG. 10

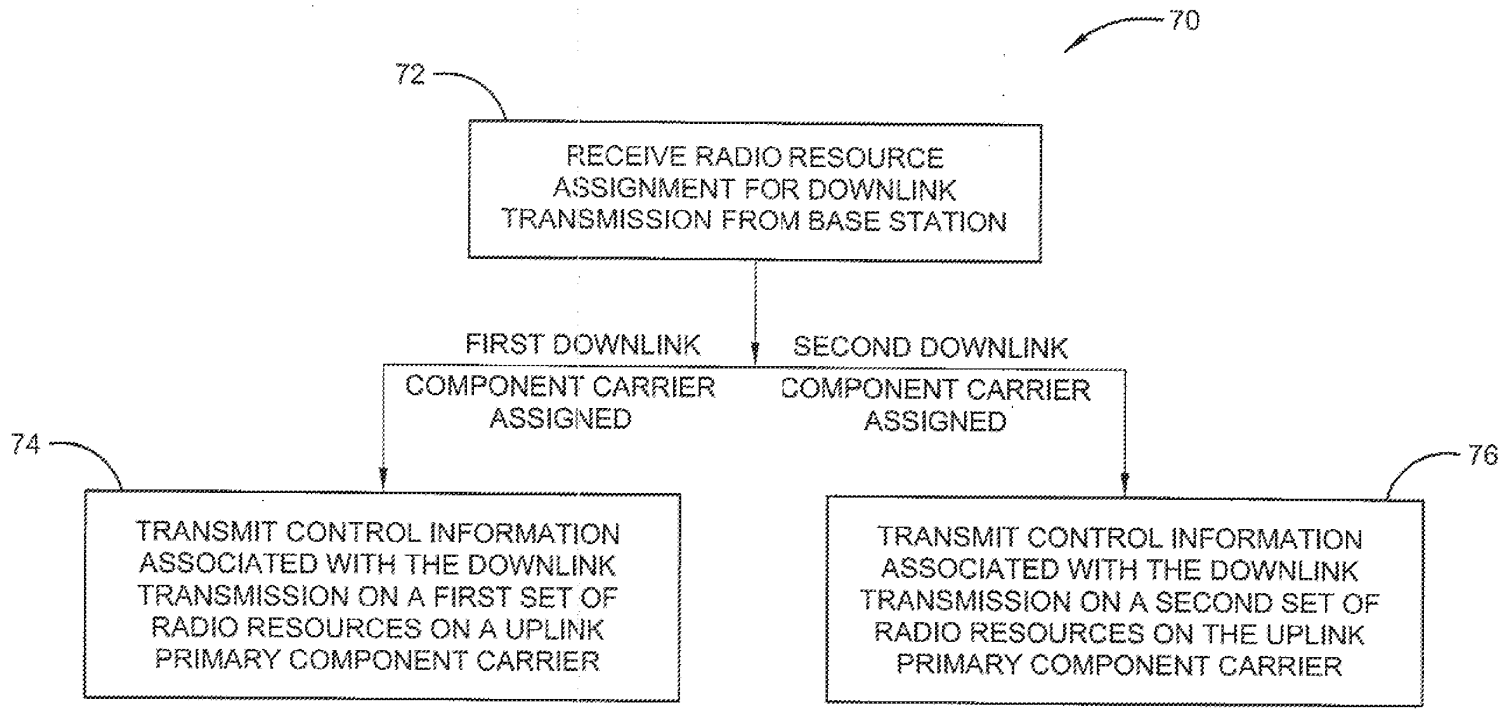

FIG. 11

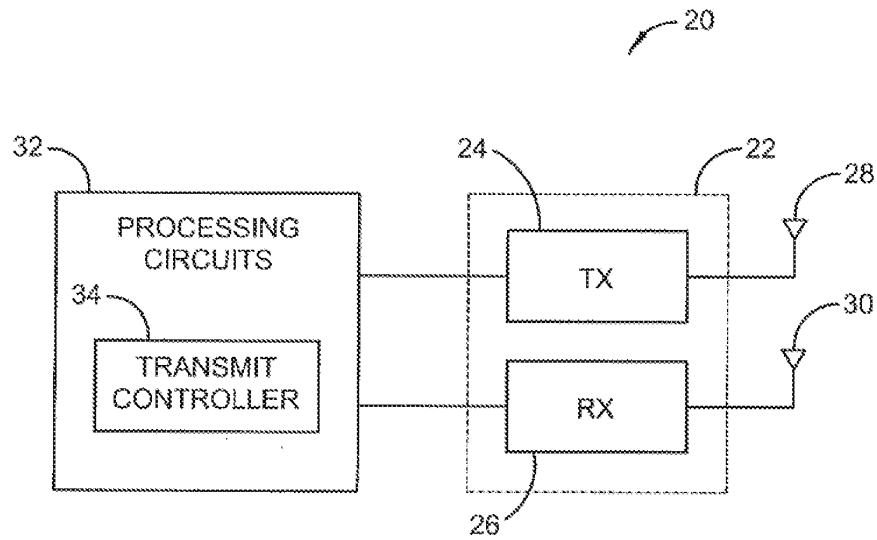

FIG. 12

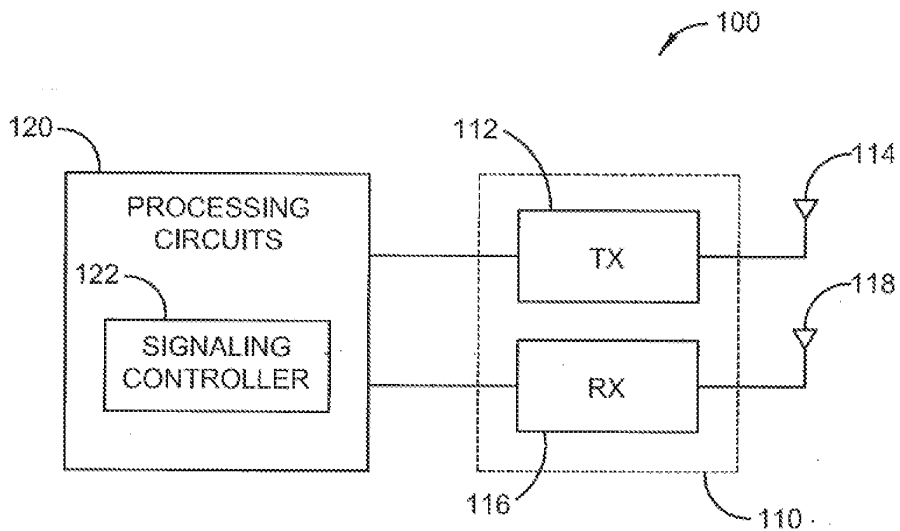

FIG. 13

Under the Paperwork Reduction Act of 1995, no persons are required to respond to a collection of information unless it contains a valid OMB control number.

Application Data Sheet 37 CFR 1.76		Attorney Docket Number	4015-9600 / P30138-US3
		Application Number	
Title of Invention	PUCCH RESOURCE ALLOCATION FOR CARRIER AGGREGATION IN LTE-ADVANCED		
The application data sheet is part of the provisional or nonprovisional application for which it is being submitted. The following form contains the bibliographic data arranged in a format specified by the United States Patent and Trademark Office as outlined in 37 CFR 1.76. This document may be completed electronically and submitted to the Office in electronic format using the Electronic Filing System (EFS) or the document may be printed and included in a paper filed application.			

Secrecy Order 37 CFR 5.2:

Portions or all of the application associated with this Application Data Sheet may fall under a Secrecy Order pursuant to 37 CFR 5.2 (Paper filers only. Applications that fall under Secrecy Order may not be filed electronically.)

Inventor Information:

Inventor 1					<input type="button" value="Remove"/>
Legal Name					
Prefix	Given Name	Middle Name	Family Name	Suffix	
	David		Astely		
Residence Information (Select One) US Residency <input type="radio"/> Non US Residency Active US Military Service					
City	Bromma	Country of Residenceⁱ	SE		
Mailing Address of Inventor:					
Address 1	Stobaeusvägen 22				
Address 2					
City	Bromma	State/Province			
Postal Code	SE-168 56	Countryⁱ	SE		
Inventor 2					<input type="button" value="Remove"/>
Legal Name					
Prefix	Given Name	Middle Name	Family Name	Suffix	
	Robert		Baldemair		
Residence Information (Select One) US Residency <input checked="" type="radio"/> Non US Residency Active US Military Service					
City	Solna	Country of Residenceⁱ	SE		
Mailing Address of Inventor:					
Address 1	Honnörsgatan 16				
Address 2					
City	Solna	State/Province			
Postal Code	SE-170 69	Countryⁱ	SE		
Inventor 3					<input type="button" value="Remove"/>
Legal Name					

Under the Paperwork Reduction Act of 1995, no persons are required to respond to a collection of information unless it contains a valid OMB control number.

Application Data Sheet 37 CFR 1.76		Attorney Docket Number	4015-9600 / P30138-US3
		Application Number	
Title of Invention	PUCCH RESOURCE ALLOCATION FOR CARRIER AGGREGATION IN LTE-ADVANCED		

Prefix	Given Name	Middle Name	Family Name	Suffix
	Dirk		Gerstenberger	

Residence Information (Select One) US Residency Non US Residency Active US Military Service

City	Stockholm	Country of Residence ⁱ	SE
------	-----------	-----------------------------------	----

Mailing Address of Inventor:

Address 1	Fleminggatan 54		
Address 2			
City	Stockholm	State/Province	
Postal Code	SE-112 45	Country ⁱ	SE

Inventor 4

Remove

Legal Name

Prefix	Given Name	Middle Name	Family Name	Suffix
	Daniel		Larsson	

Residence Information (Select One) US Residency Non US Residency Active US Military Service

City	Stockholm	Country of Residence ⁱ	SE
------	-----------	-----------------------------------	----

Mailing Address of Inventor:

Address 1	Kellgrensgatan 10, lgh 1101		
Address 2			
City	Stockholm	State/Province	
Postal Code	SE 112 18	Country ⁱ	SE

Inventor 5

Remove

Legal Name

Prefix	Given Name	Middle Name	Family Name	Suffix
	Lars		Lindbom	

Residence Information (Select One) US Residency Non US Residency Active US Military Service

City	Karlstad	Country of Residence ⁱ	SE
------	----------	-----------------------------------	----

Mailing Address of Inventor:

Address 1	Fogdegatan 7		
Address 2			
City	Karlstad	State/Province	
Postal Code	SE 654-62	Country ⁱ	SE

Under the Paperwork Reduction Act of 1995, no persons are required to respond to a collection of information unless it contains a valid OMB control number.

Application Data Sheet 37 CFR 1.76		Attorney Docket Number	4015-9600 / P30138-US3
		Application Number	
Title of Invention	PUCCH RESOURCE ALLOCATION FOR CARRIER AGGREGATION IN LTE-ADVANCED		

Inventor	6	<input type="button" value="Remove"/>		
Legal Name				
Prefix	Given Name	Middle Name	Family Name	Suffix
	Stefan		Parkvall	
Residence Information (Select One)				
US Residency		<input checked="" type="radio"/> Non US Residency		Active US Military Service
City	Bromma	Country of Residence ⁱ	SE	
Mailing Address of Inventor:				
Address 1	Hermelinstigen 24			
Address 2				
City	Bromma	State/Province		
Postal Code	SE-167 57	Country ⁱ	SE	
All Inventors Must Be Listed - Additional Inventor Information blocks may be generated within this form by selecting the Add button.				
<input type="button" value="Add"/>				

Correspondence Information:

Enter either Customer Number or complete the Correspondence Information section below.
For further information see 37 CFR 1.33(a).

An Address is being provided for the correspondence information of this application.

Customer Number	24112		
Email Address		<input type="button" value="Add Email"/>	<input type="button" value="Remove Email"/>

Application Information:

Title of the Invention	PUCCH RESOURCE ALLOCATION FOR CARRIER AGGREGATION IN LTE-ADVANCED		
Attorney Docket Number	4015-9600 / P30138-US3	Small Entity Status Claimed <input type="checkbox"/>	
Application Type	Nonprovisional		
Subject Matter	Utility		
Total Number of Drawing Sheets (if any)	12	Suggested Figure for Publication (if any)	

Under the Paperwork Reduction Act of 1995, no persons are required to respond to a collection of information unless it contains a valid OMB control number.

Application Data Sheet 37 CFR 1.76		Attorney Docket Number	4015-9600 / P30138-US3
		Application Number	
Title of Invention	PUCCH RESOURCE ALLOCATION FOR CARRIER AGGREGATION IN LTE-ADVANCED		

Filing By Reference:

Only complete this section when filing an application by reference under 35 U.S.C. 111(c) and 37 CFR 1.57(a). Do not complete this section if application papers including a specification and any drawings are being filed. Any domestic benefit or foreign priority information must be provided in the appropriate section(s) below (i.e., "Domestic Benefit/National Stage Information" and "Foreign Priority Information").

For the purposes of a filing date under 37 CFR 1.53(b), the description and any drawings of the present application are replaced by this reference to the previously filed application, subject to conditions and requirements of 37 CFR 1.57(a).

Application number of the previously filed application	Filing date (YYYY-MM-DD)	Intellectual Property Authority or Country

Publication Information:

Request Early Publication (Fee required at time of Request 37 CFR 1.219)

Request Not to Publish. I hereby request that the attached application not be published under 35 U.S.C. 122(b) and certify that the invention disclosed in the attached application **has not and will not** be the subject of an application filed in another country, or under a multilateral international agreement, that requires publication at eighteen months after filing.

Representative Information:

Representative information should be provided for all practitioners having a power of attorney in the application. Providing this information in the Application Data Sheet does not constitute a power of attorney in the application (see 37 CFR 1.32). Either enter Customer Number or complete the Representative Name section below. If both sections are completed the customer number will be used for the Representative Information during processing.

Please Select One:	<input checked="" type="radio"/> Customer Number	<input type="radio"/> US Patent Practitioner	<input type="radio"/> Limited Recognition (37 CFR 11.9)
Customer Number	24112		

Domestic Benefit/National Stage Information:

This section allows for the applicant to either claim benefit under 35 U.S.C. 119(e), 120, 121, 365(c), or 386(c) or indicate National Stage entry from a PCT application. Providing benefit claim information in the Application Data Sheet constitutes the specific reference required by 35 U.S.C. 119(e) or 120, and 37 CFR 1.78.

When referring to the current application, please leave the "Application Number" field blank.

Prior Application Status		Patented			Remove
Application Number	Continuity Type	Prior Application Number	Filing Date (YYYY-MM-DD)	Patent Number	Issue Date (YYYY-MM-DD)
	Continuation of	12/896993	2010-10-04	9497004	2016-11-15

Under the Paperwork Reduction Act of 1995, no persons are required to respond to a collection of information unless it contains a valid OMB control number.

Application Data Sheet 37 CFR 1.76		Attorney Docket Number	4015-9600 / P30138-US3	
		Application Number		
Title of Invention	PUCCH RESOURCE ALLOCATION FOR CARRIER AGGREGATION IN LTE-ADVANCED			
Prior Application Status	Expired			<input type="button" value="Remove"/>
Application Number	Continuity Type	Prior Application Number	Filing or 371(c) Date (YYYY-MM-DD)	
12/896993	Claims benefit of provisional	61/248661	2009-10-05	
Additional Domestic Benefit/National Stage Data may be generated within this form by selecting the Add button.				<input type="button" value="Add"/>

Foreign Priority Information:

This section allows for the applicant to claim priority to a foreign application. Providing this information in the application data sheet constitutes the claim for priority as required by 35 U.S.C. 119(b) and 37 CFR 1.55. When priority is claimed to a foreign application that is eligible for retrieval under the priority document exchange program (PDX)ⁱ the information will be used by the Office to automatically attempt retrieval pursuant to 37 CFR 1.55(i)(1) and (2). Under the PDX program, applicant bears the ultimate responsibility for ensuring that a copy of the foreign application is received by the Office from the participating foreign intellectual property office, or a certified copy of the foreign priority application is filed, within the time period specified in 37 CFR 1.55(g)(1).

				<input type="button" value="Remove"/>
Application Number	Country ⁱ	Filing Date (YYYY-MM-DD)	Access Code ⁱ (if applicable)	
Additional Foreign Priority Data may be generated within this form by selecting the Add button.				<input type="button" value="Add"/>

Statement under 37 CFR 1.55 or 1.78 for AIA (First Inventor to File) Transition Applications

This application (1) claims priority to or the benefit of an application filed before March 16, 2013 and (2) also contains, or contained at any time, a claim to a claimed invention that has an effective filing date on or after March 16, 2013.

NOTE: By providing this statement under 37 CFR 1.55 or 1.78, this application, with a filing date on or after March 16, 2013, will be examined under the first inventor to file provisions of the AIA.

Application Data Sheet 37 CFR 1.76		Attorney Docket Number	4015-9600 / P30138-US3
		Application Number	
Title of Invention	PUCCH RESOURCE ALLOCATION FOR CARRIER AGGREGATION IN LTE-ADVANCED		

Authorization or Opt-Out of Authorization to Permit Access:

When this Application Data Sheet is properly signed and filed with the application, applicant has provided written authority to permit a participating foreign intellectual property (IP) office access to the instant application-as-filed (see paragraph A in subsection 1 below) and the European Patent Office (EPO) access to any search results from the instant application (see paragraph B in subsection 1 below).

Should applicant choose not to provide an authorization identified in subsection 1 below, applicant **must opt-out** of the authorization by checking the corresponding box A or B or both in subsection 2 below.

NOTE: This section of the Application Data Sheet is **ONLY** reviewed and processed with the **INITIAL** filing of an application. After the initial filing of an application, an Application Data Sheet cannot be used to provide or rescind authorization for access by a foreign IP office(s). Instead, Form PTO/SB/39 or PTO/SB/69 must be used as appropriate.

1. Authorization to Permit Access by a Foreign Intellectual Property Office(s)

A. Priority Document Exchange (PDX) - Unless box A in subsection 2 (opt-out of authorization) is checked, the undersigned hereby **grants the USPTO authority** to provide the European Patent Office (EPO), the Japan Patent Office (JPO), the Korean Intellectual Property Office (KIPO), the State Intellectual Property Office of the People's Republic of China (SIPO), the World Intellectual Property Organization (WIPO), and any other foreign intellectual property office participating with the USPTO in a bilateral or multilateral priority document exchange agreement in which a foreign application claiming priority to the instant patent application is filed, access to: (1) the instant patent application-as-filed and its related bibliographic data, (2) any foreign or domestic application to which priority or benefit is claimed by the instant application and its related bibliographic data, and (3) the date of filing of this Authorization. See 37 CFR 1.14(h)(1).

B. Search Results from U.S. Application to EPO - Unless box B in subsection 2 (opt-out of authorization) is checked, the undersigned hereby **grants the USPTO authority** to provide the EPO access to the bibliographic data and search results from the instant patent application when a European patent application claiming priority to the instant patent application is filed. See 37 CFR 1.14(h)(2).

The applicant is reminded that the EPO's Rule 141(1) EPC (European Patent Convention) requires applicants to submit a copy of search results from the instant application without delay in a European patent application that claims priority to the instant application.

2. Opt-Out of Authorizations to Permit Access by a Foreign Intellectual Property Office(s)

A. Applicant **DOES NOT** authorize the USPTO to permit a participating foreign IP office access to the instant application-as-filed. If this box is checked, the USPTO will not be providing a participating foreign IP office with any documents and information identified in subsection 1A above.

B. Applicant **DOES NOT** authorize the USPTO to transmit to the EPO any search results from the instant patent application. If this box is checked, the USPTO will not be providing the EPO with search results from the instant application.

NOTE: Once the application has published or is otherwise publicly available, the USPTO may provide access to the application in accordance with 37 CFR 1.14.

Under the Paperwork Reduction Act of 1995, no persons are required to respond to a collection of information unless it contains a valid OMB control number.

Application Data Sheet 37 CFR 1.76		Attorney Docket Number	4015-9600 / P30138-US3
		Application Number	
Title of Invention	PUCCH RESOURCE ALLOCATION FOR CARRIER AGGREGATION IN LTE-ADVANCED		

Applicant Information:

Providing assignment information in this section does not substitute for compliance with any requirement of part 3 of Title 37 of CFR to have an assignment recorded by the Office.			
Applicant	1	<input type="button" value="Remove"/>	
<p>If the applicant is the inventor (or the remaining joint inventor or inventors under 37 CFR 1.45), this section should not be completed. The information to be provided in this section is the name and address of the legal representative who is the applicant under 37 CFR 1.43; or the name and address of the assignee, person to whom the inventor is under an obligation to assign the invention, or person who otherwise shows sufficient proprietary interest in the matter who is the applicant under 37 CFR 1.46. If the applicant is an applicant under 37 CFR 1.46 (assignee, person to whom the inventor is obligated to assign, or person who otherwise shows sufficient proprietary interest) together with one or more joint inventors, then the joint inventor or inventors who are also the applicant should be identified in this section.</p>			
<input type="button" value="Clear"/>			
<input checked="" type="radio"/> Assignee	Legal Representative under 35 U.S.C. 117	Joint Inventor	
Person to whom the inventor is obligated to assign.		Person who shows sufficient proprietary interest	
If applicant is the legal representative, indicate the authority to file the patent application, the inventor is:			
<input type="button" value="Clear"/>			
<input type="text" value="Name of the Deceased or Legally Incapacitated Inventor:"/>			
If the Applicant is an Organization check here. <input checked="" type="checkbox"/>			
Organization Name	Telefonaktiebolaget LM Ericsson (publ)		
Mailing Address Information For Applicant:			
Address 1	SE-164 83		
Address 2			
City	Stockholm	State/Province	
Country	SE	Postal Code	
Phone Number		Fax Number	
Email Address			
Additional Applicant Data may be generated within this form by selecting the Add button.			<input type="button" value="Add"/>

Assignee Information including Non-Applicant Assignee Information:

Providing assignment information in this section does not substitute for compliance with any requirement of part 3 of Title 37 of CFR to have an assignment recorded by the Office.

Under the Paperwork Reduction Act of 1995, no persons are required to respond to a collection of information unless it contains a valid OMB control number.

Application Data Sheet 37 CFR 1.76		Attorney Docket Number	4015-9600 / P30138-US3
		Application Number	
Title of Invention	PUCCH RESOURCE ALLOCATION FOR CARRIER AGGREGATION IN LTE-ADVANCED		

Assignee	1
-----------------	---

Complete this section if assignee information, including non-applicant assignee information, is desired to be included on the patent application publication. An assignee-applicant identified in the "Applicant Information" section will appear on the patent application publication as an applicant. For an assignee-applicant, complete this section only if identification as an assignee is also desired on the patent application publication.

If the Assignee or Non-Applicant Assignee is an Organization check here.

Prefix	Given Name	Middle Name	Family Name	Suffix

Mailing Address Information For Assignee including Non-Applicant Assignee:

Address 1				
Address 2				
City		State/Province		
Country i		Postal Code		
Phone Number		Fax Number		
Email Address				

Additional Assignee or Non-Applicant Assignee Data may be generated within this form by selecting the Add button.

Signature:

NOTE: This Application Data Sheet must be signed in accordance with 37 CFR 1.33(b). However, if this Application Data Sheet is submitted with the INITIAL filing of the application and either box A or B is not checked in subsection 2 of the "Authorization or Opt-Out of Authorization to Permit Access" section, then this form must also be signed in accordance with 37 CFR 1.14(c).

This Application Data Sheet **must** be signed by a patent practitioner if one or more of the applicants is a **juristic entity** (e.g., corporation or association). If the applicant is two or more joint inventors, this form must be signed by a patent practitioner, **all** joint inventors who are the applicant, or one or more joint inventor-applicants who have been given power of attorney (e.g., see USPTO Form PTO/AIA/81) on behalf of **all** joint inventor-applicants.

See 37 CFR 1.4(d) for the manner of making signatures and certifications.

Signature	/Edward M. Roney/		Date (YYYY-MM-DD)	2016-11-14
First Name	Edward M.	Last Name	Roney	Registration Number
				62048

Additional Signature may be generated within this form by selecting the Add button.

Under the Paperwork Reduction Act of 1995, no persons are required to respond to a collection of information unless it contains a valid OMB control number.

Application Data Sheet 37 CFR 1.76		Attorney Docket Number	4015-9600 / P30138-US3
		Application Number	
Title of Invention	PUCCH RESOURCE ALLOCATION FOR CARRIER AGGREGATION IN LTE-ADVANCED		

This collection of information is required by 37 CFR 1.76. The information is required to obtain or retain a benefit by the public which is to file (and by the USPTO to process) an application. Confidentiality is governed by 35 U.S.C. 122 and 37 CFR 1.14. This collection is estimated to take 23 minutes to complete, including gathering, preparing, and submitting the completed application data sheet form to the USPTO. Time will vary depending upon the individual case. Any comments on the amount of time you require to complete this form and/or suggestions for reducing this burden, should be sent to the Chief Information Officer, U.S. Patent and Trademark Office, U.S. Department of Commerce, P.O. Box 1450, Alexandria, VA 22313-1450. DO NOT SEND FEES OR COMPLETED FORMS TO THIS ADDRESS. **SEND TO: Commissioner for Patents, P.O. Box 1450, Alexandria, VA 22313-1450.**

Privacy Act Statement

The Privacy Act of 1974 (P.L. 93-579) requires that you be given certain information in connection with your submission of the attached form related to a patent application or patent. Accordingly, pursuant to the requirements of the Act, please be advised that: (1) the general authority for the collection of this information is 35 U.S.C. 2(b)(2); (2) furnishing of the information solicited is voluntary; and (3) the principal purpose for which the information is used by the U.S. Patent and Trademark Office is to process and/or examine your submission related to a patent application or patent. If you do not furnish the requested information, the U.S. Patent and Trademark Office may not be able to process and/or examine your submission, which may result in termination of proceedings or abandonment of the application or expiration of the patent.

The information provided by you in this form will be subject to the following routine uses:

- 1 The information on this form will be treated confidentially to the extent allowed under the Freedom of Information Act (5 U.S.C. 552) and the Privacy Act (5 U.S.C. 552a). Records from this system of records may be disclosed to the Department of Justice to determine whether the Freedom of Information Act requires disclosure of these records.
- 2 A record from this system of records may be disclosed, as a routine use, in the course of presenting evidence to a court, magistrate, or administrative tribunal, including disclosures to opposing counsel in the course of settlement negotiations.
- 3 A record in this system of records may be disclosed, as a routine use, to a Member of Congress submitting a request involving an individual, to whom the record pertains, when the individual has requested assistance from the Member with respect to the subject matter of the record.
- 4 A record in this system of records may be disclosed, as a routine use, to a contractor of the Agency having need for the information in order to perform a contract. Recipients of information shall be required to comply with the requirements of the Privacy Act of 1974, as amended, pursuant to 5 U.S.C. 552a(m).
- 5 A record related to an International Application filed under the Patent Cooperation Treaty in this system of records may be disclosed, as a routine use, to the International Bureau of the World Intellectual Property Organization, pursuant to the Patent Cooperation Treaty.
- 6 A record in this system of records may be disclosed, as a routine use, to another federal agency for purposes of National Security review (35 U.S.C. 181) and for review pursuant to the Atomic Energy Act (42 U.S.C. 218(c)).
- 7 A record from this system of records may be disclosed, as a routine use, to the Administrator, General Services, or his/her designee, during an inspection of records conducted by GSA as part of that agency's responsibility to recommend improvements in records management practices and programs, under authority of 44 U.S.C. 2904 and 2906. Such disclosure shall be made in accordance with the GSA regulations governing inspection of records for this purpose, and any other relevant (i.e., GSA or Commerce) directive. Such disclosure shall not be used to make determinations about individuals.
- 8 A record from this system of records may be disclosed, as a routine use, to the public after either publication of the application pursuant to 35 U.S.C. 122(b) or issuance of a patent pursuant to 35 U.S.C. 151. Further, a record may be disclosed, subject to the limitations of 37 CFR 1.14, as a routine use, to the public if the record was filed in an application which became abandoned or in which the proceedings were terminated and which application is referenced by either a published application, an application open to public inspections or an issued patent.
- 9 A record from this system of records may be disclosed, as a routine use, to a Federal, State, or local law enforcement agency, if the USPTO becomes aware of a violation or potential violation of law or regulation.

IN THE UNITED STATES PATENT AND TRADEMARK OFFICE

In re Application of David Astely et al.)	
)	
Serial No.: TBD)	
)	Examiner:
Filed: TBD)	
)	Group Art Unit:
For: PUCCH Resource Allocation for Carrier Aggregation in LTE-Advanced)	
)	Confirmation No.:
Attorney's Docket No: 4015-9600 / P30138-US3)	
)	
MS AMENDMENT		
Commissioner for Patents		
P.O. Box 1450		
Alexandria, VA 22313-1450		

INFORMATION DISCLOSURE STATEMENT

In accordance with 37 C.F.R. 1.56, counsel wishes to make of record the attached items of information for the Examiner's consideration in connection with this application. The references in the attached listing were previously submitted in parent application Serial No. 12/896,993 and relied upon under 35 USC 120. Copies of these references are not furnished with this listing as they were previously submitted and considered in the parent application. Also attached is Form PTO/SB/08A for the Examiner's convenience in making such consideration of record. Inclusion herein of any particular item of information is not to be construed as an admission that same is prior art. Each item of information contained in the information disclosure statement:

was first cited in any communication from a patent office in a counterpart foreign or international application or from the Office, and this communication was not received by an individual designated in §1.56(c) more than thirty days prior to the filing of the information disclosure statement; or

is a communication that was issued by a patent office in a counterpart foreign or international application or by the Office, and this communication was not received by any individual designated in § 1.56(c) more than thirty days prior to the filing of the information disclosure statement

No statement re Patent Term Adjustment (PTA).

The Commissioner is hereby authorized to charge any fees that may be required or credit any overpayment to Deposit Account 18-1167.

Respectfully submitted,
COATS & BENNETT, P.L.L.C.

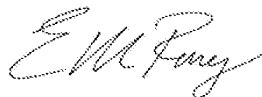

Dated: November 14, 2016

Edward M. Roney
Registration No.: 62,048
Telephone: (919) 854-1844

PATENT APPLICATION FEE DETERMINATION RECORD

Substitute for Form PTO-875

Application or Docket Number
15/350,360

APPLICATION AS FILED - PART I

		(Column 1)	(Column 2)	SMALL ENTITY		OR	OTHER THAN SMALL ENTITY	
FOR		NUMBER FILED	NUMBER EXTRA	RATE(\$)	FEE(\$)		RATE(\$)	FEE(\$)
BASIC FEE (37 CFR 1.16(a), (b), or (c))		N/A	N/A	N/A			N/A	280
SEARCH FEE (37 CFR 1.16(k), (l), or (m))		N/A	N/A	N/A			N/A	600
EXAMINATION FEE (37 CFR 1.16(o), (p), or (q))		N/A	N/A	N/A			N/A	720
TOTAL CLAIMS (37 CFR 1.16(i))		30	minus 20 = *			OR	x 80 =	800
INDEPENDENT CLAIMS (37 CFR 1.16(h))		4	minus 3 = *			OR	x 420 =	420
APPLICATION SIZE FEE (37 CFR 1.16(s))	If the specification and drawings exceed 100 sheets of paper, the application size fee due is \$310 (\$155 for small entity) for each additional 50 sheets or fraction thereof. See 35 U.S.C. 41(a)(1)(G) and 37 CFR 1.16(s).							0.00
MULTIPLE DEPENDENT CLAIM PRESENT (37 CFR 1.16(j))								
* If the difference in column 1 is less than zero, enter "0" in column 2.								
				TOTAL			TOTAL	2820

APPLICATION AS AMENDED - PART II

		(Column 1)	(Column 2)	(Column 3)	SMALL ENTITY		OR	OTHER THAN SMALL ENTITY	
AMENDMENT A		CLAIMS REMAINING AFTER AMENDMENT	HIGHEST NUMBER PREVIOUSLY PAID FOR	PRESENT EXTRA	RATE(\$)	ADDITIONAL FEE(\$)		RATE(\$)	ADDITIONAL FEE(\$)
	Total (37 CFR 1.16(i))	*	Minus	**	=		OR	x	=
	Independent (37 CFR 1.16(h))	*	Minus	***	=		OR	x	=
Application Size Fee (37 CFR 1.16(s))									
FIRST PRESENTATION OF MULTIPLE DEPENDENT CLAIM (37 CFR 1.16(j))									
					TOTAL ADD'L FEE		OR	TOTAL ADD'L FEE	
AMENDMENT B		CLAIMS REMAINING AFTER AMENDMENT	HIGHEST NUMBER PREVIOUSLY PAID FOR	PRESENT EXTRA	RATE(\$)	ADDITIONAL FEE(\$)		RATE(\$)	ADDITIONAL FEE(\$)
	Total (37 CFR 1.16(i))	*	Minus	**	=		OR	x	=
	Independent (37 CFR 1.16(h))	*	Minus	***	=		OR	x	=
Application Size Fee (37 CFR 1.16(s))									
FIRST PRESENTATION OF MULTIPLE DEPENDENT CLAIM (37 CFR 1.16(j))									
					TOTAL ADD'L FEE		OR	TOTAL ADD'L FEE	

* If the entry in column 1 is less than the entry in column 2, write "0" in column 3.
 ** If the "Highest Number Previously Paid For" IN THIS SPACE is less than 20, enter "20".
 *** If the "Highest Number Previously Paid For" IN THIS SPACE is less than 3, enter "3".
 The "Highest Number Previously Paid For" (Total or Independent) is the highest found in the appropriate box in column 1.



UNITED STATES PATENT AND TRADEMARK OFFICE

UNITED STATES DEPARTMENT OF COMMERCE
United States Patent and Trademark Office
Address: COMMISSIONER FOR PATENTS
P.O. Box 1450
Alexandria, Virginia 22313-1450
www.uspto.gov

APPLICATION NUMBER	FILING OR 371(C) DATE	FIRST NAMED APPLICANT	ATTY. DOCKET NO./TITLE
15/350,360	11/14/2016	David Astely	4015-9600 / P30138-US3

CONFIRMATION NO. 1120

24112
COATS & BENNETT, PLLC
1400 Crescent Green, Suite 300
Cary, NC 27518

INFORMAL NOTICE



Date Mailed: 11/22/2016

INFORMATIONAL NOTICE TO APPLICANT

Applicant is notified that the above-identified application contains the deficiencies noted below. No period for reply is set forth in this notice for correction of these deficiencies. However, if a deficiency relates to the inventor's oath or declaration, the applicant must file an oath or declaration in compliance with 37 CFR 1.63, or a substitute statement in compliance with 37 CFR 1.64, executed by or with respect to each actual inventor no later than the expiration of the time period set in the "Notice of Allowability" to avoid abandonment. See 37 CFR 1.53(f).

The item(s) indicated below are also required and should be submitted with any reply to this notice to avoid further processing delays.

- A properly executed inventor's oath or declaration has not been received for the following inventor(s):
David Astely
Robert Baldemair
Dirk Gerstenberger
Daniel Larsson
Lars Lindbom
Stefan Parkvall

Questions about the contents of this notice and the requirements it sets forth should be directed to the Office of Data Management, Application Assistance Unit, at (571) 272-4000 or (571) 272-4200 or 1-888-786-0101.

/sgorems/



UNITED STATES PATENT AND TRADEMARK OFFICE

UNITED STATES DEPARTMENT OF COMMERCE
United States Patent and Trademark Office
Address: COMMISSIONER FOR PATENTS
P.O. Box 1450
Alexandria, Virginia 22313-1450
www.uspto.gov

Table with 7 columns: APPLICATION NUMBER, FILING or 371(c) DATE, GRP ART UNIT, FIL FEE REC'D, ATTY.DOCKET.NO, TOT CLAIMS, IND CLAIMS. Row 1: 15/350,360, 11/14/2016, 2414, 2960, 4015-9600 / P30138-US3, 30, 4

CONFIRMATION NO. 1120

FILING RECEIPT



24112
COATS & BENNETT, PLLC
1400 Crescent Green, Suite 300
Cary, NC 27518

Date Mailed: 11/22/2016

Receipt is acknowledged of this non-provisional patent application. The application will be taken up for examination in due course. Applicant will be notified as to the results of the examination. Any correspondence concerning the application must include the following identification information: the U.S. APPLICATION NUMBER, FILING DATE, NAME OF APPLICANT, and TITLE OF INVENTION. Fees transmitted by check or draft are subject to collection. Please verify the accuracy of the data presented on this receipt. If an error is noted on this Filing Receipt, please submit a written request for a Filing Receipt Correction. Please provide a copy of this Filing Receipt with the changes noted thereon. If you received a "Notice to File Missing Parts" for this application, please submit any corrections to this Filing Receipt with your reply to the Notice. When the USPTO processes the reply to the Notice, the USPTO will generate another Filing Receipt incorporating the requested corrections

Inventor(s)

David Astely, Bromma, SWEDEN;
Robert Baldemair, Solna, SWEDEN;
Dirk Gerstenberger, Stockholm, SWEDEN;
Daniel Larsson, Stockholm, SWEDEN;
Lars Lindbom, Karlstad, SWEDEN;
Stefan Parkvall, Bromma, SWEDEN;

Applicant(s)

Telefonaktiebolaget LM Ericsson (publ), Stockholm, SWEDEN;

Power of Attorney: None

Domestic Priority data as claimed by applicant

This application is a CON of 12/896,993 10/04/2010 PAT 9497004
which claims benefit of 61/248,661 10/05/2009

Foreign Applications for which priority is claimed (You may be eligible to benefit from the Patent Prosecution Highway program at the USPTO. Please see http://www.uspto.gov for more information.) - None.

Foreign application information must be provided in an Application Data Sheet in order to constitute a claim to foreign priority. See 37 CFR 1.55 and 1.76.

Permission to Access Application via Priority Document Exchange: Yes

Permission to Access Search Results: Yes

Applicant may provide or rescind an authorization for access using Form PTO/SB/39 or Form PTO/SB/69 as appropriate.

If Required, Foreign Filing License Granted: 11/21/2016

The country code and number of your priority application, to be used for filing abroad under the Paris Convention, is **US 15/350,360**

Projected Publication Date: 03/02/2017

Non-Publication Request: No

Early Publication Request: No
Title

PUCCH RESOURCE ALLOCATION FOR CARRIER AGGREGATION IN LTE-ADVANCED

Preliminary Class

370

Statement under 37 CFR 1.55 or 1.78 for AIA (First Inventor to File) Transition Applications: No

PROTECTING YOUR INVENTION OUTSIDE THE UNITED STATES

Since the rights granted by a U.S. patent extend only throughout the territory of the United States and have no effect in a foreign country, an inventor who wishes patent protection in another country must apply for a patent in a specific country or in regional patent offices. Applicants may wish to consider the filing of an international application under the Patent Cooperation Treaty (PCT). An international (PCT) application generally has the same effect as a regular national patent application in each PCT-member country. The PCT process **simplifies** the filing of patent applications on the same invention in member countries, but **does not result** in a grant of "an international patent" and does not eliminate the need of applicants to file additional documents and fees in countries where patent protection is desired.

Almost every country has its own patent law, and a person desiring a patent in a particular country must make an application for patent in that country in accordance with its particular laws. Since the laws of many countries differ in various respects from the patent law of the United States, applicants are advised to seek guidance from specific foreign countries to ensure that patent rights are not lost prematurely.

Applicants also are advised that in the case of inventions made in the United States, the Director of the USPTO must issue a license before applicants can apply for a patent in a foreign country. The filing of a U.S. patent application serves as a request for a foreign filing license. The application's filing receipt contains further information and guidance as to the status of applicant's license for foreign filing.

Applicants may wish to consult the USPTO booklet, "General Information Concerning Patents" (specifically, the section entitled "Treaties and Foreign Patents") for more information on timeframes and deadlines for filing foreign patent applications. The guide is available either by contacting the USPTO Contact Center at 800-786-9199, or it can be viewed on the USPTO website at <http://www.uspto.gov/web/offices/pac/doc/general/index.html>.

For information on preventing theft of your intellectual property (patents, trademarks and copyrights), you may wish to consult the U.S. Government website, <http://www.stopfakes.gov>. Part of a Department of Commerce initiative, this website includes self-help "toolkits" giving innovators guidance on how to protect intellectual property in specific

page 2 of 4

countries such as China, Korea and Mexico. For questions regarding patent enforcement issues, applicants may call the U.S. Government hotline at 1-866-999-HALT (1-866-999-4258).

LICENSE FOR FOREIGN FILING UNDER
Title 35, United States Code, Section 184
Title 37, Code of Federal Regulations, 5.11 & 5.15

GRANTED

The applicant has been granted a license under 35 U.S.C. 184, if the phrase "IF REQUIRED, FOREIGN FILING LICENSE GRANTED" followed by a date appears on this form. Such licenses are issued in all applications where the conditions for issuance of a license have been met, regardless of whether or not a license may be required as set forth in 37 CFR 5.15. The scope and limitations of this license are set forth in 37 CFR 5.15(a) unless an earlier license has been issued under 37 CFR 5.15(b). The license is subject to revocation upon written notification. The date indicated is the effective date of the license, unless an earlier license of similar scope has been granted under 37 CFR 5.13 or 5.14.

This license is to be retained by the licensee and may be used at any time on or after the effective date thereof unless it is revoked. This license is automatically transferred to any related applications(s) filed under 37 CFR 1.53(d). This license is not retroactive.

The grant of a license does not in any way lessen the responsibility of a licensee for the security of the subject matter as imposed by any Government contract or the provisions of existing laws relating to espionage and the national security or the export of technical data. Licensees should apprise themselves of current regulations especially with respect to certain countries, of other agencies, particularly the Office of Defense Trade Controls, Department of State (with respect to Arms, Munitions and Implements of War (22 CFR 121-128)); the Bureau of Industry and Security, Department of Commerce (15 CFR parts 730-774); the Office of Foreign Assets Control, Department of Treasury (31 CFR Parts 500+) and the Department of Energy.

NOT GRANTED

No license under 35 U.S.C. 184 has been granted at this time, if the phrase "IF REQUIRED, FOREIGN FILING LICENSE GRANTED" DOES NOT appear on this form. Applicant may still petition for a license under 37 CFR 5.12, if a license is desired before the expiration of 6 months from the filing date of the application. If 6 months has lapsed from the filing date of this application and the licensee has not received any indication of a secrecy order under 35 U.S.C. 181, the licensee may foreign file the application pursuant to 37 CFR 5.15(b).

SelectUSA

The United States represents the largest, most dynamic marketplace in the world and is an unparalleled location for business investment, innovation, and commercialization of new technologies. The U.S. offers tremendous resources and advantages for those who invest and manufacture goods here. Through SelectUSA, our nation works to promote and facilitate business investment. SelectUSA provides information assistance to the international investor community; serves as an ombudsman for existing and potential investors; advocates on behalf of U.S. cities, states, and regions competing for global investment; and counsels U.S. economic development organizations on investment attraction best practices. To learn more about why the United States is the best country in the world to develop

technology, manufacture products, deliver services, and grow your business, visit <http://www.SelectUSA.gov> or call +1-202-482-6800.

INFORMATION DISCLOSURE STATEMENT BY APPLICANT (Not for submission under 37 CFR 1.99)	Application Number		15350360	
	Filing Date		2016-11-14	
	First Named Inventor	David Astely et al.		
	Art Unit	2414		
	Examiner Name	MD K Talukder		
	Attorney Docket Number	4015-9600 / P30138_US3		

U.S.PATENTS								Remove
Examiner Initial*	Cite No	Patent Number	Kind Code ¹	Issue Date	Name of Patentee or Applicant of cited Document	Pages,Columns,Lines where Relevant Passages or Relevant Figures Appear		
	1							
If you wish to add additional U.S. Patent citation information please click the Add button.								Add
U.S.PATENT APPLICATION PUBLICATIONS								Remove
Examiner Initial*	Cite No	Publication Number	Kind Code ¹	Publication Date	Name of Patentee or Applicant of cited Document	Pages,Columns,Lines where Relevant Passages or Relevant Figures Appear		
	1							
If you wish to add additional U.S. Published Application citation information please click the Add button.								Add
FOREIGN PATENT DOCUMENTS								Remove
Examiner Initial*	Cite No	Foreign Document Number ³	Country Code ²	Kind Code ⁴	Publication Date	Name of Patentee or Applicant of cited Document	Pages,Columns,Lines where Relevant Passages or Relevant Figures Appear	T ⁵
	1							
If you wish to add additional Foreign Patent Document citation information please click the Add button								Add
NON-PATENT LITERATURE DOCUMENTS								Remove
Examiner Initials*	Cite No	Include name of the author (in CAPITAL LETTERS), title of the article (when appropriate), title of the item (book, magazine, journal, serial, symposium, catalog, etc), date, pages(s), volume-issue number(s), publisher, city and/or country where published.						T ⁵

INFORMATION DISCLOSURE STATEMENT BY APPLICANT (Not for submission under 37 CFR 1.99)	Application Number		15350360
	Filing Date		2016-11-14
	First Named Inventor	David Astely et al.	
	Art Unit	2414	
	Examiner Name	MD K Talukder	
	Attorney Docket Number	4015-9600 / P30138_US3	

1		TEXAS INSTRUMENTS: "Dynamic ACK/NAK Channelization on PUCCH", 3GPP DRAFT; R1-081375-DACKNAK, 3RD GENERATION PARTNERSHIP PROJECT (3GPP), MOBILE COMPETENCE CENTRE; 650, ROUTE DES LUCIOLES; F-06921 SOPHIA-ANTIPOLIS CEDEX; FRANCE, vol. RAN WG1, no. Shenzhen, China; March 27, 2008, XP050109796.
---	--	--

If you wish to add additional non-patent literature document citation information please click the Add button

EXAMINER SIGNATURE

Examiner Signature		Date Considered	
--------------------	--	-----------------	--

*EXAMINER: Initial if reference considered, whether or not citation is in conformance with MPEP 609. Draw line through a citation if not in conformance and not considered. Include copy of this form with next communication to applicant.

¹ See Kind Codes of USPTO Patent Documents at www.USPTO.GOV or MPEP 901.04. ² Enter office that issued the document, by the two-letter code (WIPO Standard ST.3). ³ For Japanese patent documents, the indication of the year of the reign of the Emperor must precede the serial number of the patent document. ⁴ Kind of document by the appropriate symbols as indicated on the document under WIPO Standard ST.16 if possible. ⁵ Applicant is to place a check mark here if English language translation is attached.

INFORMATION DISCLOSURE STATEMENT BY APPLICANT (Not for submission under 37 CFR 1.99)	Application Number	15350360
	Filing Date	2016-11-14
	First Named Inventor	David Astely et al.
	Art Unit	2414
	Examiner Name	MD K Talukder
	Attorney Docket Number	4015-9600 / P30138_US3

CERTIFICATION STATEMENT

Please see 37 CFR 1.97 and 1.98 to make the appropriate selection(s):

That each item of information contained in the information disclosure statement was first cited in any communication from a foreign patent office in a counterpart foreign application not more than three months prior to the filing of the information disclosure statement. See 37 CFR 1.97(e)(1).

OR

That no item of information contained in the information disclosure statement was cited in a communication from a foreign patent office in a counterpart foreign application, and, to the knowledge of the person signing the certification after making reasonable inquiry, no item of information contained in the information disclosure statement was known to any individual designated in 37 CFR 1.56(c) more than three months prior to the filing of the information disclosure statement. See 37 CFR 1.97(e)(2).

See attached certification statement.

The fee set forth in 37 CFR 1.17 (p) has been submitted herewith.

A certification statement is not submitted herewith.

SIGNATURE

A signature of the applicant or representative is required in accordance with CFR 1.33, 10.18. Please see CFR 1.4(d) for the form of the signature.

Signature	/Edward M. Roney/	Date (YYYY-MM-DD)	2016-12-30
Name/Print	Edward M. Roney	Registration Number	62048

This collection of information is required by 37 CFR 1.97 and 1.98. The information is required to obtain or retain a benefit by the public which is to file (and by the USPTO to process) an application. Confidentiality is governed by 35 U.S.C. 122 and 37 CFR 1.14. This collection is estimated to take 1 hour to complete, including gathering, preparing and submitting the completed application form to the USPTO. Time will vary depending upon the individual case. Any comments on the amount of time you require to complete this form and/or suggestions for reducing this burden, should be sent to the Chief Information Officer, U.S. Patent and Trademark Office, U.S. Department of Commerce, P.O. Box 1450, Alexandria, VA 22313-1450. **DO NOT SEND FEES OR COMPLETED FORMS TO THIS ADDRESS. SEND TO: Commissioner for Patents, P.O. Box 1450, Alexandria, VA 22313-1450.**

Privacy Act Statement

The Privacy Act of 1974 (P.L. 93-579) requires that you be given certain information in connection with your submission of the attached form related to a patent application or patent. Accordingly, pursuant to the requirements of the Act, please be advised that: (1) the general authority for the collection of this information is 35 U.S.C. 2(b)(2); (2) furnishing of the information solicited is voluntary; and (3) the principal purpose for which the information is used by the U.S. Patent and Trademark Office is to process and/or examine your submission related to a patent application or patent. If you do not furnish the requested information, the U.S. Patent and Trademark Office may not be able to process and/or examine your submission, which may result in termination of proceedings or abandonment of the application or expiration of the patent.

The information provided by you in this form will be subject to the following routine uses:

1. The information on this form will be treated confidentially to the extent allowed under the Freedom of Information Act (5 U.S.C. 552) and the Privacy Act (5 U.S.C. 552a). Records from this system of records may be disclosed to the Department of Justice to determine whether the Freedom of Information Act requires disclosure of these records.
2. A record from this system of records may be disclosed, as a routine use, in the course of presenting evidence to a court, magistrate, or administrative tribunal, including disclosures to opposing counsel in the course of settlement negotiations.
3. A record in this system of records may be disclosed, as a routine use, to a Member of Congress submitting a request involving an individual, to whom the record pertains, when the individual has requested assistance from the Member with respect to the subject matter of the record.
4. A record in this system of records may be disclosed, as a routine use, to a contractor of the Agency having need for the information in order to perform a contract. Recipients of information shall be required to comply with the requirements of the Privacy Act of 1974, as amended, pursuant to 5 U.S.C. 552a(m).
5. A record related to an International Application filed under the Patent Cooperation Treaty in this system of records may be disclosed, as a routine use, to the International Bureau of the World Intellectual Property Organization, pursuant to the Patent Cooperation Treaty.
6. A record in this system of records may be disclosed, as a routine use, to another federal agency for purposes of National Security review (35 U.S.C. 181) and for review pursuant to the Atomic Energy Act (42 U.S.C. 218(c)).
7. A record from this system of records may be disclosed, as a routine use, to the Administrator, General Services, or his/her designee, during an inspection of records conducted by GSA as part of that agency's responsibility to recommend improvements in records management practices and programs, under authority of 44 U.S.C. 2904 and 2906. Such disclosure shall be made in accordance with the GSA regulations governing inspection of records for this purpose, and any other relevant (i.e., GSA or Commerce) directive. Such disclosure shall not be used to make determinations about individuals.
8. A record from this system of records may be disclosed, as a routine use, to the public after either publication of the application pursuant to 35 U.S.C. 122(b) or issuance of a patent pursuant to 35 U.S.C. 151. Further, a record may be disclosed, subject to the limitations of 37 CFR 1.14, as a routine use, to the public if the record was filed in an application which became abandoned or in which the proceedings were terminated and which application is referenced by either a published application, an application open to public inspections or an issued patent.
9. A record from this system of records may be disclosed, as a routine use, to a Federal, State, or local law enforcement agency, if the USPTO becomes aware of a violation or potential violation of law or regulation.

Electronic Acknowledgement Receipt

EFS ID:	27936232
Application Number:	15350360
International Application Number:	
Confirmation Number:	1120
Title of Invention:	PUCCH RESOURCE ALLOCATION FOR CARRIER AGGREGATION IN LTE-ADVANCED
First Named Inventor/Applicant Name:	David Astely
Customer Number:	24112
Filer:	Edward Milton Roney/Kenyatta Upchurch
Filer Authorized By:	Edward Milton Roney
Attorney Docket Number:	4015-9600 / P30138-US3
Receipt Date:	30-DEC-2016
Filing Date:	14-NOV-2016
Time Stamp:	10:05:10
Application Type:	Utility under 35 USC 111(a)

Payment information:

Submitted with Payment	no
------------------------	----

File Listing:

Document Number	Document Description	File Name	File Size(Bytes)/ Message Digest	Multi Part /.zip	Pages (if appl.)
1	Transmittal Letter	P30138_US3_IDS_Cover_Ltr.pdf	99798 <small>75e059f2b6fa023c1f2e2c415801e6089b5497c7</small>	no	1

Warnings:

Information:					
2	Information Disclosure Statement (IDS) Form (SB08)	P30138_US3_Supplemental_IDS.pdf	1035444 e7f535b3e7f81aacf8831260530a77b3dcee92ce	no	4
Warnings:					
Information:					
A U.S. Patent Number Citation or a U.S. Publication Number Citation is required in the Information Disclosure Statement (IDS) form for autoloading of data into USPTO systems. You may remove the form to add the required data in order to correct the Informational Message if you are citing U.S. References. If you chose not to include U.S. References, the image of the form will be processed and be made available within the Image File Wrapper (IFW) system. However, no data will be extracted from this form. Any additional data such as Foreign Patent Documents or Non Patent Literature will be manually reviewed and keyed into USPTO systems.					
3	Non Patent Literature	P30138_US3_R1-081375.pdf	232573 e4cfd2485ea3242311f8184e0d8494d60c6442fe	no	4
Warnings:					
Information:					
Total Files Size (in bytes):			1367815		
<p>This Acknowledgement Receipt evidences receipt on the noted date by the USPTO of the indicated documents, characterized by the applicant, and including page counts, where applicable. It serves as evidence of receipt similar to a Post Card, as described in MPEP 503.</p> <p><u>New Applications Under 35 U.S.C. 111</u> If a new application is being filed and the application includes the necessary components for a filing date (see 37 CFR 1.53(b)-(d) and MPEP 506), a Filing Receipt (37 CFR 1.54) will be issued in due course and the date shown on this Acknowledgement Receipt will establish the filing date of the application.</p> <p><u>National Stage of an International Application under 35 U.S.C. 371</u> If a timely submission to enter the national stage of an international application is compliant with the conditions of 35 U.S.C. 371 and other applicable requirements a Form PCT/DO/EO/903 indicating acceptance of the application as a national stage submission under 35 U.S.C. 371 will be issued in addition to the Filing Receipt, in due course.</p> <p><u>New International Application Filed with the USPTO as a Receiving Office</u> If a new international application is being filed and the international application includes the necessary components for an international filing date (see PCT Article 11 and MPEP 1810), a Notification of the International Application Number and of the International Filing Date (Form PCT/RO/105) will be issued in due course, subject to prescriptions concerning national security, and the date shown on this Acknowledgement Receipt will establish the international filing date of the application.</p>					

IN THE UNITED STATES PATENT AND TRADEMARK OFFICE

In re Application of Astely et al.)	
)	
Serial No.: 15/350,360)	
)	Examiner:
Filed: November 14, 2016)	
)	Group Art Unit: 2414
For: PUCCH Resource Allocation for Carrier)	
Aggregation in LTE-Advanced)	Confirmation No.: 1120
)	
Attorney's Docket No: 4015-9600 / P30138-US3)	
)	

MS AMENDMENT
 Commissioner for Patents
 P.O. Box 1450
 Alexandria, VA 22313-1450

SUPPLEMENTAL INFORMATION DISCLOSURE STATEMENT

In accordance with 37 C.F.R. 1.56, counsel wishes to make of record the attached items of information for the Examiner's consideration in connection with this application. Also attached is Form PTO/SB/08A for the Examiner's convenience in making such consideration of record. Inclusion herein of any particular item of information is not to be construed as an admission that same is prior art. Each item of information contained in the information disclosure statement:

- was first cited in any communication from a patent office in a counterpart foreign or international application or from the Office, and this communication was not received by an individual designated in §1.56(c) more than thirty days prior to the filing of the information disclosure statement; or
- is a communication that was issued by a patent office in a counterpart foreign or international application or by the Office, and this communication was not received by any individual designated in § 1.56(c) more than thirty days prior to the filing of the information disclosure statement
- No statement re Patent Term Adjustment (PTA).

The Commissioner is hereby authorized to charge any fees that may be required or credit any overpayment to Deposit Account 18-1167.

Respectfully submitted,
 COATS & BENNETT, P.L.L.C.

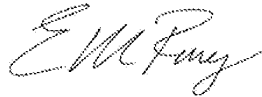

Edward M. Roney
 Registration No.: 62,048
 Telephone: (919) 854-1844

Dated: December 30, 2016

INFORMATION DISCLOSURE STATEMENT BY APPLICANT (Not for submission under 37 CFR 1.99)	Application Number		15350360	
	Filing Date		2016-11-14	
	First Named Inventor		David Astely et al.	
	Art Unit		2648	
	Examiner Name		Md K. Talukder	
	Attorney Docket Number		P30138-US3 / 4015-9600	

U.S.PATENTS							Remove	
Examiner Initial*	Cite No	Patent Number	Kind Code ¹	Issue Date	Name of Patentee or Applicant of cited Document	Pages, Columns, Lines where Relevant Passages or Relevant Figures Appear		
	1							
If you wish to add additional U.S. Patent citation information please click the Add button.							Add	
U.S.PATENT APPLICATION PUBLICATIONS							Remove	
Examiner Initial*	Cite No	Publication Number	Kind Code ¹	Publication Date	Name of Patentee or Applicant of cited Document	Pages, Columns, Lines where Relevant Passages or Relevant Figures Appear		
	1							
If you wish to add additional U.S. Published Application citation information please click the Add button.							Add	
FOREIGN PATENT DOCUMENTS							Remove	
Examiner Initial*	Cite No	Foreign Document Number ³	Country Code ²	Kind Code ⁴	Publication Date	Name of Patentee or Applicant of cited Document	Pages, Columns, Lines where Relevant Passages or Relevant Figures Appear	T ⁵
	1							
If you wish to add additional Foreign Patent Document citation information please click the Add button							Add	
NON-PATENT LITERATURE DOCUMENTS							Remove	
Examiner Initials*	Cite No	Include name of the author (in CAPITAL LETTERS), title of the article (when appropriate), title of the item (book, magazine, journal, serial, symposium, catalog, etc), date, pages(s), volume-issue number(s), publisher, city and/or country where published.						T ⁵

INFORMATION DISCLOSURE STATEMENT BY APPLICANT (Not for submission under 37 CFR 1.99)	Application Number		15350360
	Filing Date		2016-11-14
	First Named Inventor	David Astely et al.	
	Art Unit		2648
	Examiner Name	Md K. Talukder	
	Attorney Docket Number		P30138-US3 / 4015-9600

1		HUAWEI, PUCCH design for carrier aggregation, 3GPP TSG RAN WG1 Meeting #58 R1-093046, 3GPP, August 24, 2009.
---	--	--

If you wish to add additional non-patent literature document citation information please click the Add button

EXAMINER SIGNATURE

Examiner Signature		Date Considered	
--------------------	--	-----------------	--

*EXAMINER: Initial if reference considered, whether or not citation is in conformance with MPEP 609. Draw line through a citation if not in conformance and not considered. Include copy of this form with next communication to applicant.

¹ See Kind Codes of USPTO Patent Documents at www.USPTO.GOV or MPEP 901.04. ² Enter office that issued the document, by the two-letter code (WIPO Standard ST.3). ³ For Japanese patent documents, the indication of the year of the reign of the Emperor must precede the serial number of the patent document. ⁴ Kind of document by the appropriate symbols as indicated on the document under WIPO Standard ST.16 if possible. ⁵ Applicant is to place a check mark here if English language translation is attached.

INFORMATION DISCLOSURE STATEMENT BY APPLICANT (Not for submission under 37 CFR 1.99)	Application Number	15350360
	Filing Date	2016-11-14
	First Named Inventor	David Astely et al.
	Art Unit	2648
	Examiner Name	Md K. Talukder
	Attorney Docket Number	P30138-US3 / 4015-9600

CERTIFICATION STATEMENT

Please see 37 CFR 1.97 and 1.98 to make the appropriate selection(s):

That each item of information contained in the information disclosure statement was first cited in any communication from a foreign patent office in a counterpart foreign application not more than three months prior to the filing of the information disclosure statement. See 37 CFR 1.97(e)(1).

OR

That no item of information contained in the information disclosure statement was cited in a communication from a foreign patent office in a counterpart foreign application, and, to the knowledge of the person signing the certification after making reasonable inquiry, no item of information contained in the information disclosure statement was known to any individual designated in 37 CFR 1.56(c) more than three months prior to the filing of the information disclosure statement. See 37 CFR 1.97(e)(2).

See attached certification statement.

The fee set forth in 37 CFR 1.17 (p) has been submitted herewith.

A certification statement is not submitted herewith.

SIGNATURE

A signature of the applicant or representative is required in accordance with CFR 1.33, 10.18. Please see CFR 1.4(d) for the form of the signature.

Signature	/Edward M. Roney/	Date (YYYY-MM-DD)	2016-01-08
Name/Print	Edward M. Roney	Registration Number	62048

This collection of information is required by 37 CFR 1.97 and 1.98. The information is required to obtain or retain a benefit by the public which is to file (and by the USPTO to process) an application. Confidentiality is governed by 35 U.S.C. 122 and 37 CFR 1.14. This collection is estimated to take 1 hour to complete, including gathering, preparing and submitting the completed application form to the USPTO. Time will vary depending upon the individual case. Any comments on the amount of time you require to complete this form and/or suggestions for reducing this burden, should be sent to the Chief Information Officer, U.S. Patent and Trademark Office, U.S. Department of Commerce, P.O. Box 1450, Alexandria, VA 22313-1450. **DO NOT SEND FEES OR COMPLETED FORMS TO THIS ADDRESS. SEND TO: Commissioner for Patents, P.O. Box 1450, Alexandria, VA 22313-1450.**

Privacy Act Statement

The Privacy Act of 1974 (P.L. 93-579) requires that you be given certain information in connection with your submission of the attached form related to a patent application or patent. Accordingly, pursuant to the requirements of the Act, please be advised that: (1) the general authority for the collection of this information is 35 U.S.C. 2(b)(2); (2) furnishing of the information solicited is voluntary; and (3) the principal purpose for which the information is used by the U.S. Patent and Trademark Office is to process and/or examine your submission related to a patent application or patent. If you do not furnish the requested information, the U.S. Patent and Trademark Office may not be able to process and/or examine your submission, which may result in termination of proceedings or abandonment of the application or expiration of the patent.

The information provided by you in this form will be subject to the following routine uses:

1. The information on this form will be treated confidentially to the extent allowed under the Freedom of Information Act (5 U.S.C. 552) and the Privacy Act (5 U.S.C. 552a). Records from this system of records may be disclosed to the Department of Justice to determine whether the Freedom of Information Act requires disclosure of these records.
2. A record from this system of records may be disclosed, as a routine use, in the course of presenting evidence to a court, magistrate, or administrative tribunal, including disclosures to opposing counsel in the course of settlement negotiations.
3. A record in this system of records may be disclosed, as a routine use, to a Member of Congress submitting a request involving an individual, to whom the record pertains, when the individual has requested assistance from the Member with respect to the subject matter of the record.
4. A record in this system of records may be disclosed, as a routine use, to a contractor of the Agency having need for the information in order to perform a contract. Recipients of information shall be required to comply with the requirements of the Privacy Act of 1974, as amended, pursuant to 5 U.S.C. 552a(m).
5. A record related to an International Application filed under the Patent Cooperation Treaty in this system of records may be disclosed, as a routine use, to the International Bureau of the World Intellectual Property Organization, pursuant to the Patent Cooperation Treaty.
6. A record in this system of records may be disclosed, as a routine use, to another federal agency for purposes of National Security review (35 U.S.C. 181) and for review pursuant to the Atomic Energy Act (42 U.S.C. 218(c)).
7. A record from this system of records may be disclosed, as a routine use, to the Administrator, General Services, or his/her designee, during an inspection of records conducted by GSA as part of that agency's responsibility to recommend improvements in records management practices and programs, under authority of 44 U.S.C. 2904 and 2906. Such disclosure shall be made in accordance with the GSA regulations governing inspection of records for this purpose, and any other relevant (i.e., GSA or Commerce) directive. Such disclosure shall not be used to make determinations about individuals.
8. A record from this system of records may be disclosed, as a routine use, to the public after either publication of the application pursuant to 35 U.S.C. 122(b) or issuance of a patent pursuant to 35 U.S.C. 151. Further, a record may be disclosed, subject to the limitations of 37 CFR 1.14, as a routine use, to the public if the record was filed in an application which became abandoned or in which the proceedings were terminated and which application is referenced by either a published application, an application open to public inspections or an issued patent.
9. A record from this system of records may be disclosed, as a routine use, to a Federal, State, or local law enforcement agency, if the USPTO becomes aware of a violation or potential violation of law or regulation.

Electronic Acknowledgement Receipt

EFS ID:	28002178
Application Number:	15350360
International Application Number:	
Confirmation Number:	1120
Title of Invention:	PUCCH RESOURCE ALLOCATION FOR CARRIER AGGREGATION IN LTE-ADVANCED
First Named Inventor/Applicant Name:	David Astely
Customer Number:	24112
Filer:	Edward Milton Roney/Kenyatta Upchurch
Filer Authorized By:	Edward Milton Roney
Attorney Docket Number:	4015-9600 / P30138-US3
Receipt Date:	08-JAN-2017
Filing Date:	14-NOV-2016
Time Stamp:	10:21:08
Application Type:	Utility under 35 USC 111(a)

Payment information:

Submitted with Payment	no
------------------------	----

File Listing:

Document Number	Document Description	File Name	File Size(Bytes)/ Message Digest	Multi Part /.zip	Pages (if appl.)
1	Transmittal Letter	P30138-US3_IDS_Cover_Ltr.pdf	99933 <small>3391896f86b9d2919795d69a26984eab580a963c</small>	no	1

Warnings:

Information:					
2	Information Disclosure Statement (IDS) Form (SB08)	P30138-US3_Supplemental_IDS.pdf	1035299 5908e980bcf0aa2a761dfe42a8288a3e60d33b7c	no	4
Warnings:					
Information:					
A U.S. Patent Number Citation or a U.S. Publication Number Citation is required in the Information Disclosure Statement (IDS) form for autoloading of data into USPTO systems. You may remove the form to add the required data in order to correct the Informational Message if you are citing U.S. References. If you chose not to include U.S. References, the image of the form will be processed and be made available within the Image File Wrapper (IFW) system. However, no data will be extracted from this form. Any additional data such as Foreign Patent Documents or Non Patent Literature will be manually reviewed and keyed into USPTO systems.					
3	Non Patent Literature	P30138-US3_R1-093046.pdf	419435 cb73dd88e8fe1c401ccf26b3ee19cc1ea0d199f	no	8
Warnings:					
Information:					
Total Files Size (in bytes):			1554667		
<p>This Acknowledgement Receipt evidences receipt on the noted date by the USPTO of the indicated documents, characterized by the applicant, and including page counts, where applicable. It serves as evidence of receipt similar to a Post Card, as described in MPEP 503.</p> <p><u>New Applications Under 35 U.S.C. 111</u> If a new application is being filed and the application includes the necessary components for a filing date (see 37 CFR 1.53(b)-(d) and MPEP 506), a Filing Receipt (37 CFR 1.54) will be issued in due course and the date shown on this Acknowledgement Receipt will establish the filing date of the application.</p> <p><u>National Stage of an International Application under 35 U.S.C. 371</u> If a timely submission to enter the national stage of an international application is compliant with the conditions of 35 U.S.C. 371 and other applicable requirements a Form PCT/DO/EO/903 indicating acceptance of the application as a national stage submission under 35 U.S.C. 371 will be issued in addition to the Filing Receipt, in due course.</p> <p><u>New International Application Filed with the USPTO as a Receiving Office</u> If a new international application is being filed and the international application includes the necessary components for an international filing date (see PCT Article 11 and MPEP 1810), a Notification of the International Application Number and of the International Filing Date (Form PCT/RO/105) will be issued in due course, subject to prescriptions concerning national security, and the date shown on this Acknowledgement Receipt will establish the international filing date of the application.</p>					

IN THE UNITED STATES PATENT AND TRADEMARK OFFICE

In re Application of David Astely et al.)	
)	
Serial No.: 15/350,360)	
)	Examiner:
Filed: November 14, 2016)	
)	Group Art Unit: 2414
For: PUCCH Resource Allocation for Carrier Aggregation in LTE-Advanced)	Confirmation No.: 1120
)	
Attorney's Docket No: 4015-9600 / P30138-US3)	
)	

MS AMENDMENT
 Commissioner for Patents
 P.O. Box 1450
 Alexandria, VA 22313-1450

SUPPLEMENTAL INFORMATION DISCLOSURE STATEMENT

In accordance with 37 C.F.R. 1.56, counsel wishes to make of record the attached items of information for the Examiner's consideration in connection with this application. Also attached is Form PTO/SB/08A for the Examiner's convenience in making such consideration of record. Inclusion herein of any particular item of information is not to be construed as an admission that same is prior art. Each item of information contained in the information disclosure statement:

- was first cited in any communication from a patent office in a counterpart foreign or international application or from the Office, and this communication was not received by an individual designated in §1.56(c) more than thirty days prior to the filing of the information disclosure statement; or
- is a communication that was issued by a patent office in a counterpart foreign or international application or by the Office, and this communication was not received by any individual designated in § 1.56(c) more than thirty days prior to the filing of the information disclosure statement
- No statement re Patent Term Adjustment (PTA).

The Commissioner is hereby authorized to charge any fees that may be required or credit any overpayment to Deposit Account 18-1167.

Respectfully submitted,
 COATS & BENNETT, P.L.L.C.

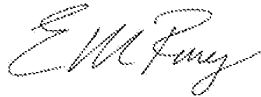

Edward M. Roney
 Registration No.: 62,048
 Telephone: (919) 854-1844

Dated: January 8, 2017



UNITED STATES PATENT AND TRADEMARK OFFICE

UNITED STATES DEPARTMENT OF COMMERCE
United States Patent and Trademark Office
Address: COMMISSIONER FOR PATENTS
P.O. Box 1450
Alexandria, Virginia 22313-1450
www.uspto.gov

Table with 4 columns: APPLICATION NUMBER (15/350,360), FILING OR 371(C) DATE (11/14/2016), FIRST NAMED APPLICANT (David Astely), ATTY. DOCKET NO./TITLE (4015-9600 / P30138-US3)

CONFIRMATION NO. 1120

24112
COATS & BENNETT, PLLC
1400 Crescent Green, Suite 300
Cary, NC 27518

PUBLICATION NOTICE



Title: PUCCH RESOURCE ALLOCATION FOR CARRIER AGGREGATION IN LTE-ADVANCED

Publication No. US-2017-0063506-A1

Publication Date: 03/02/2017

NOTICE OF PUBLICATION OF APPLICATION

The above-identified application will be electronically published as a patent application publication pursuant to 37 CFR 1.211, et seq. The patent application publication number and publication date are set forth above.

The publication may be accessed through the USPTO's publically available Searchable Databases via the Internet at www.uspto.gov. The direct link to access the publication is currently http://www.uspto.gov/patft/.

The publication process established by the Office does not provide for mailing a copy of the publication to applicant. A copy of the publication may be obtained from the Office upon payment of the appropriate fee set forth in 37 CFR 1.19(a)(1). Orders for copies of patent application publications are handled by the USPTO's Office of Public Records. The Office of Public Records can be reached by telephone at (571) 272-3150 or (800) 972-6382, by facsimile at (571) 273-3250, by mail addressed to the United States Patent and Trademark Office, Office of Public Records, Alexandria, VA 22313-1450 or via the Internet.

In addition, information on the status of the application, including the mailing date of Office actions and the dates of receipt of correspondence filed in the Office, may also be accessed via the Internet through the Patent Electronic Business Center at www.uspto.gov using the public side of the Patent Application Information and Retrieval (PAIR) system. The direct link to access this status information is currently http://pair.uspto.gov/. Prior to publication, such status information is confidential and may only be obtained by applicant using the private side of PAIR.

Further assistance in electronically accessing the publication, or about PAIR, is available by calling the Patent Electronic Business Center at 1-866-217-9197.

Office of Data Management, Application Assistance Unit (571) 272-4000, or (571) 272-4200, or 1-888-786-0101



UNITED STATES PATENT AND TRADEMARK OFFICE

UNITED STATES DEPARTMENT OF COMMERCE
United States Patent and Trademark Office
Address: COMMISSIONER FOR PATENTS
P. O. Box 1450
Alexandria, Virginia 22313-1450
www.uspto.gov

Table with 5 columns: APPLICATION NO., FILING DATE, FIRST NAMED INVENTOR, ATTORNEY DOCKET NO., CONFIRMATION NO. Includes application details for David Astely and examiner information for Talukder, MD K.

Please find below and/or attached an Office communication concerning this application or proceeding.

The time period for reply, if any, is set in the attached communication.

1. The present application is being examined under the pre-AIA first to invent provisions.

Double Patenting

2. The nonstatutory double patenting rejection is based on a judicially created doctrine grounded in public policy (a policy reflected in the statute) so as to prevent the unjustified or improper timewise extension of the “right to exclude” granted by a patent and to prevent possible harassment by multiple assignees. A nonstatutory obviousness-type double patenting rejection is appropriate where the conflicting claims are not identical, but at least one examined application claim is not patentably distinct from the reference claim(s) because the examined application claim is either anticipated by, or would have been obvious over, the reference claim(s). See, e.g., *In re Berg*, 140 F.3d 1428, 46 USPQ2d 1226 (Fed. Cir. 1998); *In re Goodman*, 11 F.3d 1046, 29 USPQ2d 2010 (Fed. Cir. 1993); *In re Longi*, 759 F.2d 887, 225 USPQ 645 (Fed. Cir. 1985); *In re Van Ornum*, 686 F.2d 937, 214 USPQ 761 (CCPA 1982); *In re Vogel*, 422 F.2d 438, 164 USPQ 619 (CCPA 1970); and *In re Thorington*, 418 F.2d 528, 163 USPQ 644 (CCPA 1969).

A timely filed terminal disclaimer in compliance with 37 CFR 1.321(c) or 1.321(d) may be used to overcome an non-provisional rejection based on a nonstatutory double patenting ground provided the conflicting application or patent either is shown to be commonly owned with this application, or claims an invention made as a result of activities undertaken within the scope of a joint research agreement. Effective January 1, 1994, a registered attorney or agent of record may sign a terminal disclaimer. A terminal disclaimer signed by the assignee must fully comply with 37 CFR 3.73(b).

Claims 1-30 of instant application are non-provisionally rejected on the ground nonstatutory obviousness-type double patenting as being unpatentable over claims 1-40 of application No. 12/896993 (US Pat. 9497004). Although the conflicting claims are not identical, they are not patentable distinct from each other because both the claims of the instant application and the claims of the copending application are almost the same in scope. Omission of an element and its function in a combination is an obvious expedient if the remaining elements perform the same function as before. In re KARLSON (CCPA) 136 USPQ 184 (1963).

An omission of an element and its function in a combination is an obvious expedient if the remaining elements perform the same function as before. In re KARLSON (CCPA) 136 USPQ 184 (1963).

Claims are not identical, however, the scope of the invention are the same.

Instant Application (15/350360)	Application (12/896993)
<p>Claim 1: A method implemented by a base station of receiving control information from a user terminal, the method comprising:</p> <p>scheduling downlink transmissions to a first user terminal on a single downlink component carrier associated with a primary cell and scheduling downlink transmissions to a second user terminal on multiple downlink component carriers or on a downlink component carrier associated with a non-primary cell;</p> <p>receiving, on a first set of radio resources, control information associated with the downlink transmissions to the first user terminal, wherein the first set of radio resources is reserved for user terminals scheduled to receive downlink transmissions on a single downlink component carrier associated with the primary cell; and</p> <p>receiving, on a second set of radio resources, control information associated with the downlink transmissions</p>	<p>Claim 1: A method implemented by a base station of receiving control information from a user terminal, the method comprising:</p> <p>scheduling downlink transmissions to a first user terminal on a single downlink component carrier associated with a primary cell and a second user terminal on multiple downlink component carriers including the single downlink component carrier associated with the primary cell;</p> <p>receiving control information associated with the downlink transmissions to the first user terminal on a first set of radio resources on an uplink component carrier associated with the primary cell, wherein the first set of radio resources is reserved for user terminals scheduled to receive downlink transmissions on the single downlink component carrier associated with the primary cell; receiving control information associated</p>

<p>to the second user terminal, wherein the second set of radio resources is reserved for user terminals scheduled to receive downlink transmissions on multiple downlink component carriers or on a downlink component carrier associated with a non-primary cell, the first and second sets of radio resources being on a same uplink component carrier associated with the primary cell.</p>	<p>with the downlink transmissions to the second user terminal on a second set of radio resources on the uplink component carrier associated with the primary cell, wherein the second set of radio resources is reserved for user terminals scheduled to receive downlink transmissions on the multiple downlink component carriers and the second set of resources are additional resources as compared to the first set of resources;</p> <p>and transmitting, on the single downlink component carrier, an indication to assign radio resources in the second set of radio resources when the second user terminal is scheduled to receive the downlink transmissions on the multiple downlink component carriers.</p>
<p>Claim 17: A base station comprising:</p> <p>a transmitter to transmit user data on one or more downlink component carriers to a first user terminal and a second user terminal; and a controller to schedule downlink transmissions to the first user terminal and the second user terminal, the controller configured to:</p> <p>schedule downlink transmissions to the first user terminal on a single downlink component carrier associated with a primary cell and schedule downlink transmissions to the second user terminal on multiple downlink component carriers or on a downlink component carrier associated with a non-primary cell; receive, on a first set of radio resources, control information associated with the downlink transmissions to the first user terminal, wherein the first set of radio resources is reserved for user terminals scheduled to receive downlink transmissions on a single downlink component carrier associated with the primary cell; and</p>	<p>Claim 9: A base station comprising:</p> <p>a transmitter to transmit user data on one or more downlink component carriers to a first user terminal and a second user terminal; and a controller to schedule downlink transmissions to the first user terminal and the second user terminal, the controller configured to:</p> <p>schedule downlink transmissions to the first user terminal on a single downlink component carrier associated with a primary cell and the second user terminal on multiple downlink component carriers including the single downlink component carrier associated with the primary cell; receive control information associated with the downlink transmissions to the first user terminal on a first set of radio resources on an uplink component carrier associated with the primary cell, wherein the first set of radio resources is reserved for user terminals scheduled to receive downlink transmissions on the single downlink component carrier</p>

<p>receive, on a second set of radio resources, control information associated with the downlink transmissions to the second user terminal, wherein the second set of radio resources is reserved for user terminals scheduled to receive downlink transmissions on multiple downlink component carriers or on a downlink component carrier associated with a non-primary cell, the first and second sets of radio resources being on a same uplink component carrier associated with the primary cell.</p>	<p>associated with the primary cell;</p> <p>receive control information associated with the downlink transmissions to the second user terminal on a second set of radio resources on the uplink component carrier associated with the primary cell, wherein the second set of radio resources is reserved for user terminals scheduled to receive downlink transmissions on the multiple downlink component carriers and the second set of resources are additional resources as compared to the first set of resources; and transmit, on the single downlink component carrier, an indication to assign radio resources in the second set of radio resources when the second user terminal is scheduled to receive the downlink transmissions on the multiple downlink component carriers.</p>
<p>Claim 18: A method implemented by a user terminal of transmitting control information in a mobile communication network, the method comprising:</p> <p>receiving an assignment of radio resources for downlink transmissions from a base station;</p> <p>transmitting, on a first set of radio resources, control information associated with the downlink transmissions responsive to being assigned radio resources on a single downlink component carrier associated with the primary cell for the downlink transmission, wherein the first set of radio resources is reserved for user terminals scheduled to receive downlink transmissions on a single downlink component carrier associated with the primary cell; and</p> <p>transmitting, on a second set of radio resources, control information associated with the downlink transmissions responsive to being assigned radio resources on multiple downlink component carriers or on a downlink component carrier associated with a non-primary cell for the downlink transmission, wherein the second set of radio resources is reserved for user terminals</p>	<p>Claim 17: A method implemented by a user terminal of transmitting control information in a mobile communication network, the method comprising:</p> <p>receiving an assignment of radio resources for downlink transmissions from a base station;</p> <p>transmitting, on a first set of radio resources on an uplink component carrier associated with a primary cell, control information associated with the downlink transmissions responsive to receiving an assignment of radio resources on a single downlink component carrier associated with the primary cell for the downlink transmission, wherein the first set of radio resources is reserved for user terminals scheduled to receive downlink transmissions on the single downlink component carrier associated with the primary cell;</p> <p>transmitting, on a second set of radio resources on the uplink component carrier associated with the primary cell, control information associated with the downlink transmissions responsive to receiving an assignment of radio resources on multiple downlink component carriers including</p>

<p>scheduled to receive downlink transmissions on multiple downlink component carriers or on a downlink component carrier associated with a non-primary cell, the first and second sets of radio resources being on a same uplink component carrier associated with the primary cell.</p>	<p>the single downlink component carrier associated with the primary cell for the downlink transmissions, wherein the second set of radio resources is reserved for user terminals scheduled to receive downlink transmissions on the multiple downlink component carriers and the second set of resources are additional resources as compared to the first set of resources; and receiving, on the single downlink component carrier, an indication to assign radio resources on the second set of radio resources when the user terminal is scheduled to receive the downlink transmissions on the multiple downlink component carriers</p>
<p>Claim 30: A user terminal for mobile communications, the user terminal comprising: a receiver to receive downlink transmissions from a base station; a transmitter to transmit control information associated with the downlink transmission to a base station; and</p> <p>a controller to select radio resources for transmission of control information associated with the downlink transmissions, the controller configured to: select a first set of radio resources responsive to being assigned radio resources on a single downlink component carrier associated with the primary cell for the downlink transmission, wherein the first set of radio resources is reserved for user terminals scheduled to receive downlink transmissions on a single downlink component carrier associated with the primary cell; and</p> <p>select a second set of radio resources responsive to being assigned radio resources on multiple downlink component carriers or on a downlink component carrier associated with a non-primary cell for the downlink transmissions, wherein the second set of radio resources is reserved for user terminals scheduled to receive downlink transmissions on multiple downlink component carriers or on a downlink component carrier associated with a non-primary cell, the first and second sets of radio resources being on a same uplink component carrier</p>	<p>Claim 24: A user terminal for mobile communications, the user terminal comprising: a receiver to receive downlink transmissions from a base station; a transmitter to transmit control information associated with the downlink transmissions to a base station; and</p> <p>a controller to select radio resources for transmission of control information associated with the downlink transmissions, the controller configured to: select a first set of radio resources on an uplink component carrier associated with a primary cell responsive to receiving an assignment of radio resources on a single downlink component carrier associated with the primary cell for the downlink transmissions, wherein the first set of radio resources is reserved for user terminals scheduled to receive downlink transmissions on the single downlink component carrier associated with the primary cell;</p> <p>select a second set of radio resources on the uplink component carrier associated with the primary cell responsive to receiving an assignment of radio resources on multiple downlink component carriers including the single downlink component carrier associated with the primary cell for the downlink transmissions, wherein the second set of radio resources is reserved for user terminals scheduled to receive downlink transmissions on the multiple downlink</p>

associated with the primary cell.	component carriers and the second set of resources are additional resources as compared to the first set of resources; and receive, on the single downlink component carrier, an indication to assign radio resources on the second set of radio resources when the user terminal is scheduled to receive the downlink transmissions on the multiple downlink component carriers.

Conclusion

Any inquiry concerning this communication or earlier communications from the examiner should be directed to MD TALUKDER whose telephone number is (571)270-3222. The examiner can normally be reached on Monday to Friday (Alt Friday off) from (9:30 to 4:00).

If attempts to reach the examiner by telephone are unsuccessful, the examiner's supervisor, Wesley Kim can be reached on 571-272-7867. The fax phone number for the organization where this application or proceeding is assigned is 571-273-8300.

Information regarding the status of an application may be obtained from the Patent Application Information Retrieval (PAIR) system. Status information for published applications may be obtained from either Private PAIR or Public PAIR. Status information for unpublished applications is available through Private PAIR only. For more information about the PAIR system, see <http://pair-direct.uspto.gov>. Should you have questions on access to the Private PAIR system, contact the Electronic Business Center (EBC) at 866-217-9197 (toll-free). If you would like assistance from a USPTO Customer Service Representative or access to the automated information system, call 800-786-9199 (IN USA OR CANADA) or 571-272-1000.

/MD TALUKDER/

Primary Examiner, Art Unit 2648

Notice of References Cited	Application/Control No. 15/350,360	Applicant(s)/Patent Under Reexamination ASTELY ET AL.	
	Examiner MD TALUKDER	Art Unit 2648	Page 1 of 3

U.S. PATENT DOCUMENTS

*		Document Number Country Code-Number-Kind Code	Date MM-YYYY	Name	CPC Classification	US Classification
*	A	US-2002/0160784 A1	10-2002	Kuwahara, Soichi	H04W28/26	455/452.1
*	B	US-2010/0003997 A1	01-2010	KOYANAGI; Kenichiro	H04L1/0003	455/450
*	C	US-2010/0098012 A1	04-2010	Bala; Erdem	H04L5/001	370/329
*	D	US-2010/0208679 A1	08-2010	Papasakellariou; Aris	H04L1/1614	370/329
*	E	US-2010/0232373 A1	09-2010	Nory; Ravikiran	H04W72/1289	370/329
*	F	US-2010/0271970 A1	10-2010	Pan; Kyle Jung-Lin	H04L1/0026	370/252
*	G	US-2010/0285809 A1	11-2010	Lindstrom; Magnus	H04L5/001	455/450
*	H	US-2010/0296389 A1	11-2010	Khandekar; Aamod Dinkar	H04L5/0007	370/216
*	I	US-2010/0322173 A1	12-2010	Marinier; Paul	H04W76/048	370/329
*	J	US-2011/0007695 A1	01-2011	Choi; Hyung-Nam	H04L5/0007	370/329
*	K	US-2011/0007699 A1	01-2011	Moon; Sung Ho	H04L5/0053	370/329
*	L	US-2011/0081913 A1	04-2011	Lee; Jung A.	H04L5/003	455/450
*	M	US-2011/0081932 A1	04-2011	Astely; David	H04L5/001	455/509

FOREIGN PATENT DOCUMENTS

*		Document Number Country Code-Number-Kind Code	Date MM-YYYY	Country	Name	CPC Classification
	N					
	O					
	P					
	Q					
	R					
	S					
	T					

NON-PATENT DOCUMENTS

*		Include as applicable: Author, Title Date, Publisher, Edition or Volume, Pertinent Pages)
	U	
	V	
	W	
	X	

*A copy of this reference is not being furnished with this Office action. (See MPEP § 707.05(a).)
Dates in MM-YYYY format are publication dates. Classifications may be US or foreign.

Notice of References Cited	Application/Control No. 15/350,360	Applicant(s)/Patent Under Reexamination ASTELY ET AL.	
	Examiner MD TALUKDER	Art Unit 2648	Page 2 of 3

U.S. PATENT DOCUMENTS

*		Document Number Country Code-Number-Kind Code	Date MM-YYYY	Name	CPC Classification	US Classification
*	A	US-2011/0243039 A1	10-2011	PAPASAKELLARIOU; Aris	H04L1/1861	370/280
*	B	US-2011/0310856 A1	12-2011	Hariharan; Priya	H04L1/1607	370/336
*	C	US-2012/0020317 A1	01-2012	Ishii; Hiroyuki	H04L1/1854	370/329
*	D	US-2012/0051306 A1	03-2012	Chung; Jae Hoon	H04L1/1893	370/329
*	E	US-2012/0082125 A1	04-2012	Huang; Yada	H04L5/0007	370/329
*	F	US-2012/0140708 A1	06-2012	Choudhury; Sayantan	H04W72/082	370/328
*	G	US-8,194,603 B2	06-2012	Nimbalker; Ajit	H04L5/001	370/329
*	H	US-8,265,030 B2	09-2012	Miki; Nobuhiko	H04W72/1257	370/330
*	I	US-2012/0314675 A1	12-2012	Vujcic; Dragan	H04L5/001	370/329
*	J	US-2013/0003700 A1	01-2013	Zhang; Jian	H04W76/028	370/331
*	K	US-2013/0010721 A1	01-2013	Aiba; Tatsushi	H04L1/1812	370/329
*	L	US-2013/0034073 A1	02-2013	Aiba; Tatsushi	H04L1/0026	370/329
*	M	US-8,447,343 B2	05-2013	Gerstenberger; Dirk	H04W52/10	370/248

FOREIGN PATENT DOCUMENTS

*		Document Number Country Code-Number-Kind Code	Date MM-YYYY	Country	Name	Classification
	N					
	O					
	P					
	Q					
	R					
	S					
	T					

NON-PATENT DOCUMENTS

*		Include as applicable: Author, Title Date, Publisher, Edition or Volume, Pertinent Pages)
	U	
	V	
	W	
	X	

*A copy of this reference is not being furnished with this Office action. (See MPEP § 707.05(a).)
Dates in MM-YYYY format are publication dates. Classifications may be US or foreign.

Notice of References Cited	Application/Control No. 15/350,360	Applicant(s)/Patent Under Reexamination ASTELY ET AL.	
	Examiner MD TALUKDER	Art Unit 2648	Page 3 of 3

U.S. PATENT DOCUMENTS

*		Document Number Country Code-Number-Kind Code	Date MM-YYYY	Name	CPC Classification	US Classification
*	A	US-2013/0136084 A1	05-2013	ZHANG; Yuantao	H04W72/0413	370/329
*	B	US-8,472,368 B2	06-2013	Baldemair; Robert	H04L5/0053	370/318
*	C	US-8,634,358 B2	01-2014	Damnjanovic; Jelena M.	H04L1/1861	370/329
*	D	US-2014/0078941 A1	03-2014	Seo; Dong Youn	H04L1/1822	370/280
*	E	US-8,792,830 B2	07-2014	Lim; Suhwan	H04L25/02	375/260
	F	US-				
	G	US-				
	H	US-				
	I	US-				
	J	US-				
	K	US-				
	L	US-				
	M	US-				

FOREIGN PATENT DOCUMENTS

*		Document Number Country Code-Number-Kind Code	Date MM-YYYY	Country	Name	Classification
	N					
	O					
	P					
	Q					
	R					
	S					
	T					

NON-PATENT DOCUMENTS

*		Include as applicable: Author, Title Date, Publisher, Edition or Volume, Pertinent Pages)
	U	
	V	
	W	
	X	

*A copy of this reference is not being furnished with this Office action. (See MPEP § 707.05(a).)
Dates in MM-YYYY format are publication dates. Classifications may be US or foreign.

Receipt date: 11/14/2016

15350360 - GAU: 2648

Doc code: IDS

PTO/SB/08a (03-15)

Doc description: Information Disclosure Statement (IDS) Filed

Approved for use through 07/31/2016. OMB 0651-0031

U.S. Patent and Trademark Office; U.S. DEPARTMENT OF COMMERCE

Under the Paperwork Reduction Act of 1995, no persons are required to respond to a collection of information unless it contains a valid OMB control number.

INFORMATION DISCLOSURE STATEMENT BY APPLICANT (Not for submission under 37 CFR 1.99)	Application Number		
	Filing Date		
	First Named Inventor	David Astely et al.	
	Art Unit		
	Examiner Name		
	Attorney Docket Number	4015-9600 / P30138-US3	

U.S.PATENTS							<input type="button" value="Remove"/>
Examiner Initial*	Cite No	Patent Number	Kind Code ¹	Issue Date	Name of Patentee or Applicant of cited Document	Pages, Columns, Lines where Relevant Passages or Relevant Figures Appear	
	1	8265030	B2	2012-09-11	Miki et al.		
	2	8447343	B2	2013-05-21	Gerstenberger et al.		
	3	8472368	B2	2013-06-25	Baldemair et al.		
	4	8634358	B2	2014-01-21	Damnjanovic et al.		
	5	8792830	B2	2014-07-29	Lim et al.		
If you wish to add additional U.S. Patent citation information please click the Add button.							<input type="button" value="Add"/>
U.S.PATENT APPLICATION PUBLICATIONS							<input type="button" value="Remove"/>
Examiner Initial*	Cite No	Publication Number	Kind Code ¹	Publication Date	Name of Patentee or Applicant of cited Document	Pages, Columns, Lines where Relevant Passages or Relevant Figures Appear	
	1	20020160784	A1	2002-10-31	Kuwahara et al.		

INFORMATION DISCLOSURE STATEMENT BY APPLICANT (Not for submission under 37 CFR 1.99)	Application Number		
	Filing Date		
	First Named Inventor	David Astely et al.	
	Art Unit		
	Examiner Name		
	Attorney Docket Number	4015-9600 / P30138-US3	

2	20100003997	A1	2010-01-07	Koyanagi
3	20100098012	A1	2010-04-22	Bala et al.
4	20100208679	A1	2010-08-19	Papsakellariou et al.
5	20100232373	A1	2010-09-16	Nory et al.
6	20100271970	A1	2010-10-28	Pan et al.
7	20100285809	A1	2010-11-11	Lindstrom et al.
8	20100296389	A1	2010-11-25	Khandekar et al.
9	20100322173	A1	2010-12-23	Marinier et al.
10	20110007695	A1	2011-01-13	Choi et al.
11	20110007699	A1	2011-01-13	Moon et al.
12	20110081913	A1	2011-04-07	Lee et al.

INFORMATION DISCLOSURE STATEMENT BY APPLICANT (Not for submission under 37 CFR 1.99)	Application Number		
	Filing Date		
	First Named Inventor	David Astely et al.	
	Art Unit		
	Examiner Name		
	Attorney Docket Number	4015-9600 / P30138-US3	

13	20110081932	A1	2011-04-07	Astely et al.
14	20110243039	A1	2011-10-06	Papasakellariou et al.
15	20110310856	A1	2011-12-22	Hariharan et al.
16	20120020317	A1	2012-01-26	Ishii et al.
17	20120051306	A1	2012-03-01	Chung et al.
18	20120082125	A1	2012-04-05	Huang
19	20120140708	A1	2012-06-07	Choudhury et al.
20	20120314675	A1	2012-12-13	Vujcic
21	20130010721	A1	2013-01-10	Aiba et al.
22	20130003700	A1	2013-01-03	Zhang et al.
23	20130034073	A1	2013-02-07	Aiba et al.

INFORMATION DISCLOSURE STATEMENT BY APPLICANT (Not for submission under 37 CFR 1.99)	Application Number		
	Filing Date		
	First Named Inventor	David Astely et al.	
	Art Unit		
	Examiner Name		
	Attorney Docket Number	4015-9600 / P30138-US3	

	24	20130136084	A1	2013-05-30	Zhang et al.	
	25	20120147847	A1	2012-06-14	Matsumoto et al.	Corresponds to WO2009022474A1

If you wish to add additional U.S. Published Application citation information please click the Add button.

FOREIGN PATENT DOCUMENTS

Examiner Initial*	Cite No	Foreign Document Number ³	Country Code ² i	Kind Code ⁴	Publication Date	Name of Patentee or Applicant of cited Document	Pages, Columns, Lines where Relevant Passages or Relevant Figures Appear	T ⁵
	1	101765208	CN	A	2010-06-30	Huawei Technologies Co., Inc.	Machine Translation Included (in parent case)	
	2	2009022474	WO	A1	2009-02-19	Panasonic Corp.	Corresponds to US2012/0147847A1	

If you wish to add additional Foreign Patent Document citation information please click the Add button

NON-PATENT LITERATURE DOCUMENTS

Examiner Initials*	Cite No	Include name of the author (in CAPITAL LETTERS), title of the article (when appropriate), title of the item (book, magazine, journal, serial, symposium, catalog, etc), date, pages(s), volume-issue number(s), publisher, city and/or country where published.	T ⁵
	1	3RD GENERATION PARTNERSHIP PROJECT, MOTOROLA (source), "Control Signalling Design for Supporting Carrier Aggregation," 3GPP TSG RAN #56, R1-090792, Athens, GR, Feb. 9-13, 2009.	
	2	3RD GENERATION PARTNERSHIP PROJECT, ZTE (source), "Uplink Control Channel Design for LTE-Advanced," TSG-RAN WG1 #58, R1-093209, Shenzhen, China, June 25 - Aug. 29, 2009.	
	3	3RD GENERATION PARTNERSHIP PROJECT, NOKIA, NOKIA SIEMENS NETWORKS (source), "L1 Control Signaling with Carrier Aggregation in LTE-Advanced," 3GPP TSG-RAN WG1 Meeting #54bis, R1-083730, Prague, Czech Republic, Sept. 29 - October 3, 2008.	

INFORMATION DISCLOSURE STATEMENT BY APPLICANT (Not for submission under 37 CFR 1.99)	Application Number		
	Filing Date		
	First Named Inventor	David Astely et al.	
	Art Unit		
	Examiner Name		
	Attorney Docket Number	4015-9600 / P30138-US3	

4	3RD GENERATION PARTNERSHIP PROJECT, NOKIA SIEMENS NETWORKS, NOKIA (source), "Channelization of SRI and Persistent ACK/NACK on PUCCH," 3GPP TSG RAN WG1 Meeting #52bis, R1-081460, Shenzhen, China, March 31 - April 4, 2008.
5	3RD GENERATION PARTNERSHIP PROJECT, QUALCOMM EUROPE, "Clarifying PUSCH Resource Allocation," 3GPP TSG-RAN WG1 Meeting #54, R1-083181, Jeju, Korea, August 18-22, 2008.
6	NTT DOCOMO, Inc., "UL Layered Control Signal Structure in LTE-Advanced", 3GPP DRAFT RAN WG1 Meeting #54bis; RI-083679 UL LAYERED CONTROL SIGNAL, 3RD GENERATION PARTNERSHIP PROJECT (3GPP), MOBILE COMPETENCE CENTRE ; 650, ROUTE DES LUCIOLES ; F-06921 SOPHIA-ANTIPOLIS CEDEX ; FRANCE, vol. Ran WG1, no. Prague, Czech Republic; 20080929-20081003, 29 September 2008 (2008-09-29), XP050597042, [retrieved on 2008-09-24].
7	ZTE (source), "ACK/NACK Design for LTE-Advanced," TSG-RAN WG1 #58bis, R1-093821, Miyazaki, Japan, October 12-16, 2009.
8	Infineon Technologies (source), "Clarification of UL DPCH slot format information usage in IE 'DTX-DRX information'," 3GPP TSG-RAN WG2 Meeting #65, Tdoc R2-091165, Athens, Greece February 9-13, 2009.
9	NTT DocCoMo, Inc. (source), "UL ACK/NACK resource allocation for DL semi-persistent scheduling," 3GPP TSG RAN WG2 #62, R2-082485 (resubmission of R2-081857), Kansas City, Missouri, USA, May 5-9, 2008.

If you wish to add additional non-patent literature document citation information please click the Add button

EXAMINER SIGNATURE

Examiner Signature	/MD K TALUKDER/	Date Considered	03/17/2017
--------------------	-----------------	-----------------	------------

*EXAMINER: Initial if reference considered, whether or not citation is in conformance with MPEP 609. Draw line through a citation if not in conformance and not considered. Include copy of this form with next communication to applicant.

¹ See Kind Codes of USPTO Patent Documents at www.USPTO.GOV or MPEP 901.04. ² Enter office that issued the document, by the two-letter code (WIPO Standard ST.3). ³ For Japanese patent documents, the indication of the year of the reign of the Emperor must precede the serial number of the patent document. ⁴ Kind of document by the appropriate symbols as indicated on the document under WIPO Standard ST.16 if possible. ⁵ Applicant is to place a check mark here if English language translation is attached.

INFORMATION DISCLOSURE STATEMENT BY APPLICANT (Not for submission under 37 CFR 1.99)	Application Number		
	Filing Date		
	First Named Inventor	David Astely et al.	
	Art Unit		
	Examiner Name		
	Attorney Docket Number	4015-9600 / P30138-US3	

CERTIFICATION STATEMENT

Please see 37 CFR 1.97 and 1.98 to make the appropriate selection(s):

That each item of information contained in the information disclosure statement was first cited in any communication from a foreign patent office in a counterpart foreign application not more than three months prior to the filing of the information disclosure statement. See 37 CFR 1.97(e)(1).

OR

That no item of information contained in the information disclosure statement was cited in a communication from a foreign patent office in a counterpart foreign application, and, to the knowledge of the person signing the certification after making reasonable inquiry, no item of information contained in the information disclosure statement was known to any individual designated in 37 CFR 1.56(c) more than three months prior to the filing of the information disclosure statement. See 37 CFR 1.97(e)(2).

See attached certification statement.

The fee set forth in 37 CFR 1.17 (p) has been submitted herewith.

A certification statement is not submitted herewith.

SIGNATURE

A signature of the applicant or representative is required in accordance with CFR 1.33, 10.18. Please see CFR 1.4(d) for the form of the signature.

Signature	/Edward M. Roney/	Date (YYYY-MM-DD)	2016-11-14
Name/Print	Edward M. Roney	Registration Number	62048

This collection of information is required by 37 CFR 1.97 and 1.98. The information is required to obtain or retain a benefit by the public which is to file (and by the USPTO to process) an application. Confidentiality is governed by 35 U.S.C. 122 and 37 CFR 1.14. This collection is estimated to take 1 hour to complete, including gathering, preparing and submitting the completed application form to the USPTO. Time will vary depending upon the individual case. Any comments on the amount of time you require to complete this form and/or suggestions for reducing this burden, should be sent to the Chief Information Officer, U.S. Patent and Trademark Office, U.S. Department of Commerce, P.O. Box 1450, Alexandria, VA 22313-1450. **DO NOT SEND FEES OR COMPLETED FORMS TO THIS ADDRESS. SEND TO: Commissioner for Patents, P.O. Box 1450, Alexandria, VA 22313-1450.**

Privacy Act Statement

The Privacy Act of 1974 (P.L. 93-579) requires that you be given certain information in connection with your submission of the attached form related to a patent application or patent. Accordingly, pursuant to the requirements of the Act, please be advised that: (1) the general authority for the collection of this information is 35 U.S.C. 2(b)(2); (2) furnishing of the information solicited is voluntary; and (3) the principal purpose for which the information is used by the U.S. Patent and Trademark Office is to process and/or examine your submission related to a patent application or patent. If you do not furnish the requested information, the U.S. Patent and Trademark Office may not be able to process and/or examine your submission, which may result in termination of proceedings or abandonment of the application or expiration of the patent.

The information provided by you in this form will be subject to the following routine uses:

1. The information on this form will be treated confidentially to the extent allowed under the Freedom of Information Act (5 U.S.C. 552) and the Privacy Act (5 U.S.C. 552a). Records from this system of records may be disclosed to the Department of Justice to determine whether the Freedom of Information Act requires disclosure of these records.
2. A record from this system of records may be disclosed, as a routine use, in the course of presenting evidence to a court, magistrate, or administrative tribunal, including disclosures to opposing counsel in the course of settlement negotiations.
3. A record in this system of records may be disclosed, as a routine use, to a Member of Congress submitting a request involving an individual, to whom the record pertains, when the individual has requested assistance from the Member with respect to the subject matter of the record.
4. A record in this system of records may be disclosed, as a routine use, to a contractor of the Agency having need for the information in order to perform a contract. Recipients of information shall be required to comply with the requirements of the Privacy Act of 1974, as amended, pursuant to 5 U.S.C. 552a(m).
5. A record related to an International Application filed under the Patent Cooperation Treaty in this system of records may be disclosed, as a routine use, to the International Bureau of the World Intellectual Property Organization, pursuant to the Patent Cooperation Treaty.
6. A record in this system of records may be disclosed, as a routine use, to another federal agency for purposes of National Security review (35 U.S.C. 181) and for review pursuant to the Atomic Energy Act (42 U.S.C. 218(c)).
7. A record from this system of records may be disclosed, as a routine use, to the Administrator, General Services, or his/her designee, during an inspection of records conducted by GSA as part of that agency's responsibility to recommend improvements in records management practices and programs, under authority of 44 U.S.C. 2904 and 2906. Such disclosure shall be made in accordance with the GSA regulations governing inspection of records for this purpose, and any other relevant (i.e., GSA or Commerce) directive. Such disclosure shall not be used to make determinations about individuals.
8. A record from this system of records may be disclosed, as a routine use, to the public after either publication of the application pursuant to 35 U.S.C. 122(b) or issuance of a patent pursuant to 35 U.S.C. 151. Further, a record may be disclosed, subject to the limitations of 37 CFR 1.14, as a routine use, to the public if the record was filed in an application which became abandoned or in which the proceedings were terminated and which application is referenced by either a published application, an application open to public inspections or an issued patent.
9. A record from this system of records may be disclosed, as a routine use, to a Federal, State, or local law enforcement agency, if the USPTO becomes aware of a violation or potential violation of law or regulation.

EAST Search History

EAST Search History (Prior Art)

Ref #	Hits	Search Query	DBs	Default Operator	Plurals	Time Stamp
L1	178	370/\$.ccls. and (allocat\$3) with (resource frequency channel Bin) same2 (reserv\$4 sav\$4) adj6 (resource frequency channel Bin) and (multiple several set) near3 component adj2 carrier	US-PGPUB; USPAT; USOCR; FPRS; EPO; JPO; DERWENT; IBM_TDB	OR	ON	2017/03/17 16:26
L2	26	455/\$.ccls. and (allocat\$3) with (resource frequency channel Bin) same2 (reserv\$4 sav\$4) adj6 (resource frequency channel Bin) and (multiple several set) near3 component adj2 carrier	US-PGPUB; USPAT; USOCR; FPRS; EPO; JPO; DERWENT; IBM_TDB	OR	ON	2017/03/17 16:28
L3	178	370/\$.ccls. and (allocat\$3) with (resource frequency channel Bin) same2 (reserv\$4 sav\$4) adj6 (resource frequency channel Bin) and (multiple several set) near3 component adj2 carrier	US-PGPUB; USPAT; USOCR; FPRS; EPO; JPO; DERWENT; IBM_TDB	OR	ON	2017/03/17 16:28
L4	81	370/\$.ccls. and (allocat\$3) with (resource frequency channel Bin) same2 (reserv\$4 sav\$4) adj6 (resource frequency channel Bin) and (multiple several set) near3 component adj2 carrier and (primary adj2 cell)	US-PGPUB; USPAT; USOCR; FPRS; EPO; JPO; DERWENT; IBM_TDB	OR	ON	2017/03/17 17:01
L5	3	"12896993"	US-PGPUB; USPAT; USOCR; FPRS; EPO; JPO; DERWENT; IBM_TDB	OR	ON	2017/03/17 17:17
L6	3	"9497004"	US-PGPUB; USPAT; USOCR; FPRS; EPO; JPO; DERWENT; IBM_TDB	OR	ON	2017/03/17 17:42
L7	3	"12896993"	US-PGPUB; USPAT; USOCR; FPRS; EPO; JPO; DERWENT; IBM_TDB	OR	ON	2017/03/17 17:43
S1	1	"12896993"	US-PGPUB;	OR	ON	2012/12/10

			USPAT; USOCR; DERWENT; IBM_TDB			17:09
S2	367	((david near2 astely) (robert near2 baldemair) (dirk near2 gerstenberger) (daniel near2 larsson) (lars near2 lindbom) (stefan near2 parkvall)).in.	US-PGPUB; USPAT; USOCR; DERWENT; IBM_TDB	OR	ON	2012/12/10 19:04
S3	176	S2 and (radio near3 resource)	US-PGPUB; USPAT; USOCR; DERWENT; IBM_TDB	OR	ON	2012/12/10 19:09
S4	28	S2 and (radio near3 resource) and (component with carrier)	US-PGPUB; USPAT; USOCR; DERWENT; IBM_TDB	OR	ON	2012/12/10 19:09
S5	173	(downlink near3 carrier) and (uplink near3 primary first initial) near3 carrier) and ((second 2nd other next) with (channel resource)) and (control with information)	US-PGPUB; USPAT; USOCR; DERWENT; IBM_TDB	OR	ON	2012/12/11 09:04
S6	137	S5 and (scheduling)	US-PGPUB; USPAT; USOCR; DERWENT; IBM_TDB	OR	ON	2012/12/11 09:04
S7	36	("20120263121" "20110310856" "20120127950" "20110310819" "20120275395" "20120287828" "20120039291" "20100271970" "20120307781" "20110286436" "20120224535" "20120140708" "20110310820" "20120163288" "20110299486" "20100098012" "20120082125" "20120294273" "20110268048" "20120113910").pn.	US-PGPUB; USPAT; USOCR; DERWENT; IBM_TDB	OR	ON	2012/12/11 09:15
S8	127	(downlink near3 carrier) and (uplink near3 primary first initial) near3 carrier) and ((second 2nd other next) with (channel resource)) and (carrier adj aggregation)	US-PGPUB; USPAT; USOCR; DERWENT; IBM_TDB	OR	ON	2012/12/11 10:16
S9	2	"20110292887"	US-PGPUB; USPAT; USOCR; DERWENT; IBM_TDB	OR	ON	2012/12/11 11:17
S11	25	((first 1st) adj6 component adj3 carrier) same ((1st first) adj6 (radio resource frame)) and ((2nd second) adj6 component adj3 carrier) same ((2nd second) adj6 (radio resource frame))	US-PGPUB; USPAT; USOCR; DERWENT; IBM_TDB	OR	ON	2012/12/11 11:22
S12	1718	((first 1st) adj6 carrier) same ((1st first) adj6 (radio resource frame)) and ((2nd second) adj6 carrier) same ((2nd second) adj6 (radio resource frame))	US-PGPUB; USPAT; USOCR; DERWENT; IBM_TDB	OR	ON	2012/12/11 11:47
S13	66	(carrier near3 aggregation) and ((first 1st) adj6	US-PGPUB;	OR	ON	2012/12/11

		carrier) same ((1st first) adj6 (radio resource frame)) and ((2nd second) adj6 carrier) same ((2nd second) adj6 (radio resource frame))	USPAT; USOCR; DERWENT; IBM_TDB			11:47
S14	10842	455/509,522,456.6,137,103,575.ccls.	US-PGPUB; USPAT; USOCR; DERWENT; IBM_TDB	OR	ON	2012/12/11 13:41
S15	28232	370/329,252,331.ccls.	US-PGPUB; USPAT; USOCR; DERWENT; IBM_TDB	OR	ON	2012/12/11 13:41
S16	102	(S14 S15) and (downlink near3 carrier) and (uplink near3 (primary first initial) near3 carrier) and ((second 2nd other next) with (channel resource)) and (control with information)	US-PGPUB; USPAT; USOCR; DERWENT; IBM_TDB	OR	ON	2012/12/11 13:42
S17	1	"13140333"	US-PGPUB; USPAT; USOCR; DERWENT; IBM_TDB	OR	ON	2012/12/11 14:18
S18	2	"20110310856"	US-PGPUB; USPAT; USOCR; DERWENT; IBM_TDB	OR	ON	2012/12/11 14:18
S19	38	((first 1st) adj6 component adj3 carrier) same ((radio resource frame)) and ((2nd second) adj6 component adj3 carrier) same ((2nd second) adj6 (radio resource frame))	US-PGPUB; USPAT; USOCR; DERWENT; IBM_TDB	OR	ON	2012/12/11 14:31
S20	38	((first 1st) adj6 component adj3 carrier) same ((radio resource frame)) and ((2nd second) adj6 component adj3 carrier) same ((2nd second) adj6 (radio resource frame))	US-PGPUB; USPAT; USOCR; DERWENT; IBM_TDB	OR	ON	2012/12/11 14:31
S21	27	((first 1st) adj6 component adj3 carrier) same ((radio resource frame)) and ((2nd second) adj6 component adj3 carrier) same ((2nd second other another) adj4 (radio resource frame))	US-PGPUB; USPAT; USOCR; DERWENT; IBM_TDB	OR	ON	2012/12/11 14:32
S22	38	((first 1st) adj6 component adj3 carrier) same ((radio resource frame)) and ((2nd second) adj6 component adj3 carrier) same ((2nd second other another) adj6 (radio resource frame))	US-PGPUB; USPAT; USOCR; DERWENT; IBM_TDB	OR	ON	2012/12/11 14:32
S23	24	(carrier adj aggregation) and (schedul\$3 near3 (downlink DL) with ((first primary initial) near6 (resource radio frequency frame)))	US-PGPUB; USPAT; USOCR; DERWENT; IBM_TDB	OR	ON	2012/12/11 14:48
S24	8	("7551898" "7649960" "7656843" "7773699").PN.	US-PGPUB; USPAT; USOCR; DERWENT; IBM_TDB	OR	ON	2012/12/11 15:14
S25	2	"20110292900"	US-PGPUB;	OR	ON	2012/12/11

			USPAT; USOCR; DERWENT; IBM_TDB			15:36
S26	2	"20100271970"	US-PGPUB; USPAT; USOCR; DERWENT; IBM_TDB	OR	ON	2012/12/11 15:37
S27	3	"8050202"	US-PGPUB; USPAT; USOCR; DERWENT; IBM_TDB	OR	ON	2012/12/11 15:38
S28	1	"20120307689"	US-PGPUB; USPAT; USOCR; DERWENT; IBM_TDB	OR	ON	2012/12/11 15:45
S29	2	"8160017"	US-PGPUB; USPAT; USOCR; DERWENT; IBM_TDB	OR	ON	2012/12/11 15:48
S30	2	"20100232373"	US-PGPUB; USPAT; USOCR; DERWENT; IBM_TDB	OR	ON	2012/12/11 15:48
S31	2	"20090016278"	US-PGPUB; USPAT; USOCR; DERWENT; IBM_TDB	OR	ON	2012/12/11 17:16
S32	2	"8265030"	US-PGPUB; USPAT; USOCR; DERWENT; IBM_TDB	OR	ON	2012/12/11 17:19
S33	3	"2008139923"	US-PGPUB; USPAT; USOCR; DERWENT; IBM_TDB	OR	ON	2012/12/11 18:17
S34	14	("20100098012" "20100232373" "20110310856" "20120020317" "20120082125" "20120140708" "8265030").PN.	US-PGPUB; USPAT; USOCR; DERWENT; IBM_TDB	OR	ON	2013/05/29 17:19
S35	7	"455"/\$.ccls. and (carrier adj aggregation) and (schemul\$3 near3 (downlink DL) with ((first primary initial) near6 (resource radio frequency frame)))	US-PGPUB; USPAT; USOCR; DERWENT; IBM_TDB	OR	ON	2013/05/29 17:22
S36	9	"455"/\$.ccls. and (((first 1st) adj6 component adj3 carrier) same ((radio resource frame))) and (((2nd second) adj6 component adj3 carrier) same ((2nd second) adj6 (radio resource frame)))	US-PGPUB; USPAT; USOCR; DERWENT; IBM_TDB	OR	ON	2013/05/29 21:37
S38	4	("20070053294" "20100290405").PN.	US-PGPUB;	OR	ON	2013/05/30

			USPAT; USOCR; DERWENT; IBM_TDB			12:42
S39	16	("7596114" "20050013279" "20030219028" "20070217406" "20020105970" "20060050664" "20090303938" "20070064669").PN.	US-PGPUB; USPAT; USOCR; DERWENT; IBM_TDB	OR	ON	2013/05/30 12:42
S40	290	(first 1st) with (component near2 carrier) with down\$1link	US-PGPUB; USPAT; USOCR; DERWENT; IBM_TDB	OR	ON	2013/06/17 10:07
S41	114	(first 1st) with (component near2 carrier) with down\$1link and receiv\$3 near3 control near3 information	US-PGPUB; USPAT; USOCR; DERWENT; IBM_TDB	OR	ON	2013/06/17 10:09
S42	47	(first 1st) near3 (radio adj resource) and (second other another 2nd) near3 (radio adj resource) and component adj carrier	US-PGPUB; USPAT; USOCR; DERWENT; IBM_TDB	OR	ON	2013/06/17 12:29
S43	26	S42 and (carrier adj aggregation) and (schedul\$3 near3 (down\$1link DL reverse\$1link))	US-PGPUB; USPAT; USOCR; DERWENT; IBM_TDB	OR	ON	2013/06/17 12:31
S44	5	(first 1st) near3 (radio adj resource) and (second other another 2nd) near3 (radio adj resource) same (carrier adj aggregation) and (schedul\$3 near3 (down\$1link DL reverse\$1link))	US-PGPUB; USPAT; USOCR; DERWENT; IBM_TDB	OR	ON	2013/06/17 12:46
S45	26	(first 1st) near3 (radio adj resource) and (second other another 2nd) near3 (radio adj resource) and (carrier adj aggregation) and (schedul\$3 near3 (down\$1link DL reverse\$1link))	US-PGPUB; USPAT; USOCR; DERWENT; IBM_TDB	OR	ON	2013/06/17 12:47
S46	31	(second other another 2nd) near3 (radio adj resource) and (carrier adj aggregation) and (schedul\$3 near3 (down\$1link DL reverse\$1link))	US-PGPUB; USPAT; USOCR; DERWENT; IBM_TDB	OR	ON	2013/06/17 12:49
S47	0	@ad<"20091003" and (second other another 2nd) near3 (radio adj resource) and (carrier adj aggregation) and (schedul\$3 near3 (down\$1link DL reverse\$1link))	US-PGPUB; USPAT; USOCR; DERWENT; IBM_TDB	OR	ON	2013/06/17 12:51
S48	0	@ad<"20091003" and (second other another 2nd) near3 (radio adj resource) and (carrier adj component) and (schedul\$3 near3 (down\$1link DL reverse\$1link))	US-PGPUB; USPAT; USOCR; DERWENT; IBM_TDB	OR	ON	2013/06/17 12:52
S49	1	@ad<"20091003" and (second other another 2nd) near3 (radio adj resource) and (carrier adj component) and ((down\$1link DL reverse\$1link))	US-PGPUB; USPAT; USOCR; DERWENT; IBM_TDB	OR	ON	2013/06/17 12:53
S50	1	@ad<"20091005" and (second other another	US-PGPUB;	OR	ON	2013/06/17

		2nd) near3 (radio adj resource) and (carrier adj component) and ((down\$1link DL reverse\$1link))	USPAT; USOCR; DERWENT; IBM_TDB			12:55
S51	1	@ad<"20091003" and (second other another 2nd) near3 (radio adj resource) and (carrier adj component)	US-PGPUB; USPAT; USOCR; DERWENT; IBM_TDB	OR	ON	2013/06/17 12:56
S52	20	(second other another 2nd) near3 (radio adj resource) and (carrier adj component)	US-PGPUB; USPAT; USOCR; DERWENT; IBM_TDB	OR	ON	2013/06/17 13:31
S53	16	(set near3 radio near3 resource) same component adj carrier	US-PGPUB; USPAT; USOCR; DERWENT; IBM_TDB	OR	ON	2013/06/17 14:14
S54	27	(set near3 ((radio near3 resource) (resource adj block))) same component adj carrier	US-PGPUB; USPAT; USOCR; DERWENT; IBM_TDB	OR	ON	2013/06/17 14:19
S55	755	((radio near3 resource) (resource adj block)) same component adj carrier	US-PGPUB; USPAT; USOCR; DERWENT; IBM_TDB	OR	ON	2013/06/17 14:25
S56	70	((second 2nd other) with ((radio near3 resource) (resource adj block))) same component adj carrier	US-PGPUB; USPAT; USOCR; DERWENT; IBM_TDB	OR	ON	2013/06/17 14:26
S57	327	((radio near3 resource) (resource adj block)) same component adj carrier and (schedul\$3 near3 downlink reverse)	US-PGPUB; USPAT; USOCR; DERWENT; IBM_TDB	OR	ON	2013/06/17 14:27
S58	29	((second 2nd other) with ((radio near3 resource) (resource adj block))) same component adj carrier and (schedul\$3 near3 down\$1link reverse\$1link)	US-PGPUB; USPAT; USOCR; DERWENT; IBM_TDB	OR	ON	2013/06/17 14:27
S59	24	((second 2nd other) with ((radio near3 resource) (resource adj block))) same component adj carrier) same (down\$1link reverse\$1link)	US-PGPUB; USPAT; USOCR; DERWENT; IBM_TDB	OR	ON	2013/06/17 14:31
S60	10	("20090097447" "20110081856" "20090116427" "20100232373" "8331307").PN.	US-PGPUB; USPAT; USOCR; DERWENT; IBM_TDB	OR	ON	2013/06/17 14:49
S61	2562	(schedul\$3 near3 downlink) and ((radio adj resource) (resource adj block)) and component	US-PGPUB; USPAT; USOCR; DERWENT; IBM_TDB	OR	ON	2013/06/17 15:16
S62	739	(schedul\$3 near3 downlink) and ((radio adj	US-PGPUB;	OR	ON	2013/06/17

		resource) (resource adj block)) and component adj carrier	USPAT; USOCR; DERWENT; IBM_TDB			15:17
S63	259	(schedul\$3 near3 downlink) same ((radio adj resource) (resource adj block)) and component adj carrier	US-PGPUB; USPAT; USOCR; DERWENT; IBM_TDB	OR	ON	2013/06/17 15:17
S64	39	(schedul\$3 near3 downlink) same ((radio adj resource) (resource adj block)) same (component adj carrier)	US-PGPUB; USPAT; USOCR; DERWENT; IBM_TDB	OR	ON	2013/06/17 15:18
S65	1	@ad< "20091005" and (schedul\$3 near3 downlink) same ((radio adj resource) (resource adj block)) same (component adj carrier)	US-PGPUB; USPAT; USOCR; DERWENT; IBM_TDB	OR	ON	2013/06/17 15:18
S66	1	@ad< "20091005" and (schedul\$3 near3 downlink) same ((radio adj resource) (resource adj block)) same (CC (component adj carrier))	US-PGPUB; USPAT; USOCR; DERWENT; IBM_TDB	OR	ON	2013/06/17 15:20
S67	47	(schedul\$3 near3 downlink) same ((radio adj resource) (resource adj block)) same (CC (component adj carrier))	US-PGPUB; USPAT; USOCR; DERWENT; IBM_TDB	OR	ON	2013/06/17 15:20
S68	356	"455"/\$.cds. and ((radio adj resource) (resource adj block)) same (CC (component adj carrier))	US-PGPUB; USPAT; USOCR; DERWENT; IBM_TDB	OR	ON	2013/06/17 17:10
S70	19	"455"/\$.cds. and (carrier near3 aggregation) and ((first 1st) adj6 carrier) same ((1st first) adj6 (radio resource frame)) and ((2nd second) adj6 carrier) same ((2nd second) adj6 (radio resource frame))	US-PGPUB; USPAT; USOCR; DERWENT; IBM_TDB	OR	ON	2013/06/17 17:17
S71	0	("2013/0107855").URPN.	USPAT	OR	ON	2013/06/18 09:15
S72	0	("2013/0107855").URPN.	US-PGPUB; USPAT	OR	ON	2013/06/18 09:16
S73	408	set near3 (radio frequency) near2 (resource band) same downlink and component	US-PGPUB; USPAT	OR	ON	2013/06/18 09:18
S74	17	set near3 (radio frequency) near2 (resource band) same downlink same (component adj carrier)	US-PGPUB; USPAT	OR	ON	2013/06/18 09:19
S75	19	(set group Cluster) near3 (radio frequency) near2 (resource band) same downlink same (component adj carrier)	US-PGPUB; USPAT	OR	ON	2013/06/18 09:21
S76	12	("8457060" "20110310819" "20100271970" "20130034073" "20100098012" "20110310856" "20110317653" "20130083742" "20130083741" "20120114021" "20120275395" "20110317645" "20110310856").pn.	US-PGPUB; USPAT	OR	ON	2013/06/18 09:31
S77	200	(DL down\$link) with (1st first first primary initial) near3 (set group) near6 (radio resource)	US-PGPUB; USPAT	OR	ON	2013/06/18 10:37

S78	2911	(UL up\$link) with (set group) near6 (radio resource)	US-PGPUB; USPAT	OR	ON	2013/06/18 10:38
S79	110	S77 and S78	US-PGPUB; USPAT	OR	ON	2013/06/18 10:38
S80	3	(DL down\$link) with (1st first first primary initial) near3 (set group) near6 (radio resource) and (DL down\$link) with (set group) near6 (radio resource) with (2nd second other another) near2 component	US-PGPUB; USPAT	OR	ON	2013/06/18 10:47
S81	28	(DL down\$link) with (1st first first primary initial) near3 (set group) near6 (radio resource) and (DL down\$link) with (component near3 carrier)	US-PGPUB; USPAT	OR	ON	2013/06/18 11:17
S82	5	(DL down\$link) with (1st first first primary initial) near3 (set group) near6 (radio resource) and (DL down\$link) with (second 2nd) near3 (component near3 carrier)	US-PGPUB; USPAT	OR	ON	2013/06/18 11:20
S83	4	(1st first first primary initial) near3 (set group) near6 (radio resource) with (DL down\$link) near3 (component near3 carrier)	US-PGPUB; USPAT	OR	ON	2013/06/18 13:50
S84	3	(set group) near6 (radio resource) with (2nd second other another) near6 (DL down\$link) near3 (component near3 carrier)	US-PGPUB; USPAT	OR	ON	2013/06/18 13:52
S85	42	(set group) near6 (radio resource) with (DL down\$link) near3 (component near3 carrier)	US-PGPUB; USPAT	OR	ON	2013/06/18 13:58
S86	30	(set group) near3 ((radio resource)(resource near2 block)) with (DL down\$link) near3 (component near3 carrier)	US-PGPUB; USPAT	OR	ON	2013/06/18 14:07
S87	2	(second 2nd) near3 (down\$1link DL) with ((component near3 carrier) CC) same (set group) with ((radio near2 resource) (resource near2 block))	US-PGPUB; USPAT	OR	ON	2013/06/18 14:14
S88	21	reserv\$3 with component near3 carrier and (second near2 (radio frequency band))	US-PGPUB; USPAT; USOCR; DERWENT; IBM_TDB	OR	ON	2013/06/25 15:31
S89	36	"739528"	US-PGPUB; USPAT; USOCR; DERWENT; IBM_TDB	OR	ON	2013/06/26 09:34
S90	30	"5754138"	US-PGPUB; USPAT; USOCR; DERWENT; IBM_TDB	OR	ON	2013/06/26 09:35
S91	2046	(carrier near3 aggregation) and up\$1link with down\$1link	US-PGPUB; USPAT; USOCR; DERWENT; IBM_TDB	OR	ON	2013/06/26 10:24
S92	1052	(carrier near3 aggregation) and (component near3 carrier) same up\$1link with down\$1link	US-PGPUB; USPAT; USOCR; DERWENT; IBM_TDB	OR	ON	2013/06/26 10:26
S93	110	(carrier near3 aggregation) and (component near3 carrier) same up\$1link with associat\$3	US-PGPUB; USPAT;	OR	ON	2013/06/26 10:27

		with down\$1link	USOCR; DERWENT; IBM_TDB			
S95	17	("370"/\$.ccls "455"/\$.ccls.) and (aggregation) and (CC (component near3 carrier)) same up\$1link with associat\$3 with down\$1link	US-PGPUB; USPAT; USOCR; DERWENT; IBM_TDB	OR	ON	2013/06/26 15:22
S96	67	370/329,341,348,395.4.ccls. and (carrier near3 aggregation) and (component near3 carrier) same up\$1link with associat\$3 with down\$1link	US-PGPUB; USPAT; USOCR; DERWENT; IBM_TDB	OR	ON	2013/06/26 15:26
S97	345368	schedule (DL (down adj link) down\$1link) and (carrier near3 aggregation) and ((UL up\$1link) adj6 associat\$4 near4 (DL down\$1link))	US-PGPUB; USPAT; USOCR; DERWENT; IBM_TDB	OR	ON	2013/06/26 16:45
S98	9	schedule near3 (DL (down adj link) down\$1link) and (carrier near3 aggregation) same((UL up\$1link) adj6 associat\$4 near4 (DL down\$1link))	US-PGPUB; USPAT; USOCR; DERWENT; IBM_TDB	OR	ON	2013/06/26 16:46
S99	35	(schedule allocat\$4) near3 (DL (down adj link) down\$1link) and (carrier near3 aggregation) same((UL up\$1link) adj6 associat\$4 near4 (DL down\$1link))	US-PGPUB; USPAT; USOCR; DERWENT; IBM_TDB	OR	ON	2013/06/26 16:48
S100	0	(1st first) near3 (radio band resource frequency) with (1st first) near3 (CCcomponent adj carrier)	US-PGPUB; USPAT; USOCR; DERWENT; IBM_TDB	OR	ON	2013/06/26 17:14
S101	216	(1st first) near3 (radio band resource frequency) with (1st first) near3 (CC (component adj carrier))	US-PGPUB; USPAT; USOCR; DERWENT; IBM_TDB	OR	ON	2013/06/26 17:14
S102	43	(1st first) near3 (radio band resource frequency) with (reserv\$3 schedul\$3 allocat\$3) with (1st first) near3 (CC (component adj carrier))	US-PGPUB; USPAT; USOCR; DERWENT; IBM_TDB	OR	ON	2013/06/26 17:15
S103	22	("20100142455" "20120009923" "20100254329" "20100091678" "20110194501" "20130010619" "20080310359" "20060274712" "20100227569" "20120208583" "20110267978").PN.	US-PGPUB; USPAT; USOCR; DERWENT; IBM_TDB	OR	ON	2013/06/27 09:57
S104	10	("20100254329" "20100195624" "20100023282" "20090274100" "20080316957").PN.	US-PGPUB; USPAT; USOCR; DERWENT; IBM_TDB	OR	ON	2013/06/27 10:15
S105	50	("20100322173" "20110081913" "20130010721" "20120140708" "20100271970" "20100285809" "20110007699" "20130003700" "20100232373" "20120051306" "20120082125" "20100098012"	US-PGPUB; USPAT; USOCR; DERWENT; IBM_TDB	OR	ON	2014/04/22 13:25

		"2010003997" "20100208679" "20110310856" "20120082125" "20120140708" "20130136084" "8265030" "20120020317" "8265030" "20110007695" "20110081932" "20120314675" "20110310856" "20100232373" "20100296389" "20120020317" "20100098012" "20130034073" "8447343" "8472368").PN.				
S106	13348	(H04W88/08, H04W72/044, H04W72/042).cpc.	US-PGPUB; USPAT; USOCR; DERWENT; IBM_TDB	OR	ON	2014/04/22 13:40
S107	4330	(H04W52/367, H04W52/12, H04W52/40).cpc.	US-PGPUB; USPAT; USOCR; DERWENT; IBM_TDB	OR	ON	2014/04/22 13:42
S108	4200	(H04L29/08657, G01S5/0252, G01S5/02).cpc.	US-PGPUB; USPAT; USOCR; DERWENT; IBM_TDB	OR	ON	2014/04/22 13:43
S109	3823	(H04B1/3833, H04M1/0247, H04M1/0237).cpc.	US-PGPUB; USPAT; USOCR; DERWENT; IBM_TDB	OR	ON	2014/04/22 13:44
S110	6130	(H03F3/211, H04B7/0617, H04B7/0669).cpc.	US-PGPUB; USPAT; USOCR; DERWENT; IBM_TDB	OR	ON	2014/04/22 13:44
S111	370	(S106 S107 S108 S109 S110) and (schedul\$4 near3 down\$1link) and (component near3 carrier)	US-PGPUB; USPAT; USOCR; DERWENT; IBM_TDB	OR	ON	2014/04/22 13:45
S112	365	(S106 S107 S108 S109 S110) and (schedul\$4 near3 down\$1link) and (component near3 carrier) and (control with information)	US-PGPUB; USPAT; USOCR; DERWENT; IBM_TDB	OR	ON	2014/04/22 13:46
S113	357	(S106 S107 S108 S109 S110) and (schedul\$4 near3 down\$1link) and (component near carrier) and (control with information)	US-PGPUB; USPAT; USOCR; DERWENT; IBM_TDB	OR	ON	2014/04/22 13:47
S114	13	(S106 S107 S108 S109 S110) and (DL down\$link) with (1st first first primary initia) near3 (set group) near6 (radio resource) and (DL down\$link) with (component near3 carrier)	US-PGPUB; USPAT; USOCR; DERWENT; IBM_TDB	OR	ON	2014/04/22 13:47
S115	40	(H03F3/211, H04B7/0617, H04B7/0669, H04B1/3833, H04M1/0247, H04M1/0237, H04L29/08657, G01S5/0252, G01S5/02, H04W52/367, H04W52/12, H04W52/40, H04W88/08, H04W72/044, H04W72/042).cpc. and (carrier near3 aggregation) and	US-PGPUB; USPAT; USOCR; DERWENT; IBM_TDB	OR	ON	2014/04/22 14:17

		(component near3 carrier) same up\$1link with associat\$3 with down\$1link				
S116	8750	(H04W88/08, H04W72/044, H04W72/042I).cpc.	US-PGPUB; USPAT; USOCR; DERWENT; IBM_TDB	OR	ON	2014/04/26 14:21
S117	4336	(H04W52/367, H04W52/12, H04W52/40).cpc.	US-PGPUB; USPAT; USOCR; DERWENT; IBM_TDB	OR	ON	2014/04/26 14:22
S118	4205	(H04L29/08657, G01S5/0252, G01S5/02).cpc.	US-PGPUB; USPAT; USOCR; DERWENT; IBM_TDB	OR	ON	2014/04/26 14:23
S119	4144	(H04L29/08657, G01S19/14, G01S5/02).cpc.	US-PGPUB; USPAT; USOCR; DERWENT; IBM_TDB	OR	ON	2014/04/26 14:23
S120	3826	(H04B1/3833, H04M1/0247, H04M1/0237).cpc.	US-PGPUB; USPAT; USOCR; DERWENT; IBM_TDB	OR	ON	2014/04/26 14:24
S121	47	(H04W88/08, H04W72/044, H04W72/042).cpc. and (1st first) near3 (radio band resource frequency) with (1st first) near3 (CC (component adj carrier))	US-PGPUB; USPAT; USOCR; DERWENT; IBM_TDB	OR	ON	2014/04/26 14:27
S122	25	(S116 S117 S118 S119 S120).cpc. and (1st first) near3 (radio band resource frequency) with (1st first) near3 (CC (component adj carrier))	US-PGPUB; USPAT; USOCR; DERWENT; IBM_TDB	OR	ON	2014/04/26 15:35
S123	13432	(H04W88/08, H04W72/044, H04W72/042).cpc.	US-PGPUB; USPAT; USOCR; DERWENT; IBM_TDB	OR	ON	2014/04/30 11:04
S124	4341	(H04W52/367, H04W52/12, H04W52/40).cpc.	US-PGPUB; USPAT; USOCR; DERWENT; IBM_TDB	OR	ON	2014/04/30 11:04
S125	4208	(H04L29/08657, G01S5/0252, G01S5/02).cpc.	US-PGPUB; USPAT; USOCR; DERWENT; IBM_TDB	OR	ON	2014/04/30 11:04
S126	3833	(H04B1/3833, H04M1/0247, H04M1/0237).cpc.	US-PGPUB; USPAT; USOCR; DERWENT; IBM_TDB	OR	ON	2014/04/30 11:04
S127	6154	(H03F3/211, H04B7/0617, H04B7/0669).cpc.	US-PGPUB; USPAT; USOCR;	OR	ON	2014/04/30 11:04

			DERWENT; IBM_TDB			
S128	98	(S123 S124 S125 S126 S127) and (schedul\$4 near3 down\$1link) and (component near3 carrier) and single with carrier same (plurality multiple several) with (DL down\$1link) with carrier	US-PGPUB; USPAT; USOCR; DERWENT; IBM_TDB	OR	ON	2014/04/30 11:04
S129	52	(S123 S124 S125 S126 S127) and (schedul\$4 near3 down\$1link) and (component near3 carrier) and single near6 carrier same (plurality multiple several) near3 (DL down\$1link) with carrier	US-PGPUB; USPAT; USOCR; DERWENT; IBM_TDB	OR	ON	2014/04/30 11:04
S130	4	(S123 S124 S125 S126 S127) and (schedul\$4) with component near3 carrier and (single near3 (DL down\$1link)) with (first with resource) and (multiple plurality several) near3 (DL downlink) with second with resource	US-PGPUB; USPAT; USOCR; DERWENT; IBM_TDB	OR	ON	2014/04/30 11:37
S131	2	(up\$1link UL) and (schedul\$4) with component near3 carrier same (single near3 (DL down\$1link)) with (first with resource) same (multiple plurality several) near3 (DL downlink) with second with resource	US-PGPUB; USPAT; USOCR; DERWENT; IBM_TDB	OR	ON	2014/04/30 11:40
S132	2	(schedul\$4) with component near3 carrier same (single near3 (DL down\$1link)) with (first with resource) same (multiple plurality several) near3 (DL downlink) with second with resource	US-PGPUB; USPAT; USOCR; DERWENT; IBM_TDB	OR	ON	2014/04/30 11:42
S133	2	(schedul\$4) same (single near3 (DL down\$1link)) with (first with resource) same (multiple plurality several) near3 (DL downlink) with second with resource	US-PGPUB; USPAT; USOCR; DERWENT; IBM_TDB	OR	ON	2014/04/30 11:44
S134	2	(schedul\$4) same (single near3 (DL down\$1link)) with (first with (frequency resource block)) same (multiple plurality several) near3 (DL downlink) with second with (frequency block resource)	US-PGPUB; USPAT; USOCR; DERWENT; IBM_TDB	OR	ON	2014/04/30 11:45
S135	16	(single near3 (DL down\$1link)) with (first with (frequency resource block)) same (multiple plurality several) near3 (DL downlink) with second with (frequency block resource)	US-PGPUB; USPAT; USOCR; DERWENT; IBM_TDB	OR	ON	2014/04/30 11:45
S136	1	allocation with (PUSCH PUCCH UL (up\$1link)) and "20100232373"	US-PGPUB; USPAT; USOCR; DERWENT; IBM_TDB	OR	ON	2014/04/30 14:19
S137	1	allocation and (PUSCH PUCCH UL (up\$1link)) and "20100232373"	US-PGPUB; USPAT; USOCR; DERWENT; IBM_TDB	OR	ON	2014/04/30 14:21
S138	2	"20100271970"	US-PGPUB; USPAT; USOCR; DERWENT; IBM_TDB	OR	ON	2014/04/30 14:32
S139	54	("20100322173" "20110081913" "20130010721" "8634358" "20120140708" "20100271970" "20100285809"	US-PGPUB; USPAT; USOCR;	OR	ON	2014/10/15 11:49

		"20110007699" "20130003700" "20100232373" "20120051306" "20120082125" "20100098012" "20100003997" "20100208679" "20110310856" "20120082125" "20120140708" "20130136084" "8265030" "20110243039" "20120020317" "8265030" "20110007695" "20110081932" "20120314675" "20110310856" "20100232373" "20100296389" "20120020317" "20100098012" "20130034073" "8447343" "8472368").PN.	DERWENT; IBM_TDB			
S140	15049	(H04W88/08, H04W72/044, H04W72/042).cpc.	US-PGPUB; USPAT; USOCR; DERWENT; IBM_TDB	OR	ON	2014/10/15 13:44
S141	4737	(H04W52/367, H04W52/12, H04W52/40).cpc.	US-PGPUB; USPAT; USOCR; DERWENT; IBM_TDB	OR	ON	2014/10/15 13:44
S142	4341	(H04L29/08657, G01S5/0252, G01S5/02).cpc.	US-PGPUB; USPAT; USOCR; DERWENT; IBM_TDB	OR	ON	2014/10/15 13:44
S143	4030	(H04B1/3833, H04M1/0247, H04M1/0237).cpc.	US-PGPUB; USPAT; USOCR; DERWENT; IBM_TDB	OR	ON	2014/10/15 13:44
S144	6785	(H03F3/211, H04B7/0617, H04B7/0669).cpc.	US-PGPUB; USPAT; USOCR; DERWENT; IBM_TDB	OR	ON	2014/10/15 13:44
S145	96	(S140 S141 S142 S143 S144) and (schedul\$4 near3 down\$1link) and (component near3 carrier) and single with carrier same (plurality multiple several) with (DL down\$1link) with carrier same (frequency resources)	US-PGPUB; USPAT; USOCR; DERWENT; IBM_TDB	OR	ON	2014/10/15 13:44
S146	1	"13315135"	US-PGPUB; USPAT; USOCR; DERWENT; IBM_TDB	OR	ON	2014/10/15 13:54
S147	2	"20080151845"	US-PGPUB; USPAT; USOCR; DERWENT; IBM_TDB	OR	ON	2014/10/15 14:58
S148	41	"455"/\$.cls. and (carrier near3 aggregation) and ((first 1st) adj6 carrier) same ((1st first) adj6 (radio resource frame)) and ((2nd second) adj6 carrier) same ((2nd second) adj6 (radio resource frame))	US-PGPUB; USPAT; USOCR; DERWENT; IBM_TDB	OR	ON	2014/10/15 15:45
S149	3	"455"/451,452.1.cls. and (carrier near3 aggregation) and ((first 1st) adj6 carrier) same ((1st first) adj6 (radio resource frame)) and	US-PGPUB; USPAT; USOCR;	OR	ON	2014/10/15 18:01

		((2nd second) adj6 carrier) same ((2nd second) adj6 (radio resource frame))	DERWENT; IBM_TDB			
S150	33889	455/451,452.1,509,456.1,522,137,103,575.ccls.	US-PGPUB; USPAT; USOCR; DERWENT; IBM_TDB	OR	ON	2014/10/23 11:25
S151	0	455/451,452.1,509,456.1,522,137,103,575.ccls. and (control\$4) with (resource frequency channel Bin) same (serv\$4 sav\$4) near3 (other 2nd second another) adj3 (resource frequency channel Bin)	US-PGPUB; USPAT; USOCR; DERWENT; IBM_TDB	OR	ON	2014/10/23 11:32
S152	0	455/451,452.1,509,456.1,522,137,103,575.ccls. and (control\$4) with (resource frequency channel Bin) same (rererv\$4 sav\$4) near3 (other 2nd second another) adj3 (resource frequency channel Bin)	US-PGPUB; USPAT; USOCR; DERWENT; IBM_TDB	OR	ON	2014/10/23 11:33
S153	4	455/451,452.1,509,456.1,522,137,103,575.ccls. and (control\$4) with (resource frequency channel Bin) same (reserv\$4 sav\$4) near3 (other 2nd second another) adj3 (resource frequency channel Bin)	US-PGPUB; USPAT; USOCR; DERWENT; IBM_TDB	OR	ON	2014/10/23 11:34
S154	3	455/451,452.1,509,456.1,522,137,103,575.ccls. and (control\$4) with (resource frequency channel Bin) same (reserv\$4 sav\$4) near3 (other 2nd second another) adj3 (resource frequency channel Bin) and (CC component)	US-PGPUB; USPAT; USOCR; DERWENT; IBM_TDB	OR	ON	2014/10/23 11:37
S155	4	"455"/\$.ccls. and (((first 1st) adj6 component adj3 carrier) same ((radio resource frame))) and ((2nd second) adj6 component adj3 carrier) same ((2nd second other another) adj6 (radio resource frame)) and (reserv\$4 sav\$4 us\$3) near3 (other 2nd second another) adj3 (resource frequency channel Bin) and (CC component)	US-PGPUB; USPAT; USOCR; DERWENT; IBM_TDB	OR	ON	2014/10/23 11:39
S156	15	("20050013279" "20030219028" "20070217406" "20020105970" "20060050664" "20090303938" "20070064669").PN.	US-PGPUB; USPAT; USOCR; DERWENT; IBM_TDB	OR	ON	2014/10/23 12:07
S157	10	"455"/\$.ccls. and (schedul\$3 near3 downlink) same ((radio adj resource) (resource adj block)) same (CC (component adj carrier))	US-PGPUB; USPAT; USOCR; DERWENT; IBM_TDB	OR	ON	2014/10/23 12:07
S158	0	455/451,452.1,509,456.1,522,137,103,575.ccls. and (control\$4) with (resource frequency channel) same (rererv\$4 sav\$4) near3 (other 2nd second another) adj3 (resource frequency channel Bin)	US-PGPUB; USPAT; USOCR; DERWENT; IBM_TDB	OR	ON	2014/10/31 15:22
S161	15374	(H04W88/08, H04W72/044, H04W72/042).qpc.	US-PGPUB; USPAT; USOCR; DERWENT; IBM_TDB	OR	ON	2014/10/31 17:18
S162	4758	(H04W52/367, H04W52/12, H04W52/40).qpc.	US-PGPUB; USPAT; USOCR; DERWENT; IBM_TDB	OR	ON	2014/10/31 17:18

S163	4377	(H04L29/08657, G01S5/0252, G01S5/02).cpc.	US-PGPUB; USPAT; USOCR; DERWENT; IBM_TDB	OR	ON	2014/10/31 17:18
S164	4042	(H04B1/3833, H04M1/0247, H04M1/0237).cpc.	US-PGPUB; USPAT; USOCR; DERWENT; IBM_TDB	OR	ON	2014/10/31 17:18
S165	6867	(H03F3/211, H04B7/0617, H04B7/0669).cpc.	US-PGPUB; USPAT; USOCR; DERWENT; IBM_TDB	OR	ON	2014/10/31 17:18
S167	1	"14170939"	US-PGPUB; USPAT; USOCR; DERWENT; IBM_TDB	OR	ON	2014/11/17 09:46
S168	499	(component near2 carrier) with (primary near2 cell)	US-PGPUB; USPAT; USOCR; DERWENT; IBM_TDB	OR	ON	2014/11/18 14:07
S169	401	"370"/\$.ccls. and (component near2 carrier) with (primary near2 cell)	US-PGPUB; USPAT; USOCR; DERWENT; IBM_TDB	OR	ON	2014/11/18 14:07
S170	378	"370"/\$.ccls. and (component adj2 carrier) with (primary adj2 cell)	US-PGPUB; USPAT; USOCR; DERWENT; IBM_TDB	OR	ON	2014/11/18 14:07
S171	185	"370"/\$.ccls. and (component adj2 carrier) with (primary adj2 cell) with (DL down\$1link)	US-PGPUB; USPAT; USOCR; DERWENT; IBM_TDB	OR	ON	2014/11/18 14:08
S172	4	"370"/\$.ccls. and single near3 (CC (component adj2 carrier)) with (primary adj2 cell) with (DL down\$1link)	US-PGPUB; USPAT; USOCR; DERWENT; IBM_TDB	OR	ON	2014/11/18 14:17
S173	4	single near4 (CC (component adj2 carrier)) with (primary adj2 cell) with (DL down\$1link)	US-PGPUB; USPAT; USOCR; DERWENT; IBM_TDB	OR	ON	2014/11/18 14:19
S174	287	"370"/\$.ccls. and (CC (component adj2 carrier)) with (primary adj2 cell) with (DL down\$1link)	US-PGPUB; USPAT; USOCR; DERWENT; IBM_TDB	OR	ON	2014/11/18 14:21
S175	1	@ad<"20091004" and "370"/\$.ccls. and (CC (component adj2 carrier)) with (primary adj2 cell) with (DL down\$1link)	US-PGPUB; USPAT; USOCR; DERWENT; IBM_TDB	OR	ON	2014/11/18 14:22

S176	287	"370"/\$.cls. and (CC (component adj2 carrier)) with (primary adj2 cell) with (DL down\$1link)	US-PGPUB; USPAT; USOCR; DERWENT; IBM_TDB	OR	ON	2014/11/18 14:22
S177	29	("20100322173" "20110081913" "20130010721" "8634358" "20120140708" "20100271970" "20100285809" "20110007699" "20130003700" "20100232373" "20120051306" "20120082125" "20100098012" "20100003997" "20100208679" "20110310856" "20120082125" "20120140708" "20130136084" "8265030" "20110243039" "8792830" "20120020317" "8265030" "20110007695" "20110081932" "20120314675" "20020160784" "20110310856" "20100232373" "20100296389" "20120020317" "20100098012" "20130034073" "8447343" "8472368").PN.	US-PGPUB; USPAT	OR	OFF	2015/10/01 11:34
S178	21250	(H04W88/08, H04W72/044, H04W72/042).cpc.	US-PGPUB; USPAT; USOCR; DERWENT; IBM_TDB	OR	ON	2015/10/01 17:24
S179	5857	(H04W52/367, H04W52/12, H04W52/40).cpc.	US-PGPUB; USPAT; USOCR; DERWENT; IBM_TDB	OR	ON	2015/10/01 17:24
S180	5079	(H04L29/08657, G01S5/0252, G01S5/02).cpc.	US-PGPUB; USPAT; USOCR; DERWENT; IBM_TDB	OR	ON	2015/10/01 17:24
S181	4391	(H04B1/3833, H04M1/0247, H04M1/0237).cpc.	US-PGPUB; USPAT; USOCR; DERWENT; IBM_TDB	OR	ON	2015/10/01 17:24
S182	8620	(H03F3/211, H04B7/0617, H04B7/0669).cpc.	US-PGPUB; USPAT; USOCR; DERWENT; IBM_TDB	OR	ON	2015/10/01 17:24
S183	221	(S178 S179 S180 S181 S182) and (schedul\$4 near3 down\$1link) and (component near3 carrier) and single with carrier same (plurality multiple several) with (DL down\$1link) with carrier same (frequency)	US-PGPUB; USPAT; USOCR; DERWENT; IBM_TDB	OR	ON	2015/10/01 17:24
S184	552	((david near2 astely) (robert near2 baldemair) (dirk near2 gerstenberger) (daniel near2 larsson) (lars near2 lindbom) (stefan near2 parkvall)).in. and ericsson.as.	US-PGPUB; USPAT; USOCR; DERWENT; IBM_TDB	OR	ON	2015/10/01 17:56
S185	1	S183 and S184	US-PGPUB; USPAT; USOCR; DERWENT; IBM_TDB	OR	ON	2015/10/01 17:56

S186	21	455/\$.ccls. and ((first 1st) adj6 component adj3 carrier) same ((1st first) adj6 (radio resource frame)) and ((2nd second) adj6 component adj3 carrier) same ((2nd second) adj6 (radio resource frame))	US-PGPUB; USPAT; USOCR; DERWENT; IBM_TDB	OR	ON	2015/10/01 18:11
S187	24	("20100322173" "20110081913" "20130003700" "20100232373" "20120051306" "20120082125" "20100098012" "20100003997" "20100208679" "20110310856" "20120082125" "20120140708" "20130136084" "8265030" "20110243039" "8792830" "20120020317" "8265030" "20110007695" "20110081932" "20120314675" "20020160784" "20110310856" "20100232373" "20100296389" "20120020317" "20100098012" "20130034073" "8447343" "8472368").PN.	US-PGPUB; USPAT	OR	OFF	2015/10/02 12:23
S188	1	"14030298"	US-PGPUB; USPAT	OR	OFF	2015/10/02 15:41
S189	198	((1st first) adj6 (radio resource frame)) and ((2nd second) adj6 component adj3 carrier) same ((2nd second) adj6 (radio resource frame))	US-PGPUB; USPAT; USOCR; DERWENT; IBM_TDB	OR	ON	2015/10/03 16:15
S190	1	"14102508"	US-PGPUB; USPAT; USOCR; DERWENT; IBM_TDB	OR	ON	2015/10/13 14:17
S191	0	"14158378"	US-PGPUB; USPAT; USOCR; DERWENT; IBM_TDB	OR	ON	2015/10/13 14:17
S192	1	"14097736"	US-PGPUB; USPAT; USOCR; DERWENT; IBM_TDB	OR	ON	2015/10/13 14:17
S193	2	"14006545"	US-PGPUB; USPAT; USOCR; DERWENT; IBM_TDB	OR	ON	2015/10/13 14:17
S194	1	"13875620"	US-PGPUB; USPAT; USOCR; DERWENT; IBM_TDB	OR	ON	2015/10/13 14:18
S195	1	"13905342"	US-PGPUB; USPAT; USOCR; DERWENT; IBM_TDB	OR	ON	2015/10/13 14:18
S196	1	"13477988"	US-PGPUB; USPAT; USOCR; DERWENT;	OR	ON	2015/10/13 14:18

			IBM_TDB			
S197	2	"13293245"	US-PGPUB; USPAT; USOCR; DERWENT; IBM_TDB	OR	ON	2015/10/13 14:18
S198	1	"13875620"	US-PGPUB; USPAT; USOCR; DERWENT; IBM_TDB	OR	ON	2015/10/13 14:19
S199	2	"13993807"	US-PGPUB; USPAT; USOCR; DERWENT; IBM_TDB	OR	ON	2015/10/13 14:19
S200	1	"13898465"	US-PGPUB; USPAT; USOCR; DERWENT; IBM_TDB	OR	ON	2015/10/13 14:19
S201	1	"13883792"	US-PGPUB; USPAT; USOCR; DERWENT; IBM_TDB	OR	ON	2015/10/13 14:19
S202	1	"13996405"	US-PGPUB; USPAT; USOCR; DERWENT; IBM_TDB	OR	ON	2015/10/13 14:19
S203	1	"13883002"	US-PGPUB; USPAT; USOCR; DERWENT; IBM_TDB	OR	ON	2015/10/13 14:20
S204	0	"14812058"	US-PGPUB; USPAT; USOCR; DERWENT; IBM_TDB	OR	ON	2015/10/13 14:20
S205	7	"8915660"	US-PGPUB; USPAT; USOCR; DERWENT; IBM_TDB	OR	ON	2015/10/13 14:20
S206	1	"13909538"	US-PGPUB; USPAT; USOCR; DERWENT; IBM_TDB	OR	ON	2015/10/13 14:21
S207	1	"13924238"	US-PGPUB; USPAT; USOCR; DERWENT; IBM_TDB	OR	ON	2015/10/13 14:22
S208	1	"13898465"	US-PGPUB; USPAT; USOCR; DERWENT;	OR	ON	2015/10/13 14:23

S209	2	"13993807"	IBM_TDB	US-PGPUB; USPAT; USOCR; DERWENT; IBM_TDB	OR	ON	2015/10/13 14:23
S210	58	("20100322173" "20110081913" "20130010721" "8634358" "20120140708" "20100271970" "20100285809" "20110007699" "20130003700" "20100232373" "20120051306" "20120082125" "20100098012" "20100003997" "20100208679" "20110310856" "20120082125" "20120140708" "20130136084" "8265030" "20110243039" "8792830" "20120020317" "8265030" "20110007695" "20110081932" "20120314675" "20020160784" "20110310856" "20100232373" "20100296389" "20120020317" "20100098012" "20130034073" "8447343" "8472368").PN.	US-PGPUB; USPAT; USOCR; DERWENT; IBM_TDB	OR	ON	2015/10/13 14:25	
S211	1	"13906370"	IBM_TDB	US-PGPUB; USPAT; USOCR; DERWENT; IBM_TDB	OR	ON	2015/10/13 14:38
S212	58	("20100322173" "20110081913" "20130010721" "8634358" "20120140708" "20100271970" "20100285809" "20110007699" "20130003700" "20100232373" "20120051306" "20120082125" "20100098012" "20100003997" "20100208679" "20110310856" "20120082125" "20120140708" "20130136084" "8265030" "20110243039" "8792830" "20120020317" "8265030" "20110007695" "20110081932" "20120314675" "20020160784" "20110310856" "20100232373" "20100296389" "20120020317" "20100098012" "20130034073" "8447343" "8472368").PN.	US-PGPUB; USPAT; USOCR; DERWENT; IBM_TDB	OR	ON	2015/10/13 14:51	
S213	0	(H04W88/08, H04W72/044, H04W72/042).cpc. and (H04W52/367, H04W52/12, H04W52/40).cpc. and (H04L29/08657, G01S5/0252, G01S5/02).cpc. and (H04B1/3833, H04M1/0247, H04M1/0237).cpc.	IBM_TDB	US-PGPUB; USPAT; USOCR; DERWENT; IBM_TDB	OR	ON	2015/10/13 14:55
S214	36289	(H04W88/08, H04W72/044, H04W72/042, H04W52/367, H04W52/12, H04W52/40, H04L29/08657, G01S5/0252, G01S5/02, H04B1/3833, H04M1/0247, H04M1/0237).cpc.	IBM_TDB	US-PGPUB; USPAT; USOCR; DERWENT; IBM_TDB	OR	ON	2015/10/13 14:56
S215	3	(H04W88/08, H04W72/044, H04W72/042, H04W52/367, H04W52/12, H04W52/40, H04L29/08657, G01S5/0252, G01S5/02, H04B1/3833, H04M1/0247, H04M1/0237).cpc. and single near3 (CC (component adj2 carrier)) with (primary adj2 cell) with (DL down\$1link)	IBM_TDB	US-PGPUB; USPAT; USOCR; DERWENT; IBM_TDB	OR	ON	2015/10/13 14:56
S216	553	((david near2 astely) (robert near2 baldemair) (dirk near2 gerstenberger) (daniel near2	IBM_TDB	US-PGPUB; USPAT;	OR	ON	2015/10/13 17:05

		larsson) (lars near2 lindbom) (stefan near2 parkvall)).in. and ericsson.as.	USOCR; DERWENT; IBM_TDB			
S217	553	((david near2 astely) (robert near2 baldemair) (dirk near2 gerstenberger) (daniel near2 larsson) (lars near2 lindbom) (stefan near2 parkvall)).in.) and ericsson.as.	US-PGPUB; USPAT; USOCR; DERWENT; IBM_TDB	OR	ON	2015/10/13 17:05
S218	131	((david near2 astely) (robert near2 baldemair) (dirk near2 gerstenberger) (daniel near2 larsson) (lars near2 lindbom) (stefan near2 parkvall)).in.) and ericsson.as. and carrier adj aggregation	US-PGPUB; USPAT; USOCR; DERWENT; IBM_TDB	OR	ON	2015/10/13 17:07
S219	48	"455"/\$.ccls. and (carrier near3 aggregation) and ((first 1st) adj6 carrier) same ((1st first) adj6 (radio resource frame)) and ((2nd second) adj6 carrier) same ((2nd second) adj6 (radio resource frame)) and carrier adj aggregation	US-PGPUB; USPAT; USOCR; DERWENT; IBM_TDB	OR	ON	2015/10/13 17:27
S220	48	(H04W88/08, H04W72/044, H04W72/042).cpc. and ((first 1st) adj6 component adj3 carrier) same ((1st first) adj6 (radio resource frame)) and ((2nd second) adj6 component adj3 carrier) same ((2nd second) adj6 (radio resource frame))	US-PGPUB; USPAT; USOCR; DERWENT; IBM_TDB	OR	ON	2016/03/09 15:13
S221	15	(set group) near6 (radio resource) with (2nd second other another) near6 (DL down\$link) near3 (component near3 carrier)	US-PGPUB; USPAT	OR	ON	2016/03/09 15:26
S222	35	455/509,522,456.6,137,103,575.ccls. and (downlink near3 carrier) and (uplink near3 (primary first initial) near3 carrier) and ((second 2nd other next) with (channel resource)) and (carrier adj aggregation)	US-PGPUB; USPAT; USOCR; DERWENT; IBM_TDB	OR	ON	2016/03/09 15:45
S223	0	(H04B1/3833, H04M1/0247, H04M1/0237).cpc. and (((first 1st) adj6 component adj3 carrier) same ((radio resource frame))) and ((2nd second) adj6 component adj3 carrier) same ((2nd second other another) adj4 (radio resource frame))	US-PGPUB; USPAT; USOCR; DERWENT; IBM_TDB	OR	ON	2016/03/09 15:48
S224	0	((david near2 astely) (robert near2 baldemair) (dirk near2 gerstenberger) (daniel near2 larsson) (lars near2 lindbom) (stefan near2 parkvall)).in.) and ericsson.as. and single near3 (CC (component adj2 carrier)) with (primary adj2 cell) with (DL down\$link)	US-PGPUB; USPAT; USOCR; DERWENT; IBM_TDB	OR	ON	2016/03/09 16:14
S225	32	((david near2 astely) (robert near2 baldemair) (dirk near2 gerstenberger) (daniel near2 larsson) (lars near2 lindbom) (stefan near2 parkvall)).in.) and ericsson.as. and (CC (component adj2 carrier)) with (primary adj2 cell)	US-PGPUB; USPAT; USOCR; DERWENT; IBM_TDB	OR	ON	2016/03/09 16:14
S226	130	455/\$.ccls. and (downlink near3 carrier) and (uplink near3 (primary first initial) near3 carrier) and ((second 2nd other next) with (channel resource)) and (control with information)	US-PGPUB; USPAT; USOCR; DERWENT; IBM_TDB	OR	ON	2016/03/09 17:02
S227	30	("20120127950" "20110310819" "20120275395" "20120287828" "20120039291" "20100271970" "20120307781" "20110286436" "20120224535" "20120140708"	US-PGPUB; USPAT; USOCR; DERWENT; IBM_TDB	OR	ON	2016/03/09 18:32

		"20120163288" "20110299486" "20100098012" "20120082125 " "20120294273").pn.				
S228	10	(carrier adj aggregation) and (schedul\$3 near3 (downlink DL) with ((first primary initial near6 (resource radio frequency frame))) and ((first 1st) adj6 component adj3 carrier) same ((1st first) adj6 (radio resource frame)) and ((2nd second) adj6 component adj3 carrier) same ((2nd second) adj6 (radio resource frame))	US-PGPUB; USPAT; USOCR; DERWENT; IBM_TDB	OR	ON	2016/03/09 20:46
S229	3	"20070030661"	US-PGPUB; USPAT; USOCR; DERWENT; IBM_TDB	OR	ON	2016/03/09 21:31
S230	76	370/329,252,331.ccls. and (((first 1st) adj6 component adj3 carrier) same ((radio resource frame))) and ((2nd second) adj6 component adj3 carrier) same ((2nd second other another) adj4 (radio resource frame))	US-PGPUB; USPAT; USOCR; DERWENT; IBM_TDB	OR	ON	2016/03/10 09:26
S231	0	(H04B1/3833, H04M1/0247, H04M1/0237).cpc. and (schedul\$3 assign\$3) with (primary adj cell) same2 (multiple several set) near3 component adj2 carrier	US-PGPUB; USPAT; USOCR; DERWENT; IBM_TDB	OR	ON	2016/03/16 11:49
S233	0	(H04B1/3833, H04M1/0247, H04M1/0237).cpc. and (schedul\$3 assign\$3) with (primary adj cell) same2 (multiple several set) near6 carrier	US-PGPUB; USPAT; USOCR; FPRS; EPO; JPO; DERWENT; IBM_TDB	OR	ON	2016/03/16 11:54
S234	18	(H04L5/0053, H04L5/001, H04L5/0094, H04B1/3833, H04M1/0247, H04M1/0237).cpc. and (schedul\$3 assign\$3) with (primary adj cell) same2 (multiple several set) near3 component adj2 carrier	US-PGPUB; USPAT; USOCR; DERWENT; IBM_TDB	OR	ON	2016/03/16 11:59
S235	18	(H04L5/0053, H04L5/001, H04L5/0094, H04B1/3833, H04M1/0247, H04M1/0237).cpc. and (schedul\$3 assign\$3) with (primary adj cell) same2 (multiple several set) near3 component adj2 carrier and (control\$4 adjust\$3) near6 (DL (down\$link))	US-PGPUB; USPAT; USOCR; DERWENT; IBM_TDB	OR	ON	2016/03/16 12:04
S236	7	(H04L5/0053, H04L5/001, H04L5/0094, H04B1/3833, H04M1/0247, H04M1/0237).cpc. and (schedul\$3 assign\$3) with (primary adj cell) same2 (multiple several set) near3 component adj2 carrier and (control\$4 adjust\$3) near6 (DL (down\$link)) and (second 2nd another other) near3 (radio frequency band resources)	US-PGPUB; USPAT; USOCR; DERWENT; IBM_TDB	OR	ON	2016/03/16 12:06
S237	0	455/509,522,456.6,137,103,575.ccls. and (schedul\$3 assign\$3) with (primary adj cell) same2 (multiple several set) near3 component adj2 carrier and (control\$4 adjust\$3) near6 (DL (down\$link)) and (second 2nd another other) near3 (radio frequency band resources)	US-PGPUB; USPAT; USOCR; DERWENT; IBM_TDB	OR	ON	2016/03/16 12:31
S238	7	(A01B12/006, H04L5/0053, H04L5/001, H04L5/0094, H04B1/3833, H04M1/0247, H04M1/0237).cpc. and (schedul\$3 assign\$3)	US-PGPUB; USPAT; USOCR;	OR	ON	2016/03/16 12:39

		with (primary adj cell) same2 (multiple several set) near3 component adj2 carrier and (control\$4 adjust\$3) near6 (DL (down\$link)) and (second 2nd another other) near3 (radio frequency band resources)	FPRS; EPO; JPO; DERWENT; IBM_TDB			
S239	4	(H04W88/08, H04W72/044, H04W72/042, H04W52/367, H04W52/12, H04W52/40, H04L29/08657, G01S5/0252, G01S5/02, H04B1/3833, H04M1/0247, H04M1/0237).cpc. and (schedul\$3 assign\$3) with (primary adj cell) same2 (multiple several set) near3 component adj2 carrier and (control\$4 adjust\$3) near6 (DL (down\$link)) and (second 2nd another other) near3 (radio frequency band resources)	US-PGPUB; USPAT; USOCR; FPRS; EPO; JPO; DERWENT; IBM_TDB	OR	ON	2016/03/16 12:47
S240	0	((david near2 astely) (robert near2 baldemair) (dirk near2 gerstenberger) (daniel near2 larsson) (lars near2 lindbom) (stefan near2 parkvall)).in. and ericsson.as. and (schedul\$3 assign\$3) with (primary adj cell) same2 (multiple several set) near3 component adj2 carrier	US-PGPUB; USPAT; USOCR; FPRS; EPO; JPO; DERWENT; IBM_TDB	OR	ON	2016/03/16 13:28
S246	60	("20100322173" "20110081913" "20130010721" "8634358" "20110007699" "8792830" "20120140708" "20100271970" "20100285809" "20110007699" "20130003700" "20100003997" "20100232373" "20130003700" "8447343" "8634358" "20100232373" "20120051306" "20100296389" "20120140708" "20130010721" "20130136084" "20120082125" "20020160784" "20110081913" "20110081932" "20110243039" "20120020317" "20100098012" "20100003997" "20100208679" "20110310856" "20120082125" "20120140708" "20130136084" "8265030" "20110243039" "8792830" "20120051306" "20120314675" "8472368" "20120147847" "20120020317" "8265030" "20110007695" "20110081932" "20120314675" "20020160784" "20100271970" "20100285809" "20130034073" "8265030" "20110310856" "20100232373" "20100296389" "20120020317" "20100098012" "20110310856" "20120082125" "20100098012" "20130034073" "8447343" "8472368" "20100208679" "20100322173" "20110007695").PN.	US-PGPUB; USPAT; USOCR; DERWENT; IBM_TDB	OR	ON	2016/06/24 11:47
S247	1	(H04W88/08, H04W72/044, H04W72/042, H04W52/367, H04W52/12, H04W52/40, H04L29/08657, G01S5/0252, G01S5/02, H04B1/3833, H04M1/0247, H04M1/0237).cpc. and (schedul\$3 assign\$3) with (primary adj cell) same2 (multiple several set) near3 component adj2 carrier and (control\$4 adjust\$3) near6 (DL (down\$link)) and (second 2nd another other) near3 (radio frequency band resources)	USPAT	OR	ON	2016/06/24 11:50
S248	7	(H04W88/08, H04W72/044, H04W72/042, H04W52/367, H04W52/12, H04W52/40,	US-PGPUB; USPAT;	OR	ON	2016/06/24 11:51

		H04L29/08657, G01S5/0252, G01S5/02, H04B1/3833, H04M1/0247, H04M1/0237).opc. and (schedul\$3 assign\$3) with (primary adj cell) same2 (multiple several set) near3 component adj2 carrier and (control\$4 adjust\$3) near6 (DL (down\$link)) and (second 2nd another other) near3 (radio frequency band resources)	USOCR; FPRS; EPO; JPO; DERWENT; IBM_TDB			
S249	269	((david near2 astely) (robert near2 baldemair) (dirk near2 gerstenberger) (daniel near2 larsson) (lars near2 lindbom) (stefan near2 parkvall)).in. and 455/\$.ccls.	US-PGPUB; USPAT; USOCR; DERWENT; IBM_TDB	OR	ON	2016/06/24 11:55
S250	2	((david near2 astely) (robert near2 baldemair) (dirk near2 gerstenberger) (daniel near2 larsson) (lars near2 lindbom) (stefan near2 parkvall)).in. and (carrier adj aggregation) and (schedul\$3 near3 (downlink DL) with ((first primary initial) near6 (resource radio frequency frame)))	US-PGPUB; USPAT; USOCR; DERWENT; IBM_TDB	OR	ON	2016/06/24 11:56
S251	5	455/451,452.1,509,456.1,522,137,103,575.ccls. and (control\$4) with (resource frequency channel Bin) same (reserv\$4 sav\$4) near3 (other 2nd second another next) adj3 (resource frequency channel Bin) and (CC component)	US-PGPUB; USPAT; USOCR; DERWENT; IBM_TDB	OR	ON	2016/06/24 11:57
S252	1	"12896993"	US-PGPUB; USPAT; USOCR; DERWENT; IBM_TDB	OR	ON	2016/06/24 12:05
S253	61	370/329,252,331.ccls. and (((first 1st) adj6 component adj3 carrier) same ((radio resource frame))) and ((2nd second) adj6 component adj3 carrier) same ((2nd second other another) adj4 (radio resource frame)) and (set group) near6 (radio resource)	US-PGPUB; USPAT	OR	ON	2016/06/24 12:21
S254	2	("20120147847").PN.	US-PGPUB; USPAT; USOCR; FPRS; EPO; JPO; DERWENT; IBM_TDB	OR	OFF	2016/06/24 12:48
S257	29	455/509,522,456.6,137,103,575.ccls. and (schedul\$3 assign\$3) with component adj2 carrier and (control\$4 adjust\$3) near6 (DL (down\$link)) and (second 2nd another other) near3 (radio frequency band resources)	US-PGPUB; USPAT; USOCR; DERWENT; IBM_TDB	OR	ON	2016/06/24 14:30
S258	22	455/\$.ccls. and (1st first) near3 (radio band resource frequency) with (reserv\$3 schedul\$3 allocat\$3) with (1st first) near3 (CC (component adj carrier))	US-PGPUB; USPAT; USOCR; DERWENT; IBM_TDB	OR	ON	2016/06/24 14:32
S259	2	("20120147847").PN.	US-PGPUB; USPAT; USOCR; DERWENT; IBM_TDB	OR	ON	2016/06/24 21:17
S260	21	455/\$.ccls. and ((first 1st) adj6 component adj3 carrier) same ((1st first) adj6 (radio resource	US-PGPUB; USPAT;	OR	ON	2016/06/24 21:58

		frame)) and ((2nd second) adj6 component adj3 carrier) same ((2nd second) adj6 (radio resource frame))	USOCR; DERWENT; IBM_TDB			
S261	33	("20120127950" "20110310819" "20120275395" "20120287828" "20120039291" "20100271970" "20120307781" "20110286436" "20120224535" "20120140708" "20110310820" "20120163288" "20110299486" "20100098012" "20120082125" "20120294273" "20110268048").pn.	US-PGPUB; USPAT; USOCR; DERWENT; IBM_TDB	OR	ON	2016/06/24 22:03
S262	13	(H04W88/08, H04W72/044, H04W72/042, H04W52/367, H04W52/12, H04W52/40, H04L29/08657, G01S5/0252, G01S5/02, H04B1/3833, H04M1/0247, H04M1/0237).cpc. and (schedul\$3 assign\$3) with (primary adj cell) same2 (multiple several set) and (control\$4 adjust\$3) near6 (DL (down\$link)) and (second 2nd another other) near3 (radio frequency band resources) same component adj carrier	US-PGPUB; USPAT; USOCR; FPRS; EPO; JPO; DERWENT; IBM_TDB	OR	ON	2016/06/24 22:18
S266	60	("20100322173" "20110081913" "20130010721" "8634358" "20110007699" "8792830" "20120140708" "20100271970" "20100285809" "20110007699" "20130003700" "20100003997" "20100232373" "20130003700" "8447343" "8634358" "20100232373" "20120051306" "20100296389" "20120140708" "20130010721" "20130136084" "20120082125" "20020160784" "20110081913" "20110081932" "20110243039" "20120020317" "20100098012" "20100003997" "20100208679" "20110310856" "20120082125" "20120140708" "20130136084" "8265030" "20110243039" "8792830" "20120051306" "20120314675" "8472368" "20120147847" "20120020317" "8265030" "20110007695" "20110081932" "20120314675" "20020160784" "20100271970" "20100285809" "20130034073" "8265030" "20110310856" "20100232373" "20100296389" "20120020317" "20100098012" "20110310856" "20120082125" "20100098012" "20130034073" "8447343" "8472368" "20100208679" "20100322173" "20110007695").PN.	US-PGPUB; USPAT; USOCR; DERWENT; IBM_TDB	OR	ON	2017/03/16 15:34
S267	0	(H04B1/3833, H04M1/0247, H04M1/0237).cpc. and (((first 1st) adj6 component adj3 carrier) same ((radio resource frame))) and ((2nd second) adj6 component adj3 carrier) same ((2nd second other another) adj4 (radio resource frame frequency))	US-PGPUB; USPAT; USOCR; DERWENT; IBM_TDB	OR	ON	2017/03/16 15:39
S268	0	455/\$.ccls. and (first 1st) near3 (radio adj resource) and (second other another 2nd) near3 (radio adj resource) same (carrier adj aggregation) and (schedul\$3 near3 (down\$link DL reverse\$link))	US-PGPUB; USPAT; USOCR; DERWENT; IBM_TDB	OR	ON	2017/03/16 15:55
S269	0	(H04B1/3833, H04M1/0247, H04M1/0237).cpc. and (first 1st) near3 (radio adj resource) and	US-PGPUB; USPAT;	OR	ON	2017/03/16 15:56

		(second other another 2nd) near3 (radio adj resource) same (carrier adj aggregation) and (schedul\$3 near3 (down\$link DL reverse\$link))	USOCR; DERWENT; IBM_TDB			
S270	0	(H04B1/3833, H04M1/0247, H04M1/0237).cpc. and (first 1st) near3 (radio adj resource) and (second other another 2nd) near3 (radio adj resource) and (schedul\$3 near3 (down\$link DL reverse\$link))	US-PGPUB; USPAT; USOCR; DERWENT; IBM_TDB	OR	ON	2017/03/16 15:57
S271	901	schedul\$3 near3 (transmit\$4 transmi\$5) with (CC (component adj2 cacarrier)) and (CI (control adj2 (info information))) with (CC (component adj2 cacarrier))	US-PGPUB; USPAT; USOCR; DERWENT; IBM_TDB	OR	ON	2017/03/16 17:30
S272	67	(H04W88/08, H04W72/044, H04W72/042I).cpc. and schedul\$3 near3 (transmit\$4 transmi\$5) with (CC (component adj2 cacarrier)) and (CI (control adj2 (info information))) with (CC (component adj2 cacarrier))	US-PGPUB; USPAT; USOCR; DERWENT; IBM_TDB	OR	ON	2017/03/16 17:31
S273	9	(H04W88/08, H04W72/044, H04W72/042I).cpc. and schedul\$3 near3 (transmit\$4 transmi\$5) with (CC (component adj2 cacarrier)) and (CI (control adj2 (info information))) with (CC (component adj2 cacarrier)) and schedul\$3 with (non\$1primary second 2nd secondary) adj2 cell	US-PGPUB; USPAT; USOCR; DERWENT; IBM_TDB	OR	ON	2017/03/16 17:37
S274	41	(H04W88/08, H04W72/044, H04W72/042I).cpc. and schedul\$3 near3 (transmit\$4 transmi\$5) with (CC (component adj2 cacarrier)) and (CI (control adj2 (info information))) with (CC (component adj2 carrier)) and (non\$1primary second 2nd secondary) adj2 (CC (component adj2 carrier))	US-PGPUB; USPAT; USOCR; DERWENT; IBM_TDB	OR	ON	2017/03/16 17:39
S275	697	Ericsson.as. and ((david near2 astely) (robert near2 baldemair) (dirk near2 gerstenberger) (daniel near2 larsson) (lars near2 lindbom) (stefan near2 parkvall)).in.	US-PGPUB; USPAT; USOCR; DERWENT; IBM_TDB	OR	ON	2017/03/16 18:16
S276	40	Ericsson.as. and ((david near2 astely) (robert near2 baldemair) (dirk near2 gerstenberger) (daniel near2 larsson) (lars near2 lindbom) (stefan near2 parkvall)).in. and (radio near3 resource) with (component near3 carrier)	US-PGPUB; USPAT; USOCR; DERWENT; IBM_TDB	OR	ON	2017/03/16 18:18
S278	5	455/\$.ccls. and (set near3 radio near3 resource) same component adj carrier	US-PGPUB; USPAT; USOCR; DERWENT; IBM_TDB	OR	ON	2017/03/16 19:44
S279	34641	(H04W88/08, H04W72/044, H04W72/042).cpc.	US-PGPUB; USPAT; USOCR; DERWENT; IBM_TDB	OR	ON	2017/03/16 20:26
S280	7394	(H04W52/367, H04W52/12, H04W52/40).cpc.	US-PGPUB; USPAT; USOCR; DERWENT; IBM_TDB	OR	ON	2017/03/16 20:26
S281	6589	(H04L29/08657, G01S5/0252, G01S5/02).cpc.	US-PGPUB; USPAT; USOCR;	OR	ON	2017/03/16 20:26

			DERWENT; IBM_TDB			
S282	5176	(H04B1/3833, H04M1/0247, H04M1/0237).cpc.	US-PGPUB; USPAT; USOCR; DERWENT; IBM_TDB	OR	ON	2017/03/16 20:26
S283	12417	(H03F3/211, H04B7/0617, H04B7/0669).cpc.	US-PGPUB; USPAT; USOCR; DERWENT; IBM_TDB	OR	ON	2017/03/16 20:26
S284	131	(S279 S280 S281 S282 S283) and (second other another 2nd) near3 (radio adj resource) and (carrier adj aggregation) and (schedul\$3 near3 (down\$link DL reverse\$link))	US-PGPUB; USPAT; USOCR; DERWENT; IBM_TDB	OR	ON	2017/03/16 20:26
S285	126	(H04W88/08, H04W72/044, H04W72/042).cpc. and (second other another 2nd) near3 (radio adj resource) and (carrier adj aggregation) and (schedul\$3 near3 (down\$link DL reverse\$link))	US-PGPUB; USPAT; USOCR; DERWENT; IBM_TDB	OR	ON	2017/03/16 20:27
S286	3	Ericsson.as. and ((david near2 astely) (robert near2 baldemair) (dirk near2 gerstenberger) (daniel near2 larsson) (lars near2 lindbom) (stefan near2 parkvall)).in. and schedul\$3 near3 (transmit\$4 transmi\$5 communication) with (CC (component adj2 cacarrier))	US-PGPUB; USPAT; USOCR; DERWENT; IBM_TDB	OR	ON	2017/03/16 22:26
S287	62	455/451,452.1,509,456.1,522,137,103,575.ccls. and (allocat\$3) with (resource frequency channel Bin) same (reserv\$4 sav\$4) adj6 (resource frequency channel Bin) and (control\$3 adjst\$3) near6 (CC component)	US-PGPUB; USPAT; USOCR; DERWENT; IBM_TDB	OR	ON	2017/03/17 11:15
S288	0	455/451,452.1,509,456.1,522,137,103,575.ccls. and (allocat\$3) with (resource frequency channel Bin) same (reserv\$4 sav\$4) adj6 (resource frequency channel Bin) and (primary adj cell) same (multiple several set) near3 component adj2 carrier	US-PGPUB; USPAT; USOCR; FPRS; EPO; JPO; DERWENT; IBM_TDB	OR	ON	2017/03/17 11:17
S289	0	455/451,452.1,509,456.1,522,137,103,575.ccls. and (allocat\$3) with (resource frequency channel Bin) same (reserv\$4 sav\$4) adj6 (resource frequency channel Bin) and (primary adj cell) same2 (multiple several set) near3 component adj2 carrier	US-PGPUB; USPAT; USOCR; FPRS; EPO; JPO; DERWENT; IBM_TDB	OR	ON	2017/03/17 11:18
S290	0	455/451,452.1,509,456.1,522,137,103,575.ccls. and (allocat\$3) with (resource frequency channel Bin) same (reserv\$4 sav\$4) adj6 (resource frequency channel Bin) and (primary adj2 cell) and (multiple several set) near3 component adj2 carrier	US-PGPUB; USPAT; USOCR; FPRS; EPO; JPO; DERWENT; IBM_TDB	OR	ON	2017/03/17 11:20
S291	1	455/451,452.1,509,456.1,522,137,103,575.ccls. and (allocat\$3) with (resource frequency channel Bin) same (reserv\$4 sav\$4) adj6 (resource frequency channel Bin) and (multiple several set) near3 component adj2 carrier	US-PGPUB; USPAT; USOCR; FPRS; EPO; JPO; DERWENT;	OR	ON	2017/03/17 11:22

			IBM_TDB			
S292	9	455/451,452.1,509,456.1,522,137,103,575.ccls. and (allocat\$3) with (resource frequency channel Bin) same2 (reserv\$4 sav\$4) adj6 (resource frequency channel Bin) and (multiple several set) near3 component adj2 carrier	US-PGPUB; USPAT; USOCR; FPRS; EPO; JPO; DERWENT; IBM_TDB	OR	ON	2017/03/17 11:23

EAST Search History (Interference)

Ref #	Hits	Search Query	DBs	Default Operator	Plurals	Time Stamp
S159	0	455/451,452.1,509,456.1,522,137,103,575.ccls. and (control\$4) with (resource frequency channel) same (rererv\$4 sav\$4) near3 (other 2nd second another) adj3 (resource frequency channel Bin)	US-PGPUB; USPAT	OR	ON	2014/10/31 15:24
S160	5	(DL down\$link) with (1st first first primary initia) near3 (set group) near6 (radio resource) and (DL down\$link) with (set group) near6 (radio resource) with (2nd second other another) near2 component	US-PGPUB; USPAT	OR	ON	2014/10/31 15:26
S241	0	(H04B1/3833, H04M1/0247, H04M1/0237).cpc. and (schedul\$3 assign\$3) with (primary adj cell) same2 (multiple several set) near3 component adj2 carrier	US-PGPUB; USPAT	OR	ON	2016/03/16 11:50
S242	7	(H04L5/0053, H04L5/001, H04L5/0094, H04B1/3833, H04M1/0247, H04M1/0237).cpc. and (schedul\$3 assign\$3) with (primary adj cell) same2 (multiple several set) near3 component adj2 carrier and (control\$4 adjust\$3) near6 (DL (down\$link)) and (second 2nd another other) near3 (radio frequency band resources)	US-PGPUB; USPAT	OR	ON	2016/03/16 12:38
S243	7	(A01B12/006, H04L5/0053, H04L5/001, H04L5/0094, H04B1/3833, H04M1/0247, H04M1/0237).cpc. and (schedul\$3 assign\$3) with (primary adj cell) same2 (multiple several set) near3 component adj2 carrier and (control\$4 adjust\$3) near6 (DL (down\$link)) and (second 2nd another other) near3 (radio frequency band resources)	US-PGPUB; USPAT	OR	ON	2016/03/16 12:39
S244	1	(H04W88/08, H04W72/044, H04W72/042, H04W52/367, H04W52/12, H04W52/40, H04L29/08657, G01S5/0252, G01S5/02, H04B1/3833, H04M1/0247, H04M1/0237).cpc. and (schedul\$3 assign\$3) with (primary adj cell) same2 (multiple several set) near3 component adj2 carrier and (control\$4 adjust\$3) near6 (DL (down\$link)) and (second 2nd another other) near3 (radio frequency band resources)	USPAT	OR	ON	2016/03/16 12:47
S245	4	(H04W88/08, H04W72/044, H04W72/042, H04W52/367, H04W52/12, H04W52/40, H04L29/08657, G01S5/0252, G01S5/02, H04B1/3833, H04M1/0247, H04M1/0237).cpc. and (schedul\$3 assign\$3) with (primary adj cell) same2 (multiple several set) near3 component adj2 carrier and (control\$4 adjust\$3) near6 (DL (down\$link)) and (second	US-PGPUB; USPAT	OR	ON	2016/03/16 12:47

		2nd another other) near3 (radio frequency band resources)				
S255	7	(H04W88/08, H04W72/044, H04W72/042, H04W52/367, H04W52/12, H04W52/40, H04L29/08657, G01S5/0252, G01S5/02, H04B1/3833, H04M1/0247, H04M1/0237).cpc. and (schedul\$3 assign\$3) with (primary adj cell) same2 (multiple several set) near3 component adj2 carrier and (control\$4 adjust\$3) near6 (DL (down\$link)) and (second 2nd another other) near3 (radio frequency band resources)	US-PGPUB; USPAT	OR	ON	2016/06/24 11:48
S256	61	370/329,252,331.ccls. and (((first 1st) adj6 component adj3 carrier) same ((radio resource frame))) and ((2nd second) adj6 component adj3 carrier) same ((2nd second other another) adj4 (radio resource frame)) and (set group) near6 (radio resource)	US-PGPUB; USPAT	OR	ON	2016/06/24 12:22
S263	14	(H04W88/08, H04W72/044, H04W72/042, H04W52/367, H04W52/12, H04W52/40, H04L29/08657, G01S5/0252, G01S5/02, H04B1/3833, H04M1/0247, H04M1/0237).cpc. and (schedul\$3 assign\$3) with (primary adj cell) same2 (multiple several set) and (control\$4 adjust\$3) near6 (DL (down\$link)) and (second 2nd another other) near3 (radio frequency band resources)	USPAT	OR	ON	2016/06/24 22:15
S264	66	(H04W88/08, H04W72/044, H04W72/042, H04W52/367, H04W52/12, H04W52/40, H04L29/08657, G01S5/0252, G01S5/02, H04B1/3833, H04M1/0247, H04M1/0237).cpc. and (schedul\$3 assign\$3) with (primary adj cell) same2 (multiple several set) and (control\$4 adjust\$3) near6 (DL (down\$link)) and (second 2nd another other) near3 (radio frequency band resources)	US-PGPUB; USPAT	OR	ON	2016/06/24 22:15
S265	13	(H04W88/08, H04W72/044, H04W72/042, H04W52/367, H04W52/12, H04W52/40, H04L29/08657, G01S5/0252, G01S5/02, H04B1/3833, H04M1/0247, H04M1/0237).cpc. and (schedul\$3 assign\$3) with (primary adj cell) same2 (multiple several set) and (control\$4 adjust\$3) near6 (DL (down\$link)) and (second 2nd another other) near3 (radio frequency band resources) same component adj carrier	US-PGPUB; USPAT	OR	ON	2016/06/24 22:17
S277	9	(H04W88/08, H04W72/044, H04W72/042).cpc. and schedul\$3 near3 (transmit\$4 transmi\$5) with (CC (component adj2 cacarrier)) and (CI (control adj2 (info information))) with (CC (component adj2 cacarrier)) and schedul\$3 with (non\$1primary second 2nd secondary) adj2 cell	US-PGPUB; USPAT	OR	ON	2017/03/16 17:37
S293	0	455/451,452.1,509,456.1,522,137,103,575.ccls. and (allocat\$3) with (resource frequency channel Bin) same (reserv\$4 sav\$4) adj6 (resource frequency channel Bin) and (primary adj cell) same (multiple several set) near3 component adj2 carrier	US-PGPUB; USPAT	OR	ON	2017/03/17 11:20

3/ 17/ 2017 6:03:51 PM

C:\Users\mtalukder\Documents\EAST\Workspaces\15350360.wsp

Doc code: IDS

Doc description: Information Disclosure Statement (IDS) Filed

PTO/SB/08a (03-15)

Approved for use through 07/31/2016. OMB 0651-0031

U.S. Patent and Trademark Office; U.S. DEPARTMENT OF COMMERCE

Under the Paperwork Reduction Act of 1995, no persons are required to respond to a collection of information unless it contains a valid OMB control number.

INFORMATION DISCLOSURE STATEMENT BY APPLICANT (Not for submission under 37 CFR 1.99)	Application Number	15350360
	Filing Date	2016-11-14
	First Named Inventor	David Astely et al.
	Art Unit	2648
	Examiner Name	Md K. Talukder
	Attorney Docket Number	P30138-US3 / 4015-9600

U.S.PATENTS							Remove	
Examiner Initial*	Cite No	Patent Number	Kind Code ¹	Issue Date	Name of Patentee or Applicant of cited Document	Pages,Columns,Lines where Relevant Passages or Relevant Figures Appear		
	1							
If you wish to add additional U.S. Patent citation information please click the Add button.							Add	
U.S.PATENT APPLICATION PUBLICATIONS							Remove	
Examiner Initial*	Cite No	Publication Number	Kind Code ¹	Publication Date	Name of Patentee or Applicant of cited Document	Pages,Columns,Lines where Relevant Passages or Relevant Figures Appear		
	1							
If you wish to add additional U.S. Published Application citation information please click the Add button.							Add	
FOREIGN PATENT DOCUMENTS							Remove	
Examiner Initial*	Cite No	Foreign Document Number ³	Country Code ²ⁱ	Kind Code ⁴	Publication Date	Name of Patentee or Applicant of cited Document	Pages,Columns,Lines where Relevant Passages or Relevant Figures Appear	T ⁵
	1							
If you wish to add additional Foreign Patent Document citation information please click the Add button							Add	
NON-PATENT LITERATURE DOCUMENTS							Remove	
Examiner Initials*	Cite No	Include name of the author (in CAPITAL LETTERS), title of the article (when appropriate), title of the item (book, magazine, journal, serial, symposium, catalog, etc), date, pages(s), volume-issue number(s), publisher, city and/or country where published.						T ⁵

INFORMATION DISCLOSURE STATEMENT BY APPLICANT (Not for submission under 37 CFR 1.99)	Application Number		15350360
	Filing Date		2016-11-14
	First Named Inventor	David Astely et al.	
	Art Unit	2648	
	Examiner Name	Md K. Talukder	
	Attorney Docket Number	P30138-US3 / 4015-9600	

1		HUAWEI, PUCCH design for carrier aggregation, 3GPP TSG RAN WG1 Meeting #58 R1-093046, 3GPP, August 24, 2009.
---	--	--

If you wish to add additional non-patent literature document citation information please click the Add button

EXAMINER SIGNATURE

Examiner Signature	/MD K TALUKDER/	Date Considered	03/17/2017
--------------------	-----------------	-----------------	------------

*EXAMINER: Initial if reference considered, whether or not citation is in conformance with MPEP 609. Draw line through a citation if not in conformance and not considered. Include copy of this form with next communication to applicant.

¹ See Kind Codes of USPTO Patent Documents at www.USPTO.GOV or MPEP 901.04. ² Enter office that issued the document, by the two-letter code (WIPO Standard ST.3). ³ For Japanese patent documents, the indication of the year of the reign of the Emperor must precede the serial number of the patent document. ⁴ Kind of document by the appropriate symbols as indicated on the document under WIPO Standard ST.16 if possible. ⁵ Applicant is to place a check mark here if English language translation is attached.

INFORMATION DISCLOSURE STATEMENT BY APPLICANT (Not for submission under 37 CFR 1.99)	Application Number		15350360
	Filing Date		2016-11-14
	First Named Inventor	David Astely et al.	
	Art Unit	2648	
	Examiner Name	Md K. Talukder	
	Attorney Docket Number	P30138-US3 / 4015-9600	

CERTIFICATION STATEMENT

Please see 37 CFR 1.97 and 1.98 to make the appropriate selection(s):

That each item of information contained in the information disclosure statement was first cited in any communication from a foreign patent office in a counterpart foreign application not more than three months prior to the filing of the information disclosure statement. See 37 CFR 1.97(e)(1).

OR

That no item of information contained in the information disclosure statement was cited in a communication from a foreign patent office in a counterpart foreign application, and, to the knowledge of the person signing the certification after making reasonable inquiry, no item of information contained in the information disclosure statement was known to any individual designated in 37 CFR 1.56(c) more than three months prior to the filing of the information disclosure statement. See 37 CFR 1.97(e)(2).

See attached certification statement.

The fee set forth in 37 CFR 1.17 (p) has been submitted herewith.

A certification statement is not submitted herewith.

SIGNATURE

A signature of the applicant or representative is required in accordance with CFR 1.33, 10.18. Please see CFR 1.4(d) for the form of the signature.

Signature	/Edward M. Roney/	Date (YYYY-MM-DD)	2016-01-08
Name/Print	Edward M. Roney	Registration Number	62048

This collection of information is required by 37 CFR 1.97 and 1.98. The information is required to obtain or retain a benefit by the public which is to file (and by the USPTO to process) an application. Confidentiality is governed by 35 U.S.C. 122 and 37 CFR 1.14. This collection is estimated to take 1 hour to complete, including gathering, preparing and submitting the completed application form to the USPTO. Time will vary depending upon the individual case. Any comments on the amount of time you require to complete this form and/or suggestions for reducing this burden, should be sent to the Chief Information Officer, U.S. Patent and Trademark Office, U.S. Department of Commerce, P.O. Box 1450, Alexandria, VA 22313-1450. **DO NOT SEND FEES OR COMPLETED FORMS TO THIS ADDRESS. SEND TO: Commissioner for Patents, P.O. Box 1450, Alexandria, VA 22313-1450.**

Privacy Act Statement

The Privacy Act of 1974 (P.L. 93-579) requires that you be given certain information in connection with your submission of the attached form related to a patent application or patent. Accordingly, pursuant to the requirements of the Act, please be advised that: (1) the general authority for the collection of this information is 35 U.S.C. 2(b)(2); (2) furnishing of the information solicited is voluntary; and (3) the principal purpose for which the information is used by the U.S. Patent and Trademark Office is to process and/or examine your submission related to a patent application or patent. If you do not furnish the requested information, the U.S. Patent and Trademark Office may not be able to process and/or examine your submission, which may result in termination of proceedings or abandonment of the application or expiration of the patent.

The information provided by you in this form will be subject to the following routine uses:

1. The information on this form will be treated confidentially to the extent allowed under the Freedom of Information Act (5 U.S.C. 552) and the Privacy Act (5 U.S.C. 552a). Records from this system of records may be disclosed to the Department of Justice to determine whether the Freedom of Information Act requires disclosure of these records.
2. A record from this system of records may be disclosed, as a routine use, in the course of presenting evidence to a court, magistrate, or administrative tribunal, including disclosures to opposing counsel in the course of settlement negotiations.
3. A record in this system of records may be disclosed, as a routine use, to a Member of Congress submitting a request involving an individual, to whom the record pertains, when the individual has requested assistance from the Member with respect to the subject matter of the record.
4. A record in this system of records may be disclosed, as a routine use, to a contractor of the Agency having need for the information in order to perform a contract. Recipients of information shall be required to comply with the requirements of the Privacy Act of 1974, as amended, pursuant to 5 U.S.C. 552a(m).
5. A record related to an International Application filed under the Patent Cooperation Treaty in this system of records may be disclosed, as a routine use, to the International Bureau of the World Intellectual Property Organization, pursuant to the Patent Cooperation Treaty.
6. A record in this system of records may be disclosed, as a routine use, to another federal agency for purposes of National Security review (35 U.S.C. 181) and for review pursuant to the Atomic Energy Act (42 U.S.C. 218(c)).
7. A record from this system of records may be disclosed, as a routine use, to the Administrator, General Services, or his/her designee, during an inspection of records conducted by GSA as part of that agency's responsibility to recommend improvements in records management practices and programs, under authority of 44 U.S.C. 2904 and 2906. Such disclosure shall be made in accordance with the GSA regulations governing inspection of records for this purpose, and any other relevant (i.e., GSA or Commerce) directive. Such disclosure shall not be used to make determinations about individuals.
8. A record from this system of records may be disclosed, as a routine use, to the public after either publication of the application pursuant to 35 U.S.C. 122(b) or issuance of a patent pursuant to 35 U.S.C. 151. Further, a record may be disclosed, subject to the limitations of 37 CFR 1.14, as a routine use, to the public if the record was filed in an application which became abandoned or in which the proceedings were terminated and which application is referenced by either a published application, an application open to public inspections or an issued patent.
9. A record from this system of records may be disclosed, as a routine use, to a Federal, State, or local law enforcement agency, if the USPTO becomes aware of a violation or potential violation of law or regulation.

Search Notes 	Application/Control No. 15350360	Applicant(s)/Patent Under Reexamination ASTELEY ET AL.
	Examiner MD TALUKDER	Art Unit 2648

CPC- SEARCHED		
Symbol	Date	Examiner
H04B1/3833, H04M1/0247, H04M1/0237	3/16/2017	Talukder

CPC COMBINATION SETS - SEARCHED		
Symbol	Date	Examiner

US CLASSIFICATION SEARCHED			
Class	Subclass	Date	Examiner
455	451,452.1,509,456.1,522,137,103,575	3/16/2017	Talukder
370	All	3/17/2017	Talukder

SEARCH NOTES		
Search Notes	Date	Examiner
Assignee Searched	3/16/2017	Talukder
Inventor Searched	3/17/2017	Talukder
East Searched	3/17/2017	Talukder

INTERFERENCE SEARCH			
US Class/ CPC Symbol	US Subclass / CPC Group	Date	Examiner
H04B1/3833, H04M1/0247, H04M1/0237		3/16/2017	Talukder
455	451,452.1,509,456.1,522,137,103,575	3/17/2017	Talukder

--	--

Doc code: IDS

Doc description: Information Disclosure Statement (IDS) Filed

PTO/SB/08a (03-15)

Approved for use through 07/31/2016. OMB 0651-0031

U.S. Patent and Trademark Office; U.S. DEPARTMENT OF COMMERCE

Under the Paperwork Reduction Act of 1995, no persons are required to respond to a collection of information unless it contains a valid OMB control number.

INFORMATION DISCLOSURE STATEMENT BY APPLICANT (Not for submission under 37 CFR 1.99)	Application Number		15350360	
	Filing Date		2016-11-14	
	First Named Inventor	David Astely et al.		
	Art Unit	2414		
	Examiner Name	MD K Talukder		
	Attorney Docket Number	4015-9600 / P30138_US3		

U.S.PATENTS

Examiner Initial*	Cite No	Patent Number	Kind Code ¹	Issue Date	Name of Patentee or Applicant of cited Document	Pages, Columns, Lines where Relevant Passages or Relevant Figures Appear
	1					

If you wish to add additional U.S. Patent citation information please click the Add button.

U.S.PATENT APPLICATION PUBLICATIONS

Examiner Initial*	Cite No	Publication Number	Kind Code ¹	Publication Date	Name of Patentee or Applicant of cited Document	Pages, Columns, Lines where Relevant Passages or Relevant Figures Appear
	1					

If you wish to add additional U.S. Published Application citation information please click the Add button.

FOREIGN PATENT DOCUMENTS

Examiner Initial*	Cite No	Foreign Document Number ³	Country Code ²ⁱ	Kind Code ⁴	Publication Date	Name of Patentee or Applicant of cited Document	Pages, Columns, Lines where Relevant Passages or Relevant Figures Appear	T ⁵
	1							

If you wish to add additional Foreign Patent Document citation information please click the Add button.

NON-PATENT LITERATURE DOCUMENTS

Examiner Initials*	Cite No	Include name of the author (in CAPITAL LETTERS), title of the article (when appropriate), title of the item (book, magazine, journal, serial, symposium, catalog, etc), date, pages(s), volume-issue number(s), publisher, city and/or country where published.	T ⁵

INFORMATION DISCLOSURE STATEMENT BY APPLICANT (Not for submission under 37 CFR 1.99)	Application Number		15350360
	Filing Date		2016-11-14
	First Named Inventor	David Astely et al.	
	Art Unit	2414	
	Examiner Name	MD K Talukder	
	Attorney Docket Number	4015-9600 / P30138_US3	

1	TEXAS INSTRUMENTS: "Dynamic ACK/NAK Channelization on PUCCH", 3GPP DRAFT; R1-081375-DACKNAK, 3RD GENERATION PARTNERSHIP PROJECT (3GPP), MOBILE COMPETENCE CENTRE; 650, ROUTE DES LUCIOLES; F-06921 SOPHIA-ANTIPOLIS CEDEX; FRANCE, vol. RAN WG1, no. Shenzhen, China; March 27, 2008, XP050109796.
If you wish to add additional non-patent literature document citation information please click the Add button <input type="button" value="Add"/>	
EXAMINER SIGNATURE	
Examiner Signature	/MD K TALUKDER/
Date Considered	03/17/2017
*EXAMINER: Initial if reference considered, whether or not citation is in conformance with MPEP 609. Draw line through a citation if not in conformance and not considered. Include copy of this form with next communication to applicant.	
¹ See Kind Codes of USPTO Patent Documents at www.USPTO.GOV or MPEP 901.04. ² Enter office that issued the document, by the two-letter code (WIPO Standard ST.3). ³ For Japanese patent documents, the indication of the year of the reign of the Emperor must precede the serial number of the patent document. ⁴ Kind of document by the appropriate symbols as indicated on the document under WIPO Standard ST.16 if possible. ⁵ Applicant is to place a check mark here if English language translation is attached.	

INFORMATION DISCLOSURE STATEMENT BY APPLICANT (Not for submission under 37 CFR 1.99)	Application Number	15350360
	Filing Date	2016-11-14
	First Named Inventor	David Astely et al.
	Art Unit	2414
	Examiner Name	MD K Talukder
	Attorney Docket Number	4015-9600 / P30138_US3

CERTIFICATION STATEMENT

Please see 37 CFR 1.97 and 1.98 to make the appropriate selection(s):

That each item of information contained in the information disclosure statement was first cited in any communication from a foreign patent office in a counterpart foreign application not more than three months prior to the filing of the information disclosure statement. See 37 CFR 1.97(e)(1).

OR

That no item of information contained in the information disclosure statement was cited in a communication from a foreign patent office in a counterpart foreign application, and, to the knowledge of the person signing the certification after making reasonable inquiry, no item of information contained in the information disclosure statement was known to any individual designated in 37 CFR 1.56(c) more than three months prior to the filing of the information disclosure statement. See 37 CFR 1.97(e)(2).

See attached certification statement.

The fee set forth in 37 CFR 1.17 (p) has been submitted herewith.

A certification statement is not submitted herewith.

SIGNATURE

A signature of the applicant or representative is required in accordance with CFR 1.33, 10.18. Please see CFR 1.4(d) for the form of the signature.

Signature	/Edward M. Roney/	Date (YYYY-MM-DD)	2016-12-30
Name/Print	Edward M. Roney	Registration Number	62048

This collection of information is required by 37 CFR 1.97 and 1.98. The information is required to obtain or retain a benefit by the public which is to file (and by the USPTO to process) an application. Confidentiality is governed by 35 U.S.C. 122 and 37 CFR 1.14. This collection is estimated to take 1 hour to complete, including gathering, preparing and submitting the completed application form to the USPTO. Time will vary depending upon the individual case. Any comments on the amount of time you require to complete this form and/or suggestions for reducing this burden, should be sent to the Chief Information Officer, U.S. Patent and Trademark Office, U.S. Department of Commerce, P.O. Box 1450, Alexandria, VA 22313-1450. **DO NOT SEND FEES OR COMPLETED FORMS TO THIS ADDRESS. SEND TO: Commissioner for Patents, P.O. Box 1450, Alexandria, VA 22313-1450.**

Privacy Act Statement

The Privacy Act of 1974 (P.L. 93-579) requires that you be given certain information in connection with your submission of the attached form related to a patent application or patent. Accordingly, pursuant to the requirements of the Act, please be advised that: (1) the general authority for the collection of this information is 35 U.S.C. 2(b)(2); (2) furnishing of the information solicited is voluntary; and (3) the principal purpose for which the information is used by the U.S. Patent and Trademark Office is to process and/or examine your submission related to a patent application or patent. If you do not furnish the requested information, the U.S. Patent and Trademark Office may not be able to process and/or examine your submission, which may result in termination of proceedings or abandonment of the application or expiration of the patent.

The information provided by you in this form will be subject to the following routine uses:

1. The information on this form will be treated confidentially to the extent allowed under the Freedom of Information Act (5 U.S.C. 552) and the Privacy Act (5 U.S.C. 552a). Records from this system of records may be disclosed to the Department of Justice to determine whether the Freedom of Information Act requires disclosure of these records.
2. A record from this system of records may be disclosed, as a routine use, in the course of presenting evidence to a court, magistrate, or administrative tribunal, including disclosures to opposing counsel in the course of settlement negotiations.
3. A record in this system of records may be disclosed, as a routine use, to a Member of Congress submitting a request involving an individual, to whom the record pertains, when the individual has requested assistance from the Member with respect to the subject matter of the record.
4. A record in this system of records may be disclosed, as a routine use, to a contractor of the Agency having need for the information in order to perform a contract. Recipients of information shall be required to comply with the requirements of the Privacy Act of 1974, as amended, pursuant to 5 U.S.C. 552a(m).
5. A record related to an International Application filed under the Patent Cooperation Treaty in this system of records may be disclosed, as a routine use, to the International Bureau of the World Intellectual Property Organization, pursuant to the Patent Cooperation Treaty.
6. A record in this system of records may be disclosed, as a routine use, to another federal agency for purposes of National Security review (35 U.S.C. 181) and for review pursuant to the Atomic Energy Act (42 U.S.C. 218(c)).
7. A record from this system of records may be disclosed, as a routine use, to the Administrator, General Services, or his/her designee, during an inspection of records conducted by GSA as part of that agency's responsibility to recommend improvements in records management practices and programs, under authority of 44 U.S.C. 2904 and 2906. Such disclosure shall be made in accordance with the GSA regulations governing inspection of records for this purpose, and any other relevant (i.e., GSA or Commerce) directive. Such disclosure shall not be used to make determinations about individuals.
8. A record from this system of records may be disclosed, as a routine use, to the public after either publication of the application pursuant to 35 U.S.C. 122(b) or issuance of a patent pursuant to 35 U.S.C. 151. Further, a record may be disclosed, subject to the limitations of 37 CFR 1.14, as a routine use, to the public if the record was filed in an application which became abandoned or in which the proceedings were terminated and which application is referenced by either a published application, an application open to public inspections or an issued patent.
9. A record from this system of records may be disclosed, as a routine use, to a Federal, State, or local law enforcement agency, if the USPTO becomes aware of a violation or potential violation of law or regulation.

Index of Claims 	Application/Control No. 15350360	Applicant(s)/Patent Under Reexamination ASTELY ET AL.
	Examiner MD TALUKDER	Art Unit 2648

✓	Rejected
=	Allowed

-	Cancelled
÷	Restricted

N	Non-Elected
I	Interference

A	Appeal
O	Objected

Claims renumbered in the same order as presented by applicant
 CPA
 T.D.
 R.1.47

CLAIM		DATE							
Final	Original	03/17/2017							
	1	✓							
	2	✓							
	3	✓							
	4	✓							
	5	✓							
	6	✓							
	7	✓							
	8	✓							
	9	✓							
	10	✓							
	11	✓							
	12	✓							
	13	✓							
	14	✓							
	15	✓							
	16	✓							
	17	✓							
	18	✓							
	19	✓							
	20	✓							
	21	✓							
	22	✓							
	23	✓							
	24	✓							
	25	✓							
	26	✓							
	27	✓							
	28	✓							
	29	✓							
	30	✓							



UNITED STATES PATENT AND TRADEMARK OFFICE

UNITED STATES DEPARTMENT OF COMMERCE
 United States Patent and Trademark Office
 Address: COMMISSIONER FOR PATENTS
 P.O. Box 1450
 Alexandria, Virginia 22313-1450
 www.uspto.gov

BIB DATA SHEET

CONFIRMATION NO. 1120

SERIAL NUMBER 15/350,360	FILING or 371(c) DATE 11/14/2016 RULE	CLASS 455	GROUP ART UNIT 2648	ATTORNEY DOCKET NO. 4015-9600 / P30138-US3		
APPLICANTS Telefonaktiebolaget LM Ericsson (publ), Stockholm, SWEDEN; INVENTORS David Astely, Bromma, SWEDEN; Robert Baldemair, Solna, SWEDEN; Dirk Gerstenberger, Stockholm, SWEDEN; Daniel Larsson, Stockholm, SWEDEN; Lars Lindbom, Karlstad, SWEDEN; Stefan Parkvall, Bromma, SWEDEN; ** CONTINUING DATA ***** This application is a CON of 12/896,993 10/04/2010 PAT 9497004 which claims benefit of 61/248,661 10/05/2009 ** FOREIGN APPLICATIONS ***** ** IF REQUIRED, FOREIGN FILING LICENSE GRANTED ** 11/21/2016						
Foreign Priority claimed <input type="checkbox"/> Yes <input checked="" type="checkbox"/> No	35 USC 119(a-d) conditions met <input type="checkbox"/> Yes <input checked="" type="checkbox"/> No	<input type="checkbox"/> Met after Allowance Initials	STATE OR COUNTRY SWEDEN	SHEETS DRAWINGS 12	TOTAL CLAIMS 30	INDEPENDENT CLAIMS 4
ADDRESS COATS & BENNETT, PLLC 1400 Crescent Green, Suite 300 Cary, NC 27518 UNITED STATES						
TITLE PUCCH RESOURCE ALLOCATION FOR CARRIER AGGREGATION IN LTE-ADVANCED						
FILING FEE RECEIVED 2960	FEES: Authority has been given in Paper No. _____ to charge/credit DEPOSIT ACCOUNT No. _____ for following:			<input type="checkbox"/> All Fees <input type="checkbox"/> 1.16 Fees (Filing) <input type="checkbox"/> 1.17 Fees (Processing Ext. of time) <input type="checkbox"/> 1.18 Fees (Issue) <input type="checkbox"/> Other _____ <input type="checkbox"/> Credit		

POWER OF ATTORNEY

The undersigned, being duly authorized representatives of **TELEFONAKTIEBOLAGET LM ERICSSON (PUBL)** (hereafter referred to as "Ericsson") having its registered office as SE - 164 83 Stockholm, Sweden, does hereby authorize **Coats & Bennett, PLLC practitioners associated with United States Patent and Trademark Office Customer Number 24112** to represent Ericsson before the United States Patent and Trademark Office in any and all matters regarding patents or patent applications filed by Ericsson or wherein Ericsson is the assignee of the entire interest thereto.

This Power of Attorney shall include the right for **Coats & Bennett, PLLC practitioners associated with United States Patent and Trademark Office Customer Number 24112** to sign and submit in Ericsson's name and on Ericsson's behalf any document, notification, filing, petition or request in connection with any patent applications or patents owned by or assigned to Ericsson.

This Power of Attorney does not include the right to appoint substitutes or make sub-authorizations.

This Power of Attorney shall be valid for five (5) years from the date hereof unless earlier revoked. This Power of Attorney may be revoked at any time by Ericsson.

Stockholm, Sweden on

TELEFONAKTIEBOLAGET LM ERICSSON (PUBL)

Signature: 

Gabriele Mohsler
Vice President Patent Development



Nabil Ayoub
Director Patent Unit RAN2

Date: 2016-04-05

I, the undersigned, _____, Notary Public of the City of Stockholm hereby certify that _____ and _____

duly authorized to sign for

TELEFONAKTIEBOLAGET LM ERICSSON (PUBL)

have issued and signed the foregoing document

Fee _____ Stockholm [Date]

Crowns _____ Ex officio:

Signature: Notary Public of the City of Stockholm

STATEMENT UNDER 37 CFR 3.73(c)Applicant/Patent Owner: Telefonaktiebolaget LM Ericsson (publ)Application No./Patent No.: 15/350360 Filed/Issue Date: November 14, 2016Titled: PUCCH RESOURCE ALLOCATION FOR CARRIER AGGREGATION IN LTE-ADVANCEDTelefonaktiebolaget LM Ericsson (publ), a Swiss corporation

(Name of Assignee)

(Type of Assignee, e.g., corporation, partnership, university, government agency, etc.)

states that, for the patent application/patent identified above, it is (choose **one** of options 1, 2, 3 or 4 below):

1. The assignee of the entire right, title, and interest.
2. An assignee of less than the entire right, title, and interest (check applicable box):
- The extent (by percentage) of its ownership interest is _____%. Additional Statement(s) by the owners holding the balance of the interest must be submitted to account for 100% of the ownership interest.
- There are unspecified percentages of ownership. The other parties, including inventors, who together own the entire right, title and interest are:

Additional Statement(s) by the owner(s) holding the balance of the interest must be submitted to account for the entire right, title, and interest.

3. The assignee of an undivided interest in the entirety (a complete assignment from one of the joint inventors was made). The other parties, including inventors, who together own the entire right, title, and interest are:

Additional Statement(s) by the owner(s) holding the balance of the interest must be submitted to account for the entire right, title, and interest.

4. The recipient, via a court proceeding or the like (e.g., bankruptcy, probate), of an undivided interest in the entirety (a complete transfer of ownership interest was made). The certified document(s) showing the transfer is attached.

The interest identified in option 1, 2 or 3 above (not option 4) is evidenced by either (choose **one** of options A or B below):

- A. An assignment from the inventor(s) of the patent application/patent identified above. The assignment was recorded in the United States Patent and Trademark Office at Reel 040308, Frame 0388, or for which a copy thereof is attached.
- B. A chain of title from the inventor(s), of the patent application/patent identified above, to the current assignee as follows:
1. From: _____ To: _____
The document was recorded in the United States Patent and Trademark Office at
Reel _____, Frame _____, or for which a copy thereof is attached.
2. From: _____ To: _____
The document was recorded in the United States Patent and Trademark Office at
Reel _____, Frame _____, or for which a copy thereof is attached.

[Page 1 of 2]

This collection of information is required by 37 CFR 3.73(b). The information is required to obtain or retain a benefit by the public which is to file (and by the USPTO to process) an application. Confidentiality is governed by 35 U.S.C. 122 and 37 CFR 1.11 and 1.14. This collection is estimated to take 12 minutes to complete, including gathering, preparing, and submitting the completed application form to the USPTO. Time will vary depending upon the individual case. Any comments on the amount of time you require to complete this form and/or suggestions for reducing this burden, should be sent to the Chief Information Officer, U.S. Patent and Trademark Office, U.S. Department of Commerce, P.O. Box 1450, Alexandria, VA 22313-1450. DO NOT SEND FEES OR COMPLETED FORMS TO THIS ADDRESS. **SEND TO: Commissioner for Patents, P.O. Box 1450, Alexandria, VA 22313-1450.**

If you need assistance in completing the form, call 1-800-PTO-9199 and select option 2.

STATEMENT UNDER 37 CFR 3.73(c)

3. From: _____ To: _____

The document was recorded in the United States Patent and Trademark Office at
Reel _____, Frame _____, or for which a copy thereof is attached.

4. From: _____ To: _____

The document was recorded in the United States Patent and Trademark Office at
Reel _____, Frame _____, or for which a copy thereof is attached.

5. From: _____ To: _____

The document was recorded in the United States Patent and Trademark Office at
Reel _____, Frame _____, or for which a copy thereof is attached.

6. From: _____ To: _____

The document was recorded in the United States Patent and Trademark Office at
Reel _____, Frame _____, or for which a copy thereof is attached.

Additional documents in the chain of title are listed on a supplemental sheet(s).

As required by 37 CFR 3.73(c)(1)(i), the documentary evidence of the chain of title from the original owner to the assignee was, or concurrently is being, submitted for recordation pursuant to 37 CFR 3.11.

[NOTE: A separate copy (i.e., a true copy of the original assignment document(s)) must be submitted to Assignment Division in accordance with 37 CFR Part 3, to record the assignment in the records of the USPTO. See MPEP 302.08]

The undersigned (whose title is supplied below) is authorized to act on behalf of the assignee.

/Edward M. Roney/

March 26, 2017

Signature

Date

Edward M. Roney

62048

Printed or Typed Name

Title or Registration Number

Privacy Act Statement

The **Privacy Act of 1974 (P.L. 93-579)** requires that you be given certain information in connection with your submission of the attached form related to a patent application or patent. Accordingly, pursuant to the requirements of the Act, please be advised that: (1) the general authority for the collection of this information is 35 U.S.C. 2(b)(2); (2) furnishing of the information solicited is voluntary; and (3) the principal purpose for which the information is used by the U.S. Patent and Trademark Office is to process and/or examine your submission related to a patent application or patent. If you do not furnish the requested information, the U.S. Patent and Trademark Office may not be able to process and/or examine your submission, which may result in termination of proceedings or abandonment of the application or expiration of the patent.

The information provided by you in this form will be subject to the following routine uses:

1. The information on this form will be treated confidentially to the extent allowed under the Freedom of Information Act (5 U.S.C. 552) and the Privacy Act (5 U.S.C. 552a). Records from this system of records may be disclosed to the Department of Justice to determine whether disclosure of these records is required by the Freedom of Information Act.
2. A record from this system of records may be disclosed, as a routine use, in the course of presenting evidence to a court, magistrate, or administrative tribunal, including disclosures to opposing counsel in the course of settlement negotiations.
3. A record in this system of records may be disclosed, as a routine use, to a Member of Congress submitting a request involving an individual, to whom the record pertains, when the individual has requested assistance from the Member with respect to the subject matter of the record.
4. A record in this system of records may be disclosed, as a routine use, to a contractor of the Agency having need for the information in order to perform a contract. Recipients of information shall be required to comply with the requirements of the Privacy Act of 1974, as amended, pursuant to 5 U.S.C. 552a(m).
5. A record related to an International Application filed under the Patent Cooperation Treaty in this system of records may be disclosed, as a routine use, to the International Bureau of the World Intellectual Property Organization, pursuant to the Patent Cooperation Treaty.
6. A record in this system of records may be disclosed, as a routine use, to another federal agency for purposes of National Security review (35 U.S.C. 181) and for review pursuant to the Atomic Energy Act (42 U.S.C. 218(c)).
7. A record from this system of records may be disclosed, as a routine use, to the Administrator, General Services, or his/her designee, during an inspection of records conducted by GSA as part of that agency's responsibility to recommend improvements in records management practices and programs, under authority of 44 U.S.C. 2904 and 2906. Such disclosure shall be made in accordance with the GSA regulations governing inspection of records for this purpose, and any other relevant (*i.e.*, GSA or Commerce) directive. Such disclosure shall not be used to make determinations about individuals.
8. A record from this system of records may be disclosed, as a routine use, to the public after either publication of the application pursuant to 35 U.S.C. 122(b) or issuance of a patent pursuant to 35 U.S.C. 151. Further, a record may be disclosed, subject to the limitations of 37 CFR 1.14, as a routine use, to the public if the record was filed in an application which became abandoned or in which the proceedings were terminated and which application is referenced by either a published application, an application open to public inspection or an issued patent.
9. A record from this system of records may be disclosed, as a routine use, to a Federal, State, or local law enforcement agency, if the USPTO becomes aware of a violation or potential violation of law or regulation.

Electronic Acknowledgement Receipt

EFS ID:	28738466
Application Number:	15350360
International Application Number:	
Confirmation Number:	1120
Title of Invention:	PUCCH RESOURCE ALLOCATION FOR CARRIER AGGREGATION IN LTE-ADVANCED
First Named Inventor/Applicant Name:	David Astely
Customer Number:	24112
Filer:	Edward Milton Roney/Kenyatta Upchurch
Filer Authorized By:	Edward Milton Roney
Attorney Docket Number:	4015-9600 / P30138-US3
Receipt Date:	26-MAR-2017
Filing Date:	14-NOV-2016
Time Stamp:	16:07:49
Application Type:	Utility under 35 USC 111(a)

Payment information:

Submitted with Payment	no
------------------------	----

File Listing:

Document Number	Document Description	File Name	File Size(Bytes)/ Message Digest	Multi Part /.zip	Pages (if appl.)
1	Oath or Declaration filed	P30138_US3_Declaration.pdf	450956 <small>20f2db1fd99388e261c5fb42eba44c7a2ae306b8</small>	no	6

Warnings:

Information:					
2	Power of Attorney	P30138_US3_Power_of_Attorney.pdf	487265 2a68e0e15e7e5742e70d768249192573191d2233	no	1
Warnings:					
Information:					
3	Assignee showing of ownership per 37 CFR 3.73	P30138_US3_Statement_Under_37CFR_373c.pdf	118403 2a91bb49a3ac32341df19199854d69dc0d37da00	no	3
Warnings:					
Information:					
Total Files Size (in bytes):			1056624		
<p>This Acknowledgement Receipt evidences receipt on the noted date by the USPTO of the indicated documents, characterized by the applicant, and including page counts, where applicable. It serves as evidence of receipt similar to a Post Card, as described in MPEP 503.</p> <p><u>New Applications Under 35 U.S.C. 111</u> If a new application is being filed and the application includes the necessary components for a filing date (see 37 CFR 1.53(b)-(d) and MPEP 506), a Filing Receipt (37 CFR 1.54) will be issued in due course and the date shown on this Acknowledgement Receipt will establish the filing date of the application.</p> <p><u>National Stage of an International Application under 35 U.S.C. 371</u> If a timely submission to enter the national stage of an international application is compliant with the conditions of 35 U.S.C. 371 and other applicable requirements a Form PCT/DO/EO/903 indicating acceptance of the application as a national stage submission under 35 U.S.C. 371 will be issued in addition to the Filing Receipt, in due course.</p> <p><u>New International Application Filed with the USPTO as a Receiving Office</u> If a new international application is being filed and the international application includes the necessary components for an international filing date (see PCT Article 11 and MPEP 1810), a Notification of the International Application Number and of the International Filing Date (Form PCT/RO/105) will be issued in due course, subject to prescriptions concerning national security, and the date shown on this Acknowledgement Receipt will establish the international filing date of the application.</p>					

DECLARATION (37 CFR 1.63) FOR UTILITY OR DESIGN APPLICATION USING AN APPLICATION DATA SHEET (37 CFR 1.76)

Title of Invention: PUCCH RESOURCE ALLOCATION FOR CARRIER AGGREGATION IN LTE-ADVANCED

As the below named inventor, I hereby declare that:

This declaration is directed to:

The attached application, or
 United States application number 15/350,360 filed on November 14, 2016 or PCT international application _____ filed on _____

The above-identified application was made or authorized to be made by me.

I believe that I am the original inventor or an original joint inventor of a claimed invention in the application.

I hereby acknowledge that any willful false statement made in the declaration is punishable under 18 U.S.C. 1001 by fine or imprisonment of not more than five (5) years, or both.

I hereby state that I have reviewed and understand the contents of the above-identified application, including the claims.

I hereby acknowledge the duty to disclose information which is material to patentability as defined in 37 C.F.R. 1.56, including for continuation-in-part applications, material information which became available between the filing date of the prior application and the national or PCT international filing date of the continuation-in-part application.

LEGAL NAME OF INVENTOR:

Inventor: David Astely

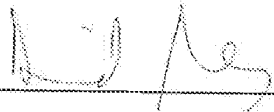
Signature:  Date: 2019-01-05

DECLARATION (37 CFR 1.63) FOR UTILITY OR DESIGN APPLICATION USING AN APPLICATION DATA SHEET (37 CFR 1.76)

Title of Invention: PUCCH RESOURCE ALLOCATION FOR CARRIER AGGREGATION IN LTE-ADVANCED

As the below named inventor, I hereby declare that:

This declaration is directed to:

The attached application, or
 United States application number 15/350,360 filed on November 14, 2016 or PCT international application _____ filed on _____

The above-identified application was made or authorized to be made by me.

I believe that I am the original inventor or an original joint inventor of a claimed invention in the application.

I hereby acknowledge that any willful false statement made in the declaration is punishable under 18 U.S.C. 1001 by fine or imprisonment of not more than five (5) years, or both.

I hereby state that I have reviewed and understand the contents of the above-identified application, including the claims.

I hereby acknowledge the duty to disclose information which is material to patentability as defined in 37 C.F.R. 1.56, including for continuation-in-part applications, material information which became available between the filing date of the prior application and the national or PCT international filing date of the continuation-in-part application.

LEGAL NAME OF INVENTOR:
Inventor: Robert Baldemair

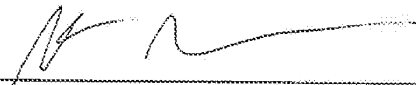
Signature:  Date: _____

DECLARATION (37 CFR 1.63) FOR UTILITY OR DESIGN APPLICATION USING AN APPLICATION DATA SHEET (37 CFR 1.76)

Title of Invention: PUCCH RESOURCE ALLOCATION FOR CARRIER AGGREGATION IN LTE-ADVANCED

As the below named inventor, I hereby declare that:

This declaration is directed to:

The attached application, or

United States application number 15/350,360 filed on November 14, 2016 or PCT international application _____ filed on _____

The above-identified application was made or authorized to be made by me.

I believe that I am the original inventor or an original joint inventor of a claimed invention in the application.

I hereby acknowledge that any willful false statement made in the declaration is punishable under 18 U.S.C. 1001 by fine or imprisonment of not more than five (5) years, or both.

I hereby state that I have reviewed and understand the contents of the above-identified application, including the claims.

I hereby acknowledge the duty to disclose information which is material to patentability as defined in 37 C.F.R. 1.56, including for continuation-in-part applications, material information which became available between the filing date of the prior application and the national or PCT international filing date of the continuation-in-part application.

LEGAL NAME OF INVENTOR:

Inventor: Dirk Gerstenberger

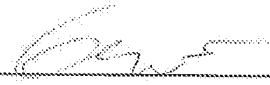
Signature:  Date: 2016-12-07

DECLARATION (37 CFR 1.63) FOR UTILITY OR DESIGN APPLICATION USING AN APPLICATION DATA SHEET (37 CFR 1.76)

Title of Invention: PUCCH RESOURCE ALLOCATION FOR CARRIER AGGREGATION IN LTE-ADVANCED

As the below named inventor, I hereby declare that:

This declaration is directed to:

The attached application, or
 United States application number 15/350,360 filed on November 14, 2016
or PCT international application _____ filed on _____

The above-identified application was made or authorized to be made by me.

I believe that I am the original inventor or an original joint inventor of a claimed invention in the application.

I hereby acknowledge that any willful false statement made in the declaration is punishable under 18 U.S.C. 1001 by fine or imprisonment of not more than five (5) years, or both.

I hereby state that I have reviewed and understand the contents of the above-identified application, including the claims.

I hereby acknowledge the duty to disclose information which is material to patentability as defined in 37 C.F.R. 1.56, including for continuation-in-part applications, material information which became available between the filing date of the prior application and the national or PCT international filing date of the continuation-in-part application.

LEGAL NAME OF INVENTOR:

Inventor: Daniel Larsson

Signature: *Daniel Larsson* Date: 2016-12-19

DECLARATION (37 CFR 1.63) FOR UTILITY OR DESIGN APPLICATION USING AN APPLICATION DATA SHEET (37 CFR 1.76)

Title of Invention: FUCCH RESOURCE ALLOCATION FOR CARRIER AGGREGATION IN LTE-ADVANCED

As the below named inventor, I hereby declare that:

This declaration is directed to:

The attached application, or

United States application number 15/360,360 filed on November 14, 2018 or PCT International application _____ filed on _____

The above-identified application was made or authorized to be made by me.

I believe that I am the original inventor or an original joint inventor of a claimed invention in the application

I hereby acknowledge that any willful false statement made in the declaration is punishable under 18 U.S.C. 1001 by fine or imprisonment of not more than five (5) years, or both

I hereby state that I have reviewed and understand the contents of the above-identified application, including the claims.

I hereby acknowledge the duty to disclose information which is material to patentability as defined in 37 C.F.R. 1.56, including for continuation-in-part applications, material information which became available between the filing date of the prior application and the national or PCT international filing date of the continuation-in-part application

LEGAL NAME OF INVENTOR:

Inventor: Lars Lindbom

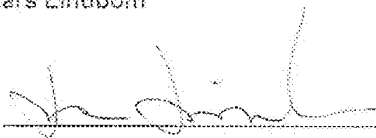
Signature:  Date: 2016-12-07

DECLARATION (37 CFR 1.63) FOR UTILITY OR DESIGN APPLICATION USING AN APPLICATION DATA SHEET (37 CFR 1.76)

Title of Invention: PUCCH RESOURCE ALLOCATION FOR CARRIER AGGREGATION IN LTE-ADVANCED

As the below named inventor, I hereby declare that:

This declaration is directed to:

The attached application, or
 United States application number 15/350,360 filed on November 14, 2016 or PCT international application _____ filed on _____

The above-identified application was made or authorized to be made by me.

I believe that I am the original inventor or an original joint inventor of a claimed invention in the application.

I hereby acknowledge that any willful false statement made in the declaration is punishable under 18 U.S.C. 1001 by fine or imprisonment of not more than five (5) years, or both.

I hereby state that I have reviewed and understand the contents of the above-identified application, including the claims.

I hereby acknowledge the duty to disclose information which is material to patentability as defined in 37 C.F.R. 1.56, including for continuation-in-part applications, material information which became available between the filing date of the prior application and the national or PCT international filing date of the continuation-in-part application.

LEGAL NAME OF INVENTOR:

Inventor: Stefan Parkvall

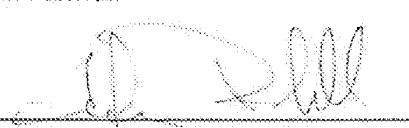
Signature:  Date: Dec 7, 2016



UNITED STATES PATENT AND TRADEMARK OFFICE

UNITED STATES DEPARTMENT OF COMMERCE
United States Patent and Trademark Office
Address: COMMISSIONER FOR PATENTS
P.O. Box 1450
Alexandria, Virginia 22313-1450
www.uspto.gov

APPLICATION NUMBER	FILING OR 371(C) DATE	FIRST NAMED APPLICANT	ATTY. DOCKET NO./TITLE
15/350,360	11/14/2016	David Astely	4015-9600 / P30138-US3

CONFIRMATION NO. 1120

POA ACCEPTANCE LETTER

24112
COATS & BENNETT, PLLC
1400 Crescent Green, Suite 300
Cary, NC 27518



Date Mailed: 03/30/2017

NOTICE OF ACCEPTANCE OF POWER OF ATTORNEY

This is in response to the Power of Attorney filed 03/26/2017.

The Power of Attorney in this application is accepted. Correspondence in this application will be mailed to the above address as provided by 37 CFR 1.33.

Questions about the contents of this notice and the requirements it sets forth should be directed to the Office of Data Management, Application Assistance Unit, at (571) 272-4000 or (571) 272-4200 or 1-888-786-0101.

/mtekle michael/

Doc Code: DIST.E.FILE Document Description: Electronic Terminal Disclaimer - Filed		PTO/SB/26 U.S. Patent and Trademark Office Department of Commerce
Electronic Petition Request	TERMINAL DISCLAIMER TO OBIVIATE A DOUBLE PATENTING REJECTION OVER A "PRIOR" PATENT	
Application Number	15350360	
Filing Date	14-Nov-2016	
First Named Inventor	David Astely	
Attorney Docket Number	4015-9600 / P30138-US3	
Title of Invention	PUCCH RESOURCE ALLOCATION FOR CARRIER AGGREGATION IN LTE-ADVANCED	
<input checked="" type="checkbox"/> Filing of terminal disclaimer does not obviate requirement for response under 37 CFR 1.111 to outstanding Office Action <input checked="" type="checkbox"/> This electronic Terminal Disclaimer is not being used for a Joint Research Agreement.		
Owner	Percent Interest	
Telefonaktiebolaget LM Ericsson (publ)	100%	
<p>The owner(s) with percent interest listed above in the instant application hereby disclaims, except as provided below, the terminal part of the statutory term of any patent granted on the instant application which would extend beyond the expiration date of the full statutory term of prior patent number(s)</p> <p>9497004</p> <p>as the term of said prior patent is presently shortened by any terminal disclaimer. The owner hereby agrees that any patent so granted on the instant application shall be enforceable only for and during such period that it and the prior patent are commonly owned. This agreement runs with any patent granted on the instant application and is binding upon the grantee, its successors or assigns.</p> <p>In making the above disclaimer, the owner does not disclaim the terminal part of the term of any patent granted on the instant application that would extend to the expiration date of the full statutory term of the prior patent, "as the term of said prior patent is presently shortened by any terminal disclaimer," in the event that said prior patent later:</p> <ul style="list-style-type: none"> - expires for failure to pay a maintenance fee; - is held unenforceable; - is found invalid by a court of competent jurisdiction; - is statutorily disclaimed in whole or terminally disclaimed under 37 CFR 1.321; - has all claims canceled by a reexamination certificate; - is reissued; or - is in any manner terminated prior to the expiration of its full statutory term as presently shortened by any terminal disclaimer. <p><input checked="" type="radio"/> Terminal disclaimer fee under 37 CFR 1.20(d) is included with Electronic Terminal Disclaimer request.</p>		

<input type="radio"/> I certify, in accordance with 37 CFR 1.4(d)(4), that the terminal disclaimer fee under 37 CFR 1.20(d) required for this terminal disclaimer has already been paid in the above-identified application.	
Applicant claims the following fee status:	
<input type="radio"/> Small Entity <input type="radio"/> Micro Entity <input checked="" type="radio"/> Regular Undiscounted	
I hereby declare that all statements made herein of my own knowledge are true and that all statements made on information and belief are believed to be true; and further that these statements were made with the knowledge that willful false statements and the like so made are punishable by fine or imprisonment, or both, under Section 1001 of Title 18 of the United States Code and that such willful false statements may jeopardize the validity of the application or any patent issued thereon.	
THIS PORTION MUST BE COMPLETED BY THE SIGNATORY OR SIGNATORIES	
I certify, in accordance with 37 CFR 1.4(d)(4) that I am:	
<input checked="" type="radio"/> An attorney or agent registered to practice before the Patent and Trademark Office who is of record in this application Registration Number <u>68795</u>	
<input type="radio"/> A sole inventor	
<input type="radio"/> A joint inventor; I certify that I am authorized to sign this submission on behalf of all of the inventors as evidenced by the power of attorney in the application	
<input type="radio"/> A joint inventor; all of whom are signing this request	
Signature	/Brandee N. Woolard, Reg. No. 68,795/
Name	Brandee N. Woolard

*Statement under 37 CFR 3.73(b) is required if terminal disclaimer is signed by the assignee (owner).
 Form PTO/SB/96 may be used for making this certification. See MPEP § 324.

Electronic Patent Application Fee Transmittal

Application Number:	15350360			
Filing Date:	14-Nov-2016			
Title of Invention:	PUCCH RESOURCE ALLOCATION FOR CARRIER AGGREGATION IN LTE-ADVANCED			
First Named Inventor/Applicant Name:	David Astely			
Filer:	Brandee N. Woolard			
Attorney Docket Number:	4015-9600 / P30138-US3			
Filed as Large Entity				
Filing Fees for Utility under 35 USC 111(a)				
Description	Fee Code	Quantity	Amount	Sub-Total in USD(\$)
Basic Filing:				
STATUTORY OR TERMINAL DISCLAIMER	1814	1	160	160
Pages:				
Claims:				
Miscellaneous-Filing:				
Petition:				
Patent-Appeals-and-Interference:				
Post-Allowance-and-Post-Issuance:				

Description	Fee Code	Quantity	Amount	Sub-Total in USD(\$)
Extension-of-Time:				
Miscellaneous:				
Total in USD (\$)				160

Doc Code: DISQ.E.FILE
Document Description: Electronic Terminal Disclaimer – Approved

Application No.: 15350360

Filing Date: 14-Nov-2016

Applicant/Patent under Reexamination: Astely

Electronic Terminal Disclaimer filed on May 24, 2017

APPROVED

This patent is subject to a terminal disclaimer

DISAPPROVED

Approved/Disapproved by: Electronic Terminal Disclaimer automatically approved by EFS-Web

U.S. Patent and Trademark Office

Electronic Acknowledgement Receipt

EFS ID:	29302305
Application Number:	15350360
International Application Number:	
Confirmation Number:	1120
Title of Invention:	PUCCH RESOURCE ALLOCATION FOR CARRIER AGGREGATION IN LTE-ADVANCED
First Named Inventor/Applicant Name:	David Astely
Customer Number:	24112
Filer:	Brandee N. Woolard
Filer Authorized By:	
Attorney Docket Number:	4015-9600 / P30138-US3
Receipt Date:	24-MAY-2017
Filing Date:	14-NOV-2016
Time Stamp:	15:07:19
Application Type:	Utility under 35 USC 111(a)

Payment information:

Submitted with Payment	yes
Payment Type	EFT
Payment was successfully received in RAM	\$160
RAM confirmation Number	052517INTEFSW15071700
Deposit Account	
Authorized User	

The Director of the USPTO is hereby authorized to charge indicated fees and credit any overpayment as follows:

File Listing:					
Document Number	Document Description	File Name	File Size(Bytes)/ Message Digest	Multi Part /.zip	Pages (if appl.)
1	Electronic Terminal Disclaimer-Filed	eTerminal-Disclaimer.pdf	33567	no	2
			4d3a87e019587c2166e49d7d90482f2d2012346a		
Warnings:					
Information:					
2	Fee Worksheet (SB06)	fee-info.pdf	30408	no	2
			928dd612837266c3a192627169ec5b77b9856778		
Warnings:					
Information:					
Total Files Size (in bytes):			63975		
<p>This Acknowledgement Receipt evidences receipt on the noted date by the USPTO of the indicated documents, characterized by the applicant, and including page counts, where applicable. It serves as evidence of receipt similar to a Post Card, as described in MPEP 503.</p> <p><u>New Applications Under 35 U.S.C. 111</u> If a new application is being filed and the application includes the necessary components for a filing date (see 37 CFR 1.53(b)-(d) and MPEP 506), a Filing Receipt (37 CFR 1.54) will be issued in due course and the date shown on this Acknowledgement Receipt will establish the filing date of the application.</p> <p><u>National Stage of an International Application under 35 U.S.C. 371</u> If a timely submission to enter the national stage of an international application is compliant with the conditions of 35 U.S.C. 371 and other applicable requirements a Form PCT/DO/EO/903 indicating acceptance of the application as a national stage submission under 35 U.S.C. 371 will be issued in addition to the Filing Receipt, in due course.</p> <p><u>New International Application Filed with the USPTO as a Receiving Office</u> If a new international application is being filed and the international application includes the necessary components for an international filing date (see PCT Article 11 and MPEP 1810), a Notification of the International Application Number and of the International Filing Date (Form PCT/RO/105) will be issued in due course, subject to prescriptions concerning national security, and the date shown on this Acknowledgement Receipt will establish the international filing date of the application.</p>					

IN THE UNITED STATES PATENT AND TRADEMARK OFFICE

In re Application of Astely <i>et al.</i>)	
)	
Serial No.: 15/350,360)	
)	Examiner: Md K. Talukder
Filed: November 14, 2016)	
)	Group Art Unit: 2648
For: PUCCH Resource Allocation for Carrier)	
Aggregation in LTE-Advanced)	Confirmation No.: 1120
)	
Docket No: 4015-9600 / P30138-US3)	

Mail Stop Amendment
Commissioner for Patents
P.O. Box 1450
Alexandria, VA 22313-1450

RESPONSE TO OFFICE ACTION

This paper is being filed in response to the Office Action mailed 22 March 2017 having a reply due date of 22 June 2017. Reconsideration is respectfully requested in light of the amendments and/or remarks below. The Office is hereby authorized to charge any fees required for entry of this paper to Deposit Account 18-1167.

CLAIMS LISTING

1. (Currently Amended) A method implemented by a base station of receiving control information from a user terminal, the method comprising:
 - scheduling downlink transmissions to a first user terminal only on a single downlink component carrier associated with a primary cell and scheduling downlink transmissions to a second user terminal on multiple downlink component carriers or on a downlink component carrier associated with a non-primary cell;
 - receiving, on a first set of radio resources, control information associated with the downlink transmissions to the first user terminal, wherein the first set of radio resources is reserved for a user terminal[[s]] scheduled to receive downlink transmissions only on a single downlink component carrier associated with the primary cell; and
 - receiving, on a second set of radio resources, control information associated with the downlink transmissions to the second user terminal, wherein the second set of radio resources is reserved for a user terminal[[s]] scheduled to receive downlink transmissions on multiple downlink component carriers or on a downlink component carrier associated with a non-primary cell, the first and second sets of radio resources being on a same uplink component carrier associated with the primary cell.

2. (Original) The method of claim 1, wherein the first and second sets of radio resources are different.

3. (Original) The method of claim 2, wherein the second set of radio resources are additional resources as compared to the first set of radio resources.

4. (Original) The method of claim 1, further comprising transmitting control information to the first user terminal to explicitly indicate the first set of radio resources on the uplink component carrier associated with the primary cell.

5. (Original) The method of claim 1, further comprising providing the first user terminal with an implicit indication to dynamically assign radio resources in said first set of radio resources.

6. (Original) The method of claim 5, wherein the implicit indication is a control channel element (CCE) of a Physical Downlink Control Channel (PDCCH) used for scheduling the first user terminal.

7. (Original) The method of claim 1, further comprising transmitting control information to the second user terminal on a downlink component carrier to implicitly or explicitly indicate the second set of radio resources on the uplink component carrier associated with the primary cell.

8. (Original) The method of claim 7, wherein at least one of the first and second sets of radio resources is indicated explicitly by an uplink control channel resource index.

9. (Original) The method of claim 8, wherein an explicit indication related to the second set of radio resources is transmitted as radio resource control signaling.

10. (Currently Amended) The method of claim 1, further comprising transmitting, on the single downlink component carrier, an ~~indication to assignment of~~ indication to assignment of radio resources in the second set of radio resources when the second user terminal is scheduled to receive the downlink transmissions on the multiple downlink component carriers or on the downlink component carrier associated with the non-primary cell

11. (Currently Amended) The method of claim 10, wherein the ~~indication to assignment of~~ indication to assignment of radio resources in said second set of radio resources is an acknowledgement resource indication to dynamically assign radio resources to the second user terminal when the second user terminal is scheduled to receive downlink transmissions on the multiple downlink component carriers or on the downlink component carrier associated with the non-primary cell.

12. (Original) The method of claim 11, wherein the acknowledgement resource indication selects radio resources in the second set of radio resources, which is a semi-statically configured set of uplink resources.

13. (Original) The method of claim 1, further comprising:

receiving control signaling on the second set of radio resources if radio resources on a single downlink component carrier associated with a non-primary cell are assigned for the downlink transmissions.

14. (Currently Amended) The method of claim 1, further comprising:

if the first user terminal is scheduled to receive downlink transmissions on a second single downlink component carrier associated with a non-primary cell, receiving control information associated with the downlink transmissions to the first user terminal on the second set of radio resources on the uplink component carrier associated with the primary cell, wherein the second set of radio resources is reserved for a user terminal[[s]] scheduled to receive downlink transmissions on the second single downlink component carrier.

15. (Original) The method of claim 1, wherein the first user equipment is the same as the second user equipment.

16. (Original) The method of claim 1, wherein the first user equipment is different from the second user equipment.

17. (Currently Amended) A base station comprising:

a transmitter to transmit user data on one or more downlink component carriers to a first user terminal and a second user terminal; and

a controller to schedule downlink transmissions to the first user terminal and the second user terminal, the controller configured to:

schedule downlink transmissions to the first user terminal only on a single downlink component carrier associated with a primary cell and schedule downlink transmissions to the second user terminal on multiple downlink component carriers or on a downlink component carrier associated with a non-primary cell;

receive, on a first set of radio resources, control information associated with the downlink transmissions to the first user terminal, wherein the first set of radio resources is reserved for a user terminal[[s]] scheduled to receive downlink transmissions only on a single downlink component carrier associated with the primary cell; and

receive, on a second set of radio resources, control information associated with the downlink transmissions to the second user terminal, wherein the second set of radio resources is reserved for a user terminal[[s]] scheduled to receive downlink transmissions on multiple downlink component carriers or on a downlink component carrier associated with a non-primary cell, the first and second sets of radio resources being on a same uplink component carrier associated with the primary cell.

18. (Currently Amended) A method implemented by a user terminal of transmitting control information in a mobile communication network, the method comprising:

receiving an assignment of radio resources for downlink transmissions from a base station;

transmitting, on a first set of radio resources, control information associated with the downlink transmissions responsive to being assigned radio resources only on a single downlink component carrier associated with the primary cell for the downlink transmission, wherein the first set of radio resources is reserved for a user terminal[[s]] scheduled to receive downlink transmissions on a single downlink component carrier associated with the primary cell; and

transmitting, on a second set of radio resources, control information associated with the downlink transmissions responsive to being assigned radio resources on multiple downlink component carriers or on a downlink component carrier associated with a non-primary cell for the downlink transmission, wherein the second set of radio resources is reserved for a user terminal[[s]] scheduled to receive downlink transmissions on multiple downlink component carriers or on a downlink component carrier associated with a non-primary cell, the first and second sets of radio resources being on a same uplink component carrier associated with the primary cell.

19. (Original) The method of claim 18, wherein the first and second sets of radio resources are different.

20. (Original) The method of claim 19, wherein the second set of radio resources are additional resources as compared to the first set of radio resources.

21. (Original) The method of claim 18, further comprising receiving control information from the base station explicitly indicating the first set of radio resources on the uplink component carrier associated with the primary cell.

22. (Original) The method of claim 21, wherein said receiving the control information comprises receiving an uplink control channel resource index explicitly indicating said first set of radio resources.

23. (Original) The method of claim 22, wherein an explicit indication relating to the second set of radio resources is received as radio resource control signaling.

24. (Original) The method of claim 18, further comprising receiving an implicit indication to dynamically assign radio resources in said first set of radio resources.

25. (Original) The method of claim 24, wherein the implicit indication is a control channel element (CCE) of a Physical Downlink Control Channel (PDCCH) on which the assignment of radio resources for downlink transmissions is received.

26. (Currently Amended) The method of claim 18, further comprising receiving, on the single downlink component carrier, an ~~indication to assignment of~~ indication to assignment of radio resources in the second set of radio resources when the user terminal is scheduled to receive the downlink transmissions on the multiple downlink component carriers or on the downlink component carrier associated with the non-primary cell.

27. (Currently Amended) The method of claim 26, wherein the ~~indication to assignment of~~ indication to assignment of radio resources in said second set of radio resources is an acknowledgement resource indication to dynamically assign radio resources in when the user terminal is scheduled to receive downlink transmissions on the multiple downlink component carriers or on the downlink component carrier associated with the non-primary cell.

28. (Original) The method of claim 27, further comprising selecting radio resources in the second set of radio resources, which is a semi-statically configured set of uplink resources, responsive to the acknowledgement resource indication.

29. (Original) The method of claim 18, further comprising:
transmitting control signaling on the second set of radio resources if radio resources on a single downlink component carrier associated with a non-primary cell are assigned for the downlink transmissions.

30. (Currently Amended) A user terminal for mobile communications, the user terminal comprising:

a receiver to receive downlink transmissions from a base station;

a transmitter to transmit control information associated with the downlink transmission to a base station; and

a controller to select radio resources for transmission of control information associated with the downlink transmissions, the controller configured to:

select a first set of radio resources responsive to being assigned radio resources only on a single downlink component carrier associated with the primary cell for the downlink transmission, wherein the first set of radio resources is reserved for a user terminal[[s]] scheduled to receive downlink transmissions on a single downlink component carrier associated with the primary cell; and
select a second set of radio resources responsive to being assigned radio resources on multiple downlink component carriers or on a downlink component carrier associated with a non-primary cell for the downlink transmissions, wherein the second set of radio resources is reserved for a user terminal[[s]] scheduled to receive downlink transmissions on multiple downlink component carriers or on a downlink component carrier associated with a non-primary cell, the first and second sets of radio resources being on a same uplink component carrier associated with the primary cell.

REMARKS

Claims 1-30 are pending. Claims 1, 10-11, 14, 17-18, 26-27, and 30. No new matter is added by these amendments; support can be found generally in the specification and in at least paragraph [0060]. Applicant submits that all claims are in condition for allowance, and a notice to that effect is respectfully requested.

Claims 1-30 stand rejected under the ground of non-statutory double patenting over claims 1-40 of US Patent Application No. 12/896993 (US Pat. 9497001). To expedite prosecution, Applicant has submitted an electronic terminal disclaimer to overcome the rejection.

Respectfully submitted,
COATS & BENNETT, P.L.L.C.

Dated: May 24, 2017

/Brandee N. Woolard/
Brandee N. Woolard
Registration No.: 68,795
Telephone: (919) 854-1844

Electronic Acknowledgement Receipt

EFS ID:	29302576
Application Number:	15350360
International Application Number:	
Confirmation Number:	1120
Title of Invention:	PUCCH RESOURCE ALLOCATION FOR CARRIER AGGREGATION IN LTE-ADVANCED
First Named Inventor/Applicant Name:	David Astely
Customer Number:	24112
Filer:	Brandee N. Woolard/Leslie Ruckdeschel
Filer Authorized By:	Brandee N. Woolard
Attorney Docket Number:	4015-9600 / P30138-US3
Receipt Date:	24-MAY-2017
Filing Date:	14-NOV-2016
Time Stamp:	15:17:00
Application Type:	Utility under 35 USC 111(a)

Payment information:

Submitted with Payment	no
------------------------	----

File Listing:

Document Number	Document Description	File Name	File Size(Bytes)/ Message Digest	Multi Part /.zip	Pages (if appl.)
1		Response_OA.pdf	42403 1b1a6fc746cdcee00f4d5e2760d933348a77b63	yes	11

Multipart Description/PDF files in .zip description		
Document Description	Start	End
Amendment/Req. Reconsideration-After Non-Final Reject	1	1
Claims	2	10
Applicant Arguments/Remarks Made in an Amendment	11	11

Warnings:

Information:

Total Files Size (in bytes):	42403
-------------------------------------	-------

This Acknowledgement Receipt evidences receipt on the noted date by the USPTO of the indicated documents, characterized by the applicant, and including page counts, where applicable. It serves as evidence of receipt similar to a Post Card, as described in MPEP 503.

New Applications Under 35 U.S.C. 111

If a new application is being filed and the application includes the necessary components for a filing date (see 37 CFR 1.53(b)-(d) and MPEP 506), a Filing Receipt (37 CFR 1.54) will be issued in due course and the date shown on this Acknowledgement Receipt will establish the filing date of the application.

National Stage of an International Application under 35 U.S.C. 371

If a timely submission to enter the national stage of an international application is compliant with the conditions of 35 U.S.C. 371 and other applicable requirements a Form PCT/DO/EO/903 indicating acceptance of the application as a national stage submission under 35 U.S.C. 371 will be issued in addition to the Filing Receipt, in due course.

New International Application Filed with the USPTO as a Receiving Office

If a new international application is being filed and the international application includes the necessary components for an international filing date (see PCT Article 11 and MPEP 1810), a Notification of the International Application Number and of the International Filing Date (Form PCT/RO/105) will be issued in due course, subject to prescriptions concerning national security, and the date shown on this Acknowledgement Receipt will establish the international filing date of the application.

Under the Paperwork Reduction Act of 1995, no persons are required to respond to a collection of information unless it displays a valid OMB control number.

PATENT APPLICATION FEE DETERMINATION RECORD Substitute for Form PTO-875			Application or Docket Number 15/350,360	Filing Date 11/14/2016	<input type="checkbox"/> To be Mailed
ENTITY: <input checked="" type="checkbox"/> LARGE <input type="checkbox"/> SMALL <input type="checkbox"/> MICRO					
APPLICATION AS FILED – PART I					
(Column 1)		(Column 2)			
FOR	NUMBER FILED	NUMBER EXTRA	RATE (\$)	FEE (\$)	
<input type="checkbox"/> BASIC FEE <small>(37 CFR 1.16(a), (b), or (c))</small>	N/A	N/A	N/A		
<input type="checkbox"/> SEARCH FEE <small>(37 CFR 1.16(k), (l), or (m))</small>	N/A	N/A	N/A		
<input type="checkbox"/> EXAMINATION FEE <small>(37 CFR 1.16(o), (p), or (q))</small>	N/A	N/A	N/A		
TOTAL CLAIMS <small>(37 CFR 1.16(j))</small>	minus 20 =	*	X \$ =		
INDEPENDENT CLAIMS <small>(37 CFR 1.16(h))</small>	minus 3 =	*	X \$ =		
<input type="checkbox"/> APPLICATION SIZE FEE <small>(37 CFR 1.16(s))</small>	If the specification and drawings exceed 100 sheets of paper, the application size fee due is \$310 (\$155 for small entity) for each additional 50 sheets or fraction thereof. See 35 U.S.C. 41(a)(1)(G) and 37 CFR 1.16(s).				
<input type="checkbox"/> MULTIPLE DEPENDENT CLAIM PRESENT <small>(37 CFR 1.16(j))</small>					
* If the difference in column 1 is less than zero, enter "0" in column 2.			TOTAL		

APPLICATION AS AMENDED – PART II								
(Column 1)		(Column 2)		(Column 3)				
AMENDMENT	05/24/2017	CLAIMS REMAINING AFTER AMENDMENT		HIGHEST NUMBER PREVIOUSLY PAID FOR	PRESENT EXTRA	RATE (\$)	ADDITIONAL FEE (\$)	
	Total (37 CFR 1.16(i))	* 30	Minus	** 30	= 0	X \$80 =	0	
	Independent (37 CFR 1.16(h))	* 4	Minus	***4	= 0	X \$420 =	0	
	<input type="checkbox"/> Application Size Fee (37 CFR 1.16(s))							
	<input type="checkbox"/> FIRST PRESENTATION OF MULTIPLE DEPENDENT CLAIM (37 CFR 1.16(j))							
TOTAL ADD'L FEE						0		

(Column 1)		(Column 2)		(Column 3)				
AMENDMENT		CLAIMS REMAINING AFTER AMENDMENT		HIGHEST NUMBER PREVIOUSLY PAID FOR	PRESENT EXTRA	RATE (\$)	ADDITIONAL FEE (\$)	
	Total (37 CFR 1.16(i))	*	Minus	**	=	X \$ =		
	Independent (37 CFR 1.16(h))	*	Minus	***	=	X \$ =		
	<input type="checkbox"/> Application Size Fee (37 CFR 1.16(s))							
	<input type="checkbox"/> FIRST PRESENTATION OF MULTIPLE DEPENDENT CLAIM (37 CFR 1.16(j))							
TOTAL ADD'L FEE								
* If the entry in column 1 is less than the entry in column 2, write "0" in column 3.						LIE EMORY LANE		
** If the "Highest Number Previously Paid For" IN THIS SPACE is less than 20, enter "20".								
*** If the "Highest Number Previously Paid For" IN THIS SPACE is less than 3, enter "3".								
The "Highest Number Previously Paid For" (Total or Independent) is the highest number found in the appropriate box in column 1.								

This collection of information is required by 37 CFR 1.16. The information is required to obtain or retain a benefit by the public which is to file (and by the USPTO to process) an application. Confidentiality is governed by 35 U.S.C. 122 and 37 CFR 1.14. This collection is estimated to take 12 minutes to complete, including gathering, preparing, and submitting the completed application form to the USPTO. Time will vary depending upon the individual case. Any comments on the amount of time you require to complete this form and/or suggestions for reducing this burden, should be sent to the Chief Information Officer, U.S. Patent and Trademark Office, U.S. Department of Commerce, P.O. Box 1450, Alexandria, VA 22313-1450. DO NOT SEND FEES OR COMPLETED FORMS TO THIS ADDRESS. **SEND TO: Commissioner for Patents, P.O. Box 1450, Alexandria, VA 22313-1450.**
 If you need assistance in completing the form, call 1-800-PTO-9199 and select option 2.



UNITED STATES PATENT AND TRADEMARK OFFICE

UNITED STATES DEPARTMENT OF COMMERCE
United States Patent and Trademark Office
Address: COMMISSIONER FOR PATENTS
P.O. Box 1450
Alexandria, Virginia 22313-1450
www.uspto.gov

NOTICE OF ALLOWANCE AND FEE(S) DUE

24112 7590 07/05/2017
COATS & BENNETT, PLLC
1400 Crescent Green, Suite 300
Cary, NC 27518

EXAMINER

TALUKDER, MD K

ART UNIT PAPER NUMBER

2648

DATE MAILED: 07/05/2017

Table with 5 columns: APPLICATION NO., FILING DATE, FIRST NAMED INVENTOR, ATTORNEY DOCKET NO., CONFIRMATION NO.

15/350,360 11/14/2016 David Astely 4015-9600 / P30138-US3 1120

TITLE OF INVENTION: PUCCH RESOURCE ALLOCATION FOR CARRIER AGGREGATION IN LTE-ADVANCED

Table with 7 columns: APPLN. TYPE, ENTITY STATUS, ISSUE FEE DUE, PUBLICATION FEE DUE, PREV. PAID ISSUE FEE, TOTAL FEE(S) DUE, DATE DUE

nonprovisional UNDISCOUNTED \$960 \$0 \$0 \$960 10/05/2017

THE APPLICATION IDENTIFIED ABOVE HAS BEEN EXAMINED AND IS ALLOWED FOR ISSUANCE AS A PATENT. PROSECUTION ON THE MERITS IS CLOSED. THIS NOTICE OF ALLOWANCE IS NOT A GRANT OF PATENT RIGHTS. THIS APPLICATION IS SUBJECT TO WITHDRAWAL FROM ISSUE AT THE INITIATIVE OF THE OFFICE OR UPON PETITION BY THE APPLICANT. SEE 37 CFR 1.313 AND MPEP 1308.

THE ISSUE FEE AND PUBLICATION FEE (IF REQUIRED) MUST BE PAID WITHIN THREE MONTHS FROM THE MAILING DATE OF THIS NOTICE OR THIS APPLICATION SHALL BE REGARDED AS ABANDONED. THIS STATUTORY PERIOD CANNOT BE EXTENDED. SEE 35 U.S.C. 151. THE ISSUE FEE DUE INDICATED ABOVE DOES NOT REFLECT A CREDIT FOR ANY PREVIOUSLY PAID ISSUE FEE IN THIS APPLICATION. IF AN ISSUE FEE HAS PREVIOUSLY BEEN PAID IN THIS APPLICATION (AS SHOWN ABOVE), THE RETURN OF PART B OF THIS FORM WILL BE CONSIDERED A REQUEST TO REAPPLY THE PREVIOUSLY PAID ISSUE FEE TOWARD THE ISSUE FEE NOW DUE.

HOW TO REPLY TO THIS NOTICE:

I. Review the ENTITY STATUS shown above. If the ENTITY STATUS is shown as SMALL or MICRO, verify whether entitlement to that entity status still applies.

If the ENTITY STATUS is the same as shown above, pay the TOTAL FEE(S) DUE shown above.

If the ENTITY STATUS is changed from that shown above, on PART B - FEE(S) TRANSMITTAL, complete section number 5 titled "Change in Entity Status (from status indicated above)".

For purposes of this notice, small entity fees are 1/2 the amount of undiscounted fees, and micro entity fees are 1/2 the amount of small entity fees.

II. PART B - FEE(S) TRANSMITTAL, or its equivalent, must be completed and returned to the United States Patent and Trademark Office (USPTO) with your ISSUE FEE and PUBLICATION FEE (if required). If you are charging the fee(s) to your deposit account, section "4b" of Part B - Fee(s) Transmittal should be completed and an extra copy of the form should be submitted. If an equivalent of Part B is filed, a request to reapply a previously paid issue fee must be clearly made, and delays in processing may occur due to the difficulty in recognizing the paper as an equivalent of Part B.

III. All communications regarding this application must give the application number. Please direct all communications prior to issuance to Mail Stop ISSUE FEE unless advised to the contrary.

IMPORTANT REMINDER: Utility patents issuing on applications filed on or after Dec. 12, 1980 may require payment of maintenance fees. It is patentee's responsibility to ensure timely payment of maintenance fees when due.

PART B - FEE(S) TRANSMITTAL

**Complete and send this form, together with applicable fee(s), to: Mail Mail Stop ISSUE FEE
 Commissioner for Patents
 P.O. Box 1450
 Alexandria, Virginia 22313-1450
 or Fax (571)-273-2885**

INSTRUCTIONS: This form should be used for transmitting the ISSUE FEE and PUBLICATION FEE (if required). Blocks 1 through 5 should be completed where appropriate. All further correspondence including the Patent, advance orders and notification of maintenance fees will be mailed to the current correspondence address as indicated unless corrected below or directed otherwise in Block 1, by (a) specifying a new correspondence address; and/or (b) indicating a separate "FEE ADDRESS" for maintenance fee notifications.

CURRENT CORRESPONDENCE ADDRESS (Note: Use Block 1 for any change of address)

24112 7590 07/05/2017
 COATS & BENNETT, PLLC
 1400 Crescent Green, Suite 300
 Cary, NC 27518

Note: A certificate of mailing can only be used for domestic mailings of the Fee(s) Transmittal. This certificate cannot be used for any other accompanying papers. Each additional paper, such as an assignment or formal drawing, must have its own certificate of mailing or transmission.

Certificate of Mailing or Transmission

I hereby certify that this Fee(s) Transmittal is being deposited with the United States Postal Service with sufficient postage for first class mail in an envelope addressed to the Mail Stop ISSUE FEE address above, or being facsimile transmitted to the USPTO (571) 273-2885, on the date indicated below.

_____ (Depositor's name)
_____ (Signature)
_____ (Date)

APPLICATION NO.	FILING DATE	FIRST NAMED INVENTOR	ATTORNEY DOCKET NO.	CONFIRMATION NO.
15/350,360	11/14/2016	David Astely	4015-9600 / P30138-US3	1120

TITLE OF INVENTION: PUCCH RESOURCE ALLOCATION FOR CARRIER AGGREGATION IN LTE-ADVANCED

APPLN. TYPE	ENTITY STATUS	ISSUE FEE DUE	PUBLICATION FEE DUE	PREV. PAID ISSUE FEE	TOTAL FEE(S) DUE	DATE DUE
nonprovisional	UNDISCOUNTED	\$960	\$0	\$0	\$960	10/05/2017

EXAMINER	ART UNIT	CLASS-SUBCLASS
TALUKDER, MD K	2648	455-509000

1. Change of correspondence address or indication of "Fee Address" (37 CFR 1.363).

- Change of correspondence address (or Change of Correspondence Address form PTO/SB/122) attached.
- "Fee Address" indication (or "Fee Address" Indication form PTO/SB/47; Rev 03-02 or more recent) attached. **Use of a Customer Number is required.**

2. For printing on the patent front page, list

- (1) The names of up to 3 registered patent attorneys or agents OR, alternatively, 1 _____
- (2) The name of a single firm (having as a member a registered attorney or agent) and the names of up to 2 registered patent attorneys or agents. If no name is listed, no name will be printed. 2 _____
- 3 _____

3. ASSIGNEE NAME AND RESIDENCE DATA TO BE PRINTED ON THE PATENT (print or type)

PLEASE NOTE: Unless an assignee is identified below, no assignee data will appear on the patent. If an assignee is identified below, the document has been filed for recordation as set forth in 37 CFR 3.11. Completion of this form is NOT a substitute for filing an assignment.

(A) NAME OF ASSIGNEE _____ (B) RESIDENCE: (CITY and STATE OR COUNTRY) _____

Please check the appropriate assignee category or categories (will not be printed on the patent): Individual Corporation or other private group entity Government

4a. The following fee(s) are submitted:
 Issue Fee
 Publication Fee (No small entity discount permitted)
 Advance Order - # of Copies _____

4b. Payment of Fee(s): (**Please first reapply any previously paid issue fee shown above**)
 A check is enclosed.
 Payment by credit card. Form PTO-2038 is attached.
 The director is hereby authorized to charge the required fee(s), any deficiency, or credits any overpayment, to Deposit Account Number _____ (enclose an extra copy of this form).

5. **Change in Entity Status** (from status indicated above)
 Applicant certifying micro entity status. See 37 CFR 1.29
 Applicant asserting small entity status. See 37 CFR 1.27
 Applicant changing to regular undiscounted fee status.

NOTE: Absent a valid certification of Micro Entity Status (see forms PTO/SB/15A and 15B), issue fee payment in the micro entity amount will not be accepted at the risk of application abandonment.
NOTE: If the application was previously under micro entity status, checking this box will be taken to be a notification of loss of entitlement to micro entity status.
NOTE: Checking this box will be taken to be a notification of loss of entitlement to small or micro entity status, as applicable.

NOTE: This form must be signed in accordance with 37 CFR 1.31 and 1.33. See 37 CFR 1.4 for signature requirements and certifications.

Authorized Signature _____ Date _____
 Typed or printed name _____ Registration No. _____



UNITED STATES PATENT AND TRADEMARK OFFICE

UNITED STATES DEPARTMENT OF COMMERCE
United States Patent and Trademark Office
Address: COMMISSIONER FOR PATENTS
P. O. Box 1450
Alexandria, Virginia 22313-1450
www.uspto.gov

Table with 5 columns: APPLICATION NO., FILING DATE, FIRST NAMED INVENTOR, ATTORNEY DOCKET NO., CONFIRMATION NO.
Row 1: 15/350,360, 11/14/2016, David Astely, 4015-9600 / P30138-US3, 1120
Row 2: 24112, 7590, 07/05/2017, COATS & BENNETT, PLLC, 1400 Crescent Green, Suite 300, Cary, NC 27518
Row 3: EXAMINER TALUKDER, MD K
Row 4: ART UNIT 2648, PAPER NUMBER

DATE MAILED: 07/05/2017

Determination of Patent Term Adjustment under 35 U.S.C. 154 (b)
(Applications filed on or after May 29, 2000)

The Office has discontinued providing a Patent Term Adjustment (PTA) calculation with the Notice of Allowance.

Section 1(h)(2) of the AIA Technical Corrections Act amended 35 U.S.C. 154(b)(3)(B)(i) to eliminate the requirement that the Office provide a patent term adjustment determination with the notice of allowance. See Revisions to Patent Term Adjustment, 78 Fed. Reg. 19416, 19417 (Apr. 1, 2013). Therefore, the Office is no longer providing an initial patent term adjustment determination with the notice of allowance. The Office will continue to provide a patent term adjustment determination with the Issue Notification Letter that is mailed to applicant approximately three weeks prior to the issue date of the patent, and will include the patent term adjustment on the patent. Any request for reconsideration of the patent term adjustment determination (or reinstatement of patent term adjustment) should follow the process outlined in 37 CFR 1.705.

Any questions regarding the Patent Term Extension or Adjustment determination should be directed to the Office of Patent Legal Administration at (571)-272-7702. Questions relating to issue and publication fee payments should be directed to the Customer Service Center of the Office of Patent Publication at 1-(888)-786-0101 or (571)-272-4200.

OMB Clearance and PRA Burden Statement for PTOL-85 Part B

The Paperwork Reduction Act (PRA) of 1995 requires Federal agencies to obtain Office of Management and Budget approval before requesting most types of information from the public. When OMB approves an agency request to collect information from the public, OMB (i) provides a valid OMB Control Number and expiration date for the agency to display on the instrument that will be used to collect the information and (ii) requires the agency to inform the public about the OMB Control Number's legal significance in accordance with 5 CFR 1320.5(b).

The information collected by PTOL-85 Part B is required by 37 CFR 1.311. The information is required to obtain or retain a benefit by the public which is to file (and by the USPTO to process) an application. Confidentiality is governed by 35 U.S.C. 122 and 37 CFR 1.14. This collection is estimated to take 12 minutes to complete, including gathering, preparing, and submitting the completed application form to the USPTO. Time will vary depending upon the individual case. Any comments on the amount of time you require to complete this form and/or suggestions for reducing this burden, should be sent to the Chief Information Officer, U.S. Patent and Trademark Office, U.S. Department of Commerce, P.O. Box 1450, Alexandria, Virginia 22313-1450. DO NOT SEND FEES OR COMPLETED FORMS TO THIS ADDRESS. SEND TO: Commissioner for Patents, P.O. Box 1450, Alexandria, Virginia 22313-1450. Under the Paperwork Reduction Act of 1995, no persons are required to respond to a collection of information unless it displays a valid OMB control number.

Privacy Act Statement

The Privacy Act of 1974 (P.L. 93-579) requires that you be given certain information in connection with your submission of the attached form related to a patent application or patent. Accordingly, pursuant to the requirements of the Act, please be advised that: (1) the general authority for the collection of this information is 35 U.S.C. 2(b)(2); (2) furnishing of the information solicited is voluntary; and (3) the principal purpose for which the information is used by the U.S. Patent and Trademark Office is to process and/or examine your submission related to a patent application or patent. If you do not furnish the requested information, the U.S. Patent and Trademark Office may not be able to process and/or examine your submission, which may result in termination of proceedings or abandonment of the application or expiration of the patent.

The information provided by you in this form will be subject to the following routine uses:

1. The information on this form will be treated confidentially to the extent allowed under the Freedom of Information Act (5 U.S.C. 552) and the Privacy Act (5 U.S.C. 552a). Records from this system of records may be disclosed to the Department of Justice to determine whether disclosure of these records is required by the Freedom of Information Act.
2. A record from this system of records may be disclosed, as a routine use, in the course of presenting evidence to a court, magistrate, or administrative tribunal, including disclosures to opposing counsel in the course of settlement negotiations.
3. A record in this system of records may be disclosed, as a routine use, to a Member of Congress submitting a request involving an individual, to whom the record pertains, when the individual has requested assistance from the Member with respect to the subject matter of the record.
4. A record in this system of records may be disclosed, as a routine use, to a contractor of the Agency having need for the information in order to perform a contract. Recipients of information shall be required to comply with the requirements of the Privacy Act of 1974, as amended, pursuant to 5 U.S.C. 552a(m).
5. A record related to an International Application filed under the Patent Cooperation Treaty in this system of records may be disclosed, as a routine use, to the International Bureau of the World Intellectual Property Organization, pursuant to the Patent Cooperation Treaty.
6. A record in this system of records may be disclosed, as a routine use, to another federal agency for purposes of National Security review (35 U.S.C. 181) and for review pursuant to the Atomic Energy Act (42 U.S.C. 218(c)).
7. A record from this system of records may be disclosed, as a routine use, to the Administrator, General Services, or his/her designee, during an inspection of records conducted by GSA as part of that agency's responsibility to recommend improvements in records management practices and programs, under authority of 44 U.S.C. 2904 and 2906. Such disclosure shall be made in accordance with the GSA regulations governing inspection of records for this purpose, and any other relevant (i.e., GSA or Commerce) directive. Such disclosure shall not be used to make determinations about individuals.
8. A record from this system of records may be disclosed, as a routine use, to the public after either publication of the application pursuant to 35 U.S.C. 122(b) or issuance of a patent pursuant to 35 U.S.C. 151. Further, a record may be disclosed, subject to the limitations of 37 CFR 1.14, as a routine use, to the public if the record was filed in an application which became abandoned or in which the proceedings were terminated and which application is referenced by either a published application, an application open to public inspection or an issued patent.
9. A record from this system of records may be disclosed, as a routine use, to a Federal, State, or local law enforcement agency, if the USPTO becomes aware of a violation or potential violation of law or regulation.

Notice of Allowability	Application No. 15/350,360	Applicant(s) ASTELY ET AL.	
	Examiner MD TALUKDER	Art Unit 2648	AIA (First Inventor to File) Status No

-- The MAILING DATE of this communication appears on the cover sheet with the correspondence address--

All claims being allowable, PROSECUTION ON THE MERITS IS (OR REMAINS) CLOSED in this application. If not included herewith (or previously mailed), a Notice of Allowance (PTOL-85) or other appropriate communication will be mailed in due course. **THIS NOTICE OF ALLOWABILITY IS NOT A GRANT OF PATENT RIGHTS.** This application is subject to withdrawal from issue at the initiative of the Office or upon petition by the applicant. See 37 CFR 1.313 and MPEP 1308.

1. This communication is responsive to 5/24/2017.
 A declaration(s)/affidavit(s) under **37 CFR 1.130(b)** was/were filed on _____.
2. An election was made by the applicant in response to a restriction requirement set forth during the interview on _____; the restriction requirement and election have been incorporated into this action.
3. The allowed claim(s) is/are 1-30. As a result of the allowed claim(s), you may be eligible to benefit from the **Patent Prosecution Highway** program at a participating intellectual property office for the corresponding application. For more information, please see http://www.uspto.gov/patents/init_events/pph/index.jsp or send an inquiry to PPHfeedback@uspto.gov.
4. Acknowledgment is made of a claim for foreign priority under 35 U.S.C. § 119(a)-(d) or (f).

Certified copies:

- a) All b) Some *c) None of the:
1. Certified copies of the priority documents have been received.
 2. Certified copies of the priority documents have been received in Application No. _____.
 3. Copies of the certified copies of the priority documents have been received in this national stage application from the International Bureau (PCT Rule 17.2(a)).

* Certified copies not received: _____.

Applicant has THREE MONTHS FROM THE "MAILING DATE" of this communication to file a reply complying with the requirements noted below. Failure to timely comply will result in ABANDONMENT of this application.
THIS THREE-MONTH PERIOD IS NOT EXTENDABLE.

5. CORRECTED DRAWINGS (as "replacement sheets") must be submitted.
 including changes required by the attached Examiner's Amendment / Comment or in the Office action of Paper No./Mail Date _____.
Identifying indicia such as the application number (see 37 CFR 1.84(c)) should be written on the drawings in the front (not the back) of each sheet. Replacement sheet(s) should be labeled as such in the header according to 37 CFR 1.121(d).
6. DEPOSIT OF and/or INFORMATION about the deposit of BIOLOGICAL MATERIAL must be submitted. Note the attached Examiner's comment regarding REQUIREMENT FOR THE DEPOSIT OF BIOLOGICAL MATERIAL.

Attachment(s)

- | | |
|--|---|
| <ol style="list-style-type: none"> 1. <input checked="" type="checkbox"/> Notice of References Cited (PTO-892) 2. <input type="checkbox"/> Information Disclosure Statements (PTO/SB/08),
Paper No./Mail Date _____ 3. <input type="checkbox"/> Examiner's Comment Regarding Requirement for Deposit
of Biological Material 4. <input type="checkbox"/> Interview Summary (PTO-413),
Paper No./Mail Date _____ | <ol style="list-style-type: none"> 5. <input type="checkbox"/> Examiner's Amendment/Comment 6. <input checked="" type="checkbox"/> Examiner's Statement of Reasons for Allowance 7. <input type="checkbox"/> Other _____ |
|--|---|

/MD TALUKDER/
Primary Examiner, Art Unit 2648

1. The present application is being examined under the pre-AIA first to invent provisions.

REASONS FOR ALLOWANCE

2. Claims 1-30 are allowed over the prior art of record. Interpreting the claims in light of the specification. The following is an examiner's statement of reasons for allowance: Interpreting the claims in light of the specification. Claims has been found allowable because the prior art of record, does not teach, suggest or disclose "scheduling downlink transmissions to a first user terminal only on a single downlink component carrier associated with a primary cell and scheduling downlink transmissions to a second user terminal on multiple downlink component carriers or on a downlink component carrier associated with a non-primary cell; receiving, on a first set of radio resources, control information associated with the downlink transmissions to the first user terminal, wherein the first set of radio resources is reserved for a user terminal[s] scheduled to receive downlink transmissions only on a single downlink component carrier associated with the primary cell; and receiving, on a second set of radio resources, control information associated with the downlink transmissions to the second user terminal, wherein the second set of radio resources is reserved for a user terminal[s] scheduled to receive downlink transmissions on multiple downlink component carriers or on a downlink component carrier associated with a non-primary cell, the first and second sets of radio resources being on a same uplink component carrier associated with the primary cell" in combination with the rest of the limitations of the claim. The prior art of the record discloses a communication method between access point and a user station in a specific cell but does not disclose each and every aspect of the above limitation. Any comments considered necessary by applicant must be

submitted no later than the payment of the issue fee and, to avoid processing delays, should preferably accompany the issue fee. Such submissions should be clearly labeled "Comments on Statement of Reasons for Allowance."

Conclusion

Any inquiry concerning this communication or earlier communications from the examiner should be directed to MD TALUKDER whose telephone number is (571)270-3222. The examiner can normally be reached on Monday to Friday from (9:30 to 4:00).

If attempts to reach the examiner by telephone are unsuccessful, the examiner's supervisor, Wesley Kim can be reached on 571-272-7867. The fax phone number for the organization where this application or proceeding is assigned is 571-273-8300.

Information regarding the status of an application may be obtained from the Patent Application Information Retrieval (PAIR) system. Status information for published applications may be obtained from either Private PAIR or Public PAIR. Status information for unpublished applications is available through Private PAIR only. For more information about the PAIR system, see <http://pair-direct.uspto.gov>. Should you have questions on access to the Private PAIR system, contact the Electronic Business Center (EBC) at 866-217-9197 (toll-free). If you would like assistance from a USPTO Customer Service Representative or access to the automated information system, call 800-786-9199 (IN USA OR CANADA) or 571-272-1000.

Application/Control Number: 15/350,360
Art Unit: 2648

Page 4

/MD TALUKDER/

Primary Examiner, Art Unit 2648

Notice of References Cited	Application/Control No. 15/350,360	Applicant(s)/Patent Under Reexamination ASTELY ET AL.	
	Examiner MD TALUKDER	Art Unit 2648	Page 1 of 3

U.S. PATENT DOCUMENTS

*		Document Number Country Code-Number-Kind Code	Date MM-YYYY	Name	CPC Classification	US Classification
*	A	US-2002/0160784 A1	10-2002	Kuwahara, Soichi	H04W28/26	455/452.1
*	B	US-2010/0003997 A1	01-2010	KOYANAGI; Kenichiro	H04L1/0003	455/450
*	C	US-2010/0098012 A1	04-2010	Bala; Erdem	H04L5/001	370/329
*	D	US-2010/0208679 A1	08-2010	Papasakellariou; Aris	H04L1/1614	370/329
*	E	US-2010/0232373 A1	09-2010	Nory; Ravikiran	H04W72/1289	370/329
*	F	US-2010/0271970 A1	10-2010	Pan; Kyle Jung-Lin	H04L1/0026	370/252
*	G	US-2010/0285809 A1	11-2010	Lindstrom; Magnus	H04L5/001	455/450
*	H	US-2010/0296389 A1	11-2010	Khandekar; Aamod Dinkar	H04L5/0007	370/216
*	I	US-2010/0322173 A1	12-2010	Marinier; Paul	H04W76/048	370/329
*	J	US-2011/0007695 A1	01-2011	Choi; Hyung-Nam	H04L5/0007	370/329
*	K	US-2011/0007699 A1	01-2011	Moon; Sung Ho	H04L5/0053	370/329
*	L	US-2011/0081913 A1	04-2011	Lee; Jung A.	H04L5/003	455/450
*	M	US-2011/0081932 A1	04-2011	Astely; David	H04L5/001	455/509

FOREIGN PATENT DOCUMENTS

*		Document Number Country Code-Number-Kind Code	Date MM-YYYY	Country	Name	CPC Classification
	N					
	O					
	P					
	Q					
	R					
	S					
	T					

NON-PATENT DOCUMENTS

*		Include as applicable: Author, Title Date, Publisher, Edition or Volume, Pertinent Pages)
	U	
	V	
	W	
	X	

*A copy of this reference is not being furnished with this Office action. (See MPEP § 707.05(a).)
Dates in MM-YYYY format are publication dates. Classifications may be US or foreign.

Notice of References Cited	Application/Control No. 15/350,360	Applicant(s)/Patent Under Reexamination ASTELY ET AL.	
	Examiner MD TALUKDER	Art Unit 2648	Page 2 of 3

U.S. PATENT DOCUMENTS

*		Document Number Country Code-Number-Kind Code	Date MM-YYYY	Name	CPC Classification	US Classification
*	A	US-2011/0243039 A1	10-2011	PAPASAKELLARIOU; Aris	H04L1/1861	370/280
*	B	US-2011/0310856 A1	12-2011	Hariharan; Priya	H04L1/1607	370/336
*	C	US-2012/0020317 A1	01-2012	Ishii; Hiroyuki	H04L1/1854	370/329
*	D	US-2012/0051306 A1	03-2012	Chung; Jae Hoon	H04L1/1893	370/329
*	E	US-2012/0082125 A1	04-2012	Huang; Yada	H04L5/0007	370/329
*	F	US-2012/0140708 A1	06-2012	Choudhury; Sayantan	H04W72/082	370/328
*	G	US-8,194,603 B2	06-2012	Nimbalker; Ajit	H04L5/001	370/329
*	H	US-8,265,030 B2	09-2012	Miki; Nobuhiko	H04W72/1257	370/330
*	I	US-2012/0314675 A1	12-2012	Vujcic; Dragan	H04L5/001	370/329
*	J	US-2013/0003700 A1	01-2013	Zhang; Jian	H04W76/028	370/331
*	K	US-2013/0010721 A1	01-2013	Aiba; Tatsushi	H04L1/1812	370/329
*	L	US-2013/0034073 A1	02-2013	Aiba; Tatsushi	H04L1/0026	370/329
*	M	US-8,447,343 B2	05-2013	Gerstenberger; Dirk	H04W52/10	370/248

FOREIGN PATENT DOCUMENTS

*		Document Number Country Code-Number-Kind Code	Date MM-YYYY	Country	Name	Classification
	N					
	O					
	P					
	Q					
	R					
	S					
	T					

NON-PATENT DOCUMENTS

*		Include as applicable: Author, Title Date, Publisher, Edition or Volume, Pertinent Pages)
	U	
	V	
	W	
	X	

*A copy of this reference is not being furnished with this Office action. (See MPEP § 707.05(a).)
Dates in MM-YYYY format are publication dates. Classifications may be US or foreign.

Notice of References Cited	Application/Control No. 15/350,360	Applicant(s)/Patent Under Reexamination ASTELY ET AL.	
	Examiner MD TALUKDER	Art Unit 2648	Page 3 of 3

U.S. PATENT DOCUMENTS

*	Document Number Country Code-Number-Kind Code	Date MM-YYYY	Name	CPC Classification	US Classification
*	A US-2013/0136084 A1	05-2013	ZHANG; Yuantao	H04W72/0413	370/329
*	B US-8,472,368 B2	06-2013	Baldemair; Robert	H04L5/0053	370/318
*	C US-8,634,358 B2	01-2014	Damnjanovic; Jelena M.	H04L1/1861	370/329
*	D US-2014/0078941 A1	03-2014	Seo; Dong Youn	H04L1/1822	370/280
*	E US-8,792,830 B2	07-2014	Lim; Suhwan	H04L25/02	375/260
	F US-				
	G US-				
	H US-				
	I US-				
	J US-				
	K US-				
	L US-				
	M US-				

FOREIGN PATENT DOCUMENTS

*	Document Number Country Code-Number-Kind Code	Date MM-YYYY	Country	Name	Classification
	N				
	O				
	P				
	Q				
	R				
	S				
	T				

NON-PATENT DOCUMENTS

*	Document Number Country Code-Number-Kind Code	Date MM-YYYY	Country	Name	Classification
	Include as applicable: Author, Title Date, Publisher, Edition or Volume, Pertinent Pages)				
	U				
	V				
	W				
	X				

*A copy of this reference is not being furnished with this Office action. (See MPEP § 707.05(a).)
Dates in MM-YYYY format are publication dates. Classifications may be US or foreign.

Search Notes 	Application/Control No. 15350360	Applicant(s)/Patent Under Reexamination ASTELY ET AL.
	Examiner MD TALUKDER	Art Unit 2648

CPC- SEARCHED		
Symbol	Date	Examiner
H04B1/3833, H04M1/0247, H04M1/0237	3/16/2017	Talukder
H04B1/3833, H04M1/0247, H04M1/0237	6/26/2017	Talukder

CPC COMBINATION SETS - SEARCHED		
Symbol	Date	Examiner

US CLASSIFICATION SEARCHED			
Class	Subclass	Date	Examiner
455	451,452.1,509,456.1,522,137,103,575	3/16/2017	Talukder
370	All	3/17/2017	Talukder
455	509,522,456.6,137,103,575	6/26/2017	Talukder

SEARCH NOTES		
Search Notes	Date	Examiner
Assignee Searched	3/16/2017	Talukder
Inventor Searched	3/17/2017	Talukder
East Searched	3/17/2017	Talukder
Assignee Searched	6/25/2017	Talukder
Inventor Searched	6/26/2017	
East Searched	6/26/2017	Talukder
		Talukder

INTERFERENCE SEARCH			
US Class/ CPC Symbol	US Subclass / CPC Group	Date	Examiner
H04B1/3833, H04M1/0247, H04M1/0237		3/16/2017	Talukder

--	--

INTERFERENCE SEARCH

US Class/ CPC Symbol	US Subclass / CPC Group	Date	Examiner
455	451,452.1,509,456.1,522,137,103,575	3/17/2017	Talukder
455	509,522,456.6,137,103,575	6/26/2017	Talukder
H04B1/3833, H04M1/0247, H04M1/0237		6/25/2017	Talukder

--	--



UNITED STATES PATENT AND TRADEMARK OFFICE

UNITED STATES DEPARTMENT OF COMMERCE
 United States Patent and Trademark Office
 Address: COMMISSIONER FOR PATENTS
 P.O. Box 1450
 Alexandria, Virginia 22313-1450
 www.uspto.gov

BIB DATA SHEET

CONFIRMATION NO. 1120

SERIAL NUMBER 15/350,360	FILING or 371(c) DATE 11/14/2016 RULE	CLASS 455	GROUP ART UNIT 2648	ATTORNEY DOCKET NO. 4015-9600 / P30138-US3		
APPLICANTS Telefonaktiebolaget LM Ericsson (publ), Stockholm, SWEDEN; INVENTORS David Astely, Bromma, SWEDEN; Robert Baldemair, Solna, SWEDEN; Dirk Gerstenberger, Stockholm, SWEDEN; Daniel Larsson, Stockholm, SWEDEN; Lars Lindbom, Karlstad, SWEDEN; Stefan Parkvall, Bromma, SWEDEN; ** CONTINUING DATA ***** This application is a CON of 12/896,993 10/04/2010 PAT 9497004 which claims benefit of 61/248,661 10/05/2009 ** FOREIGN APPLICATIONS ***** ** IF REQUIRED, FOREIGN FILING LICENSE GRANTED ** 11/21/2016						
Foreign Priority claimed <input type="checkbox"/> Yes <input checked="" type="checkbox"/> No	35 USC 119(a-d) conditions met <input type="checkbox"/> Yes <input checked="" type="checkbox"/> No	<input type="checkbox"/> Met after Allowance Initials	STATE OR COUNTRY SWEDEN	SHEETS DRAWINGS 12	TOTAL CLAIMS 30	INDEPENDENT CLAIMS 4
ADDRESS COATS & BENNETT, PLLC 1400 Crescent Green, Suite 300 Cary, NC 27518 UNITED STATES						
TITLE PUCCH RESOURCE ALLOCATION FOR CARRIER AGGREGATION IN LTE-ADVANCED						
FILING FEE RECEIVED 2960	FEES: Authority has been given in Paper No. _____ to charge/credit DEPOSIT ACCOUNT No. _____ for following:			<input type="checkbox"/> All Fees <input type="checkbox"/> 1.16 Fees (Filing) <input type="checkbox"/> 1.17 Fees (Processing Ext. of time) <input type="checkbox"/> 1.18 Fees (Issue) <input type="checkbox"/> Other _____ <input type="checkbox"/> Credit		

EAST Search History

EAST Search History (Prior Art)

Ref #	Hits	Search Query	DBs	Default Operator	Plurals	Time Stamp
L1	37	455/509,522,456.6,137,103,575.ccls. and (downlink near3 carrier) and (uplink near3 (primary first initial) near3 carrier) and ((second 2nd other next) with (channel resource)) and (carrier adj aggregation)	US-PGPUB; USPAT; USOCR; DERWENT; IBM_TDB	OR	ON	2017/06/26 18:41
L2	37	455/509,522,456.6,137,103,575.ccls. and (downlink near3 carrier) and (uplink near3 (primary first initial) near3 carrier) and ((second 2nd other next) with (channel resource)) and (carrier adj aggregation) and (carrier adj aggregation)	US-PGPUB; USPAT; USOCR; DERWENT; IBM_TDB	OR	ON	2017/06/26 18:43
L3	3	455/509,522,456.6,137,103,575.ccls. and (downlink near3 carrier) and (uplink near3 (primary first initial) near3 carrier) and ((second 2nd other next) with (channel resource)) same(carrier adj aggregation)	US-PGPUB; USPAT; USOCR; DERWENT; IBM_TDB	OR	ON	2017/06/26 18:44
L5	75	370/329,341,348,395.4.ccls. and (downlink near3 carrier) and (uplink near3 (primary first initial) near3 carrier) and ((second 2nd other next) with (channel resource)) same(carrier adj aggregation)	US-PGPUB; USPAT; USOCR; DERWENT; IBM_TDB	OR	ON	2017/06/26 18:54
L6	12	(H04W52/367, H04W52/12, H04W52/40).cpc. and (downlink near3 carrier) and (uplink near3 (primary first initial) near3 carrier) and ((second 2nd other next) with (channel resource)) same(carrier adj aggregation)	US-PGPUB; USPAT; USOCR; DERWENT; IBM_TDB	OR	ON	2017/06/26 18:55
L8	11	Ericsson.as. and ((david near2 astely) (robert near2 baldemair) (dirk near2 gerstenberger) (daniel near2 larsson) (lars near2 lindbom) (stefan near2 parkvall)).in. and (radio near3 resource) with (component near3 carrier) and ((second 2nd other next) with (channel resource)) same(carrier adj aggregation)	US-PGPUB; USPAT; USOCR; FPRS; EPO; JPO; DERWENT; IBM_TDB	OR	ON	2017/06/26 19:04
L9	174	(radio near3 resource) with (component near3 carrier) and ((second 2nd other next) with (channel resource)) same(carrier adj aggregation)	US-PGPUB; USPAT; USOCR; FPRS; EPO; JPO; DERWENT; IBM_TDB	OR	ON	2017/06/26 19:05
L10	3	(H04W52/367, H04W52/12, H04W52/40).cpc. and (radio near3 resource) with (component near3 carrier) and ((second 2nd other next) with (channel resource)) same(carrier adj aggregation)	US-PGPUB; USPAT; USOCR; DERWENT; IBM_TDB	OR	ON	2017/06/26 19:06
S1	1	"12896993"	US-PGPUB; USPAT; USOCR; DERWENT; IBM_TDB	OR	ON	2012/12/10 17:09

S2	367	((david near2 astely) (robert near2 baldemair) (dirk near2 gerstenberger) (daniel near2 larsson) (lars near2 lindbom) (stefan near2 parkvall)).in.	US-PGPUB; USPAT; USOCR; DERWENT; IBM_TDB	OR	ON	2012/12/10 19:04
S3	176	S2 and (radio near3 resource)	US-PGPUB; USPAT; USOCR; DERWENT; IBM_TDB	OR	ON	2012/12/10 19:09
S4	28	S2 and (radio near3 resource) and (component with carrier)	US-PGPUB; USPAT; USOCR; DERWENT; IBM_TDB	OR	ON	2012/12/10 19:09
S5	173	(downlink near3 carrier) and (uplink near3 (primary first initial) near3 carrier) and ((second 2nd other next) with (channel resource)) and (control with information)	US-PGPUB; USPAT; USOCR; DERWENT; IBM_TDB	OR	ON	2012/12/11 09:04
S6	137	S5 and (scheduling)	US-PGPUB; USPAT; USOCR; DERWENT; IBM_TDB	OR	ON	2012/12/11 09:04
S7	36	("20120263121" "20110310856" "20120127950" "20110310819" "20120275395" "20120287828" "20120039291" "20100271970" "20120307781" "20110286436" "20120224535" "20120140708" "20110310820" "20120163288" "20110299486" "20100098012" "20120082125" "20120294273" "20110268048" "20120113910").pn.	US-PGPUB; USPAT; USOCR; DERWENT; IBM_TDB	OR	ON	2012/12/11 09:15
S8	127	(downlink near3 carrier) and (uplink near3 (primary first initial) near3 carrier) and ((second 2nd other next) with (channel resource)) and (carrier adj aggregation)	US-PGPUB; USPAT; USOCR; DERWENT; IBM_TDB	OR	ON	2012/12/11 10:16
S9	2	"20110292887"	US-PGPUB; USPAT; USOCR; DERWENT; IBM_TDB	OR	ON	2012/12/11 11:17
S11	25	((first 1st) adj6 component adj3 carrier) same ((1st first) adj6 (radio resource frame)) and ((2nd second) adj6 component adj3 carrier) same ((2nd second) adj6 (radio resource frame))	US-PGPUB; USPAT; USOCR; DERWENT; IBM_TDB	OR	ON	2012/12/11 11:22
S12	1718	((first 1st) adj6 carrier) same ((1st first) adj6 (radio resource frame)) and ((2nd second) adj6 carrier) same ((2nd second) adj6 (radio resource frame))	US-PGPUB; USPAT; USOCR; DERWENT; IBM_TDB	OR	ON	2012/12/11 11:47
S13	66	(carrier near3 aggregation) and ((first 1st) adj6 carrier) same ((1st first) adj6 (radio resource frame)) and ((2nd second) adj6 carrier) same ((2nd second) adj6 (radio resource frame))	US-PGPUB; USPAT; USOCR; DERWENT; IBM_TDB	OR	ON	2012/12/11 11:47

S14	10842	455/509,522,456.6,137,103,575.ccls.	US-PGPUB; USPAT; USOCR; DERWENT; IBM_TDB	OR	ON	2012/12/11 13:41
S15	28232	370/329,252,331.ccls.	US-PGPUB; USPAT; USOCR; DERWENT; IBM_TDB	OR	ON	2012/12/11 13:41
S16	102	((S14 S15) and (downlink near3 carrier) and (uplink near3 (primary first initial) near3 carrier) and ((second 2nd other next) with (channel resource)) and (control with information))	US-PGPUB; USPAT; USOCR; DERWENT; IBM_TDB	OR	ON	2012/12/11 13:42
S17	1	"13140333"	US-PGPUB; USPAT; USOCR; DERWENT; IBM_TDB	OR	ON	2012/12/11 14:18
S18	2	"20110310856"	US-PGPUB; USPAT; USOCR; DERWENT; IBM_TDB	OR	ON	2012/12/11 14:18
S19	38	((first 1st) adj6 component adj3 carrier) same ((radio resource frame)) and ((2nd second) adj6 component adj3 carrier) same ((2nd second) adj6 (radio resource frame))	US-PGPUB; USPAT; USOCR; DERWENT; IBM_TDB	OR	ON	2012/12/11 14:31
S20	38	((((first 1st) adj6 component adj3 carrier) same ((radio resource frame))) and ((2nd second) adj6 component adj3 carrier) same ((2nd second) adj6 (radio resource frame)))	US-PGPUB; USPAT; USOCR; DERWENT; IBM_TDB	OR	ON	2012/12/11 14:31
S21	27	((((first 1st) adj6 component adj3 carrier) same ((radio resource frame))) and ((2nd second) adj6 component adj3 carrier) same ((2nd second other another) adj4 (radio resource frame)))	US-PGPUB; USPAT; USOCR; DERWENT; IBM_TDB	OR	ON	2012/12/11 14:32
S22	38	((((first 1st) adj6 component adj3 carrier) same ((radio resource frame))) and ((2nd second) adj6 component adj3 carrier) same ((2nd second other another) adj6 (radio resource frame)))	US-PGPUB; USPAT; USOCR; DERWENT; IBM_TDB	OR	ON	2012/12/11 14:32
S23	24	(carrier adj aggregation) and (schedul\$3 near3 (downlink DL) with ((first primary initial) near6 (resource radio frequency frame)))	US-PGPUB; USPAT; USOCR; DERWENT; IBM_TDB	OR	ON	2012/12/11 14:48
S24	8	("7551898" "7649960" "7656843" "7773699").FN.	US-PGPUB; USPAT; USOCR; DERWENT; IBM_TDB	OR	ON	2012/12/11 15:14
S25	2	"20110292900"	US-PGPUB; USPAT; USOCR; DERWENT; IBM_TDB	OR	ON	2012/12/11 15:36

S26	2	"20100271970"	US-PGPUB; USPAT; USOCR; DERWENT; IBM_TDB	OR	ON	2012/12/11 15:37
S27	3	"8050202"	US-PGPUB; USPAT; USOCR; DERWENT; IBM_TDB	OR	ON	2012/12/11 15:38
S28	1	"20120307689"	US-PGPUB; USPAT; USOCR; DERWENT; IBM_TDB	OR	ON	2012/12/11 15:45
S29	2	"8160017"	US-PGPUB; USPAT; USOCR; DERWENT; IBM_TDB	OR	ON	2012/12/11 15:48
S30	2	"20100232373"	US-PGPUB; USPAT; USOCR; DERWENT; IBM_TDB	OR	ON	2012/12/11 15:48
S31	2	"20090016278"	US-PGPUB; USPAT; USOCR; DERWENT; IBM_TDB	OR	ON	2012/12/11 17:16
S32	2	"8265030"	US-PGPUB; USPAT; USOCR; DERWENT; IBM_TDB	OR	ON	2012/12/11 17:19
S33	3	"2008139923"	US-PGPUB; USPAT; USOCR; DERWENT; IBM_TDB	OR	ON	2012/12/11 18:17
S34	14	("20100098012" "20100232373" "20110310856" "20120020317" "20120082125" "20120140708" "8265030").PN.	US-PGPUB; USPAT; USOCR; DERWENT; IBM_TDB	OR	ON	2013/05/29 17:19
S35	7	"455"/\$.cls. and (carrier adj aggregation) and (scheduling near3 (downlink DL) with ((first primary initial) near6 (resource radio frequency frame)))	US-PGPUB; USPAT; USOCR; DERWENT; IBM_TDB	OR	ON	2013/05/29 17:22
S36	9	"455"/\$.cls. and (((first 1st) adj6 component adj3 carrier) same ((radio resource frame))) and (((2nd second) adj6 component adj3 carrier) same (((2nd second) adj6 (radio resource frame)))	US-PGPUB; USPAT; USOCR; DERWENT; IBM_TDB	OR	ON	2013/05/29 21:37
S38	4	("20070053294" "20100290405").PN.	US-PGPUB; USPAT; USOCR; DERWENT; IBM_TDB	OR	ON	2013/05/30 12:42

S39	16	("7596114" "20050013279" "20030219028" "20070217406" "20020105970" "20060050664" "20090303938" "20070064669").PN.	US-PGPUB; USPAT; USOCR; DERWENT; IBM_TDB	OR	ON	2013/05/30 12:42
S40	290	(first 1st) with (component near2 carrier) with down\$1link	US-PGPUB; USPAT; USOCR; DERWENT; IBM_TDB	OR	ON	2013/06/17 10:07
S41	114	(first 1st) with (component near2 carrier) with down\$1link and receiv\$3 near3 control near3 information	US-PGPUB; USPAT; USOCR; DERWENT; IBM_TDB	OR	ON	2013/06/17 10:09
S42	47	(first 1st) near3 (radio adj resource) and (second other another 2nd) near3 (radio adj resource) and component adj carrier	US-PGPUB; USPAT; USOCR; DERWENT; IBM_TDB	OR	ON	2013/06/17 12:29
S43	26	S42 and (carrier adj aggregation) and (schedul\$3 near3 (down\$link DL reverse\$1link))	US-PGPUB; USPAT; USOCR; DERWENT; IBM_TDB	OR	ON	2013/06/17 12:31
S44	5	(first 1st) near3 (radio adj resource) and (second other another 2nd) near3 (radio adj resource) same (carrier adj aggregation) and (schedul\$3 near3 (down\$link DL reverse\$1link))	US-PGPUB; USPAT; USOCR; DERWENT; IBM_TDB	OR	ON	2013/06/17 12:46
S45	26	(first 1st) near3 (radio adj resource) and (second other another 2nd) near3 (radio adj resource) and (carrier adj aggregation) and (schedul\$3 near3 (down\$link DL reverse\$1link))	US-PGPUB; USPAT; USOCR; DERWENT; IBM_TDB	OR	ON	2013/06/17 12:47
S46	31	(second other another 2nd) near3 (radio adj resource) and (carrier adj aggregation) and (schedul\$3 near3 (down\$link DL reverse\$1link))	US-PGPUB; USPAT; USOCR; DERWENT; IBM_TDB	OR	ON	2013/06/17 12:49
S47	0	@ad<"20091003" and (second other another 2nd) near3 (radio adj resource) and (carrier adj aggregation) and (schedul\$3 near3 (down\$link DL reverse\$1link))	US-PGPUB; USPAT; USOCR; DERWENT; IBM_TDB	OR	ON	2013/06/17 12:51
S48	0	@ad<"20091003" and (second other another 2nd) near3 (radio adj resource) and (carrier adj component) and (schedul\$3 near3 (down\$link DL reverse\$1link))	US-PGPUB; USPAT; USOCR; DERWENT; IBM_TDB	OR	ON	2013/06/17 12:52
S49	1	@ad<"20091003" and (second other another 2nd) near3 (radio adj resource) and (carrier adj component) and ((down\$link DL reverse\$1link))	US-PGPUB; USPAT; USOCR; DERWENT; IBM_TDB	OR	ON	2013/06/17 12:53
S50	1	@ad<"20091005" and (second other another 2nd) near3 (radio adj resource) and (carrier adj component) and ((down\$link DL reverse\$1link))	US-PGPUB; USPAT; USOCR; DERWENT; IBM_TDB	OR	ON	2013/06/17 12:55

S51	1	@ad< "20091003" and (second other another 2nd) near3 (radio adj resource) and (carrier adj component)	US-PGPUB; USPAT; USOCR; DERWENT; IBM_TDB	OR	ON	2013/06/17 12:56
S52	20	(second other another 2nd) near3 (radio adj resource) and (carrier adj component)	US-PGPUB; USPAT; USOCR; DERWENT; IBM_TDB	OR	ON	2013/06/17 13:31
S53	16	(set near3 radio near3 resource) same component adj carrier	US-PGPUB; USPAT; USOCR; DERWENT; IBM_TDB	OR	ON	2013/06/17 14:14
S54	27	(set near3 ((radio near3 resource) (resource adj block))) same component adj carrier	US-PGPUB; USPAT; USOCR; DERWENT; IBM_TDB	OR	ON	2013/06/17 14:19
S55	755	((radio near3 resource) (resource adj block))) same component adj carrier	US-PGPUB; USPAT; USOCR; DERWENT; IBM_TDB	OR	ON	2013/06/17 14:25
S56	70	((second 2nd other) with ((radio near3 resource) (resource adj block))) same component adj carrier	US-PGPUB; USPAT; USOCR; DERWENT; IBM_TDB	OR	ON	2013/06/17 14:26
S57	327	((radio near3 resource) (resource adj block))) same component adj carrier and (schedul\$3 near3 downlink reverse)	US-PGPUB; USPAT; USOCR; DERWENT; IBM_TDB	OR	ON	2013/06/17 14:27
S58	29	((second 2nd other) with ((radio near3 resource) (resource adj block))) same component adj carrier and (schedul\$3 near3 down\$1link reverse\$1link)	US-PGPUB; USPAT; USOCR; DERWENT; IBM_TDB	OR	ON	2013/06/17 14:27
S59	24	((second 2nd other) with ((radio near3 resource) (resource adj block))) same (component adj carrier) same (down\$1link reverse\$1link)	US-PGPUB; USPAT; USOCR; DERWENT; IBM_TDB	OR	ON	2013/06/17 14:31
S60	10	("20090097447" "20110081856" "20090116427" "20100232373" "8331307").PN.	US-PGPUB; USPAT; USOCR; DERWENT; IBM_TDB	OR	ON	2013/06/17 14:49
S61	2562	(schedul\$3 near3 downlink) and ((radio adj resource) (resource adj block)) and component	US-PGPUB; USPAT; USOCR; DERWENT; IBM_TDB	OR	ON	2013/06/17 15:16
S62	739	(schedul\$3 near3 downlink) and ((radio adj resource) (resource adj block)) and component adj carrier	US-PGPUB; USPAT; USOCR; DERWENT; IBM_TDB	OR	ON	2013/06/17 15:17

S63	259	(schedul\$3 near3 downlink) same ((radio adj resource) (resource adj block)) and component adj carrier	US-PGPUB; USPAT; USOCR; DERWENT; IBM_TDB	OR	ON	2013/06/17 15:17
S64	39	(schedul\$3 near3 downlink) same ((radio adj resource) (resource adj block)) same (component adj carrier)	US-PGPUB; USPAT; USOCR; DERWENT; IBM_TDB	OR	ON	2013/06/17 15:18
S65	1	@ad<"20091005" and (schedul\$3 near3 downlink) same ((radio adj resource) (resource adj block)) same (component adj carrier)	US-PGPUB; USPAT; USOCR; DERWENT; IBM_TDB	OR	ON	2013/06/17 15:18
S66	1	@ad<"20091005" and (schedul\$3 near3 downlink) same ((radio adj resource) (resource adj block)) same (CC (component adj carrier))	US-PGPUB; USPAT; USOCR; DERWENT; IBM_TDB	OR	ON	2013/06/17 15:20
S67	47	(schedul\$3 near3 downlink) same ((radio adj resource) (resource adj block)) same (CC (component adj carrier))	US-PGPUB; USPAT; USOCR; DERWENT; IBM_TDB	OR	ON	2013/06/17 15:20
S68	356	"455"/\$.ccls. and ((radio adj resource) (resource adj block)) same (CC (component adj carrier))	US-PGPUB; USPAT; USOCR; DERWENT; IBM_TDB	OR	ON	2013/06/17 17:10
S70	19	"455"/\$.ccls. and (carrier near3 aggregation) and ((first 1st) adj6 carrier) same ((1st first) adj6 (radio resource frame)) and ((2nd second) adj6 carrier) same ((2nd second) adj6 (radio resource frame))	US-PGPUB; USPAT; USOCR; DERWENT; IBM_TDB	OR	ON	2013/06/17 17:17
S71	0	("2013/0107855").URPN.	USPAT	OR	ON	2013/06/18 09:15
S72	0	("2013/0107855").URPN.	US-PGPUB; USPAT	OR	ON	2013/06/18 09:16
S73	408	set near3 (radio frequency) near2 (resource band) same downlink and component	US-PGPUB; USPAT	OR	ON	2013/06/18 09:18
S74	17	set near3 (radio frequency) near2 (resource band) same downlink same (component adj carrier)	US-PGPUB; USPAT	OR	ON	2013/06/18 09:19
S75	19	(set group Cluster) near3 (radio frequency) near2 (resource band) same downlink same (component adj carrier)	US-PGPUB; USPAT	OR	ON	2013/06/18 09:21
S76	12	("8457060" "20110310819" "20100271970" "20130034073" "20100098012" "20110310856" "20110317653" "20130083742" "20130083741" "20120114021" "20120275395" "20110317645" "20110310856").pn.	US-PGPUB; USPAT	OR	ON	2013/06/18 09:31
S77	200	(DL down\$link) with (1st first first primary initia) near3 (set group) near6 (radio resource)	US-PGPUB; USPAT	OR	ON	2013/06/18 10:37
S78	2911	(UL up\$link) with (set group) near6 (radio resource)	US-PGPUB; USPAT	OR	ON	2013/06/18 10:38
S79	110	S77 and S78	US-PGPUB; USPAT	OR	ON	2013/06/18 10:38

S80	3	(DL down\$link) with (1st first first primary initia) near3 (set group) near6 (radio resource) and (DL down\$link) with (set group) near6 (radio resource) with (2nd second other another) near2 component	US-PGPUB; USPAT	OR	ON	2013/06/18 10:47
S81	28	(DL down\$link) with (1st first first primary initia) near3 (set group) near6 (radio resource) and (DL down\$link) with (component near3 carrier)	US-PGPUB; USPAT	OR	ON	2013/06/18 11:17
S82	5	(DL down\$link) with (1st first first primary initia) near3 (set group) near6 (radio resource) and (DL down\$link) with (second 2nd) near3 (component near3 carrier)	US-PGPUB; USPAT	OR	ON	2013/06/18 11:20
S83	4	(1st first first primary initia) near3 (set group) near6 (radio resource) with (DL down\$link) near3 (component near3 carrier)	US-PGPUB; USPAT	OR	ON	2013/06/18 13:50
S84	3	(set group) near6 (radio resource) with (2nd second other another) near6 (DL down\$link) near3 (component near3 carrier)	US-PGPUB; USPAT	OR	ON	2013/06/18 13:52
S85	42	(set group) near6 (radio resource) with (DL down\$link) near3 (component near3 carrier)	US-PGPUB; USPAT	OR	ON	2013/06/18 13:58
S86	30	(set group) near3 ((radio resource)(resource near2 block)) with (DL down\$link) near3 (component near3 carrier)	US-PGPUB; USPAT	OR	ON	2013/06/18 14:07
S87	2	(second 2nd) near3 (down\$1link DL) with ((component near3 carrier) CC) same (set group) with ((radio near2 resource) (resource near2 block))	US-PGPUB; USPAT	OR	ON	2013/06/18 14:14
S88	21	reserv\$3 with component near3 carrier and (second near2 (radio frequency band))	US-PGPUB; USPAT; USOCR; DERWENT; IBM_TDB	OR	ON	2013/06/25 15:31
S89	36	"739528"	US-PGPUB; USPAT; USOCR; DERWENT; IBM_TDB	OR	ON	2013/06/26 09:34
S90	30	"5754138"	US-PGPUB; USPAT; USOCR; DERWENT; IBM_TDB	OR	ON	2013/06/26 09:35
S91	2046	(carrier near3 aggregation) and up\$1link with down\$1link	US-PGPUB; USPAT; USOCR; DERWENT; IBM_TDB	OR	ON	2013/06/26 10:24
S92	1052	(carrier near3 aggregation) and (component near3 carrier) same up\$1link with down\$1link	US-PGPUB; USPAT; USOCR; DERWENT; IBM_TDB	OR	ON	2013/06/26 10:26
S93	110	(carrier near3 aggregation) and (component near3 carrier) same up\$1link with associat\$3 with down\$1link	US-PGPUB; USPAT; USOCR; DERWENT; IBM_TDB	OR	ON	2013/06/26 10:27
S95	17	("370"/\$.cls "455"/\$.cls.) and (aggregation) and (CC (component near3 carrier)) same up\$1link	US-PGPUB; USPAT;	OR	ON	2013/06/26 15:22

		with associat\$3 with down\$1link	USOCR; DERWENT; IBM_TDB			
S96	67	370/329,341,348,395.4.ccls. and (carrier near3 aggregation) and (component near3 carrier) same up\$1link with associat\$3 with down\$1link	US-PGPUB; USPAT; USOCR; DERWENT; IBM_TDB	OR	ON	2013/06/26 15:26
S97	345368	schedule (DL (down adj link) down\$1link) and (carrier near3 aggregation) and ((UL up\$link) adj6 associat\$4 near4 (DL down\$link))	US-PGPUB; USPAT; USOCR; DERWENT; IBM_TDB	OR	ON	2013/06/26 16:45
S98	9	schedule near3 (DL (down adj link) down\$1link) and (carrier near3 aggregation) same((UL up\$link) adj6 associat\$4 near4 (DL down\$link))	US-PGPUB; USPAT; USOCR; DERWENT; IBM_TDB	OR	ON	2013/06/26 16:46
S99	35	(schedule allocat\$4) near3 (DL (down adj link) down\$1link) and (carrier near3 aggregation) same((UL up\$link) adj6 associat\$4 near4 (DL down\$link))	US-PGPUB; USPAT; USOCR; DERWENT; IBM_TDB	OR	ON	2013/06/26 16:48
S100	0	(1st first) near3 (radio band resource frequency) with (1st first) near3 (CCcomponent adj carrier)	US-PGPUB; USPAT; USOCR; DERWENT; IBM_TDB	OR	ON	2013/06/26 17:14
S101	216	(1st first) near3 (radio band resource frequency) with (1st first) near3 (CC (component adj carrier))	US-PGPUB; USPAT; USOCR; DERWENT; IBM_TDB	OR	ON	2013/06/26 17:14
S102	43	(1st first) near3 (radio band resource frequency) with (reserv\$3 schedul\$3 allocat\$3) with (1st first) near3 (CC (component adj carrier))	US-PGPUB; USPAT; USOCR; DERWENT; IBM_TDB	OR	ON	2013/06/26 17:15
S103	22	("20100142455" "20120009923" "20100254329" "20100091678" "20110194501" "20130010619" "20080310359" "20060274712" "20100227569" "20120208583" "20110267978").PN.	US-PGPUB; USPAT; USOCR; DERWENT; IBM_TDB	OR	ON	2013/06/27 09:57
S104	10	("20100254329" "20100195624" "20100023282" "20090274100" "20080316957").PN.	US-PGPUB; USPAT; USOCR; DERWENT; IBM_TDB	OR	ON	2013/06/27 10:15
S105	50	("20100322173" "20110081913" "20130010721" "20120140708" "20100271970" "20100285809" "20110007699" "20130003700" "20100232373" "20120051306" "20120082125" "20100098012" "20100003997" "20100208679" "20110310856" "20120082125" "20120140708" "20130136084" "8265030" "20120020317" "8265030" "20110007695" "20110081932" "20120314675"	US-PGPUB; USPAT; USOCR; DERWENT; IBM_TDB	OR	ON	2014/04/22 13:25

		"20110310856" "20100232373" "20100296389" "20120020317" "20100098012" "20130034073" "8447343" "8472368").PN.				
S106	13348	(H04W88/08, H04W72/044, H04W72/042).cpc.	US-PGPUB; USPAT; USOCR; DERWENT; IBM_TDB	OR	ON	2014/04/22 13:40
S107	4330	(H04W52/367, H04W52/12, H04W52/40).cpc.	US-PGPUB; USPAT; USOCR; DERWENT; IBM_TDB	OR	ON	2014/04/22 13:42
S108	4200	(H04L29/08657, G01S5/0252, G01S5/02).cpc.	US-PGPUB; USPAT; USOCR; DERWENT; IBM_TDB	OR	ON	2014/04/22 13:43
S109	3823	(H04B1/3833, H04M1/0247, H04M1/0237).cpc.	US-PGPUB; USPAT; USOCR; DERWENT; IBM_TDB	OR	ON	2014/04/22 13:44
S110	6130	(H03F3/211, H04B7/0617, H04B7/0669).cpc.	US-PGPUB; USPAT; USOCR; DERWENT; IBM_TDB	OR	ON	2014/04/22 13:44
S111	370	(S106 S107 S108 S109 S110) and (schedul\$4 near3 down\$1link) and (component near3 carrier)	US-PGPUB; USPAT; USOCR; DERWENT; IBM_TDB	OR	ON	2014/04/22 13:45
S112	365	(S106 S107 S108 S109 S110) and (schedul\$4 near3 down\$1link) and (component near3 carrier) and (control with information)	US-PGPUB; USPAT; USOCR; DERWENT; IBM_TDB	OR	ON	2014/04/22 13:46
S113	357	(S106 S107 S108 S109 S110) and (schedul\$4 near3 down\$1link) and (component near carrier) and (control with information)	US-PGPUB; USPAT; USOCR; DERWENT; IBM_TDB	OR	ON	2014/04/22 13:47
S114	13	(S106 S107 S108 S109 S110) and (DL down\$link) with (1st first first primary initia) near3 (set group) near6 (radio resource) and (DL down\$link) with (component near3 carrier)	US-PGPUB; USPAT; USOCR; DERWENT; IBM_TDB	OR	ON	2014/04/22 13:47
S115	40	(H03F3/211, H04B7/0617, H04B7/0669, H04B1/3833, H04M1/0247, H04M1/0237, H04L29/08657, G01S5/0252, G01S5/02, H04W52/367, H04W52/12, H04W52/40, H04W88/08, H04W72/044, H04W72/042).cpc. and (carrier near3 aggregation) and (component near3 carrier) same up\$1link with associat\$3 with down\$1link	US-PGPUB; USPAT; USOCR; DERWENT; IBM_TDB	OR	ON	2014/04/22 14:17
S116	8750	(H04W88/08, H04W72/044, H04W72/042l).cpc.	US-PGPUB; USPAT; USOCR;	OR	ON	2014/04/26 14:21

			DERWENT; IBM_TDB				
S117	4336	(H04W52/367, H04W52/12, H04W52/40).cpc.	US-PGPUB; USPAT; USOCR; DERWENT; IBM_TDB	OR	ON	2014/04/26 14:22	
S118	4205	(H04L29/08657, G01S5/0252, G01S5/02).cpc.	US-PGPUB; USPAT; USOCR; DERWENT; IBM_TDB	OR	ON	2014/04/26 14:23	
S119	4144	(H04L29/08657, G01S19/14, G01S5/02).cpc.	US-PGPUB; USPAT; USOCR; DERWENT; IBM_TDB	OR	ON	2014/04/26 14:23	
S120	3826	(H04B1/3833, H04M1/0247, H04M1/0237).cpc.	US-PGPUB; USPAT; USOCR; DERWENT; IBM_TDB	OR	ON	2014/04/26 14:24	
S121	47	(H04W88/08, H04W72/044, H04W72/042).cpc. and (1st first) near3 (radio band resource frequency) with (1st first) near3 (CC (component adj carrier))	US-PGPUB; USPAT; USOCR; DERWENT; IBM_TDB	OR	ON	2014/04/26 14:27	
S122	25	(S116 S117 S118 S119 S120).cpc. and (1st first) near3 (radio band resource frequency) with (1st first) near3 (CC (component adj carrier))	US-PGPUB; USPAT; USOCR; DERWENT; IBM_TDB	OR	ON	2014/04/26 15:35	
S123	13432	(H04W88/08, H04W72/044, H04W72/042).cpc.	US-PGPUB; USPAT; USOCR; DERWENT; IBM_TDB	OR	ON	2014/04/30 11:04	
S124	4341	(H04W52/367, H04W52/12, H04W52/40).cpc.	US-PGPUB; USPAT; USOCR; DERWENT; IBM_TDB	OR	ON	2014/04/30 11:04	
S125	4208	(H04L29/08657, G01S5/0252, G01S5/02).cpc.	US-PGPUB; USPAT; USOCR; DERWENT; IBM_TDB	OR	ON	2014/04/30 11:04	
S126	3833	(H04B1/3833, H04M1/0247, H04M1/0237).cpc.	US-PGPUB; USPAT; USOCR; DERWENT; IBM_TDB	OR	ON	2014/04/30 11:04	
S127	6154	(H03F3/211, H04B7/0617, H04B7/0669).cpc.	US-PGPUB; USPAT; USOCR; DERWENT; IBM_TDB	OR	ON	2014/04/30 11:04	
S128	98	(S123 S124 S125 S126 S127) and (schemul\$4 near3 down\$1link) and (component near3 carrier) and single with carrier same (plurality multiple	US-PGPUB; USPAT; USOCR;	OR	ON	2014/04/30 11:04	

		several) with (DL down\$1link) with carrier	DERWENT; IBM_TDB			
S129	52	(S123 S124 S125 S126 S127) and (schedul\$4 near3 down\$1link) and (component near3 carrier) and single near6 carrier same (plurality multiple several) near3 (DL down\$1link) with carrier	US-PGPUB; USPAT; USOCR; DERWENT; IBM_TDB	OR	ON	2014/04/30 11:04
S130	4	(S123 S124 S125 S126 S127) and (schedul\$4) with component near3 carrier and (single near3 (DL down\$1link)) with (first with resource) and (multiple plurality several) near3 (DL downlink) with second with resource	US-PGPUB; USPAT; USOCR; DERWENT; IBM_TDB	OR	ON	2014/04/30 11:37
S131	2	(up\$1link UL) and (schedul\$4) with component near3 carrier same (single near3 (DL down\$1link)) with (first with resource) same (multiple plurality several) near3 (DL downlink) with second with resource	US-PGPUB; USPAT; USOCR; DERWENT; IBM_TDB	OR	ON	2014/04/30 11:40
S132	2	(schedul\$4) with component near3 carrier same (single near3 (DL down\$1link)) with (first with resource) same (multiple plurality several) near3 (DL downlink) with second with resource	US-PGPUB; USPAT; USOCR; DERWENT; IBM_TDB	OR	ON	2014/04/30 11:42
S133	2	(schedul\$4) same (single near3 (DL down\$1link)) with (first with resource) same (multiple plurality several) near3 (DL downlink) with second with resource	US-PGPUB; USPAT; USOCR; DERWENT; IBM_TDB	OR	ON	2014/04/30 11:44
S134	2	(schedul\$4) same (single near3 (DL down\$1link)) with (first with (frequency resource block)) same (multiple plurality several) near3 (DL downlink) with second with (frequency block resource)	US-PGPUB; USPAT; USOCR; DERWENT; IBM_TDB	OR	ON	2014/04/30 11:45
S135	16	(single near3 (DL down\$1link)) with (first with (frequency resource block)) same (multiple plurality several) near3 (DL downlink) with second with (frequency block resource)	US-PGPUB; USPAT; USOCR; DERWENT; IBM_TDB	OR	ON	2014/04/30 11:45
S136	1	allocation with (PUSCH PUCCH UL (up\$1link)) and "20100232373"	US-PGPUB; USPAT; USOCR; DERWENT; IBM_TDB	OR	ON	2014/04/30 14:19
S137	1	allocation and (PUSCH PUCCH UL (up\$1link)) and "20100232373"	US-PGPUB; USPAT; USOCR; DERWENT; IBM_TDB	OR	ON	2014/04/30 14:21
S138	2	"20100271970"	US-PGPUB; USPAT; USOCR; DERWENT; IBM_TDB	OR	ON	2014/04/30 14:32
S139	54	("20100322173" "20110081913" "20130010721" "8634358" "20120140708" "20100271970" "20100285809" "20110007699" "20130003700" "20100232373" "20120051306" "20120082125" "20100098012" "20100003997" "20100208679" "20110310856" "20120082125"	US-PGPUB; USPAT; USOCR; DERWENT; IBM_TDB	OR	ON	2014/10/15 11:49

		"20120140708" "20130136084" "8265030" "20110243039" "20120020317" "8265030" "20110007695" "20110081932" "20120314675" "20110310856" "20100232373" "20100296389" "20120020317" "20100098012" "20130034073" "8447343" "8472368").PN.				
S140	15049	(H04W88/08, H04W72/044, H04W72/042).cpc.	US-PGPUB; USPAT; USOCR; DERWENT; IBM_TDB	OR	ON	2014/10/15 13:44
S141	4737	(H04W52/367, H04W52/12, H04W52/40).cpc.	US-PGPUB; USPAT; USOCR; DERWENT; IBM_TDB	OR	ON	2014/10/15 13:44
S142	4341	(H04L29/08657, G01S5/0252, G01S5/02).cpc.	US-PGPUB; USPAT; USOCR; DERWENT; IBM_TDB	OR	ON	2014/10/15 13:44
S143	4030	(H04B1/3833, H04M1/0247, H04M1/0237).cpc.	US-PGPUB; USPAT; USOCR; DERWENT; IBM_TDB	OR	ON	2014/10/15 13:44
S144	6785	(H03F3/211, H04B7/0617, H04B7/0669).cpc.	US-PGPUB; USPAT; USOCR; DERWENT; IBM_TDB	OR	ON	2014/10/15 13:44
S145	96	(S140 S141 S142 S143 S144) and (schedul\$4 near3 down\$1link) and (component near3 carrier) and single with carrier same (plurality multiple several) with (DL down\$1link) with carrier same (frequency resources)	US-PGPUB; USPAT; USOCR; DERWENT; IBM_TDB	OR	ON	2014/10/15 13:44
S146	1	"13315135"	US-PGPUB; USPAT; USOCR; DERWENT; IBM_TDB	OR	ON	2014/10/15 13:54
S147	2	"20080151845"	US-PGPUB; USPAT; USOCR; DERWENT; IBM_TDB	OR	ON	2014/10/15 14:58
S148	41	"455"/\$.ccls. and (carrier near3 aggregation) and ((first 1st) adj6 carrier) same ((1st first) adj6 (radio resource frame)) and ((2nd second) adj6 carrier) same ((2nd second) adj6 (radio resource frame))	US-PGPUB; USPAT; USOCR; DERWENT; IBM_TDB	OR	ON	2014/10/15 15:45
S149	3	"455"/451,452.1.ccls. and (carrier near3 aggregation) and ((first 1st) adj6 carrier) same ((1st first) adj6 (radio resource frame)) and ((2nd second) adj6 carrier) same ((2nd second) adj6 (radio resource frame))	US-PGPUB; USPAT; USOCR; DERWENT; IBM_TDB	OR	ON	2014/10/15 18:01
S150	33889	455/451,452.1,509,456.1,522,137,103,575.ccls.	US-PGPUB; USPAT; USOCR;	OR	ON	2014/10/23 11:25

			DERWENT; IBM_TDB			
S151	0	455/451,452.1,509,456.1,522,137,103,575.ccls. and (control\$4) with (resource frequency channel Bin) same (sererv\$4 sav\$4) near3 (other 2nd second another) adj3 (resource frequency channel Bin)	US-PGPUB; USPAT; USOCR; DERWENT; IBM_TDB	OR	ON	2014/10/23 11:32
S152	0	455/451,452.1,509,456.1,522,137,103,575.ccls. and (control\$4) with (resource frequency channel Bin) same (rererv\$4 sav\$4) near3 (other 2nd second another) adj3 (resource frequency channel Bin)	US-PGPUB; USPAT; USOCR; DERWENT; IBM_TDB	OR	ON	2014/10/23 11:33
S153	4	455/451,452.1,509,456.1,522,137,103,575.ccls. and (control\$4) with (resource frequency channel Bin) same (reserv\$4 sav\$4) near3 (other 2nd second another) adj3 (resource frequency channel Bin)	US-PGPUB; USPAT; USOCR; DERWENT; IBM_TDB	OR	ON	2014/10/23 11:34
S154	3	455/451,452.1,509,456.1,522,137,103,575.ccls. and (control\$4) with (resource frequency channel Bin) same (reserv\$4 sav\$4) near3 (other 2nd second another) adj3 (resource frequency channel Bin) and (CC component)	US-PGPUB; USPAT; USOCR; DERWENT; IBM_TDB	OR	ON	2014/10/23 11:37
S155	4	"455"/\$.ccls. and (((first 1st) adj6 component adj3 carrier) same ((radio resource frame))) and (((2nd second) adj6 component adj3 carrier) same (((2nd second other another) adj6 (radio resource frame)) and (reserv\$4 sav\$4 us\$3) near3 (other 2nd second another) adj3 (resource frequency channel Bin) and (CC component)	US-PGPUB; USPAT; USOCR; DERWENT; IBM_TDB	OR	ON	2014/10/23 11:39
S156	15	("20050013279" "20030219028" "20070217406" "20020105970" "20060050664" "20090303938" "20070064669").PN.	US-PGPUB; USPAT; USOCR; DERWENT; IBM_TDB	OR	ON	2014/10/23 12:07
S157	10	"455"/\$.ccls. and (schedul\$3 near3 downlink) same ((radio adj resource) (resource adj block)) same (CC (component adj carrier))	US-PGPUB; USPAT; USOCR; DERWENT; IBM_TDB	OR	ON	2014/10/23 12:07
S158	0	455/451,452.1,509,456.1,522,137,103,575.ccls. and (control\$4) with (resource frequency channel) same (rererv\$4 sav\$4) near3 (other 2nd second another) adj3 (resource frequency channel Bin)	US-PGPUB; USPAT; USOCR; DERWENT; IBM_TDB	OR	ON	2014/10/31 15:22
S161	15374	(H04W88/08, H04W72/044, H04W72/042).cpc.	US-PGPUB; USPAT; USOCR; DERWENT; IBM_TDB	OR	ON	2014/10/31 17:18
S162	4758	(H04W52/367, H04W52/12, H04W52/40).cpc.	US-PGPUB; USPAT; USOCR; DERWENT; IBM_TDB	OR	ON	2014/10/31 17:18
S163	4377	(H04L29/08657, G01S5/0252, G01S5/02).cpc.	US-PGPUB; USPAT; USOCR; DERWENT; IBM_TDB	OR	ON	2014/10/31 17:18
S164	4042	(H04B1/3833, H04M1/0247, H04M1/0237).cpc.	US-PGPUB;	OR	ON	2014/10/31

			USPAT; USOCR; DERWENT; IBM_TDB			17:18
S165	6867	(H03F3/211, H04B7/0617, H04B7/0669).cpc.	US-PGPUB; USPAT; USOCR; DERWENT; IBM_TDB	OR	ON	2014/10/31 17:18
S167	1	"14170939"	US-PGPUB; USPAT; USOCR; DERWENT; IBM_TDB	OR	ON	2014/11/17 09:46
S168	499	(component near2 carrier) with (primary near2 cell)	US-PGPUB; USPAT; USOCR; DERWENT; IBM_TDB	OR	ON	2014/11/18 14:07
S169	401	"370"/\$.cls. and (component near2 carrier) with (primary near2 cell)	US-PGPUB; USPAT; USOCR; DERWENT; IBM_TDB	OR	ON	2014/11/18 14:07
S170	378	"370"/\$.cls. and (component adj2 carrier) with (primary adj2 cell)	US-PGPUB; USPAT; USOCR; DERWENT; IBM_TDB	OR	ON	2014/11/18 14:07
S171	185	"370"/\$.cls. and (component adj2 carrier) with (primary adj2 cell) with (DL down\$1link)	US-PGPUB; USPAT; USOCR; DERWENT; IBM_TDB	OR	ON	2014/11/18 14:08
S172	4	"370"/\$.cls. and single near3 (CC (component adj2 carrier)) with (primary adj2 cell) with (DL down\$1link)	US-PGPUB; USPAT; USOCR; DERWENT; IBM_TDB	OR	ON	2014/11/18 14:17
S173	4	single near4 (CC (component adj2 carrier)) with (primary adj2 cell) with (DL down\$1link)	US-PGPUB; USPAT; USOCR; DERWENT; IBM_TDB	OR	ON	2014/11/18 14:19
S174	287	"370"/\$.cls. and (CC (component adj2 carrier)) with (primary adj2 cell) with (DL down\$1link)	US-PGPUB; USPAT; USOCR; DERWENT; IBM_TDB	OR	ON	2014/11/18 14:21
S175	1	@ad<"20091004" and "370"/\$.cls. and (CC (component adj2 carrier)) with (primary adj2 cell) with (DL down\$1link)	US-PGPUB; USPAT; USOCR; DERWENT; IBM_TDB	OR	ON	2014/11/18 14:22
S176	287	"370"/\$.cls. and (CC (component adj2 carrier)) with (primary adj2 cell) with (DL down\$1link)	US-PGPUB; USPAT; USOCR; DERWENT; IBM_TDB	OR	ON	2014/11/18 14:22
S177	29	("20100322173" "20110081913"	US-PGPUB;	OR	OFF	2015/10/01

		"20130010721" "8634358" "20120140708" "20100271970" "20100285809" "20110007699" "20130003700" "20100232373" "20120051306" "20120082125" "20100098012" "20100003997" "20100208679" "20110310856" "20120082125" "20120140708" "20130136084" "8265030" "20110243039" "8792830" "20120020317" "8265030" "20110007695" "20110081932" "20120314675" "20020160784" "20110310856" "20100232373" "20100296389" "20120020317" "20100098012" "20130034073" "8447343" "8472368").PN.	USPAT			11:34
S178	21250	(H04W88/08, H04W72/044, H04W72/042).cpc.	US-PGPUB; USPAT; USOCR; DERWENT; IBM_TDB	OR	ON	2015/10/01 17:24
S179	5857	(H04W52/367, H04W52/12, H04W52/40).cpc.	US-PGPUB; USPAT; USOCR; DERWENT; IBM_TDB	OR	ON	2015/10/01 17:24
S180	5079	(H04L29/08657, G01S5/0252, G01S5/02).cpc.	US-PGPUB; USPAT; USOCR; DERWENT; IBM_TDB	OR	ON	2015/10/01 17:24
S181	4391	(H04B1/3833, H04M1/0247, H04M1/0237).cpc.	US-PGPUB; USPAT; USOCR; DERWENT; IBM_TDB	OR	ON	2015/10/01 17:24
S182	8620	(H03F3/211, H04B7/0617, H04B7/0669).cpc.	US-PGPUB; USPAT; USOCR; DERWENT; IBM_TDB	OR	ON	2015/10/01 17:24
S183	221	(S178 S179 S180 S181 S182) and (schedul\$4 near3 down\$1link) and (component near3 carrier) and single with carrier same (plurality multiple several) with (DL down\$1link) with carrier same (frequency)	US-PGPUB; USPAT; USOCR; DERWENT; IBM_TDB	OR	ON	2015/10/01 17:24
S184	552	((david near2 astely) (robert near2 baldemair) (dirk near2 gerstenberger) (daniel near2 larsson) (lars near2 lindbom) (stefan near2 parkvall)).in. and ericsson.as.	US-PGPUB; USPAT; USOCR; DERWENT; IBM_TDB	OR	ON	2015/10/01 17:56
S185	1	S183 and S184	US-PGPUB; USPAT; USOCR; DERWENT; IBM_TDB	OR	ON	2015/10/01 17:56
S186	21	455/\$.ccls. and ((first 1st) adj6 component adj3 carrier) same ((1st first) adj6 (radio resource frame)) and ((2nd second) adj6 component adj3 carrier) same ((2nd second) adj6 (radio resource frame))	US-PGPUB; USPAT; USOCR; DERWENT; IBM_TDB	OR	ON	2015/10/01 18:11

S187	24	("20100322173" "20110081913" "20130003700" "20100232373" "20120051306" "20120082125" "20100098012" "2010003997" "20100208679" "20110310856" "20120082125" "20120140708" "20130136084" "8265030" "20110243039" "8792830" "20120020317" "8265030" "20110007695" "20110081932" "20120314675" "20020160784" "20110310856" "20100232373" "20100296389" "20120020317" "20100098012" "20130034073" "8447343" "8472368").PN.	US-PGPUB; USPAT	OR	OFF	2015/10/02 12:23
S188	1	"14030298"	US-PGPUB; USPAT	OR	OFF	2015/10/02 15:41
S189	198	((1st first) adj6 (radio resource frame) and ((2nd second) adj6 component adj3 carrier) same ((2nd second) adj6 (radio resource frame))	US-PGPUB; USPAT; USOCR; DERWENT; IBM_TDB	OR	ON	2015/10/03 16:15
S190	1	"14102508"	US-PGPUB; USPAT; USOCR; DERWENT; IBM_TDB	OR	ON	2015/10/13 14:17
S191	0	"14158378"	US-PGPUB; USPAT; USOCR; DERWENT; IBM_TDB	OR	ON	2015/10/13 14:17
S192	1	"14097736"	US-PGPUB; USPAT; USOCR; DERWENT; IBM_TDB	OR	ON	2015/10/13 14:17
S193	2	"14006545"	US-PGPUB; USPAT; USOCR; DERWENT; IBM_TDB	OR	ON	2015/10/13 14:17
S194	1	"13875620"	US-PGPUB; USPAT; USOCR; DERWENT; IBM_TDB	OR	ON	2015/10/13 14:18
S195	1	"13905342"	US-PGPUB; USPAT; USOCR; DERWENT; IBM_TDB	OR	ON	2015/10/13 14:18
S196	1	"13477988"	US-PGPUB; USPAT; USOCR; DERWENT; IBM_TDB	OR	ON	2015/10/13 14:18
S197	2	"13293245"	US-PGPUB; USPAT; USOCR; DERWENT;	OR	ON	2015/10/13 14:18

			IBM_TDB			
S198	1	"13875620"	US-PGPUB; USPAT; USOCR; DERWENT; IBM_TDB	OR	ON	2015/10/13 14:19
S199	2	"13993807"	US-PGPUB; USPAT; USOCR; DERWENT; IBM_TDB	OR	ON	2015/10/13 14:19
S200	1	"13898465"	US-PGPUB; USPAT; USOCR; DERWENT; IBM_TDB	OR	ON	2015/10/13 14:19
S201	1	"13883792"	US-PGPUB; USPAT; USOCR; DERWENT; IBM_TDB	OR	ON	2015/10/13 14:19
S202	1	"13996405"	US-PGPUB; USPAT; USOCR; DERWENT; IBM_TDB	OR	ON	2015/10/13 14:19
S203	1	"13883002"	US-PGPUB; USPAT; USOCR; DERWENT; IBM_TDB	OR	ON	2015/10/13 14:20
S204	0	"14812058"	US-PGPUB; USPAT; USOCR; DERWENT; IBM_TDB	OR	ON	2015/10/13 14:20
S205	7	"8915660"	US-PGPUB; USPAT; USOCR; DERWENT; IBM_TDB	OR	ON	2015/10/13 14:20
S206	1	"13909538"	US-PGPUB; USPAT; USOCR; DERWENT; IBM_TDB	OR	ON	2015/10/13 14:21
S207	1	"13924238"	US-PGPUB; USPAT; USOCR; DERWENT; IBM_TDB	OR	ON	2015/10/13 14:22
S208	1	"13898465"	US-PGPUB; USPAT; USOCR; DERWENT; IBM_TDB	OR	ON	2015/10/13 14:23
S209	2	"13993807"	US-PGPUB; USPAT; USOCR; DERWENT;	OR	ON	2015/10/13 14:23

			IBM_TDB			
S210	58	("20100322173" "20110081913" "20130010721" "8634358" "20120140708" "20100271970" "20100285809" "20110007699" "20130003700" "20100232373" "20120051306" "20120082125" "20100098012" "20100003997" "20100208679" "20110310856" "20120082125" "20120140708" "20130136084" "8265030" "20110243039" "8792830" "20120020317" "8265030" "20110007695" "20110081932" "20120314675" "20020160784" "20110310856" "20100232373" "20100296389" "20120020317" "20100098012" "20130034073" "8447343" "8472368").PN.	US-PGPUB; USPAT; USOCR; DERWENT; IBM_TDB	OR	ON	2015/10/13 14:25
S211	1	"13906370"	US-PGPUB; USPAT; USOCR; DERWENT; IBM_TDB	OR	ON	2015/10/13 14:38
S212	58	("20100322173" "20110081913" "20130010721" "8634358" "20120140708" "20100271970" "20100285809" "20110007699" "20130003700" "20100232373" "20120051306" "20120082125" "20100098012" "20100003997" "20100208679" "20110310856" "20120082125" "20120140708" "20130136084" "8265030" "20110243039" "8792830" "20120020317" "8265030" "20110007695" "20110081932" "20120314675" "20020160784" "20110310856" "20100232373" "20100296389" "20120020317" "20100098012" "20130034073" "8447343" "8472368").PN.	US-PGPUB; USPAT; USOCR; DERWENT; IBM_TDB	OR	ON	2015/10/13 14:51
S213	0	(H04W88/08, H04W72/044, H04W72/042).cpc. and (H04W52/367, H04W52/12, H04W52/40).cpc. and (H04L29/08657, G01S5/0252, G01S5/02).cpc. and (H04B1/3833, H04M1/0247, H04M1/0237).cpc.	US-PGPUB; USPAT; USOCR; DERWENT; IBM_TDB	OR	ON	2015/10/13 14:55
S214	36289	(H04W88/08, H04W72/044, H04W72/042, H04W52/367, H04W52/12, H04W52/40, H04L29/08657, G01S5/0252, G01S5/02, H04B1/3833, H04M1/0247, H04M1/0237).cpc.	US-PGPUB; USPAT; USOCR; DERWENT; IBM_TDB	OR	ON	2015/10/13 14:56
S215	3	(H04W88/08, H04W72/044, H04W72/042, H04W52/367, H04W52/12, H04W52/40, H04L29/08657, G01S5/0252, G01S5/02, H04B1/3833, H04M1/0247, H04M1/0237).cpc. and single near3 (CC (component adj2 carrier)) with (primary adj2 cell) with (DL down\$1link)	US-PGPUB; USPAT; USOCR; DERWENT; IBM_TDB	OR	ON	2015/10/13 14:56
S216	553	((david near2 astely) (robert near2 baldemair) (dirk near2 gerstenberger) (daniel near2 larsson) (lars near2 lindbom) (stefan near2 parkvall)).in. and ericsson.as.	US-PGPUB; USPAT; USOCR; DERWENT; IBM_TDB	OR	ON	2015/10/13 17:05
S217	553	((david near2 astely) (robert near2 baldemair) (dirk near2 gerstenberger) (daniel near2 larsson)	US-PGPUB; USPAT;	OR	ON	2015/10/13 17:05

		(lars near2 lindbom) (stefan near2 parkvall)).in.) and ericsson.as.	USOCR; DERWENT; IBM_TDB			
S218	131	((david near2 astely) (robert near2 baldemair) (dirk near2 gerstenberger) (daniel near2 larsson) (lars near2 lindbom) (stefan near2 parkvall)).in.) and ericsson.as. and carrier adj aggregation	US-PGPUB; USPAT; USOCR; DERWENT; IBM_TDB	OR	ON	2015/10/13 17:07
S219	48	"455"/\$.ccls. and (carrier near3 aggregation) and ((first 1st) adj6 carrier) same ((1st first) adj6 (radio resource frame)) and ((2nd second) adj6 carrier) same ((2nd second) adj6 (radio resource frame)) and carrier adj aggregation	US-PGPUB; USPAT; USOCR; DERWENT; IBM_TDB	OR	ON	2015/10/13 17:27
S220	48	(H04W88/08, H04W72/044, H04W72/042).cpc. and ((first 1st) adj6 component adj3 carrier) same ((1st first) adj6 (radio resource frame)) and ((2nd second) adj6 component adj3 carrier) same ((2nd second) adj6 (radio resource frame))	US-PGPUB; USPAT; USOCR; DERWENT; IBM_TDB	OR	ON	2016/03/09 15:13
S221	15	(set group) near6 (radio resource) with (2nd second other another) near6 (DL down\$link) near3 (component near3 carrier)	US-PGPUB; USPAT	OR	ON	2016/03/09 15:26
S222	35	455/509,522,456.6,137,103,575.ccls. and (downlink near3 carrier) and (uplink near3 (primary first initial) near3 carrier) and ((second 2nd other next) with (channel resource)) and (carrier adj aggregation)	US-PGPUB; USPAT; USOCR; DERWENT; IBM_TDB	OR	ON	2016/03/09 15:45
S223	0	(H04B1/3833, H04M1/0247, H04M1/0237).cpc. and (((first 1st) adj6 component adj3 carrier) same ((radio resource frame))) and ((2nd second) adj6 component adj3 carrier) same ((2nd second other another) adj4 (radio resource frame))	US-PGPUB; USPAT; USOCR; DERWENT; IBM_TDB	OR	ON	2016/03/09 15:48
S224	0	((david near2 astely) (robert near2 baldemair) (dirk near2 gerstenberger) (daniel near2 larsson) (lars near2 lindbom) (stefan near2 parkvall)).in.) and ericsson.as. and single near3 (CC (component adj2 carrier)) with (primary adj2 cell) with (DL down\$link)	US-PGPUB; USPAT; USOCR; DERWENT; IBM_TDB	OR	ON	2016/03/09 16:14
S225	32	((david near2 astely) (robert near2 baldemair) (dirk near2 gerstenberger) (daniel near2 larsson) (lars near2 lindbom) (stefan near2 parkvall)).in.) and ericsson.as. and (CC (component adj2 carrier)) with (primary adj2 cell)	US-PGPUB; USPAT; USOCR; DERWENT; IBM_TDB	OR	ON	2016/03/09 16:14
S226	130	455/\$.ccls. and (downlink near3 carrier) and (uplink near3 (primary first initial) near3 carrier) and ((second 2nd other next) with (channel resource)) and (control with information)	US-PGPUB; USPAT; USOCR; DERWENT; IBM_TDB	OR	ON	2016/03/09 17:02
S227	30	("20120127950" "20110310819" "20120275395" "20120287828" "20120039291" "20100271970" "20120307781" "20110286436" "20120224535" "20120140708" "20120163288" "20110299486" "20100098012" "20120082125" "20120294273").pn.	US-PGPUB; USPAT; USOCR; DERWENT; IBM_TDB	OR	ON	2016/03/09 18:32
S228	10	(carrier adj aggregation) and (schedul\$3 near3 (downlink DL) with ((first primary initial) near6 (resource radio frequency frame))) and ((first 1st) adj6 component adj3 carrier) same ((1st first) adj6 (radio resource frame)) and ((2nd second)	US-PGPUB; USPAT; USOCR; DERWENT; IBM_TDB	OR	ON	2016/03/09 20:46

		adj6 component adj3 carrier) same ((2nd second) adj6 (radio resource frame))				
S229	3	"20070030661"	US-PGPUB; USPAT; USOCR; DERWENT; IBM_TDB	OR	ON	2016/03/09 21:31
S230	76	370/329,252,331.ccls. and (((first 1st) adj6 component adj3 carrier) same ((radio resource frame))) and ((2nd second) adj6 component adj3 carrier) same ((2nd second other another) adj4 (radio resource frame))	US-PGPUB; USPAT; USOCR; DERWENT; IBM_TDB	OR	ON	2016/03/10 09:26
S231	0	(H04B1/3833, H04M1/0247, H04M1/0237).cpc. and (schedul\$3 assign\$3) with (primary adj cell) same2 (multiple several set) near3 component adj2 carrier	US-PGPUB; USPAT; USOCR; DERWENT; IBM_TDB	OR	ON	2016/03/16 11:49
S233	0	(H04B1/3833, H04M1/0247, H04M1/0237).cpc. and (schedul\$3 assign\$3) with (primary adj cell) same2 (multiple several set) near6 carrier	US-PGPUB; USPAT; USOCR; FPRS; EPO; JPO; DERWENT; IBM_TDB	OR	ON	2016/03/16 11:54
S234	18	(H04L5/0053, H04L5/001, H04L5/0094, H04B1/3833, H04M1/0247, H04M1/0237).cpc. and (schedul\$3 assign\$3) with (primary adj cell) same2 (multiple several set) near3 component adj2 carrier	US-PGPUB; USPAT; USOCR; DERWENT; IBM_TDB	OR	ON	2016/03/16 11:59
S235	18	(H04L5/0053, H04L5/001, H04L5/0094, H04B1/3833, H04M1/0247, H04M1/0237).cpc. and (schedul\$3 assign\$3) with (primary adj cell) same2 (multiple several set) near3 component adj2 carrier and (control\$4 adjust\$3) near6 (DL (down\$link))	US-PGPUB; USPAT; USOCR; DERWENT; IBM_TDB	OR	ON	2016/03/16 12:04
S236	7	(H04L5/0053, H04L5/001, H04L5/0094, H04B1/3833, H04M1/0247, H04M1/0237).cpc. and (schedul\$3 assign\$3) with (primary adj cell) same2 (multiple several set) near3 component adj2 carrier and (control\$4 adjust\$3) near6 (DL (down\$link)) and (second 2nd another other) near3 (radio frequency band resources)	US-PGPUB; USPAT; USOCR; DERWENT; IBM_TDB	OR	ON	2016/03/16 12:06
S237	0	455/509,522,456.6,137,103,575.ccls. and (schedul\$3 assign\$3) with (primary adj cell) same2 (multiple several set) near3 component adj2 carrier and (control\$4 adjust\$3) near6 (DL (down\$link)) and (second 2nd another other) near3 (radio frequency band resources)	US-PGPUB; USPAT; USOCR; DERWENT; IBM_TDB	OR	ON	2016/03/16 12:31
S238	7	(A01B12/006, H04L5/0053, H04L5/001, H04L5/0094, H04B1/3833, H04M1/0247, H04M1/0237).cpc. and (schedul\$3 assign\$3) with (primary adj cell) same2 (multiple several set) near3 component adj2 carrier and (control\$4 adjust\$3) near6 (DL (down\$link)) and (second 2nd another other) near3 (radio frequency band resources)	US-PGPUB; USPAT; USOCR; FPRS; EPO; JPO; DERWENT; IBM_TDB	OR	ON	2016/03/16 12:39
S239	4	(H04W88/08, H04W72/044, H04W72/042, H04W52/367, H04W52/12, H04W52/40, H04L29/08657, G01S5/0252, G01S5/02, H04B1/3833, H04M1/0247, H04M1/0237).cpc.	US-PGPUB; USPAT; USOCR; FPRS;	OR	ON	2016/03/16 12:47

		and (schedul\$3 assign\$3) with (primary adj cell) same2 (multiple several set) near3 component adj2 carrier and (control\$4 adjust\$3) near6 (DL (down\$link)) and (second 2nd another other) near3 (radio frequency band resources)	EPO; JPO; DERWENT; IBM_TDB			
S240	0	((david near2 astely) (robert near2 baldemair) (dirk near2 gerstenberger) (daniel near2 larsson) (lars near2 lindbom) (stefan near2 parkvall)).in. and ericsson.as. and (schedul\$3 assign\$3) with (primary adj cell) same2 (multiple several set) near3 component adj2 carrier	US-PGPUB; USPAT; USOCR; FPRS; EPO; JPO; DERWENT; IBM_TDB	OR	ON	2016/03/16 13:28
S246	60	("20100322173" "20110081913" "20130010721" "8634358" "20110007699" "8792830" "20120140708" "20100271970" "20100285809" "20110007699" "20130003700" "20100003997" "20100232373" "20130003700" "8447343" "8634358" "20100232373" "20120051306" "20100296389" "20120140708" "20130010721" "20130136084" "20120082125" "20020160784" "20110081913" "20110081932" "20110243039" "20120020317" "20100098012" "20100003997" "20100208679" "20110310856" "20120082125" "20120140708" "20130136084" "8265030" "20110243039" "8792830" "20120051306" "20120314675" "8472368" "20120147847" "20120020317" "8265030" "20110007695" "20110081932" "20120314675" "20020160784" "20100271970" "20100285809" "20130034073" "8265030" "20110310856" "20100232373" "20100296389" "20120020317" "20100098012" "20110310856" "20120082125" "20100098012" "20130034073" "8447343" "8472368" "20100208679" "20100322173" "20110007695"). PN.	US-PGPUB; USPAT; USOCR; DERWENT; IBM_TDB	OR	ON	2016/06/24 11:47
S247	1	(H04W88/08, H04W72/044, H04W72/042, H04W52/367, H04W52/12, H04W52/40, H04L29/08657, G01S5/0252, G01S5/02, H04B1/3833, H04M1/0247, H04M1/0237).cpc. and (schedul\$3 assign\$3) with (primary adj cell) same2 (multiple several set) near3 component adj2 carrier and (control\$4 adjust\$3) near6 (DL (down\$link)) and (second 2nd another other) near3 (radio frequency band resources)	USPAT	OR	ON	2016/06/24 11:50
S248	7	(H04W88/08, H04W72/044, H04W72/042, H04W52/367, H04W52/12, H04W52/40, H04L29/08657, G01S5/0252, G01S5/02, H04B1/3833, H04M1/0247, H04M1/0237).cpc. and (schedul\$3 assign\$3) with (primary adj cell) same2 (multiple several set) near3 component adj2 carrier and (control\$4 adjust\$3) near6 (DL (down\$link)) and (second 2nd another other) near3 (radio frequency band resources)	US-PGPUB; USPAT; USOCR; FPRS; EPO; JPO; DERWENT; IBM_TDB	OR	ON	2016/06/24 11:51
S249	269	((david near2 astely) (robert near2 baldemair) (dirk near2 gerstenberger) (daniel near2 larsson) (lars near2 lindbom) (stefan near2 parkvall)).in. and 455/\$.ccls.	US-PGPUB; USPAT; USOCR; DERWENT;	OR	ON	2016/06/24 11:55

			IBM_TDB			
S250	2	((david near2 astely) (robert near2 baldemair) (dirk near2 gerstenberger) (daniel near2 larsson) (lars near2 lindbom) (stefan near2 parkvall)).in. and (carrier adj aggregation) and (schedul\$3 near3 (downlink DL) with ((first primary initial) near6 (resource radio frequency frame)))	US-PGPUB; USPAT; USOCR; DERWENT; IBM_TDB	OR	ON	2016/06/24 11:56
S251	5	455/451,452.1,509,456.1,522,137,103,575.ccls. and (control\$4) with (resource frequency channel Bin) same (reserv\$4 sav\$4) near3 (other 2nd second another next) adj3 (resource frequency channel Bin) and (CC component)	US-PGPUB; USPAT; USOCR; DERWENT; IBM_TDB	OR	ON	2016/06/24 11:57
S252	1	"12896993"	US-PGPUB; USPAT; USOCR; DERWENT; IBM_TDB	OR	ON	2016/06/24 12:05
S253	61	370/329,252,331.ccls. and (((first 1st) adj6 component adj3 carrier) same ((radio resource frame))) and ((2nd second) adj6 component adj3 carrier) same ((2nd second other another) adj4 (radio resource frame)) and (set group) near6 (radio resource)	US-PGPUB; USPAT	OR	ON	2016/06/24 12:21
S254	2	("20120147847").PN.	US-PGPUB; USPAT; USOCR; FPRS; EPO; JPO; DERWENT; IBM_TDB	OR	OFF	2016/06/24 12:48
S257	29	455/509,522,456.6,137,103,575.ccls. and (schedul\$3 assign\$3) with component adj2 carrier and (control\$4 adjust\$3) near6 (DL (down\$link)) and (second 2nd another other) near3 (radio frequency band resources)	US-PGPUB; USPAT; USOCR; DERWENT; IBM_TDB	OR	ON	2016/06/24 14:30
S258	22	455/\$.ccls. and (1st first) near3 (radio band resource frequency) with (reserv\$3 schedul\$3 allocat\$3) with (1st first) near3 (CC (component adj carrier))	US-PGPUB; USPAT; USOCR; DERWENT; IBM_TDB	OR	ON	2016/06/24 14:32
S259	2	("20120147847").PN.	US-PGPUB; USPAT; USOCR; DERWENT; IBM_TDB	OR	ON	2016/06/24 21:17
S260	21	455/\$.ccls. and ((first 1st) adj6 component adj3 carrier) same ((1st first) adj6 (radio resource frame)) and ((2nd second) adj6 component adj3 carrier) same ((2nd second) adj6 (radio resource frame))	US-PGPUB; USPAT; USOCR; DERWENT; IBM_TDB	OR	ON	2016/06/24 21:58
S261	33	("20120127950" "20110310819" "20120275395" "20120287828" "20120039291" "20100271970" "20120307781" "20110286436" "20120224535" "20120140708" "20110310820" "20120163288" "20110299486" "20100098012" "20120082125" "20120294273" "20110268048").pn.	US-PGPUB; USPAT; USOCR; DERWENT; IBM_TDB	OR	ON	2016/06/24 22:03
S262	13	(H04W88/08, H04W72/044, H04W72/042, H04W52/367, H04W52/12, H04W52/40,	US-PGPUB; USPAT;	OR	ON	2016/06/24 22:18

		H04L29/08657, G01S5/0252, G01S5/02, H04B1/3833, H04M1/0247, H04M1/0237).cpc. and (schedul\$3 assign\$3) with (primary adj cell same2 (multiple several set) and (control\$4 adjust\$3) near6 (DL (down\$link)) and (second 2nd another other) near3 (radio frequency band resources) same component adj carrier	USOCR; FPRS; EPO; JPO; DERWENT; IBM_TDB			
S266	60	("20100322173" "20110081913" "20130010721" "8634358" "20110007699" "8792830" "20120140708" "20100271970" "20100285809" "20110007699" "20130003700" "20100003997" "20100232373" "20130003700" "8447343" "8634358" "20100232373" "20120051306" "20100296389" "20120140708" "20130010721" "20130136084" "20120082125" "20020160784" "20110081913" "20110081932" "20110243039" "20120020317" "20100098012" "20100003997" "20100208679" "20110310856" "20120082125" "20120140708" "20130136084" "8265030" "20110243039" "8792830" "20120051306" "20120314675" "8472368" "20120147847" "20120020317" "8265030" "20110007695" "20110081932" "20120314675" "20020160784" "20100271970" "20100285809" "20130034073" "8265030" "20110310856" "20100232373" "20100296389" "20120020317" "20100098012" "20110310856" "20120082125" "20100098012" "20130034073" "8447343" "8472368" "20100208679" "20100322173" "20110007695").PN.	US-PGPUB; USPAT; USOCR; DERWENT; IBM_TDB	OR	ON	2017/03/16 15:34
S267	0	(H04B1/3833, H04M1/0247, H04M1/0237).cpc. and (((first 1st) adj6 component adj3 carrier) same ((radio resource frame))) and ((2nd second) adj6 component adj3 carrier) same ((2nd second other another) adj4 (radio resource frame frequency))	US-PGPUB; USPAT; USOCR; DERWENT; IBM_TDB	OR	ON	2017/03/16 15:39
S268	0	455/\$.ccls. and (first 1st) near3 (radio adj resource) and (second other another 2nd) near3 (radio adj resource) same (carrier adj aggregation) and (schedul\$3 near3 (down\$link DL reverse\$1link))	US-PGPUB; USPAT; USOCR; DERWENT; IBM_TDB	OR	ON	2017/03/16 15:55
S269	0	(H04B1/3833, H04M1/0247, H04M1/0237).cpc. and (first 1st) near3 (radio adj resource) and (second other another 2nd) near3 (radio adj resource) same (carrier adj aggregation) and (schedul\$3 near3 (down\$link DL reverse\$1link))	US-PGPUB; USPAT; USOCR; DERWENT; IBM_TDB	OR	ON	2017/03/16 15:56
S270	0	(H04B1/3833, H04M1/0247, H04M1/0237).cpc. and (first 1st) near3 (radio adj resource) and (second other another 2nd) near3 (radio adj resource) and (schedul\$3 near3 (down\$link DL reverse\$1link))	US-PGPUB; USPAT; USOCR; DERWENT; IBM_TDB	OR	ON	2017/03/16 15:57
S271	901	schedul\$3 near3 (transmit\$4 transmi\$5) with (CC (component adj2 cacarrier)) and (CI (control adj2 (info information))) with (CC (component adj2 cacarrier))	US-PGPUB; USPAT; USOCR; DERWENT; IBM_TDB	OR	ON	2017/03/16 17:30
S272	67	(H04W88/08, H04W72/044, H04W72/042I).cpc.	US-PGPUB;	OR	ON	2017/03/16

		and schedul\$3 near3 (transmit\$4 transmi\$5) with (CC (component adj2 cacarrier)) and (CI (control adj2 (info information))) with (OC (component adj2 cacarrier))	USPAT; USOCR; DERWENT; IBM_TDB			17:31
S273	9	(H04W88/08, H04W72/044, H04W72/042I).cpc. and schedul\$3 near3 (transmit\$4 transmi\$5) with (CC (component adj2 cacarrier)) and (CI (control adj2 (info information))) with (OC (component adj2 cacarrier)) and schedul\$3 with (non\$1primary second 2nd secondary) adj2 cell	US-PGPUB; USPAT; USOCR; DERWENT; IBM_TDB	OR	ON	2017/03/16 17:37
S274	41	(H04W88/08, H04W72/044, H04W72/042I).cpc. and schedul\$3 near3 (transmit\$4 transmi\$5) with (CC (component adj2 cacarrier)) and (CI (control adj2 (info information))) with (OC (component adj2 carrier)) and (non\$1primary second 2nd secondary) adj2 (CC (component adj2 carrier))	US-PGPUB; USPAT; USOCR; DERWENT; IBM_TDB	OR	ON	2017/03/16 17:39
S275	697	Ericsson.as. and ((david near2 astely) (robert near2 baldemair) (dirk near2 gerstenberger) (daniel near2 larsson) (lars near2 lindbom) (stefan near2 parkvall)).in.	US-PGPUB; USPAT; USOCR; DERWENT; IBM_TDB	OR	ON	2017/03/16 18:16
S276	40	Ericsson.as. and ((david near2 astely) (robert near2 baldemair) (dirk near2 gerstenberger) (daniel near2 larsson) (lars near2 lindbom) (stefan near2 parkvall)).in. and (radio near3 resource) with (component near3 carrier)	US-PGPUB; USPAT; USOCR; DERWENT; IBM_TDB	OR	ON	2017/03/16 18:18
S278	5	455/\$.ccls. and (set near3 radio near3 resource) same component adj carrier	US-PGPUB; USPAT; USOCR; DERWENT; IBM_TDB	OR	ON	2017/03/16 19:44
S279	34641	(H04W88/08, H04W72/044, H04W72/042).cpc.	US-PGPUB; USPAT; USOCR; DERWENT; IBM_TDB	OR	ON	2017/03/16 20:26
S280	7394	(H04W52/367, H04W52/12, H04W52/40).cpc.	US-PGPUB; USPAT; USOCR; DERWENT; IBM_TDB	OR	ON	2017/03/16 20:26
S281	6589	(H04L29/08657, G01S5/0252, G01S5/02).cpc.	US-PGPUB; USPAT; USOCR; DERWENT; IBM_TDB	OR	ON	2017/03/16 20:26
S282	5176	(H04B1/3833, H04M1/0247, H04M1/0237).cpc.	US-PGPUB; USPAT; USOCR; DERWENT; IBM_TDB	OR	ON	2017/03/16 20:26
S283	12417	(H03F3/211, H04B7/0617, H04B7/0669).cpc.	US-PGPUB; USPAT; USOCR; DERWENT; IBM_TDB	OR	ON	2017/03/16 20:26
S284	131	(S279 S280 S281 S282 S283) and (second other another 2nd) near3 (radio adj resource) and (carrier adj aggregation) and (schedul\$3 near3 (down\$link DL reverse\$link))	US-PGPUB; USPAT; USOCR; DERWENT;	OR	ON	2017/03/16 20:26

			IBM_TDB			
S285	126	(H04W88/08, H04W72/044, H04W72/042).cpc. and (second other another 2nd) near3 (radio adj resource) and (carrier adj aggregation) and (schemul\$3 near3 (down\$link DL reverse\$1link))	US-PGPUB; USPAT; USOCR; DERWENT; IBM_TDB	OR	ON	2017/03/16 20:27
S286	3	Ericsson.as. and ((david near2 astely) (robert near2 baldemair) (dirk near2 gerstenberger) (daniel near2 larsson) (lars near2 lindbom) (stefan near2 parkvall)).in. and schemul\$3 near3 (transmit\$4 transmi\$5 communication) with (CC component adj2 cacarrier)	US-PGPUB; USPAT; USOCR; DERWENT; IBM_TDB	OR	ON	2017/03/16 22:26
S287	62	455/451,452.1,509,456.1,522,137,103,575.ccls. and (allocat\$3) with (resource frequency channel Bin) same (reserv\$4 sav\$4) adj6 (resource frequency channel Bin) and (control\$3 adjst\$3) near6 (CC component)	US-PGPUB; USPAT; USOCR; DERWENT; IBM_TDB	OR	ON	2017/03/17 11:15
S288	0	455/451,452.1,509,456.1,522,137,103,575.ccls. and (allocat\$3) with (resource frequency channel Bin) same (reserv\$4 sav\$4) adj6 (resource frequency channel Bin) and (primary adj cell) same (multiple several set) near3 component adj2 carrier	US-PGPUB; USPAT; USOCR; FPRS; EPO; JPO; DERWENT; IBM_TDB	OR	ON	2017/03/17 11:17
S289	0	455/451,452.1,509,456.1,522,137,103,575.ccls. and (allocat\$3) with (resource frequency channel Bin) same (reserv\$4 sav\$4) adj6 (resource frequency channel Bin) and (primary adj cell) same2 (multiple several set) near3 component adj2 carrier	US-PGPUB; USPAT; USOCR; FPRS; EPO; JPO; DERWENT; IBM_TDB	OR	ON	2017/03/17 11:18
S290	0	455/451,452.1,509,456.1,522,137,103,575.ccls. and (allocat\$3) with (resource frequency channel Bin) same (reserv\$4 sav\$4) adj6 (resource frequency channel Bin) and (primary adj2 cell) and (multiple several set) near3 component adj2 carrier	US-PGPUB; USPAT; USOCR; FPRS; EPO; JPO; DERWENT; IBM_TDB	OR	ON	2017/03/17 11:20
S291	1	455/451,452.1,509,456.1,522,137,103,575.ccls. and (allocat\$3) with (resource frequency channel Bin) same (reserv\$4 sav\$4) adj6 (resource frequency channel Bin) and (multiple several set) near3 component adj2 carrier	US-PGPUB; USPAT; USOCR; FPRS; EPO; JPO; DERWENT; IBM_TDB	OR	ON	2017/03/17 11:22
S292	9	455/451,452.1,509,456.1,522,137,103,575.ccls. and (allocat\$3) with (resource frequency channel Bin) same2 (reserv\$4 sav\$4) adj6 (resource frequency channel Bin) and (multiple several set) near3 component adj2 carrier	US-PGPUB; USPAT; USOCR; FPRS; EPO; JPO; DERWENT; IBM_TDB	OR	ON	2017/03/17 11:23
S294	178	370/\$.ccls. and (allocat\$3) with (resource frequency channel Bin) same2 (reserv\$4 sav\$4) adj6 (resource frequency channel Bin) and (multiple several set) near3 component adj2 carrier	US-PGPUB; USPAT; USOCR; FPRS; EPO; JPO; DERWENT; IBM_TDB	OR	ON	2017/03/17 16:26
S295	26	455/\$.ccls. and (allocat\$3) with (resource	US-PGPUB;	OR	ON	2017/03/17

		frequency channel Bin) same2 (reserv\$4 sav\$4) adj6 (resource frequency channel Bin) and (multiple several set) near3 component adj2 carrier	USPAT; USOCR; FPRS; EPO; JPO; DERWENT; IBM_TDB			16:28
S296	178	370/\$.ccls. and (allocat\$3) with (resource frequency channel Bin) same2 (reserv\$4 sav\$4) adj6 (resource frequency channel Bin) and (multiple several set) near3 component adj2 carrier	US-PGPUB; USPAT; USOCR; FPRS; EPO; JPO; DERWENT; IBM_TDB	OR	ON	2017/03/17 16:28
S297	81	370/\$.ccls. and (allocat\$3) with (resource frequency channel Bin) same2 (reserv\$4 sav\$4) adj6 (resource frequency channel Bin) and (multiple several set) near3 component adj2 carrier and (primary adj2 cell)	US-PGPUB; USPAT; USOCR; FPRS; EPO; JPO; DERWENT; IBM_TDB	OR	ON	2017/03/17 17:01
S298	3	"12896993"	US-PGPUB; USPAT; USOCR; FPRS; EPO; JPO; DERWENT; IBM_TDB	OR	ON	2017/03/17 17:17
S299	3	"9497004"	US-PGPUB; USPAT; USOCR; FPRS; EPO; JPO; DERWENT; IBM_TDB	OR	ON	2017/03/17 17:42
S300	3	"12896993"	US-PGPUB; USPAT; USOCR; FPRS; EPO; JPO; DERWENT; IBM_TDB	OR	ON	2017/03/17 17:43
S301	223	370/329,341,348,395.4.ccls. and (carrier near3 aggregat\$3) and (component near3 carrier) same (up\$1link UL) with associat\$3 with down\$1link	US-PGPUB; USPAT; USOCR; DERWENT; IBM_TDB	OR	ON	2017/06/25 12:46
S302	264	370/329,341,348,395.4.ccls. and (carrier near3 aggregat\$3) and (component near3 carrier) same (up\$1link UL) with associat\$3 with (DL down\$1link)	US-PGPUB; USPAT; USOCR; DERWENT; IBM_TDB	OR	ON	2017/06/25 12:47
S303	121	370/329,341,348,395.4.ccls. and (carrier near3 aggregat\$3) same (component near3 carrier) same (up\$1link UL) with associat\$3 with (DL down\$1link)	US-PGPUB; USPAT; USOCR; DERWENT; IBM_TDB	OR	ON	2017/06/25 12:47
S304	75	((455/451,452.1,509,456.1,522,137,103,575.ccls.) (370/329,341,348,395.4.ccls.)) and (carrier near3 aggregat\$3) same (component near3 carrier) same (up\$1link UL) with associat\$3 with (DL down\$1link) and (schedul\$3 near3 downlink)	US-PGPUB; USPAT; USOCR; DERWENT; IBM_TDB	OR	ON	2017/06/25 12:48

EAST Search History (Interference)

Ref #	Hits	Search Query	DBs	Default Operator	Plurals	Time Stamp
L4	3	455/509,522,456.6,137,103,575.ccls. and (downlink near3 carrier) and (uplink near3 (primary first initial) near3 carrier) and ((second 2nd other next) with (channel resource)) same(carrier adj aggregation)	US-PGPUB; USPAT	OR	ON	2017/06/26 18:44
L7	12	(H04W52/367, H04W52/12, H04W52/40).cpc. and (downlink near3 carrier) and (uplink near3 (primary first initial) near3 carrier) and ((second 2nd other next) with (channel resource)) same(carrier adj aggregation)	US-PGPUB; USPAT	OR	ON	2017/06/26 18:55
S159	0	455/451,452.1,509,456.1,522,137,103,575.ccls. and (control\$4) with (resource frequency channel) same (rererv\$4 sav\$4) near3 (other 2nd second another) adj3 (resource frequency channel Bin)	US-PGPUB; USPAT	OR	ON	2014/10/31 15:24
S160	5	(DL down\$link) with (1st first first primary initia) near3 (set group) near6 (radio resource) and (DL down\$link) with (set group) near6 (radio resource) with (2nd second other another) near2 component	US-PGPUB; USPAT	OR	ON	2014/10/31 15:26
S241	0	(H04B1/3833, H04M1/0247, H04M1/0237).cpc. and (schedul\$3 assign\$3) with (primary adj cell) same2 (multiple several set) near3 component adj2 carrier	US-PGPUB; USPAT	OR	ON	2016/03/16 11:50
S242	7	(H04L5/0053, H04L5/001, H04L5/0094, H04B1/3833, H04M1/0247, H04M1/0237).cpc. and (schedul\$3 assign\$3) with (primary adj cell) same2 (multiple several set) near3 component adj2 carrier and (control\$4 adjust\$3) near6 (DL (down\$link)) and (second 2nd another other) near3 (radio frequency band resources)	US-PGPUB; USPAT	OR	ON	2016/03/16 12:38
S243	7	(A01B12/006, H04L5/0053, H04L5/001, H04L5/0094, H04B1/3833, H04M1/0247, H04M1/0237).cpc. and (schedul\$3 assign\$3) with (primary adj cell) same2 (multiple several set) near3 component adj2 carrier and (control\$4 adjust\$3) near6 (DL (down\$link)) and (second 2nd another other) near3 (radio frequency band resources)	US-PGPUB; USPAT	OR	ON	2016/03/16 12:39
S244	1	(H04W88/08, H04W72/044, H04W72/042, H04W52/367, H04W52/12, H04W52/40, H04L29/08657, G01S5/0252, G01S5/02, H04B1/3833, H04M1/0247, H04M1/0237).cpc. and (schedul\$3 assign\$3) with (primary adj cell) same2 (multiple several set) near3 component adj2 carrier and (control\$4 adjust\$3) near6 (DL (down\$link)) and (second 2nd another other) near3 (radio frequency band resources)	USPAT	OR	ON	2016/03/16 12:47
S245	4	(H04W88/08, H04W72/044, H04W72/042, H04W52/367, H04W52/12, H04W52/40, H04L29/08657, G01S5/0252, G01S5/02, H04B1/3833, H04M1/0247, H04M1/0237).cpc. and (schedul\$3 assign\$3) with (primary adj cell) same2 (multiple several set) near3	US-PGPUB; USPAT	OR	ON	2016/03/16 12:47

		component adj2 carrier and (control\$4 adjust\$3) near6 (DL (down\$link)) and (second 2nd another other) near3 (radio frequency band resources)				
S255	7	(H04W88/08, H04W72/044, H04W72/042, H04W52/367, H04W52/12, H04W52/40, H04L29/08657, G01S5/0252, G01S5/02, H04B1/3833, H04M1/0247, H04M1/0237).cpc. and (schedul\$3 assign\$3) with (primary adj cell) same2 (multiple several set) near3 component adj2 carrier and (control\$4 adjust\$3) near6 (DL (down\$link)) and (second 2nd another other) near3 (radio frequency band resources)	US-PGPUB; USPAT	OR	ON	2016/06/24 11:48
S256	61	370/329,252,331.ccls. and (((first 1st) adj6 component adj3 carrier) same ((radio resource frame))) and ((2nd second) adj6 component adj3 carrier) same ((2nd second other another) adj4 (radio resource frame)) and (set group) near6 (radio resource)	US-PGPUB; USPAT	OR	ON	2016/06/24 12:22
S263	14	(H04W88/08, H04W72/044, H04W72/042, H04W52/367, H04W52/12, H04W52/40, H04L29/08657, G01S5/0252, G01S5/02, H04B1/3833, H04M1/0247, H04M1/0237).cpc. and (schedul\$3 assign\$3) with (primary adj cell) same2 (multiple several set) and (control\$4 adjust\$3) near6 (DL (down\$link)) and (second 2nd another other) near3 (radio frequency band resources)	USPAT	OR	ON	2016/06/24 22:15
S264	66	(H04W88/08, H04W72/044, H04W72/042, H04W52/367, H04W52/12, H04W52/40, H04L29/08657, G01S5/0252, G01S5/02, H04B1/3833, H04M1/0247, H04M1/0237).cpc. and (schedul\$3 assign\$3) with (primary adj cell) same2 (multiple several set) and (control\$4 adjust\$3) near6 (DL (down\$link)) and (second 2nd another other) near3 (radio frequency band resources)	US-PGPUB; USPAT	OR	ON	2016/06/24 22:15
S265	13	(H04W88/08, H04W72/044, H04W72/042, H04W52/367, H04W52/12, H04W52/40, H04L29/08657, G01S5/0252, G01S5/02, H04B1/3833, H04M1/0247, H04M1/0237).cpc. and (schedul\$3 assign\$3) with (primary adj cell) same2 (multiple several set) and (control\$4 adjust\$3) near6 (DL (down\$link)) and (second 2nd another other) near3 (radio frequency band resources) same component adj carrier	US-PGPUB; USPAT	OR	ON	2016/06/24 22:17
S277	9	(H04W88/08, H04W72/044, H04W72/042).cpc. and schedul\$3 near3 (transmit\$4 transmi\$5) with (CC (component adj2 cacarrier)) and (CI (control adj2 (info information))) with (CC (component adj2 cacarrier)) and schedul\$3 with (non\$1primary second 2nd secondary) adj2 cell	US-PGPUB; USPAT	OR	ON	2017/03/16 17:37
S293	0	455/451,452.1,509,456.1,522,137,103,575.ccls. and (allocat\$3) with (resource frequency channel Bin) same (reserv\$4 sav\$4) adj6 (resource frequency channel Bin) and (primary adj cell) same (multiple several set) near3 component adj2 carrier	US-PGPUB; USPAT	OR	ON	2017/03/17 11:20

6/26/2017 8:07:36 PM

C:\Users\mtalukder\Documents\EAST\Workspaces\15350360.wsp

Issue Classification 	Application/Control No. 15350360	Applicant(s)/Patent Under Reexamination ASTELY ET AL.	
	Examiner MD TALUKDER	Art Unit 2648	

CPC						
Symbol				Type	Version	
H04L		5		0053	F	2013-01-01
H04L		5		0005	A	2013-01-01
H04L		5		001	I	2013-01-01
H04L		5		0094	I	2013-01-01
H04W		8		24	A	2013-01-01
H04W		28		26	I	2013-01-01
H04W		48		16	A	2013-01-01
H04W		72		0453	I	2013-01-01
H04W		72		1273	I	2013-01-01
H04W		88		02	A	2013-01-01
H04W		88		08	A	2013-01-01

CPC Combination Sets				
Symbol	Type	Set	Ranking	Version

NONE		Total Claims Allowed:	
(Assistant Examiner)	(Date)	30	
/MD TALUKDER/ Primary Examiner.Art Unit 2648	06/26/2017	O.G. Print Claim(s)	O.G. Print Figure
(Primary Examiner)	(Date)	1	1

**REQUEST FOR CONTINUED EXAMINATION(RCE)TRANSMITTAL
 (Submitted Only via EFS-Web)**

Application Number	15350360	Filing Date	2016-11-14	Docket Number (if applicable)	4015-9600 / P30138-US3	Art Unit	2648
First Named Inventor	Astely			Examiner Name	Md K. Talukder		

This is a Request for Continued Examination (RCE) under 37 CFR 1.114 of the above-identified application.
 Request for Continued Examination (RCE) practice under 37 CFR 1.114 does not apply to any utility or plant application filed prior to June 8, 1995, or to any design application. The Instruction Sheet for this form is located at WWW.USPTO.GOV

SUBMISSION REQUIRED UNDER 37 CFR 1.114

Note: If the RCE is proper, any previously filed unentered amendments and amendments enclosed with the RCE will be entered in the order in which they were filed unless applicant instructs otherwise. If applicant does not wish to have any previously filed unentered amendment(s) entered, applicant must request non-entry of such amendment(s).

- Previously submitted. If a final Office action is outstanding, any amendments filed after the final Office action may be considered as a submission even if this box is not checked.
- Consider the arguments in the Appeal Brief or Reply Brief previously filed on _____
- Other _____
- Enclosed
- Amendment/Reply
- Information Disclosure Statement (IDS)
- Affidavit(s)/ Declaration(s)
- Other _____

MISCELLANEOUS

- Suspension of action on the above-identified application is requested under 37 CFR 1.103(c) for a period of months _____
 (Period of suspension shall not exceed 3 months; Fee under 37 CFR 1.17(i) required)
- Other _____

FEES

- The RCE fee under 37 CFR 1.17(e) is required by 37 CFR 1.114 when the RCE is filed.**
- The Director is hereby authorized to charge any underpayment of fees, or credit any overpayments, to Deposit Account No 181167

SIGNATURE OF APPLICANT, ATTORNEY, OR AGENT REQUIRED

<input checked="" type="checkbox"/> Patent Practitioner Signature
Applicant Signature

Doc code: RCEX

Doc description: Request for Continued Examination (RCE)

PTO/SB/30EFS (07-09)

Approved for use through 07/31/2012. OMB 0651-0031
U.S. Patent and Trademark Office; U.S. DEPARTMENT OF COMMERCE

Under the Paperwork Reduction Act of 1995, no persons are required to respond to a collection of information unless it contains a valid OMB control number.

Signature of Registered U.S. Patent Practitioner			
Signature	David E. Bennett, Reg. No. 32194/	Date (YYYY-MM-DD)	2017-09-14
Name	David E. Bennett	Registration Number	32194

This collection of information is required by 37 CFR 1.114. The information is required to obtain or retain a benefit by the public which is to file (and by the USPTO to process) an application. Confidentiality is governed by 35 U.S.C. 122 and 37 CFR 1.11 and 1.14. This collection is estimated to take 12 minutes to complete, including gathering, preparing, and submitting the completed application form to the USPTO. Time will vary depending upon the individual case. Any comments on the amount of time you require to complete this form and/or suggestions for reducing this burden, should be sent to the Chief Information Officer, U.S. Patent and Trademark Office, U.S. Department of Commerce, P.O. Box 1450, Alexandria, VA 22313-1450.

If you need assistance in completing the form, call 1-800-PTO-9199 and select option 2.

Privacy Act Statement

The Privacy Act of 1974 (P.L. 93-579) requires that you be given certain information in connection with your submission of the attached form related to a patent application or patent. Accordingly, pursuant to the requirements of the Act, please be advised that: (1) the general authority for the collection of this information is 35 U.S.C. 2(b)(2); (2) furnishing of the information solicited is voluntary; and (3) the principal purpose for which the information is used by the U.S. Patent and Trademark Office is to process and/or examine your submission related to a patent application or patent. If you do not furnish the requested information, the U.S. Patent and Trademark Office may not be able to process and/or examine your submission, which may result in termination of proceedings or abandonment of the application or expiration of the patent.

The information provided by you in this form will be subject to the following routine uses:

1. The information on this form will be treated confidentially to the extent allowed under the Freedom of Information Act (5 U.S.C. 552) and the Privacy Act (5 U.S.C. 552a). Records from this system of records may be disclosed to the Department of Justice to determine whether the Freedom of Information Act requires disclosure of these records.
2. A record from this system of records may be disclosed, as a routine use, in the course of presenting evidence to a court, magistrate, or administrative tribunal, including disclosures to opposing counsel in the course of settlement negotiations.
3. A record in this system of records may be disclosed, as a routine use, to a Member of Congress submitting a request involving an individual, to whom the record pertains, when the individual has requested assistance from the Member with respect to the subject matter of the record.
4. A record in this system of records may be disclosed, as a routine use, to a contractor of the Agency having need for the information in order to perform a contract. Recipients of information shall be required to comply with the requirements of the Privacy Act of 1974, as amended, pursuant to 5 U.S.C. 552a(m).
5. A record related to an International Application filed under the Patent Cooperation Treaty in this system of records may be disclosed, as a routine use, to the International Bureau of the World Intellectual Property Organization, pursuant to the Patent Cooperation Treaty.
6. A record in this system of records may be disclosed, as a routine use, to another federal agency for purposes of National Security review (35 U.S.C. 181) and for review pursuant to the Atomic Energy Act (42 U.S.C. 218(c)).
7. A record from this system of records may be disclosed, as a routine use, to the Administrator, General Services, or his/her designee, during an inspection of records conducted by GSA as part of that agency's responsibility to recommend improvements in records management practices and programs, under authority of 44 U.S.C. 2904 and 2906. Such disclosure shall be made in accordance with the GSA regulations governing inspection of records for this purpose, and any other relevant (i.e., GSA or Commerce) directive. Such disclosure shall not be used to make determinations about individuals.
8. A record from this system of records may be disclosed, as a routine use, to the public after either publication of the application pursuant to 35 U.S.C. 122(b) or issuance of a patent pursuant to 35 U.S.C. 151. Further, a record may be disclosed, subject to the limitations of 37 CFR 1.14, as a routine use, to the public if the record was filed in an application which became abandoned or in which the proceedings were terminated and which application is referenced by either a published application, an application open to public inspections or an issued patent.
9. A record from this system of records may be disclosed, as a routine use, to a Federal, State, or local law enforcement agency, if the USPTO becomes aware of a violation or potential violation of law or regulation.

IN THE UNITED STATES PATENT AND TRADEMARK OFFICE

In re Application of: **Astely et al.**)
)
Serial No.: **15/350,360**)
)
Filed: **November 14, 2016**)
)
For: **PUCCH Resource Allocation for Carrier**)
 Aggregation in LTE-Advanced)
)
Docket No: **4015-9600 / P30138-US3**)

Examiner: Md K. Talukder
Group Art Unit: 2648
Confirmation No.: 1120

Mail Stop RCE
Commissioner for Patents
P.O. Box 1450
Alexandria, VA 22313-1450

14 September 2017

PRELIMINARY AMENDMENT

This paper is being filed accompanying a Request for Continued Examination. The requisite fee of \$1,200 is submitted for filing the Request for Continued Examination. Reconsideration is respectfully requested in light of the amendments and/or remarks below. The Office is hereby authorized to charge any fees required for entry of this paper to Deposit Account 18-1167.

CLAIMS LISTING

1. (Previously Presented) A method implemented by a base station of receiving control information from a user terminal, the method comprising:
 - scheduling downlink transmissions to a first user terminal only on a single downlink component carrier associated with a primary cell and scheduling downlink transmissions to a second user terminal on multiple downlink component carriers or on a downlink component carrier associated with a non-primary cell;
 - receiving, on a first set of radio resources, control information associated with the downlink transmissions to the first user terminal, wherein the first set of radio resources is reserved for a user terminal scheduled to receive downlink transmissions only on a single downlink component carrier associated with the primary cell; and
 - receiving, on a second set of radio resources, control information associated with the downlink transmissions to the second user terminal, wherein the second set of radio resources is reserved for a user terminal scheduled to receive downlink transmissions on multiple downlink component carriers or on a downlink component carrier associated with a non-primary cell, the first and second sets of radio resources being on a same uplink component carrier associated with the primary cell.

2. (Previously Presented) The method of claim 1, wherein the first and second sets of radio resources are different.

3. (Previously Presented) The method of claim 2, wherein the second set of radio resources are additional resources as compared to the first set of radio resources.

4. (Previously Presented) The method of claim 1, further comprising transmitting control information to the first user terminal to explicitly indicate the first set of radio resources on the uplink component carrier associated with the primary cell.

5. (Previously Presented) The method of claim 1, further comprising providing the first user terminal with an implicit indication to dynamically assign radio resources in said first set of radio resources.

6. (Previously Presented) The method of claim 5, wherein the implicit indication is a control channel element (CCE) of a Physical Downlink Control Channel (PDCCH) used for scheduling the first user terminal.

7. (Previously Presented) The method of claim 1, further comprising transmitting control information to the second user terminal on a downlink component carrier to implicitly or explicitly indicate the second set of radio resources on the uplink component carrier associated with the primary cell.

8. (Previously Presented) The method of claim 7, wherein at least one of the first and second sets of radio resources is indicated explicitly by an uplink control channel resource index.

9. (Previously Presented) The method of claim 8, wherein an explicit indication related to the second set of radio resources is transmitted as radio resource control signaling.

10. (Previously Presented) The method of claim 1, further comprising transmitting, on the single downlink component carrier, an assignment of radio resources in the second set of radio resources when the second user terminal is scheduled to receive the downlink transmissions on the multiple downlink component carriers or on the downlink component carrier associated with the non-primary cell.

11. (Previously Presented) The method of claim 10, wherein the assignment of radio resources in said second set of radio resources is an acknowledgement resource indication to dynamically assign radio resources to the second user terminal when the second user terminal is scheduled to receive downlink transmissions on the multiple downlink component carriers or on the downlink component carrier associated with the non-primary cell.

12. (Previously Presented) The method of claim 11, wherein the acknowledgement resource indication selects radio resources in the second set of radio resources, which is a semi-statically configured set of uplink resources.

13. (Previously Presented) The method of claim 1, further comprising:
receiving control signaling on the second set of radio resources if radio resources on a single downlink component carrier associated with a non-primary cell are assigned for the downlink transmissions.

14. (Previously Presented) The method of claim 1, further comprising:
if the first user terminal is scheduled to receive downlink transmissions on a second single downlink component carrier associated with a non-primary cell, receiving control information associated with the downlink transmissions to the first user terminal on the second set of radio resources on the uplink component carrier associated with the primary cell, wherein the second set of radio resources is reserved for a user terminal scheduled to receive downlink transmissions on the second single downlink component carrier.
15. (Previously Presented) The method of claim 1, wherein the first user equipment is the same as the second user equipment.
16. (Previously Presented) The method of claim 1, wherein the first user equipment is different from the second user equipment.
17. (Previously Presented) A base station comprising:
a transmitter to transmit user data on one or more downlink component carriers to a first user terminal and a second user terminal; and
a controller to schedule downlink transmissions to the first user terminal and the second user terminal, the controller configured to:
schedule downlink transmissions to the first user terminal only on a single downlink component carrier associated with a primary cell and schedule downlink transmissions to the second user terminal on multiple downlink component carriers or on a downlink component carrier associated with a non-primary cell;

receive, on a first set of radio resources, control information associated with the downlink transmissions to the first user terminal, wherein the first set of radio resources is reserved for a user terminal scheduled to receive downlink transmissions only on a single downlink component carrier associated with the primary cell; and

receive, on a second set of radio resources, control information associated with the downlink transmissions to the second user terminal, wherein the second set of radio resources is reserved for a user terminal scheduled to receive downlink transmissions on multiple downlink component carriers or on a downlink component carrier associated with a non-primary cell, the first and second sets of radio resources being on a same uplink component carrier associated with the primary cell.

18. (Previously Presented) A method implemented by a user terminal of transmitting control information in a mobile communication network, the method comprising:

receiving an assignment of radio resources for downlink transmissions from a base station;

transmitting, on a first set of radio resources, control information associated with the downlink transmissions responsive to being assigned radio resources only on a single downlink component carrier associated with the primary cell for the downlink transmission, wherein the first set of radio resources is reserved for a user terminal scheduled to receive downlink transmissions on a single downlink component carrier associated with the primary cell; and

transmitting, on a second set of radio resources, control information associated with the downlink transmissions responsive to being assigned radio resources on multiple downlink component carriers or on a downlink component carrier associated with a non-primary cell for the downlink transmission, wherein the second set of radio resources is reserved for a user terminal scheduled to receive downlink transmissions on multiple downlink component carriers or on a downlink component carrier associated with a non-primary cell, the first and second sets of radio resources being on a same uplink component carrier associated with the primary cell.

19. (Previously Presented) The method of claim 18, wherein the first and second sets of radio resources are different.

20. (Previously Presented) The method of claim 19, wherein the second set of radio resources are additional resources as compared to the first set of radio resources.

21. (Previously Presented) The method of claim 18, further comprising receiving control information from the base station explicitly indicating the first set of radio resources on the uplink component carrier associated with the primary cell.

22. (Previously Presented) The method of claim 21, wherein said receiving the control information comprises receiving an uplink control channel resource index explicitly indicating said first set of radio resources.

23. (Previously Presented) The method of claim 22, wherein an explicit indication relating to the second set of radio resources is received as radio resource control signaling.

24. (Previously Presented) The method of claim 18, further comprising receiving an implicit indication to dynamically assign radio resources in said first set of radio resources.

25. (Previously Presented) The method of claim 24, wherein the implicit indication is a control channel element (CCE) of a Physical Downlink Control Channel (PDCCH) on which the assignment of radio resources for downlink transmissions is received.

26. (Previously Presented) The method of claim 18, further comprising receiving, on the single downlink component carrier, an assignment of radio resources in the second set of radio resources when the user terminal is scheduled to receive the downlink transmissions on the multiple downlink component carriers or on the downlink component carrier associated with the non-primary cell.

27. (Previously Presented) The method of claim 26, wherein the assignment of radio resources in said second set of radio resources is an acknowledgement resource indication to dynamically assign radio resources in when the user terminal is scheduled to receive downlink transmissions on the multiple downlink component carriers or on the downlink component carrier associated with the non-primary cell.
28. (Previously Presented) The method of claim 27, further comprising selecting radio resources in the second set of radio resources, which is a semi-statically configured set of uplink resources, responsive to the acknowledgement resource indication.
29. (Previously Presented) The method of claim 18, further comprising:
transmitting control signaling on the second set of radio resources if radio resources on a single downlink component carrier associated with a non-primary cell are assigned for the downlink transmissions.
30. (Previously Presented) A user terminal for mobile communications, the user terminal comprising:
a receiver to receive downlink transmissions from a base station;
a transmitter to transmit control information associated with the downlink transmission to a base station; and
a controller to select radio resources for transmission of control information associated with the downlink transmissions, the controller configured to:

select a first set of radio resources responsive to being assigned radio resources only on a single downlink component carrier associated with the primary cell for the downlink transmission, wherein the first set of radio resources is reserved for a user terminal scheduled to receive downlink transmissions on a single downlink component carrier associated with the primary cell; and select a second set of radio resources responsive to being assigned radio resources on multiple downlink component carriers or on a downlink component carrier associated with a non-primary cell for the downlink transmissions, wherein the second set of radio resources is reserved for a user terminal scheduled to receive downlink transmissions on multiple downlink component carriers or on a downlink component carrier associated with a non-primary cell, the first and second sets of radio resources being on a same uplink component carrier associated with the primary cell.

31. (New) The user terminal of claim 30, wherein the controller is further configured to select, as the second set of radio resources, a set of radio resources different than the first set of radio resources.

32. (New) The user terminal of claim 31, wherein the controller is further configured to select, as the second set of radio resources, additional resources as compared to the first set of radio resources.

33. (New) The user terminal of claim 30, wherein the controller is further configured to receive control information from the base station explicitly indicating the first set of radio resources on the uplink component carrier associated with the primary cell.

34. (New) The user terminal of claim 33, wherein the controller is further configured to receive, as the control information, an uplink control channel resource index explicitly indicating said first set of radio resources.

35. (New) The user terminal of claim 34, wherein the controller is further configured to receive radio resource control signaling including an explicit indication relating to the second set of radio resources.

36. (New) The user terminal of claim 30, wherein the controller is further configured to receive an implicit indication to dynamically assign radio resources in said first set of radio resources.

37. (New) The user terminal of claim 36, wherein the implicit indication comprises a control channel element (CCE) of a Physical Downlink Control Channel (PDCCH) on which the assignment of radio resources for downlink transmissions is received.

38. (New) The user terminal of claim 30, wherein the controller is further configured to receive, on the single downlink component carrier, an assignment of radio resources in the second set of radio resources when the user terminal is scheduled to receive the downlink transmissions on the multiple downlink component carriers or on the downlink component carrier associated with the non-primary cell.

39. (New) The user terminal of claim 26, wherein the assignment of radio resources in said second set of radio resources comprises an acknowledgement resource indication to dynamically assign radio resources in when the user terminal is scheduled to receive downlink transmissions on the multiple downlink component carriers or on the downlink component carrier associated with the non-primary cell.

40. (New) The user terminal of claim 27, wherein the controller is further configured to select radio resources in the second set of radio resources, which is a semi-statically configured set of uplink resources, responsive to the acknowledgement resource indication.

41. (New) The user terminal of claim 18, wherein the controller is further configured to transmit control signaling on the second set of radio resources if radio resources on a single downlink component carrier associated with a non-primary cell are assigned for the downlink transmissions.

REMARKS

In the Notice of Allowance dated July 5, 2017, the Examiner indicated that claims 1-30 were allowable. New claims 31-41 have been added. The new claims all depend directly or indirectly from independent claim 30, which was deemed to be allowable over the prior art of record. New claims 31-41 correspond to allowed dependent claims 19-29, which were also deemed to be allowable. Therefore, it is respectfully submitted that the application is in condition for allowance.

Respectfully submitted,
COATS & BENNETT, P.L.L.C.

Dated: 14 September 2017

/ David E. Bennett, Reg. No. 32,194 /
David E. Bennett
Registration No.: 32,194
Telephone: (919) 854-1844

Electronic Patent Application Fee Transmittal

Application Number:	15350360			
Filing Date:	14-Nov-2016			
Title of Invention:	PUCCH RESOURCE ALLOCATION FOR CARRIER AGGREGATION IN LTE-ADVANCED			
First Named Inventor/Applicant Name:	David Astely			
Filer:	David E. Bennett/Robert Sivigny			
Attorney Docket Number:	4015-9600 / P30138-US3			
Filed as Large Entity				
Filing Fees for Utility under 35 USC 111(a)				
Description	Fee Code	Quantity	Amount	Sub-Total in USD(\$)
Basic Filing:				
Pages:				
Claims:				
CLAIMS IN EXCESS OF 20	1202	11	80	880
Miscellaneous-Filing:				
Petition:				
Patent-Appeals-and-Interference:				
Post-Allowance-and-Post-Issuance:				

Description	Fee Code	Quantity	Amount	Sub-Total in USD(\$)
Extension-of-Time:				
Miscellaneous:				
RCE- 1st Request	1801	1	1200	1200
Total in USD (\$)				2080

Electronic Acknowledgement Receipt

EFS ID:	30360483
Application Number:	15350360
International Application Number:	
Confirmation Number:	1120
Title of Invention:	PUCCH RESOURCE ALLOCATION FOR CARRIER AGGREGATION IN LTE-ADVANCED
First Named Inventor/Applicant Name:	David Astely
Customer Number:	24112
Filer:	David E. Bennett/Robert Sivigny
Filer Authorized By:	David E. Bennett
Attorney Docket Number:	4015-9600 / P30138-US3
Receipt Date:	14-SEP-2017
Filing Date:	14-NOV-2016
Time Stamp:	10:44:47
Application Type:	Utility under 35 USC 111(a)

Payment information:

Submitted with Payment	yes
Payment Type	EFT
Payment was successfully received in RAM	\$2080
RAM confirmation Number	091417INTEFSW10450400
Deposit Account	
Authorized User	

The Director of the USPTO is hereby authorized to charge indicated fees and credit any overpayment as follows:

File Listing:					
Document Number	Document Description	File Name	File Size(Bytes)/ Message Digest	Multi Part /.zip	Pages (if appl.)
1	Request for Continued Examination (RCE)	4015-9600_RCE.pdf	697830	no	3
			f1e810a1cd2e4f0d138d261be7a1bb33617 aa1c		
Warnings:					
Information:					
2		4015-9600_Amendment.pdf	87633	yes	13
			e642aa721efafbb232123308ae6a4408ba7e 5053		
	Multipart Description/PDF files in .zip description				
	Document Description		Start	End	
	Amendment Submitted/Entered with Filing of CPA/RCE		1	1	
	Claims		2	12	
	Applicant Arguments/Remarks Made in an Amendment		13	13	
Warnings:					
Information:					
3	Fee Worksheet (SB06)	fee-info.pdf	32296	no	2
			9e6000dd911b4077d27e82c4fa2e120152b 09d32		
Warnings:					
Information:					
Total Files Size (in bytes):			817759		

This Acknowledgement Receipt evidences receipt on the noted date by the USPTO of the indicated documents, characterized by the applicant, and including page counts, where applicable. It serves as evidence of receipt similar to a Post Card, as described in MPEP 503.

New Applications Under 35 U.S.C. 111

If a new application is being filed and the application includes the necessary components for a filing date (see 37 CFR 1.53(b)-(d) and MPEP 506), a Filing Receipt (37 CFR 1.54) will be issued in due course and the date shown on this Acknowledgement Receipt will establish the filing date of the application.

National Stage of an International Application under 35 U.S.C. 371

If a timely submission to enter the national stage of an international application is compliant with the conditions of 35 U.S.C. 371 and other applicable requirements a Form PCT/DO/EO/903 indicating acceptance of the application as a national stage submission under 35 U.S.C. 371 will be issued in addition to the Filing Receipt, in due course.

New International Application Filed with the USPTO as a Receiving Office

If a new international application is being filed and the international application includes the necessary components for an international filing date (see PCT Article 11 and MPEP 1810), a Notification of the International Application Number and of the International Filing Date (Form PCT/RO/105) will be issued in due course, subject to prescriptions concerning national security, and the date shown on this Acknowledgement Receipt will establish the international filing date of the application.

Under the Paperwork Reduction Act of 1995, no persons are required to respond to a collection of information unless it displays a valid OMB control number.

PATENT APPLICATION FEE DETERMINATION RECORD Substitute for Form PTO-875	Application or Docket Number 15/350,360	Filing Date 11/14/2016	<input type="checkbox"/> To be Mailed
---	--	---------------------------	---------------------------------------

ENTITY: LARGE SMALL MICRO

APPLICATION AS FILED - PART I

FOR	(Column 1) NUMBER FILED	(Column 2) NUMBER EXTRA	RATE (\$)	FEE (\$)
<input type="checkbox"/> BASIC FEE (37 CFR 1.16(a), (b), or (c))	N/A	N/A	N/A	
<input type="checkbox"/> SEARCH FEE (37 CFR 1.16(k), (l), or (m))	N/A	N/A	N/A	
<input type="checkbox"/> EXAMINATION FEE (37 CFR 1.16(o), (p), or (q))	N/A	N/A	N/A	
TOTAL CLAIMS (37 CFR 1.16(j))	minus 20 = *		x \$80 =	
INDEPENDENT CLAIMS (37 CFR 1.16(h))	minus 3 = *		x \$420 =	
<input type="checkbox"/> APPLICATION SIZE FEE (37 CFR 1.16(s))	If the specification and drawings exceed 100 sheets of paper, the application size fee due is \$310 (\$155 for small entity) for each additional 50 sheets or fraction thereof. See 35 U.S.C. 41(a)(1)(G) and 37 CFR 1.16(s).			
<input type="checkbox"/> MULTIPLE DEPENDENT CLAIM PRESENT (37 CFR 1.16(j))				
* If the difference in column 1 is less than zero, enter "0" in column 2.				TOTAL

APPLICATION AS AMENDED - PART II

	(Column 1)		(Column 2)	(Column 3)	RATE (\$)	ADDITIONAL FEE (\$)
AMENDMENT	09/14/2017		HIGHEST NUMBER PREVIOUSLY PAID FOR	PRESENT EXTRA		
	Total (37 CFR 1.16(i))	* 41	Minus	** 30	= 11	x \$80 = 880
	Independent (37 CFR 1.16(h))	* 4	Minus	*** 4	= 0	x \$420 = 0
<input type="checkbox"/> Application Size Fee (37 CFR 1.16(s))						
<input type="checkbox"/> FIRST PRESENTATION OF MULTIPLE DEPENDENT CLAIM (37 CFR 1.16(j))						
					TOTAL ADD'L FEE	880

	(Column 1)		(Column 2)	(Column 3)	RATE (\$)	ADDITIONAL FEE (\$)
AMENDMENT			HIGHEST NUMBER PREVIOUSLY PAID FOR	PRESENT EXTRA		
	Total (37 CFR 1.16(i))	*	Minus	**	=	x \$0 =
	Independent (37 CFR 1.16(h))	*	Minus	***	=	x \$0 =
<input type="checkbox"/> Application Size Fee (37 CFR 1.16(s))						
<input type="checkbox"/> FIRST PRESENTATION OF MULTIPLE DEPENDENT CLAIM (37 CFR 1.16(j))						
					TOTAL ADD'L FEE	

* If the entry in column 1 is less than the entry in column 2, write "0" in column 3. SLIE

** If the "Highest Number Previously Paid For" IN THIS SPACE is less than 20, enter "20". juliet mcmillan

*** If the "Highest Number Previously Paid For" IN THIS SPACE is less than 3, enter "3".

The "Highest Number Previously Paid For" (Total or Independent) is the highest number found in the appropriate box in column 1.

This collection of information is required by 37 CFR 1.16. The information is required to obtain or retain a benefit by the public which is to file (and by the USPTO to process) an application. Confidentiality is governed by 35 U.S.C. 122 and 37 CFR 1.14. This collection is estimated to take 12 minutes to complete, including gathering, preparing, and submitting the completed application form to the USPTO. Time will vary depending upon the individual case. Any comments on the amount of time you require to complete this form and/or suggestions for reducing this burden, should be sent to the Chief Information Officer, U.S. Patent and Trademark Office, U.S. Department of Commerce, P.O. Box 1450, Alexandria, VA 22313-1450. DO NOT SEND FEES OR COMPLETED FORMS TO THIS ADDRESS. **SEND TO: Commissioner for Patents, P.O. Box 1450, Alexandria, VA 22313-1450.**

If you need assistance in completing the form, call 1-800-PTO-9199 and select option 2.

IN THE UNITED STATES PATENT AND TRADEMARK OFFICE

In re Application of Astely <i>et al.</i>)	
)	
Serial No.: 15/350,360)	
)	
Filed: November 14, 2016)	Examiner: Md K. Talukder
)	
For: PUCCH Resource Allocation for Carrier)	Group Art Unit: 2648
Aggregation in LTE-Advanced)	
)	Confirmation No.: 1120
Docket No: 4015-9600 / P30138-US3)	

Mail Stop Amendment	
Commissioner for Patents	17 October 2017
P.O. Box 1450	
Alexandria, VA 22313-1450	

SUPPLEMENTAL PRELIMINARY AMENDMENT ACCOMPANYING RCE

This paper is being filed as a supplemental preliminary amendment to the Request for Continued Examination (RCE) filed 14 September 2017. Reconsideration is respectfully requested in light of the amendments and/or remarks below. It is believed that no fees are due at this time, however, the Office is hereby authorized to charge any fees required for entry of this paper to Deposit Account 18-1167.

AMENDMENTS TO THE SPECIFICATION

Please replace paragraph [0045] with the following amended paragraph:

[0045] Both PUCCH format 1 and format 2 signaling messages are transmitted on a resource-block pair with one resource block in each slot. The resource-block pair is determined from the PUCCH resource index. Thus, the resource-block number to use in the first and second slot of a subframe can be expressed as:

Please replace paragraph [0065] with the following amended paragraph:

[0065] Fig. 9 illustrates an exemplary method 50 implemented by a base station 20 in a communication network 10 of receiving uplink control information from a user terminal 100 depending ~~on~~ on the assignment of downlink component carriers. The base station 20 schedules the user terminal 100 to receive downlink transmissions on one or more downlink component carriers (block 52). The user terminal 100 may be scheduled to receive downlink transmissions on a single downlink component carrier associated with a primary uplink component carrier. In this case, the base station 20 receives control information associated with the downlink transmissions to the user terminal 100 on a first set of radio resources on the uplink primary component carrier (block 54). Alternatively, the user terminal 100 may be scheduled to receive downlink transmissions on multiple downlink component carriers, or on a single downlink component carrier other than the downlink component carrier associated with the uplink primary component carrier. In this alternative case, the base station 20 receives uplink control information associated with the downlink transmissions from the user terminal 100 on a second set of radio resources on the uplink component carrier (block 56).

Please replace paragraph [0066] with the following amended paragraph:

[0066] Fig. 10 illustrates an exemplary method 60 implemented by a user terminal of transmission of uplink control signaling to a base station 20. The user terminal 100 receives a radio resource assignment for a downlink transmission from the base station 20 (block 62). If the user terminal 100 detects assignments of radio resources for a single downlink component carrier, the user terminal 100 transmits, on a first set of radio resources on an uplink primary component carrier, uplink control information associated with the downlink transmissions (block 64). On the other ~~hands~~ hand, if the user terminal 100 receives assignments for multiple downlink component carriers, the user terminal 100 transmits, on a second set of radio resources on the uplink primary component carrier, uplink control information associated with downlink transmissions (block 66).

Please replace paragraph [0067] with the following amended paragraph:

[0067] Fig. 11 illustrates another exemplary method 70 implemented by a user terminal 100 of transmission of uplink control signaling to a base station 20. The user terminal 100 receives a radio resource assignment for a downlink transmission from the base station 20 (block 72). If the user terminal 100 detects assignments of radio resources for a first downlink component carrier, the user terminal 100 transmits, on a first set of radio resources on a uplink primary component carrier, uplink control information associated with the downlink transmissions (block 74). On the other ~~hands~~ hand, if the user terminal 100 receives assignments for a second downlink component carrier, the user terminal 100 transmits, on a second set of radio resources on the primary uplink component carrier, uplink control information associated with downlink transmissions (block 76).

REMARKS

Paragraphs 45, 65, 66 and 67 in the Specification have been amended to correct minor typographical errors. No new matter had been added therefore, it is respectfully submitted that the application is in condition for allowance.

Respectfully submitted,
COATS & BENNETT, P.L.L.C.

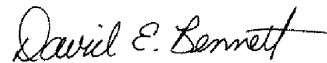

Dated: 17 October 2017

David E. Bennett
Registration No.: 32,194
Telephone: (919) 854-1844

Electronic Acknowledgement Receipt

EFS ID:	30679381
Application Number:	15350360
International Application Number:	
Confirmation Number:	1120
Title of Invention:	PUCCH RESOURCE ALLOCATION FOR CARRIER AGGREGATION IN LTE-ADVANCED
First Named Inventor/Applicant Name:	David Astely
Customer Number:	24112
Filer:	David E. Bennett/Karen Nelson
Filer Authorized By:	David E. Bennett
Attorney Docket Number:	4015-9600 / P30138-US3
Receipt Date:	17-OCT-2017
Filing Date:	14-NOV-2016
Time Stamp:	14:51:32
Application Type:	Utility under 35 USC 111(a)

Payment information:

Submitted with Payment	no
------------------------	----

File Listing:

Document Number	Document Description	File Name	File Size(Bytes)/ Message Digest	Multi Part /.zip	Pages (if appl.)
1		4015-9600_Supplemental_Preliminary_Amendment_to_RCE.pdf	27140 <small>56a178b49c53d4df62dfc7d62436a02cfa4c0a71</small>	yes	4

Multipart Description/PDF files in .zip description		
Document Description	Start	End
Preliminary Amendment	1	1
Specification	2	3
Applicant Arguments/Remarks Made in an Amendment	4	4

Warnings:

Information:

Total Files Size (in bytes):	27140
-------------------------------------	-------

This Acknowledgement Receipt evidences receipt on the noted date by the USPTO of the indicated documents, characterized by the applicant, and including page counts, where applicable. It serves as evidence of receipt similar to a Post Card, as described in MPEP 503.

New Applications Under 35 U.S.C. 111

If a new application is being filed and the application includes the necessary components for a filing date (see 37 CFR 1.53(b)-(d) and MPEP 506), a Filing Receipt (37 CFR 1.54) will be issued in due course and the date shown on this Acknowledgement Receipt will establish the filing date of the application.

National Stage of an International Application under 35 U.S.C. 371

If a timely submission to enter the national stage of an international application is compliant with the conditions of 35 U.S.C. 371 and other applicable requirements a Form PCT/DO/EO/903 indicating acceptance of the application as a national stage submission under 35 U.S.C. 371 will be issued in addition to the Filing Receipt, in due course.

New International Application Filed with the USPTO as a Receiving Office

If a new international application is being filed and the international application includes the necessary components for an international filing date (see PCT Article 11 and MPEP 1810), a Notification of the International Application Number and of the International Filing Date (Form PCT/RO/105) will be issued in due course, subject to prescriptions concerning national security, and the date shown on this Acknowledgement Receipt will establish the international filing date of the application.



UNITED STATES PATENT AND TRADEMARK OFFICE

UNITED STATES DEPARTMENT OF COMMERCE
United States Patent and Trademark Office
Address: COMMISSIONER FOR PATENTS
P.O. Box 1450
Alexandria, Virginia 22313-1450
www.uspto.gov

NOTICE OF ALLOWANCE AND FEE(S) DUE

24112 7590 10/24/2017
COATS & BENNETT, PLLC
1400 Crescent Green, Suite 300
Cary, NC 27518

EXAMINER

TALUKDER, MD K

ART UNIT PAPER NUMBER

2648

DATE MAILED: 10/24/2017

Table with 5 columns: APPLICATION NO., FILING DATE, FIRST NAMED INVENTOR, ATTORNEY DOCKET NO., CONFIRMATION NO.

15/350,360 11/14/2016 David Astely 4015-9600 / P30138-US3 1120

TITLE OF INVENTION: PUCCH RESOURCE ALLOCATION FOR CARRIER AGGREGATION IN LTE-ADVANCED

Table with 7 columns: APPLN. TYPE, ENTITY STATUS, ISSUE FEE DUE, PUBLICATION FEE DUE, PREV. PAID ISSUE FEE, TOTAL FEE(S) DUE, DATE DUE

nonprovisional UNDISCOUNTED \$960 \$0 \$0 \$960 01/24/2018

THE APPLICATION IDENTIFIED ABOVE HAS BEEN EXAMINED AND IS ALLOWED FOR ISSUANCE AS A PATENT. PROSECUTION ON THE MERITS IS CLOSED. THIS NOTICE OF ALLOWANCE IS NOT A GRANT OF PATENT RIGHTS. THIS APPLICATION IS SUBJECT TO WITHDRAWAL FROM ISSUE AT THE INITIATIVE OF THE OFFICE OR UPON PETITION BY THE APPLICANT. SEE 37 CFR 1.313 AND MPEP 1308.

THE ISSUE FEE AND PUBLICATION FEE (IF REQUIRED) MUST BE PAID WITHIN THREE MONTHS FROM THE MAILING DATE OF THIS NOTICE OR THIS APPLICATION SHALL BE REGARDED AS ABANDONED. THIS STATUTORY PERIOD CANNOT BE EXTENDED. SEE 35 U.S.C. 151. THE ISSUE FEE DUE INDICATED ABOVE DOES NOT REFLECT A CREDIT FOR ANY PREVIOUSLY PAID ISSUE FEE IN THIS APPLICATION. IF AN ISSUE FEE HAS PREVIOUSLY BEEN PAID IN THIS APPLICATION (AS SHOWN ABOVE), THE RETURN OF PART B OF THIS FORM WILL BE CONSIDERED A REQUEST TO REAPPLY THE PREVIOUSLY PAID ISSUE FEE TOWARD THE ISSUE FEE NOW DUE.

HOW TO REPLY TO THIS NOTICE:

I. Review the ENTITY STATUS shown above. If the ENTITY STATUS is shown as SMALL or MICRO, verify whether entitlement to that entity status still applies.

If the ENTITY STATUS is the same as shown above, pay the TOTAL FEE(S) DUE shown above.

If the ENTITY STATUS is changed from that shown above, on PART B - FEE(S) TRANSMITTAL, complete section number 5 titled "Change in Entity Status (from status indicated above)".

For purposes of this notice, small entity fees are 1/2 the amount of undiscounted fees, and micro entity fees are 1/2 the amount of small entity fees.

II. PART B - FEE(S) TRANSMITTAL, or its equivalent, must be completed and returned to the United States Patent and Trademark Office (USPTO) with your ISSUE FEE and PUBLICATION FEE (if required). If you are charging the fee(s) to your deposit account, section "4b" of Part B - Fee(s) Transmittal should be completed and an extra copy of the form should be submitted. If an equivalent of Part B is filed, a request to reapply a previously paid issue fee must be clearly made, and delays in processing may occur due to the difficulty in recognizing the paper as an equivalent of Part B.

III. All communications regarding this application must give the application number. Please direct all communications prior to issuance to Mail Stop ISSUE FEE unless advised to the contrary.

IMPORTANT REMINDER: Maintenance fees are due in utility patents issuing on applications filed on or after Dec. 12, 1980. It is patentee's responsibility to ensure timely payment of maintenance fees when due. More information is available at www.uspto.gov/PatentMaintenanceFees.

PART B - FEE(S) TRANSMITTAL

**Complete and send this form, together with applicable fee(s), to: Mail Mail Stop ISSUE FEE
 Commissioner for Patents
 P.O. Box 1450
 Alexandria, Virginia 22313-1450
 or Fax (571)-273-2885**

INSTRUCTIONS: This form should be used for transmitting the ISSUE FEE and PUBLICATION FEE (if required). Blocks 1 through 5 should be completed where appropriate. All further correspondence including the Patent, advance orders and notification of maintenance fees will be mailed to the current correspondence address as indicated unless corrected below or directed otherwise in Block 1, by (a) specifying a new correspondence address; and/or (b) indicating a separate "FEE ADDRESS" for maintenance fee notifications.

CURRENT CORRESPONDENCE ADDRESS (Note: Use Block 1 for any change of address)

24112 7590 10/24/2017
 COATS & BENNETT, PLLC
 1400 Crescent Green, Suite 300
 Cary, NC 27518

Note: A certificate of mailing can only be used for domestic mailings of the Fee(s) Transmittal. This certificate cannot be used for any other accompanying papers. Each additional paper, such as an assignment or formal drawing, must have its own certificate of mailing or transmission.

Certificate of Mailing or Transmission

I hereby certify that this Fee(s) Transmittal is being deposited with the United States Postal Service with sufficient postage for first class mail in an envelope addressed to the Mail Stop ISSUE FEE address above, or being facsimile transmitted to the USPTO (571) 273-2885, on the date indicated below.

_____ (Depositor's name)
_____ (Signature)
_____ (Date)

APPLICATION NO.	FILING DATE	FIRST NAMED INVENTOR	ATTORNEY DOCKET NO.	CONFIRMATION NO.
15/350,360	11/14/2016	David Astely	4015-9600 / P30138-US3	1120

TITLE OF INVENTION: PUCCH RESOURCE ALLOCATION FOR CARRIER AGGREGATION IN LTE-ADVANCED

APPLN. TYPE	ENTITY STATUS	ISSUE FEE DUE	PUBLICATION FEE DUE	PREV. PAID ISSUE FEE	TOTAL FEE(S) DUE	DATE DUE
nonprovisional	UNDISCOUNTED	\$960	\$0	\$0	\$960	01/24/2018

EXAMINER	ART UNIT	CLASS-SUBCLASS
TALUKDER, MD K	2648	455-509000

1. Change of correspondence address or indication of "Fee Address" (37 CFR 1.363).

- Change of correspondence address (or Change of Correspondence Address form PTO/SB/122) attached.
- "Fee Address" indication (or "Fee Address" Indication form PTO/SB/47; Rev 03-02 or more recent) attached. **Use of a Customer Number is required.**

2. For printing on the patent front page, list

- (1) The names of up to 3 registered patent attorneys or agents OR, alternatively, 1 _____
- (2) The name of a single firm (having as a member a registered attorney or agent) and the names of up to 2 registered patent attorneys or agents. If no name is listed, no name will be printed. 2 _____
- 3 _____

3. ASSIGNEE NAME AND RESIDENCE DATA TO BE PRINTED ON THE PATENT (print or type)

PLEASE NOTE: Unless an assignee is identified below, no assignee data will appear on the patent. If an assignee is identified below, the document has been filed for recordation as set forth in 37 CFR 3.11. Completion of this form is NOT a substitute for filing an assignment.

(A) NAME OF ASSIGNEE _____

(B) RESIDENCE: (CITY and STATE OR COUNTRY) _____

Please check the appropriate assignee category or categories (will not be printed on the patent): Individual Corporation or other private group entity Government

4a. The following fee(s) are submitted:

- Issue Fee
- Publication Fee (No small entity discount permitted)
- Advance Order - # of Copies _____

4b. Payment of Fee(s): (Please first reapply any previously paid issue fee shown above)

- A check is enclosed.
- Payment by credit card. Form PTO-2038 is attached.
- The director is hereby authorized to charge the required fee(s), any deficiency, or credits any overpayment, to Deposit Account Number _____ (enclose an extra copy of this form).

5. Change in Entity Status (from status indicated above)

- Applicant certifying micro entity status. See 37 CFR 1.29
- Applicant asserting small entity status. See 37 CFR 1.27
- Applicant changing to regular undiscounted fee status.

NOTE: Absent a valid certification of Micro Entity Status (see forms PTO/SB/15A and 15B), issue fee payment in the micro entity amount will not be accepted at the risk of application abandonment.

NOTE: If the application was previously under micro entity status, checking this box will be taken to be a notification of loss of entitlement to micro entity status.

NOTE: Checking this box will be taken to be a notification of loss of entitlement to small or micro entity status, as applicable.

NOTE: This form must be signed in accordance with 37 CFR 1.31 and 1.33. See 37 CFR 1.4 for signature requirements and certifications.

Authorized Signature _____

Date _____

Typed or printed name _____

Registration No. _____



UNITED STATES PATENT AND TRADEMARK OFFICE

UNITED STATES DEPARTMENT OF COMMERCE
United States Patent and Trademark Office
Address: COMMISSIONER FOR PATENTS
P.O. Box 1450
Alexandria, Virginia 22313-1450
www.uspto.gov

Table with 5 columns: APPLICATION NO., FILING DATE, FIRST NAMED INVENTOR, ATTORNEY DOCKET NO., CONFIRMATION NO.
Row 1: 15/350,360, 11/14/2016, David Astely, 4015-9600 / P30138-US3, 1120
Row 2: 24112, 7590, 10/24/2017, COATS & BENNETT, PLLC, 1400 Crescent Green, Suite 300, Cary, NC 27518

EXAMINER

TALUKDER, MD K

ART UNIT PAPER NUMBER

2648

DATE MAILED: 10/24/2017

Determination of Patent Term Adjustment under 35 U.S.C. 154 (b)
(Applications filed on or after May 29, 2000)

The Office has discontinued providing a Patent Term Adjustment (PTA) calculation with the Notice of Allowance.

Section 1(h)(2) of the AIA Technical Corrections Act amended 35 U.S.C. 154(b)(3)(B)(i) to eliminate the requirement that the Office provide a patent term adjustment determination with the notice of allowance. See Revisions to Patent Term Adjustment, 78 Fed. Reg. 19416, 19417 (Apr. 1, 2013). Therefore, the Office is no longer providing an initial patent term adjustment determination with the notice of allowance. The Office will continue to provide a patent term adjustment determination with the Issue Notification Letter that is mailed to applicant approximately three weeks prior to the issue date of the patent, and will include the patent term adjustment on the patent. Any request for reconsideration of the patent term adjustment determination (or reinstatement of patent term adjustment) should follow the process outlined in 37 CFR 1.705.

Any questions regarding the Patent Term Extension or Adjustment determination should be directed to the Office of Patent Legal Administration at (571)-272-7702. Questions relating to issue and publication fee payments should be directed to the Customer Service Center of the Office of Patent Publication at 1-(888)-786-0101 or (571)-272-4200.

OMB Clearance and PRA Burden Statement for PTOL-85 Part B

The Paperwork Reduction Act (PRA) of 1995 requires Federal agencies to obtain Office of Management and Budget approval before requesting most types of information from the public. When OMB approves an agency request to collect information from the public, OMB (i) provides a valid OMB Control Number and expiration date for the agency to display on the instrument that will be used to collect the information and (ii) requires the agency to inform the public about the OMB Control Number's legal significance in accordance with 5 CFR 1320.5(b).

The information collected by PTOL-85 Part B is required by 37 CFR 1.311. The information is required to obtain or retain a benefit by the public which is to file (and by the USPTO to process) an application. Confidentiality is governed by 35 U.S.C. 122 and 37 CFR 1.14. This collection is estimated to take 12 minutes to complete, including gathering, preparing, and submitting the completed application form to the USPTO. Time will vary depending upon the individual case. Any comments on the amount of time you require to complete this form and/or suggestions for reducing this burden, should be sent to the Chief Information Officer, U.S. Patent and Trademark Office, U.S. Department of Commerce, P.O. Box 1450, Alexandria, Virginia 22313-1450. DO NOT SEND FEES OR COMPLETED FORMS TO THIS ADDRESS. SEND TO: Commissioner for Patents, P.O. Box 1450, Alexandria, Virginia 22313-1450. Under the Paperwork Reduction Act of 1995, no persons are required to respond to a collection of information unless it displays a valid OMB control number.

Privacy Act Statement

The Privacy Act of 1974 (P.L. 93-579) requires that you be given certain information in connection with your submission of the attached form related to a patent application or patent. Accordingly, pursuant to the requirements of the Act, please be advised that: (1) the general authority for the collection of this information is 35 U.S.C. 2(b)(2); (2) furnishing of the information solicited is voluntary; and (3) the principal purpose for which the information is used by the U.S. Patent and Trademark Office is to process and/or examine your submission related to a patent application or patent. If you do not furnish the requested information, the U.S. Patent and Trademark Office may not be able to process and/or examine your submission, which may result in termination of proceedings or abandonment of the application or expiration of the patent.

The information provided by you in this form will be subject to the following routine uses:

1. The information on this form will be treated confidentially to the extent allowed under the Freedom of Information Act (5 U.S.C. 552) and the Privacy Act (5 U.S.C. 552a). Records from this system of records may be disclosed to the Department of Justice to determine whether disclosure of these records is required by the Freedom of Information Act.
2. A record from this system of records may be disclosed, as a routine use, in the course of presenting evidence to a court, magistrate, or administrative tribunal, including disclosures to opposing counsel in the course of settlement negotiations.
3. A record in this system of records may be disclosed, as a routine use, to a Member of Congress submitting a request involving an individual, to whom the record pertains, when the individual has requested assistance from the Member with respect to the subject matter of the record.
4. A record in this system of records may be disclosed, as a routine use, to a contractor of the Agency having need for the information in order to perform a contract. Recipients of information shall be required to comply with the requirements of the Privacy Act of 1974, as amended, pursuant to 5 U.S.C. 552a(m).
5. A record related to an International Application filed under the Patent Cooperation Treaty in this system of records may be disclosed, as a routine use, to the International Bureau of the World Intellectual Property Organization, pursuant to the Patent Cooperation Treaty.
6. A record in this system of records may be disclosed, as a routine use, to another federal agency for purposes of National Security review (35 U.S.C. 181) and for review pursuant to the Atomic Energy Act (42 U.S.C. 218(c)).
7. A record from this system of records may be disclosed, as a routine use, to the Administrator, General Services, or his/her designee, during an inspection of records conducted by GSA as part of that agency's responsibility to recommend improvements in records management practices and programs, under authority of 44 U.S.C. 2904 and 2906. Such disclosure shall be made in accordance with the GSA regulations governing inspection of records for this purpose, and any other relevant (i.e., GSA or Commerce) directive. Such disclosure shall not be used to make determinations about individuals.
8. A record from this system of records may be disclosed, as a routine use, to the public after either publication of the application pursuant to 35 U.S.C. 122(b) or issuance of a patent pursuant to 35 U.S.C. 151. Further, a record may be disclosed, subject to the limitations of 37 CFR 1.14, as a routine use, to the public if the record was filed in an application which became abandoned or in which the proceedings were terminated and which application is referenced by either a published application, an application open to public inspection or an issued patent.
9. A record from this system of records may be disclosed, as a routine use, to a Federal, State, or local law enforcement agency, if the USPTO becomes aware of a violation or potential violation of law or regulation.

Notice of Allowability	Application No. 15/350,360	Applicant(s) ASTELY ET AL.	
	Examiner MD TALUKDER	Art Unit 2648	AIA (First Inventor to File) Status No

-- The MAILING DATE of this communication appears on the cover sheet with the correspondence address--

All claims being allowable, PROSECUTION ON THE MERITS IS (OR REMAINS) CLOSED in this application. If not included herewith (or previously mailed), a Notice of Allowance (PTOL-85) or other appropriate communication will be mailed in due course. **THIS NOTICE OF ALLOWABILITY IS NOT A GRANT OF PATENT RIGHTS.** This application is subject to withdrawal from issue at the initiative of the Office or upon petition by the applicant. See 37 CFR 1.313 and MPEP 1308.

1. This communication is responsive to 09/14/2017.
 A declaration(s)/affidavit(s) under **37 CFR 1.130(b)** was/were filed on _____.
2. An election was made by the applicant in response to a restriction requirement set forth during the interview on _____; the restriction requirement and election have been incorporated into this action.
3. The allowed claim(s) is/are 1-41. As a result of the allowed claim(s), you may be eligible to benefit from the **Patent Prosecution Highway** program at a participating intellectual property office for the corresponding application. For more information, please see http://www.uspto.gov/patents/init_events/pph/index.jsp or send an inquiry to PPHfeedback@uspto.gov.
4. Acknowledgment is made of a claim for foreign priority under 35 U.S.C. § 119(a)-(d) or (f).
Certified copies:
a) All b) Some *c) None of the:
1. Certified copies of the priority documents have been received.
2. Certified copies of the priority documents have been received in Application No. _____.
3. Copies of the certified copies of the priority documents have been received in this national stage application from the International Bureau (PCT Rule 17.2(a)).
* Certified copies not received: _____.

Applicant has THREE MONTHS FROM THE "MAILING DATE" of this communication to file a reply complying with the requirements noted below. Failure to timely comply will result in ABANDONMENT of this application.
THIS THREE-MONTH PERIOD IS NOT EXTENDABLE.

5. CORRECTED DRAWINGS (as "replacement sheets") must be submitted.
 including changes required by the attached Examiner's Amendment / Comment or in the Office action of Paper No./Mail Date _____.
Identifying indicia such as the application number (see 37 CFR 1.84(c)) should be written on the drawings in the front (not the back) of each sheet. Replacement sheet(s) should be labeled as such in the header according to 37 CFR 1.121(d).
6. DEPOSIT OF and/or INFORMATION about the deposit of BIOLOGICAL MATERIAL must be submitted. Note the attached Examiner's comment regarding REQUIREMENT FOR THE DEPOSIT OF BIOLOGICAL MATERIAL.

Attachment(s)

1. <input checked="" type="checkbox"/> Notice of References Cited (PTO-892)	5. <input type="checkbox"/> Examiner's Amendment/Comment
2. <input type="checkbox"/> Information Disclosure Statements (PTO/SB/08), Paper No./Mail Date _____	6. <input checked="" type="checkbox"/> Examiner's Statement of Reasons for Allowance
3. <input type="checkbox"/> Examiner's Comment Regarding Requirement for Deposit of Biological Material	7. <input type="checkbox"/> Other _____
4. <input type="checkbox"/> Interview Summary (PTO-413), Paper No./Mail Date _____	

/MD TALUKDER/ Primary Examiner, Art Unit 2648	
--	--

1. The present application is being examined under the pre-AIA first to invent provisions.

REASONS FOR ALLOWANCE

2. Claims 1-41 are allowed over the prior art of record. The following is an examiner's statement of reasons for allowance: Interpreting the claims in light of the specification. Claims has been found allowable because the prior art of record, does not teach, suggest or disclose "scheduling downlink transmissions to a first user terminal only on a single downlink component carrier associated with a primary cell and scheduling downlink transmissions to a second user terminal on multiple downlink component carriers or on a downlink component carrier associated with a non-primary cell; receiving, on a first set of radio resources, control information associated with the downlink transmissions to the first user terminal, wherein the first set of radio resources is reserved for a user terminal scheduled to receive downlink transmissions only on a single downlink component carrier associated with the primary cell; and receiving, on a second set of radio resources, control information associated with the downlink transmissions to the second user terminal, wherein the second set of radio resources is reserved for a user terminal scheduled to receive downlink transmissions on multiple downlink component carriers or on a downlink component carrier associated with a non-primary cell, the first and second sets of radio resources being on a same uplink component carrier associated with the primary cell" in combination with the rest of the limitations of the claim. The prior art of the record discloses a communication method between access point and a user station in a specific cell but does not disclose each and every aspect of the above limitation. Any comments considered necessary by applicant must be submitted no later than the payment of the issue fee

and, to avoid processing delays, should preferably accompany the issue fee. Such submissions should be clearly labeled "Comments on Statement of Reasons for Allowance."

Conclusion

Any inquiry concerning this communication or earlier communications from the examiner should be directed to MD TALUKDER whose telephone number is (571)270-3222.

The examiner can normally be reached on Monday to Friday from (9:30 to 4:00).

If attempts to reach the examiner by telephone are unsuccessful, the examiner's supervisor, Wesley Kim can be reached on 571-272-7867. The fax phone number for the organization where this application or proceeding is assigned is 571-273-8300.

Information regarding the status of an application may be obtained from the Patent Application Information Retrieval (PAIR) system. Status information for published applications may be obtained from either Private PAIR or Public PAIR. Status information for unpublished applications is available through Private PAIR only. For more information about the PAIR system, see <http://pair-direct.uspto.gov>. Should you have questions on access to the Private PAIR system, contact the Electronic Business Center (EBC) at 866-217-9197 (toll-free). If you would like assistance from a USPTO Customer Service Representative or access to the automated information system, call 800-786-9199 (IN USA OR CANADA) or 571-272-1000.

/MD TALUKDER/

Primary Examiner, Art Unit 2648

Notice of References Cited	Application/Control No. 15/350,360	Applicant(s)/Patent Under Reexamination ASTELY ET AL.	
	Examiner MD TALUKDER	Art Unit 2648	Page 1 of 3

U.S. PATENT DOCUMENTS

*		Document Number Country Code-Number-Kind Code	Date MM-YYYY	Name	CPC Classification	US Classification
*	A	US-2002/0160784 A1	10-2002	Kuwahara, Soichi	H04W52/223	455/452.1
*	B	US-2010/0003997 A1	01-2010	KOYANAGI; Kenichiro	H04L1/0003	455/450
*	C	US-2010/0098012 A1	04-2010	Bala; Erdem	H04L5/001	370/329
*	D	US-2010/0208679 A1	08-2010	Papasakellariou; Aris	H04L1/1614	370/329
*	E	US-2010/0232373 A1	09-2010	Nory; Ravikiran	H04W72/1289	370/329
*	F	US-2010/0271970 A1	10-2010	Pan; Kyle Jung-Lin	H04L1/0026	370/252
*	G	US-2010/0285809 A1	11-2010	Lindstrom; Magnus	H04L5/001	455/450
*	H	US-2010/0296389 A1	11-2010	Khandekar; Aamod Dinkar	H04L5/0007	370/216
*	I	US-2010/0322173 A1	12-2010	Marinier; Paul	H04W76/048	370/329
*	J	US-2011/0007695 A1	01-2011	Choi; Hyung-Nam	H04L5/0007	370/329
*	K	US-2011/0007699 A1	01-2011	Moon; Sung Ho	H04L5/0053	370/329
*	L	US-2011/0081913 A1	04-2011	Lee; Jung A.	H04L5/003	455/450
*	M	US-2011/0081932 A1	04-2011	Astely; David	H04L5/001	455/509

FOREIGN PATENT DOCUMENTS

*		Document Number Country Code-Number-Kind Code	Date MM-YYYY	Country	Name	CPC Classification
	N					
	O					
	P					
	Q					
	R					
	S					
	T					

NON-PATENT DOCUMENTS

*		Include as applicable: Author, Title Date, Publisher, Edition or Volume, Pertinent Pages)
	U	
	V	
	W	
	X	

*A copy of this reference is not being furnished with this Office action. (See MPEP § 707.05(a).)
Dates in MM-YYYY format are publication dates. Classifications may be US or foreign.

Notice of References Cited	Application/Control No. 15/350,360	Applicant(s)/Patent Under Reexamination ASTELY ET AL.	
	Examiner MD TALUKDER	Art Unit 2648	Page 2 of 3

U.S. PATENT DOCUMENTS

*		Document Number Country Code-Number-Kind Code	Date MM-YYYY	Name	CPC Classification	US Classification
*	A	US-2011/0243039 A1	10-2011	PAPASAKELLARIOU; Aris	H04L1/1861	370/280
*	B	US-2011/0310856 A1	12-2011	Hariharan; Priya	H04L1/1607	370/336
*	C	US-2012/0020317 A1	01-2012	Ishii; Hiroyuki	H04L1/1854	370/329
*	D	US-2012/0051306 A1	03-2012	Chung; Jae Hoon	H04L1/1893	370/329
*	E	US-2012/0082125 A1	04-2012	Huang; Yada	H04L5/0007	370/329
*	F	US-2012/0140708 A1	06-2012	Choudhury; Sayantan	H04W72/082	370/328
*	G	US-8,194,603 B2	06-2012	Nimbalker; Ajit	H04L5/001	370/329
*	H	US-8,265,030 B2	09-2012	Miki; Nobuhiko	H04W72/1257	370/330
*	I	US-2012/0314675 A1	12-2012	Vujcic; Dragan	H04L5/001	370/329
*	J	US-2013/0003700 A1	01-2013	Zhang; Jian	H04W76/028	370/331
*	K	US-2013/0010721 A1	01-2013	Aiba; Tatsushi	H04L1/1812	370/329
*	L	US-2013/0034073 A1	02-2013	Aiba; Tatsushi	H04L1/0026	370/329
*	M	US-8,447,343 B2	05-2013	Gerstenberger; Dirk	H04W52/10	370/248

FOREIGN PATENT DOCUMENTS

*		Document Number Country Code-Number-Kind Code	Date MM-YYYY	Country	Name	Classification
	N					
	O					
	P					
	Q					
	R					
	S					
	T					

NON-PATENT DOCUMENTS

*		Include as applicable: Author, Title Date, Publisher, Edition or Volume, Pertinent Pages)
	U	
	V	
	W	
	X	

*A copy of this reference is not being furnished with this Office action. (See MPEP § 707.05(a).)
Dates in MM-YYYY format are publication dates. Classifications may be US or foreign.

Notice of References Cited	Application/Control No. 15/350,360	Applicant(s)/Patent Under Reexamination ASTELY ET AL.	
	Examiner MD TALUKDER	Art Unit 2648	Page 3 of 3

U.S. PATENT DOCUMENTS

*	Document Number Country Code-Number-Kind Code	Date MM-YYYY	Name	CPC Classification	US Classification
*	A US-2013/0136084 A1	05-2013	ZHANG; Yuantao	H04W72/0413	370/329
*	B US-8,472,368 B2	06-2013	Baldemair; Robert	H04L5/0053	370/318
*	C US-8,634,358 B2	01-2014	Damnjanovic; Jelena M.	H04L1/1861	370/329
*	D US-2014/0078941 A1	03-2014	Seo; Dong Youn	H04L1/1822	370/280
*	E US-8,792,830 B2	07-2014	Lim; Suhwan	H04L25/02	375/260
	F US-				
	G US-				
	H US-				
	I US-				
	J US-				
	K US-				
	L US-				
	M US-				

FOREIGN PATENT DOCUMENTS

*	Document Number Country Code-Number-Kind Code	Date MM-YYYY	Country	Name	Classification
	N				
	O				
	P				
	Q				
	R				
	S				
	T				

NON-PATENT DOCUMENTS

*	Document Number Country Code-Number-Kind Code	Date MM-YYYY	Country	Name	Classification
	Include as applicable: Author, Title Date, Publisher, Edition or Volume, Pertinent Pages)				
	U				
	V				
	W				
	X				

*A copy of this reference is not being furnished with this Office action. (See MPEP § 707.05(a).)
Dates in MM-YYYY format are publication dates. Classifications may be US or foreign.



UNITED STATES PATENT AND TRADEMARK OFFICE

UNITED STATES DEPARTMENT OF COMMERCE
 United States Patent and Trademark Office
 Address: COMMISSIONER FOR PATENTS
 P.O. Box 1450
 Alexandria, Virginia 22313-1450
 www.uspto.gov

BIB DATA SHEET

CONFIRMATION NO. 1120

SERIAL NUMBER 15/350,360	FILING or 371(c) DATE 11/14/2016 RULE	CLASS 455	GROUP ART UNIT 2648	ATTORNEY DOCKET NO. 4015-9600 / P30138-US3		
APPLICANTS Telefonaktiebolaget LM Ericsson (publ), Stockholm, SWEDEN; INVENTORS David Astely, Bromma, SWEDEN; Robert Baldemair, Solna, SWEDEN; Dirk Gerstenberger, Stockholm, SWEDEN; Daniel Larsson, Stockholm, SWEDEN; Lars Lindbom, Karlstad, SWEDEN; Stefan Parkvall, Bromma, SWEDEN; ** CONTINUING DATA ***** This application is a CON of 12/896,993 10/04/2010 PAT 9497004 which claims benefit of 61/248,661 10/05/2009 ** FOREIGN APPLICATIONS ***** ** IF REQUIRED, FOREIGN FILING LICENSE GRANTED ** 11/21/2016						
Foreign Priority claimed <input type="checkbox"/> Yes <input checked="" type="checkbox"/> No 35 USC 119(a-d) conditions met <input type="checkbox"/> Yes <input checked="" type="checkbox"/> No Verified and Acknowledged /MD K TALUKDER/ Examiner's Signature		<input type="checkbox"/> Met after Allowance Initials	STATE OR COUNTRY SWEDEN	SHEETS DRAWINGS 12	TOTAL CLAIMS 41 30	INDEPENDENT CLAIMS 4
ADDRESS COATS & BENNETT, PLLC 1400 Crescent Green, Suite 300 Cary, NC 27518 UNITED STATES						
TITLE PUCCH RESOURCE ALLOCATION FOR CARRIER AGGREGATION IN LTE-ADVANCED						
FILING FEE RECEIVED 3840	FEES: Authority has been given in Paper No. _____ to charge/credit DEPOSIT ACCOUNT No. _____ for following:			<input type="checkbox"/> All Fees		
				<input type="checkbox"/> 1.16 Fees (Filing)		
				<input type="checkbox"/> 1.17 Fees (Processing Ext. of time)		
				<input type="checkbox"/> 1.18 Fees (Issue)		
				<input type="checkbox"/> Other _____		
			<input type="checkbox"/> Credit			

Search Notes 	Application/Control No. 15350360	Applicant(s)/Patent Under Reexamination ASTELY ET AL.
	Examiner MD TALUKDER	Art Unit 2648

CPC- SEARCHED		
Symbol	Date	Examiner
H04B1/3833, H04M1/0247, H04M1/0237	3/16/2017	Talukder
H04B1/3833, H04M1/0247, H04M1/0237	6/26/2017	Talukder
H04B1/3833, H04M1/0247, H04M1/0237	10/13/2017	Talukder

CPC COMBINATION SETS - SEARCHED		
Symbol	Date	Examiner

US CLASSIFICATION SEARCHED			
Class	Subclass	Date	Examiner
455	451,452.1,509,456.1,522,137,103,575	3/16/2017	Talukder
370	All	3/17/2017	Talukder
455	509,522,456.6,137,103,575	6/26/2017	Talukder
455	451,452.1,509,456.1,522,137,103,575	10/14/2017	Talukder

* See search history printout included with this form or the SEARCH NOTES box below to determine the scope of the search.

SEARCH NOTES		
Search Notes	Date	Examiner
Assignee Searched	3/16/2017	Talukder
Inventor Searched	3/17/2017	Talukder
East Searched	3/17/2017	Talukder
Assignee Searched	6/25/2017	Talukder
Inventor Searched	6/26/2017	
East Searched	6/26/2017	Talukder
Assignee Searched	10/14/2017	Talukder
Inventor Searched	10/13/2017	Talukder
East Searched	10/13/2017	Talukder

--	--

INTERFERENCE SEARCH

US Class/ CPC Symbol	US Subclass / CPC Group	Date	Examiner
H04B1/3833, H04M1/0247, H04M1/0237		3/16/2017	Talukder
455	451,452.1,509,456.1,522,137,103,575	3/17/2017	Talukder
455	509,522,456.6,137,103,575	6/26/2017	Talukder
H04B1/3833, H04M1/0247, H04M1/0237		6/25/2017	Talukder
H04B1/3833, H04M1/0247, H04M1/0237		10/14/2017	Talukder
455	451,452.1,509,456.1,522,137,103,575	10/14/2017	Talukder

--	--

Issue Classification 	Application/Control No. 15350360	Applicant(s)/Patent Under Reexamination ASTELY ET AL.	
	Examiner MD TALUKDER	Art Unit 2648	

CPC					
Symbol				Type	Version
H04L	5		0053	F	2013-01-01
H04L	5		0005	A	2013-01-01
H04L	5		001	I	2013-01-01
H04L	5		0094	I	2013-01-01
H04W	8		24	A	2013-01-01
H04W	28		26	I	2013-01-01
H04W	48		16	A	2013-01-01
H04W	72		0453	I	2013-01-01
H04W	72		1273	I	2013-01-01
H04W	88		02	A	2013-01-01
H04W	88		08	A	2013-01-01

CPC Combination Sets				
Symbol	Type	Set	Ranking	Version

NONE		Total Claims Allowed:	
(Assistant Examiner)	(Date)	41	
/MD TALUKDER/ Primary Examiner. Art Unit 2648	10/14/2017	O.G. Print Claim(s)	O.G. Print Figure
(Primary Examiner)	(Date)	1	1

Issue Classification 	Application/Control No. 15350360	Applicant(s)/Patent Under Reexamination ASTELY ET AL.
	Examiner MD TALUKDER	Art Unit 2648

<input type="checkbox"/> Claims renumbered in the same order as presented by applicant																<input type="checkbox"/> CPA		<input checked="" type="checkbox"/> T.D.		<input type="checkbox"/> R.1.47	
Final	Original	Final	Original	Final	Original	Final	Original	Final	Original	Final	Original	Final	Original	Final	Original						
1	1	17	17	33	30																
2	2	18	18	34	31																
3	3	19	19	35	32																
4	4	20	20	36	33																
5	5	21	21	37	34																
6	6	22	22	38	35																
7	7	23	23	39	36																
8	8	24	24	40	37																
9	9	25	25	41	38																
10	10	26	26																		
11	11	27	27																		
12	12	28	39																		
13	13	29	28																		
14	14	30	40																		
15	15	31	29																		
16	16	32	41																		

NONE		Total Claims Allowed:	
		41	
(Assistant Examiner)	(Date)		
/MD TALUKDER/ Primary Examiner. Art Unit 2648	10/14/2017	O.G. Print Claim(s)	O.G. Print Figure
(Primary Examiner)	(Date)	1	1

EAST Search History

EAST Search History (Prior Art)

Ref #	Hits	Search Query	DBs	Default Operator	Plurals	Time Stamp
S1	1	"12896993"	US-PGPUB; USPAT; USOCR; DERWENT; IBM_TDB	OR	ON	2012/12/10 17:09
S2	367	((david near2 astely) (robert near2 baldemair) (dirk near2 gerstenberger) (daniel near2 larsson) (lars near2 lindbom) (stefan near2 parkvall)).in.	US-PGPUB; USPAT; USOCR; DERWENT; IBM_TDB	OR	ON	2012/12/10 19:04
S3	176	S2 and (radio near3 resource)	US-PGPUB; USPAT; USOCR; DERWENT; IBM_TDB	OR	ON	2012/12/10 19:09
S4	28	S2 and (radio near3 resource) and (component with carrier)	US-PGPUB; USPAT; USOCR; DERWENT; IBM_TDB	OR	ON	2012/12/10 19:09
S5	173	(downlink near3 carrier) and (uplink near3 (primary first initial) near3 carrier) and ((second 2nd other next) with (channel resource)) and (control with information)	US-PGPUB; USPAT; USOCR; DERWENT; IBM_TDB	OR	ON	2012/12/11 09:04
S6	137	S5 and (scheduling)	US-PGPUB; USPAT; USOCR; DERWENT; IBM_TDB	OR	ON	2012/12/11 09:04
S7	36	("20120263121" "20110310856" "20120127950" "20110310819" "20120275395" "20120287828" "20120039291" "20100271970" "20120307781" "20110286436" "20120224535" "20120140708" "20110310820" "20120163288" "20110299486" "20100098012" "20120082125" "20120294273" "20110268048" "20120113910").pn.	US-PGPUB; USPAT; USOCR; DERWENT; IBM_TDB	OR	ON	2012/12/11 09:15
S8	127	(downlink near3 carrier) and (uplink near3 (primary first initial) near3 carrier) and ((second 2nd other next) with (channel resource)) and (carrier adj aggregation)	US-PGPUB; USPAT; USOCR; DERWENT; IBM_TDB	OR	ON	2012/12/11 10:16
S9	2	"20110292887"	US-PGPUB; USPAT; USOCR; DERWENT; IBM_TDB	OR	ON	2012/12/11 11:17

S11	25	((first 1st) adj6 component adj3 carrier) same ((1st first) adj6 (radio resource frame)) and ((2nd second) adj6 component adj3 carrier) same ((2nd second) adj6 (radio resource frame))	US-PGPUB; USPAT; USOCR; DERWENT; IBM_TDB	OR	ON	2012/12/11 11:22
S12	1718	((first 1st) adj6 carrier) same ((1st first) adj6 (radio resource frame)) and ((2nd second) adj6 carrier) same ((2nd second) adj6 (radio resource frame))	US-PGPUB; USPAT; USOCR; DERWENT; IBM_TDB	OR	ON	2012/12/11 11:47
S13	66	(carrier near3 aggregation) and ((first 1st) adj6 carrier) same ((1st first) adj6 (radio resource frame)) and ((2nd second) adj6 carrier) same ((2nd second) adj6 (radio resource frame))	US-PGPUB; USPAT; USOCR; DERWENT; IBM_TDB	OR	ON	2012/12/11 11:47
S14	10842	455/509,522,456.6,137,103,575.ccls.	US-PGPUB; USPAT; USOCR; DERWENT; IBM_TDB	OR	ON	2012/12/11 13:41
S15	28232	370/329,252,331.ccls.	US-PGPUB; USPAT; USOCR; DERWENT; IBM_TDB	OR	ON	2012/12/11 13:41
S16	102	(S14 S15) and (downlink near3 carrier) and (uplink near3 (primary first initial) near3 carrier) and ((second 2nd other next) with (channel resource)) and (control with information)	US-PGPUB; USPAT; USOCR; DERWENT; IBM_TDB	OR	ON	2012/12/11 13:42
S17	1	"13140333"	US-PGPUB; USPAT; USOCR; DERWENT; IBM_TDB	OR	ON	2012/12/11 14:18
S18	2	"20110310856"	US-PGPUB; USPAT; USOCR; DERWENT; IBM_TDB	OR	ON	2012/12/11 14:18
S19	38	((first 1st) adj6 component adj3 carrier) same ((radio resource frame)) and ((2nd second) adj6 component adj3 carrier) same ((2nd second) adj6 (radio resource frame))	US-PGPUB; USPAT; USOCR; DERWENT; IBM_TDB	OR	ON	2012/12/11 14:31
S20	38	((first 1st) adj6 component adj3 carrier) same ((radio resource frame)) and ((2nd second) adj6 component adj3 carrier) same ((2nd second) adj6 (radio resource frame))	US-PGPUB; USPAT; USOCR; DERWENT; IBM_TDB	OR	ON	2012/12/11 14:31
S21	27	((first 1st) adj6 component adj3 carrier) same ((radio resource frame)) and ((2nd second) adj6 component adj3 carrier) same ((2nd second other another) adj4 (radio resource frame))	US-PGPUB; USPAT; USOCR; DERWENT; IBM_TDB	OR	ON	2012/12/11 14:32
S22	38	((first 1st) adj6 component adj3 carrier) same ((radio resource frame)) and ((2nd second) adj6 component adj3 carrier) same ((2nd second other another) adj6 (radio resource frame))	US-PGPUB; USPAT; USOCR; DERWENT; IBM_TDB	OR	ON	2012/12/11 14:32

S23	24	(carrier adj aggregation) and (scheduling\$3 near3 (downlink DL) with ((first primary initial) near6 (resource radio frequency frame)))	US-PGPUB; USPAT; USOCR; DERWENT; IBM_TDB	OR	ON	2012/12/11 14:48
S24	8	("7551898" "7649960" "7656843" "7773699").PN.	US-PGPUB; USPAT; USOCR; DERWENT; IBM_TDB	OR	ON	2012/12/11 15:14
S25	2	"20110292900"	US-PGPUB; USPAT; USOCR; DERWENT; IBM_TDB	OR	ON	2012/12/11 15:36
S26	2	"20100271970"	US-PGPUB; USPAT; USOCR; DERWENT; IBM_TDB	OR	ON	2012/12/11 15:37
S27	3	"8050202"	US-PGPUB; USPAT; USOCR; DERWENT; IBM_TDB	OR	ON	2012/12/11 15:38
S28	1	"20120307689"	US-PGPUB; USPAT; USOCR; DERWENT; IBM_TDB	OR	ON	2012/12/11 15:45
S29	2	"8160017"	US-PGPUB; USPAT; USOCR; DERWENT; IBM_TDB	OR	ON	2012/12/11 15:48
S30	2	"20100232373"	US-PGPUB; USPAT; USOCR; DERWENT; IBM_TDB	OR	ON	2012/12/11 15:48
S31	2	"20090016278"	US-PGPUB; USPAT; USOCR; DERWENT; IBM_TDB	OR	ON	2012/12/11 17:16
S32	2	"8265030"	US-PGPUB; USPAT; USOCR; DERWENT; IBM_TDB	OR	ON	2012/12/11 17:19
S33	3	"2008139923"	US-PGPUB; USPAT; USOCR; DERWENT; IBM_TDB	OR	ON	2012/12/11 18:17
S34	14	("20100098012" "20100232373" "20110310856" "20120020317" "20120082125" "20120140708" "8265030").PN.	US-PGPUB; USPAT; USOCR; DERWENT; IBM_TDB	OR	ON	2013/05/29 17:19

S35	7	"455"/\$.ccls. and (carrier adj aggregation) and (schedul\$3 near3 (downlink DL) with ((first primary initial) near6 (resource radio frequency frame)))	US-PGPUB; USPAT; USOCR; DERWENT; IBM_TDB	OR	ON	2013/05/29 17:22
S36	9	"455"/\$.ccls. and (((first 1st) adj6 component adj3 carrier) same ((radio resource frame))) and ((2nd second) adj6 component adj3 carrier) same ((2nd second) adj6 (radio resource frame))	US-PGPUB; USPAT; USOCR; DERWENT; IBM_TDB	OR	ON	2013/05/29 21:37
S38	4	("20070053294" "20100290405").PN.	US-PGPUB; USPAT; USOCR; DERWENT; IBM_TDB	OR	ON	2013/05/30 12:42
S39	16	("7596114" "20050013279" "20030219028" "20070217406" "20020105970" "20060050664" "20090303938" "20070064669").PN.	US-PGPUB; USPAT; USOCR; DERWENT; IBM_TDB	OR	ON	2013/05/30 12:42
S40	290	(first 1st) with (component near2 carrier) with down\$1link	US-PGPUB; USPAT; USOCR; DERWENT; IBM_TDB	OR	ON	2013/06/17 10:07
S41	114	(first 1st) with (component near2 carrier) with down\$1link and receiv\$3 near3 control near3 information	US-PGPUB; USPAT; USOCR; DERWENT; IBM_TDB	OR	ON	2013/06/17 10:09
S42	47	(first 1st) near3 (radio adj resource) and (second other another 2nd) near3 (radio adj resource) and component adj carrier	US-PGPUB; USPAT; USOCR; DERWENT; IBM_TDB	OR	ON	2013/06/17 12:29
S43	26	S42 and (carrier adj aggregation) and (schedul\$3 near3 (down\$1link DL reverse\$1link))	US-PGPUB; USPAT; USOCR; DERWENT; IBM_TDB	OR	ON	2013/06/17 12:31
S44	5	(first 1st) near3 (radio adj resource) and (second other another 2nd) near3 (radio adj resource) same (carrier adj aggregation) and (schedul\$3 near3 (down\$1link DL reverse\$1link))	US-PGPUB; USPAT; USOCR; DERWENT; IBM_TDB	OR	ON	2013/06/17 12:46
S45	26	(first 1st) near3 (radio adj resource) and (second other another 2nd) near3 (radio adj resource) and (carrier adj aggregation) and (schedul\$3 near3 (down\$1link DL reverse\$1link))	US-PGPUB; USPAT; USOCR; DERWENT; IBM_TDB	OR	ON	2013/06/17 12:47
S46	31	(second other another 2nd) near3 (radio adj resource) and (carrier adj aggregation) and (schedul\$3 near3 (down\$1link DL reverse\$1link))	US-PGPUB; USPAT; USOCR; DERWENT; IBM_TDB	OR	ON	2013/06/17 12:49
S47	0	@ad<"20091003" and (second other another 2nd) near3 (radio adj resource) and (carrier adj aggregation) and (schedul\$3 near3 (down\$1link DL reverse\$1link))	US-PGPUB; USPAT; USOCR; DERWENT; IBM_TDB	OR	ON	2013/06/17 12:51

S48	0	@ad<"20091003" and (second other another 2nd near3 (radio adj resource) and (carrier adj component) and (schedul\$3 near3 (down\$link DL reverse\$1link))	US-PGPUB; USPAT; USOCR; DERWENT; IBM_TDB	OR	ON	2013/06/17 12:52
S49	1	@ad<"20091003" and (second other another 2nd near3 (radio adj resource) and (carrier adj component) and ((down\$link DL reverse\$1link))	US-PGPUB; USPAT; USOCR; DERWENT; IBM_TDB	OR	ON	2013/06/17 12:53
S50	1	@ad<"20091005" and (second other another 2nd near3 (radio adj resource) and (carrier adj component) and ((down\$link DL reverse\$1link))	US-PGPUB; USPAT; USOCR; DERWENT; IBM_TDB	OR	ON	2013/06/17 12:55
S51	1	@ad<"20091003" and (second other another 2nd near3 (radio adj resource) and (carrier adj component)	US-PGPUB; USPAT; USOCR; DERWENT; IBM_TDB	OR	ON	2013/06/17 12:56
S52	20	(second other another 2nd) near3 (radio adj resource) and (carrier adj component)	US-PGPUB; USPAT; USOCR; DERWENT; IBM_TDB	OR	ON	2013/06/17 13:31
S53	16	(set near3 radio near3 resource) same component adj carrier	US-PGPUB; USPAT; USOCR; DERWENT; IBM_TDB	OR	ON	2013/06/17 14:14
S54	27	(set near3 ((radio near3 resource) (resource adj block))) same component adj carrier	US-PGPUB; USPAT; USOCR; DERWENT; IBM_TDB	OR	ON	2013/06/17 14:19
S55	755	((radio near3 resource) (resource adj block))) same component adj carrier	US-PGPUB; USPAT; USOCR; DERWENT; IBM_TDB	OR	ON	2013/06/17 14:25
S56	70	((second 2nd other) with ((radio near3 resource) (resource adj block))) same component adj carrier	US-PGPUB; USPAT; USOCR; DERWENT; IBM_TDB	OR	ON	2013/06/17 14:26
S57	327	((radio near3 resource) (resource adj block))) same component adj carrier and (schedul\$3 near3 downlink reverse)	US-PGPUB; USPAT; USOCR; DERWENT; IBM_TDB	OR	ON	2013/06/17 14:27
S58	29	((second 2nd other) with ((radio near3 resource) (resource adj block))) same component adj carrier and (schedul\$3 near3 down\$link reverse\$1link)	US-PGPUB; USPAT; USOCR; DERWENT; IBM_TDB	OR	ON	2013/06/17 14:27
S59	24	((second 2nd other) with ((radio near3 resource) (resource adj block))) same (component adj carrier) same (down\$link reverse\$1link)	US-PGPUB; USPAT; USOCR; DERWENT; IBM_TDB	OR	ON	2013/06/17 14:31

S60	10	("20090097447" "20110081856" "20090116427" "20100232373" "8331307").PN.	US-PGPUB; USPAT; USOCR; DERWENT; IBM_TDB	OR	ON	2013/06/17 14:49
S61	2562	(schedul\$3 near3 downlink) and ((radio adj resource) (resource adj block)) and component	US-PGPUB; USPAT; USOCR; DERWENT; IBM_TDB	OR	ON	2013/06/17 15:16
S62	739	(schedul\$3 near3 downlink) and ((radio adj resource) (resource adj block)) and component adj carrier	US-PGPUB; USPAT; USOCR; DERWENT; IBM_TDB	OR	ON	2013/06/17 15:17
S63	259	(schedul\$3 near3 downlink) same ((radio adj resource) (resource adj block)) and component adj carrier	US-PGPUB; USPAT; USOCR; DERWENT; IBM_TDB	OR	ON	2013/06/17 15:17
S64	39	(schedul\$3 near3 downlink) same ((radio adj resource) (resource adj block)) same (component adj carrier)	US-PGPUB; USPAT; USOCR; DERWENT; IBM_TDB	OR	ON	2013/06/17 15:18
S65	1	@ad< "20091005" and (schedul\$3 near3 downlink) same ((radio adj resource) (resource adj block)) same (component adj carrier)	US-PGPUB; USPAT; USOCR; DERWENT; IBM_TDB	OR	ON	2013/06/17 15:18
S66	1	@ad< "20091005" and (schedul\$3 near3 downlink) same ((radio adj resource) (resource adj block)) same (CC (component adj carrier))	US-PGPUB; USPAT; USOCR; DERWENT; IBM_TDB	OR	ON	2013/06/17 15:20
S67	47	(schedul\$3 near3 downlink) same ((radio adj resource) (resource adj block)) same (CC (component adj carrier))	US-PGPUB; USPAT; USOCR; DERWENT; IBM_TDB	OR	ON	2013/06/17 15:20
S68	356	"455"/\$.ccls. and ((radio adj resource) (resource adj block)) same (CC (component adj carrier))	US-PGPUB; USPAT; USOCR; DERWENT; IBM_TDB	OR	ON	2013/06/17 17:10
S70	19	"455"/\$.ccls. and (carrier near3 aggregation) and ((first 1st) adj6 carrier) same ((1st first) adj6 (radio resource frame)) and ((2nd second) adj6 carrier) same ((2nd second) adj6 (radio resource frame))	US-PGPUB; USPAT; USOCR; DERWENT; IBM_TDB	OR	ON	2013/06/17 17:17
S71	0	("2013/0107855").URPN.	USPAT	OR	ON	2013/06/18 09:15
S72	0	("2013/0107855").URPN.	US-PGPUB; USPAT	OR	ON	2013/06/18 09:16
S73	408	set near3 (radio frequency) near2 (resource band) same downlink and component	US-PGPUB; USPAT	OR	ON	2013/06/18 09:18
S74	17	set near3 (radio frequency) near2 (resource band) same downlink same (component adj carrier)	US-PGPUB; USPAT	OR	ON	2013/06/18 09:19
S75	19	(set group Cluster) near3 (radio frequency) near2	US-PGPUB;	OR	ON	2013/06/18

		(resource band) same downlink same (component adj carrier)	USPAT			09:21
S76	12	("8457060" "20110310819" "20100271970" "20130034073" "20100098012" "20110310856" "20110317653" "20130083742" "20130083741" "20120114021" "20120275395" "20110317645" "20110310856").pn.	US-PGPUB; USPAT	OR	ON	2013/06/18 09:31
S77	200	(DL down\$link) with (1st first first primary initia near3 (set group) near6 (radio resource)	US-PGPUB; USPAT	OR	ON	2013/06/18 10:37
S78	2911	(UL up\$link) with (set group) near6 (radio resource)	US-PGPUB; USPAT	OR	ON	2013/06/18 10:38
S79	110	S77 and S78	US-PGPUB; USPAT	OR	ON	2013/06/18 10:38
S80	3	(DL down\$link) with (1st first first primary initia near3 (set group) near6 (radio resource) and (DL down\$link) with (set group) near6 (radio resource) with (2nd second other another) near2 component	US-PGPUB; USPAT	OR	ON	2013/06/18 10:47
S81	28	(DL down\$link) with (1st first first primary initia near3 (set group) near6 (radio resource) and (DL down\$link) with (component near3 carrier)	US-PGPUB; USPAT	OR	ON	2013/06/18 11:17
S82	5	(DL down\$link) with (1st first first primary initia near3 (set group) near6 (radio resource) and (DL down\$link) with (second 2nd) near3 (component near3 carrier)	US-PGPUB; USPAT	OR	ON	2013/06/18 11:20
S83	4	(1st first first primary initia) near3 (set group) near6 (radio resource) with (DL down\$link) near3 (component near3 carrier)	US-PGPUB; USPAT	OR	ON	2013/06/18 13:50
S84	3	(set group) near6 (radio resource) with (2nd second other another) near6 (DL down\$link) near3 (component near3 carrier)	US-PGPUB; USPAT	OR	ON	2013/06/18 13:52
S85	42	(set group) near6 (radio resource) with (DL down\$link) near3 (component near3 carrier)	US-PGPUB; USPAT	OR	ON	2013/06/18 13:58
S86	30	(set group) near3 ((radio resource)(resource near2 block)) with (DL down\$link) near3 (component near3 carrier)	US-PGPUB; USPAT	OR	ON	2013/06/18 14:07
S87	2	(second 2nd) near3 (down\$1link DL) with ((component near3 carrier) CC) same (set group) with ((radio near2 resource) (resource near2 block))	US-PGPUB; USPAT	OR	ON	2013/06/18 14:14
S88	21	reserv\$3 with component near3 carrier and (second near2 (radio frequency band))	US-PGPUB; USPAT; USOCR; DERWENT; IBM_TDB	OR	ON	2013/06/25 15:31
S89	36	"739528"	US-PGPUB; USPAT; USOCR; DERWENT; IBM_TDB	OR	ON	2013/06/26 09:34
S90	30	"5754138"	US-PGPUB; USPAT; USOCR; DERWENT; IBM_TDB	OR	ON	2013/06/26 09:35
S91	2046	(carrier near3 aggregation) and up\$1link with down\$1link	US-PGPUB; USPAT;	OR	ON	2013/06/26 10:24

			USOCR; DERWENT; IBM_TDB			
S92	1052	(carrier near3 aggregation) and (component near3 carrier) same up\$1link with down\$1link	US-PGPUB; USPAT; USOCR; DERWENT; IBM_TDB	OR	ON	2013/06/26 10:26
S93	110	(carrier near3 aggregation) and (component near3 carrier) same up\$1link with associat\$3 with down\$1link	US-PGPUB; USPAT; USOCR; DERWENT; IBM_TDB	OR	ON	2013/06/26 10:27
S95	17	("370"/\$.ccls "455"/\$.ccls.) and (aggregation) and (CC (component near3 carrier)) same up\$1link with associat\$3 with down\$1link	US-PGPUB; USPAT; USOCR; DERWENT; IBM_TDB	OR	ON	2013/06/26 15:22
S96	67	370/329,341,348,395.4.ccls. and (carrier near3 aggregation) and (component near3 carrier) same up\$1link with associat\$3 with down\$1link	US-PGPUB; USPAT; USOCR; DERWENT; IBM_TDB	OR	ON	2013/06/26 15:26
S97	345368	schedule (DL (down adj link) down\$1link) and (carrier near3 aggregation) and ((UL up\$1link) adj6 associat\$4 near4 (DL down\$1link))	US-PGPUB; USPAT; USOCR; DERWENT; IBM_TDB	OR	ON	2013/06/26 16:45
S98	9	schedule near3 (DL (down adj link) down\$1link) and (carrier near3 aggregation) same((UL up\$1link) adj6 associat\$4 near4 (DL down\$1link))	US-PGPUB; USPAT; USOCR; DERWENT; IBM_TDB	OR	ON	2013/06/26 16:46
S99	35	(schedule allocat\$4) near3 (DL (down adj link) down\$1link) and (carrier near3 aggregation) same((UL up\$1link) adj6 associat\$4 near4 (DL down\$1link))	US-PGPUB; USPAT; USOCR; DERWENT; IBM_TDB	OR	ON	2013/06/26 16:48
S100	0	(1st first) near3 (radio band resource frequency) with (1st first) near3 (CCcomponent adj carrier)	US-PGPUB; USPAT; USOCR; DERWENT; IBM_TDB	OR	ON	2013/06/26 17:14
S101	216	(1st first) near3 (radio band resource frequency) with (1st first) near3 (CC (component adj carrier))	US-PGPUB; USPAT; USOCR; DERWENT; IBM_TDB	OR	ON	2013/06/26 17:14
S102	43	(1st first) near3 (radio band resource frequency) with (reserv\$3 schedul\$3 allocat\$3) with (1st first) near3 (CC (component adj carrier))	US-PGPUB; USPAT; USOCR; DERWENT; IBM_TDB	OR	ON	2013/06/26 17:15
S103	22	("20100142455" "20120009923" "20100254329" "20100091678" "20110194501" "20130010619" "20080310359" "20060274712" "20100227569" "20120208583" "20110267978").PN.	US-PGPUB; USPAT; USOCR; DERWENT; IBM_TDB	OR	ON	2013/06/27 09:57
S104	10	("20100254329" "20100195624"	US-PGPUB;	OR	ON	2013/06/27

		"20100023282" "20090274100" "20080316957").PN.	USPAT; USOCR; DERWENT; IBM_TDB			10:15
S105	50	("20100322173" "20110081913" "20130010721" "20120140708" "20100271970" "20100285809" "20110007699" "20130003700" "20100232373" "20120051306" "20120082125" "20100098012" "20100003997" "20100208679" "20110310856" "20120082125" "20120140708" "20130136084" "8265030" "20120020317" "8265030" "20110007695" "20110081932" "20120314675" "20110310856" "20100232373" "20100296389" "20120020317" "20100098012" "20130034073" "8447343" "8472368").PN.	US-PGPUB; USPAT; USOCR; DERWENT; IBM_TDB	OR	ON	2014/04/22 13:25
S106	13348	(H04W88/08, H04W72/044, H04W72/042).cpc.	US-PGPUB; USPAT; USOCR; DERWENT; IBM_TDB	OR	ON	2014/04/22 13:40
S107	4330	(H04W52/367, H04W52/12, H04W52/40).cpc.	US-PGPUB; USPAT; USOCR; DERWENT; IBM_TDB	OR	ON	2014/04/22 13:42
S108	4200	(H04L29/08657, G01S5/0252, G01S5/02).cpc.	US-PGPUB; USPAT; USOCR; DERWENT; IBM_TDB	OR	ON	2014/04/22 13:43
S109	3823	(H04B1/3833, H04M1/0247, H04M1/0237).cpc.	US-PGPUB; USPAT; USOCR; DERWENT; IBM_TDB	OR	ON	2014/04/22 13:44
S110	6130	(H03F3/211, H04B7/0617, H04B7/0669).cpc.	US-PGPUB; USPAT; USOCR; DERWENT; IBM_TDB	OR	ON	2014/04/22 13:44
S111	370	(S106 S107 S108 S109 S110) and (schedul\$4 near3 down\$1link) and (component near3 carrier)	US-PGPUB; USPAT; USOCR; DERWENT; IBM_TDB	OR	ON	2014/04/22 13:45
S112	365	(S106 S107 S108 S109 S110) and (schedul\$4 near3 down\$1link) and (component near3 carrier) and (control with information)	US-PGPUB; USPAT; USOCR; DERWENT; IBM_TDB	OR	ON	2014/04/22 13:46
S113	357	(S106 S107 S108 S109 S110) and (schedul\$4 near3 down\$1link) and (component near carrier) and (control with information)	US-PGPUB; USPAT; USOCR; DERWENT; IBM_TDB	OR	ON	2014/04/22 13:47
S114	13	(S106 S107 S108 S109 S110) and (DL down\$1link)	US-PGPUB;	OR	ON	2014/04/22

		with (1st first first primary initial) near3 (set group) near6 (radio resource) and (DL down\$link with (component near3 carrier)	USPAT; USOCR; DERWENT; IBM_TDB			13:47
S115	40	(H03F3/211, H04B7/0617, H04B7/0669, H04B1/3833, H04M1/0247, H04M1/0237, H04L29/08657, G01S5/0252, G01S5/02, H04W52/367, H04W52/12, H04W52/40, H04W88/08, H04W72/044, H04W72/042).cpc. and (carrier near3 aggregation) and (component near3 carrier) same up\$1link with associat\$3 with down\$1link	US-PGPUB; USPAT; USOCR; DERWENT; IBM_TDB	OR	ON	2014/04/22 14:17
S116	8750	(H04W88/08, H04W72/044, H04W72/042l).cpc.	US-PGPUB; USPAT; USOCR; DERWENT; IBM_TDB	OR	ON	2014/04/26 14:21
S117	4336	(H04W52/367, H04W52/12, H04W52/40).cpc.	US-PGPUB; USPAT; USOCR; DERWENT; IBM_TDB	OR	ON	2014/04/26 14:22
S118	4205	(H04L29/08657, G01S5/0252, G01S5/02).cpc.	US-PGPUB; USPAT; USOCR; DERWENT; IBM_TDB	OR	ON	2014/04/26 14:23
S119	4144	(H04L29/08657, G01S19/14, G01S5/02).cpc.	US-PGPUB; USPAT; USOCR; DERWENT; IBM_TDB	OR	ON	2014/04/26 14:23
S120	3826	(H04B1/3833, H04M1/0247, H04M1/0237).cpc.	US-PGPUB; USPAT; USOCR; DERWENT; IBM_TDB	OR	ON	2014/04/26 14:24
S121	47	(H04W88/08, H04W72/044, H04W72/042).cpc. and (1st first) near3 (radio band resource frequency) with (1st first) near3 (CC (component adj carrier))	US-PGPUB; USPAT; USOCR; DERWENT; IBM_TDB	OR	ON	2014/04/26 14:27
S122	25	(S116 S117 S118 S119 S120).cpc. and (1st first) near3 (radio band resource frequency) with (1st first) near3 (CC (component adj carrier))	US-PGPUB; USPAT; USOCR; DERWENT; IBM_TDB	OR	ON	2014/04/26 15:35
S123	13432	(H04W88/08, H04W72/044, H04W72/042).cpc.	US-PGPUB; USPAT; USOCR; DERWENT; IBM_TDB	OR	ON	2014/04/30 11:04
S124	4341	(H04W52/367, H04W52/12, H04W52/40).cpc.	US-PGPUB; USPAT; USOCR; DERWENT; IBM_TDB	OR	ON	2014/04/30 11:04
S125	4208	(H04L29/08657, G01S5/0252, G01S5/02).cpc.	US-PGPUB; USPAT; USOCR;	OR	ON	2014/04/30 11:04

			DERWENT; IBM_TDB				
S126	3833	(H04B1/3833, H04M1/0247, H04M1/0237).cpc.	US-PGPUB; USPAT; USOCR; DERWENT; IBM_TDB	OR	ON	2014/04/30 11:04	
S127	6154	(H03F3/211, H04B7/0617, H04B7/0669).cpc.	US-PGPUB; USPAT; USOCR; DERWENT; IBM_TDB	OR	ON	2014/04/30 11:04	
S128	98	(S123 S124 S125 S126 S127) and (schedul\$4 near3 down\$1link) and (component near3 carrier) and single with carrier same (plurality multiple several) with (DL down\$1link) with carrier	US-PGPUB; USPAT; USOCR; DERWENT; IBM_TDB	OR	ON	2014/04/30 11:04	
S129	52	(S123 S124 S125 S126 S127) and (schedul\$4 near3 down\$1link) and (component near3 carrier) and single near6 carrier same (plurality multiple several) near3 (DL down\$1link) with carrier	US-PGPUB; USPAT; USOCR; DERWENT; IBM_TDB	OR	ON	2014/04/30 11:04	
S130	4	(S123 S124 S125 S126 S127) and (schedul\$4) with component near3 carrier and (single near3 (DL down\$1link)) with (first with resource) and (multiple plurality several) near3 (DL downlink) with second with resource	US-PGPUB; USPAT; USOCR; DERWENT; IBM_TDB	OR	ON	2014/04/30 11:37	
S131	2	(up\$1link UL) and (schedul\$4) with component near3 carrier same (single near3 (DL down\$1link)) with (first with resource) same (multiple plurality several) near3 (DL downlink) with second with resource	US-PGPUB; USPAT; USOCR; DERWENT; IBM_TDB	OR	ON	2014/04/30 11:40	
S132	2	(schedul\$4) with component near3 carrier same (single near3 (DL down\$1link)) with (first with resource) same (multiple plurality several) near3 (DL downlink) with second with resource	US-PGPUB; USPAT; USOCR; DERWENT; IBM_TDB	OR	ON	2014/04/30 11:42	
S133	2	(schedul\$4) same (single near3 (DL down\$1link)) with (first with resource) same (multiple plurality several) near3 (DL downlink) with second with resource	US-PGPUB; USPAT; USOCR; DERWENT; IBM_TDB	OR	ON	2014/04/30 11:44	
S134	2	(schedul\$4) same (single near3 (DL down\$1link)) with (first with (frequency resource block)) same (multiple plurality several) near3 (DL downlink) with second with (frequency block resource)	US-PGPUB; USPAT; USOCR; DERWENT; IBM_TDB	OR	ON	2014/04/30 11:45	
S135	16	(single near3 (DL down\$1link)) with (first with (frequency resource block)) same (multiple plurality several) near3 (DL downlink) with second with (frequency block resource)	US-PGPUB; USPAT; USOCR; DERWENT; IBM_TDB	OR	ON	2014/04/30 11:45	
S136	1	allocation with (PUSCH PUCCH UL (up\$1link)) and "20100232373"	US-PGPUB; USPAT; USOCR; DERWENT; IBM_TDB	OR	ON	2014/04/30 14:19	
S137	1	allocation and (PUSCH PUCCH UL (up\$1link)) and "20100232373"	US-PGPUB; USPAT; USOCR;	OR	ON	2014/04/30 14:21	

			DERWENT; IBM_TDB			
S138	2	"20100271970"	US-PGPUB; USPAT; USOCR; DERWENT; IBM_TDB	OR	ON	2014/04/30 14:32
S139	54	("20100322173" "20110081913" "20130010721" "8634358" "20120140708" "20100271970" "20100285809" "20110007699" "20130003700" "20100232373" "20120051306" "20120082125" "20100098012" "20100003997" "20100208679" "20110310856" "20120082125" "20120140708" "20130136084" "8265030" "20110243039" "20120020317" "8265030" "20110007695" "20110081932" "20120314675" "20110310856" "20100232373" "20100296389" "20120020317" "20100098012" "20130034073" "8447343" "8472368").PN.	US-PGPUB; USPAT; USOCR; DERWENT; IBM_TDB	OR	ON	2014/10/15 11:49
S140	15049	(H04W88/08, H04W72/044, H04W72/042).cpc.	US-PGPUB; USPAT; USOCR; DERWENT; IBM_TDB	OR	ON	2014/10/15 13:44
S141	4737	(H04W52/367, H04W52/12, H04W52/40).cpc.	US-PGPUB; USPAT; USOCR; DERWENT; IBM_TDB	OR	ON	2014/10/15 13:44
S142	4341	(H04L29/08657, G01S5/0252, G01S5/02).cpc.	US-PGPUB; USPAT; USOCR; DERWENT; IBM_TDB	OR	ON	2014/10/15 13:44
S143	4030	(H04B1/3833, H04M1/0247, H04M1/0237).cpc.	US-PGPUB; USPAT; USOCR; DERWENT; IBM_TDB	OR	ON	2014/10/15 13:44
S144	6785	(H03F3/211, H04B7/0617, H04B7/0669).cpc.	US-PGPUB; USPAT; USOCR; DERWENT; IBM_TDB	OR	ON	2014/10/15 13:44
S145	96	(S140 S141 S142 S143 S144) and (schedul\$4 near3 down\$1link) and (component near3 carrier) and single with carrier same (plurality multiple several) with (DL down\$1link) with carrier same (frequency resources)	US-PGPUB; USPAT; USOCR; DERWENT; IBM_TDB	OR	ON	2014/10/15 13:44
S146	1	"13315135"	US-PGPUB; USPAT; USOCR; DERWENT; IBM_TDB	OR	ON	2014/10/15 13:54
S147	2	"20080151845"	US-PGPUB; USPAT; USOCR;	OR	ON	2014/10/15 14:58

			DERWENT; IBM_TDB			
S148	41	"455"/\$.ccls. and (carrier near3 aggregation) and ((first 1st) adj6 carrier) same ((1st first) adj6 (radio resource frame)) and ((2nd second) adj6 carrier) same ((2nd second) adj6 (radio resource frame))	US-PGPUB; USPAT; USOCR; DERWENT; IBM_TDB	OR	ON	2014/10/15 15:45
S149	3	"455"/451,452.1.ccls. and (carrier near3 aggregation) and ((first 1st) adj6 carrier) same ((1st first) adj6 (radio resource frame)) and ((2nd second) adj6 carrier) same ((2nd second) adj6 (radio resource frame))	US-PGPUB; USPAT; USOCR; DERWENT; IBM_TDB	OR	ON	2014/10/15 18:01
S150	33889	455/451,452.1,509,456.1,522,137,103,575.ccls.	US-PGPUB; USPAT; USOCR; DERWENT; IBM_TDB	OR	ON	2014/10/23 11:25
S151	0	455/451,452.1,509,456.1,522,137,103,575.ccls. and (control\$4) with (resource frequency channel Bin) same (sererv\$4 sav\$4) near3 (other 2nd second another) adj3 (resource frequency channel Bin)	US-PGPUB; USPAT; USOCR; DERWENT; IBM_TDB	OR	ON	2014/10/23 11:32
S152	0	455/451,452.1,509,456.1,522,137,103,575.ccls. and (control\$4) with (resource frequency channel Bin) same (rererv\$4 sav\$4) near3 (other 2nd second another) adj3 (resource frequency channel Bin)	US-PGPUB; USPAT; USOCR; DERWENT; IBM_TDB	OR	ON	2014/10/23 11:33
S153	4	455/451,452.1,509,456.1,522,137,103,575.ccls. and (control\$4) with (resource frequency channel Bin) same (reserv\$4 sav\$4) near3 (other 2nd second another) adj3 (resource frequency channel Bin)	US-PGPUB; USPAT; USOCR; DERWENT; IBM_TDB	OR	ON	2014/10/23 11:34
S154	3	455/451,452.1,509,456.1,522,137,103,575.ccls. and (control\$4) with (resource frequency channel Bin) same (reserv\$4 sav\$4) near3 (other 2nd second another) adj3 (resource frequency channel Bin) and (CC component)	US-PGPUB; USPAT; USOCR; DERWENT; IBM_TDB	OR	ON	2014/10/23 11:37
S155	4	"455"/\$.ccls. and (((first 1st) adj6 component adj3 carrier) same ((radio resource frame))) and ((2nd second) adj6 component adj3 carrier) same ((2nd second other another) adj6 (radio resource frame)) and (reserv\$4 sav\$4 us\$3) near3 (other 2nd second another) adj3 (resource frequency channel Bin) and (CC component)	US-PGPUB; USPAT; USOCR; DERWENT; IBM_TDB	OR	ON	2014/10/23 11:39
S156	15	("20050013279" "20030219028" "20070217406" "20020105970" "20060050664" "20090303938" "20070064669").PN.	US-PGPUB; USPAT; USOCR; DERWENT; IBM_TDB	OR	ON	2014/10/23 12:07
S157	10	"455"/\$.ccls. and (schedul\$3 near3 downlink) same ((radio adj resource) (resource adj block)) same (CC (component adj carrier))	US-PGPUB; USPAT; USOCR; DERWENT; IBM_TDB	OR	ON	2014/10/23 12:07
S158	0	455/451,452.1,509,456.1,522,137,103,575.ccls. and (control\$4) with (resource frequency channel) same (rererv\$4 sav\$4) near3 (other 2nd second another) adj3 (resource frequency channel Bin)	US-PGPUB; USPAT; USOCR; DERWENT; IBM_TDB	OR	ON	2014/10/31 15:22
S161	15374	(H04W88/08, H04W72/044, H04W72/042).cpc.	US-PGPUB;	OR	ON	2014/10/31

			USPAT; USOCR; DERWENT; IBM_TDB			17:18
S162	4758	(H04W52/367, H04W52/12, H04W52/40).cpc.	US-PGPUB; USPAT; USOCR; DERWENT; IBM_TDB	OR	ON	2014/10/31 17:18
S163	4377	(H04L29/08657, G01S5/0252, G01S5/02).cpc.	US-PGPUB; USPAT; USOCR; DERWENT; IBM_TDB	OR	ON	2014/10/31 17:18
S164	4042	(H04B1/3833, H04M1/0247, H04M1/0237).cpc.	US-PGPUB; USPAT; USOCR; DERWENT; IBM_TDB	OR	ON	2014/10/31 17:18
S165	6867	(H03F3/211, H04B7/0617, H04B7/0669).cpc.	US-PGPUB; USPAT; USOCR; DERWENT; IBM_TDB	OR	ON	2014/10/31 17:18
S167	1	"14170939"	US-PGPUB; USPAT; USOCR; DERWENT; IBM_TDB	OR	ON	2014/11/17 09:46
S168	499	(component near2 carrier) with (primary near2 cell)	US-PGPUB; USPAT; USOCR; DERWENT; IBM_TDB	OR	ON	2014/11/18 14:07
S169	401	"370"/\$.cls. and (component near2 carrier) with (primary near2 cell)	US-PGPUB; USPAT; USOCR; DERWENT; IBM_TDB	OR	ON	2014/11/18 14:07
S170	378	"370"/\$.cls. and (component adj2 carrier) with (primary adj2 cell)	US-PGPUB; USPAT; USOCR; DERWENT; IBM_TDB	OR	ON	2014/11/18 14:07
S171	185	"370"/\$.cls. and (component adj2 carrier) with (primary adj2 cell) with (DL down\$1link)	US-PGPUB; USPAT; USOCR; DERWENT; IBM_TDB	OR	ON	2014/11/18 14:08
S172	4	"370"/\$.cls. and single near3 (CC (component adj2 carrier)) with (primary adj2 cell) with (DL down\$1link)	US-PGPUB; USPAT; USOCR; DERWENT; IBM_TDB	OR	ON	2014/11/18 14:17
S173	4	single near4 (CC (component adj2 carrier)) with (primary adj2 cell) with (DL down\$1link)	US-PGPUB; USPAT; USOCR; DERWENT; IBM_TDB	OR	ON	2014/11/18 14:19
S174	287	"370"/\$.cls. and (CC (component adj2 carrier))	US-PGPUB;	OR	ON	2014/11/18

		with (primary adj2 cell) with (DL down\$1link)	USPAT; USOCR; DERWENT; IBM_TDB			14:21
S175	1	@ad<"20091004" and "370"/\$.cls. and (CC (component adj2 carrier)) with (primary adj2 cell) with (DL down\$1link)	US-PGPUB; USPAT; USOCR; DERWENT; IBM_TDB	OR	ON	2014/11/18 14:22
S176	287	"370"/\$.cls. and (CC (component adj2 carrier)) with (primary adj2 cell) with (DL down\$1link)	US-PGPUB; USPAT; USOCR; DERWENT; IBM_TDB	OR	ON	2014/11/18 14:22
S177	29	("20100322173" "20110081913" "20130010721" "8634358" "20120140708" "20100271970" "20100285809" "20110007699" "20130003700" "20100232373" "20120051306" "20120082125" "20100098012" "20100003997" "20100208679" "20110310856" "20120082125" "20120140708" "20130136084" "8265030" "20110243039" "8792830" "20120020317" "8265030" "20110007695" "20110081932" "20120314675" "20020160784" "20110310856" "20100232373" "20100296389" "20120020317" "20100098012" "20130034073" "8447343" "8472368").PN.	US-PGPUB; USPAT	OR	OFF	2015/10/01 11:34
S178	21250	(H04W88/08, H04W72/044, H04W72/042).cpc.	US-PGPUB; USPAT; USOCR; DERWENT; IBM_TDB	OR	ON	2015/10/01 17:24
S179	5857	(H04W52/367, H04W52/12, H04W52/40).cpc.	US-PGPUB; USPAT; USOCR; DERWENT; IBM_TDB	OR	ON	2015/10/01 17:24
S180	5079	(H04L29/08657, G01S5/0252, G01S5/02).cpc.	US-PGPUB; USPAT; USOCR; DERWENT; IBM_TDB	OR	ON	2015/10/01 17:24
S181	4391	(H04B1/3833, H04M1/0247, H04M1/0237).cpc.	US-PGPUB; USPAT; USOCR; DERWENT; IBM_TDB	OR	ON	2015/10/01 17:24
S182	8620	(H03F3/211, H04B7/0617, H04B7/0669).cpc.	US-PGPUB; USPAT; USOCR; DERWENT; IBM_TDB	OR	ON	2015/10/01 17:24
S183	221	(S178 S179 S180 S181 S182) and (schedul\$4 near3 down\$1link) and (component near3 carrier) and single with carrier same (plurality multiple several) with (DL down\$1link) with carrier same (frequency)	US-PGPUB; USPAT; USOCR; DERWENT; IBM_TDB	OR	ON	2015/10/01 17:24

S184	552	((david near2 astely) (robert near2 baldemair) (dirk near2 gerstenberger) (daniel near2 larsson) (lars near2 lindbom) (stefan near2 parkvall)).in. and ericsson.as.	US-PGPUB; USPAT; USOCR; DERWENT; IBM_TDB	OR	ON	2015/10/01 17:56
S185	1	S183 and S184	US-PGPUB; USPAT; USOCR; DERWENT; IBM_TDB	OR	ON	2015/10/01 17:56
S186	21	455/\$.ccls. and ((first 1st) adj6 component adj3 carrier) same ((1st first) adj6 (radio resource frame)) and ((2nd second) adj6 component adj3 carrier) same ((2nd second) adj6 (radio resource frame))	US-PGPUB; USPAT; USOCR; DERWENT; IBM_TDB	OR	ON	2015/10/01 18:11
S187	24	("20100322173" "20110081913" "20130003700" "20100232373" "20120051306" "20120082125" "20100098012" "20100003997" "20100208679" "20110310856" "20120082125" "20120140708" "20130136084" "8265030" "20110243039" "8792830" "20120020317" "8265030" "20110007695" "20110081932" "20120314675" "20020160784" "20110310856" "20100232373" "20100296389" "20120020317" "20100098012" "20130034073" "8447343" "8472368").PN.	US-PGPUB; USPAT	OR	OFF	2015/10/02 12:23
S188	1	"14030298"	US-PGPUB; USPAT	OR	OFF	2015/10/02 15:41
S189	198	((1st first) adj6 (radio resource frame)) and ((2nd second) adj6 component adj3 carrier) same ((2nd second) adj6 (radio resource frame))	US-PGPUB; USPAT; USOCR; DERWENT; IBM_TDB	OR	ON	2015/10/03 16:15
S190	1	"14102508"	US-PGPUB; USPAT; USOCR; DERWENT; IBM_TDB	OR	ON	2015/10/13 14:17
S191	0	"14158378"	US-PGPUB; USPAT; USOCR; DERWENT; IBM_TDB	OR	ON	2015/10/13 14:17
S192	1	"14097736"	US-PGPUB; USPAT; USOCR; DERWENT; IBM_TDB	OR	ON	2015/10/13 14:17
S193	2	"14006545"	US-PGPUB; USPAT; USOCR; DERWENT; IBM_TDB	OR	ON	2015/10/13 14:17
S194	1	"13875620"	US-PGPUB; USPAT; USOCR; DERWENT;	OR	ON	2015/10/13 14:18

			IBM_TDB			
S195	1	"13905342"	US-PGPUB; USPAT; USOCR; DERWENT; IBM_TDB	OR	ON	2015/10/13 14:18
S196	1	"13477988"	US-PGPUB; USPAT; USOCR; DERWENT; IBM_TDB	OR	ON	2015/10/13 14:18
S197	2	"13293245"	US-PGPUB; USPAT; USOCR; DERWENT; IBM_TDB	OR	ON	2015/10/13 14:18
S198	1	"13875620"	US-PGPUB; USPAT; USOCR; DERWENT; IBM_TDB	OR	ON	2015/10/13 14:19
S199	2	"13993807"	US-PGPUB; USPAT; USOCR; DERWENT; IBM_TDB	OR	ON	2015/10/13 14:19
S200	1	"13898465"	US-PGPUB; USPAT; USOCR; DERWENT; IBM_TDB	OR	ON	2015/10/13 14:19
S201	1	"13883792"	US-PGPUB; USPAT; USOCR; DERWENT; IBM_TDB	OR	ON	2015/10/13 14:19
S202	1	"13996405"	US-PGPUB; USPAT; USOCR; DERWENT; IBM_TDB	OR	ON	2015/10/13 14:19
S203	1	"13883002"	US-PGPUB; USPAT; USOCR; DERWENT; IBM_TDB	OR	ON	2015/10/13 14:20
S204	0	"14812058"	US-PGPUB; USPAT; USOCR; DERWENT; IBM_TDB	OR	ON	2015/10/13 14:20
S205	7	"8915660"	US-PGPUB; USPAT; USOCR; DERWENT; IBM_TDB	OR	ON	2015/10/13 14:20
S206	1	"13909538"	US-PGPUB; USPAT; USOCR; DERWENT;	OR	ON	2015/10/13 14:21

			IBM_TDB			
S207	1	"13924238"	US-PGPUB; USPAT; USOCR; DERWENT; IBM_TDB	OR	ON	2015/10/13 14:22
S208	1	"13898465"	US-PGPUB; USPAT; USOCR; DERWENT; IBM_TDB	OR	ON	2015/10/13 14:23
S209	2	"13993807"	US-PGPUB; USPAT; USOCR; DERWENT; IBM_TDB	OR	ON	2015/10/13 14:23
S210	58	("20100322173" "20110081913" "20130010721" "8634358" "20120140708" "20100271970" "20100285809" "20110007699" "20130003700" "20100232373" "20120051306" "20120082125" "20100098012" "20100003997" "20100208679" "20110310856" "20120082125" "20120140708" "20130136084" "8265030" "20110243039" "8792830" "20120020317" "8265030" "20110007695" "20110081932" "20120314675" "20020160784" "20110310856" "20100232373" "20100296389" "20120020317" "20100098012" "20130034073" "8447343" "8472368").PN.	US-PGPUB; USPAT; USOCR; DERWENT; IBM_TDB	OR	ON	2015/10/13 14:25
S211	1	"13906370"	US-PGPUB; USPAT; USOCR; DERWENT; IBM_TDB	OR	ON	2015/10/13 14:38
S212	58	("20100322173" "20110081913" "20130010721" "8634358" "20120140708" "20100271970" "20100285809" "20110007699" "20130003700" "20100232373" "20120051306" "20120082125" "20100098012" "20100003997" "20100208679" "20110310856" "20120082125" "20120140708" "20130136084" "8265030" "20110243039" "8792830" "20120020317" "8265030" "20110007695" "20110081932" "20120314675" "20020160784" "20110310856" "20100232373" "20100296389" "20120020317" "20100098012" "20130034073" "8447343" "8472368").PN.	US-PGPUB; USPAT; USOCR; DERWENT; IBM_TDB	OR	ON	2015/10/13 14:51
S213	0	(H04W88/08, H04W72/044, H04W72/042).cpc. and (H04W52/367, H04W52/12, H04W52/40).cpc. and (H04L29/08657, G01S5/0252, G01S5/02).cpc. and (H04B1/3833, H04M1/0247, H04M1/0237).cpc.	US-PGPUB; USPAT; USOCR; DERWENT; IBM_TDB	OR	ON	2015/10/13 14:55
S214	36289	(H04W88/08, H04W72/044, H04W72/042, H04W52/367, H04W52/12, H04W52/40, H04L29/08657, G01S5/0252, G01S5/02,	US-PGPUB; USPAT; USOCR;	OR	ON	2015/10/13 14:56

		H04B1/3833, H04M1/0247, H04M1/0237).cpc.	DERWENT; IBM_TDB			
S215	3	(H04W88/08, H04W72/044, H04W72/042, H04W52/367, H04W52/12, H04W52/40, H04L29/08657, G01S5/0252, G01S5/02, H04B1/3833, H04M1/0247, H04M1/0237).cpc. and single near3 (CC (component adj2 carrier)) with (primary adj2 cell) with (DL down\$1link)	US-PGPUB; USPAT; USOCR; DERWENT; IBM_TDB	OR	ON	2015/10/13 14:56
S216	553	((david near2 astely) (robert near2 baldemair) (dirk near2 gerstenberger) (daniel near2 larsson) (lars near2 lindbom) (stefan near2 parkvall)).in. and ericsson.as.	US-PGPUB; USPAT; USOCR; DERWENT; IBM_TDB	OR	ON	2015/10/13 17:05
S217	553	((david near2 astely) (robert near2 baldemair) (dirk near2 gerstenberger) (daniel near2 larsson) (lars near2 lindbom) (stefan near2 parkvall)).in. and ericsson.as.	US-PGPUB; USPAT; USOCR; DERWENT; IBM_TDB	OR	ON	2015/10/13 17:05
S218	131	((david near2 astely) (robert near2 baldemair) (dirk near2 gerstenberger) (daniel near2 larsson) (lars near2 lindbom) (stefan near2 parkvall)).in. and ericsson.as. and carrier adj aggregation	US-PGPUB; USPAT; USOCR; DERWENT; IBM_TDB	OR	ON	2015/10/13 17:07
S219	48	"455"/\$.ccls. and (carrier near3 aggregation) and ((first 1st) adj6 carrier) same ((1st first) adj6 (radio resource frame)) and ((2nd second) adj6 carrier) same ((2nd second) adj6 (radio resource frame)) and carrier adj aggregation	US-PGPUB; USPAT; USOCR; DERWENT; IBM_TDB	OR	ON	2015/10/13 17:27
S220	48	(H04W88/08, H04W72/044, H04W72/042).cpc. and ((first 1st) adj6 component adj3 carrier) same ((1st first) adj6 (radio resource frame)) and ((2nd second) adj6 component adj3 carrier) same ((2nd second) adj6 (radio resource frame))	US-PGPUB; USPAT; USOCR; DERWENT; IBM_TDB	OR	ON	2016/03/09 15:13
S221	15	(set group) near6 (radio resource) with (2nd second other another) near6 (DL down\$1link) near3 (component near3 carrier)	US-PGPUB; USPAT	OR	ON	2016/03/09 15:26
S222	35	455/509,522,456.6,137,103,575.ccls. and (downlink near3 carrier) and (uplink near3 (primary first initial) near3 carrier) and ((second 2nd other next) with (channel resource)) and (carrier adj aggregation)	US-PGPUB; USPAT; USOCR; DERWENT; IBM_TDB	OR	ON	2016/03/09 15:45
S223	0	(H04B1/3833, H04M1/0247, H04M1/0237).cpc. and (((first 1st) adj6 component adj3 carrier) same ((radio resource frame))) and ((2nd second) adj6 component adj3 carrier) same ((2nd second other another) adj4 (radio resource frame))	US-PGPUB; USPAT; USOCR; DERWENT; IBM_TDB	OR	ON	2016/03/09 15:48
S224	0	((david near2 astely) (robert near2 baldemair) (dirk near2 gerstenberger) (daniel near2 larsson) (lars near2 lindbom) (stefan near2 parkvall)).in. and ericsson.as. and single near3 (CC (component adj2 carrier)) with (primary adj2 cell) with (DL down\$1link)	US-PGPUB; USPAT; USOCR; DERWENT; IBM_TDB	OR	ON	2016/03/09 16:14
S225	32	((david near2 astely) (robert near2 baldemair) (dirk near2 gerstenberger) (daniel near2 larsson) (lars near2 lindbom) (stefan near2 parkvall)).in. and ericsson.as. and (CC (component adj2 carrier)) with (primary adj2 cell)	US-PGPUB; USPAT; USOCR; DERWENT; IBM_TDB	OR	ON	2016/03/09 16:14
S226	130	455/\$.ccls. and (downlink near3 carrier) and (uplink near3 (primary first initial) near3 carrier) and ((second 2nd other next) with (channel	US-PGPUB; USPAT; USOCR;	OR	ON	2016/03/09 17:02

		(resource)) and (control with information)	DERWENT; IBM_TDB			
S227	30	("20120127950" "20110310819" "20120275395" "20120287828" "20120039291" "20100271970" "20120307781" "20110286436" "20120224535" "20120140708" "20120163288" "20110299486" "20100098012" "20120082125" "20120294273").pn.	US-PGPUB; USPAT; USOCR; DERWENT; IBM_TDB	OR	ON	2016/03/09 18:32
S228	10	(carrier adj aggregation) and (schedul\$3 near3 (downlink DL) with ((first primary initial) near6 (resource radio frequency frame))) and ((first 1st adj6 component adj3 carrier) same ((1st first) adj6 (radio resource frame)) and ((2nd second) adj6 component adj3 carrier) same ((2nd second) adj6 (radio resource frame))	US-PGPUB; USPAT; USOCR; DERWENT; IBM_TDB	OR	ON	2016/03/09 20:46
S229	3	"20070030661"	US-PGPUB; USPAT; USOCR; DERWENT; IBM_TDB	OR	ON	2016/03/09 21:31
S230	76	370/329,252,331.ccls. and (((first 1st) adj6 component adj3 carrier) same ((radio resource frame))) and ((2nd second) adj6 component adj3 carrier) same ((2nd second other another) adj4 (radio resource frame))	US-PGPUB; USPAT; USOCR; DERWENT; IBM_TDB	OR	ON	2016/03/10 09:26
S231	0	(H04B1/3833, H04M1/0247, H04M1/0237).cpc. and (schedul\$3 assign\$3) with (primary adj cell) same2 (multiple several set) near3 component adj2 carrier	US-PGPUB; USPAT; USOCR; DERWENT; IBM_TDB	OR	ON	2016/03/16 11:49
S233	0	(H04B1/3833, H04M1/0247, H04M1/0237).cpc. and (schedul\$3 assign\$3) with (primary adj cell) same2 (multiple several set) near6 carrier	US-PGPUB; USPAT; USOCR; FPRS; EPO; JPO; DERWENT; IBM_TDB	OR	ON	2016/03/16 11:54
S234	18	(H04L5/0053, H04L5/001, H04L5/0094, H04B1/3833, H04M1/0247, H04M1/0237).cpc. and (schedul\$3 assign\$3) with (primary adj cell) same2 (multiple several set) near3 component adj2 carrier	US-PGPUB; USPAT; USOCR; DERWENT; IBM_TDB	OR	ON	2016/03/16 11:59
S235	18	(H04L5/0053, H04L5/001, H04L5/0094, H04B1/3833, H04M1/0247, H04M1/0237).cpc. and (schedul\$3 assign\$3) with (primary adj cell) same2 (multiple several set) near3 component adj2 carrier and (control\$4 adjust\$3) near6 (DL (down\$link))	US-PGPUB; USPAT; USOCR; DERWENT; IBM_TDB	OR	ON	2016/03/16 12:04
S236	7	(H04L5/0053, H04L5/001, H04L5/0094, H04B1/3833, H04M1/0247, H04M1/0237).cpc. and (schedul\$3 assign\$3) with (primary adj cell) same2 (multiple several set) near3 component adj2 carrier and (control\$4 adjust\$3) near6 (DL (down\$link)) and (second 2nd another other) near3 (radio frequency band resources)	US-PGPUB; USPAT; USOCR; DERWENT; IBM_TDB	OR	ON	2016/03/16 12:06
S237	0	455/509,522,456.6,137,103,575.ccls. and (schedul\$3 assign\$3) with (primary adj cell) same2 (multiple several set) near3 component	US-PGPUB; USPAT; USOCR;	OR	ON	2016/03/16 12:31

		adj2 carrier and (control\$4 adjust\$3) near6 (DL (down\$link)) and (second 2nd another other) near3 (radio frequency band resources)	DERWENT; IBM_TDB			
S238	7	(A01B12/006, H04L5/0053, H04L5/001, H04L5/0094, H04B1/3833, H04M1/0247, H04M1/0237).cpc. and (schedul\$3 assign\$3) with (primary adj cell) same2 (multiple several set) near3 component adj2 carrier and (control\$4 adjust\$3) near6 (DL (down\$link)) and (second 2nd another other) near3 (radio frequency band resources)	US-PGPUB; USPAT; USOCR; FPRS; EPO; JPO; DERWENT; IBM_TDB	OR	ON	2016/03/16 12:39
S239	4	(H04W88/08, H04W72/044, H04W72/042, H04W52/367, H04W52/12, H04W52/40, H04L29/08657, G01S5/0252, G01S5/02, H04B1/3833, H04M1/0247, H04M1/0237).cpc. and (schedul\$3 assign\$3) with (primary adj cell) same2 (multiple several set) near3 component adj2 carrier and (control\$4 adjust\$3) near6 (DL (down\$link)) and (second 2nd another other) near3 (radio frequency band resources)	US-PGPUB; USPAT; USOCR; FPRS; EPO; JPO; DERWENT; IBM_TDB	OR	ON	2016/03/16 12:47
S240	0	((david near2 astely) (robert near2 baldemair) (dirk near2 gerstenberger) (daniel near2 larsson) (lars near2 lindbom) (stefan near2 parkvall)).in. and ericsson.as. and (schedul\$3 assign\$3) with (primary adj cell) same2 (multiple several set) near3 component adj2 carrier	US-PGPUB; USPAT; USOCR; FPRS; EPO; JPO; DERWENT; IBM_TDB	OR	ON	2016/03/16 13:28
S246	60	("20100322173" "20110081913" "20130010721" "8634358" "20110007699" "8792830" "20120140708" "20100271970" "20100285809" "20110007699" "20130003700" "20100003997" "20100232373" "20130003700" "8447343" "8634358" "20100232373" "20120051306" "20100296389" "20120140708" "20130010721" "20130136084" "20120082125" "20020160784" "20110081913" "20110081932" "20110243039" "20120020317" "20100098012" "20100003997" "20100208679" "20110310856" "20120082125" "20120140708" "20130136084" "8265030" "20110243039" "8792830" "20120051306" "20120314675" "8472368" "20120147847" "20120020317" "8265030" "20110007695" "20110081932" "20120314675" "20020160784" "20100271970" "20100285809" "20130034073" "8265030" "20110310856" "20100232373" "20100296389" "20120020317" "20100098012" "20110310856" "20120082125" "20100098012" "20130034073" "8447343" "8472368" "20100208679" "20100322173" "20110007695").FN.	US-PGPUB; USPAT; USOCR; DERWENT; IBM_TDB	OR	ON	2016/06/24 11:47
S247	1	(H04W88/08, H04W72/044, H04W72/042, H04W52/367, H04W52/12, H04W52/40, H04L29/08657, G01S5/0252, G01S5/02, H04B1/3833, H04M1/0247, H04M1/0237).cpc. and (schedul\$3 assign\$3) with (primary adj cell) same2 (multiple several set) near3 component adj2 carrier and (control\$4 adjust\$3) near6 (DL	USPAT	OR	ON	2016/06/24 11:50

		(down\$link) and (second 2nd another other) near3 (radio frequency band resources)				
S248	7	(H04W88/08, H04W72/044, H04W72/042, H04W52/367, H04W52/12, H04W52/40, H04L29/08657, G01S5/0252, G01S5/02, H04B1/3833, H04M1/0247, H04M1/0237).cpc. and (schedul\$3 assign\$3) with (primary adj cell) same2 (multiple several set) near3 component adj2 carrier and (control\$4 adjust\$3) near6 (DL (down\$link) and (second 2nd another other) near3 (radio frequency band resources)	US-PGPUB; USPAT; USOCR; FPRS; EPO; JPO; DERWENT; IBM_TDB	OR	ON	2016/06/24 11:51
S249	269	((david near2 astely) (robert near2 baldemair) (dirk near2 gerstenberger) (daniel near2 larsson) (lars near2 lindbom) (stefan near2 parkvall)).in. and 455/\$.ccls.	US-PGPUB; USPAT; USOCR; DERWENT; IBM_TDB	OR	ON	2016/06/24 11:55
S250	2	((david near2 astely) (robert near2 baldemair) (dirk near2 gerstenberger) (daniel near2 larsson) (lars near2 lindbom) (stefan near2 parkvall)).in. and (carrier adj aggregation) and (schedul\$3 near3 (downlink DL) with ((first primary initial) near6 (resource radio frequency frame)))	US-PGPUB; USPAT; USOCR; DERWENT; IBM_TDB	OR	ON	2016/06/24 11:56
S251	5	455/451,452.1,509,456.1,522,137,103,575.ccls. and (control\$4) with (resource frequency channel Bin) same (reserv\$4 sav\$4) near3 (other 2nd second another next) adj3 (resource frequency channel Bin) and (CC component)	US-PGPUB; USPAT; USOCR; DERWENT; IBM_TDB	OR	ON	2016/06/24 11:57
S252	1	"12896993"	US-PGPUB; USPAT; USOCR; DERWENT; IBM_TDB	OR	ON	2016/06/24 12:05
S253	61	370/329,252,331.ccls. and (((first 1st) adj6 component adj3 carrier) same ((radio resource frame))) and ((2nd second) adj6 component adj3 carrier) same ((2nd second other another) adj4 (radio resource frame)) and (set group) near6 (radio resource)	US-PGPUB; USPAT	OR	ON	2016/06/24 12:21
S254	2	("20120147847").FN.	US-PGPUB; USPAT; USOCR; FPRS; EPO; JPO; DERWENT; IBM_TDB	OR	OFF	2016/06/24 12:48
S257	29	455/509,522,456.6,137,103,575.ccls. and (schedul\$3 assign\$3) with component adj2 carrier and (control\$4 adjust\$3) near6 (DL (down\$link) and (second 2nd another other) near3 (radio frequency band resources)	US-PGPUB; USPAT; USOCR; DERWENT; IBM_TDB	OR	ON	2016/06/24 14:30
S258	22	455/\$.ccls. and (1st first) near3 (radio band resource frequency) with (reserv\$3 schedul\$3 allocat\$3) with (1st first) near3 (CC (component adj carrier))	US-PGPUB; USPAT; USOCR; DERWENT; IBM_TDB	OR	ON	2016/06/24 14:32
S259	2	("20120147847").FN.	US-PGPUB; USPAT; USOCR; DERWENT; IBM_TDB	OR	ON	2016/06/24 21:17

S260	21	455/\$.ccls. and ((first 1st) adj6 component adj3 carrier) same ((1st first) adj6 (radio resource frame)) and ((2nd second) adj6 component adj3 carrier) same ((2nd second) adj6 (radio resource frame))	US-PGPUB; USPAT; USOCR; DERWENT; IBM_TDB	OR	ON	2016/06/24 21:58
S261	33	("20120127950" "20110310819" "20120275395" "20120287828" "20120039291" "20100271970" "20120307781" "20110286436" "20120224535" "20120140708" "20110310820" "20120163288" "20110299486" "20100098012" "20120082125" "20120294273" "20110268048").pn.	US-PGPUB; USPAT; USOCR; DERWENT; IBM_TDB	OR	ON	2016/06/24 22:03
S262	13	(H04W88/08, H04W72/044, H04W72/042, H04W52/367, H04W52/12, H04W52/40, H04L29/08657, G01S5/0252, G01S5/02, H04B1/3833, H04M1/0247, H04M1/0237).cpc. and (schedul\$3 assign\$3) with (primary adj cell) same2 (multiple several set) and (control\$4 adjust\$3) near6 (DL (down\$link)) and (second 2nd another other) near3 (radio frequency band resources) same component adj carrier	US-PGPUB; USPAT; USOCR; FPRS; EPO; JPO; DERWENT; IBM_TDB	OR	ON	2016/06/24 22:18
S266	60	("20100322173" "20110081913" "20130010721" "8634358" "20110007699" "8792830" "20120140708" "20100271970" "20100285809" "20110007699" "20130003700" "20100003997" "20100232373" "20130003700" "8447343" "8634358" "20100232373" "20120051306" "20100296389" "20120140708" "20130010721" "20130136084" "20120082125" "20020160784" "20110081913" "20110081932" "20110243039" "20120020317" "20100098012" "20100003997" "20100208679" "20110310856" "20120082125" "20120140708" "20130136084" "8265030" "20110243039" "8792830" "20120051306" "20120314675" "8472368" "20120147847" "20120020317" "8265030" "20110007695" "20110081932" "20120314675" "20020160784" "20100271970" "20100285809" "20130034073" "8265030" "20110310856" "20100232373" "20100296389" "20120020317" "20100098012" "20110310856" "20120082125" "20100098012" "20130034073" "8447343" "8472368" "20100208679" "20100322173" "20110007695").PN.	US-PGPUB; USPAT; USOCR; DERWENT; IBM_TDB	OR	ON	2017/03/16 15:34
S267	0	(H04B1/3833, H04M1/0247, H04M1/0237).cpc. and (((first 1st) adj6 component adj3 carrier) same ((radio resource frame))) and ((2nd second) adj6 component adj3 carrier) same ((2nd second other another) adj4 (radio resource frame frequency))	US-PGPUB; USPAT; USOCR; DERWENT; IBM_TDB	OR	ON	2017/03/16 15:39
S268	0	455/\$.ccls. and (first 1st) near3 (radio adj resource) and (second other another 2nd) near3 (radio adj resource) same (carrier adj aggregation) and (schedul\$3 near3 (down\$link DL reverse\$1link))	US-PGPUB; USPAT; USOCR; DERWENT; IBM_TDB	OR	ON	2017/03/16 15:55
S269	0	(H04B1/3833, H04M1/0247, H04M1/0237).cpc.	US-PGPUB;	OR	ON	2017/03/16

		and (first 1st) near3 (radio adj resource) and (second other another 2nd) near3 (radio adj resource) same (carrier adj aggregation) and (schedul\$3 near3 (down\$link DL reverse\$1link))	USPAT; USOCR; DERWENT; IBM_TDB			15:56
S270	0	(H04B1/3833, H04M1/0247, H04M1/0237).cpc. and (first 1st) near3 (radio adj resource) and (second other another 2nd) near3 (radio adj resource) and (schedul\$3 near3 (down\$link DL reverse\$1link))	US-PGPUB; USPAT; USOCR; DERWENT; IBM_TDB	OR	ON	2017/03/16 15:57
S271	901	schedul\$3 near3 (transmit\$4 transmi\$5) with (CC (component adj2 cacarrier)) and (CI (control adj2 (info information))) with (CC (component adj2 cacarrier))	US-PGPUB; USPAT; USOCR; DERWENT; IBM_TDB	OR	ON	2017/03/16 17:30
S272	67	(H04W88/08, H04W72/044, H04W72/042I).cpc. and schedul\$3 near3 (transmit\$4 transmi\$5) with (CC (component adj2 cacarrier)) and (CI (control adj2 (info information))) with (CC (component adj2 cacarrier))	US-PGPUB; USPAT; USOCR; DERWENT; IBM_TDB	OR	ON	2017/03/16 17:31
S273	9	(H04W88/08, H04W72/044, H04W72/042I).cpc. and schedul\$3 near3 (transmit\$4 transmi\$5) with (CC (component adj2 cacarrier)) and (CI (control adj2 (info information))) with (CC (component adj2 cacarrier)) and schedul\$3 with (non\$1primary second 2nd secondary) adj2 cell	US-PGPUB; USPAT; USOCR; DERWENT; IBM_TDB	OR	ON	2017/03/16 17:37
S274	41	(H04W88/08, H04W72/044, H04W72/042I).cpc. and schedul\$3 near3 (transmit\$4 transmi\$5) with (CC (component adj2 cacarrier)) and (CI (control adj2 (info information))) with (CC (component adj2 carrier)) and (non\$1primary second 2nd secondary) adj2 (CC (component adj2 carrier))	US-PGPUB; USPAT; USOCR; DERWENT; IBM_TDB	OR	ON	2017/03/16 17:39
S275	697	Ericsson.as. and ((david near2 astely) (robert near2 baldemair) (dirk near2 gerstenberger) (daniel near2 larsson) (lars near2 lindbom) (stefan near2 parkvall)).in.	US-PGPUB; USPAT; USOCR; DERWENT; IBM_TDB	OR	ON	2017/03/16 18:16
S276	40	Ericsson.as. and ((david near2 astely) (robert near2 baldemair) (dirk near2 gerstenberger) (daniel near2 larsson) (lars near2 lindbom) (stefan near2 parkvall)).in. and (radio near3 resource) with (component near3 carrier)	US-PGPUB; USPAT; USOCR; DERWENT; IBM_TDB	OR	ON	2017/03/16 18:18
S278	5	455/\$.ccls. and (set near3 radio near3 resource) same component adj carrier	US-PGPUB; USPAT; USOCR; DERWENT; IBM_TDB	OR	ON	2017/03/16 19:44
S279	34641	(H04W88/08, H04W72/044, H04W72/042).cpc.	US-PGPUB; USPAT; USOCR; DERWENT; IBM_TDB	OR	ON	2017/03/16 20:26
S280	7394	(H04W52/367, H04W52/12, H04W52/40).cpc.	US-PGPUB; USPAT; USOCR; DERWENT; IBM_TDB	OR	ON	2017/03/16 20:26
S281	6589	(H04L29/08657, G01S5/0252, G01S5/02).cpc.	US-PGPUB; USPAT; USOCR; DERWENT;	OR	ON	2017/03/16 20:26

			IBM_TDB			
S282	5176	(H04B1/3833, H04M1/0247, H04M1/0237).cpc.	US-PGPUB; USPAT; USOCR; DERWENT; IBM_TDB	OR	ON	2017/03/16 20:26
S283	12417	(H03F3/211, H04B7/0617, H04B7/0669).cpc.	US-PGPUB; USPAT; USOCR; DERWENT; IBM_TDB	OR	ON	2017/03/16 20:26
S284	131	(S279 S280 S281 S282 S283) and (second other another 2nd) near3 (radio adj resource) and (carrier adj aggregation) and (schedul\$3 near3 (down\$link DL reverse\$link))	US-PGPUB; USPAT; USOCR; DERWENT; IBM_TDB	OR	ON	2017/03/16 20:26
S285	126	(H04W88/08, H04W72/044, H04W72/042).cpc. and (second other another 2nd) near3 (radio adj resource) and (carrier adj aggregation) and (schedul\$3 near3 (down\$link DL reverse\$link))	US-PGPUB; USPAT; USOCR; DERWENT; IBM_TDB	OR	ON	2017/03/16 20:27
S286	3	Ericsson.as. and ((david near2 astely) (robert near2 baldemair) (dirk near2 gerstenberger) (daniel near2 larsson) (lars near2 lindbom) (stefan near2 parkvall)).in. and schedul\$3 near3 (transmit\$4 transmi\$5 communication) with (CC component adj2 cacarrier)	US-PGPUB; USPAT; USOCR; DERWENT; IBM_TDB	OR	ON	2017/03/16 22:26
S287	62	455/451,452.1,509,456.1,522,137,103,575.ccls. and (allocat\$3) with (resource frequency channel Bin) same (reserv\$4 sav\$4) adj6 (resource frequency channel Bin) and (control\$3 adjst\$3) near6 (CC component)	US-PGPUB; USPAT; USOCR; DERWENT; IBM_TDB	OR	ON	2017/03/17 11:15
S288	0	455/451,452.1,509,456.1,522,137,103,575.ccls. and (allocat\$3) with (resource frequency channel Bin) same (reserv\$4 sav\$4) adj6 (resource frequency channel Bin) and (primary adj cell) same (multiple several set) near3 component adj2 carrier	US-PGPUB; USPAT; USOCR; FPRS; EPO; JPO; DERWENT; IBM_TDB	OR	ON	2017/03/17 11:17
S289	0	455/451,452.1,509,456.1,522,137,103,575.ccls. and (allocat\$3) with (resource frequency channel Bin) same (reserv\$4 sav\$4) adj6 (resource frequency channel Bin) and (primary adj cell) same2 (multiple several set) near3 component adj2 carrier	US-PGPUB; USPAT; USOCR; FPRS; EPO; JPO; DERWENT; IBM_TDB	OR	ON	2017/03/17 11:18
S290	0	455/451,452.1,509,456.1,522,137,103,575.ccls. and (allocat\$3) with (resource frequency channel Bin) same (reserv\$4 sav\$4) adj6 (resource frequency channel Bin) and (primary adj2 cell) and (multiple several set) near3 component adj2 carrier	US-PGPUB; USPAT; USOCR; FPRS; EPO; JPO; DERWENT; IBM_TDB	OR	ON	2017/03/17 11:20
S291	1	455/451,452.1,509,456.1,522,137,103,575.ccls. and (allocat\$3) with (resource frequency channel Bin) same (reserv\$4 sav\$4) adj6 (resource frequency channel Bin) and (multiple several set) near3 component adj2 carrier	US-PGPUB; USPAT; USOCR; FPRS; EPO; JPO; DERWENT; IBM_TDB	OR	ON	2017/03/17 11:22

S292	9	455/451,452.1,509,456.1,522,137,103,575.ccls. and (allocat\$3) with (resource frequency channel Bin) same2 (reserv\$4 sav\$4) adj6 (resource frequency channel Bin) and (multiple several set) near3 component adj2 carrier	US-PGPUB; USPAT; USOCR; FPRS; EPO; JPO; DERWENT; IBM_TDB	OR	ON	2017/03/17 11:23
S294	178	370/\$.ccls. and (allocat\$3) with (resource frequency channel Bin) same2 (reserv\$4 sav\$4) adj6 (resource frequency channel Bin) and (multiple several set) near3 component adj2 carrier	US-PGPUB; USPAT; USOCR; FPRS; EPO; JPO; DERWENT; IBM_TDB	OR	ON	2017/03/17 16:26
S295	26	455/\$.ccls. and (allocat\$3) with (resource frequency channel Bin) same2 (reserv\$4 sav\$4) adj6 (resource frequency channel Bin) and (multiple several set) near3 component adj2 carrier	US-PGPUB; USPAT; USOCR; FPRS; EPO; JPO; DERWENT; IBM_TDB	OR	ON	2017/03/17 16:28
S296	178	370/\$.ccls. and (allocat\$3) with (resource frequency channel Bin) same2 (reserv\$4 sav\$4) adj6 (resource frequency channel Bin) and (multiple several set) near3 component adj2 carrier	US-PGPUB; USPAT; USOCR; FPRS; EPO; JPO; DERWENT; IBM_TDB	OR	ON	2017/03/17 16:28
S297	81	370/\$.ccls. and (allocat\$3) with (resource frequency channel Bin) same2 (reserv\$4 sav\$4) adj6 (resource frequency channel Bin) and (multiple several set) near3 component adj2 carrier and (primary adj2 cell)	US-PGPUB; USPAT; USOCR; FPRS; EPO; JPO; DERWENT; IBM_TDB	OR	ON	2017/03/17 17:01
S298	3	"12896993"	US-PGPUB; USPAT; USOCR; FPRS; EPO; JPO; DERWENT; IBM_TDB	OR	ON	2017/03/17 17:17
S299	3	"9497004"	US-PGPUB; USPAT; USOCR; FPRS; EPO; JPO; DERWENT; IBM_TDB	OR	ON	2017/03/17 17:42
S300	3	"12896993"	US-PGPUB; USPAT; USOCR; FPRS; EPO; JPO; DERWENT; IBM_TDB	OR	ON	2017/03/17 17:43
S301	223	370/329,341,348,395.4.ccls. and (carrier near3 aggregat\$3) and (component near3 carrier) same (up\$1link UL) with associat\$3 with down\$1link	US-PGPUB; USPAT; USOCR; DERWENT; IBM_TDB	OR	ON	2017/06/25 12:46

S302	264	370/329,341,348,395.4.ccls. and (carrier near3 aggregat\$3) and (component near3 carrier) same (up\$1link UL) with associat\$3 with (DL down\$1link)	US-PGPUB; USPAT; USOCR; DERWENT; IBM_TDB	OR	ON	2017/06/25 12:47
S303	121	370/329,341,348,395.4.ccls. and (carrier near3 aggregat\$3) same (component near3 carrier) same (up\$1link UL) with associat\$3 with (DL down\$1link)	US-PGPUB; USPAT; USOCR; DERWENT; IBM_TDB	OR	ON	2017/06/25 12:47
S304	75	((455/451,452.1,509,456.1,522,137,103,575.ccls.) (370/329,341,348,395.4.ccls.)) and (carrier near3 aggregat\$3) same (component near3 carrier) same (up\$1link UL) with associat\$3 with (DL down\$1link) and (schedul\$3 near3 downlink)	US-PGPUB; USPAT; USOCR; DERWENT; IBM_TDB	OR	ON	2017/06/25 12:48
S305	37	455/509,522,456.6,137,103,575.ccls. and (downlink near3 carrier) and (uplink near3 (primary first initial) near3 carrier) and ((second 2nd other next) with (channel resource)) and (carrier adj aggregation)	US-PGPUB; USPAT; USOCR; DERWENT; IBM_TDB	OR	ON	2017/06/26 18:41
S306	37	455/509,522,456.6,137,103,575.ccls. and (downlink near3 carrier) and (uplink near3 (primary first initial) near3 carrier) and ((second 2nd other next) with (channel resource)) and (carrier adj aggregation) and (carrier adj aggregation)	US-PGPUB; USPAT; USOCR; DERWENT; IBM_TDB	OR	ON	2017/06/26 18:43
S307	3	455/509,522,456.6,137,103,575.ccls. and (downlink near3 carrier) and (uplink near3 (primary first initial) near3 carrier) and ((second 2nd other next) with (channel resource)) same(carrier adj aggregation)	US-PGPUB; USPAT; USOCR; DERWENT; IBM_TDB	OR	ON	2017/06/26 18:44
S308	75	370/329,341,348,395.4.ccls. and (downlink near3 carrier) and (uplink near3 (primary first initial) near3 carrier) and ((second 2nd other next) with (channel resource)) same(carrier adj aggregation)	US-PGPUB; USPAT; USOCR; DERWENT; IBM_TDB	OR	ON	2017/06/26 18:54
S309	12	(H04W52/367, H04W52/12, H04W52/40).cpc. and (downlink near3 carrier) and (uplink near3 (primary first initial) near3 carrier) and ((second 2nd other next) with (channel resource)) same(carrier adj aggregation)	US-PGPUB; USPAT; USOCR; DERWENT; IBM_TDB	OR	ON	2017/06/26 18:55
S310	11	Ericsson.as. and ((david near2 astely) (robert near2 baldemair) (dirk near2 gerstenberger) (daniel near2 larsson) (lars near2 lindbom) (stefan near2 parkvall)).in. and (radio near3 resource) with (component near3 carrier) and ((second 2nd other next) with (channel resource)) same(carrier adj aggregation)	US-PGPUB; USPAT; USOCR; FPRS; EPO; JPO; DERWENT; IBM_TDB	OR	ON	2017/06/26 19:04
S311	174	(radio near3 resource) with (component near3 carrier) and ((second 2nd other next) with (channel resource)) same(carrier adj aggregation)	US-PGPUB; USPAT; USOCR; FPRS; EPO; JPO; DERWENT; IBM_TDB	OR	ON	2017/06/26 19:05
S312	3	(H04W52/367, H04W52/12, H04W52/40).cpc. and (radio near3 resource) with (component near3 carrier) and ((second 2nd other next) with (channel resource)) same(carrier adj aggregation)	US-PGPUB; USPAT; USOCR; DERWENT; IBM_TDB	OR	ON	2017/06/26 19:06

S315	3	"12896993"	US-PGPUB; USPAT; USOCR; DERWENT; IBM_TDB	OR	ON	2017/09/23 13:47
S316	1193	((david near2 astely) (robert near2 baldemair) (dirk near2 gerstenberger) (daniel near2 larsson) (lars near2 lindbom) (stefan near2 parkvall)).in.	US-PGPUB; USPAT; USOCR; DERWENT; IBM_TDB	OR	ON	2017/09/23 13:47
S317	715	S316 and (radio near3 resource)	US-PGPUB; USPAT; USOCR; DERWENT; IBM_TDB	OR	ON	2017/09/23 13:47
S318	237	S316 and (radio near3 resource) and (component with carrier)	US-PGPUB; USPAT; USOCR; DERWENT; IBM_TDB	OR	ON	2017/09/23 13:47
S319	1729	(downlink near3 carrier) and (uplink near3 (primary first initial) near3 carrier) and ((second 2nd other next) with (channel resource)) and (control with information)	US-PGPUB; USPAT; USOCR; DERWENT; IBM_TDB	OR	ON	2017/09/23 13:47
S320	1634	S319 and (scheduling)	US-PGPUB; USPAT; USOCR; DERWENT; IBM_TDB	OR	ON	2017/09/23 13:47
S321	39	("20120263121" "20110310856" "20120127950" "20110310819 " "20120275395" "20120287828" "20120039291" "20100271970" "20120307781" "20110286436" "20120224535" "20120140708" "20110310820" "20120163288" "20110299486" "20100098012" "20120082125" "20120294273" "20110268048" "20120113910").pn.	US-PGPUB; USPAT; USOCR; DERWENT; IBM_TDB	OR	ON	2017/09/23 13:47
S322	1618	(downlink near3 carrier) and (uplink near3 (primary first initial) near3 carrier) and ((second 2nd other next) with (channel resource)) and (carrier adj aggregation)	US-PGPUB; USPAT; USOCR; DERWENT; IBM_TDB	OR	ON	2017/09/23 13:47
S323	3	"20110292887"	US-PGPUB; USPAT; USOCR; DERWENT; IBM_TDB	OR	ON	2017/09/23 13:47
S324	254	((first 1st) adj6 component adj3 carrier) same ((1st first) adj6 (radio resource frame)) and ((2nd second) adj6 component adj3 carrier) same ((2nd second) adj6 (radio resource frame))	US-PGPUB; USPAT; USOCR; DERWENT; IBM_TDB	OR	ON	2017/09/23 13:47
S325	3395	((first 1st) adj6 carrier) same ((1st first) adj6 (radio resource frame)) and ((2nd second) adj6 carrier) same ((2nd second) adj6 (radio resource frame))	US-PGPUB; USPAT; USOCR; DERWENT; IBM_TDB	OR	ON	2017/09/23 13:47

S326	723	(carrier near3 aggregation) and ((first 1st) adj6 carrier) same ((1st first) adj6 (radio resource frame)) and ((2nd second) adj6 carrier) same ((2nd second) adj6 (radio resource frame))	US-PGPUB; USPAT; USOCR; DERWENT; IBM_TDB	OR	ON	2017/09/23 13:47
S327	22237	455/509,522,456.6,137,103,575.ccls.	US-PGPUB; USPAT; USOCR; DERWENT; IBM_TDB	OR	ON	2017/09/23 13:47
S328	89300	370/329,252,331.ccls.	US-PGPUB; USPAT; USOCR; DERWENT; IBM_TDB	OR	ON	2017/09/23 13:47
S329	717	(S327 S328) and (downlink near3 carrier) and (uplink near3 (primary first initial) near3 carrier) and ((second 2nd other next) with (channel resource)) and (control with information)	US-PGPUB; USPAT; USOCR; DERWENT; IBM_TDB	OR	ON	2017/09/23 13:47
S330	3	"13140333"	US-PGPUB; USPAT; USOCR; DERWENT; IBM_TDB	OR	ON	2017/09/23 13:47
S331	3	"20110310856"	US-PGPUB; USPAT; USOCR; DERWENT; IBM_TDB	OR	ON	2017/09/23 13:47
S332	316	((first 1st) adj6 component adj3 carrier) same ((radio resource frame)) and ((2nd second) adj6 component adj3 carrier) same ((2nd second) adj6 (radio resource frame))	US-PGPUB; USPAT; USOCR; DERWENT; IBM_TDB	OR	ON	2017/09/23 13:47
S333	316	((first 1st) adj6 component adj3 carrier) same ((radio resource frame)) and ((2nd second) adj6 component adj3 carrier) same ((2nd second) adj6 (radio resource frame))	US-PGPUB; USPAT; USOCR; DERWENT; IBM_TDB	OR	ON	2017/09/23 13:47
S334	240	((first 1st) adj6 component adj3 carrier) same ((radio resource frame)) and ((2nd second) adj6 component adj3 carrier) same ((2nd second other another) adj4 (radio resource frame))	US-PGPUB; USPAT; USOCR; DERWENT; IBM_TDB	OR	ON	2017/09/23 13:47
S335	316	((first 1st) adj6 component adj3 carrier) same ((radio resource frame)) and ((2nd second) adj6 component adj3 carrier) same ((2nd second other another) adj6 (radio resource frame))	US-PGPUB; USPAT; USOCR; DERWENT; IBM_TDB	OR	ON	2017/09/23 13:47
S336	313	(carrier adj aggregation) and (schedul\$3 near3 (downlink DL) with ((first primary initial) near6 (resource radio frequency frame)))	US-PGPUB; USPAT; USOCR; DERWENT; IBM_TDB	OR	ON	2017/09/23 13:47
S337	8	("7551898" "7649960" "7656843" "7773699").PN.	US-PGPUB; USPAT; USOCR; DERWENT; IBM_TDB	OR	ON	2017/09/23 13:47

S338	3	"20110292900"	US-PGPUB; USPAT; USOCR; DERWENT; IBM_TDB	OR	ON	2017/09/23 13:47
S339	2	"20100271970"	US-PGPUB; USPAT; USOCR; DERWENT; IBM_TDB	OR	ON	2017/09/23 13:47
S340	5	"8050202"	US-PGPUB; USPAT; USOCR; DERWENT; IBM_TDB	OR	ON	2017/09/23 13:47
S341	3	"20120307689"	US-PGPUB; USPAT; USOCR; DERWENT; IBM_TDB	OR	ON	2017/09/23 13:47
S342	2	"8160017"	US-PGPUB; USPAT; USOCR; DERWENT; IBM_TDB	OR	ON	2017/09/23 13:47
S343	3	"20100232373"	US-PGPUB; USPAT; USOCR; DERWENT; IBM_TDB	OR	ON	2017/09/23 13:47
S344	2	"20090016278"	US-PGPUB; USPAT; USOCR; DERWENT; IBM_TDB	OR	ON	2017/09/23 13:47
S345	3	"8265030"	US-PGPUB; USPAT; USOCR; DERWENT; IBM_TDB	OR	ON	2017/09/23 13:47
S346	3	"2008139923"	US-PGPUB; USPAT; USOCR; DERWENT; IBM_TDB	OR	ON	2017/09/23 13:47
S347	14	("20100098012" "20100232373" "20110310856" "20120020317" "20120082125" "20120140708" "8265030").PN.	US-PGPUB; USPAT; USOCR; DERWENT; IBM_TDB	OR	ON	2017/09/23 13:47
S348	20	"455"/\$.ccls. and (carrier adj aggregation) and (schedul\$3 near3 (downlink DL) with ((first primary initial) near6 (resource radio frequency frame)))	US-PGPUB; USPAT; USOCR; DERWENT; IBM_TDB	OR	ON	2017/09/23 13:47
S349	23	"455"/\$.ccls. and (((first 1st) adj6 component adj3 carrier) same ((radio resource frame))) and (((2nd second) adj6 component adj3 carrier) same (((2nd second) adj6 (radio resource frame)))	US-PGPUB; USPAT; USOCR; DERWENT; IBM_TDB	OR	ON	2017/09/23 13:47

S350	4	("20070053294" "20100290405").PN.	US-PGPUB; USPAT; USOCR; DERWENT; IBM_TDB	OR	ON	2017/09/23 13:47
S351	16	("7596114" "20050013279" "20030219028" "20070217406" "20020105970" "20060050664" "20090303938" "20070064669").PN.	US-PGPUB; USPAT; USOCR; DERWENT; IBM_TDB	OR	ON	2017/09/23 13:47
S352	1358	(first 1st) with (component near2 carrier) with down\$1link	US-PGPUB; USPAT; USOCR; DERWENT; IBM_TDB	OR	ON	2017/09/23 13:47
S353	628	(first 1st) with (component near2 carrier) with down\$1link and receiv\$3 near3 control near3 information	US-PGPUB; USPAT; USOCR; DERWENT; IBM_TDB	OR	ON	2017/09/23 13:47
S354	344	(first 1st) near3 (radio adj resource) and (second other another 2nd) near3 (radio adj resource) and component adj carrier	US-PGPUB; USPAT; USOCR; DERWENT; IBM_TDB	OR	ON	2017/09/23 13:47
S355	169	S354 and (carrier adj aggregation) and (schedul\$3 near3 (down\$link DL reverse\$1link))	US-PGPUB; USPAT; USOCR; DERWENT; IBM_TDB	OR	ON	2017/09/23 13:47
S356	17	(first 1st) near3 (radio adj resource) and (second other another 2nd) near3 (radio adj resource) same (carrier adj aggregation) and (schedul\$3 near3 (down\$link DL reverse\$1link))	US-PGPUB; USPAT; USOCR; DERWENT; IBM_TDB	OR	ON	2017/09/23 13:47
S357	199	(first 1st) near3 (radio adj resource) and (second other another 2nd) near3 (radio adj resource) and (carrier adj aggregation) and (schedul\$3 near3 (down\$link DL reverse\$1link))	US-PGPUB; USPAT; USOCR; DERWENT; IBM_TDB	OR	ON	2017/09/23 13:47
S358	279	(second other another 2nd) near3 (radio adj resource) and (carrier adj aggregation) and (schedul\$3 near3 (down\$link DL reverse\$1link))	US-PGPUB; USPAT; USOCR; DERWENT; IBM_TDB	OR	ON	2017/09/23 13:47
S359	3	@ad<"20091003" and (second other another 2nd) near3 (radio adj resource) and (carrier adj aggregation) and (schedul\$3 near3 (down\$link DL reverse\$1link))	US-PGPUB; USPAT; USOCR; DERWENT; IBM_TDB	OR	ON	2017/09/23 13:47
S360	1	@ad<"20091003" and (second other another 2nd) near3 (radio adj resource) and (carrier adj component) and (schedul\$3 near3 (down\$link DL reverse\$1link))	US-PGPUB; USPAT; USOCR; DERWENT; IBM_TDB	OR	ON	2017/09/23 13:47
S361	3	@ad<"20091003" and (second other another 2nd) near3 (radio adj resource) and (carrier adj component) and ((down\$link DL reverse\$1link))	US-PGPUB; USPAT; USOCR; DERWENT; IBM_TDB	OR	ON	2017/09/23 13:47

S362	3	@ad< "20091005" and (second other another 2nd) near3 (radio adj resource) and (carrier adj component) and ((down\$1link DL reverse\$1link))	US-PGPUB; USPAT; USOCR; DERWENT; IBM_TDB	OR	ON	2017/09/23 13:47
S363	3	@ad< "20091003" and (second other another 2nd) near3 (radio adj resource) and (carrier adj component)	US-PGPUB; USPAT; USOCR; DERWENT; IBM_TDB	OR	ON	2017/09/23 13:47
S364	86	(second other another 2nd) near3 (radio adj resource) and (carrier adj component)	US-PGPUB; USPAT; USOCR; DERWENT; IBM_TDB	OR	ON	2017/09/23 13:47
S365	69	(set near3 radio near3 resource) same component adj carrier	US-PGPUB; USPAT; USOCR; DERWENT; IBM_TDB	OR	ON	2017/09/23 13:47
S366	139	(set near3 ((radio near3 resource) (resource adj block))) same component adj carrier	US-PGPUB; USPAT; USOCR; DERWENT; IBM_TDB	OR	ON	2017/09/23 13:47
S367	3893	((radio near3 resource) (resource adj block))) same component adj carrier	US-PGPUB; USPAT; USOCR; DERWENT; IBM_TDB	OR	ON	2017/09/23 13:47
S368	382	((second 2nd other) with ((radio near3 resource) (resource adj block))) same component adj carrier	US-PGPUB; USPAT; USOCR; DERWENT; IBM_TDB	OR	ON	2017/09/23 13:47
S369	2015	((radio near3 resource) (resource adj block))) same component adj carrier and (schedul\$3 near3 downlink reverse)	US-PGPUB; USPAT; USOCR; DERWENT; IBM_TDB	OR	ON	2017/09/23 13:47
S370	178	((second 2nd other) with ((radio near3 resource) (resource adj block))) same component adj carrier and (schedul\$3 near3 down\$1link reverse\$1link)	US-PGPUB; USPAT; USOCR; DERWENT; IBM_TDB	OR	ON	2017/09/23 13:47
S371	154	((second 2nd other) with ((radio near3 resource) (resource adj block))) same (component adj carrier) same (down\$1link reverse\$1link)	US-PGPUB; USPAT; USOCR; DERWENT; IBM_TDB	OR	ON	2017/09/23 13:47
S372	10	("20090097447" "20110081856" "20090116427" "20100232373" "8331307").PN.	US-PGPUB; USPAT; USOCR; DERWENT; IBM_TDB	OR	ON	2017/09/23 13:47
S373	11659	(schedul\$3 near3 downlink) and ((radio adj resource) (resource adj block)) and component	US-PGPUB; USPAT; USOCR; DERWENT; IBM_TDB	OR	ON	2017/09/23 13:47

S374	4944	(schedul\$3 near3 downlink) and ((radio adj resource) (resource adj block)) and component adj carrier	US-PGPUB; USPAT; USOCR; DERWENT; IBM_TDB	OR	ON	2017/09/23 13:47
S375	1646	(schedul\$3 near3 downlink) same ((radio adj resource) (resource adj block)) and component adj carrier	US-PGPUB; USPAT; USOCR; DERWENT; IBM_TDB	OR	ON	2017/09/23 13:47
S376	189	(schedul\$3 near3 downlink) same ((radio adj resource) (resource adj block)) same (component adj carrier)	US-PGPUB; USPAT; USOCR; DERWENT; IBM_TDB	OR	ON	2017/09/23 13:47
S377	2	@ad<"20091005" and (schedul\$3 near3 downlink) same ((radio adj resource) (resource adj block)) same (component adj carrier)	US-PGPUB; USPAT; USOCR; DERWENT; IBM_TDB	OR	ON	2017/09/23 13:48
S378	2	@ad<"20091005" and (schedul\$3 near3 downlink) same ((radio adj resource) (resource adj block)) same (CC (component adj carrier))	US-PGPUB; USPAT; USOCR; DERWENT; IBM_TDB	OR	ON	2017/09/23 13:48
S379	221	(schedul\$3 near3 downlink) same ((radio adj resource) (resource adj block)) same (CC (component adj carrier))	US-PGPUB; USPAT; USOCR; DERWENT; IBM_TDB	OR	ON	2017/09/23 13:48
S380	726	"455"/\$.ccls. and ((radio adj resource) (resource adj block)) same (CC (component adj carrier))	US-PGPUB; USPAT; USOCR; DERWENT; IBM_TDB	OR	ON	2017/09/23 13:48
S381	53	"455"/\$.ccls. and (carrier near3 aggregation) and ((first 1st) adj6 carrier) same ((1st first) adj6 (radio resource frame)) and ((2nd second) adj6 carrier) same ((2nd second) adj6 (radio resource frame))	US-PGPUB; USPAT; USOCR; DERWENT; IBM_TDB	OR	ON	2017/09/23 13:48
S382	0	("2013/0107855").URPN.	USPAT	OR	ON	2017/09/23 13:48
S383	0	("2013/0107855").URPN.	US-PGPUB; USPAT	OR	ON	2017/09/23 13:48
S384	1450	set near3 (radio frequency) near2 (resource band) same downlink and component	US-PGPUB; USPAT	OR	ON	2017/09/23 13:48
S385	64	set near3 (radio frequency) near2 (resource band) same downlink same (component adj carrier)	US-PGPUB; USPAT	OR	ON	2017/09/23 13:48
S386	158	(set group Cluster) near3 (radio frequency) near2 (resource band) same downlink same (component adj carrier)	US-PGPUB; USPAT	OR	ON	2017/09/23 13:48
S387	12	("8457060" "20110310819" "20100271970" "20130034073" "20100098012" "20110310856" "20110317653" "20130083742" "20130083741" "20120114021" "20120275395" "20110317645" "20110310856").pn.	US-PGPUB; USPAT	OR	ON	2017/09/23 13:48
S388	850	(DL down\$link) with (1st first first primary initia) near3 (set group) near6 (radio resource)	US-PGPUB; USPAT	OR	ON	2017/09/23 13:48

S389	9921	(UL up\$link) with (set group) near6 (radio resource)	US-PGPUB; USPAT	OR	ON	2017/09/23 13:48
S390	496	S388 and S389	US-PGPUB; USPAT	OR	ON	2017/09/23 13:48
S391	17	(DL down\$link) with (1st first first primary initia) near3 (set group) near6 (radio resource) and (DL down\$link) with (set group) near6 (radio resource) with (2nd second other another) near2 component	US-PGPUB; USPAT	OR	ON	2017/09/23 13:48
S392	197	(DL down\$link) with (1st first first primary initia) near3 (set group) near6 (radio resource) and (DL down\$link) with (component near3 carrier)	US-PGPUB; USPAT	OR	ON	2017/09/23 13:48
S393	34	(DL down\$link) with (1st first first primary initia) near3 (set group) near6 (radio resource) and (DL down\$link) with (second 2nd) near3 (component near3 carrier)	US-PGPUB; USPAT	OR	ON	2017/09/23 13:48
S394	17	(1st first first primary initia) near3 (set group) near6 (radio resource) with (DL down\$link) near3 (component near3 carrier)	US-PGPUB; USPAT	OR	ON	2017/09/23 13:48
S395	27	(set group) near6 (radio resource) with (2nd second other another) near6 (DL down\$link) near3 (component near3 carrier)	US-PGPUB; USPAT	OR	ON	2017/09/23 13:48
S396	283	(set group) near6 (radio resource) with (DL down\$link) near3 (component near3 carrier)	US-PGPUB; USPAT	OR	ON	2017/09/23 13:48
S397	235	(set group) near3 ((radio resource)(resource near2 block)) with (DL down\$link) near3 (component near3 carrier)	US-PGPUB; USPAT	OR	ON	2017/09/23 13:48
S398	19	(second 2nd) near3 (down\$1link DL) with ((component near3 carrier) CC) same (set group) with ((radio near2 resource) (resource near2 block))	US-PGPUB; USPAT	OR	ON	2017/09/23 13:48
S399	67	reserv\$3 with component near3 carrier and (second near2 (radio frequency band))	US-PGPUB; USPAT; USOCR; DERWENT; IBM_TDB	OR	ON	2017/09/23 13:48
S400	46	"739528"	US-PGPUB; USPAT; USOCR; DERWENT; IBM_TDB	OR	ON	2017/09/23 13:48
S401	48	"5754138"	US-PGPUB; USPAT; USOCR; DERWENT; IBM_TDB	OR	ON	2017/09/23 13:48
S402	14942	(carrier near3 aggregation) and up\$1link with down\$1link	US-PGPUB; USPAT; USOCR; DERWENT; IBM_TDB	OR	ON	2017/09/23 13:48
S403	6434	(carrier near3 aggregation) and (component near3 carrier) same up\$1link with down\$1link	US-PGPUB; USPAT; USOCR; DERWENT; IBM_TDB	OR	ON	2017/09/23 13:48
S404	583	(carrier near3 aggregation) and (component near3 carrier) same up\$1link with associat\$3 with	US-PGPUB; USPAT;	OR	ON	2017/09/23 13:48

		down\$1link	USOCR; DERWENT; IBM_TDB			
S405	52	("370"/\$.ccls "455"/\$.ccls.) and (aggregation) and (CC (component near3 carrier)) same up\$1link with associat\$3 with down\$1link	US-PGPUB; USPAT; USOCR; DERWENT; IBM_TDB	OR	ON	2017/09/23 13:48
S406	221	370/329,341,348,395.4.ccls. and (carrier near3 aggregation) and (component near3 carrier) same up\$1link with associat\$3 with down\$1link	US-PGPUB; USPAT; USOCR; DERWENT; IBM_TDB	OR	ON	2017/09/23 13:48
S407	556120	schedule (DL (down adj link) down\$1link) and (carrier near3 aggregation) and ((UL up\$1link) adj6 associat\$4 near4 (DL down\$1link))	US-PGPUB; USPAT; USOCR; DERWENT; IBM_TDB	OR	ON	2017/09/23 13:48
S408	64	schedule near3 (DL (down adj link) down\$1link) and (carrier near3 aggregation) same((UL up\$1link) adj6 associat\$4 near4 (DL down\$1link))	US-PGPUB; USPAT; USOCR; DERWENT; IBM_TDB	OR	ON	2017/09/23 13:48
S409	190	(schedule allocat\$4) near3 (DL (down adj link) down\$1link) and (carrier near3 aggregation) same((UL up\$1link) adj6 associat\$4 near4 (DL down\$1link))	US-PGPUB; USPAT; USOCR; DERWENT; IBM_TDB	OR	ON	2017/09/23 13:48
S410	0	(1st first) near3 (radio band resource frequency) with (1st first) near3 (CCcomponent adj carrier)	US-PGPUB; USPAT; USOCR; DERWENT; IBM_TDB	OR	ON	2017/09/23 13:48
S411	846	(1st first) near3 (radio band resource frequency) with (1st first) near3 (CC (component adj carrier))	US-PGPUB; USPAT; USOCR; DERWENT; IBM_TDB	OR	ON	2017/09/23 13:48
S412	224	(1st first) near3 (radio band resource frequency) with (reserv\$3 schedul\$3 allocat\$3) with (1st first) near3 (CC (component adj carrier))	US-PGPUB; USPAT; USOCR; DERWENT; IBM_TDB	OR	ON	2017/09/23 13:48
S413	22	("20100142455" "20120009923" "20100254329" "20100091678" "20110194501" "20130010619" "20080310359" "20060274712" "20100227569" "20120208583" "20110267978").PN.	US-PGPUB; USPAT; USOCR; DERWENT; IBM_TDB	OR	ON	2017/09/23 13:48
S414	10	("20100254329" "20100195624" "20100023282" "20090274100" "20080316957").PN.	US-PGPUB; USPAT; USOCR; DERWENT; IBM_TDB	OR	ON	2017/09/23 13:48
S415	50	("20100322173" "20110081913" "20130010721" "20120140708" "20100271970" "20100285809" "20110007699" "20130003700" "20100232373" "20120051306" "20120082125" "20100098012"	US-PGPUB; USPAT; USOCR; DERWENT; IBM_TDB	OR	ON	2017/09/23 13:48

		"2010003997" "20100208679" "20110310856" "20120082125" "20120140708" "20130136084" "8265030" "20120020317" "8265030" "20110007695" "20110081932" "20120314675" "20110310856" "20100232373" "20100296389" "20120020317" "20100098012" "20130034073" "8447343" "8472368").PN.				
S416	38958	(H04W88/08, H04W72/044, H04W72/042).cpc.	US-PGPUB; USPAT; USOCR; DERWENT; IBM_TDB	OR	ON	2017/09/23 13:48
S417	8021	(H04W52/367, H04W52/12, H04W52/40).cpc.	US-PGPUB; USPAT; USOCR; DERWENT; IBM_TDB	OR	ON	2017/09/23 13:48
S418	7123	(H04L29/08657, G01S5/0252, G01S5/02).cpc.	US-PGPUB; USPAT; USOCR; DERWENT; IBM_TDB	OR	ON	2017/09/23 13:48
S419	5604	(H04B1/3833, H04M1/0247, H04M1/0237).cpc.	US-PGPUB; USPAT; USOCR; DERWENT; IBM_TDB	OR	ON	2017/09/23 13:48
S420	13652	(H03F3/211, H04B7/0617, H04B7/0669).cpc.	US-PGPUB; USPAT; USOCR; DERWENT; IBM_TDB	OR	ON	2017/09/23 13:48
S421	2321	(S416 S417 S418 S419 S420) and (schedul\$4 near3 down\$1link) and (component near3 carrier)	US-PGPUB; USPAT; USOCR; DERWENT; IBM_TDB	OR	ON	2017/09/23 13:48
S422	2295	(S416 S417 S418 S419 S420) and (schedul\$4 near3 down\$1link) and (component near3 carrier) and (control with information)	US-PGPUB; USPAT; USOCR; DERWENT; IBM_TDB	OR	ON	2017/09/23 13:48
S423	2275	(S416 S417 S418 S419 S420) and (schedul\$4 near3 down\$1link) and (component near carrier) and (control with information)	US-PGPUB; USPAT; USOCR; DERWENT; IBM_TDB	OR	ON	2017/09/23 13:48
S424	108	(S416 S417 S418 S419 S420) and (DL down\$link) with (1st first first primary initia) near3 (set group) near6 (radio resource) and (DL down\$link) with (component near3 carrier)	US-PGPUB; USPAT; USOCR; DERWENT; IBM_TDB	OR	ON	2017/09/23 13:48
S425	230	(H03F3/211, H04B7/0617, H04B7/0669, H04B1/3833, H04M1/0247, H04M1/0237, H04L29/08657, G01S5/0252, G01S5/02, H04W52/367, H04W52/12, H04W52/40, H04W88/08, H04W72/044, H04W72/042).cpc. and (carrier near3 aggregation) and (component	US-PGPUB; USPAT; USOCR; DERWENT; IBM_TDB	OR	ON	2017/09/23 13:48

		near3 carrier) same up\$1link with associat\$3 with down\$1link				
S426	23682	(H04W88/08, H04W72/044, H04W72/042I).cpc.	US-PGPUB; USPAT; USOCR; DERWENT; IBM_TDB	OR	ON	2017/09/23 13:48
S427	8021	(H04W52/367, H04W52/12, H04W52/40).cpc.	US-PGPUB; USPAT; USOCR; DERWENT; IBM_TDB	OR	ON	2017/09/23 13:48
S428	7123	(H04L29/08657, G01S5/0252, G01S5/02).cpc.	US-PGPUB; USPAT; USOCR; DERWENT; IBM_TDB	OR	ON	2017/09/23 13:48
S429	6683	(H04L29/08657, G01S19/14, G01S5/02).cpc.	US-PGPUB; USPAT; USOCR; DERWENT; IBM_TDB	OR	ON	2017/09/23 13:48
S430	5604	(H04B1/3833, H04M1/0247, H04M1/0237).cpc.	US-PGPUB; USPAT; USOCR; DERWENT; IBM_TDB	OR	ON	2017/09/23 13:48
S431	267	(H04W88/08, H04W72/044, H04W72/042).cpc. and (1st first) near3 (radio band resource frequency) with (1st first) near3 (CC (component adj carrier))	US-PGPUB; USPAT; USOCR; DERWENT; IBM_TDB	OR	ON	2017/09/23 13:48
S432	129	(S426 S427 S428 S429 S430).cpc. and (1st first) near3 (radio band resource frequency) with (1st first) near3 (CC (component adj carrier))	US-PGPUB; USPAT; USOCR; DERWENT; IBM_TDB	OR	ON	2017/09/23 13:48
S433	38958	(H04W88/08, H04W72/044, H04W72/042).cpc.	US-PGPUB; USPAT; USOCR; DERWENT; IBM_TDB	OR	ON	2017/09/23 13:48
S434	8021	(H04W52/367, H04W52/12, H04W52/40).cpc.	US-PGPUB; USPAT; USOCR; DERWENT; IBM_TDB	OR	ON	2017/09/23 13:48
S435	7123	(H04L29/08657, G01S5/0252, G01S5/02).cpc.	US-PGPUB; USPAT; USOCR; DERWENT; IBM_TDB	OR	ON	2017/09/23 13:48
S436	5604	(H04B1/3833, H04M1/0247, H04M1/0237).cpc.	US-PGPUB; USPAT; USOCR; DERWENT; IBM_TDB	OR	ON	2017/09/23 13:48
S437	13652	(H03F3/211, H04B7/0617, H04B7/0669).cpc.	US-PGPUB; USPAT; USOCR;	OR	ON	2017/09/23 13:48

			DERWENT; IBM_TDB			
S438	700	(S433 S434 S435 S436 S437) and (schedul\$4 near3 down\$1link) and (component near3 carrier) and single with carrier same (plurality multiple several) with (DL down\$1link) with carrier	US-PGPUB; USPAT; USOCR; DERWENT; IBM_TDB	OR	ON	2017/09/23 13:48
S439	323	(S433 S434 S435 S436 S437) and (schedul\$4 near3 down\$1link) and (component near3 carrier) and single near6 carrier same (plurality multiple several) near3 (DL down\$1link) with carrier	US-PGPUB; USPAT; USOCR; DERWENT; IBM_TDB	OR	ON	2017/09/23 13:48
S440	12	(S433 S434 S435 S436 S437) and (schedul\$4) with component near3 carrier and (single near3 (DL down\$1link)) with (first with resource) and (multiple plurality several) near3 (DL downlink) with second with resource	US-PGPUB; USPAT; USOCR; DERWENT; IBM_TDB	OR	ON	2017/09/23 13:48
S441	4	(up\$1link UL) and (schedul\$4) with component near3 carrier same (single near3 (DL down\$1link)) with (first with resource) same (multiple plurality several) near3 (DL downlink) with second with resource	US-PGPUB; USPAT; USOCR; DERWENT; IBM_TDB	OR	ON	2017/09/23 13:48
S442	4	(schedul\$4) with component near3 carrier same (single near3 (DL down\$1link)) with (first with resource) same (multiple plurality several) near3 (DL downlink) with second with resource	US-PGPUB; USPAT; USOCR; DERWENT; IBM_TDB	OR	ON	2017/09/23 13:48
S443	5	(schedul\$4) same (single near3 (DL down\$1link)) with (first with resource) same (multiple plurality several) near3 (DL downlink) with second with resource	US-PGPUB; USPAT; USOCR; DERWENT; IBM_TDB	OR	ON	2017/09/23 13:48
S444	5	(schedul\$4) same (single near3 (DL down\$1link)) with (first with (frequency resource block)) same (multiple plurality several) near3 (DL downlink) with second with (frequency block resource)	US-PGPUB; USPAT; USOCR; DERWENT; IBM_TDB	OR	ON	2017/09/23 13:48
S445	33	(single near3 (DL down\$1link)) with (first with (frequency resource block)) same (multiple plurality several) near3 (DL downlink) with second with (frequency block resource)	US-PGPUB; USPAT; USOCR; DERWENT; IBM_TDB	OR	ON	2017/09/23 13:48
S446	2	allocation with (PUSCH PUCCH UL (up\$1link)) and "20100232373"	US-PGPUB; USPAT; USOCR; DERWENT; IBM_TDB	OR	ON	2017/09/23 13:48
S447	2	allocation and (PUSCH PUCCH UL (up\$1link)) and "20100232373"	US-PGPUB; USPAT; USOCR; DERWENT; IBM_TDB	OR	ON	2017/09/23 13:48
S448	2	"20100271970"	US-PGPUB; USPAT; USOCR; DERWENT; IBM_TDB	OR	ON	2017/09/23 13:48
S449	54	("20100322173" "20110081913" "20130010721" "8634358" "20120140708" "20100271970" "20100285809"	US-PGPUB; USPAT; USOCR;	OR	ON	2017/09/23 13:48

		"20110007699" "20130003700" "20100232373" "20120051306" "20120082125" "20100098012" "20100003997" "20100208679" "20110310856" "20120082125" "20120140708" "20130136084" "8265030" "20110243039" "20120020317" "8265030" "20110007695" "20110081932" "20120314675" "20110310856" "20100232373" "20100296389" "20120020317" "20100098012" "20130034073" "8447343" "8472368").PN.	DERWENT; IBM_TDB			
S450	38958	(H04W88/08, H04W72/044, H04W72/042).cpc.	US-PGPUB; USPAT; USOCR; DERWENT; IBM_TDB	OR	ON	2017/09/23 13:48
S451	8021	(H04W52/367, H04W52/12, H04W52/40).cpc.	US-PGPUB; USPAT; USOCR; DERWENT; IBM_TDB	OR	ON	2017/09/23 13:48
S452	7123	(H04L29/08657, G01S5/0252, G01S5/02).cpc.	US-PGPUB; USPAT; USOCR; DERWENT; IBM_TDB	OR	ON	2017/09/23 13:48
S453	5604	(H04B1/3833, H04M1/0247, H04M1/0237).cpc.	US-PGPUB; USPAT; USOCR; DERWENT; IBM_TDB	OR	ON	2017/09/23 13:48
S454	13652	(H03F3/211, H04B7/0617, H04B7/0669).cpc.	US-PGPUB; USPAT; USOCR; DERWENT; IBM_TDB	OR	ON	2017/09/23 13:48
S455	641	(S450 S451 S452 S453 S454) and (schedul\$4 near3 down\$1link) and (component near3 carrier) and single with carrier same (plurality multiple several) with (DL down\$1link) with carrier same (frequency resources)	US-PGPUB; USPAT; USOCR; DERWENT; IBM_TDB	OR	ON	2017/09/23 13:48
S456	1	"13315135"	US-PGPUB; USPAT; USOCR; DERWENT; IBM_TDB	OR	ON	2017/09/23 13:48
S457	2	"20080151845"	US-PGPUB; USPAT; USOCR; DERWENT; IBM_TDB	OR	ON	2017/09/23 13:48
S458	53	"455"/\$.cls. and (carrier near3 aggregation) and ((first 1st) adj6 carrier) same ((1st first) adj6 (radio resource frame)) and ((2nd second) adj6 carrier) same ((2nd second) adj6 (radio resource frame))	US-PGPUB; USPAT; USOCR; DERWENT; IBM_TDB	OR	ON	2017/09/23 13:48
S459	4	"455"/451,452.1.cls. and (carrier near3 aggregation) and ((first 1st) adj6 carrier) same ((1st first) adj6 (radio resource frame)) and ((2nd	US-PGPUB; USPAT; USOCR;	OR	ON	2017/09/23 13:48

		second) adj6 carrier) same ((2nd second) adj6 (radio resource frame))	DERWENT; IBM_TDB				
S460	42855	455/451,452.1,509,456.1,522,137,103,575.ccls.	US-PGPUB; USPAT; USOCR; DERWENT; IBM_TDB	OR	ON	2017/09/23 13:48	
S461	1	455/451,452.1,509,456.1,522,137,103,575.ccls. and (control\$4) with (resource frequency channel Bin) same (serv\$4 sav\$4) near3 (other 2nd second another) adj3 (resource frequency channel Bin)	US-PGPUB; USPAT; USOCR; DERWENT; IBM_TDB	OR	ON	2017/09/23 13:48	
S462	1	455/451,452.1,509,456.1,522,137,103,575.ccls. and (control\$4) with (resource frequency channel Bin) same (rerv\$4 sav\$4) near3 (other 2nd second another) adj3 (resource frequency channel Bin)	US-PGPUB; USPAT; USOCR; DERWENT; IBM_TDB	OR	ON	2017/09/23 13:48	
S463	6	455/451,452.1,509,456.1,522,137,103,575.ccls. and (control\$4) with (resource frequency channel Bin) same (reserv\$4 sav\$4) near3 (other 2nd second another) adj3 (resource frequency channel Bin)	US-PGPUB; USPAT; USOCR; DERWENT; IBM_TDB	OR	ON	2017/09/23 13:48	
S464	5	455/451,452.1,509,456.1,522,137,103,575.ccls. and (control\$4) with (resource frequency channel Bin) same (reserv\$4 sav\$4) near3 (other 2nd second another) adj3 (resource frequency channel Bin) and (CC component)	US-PGPUB; USPAT; USOCR; DERWENT; IBM_TDB	OR	ON	2017/09/23 13:48	
S465	4	"455"/\$.ccls. and (((first 1st) adj6 component adj3 carrier) same ((radio resource frame))) and ((2nd second) adj6 component adj3 carrier) same ((2nd second other another) adj6 (radio resource frame)) and (reserv\$4 sav\$4 us\$3) near3 (other 2nd second another) adj3 (resource frequency channel Bin) and (CC component)	US-PGPUB; USPAT; USOCR; DERWENT; IBM_TDB	OR	ON	2017/09/23 13:48	
S466	14	("20050013279" "20030219028" "20070217406" "20020105970" "20060050664" "20090303938" "20070064669").PN.	US-PGPUB; USPAT; USOCR; DERWENT; IBM_TDB	OR	ON	2017/09/23 13:48	
S467	13	"455"/\$.ccls. and (schedul\$3 near3 downlink) same ((radio adj resource) (resource adj block)) same (CC (component adj carrier))	US-PGPUB; USPAT; USOCR; DERWENT; IBM_TDB	OR	ON	2017/09/23 13:48	
S468	1	455/451,452.1,509,456.1,522,137,103,575.ccls. and (control\$4) with (resource frequency channel) same (rerv\$4 sav\$4) near3 (other 2nd second another) adj3 (resource frequency channel Bin)	US-PGPUB; USPAT; USOCR; DERWENT; IBM_TDB	OR	ON	2017/09/23 13:48	
S469	38958	(H04W88/08, H04W72/044, H04W72/042).cpc.	US-PGPUB; USPAT; USOCR; DERWENT; IBM_TDB	OR	ON	2017/09/23 13:48	
S470	8021	(H04W52/367, H04W52/12, H04W52/40).cpc.	US-PGPUB; USPAT; USOCR; DERWENT; IBM_TDB	OR	ON	2017/09/23 13:48	
S471	7123	(H04L29/08657, G01S5/0252, G01S5/02).cpc.	US-PGPUB;	OR	ON	2017/09/23	

			USPAT; USOCR; DERWENT; IBM_TDB			13:48
S472	5604	(H04B1/3833, H04M1/0247, H04M1/0237).cpc.	US-PGPUB; USPAT; USOCR; DERWENT; IBM_TDB	OR	ON	2017/09/23 13:48
S473	13652	(H03F3/211, H04B7/0617, H04B7/0669).cpc.	US-PGPUB; USPAT; USOCR; DERWENT; IBM_TDB	OR	ON	2017/09/23 13:48
S474	2	"14170939"	US-PGPUB; USPAT; USOCR; DERWENT; IBM_TDB	OR	ON	2017/09/23 13:48
S475	1911	(component near2 carrier) with (primary near2 cell)	US-PGPUB; USPAT; USOCR; DERWENT; IBM_TDB	OR	ON	2017/09/23 13:48
S476	887	"370"/\$.cls. and (component near2 carrier) with (primary near2 cell)	US-PGPUB; USPAT; USOCR; DERWENT; IBM_TDB	OR	ON	2017/09/23 13:48
S477	850	"370"/\$.cls. and (component adj2 carrier) with (primary adj2 cell)	US-PGPUB; USPAT; USOCR; DERWENT; IBM_TDB	OR	ON	2017/09/23 13:48
S478	410	"370"/\$.cls. and (component adj2 carrier) with (primary adj2 cell) with (DL down\$1link)	US-PGPUB; USPAT; USOCR; DERWENT; IBM_TDB	OR	ON	2017/09/23 13:48
S479	10	"370"/\$.cls. and single near3 (CC (component adj2 carrier)) with (primary adj2 cell) with (DL down\$1link)	US-PGPUB; USPAT; USOCR; DERWENT; IBM_TDB	OR	ON	2017/09/23 13:48
S480	16	single near4 (CC (component adj2 carrier)) with (primary adj2 cell) with (DL down\$1link)	US-PGPUB; USPAT; USOCR; DERWENT; IBM_TDB	OR	ON	2017/09/23 13:48
S481	581	"370"/\$.cls. and (CC (component adj2 carrier)) with (primary adj2 cell) with (DL down\$1link)	US-PGPUB; USPAT; USOCR; DERWENT; IBM_TDB	OR	ON	2017/09/23 13:48
S482	2	@ad<"20091004" and "370"/\$.cls. and (CC (component adj2 carrier)) with (primary adj2 cell) with (DL down\$1link)	US-PGPUB; USPAT; USOCR; DERWENT; IBM_TDB	OR	ON	2017/09/23 13:48
S483	581	"370"/\$.cls. and (CC (component adj2 carrier))	US-PGPUB;	OR	ON	2017/09/23

		with (primary adj2 cell) with (DL down\$1link)	USPAT; USOCR; DERWENT; IBM_TDB			13:48
S484	29	("20100322173" "20110081913" "20130010721" "8634358" "20120140708" "20100271970" "20100285809" "20110007699" "20130003700" "20100232373" "20120051306" "20120082125" "20100098012" "20100003997" "20100208679" "20110310856" "20120082125" "20120140708" "20130136084" "8265030" "20110243039" "8792830" "20120020317" "8265030" "20110007695" "20110081932" "20120314675" "20020160784" "20110310856" "20100232373" "20100296389" "20120020317" "20100098012" "20130034073" "8447343" "8472368").PN.	US-PGPUB; USPAT	OR	OFF	2017/09/23 13:48
S485	38958	(H04W88/08, H04W72/044, H04W72/042).cpc.	US-PGPUB; USPAT; USOCR; DERWENT; IBM_TDB	OR	ON	2017/09/23 13:48
S486	8021	(H04W52/367, H04W52/12, H04W52/40).cpc.	US-PGPUB; USPAT; USOCR; DERWENT; IBM_TDB	OR	ON	2017/09/23 13:48
S487	7123	(H04L29/08657, G01S5/0252, G01S5/02).cpc.	US-PGPUB; USPAT; USOCR; DERWENT; IBM_TDB	OR	ON	2017/09/23 13:48
S488	5604	(H04B1/3833, H04M1/0247, H04M1/0237).cpc.	US-PGPUB; USPAT; USOCR; DERWENT; IBM_TDB	OR	ON	2017/09/23 13:48
S489	13652	(H03F3/211, H04B7/0617, H04B7/0669).cpc.	US-PGPUB; USPAT; USOCR; DERWENT; IBM_TDB	OR	ON	2017/09/23 13:48
S490	593	(S485 S486 S487 S488 S489) and (schedul\$4 near3 down\$1link) and (component near3 carrier) and single with carrier same (plurality multiple several) with (DL down\$1link) with carrier same (frequency)	US-PGPUB; USPAT; USOCR; DERWENT; IBM_TDB	OR	ON	2017/09/23 13:48
S491	752	((david near2 astely) (robert near2 baldemair) (dirk near2 gerstenberger) (daniel near2 larsson) (lars near2 lindbom) (stefan near2 parkvall)).in. and ericsson.as.	US-PGPUB; USPAT; USOCR; DERWENT; IBM_TDB	OR	ON	2017/09/23 13:48
S492	1	S490 and S491	US-PGPUB; USPAT; USOCR; DERWENT; IBM_TDB	OR	ON	2017/09/23 13:48

S493	21	455/\$.cls. and ((first 1st) adj6 component adj3 carrier) same ((1st first) adj6 (radio resource frame)) and ((2nd second) adj6 component adj3 carrier) same ((2nd second) adj6 (radio resource frame))	US-PGPUB; USPAT; USOCR; DERWENT; IBM_TDB	OR	ON	2017/09/23 13:48
S494	24	("20100322173" "20110081913" "20130003700" "20100232373" "20120051306" "20120082125" "20100098012" "20100003997" "20100208679" "20110310856" "20120082125" "20120140708" "20130136084" "8265030" "20110243039" "8792830" "20120020317" "8265030" "20110007695" "20110081932" "20120314675" "20020160784" "20110310856" "20100232373" "20100296389" "20120020317" "20100098012" "20130034073" "8447343" "8472368").PN.	US-PGPUB; USPAT	OR	OFF	2017/09/23 13:48
S495	1	"14030298"	US-PGPUB; USPAT	OR	OFF	2017/09/23 13:48
S496	339	((1st first) adj6 (radio resource frame)) and ((2nd second) adj6 component adj3 carrier) same ((2nd second) adj6 (radio resource frame))	US-PGPUB; USPAT; USOCR; DERWENT; IBM_TDB	OR	ON	2017/09/23 13:48
S497	2	"14102508"	US-PGPUB; USPAT; USOCR; DERWENT; IBM_TDB	OR	ON	2017/09/23 13:48
S498	2	"14158378"	US-PGPUB; USPAT; USOCR; DERWENT; IBM_TDB	OR	ON	2017/09/23 13:48
S499	2	"14097736"	US-PGPUB; USPAT; USOCR; DERWENT; IBM_TDB	OR	ON	2017/09/23 13:48
S500	3	"14006545"	US-PGPUB; USPAT; USOCR; DERWENT; IBM_TDB	OR	ON	2017/09/23 13:48
S501	2	"13875620"	US-PGPUB; USPAT; USOCR; DERWENT; IBM_TDB	OR	ON	2017/09/23 13:48
S502	3	"13905342"	US-PGPUB; USPAT; USOCR; DERWENT; IBM_TDB	OR	ON	2017/09/23 13:48
S503	2	"13477988"	US-PGPUB; USPAT; USOCR; DERWENT;	OR	ON	2017/09/23 13:48

			IBM_TDB			
S504	4	"13293245"	US-PGPUB; USPAT; USOCR; DERWENT; IBM_TDB	OR	ON	2017/09/23 13:48
S505	2	"13875620"	US-PGPUB; USPAT; USOCR; DERWENT; IBM_TDB	OR	ON	2017/09/23 13:48
S506	3	"13993807"	US-PGPUB; USPAT; USOCR; DERWENT; IBM_TDB	OR	ON	2017/09/23 13:48
S507	1	"13898465"	US-PGPUB; USPAT; USOCR; DERWENT; IBM_TDB	OR	ON	2017/09/23 13:48
S508	1	"13883792"	US-PGPUB; USPAT; USOCR; DERWENT; IBM_TDB	OR	ON	2017/09/23 13:48
S509	2	"13996405"	US-PGPUB; USPAT; USOCR; DERWENT; IBM_TDB	OR	ON	2017/09/23 13:48
S510	2	"13883002"	US-PGPUB; USPAT; USOCR; DERWENT; IBM_TDB	OR	ON	2017/09/23 13:48
S511	1	"14812058"	US-PGPUB; USPAT; USOCR; DERWENT; IBM_TDB	OR	ON	2017/09/23 13:48
S512	17	"8915660"	US-PGPUB; USPAT; USOCR; DERWENT; IBM_TDB	OR	ON	2017/09/23 13:48
S513	1	"13909538"	US-PGPUB; USPAT; USOCR; DERWENT; IBM_TDB	OR	ON	2017/09/23 13:48
S514	1	"13924238"	US-PGPUB; USPAT; USOCR; DERWENT; IBM_TDB	OR	ON	2017/09/23 13:48
S515	1	"13898465"	US-PGPUB; USPAT; USOCR; DERWENT;	OR	ON	2017/09/23 13:48

			IBM_TDB			
S516	3	"13993807"	US-PGPUB; USPAT; USOCR; DERWENT; IBM_TDB	OR	ON	2017/09/23 13:48
S517	58	("20100322173" "20110081913" "20130010721" "8634358" "20120140708" "20100271970" "20100285809" "20110007699" "20130003700" "20100232373" "20120051306" "20120082125" "20100098012" "20100003997" "20100208679" "20110310856" "20120082125" "20120140708" "20130136084" "8265030" "20110243039" "8792830" "20120020317" "8265030" "20110007695" "20110081932" "20120314675" "20020160784" "20110310856" "20100232373" "20100296389" "20120020317" "20100098012" "20130034073" "8447343" "8472368").PN.	US-PGPUB; USPAT; USOCR; DERWENT; IBM_TDB	OR	ON	2017/09/23 13:48
S518	2	"13906370"	US-PGPUB; USPAT; USOCR; DERWENT; IBM_TDB	OR	ON	2017/09/23 13:48
S519	58	("20100322173" "20110081913" "20130010721" "8634358" "20120140708" "20100271970" "20100285809" "20110007699" "20130003700" "20100232373" "20120051306" "20120082125" "20100098012" "20100003997" "20100208679" "20110310856" "20120082125" "20120140708" "20130136084" "8265030" "20110243039" "8792830" "20120020317" "8265030" "20110007695" "20110081932" "20120314675" "20020160784" "20110310856" "20100232373" "20100296389" "20120020317" "20100098012" "20130034073" "8447343" "8472368").PN.	US-PGPUB; USPAT; USOCR; DERWENT; IBM_TDB	OR	ON	2017/09/23 13:48
S520	0	(H04W88/08, H04W72/044, H04W72/042).cpc. and (H04W52/367, H04W52/12, H04W52/40).cpc. and (H04L29/08657, G01S5/0252, G01S5/02).cpc. and (H04B1/3833, H04M1/0247, H04M1/0237).cpc.	US-PGPUB; USPAT; USOCR; DERWENT; IBM_TDB	OR	ON	2017/09/23 13:48
S521	58461	(H04W88/08, H04W72/044, H04W72/042, H04W52/367, H04W52/12, H04W52/40, H04L29/08657, G01S5/0252, G01S5/02, H04B1/3833, H04M1/0247, H04M1/0237).cpc.	US-PGPUB; USPAT; USOCR; DERWENT; IBM_TDB	OR	ON	2017/09/23 13:48
S522	6	(H04W88/08, H04W72/044, H04W72/042, H04W52/367, H04W52/12, H04W52/40, H04L29/08657, G01S5/0252, G01S5/02, H04B1/3833, H04M1/0247, H04M1/0237).cpc. and single near3 (CC (component adj2 carrier)) with (primary adj2 cell) with (DL down\$1link)	US-PGPUB; USPAT; USOCR; DERWENT; IBM_TDB	OR	ON	2017/09/23 13:48
S523	752	((david near2 astely) (robert near2 baldemair) (dirk near2 gerstenberger) (daniel near2 larsson)	US-PGPUB; USPAT;	OR	ON	2017/09/23 13:48

		(lars near2 lindbom) (stefan near2 parkvall)).in. and ericsson.as.	USOCR; DERWENT; IBM_TDB			
S524	752	((david near2 astely) (robert near2 baldemair) (dirk near2 gerstenberger) (daniel near2 larsson) (lars near2 lindbom) (stefan near2 parkvall)).in.) and ericsson.as.	US-PGPUB; USPAT; USOCR; DERWENT; IBM_TDB	OR	ON	2017/09/23 13:48
S525	209	((david near2 astely) (robert near2 baldemair) (dirk near2 gerstenberger) (daniel near2 larsson) (lars near2 lindbom) (stefan near2 parkvall)).in.) and ericsson.as. and carrier adj aggregation	US-PGPUB; USPAT; USOCR; DERWENT; IBM_TDB	OR	ON	2017/09/23 13:48
S526	53	"455"/\$.ccls. and (carrier near3 aggregation) and ((first 1st) adj6 carrier) same ((1st first) adj6 (radio resource frame)) and ((2nd second) adj6 carrier) same ((2nd second) adj6 (radio resource frame)) and carrier adj aggregation	US-PGPUB; USPAT; USOCR; DERWENT; IBM_TDB	OR	ON	2017/09/23 13:48
S527	99	(H04W88/08, H04W72/044, H04W72/042).cpc. and ((first 1st) adj6 component adj3 carrier) same ((1st first) adj6 (radio resource frame)) and ((2nd second) adj6 component adj3 carrier) same ((2nd second) adj6 (radio resource frame))	US-PGPUB; USPAT; USOCR; DERWENT; IBM_TDB	OR	ON	2017/09/23 13:48
S528	27	(set group) near6 (radio resource) with (2nd second other another) near6 (DL down\$link) near3 (component near3 carrier)	US-PGPUB; USPAT	OR	ON	2017/09/23 13:48
S529	38	455/509,522,456.6,137,103,575.ccls. and (downlink near3 carrier) and (uplink near3 (primary first initial) near3 carrier) and ((second 2nd other next) with (channel resource)) and (carrier adj aggregation)	US-PGPUB; USPAT; USOCR; DERWENT; IBM_TDB	OR	ON	2017/09/23 13:48
S530	0	(H04B1/3833, H04M1/0247, H04M1/0237).cpc. and (((first 1st) adj6 component adj3 carrier) same ((radio resource frame))) and ((2nd second) adj6 component adj3 carrier) same ((2nd second other another) adj4 (radio resource frame))	US-PGPUB; USPAT; USOCR; DERWENT; IBM_TDB	OR	ON	2017/09/23 13:48
S531	1	((david near2 astely) (robert near2 baldemair) (dirk near2 gerstenberger) (daniel near2 larsson) (lars near2 lindbom) (stefan near2 parkvall)).in.) and ericsson.as. and single near3 (CC (component adj2 carrier)) with (primary adj2 cell) with (DL down\$link)	US-PGPUB; USPAT; USOCR; DERWENT; IBM_TDB	OR	ON	2017/09/23 13:48
S532	44	((david near2 astely) (robert near2 baldemair) (dirk near2 gerstenberger) (daniel near2 larsson) (lars near2 lindbom) (stefan near2 parkvall)).in.) and ericsson.as. and (CC (component adj2 carrier)) with (primary adj2 cell)	US-PGPUB; USPAT; USOCR; DERWENT; IBM_TDB	OR	ON	2017/09/23 13:48
S533	136	455/\$.ccls. and (downlink near3 carrier) and (uplink near3 (primary first initial) near3 carrier) and ((second 2nd other next) with (channel resource)) and (control with information)	US-PGPUB; USPAT; USOCR; DERWENT; IBM_TDB	OR	ON	2017/09/23 13:48
S534	30	("20120127950" "20110310819" "20120275395" "20120287828" "20120039291" "20100271970" "20120307781" "20110286436" "20120224535" "20120140708" "20120163288" "20110299486" "20100098012" "20120082125" "20120294273").pn.	US-PGPUB; USPAT; USOCR; DERWENT; IBM_TDB	OR	ON	2017/09/23 13:48

S535	20	((carrier adj aggregation) and (schemul\$3 near3 (downlink DL) with ((first primary initial) near6 (resource radio frequency frame))) and ((first 1st) adj6 component adj3 carrier) same ((1st first) adj6 (radio resource frame)) and ((2nd second) adj6 component adj3 carrier) same ((2nd second) adj6 (radio resource frame)))	US-PGPUB; USPAT; USOCR; DERWENT; IBM_TDB	OR	ON	2017/09/23 13:48
S536	3	"20070030661"	US-PGPUB; USPAT; USOCR; DERWENT; IBM_TDB	OR	ON	2017/09/23 13:48
S537	82	370/329,252,331.ccls. and (((first 1st) adj6 component adj3 carrier) same ((radio resource frame))) and ((2nd second) adj6 component adj3 carrier) same ((2nd second other another) adj4 (radio resource frame))	US-PGPUB; USPAT; USOCR; DERWENT; IBM_TDB	OR	ON	2017/09/23 13:48
S538	0	(H04B1/3833, H04M1/0247, H04M1/0237).cpc. and (schemul\$3 assign\$3) with (primary adj cell) same2 (multiple several set) near3 component adj2 carrier	US-PGPUB; USPAT; USOCR; DERWENT; IBM_TDB	OR	ON	2017/09/23 13:48
S539	0	(H04B1/3833, H04M1/0247, H04M1/0237).cpc. and (schemul\$3 assign\$3) with (primary adj cell) same2 (multiple several set) near6 carrier	US-PGPUB; USPAT; USOCR; FPRS; EPO; JPO; DERWENT; IBM_TDB	OR	ON	2017/09/23 13:48
S540	38	(H04L5/0053, H04L5/001, H04L5/0094, H04B1/3833, H04M1/0247, H04M1/0237).cpc. and (schemul\$3 assign\$3) with (primary adj cell) same2 (multiple several set) near3 component adj2 carrier	US-PGPUB; USPAT; USOCR; DERWENT; IBM_TDB	OR	ON	2017/09/23 13:48
S541	38	(H04L5/0053, H04L5/001, H04L5/0094, H04B1/3833, H04M1/0247, H04M1/0237).cpc. and (schemul\$3 assign\$3) with (primary adj cell) same2 (multiple several set) near3 component adj2 carrier and (control\$4 adjust\$3) near6 (DL (down\$link))	US-PGPUB; USPAT; USOCR; DERWENT; IBM_TDB	OR	ON	2017/09/23 13:48
S542	18	(H04L5/0053, H04L5/001, H04L5/0094, H04B1/3833, H04M1/0247, H04M1/0237).cpc. and (schemul\$3 assign\$3) with (primary adj cell) same2 (multiple several set) near3 component adj2 carrier and (control\$4 adjust\$3) near6 (DL (down\$link)) and (second 2nd another other) near3 (radio frequency band resources)	US-PGPUB; USPAT; USOCR; DERWENT; IBM_TDB	OR	ON	2017/09/23 13:48
S543	0	455/509,522,456.6,137,103,575.ccls. and (schemul\$3 assign\$3) with (primary adj cell) same2 (multiple several set) near3 component adj2 carrier and (control\$4 adjust\$3) near6 (DL (down\$link)) and (second 2nd another other) near3 (radio frequency band resources)	US-PGPUB; USPAT; USOCR; DERWENT; IBM_TDB	OR	ON	2017/09/23 13:48
S544	18	(A01B12/006, H04L5/0053, H04L5/001, H04L5/0094, H04B1/3833, H04M1/0247, H04M1/0237).cpc. and (schemul\$3 assign\$3) with (primary adj cell) same2 (multiple several set) near3 component adj2 carrier and (control\$4 adjust\$3) near6 (DL (down\$link)) and (second 2nd another other) near3 (radio frequency band resources)	US-PGPUB; USPAT; USOCR; FPRS; EPO; JPO; DERWENT; IBM_TDB	OR	ON	2017/09/23 13:48

S545	14	(H04W88/08, H04W72/044, H04W72/042, H04W52/367, H04W52/12, H04W52/40, H04L29/08657, G01S5/0252, G01S5/02, H04B1/3833, H04M1/0247, H04M1/0237).cpc. and (schedul\$3 assign\$3) with (primary adj cell) same2 (multiple several set) near3 component adj2 carrier and (control\$4 adjust\$3) near6 (DL (down\$link)) and (second 2nd another other) near3 (radio frequency band resources)	US-PGPUB; USPAT; USOCR; FPRS; EPO; JPO; DERWENT; IBM_TDB	OR	ON	2017/09/23 13:48
S546	1	((david near2 astely) (robert near2 baldemair) (dirk near2 gerstenberger) (daniel near2 larsson) (lars near2 lindbom) (stefan near2 parkvall)).in. and ericsson.as. and (schedul\$3 assign\$3) with (primary adj cell) same2 (multiple several set) near3 component adj2 carrier	US-PGPUB; USPAT; USOCR; FPRS; EPO; JPO; DERWENT; IBM_TDB	OR	ON	2017/09/23 13:48
S547	60	("20100322173" "20110081913" "20130010721" "8634358" "20110007699" "8792830" "20120140708" "20100271970" "20100285809" "20110007699" "20130003700" "20100003997" "20100232373" "20130003700" "8447343" "8634358" "20100232373" "20120051306" "20100296389" "20120140708" "20130010721" "20130136084" "20120082125" "20020160784" "20110081913" "20110081932" "20110243039" "20120020317" "20100098012" "20100003997" "20100208679" "20110310856" "20120082125" "20120140708" "20130136084" "8265030" "20110243039" "8792830" "20120051306" "20120314675" "8472368" "20120147847" "20120020317" "8265030" "20110007695" "20110081932" "20120314675" "20020160784" "20100271970" "20100285809" "20130034073" "8265030" "20110310856" "20100232373" "20100296389" "20120020317" "20100098012" "20110310856" "20120082125" "20100098012" "20130034073" "8447343" "8472368" "20100208679" "20100322173" "20110007695").FN.	US-PGPUB; USPAT; USOCR; DERWENT; IBM_TDB	OR	ON	2017/09/23 13:48
S548	2	(H04W88/08, H04W72/044, H04W72/042, H04W52/367, H04W52/12, H04W52/40, H04L29/08657, G01S5/0252, G01S5/02, H04B1/3833, H04M1/0247, H04M1/0237).cpc. and (schedul\$3 assign\$3) with (primary adj cell) same2 (multiple several set) near3 component adj2 carrier and (control\$4 adjust\$3) near6 (DL (down\$link)) and (second 2nd another other) near3 (radio frequency band resources)	USPAT	OR	ON	2017/09/23 13:48
S549	14	(H04W88/08, H04W72/044, H04W72/042, H04W52/367, H04W52/12, H04W52/40, H04L29/08657, G01S5/0252, G01S5/02, H04B1/3833, H04M1/0247, H04M1/0237).cpc. and (schedul\$3 assign\$3) with (primary adj cell) same2 (multiple several set) near3 component adj2 carrier and (control\$4 adjust\$3) near6 (DL (down\$link)) and (second 2nd another other) near3 (radio frequency band resources)	US-PGPUB; USPAT; USOCR; FPRS; EPO; JPO; DERWENT; IBM_TDB	OR	ON	2017/09/23 13:48

S550	270	((david near2 astely) (robert near2 baldemair) (dirk near2 gerstenberger) (daniel near2 larsson) (lars near2 lindbom) (stefan near2 parkvall)).in. and 455/\$.ccls.	US-PGPUB; USPAT; USOCR; DERWENT; IBM_TDB	OR	ON	2017/09/23 13:48
S551	5	((david near2 astely) (robert near2 baldemair) (dirk near2 gerstenberger) (daniel near2 larsson) (lars near2 lindbom) (stefan near2 parkvall)).in. and (carrier adj aggregation) and (schedul\$3 near3 (downlink DL) with ((first primary initial) near6 (resource radio frequency frame)))	US-PGPUB; USPAT; USOCR; DERWENT; IBM_TDB	OR	ON	2017/09/23 13:48
S552	5	455/451,452.1,509,456.1,522,137,103,575.ccls. and (control\$4) with (resource frequency channel Bin) same (reserv\$4 sav\$4) near3 (other 2nd second another next) adj3 (resource frequency channel Bin) and (CC component)	US-PGPUB; USPAT; USOCR; DERWENT; IBM_TDB	OR	ON	2017/09/23 13:48
S553	3	"12896993"	US-PGPUB; USPAT; USOCR; DERWENT; IBM_TDB	OR	ON	2017/09/23 13:48
S554	62	370/329,252,331.ccls. and (((first 1st) adj6 component adj3 carrier) same ((radio resource frame))) and ((2nd second) adj6 component adj3 carrier) same ((2nd second other another) adj4 (radio resource frame)) and (set group) near6 (radio resource)	US-PGPUB; USPAT	OR	ON	2017/09/23 13:48
S555	2	("20120147847").PN.	US-PGPUB; USPAT; USOCR; FPRS; EPO; JPO; DERWENT; IBM_TDB	OR	OFF	2017/09/23 13:48
S556	30	455/509,522,456.6,137,103,575.ccls. and (schedul\$3 assign\$3) with component adj2 carrier and (control\$4 adjust\$3) near6 (DL (down\$link)) and (second 2nd another other) near3 (radio frequency band resources)	US-PGPUB; USPAT; USOCR; DERWENT; IBM_TDB	OR	ON	2017/09/23 13:48
S557	22	455/\$.ccls. and (1st first) near3 (radio band resource frequency) with (reserv\$3 schedul\$3 allocat\$3) with (1st first) near3 (CC (component adj carrier))	US-PGPUB; USPAT; USOCR; DERWENT; IBM_TDB	OR	ON	2017/09/23 13:48
S558	2	("20120147847").PN.	US-PGPUB; USPAT; USOCR; DERWENT; IBM_TDB	OR	ON	2017/09/23 13:48
S559	21	455/\$.ccls. and ((first 1st) adj6 component adj3 carrier) same ((1st first) adj6 (radio resource frame)) and ((2nd second) adj6 component adj3 carrier) same ((2nd second) adj6 (radio resource frame))	US-PGPUB; USPAT; USOCR; DERWENT; IBM_TDB	OR	ON	2017/09/23 13:48
S560	33	("20120127950" "20110310819" "20120275395" "20120287828" "20120039291" "20100271970" "20120307781" "20110286436" "20120224535" "20120140708" "20110310820" "20120163288"	US-PGPUB; USPAT; USOCR; DERWENT; IBM_TDB	OR	ON	2017/09/23 13:48

		"20110299486" "20100098012" "20120082125" "20120294273" "20110268048").pn.				
S561	26	(H04W88/08, H04W72/044, H04W72/042, H04W52/367, H04W52/12, H04W52/40, H04L29/08657, G01S5/0252, G01S5/02, H04B1/3833, H04M1/0247, H04M1/0237).cpc. and (schedul\$3 assign\$3) with (primary adj cell) same2 (multiple several set) and (control\$4 adjust\$3) near6 (DL (down\$link)) and (second 2nd another other) near3 (radio frequency band resources) same component adj carrier	US-PGPUB; USPAT; USOCR; FPRS; EPO; JPO; DERWENT; IBM_TDB	OR	ON	2017/09/23 13:48
S562	60	("20100322173" "20110081913" "20130010721" "8634358" "20110007699" "8792830" "20120140708" "20100271970" "20100285809" "20110007699" "20130003700" "20100003997" "20100232373" "20130003700" "8447343" "8634358" "20100232373" "20120051306" "20100296389" "20120140708" "20130010721" "20130136084" "20120082125" "20020160784" "20110081913" "20110081932" "20110243039" "20120020317" "20100098012" "20100003997" "20100208679" "20110310856" "20120082125" "20120140708" "20130136084" "8265030" "20110243039" "8792830" "20120051306" "20120314675" "8472368" "20120147847" "20120020317" "8265030" "20110007695" "20110081932" "20120314675" "20020160784" "20100271970" "20100285809" "20130034073" "8265030" "20110310856" "20100232373" "20100296389" "20120020317" "20100098012" "20110310856" "20120082125" "20100098012" "20130034073" "8447343" "8472368" "20100208679" "20100322173" "20110007695").PN.	US-PGPUB; USPAT; USOCR; DERWENT; IBM_TDB	OR	ON	2017/09/23 13:48
S563	0	(H04B1/3833, H04M1/0247, H04M1/0237).cpc. and (((first 1st) adj6 component adj3 carrier) same ((radio resource frame))) and ((2nd second) adj6 component adj3 carrier) same ((2nd second other another) adj4 (radio resource frame frequency))	US-PGPUB; USPAT; USOCR; DERWENT; IBM_TDB	OR	ON	2017/09/23 13:48
S564	0	455/\$.ccls. and (first 1st) near3 (radio adj resource) and (second other another 2nd) near3 (radio adj resource) same (carrier adj aggregation) and (schedul\$3 near3 (down\$link DL reverse\$1link))	US-PGPUB; USPAT; USOCR; DERWENT; IBM_TDB	OR	ON	2017/09/23 13:48
S565	0	(H04B1/3833, H04M1/0247, H04M1/0237).cpc. and (first 1st) near3 (radio adj resource) and (second other another 2nd) near3 (radio adj resource) same (carrier adj aggregation) and (schedul\$3 near3 (down\$link DL reverse\$1link))	US-PGPUB; USPAT; USOCR; DERWENT; IBM_TDB	OR	ON	2017/09/23 13:48
S566	0	(H04B1/3833, H04M1/0247, H04M1/0237).cpc. and (first 1st) near3 (radio adj resource) and (second other another 2nd) near3 (radio adj resource) and (schedul\$3 near3 (down\$link DL reverse\$1link))	US-PGPUB; USPAT; USOCR; DERWENT; IBM_TDB	OR	ON	2017/09/23 13:48
S567	1010	schedul\$3 near3 (transmit\$4 transmi\$5) with (CC (component adj2 cacarrier)) and (CI (control adj2	US-PGPUB; USPAT;	OR	ON	2017/09/23 13:48

		(info information))) with (CC (component adj2 cacarrier))	USOCR; DERWENT; IBM_TDB			
S568	78	(H04W88/08, H04W72/044, H04W72/042I).cpc. and schedul\$3 near3 (transmit\$4 transmi\$5) with (CC (component adj2 cacarrier)) and (CI (control adj2 (info information))) with (CC (component adj2 cacarrier))	US-PGPUB; USPAT; USOCR; DERWENT; IBM_TDB	OR	ON	2017/09/23 13:48
S569	12	(H04W88/08, H04W72/044, H04W72/042I).cpc. and schedul\$3 near3 (transmit\$4 transmi\$5) with (CC (component adj2 cacarrier)) and (CI (control adj2 (info information))) with (CC (component adj2 cacarrier)) and schedul\$3 with (non\$1primary second 2nd secondary) adj2 cell	US-PGPUB; USPAT; USOCR; DERWENT; IBM_TDB	OR	ON	2017/09/23 13:48
S570	52	(H04W88/08, H04W72/044, H04W72/042I).cpc. and schedul\$3 near3 (transmit\$4 transmi\$5) with (CC (component adj2 cacarrier)) and (CI (control adj2 (info information))) with (CC (component adj2 carrier)) and (non\$1primary second 2nd secondary) adj2 (CC (component adj2 carrier))	US-PGPUB; USPAT; USOCR; DERWENT; IBM_TDB	OR	ON	2017/09/23 13:48
S571	752	Ericsson.as. and ((david near2 astely) (robert near2 baldemair) (dirk near2 gerstenberger) (daniel near2 larsson) (lars near2 lindbom) (stefan near2 parkvall)).in.	US-PGPUB; USPAT; USOCR; DERWENT; IBM_TDB	OR	ON	2017/09/23 13:48
S572	43	Ericsson.as. and ((david near2 astely) (robert near2 baldemair) (dirk near2 gerstenberger) (daniel near2 larsson) (lars near2 lindbom) (stefan near2 parkvall)).in. and (radio near3 resource) with (component near3 carrier)	US-PGPUB; USPAT; USOCR; DERWENT; IBM_TDB	OR	ON	2017/09/23 13:48
S573	5	455/\$.cls. and (set near3 radio near3 resource) same component adj carrier	US-PGPUB; USPAT; USOCR; DERWENT; IBM_TDB	OR	ON	2017/09/23 13:48
S574	38958	(H04W88/08, H04W72/044, H04W72/042).cpc.	US-PGPUB; USPAT; USOCR; DERWENT; IBM_TDB	OR	ON	2017/09/23 13:48
S575	8021	(H04W52/367, H04W52/12, H04W52/40).cpc.	US-PGPUB; USPAT; USOCR; DERWENT; IBM_TDB	OR	ON	2017/09/23 13:48
S576	7123	(H04L29/08657, G01S5/0252, G01S5/02).cpc.	US-PGPUB; USPAT; USOCR; DERWENT; IBM_TDB	OR	ON	2017/09/23 13:48
S577	5604	(H04B1/3833, H04M1/0247, H04M1/0237).cpc.	US-PGPUB; USPAT; USOCR; DERWENT; IBM_TDB	OR	ON	2017/09/23 13:48
S578	13652	(H03F3/211, H04B7/0617, H04B7/0669).cpc.	US-PGPUB; USPAT; USOCR; DERWENT; IBM_TDB	OR	ON	2017/09/23 13:48

S579	152	(S574 S575 S576 S577 S578) and (second other another 2nd) near3 (radio adj resource) and (carrier adj aggregation) and (schedul\$3 near3 (down\$link DL reverse\$1link))	US-PGPUB; USPAT; USOCR; DERWENT; IBM_TDB	OR	ON	2017/09/23 13:48
S580	147	(H04W88/08, H04W72/044, H04W72/042).cpc. and (second other another 2nd) near3 (radio adj resource) and (carrier adj aggregation) and (schedul\$3 near3 (down\$link DL reverse\$1link))	US-PGPUB; USPAT; USOCR; DERWENT; IBM_TDB	OR	ON	2017/09/23 13:48
S581	3	Ericsson.as. and ((david near2 astely) (robert near2 baldemair) (dirk near2 gerstenberger) (daniel near2 larsson) (lars near2 lindbom) (stefan near2 parkvall)).in. and schedul\$3 near3 (transmit\$4 transmi\$5 communication) with (CC component adj2 cacarrier))	US-PGPUB; USPAT; USOCR; DERWENT; IBM_TDB	OR	ON	2017/09/23 13:48
S582	63	455/451,452.1,509,456.1,522,137,103,575.ccls. and (allocat\$3) with (resource frequency channel Bin) same (reserv\$4 sav\$4) adj6 (resource frequency channel Bin) and (control\$3 adjst\$3) near6 (CC component)	US-PGPUB; USPAT; USOCR; DERWENT; IBM_TDB	OR	ON	2017/09/23 13:48
S583	0	455/451,452.1,509,456.1,522,137,103,575.ccls. and (allocat\$3) with (resource frequency channel Bin) same (reserv\$4 sav\$4) adj6 (resource frequency channel Bin) and (primary adj cell) same (multiple several set) near3 component adj2 carrier	US-PGPUB; USPAT; USOCR; FPRS; EPO; JPO; DERWENT; IBM_TDB	OR	ON	2017/09/23 13:48
S584	0	455/451,452.1,509,456.1,522,137,103,575.ccls. and (allocat\$3) with (resource frequency channel Bin) same (reserv\$4 sav\$4) adj6 (resource frequency channel Bin) and (primary adj cell) same2 (multiple several set) near3 component adj2 carrier	US-PGPUB; USPAT; USOCR; FPRS; EPO; JPO; DERWENT; IBM_TDB	OR	ON	2017/09/23 13:48
S585	1	455/451,452.1,509,456.1,522,137,103,575.ccls. and (allocat\$3) with (resource frequency channel Bin) same (reserv\$4 sav\$4) adj6 (resource frequency channel Bin) and (primary adj2 cell) and (multiple several set) near3 component adj2 carrier	US-PGPUB; USPAT; USOCR; FPRS; EPO; JPO; DERWENT; IBM_TDB	OR	ON	2017/09/23 13:48
S586	2	455/451,452.1,509,456.1,522,137,103,575.ccls. and (allocat\$3) with (resource frequency channel Bin) same (reserv\$4 sav\$4) adj6 (resource frequency channel Bin) and (multiple several set) near3 component adj2 carrier	US-PGPUB; USPAT; USOCR; FPRS; EPO; JPO; DERWENT; IBM_TDB	OR	ON	2017/09/23 13:48
S587	10	455/451,452.1,509,456.1,522,137,103,575.ccls. and (allocat\$3) with (resource frequency channel Bin) same2 (reserv\$4 sav\$4) adj6 (resource frequency channel Bin) and (multiple several set) near3 component adj2 carrier	US-PGPUB; USPAT; USOCR; FPRS; EPO; JPO; DERWENT; IBM_TDB	OR	ON	2017/09/23 13:48
S588	178	370/\$.ccls. and (allocat\$3) with (resource frequency channel Bin) same2 (reserv\$4 sav\$4) adj6 (resource frequency channel Bin) and (multiple several set) near3 component adj2 carrier	US-PGPUB; USPAT; USOCR; FPRS; EPO; JPO;	OR	ON	2017/09/23 13:48

			DERWENT; IBM_TDB			
S589	27	455/\$.ccls. and (allocat\$3) with (resource frequency channel Bin) same2 (reserv\$4 sav\$4) adj6 (resource frequency channel Bin) and (multiple several set) near3 component adj2 carrier	US-PGPUB; USPAT; USOCR; FPRS; EPO; JPO; DERWENT; IBM_TDB	OR	ON	2017/09/23 13:48
S590	178	370/\$.ccls. and (allocat\$3) with (resource frequency channel Bin) same2 (reserv\$4 sav\$4) adj6 (resource frequency channel Bin) and (multiple several set) near3 component adj2 carrier	US-PGPUB; USPAT; USOCR; FPRS; EPO; JPO; DERWENT; IBM_TDB	OR	ON	2017/09/23 13:48
S591	81	370/\$.ccls. and (allocat\$3) with (resource frequency channel Bin) same2 (reserv\$4 sav\$4) adj6 (resource frequency channel Bin) and (multiple several set) near3 component adj2 carrier and (primary adj2 cell)	US-PGPUB; USPAT; USOCR; FPRS; EPO; JPO; DERWENT; IBM_TDB	OR	ON	2017/09/23 13:48
S592	3	"12896993"	US-PGPUB; USPAT; USOCR; FPRS; EPO; JPO; DERWENT; IBM_TDB	OR	ON	2017/09/23 13:48
S593	3	"9497004"	US-PGPUB; USPAT; USOCR; FPRS; EPO; JPO; DERWENT; IBM_TDB	OR	ON	2017/09/23 13:48
S594	3	"12896993"	US-PGPUB; USPAT; USOCR; FPRS; EPO; JPO; DERWENT; IBM_TDB	OR	ON	2017/09/23 13:48
S595	224	370/329,341,348,395.4.ccls. and (carrier near3 aggregat\$3) and (component near3 carrier) same (up\$1link UL) with associat\$3 with down\$1link	US-PGPUB; USPAT; USOCR; DERWENT; IBM_TDB	OR	ON	2017/09/23 13:48
S596	265	370/329,341,348,395.4.ccls. and (carrier near3 aggregat\$3) and (component near3 carrier) same (up\$1link UL) with associat\$3 with (DL down\$1link)	US-PGPUB; USPAT; USOCR; DERWENT; IBM_TDB	OR	ON	2017/09/23 13:48
S597	122	370/329,341,348,395.4.ccls. and (carrier near3 aggregat\$3) same (component near3 carrier) same (up\$1link UL) with associat\$3 with (DL down\$1link)	US-PGPUB; USPAT; USOCR; DERWENT; IBM_TDB	OR	ON	2017/09/23 13:48
S598	75	((455/451,452.1,509,456.1,522,137,103,575.ccls.))	US-PGPUB;	OR	ON	2017/09/23

		(370/329,341,348,395.4.ccls.) and (carrier near3 aggregat\$3) same (component near3 carrier) same (up\$1link UL) with associat\$3 with (DL down\$1link) and (schedul\$3 near3 downlink)	USPAT; USOCR; DERWENT; IBM_TDB			13:48
S599	38	455/509,522,456.6,137,103,575.ccls. and (downlink near3 carrier) and (uplink near3 (primary first initial) near3 carrier) and ((second 2nd other next) with (channel resource)) and (carrier adj aggregation)	US-PGPUB; USPAT; USOCR; DERWENT; IBM_TDB	OR	ON	2017/09/23 13:48
S600	38	455/509,522,456.6,137,103,575.ccls. and (downlink near3 carrier) and (uplink near3 (primary first initial) near3 carrier) and ((second 2nd other next) with (channel resource)) and (carrier adj aggregation) and (carrier adj aggregation)	US-PGPUB; USPAT; USOCR; DERWENT; IBM_TDB	OR	ON	2017/09/23 13:48
S601	3	455/509,522,456.6,137,103,575.ccls. and (downlink near3 carrier) and (uplink near3 (primary first initial) near3 carrier) and ((second 2nd other next) with (channel resource)) same(carrier adj aggregation)	US-PGPUB; USPAT; USOCR; DERWENT; IBM_TDB	OR	ON	2017/09/23 13:48
S602	75	370/329,341,348,395.4.ccls. and (downlink near3 carrier) and (uplink near3 (primary first initial) near3 carrier) and ((second 2nd other next) with (channel resource)) same(carrier adj aggregation)	US-PGPUB; USPAT; USOCR; DERWENT; IBM_TDB	OR	ON	2017/09/23 13:48
S603	13	(H04W52/367, H04W52/12, H04W52/40).cpc. and (downlink near3 carrier) and (uplink near3 (primary first initial) near3 carrier) and ((second 2nd other next) with (channel resource)) same(carrier adj aggregation)	US-PGPUB; USPAT; USOCR; DERWENT; IBM_TDB	OR	ON	2017/09/23 13:48
S604	13	Ericsson.as. and ((david near2 astely) (robert near2 baldemair) (dirk near2 gerstenberger) (daniel near2 larsson) (lars near2 lindbom) (stefan near2 parkvall)).in. and (radio near3 resource) with (component near3 carrier) and ((second 2nd other next) with (channel resource)) same(carrier adj aggregation)	US-PGPUB; USPAT; USOCR; FPRS; EPO; JPO; DERWENT; IBM_TDB	OR	ON	2017/09/23 13:48
S605	184	(radio near3 resource) with (component near3 carrier) and ((second 2nd other next) with (channel resource)) same(carrier adj aggregation)	US-PGPUB; USPAT; USOCR; FPRS; EPO; JPO; DERWENT; IBM_TDB	OR	ON	2017/09/23 13:48
S606	4	(H04W52/367, H04W52/12, H04W52/40).cpc. and (radio near3 resource) with (component near3 carrier) and ((second 2nd other next) with (channel resource)) same(carrier adj aggregation)	US-PGPUB; USPAT; USOCR; DERWENT; IBM_TDB	OR	ON	2017/09/23 13:48
S623	13	Ericsson.as. and ((david near2 astely) (robert near2 baldemair) (dirk near2 gerstenberger) (daniel near2 larsson) (lars near2 lindbom) (stefan near2 parkvall)).in. and (radio near3 resource) with (component near3 carrier) and ((second 2nd other next) with (channel resource)) same(carrier adj aggregation)	US-PGPUB; USPAT; USOCR; FPRS; EPO; JPO	OR	ON	2017/10/13 18:00
S624	38	455/509,522,456.6,137,103,575.ccls. and (downlink near3 carrier) and (uplink near3 (primary first initial) near3 carrier) and ((second 2nd other next) with (channel resource)) and	US-PGPUB; USPAT; USOCR; DERWENT;	OR	ON	2017/10/13 18:15

		(carrier adj aggregation)	IBM_TDB			
S625	0	455/\$.ccls. and (first 1st) near3 (radio adj resource) and (second other another 2nd) near3 (radio adj resource) same (carrier adj aggregation) and (schemul\$3 near3 (down\$link DL reverse\$link))	US-PGPUB; USPAT; USOCR; DERWENT; IBM_TDB	OR	ON	2017/10/13 18:32
S626	639	((second 2nd other) with ((radio near3 (resource band frequency)) (resource adj block))) same component adj carrier	US-PGPUB; USPAT; USOCR; DERWENT; IBM_TDB	OR	ON	2017/10/13 18:38
S627	19	(DL down\$link) with (1st first first primary initia) near3 (set group) near6 (radio resource) and (DL down\$link) with (set group) near6 (radio resource) with (2nd second other another) near2 component	US-PGPUB; USPAT; USOCR; FPRS; EPO; JPO; DERWENT; IBM_TDB	OR	ON	2017/10/13 18:56
S628	8	("20110081856" "20090116427" "20100232373" "8331307").PN.	US-PGPUB; USPAT; USOCR; DERWENT; IBM_TDB	OR	ON	2017/10/13 19:43
S629	0	(H04B1/3833, H04M1/0247, H04M1/0237).cpc. and (schemul\$4 near3 down\$link) and (component near3 carrier) and single with carrier same (plurality multiple several) with (DL down\$link) with carrier same (frequency)	US-PGPUB; USPAT; USOCR; DERWENT; IBM_TDB	OR	ON	2017/10/13 22:36
S630	0	(H04B1/3833, H04M1/0247, H04M1/0237).cpc. and (schemul\$4 near3 down\$link) and (component near3 carrier) and single with carrier same (plurality multiple several) with (DL down\$link) with carrier same (frequency)	US-PGPUB; USPAT; USOCR; FPRS; EPO; JPO; DERWENT; IBM_TDB	OR	ON	2017/10/13 22:36
S631	51	(DL down\$link) with (1st first first primary initia) near3 (set group\$3) near6 (radio resource band frequency) and (DL down\$link) with (second 2nd) near3 (component near3 carrier)	US-PGPUB; USPAT	OR	ON	2017/10/13 22:37
S634	3	455/509,522,456.6,137,103,575.ccls. and (downlink near3 carrier) and (uplink near3 (primary first initial) near3 carrier) and ((second 2nd other next) with (channel resource)) same (carrier adj2 aggregat\$3)	US-PGPUB; USPAT; USOCR; DERWENT; IBM_TDB	OR	ON	2017/10/14 11:26
S635	14	(H04W88/08, H04W72/044, H04W72/042, H04W52/367, H04W52/12, H04W52/40, H04L29/08657, G01S5/0252, G01S5/02, H04B1/3833, H04M1/0247, H04M1/0237).cpc. and (schemul\$3 assign\$3) with (primary adj cell) same2 (multiple several set) near3 component adj2 carrier and (control\$4 adjust\$3) near6 (DL (down\$link)) and (second 2nd another other) near3 (radio frequency band resources)	US-PGPUB; USPAT; USOCR; FPRS; EPO; JPO; DERWENT; IBM_TDB	OR	ON	2017/10/14 12:46

EAST Search History (Interference)

Ref #	Hits	Search Query	DBs	Default Operator	Plurals	Time Stamp
S159	0	455/451,452.1,509,456.1,522,137,103,575.ccls. and (control\$4) with (resource frequency	US-PGPUB;	OR	ON	2014/10/31 15:24

		channel) same (rererv\$4 sav\$4) near3 (other 2nd second another) adj3 (resource frequency channel Bin)	USPAT				
S160	5	(DL down\$link) with (1st first first primary initia) near3 (set group) near6 (radio resource) and (DL down\$link) with (set group) near6 (radio resource) with (2nd second other another) near2 component	US-PGPUB; USPAT	OR	ON	2014/10/31 15:26	
S241	0	(H04B1/3833, H04M1/0247, H04M1/0237).cpc. and (schedul\$3 assign\$3) with (primary adj cell) same2 (multiple several set) near3 component adj2 carrier	US-PGPUB; USPAT	OR	ON	2016/03/16 11:50	
S242	7	(H04L5/0053, H04L5/001, H04L5/0094, H04B1/3833, H04M1/0247, H04M1/0237).cpc. and (schedul\$3 assign\$3) with (primary adj cell) same2 (multiple several set) near3 component adj2 carrier and (control\$4 adjust\$3) near6 (DL (down\$link)) and (second 2nd another other) near3 (radio frequency band resources)	US-PGPUB; USPAT	OR	ON	2016/03/16 12:38	
S243	7	(A01B12/006, H04L5/0053, H04L5/001, H04L5/0094, H04B1/3833, H04M1/0247, H04M1/0237).cpc. and (schedul\$3 assign\$3) with (primary adj cell) same2 (multiple several set) near3 component adj2 carrier and (control\$4 adjust\$3) near6 (DL (down\$link)) and (second 2nd another other) near3 (radio frequency band resources)	US-PGPUB; USPAT	OR	ON	2016/03/16 12:39	
S244	1	(H04W88/08, H04W72/044, H04W72/042, H04W52/367, H04W52/12, H04W52/40, H04L29/08657, G01S5/0252, G01S5/02, H04B1/3833, H04M1/0247, H04M1/0237).cpc. and (schedul\$3 assign\$3) with (primary adj cell) same2 (multiple several set) near3 component adj2 carrier and (control\$4 adjust\$3) near6 (DL (down\$link)) and (second 2nd another other) near3 (radio frequency band resources)	USPAT	OR	ON	2016/03/16 12:47	
S245	4	(H04W88/08, H04W72/044, H04W72/042, H04W52/367, H04W52/12, H04W52/40, H04L29/08657, G01S5/0252, G01S5/02, H04B1/3833, H04M1/0247, H04M1/0237).cpc. and (schedul\$3 assign\$3) with (primary adj cell) same2 (multiple several set) near3 component adj2 carrier and (control\$4 adjust\$3) near6 (DL (down\$link)) and (second 2nd another other) near3 (radio frequency band resources)	US-PGPUB; USPAT	OR	ON	2016/03/16 12:47	
S255	7	(H04W88/08, H04W72/044, H04W72/042, H04W52/367, H04W52/12, H04W52/40, H04L29/08657, G01S5/0252, G01S5/02, H04B1/3833, H04M1/0247, H04M1/0237).cpc. and (schedul\$3 assign\$3) with (primary adj cell) same2 (multiple several set) near3 component adj2 carrier and (control\$4 adjust\$3) near6 (DL (down\$link)) and (second 2nd another other) near3 (radio frequency band resources)	US-PGPUB; USPAT	OR	ON	2016/06/24 11:48	
S256	61	370/329,252,331.ccls. and (((first 1st) adj6 component adj3 carrier) same ((radio resource frame))) and ((2nd second) adj6 component	US-PGPUB; USPAT	OR	ON	2016/06/24 12:22	

		adj3 carrier) same ((2nd second other another) adj4 (radio resource frame)) and (set group) near6 (radio resource)				
S263	14	(H04W88/08, H04W72/044, H04W72/042, H04W52/367, H04W52/12, H04W52/40, H04L29/08657, G01S5/0252, G01S5/02, H04B1/3833, H04M1/0247, H04M1/0237).cpc. and (schedul\$3 assign\$3) with (primary adj cell) same2 (multiple several set) and (control\$4 adjust\$3) near6 (DL (down\$link)) and (second 2nd another other) near3 (radio frequency band resources)	USPAT	OR	ON	2016/06/24 22:15
S264	66	(H04W88/08, H04W72/044, H04W72/042, H04W52/367, H04W52/12, H04W52/40, H04L29/08657, G01S5/0252, G01S5/02, H04B1/3833, H04M1/0247, H04M1/0237).cpc. and (schedul\$3 assign\$3) with (primary adj cell) same2 (multiple several set) and (control\$4 adjust\$3) near6 (DL (down\$link)) and (second 2nd another other) near3 (radio frequency band resources)	US-PGPUB; USPAT	OR	ON	2016/06/24 22:15
S265	13	(H04W88/08, H04W72/044, H04W72/042, H04W52/367, H04W52/12, H04W52/40, H04L29/08657, G01S5/0252, G01S5/02, H04B1/3833, H04M1/0247, H04M1/0237).cpc. and (schedul\$3 assign\$3) with (primary adj cell) same2 (multiple several set) and (control\$4 adjust\$3) near6 (DL (down\$link)) and (second 2nd another other) near3 (radio frequency band resources) same component adj carrier	US-PGPUB; USPAT	OR	ON	2016/06/24 22:17
S277	9	(H04W88/08, H04W72/044, H04W72/042).cpc. and schedul\$3 near3 (transmit\$4 transmi\$5) with (CC (component adj2 cacarrier)) and (CI (control adj2 (info information))) with (CC (component adj2 cacarrier)) and schedul\$3 with (non\$1primary second 2nd secondary) adj2 cell	US-PGPUB; USPAT	OR	ON	2017/03/16 17:37
S293	0	455/451,452.1,509,456.1,522,137,103,575.ccls. and (allocat\$3) with (resource frequency channel Bin) same (reserv\$4 sav\$4) adj6 (resource frequency channel Bin) and (primary adj cell) same (multiple several set) near3 component adj2 carrier	US-PGPUB; USPAT	OR	ON	2017/03/17 11:20
S313	3	455/509,522,456.6,137,103,575.ccls. and (downlink near3 carrier) and (uplink near3 (primary first initial) near3 carrier) and ((second 2nd other next) with (channel resource)) same(carrier adj aggregation)	US-PGPUB; USPAT	OR	ON	2017/06/26 18:44
S314	12	(H04W52/367, H04W52/12, H04W52/40).cpc. and (downlink near3 carrier) and (uplink near3 (primary first initial) near3 carrier) and ((second 2nd other next) with (channel resource)) same(carrier adj aggregation)	US-PGPUB; USPAT	OR	ON	2017/06/26 18:55
S607	1	455/451,452.1,509,456.1,522,137,103,575.ccls. and (control\$4) with (resource frequency channel) same (rererv\$4 sav\$4) near3 (other 2nd second another) adj3 (resource frequency channel Bin)	US-PGPUB; USPAT	OR	ON	2017/09/23 13:48
S608	17	(DL down\$link) with (1st first first primary initia) near3 (set group) near6 (radio resource)	US-PGPUB;	OR	ON	2017/09/23 13:48

		and (DL down\$link) with (set group) near6 (radio resource) with (2nd second other another) near2 component	USPAT				
S609	0	(H04B1/3833, H04M1/0247, H04M1/0237).cpc. and (schedul\$3 assign\$3) with (primary adj cell) same2 (multiple several set) near3 component adj2 carrier	US-PGPUB; USPAT	OR	ON	2017/09/23 13:48	
S610	18	(H04L5/0053, H04L5/001, H04L5/0094, H04B1/3833, H04M1/0247, H04M1/0237).cpc. and (schedul\$3 assign\$3) with (primary adj cell) same2 (multiple several set) near3 component adj2 carrier and (control\$4 adjust\$3) near6 (DL (down\$link)) and (second 2nd another other) near3 (radio frequency band resources)	US-PGPUB; USPAT	OR	ON	2017/09/23 13:48	
S611	18	(A01B12/006, H04L5/0053, H04L5/001, H04L5/0094, H04B1/3833, H04M1/0247, H04M1/0237).cpc. and (schedul\$3 assign\$3) with (primary adj cell) same2 (multiple several set) near3 component adj2 carrier and (control\$4 adjust\$3) near6 (DL (down\$link)) and (second 2nd another other) near3 (radio frequency band resources)	US-PGPUB; USPAT	OR	ON	2017/09/23 13:48	
S612	2	(H04W88/08, H04W72/044, H04W72/042, H04W52/367, H04W52/12, H04W52/40, H04L29/08657, G01S5/0252, G01S5/02, H04B1/3833, H04M1/0247, H04M1/0237).cpc. and (schedul\$3 assign\$3) with (primary adj cell) same2 (multiple several set) near3 component adj2 carrier and (control\$4 adjust\$3) near6 (DL (down\$link)) and (second 2nd another other) near3 (radio frequency band resources)	USPAT	OR	ON	2017/09/23 13:48	
S613	14	(H04W88/08, H04W72/044, H04W72/042, H04W52/367, H04W52/12, H04W52/40, H04L29/08657, G01S5/0252, G01S5/02, H04B1/3833, H04M1/0247, H04M1/0237).cpc. and (schedul\$3 assign\$3) with (primary adj cell) same2 (multiple several set) near3 component adj2 carrier and (control\$4 adjust\$3) near6 (DL (down\$link)) and (second 2nd another other) near3 (radio frequency band resources)	US-PGPUB; USPAT	OR	ON	2017/09/23 13:48	
S614	14	(H04W88/08, H04W72/044, H04W72/042, H04W52/367, H04W52/12, H04W52/40, H04L29/08657, G01S5/0252, G01S5/02, H04B1/3833, H04M1/0247, H04M1/0237).cpc. and (schedul\$3 assign\$3) with (primary adj cell) same2 (multiple several set) near3 component adj2 carrier and (control\$4 adjust\$3) near6 (DL (down\$link)) and (second 2nd another other) near3 (radio frequency band resources)	US-PGPUB; USPAT	OR	ON	2017/09/23 13:48	
S615	62	370/329,252,331.cds. and (((first 1st) adj6 component adj3 carrier) same ((radio resource frame))) and ((2nd second) adj6 component adj3 carrier) same ((2nd second other another) adj4 (radio resource frame)) and (set group) near6 (radio resource)	US-PGPUB; USPAT	OR	ON	2017/09/23 13:48	
S616	43	(H04W88/08, H04W72/044, H04W72/042, H04W52/367, H04W52/12, H04W52/40,	USPAT	OR	ON	2017/09/23 13:48	

		H04L29/08657, G01S5/0252, G01S5/02, H04B1/3833, H04M1/0247, H04M1/0237).cpc. and (schedul\$3 assign\$3) with (primary adj cell) same2 (multiple several set) and (control\$4 adjust\$3) near6 (DL (down\$link)) and (second 2nd another other) near3 (radio frequency band resources)				
S617	146	(H04W88/08, H04W72/044, H04W72/042, H04W52/367, H04W52/12, H04W52/40, H04L29/08657, G01S5/0252, G01S5/02, H04B1/3833, H04M1/0247, H04M1/0237).cpc. and (schedul\$3 assign\$3) with (primary adj cell) same2 (multiple several set) and (control\$4 adjust\$3) near6 (DL (down\$link)) and (second 2nd another other) near3 (radio frequency band resources)	US-PGPUB; USPAT	OR	ON	2017/09/23 13:48
S618	20	(H04W88/08, H04W72/044, H04W72/042, H04W52/367, H04W52/12, H04W52/40, H04L29/08657, G01S5/0252, G01S5/02, H04B1/3833, H04M1/0247, H04M1/0237).cpc. and (schedul\$3 assign\$3) with (primary adj cell) same2 (multiple several set) and (control\$4 adjust\$3) near6 (DL (down\$link)) and (second 2nd another other) near3 (radio frequency band resources) same component adj carrier	US-PGPUB; USPAT	OR	ON	2017/09/23 13:48
S619	12	(H04W88/08, H04W72/044, H04W72/042).cpc. and schedul\$3 near3 (transmit\$4 transmi\$5) with (CC (component adj2 cacarrier)) and (CI (control adj2 (info information))) with (CC (component adj2 cacarrier)) and schedul\$3 with (non\$1primary second 2nd secondary) adj2 cell	US-PGPUB; USPAT	OR	ON	2017/09/23 13:48
S620	0	455/451,452.1,509,456.1,522,137,103,575.ccls. and (allocat\$3) with (resource frequency channel Bin) same (reserv\$4 sav\$4) adj6 (resource frequency channel Bin) and (primary adj cell) same (multiple several set) near3 component adj2 carrier	US-PGPUB; USPAT	OR	ON	2017/09/23 13:48
S621	3	455/509,522,456.6,137,103,575.ccls. and (downlink near3 carrier) and (uplink near3 (primary first initial) near3 carrier) and ((second 2nd other next) with (channel resource)) same(carrier adj aggregation)	US-PGPUB; USPAT	OR	ON	2017/09/23 13:48
S622	13	(H04W52/367, H04W52/12, H04W52/40).cpc. and (downlink near3 carrier) and (uplink near3 (primary first initial) near3 carrier) and ((second 2nd other next) with (channel resource)) same(carrier adj aggregation)	US-PGPUB; USPAT	OR	ON	2017/09/23 13:48
S632	148	(H04W88/08, H04W72/044, H04W72/042, H04W52/367, H04W52/12, H04W52/40, H04L29/08657, G01S5/0252, G01S5/02, H04B1/3833, H04M1/0247, H04M1/0237).cpc. and (schedul\$3 assign\$3) with (primary adj cell) same2 (multiple several set) and (control\$4 adjust\$3) near6 (DL (down\$link)) and (second 2nd another other) near3 (radio frequency band resources)	US-PGPUB; USPAT	OR	ON	2017/10/13 17:59
S633	0	(H04B1/3833, H04M1/0247, H04M1/0237).cpc. and (schedul\$4 near3 down\$1link) and (component near3 carrier) and single with	US-PGPUB; USPAT	OR	ON	2017/10/13 22:36

EAST Search History

		carrier same (plurality multiple several) with (DL down\$1link) with carrier same (frequency)				
S636	3	455/509,522,456.6,137,103,575.ccls. and (downlink near3 carrier) and (uplink near3 (primary first initial) near3 carrier) and ((second 2nd other next) with (channel resource)) same (carrier adj2 aggregat\$3)	US-PGPUB; USPAT	OR	ON	2017/10/14 11:33

10/ 14/ 2017 5:40:21 PM

C:\ Users\ mtalukder\ Documents\ EAST\ Workspaces\ 15350360.wsp

IN THE UNITED STATES PATENT AND TRADEMARK OFFICE

In re Application of Astely <i>et al.</i>)	
)	
Serial No.: 15/350,360)	
)	Examiner: Md K. Talukder
Filed: November 14, 2016)	
)	Group Art Unit: 2648
For: PUCCH Resource Allocation for Carrier)	
Aggregation in LTE-Advanced)	Confirmation No.: 1120
)	
Docket No: 4015-9600 / P30138-US3)	

Mail Stop Amendment
Commissioner for Patents
P.O. Box 1450
Alexandria, VA 22313-1450

10 November 2017

AMENDMENT PURSUANT TO 37 CFR § 1.312

This paper is being filed in response to the Notice of Allowance mailed 24 October 2017. Applicant timely submits this amendment pursuant to 37 CFR § 1.312. Entry of the following amendments to the Specification and consideration of the remarks below is respectfully requested. The Office is hereby authorized to charge any fees required for entry of this paper to Deposit Account 18-1167.

Electronic Acknowledgement Receipt

EFS ID:	30913817
Application Number:	15350360
International Application Number:	
Confirmation Number:	1120
Title of Invention:	PUCCH RESOURCE ALLOCATION FOR CARRIER AGGREGATION IN LTE-ADVANCED
First Named Inventor/Applicant Name:	David Astely
Customer Number:	24112
Filer:	David E. Bennett/Karen Nelson
Filer Authorized By:	David E. Bennett
Attorney Docket Number:	4015-9600 / P30138-US3
Receipt Date:	10-NOV-2017
Filing Date:	14-NOV-2016
Time Stamp:	11:43:43
Application Type:	Utility under 35 USC 111(a)

Payment information:

Submitted with Payment	no
------------------------	----

File Listing:

Document Number	Document Description	File Name	File Size(Bytes)/ Message Digest	Multi Part /.zip	Pages (if appl.)
1		4015-9600_312_Amendment.pdf	58008 7ca626df38709cc5faeeacbc81a3a66401ceb303	yes	15

Multipart Description/PDF files in .zip description		
Document Description	Start	End
Applicant Arguments/Remarks Made in an Amendment	15	15
Claims	4	14
Specification	2	3
Amendment after Notice of Allowance (Rule 312)	1	1

Warnings:

Information:

Total Files Size (in bytes):	58008
-------------------------------------	-------

This Acknowledgement Receipt evidences receipt on the noted date by the USPTO of the indicated documents, characterized by the applicant, and including page counts, where applicable. It serves as evidence of receipt similar to a Post Card, as described in MPEP 503.

New Applications Under 35 U.S.C. 111

If a new application is being filed and the application includes the necessary components for a filing date (see 37 CFR 1.53(b)-(d) and MPEP 506), a Filing Receipt (37 CFR 1.54) will be issued in due course and the date shown on this Acknowledgement Receipt will establish the filing date of the application.

National Stage of an International Application under 35 U.S.C. 371

If a timely submission to enter the national stage of an international application is compliant with the conditions of 35 U.S.C. 371 and other applicable requirements a Form PCT/DO/EO/903 indicating acceptance of the application as a national stage submission under 35 U.S.C. 371 will be issued in addition to the Filing Receipt, in due course.

New International Application Filed with the USPTO as a Receiving Office

If a new international application is being filed and the international application includes the necessary components for an international filing date (see PCT Article 11 and MPEP 1810), a Notification of the International Application Number and of the International Filing Date (Form PCT/RO/105) will be issued in due course, subject to prescriptions concerning national security, and the date shown on this Acknowledgement Receipt will establish the international filing date of the application.

REMARKS

No claims are amended. A full claim set is provided solely for convenience.

Paragraphs 45, 65, 66 and 67 in the Specification have been amended to correct minor typographical errors. No new matter had been added. Entry of these amendments is requested under 37 C.F.R. §1.312. Applicant respectfully submits that the present application is now in condition to proceed to issue. It is unclear whether the amendment filed 17 October 2017 has been entered since it is not mentioned in the Notice of Allowance. If it has been entered, please ignore this §1.312 amendment.

Respectfully submitted,
COATS & BENNETT, P.L.L.C.

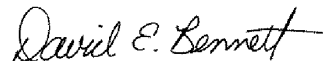

Dated: 10 November 2017

David E. Bennett
Registration No.: 32,194
Telephone: (919) 854-1844

CLAIMS LISTING

1. (Previously Presented) A method implemented by a base station of receiving control information from a user terminal, the method comprising:

scheduling downlink transmissions to a first user terminal only on a single downlink component carrier associated with a primary cell and scheduling downlink transmissions to a second user terminal on multiple downlink component carriers or on a downlink component carrier associated with a non-primary cell;

receiving, on a first set of radio resources, control information associated with the downlink transmissions to the first user terminal, wherein the first set of radio resources is reserved for a user terminal scheduled to receive downlink transmissions only on a single downlink component carrier associated with the primary cell; and

receiving, on a second set of radio resources, control information associated with the downlink transmissions to the second user terminal, wherein the second set of radio resources is reserved for a user terminal scheduled to receive downlink transmissions on multiple downlink component carriers or on a downlink component carrier associated with a non-primary cell, the first and second sets of radio resources being on a same uplink component carrier associated with the primary cell.

2. (Previously Presented) The method of claim 1, wherein the first and second sets of radio resources are different.

3. (Previously Presented) The method of claim 2, wherein the second set of radio resources are additional resources as compared to the first set of radio resources.

4. (Previously Presented) The method of claim 1, further comprising transmitting control information to the first user terminal to explicitly indicate the first set of radio resources on the uplink component carrier associated with the primary cell.

5. (Previously Presented) The method of claim 1, further comprising providing the first user terminal with an implicit indication to dynamically assign radio resources in said first set of radio resources.

6. (Previously Presented) The method of claim 5, wherein the implicit indication is a control channel element (CCE) of a Physical Downlink Control Channel (PDCCH) used for scheduling the first user terminal.

7. (Previously Presented) The method of claim 1, further comprising transmitting control information to the second user terminal on a downlink component carrier to implicitly or explicitly indicate the second set of radio resources on the uplink component carrier associated with the primary cell.

8. (Previously Presented) The method of claim 7, wherein at least one of the first and second sets of radio resources is indicated explicitly by an uplink control channel resource index.

9. (Previously Presented) The method of claim 8, wherein an explicit indication related to the second set of radio resources is transmitted as radio resource control signaling.
10. (Previously Presented) The method of claim 1, further comprising transmitting, on the single downlink component carrier, an assignment of radio resources in the second set of radio resources when the second user terminal is scheduled to receive the downlink transmissions on the multiple downlink component carriers or on the downlink component carrier associated with the non-primary cell.
11. (Previously Presented) The method of claim 10, wherein the assignment of radio resources in said second set of radio resources is an acknowledgement resource indication to dynamically assign radio resources to the second user terminal when the second user terminal is scheduled to receive downlink transmissions on the multiple downlink component carriers or on the downlink component carrier associated with the non-primary cell.
12. (Previously Presented) The method of claim 11, wherein the acknowledgement resource indication selects radio resources in the second set of radio resources, which is a semi-statically configured set of uplink resources.
13. (Previously Presented) The method of claim 1, further comprising:
receiving control signaling on the second set of radio resources if radio resources on a single downlink component carrier associated with a non-primary cell are assigned for the downlink transmissions.

14. (Previously Presented) The method of claim 1, further comprising:
if the first user terminal is scheduled to receive downlink transmissions on a second single downlink component carrier associated with a non-primary cell, receiving control information associated with the downlink transmissions to the first user terminal on the second set of radio resources on the uplink component carrier associated with the primary cell, wherein the second set of radio resources is reserved for a user terminal scheduled to receive downlink transmissions on the second single downlink component carrier.

15. (Previously Presented) The method of claim 1, wherein the first user equipment is the same as the second user equipment.

16. (Previously Presented) The method of claim 1, wherein the first user equipment is different from the second user equipment.

17. (Previously Presented) A base station comprising:
a transmitter to transmit user data on one or more downlink component carriers to a first user terminal and a second user terminal; and
a controller to schedule downlink transmissions to the first user terminal and the second user terminal, the controller configured to:
schedule downlink transmissions to the first user terminal only on a single downlink component carrier associated with a primary cell and schedule downlink transmissions to the second user terminal on multiple downlink

component carriers or on a downlink component carrier associated with a non-primary cell;

receive, on a first set of radio resources, control information associated with the downlink transmissions to the first user terminal, wherein the first set of radio resources is reserved for a user terminal scheduled to receive downlink transmissions only on a single downlink component carrier associated with the primary cell; and

receive, on a second set of radio resources, control information associated with the downlink transmissions to the second user terminal, wherein the second set of radio resources is reserved for a user terminal scheduled to receive downlink transmissions on multiple downlink component carriers or on a downlink component carrier associated with a non-primary cell, the first and second sets of radio resources being on a same uplink component carrier associated with the primary cell.

18. (Previously Presented) A method implemented by a user terminal of transmitting control information in a mobile communication network, the method comprising:

receiving an assignment of radio resources for downlink transmissions from a base station;

transmitting, on a first set of radio resources, control information associated with the downlink transmissions responsive to being assigned radio resources only on a single downlink component carrier associated with the primary cell for the downlink transmission, wherein the first set of radio resources is reserved for a user terminal scheduled to receive downlink transmissions on a single downlink component carrier associated with the primary cell; and

transmitting, on a second set of radio resources, control information associated with the downlink transmissions responsive to being assigned radio resources on multiple downlink component carriers or on a downlink component carrier associated with a non-primary cell for the downlink transmission, wherein the second set of radio resources is reserved for a user terminal scheduled to receive downlink transmissions on multiple downlink component carriers or on a downlink component carrier associated with a non-primary cell, the first and second sets of radio resources being on a same uplink component carrier associated with the primary cell.

19. (Previously Presented) The method of claim 18, wherein the first and second sets of radio resources are different.

20. (Previously Presented) The method of claim 19, wherein the second set of radio resources are additional resources as compared to the first set of radio resources.
21. (Previously Presented) The method of claim 18, further comprising receiving control information from the base station explicitly indicating the first set of radio resources on the uplink component carrier associated with the primary cell.
22. (Previously Presented) The method of claim 21, wherein said receiving the control information comprises receiving an uplink control channel resource index explicitly indicating said first set of radio resources.
23. (Previously Presented) The method of claim 22, wherein an explicit indication relating to the second set of radio resources is received as radio resource control signaling.
24. (Previously Presented) The method of claim 18, further comprising receiving an implicit indication to dynamically assign radio resources in said first set of radio resources.
25. (Previously Presented) The method of claim 24, wherein the implicit indication is a control channel element (CCE) of a Physical Downlink Control Channel (PDCCH) on which the assignment of radio resources for downlink transmissions is received.

26. (Previously Presented) The method of claim 18, further comprising receiving, on the single downlink component carrier, an assignment of radio resources in the second set of radio resources when the user terminal is scheduled to receive the downlink transmissions on the multiple downlink component carriers or on the downlink component carrier associated with the non-primary cell.

27. (Previously Presented) The method of claim 26, wherein the assignment of radio resources in said second set of radio resources is an acknowledgement resource indication to dynamically assign radio resources in when the user terminal is scheduled to receive downlink transmissions on the multiple downlink component carriers or on the downlink component carrier associated with the non-primary cell.

28. (Previously Presented) The method of claim 27, further comprising selecting radio resources in the second set of radio resources, which is a semi-statically configured set of uplink resources, responsive to the acknowledgement resource indication.

29. (Previously Presented) The method of claim 18, further comprising:
transmitting control signaling on the second set of radio resources if radio resources on
a single downlink component carrier associated with a non-primary cell are assigned
for the downlink transmissions.

30. (Previously Presented) A user terminal for mobile communications, the user terminal comprising:

a receiver to receive downlink transmissions from a base station;

a transmitter to transmit control information associated with the downlink transmission to a base station; and

a controller to select radio resources for transmission of control information associated with the downlink transmissions, the controller configured to:

select a first set of radio resources responsive to being assigned radio resources

only on a single downlink component carrier associated with the primary cell for the downlink transmission, wherein the first set of radio resources is

reserved for a user terminal scheduled to receive downlink transmissions on a single downlink component carrier associated with the primary cell; and

select a second set of radio resources responsive to being assigned radio

resources on multiple downlink component carriers or on a downlink component carrier associated with a non-primary cell for the downlink

transmissions, wherein the second set of radio resources is reserved for a user terminal scheduled to receive downlink transmissions on multiple

downlink component carriers or on a downlink component carrier associated with a non-primary cell, the first and second sets of radio resources being on

a same uplink component carrier associated with the primary cell.

31. (Previously Presented) The user terminal of claim 30, wherein the controller is further configured to select, as the second set of radio resources, a set of radio resources different than the first set of radio resources.

32. (Previously Presented) The user terminal of claim 31, wherein the controller is further configured to select, as the second set of radio resources, additional resources as compared to the first set of radio resources.

33. (Previously Presented) The user terminal of claim 30, wherein the controller is further configured to receive control information from the base station explicitly indicating the first set of radio resources on the uplink component carrier associated with the primary cell.

34. (Previously Presented) The user terminal of claim 33, wherein the controller is further configured to receive, as the control information, an uplink control channel resource index explicitly indicating said first set of radio resources.

35. (Previously Presented) The user terminal of claim 34, wherein the controller is further configured to receive radio resource control signaling including an explicit indication relating to the second set of radio resources.

36. (Previously Presented) The user terminal of claim 30, wherein the controller is further configured to receive an implicit indication to dynamically assign radio resources in said first set of radio resources.

37. (Previously Presented) The user terminal of claim 36, wherein the implicit indication comprises a control channel element (CCE) of a Physical Downlink Control Channel (PDCCH) on which the assignment of radio resources for downlink transmissions is received.

38. (Previously Presented) The user terminal of claim 30, wherein the controller is further configured to receive, on the single downlink component carrier, an assignment of radio resources in the second set of radio resources when the user terminal is scheduled to receive the downlink transmissions on the multiple downlink component carriers or on the downlink component carrier associated with the non-primary cell.

39. (Previously Presented) The user terminal of claim 26, wherein the assignment of radio resources in said second set of radio resources comprises an acknowledgement resource indication to dynamically assign radio resources in when the user terminal is scheduled to receive downlink transmissions on the multiple downlink component carriers or on the downlink component carrier associated with the non-primary cell.

40. (Previously Presented) The user terminal of claim 27, wherein the controller is further configured to select radio resources in the second set of radio resources, which is a semi-statically configured set of uplink resources, responsive to the acknowledgement resource indication.

41. (Previously Presented) The user terminal of claim 18, wherein the controller is further configured to transmit control signaling on the second set of radio resources if radio resources on a single downlink component carrier associated with a non-primary cell are assigned for the downlink transmissions.

AMENDMENTS TO THE SPECIFICATION

Please replace paragraph [0045] with the following amended paragraph:

[0045] Both PUCCH format 1 and format 2 signaling messages are transmitted on a resource-block pair with one resource block in each slot. The resource-block pair is determined from the PUCCH resource index. Thus, the resource-block number to use in the first and second slot of a subframe can be expressed as:

Please replace paragraph [0065] with the following amended paragraph:

[0065] Fig. 9 illustrates an exemplary method 50 implemented by a base station 20 in a communication network 10 of receiving uplink control information from a user terminal 100 depending ~~on~~ on the assignment of downlink component carriers. The base station 20 schedules the user terminal 100 to receive downlink transmissions on one or more downlink component carriers (block 52). The user terminal 100 may be scheduled to receive downlink transmissions on a single downlink component carrier associated with a primary uplink component carrier. In this case, the base station 20 receives control information associated with the downlink transmissions to the user terminal 100 on a first set of radio resources on the uplink primary component carrier (block 54). Alternatively, the user terminal 100 may be scheduled to receive downlink transmissions on multiple downlink component carriers, or on a single downlink component carrier other than the downlink component carrier associated with the uplink primary component carrier. In this alternative case, the base station 20 receives uplink control information associated with the downlink transmissions from the user terminal 100 on a second set of radio resources on the uplink component carrier (block 56).

Please replace paragraph [0066] with the following amended paragraph:

[0066] Fig. 10 illustrates an exemplary method 60 implemented by a user terminal of transmission of uplink control signaling to a base station 20. The user terminal 100 receives a radio resource assignment for a downlink transmission from the base station 20 (block 62). If the user terminal 100 detects assignments of radio resources for a single downlink component carrier, the user terminal 100 transmits, on a first set of radio resources on an uplink primary component carrier, uplink control information associated with the downlink transmissions (block 64). On the other ~~hands~~ hand, if the user terminal 100 receives assignments for multiple downlink component carriers, the user terminal 100 transmits, on a second set of radio resources on the uplink primary component carrier, uplink control information associated with downlink transmissions (block 66).

Please replace paragraph [0067] with the following amended paragraph:

[0067] Fig. 11 illustrates another exemplary method 70 implemented by a user terminal 100 of transmission of uplink control signaling to a base station 20. The user terminal 100 receives a radio resource assignment for a downlink transmission from the base station 20 (block 72). If the user terminal 100 detects assignments of radio resources for a first downlink component carrier, the user terminal 100 transmits, on a first set of radio resources on a uplink primary component carrier, uplink control information associated with the downlink transmissions (block 74). On the other ~~hands~~ hand, if the user terminal 100 receives assignments for a second downlink component carrier, the user terminal 100 transmits, on a second set of radio resources on the primary uplink component carrier, uplink control information associated with downlink transmissions (block 76).

PART B - FEE(S) TRANSMITTAL

Complete and send this form, together with applicable fee(s), to: **Mail** Mail Stop ISSUE FEE
Commissioner for Patents
P.O. Box 1450
Alexandria, Virginia 22313-1450
 or **Fax** (571)-273-2885

INSTRUCTIONS: This form should be used for transmitting the ISSUE FEE and PUBLICATION FEE (if required). Blocks 1 through 5 should be completed where appropriate. All further correspondence including the Patent, advance orders and notification of maintenance fees will be mailed to the current correspondence address as indicated unless corrected below or directed otherwise in Block 1, by (a) specifying a new correspondence address; and/or (b) indicating a separate "FEE ADDRESS" for maintenance fee notifications.

CURRENT CORRESPONDENCE ADDRESS (Note: Use Block 1 for any change of address)

24112 7590 10/24/2017
COATS & BENNETT, PLLC
 1400 Crescent Green, Suite 300
 Cary, NC 27518

Note: A certificate of mailing can only be used for domestic mailings of the Fee(s) Transmittal. This certificate cannot be used for any other accompanying papers. Each additional paper, such as an assignment or formal drawing, must have its own certificate of mailing or transmission.

Certificate of Mailing or Transmission

I hereby certify that this Fee(s) Transmittal is being deposited with the United States Postal Service with sufficient postage for first class mail in an envelope addressed to the Mail Stop ISSUE FEE address above, or being facsimile transmitted to the USPTO (571) 273-2885, on the date indicated below.

(Depositor's name)
(Signature)
(Date)

APPLICATION NO.	FILING DATE	FIRST NAMED INVENTOR	ATTORNEY DOCKET NO.	CONFIRMATION NO.
15/350,360	11/14/2016	David Astely	4015-9600 / P30138-US3	1120

TITLE OF INVENTION: PUCCH RESOURCE ALLOCATION FOR CARRIER AGGREGATION IN LTE-ADVANCED

APPLN. TYPE	ENTITY STATUS	ISSUE FEE DUE	PUBLICATION FEE DUE	PREV. PAID ISSUE FEE	TOTAL FEE(S) DUE	DATE DUE
nonprovisional	UNDISCOUNTED	\$960	\$0	\$0	\$960	01/24/2018

EXAMINER	ART UNIT	CLASS-SUBCLASS
TALUKDER, MD K	2648	455-509000

1. Change of correspondence address or indication of "Fee Address" (37 CFR 1.363).

- Change of correspondence address (or Change of Correspondence Address form PTO/SB/122) attached.
- "Fee Address" indication (or "Fee Address" Indication form PTO/SB/47; Rev 03-02 or more recent) attached. **Use of a Customer Number is required.**

2. For printing on the patent front page, list

- (1) The names of up to 3 registered patent attorneys or agents OR, alternatively,
- (2) The name of a single firm (having as a member a registered attorney or agent) and the names of up to 2 registered patent attorneys or agents. If no name is listed, no name will be printed.

1 COATS & BENNETT, PLLC
 2 _____
 3 _____

3. ASSIGNEE NAME AND RESIDENCE DATA TO BE PRINTED ON THE PATENT (print or type)

PLEASE NOTE: Unless an assignee is identified below, no assignee data will appear on the patent. If an assignee is identified below, the document has been filed for recordation as set forth in 37 CFR 3.11. Completion of this form is NOT a substitute for filing an assignment.

(A) NAME OF ASSIGNEE

(B) RESIDENCE: (CITY and STATE OR COUNTRY)

TELEFONAKTIEBOLAGET LM ERICSSON (PUBL)

STOCKHOLM, SWEDEN

Please check the appropriate assignee category or categories (will not be printed on the patent): Individual Corporation or other private group entity Government

4a. The following fee(s) are submitted:

- Issue Fee
- Publication Fee (No small entity discount permitted)
- Advance Order - # of Copies _____

4b. Payment of Fee(s): (Please first reapply any previously paid issue fee shown above)

- A check is enclosed.
- Payment by credit card. Form PTO-2038 is attached.
- The director is hereby authorized to charge the required fee(s), any deficiency, or credits any overpayment, to Deposit Account Number 181167 (enclose an extra copy of this form).

5. Change in Entity Status (from status indicated above)

- Applicant certifying micro entity status. See 37 CFR 1.29
- Applicant asserting small entity status. See 37 CFR 1.27
- Applicant changing to regular undiscounted fee status.

NOTE: Absent a valid certification of Micro Entity Status (see forms PTO/SB/15A and 15B), issue fee payment in the micro entity amount will not be accepted at the risk of application abandonment.

NOTE: If the application was previously under micro entity status, checking this box will be taken to be a notification of loss of entitlement to micro entity status.

NOTE: Checking this box will be taken to be a notification of loss of entitlement to small or micro entity status, as applicable.

NOTE: This form must be signed in accordance with 37 CFR 1.31 and 1.33. See 37 CFR 1.4 for signature requirements and certifications.

Authorized Signature /David E. Bennett, Reg. No. 32,194/

Date 10 November 2017

Typed or printed name David E. Bennett

Registration No. 32194

Electronic Patent Application Fee Transmittal

Application Number:	15350360			
Filing Date:	14-Nov-2016			
Title of Invention:	PUCCH RESOURCE ALLOCATION FOR CARRIER AGGREGATION IN LTE-ADVANCED			
First Named Inventor/Applicant Name:	David Astely			
Filer:	David E. Bennett/Karen Nelson			
Attorney Docket Number:	4015-9600 / P30138-US3			
Filed as Large Entity				
Filing Fees for Utility under 35 USC 111(a)				
Description	Fee Code	Quantity	Amount	Sub-Total in USD(\$)
Basic Filing:				
Pages:				
Claims:				
Miscellaneous-Filing:				
Petition:				
Patent-Appeals-and-Interference:				
Post-Allowance-and-Post-Issuance:				

Description	Fee Code	Quantity	Amount	Sub-Total in USD(\$)
UTILITY APPL ISSUE FEE	1501	1	960	960
PUBL. FEE- EARLY, VOLUNTARY, OR NORMAL	1504	1	0	0
Extension-of-Time:				
Miscellaneous:				
Total in USD (\$)				960

Electronic Acknowledgement Receipt

EFS ID:	30913931
Application Number:	15350360
International Application Number:	
Confirmation Number:	1120
Title of Invention:	PUCCH RESOURCE ALLOCATION FOR CARRIER AGGREGATION IN LTE-ADVANCED
First Named Inventor/Applicant Name:	David Astely
Customer Number:	24112
Filer:	David E. Bennett/Karen Nelson
Filer Authorized By:	David E. Bennett
Attorney Docket Number:	4015-9600 / P30138-US3
Receipt Date:	10-NOV-2017
Filing Date:	14-NOV-2016
Time Stamp:	11:49:26
Application Type:	Utility under 35 USC 111(a)

Payment information:

Submitted with Payment	yes
Payment Type	EFT
Payment was successfully received in RAM	\$960
RAM confirmation Number	111317INTEFSW11495000
Deposit Account	
Authorized User	

The Director of the USPTO is hereby authorized to charge indicated fees and credit any overpayment as follows:

File Listing:					
Document Number	Document Description	File Name	File Size(Bytes)/ Message Digest	Multi Part /.zip	Pages (if appl.)
1	Issue Fee Payment (PTO-85B)	4015-9600_Issue_Fee_Transmittal.pdf	188989 268a1b9c8f0e5079e77053368d9d9ba2db7b6f98	no	1
Warnings:					
Information:					
2	Fee Worksheet (SB06)	fee-info.pdf	32053 770ccbba4d9b3be7981a4c82358418235b0c3cc1	no	2
Warnings:					
Information:					
Total Files Size (in bytes):			221042		
<p>This Acknowledgement Receipt evidences receipt on the noted date by the USPTO of the indicated documents, characterized by the applicant, and including page counts, where applicable. It serves as evidence of receipt similar to a Post Card, as described in MPEP 503.</p> <p><u>New Applications Under 35 U.S.C. 111</u> If a new application is being filed and the application includes the necessary components for a filing date (see 37 CFR 1.53(b)-(d) and MPEP 506), a Filing Receipt (37 CFR 1.54) will be issued in due course and the date shown on this Acknowledgement Receipt will establish the filing date of the application.</p> <p><u>National Stage of an International Application under 35 U.S.C. 371</u> If a timely submission to enter the national stage of an international application is compliant with the conditions of 35 U.S.C. 371 and other applicable requirements a Form PCT/DO/EO/903 indicating acceptance of the application as a national stage submission under 35 U.S.C. 371 will be issued in addition to the Filing Receipt, in due course.</p> <p><u>New International Application Filed with the USPTO as a Receiving Office</u> If a new international application is being filed and the international application includes the necessary components for an international filing date (see PCT Article 11 and MPEP 1810), a Notification of the International Application Number and of the International Filing Date (Form PCT/RO/105) will be issued in due course, subject to prescriptions concerning national security, and the date shown on this Acknowledgement Receipt will establish the international filing date of the application.</p>					

OK TO ENTER: /M.K.T/
11/14/2017

Application Ser. No. 15/350,360
Attorney Docket No. 4015-9600
Client Docket No. P30138-US3

IN THE UNITED STATES PATENT AND TRADEMARK OFFICE

In re Application of Astely <i>et al.</i>)	
)	
Serial No.: 15/350,360)	
)	Examiner: Md K. Talukder
Filed: November 14, 2016)	
)	Group Art Unit: 2648
For: PUCCH Resource Allocation for Carrier)	
Aggregation in LTE-Advanced)	Confirmation No.: 1120
)	
Docket No: 4015-9600 / P30138-US3)	

Mail Stop Amendment
Commissioner for Patents
P.O. Box 1450
Alexandria, VA 22313-1450

10 November 2017

AMENDMENT PURSUANT TO 37 CFR § 1.312

This paper is being filed in response to the Notice of Allowance mailed 24 October 2017. Applicant timely submits this amendment pursuant to 37 CFR § 1.312. Entry of the following amendments to the Specification and consideration of the remarks below is respectfully requested. The Office is hereby authorized to charge any fees required for entry of this paper to Deposit Account 18-1167.



UNITED STATES PATENT AND TRADEMARK OFFICE

UNITED STATES DEPARTMENT OF COMMERCE
United States Patent and Trademark Office
Address: COMMISSIONER FOR PATENTS
P. O. Box 1450
Alexandria, Virginia 22313-1450
www.uspto.gov

APPLICATION NO.	ISSUE DATE	PATENT NO.	ATTORNEY DOCKET NO.	CONFIRMATION NO.
15/350,360	01/02/2018	9860044	4015-9600 / P30138-US3	1120

24112 7590 12/13/2017
COATS & BENNETT, PLLC
1400 Crescent Green, Suite 300
Cary, NC 27518

ISSUE NOTIFICATION

The projected patent number and issue date are specified above.

Determination of Patent Term Adjustment under 35 U.S.C. 154 (b)
(application filed on or after May 29, 2000)

The Patent Term Adjustment is 0 day(s). Any patent to issue from the above-identified application will include an indication of the adjustment on the front page.

If a Continued Prosecution Application (CPA) was filed in the above-identified application, the filing date that determines Patent Term Adjustment is the filing date of the most recent CPA.

Applicant will be able to obtain more detailed information by accessing the Patent Application Information Retrieval (PAIR) WEB site (<http://pair.uspto.gov>).

Any questions regarding the Patent Term Extension or Adjustment determination should be directed to the Office of Patent Legal Administration at (571)-272-7702. Questions relating to issue and publication fee payments should be directed to the Application Assistance Unit (AAU) of the Office of Data Management (ODM) at (571)-272-4200.

APPLICANT(s) (Please see PAIR WEB site <http://pair.uspto.gov> for additional applicants):

David Astely, Bromma, SWEDEN;
Telefonaktiebolaget LM Ericsson (publ), Stockholm, SWEDEN;
Robert Baldemair, Solna, SWEDEN;
Dirk Gerstenberger, Stockholm, SWEDEN;
Daniel Larsson, Stockholm, SWEDEN;
Lars Lindbom, Karlstad, SWEDEN;
Stefan Parkvall, Bromma, SWEDEN;

The United States represents the largest, most dynamic marketplace in the world and is an unparalleled location for business investment, innovation, and commercialization of new technologies. The USA offers tremendous resources and advantages for those who invest and manufacture goods here. Through SelectUSA, our nation works to encourage and facilitate business investment. To learn more about why the USA is the best country in the world to develop technology, manufacture products, and grow your business, visit SelectUSA.gov.

Under the Paperwork Reduction Act of 1995, no persons are required to respond to a collection of information unless it displays a valid OMB control number.
(Also Form PTO-1050)

UNITED STATES PATENT AND TRADEMARK OFFICE CERTIFICATE OF CORRECTION

Page 1 of 2

PATENT NO. : 9,860,044 B2
APPLICATION NO. : 15/350,360
ISSUE DATE : January 2, 2018
INVENTOR(S) : Astely, et al.

It is certified that an error appears or errors appear in the above-identified patent and that said Letters Patent is hereby corrected as shown below:

On the Face Page, in Field (63), under "Related U.S. Application Data", in Column 1, Line 2, delete "Oct. 14, 2010," and insert - - Oct. 4, 2010, - -, therefor.

In Column 4, Line 14, delete "terminals" and insert - - terminals. - -, therefor.

In Column 5, Line 32, delete "(ACK/NACK" and insert - - (ACK/NACK) - -, therefor.

In Column 6, Line 57, delete "specifications" and insert - - specifications. - -, therefor.

In Column 10, Line 13, delete "PDDCH" and insert - - PDCCH - -, therefor.

In Column 15, Line 34, in Claim 27, delete "in when" and insert - - when - -, therefor.

In Column 15, Line 38, in Claim 28, delete "The user terminal of claim" and insert - - The method of claim - -, therefor.

In Column 15, Line 41, in Claim 28, delete "in when" and insert - - when - -, therefor.

MAILING ADDRESS OF SENDER (Please do not use customer number below):

6300 Legacy, MS EVR 1-C-11
Plano, TX 75024
972-583-8656

This collection of information is required by 37 CFR 1.322, 1.323, and 1.324. The information is required to obtain or retain a benefit by the public which is to file (and by the USPTO to process) an application. Confidentiality is governed by 35 U.S.C. 122 and 37 CFR 1.14. This collection is estimated to take 1.0 hour to complete, including gathering, preparing, and submitting the completed application form to the USPTO. Time will vary depending upon the individual case. Any comments on the amount of time you require to complete this form and/or suggestions for reducing this burden, should be sent to the Chief Information Officer, U.S. Patent and Trademark Office, U.S. Department of Commerce, P.O. Box 1450, Alexandria, VA 22313-1450. DO NOT SEND FEES OR COMPLETED FORMS TO THIS ADDRESS. SEND TO: **Attention Certificate of Corrections Branch, Commissioner for Patents, P.O. Box 1450, Alexandria, VA 22313-1450.**

If you need assistance in completing the form, call 1-800-PTO-9199 and select option 2.

UNITED STATES PATENT AND TRADEMARK OFFICE CERTIFICATE OF CORRECTION

Page 2 of 2

PATENT NO. : 9,860,044 B2
APPLICATION NO. : 15/350,360
ISSUE DATE : January 2, 2018
INVENTOR(S) : Astely, et al.

It is certified that an error appears or errors appear in the above-identified patent and that said Letters Patent is hereby corrected as shown below:

In Column 15, Line 49, in Claim 30, delete “The user terminal of claim” and insert - - The method of claim - -, therefor.

In Column 15, Line 59, in Claim 32, delete “The user terminal of claim” and insert - - The method of claim - -, therefor.

In Column 15, Line 59, in Claim 32, delete “wherein he” and insert - - wherein the - -, therefor.

MAILING ADDRESS OF SENDER (Please do not use customer number below):

6300 Legacy, MS EVR 1-C-11
Plano, TX 75024
972-583-8656

This collection of information is required by 37 CFR 1.322, 1.323, and 1.324. The information is required to obtain or retain a benefit by the public which is to file (and by the USPTO to process) an application. Confidentiality is governed by 35 U.S.C. 122 and 37 CFR 1.14. This collection is estimated to take 1.0 hour to complete, including gathering, preparing, and submitting the completed application form to the USPTO. Time will vary depending upon the individual case. Any comments on the amount of time you require to complete this form and/or suggestions for reducing this burden, should be sent to the Chief Information Officer, U.S. Patent and Trademark Office, U.S. Department of Commerce, P.O. Box 1450, Alexandria, VA 22313-1450. DO NOT SEND FEES OR COMPLETED FORMS TO THIS ADDRESS. SEND TO: **Attention Certificate of Corrections Branch, Commissioner for Patents, P.O. Box 1450, Alexandria, VA 22313-1450.**

If you need assistance in completing the form, call 1-800-PTO-9199 and select option 2.

Privacy Act Statement

The **Privacy Act of 1974 (P.L. 93-579)** requires that you be given certain information in connection with your submission of the attached form related to a patent application or patent. Accordingly, pursuant to the requirements of the Act, please be advised that: (1) the general authority for the collection of this information is 35 U.S.C. 2(b)(2); (2) furnishing of the information solicited is voluntary; and (3) the principal purpose for which the information is used by the U.S. Patent and Trademark Office is to process and/or examine your submission related to a patent application or patent. If you do not furnish the requested information, the U.S. Patent and Trademark Office may not be able to process and/or examine your submission, which may result in termination of proceedings or abandonment of the application or expiration of the patent.

The information provided by you in this form will be subject to the following routine uses:

1. The information on this form will be treated confidentially to the extent allowed under the Freedom of Information Act (5 U.S.C. 552) and the Privacy Act (5 U.S.C. 552a). Records from this system of records may be disclosed to the Department of Justice to determine whether disclosure of these records is required by the Freedom of Information Act.
2. A record from this system of records may be disclosed, as a routine use, in the course of presenting evidence to a court, magistrate, or administrative tribunal, including disclosures to opposing counsel in the course of settlement negotiations.
3. A record in this system of records may be disclosed, as a routine use, to a Member of Congress submitting a request involving an individual, to whom the record pertains, when the individual has requested assistance from the Member with respect to the subject matter of the record.
4. A record in this system of records may be disclosed, as a routine use, to a contractor of the Agency having need for the information in order to perform a contract. Recipients of information shall be required to comply with the requirements of the Privacy Act of 1974, as amended, pursuant to 5 U.S.C. 552a(m).
5. A record related to an International Application filed under the Patent Cooperation Treaty in this system of records may be disclosed, as a routine use, to the International Bureau of the World Intellectual Property Organization, pursuant to the Patent Cooperation Treaty.
6. A record in this system of records may be disclosed, as a routine use, to another federal agency for purposes of National Security review (35 U.S.C. 181) and for review pursuant to the Atomic Energy Act (42 U.S.C. 218(c)).
7. A record from this system of records may be disclosed, as a routine use, to the Administrator, General Services, or his/her designee, during an inspection of records conducted by GSA as part of that agency's responsibility to recommend improvements in records management practices and programs, under authority of 44 U.S.C. 2904 and 2906. Such disclosure shall be made in accordance with the GSA regulations governing inspection of records for this purpose, and any other relevant (*i.e.*, GSA or Commerce) directive. Such disclosure shall not be used to make determinations about individuals.
8. A record from this system of records may be disclosed, as a routine use, to the public after either publication of the application pursuant to 35 U.S.C. 122(b) or issuance of a patent pursuant to 35 U.S.C. 151. Further, a record may be disclosed, subject to the limitations of 37 CFR 1.14, as a routine use, to the public if the record was filed in an application which became abandoned or in which the proceedings were terminated and which application is referenced by either a published application, an application open to public inspection or an issued patent.
9. A record from this system of records may be disclosed, as a routine use, to a Federal, State, or local law enforcement agency, if the USPTO becomes aware of a violation or potential violation of law or regulation.

IN THE UNITED STATES PATENT & TRADEMARK OFFICE

IN RE APPLICATION OF: U.S. Patent No. 9,860,044

USPTO CONFIRMATION CODE: 1120

APPLICATION NO.: 15/350,360

FILED: November 14, 2016

EXAMINER: Md Talukder

GROUP ART UNIT: 2648

FOR: PUCCH RESOURCE ALLOCATION FOR CARRIER AGGREGATION IN
LTE-ADVANCED

37 CFR 1.322 & 37 CFR 1.323 REQUEST FOR CERTIFICATE OF CORRECTION
FOR USPTO AND/OR APPLICANT MISTAKE

HONORABLE COMMISSIONER OF PATENTS & TRADEMARKS

SIR:

The following is a request for a certificate of correction in Serial Number 15/350,360, now Patent Number 9,860,044.

A certificate of correction under 35 USC 254 is respectfully requested in the above-identified patent.

The errors were the fault of both the applicant and USPTO and, accordingly, please charge **\$150.00** to our Deposit Account No. 50-1379. In the event that a further fee is required, please charge the amount to the same Deposit Account.

The exact locations where the errors appear in the patent and patent application are as follows:

On the Face Page, in Field (63), under “Related U.S. Application Data”, in Column 1, Line 2, delete “Oct. 14, 2010,” and insert - - Oct. 4, 2010, - -, therefor. (BIBLIOGRAPHIC DATA SHEET DATED OCTOBER 24, 2017, PAGE 1 OF 1 (PAGE 35 OF FW), UNDER “CONTINUING DATA”, LINE 1)

In Column 4, Line 14, delete “terminals” and insert - - terminals. - -, therefor. (ORIGINALLY FILED SPECIFICATION DATED NOVEMBER 14, 2016, PAGE 5, PARAGRAPH [0024], LINE 3)

In Column 5, Line 32, delete “(ACK/NACK)” and insert - - (ACK/NACK) - -, therefor. (ORIGINALLY FILED SPECIFICATION DATED NOVEMBER 14, 2016, PAGE 7, PARAGRAPH [0031], LINE 4)

In Column 6, Line 57, delete “specifications” and insert - - specifications. - -, therefor. (ORIGINALLY FILED SPECIFICATION DATED NOVEMBER 14, 2016, PAGE 9, PARAGRAPH [0038], LINE 10)

In Column 10, Line 13, delete “PDDCH” and insert - - PDCCH - -, therefor. (ORIGINALLY FILED SPECIFICATION DATED NOVEMBER 14, 2016, PAGE 14, LINE 9)

In Column 15, Line 34, in Claim 27, delete “in when” and insert - - when - -, therefor. (AMENDMENTS TO THE CLAIMS DATED NOVEMBER 10, 2017, PAGE 11 OF 15, CLAIM 27, LINE 3)

In Column 15, Line 38, in Claim 28, delete “The user terminal of claim” and insert - - The method of claim - -, therefor. (AMENDMENTS TO THE CLAIMS DATED NOVEMBER 10, 2017, PAGE 14 OF 15, CLAIM 39, LINE 1)

In Column 15, Line 41, in Claim 28, delete “in when” and insert - - when - -, therefor. (AMENDMENTS TO THE CLAIMS DATED NOVEMBER 10, 2017, PAGE 14 OF 15, CLAIM 39, LINE 3)

In Column 15, Line 49, in Claim 30, delete “The user terminal of claim” and insert - - The method of claim - -, therefor. (AMENDMENTS TO THE CLAIMS DATED NOVEMBER 10, 2017, PAGE 14 OF 15, CLAIM 40, LINE 1)

In Column 15, Line 59, in Claim 32, delete “The user terminal of claim” and insert - - The method of claim - -, therefor.
(AMENDMENTS TO THE CLAIMS DATED NOVEMBER 10, 2017,
PAGE 14 OF 15, CLAIM 41, LINE 1)

In Column 15, Line 59, in Claim 32, delete “wherein he” and insert - - wherein the - -, therefor.
(AMENDMENTS TO THE CLAIMS DATED NOVEMBER 10, 2017,
PAGE 14 OF 15, CLAIM 41, LINE 1)

The requested corrections are attached on Form PTO 1050.

Respectfully Submitted

, 2018

DATE

/Ronald J. Ward, Reg#54870/

Ronald J. Ward
Registration No. 54,870
Attorney of Record

Electronic Patent Application Fee Transmittal

Application Number:	15350360			
Filing Date:	14-Nov-2016			
Title of Invention:	PUCCH RESOURCE ALLOCATION FOR CARRIER AGGREGATION IN LTE-ADVANCED			
First Named Inventor/Applicant Name:	David Astely			
Filer:	Roger Scott Burleigh/Michelle Sanderson			
Attorney Docket Number:	4015-9600 / P30138-US3			
Filed as Large Entity				
Filing Fees for Utility under 35 USC 111(a)				
Description	Fee Code	Quantity	Amount	Sub-Total in USD(\$)
Basic Filing:				
Pages:				
Claims:				
Miscellaneous-Filing:				
Petition:				
Patent-Appeals-and-Interference:				
Post-Allowance-and-Post-Issuance:				
Certificate of correction	1811	1	150	150

Description	Fee Code	Quantity	Amount	Sub-Total in USD(\$)
Extension-of-Time:				
Miscellaneous:				
Total in USD (\$)				150

Electronic Acknowledgement Receipt

EFS ID:	31800326
Application Number:	15350360
International Application Number:	
Confirmation Number:	1120
Title of Invention:	PUCCH RESOURCE ALLOCATION FOR CARRIER AGGREGATION IN LTE-ADVANCED
First Named Inventor/Applicant Name:	David Astely
Customer Number:	24112
Filer:	Roger Scott Burleigh/Michelle Sanderson
Filer Authorized By:	Roger Scott Burleigh
Attorney Docket Number:	4015-9600 / P30138-US3
Receipt Date:	15-FEB-2018
Filing Date:	14-NOV-2016
Time Stamp:	11:56:35
Application Type:	Utility under 35 USC 111(a)

Payment information:

Submitted with Payment	yes
Payment Type	DA
Payment was successfully received in RAM	\$150
RAM confirmation Number	021518INTEFSW00013748501379
Deposit Account	
Authorized User	

The Director of the USPTO is hereby authorized to charge indicated fees and credit any overpayment as follows:

File Listing:					
Document Number	Document Description	File Name	File Size(Bytes)/ Message Digest	Multi Part /.zip	Pages (if appl.)
1	Request for Certificate of Correction	P30138- US3_2018-02-15_CoC_PTO-105 0.pdf	112831 3d3c1c723f7dae44307b690e980df773bd38fb0a	no	3
Warnings:					
Information:					
2	Transmittal Letter	P30138- US3_2018-02-15_CoC_Request _Letter.pdf	145918 02a5477e5f89313f9333784cb68e1a440d1d60ce	no	4
Warnings:					
Information:					
3	Fee Worksheet (SB06)	fee-info.pdf	30362 a1e7e66f1625491d683d2ad550f54eabc5aab73	no	2
Warnings:					
Information:					
Total Files Size (in bytes):			289111		
<p>This Acknowledgement Receipt evidences receipt on the noted date by the USPTO of the indicated documents, characterized by the applicant, and including page counts, where applicable. It serves as evidence of receipt similar to a Post Card, as described in MPEP 503.</p> <p><u>New Applications Under 35 U.S.C. 111</u> If a new application is being filed and the application includes the necessary components for a filing date (see 37 CFR 1.53(b)-(d) and MPEP 506), a Filing Receipt (37 CFR 1.54) will be issued in due course and the date shown on this Acknowledgement Receipt will establish the filing date of the application.</p> <p><u>National Stage of an International Application under 35 U.S.C. 371</u> If a timely submission to enter the national stage of an international application is compliant with the conditions of 35 U.S.C. 371 and other applicable requirements a Form PCT/DO/EO/903 indicating acceptance of the application as a national stage submission under 35 U.S.C. 371 will be issued in addition to the Filing Receipt, in due course.</p> <p><u>New International Application Filed with the USPTO as a Receiving Office</u> If a new international application is being filed and the international application includes the necessary components for an international filing date (see PCT Article 11 and MPEP 1810), a Notification of the International Application Number and of the International Filing Date (Form PCT/RO/105) will be issued in due course, subject to prescriptions concerning national security, and the date shown on this Acknowledgement Receipt will establish the international filing date of the application.</p>					

UNITED STATES PATENT AND TRADEMARK OFFICE
CERTIFICATE OF CORRECTION

PATENT NO. : 9,860,044 B2
APPLICATION NO. : 15/350360
DATED : January 2, 2018
INVENTOR(S) : Astely et al.

Page 1 of 2

It is certified that error appears in the above-identified patent and that said Letters Patent is hereby corrected as shown below:

On the Title Page

In Item (63), under "Related U.S. Application Data", in Column 1, Line 2, delete "Oct. 14, 2010," and insert -- Oct. 4, 2010, --, therefor.

In the Specification

In Column 4, Line 14, delete "terminals" and insert -- terminals. --, therefor.

In Column 5, Line 32, delete "(ACK/NACK" and insert -- (ACK/NACK) --, therefor.

In Column 6, Line 57, delete "specifications" and insert -- specifications. --, therefor.

In Column 10, Line 13, delete "PDDCH" and insert -- PDCCH --, therefor.

In the Claims

In Column 15, Line 34, in Claim 27, delete "in when" and insert -- when --, therefor.

In Column 15, Line 38, in Claim 28, delete "The user terminal of claim" and insert -- The method of claim --, therefor.

In Column 15, Line 41, in Claim 28, delete "in when" and insert -- when --, therefor.

In Column 15, Line 49, in Claim 30, delete "The user terminal of claim" and insert -- The method of claim --, therefor.

Signed and Sealed this
Tenth Day of July, 2018

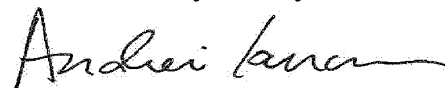

Andrei Iancu
Director of the United States Patent and Trademark Office

CERTIFICATE OF CORRECTION (continued)
U.S. Pat. No. 9,860,044 B2

Page 2 of 2

In Column 15, Line 59, in Claim 32, delete “The user terminal of claim” and insert -- The method of claim --, therefor.

In Column 15, Line 59, in Claim 32, delete “wherein he” and insert -- wherein the --, therefor.