

TD 2.30:94-141

TRAVTEK, SYSTEM ARCHITECTURE  
EVALUATION... PUBLICATION NO.  
FHWA-RD-94-141... U.S. DEPARTMENT  
OF TRANSPORTATION... JULY 1995

01 OF 03  
24X  
SUPTDOCS/GPO  
P.0001-0077

UNIV. OF WASHINGTON LIBRARIES  
Travier, System Architecture E  
TD 2.30: 94-141



**TD 2.30: 94-141**

Travier, System Architecture E

GOVERNMENT PUBLICATIONS  
UNIV. OF WASH. LIBRARIES

FEB 21 1996

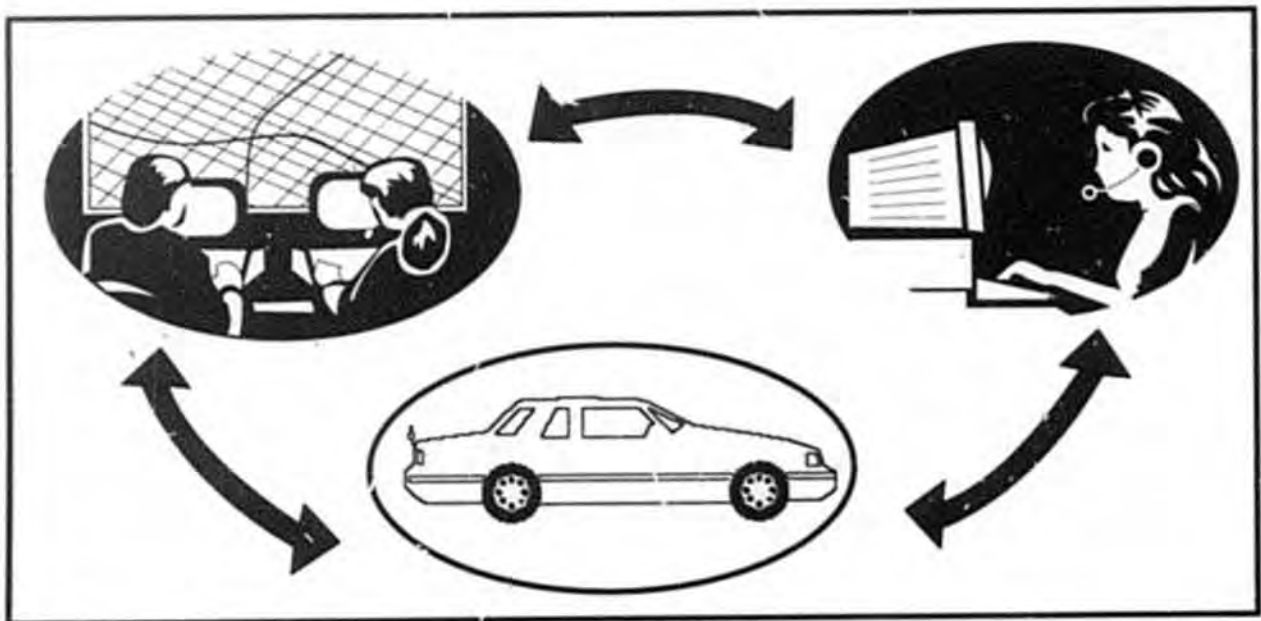
U.S. DEPOSITORY COPY

Google Ex. 1017

# TravTek System Architecture Evaluation

Publication No. FHWA-RD-94-141

July 1995



**BEST COPY AVAILABLE**

U.S. Department of Transportation  
**Federal Highway Administration**

**COMPLETED**

Research and Development  
Turner-Fairbank Highway Research Center  
6300 Georgetown Pike  
McLean, Virginia 22101-2296

**BEST COPY AVAILABLE**

Google Ex. 1017

ak

**BLANK PAGE**

## FOREWORD

This report is one of eight reports produced as part of the evaluation of the Travtek operational field test, conducted in Orlando, Florida, during 1992-1993. Travtek, short for Travel Technology, was an advanced driver information and traffic management system that provided a combination of traveler information services and route navigation and guidance support to the driver. Twelve individual but related studies were conducted during the evaluation. Evaluation goals and objectives were represented by the following basic questions: (1) Did the TravTek system work? (2) Did drivers save time and avoid congestion? (3) Will drivers use the system? (4) How effective was voice guidance compared to moving map and turn-by-turn displays? (5) Was TravTek safe? (6) Could TravTek benefit travelers who do not have the TravTek system? (7) Will people be willing to pay for TravTek features?

Evaluation data were obtained from more than 4,000 volunteer drivers during the operation of 100 specially equipped automobiles for a 1-year period. Results of the evaluation demonstrated and validated the concept of in-vehicle navigation and the provision of traveler information services to the driver. The test also provided valuable results concerning the drivers' interaction with and use of the in-vehicle displays. This project has made many important contributions supporting the goals and objectives of the Intelligent Transportation Systems Program.



Lyle Saxton, Director  
Office of Safety and Traffic  
Operations Research and Development

## NOTICE

This document is disseminated under the sponsorship of the Department of Transportation in the interest of information exchange. The United States Government assumes no liability for the contents or the use thereof. This report does not constitute a standard, specification, or regulation.

The United States Government does not endorse products of manufacturers. Trade and manufacturers' names appear in this report only because they are considered essential to the object of the document.

**BEST COPY AVAILABLE**

1. Report No. FHWA-RD-94-141	2. Government Accession No.	3. Recipient's Catalog No.	
4. Title and Subtitle TravTek SYSTEM ARCHITECTURE EVALUATION		5. Report Date July 1995	
		6. Performing Organization Code	
7. Author(s) C. Blumentritt, K. Balke, E. Seymour, R. Sanchez		8. Performing Organization Report No.	
9. Performing Organization Name and Address Texas Transportation Institute 8150 North Central Expressway, Suite 815 Dallas, Texas 75206		10. Work Unit No. (TRAIS) 3B7A	
		11. Contract or Grant No. DTFH61-91-C-00106	
12. Sponsoring Agency Name and Address Office of Safety and Traffic Operations R&D Federal Highway Administration, 6300 Georgetown Pike McLean, VA 22101-2296		13. Type of Report and Period Covered Final Report 11/91 - 3/94	
		14. Sponsoring Agency Code	
15. Supplementary Notes Contracting Officer's Technical Representative (COTR) - Frank Mammano, HSR-12			
16. Abstract The TravTek System Architecture Evaluation documents in detail the TravTek system, including the Traffic Information Network (TIN), TravTek Information Services Center (TISC), Traffic Management Center (TMC), and the TravTek vehicle. The TravTek system achieved a high state of automation. Link travel time data were received automatically from the probe vehicles, freeway management system, and arterial control management system. These data were fused and distributed to the vehicles, all without operator intervention. The process for estimating link travel times worked well on the basis of information available. TravTek needed more high quality traffic information to provide vehicle routing that had the benefit of accurate, up to minute traffic information. Probe vehicles provided reliable travel times, but reported significant travel time variations on arterial links due to stop time at intersections. Incident information available to TravTek was sparse and usually not timely. Historical link travel time, map, and local information data base accuracy was good. A human factors study, regarding the TMC operation and environment, found operator improvement was needed. The TravTek system was very reliable, largely due to a distributed architecture. Problems with the TravTek system were largely implementation related, as opposed to architecture related. Lessons learned during TravTek are enumerated, and conclusions are stated which sustain the overall success of TravTek.			
17. Key Words TravTek, ATIS, IVHS Architecture, Architecture Evaluation		18. Distribution Statement No restrictions. This document is available to the public through the National Technical Information Service, Springfield, Virginia 22161	
19. Security Classif. (of this report) Unclassified	20. Security Classif. (of this page) Unclassified	21. No. of Pages 250	22. Price

## SI\* (MODERN METRIC) CONVERSION FACTORS

### APPROXIMATE CONVERSIONS TO SI UNITS

### APPROXIMATE CONVERSIONS FROM SI UNITS

Symbol	When You Know	Multiply By	To Find	Symbol	Symbol	When You Know	Multiply By	To Find	Symbol
<b>LENGTH</b>									
in	inches	25.4	millimeters	mm	mm	millimeters	0.039	inches	in
ft	feet	0.305	meters	m	m	meters	3.28	feet	ft
yd	yards	0.914	meters	m	m	meters	1.09	yards	yd
mi	miles	1.61	kilometers	km	km	kilometers	0.621	miles	mi
<b>AREA</b>									
in <sup>2</sup>	square inches	645.2	square millimeters	mm <sup>2</sup>	mm <sup>2</sup>	square millimeters	0.0016	square inches	in <sup>2</sup>
ft <sup>2</sup>	square feet	0.093	square meters	m <sup>2</sup>	m <sup>2</sup>	square meters	10.764	square feet	ft <sup>2</sup>
yd <sup>2</sup>	square yards	0.836	square meters	m <sup>2</sup>	m <sup>2</sup>	square meters	1.195	square yards	yd <sup>2</sup>
ac	acres	0.405	hectares	ha	ha	hectares	2.47	acres	ac
mi <sup>2</sup>	square miles	2.60	square kilometers	km <sup>2</sup>	km <sup>2</sup>	square kilometers	0.386	square miles	mi <sup>2</sup>
<b>VOLUME</b>									
fl oz	fluid ounces	29.57	milliliters	mL	mL	milliliters	0.034	fluid ounces	fl oz
gal	gallons	3.785	liters	L	L	liters	0.264	gallons	gal
ft <sup>3</sup>	cubic feet	0.028	cubic meters	m <sup>3</sup>	m <sup>3</sup>	cubic meters	35.71	cubic feet	ft <sup>3</sup>
yd <sup>3</sup>	cubic yards	0.765	cubic meters	m <sup>3</sup>	m <sup>3</sup>	cubic meters	1.307	cubic yards	yd <sup>3</sup>
NOTE: Volumes greater than 1000 l shall be shown in m <sup>3</sup> .									
<b>MASS</b>									
oz	ounces	28.35	grams	g	g	grams	0.035	ounces	oz
lb	pounds	4.54	kilograms	kg	kg	kilograms	2.202	pounds	lb
T	short tons (2000 lb)	0.907	megagrams (or "metric ton")	Mg (or "T")	Mg (or "T")	megagrams (or "metric ton")	1.103	short tons (2000 lb)	T
<b>TEMPERATURE (exact)</b>									
°F	Fahrenheit temperature	$5(F-32)/9$ or $(F-32)/1.8$	Celsius temperature	°C	°C	Celsius temperature	$1.8C + 32$	Fahrenheit temperature	°F
<b>ILLUMINATION</b>									
fc	foot-candles	10.76	lux	lx	lx	lux	0.0929	foot-candles	fc
f	foot-Lamberts	3.426	candela/m <sup>2</sup>	cd/m <sup>2</sup>	cd/m <sup>2</sup>	candela/m <sup>2</sup>	0.2919	foot-Lamberts	f
<b>FORCE and PRESSURE or STRESS</b>									
lbf	poundforce	4.45	newtons	N	N	newtons	0.225	poundforce	lbf
lbf/in <sup>2</sup>	poundforce per square inch	6.89	kilopascals	kPa	kPa	kilopascals	0.145	poundforce per square inch	lbf/in <sup>2</sup>

\* SI is the symbol for the International System of Units. Appropriate rounding should be made to comply with Section 4 of ASTM E380.

(Revised September 1993)

**BLANK PAGE**

## PREFACE

TravTek was a joint public sector - private sector project to develop, test and evaluate an integrated driver information system and supporting infrastructure in metropolitan Orlando, Florida. TravTek provided motorists with navigation, real-time traffic information, route selection and guidance, and motorist information services. TravTek systems were installed in 100 1992 Oldsmobile Toronados operating in a 1900 km<sup>2</sup> area surrounding Orlando. Seventy-five of the cars were in a car rental fleet for use by visitors to Orlando and 25 of the cars were used by local residents and for special controlled tests.

The project was the largest, most comprehensive advanced driver information system project to date attempted in the United States. It officially started on March 23, 1992 and operated for 1 year. TravTek was a partnership between the private sector, represented by General Motors and the American Automobile Association, and the public sector, represented by the Federal Highway Administration, the Florida Department of Transportation, and the City of Orlando. Additional private sector participants included Motorola and Avis.

The TravTek evaluation consisted of a series of connected research efforts that addressed every facet of the system. This effort was organized as a collection of major tasks. Task A was the Project Management task, and coordinated all efforts of the evaluation team, as well as provided liaison with the TravTek partners. Task B included the Rental User Study, to evaluate the drivers' impressions of TravTek, and the Local User Study, to evaluate the participation of local users in longer term experiments. Task C included the Yoked Driver Study, to evaluate the relationship between use of the TravTek functions and measures of driver/vehicle performance, the Orlando Traffic Network study, to evaluate alternative TravTek/driver interface features, and the Camera Car Study, to examine driver interactions with different versions of the TravTek in-vehicle system. Task D included the Debriefing and Interview Study, to gather qualitative information from participants, and the Questionnaire Study, to obtain user perceptions from a wider range of attributes. Task E included the TravTek Modeling Study, to model the traffic and safety performance of the TravTek system, and the Safety Study, to evaluate the safety of using in-vehicle information systems. Task F was the System Architecture Study, to evaluate all aspects of the TravTek system design.

This report presents the results of the Task F System Architecture Evaluation. It documents in detail the TravTek system, including the Traffic Information Network (TIN), TravTek Information Services Center (TISC), Traffic Management Center (TMC), and the TravTek Vehicle. Each of these system entities has an overall description, and in turn each entity has a detailed functional description, a process description, and data flow diagrams. Issues addressed in the system architecture evaluation include: accuracy of the link travel times provided by the various real-time sources; accuracy and timeliness of the incident information broadcast to the TravTek vehicles; data base accuracy; performance of the data fusion process; system operation considerations: evaluation of operator interface, network covering, and degree of automation; reliability of subsystems, TMC/vehicle communications, and software; and system architecture features. The lessons learned during TravTek are given, and conclusions are stated which sustain the overall success of TravTek.



## TABLE OF CONTENTS

<u>Section</u>	<u>Page</u>
<b>INTRODUCTION</b> .....	1
<b>TravTek BACKGROUND</b> .....	1
<b>TravTek EVALUATION</b> .....	3
<b>TravTek ARCHITECTURE EVALUATION OBJECTIVES</b> .....	6
<b>SYSTEM OVERVIEW</b> .....	9
<b>TRAFFIC INFORMATION NETWORK (TIN)</b> .....	10
<b>TravTek INFORMATION AND SERVICES CENTER (TISC)</b> .....	11
<b>TRAFFIC MANAGEMENT CENTER (TMC)</b> .....	12
<b>TravTek VEHICLE</b> .....	12
<b>TELECOMMUNICATIONS</b> .....	16
<b>SYSTEM DESCRIPTION</b> .....	17
<b>TRAFFIC INFORMATION NETWORK (TIN)</b> .....	17
<b>TIN Functional Description</b> .....	18
<i>Link Travel Times</i> .....	19
<i>Incident and Congestion Reporting</i> .....	20
<i>Information Dissemination</i> .....	24
<b>TravTek INFORMATION AND SERVICES CENTER (TISC)</b> .....	26
<b>TISC Functional Description</b> .....	27
<b>TISC Process Description</b> .....	30
<b>TISC Data Flow</b> .....	30
<b>TRAFFIC MANAGEMENT CENTER (TMC)</b> .....	30
<b>TMC Functional Description</b> .....	33
<i>Traffic Information Collection</i> .....	34
<i>Data Logging</i> .....	35
<i>Traffic Data Fusion</i> .....	38
<i>Traffic Information Dissemination</i> .....	41
<i>Communications</i> .....	42
<i>Operator Interface</i> .....	49
<b>TravTek VEHICLE</b> .....	53
<b>TravTek Vehicle Functional Description</b> .....	56
<i>Navigation</i> .....	57
<i>Route Selection</i> .....	59
<i>Route Guidance</i> .....	62
<i>Local Information</i> .....	65
<i>Driver Interface</i> .....	66
<i>Vehicle Probe</i> .....	69
<i>Data Logging</i> .....	70

**TABLE OF CONTENTS**  
(continued)

<u>Section</u>	<u>Page</u>
<b>QUALITY OF TRAFFIC AND TRAVEL INFORMATION</b> .....	75
<b>QUALITY OF TRAVEL TIME INFORMATION</b> .....	75
Evaluation Methodology .....	77
Data Sources .....	78
Results .....	78
<i>System Performance</i> .....	78
<i>Source Errors</i> .....	83
<b>QUALITY OF INCIDENT INFORMATION</b> .....	96
Evaluation Methodology .....	97
Data Sources .....	97
Results .....	98
<b>DATA BASE ACCURACY</b> .....	101
Historical Data Base .....	101
Map Data Base .....	102
Local Information Data Base .....	103
<b>EVALUATION OF THE DATA FUSION PROCESS</b> .....	107
<b>DATA FUSION PROCESS</b> .....	107
Evaluation Methodology .....	111
Data Sources .....	111
Results .....	112
<b>EVALUATION OF SYSTEM AND NETWORK OPERATIONS</b> .....	119
<b>TMC OPERATOR INTERFACE</b> .....	119
Method .....	119
<i>Information Analysis</i> .....	120
<i>Job Analysis</i> .....	120
<i>Workload Analysis</i> .....	120
Results .....	121
<i>Information Flow Analysis</i> .....	121
<i>Job Analysis</i> .....	123
<i>Workload Analysis</i> .....	126
Discussion .....	130
Conclusions .....	131
<b>NETWORK COVERING</b> .....	131
Network Description .....	131
Data Sources .....	131
Probe Vehicle Activity .....	134
Analysis .....	141
Conclusions .....	141
<b>DEGREE OF AUTOMATION</b> .....	143
Discussion .....	143

**TABLE OF CONTENTS**  
(continued)

<u>Section</u>	<u>Page</u>
<b>SYSTEM RELIABILITY</b> .....	147
<b>SUBSYSTEM RELIABILITY</b> .....	147
<b>Data Sources</b> .....	147
<i>Manual and Computer Generated Logs</i> .....	147
<b>Log Analysis</b> .....	149
<i>Onsite Interviews of Key TravTek Participants</i> .....	150
<b>Results</b> .....	151
<i>Results: June 1 Through December 31, 1992</i> .....	151
Number of Failures .....	151
Duration of Failures .....	152
Time of Day Failures .....	156
<i>Results: January 1 Through March 31, 1993</i> .....	160
Number of Failures .....	160
Duration of Failures .....	160
Time of Day Failures .....	164
<i>Results: June 1, 1992 Through March 31, 1993</i> .....	168
Number of Failures .....	168
Duration of Failures .....	171
Time of Day Failures .....	175
<i>Onsite Interview Results</i> .....	179
<b>Conclusions</b> .....	180
<b>TMC/VEHICLE COMMUNICATION SUBSYSTEM RELIABILITY</b> .....	180
<b>Evaluation Methodology</b> .....	180
<b>Data Sources</b> .....	181
<b>Results</b> .....	182
<b>SOFTWARE RELIABILITY</b> .....	190
<b>SYSTEM ARCHITECTURE</b> .....	195
<b>TravTek DISTRIBUTED ARCHITECTURE</b> .....	195
<b>CENTRAL ARCHITECTURE DESIGN ALTERNATIVE</b> .....	196
<b>RELATIONSHIP OF TravTek ARCHITECTURE TO PROBLEMS</b> .....	199
<b>CRITIQUE OF IMPLEMENTATION</b> .....	199
<b>COMMUNICATION SYSTEM ALTERNATIVES</b> .....	201
<b>IMPLEMENTATION CRITERIA</b> .....	202
<b>LESSONS LEARNED</b> .....	205
<b>LIST OF LESSONS LEARNED</b> .....	205
<b>Lesson # 1: Truncated Test Period</b> .....	205
<b>Lesson # 2: Diagnostic Information in Distributed System</b> .....	205
<b>Lesson # 3: Improve Degree of Automation</b> .....	205
<b>Lesson # 4: Map Data Bases</b> .....	205
<b>Lesson # 5: Dual Map Data Bases in Vehicle</b> .....	206
<b>Lesson # 6: Manual Record Keeping</b> .....	206

**TABLE OF CONTENTS**  
(continued)

<u>Section</u>	<u>Page</u>
<b>LESSONS LEARNED (Continued)</b>	
Lesson # 7: Quality of Travel Information .....	206
Lesson # 8: TMC Manual Record Keeping .....	206
Lesson # 9: TIN Network Concept .....	206
Lesson # 10: Traffic Data Timeliness .....	207
Lesson # 11: Public/Private Partnership .....	207
Lesson # 12: Development of Evaluation Plans .....	207
Lesson # 13: Timeliness and Quality of Incident Information .....	207
Lesson # 14: Importance of Machine Logs .....	208
Lesson # 15: Involvement of Project Personnel .....	208
Lesson # 16: Performance of Distributed System .....	208
Lesson # 17: Operation of Complex System .....	208
Lesson # 18: Benefits of ATIS to Traffic Mangement .....	208
Lesson # 19: Acceptable Level of Operation .....	208
Lesson # 20: Timely Processing of Log Data .....	209
SUGGESTIONS FOR FURTHER DATA EVALUATIONS .....	209
CONCLUSIONS .....	211
APPENDIX A. TMC SYSTEM HARDWARE .....	213
APPENDIX B. TMC OPERATOR MENU FUNCTIONS .....	215
APPENDIX C. DATA BASE OF TravTek AND FMC INCIDENTS (JANUARY 22, 1993 THROUGH MARCH 26, 1993) .....	225
APPENDIX D. PROBE VEHICLE FREQUENCY BY MONTH .....	229
REFERENCES .....	235

## LIST OF FIGURES

<u>Figure No.</u>		<u>Page</u>
1.	TravTek geographic area .....	2
2.	TravTek system diagram .....	9
3.	Traffic management center location .....	13
4.	Vehicle information flow .....	15
5.	Elements of traffic information network .....	18
6.	Illustration of travel time reporting function .....	20
7.	Data flow requirements for travel time reporting function .....	21
8.	Illustration of moderate and heavy congestion levels .....	23
9.	Functional diagram of incident/congestion reporting task .....	24
10.	Data flow requirements for reporting incidents and congestion .....	25
11.	Functional diagram of information dissemination process .....	25
12.	Data flow requirements for disseminating travel time and incident information .....	26
13.	TISC system .....	28
14.	TISC help desk information flow .....	31
15.	TMC computer configuration .....	32
16.	TMC basic system configuration .....	32
17.	Traffic information collection data flow diagram .....	35
18.	TMC log data distribution path .....	38
19.	Vehicle log data distribution path .....	39
20.	TMC data fusion process data flow (all links updated each minute) .....	41
21.	Traffic dissemination function data flow .....	43
22.	TMC/vehicle data radio system .....	48
23.	TMC communications data flow .....	49
24.	TMC operator screen display (typical) .....	51
25.	TMC operator menu selection diagram .....	53
26.	TMC operator interaction process data flow .....	54
27.	TravTek vehicle architecture .....	55
28.	Layout of the TravTek equipment in the vehicle .....	55
29.	Interactions between TravTek vehicle functions .....	57
30.	Vehicle positioning function .....	58
31.	Vehicle navigation data flow .....	59
32.	Vehicle route planning/route selection function .....	61
33.	Illustration of route selection process for rerouting .....	63
34.	Route selection data flow .....	63
35.	Route guidance functional diagram .....	64
36.	Route guidance data flow .....	65
37.	Local information functional diagram .....	66
38.	Local information data flow .....	66
39.	Driver interface function diagram .....	68
40.	Data flow diagram for driver interface function .....	69

**LIST OF FIGURES**  
(Continued)

<u>Figure No.</u>		<u>Page</u>
41.	Vehicle probe function .....	70
42.	Probe report data flow .....	71
43.	Data logging function diagram .....	72
44.	In-vehicle data logging data flow .....	73
45.	Distribution of winning travel time sources for instrumented arterial links .....	79
46.	Distribution of winning travel time sources for non-instrumented arterial links .....	80
47.	Distribution of winning travel time sources on instrumented freeway links .....	81
48.	Distribution of winning travel time sources on non-instrumented freeway links .....	82
49.	Relative error of sources of travel time information on freeway links .....	86
50.	Relative error of sources of travel time information on arterial links .....	87
51.	Correlation between travel times estimated using speed information from freeway surveillance system and probe-measured travel times during AM peak periods .....	90
52.	Correlation between travel times estimated using speed information from freeway surveillance system and probe-measured travel times during Off peak periods .....	91
53.	Correlation between travel times estimated using speed information from freeway surveillance system and probe-measured travel times during PM peak periods .....	92
54.	Correlation between travel times estimated using delay measurements from computerized traffic signal system (UTCS) and probe-measured travel times during AM peak periods .....	93
55.	Correlation between travel times estimated using delay measurements from computerized traffic signal system (UTCS) and probe-measured travel times during Off peak periods .....	94
56.	Correlation between travel times estimated using delay measurements from computerized traffic signal system (UTCS) and probe-measured travel times during PM peak periods .....	95
57.	Type of incident information logged at the TravTek traffic management center (TMC) .....	99
58.	Versions of navigation map data bases .....	104
59.	Versions of routing map data bases .....	104
60.	Versions of local information data bases .....	105
61.	Illustration of data fusion process on non-instrumented TravTek traffic network link .....	109
62.	Illustration of data fusion process on link covered by real-time surveillance system (UTCS or freeway surveillance system) .....	110
63.	Relative error rates for each iteration of the data fusion process in the Off peak .....	116
64.	Relative error rates for each iteration of the data fusion process in the AM peak .....	117
65.	Relative error rates for each iteration of the data fusion process in the PM peak .....	118
66.	Greater Orlando road map .....	132

**LIST OF FIGURES**  
(Continued)

<u>Figure No.</u>		<u>Page</u>
67.	TravTek traffic link network .....	133
68.	Number of links by roadway type .....	134
69.	Link category distribution by distance .....	134
70.	TravTek vehicle probe reports .....	135
71.	TravTek traffic network - daily average link km .....	135
72.	TravTek traffic network - monthly average link km .....	136
73.	Links without probe vehicle traffic by month .....	136
74.	Probe vehicle volumes band map - total during operational test .....	138
75.	Probe vehicle mileage distribution by month .....	139
76.	Plot of coordinates reported by vehicles for 10 days during month of September, 1992 .....	140
77.	Illustration of route preference .....	142
78.	Frequency of failures by subsystem, 6/92 - 12/92 .....	152
79.	Down times for all subsystems, 6/92 - 12/92 .....	153
80.	Down times for the UTCS subsystem, 6/92 - 12/92 .....	153
81.	Down times for the FMC subsystem, 6/92 - 12/92 .....	154
82.	Down times for the TIN subsystem, 6/92 - 12/92 .....	154
83.	Down times for the TISC subsystem, 6/92 - 12/92 .....	155
84.	Down times for the Radio subsystem, 6/92 - 12/92 .....	155
85.	Frequency of failures by time of day for all subsystems, 6/92 - 12/92 .....	157
86.	Frequency of failures by time of day for UTCS subsystem, 6/92 - 12/92 .....	157
87.	Frequency of failures by time of day for FMC subsystem, 6/92 - 12/92 .....	158
88.	Frequency of failures by time of day for TIN subsystem, 6/92 - 12/92 .....	158
89.	Frequency of failures by time of day for TISC subsystem, 6/92 - 12/92 .....	159
90.	Frequency of failures by time of day for Radio subsystem, 6/92 - 12/92 .....	159
91.	Frequency of failures by subsystem, 1/93 - 3/93 .....	160
92.	Down times for all subsystems, 1/93 - 3/93 .....	161
93.	Down times for UTCS subsystem, 1/93 - 3/93 .....	161
94.	Down times for FMC subsystem, 1/93 - 3/93 .....	162
95.	Down times for TIN subsystem, 1/93 - 3/93 .....	162
96.	Down times for TISC subsystem, 1/93 - 3/93 .....	163
97.	Down times for the Radio subsystem, 1/93 - 3/93 .....	163
98.	Time of day of failures for all subsystems, 1/93 - 3/93 .....	165
99.	Time of day of failures for UTCS subsystem, 1/93 - 3/93 .....	165
100.	Time of day of failures for FMC subsystem, 1/93 - 3/93 .....	166
101.	Time of day of failures for TIN subsystem, 1/93 - 3/93 .....	166
102.	Time of day of failures for TISC subsystem, 1/93 - 3/93 .....	167
103.	Time of day of failures for Radio subsystem, 1/93 - 3/93 .....	167
104.	Frequency of failures by subsystem, 6/92 - 3/93 .....	168
105.	Frequency of failure by month for all subsystems .....	169
106.	Failure frequency by month for the UTCS subsystem .....	169

## LIST OF FIGURES

(Continued)

<u>Figure No.</u>		<u>Page</u>
107.	Frequency of failures by month for the FMC subsystem .....	170
108.	Frequency of failures by month for the TIN subsystem .....	170
109.	Frequency of failures by month for the Radio subsystem .....	171
110.	Down times for all systems .....	172
111.	Down times for the UTCS subsystem .....	173
112.	Down times for the FMC subsystem .....	173
113.	Minimum, average, and maximum down times .....	174
114.	Minimum, average, and maximum down times by subsystem .....	174
115.	Time of day of all subsystem failures .....	176
116.	Time of day of UTCS subsystem failures .....	176
117.	Time of day of FMC subsystem failures .....	177
118.	Time of day of TIN subsystem failures .....	177
119.	Time of day of TISC subsystem failures .....	178
120.	Time of day of Radio subsystem failures .....	178
121.	Percent downtime by subsystem by month .....	180
122.	Percentage of TMC to vehicle communications failures .....	182
123.	Percentage of vehicle to TMC communications failures .....	183
124.	Percentage of TMC to vehicle communications failures by month .....	183
125.	Percentage of vehicle to TMC communications failures by month .....	184
126.	Vehicle transmit time slot accuracy .....	185
127.	Location of vehicles with successful TMC to vehicle communications .....	186
128.	Location of vehicles with unsuccessful TMC to vehicle communications .....	187
129.	Location of vehicles with successful vehicle to TMC communications .....	188
130.	Location of vehicles with unsuccessful vehicle to TMC communications .....	189
131.	TravTek vehicle program version service times .....	192
132.	Probe vehicle frequency, June 1992 .....	229
133.	Probe vehicle frequency, July 1992 .....	229
134.	Probe vehicle frequency, August 1992 .....	230
135.	Probe vehicle frequency, September 1992 .....	230
136.	Probe vehicle frequency, October 1992 .....	231
137.	Probe vehicle frequency, November 1992 .....	231
138.	Probe vehicle frequency, December 1992 .....	232
139.	Probe vehicle frequency, January 1993 .....	232
140.	Probe vehicle frequency, February 1993 .....	233
141.	Probe vehicle frequency, March 1993 .....	233



## LIST OF TABLES

<u>Table No.</u>		<u>Page</u>
1.	TravTek TIN network user station list (as of 4/8/92) .....	11
2.	TISC staffing .....	27
3.	TMC operator schedule .....	33
4.	Dynamic link time message ratios .....	45
5.	Tasks performed by each of the TravTek vehicle computers .....	56
6.	Relative error of sources of travel time information for arterial links .....	84
7.	Relative error of sources of travel time information for freeway links .....	85
8.	Correlation between travel time estimates produced by probes and those produced by real-time surveillance systems .....	89
9.	Peak period incidents on I-4 logged by the TravTek system .....	100
10.	Delays in incident information in TravTek system .....	101
11.	Default quality and age values assigned to travel time sources .....	108
12.	Relative error of probe-measured travel times to travel times measured by surveillance system each minute in data fusion on freeway links during AM peak periods .....	113
13.	Relative error of probe-measured travel times to travel times measured by surveillance system each minute in data fusion on freeway links during Off peak periods .....	114
14.	Relative error of probe-measured travel times to travel times measured by surveillance system each minute in data fusion on freeway links during PM peak periods .....	115
15.	Information flow analysis .....	122
16.	Job analysis table .....	124
17.	Workstation design stressor checklist .....	127
18.	Links which had no probe vehicle activity during test .....	137
19.	Summary of network link percentages and probe vehicle mileage by category .....	139
20.	Major automated and non-automated functions of TravTek .....	143
21.	Sources of reliability data .....	148
22.	Time between computer task startup attempts .....	149
23.	Travtek participants interviewed during March 1993 .....	150
24.	Number of failures by subsystem by month, 6/92 - 12/92 .....	151
25.	Duration of failures by month, 6/92 - 12/92 .....	152
26.	Number of failures by subsystem by time of day, 6/92 - 12/92 .....	156
27.	Number of failures by subsystem by month, 1/93 - 3/93 .....	160
28.	Duration of failures by month, 1/93 - 3/93 .....	160
29.	Number of failures by subsystem by time of day, 1/93 - 3/93 .....	164
30.	Number of failures by subsystem by month, 6/92 - 3/93 .....	168
31.	Duration of failures by month, 6/92 - 3/93 .....	171
32.	Duration of failures by subsystem by time of day, 6/92 - 3/93 .....	172
33.	Number of failures by subsystem by time of day, 6/92 - 3/93 .....	175
34.	Vehicles with high error rates when transmitting to TMC .....	184

**LIST OF TABLES**  
(Continued)

<u>Table No.</u>		<u>Page</u>
35.	Vehicle software change history .....	191
36.	TravTek TMC computers - reboot frequency .....	193
37.	Benefits of distributed systems .....	195
38.	Contrasting central versus distributed implementation .....	197
39.	Relationship of TravTek problems to architecture and implementation .....	200

## GLOSSARY

AAA -	American Automobile Association
ATIS-	Advanced Traveler Information System
CAR -	Center for Applied Research
CRT -	Cathode Ray Tube. A video or computer screen using electron beams to strike a phosphor screen, as opposed to a liquid crystal display.
DFD -	Data Flow Diagram. A network representation of a system from the viewpoint of the data, made up of the four basic elements: <ol style="list-style-type: none"><li>1. data flows, represented by named vectors</li><li>2. processes, represented by circles or bubbles</li><li>3. files or databases, represented by straight lines</li><li>4. data sources and sinks, represented by boxes.</li></ol>
DPS -	Department of Public Safety
FDOT -	Florida Department of Transportation
FHWA -	Federal Highway Administration
FMC -	Freeway Management Center
GM -	General Motors Corporation
GMR -	General Motors Research Laboratories
GPS -	Global Positioning System. A system of satellites which give the precise position, velocity and heading of a GPS receiver.
IVSS-	In-Vehicle Subsystem Simulator
ITE -	Institute of Transportation Engineers
LID -	Local Information Database
Map Link -	A representation of a roadway section beginning with intersecting, merging or diverging roadways, and ending with the next intersecting, merging or diverging roadway in the forward direction of travel.
NavTech -	Navigation Technologies
MRM-	Mobile Radio Modem
RVS -	Radio Verification System in Traffic Management Center
SAIC -	Science Applications International Corporation
TIN -	Traffic Information Network
TISC -	Traffic Information and Services Center
TMC -	Traffic Management Center
Traffic Link -	An aggregation of consecutive map links.
TravTek -	Travel technology.
TT -	Travel time.
TTI -	Texas Transportation Institute
UCF -	University of Central Florida
USF -	University of South Florida
VMS -	Avis Vehicle Maintenance Station

## INTRODUCTION

### TravTek BACKGROUND

In the early stages of IVHS, significant milestones were the Mobility 2000 Conference in Dallas, the IVHS report to Congress, design and implementation of the Pathfinder project (the forerunner of TravTek), and the formation of IVHS AMERICA. A parallel effort was the inception of the TravTek project for ultimate demonstration in Orlando, Florida. The TravTek Project encompassed an area of 3,100 km<sup>2</sup>, and a highway network of 1,300 km (directional) in the geographic area shown in figure 1.

After 3 years of planning and design work by the partners, the TravTek project reached operational status on March 23, 1992. A 1 year operational study was used to evaluate all aspects of the system implementation. This evaluation included the system infrastructure, operating characteristics, and driver interaction.

The TravTek Project provided traffic information, motorist services information, tourist information and route guidance to operators of 100 test vehicles equipped with in-vehicle TravTek devices.<sup>(1,2)</sup> Route guidance reflected current traffic conditions in the TravTek traffic network. The project involved a partnership of General Motors (GM), the American Automobile Association (AAA) and public sector partners. The public sector partners were the Federal Highway Administration (FHWA), the Florida Department of Transportation (FDOT), and the City of Orlando.

The TravTek system was a good example of public and private sector partnerships that must exist for the successful implementation of an IVHS system. With an early implementation, a broad range of options were available that would otherwise not exist with a rigid set of nationwide IVHS standards. The TravTek system set an early pace, and provided an excellent test-bed for exploring options and identifying problems. The system was an experiment, and the 1 year test period provided a rich source of data for evaluation. After that time, more information was available to determine the benefits of continuing TravTek, and the merits of replicating the TravTek system.

The system included three major subsystems. The Traffic Management Center (TMC) obtained digital data and information via voice from various sources, encoded voice information into the TMC data base, processed the information to provide fused data, and provided these fused data to the fleet of test vehicles and the various sources. These fused data related to incident information and link travel times when incidents or unusual traffic conditions occurred. The "various sources" included an I-4 Freeway Management Center (FMC), the City of Orlando Traffic Signal Control Center, the TravTek Information and Services Center (TISC), the TravTek vehicles themselves, media traffic information centers, police agencies, etc. Collectively, they formed the Traffic Information Network (TIN). The TMC was located in space provided by the City of Orlando, and was operated by the City.

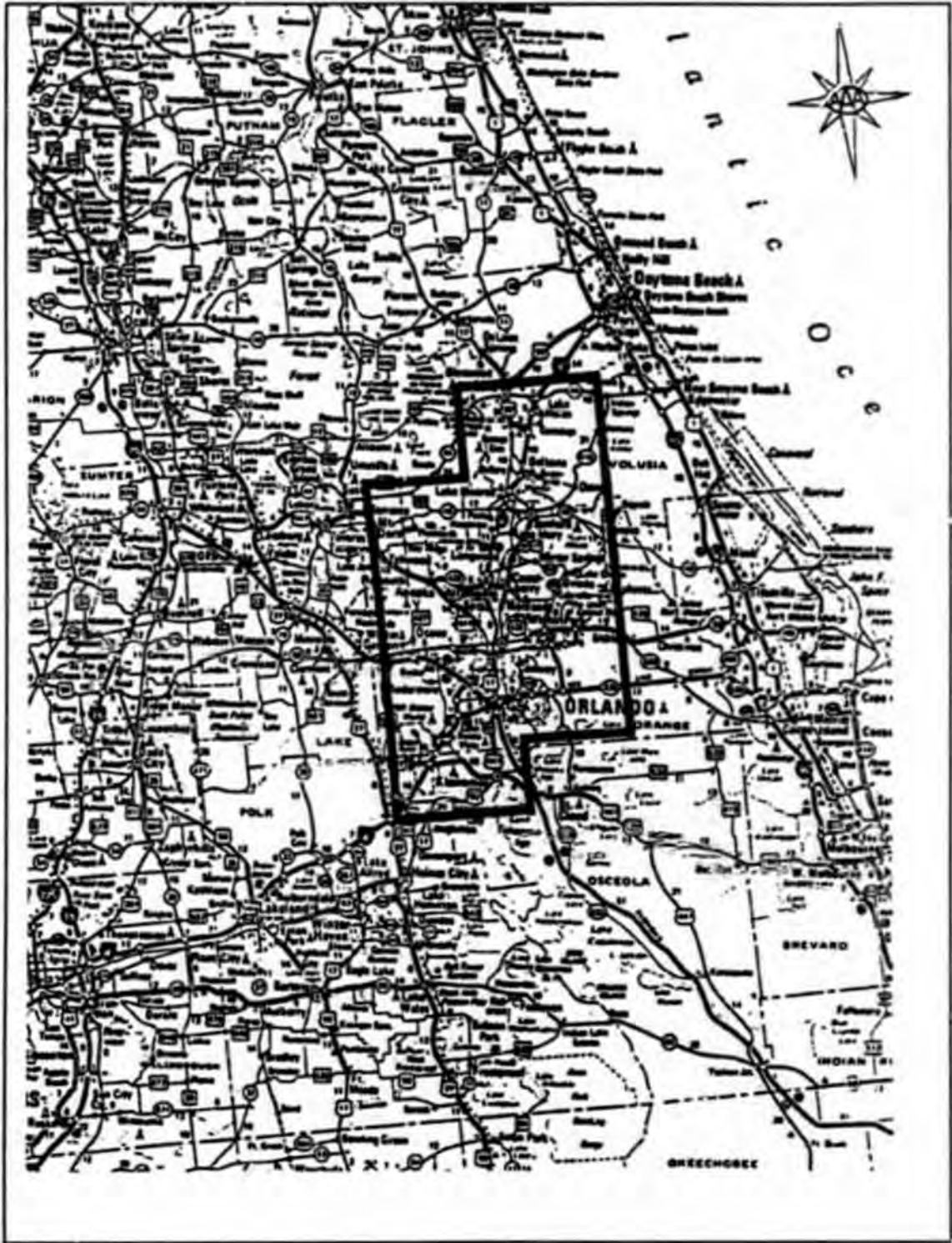


Figure 1. TravTek geographic area. <sup>(1)</sup>

The vehicle subsystem included radio equipment, processors, data storage devices for map data bases and other data, and a display for the driver interface. Trip assignments for route guidance purposes were derived from an in-vehicle historical data base of link travel times that was updated by dynamic link travel times broadcast from the TMC. When incidents or congestion affected the selected routings, drivers were informed and given the opportunity to accept new routings developed by the in-vehicle subsystem which reflected the changed conditions.

The responsibilities of GM were to provide the vehicles, in-vehicle radios and radio subsystem, the interface between the TMC and test vehicles, the Etak map data base, system level engineering, operational readiness review, system test, and evaluation of customer satisfaction.

The responsibilities of FHWA were to provide systems manager services for the TMC, traffic operations effectiveness with FDOT, leasing of radio subsystem from GM, and assisting the City of Orlando in operating and maintaining the TMC.

The responsibilities of AAA were to provide the TravTek Information and Services Center (TISC), the map data base (except for Etak), updates of the map data base, identification of the need for in-vehicle equipment repairs, recruitment and instruction of rental fleet customers, and training of and coordination with rental car staff. The TISC provided motorist services information and tourist information. The TISC periodically transmitted information about local events to the TMC which transmitted it to the TravTek vehicles.

The City of Orlando provided coordination of the TMC, space allocation for the TMC, hardware and software for the TMC, maintenance of TMC data base, procurement and installation of any "standard" data base needs, 24 hour operation of the TMC, and traffic signal system interface with the TMC.

FDOT provided the freeway surveillance system on I-4, interface of the freeway surveillance system with the TMC, and revision and maintenance of the TravTek Traffic Link network map and link-node listing.

### **TravTek EVALUATION**

The TravTek Evaluation Study provided the design, management, implementation and support for the evaluation of the TravTek project in Orlando, Florida. (See references 1, 4, 5, and 6.) The TravTek Evaluation was a crucial study which influenced how similar IVHS systems will be evaluated in the future. The evaluation study was divided into seven tasks as follows:

- Task A (Project Management) - Coordinated and managed the study activities of Tasks B, C, D, E, F, and G.
- Task B (TravTek User Studies) - Collected and analyzed data on driver performance, perceptions and opinions, and system performance.

- Task C (TravTek Design and Effectiveness Studies) - Evaluated drivers traversing designated routes under varying conditions, effectiveness of operational aspects of the various TravTek/driver interface features, and measured drivers system interactions and the effect of the system on the driving task.
- Task D (TravTek Debriefing, Interview, and Questionnaire Study) - Assessed driver perceptions of all aspects of the system.
- Task E (TravTek Traffic Studies) - Evaluated the traffic and safety performance of the system.
- Task F (TravTek System Architecture Evaluation) - Evaluated the system architecture.
- Task G (Global Evaluation) - Provided overall evaluation of the TravTek project.

Tasks B through D focused on the human factors aspects of the driver interaction with the system, while Task E focused on the traffic and safety performance of the system. Task F was the system architecture evaluation phase which examined the TravTek system physical platform that provided the basic service of an in-vehicle driver information system.

Task F performed the evaluation to determine the usefulness of all aspects of the TravTek system design as implemented. The scope of the TravTek system under consideration by Task F was the entire system and operation, including the person/machine interface, but exclusive of driver interpretation and action. The analysis covered three broad areas of system architecture evaluation: **system effectiveness**, **system verification**, and **system critique**.

**System effectiveness** is a measure of how well the system performs the functions that it was designed to perform. The performance of a system is usually a complex multidimensional parameter, and it is appropriate to express system effectiveness as a combination of assessments of the individual properties of system design. The list of properties of general system design that can be evaluated is extensive, but can be narrowed for an independent evaluation of an operational system. This implies that the basic phases of the system design are accomplished, such as definition, analysis, design and implementation. In the **system verification** phase, verification depends considerably on the type of project and the complexity of the objectives. Its purpose is always the same: to verify that the requirements of the system specification have been satisfied.

**System critique** is the final architecture appraisal. The system design phase provided the iterative design changes from the point of inception to implementation, and the critique phase has the added advantages of observation during the operation period. This post analysis phase provides the final assessment of design details, and recommends improvements, changes or new versions of the system.

Although the central feature of any system is its composite nature, it consists of and is described in terms of elements. Elements are distinguished by their functionality. System operation is determined by the interchange of information among the system elements. Certain

system properties can be assessed through a study of the elements and their interactions. The nature of the elements and their interactions is obviously system dependent. The salient properties which are of interest in the TravTek system architecture evaluation included:

- **Reliability** - The reliability of a system is a characteristic deriving from its design and identified with the frequency of operational failures and their effects on performance.
- **Expandability** - The expandability of a system is a measure of the effect on interaction when elements and interactions are increased.
- **Extensibility** - The extensibility of a system is its ability to be placed in another geographical setting.
- **Maintainability** - The maintainability of a system is a characteristic deriving from its design and installation, and is identified with the ease, efficacy, safety and cost of maintenance actions taken to retain or restore its performance.
- **Performance** - The performance of a system is a characteristic which measures the ability of the system to complete the intent of the design.
- **Human Engineering** - Human engineering is concerned with the interface between users and machines, defined as the total set of activities concerned with optimizing the combined performance of humans and equipment.
- **Cost Analysis** - The cost analysis is the determination of the total system cost, including costs of research and development, implementation, operation and support, improvements, and finally continuation /deactivation assessments.
- **Complexity** - The complexity of a system is a measure of the interconnection of its elements.
- **Input Configuration** - This is the tolerance of the information system to produce the intended process with a variation of the number of inputs and the amount of information supplied by each.
- **Processing Distribution** - The processing distribution of a system is characterized by having both the processing elements physically dispersed and interconnected by data communication facilities.
- **Channel Capacity** - The channel capacity is the characteristic of the system to communicate over various communication links of finite capacity.
- **Processing Algorithms** - The processing algorithms comprise the computational algorithms and their efficacy.



- **Accuracy** - This is the precision of the system and the net effect of errors on system output.
- **Fault Tolerance** - The ability of the system to operate with reduced input, processing or interaction is its fault tolerance.

### **TravTek ARCHITECTURE EVALUATION OBJECTIVES**

The TravTek Architecture Evaluation had the objectives of analyzing the hardware, software and data base triad as a system, verifying system accuracy, establishing reliability, assessing system design alternatives, and examining system staffing and operation requirements.

The architecture evaluation approached the system analysis from a functional perspective, where a function constitutes an action required to achieve a given purpose. Such actions may be accomplished through the use of equipment, personnel, facilities, software, data, or a combination thereof. The functional approach helps to assure that:

1. All facets of the TravTek system development, operation, and support are fully described and documented.
2. All elements of the TravTek system are fully recognized and defined.
3. A means of relating TravTek equipment concepts and support requirements is provided.

Many diverse aspects of the TravTek system were bridged in the architecture evaluation. To retain the system perspective, functions were sometimes overlapped with other task evaluations. Cross referencing with other studies was used as necessary to retain continuity of discussions.

Major system topics and associated objectives are:

- **System Description** - Describe all aspects of system design, implementation, and operation.
- **Driver Information System** - Measure the quality and timeliness of information conveyed to the driver through the in-vehicle display and audio system.
- **Public Traffic Information System** - Measure the quality of information conveyed to external users of the system.
- **System Information Source** - Evaluate the information sources that are fundamental inputs to the system, such as determining the quality of current traffic flow and status information, as well as determining the type and amount of traffic information required.

- **System Data Bases** - Evaluate the accuracy of the major system data bases, and the resulting impact on system operation.
- **System Equipment** - Evaluate the reliability of the system equipment and communication systems.
- **System Operation** - Evaluate the system operating requirements, including personnel and facilities.
- **System Architecture** - Describe the architectural structure, its strong and weak points, and suggested changes and alternatives.
- **System Person/Machine Interface** - Assess the effect of the system person/machine interface on system performance.
- **System Lessons Learned** - Document the lessons learned from the TravTek architecture implementation. ~~SECRET~~

These objectives are more closely detailed in following sections.

The analyses were mainly based on data obtained from the TMC logs. No field studies were made; this ultimately governed the depth of the various analyses.

**BLANK PAGE**

## SYSTEM OVERVIEW

The Task F TravTek test configuration was the entire physical system that had been installed specifically to implement TravTek, as well as other traffic management systems and services already in place that coincidentally supported TravTek. The TravTek system diagram is shown in figure 2.

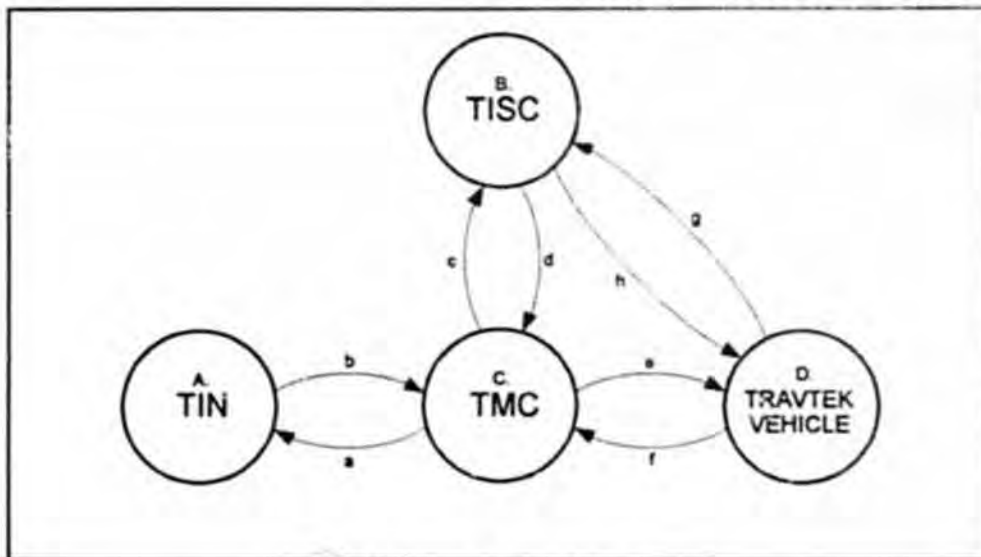


Figure 2. TravTek system diagram.

Four major system elements contributed to the TravTek system operation:

- A. **Traffic Information Network (TIN)** - Network traffic data source and/or sink; online, usually manned.
- B. **TravTek Information and Services Center (TISC)** - Local business services, events and help center; online, manned.
- C. **Traffic Management Center (TMC)** - Traffic data collection and management, operations, and communications center; online, manned.
- D. **TravTek Vehicle** - Onboard driver information platform with mobile communications; provided link travel time feedback.

Each of these elements in turn had additional subelements. The directed arcs labeled with lowercase letters in figure 2 represent interconnections between the system elements. Functionally, they represent system interactions, while physically they represent communication links. The critical nature of data communications in the system design is clearly seen in the schematic.

The system elements will now be described briefly to clarify the architecture and identify the components that are involved in the architecture evaluation. A detailed functional description of the system elements is given in the next section.

### **TRAFFIC INFORMATION NETWORK (TIN)**

The TIN was the collective designation given to the sources of real-time traffic information for the TravTek system.<sup>(7,8)</sup> The TIN encompassed the TravTek Information and Services Center (TISC) which, among other things, supplied timely special events information. The Freeway Management Center (FMC) and the Traffic Control System (UTCS) were traditional traffic management facilities also encompassed by the TIN, and the remaining components of the TIN were established specifically for TravTek.

The FMC, under the jurisdiction of the Florida Department of Transportation, is a freeway surveillance and motorist information system on 18 km of I-4 through downtown Orlando. Closed circuit television (CCTV) cameras are located at approximately 1.6 km spacings, with speed stations at 0.8 km spacings. The CCTV images are multiplexed into a single screen quad display, and fed to the TMC for operator viewing. The usual multiple monitor displays are in the FMC, which is staffed by the Florida Highway Patrol. The FMC computer monitors the speed stations using an incident detection algorithm.

The UTCS system in downtown Orlando supervises approximately 375 signalized intersections and 300 loop detectors. Travel time delays were calculated for the control network links, and sent to the TravTek data base computer in response to 1 min polls. This system provided a substantial number of the arterial link travel times to the TravTek system.

The probe vehicles provided a feedback mechanism for link travel times. At 1 min intervals, each probe vehicle reported its travel time over the previous link it had traversed. The efficacy of this feedback was a function of the number of probe vehicles, as well as their distribution over the network.

The TISC and its many TravTek system functions are described in the following section. Its contribution to the online TIN network was to provide updates to the special event information in the vehicles. The updates were sent daily via a leased telephone line to the TMC, where the information was in turn broadcast to the vehicles to update the appropriate onboard data base.

The TIN network user stations connected to the TMC, which served as the network hub. The three types of TIN station users were: phone users, terminal users, and graphics workstation users. This TIN network furnished travel time (mainly incident) data to the TMC, as well as received real time information regarding link travel times currently known to the TMC. The phone user used a voice menu to enter incident information. Terminal users logged in to the TIN via their terminal program, and entered link incident information via a keyboard. Additionally, a series of links could be defined at the terminal, with the ability to query the system for the travel time along the route described by the links. Graphics workstation users also logged in to the TIN via their workstation. A map of the network could be viewed, with graphic elements highlighted

according to the status of each traffic link. Similar to the terminal user, specific route travel times could be obtained by the graphics workstation user.

As of April 8, 1992, 13 TIN network user stations were signed up for operation, as listed in table 1.

**Table 1. TravTek TIN network user station list (as of 4/8/92).**

1. City of Maitland Department of Public Safety (DPS)
2. American Automobile Association
3. Ace Expeditors
4. Emery Worldwide
5. City of Lake Mary DPS
6. City of Ocoee DPS
7. Mears Transportation Group
8. Post, Buckley, Schuh & Jernigan (PBS&J)
9. Prestige Delivery Service
10. City of Sanford DPS
11. City of Winter Park DPS
12. City of Casselberry DPS
13. Metro Traffic Control

Note: This list courtesy of the TravTek System Manger, Scott Friedman, PBS&J

### **TravTek INFORMATION AND SERVICES CENTER (TISC)**

The TISC was established and operated by the American Automobile Association (AAA), a TravTek partner.<sup>(3,8)</sup> This center provided tourist and motorist services information as well as a help desk for assistance to users in the operation of the TravTek in-vehicle system. The TISC also compiled special event information and transmitted this information daily to the TMC for broadcast to TravTek vehicles. The six components of the TISC were:

1. Driver Recruitment - Approximately 5,000 drivers would be recruited for the 75 vehicles in the rental pool over the 1 year operational period.
2. Driver Orientation - Training for the in-vehicle system was provided through a videotape, orientation session, and pre-rental briefing documents.
3. Motorists' Assistance - Telephone counselors were available 24 hours a day to assist motorists in the use of the in-vehicle system or other related services.
4. Vehicle Diagnostics and Repair - The first line of diagnostic maintenance was provided for the in-vehicle system at the end of each rental period.

5. Data Base Management - The TISC subsystem was responsible for maintaining the following in-vehicle data bases:
  - Navigable Map Data Base (maintained by NavTech).
  - Local Information Directory (maintained by AAA).
6. System Support - The TISC technical staff was responsible for maintaining computer programs, hardware, data communications, and data bases on a daily basis.

### **TRAFFIC MANAGEMENT CENTER (TMC)**

The Traffic Management Center was located at the offices of the Orlando City Traffic Engineer in downtown Orlando, as shown in figure 3. The TMC was the focal point of data and information flow, while both processing and forwarding these data. <sup>(2,9,10)</sup> Traffic related information from a variety of sources throughout the Orlando metropolitan area was combined and sorted (fused). This traffic information included the probe vehicle link travel times. Link travel times, based on the current information available, were sent as coded updates to all vehicles each min via a data radio. Weather, special event information, and traffic reports were included with the link travel time data sent to the vehicles. The same data radio system received the probe vehicle link travel time reports each min.

The TMC was operated by the City of Orlando and had an operator on duty 24 hours a day to make operational decisions as required to enhance system operation.

A networked system of three computers supported the TMC. A **communication computer** handled tasks associated with controlling the data to and from the radio communication system to the vehicles, in addition to managing communication with the TIN stations. A **data base computer** controlled the data fusion process. A **graphics workstation** provided the graphical interface to the system operator. A non-networked **librarian computer** archived system log data for the evaluation study. The TravTek-related equipment was installed in the downtown Orlando control center where the UTCS system has been operational since 1987.

### **TravTek VEHICLE**

The 100 prototype vehicles were supplied by General Motors, with in-vehicle driver information system hardware and software. <sup>(2,11)</sup> The vehicles were 1992 Oldsmobile Toronados, with a production in-vehicle dashboard touch screen color CRT. A cellular telephone and data radio provided voice and data communications, and a GPS receiver provided vehicle position inputs to the in-vehicle navigation system.

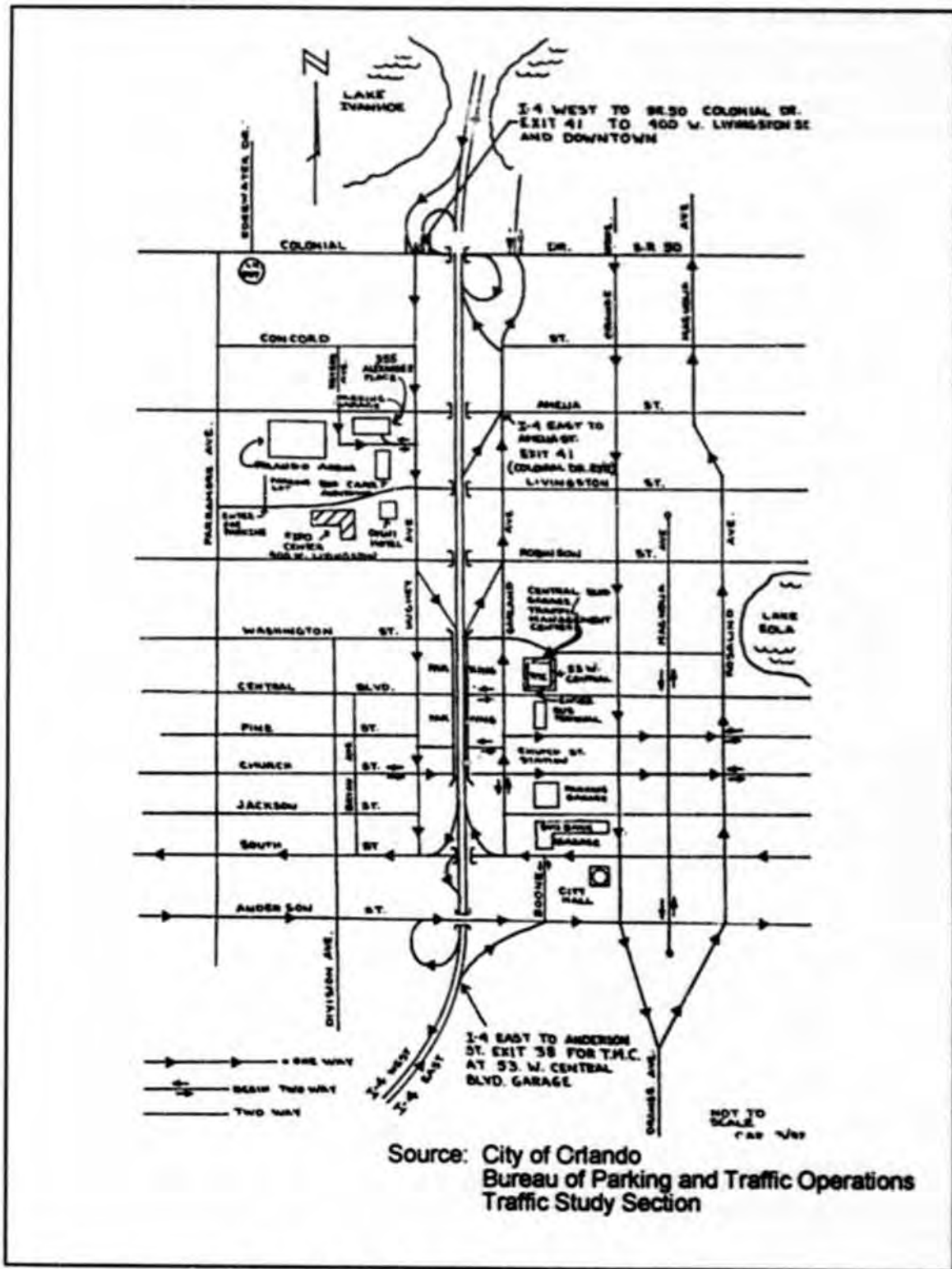


Figure 3. Traffic management center location.



Via the color CRT, the driver was provided with maps of the Orlando area, messages about local services, traffic conditions, and route guidance information. On a once per min basis, a TravTek vehicle received current updates of travel times on the contiguous segments of the major arterials and expressways in the TravTek communications system coverage area. Figure 4 illustrates the general flow of information with respect to the vehicle domain.

The major functions of the driver information system included Navigation, Route Selection, Route Guidance, Local Information, Driver Interface, Probe Report, and Data Logging. Each of these tasks will be discussed briefly.

**Navigation Function** - This function consisted of showing the vehicle position on a map displayed via the color CRT. The map data base was supplied by Etak, and the vehicle position was monitored by a flux gate compass, with distance sensing via wheel sensors, and a GPS receiver for position correction.

**Route Selection Function** - The suggested route to a selected location within the TravTek network was provided by this function. The destination was selected via the touch screen while the vehicle was in park, and the suggested route was displayed as highlighted links on the color CRT.

**Route Guidance Function** - This function tracked the vehicle's progress along the suggested route, giving visual, and optionally audible, guidance cues for navigation assistance. A magnified network section was shown on the color CRT, with arrow indications for direction assistance. The remaining distance to the destination was displayed. Audible traffic reports were handled by this function to report traffic conditions in the general heading of the vehicle.

**Local Information Function** - The in-vehicle local information data base was accessed by this function to supply information and services on the color CRT while the vehicle was in park. This data base contained information on local events, restaurants, overnight accommodations, various services, attractions, and weather information. Function operation was controlled by the touch screen, and the cellular telephone link was accessible for automatically dialing the displayed selection.

**Driver Interface Function** - The driver interface function handled hard and soft button inputs, visual displays and auditory cues, menus, sequencing, and other duties relating to controlling the man machine interface. This utility function performed the critical role of menu control sequencing and dispatching of action commands.

**Probe Report Function** - This function handled the reporting of the vehicle's link travel times to the TMC.

**Data Logging Function** - Driver interactions, vehicle location information, and TMC communications data were logged on a removable hard disk in the vehicle, under control of this function.

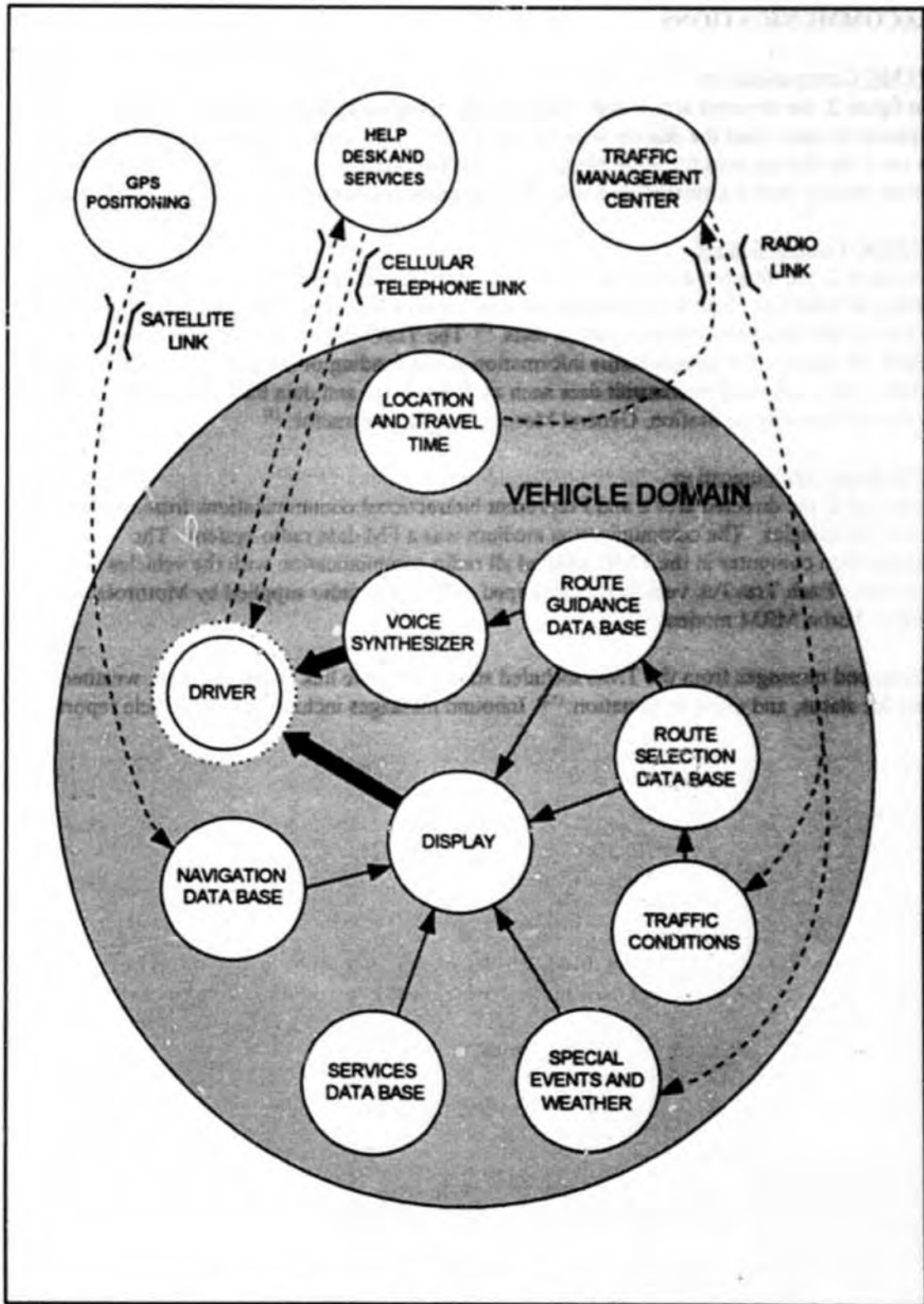


Figure 4. Vehicle information flow.

## TELECOMMUNICATIONS

### TIN/TMC Communication

In figure 2, the directed arcs a and b represent both dedicated and dial-up voice grade lines. TIN phone-in users used the dial-up lines for voice only. TIN Terminal and workstation grade users used the dial-up lines for 9600 bits per second (bps) data communication. The dedicated (full time leased) line(s) similarly used 9600 bps communication rates.

### TISC/TMC Communication

In figure 2, the directed arcs c and d represent both dedicated and dial-up voice grade lines, operating at 9600 bps. Primary communication on the dedicated line from the TMC to the TISC were for vehicle alerts and communication tests. <sup>(9)</sup> The TISC-originated communications consisted of requests for vehicle status information and uploading of the event data base updates. The dial-up line was used to transmit data such as vehicle logs and data base updates to and from the Vehicle Maintenance Station, General Motors, and the contractor. <sup>(10)</sup>

### TMC/Vehicle Communication

In figure 2, the directed arcs e and f represent bidirectional communications from the TMC to the TravTek vehicles. The communication medium was a FM data radio system. The communication computer in the TMC handled all radio communication with the vehicles via a base station. Each TravTek vehicle was equipped with a data radio supplied by Motorola, and a Dataradio Turbo MRM modem. <sup>(11)</sup>

Outbound messages from the TMC included status, dynamic link times, incident, weather, parking lot status, and event information. <sup>(12)</sup> Inbound messages included probe vehicle reports.

## SYSTEM DESCRIPTION

The Task F evaluation environment was the entire TravTek system, including **system inputs, system outputs, internal system activity, and system operator interaction**. This included an evaluation of **computer programs and supporting data bases, and their combined effects**.

The operational elements evaluated were the TIN, TISC, TMC, and TravTek vehicle systems, and their associated data bases and data communication links.

The **system inputs** environment included vehicle systems input, traffic systems input, TIN user stations, and TMC operator station. The **system outputs** environment included the driver interface, TIN user stations, and TMC operator station. The **computer program** environment included the FMC, TIN, TISC, TMC, TravTek Vehicle and UTCS software. The **system data base** environment included the Orlando network description, and data bases for map links, traffic links, historical link travel times, and events, accommodations and services.

The following sections describe the functions, processes and data flows of the TravTek system elements that defined the evaluation environment.

### TRAFFIC INFORMATION NETWORK (TIN)

The Traffic Information Network (TIN) was a collective designation given to all of the sources of current traffic information for the TravTek system. <sup>(7,8)</sup> The concept of the TIN was to provide a network whereby current travel time and incident information could be shared by all members (or users) of the TIN. TIN members could also contribute information to the TIN which in turn increased the utility and timeliness of the information in the network. By providing multiple TIN users, information in the TIN increased in scope, timeliness, and credibility. Through the network, all TIN users were kept apprised of changing roadway and travel conditions in the network. <sup>(13)</sup>

The TIN was composed of both public and private transportation and law enforcement agencies that either reported or responded to incidents on the freeway and arterial street network. The various elements of the TIN included the following:

- The City of Orlando's computerized center traffic signal system.
- The Florida Department of Transportation's Freeway Management Center (FMC).
- The various police agencies in the area.
- The local media agencies responsible for reporting traffic information.
- The dispatching centers of commercial fleet operators in the area.

Figure 5 illustrates the various elements of the TIN.

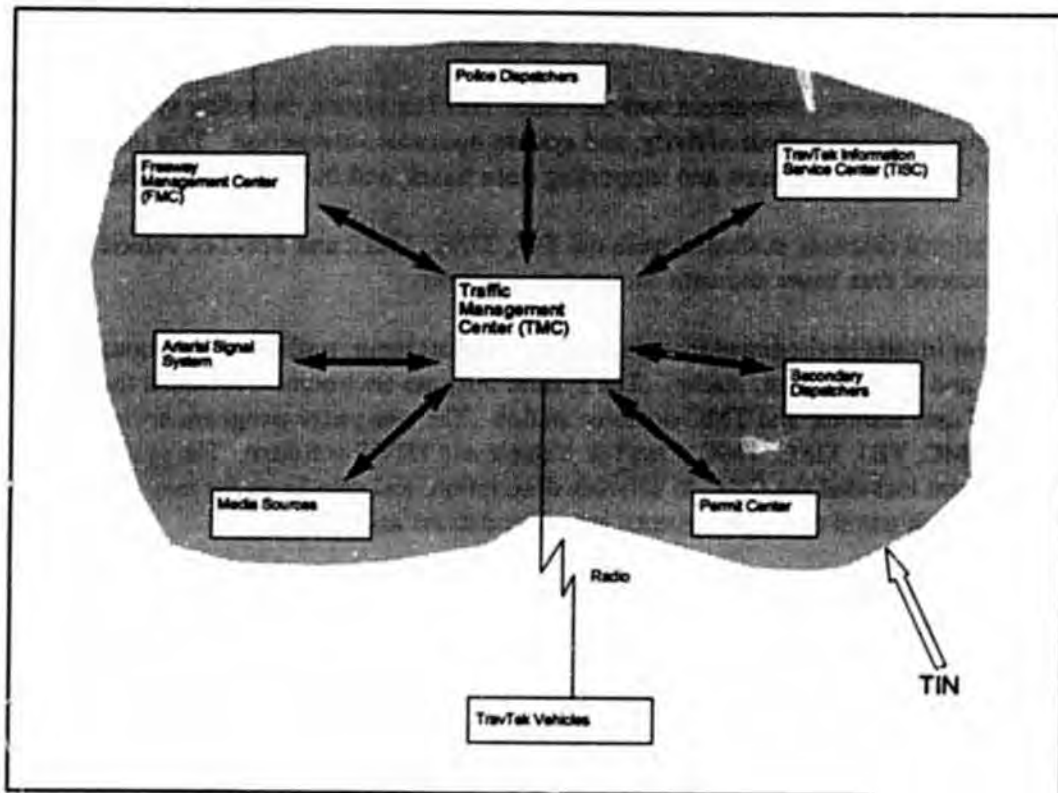


Figure 5. Elements of traffic information network. (6)

The TIN also included the TMC, which was the hub of the network. At the TMC, incoming information was received, organized, confirmed, and disseminated back through the TIN to various users and to the vehicles.

Users of the TIN could enter congestion and incident information through one of three systems: a phone-in system, a computer terminal system, or a graphics workstation system. Phone-in users (PTIN's) entered congestion and incident information using voice prompt questions about traffic conditions. Terminal users (TTIN's) and graphics workstation users (GTIN's) were provided a series of menus to assist them in entering incident and congestion information. Depending upon the user's classification (PTIN, TTIN, or GTIN), different levels of information and modes of presentation could be used to enter and obtain information; however, the basic functions, processes, and data flow were the same regardless of the user's classification.

#### TIN Functional Description

The TIN had three primary functions; to:

- Provide the TMC with accurate and current link travel time information.
- Provide the TMC with accurate and timely incident information.

- Serve as a mechanism for disseminating travel time and incident information to various public and private system users.

Each of these functions are discussed in detail below.

### *Link Travel Times*

One of the primary objectives of the TravTek system was to provide drivers with routes that minimized their individual travel times to their destinations. Using information provided by the TMC, software in the vehicle continuously determined the optimum route that minimized the travel time to a destination. One of the key inputs to this process was link travel time. Estimates of the current travel time on every route in the TravTek Network were broadcast from the TMC to the vehicle every minute. One of the primary functions of the TIN was to provide the TMC with measurements of the current travel time on each of the links in the TravTek network.

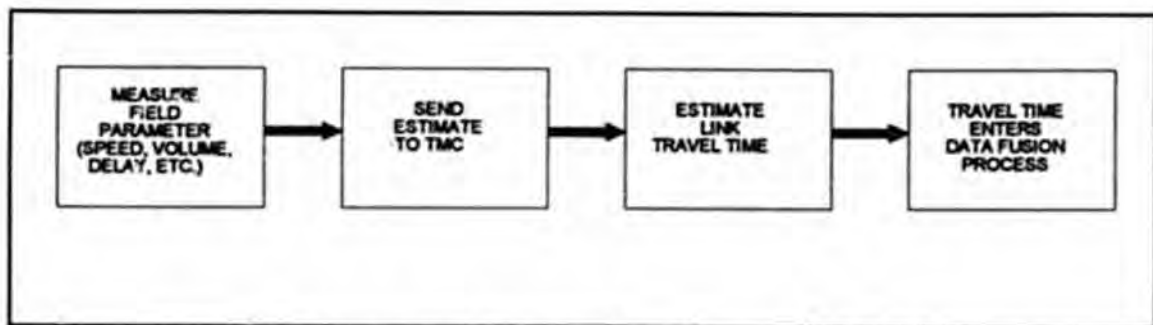
There were three sources of current link travel time information and three sources of non-current link travel time information in the TravTek system. The three sources of current link travel time were the vehicle probes, the City of Orlando's Computerized Traffic Signal Control System, and the Florida Department of Transportation's Freeway Management Center. The three sources of non-current included a historical data base of measured link travel times, a computer model (FREFLO) which was used to predict freeway link travel times under incident conditions, and operator overrides. The TIN provided the mechanism for communicating current link travel times to the TMC.

### Functional Description

Estimates of link travel times were based on actual field measurements of traffic conditions. For example, estimates of the travel times on the freeway links were based upon speed data measured at the loop detectors in the freeway. Estimates of travel times on the arterial links were based on the amount of delay measured by the Urban Traffic Control System. Link performance data (i.e., speed on freeways, delays on the arterials) was transmitted to the TMC at regular intervals. These data were then converted into an estimate of link travel time. Once the travel time had been estimated for a link, it was then entered the data fusion process, where the competing estimates of link travel times were evaluated. A function diagram of how link travel times entered the data fusion process is depicted in figure 6.

### Process Description

Probe vehicles, which were TravTek vehicles, monitored the time it takes to traverse a link. The vehicle then sent information on the last link it had traversed to the TMC once every minute. A detailed description of how the TravTek vehicle functioned as a probe is provided under the TravTek Vehicle heading of this section. <sup>(14)</sup>



**Figure 6. Illustration of travel time reporting function.**

The Florida Department of Transportation (FDOT) installed a freeway surveillance and motorist information system on 18 km of I-4 through downtown Orlando. The system included CCTV cameras located at approximately 1.6 km spacings and loop detector stations located at 0.8 km spacings. The loop detector stations collect volume, loop occupancy, and speed data for 30-second intervals. The speed data was then transmitted to the TMC where it was converted into travel time information by dividing the link distance by the speed.

Current travel time information for selected arterial links was provided by the City of Orlando's computerized traffic signal system. The system software is an enhanced version of the Extended Urban Traffic Control System (UTCS) software package developed by FHWA. The UTCS system supervises approximately 375 signalized intersections and 300 loop detectors. Link travel time was estimated by adding the measured delay (seconds per vehicle) at the intersection to the nominal travel time for the link.

#### Data Flow

A data flow diagram showing the sources and type of current link travel time information is shown in figure 7. Link travel time information from the FMC was received every 30 seconds. Information from the UTCS and the vehicle probes was received once every minute.

#### *Incident and Congestion Reporting*

Another of the functions of the TIN was to provide current traffic congestion and incident information to the TMC. An incident in the TravTek system was defined as any occurrence on the roadway which affects traffic conditions. Examples of incidents include the following:

- Accidents that block 1 or more travel lanes.
- Stalled or disabled vehicles that block 1 or more travel lanes.
- Spilled loads or debris in the roadway which impede traffic flow.

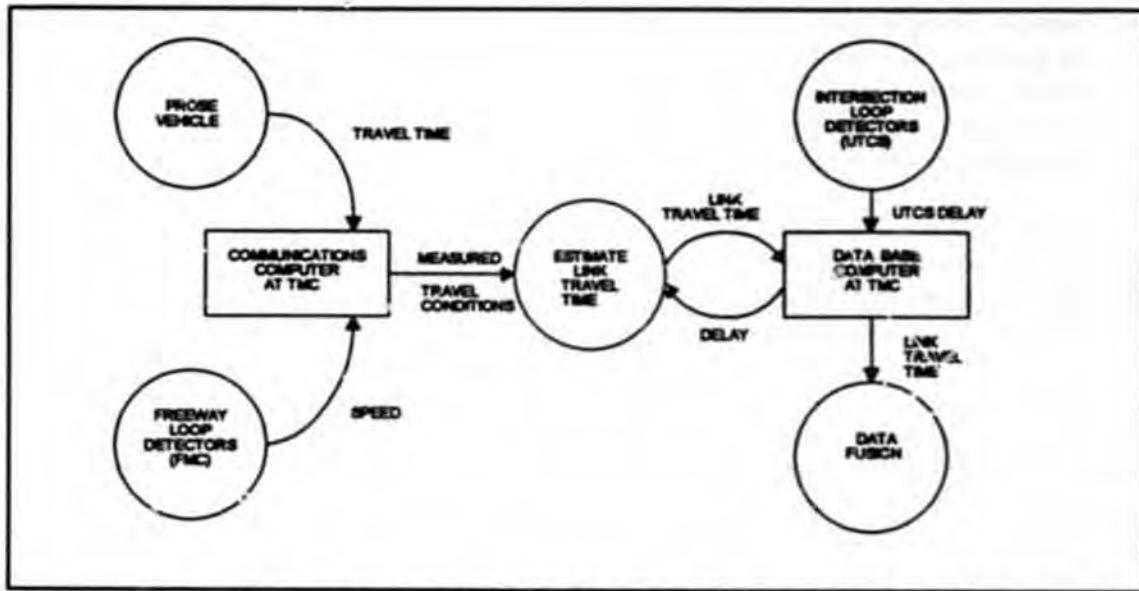


Figure 7. Data flow requirements for travel time reporting function.

- Malfunctioning traffic signal or traffic control equipment.
- Construction or maintenance activities.
- Unusual environmental situations (such as flooding, heavy rains, or high winds, etc.) that create hazardous driving conditions.
- Any other unusual or special event which either alters the demand for, or capacity of, the roadway.

The primary sources of incident data and the type of information they provided are listed below:<sup>(9)</sup>

- **CAD System** – The City of Orlando police department's Computer Aided Dispatch (CAD) system provided reports that are related to traffic information.
- **Metro Traffic** – This commercial traffic service provided a summary screen of the status of Metro Traffic's current data. As new data were provided to Metro Traffic by its operators, these data appeared on the TravTek operator's screen.
- **FMC** – The FMC user could type free form text messages that were transmitted to the TMC and displayed as TIN incident reports.
- **TIN Users** – TIN users could provide textual input in response to questions from the system, including location by link ID and other pertinent data.



- Phone -- Phone-in users could use three options to enter incidents. The first was to page the operator, who then entered the incident while talking to the user. The second was to record a message for the operator to enter later. The third was to enter the information by responding to a series of questions using a touch-tone phone. The phone system was not operational during the test period.

In addition to incident information, TIN Users also provided information about the location, magnitude, and expected duration of traffic congestion. Traffic congestion was entered in the system as either **HEAVY** or **MODERATE**. Examples of heavy and moderate traffic congestion levels are shown in figure 8.

#### Functional Description

The incident reporting function was intended to supply current and accurate information about the location, cause, and anticipated duration of incidents and congestion. This information was important for the TravTek system to achieve one of its primary goals: to provide traffic incident/congestion information to the driver. The type of information to be entered for each incident or congestion report included the following:

- The traffic link where the incident or congestion was occurring.
- The location of the incident (i.e., which lane(s) are blocked).
- The type of congestion resulting from the incident.
- The presence of hazardous driving conditions.
- The cause(s) of the incident.
- The expected duration of the incident (in minutes).
- The number of lanes affected by the incident.
- The number of shoulders affected by the incident.
- Any additional information that might be necessary to clarify the above information.

Through the TMC, this information was broadcast to the TravTek vehicle where it was used to determine optimum travel routes to drivers' selected destinations and to keep drivers informed of changing traffic conditions in the network. A function diagram of the incident reporting task is shown in figure 9.

#### Process Description

To enter incident and congestion information into the TIN, each user was provided with a user identification number. This number allowed the user access to the network. Once in the network, the user responded to system prompts and questions to complete the report. Depending upon the type of system being used to enter the information (PTIN, TTIN, or GTIN), congestion

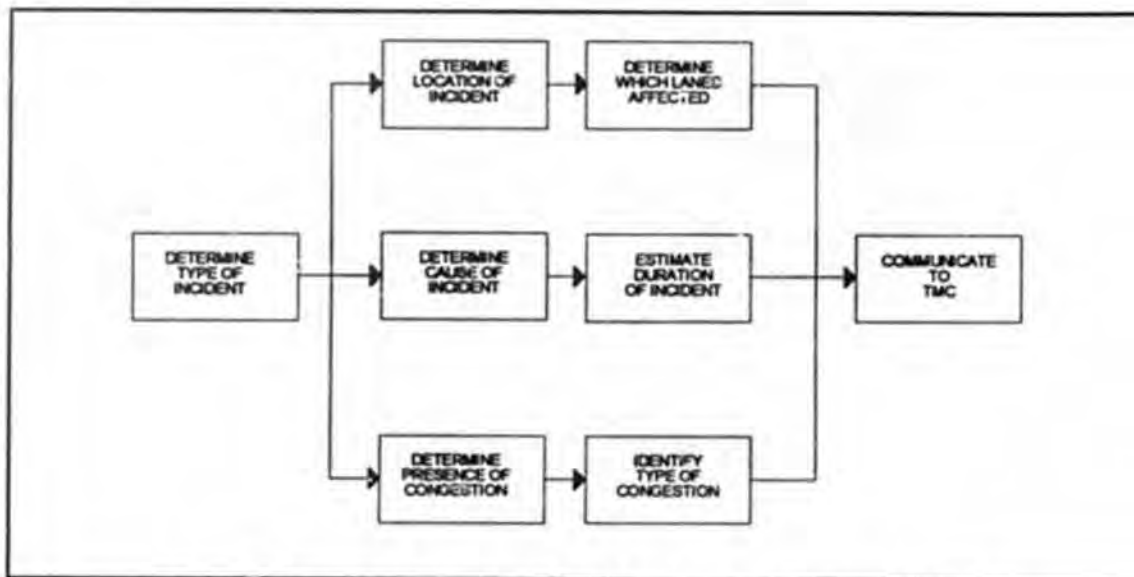


**MODERATE CONGESTION**



**HEAVY CONGESTION**

**Figure 8. Illustration of moderate and heavy congestion levels.<sup>(15)</sup>**



**Figure 9. Functional diagram of incident/congestion reporting task.**

information was entered as a number, letter, or menu entry. To report incidents, users responded to a series of questions. For the PTIN system, users had direct communication with the TMC operator. With the other systems, users responded to a series of computer prompts.

#### Data Flow

The data flow to enter traffic congestion and incident information in the TIN is shown in figure 10. As indicated above, information could be entered using a phone station, a terminal station, or a graphics workstation.

#### *Information Dissemination*

The TIN was also a mechanism for disseminating travel time and incident information back to various users. Using their telephones or computers, TIN users could access the TMC to receive information about incidents and travel conditions. Depending upon the users' needs, information could be received about the entire network or about specific user-defined routes in the corridor. Through the TIN, users could obtain information that would assist them in making informed travel decisions.

#### Functional Description

Using several different processes, the TIN user could access the information at the TMC to obtain information about the current travel conditions on the street network. Information could be obtained for all of the links in the TravTek network or for specific user-defined routes. The TIN could be used to provide users with a listing of the location of all confirmed incidents and congestion in the TravTek network at 1 min intervals. Users could also obtain information

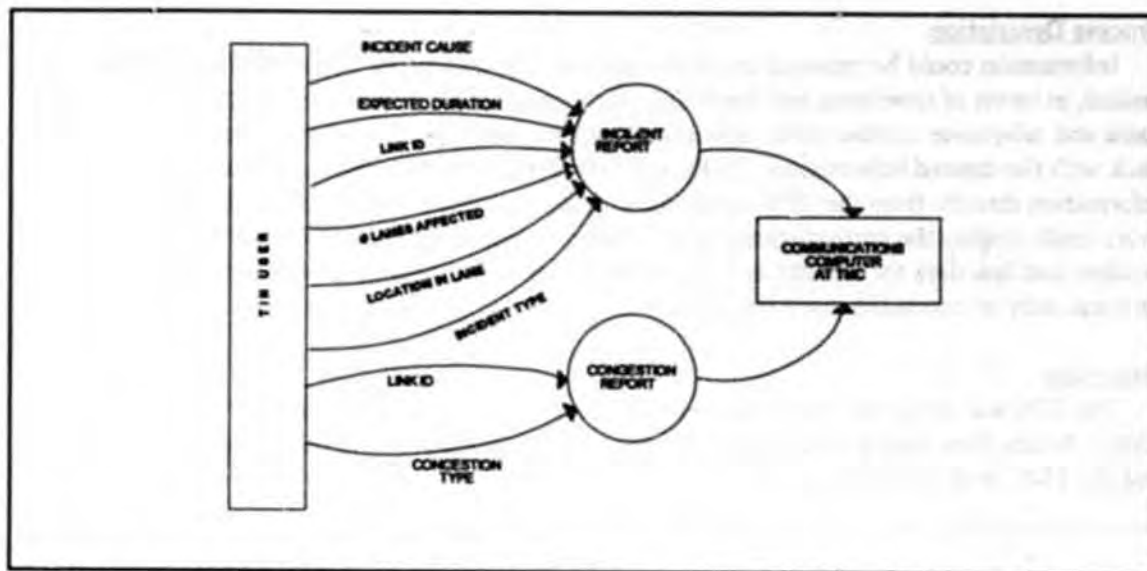


Figure 10. Data flow requirements for reporting incidents and congestion.

(such as total travel time, normal travel time, and incident and congestion information) on important or frequently traveled routes in the TravTek Network. A functional diagram illustrating the information dissemination process is shown in figure 11.

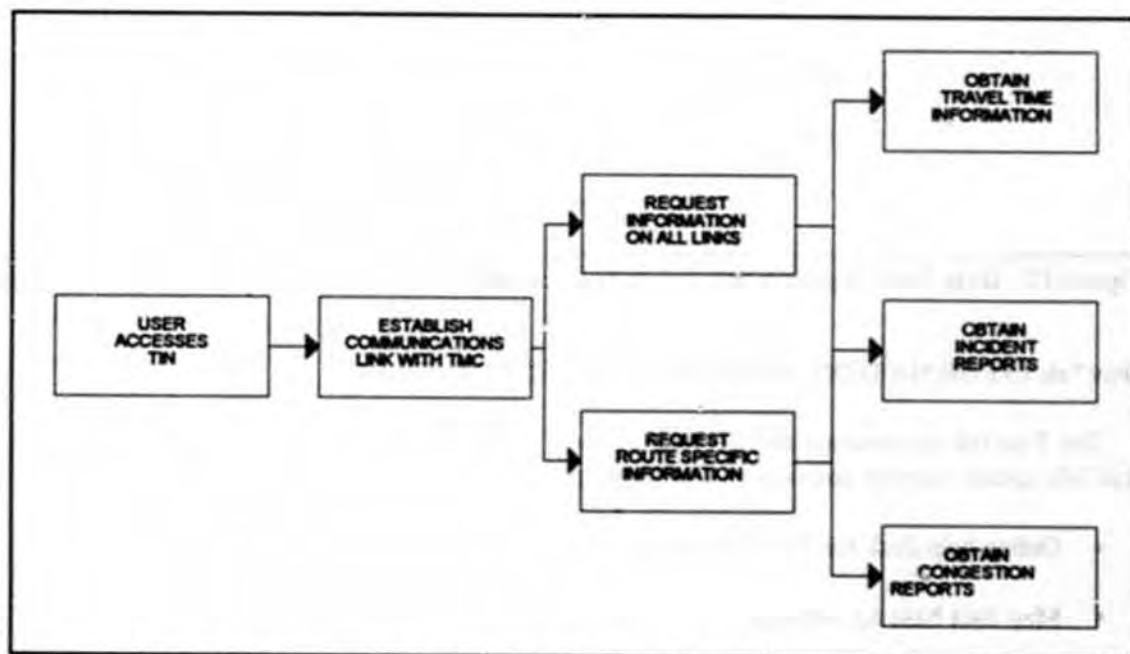


Figure 11. Functional diagram of information dissemination process.

### Process Description

Information could be received by all three of the TIN user types. The PTIN was the most limited, in terms of timeliness and flexibility. To receive traffic information, PTIN users left their name and telephone number on an answering machine, and waited for the operator to call them back with the desired information. TTIN and GTIN users, on the other hand, could obtain information directly from the TMC computers. Using various menu options, TTIN and GTIN users could display the current status of all existing incidents reported to the TMC, display incident and link data for all links at 1 min intervals, or make inquiries about the travel conditions on frequently or commonly used travel routes.

### Data Flow

The TIN was designed to provide two-way flow of information between the users and the TMC. A data flow diagram depicting the flow of information between the various TIN user types and the TMC is shown in figure 12.

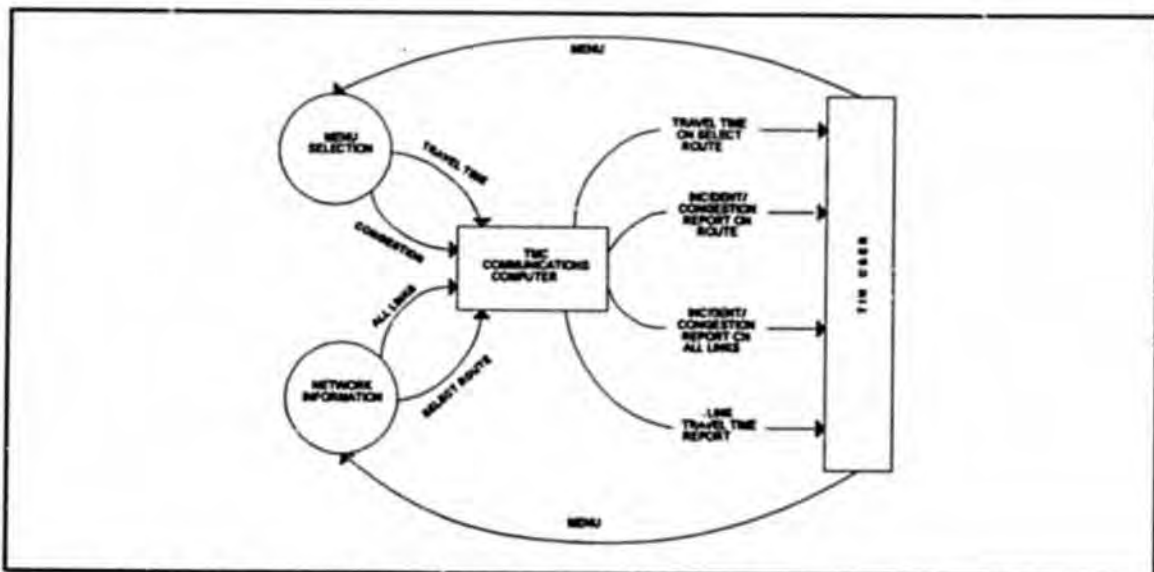


Figure 12. Data flow requirements for disseminating travel time and incident information.

### **TravTek INFORMATION AND SERVICES CENTER (TISC)**

The TravTek Information and Services Center (TISC) provided several functions in the TravTek system support and operation. These included: <sup>(3)</sup>

- Online help desk for TravTek users.
- Map data base for vehicles.
- Local Information Data Base (LID) for vehicles.
- Recruiting and screening of TravTek users.

- Liaison with car rental operations.
- Daily event data to TMC.
- TravTek user training materials.

The TISC was located at the AAA headquarters in Heathrow, Florida. The TISC was open 24 hours a day, 7 days a week. The need for this around the clock staffing was to provide motorist assistance anytime to TravTek users. This "help desk" service was available from a cellular telephone that was in each of the TravTek vehicles. The staff manning the telephones were designated Motorist Assistance Counselors, with training to assist in the operation of the in-vehicle system, and to provide other auto travel related services such as out of area driving directions, emergency road service, etc. The operations staffing arrangement is shown in table 2.

**Table 2. TISC staffing.** <sup>(3)</sup>

Personnel	Shifts
Manager	1
Lead Motorist Assistance Counselor	3
Motorists Assistance Counselor	3
System Support Administrator	1
Driver Recruitment Market Analyst	1

The shifts were staggered, and a special weekend crew was used. Between midnight and 6 AM, the regular AAA dispatchers provided help desk services.

The physical facilities of the TISC consisted of two cubicles with computer terminals and an in-vehicle simulator supplied by GM. A computer resource which functioned as a data base computer was shared with other computer activities in AAA. The TISC system configuration is shown in figure 13.

#### **TISC Functional Description** <sup>(3)</sup>

The motorist assistance services help desk was the nerve center of the TISC operations. The help desk was reached by cellular telephone calls from the TravTek vehicle drivers. A call to the help desk from a vehicle was toll free. The help desk staff, termed motorist assistance counselors, were completely familiar with the TravTek vehicles and system operation. To assist the counselors with queries relating to vehicle navigation, an in-vehicle simulator was also located at the TISC. The simulator, when given the location of the vehicle, could replicate the screens that the driver was observing. The vehicle location was obtained from the TMC via a leased line by computer to computer communications. The simulator had a radio receiver to routinely receive the same information from the TMC as the vehicles.

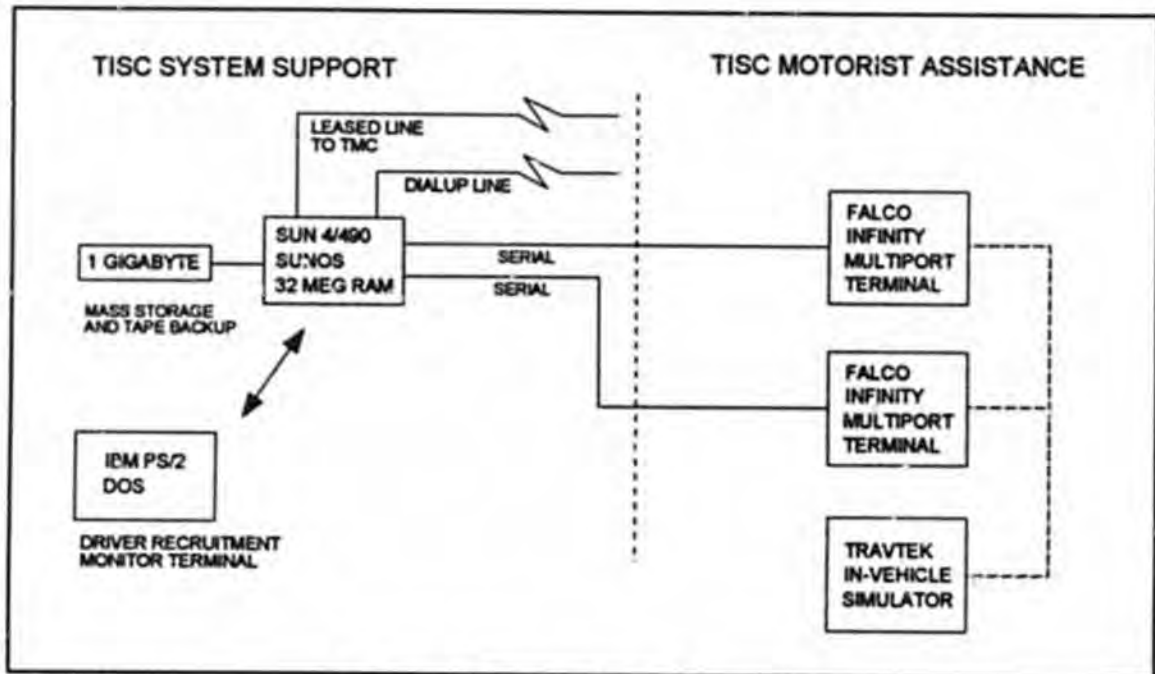


Figure 13. TISC system configuration.

Each call to the TISC was logged in a call management data base. The TISC data base had full information on the vehicle fleet, as well as individual driver information provided by the Avis central reservation system. All details regarding the nature of the calls were entered through the online terminals by the counselors. If the computer system was down, the details were handwritten for later entry.

Motorist assistance counselors were also responsible for placing a call to each TravTek user after 2 days into the rental period. The purpose of this call was to reiterate the availability of personalized support from the TISC staff, and to discuss any problems or answer any questions about TravTek.

The TISC provided and maintained the map data base in the vehicles, which was used as the base for the in-vehicle routing and route guidance functions. The map data base was provided by contract with Navigation Technologies (NavTech). The maintenance of this data base was part of the TISC role, where errors in the data base were reported directly by drivers while in Orlando, or later through questionnaire or comments. The navigable map data base represented a 3100 km<sup>2</sup> area of metropolitan Orlando, consisting of approximately 87,000 links. This data base was considered a city-level data base that contained all of the features and attributes required for in-vehicle navigation.

Vehicle diagnostics and repair were coordinated with the TISC, including updating of in-vehicle hard disks with new versions of the Local Information Data Base and the Map Data Base.

The first line of vehicle maintenance was provided at the Avis Vehicle Maintenance Service (VMS) facility at the Orlando International Airport.

Data base management was a large effort of the TISC. The map data base was a detailed representation of the greater Orlando metropolitan network. Of the total 87,000+ links in the Orlando area data base, 74,000 were navigable links. Approximately 11,000 of these represented the arterial (major roads) road network. There were 17,700 unique street names and 46 municipalities (cities) within the area of coverage. Over 13,000 non-navigable links represented water boundaries, railroads, parks, and other topological boundaries that were necessary for a comprehensive map display. Other information associated with network link records in the data base consisted of data such as:

- Attributes separately defined for each side of the link.
  - zip code.
  - lowest address.
  - highest address.
  - city.
- Name.
  - Prefix, such as North, Southwest, etc.
  - Type, such as street or avenue.
  - Suffix, such as east, west, etc.
- Length in miles and km.
- Ramp sign text.
- Road or lane restriction information.
- Link type, such as freeway, local street, etc.
- Turns restriction.
- Position: latitude and longitude.
- Points of interest.
  - Name and address.
  - Phone number.
  - Hours of operation.
  - City code.

An equally large data base management effort was associated with the Local Information Directory Data Base. The local information directory included:



- Where to stay.
  - 250 Orlando area hotels and motels.
  - Site information: credit cards accepted, meal plans, etc.
- Where to eat.
  - 170 Orlando area restaurants.
  - Site information: cuisine type, price range, etc.
- Yellow page listings.
  - Central Florida Phone Book Yellow Pages selected listings.
  - 33 sub-categories.
  - Name, address, telephone number.
  - Only within TravTek map area of coverage.

### **TISC Process Description**

Telephone calls from TravTek users were received at the TISC help desk by the Motorist Assistance Counselors. They entered the vehicle number in the range 26 to 100 to obtain basic driver information. If the query related to a navigation problem, the vehicle location was requested from the TMC via the AAA data base computer, which was connected by a dedicated lease line using 9600 baud modems. The vehicle location was then entered in the vehicle simulator for replication of in-vehicle screens that were dependent on vehicle location. All pertinent statistics relative to the call from the TravTek user were logged in the AAA call management data base.

The map data base management process was managed by Navigation Technologies personnel at their company facility.

The local information directory data base management process was managed at the AAA headquarters site, using the AAA data base computer.

### **TISC Data Flow**

The TISC help desk information flow is shown in figure 14.

### **TRAFFIC MANAGEMENT CENTER (TMC)**

The TravTek Traffic Management Center (TMC) received traffic information from a number of sources, processed these data, and transmitted current traffic conditions to the TravTek vehicles on a periodic basis. The traffic information sources for the TMC were collectively referred to as the TIN (Traffic Information Network). This included the Florida Department of Transportation Freeway Management Center (FMC), the City of Orlando Traffic Control System (UTCS), and an network of operator reporting stations in the public and private sectors. <sup>(9)</sup>

The TMC received either digital or voice messages from the TIN sources and other agencies and citizens. It facilitated and pursued accident and congestion confirmation and clearance

information from TIN sources, fused the information and provided it in the form of a computerized report to the TravTek vehicles, as well as the TIN users. (6) The synergistic nature

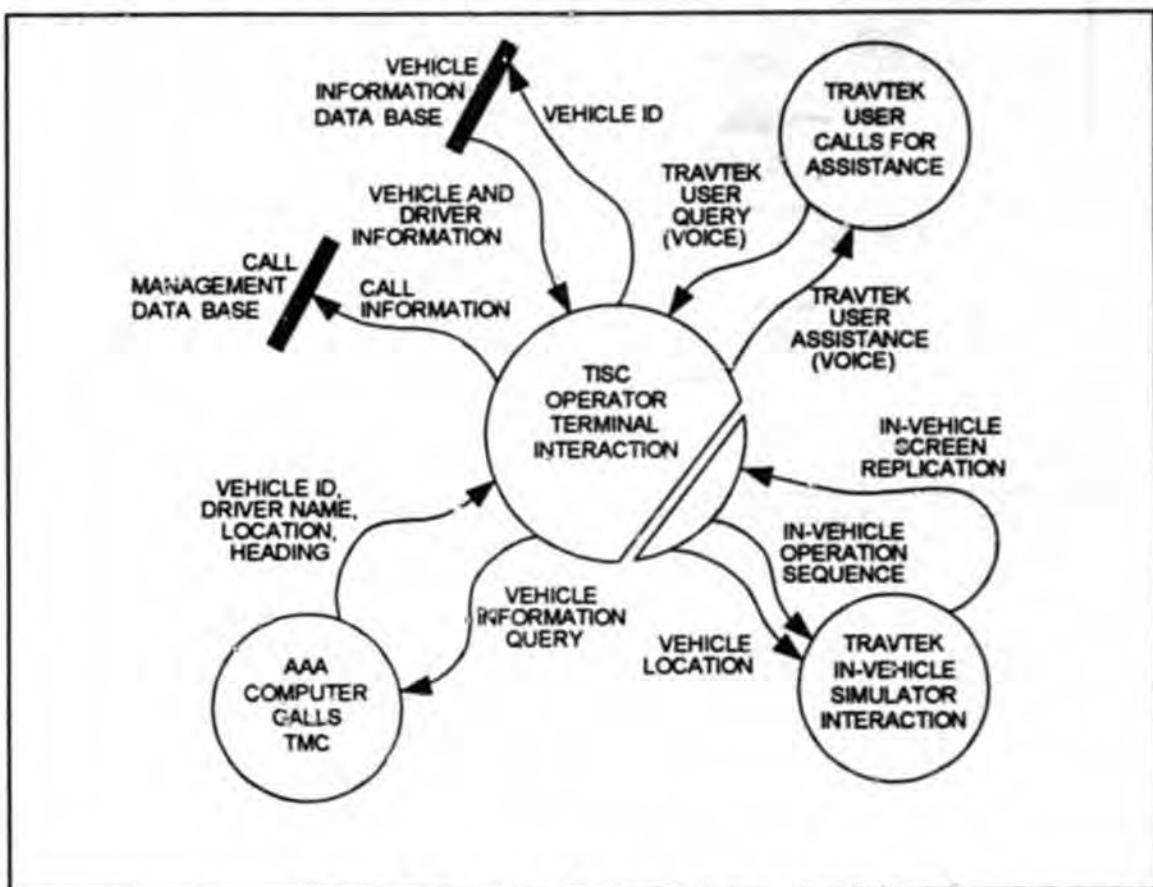


Figure 14. TISC help desk information flow.

of the TravTek traffic information system was illustrated by the contribution and withdrawal of information by the TravTek vehicles and the TIN sources. Each contributed in small part to the traffic information data base, and in turn had access to the entire volume.

The Traffic Control Center for the downtown Orlando traffic control system served as the host for the equipment that enabled the site to become the TravTek Traffic Management Center. The bulk of the equipment for this installation was four microcomputers and associated LAN cabling, together with hookups to the Freeway Management Center and UTCS data sources, plus telephone line connections. The computer and system configurations are shown in figures 15 and 16. The communication, data base, and graphics workstation computers were located in the main control room of the Orlando Traffic Control Center, and the library computer was located in a nearby office. The system hardware and software is detailed in appendix A.

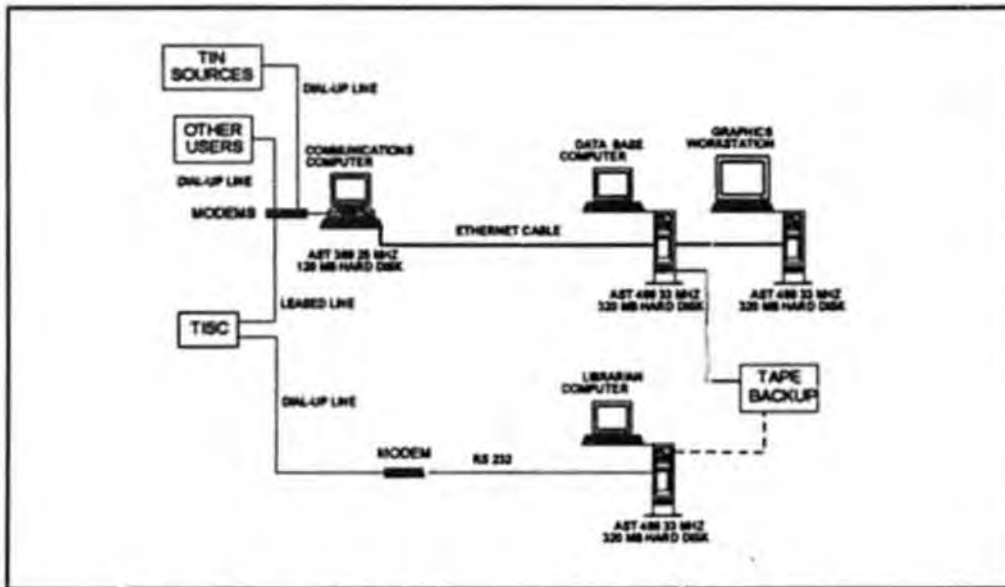


Figure 15. TMC computer configuration. <sup>(1)</sup>

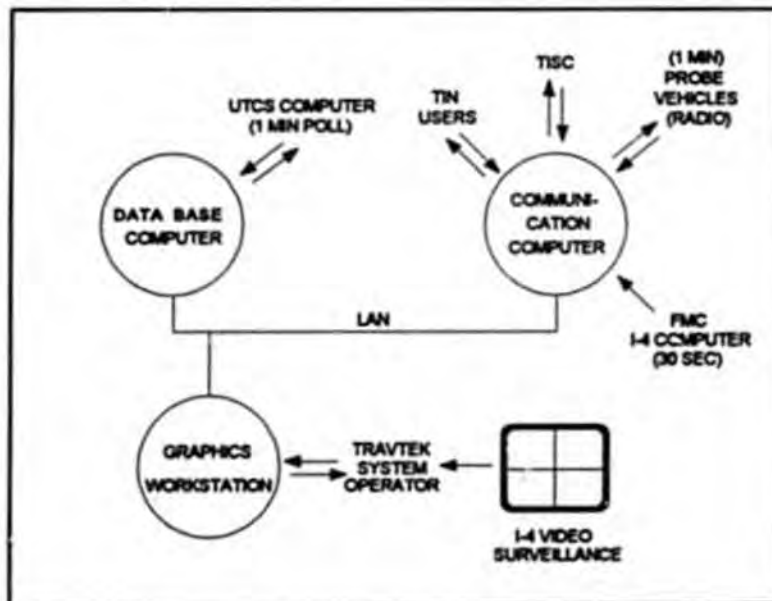


Figure 16. TMC basic system configuration.

The TMC was operated 24 hours a day, 7 days a week. Three additional operators were hired for the TravTek demonstration period. The shift schedule is shown in table 3. All operators were cross trained to operate both the TravTek system and the UTCS System. A total of 5 operators and 2 supervisors operated the control center.

**Table 3. TMC operator schedule.**

Downtown Orlando Traffic Management Center Computer Operator Schedule Start Date: May 15, 1992						
	Operator #		Operator #		Operator #	
<b>SUNDAY</b>	0500-1500	5	1450-1920	3	1915-0505	4
<b>MONDAY</b>	0500-1500	5	1000-1900	2	1850-0505	4
<b>TUESDAY</b>	0500-1500	5	1000-1900	2	1845-0505	3
<b>WEDNESDAY</b>	0500-1500	1 & 5	1000-1900	2	1845-0505	3
<b>THURSDAY</b>	0500-1500	1	1000-1900	2	1845-0505	3
<b>FRIDAY</b>	0500-1500	1	1000-1900	2	1850-0505	4
<b>SATURDAY</b>	0500-1500	1	1000-1900	3	1915-0505	4

The process of receiving messages, providing messages, fusing information and providing reports was a semi-automated, computerized operation. However, human insight, interface, and judgement was required to operate the system.

#### **TMC Functional Description**

The primary functions of the TMC were:

- Traffic Information Collection.
- Traffic Data Fusion.

- Traffic Information Dissemination.
- Data Logging.
- Communications Management.
- Receive Vehicle Status Data.
- Operator Interaction.

Each of these will be discussed in further detail below.

### *Traffic Information Collection*

The traffic information collection function collected traffic information from external sources and from the TravTek vehicles.

### Functional Description

In the TravTek system, the primary sources of traffic information were known collectively as the Traffic Information Network (TIN). Previously described as a major subsystem of TravTek, the TIN consisted of telephone and data terminals, the Freeway Management Center, and the downtown Orlando traffic control system. The secondary sources of traffic information were the probe vehicles.

The TIN sources functioned primarily to report incident information, where an incident is defined as anything that reduces the normal capacity of the roadway. Incident reporting was categorized at the TMC as either an alert or a confirm. An incident alert was an incident report that has not been positively confirmed; however, two similar incident reports from different sources caused the incident to be confirmed. Some TIN sources, such as police agencies and Metro Traffic Control, had their reports immediately confirmed.

The FDOT offices in DeLand also served as a TIN source. Each weekday, State highway construction and scheduled maintenance information was sent by fax to the TMC, where it was the system operator's responsibility to enter the lane closure and/or reduced capacity information via the graphics workstation.

### Process Description

The entry of incident information in the system by a TIN user required operator interaction because of the wide variety of sources. A window that contained the information entered by the TIN source appeared on the operator's screen. The operator verified the information and either entered the incident as confirmed, in which case link travel times were affected, or else allowed the incident to remain an alert, pending further reports. When an incident was confirmed, the operator entered the severity (i.e., number of lanes affected) and estimated duration. This information was then processed by the system and used as input to the simulation model to develop travel time updates for freeway links that were projected to be affected by the incident.

### Data Flow

Incident information was reported by an on-site observer, either directly or indirectly to a TIN station. The TIN station operator relayed the message to the TMC by voice or digital data, where it was entered into the data base computer by the TMC operator. The impact of the incident on freeway link travel times was calculated by a simulation model.

Updated link travel times were broadcast to the TravTek vehicles. The data flow diagram for this process is shown in figure 17.

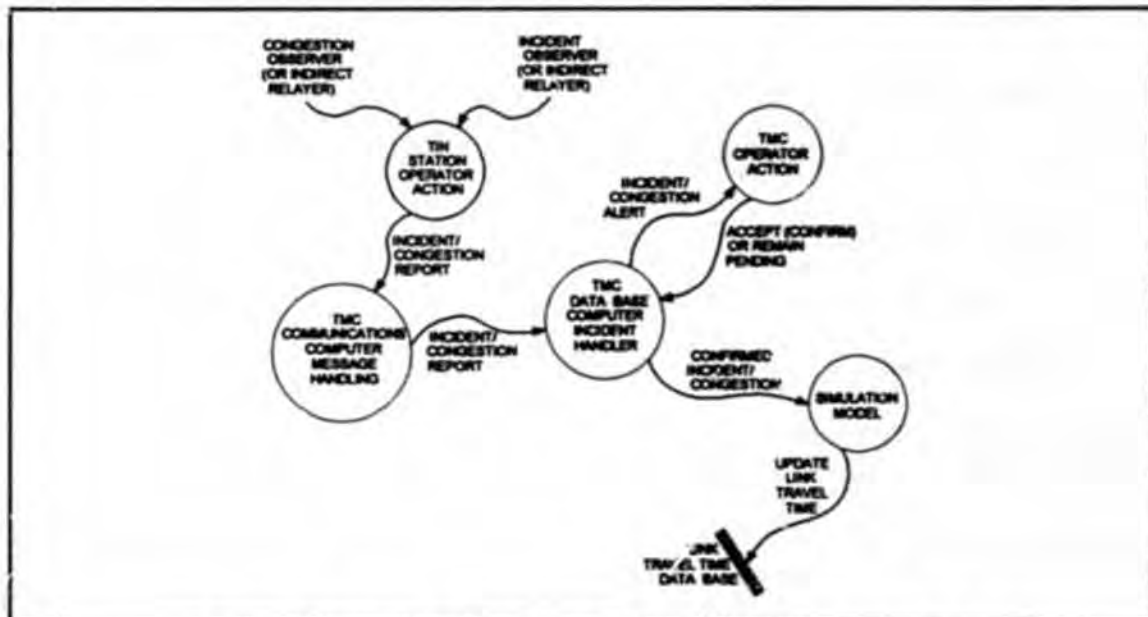


Figure 17. Traffic information collection data flow diagram.

### Data Logging

The data logging function provided the permanent record of the daily activity at the TMC. Information that was handled by the data base, graphics and communication computers was logged for the short term on each respective computer's hard disk. For the long term, the data were transferred each 24 hours to the library computer for archiving and eventual distribution to the evaluation team. The TMC data logs were a primary data source for the evaluation team, and were transmitted weekly to the central processing facility. Approximately 15 megabytes of data per week were logged at the TMC.

### Functional Description

A series of data reports was recorded in the TMC. These reports were logged with time and date stamps to synchronize with the vehicle log data. The TMC provided the time base for the vehicle's time of day clock. The items included in the data logging function were: <sup>(9)</sup>

1. **Radio Transmission.** Current link travel times for the TravTek network, congestion information, special event data, and weather conditions were broadcast to all vehicles at 1 min

intervals. This aggregation of transmitted data was logged in the communication computer. The special event data and weather data were only logged when there was a change from the previous transmission.

**2. Incoming Probe Reports.** Each vehicle transmitted its probe report once each minute. The individual vehicle data were sequenced by vehicle ID 1-100 such that each vehicle was allocated a 0.4 second time slot. All vehicles could report in during a 1 min probe report. The principal items included in a vehicle probe report were:

- Vehicle ID.
- Latitude, longitude, and heading.
- Last link traversed and travel time.
- Second to last link traversed and travel time.
- Third to last link traversed and travel time.
- Equipment status.

**3. TIN Report.** The TIN source ID and incident information was logged whenever a TIN reported an incident.

**4. TIN Requests.** The requests for traffic information from TIN users was logged, which included the source, nature of inquiry, and time of system response.

**5. Incident Reports.** The current state of all incidents was logged once each minute, including both alarms and confirmations.

**6. Communication Status Report.** All communication activity with the FMC, the TISC, the UTCS system and the vehicle radio links were continuously monitored for status and error information. Any changes were logged.

**7. FMC Reports.** Summary data from the Florida Department of Transportation Freeway Management Center were logged once each minute. This included speed, occupancy, and volume data from 28 detector stations.

**8. UTCS Reports.** Summary data from the City of Orlando Traffic Control System were logged once each minute. These were the delay data calculated by the UTCS system, which were added to the nominal link travel time on each of the links.

**9. Workstation Logs.** Each workstation maintained a log of low level system operations that tracked the sequence of programmed tasks, their time of occurrence, and any associated errors.

10. **System Statistics.** Data on basic system operation were maintained, such as the operational status of the computers, status of communication links, etc.

11. **Data Fusion Process.** The data fusion process determined the best estimate of the likely travel time on each traffic link. The inputs to the process were quality of the data source and an aging factor that provided a measure of how long the data from this source was considered valid. The winner of this representation of the current link travel time was sent to the vehicles each minute, for each of the 1,488 links in the TravTek network. Each minute, the raw inputs to the data fusion process, as well as the winner selected, were logged for evaluation.

12. **Operator Actions.** All operator interaction with the system was logged.

#### Process Description

The data associated with each of the reports described in the previous section were logged on a temporary basis by the appropriate computer. The computers and their respective log functions were:

##### **1. Communication Computer**

- Radio Transmission.
- Incoming Probe Reports.
- Communication Status Report.
- Workstation Logs.

##### **2. Data Base Computer**

- TIN Report.
- TIN Requests.
- Incident Reports.
- FMC Reports.
- UTCS Reports.
- Data Fusion Process.
- Operator Actions.
- Workstation Logs.



Each 24 hours, the various items logged in the communication and data base computers were transferred to the library computer over the Ethernet Local Area Network (LAN).

#### Data Flow

The log data migrated from the hard disks of the communication and data base computers via the Ethernet LAN to the library computer. There, it was handled by the data librarian in the TMC to transfer the data to tape for external distribution. The diagram in figure 18 illustrates the flow of data in the TMC and beyond. Because of the close coupling of the TMC and vehicle log data

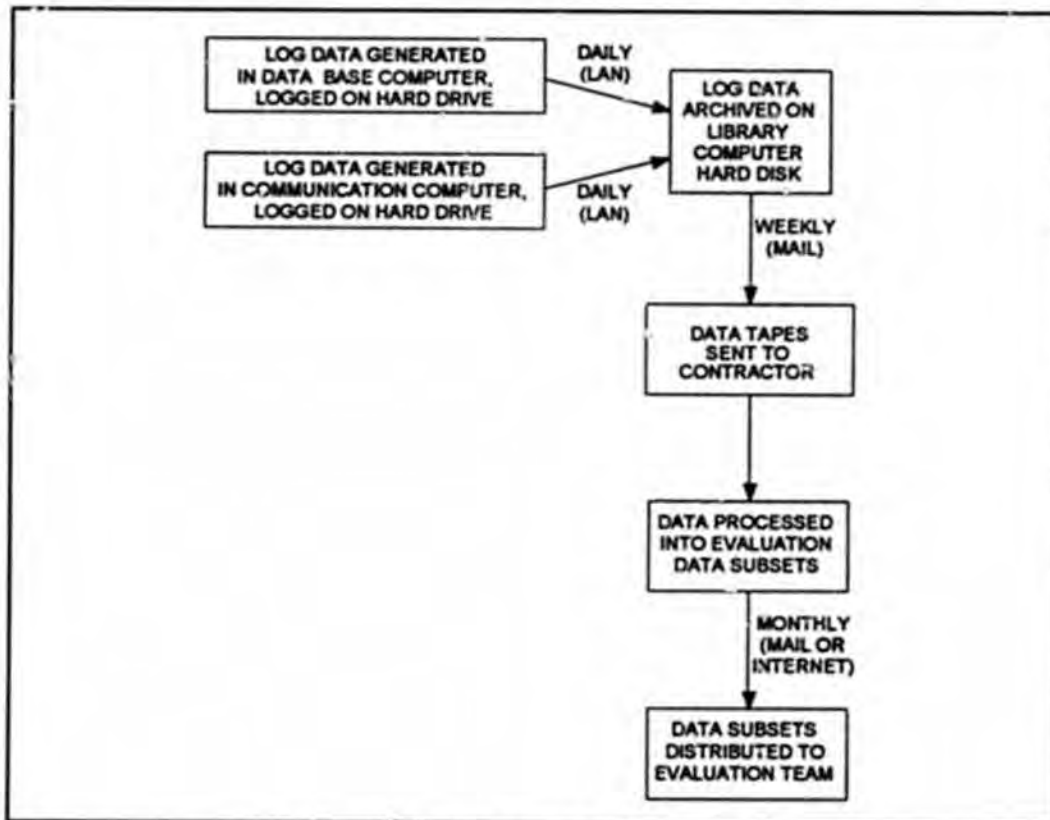


Figure 18. TMC log data distribution path.

in the evaluation process, figure 19 is included at this point to illustrate the similar distribution path of the vehicle log data.

#### *Traffic Data Fusion*

Data fusion was the process by which all incoming traffic information was received and evaluated to derive an estimate on a minute by minute basis of the link travel times in the system. Frequently, these data could conflict, as for example: a probe vehicle traversed a link at the speed limit or above, while the historical travel time for that time of day was significantly lower, or, two probe vehicles in succeeding minutes had greatly differing travel times. At best, the data fusion process was an estimate of active field conditions.

Competing values originated from six different data sources: freeway, arterial, probe vehicle, historical, operator, and modeling. <sup>(16)</sup> The objective was to resolve the ambiguities that arise as a result of deciding which of the data sources should be used for transmission of congestion data to the vehicle. Each of the 1,488 directional links in the TravTek network had one or more potential sources each minute. The data fusion process for resolving the ambiguities of source information involved a fuzzy logic maximum height solution process. The two fuzzy inputs were quality of data and aging. Fuzzy logic is a mathematical technique that deals with ambiguities and vagueness in data. <sup>(16)</sup>

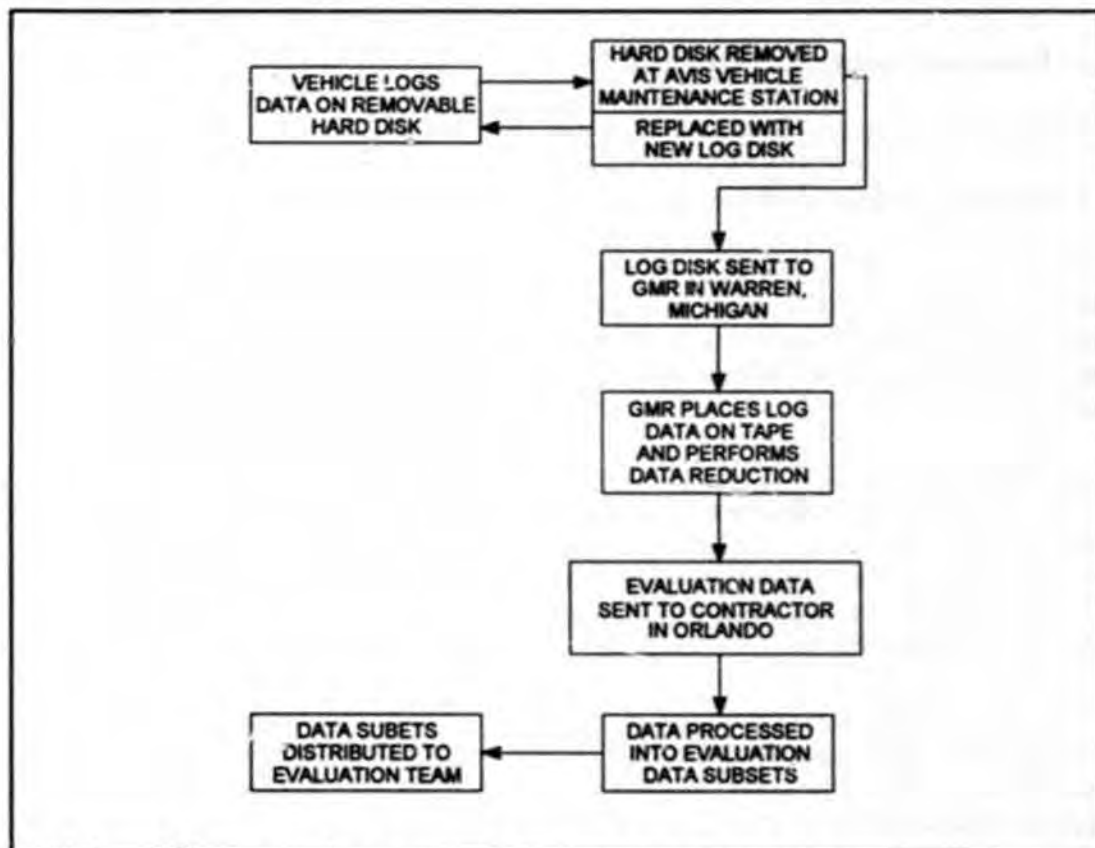


Figure 19. Vehicle log data distribution path.

#### Functional Description

With the exception of the modeling source (which was used during incident conditions only), each of the data sources (freeway, arterial, probe vehicle, historical, and operator) were considered for each link, each minute. Each data source had an associated score that determined its priority of consideration. Once considered as a valid data source for a particular link, however, the score of the data source began to decay with time. It would eventually expire to a value below the historical data score, which remained constant. Thus, the historical data were always the default fallback for link travel times.

The influence of the various data sources were:

1. **Freeway** - 18 km of I-4 from just north of SR 414 (Maitland Boulevard) to South Orange Blossom Trail, representing 38 directional TravTek links.
2. **Arterial** - arterial streets controlled by the UTCS traffic control system, representing 185 directional TravTek links.
3. **Probe vehicle** - applies to any TravTek link traversed by a TravTek vehicle.
4. **Historical** - applies to all TravTek links.
5. **Operator** - may be applied to any TravTek link.
6. **Modeling** - may be applied to any freeway link.

The operator could override any link travel time at any time when it was deemed justifiable to impose a value that could not be determined by normal system operation. The modeling data source was triggered by an incident entered by the operator, whereupon the network simulation model was activated and new link travel times were generated according to the simulated area of influence of the incident.

#### Process Description

A weight and decay time was assigned to each of the six data sources. For each active data source on a link, a score was produced by tagging the data source with the associated weight, and then decrementing the decay time by one each minute. At any point in time, the data source with the maximum score was considered the best estimate and the data from that source was assigned to the link travel time. <sup>(16)</sup>

Using the example from reference 16, if a particular data source is allocated a weight of 80 (on a scale of 1 to 100) and a decay factor of 10 min, then at the first minute the score would be 80; at the second minute the score is reduced by an amount equal to the weight divided by decay ( $80/10=8$ ). The score is now 72. One minute later it would be  $72-8 = 64$ . This decrement continues once per minute until the score reaches zero.

The data base computer screen displayed the distribution of data sources selected by the data fusion process for the current minute.

#### Data Flow

The TMC data base computer had access to, on a minute by minute basis, the I-4 freeway data from the FMC, the UTCS link delay data from the downtown Orlando traffic control system, and the historical link travel times. Based on the incident scenario, the operator could enter a quick override response by setting congestion levels. This action, in turn, would trigger the network simulation model to calculate new freeway link travel times affected by the operator action. At any time, a probe vehicle could traverse any link and generate a new link travel time.

All these data sources were considered once each minute for each link. For the majority of the links, the historical travel times were the only candidates for input to the data fusion process. The historical travel times varied by time of day according to a set of 20 pre-established "plans."

The data flow for the data fusion process is shown in figure 20.

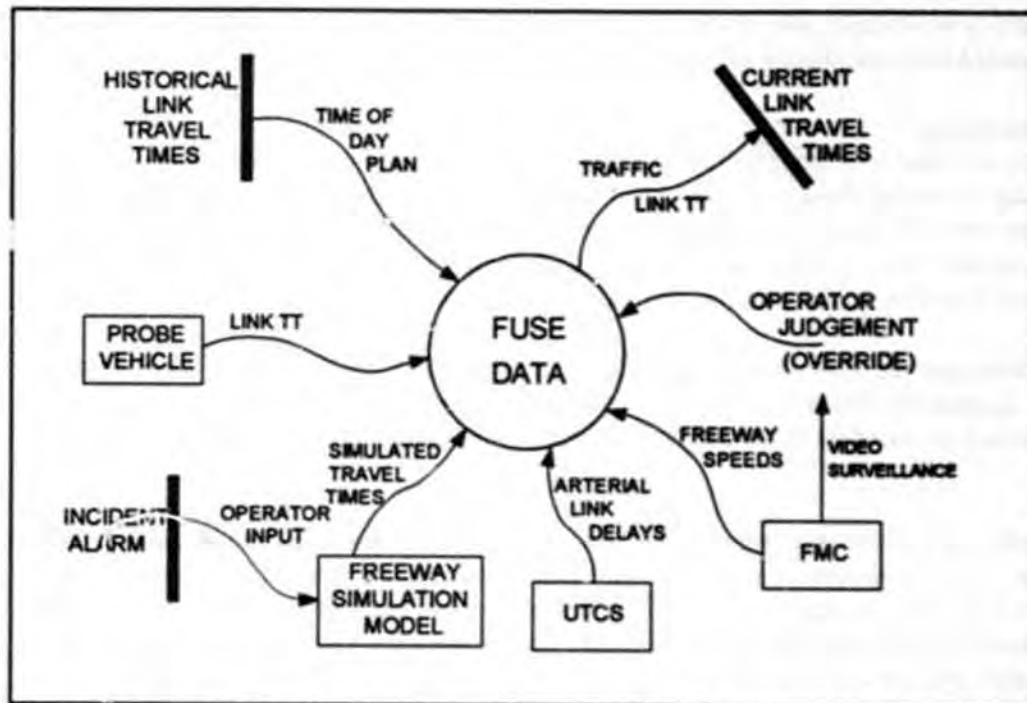


Figure 20. TMC data fusion process data flow (all links updated each minute).

### *Traffic Information Dissemination*

Traffic information was disseminated by the TMC to two primary destinations: the TravTek vehicles and the TIN network. The vehicles received dynamic link travel time and congestion information, and additionally parking lot status, weather, and special event information.

### Functional Description

The TMC served as a clearinghouse for traffic information, and had data on the following:

- Link travel times.
- Incident status.
- Congestion sites.

Routinely, travel times on all the TravTek traffic links were broadcast to the vehicles each minute. Incident locations and congestion sites were broadcast as well for spotting on the network display in the vehicle. Other messages transmitted to the vehicle included parking lot status, weather status and special event information.

The same information was made available to TIN users. A TIN terminal user could query the system for the travel time over a designated set of links, or receive a list of all reported incidents. A TIN graphics workstation user received the same information, but in this case it was available as a color coded network display with descriptive information in selected windows on the screen.

#### Process Description

The current travel times for the TravTek links were in the current link travel time data base which resided in the data base computer. This data base was updated on a minute by minute basis to reflect the status of current travel times. This data base was available to the communication computer via the LAN. A coded representation of the link travel times was broadcast once each minute to the TravTek vehicles via the data radio connected to the communication computer.

TIN station queries were via dial-up telephone lines that were handled by the communication computer. Queries for incident and travel time information were directed to the data base computer which accessed its link travel time data base and incident status list.

#### Data Flow

The traffic information dissemination function used link travel time, congestion, and incident information. Link travel time was available on a link by link basis in the link travel time information data base. A data base of incident and congestion information contained current incident status data that had been reported. Link travel times were transmitted to the vehicles by radio, together with incident and congestion information, where these data were processed in the in-vehicle computers for display or voice information.

Similarly, link travel times, congestion and incident information was sent upon request to any TIN user with a computer terminal or graphics workstation. The data flow of the traffic dissemination function is shown in figure 21.

#### *Communications*

The data communications function of the TMC was handled by a communication computer that performed tasks associated with controlling the data to the following:

- Communications to TravTek vehicles (via data radio).
- Communications to surface street computer (UTCS) (via direct connection).
- Communications to Freeway Management Center (FMC) (via direct connection).

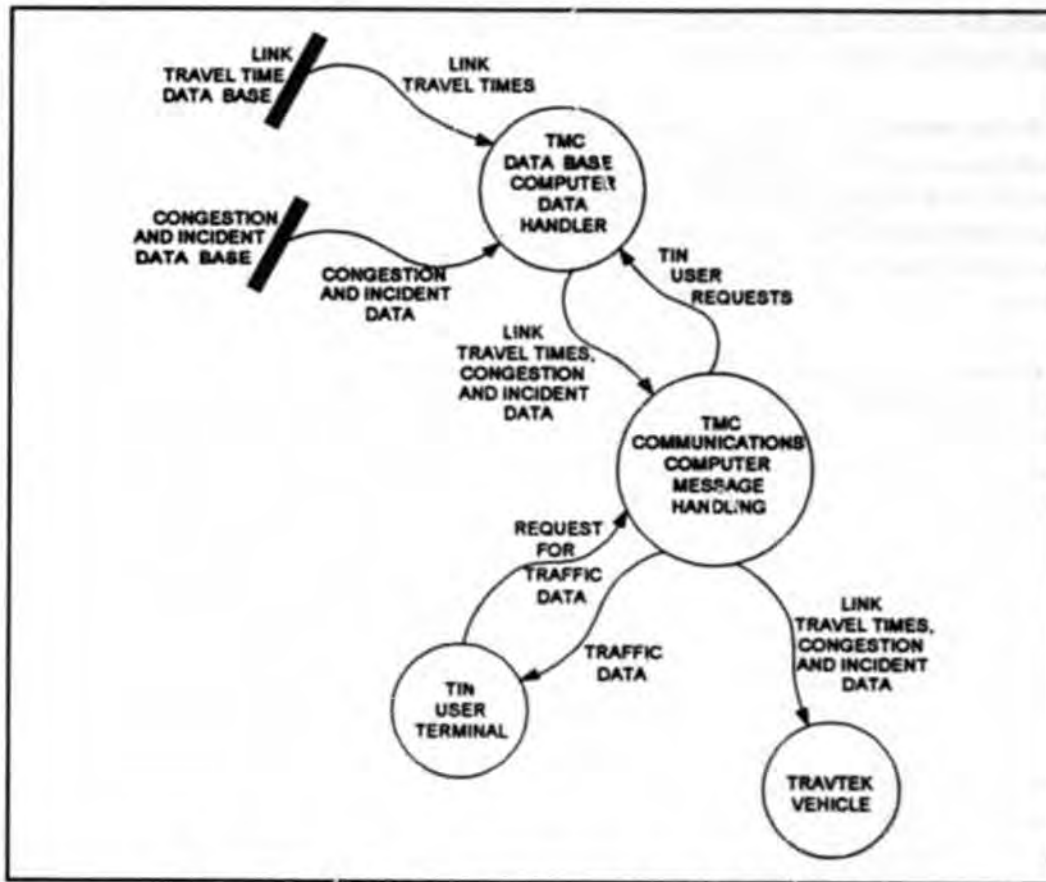


Figure 21. Traffic dissemination function data flow.

- Communications to TISC (via leased telephone line).
- Communications to TIN stations (via dial-up telephone line).
- Communications to radio verification system (via data radio).<sup>(9)</sup>

#### Functional Description

The communications function was managed by the TMC communication computer, with one exception. The data base computer handled the communications to and from the UTCS system.

The TMC system communicated to the probe vehicles through the communication computer. The communication computer provided a stream of data that was appropriately formatted for transmission by the radio communication system. The communication computer was also

responsible for transmitting commands to the radio hardware to control its behavior. <sup>(9)</sup> Outbound messages from the TMC to the probe vehicles were five different types: <sup>(12)</sup>

1. **Status message** - The status message consisted of the time and date. The time field contained the time of day in seconds from midnight local Orlando time. It was used by the vehicle to adjust the time of the vehicle clock which was used to time stamp all logged data and to time stamp the transmission of the probe report message from the vehicle. The date field contained a number representing the current date, which was used in the vehicle to set the current date for various uses. <sup>(12)</sup>

2. **Dynamic Link Time Message** - The dynamic link time message consisted of pairs of TravTek traffic network link ID numbers (1-1,488) and associated link travel time ratios. In the interest of minimizing the quantity of data broadcast to the vehicles, the link travel times were encoded as 1 of 32 ratios, as shown in table 4. The ratios were calculated in the TMC data base computer as:

$$\frac{( \text{Current link time} )}{( \text{Free flow link time} )}$$

The free flow, or nominal, link times were identical in the TMC and TravTek vehicle data bases. Congestion level displays and map color displays in the vehicle were determined both by the types of links represented and the associated ratio. To further conserve broadcast time, and since each ratio was tagged with a link number, ratios resulting in a code of zero were not transmitted by the TMC. <sup>(12)</sup> (The distribution of link time ratios for the current minute were shown on the data base computer screen).

3. **Incident Message** - The incident message identified the incident for internal processing by the probe vehicle, and consisted of sequence and ID numbers, location, traffic link ID, and condition and cause codes. The sequence number was changed only when the message was changed, in order that the vehicle could ignore redundant references to the same incident. The incident ID number was unique to each incident, and was not reused in less than 8 min. The vehicle would continue to display an incident for 4 min after the TMC had ceased to transmit information on the incident, which was the default action indicating the incident had been cleared. The incident location was described by longitude and latitude. Condition codes reflected traffic conditions resulting from the incident, such as congestion, lane blockage, etc, which were used in the vehicle to generate the voice incident message. The cause codes were coded indicators of the reason for the incident, such as accident, construction, etc., and were used in the vehicle to generate the voice incident message. <sup>(12)</sup>

4. **Parking Lot Status Message** - The parking lot status message was used to report the status of amusement park parking lots, consisting of the parking lot ID number, expected opening time, and advisory message number. The parking lot ID number field was used by the vehicle to relate this message to a specific entry in the local information data base or in the event data base.

**Table 4. Dynamic link time message ratios.**

<b>ID Code</b>	<b>Range of Ratio</b>	<b>Ratio used in</b>
0	0.00 - 1.05	1.00
1	1.06 - 1.11	1.06
2	1.12 - 1.17	1.12
3	1.12 - 1.17	1.12
4	1.18 - 1.23	1.18
5	1.18 - 1.23	1.18
6	1.24 - 1.30	1.24
7	1.24 - 1.30	1.24
8	1.31 - 1.36	1.31
9	1.31 - 1.36	1.31
10	1.37 - 1.54	1.37
11	1.37 - 1.54	1.37
12	1.55 - 1.65	1.55
13	1.55 - 1.65	1.55
14	1.66 - 1.76	1.66
15	1.66 - 1.76	1.66
16	1.77 - 1.88	1.77
17	1.89 - 2.00	1.89
18	2.01 - 2.10	2.01
19	2.11 - 2.20	2.11
20	2.21 - 2.45	2.21
21	2.46 - 2.77	2.46
22	2.78 - 3.17	2.76
23	3.18 - 3.70	3.18
24	3.71 - 4.40	3.71
25	4.40 - 5.34	4.41
26	5.35 - 6.66	5.35
27	6.67 - 8.53	6.67
28	8.54 - 11.29	8.54
29	11.30 - 15.49	11.30
30	> 15.49	15.50
31	Road Closed	Not Applicable



The expected opening time field contained the hour the parking lot is expected to reopen. The advisory message number was used by the vehicle to select an advisory message to be displayed from a list of messages contained within the vehicle. <sup>(12)</sup>

5. **Weather Message** - The weather message was a text field normally containing information on the high and low temperatures and a climatic forecast.

6. **Event Message** - The event message contained information on special events. This included event ID's and sequence numbers to notify the vehicle whether this was a new event or an update of a previous event. The name, address, and city were sent as text characters, together with latitude and longitude for use by the vehicle to position the event symbol on the map display. The information telephone number was sent, as well as start and end dates for the event. A parking lot ID was sent to relate the event to a parking lot status message. Finally, a descriptive text message was sent for the event description. <sup>(12)</sup>

The TMC system received messages from the probe vehicles through the communication computer. The probe report message contained several pieces of information relating to the vehicle, its location, and link travel times. The vehicle was identified by a vehicle ID number (1-100). Associated information was the vehicle status and TravTek equipment status. The current position of the vehicle was transmitted as latitude and longitude, as well as the street name currently being traveled. Vehicle mode information identified the vehicle as being in the Services, Navigation, or Navigation Plus mode, as well as other detailed vehicle information.

As previously noted, the TMC system communicated with the City of Orlando UTCS control computer by a direct connection from the TMC data base computer. Once each minute, the data base computer requested status information on the UTCS system operation. The UTCS system responded by returning the current delay times on all the UTCS links. These data were used by the data fusion process as part of the procedure to determine current link travel times in the TravTek system.

Communication to the Florida Department of Transportation Freeway Management Center (FMC) was by direct connection from the TMC communications computer to the FMC online computer. Once each 30 seconds, status information was received on the 24 freeway detector stations in the form of speed, volume and occupancy data. These data were edited and combined as necessary to obtain representative link travel time information for the TravTek network traffic links.

The TravTek Information and Services Center (TISC), located at AAA headquarters, communicated with the TMC via a dedicated telephone line. The TISC functioned as a help desk via direct telephone communication with TravTek drivers, and as a result had need for vehicle status and location information. These data were transferred via the TMC communication computer in response to a query from a TISC operator. Given basic vehicle information, the TISC operator was able to enter this information into a vehicle system simulator at the TISC site and obtain a screen display identical to that in the subject vehicle. Additionally, the TISC communicated special event information to the TMC on a daily basis, where it was passed through the communication computer to the data base computer's special event data base.

The TIN stations communicated information to the TMC, and vice versa, via dial-up telephone lines. The TMC communications computer had multiple ports and dial-up modems to handle several simultaneous online TIN users. The ultimate destination of incoming incident and congestion data from the TIN's was the data base computer, where it would be handled by the operator. Similarly, requests from the TIN's for traffic status information were handled by the data base computer as queries to the current link travel time data base.

The radio verification system (RVS) served as a dummy vehicle receiver, which could be monitored for verification of the radio system operation. The RVS both transmitted information to and received information from the TMC communications computer. Assigned a vehicle ID of zero, the RVS functioned as a positive confirmation that information transmitted by the TMC via the data radio system was being received by a typical vehicle data radio.

#### Process Description

The TMC communicated to and from the vehicles via a Motorola data radio system as shown in figure 22. <sup>(12)</sup> The TMC communications computer provided a stream of data that was appropriately formatted for transmission by the radio communications system. The communication computer was also responsible for transmitting commands to the radio hardware to control its behavior. The only time-critical factor involved in this communication system was the transmission of a special block once per minute. This block was used by the vehicle systems to determine the time slot during which they transmitted their return data. This was accomplished by implementing a device driver that activated an interrupt on the system hardware. This driver counted the interrupts, and when 60 seconds was reached, it transmitted the block. <sup>(9)</sup>

The TravTek/TMC to UTCS link consisted of a standard RS-232 connection (9600 bps, 8 data bit, no parity, 1 stop bit) between the data base computer and the system running the UTCS software. Once per minute, the TMC sent a polling message to the UTCS system requesting a data return. The link to the FMC system consisted of a standard RS-232 connection (9600 bps, 8 data bit, no parity, 1 stop bit) to an outlet provided in the TMC. The FMC was responsible for providing data on speed and volume for all detector stations. It also provided any incident data that was entered at the FMC. The format of messages for this link included a common header and trailer block framing the packets. These data were transmitted from the I-4 computer to the TravTek computers every 30 seconds.

The link between the TMC/communications computer and the TISC consisted of a leased line connection (9600 bps, 8 data bit, no parity, 1 stop bit). Communications could be originated from either end and all transmissions would be positively acknowledged. The acknowledgement could consist of either a special acknowledge block, or a data block. There were four types of primary communication blocks and four possible response blocks. The first two originated at the TMC. These were vehicle alerts (derived from data that is returned by the vehicle) and communications test blocks that were used to determine if a link is active. The TISC originated blocks consisting of requests for vehicle status information, and uploading of the event data base updates. The event uploads consisted of one transmission per record to be updated.

The link between the TMC/communication computer and the Radio Verification System (RVS) consisted of a direct connection (9600 bps, 8 data bit, no parity, 1 stop bit) to a Turbo

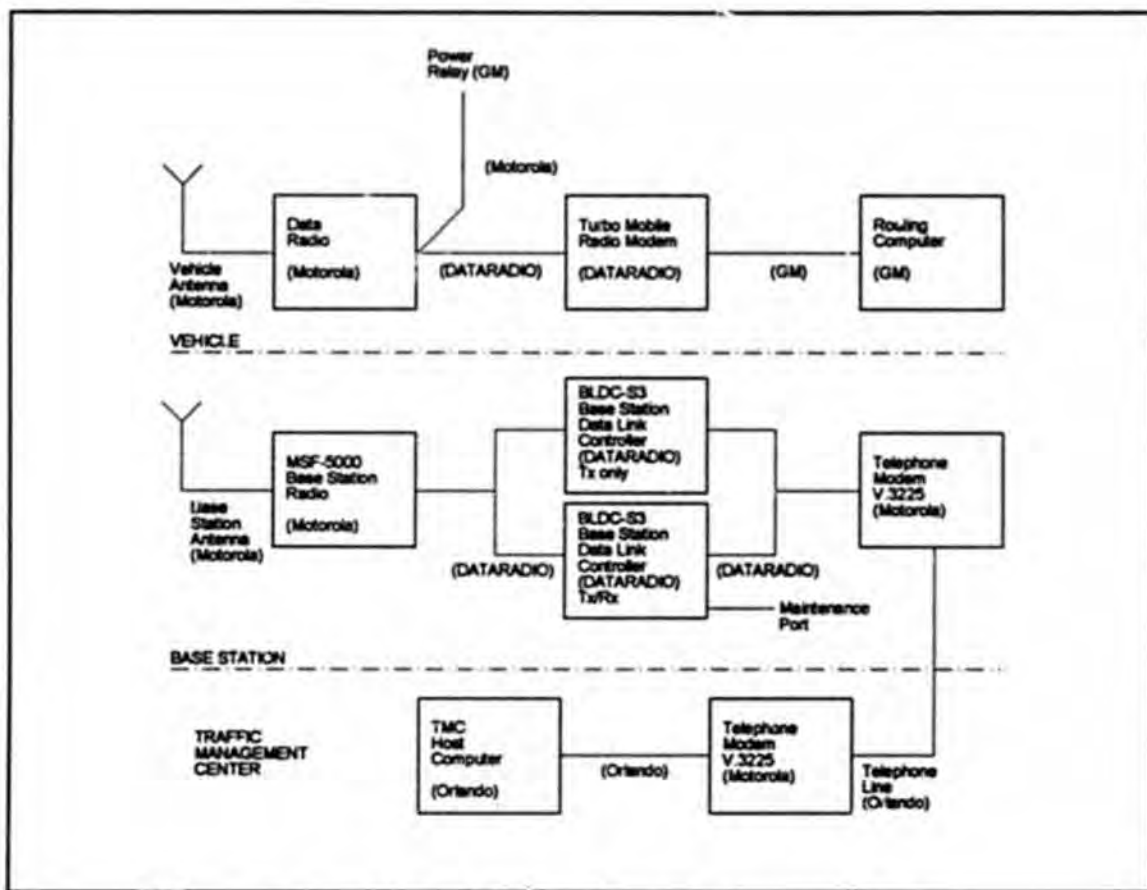


Figure 22. TMC/vehicle data radio system. <sup>(12)</sup>

Mobile Radio Modem (MRM) located in the TMC. This unit was used for two purposes. The first was to verify the data being transmitted was being received correctly. The second was to transmit a special test block once per minute to allow the receive portion of the base station to be tested. <sup>(9)</sup>

The communication computer screen was not normally used during the daily operations of TravTek. It was used by the system developers for debugging and maintenance. The communication computer screen indicated: <sup>(9)</sup>

- Current connected TIN sources and line status of the modems.
- GPS receiver status.
- Broadcast radio communication status.
- Vehicle communication status and the number of vehicles on line.

### Data Flow

The flow of information relative to the TMC communications function was primarily through the communication computer, which acted as a hub. All communication transactions were logged in the communication computer, and were transferred daily to the library computer for permanent archiving. The data flow surrounding the communication computer is shown in figure 23.

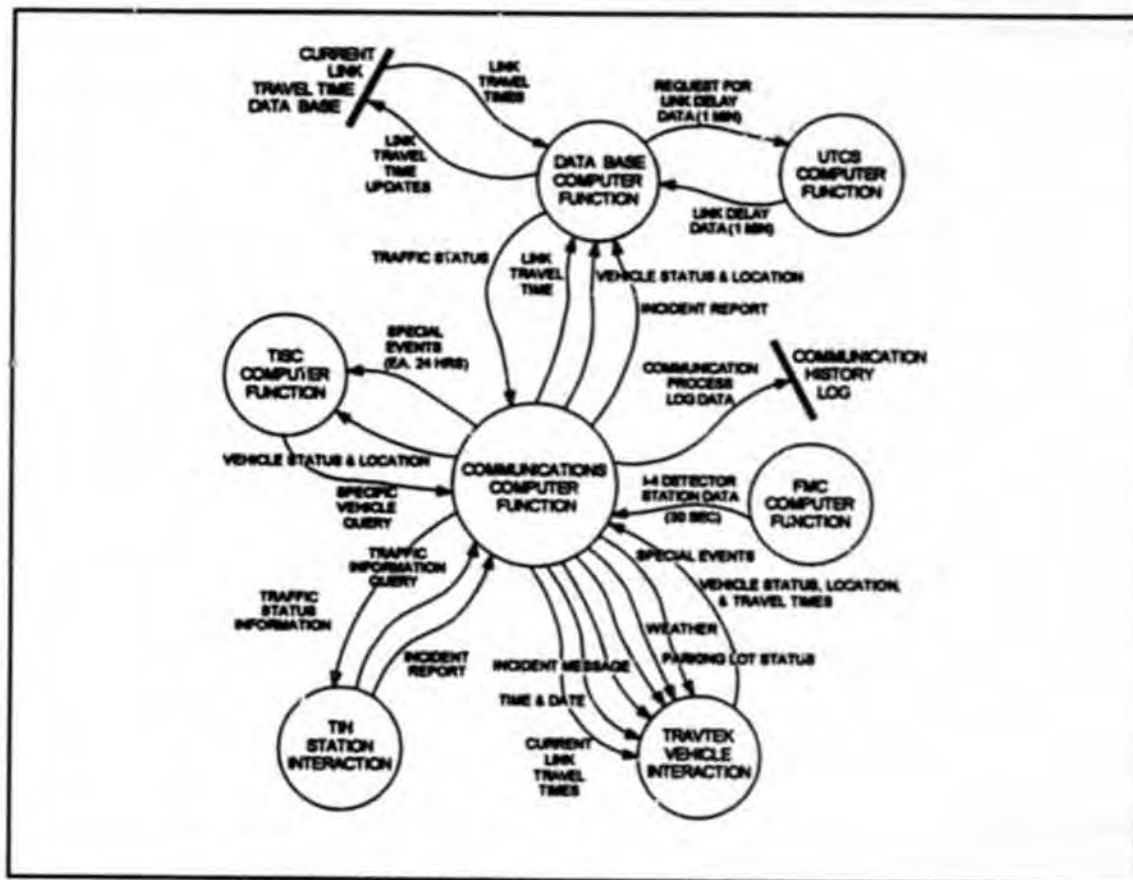


Figure 23. TMC communications data flow.

### Operator Interface

The operator interface function of the TMC was the central command post for operation of the system. The system had been automated to a practical extent, but the physical handling of incoming traffic information from TIN stations ultimately rested with the operator. Incident data was the particular category of information that required special handling, while the input of UTCS and FMC (non video) data was entirely automated. The role of the operator was still a critical link in system operation. The simple verification of normal system operation was a basic requirement for manned operation, if system integrity and assurance of traffic information credibility was to be maintained.

A substantial amount of planning, design, and implementation time went into the operator interface function. This was reflected in the comprehensive documentation on this topic in reference 9, TMC Functional Design.

#### Functional Description

The operator interfaced to the system through a windowed workstation environment. Pull-down menus were selected (most practically with a mouse action) to initiate one of the following menu functions: <sup>(9)</sup>

- SYSTEM - used to log the operator in and out of the TravTek system.
- VIEW - presented a sublist of items to view.
- EDIT - allowed users to view, add, edit, or delete records from a variety of system data base tables.
- REPORTS - selected routines responsible for creating reports.
- VOICE - controlled the voice mail system.
- INCIDENTS - allowed the operator to enter and remove incident information from the system.
- LINK - permitted operations which are specific to the traffic links.
- INFO - gave information on the currently selected object.

The details of these functions and the manipulation actions required are given in the next section.

#### Process Description <sup>(9)</sup>

The following material has been excerpted from reference 9, *TMC Functional Design*.

The operator interface of the TravTek system was designed to minimize operations performed by the operator. All electronic sources of data were incorporated into the software processes. However, there were functions, specifically the input of incidents, that were not possible to automate. This is because the data arrived from a wide variety of sources and in a range of formats. For example, an incident alarm might be triggered by a commercial radio report and confirmed via listening to a police message detected on a scanner.

The TravTek project incorporated graphical user interfaces (GUI) in their operator interface designs. GUI's are graphic objects on the screen that can be selected and manipulated with a mouse. For example, clicking on a graphical object such as a line representing a road would cause the related data base items to be presented for manipulation in a window.

Most menu functions operated on an OBJECT - ACTION basis. The operator would first select the object to be manipulated, changed, queried, etc., followed by the desired action. For example, if the operator wanted to set link congestion for link #123, the operator would first select the object, link #123, by clicking on the map where link #123 lies. Next, the operator would choose the action, Set Link Congestion, from the main menu. Once an object had been selected, it became the currently selected object and was displayed in the title bar. It would remain the currently selected object until another was selected. All actions referred to this current object.

Figure 24 shows the layout of the TravTek TMC operator's screen. This screen consisted of a series of windows. These windows had default sizes and positions, however, the operator could move and size most windows to suit their individual taste.

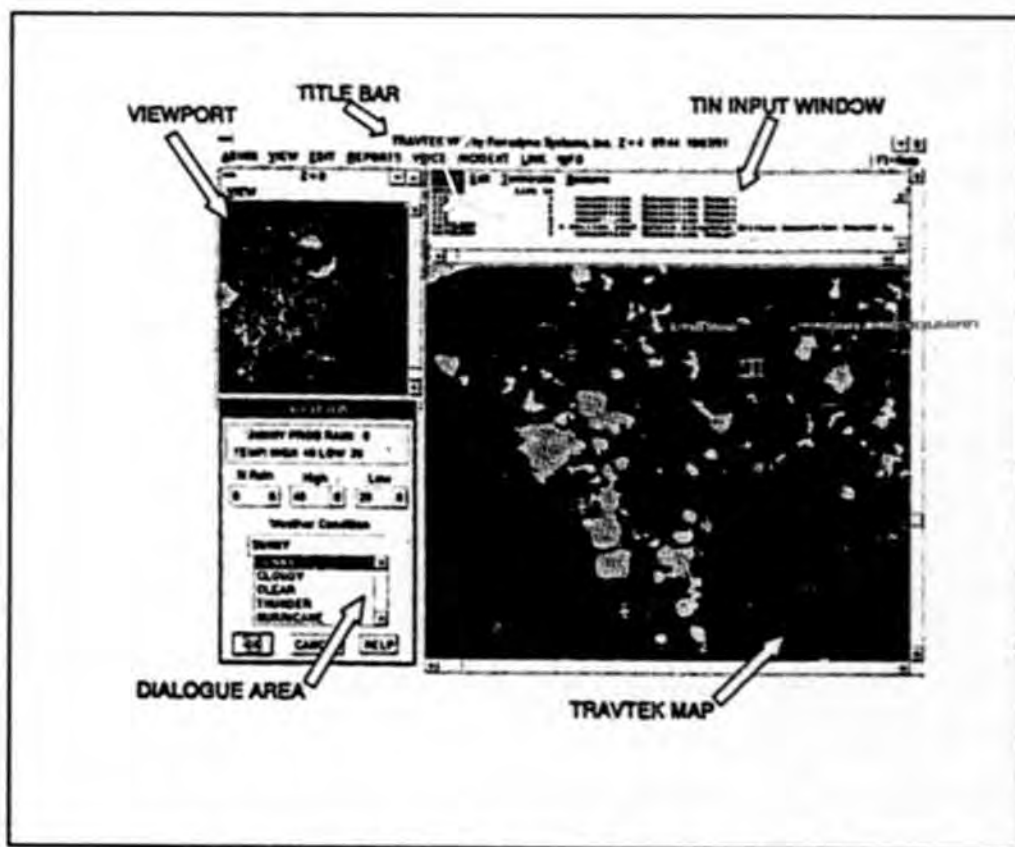


Figure 24. TMC operator screen display (typical). (9)

The title bar and the menu were fixed. The status window was not normally present. This area was used to contain system error and warning messages. The window opened when any of these occurred.

BEST COPY AVAILABLE

The TIN input window displayed a chronological list of the messages that have been received from all external sources. These data were used by the operator for entering, confirming, and canceling incidents. When the operator acted on the data received in the window, he or she could then delete the message. When all messages were deleted, the window disappeared.

TravTek Map - this region was used to display a map of the TravTek area. It was a titleless, menuless, non-movable window. It, however, did have horizontal and vertical scroll bars to scroll and view information.

The Viewport area had horizontal and vertical scroll bars. It provided the operator with the ability to have a second view of the map at a different zoom level or location. More viewpoints of any size or shape could be opened by the operator. Such procedures, however, dramatically slowed down the display as well as the overall system's performance.

The dialogue area was a region used for any type of window. Most frequently, it was used for any dialogue boxes and windows from which operator input was required.

The following items were available by selection from the list on the menu bar. Some of these items also existed in the viewport menu bar. These menu selections were:

- System.
- View.
- Edit.
- Reports.
- Voice.
- Incidents.
- Link.
- Info.

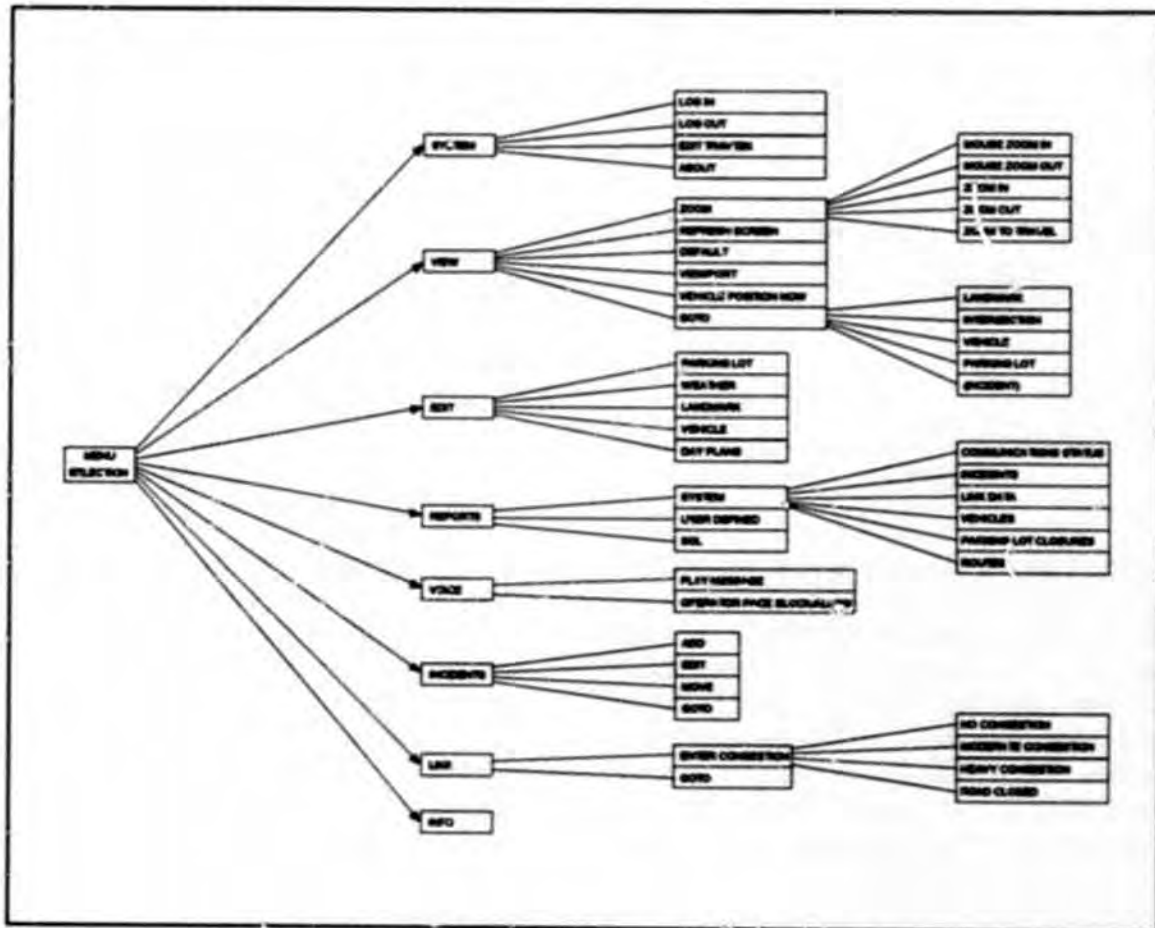
There were two additional functions that were available from remote workstations only, these were:

- Communications.
- TIN functions.

These functions, when selected, pointed to other choices. The full details of the menu function processes are given in appendix B.

**Data Flow**

The system operator actions were controlled through a series of mouse and keyboard operations. Most system controls could be effected with the mouse; only the entry of text information required the use of the keyboard. Figure 25 illustrates the menu selection process, for the graphics workstation.



**Figure 25. TMC operator menu selection diagram.**

The data flow for the TMC operator interaction process is shown in figure 26.

**TravTek VEHICLE**

The final element of the TravTek system was the vehicle. A total of 100 specially equipped 1992 Oldsmobile Toronados was used in TravTek. Each vehicle was equipped with a prototype system of computers and communications equipment for the purpose of providing motorists with current travel and routing information. Seventy-five of these vehicles were rented to the public to demonstrate the capabilities of the system. The remaining 25 vehicles were leased to the Evaluation Study team for use in various field studies and experiments.



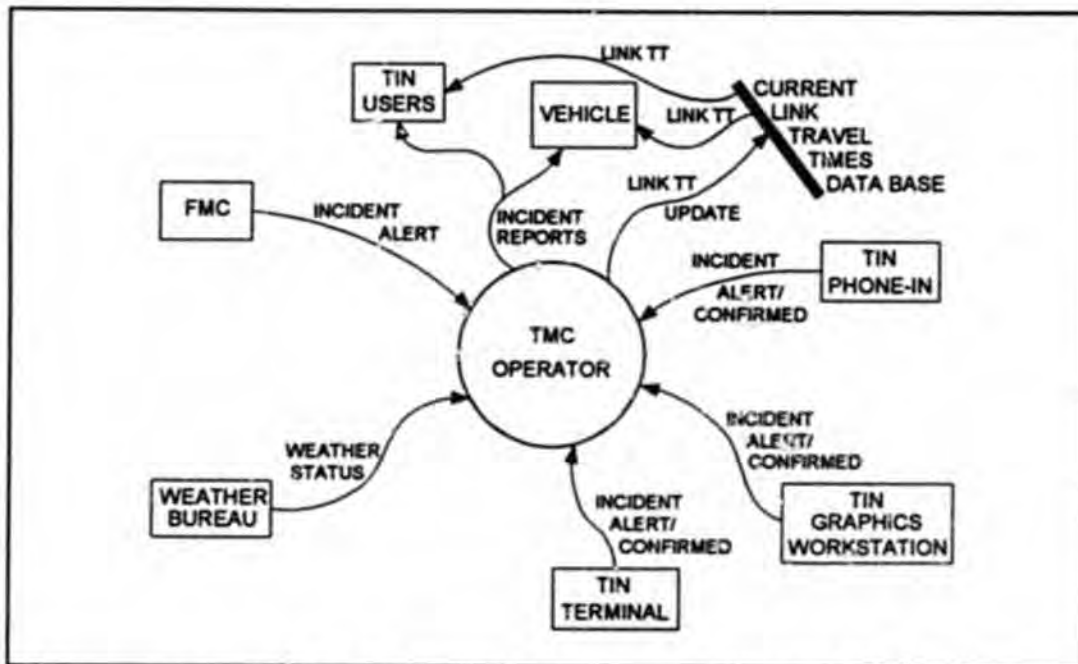


Figure 26. TMC operator interaction process data flow.

The TravTek vehicle system architecture is illustrated in figure 27. The Oldsmobile Toronado was equipped with a production 12 cm diagonal color video display terminal (which had infrared touch screen capabilities) embedded in the dashboard. In order to perform the various subsystem functions of the vehicle, two 20 MHz Ampro 386-PC computers with 4 MB of RAM and a 20 MB removable hard drive were added to the vehicle. Interprocessor communication was achieved through both a 9600 baud serial link and a separate parallel link so that information could be shared by each computer. Other production items that led to using the Toronado as the prototype<sup>(2)</sup> included a hands-free cellular telephone and an internal digital communications bus. A Data Speaker™ text-to-speech voice synthesizer was used to convert turning maneuvers into voice route guidance messages. Various other electronic components, such as a GPS receiver and a digital RF mobile radio communication system, were added so the vehicle could provide the driver with Advanced Driver Information System (ADIS) features. The location of the various components in the TravTek vehicle is shown in figure 28.

The two computers in the architecture each performed specific tasks. The two primary tasks of the computers were the navigation and routing functions. One task was assigned to each computer. In addition, the computers were responsible for generating the displays for the driver interface screen, managing data and communication flow, and logging system performance information. The tasks performed by each computer are listed in table 5. Even though two separate computers were used in this system, all of the functions of the vehicle subsystem could be performed, at least theoretically, by one computer. Since the TravTek system was designed to use currently available route selection and navigation software, two computers were required in

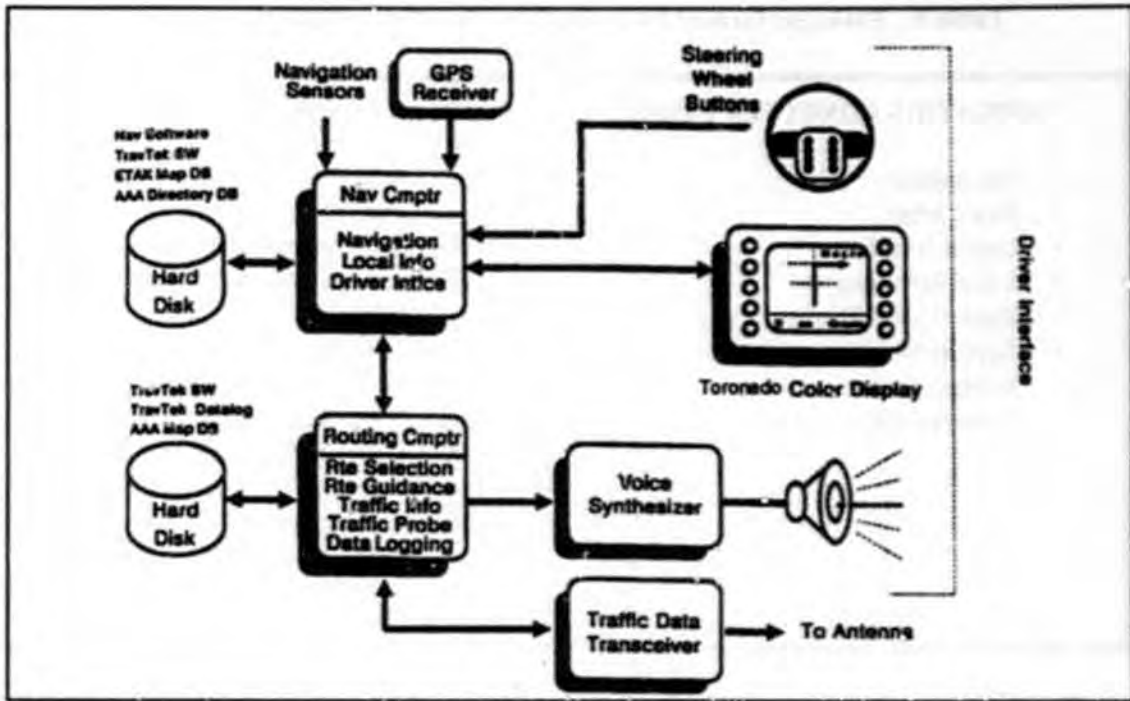


Figure 27. TravTek vehicle architecture. <sup>(2)</sup>

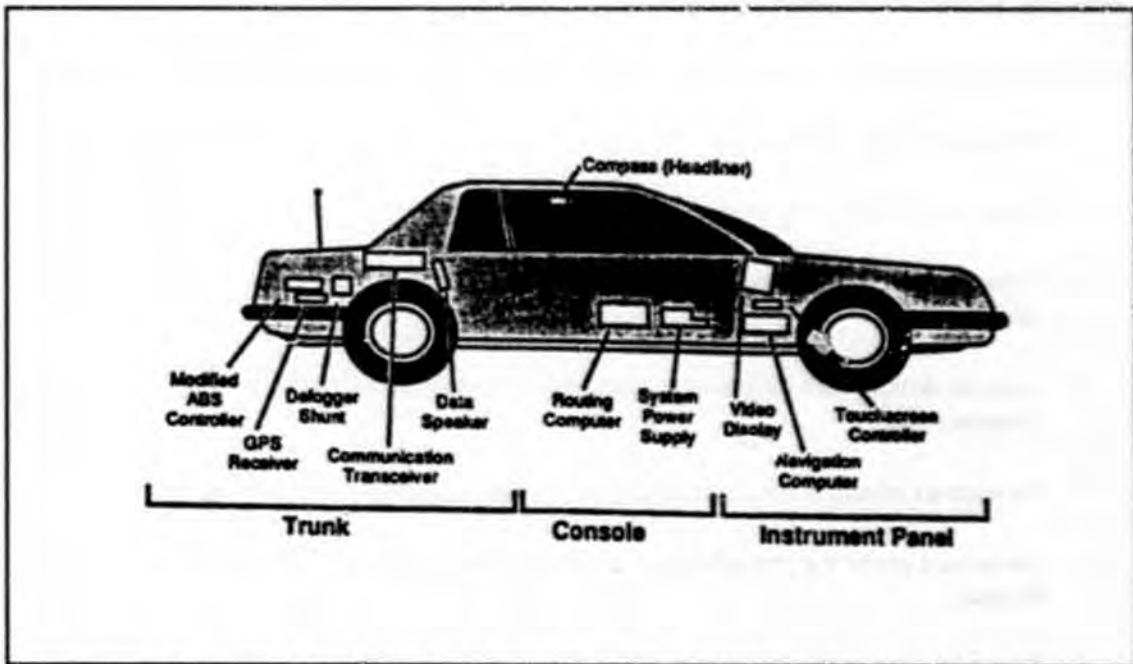


Figure 28. Layout of the TravTek equipment in the vehicle. <sup>(11)</sup>

**Table 5. Tasks performed by each of the TravTek vehicle computers. <sup>(11)</sup>**

NAVIGATION COMPUTER TASKS	ROUTING COMPUTER TASKS
<ul style="list-style-type: none"> <li>• Navigation</li> <li>• Draw Map</li> <li>• Driver Interface</li> <li>• Local Information</li> <li>• Draw Visual Display</li> <li>• System Services</li> <li>• Interprocessor Communication</li> </ul>	<ul style="list-style-type: none"> <li>• Route Selection</li> <li>• Route Guidance</li> <li>• Generate Guidance Screens</li> <li>• Generate Voice Messages</li> <li>• Probe Reports</li> <li>• System Services</li> <li>• Interprocessor Communications</li> <li>• Manage RF Communications</li> <li>• Manage Traffic Information</li> <li>• Log Data</li> <li>• Control Program</li> </ul>

the TravTek system because of the differences in the operating systems of each of the existing major software modules. <sup>(11)</sup>

#### **TravTek Vehicle Functional Description**

The core functions of the vehicle subsystem were to: <sup>(2,11,17)</sup>

- Provide drivers with navigation information (**Navigation**).
- Assist drivers in selecting routes to their destination (**Route Selection**).
- Provide drivers with turn-by-turn instructions to guide them on their route (**Route Guidance**).
- Provide drivers with information about local services and attractions (**Local Information**).
- Provide an interface for communicating with the driver (**Driver Interface**).
- Serve as a probe for providing current traffic information to the TMC (**Vehicle Probe**).
- Log data used in the evaluation of the TravTek system (**Data Logging**).

Each of these functions are discussed in detail in the following sections. The relationship between these functions is illustrated in figure 29.

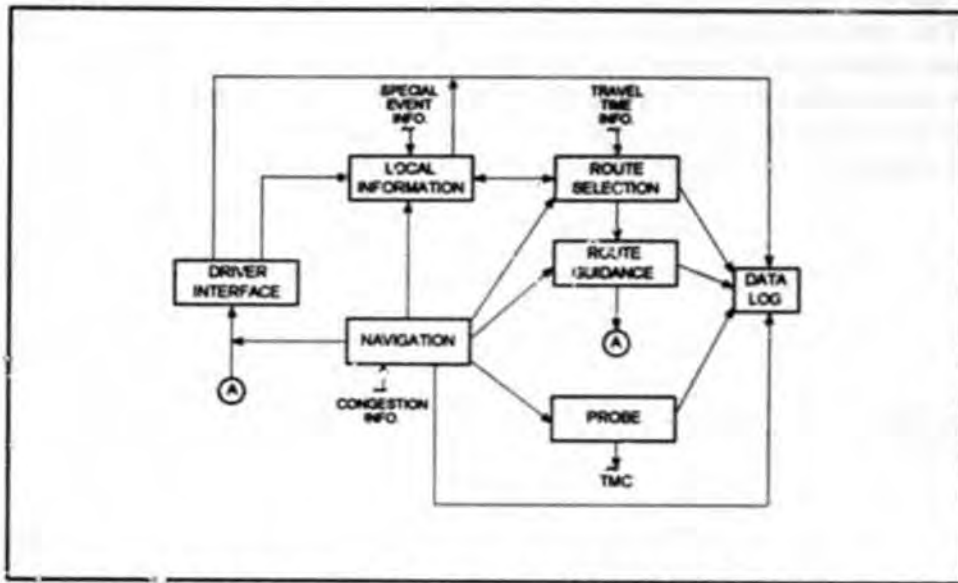


Figure 29. Interactions between TravTek vehicle functions.

The vehicle made use of, as well as generated, current (real-time) traffic information. Current traffic conditions were received by the vehicle's radio receiver each minute. These conditions were displayed through the driver interface, and were used in the routing (and rerouting) calculations. Further, the vehicle itself, functioning as a probe, transmitted its current travel times on a minute by minute basis back to the TMC for integration in the current link travel time data base.

### Navigation

The navigation function was one of the most critical functions of all the subsystems in the vehicle. Through the navigation function, the position of the vehicle on the street network was determined. Once the exact position of the vehicle was determined, a series of computer-generated maps of the street network were developed and displayed to the driver on the color video display terminal mounted in the dashboard of the vehicle. The position of the vehicle was superimposed over the maps so that the driver could determine his or her relative location on the street network. All the displays developed through the navigation function were intended to assist the driver in traveling throughout the greater Orlando area.

In addition to providing navigation assistance to the driver, the navigation function also determined the exact location of the vehicle on the street network. Accurate placement of the vehicle on the street network was a key piece of information used in many of the other vehicle functions. For example, vehicle position information was used to plan routes and reroute vehicles. Accurate vehicle position information was also needed to trigger appropriate displays and commands in the route guidance process. Furthermore, the position of the vehicle on the street network was necessary for the vehicle to function as a probe. Therefore, it was essential

that the navigation process accurately determine the exact position of the vehicle on the street network. This made the navigation function one of the most critical of all of the vehicle functions. If the vehicle's position could not be accurately determined, many of the other systems would provide the driver with erroneous information, which not only degraded the driver's impression of the utility of the system, but also increased travel time and navigational waste by TravTek vehicles. A diagram of the Navigation Function is shown in figure 30.

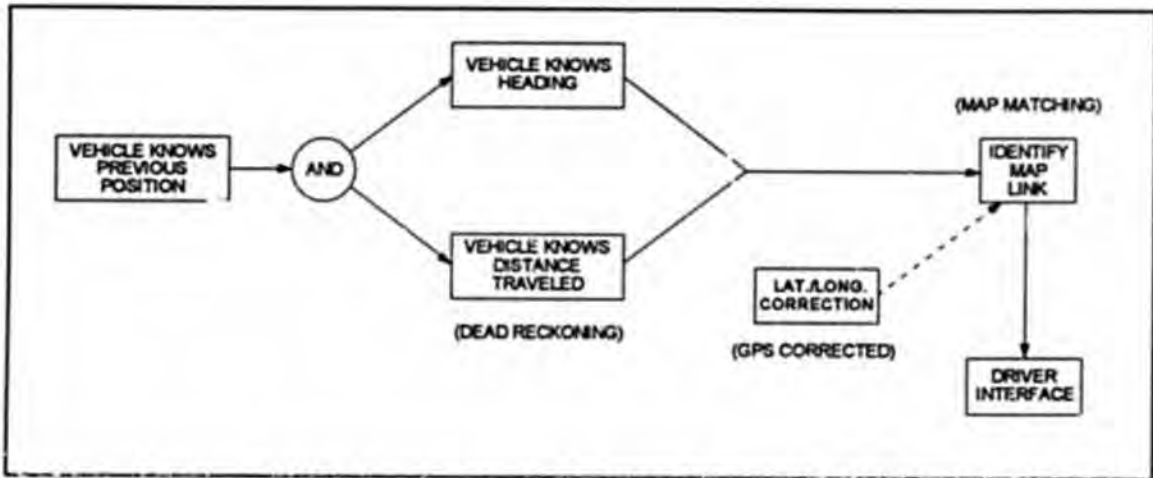


Figure 30. Vehicle positioning function.

#### Functional Description

In order to accurately determine the vehicle position by dead reckoning, the vehicle started at a known reference location. In most instances, the location of the last destination selected and reached by the driver in the route selection process served as the starting point. As the vehicle traveled through the network, it used changes in heading and distance traveled to update the position of the vehicle. The position of the vehicle on the street network was established by comparing heading and distance changes to a digitized map data base stored in the navigation computer. This process was called map matching. Additional errors in the positioning estimate were corrected by one of two methods: satellite positioning and driver interaction. The vehicle position was displayed to the driver through the driver interface.

#### Process Description

The vehicle used an inertial dead-reckoning system to estimate the vehicle position. The dead-reckoning system used the wheel sensors from the anti-lock braking system to measure the distance traveled between vehicle position updates. A flux gate compass in the roof of the vehicle was used to provide current heading information. The vehicle estimated its position on the network through a map-matching process where the heading and distance traveled information was compared to a digital map data base supplied by Etak. The navigation map data base was stored in the navigation computer.

A GPS system was one method used to correct the vehicle position. The GPS system used a Magnavox MX422 six-channel receiver to estimate the vehicle's current position. The GPS system was used mainly as a watchdog to prevent unrecoverable dead-reckoning errors. The position of the vehicle through the dead-reckoning process was compared with the position indicated by the GPS system to determine gross positioning errors. If the difference in position readings exceeded a preset factor, the dead-reckoning system was initialized to the position determined by the GPS system.

There were two methods in which the driver could correct the position of the vehicle. The first was through repositioning the car indicator on the map to correspond with the outside street environment. This was accomplished by either using the route selection process to identify a nearby landmark, or by using the cursor controls to move the vehicle cursor to the appropriate location.<sup>(17)</sup> The driver could also use the **Hop Right/Hop Left** keys to move the vehicle laterally between parallel streets. The first method could only be performed while the vehicle was in PARK, while the second method could be used while the vehicle was stationary or moving.

### Data Flow

The flow of data in the navigation function is illustrated in figure 31. The data input requirements included the heading and velocity of the vehicle, the distance traveled between last updates, and the estimated latitude/longitude of the vehicle from the GPS receiver. The primary output of the navigation function was the position of the vehicle which was then used in a number of other TravTek vehicle functions. Vehicle position was also displayed as an arrow overlay on a computer-generated map of the Orlando street network via the color video display.

### Route Selection

One of the overall objectives of the TravTek system was to minimize the travel time to destinations selected by the driver, while implicitly minimizing the possibility that a driver unfamiliar with the network would get lost. This objective was accomplished through the Route Selection process. The process was performed in the vehicle using proprietary software developed by Navigation Technologies and a digital route-map data base supplied by AAA. The type of information needed to perform this function depended, in part, on the configuration of the TravTek vehicle. For the Evaluation Project, three different configurations of TravTek vehicles were used: the Navigation Plus vehicle, the Navigation vehicle, and the Services vehicle. With a Navigation Plus vehicle, current link travel time

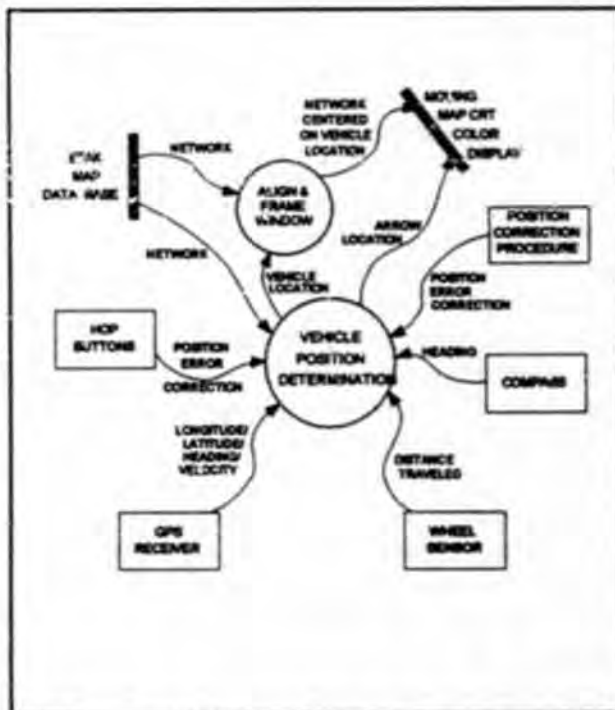


Figure 31. Vehicle navigation data flow.

information from the TMC and nominal travel times stored in the routing computer data base were used in determining the minimum travel time path. In the Navigation vehicle, only nominal travel times were used. A vehicle configured in the Services Only condition did not have the capabilities of performing the route selection process.

The driver could also control the type of roadways that were considered in the route selection process. The driver had three different options for routing the vehicle:

- **FASTEST** -- considered all of the roadways in the TravTek network (all arterials, toll roads, and freeways) in the route selection process.
- **NO INTERSTATES** -- eliminated all Interstate freeways and toll roads from consideration in the route selection process.
- **NO TOLL ROADS** -- eliminated all Toll Roads from consideration in the route selection process.

Regardless of the configuration of the vehicle and driver routing preferences, the process of determining the minimum travel time path was the same in each vehicle.

#### Functional Description

TravTek used a distributed architecture in determining minimum travel time routes; that is, the selection of the minimum travel time routes was performed by processors in the vehicle. The route selection process began after the driver had entered his or her desired destination and had instructed the vehicle to compute the minimum travel time path. The vehicle used its current position as the origin for the trip. Using nominal travel times, the routing algorithm in the vehicle simultaneously computed the minimum travel paths from the origin to the TravTek network and from the destination to the TravTek Network. A geocoded location corresponded to the destination. Once on the TravTek network, the double ended search process continued to search for a minimum travel time path (within the constraints selected by the driver and the legal connectivity of the roadway network) until a connected path was formed between the origin and the destination. The double ended search procedure significantly reduced the amount and time of the calculations involved in determining a route for the vehicle over a single ended search procedure. Because the routing process had been designed to route vehicles primarily on the TravTek network and used a number of heuristic search rules, a route that was not the absolute minimum travel time path could be selected. However, the route that was selected was generally near optimum under the design constraints.

A similar approach was used to reroute drivers around areas of congestion and incidents. As the vehicle traveled through the network, it received current updates of the travel times on links in the TravTek network. Since the vehicle was receiving current travel time information updates once a minute via an FM data radio system, the vehicle continuously searched for routes that provided a significant time savings to the driver. If the alternative route provided the driver time savings of at least 30 percent of the estimated trip time on the original route, the driver was notified that a shorter route had been identified by the route selection process. <sup>(18)</sup> If the driver accepted the new route, it was spliced into the initial route.

A functional diagram of the route selection and rerouting process is shown in figure 32.

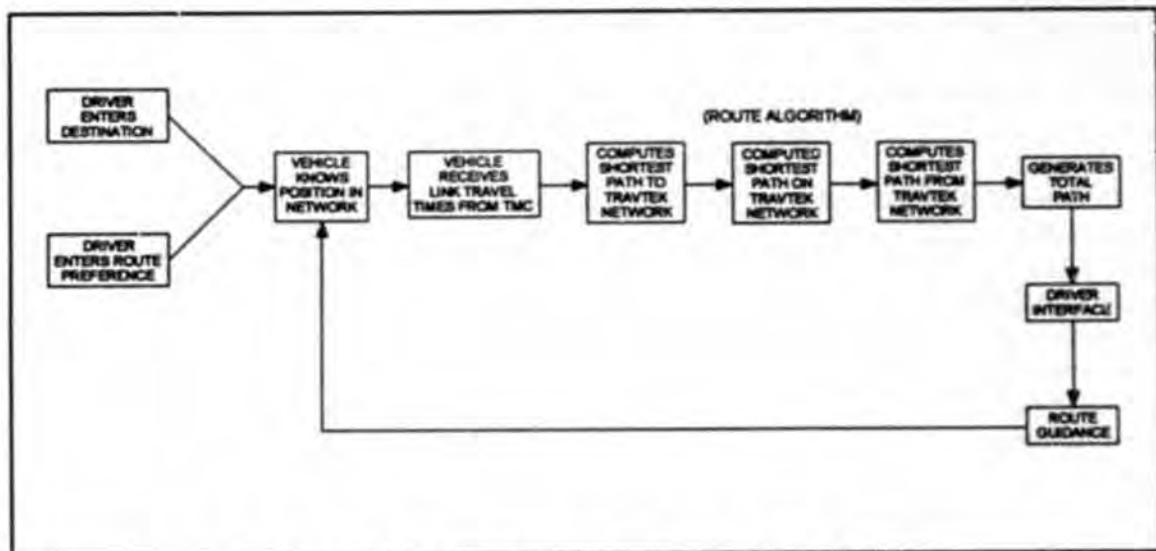


Figure 32. Vehicle route planning/route selection function.

#### Process Description

The software used to perform the route selection function was developed by Navigation Technologies (NavTech). The data base of alternative roadways that could be used in the routing process was provided by AAA. Due to the proprietary nature of the routing software, a detailed description of the mathematics used to calculate the minimum travel time paths cannot be provided. The technique used can be characterized as a constrained optimization algorithm.

In searching for alternate routes, the route selection process did not consider all possible travel routes to the selected destination. The first step in the rerouting process was to locate an appropriate downstream link to serve as the starting point for the rerouting process. This link was more than 120 seconds (using the nominal link travel times stored in the NavTech data base) but less than 300 seconds (again using the nominal link travel times stored in the NavTech data base) ahead of the current location of the vehicle. (The maximum amount of time assumed to be needed for replanning a route for a TravTek vehicle was 120 seconds.) Any link on the originally planned route within this range of values could be used as the starting location for the rerouting process. Potential origins for beginning the rerouting process were determined by comparing the current link travel times to the travel times used in planning the original route. If the current travel time on a link was at least 1.5 times greater than the travel time used in planning the original route, the link was flagged as a potential starting point (origin) for the rerouting process. If a potential starting link could not be found within 300 seconds ahead of the current location of the vehicle, the rerouting process was aborted.

Once a potential starting link for the rerouting process had been identified, a destination link for the rerouting process required identification. Only links on the original route were considered



feasible new destinations in the rerouting process. Beginning at the new starting link, the destination link was determined by comparing the travel time on each successive link along the originally planned route. A destination link was selected when the current travel time on the link was within 5 percent or less of the travel time used in the route selection process. If no link was identified that met this criterion, the routing computer would use the link on the originally planned route that was approximately 8 km (<8,000 m) ahead of the current location of the vehicle as the destination link for the rerouting process.

Once a new potential origin and destination had been identified, the rerouting origin was adjusted to a link that was 150 m closer to the vehicle (but still no closer than 120 seconds ahead of the vehicle). Similarly, the destination used in the rerouting process was moved to a link that was 150 m further away from the current position of the vehicle (but not past the original destination link). Adjusting the origin and destination by 150 m ensured that an adequate route around the area of congestion could be planned. Unless a road closure message had been sent by the TMC, the rerouting process was aborted if the total distance between the proposed new rerouting origin and destination was less than approximately 4 km (<4,000 m). If a road closure message had been received by the vehicle a new route would be planned.

After the revised origin and destination had been adjusted, the dynamic link travel times were then used to plan a route to the revised destination. If a new route existed that could provide a motorist with a 30 percent time savings (using the link travel times on the original route), the new route was offered to the driver. If a new route could not be found that was 30 percent shorter than the original route, the travel time of the original route was updated using the current link travel times broadcast by the TMC. Figure 33 illustrates the process used for rerouting vehicles around areas of congestion.

#### Data Flow

The flow of data in the route selection process is illustrated in figure 34. The primary data inputs included travel time and incident information from the TMC, accurate vehicle positioning information from the navigation process, a trip destination entered by the driver, and the routing network supplied by AAA. As an output, the route selection process provided information that was interpreted by the route guidance system to provide drivers with visual and voice synthesized turn-by-turn instructions.

#### *Route Guidance*

TravTek also had the capability of providing drivers with route guidance information to assist them in locating and driving to their selected destination. TravTek provided three different forms of route guidance information: simplified turn-by-turn graphics, a highlighted overlay of the planned route, and voice generated turn-by-turn instructions. However, each of these message forms served the same function: to aid the driver in reaching his or her destination as quickly as possible with a minimal amount of navigational waste.

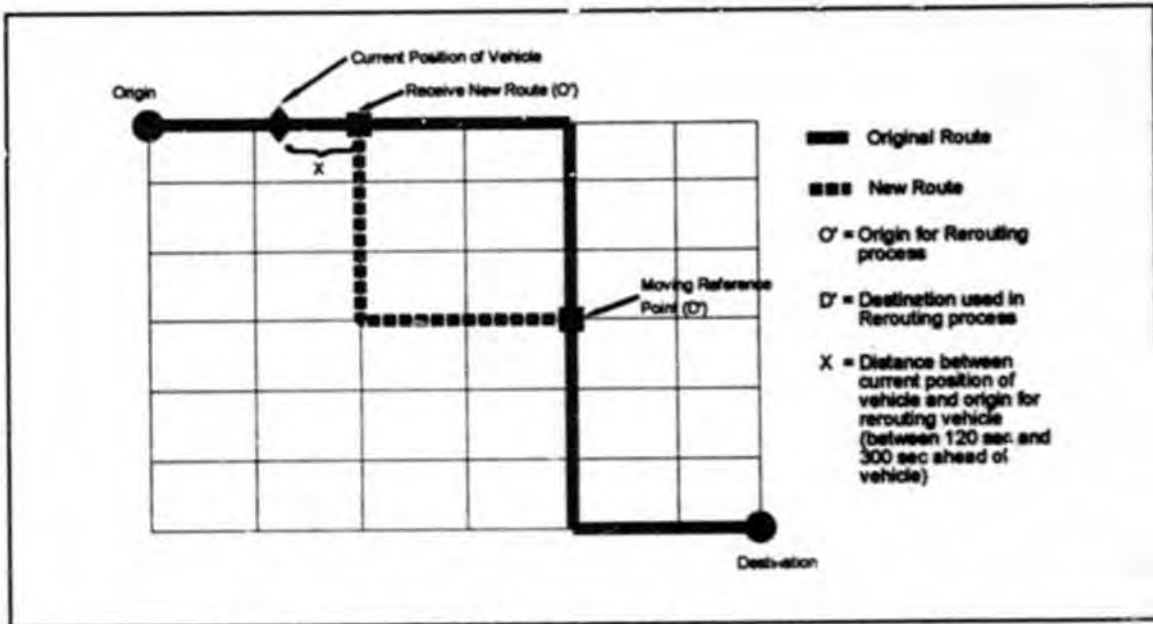


Figure 33. Illustration of route selection process for rerouting.

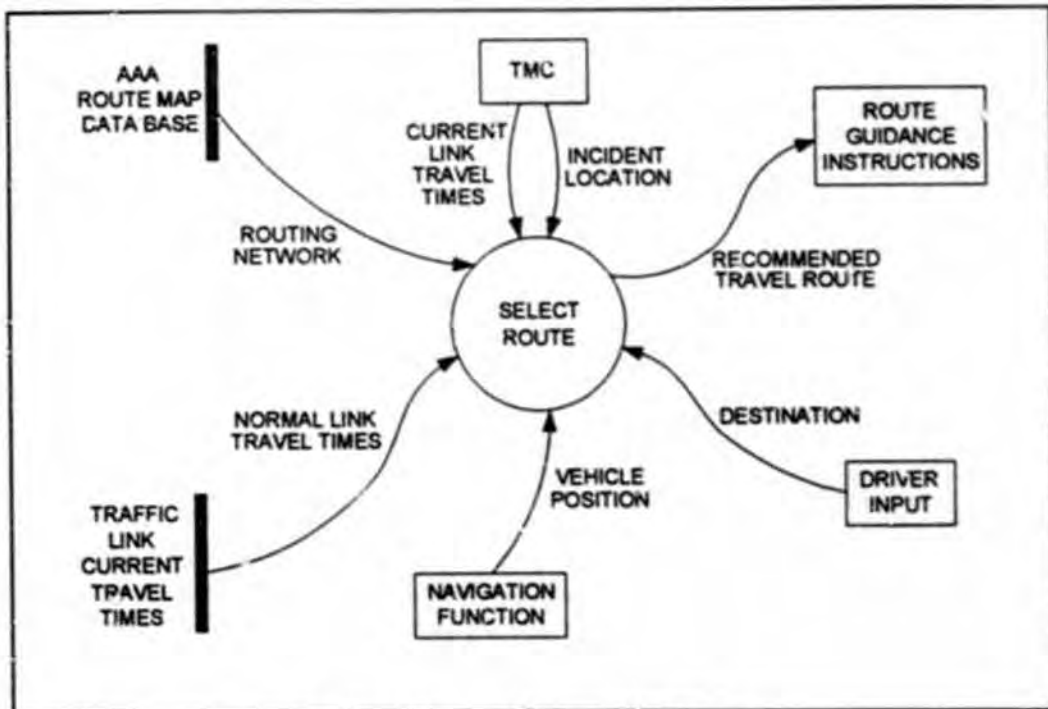


Figure 34. Route selection data flow.

The Evaluation Project had several different human factors studies to determine the optimum mode and format of presenting route guidance information. These studies included the Orlando Traffic Network Study (Task C2), the Yoked Driving Study (Task C1) and the Camera Car Study (C3). The reader is referred to the reports of these tasks for information on these studies.

### Functional Description

The primary objective of the route guidance task was to provide motorists with navigational aids to assist them in reaching their desired destination. In order to accomplish this goal, a number of functions were required in the route guidance tasks. First, a route was generated and selected. This was accomplished in the Route Selection function (see above). From this process, coupled with the knowledge of the street network, a list of maneuvers required to reach the desired destination was generated. The list of maneuvers was then converted into both visual and voice route guidance instructions, which were then displayed to the driver in the form of an overlay on the computer generated map, stylized turning instructions, and voice turning instructions. As a driver approached a turn, both visual and voice instructions were provided in advance of the turn so the driver had the opportunity to safely position the vehicle in the correct lane to execute the maneuver. A functional diagram of the route guidance process is shown in figure 35.

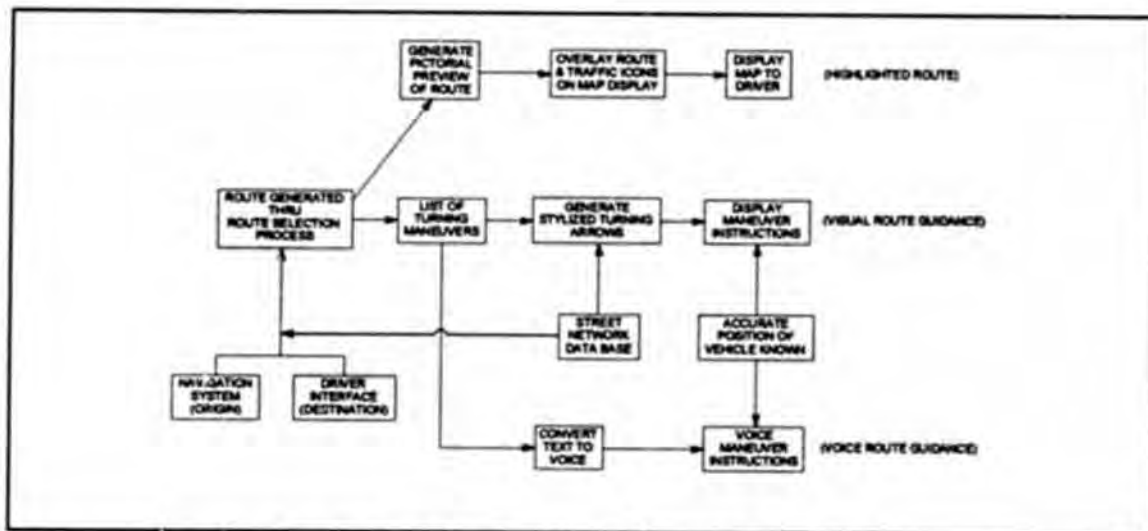


Figure 35. Route guidance functional diagram.

### Process Description

There were two methods by which motorists were provided with route guidance information: visual and voice. The visual presentation involved overlaying the highlighted route on the map display. Both the current position of the vehicle and the destination of the driver were displayed on the map. Relevant congestion and incident icons were also shown on the map.

Drivers were also provided with visual maneuver-by-maneuver guidance screens. These screens consisted of simplified, stylized diagrams showing the distance to the next turn, the geometry of intersection of the next turn or significant maneuver, the direction in which the driver

was supposed to turn, and the name of the street where the maneuver was supposed to occur. Through the Swap Map button on the steering wheel, the driver had the option to switch back and forth between the maneuver-by-maneuver screen and the highlighted map display.

In addition to these visual displays, voice route guidance messages were available to the driver. The voice guidance information consisted of turning instructions (including the direction of the turn and the street name), traffic information, and **Where Am I?** information such as the current heading of the vehicle, the name of the street being driven, and the name of the relevant cross street. The voice guidance messages were generated from the maneuver list produced by the route selection process using the routing network data base. The voice messages were intended to supplement the visual guidance information and could be alternately disabled or enabled by the driver by pressing the Voice Guide steering wheel button.

### Data Flow

As shown in figure 36, there were numerous data flows associated with the route guidance function. In addition to the communication requirements between the various vehicle subsystem components, data also flowed between the routing computer and the navigation computer. The routing computer was responsible not only for generating the route guidance instructions and screens, but also for generating the voice messages. The navigation computer drew the map and displayed the map to the driver.

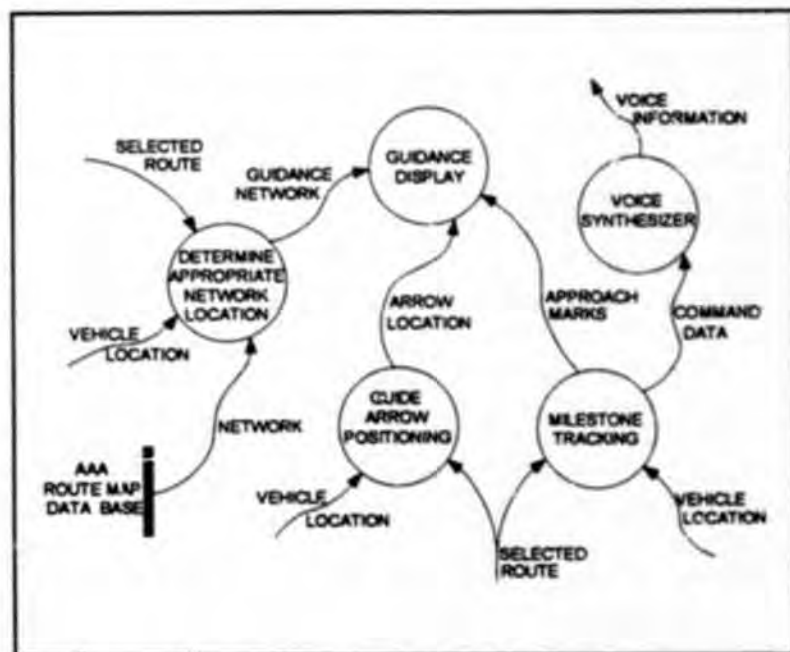


Figure 36. Route guidance data flow.

### Local Information

Another function of the vehicle subsystem was to provide drivers with information about services and attractions in the local area. Information was provided on a number of services and attractions including hotel accommodations, restaurants, points of interest, amusement parks, automatic teller machines (ATM's), etc. This information was stored in data bases in the navigation computer. Local event and weather information, which was updated by the TMC, were also provided through this function.

### Functional Description

The primary roles of the Local Information function were to 1) provide drivers with current and accurate information about services, attractions, and points of interest in the greater Orlando metropolitan area, 2) assist drivers in selecting destinations for the route selection process, and 3) display the location of services and attractions to driver via the driver interface unit. The type of information provided by this function included the location, pricing structure, AAA rating, and hours of operations of services and attractions; parking availability at select parking facilities; and current weather information. Information on special events such as concerts, plays, sporting events, and similar transitory items were also provided by this function. Function operation was controlled by the touch sensitive screen of the video display in the dashboard. A diagram of the functions performed in this task is shown in figure 37.

### Process Description

By design, the Local Information function could be performed only when the vehicle was in PARK. While the vehicle was in motion, the Local Information function was disabled. Most of the information provided by the Local Information function was contained in

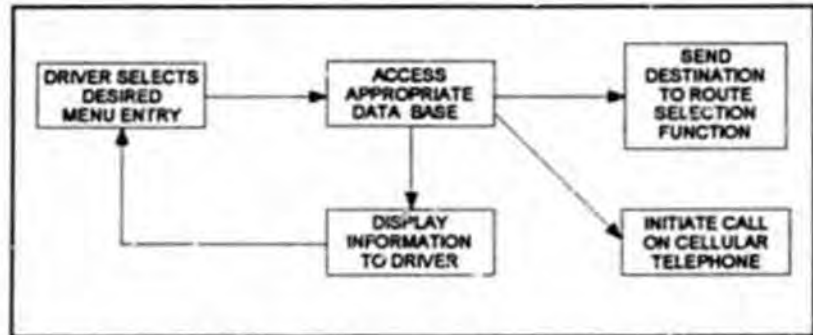


Figure 37. Local information functional diagram.

data bases resident in the navigation computer. A system of menus was designed to assist the driver in selecting a desired location. The driver had the option of searching a listing of the available services and attractions or entering a destination through the touch sensitive screen. Once the desired service or attraction had been identified, the driver could review important information about the selected attraction, such as hours of operations, price structure, AAA rating, etc. The driver could also display the location of a desired service or attraction on the computer generated map. Through finger touches on the driver interface unit, the establishment could be entered as the destination to be used in the route selection process or the driver could call the establishment on the cellular telephone.

### Data Flow

Although there was some flow of information between the TMC and the navigation computer, most of the data flows in the Local Information function were menu entries from the driver interface unit. The type and direction of flow of information is shown in figure 38.

### *Driver Interface*

TravTek was designed to make available to drivers a wealth of travel-related information. The information was intended to assist motorists in selecting destinations and planning routes to their destination. However, without a properly designed means of communicating the

information, drivers would not be able to use the TravTek system to its fullest potential. Therefore, the driver interface was one of the critical components of the TravTek system. The driver interface was designed to 1) maximize the driver's comprehension of the information presented, and 2) minimize distraction from the driving task. <sup>(2)</sup>

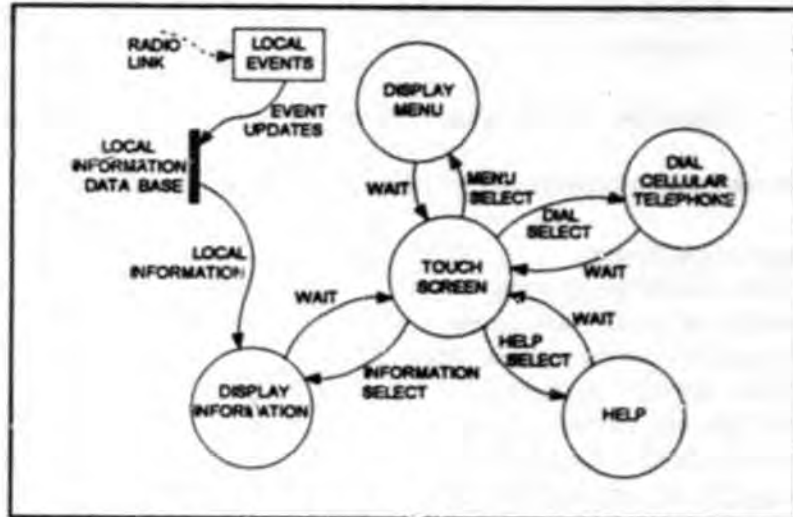


Figure 38. Local information data flow.

Because of the critical nature of the driver interface, there were numerous studies in the TravTek Evaluation Project that evaluated the effectiveness, usability, and acceptance of the driver interface. The reader is encouraged to consult the study reports for further information on the human factors analysis and evaluation of the driver interface.

#### Functional Description

The primary function of the driver interface unit was to display information in such a way as to maximize the transfer and comprehension of critical information while minimizing driver distraction. The functions of the driver interface systems were as follows:

- Provide the driver with access to the local information data base of local businesses and attractions.
- Allow the driver to select a destination based on street address, type of location, or menu entry.
- Provide cellular telephone communication to places listed in the local information data base.
- Display to the driver an electronic map of the street network in local areas.
- Accurately display the current position of the vehicle on the electronic map.
- Display to the driver the location of a selected destination.
- Display to the driver the optimum route to a selected destination.
- Provide guidance instructions to a selected destination.

- Provide the driver with information relative to the location and magnitude of incidents and congestion.
- Allow the driver to access information critical to the driving task.

The relationship between these functions is illustrated in figure 39.

### Process Description

There were three primary ways in which the driver could obtain information from the vehicle. The first was through visual displays. Color displays, menus, and maps were presented to the driver via a production 12 cm (diagonal) color display with a touch sensitive feature. The color display was mounted in the center of the dashboard of the vehicle. Through this interface unit, the driver could review and select destinations from the local information data base, execute route planning features, and initiate calls on the cellular telephone. The color display was also used to provide the driver with route guidance instructions, information on traffic congestion and incidents, and navigation information.

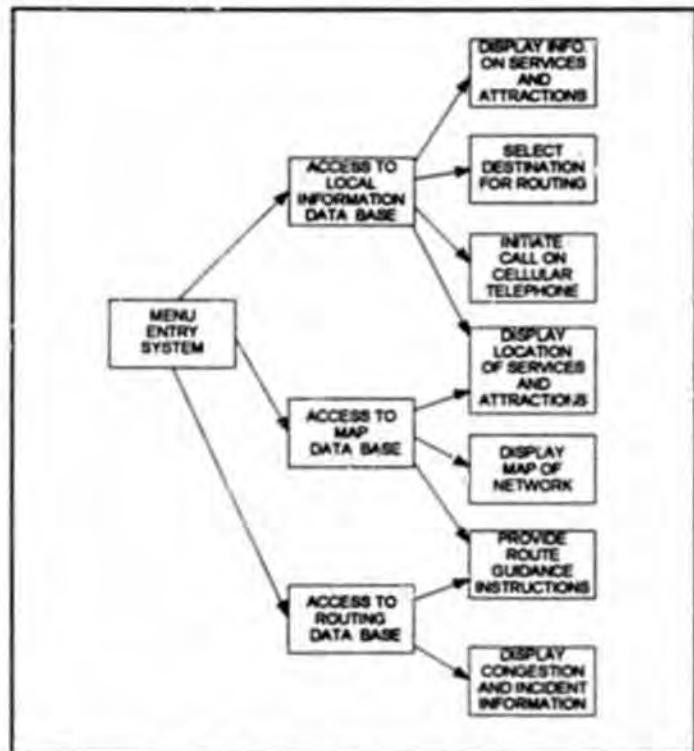


Figure 39. Driver interface function diagram.

In addition, the driver had the option of receiving traffic and congestion reports as well as route guidance instructions via voice communications. A text-to-speech voice synthesizer was used to convert text traffic messages and turn-by-turn instructions from the routing computer into voice messages. Through a switch on the steering wheel, the driver could select whether or not to hear voice messages.

Certain features of the driver interface function could be controlled by eight buttons placed on the steering wheel. The buttons allowed the driver to accept a new route offered by the route selection process (**OK New Route**), toggle between the route map and the guidance displays (**Swap Map**), adjust the vehicle's on-screen position (**Hop Right/Hop Left**), activate a voice message indicating the current position of the vehicle (**Where Am I?**), repeat the last voice message (**Repeat Voice**), and turn the voice guidance function on or off (**Voice Guide**). All of these interface components allowed the driver ready access to critical information needed to complete the driving task.

### Data Flow

Figure 40 illustrates how information flows between the driver and the other vehicle subsystems through the driver interface.

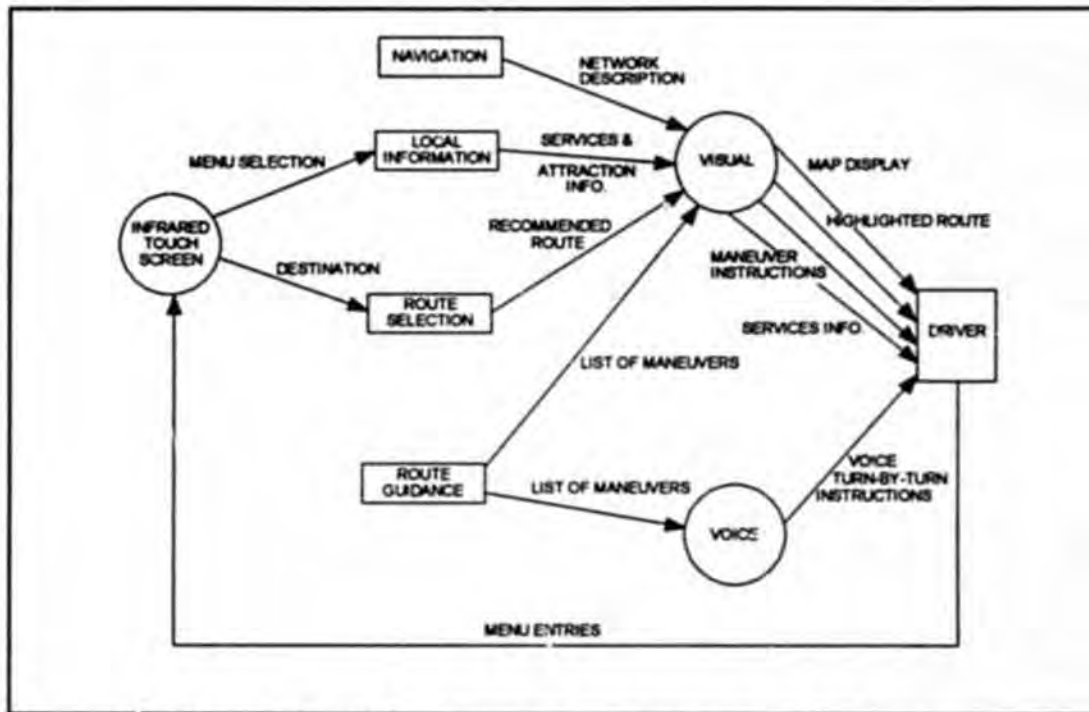


Figure 40. Data flow diagram for driver interface function.

### Vehicle Probe

The TravTek vehicle was also designed to function as a "probe" or moving sensor to collect information on the operations of traffic on the TravTek Network. The primary data provided by the probe vehicles were link travel times. As the vehicle traveled through the TravTek network, the time required to traverse a TravTek Network link was broadcast to the TMC. At the TMC, the probe reports were combined with other sources of link travel time to provide a current representation of the travel conditions on the TravTek Network. This information was then used by the TravTek vehicles in the route selection and route guidance processes.

### Functional Description

The manner in which the vehicle functioned as a probe is illustrated in figure 41. Through the Navigation function, the TravTek vehicle knew its current position in the network. As it traveled through the network, the time required for the TravTek vehicle to travel a link was determined by monitoring the time it crossed the beginning and end of the link. The link travel time, along with link travel time information from as many as two other TravTek links traversed by the vehicle during that minute, was broadcast to the TMC. The TMC used the link travel time information as one of the inputs into the data fusion process.



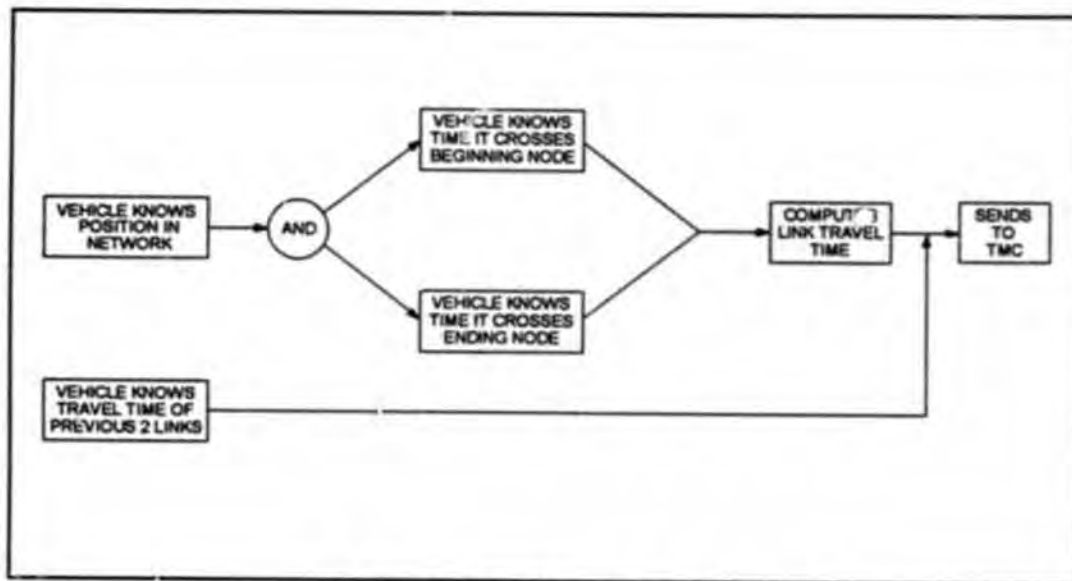


Figure 41. Vehicle probe function.

#### Process Description

The routing computer was responsible for performing the vehicle probe function. Software in the routing computer monitored the time required to traverse links in the TravTek Network. Vehicle positioning information was provided by the Navigation task (which is performed by the navigation computer). The routing computer combined the vehicle position information and the link travel time information. The information was then transmitted to the TMC via the FM data radio system.

#### Data Flow

The flow of data as the vehicle performed the probe reporting function is illustrated in figure 42. The primary types of information used as inputs in the probe reporting function were the description of the TravTek network, and vehicle position and heading information. Outputs from the vehicle probe function were the travel times of the last three TravTek Network Links traversed by the vehicle during the minute. Link travel time information was broadcast to the TMC once every minute.

#### Data Logging

The final function of the vehicle subsystem was to log data needed for evaluating how drivers use the system and the type of benefits, in terms of time saving and reduced navigational waste, that could be obtained from the system. The TravTek vehicle was somewhat unique in that the computers in the vehicle also logged data that was used in the evaluation process. Therefore, the vehicle was one of the primary tools for measuring the operational benefits of the TravTek System.

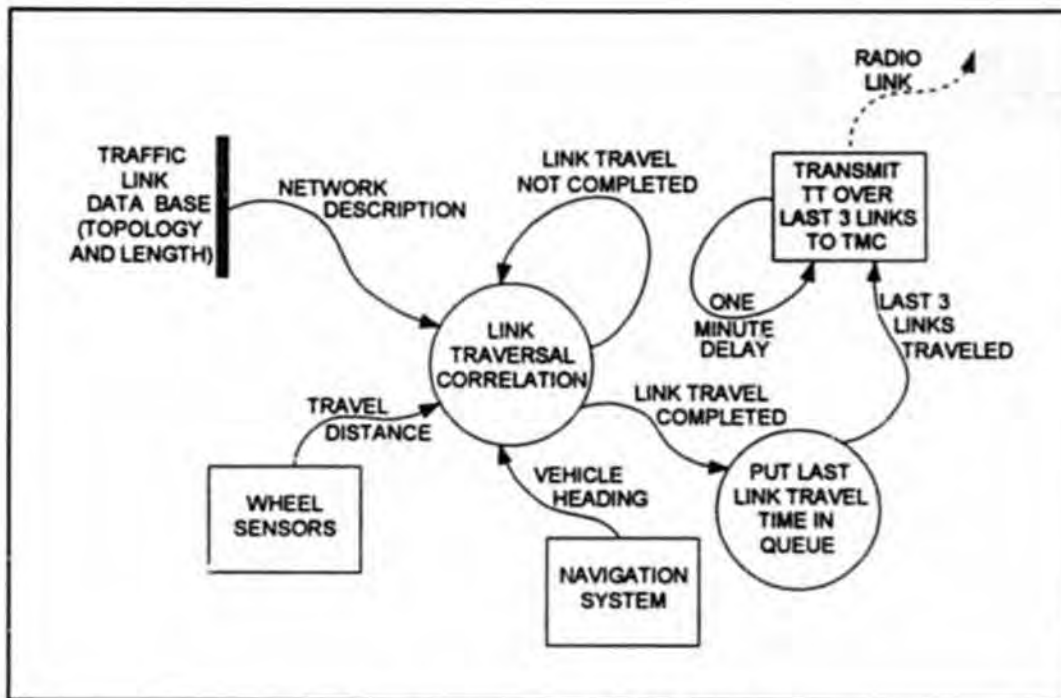


Figure 42. Probe report data flow.

#### Functional Description

The type of information logged included interactions between the driver and the system as well as what information was available to the driver at any time and how he or she used it. The specific information logged by the system included all touch screen interactions, steering wheel button interactions, the routes selected by the vehicle route selection process, the routes driven by the driver, and all messages transmitted to and received from the TMC. Vehicle and driver performance data (e.g., vehicle speeds, brake applications, etc.) were also stored in the vehicle logs. Figure 43 illustrates the functions of the data logging procedure.

#### Process Description

The log data were stored on the removable hard drive of the routing computer resident in the vehicle. When the vehicle was returned to AVIS, the hard drive was removed from the vehicle and the data downloaded. The raw data were then sent to GM Research for processing and analysis. The data were then entered into the TravTek library where they could be accessed by the Evaluation Team.

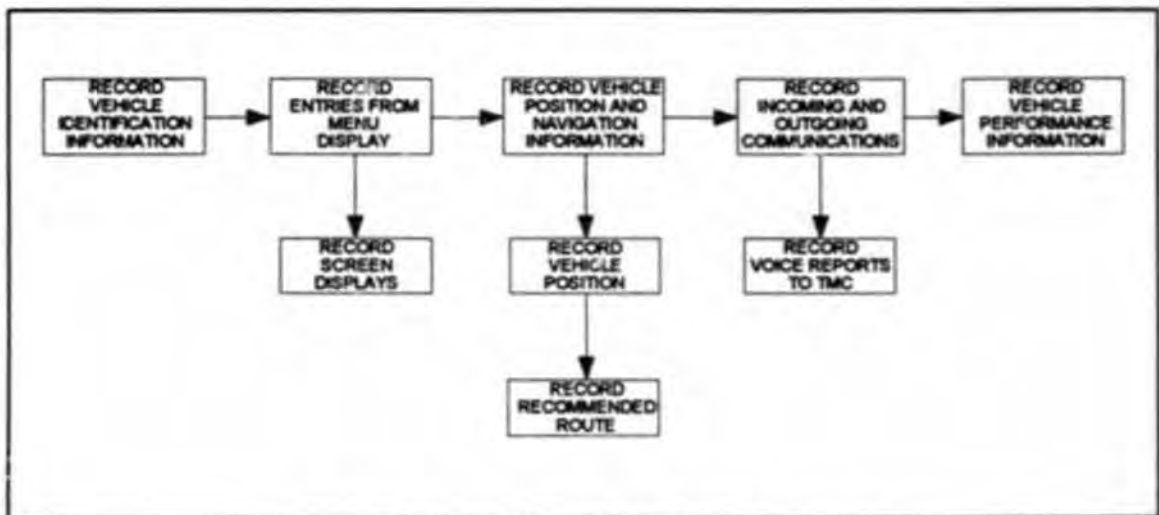


Figure 43. Data logging function diagram.

#### Data Flow

A data flow diagram illustrating the type of information logged in the process is shown in figure 44. All data flowing into the vehicle log were date and time stamped. The log data included, among other things, the following items: <sup>(17)</sup>

- Hard and soft switch action taken by the driver during interaction with the TravTek functions.
- The screen from which the switch function was taken.
- Voice and display messages provided to the driver by the TravTek functions.
- Each vehicle Probe Report sent to the TMC.
- Position of the vehicle.
- Current selected route.

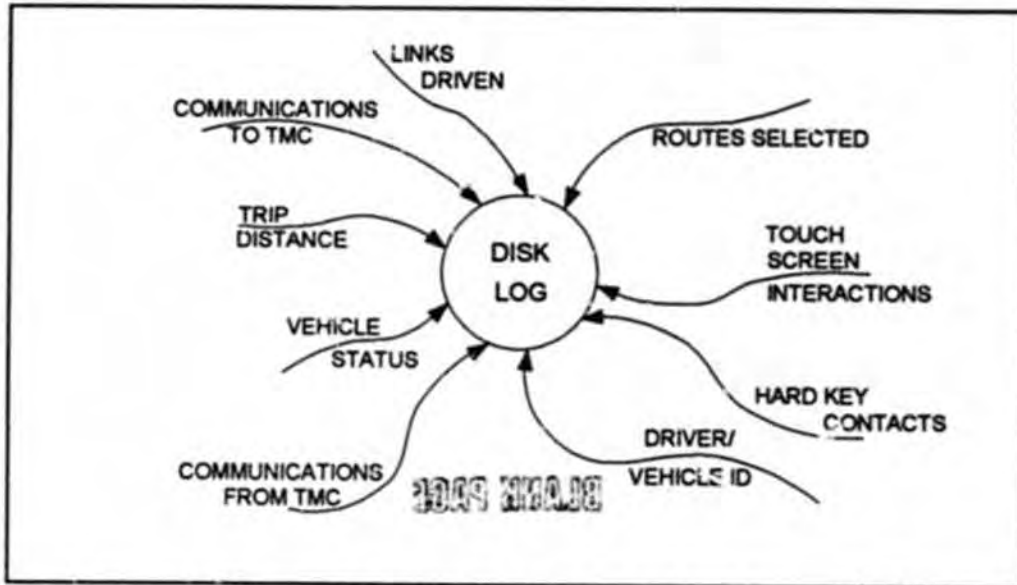


Figure 44. In-vehicle data logging data flow.

**BLANK PAGE**

## QUALITY OF TRAFFIC AND TRAVEL INFORMATION

One function of the TravTek system was to provide drivers with current information about travel conditions on the roadway network in the Orlando, Florida area. TravTek was designed to help drivers reach their intended destinations in the shortest amount of time and with less frustration by providing real-time information about travel and incident conditions on select roadways in the Orlando metropolitan areas. Real-time travel time and incident information was used to select the quickest route to a driver's entered destination while avoiding areas of congestion and incident locations. In order for TravTek to achieve this objective, accurate and timely travel time and incident information had to be provided to the vehicles. Because inaccurate and untimely information could degrade the performance of the system and affect drivers' perceptions and acceptance of the system, one objective of the System Architecture evaluation was to assess the quality of the traffic and travel information, both incident and travel time, provided by the various sources. Specifically, two issues related to the quality of the traffic information addressed in the System Architecture evaluation were as follows:

- How closely did the link travel times provided by the various real-time sources represent actual conditions in the TravTek network?
- How accurate and timely was the incident information that was broadcast to the TravTek vehicles?

This section presents the results of the analyses of these two issues.

### QUALITY OF TRAVEL TIME INFORMATION

Estimates of travel times for the links in the TravTek traffic link network were derived from information obtained from a number of sources, including the following: <sup>(9)</sup>

- FDOT's freeway surveillance system.
- The City of Orlando's computerized traffic signal system.
- A background computer simulation model.
- A data base of historical travel times.
- Operator overrides and inputs.
- The TravTek vehicles themselves.

FDOT maintains a computerized traffic surveillance system on approximately 18 km of I-4 through downtown Orlando. Loop detectors embedded in each lane of the freeway provide measurements of the volume, speed, and occupancy of traffic traveling in each direction. Loop detectors were spaced approximately every 0.8 km. Data from the loop detector were collected at the Freeway Management Center (FMC) and sent electronically to the TMC, where it was

mapped onto the TravTek network. The speed measurements were then used to estimate link travel times by dividing the link distance by the link speed.

Estimates of link travel times were provided on select arterial links using information from the City of Orlando's computerized traffic signal system. The software used to operate this system is an enhanced version of the Urban Traffic Control System (UTCS) software package developed by FHWA. This system collects several measures of traffic performance including the volume (in vehicles per hour) and the average delay (in seconds per vehicle) for each link active in the UTCS system. This information was sent electronically to the TMC workstation computer where it was used to estimate the travel time on the corresponding TravTek traffic links. TravTek estimated the travel time on the UTCS link by adding the measured delay to the nominal travel time for that link.

A computer simulation model (FREFLO) was used to provide estimates on link travel times during incident conditions on the freeway (I-4) and the toll roads (Beeline Expressway, Florida Turnpike, the East-West Expressway, and East Beltway). These facilities were modeled on demand when a report of an incident was received at the TMC. The dynamic data used by the model consisted of flow and capacity values which were either obtained from the FMC (in the case of incidents of the freeway) or from historical files (when the incident occurred on a toll road). When a change in capacity was received (in the form of the operator reducing the number of lanes), the changes were automatically made to the FREFLO input file. The model produced a series of future travel times on links upstream of the incident. At the time these data became current, they were added to the data fusion process for analysis.

The TMC also maintained a data base of historical travel times for each link in the TravTek traffic network. This information was used to estimate the link travel time when no other sources of information were available. Historical travel times were indexed by day-type (i.e., weekday, weekend, and holiday) and time-of-day. Different historical travel times were for different time-of-day and day-type categories. An exponential smoothing algorithm was used to constantly update the historical data base from the other non-incident travel time sources.

The operator also had the ability to override the link travel time selected by the data fusion process. The operator could enter congestion indicators which provided estimates of travel times in response to incidents (particularly on arterial links), or to construction or event-related lane closures. Like the other sources, these travel time values entered by the operator were used in the data fusion process to select a travel time that most closely represented actual travel conditions.

The TravTek system also tested the concept of using probe vehicles to collect real-time information on current traffic and travel conditions in a network. As a TravTek vehicle traveled through the network, it acted as a probe vehicle, providing the TMC with its measured travel time on the last link traversed. This information was broadcast to the TMC every minute by an FM data radio in the vehicle. Because the probe vehicle was measuring actual travel times (as opposed to estimating travel time from other measured traffic parameters), the travel time information from the probe vehicle was considered to be the most accurate measure of actual travel conditions by the TravTek system.

Of these six sources of travel time information, only three were capable of providing dynamic, real-time estimates of travel time on a link: the freeway surveillance system on I-4, the UTCS on select arterial links, and the TravTek vehicles. The other three sources provided only static estimates of link travel times.

One of the primary functions of the TMC was to collect the current travel time information from the various sources and transmit this information to the TravTek vehicles en route to their specific destinations. The TravTek vehicles, in turn, used this information to determine optimum routes that minimized the remaining travel time to the entered destination. The success of the routing algorithm to provide minimum travel time paths depended on the availability of accurate and timely link travel time information. If the TMC was unable to obtain a realistic representation of the actual travel conditions that existed in the network, drivers were provided with less than optimum routes to their destinations. Therefore, it was essential that the sources of real-time information provide estimates of link travel times that accurately reflected actual conditions in the network. This analysis examined how well the various sources of real-time information provided estimates of actual travel conditions in the network.

### Evaluation Methodology

System performance statistics were prepared depicting the general degree of automation in the TravTek system. These statistics were intended to measure the ability of the system to collect, synthesize, and distribute real-time travel time information to the TravTek vehicles and to the TIN users. They provide insight into the amount and nature of the current travel time information in the system at any point. Using the Data Fusion Winner logs, frequency distributions were prepared for the winning sources of travel time on each link. These data were then used to determine the following summary statistics:

- Number of link travel times generated by each automated source.
- Number of link travel times generated by each non-automated source.
- Number of times the operator was forced to override a dynamic link time generated by the system.

To examine the ability of the various sources to accurately estimate current conditions on the TravTek traffic network, actual link travel times (as measured by the probe vehicles) were compared to link travel times estimated by the other real-time sources (i.e., the travel times estimated from the freeway surveillance systems and from the computerized traffic signal system). Non-automated sources (i.e., the traffic model, incident reports, and operator overrides) were not included in the analysis because of the relatively low likelihood that they would be selected as the winning source of travel time in the data fusion process.

Sources of travel time information were compared using a relative error measure computed by the following equation:



$$\text{Relative Error} = 1 - \frac{\text{Travel Time Estimated by Other Sources}}{\text{Travel Time Measured by Probe}}$$

This measure was selected because it quantifies not only the magnitude of the error but also the dimension of the error. For example, a negative relative error measure indicated that a particular source overestimated the actual travel time on a link (as measured by the probe vehicle). A positive relative error measure indicated that the source underestimated the actual travel time on a link. A relative error measure of zero indicated that the source estimated the actual travel time on a link exactly.

### **Data Sources**

All the data used in this part of the evaluation was collected automatically by the TravTek system at the TMC. System performance statistics were developed using the Data Fusion Logs. Logs of the data fusion winners were available for June 1992 to March 1993.

To analyze the accuracy of the travel time estimates, both the Data Fusion Winner Log and the Data Fusion Input Logs were used. No direct field measurements of actual travel times were performed. It was assumed that the travel times provided by the probes (i.e., the TravTek vehicles themselves and logged at the TMC) accurately represented actual travel conditions at the time the vehicle traversed a link. (Limited comparisons of measured travel times and travel times values logged by TravTek vehicles at the TMC by other members of the evaluation team suggest that this assumption is valid.) Therefore, link travel times provided by the probes were compared to the travel times provided by the other real-time sources (i.e., the FMC and the UTCS). The Data Fusion Winner Log was used to find instances where the probe was the winning source of travel time. Corresponding input sources were obtained from the Data Fusion Input Log. Data Fusion Input Logs were available only for January 1993 through March 1993.

Because the same probe measurement stayed active in the data fusion process for approximately 10 min and because travel conditions can change on a link during this time, only the first entry of a probe as the winning travel time source was used in the comparisons. It was felt that the ability of the various sources to estimate travel times differed during peak and non-peak traffic periods. For this reason, comparisons of link travel times in the peak and non-peak traffic periods were performed separately. The morning peak period (AM peak) was defined as occurring from 7:00 AM to 9:00 AM weekdays, and the afternoon peak period (PM peak) was defined as occurring from 4:30 PM to 6:30 PM weekdays. The remaining weekday periods were designated as Off peak.

### **Results**

#### *System Performance*

One of the objectives of TravTek was to rely, wherever possible, on automated sources to provide real-time information. Using the Data Fusion Winner Log, frequency distributions were

prepared summarizing how often each source was selected by the data fusion process as providing a travel time estimate that was believed to most closely represent actual conditions. Figures 45 through 48 show the distribution of the winning sources of travel time information on instrumented and non-instrumented arterial and freeway links.

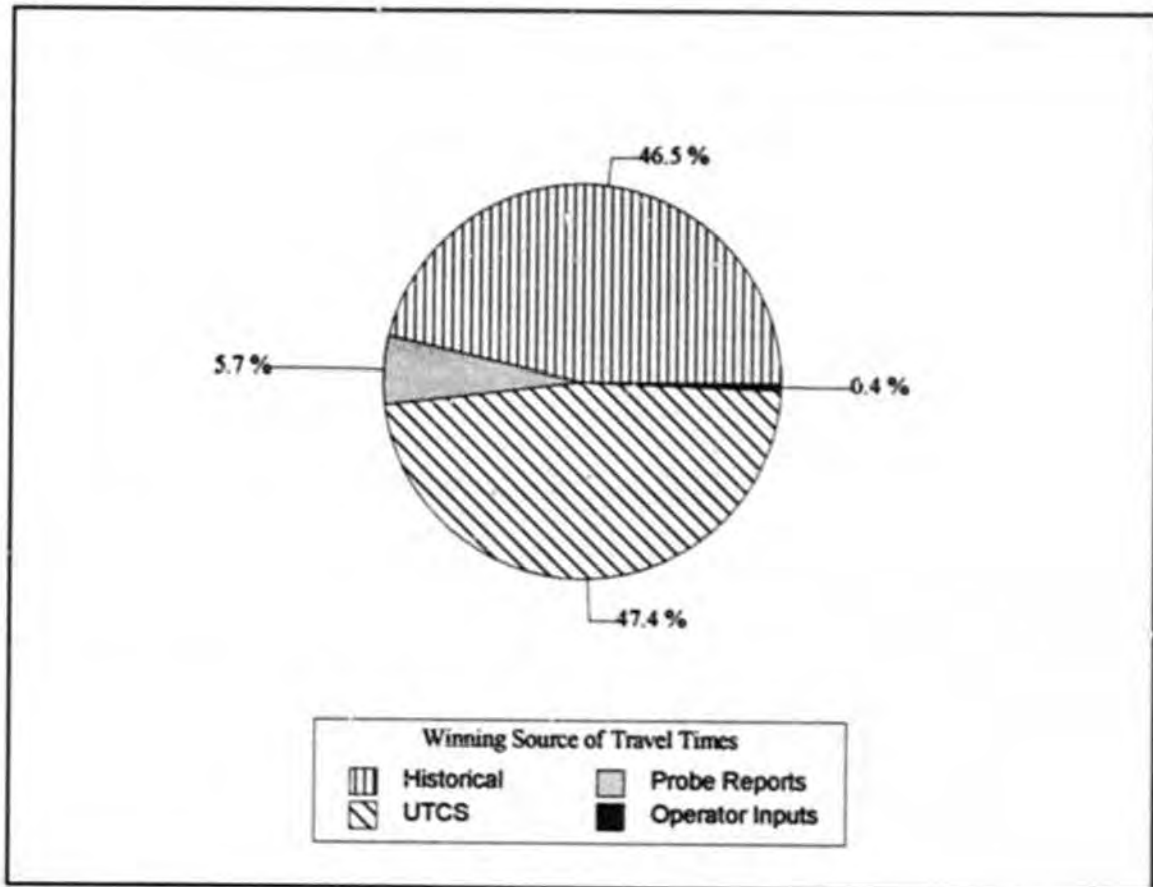
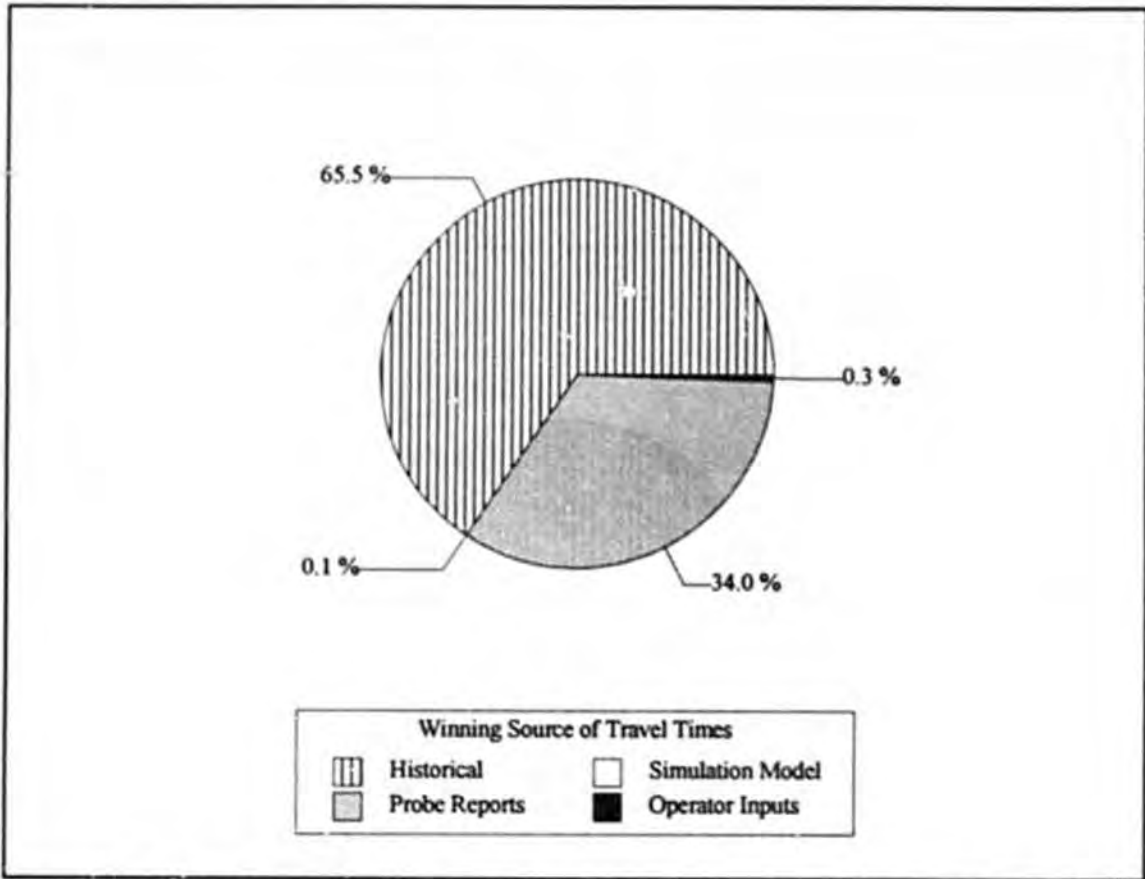


Figure 45. Distribution of winning travel time sources for instrumented arterial links.



**Figure 46. Distribution of winning travel time sources for non-instrumented arterial links.**

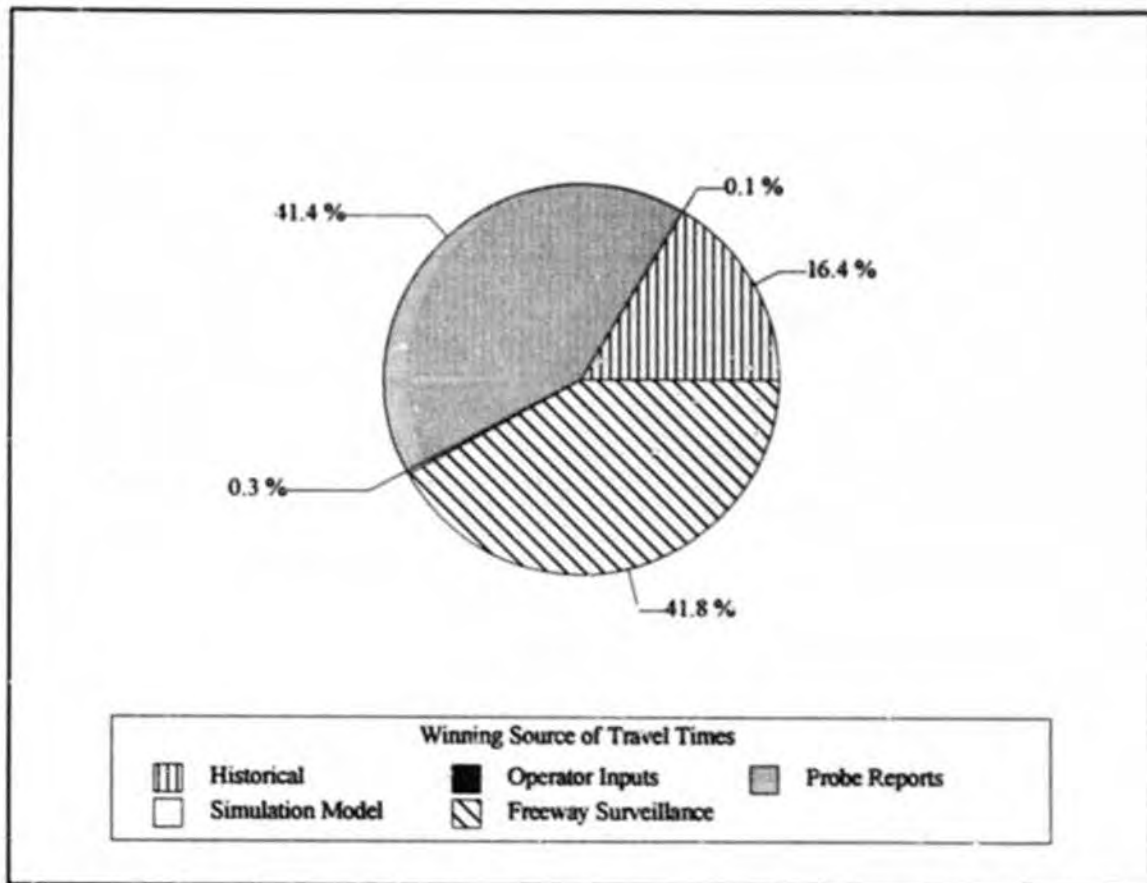
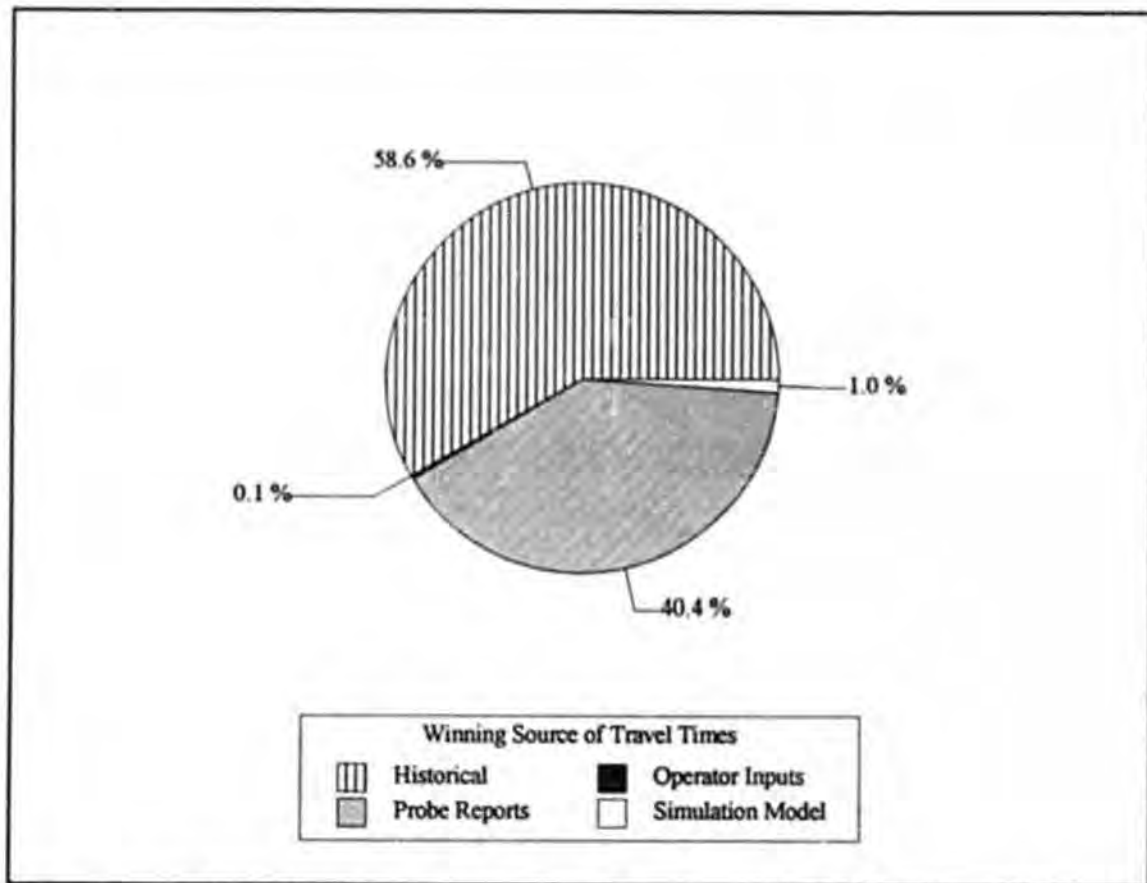


Figure 47. Distribution of winning travel time sources on instrumented freeway links.



**Figure 48. Distribution of winning travel time sources on non-instrumented freeway links.**

As indicated by these figures, much of the travel time information that was contained in the TravTek system came from automated sources. Automated sources of travel times included the FDOT's freeway surveillance center (FMC), the City of Orlando's traffic signal system (UTCS), and the TravTek vehicles themselves. On both the instrumented arterial and freeway links, over half of the winning sources of travel time information came from automated sources. On the non-instrumented links, more than a third of the winning travel times came from automated sources (essentially probe vehicles). Almost all of the remaining winning travel time sources were historical, which was considered a nonautomated source. Operator overrides consisted of less than 1 percent of the winning travel times on both the instrumented and non-instrumented links.

It should be noted that continuous automated updates of travel time information were available on only a small portion of the TravTek network. Only those links covered by the FMC and the UTCS were capable of providing continuous real-time information automatically. These links comprised only 12 percent of the 1,488 links in the TravTek traffic network. This accounted for only 145 km of the total 1854 km of roadways in the TravTek traffic network.

### *Source Errors*

Tables 6 and 7 provide the mean and standard deviation of the relative error for each of the sources of real-time information (excluding historical data) used in the TravTek system. A t-test was used to determine whether the computed relative error measures differed statistically from zero. (Recall that a relative error measure of zero implies that the travel time measured by the real-time source and the actual travel time on a link are equal.) The results of the t-test are also included on these tables. In most cases, the mean relative error differed statistically from zero with relatively high degrees of significance.

The relative error measures for non-historical sources of travel time information for the freeway and arterial links are shown in figures 49 and 50. As can be seen in these figures, the mean relative errors of all of the sources of travel time information were negative. This implies that all of the sources provided estimates of link travel times that were higher than the actual travel times (as measured by a probe vehicle). Most noticeably, the computer simulation model (the FREFLO model) dramatically overestimated the link travel time on both the freeway and the arterial links. Travel time estimates derived from this source overestimated actual travel times on a link by as much 1,000 percent. However, it should be noted that the FREFLO model was not developed specifically for estimating link travel times during incident conditions, which is how it was used in the TravTek system. Therefore, one would not expect this source to provide reliable estimates of link travel times. Because of the complex traffic patterns that typically occur during incident conditions, no existing computer simulation software package currently available to the traffic engineering community can adequately predict traffic operations during incident conditions.

The operator also had a tendency to overestimate the travel time on a link. Figures 49 and 50 show that, with the exception of arterial links during the PM peak, the operator had a tendency to overestimate the travel time both on the freeway and arterial street links by approximately 70 percent or more. The comparatively low relative error by the operator for the arterial links during the PM peak may be indicative of the operator's knowledge of traffic operations on the arterial street system during these periods. By design, the TravTek system operators were also the operators of the City of Orlando's Computerized Traffic Signal System. Through their experience with working with traffic control system, traffic system operators generally have a good working knowledge of traffic operations in their system. As a result, a knowledgeable operator can make fairly accurate estimates of traffic conditions based on limited information. It is possible in those situations where the operator was required to input a travel time, the operator was able to make an accurate estimate of the travel conditions on the links. However, it must be pointed out that this relative error measure is based on only four data points over a 3 month period.

Of the two surveillance systems, the one that supported the UTCS computerized traffic signal system provided the least accurate estimates of travel times. The relative error produced by the surveillance system on the arterial streets ranged from -1.8 in the AM peak to -0.71 in the PM peak. In the AM peak, a relative error of -1.8 implies that the surveillance system overestimated the actual travel time on a link by over 180 percent. In the PM peak, the surveillance system overestimated link travel times by 71 percent. During the Off peak, travel times were overestimated by the UTCS surveillance system by 86 percent.

**Table 6. Relative error of sources of travel time information for arterial links.**

Source of Travel Time Estimate	Period	Sample Size	Mean Relative Error	Standard Deviation	t Statistic [Mean = 0]	Prob >  t
Operator Inputs	AM Peak	0	-	-	-	-
	Off Peak	16	-0.72	1.04	-2.79	0.0138
	PM Peak	4	-0.19	0.65	-0.58	0.6026
Computerized Traffic Signal System (UTCS)	AM Peak	371	-1.80	4.59	-7.54	0.0001
	Off Peak	3493	-0.86	3.32	-15.33	0.0001
	PM Peak	741	-0.71	3.03	-6.35	0.0001
Computer Model for Incidents (FREFLO)	AM Peak	0	-	-	-	-
	Off Peak	20	-7.81	6.48	-5.39	0.0001
	PM Peak	12	-4.75	3.16	-5.20	0.0003

8

84

**Table 7. Relative error of sources of travel time information for freeway links.**

Source of Travel Time Estimate	Period	Sample Size	Mean Relative Error	Standard Deviation	t Statistic [Mean = 0]	Prob >  t
Operator Inputs	AM Peak	1	-0.90	-	-	-
	Off Peak	13	-0.79	0.62	-4.60	0.0006
	PM Peak	6	-0.69	0.89	-1.89	0.1172
Freeway Loop Detectors (FMC)	AM Peak	671	-0.16	0.27	-15.10	0.0001
	Off Peak	4462	-0.18	0.57	-20.59	0.0001
	PM Peak	753	-0.27	0.55	-13.51	0.0001
Computer Model for Incidents (FREFLO)	AM Peak	2	-0.25	0.35	-1.02	0.4949
	Off Peak	95	-10.32	18.50	-5.43	0.0001
	PM Peak	47	-2.12	4.99	-2.91	0.0056

85

85



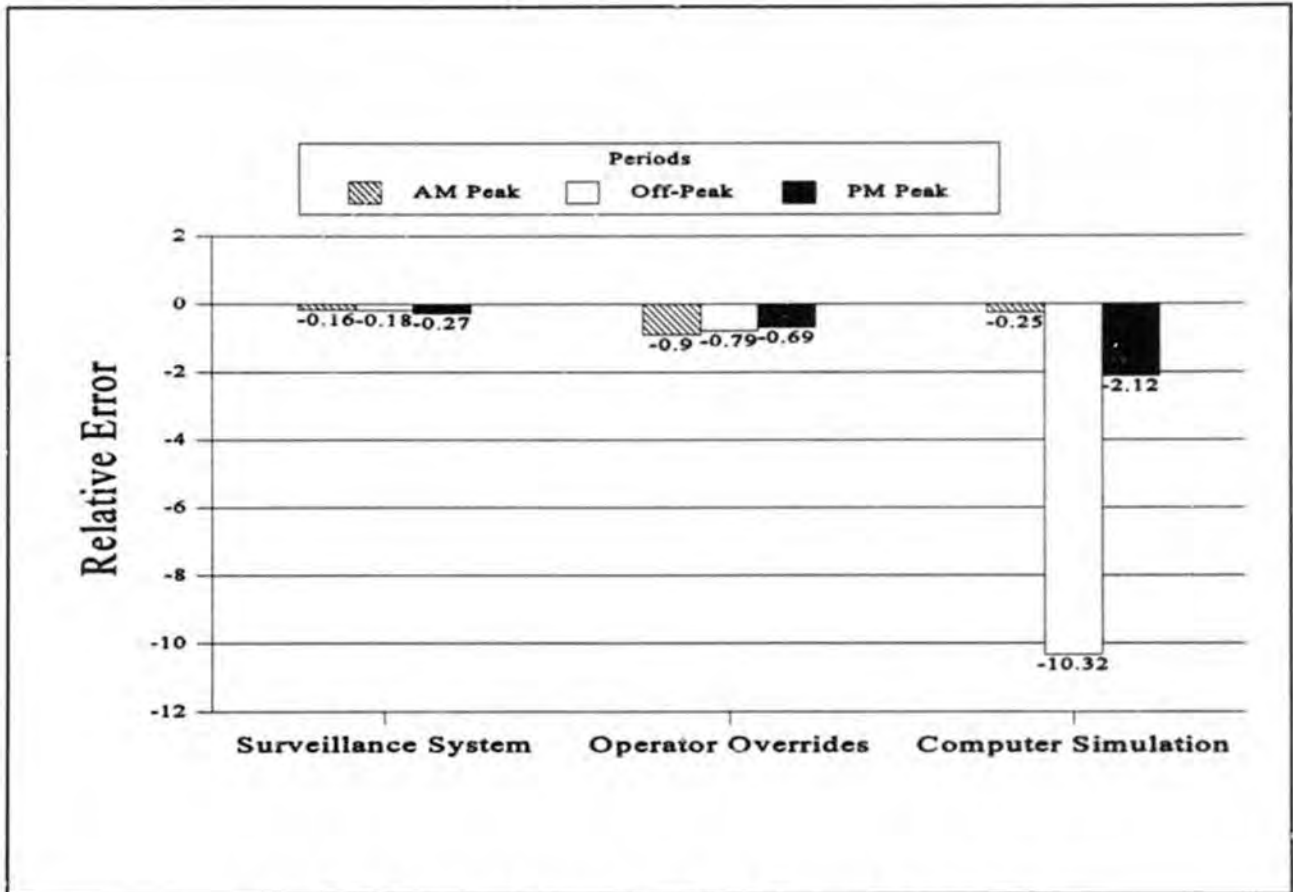


Figure 49. Relative error of sources of travel time information on freeway links.

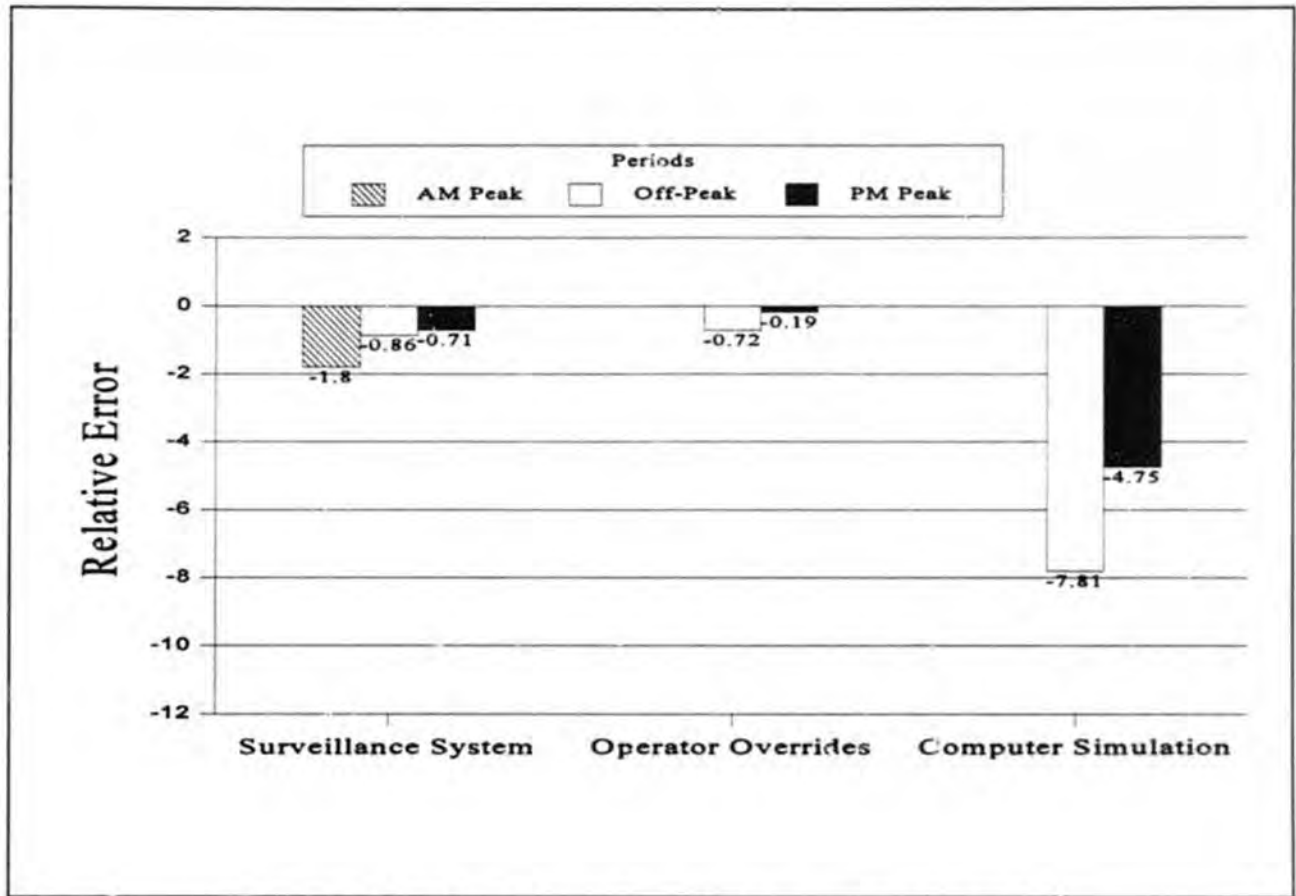


Figure 50. Relative error of sources of travel time information on arterial links.

In comparison, the freeway surveillance system only slightly overestimated link travel times, as compared to probes. During the AM peak period, the freeway surveillance system overestimated actual travel times (as measured by the probe) by only 16 percent. In the Off peak, the freeway system provided travel time estimates that were only 19 percent higher than those measured by the probes. Unlike the arterial street network where the most accurate travel times were produced by the surveillance system during the PM peak, the travel time estimates produced by the freeway surveillance system were the least accurate. During the PM peak, the freeway surveillance system tended to overestimate the actual travel times by 27 percent.

Even though surveillance systems for both the arterial and freeway links overestimated the travel time on a link, this does not automatically imply that the travel time information provided by these sources were not valid. As long as a source consistently predicted high travel times when the actual travel times are high, correction factors could have been applied to the estimated travel times to calibrate them to more accurately reflect actual conditions. Figures 51 through 53 compare the estimated link travel time from the freeway surveillance center to the travel time provided by the probes during AM peak, PM peak, and Off peak periods, respectively. These figures show that, for the most part, the travel time provided by the freeway surveillance system and those provided by the probe vehicles are fairly consistent (as seen by the relatively straight-line on which the data falls). These figures show that when the actual travel times on the freeway were high, the freeway surveillance system also provided high estimates of the travel time.

Figures 54 through 56 show plots for travel times estimated by the surveillance system that supports the UTCS. In these figures, travel times estimated by this surveillance system in all periods do not correspond well with the actual travel times as measured by the probes. Unlike the travel times estimated using the speed data from the freeway surveillance system, there does not seem to be a consistent pattern in the accuracy of the travel time information derived from the arterial links.

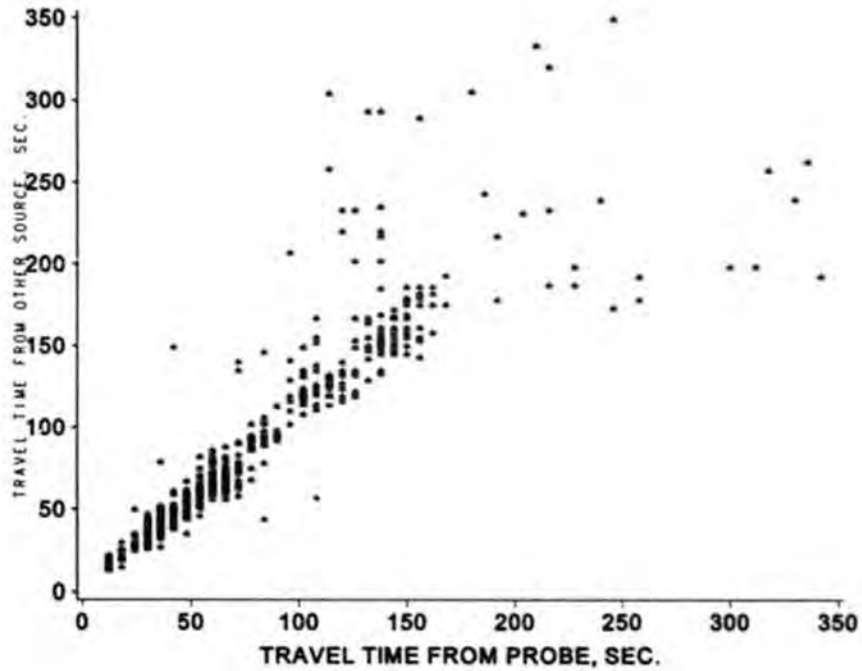
A correlation analysis was performed to statistically determine whether the sources consistently overestimated link travel times. The results of the correlation analysis are shown in table 8. The analysis showed there was not a good statistical correlation between the travel times estimated using the delay measurements produced by the computerized signal system and actual travel times in both peak and the non-peak periods (with Pearson correlation coefficients of less than 0.36 in both cases). A high degree of correlation (Pearson correlation coefficients greater than 0.45) was observed between travel times estimated using speed information from the freeway surveillance system and actual travel conditions in the AM peak, PM peak, and Off peak periods.

Based on these analyses, it was concluded that while the freeway surveillance system consistently overestimated actual travel times, it was a relatively good source of travel time information. The travel times provided by this system consistently followed the same trends as actual travel times on the freeway links. This implies that using measurements of speed from loop detectors embedded in the freeway lanes can provide reasonably accurate estimates of travel time on a freeway link. Better calibration of the loop detectors or correction factors may need to be applied to the estimated travel times to compensate for the tendency of this source to overestimate actual conditions. On the other hand, it can also be concluded from these analyses that the surveillance system on the arterial street network did not provide accurate estimates of

actual travel conditions on the arterial links. The analyses showed there was no consistent relationship between the travel times estimated using the delay measurements produced by the computerized traffic signal system and actual travel conditions on the arterial links.

**Table 8. Correlation between travel time estimates produced by probes and those produced by real-time surveillance systems.**

Source of Travel Time Estimate	Period	Pearson Correlation Coefficient
Computerized Traffic Signal System (UTCS)	AM peak	0.36
	Off peak	0.32
	PM peak	0.29
Freeway Surveillance System	AM peak	0.81
	Off peak	0.45
	PM peak	0.78



**Figure 51. Correlation between travel times estimated using speed information from freeway surveillance system and probe-measured travel times during AM peak periods.**

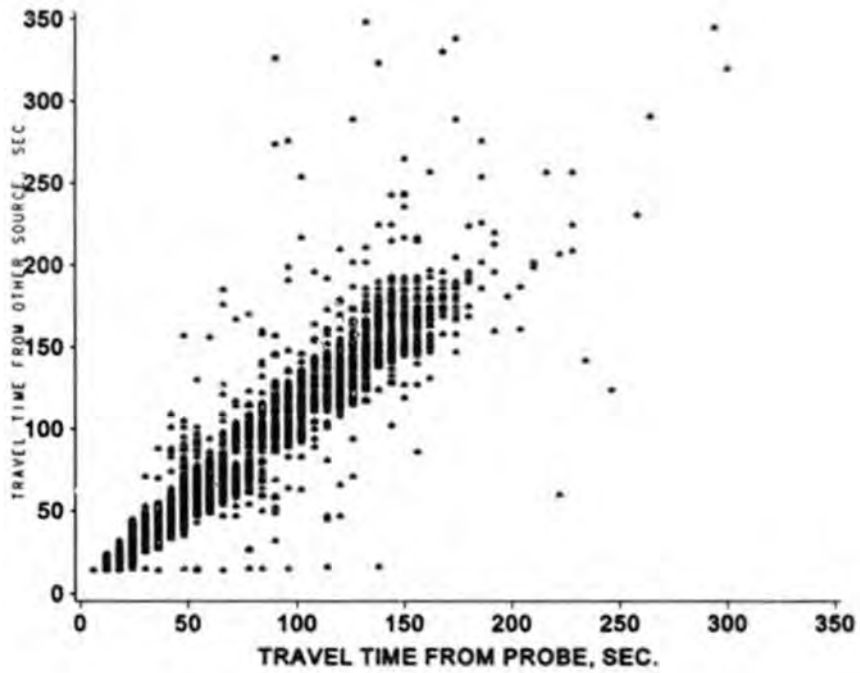
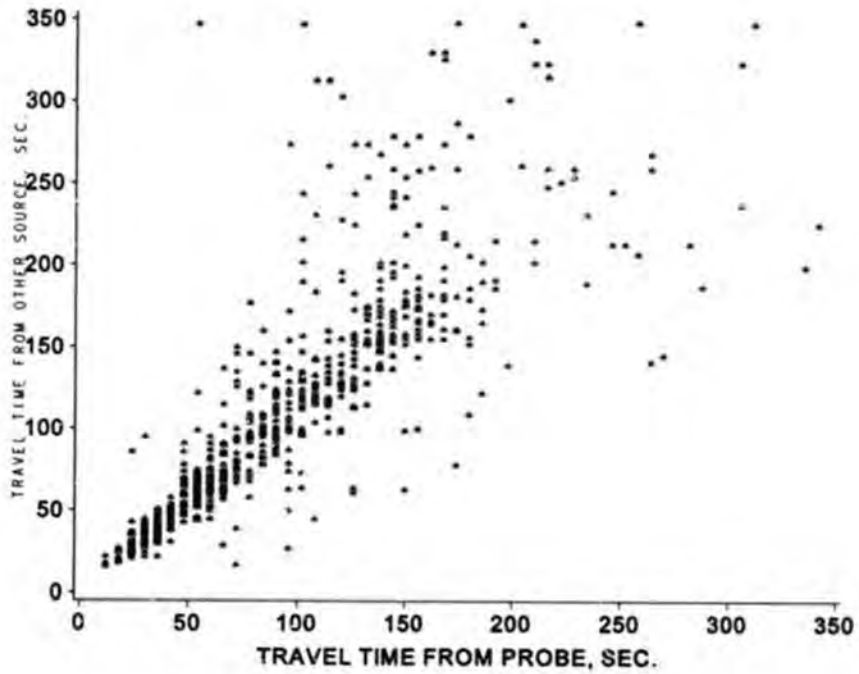


Figure 52. Correlation between travel times estimated using speed information from freeway surveillance system and probe-measured travel times during Off peak periods.



**Figure 53. Correlation between travel times estimated using speed information from freeway surveillance system and probe-measured travel times during PM peak periods.**

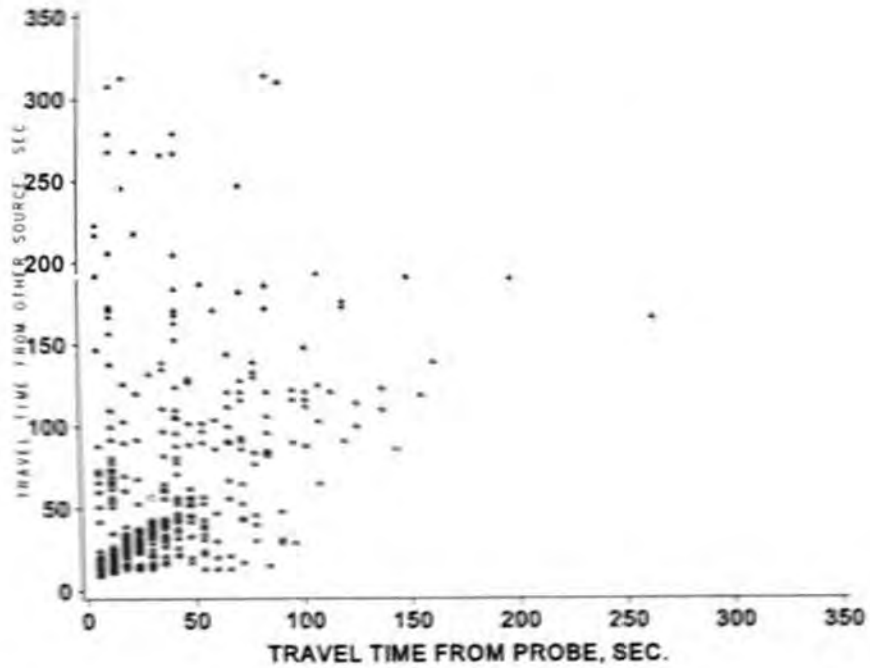


Figure 54. Correlation between travel times estimated using delay measurements from computerized traffic signal system (UTCS) and probe-measured travel times during AM peak periods.



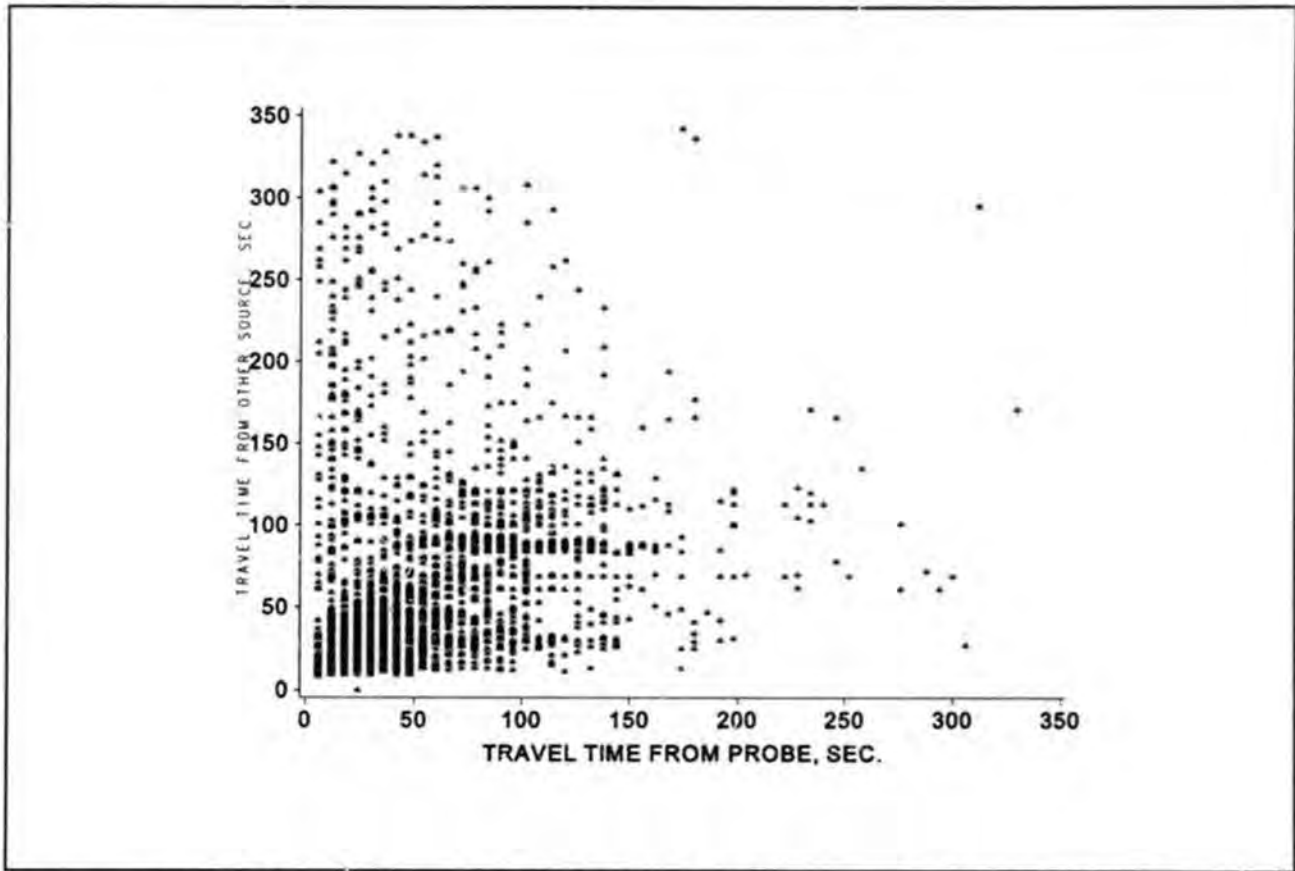


Figure 55. Correlation between travel times estimated using delay measurements from computerized traffic signal system (UTCS) and probe-measured travel times during Off peak periods.

94

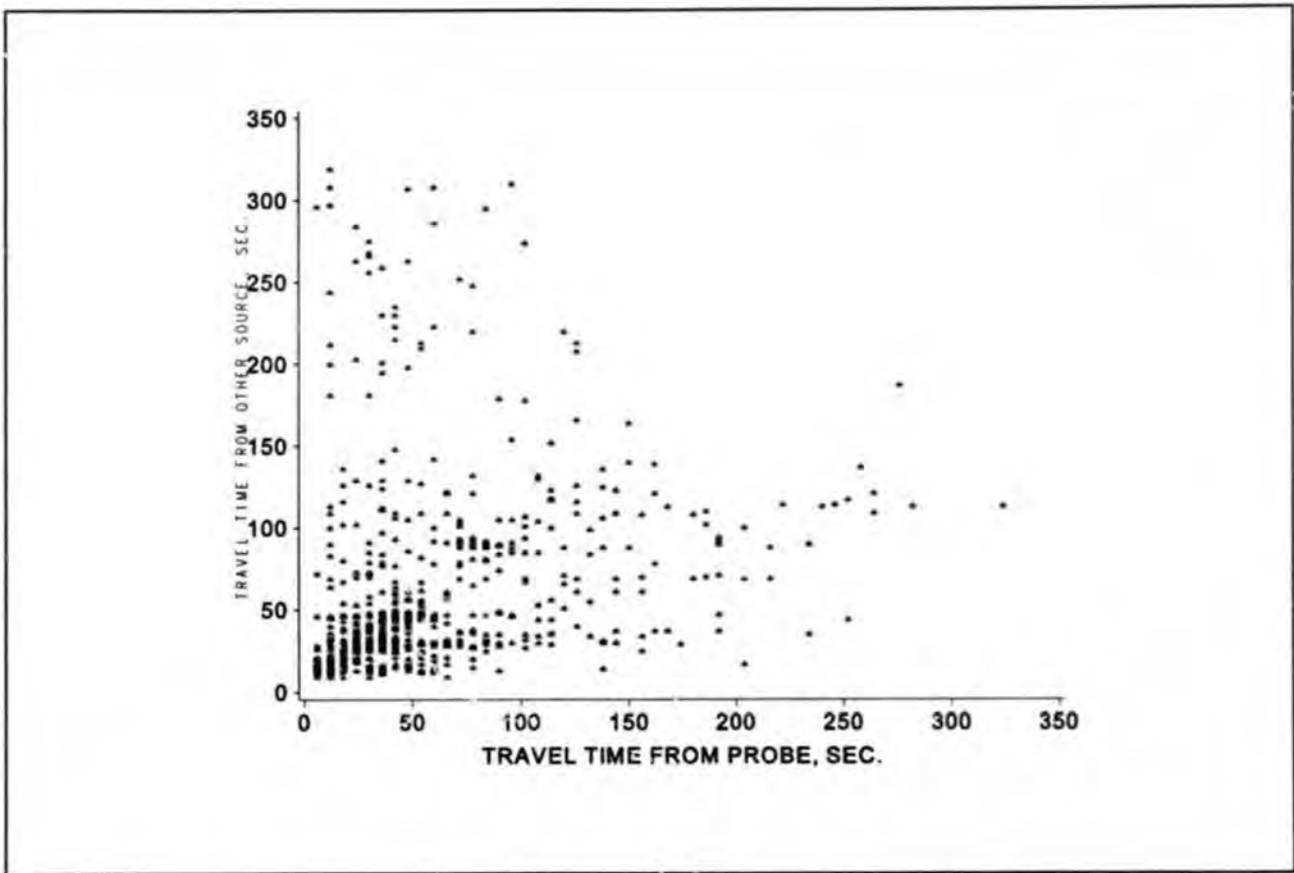


Figure 56. Correlation between travel times estimated using delay measurements from computerized traffic signal system (UTCS) and probe-measured travel times during PM peak periods.

## QUALITY OF INCIDENT INFORMATION

Another major function of the TravTek system was to provide motorists with accurate and timely information about incidents that affect traffic flow in the network. Like any other system that operates in real-time, the incident information in the TravTek system must accurately reflect actual conditions for it to maintain credibility with drivers. Part of the System Architecture evaluation was to examine the ability of the TravTek system to provide motorists with accurate and timely incident information. Specifically, the issues addressed in this portion of the evaluation were as follows:

- Was the incident information in the TravTek system indicative of actual conditions on the TravTek traffic network?
- How timely was the incident information contained in the TravTek network?

Incident information was provided to the TravTek system through the Traffic Information Network (TIN). The TIN was a collection of private and public agencies and organizations that operated in the transportation arena in the Orlando area. Members of the TIN included the following:

- Several local and State police agencies.
- The Freeway Management Center (FMC) operated by FDOT.
- A private traffic reporting service (Metro Traffic).

TIN users were the primary source of incident information. Upon becoming aware of an incident, the TIN users were to report the incident to the TMC. A variety of electronic means were available to the TIN users for notifying the TMC of an incident condition, including the following:

- Dial-up computer terminal (TTIN).
- Telephones (PTIN)
- Graphic workstations (GTIN).

In addition, the TMC operators were also able to enter incidents into the system based on other personal observations or other available sources.

There were no automated means for incident information to enter the TravTek system. No TIN sources were permitted to enter incident data directly into the system. In order for an incident to become active in the TravTek system, it had to be acknowledged and entered by the operator. All incidents had to be confirmed by the operator before they were accepted in the system. This procedure was adopted in TravTek to ensure the accuracy of the incident information in the system.

As another means of ensuring the quality of the incident information, only confirmed incidents were broadcast to the TravTek vehicles. Incidents were classified as either ALERTS or CONFIRMED incidents, depending upon the source reporting the incident. Alerts were incidents that were reported to the TMC by unverifiable sources (such as a TTIN or PTIN user). Confirmed incidents were those that were reported by sources that were considered credible (such as the FMC and Metro Traffic). Incident alarms become confirmed if two or more alarms were received about the same incident. An additional message was required to clear an incident alarm.

### **Evaluation Methodology**

To evaluate the quality of the incident information, the incident data logged at the TMC were compared to incident data logged at the FMC. There was a lack of adequate surveillance and detailed incident records on the arterial streets. Only incidents that occurred along the section of I-4 that was covered by FDOT's freeway surveillance system were used to evaluate the timeliness of the incident information in the TravTek system. Furthermore, it was assumed for this analysis that the information provided by the FMC reflected actual conditions on I-4. The following performance measures were used to evaluate the accuracy and timeliness of the incident information in the TravTek system:

- *Number of Reported Incidents* -- This was defined as the number of incidents logged at both the TMC and the FMC.
- *Number of Unreported Incidents* -- This was defined as the number of incidents logged at the FMC but not logged at the TMC.
- *Number of Falsely Reported Incidents* -- This was defined as the number of incidents logged at the TMC but not logged at the FMC.
- *Reporting Delay* -- This was defined as the difference in the time the incident was logged at the FMC and the time it entered the TravTek system.
- *Clearance Delay* -- This was defined as the difference in the time the incident was logged by the FMC as being clear and the time that the TravTek system reported the incident as being cleared.

### **Data Sources**

The TMC maintained an automated daily log of all incidents (both alerts and confirmed incidents) that were entered into the TravTek system for both the arterial and freeway links. The log contained, among other things, the link on which the incident occurred, the time the incident was reported to have occurred, and the time at which the incident was believed to have cleared the travel lanes. The information contained in this log replicated the information that was broadcast to the vehicles.

The data in these logs were compared to manual incident logs kept at the FMC. The incident logs contained information on incidents observed using the freeway surveillance cameras

and loop detectors. The Florida Highway Patrol (FHP) continuously operates the FMC with the assistance from FDOT. FHP is responsible for monitoring the surveillance cameras and dispatching officers to remove incidents when they occur on I-4. Since the video cameras are monitored only during peak hours (i.e., from 6:30 AM to approximately 10:00 AM and 3:30 PM to approximately 6:00 PM), only incidents occurring during peak periods were used in the evaluation. Detailed logs of incidents were not kept until late in the TravTek evaluation; therefore, incident logs were available only from the period spanning January 22, 1993 to March 26, 1993. The data base generated from combining these two logs is shown in appendix C.

## Results

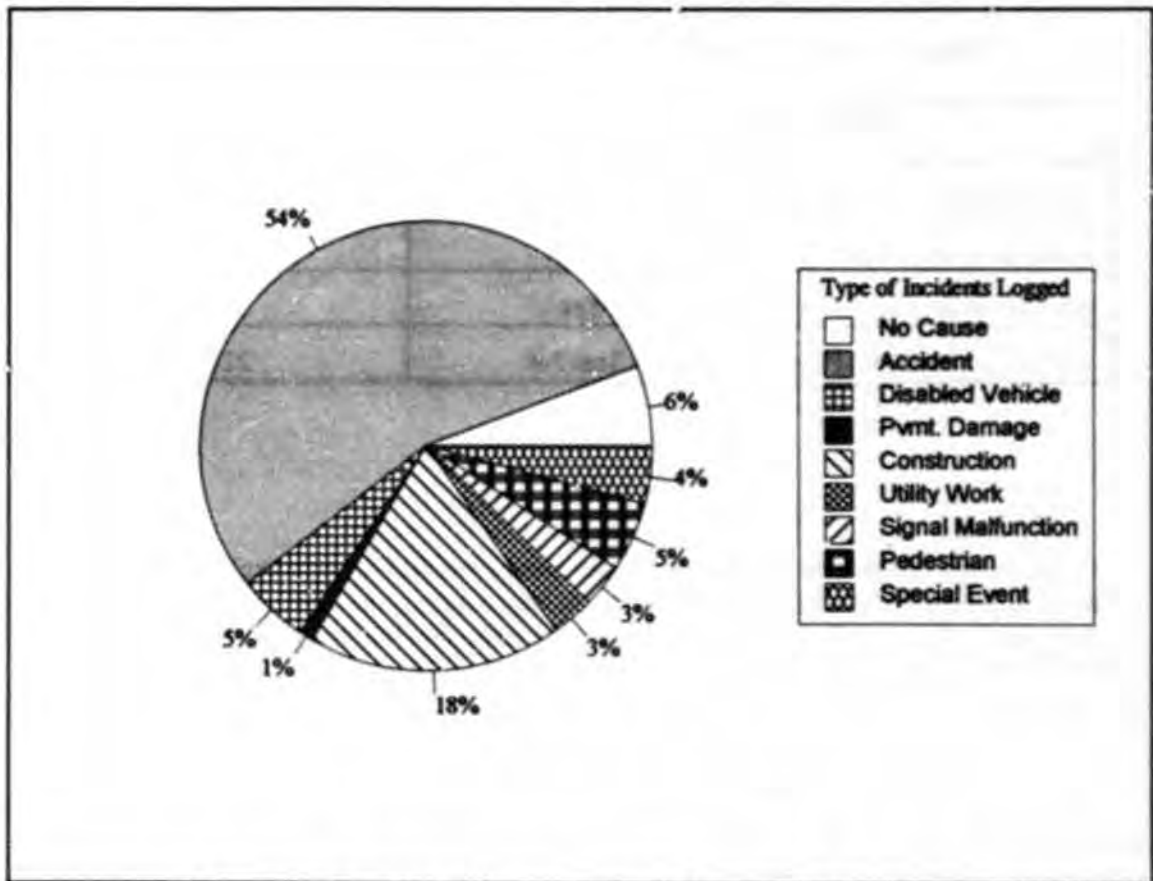
Figure 57 shows the type of incident information contained in the TravTek system. As expected, the most frequent types of incident information logged at the TMC were accidents (54 percent), and construction activities (18 percent). Relatively few stalled or disabled vehicles (5 percent of the total number of incident reports) were logged in the system. One possible explanation for this observation, however, is that unless the vehicle is blocking a lane, most stalled or disabled vehicles have only a minor impact on traffic operations. As a result, agencies responsible for providing information through the TIN to the TMC may not have reported incidents that did not impact traffic flow.

Another interesting result is the relatively high frequency of incidents (6 percent) that were logged as having no cause. It is unclear why so many incident reports were labelled as having no cause. One possible explanation for this is that reporting agencies failed to notify the TMC operator as to the cause of the incident. Another possible explanation is that the TMC operator failed to enter the information into the system. Both explanations suggest that better, more automated mechanisms for entering incidents into the TravTek system may have helped to improve the quality of the incident information.

The operator was listed as the primary source of almost all of the incidents in the TravTek system. Relatively few incidents (less than 1 percent) were logged as being reported by other TIN users. Two possible explanation for this are as follows:

- The TIN users did not use the TravTek system to report incidents.
- The TMC operators did not properly enter the source of the travel time information.

Based on interviews with both the TMC operators and various TIN users (i.e., Metro Traffic and the FMC), both explanations are plausible. Several of the TIN users reported problems with accessing the TravTek system early in the evaluation period. These experiences may have caused some of the TIN users to lose confidence in the system. In addition, in interviews, TMC operators indicated they received very little incident information from external sources. In fact, the operators at the TMC indicated that much of the incident information they entered in the system was obtained by listening to commercial radio stations.



**Figure 57. Type of incident information logged at the TravTek traffic management center (TMC).**

To examine the accuracy and timeliness of the incident data, incidents logged at the TMC were compared to manual logs of incidents observed by operators at the FMC on the freeway surveillance system. The results of this comparison are shown in table 9.

Of the total 50 incidents observed by operators at the FMC on the video system, only 18 (36 percent) were logged at the TMC. Thirty-two incidents (64 percent) observed by FDOT personnel using the surveillance system went unreported by the TravTek system. There are two possible explanations for this observation. First, not all incidents observed by operators at the FMC were communicated through the TIN to the TMC. Through interviews with FDOT personnel at the FMC, it was discovered that operators at the FMC only reported what they considered major incidents (ones have a great impact on traffic conditions on I-4) to the TMC. Since most incidents tend to be minor in nature (fender benders and stalled vehicles), it is unlikely the FMC operators reported many of these incidents to the TMC.

**Table 9. Peak period incidents on I-4 logged by the TravTek systems.**

Incident Types	Frequency
Total Number of Incidents Logged at FMC	50
Number of Incidents Logged by TravTek	18
Number of Incidents Not Logged by TravTek	32
Number of Incidents Falsely Logged by TravTek	21

Confusion about the level of automation may also be another possible explanation for the relatively high number of unreported incidents. In interviews, some TMC operators thought that incident reports from the FMC were entered automatically into the TravTek system, since the reports were transmitted electronically. However, the TravTek system was designed so that the operator had to verify incident reports coming from the FMC. Therefore, it is possible that many of the incident messages reported by the FMC were not entered by operators at the TMC.

There were also a high number of incidents that were logged at the TMC that were not observed at the FMC. These incidents were classified as falsely reported incidents because there was not a corresponding entry in the FMC logs. However, it is uncertain whether these incidents were truly false alarms (i.e., reported incidents that did not actually occur) or actual incidents that were not observed or logged at the FMC.

The times that the 18 matched incidents were logged at both the FMC and the TMC were compared to provide an indication of the timeliness of the incident information in the TravTek system. The results of this comparison are summarized in table 10. A negative value indicates there was a delay in the time that an incident was reported at the FMC and the time that it was entered into the TravTek system at the TMC. A positive value indicates that the incident was reported by the TravTek system before it was observed and/or logged at the FMC.

From this table, it can be seen there was a considerable delay between the time incidents were observed at the FMC and when they entered the TravTek system. The average delay between when an incident occurred (assuming that the FMC logged the incident as soon as it occurred) and when it appeared in the TravTek system was 20 min. While most of the reporting delays were between 8 and 30 minutes, one incident experienced a 91 minute delay before it was logged by the TravTek system. Only one incident appeared in the TravTek logs before it was recorded as being observed by operators at the FMC. In two cases, the incident was logged by the FMC as being cleared before it was even logged in the TravTek system.

**Table 10. Delays in incident information in TravTek system.**

Type of Delay	Mean	Standard Deviation	Range
Reporting Delay	-20 mins	25 mins	-91 mins to +15 mins
Clearance Delay	- 6 mins	39 mins	-85 mins to +65 mins

While the magnitude of the clearance reporting delay was not as great (6 min), there was considerable variation in times the incidents were reported cleared by the two systems. In seven of the incidents, the TravTek system indicated that the incident had cleared the freeway lanes before the FMC. In one case, the TMC logs indicated that an incident had cleared 65 min before it was logged by the FMC as being cleared from the freeway lanes. In 10 of the remaining 11 incidents, the TravTek system reported the incident cleared approximately 33 min after it was reported cleared at the FMC. Only one incident had exactly the same clearance times recorded in both logs.

#### **DATA BASE ACCURACY**

The TravTek system had three major data bases: historical, map, and local information. Many other data bases were in the system, but these were not considered in the evaluation. The three major data bases were unique to the Orlando area, while other system data bases would have been required at any location. The original plan was to conduct a series of field studies to sample the accuracy of the data bases. For various reasons, these field studies were not conducted. The results discussed here are based on anecdotal information.

#### **Historical Data Base**

The term historical data base refers to the historical, or fallback, set of link travel times. These travel times (in seconds) were initially established by the usual technique of dividing the link length (in feet) by the posted speed limit for that link, and multiplying by 0.68. This procedure established a reference data base of theoretically irreducible travel times. This reference data base resided in both the TMC and vehicles. Since link travel times were transmitted from the TMC to the vehicles in the form of ratios relative to this reference set, this enabled current travel times to be replicated in the vehicle. Ratios were used to reduce the amount of data broadcast to the vehicles from the TMC.

The initial set of minimum link travel times in the reference data base were then augmented by a series of travel time runs over major thoroughfares. This procedure established the initial version of the historical travel time data base, commonly referred to as the historical data base.



This collective procedure produced a fairly accurate representation of link travel times. The routes produced by the routing algorithm yielded reasonable results. Since this is the ultimate measure the driver uses to critique the routing technique, TravTek passed this cursory test. As in most routing techniques, the questionable results occur when there is a "tie," which may differ from the driver's test of reasonableness over a known route.

For the period June, 1992 through September, 1992, a problem occurred with the historical data base versions. One version was in the TMC, and most vehicles had a different version. This caused the referencing of link travel times to be in error, the associated link ratios to be in error, and ultimately the link travel times to be in error. Software versions and data base versions were frequently updated. The coordination of these updates temporarily failed, and produced obvious errors in routing for about 2 months. This condition was thought to be a contributing factor to the situation with excessive and incorrect congestion symbols appearing on the screen. While this did exacerbate the problem, it still existed when the historical data base versions were later correctly matched.

The historical data base was actually several data bases corresponding to different times of the day and days of the week. The system automatically accessed the appropriate data base according to time of day, since link travel times vary considerably during a 24 hour period. On a very coarse scale, this is evident for the three most basic operating periods: AM Peak, PM Peak, and Off Peak, coupled with weekday, weekend and holiday categories.

An exponential smoothing technique was applied to update historical link travel times which were influenced by probe vehicles, as well as for those links which had update information from the FMC and UTCS.

Prior to the implementation of a software modification at the TMC in January, 1993, the historical data base information was not available for analysis. This made it difficult to determine the bounds of dynamic changes in the historical data base.

One problem that surfaced was the abruptness of change in link travel times when a new time or day period started. The data smoothing technique did not cross these boundaries and some noticeable routing anomalies occurred, as well as exacerbating the consistent problem with false indicators of congestion appearing on the vehicle's screen. In effect, there were occurrences of congestion indicators appearing which reflected traffic conditions from those existing exactly 24 hours ago. When this problem was identified and remedied, it still did not completely solve the persistent false congestion symbol displays.

### **Map Data Base**

The map data base was the Orlando network description used in the vehicles. This data base consisted of two map data bases, the navigation data base from Etak, and the routing data base from Navigation Technologies (NavTech).

Map data bases require a significant effort to create and maintain. Ultimately, the kickoff date for TravTek was delayed 3 months to remedy the many errors in the map data base. At least 10

vehicles, both full and part time, were on the network checking the accuracy of the data bases prior to initiation of the TravTek demonstration period of 1 year. This major effort produced map data bases with a reasonable level of error. Map data bases were updated throughout the life of TravTek. Consistent improvements were made in the level of network accuracy during the 1 year evaluation period. One hundred percent accuracy could not be achieved, if for no other reason than the fact that the network changed, as for example with construction activities. Map data base maintenance will be a steady, ongoing process at any level of IVHS system implementation.

The NavTech map data base consisted of over 80,000 links, some of which defined geographical features. The maintenance of this large data base was a relatively slow process early in the system operation, due to the large number of changes being made. Changes were batched to complete a new version of the network. Changes also created errors. These errors would remain undiscovered in a new version until the links were driven again. After the system became operational, it was difficult to match feedback from the users with specific network errors. The measure of performance for acceptable levels of accuracy in a network is undefined, but probably relates to the volume over the affected links.

A further glitch occurred when the versions of the Etak and NavTech map data bases were mismatched. This occurred in several cars and was discovered and remedied quickly after strong complaints. The result of the mismatch was to incorrectly route vehicles to a destination along Bumby Avenue, regardless of the destination selected by the driver.

The map data base versions were logged at the TMC. These data were a part of the header information received from the vehicle transmissions. The inservice times of the navigation map data base versions are shown in figure 58. Similarly, the duration of the routing data base version numbers are shown in figure 59. Since only one major navigation map version was used, and only two major routing map versions were used, these data indicate that the map data bases may have been updated without recording a new version number in the vehicle. Other information indicates that many more map data base versions were installed.

It was observed that map data base maintenance is very critical, and it is necessary to be careful to ensure that a correction does not cause another error. The new error may be difficult to find if it is an area of a network that is not being reviewed for errors. The creation and maintenance of map data bases was observed as an exceedingly meticulous and labor intensive effort.

### **Local Information Data Base**

The local information data base, commonly referred to as the LID, provided in-vehicle "yellow pages" information to the driver. This information was accurate, and the number of complaints registered by drivers were relatively few. Suggestions were received for improvement, but were not considered criticisms. One of the suggestions was to have aliases for addresses, since locations could be identified in several ways.

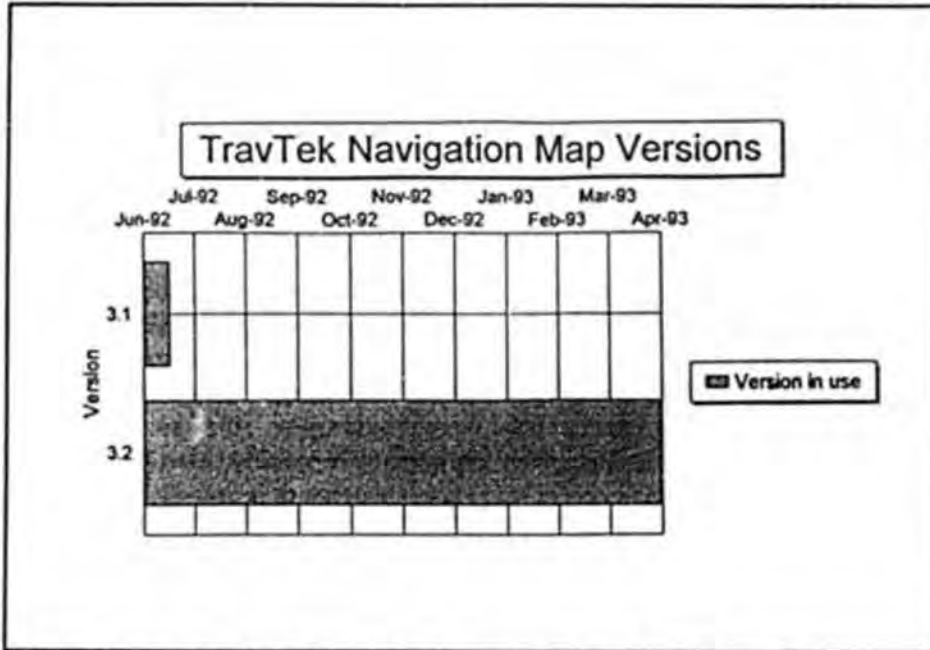


Figure 58. Versions of navigation map data bases.

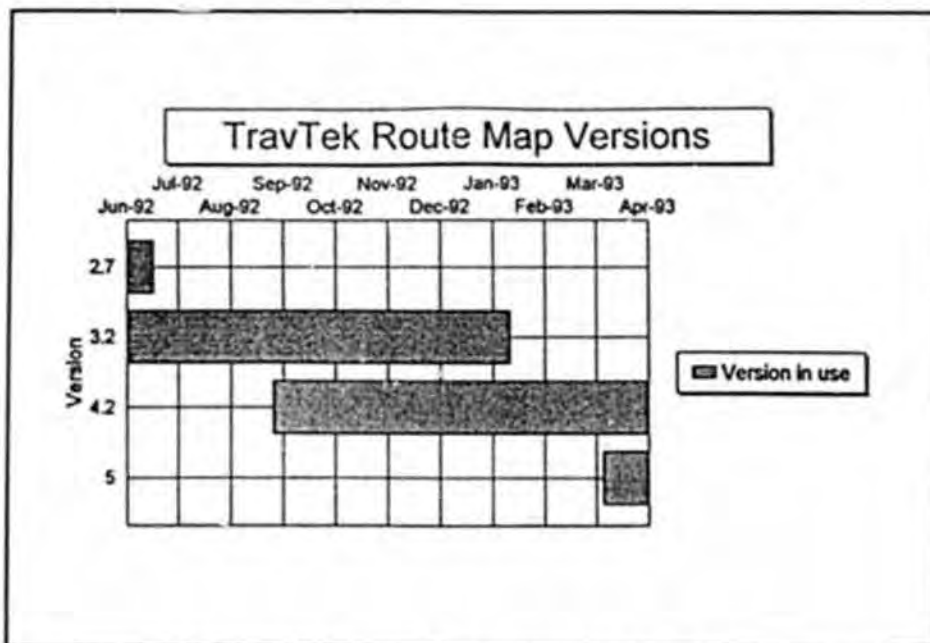


Figure 59. Versions of routing map data bases.

The LID was easily maintainable, and upgrades were not likely to produce additional errors. During the course of the operational test, the LID underwent 5 version changes as shown in figure 60.

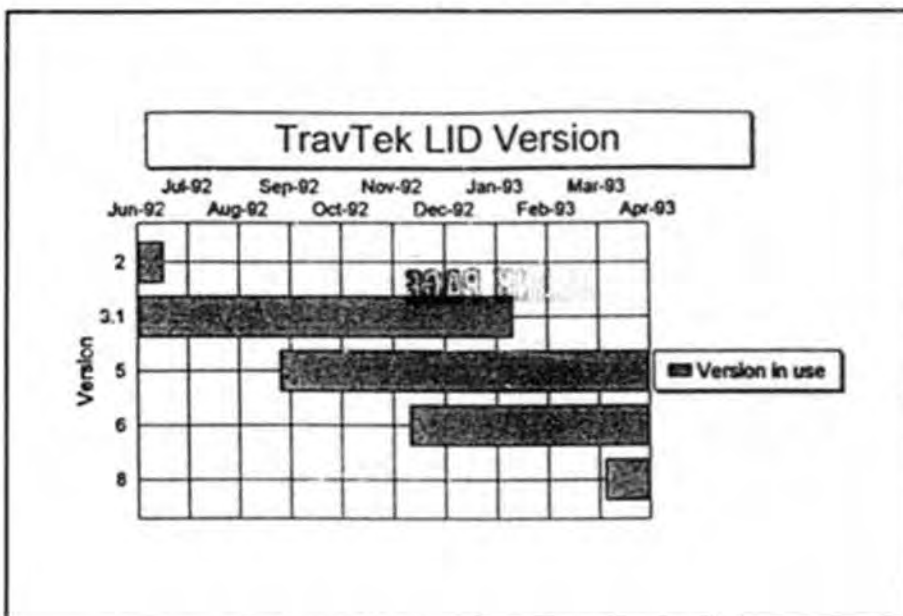


Figure 60. Versions of local information data bases.

**BLANK PAGE**

## EVALUATION OF THE DATA FUSION PROCESS

Each of the methods for estimating link travel times was a potential data source for the vehicle's route optimization process. All of the sources of travel time on each link were accumulated, analyzed, and processed at the TMC before a final link travel time was broadcast to the vehicle. The process of selecting a link travel time to broadcast to the vehicle was termed "data fusion" in TravTek.

The selection of the travel time information through the data fusion process was one of the potential sources of error in the TravTek system. The ability of the data fusion process to select travel time values that accurately reflect true travel conditions on the network was critical to the route optimization process. Errors in the data fusion process or in the selection of the travel time source could have produced routing inefficiencies and impacted user acceptance of the TravTek system. The objective of this evaluation was to assess the ability of the data fusion process to select the "best" source of travel time information that accurately reflected actual conditions in the TravTek traffic network. Specifically, the goal of this evaluation was to determine whether or not the assumption was valid that a probe-measured travel time accurately reflected actual travel conditions in the network for 10 minutes.

### DATA FUSION PROCESS

The data fusion algorithm used in the TravTek system was a fuzzy logic, maximum height solution process that evaluated the quality of the source and the age of the travel time information.<sup>(16)</sup> It selected the travel time source believed to provide the "best" estimate of actual conditions on the link. All of the active sources of travel time on each TravTek traffic network link were evaluated every minute by assigning a score to every travel time estimate on each link. The score reflected not only which source provided the travel time estimate, but also how long ago the source provided the estimate. The source with the highest score was selected as the "winner" and its travel time was broadcast to the vehicle. If an updated travel time was not available from the source on the link at the beginning of the next minute, the score of the previous travel time estimate was reduced in a linear fashion. If no updated travel time was received, the score continued to be decreased every minute until it reached zero, or was overruled by another source.

On any given link in the system, there were a number of competing sources of travel time estimates (e.g., history files, operator inputs, the UTCS system, the FMC, probes, etc.). (See the previous section entitled "Quality of Traffic and Travel Information" for a detailed discussion about the sources of travel time information used in the TravTek system.) In the design of the system, assumptions were made about the quality of the estimate and the length of time that the estimate could represent actual conditions in the network for each of the sources of travel time information. In addition, each source had an override value where the scores of the travel time would remain constant for a number of minutes before beginning the decay process. The default quality, duration, and override values used for each source in the TravTek system are shown in table 11. These values were established based on the designer's judgement and experience with traffic control systems.<sup>(17)</sup>

**Table 11. Default quality and age values assigned to travel time sources. <sup>(41)</sup>**

Source	Quality	Duration (minutes)	Override (minutes)
Arterial Computerized Traffic Signal System (UTCS)	40	2	0
Freeway Surveillance System (FMC)	40	2	0
Input from Operator about Incidents	3	1	User Specified
Input from Operator about Congestion	100	1	User Specified
Computer Simulation Model (FreFlo)	20	2	0
Probe Vehicles	50	10	3
Historical Data	2	1	1 week

Figure 51 illustrates how the data fusion process used in the TravTek system was designed to work for typical TravTek traffic network link not equipped to provide real-time travel time information (i.e., those links not covered by the UTCS or freeway surveillance systems). In this example, estimates of travel times were provided by the history file, the computer simulation model, and a probe vehicle. Up until time t1, the only known source of travel time information on this hypothetical link came from the historical data. At time t1, an incident caused the computer simulation model to provide an estimate of the travel time on the link. Because the score of the computer simulation model (20) exceeded the score of the historical data (2), the computer simulation model was selected by the data fusion process as the winning source of travel time information on this link. The score of the computer simulation model then begins to decay at a rate dictated by the quality divided by duration (e.g.,  $20/2 = 10$  points per time slice). Therefore, after two time slices (1 min each), the score of the computer simulation model has decayed to zero, and the historical data file is then selected by the data fusion algorithm as the winning source of travel time information. The historical data remains as the winning source of travel time information until t3 when a probe vehicle traverses the link. At this time, the data fusion process

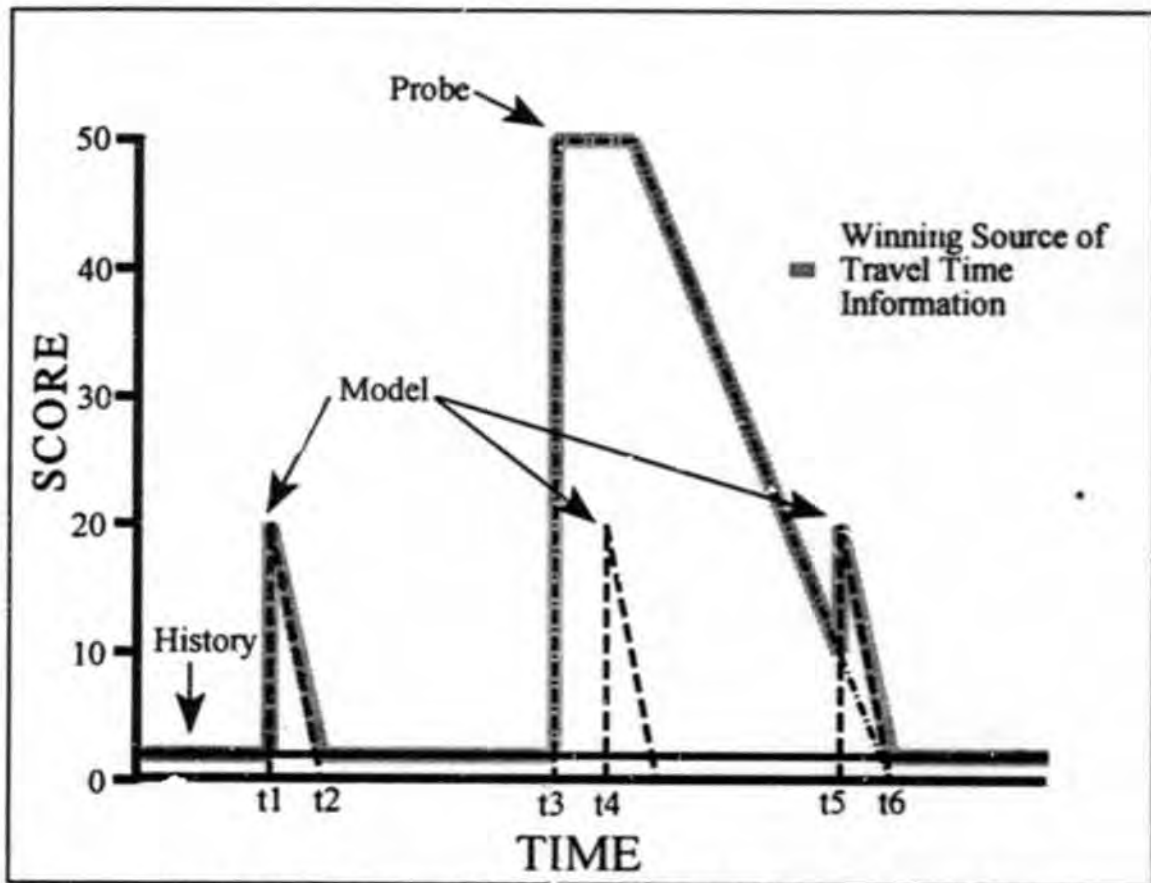


Figure 61. Illustration of data fusion process on non-instrumented TravTek traffic network link.

selects the probe as the winning travel time source. The probe remains the winning source of travel time information on this link until  $t_5$ , even though the simulation model provides an estimate of link travel time at  $t_4$ . At  $t_5$ , the computer simulation model takes over and remains as the winning source until its score decays to zero at  $t_6$ . Because there are no other inputs after  $t_6$ , the data fusion process selects the winning travel time from the historical data base.

Figure 62 illustrates how the data fusion process was designed to work on the links covered by real-time sources of travel time information (i.e., the UTCS or the freeway surveillance systems links). Prior to the TMC receiving real-time information from the surveillance system covering the link, there are no inputs into the data fusion process other than historical data. At  $t_1$ , the data fusion process receives its first report from the real-time surveillance system. Because the real-time sources provide fairly regular reports, a rapid decay rate has been selected for these sources. As such, the real-time sources decay to zero after only 2 min in the data fusion process. Because real-time sources are polled by the TMC once a minute, new travel time reports are received every minute. Therefore, new travel time reports are constantly entering the data fusion process (as long as the surveillance and the communication



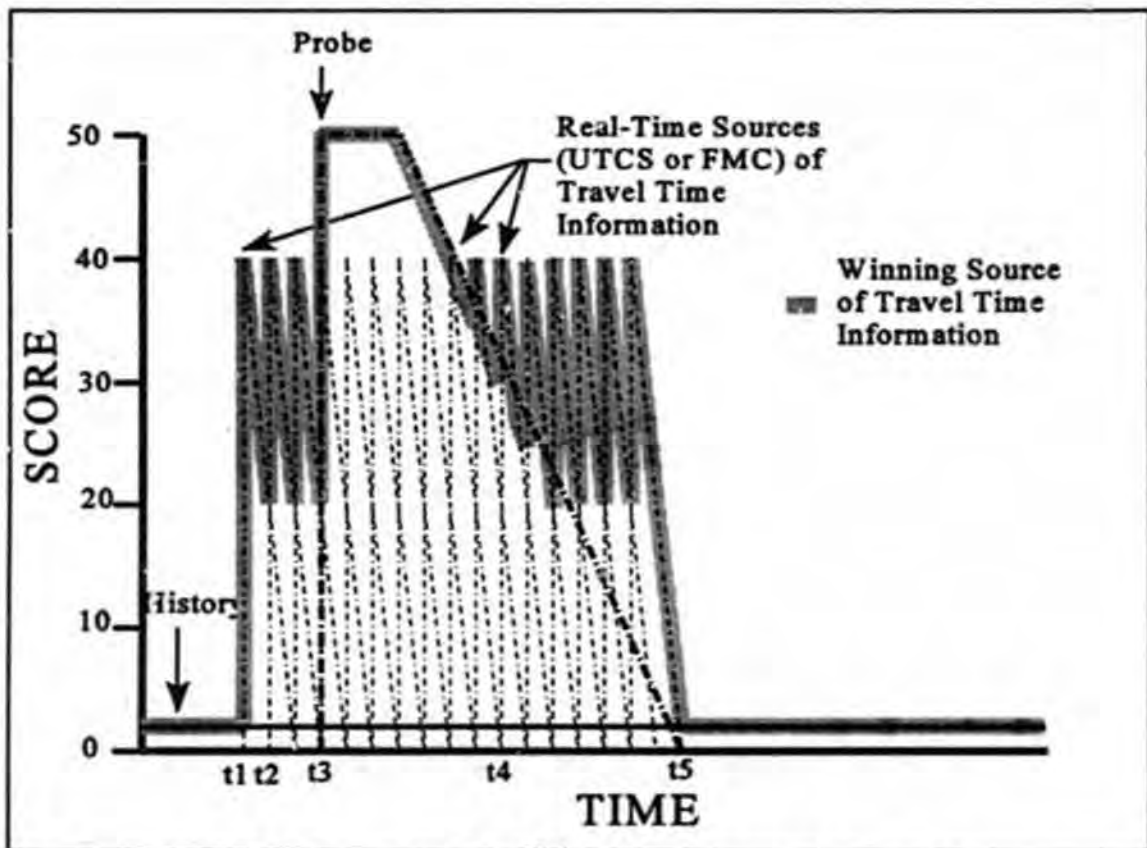


Figure 62. Illustration of data fusion process on link covered by real-time surveillance system (UTCS or freeway surveillance system).

systems are operational). Before the first report decays to zero, a new report is received from the real-time source (at t2), which is only 1 minute after t1.

The real-time source continues to provide the winning travel time estimates until a probe traverses the link at t3. At this time, the data fusion process selects the probe as the winning source of travel time information on this link because it initially has a score higher than the score produced by the real-time source. With a combination of the decay rate and the override values assigned to the probe, the probe remains the winning source of travel time for 6 min, where (at t4) the real-time source then becomes the winning source. The real-time source of travel time information continues to produce the winning travel times until t5 where the data fusion process stops receiving reports from the source (as in the case of a communication failure between the TMC and the surveillance system, or where the surveillance system has stopped functioning properly). After the score of the last report from the surveillance system has decayed to zero, the winning source of travel time information on this link would come from the historical data base.

Because of the impact that the data fusion process had on the operations and performance of the TravTek system, it is critical to know 1) whether the data fusion process was functioning as it was intended, and 2) whether the assumptions used in the design of the system (i.e., the quality

and the rate at which the travel time source decayed) were valid. The following section describes the procedure that was used to assess the performance of the data fusion process.

### **Evaluation Methodology**

The methodology used to evaluate the performance of the data fusion process was similar to that used to analyze the quality of the travel time information provided by the various sources. In the analysis of the quality of travel time information, the emphasis was on determining how well the travel time estimates produced by the various real-time sources compared to the probe-measured travel times. This analysis focused on how long a single probe-measured travel time should be used in the data fusion process until it no longer reflected actual conditions on the link.

Only probe-measured travel times were evaluated in this analysis. This was because of the relative importance of probe information in the TravTek system. Probes were assumed to be a high quality source of travel time information. As such, the data fusion process was designed such that probe-measured travel times remained in the system for relatively long periods of time (6 to 10 min as opposed to 2 min with most other sources). Most of the other sources had a fast decay rate so that travel time estimates produced by the other sources did not remain in the data fusion process for long periods.

As in the analysis of the quality of the travel time estimates provided by the various real-time sources, a relative error measure was used to evaluate the data fusion process. (See the Evaluation Methodology topic in the previous section entitled "Quality of Traffic and Travel Information" for a discussion on the relative error measure.) However, unlike the analysis of the quality of travel time estimates, relative error measures were developed every time the probe was listed as the winning source of travel time information. Confidence intervals (95 percent) were constructed around the mean relative error measure for each minute that the probe-measured travel time was a valid input into the data fusion process. If the confidence interval of a given minute fell outside the 95th percentile confidence interval of the first time slice, then the travel time estimate was considered not to be representative of actual conditions anymore. The minute at which this occurred was then used to indicate how long a probe-measured travel time remained a valid estimator of actual travel conditions in the TravTek network.

### **Data Sources**

All the data used in the analysis came from two of the computer data logs maintained by the TravTek system: the Data Fusion Input Log and the Data Fusion Winner Log. Every time the probe was logged as the winning travel time source in the Data Fusion Winner Log, the corresponding inputs into the data fusion process were extracted for the Data Fusion Input Log. Because previous assessments showed that only the freeway surveillance center could provide estimates that consistently represented actual travel conditions, only those links covered by the freeway surveillance center were used in this analysis. Furthermore, because traffic varied by time of day, the travel time estimates were grouped into different periods with the AM peak containing log entries between 7:00 AM and 9:00 AM, and the PM peak containing log entries between 4:30 PM and 6:30 PM. All other log entries not included in these ranges were considered to have occurred during Off peak conditions.

As in the analysis of the quality of the travel time information, no direct field measurements of actual link travel times were performed. For this analysis, the travel times provided by the TravTek vehicle (i.e., probe measured travel times) was assumed to provide accurate measurements of actual travel conditions on the link. Limited comparisons of measured travel times and travel times logged by the TravTek vehicle conducted by others in the TravTek evaluation supported this assumption. Only those data logged between January 6, 1993 and January 28, 1993 were used in this analysis.

## Results

One of the first things noted in reviewing the Data Fusion Winning and Data Fusion Input Logs was the way in which the data fusion process functioned. The Data Fusion Winning Logs showed that, unless another probe traversed the link, the same probe measurement for any given link remained as the winning source of travel time information in the data fusion process for approximately 10 min. While this is correct for those links not covered by automated sources of travel time, probe reports should have been selected as the winning source of travel time information for only 6 min on those links covered by the UTCS and the freeway surveillance system. (This observation is based on the design of the data fusion process as reported in reference 9.) This suggests some variation in the functioning of the data fusion process from its design description. There are several possible explanations for this observation. First, the default quality and duration values assigned to probe-measured travel times may have been changed by the operators so that the combination of these two values permitted the probe to remain as the winning travel time source 4 min longer than designed. Another explanation for this observation is that the data fusion process was reprogrammed, thereby causing the probes to remain as the winning source of travel time longer than was intended in the design of the data fusion process. Unfortunately, this observation was made late in the evaluation process, after the TravTek system ceased operating in Orlando, so it was not possible to identify the cause of this discrepancy.

Tables 12 through 14 provide the mean and standard deviation of the relative error measures for each 1 min interval that the probe was listed as a winning source of travel time information. The upper and low bounds of the 95th percentile confidence interval are also shown in these tables. Figures 63 through 65 graphically represent the data in these tables. A threshold was established by using the 95th percentile confidence interval about the relative error corresponding to the first time a probe-measured travel time was selected as the winning source of travel time information. This threshold was used to evaluate how long the probe-measured travel time remained a valid estimator of actual conditions. The probe-measured travel time was considered not to be a valid estimator of actual conditions when the 95th percentile confidence interval of the relative error for each subsequent iteration in the data fusion process exceeded the threshold.

**Table 12. Relative error of probe-measured travel times to travel times measured by surveillance system each minute in data fusion on freeway links during AM peak periods.**

Time Interval	Sample Size	Mean Relative Error	Standard Deviation	95% Confidence Interval	
				Upper Bound	Lower Bound
1	209	-0.165	0.363	0.562	-0.891
2	204	-0.142	0.276	0.410	-0.694
3	201	-0.164	0.509	0.853	-1.181
4	199	-0.122	0.258	0.395	-0.639
5	194	-0.113	0.252	0.390	-0.617
6	193	-0.095	0.198	0.301	-0.490
7	186	-0.122	0.251	0.380	-0.624
8	186	-0.139	0.356	0.573	-0.851
9	184	-0.122	0.268	0.414	-0.657
10	174	-0.134	0.351	0.567	-0.836

From these figures and tables, it can be seen that the mean relative error remained fairly constant for each of the 10 min the probe served as an input into the data fusion process in all three of the peak periods. This implies that for every iteration of the data fusion process, the freeway surveillance system overestimated the link travel times as compared to the probe measurement.

The data showed there is very little variability in the relative error between a probe-measured travel time and a travel time estimate derived from the freeway surveillance center during Off peak periods. Figure 63 shows that the probe-measured travel remained a valid estimator of travel time on a link for at least six to eight iterations in the data fusion process. After eight iterations, the variance in the relative error caused the 95th percentile confidence interval to fall outside the threshold established by the first probe report. This implies that the probe-measured travel time may be assumed to be indicative of actual travel conditions on a link for up to 8 min after the probe has traversed a link in the Off peak period. In other words, during Off peak periods, a probe-measured travel time can be used for up to 8 min and still be considered representative of actual travel conditions on a link. This is to be expected because, during Off peak periods, speeds on the freeway are relatively constant. Congestion can cause rapid fluctuations in travel speeds on the freeway during peak periods. In contrast, there is typically little congestion during Off peak periods, and therefore one would not expect travel times on a link to change dramatically.

**Table 13. Relative error of probe-measured travel times to travel times measured by surveillance system each minute in data fusion on freeway links during Off peak periods.**

Time Interval	Sample Size	Mean Relative Error	Standard Deviation	95% Confidence Interval	
				Upper Bound	Lower Bound
1	3446	-0.147	0.398	0.646	-0.946
2	3353	-0.146	0.380	0.615	-0.906
3	3269	-0.137	0.196	0.255	-0.529
4	3194	-0.143	0.252	0.361	-0.647
5	3124	-0.143	0.223	0.303	-0.589
6	3048	-0.149	0.438	0.723	-1.021
7	2979	-0.147	0.316	0.485	-0.779
8	2924	-0.164	1.230	2.296	-2.625
9	2854	-0.148	0.288	0.427	-0.723
10	2787	-0.152	0.478	0.804	-1.108

This is not the case, however, in the AM and PM peak periods. Figures 64 and 65 graphically show the mean and the 95th percentile confidence intervals of the relative error between the probe-measured travel time and the travel time estimated using speed data from the freeway surveillance center for the AM and PM peaks, respectively. As in the Off peak periods, the mean relative error rate for each of the times the probe-measured travel time was logged as the winning source of travel time information remained relatively constant in each of the iterations of the data fusion process. However, the variability of the relative error caused the probe not be as reliable in estimating of traffic conditions during the AM and PM peaks. In the AM peak, the variability in relative error exceeded the 95th percentile confidence interval of the initial probe report after three iterations in the data fusion process. This implies that on the freeway system in G:lando during the AM peak, a probe-measured travel time can be assumed to be representative for only 3 min after it has traversed a link. After 3 min, enough changes in the traffic stream have occurred that would cause the probe-measured travel time to no longer be a valid estimator of travel conditions on a link.

**Table 14. Relative error of probe-measured travel times to travel times measured by surveillance system each minute in data fusion on freeway links during PM peak periods.**

Time Interval	Sample Size	Mean Relative Error	Standard Deviation	95% Confidence Interval	
				Upper Bound	Lower Bound
1	426	-0.209	0.449	0.689	-1.107
2	404	-0.248	0.718	1.190	-1.685
3	393	-0.247	0.540	0.833	-1.328
4	386	-0.257	0.618	0.979	-1.492
5	369	-0.336	1.642	2.949	-3.620
6	355	-0.228	0.500	0.773	-1.230
7	349	-0.288	0.756	1.224	-1.800
8	341	-0.231	0.521	0.812	-1.273
9	335	-0.268	0.800	1.332	-1.868
10	327	-0.230	0.579	0.928	-1.388

In the PM peak, the variability in the travel time caused the relative error measure to exceed the 95th percentile confidence interval after the first iteration of the data fusion process. Therefore, in the PM peak, probe-measured travel times were only valid for the first 1 minute interval they were in the data fusion process. After that first minute, the variation in the travel conditions on the freeway caused the probe-measured travel time not to be a valid estimator of travel conditions on the network.

This analysis showed that the assumption that a probe-measured travel time could provide a good estimator of link travel times for up to ten minutes after the probe had traversed a link may not be valid. The analysis showed that, during the Off peak periods, probe reports could be used as valid estimators for approximately eight minutes. However, during the AM and PM peak periods, the general fluctuation in traffic does not permit a probe-measured travel time to remain valid for extended periods. Because of the emphasis placed on probe measurements in the data fusion process, the probe-measured travel times may have remained in the data fusion process past the time where they providing reasonable estimates of actual conditions in the network. As a result, there may have been some inefficiencies introduced into the route optimization process in the TravTek vehicle.

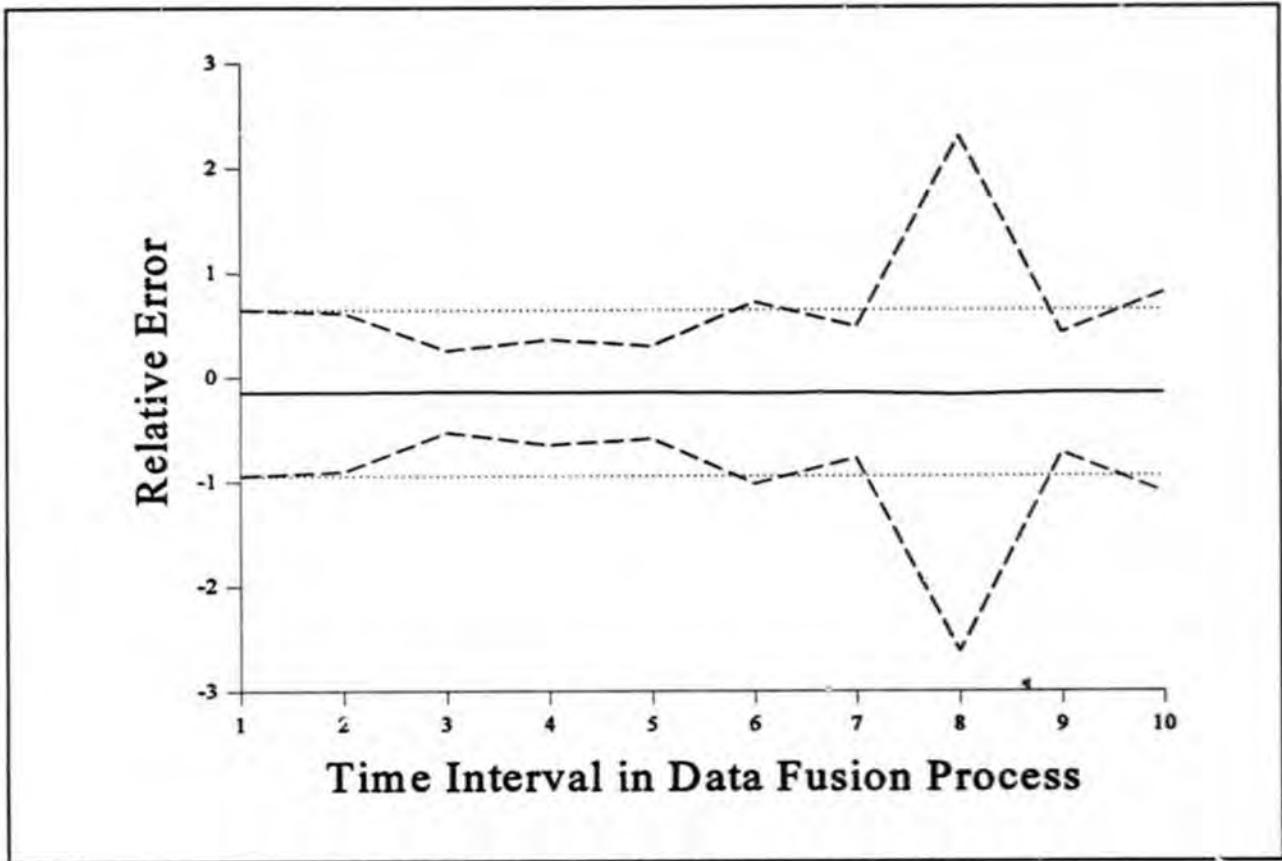


Figure 63. Relative error rates for each iteration of the data fusion process in the Off peak.

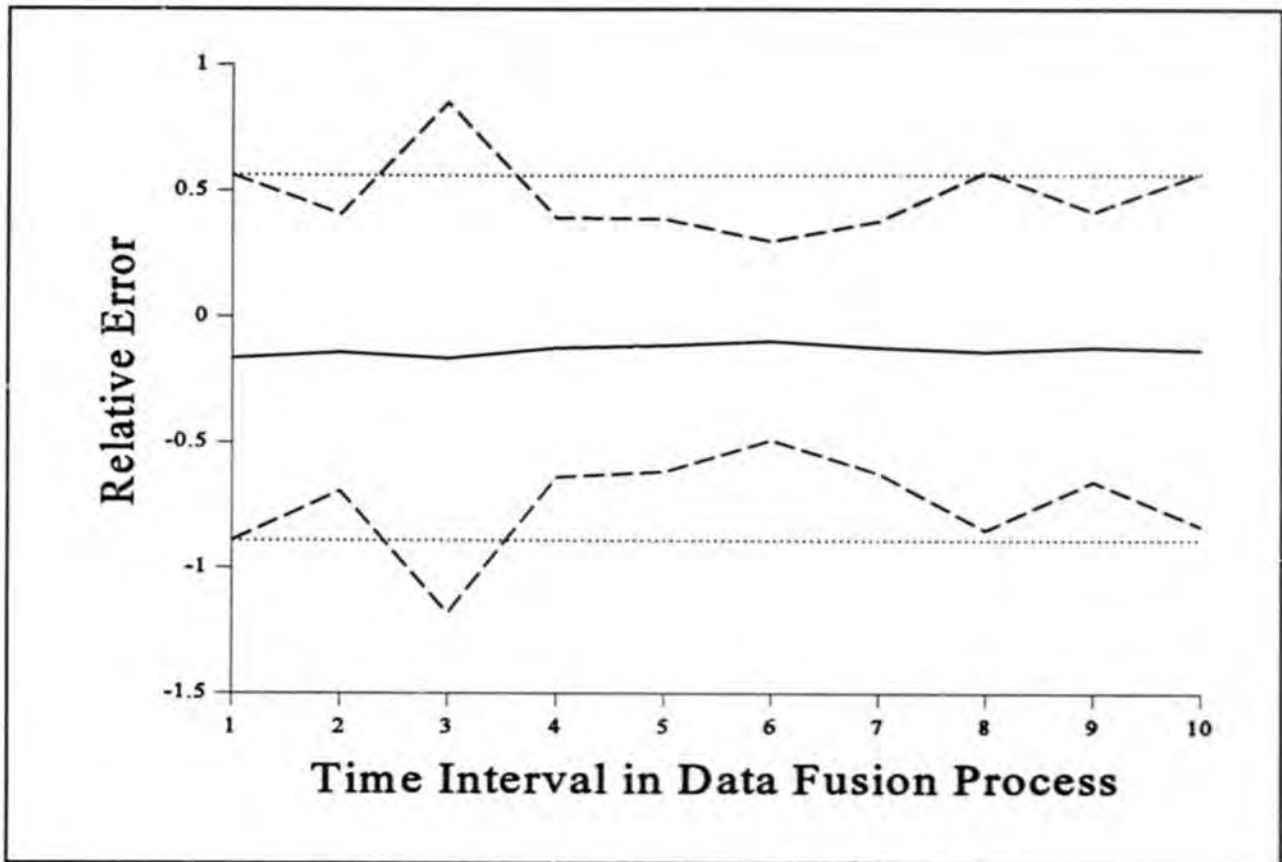


Figure 64. Relative error rates for each iteration of the data fusion process in the AM peak.



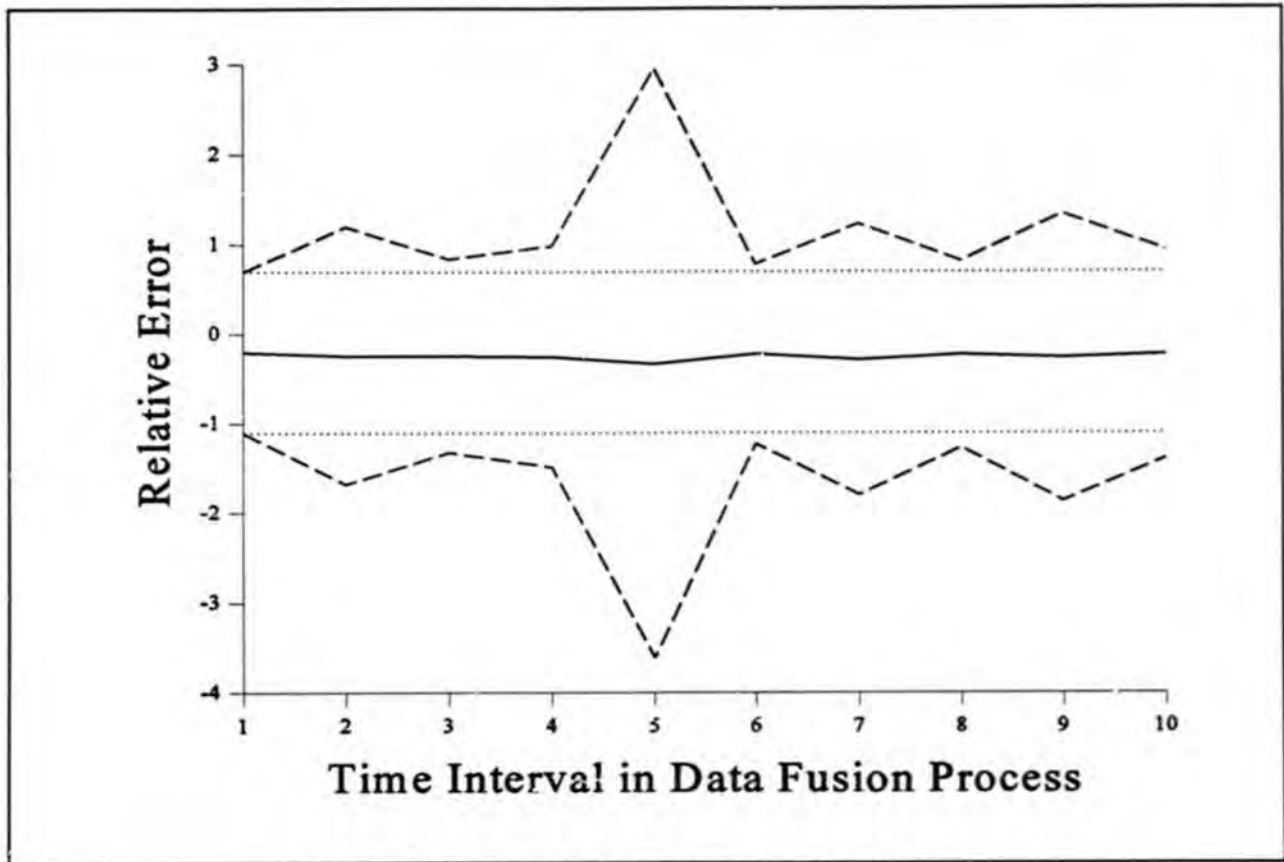


Figure 65. Relative error rates for each iteration of the data fusion process in the PM peak.

## EVALUATION OF SYSTEM AND NETWORK OPERATIONS

### TMC OPERATOR INTERFACE

This section focuses on the human factors evaluation of the operator interface at the TMC. This qualitative evaluation examined operator interface factors that may affect the flow of information within the TravTek system. The operator's job responsibilities and tasks were evaluated in conjunction with assessments of operator workload. Qualitative analyses resulted in the identification of: 1) operator tasks that may restrict information flow; 2) job performance stressors; 3) workload factors influencing operator job performance; and 4) potential solutions to improve the operator interface.

The TMC contained a considerable amount of automation in the collection and processing of information. The TMC operators served as system monitors. Furthermore, they interacted with TIN sources and input incidents into the system that affected the estimation of travel times. The primary interface of the operator to the TMC system was the graphic workstation. This was a 486 personal computer with a large screen color display. The system operated under OS/2, providing the user a Windows-like environment. The operator was presented a map representation of the TravTek network showing the location of incidents, level of congestion, and the position of the last reported location of the TravTek vehicles. The operator interacted with the system using a mouse and keyboard through a series of pop-up menus. The operator performed such functions as zooming into a specific area of the network, entering an incident, and setting congestion indicators.

The collection and transmission of data at the TMC were designed to be highly automated to reduce the amount of labor required. However, the system still required human decision making and system monitoring. Therefore, a human factors evaluation of the TMC interface was conducted to determine levels of workload and identify potential chokepoints.

#### Method

The evaluation of the TMC/operator interface involved observation, discussions, and interviews with subject matter experts (the operators and their supervisors). The evaluation was divided into three stages:

- Information analysis.
- Job analysis.
- Workload analysis.

These three evaluation stages were used together to develop a picture of operator interface factors and how they correspond to the flow of information within the system.

### *Information Analysis*

The first stage of the evaluation entailed an information flow analysis. This stage described the sources of data, data communication methods, data transfer controls, where information was received, the flow path, and its final destination. The information required by this analysis was obtained through discussions with the TMC personnel and review of system documentation.

The information analysis was used to obtain a list of the data sources, describe the flow of information, and understand how the information was manipulated. This analysis provided a framework for identifying operator chokepoints in the information flow.

### *Job Analysis*

The job analysis provided insight into how the operators interact with the system and the data flow within the system. Identifying the operator's job responsibilities and tasks began by developing a list of the operator job responsibilities, reviewing and verifying the accuracy with TMC operators, observing the operators performing their duties, obtaining job performance frequency and difficulties, identifying cues that initiate and guide performance of the task, listing any job aids used to perform tasks, and describing the standards that determine adequate job performance.

The job analysis was used to: 1) generate a list of operator responsibilities and tasks, 2) identify job performance factors, and 3) gain insight into the operator's job. The analysis provided the background data for conducting the workload assessment and facilitates the process of identifying factors that affect information flow.

### *Workload Analysis*

The workload analysis was conducted in two phases. The first phase examined workload stressors associated with job tasks by investigating operator subjective ratings of time pressure, visual effort, and mental stress. Subjective workload measures were obtained from discussions with the operators. For each task, subjective ratings of low, medium, or high were obtained for each of the three dimensions (time, effort, and stress).

The second phase of this analysis assessed workstation design stressors. The American National Standard for Human Factors Engineering of Visual Display Terminal Workstations<sup>(20)</sup> (ANSI/HFS 100-1988) was used as a guide to develop a checklist to identify areas that may hinder the operator's job performance. The operator's workstations were assessed through visual inspections and discussions with the operators. Performance data were not collected to show performance decrements or information chokepoints. Factors which had the potential to cause decrements in performance or information flow were investigated. The evaluation focused on areas identified in the ANSI/HFS 100-1988 standard and used three types of ratings: acceptable, questionable, or not applicable.

The analysis examined the operator's environment for factors that may be subjecting the operator to unnecessary physical stress, which, especially over extended periods of time, may lead to degraded operator performance. The analysis investigated four categories of workstation characteristics: the working environment, visual displays, keyboard, and furniture. Within each of these four categories, workstation characteristics were evaluated to determine if the workstation design meets the requirements stated in the ANSI/HFS 100-1988 standard.

## Results

The operator's job responsibilities and tasks and the data flow information were evaluated in conjunction with the assessments of workload. The analysis examined: 1) areas that have been identified as operator-induced information flow chokepoints; 2) tasks that may be potential chokepoints; 3) tasks that have job performance stressors associated with them; and 4) other areas that could benefit from further investigation and research.

### *Information Flow Analysis:*

The information flow analysis table is shown in table 15. For each data source used by the TravTek system, the table lists the type of data, its source or origin, the communication method used to transfer the data, the data transfer controls, who the initial receiver at the TMC was, the flow path of the data from source to the TMC, and the final destination of the data.

The 10 sources of data identified and described by the TMC operators were grouped according to the type of transfer controls affecting the transfer of information from the source to the TravTek computer. The transfer controls were separated into three categories based on the amount of operator attention required to detect the arrival of new data (for entry into the TravTek system).

The first category required no operator attention and had automatic and continuous data transfer from the source to the TravTek computer. The first four data sources in table 15 were classified into the first category. These four sources were 1) the Traffic Signal System data, 2) I-4 congestion reports from the FMC, 3) event data from the TISC, and 4) the congestion reports from the TravTek vehicles. Each of these sources had direct communication links that automatically and continuously fed data to the TravTek computer. Therefore, for this group of data, operator attention was not required for the data to enter into the TravTek computer. The flow path for the Traffic Signal System data was from the roadway detectors to the traffic signal system and directly to the TravTek computer. The FMC and TISC data flowed directly from the source to the TravTek communication computer, and the TravTek vehicle data was transmitted from the car to the TravTek communication computer via the car's radio broadcast.

Table 15. Information flow analysis.

Source	Data Name	Communication Method	Transfer Controls	Initial Receiver	Flow Path	Final Destination
Traffic Signal System	Traffic Signal System	Direct communication link (DCL)	Automatic and continuous	TravTek computer	Detectors, communication line, traffic signal system, TravTek computer	Vehicle
FDOT, FMC	I-4 C & I Reports	DCL	Automatic and continuous	TravTek communication computer	I-4 signal link, FHP, TravTek communication computer	Vehicle
AAA, TISC	Event Data	DCL	Automatic and continuous	TravTek communication computer	AAA, TravTek communication computer, TravTek database computer	Vehicle
TravTek Vehicles	Congestion Report	Vehicle data radio	Automatic and continuous	TravTek communication computer	Vehicle, communication computer, database computer, OI computer	Vehicle
City of Orlando	Street/Lane Closure Permits	Fax	Daily from City of Orlando	TMC fax machine	TMC Fax, TMC operator, OI computer	Vehicle
FDOT	Construction Reports	Fax	Weekly from FDOT	TMC fax machine	TMC Fax, TMC operator, OI computer	Vehicle
Metro Traffic	C & I Reports	Modem	As it occurs (intermittent intervals)	TravTek OI computer	Modem, OI computer, TMC operator, TravTek database computer	Vehicle
Local Radio Stations	C & I Reports	One-way radio broadcast	As it occurs (intermittent intervals)	TMC operator	Broadcast, TMC operator, OI computer	Vehicle
City Traffic Operations Personnel	C & I Reports	Telephone or two-way radio	As it occurs (at their discretion)	TMC operator	Two-way radio, TMC operator, OI computer	Vehicle
Local Radio Stations	Weather Reports	One-way radio broadcast	As it occurs (intermittent intervals)	TMC operator	Broadcast, TMC operator, OI computer	Vehicle

122

122

The second category had a predictable timetable for arrival which required minimal operator attention until the anticipated time of arrival. The next two data sources were classified into the second category. The City of Orlando Street and Lane Closure permits and FDOT Construction reports were transmitted to the TMC facsimile machine and the operators knew when and where to pick up new data. The TMC received City of Orlando Street and Lane Closure permit reports daily and FDOT Construction reports weekly. Because this group of data arrived at a pre-determined time, the operators only had to monitor arrival of the new data at the pre-set time. Therefore, the operators did not have to monitor arrival of the new data beyond the expected timetable of arrival. Although the operator was an integral part of the flow path, the predictable nature of new data arrival minimized the likelihood of missing the arrival of new data.

The third category had an intermittent and uncertain timetable for arrival, thus requiring the operator to monitor and detect the arrival of new data and enter it into the system. The last four data sources were classified into the third category. The Metro Traffic Congestion and Incident (C & I) reports, Local Radio Station C & I reports, City Traffic Operations Personnel C & I reports, and Local Radio Station weather broadcasts, had data arriving at the TMC at intermittent time intervals. For this group of data, the TMC operators were required to continuously monitor either the TravTek computer screen (Metro Traffic reports) or local radio broadcasts for congestion, incidents, and weather information.

Since the operator was in the flow path for all four data sources, if the arrival signal for new information was missed, the data were not entered into the TravTek computer. The arrival signal for Metro Traffic reports was the presence of a window on the TravTek computer's screen, which required the operator to maintain visual contact with the computer's display. (In reality, the operators did not remain seated in front of the display but would periodically check the screen for new information.) The arrival signal for the radio broadcasts were not so apparent, since the signal was auditory not visual, masked by other noises (fans/air conditioning blowers), and the cue or signal (if any) varied depending on radio station. However, the operators did know that reports came either hourly or every few minutes depending on the time of day and the local station.

### *Job Analysis*

The information analysis was used to identify and describe the sources of information used by the TravTek system. The next phase in the evaluation examined the operators' role in TravTek system's information flow. Since the focus of the evaluation was to identify choke points in the flow of information and identify operator interface factors that may affect the flow of information within the TravTek system, the job analysis focused on the tasks/subtasks that directly affected the flow of information.

The Job Analysis table, shown in table 16, uses eight columns to describe the critical tasks performed by the TravTek operators. Discussions with the operators identified seven tasks (listed in column 1) that the operators described as being important for maintaining the flow of information through the system. For each task, the task initiation cues used to signal the operator to begin the task are shown in column two. Column three shows the subtask or type of activity

Table 16. Job analysis table.

Task	Cues	Subtask	Job Aids	Difficulties	Frequency	Consequences	Performance Indicators
Input Metro Traffic C & I Reports	Window appears on OI Computer	Edit Data	TIN Users Manual	None	Higher during rush hour & rain	Info. not transmitted to vehicles & loss of info. for route planning/updates	OI Computer updates screen with an icon
Input Radio Broadcast C & I Reports	Listen for radio broadcast	Data Entry	TIN Users Manual, OI Computer Utilities	Look up Link #, Enter Cause, Duration, Lane Blockage Info.	Approx. every 15 to 30 min	Same as above	Same as above
Input City Employee C & I Reports	Telephone call	Data Entry	TIN Users Manual, OI Computer Utilities	Same as Above	Intermittent during normal duty hours	Same as above	Same as above
Input City of Orlando Street/Lane Closure Permits	Fax received	Data Entry	TIN Users Manual, OI Computer Utilities	Same as Above	Once	Same as above	Same as above
Input FDOT Construction Reports	Fax received	Data Entry	TIN Users Manual, OI Computer Utilities	Same as Above	Once weekly	Same as above	Same as above
Input Weather Conditions	First thing in AM or as changes occur	Data Entry	Radio Broadcast	None	Daily or as conditions change	Does not update in vehicles	Updated info. on the OI Computer
Reboot System Computers	Message appears on OI computer	Follow instructions in TIN Users Manual	TIN Users Manual	Sequence of instructions must be done correctly	Approx. once a week	None of the system computers will work correctly	Message appears on all computer screens

124

124

required by the operator before the information was entered into the TravTek computer. The job aids used by the operator to assist in completing the task were recorded in column four, as were any difficulties or inconveniences regarding the task (column five). Next, column six shows the number of times the task was normally performed by the operator, and the consequences of not performing or completing the task was also listed (column seven). Finally, in column eight, the performance indicators which were used by the operator to determine whether or not the task was done correctly and successfully completed were also recorded.

The cue information contained in table 16 shows that two tasks required the operator to monitor the TravTek computer display for a message window, input Metro Traffic C & I reports and reboot system computers. Two tasks required the operator to monitor local radio broadcasts for information, input radio broadcasts of C & I reports and input weather conditions. One task required the operator to listen for telephone calls and City of Orlando employee C & I reports. Two of the tasks required monitoring the TMC fax machine either once a day or once a week for new information, street/lane closures and construction reports.

Once the operator had detected that new information was available and waiting to be entered into the system, six of the seven tasks involved entering or editing data. When entering data, the operator used the TravTek Traffic Information Network (TIN) Users Manual as an aid. The TIN Users Manual was used to look up the link number, enter an incident code, and any lane blockage codes. The TIN Users Manual was also used to provide instructions for rebooting the system computers.

When discussing difficult tasks, the operators stated that none of the tasks were particularly difficult. However, two tasks were identified as being "inconvenient," looking up information in the TIN Users Manual and rebooting the TravTek computers. No other tasks were identified as being particularly difficult or inconvenient.

The frequency of performing the tasks were found to vary depending on the task. Inputting congestion and incidents from Metro Traffic, radio broadcasts, and City of Orlando employees could occur as often as every 15 to 30 min depending on time of day and weather conditions. The weather information was entered first thing in the morning and then modified as conditions changed. Street closure or construction reports occurred at predictable daily or weekly intervals, so consequently, the information was entered daily or weekly. The frequency of rebooting the computers was reported by the operators to occur approximately once a week or so. However, during the first few months of the TravTek evaluation, the system required rebooting more frequently and decreased as time went on.

Operators seemed to understand the consequences of missing a C&I, street/lane closure, construction report, or weather report and delaying the input of information into the TravTek system. If they missed or delayed the data entry, the information would not be transmitted to the vehicles and the vehicles would not have the most current information for route planning and route updates. The consequence of not rebooting the TravTek system computers correctly would result in the computers not working correctly and not providing data to the vehicles.



The operators relied on the TravTek operator interface computer to provide feedback that they had adequately performed their tasks. Depending on the task the computer would display either an icon, update the information on the screen, or provide a message to the operator.

### *Workload Analysis*

The workload analysis examined the operators' workload stressors and workstation design stressors. The analysis was segmented into two phases. The first phase examined workload stressors associated with each of the job tasks. The second phase assessed workstation design stressors for the TravTek operator interface computer and the communications computer.

Workload Assessment. Using the three measures of workload (time pressure, visual effort, and mental stress), all tasks except system reboot were rated as having low workload. Even during rush hour and during rain storms the tasks were rated to have low workload. Rebooting the system computers was rated as having medium workload for all three measures. Time pressure was rated as medium because the operators knew that at certain times of the day the TravTek evaluation studies were running and they wanted to get the system back up and running as soon as possible. Visual effort was also rated as medium because there were three computers to monitor and re-start to get the system working correctly. First, the data base computer, second, the communication computer, and finally the operator interface computer. Mental stress during system reboot also was rated as medium. The comments indicated there was medium mental stress associated with rebooting the system because 1) they had to monitor three computers, 2) it was important that a specific sequence of instructions (in the TIN Users Manual) be followed, and 3) there were time pressures to get the system back up.

Workstation Design Assessment. The workstation design checklist was completed using discussions with the operators and visually inspecting their workstations. The checklists are shown in table 17 for both the operator interface computer and the communications computer. Four areas of the workstation were examined: working environment (office illuminance, visual distractions, noise, etc.); visual display characteristics (resolution, screen glare, etc.); keyboard characteristics (height, slope, etc.); and furniture (worksurface, seating, and accessories).

Working Environment. The working environment for both the operator interface computer and the communication computer had identical ratings. Five of the six factors (office illuminance, visual distractions, temperature, air movement, and air quality) were rated as acceptable. However, acoustic noise was rated as questionable. This was judged to be questionable because of the constant noise generated from fans, air conditioning, and radio broadcasts.

Visual Display. The visual display for the operator interface computer was rated acceptable for all factors. The communications computer was rated acceptable for all factors except screen glare. The screen glare for the TravTek Communication computer display was judged questionable because the display position was not easily adjustable and the overhead lighting was clearly visible on the display face.

**Table 17. Workstation design stressor checklist.**

	Operator Interface Computer	Communication Computer
<b>1. Working Environment:</b>		
Office Illuminance	Acceptable	Acceptable
Visual Distractions	Acceptable	Acceptable
Acoustic Noise	Questionable	Questionable
Temperature Distractions	Acceptable	Acceptable
Air Movement	Acceptable	Acceptable
Air Quality (Odors, Stuffiness)	Acceptable	Acceptable
<b>2. Visual Display:</b>		
Resolution	Acceptable	Acceptable
Screen Glare	Acceptable	Questionable
Luminance	Acceptable	Acceptable
Contrast	Acceptable	Acceptable
Color Usage	Acceptable	Acceptable
Blinking	Acceptable	Acceptable
Image Stability		
Jitter	Acceptable	Acceptable
Flicker	Acceptable	Acceptable
Font Type	Acceptable	Acceptable
Character Height	Acceptable	Acceptable
Legibility/Readability	Acceptable	Acceptable
Symbol Color Contrast	Acceptable	Acceptable
Viewing Distance	Acceptable	Acceptable
Controls		
Adequacy	Acceptable	Acceptable
Adjustability	Acceptable	Acceptable
<b>3. Keyboard:</b>		
Height	Acceptable	Acceptable
Slope	Acceptable	Acceptable
Placement	Acceptable	Acceptable

**Table 17. Workstation design stressor checklist (continued).**

	<b>Operator Interface Computer</b>	<b>Communication Computer</b>
<b>3. Keyboard (continued)</b>		
Key force	Acceptable	Acceptable
Stability	Acceptable	Acceptable
<b>4. Furniture:</b>		
<b>Worksurface:</b>		
General Principles	Acceptable	Questionable
Clearances	Questionable	Questionable
Adjustability	Acceptable	Questionable
Keyboard Support Surface	Acceptable	Questionable
Worksurface Width & Height	Acceptable	Questionable
Display Support Surface	Acceptable	Questionable
<b>Seating:</b>		
Height	Acceptable	Acceptable
Depth	Acceptable	Acceptable
Width	Acceptable	Acceptable
Pan Angle	Acceptable	Acceptable
Pan to Backrest Angle	Acceptable	Acceptable
Backrest	Acceptable	Acceptable
Support Width	Acceptable	Acceptable
Arm Rest	Acceptable	Acceptable
Casters	Acceptable	Acceptable
<b>Accessories:</b>		
Wrist Support	N/A	N/A
Footrest	N/A	N/A
Anti-glare Screen	N/A	N/A
Document Ho'der	N/A	N/A

**Keyboard.** The keyboards for both computers were judged to be acceptable for height, slope, placement, key force, and stability.

**Furniture.** The furniture assessment was divided into three areas: worksurface, seating, and accessories. As shown in table 17, the worksurface for the operator interface computer was rated as acceptable for five of the six worksurface factors. One area of concern for the operator interface computer was leg clearance. Due to the layout of hardware under the worksurface, leg clearance was very limited. Consequently, leg clearance was judged as questionable for the operator interface computer.

The worksurface factors for the communication computer were rated as questionable for all six factors. Worksurface general principles were judged to be questionable because several workstation design concerns were identified. For example, the design of the furniture limited the location and placement of the hardware components, and consequently the reset button was located near the operator's feet approximately 15 cm above the floor. Also the hardware cabinet which contained the keyboard, display, and computer hardware was generally low to the floor, cramped, and not adjustable.

Next, the communication computer clearance under the worksurface did not meet the leg clearance envelopes described in the ANSI/HFS standard. Because of the design, there was no room under the worksurface for the operators legs, therefore it was rated as questionable.

The communication computer worksurface was also the keyboard support surface. In contrast to the operator interface computer, which had a large worksurface, the communications computer worksurface was just large enough for the keyboard. The worksurface width (and depth) was too small to allow the user access to the mouse unless the keyboard was moved. In addition, the keyboard support surface was too low (approximately 53 cm above the floor) and non-adjustable. As a result, the communication computer cabinet's worksurface adjustability, keyboard support surface, and worksurface width and height was rated as questionable.

The communication computer's display support surface tilted the display backwards such that the overhead lights were clearly visible on the face of the display. Although the display could be slightly repositioned in the cabinet, the display could not be adjusted enough to eliminate the reflections. Consequently, the communication computer display support surface was rated as questionable.

The second furniture area, seating, was rated as acceptable for all nine subareas related to seating. Both the operator interface computer and the communications computer were acceptable for: seat height adjustability, seat depth, seat width, pan angle, pan to backrest angle, backrest design, support width, arm rest support, and chair casters.

The third furniture area, accessories, was not rated and received an N/A because the items listed in the table were not present or used by the operators at the TMC.

## Discussion

The operators' job responsibilities and tasks, and the data flow information were evaluated in conjunction with the assessments of workload. From this collection of information, four information sources were identified that had the potential to delay the TravTek computers' data reception. The four information sources were: Metro Traffic congestion and incident reports, local radio station congestion and incident reports, City of Orlando traffic operations personnel congestion and incident reports, and weather reports from local radio broadcasts.

Although it appears that the intermittent unpredictable reporting intervals were primarily responsible for delays in information flow, several other factors appear to have also contributed to the problem:

- The "new data" warning signals were sometimes missed by operators.
- Operators were required to monitor a variety of sources for "new data."
- Operators were required to monitor auditory signals over the noise of air conditioning blowers, computer fans, and radio broadcasts.
- Manual editing or data entry was sometimes required before information was available to the system.
- Job aids were sometimes needed to complete data entry and keep the system running.

Although, high workload levels did not appear to be a factor, low workload levels seemed to add to the likelihood that new information would be delayed in getting into the system. For most tasks, the operator's workload was low. The only task that was rated as medium workload was rebooting the system computers. The operator had a key role in keeping the system up/running with up-to-date data. However, much of the incoming data requiring operator entry or editing arrived at sporadic, unpredictable times and intervals, and reduced operator vigilance due to boredom can result in frequent delays in the dissemination of timely data. This evaluation found that the network of information sources needed further refinement, and the comments received indicated that while the system did not suffer from too much information coming in, it actually could have used more (and better) information.

Several workstation design factors were identified that had the potential to degrade operator performance. For example, the communication computer display could not be positioned to reduce screen glare from overhead lighting, the worksurface was found to be too low (approximately 56 cm), there was no leg clearance, the keyboard was too low (approximately 56 cm), there was insufficient room for mouse operation, and the computer reset switch to reboot the computer was too low (approximately 15 cm above floor).

## Conclusions

The evaluation of the TravTek TMC operator interface provides lessons learned for the design of advanced traffic management systems. Recommendations for improving operator performance and information flow include: better training and instruction so operators understand their role in the information flow process; improving and integrating the information flow process; providing operators with an integrated source of warning signals when the system requires operator intervention; reducing ambient noise levels; and improving workstation design to meet ergonomic requirements.

## NETWORK COVERING

The TravTek Traffic Link Network was a macroscopic representation of the Orlando road network. It was used as the base network for dynamic link travel times. All travel times transmitted to the vehicles were expressed as a ratio with respect to a reference time. These reference times were the minimum travel times for the links, and generally corresponded to the speed limit. If a link was operating at its minimum travel time, then no ratio was transmitted to the vehicle from the TMC for that link, and the vehicle used the fallback reference time for that link. The TMC and vehicles had the same reference data bases for the links. Link travel times above the minimum were expressed as a ratio greater than unity to be used as a multiplier. The transmitted ratios were biased by negative 1 to minimize the number of bits transmitted. The unity ratio (effectively zero) was never transmitted.

### Network Description

The area represented by the network was approximately 3,100 km<sup>2</sup>. There were 1,488 links representing a total distance of 1854 km. The network average speed was 50.5 km/hour. The greater Orlando map is shown in figure 66, and a plot of the corresponding TravTek Traffic Link Network is shown in figure 67.

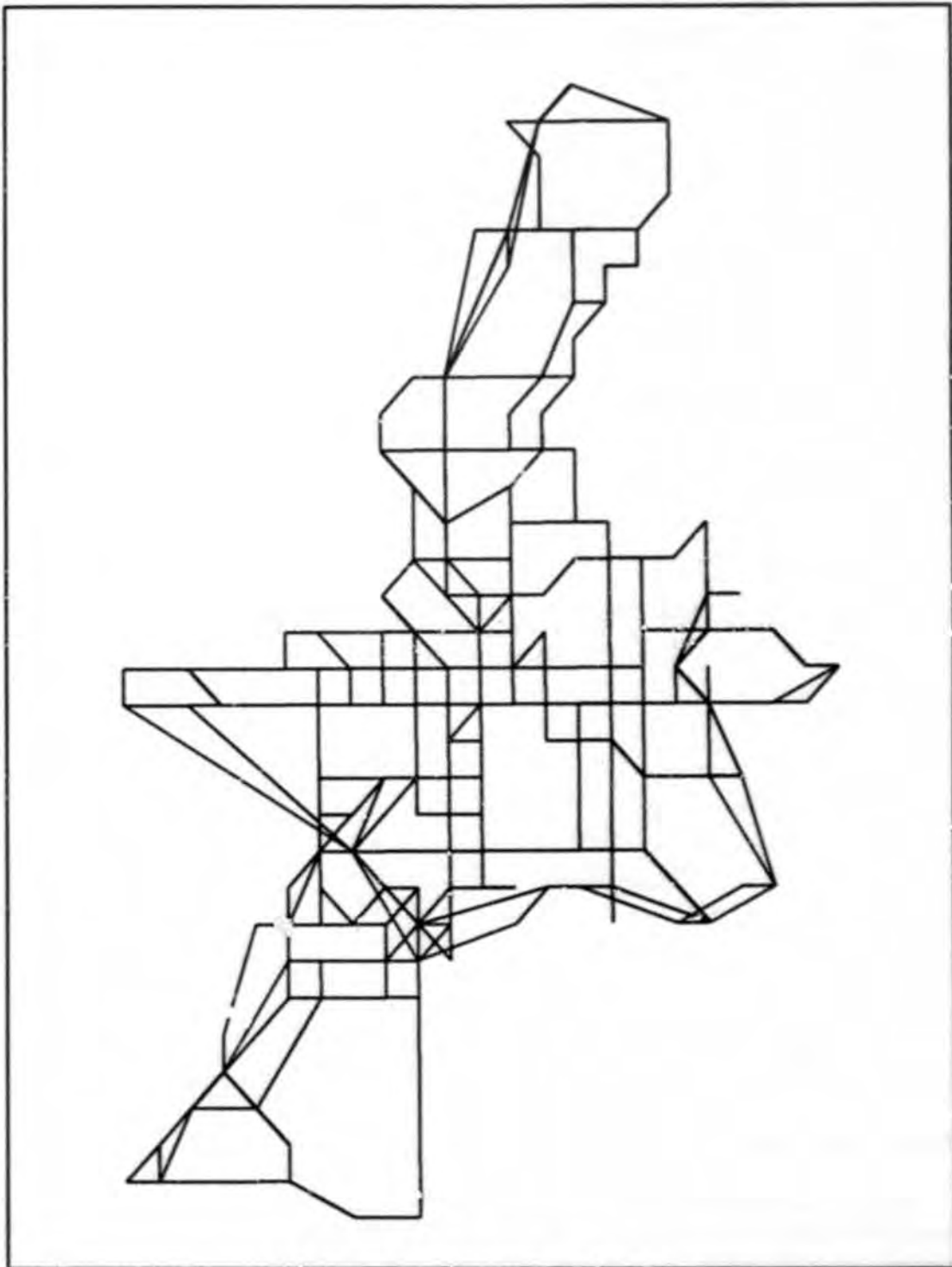
The network has three categories of links: arterial, interstate, and toll. The percentage distribution for these categories is shown in figure 68. The roadway distance percentage represented by each of these categories is shown in figure 65.

### Data Sources

The data for the TravTek Traffic Link Network categories were supplied by the Florida Department of Transportation, and the coordinates of the nodes were provided by General Motors. <sup>(1,22)</sup> Probe vehicle activity was determined by processing the TMC radio logs. Various computer programs were written to acquire, edit, process and analyze these data.

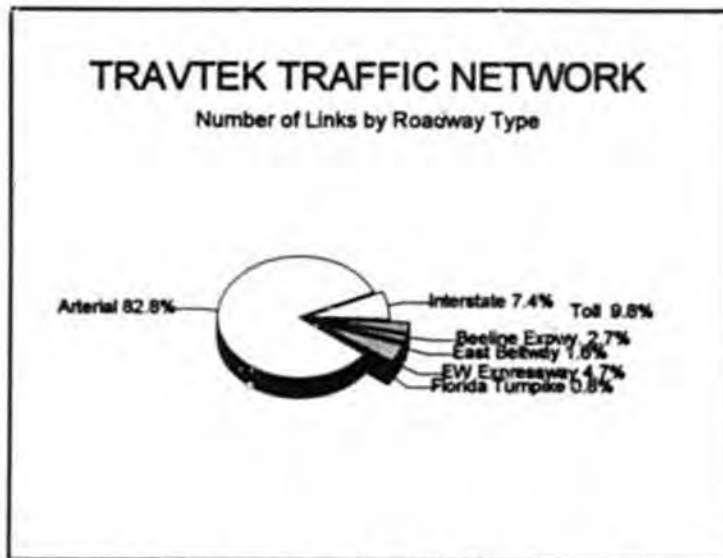


Figure 66. Greater Orlando road map.

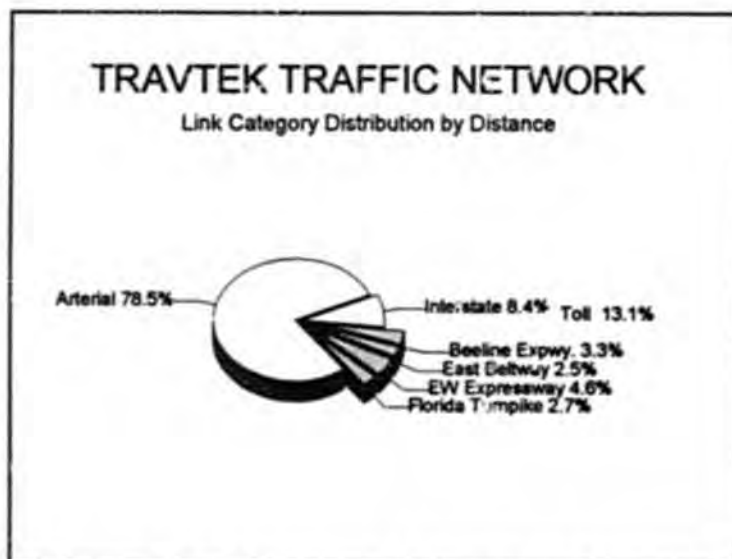


**Figure 67. TravTek traffic link network.**





**Figure 68. Number of links by roadway type.**



**Figure 69. Link category distribution by distance.**

#### Probe Vehicle Activity

Probe reports are an essential ingredient of the IVHS concept. The capability to have link travel times measured throughout the network provides traffic information that is not available through any other means. The TravTek operational test provided the opportunity to observe the interaction of probe reporting with system operation. With only 100 vehicles available,

there were generally fewer than 50 vehicles in daily operation. Link travel times reported by probe vehicles averaged approximately 45,000 per month as shown in figure 70. The daily averages of link km covered during the test are shown in figure 71.

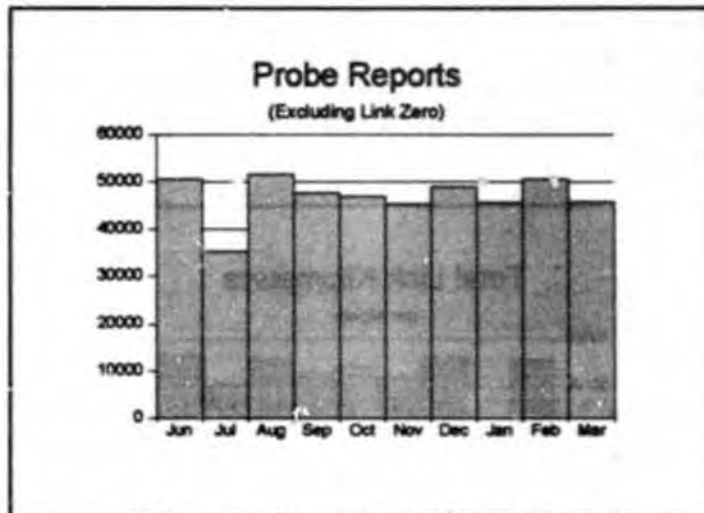


Figure 70. TravTek vehicle probe reports.

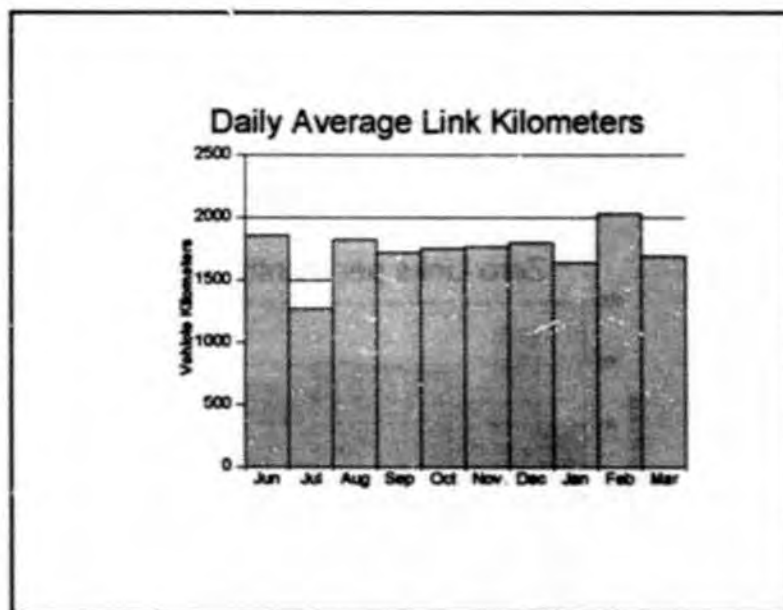


Figure 71. TravTek traffic network - daily average link km.

The total monthly link km are shown in figure 72, averaging approximately 53,000 vehicle km per month. In assessing network covering, it is important to consider those links which had no probe vehicle activity during the month. Figure 73 shows the number of links which did not receive any probe traffic during the month. These links, referred to as zero traversal links, deserve special scrutiny because of the possibility that they are part of a network coding problem or link travel time error. While figure 73 depicts zero traversals, there was some variation between months as to which set of links occupied this category. However, the intersection of these sets represent those links which did not experience any probe vehicle traffic during the entire test. These 14 links are shown in table 18, and are suspect in terms of their eligibility to be considered by the routing algorithm.

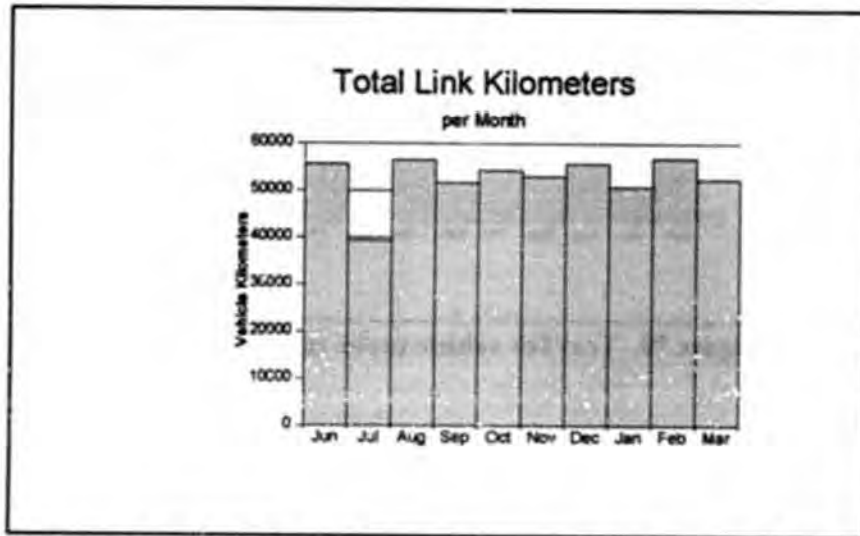


Figure 72. TravTek traffic network - monthly average link km.

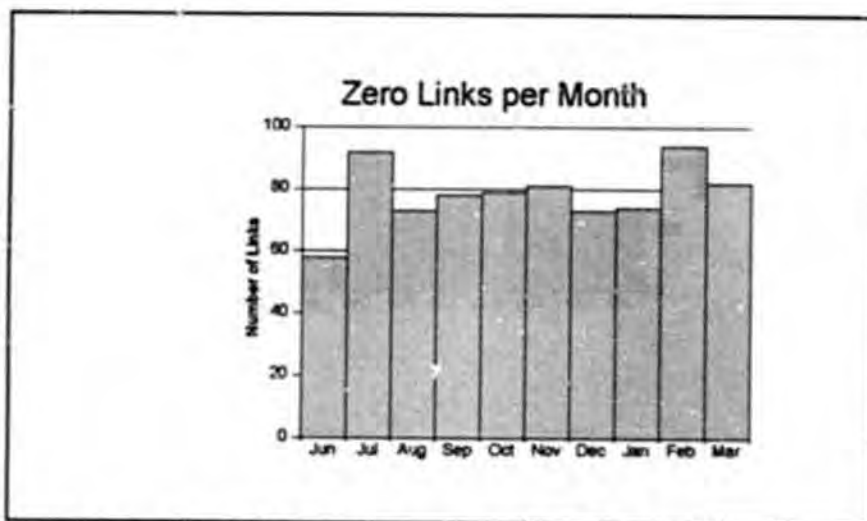


Figure 73. Links without probe vehicle traffic by month.

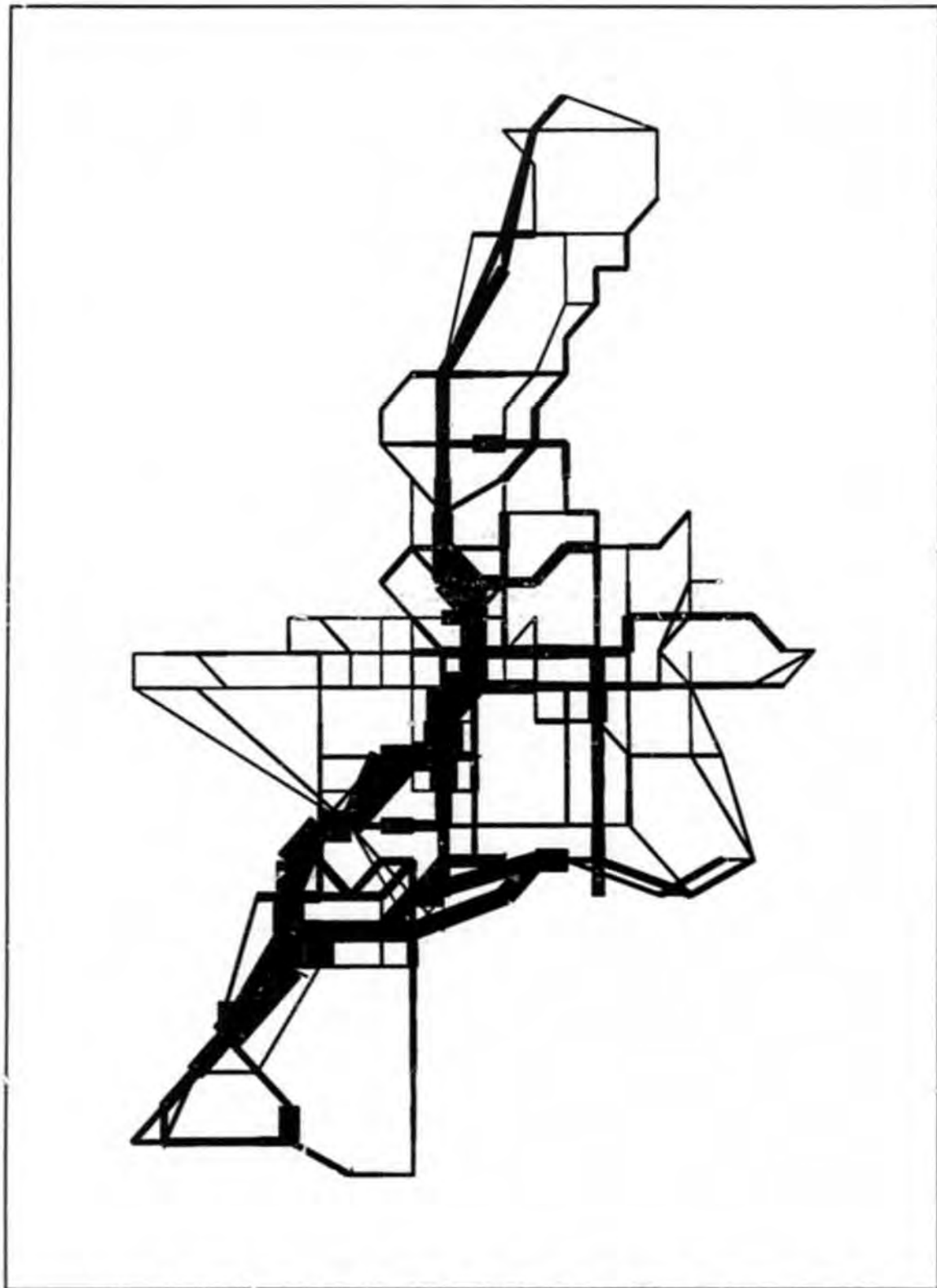
**Table 18. Links which had no probe vehicle activity during test.**

<b>TravTek LINK NUMBER</b>	<b>LINK NAME</b>	<b>FROM</b>	<b>TO</b>
545	Magnolia	SR 527	Anderson
554	Magnolia	Robinson	Livingston
798	US 17/92	CR 15	I-4 WB
799	US 17/92	I-4 WB	CR 15
800	US 17/92		I-4 WB
866	C46A/431	Rinehart (431B)	SR 46
1184	Rosalind	Livingston	Robinson
1185	Rosalind	Robinson	Washington
1186	Rosalind	Washington	Central
1187	Rosalind	Central	Church
1188	Rosalind	Church	South
1189	Rosalind	South	Anderson
1279	Fla Tpk Exit		SR 528/OBT
1287	E/W Exp Exit		Hiwassee

The total probe vehicle volumes for the duration of the operational test, plotted as variable width bands, are shown in figure 74. The distribution of probe vehicle frequencies by month are shown in appendix D.

Table 19 is a summary of network link percentages and probe vehicle mileage by roadway category: arterial, toll road and Interstate. Figure 75 is a perspective chart of the probe vehicle mileage distribution by month.

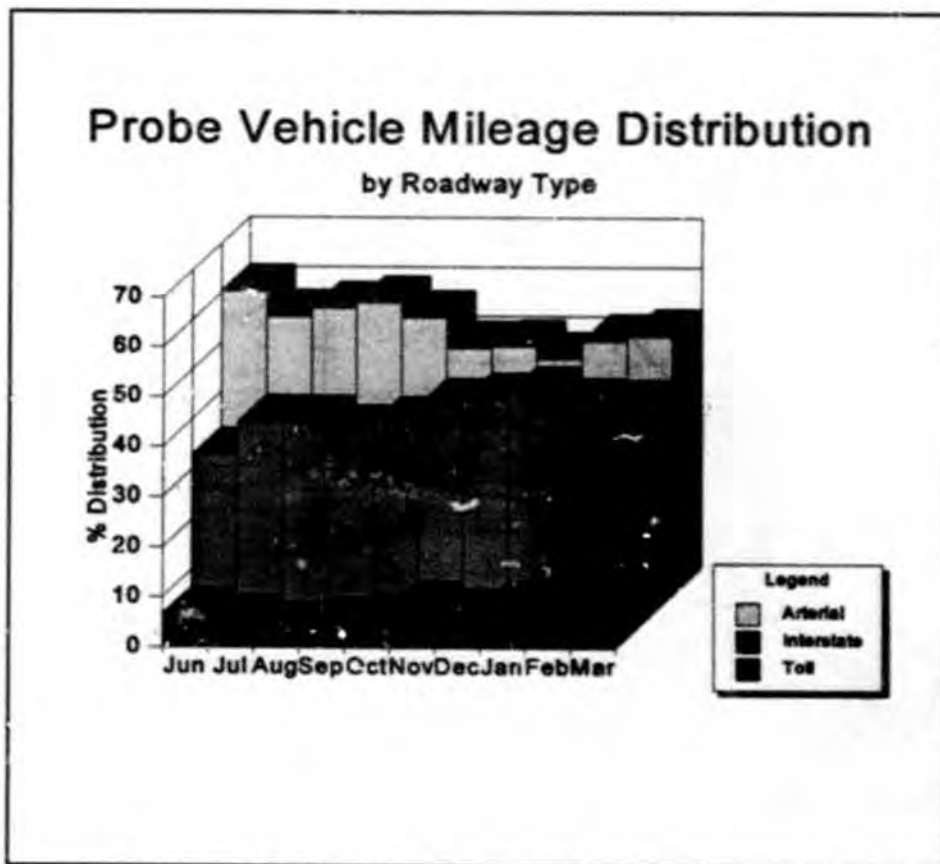
A plot of probe vehicle coordinates routinely reported to the TMC for 10 days during the month of September, 1992 is shown in figure 76.



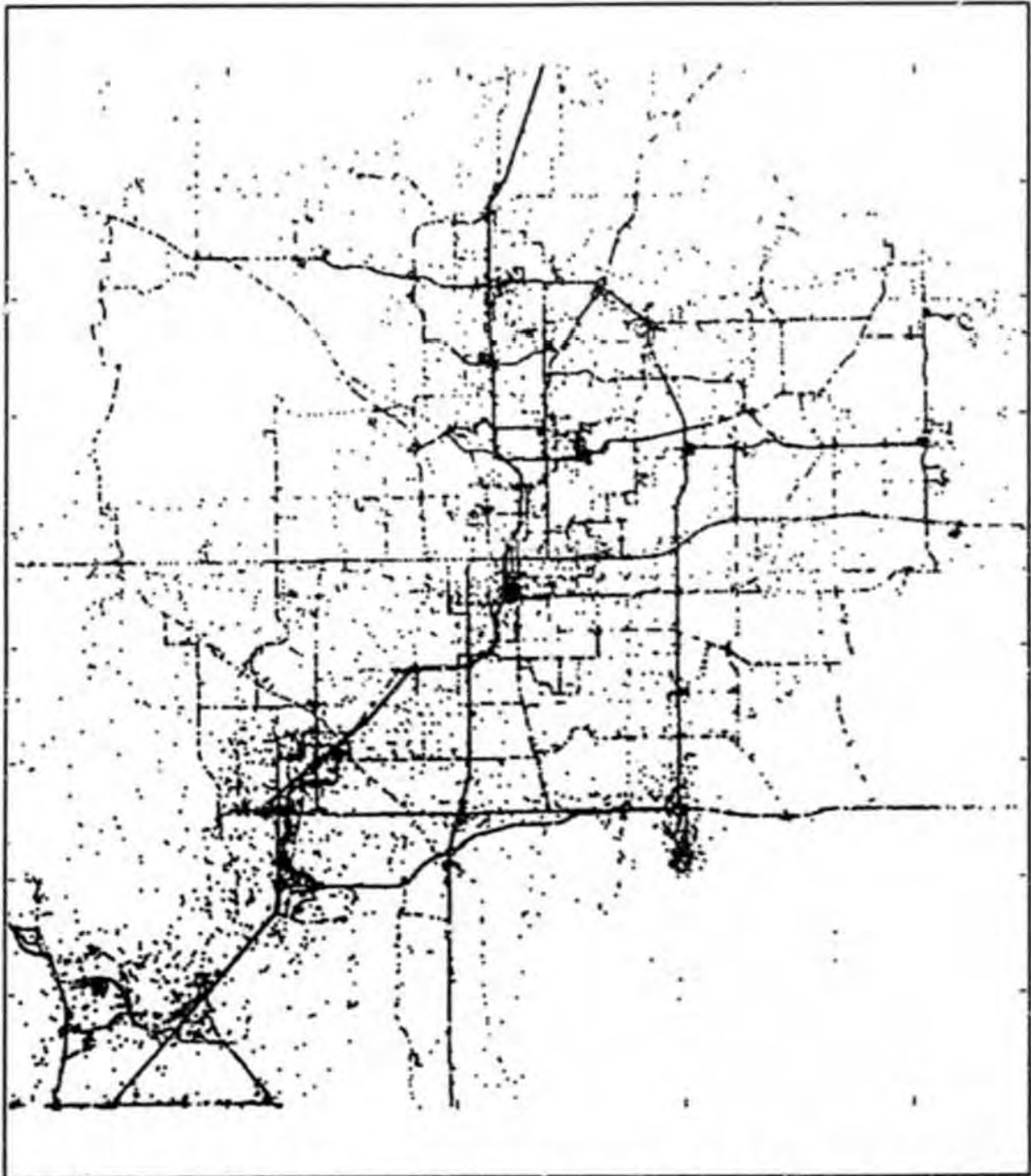
**Figure 74. Probe vehicle volumes band map - total during operational test.**

**Table 19. Summary of network link percentages and probe vehicle mileage by category.**

	% of Network	% of Links	1992							1993		
			Jun	Jul	Aug	Sep	Oct	Nov	Dec	Jan	Feb	Mar
Arterial	78.5	82.8	60.4	55.2	56.9	58.1	55.1	49.0	49.3	46.8	50.5	51.5
Toll	13.1	9.8	6.7	5.3	3.7	4.5	5.7	8.0	6.6	7.9	6.5	5.9
Interstate	8.4	7.4	32.9	39.5	39.4	37.4	39.2	43.0	44.1	45.3	43.0	42.6



**Figure 75. Probe vehicle mileage distribution by month.**



**Figure 76. Plot of coordinates reported by probe vehicles for 10 days during month of September, 1992.**

**BEST COPY AVAILABLE**

## Analysis

As shown in table 18, 14 links did not receive traffic for the duration of the operational test. Links 1,184 through 1,189 were along Rosalind Avenue in downtown Orlando. A check of the link data revealed that this section of Rosalind Avenue was changed from two-way to one-way operation at the time the TravTek operational test was initiated. The upgrading of the network description in the vehicles was totally satisfactory, and the routing algorithm was prevented from using these links.

Link 1279, an exit from the Florida Turnpike to SR 528/Orange Blossom Trail, was on a high-type facility and would otherwise have had an expectation of probe traffic. However, with limited access to the Florida Turnpike, and the need for a trip with origin well to the west of downtown Orlando, it is possible that no trips required this link on a route.

Link 1287, an eastbound exit from the East-West Expressway (a toll facility) to Hiwassee, should have experienced probe traffic. No explanation is available for the lack of probe traffic, other than either a topology or travel time coding problem.

Links 798, 799, and 800 are at the crossing of US 17/92 under I-4. These links are at the extreme northeast of the network, and can be considered external nodes. The link coding description does not match the geometry of the roadways; an error in coding is suspected.

Links 545 and 554 are on opposing ends of the one-way section of Magnolia in downtown Orlando. Again, the absence of probe traffic on these two links is probably related to the changeover to one-way operation at the time of initiation of TravTek operations.

Link 866 had the name C46A/431 (county road/State secondary). The map section for link 866 is shown in figure 77. The link definition is from Rinehart (431B) to SR 46. This link is in a sparse area of the network. The tail of link 866 has a single connecting link, which is the head of link 865. Link 865 has a length of 3.38 km, and link 866 has a length of 4.38 km. A path from Lake Mary Boulevard (the tail of link 865) to SH 46 (the head of link 866) has two turns and crosses under I-4. An alternate path, also with 2 turns (one of which is a freeway ramp), traverses a boulevard, an Interstate and a State highway. Visual inspection indicates the attractiveness of using the alternate route since it can predominately use I-4. Referring again to figure 77, the travel time over the solid route (using I-4) is  $0 + 251 + 0 + 121 = 372$  seconds. The travel time over the dashed route is  $188 + 253 = 441$  seconds. Unless a trip had an origin along link 865, a path over link 866 was probably never selected by the routing algorithm.

## Conclusions

The TravTek Traffic Link network had almost total coverage by TravTek vehicles. While an average of about 70 of the 1,488 links did not receive probe traffic during any month, the links not traveled by probe vehicles varied from month to month.



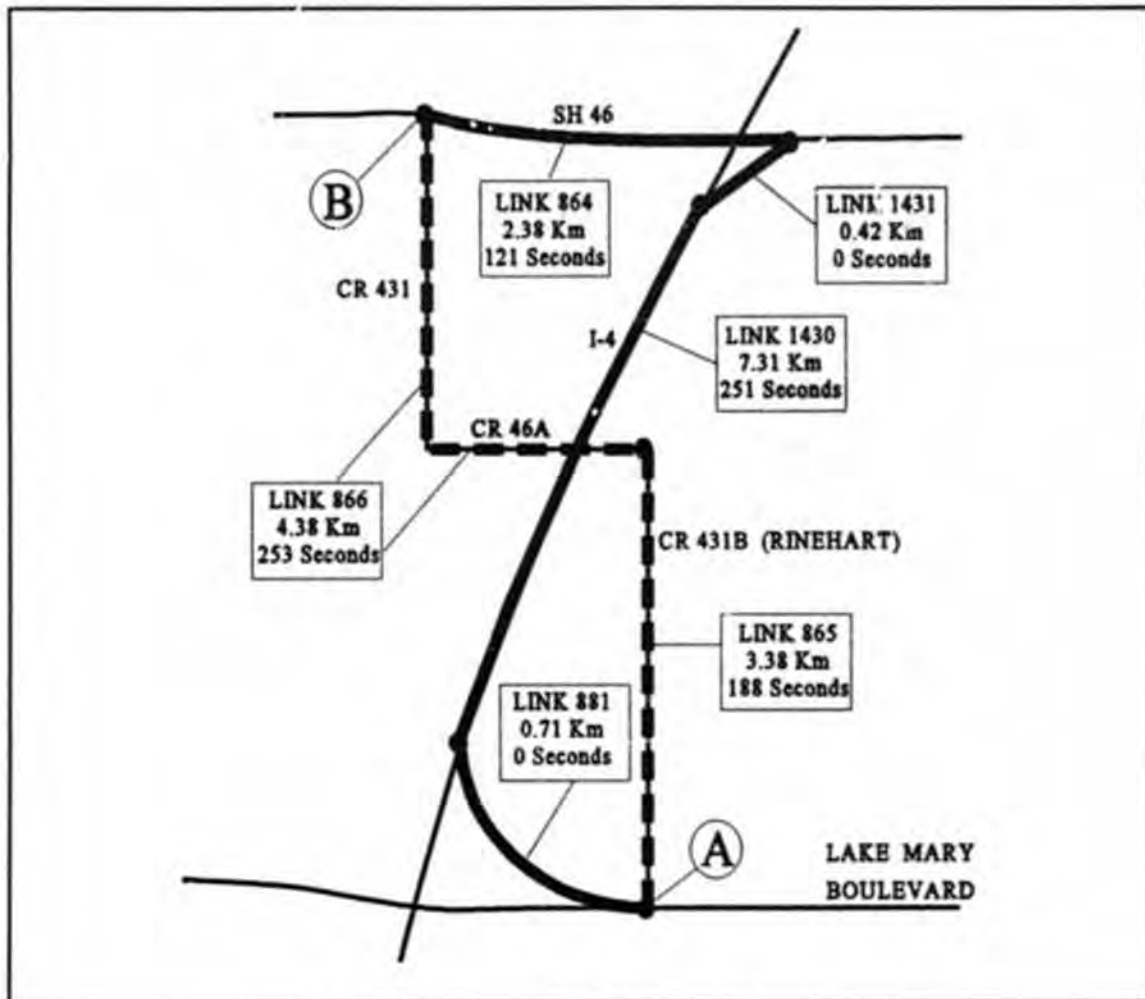


Figure 77. Illustration of route preference.

There were approximately 45,000 probe reports per month, or about 1,500 link travel times reported daily. This generally amounted to 53,000 probe vehicle km per month, or 1,800 probe vehicle km per day.

During the operational test, probe vehicle mileage essentially remained constant over the toll facilities. However, arterial mileage decreased 10 percent, and interstate and toll mileage increased 10 percent during the operational test. Since only 10 months of the data were available for this analysis, it is unknown if this phenomenon has a seasonal correlation.

The network was a good representation of the actual roadways and their travel times. For a limited fleet of only 100 vehicles, there was a good balance of coverage over the network by the probe vehicles.

The plot of the TravTek Traffic Link Network in figure 67 reveals one or more nodes that have coordinates in error. Probe reports will have substantial errors for any links connected to nodes with incorrect coordinates. Since the coordinates represent thresholds of achievement to signal completion of the link travel, miscoded coordinates can suppress probe reports. This problem was discovered late in the analysis, and could not be verified in detail. Some unexpected instances of skipped links in probe reports for a specific trip may be attributed to node coordinate error.

## DEGREE OF AUTOMATION

### Discussion

Table 20 depicts the major automated and non-automated functions of TravTek. The TravTek system was highly automated, except for the handling of incident information.

**Table 20. Major automated and non-automated functions of TravTek.**

Automated	Non-Automated
Routing, Turn by Turn	Weather Reports
Probe Reports	Events
Map Matching	Incident Detection
Dead Reckoning	Incident Verification
Data Logging	Incident Duration
Vehicle Navigation	Incident Logging
Dynamic Link Times	Parking Lot Status
Route Calculation	

The TravTek system operator was on duty at the TMC to monitor system operation and interact with the system as needed to enter, monitor and clear incident information. An operator was present 24 hours a day, and 7 days a week. Even with this full time vigilance, it was found that the entry of incident information was not always timely. One system operator was adequate for handling all the system operating requirements at the TMC.

Another full-time, online service was the help desk at the TISC. Two full time operators provided telephone call-in assistance 16 hours a day. For the remainder of the time, calls were routed to the AAA service operators. The TISC operators also provided daily updates to the TMC data base for broadcasting weather, event, and parking lot status information to the vehicles. Because of the nature of the TravTek Operational Test, the sophistication of the system, and the need to provide a high level of service to drivers unfamiliar with the TravTek system, the TravTek help desk was essential. As in-vehicle systems become commonplace, a help desk

function will not be necessary. The monitoring, acquisition, verification, clearing and distribution of dynamic local information will still be handled by an operator or operators. Depending on the extent of privatization, this function could be handled at the TMC.

The Traffic Information Network comprised the entire traffic information sources and targets of this information. By definition, anything or anybody capable of providing traffic information was a part of the TIN. This in essence included the probe vehicles. All police and fire departments and major delivery services were intended to have a TIN communication link to the TMC, either by voice telephone or digital data by modem. This effort was unsuccessful, for several reasons detailed elsewhere in this report. Regardless, the majority of the TIN interaction is envisioned to be due to incident activities, and this presupposes the presence of a person either in the field or a person at a fixed location receiving information from a person in the field. These sentries will be the major part of the non-automated feature of an ATIS system, representing the intelligent eyes of the system. It is assumed there will be a sufficient number of probe vehicles on the network to report routine congestion information.

The TIN users, in turn, are beneficiaries of traffic information. Police and fire units, as well as commercial vehicle operators, need timely, detailed traffic information. The participation of a broad base of traffic information providers and users is in effect a degree of automation, because the large numbers involved represent a dependable degree of redundancy.

Metro Traffic Control, a commercial traffic service, was the most consistent provider and user of TravTek traffic information. Their link with TravTek provided an additional information source, and in turn provided timely and valuable incident information. Since their information was verified by either aerial or ground units prior to being broadcast, they were considered a confirmed source of incident information. In other words, information from this source was immediately input to the TravTek system without the need to wait for confirming data.

Two other important and fundamental data sources were the Florida DOT Freeway Management Center and the City of Orlando Traffic Signal Control Center. The latter is referred to as the UTCS system in other parts of this report.

The freeway Management Center was staffed around the clock, since it was located at the Florida Highway Patrol (FHP) Dispatch Office. Eighteen video monitors were installed at this center as part of the I-4 video surveillance system. There was not an assigned operator at this center to view the monitors, but the FHP dispatchers did scan the monitors for incidents during peak periods. Live video was transmitted to the TMC for viewing on a single monitor, which by default displayed a series of four images on the screen. Alternately, the TMC operator could select a single camera and control it. There were some automated data that was fed to the TMC from the FMC every 30 seconds. This consisted of speed and volume data from loop detector stations along I-4. These data were a valuable source of data in regard to I-4 traffic conditions.

The Traffic Signal Control Center was the host facility for the TravTek TMC. Information from the UTCS computer was supplied to the TravTek computers each minute. This was an automated process, and the UTCS computer provided delay times for the links affected by the

UTCS. The Traffic Signal Control Center was routinely staffed 5 days a week, 10 hours a day, and at other times for special events or emergencies.

Thus, automated data were received from the vehicles, the FMC and the UTCS system. Other data received by the system required the TMC operator to collect and/or forward these data.

For TravTek, it would have been beneficial to have a full-time operator at the FMC to raise the incident awareness of that facility. Similarly, having the full set of video monitors at the TMC would have been beneficial. But, this is the real-world and various pieces of the system are operated by separate jurisdictions, and budgets do not always permit flexibility in staffing. The TravTek effort should have included funding for a FMC operator or operators.

Although the TravTek system was not completely automated, the level of automation during the operational test was the highest that could reasonably be achieved. Given the current state-of-the-art in surveillance and control technology. Current surveillance technology (loop detectors and CCTV cameras) do not permit accurate measurements of traffic conditions on freeways and arterials. Existing automatic incident detection algorithms cannot reliably detect when and where incidents occur, even with a reasonable investment in vehicle detectors along the roadway. Because of these limitations, human operators have to be present in traffic management and control centers to verify field measurements and implement appropriate control strategies. Until these limitations can be corrected, the human operator will continue to be an integral part of a traffic control center for the foreseeable future.

A single system operator can provide a good measure of control for thousands of probe vehicles. The control center staff must be made aware that they have a key role in system operations. The collection of onsite incident data for traffic management requires the cooperation of emergency services. In turn, these data suppliers must perceive a benefit to participate in this effort.

**BLANK PAGE**

## SYSTEM RELIABILITY

### SUBSYSTEM RELIABILITY

The following subsystems comprise the non-vehicle reliability assessment presented in this section:

- The UTCS Traffic Signal Control Computer (UTCS).
- The TravTek Information and Services Center (TISC).
- The Traffic Information Network (TIN).
- The Freeway Management Center (FMC).
- Radio transmission to vehicles (Radio).

This section describes the reliability of these systems with respect to frequency of failures, duration of failures, time of day of failures, and percent downtime. For the purposes of this analysis, a failure is defined as the inability of a subsystem to perform its function. This lack of performance was generally caused when a computer or one of the software tasks running on the computer failed to operate for some period of time. The following section discusses the sources of the reliability data.

#### Data Sources

##### *Manual and Computer Generated Logs*

Reliability data were gathered through manual event logging by operational staff and through computer event logging. In addition, anecdotal data were collected through interviews with key individuals involved in the project. Table 21 summarizes the sources of data.

When assembling the data for analysis it was apparent there were substantially fewer manual entries than computer generated entries in the logs. For example, there were 168 manual entries for the UTCS system and over 500 computer generated entries during the same time period. This variation was caused by the different logging methodologies employed by the operators and the computer software.

The operators generally logged only major, extended time failures that required them to "re-start" the computer system. Further, the UTCS system was not staffed 24 hours per day.

**Table 21. Sources of reliability data.**

<b>Subsystem</b>	<b>Manual Logs</b>	<b>Computer Logs</b>
UTCS	Yes	Yes
Radio	No	Yes
TISC	No	Yes
FMC	Yes	Yes
TIN	Yes	Yes

The computer software, on the other hand, logged continuously and recorded failures of individual computer tasks that had durations of only a few minutes. The primary computer tasks relevant to monitoring and recording reliability are as follows:

- UTCS - Inputs City of Orlando traffic signal and traffic volume data.
- FMC - Inputs State of Florida freeway volume data.
- TISC - AAA's TravTek Information and Services Center (TISC).
- RADIO - Communicates to and from vehicles.
- LOADTIN - Communicates to Terminal-Access Traffic Information Network (TTIN) and Graphics Traffic Information Network (GTIN) users.

The software was structured to attempt re-starting these failed computer tasks on a periodic basis. After a maximum number of failures, the task would no longer be tested for startup capability. It would be "failed" until either operator action or until the midnight restart attempt of all subsystems. Table 22 identifies the time intervals between startup attempts of subsystem tasks.

The computer generated logs were compiled and written to tape on 250 MB cartridges. These tapes were consolidations of various logs generated by the TravTek computers. These data were aggregated on a monthly basis and made available for analysis.

**Table 22. Time between computer task startup attempts.**

<b>Computer Task</b>	<b>Minutes Between "Startup" Attempts</b>
UTCS	5
FMC	30
TISC	10
RADIO	10
LOADTIN	5

### **Log Analysis**

Relevant data were extracted from each tape to produce a failure profile for each subsystem and for the system as a whole. This effort required:

- Loading the data onto a hard disk drive.
- Decompressing (unzipping) the data stored on tape.
- Decoding the data.
- Building a sequential failure history log (the files were generally one day's data for each subsystem as provided on the tapes).
- Resolving any discrepancies between data extracted from various files.
- Comparing the computer generated failure data to the manually collected logs.
- Resolving any discrepancies between computer generated failure data and manually logged data.
- Writing SAS code to statistically analyze the sequential failure history log.
- Running the SAS programs and producing tabular output.
- Inputting the tabular output into Microsoft Excel programs for the purpose of generating presentation quality material.



### *On-Site Interviews of Key TravTek Participants*

From March 8, 1993 to March 12, 1993, on-site interviews of key TravTek participants in the Orlando area were conducted. Those interviewed are listed in table 23.

**Table 23. TravTek participants interviewed during March 1993.**

<b>Name</b>	<b>Organization</b>
Deborah Dennard	AAA
Don Gordon	AAA
Kent Taylor	AAA
Ian Edwards	Avis
Joe Bannister	City of Orlando
Jake Blazsek	City of Orlando
Harry Campbell	City of Orlando
Elford Jackson	City of Orlando
Chris Kibler	City of Orlando
Noel Oakes	City of Orlando
Larry Rivera	Farradyne Systems
John Vasquez	General Motors
Scott Friedman	PBS&J
Crystal Johnson	SAIC
Robert Sanchez	SAIC
J.L. Schroeder	SEI Information Technology
Jon Cheney	State of Florida DOT
George Gilhooley	State of Florida DOT
Gene Lee	University of Central Florida
A. Essam Radwan	University of Central Florida
Stacey Bricka	University of South Florida
Edward Mierzejewski	University of South Florida

The primary objective of the interviews was to assess these participants' opinions of the reliability of the TravTek project and to uncover any reliability issues not readily apparent through analysis of the data. A general, open-ended set of questions was used as an outline for the interviews. The questions were:

- What is (was) your role in the project?
- How satisfied are you with the system or its components?
- What works?
- What doesn't work?
- What would you change?
- Any interesting stories related to TravTek?

## Results

For the purposes of analysis the reliability data were aggregated into two time periods:

- June 1, 1992 through December 31, 1992.
- January 1, 1993 through March 31, 1993.

This action was taken to account for the different levels of stability that existed with the system during the evaluation period. Between June, 1992 through December, 1992, several modifications to both the TMC and vehicle software systems occurred. After December 1992, the system stabilized. Significant differences in reliability may have existed between these periods.

In addition, an aggregate analysis was performed across the entire project's operational phase for which log data were available, June, 1992 through March, 1993. Log data were not available prior to June, 1992.

*Results: June 1 Through December 31, 1992*

### Number of Failures

Table 24 identifies the number of failures by subsystem by month. Again, a failure is defined as the inability of a subsystem to perform its function. Figure 78 illustrates the cumulative number of failures during the 7 month period beginning in June 1992.

**Table 24. Number of failures by subsystem by month, 6/92 - 12/92.**

Month	Subsystem					Totals
	UTCS	FMC	TISC	TIN	Radio	
June	57	6	2	1	0	66
July	76	4	18	1	8	107
August	24	6	9	0	28	67
September	21	5	9	13	21	69
October	30	4	0	3	7	44
November	55	1	2	9	3	70
December	69	2	7	1	0	79
<b>TOTALS</b>	<b>332</b>	<b>28</b>	<b>47</b>	<b>28</b>	<b>67</b>	<b>502</b>

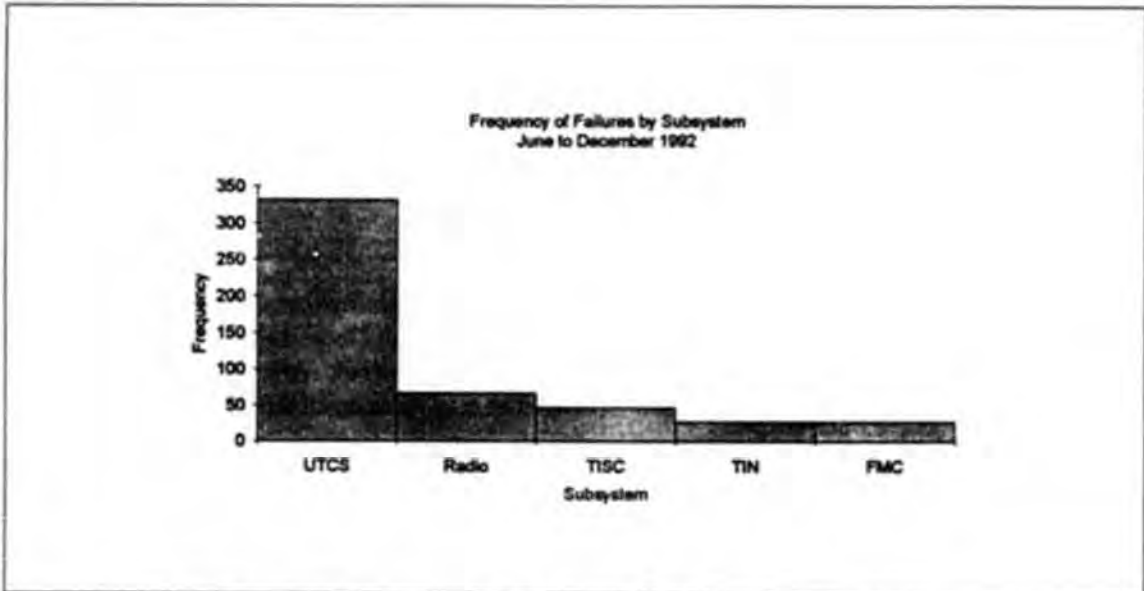


Figure 78. Frequency of failures by subsystem, 6/92 - 12/92.

#### Duration of Failures

Durations of failures are described in this section. Table 25 identifies the average, minimum and maximum down times associated with subsystems from June 1992 through December 1992. Figure 79 illustrates the data defined in table 25.

Table 25. Duration of failures by month, 6/92 -12/92.

Month	Down Time Data in Minutes			
	Mean	Min	Max	Total
June	11.89	5	30.0	785
July	12.32	5	93.0	1,318
August	17.55	10	73.5	1,176
September	17.55	5	94.5	1,211
October	11.67	5	30.0	513
November	9.86	5	30.0	690
December	11.06	5	49.0	874

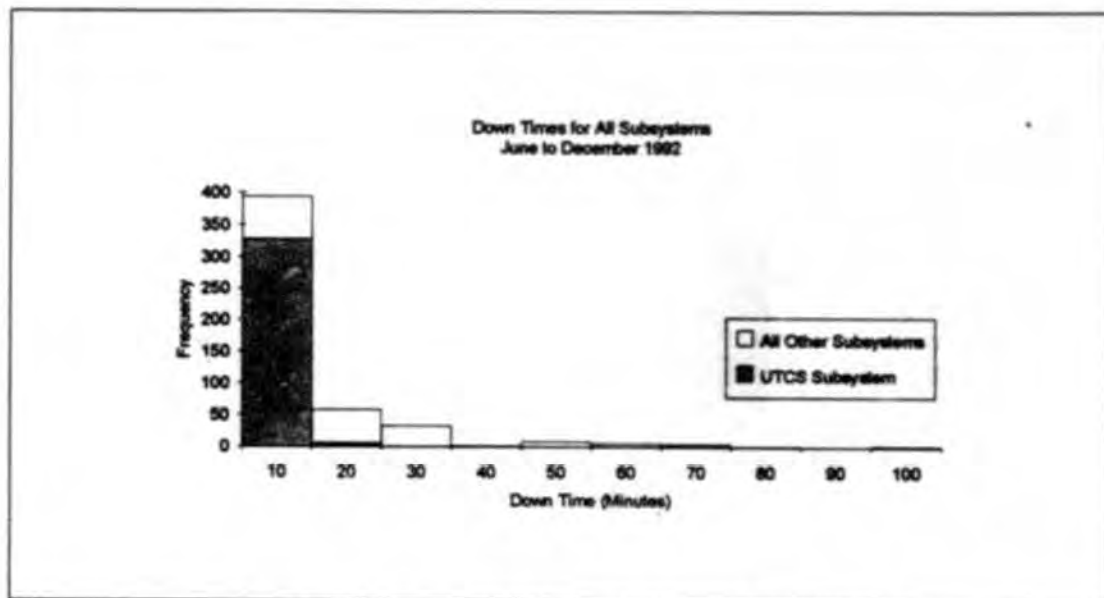


Figure 79. Down times for all subsystems, 6/92 - 12/92.

Figures 80 through 84 pictorially illustrate the down times for each of the subsystems: UTCS, FMC, TIN, TISC, Radio.

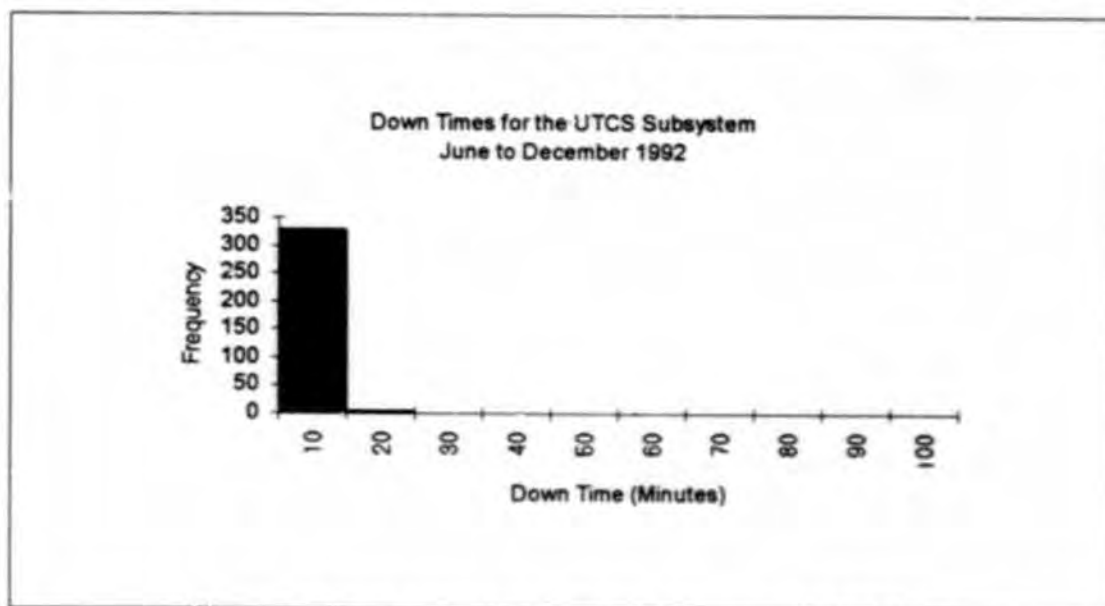
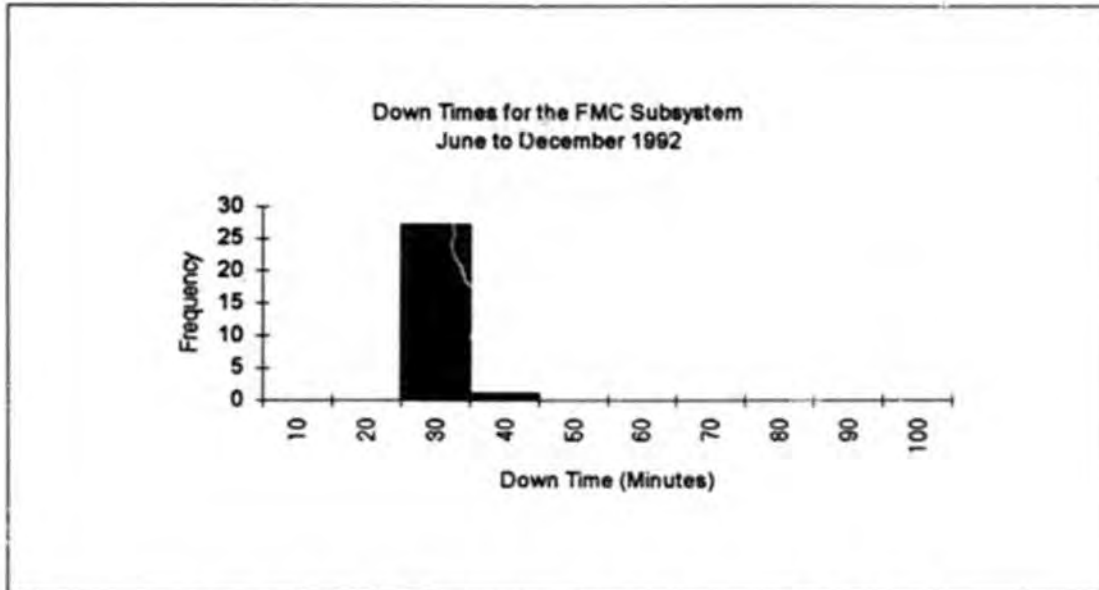
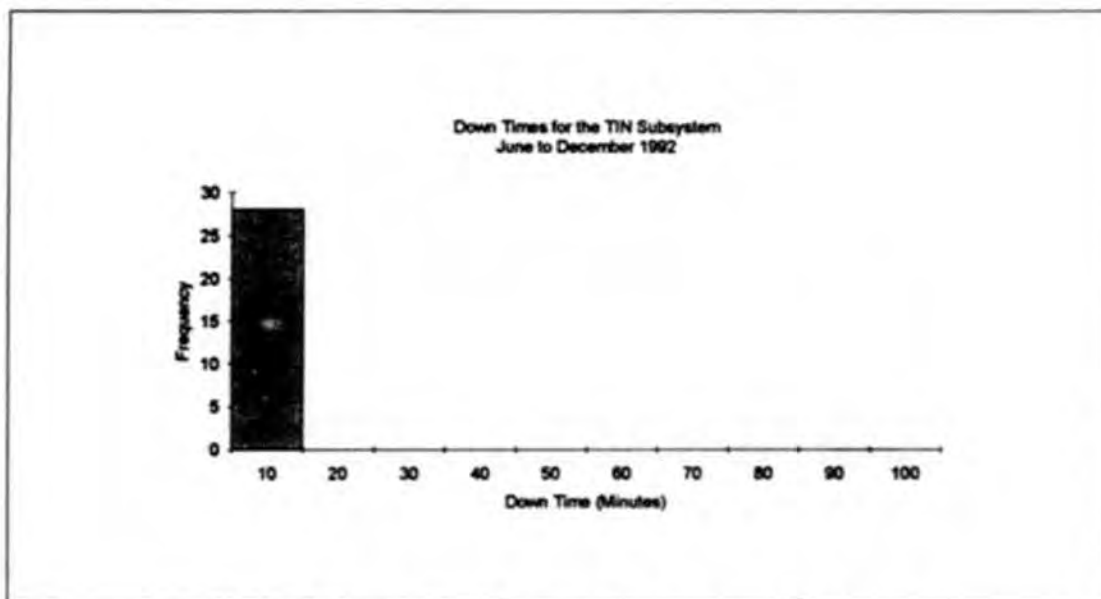


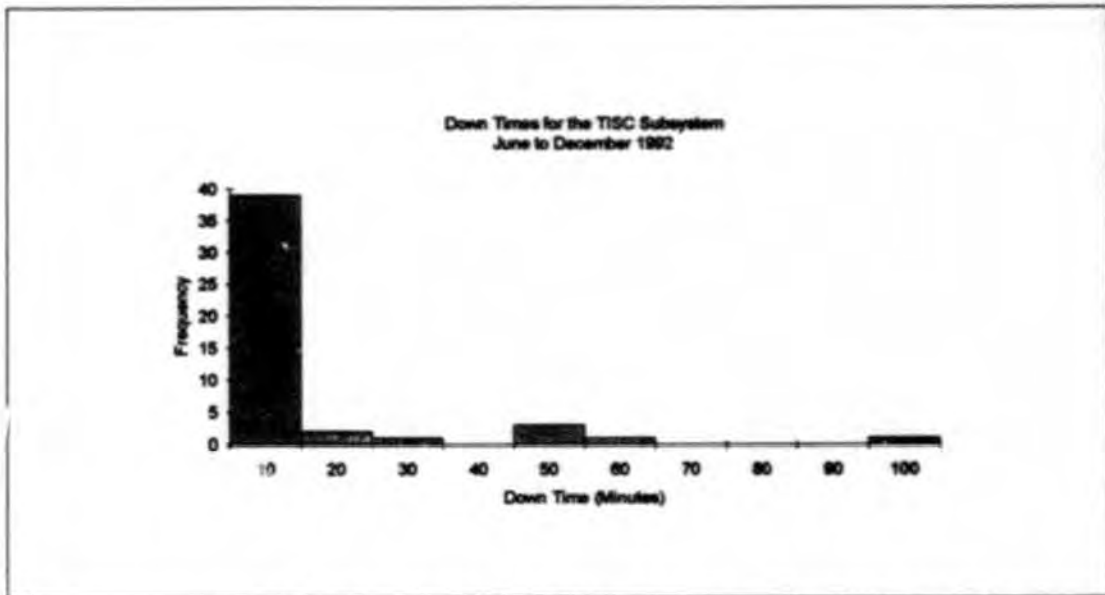
Figure 80. Down times for the UTCS subsystem, 6/92 - 12/92.



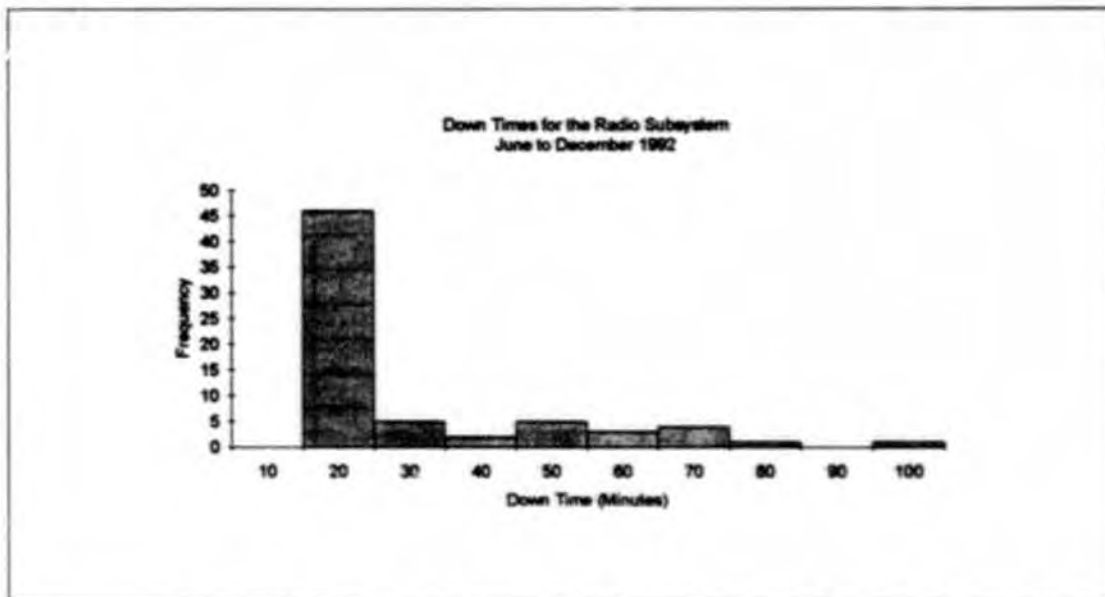
**Figure 81. Down times for the FMC subsystem, 6/92 - 12/92.**



**Figure 82. Down times for the TIN subsystem, 6/92 - 12/92.**



**Figure 83. Down times for TISC subsystem, 6/92 - 12/92.**



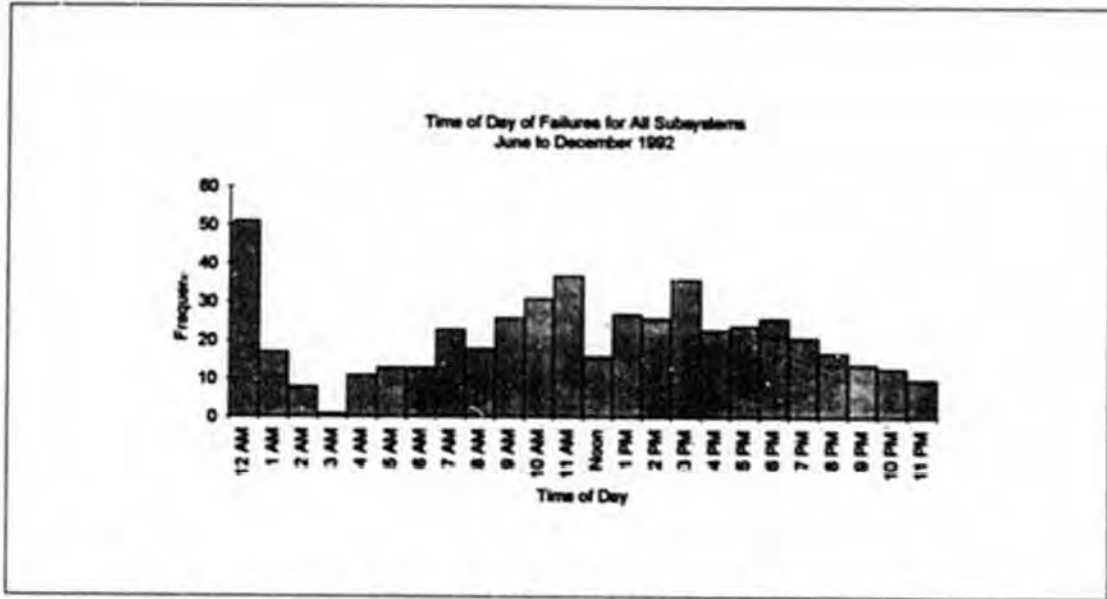
**Figure 84. Down times for the Radio subsystem, 6/92 - 12/92.**

## Time of Day of Failures

Table 26 and figure 85 illustrate the time of day of failures for the period of June 1992 through December 1992. The larger number of failures occurring between 12:00 midnight and 1:00 am might be attributed to the unique end-of-day tasks run in the computer at that time.

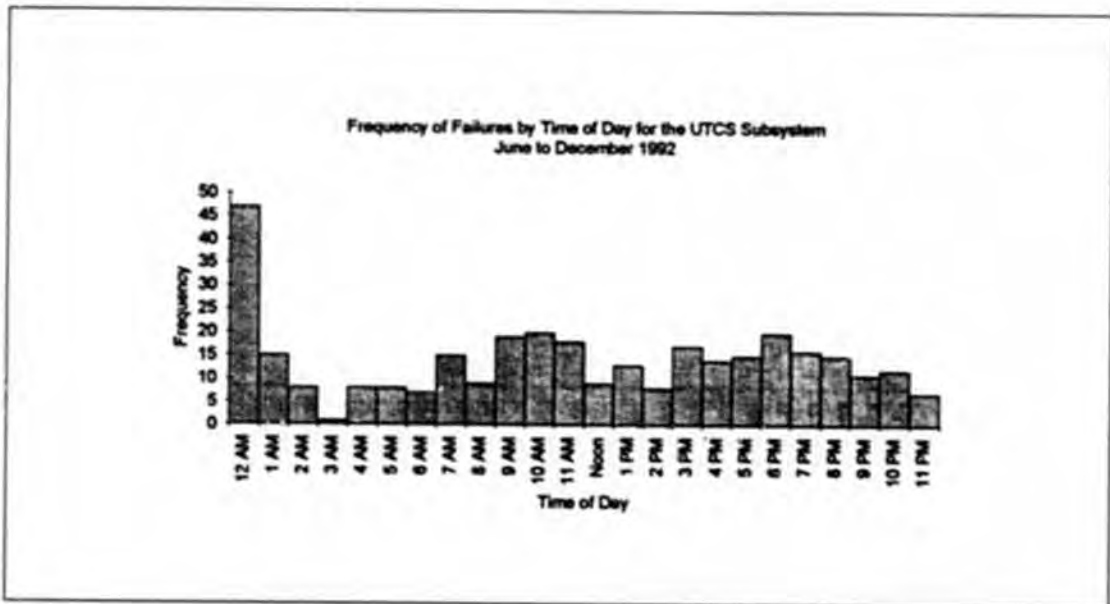
**Table 26. Number of failures by subsystem by time of day, 6/92 - 12/92**

Hour	Subsystem					Total
	UTCS	FMC	TISC	TIN	Radio	
12 AM	47	0	0	0	4	51
1 AM	15	0	0	1	1	17
2 AM	8	0	0	0	0	8
3 AM	1	0	0	0	0	1
4 AM	8	0	0	0	3	11
5 AM	8	1	2	0	2	13
6 AM	7	1	2	0	3	13
7 AM	15	2	2	0	4	23
8 AM	9	1	5	0	3	18
9 AM	19	2	3	0	2	26
10 AM	20	3	1	4	3	31
11 AM	18	2	3	4	10	37
Noon	9	1	2	2	2	16
1 PM	13	2	6	5	1	27
2 PM	8	3	5	4	6	26
3 PM	17	3	7	3	6	36
4 PM	14	2	2	4	1	23
5 PM	15	1	3	1	4	24
6 PM	20	2	0	0	4	26
7 PM	16	0	0	0	5	21
8 PM	15	0	2	0	0	17
9 PM	11	1	0	0	2	14
10 PM	12	0	0	0	1	13
11 PM	7	1	2	0	0	10
<b>TOTALS</b>	<b>332</b>	<b>28</b>	<b>47</b>	<b>28</b>	<b>67</b>	<b>502</b>



**Figure 85. Frequency of failures by time of day for all subsystems, 6/92 - 12/92.**

Figures 86 through 90 illustrate the frequency of failures by time of day by subsystem: UTCS, FMC, TIN, TISC and Radio.



**Figure 86. Frequency of failures by time of day for UTCS subsystem, 6/92 - 12/92.**



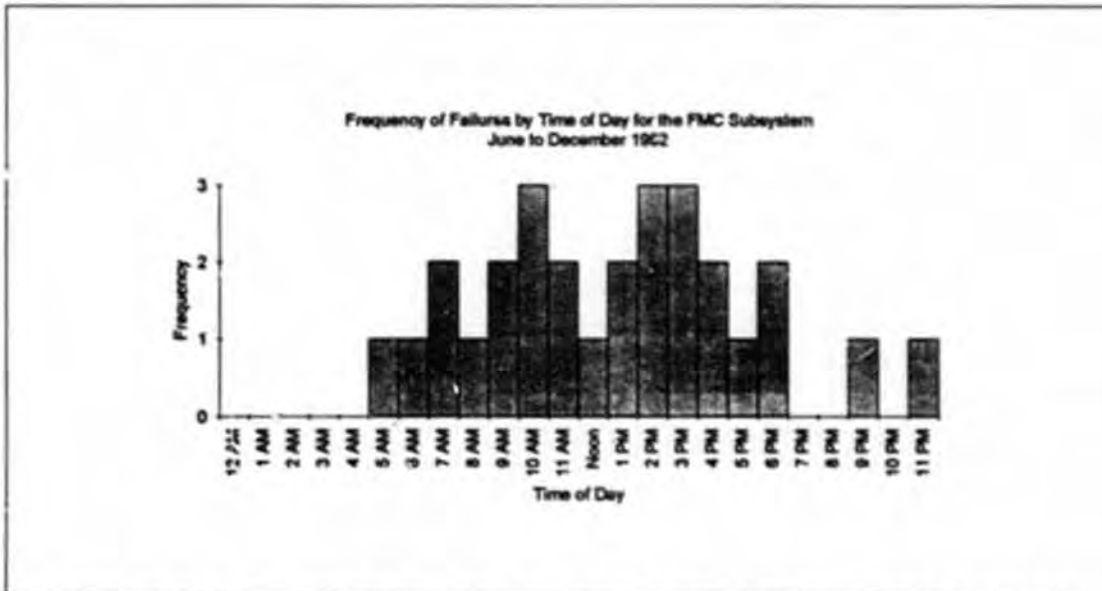


Figure 87. Frequency of failures by time of day for FMC subsystem, 6/92 -12/92.

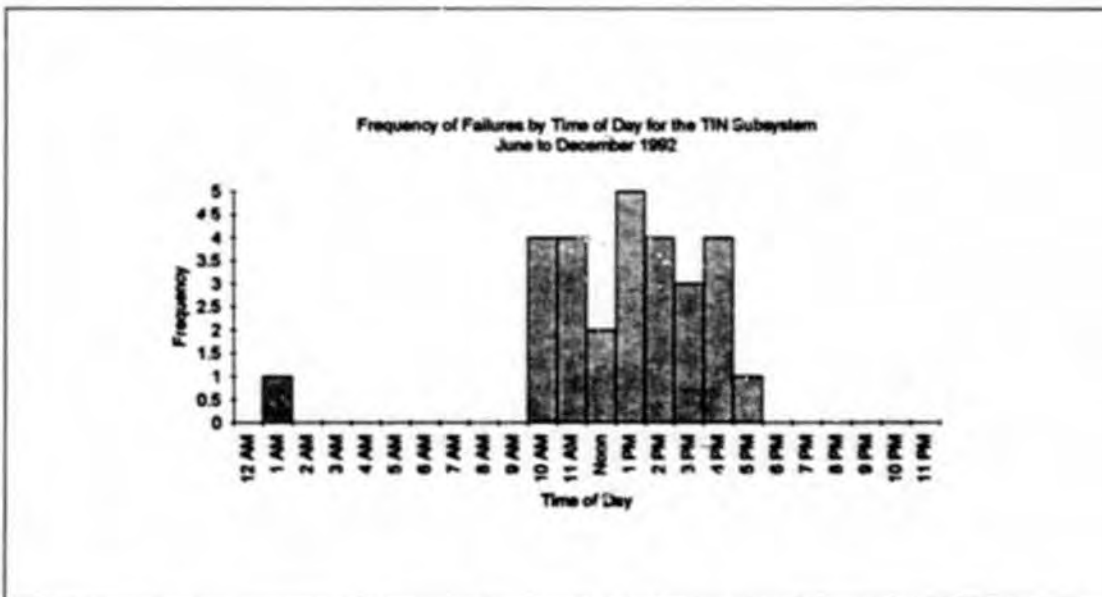


Figure 88. Frequency of failures by time of day for TIN subsystem, 6/92 - 12/92.

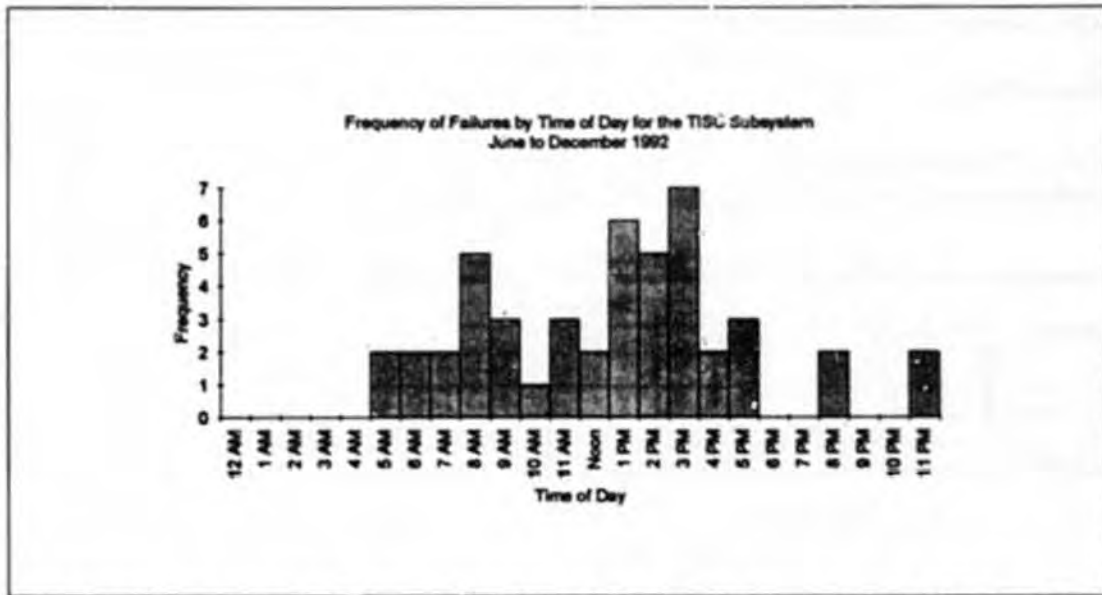


Figure 89. Frequency of failures by time of day for TISC subsystem, 6/92 - 12/92.

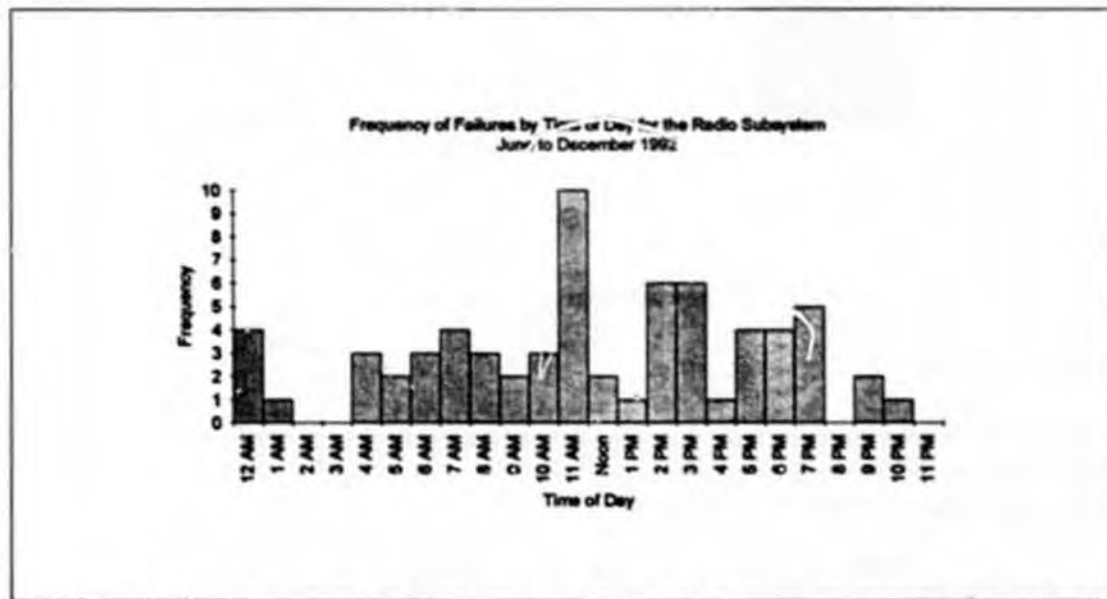


Figure 90. Frequency of failures by time of day for Radio subsystem, 6/92 - 12/92.

Results: January 1 Through March 31, 1993

Number of Failures

Table 27 identifies the number of failures by subsystem by month. Figure 91 illustrates the cumulative number of failures during the 3-month period beginning in January 1993.

Table 27. Number of failures by subsystem by month, 1/93 - 3/93.

Month	Subsystem					Totals
	UTCS	FMC	TISC	TIN	Radio	
January	80	1	6	5	0	92
February	90	1	9	1	10	111
March	0	6	3	0	7	16
<b>TOTALS</b>	170	8	18	6	17	219

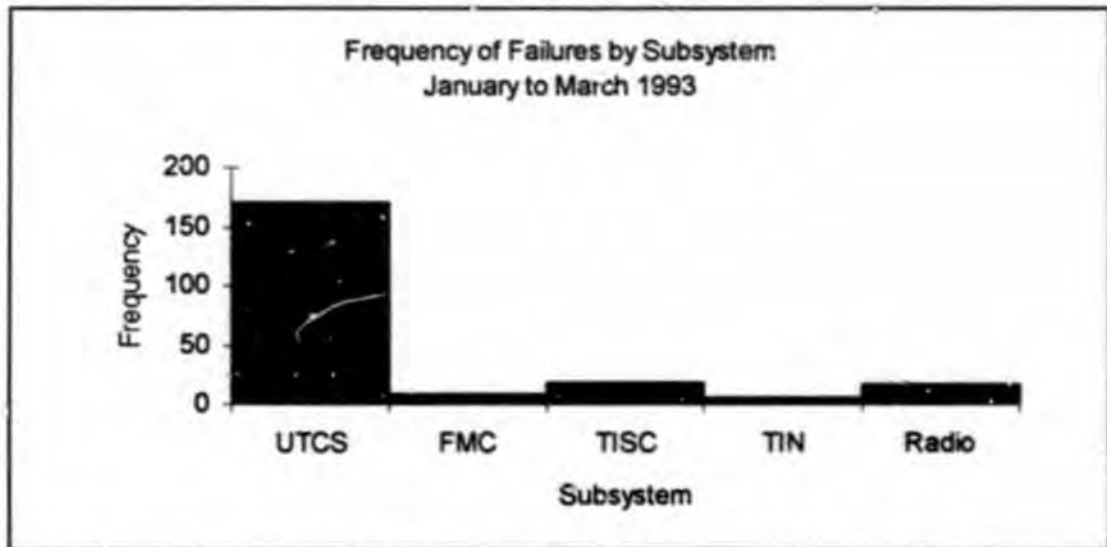


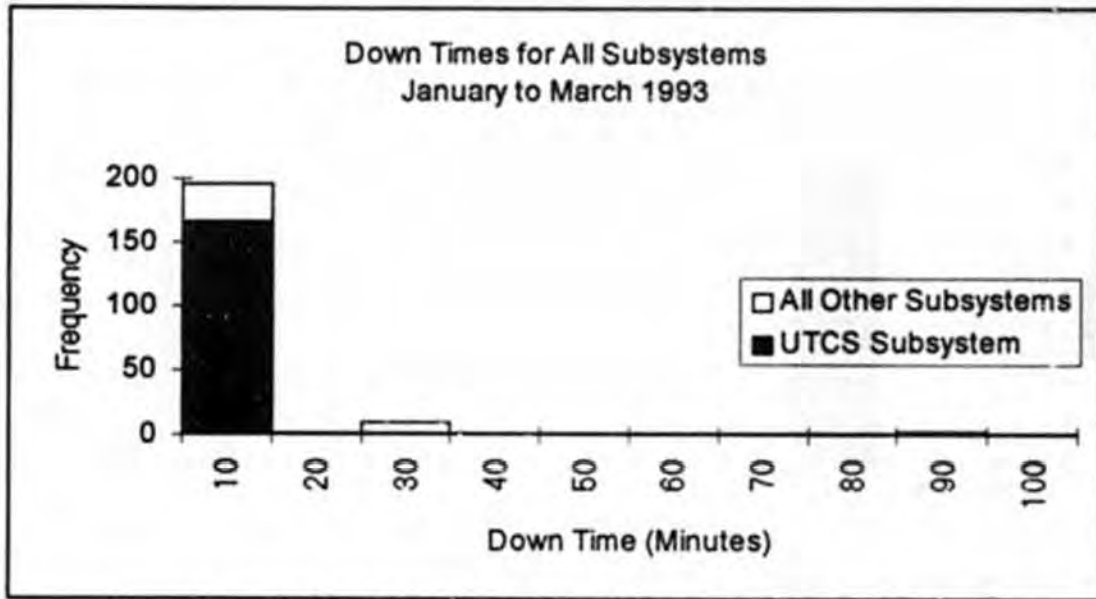
Figure 91. Frequency of failures by subsystem, 1/93 - 3/93.

Duration of Failures

Duration of failures are described in this section. Table 28 identifies the average, minimum and maximum down times associated with subsystems from January 1993 through March 1993. Figure 92 illustrates the data defined in table 28.

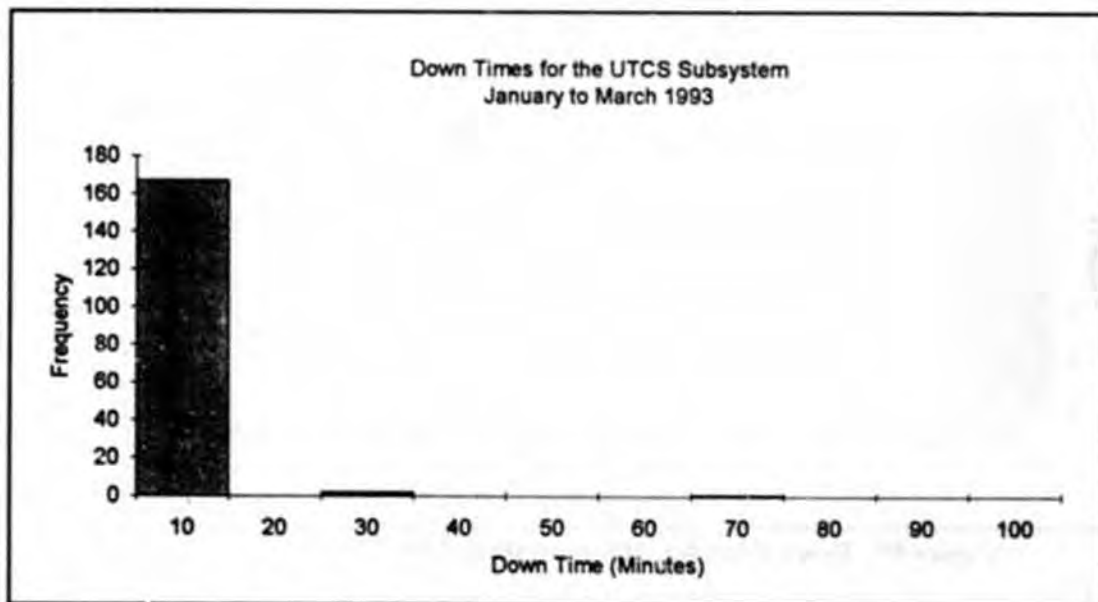
Table 28. Duration of failures by month, 1/93 - 3/93.

Month	Down Time in Minutes			
	Mean	Min	Max	Total
January	11.47	5	66.0	1,055
February	12.13	5	86.5	1,346
March	37.34	10	97.5	597



**Figure 92. Down times for all subsystems, 1/93 - 3/93.**

Figures 93 through 97 pictorially illustrate the down times for each of the subsystems: UTCS, FMC, TIN, TISC and Radio.



**Figure 93. Down times for UTCS subsystem, 1/93 - 3/93.**

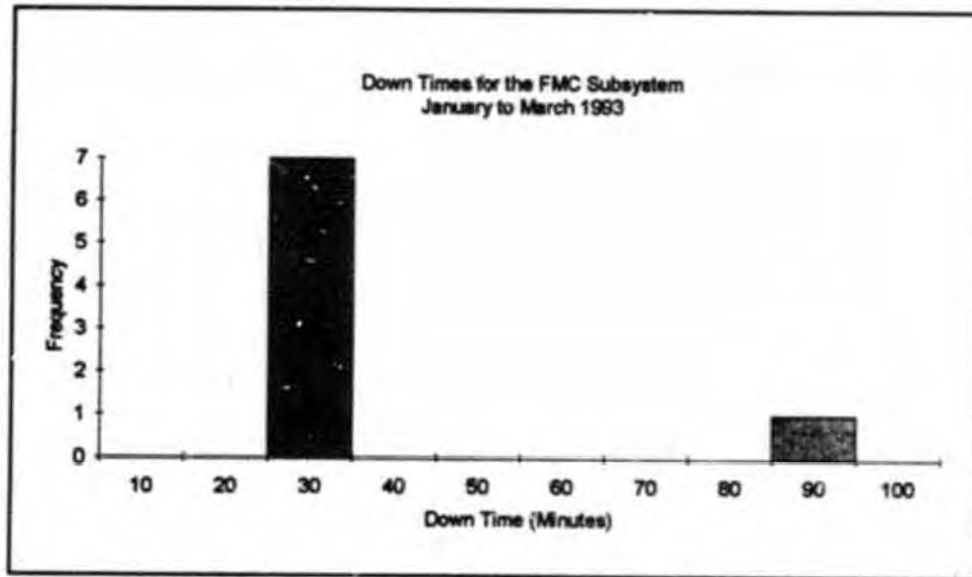


Figure 94. Down times for FMC subsystem, 1/93 - 3/93.

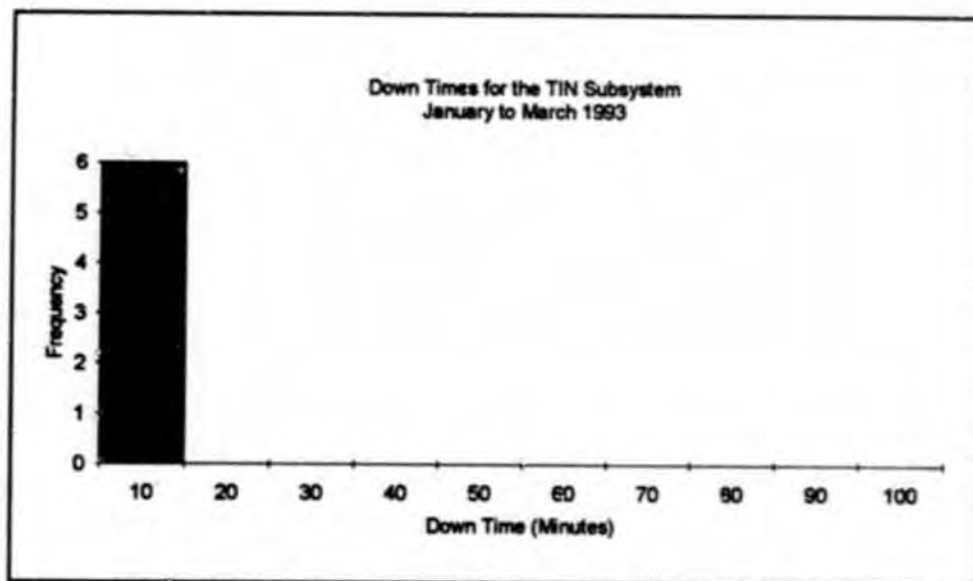
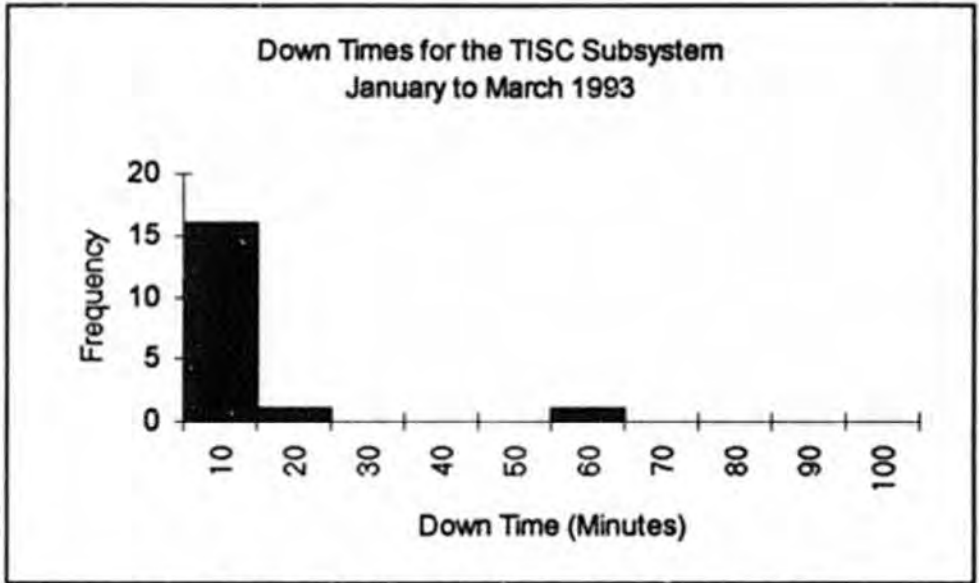
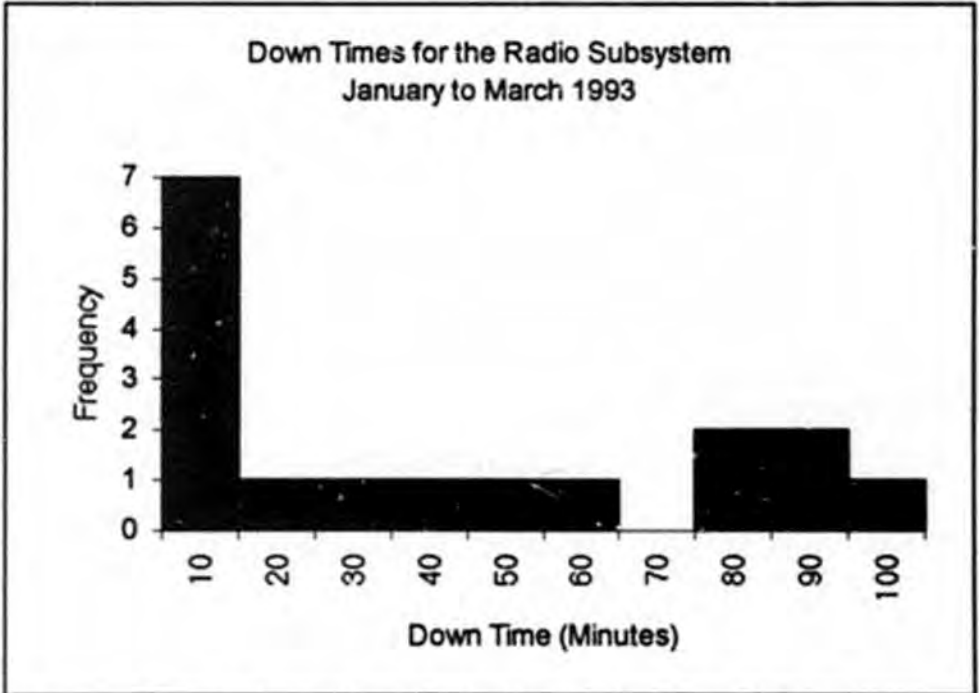


Figure 95. Down times for TIN subsystem, 1/93 - 3/93.



**Figure 96. Down times for TISC subsystem, 1/93 - 3/93.**



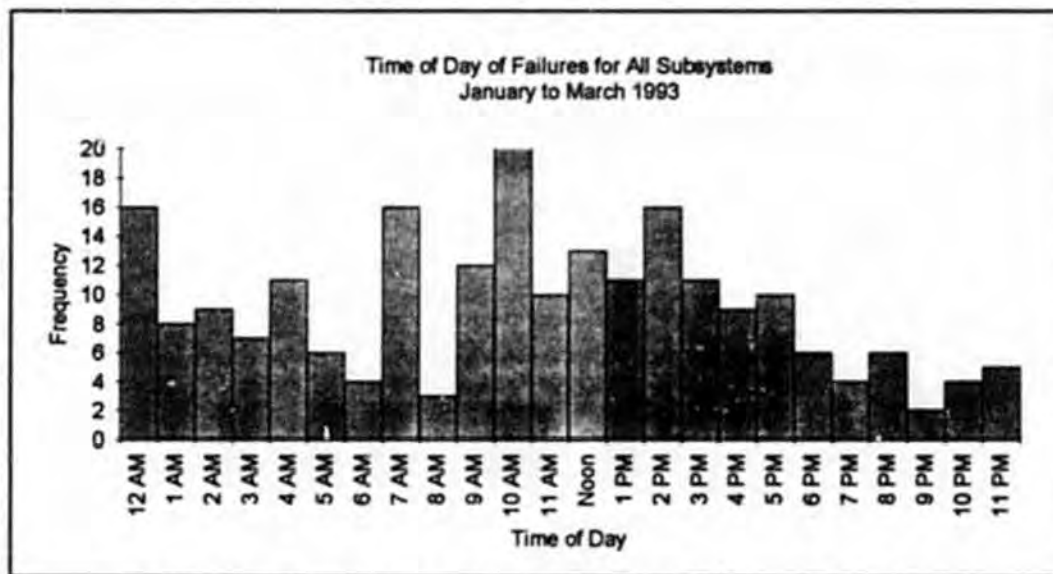
**Figure 97. Down times for the Radio subsystem, 1/93 - 3/93.**

### Time of Day of Failures

Table 29 and figure 98 illustrate the time of day of failures for the period January 1993 through March 1993. Please note a proportionately smaller number of failures between 12:00 midnight and 1:00 am than in the time period June 1992 through December 1992 (see figure 85). The proportion of these failures decreased 27 percent from the June 1992 through December 1992 period. This reduction is probably due to improvements in end-of-day task processing.

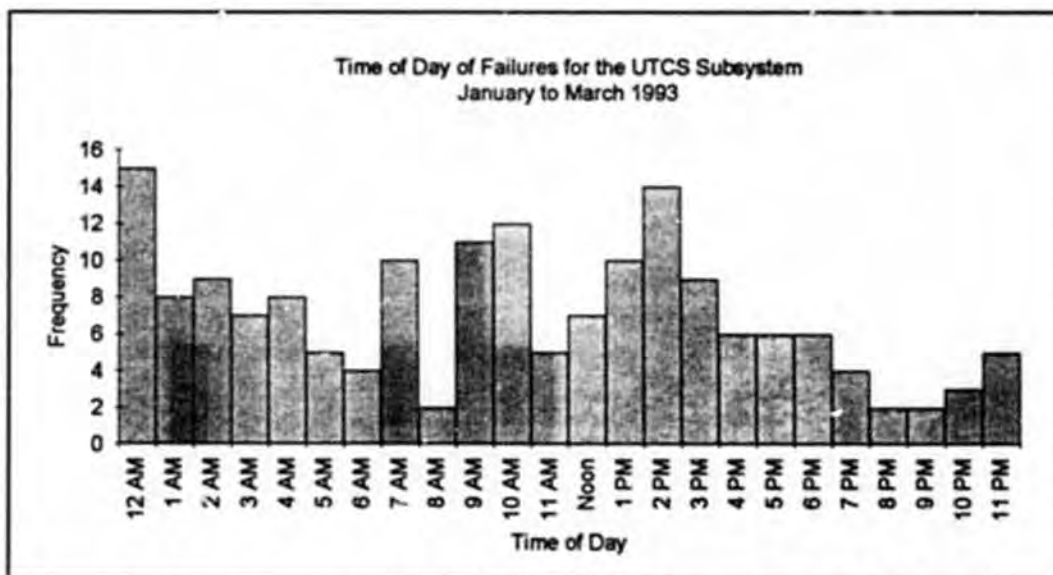
**Table 29. Number of failures by subsystem by time of day, 1/93 - 3/93.**

Hour	Subsystem					Total
	UTCS	FMC	TISC	TIN	Radio	
12 AM	15	0	0	0	1	16
1 AM	8	0	0	0	0	8
2 AM	9	0	0	0	0	9
3 AM	7	0	0	0	0	7
4 AM	8	0	1	0	2	11
5 AM	5	0	0	0	1	6
6 AM	4	0	0	0	0	4
7 AM	10	3	2	0	1	16
8 AM	2	0	1	0	0	3
9 AM	11	0	1	0	0	12
10 AM	12	1	5	1	1	20
11 AM	5	1	2	1	1	10
Noon	7	0	2	2	2	13
1 PM	10	0	0	0	1	11
2 PM	14	0	1	1	0	16
3 PM	9	1	0	0	1	11
4 PM	6	0	1	0	2	9
5 PM	6	1	0	0	3	10
6 PM	6	0	0	0	0	6
7 PM	4	0	0	0	0	4
8 PM	2	1	1	1	1	6
9 PM	2	0	0	0	0	2
10 PM	3	0	1	0	0	4
11 PM	5	0	0	0	0	5
<b>TOTALS</b>	<b>170</b>	<b>8</b>	<b>18</b>	<b>6</b>	<b>17</b>	<b>219</b>



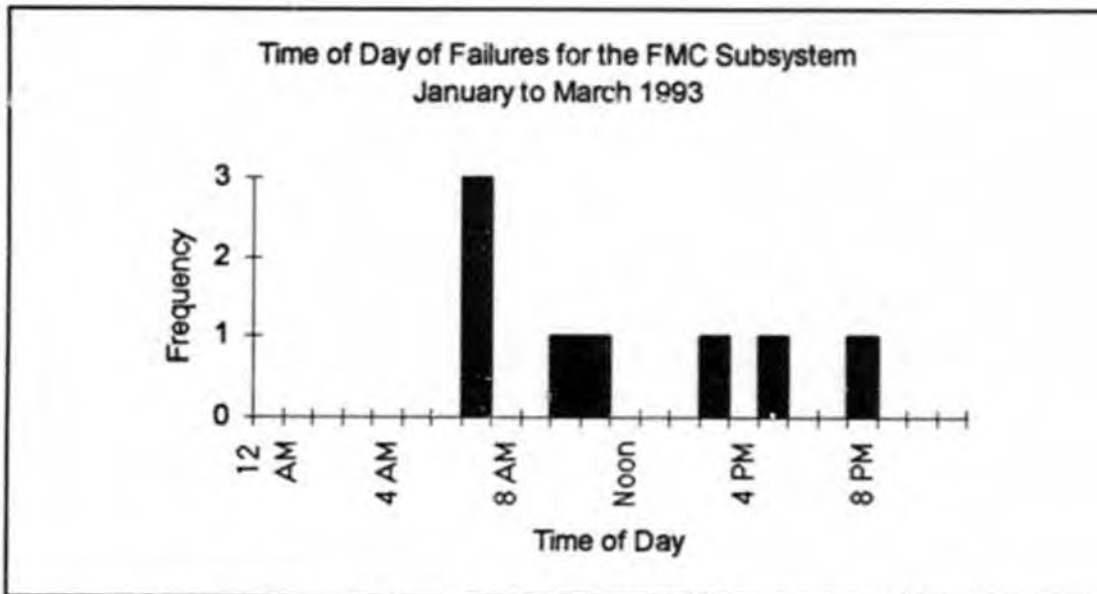
**Figure 98. Time of day of failures for all subsystems, 1/93 - 3/93.**

Figures 99 through 103 illustrate the time of day of failures for each subsystem: UTCS, FMC, TIN, TISC and Radio.

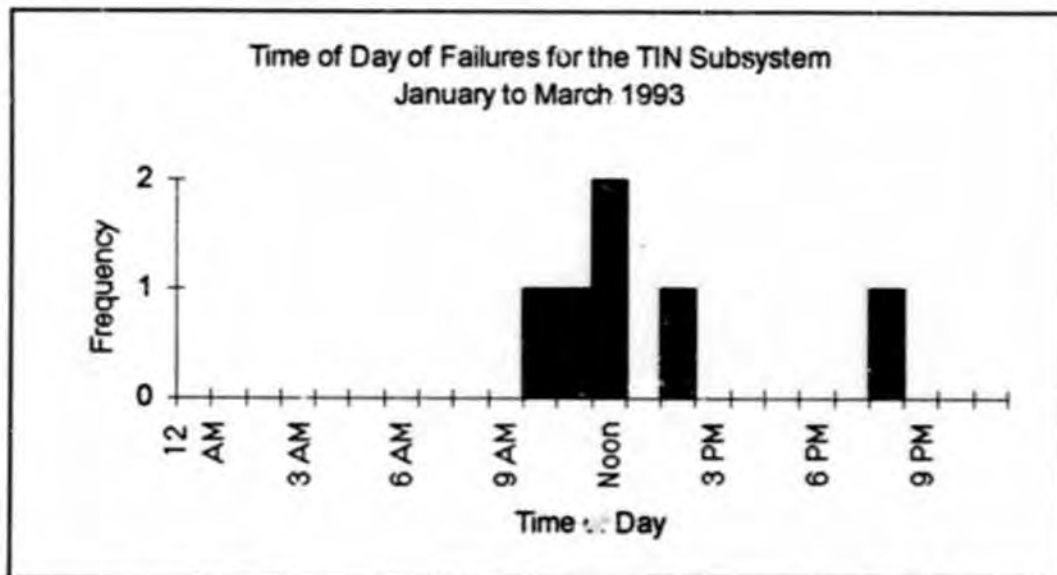


**Figure 99. Time of day of failures for UTCS subsystem, 1/93 - 3/93.**





**Figure 100. Time of day of failures for FMC subsystem, 1/93 - 3/93.**



**Figure 101. Time of day of failures for TIN subsystem, 1/93 - 3/93.**

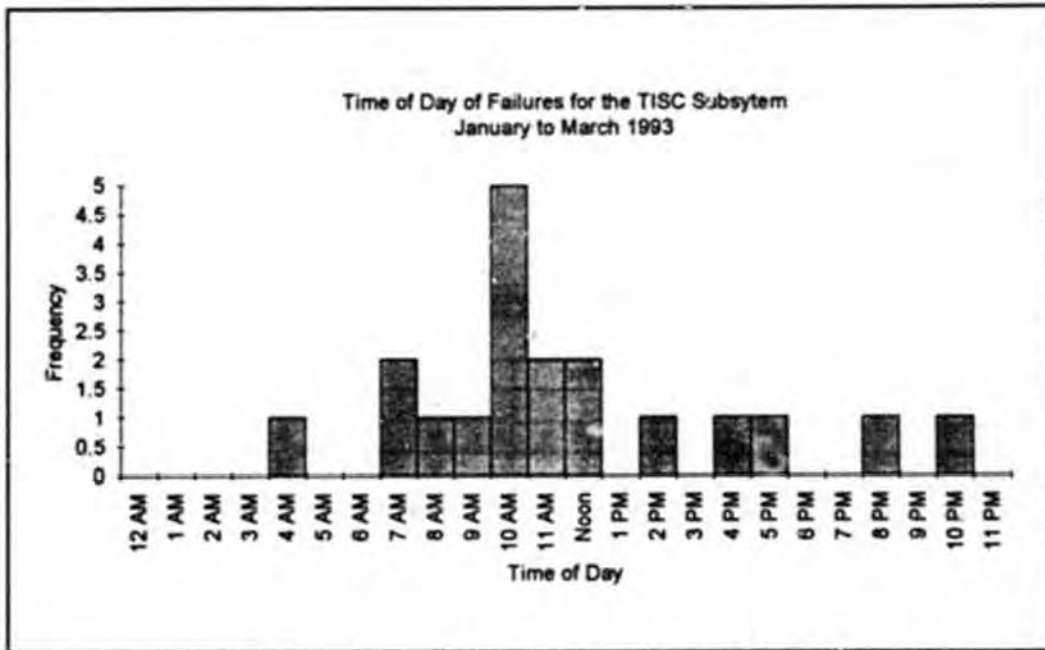


Figure 102. Time of day of failures for TISC subsystem, 1/93 - 3/93.

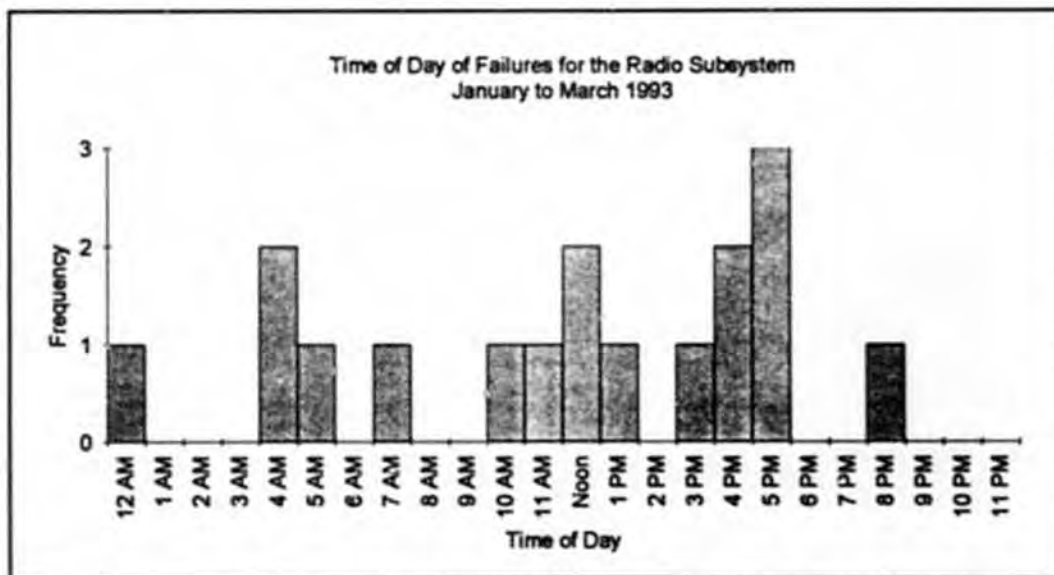


Figure 103. Time of day of failures for Radio subsystem, 1/93 - 3/93.

Results: June 1, 1992 Through March 31, 1993

Number of Failures

Table 30 identifies the number of failures by subsystem by month. Figure 104 illustrates the number of failures during the 10 month period.

Table 30. Number of failures by subsystem by month, 6/92 - 3/93.

Month	Subsystem					Totals
	UTCS	FMC	TISC	TIN	Radio	
June	57	6	2	1	0	66
July	76	4	18	1	8	107
August	24	6	9	0	28	67
September	21	5	9	13	21	69
October	30	4	0	3	7	44
November	55	1	2	9	3	70
December	69	2	7	1	0	79
January	80	1	6	5	0	92
February	90	1	9	1	10	111
March	0	6	3	0	7	16
<b>TOTALS</b>	<b>502</b>	<b>36</b>	<b>65</b>	<b>34</b>	<b>84</b>	<b>721</b>

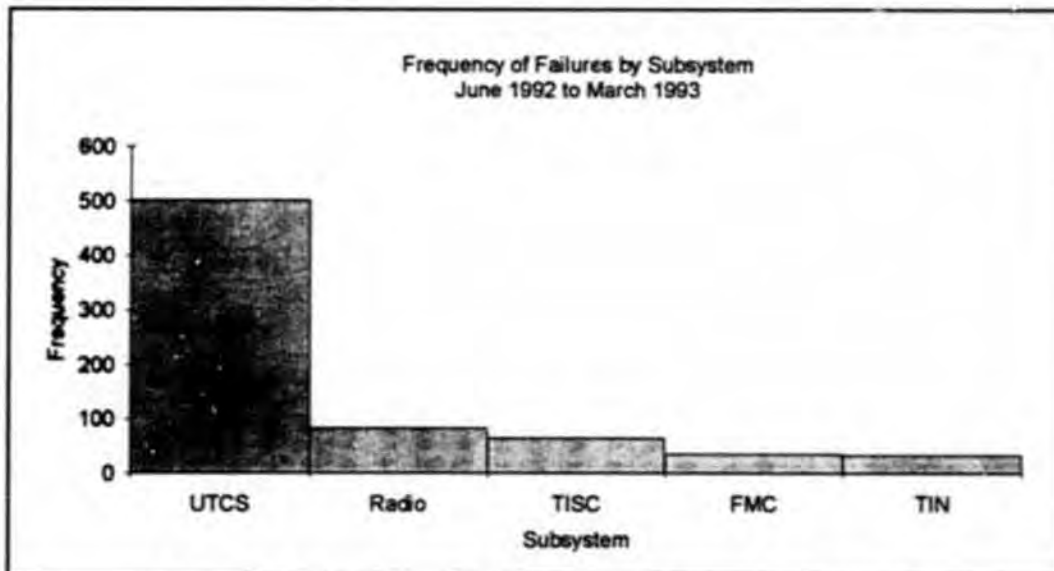
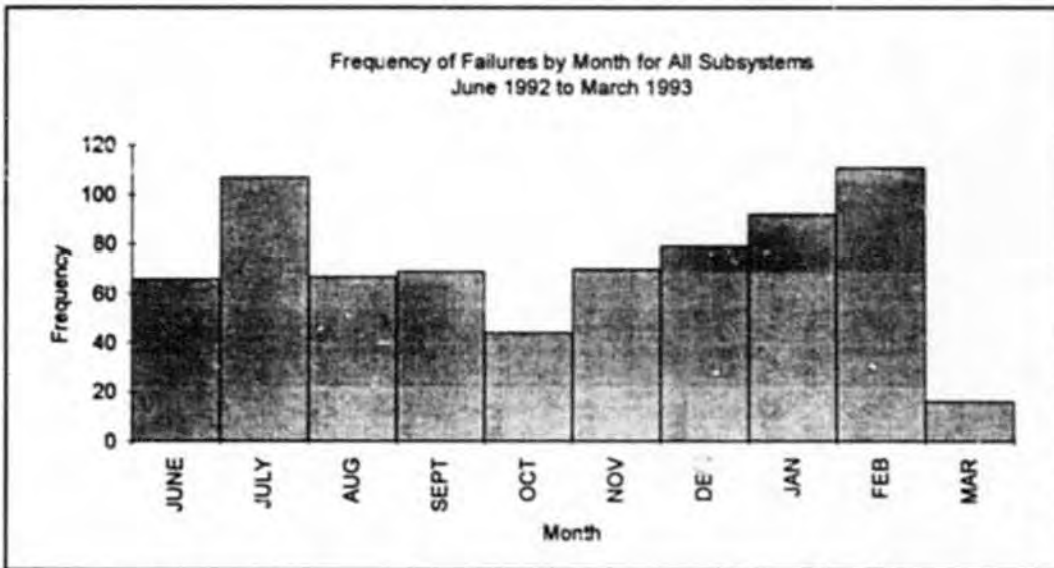
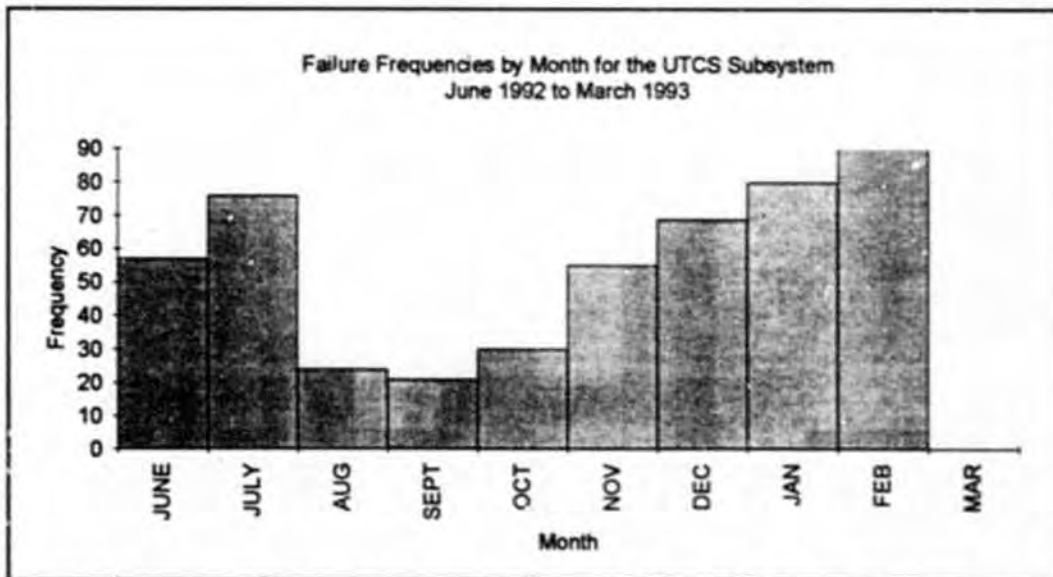


Figure 104. Frequency of failures by subsystem, 6/92 - 3/93.

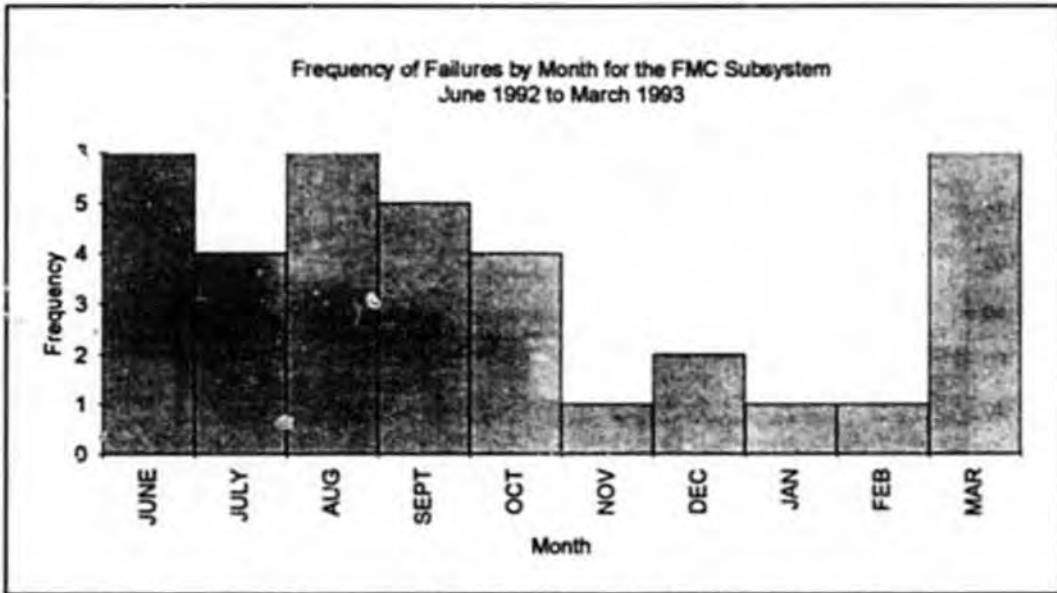
Figures 105 through 109 illustrate the frequency of failures by month during the period June 1992 through March 1993.



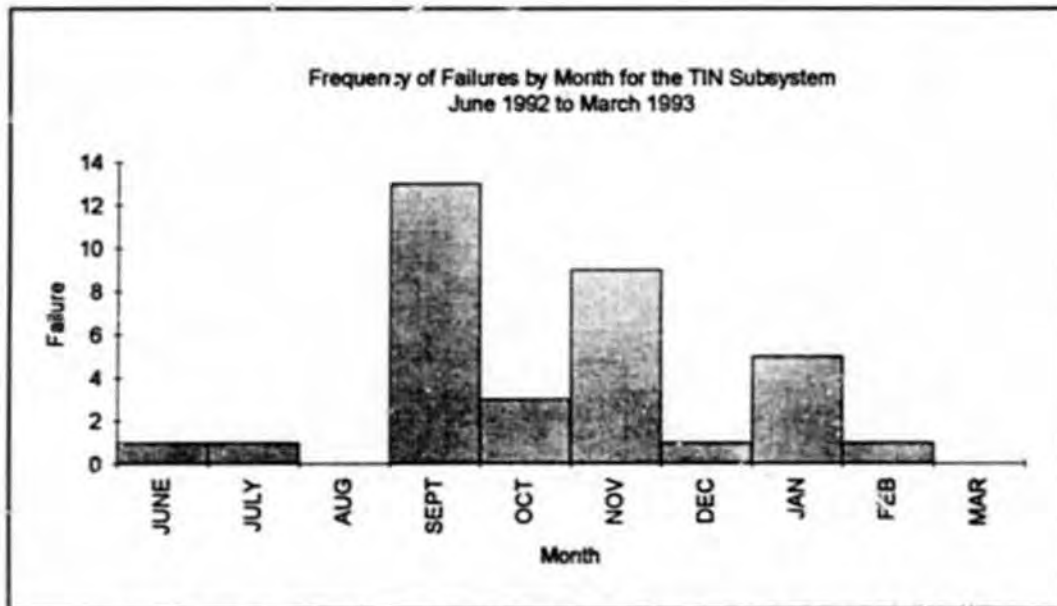
**Figure 105. Frequency of failures by month for all subsystems.**



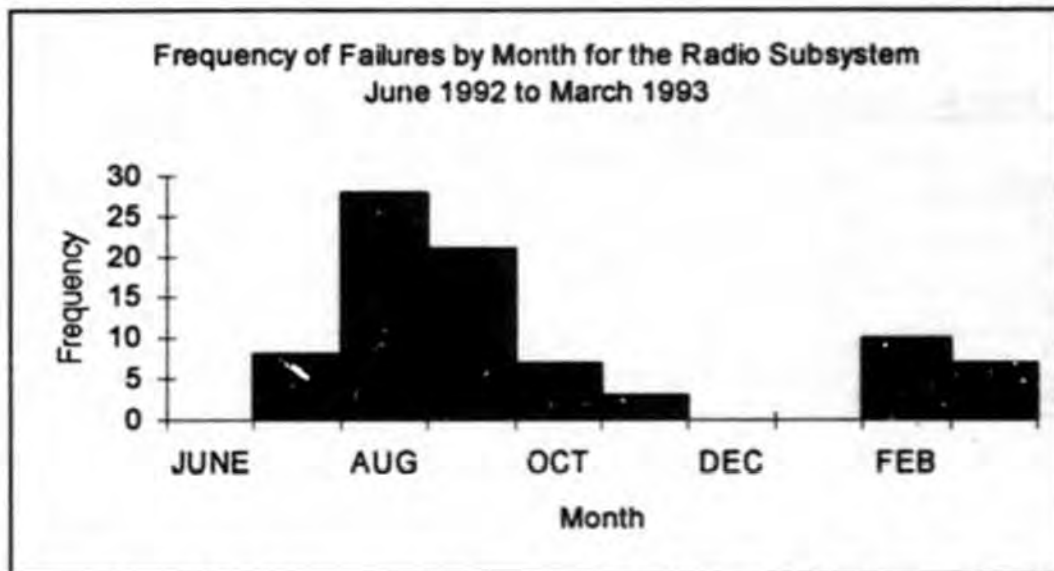
**Figure 106. Failure frequencies by month for the UTCS subsystem.**



**Figure 10 . Frequency of failures by month for the FMC subsystem.**



**Figure 108. Frequency of failures by month for the TIN subsystem.**



**Figure 109. Frequency of failures by month for the Radio subsystem.**

#### Duration of Failures

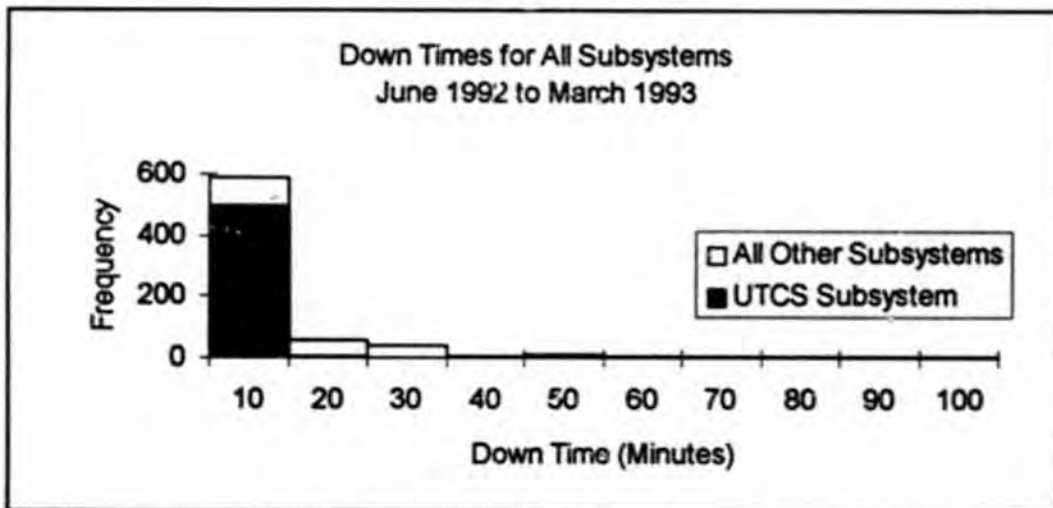
Duration of failures are described in this section. Table 31 identifies the down times categorized by month. Table 32 identifies the down times categorized by subsystem. Figure 110 illustrates the down times for all systems. Figures 111 and 112 illustrate the down times for the UTCS and the FMC subsystems respectively.

**Table 31. Duration of failures by month, 6/92 - 3/93.**

Month	Down Time in Minutes			Total
	Mean	Min	Max	
June	11.89	5	30.0	785
July	12.32	5	93.0	1,318
August	17.55	10	73.5	1,176
September	17.55	5	94.5	1,211
October	11.67	5	30.0	513
November	9.86	5	30.0	690
December	11.06	5	49.0	874
January	11.47	5	66.0	1,055
February	12.13	5	86.5	1,346
March	37.34	10	97.5	597
<b>Total</b>				<b>9,566</b>

**Table 32. Duration of failures by subsystem by time of day, 6/92 - 3/93.**

Subsystem	Down Time in Minutes			Total
	Mean	Min	Max	
UTCS	10.26	10	66	5,151
FMC	32.50	30	90	1,170
TISC	15.26	10	93	992
TIN	5.12	5	9	174
Radio	24.79	10	97.5	2,082



**Figure 110. Down times for all systems.**

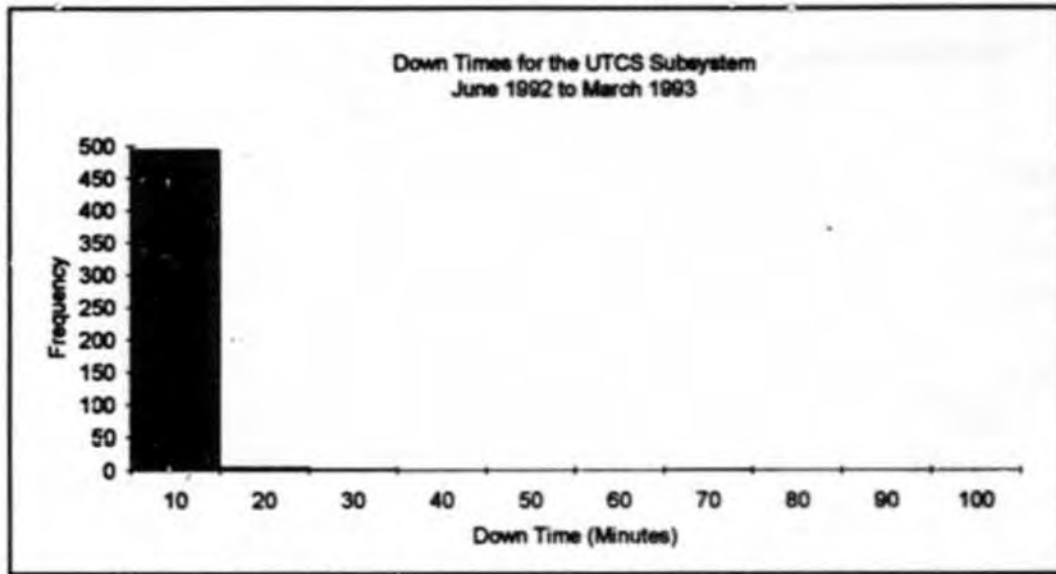


Figure 111. Down times for the UTCS subsystem.

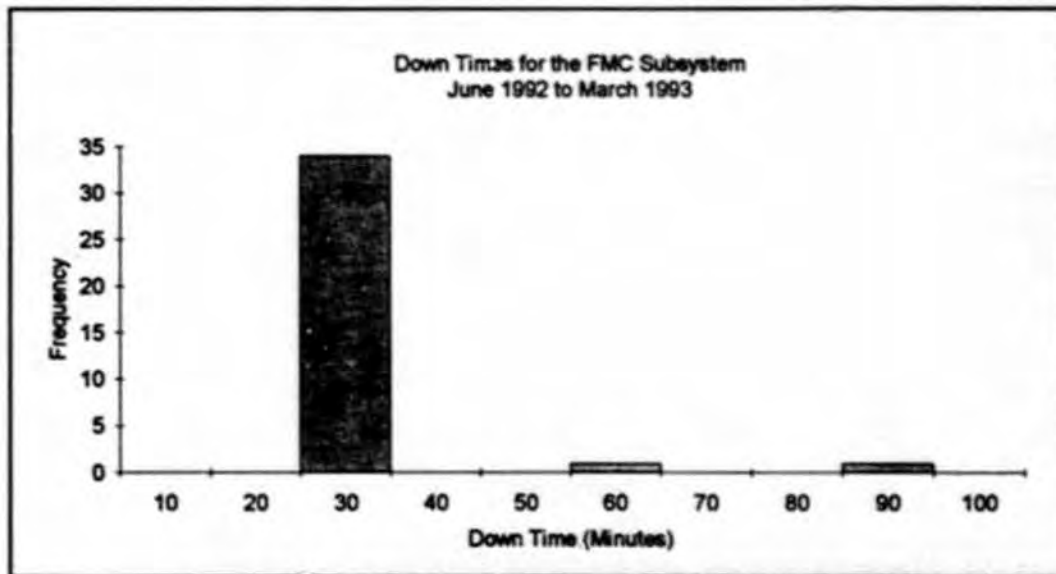
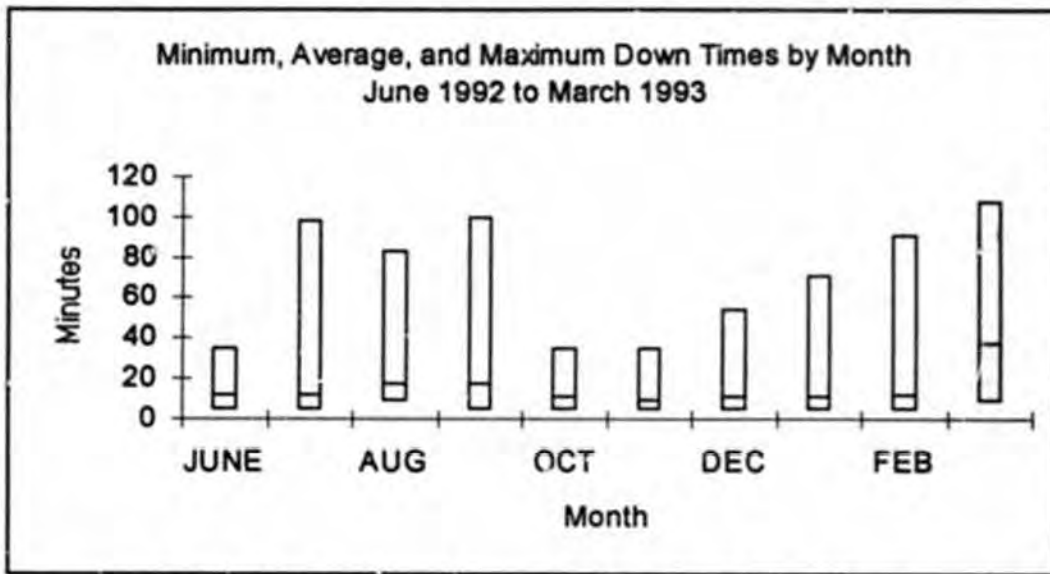


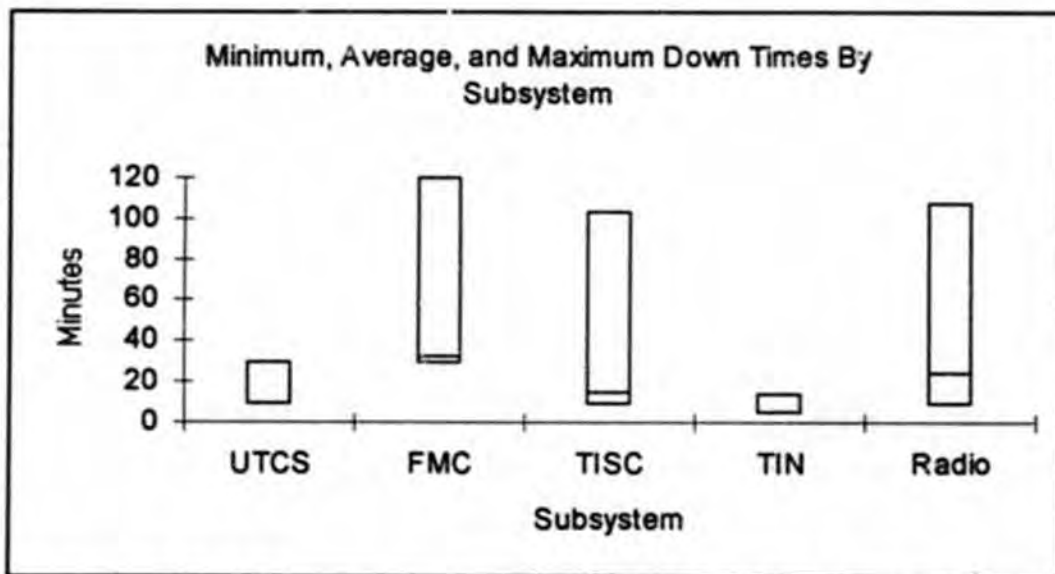
Figure 112. Down times for the FMC subsystem.

Figures 113 and 114 illustrate the minimum, average and maximum down times by month and by subsystem respectively.





**Figure 113. Minimum, average, and maximum down times.**



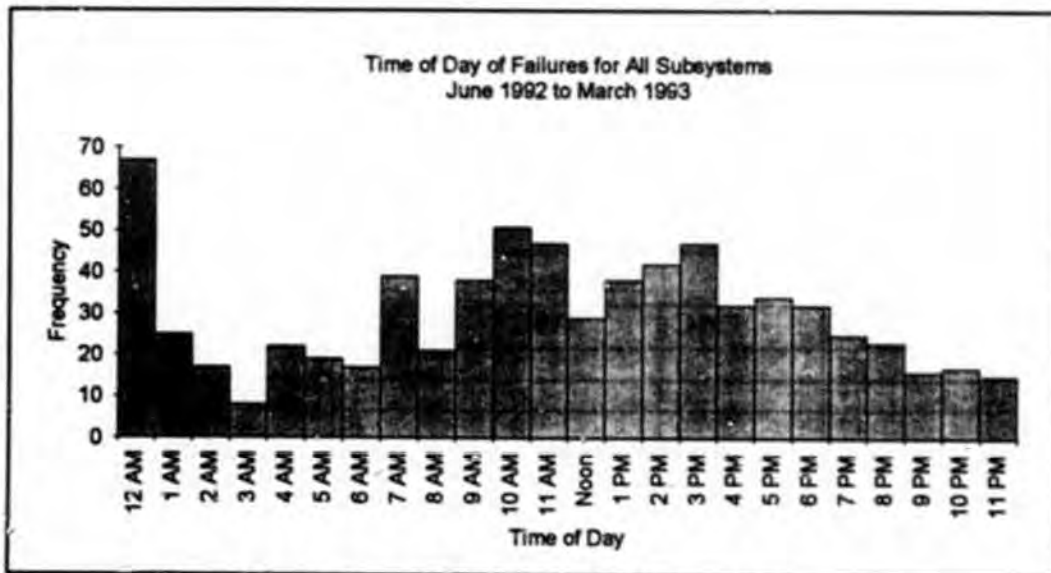
**Figure 114. Minimum, average, and maximum down times by subsystem.**

Time of Day of Failures

Table 33 and figure 115 illustrate the time of day of failures for the period June 1992 through March 1993.

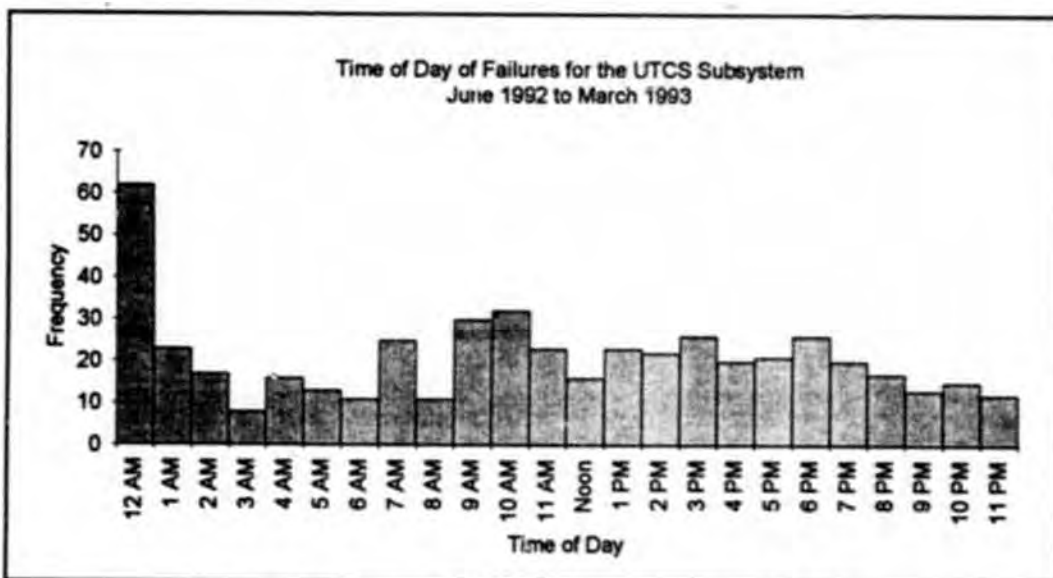
Table 35. Number of failures by subsystem by time of day, 6/92 - 3/93.

Hour	Subsystem					Total
	UTCS	FMC	TISC	TIN	Radio	
12 AM	62	0	0	0	5	67
1 AM	23	0	0	1	1	25
2 AM	17	0	0	0	0	17
3 AM	8	0	0	0	0	8
4 AM	16	0	1	0	5	22
5 AM	13	1	2	0	3	19
6 AM	11	1	2	0	3	17
7 AM	25	5	4	0	5	39
8 AM	11	1	6	0	3	21
9 AM	30	2	4	0	2	38
10 AM	32	4	6	5	4	51
11 AM	23	3	5	5	11	47
Noon	16	1	4	4	4	29
1 PM	23	2	6	5	2	38
2 PM	22	3	6	5	6	42
3 PM	26	4	7	3	7	47
4 PM	20	2	3	4	3	32
5 PM	21	2	3	1	7	34
6 PM	26	2	0	0	4	32
7 PM	20	0	0	0	5	25
8 PM	17	1	3	1	1	23
9 PM	13	1	0	0	2	16
10 PM	15	0	1	0	1	17
11 PM	12	1	2	0	0	15
<b>TOTALS</b>	<b>502</b>	<b>36</b>	<b>65</b>	<b>34</b>	<b>84</b>	<b>721</b>

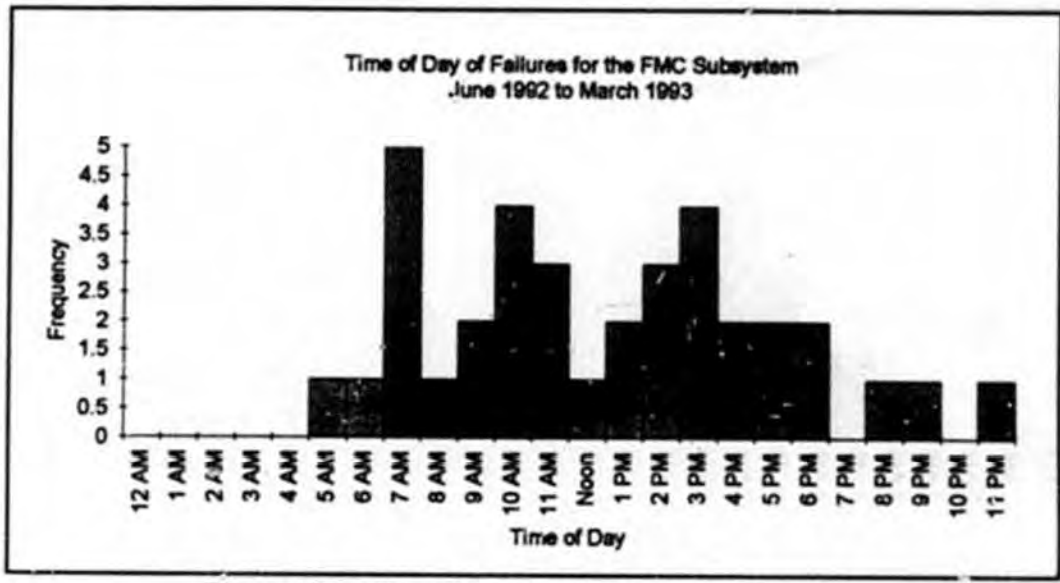


**Figure 115. Time of day of all subsystem failures.**

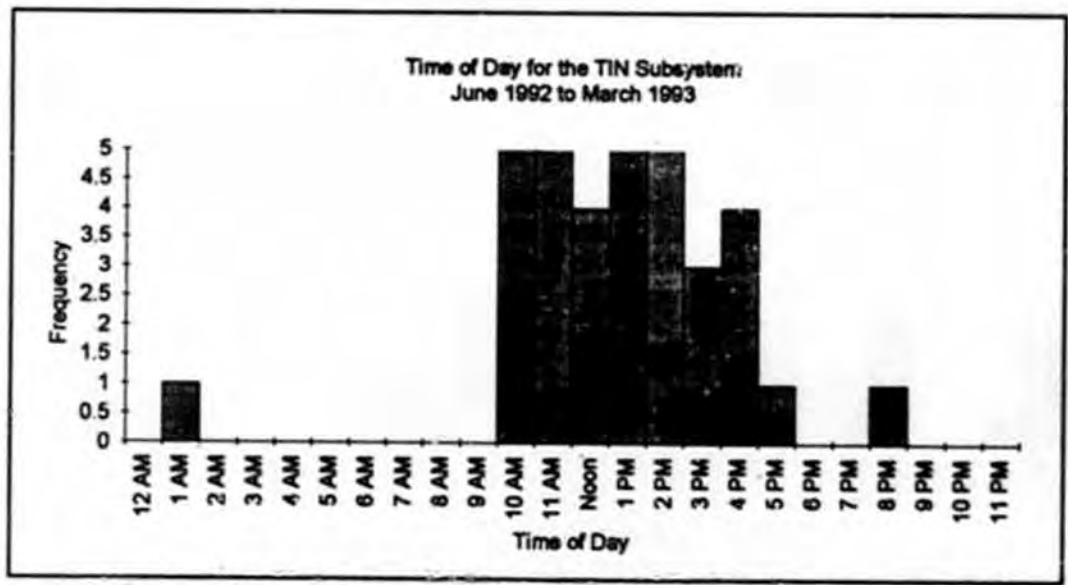
Figures 116 through 120 illustrate the time of day of failures for each subsystem: UTCS, FMC, TIN, TISC and Radio.



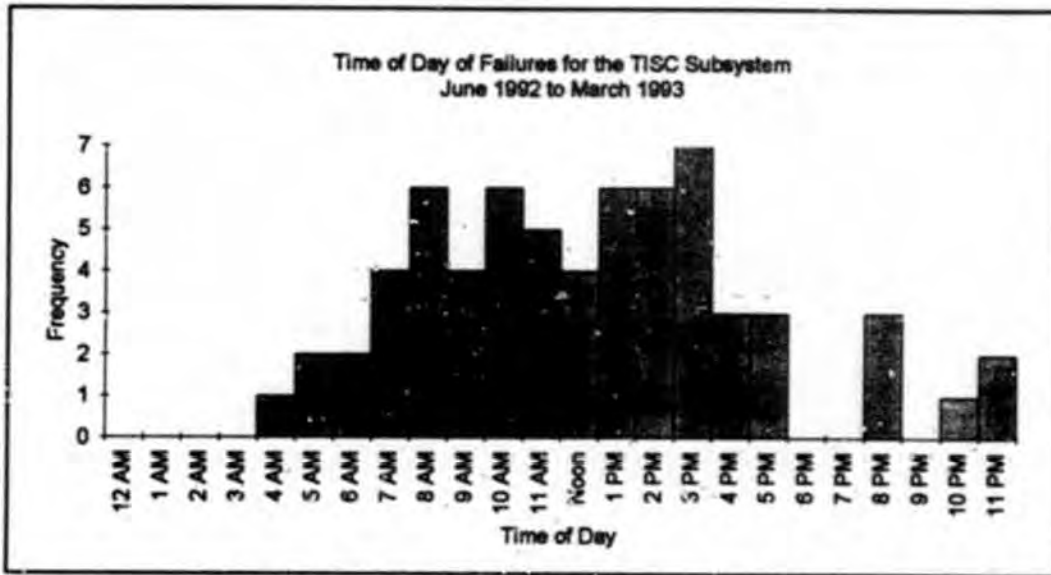
**Figure 116. Time of day of UTCS subsystem failures.**



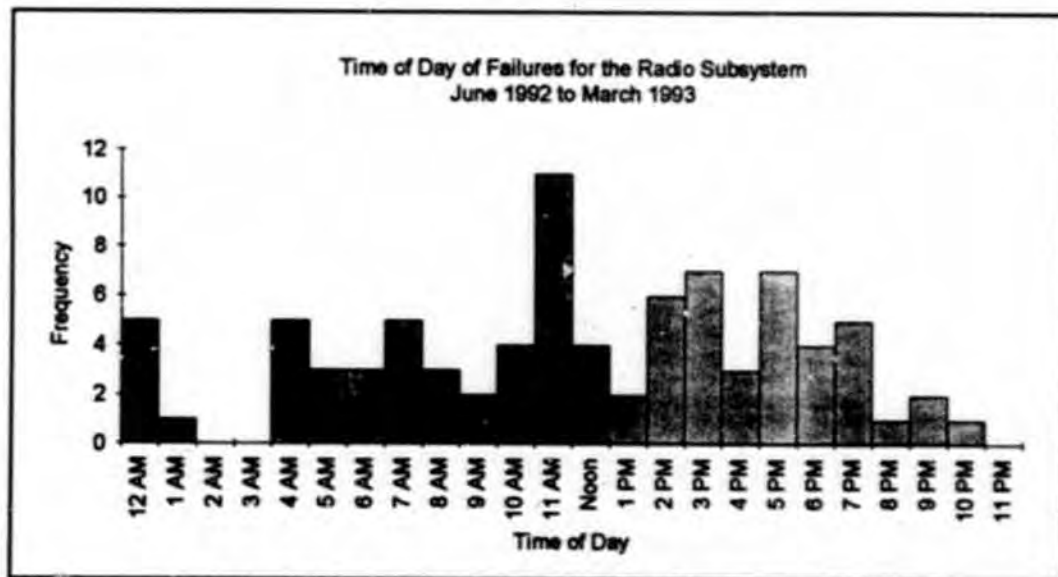
**Figure 117. Time of day of FMC subsystem failures.**



**Figure 118. Time of day of TIN subsystem failures.**



**Figure 119. Time of day of TISC subsystem failures.**



**Figure 120. Time of day of Radio subsystem failures.**

### *Onsite Interview Results*

Onsite interviews were conducted with key TravTek participants. Major issues that emerged from the interviews are as follows:

- Many voiced their concern regarding car batteries. A review of repair logs shows very few recorded battery failures. Followup discussions with Avis indicates that many vehicles were returned to the airport with battery failures noted by the customers. Avis routinely placed the batteries on their 2 hour battery charger and returned them to rental status without recording the problem on GM logs.
- Many thought the congestion information provided to vehicles was unsatisfactory. A number of hypotheses were suggested why the congestion information was unsatisfactory, including: a) the fusion process frequently chose historical data; 2) link ratios have a disproportionate impact on shorter links; 3) signal delay could appear as congestion; and 4) inaccurate data caused loss of confidence.
- The screen on the vehicle display occasionally went blank when exposed to direct sunlight.
- Link travel times were not accurate enough. Posted speeds were too frequently used.
- Metro Traffic was the only TIN user that regularly reported incidents. Very few were reported first by the FMC.
- Directions from TravTek sometimes caused drivers to become confused (e.g., directions could tell the driver to make a U-turn which is illegal in some States).
- A way to designate off-network incidents was needed.
- TravTek got some people to venture out further from the hotels and theme parks. They felt safer, therefore TravTek tended to "spread out" its economic benefit.
- Address structure of the yellow pages information was not complete. A business or service needs multiple addresses. Address choices should include: street address, mailing address and a "vanity" address (e.g., designation of "at the corner of x street and y avenue").
- The hard disk drives in the cars were a significant problem because of increasing failures toward the end of the test.

## Conclusions

Figure 121 illustrates the reliability of the TravTek system by month by subsystem. This figure illustrates availability in excess of 96.5 percent throughout the project across all subsystems.

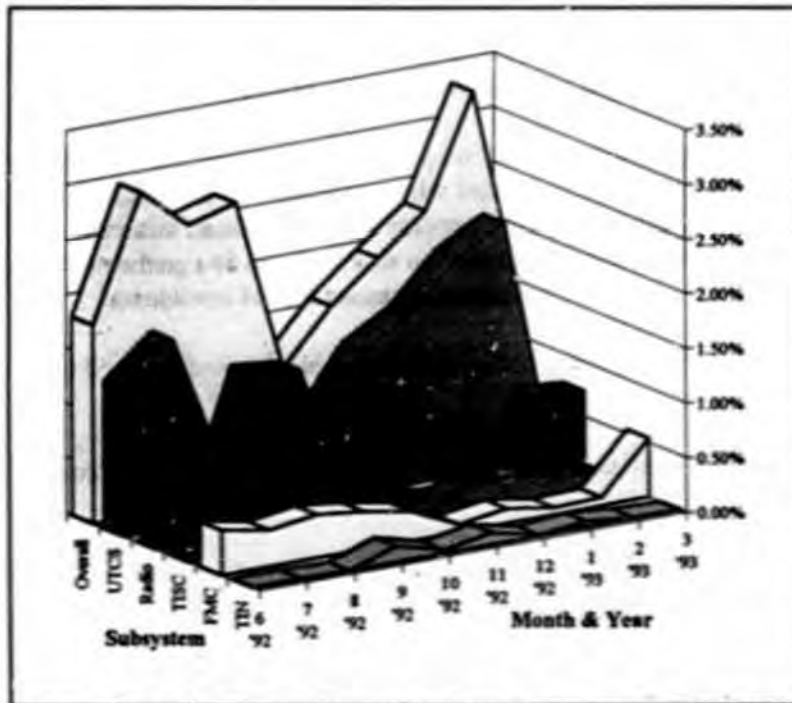


Figure 121. Percent downtime by subsystem by month.

## TMC/VEHICLE COMMUNICATION SUBSYSTEM RELIABILITY

A study was performed to evaluate the reliability of the two way communication links between the TMC and the vehicles. This study was conducted to determine the error rates associated with the communication channels, as well as to determine if there were localized areas in the network where error rates were high.

### Evaluation Methodology

The basic questions to be answered in the TMC/vehicle communication reliability study were:

- Did the vehicles receive data when the TMC transmitted?
- Did the TMC receive data when the vehicles transmitted?

The data for this study were derived from the TMC logs and the vehicle logs. The TMC logs were used to develop TMC up-time vectors, which were 1,440 character records for each day of operation from June, 1992 through March 1993 (April and May, 1992 TMC log data were not available). Each character in the up-time vector corresponded to a minute of the day, and had the value 1 if the TMC was operating and broadcasting data to the vehicle, and had the value 0 if the TMC was down. For purposes of this discussion, the vehicle's receipt of broadcast data will be termed an event "R." Similarly, the vehicle's transmission of a probe report will be termed an event "T."

To develop the basic data for the error rate analysis, the following procedure was followed:

1) TMC to vehicle error rate data. For each 1 in the up-time vector, a check was made in the vehicle logs for the corresponding minute to determine if the vehicles received the broadcast data (denoted by registering an event "R").

2) Vehicle to TMC error rate data. For each event "T" registered by the vehicles, a check was made in the TMC's up-time vector to determine if the TMC was up and receiving probe reports. If the TMC was up, the logs were checked for probe reports matching the "T" events.

### **Data Sources**

The data sources for the TMC/vehicle communication reliability study included the TMC logs and the TravTek vehicle logs. The up-time vectors were developed according to whether or not data were being logged by the TMC. Missing data generated the zeros in the up-time vectors. The TMC up-time vectors were used as the basic data set which indicated whether or not the TMC broadcast data to the TravTek vehicles. Also, the TMC radio logs recorded the probe reports on a minute by minute basis. These probe reports included the vehicle ID, latitude, longitude, and link travel times, among other things.

The vehicles logged an event "R" when a radio transmission was received from the TMC. An event "T" would not occur unless preceded by an event "R." If the TMC broadcast data, and the vehicle did not receive, an error was logged for that vehicle for that minute. Additionally, it was important to know the location of the vehicle at the time of missed radio reception. This was determined by interpolating the latitude/longitude values between the last time the vehicle received data, and the first time it received data after the missed radio reception. When the vehicle transmitted and the TMC did not receive (assuming it was up), an error was logged, as well as the location of the vehicle when it transmitted.

Additionally, the time of the vehicle's radio transmission was logged as part of the event "T." This time, relative to the beginning of the minute, was critical to the probe reporting process. The system timing procedure for probe reports was that the TMC would transmit for approximately 15 seconds, and the 100 probe vehicles would report in during the next 45 seconds. Each vehicle had a designated time slot according to the formula:



$$14.6 + 0.4 \times I, \text{ (seconds)}$$

where I is the vehicle's I.D. number 1-100. With the need to maintain this rigorous timing sequence, all the vehicle's logged transmit times were compared to their calculated transmit times to determine how well the vehicles were limiting their radio transmissions to their assigned slots.

## Results

The data were processed as described in the previous 2 sections. Massive amounts of data were handled during these processing runs, routinely ranging from 35 to 70 megabytes. Approximately 8 hours were required for each of the set up runs. Initial results indicated a much higher than expected error rate, in both directions. These figures were reported early and found to be in error. After correcting the processing programs, the average error rate for TMC to vehicle communications was found to be 14.8 percent. The error rate for vehicle to TMC communications was found to be 14.1 percent. These results were still higher than expected. Because of the flat terrain in Orlando, and the relatively small central business district (CBD), an error rate of not more than 5 percent was expected.

The TMC to vehicle communications history consisted of 1,052,522 communications attempts between June 1992 and February 1993 inclusive. Of these attempts, 155,948 were failures (14.8 percent). That is, 85.2 percent of the TMC initiated communications messages were received successfully by the vehicles. Figure 122 contains a histogram of the failure distribution.

The vehicle to TMC communications history consisted of 885,534 communications attempts between June 1992 and February 1993 inclusive. Of these attempts, 125,230 were failures (14.1 percent). That is, 85.9 percent of the TMC initiated communications messages were received successfully by the vehicles. Figure 123 contains a histogram of the failure distribution.

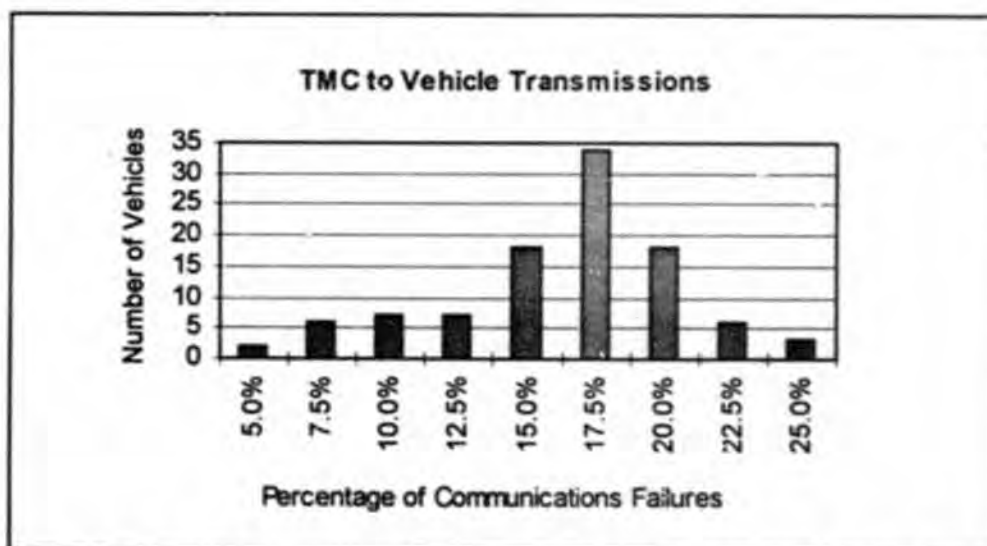
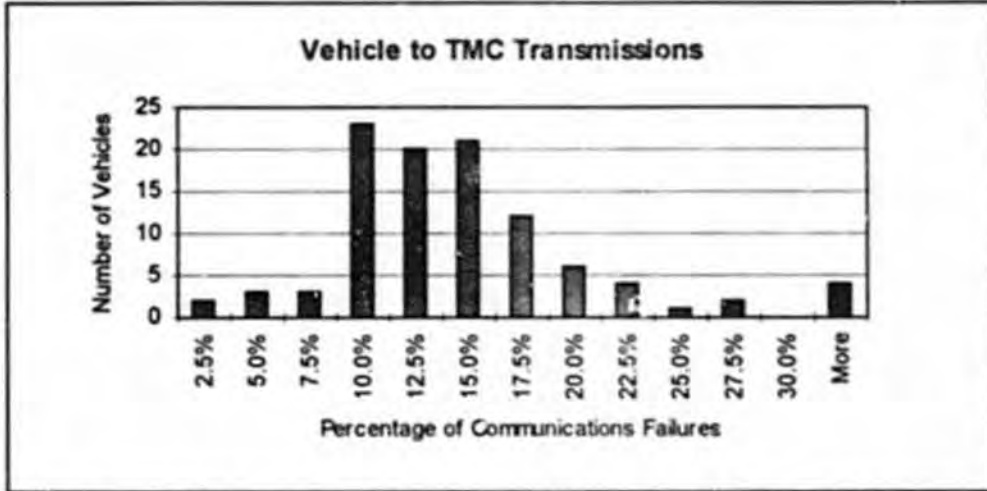
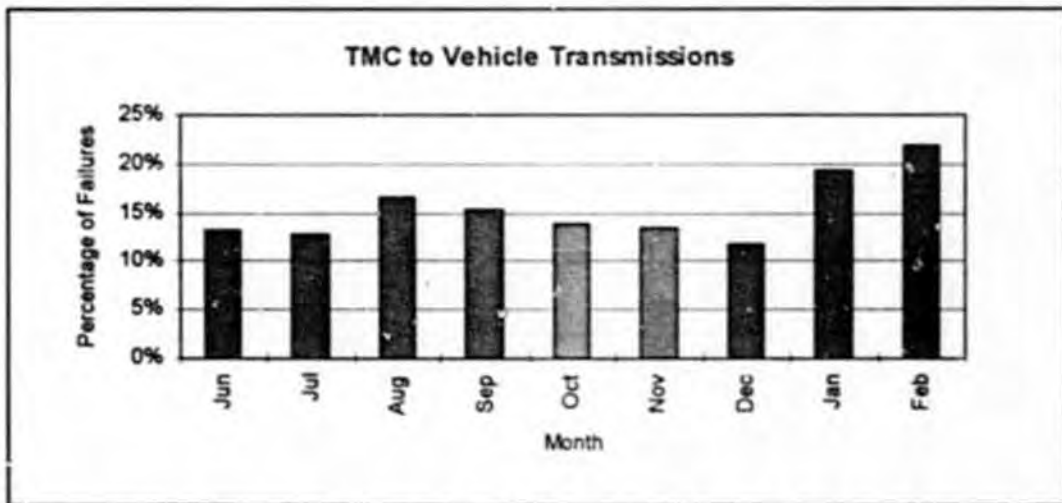


Figure 122. Percentage of TMC to vehicle communications failures.



**Figure 123. Percentage of vehicle to TMC communications failures.**

Figures 124 and 125 illustrate the percentage of communications failures by month. Figure 124 depicts TMC to vehicles failures, and figure 125 depicts vehicle to TMC failures.



**Figure 124. Percentage of TMC to vehicle communications failures by month.**

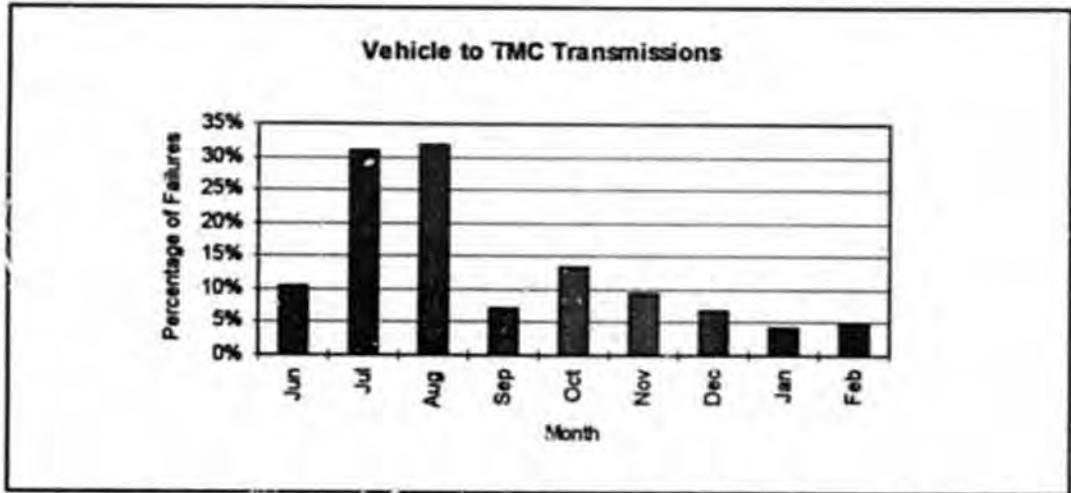


Figure 125. Percentage of vehicle to TMC communications failures by month.

The next stage of the processing was to determine whether a few cars were contributing to these higher than expected results. The data were reprocessed by month by vehicle number, in effect achieving a 101 x 10 matrix of error rates. The first 9 columns represented June - March, and the last column was the total for each vehicle for the study. Similarly, rows 1 - 100 represented each vehicle, and row 101 was the totals. Only four vehicles had a failure rate higher than 30 percent when initiating communications to the TMC. The vehicle ID numbers and their associated failure rates are shown in following table 34. Forty two percent of the vehicles had error rates in the 10-15 percent range.

Table 34. Vehicles with high error rates when transmitting to TMC.

Vehicle ID #	Failure Percentage	Total Number of Communications Attempts
49	96.8%	12,006
79	39.1%	7,203
97	37.8%	6,402
100	31.3%	7,875

As a further check, the transmit time slots were evaluated to determine if vehicles were transmitting outside their designated time slots, and possibly interfering with the data transmissions of other vehicles. Figure 126 shows the results of this study. Indeed, a large number of data transmissions did occur outside designated time slots. The zero point in figure 126 is the point at which the transmission was to have occurred. If it was early, it is shown as a negative value. If it was late, it is shown as a positive value. The time slots were each 0.4

seconds in duration. It is unknown exactly how incoming data transmissions to the TMC from the vehicles were affected by possible simultaneity. This was a possible contributing factor to the higher error rates.

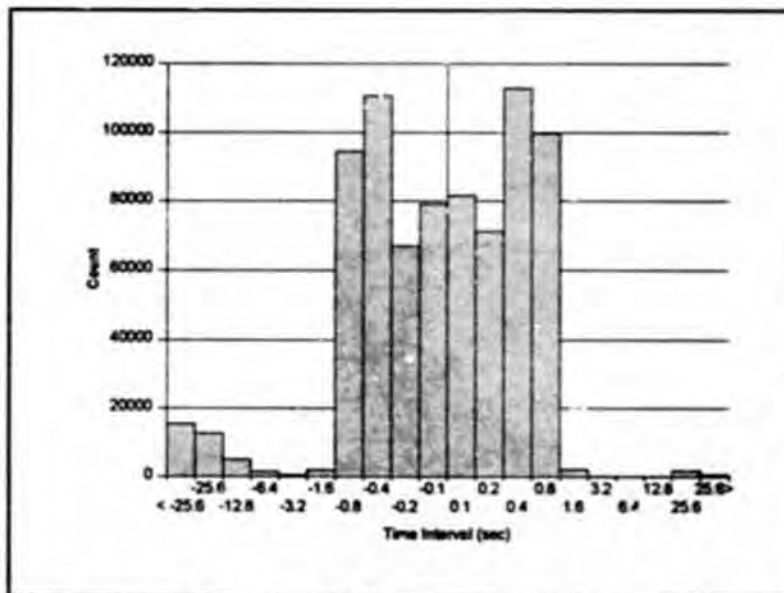


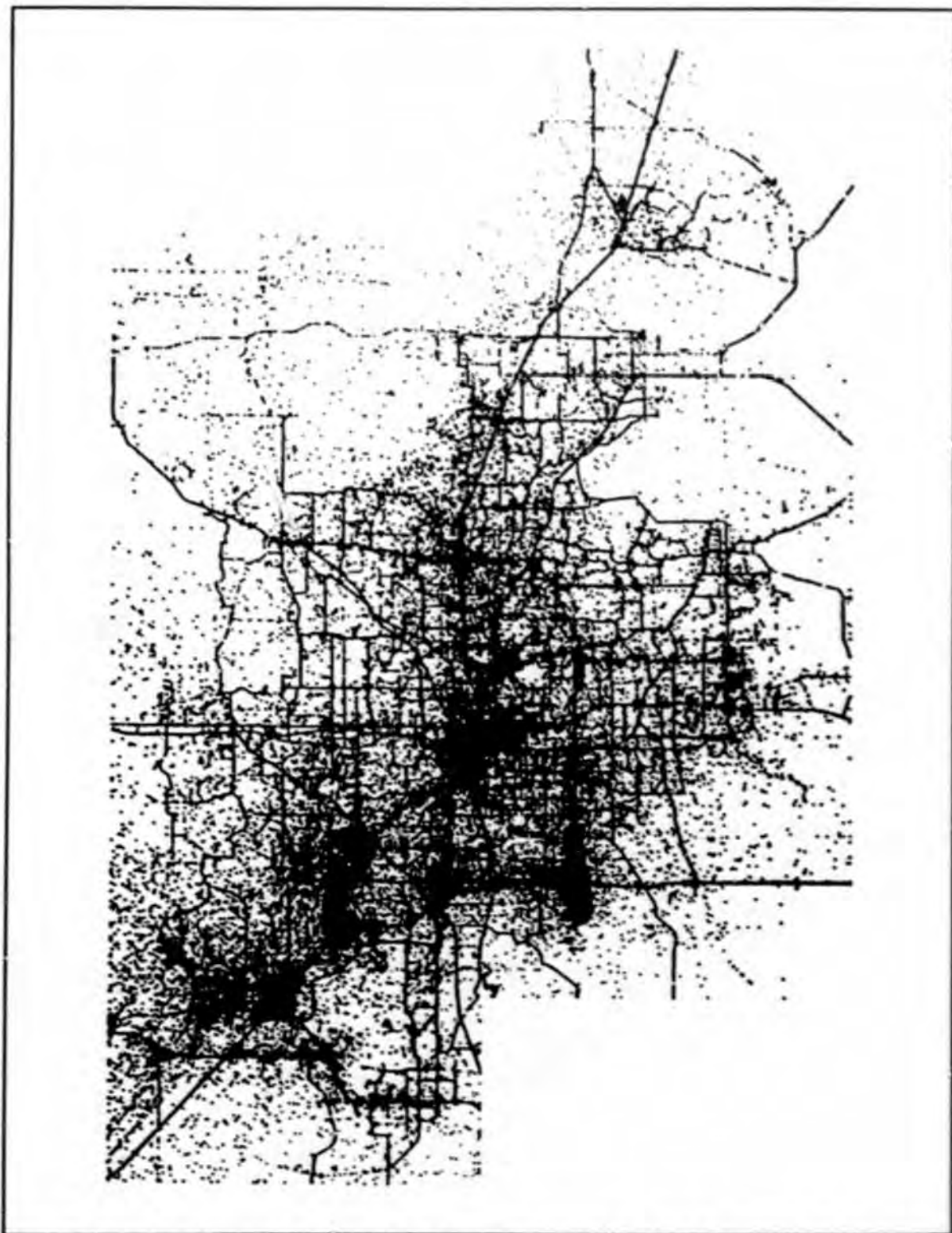
Figure 126. Vehicle transmit time slot accuracy.

The radio equipment in the vehicles may have had antenna lead-in problems with radiation from the SMR radio system inducing interference in the GPS units. An early problem occurred with the coaxial cables in the vehicles experiencing induced EMF from equipment installed for TravTek.

The signal received from the vehicles at the master antenna was weak. There were 2 receivers, and voting logic was used to honor the strongest reception. This low power reception could have been a problem for incoming data.

Finally, a plot of the latitude / longitude pairs was made to determine the location of data communication problems. Figure 127 is a plot of the latitude / longitude pairs for which all TMC to vehicle data transmissions were successfully completed. Conversely, figure 128 is a plot of the latitude / longitude pairs for which all unsuccessful TMC to vehicle data transmissions were made. Figure 129 is a plot of the latitude / longitude pairs for which all successful vehicle to TMC data transmissions were completed. Conversely, figure 130 is a plot of the latitude / longitude pairs for which all unsuccessful vehicle to TMC data transmissions were made.

Figures 127 through 130 rather clearly demonstrate that data transmission errors were not confined to a subset of the vehicle fleet nor were they confined to specific areas of the network.



**Figure 127. Location of vehicles with successful TMC to vehicle communications.**

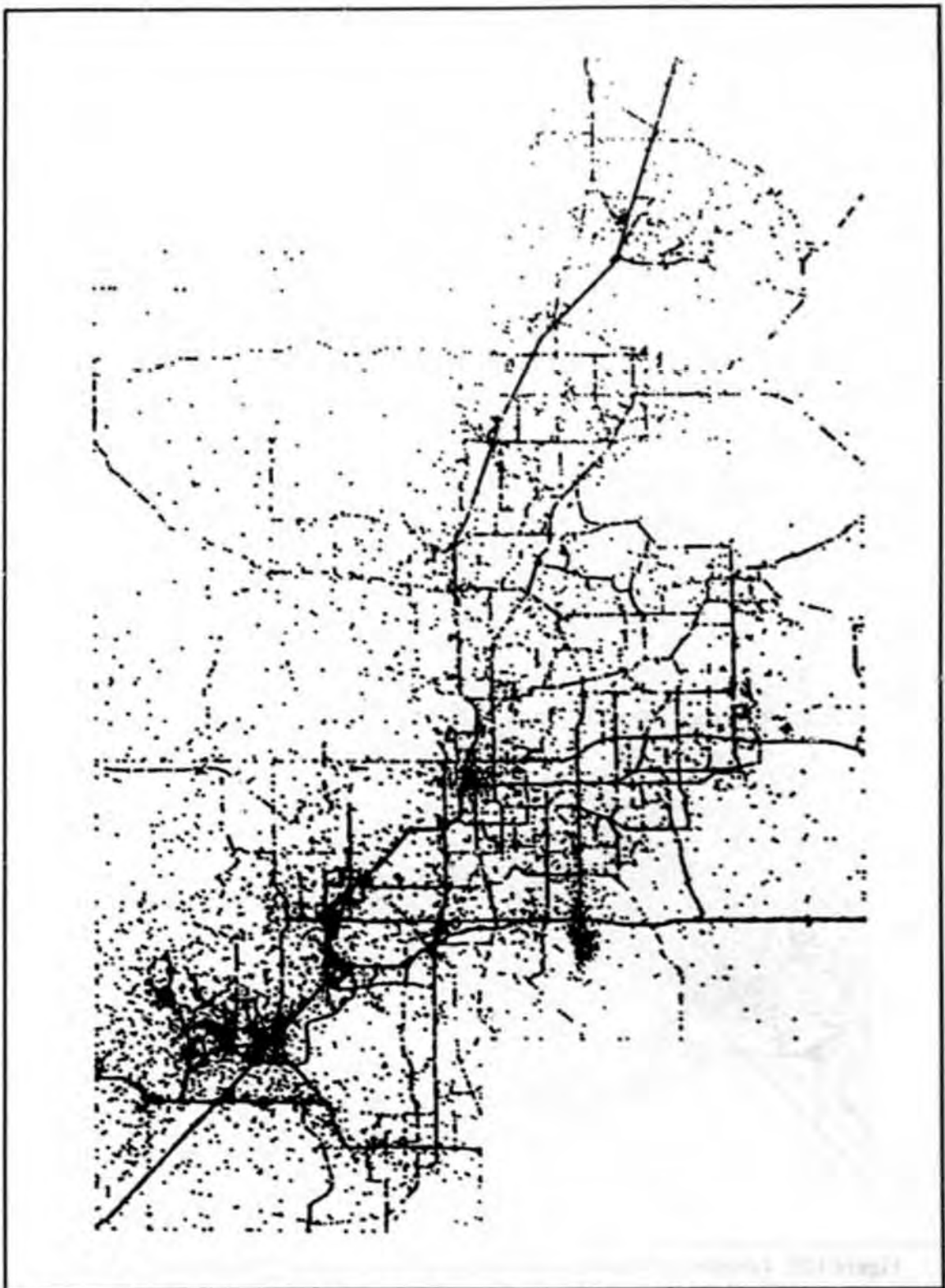
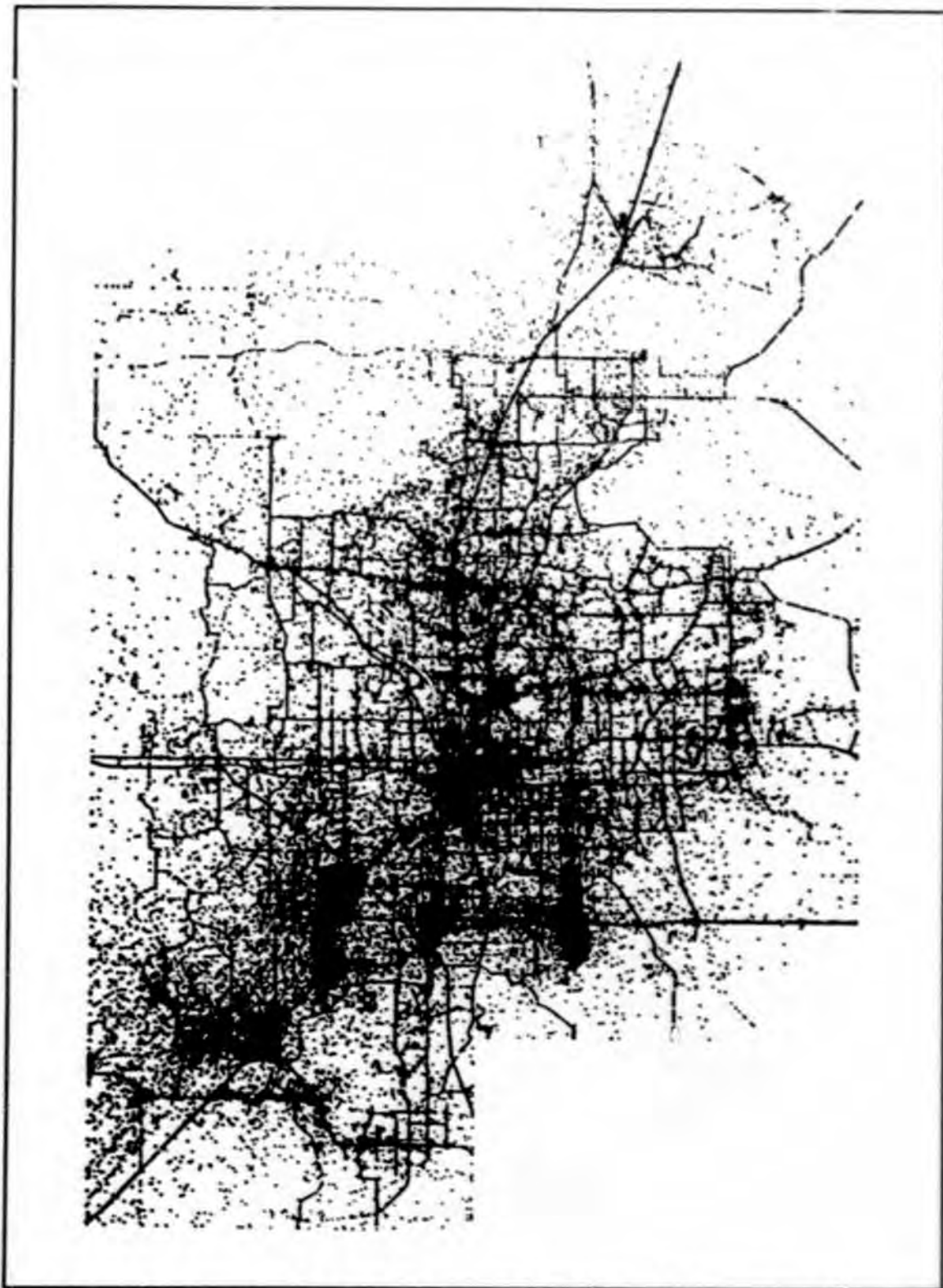
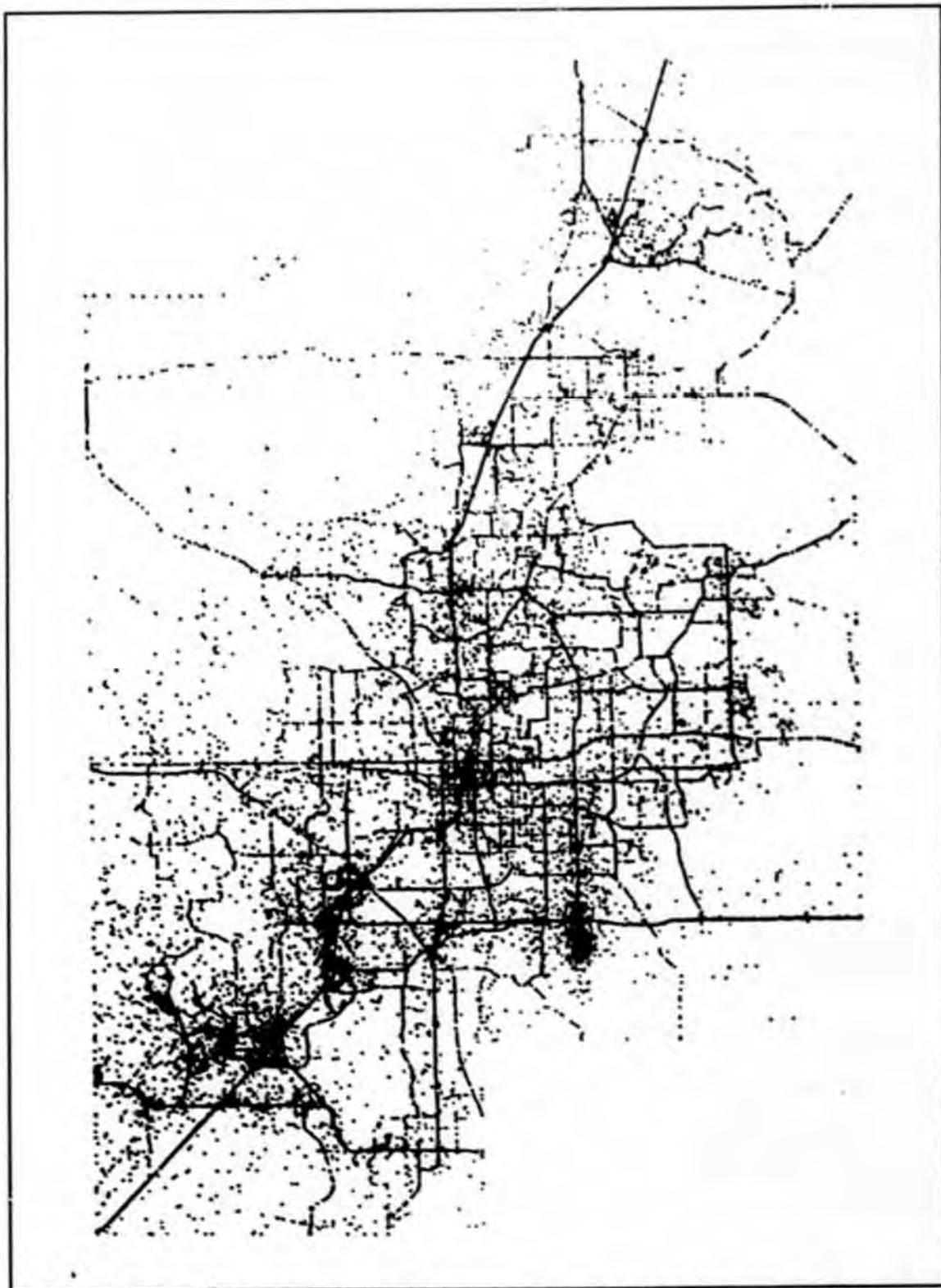


Figure 128. Location of vehicles with unsuccessful TMC to vehicle communications.



**Figure 129. Location of vehicles with successful vehicle to TMC communications.**



**Figure 130. Location of vehicles with unsuccessful vehicle to TMC communications.**



If they were, they are masked by data logging artifacts that caused the errors to be uniformly distributed over the network.

It was thought that many vehicles may have been outside the designated study area, and thus were out of range of the master radio transmitter. Similarly, it was possible the vehicles were receiving data from the TMC while outside the study area, but their transmitters were out of range of the master radio receivers. Neither of these assumptions proved to be true, as shown in the plots of unsuccessful radio transmissions depicted by figures 128 and 130. Since the radios were licensed for a specific geographic area, the vehicle software apparently did not log events "T" and "R" when the vehicle's location was outside the licensed boundaries.

With all these data in hand, it is concluded that data communication errors may have been as much a problem with data logging as it was a problem with actual communication errors. Unfortunately, the operational test was over before these data were processed and the results known.

## **SOFTWARE RELIABILITY**

This section will describe the software reliability of TravTek. This description is partially anecdotal, because a limited amount of data were available for the analysis. A data collection procedure was not in place for logging software failures, plus the fixes were not always documented by the programmers.

During early months of the project, a Technical Committee existed to discuss and resolve technical problems. By July 1992, this committee was replaced by the Configuration Control Committee, which had a similar function and smaller membership. By this time, it was felt that the list of technical problems had become more manageable and there was need to regulate the process to minimize system changes which might impact the overall TravTek evaluation effort. Many studies were being conducted that depended on uniformity of system operation.

A TravTek system manager was hired after the operational test was underway. The manager was assigned the task of monitoring operations of the TravTek system, primarily through observing operations of the TMC, examining various data logged by the TravTek Librarian, and periodically checking with representatives of the various TravTek subsystems.

The TravTek system performed normally with respect to the reliability of software. As more changes and fixes were made, the reliability improved. Had detailed data been taken, it would have shown that the number of failures declined with time. Software fails because it contains faults (or omissions) that were introduced during its creation, or at later stages of its life. An example of later stage failure is when it is changed in an attempt to fix other faults, or when it is enhanced by the addition of new functionality. The general perception with TravTek was that the successful removal of design faults resulted in an overall improvement in software reliability.

Table 35 depicts the vehicle software change history for the first seven releases. The utilization of various TravTek vehicle program versions was determined through processing of TMC radio logs. Figure 131 illustrates the deployment periods for the vehicle computer program versions.

Table 36 shows the reboot frequency for each of the 3 networked computers that performed the TravTek control function. No logs were kept for the library computer, since it was not critical to the control process. Ninety three percent of the entries in the operator's logbook noted reboots as the action.

Table 35. Vehicle software change history. <sup>(23)</sup>

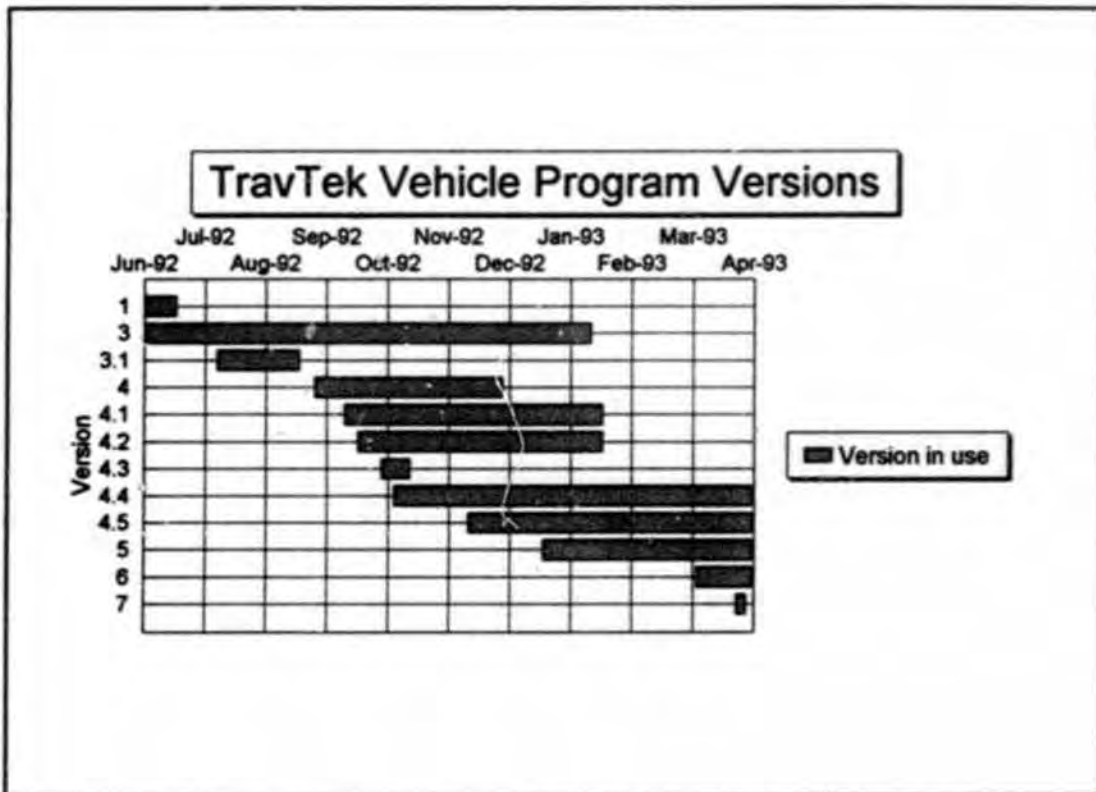
Release Number	Number of Routing Software Changes	Estimated Time to Fix (Man Months)	Number of Navigation Software Changes	Estimated Time to Fix (Man Months)
1	First Release		First Release	
2	Test Release Only		Test Release Only	
3	16	3	6	2
4.1	9	4	9	2
4.2	0	0	1	0.25
4.3	1	0.5	0	0
4.4	1	0.1	0	0

Very few other TravTek system problem reports were available. Minutes of Technical Committee and Configuration Control Board meetings were not available. A system status report from the system manager for July 1992 is summarized as follows:

- Two failures due to communication component of base station.
  - lightning strike (3 days).
  - air conditioning system failure (5 days).
- One failure due to AAA computer hard disk (70 hours).
- Two trouble reports due to TMC software.
  - slow down of SQL server (not releasing system memory).
  - illegal character in vehicle log (communication failure).
- One trouble report due to GTIN software (communication handler).

- Ongoing investigation.
  - false congestion reports.
  - TTIN access to TMC.

These sparse records show that data were not available for a comprehensive analysis of the software reliability.



**Figure 131. TravTek vehicle program version service times.**

**Table 36. TravTek TMC computers - reboot frequency.**

<b>Month</b>	<b>Operator Interface Computer</b>	<b>Data Base Computer</b>	<b>Communication Computer</b>	<b>Total</b>
April 1992	25	9	16	50
May 1992	11	5	20	36
June 1992	13	5	10	28
July 1992	28	16	22	66
August 1992	10	8	13	31
September 1992	7	4	10	21
October 1992	7	6	7	20
November 1992	14	8	12	34
December 1992	6	4	7	17
January 1993	9	5	11	25
February 1993	3	2	5	10
March 1993	5	3	9	17
<b>Totals</b>	<b>138</b>	<b>75</b>	<b>142</b>	<b>355</b>

**BLANK PAGE**

## SYSTEM ARCHITECTURE

### TravTek DISTRIBUTED ARCHITECTURE

A distributed system is characterized by having the processing and storage elements physically dispersed and interconnected by data communications facilities. Distributed architecture systems provide a large number of highly desirable user and operational benefits. Some of these benefits are listed in table 37.

**Table 37. Benefits of distributed systems.** <sup>(24)</sup>

High system performance -- fast response
High throughput
High system reliability / high system availability
Graceful degradation (fail-soft capability)
Ease of modular and incremental growth
Configuration flexibility
Automatic resource sharing
Automatic load distribution
High adaptability to changes in workload
Incremental replacement and / or upgrading of components ( hardware and s/ ftware )
Easy expansion to new functions
Good response to temporary overloads

A good distributed system should provide at least the following capabilities:

- The user should view the system in the same manner as a centralized or uniprocessor system.
- The selection of the specific resources to be utilized in servicing a user's request should be transparent to the users (i.e., occur without his or her knowledge), unless a specific designation of the resources to be used is desired.
- The distributed operating system should automatically distribute and balance the load over the resources available.
- The distributed data base manager should control concurrent access to data files by different processors and should ensure that the contents of redundant copies of the data base are at all times consistent.

- The system should be able to continue in operation despite the failure of individual components.

These classical features of distributed systems, with the exception of load distribution, were embraced by the TravTek design. TravTek received and transmitted data from a commercial radio service in Orlando. The vehicles were each equipped with a data radio for transmitting to, and receiving from, the TMC. The complex of four networked computers at the TMC implemented the function of TravTek at the TMC. Each vehicle had two computers installed for TravTek with bus interconnection, to perform the vehicle's TravTek functions. The remaining elements of the system, the TISC and TIN participants, were linked to the TMC by telephone lines. These processing elements, linked by various communication media, were the heart of the TravTek system.

### CENTRAL ARCHITECTURE DESIGN ALTERNATIVE

This section will contrast the implementation of TravTek as a system with central architecture. This would be a system design that uses a substantial computing resource at the TMC. This additional computing power would primarily be necessary to handle the task of route calculation for the TravTek vehicle fleet, as well as monitor all vehicle movements and constantly provide a route recalculation for all vehicles while en route. While there may be some economies of scale in a large computer in terms of the size of problem that can be handled, it should be pointed out that the central computer would emulate the tasks of 200 20 MHz, 4 MB 80386-based computers. Although the two computers in each vehicle were designated the routing and navigation computers, respectively, the route calculation algorithm had to limit the path choices because the computer could not handle the full calculations. So, it is assumed that the in-vehicle routing task could be fully handled with the equivalent of a 40 MHz, 8 MB 80386 computer. The TravTek architecture had a fully distributed routing system, as contrasted with a central-based routing system (see reference 25 for a discussion of system architecture alternatives).

Table 38 contrasts the implementation of TravTek as both distributed and central architecture. The assumption in preparing this table is that, with all other aspects of the system remaining constant, more computing power is added to the TMC, and less computing power remains in the vehicle. This shift in processing power is accompanied by a shift in the level of logic processing functions as well. All major processing functions would then reside at the top of the computing hierarchy, and the remaining logic processing functions would be largely confined to data transfer and formatting. Note that the data communication system has remained the same. In actual practice, this would not be the case, since much more bandwidth would be needed for TMC to vehicle data transfers in a central-based environment. The vehicle to TMC bandwidth requirements would essentially remain the same, with one exception. A provision for resolving contention would have to be made to accommodate simultaneous data transmissions. This is due to the need to handle random queries to the TMC for services no longer available in the vehicle. These queries would have to be interleaved with the probe reports, which are transmitted sequentially beginning with vehicle number 1, and continuing almost 45 seconds each minute.

**Table 38. Contrasting central versus distributed implementation.**

<b>TravTek FUNCTIONS</b>	<b>DISTRIBUTED ARCHITECTURE</b>	<b>CENTRAL ARCHITECTURE</b>
Route calculation	Performed in vehicle	Performed at TMC
Result of route calculation	Already present in in-vehicle computer	Must be transmitted to vehicle
Navigation map data base	Resides in vehicle; each vehicle has copy	Resides at TMC; single copy
Routine map data base	Resides in vehicle; each vehicle has copy	Resides at TMC; single copy
Turn-by-turn instructions (both visual and voice)	Resides in vehicle; each vehicle has copy	Resides at TMC; transmitted to vehicle
Local information data base (LID)	Resides in vehicle	Resides at TMC; transmitted to vehicle
LID queries	Handled in vehicle	Transmitted to TMC from vehicle
LID response	Handled in vehicle	Transmitted to vehicle from TMC
Individual probe reporting	Transmitted from vehicle to TMC	Transmitted from vehicle to TMC
Events	Transmitted to vehicle from TMC	Transmitted to vehicle from TMC
Weather reports	Transmitted to vehicle from TMC	Transmitted to vehicle from TMC
Parking lot status	Transmitted to vehicle from TMC	Transmitted to vehicle from TMC
Link travel times	Transmitted from TMC to vehicle for route calculation	Remain at TMC for route calculation
Reroutes	Calculated in vehicle	Calculated at TMC and transmitted to vehicle
Historical data base	Resides/updated at TMC	Resides/updated at TMC
Vehicle location	Determined in vehicle; transmitted to TMC	Determined in vehicle; transmitted to TMC



**Table 38. Contrasting central versus distributed implementation. (continued)**

<b>TravTek FUNCTIONS</b>	<b>DISTRIBUTED ARCHITECTURE</b>	<b>CENTRAL ARCHITECTURE</b>
Vehicle to TMC telemetry bandwidth	As implemented, for 100 vehicles	Same as implemented for 100 vehicles
TMC to vehicle telemetry bandwidth	As implemented, for 100 vehicles	Estimated at 5x as implemented, for 100 vehicles
Route calculation time	Averages 20 seconds per route	Would average 5 min, including telemetry time over existing channel
Computing resource at TMC	Four 486 computers: data base, operator, communication, and library	Superscalar parallel processor
Computing resource in vehicle	Two 80386 computers per vehicle x 100 vehicles = 200 80386's	One 80386 per vehicle
Traffic management potential	TMC would bias link travel times for broadcast to vehicles, for route diversion	Would perform on-line simulation, i.e. dynamic traffic assignment, to manage routing
Suggested route compliance	Vehicle paths known from probe reports; suggested routes unknown	Would be able to measure suggested route compliance since routes originate, and probe reports terminate, at TMC
Incident reporting	As implemented	Same
FMC data	As implemented	Same
UTCS data	As implemented	Same
Traffic information network	As implemented	Same
Availability of travel time data to routing algorithm	Two minutes	Immediate

Table 38 shows that the transition to a central architecture would add a measure of imbalance to the processing elements in the system, and would place a larger burden on the communications subsystem. The reward is that a centralized operation implies centralized data bases, which are easier to manage. In the case of TravTek, data bases were not distributed but rather were duplicated. This did contribute to logistical problems when updates were required. TravTek was able to overcome this problem since the fleet was controlled, and in the main, each vehicle always returned to a servicing center after the rental period.

## **RELATIONSHIP OF TravTek ARCHITECTURE TO PROBLEMS**

This section identifies the problems experienced with TravTek during the operational test, and subjectively places these problems in bins that categorize the problem either as architecture related or implementation related. The category "architecture related" is intended to contrast the TravTek distributed architecture with an identical system implemented with central architecture. In a central-based architecture, the TMC would have had much more computing power, and the vehicles would have had much less. All route calculations would have been performed centrally, and the individual routes (and reroutes) would have been transmitted to the vehicles for display. The local information data base would have resided at the TMC. Queries to the local information data base would have been sent to the TMC, and the response would have been transmitted to the car. Link travel times would not have been sent from the TMC to the vehicles. Instead, these would have been retained in the TMC as data for the calculation of routes as needed in response to requests from the vehicles. The map data base would have resided at the TMC. Major roadways to augment the display of the route would have been transmitted to the vehicles from the TMC as well. Table 39 provides the classification of problems and their respective categories.

## **CRITIQUE OF IMPLEMENTATION**

The TravTek system reached operational status only 3 years after inception. This ambitious effort brought together a broad cross section of disciplines to achieve a first-of-its-kind in IVHS operational tests. The bottom line is a success story for all the participants in this project.

TravTek could have been implemented in many cities, but with a limited number of vehicles, TravTek was best suited for a smaller city. A larger city would have required larger data bases: historical, map and local information. The creation and maintenance of data bases is a major part of the system implementation. The existing traffic management infrastructure in Orlando provided a freeway surveillance system and a computer controlled network of intersection controllers. The disbenefit of locating in Orlando was the network configuration with an Interstate highway dominating north-south traffic, and toll facilities likewise drawing east-west traffic. There was insufficient opportunity to select alternate routes. This impacted dynamic re-routing of the vehicles as well, which was a rarity. Instead there should have been more re-routing occurring during highly congested peak periods.

**Table 39. Relationship of TravTek problems to architecture and implementation.**

Problem	Architecture Related			Implementation Related
	Favorable	Neutral	Unfavorable	
Cost	✓			
Congestion Symbols				✓
Communication Errors				✓
Software				✓
Map Data Bases				✓
Car Batteries				✓
Reliability	✓			
Vehicle Location				✓
Link Travel Times				✓
Incident Reporting				✓
Expandability	✓			
Map Data Base Upgrades			✓	
Separate Navigation and Route Maps				✓
Local Information Data Base Upgrades			✓	
Historical Data Base Upgrades		✓		
Vehicle System Maintenance			✓	

TravTek needed much more traffic information than it had. Probe vehicle reports were shown to be valuable but lacking in quantity. The concept of marrying high technology with existing traffic control systems left a gap in the implementation. In existing systems, a lot more data would not produce correspondingly better traffic management. A lot more data would have improved TravTek.

A large number of people worked tirelessly during the entire operational test. Still, it seemed as if the heavy hitters left the project too early. The very serious problem of false congestion symbols appearing on the vehicle's screen was never resolved satisfactorily. More key personnel should have remained on site for the duration of the study.

A degree of automation was implicit in the system design. Yet, the system had instances when it was regarded as fully automated. It needed closer supervision. TravTek, though intricate, seemed to not have anyone permanently on site who thoroughly knew and managed the system. Sometimes, it was difficult to know where problems should be reported. One had to know in advance whose area of specialty was involved in order to report the problem.

TravTek was a bonus for Orlando. It achieved national publicity, and local residents were well acquainted with the project, and recognized the cars. With such microscopic scrutiny, a mechanism was needed to ground the fleet when problems surfaced. The system was still being debugged after the formal beginning. The system needed more time for problem resolution before going online. At times, it seemed that the glitz and technology marvel overshadowed one of the ultimate, bottom line reasons why this combination of technology is important in future implementations: traffic management. Traffic engineering had a voice in the system, but it was not allowed to be a primary driving force.

A differential GPS (DGPS) study was conducted during the latter stages of the project. Since most of the GPS receivers were upgraded for DGPS function, it would have been helpful if this testing had involved the entire fleet. The DGPS study is documented in a separate report.

#### COMMUNICATION SYSTEM ALTERNATIVES

The TMC to vehicle communications system was a full duplex time slotted packet radio system. The broadcast of a 1 minute status message from the TMC each minute served as a synchronization signal to the vehicles. This synchronization signal enabled each vehicle to transmit during its assigned time slot. The TMC could transmit for approximately 15 seconds; the 100 vehicles transmitted during the remaining 45 seconds. Each vehicle was allocated approximately 0.4 seconds to transmit.

By narrowing the time interval that each vehicle could transmit to 0.2 seconds or less, it would have been possible to expand the vehicle fleet to as many as 250. This would have been the absolute upper limit for the number of vehicles that could have been accommodated by simple expansion of the existing data radio usage.

In TravTek-like systems, the relatively easy communication task is from a single point (TMC) to multipoint (vehicles). The more difficult arrangement is multipoint to single point. This is not so much a problem in light communication traffic, but a difficult problem when contention is high, as with a large fleet of vehicles. The analogue is light versus heavy two-way radio traffic. In light traffic, if someone is talking, you wait until they're through. In heavy traffic, many others are also waiting to talk, and you may experience considerable delay. But, when radio traffic is heavy, messages tend to become more terse.

The single to multipoint communication in TravTek could have been accomplished with an FM subcarrier broadcast. The number of vehicles that could have been reached would only have been limited by the range of the radio. All vehicles in the Orlando metropolitan area could have been reached by this method, but so could any vehicle with TravTek equipment have received TMC broadcasts. The difference is that the FM subcarrier would have operated independently of

the packet radio system, thus freeing up 15 seconds of the packet radio system's time for additional simplex vehicle data transmissions.

The typical information message from a vehicle to the TMC was 248 bits. This excludes other "bookkeeping" bits that formed the message. The message content included the vehicle ID number, latitude, longitude, street name, heading, last three links and link travel times for links traversed last minute, version numbers of programs and data bases, and vehicle and TravTek equipment status. Some of this information was in the message to provide a service benefit to drivers through the vehicle for online assistance. By making this message more terse and "packing" the message, the original message content could be reduced from 31 bytes to 5 bytes. This would reduce the message content to vehicle number, last link traveled and the link travel time, and would sacrifice the provision for reporting up to three links traveled per minute. At most only a single link travel time would be reported by each vehicle. A one or two link queue could allow link travel time reporting to be delayed one or two minutes, if there was absence of a more current link travel time to report. This technique would theoretically permit 1,023 vehicles to be accommodated. But, this does not account for bookkeeping bits for packetizing, and timing becomes very critical for the transmit time slots. This would not be considered a practical upper limit. A maximum of 500 vehicles might have been accommodated using this technique.

Another communication alternative would be to use the FM subcarrier to broadcast requests for probe reports that are area specific, such as for specific links or coordinate bounds. Corrupted transmissions, signalling simultaneous responses, could cause a request for random response to lessen the possibility of transmit collisions. This technique could also be used to address select groups of the fleet. This concept fully applies to utilization of alternate frequencies for vehicle-based communications, such as may be available for dedicated use in IVHS. Because of the investment in infrastructure, the use of beacons would not have been practical for use with TravTek.

A final communication alternative would be to use some of the optimization techniques mentioned above, and establish the maximum number of probe vehicles that can be accommodated with the radio system. These probe vehicles, a subset of the remainder of the fleet which has only radio receivers, serve as the master probes for the rest of the fleet. This diminishes the number of probe reports available for feedback to the fleet, but it also allows the expansion of the TravTek fleet to any size.

## **IMPLEMENTATION CRITERIA**

This section will discuss the implementation criteria for replicating a TravTek system. The infrastructure in place in Orlando that contributed to the success of TravTek was the Florida DOT Freeway Management Center and the City of Orlando Traffic Management Center. These centers were supported by ongoing operation activities. A commercial radio service was available for use to implement the TMC to vehicle data communications link.

To replicate a system comparable to TravTek, the following must be considered:

- Video surveillance system.
  - monitor freeways.
  - monitor key arterials.
  - surveillance system maintenance.
- Vehicle detection system.
  - freeway speed and volume detectors.
  - arterial speed and volume detectors.
  - detector system maintenance.
- Traffic management center.
  - site where TravTek computers are installed.
  - TMC operations staff.
  - TMC maintenance staff.
  - focal point of surveillance and detection system.
- Communications with traffic management subsystems.
  - coaxial cable.
  - fiber optic cable.
  - leased telephone lines.
  - private twisted pair cable.
  - wireless links.
- In-vehicle equipment.
  - routing computer function.
  - navigation computer function.
  - data radio.
  - map display.
  - voice synthesizer.
  - dead reckoning system.
  - GPS receiver.
  - cellular telephone.
- Traffic information network.
  - commercial traffic service.
  - terminals at police departments.
  - terminals at fire departments.
  - terminals at commercial vehicle operations.

The software system consisted of the following software and data bases:

- TMC operating software.
- Vehicle operating software.

- Map data base.
- Historical travel time data base.
- Local information data base.
- Remote user operating software.

These components comprised the TravTek system. Major considerations not addressed by the System Architecture Evaluation were the institutional issues. The participants in the TravTek Operational Test had an excellent spirit of cooperation. This favorable implementation "climate" is key in multijurisdictional implementation.

Sites have either more or less traffic management infrastructure than Orlando. The balance needed to offset the absence of either a freeway or arterial management system will be a larger number of probes. A comprehensive set of online, real-time diagnostics will be needed to ensure the correctness of system operation and data accuracy and timeliness.

Improvements in vehicle location, particularly differential GPS (DGPS), should be a part of new system implementation. Improvement in vehicle dead reckoning system will be an additional benefit to be sought. Coupled with DGPS, vehicle location can be greatly improved.

## LESSONS LEARNED

The TravTek Operational Test had an inception-to-implementation time span of 3 years. The evaluation period was the 12 months following the time of system implementation. The total 4 year period yielded many lessons learned. This section discusses the lessons learned during the evaluation period for the system architecture evaluation. Many other lessons were learned by others prior to this period, and will be reported elsewhere.

### LIST OF LESSONS LEARNED

#### **Lesson # 1: Truncated Test Period.**

The 1 year evaluation period seemed brief after the considerable expense and effort to bring the system online. The evaluation period should have continued at least 6 months longer. As the system continued operation, the data quality was improving and system bugs were still being resolved. The quality of data acquired at the TMC reached a peak during the last 3 months of operation.

#### **Lesson # 2: Diagnostic Information in Distributed System.**

A distributed system is more difficult to troubleshoot than a centralized system. Accordingly, a distributed system requires many diagnostic features to verify system operation. Software features for verification of correct system operation could have been more widespread throughout the system.

#### **Lesson # 3: Improve Degree of Automation.**

The success of operator interaction with a complex system depends on the operator. The TMC was at times either unattended or without attention. Use could be made of an expert system for operator assistance. Delays in operator action caused corresponding delays in making the system aware of an incident. A higher state of automation was desirable. Incident information should enter the system automatically without requiring the TMC operator to acknowledge the incident report. Fully automating the process would remove the operator from the system and would improve the timeliness of the incident information. However, there needs to be some logic developed for entering information to ensure the quality of the information as well.

#### **Lesson # 4: Map Data Bases.**

A high level of data base accuracy is necessary to support reliable route guidance. A substantial effort was put forth to create and maintain the map data bases. Ultimately, the official initiation of the project was delayed 3 months because of problems with the map data bases. After 12 months of error corrections, there were still errors in the mapping representation, but with good closure on acceptable accuracy. The creation of map data bases is a significant effort in the IVHS scenario, and new techniques must be found for creating and updating map data bases.



#### **Lesson # 5: Dual Map Data Bases in Vehicle.**

Because of the state of the art in developing navigation and routing data bases, TravTek had to be designed using dual data bases. This type of design is peculiar to TravTek. There was unanimous consensus that the use of these two map data bases in the vehicle was redundant and required an increased effort to manage both data bases. The transitions from use of the TravTek traffic link network (coarse) to the map link network (fine) presented interfacing problems. Routing and navigation require different levels of network aggregation. Development of future data bases need to be able to support both functions.

#### **Lesson # 6: Manual Record Keeping.**

The reliance on manual record keeping is discouraged. Vehicle service records did not reflect all of the problems that were being experienced. For example the battery problem was so commonplace that the difficulty was no longer reported in the vehicle maintenance records. Many other routine problems were fixed without logging the problem.

#### **Lesson # 7: Quality of Travel Information.**

Few data information sources in an ATIS are checked more thoroughly by drivers than traffic information. As a result it is vital that the information contained in the system represent actual traffic conditions in the network. The results of the System Architecture evaluation showed that the conventional sources and method of obtaining traffic and incident information (particularly those on arterial streets) may not be able to provide the high quality information that is needed to support ATIS. In particular, the evaluation showed that using the delay estimates from the UTCS system did not provide consistent or accurate measurements of actual travel times on the arterial links. A better means of estimating travel times on arterial links should be developed. This method should address the variability in travel times that exists on arterial streets caused by the traffic signals.

#### **Lesson # 8: TMC Manual Record Keeping.**

The keeping of manual records to reflect problems in the TMC was minimal. Many problems were experienced that were solved by rebooting, without a clear identification of the machine status that led to the problem. If record keeping cannot be automated, its importance must be communicated and monitored, and those responsible for adequate record keeping should be rewarded.

#### **Lesson # 9: TIN Network Concept.**

The Traffic Information Network (TIN) was a sound concept that attempted to bring both generators and users of traffic information together on a network. Many users were signed up, but system problems prevented their going online with terminals. Interest waned, and eventually the only real user was a commercial traffic service. The TIN concept was never really given an opportunity to function, and thus could not be evaluated.

#### **Lesson # 10: Traffic Data Timeliness.**

Observations indicated that there was often a considerable time lag between communication events occurring in the system. There appeared to be a considerable time lag between when a message was generated at the TMC to when the message was received by the vehicle. One possible explanation for this was the way that the TravTek system permitted data flow between the various subsystems. Because the architecture required vehicle-to-TMC and TMC-to-vehicle communications to occur at specific time slots every minute, data were grouped in 1 min packets. Data packets would then move through the TravTek system in 1 min intervals. This led to delays in how soon data could be processed by the system and new data broadcast to the vehicles. One way of ensuring that information is disseminated in a timely fashion in future ATIS is to use an event-driven method of processing and communicating data. With an event-driven system, data is processed as soon as a probe report is received by the communications computer. In this way, data is being continually processed by the system (as opposed to being processed in specific time slots).

#### **Lesson # 11: Public/Private Partnership.**

The TravTek Demonstration Project was an early demonstration of the workability of public/private partnerships. Clearly, the momentum of IVHS can only be maintained through continuing these partnerships, at least until the majority of the effort is privatized.

#### **Lesson # 12: Development of Evaluation Plans.**

It is important that the development of the evaluation plan and the development of the automated data collection systems be coordinated. In some cases, a massive amount of data was logged by the TravTek system that was not particularly useful in the evaluation. Some logs, both manual and automatic, were incomplete or did not provide the data needed for analysis. Because the development of the evaluation plan occurred after the system was developed, some of the automated data collection systems had to be modified in order to collect data after the evaluation had commenced. This resulted in data not only being lost to the evaluation team, but also additional costs to the system developers. Early coordination between the evaluation team and the system designers could have reduced the need to modify the data collection process during the evaluation period.

#### **Lesson #13: Timeliness and Quality of Incident Information.**

One of the problems associated with the architecture of the TravTek systems was the way in which incident information entered the system. The result of the evaluation showed that this information often did not reflect what was actually occurring on the roadway. In addition, the incident information that did enter the TravTek system was often not timely. Based on these results, it is recommended that future ATIS use automatic methods of entering and verifying incident and congestion information. Fully automating the process would remove the operator from the system and improve the timeliness of the information. This automated process should include, however, some type of logic for ensuring that the information accurately reflects actual conditions.

#### **Lesson # 14: Importance of Machine Logs.**

It was found that there were substantial discrepancies between the machine and operator logs at the TMC. It is important that the machine automatically log as many of the system malfunctions as possible. For example, a system reboot should require an online operator interaction to enter the reason for the reboot. Such interactions should be controlled by artificial intelligence software to ensure adequacy of responses.

#### **Lesson # 15: Involvement of Project Personnel.**

Several system operators and key participants had never been in a TravTek vehicle. The involvement of project participants at all levels is necessary to sustain a high level of interest.

#### **Lesson # 16: Performance of Distributed System.**

A distributed architecture system allows the system to perform effectively in a degraded mode. Even if all parts of the system are not totally operational, key functions can be performed by various distributed subsystems. This is an important feature of the fallback design of a distributed system.

#### **Lesson # 17: Operation of Complex System.**

In a system which is complex and constructed and maintained by several different organizations, there is need for a central organization totally responsible for the system. This organization should be the system integrator, and serve as the party who oversees all phases of the system installation, maintenance, and operation.

#### **Lesson # 18: Benefits of ATIS to Traffic Management.**

As designed, TravTek was an evaluation of an Advanced Traveler Information System. The full benefits of ATIS as a traffic management tool was not evaluated. There is a large interdependency between ATIS and traffic management, such as: 1) diversion around incidents, 2) prediction of traffic patterns, and 3) ability to design control strategies to meet demand.

#### **Lesson # 19: Acceptable Level of Operation.**

The more complex the system, the more difficult it is to determine its operational efficiency. TravTek did not have sufficient online diagnostics to determine whether or not it was working properly. A more comprehensive system of online analysis was needed throughout the system to continuously assess the system state, perform diagnostics, and report problems in a timely manner. In some cases, the evaluation was serving as a diagnostic function. As a result, some of the more important evaluation issues could not be pursued in adequate detail, such as analysis of levels of processing in a distributed system, better ways of fusing data, and replication of the TravTek concept in other areas of the country.

## **Lesson # 20: Timely Processing of Log Data.**

The data needed for evaluating an ATIS should be specified in a timely manner by the evaluators. Data logging and testing should not be the last priority of an operational field test. Ideally, first level processing should occur on the data logs before they are more than one week old. Experimenters should begin looking at the data as early as possible, to test reasonableness and accuracy. Furthermore, the complexity and size of conducting the evaluation should not be underestimated, including the amount of labor needed to conduct the experiments, build the data base, and analyze the data.

### **SUGGESTIONS FOR FURTHER DATA EVALUATIONS**

During the course of the system architecture evaluation, many ideas for further investigations emerged. These are based on the data available in the TravTek data bank. Because of the massive amounts of data, time constraints, and limited resources, these interesting and exploratory avenues could not be pursued. The following is a list of possible data analyses that could be performed in the future.

1. Events 62 and 63 in the log data signaled the reception and transmission of data from and to the TMC. Since data communication errors associated with TMC/vehicles communications were uniformly distributed over the network, it is possible that many of these perceived errors were related to data logging. A more detailed evaluation of these data is suggested to confirm this hypothesis.
2. When tracking a vehicle during a trip by monitoring the successive links traveled, it was noticed that links are skipped. These data are available in the TMC radio file. A deeper investigation of these data needs to be pursued, such that the successive links reported by a probe vehicle are indeed contiguous links on the TravTek network.
3. Network coordinates may have been in error. A further analysis of these potential errors should be pursued, with details on how these errors affected link travel times reported by the probe vehicles.
4. Determine if the relationship between driver satisfaction and system performance varied during the operational phase of the project, i. e., determine if driver satisfaction improved in concert with improvements in operation as the system matured.
5. The "services only" mode of the TravTek vehicle did not permit driver interaction to correct vehicle location, such as would be accomplished by pressing the "hop left" or "hop right" buttons. Thus, this mode of operation may have allowed link travel times to be reported for links other than those traveled by the vehicle. The data for trips using the "services only" mode should be analyzed to determine if these probe reports were less reliable.

**BLANK PAGE**

## CONCLUSIONS

The TravTek system operated in Orlando for 1 year beginning in late March, 1992. The system brought together a multidisciplinary team to design and implement TravTek in a multijurisdictional environment. A unique partnership was formed between the public and private sectors to provide the impetus for the project. Only 3 years were required from time of inception to time of deployment, and a unique spirit of cooperation prevailed to maintain this schedule.

A brief summary of conclusions follows for each of the issues addressed in the System Architecture Evaluation. The ordering follows the sequence of preceding materials in this report.

TravTek was an Advanced Traffic Information System (ATIS). Good quality and timely traffic information is a fundamental need of such a system. TravTek needed much more high quality traffic information to provide vehicle routing that had the benefit of accurate, up to minute traffic information. The freeway surveillance system was a relatively good source of travel time information, and the arterial street network surveillance system did not provide accurate estimates of actual travel conditions. Probe vehicles provided reliable travel times, but reported significant travel time variations on arterial links due to stop time at intersections. A much larger number of probe reports would provide a better sampling of average travel times.

Incident information available to TravTek was sparse and usually not timely. While incidents are hopefully the exception in traffic operations, they are nonetheless highly visible and well noted by drivers. Drivers had the expectation that the TravTek system "knew" about incidents, but this was generally not the case. Frequently, TravTek's awareness of incidents was tardy. Better incident reporting was needed.

Data base accuracy was good. The historical travel time data base improved over time with updates from probe vehicles. The map data base provided a good representation of the network, as evidenced by the in-vehicle display. This is a highly visible element of the system, and errors in mapping are certainly noticed by drivers. The map data base development required a substantial effort, and maintenance was very important since the network changed on occasion. After 1 year of operation, there were still some original errors remaining in the maps, plus those impacted by construction. The local information data base accuracy was good and improved with each new version.

The data fusion process for estimating link travel times was the core of the TMC software. This process assimilated inputs from all relevant sources and chose a winner based on a fuzzy logic algorithm. The duration of the influence of probe vehicles may have been too long, but the algorithm worked well otherwise. Field studies were not conducted to evaluate the estimating process, and would have been helpful in the assessment.

A human factors study was made regarding the TMC operation and environment. A medium workload was occasionally experienced, punctuated by long periods of light workload. Better training of operators was needed, workstation design could have been improved, and the work environment was possibly too noisy.

The TravTek Traffic Link network had almost total coverage by the TravTek vehicles. There were approximately 45,000 probe reports per month. The network was generally a good representation of the actual roadways and their travel times. Some error in the node coordinates may have contributed to missing or erroneous probe reports.

The TravTek system achieved the highest state of automation that could have been achieved with its design. An operator must be present in the TMC. The gathering and processing of incident information remains an interactive process. Link travel time data were received automatically from the probe vehicles, freeway management system, and arterial control management system. In turn, these data were processed and distributed to the vehicles, all without operator intervention.

The TravTek system was very reliable, largely due to a distributed architecture. The availability of the system was in excess of 96 percent throughout the project across all subsystems, based on data processed from the TMC logs. The subsystems considered were UTCS, TISC, TIN, FMC and Radio. The TMC/Vehicle communication subsystem was analyzed separately, to measure the two-way radio data error rates. The average error rate for TMC to vehicle communications was found to be 14.8 percent. The error rate for vehicle to TMC communication was found to be 14.1 percent. The logging procedure for the data used to analyze error rates apparently contributed to the high values of 14 plus percent.

The TravTek system performed normally with respect to the reliability of software. As more changes and fixes were made, the reliability improved. A minimum amount of data were available for analyzing software failures, but the general perception was that the successful removal of software design faults resulted in better system operation.

The TravTek distributed architecture was a logical choice for the implementation. It performed well and generally did not show any weaknesses that ultimately limited its performance. It promoted a parallel effort during development, since GM, AAA, and FHWA each were in charge of developing a separate portion of the system that would later be linked by communications. If TravTek had been implemented as a central-based architecture, much more computing power would have been required at the TMC, and much less in the vehicles. This would have simplified data base maintenance, yet would have increased the communication requirements and imposed an imbalance of the system processing elements. The problems with the TravTek system were largely implementation related, as opposed to architecture related. Communication system alternatives would have permitted a much larger vehicle fleet to be deployed, but with limits on probe reporting.

There were many lessons learned from TravTek. It established feasibility, and ventured into uncharted territory. The implementation and evaluation will serve as a model for subsequent projects.

## APPENDIX A. TMC SYSTEM HARDWARE

The following system hardware is used by the TravTek/TMC system. <sup>(9)</sup>

### Data Base & OI Workstation

#### AST Premium 486/33TE System

- 16MB Ram
- 320MB Hard Disk
- EISA Hard Drive Controller
- 3.5" 1.44MB Floppy Disk Drive
- 5.25" 1.2MB Floppy Disk Drive
- Logitech Bus Mouse
- Video 7 VRAM VGA Video Board with 512K
- NEC Multisync 3D / NEC Multisync 5D Monitor
- 3-Com Etherlink 16 Network Adaptor
- Digiboard DigiChannel PC/8i
- Power Distribution System
- SY-TOS Tape Backup Software
- Tape Backup System (250MB)
- Tapes, Extended Length, Pre-Formatted (100)

### Communications Workstation

#### AST Premium 386/25 System

- 8MB Ram
- Memory Expansion Board
- 3.5" 1.44MB Floppy Disk Drive
- 5.25" 1.2MB Floppy Disk Drive
- 120MB Hard Drive
- Logitech Inport Mouse
- NEC Multisync 3D Monitor
- 3-Com Etherlink 16 Network Adaptor
- Digiboard DigiChannel PC/16i (Standard Configuration)
- Power Filter/Distribution System

### Communications Hardware

- Codex 80002 Modulus 18 Slot Enclosure
- Codex 80005 Power Supply
- Codex 41805 V.32 Modem 1200-9600bps Dial Up & Leased (4)
- Codex #2239 2 modem cards V.22 300-2400bps (3)
- Codex Assorted Installation Hardware & Cables

### Other Hardware

- RS-232 Cables
- Miscellaneous RS-232 Adaptors
- RJ11 Phone Cables
- Thin Ethernet Cabling (For Test Site)



Thin Ethernet Cabling (At TMC)

Modem 2400bps V.42

In-line UPS

System Software

The following commercial software packages are used by the TravTek/TMC system:

MS-DOS V. 3.3

IBM or OS/2 V. 2.0 Standard Edition for each machine

Remote OS (1 user license)

RT-Graphics V. 2.0

Microsoft SQL-Server V. 1.1 (5 User license)

Microsoft LAN Manager V. 2.0 (5 workstation license)

QMODEM

Logicom

## APPENDIX B. TMC OPERATOR MENU FUNCTIONS

### System

This selection contains all of the routines relating to administrative functions. The following menu choices are available:

- Login.
- Logout.
- User.

System - Login - the system presents a dialogue box that allows the user to enter a login ID and password. The system checks the data entered. If the login fails, this is recorded in the system log and an error message appears that requires acknowledgement.

If there are TIN or status messages waiting, their windows are opened and the message(s) are presented.

System - Logout - upon selection, the system disables all operator functions. The system removes all windows and dialogue boxes. The map and viewport are changes to the system default view. All menus are deactivated except 'Login'.

System - User - provides the ability to view, add edit or delete a users' data records. Only the supervisor can add or delete a record. The supervisor can view or edit the data for any user. Users can only view or edit their own data record.

### View

These options are also available from a viewport. They are:

- Zoom.
  - Mouse Zoom In.
  - Mouse Zoom Out.
  - Zoom In.
  - Zoom Out.
  - Zoom to Level.
- Refresh Screen.
- Default.
- Viewport.
- Vehicle Positions Now.

- Go To:
  - Landmark.
  - Intersection.
  - Vehicle.
  - Parking Lot.
  - (Incident).

#### View - Zoom

This module contains all of the routines responsible for magnifying or reducing (zooming) the map display. The following menu choices are available:

- Mouse In.
- Mouse Out.
- Zoom In.
- Zoom Out.
- Zoom To Level.

View - Zoom - Mouse In - the user has the ability to zoom in on a map by using the mouse. Select the map area to zoom in on by selecting and holding down the left mouse button, and stretching a rubber band box around the area of interest for zoom in.

View - Zoom - Mouse Out - the user has the ability to zoom out on a map by using the mouse. Select the map area to zoom out on by selecting and holding down the left mouse button, and stretching a rubber band box around the area of interest for zoom out. This action causes a new zoom level that places the previous view in the area selected. The center of the rubber band box becomes the new center of the screen displayed.

View - Zoom - In - with this function, the user zooms in one zoom level on the current map.

View - Zoom - Out - with this function, the user zooms out one zoom level on the current map.

View - Zoom - To Level - with this function, the user can zoom to any level directly.

View - Refresh Screen - the user can refresh the map display. Occasionally when windows are moved blank sections can occur, at these times refresh is used.

View - Default - this function allows the operator to update the map with the latest known vehicle positions.

View - Viewport - the user can create another view of the map with this function. A window is created containing the map at its default position, zoom level, and scale. This window can then be

adjusted to suit the user. Multiple viewports take large amounts of system resources and slow the drawing times of all maps. Use of more than 2 viewports is discouraged.

#### View - Goto

This module contains all of the routines responsible for locating items on the map display. The following menu choices are available:

- Landmark.
- Intersection.
- Vehicle.
- Parking Lot.
- Incident.

View - Go To - Landmark - the system presents a list of landmarks. Landmarks can be defined by the operator and may include significant areas of interest such as the TMC location or the Oldsmobile dealer. Any landmark can be selected from the list. The current map is centered on that position with a zoom level appropriate to viewing a landmark.

View - Go To - Intersection - the system presents a dialogue box with 2 list boxes. The first box contains a list of all streets in the data base. There is also a name entry field where all, or part of the name can be typed. As the name is typed, the list box is moved to show the current matches centered.

The operator must then select the first street. The second list box is presented and filled with a list of all the streets that intersect the first street. The operator must select the second street from this list. The current map is centered on that position with a zoom level appropriate to viewing an intersection.

View - Go To - Vehicle - the system presents a combination dialogue box that allows the user to either type in the vehicle number, or select from a list of all vehicle numbers.

The current map is centered on the last received position with a zoom level appropriate to viewing a vehicle's location.

View - Go TO - Parking Lot - the system presents a list of all parking lots, and allows the user to select one. The current map is centered on that position with a zoom level appropriate to viewing a parking lot.

View - Go To - Incident - this function is the same as Incident - Move To function which is defined in the incident section below.

### Data Base

This menu choice allows the user to view, add, edit, or delete records from a variety of system data base tables. These are:

- Parking Lot.
- Weather.
- Landmark.
- Vehicle.
- Day Plans.

### Data Base - Parking Lot

This option presents a screen containing the first Park Lot data base record. The user can search for a different record, edit the current record, delete the current record, or add a new record.

### Data Base - Weather

This option presents a screen containing the weather record. The user can edit the record, or clear the record to a default (no data available) message.

The weather data must be entered by this operator at regular intervals. This is done by calling the local weather information telephone number, and entering the data. The system will check the date and time that the data was last updated, and will erase the current entry if it is older than a certain time period (4 hours). When this happens, a message will be placed in the system status window reminding the operator to call for updated weather information. After 4 hours and 15 minutes without an update to the weather message the 'No Data Available' message will be transmitted to the vehicles.

### Data Base - Landmark

This option presents a screen containing the first Landmark data base record. The user can search for a different record, edit the current record, delete the current record, or add a new record.

### Data Base - Route

This option presents a screen containing a list of the current system route files. The user can choose to edit, or delete one of these, or to add a new one. The route files are edited using the system editor.

### Data Base - Vehicle

This option presents a screen containing the first Vehicle data base record. The user can search for a different record. This option only allows viewing of the records.

### Data Base - Day Plan

This option presents a screen containing the first Day Plan data base record. The user can search for a different record, edit the current record, delete the current record, or add a new record.

### Reports

This allows all the routines responsible for creating reports. The reports appear in scrollable, movable, sizable windows. The following menu choices are available:

- System:
  - Communication Status.
  - Incidents.
  - Link Data.
  - Vehicles.
  - Parking Lot Closures.
  - Routes.
- User Defined.
- SQL.

### Reports - System

This module contains all of the routines for creating system specific reports. The following menu choices are available:

- Communications Status.
- Incidents.
- Link Data.
- Vehicles.
- Parking Lot Closures.
- Routes.

It is important to realize, that report screens differ from data base screens in that report screens are movable sizable windows, whereas the data base screens are dialogue boxes that require user response.

### Reports - System - Communications Status

The communications status report provides information for each of the permanent communications links (FMC, UTCS, TISC, Metro Traffic, GPS, Radio Verification and Radio) such as the current status and the percentage of time connected since system startup.

### Reports - System - Incidents

The incident status report provides information for all incidents in the system. The report shows the incident ID, the link it falls on, the incident type, and the start and end times.

### Reports - System - Link Data

The link data report shows a list of all non-nominal links, with an indication of the current travel time, the nominal travel time, and the source ID that is providing the non-nominal time.

### Reports - System - Vehicles

The vehicle status report shows a list of all vehicles in the system, with an indication of their current status, last reported position, and other information available from the probe reports.

### Reports System - Parking Lot Closures

The parking lot closure report provides a list of all closed parking lots and when they re-open.

Reports - System - Routes - This option allows the user to select a route from the list and generate a route report. The report contains information such as the total predicted travel time on the route, the links that are non-nominal, and the incidents that are active on the route.

### Report - User Defined

This option allows the user to generate a custom report from the system data base tables. The user selects the table and fields that are to be displayed. The system lays out and generates the report.

### Reports - SQL

This option allows the user to generate a custom report using standard SQL query syntax. The user may enter an SQL query from which a report is generated.

### Voice

The TIN users who use phones as data input are encouraged to enter data in an electronic form using the phones' push buttons. However, should they elect to do so they can leave a message on the TravTek computer.

The following menu choices are available:

- Play Message.
- Operator Page Block-Allow.

### Voice - Play Message

This option gives the user the ability to delete or play messages that have been recorded by the voice mail system.

### Voice - Operator Page Block/Allow

This option is a toggle that notifies the system that the user is/isn't available to answer pages from the voice mail system.

### Incident

These options are also available from a viewport. There are two types of incidents, these are:

- Alert.
- Confirmed.

An incident report from a confirmed source, such as the police or Metro Traffic is a confirmed incident. An incident from a alert source is a alert incident. A second report, on the same incident from an alert source is considered a confirmed incident. Only confirmed incidents are transmitted to the vehicles. Confirmed and alert incidents are sent to the TIN users. This allows the TIM users to return any data they have from their own sources concerning incident alerts.

The menu choices include:

- Add.
- Edit.
- Move.
- Goto.

Incident - Add - the operator must specify the location, duration, lane closure information and nature of the incident. The operator selects the incident type (alert or confirmed).

The System automatically enters the GOTO mode (see Incident, Move To menu item). The operator can specify the link ID or the cross streets involved. The currently active map image is centered on that location and placed at a zoom level appropriate to incident entry.

If the link ID was not used in the previous step, the operator must specify the link with which the incident is associated. This is performed by allowing the operator to enter the link ID number, or select the link from the map. This mode removes the dialogue box and locks out all system functions except selecting a link. The operator must then select a link from the map. This is performed by clicking on a link with the mouse.

In many cases one graphic element represents two links; one for each direction. In these cases, following selection of a graphic object, the operator is presented with a choice of directions. After selecting one of these the link number is defined. If a link is selected, its number appears in the title bar.

The operator must specify the incident location. Initially the incident is automatically placed at the default location and the operator is given the choice of accepting it, or moving it to a different position. If it is moved, a process similar to the link ID selection is employed.



The operator must specify the duration of the incident. If the incident is to be scheduled, the operator can select a button that allows the incident start/end time to be entered.

The incident duration is listed as a start time (the current time) and an end time. If the operator selects a duration of 30 minutes, the end time is calculated and the value is placed in the box. If the spin box is used, its value is copied to the end time. The start time cannot be edited unless the schedule button is pressed.

The operator must indicate which lanes and shoulders are closed by using pulldown boxes.

A second dialogue box appears that allows the operator to select from a list of preselected messages. Following message selection and confirmation by the operator the incident record is entered into the system.

#### Incident - Edit

This function allows the user to edit, delete, or confirm an existing incident. The operator can change the incident location, duration, lane closure information, link ID, or vehicle message.

Incident edit can be reached either by selecting Edit from the Incident Menu or by clicking on the incident symbol on the map and then choosing the Modify button from the incident information screen that is displayed. If the menu was used, the operator must select the incident to modify from a list of all those active or scheduled in the system. The list of incidents is ordered by link number.

The edit procedure is exactly the same as the add procedure, except that all fields contain a default derived from the previous values entered. Selecting 'OK' keeps the previous information unless it has been explicitly changed.

When an incident is edited (changed), a new data base entry is created with the next logical sequence number. The old entry is archived and then deleted.

Incident - Move - this function allows the operator to move the physical position of an existing incident. The operator first selects the incident with the mouse, chooses the Incident - Move menu, and selects the new location on the map by clicking at the desired position. The incident symbol will be moved, but will remain associated with its previous ID.

Incident - Goto - this function allows the operator to locate incidents on the map display. The operator selects the desired incident from the list of incidents and the map is redrawn at that incident location.

Link - these function contain operations specific to links. The menu choices are:

- Enter Congestion.
- Goto.

Link - Enter Congestion - this function allows the operator to set a congestion level for a link. The link must have been previously selected as the current object. There are four levels of congestion:

- No Congestion.
- Moderate Congestion.
- Heavy Congestion.
- Road Closed.

In addition to the above 4 levels, a timeout duration in minutes may be entered.

Link - Go To - see View - GoTo - Link above.

Info - this function gives information on the currently selected object. The information is presented in a standard window that can be sized, moved, etc.

#### TIN Functions

This menu choice is only available at remote workstations. The menu options include:

- Route
  - Upload.
  - Delete.
  - Show Info.

Route - Upload - This option allows the user to send a file that has been created on the local workstation to the TravTek system. All route files must be uploaded before they can be used.

Route - Delete - This option allows the user to delete one of the route files that they have previously uploaded. It presents a list of those currently on the system, and the user may choose which one to delete.

Route - Show Info - This option allows the user to display the header portion of a route file. The header portion may contain information that gives a more detailed description of the contents of the file.

#### DATA BASE COMPUTER SCREEN

The data base computer is not normally used during the daily operations of TravTek. It is used by the system developers for debugging and maintenance. The screen will display various data concerning the processes currently underway within those aspects of the TravTek that are being performed on this machine. These will include:

- The distribution of data sources selected by the data fusion process for the current minute.
- The distribution of the link time ratios for the current minute.
- Applications currently connected such as operator interface; FREFLO, UTCS etc.

#### COMMUNICATIONS COMPUTER SCREEN

The communications computer is not normally used during the daily operations of TravTek. It is used by the system developers for debugging and maintenance. The communications computer screen will indicate:

- Current connected TIN sources and line status of the modems.
- GPS receiver status.
- Broadcast radio communication status.
- Vehicle communication status and the number of vehicles on line.

**APPENDIX C. DATA BASE OF TravTek AND FMC INCIDENTS  
(JANUARY 22, 1993 THROUGH MARCH 26, 1993)**

TravTek Incident ID	Date	TravTek Link	Time Logged				Incident Type
			TMC		FMC		
			Beginning	Ending	Beginning	Ending	
3868	1/22/93	1455	17:33	18:00	17:29	18:16	Stall
	1/22/93	1415	-	-	15:15	15:48	Disabled
	1/27/93	1445	06:59	07:29	-	-	Accident
3938	1/27/93	1421	08:35	09:35	08:27	09:25	Accident
	1/28/93	1409	-	-	16:07	16:42	Disabled
	1/29/93	1415	-	-	14:45	-	Disabled
	1/29/93	1428	18:06	19:06	-	-	Accident
4007	2/1/93	1451	08:32	09:02	08:28	08:53	Accident
4012	2/1/93	1449	09:11	09:41	08:44	09:46	None
4014	2/1/93	1445	09:38	10:08	08:44	09:23	Accident
	2/1/93	1398	-	-	16:03	16:55	Accident
	2/2/93	1403	-	-	07:35	08:21	Accident
4049	2/3/93	1466	07:42	08:41	07:13	08:41	Accident
	2/3/93	1401	-	-	17:31	18:09	Accident
	2/5/93	1466	-	-	07:15	07:24	Disabled
	2/5/93	1461	-	-	15:25	15:44	Disabled
	2/5/93	1413	-	-	14:28	15:00	Disable
	2/5/93	1421	-	-	16:31	17:08	Police Activity
	2/5/93	1421	-	-	17:10	17:14	Disabled
	2/5/93	1398	-	-	16:42	17:36	Accident
	2/5/93	1401	-	-	19:13	20:14	Accident
	2/5/93	1408	-	-	15:48	16:17	Accident
4145	2/8/93	1407	17:44	18:14	-	-	Accident
4147	2/8/93	1445	08:02	08:32	07:49	08:51	Accident
4163	2/10/93	1447	09:03	10:03	-	-	Disabled
4165	2/10/93	1457	09:25	10:10	09:17	09:33	Accident

**APPENDIX C. DATA BASE OF TravTek AND FMC INCIDENTS (CONTINUED)  
(JANUARY 22, 1993 THROUGH MARCH 26, 1993)**

TravTek Incident ID	Date	TravTek Link	Time Logged				Incident Type
			TMC		FMC		
			Beginning	Ending	Beginning	Ending	
4195	2/11/93	1413	17:06	18:06	16:57	17:25	Disabled
	2/11/93	1459	-	-	08:08	08:46	Accident
4211	2/11/93	1472	16:43	17:43	-	-	Accident
	2/12/93	1403	-	-	17:46	17:50	Disabled
4260	2/16/93	1417	15:27	16:27	-	-	Accident
	2/17/93	1421	-	-	18:19	18:31	Accident
	2/17/93	1411	-	-	18:24	19:06	Accident
4293	2/17/93	1409	14:53	15:13	14:38	15:07	Accident
	2/18/93	1421	-	-	16:05	16:30	Disabled
4322	2/19/93	1417	08:47	09:07	08:28	10:12	Accident
4325	2/19/93	1449	09:46	10:40	09:31	10:38	Accident
4337	2/19/93	1398	16:07	17:07	-	-	Accident
4343	2/22/93	1445	07:13	07:38	-	-	Accident
4360	2/22/93	1421	15:47	16:08	-	-	Accident
4361	2/22/93	1445	16:06	17:56	-	-	Accident
4362	2/22/93	1396	16:08	17:28	15:55	18:03	Accident
	2/22/93	1453	-	-	18:50	19:11	Disabled
	2/22/93	1396	18:09	18:39	-	-	Disabled
4403	2/25/93	1421	07:10	07:40	-	-	Accident
4418	2/25/93	1421	16:31	17:01	-	-	Accident
4421	2/25/93	1413	17:43	18:43	16:12	17:34	Accident
	2/26/93	1403	-	-	15:54	18:16	Accident
	2/26/93	1415	18:46	20:46	-	-	Spilled Load
4456	3/2/93	1407	08:14	09:14	-	-	Disabled
	3/2/93	1407	-	-	17:24	18:34	Accident
	3/3/93	1421	-	-	15:30	18:03	Disabled

**APPENDIX C. DATA BASE OF TravTek AND FMC INCIDENTS (CONTINUED)  
(JANUARY 22, 1993 THROUGH MARCH 26, 1993)**

TravTek Incident ID	Date	TravTek Link	Time Logged				Incident Type
			TMC		FMC		
			Beginning	Ending	Beginning	Ending	
	3/3/93	1413	-	-	17:20	17:39	Accident
	3/4/93	1407	-	-	16:22	17:00	Disabled
	3/5/93	1421	-	-	07:55	07:59	Unknown
	3/5/93	1455	-	-	16:45	17:26	Disabled
4605	3/10/93	1401	16:08	17:08	16:23	17:33	Accident
	3/12/93	1443	-	-	07:03	07:43	Accident
	3/11/93	1411	-	-	17:12	18:09	Accident
	3/11/93	1455	-	-	17:12	18:31	Accident
4671	3/15/93	1469	08:12	08:27	-	-	Accident
	3/15/93	1411	17:56	18:56	17:54	18:35	Accident
	3/16/93	1459	-	-	08:03	18:07	Police Activity
4805	3/19/93	1445	17:43	18:43	-	-	Accident
4830	3/23/93	1417	07:59	08:27	07:54	09:13	Accident
4848	3/23/93	1459	07:23	07:53	-	-	Accident
4849	3/23/93	1466	07:27	07:57	-	-	Accident
4963	3/25/93	1398	16:00	17:00	-	-	Accident
4866	3/25/93	1398	17:09	17:39	-	-	Accident
4886	3/26/93	1419	15:44	16:44	14:43	15:19	Accident
	3/26/93	1411	-	-	15:58	16:36	Accident

**BLANK PAGE**

### APPENDIX D. PROBE VEHICLE FREQUENCY BY MONTH

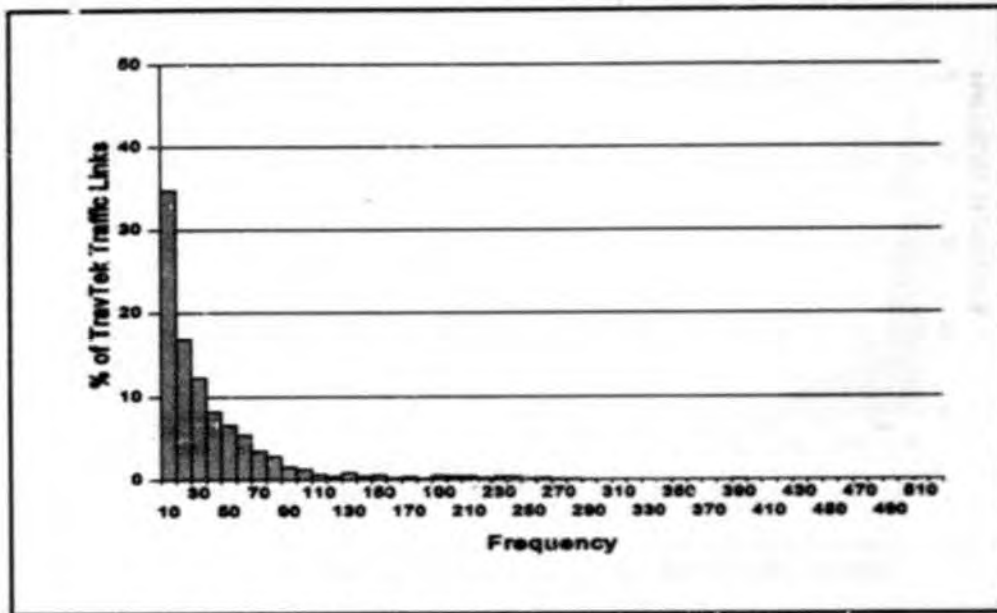


Figure 132. Probe vehicle frequency, June 1992.

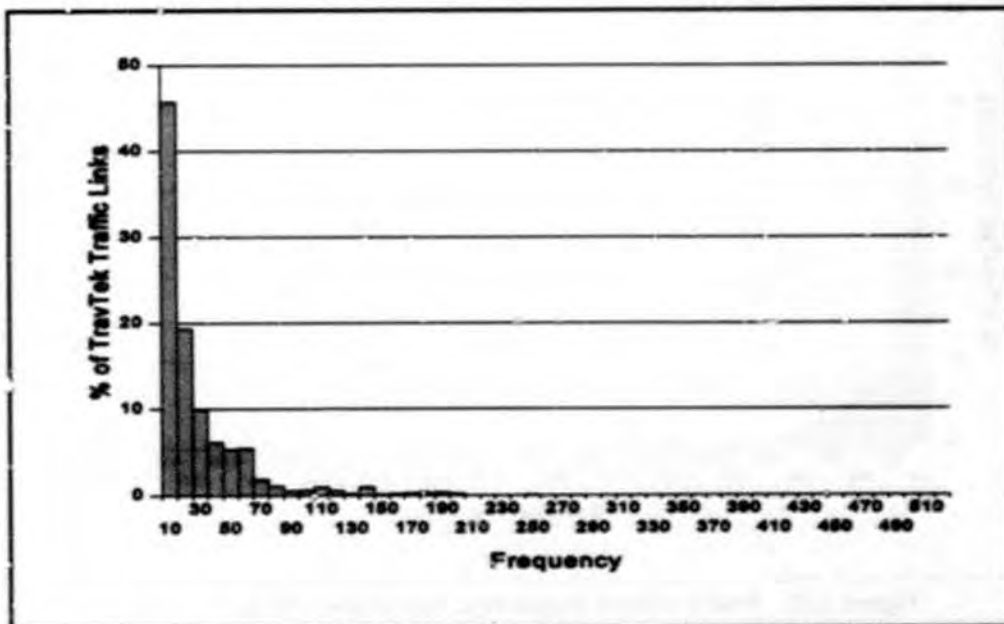


Figure 133. Probe vehicle frequency, July 1992.



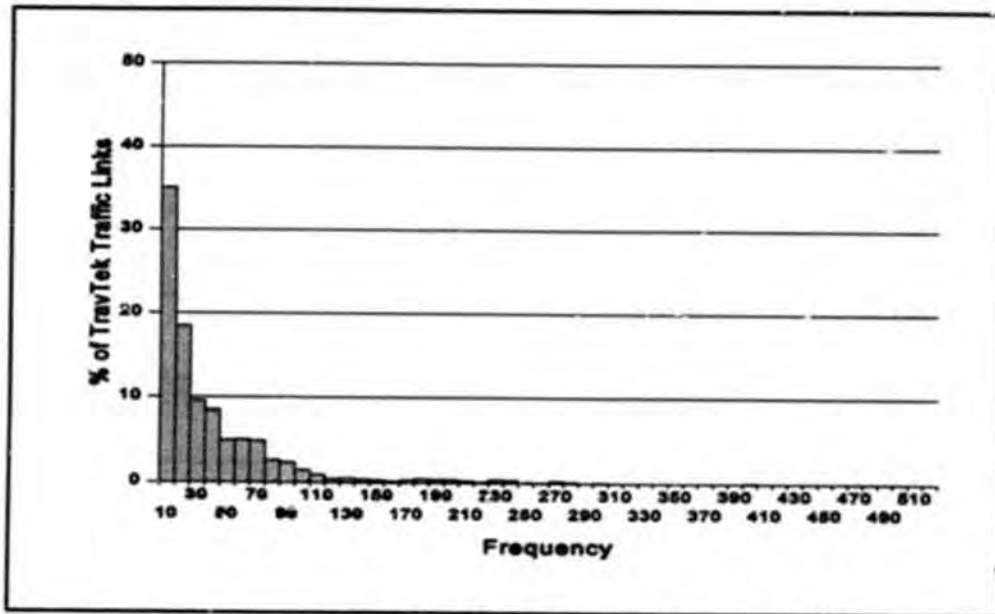


Figure 134. Probe vehicle frequency, August 1992.

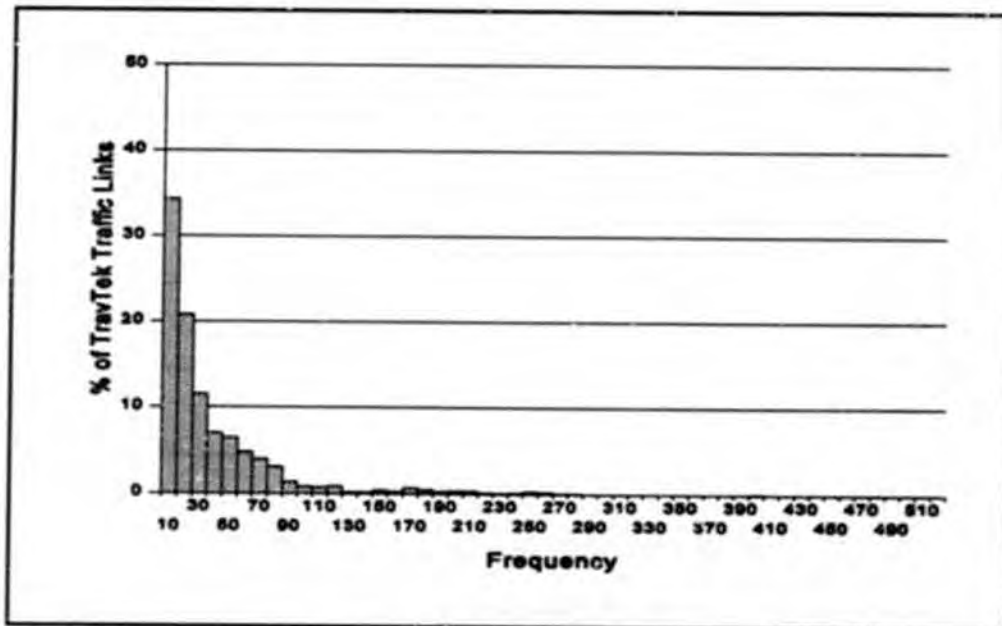


Figure 135. Probe vehicle frequency, September 1992.

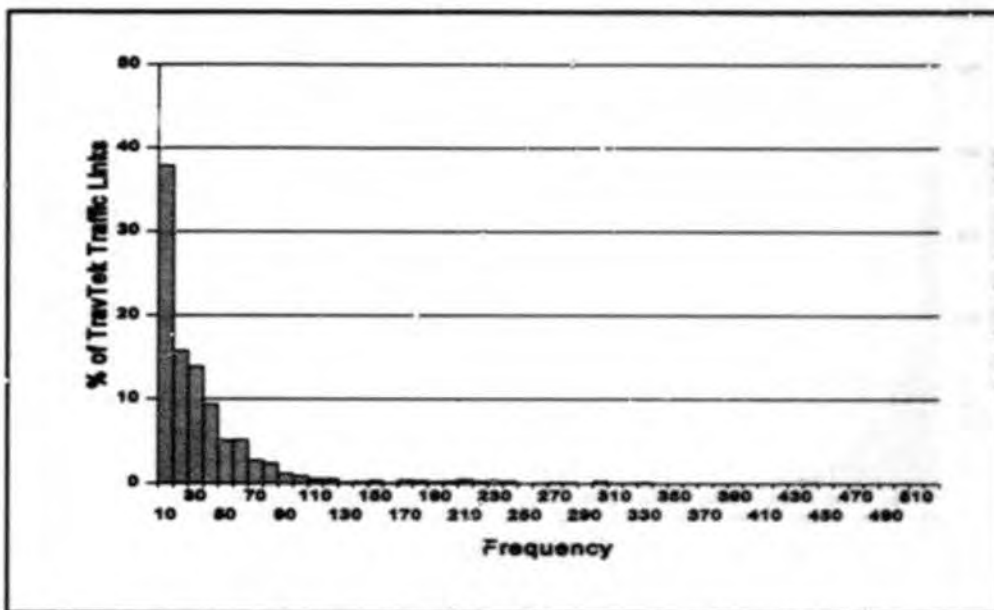


Figure 136. Probe vehicle frequency, October 1992.

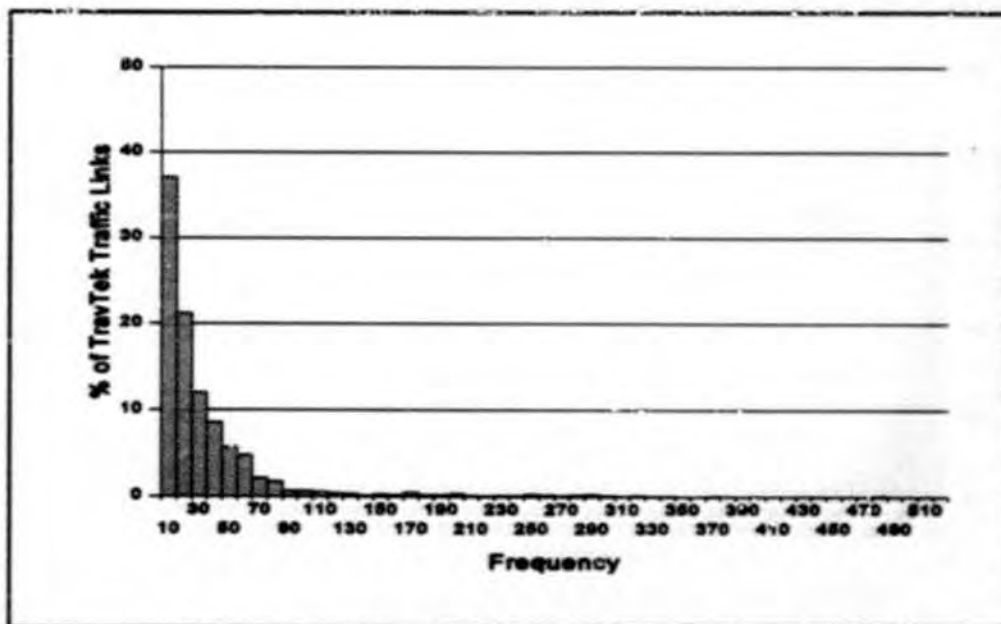


Figure 137. Probe vehicle frequency, November 1992.

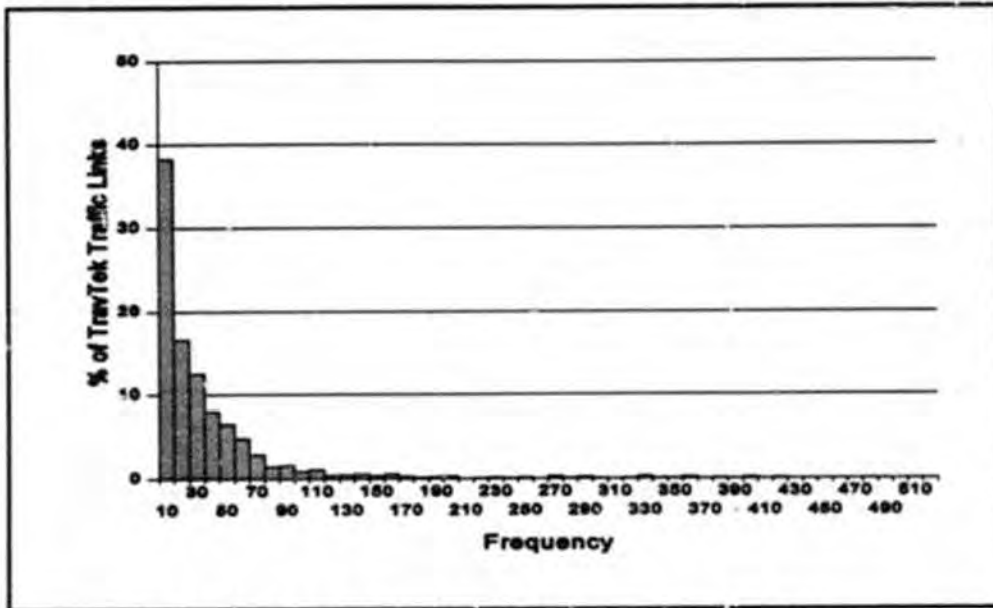


Figure 138. Probe vehicle frequency, December 1992.

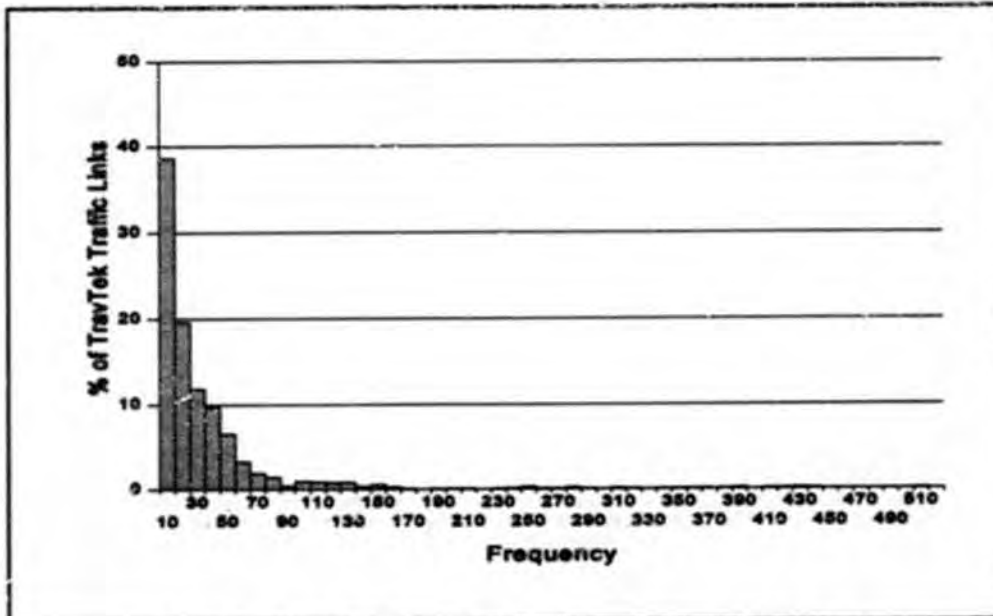


Figure 139. Probe vehicle frequency, January 1993.

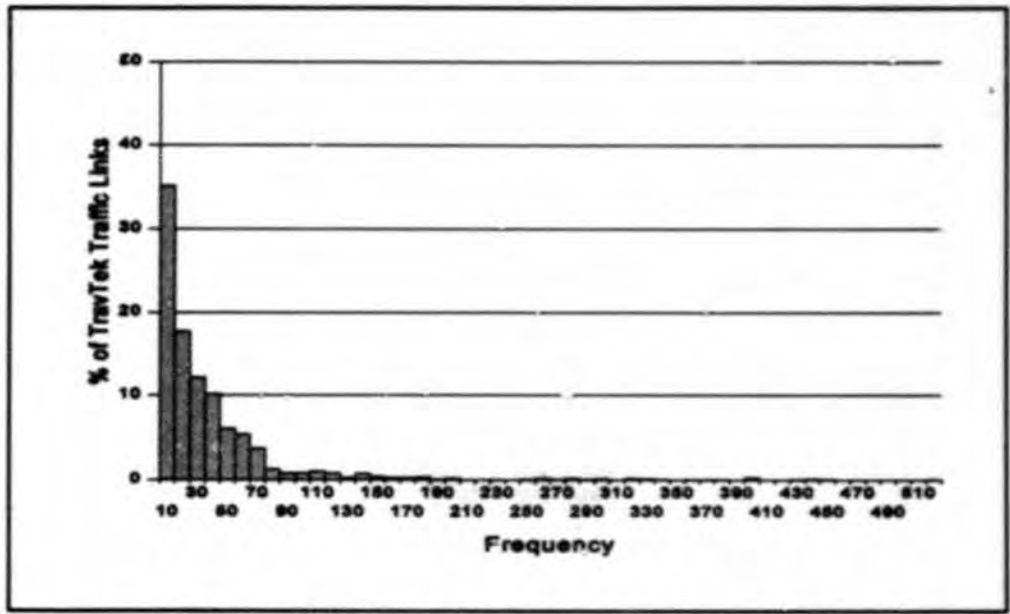


Figure 140. Probe vehicle frequency, February 1993.

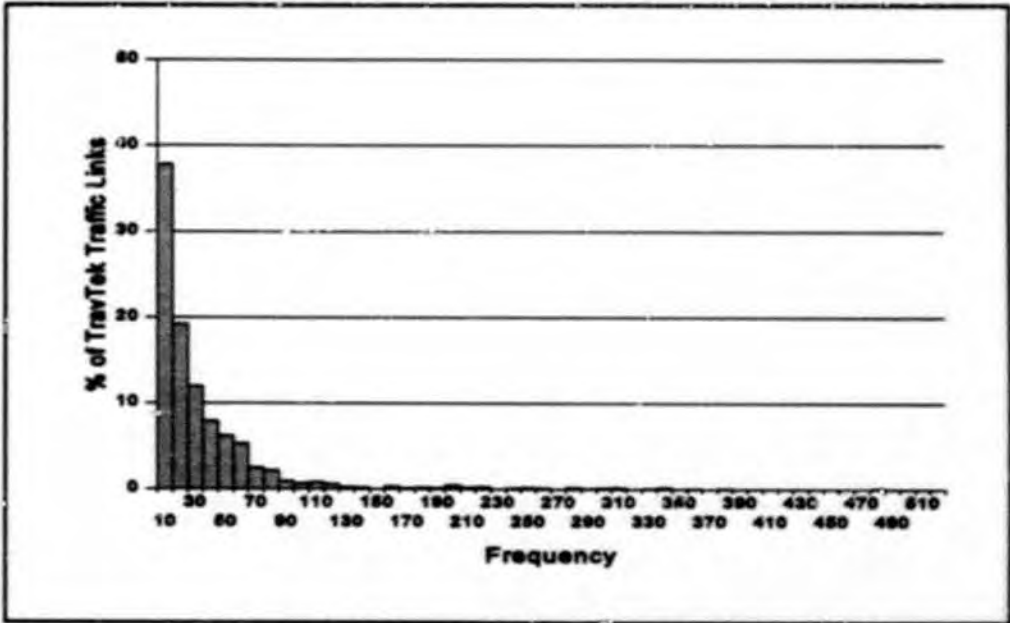


Figure 141. Probe vehicle frequency, March 1993.

**BLANK PAGE**

## REFERENCES

1. *Federal Highway Administration RFP solicitation number DTFH61-91-R-00106*, June 5, 1991.
2. Sumner, Roy, *Data Fusion in Pathfinder and TravTek*, Vehicle Navigation & Information Systems (VNIS) '91 Conference Proceedings, page 71.
3. Taylor, K. B., *TravTek - Information and Services Center*, Vehicle Navigation & Information Systems (VNIS) '91 Conference Proceedings, page 763.
4. Aslaksen, E., and Belcher, R., *Systems Engineering*, Prentice Hall, 1992.
5. Athey, T. H., *Systematic Systems Approach*, Prentice Hall, 1982.
6. Blanchard, B. S., and Fabrycky, W. J., *Systems Engineering and Analysis*, Prentice Hall, 1990.
7. Rosen, Dan A., Mammano, Frank J., Favout, Rinaldo, *An Electronic Route - Guidance System for Highway Vehicles*.
8. Rupert, Robert, *TravTek: An Advanced Traveler Information System*, ITE 1991 Compendium of Technical Papers.
9. *TravTek TMC - Functional Design*, unpublished, available from Farradyne Systems, Rockville MD 20852, October 7, 1991.
10. Rupert, R. L., *The TravTek Traffic Management Center and Traffic Information Network*, Vehicle Navigation & Information Systems (VNIS) '91 Conference Proceedings, page 757.
11. Krage, M. K., *The TravTek Driver Information System*, Vehicle Navigation & Information Systems (VNIS) '91 Conference Proceedings, page 739.
12. Lewis, J. W., *TravTek System Interface Specification TMC-Vehicle Communications Protocol*, Document Number SIS-01 (DI 7), December 4, 1991.
13. *Task C. Potential TIN Sources Draft Report*, unpublished, available from Farradyne Systems, Rockville MD 20852, November 5, 1991.
14. Corsi, K., and Lewis, J. W., *TravTek System Interface Specification - Local Information Database*, Document Number SIS-02 (DI 7), January 9, 1992.
15. *Highway Capacity Manual*, Special Report 209, Transportation Research Board, National Research Council, Washington, D.C., 1985.

16. Rillings, J. H., Lewis, J. W., *TravTek*, Vehicle Navigation & Information Systems (VNIS) '91 Conference Proceedings, page 729.
17. Lewis, J. W., and Zazulak, M. A., *TravTek Functional Requirements*, Document Number FR-001, (DI 5), January 8, 1992.
18. Facsimile communication from Mark Krage, GM Research Laboratories, September 9, 1992.
19. *The TravTek System*, Draft Final Report, unpublished, available from Farradyne Systems, Rockville MD 20852, May, 1993.
20. American National Standard for Human Factors Engineering of Visual Display Terminal Workstations ANSI/HFS 100-1988, Human Factors Society, Santa Monica, California.
21. TravTek Traffic Link Network supplied in Lotus spreadsheet format by George Gilhooley, Florida Department of Transportation, De Land, Florida, April 1992.
22. TravTek Traffic Link Network Coordinates furnished by Mark Krage, General Motors Research Laboratories, Warren, Michigan, August 1993.
23. TravTek Traffic Link Network coordinate data supplied by Mark Krage, General Motors Research Laboratories, Warren, Michigan, August, 1993.
24. *Encyclopedia of Computer Science*, Third Edition, Van Nostrand Reinhold, New York, 1993.
25. Cheslow, Melvyn, Hatcher, S. Gregory, and Patel, Vijay M., *An Initial Evaluation of Alternative Intelligent Vehicle Highway Systems Architectures*, MITRE Technical Report (MTR) 92W0000063, MITRE Corporation, April 1992.



HSR-12/9-95(700)QE