



US005808566A

United States Patent [19]
Behr et al.

[11] Patent Number: 5,808,566
[45] Date of Patent: Sep. 15, 1998

[54] ELECTRONIC NAVIGATION SYSTEM AND METHOD

FOREIGN PATENT DOCUMENTS

[75] Inventors: David A. Behr, Roselle; Ramesh Ramakrishnan, Mount Prospect, both of Ill.

0 379 198 A3 7/1990 European Pat. Off. .
3150699 6/1991 Japan .
WO 92/14215 8/1992 WIPO .
WO 92/21001 11/1992 WIPO .

[73] Assignee: Navigation Technologies Corporation, Rosemont, Ill.

OTHER PUBLICATIONS

[21] Appl. No.: 494,198

Hoffman, Steve and Stewart, Charles, "Text-based Routing: An Affordable Way Ahead?", Proceedings of the IEEE-IEE Vehicle Navigation & Information System Conference, Ottawa, Canada -VNIS 1993.

[22] Filed: Jun. 23, 1995

PCT-Notification of Transmittal of the International Search Report, dated Nov. 2, 1995, in International application No. PCT/US95/07859, Applicant Shields Enterprises, Inc.

Related U.S. Application Data

"Smart cars, Smart Highways," Collier, W. Clay and Weiland, Richard J., *IEEE Spectrum*, Apr. 1994, pp. 27-33.

[63] Continuation-in-part of Ser. No. 265,094, Jun. 24, 1994, Pat. No. 5,543,789.

Primary Examiner—Brent A. Swarthout

[51] Int. Cl.⁶ G08G 1/123

Attorney, Agent, or Firm—Brinks Hofer Gilson & Lione

[52] U.S. Cl. 340/995; 340/988; 701/208; 701/211

[57] ABSTRACT

[58] Field of Search 340/988, 990, 340/995, 991; 364/444, 449; 701/200, 208, 209, 211

The invention provides a method and system for providing route guidance and other information from a base unit to a remote unit in response to a request from the remote unit. A query is formatted at the remote unit, the query including the request, and is transmitted from the remote unit to the base unit. Requested route guidance information is calculated at the base unit in response to the query, using a large up-to-date database located at the base unit. A response to the query is formatted at the base unit, the response including route guidance information. The response is then transmitted from the base unit to the remote unit for display. The transmission is made in a compact form through the use of maneuver arms and combined maneuver arms and through the use of tokenized forms. A maneuver arm represents a road at an intersection, for depiction on a display, by one or two endpoint coordinates. The tokenized forms are expanded at the remote unit into textual driving instructions for each of one or more languages. In addition, the amount of information available at a remote unit can be increased by providing the remote unit with information from the base unit which is not adequately covered by any databases on-board the remote unit.

[56] References Cited

U.S. PATENT DOCUMENTS

4,301,506	11/1981	Turco	364/436
4,311,876	1/1982	Endo et al.	455/54.1
4,428,057	1/1984	Setliff et al.	364/521
4,466,125	8/1984	Kanayama	340/990
4,481,584	11/1984	Holland	364/424
4,546,439	10/1985	Esparza	364/444
4,570,227	2/1986	Tachi et al.	364/444
4,642,775	2/1987	Cline et al.	364/443
4,733,356	3/1988	Haeussermann et al.	364/424
4,758,959	7/1988	Thoone et al.	364/454
4,780,717	10/1988	Takanabe et al.	340/995
4,812,843	3/1989	Champion, III et al.	340/905
4,951,212	8/1990	Kurihara et al.	340/995
4,954,958	9/1990	Savage et al.	364/444
5,043,902	8/1991	Yokoyama et al.	340/988
5,172,321	12/1992	Ghaem et al.	364/444

(List continued on next page.)

11 Claims, 15 Drawing Sheets

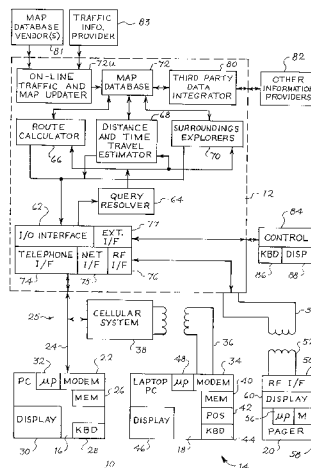

U.S. PATENT DOCUMENTS				
		5,291,412	3/1994 Tamai et al.	364/449
		5,291,413	3/1994 Tamai et al.	364/449
5,243,528	9/1993 Lefebvre	5,293,163	3/1994 Kakihara et al.	340/988
		5,293,484	3/1994 Dabbs, III et al.	340/825.44
5,262,775	11/1993 Tamai et al.	5,396,429	3/1995 Hanchett	364/436
		5,559,707	9/1996 DeLorme et al.	340/995
5,283,575	2/1994 Kao et al.			

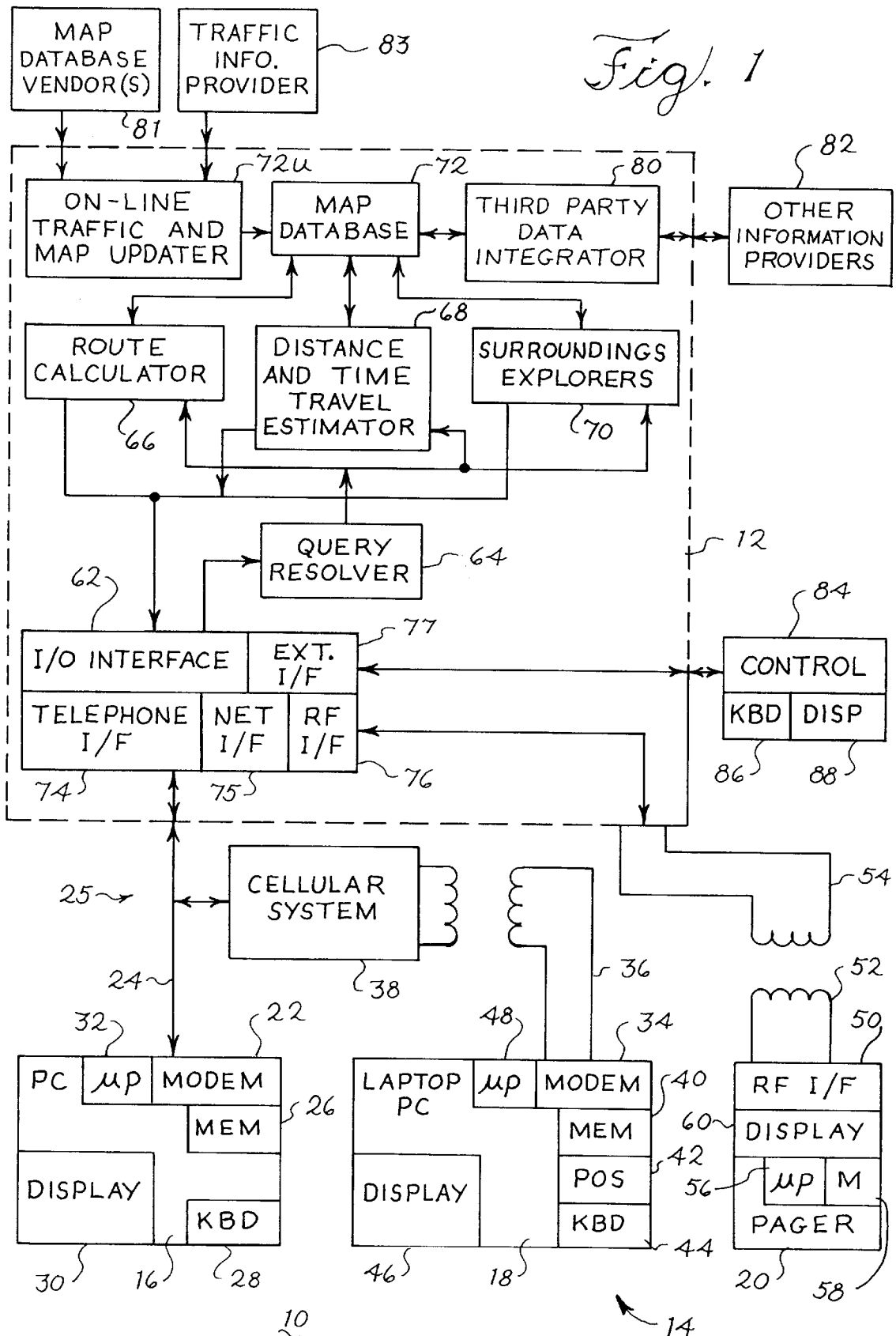

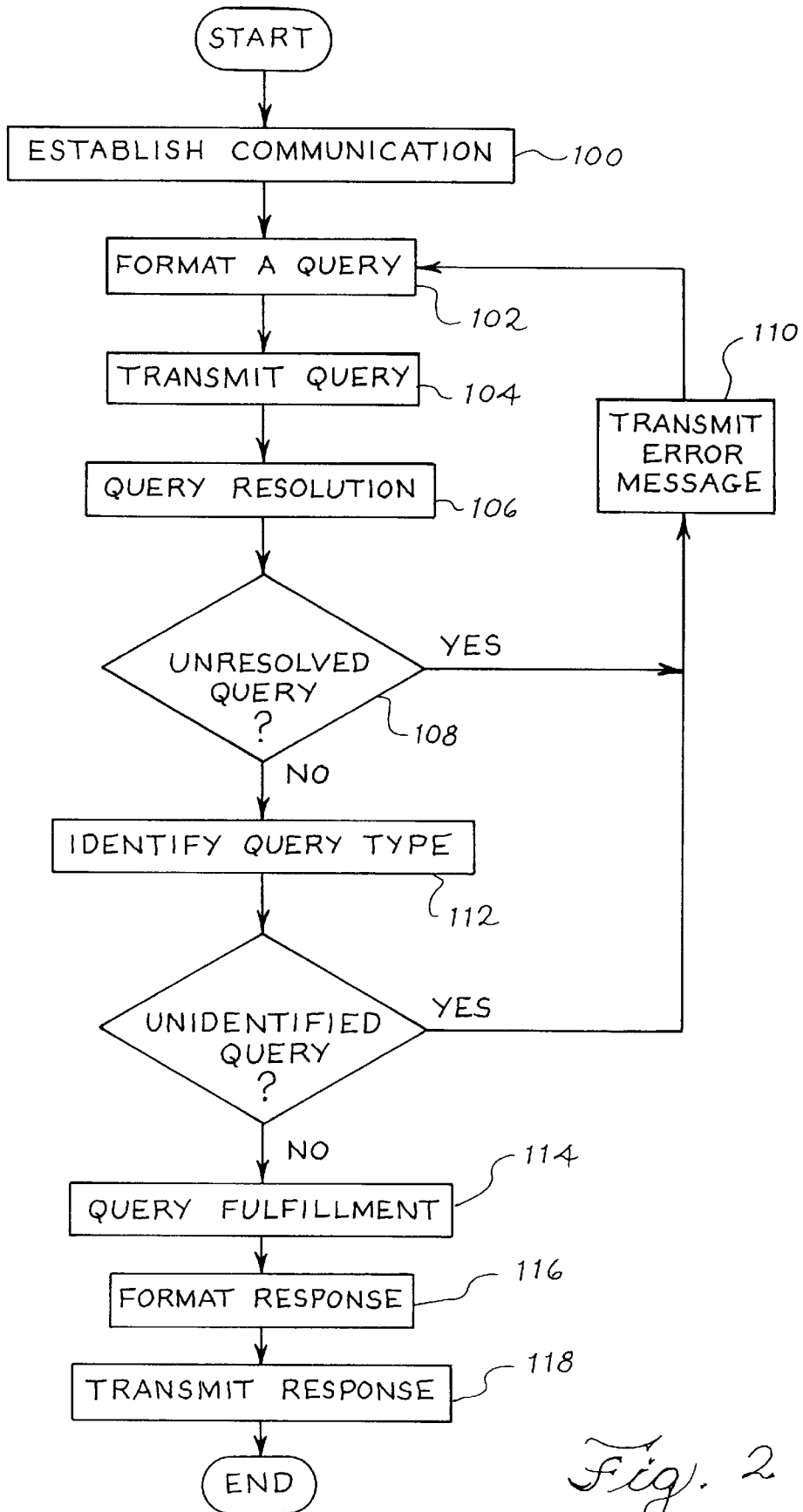

Fig. 2

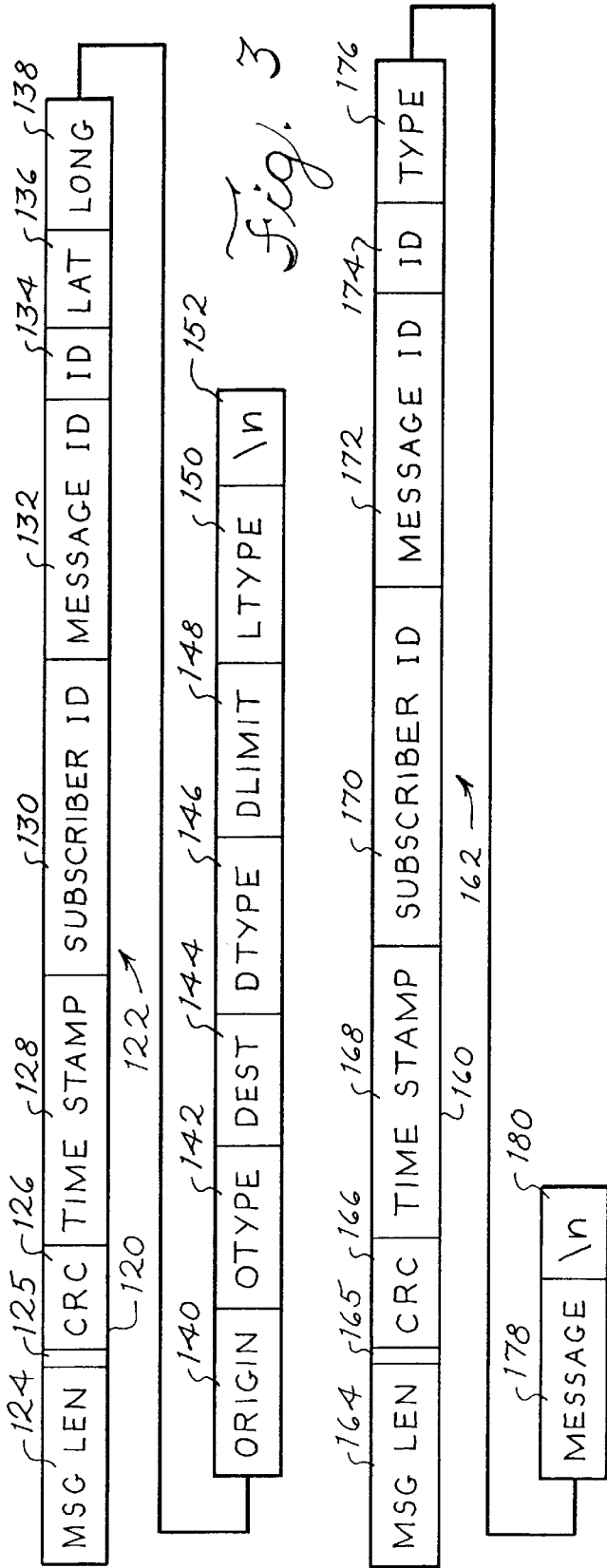

Fig. 3

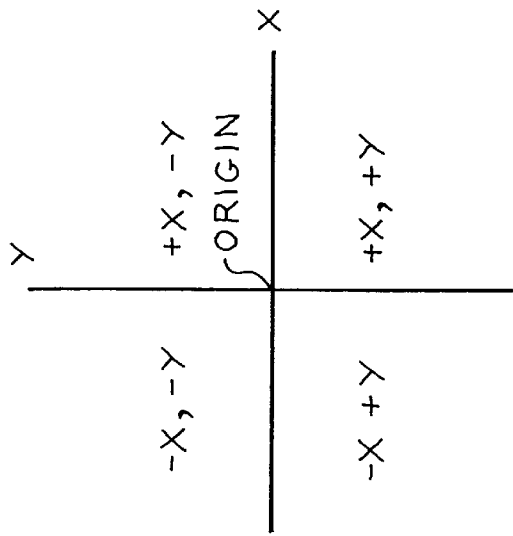

Fig. 4

Fig. 5

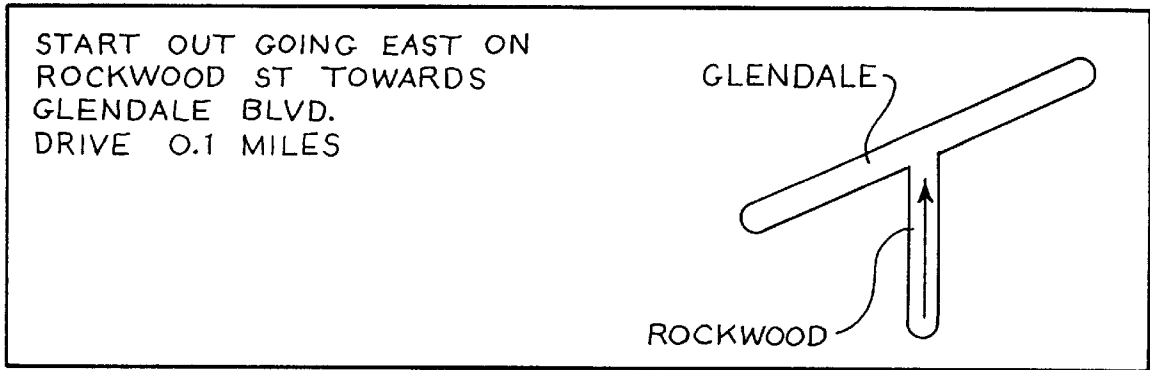

Fig. 6

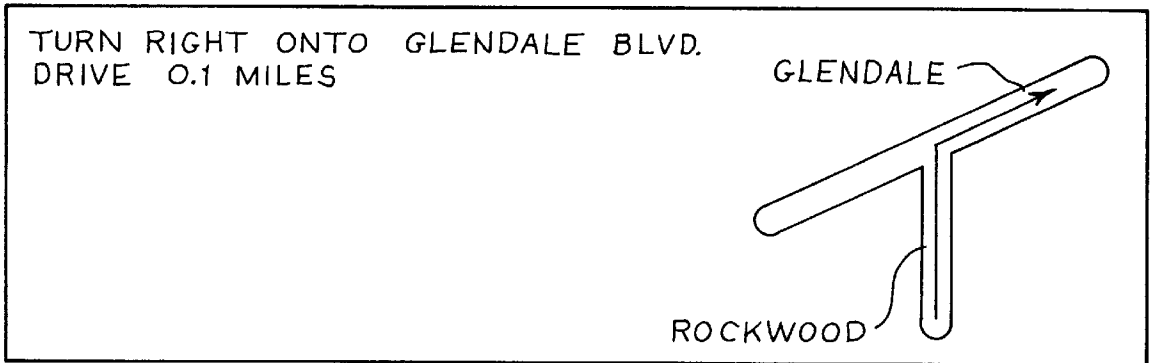

Fig. 7

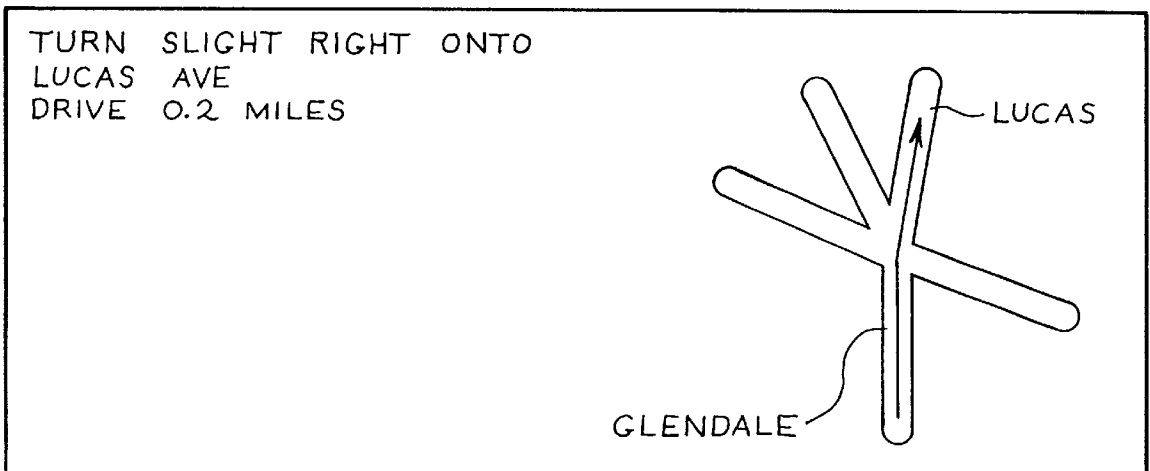

Fig. 8

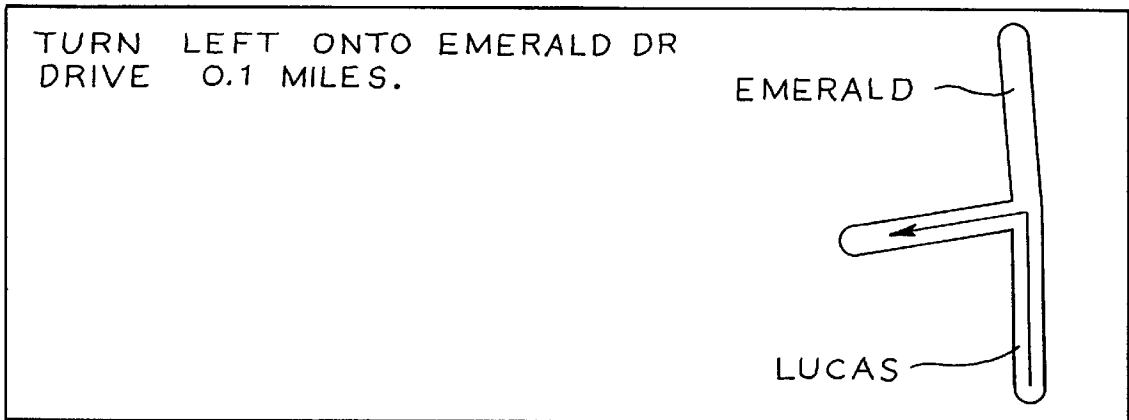

Fig. 9

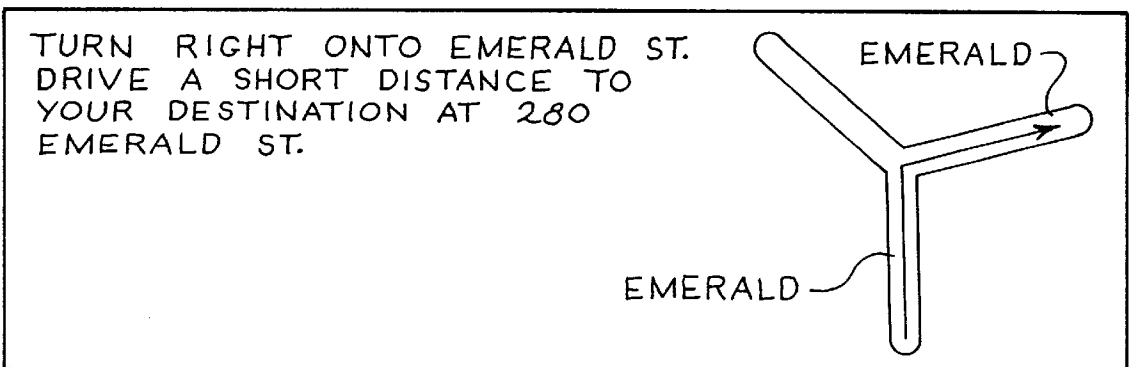

Fig. 10

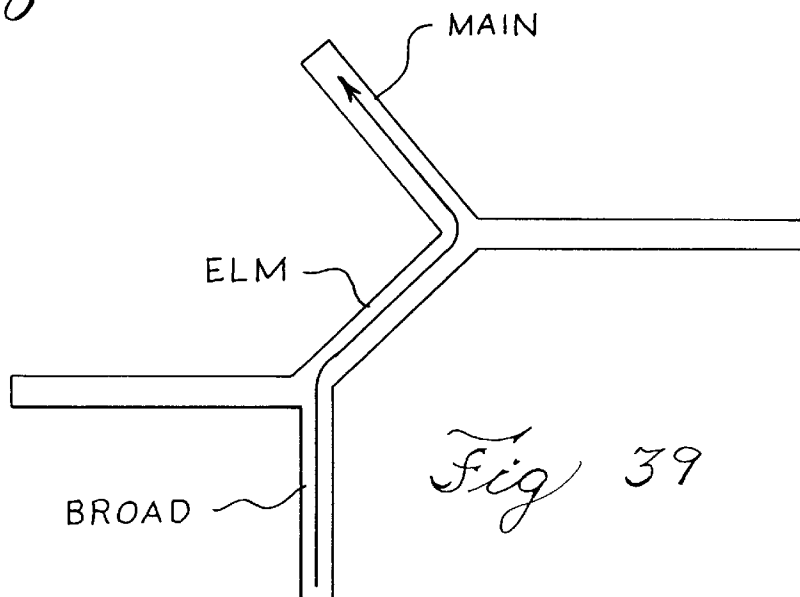

Fig 39

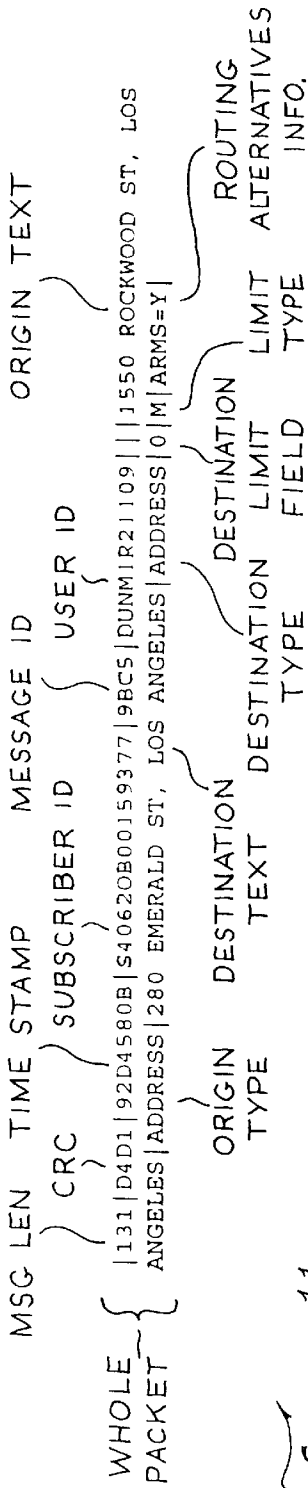
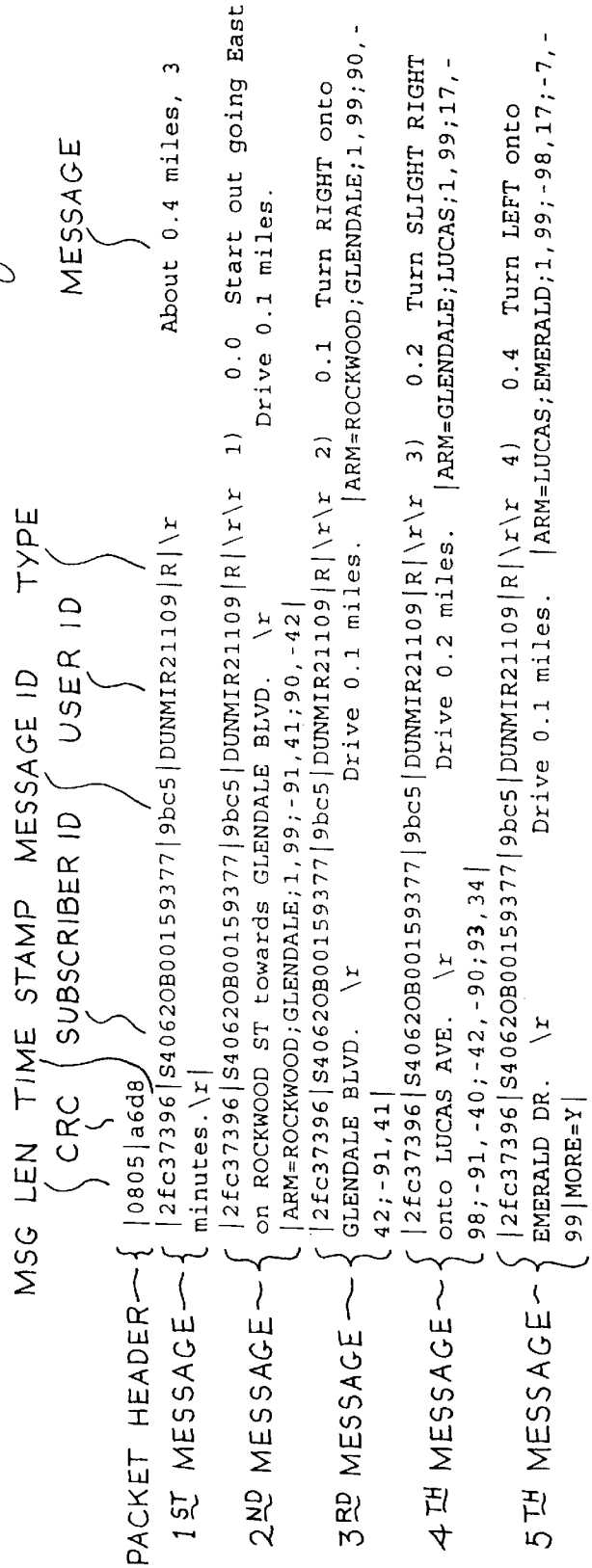

Fig. 11

Fig. 12



WHOLE PACKET~{|073|2F39|92D45811|S40620B00159377|9BCA|DUNMIR21109|}|}|}|MANEUVER=NEXT|ARMS=Y|

Fig. 13

PACKET HEADER ~{|0495|9588
 { |2fc3739b|S40620B00159377|9bca|DUNMIR21109|R|\r 5) 0.4 Turn RIGHT onto
 1ST MESSAGE~{ EMERALD ST. \r Drive a short distance to your destination at 280
 EMERALD ST.\r|ARM=EMERALD;EMERALD;1,99;96,-26;-74,-66|
 { |2fc3739b|S40620B00159377|9bca|DUNMIR21109|R|\r Thank you for using
 SEI/EnRoute!\r\rDatabase Copyright 1992 - 94 Navigation Technologies
 2ND MESSAGE~{ Corp.\r(Database version wsall0076_2.3.0, SEI/EnRoute Copyright 1993-1994 SEI
 Information Technology/IDS Software version 1.2)\r|MORE=N|

Fig. 14

Fig. 15
 |078|0A8D|80DC0960|IDSDIVISION|9D89|BOBD|}|}|}|SESSION=00000000|BURST=N
 MAXPKT=1024|~

Fig. 16
 |0039|67f1|2ef5d974|IDSDIVISION|9d89|BOBD|E|OK|~

Fig. 17

|055|800B|80DC0962|IDSDIVISION|9D8B|BOBD|||||CONFIG=LA.CFG|~

Fig. 18

|0039|3d8a|2ef5d976|IDSDIVISION|9d8b|BOBD|E|OK|~

Fig. 19

|119|A4C8|80DC096E|IDSDIVISION|9D98|BOBD||950 S FLINT RIDGE WAY,
ANAHEIM|ADDRESS|2043 N SACRAMENTO, ORANGE|ADDRESS|0|M|ARMS=Y|~

Fig. 20

|0753|2bc6|2ef5d987|IDSDIVISION|9d98|BOBD|R|\r About 9.1 miles
20 minutes.\r|~
|2ef5d987|IDSDIVISION|9d98|BOBD|R|\r|r 1) 0.0 Start out going
Northwest on S FLINT RIDGE WAY. \r Drive a short distance.
|ARM=FLINT RIDGE;WHITE FIR;1,99;-79,-61;24,-96|~
|2ef5d987|IDSDIVISION|9d98|BOBD|R|\r|r 2) 0.0 Turn LEFT onto E WHITE
FIR LN. \r Drive 0.1 miles. |ARM=FLINT RIDGE;WHITE FIR;1,99;
79,-61;24,-96|~
|2ef5d987|IDSDIVISION|9d98|BOBD|R|\r|r 3) 0.1 Turn RIGHT onto S LONE
PINE LN. \r Drive 0.1 miles. |ARM=WHITE FIR;LONE
PINE;1,99;67,-73|~
|2ef5d987|IDSDIVISION|9d98|BOBD|R|\r|r 4) 0.2 Turn LEFT onto E
SOMERSET LN. \r Drive a short distance. |ARM=LONE
PINE;SOMERSET;1,99;-93,-35;38,-92|MORE=Y|~

Fig. 21

|062|61D6|80DC0975|IDSDIVISION|9D9F|BOBD|||||MANEUVER=NEXT|ARMS=Y|~

Fig. 22

|0664|449c|2ef5d98a|IDSDIVISION|9d9f|BOBD|R|\r\r 5) 0.2 Turn RIGHT
 onto SERRANO AVE. \r Drive 0.3 miles.
 |ARM=SOMERSET;SERRANO;1,99;98,-18;-97,22;-12,-99|\r
 |2ef5d98a|IDSDIVISION|9d9f|BOBD|R|\r\r 6) 0.6 Turn LEFT onto S WEIR
 CANYON RD. \r Drive 0.8 miles. |ARM=SERRANO;WEIR
 CANYON;1,99;-99,0;-26,-96;97,-21|\r
 |2ef5d98a|IDSDIVISION|9d9f|BOBD|R|\r\r 7) 1.4 Turn RIGHT onto the CA-
 91 WEST RAMP. \r Drive 5.3 miles. |ARM=YORBA LINDA;CA-91
 WEST;1,99;83,-55;2,-99|\r
 |2ef5d98a|IDSDIVISION|9d9f|BOBD|R|\r\r 8) 6.7 Take the CA-55 HWY SOUTH
 exit. \r Drive 0.7 miles. |ARM=RIVERSIDE;CA-55 SOUTH;1,99;0,-
 100;7,-99|MORE=Y|\r

Fig. 23

|062|F22E|80DC0978|IDSDIVISION|9DA2|BOBD|||||||MANEUVER=NEXT|ARMS=Y|\r

Fig. 24

|0652|6dc9|2ef5d98d|IDSDIVISION|9da2|BOBD|R|\r\r 9) 7.4 Take the NOHL
 RANCH RD/LINCOLN AVE exit. \r Drive 0.2 miles. |ARM=COSTA
 MESA;TUSTIN ST;1,99;-2,-99;-21,-97|\r
 |2ef5d98d|IDSDIVISION|9da2|BOBD|R|\r\r 10) 7.6 Turn LEFT onto N TUSTIN
 ST. \r Drive 1.0 miles. |ARM=TUSTIN ST;TUSTIN;1,99;-99,-
 6;98,15|\r
 |2ef5d98d|IDSDIVISION|9da2|BOBD|R|\r\r 11) 8.6 Turn LEFT onto E MEATS
 AVE. \r Drive 0.4 miles. |ARM=TUSTIN;MEATS;1,99;-99,3;-4,-
 99;99,-11|\r
 |2ef5d98d|IDSDIVISION|9da2|BOBD|R|\r\r 12) 8.9 Turn RIGHT onto N
 BRECKENRIDGE ST. \r Drive a short distance.
 |ARM=MEATS;BRECKENRIDGE;1,99;99,3;0,-100|MORE=Y|\r

|062|1595|80DC097B|IDSDIVISION|9DA5|BOBD|||||MANEUVER=NEXT|ARMS=Y|~

Fig. 25

|0640|638b|2ef5d990|IDSDIVISION|9da5|BOBD|R|\r|13) 9.0 Turn RIGHT
onto E BRENTFORD AVE. \r Drive 0.1 miles.
|ARM=BRECKENRIDGE;BRENTFORD;1,99;99,-4;-4,-99|~
|2ef5d990|IDSDIVISION|9da5|BOBD|R|\r|14) 9.0 Turn LEFT onto N
SACRAMENTO ST. \r Drive a short distance to your destination
at 2043 N SACRAMENTO ST.\r|ARM=BRENTFORD;SACRAMENTO;1,99;-99,0|~
|2ef5d990|IDSDIVISION|9da5|BOBD|R|\r Thank you for using
SEI/EnRoute!\r\rDatabase Copyright 1992 - 94 Navigation Technologies
Corp.\r(Database version la00104_2.3.0, SEI/EnRoute Copyright 1993-1994
SEI Information Technology/IDS Software version 5.48)\r|MORE=N|~

Fig. 26

|121|7372|80DC099C|IDSDIVISION|9DC6|BOBD|||1750 QUEENS RD, LOS
ANGELES|ADDRESS|7530 ORANGETHORPE, BUENA PARK|ADDRESS|0|M|ARMS=Y|~

Fig. 27

Fig. 28

```

|0746|fef2|2ef5d9b8|IDSDIVISION|9dc6|BOBD|R|\r
miles, 51 minutes.\r|^
|2ef5d9b8|IDSDIVISION|9dc6|BOBD|R|\r|r 1) 0.0 Start out going
Northwest on QUEENS RD towards FRANKLIN AVE. \r Drive a short
distance. |ARM=QUEENS;QUEENS;1,99;-64,76|^
|2ef5d9b8|IDSDIVISION|9dc6|BOBD|R|\r|r 2) 0.1 Turn SLIGHT RIGHT onto
QUEENS RD. \r Drive 0.5 miles. |ARM=FRANKLIN;QUEENS;1,99;4,-
99;95,-30|^
|2ef5d9b8|IDSDIVISION|9dc6|BOBD|R|\r|r 3) 0.5 Turn LEFT onto W SUNSET
BLVD. \r Drive 3.5 miles. |ARM=QUEENS;SUNSET;1,99;-99,5;99,-
6|^
|2ef5d9b8|IDSDIVISION|9dc6|BOBD|R|\r|r 4) 4.1 Turn RIGHT onto the US-
101 SOUTH RAMP. \r Drive 24.5 miles. |ARM=SUNSET;US-101
SOUTH;1,99;92,-37;-2,-99|MORE=Y|^

```

About 30.2

Fig. 29

```

|062|EB9C|80DC09A6|IDSDIVISION|9DD0|BOBD|||||MANEUVER=NEXT|ARMS=Y|^

```

```

|0802|db71|2ef5d9bb|IDSDIVISION|9dd0|BOBD|R|\r 5) 28.6 Take the KNOTT
AVE exit. \r Drive 0.1 miles. |ARM=SANTA ANA;ARTESIA
BLVD;1,99;77,-63;12,-99|~
|2ef5d9bb|IDSDIVISION|9dd0|BOBD|R|\r 6) 28.7 Merge onto KNOTT AVE.
\r Drive 1.0 miles. |ARM=ARTESIA BLVD;KNOTT;1,99;19,-98;-
23,97;-97,-21;97,22|~
|2ef5d9bb|IDSDIVISION|9dd0|BOBD|R|\r 7) 29.7 Turn LEFT onto
ORANGETHORPE AVE. \r Drive 0.5 miles to your destination at
7530 ORANGETHORPE AVE.\r|ARM=KNOTT;ORANGETHORPE;1,99;-99,3;-4,-99;99,-1|~
|2ef5d9bb|IDSDIVISION|9dd0|BOBD|R|\r Thank you for using
SEI/EnRoute!\r\rDatabase Copyright 1992 - 94 Navigation Technologies
Corp.\r(Database version la0104_2.3.0, SEI/EnRoute Copyright 1993-1994
SEI Information Technology/IDS Software version 5.48)\r\MORE=N|~

```

Fig. 30

```

|104|5F31|80DC09DF|IDSDIVISION|9E08|BOBD|||1855 W KATELLA AVE,
ORANGE|ADDRESS|HAPPY|RESTAURANT|100|M|QUERY=POIS|~

```

Fig. 31

```

|0085|30dd|2ef5d9f4|IDSDIVISION|9e08|BOBD|Q|No of POIs found:00000: : : -
- - , , : : |MORE=N|~

```

Fig. 32

|105|E9C4|80DC09F6|IDSDIVISION|9E20|BOBD|||1855 W KATELLA AVE,
ORANGE|ADDRESS|HUNGRY|RESTAURANT|100|M|QUERY=FCIS|~

Fig. 33

|0269|523a|2ef5da0c|IDSDIVISION|9e20|BOBD|Q|No of POIs found:00002: : : -
- - , : : ;HUNGRY TIGER SEAFOOD RESTAURANT:6231 MANCHESTER BLVD, BUENA
PARK:36:23606:0-0-223-137,4,1:46646:N;HUNGRY BEAR RESTAURANT:2219 N HARBOR
BLVD, FULLERTON:36:24034:0-0-459-108,4,2:38570:N|MORE=N|~

Fig. 34

|105|F245|80DC0A07|IDSDIVISION|9E31|BOBD|||1855 W KATELLA AVE,
ORANGE|ADDRESS|BURGER|RESTAURANT|100|M|QUERY=POIS|~

Fig. 35

|0704|1c86|2ef5da1d|IDSDIVISION|9e31|BOBD|Q|No of POIs found:00016: : : -
- - , : : ;BREA'S BEST BURGERS:707 S BREA BLVD, BREA:36:23589:0-0-230-
190,4,1:38608:N;BURGER KING:959 S COAST DR, COSTA MESA:36:23729:0-0-395-
82,4,1:43298:N;BURGER KING:19201 BROOKHURST ST, HUNTINGTON
BEACH:36:24237:0-0-779-194,4,2:51444:N;BURGER KING:1236 W IMPERIAL HWY, LA
HABRA:36:24406:0-0-453-165,4,2:49052:N;C AND J BURGER:421 E LA HABRA BLVD,
LA HABRA:36:24408:0-0-229-139,4,1:50512:N;GEORGE'S BURGERS:601 W LA HABRA
BLVD, LA HABRA:36:24429:0-0-908-180,4,1:52112:N;IMPERIAL BURGERS:241 E
IMPERIAL HWY, LA HABRA:36:24435:0-0-919-268,4,-:46502:N;T AND S BURGER:650
W LA HABRA BLVD, LA HABRA:36:24484:0-0-908-180,4,2:52112:N|MORE=Y|~

Fig. 36

|055|A5C1|80DC0A0B|IDSDIVISION|9E34|BOBD||| |||||MANEUVER=NEXT|~

Fig. 37

|0643|833e|2ef5da1f|IDSDIVISION|9e34|BOBD|Q|IN-N-OUT BURGER:7926
VALLEY VIEW ST, LA PALMA:36:24514:0-0-1210-243,4,2:50592:N;BURGER
KING:245 N CITRUS ST, ORANGE:36:26021:0-0-829-124,4,1:6189:N;IN-N-
OUT BURGER:825 W CHAPMAN AVE, PLACENTIA:36:26314:0-0-959-
137,4,1:24590:N;BURGER KING:2850 S BRISTOL ST, SANTA
ANA:36:26542:0-0-396-111,4,1:36418:N;BURGER KING:601 E DYER RD,
SANTA ANA:36:26543:0-0-797-207,4,1:35830:N;BURGER KING:13431
NEWPORT AVE, TUSTIN:36:26864:0-0-871-69,4,1:28304:N;BOB'S
BURGER:13891 BEACH BLVD, WESTMINSTER:36:27177:0-0-199-
315,4,2:40114:N;IN-N-OUT BURGER:6292 WESTMINSTER BLVD,
WESTMINSTER:36:27186:0-0-1197-216,4,2:49140:N|MORE=N|~

Fig. 38

TOKEN	ENGLISH TABLE	SPANISH TABLE	GERMAN TABLE
1	MAKE A U TURN AT ____.	HAGA UNA VUELTA EN U EN ____.	AN DER KREUZUNG MIT ____ BITTE EINE KEHRTWENDUNG MACHEN.
2	____ CHANGES NAME TO ____.	____ CAMBIA EL NOMBRE A ____.	____ ÜNDERT DEN NAMEN ZU ____.
3	TURN LEFT ON ____ AND DRIVE ____ MILES.	DÉ VUELTA A LA IZQUIERDA EN ____ Y MANEJE ____ MILLAS.	AUF ____ LINKS ABBIEGEN UND ____ MEILEN WEITERFUHREN.

Fig. 40

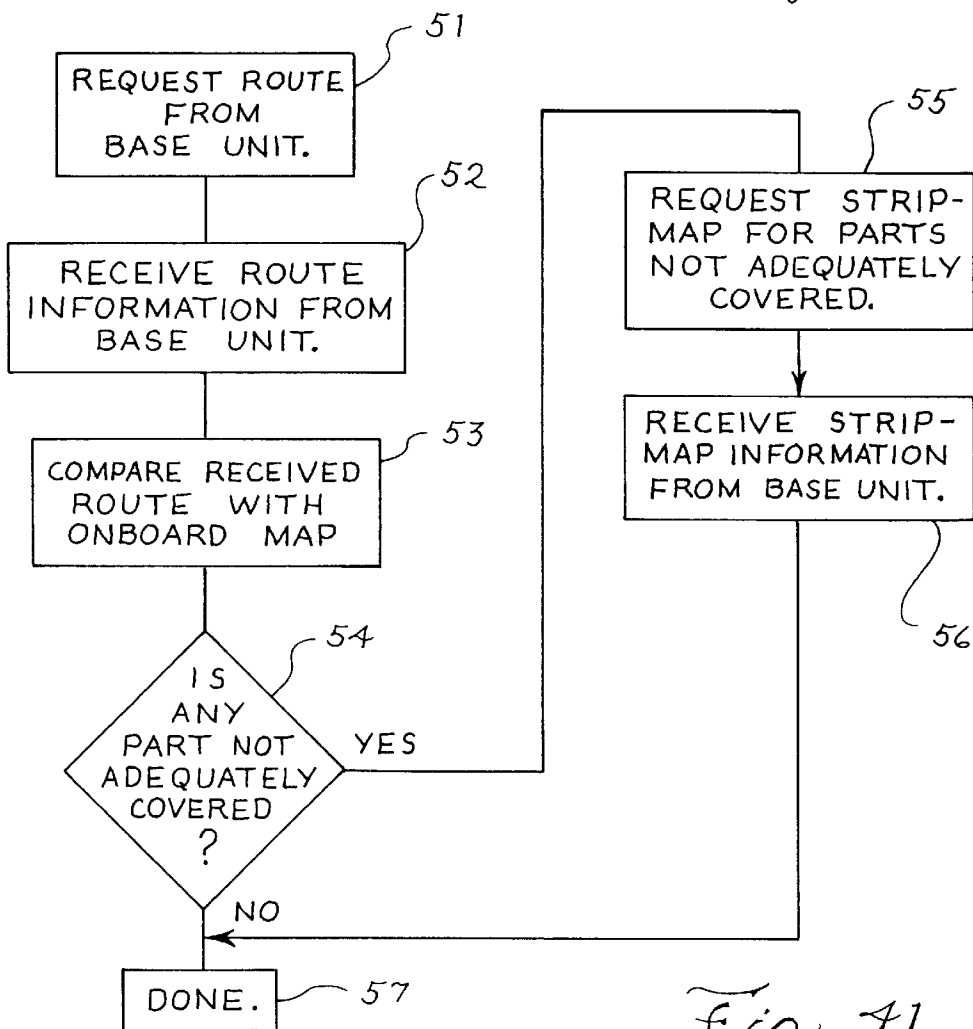

Fig. 41

ELECTRONIC NAVIGATION SYSTEM AND METHOD

This application is a continuation-in-part of U.S. patent application Ser. No. 08/265,094 filed on Jun. 24, 1994 by David A. Behr and Randall B. Jones, now U.S. Pat. No. 5,543,789, entitled "Computerized Navigation System." The entire contents of the Ser. No. 08/265,094 application is incorporated herein by reference.

A portion of the disclosure of this patent document contains material which is subject to copyright protection. The copyright owner has no objection to the facsimile reproduction by anyone of the patent document or the patent disclosure, as it appears in the Patent and Trademark Office patent file or records, but otherwise reserves all copyright rights whatsoever.

BACKGROUND OF THE INVENTION

The invention relates generally to a system and method for providing route guidance and tracking information and other information from a base unit to a mobile unit over wireless, wireline, or optical devices. The invention more particularly relates to an apparatus and method for providing to a mobile unit route guidance and tracking information and other information which has been calculated and/or stored at a base unit in response to a query from the mobile unit.

Systems have already been developed which provide geographical or position-dependent information to a mobile user. Such systems are generally installed in an automobile or other vehicle. These systems generally include an on-board geographic database which may be accessed to determine geographic information, such as locations of points of interest, directions to points of interest, and directions between a specified origin and a destination. An on-board computer calculates route guidance information using data from the database in response to user inputs.

Such systems are known as autonomous route guidance systems since they are independent and self-contained. The systems generally include a geographic database, positioning sensors, and a computer including a keyboard and display. The geographic database is a representation of a region or metropolitan area and may include, for example, street names, navigation attributes, such as turn restrictions and one-way streets, street addresses, and points of interest, such as airports, restaurants and museums. The positioning sensors may determine geographic position from RF (Radio Frequency) triangulation or in response to signals from, for example, GPS (Global Positioning System), LORAN C or other similar positioning systems, and from motion and direction detectors. The computer calculates route guidance information in response to inputs from the other system components as well as from operator input. The route guidance information is provided to the user in the form of navigational text or map graphics.

Autonomous route guidance systems have many drawbacks, however, which have prevented their widespread use. Because the system is autonomous and has an on-board database, the system must include large storage capabilities for storing all of the data which form the database. Technologies such as CD-ROM have allowed storage of an entire database but require still a tradeoff between cost and fast, efficient data access.

Another problem with autonomous route guidance systems is maintenance and currency of the database. As new streets are built, or as old streets are reconfigured, as businesses and other points of interest open and close, the

database on CD-ROM or other media becomes out of date. In addition, when a database is compiled, it may include errors which are then replicated in the many copies provided to users. These errors may require correction in the user copies by replacing those database copies. Moreover, incorrect or outdated information in the database can lead to errors when calculating routes. When an out-of-date database does not include the information that a particular roadway is closed, the system may be unable to calculate an alternate route.

Autonomous route guidance system providers may improve the accuracy of the system by providing occasional database updates to users. However, distribution of the database, in a medium such as CD-ROM or floppy disk, to remotely located mobile users may be difficult. In addition, the media themselves are expensive since they may generally be used only a single time.

Other aspects of such prior art autonomous route guidance systems add to their cost and inconvenience. Because the systems are autonomous, they must include all components, including the computer, the database and the position sensor. Using present technology, such a system is too heavy and too large to be readily transported by an individual. In addition, the complete system has power requirements which make battery operation impractical. As a result, autonomous route guidance systems have been limited to installation in automobiles or other vehicles which can accommodate the size and power requirements of such a system. The current best price for a complete autonomous route guidance system is substantial. This includes only the cost for a single, dedicated autonomous route guidance system.

Another type of route guidance system has been tested in Europe using beacons to provide a guidance signal to on-board equipment. The system directs the user to travel from beacon to beacon, creating a stepwise path between an origin and a destination because of the fixed locations of the beacons. The navigational information thus provided forms a generally inefficient routing path from origin to destination. In addition, such a system does not provide the capability to query a database for information about nearby points of interest and other geographical information.

Therefore, there is a need for a routing and information system that continually provides access to up-to-date, correct geographic information by a remote user. There is a further need for a routing and information system which can be implemented on lightweight, portable devices for easy, convenient transportation and use. There is a further need for a routing and information system which is independent of any particular hardware configuration and which may be implemented on any suitably equipped data processing apparatus, such as a desktop personal computer, a laptop computer, a personal digital assistant or even a pager. There is a further need for a routing and information system which provides communication between mobile units and a base unit over any available channel, including wireless, wireline, and optical channels. There is a still further need for a data communication protocol for providing accurate, reliable communication in such a system, independent of hardware configuration and in a compact form.

SUMMARY OF THE INVENTION

An object of the invention is to provide a method and system for transmitting route guidance and other information from a base unit to a remote unit in a compact form.

Another object of the invention is to provide a method and system for transmitting route guidance and other informa-

tion from a base unit to a remote unit in a language independent form such that the remote unit can provide the information to a user in any language or form desired by the user at the remote unit.

Another object of the invention is to provide a method and system for transmitting route guidance and other information from a base unit to a remote unit in which the amount of information available at a remote unit can be expanded by providing the remote unit with information from the base unit which is not adequately covered by any databases on-board the remote unit.

The invention provides a method and system for providing route guidance and other information from a base unit to a remote unit in response to a request from the remote unit. A query is formatted at the remote unit, the query including the request, and is transmitted from the remote unit to the base unit. Requested route guidance information is calculated at the base unit in response to the query, using a large up-to-date database located at the base unit. A response to the query is formatted at the base unit, the response including route guidance information. The response is then transmitted from the base unit to the remote unit for display.

The transmission is made in a compact form through the use of maneuver arms and combined maneuver arms and through the use of tokenized forms. These tokenized forms represent a large amount of textual information by one or several alphanumeric characters.

A maneuver arm represents a road at an intersection, for depiction on a display, by one or two endpoint coordinates. If two intersections are sufficiently close together, a first set of maneuver arms for one intersection and a second set of maneuver arms for the other intersection are combined to produce a combined set of endpoints for transmission in a compact form to depict the first set of maneuver arms and the second set of maneuver arms on a common display.

The tokenized forms are expanded at the remote unit into textual driving instructions for each of one or more languages. In addition, the amount of information available at a remote unit can be increased by providing the remote unit with information from the base unit which is not adequately covered by any databases on-board the remote unit.

Other objects, features, and advantages of the invention will be apparent from the detailed description set forth below.

BRIEF DESCRIPTION OF THE DRAWINGS

The features of the invention are set forth with particularity in the appended claims. The invention, together with further objects and advantages thereof, may be further understood by making reference to the following description taken in conjunction with the accompanying drawings, wherein:

FIG. 1 is a functional block diagram illustrating a system of the invention;

FIG. 2 is a flow diagram illustrating a method of the invention;

FIG. 3 is a diagram illustrating a data communication protocol for communicating data from a mobile, or remote, unit to a base unit in accordance with the invention and which is used in conjunction with the system of FIG. 1 and the method of FIG. 2;

FIG. 4 is a diagram illustrating a data communication protocol for communicating data from a base unit to a mobile unit in accordance with the invention and which is used in conjunction with the system of FIG. 1 and the method of FIG. 2;

FIG. 5 is a diagram illustrating a suitable sign convention for maneuver arm endpoint coordinates;

FIGS. 6 to 10 show examples of maneuver arms displays in a remote unit;

FIGS. 11 to 14 illustrate data that is transferred between a remote unit and a base unit in the example of FIGS. 6 to 10;

FIGS. 15 to 38 illustrate additional examples of data transferred between a remote unit and a base unit;

FIG. 39 illustrates a combined maneuver arms display;

FIG. 40 illustrates some examples of tokens and corresponding expanded English, Spanish, and German text; and

FIG. 41 is a flowchart used for explaining operation of a stripmap request feature of the invention.

DETAILED DESCRIPTION OF PREFERRED EMBODIMENTS

Overview

The invention provides a method of providing route guidance information and other information from a base unit to a mobile unit in response to a request from the mobile unit. The method comprises the steps of formatting a query at the mobile unit, the query including the request, communicating the query from the mobile unit to the base unit, and calculating route guidance information at the base unit in response to the query. The method further comprises the steps of formatting a response to the query at the base unit, the response including route guidance information, and communicating the response from the base unit to the mobile unit. The guidance information may include navigation instructions from an origin to a destination, information about one or more points of interest within a particular region, or other geographically referenced information.

The invention further provides a system for communicating routing information between a base unit and a mobile unit. The system comprises an input means at the mobile unit for providing an origin and a destination. The system further comprises a calculating means at the base unit for calculating a route between the origin and the destination. The system still further comprises communication means for communicating the origin and the destination from the mobile unit to the base unit and for communicating the route from the base unit to the mobile unit. The routing information may include navigation instructions from an origin to a destination, information about one or more points of interest within a particular region, or other geographically referenced information.

The invention still further provides a method of providing routing information to a mobile unit. The method comprises the steps of providing an origin and a destination from the mobile unit to a base unit, the base unit located remotely from the mobile unit. The method further comprises the steps of calculating at the base unit a route between the origin and the destination, and providing the route to the mobile unit.

The invention still further provides a system for providing route guidance information to a remote location from a central location. The system comprises a mobile unit including an input means for providing at least a route destination and an output means for providing an indication of the route guidance information. The system further comprises a first transmission means at the mobile unit for transmitting destination data and origin data from the mobile unit, the destination data being indicative of a route destination and

the origin data being indicative of a route origin. The system still further comprises a base unit at the central location. The base unit includes a first receiving means for receiving the destination data and the origin data from the first transmission means, a calculating means coupled with the receiving means for calculating a route to the route destination from a route origin responsive to the destination data and the origin data, and a second transmission means for transmitting routing data, the routing data being indicative of the route. The system still further comprises a second receiving means at the mobile unit for receiving the routing data from the second transmission means, the second receiving means being coupled with the output means for providing the route guidance information to the input means responsive to the routing data.

The invention also provides a system and method for providing geographically referenced information from a base unit or server to a mobile unit. The mobile unit may be a transportable device such as a laptop computer or personal digital assistant (PDA), or may be a desktop personal computer or any other device permitting data entry and display, printing, or sounding of the provided information.

The mobile unit communicates with the base unit using any available communication system, such as land line telephone link, cellular telephone or radio frequency transmission. Queries are communicated from the mobile unit to the base unit. The query requests route guidance information, information about a point of interest or other geographical information. The query is formatted in a specified protocol. The base unit communicates responses to queries, the responses also being formatted in a specified protocol. The responses may include, for example, textual navigational directions and/or maneuver arms showing graphical representations of street intersections and the calculated route through the intersection. Transmitting only a representation of the intersection, rather than all geographical features around the intersection, allows the response, including the maneuver arms, to be transmitted over a low bandwidth channel. The invention operates independently of the communication system and is adaptable to any system. The invention allows support for many different mobile unit platforms, taking advantage of each platform's capabilities while retaining as much system-level look and feel consistency as possible.

The base unit includes a geographical database, such as the Navigation Technologies Corp. navigable map database. The geographical database stores a variety of geographical and position-oriented attributes, such as street addresses, turn restrictions and points of interest. The points of interest are preferably organized according to different parameters, including point of interest type, such as "restaurant" or "museum;" point of interest name; city; driving distance; and/or driving time. The base unit further includes a server for receiving queries from one or more mobile units, resolving ambiguities in the queries, determining a response to a query, and accessing the geographical database as needed. The server formats a response to the query and communicates the response to the mobile unit.

In a first mode of operation, an origin and a destination are entered at the mobile unit. The origin and/or the destination may be in the form of a street address, an intersection of two streets, or a point of interest previously identified in the geographical database. The origin and destination are communicated from the mobile unit to the base unit. The base unit calculates a route between the specified origin and destination. The routing information is communicated from the base unit to the mobile unit where it is displayed by the

mobile unit. The display can be a graphical display, showing map portions and providing travel directions along with a display of highway signs and other information. The display can include textual information providing travel directions.

The mobile unit may supply a digitally synthesized voice which audibly presents the travel directions to the user. In some applications, the display is stylized to display additional information to the user or to display information in a more realistic or more informative form. For example, the display can indicate in graphical form whether an on or off ramp is a tight or gentle turn by displaying stylized ramps. Shapepoints, that is, points which more accurately depict the physical shape of a road, can be generated either by the base unit or by a remote unit.

In a second mode of operation, the mobile unit formulates a query requesting information about points of interest within a specified distance of an origin. The origin may be specified by street address, intersecting streets, by geographic position or by reference to a point of interest. The query is communicated from the mobile unit to the base unit. The base unit uses the geographical database to formulate a response. The response is communicated from the base unit to the mobile unit for display to the user.

In a third mode of operation, a mobile unit provides information specifying its location to the base unit. A control unit requests tracking information about the mobile unit from the base unit. The control unit may be, for example, another personal computer, coupled to the base unit through an external interface, either directly or through a communications network. The base unit provides to the control unit tracking information including the current location of the mobile unit with respect to the street network and the route covered by the mobile unit.

The invention further provides a protocol for communicating a query from the mobile unit to the base unit and for communicating a response from the base unit to the mobile unit. The protocol allows transmission of variable length messages, as required by the individual mobile unit or communication link. The protocol includes error checking, time stamping and subscriber information. The protocol further includes information specifying origin and destination, for a query, and message type and message contents, such as route information, for a response.

The invention thus provides geographically referenced information from a base unit to a mobile unit, the mobile unit needing only data entry and display devices and a communications link. An advantage of the invention is that the invention provides this capability in a mobile unit which does not require on-board database storage or position finding equipment at the mobile unit. A further advantage of the invention is that the invention provides a mobile unit with access to a larger, more comprehensive database. For example, prior art CD-ROM-based databases are limited to 600 MB of storage which may be sufficient to store map information for only a single metropolitan region. In contrast, the invention allows the mobile unit to access map information for many metropolitan regions or an entire nation, as well as other information, such as on-line yellow page information or news, weather and/or traffic advisory information, which may be provided by third-party information providers. Such information can be provided on a geographic specific basis. A still further advantage of the invention is that the invention permits automatic, real time database updates by maintaining the database only at the base unit, avoiding the need to distribute database updates to the mobile units.

A further advantage of the invention is that the invention provides a method for communicating requests for routing

information and responses including routing information in which the method is independent of specific hardware. A further advantage of the invention is providing a system which can be implemented using any commonly available hardware devices, including laptop computers, personal digital assistants and other transportable units communicating via wireless, wireline, and/or optical systems.

A still further advantage of the invention is efficiently conveying complex information, including graphical information, over communication channels having a limited bandwidth using data compression and a novel protocol, to be described in detail below. This allows a system in accordance with the invention to dynamically transmit selected map portions for display on a capable mobile unit. The geographical information may be saved at the mobile unit for later retrieval and display, without having to again access the base unit.

System Description

FIG. 1 is a functional block diagram of a system 10 embodying the invention. The system 10 includes a base unit 12 and a plurality 14 of remote units arranged to communicate with the base unit 12. The base unit 12 includes a central processing unit (CPU) and a program memory which stores programs for performing the functions described below. IBM RS/6000 series computers are suitable for such a purpose; however, many other computer systems can be used. The plurality 14 of remote units may include, for example, a desktop personal computer (PC) 16 such as IBM compatible PC's and the Apple Newton, a laptop personal computer (PC) 18, or a pager 20. Suitable program languages include ANSI C and MS-Visual Basic.

The plurality 14 of remote units may include any number of mobile units. The base unit 12 is preferably located at a single, central location. One remote unit may be permanently located at a single site, such as desktop personal computer 16. Another remote unit may be mobile or transportable, such as laptop personal computer 18 or pager 20. As used herein, the term "mobile unit" includes both remote units which may be permanently located at a single site and remote units which are mobile or transportable.

Communications between the base unit and the remote units are packetized. A packet contains one or more messages.

The desktop personal computer 16 is an example of one type of mobile unit which may be included in the system 10. The desktop personal computer 16 preferably includes a modem 22, a memory 26, a keyboard 28, a display 30 and a microprocessor 32. The modem 22 is adapted to be coupled to a telephone line 24. The telephone line 24 is in turn coupled to the commercial telephone system 25. The modem 22 may be, for example, a serial (dial-up line) modem such as a modem compatible with an AT command set which is built into the desktop personal computer 16, a stand-alone modem, or a PCMCIA modem. Alternatively, the modem may be for use with a specialty wireless transmission network such as ARDIS, CDPD (cellular digital packet data) or RAM. Still further, the modem may be of a type custom designed for the desktop personal computer 16. The modem 22 forms a transmission means at the mobile unit for transmitting the origin and the destination and a receiving means at the mobile unit for receiving the responses, including the route, from the base unit 12.

The microprocessor 32 responds to program instructions and data stored in the memory 26. To activate the system 10, a user manipulates the keyboard 28 to formulate a request.

The request may, for example, seek the route between an origin and a destination. The keyboard 28 thus provides an input means at the mobile unit for providing an origin and a destination. The desktop PC 16, under control of a program of instructions stored in the memory 26, conveys the request over the telephone line 24 to the base unit 12. The base unit 12 formulates a response to the request and conveys the response over the telephone line 24 to the desktop PC 16. The response to the request is displayed on the display 30. The display 30 thus forms an output means at the mobile unit for providing an indication of the route provided in the response. In addition, the response may be stored in the memory 26 for later retrieval and display. The memory 26 thus provides a storage means at the mobile unit for storing the route communicated from the base unit.

The laptop personal computer 18 is another example of a mobile unit which can be used in the system 10. The laptop PC 18 includes a modem 34, a memory 40, a position locator 42, a keyboard 44, a display 46 and a microprocessor 48. The modem 34 is coupled to an antenna 36 for sending and receiving cellular telephone calls in conjunction with the cellular telephone system 38, which is a portion of the commercial telephone system 25. The modem 34 may be, for example, any of the modem types described in conjunction with the modem 22 of the desktop personal computer 16.

The microprocessor 48 operates in response to program instructions and data stored in the memory 40. The position locator 42 provides the geographical position of the laptop PC 18. For example, the position indicator 42 may perform radio frequency (RF) triangulation or may be responsive to GPS (Global Positioning System), LORAN C signals or other satellite positioning systems for providing latitude and longitude positioning information. The position locator 42 thus provides a position determining means for determining the geographical position of the mobile unit. The laptop PC 18, in response to the program instructions stored in the memory 40, provides a request over the commercial telephone system to the base unit 12. The request may be, for example, for the route between an origin and a destination. The origin may be specified either by manipulating the keyboard 44 or by providing the latitude and longitude information produced by the position locator 42. The base unit 12 provides a response to the request to the laptop PC 18. The response is displayed on the display 46.

The pager 20 provides another example of a remote unit which can be used in the system 10. The pager 20 includes an RF interface 50 coupled to an antenna 52 for receiving RF signals from an antenna 54 coupled to the base unit 12. The pager 20 further includes a microprocessor 56 responsive to program instructions and data stored in a memory 58. In response to information transmitted from the base unit 12 and received at the antenna 52, the microprocessor 56 displays information, such as geographical directions, on a display 60.

In another mode of operation, one mobile unit, such as the desktop personal computer 16, may track another mobile unit, such as the laptop personal computer 18, using the system 10. A user of the desktop personal computer 16 may manipulate the keyboard 28 to request route guidance information such as tracking information. The request is transmitted over the telephone line 24 to the base unit 12. The base unit 12 formulates a response based on the geographic position information provided by the position locator 42 of the laptop PC 18. The response is transmitted over the telephone line 24 to the desktop personal computer 16 for display on the display 30.

Thus, the system 10 provides geo-referenced information over, for example, wireless and wireline devices to mobile and remote users. It is understood that the communications technologies and the mobile units illustrated in FIG. 1 may be combined in ways other than those illustrated in FIG. 1. For example, the desktop personal computer 16 may include an RF interface such as the RF interface 50 of the pager 20. Similarly, the modem 34 of the laptop PC 18 may be adapted for coupling directly to a telephone line such as telephone line 24. In addition, other types of mobile units, such as personal digital assistants (PDAs), may be included in the system 10. Moreover, mobile units may access the base unit indirectly by communicating directly with a third-party information provider, such as Prodigy™, which in turn conveys queries to and responses from the base unit 12. In accordance with the invention, the invention operates independently of particular hardware configurations of the plurality 14 of remote units and of the communications system.

The base unit 12 includes an I/O interface 62, a query resolver 64, a route calculator 66, a distance and time travel estimator 68, a surroundings explorer 70, a map database 72, an on-line traffic and map updater 72U, and a third-party data integrator 80. The I/O interface 62 includes a telephone interface 74 for coupling the base unit 12 to the commercial telephone system 25 including the telephone line 24. The I/O interface 62 further includes an RF interface 76 for coupling the base unit 12 with RF communication devices such as an antenna 54. The I/O interface 62 and the modem 22 thus provide a communication means for communicating an origin and a destination from the desktop personal computer 16 to the base unit 12 and for communicating a route from the base unit 12 to the desktop personal computer 16. The I/O interface 62, the modem 34 and the antenna 36 provide a communication means for communicating the origin and the destination from the laptop personal computer 18 to the base unit 12 and for communicating the route from the base unit 12 to the laptop personal computer 18.

The I/O interface 62 may further include a network interface 75 for coupling the base unit 12 to one or more wireless or wireline communication networks such as CDPD (cellular digital packet data), TCP/IP (transmission control protocol/Internet protocol), ARDIS or RAM. The I/O interface 62 may further include an external interface 77 for coupling the base unit 12 to a control unit 84. The control unit 84 provides an external link to the base unit 12 and may be, for example, a personal computer coupled over a wireless or wireline network or a directly connected terminal. The control unit 84 may include, for example, a keyboard 86 and a display 88. The control unit 84 may request tracking information about the location of one or more mobile units. For example, a mobile unit may be located in an armored vehicle transporting valuables along a specified route. The control unit may receive tracking information from the base unit and, if the mobile unit in the armored vehicle varies from the specified route by a predetermined amount, sound an alarm or trigger some other action.

The I/O interface 62, including the telephone interface 74 and the RF interface 76, provide a means for coupling the base unit 12 with communications media such as the commercial telephone system and other wireline and wireless devices. The I/O interface 62 thus receives queries from the plurality 14 of remote units and transmits the responses from the base unit 12 to the plurality 14 of remote units. The I/O interface 62 therefore provides a receiving means at the base unit for receiving the origin and destination and a transmitting means at the base unit for transmitting the route to a mobile unit.

The query resolver 64 receives the request from the I/O interface 62. When a request is entered at one of the plurality 14 of remote units, a mistake may be made. For example, in manipulating the keyboard 44 of the laptop personal computer 18, the user may have entered "O'HAIR," intending to enter "O'HARE," indicating O'Hare Airport. Other ambiguities may be in the format of the address provided, in the latitude and longitude of the position provided, or in the definition of cross streets. The function of the query resolver 64 is to resolve such ambiguities in the query at the base unit 12 and convey the query for further processing.

After the query resolver, the query is routed to the route calculator 66. In a manner well known in the art, the route calculator 66 determines a route between a specified origin and destination using the map database 72. The map database 72 may be, for example, the navigable map database maintained by Navigation Technologies Corp. The map database 72 preferably includes an accurate, complete, and up-to-date representation of geographic information such as addresses, street names, navigation attributes (including turn restrictions, one-way streets, physical dividers, relative heights, freeway sign text, and so forth), as well as point of interest categories, such as parks, schools, hospitals, restaurants, and golf courses associated with the geographic information. The on-line traffic and map updater 72U receives updating information from map database vendor(s) 81 and traffic information providers 83 and maintains map database 72 current.

In determining the route, the route calculator 66 preferably takes into account routing restrictions such as toll road avoidance, turn restrictions at a specified time of day, and other restrictions. Such routing restrictions may be specified by an operator at the base unit 12 in response to a temporary condition or may be added to the map database 72 when the restrictions become nationally available. The route calculator 66 thus forms a calculating means at the base unit for calculating a route between the origin and the destination. The map database may be divided into geographic areas such as metropolitan areas. Providing the route calculation function in the base unit 12 reduces the data storage and data processing requirements for the remote units. In certain applications, however, it may be desirable to provide the remote units with a limited route calculation function.

After a route has been calculated, the route is conveyed from the route calculator 66 to the I/O interface 62. The I/O interface 62 formats a response to the query. The response includes the route guidance information determined by the route calculator 66. The I/O interface 62 then communicates the response from the base unit 12 to the mobile unit which originally requested the information.

If the query requests a distance or a time of travel, the query is forwarded to the distance and time travel estimator 68. The distance and time travel estimator 68, in response to the query and using the map database 72, formulates a response to the query. The response is conveyed from the distance and time travel estimator 68 to the I/O interface 62. The response is formatted at the I/O interface 62 and communicated from the base unit 12 to the mobile unit which originally requested the information.

If the query requests information about points of interest in the area surrounding an origin, the query is conveyed to the surroundings explorer 70. The surroundings explorer 70 provides an optimized method for searching for points of interest satisfying specified criteria or parameters such as time or distance. For example, the surroundings explorer 70 may locate all McDonald's™ restaurants within a specified

driving distance or driving time of a specified origin, or it may locate the McDonald's™ restaurant nearest the specified origin. The origin and search parameters are specified in the query received from the mobile unit. In response to the query, the surroundings explorer 70 accesses the map database 72 and searches outward from the specified origin. The surroundings explorer 70 analyzes paths in the map database 72 over which a mobile unit, in a car for example, could legitimately travel. The surroundings explorer 70 examines the associated point of interest information for entries satisfying the specified search parameters. The surroundings explorer 70 thus determines which points of interest satisfy the query. The information is then conveyed from the surroundings explorer 70 to the I/O interface 62 and a response is formatted. The response is then communicated from the base unit 12 to the remote unit which requested the information.

The third-party data integrator 80 provides additional data such as on-line yellow pages information or news, weather, and/or traffic advisory information for responding to queries from a mobile unit. The additional data are preferably received from other information providers, illustrated in FIG. 1 as functional block 82. The additional data may also be added directly to and located within the map database 72. The additional data may be supplied external to the base unit 12 via any known data communications network.

The functions performed by the base unit 12, as described above and illustrated in the functional block diagram of FIG. 1, are performed in a data processing system. The data processing system may be in one or more units and include a processor for executing program instructions, a memory for storage of the program instructions and data such as the map database 72. The data processing system further includes other equipment such as digital logic for implementing the I/O interface 62 for receiving queries and sending responses. The data processing system may include a display and a keyboard as an operator interface.

FIG. 2 is a flow diagram illustrating a method of the invention. The method begins at step 100 where communication is established between the mobile unit and the base unit 12. Performance of this step is largely dependent on the specific implementation of both the base unit 12 and the mobile unit. For example, with reference to FIG. 1, the desktop personal computer 16 would establish communications using the modem 22 to place a telephone call over the telephone line 24 to the base unit 12. The telephone interface 74 of the base unit 12 and the modem 22 would establish communication in a manner well known in the art. Similarly, the laptop personal computer 18 would establish communications with the base unit 12 by completing a telephone call through the cellular telephone system 38. However, the basic operation of the invention is independent of the particular hardware and communication channels employed.

The method continues at step 102, in which a query is formatted at the remote unit. The query is formatted in accordance with the protocol of the invention, to be described in further detail below in conjunction with FIG. 3. The query comprises a serial stream of data and control bits. The control bits, for example, identify the remote user originating the query. The data bits specify the precise request being made of the base unit. For example, the data bits may specify an origin point and a destination point, from which the route calculator 66 (FIG. 1) of the base unit 12 is to calculate the route. Certain communications transport protocols, specific to the particular hardware implementation of the system 10, may prepend or append characters or other control bits to the control and data bits which form the

query. For example, the modem 22 of the desktop PC 16 may include handshaking bits or signals to be used by the telephone interface 74 of the base unit 12 for processing the query. At step 104, the query is transmitted from the mobile unit to the base unit 12.

The method continues at step 106, where ambiguities in the query are resolved by the query resolver 64 (FIG. 1). Ambiguities may be in the form of spelling errors in the identification of an origin or a destination, an inconsistent latitude or longitude specification, and the like. At step 108, if the query resolver 64 cannot resolve the ambiguity, an error message may be communicated from the base unit to the remote unit at step 110, and the query must be repeated.

The method continues at step 112, where the query type is identified. The query may be one of several different types, including a route query, a point of interest query, a language query, or a metro area query. A route query asks the base unit 12 to identify a route between a specified origin point and a specified destination point. A route query includes the origin and the destination. A point of interest query requests a list of points of interest which satisfy specified criteria. For example, a point of interest query might request a list of all restaurants of a specific type, such as McDonald's™, within a specified distance or a specified driving time of a specified origin. A language query requests a list of available languages for display of information at the mobile unit or specifies the language (such as English or Dutch) in which the routing information is to be displayed at the remote unit. Such language queries are not needed if the language independent mode (to be described below) is being used. A metro area query requests a list of available metropolitan areas or specifies the metropolitan area within the map database 72 (FIG. 1) to be used for responding to the query. For example, a query which has as its origin "77 W. Chestnut Street" in Chicago must specify the Chicago metropolitan area rather than, for example, the Cincinnati metropolitan area, in order to prevent confusion. If a query cannot be identified, an error message is generated at step 110 and the query must be repeated. After the query type has been determined at step 112, the query is routed to, for example, the route calculator 66, the distance and travel estimator 68, and/or the surroundings explorer 70 (FIG. 1) for processing.

The method continues at step 114, where the query is fulfilled. For example, if the query requested routing information between an origin and a destination, the route calculator 66, operating in conjunction with the map database 72, calculates a route between the origin and the destination. Similarly, if the query was a point of interest query, the surroundings explorer 70 will determine points of interest which satisfy the query.

The method continues at step 116, where the response to the query is formatted. The response is formatted in accordance with a data communications protocol to be described in detail in conjunction with FIG. 4. The formatted response includes control and data bits. The control bits specify information such as the mobile unit which initiated the request. The data bits specify the information, such as route guidance information, which fulfills the query. At step 118, the method concludes when the response is electromagnetically transmitted from the base unit 12 to the mobile unit.

Referring now to FIG. 3, it is a diagram illustrating a data communication protocol for communicating data from a mobile unit to a base unit in accordance with the invention and which can be used in conjunction with the system of FIG. 1 and the method of FIG. 2. The protocol illustrated in

FIG. 3 is defined by a communications syntax including variable message lengths, allowing as little or as much data transfer as necessary for the specific application requirement. In this implementation example, the protocol can be used across all communications systems, as long as the printable, seven-bit ASCII character set, plus the “newline” character (0x0A) can be transmitted by the communications system.

The transmitted character set consists of the principal ASCII character set plus the newline character. To transmit bytes of data which do not fit in this character set, or for communication protocols which do not allow transmission of the newline character, an escape mechanism is provided to allow transmission of these characters. For communication in binary format, numeric fields or numeric values are transmitted using two’s complement notation, in network byte order (most significant byte first, followed by bytes of decreasing significance). Floating point numbers are transmitted using the IEEE 64-bit double precision format, with the most significant byte transmitted first.

Only a single query message 120 is needed to transmit a query from a mobile unit to the base unit 12. This query message 120 provides for both current location tracking information as well as route calculation requests. The query message 120 includes a plurality of fields 122. Each field of the plurality 122 of fields is separated by a delimiter, preferably the vertical bar “|” (ASCII code 0x7C). The start of the query message 120 begins with a delimiter character. The end of each message is marked by a delimiter character immediately followed by a newline character (ASCII code 0x0A), represented in FIGS. 3 and 4 as “\n”. Any characters between the ending newline character and the starting delimiter are preferably ignored by the base unit 12 and the mobile unit.

As noted, the query message 120 includes a plurality of fields 122. Some communications transport protocols may prepend or append characters for controlling communication of the message in accordance with the specific hardware implementation of the system 10.

The query message 120 includes a message length field 124. This field specifies the length of the query message 120. The message length field 124 may also include a compression marker 125 indicating the compression status of the message. For example, the compression marker 125 may take on a first value if the query message 120 is compressed using a current phrase compression table. The compression marker 125 may take on a second value if the query message 120 is compressed using the current dictionary (bit compression) table. The compression marker 125 may take on a third value if the query message 120 is compressed using the L-Z (Lev-Zempel) compression algorithm. And the compression marker 125 may take on a fourth value or simply not be present if the query message 120 is not compressed in any way.

The query message 120 further includes a cyclical redundancy check (CRC) field 126. This field is preferably the computed CRC-16 of the query message 120, starting with the delimiter following the CRC field 126 up to and including the ending newline, as actually transmitted (i.e., as compressed). The query message 120 further includes a time stamp field 128 which gives the number of seconds since the epoch (00:00:00 GMT Jan. 1, 1970) when this message was sent. Preferably, messages older than 20 minutes will be ignored when received by the base unit 12.

The query message 120 further includes a subscriber identifier field 130. The information provided in this field

may be used for billing and audit information. The query message 120 further includes a message identifier field 132. The characters in this field are used to tag response messages transmitted from the base unit 12 to the requesting mobile unit. The base unit 12 will place the characters in the message ID field 132 in any return message so that the mobile unit may determine what original message the base unit 12 is responding to. The query message 120 further includes an identifier field 134, which provides identification information uniquely identifying the mobile unit which transmitted the query message 120. The identification field 134 is used for tracking and communications addressing.

The query message 120 further includes a latitude field 136 and a longitude field 138. These fields specify the current position of the mobile unit by latitude and longitude, respectively. By default, the current latitude and longitude provide the origin for all routing requests, and also provide the position used for default tracking address translation.

The query message 120 further includes an origin field 140. The origin field 140 specifies the origin address for a routing information request. If this field is empty, the current position specified by the latitude field 136 and the longitude field 138 is used as the origin address. The query message 120 further includes an origin type field 142, which may be either an address or a point of interest category (such as “restaurant”, “museum” or “airport”) which is recognizable by the base unit 12.

The query message 120 further includes a destination field 144, which specifies the destination address if routing information is requested by the mobile unit from the base unit 12. If the destination field 144 is empty, then no route is calculated by the base unit 12. Instead, the message 120 is considered to be a tracking message only, merely providing the location of the mobile unit.

The query message 120 further includes a destination type field 146 which specifies the type of destination. For example, the destination may be an address or a point of interest category recognizable by the base unit 12. For example, the point of interest categories may include “restaurant”, “airport”, or “museum.” As one example, the destination type field 146 may be “restaurant”, and the destination field 144 may be “McDonald’s™”.

The query message 120 further includes a destination limit field 148. This field specifies a limit for point of interest searches. Such a search will be limited to the range specified by the value in the destination limit field 148 about the origin. For example, if the destination limit field 148 is empty or has a value 0, the base unit 12 preferably interprets this to indicate that the nearest point of interest satisfying the requirements specified by the destination field 144 and the destination type field 146 should be located. If the destination limit field 148 is non-zero, then the limit specified sets the maximum range searched for a matching point of interest. If no matching point of interest is in the range specified, a “no match” route error is returned.

The value of the destination limit specified in the destination limit field 148 depends on the limit type field 150. The limit type field 150 determines what unit of measurement is in the destination limit field. For example, the limit type field may take on a first value (for example “M”) when the destination limit specifies a straight line distance. The limit type field 150 may take on a second value when the destination limit is driving distance. Or, the limit type field 150 may take on a third value when the destination limit is driving time, in minutes.

The query message 120 concludes with an ending field 152. The ending field 152 preferably includes the newline character, represented in FIG. 3 as “\n”.

Before the ending field **152**, the query message **120** may also include additional optional fields which specify additional information or service requests from the mobile unit to the base unit **12**. For example, the query message **120** may additionally specify a text message to an operator of the base unit **12**, or specify whether the base unit **12** should provide maneuver arms information or combined maneuver arms information along with route guidance text. The query message **120** can also specify, for example, whether the base unit **12** should send route stripmap information for a specified strip width with the returned route text, whether the base unit **12** should send responses in a language independent manner, and/or whether map information should be sent by the base unit **12** in bitmap or vector form.

Maneuver arms information is used to represent intersections along the route determined by the base unit **12**. Combined maneuver arms information can be provided when two intersections are sufficiently close together. Further, the query message **120** can additionally specify routing options such as route calculations which avoid tolls, avoid left turns or avoid limited access roads, or specify a time of day for the start of the route. Still further, the message **120** could optionally request additional information from the base unit **12**, such as a list of point of interest types, a list of points of interest matching search criteria or a list of files which may be communicated from the base unit **12** to the mobile unit to provide descriptive information.

Referring now to FIG. 4, FIG. 4 illustrates a data communications protocol for communicating data from a base unit to a mobile unit in accordance with the invention and which can be used in conjunction with the system of FIG. 1 and the method of FIG. 2. In FIG. 4, a response message **160** is illustrated as including a plurality of fields **162**.

In accordance with the invention, the response message **160** may be transmitted in a continuous stream of data, called the burst mode, or in a plurality of discrete responses to queries for data, called the normal mode. The mode of data transmission can be specified by the mobile unit, for example, in an additional field included in the query message **120**. In the burst mode, the base unit **12** transmits data as fast as possible, without waiting for requests from the mobile unit. In the normal mode, the base unit **12** sends a packet, then waits for the mobile unit to request the next packet before sending the next packet.

As mentioned above, the response transmitted from the base unit **12** to a mobile unit may include maneuver arms information. Maneuver arms are graphical vectors used by the mobile unit for displaying a graphical representation of an intersection to be traversed. At least three types of visual information can be transmitted by the base unit. These include a geometric representation of the intersection, including arms representing the streets approaching an intersection and the angles at which the streets approach the intersection. The transmitted information can further include which of the streets is included in the route to be travelled so that, for example, that street may be highlighted in the graphical display. The transmitted information can further include information about street signs located at the intersection.

In one embodiment, the maneuver arms information includes only sufficient data to create a display showing only what the driver of a vehicle containing the mobile unit will see as the driver traverses the displayed intersection. Other, extraneous information, such as a map of the region around the intersection or of the entire metropolitan region, is not transmitted.

Transmitting only a representation of intersections to be traversed, rather than extraneous information, greatly reduces data transmission and storage requirements. Thus, a relatively low bandwidth channel may be used for transmitting queries and responses between the base unit **12** and the mobile unit. For example, a channel having a bandwidth as low as 1,200 bits per second may be used. In contrast, transmitting extraneous information may require a bandwidth as high as 1 megabit per second. Since, with the invention, the amount of data transmitted is relatively small, the entire response, including maneuver arms information, may be transmitted in a reasonable time, even at a low bandwidth. In addition, since only pertinent information about intersections is transmitted, only a small amount of memory, such as memory **26** of the desktop personal computer **16** (FIG. 1) is required at the mobile unit.

After an intersection has been traversed, the display is, in general, updated to show the next intersection to be traversed, using maneuver arms information received from the base unit and stored in memory. The display can be updated in response to operator control, for example, by operating a switch or by voice control, or automatically in response to a position sensor such as the position locator **42** of the laptop personal computer **18** (FIG. 1).

The response message **160** preferably includes a message length field **164** which specifies the length of the response message **160**. In addition, the message length field **164** may include a compression marker character **165**. The compression marker character **165** may take on one of a number of values. For example, the compression marker character **165** may take on a first value if the response message **160** is compressed using the current phrase compression table. The compression marker character **165** may take on a second value if the response message **160** is compressed using the current dictionary (bit compression) table. The compression marker character **165** may take on a third value if the response message **160** is compressed according to the L-Z (Lev-Zempel) compression algorithm. The compression marker character **165** may take on a fourth value or simply not be present if the response message **160** is not compressed in any way.

The response message **160** further includes a CRC field **166** which is preferably the computed CRC-16 of the message **160**, starting with the delimiter following the CRC field **166** up to and including the ending character of the message **160**. The response message **160** further includes a time stamp field **168** which specifies the number of seconds since the epoch (00:00:00 GMT Jan. 1, 1970) when this message was sent. Preferably, messages older than 20 minutes will be ignored by the mobile unit which receives the message.

The response message **160** further includes a subscriber identifier field **170**. This field preferably specifies information used for auditing, billing and authorization.

The response message **160** further includes a message identification field **172**. In accordance with the invention, the contents of the message identification field **170** of the response message **160** match the contents of the message ID field **132** of the query message **120**. The response message **160** further includes an identifier field **174**. Preferably, the contents of the identifier field **174** of the response message **160** match the contents of the identifier field **134** of the query message **120**.

The response message **160** also includes a type field **176** and a message field **178**. The type field **176** specifies the type of the message contained in the message field **178**. For

example, the type field 176 may have a first value (for example type "R") specifying that the message field 178 contains route tracking address translation information. Such a message would result from the base unit 12 having received a route tracking query. The message in the message field 178 is then the address corresponding to the current position (latitude, longitude). The type field 176 may have a second value specifying that the message field 178 includes route guidance information. This message would result from the base unit 12 having received a route calculation request. The message is the set of driving instructions. The instructions will contain several lines of text, each separated by carriage return/newline characters. There may be several messages of this type communicated for a single route. Each message will correspond to a single maneuver if arms are requested, or be the complete text if arms are not requested.

The message type field 176 may take on a third value to indicate that the message field 178 contains a download of information. This message would result from a query requesting particular information from the base unit 12. The type field 176 may take on a fourth value to indicate that the message field 178 contains an error message. For example, the latitude and longitude specified by the latitude field 136 and the longitude field 138 in the query message may be outside the specified metropolitan region, or the specified address may be invalid or not found for a route calculation. The message field 178 contains the error text defining the error.

The type field 176 may take on a fifth value to specify that the message field 178 contains a query response. Such a message would be the result of a query made of the database, for example requesting a list of point of interest types. The message field 178 includes the query data.

The response message 160 concludes with an ending field 180. Preferably, the ending field 180 includes the newline character, illustrated in FIG. 4 as "\n".

The use of maneuver arms will now be described in greater detail. Maneuver arms are used to depict roads at intersections. If maneuver arms information is requested by a remote unit, the base unit 12 generates the maneuver arms information in a maneuver arm generation module and provides this arms information for a current maneuver to the remote unit. The remote unit, for example computer 18, processes this information and displays the information on a display, for example display 46. The base unit 12 provides the information to the remote unit in the following form:

FromName; ToName; $x_1, y_1; x_2, y_2 [\dots ; x_n, y_n]$

"FromName" is the road being driven on at the beginning of the maneuver. "ToName" is the road being driven on at the end of the maneuver (except for the first maneuver). The x, y values specify the endpoints of the arms from an origin, which is set at the intersection. Each arm starts at the origin and radiates outward to an endpoint x, y . In one preferred embodiment, x and y are integer values between -100 and $+100$. The base unit 12 scales and rotates the arms so that the from road is vertical on the display and approaches the intersection from the bottom. If there are any arms, in general there will be at least two: a first arm to represent the "from" road using x_1 and y_1 , and a second arm to represent the "to" road using x_2 and y_2 . Other arms specified by x_n and y_n are used to represent any additional roads at the intersection. The signs of the x and y coordinates are shown in FIG. 5.

In one embodiment, the endpoint coordinates of the first, or from, arm are 1, 99 so that the first arm appears to be going straight up from the bottom of the display to the

origin. The other arms are mapped relative to the position of this first arm. In this embodiment, endpoint coordinates of 99, -1 correspond to an approximately 90° right turn from the first arm. Endpoint coordinates of $-99, 0$ correspond to an approximately 90° left turn from the first arm. Endpoint coordinates of 1, -100 correspond to proceeding straight ahead through the intersection.

For the first maneuver, the ToName can represent a cross street near the beginning of a route to orient the driver even though this cross street is not to be turned onto.

FIGS. 6 to 10 illustrate examples of displays in a remote unit in the course of a trip from 1550 Rockwood St., Los Angeles, to 280 Emerald St., Los Angeles. In this example, after the driver enters the from information "1550 ROCKWOOD ST, LOS ANGELES" and the to information "280 EMERALD ST, LOS ANGELES" the display in the remote unit informs the driver of the approximate driving distance and driving time by displaying "ABOUT 0.4 MILES, 3 MINUTES" (not shown in FIGS. 6 to 10). Then, as the driver proceeds, the display displays the textual and graphic information shown in FIGS. 6 to 10. The directions in textual form are displayed on the left, and corresponding maneuver arms are graphically displayed on the right based on the x, y endpoint coordinates received from the base unit 12. The exact appearance of the display, for example, road width and road edge color, can be customized by the remote user.

FIGS. 11 to 14 illustrate the data transferred between the remote unit and the base unit in the example of FIGS. 6 to 10. More specifically, FIG. 11 illustrates the packet transmitted from the remote unit to the base unit. FIG. 12 illustrates the packet issued from the base unit in response. FIG. 13 illustrates a second communication from the remote unit to the base unit. And, FIG. 14 illustrates a corresponding response from the base unit. In the example of FIGS. 11 to 14, not all of the fields shown in FIGS. 3 and 4 are needed and are thus omitted.

As shown by the "ARMS=Y" designation in an optional routing alternatives field, the request in FIG. 11 includes a request for maneuver arms information. In the second message in FIG. 12, the base unit begins to send maneuver arms information, in the format described above, via the "ARM=ROCKWOOD, GLENDALE; 1, 99; -91, 41; 90, -42" instruction. The optional "MORE=Y" instruction in the fifth message of FIG. 12 indicates that there are more packets of messages to follow. The "MANEUVER=NEXT" and "ARMS=Y" instructions of FIG. 13 direct the base unit 12 to send the additional information, including maneuver arms information. This additional information is sent via the packet shown in FIG. 14.

FIGS. 15 to 38 illustrate additional examples of data transferred between a remote unit and a base unit. FIG. 15 illustrates a packet sent by a remote unit to a base unit which constitutes the initial log-in communication that sets a non-burst mode and a 1K maximum packet size. FIG. 16 illustrates the response to the request of FIG. 15. FIG. 16 is a response which merely acknowledges the request of FIG. 15 because there is insufficient information for a route request or a query. FIG. 17 illustrates a request to use a Los Angeles, Calif. database for future requests and FIG. 18 illustrates the corresponding acknowledgement.

FIG. 19 illustrates a request for a route from 950 S. Flint Ridge Way to 2043 N. Sacramento along with maneuver arms. FIG. 20 illustrates a first packet in response to the request of FIG. 19. FIG. 21 illustrates a request from the remote unit to the base unit to send the next packet of instructions along with maneuver arms. FIG. 22 illustrates a

response providing the next packet, as requested. FIG. 23 illustrates a request for the next block of instructions and FIG. 24 illustrates the next block of instructions. Finally, FIG. 25 illustrates a request for the last block of instructions and FIG. 26 illustrates the corresponding response. Thus, FIGS. 19 to 26 together illustrate the communications to provide the route from 950 S. Flint Ridge Way to 2043 N. Sacramento.

FIG. 27 illustrates a request for a route from 1750 Queens Road to 7530 Orangethorpe, along with maneuver arms. FIG. 28 illustrates the packet giving the first block of instructions in response to the FIG. 27 request. FIG. 29 requests the next block of maneuvers. And, FIG. 30 illustrates the final block of maneuvers.

FIG. 31 illustrates a request for a list of all points of interest (POIS) of the restaurant type with "HAPPY" in their name within 10.0 miles (encoded as "100" and "M") of 1855 W. Katella Avenue. FIG. 32 illustrates the response indicating that there are no such points of interest found which satisfy the given criteria. FIG. 33 illustrates another request for a list of points of interest of the restaurant type with "HUNGRY" in their name within 10.0 miles of 1855 W. Katella Avenue. FIG. 34 illustrates the corresponding response providing the information for two points of interest satisfying the criteria set forth in the message of FIG. 33. In FIG. 34, "HUNGRY TIGER SEAFOOD RESTAURANT" at "6231 MANCHESTER BLVD, BUENA PARK" is the first point of interest. The "36" is the type of point of interest, i.e., restaurant. The "23606" is a unique identification number for the point of interest. The "0-0-223-137,4,1" specifies the restaurant location relative to a known node in the metropolitan region. The "46646" is the distance to the restaurant in feet and the "N" indicates that no additional information regarding the restaurant is available.

FIG. 35 is a packet sent from a remote unit to a base unit which requests a list of points of interest of the restaurant type with "BURGER" in their name within 10.0 miles of 1855 W. Katella Avenue. FIG. 36 illustrates the first packet in response to the request of FIG. 35. FIG. 37 requests additional points of interest in response to the request of FIG. 35. FIG. 38 provides additional points of interest satisfying the criteria in the request in FIG. 35.

The invention generates combined maneuver arms in situations where turns are required at two different intersections which are close together. FIG. 39 illustrates an example of a combined maneuver arm. In the example of FIG. 39, a slight right turn is required at the corner of Broad Street and Elm Street and a left turn is required at the intersection of Elm Street and Main Street. Instead of generating maneuver arms for the Broad-to-Elm turn and another set of maneuver arms for the Elm-to-Main turn, the invention generates a single combined maneuver arms display, as shown in FIG. 39, by the following process.

For each set of maneuver arms generated at an intersection, the base unit 12 determines whether there is a sufficiently close intersection at which the driver must turn. If sufficiently close intersections requiring turns occur, then the maneuver arms information for both of these intersections are merged for a single combined maneuver arms display such as that shown in FIG. 39. For the combined maneuver arms, the roads are designated by sets of endpoints, similar to that described above in connection with FIG. 5. One acceptable form for combined maneuver arms is as follows:

FromName, ToName, $ox_a, oy_a, x_{a1}, y_{a1}; x_{a2}, y_{a2}; X_{an}, y_{an}$; ToName, $ox_b, oy_b, x_{b1}, y_{b1}; x_{b2}, y_{b2}; X_{bn}, y_{bn}$

The ox_a and oy_a coordinates specify the coordinates of the first, or a^{th} , intersection, or origin, and the ox_b and oy_b

coordinates specify the coordinates of the second, or b^{th} , intersection, or "origin." The arms are specified with respect to these origins. For example, x_{a1} and y_{a1} are the endpoint coordinates of the 1st road at the first, or a^{th} , intersection. To conserve space, coordinates for "origins" other than the first can be omitted because they can be reconstructed from the from/to arm data.

Combined textual information is also displayed along with combined maneuver arms. Thus, along with the graphic display shown in FIG. 39, the following textual instructions are also displayed: "Turn slight right on ELM ST. followed shortly by a left turn onto MAIN ST. Drive 5.6 miles." Three or more intersections can be combined.

An additional feature of the invention is the transmission of message information, that is, the information in message field 178 in FIG. 4, in a further compressed form. The use of such a form has at least two advantages. First, use of such a form allows message information to be transmitted electromagnetically in a more efficient way. Second, use of such a form allows transmission of information from the base unit 12 to a remote unit in a language independent manner. Upon receipt of the information in this form, the remote unit then converts the information for display into expanded textual instructions in any desired language such as English, Spanish, Japanese, and/or German. This form will generally be referred to herein as the language independent form or language independent mode.

In the language independent mode, the textual description of maneuvers are generated by a token generation module in base unit 12 and are transmitted to the remote unit in a tokenized form. For example, instructions to:

Turn left on W. MAIN ST. and drive 4.3 miles.

Would be transmitted as:

3,W.MAIN ST.,4.3.

In this example, the "3" represents the English instruction to:

Turn left on [blank 1.] and drive [blank 2] miles.

The "W. MAIN ST." field is the information to be inserted in the [blank 1] position (corresponding to a street sign) and the "4.3" field is the information to be inserted in the [blank 2] position. If German language instructions are desired, then the remote unit displays the following text for a type "3" instruction:

Auf [blank 1] links abbiegen und [blank 2] Meilen weiterfahren.

Thus, using the 5th message of FIG. 12 as another example, instead of transmitting "Turn LEFT onto EMERALD DR. \r Drive 0.1 miles." the following tokenized information is transmitted to convey the same information in a much more compact form:

3,EMERALD DR.,0.1

FIG. 40 provides additional examples of tokens and corresponding expanded text in English, Spanish, and German.

Upon receiving the tokenized route information, the remote unit applies a set of translating instructions contained in a lookup table implemented, example, in computer 18, one table per language, or sounding, desired. For example, the English token translation instructions for a type 3 token indicate that "Turn left on" is displayed, then the signage or street name, then "and drive," then the distance, and then "miles." The remote unit can be equipped with a set of buttons for the user to specify the desired language(s).

Translation instruction can be more or less complicated and can include conditions for added flexibility. For example, the English token translation instructions for a type

5 instruction indicate that "Follow the sign" is displayed first, then if the number of signs in the message is greater than one an "s" should be added to "sign," then the sign(s) should be displayed, then "on the ramp." should be displayed. Thus, in one instance a type 5 token might produce, 5 expanded English maneuver text of:

Follow the signs TO O'HARE, TO INDIANA on the ramp.

In another instance, a type 5 token might produce the expanded English maneuver text of:

Follow the sign TO CHICAGO on the ramp.

The remote unit can also convert the miles information into kilometers, if desired.

Thus, in the language independent mode, information is transmitted from the base unit without regard to any particular language. Accordingly, the transmission bandwidth does not depend on the language of the instructions to be displayed on the display in the remote unit. Because the remote unit produces the actual text portion, routes can be presented in more than one language or way either concurrently or serially, as desired by the remote user, without the need for additional information from the base unit.

Use of tokens allows remote system users to create their own language formats, if desired, to best fit particular needs and capabilities. Alternatively, a remote unit can download language formats (that is, expanded text corresponding to various tokens) that have already been created from the base unit.

The base unit can also provide the remote units with other information in addition to the textual directions and maneuver arms information discussed above. In some applications, a remote user desires more information than just the textual directions and maneuver arms information and more information than is stored and maintained in the remote unit. For various practical reasons, such as cost, remote units generally have at best only a limited database on-board. Such a limited database may, for example, include information and/or maps for a limited metropolitan area.

Even though a remote user may have no or a limited on-board database, the invention allows the remote user to obtain a large amount of information from the base unit. Thus, the invention allows a remote unit to access a large amount of information without burdening the remote unit with storage and maintenance of a large database. Such information can include, for example, maps for a complete route (not just information about intersections which require turns) or maps for an area which is simply not covered by any on-board database.

FIG. 41 is a flowchart which illustrates the operations in a remote unit, such as computer 18, for determining whether the remote unit needs additional information from the base unit and for obtaining such additional information when it is needed. In the operations illustrated in FIG. 41, the remote unit has a small on-board database.

In step S1, the remote unit requests a route between an origin and a destination from the base unit using the protocol shown in FIGS. 3 and 11. The base unit 12 calculates the route in route calculator 66 and this route is received in the remote unit in step S2. In step S3, the remote unit compares

the route received from the base unit with map information stored on-board the remote unit. In a preferred embodiment, the comparison is made on a node basis. If any part of the route is not adequately covered by on-board maps in terms of geographic scope/bound or level of detail/content, as determined at step S4, then the processing proceeds on to step S5. Otherwise, the processing proceeds on to step S7 and is completed.

In step S5, the remote unit requests, from the base unit 12, stripmaps for those portions of the route which are not adequately covered by maps available on-board the remote unit. Maps are not requested for areas which are adequately covered by on-board maps. A stripmap can be relatively simple or it can be fairly detailed and include side roads, intersections, points of interest, and features for map-matching in the remote unit. In step S6, the remote unit receives the requested stripmap information from the base unit.

A similar procedure is used when a route is within the area covered by the on-board database but the base unit has more up-to-date information. The remote unit can also download updated maps, new programs, and the like. Remote units without any on-board database must obtain all information from the base unit. A remote unit specifies what information it needs, using the above-described protocol, based on what information the remote unit desires and can handle.

Included herewith as Appendix A is a copy of computer code for implementing the packet/message interpretation and parsing functions described above.

As can be seen from the foregoing, the invention provides a system and method for providing graphically referenced information from a base unit or server to a mobile unit in a compact form. The invention allows the mobile unit to operate with limited or no database storage or position sensor requirements. Software for controlling the mobile unit runs on generic hand-held devices or desktop computers with wireless or wireline communications capability. A query, communicated from the mobile unit to the base unit, and the response, communicated from the base unit to the mobile unit, are packaged into a standard data communications protocol that manages a broad spectrum of queries and responses available. This approach to providing route guidance information allows automatic real time database updates and corrections at the base unit, avoiding database distribution problems. In addition, the cost and technical requirements for the on-board or mobile unit equipment are substantially lower than for prior art route guidance information systems.

It is to be understood that, while the detailed drawings and specific examples given describe preferred embodiments of the invention, they are for the purpose of illustration only. The invention is not limited to the precise details disclosed, and various changes may be made therein. For example, the format or protocol of the query message and the response message, illustrated in FIGS. 3 and 4, respectively, may be modified to request different types of information from the map database or to specify different formats or subsets of information to be conveyed to the mobile unit. Such changes may be made without departing from the spirit of the invention which is defined by the following claims.

```

if (SD_BTRF(pSD).palFEBTmplOffsets != NULL)
{
    vCI_MemFree(pSD, SD_BTRF(pSD).palFEBTmplOffsets);
    SD_BTRF(pSD).palFEBTmplOffsets = NULL;
}

if (SD_BTRF(pSD).pbyData != NULL)
{
    vCI_MemFree(pSD, SD_BTRF(pSD).pbyData);
    SD_BTRF(pSD).pbyData = NULL;
}

if (SD_BTRF(pSD).pcTmplBuf != NULL)
{
    vCI_MemFree(pSD, SD_BTRF(pSD).pcTmplBuf);
    SD_BTRF(pSD).pcTmplBuf = NULL;
}

if (SD_BTRF(pSD).pcManBuf != NULL)
{
    vCI_MemFree(pSD, SD_BTRF(pSD).pcManBuf);
    SD_BTRF(pSD).pcManBuf = NULL;
}

SD_BTRF(pSD).sDataLen = 0;
SD_BTRF(pSD).pbyCurrInput = NULL;
SD_BTRF(pSD).ulTotalMansLen = 0L;
SD_BTRF(pSD).sTotalMans = 0;
SD_BTRF(pSD).sCurrManNum = 0;
SD_BTRF(pSD).sCurrManTmplCount = 0;
SD_BTRF(pSD).usCurrTmplSize = 0;
SD_BTRF(pSD).pcCurrTmpl = NULL;

/* Reset sub container */
sResult = sCI_BSCReset(pSD);
if (sResult != SUCCESS)
{
    return sResult;
}

return SUCCESS;
}

/* ::::::::::::::::::::::::::::::::::::::::::::::::::::::::::::
:: ::::::::::::::::::::
:: Function:          sCI_BTRFDealloc
:: Purpose:          Clean up BTRF translator. Release all
used resources.
::
:: Perform when BTRF translator is no
longer needed.
::
:: Arguments:        pSD: Pointer to State Data structure.
::
:: Return value:     SUCCESS:
::                   FAILURE:

```

APPENDIX A - PAGE 4 OF 279

```

:.....
:.....*/
SHORT sCI_BTRFSetLangFile(CI_STATE_DATA * pSD, CHAR * pcFileName)
{
    CHAR *    pcLangFile;

    if (pcFileName == NULL)
    {
        vCI_ErrorQPut(pSD,    CI_ER_INVLANGFILE,
CI_FUNC_BTRFSETLANGFILE, 0);
        return CI_ER_INVLANGFILE;
    }
    if (*pcFileName == '\0')
    {
        vCI_ErrorQPut(pSD,    CI_ER_INVLANGFILE,
CI_FUNC_BTRFSETLANGFILE, 0);
        return CI_ER_INVLANGFILE;
    }

    if (SD_BTRF(pSD).pcFEBLangFilename != NULL)
    {
        vCI_MemFree(pSD, SD_BTRF(pSD).pcFEBLangFilename);
        SD_BTRF(pSD).pcFEBLangFilename = NULL;
    }

    SD_BTRF(pSD).pcFEBLangFilename =
        (CHAR *)pvCI_MemAlloc(pSD,
STRLEN(pcFileName) + 1);
    if (SD_BTRF(pSD).pcFEBLangFilename == NULL)
    {
        vCI_ErrorQPut(pSD,    CI_ER_NOMEM,
CI_FUNC_BTRFSETLANGFILE,
        STRLEN(pcFileName) + 1);
        return CI_ER_NOMEM;
    }

    /* copy string */
    STRCPY(SD_BTRF(pSD).pcFEBLangFilename, pcFileName);

    return SUCCESS;
}

VOID fake_it(CI_STATE_DATA * pSD, CI_RES_MSG * pMsg)
{
    /* Fake Controller into arrival of data */
    memset(&(pSD->ManInfo), 0, sizeof(CI_MAN_REC));
    vCI_CtrlPreProcItem(pSD, pMsg->usMsgId);
    sCI_ROSAddMan(pSD, &(pSD->ManInfo));
    vCI_CtrlPostProcItem(pSD);
}

/*.....
:.....
:: Function:          sCI_BTRFOpenFEB

```

APPENDIX A - PAGE 6 OF 279

```

:: Purpose:                Open and perform initial processing on
FEB file.
::
:: Arguments:              PSD: Pointer to State Data structure.
::
:: Return value:          SUCCESS:
::                          FAILURE:
::
:: Side affects:
:: Revision:              03/22/95      RPD      Original
::::::::::::::::::::::::::::::::::::::::::::::::::::::::::::::::::
::::::::::::*/
SHORT sCI_BTRFOpenFEB(CI_STATE_DATA * pSD)
{
    INT  iFileHndl;
    LONG lOffset;
    SHORT sShort;
    INT   iResult;
    LONG * palOffsets;

#ifdef _WINDOWS
    iFileHndl = open(SD_BTRF(pSD).pcFEBLangFilename, O_RDONLY)
#else
    iFileHndl = open(SD_BTRF(pSD).pcFEBLangFilename, O_RDONLY);
#endif

    if (iFileHndl == -1)
    {
        vCI_ErrorQPut(pSD, CI_ER_FEBOPEN, CI_FUNC_BTRFOpenFEB,
0);
        return CI_ER_FEBOPEN;
    }

    /* seek past language desc. */
    lOffset = lseek(iFileHndl, CI_FEB_DESCLEN, SEEK_SET);
    if (lOffset != CI_FEB_DESCLEN)
    {
        close(iFileHndl);
        vCI_ErrorQPut(pSD, CI_ER_INVFEB, CI_FUNC_BTRFOpenFEB,
0);
        return CI_ER_INVFEB;
    }

    /* read template count */
    iResult = read(iFileHndl, &sShort, sizeof(sShort));
    vCI_SwapShorts(&sShort, 1);
    if (iResult != sizeof(sShort))
    {
        close(iFileHndl);
        vCI_ErrorQPut(pSD, CI_ER_INVFEB, CI_FUNC_BTRFOpenFEB,
0);
        return CI_ER_INVFEB;
    }
    SD_BTRF(pSD).sFEBTplCount = sShort;

    /* prepare for FEB template offsets */

```

APPENDIX A - PAGE 7 OF 279

```

SHORT sCI_BTRFHeader(CI_STATE_DATA * pSD)
{
    BYTE *      pbyInput;
    SHORT      sBytesRead = 0;
    SHORT      sHdrLen;
    LONG *     pLong;
    LONG      lLongVal;
    SHORT *    pShort;
    SHORT      sShortVal;
#ifdef 0
    fprintf(stderr, "sCI_BTRFHeader()\n");
#endif
    pbyInput = SD_BTRF(pSD).pbyCurrInput;

    /* Read Magic Number */
    if (SD_BTRF_DATA_REMAINING(pSD, pbyInput) < sizeof(LONG))
    {
        vCI_ErrorQPut(pSD, CI_ER_INVBTRFHDR,
CI_FUNC_BTRFHEADER, 0);
        return CI_ER_INVBTRFHDR;
    }
    pLong = (LONG *)pbyInput;
    lLongVal = *pLong;
    vCI_SwapLongs(&lLongVal, 1);
    /* Verify Magic Number */
    if (lLongVal != CI_BTRF_MAGIC_NUMBER)
    {
        vCI_ErrorQPut(pSD, CI_ER_INVBTRFHDR,
CI_FUNC_BTRFHEADER, 0);
        return CI_ER_INVBTRFHDR;
    }
    /* Move on to next field */
    pLong++;
    sBytesRead += sizeof(LONG);

    /* Read header size */
    pShort = (SHORT *)pLong;
    if (SD_BTRF_DATA_REMAINING(pSD, pShort) < sizeof(SHORT))
    {
        vCI_ErrorQPut(pSD, CI_ER_INVBTRFHDR,
CI_FUNC_BTRFHEADER, 0);
        return CI_ER_INVBTRFHDR;
    }
    sHdrLen = *pShort;
    vCI_SwapShorts(&sHdrLen, 1);
    pShort++;
    sBytesRead += sizeof(SHORT);

    /* Do we have enough data for remaining header? */
    if (SD_BTRF_DATA_REMAINING(pSD, pShort) < sHdrLen)
    {
        vCI_ErrorQPut(pSD, CI_ER_INVBTRFHDR,
CI_FUNC_BTRFHEADER, 0);
        return CI_ER_INVBTRFHDR;
    }
}

```

APPENDIX A - PAGE 9 OF 279

```

/* Read File Version */
sShortVal = *pShort;
vCI_SwapShorts(&sShortVal, 1);
if (sShortVal != CI_BTRF_FILE_VER)
{
    vCI_ErrorQPut(pSD, CI_ER_INVBTRFHDR,
CI_FUNC_BTRFHDR, 0);
    return CI_ER_INVBTRFHDR;
}
pShort++;
sBytesRead += sizeof(SHORT);

pbyInput = (BYTE *)pShort;

/*
 * Skip Data Flags, Offset to Node VID
 * info, System time and DBE ver fields.
 */
pbyInput += sizeof(SHORT) + sizeof(LONG) + sizeof(LONG) +
16 * sizeof(CHAR);
sBytesRead += sizeof(SHORT) + sizeof(LONG) + sizeof(LONG)
+
16 * sizeof(CHAR);

/* Save copyright info */
if (SD_BTRF(pSD).pcCopyright == NULL)
{
    SD_BTRF(pSD).pcCopyright =
(CHAR *) pvCI_MemAlloc(pSD,
CI_BTRF_COPYRIGHT_LEN);
    if (SD_BTRF(pSD).pcCopyright == NULL)
    {
        vCI_ErrorQPut(pSD, CI_ER_NOMEM,
CI_FUNC_BTRFHDR, 0);
        return CI_ER_NOMEM;
    }
    memcpy(SD_BTRF(pSD).pcCopyright, pbyInput,
CI_BTRF_COPYRIGHT_LEN);

    pbyInput += CI_BTRF_COPYRIGHT_LEN;
    sBytesRead += CI_BTRF_COPYRIGHT_LEN;

/* Read size of maneuver data */
pLong = (LONG *)pbyInput;
lLongVal = *pLong;
vCI_SwapLongs(&lLongVal, 1);
SD_BTRF(pSD).ulTotalMansLen = (ULONG)lLongVal;
pLong++;
sBytesRead += sizeof(LONG);

/* Read # of maneuvers */
pShort = (SHORT *)pLong;
sShortVal = *pShort;
vCI_SwapShorts(&sShortVal, 1);
SD_BTRF(pSD).sTotalMans = sShortVal;

```

APPENDIX A - PAGE 10 OF 279

```

/* Add to substitution container */
sResult  =  sCI_BSCAddSub(pSD,  sSubNum,  acSubData,
sSubDataLen);

pChar += sSubDataLen;
SD_BTRF(pSD).pbyCurrInput = (BYTE *)pChar;

return SUCCESS;
}

```

```

/*::::::::::::::::::::::::::::::::::::::::::::::::::
::::::::::::::::::
:: Function:          sCI_BTRFReadFEBTmp1
:: Purpose:
::
:: Arguments:        pSD: Pointer to State Data structure.
::                   sTplNum: Template number to read.
::
:: Return value:     SUCCESS:
::                   CI_ER_INVINDX: Invalid sTplNum
::                   FAILURE:
::
:: Side affects:
:: Revision:         03/28/95      RPD      Original
::::::::::::::::::
::::::::::::::::::*/

```

```

SHORT sCI_BTRFReadFEBTmp1(CI_STATE_DATA * pSD, SHORT sTplNum)
{
    LONG lFEBOffset;
    LONG lResult;
    SHORT sTplLen;
    INT iResult;

    if (sTplNum < 0 || sTplNum > CI_MAX_FEBTMPLS)
    {
        vCI_ErrorQPut(pSD, CI_ER_INVINDX, CI_FUNC_UNDEFINED,
sTplNum);
        return CI_ER_INVINDX;
    }

    lFEBOffset = SD_BTRF(pSD).palFEBTmpOffsets[sTplNum];

    if (lFEBOffset == 0L)
    {
        /* Invalid template */
        vCI_ErrorQPut(pSD, CI_ER_INVINDX, CI_FUNC_UNDEFINED,
sTplNum);
        return CI_ER_INVINDX;
    }

    /* Seek to template */
    lResult = lseek(SD_BTRF(pSD).iFEBInFile, lFEBOffset,
SEEK_SET);
    if (lResult == -1)
    {

```

```

        vCI_ErrorQPut(pSD, CI_ER_INVINDX, CI_FUNC_UNDEFINED,
sTplNum);
        return CI_ER_INVINDX;
    }

    /* read template size */
    iResult = read(SD_BTRF(pSD).iFEBInFile, &sTplLen,
sizeof(sTplLen));
    if (iResult != sizeof(sTplLen))
    {
        vCI_ErrorQPut(pSD, CI_ER_INVFEB, CI_FUNC_UNDEFINED, 0);
        return CI_ER_INVFEB;
    }
    vCI_SwapShorts(&sTplLen, 1);

    /* Prepare template buffer */
    if (SD_BTRF(pSD).pcTplBuf != 0)
    {
        vCI_MemFree(pSD, SD_BTRF(pSD).pcTplBuf);
    }
    SD_BTRF(pSD).pcTplBuf = (CHAR *)pvCI_MemAlloc(pSD, sTplLen
+ 1);
    if (SD_BTRF(pSD).pcTplBuf == NULL)
    {
        vCI_ErrorQPut(pSD, CI_ER_NOMEM, CI_FUNC_UNDEFINED,
sTplLen + 1);
        return CI_ER_NOMEM;
    }
    /* read template */
    iResult = read(SD_BTRF(pSD).iFEBInFile,
SD_BTRF(pSD).pcTplBuf, sTplLen);
    if (iResult != sTplLen)
    {
        vCI_ErrorQPut(pSD, CI_ER_INVFEB, CI_FUNC_UNDEFINED, 0);
        return CI_ER_INVFEB;
    }
    SD_BTRF(pSD).pcTplBuf[sTplLen] = '\0';

    return SUCCESS;
}

/* ::::::::::::::::::::::::::::::::::::::::::::::::::::::::::::
::: Function:          sCI_BTRFTransTpl
::: Purpose:
:::
::: Arguments:        pSD: Pointer to State Data structure.
:::
::: Return value:     SUCCESS:
:::                   FAILURE:
:::
::: Side affects:
::: Revision:         03/28/95          RPD          Original
::: ::::::::::::::::::::::::::::::::::::::::::::::::::::::::::::
::: ::::::::::::::*/

```

APPENDIX A - PAGE 15 OF 279

```

SHORT sCI_BTRFTransTpl(CI_STATE_DATA * pSD)
{
    CHAR *   pcChar = SD_BTRF(pSD).pcTplBuf;
    SHORT *  pShort;
    SHORT    sSubNum;
    CHAR *   pcSubText;

    while (*pcChar != '\0')
    {
        /* Is this a substitution mark? */
        if (*pcChar == (CHAR)0xFF)
        {
            pShort = (SHORT *)pcChar;
            sSubNum = *pShort;
            vCI_SwapShorts(&sSubNum, 1);
            /* Lookup Substitution */
            pcSubText = pcCI_BSCFindSub(pSD, sSubNum);
            if (pcSubText != NULL)
            {
                /* Copy Substitution text to result */
                while (*pcSubText != '\0')
                {
                    *(SD_BTRF(pSD).pcCurrTpl) = *pcSubText;
                    SD_BTRF(pSD).pcCurrTpl++;
                    pcSubText++;
                }
                /* Skip over sub marker */
                pcChar++;
                pcChar++;
            }
            else
            {
                /* Copy template text */
                *(SD_BTRF(pSD).pcCurrTpl) = *pcChar;
                SD_BTRF(pSD).pcCurrTpl++;
                pcChar++;
            }
        }
    }

    return SUCCESS;
}

/*::::::::::::::::::::::::::::::::::::::::::::::::::::::::::::::::::
::::::::::::::::::
:: Function:          sCI_BTRFProcTpl
:: Purpose:
::
:: Arguments:        pSD: Pointer to State Data structure.
::
:: Return value:     SUCCESS:
::                   FAILURE:
:: Notes:            All data is assured to exist by
sCI_BTRFTransMan().
::

```

APPENDIX A - PAGE 16 OF 279

```

:: Side affects:
:: Revision:      03/28/95      RPD      Original
::::::::::::::::::::::::::::::::::::::::::::::::::::::::::::::::::
::::::::::::::::::::*/
SHORT sCI_BTRFProcTpl(CI_STATE_DATA * pSD)
{
    CHAR *      pChar;
    SHORT *     pShort;
    SHORT       sTplNum;
    SHORT       sSubCount;
    SHORT       sSubDataLen;
    SHORT       sCount;
    SHORT       sResult;

    pChar = (CHAR *)SD_BTRF(pSD).pbyCurrInput;

    /* Read Template number */
    sTplNum = (SHORT)*pChar;
    pChar++;

    /* Read Substitution count */
    sSubCount = (SHORT)*pChar;
    pChar++;

    /* Read Substitution data size */
    pShort = (SHORT *)pChar;
    sSubDataLen = *pShort;
    vCI_SwapShorts(&sSubDataLen, 1);
    pShort++;

#if 0
    fprintf(stderr, "\t Template # = %d\n", sTplNum);
    fprintf(stderr, "\t Sub count = %d\n", sSubCount);
    fprintf(stderr, "\t Sub Data Len = %d\n", sSubDataLen);
#endif

    SD_BTRF(pSD).pbyCurrInput = (BYTE *)pShort;

    /* Reset Substitution container */
    sResult = sCI_BSCReset(pSD);
    if (sResult != SUCCESS)
    {
        return sResult;
    }

    for (sCount = sSubCount; sCount > 0; sCount--)
    {
        sResult = sCI_BTRFReadSub(pSD);
        if (sResult != SUCCESS)
        {
            return sResult;
        }
    }
}

#if 0
    /* RPD : Debug print */
    vCI_BSCPrint(pSD);
#endif
}

```

APPENDIX A - PAGE 17 OF 279

```

    /* Read Template from FEB */
    sResult = sCI_BTRFReadFEBTpl(pSD, sTplNum);
    if (sResult != SUCCESS)
    {
        return sResult;
    }

    /* Translate template and substitutions */
    /* into text appending to result */
    sResult = sCI_BTRFTransTpl(pSD);
    if (sResult != SUCCESS)
    {
        return sResult;
    }

    /* Dump template data */
    *(SD_BTRF(pSD).pcCurrTpl) = '\0';
#ifdef 0
    fprintf(stderr, "\t\ttext = <%s>\n", SD_BTRF(pSD).pcManBuf);
#endif

    /* Reset Substitution container */
    sResult = sCI_BSCReset(pSD);
    if (sResult != SUCCESS)
    {
        return sResult;
    }

    return SUCCESS;
}

/*:.....:
:::.....:
:: Function:          sCI_BTRFProcInter
:: Purpose:
::
:: Arguments:        pSD: Pointer to State Data structure.
::
:: Return value:     SUCCESS:
::                   FAILURE:
:: Notes:            All data is assured to exist by
sCI_BTRFTransMan().
::
:: Side affects:
:: Revision:         03/28/95      RPD      Original
:::.....:
::::::::::*/
SHORT sCI_BTRFProcInter(CI_STATE_DATA * pSD)
{
    LONG *      pLong;
    CHAR *      pChar;
    SHORT *     pShort;
    SHORT       sShort;
    SHORT       sArmCount;
    SHORT       sNameLen;
}

```

APPENDIX A - PAGE 18 OF 279

```

SHORT          sCount = 0;

pLong = (LONG *)SD_BTRF(pSD).pbyCurrInput;
/* Skip longitude */
pLong++;
/* Skip latitude */
pLong++;

pChar = (CHAR *)pLong;
/* Skip intersection # */
pChar++;

/* Read arm count */
sArmCount = (SHORT)*pChar;
pChar++;

pSD->ManInfo.sArmCount = min(sArmCount, CI_MAX_ARMS);

pShort = (SHORT *)pChar;

/* Read From name len */
sNameLen = *pShort;
vCI_SwapShorts(&sNameLen, 1);
pShort++;
pSD->ManInfo.sFromLen = min(sNameLen,
sizeof(pSD->ManInfo.acFromName));
/* Copy from name */
pChar = (CHAR *)pShort;
STRNCPY(pSD->ManInfo.acFromName, pChar,
sizeof(pSD->ManInfo.acFromName));
pSD->ManInfo.acFromName[sizeof(pSD->ManInfo.acFromName)-1]
= '\0';
while (*pChar != '\0')
{
    pChar++;
}
pChar++;

pShort = (SHORT *)pChar;

/* Read To name len */
sNameLen = *pShort;
vCI_SwapShorts(&sNameLen, 1);
pShort++;
pSD->ManInfo.sToLen = min(sNameLen,
sizeof(pSD->ManInfo.acToName));
/* Copy to name */
pChar = (CHAR *)pShort;
STRNCPY(pSD->ManInfo.acToName, pChar,
sizeof(pSD->ManInfo.acToName));
pSD->ManInfo.acToName[sizeof(pSD->ManInfo.acToName)-1] =
'\0';
while (*pChar != '\0')
{
    pChar++;
}

```

APPENDIX A - PAGE 19 OF 279

```

pChar++;

/* Skip X-coordinate for intersection */
pChar++;
/* Skip Y-coordinate for intersection */
pChar++;

/* Read from arm X-coordinate */
sShort = (SHORT) *pChar;
pChar++;
pSD->ManInfo.aPoint[sCount].sX = sShort;
/* Skip shape points */
pChar++;
pChar++;

/* Read from arm Y-coordinate */
sShort = (SHORT) *pChar;
pChar++;
pSD->ManInfo.aPoint[sCount].sY = sShort;
/* Skip shape points */
pChar++;
pChar++;
sCount++;

/* Read to arm X-coordinate */
sShort = (SHORT) *pChar;
pChar++;
pSD->ManInfo.aPoint[sCount].sX = sShort;
/* Skip shape points */
pChar++;
pChar++;

/* Read to arm Y-coordinate */
sShort = (SHORT) *pChar;
pChar++;
pSD->ManInfo.aPoint[sCount].sY = sShort;
/* Skip shape points */
pChar++;
pChar++;
sCount++;

/* Read remaining arm points */
while (sCount < sArmCount)
{
    /* Read X-coordinate */
    sShort = (SHORT) *pChar;
    pChar++;
    pSD->ManInfo.aPoint[sCount].sX = sShort;
    /* Skip shape points */
    pChar++;
    pChar++;

    /* Read Y-coordinate */
    sShort = (SHORT) *pChar;
    pChar++;
    pSD->ManInfo.aPoint[sCount].sY = sShort;

```

APPENDIX A — PAGE 20 OF 279

```

        return SUCCESS;
#endif
/* Read intersection count */
sIntersectionCount = *pShort;
vCI_SwapShorts(&sIntersectionCount, 1);
pShort++;
SD_BTRF(pSD).pbyCurrInput = (BYTE *)pShort;

/* Process each intersection */
for (sCount = 0; sCount < sIntersectionCount; sCount++)
{
    sResult = sCI_BTRFProcInter(pSD);
    if (sResult != SUCCESS)
    {
        return sResult;
    }
}

return SUCCESS;
}

/*:.....:
:.....:
:: Function:      sCI_BTRFTransMan
:: Purpose:
::
:: Arguments:    pSD: Pointer to State Data structure.
::
:: Return value: SUCCESS:
:             FAILURE:
::
:: Side affects:
:: Revision:     03/28/95      RPD      Original
:.....:
:.....:*/
SHORT sCI_BTRFTransMan(CI_STATE_DATA * pSD)
{
    SHORT *    pShort;
    SHORT      sArmDataSize;
    SHORT      sCount;
    SHORT      sResult;

    /* Do we have entire maneuver data? */
    if (SD_BTRF_DATA_REMAINING(pSD, SD_BTRF(pSD).pbyCurrInput)
<
        SD_BTRF(pSD).usCurrTmplSize)
    {
        return CI_BTRF_NEED_DATA;
    }

    /* Do we have entire arm data? */
    pShort = (SHORT *) (SD_BTRF(pSD).pbyCurrInput +
        SD_BTRF(pSD).usCurrTmplSize);

    /* Do we have enough data for arms data size? */

```

APPENDIX A – PAGE 22 OF 279

```

if (SD_BTRF_DATA_REMAINING(pSD, pShort) < sizeof(SHORT))
{
    return CI_BTRF_NEED_DATA;
}
sArmDataSize = *pShort;
vCI_SwapShorts(&sArmDataSize, 1);

/* Do we have enough data for arms? */
if (SD_BTRF_DATA_REMAINING(pSD, pShort) < sArmDataSize)
{
    return CI_BTRF_NEED_DATA;
}

/* Setup maneuver buffer */
if (SD_BTRF(pSD).pcManBuf != NULL)
{
    vCI_MemFree(pSD, SD_BTRF(pSD).pcManBuf);
    SD_BTRF(pSD).pcManBuf = NULL;
    SD_BTRF(pSD).pcCurrTpl = NULL;
}
SD_BTRF(pSD).pcManBuf = (CHAR *)pvCI_MemAlloc(pSD,
CI_BTRF_MAX_MAN);
if (SD_BTRF(pSD).pcManBuf == NULL)
{
    vCI_ErrorQPut(pSD, CI_ER_NOMEM, CI_FUNC_UNDEFINED,
CI_BTRF_MAX_MAN);
    return CI_ER_NOMEM;
}
SD_BTRF(pSD).pcCurrTpl = SD_BTRF(pSD).pcManBuf;

for (sCount = SD_BTRF(pSD).sCurrManTplCount; sCount > 0;
sCount--)
{
    sResult = sCI_BTRFProcTpl(pSD);
    if (sResult != SUCCESS)
    {
        return sResult;
    }
}

/* Move maneuver text into ROS result item */
memset(&(pSD->ManInfo), 0, sizeof(CI_MAN_REC));
pSD->ManInfo.pcManText = SD_BTRF(pSD).pcManBuf;
pSD->ManInfo.sTextLen = strlen(SD_BTRF(pSD).pcManBuf);
SD_BTRF(pSD).pcManBuf = NULL;
SD_BTRF(pSD).pcCurrTpl = NULL;

sResult = sCI_BTRFProcArms(pSD);
if (sResult != SUCCESS)
{
    return sResult;
}

/* Add maneuver to ROS */
vCI_CtrlPreProcItem(pSD, SD_BTRF(pSD).usMsgId);
sResult = sCI_ROSAddMan(pSD, &(pSD->ManInfo));

```

APPENDIX A - PAGE 23 OF 279

```

/*:.....
:::.....
:: Function:          sCI_BTRFAddData
:: Purpose:
::
:: Arguments:        pSD: Pointer to State Data structure.
::                   pbyData: Pointer to data to add.
::                   sDataLen: Length of data.
::
:: Return value:     SUCCESS:
::                   CI_ER_NOMEM:  Unable to alloc buffer
::
:: Side affects:
:: Revision:         03/03/95      RPD      Original
:::.....*/
SHORT sCI_BTRFAddData(CI_STATE_DATA * pSD, BYTE * pbyData, SHORT
sDataLen)
{
    BYTE *    pbyTmp;

    if (SD_BTRF(pSD).pbyData == NULL)
    {
        SD_BTRF(pSD).pbyData = (BYTE *) pvCI_MemAlloc(pSD,
CI_BTRF_BUF_SZ);
        if (SD_BTRF(pSD).pbyData == NULL)
        {
            vCI_ErrorQPut(pSD,    CI_ER_NOMEM,
CI_FUNC_BTRFADDDATA,
                CI_BTRF_BUF_SZ);
            return CI_ER_NOMEM;
        }
        memset(SD_BTRF(pSD).pbyData, 0, CI_BTRF_BUF_SZ);
        SD_BTRF(pSD).sDataLen = 0;
        SD_BTRF(pSD).pbyCurrInput = SD_BTRF(pSD).pbyData;
    }

    pbyTmp = SD_BTRF(pSD).pbyData + SD_BTRF(pSD).sDataLen;

    memcpy(pbyTmp, pbyData, sDataLen);
    SD_BTRF(pSD).sDataLen += sDataLen;

    return SUCCESS;
}

/*:.....
:::.....
:: Function:          sCI_BTRFProcData
:: Purpose:
::
:: Arguments:        pSD: Pointer to State Data structure.
::
:: Return value:     SUCCESS:
::                   FAILURE:

```

APPENDIX A - PAGE 25 OF 279

```

::
:: Side affects:
:: Revision:      03/03/95      RPD      Original
:::
:::
:::
:::
SHORT sCI_BTRFProcData(CI_STATE_DATA * pSD)
{
    BOOL      bExit = FALSE;
    SHORT     sResult;

    do
    {
        /* process according to current state */
        switch (SD_BTRF(pSD).sBTRFState)
        {
        case eBTRFInit:
            sResult = sCI_BTRFOpenFEB(pSD);
            if (sResult == CI_BTRF_NEED_DATA)
            {
                bExit = TRUE;
                break;
            }
            else if (sResult != SUCCESS)
            {
                return sResult;
            }
            /* transition to reading BTRF header state */
            SD_BTRF(pSD).sBTRFState = eBTRFHeader;
            break;
        case eBTRFHeader:
            sResult = sCI_BTRFHeader(pSD);
            if (sResult == CI_BTRF_NEED_DATA)
            {
                bExit = TRUE;
                break;
            }
            else if (sResult != SUCCESS)
            {
                return sResult;
            }
            /* transition to reading BTRF Maneuver Header
state */
            SD_BTRF(pSD).sBTRFState = eBTRFManHdr;
            break;
        case eBTRFManHdr:
            sResult = sCI_BTRFManHdr(pSD);
            if (sResult == CI_BTRF_NEED_DATA)
            {
                bExit = TRUE;
                break;
            }
            else if (sResult != SUCCESS)
            {
                return sResult;
            }
            SD_BTRF(pSD).sBTRFState = eBTRFManeuver;

```

APPENDIX A - PAGE 26 OF 279

```

#endif

/* Does ROS contain proper result type? */
if (SD_ROS_TYPE(pSD) != CI_ROS_ROUTE)
{
    /* Existing incorrect object type! */
    vCI_ErrorQPut(pSD, CI_ER_INVROS, CI_FUNC_PROCBTRF, 0);
    return FAILURE;
}

/* Remember message id */
SD_BTRF(pSD).usMsgId = pMsg->usMsgId;

/*
 * Find start of binary data as well as data length.
 */

pcData = (CHAR *)pMsg->pbyData;

/* Skip filename */
pcTmp = STRCHR(pcData, CI_DOWNLOAD_DELIM_CHAR);
if (pcTmp == NULL)
{
    return SUCCESS;
}
pcTmp++; /* skip delim */
pcData = pcTmp;

/* get offset */
lOffset = strtol(pcData, &pcTmp, CI_BASE_DEC);
pcData = pcTmp;
/* Skip upto delim */
pcTmp = STRCHR(pcData, CI_DOWNLOAD_DELIM_CHAR);
if (pcTmp == NULL)
{
    return SUCCESS;
}
pcTmp++; /* skip delim */
pcData = pcTmp;

/* get length */
sDataLen = (SHORT)strtol(pcData, &pcTmp, CI_BASE_DEC);
pcData = pcTmp;
/* skip upto delim */
pcTmp = STRCHR(pcData, CI_DOWNLOAD_DELIM_CHAR);
if (pcTmp == NULL)
{
    return SUCCESS;
}
pcTmp++; /* skip delim */
pcData = pcTmp;

/* quick sanity check */
if (sDataLen > pMsg->sDataLen)
{
    /* insane data, ignore by reporting success */

```

APPENDIX A - PAGE 28 OF 279

```

        return SUCCESS;
    }

    /* point to end of data */
    pbyData = (BYTE *)pcData;
    pbyData += sDataLen;

    /* process alternates */
    sResult = sCI_ProcAlts(pSD, pbyData,
        pMsg->sDataLen - (SHORT)(pbyData
- pMsg->pbyData));
    if (sResult != SUCCESS)
    {
        /* Error recorded in called func */
        return sResult;
    }

    /* point to start of data */
    pbyData = (BYTE *)pcData;

    /* Append to data buffer */
    sResult = sCI_BTRFAddData(pSD, (BYTE *)pcData, sDataLen);
    if (sResult != SUCCESS)
    {
        return sResult;
    }

    /* Process data */
    sResult = sCI_BTRFProcData(pSD);
    if (sResult != SUCCESS)
    {
        return sResult;
    }

    return SUCCESS;
}

```

```
/* _sccs_ "@(#)ER %P% Ver: %I% Date: %G%" */
/* _rcs_ "$Id: capi.h,v 1.5 1995/02/28 19:09:47 bobd Exp bobd $"
*/
/* Copyright (C) 1994,1995 SEI Information Technology, Inc. */
/* :::::::::::::::::::::::::::::::::::::::::::::::::::::::::::::
:::
::: Filename:             capi.h
::: Purpose:             Public header file for CAPI.
::: Revision:           01/03/95         RPD         Original
:::
::: :::::::::::::::::::::::::::::::::::::::::::::::::::::::::::::
::: ::::::::::::::::::::::*/
#ifdef _CAPI_H
#define _CAPI_H

/*
 * Error codes
 */
#define CI_ER_FIRST           -30000
#define CI_ER_OK             CI_ER_FIRST - 0          /* No
error available           */
#define CI_ER_ABORT         CI_ER_FIRST - 1          /   *
Operation aborted       */
#define CI_ER_BUFFULL      CI_ER_FIRST - 2          /  *   A
required buffer is full*/
#define CI_ER_BUSY         CI_ER_FIRST - 3          /* Process
is busy                 */
#define CI_ER_COMMIT       CI_ER_FIRST - 4          /* Comm.
not established         */
#define CI_ER_COMMIO       CI_ER_FIRST - 5          /   *
Communications failed   */
#define CI_ER_DESTBEARING  CI_ER_FIRST - 6          /* Invalid
dest. bearing           */
#define CI_ER_DESTLATLONG  CI_ER_FIRST - 7          /* Invalid
dest. lat/long          */
#define CI_ER_DESTLOC      CI_ER_FIRST - 8          /* Invalid
dest. location          */
#define CI_ER_DESTNAME     CI_ER_FIRST - 9          /* Invalid
destination name        */
#define CI_ER_DESTSXLOCUS  CI_ER_FIRST - 10         /* Invalid dest
sxlocus                 */
#define CI_ER_DESTTYPE     CI_ER_FIRST - 11         /* Invalid
dest. type              */
#define CI_ER_ENCODE       CI_ER_FIRST - 12         /* Encode
process failed          */
#define CI_ER_ERREXTSZ     CI_ER_FIRST - 13         /* Invalid
error text size         */
#define CI_ER_FROMNAMESZ   CI_ER_FIRST - 14         /* From name size#
#define CI_ER_INVALT      CI_ER_FIRST - 15         /* Invalid
alternate.              */
#define CI_ER_INVARG       CI_ER_FIRST - 16         /* Invalid
argument                */
#define CI_ER_INVARMCOUNT CI_ER_FIRST - 17         /* Invalid arm
count                   */
#define CI_ER_INVFIELD     CI_ER_FIRST - 18         /* Detected
invalid field           */
```

APPENDIX A - PAGE 30 OF 279

```

#define CI_ER_INVFILEDSC CI_ER_FIRST - 19 /* Invalid file
descriptor */
#define CI_ER_INVINDX CI_ER_FIRST - 20 /* Invalid
array index */
#define CI_ER_INVITEM CI_ER_FIRST - 21 /* Invalid
result item */
#define CI_ER_INVMANCOUNT CI_ER_FIRST - 22 /* Invalid
maneuver cfg cnt */
#define CI_ER_INVMSGQ CI_ER_FIRST - 23 /* Corrupt
MsgQ */
#define CI_ER_INVPOICOUNT CI_ER_FIRST - 24 /* Invalid POI
config count */
#define CI_ER_INVRGNCOUNT CI_ER_FIRST - 25 /* Invalid
region config cnt*/
#define CI_ER_INVROS CI_ER_FIRST - 26 /* Corrupt
ROS */
#define CI_ER_INVSD CI_ER_FIRST - 27 /* State Data
is invalid */
#define CI_ER_IOBUFCONFIG CI_ER_FIRST - 28 /* Error
configing IO bufs */
#define CI_ER_LIMIT CI_ER_FIRST - 29 /* Invalid
limit value */
#define CI_ER_LIMITTYPE CI_ER_FIRST - 30 /* Invalid
limit type */
#define CI_ER_LOGGEDIN CI_ER_FIRST - 31 /* Already
loggedin to host */
#define CI_ER_LOGGEDOUT CI_ER_FIRST - 32 /* Already
loggedout of host*/
#define CI_ER_MANSZ CI_ER_FIRST - 33 /* Maneuver
size */
#define CI_ER_MISSINGDEST CI_ER_FIRST - 34 /* Missing a
destination */
#define CI_ER_MISSINGORG CI_ER_FIRST - 35 /* Missing a
origin */
#define CI_ER_NOARG CI_ER_FIRST - 36 /* Required
argument missing*/
#define CI_ER_NODATA CI_ER_FIRST - 37 /* No data for
operation */
#define CI_ER_NOMEM CI_ER_FIRST - 38 /* Memory
allocation failed */
#define CI_ER_NOSUPPORT CI_ER_FIRST - 39 /* Feature not
supported. */
#define CI_ER_OBJ_CREATE CI_ER_FIRST - 40 /* Error creating
object */
#define CI_ER_OFFLINE CI_ER_FIRST - 41 /* Comm.
already disconn. */
#define CI_ER_ONLINE CI_ER_FIRST - 42 /* Comm.
already connected */
#define CI_ER_ORGBEARING CI_ER_FIRST - 43 /* Invalid origin
bearing */
#define CI_ER_ORGLAT CI_ER_FIRST - 44 /* Invalid
origin latitude */
#define CI_ER_ORGLATLONG CI_ER_FIRST - 45 /* Invalid org.
lat/long */
#define CI_ER_ORGLOC CI_ER_FIRST - 46 /* Invalid
origin location */

```

APPENDIX A - PAGE 31 OF 279

```

#define CI_ER_ORGLONG          CI_ER_FIRST - 47    /* Invalid
origin longitude */
#define CI_ER_ORGNAME         CI_ER_FIRST - 48    /* Invalid
origin name */
#define CI_ER_ORGSXLOCUS     CI_ER_FIRST - 49    /* Invalid origin
sxlocus */
#define CI_ER_ORGTYPE        CI_ER_FIRST - 50    /* Invalid
origin type */
#define CI_ER_POIADDRSZ      CI_ER_FIRST - 51    /* POI address
size */
#define CI_ER_POIHDRSZ       CI_ER_FIRST - 52    /* Invalid POI
header size */
#define CI_ER_POINAMESZ      CI_ER_FIRST - 53    /* POI name
size */
#define CI_ER_POISXLOCUSSZ   CI_ER_FIRST - 54    /* POI SXLocus
size */
#define CI_ER_PROTOCOL       CI_ER_FIRST - 55    /* Protocol
error from host */
#define CI_ER_RGNFILESZ      CI_ER_FIRST - 56    /* Region
Filename Size */
#define CI_ER_RGNNAMESZ      CI_ER_FIRST - 57    /* Region Name
Size */
#define CI_ER_ROSTYPE        CI_ER_FIRST - 58    /* Invalid ROS
type for op. */
#define CI_ER_ROUTEHDRSZ     CI_ER_FIRST - 59    /* Route header
size */
#define CI_ER_ROUTETRLSZ     CI_ER_FIRST - 60    /* Route trailer
size */
#define CI_ER_TIMEOUT        CI_ER_FIRST - 61    /* Time-out
waiting response*/
#define CI_ER_TONAMESZ       CI_ER_FIRST - 62    /* To name
size */
#define CI_ER_UNEXPMMSGID    CI_ER_FIRST - 63    /* Unexpected Msg
Id */
#define CI_ER_UNSOLMSGSZ     CI_ER_FIRST - 64    /* Invalid unsol.
msg. size */
#define CI_ER_UNSPECIFIED    CI_ER_FIRST - 65    /* General
error */
#define CI_ER_INVDLFMT       CI_ER_FIRST - 66    /* Invalid
download format */
#define CI_ER_WRITE_FD       CI_ER_FIRST - 67    /* Write to
file failed */
#define CI_ER_INVLANGFILE    CI_ER_FIRST - 68    /* Invalid
language file */
#define CI_ER_FEBOPEN        CI_ER_FIRST - 69    /* Open lang
file failed */
#define CI_ER_INVFEB         CI_ER_FIRST - 70    /* Invalid FEB
file */
#define CI_ER_INVBTRFHDR     CI_ER_FIRST - 71    /* Invalid BTRF
header */
#define CI_ER_LAST           CI_ER_FIRST - 72    /* Always 1
less than last */

/*
 * Defines needed for platform specific functions
 */

```

APPENDIX A - PAGE 32 OF 279

```

#define CI_TIMEOUT -2

/*
 * Defines for Gets
 */
#define CI_ITEM_NEXT -1
#define CI_ITEM_PREV -2
#define CI_ITEM_CURR -3
#define CI_ITEM_FIRST -4

/*
 * Communications modes
 */
#define CI_COMMMODE_INIT 0
#if 0 /* Not supported */
#define CI_COMMMODE_FIRST 1
#define CI_COMMMODE_ALLWAYS 2
#endif

/*
 * Result Memory Models
 */
#define CI_STORE_RESULT 0 /* Store entire
result in ROS */
#if 0 /* Not supported */
#define CI_STORE_PACKET 1 /* Store packet only
in ROS */
#define CI_STORE BURST 2 /* Store entire
burst in ROS */
#endif

/*
 * Limit Types
 */
#define CI_LIMIT_SLD 1 /* Straight line
distance */
#if 0 /* Not supported */
#define CI_LIMIT_DD 2 /* Driving distance
*/
#define CI_LIMIT_DT 3 /* Driving time */
#endif

/*
 * O/D Lat, Long, Bearing defines
 */
#define CI_LL_UNDEFINED -(LONG)2147483648L / *
Undefined Lat./Long. */
#define CI_BEARING_UNDEFINED -1 /* Undefined bearing*/

/* Blocking Modes (needed by PSxxxComm functions) */
#define CI_IO_NONBLOCK 0
#define CI_IO_BLOCK 1

/*
 * Compression Modes
 */

```

APPENDIX A - PAGE 33 OF 279

```

#define CI_COMP_NONE                0

/*
 * Download formats
 */
#define CI_DL_ASCII                0        /* Standard route
transfer */
#define CI_DL_BINARY                1        /* BTRF route
transfer */

/*
 * Field sizes
 */
#define CI_MSG_SUBS_MAX_LEN        64        /* Max length of
Sub. Id field */
#define CI_MSG_CLI_MAX_LEN        64        /* Max length of
Cli. Id field */
#define CI_MAX_ARMS                8        /* Max arms in a
maneuver */

/*
 * Function pointer types
 */
/* Idle processing function */
typedef SHORT (* PS_ON_IDLE)(VOID * pvUserData);
/* Unsolicited Message notification */
typedef SHORT (* PS_ON_MESSAGE)(VOID * pvUserData);
/* Opening Comm. Dev. */
typedef SHORT (* PS_DEV_OPEN)(VOID ** ppvCD, VOID *
pvUserData);
/* Closing Comm. Dev. */
typedef SHORT (* PS_DEV_CLOSE)(VOID * pvDevHndl, VOID *
pvUserData);
/* Read from Comm. Dev. */
typedef SHORT (* PS_DEV_READ)(VOID * pvDevHndl,
BYTE * pbyBuf,
USHORT usSize, BYTE byMode,
VOID * pvUserData);
/* Write to Comm. Dev. */
typedef SHORT (* PS_DEV_WRITE)(VOID * pvDevHndl,
BYTE * pbyBuf,
USHORT usSize,
VOID * pvUserData);
/* Allocate memory */
typedef VOID * (* PS_MEM_ALLOC)(size_t size);
/* Free memory */
typedef VOID (* PS_MEM_FREE)(VOID * pvData);

/* File Open */
typedef VOID * (* PS_FILE_OPEN)(CHAR * pFilename, CHAR *
pMode);
/* File Close */
typedef INT (* PS_FILE_CLOSE)(VOID * pFile);
/* File Seek */
typedef INT (* PS_FILE_SEEK)(VOID * pFile, LONG
lOffset, INT iOrigin);

```

APPENDIX A - PAGE 34 OF 279

```

/* File Read */
typedef size_t      (* PS_FILE_READ) (VOID * pBuf, size_t size,
                                      size_t count,
VOID * pFile);
/* File Write */
typedef size_t      (* PS_FILE_WRITE) (VOID * pBuf, size_t size,
                                       size_t count,
VOID * pFile);

/*
 * User config field types
 */
typedef CHAR        SubscriberId[CI_MSG_SUBS_MAX_LEN + 1];
typedef CHAR        ClientId[CI_MSG_CLI_MAX_LEN + 1];

/* Used for supplying user config arguments to OpenAPI */
typedef struct ci_user_config
{
    SubscriberId    acSubscriberId;
    ClientId        acClientId;
    USHORT          usMaxPktSize;
    BYTE           byMemModel;          /* Store entire result
or packet only */
    USHORT          usMaxMans;
    USHORT          usMaxPOIs;
    USHORT          usMaxRegions;
    BYTE           byCommMode;
    USHORT          usTimeout;
    BYTE           byDownloadFormat;    /* BTRF related */
    CHAR *          pcLangFileName;
    PS_ON_IDLE      pfsOnIdle;
    PS_ON_MESSAGE   pfsOnMessage;
    PS_DEV_OPEN     pfsDevOpen;
    PS_DEV_CLOSE    pfsDevClose;
    PS_DEV_READ     pfsDevRead;
    PS_DEV_WRITE    pfsDevWrite;
    PS_MEM_ALLOC    pfpvMemAlloc;
    PS_MEM_FREE     pfvMemFree;
    VOID *          pvUserData;
} CI_USER_CONFIG;

/* Point struct for Arms */
typedef struct ci_point
{
    SHORT          sX;
    SHORT          sY;
} CI_POINT;

typedef struct ci_resman_rec
{
    CHAR *         pcManText;
    USHORT         usManLen;
    CHAR *         pcFromName;
    USHORT         usFromLen;
    CHAR *         pcToName;
}

```

APPENDIX A - PAGE 35 OF 279

```

        USHORT          usToLen;
        USHORT          usArmCount;
        CI_POINT        aPoint [CI_MAX_ARMS];
    } CI_RESMAN_REC;

typedef struct ci_respoi_rec
{
    CHAR *              pcName;
    USHORT              usNameLen;
    CHAR *              pcAddr;
    USHORT              usAddrLen;
    SHORT               sPOIType;
    LONG                lPOIId;
    CHAR *              pcSXLocus;
    USHORT              usLocusLen;
    LONG                lDist;
    BOOL                bHasCustInfo;
} CI_RESPOI_REC;

typedef struct ci_resrgn_rec
{
    CHAR *              pcName;
    USHORT              usNameLen;
    CHAR *              pcFile;
    USHORT              usFileLen;
} CI_RESRGN_REC;

/*
 * Function prototypes
 */
SHORT FUNC_DECL       sCI_OpenAPI (VOID ** ppvCAPI, CI_USER_CONFIG
 * pConfig);
SHORT FUNC_DECL       sCI_OpenComm (VOID * pvCAPI);
SHORT FUNC_DECL       sCI_CloseComm (VOID * pvCAPI);
SHORT FUNC_DECL       sCI_ConnectComm (VOID * pvCAPI);
SHORT FUNC_DECL       sCI_DisconnectComm (VOID * pvCAPI);
SHORT FUNC_DECL       sCI_CloseAPI (VOID * pvCAPI, BOOL bForce);
VOID FUNC_DECL        vCI_AbortTask (VOID * pvCAPI);

SHORT FUNC_DECL       sCI_GetError (VOID * pvCAPI,
SHORT * psErrType,   SHORT *
psErrData,
CHAR * pcErrText,   USHORT *
pusTextLen);

SHORT FUNC_DECL       sCI_SetRoute (VOID * pvCAPI,
CHAR * pcOrgName, CHAR * pcOrgType,
LONG lOrgLat, LONG lOrgLong, SHORT
sOrgBearing,
CHAR * pcOrgSXLocus,
CHAR * pcDestName, CHAR *
pcDestType,
LONG lDestLat, LONG lDestLong,
SHORT sDestBearing,

APPENDIX A - PAGE 36 OF 279

```



```

CHAR * pcDestSXLocus,
LONG lLimit, BYTE byLimitType,
BOOL bArms, CHAR * pcTOD);
SHORT FUNC_DECL   sCI_SetPOI(VOID * pvCAPI,
CHAR * pcOrgName, CHAR * pcOrgType,
LONG lOrgLat, LONG lOrgLong, SHORT
sOrgBearing,
CHAR * pcOrgSXLocus,
CHAR * pcDestName, CHAR *
pcDestType,
LONG lDestLat, LONG lDestLong,
SHORT sDestBearing,
CHAR * pcDestSXLocus,
LONG lLimit, BYTE byLimitType,
CHAR * pcTOD);
SHORT FUNC_DECL   sCI_SetBugReport(VOID * pvCAPI,
CHAR * pcMsgText);
SHORT FUNC_DECL   sCI_SetIncludeArms(VOID * pvCAPI, BOOL
bValue);
SHORT FUNC_DECL   sCI_SetRegion(VOID * pvCAPI, CHAR * pcName,
CHAR * pcFile);
SHORT FUNC_DECL   sCI_SetMaxPacket(VOID * pvCAPI, USHORT
usPktSize);
SHORT FUNC_DECL   sCI_SetBurstMode(VOID * pvCAPI, BOOL sState);
SHORT FUNC_DECL   sCI_SetLanguageFile(VOID * pvCAPI, CHAR *
pcLangFile);
SHORT FUNC_DECL   sCI_SetDownloadFormat(VOID * pvCAPI, BYTE
byFormat);

SHORT FUNC_DECL   sCI_GetRouteHeader(VOID * pvCAPI,
CHAR * pcHdrText, USHORT *
pusHdrLen);
SHORT FUNC_DECL   sCI_GetRouteTrailer(VOID * pvCAPI,
CHAR * pcTrlText, USHORT *
pusTrlLen);
SHORT FUNC_DECL   sCI_GetManeuver(VOID * pvCAPI, SHORT sIndex,
CHAR * pcManText, USHORT *
pusManLen,
USHORT * pusArmCount,
CHAR * pcFromName, USHORT *
pusFromLen,
CHAR * pcToName, USHORT * pusToLen,
CI_POINT * paArmPoints);
SHORT FUNC_DECL   sCI_GetRouteAsFile(VOID * pvCAPI, CHAR *
pcFilename);
SHORT FUNC_DECL   sCI_GetPOIHeader(VOID * pvCAPI,
CHAR * pcHdrText, USHORT *
pusHdrLen);
SHORT FUNC_DECL   sCI_GetPOIItem(VOID * pvCAPI, SHORT sIndex,
CHAR * pcName, USHORT * pusNameLen,
CHAR * pcAddr, USHORT * pusAddrLen,
SHORT * psPOIType, LONG * plPOIID,
CHAR * pcSXLocus, USHORT *
pusSXLocusLen,
LONG * plDist, BOOL *
pbHasCustInfo);

```

APPENDIX A - PAGE 37 OF 279

```

SHORT FUNC_DECL   sCI_GetRegionItem(VOID * pvCAPI,  SHORT
sIndex,
                  CHAR * pcName, USHORT * pusNameLen,
                  CHAR * pcFile,  USHORT *
pusFileLen);
SHORT FUNC_DECL   sCI_GetActiveRegion(VOID * pvCAPI,
                  CHAR * pcName, USHORT * pusNameLen,
                  CHAR * pcFile,  USHORT *
pusFileLen);
USHORT FUNC_DECL  usCI_GetActiveMaxPacket(VOID * pvCAPI);
USHORT FUNC_DECL  usCI_GetActiveTimeout(VOID * pvCAPI);
BOOL FUNC_DECL   bCI_GetActiveBurstMode(VOID * pvCAPI);
SHORT FUNC_DECL   sCI_GetCommStatus(VOID * pvCAPI,
                  BOOL * pbOnLine,  BOOL *
pbLoggedIn);
VOID FUNC_DECL   vCI_GetAPIVersion(SHORT * psMajor,
                  SHORT * psMinor, SHORT * psInter);
SHORT FUNC_DECL   sCI_GetFile(VOID * pvCAPI,
                  CHAR * pcSourceFile, CHAR *
pcDestFile,
                  BYTE byFormat);

SHORT FUNC_DECL   sCI_Login(VOID * pvCAPI);
SHORT FUNC_DECL   sCI_Logout(VOID * pvCAPI);

SHORT FUNC_DECL   sCI_BGMsgHandler(VOID * pvCAPI);

SHORT FUNC_DECL   sCI_ReceiveMessage(VOID * pvCAPI,
                  CHAR * pcMsg, USHORT * pusMsgLen);
SHORT FUNC_DECL   sCI_SendMessage(VOID * pvCAPI, CHAR *
pcUserMsg);

VOID * FUNC_DECL  pvCI_GetUserData(VOID * pvCAPI);

#endif /* _CAPI_H */

```

```

/* _sccs_ "@(#)ER %P% Ver: %I% Date: %G%" */
/* _rcs_ "$Id: ci_defs.h,v 1.5 1995/02/28 19:11:17 bobd Exp bobd
$" */
/* Copyright (C) 1994,1995 SEI Information Technology, Inc. */
/*.....:
.....:
:: Filename:          ci_defs.h
:: Purpose:           Defines for Protocol Layer of CAPI
library.
:: Revision:          09/19/94          RPD          Original
.....:
.....:
.....:
#ifndef CI_DEFS_H
#define CI_DEFS_H

/* Additional return codes to those defined in ids_defs.h */
#define CI_NODATA          -3

/*
 * API version number
 */
#define CI_VER_MAJOR          1
#define CI_VER_MINOR         0
#define CI_VER_INTER         1

/*
 * General size and limit defines
 */
#define CI_MIN_MAXPKT_SIZE    220          /* Smallest MaxPkt
setting */
#define CI_DEF_ERRQ_SIZE      5
#define CI_MAX_ERR_MSG_LEN    80
#define CI_MAX_UNSOLMSG_LEN   256
#define CI_DEF_PKT_SIZE       1024
#define CI_MAX_PROTO_VER      1          /* Supported protocol
version */
#define CI_MANEUVER_MIN_LEN    30          /* Smallest
reasonable maneuver */

#define CI_BASE_DEC            10          /* Used for strtol
conversions */
#define CI_BASE_HEX            16

#define CI_MAX_MANEUVERS      128          /* Max maneuvers per
result */
#define CI_MAX_POIS           3000 /* Max poi's per
result */
#define CI_MAX_REGIONS        500          /* Max regions per
result */

#define CI_NO_ITEM             -1          /* Use to indicate
no current item */

#define CI_BTRF_MAGIC_NUMBER   42330L     /* BTRF file magic
number */
#define CI_BTRF_FILE_VER       1          /* BTRF file version*/

```

APPENDIX A - PAGE 39 OF 279

```

#define CI_BTRF_COPYRIGHT_LEN 128
#define CI_BTRF_BUF_SZ          32767 /* Data buffer
size */
#define CI_BTRF_MANHDR_SZ      sizeof(CHAR) + sizeof(CHAR)
+ \
                                sizeof(SHORT) +
sizeof(SHORT)
#define CI_BTRF_MAX_SUB_LEN    256
#define CI_BTRF_MAX_SUBS      15
#define CI_BTRF_NEED_DATA     10 /* != SUCCESS or an
error */
#define CI_BTRF_MAX_MAN       350 /* Max len of man
text */

/* BTRF Maneuver types */
#define CI_BTRF_FOOTER_MAN     -1
#define CI_BTRF_SUMMARY_MAN    -2
#define CI_BTRF_DRIVETIME_MAN -3
#define CI_BTRF_DELAYTIME_MAN -4
#define CI_BTRF_ORIGIN_MAN     -5
#define CI_BTRF_DEST_MAN       -6
#define CI_BTRF_VERSION_MAN    -7
#define CI_BTRF_HEADER_MAN     -8

/* Location types */
#define CI_LOC_ORIGIN          1 /* An origin
location */
#define CI_LOC_DEST            2 /* A destination
location */

/*
 * Field position ID's
 */
/* Relative to start of message */
#define CI_TIMESTAMP_FLDID     1
#define CI_MSGTYPE_FLDID       5

/*
 * General Field Lengths
 */
#define CI_MAX_ARM_LEN         512
#define CI_MAX_ARM_NAME_LEN    50
#define CI_MIN_ARMS            2
#define CI_MAX_POI_NAME_LEN    80
#define CI_MAX_POI_ADDR_LEN    64
#define CI_MAX_SXLOCUS_LEN     50 /* Length of SXLocus
as text */
#define CI_MAX_REGION_NAME_LEN 30
#define CI_MAX_REGION_FILE_LEN 30

/*
 * General Packet field defines
 */
#define CI_DELIM_CHAR          '|'
#define CI_DELIM_STR           "||"

```

APPENDIX A - PAGE 40 OF 279

```

#define CI_EQUAL_CHAR           '='
#define CI_NO_CHAR              'N'
#define CI_YES_CHAR             'Y'
#define CI_ESCAPE_CHAR         '\\\ '
#define CI_NEW_LINE            '\n'
#define CI_ARM_DELIM_CHAR      ';'
#define CI_POINT_DELIM_CHAR    ','
#define CI_POI_DELIM1_CHAR     ':'
#define CI_POI_DELIM2_CHAR     ':'
#define CI_REGION_DELIM1_CHAR ':'
#define CI_DOWNLOAD_DELIM_CHAR ':'
#define CI_REGION_DELIM2_CHAR ';'
#define CI_MANNEXT_STR         "NEXT"
#define CI_MANPREV_STR         "PREVIOUS="
#define CI_BEARING_DELIM_CHAR ';'

/*
 * Result Object Storage types
 */
#define CI_ROS_NONE            0
#define CI_ROS_ROUTE           1
#define CI_ROS_POIS            2
#define CI_ROS_REGION          3
#define CI_ROS_LANG            4

/*
 * Result Memory Models
 */
#if 0
#define CI_STORE_RESULT        0 /* Store entire result
in ROS */
#endif
#define CI_STORE_PACKET        1 /* Store a packets worth
in ROS */
#define CI_STORE_BURST         2 /* Store entire burst in
ROS */

/*
 * Result Object page sizes
 */
#define CI_MANS_PER_PG         64
#define CI_POIS_PER_PG         100
#define CI_RGNS_PER_PG         25

/*
 * Request Type defines
 */
#define CI_REQ_ROUTE           1
#define CI_REQ_POIS            2
#define CI_REQ_LOGIN           3
#define CI_REQ_CONFIG          4
#define CI_REQ_LOGOUT          5
#define CI_REQ_GENERIC         6
#define CI_REQ_REGIONS         7
#define CI_REQ_MAXPKT          8
#define CI_REQ_BUGRPT          9

```

APPENDIX A - PAGE 41 OF 279

```

#define CI_REQ_HB                10
#define CI_REQ_MAN                11
#define CI_REQ_MSG                12
#define CI_REQ_DL                 13

/*
 * Limit Types
 */
#if 0 /* Moved to public header file capi.h */
#define CI_LIMIT_SLD              1 /* Straight line
distance */
#endif
#define CI_LIMIT_DD                2 /* Driving distance */
#define CI_LIMIT_DT                3 /* Driving time */

/*
 * Request Packet field format strings
 */
#define CI_MSGLEN_FMT              CI_DELIM_STR "%04d"
#define CI_CRC_FMT                 CI_DELIM_STR "%04lX"
#define CI_TIMESTAMP_FMT           CI_DELIM_STR "%08lX"
#define CI_SUBSCRIB_FMT            CI_DELIM_STR "%8.64s"
#define CI_MSGID_FMT               CI_DELIM_STR "%04X"
#define CI_CLIENID_FMT             CI_DELIM_STR "%0.64s"

#define CI_LAT_FMT                 CI_DELIM_STR "%s"
#define CI_LONG_FMT                CI_DELIM_STR "%s"
#define CI_ORGNAME_FMT             CI_DELIM_STR "%s"
#define CI_ORGTYPE_FMT             CI_DELIM_STR "%s"
#define CI_DESTNAME_FMT            CI_DELIM_STR "%s"
#define CI_DESTTYPE_FMT            CI_DELIM_STR "%s"
#define CI_LIMIT_FMT               CI_DELIM_STR "%s"
#define CI_LIMITTYPE_FMT           CI_DELIM_STR "%s"

/*
 * Login field defines
 */
#define CI_XMIT_ASCII              0 /* Transmission types*/
#define CI_XMIT_BINARY             1

#define CI_COMP_NONE                0 /* Compression Modes*/
#define CI_COMP_PHRASE              1 /* ... phrase table */
#define CI_COMP_DICT                2 /* ... dictionary */
#define CI_COMP_LZ                  3 /* ... lz(w?) */

#define CI_VECTOR                   0 /* Vector Map */
#define CI_BITMAP                   1 /* Bitmap is Bitmap!*/

/*
 * Request alternate defines
 */
#define CI_MAX_ALT_LEN              255
#define CI_MAX_REQ_ALTS             8

#define CI_ALT_SESSION_ID           "SESSION="

```

APPENDIX A - PAGE 42 OF 279

```

#define CI_ALT_CONFIG_ID          "CONFIG="
#define CI_ALT_QUERY_ID           "QUERY="
#define CI_ALT_MAN_ID             "MANEUVER="
#define CI_ALT_LOGOUT_ID         "LOGOUT="
#define CI_ALT_MSG_ID            "MSG="
#define CI_ALT_BUG_ID            "BGRPT="
#define CI_ALT_HB_ID             "HEARTBEAT="
#define CI_ALT_LANG_ID           "LANGUAGE="
#define CI_ALT_BUG_ID            "BGRPT="
#define CI_ALT_ARMS_ID           "ARMS="
#define CI_ALT_MAP_ID            "MAP="
#define CI_ALT_BURST_ID          "BURST="
#define CI_ALT_MAXPKT_ID         "MAXPKT="
#define CI_ALT_BEARING_ID        "BEARING="
#define CI_ALT_SXLOCUS_ID        "SXLOCUS="
#define CI_ALT_TOD_ID            "ROUTETOD="
#define CI_ALT_DOWNLOAD_ID       "DOWNLOAD="
#define CI_ALT_FORMAT_ID         "FORMAT="

#define CI_ALT_ARM_ID            "ARM="
#define CI_ALT_MORE_ID           "MORE="
#define CI_ALT_CONT_ID           "CONFCONT="

/*
 * Limit type defines
 */
#define CI_LIMIT_SLD_ID          "M"          /* Straight line
distance */
#define CI_LIMIT_DD_ID          "D"          /* Driving distance
*/
#define CI_LIMIT_DT_ID          "T"          /* Driving time */

/*
 * Query type defines
 */
#define CI_Q_POIS_ID            "POIS"
#define CI_Q_REGIONS_ID        "CONFIG"

/*
 * Result Query type defines
 */
#define CI_Q_POIS_TYPE          1
#define CI_Q_REGIONS_TYPE      2

/*
 * Download format types
 */
#define CI_DL_BINARY_ID         "DL"          /* Binary
download */
#define CI_DL_BTRF_ID          "BTRF,DL"     /* BTRF,
binary */

/*
 * FEB sizes
 */

```

APPENDIX A - PAGE 43 OF 279

```

#define CI_FEB_DESCLEN          128          /* Lang
desc length */
#define CI_MAX_FEBTPLS         300          /* Max #
FEB templates */

/*
 * Result alternate "tags" for determining alt contents
 */
#define CI_ALT_HB_TAG           "|HEARTBEAT=Y"
#define CI_RSP_ER_OK_TAG       "OK"

/*
 * Result alternate "types".
 */
#define CI_ALT_UNKNOWN_TYPE     0
#define CI_ALT_ARM_TYPE        1
#define CI_ALT_MORE_TYPE       2
#define CI_ALT_CONT_TYPE       3
#define CI_ALT_MAXPKT_TYPE     4

/*
 * Request alternate states
 */
#define CI_ALT_CLEAR            0
#define CI_ALT_SET              1
#define CI_ALT_SENT             2

/*
 * Request field defines
 */
#define CI_MAX_LL_LEN           15
#define CI_MAX_OD_NAME_LEN     80
#define CI_MAX_OD_TYPE_LEN     40
#define CI_MAX_LIMIT_LEN       15
#define CI_MAX_LIMIT_TYPE_LEN  2
#define CI_MAX_FLD_LEN         80          /* Equal to largest
of above */

/*
 * Request field states
 */
#define CI_FIELD_CLEAR          0
#define CI_FIELD_SET            1

/*
 * Transmission Modes
 */
#define CI_XMIT_ASCII           0
#define CI_XMIT_BINARY         1

/*
 * Amount to increment MsgId each request
 */
#define CI_MSGID_INC            15
#define CI_MAX_MSGID           30000

```

APPENDIX A - PAGE 44 OF 279

```

/*
 * Message type markers
 * (As delivered from host)
 */
#define CI_MSG_TYPE_ADDR      'A'
#define CI_MSG_TYPE_ROUTE    'R'
#define CI_MSG_TYPE_DL       'D'
#define CI_MSG_TYPE_ERROR    'E'
#define CI_MSG_TYPE_QUERY    'Q'
#define CI_MSG_TYPE_MSG      'M'

/*
 * Result Message Type defines
 * (converted from message type
 * markers, recorded within a msg)
 */
#define CI_RES_ADDR_TYPE      1
#define CI_RES_ROUTE_TYPE    2
#define CI_RES_DL_TYPE       3
#define CI_RES_ERROR_TYPE    4
#define CI_RES_QUERY_TYPE    5
#define CI_RES_MSG_TYPE      6

/*
 * Msg field sizes
 */
#define CI_MSG_SUBS_LEN      8 /* Min length of
Subscriber Id */
#define CI_MSG_CLI_LEN      0 /* Min length of Client
Id */
#define CI_MSG_ID_LEN       4 /* Length of Message Id
field */
#define CI_MSG_TS_LEN       8 /* Length of Time Stamp
field */

/*
 * Packet field sizes
 */
#define CI_PKT_MSGLEN_LEN    4
#define CI_PKT_COM_LEN      1
#define CI_PKT_CRC_LEN      4
#define CI_PKT_HDR_MIN_SIZE (1 + CI_PKT_MSGLEN_LEN + 1 +
CI_PKT_CRC_LEN)

#define CI_PKT_END          "|\n"

/*
 * State Data accessor macros
 */

/* For accessing the ROS */
#define SD_ROS_HDR(pSD)      ((pSD)->ROSHdr)
#define SD_ROS_TYPE(pSD)    ((pSD)->ROSHdr.byObjectType)

/* For accessing the BTRF translator */

```

APPENDIX A - PAGE 45 OF 279

```

#define SD_BTRF(pSD)                ((pSD)->BTRFInfo)

/* For accessing BTRF substitution container */
#define SD_BSC(pSD)
((pSD)->BTRFInfo).SubContainer)

/* For accessing the Message Queue */
#define SD_MSGQ_GET(pSD)            ((pSD)->msgQ)

/*
 * Called once on entry to API: if TRUE is returned, current API
func
 * can continue. If FALSE is returned, app. is currently within
API and
 * func should return.
 */

#define SD_API_ENTER(pSD)           \
(((pSD)->bWithinAPI == TRUE) ? FALSE :
((pSD)->bWithinAPI = TRUE))
/* Called once on exit from API */
#define SD_API_LEAVE(pSD)          ((pSD)->bWithinAPI =
FALSE)

/* For accessing origin name and type */
#define SD_ORGNAME_GET(pSD)         ((pSD)->acReqOrgName)
#define SD_ORGTYPE_GET(pSD)        ((pSD)->acReqOrgType)
/* For accessing destination name and type */
#define SD_DESTNAME_GET(pSD)       ((pSD)->acReqDestName)
#define SD_DESTTYPE_GET(pSD)       ((pSD)->acReqDestType)

/* Set/Get Initial Request State */
#define SD_MARK_NEW_REQUEST(pSD)    ((pSD)->bNewRequest = TRUE)
#define SD_MARK_OLD_REQUEST(pSD)    ((pSD)->bNewRequest = FALSE)
#define SD_IS_NEW_REQUEST(pSD)      ((pSD)->bNewRequest)

/* For accessing the request type */
#define SD_REQ_TYPE_SET(pSD, reqType) \
((pSD)->byReqType
= (reqType))
#define SD_EXP_QUERYTYPE_SET(pSD, qType) \
((pSD)->byExpQueryType = (qType))

/* For accessing the result more alternate indicator */
#define SD_RES_ALTMORE_SET(pSD, value) \
((pSD)->bResAltMore
= (value))
#define SD_RES_ALTMORE_GET(pSD)      ((pSD)->bResAltMore)

/* For accessing the result confirm/continue alternate indicator
*/
#define SD_RES_ALTCONTINUE_SET(pSD, value) \
((pSD)->bResAltContinue = (value))
#define SD_RES_ALTCONTINUE_GET(pSD)  ((pSD)->bResAltContinue)

```

APPENDIX A -- PAGE 46 OF 279

```

/* For accessing the message id (both current and expected). */
#define SD_MSGID_SET(pSD, value) ((pSD)->usMsgId = (value))
#define SD_MSGID_GET(pSD) ((pSD)->usMsgId)
#define SD_EXP_MSGID_SET(pSD) ((pSD)->usExpMsgId =
SD_MSGID_GET(pSD))
#define SD_EXP_MSGID_GET(pSD) ((pSD)->usExpMsgId)
/* For accessing the message type */
#define SD_EXP_MSGTYPE_SET(pSD, type) \
((pSD)->byExpMsgType
= (type))
#define SD_EXP_MSGTYPE_GET(pSD) ((pSD)->byExpMsgType)

/* For accessing the request acknowledgement */
#define SD_ACK_GET(pSD) ((pSD)->byAck)
#define SD_ACK_SET(pSD, value) ((pSD)->byAck = (value))

#define SD_XMIT_FMT_GET(pSD) ((pSD)->byXmitFmt)
#define SD_XMIT_FMT_SET(pSD, value) ((pSD)->byXmitFmt =
(value))

#define SD_COMP_MODE_GET(pSD) ((pSD)->byCompMode)
#define SD_COMP_MODE_SET(pSD, value) ((pSD)->byCompMode =
(value))

#define SD_COLOR_DEPTH_GET(pSD) ((pSD)->sColorDepth)
#define SD_COLOR_DEPTH_SET(pSD, value) ((pSD)->sColorDepth =
(value))

#define SD_MAP_FMT_GET(pSD) ((pSD)->byMapFmt)
#define SD_MAP_FMT_SET(pSD, value) ((pSD)->byMapFmt = (value))

/* For accessing protocol version */
#define SD_PROTO_VER_GET(pSD) ((pSD)->sProtoVer)
#define SD_PROTO_VER_SET(pSD, value) ((pSD)->sProtoVer = (value))

/* For accessing BURST mode */
#define SD_BURST_MODE_GET(pSD) ((pSD)->bBurstMode)
#define SD_BURST_MODE_SET(pSD, value) ((pSD)->bBurstMode =
(value))

/* Flags burst mode state change */
#define SD_BURST_CHANGED_SET(pSD, value)
((pSD)->bBurstChanged = (value))
#define SD_BURST_CHANGED_GET(pSD) ((pSD)->bBurstChanged)

/* For accessing the logged in indicator */
#define SD_LOGGEDIN_GET(pSD) ((pSD)->bLoggedIn)
#define SD_LOGGEDIN_SET(pSD, value) ((pSD)->bLoggedIn =
(value))

/* For accessing online status. */
#define SD_IS_ONLINE(pSD) ((pSD)->bOnline)
#define SD_ONLINE_SET(pSD, value) ((pSD)->bOnline = (value))

/* For accessing comm. device */
#define SD_COMMDEV_GET(pSD) ((pSD)->pvCD)

```

APPENDIX A — PAGE 47 OF 279

```

#define SD_COMMDEV_SET(pSD, value) ((pSD)->pvCD = (value))

/* For accessing desired maxpkt */
#define SD_DESIRE_MAXPKT_GET(pSD) ((pSD)->sDesMaxPkt)
#define SD_DESIRE_MAXPKT_SET(pSD, value) ((pSD)->sDesMaxPkt =
(value))
/* For accessing result maxpkt */
#define SD_RES_MAXPKT_GET(pSD) ((pSD)->sResMaxPkt)
#define SD_RES_MAXPKT_SET(pSD, value) ((pSD)->sResMaxPkt =
(value))
/* For accessing current maxpkt */
#define SD_CUR_MAXPKT_GET(pSD) ((pSD)->sCurMaxPkt)
#define SD_CUR_MAXPKT_SET(pSD, value) ((pSD)->sCurMaxPkt =
(value))

/* For accessing state of request fields. */
#define SD_REQFLDSTATE_GET(pSD, sFieldId) \
((pSD)->abyReqFldState[sFieldId])
#define SD_REQFLDSTATE_SET(pSD, sFieldId, value) \
((pSD)->abyReqFldState[sFieldId] = (value))

/* For accessing Ctrl Current Item */
#define SD_CTRL_CURRITEM_GET(pSD) ((pSD)->sCtrlCurrItem)
#define SD_CTRL_CURRITEM_SET(pSD, value) \
((pSD)->sCtrlCurrItem = (value))

/* For accessing Ctrl User Item index */
#define SD_CTRL_USERITEM_GET(pSD) ((pSD)->sCtrlUserItem)
#define SD_CTRL_USERITEM_SET(pSD, value) \
((pSD)->sCtrlUserItem = (value))

/* For accessing Ctrl ROS Offset */
#define SD_CTRL_ROSOFFSET_GET(pSD) ((pSD)->sCtrlROSOffset)
#define SD_CTRL_ROSOFFSET_SET(pSD, value) \
((pSD)->sCtrlROSOffset = (value))

/* Access to Ctrl file download req. */
#define SD_CTRL_REQDL_GET(pSD) ((pSD)->bReqDownload)
#define SD_CTRL_REQDL_SET(pSD, value) \
((pSD)->bReqDownload
= (value))
/* For accessing Greatest (relevant) item received */
#define SD_GREATEST_ITEM_GET(pSD) ((pSD)->sGreatestItem)
#define SD_GREATEST_ITEM_SET(pSD, value) \
((pSD)->sGreatestItem = (value))
/* For accessing the previous Msg Id */
#define SD_PREV_MSGID_GET(pSD) ((pSD)->sPrevMsgId)
#define SD_PREV_MSGID_SET(pSD, value) \
((pSD)->sPrevMsgId
= (value))

```

APPENDIX A - PAGE 48 OF 279

```

/* For accessing memory model field */
#define SD_MEM_MODEL_GET(pSD) ((pSD)->byMemModel)
#define SD_MEM_MODEL_SET(pSD, value) \
    ((pSD)->byMemModel
= (value))

/* For accessing state of result */
#define SD_RESULT_COMPLETE_GET(pSD) ((pSD)->bResultComplete)
#define SD_RESULT_COMPLETE_SET(pSD, value) \
    ((pSD)->bResultComplete = (value))

/* For accessing last msg id */
#define SD_LAST_MSGID_GET(pSD) ((pSD)->usLastMsgId)
#define SD_LAST_MSGID_SET(pSD, value) \
    ((pSD)->usLastMsgId
= (value))

/* For accessing error code */
#define SD_ERRCODE_GET(pSD) ((pSD)->sErrCode)
#define SD_ERRCODE_SET(pSD, value) ((pSD)->sErrCode = (value))

/* For accessing abort flag */
#define SD_ABORT_GET(pSD) ((pSD)->bAbortTask)
#define SD_ABORT_SET(pSD, value) ((pSD)->bAbortTask = (value))

/* For accessing user data */
#define SD_USERDATA_GET(pSD) ((pSD)->pvUserData)
#define SD_USERDATA_SET(pSD, value) ((pSD)->pvUserData =
(value))

/* For accessing API timeout value */
#define SD_TIMEOUT_GET(pSD) ((pSD)->dTimeout)
#define SD_TIMEOUT_SET(pSD, value) ((pSD)->dTimeout = (value))

/* For accessing File Desc on downloads */
#define SD_DOWNLOAD_FD_GET(pSD) ((pSD)->iDnldFD)
#define SD_DOWNLOAD_FD_SET(pSD, fileDesc) ((pSD)->iDnldFD =
(fileDesc))

/* Access to download format */
#define SD_DLFORMAT_GET(pSD) ((pSD)->byDownloadFormat)
#define SD_DLFORMAT_SET(pSD, byFormat) \
    ((pSD)->byDownloadFormat = (byFormat))

#define SD_BTRF_DATA_REMAINING(pSD, pbyInput) \
    (SD_BTRF(pSD).sDataLen - \
    ((CHAR *) (pbyInput) - (CHAR
*)SD_BTRF(pSD).pbyData))

#endif /* _CI_DEFS_H */

```

APPENDIX A — PAGE 49 OF 279

```

#define CI_FUNC_PROCREGIONITEM 34
#define CI_FUNC_SETORIGINNT 35
#define CI_FUNC_SETDESTNT 36
#define CI_FUNC_SETINCLUDEARMS 37
#define CI_FUNC_SETLIMITVT 38
#define CI_FUNC_SETXMITFORMAT 39
#define CI_FUNC_SETCOMPRESSION 40
#define CI_FUNC_SETCOLORDEPTH 41
#define CI_FUNC_SETMAPFORMAT 42
#define CI_FUNC_SETPROTOCOLVER 43
#define CI_FUNC_SETBURSTMODE 44
#define CI_FUNC_DOLOGIN 45
#define CI_FUNC_DOLOGOUT 46
#define CI_FUNC_GETNEXTMANEUVER 47
#define CI_FUNC_GETNEXTPOI 48
#define CI_FUNC_GETNEXTREGION 49
#define CI_FUNC_SETREGION 50
#define CI_FUNC_DOREGIONSELECT 51
#define CI_FUNC_PROCALTS 52
#define CI_FUNC_MSGQPUT 53
#define CI_FUNC_BGMSGHANDLER 54
#define CI_FUNC_DOMAXPACKET 55
#define CI_FUNC_SETMAXPACKET 56
#define CI_FUNC_ROUTEISVALID 57
#define CI_FUNC_GETMANEUVER 58
#define CI_FUNC_SETNEWREQUEST 59
#define CI_FUNC_CTRLLOADROSA 60
#define CI_FUNC_CTRLLOADROSB 61
#define CI_FUNC_GETREGIONITEM 62
#define CI_FUNC_GETPOIITEM 63
#define CI_FUNC_SETPOI 64
#define CI_FUNC_SETROUTE 65
#define CI_FUNC_GETACTIVEREGION 66
#define CI_FUNC_SDACTIVEREGIONGET 67
#define CI_FUNC_GETERROR 68
#define CI_FUNC_LOADMSGQ 69
#define CI_FUNC_CLOSECOMM 70
#define CI_FUNC_SDMESSAGEGET 71
#define CI_FUNC_CLOSEAPI 72
#define CI_FUNC_GETRESULT 73
#define CI_FUNC_SENDEMMESSAGE 74
#define CI_FUNC_GETROUTEHEADER 75
#define CI_FUNC_GETROUTETRAILER 76
#define CI_FUNC_GETPOIHEADER 77
#define CI_FUNC_SETBUGREPORT 78
#define CI_FUNC_SETTOD 79
#define CI_FUNC_GETFILE 80
#define CI_FUNC_GETROUTEASFILE 81
#define CI_FUNC_PROCDOWNLOAD 82
#define CI_FUNC_SETLANGUAGEFILE 83
#define CI_FUNC_BTRFSETLANGFILE 84
#define CI_FUNC_CTRLSETDLFORMAT 85
#define CI_FUNC_SETDOWNLOADFORMAT 86
#define CI_FUNC_PROCBTRF 87
#define CI_FUNC_BTRFOPENFEB 88
#define CI_FUNC_BTRFHEADER 89

```

APPENDIX A — PAGE 51 OF 279

```
#define CI_FUNC_BTRFADDDATA          90
#endif    /* _CI_ERR_H */
```



```

/*
 * Module sendreq.c
 */
SHORT      SCI_SendRequest(CI_STATE_DATA * pSD);
SHORT      SCI_CreateRequest(CI_STATE_DATA * pSD);
SHORT      SCI_CreateEmptyReq(CI_STATE_DATA * pSD);
SHORT      SCI_CreateLoginReq(CI_STATE_DATA * pSD);
SHORT      SCI_CreateConfigReq(CI_STATE_DATA * pSD);
SHORT      SCI_CreateRouteReq(CI_STATE_DATA * pSD);
SHORT      SCI_CreatePOISReq(CI_STATE_DATA * pSD);
SHORT      SCI_CreateLogoutReq(CI_STATE_DATA * pSD);
SHORT      SCI_CreateGenericReq(CI_STATE_DATA * pSD);

/*
 * Module reqpack.c
 */
SHORT      SCI_PacketReq(CI_STATE_DATA * pSD);
SHORT      SCI_CreateReqHeader(CI_STATE_DATA * pSD, SHORT sMsgLen,
LONG lCRC);

/*
 * Module reqalt.c
 */
SHORT      SCI_AltInit(CI_STATE_DATA * pSD);
SHORT      SCI_AltClearAll(CI_STATE_DATA * pSD);
SHORT      SCI_AltClear(CI_STATE_DATA * pSD, SHORT sAltId);
SHORT      SCI_AltAppendAll(CI_STATE_DATA * pSD);
SHORT      SCI_AltAppendToReq(CI_STATE_DATA * pSD, SHORT sAltId);
SHORT      SCI_AltSetValue(CI_STATE_DATA * pSD,
                          SHORT sAltId, CHAR * pcAltValue);
VOID vCI_AltChangeState(CI_STATE_DATA * pSD, SHORT sAltId,
                        BYTE ucFromState, BYTE ucToState);
VOID vCI_AltChangeStates(CI_STATE_DATA * pSD,
                        BYTE ucFromState, BYTE ucToState);

/*
 * Module reqfld.c
 */
SHORT      SCI_ReqFldSetValue(CI_STATE_DATA * pSD,
                              SHORT sFieldId, CHAR *
pcValue);
SHORT      SCI_ReqFldAppend(CI_STATE_DATA * pSD, SHORT sFieldId);
SHORT      SCI_ReqFldGetState(CI_STATE_DATA * pSD, SHORT
sFieldId);
SHORT      SCI_ReqFldClrState(CI_STATE_DATA * pSD, SHORT
sFieldId);
SHORT      SCI_ReqFldClrAll(CI_STATE_DATA * pSD);

/*
 * Module cp_utils.c
 */
VOID vCI_MsgIdSetNext(CI_STATE_DATA * pSD);
LONG lCI_ComputeCRC(BYTE * pbyBuff, SHORT sNumBytes, LONG lSeed);
VOID * pvCI_MemAlloc(CI_STATE_DATA * pSD, size_t size);
VOID vCI_MemFree(CI_STATE_DATA * pSD, VOID * pvData);
VOID vCI_ErrorSet(CI_STATE_DATA * pSD, BYTE byErrType,

```

APPENDIX A - PAGE 54 OF 279

```

                                BYTE byWhere, SHORT sData);
SHORT      sCI_ReqBufAppend(CI_STATE_DATA * pSD, BYTE * pbyData,
SHORT sDataLen);
SHORT      sCI_FieldGetLong(CHAR ** ppcBuffer, SHORT sBase, LONG
* pIDest,
                                SHORT sMinLen, SHORT sMaxLen, CHAR
cDelim);
SHORT      sCI_FieldGetString(CHAR ** ppcBuffer, CHAR * pcDest,
                                SHORT sMinLen, SHORT sMaxLen, CHAR
cDelim);
BYTE *     pbyCI_BufFind(BYTE * pbySource, SHORT sSourceLen,
                                BYTE * pbyTarget, SHORT
sTargetLen);
BYTE *     pbyCI_ByteFindNE(BYTE * pbySource, SHORT sSourceLen,
BYTE byTarget);
VOID vCI_SwapLongs(LONG * pLongs, SHORT sCount);
VOID vCI_SwapShorts(SHORT * pShorts, SHORT sCount);

/*
 * Module errorq.c
 */
VOID vCI_ErrorQClear(CI_STATE_DATA * pSD);
BOOL bCI_ErrorQIsEmpty(CI_STATE_DATA * pSD);
VOID vCI_ErrorQPut(CI_STATE_DATA * pSD, SHORT sErrType,
                                BYTE byWhere, SHORT sData);
VOID vCI_ErrorQPutProto(CI_STATE_DATA * pSD, BYTE * pbyData,
                                SHORT sDataLen);
BOOL bCI_ErrorQGet(CI_STATE_DATA * pSD, SHORT * psErrType,
                                BYTE * pbyErrData, SHORT *
psDataLen);

/*
 * Module recvdata.c
 */
SHORT      sCI_ReceiveData(CI_STATE_DATA * pSD, BYTE byBlockMode);

/*
 * Module recvpack.c
 */
SHORT      sCI_GetResult(CI_STATE_DATA * pSD);
SHORT      sCI_LoadMsgQ(CI_STATE_DATA * pSD);
BOOL bCI_InBufContainsPkt(CI_STATE_DATA * pSD);
SHORT      sCI_PktReadHdr(CI_STATE_DATA * pSD, BYTE * pbyBuf,
SHORT sBufLen);
BOOL bCI_PktIsValid(CI_STATE_DATA * pSD);
BOOL bCI_MsgIsHeartbeat(CI_RES_MSG * pResMsg);
SHORT      sCI_HBSend(CI_STATE_DATA * pSD);

/*
 * Module stripmsg.c
 */
SHORT      sCI_PktStripMsgs(CI_STATE_DATA * pSD);

/*
 * Module msgend.c
 */

```

APPENDIX A - PAGE 55 OF 279

```

VOID vCI_FindMsgEnd(BYTE ** ppbyMsg, SHORT * psBufLen);
VOID vCI_FindDownloadEnd(BYTE ** ppbyMsg, SHORT * psBufLen);

/*
 * Module msgdcode.c
 */
SHORT      sCI_MsgDecode(CI_STATE_DATA * pSD, CI_RES_MSG *
pResMsg,
                                BYTE * pbyMsg, SHORT sMsgLen);

/*
 * Module btrftran.c
 */
SHORT      sCI_BTRFInit(CI_STATE_DATA * pSD);
SHORT      sCI_BTRFReset(CI_STATE_DATA * pSD);
SHORT      sCI_BTRFDealloc(CI_STATE_DATA * pSD);
SHORT      sCI_BTRFSetLangFile(CI_STATE_DATA * pSD, CHAR *
pcFileName);
SHORT      sCI_ProcBTRF(CI_STATE_DATA * pSD, CI_RES_MSG * pMsg);

/*
 * Module subcont.c
 */
SHORT      sCI_BSCInit(CI_STATE_DATA * pSD);
SHORT      sCI_BSCReset(CI_STATE_DATA * pSD);
SHORT      sCI_BSCAddSub(CI_STATE_DATA * pSD, SHORT sSubNum,
                                CHAR * pcData, SHORT sDataLen);
CHAR *      pcCI_BSCFindSub(CI_STATE_DATA * pSD, SHORT sSubNum);
VOID vCI_BSCPrint(CI_STATE_DATA * pSD);

/*
 * Module msgq.c
 */
SHORT      sCI_MsgQCreate(CI_STATE_DATA * pSD);
VOID vCI_MsgQDestroy(CI_STATE_DATA * pSD);
BOOL bCI_MsgQIsEmpty(CI_STATE_DATA * pSD);
CI_RES_MSG * pCI_MsgQGet(CI_STATE_DATA * pSD);
SHORT      sCI_MsgQPut(CI_STATE_DATA * pSD, CI_RES_MSG * pResMsg);
VOID vCI_MsgQDelMsg(CI_STATE_DATA * pSD, CI_RES_MSG * pMsg);
VOID vCI_MsgQFlush(CI_STATE_DATA * pSD);

/*
 * Module proc_res.c
 */
SHORT      sCI_ProcResults(CI_STATE_DATA * pSD);
SHORT      sCI_ProcMsg(CI_STATE_DATA * pSD, CI_RES_MSG * pMsg);
SHORT      sCI_ProcAddr(CI_STATE_DATA * pSD, CI_RES_MSG * pMsg);
SHORT      sCI_ProcRoute(CI_STATE_DATA * pSD, CI_RES_MSG * pMsg);
SHORT      sCI_ProcQuery(CI_STATE_DATA * pSD, CI_RES_MSG * pMsg);
SHORT      sCI_ProcQPOIS(CI_STATE_DATA * pSD, CI_RES_MSG * pMsg);
SHORT      sCI_ProcPOISItem(CI_STATE_DATA * pSD, USHORT usMsgId,
                                CHAR * pcPOI, SHORT sPOILen);
SHORT      sCI_ProcQRegion(CI_STATE_DATA * pSD, CI_RES_MSG *
pMsg);
SHORT      sCI_ProcRegionItem(CI_STATE_DATA * pSD, USHORT usMsgId,

```

APPENDIX A — PAGE 56 OF 279

```

                                CHAR * pcRegion, SHORT
sRegionLen);
SHORT   sCI_ProcUnexpMsgId(CI_STATE_DATA * pSD, CI_RES_MSG *
pMsg);
SHORT   sCI_ProcUnexpMsgType(CI_STATE_DATA * pSD, CI_RES_MSG
* pMsg);
BOOL bCI_MsgIdIsExpected(CI_STATE_DATA * pSD, USHORT usMsgId);
BOOL bCI_MsgTypeIsExpected(CI_STATE_DATA * pSD, BYTE byMsgType);

/*
 * Module procerr.c
 */
SHORT   sCI_ProcError(CI_STATE_DATA * pSD, CI_RES_MSG * pMsg);

/*
 * Module procdnld.c
 */
SHORT   sCI_ProcDownload(CI_STATE_DATA * pSD, CI_RES_MSG *
pMsg);

/*
 * Module resalt.c
 */
SHORT   sCI_ProcAlts(CI_STATE_DATA * pSD, BYTE * pbyAltsBuf,
SHORT sBufLen);
SHORT   sCI_AltGetType(BYTE * pbyAlt, SHORT sBufLen);
SHORT   sCI_ProcArms(CI_STATE_DATA * pSD, BYTE * pbyAltData,
SHORT sBufLen);

/*
 * Module ros.c
 */
SHORT   sCI_ROSCreate(CI_STATE_DATA * pSD);
SHORT   sCI_ROSConfig(CI_STATE_DATA * pSD,
                    SHORT sMaxMans, SHORT sMaxPOIs, SHORT
sMaxRegions);
SHORT   sCI_ROSAlloc(CI_STATE_DATA * pSD, BYTE byROSType);
SHORT   sCI_ROSRouteAlloc(CI_STATE_DATA * pSD);
SHORT   sCI_ROSPOISAlloc(CI_STATE_DATA * pSD);
SHORT   sCI_ROSRegionAlloc(CI_STATE_DATA * pSD);
SHORT   sCI_ROSDealloc(CI_STATE_DATA * pSD);
SHORT   sCI_ROSGetItemCount(CI_STATE_DATA * pSD);
VOID vCI_ROSFlush(CI_STATE_DATA * pSD);

SHORT   sCI_ROSAddMan(CI_STATE_DATA * pSD, CI_MAN_REC * pMan);
SHORT   sCI_ROSAddManAt(CI_STATE_DATA * pSD, CI_MAN_REC * pMan,
SHORT sIndex);
SHORT   sCI_ROSGetManAt(CI_STATE_DATA * pSD, SHORT sIndex,
CI_MAN_REC * pMan);

SHORT   sCI_ROSAddPOI(CI_STATE_DATA * pSD, CI_POI_REC * pPOI);
SHORT   sCI_ROSAddPOIAt(CI_STATE_DATA * pSD, CI_POI_REC * pPOI,
SHORT sIndex);
SHORT   sCI_ROSGetPOIAt(CI_STATE_DATA * pSD, SHORT sIndex,
CI_POI_REC * pPOI);

```

APPENDIX A -- PAGE 57 OF 279

```

SHORT   sCI_ROSAddRegion(CI_STATE_DATA * pSD, CI_REGION_REC *
pRegion);
SHORT   sCI_ROSAddRegionAt(CI_STATE_DATA * pSD,
                           CI_REGION_REC * pRegion, SHORT
sIndex);
SHORT   sCI_ROSGetRegionAt(CI_STATE_DATA * pSD,
                           SHORT sIndex, CI_REGION_REC
* pRegion);
VOID    vCI_ROSRouteDealloc(CI_STATE_DATA * pSD);
VOID    vCI_ROSPOISDealloc(CI_STATE_DATA * pSD);
VOID    vCI_ROSRgnDealloc(CI_STATE_DATA * pSD);
VOID    vCI_ROSFreeManText(CI_STATE_DATA * pSD, CI_ROS_HEADER *
pROS,
                           SHORT sPageNum);

/*
 * Module sets.c
 */
SHORT   sCI_SetXmitFormat(CI_STATE_DATA * pSD, BYTE byXmitFmt);
SHORT   sCI_SetCompression(CI_STATE_DATA * pSD, BYTE
byCompMode);
SHORT   sCI_SetColorDepth(CI_STATE_DATA * pSD, SHORT sDepth);
SHORT   sCI_SetMapFormat(CI_STATE_DATA * pSD, BYTE byMapFmt);
SHORT   sCI_SetProtocolVer(CI_STATE_DATA * pSD, SHORT sVer);
SHORT   sCI_SetNewRequest(CI_STATE_DATA * pSD);
#if 0
SHORT FUNC_DECL   sCI_SetOriginNT(CI_STATE_DATA * pSD, CHAR *
pcName,
                                CHAR * pcType);
SHORT FUNC_DECL   sCI_SetDestNT(CI_STATE_DATA * pSD, CHAR *
pcName,
                                CHAR * pcType);
SHORT FUNC_DECL   sCI_SetLimitVT(CI_STATE_DATA * pSD, LONG
lValue,
                                BYTE byType);
#endif

SHORT   sCI_AssignOrigin(CI_STATE_DATA * pSD,
                          CHAR * pcName, CHAR * pcType,
                          LONG lLat, LONG lLong,
                          SHORT sBearing,
                          CHAR * pcSXLocus);
SHORT   sCI_AssignDest(CI_STATE_DATA * pSD,
                       CHAR * pcName, CHAR * pcType,
                       LONG lLat, LONG lLong,
                       SHORT sBearing,
                       CHAR * pcSXLocus);

/*
 * Module gets.c
 */
#if 0
SHORT   sCI_GetNextRegion(CI_STATE_DATA * pSD, CI_REGION_REC
* pRegion);
SHORT   sCI_GetNextManeuver(CI_STATE_DATA * pSD, CI_MAN_REC *
pMan);

```

APPENDIX A - PAGE 58 OF 279

```

SHORT      sCI_GetPrevManeuver(CI_STATE_DATA * pSD, CI_MAN_REC *
pMan);
SHORT      sCI_GetNextPOI(CI_STATE_DATA * pSD, CI_POI_REC * pPOI);
#endif
SHORT      sCI_GetTotalPktsSent(CI_STATE_DATA * pSD);
SHORT      sCI_GetTotalPktsRcvd(CI_STATE_DATA * pSD);
LONG lCI_GetTotalBytesSent(CI_STATE_DATA * pSD);
LONG lCI_GetTotalBytesRcvd(CI_STATE_DATA * pSD);

/*
 * Module validate.c
 */
BOOL bCI_RouteIsValid(CI_STATE_DATA * pSD);
BOOL bCI_POIQIsValid(CI_STATE_DATA * pSD);
BOOL bCI_LoginIsValid(CI_STATE_DATA * pSD);
BOOL bCI_RegionSelectIsValid(CI_STATE_DATA * pSD);
SHORT      sCI_ValidateLocation(CI_STATE_DATA * pSD, BYTE
byLocType,
                                     CHAR * pcName, CHAR * pcType,
LONG lLat, LONG lLong, SHORT
sBearing,
                                     CHAR * pcSXLocus);

/*
 * Module doos.c
 */
SHORT      sCI_DoLogin(CI_STATE_DATA * pSD);
SHORT      sCI_DoLogout(CI_STATE_DATA * pSD);
SHORT      sCI_DoRegionSelect(CI_STATE_DATA * pSD);
SHORT      sCI_DoMaxPacket(CI_STATE_DATA * pSD);

/*
 * Module ctrlr.c
 */
VOID vCI_CtrlReset(CI_STATE_DATA * pSD);
VOID vCI_CtrlClearResult(CI_STATE_DATA * pSD);
SHORT      sCI_CtrlSetDownloadFormat(CI_STATE_DATA * pSD, BYTE
byFormat);
SHORT      sCI_CtrlRouteReq(CI_STATE_DATA * pSD);
SHORT      sCI_CtrlRouteGet(CI_STATE_DATA * pSD, SHORT sItem,
CI_MAN_REC * pMan);
SHORT      sCI_CtrlPOISReq(CI_STATE_DATA * pSD);
SHORT      sCI_CtrlPOISGet(CI_STATE_DATA * pSD, SHORT sItem,
CI_POI_REC * pPOI);
SHORT      sCI_CtrlRegionsReq(CI_STATE_DATA * pSD);
SHORT      sCI_CtrlRegionGet(CI_STATE_DATA * pSD, SHORT sItem,
CI_REGION_REC * pRegion);
SHORT      sCI_CtrlLoadROSA(CI_STATE_DATA * pSD, SHORT sItem);
SHORT      sCI_CtrlLoadROSB(CI_STATE_DATA * pSD, SHORT sItem);
VOID vCI_CtrlPreProcItem(CI_STATE_DATA * pSD, USHORT usMsgId);
VOID vCI_CtrlPostProcItem(CI_STATE_DATA * pSD);

/*
 * Module update.c
 */

```

APPENDIX A - PAGE 59 OF 279

```
SHORT      sCI_CommFunctional(CI_STATE_DATA * pSD, BYTE
byErrWhere);

/*
 * Module msgmap.c
 */
VOID vCI_MMAddMsgId(CI_STATE_DATA * pSD, USHORT usMsgId, SHORT
sFirstItem);
USHORT usCI_MMFind(CI_STATE_DATA * pSD, SHORT sItem);
SHORT sCI_MMFirstItem(CI_STATE_DATA * pSD, USHORT
usTargetMsgId);

/*
 * Module unsolmsg.c
 */
SHORT sCI_RecvUnsolMsg(CI_STATE_DATA * pSD, CI_RES_MSG *
pMsg);

/*
 * Module vb_utils.c
 */
ULONG FUNC_DECL ulCI_StrAddr(CHAR * pcString);

#endif /* _CI_PROTO_H */
```



```

/* _sccs_ "@(#)ER %P% Ver: %I% Date: %G%" */
/* _rcs_ "$Id: ci_types.h,v 1.3 1995/02/11 00:15:24 bobd Exp bobd
$" */
/* Copyright (C) 1994,1995 SEI Information Technology, Inc. */
/*.....:
:.....:
:: Filename:          ci_types.h
:: Purpose:          Declares types required for use and
functioning of API.
:: Revision:        09/19/94          RPD          Original
:.....:
:.....:
:.....:*/
#ifndef _CI_TYPES_H
#define _CI_TYPES_H

/*
 * Enumeration types
 */
typedef enum ci_req_alt_type /* Types of request alternates */
{
    eReqAltSession = 0,          /* Identifies index in
array */
    eReqAltConfig,              /* Config */
    eReqAltQuery,               /* Query */
    eReqAltMan,                  /* Maneuver */
    eReqAltLogout,              /* Logout */
    eReqAltMsg,                  /* User Message */
    eReqAltHB,                   /* Heartbeat */
    eReqAltLang,                 /* Language */
    eReqAltBug,                  /* Bug Report */

    eReqAltOrgSXLocus,           /* Origin SXLocus */
    eReqAltDestSXLocus,          /* Dest. SXLocus */
    eReqAltOrgBearing,           /* Origin Bearing */
    eReqAltDestBearing,          /* Dest. Bearing */
    eReqAltArms,                 /* Arms */
    eReqAltBurst,                /* Burst */
    eReqAltMaxPkt,               /* MaxPkt */
    eReqAltTOD,                  /* Time of day */
    eReqAltDownload,             /* File download */
    eReqAltFormat,               /* Download format */
    eReqAltMaxAlts               /* Records total number of
request alts */
} CI_REQ_ALT_TYPE;

typedef enum ci_req_field_type /* Types of request fields */
{
    eReqFldOrgLat = 0,           /* Origin Latitude */
    eReqFldOrgLong,              /* Origin Longitude */
    eReqFldOrgName,               /* Origin Name */
    eReqFldOrgType,               /* Origin Type */
    eReqFldDestName,              /* Destination Name */
    eReqFldDestType,              /* Destination Type */
    eReqFldLimit,                 /* Limit */
    eReqFldLimitType,             /* Limit Type */
}

```

APPENDIX A - PAGE 61 OF 279

```

        eReqFldMaxFlags          /* Records total number
of fields */
} CI_REQ_FIELD_TYPE;

typedef enum ci_btrf_state      /* BTRF download states */
{
    eBTRFInit = 0,              /* Initialized          */
    eBTRFHeader,                /* Awaiting file header */
    eBTRFManHdr,                /* Awaiting maneuver header */
    eBTRFManeuver,              /* Awaiting maneuver    */
    eBTRFComplete               /* BTRF download complete */
} CI_BTRF_STATE;

/*
 * Type declarations...
 */
/* Describes a request alternate */
typedef struct ci_req_alt
{
    BYTE          byState;
    CHAR          acValue[CI_MAX_ALT_LEN + 1];
} CI_REQ_ALT;

/*
 * State data field types
 */
typedef CHAR     ReqLL[CI_MAX_LL_LEN + 1];
typedef CHAR     ReqODName[CI_MAX_OD_NAME_LEN + 1];
typedef CHAR     ReqODType[CI_MAX_OD_TYPE_LEN + 1];
typedef CHAR     ReqLimit[CI_MAX_LIMIT_LEN + 1];
typedef CHAR     ReqLimitType[CI_MAX_LIMIT_TYPE_LEN + 1];

/* Result Message Header */
typedef struct ci_res_msg
{
    LONG          lTimestamp;
    SubscriberId acSubscriberId;
    USHORT       usMsgId;
    ClientId     acClientId;
    BYTE         byType;          /* Message type */
    BYTE *       pbyData;        /* Data of message */
    /*
    */
    SHORT        sDataLen;       /* Length of data */
    /*
    */
    struct ci_res_msg * pNext;    /* Link to next msg
in q */
} CI_RES_MSG;

/* Message Queue */
typedef struct ci_msgq
{
    SHORT        sLen;           /* Count of
items in queue. */
    CI_RES_MSG * pHead;         /* Pointer to head
of queue. */
}

```

APPENDIX A - PAGE 62 OF 279

```

        CI_RES MSG *   pTail;                /* Pointer to tail
of queue. */
    } CI_MSGQ;

/* API error information */
typedef struct ci_err_data
{
    SHORT                sErrorId;
    SHORT                sErrorData;
    BYTE                abyMsgText[CI_MAX_ERR_MSG_LEN + 1];
    SHORT                sMsgLen;           /* Actual length of
msgtext */
} CI_ERR_DATA;

/* Maneuver Arm information */
typedef CHAR            ArmName[CI_MAX_ARM_NAME_LEN];
typedef struct ci_arm_rec
{
    ArmName              acFromName;       /* From
Street */
    SHORT                sFromLen;
    ArmName              acToName;       /* To Street*/
    SHORT                sToLen;
    SHORT                sArmCount;      /* # of
Arms */
    CI_POINT            aPoint[CI_MAX_ARMS]; /* Arm positions*/
} CI_ARM_REC;

/* Maneuver (with Arms) information */
typedef struct ci_man_rec
{
    CHAR *              pcManText;        / *
Maneuver text */
    SHORT                sTextLen;
    ArmName              acFromName;     /* From
Street */
    SHORT                sFromLen;
    ArmName              acToName;     /* To Street*/
    SHORT                sToLen;
    SHORT                sArmCount;     /* # of
Arms */
    CI_POINT            aPoint[CI_MAX_ARMS]; /* Arm positions*/
} CI_MAN_REC;

/* Describes a POI result */
typedef CHAR            POIName[CI_MAX_POI_NAME_LEN];
typedef CHAR            POIAddr[CI_MAX_POI_ADDR_LEN];
typedef CHAR            SXLocus[CI_MAX_SXLLOCUS_LEN];
typedef struct ci_poi_rec
{
    POIName              acName;          /* POI Name*/
    SHORT                sNameLen;
    POIAddr              acAddr;         / *   P O I
Address */
    SHORT                sAddrLen;
    SHORT                sPOIType;      /* POI Type */
}

```

APPENDIX A — PAGE 63 OF 279

```

LONG          lPOIID;          /* POI Id      */
SXLocus      acSXLocus;
SHORT        sSXLocusLen;
LONG         lDist;          /* Dist. from origin */
*/
  BOOL        bHasCustInfo;
} CI_POI_REC;

/* Describes a Metro Region selection */
typedef CHAR  RegionName[CI_MAX_REGION_NAME_LEN];
typedef CHAR  RegionFile[CI_MAX_REGION_FILE_LEN];
typedef struct ci_region_rec
{
  RegionName  acName;          /* Name of
region        */
  SHORT       sNameLen;
  RegionFile  acFile;         /* Filename of
region        */
  SHORT       sFileLen;
} CI_REGION_REC;

/* ROS header record */
typedef struct ci_ros_header
{
  BYTE        byObjectType;   /* Current storage type */
*/
  SHORT       sFirstItemNum;
  SHORT       sTotalItems;
  CI_MAN_REC ** papManPages;
  SHORT       sMaxManeuvers;
  SHORT       sMaxManPages;
  CI_POI_REC ** papPOIPages;
  SHORT       sMaxPOIs;
  SHORT       sMaxPOIPages;
  CI_REGION_REC ** papRgnPages;
  SHORT       sMaxRegions;
  SHORT       sMaxRgnPages;
} CI_ROS_HEADER;

/* BTRF Substitution data */
typedef struct ci_btrf_subdata
{
  SHORT       sNum;          /* Substitution
number        */
  SHORT       sDataLen;     /* Data length */
  CHAR *      pcData;       /* Pointer to
sub data     */
} CI_BTRF_SUBDATA;

/* BTRF Substitution Container info */
typedef struct ci_bsc_info
{
  CI_BTRF_SUBDATA * apSubData[CI_BTRF_MAX_SUBS];
  SHORT             sSize;          /* # of subs
in array          */
} CI_BSC_INFO;

```

APPENDIX A - PAGE 64 OF 279

```

/* State Data BTRF translation info */
typedef struct ci_btrf_info
{
    CI_BSC_INFO          SubContainer;          /* Sub data
container          */
    SHORT                sBTRFState;          /* BTRF
download state      */
    INT                  iFEBInFile;          /* FEB file
handle              */
    CHAR *               pcFEBLangFilename;   /* Name of language
file               */
    SHORT                sFEBTplCount;        /* # templates in
FEB                */
    LONG *               palFEBTplOffsets;    /* FEB template
array              */
    BYTE *               pbyData;             /* Input buffer*/
    SHORT                sDataLen;           /* Current length
of data buf       */
    BYTE *               pbyCurrInput;        /* Current pointer
into data         */
    CHAR *               pcCopyright;         /* BTRF header
copyright         */
    ULONG                ulTotalMansLen;      /* Total length
(all man info)    */
    SHORT                sTotalMans;         /* Total
maneuver count    */
    SHORT                sCurrManNum;         /* Current Maneuver
number           */
    SHORT                sCurrManTplCount;    /* Current man
template count    */
    USHORT               usCurrTplSize;      /* Current man
tpl size         */
    CHAR *               pcTplBuf;           /* Template
buffer           */
    CHAR *               pcManBuf;           /* Maneuver text
buffer           */
    CHAR *               pcCurrTpl;          /* Offset
within pcManBuf  */
    USHORT               usMsgId;           /* Incoming message
Id               */
} CI_BTRF_INFO;

typedef CHAR            UnsolMsg[CI_MAX_UNSO MSG_LEN];
/* THE State Data */
typedef struct ci_state_data
{
    SHORT                sErrCode;           /* Most recent
error code       */
    BOOL                 bAbortTask;        /* Flag to abort
current operation */

    /* Unsol. Msg storage */
    UnsolMsg             acUnsolMsg;

    /* Active region */

```

APPENDIX A - PAGE 65 OF 279

```

RegionName          acActiveRegionName;
RegionFile          acActiveRegionFile;

/* Controller Layer */
SHORT              sCtrlCurrItem;          /* Current controller
item index        */
SHORT              sCtrlUserItem;         /* Current users
item index        */
SHORT              sCtrlROSOOffset;       /* Offset of
1st ROS item from Ctrl */
BYTE              byMemModel;             /* Entire result or
packet only        */

SHORT              sGreatestItem;        /* Greatest
(relevant) item rcvd. */
SHORT              sPrevMsgId;            /* MsgId of
Previous Message   */
BOOL              bReqDownload;           /* Requesting a file
download          */
INT               iDnldFD;                /* File desc. for
downloads         */
BYTE              byDownloadFormat;       /* ASCII or BINARY
(BTRF)           */

/* Result Object Storage */
CI_ROS_HEADER     ROSHdr;

/* Request or Result Packet */
USHORT            usMsgId;
USHORT            usLastMsgId;           /* Id of last msg
received          */

/* General State Info */
BOOL              bWithinAPI;             /* Guard against
reentry          */
BOOL              bNewRequest;            /* Flag req. for new req.
*/

/* Login values */
BYTE              byXmitFmt;              /* Transmission
format (ASCII/BIN) */
BOOL              bLoggedIn;              /* Logged in to
host              */
BOOL              bOnline;                 /* Connected to host */
BYTE              byCompMode;             /* Compression
mode              */
SHORT             sColorDepth;            /* Color depth of
client            */
BYTE              byMapFmt;                /* Map format */
SHORT             sProtoVer;              /* Desired
protocol version */
BOOL              bBurstMode;             /* Burst mode
state            */
BOOL              bBurstChanged;          /* Flags change in burst
mode            */

```

```

        SHORT          sDesMaxPkt;          /* Desired
MaxPkt size          */
        SHORT          sResMaxPkt;          /* MaxPkt from
host                  */
        SHORT          sCurMaxPkt;         /* Current
MaxPkt size          */

        /* For Result processing */
        SHORT          sCurMan;            /* Used for transfer
to ROS               */
        SHORT          sCurPOI;           /* " "
"                   */
        SHORT          sCurRegion;        /* "
"                   */

        /* ProcRoute() inits ManInfo, then ProcAlts() will add any
arm data,*/
        /* and finally, ProcRoute() will add maneuver data */
        CI MAN_REC     ManInfo;            /* Temp. until Man.
complete */

        /* Communication buffers */
        BYTE *         pbyOutputBuf;
        SHORT          sOutBufLen;         /* Current
length of output buf */
        SHORT          sOutBufSize;        /* Max length of
output buf          */
        BYTE *         pbyInputBuf;
        SHORT          sInBufLen;         /* Current
length of input buf */
        SHORT          sInBufSize;        /* Max length
of input buf       */

        /* Result Packet info */
        BYTE *         pbyResBuf;          /* Stores msgs
from pkt           */
        SHORT          sResBufLen;        /* Current
length of resbuf */
        SHORT          sResBufSize;       /* Max length of
resbuf             */
        BYTE *         pbyResPktStart;    /* Start of
Packet             */
        SHORT          sResPktDataLen;    /* Len of data
in Pkt            */
        SHORT          sResPktHdrLen;     /* Len of header in
Pkt               */
        BYTE          byResCompMode;      /* Compression Mode */
        LONG           lCRC;              /* CRC of data */

        /* Message Queue */
        CI_MSGQ        msgQ;

        /* Error Queue */
        SHORT          sErrQHead;
        SHORT          sErrQTail;
        SHORT          sErrQSize;

```

APPENDIX A - PAGE 67 OF 279

```

CI_ERR_DATA * paErrQ;

/* User supplied function pointers */
PS_ON_IDLE      pfsOnIdle;
PS_ON_MESSAGE   pfsOnMessage;
PS_DEV_OPEN     pfsDevOpen;
PS_DEV_CLOSE    pfsDevClose;
PS_DEV_READ     pfsDevRead;
PS_DEV_WRITE    pfsDevWrite;
PS_MEM_ALLOC    pfpvMemAlloc;
PS_MEM_FREE     pfvMemFree;

BYTE            byCommMode;          /* Communications
mode */
VOID *          pvCD;                /
Communications device. */
VOID *          pvUserData;

/* Registration info */
SubscriberId    acSubscriberId;
ClientId        acClientId;
DOUBLE          dTimeout;

/* Result Data info */
BYTE            byAck;              /* Acknowledgement
from host */
USHORT          usExpMsgId;
BYTE            byExpMsgType;
BYTE            byExpQueryType;    /* Type of Query
(Msg Type = Query) */
BOOL            bResAltMore;       /* Records state of alt
"MORE=" */
BOOL            bResAltContinue;   /* Records state of
CONTCONF=" */
BOOL            bResultComplete;  /* State of current
result */

/* Request Info */
BYTE            byReqType;
BYTE            byReqCompMode;
BYTE *          pbyReqBuf;
SHORT          sReqBufLen;        /* Amount of
data in buf */
SHORT          sReqBufSize;      /* Max size of req
buf */

/* Request alternates */
SHORT          sReqNumAlts;
CI_REQ_ALT     aReqAlt[eReqAltMaxAlts];

/* Request fields */
BYTE            abyReqFldState[eReqFldMaxFlags];
ReqLL          acReqOrgLat;      /* Origin Latitude
*/
ReqLL          acReqOrgLong;    /* Origin
Longitude */

```

APPENDIX A - PAGE 68 OF 279

```

ReqODName      acReqOrgName;      /* Origin Name      */
ReqODType      acReqOrgType;      /* Origin Type      */
ReqODName      acReqDestName;     /* Destination Name */
ReqODType      acReqDestType;     /* Destination Type */
ReqLimit       acReqLimit;        /* Limit            */
ReqLimitType   acReqLimitType;    /* Limit Type      */

/* Misc. Info. */
SHORT          sPktsRcvd;
LONG           lBytesRcvd;
SHORT         sPktsSent;
LONG          lBytesSent;

/* BTRF translation */
CI_BTRF_INFO  BTRFInfo;
} CI_STATE_DATA;

#endif /* _CI_TYPES_H */

```

```
/* _sccs_ $Source: /ids/cvs/host/libut/src/errhand.h,v $ Ver:
$Revision: 1.1 $ Date: $Date: 1994/12/20 16:19:09 $ */
/* Copyright (C) 1994,1995 SEI Information Technology, Inc. */
/***** Start of ERRHAND.H *****/

#ifndef _ERRHAND_H
#define _ERRHAND_H

#ifdef __STDC__
void fatal_error( char *fmt, ... );
#else /* __STDC__ */
void fatal_error();
#endif /* __STDC__ */
#endif /* _ERRHAND_H */

/***** End of ERRHAND.H *****/
```

```

static char * _s c c s _ = { " $ S o u r c e :
/ids/cvs/host/fe_spif/src/fe_climsg.c,v $ Ver: $Revision: 1.10
$ Date: $Date: 1995/05/26 22:50:37 $" };
/* Copyright (C) 1994,1995 SEI Information Technology, Inc. */

/*.....
.....
:: FileName:    fe_climsg.c
::
:: Purpose :    Function that handle Passthrough client messages.
::
:: Revision:
:: WHO        --WHEN--   WHAT
:: DAB & VI         Original
:: Raju          08/20/94 Modified for Message Queue and SPIF
.....
.....*/

#include <stdio.h>
#include <signal.h>
#include <errno.h>
#include <fcntl.h>
#include <netinet/in.h>
#include <sys/types.h>
#include <sys/stat.h>

#include "gdefines.h"
#include "gerror.h"
#include "mq_pub.h"
#include "queue.h"
#include "spif.h"
#include "fe_common.h"
#include "ut_audit.h"

#define    MAX_LOCUS_SIZE        128
#define    MAX_TMPFILE_SIZE    128
#define    MAX_TMPBUFF_SIZE    1024

extern long    lQID;
extern long    lFID;
extern long    lSize;
extern int     iDebug;
extern int     argcnt;
extern short   sMsglen;
extern long    lg_addr;
extern int     bit_map;
extern long    lfe_tcp;
extern long    lFrontID;
extern long    lAddress;
extern int     iDataPort;
extern int     last_baud;
extern time_t  start_time;
extern long    lHeartbeat;
extern int     iListenPort;
extern short   sMaxPackets;
extern short   sPacketFlag;

```

APPENDIX A - PAGE 71 OF 279

```

extern int      ipacketflag;
extern short   sBurstflag;
extern short   sConfirmMax;
extern short   sAckPending;
extern long    lMap_format;
extern long    lFormat_mode;
extern short   sDefaultBaud;
extern short   sPacketLimit;
extern short   sMinPacketLimit;
extern int     iQueue_master;
extern long    lLastCommtime;
extern long    lLastCommtime;
extern long    lConstantBaud;
extern long    lCompress_mode;
extern long    lDisplay_panes;
extern short   sTransmitLimit;
extern short   sMinPacketLimit;
extern long    lHeartbeat_wait;
extern int     socket_port_num;
extern short   sInterPacketGap;
extern struct  sockaddr_in addr;
extern short   sProcess_heartbeat;
extern short   sTerm_After_Service;
extern long    lExit_on_disconnect;
extern unsigned long ulSessionID;

extern void    *pMQU_master;
extern void    *pvMQ_master;

extern char    *cpQID;
extern char    *cpFrontID;
extern char    *cpConfigPath;
extern char    *caCommDevice;
extern char    *caDeviceConfig;
extern char    *cpDownload_dir;
extern char    *cpDictionary_dir;

extern char    caID[];
extern char    caBuff[];
extern char    caHangup[];
extern char    caOrigin[];
extern char    caOriginType[];
extern char    caLimitValue[];
extern char    caDestination[];
extern char    caNoAutoAnswer[];
extern char    caDestinationType[];

extern char    *caAlternative[];

extern Q_HEAD  sHead;
extern Q_HEAD  sConfig;
extern Q_HEAD  *pQhead;
extern Q_HEAD  *pQConfig;
extern FILE    *pMsgsfile;
extern SUBSCRIBER *pGSub;
extern void    vDeleteTmpfile();

```

APPENDIX A - PAGE 72 OF 279

```

extern short sFeFindPOIMapping();

#ifdef ANSI
short sFeFileCheck(char *cpFile);
void vReset_status_flags(SUBSCRIBER *pSub);
#else
short sFeFileCheck();
void vReset_status_flags()
#endif

/*::::::::::::::::::::::::::::::::::::::::::::::::::::::::::
::::::::::::::::::
:: Function: vFePassThrough_all
::
:: Purpose :
:: This is the main routine which parses the message from
the SPIF
:: and updates the subscriber structure based on the
request.
:: The SPIF request is parsed and appropriate action is
taken here.
:: If request has to be sent to DBE for POI or for ROUTE
it is done here.
:: If next maneuver has to be sent it is done here.
::
:: Returns: None.
::
:: Input: Pointer to SPIF header and Message buffer.
::
:: Output: None.
::
:: Globals:
::
:: Called Routines:
::
:: Revision:
:: WHO --WHEN-- WHAT
:: Raju 08/20/94 Original Coded for Message Queue and SPIF
::::::::::::::::::::::::::::::::::::::::::::::::::::::::::
::::::::::::::::::*/

void vFePassThrough_all(pspif_header, cpbuff)
SPIF_HEADER *pspif_header;
char *cpbuff;
{
    short sLen;
    short sagain;
    short sStep;
    short status;
    short sPktsize;
    long lMatch, i;
    char *cpalt;
    char *cp, *cpnewbuff;
    char casxlocuso[MAX_LOCUS_SIZE];
    char casxlocusd[MAX_LOCUS_SIZE];
}

```

APPENDIX A - PAGE 73 OF 279

```

char      caBuffer[MAX_TMPBUFF_SIZE];
char      caUserID[MAX_TMPFILE_SIZE];
char      caTBuf[ MAX_TMPFILE_SIZE];
char      caTmpFile[MAX_FILENAME_SIZE];
char      caReadBuf[MAX_FILENAME_SIZE];
FILE      *fp, *to;
struct stat *pStat;
SUBSCRIBER *pSub;

vMQ_Log(NULL, NULL, 20, "[FE%d] vFePassThrough_all spifid %ld
msglen%d\n",
        lAddress, pspif_header->lSpifID, strlen(cpbuff));
cp = cpbuff;

/* Check if the Gateway has already logged and validated.
*/
if( (pGSub == NULL) || (pGSub->iValidated == 0) ||
    (pGSub->sGatewayFlag == 0))
{
    /* Error response is sent if gateway has not logged */
    vMQ_Log( NULL, NULL, 0,
            "[FE%d] Invalid Request. Gateway not
validated\n", lAddress);
    /*
    vFeLogout_Sub(    pspif_header->lSpifID,
LOGOUT_BY_OPERATOR );
    */
    return;
}

/* check the SPIFID and if it is not found then it is an
error */
/* Passthrough for a subscriber */
if((pSub = pFindSpifID(pspif_header->lSpifID)) == NULL)
{
    sprintf( caBuffer, "[FE%d] Invalid SPIFID/SubscriberID
%d\n",
            lAddress, pspif_header->lSpifID);
    vMQ_Log( NULL, NULL, 0, "%s", caBuffer);
    vFeLogout_Sub(    pspif_header->lSpifID,
LOGOUT_BY_OPERATOR );
    return;
}

/*
** increment the receiving count of that subscriber and the
gateway
** receive counter.
*/
#ifdef DEBUG
vMQ_Log( NULL, NULL, 20, "[FE%d] sub SpifID %ld\n",
lAddress,
        pSub->lSpifID);
#endif
pSub->lRcv_count++;
pGSub->lRcv_count++;

```

APPENDIX A - PAGE 74 OF 279

```

/* Check if the subscriber has already been validated */
if( pSub->iValidated == 0)
{
    /* If not validated already then the next request
cannot be accepted */
    vMQ_Log( NULL, NULL, 0, "[FE%ld] Subscriber not yet
validated %ld\n",
            lAddress, pSub->lSpifID);

    if(pSub->sResultCode<1) pSub->sResultCode=FEERR_SUVA;
vSendErrorResponse(pSub, "Subscriber Not Yet
Validated");

    return;
}
else if( pSub->lResponsePending )
{
    /* Old request is being processed. Next request is
stored. */
    strcpy(pSub->caMsg, cpbuff);
    pSub->lRequestPending = 1;
    vMQ_Log( NULL, NULL, 10, "[FE%ld] Pending request for
SPIFID %ld\n",
            lAddress, pSub->lSpifID);
    return;
}

#ifdef DEBUG
    vMQ_Log(NULL, NULL, 20,
            "[FE%ld] Parsing Passthrough message! size %ld\n",
            lAddress, strlen(cpbuff));
#endif

/* check for the correctness of CRC */
if((sMsgLen = sCheckCRC( cpbuff )) == 0)
{
    vMQ_Log( NULL, NULL, 0, "[FE%ld] Invalid CRC\n",
            lAddress, pSub->lSpifID);
    vFeLogout_Sub( pSub->lSpifID, LOGOUT_BY_OPERATOR );
    return;
}
sLen = strlen( cpbuff ) - sMsgLen;
cpbuff = cpbuff + sLen;

vMakeUpper( cpbuff );

strcpy( caUserID, pSub->ServerRequest.caID);

/* Initialize the pSub structure */
memset((char *)&pSub->OriginLocus, -1, sizeof(ALOCUS));
memset((char *)&pSub->DestinationLocus, -1, sizeof(ALOCUS));
memset((char *)&pSub->ServerRequest, 0, sizeof(SPIFPARSE));

/* 0 indicates parse message from client to server */
if ((status = sHandleSPIFParse(cpbuff, &pSub->ServerRequest,
0)) != SUCCESS)

```

APPENDIX A - PAGE 75 OF 279

```

    {
        /* Error in the format of the message. */
        vMQ_Log(NULL, NULL, 0, "[FE%ld] SPIF msg parse
failed\n", lAddress);

        if(pSub->sResultCode<1) pSub->sResultCode=FEERR_INFO;
        vSendErrorResponse(pSub, "Invalid Request string
format");
    }
    /* end if parse NOT OK */
    else
    {
        /* check so that user does not change subscriberID or
userid */
        /* within a session */
        if( (strcmp( caUserID, pSub->ServerRequest.caID) != 0
) ||
        ( strcmp( pSub->caSCR,
pSub->ServerRequest.caSubscriber) != 0))
        {
            vMQ_Log(NULL, NULL, 0,
"[FE%ld] ERROR: SubscriberID/UserID
Mismatch\n", lAddress);
            vMQ_EventLog(NULL, NULL, MQ_EVB_ATEMPT,
pSub->caSCR, strlen(pSub->caSCR));
            vMQ_Log(NULL, NULL, 0,
"[FE%ld] Current SUBID %s User %s, New SUBID
%s user %s\n",
lAddress, pSub->caSCR, caUserID,
pSub->ServerRequest.caSubscriber,
pSub->ServerRequest.caID);
            pSub->lErrorCount++;

            if( pSub->lErrorCount >= MAX_ERROR_COUNT )
            {
                pSub->lMsgtype = SPIF_SUBSCRIBER_DISCONNECT;
                pSub->sResultCode = LOGOUT_BY_OPERATOR;
                vMQ_Log(NULL, NULL, 0,
"[FE%ld] ERROR: Disconnecting after max.
attempts\n",
lAddress);
                vHandleAuditLog(NULL, NULL,
MQ_MTS_AUDIT_CLLOGOUT,
lFID, (void *)pSub, NULL, 1);
                sSendHeader( 8, pSub->lSpifID, pSub->lMsgtype
);

                /* Delete the subscriber */
                if( iDelSub( pSub->lSpifID) != SUCCESS)
                {
                    vMQ_Log(NULL, NULL, 0,
"[FE%ld] ERROR: Unable to delete
subscriber\n",
lAddress);
                }
            }
        }
    }
}

```

APPENDIX A - PAGE 76 OF 279

```

        else
        {
            if ( pSub->sResultCode < 1 )
                pSub->sResultCode=FEERR_SUMI;
            vSendErrorResponse(pSub, "SubscriberID/UserID
Mismatch");

            strcpy(pSub->ServerRequest.caID, caUserID);
            strcpy( pSub->ServerRequest.caSubscriber,
pSub->caSCR);
        }
        return;
    }

    if( ((pSub->ServerRequest.lLatitude < MIN_LAT) ||
        (pSub->ServerRequest.lLatitude > MAX_LAT)) &&
        (pSub->ServerRequest.lLatitude !=
DEFAULT_LAT_LONG))
    {
        pSub->ServerRequest.lLatitude = DEFAULT_LAT_LONG;

        if ( pSub->sResultCode < 1 )
            pSub->sResultCode=FEERR_INLA;
        vSendErrorResponse(pSub, "Invalid Latitude");

        return;
    }

    if( ((pSub->ServerRequest.lLongitude < MIN_LONG) ||
        (pSub->ServerRequest.lLongitude > MAX_LONG)) &&
        (pSub->ServerRequest.lLongitude !=
DEFAULT_LAT_LONG))
    {
        pSub->ServerRequest.lLongitude =
DEFAULT_LAT_LONG;

        if ( pSub->sResultCode < 1 )
            pSub->sResultCode=FEERR_INLO;
        vSendErrorResponse(pSub, "Invalid Longitude");

        return;
    }

    /* print out serverRequest */
#ifdef DEBUG
    vMQ_Log(NULL, NULL, 30, "[FE%d] ID %s\n",
            lAddress, pSub->ServerRequest.caID);
    vMQ_Log(NULL, NULL, 30, "[FE%d] Origin %s\n",
            lAddress, pSub->ServerRequest.caOrigin);
    vMQ_Log(NULL, NULL, 30, "[FE%d] Origin type %s\n",
            lAddress, pSub->ServerRequest.caOriginType);
    vMQ_Log(NULL, NULL, 30, "[FE%d] Destination %s\n",
            lAddress, pSub->ServerRequest.caDestination);
    vMQ_Log(NULL, NULL, 30, "[FE%d] Destination type
%s\n",

```

APPENDIX A - PAGE 77 OF 279

```

        lAddress, pSub->ServerRequest.caDestinationType);
    vMQ_Log(NULL, NULL, 30, "[FE%d] Origin lat %d\n",
        lAddress, pSub->ServerRequest.lLatitude);
    vMQ_Log(NULL, NULL, 30, "[FE%d] Origin long %d\n",
        lAddress, pSub->ServerRequest.lLongitude);
    for (sagain = 0; sagain < 8; sagain++)

if (pSub->ServerRequest.aAlternatives[sagain].caAlternatives !=
NULL)
    {
        vMQ_Log(NULL, NULL, 30, "[FE%d] %s\n",
lAddress,
pSub->ServerRequest.aAlternatives[sagain].caAlternatives);
    }
#endif

has */
/* Reset heartbeat_sent flag to indicate that a message
/* been received from client */
pSub->lStatus = (pSub->lStatus & ~SS_SEND_HBEAT);
pSub->lStatus = (pSub->lStatus & ~SS_HBEAT_SENT);
pSub->ServerRequest.sOriginBearing = -1;
pSub->ServerRequest.sDestinationBearing = -1;

/* Check if the Origintype and/or Destination type
length is equal to */
/* Four. If so then External to internal translation
of POI names */
/* needs to be done. */
if( strlen( pSub->ServerRequest.caOriginType ) == 4 )
{
    /* POI Mapping translation is required. */
    /* Check if there is actually any translation
possible */
    i                                     f                                     (
sFeFindPOIMapping(pSub->ServerRequest.caOriginType,
&caTBuff) != SUCCESS)
    {
        vMQ_Log(NULL, NULL, 0, "[FE%d] Src No
Matching POI for <%s>\n",
l A d d r e s s ,
pSub->ServerRequest.caOriginType);
    }
    else
    {
        vMQ_Log(NULL, NULL, 21, "[FE%d] Src POI for
<%s> is <%s>\n",
l A d d r e s s ,
pSub->ServerRequest.caOriginType, caTBuff);
        strcpy( pSub->ServerRequest.caOriginType,
caTBuff);
    }
}
else
{

```

```

vmQ_Log(NULL, NULL, 21, "[FE%ld] origin type is
<%s>\n",
    lAddress, pSub->ServerRequest.caOriginType);
}
/* Check if the Destination type length is equal to */
/* Four. If so then External to internal translation
of POI names */
/* needs to be done. */
if( strlen( pSub->ServerRequest.caDestinationType ) ==
4 )
{
/* POI Mapping translation is required. */
/* Check if there is actually any translation
possible */
i f (
sFeFindPOIMapping( pSub->ServerRequest.caDestinationType,
&caTBuff) != SUCCESS)
{
vmQ_Log( NULL, NULL, 0, "[FE%ld] Dst No
Matching POI for <%s>\n",
l A d d r e s s ,
pSub->ServerRequest.caDestinationType);
}
else
{
vmQ_Log( NULL, NULL, 21, "[FE%ld] Dst POI for
<%s> is <%s>\n",
l A d d r e s s ,
pSub->ServerRequest.caDestinationType, caTBuff);
s t r c m p (
pSub->ServerRequest.caDestinationType, caTBuff);
}
}
else
{
vmQ_Log( NULL, NULL, 21, "[FE%ld] Destination type
is <%s> \n",
lAddress, pSub->ServerRequest.caOriginType);
}
/* If the type of origin is not ADDR or similar,
** then change the comma to (or add) a colon.
*/
if( strcmp( pSub->ServerRequest.caOriginType, "ADDR",
4) != 0
NULL )
|| strchr( pSub->ServerRequest.caOrigin, ':' ) !=
NULL )
{
if ( strcmp( pSub->ServerRequest.caOriginType,
"POSITION", 8) != 0 )
{
/* We need to put it in the form of....
** CITY:NAME
*/

```

```

        i f ( ( c p =
strchr(pSub->ServerRequest.caOrigin, ':') != NULL )
    {
        *cp = '\0';
        s t r c p y ( c a B u f f e r ,
pSub->ServerRequest.caOrigin );
        *cp = ':';
    }
    else
        strcpy(caBuffer, "\0");

        /* Is there a city given? */
        i f ( ( c p =
strchr(pSub->ServerRequest.caOrigin, ',') != NULL)
            strcat(caBuffer, cp+1);
            strcat(caBuffer, ":");

        if (cp != NULL)
        {
            /* There is a city component */
            *cp = '\0';
            s t r c a t ( c a B u f f e r ,
pSub->ServerRequest.caOrigin);
            *cp = ','; /* Restore the comma */
        }
        else
            s t r c a t ( c a B u f f e r ,
pSub->ServerRequest.caOrigin);

        strcpy(pSub->ServerRequest.caOrigin,
caBuffer);
    }
}
VMQ_Log(NULL, NULL, 30, "[FE%d] Done with origin
ADDR\n", lAddress);

if (strncmp(pSub->ServerRequest.caDestinationType,
"ADDR", 4) != 0
|| strchr(pSub->ServerRequest.caDestination, ':')
!= NULL )
{
    if (strncmp(pSub->ServerRequest.caDestinationType,
"POSITION", 8) != 0 )
    {
        /* We need to put it in the form of....
        ** CITY:NAME
        */
        i f ( ( c p =
strchr(pSub->ServerRequest.caDestination, ':')
            != NULL )
        {
            *cp = '\0';
            s t r c p y ( c a B u f f e r ,
pSub->ServerRequest.caDestination );
            *cp = ':';

```

APPENDIX A - PAGE 80 OF 279

```

    }
    else
        strcpy(caBuffer, "\0");

        /* Is there a city given? */
        i f ( ( ( c p
= strchr(pSub->ServerRequest.caDestination, ',') != NULL)
            strcat(caBuffer, cp+1);
            strcat(caBuffer, ":");

            if (cp != NULL)
            {
                /* There is a city component */
                *cp = '\0';
                s t r c a t ( c a B u f f e r ,
pSub->ServerRequest.caDestination);
                *cp = ','; /* Restore the comma */
            }
            else
                s t r c a t ( c a B u f f e r ,
pSub->ServerRequest.caDestination);

            strcpy(pSub->ServerRequest.caDestination,
caBuffer);
        }
    }
    vMQ_Log(NULL, NULL, 30, "[FE%d] Done with Destination
ADDR\n",
        lAddress);

    pSub->bit_map &= ~( BIT_NEXT_MAN | BIT_PREV_MAN |
BIT_CURR_MAN |
        BIT_ACK | BIT_QUERY | BIT_SXOLOCUS | BIT_BRBF |
BIT_BTRF |
        BIT_SXDLOCUS | BIT_NORESPONSE | BIT_DOWNLOAD |
BIT_BINARY);

    for (sagain = 0; sagain < 8; sagain++)
    {
        if (strncmp(
pSub->ServerRequest.aAlternatives[sagain].caAlternatives,
"CONFIG=", 7) == 0)
        {
            /* New config file wanted */
            if (
*(pSub->ServerRequest.aAlternatives[sagain].caAlternatives+7)
                == '\0')
            {
                vMQ_Log(NULL, NULL, 0, "[FE%d] Invalid
Metro Region \n",
                    lAddress);

                i f ( p S u b - > s R e s u l t C o d e < 1 )
pSub->sResultCode=FEERR_INME;

```

APPENDIX A - PAGE 81 OF 279

```

Region " );
                                vSendErrorResponse (pSub, "InvalidMetro
                                return;
                                }
                                else
                                {
                                    strcpy(caBuffer,
pSub->ServerRequest.aAlternatives[sagain].caAlternatives+7);
                                    if (strstr(caBuffer, ".CFG") != NULL)
                                    {
                                        caBuffer[strlen(caBuffer) - 4] =
'\0';
                                    }
                                    }
                                errno = 0;
                                vMQ_Log(NULL, NULL, 10,
pSub->caSCR, caBuffer);
                                "[FE%ld] config <%s>:%s\n", lAddress,
                                if ( strlen(pSub->caConfig) != 0)
                                {
                                    if (lMQU_ValidateName(pMQU_master,
caBuffer) == FAILURE)
                                    {
                                        sprintf(cpbuff,
available at this time.",
                                        "Metro Region %s not
                                        caBuffer);
                                        vMQ_Log(NULL, NULL, 0, "[FE%ld]
%s\n", lAddress, cpbuff);
                                        if (pSub->sResultCode < 1)
pSub->sResultCode=FEERR_SVGD;
                                        vSendErrorResponse (pSub, cpbuff);
                                        return;
                                    }
                                }
                                strcpy(pSub->caConfig, caBuffer);
                                vHandleAuditLog(NULL, NULL,
MQ_MTS_AUDIT_SELMETRO_I , lFID, (void
*)pSub, NULL, 1);
                                pSub->lInternalQuery_count++;
                                pGSub->lInternalQuery_count++;
                                pSub->bit_map |= BIT_ACK;
                                continue;
                            }
                                if (strncmp(

```

```

pSub->ServerRequest.aAlternatives[sagain].caAlternatives,
    "BURST=", 6) == 0)
    {
        i
        (pSub->ServerRequest.aAlternatives[sagain].caAlternatives[6]
         == 'Y')
        pSub->lStatus |= SS_BURST_MODE;
        else
        pSub->lStatus &= ~SS_BURST_MODE;

        pSub->bit_map |= BIT_ACK;
        continue;
    }
    if (strncmp(
pSub->ServerRequest.aAlternatives[sagain].caAlternatives,
    "LANGUAGE=", 9) == 0)
    {
        strcpy(pSub->caLanguage,
pSub->ServerRequest.aAlternatives[sagain].caAlternatives+9);
        errno = 0;
        vMQ_Log(NULL, NULL, 10, "[FE%ld] language
<%s>:%s\n",
pSub->caLanguage);
        lAddress, pSub->caSCR,
        /* Check if the Language file exists now. */
        if (sCheckLanguage(pSub->caLanguage) < 0)
        {
            vMQ_Log(NULL, NULL, 0,
            "[FE%ld] LANGUAGE unknown
<%s>:%s\n",
            lAddress, pSub->caSCR,
pSub->caLanguage);
            sprintf(cpbuff, "Invalid language
request.\n");
            if (pSub->sResultCode < 1)
pSub->sResultCode=FEERR_INNA;
            vSendErrorResponse(pSub, "Invalid
Language name");
            return;
        }
        vHandleAuditLog(NULL, NULL,
            MQ_MTS_AUDIT_SELLANGUAGE, lFID, (void
*)pSub, NULL, 1);
        pSub->bit_map |= BIT_LANGUAGE ;
        continue;
    }

```

APPENDIX A - PAGE 83 OF 279

```

        if (strcmp(
pSub->ServerRequest.aAlternatives[sagain].caAlternatives,
        "DOWNLOAD=", 9) == 0)
        {
            vReset_status_flags(pSub);

            if( pSub->sStateflag == 0 )
            {
                pSub->sStateflag = 1;
            }
            else
            {
                vDeleteTmpfile( pSub );
            }

            sprintf(pSub->caDownload, "%s/%s",
cpDownload_dir,
pSub->ServerRequest.aAlternatives[sagain].caAlternatives+9);
            vMQ_Log(NULL, NULL, 0, "[FE%d] Download
request for [%s]\n", lAddress, pSub->caDownload);

                i                                     f
(sFeFileCheck(pSub->ServerRequest.aAlternatives[sagain].caAlte
rnatives+9)<0)
                {
                    sprintf(cpbuff, "SEI/EnRoute cannot
transfer %s", pSub->caDownload);
                    vMQ_Log(NULL, NULL, 0, "[FE%d] %s\n",
lAddress, cpbuff);

                    i f ( p S u b - > s R e s u l t C o d e < 1 )
pSub->sResultCode=FEERR_SEFO;
                    vSendErrorResponse(pSub, cpbuff);

                    pSub->bit_map |= BIT_NORESPONSE;
                }
                else
                {
                    pSub->lStatus = (pSub->lStatus &
~SS_SEND_QMASK)
                        | SS_SEND_DWNL;

                    pSub->bit_map |= BIT_DOWNLOAD;

                    vHandleAuditLog(NULL, NULL,
MQ_MTS_AUDIT_DOWNLOAD_I, lFID,
(void *)pSub, NULL, 1);
                }
                continue;
            }

            if (strcmp(

```



```

pSub->ServerRequest.aAlternatives[sagain].caAlternatives,
    "SESSION=", 8) == 0)
    {
        strcpy(caBuffer,

pSub->ServerRequest.aAlternatives[sagain].caAlternatives+8);
        sscanf(caBuffer, "%2d%2d%2d%2d",
&lFormat_mode,
        &lCompress_mode, &lDisplay_panes,
&lMap_format);

/* We do not support Phrase compression --
VI */
        if( lCompress_mode == FE_COMPRESS_LZ )
            pSub->lStatus |= SS_LZ_COMPRESS;
        else if( lCompress_mode == FE_COMPRESS_NONE
)
            pSub->lStatus &= ~SS_LZ_COMPRESS;

        pSub->bit_map |= BIT_ACK;
        continue;
    }

/* Specifies the maximum packet size from the
client end. */
/* The lesser of the 2 sizes( client, server) will
be used */
    if (

strncmp(pSub->ServerRequest.aAlternatives[sagain].caAlternatives,
        "MAXPKT=", 7) == 0)
    {
        strcpy(cpbuff,

pSub->ServerRequest.aAlternatives[sagain].caAlternatives+7);
        sPktsize = atoi(cpbuff);

        ipacketflag = 0;

        if( sPktsize > sPacketLimit )
        {
            ipacketflag = 1;
            pSub->sPacketLimit = sPacketLimit;
        }
        else
        if( sPktsize < sMinPacketLimit)
        {
            ipacketflag = 1;
            pSub->sPacketLimit = sMinPacketLimit;
        }
        else
        {
            pSub->sPacketLimit = sPktsize;
        }
    }

```

APPENDIX A - PAGE 85 OF 279

```

        pSub->bit_map |= BIT_ACK;
        continue;
    }
    /* Specifies the maximum burst count from the
client end. */
    /* The lesser of the 2 sizes( client, server) will
be used */
    if (
strncmp(pSub->ServerRequest.aAlternatives[sagain].caAlternatives,
"MAXBURST=", 9) == 0)
    {
        strcpy(cpbuff,
pSub->ServerRequest.aAlternatives[sagain].caAlternatives+9);
        sPktsize = atoi(cpbuff);

        sBurstflag = 0;
        if(( sPktsize > sConfirmMax ) || ( sPktsize
< 1))
        {
            sBurstflag = 1;
            pSub->sBurstCount = sConfirmMax;
        }
        else
        {
            pSub->sBurstCount = sPktsize;
        }

        pSub->bit_map |= BIT_ACK;
        continue;
    }

    /* Termination request from client */
    if (
strncmp(pSub->ServerRequest.aAlternatives[sagain].caAlternatives,
"LOGOUT=", 7) == 0)
    {
        if( strncmp(
pSub->ServerRequest.aAlternatives[sagain].caAlternatives+7,
"Y", 1) == 0 )
        {
            p S u b - > l M s g t y p e =
SPIF_SUBSCRIBER_DISCONNECT;
            sSendHeader( 8, pSub->lSpifID,
pSub->lMsgtype );
            vMQ_Log(NULL, NULL, 10,
" [FE%d] Delete subscriber request
from client\n",
lAddress);
            pSub->sResultCode = LOGOUT_BY_USER;
            vHandleAuditLog(NULL, NULL,

```

APPENDIX A - PAGE 86 OF 279

```

MQ_MTS_AUDIT_CLLOGOUT, lFID, (void
*)pSub, NULL, 1);
vMQ_EventLog(NULL, NULL, MQ_EVB_LOGOUT,
pSub->caSCR, strlen(pSub->caSCR)
);

if( iDelSub( pSub->lSpifID) != SUCCESS)
{
vMQ_Log(NULL, NULL, 0,
"[FE%ld] Unable to delete
subscriber %ld\n",
lAddress, pSub->lSpifID );
}
pSub->bit_map |= BIT_NORESPONSE;
break;
}
}

if(strncmp(pSub->ServerRequest.aAlternatives[sagain].caAlternatives,
"QUERY=", 6) == 0)
{
vReset_status_flags(pSub);
if( pSub->sStateflag == 0 )
{
pSub->sStateflag = 1;
}
else
{
vDeleteTmpfile( pSub );
}
pSub->bit_map |= BIT_QUERY;
/* Determine the type of query.
** Currently, only configs, pois and
languages allowed.
*/
c = pSub->ServerRequest.aAlternatives[sagain].caAlternatives+p =
/* What type of query ? */
if (strncmp(cp, "CONFIG", 6) == 0)
{
/* A type we like */
if ((fp = fopen(pSub->caTmpfile, "w"))
== (FILE*)NULL)
{
if (pSub->sResultCode < 1)
pSub->sResultCode=FEERR_SEFO;
vSendErrorResponse(pSub,
"SEI/EnRoute file open error");
}
}
}
}
APPENDIX A - PAGE 87 OF 279

```

```

                                vMQ_Log(NULL, NULL, 0,
                                "[FE%ld] CONFIG Unable to open
Tempfile\n",
                                lAddress);
                                pSub->bit_map |= BIT_NORESPONSE;
                                }
                                else
                                {
                                (void)sGenerateConfigQuery(fp);
                                pSub->lStatus = (pSub->lStatus &
~SS_SEND_QMASK)
                                | SS_SEND_QCONF;
                                fclose(fp);
                                vHandleAuditLog(NULL, NULL,
MQ_MTS_AUDIT_QUMETRO_I, lFID, (void *)pSub, NULL, 1 );
                                }
                                }
                                else if (strncmp(cp, "POIS", 4) == 0)
                                {
                                vMQ_Log( NULL, NULL, 20,
                                "[ FE % l d ] c a l l
sFeRequestPOIQuery_all %ld\n",
                                lAddress, pSub->lSpifID);
                                if( strlen( pSub->caConfig ) != 0 )
                                {
                                if( sFeRequestPOIQuery_all( pSub
) == FAILURE )
                                {
                                vMQ_Log( NULL, NULL, 20,
                                "[ FE % l d ]
sFeRequestPOIQuery_all failed\n",
                                lAddress);
                                }
                                else
                                {
                                pSub->lResponsePending = 1;
                                }
                                }
                                else
                                {
                                /* empty metroregion */
                                vMQ_Log( NULL, NULL, 0,
                                "[FE%ld] INVALID Metroregion by
%ld\n",
                                lAddress, pSub->lSpifID);
                                strcpy( caBuffer, "Insufficient
Data(Metroregion)");
                                pSub->sResultCode=FEERR_SVGD;
                                if ( pSub->sResultCode < 1 )
                                vSendErrorResponse(pSub, caBuffer);
                                }
                                }

```

```

        return;
    }
    else if (strncmp(cp, "LANG", 4) == 0)
    {
        /* Template languages */
        /* A type we like */
        if ((fp = fopen(pSub->caTmpfile, "w"))
== (FILE*)NULL)
        {
            if (pSub->sResultCode < 1)
                pSub->sResultCode = FEERR_SEFO;
            vSendErrorResponse(pSub,
"SEI/EnRoute file open error");

            vMQ_Log(NULL, NULL, 0,
                "[FE%d] LANG Unable to open
Tempfile\n", lAddress);
            pSub->bit_map |= BIT_NORESPONSE;
        }
        else
        {
            (void)sGenerateLanguageQuery(fp);
            pSub->lStatus = (pSub->lStatus &
~SS_SEND_QMASK)
                | SS_SEND_QLANG;
            fclose(fp);

            vHandleAuditLog(NULL, NULL,
                MQ_MTS_AUDIT_QULANGUAGE_I, lFID,
(void *)pSub, NULL, 1);
        }
        break;
    }
    else if (strncmp(cp, "FILES", 5) == 0)
    {
        sprintf(caTmpFile, "%s/%s",
cpDownload_dir, FE_DOWNLOAD_CAT);

        if ((fp = fopen(caTmpFile, "r")) == NULL)
        {
            if (pSub->sResultCode < 1)
                pSub->sResultCode = FEERR_SEFO;
            vSendErrorResponse(pSub, "SEI/EnRoute file open error");
            pSub->bit_map |= BIT_NORESPONSE;
        }
        else
        {
            /* First Copy the catalog file in
order to avoid transmission
                during updates */

```

APPENDIX A - PAGE 89 OF 279

```

sprintf(pSub->caTmpfile, "%s/download.bak", cpDownload_dir);

if ((to=fopen(pSub->caTmpfile, "w+") != NULL)
    {
while (fgets(caReadBuf, MAX_FILENAME_SIZE, fp) != NULL)
    fputs(caReadBuf, to);

    fflush(to);
    pSub->lStatus = (pSub->lStatus
& ~ SS_SEND_QMASK)
        | SS_SEND_QFILES;
    fclose(to);
    }
else
    {
pSub->sResultCode=FEERR_SEFO;
    if (pSub->sResultCode<1)
vSendErrorResponse(pSub, "SEI/EnRoute file create error");
        pSub->bit_map |=
BIT_NORESPONSE;
    }
    fclose(fp);

vHandleAuditLog(NULL, NULL, AU_QUERY_FILE, lFID, (void *)pSub, 1);
    }
continue;
    }
else
    {
        if (pSub->sResultCode<1)
pSub->sResultCode=FEERR_QUSU;
        vSendErrorResponse(pSub, "Query type not
supported\r");
        pSub->bit_map |= BIT_NORESPONSE;
    }
break;
}

/* If a heartbeat response is received from the
client */
/* update the time and reset status flags. */
if (strncmp(
pSub->ServerRequest.aAlternatives[sagain].caAlternatives,
"HEARTBEAT=", 10) == 0)
    {
        vReset_status_flags(pSub);
    }

```

APPENDIX A - PAGE 90 OF 279

```

        /* HEARTBEAT response from client */
        pSub->lStatus &= ~SS_SEND_HBEAT;
        pSub->lStatus &= ~SS_HBEAT_SENT;
        pSub->bit_map |= BIT_NORESPONSE;
        pSub->lLastCommtime = time(0L);
        continue;
    }

    /* In case a bug is reported then log it */
    if (strncmp(pSub->ServerRequest.aAlternatives[sagain].caAlternatives,
                "BGRPT=", 6) == 0)
    {
        vReset_status_flags(pSub);

        /* Bug report data - cannot mix with other
requests */
        strcpy( caBuffer,
pSub->ServerRequest.aAlternatives[sagain].caAlternatives +6);
        vMQ_Log(NULL, NULL, 0, "[FE%d] BUGREPORT %s
\n",
                lAddress, caBuffer );
        vHandleAuditLog(NULL, NULL,
                MQ_MTS_AUDIT_BUGRPT, lFID, (void
*)pSub, NULL, 1);
        pSub->bit_map |= BIT_ACK;
        continue;
    }

    /* In case a bearing data */
    if (strncmp(pSub->ServerRequest.aAlternatives[sagain].caAlternatives,
                "BEARING=0;", 10) == 0)
    {
        pSub->ServerRequest.sOriginBearing = atoi(
pSub->ServerRequest.aAlternatives[sagain].caAlternatives +10);
        vMQ_Log(NULL, NULL, 29, "[FE%d] Origin
Bearing %d \n",
                l A d d r e s s ,
pSub->ServerRequest.sOriginBearing );

        if( ( pSub->ServerRequest.sOriginBearing <
0 ) ||
( pSub->ServerRequest.sOriginBearing > 255
) )
        {
            pSub->ServerRequest.sOriginBearing = -1;
        }
        pSub->bit_map |= BIT_ACK;
        continue;
    }
}

```

APPENDIX A - PAGE 91 OF 279

```

if (strncmp(pSub->ServerRequest.aAlternatives[sagain].caAlternatives,
           "BEARING=D;", 10) == 0)
    {
        pSub->ServerRequest.sDestinationBearing =
        atoi(
        pSub->ServerRequest.aAlternatives[sagain].caAlternatives +10);
        vMQ_Log(NULL, NULL, 29, "[FE%d] Dest.
        Bearing %d \n",
        l A d d r e s s ,
        pSub->ServerRequest.sDestinationBearing );
        if ( ( pSub->ServerRequest.sDestinationBearing
        < 0 ) ||
        ( pSub->ServerRequest.sDestinationBearing >
        255 ) )
            {
                pSub->ServerRequest.sDestinationBearing
                = -1;
            }
        pSub->bit_map |= BIT_ACK;
        continue;
    }
    /* If the request is for a maneuver the next,
    previous or current */
    /* maneuvers are supported. */

if (strncmp(pSub->ServerRequest.aAlternatives[sagain].caAlternatives,
           "MANEUVER=", 9) == 0)
    {
        if (pSub->sStateflag == 0)
            {
                if (pSub->sResultCode < 1)
                    vSendErrorResponse(pSub,
                    "Invalid Maneuver Request");
                return;
            }
        /* Requesting maneuver information -
        ** not a route request.
        */
        if (strncmp(
        pSub->ServerRequest.aAlternatives[sagain].caAlternatives+9,
        "NEXT", 4) == 0)
            {
                /* Requesting next one */
                pSub->bit_map |= BIT_NEXT_MAN;
                sStep = 1;
            }
    }

```

APPENDIX A - PAGE 92 OF 279

```

    }
    else if (strcmp(
pSub->ServerRequest.aAlternatives[sagain].caAlternatives+9,
        "CURRENT", 7) == 0)
    {
        /* Retry the current */
        pSub->bit_map |= BIT_CURR_MAN;
        sStep = -1;
        pSub->lMsgid--;
    }
    else if (strcmp(
pSub->ServerRequest.aAlternatives[sagain].caAlternatives+9,
        "PREVIOUS", 8) == 0)
    {
        if(
pSub->ServerRequest.aAlternatives[sagain].caAlternatives[17]
            == '=' )
        {
            /* sStep represents previous msgid
*/
            sStep = atoi(
pSub->ServerRequest.aAlternatives[sagain].caAlternatives+18);
        }
        else
        {
            /* If previous msgid not given,
assume the
                previous msgid */
            sStep = pSub->lMsgid-1;
pSub->lMsgidsent[pSub->lMsgid-1];
        }
        pSub->bit_map |= BIT_PREV_MAN;
    }
    else
    {
        if (pSub->sResultCode < 1)
pSub->sResultCode = FEERR_INRE;
        vSendErrorResponse(pSub, "Invalid
Maneuver Request Directive");
        pSub->bit_map |= BIT_NORESPONSE;
    }
}

/* 4/17/95 ND Check for STRIPMAP, FORMAT and
ROUTE BAND options */

if (strcmp(pSub->ServerRequest.aAlternatives[sagain].caAlternatives, "STRIPMAP=", 9) == 0)
{

```

APPENDIX A - PAGE 93 OF 279

```

if (strncmp (pSub->ServerRequest.aAlternatives[sagain].caAlternatives+9, "Y", 1) == 0)
    {
        pSub->lStatus |= SS_STRIPMAP;
        continue;
    }

if (strncmp (pSub->ServerRequest.aAlternatives[sagain].caAlternatives, "FORMAT=", 7) == 0)
    {

if (strncmp (pSub->ServerRequest.aAlternatives[sagain].caAlternatives+7, "BTRF,DL", 7) == 0)
    {
        pSub->lStatus |= SS_BTRF;
        pSub->lStatus |= SS_ROUTE_DWNL;
        pSub->bit_map |= BIT_BINARY;
        pSub->bit_map |= BIT_BTRF;
        pSub->lStatus &= ~SS_SEND_DWNL;
        pSub->bit_map &= ~BIT_DOWNLOAD;

        continue;
    }
else if
(strncmp (pSub->ServerRequest.aAlternatives[sagain].caAlternatives+7, "BRF,DL", 6) == 0)
    {
        pSub->lStatus |= SS_ROUTE_DWNL;
        pSub->lStatus &= ~SS_SEND_DWNL;
        pSub->bit_map &= ~BIT_DOWNLOAD;
        pSub->bit_map |= BIT_BINARY;

        continue;
    }
else if
(strncmp (pSub->ServerRequest.aAlternatives[sagain].caAlternatives+7, "DL", 2) == 0)
    {
        pSub->bit_map |= BIT_BINARY;
        pSub->lStatus |= SS_SEND_DWNL;
        pSub->lStatus |= SS_SEND_BINARY;
        pSub->lStatus |= SS_ROUTE_DWNL;

        continue;
    }
}

if
(strncmp (pSub->ServerRequest.aAlternatives[sagain].caAlternatives, "ROUTEBAND=", 10) == 0)
    {

```

APPENDIX A - PAGE 94 OF 279

```

        vMQ_Log(NULL, NULL, 29, "[FE%ld]
m%d,l%d,p%d,i%d,s%c,sd%c\n",
        lAddress, pSub->OriginLocus.sMap,
        pSub->OriginLocus.sLayer,
        pSub->OriginLocus.sParcel,
        pSub->OriginLocus.sIndex,
        pSub->OriginLocus.spot,
        pSub->OriginLocus.side);
    }

    /* in case of destination locus the information
is written into */
    /* the structure elements */

    if (strncmp(pSub->ServerRequest.aAlternatives[sagain].caAlternatives,
        "SXLOCUS=D", 9) == 0)
    {
        pSub->bit_map |= BIT_SXDLOCUS;
        strcpy(casxlocusd,
pSub->ServerRequest.aAlternatives[sagain].caAlternatives+10);
        vMQ_Log(NULL, NULL, 29, "[FE%ld] dlocus
%s\n",
            lAddress, casxlocusd);

        sscanf(casxlocusd, "%hd-%hd-%hd-%hd;%c;%c",
            &pSub->DestinationLocus.sMap,
            &pSub->DestinationLocus.sLayer,
            &pSub->DestinationLocus.sParcel,
            &pSub->DestinationLocus.sIndex,
            &pSub->DestinationLocus.spot,
            &pSub->DestinationLocus.side);

        vMQ_Log(NULL, NULL, 29, "[FE%ld]
m%d,l%d,p%d,i%d,s%c,sd%c\n",
        lAddress, pSub->DestinationLocus.sMap,
        pSub->DestinationLocus.sLayer,
        pSub->DestinationLocus.sParcel,
        pSub->DestinationLocus.sIndex,
        pSub->DestinationLocus.spot,
        pSub->DestinationLocus.side);
    }
}

vMQ_Log(NULL, NULL, 25, "[FE%ld] bit_map is %.8x\n",
    lAddress, pSub->bit_map );

if (pSub->bit_map & BIT_NORESPONSE)
{
    return;
}

vMQ_Log(NULL, NULL, 25, "[FE%ld] BIT_NORESPONSE not
set!\n", lAddress);

```

APPENDIX A - PAGE 96 OF 279

```

if (pSub->bit_map & BIT_DOWNLOAD)
{
    sGenerateDownload(pSub);
    return;
}

if (pSub->bit_map & BIT_QUERY)
{
    /* Start the query response back */
    vMQ_Log(NULL, NULL, 10, "[FE%ld] sending query
file!\n", lAddress);
    vSendQueryFile(pSub);
    return;
}

vMQ_Log(NULL, NULL, 25, "[FE%ld] BIT_QUERY not set!\n",
lAddress);

if (pSub->bit_map & (BIT_NEXT_MAN))
{
    if(pSub->lStatus & SS_SEND_DWNL)
        sprintf(caTmpFile, "%s", pSub->caDownload);
    else
        sprintf(caTmpFile, "%s", pSub->caTmpfile);

    if(stat(caTmpFile, pStat) < 0 )
    {
        if( errno == ENOENT )
        {
            if (pSub->sResultCode<1)
                pSub->sResultCode=FEERR_INRE;
            vSendErrorResponse(pSub,
"Invalid Next Maneuver Request");

            return;
        }
    }

    if(pSub->lManeuverOffsets[pSub->lMsgid] >
pSub->lQueryFilesize )
    {
        if (pSub->sResultCode<1)
            pSub->sResultCode=FEERR_ALME;
        vSendErrorResponse(pSub, "Already
at the last message");

        return;
    }

    if (pSub->lStatus & SS_BURST_MODE)
    {
        short sBurstCount;

```

APPENDIX A - PAGE 97 OF 279

```

        sBurstCount = 0;
        while( pSub->lManeuverOffsets[pSub->lMsgid]
<=
pSub->sBurstCount )
        {
            if((pSub->lStatus & SS_ROUTE_DWNL) ||
(pSub->lStatus & SS_SEND_DWNL))
vSendDownload(pSub,1,++sBurstCount);
            else
                vSendManeuver(pSub, 1,
++sBurstCount);
                if (sInterPacketGap > 0)
                    sleep(sInterPacketGap);
        }
    }
    else
        if((pSub->lStatus & SS_ROUTE_DWNL) ||
(pSub->lStatus & SS_SEND_DWNL))
            vSendDownload(pSub,sStep,0);
        else
            vSendManeuver(pSub, sStep, 0);
    return;
}
else if (pSub->bit_map & (BIT_CURR_MAN))
{
    if(pSub->lStatus & SS_SEND_DWNL)
        sprintf(caTmpFile, "%s",pSub->caDownload);
    else
        sprintf(caTmpFile,"%s",pSub->caTmpfile);

    if(stat(caTmpFile, pStat) < 0 )
    {
        if( errno == ENOENT )
        {
            if (pSub->sResultCode<1)
pSub->sResultCode=FEERR_INRE;
                vSendErrorResponse(pSub,
"Invalid Current Maneuver Request");

                return;
            }
        }

        if(pSub->lManeuverOffsets[pSub->lMsgid] >
pSub->lQueryFilesize )
        {
            if (pSub->sResultCode<1)
pSub->sResultCode=FEERR_ALME;
                vSendErrorResponse(pSub, "Already
at the last message");
        }
    }
}

```

APPENDIX A - PAGE 98 OF 279

```

        return;
    }

    if((pSub->lStatus & SS_ROUTE_DWNL) ||
(pSub->lStatus & SS_SEND_DWNL))
        vSendDownload(pSub, sStep, 0);
    else
        vSendManeuver(pSub, sStep, 0);

    return;
}
else if( pSub->bit_map & (BIT_PREV_MAN))
{
    if(pSub->lStatus & SS_SEND_DWNL)
        sprintf(caTmpFile, "%s", pSub->caDownload);
    else
        sprintf(caTmpFile, "%s", pSub->caTmpfile);

    if(stat(caTmpFile, pStat) < 0 )
    {
        if( errno == ENOENT )
        {
            if(pSub->sResultCode<1)
pSub->sResultCode=FEERR_INRE;
            vSendErrorResponse(pSub,
"Invalid Previous Maneuver Request");

            return;
        }
    }

    /* sStep represents msgid to start from */
    /* if sStep == -1, start from beginning of file
*/
    if( sStep == -1 )
    {
        if( pSub->bit_map & BIT_QUERY )
            vSendQueryFile(pSub);
        else
        {
            if((pSub->lStatus & SS_ROUTE_DWNL) ||
(pSub->lStatus & SS_SEND_DWNL))
            {
                vMQ_Log(NULL, NULL, 8, "About to
download route file\n");
                vMQ_Log(NULL, NULL, 12, "LSTATUS
= %08x\n", pSub->lStatus);
                sGenerateDownload(pSub);
            }
            else
            {
                if(stat(pSub->caTmpfile, pStat) <
0 )
                {

```

APPENDIX A - PAGE 99 OF 279

```

                                if( errno == ENOENT )
                                {
if(pSub->sResultCode<1) pSub->sResultCode=FEERR_INRE;
vSendErrorResponse(pSub, "Invalid Previous Maneuver Request");

                                return;
                                }
                                }
                                vSendRouteFile(pSub);
                                }
                                }
else
{
    /* Get corresponding msgid */
    lMatch = 0;
    for( i=0; i<pSub->lNum_msgs; i++)
    {
        if( pSub->lMsgidsent[i] == sStep )
        {
            lMatch = 1;
            break;
        }
    }
    if( lMatch == 1 )
    {
        pSub->lMsgid = i;
        if (pSub->lStatus & SS_BURST_MODE)
        {
            short sBurstCount;
            sBurstCount = 0;

                                w             h             i             l             e             (
pSub->lManeuverOffsets[pSub->lMsgid] <=
                                pSub->lQueryFilesize &&
                                s B u r s t C o u n t <
pSub->sBurstCount )
                                {
                                if ((pSub->lStatus &
SS_ROUTE_DWNL) || (pSub->lStatus & SS_SEND_DWNL))
vSendDownload(pSub,1,++sBurstCount);
                                else
vSendManeuver(pSub,1,++sBurstCount);

                                if (sInterPacketGap > 0)
                                    sleep(sInterPacketGap);
                                }
                                }
                                else
                                {

```

APPENDIX A - PAGE 100 OF 279

```

        if((pSub->lStatus & SS_ROUTE_DWNL)
|| (pSub->lStatus & SS_SEND_DWNL))
            vSendDownload(pSub,
pSub->lMsgid, 0);
            else
                vSendManeuver(pSub,
pSub->lMsgid, 0);
        }
    }
    else
    {
        /* Illegal message id with PREVIOUS
message */
        if (pSub->sResultCode < 1)
pSub->sResultCode=FEERR_NOMS;
        vSendErrorResponse(pSub, "Non existent
msgid\r");
    }
}
return; /* Handled MANEUVER request */
}

if (pSub->bit_map & BIT_BRBF)
{
    if( pSub->sStateflag == 0 )
    {
        pSub->sStateflag = 1;
    }
    else
    {
        vDeleteTmpfile( pSub );
    }

    /* Send route request */
    vMQ_Log( NULL, NULL, 10, "[FE%d] call
sFeRequestRoute_all %d\n",
lAddress, pSub->lSpifID);
    if( sFeRequestRoute_all( (SUBSCRIBER *)pSub ) ==
FAILURE)
    {
        vMQ_Log( NULL, NULL, 20,
" [FE%d] sFeRequestRoute_all failed\n",
lAddress);
    }
    else
        pSub->lResponsePending = 1;

    return;
}
else

```

APPENDIX A - PAGE 101 OF 279

```

    {
        vReset_status_flags(pSub);
    }

    /* Check if a map of exploration is wanted */
    pSub->lStatus &= ~SS_SEND_QMASK;

    if( ( (strlen( pSub->ServerRequest.caOriginType ) ==
0 ) ||
== 0 ) ||
        (strlen( pSub->ServerRequest.caDestinationType )
        (strlen( pSub->caConfig ) == 0 ) ) ||
        ((strlen( pSub->ServerRequest.caOrigin ) == 0 )
&&
        ((pSub->ServerRequest.lLatitude ==
DEFAULT_LAT_LONG ) &&
        (pSub->ServerRequest.lLongitude ==
DEFAULT_LAT_LONG )))
    {
        if (pSub->bit_map & BIT_ACK )
        {
            pSub->lMsgtype = SPIF_PASS_THROUGH;
            vSendOkResponse(pSub);
            return;
        }

        vMQ_Log(NULL, NULL, 25, "[FE%ld] BIT_ACK not
set!\n", lAddress);

        /* empty origintype/ destinationtype/ metroregion
*/
        vMQ_Log( NULL, NULL, 0,
        "[ F E % l d ] I N V A L I D
Origin/DestinationType/Metroregion by %ld\n",
        lAddress, pSub->lSpifID);

        strcpy( caBuffer,
        " I n s u f f i c i e n t
Data(Origin/OriginType/DestinationType/Metroregion)");

        i f ( p S u b - > s R e s u l t C o d e < 1 )
pSub->sResultCode=FEERR_SVGD;
        vSendErrorResponse(pSub, caBuffer);

    }
    else
    {
        if( pSub->sStateflag == 0 )
        {
            pSub->sStateflag = 1;
        }
        else
        {
            vDeleteTmpfile( pSub );
        }
    }
}

```

APPENDIX A - PAGE 102 OF 279

```

    }
    if(strlen( pSub->ServerRequest.caOrigin ) == 0 )
    {
        if ( (pSub->ServerRequest.lLatitude ==
DEFAULT_LAT_LONG ) ||
        (pSub->ServerRequest.lLongitude ==
DEFAULT_LAT_LONG ))
        {
            if ( pSub->sResultCode < 1 )
pSub->sResultCode=FEERR_INLA;
            vSendErrorResponse( pSub, "Invalid
Latitude/Longitude");
            return;
        }
        strcpy( pSub->ServerRequest.caOriginType,
"POSITION" );
    }
    /* Send route request */
    vMQ_Log( NULL, NULL, 10, "[FE%ld] call
sFeRequestRoute_all %ld\n",
lAddress, pSub->lSpifID);
    if( sFeRequestRoute_all( (SUBSCRIBER *)pSub ) ==
FAILURE)
    {
        vMQ_Log( NULL, NULL, 20,
"[FE%ld] sFeRequestRoute_all failed\n",
lAddress);
    }
    else
        pSub->lResponsePending = 1;
    }
} /* end if(parse OK) */
return;
}

/*::::::::::::::::::::::::::::::::::::::::::::::::::
::::::::::::::::::
:: Function: vReset_status_flags
::
:: Purpose :
:: Reset Status flags
::
:: Returns: None.
::
:: Input: Pointer to Subscriber Structure
::
:: Output: None.
::
::
:: Revision:
:: WHO --WHEN-- WHAT

```

APPENDIX A - PAGE 103 OF 279

```

:: Norik 04/26/95 From Nippon Denso Code
:::
:::*/

#ifdef ANSI
void vReset_status_flags(
SUBSCRIBER *pSub)
#else
void vReset_status_flags(pSub)
SUBSCRIBER *pSub;
#endif
{
    if(!(pSub->bit_map & BIT_BTRF) && !(pSub->bit_map &
BIT_BRBF))
    {
        pSub->lStatus &= ~SS_BTRF;
        pSub->lStatus &= ~SS_BRBF;
        pSub->lStatus &= ~SS_STRIPMAP;
    }

    if(!(pSub->bit_map & BIT_BINARY) && !(pSub->bit_map &
BIT_BRBF))
    {
        pSub->lStatus &= ~SS_ROUTE_DWNL;
        pSub->lStatus &= ~SS_SEND_BINARY;
    }
}

/*:
:::
::: Function: sFeFileCheck
:::
::: Purpose :
::: This routine validates a file before a download can
::: take place.
:::
::: Returns: Negative value if file cannot be downloaded.
:::
::: Input: Pointer File Name
:::
::: Output: None.
:::
:::
::: Revision:
::: WHO --WHEN-- WHAT
::: Norik 04/20/95 Original
:::
:::*/

#ifdef ANSI
short sFeFileCheck(char *cpFile)
#else
short sFeFileCheck(cpFile)
char *cpFile;

```

APPENDIX A - PAGE 104 OF 279

```

#endif
{
    char          caDwnFiles[MAX_FILENAME_SIZE];
    char          caBuffer[MAX_FILENAME_SIZE];
    struct stat   stbuf;
    FILE          *fp;

    /* Does file exist? */
    sprintf(caDwnFiles, "%s/%s", cpDownload_dir, cpFile);

    if (stat(caDwnFiles, &stbuf)<0)
    {
        vMQ_Log( NULL, NULL, 20, "[FE%ld] sFeFileCheck stat
failed for %s\n", lAddress, caDwnFiles);
        return(-1);
    }

    /* if file is a symbolic link, don't transfer it */
    if ((stbuf.st_mode & S_IFMT) == S_IFLNK)
    {
        vMQ_Log( NULL, NULL, 20, "[FE%ld] sFeFileCheck %s is
a linked file\n", lAddress, caDwnFiles);
        return(-1);
    }

    sprintf(caDwnFiles,      "%s/%s",      cpDownload_dir,
FE_DOWNLOAD_CAT);

    /* Can we open file list? */
    if ((fp=fopen(caDwnFiles,"r"))<0)
    {
        vMQ_Log( NULL, NULL, 20, "[FE%ld] sFeFileCheck open
fialed for %s\n", lAddress, caDwnFiles);
        return(-1);
    }

    /* Is requested file in our list? */
    while (fgets(caBuffer, MAX_FILENAME_SIZE, fp) != NULL)
    {
        if(strstr(caBuffer,cpFile) != NULL)
        {
            fclose(fp);
            return(1);
        }
    }

    fclose(fp);
    return(-1);
}

```

APPENDIX A — PAGE 105 OF 279

```

#include "fe_common.h"

#define INIT_RESET_WAIT 300 /* Initial reset wait time */
#define TEMP_BUFF_SIZE 128

short   sMsglen      = 0; /* Actual message length */
int     iDebug       = 0; /* Default Debug level. */
int     iDataPort    = -1; /* Initial data port number */
int     iListenPort  = -1; /* Initial Listen port number */
short   sMaxPackets  = 2; /* Maximum maneuvers per packet */
short   sPacketFlag  = 1; /* By default, each packet gets a
header */
int     ipacketflag  = 0; /* Flag to indicate if packet size
is changed */
short   sBurstflag   = 0; /* Flag to indicate if burst size is
changed */
short   sConfirmMax  = 5; /* Maximum packets before confirm
in burst */
short   sPacketLimit = 220; /* Maximum packet size (Default ARDIS
size) */
short   sMinPacketLimit = MINPACKETSIZE ; /* Minimum packet size
(Phase1) */
short   sMultipleFlag = 0; /* Flag to indicate more read
needed */
short   sInterPacketGap = 0; /* Indicates if interpacket gap is
needed */
short   sDefaultBaud = 4800; /* Default baud rate */
short   sTransmitLimit = 220; /* Maximum transmission limit */
int     socket_port_num = {0}; /* Socket port number accept from
config file */
long    lfe_tcp      = MQ_MTLLOW_FE_NET; /* Default Front End
TCP ID */
long    lQID         = MQ_DEFAULT_QUEUE_ID; /* Default Queue ID
*/
long    lDBETimeout  = DBETIMEOUT; /* Default value if
server guide */
/* response
times out */
unsigned long ulSessionID = 0; /* stores the session id
*/

short   sAckPending = 0; /* Flag to indicate if
Acknowledgements are */
/* pending */
long    lHeartbeat  = 300; /* Heartbeat time after which a
heart beat is */
/* sent to the client to check
if awake */
long    lHeartbeat_wait = 30; /* heartbeat waits for this
time after */
/* heartbeat is sent.
*/
short   sTerm_After_Service = 0; /* Flag to indicate if service
should be */
/* terminated after
service */

```

APPENDIX A - PAGE 107 OF 279

```

short      sGateDisconnectFlag = 0; /* Flag to indicate if system
will accept */
client */
/* any message from

Q_HEAD    sHead;          /* Queue head for the subscriber queue */
Q_HEAD    sConfig;       /* Queue head for the valid DBEs list */
Q_HEAD    *pQConfig;     /* Pointer to the first element in the valid
DBEs list */
Q_HEAD    *pQhead = &sHead; /* Pointer to first element in
subscriber list */

long      lFID; /* Front End ID */
long      lSize; /* Global size variable */
int       argcnt; /* Arguments count */
long      lg_addr; /* Global address variable */
int       bit_map; /* Global variable to indicate the status */
/* bits are used to indicate ack and
response required */
long      lFrontID; /* Original Front end ID specified at command
line */
long      lAddress; /* Global address variable */
int       last_baud;
time_t    start_time;
long      lMap_format;
long      lFormat_mode;
void      *pMQU_master;
void      *pvMQ_master;
long      lLastCommtime; /* Store the last Acknowledge
received time */
int       iQueue_master;
long      lCompress_mode;
long      lDisplay_panes;
struct    sockaddr in addr;
char      caBuff[MAX_MSG_SIZE];
char      caExtBuff[MAX_MSG_SIZE];
char      caID[FE_SUBSCRIBER_LEN+1];
char      caOrigin[MAX_ORIGIN_SIZE];
char      caLimitValue[MAX_LIMIT_SIZE];
char      caOriginType[MAX_ORIGIN_TYPE_SIZE];
char      caDestination[MAX_DESTINATION_SIZE];
char      caCompressionMarker[COMP_MARKER_SIZE];
char      caDestinationType[MAX_DESTINATION_TYPE_SIZE];
char      caAlternative[MAX_ALTERNATIVES][MAX_ALTERNATIVE_SIZE];

char      *cpQID;
char      *cpFrontID;
char      *cpConfigPath;
char      *caCommDevice;
char      *caDeviceConfig;

FILE      *pMsgsfile = NULL;
SUBSCRIBER *pGSub = NULL; /* Pointer to the Gateway
subscriber structure */

extern UT_DISPATCHTABLE DTable[];

```

APPENDIX A - PAGE 108 OF 279

```

:: Revision:
:: WHO      --WHEN--  WHAT
:: Raju     10/10/94   Original
:::.....:
:::.....:*/

SPIF_HEADER *pReceiveExtMsg( Qwatch, lLength )
void      *Qwatch;
long      lLength;
{
    long len;
    static short count=0;
    static long   lmsgsize;
    static long   lmsgtype;
    static long   lspifID;
    SPIF_HEADER  spif;
    SPIF_HEADER *pSpif_header = &spif;

    /* initialize multiple read to zero */
    sMultipleFlag = 0;

    /* check if there is something to read */
    if( lLength <= 0 )
    {
        return (NULL);
    }

    /* check If we have read the first four bytes */
    while( count < 4 )
    {
        /* read one byte at a time */
        if (lMQ_GetData(Qwatch, iDataPort, caBuff, 1 ) != 1 )
        {
            vMQ_Log(NULL,NULL,0,
                "[FRONTEND] Couldn't read spifsync. byte
%d\n", count );
            count = 0;
            return (NULL);
        }

        /* decrement number of bytes to be read */
        lLength -= 1;

        /* check if the first byte matches */
        if( caBuff[0] != sync[count] )
        {
            vMQ_Log(NULL,NULL,0,
                "[FRONTEND] Invalid spifsync. byte %d %x\n",
                count, caBuff[0] );
            lMQ_GetData(Qwatch, iDataPort, caBuff, lLength );
            count = 0;
            return (NULL);
        }

        count++;
    }
}

```

APPENDIX A – PAGE 111 OF 279

```

        if( lLength == 0)
            return (NULL);
    }
    if( count < 8 )
    {
        if( lLength < 4 )
            return (NULL);

        /* read msgsize */
        if ( lMQ_GetData(Qwatch, iDataPort, (void*)&lmsgsize,
            sizeof(long)) != sizeof(long))
        {
            count = 0;
            vMQ_Log(NULL, NULL, 0, "[FRONTEND] Couldn't read
spifmsgsize.\n");
            lMQ_GetData(Qwatch, iDataPort, caBuff, lLength);
            return (NULL);
        }

        /* decrement number of bytes to be read and increment
bytes read */
        lLength -= 4;
        count += 4;
    }

    if( lLength < lmsgsize )
    {
        return (NULL);
    }
    else
    {
        /* read SPIFID */
        if (lMQ_GetData(Qwatch, iDataPort, (void*)&lspifID,
            sizeof(long)) != sizeof(long))
        {
            vMQ_Log(NULL, NULL, 0, "[FRONTEND] Couldn't read
spifID.\n");
            count = 0;
            lMQ_GetData(Qwatch, iDataPort, caBuff, lLength);
            return (NULL);
        }

        /* decrement number of bytes to be read and increment
bytes read */
        lLength -= 4;
        count += 4;

        /* read msgtype */
        if (lMQ_GetData(Qwatch, iDataPort, (void*)&lmsgtype,
            sizeof(long)) != sizeof(long))
        {
            vMQ_Log(NULL, NULL, 0, "[FRONTEND] Couldn't read
SPIFmsgtype.\n");
            lMQ_GetData(Qwatch, iDataPort, caBuff, lLength);
            count = 0;

```

APPENDIX A - PAGE 112 OF 279

```

:: Returns:
::
:: Input: Input parameters.
::
:: Output:
::
:: Globals:
::
:: Called Routines:
::
:: Revision:
:: WHO      --WHEN--  WHAT
:: Raju     08/08/94  Original
:::
:::
:::*/

void main(argc, argv)
int argc;
char **argv;
{
    char          caTempFilename[36];
    char          *cp;
    short         sagain = 1;
    void          *mqwatch = NULL;
    void          *mq = NULL;
    short        stype;
    long          now;
    long          lSelected;
    long          lLength;
    long          lLen;
    MQ_HEADER    *mqHeader;
    struct timeval timeout;
    struct tm     *pTime;
    SPIF_HEADER  tspif;
    SPIF_HEADER  *spif_head;
    SPIF_HEADER  *Newspif_head = &tspif;

    /* So that all temp files are commonly usable */
    umask(0);

    /* create a new linked list head for subscribers */
    q_newlist(pQhead);
    signal(SIGALRM, vAlarm_proc);

#ifdef DEBUG
    if( iDebug > 5 )
    {
        sprintf( caTempFilename, "msgs.%ld", getpid());
        if (( pMsgsfile = fopen(caTempFilename, "w") ) == NULL)
        {
            fprintf(stderr, "\n Unable to open msgs.pid\n");
            fprintf(stderr, "Exiting\n");
            exit(0);
        }
    }
#endif
}

```

APPENDIX A — PAGE 114 OF 279

```

/*****
fprintf(pMsgsfile, "\nSIZE MQ_HEADER %ld, MQ_TERMINATE
%ld, MQ_RESET \
%ld, ", sizeof(MQ_HEADER), sizeof(MQ_TERMINATE),
sizeof(MQ_RESET));
fprintf(pMsgsfile, "MQ_OP_ADDSERVICE %ld, MQ_STATUS_FE
%ld, ",
sizeof(MQ_OP_ADDSERVICE), sizeof(MQ_STATUS_FE));
*****/
}
#endif

/* Parse the command line options */
while (sagain)
{
switch (getopt(argc, argv, "f:q:"))
{
case 'f': /* FrontID Frontend ID */
cpFrontID = optarg;
break;

case 'q': /* QID Queue ID */
cpQID = optarg;
break;

case '?': /* Unknown argument */
fprintf(stderr, "%s: Unknown argument %s\n", argv[0],
argv[optind]);
vFePrintUsage(argv[0]);

fprintf(stderr, "Exiting\n");
exit(GERR_USAGE);

default:
sagain = 0;
break;
}
}

/* if a QID is specified then use it otherwise use default
QID */
if( cpQID != NULL )
{
lQID = atoi(cpQID);
}

/* check if QID is within range */
if( lQID < MQ_DEFAULT_QUEUE_ID || lQID > MQ_MAX_QUEUE_ID )
{
fprintf(stderr, "[FRONTEND] Invalid QID. ValidRange 1
to 10 \n");
fprintf(stderr, "Exiting\n");
exit(GERR_PROCESSING);
}
}

```

APPENDIX A - PAGE 115 OF 279

```

/* check if the FID is within range */
if( sFeCheckFID() < 0 )
{
    fprintf(stderr,
        "[FRONTEND] Invalid FrontEnd ID. ValidRange 1000
to 2999 \n");
    fprintf(stderr, "Exiting\n");
    exit (GERR_PROCESSING);
}

/* Get unique frontend id */
lAddress = getpid();
lFID = lAddress;
lFID = (lFrontID << 16) | lFID;

/* attach the frontend to the queue */
if ((iMQ_AttachQueueEx (&mqwatch, lQID, lAddress, 0, lFID))
< 0)
{
    fprintf(stderr, "[FRONTEND] Cannot attach to queue
main\n");
    fprintf(stderr, "Exiting\n");
    exit (GERR_QATTACH);
}

/* read the queconfiguration file */
if (iMQU_ReadConfig (&mqu) < 0)
{
    fprintf(stderr, "[FRONTEND] iMQU_ReadConfig error\n");
    iMQ_Terminate(mqwatch);
    fprintf(stderr, "Exiting\n");
    exit(GERR_PROCESSING);
}

/* assign the pointer to global variables */
pvMQ_master = (void *)mqwatch;
pMQU_master = (void *)mqu;

/* terminate handler */
signal(SIGTERM, vFeHandleSigTerm);

/* Timeout for initial RESET is 5 minutes */
timeout.tv_usec = 0;
timeout.tv_sec = INIT_RESET_WAIT;

/* Inital call for vMQ_log with high debug value */
vMQ_Log(pvMQ_master, pMQU_master, 90, "[FRONTEND] Dummy Call
\n");

/* Initial RESET while loop */
while(1)
{
    /* Look for a private reset message only */
    if ((lSelected =
        lMQ_QueueWatch(mqwatch, MQ_PRIVATE_ONLY,
&timeout)) == FAILURE )

```

APPENDIX A - PAGE 116 OF 279

```

    {
        vMQ_Log(NULL, NULL, 0, "[FRONTEND] error
lMQ_QueueWatch private\n");
        vFeHandleTerminate(TERMINATE_ABORT);
    }
    else if( lSelected == (FAILURE -1) )
    {
        vMQ_Log(NULL, NULL, 0, "[FRONTEND] Private
Listener Died\n");
        vFeHandleTerminate(TERMINATE_ABORT);
    }
    else if( lSelected < 0 )
    {
        vMQ_Log(NULL, NULL, 0, "[FRONTEND] External
Listener Died\n");
        vFeHandleTerminate(TERMINATE_ABORT);
    }
    else if( lSelected == 0 )
    {
        /* timed out on reset */
        vMQ_Log(NULL, NULL, 0, "[FRONTEND] TIMEOUT for
RESET\n");
        vFeHandleTerminate(TERMINATE_ABORT);
    }

    /* Expecting first Reset message */
    /* Here when there is data available */
    if ((lSelected & MQ_PRIVATE_FD) != 0)
    {
        /* get data from the queue */
        lLength = lMQ_GetQueueMessage(mqwatch,
MQ_PRIVATE_FD, caBuff,
sizeof(caBuff), MSG_NOERROR );

        if( lLength < 0 )
        {
            /* Error has occured */
            vMQ_Log(NULL, NULL, 0,
"[FRONTEND] Insufficient buffersize OR
Invalid \
value/address OR bad mqwatch \n");
            vFeHandleTerminate(TERMINATE_ABORT);
        }
        else
        if( lLength == 0 )
        {
            /* no message continue */
            vMQ_Log(NULL, NULL, 5, "[FRONTEND] No message
yet try again\n");
            continue;
        }
        else
        {
            /* received the message */
            mqHeader = (MQ_HEADER *)caBuff;

```

APPENDIX A — PAGE 117 OF 279

```

dispatch it */      /* check if it is a reply or a command and
*/                /* If ReplyID is zero then it is a command
0 )                if( mqHeader->tReplyID.tOriginTime != 0 ||
                    mqHeader->tReplyID.lOriginSequence !=
                    {
                        vMQ_Log(NULL, NULL, 0,
                            "[FRONTEND] Reply is not expected
here.\n");
                    }
                    continue;
                    }
                    /* RESET is a command */
                    if( mqHeader->lMessageType == MQ_MT_RESET)
                    {
appropriate handle */      /* Dispatching the message to
                        /* to the reset handle in this case. */
                        vMQ_Log(NULL, NULL, 5,
                            "[FRONTEND] Dispatch message to
RESET\n");
                        vDispatch(mqwatch, caBuff);
                        break;
                    }
                    else
                    {
be processed */        /* Command other than RESET should not
                        vMQ_Log(NULL, NULL, 0,
                            "[FRONTEND] Only Reset command
Expected here\n");
                        continue;
                    }
                }
            }
        }
    }
    signal(SIGUSR1, vFeHandleSigUsr1);

    /* time out parameter is set to a value read from config
file on reset */
    timeout.tv_usec = 0;
    timeout.tv_sec = lHeartbeat;

    /* main while loop accepting messages from queue and */
    /* from external devices. */
    while(1)
    {
        vMQ_Log(NULL, NULL, 20, "[FRONTEND] QWatch looking for
messages \n");
        /* if sMultipleFlag is set then the previous message
has not */
        /* been read completely */

```

APPENDIX A - PAGE 118 OF 279

```

        if( sMultipleFlag == 0 )
        {
            /* watch out for External and private messages.
            */
            /* Private messages are received from the message
            queue */
            /* While the external messages are received from
            the SPIF */
            if ((lSelected == lMQ_QueueWatch(mqwatch,
            MQ_PRIVATE_EXTERNAL,
                &timeout)) == FAILURE)
            {
                if( errno == EINTR )
                    continue;

                /* Error has occurred */
                vMQ_Log(NULL, NULL, 0,
                    "[FRONTEND] error lMQ_QueueWatch
PRIVATE_EXTERNAL\n");
                vFeHandleTerminate(TERMINATE_ABORT);
            }
            else if( lSelected == (FAILURE -1) )
            {
                vMQ_Log(NULL, NULL, 0, "[FRONTEND] Private
Listener Died\n");
                vFeHandleTerminate(TERMINATE_ABORT);
            }
            else if( lSelected < 0 )
            {
                vMQ_Log(NULL, NULL, 0, "[FRONTEND] External
Listener Died\n");
                vFeHandleTerminate(TERMINATE_ABORT);
            }
            else if (lSelected == 0)
            {
                /* Frontend has timed out on messages */
                vMQ_Log(NULL, NULL, 12, "[FRONTEND] Handling
Timeout\n");
                vFeHandleTimeout_all();
                continue;
            }
        }

        /* Here when there is data available */
        /* check if the data is from the private port */
        if ((lSelected & MQ_PRIVATE_FD) != 0)
        {
            /* get the private port message */
            lLength = lMQ_GetQueueMessage(mqwatch,
            MQ_PRIVATE_FD, caBuff,
                sizeof(caBuff), MSG_NOERROR );

            vMQ_Log(NULL, NULL, 12,
                "[FRONTEND] Received Private Message size
%d\n", lLength);
        }
    }
}

```

APPENDIX A — PAGE 119 OF 279

```

        if( lLength < 0 )
        {
            /* Error in getting the message */
            vMQ_Log(NULL, NULL, 0,
                "[FRONTEND] Insufficient buffersize OR
Invalid MQ_FD \
                value/address OR bad mqwatch \n");
            vFeHandleTerminate(TERMINATE_NORMAL);
        }
        else
        if( lLength == 0 )
        {
            /* no message */
            vMQ_Log(NULL, NULL, 5, "[FRONTEND] No message
yet try again\n");
        }
        else
        {
            /* Dispatch the message */
            vDispatch(mqwatch, caBuff);
        }

        lSelected &= ~(MQ_PRIVATE_FD);
    } /* end private messages */

    if ((lSelected & ~(MQ_PRIVATE_FD | MQ_PUBLIC_FD)) !=
0)
    {
        /* Initially iDataPort is -1 */
        if( iDataPort == -1 )
        {
            iFeAccept();
            continue;
        }

        /* could be disconnected or there is a message */
        if(( lLength = lMQ_QueueTell(mqwatch, iDataPort))
==0)
        {
            vMQ_Log(NULL, NULL, 0,
                "[FRONTEND] No data(Disconnected). Disconnect
Gateway\n");

            /* Died abruptly disconnect all subscribers
and */
            /* gateway for audit purposes */
            vFeGateDisconnect_all(GATEDISCONNECT_BY_CARRIER);
        }
        else
        {
            /* received an external message */
            vMQ_Log(NULL, NULL, 12,
                "[FRONTEND] Received ExtMsg dataport %d
datalength %ld\n",

```

APPENDIX A - PAGE 120 OF 279

```

        iDataPort, lLength);

        /* Read message from SPIF */
        if( (spif_head = pReceiveExtMsg( mqwatch,
lLength )) == NULL )
        {
            /* message not complete continue */
            continue;
        }
        else
        {
            Newspif_head->lMsgsize      =
spif_head->lMsgsize;
            Newspif_head->lMsgtype      =
spif_head->lMsgtype;
            Newspif_head->lSpifID       =
spif_head->lSpifID;

#ifdef DEBUG
            vMQ_Log(NULL, NULL, 20,
                "[FRONTEND] tp %ld sz %ld id %ld
\n",
                spif_head->lMsgtype,
                spif_head->lMsgsize,
                spif_head->lSpifID);

            if( iDebug > 5 )
            {
                /* file fe_spif.msgs */
                /* check if file size exceeds the
limit */
                if( ftell(pMsgsfile) > SIZELIMIT
)
                {
                    if    ((    pMsgsfile    =
                                == NULL)
                    {
                        fprintf(stderr, "\n
Unable to open msgs.pid\n");
                    }
                }

                now = time(0L);
                pTime = localtime( &now);

                fprintf( pMsgsfile, "\n
%.2d/%.2d/%.2d %.2d:%.2d:%.2d",
                    pTime->tm_mon+1,
                    pTime->tm_mday,
                    pTime->tm_year,
                    pTime->tm_hour,
                    pTime->tm_min,
                    pTime->tm_sec);

                fprintf(pMsgsfile,

```

APPENDIX A - PAGE 121 OF 279

```

%ld Size %ld]",
                                " RECEIVED Header [ID %ld Type
                                Newspif_head->lSpifID,
                                Newspif_head->lMsgtype,
                                Newspif_head->lMsgsize);
                                fprintf(pMsgsfile, "\n RECEIVED Msg
[%s]", caBuff);
                                fflush( pMsgsfile );
                                }
#endif
vMQ_Log( NULL, NULL, 10,
" [FRONTEND] RECEIVED Header [ID %ld Type
%ld Size %ld]\n",
                                Newspif_head->lSpifID,
                                Newspif_head->lMsgtype,
                                Newspif_head->lMsgsize);
cp = &caBuff[0];
lLen = Newspif_head->lMsgsize - 8;
if( lLen < 220 )
{
    vMQ_Log( NULL, NULL, 10,
            " [FRONTEND] RECEIVED Msg
[%s]", cp);
}
/* check if the message is an internal
message from SPIF */
if( Newspif_head->lSpifID == -1 )
{
    /* internal SPIF message */
    if(sFeProcessSpifMsg(Newspif_head,
caBuff) != SUCCESS)
    {
        /* unable to process client
message */
        vMQ_Log(NULL, NULL, 0,
                "[FRONTEND] Unable to
Process SPIF msg\n");
vFeGateDisconnect_all(GATEDISCONNECT_BY_OPERATOR);
    }
}
else
{
    if( (Newspif_head->lMsgsize == 8)
&&
(SPIF_SUBSCRIBER_DISCONNECT))
    {
        /* just log the information
        /* subscriber (maybe invalid)
        /* record cannot be written
        vMQ_Log(NULL, NULL, 0,

```

APPENDIX A - PAGE 122 OF 279

```

message only header\n");
vFeLogout_Sub(Newspif_head->lSpifID,
LOGOUT_BY_OPERATOR);
    }
    else
if (sFeProcessClientMsg(Newspif_head, caBuff) != SUCCESS)
    {
message /*
do not delete /*
since audit /*
*/
        /* unable to process client
        /* just log the information
        /* subscriber (may be invalid)
        /* record cannot be written
        VMQ_Log(NULL, NULL, 0,
        "[FRONTEND] Unable to
Process client msg\n");
vFeLogout_Sub(Newspif_head->lSpifID,
LOGOUT_BY_OPERATOR);
    } /* end processing client message
*/
    } /* end message from client */
    } /* end receive external messages */
    } /* end QueueTell */
    } /* end external messages processing */
    } /* end main while loop */
}

/*::::::::::::::::::::::::::::::::::::::::::::::::::::::::::
:::::::::::::
:: Function: vDispatch
::
:: Purpose: Basic message type dispatcher from message Queue
::
:: Returns: None.
::
:: Input: Pointer to qwatch structure and message from SPIF.
::
:: Output: None.
::
:: Globals:
::
:: Called Routines:
::
:: Revision:
:: WHO --WHEN-- WHAT
:: Raju 08/08/94 Original

```

APPENDIX A - PAGE 123 OF 279

```

.....
.....*/

void vDispatch(void *pmq, void *pdata)
{
    MQ_HEADER *pHeader;
    struct tm *tm;
    char buff[TEMP_BUFF_SIZE];
    static short sCounter = 0;

    pHeader = (MQ_HEADER *)pdata;
    tm = localtime(&pHeader->tSendTime);

    sprintf(buff, "[FRONTEND] Dispatching type %ld subtype %ld
sent by PID %ld",
            pHeader->lMessageType, pHeader->lMessageSubType,
            pHeader->lSenderPID);

    vMQ_Log(NULL, NULL, 15, buff);

    vMQ_Log(NULL, NULL, 30,
            "[FRONTEND] sender = %ld sst = %ld
tm=%ld/%ld/%ld-%ld:%ld:%ld seq=%ld\n",
            pHeader->lSenderPID,
            pHeader->lSenderSubType,
            tm->tm_mon+1,
            tm->tm_mday,
            tm->tm_year,
            tm->tm_hour,
            tm->tm_min,
            tm->tm_sec,
            pHeader->lSequenceNumber);
    vMQ_Log(NULL, NULL, 30,
            "[FRONTEND]cont. mt=%ld [0x%lx] mst=%ld rc=%d
rt=%ld rs=%ld\n",
            pHeader->lMessageType, pHeader->lMessageSubType,
            pHeader->lReturnCode,
            pHeader->tReplyID.tOriginTime,
            pHeader->tReplyID.lOriginSequence);

    /* If acknowledge required, do it here */
    if ((pHeader->lMessageType & MQ_MT_ACKNOWLEDGE_REQUIRED) !=
0)
    {
        vMQ_Log(NULL, NULL, 20, "[FRONTEND] Acknowledging\n");
        vMQ_SendAck ( pmq, pHeader );
    }

    if( sGateDisconnectFlag == 1 )
    {
        if( pHeader->lMessageType == MQ_MT_OPCOMMAND )
        {
            if( ( pHeader->lMessageSubType == MQ_MTS_OP_ROUTE
) ||

```



```

                ( pHeader->lMessageSubType ==
MQ_MTS_OP_POIQUERY ) ||
                ( pHeader->lMessageSubType ==
MQ_MTS_OP_VALIDATE_Q ) )
            {
                VMQ_Log(NULL, NULL, 0,
                    "[FE%ld] Discarding Queue Message.
Waiting to disconnect\n",
                    lAddress);
                return;
            }
        }
    }

    if (sUtDispatchMessage ( pvMQ_master, (void*)pMQU_master,
DTable,
        pHeader->lMessageType, pHeader->lMessageSubType,
        (void*)pHeader) != SUCCESS)
    {
        /* just log the information do not delete subscriber,
we may not */
        /* find a subscriber and since audit record cannot be
written */
        VMQ_Log(NULL, NULL, 0,
            "[FRONTEND] INVALID Message received. From Queue.\n");
    }
}

```

```

static char * _ s c c s _ = { " $ S o u r c e :
/ids/cvs/host/fe_spif/src/fe_conf.c,v $ Ver: $Revision: 1.2 $
Date: $Date: 1995/01/13 08:39:01 $" };
/* Copyright (C) 1994,1995 SEI Information Technology, Inc. */

/*::::::::::::::::::::::::::::::::::::::::::::::::::::::::::
:::::::::::::
:: Filename:          fe_conf.c
::
:: Purpose:          Init known languages and queries known
languages.
::
:: Revision:
:: WHO              --WHEN--  WHAT
:: DAB & VI        Original
:: Raju            09/09/94    Modified for message queue and SPIF
:::::::::::::
::::::::::::*/

#include <stdio.h>
#include <stdlib.h>
#include <string.h>
#include <sys/types.h>
#include <fcntl.h>
#include <netinet/in.h>

#ifndef DIRENT
#include <sys/dirent.h>          /* sun uses sys/dirent */
#else
#include <sys/dir.h>           /* RS/6000 uses sys/dir */
#endif

#include "gdefines.h"
#include "gerror.h"
#include "mq_pub.h"
#include "queue.h"
#include "spif.h"
#include "fe_common.h"

#define MAX_KNOWN_LANGUAGES      16
#define MAX_LANGUAGE_NAME_LEN   128
#define MAX_PATH_LEN            256

extern long    lQID;
extern long    lFID;
extern long    lSize;
extern int     iDebug;
extern int     argcnt;
extern long    lg_addr;
extern int     bit_map;
extern long    lfe_tcp;
extern long    lFrontID;
extern long    lAddress;
extern int     iDataPort;
extern int     last_baud;
extern time_t  start_time;

```

APPENDIX A -- PAGE 126 OF 279

```

extern long      lHeartbeat;
extern int       iListenPort;
extern short     sMaxPackets;
extern short     sPacketFlag;
extern int       ipacketflag;
extern short     sConfirmMax;
extern short     sAckPending;
extern long      lMap_format;
extern long      lFormat_mode;
extern short     sDefaultBaud;
extern short     sPacketLimit;
extern int       iQueue_master;
extern long      lLastCommtime;
extern long      lLastCommtime;
extern long      lConstantBaud;
extern long      lCompress_mode;
extern long      lDisplay_panes;
extern short     sTransmitLimit;
extern long      lHeartbeat_wait;
extern int       socket_port_num;
extern short     sInterPacketGap;
extern struct    sockaddr_in addr;
extern short     sProcess_heartbeat;
extern short     sTerm_After_Service;
extern long      lExit_on_disconnect;
extern unsigned long ulSessionID;

extern void      *pMQU_master;
extern void      *pvMQ_master;

extern char      *cpQID;
extern char      *cpFrontID;
extern char      *cpConfigPath;
extern char      *caCommDevice;
extern char      *caDeviceConfig;
extern char      *cpDownload_dir;
extern char      *cpDictionary_dir;

extern char      caID[];
extern char      caBuff[];
extern char      caHangup[];
extern char      caOrigin[];
extern char      caOriginType[];
extern char      caLimitValue[];
extern char      caDestination[];
extern char      caNoAutoAnswer[];
extern char      caDestinationType[];

extern char      *caAlternative[];

extern Q_HEAD    sHead;
extern Q_HEAD    sConfig;
extern Q_HEAD    *pQhead;
extern Q_HEAD    *pQConfig;
extern FILE      *pMsgsfile;
extern SUBSCRIBER *pGSub;

```

APPENDIX A - PAGE 127 OF 279

```
/*:.....:
:.....:
:: Function:   iDirLanguageFilter
::
:: Purpose:    Like iDirFilter, but for language files
::
:: Returns:
::
:: Input:
::
:: Output:
::
:: Globals:
::
:: Called Routines:
::
:: Revision:
:: WHO          --WHEN--  WHAT
:: DAB          Original
:.....:
:.....:*/

int iDirLanguageFilter(struct dirent *thisDir)
{
    int len;

    /* The name must be at least 5 characters long to qualify
   */
    if (((len = strlen(thisDir->d_name)) > 4) &&
        strcmp(thisDir->d_name+len-4, ".FEB") == 0)
        return 1;
    else
        return 0;
}

/*:.....:
:.....:
:: Function:   sInitKnownLanguages
::
:: Purpose:    This is the initialization/reconfiguration
process. Its only
::              parameter is the path of the directory to examine
(and is
::              typically '.'). It returns the number of
validated language
::              files found. -1 is returned if there was an error.
It is possible
::              to return 0 valid languages. Only files ending
in '.FEB' are
::              considered.
::
:: Returns:
::
:: Input:
::
```

APPENDIX A — PAGE 131 OF 279

```

:: Output:
::
:: Globals:
::
:: Called Routines:
::
:: Revision:
:: WHO          --WHEN--  WHAT
:: DAB          Original
::
::
short      sInitKnownLanguages(char *dirpath)
{
    struct    dirent    **dir_head = NULL, *current_dir;
    int       dir_count;
    int       loop_count;
    int       temp_configs = 0;
    char      caFpath[MAX_PATH_LEN];
    char      caBuffer[MAX_LANGUAGE_NAME_LEN];
    int       fd;

    dir_count = scandir(dirpath, &dir_head, iDirLanguageFilter,
alphasort);

    if (dir_count < 0)
    {
        /* There was an error. In this case, leave the
        ** current list alone.
        */
        return -1;
    }

    /* We have to now examine each file and extract the
description. */
    current_dir = dir_head[0];
    for (loop_count = 0; loop_count < dir_count;
        loop_count++, current_dir = dir_head[loop_count])
    {
        strcpy(caFpath, dirpath);
        strcat(caFpath, "/");
        strcat(caFpath, current_dir->d_name);
        if ((fd = open(caFpath, O_RDONLY)) < 0)
            /* bad file */
            continue;

        if (read(fd, caBuffer, sizeof(caBuffer)) !=
sizeof(caBuffer))
        {
            sprintf(caBuffer,
                "Bad file length in language file <%s>\n",
caFpath);
            close(fd);
            continue;
        }
    }
}

```

APPENDIX A — PAGE 132 OF 279

```

        close(fd);
        /* At this point, it looks like it's probably a good
config. */
        if (temp_configs < MAX_KNOWN_LANGUAGES)
        {
            strcpy(KnownLanguages[temp_configs].caLanguagePath,
                current_dir->d_name);
            strcpy(KnownLanguages[temp_configs++].caDescription, caBuffer);
        }
        if (temp_configs > 0)
            sKnownLanguageCount = temp_configs;

        /* We need to free the memory malloced by scandir now */
        for (current_dir = dir_head[0], loop_count = 0; loop_count
< dir_count;
            loop_count++, current_dir = dir_head[loop_count])
        {
            free(current_dir);
        }
        if (dir_head != NULL)
            free(dir_head);
        return temp_configs;
    }

/*::::::::::::::::::::::::::::::::::::::::::::::::::::::::::::::::::
::::::::::::::::::
:: Function:      sGenerateLanguageQuery
::
:: Purpose:      This function produces the formatted output file
which contains
::              the list of currently known language files. Each
line of output
::              represents one language file in the form:
::              'description text' ':' 'language file name' '\n'
::
:: Returns:
::
:: Input:
::
:: Output:
::
:: Globals:
::
:: Called Routines:
::
:: Revision:
:: WHO          --WHEN--  WHAT
:: DAB          Original
::::::::::::::::::
::::::::::::::::::*/

short      sGenerateLanguageQuery(FILE *fp)

```

APPENDIX A - PAGE 133 OF 279

```

{
    int sCount;

    for (sCount = 0; sCount < sKnownLanguageCount; sCount++)
    {
        fprintf(fp, "%s:%s\n",
            KnownLanguages[sCount].caDescription,
            KnownLanguages[sCount].caLanguagePath);
    }

    return sKnownLanguageCount;
}

/*::::::::::::::::::::::::::::::::::::::::::::::::::::::::::
::: Function:      sCheckLanguage
:::
::: Purpose:      Check if a particular language exists or not.
:::
::: Returns:
:::
::: Input:
:::
::: Output:
:::
::: Globals:
:::
::: Called Routines:
:::
::: Revision:
::: WHO          --WHEN--  WHAT
::: DAB          Original
::::::::::::::::::::::::::::::::::::::::::::::::::::::::::
::::::::::*/

short sCheckLanguage( name)
char *name;
{
    int sCount;

    for (sCount = 0; sCount < sKnownLanguageCount; sCount++)
    {
        if (strcmp(name, KnownLanguages[sCount].caLanguagePath)
== 0)
        {
            return SUCCESS;
        }
    }
    return FAILURE;
}

```



```

extern short    sAckPending;
extern long     lMap_format;
extern long     lFormat_mode;
extern short    sDefaultBaud;
extern short    sPacketLimit;
extern int      iQueue_master;
extern long     lLastCommtime;
extern long     lLastCommtime;
extern long     lConstantBaud;
extern long     lCompress_mode;
extern long     lDisplay_panes;
extern short    sTransmitLimit;
extern long     lHeartbeat_wait;
extern int      socket_port_num;
extern short    sInterPacketGap;
extern struct   sockaddr_in addr;
extern short    sProcess_heartbeat;
extern short    sTerm_After_Service;
extern long     lExit_on_disconnect;
extern unsigned long    ulSessionID;

extern void     *pMQU_master;
extern void     *pvMQ_master;

extern char     *cpQID;
extern char     *cpFrontID;
extern char     *cpConfigPath;
extern char     *caCommDevice;
extern char     *caDeviceConfig;
extern char     *cpDownload_dir;
extern char     *cpDictionary_dir;

extern char     caID[];
extern char     caBuff[];
extern char     caHangup[];
extern char     caOrigin[];
extern char     caOriginType[];
extern char     caLimitValue[];
extern char     caDestination[];
extern char     caNoAutoAnswer[];
extern char     caDestinationType[];

extern char     *caAlternative[];

extern Q_HEAD  sHead;
extern Q_HEAD  sConfig;
extern Q_HEAD  *pQhead;
extern Q_HEAD  *pQConfig;
extern FILE    *pMsgsfile;
extern SUBSCRIBER *pGSub;

/* ::::::::::::::::::::::::::::::::::::::::::::::::::::::::::::
:: ::::::::::::::::::::
:: Function : cpFillDownBuffer
::

```

APPENDIX A - PAGE 136 OF 279

```

        msglen:4, crc:4, timestamp:8, subscriberID:16, msgID:4,
ID:72: type:1,
        filename:20, fileoffset:8, data bytes:4, delimiters:11
        */
        if ((pSub->lStatus & SS_ROUTE_DWNL) || (pSub->lStatus &
SS_SEND_BINARY))
            byte_cnt = (pSub->sPacketLimit - DATA_SIZE);
        else
            byte_cnt = (pSub->sPacketLimit - DATA_SIZE)/2;

        pSub->sCurrentManeuver++;

        if((byte_cnt+lCurr_fileoffs)>pSub->lQueryFilesize)
        {
            byte_cnt = pSub->lQueryFilesize-lCurr_fileoffs+1;
        }

        if ((num_bytes = read(fd, &tmpBuf[0], byte_cnt)) <= 0 )
        {
            vMQ_Log( NULL, NULL, 0,
                "[FRONTEND] Cannot read file %s",pSub->caTmpfile);
            return NULL;
        }

        if(pSub->lStatus & SS_SEND_DWNL)
            sprintf(cp,"%s:%ld:%ld:",    pSub->caDownload,
lCurr_fileoffs, num_bytes);
        else
            sprintf(cp,"%s:%ld:%ld:",    pSub->caTmpfile,
lCurr_fileoffs, num_bytes);

        cp+=strlen(cp);

        if ((pSub->lStatus & SS_ROUTE_DWNL) || (pSub->lStatus &
SS_SEND_BINARY))
        {
            memcpy(cp,tmpBuf,num_bytes);
            cp += num_bytes;
        }
        else
            for( lI=0; lI<num_bytes; lI++, cp+=2 )
                sprintf(cp,"%x", tmpBuf[lI]);

        lCurr_fileoffs = ftell(fp);
        pSub->lMsgidsent[pSub->lMsgid] = pSub->ServerRequest.lMsgid;
        pSub->lMsgid++;
        pSub->lManeuverOffsets[pSub->lMsgid] = lCurr_fileoffs;

        return cp;
    }

    /*::::::::::::::::::::::::::::::::::::::::::::::::::::::::::
    ::::::::::::::::::::
    :: Function : vSendDownload

```

APPENDIX A — PAGE 138 OF 279

```

        vMQ_Log( NULL, NULL, 0, "[FRONTEND] %s\n", caBuf);

        if(pSub->sResultCode<1) pSub->sResultCode=FEERR_SVGD;
        vSendErrorResponse(pSub, caBuf);

        return(-1);
    }

    cp = cpFillDownBuffer(fdesc, buff, pSub);

    if(cp==NULL)
    {
        sprintf( caBuf," Cannot read file %s",pSub->caTmpfile);
        vMQ_Log( NULL, NULL, 0, "[FRONTEND] %s\n", caBuf);

        if(pSub->sResultCode<1) pSub->sResultCode=FEERR_SVGD;
        vSendErrorResponse(pSub, caBuf);
        close(fdesc);
        return(-1);
    }

    if( (pSub->lManeuverOffsets[pSub->lMsgid] <=
pSub->lQueryFileSize) &&
        (sBurstCount < pSub->sBurstCount))
    {
        sDeletefile = 0;
    }
    else
    {
        sDeletefile = 1;
    }

    sprintf(cp, "|MORE=%c|", (sDeletefile) ? 'N' : 'Y' );
    cp += strlen(cp);

    if ( (pSub->lManeuverOffsets[pSub->lMsgid] <=
pSub->lQueryFileSize) &&
        ( sBurstCount >= pSub->sBurstCount))

        strcat(cp, "CONFCONT=Y|\n");
    else
    {
        strcat(cp, "\n");
        if( sDeletefile == 1 )
        {
            pSub->lResponsePending = 0;
        }
    }

    strcat(cp, "\r");

    sDeletefile = 0;
    cp +=strlen(cp);
    msglen = cp - buff;

```

APPENDIX A - PAGE 140 OF 279

```

    close(fdesc);
    sSendMsg( pSub, (void *)buff, msglen);
}

/*::::::::::::::::::::::::::::::::::::::::::::::::::::::::::
::::::::::
:: Function :  sGenerateDownload
::
:: Purpose  :  Generates a download file
::
:: Returns:
::
:: Input:
::
:: Output:
::
:: Globals:
::
:: Revision :
:: WHO      --WHEN--  WHAT
:: DAB                      Original
:: Raju      09/09/94  Modified for MessageQueue and SPIF
::::::::::
::::::::::*/

short sGenerateDownload(pSub)
SUBSCRIBER *pSub;
{
    int          fdesc;
    short        burst_count;
    char         caBuf[MAX_TEMPBUFF_SIZE];
    struct stat  Status;

    pSub->sManeuverCount = 0;
    pSub->lMsgid = 0;
    memset((char *)&pSub->lMsgidsent,0,MAX_MANEUVER_MSGS);
    memset((char *)&pSub->lManeuverOffsets,0,MAX_MANEUVER_MSGS);

    vMQ_Log( NULL, NULL, 0, "[FRONTEND] sGenerateDownload: port
number %d\n", pSub->iCommPort);

    /* Check to make sure that file exists, */
    /* open the file, read it and format messages */
    /*
    if (!(pSub->lStatus & SS_BTRF) && !(pSub->lStatus &
SS_BRBF))
    */
        if (pSub->lStatus & SS_SEND_DWNL)
        {
            if( (fdesc = open( pSub->caDownload, O_RDONLY)) == -1
            )
                {
                    sprintf( caBuf," Cannot open download file
%s",pSub->caDownload);
                    vMQ_Log( NULL, NULL, 0, "[FRONTEND] %s\n", caBuf);
                }
        }
}

APPENDIX A - PAGE 141 OF 279

```

```

        if ( pSub->sResultCode < 1 )
pSub->sResultCode=FEERR_SVGD;
        vSendErrorOrResponse(pSub, caBuf);

        return(-1);
    }
}
else if ((fdesc = open(pSub->caTmpfile, O_RDONLY)) == -1 )
{
    sprintf( caBuf," Cannot read download file
%s",pSub->caTmpfile);
    vMQ_Log( NULL, NULL, 0, "[FRONTEND] %s\n", caBuf);

    if(pSub->sResultCode<1) pSub->sResultCode=FEERR_SVGD;
    vSendErrorResponse(pSub, caBuf);

    return(-1);
}

if( fstat(fdesc,&Status) == -1 )
{
    sprintf( caBuf," Cannot access download file");
    vMQ_Log( NULL, NULL, 0, "[FRONTEND] %s\n", caBuf);

    if(pSub->sResultCode<1) pSub->sResultCode=FEERR_SVGD;
    vSendErrorResponse(pSub, caBuf);

    return(-1);
}

if (!(pSub->lStatus & SS_STRIPMAP)|| (pSub->lStatus &
SS_BRBF))
    pSub->lQueryFilesize = Status.st_size - 1;

close(fdesc);

/* Read in the maximum allowable size */
if (pSub->lStatus & SS_BURST_MODE)
{
    burst_count = 0;
    while ( pSub->lManeuverOffsets[pSub->lMsgid] <
pSub->lQueryFilesize &&
        burst_count < pSub->sBurstCount)
    {
        vSendDownload(pSub, 1, ++burst_count);
        if (sInterPacketGap > 0)
            sleep(sInterPacketGap);
    }
}
else
    vSendDownload(pSub, 0, 0);

return(SUCCESS);
}

```

APPENDIX A - PAGE 142 OF 279

```

#define MC_SOCKETPORT      10
#define MC_CONSTANTBAUD   11
#define MC_HEARTBEAT      12
#define MC_HEARTBEAT_WAIT 13
#define MC_DOWNLOAD_DIR   14
#define MC_EXIT_ON_DISCONNECT 15
#define MC_DBETIMEOUT     16

#define MAX_ADDRESS_SIZE   80
#define DATA_SIZE         152 /* Assumption based on
datasizes */

struct sDecodeTable {
    char *name;
    short sValue;
} sDecodeTable[] = {
    "PACKETSIZE",      MC_PACKETSIZE,
    "PACKETHEADER",   MC_PACKETHEADER,
    "BAUD",            MC_BAUD,
    "INTERPACKETGAP", MC_INTERPACKETGAP,
    "TRANSMITSIZE",   MC_TRANSMITSIZE,
    "HANGUP",          MC_HANGUP,
    "RESET",           MC_RESET,
    "INIT",            MC_INIT,
    "CONFIRMREQMAX",  MC_CONFIRMREQMAX,
    "SOCKETPORT",     MC_SOCKETPORT,
    "CONSTANTBAUD",   MC_CONSTANTBAUD,
    "HEARTBEAT_WAIT", MC_HEARTBEAT_WAIT,
    "HEARTBEAT",       MC_HEARTBEAT,
    "DOWNLOAD_DIR",   MC_DOWNLOAD_DIR,
    "EXIT_ON_DISCONNECT", MC_EXIT_ON_DISCONNECT,
    "DBETIMEOUT",     MC_DBETIMEOUT,
    NULL,              0
};

extern long    lQID;
extern long    lFID;
extern long    lSize;
extern int     iDebug;
extern int     argcnt;
extern long    lg_addr;
extern int     bit_map;
extern long    lfe_tcp;
extern long    lFrontID;
extern long    lAddress;
extern int     iDataPort;
extern int     last_baud;
extern time_t  start_time;
extern long    lHeartbeat;
extern int     iListenPort;
extern short   sMaxPackets;
extern short   sPacketFlag;
extern int     ipacketflag;
extern short   sBurstflag;
extern short   sConfirmMax;
extern short   sAckPending;

```

APPENDIX A — PAGE 144 OF 279

```

extern long          lDBTimeout;
extern long          lMap_format;
extern long          lFormat_mode;
extern short         sDefaultBaud;
extern short         sPacketLimit;
extern int           iQueue_master;
extern long          lLastCommtime;
extern long          lLastCommtime;
extern long          lConstantBaud;
extern long          lCompress_mode;
extern long          lDisplay_panes;
extern short         sTransmitLimit;
extern short         sMinPacketLimit;
extern long          lHeartbeat_wait;
extern int           socket_port_num;
extern short         sInterPacketGap;
extern struct        sockaddr_in addr;
extern short         sProcess_heartbeat;
extern short         sTerm_After_Service;
extern long          lExit_on_disconnect;
extern unsigned long ulSessionID;

extern void          *pMQU_master;
extern void          *pvMQ_master;

extern char          *cpQID;
extern char          *cpFrontID;
extern char          *cpConfigPath;
extern char          *caCommDevice;
extern char          *caDeviceConfig;
extern char          *cpDownload_dir;
extern char          *cpDictionary_dir;

extern char          caID[];
extern char          caBuff[];
extern char          caHangup[];
extern char          caOrigin[];
extern char          caOriginType[];
extern char          caLimitValue[];
extern char          caDestination[];
extern char          caNoAutoAnswer[];
extern char          caDestinationType[];

extern char          *caAlternative[];

extern Q_HEAD       sHead;
extern Q_HEAD       sConfig;
extern Q_HEAD       *pQhead;
extern Q_HEAD       *pQConfig;
extern FILE         *pMsgsfile;
extern SUBSCRIBER   *pGSub;

extern void *vFeHandleSigUsrl();

/*:.....

```



```

        lseek(fd, pos, SEEK_SET);
    return;
}

/*:.....
:: Function: vFixCR
::
:: Purpose : Change CR's to escaped characters if they are
::           preceded by a blank.
::
:: Returns:
::
:: Input:
::
:: Output:
::
:: Globals:
::
:: Revision:
:: WHO           --WHEN--   WHAT
:: DAB & VI        Original
:: Raju           09/09/94 Modified for Message queue and SPIF
:::.....*/

void vFixCR(buff)
char *buff;
{
    if (buff == NULL || *buff == '\0')
        return; /* Null string, nothing to do */

    buff++;
    while (*buff != '\0')
    {
        if (*buff == '\r' && *(buff-1) == ' ')
        {
            *(buff-1) = '\\';
            *buff = 'r';
        }
        buff++;
    }
}

/*:.....
:: Function: vSendOkResponse
::
:: Purpose : Format and send an ACK message to the client
::           process. This message is currently sent for
requests that
::           have at least one of the BURST, MAXPKT or SESSION
options.
::
:: Returns:
::
:: Input:

```

APPENDIX A — PAGE 147 OF 279

```

::
:: Returns:
::
:: Input:
::
:: Output:
::
:: Globals:
::
:: Revision:
:: WHO          --WHEN--  WHAT
:: DAB & VI     09/09/94  Original
:: Raju         09/09/94  Modified for Message queue and SPIF
:::.....*/
char *cpFillQueryBuffer(FILE *fp, char *buff, SUBSCRIBER
*pSub,int burst_cnt)
{
    time_t    now;
    short     charcount,
             cplen;
    char *cp;
    long lCurr_fileoffs;

    cp = buff;
    charcount = 0;

    time(&now);
    if( burst_cnt > 1 )
    {
        pSub->ServerRequest.lMsgid++;
    }
    cplen = lFillMsgFields(pSub, cp);
    cp += cplen;
    sprintf(cp, "Q|");
    cp += 2;

    /* As long as the current file offset is less than the query
file size */
    lCurr_fileoffs = pSub->lManeuverOffsets[pSub->lMsgid];
    while ( lCurr_fileoffs <= pSub->lQueryFilesize )
    {
        fseek(fp, lCurr_fileoffs, SEEK_SET);
        if (charcount > 0) {
            strcat(cp, ";");
        }
        else
            cp--;

        if (fgets(cp+1, 128, fp) == NULL)
        {
            break;
        }

        charcount = strlen(cp) - 1;
        cp[charcount] = '\0';    /* remove nl */
    }
}

```

APPENDIX A - PAGE 153 OF 279

```

/* Switch depending on type of data to be transmitted.
** maneuvers, QCONF, etc.
*/
if (pSub->lStatus & (SS_SEND_QCONF | SS_SEND_QPOIS |
SS_SEND_QLANG
| SS_SEND_QVER | SS_SEND_QFILES ))
{
    if ((fp = fopen(pSub->caTmpfile, "r")) == (FILE*)NULL)
    {
file\n");
        vMQ_Log(NULL, NULL, 0, "[FRONTEND] Unable to open
        return;
    }
}

#ifdef DEBUG
    vMQ_Log(NULL, NULL, 20, "[FRONTEND] Call to
cpFillQueryBuffer!\n");
#endif

    cp = cpFillQueryBuffer(fp, buff, pSub, sBurstCount);
    fclose(fp);
}
else /* default is maneuver */
{
    if ((fd = open(pSub->caTmpfile, O_RDONLY)) < 0)
    {
file %s\n",
        pSub->caTmpfile);
        return;
    }

    cp = buff;
    packcount = 0;

    lCurr_fileoffs = pSub->lManeuverOffsets[pSub->lMsgid];
    fp = fdopen(fd, "r");

    vMQ_Log(NULL, NULL, 21,
"[FRONTEND] MxPkts %d Msgid %ld Fnm %s Foffs %ld fsz
%ld\n",
    sMaxPackets, pSub->lMsgid, pSub->caTmpfile,
lCurr_fileoffs,
pSub->lQueryFilesize);

    lMnvr_overflow = 0;

    /* Increment the serverrequest.msgid here */
    if ( pSub->lMsgid > 0 && sBurstCount > 1 )
        pSub->ServerRequest.lMsgid++;

    while ( lCurr_fileoffs <= pSub->lQueryFilesize )
    {
        ++packcount;
        sThisStep = -20;
        cp_prev = cp;

```

APPENDIX A - PAGE 156 OF 279

```

lseek(fd, lCurr_fileoffs, SEEK_SET);
if (packcount > 1) {
    sprintf(cp, "|\\n");
    cp = cp + strlen(cp);
}
cplen = lFillMsgFields(pSub, cp);
cp += cplen;
sprintf(cp, "R|");
cp += 2;

armtext[0] = '\\0';
lPrev_fileoffs = ftell(fp);

while (read(fd, &maneuver, sizeof(maneuver)) ==
        sizeof(maneuver) &&
        (sThisStep == -20 || maneuver.sStep ==
sThisStep))
{
length %d\\n",
maneuver.sStep, maneuver.sTextLength);
if (maneuver.sStep != -1 && maneuver.sStep
!= -2 &&
maneuver.sStep < 0)
{
/* This is not an interesting maneuver,
so skip it */
#ifdef DEBUG
vMQ_Log(NULL, NULL, 21, "[FRONTEND] Skip maneuver #%d\\n",
maneuver.sStep);
#endif
vSkipManeuver(fd, &maneuver);
continue;
}

/* Get the maneuver text */
if (maneuver.sTextLength > 0)
{
if (*(cp-1) == '|')
{
/* Need to make sure that a newline
** immediately follow a vertical
*/
read(fd, cp, 1);
maneuver.sTextLength--;
if (*cp == '\\n')
{
*cp++ = '\\\\';
*cp++ = 'n';
}
else
cp++;
}
}
}
}

```

APPENDIX A - PAGE 157 OF 279

```

pairs to an
transmission.
/* Also want to translate any blank/CR
** escaped carriage return for
*/
if (*(cp-1) == ' ' && *cp == '\r')
{
    *(cp-1) = '\\';
    *cp = 'r';
}
if (maneuver.sTextLength > 0)
    cp += read(fd, cp,
maneuver.sTextLength);
}
*cp = '\0';
/* Read FROM and TO streets */
read(fd, &len, sizeof(len));
#ifdef DEBUG
vmq_Log(NULL, NULL, 21,
"[FRONTEND] sThisStep = %d, buflen %d
fromlen %d\n",
sThisStep, strlen(buff), len);
#endif
if (sThisStep == -20 && len > 0)
{
    read(fd, fromstreet, len);
    fromstreet[len] = '\0';
    vmq_Log(NULL, NULL, 21,
"[FRONTEND] FROM STREET <%s>\n",
fromstreet);
}
else
    lseek(fd, (long)len, SEEK_CUR);
read(fd, &len, sizeof(len));
if (sThisStep == -20 && len > 0)
{
    read(fd, tostreet, len);
    tostreet[len] = '\0';
    vmq_Log(NULL, NULL, 21,
"[FRONTEND] TO STREET <%s>\n",
tostreet);
}
else
    lseek(fd, (long)len, SEEK_CUR);
#ifdef DEBUG
vmq_Log(NULL, NULL, 21, "[FRONTEND] token %d,
fingercount %d\n",
len, maneuver.cFingerCount);
#endif

```

APPENDIX A — PAGE 158 OF 279

```

/* If there are any arms - output that info
*/
if (maneuver.cFingerCount > 0)
{
    vMQ_Log(NULL, NULL, 21,
    "[FRONTEND] cFingerCount = %d\n",
maneuver.cFingerCount);
    r e a d ( f d ,      a r m s ,
sizeof(VBDG_FINGER)*maneuver.cFingerCount);

/* There are fingers, so the from/to
** need to be output as part of the arms
*/
cpa = armtext;
if (sThisStep == -20)
{
    vMQ_Log(NULL, NULL, 21, "[FRONTEND]
Add Arms\n");
    sprintf(cpa,
    "|ARM=%s;%s;", fromstreet,
tostreet);
    cpa = cpa + strlen(cpa);
}
for (armcnt = 0; armcnt <
maneuver.cFingerCount;
armcnt++)
{
    /* Do we need ; delimiter? */
    if (armcnt > 0)
        *cpa++ = ',';
    for (cnt = 0; cnt < 3; cnt++)
    {
        if ((cnt > 0 && (
arms[armcnt].X[cnt-1] ||
arms[armcnt].Y[cnt-1])) ||
cnt == 0)
        {
            /* This set goes out */
            if (sThisStep == -20)
            {
                if (cnt > 0)
                    *cpa++ = ',';
                s p r i n t f ( c p a ,
"%d,%d",
arms[armcnt].X[cnt],

```

APPENDIX A - PAGE 159 OF 279

```

                                                                                     arm[arm].Y[ct]);
                                                                                     cpa = cpa +
strlen(cpa);
}
}
}
}
}
}
sThisStep = maneuver.sStep;
}
vMQ_Log(NULL, NULL, 21,
%ld\n", "[FRONTEND] offset %ld, ftell %ld size
      lCurr_fileoffs, ftell(fp), sizeof(maneuver));
/* Reset the file offset */
lCurr_fileoffs = ftell(fp) - sizeof(maneuver);
vMQ_Log(NULL, NULL, 21,
%ld\n", "[FRONTEND] bit_map & BIT_ARMS = 0x%x offset
      pSub->bit_map & BIT_ARMS, lCurr_fileoffs);
if (pSub->bit_map & BIT_ARMS)
{
  strcat(buff, armtxt);
  cp += strlen(armtxt);
}
cplen = cp - &buff[0];

#ifdef DEBUG
vMQ_Log(NULL, NULL, 21,
%ld\n", "[FRONTEND] is maneuver overflow %ld pack
      cplen, pSub->sPacketLimit);
#endif

/* subtract 15 to accomdate the first two fields
of message */
/* length and crc and 10 for MORE and 15 for
CONFCONT*/
if( cplen > (pSub->sPacketLimit - 40) )
{
  vMQ_Log(NULL, NULL, 21,
%ld\n", "[FRONTEND] maneuver overflow %ld pack
      cplen, pSub->sPacketLimit);
  lMnvr_overflow = 1;
  break;
}
}

pSub->lMsgidsent[pSub->lMsgid] =
pSub->ServerRequest.lMsgid;
pSub->lNum_msgs++;

```

```

        pSub->lMsgid++;          /* counter for number of
messages sent */

        /* If the number of messages exceed the max limit, get
rid of the
        first one */
        if( pSub->lMsgid > MAX MANEUVER_MSGS )
            vShiftManeuvers(pSub);

        if( lMnvr_overflow == 1 )
        {
            pSub->lManeuverOffsets[pSub->lMsgid] =
lPrev_fileoffs;
            /* Reset cp to point to previous maneuver */
            cp = cp_prev;
        }
        else
            pSub->lManeuverOffsets[pSub->lMsgid] =
lCurr_fileoffs;
        fclose (fp);
    }

    /* Are there more maneuvers after this one? */
    if( (pSub->lManeuverOffsets[pSub->lMsgid] <=
pSub->lQueryFilesize) &&
        ( sBurstCount < pSub->sBurstCount ) )
    {
        sprintf(cp, "|MORE=Y|");
    }
    else
    {
        sprintf(cp, "|MORE=N|");
        sDeletefile = 1;
    }
    cp = cp + strlen(cp);

    if( (pSub->lManeuverOffsets[pSub->lMsgid] <=
pSub->lQueryFilesize) &&
        (sBurstCount >= pSub->sBurstCount))
    {
        strcat(cp, "CONFCONT=Y|\n");
    }
    else
    {
        strcat(cp, "\n");
        if( sDeletefile == 1)
        {
            pSub->lResponsePending = 0;
        }
    }
    cp = cp + strlen(cp);
    sDeletefile = 0;

    /* Compress the maneuver(s) */
    vFixCR(buff);

```

APPENDIX A - PAGE 161 OF 279

```
        strcat(buff, "\r");
        strcpy(armtext, buff);

        vMQ_Log(NULL, NULL, 21, "[FRONTEND] vSendManeuver: Sending
%d bytes\n",
                strlen(buff));

        if( iDebug >= 10 )
        {
            len = strlen(buff);
            cp = &buff[0];
            while( len > 0 )
            {
                if( len > 222 )
                {
                    strncpy( armtext, cp, 222);
                    armtext[222] = '\0';
                }
                else
                {
                    strcpy( armtext, cp);
                }
                vMQ_Log(NULL, NULL, 10, "[FRONTEND] MSG [%s]\n",
armtext);
                len = len - 222;
                if( len > 0 )
                    cp = cp + 222;
            }

            sSendMsg(pSub, (void *)buff, strlen(buff));

            if (fd >= 0)
                close(fd);
            return;
        }
    }
}
```

```
/*:.....:
:: Function: vSendRouteFile
::
:: Purpose : Initializes the sending of route maneuvers, and
::           sends the first maneuver.
::
:: Returns:
::
:: Input:
::
:: Output:
::
:: Globals:
::
:: Revision:
:: WHO           --WHEN--  WHAT
:: DAB & VI      Original
:: Raju         09/09/94  Modified for Message queue and SPIF
```

```

.....*/
vSendRouteFile(pSub)
SUBSCRIBER *pSub;
{
    int      fd;
    long pos;
    short   len;
    short   sCurrentManeuver;
    short   sBurstCount;
    VBDG_MANEUVER maneuver;
    char buff[MAX_ALTERNATIVE_SIZE];

    vMQ_Log(NULL, NULL, 21,
        "[FRONTEND] Sending route file to spifid %ld\n",
pSub->lSpifID);
    pSub->sManeuverCount = 0;
    pSub->lQueryFileSize = -1;
    sCurrentManeuver = -3;
    pSub->lMsgid = 0;
    memset((char *)&pSub->lMsgidsent, 0, MAX_MANEUVER_MSGS);
    memset((char *) &pSub->lManeuverOffsets, 0,
MAX_MANEUVER_MSGS);
    pos = 0L;

    if ((fd = open(pSub->caTmpfile, O_RDONLY)) < 0) {
        sprintf(buff, "Error opening file %s [%d]\n",
pSub->caTmpfile, errno );
        vMQ_Log(NULL, NULL, 0, "[FRONTEND] %s\n", buff);
        if (pSub->sResultCode < 1) pSub->sResultCode = FEERR_SEER;
        vSendErrorResponse (pSub, buff);
        return;
    }

    while (read(fd, &maneuver, sizeof(maneuver)) ==
sizeof(maneuver))
    {
        pos = lseek(fd, 0L, SEEK_CUR);

        /* Make sure it is a maneuver and not an interloping
        ** text file (error output file) instead. We can infer
        ** this from the latitude - if it is >9,000,000 or
        ** < -9,000,000 then it must be a text file.
        */
        if (maneuver.lLatitude > 9000000 ||
            maneuver.lLatitude < -9000000)
        {
            /* Can't be a route - so send it as an error */
            vMQ_Log(NULL, NULL, 0, "[FRONTEND] Can't be a
route.\n");
            close(fd);
            vSendErrorFile(pSub);
            return;
        }

        /* If this is an interesting maneuver, then remember

```

APPENDIX A — PAGE 163 OF 279

```

interesting    ** its position in the offset array. It's only
entry.        ** if it's an actual maneuver, or it's the footer
start.        ** Backup by the sizeof(maneuver) though, to get the
*/
if ((maneuver.sStep == -1 || maneuver.sStep == -2 ||
maneuver.sStep >= 0) &&
sCurrentManeuver != maneuver.sStep)
{
/* Dump maneuver */
#ifdef DEBUG
vMQ_Log(NULL, NULL, 21,
"[FRONTEND] Interesting maneuver: %ld %ld %d
%d\n",
maneuver.lLatitude,
maneuver.lLongitude, maneuver.sStep,
maneuver.sTextLength);
#endif
/* An interesting one */
pSub->lQueryFilesize = pos - sizeof(maneuver);
if( pSub->sManeuverCount == 0 )
pSub->lManeuverOffsets[pSub->sManeuverCount]
= pSub->lQueryFilesize;
pSub->sManeuverCount++;
sCurrentManeuver = maneuver.sStep;
}

/* Now finish reading the maneuver information */
pos += maneuver.sTextLength; /* The maneuver text */
lseek(fd, pos, SEEK_SET);

/* Now the from/two strings that are there (may be
zero) */
if (read(fd, &len, sizeof(len)) != sizeof(len))
{
/* Technically an error. We'll just assume eof */
vMQ_Log(NULL, NULL, 0, "[FRONTEND] Read error.\n");
break;
}

/* SANITY CHECK ON LENGTH and latitude */
if (len > 512 || maneuver.lLatitude > 8999999 ||
maneuver.lLatitude < -8999999)
{
/* This signals that the file is probably NOT
** a binary route file, but is instead a textual
** i.e. error response file.
*/
vMQ_Log(NULL, NULL, 0, "[FRONTEND] Sanity check
failed.\n");
close(fd);
vSendErrorFile(pSub);
return;
}

```

APPENDIX A — PAGE 164 OF 279

```

    }

    pos += sizeof(len) + len;
    lseek(fd, pos, SEEK_SET);

    /* TO */
    if (read(fd, &len, sizeof(len)) != sizeof(len))
    {
        /* Technically an error. We'll just assume eof */
        vMQ_Log(NULL, NULL, 0, "[FRONTEND] TO read
error.\n");
        break;
    }

    pos += sizeof(len) + len;

    /* Now position past the arms */
    pos += sizeof(VBDG_FINGER) * maneuver.cFingerCount;
    lseek(fd, pos, SEEK_SET);
}

close(fd);

pSub->sItemCount = pSub->sManeuverCount;
vHandleAuditLog( NULL, NULL, MQ_MTS_AUDIT_ROUTE_I, lFID,
(void *)pSub,
    NULL, 1);
pSub->lCpu_usage = 0;

/* Send the first maneuver */
if (pSub->lStatus & SS_BURST_MODE)
{
    sBurstCount = 0;
    while ((pSub->lManeuverOffsets[pSub->lMsgid] <=
pSub->lQueryFilesize) &&
        (sBurstCount < pSub->sBurstCount))
    {
        /* Real routes do not have burst limits */
        vSendManeuver(pSub, 1, ++sBurstCount);
        if (sInterPacketGap > 0)
            sleep(sInterPacketGap);
    }
}
else
{
    vMQ_Log(NULL, NULL, 21, "[FRONTEND] SendManeuver 0
0.\n");
    vSendManeuver(pSub, 0, 0);
}
}

```

```

/*:.....:
:: Function: vSendQueryFile
::
:: Purpose : Prepare to send a query response file back to

```

APPENDIX A - PAGE 165 OF 279

```

}
lTmpsize = -1;
while( fgets(buff, sizeof(buff), fp) != NULL)
{
    pSub->sManeuverCount++;
    lTmpsize = pSub->lQueryFilesize;
    pSub->lQueryFilesize = ftell(fp);
}
pSub->lQueryFilesize = lTmpsize;

/* Send the first maneuver */
if ( lTmpsize == -1 )
{
    if(pSub->sResultCode<1) pSub->sResultCode=FEERR_NOAV;
    vSendErrorResponse( pSub, "No POIs available");
}
else if (pSub->lStatus & SS_BURST_MODE)
{
    burst_count = 0;
    while((pSub->lManeuverOffsets[pSub->lMsgid] <=
pSub->lQueryFilesize) &&
(burst_count < pSub->sBurstCount))
    {
        vSendManeuver(pSub, 1, ++burst_count);
        if (sInterPacketGap > 0)
            sleep(sInterPacketGap);
    }
}
else
    vSendManeuver(pSub, 0, 0);
}

```

```

/*:.....:
:: Function: vMakeUpper
::
:: Purpose : Make a string all upper case
::
:: Returns:
::
:: Input:
::
:: Output:
::
:: Globals:
::
:: Revision:
:: WHO          --WHEN--  WHAT
:: DAB & VI          Original
:: Raju          09/09/94 Modified for Message queue and SPIF
:.....*/

```

```
void vMakeUpper(buff)
```

APPENDIX A — PAGE 167 OF 279

```

char *buff;
{
    while (*buff != '\0')
    {
        if (islower(*buff))
            *buff = toupper(*buff);
        buff++;
    }
}

/*:.....:
:: Function: sDecodeLine
::
:: Purpose : Decodes the buffer and sends it to appropriate
:: routine.
::
:: Returns:
::
:: Input:
::
:: Output:
::
:: Globals:
::
:: Revision:
:: WHO      --WHEN--  WHAT
:: DAB & VI      Original
:: Raju      09/09/94  Modified for Message queue and SPIF
:::.....*/

short    sDecodeLine(char *buff, char **param, long *lValue)
{
    struct    sDecodeTable    *sp;
    char      *cp;

    sp = sDecodeTable;

    while (sp->name != NULL)
    {
        if (strncasecmp(buff, sp->name, strlen(sp->name)) ==
0)
        {
            /* Remove trailing comments and white space */
            if ((cp = strrchr(buff, '#')) != NULL)
            {
                *cp = '\0';
            }

            /* Now the trailing white space */
            cp = buff + strlen(buff) - 1;
            while (*cp == ' ' || *cp == '\t')
                *(cp--) = '\0';

            if ((cp = strchr(buff, '=')) == NULL)
            {

```

APPENDIX A - PAGE 168 OF 279

```

        *lValue = 0L;
        cp = buff + strlen(buff) - 1;
        *param = cp;
        return sp->sValue;
    }
    else
    {
        cp++;
        while (*cp == ' ' || *cp == '\t')
            cp++;
        *lValue = strtol(cp, NULL, 0);
        *param = cp;
        return sp->sValue;
    }
    }
    sp++;
}

return 0;
}

/*:.....:
:: Function: lRead_config
::
:: Purpose : Reads the config file.
::
:: Returns:
::
:: Input:
::
:: Output:
::
:: Globals:
::
:: Revision:
:: WHO      --WHEN--  WHAT
:: DAB & VI      Original
:: Raju      09/09/94  Modified for Message queue and SPIF
:::.....:*/

long lRead_config(ifp)
FILE *ifp;
{
    char buff[128];
    char *cp;
    long again = 1;
    long lValue;

    /* Read until we get to the init strings */
    while (again != 0 && fgets(buff, sizeof(buff), ifp) != NULL)
    {
        if (buff[0] == '#')
            continue; /* A comment line */
        buff[strlen(buff)-1] = '\0';
        switch(sDecodeLine(buff, &cp, &lValue))

```

APPENDIX A - PAGE 169 OF 279

```

    {
        case MC_PACKETSIZE:
            vMQ_Log(NULL, NULL, 20, "[FRONTEND]
MC_PACKETSIZE: %ld\n",
                lValue);
            if ((sPacketLimit = lValue) <
sMinPacketLimit)
            {
                vMQ_Log(NULL, NULL, 0,
                    "[FRONTEND] Packet size %ld not >=
512. Using 512\n",
                    lValue);
                sPacketLimit = sMinPacketLimit;
            }
            break;

        case MC_PACKETHEADER:
            sPacketFlag = (short)lValue;
            vMQ_Log(NULL, NULL, 20, "[FRONTEND]
MC_PACKETHEADER: %ld\n",
                lValue);
            break;

        case MC_BAUD:
            sDefaultBaud = (short)lValue;
            vMQ_Log(NULL, NULL, 20, "[FRONTEND] MC_BAUD:
%ld\n", lValue);
            break;

        case MC_INTERPACKETGAP:
            sInterPacketGap = (short)lValue;
            vMQ_Log(NULL, NULL, 20, "[FRONTEND]
MC_INTERPACKETGAP: %ld\n",
                lValue);
            break;

        case MC_TRANSMITSIZE:
            sTransmitLimit = (short)lValue;
            vMQ_Log(NULL, NULL, 20, "[FRONTEND]
MC_TRANSMITSIZE: %ld\n",
                lValue);
            break;

        case MC_CONFIRMREQMAX:
            sConfirmMax = (short)lValue;
            vMQ_Log(NULL, NULL, 20, "[FRONTEND]
MC_CONFIRMREQMAX: %ld\n",
                lValue);
            break;

        case MC_INIT:
            vMQ_Log(NULL, NULL, 20, "[FRONTEND]
MC_INIT:\n");
            again = 0;
            break;
    }

```

APPENDIX A - PAGE 170 OF 279

```

        case MC_SOCKETPORT:
            vMQ_Log(NULL, NULL, 20, "[FRONTEND]
MC_SOCKETPORT: %d\n", lValue);
            socket_port_num = (int)lValue;
            break;

        case MC_HEARTBEAT:
            vMQ_Log(NULL, NULL, 20, "[FRONTEND]
MC_HEARTBEAT: %d\n", lValue);
            lHeartbeat = lValue;
            break;

        case MC_HEARTBEAT_WAIT:
            vMQ_Log(NULL, NULL, 20, "[FRONTEND]
MC_HEARTBEAT_WAIT: %d\n",
                lValue);
            lHeartbeat_wait = lValue;
            break;

        case MC_DBETIMEOUT:
            vMQ_Log(NULL, NULL, 20, "[FRONTEND]
MC_DBETIMEOUT: %d\n",
                lValue);
            lDBETimeout = lValue;
            break;
    }
    return( 1 );
}

```

```

/*:.....
:: Function: lFillMsgFields
::
:: Purpose : Fills the message fields for sending the message.
::
:: Returns:
::
:: Input:
::
:: Output:
::
:: Globals:
::
:: Revision:
:: WHO          --WHEN--  WHAT
:: DAB & VI          Original
:: Raju          09/09/94 Modified for Message queue and SPIF
:::.....*/

```

```

long lFillMsgFields(SUBSCRIBER *pSub, char *cp)
{
    time_t    now;
    char *cp_start;

    vMQ_Log(NULL, NULL, 21, "[FRONTEND] Filling Message\n");
}

```

APPENDIX A - PAGE 171 OF 279

```

/* Put in timestamp for message */
time(&now);
cp_start = cp;

sprintf(cp, "|%.8x|s|%.4x|s|", now, pSub->caSCR,
        pSub->ServerRequest.lMsgid, pSub->ServerRequest.caID);

cp += strlen(cp);
return(cp - cp_start);
}

/*:.....
:: Function: vDeleteTmpfile
::
:: Purpose : Deletes temporary file if present.
::
:: Returns:
::
:: Input:
::
:: Output:
::
:: Globals:
::
:: Revision:
:: WHO          --WHEN--  WHAT
:: Raju         12/27/94  Original
:::.....*/

void vDeleteTmpfile(SUBSCRIBER *pSub)
{
    time_t    now;
    char caTmpfile[100];

    vMQ_Log(NULL, NULL, 21, "[FRONTEND] Deleting tmpfile %s\n",
            pSub->caTmpfile );
    sprintf( caTmpfile, "tmp.%ld.%ld", getpid(), pSub->lSpifID);
    if( strcmp( pSub->caTmpfile, caTmpfile ) != 0 )
    {
#ifdef DELETE
        unlink(pSub->caTmpfile);
#endif
        strcpy(pSub->caTmpfile, caTmpfile);
        pSub->sManeuverCount = 0;
    }

    return;
}

```



```

extern int          last_baud;
extern time_t      start_time;
extern long        lHeartbeat;
extern int         iListenPort;
extern short       sMaxPackets;
extern short       sPacketFlag;
extern int         ipacketflag;
extern short       sConfirmMax;
extern short       sAckPending;
extern long        lMap_format;
extern long        lFormat_mode;
extern short       sDefaultBaud;
extern short       sPacketLimit;
extern int         iQueue_master;
extern long        lLastCommtime;
extern long        lLastCommtime;
extern long        lConstantBaud;
extern long        lCompress_mode;
extern long        lDisplay_panes;
extern short       sTransmitLimit;
extern long        lHeartbeat_wait;
extern int         socket_port_num;
extern short       sInterPacketGap;
extern struct      sockaddr_in addr;
extern short       sProcess_heartbeat;
extern short       sTerm_After_Service;
extern long        lExit_on_disconnect;
extern unsigned long ulSessionID;
extern short       sGateDisconnectFlag;

extern void        *pMQU_master;
extern void        *pvMQ_master;

extern char        *cpQID;
extern char        *cpFrontID;
extern char        *cpConfigPath;
extern char        *caCommDevice;
extern char        *caDeviceConfig;
extern char        *cpDownload_dir;
extern char        *cpDictionary_dir;

extern char        caID[];
extern char        caBuff[];
extern char        caHangup[];
extern char        caOrigin[];
extern char        caOriginType[];
extern char        caLimitValue[];
extern char        caDestination[];
extern char        caNoAutoAnswer[];
extern char        caDestinationType[];

extern char        *caAlternative[];

extern Q_HEAD      sHead;
extern Q_HEAD      sConfig;
extern Q_HEAD      *pQhead;

```

APPENDIX A -- PAGE 174 OF 279

```

extern Q_HEAD      *pQConfig;
extern FILE        *pMsgsfile;
extern SUBSCRIBER *pGSub;

void vFeGateDisconnect_all();

/*::::::::::::::::::::::::::::::::::::::::::::::::::::::::::
::::::::::::
:: Function:      sSendHeader
::
:: Purpose:      Send the SPIF header.
::
:: Returns:      SUCCESS or FAILURE.
::
:: Input:
::
:: Output :
::
:: Globals:
::
:: Called routines :
::
:: Revision:
:: WHO          --WHEN--  WHAT
:: Raju         10/19/94  Original
::::::::::::::::::
::::::::::::*/

short sSendHeader( lMsgsize, lSpifID, lMsgtype )
long lMsgsize;
long lSpifID;
long lMsgtype;
{
    char      caBuffer[TEMP_BUFF_SIZE];
    long      now;
    struct tm *pTime;
    SPIF_HEADER spif_header;

    if( lSpifID == -1 )
    {
        pGSub->lTrx_count++;
    }

    /* write the header information first */
    sprintf(caBuffer,"%c",sync[0]);
    mod_write(pGSub->iCommPort, caBuffer, 1);
    sprintf(caBuffer,"%c",sync[1]);
    mod_write(pGSub->iCommPort, caBuffer, 1);
    sprintf(caBuffer,"%c",sync[2]);
    mod_write(pGSub->iCommPort, caBuffer, 1);
    sprintf(caBuffer,"%c",sync[3]);
    mod_write(pGSub->iCommPort, caBuffer, 1);

    vMQ_Log(NULL, NULL, 10,

```

APPENDIX A – PAGE 175 OF 279

```
                                                                "[FRONTEND] SENT HEADER size %ld SPIFID %ld type
%ld \n",
                                                                lMsgsize, lSpifID, lMsgtype);
mod_write(pGSub->iCommPort, &lMsgsize, sizeof(long));
mod_write(pGSub->iCommPort, &lSpifID, sizeof(long));
mod_write(pGSub->iCommPort, &lMsgtype, sizeof(long));

#ifdef DEBUG
/* file fe_spif.msgs */
if( iDebug > 5 )
{
    now = time(0L);
    pTime = localtime(&now);

    fprintf( pMsgsfile, "\n %.2d/%.2d/%.2d %.2d:%.2d:%.2d
",
            pTime->tm_mon+1,
            pTime->tm_mday,
            pTime->tm_year,
            pTime->tm_hour,
            pTime->tm_min,
            pTime->tm_sec);

    fprintf( pMsgsfile, " SENT Header [ID %ld Type %ld Size
%ld]\n",
            lSpifID, lMsgtype, lMsgsize);
    fflush( pMsgsfile );
}
#endif

return(SUCCESS);
}
```

```
/*:.....
:::
:: Function: vLoadVariablesFe
::
:: Purpose: This routine loads the variable overlay area with
data when
:: record type is route
request(lRecordType=AU_ROUTE) or POI query
:: (AU_QUERY_POI). Most of the data are found
in the subscriber
:: structure.
::
:: Returns: none
::
:: Input : pointer to Audit record
:: pointer to Subscriber data
::
:: Output: none
::
:: Globals:
::
:: Called Routines:
```

```
::  
:: Revision:  
:: WHO      --WHEN--  WHAT  
:: Raju     08/28/94  Original  
:.....*  
:.....*/  
  
void vLoadVariablesFe(pAudFe, pSub)  
MQ_AUDIT_FE      *pAudFe;  
SUBSCRIBER      *pSub;  
{  
    if (pSub == NULL)  
        return;  
  
#ifdef DEBUG  
    vMQ_Log(NULL, NULL, 20,  
            "[FRONTEND] vLoadVariablesFe o %s, ot %s, d %s, dt %s,  
1 %ld, lt %s\n",  
            pSub->ServerRequest.caOrigin,  
            pSub->ServerRequest.caOriginType,  
            pSub->ServerRequest.caDestination,  
            pSub->ServerRequest.caDestinationType,  
            pSub->ServerRequest.lDestinationLimit,  
            pSub->ServerRequest.caDestinationLimitType);  
#endif  
  
    /* update the audit structure with information in the  
subscriber struct */  
    strcpy(pAudFe->vars.RouteInfo.caOrigin,  
pSub->ServerRequest.caOrigin);  
    strcpy(pAudFe->vars.RouteInfo.caOriginType,  
pSub->ServerRequest.caOriginType);  
    strcpy(pAudFe->vars.RouteInfo.caDestination,  
pSub->ServerRequest.caDestination);  
    strcpy(pAudFe->vars.RouteInfo.caDestinationType,  
pSub->ServerRequest.caDestinationType);  
    pAudFe->vars.RouteInfo.usDestinationLimit=  
pSub->ServerRequest.lDestinationLimit;  
    strcpy(pAudFe->vars.RouteInfo.caDestinationLimitType,  
pSub->ServerRequest.caDestinationLimitType);  
#ifdef DEBUG  
    vMQ_Log(NULL, NULL, 20,  
            "[FRONTEND] ret vLoadVariablesFe o %s ot %s d %s dt %s  
1 %ld lt %s\n",  
            pAudFe->vars.RouteInfo.caOrigin,  
pAudFe->vars.RouteInfo.caOriginType,  
pAudFe->vars.RouteInfo.caDestination,  
pAudFe->vars.RouteInfo.caDestinationType,  
pAudFe->vars.RouteInfo.usDestinationLimit,  
pAudFe->vars.RouteInfo.caDestinationLimitType);  
#endif  
}
```

APPENDIX A — PAGE 177 OF 279

```

    return;
}

/* :::::::::::::::::::::::::::::::::::::::::::::::::::::::::::::
::: :::::::::::::::
::: Function:   vAuditLogFe
:::
::: Purpose:    This routine loads the data for the audit log. The
record layout
:::             can be found in the auditlog.doc design document.
This record
:::             is binary. Most of the data are supplied by the
subscriber
:::             struture.
:::
::: Returns:    None.
:::
::: Input:
:::           long lRecordType - values, begin with AU_ are defined
in
:::           audit.h
:::           long lFID         -
:::           SUBSCRIBER *pSubscriber - pointer the subscriber data
:::           void *pVariable   - pointer to the variable information
that
:::
:::           is not part of the subscriber data.
For example, client message.
:::           long lMySubType  - Front end ID.
:::           short sflag      - Flag to indicate acknowledge
required or not
:::
:::           0 indicates acknowledge not
needed and
:::           1  indicates  acknowledge
needed.
:::
::: Output : none
:::
::: Globals:
:::
::: Called routines :   vLoadVariablesFe
:::
::: Revision:
::: WHO           --WHEN--  WHAT
::: Raju          08/28/94  Original
:::::::::::::::::::::::::::::::::::::::::::::::::::::::::::
::::::::::*/

void vAuditLogFe(pwatch, lRecordType, lFID, pSubscriber,
pVariable, lMySubType,
sflag)
void *pwatch;
long lRecordType;
long lFID;
SUBSCRIBER *pSubscriber;
void *pVariable;

```

APPENDIX A - PAGE 178 OF 279

```

long      lMySubType;
short     sflag;
{
    int          i;
    FILE         *fp;
    MQ_AUDIT_FE  *pAuditFe;
    SUBSCRIBER   *pSub;
    MQ_HEADER    *mqHeader;
    long         lsize, lLength;
    time_t       now;

    l          s          i          z          e          =
sizeof(MQ_HEADER)+sizeof(MQ_AUDIT_FE)-sizeof(mqHeader->caBody);

    vMQ_Log(NULL, NULL, 20,
            "[FRONTEND] vAuditLogFe type %ld, fid %ld \n",
lRecordType, lFID);

    if ((mqHeader = (MQ_HEADER *)malloc(lsize)) == NULL)
    {
        vMQ_Log(NULL, NULL, 0, "[FRONTEND] Could not
allocate\n");
        vFeGateDisconnect_all(GATEDISCONNECT_BY_OPERATOR);
    }
    pAuditFe = (MQ_AUDIT_FE *)mqHeader->caBody;
    pSub = pSubscriber;

    /*
    ** Load data for the audit record
    */
    if( sflag == 1)
    {
        mqHeader->lMessageType      =      MQ_MT_AUDIT      |
MQ_MT_ACKNOWLEDGE_REQUIRED;
    }
    else
    {
        mqHeader->lMessageType = MQ_MT_AUDIT;
    }

    mqHeader->lMessageSubType = lRecordType;          /* record
type */
    mqHeader->lSenderNode = gethostid(); /* IP Address of
host */

    if (pSub != (SUBSCRIBER *)NULL)
    {
        pAuditFe->lResultCode = pSub->sResultCode; /* calculation
result code */
        strcpy(pAuditFe->caSubscriberID, pSub->caSCR);
        strcpy(pAuditFe->caUnitID, pSub->ServerRequest.caID);
        pAuditFe->lSessionID = pSub->lSessionID; /* Session ID
*/
        pAuditFe->lCPUtime = 0;
        pAuditFe->lTxCnt = pSub->lTrx_count;          /* transmission
count */
    }

```

APPENDIX A - PAGE 179 OF 279

```

    pAuditFe->lRxCnt = pSub->lRcv_count;    /* receiving count
*/
    pAuditFe->sInformationCount = pSub->sManeuverCount;
}

#ifdef DEBUG
    vMQ_Log(NULL, NULL, 20,
    "[FRONTEND] Audit %s, %s, %ld, %ld, %ld, %ld, %d\n",
        pAuditFe->caSubscriberID,
        pAuditFe->caUnitID,
        pAuditFe->lResultCode,
        pAuditFe->lSessionID,
        pAuditFe->lTxCnt,
        pAuditFe->lRxCnt,
        pAuditFe->sInformationCount);
#endif

/*
** Load data for the variable portion, record type
dependent, of
** the audit record.
*/

switch(lRecordType)
{
    case MQ_MTS_AUDIT_QUMETRO_I:
    case MQ_MTS_AUDIT_QULANGUAGE_I:
    case MQ_MTS_AUDIT_CLLOGIN:
        pAuditFe->lCPUtime = 0;
        break;

    case MQ_MTS_AUDIT_ROUTE_I:
    case MQ_MTS_AUDIT_QUPOI_I:
        /* CPU time for calculation */
        pAuditFe->lCPUtime = pSub->lCpu_usage;
        vLoadVariablesFe(pAuditFe, pSubscriber);

        vMQ_Log(NULL, NULL, 21,
        "[FRONTEND] VariablesFe o %s ot %s d %s dt
%s l %ld lt %s\n",
            pAuditFe->vars.RouteInfo.caOrigin,
            pAuditFe->vars.RouteInfo.caOriginType,
            pAuditFe->vars.RouteInfo.caDestination,
            pAuditFe->vars.RouteInfo.caDestinationType,
            pAuditFe->vars.RouteInfo.usDestinationLimit,
            pAuditFe->vars.RouteInfo.caDestinationLimitType);
        break;

    case MQ_MTS_AUDIT_BUGRPT:
        if (pSub != (SUBSCRIBER *)NULL)
        {
            for( i = 0; i < 8; i++)
            {
                if(strncmp(

```

APPENDIX A -- PAGE 180 OF 279

```

pSub->ServerRequest.aAlternatives[i].caAlternatives,
    "BGRPT=", 6) == 0)
    {
        strcpy(pAuditFe->vars.Bugrpt.caBugrpt,
pSub->ServerRequest.aAlternatives[i].caAlternatives+6);
        break;
    }
}
break;

case MQ_MTS_AUDIT_DOWNLOAD_I:
    if (pSub != (SUBSCRIBER *)NULL)
    {
        strcpy(pAuditFe->vars.Download.caPath,
pSub->caTmpfile);
        pAuditFe->vars.Download.lFileSize =
pSub->lQueryFileSize;
    }
    break;

case MQ_MTS_AUDIT_SELMETRO_I:
    if (pSub != (SUBSCRIBER *)NULL)
    {
        strcpy(pAuditFe->vars.SelMetro.caMetro,
pSub->caConfig);
    }
    break;

case MQ_MTS_AUDIT_SELLANGUAGE:
    if (pSub != (SUBSCRIBER *)NULL)
    {
        strcpy(pAuditFe->vars.SellLang.caLanguage,
pSub->caLanguage);
    }
    break;

case MQ_MTS_AUDIT_CLLOGOUT:
    if (pSub != (SUBSCRIBER *)NULL)
    {
        now = time(0L);
        pAuditFe->vars.LogoutInfo.lTotalTime = now -
pSub->tstart_time;
        pAuditFe->vars.LogoutInfo.lTotalRouteReq =
pSub->lRoute_count;
        pAuditFe->vars.LogoutInfo.lTotalQueryReq =
pSub->lExternalQuery_count +
pSub->lInternalQuery_count;
    }
    break;
}

vMQ_FillHeader (mqHeader, MQ_GADDR_AUDIT, 0,
mqHeader->lMessageType,

```

APPENDIX A - PAGE 181 OF 279

```

.....
.....*/

void vHandleAuditLog(void *qwatch, void *config, long
lRecordType, long lFID,
SUBSCRIBER *pSub, void *pVariable, short sflag)
{
    vMQ_Log(NULL, NULL, 21,
        "[FRONTEND] AUDITREQ request %d from frontend %ld\n",
        sAckPending, lRecordType);

    vAuditLogFe(qwatch, lRecordType, lFID, pSub, pVariable,
lFrontID, sflag);

    if(sAckPending == 0)
    {
        lLastCommtime = time(0L);
    }

    sAckPending++;
    return;
}

/*.....
.....:
:: Function: vFeHandleAcknowledge_all
::
:: Purpose: Acknowledge handle for audit/Route/POI etc.
::
:: Returns: None.
::
:: Input: Pointer to Dispatch table, message type, message
subType and
:: mq_header pointer.
::
:: Output : none
::
:: Globals:
::
:: Called routines :
::
:: Revision:
:: WHO --WHEN-- WHAT
:: Raju 08/28/94 Original
.....
.....*/

void vFeHandleAcknowledge_all(pconfig, pqwatch, ptDTable,
lMessageType,
lMessageSubType, plHeader)
void *pconfig, *pqwatch, *ptDTable;
long lMessageType, lMessageSubType;
void *plHeader;
{
    MQ_HEADER *pHeader;
}

```

APPENDIX A - PAGE 183 OF 279

```

    pHeader = (MQ_HEADER *)plHeader;
    sAckPending--;
    vMQ_Log(NULL, NULL, 21,
            "[FRONTEND] Received Acknowledgement from %ld.\n",
pHeader->lSenderPID);
    vMQ_Log(NULL, NULL, 51,
            "[FRONTEND] Yet to receive %d acknowledgements\n",
sAckPending);
    lLastCommtime = time(0L);
    return;
}

```

```

/*::::::::::::::::::::::::::::::::::::::::::::::::::::::::::::::::::
:::
:: Function:   vFeHandleSetdebug_all
::
:: Purpose:   setdebug handle.
::
:: Returns:   None.
::
:: Input:     Pointer to Dispatch table, message type, message
subype and
::           mq_header pointer.
::
:: Output :   none
::
:: Globals:
::
:: Called routines :
::
:: Revision:
:: WHO        --WHEN--  WHAT
:: Raju        08/28/94  Original
::::::::::::::::::::::::::::::::::::::::::::::::::::::::::::::::::
::::::::::*/

```

```

void          vFeHandleSetdebug_all(pconfig, pqwatch, ptDTable,
lMessageType,
        lMessageSubType, plHeader)
void          *pconfig, *pqwatch, *ptDTable;
long lMessageType, lMessageSubType;
void *plHeader;
{
    MQ_HEADER    *pHeader;
    char         caTempFilename[36];

    pHeader = (MQ_HEADER *)plHeader;
    iDebug = *(long *)pHeader->caBody;
    vMQ_Log(NULL, NULL, 10, "[FRONTEND]setdebug debug level to
%d\n", iDebug);

#ifdef DEBUG
    if( (iDebug > 5) && (pMsgsfile == NULL))
    {
        sprintf( caTempFilename,"msgs.%ld",getpid());

```

APPENDIX A – PAGE 184 OF 279

```

        if((pMsgsfile = fopen(caTempFilename,"w")) == NULL)
        {
            fprintf(stderr,"\n Unable to open msgs.pid\n");
            fprintf(stderr," Exiting\n");
            exit(0);
        }
    }
#endif

    return;
}

/* :::::::::::::::::::::::::::::::::::::::::::::::::::::::::::::
   ::::::::::::::
   :: Function:    vFeHandleAddservice_all
   ::
   :: Purpose:    AddService handle.
   ::
   :: Returns:    None.
   ::
   :: Input:      Pointer to Dispatch table, message type, message
   subtype and
   ::              mq_header pointer.
   ::
   :: Output :    none
   ::
   :: Globals:
   ::
   :: Called routines :
   ::
   :: Revision:
   :: WHO          --WHEN--  WHAT
   :: Raju          08/28/94  Original
   :::::::::::::::::::::::::::::::::::::::::::::::::::::::::::::
   ::::::::::::::*/

void          vFeHandleAddservice_all(pconfig, pqwatch, ptDTable,
lMessageType,
           lMessageSubType, plHeader)
void          *pconfig, *pqwatch, *ptDTable;
long lMessageType, lMessageSubType;
void *plHeader;
{
    MQ_OP_ADDSERVICE *pAddService;
    MQ_HEADER          *pHeader;
    Q_ELEM             *pconfig_elem;
    Q_HEAD             *pConfig;
    CONFIGTABLE        sTable, *pTable = &sTable;

    vMQ_Log(NULL, NULL, 20, "[FRONTEND] Received AddService
request\n");

    /* Get the request from the monitor */
    pHeader = (MQ_HEADER *)plHeader;

```

APPENDIX A — PAGE 185 OF 279

```

        vFeHandleTerminate(TERMINATE_ABORT);
    }

    vMQ_Log(NULL, NULL, 21, "[FRONTEND] Calling AddSub\n");
    /* Add the subscriber to the subscriber list */
    if( (pSub = pAddSub(pSpifHeader, Msg)) == NULL);
    {
        /* Get a pointer to the subscriber */
        if( (pSub = pFindSpifID( pSpifHeader->lSpifID )) ==
NULL)
        {
            vMQ_Log(NULL, NULL, 0, "[FRONTEND] Subscriber not
Added\n");
            vFeHandleTerminate(TERMINATE_NORMAL);
        }
    }

    vMQ_Log(NULL, NULL, 21, "[FRONTEND] VALIDATE
scr=%s,spifid=%ld\n",
        pSub->caSCR, pSub->lSpifID);

    /* Global Address of Validate process */
    lg_addr = MQ_GADDR_VALIDATE;
    lSize = MQ_MESSAGE_SIZE2(MQ_OP_VALIDATE_Q,mqHeader);

    if((mqHeader = (MQ_HEADER *)malloc(lSize)) == NULL)
    {
        vMQ_Log(NULL, NULL, 0, "[FRONTEND] Unable to allocate
memory");
        vFeHandleTerminate(TERMINATE_NORMAL);
    }

    /* Fill up the validation request structure */
    mqHeader->lMessageType = MQ_MT_OPCOMMAND;
    mqHeader->lMessageSubType = MQ_MTS_OP_VALIDATE_Q;
    pValidate = (MQ_OP_VALIDATE_Q *)mqHeader->caBody;
    strcpy(pValidate->caSubscriberID, pSub->caSCR );
    strcpy(pValidate->caUnitID, pSub->ServerRequest.caID);

    /* fill the message header */
    vMQ_FillHeader(mqHeader, lg_addr, 0, mqHeader->lMessageType,
        mqHeader->lMessageSubType, lFID );

    /* store the sendtime and sequence number to refer to them
on */
    /* receiving a message */
    pSub->tReplyTime = mqHeader->tSendTime;
    pSub->lSequence = mqHeader->lSequenceNumber;

    vMQ_Log(NULL, NULL, 21, "[FRONTEND]
time=%ld,sequence=%ld,file=%s\n",
        pSub->tReplyTime, pSub->lSequence, pSub->caTmpfile);

    /* Send a validation request to validate process */

```

APPENDIX A – PAGE 187 OF 279

```

        if( lMQ_QueueWrite( pvMQ_master, (void *)mqHeader, lSize,
0) != lSize)
        {
            vMQ_Log(NULL, NULL, 0, "[FRONTEND] Unable to write
queue Validate\n");
            vFeHandleTerminate(TERMINATE_NORMAL);
        }

        free( mqHeader );
        return;
    }

```

```

/*::::::::::::::::::::::::::::::::::::::::::::::::::
::::::::::
:: Function:   vFeSubDisconnect_all
::
:: Purpose:   Handle to disconnect a subscriber.
::
:: Returns:   None.
::
:: Input:     Pointer to SPIFheader and message.
::
:: Output :   none
::
:: Globals:
::
:: Called routines :
::
:: Revision:
:: WHO           --WHEN--  WHAT
:: Raju           08/28/94  Original
::::::::::*/

```

```

void   vFeSubDisconnect_all(pSpifHeader)
SPIF_HEADER *pSpifHeader;
{
    SUBSCRIBER *pSub;

    /* Get the specified subscriber */
    if((pSub = pFindSpifID( pSpifHeader->lSpifID)) == NULL)
    {
        vMQ_Log(NULL, NULL, 0, "[FRONTEND] Subscriber not
found\n");
        return;
    }

    vMQ_Log(NULL,NULL,10,"[FRONTEND] Delete Subscriber request
from SPIF\n");
    pSub->sResultCode = LOGOUT_BY_CARRIER;
    vHandleAuditLog(NULL, NULL, MQ_MTS_AUDIT_CLLOGOUT,
lFID, (void *)pSub,
NULL, 1);
    vMQ_EventLog(NULL,NULL, MQ_EVB_LOGOUT, pSub->caSCR,
strlen(pSub->caSCR) );
}

```

APPENDIX A - PAGE 188 OF 279

```

    /* Delete the subscriber */
    if(iDelSub( pSpifHeader->lSpifID) != SUCCESS)
    {
        vMQ_Log(NULL, NULL, 0, "[FRONTEND] Unable to Delete
Subscriber\n");
    }
    return;
}

```

```

/*:::.....
:::
:: Function: vFeGateDisconnect_all
::
:: Purpose: Handle to disconnect the Gateway.
:: Gateway disconnect should disconnect all current
active subscribers
:: before actually disconnecting the Gateway.
:: 0 Indicates direct request from SPIF.
:: 1 Indicates because of other reasons like
terminate or errors.
:: 2 Indicates SPIF is dead. So auditlog all
subscribers
:: and Gateway for logout without any messages
to the SPIF.
:: 0 GATEDISCONNECT_BY_SPIF
:: 1 GATEDISCONNECT_BY_OPERATOR
:: 2 GATEDISCONNECT_BY_CARRIER
::
:: Returns: None.
::
:: Input: flag to indicate proper or abrupt disconnect.
::
:: Output : none
::
:: Globals:
::
:: Called routines :
::
:: Revision:
:: WHO --WHEN-- WHAT
:: Raju 08/28/94 Original
:::.....*/

```

```

void vFeGateDisconnect_all(sflag)
short sflag;
{
    Q_ELEM *pq_elem;
    Q_HEAD *pq;
    SUBSCRIBER *pSub;

    /* Check if anyone is logged in */
    if( pQhead != NULL)
    {
        pq = pQhead;

```

```

VMQ_Log(NULL, NULL, 10, "[FRONTEND] Gateway
disconnect\n");
/* Traverse the subscriber list */
Q_FORWTRAV(pq_elem, pq)
{
    pSub = (SUBSCRIBER *) q_data(pq_elem);

/* If the subscriber is not a gateway then
disconnect. */
if(pSub->sGatewayFlag != 1)
{
    /* Disconnect the subscriber after sending
a Ok response */
    pSub->lMsgtype = SPIF_SUBSCRIBER_DISCONNECT;

/* if SPIF has died abruptly then sflag is
2 */
if( sflag != GATEDISCONNECT_BY_CARRIER )
{
    sSendHeader( 8, pSub->lSpifID,
pSub->lMsgtype );
}

    pSub->sResultCode = LOGOUT_BY_OPERATOR;
    vHandleAuditLog(NULL, NULL,
MQ_MTS_AUDIT_CLLOGOUT, lFID,
(void *)pSub, NULL, 1);
    vMQ_EventLog(NULL, NULL, MQ_EVB_LOGOUT,
pSub->caSCR, strlen(pSub->caSCR) );
    vMQ_Log(NULL, NULL, 10, "[FRONTEND] Deleting
subscriber\n");

/* delete the subscriber */
if( iDelSub(pSub->lSpifID) != SUCCESS)
{
    vMQ_Log(NULL, NULL, 0,
"[FRONTEND] Unable to delete
subscriber\n");
}
}

if( (pGSub == NULL) || (pGSub->iValidated == 0) ||
(pGSub->sGatewayFlag == 0) )
{
    vMQ_Log(NULL, NULL, 0, "[FRONTEND] Invalid request.
No Gateway\n");
}
else
{
/* Delete the gateway after deleting all the
subscribers */
if( (sflag == GATEDISCONNECT_BY_OPERATOR) ||
(sTerm_After_Service == 1) )
{

```

APPENDIX A - PAGE 190 OF 279

```

                sSendHeader( 8, pGSub->lSpifID,
SPIF_GATEWAY_DISCONNECT );
            }

            vHandleAuditLog( NULL, NULL,
MQ_MTS_AUDIT_DISCONNECT, lFID,
                (void *)pGSub, NULL, 1);
            vMQ_EventLog( NULL, NULL, MQ_EVB_LOGOUT,
pGSub->caSCR,
                strlen(pGSub->caSCR) );

            pGSub->sGatewayFlag = 0;
            vMQ_Log( NULL, NULL, 10, "[FRONTEND] Deleting
Gateway\n");
            if( iDelSub(pGSub->lSpifID) != SUCCESS)
            {
                vMQ_Log( NULL, NULL, 0, "[FRONTEND] Unable to
delete Gateway\n");
            }
        }
    }

    /* create a new empty list of subscribers */
    pGSub = NULL;
    pQhead = NULL;

    /* Terminate after disconnecting all subscribers and Gateway
*/
    /* if the sTerm_After_Service flag is set. */
    if( sTerm_After_Service == 1)
    {
        vMQ_Log( NULL, NULL, 0, "[FRONTEND] Exiting After Service
completion.\n");
        vFeHandleTerminate( TERMINATE_ABORT);
    }

    pQhead = &sHead;
    q_newlist( pQhead);
    sAckPending = 0;

    if( sflag == GATEDISCONNECT_BY_CARRIER )
    {
        /* delete the dataport and add listen port to the
queuwatch */
        iFeListen();
    }
    else
    {
        sGateDisconnectFlag = 1;
    }
    return;
}

/*:.....
:.....

```

APPENDIX A — PAGE 191 OF 279

```

    pStatusFe->lInternalQueryCount    =
pGSub->lInternalQuery_count    ;
    pStatusFe->lSessionSettings      = 0 ;
    pStatusFe->tLogin = pGSub->tstart_time ;
    strcpy(pStatusFe->caUnitID,pGSub->ServerRequest.caID
);
    strcpy(pStatusFe->caSubscriberID,pGSub->caSCR );
    }
    else
    {
        /* If the gate way is not yet logged in then there is
no infromation */
        pStatusFe->lTxCount = 0;
        pStatusFe->lRxCount = 0;
        pStatusFe->lRouteCount = 0;
        pStatusFe->lExternalQueryCount = 0;
        pStatusFe->lInternalQueryCount = 0;
        pStatusFe->lSessionSettings      = 0 ;
        pStatusFe->tLogin = 0;
        strcpy(pStatusFe->caUnitID,"\0");
        strcpy(pStatusFe->caSubscriberID,"\0");
    }

    /* Send back the message to the requester. */
    if( lMQ_QueueWrite( pvMQ_master, (void *)pReply, lSize, 0)
!= lSize)
    {
        vMQ_Log(NULL, NULL, 0, "[FRONTEND] Unable to write
queue status\n");
        vFeHandleTerminate(TERMINATE_NORMAL);
    }

    vMQ_Log(NULL, NULL, 21, "[FRONTEND] Returned Status to
%d\n",
pHeader->lDestinationPID);
    free(pReply);

    return;
}

/*::::::::::::::::::::::::::::::::::::::::::::::::::::::::::
::::::::::
:: Function:  vFeHandleRoute_all
::
:: Purpose: Handle the route reply from the queue.
::
:: Returns:  None.
::
:: Input:    Pointer to Dispatch table, message type, message
subtype and
::           mq_header pointer.
::
:: Output : none
::
:: Globals:

```



```

        pSub->lCpu_usage = 0;

        /* Parse the pending request */
        pSub->lStatus = 0;
#ifdef DELETE
        unlink(pSub->caTmpfile);
        unlink(pSub->caBtrfFile);
#endif
        sprintf(pSub->caTmpfile, "tmp.%ld.%ld", getpid(),
pSub->lSpifID);
        pSub->lResponsePending = 0;
        pSpif_head->lMsgsize = strlen(pSub->caMsg) + 8;
        pSpif_head->lSpifID = pSub->lSpifID;
        pSpif_head->lMsgtype = pSub->lMsgtype;
        vFePassThrough all(pSpif_head, pSub->caMsg);
        pSub->lRequestPending = 0;
        return;
    }

    pSub->lResponsePending = 0;

    /* If no request is pending then check the return code */
    if( pHeader->lReturnCode != 0)
    {
        vHandleAuditLog(NULL, NULL, MQ_MTS_AUDIT_ROUTE_I, lFID,
(void *)pSub,
        NULL, 1);
        pSub->lCpu_usage = 0;
        pSub->sResultCode = (short)pHeader->lReturnCode;

        /* There was an error in the route - in
        ** this case the file should contain the
        ** error message, not route structures.
        */
        errno = pHeader->lReturnCode;
        vMQ_Log(NULL, NULL, 29, "[FRONTEND] Route failed code
%ld\n",
        pHeader->lReturnCode);
        vSendErrorFile(pSub);

#ifdef DELETE
        unlink(pSub->caTmpfile);
        unlink(pSub->caBtrfFile);
#endif
        sprintf(pSub->caTmpfile, "tmp.%ld.%ld", getpid(),
pSub->lSpifID);
    } /* end if status - not OK path */
    else
    {
        /* Increment successful route count var */
        pSub->lRoute_count++;
        pGSub->lRoute_count++;
        /* Send route file */
        vMQ_Log(NULL, NULL, 21,
        "[FRONTEND] Route successful - sending
message!\n");
    }

```

APPENDIX A - PAGE 197 OF 279

```

        if(!(pSub->lStatus & SS_BRBF))
        {
            vReset_status_flags(pSub);
#ifdef DELETE
            unlink(pSub->caBtrfFile);
#endif
        }

        if (pSub->lStatus & SS_ROUTE_DWNL)
        {
            pSub->lQueryFilesize = pHeader->lBTRFDataSize;
            sGenerateDownload(pSub);
            /* if btrf make a copy of the route file */
            if ((pSub->lStatus & SS_BTRF)&&!(pSub->lStatus
& SS_BRBF))
                i f ( ( p c E x t =
strchr(pSub->caTmpfile, '.')!=NULL)
                {
                    strcpy(pSub->caBtrfFile, "./btrf");
                    strcat(pSub->caBtrfFile, pcExt);
                    link(pSub->caTmpfile, pSub->caBtrfFile);
                }
            }
        }
        else
            vSendRouteFile(pSub);
    } /* end else status - is OK path */

    vReset_status_flags(pSub);
    return;
}

/*:.....:
:::
:: Function: vFeHandlePOIQuery_all
::
:: Purpose: Handle the POIQuery reply from the queue.
::
:: Returns: None.
::
:: Input: Pointer to Dispatch table, message type, message
subtype and
:: mq_header pointer.
::
:: Output : none
::
:: Globals:
::
:: Called routines :
::
:: Revision:
:: WHO --WHEN-- WHAT
:: Raju 08/28/94 Original

```

APPENDIX A — PAGE 198 OF 279

```

:.....:
:.....*/

void      vFeHandlePOIQuery_all(pconfig, pqwatch, ptDTable,
lMessageType,
      lMessageSubType, plHeader)
void      *pconfig, *pqwatch, *ptDTable;
long lMessageType, lMessageSubType;
void *plHeader;
{
    SUBSCRIBER *pSub;
    MQ_HEADER *pHeader;
    SPIF_HEADER sSpif_head;
    SPIF_HEADER *pSpif_head = &sSpif_head;

    pHeader = (MQ_HEADER *)plHeader;
    vMQ_Log(NULL, NULL, 10, "[FRONTEND] POIs return code %ld
count %ld\n",
      pHeader->lReturnCode, pHeader->lItemCount);

    /* Get the subscriber to whom the reply is meant to */
    if((pSub = pFindResponse(pHeader->tReplyID.tOriginTime,
      pHeader->tReplyID.lOriginSequence) ) == NULL)
    {
        vMQ_Log(NULL, NULL, 0, "[FRONTEND] subscriber not
found\n");
        return;
    }

    /* get the cpuusage and result code */
    pSub->lLastCommtime = time(0L);
    pSub->lCpu_usage = pHeader->lResourceUsage;
    pSub->sResultCode = (short)pHeader->lReturnCode ;
    pSub->sManeuverCount = pHeader->lItemCount ;
    vHandleAuditLog(NULL, NULL, MQ_MTS_AUDIT_QUPOI_I, lFID,
      (void *)pSub, NULL, 1 );
    pSub->lCpu_usage = 0;
    pSub->sManeuverCount = 0;

    /* check if a request is pending */
    /* if request is pending, forget the reply for the previous
request */
    /* and parse the next request */
    if( pSub->lRequestPending)
    {
        /* Parse the pending request */
        pSub->lStatus = 0;
#ifdef DELETE
        unlink(pSub->caTmpfile);
#endif
        sprintf(pSub->caTmpfile, "tmp.%ld.%ld", getpid(),
pSub->lSpifID);
        pSub->lResponsePending = 0;
        pSpif_head->lMsgsize = strlen(pSub->caMsg) + 8;
        pSpif_head->lSpifID = pSub->lSpifID;
        pSpif_head->lMsgtype = pSub->lMsgtype;

```

APPENDIX A - PAGE 199 OF 279

```

SUBSCRIBER *pSub;
{
    MQ_HEADER *mqHeader;
    MQ_OP_POIQUERY *pPOIQuery;
    long lg_addr;
    long lSize;
    char tempBuff[200];
    short    sIndex;

    /* get the address from the monitor for this config. */
    if( (lMQU_ValidateName( pMQU_master, pSub->caConfig) ==
FAILURE) ||
((lg_addr = lMQU_TranslateName( pMQU_master,
pSub->caConfig)) == FAILURE))
    {
        sprintf(tempBuff, "Metro region %s not available now\n",
                pSub->caConfig );
        vMQ_Log(NULL, NULL, 0, "[FRONTEND] %s", tempBuff);

        if(pSub->sResultCode<1) pSub->sResultCode=FEERR_SVGD;
        vSendErrorResponse(pSub, tempBuff);

        return FAILURE;
    }

    lSize = MQ_MESSAGE_SIZE2(MQ_OP_POIQUERY, mqHeader);

    if((mqHeader = (MQ_HEADER *)malloc(lSize)) == NULL)
    {
        vMQ_Log(NULL, NULL, 0, "[FRONTEND] Unable to allocate
memory\n");
        vFeGateDisconnect_all(GATEDISCONNECT_BY_OPERATOR);
    }

    /* Update the request structure for POI request */
    mqHeader->lMessageType = MQ_MT_OPCOMMAND |
MQ_MT_ACKNOWLEDGE_REQUIRED;
    mqHeader->lMessageSubType = MQ_MTS_OP_POIQUERY;
    pPOIQuery = (MQ_OP_POIQUERY *)mqHeader->caBody;

    if(sAckPending == 0)
    {
        lLastCommtime = time(0L);
    }

    sAckPending++;

    memset(pPOIQuery->caSort, '\0', MQ_ALT_SZ);

    for(sIndex=0; sIndex<AR_MAX_ALTS; sIndex++)
    {
        if(strncmp(pSub->ServerRequest.
aAlternatives[sIndex].caAlternatives, "SORT=", 5)==0)
        {
            strncpy(pPOIQuery->caSort,

```

APPENDIX A - PAGE 201 OF 279

```

        pSub->ServerRequest.
        aAlternatives[sIndex].caAlternatives+5,
        FE_ALT_LEN-5);
    }
}

pPOIQuery->lQueryType = MQ_QT_NORMAL;
pPOIQuery->lMaximumPOIs = 0 ;
pPOIQuery->sDestinationLimit =
pSub->ServerRequest.lDestinationLimit;
pPOIQuery->sOriginBearing =
pSub->ServerRequest.sOriginBearing;
pPOIQuery->lOriginLatitude =
pSub->ServerRequest.lLatitude;
pPOIQuery->lOriginLongitude =
pSub->ServerRequest.lLongitude;
strcpy(pPOIQuery->caOrigin, pSub->ServerRequest.caOrigin);
strcpy(pPOIQuery->caOriginType,
pSub->ServerRequest.caOriginType );

strcpy(pPOIQuery->caDestination, pSub->ServerRequest.caDestination
);

strcpy(pPOIQuery->caDestinationType, pSub->ServerRequest.caDest
inationType );

switch( pSub->ServerRequest.caDestinationLimitType[0])
{
    case 'M':
        pPOIQuery->sDestinationLimitType = 0;
        break;
    case 'D':
        pPOIQuery->sDestinationLimitType = 1;
        break;
    case 'T':
        pPOIQuery->sDestinationLimitType = 2;
        break;
    default:
        pPOIQuery->sDestinationLimitType = 0;
        break;
}

/* Fill the header */
vMQ_FillHeader(mqHeader, lg_addr, 0, mqHeader->lMessageType,
mqHeader->lMessageSubType, lFID );

pSub->tReplyTime = mqHeader->tSendTime;
pSub->lSequence = mqHeader->lSequenceNumber;
pSub->lStatus = (pSub->lStatus & ~SS_SEND_QMASK) |
SS_SEND_QPOIS;
sprintf( pSub->caTmpfile, "tmp.%ld.%ld", getpid(),
pSub->lSequence);
strcpy(pPOIQuery->caTempPath, pSub->caTmpfile );

#ifdef DEBUG2

```

APPENDIX A - PAGE 202 OF 279

```

printf("\nPOIQuery:\noutfile=%s\n", pPOIQuery->caTempPath);
printf("querytype=%ld\n", pPOIQuery->lQueryType);
printf("origin =%s", pPOIQuery->caOrigin);
printf("origintype =%s", pPOIQuery->caOriginType);
printf("destination =%s", pPOIQuery->caDestination);
printf("destinationtype=%s", pPOIQuery->caDestinationType);
printf("destlimit =%d\n", pPOIQuery->sDestinationLimit);

printf("destlimittype=%d\n", pPOIQuery->sDestinationLimitType);
printf("maxpois=%ld\n", pPOIQuery->lMaximumPOIs);
#endif
    vMQ_Log(NULL, NULL, 29,
        "[FRONTEND] poi orlat orlat orlong orb %ld %ld %d \n",
        pPOIQuery->lOriginLatitude,
        pPOIQuery->lOriginLongitude,
        pPOIQuery->sOriginBearing);
    vMQ_Log(NULL, NULL, 29,
        "[FRONTEND] poi qtype %ld, maxpois %ld, destlmt %d,
desttype %d \n",
        pPOIQuery->lQueryType,
        pPOIQuery->lMaximumPOIs,
        pPOIQuery->sDestinationLimit,
        pPOIQuery->sDestinationLimitType);
    vMQ_Log(NULL, NULL, 29,
        "[FRONTEND] poi or %s, otyp %s, dest %s, destyp %s,
tmpfile %s \n",
        pPOIQuery->caOrigin,
        pPOIQuery->caOriginType,
        pPOIQuery->caDestination,
        pPOIQuery->caDestinationType,
        pPOIQuery->caTempPath);

    vMQ_Log(NULL, NULL, 21, "[FRONTEND] POIRequest type %ld
subtype %ld\n",
        mqHeader->lMessageType, mqHeader->lMessageSubType);
    /* Send it to the queue */
    if( lMQ_QueueWrite( pvMQ_master, (void *)mqHeader, lSize,
0) != lSize)
    {
        vMQ_Log(NULL, NULL, 0, "[FRONTEND] Unable to write
queue poiquery\n");
        vFeHandleTerminate(TERMINATE_NORMAL);
    }

    free( mqHeader );
    return SUCCESS;
}

/*::::::::::::::::::::::::::::::::::::::::::::::::::::::::::::::::::
::::::::::
:: Function:    sFeRequestRoute_all
::
:: Purpose:    Handle to send the route request to the backend.
::
:: Returns:    Success or FAILURE.

```

APPENDIX A – PAGE 203 OF 279

```

pRoute = (MQ_OP_ROUTE *)mqHeader->caBody;
if(sAckPending == 0)
{
    lLastCommtime = time(0L);
}

sAckPending++;

pRoute->lSpecials = 0;
memset(pRoute->caRouteBandParam, '\0', MQ_ALT_SZ);

if(pSub->lStatus & SS_STRIPMAP)
    pRoute->lSpecials |= MQ_ROUTE_SP_STRIP;

if(pSub->lStatus & SS_BTRF)
    pRoute->lSpecials |= MQ_ROUTE_SP_BTRF;

if(pSub->bit_map & BIT_ARMS)
    pRoute->lSpecials |= MQ_ROUTE_SP_ARMS;

if(pSub->lStatus & SS_BRBF)
{
    pRoute->lSpecials |= MQ_ROUTE_SP_BAND;
    strcpy(pRoute->caBtrfFile, pSub->caBtrfFile);
}

for(sIndex=0; sIndex<AR_MAX_ALTS; sIndex++)
{
    if(strncmp(pSub->ServerRequest.
        aAlternatives[sIndex].caAlternatives,
        "ROUTEBAND=", 10) == 0)
    {
        strncpy(pRoute->caRouteBandParam,
            pSub->ServerRequest.
            aAlternatives[sIndex].caAlternatives+10,
            FE_ALT_LEN-10);
    }
}

pRoute->sDestinationLimit =
pSub->ServerRequest.lDestinationLimit;
pRoute->sDestinationBearing =
pSub->ServerRequest.sDestinationBearing;
pRoute->sOriginBearing =
pSub->ServerRequest.sOriginBearing;
pRoute->lOriginLatitude = pSub->ServerRequest.lLatitude;
pRoute->lOriginLongitude =
pSub->ServerRequest.lLongitude;

strcpy(pRoute->caOrigin, pSub->ServerRequest.caOrigin);
strcpy(pRoute->caOriginType,
pSub->ServerRequest.caOriginType);

```

APPENDIX A - PAGE 205 OF 279

```

strcpy(pRoute->caDestination,
pSub->ServerRequest.caDestination );
strcpy ( pRoute - > caDestinationType ,
pSub->ServerRequest.caDestinationType );
strcpy(pRoute->caLanguage, pSub->caLanguage );

pRoute->OriginLocus.sMap = pSub->OriginLocus.sMap;
pRoute->OriginLocus.sLayer = pSub->OriginLocus.sLayer;
pRoute->OriginLocus.sParcel = pSub->OriginLocus.sParcel;
pRoute->OriginLocus.sIndex = pSub->OriginLocus.sIndex;
pRoute->OriginLocus.spot = pSub->OriginLocus.spot;
pRoute->OriginLocus.side = pSub->OriginLocus.side;

pRoute->DestinationLocus.sMap =
pSub->DestinationLocus.sMap;
pRoute->DestinationLocus.sLayer =
pSub->DestinationLocus.sLayer;
pRoute->DestinationLocus.sParcel =
pSub->DestinationLocus.sParcel;
pRoute->DestinationLocus.sIndex =
pSub->DestinationLocus.sIndex;
pRoute->DestinationLocus.spot = pSub->DestinationLocus.spot;
pRoute->DestinationLocus.side = pSub->DestinationLocus.side;

vMQ_Log(NULL, NULL, 29,
"[FRONTEND] route Size %ld orlat orlong orb db dlmt %ld
%ld %d %d %s\n",
lSize,
pRoute->lOriginLatitude,
pRoute->lOriginLongitude,
pRoute->sOriginBearing,
pRoute->sDestinationBearing,
pRoute->sDestinationLimit);
vMQ_Log(NULL, NULL, 29,
"[FRONTEND] route or M-L-P-I-sp(decimal)-sd(dec)
%d-%d-%d-%d-%d \n",
pRoute->OriginLocus.sMap,
pRoute->OriginLocus.sLayer,
pRoute->OriginLocus.sParcel,
pRoute->OriginLocus.sIndex,
pRoute->OriginLocus.spot,
pRoute->OriginLocus.side);

vMQ_Log(NULL, NULL, 29,
"[FRONTEND] route dest M-L-P-I-sp(dec)-sd(dec)
%d-%d-%d-%d-%d \n",
pRoute->DestinationLocus.sMap,
pRoute->DestinationLocus.sLayer,
pRoute->DestinationLocus.sParcel,
pRoute->DestinationLocus.sIndex,
pRoute->DestinationLocus.spot,
pRoute->DestinationLocus.side);

switch( pSub->ServerRequest.caDestinationLimitType[0] )
{
case 'M':

```

```

        pRoute->sDestinationLimitType = 0;
        break;
    case 'D':
        pRoute->sDestinationLimitType = 1;
        break;
    case 'T':
        pRoute->sDestinationLimitType = 2;
        break;
    default:
        pRoute->sDestinationLimitType = 0;
        break;
}

/* fill the header */
vMQ_FillHeader(mqHeader, lg_addr, 0, mqHeader->lMessageType,
              mqHeader->lMessageSubType, lFID );

pSub->tReplyTime = mqHeader->tSendTime;
pSub->lSequence = mqHeader->lSequenceNumber;

sprintf( pSub->caTmpfile, "tmp.%ld.%ld", getpid(),
pSub->lSequence);
strcpy( pRoute->caTempPath, pSub->caTmpfile);

vMQ_Log(NULL, NULL, 29,
"[FRONTEND] routedBE %ld tmpfile %s btrf file %s\n",
mqHeader->lDestinationPID,
pRoute->caTempPath,
pRoute->caBtrfFile);

vMQ_Log(NULL, NULL, 29,
"[FRONTEND] routedBE or %s, otyp %s\n",
pRoute->caOrigin,
pRoute->caOriginType);

vMQ_Log(NULL, NULL, 29,
"[FRONTEND] routedBE dest %s, destyp %s\n",
pRoute->caDestination,
pRoute->caDestinationType);

/* Send the message to the queue */
if( lMQ_QueueWrite( pvMQ_master, (void *)mqHeader, lSize,
0) != lSize)
{
    vMQ_Log(NULL, NULL, 0, "[FRONTEND] Write queue error
routerequest\n");
    vFeHandleTerminate(TERMINATE_NORMAL);
}

free( mqHeader );
return SUCCESS;
}

```

APPENDIX A — PAGE 207 OF 279

```

/*:.....
:.....
:: Function:   vFeRequestUnRegistry_all
::
:: Purpose:   Handle to request unregister of the front end on
terminate.
::
:: Returns:   None.
::
:: Input:    None.
::
:: Output :  none
::
:: Globals:
::
:: Called routines :
::
:: Revision:
:: WHO      --WHEN--  WHAT
:: Raju      08/28/94  Original
:.....
:.....*/

```

```

void   vFeRequestUnRegistry_all()
{
    MQ_HEADER *mqHeader;
    MQ_REG_QUREGISTRYP *pRegistryDel;
    long lg_addr;
    long lSize;

    lg_addr = MQ_GADDR_MONITOR;
    lSize = MQ_MESSAGE_SIZE2(MQ_REG_QUREGISTRYP, mqHeader);

    if((mqHeader = (MQ_HEADER *)malloc(lSize)) == NULL)
    {
        vMQ_Log(NULL, NULL, 0, "[FRONTEND] Unable to allocate
memory\n");
        return;
    }

    /* Update the unregister structure */
    mqHeader->lMessageType = MQ_MT_REGISTRY;
    mqHeader->lMessageSubType = MQ_MTS_REG_REGISTRY_DEL;
    pRegistryDel = (MQ_REG_QUREGISTRYP *)mqHeader->CaBody;

    sprintf(pRegistryDel->caName, "%ld", lFID );

    vMQ_FillHeader(mqHeader, lg_addr, 0, mqHeader->lMessageType,
        mqHeader->lMessageSubType, lFID );

    /* Send the message to the monitor */
    if( lMQ_QueueWrite( pVMQ_master, (void *)mqHeader, lSize,
IPC_NOWAIT)
        != lSize)
    {

```

APPENDIX A - PAGE 208 OF 279

```

        vMQ_Log(NULL, NULL, 0, "[FRONTEND] Unable to write
queue unregister\n");
        vFeHandleTerminate(TERMINATE_ABORT);
    }

    free( mqHeader );
    return;
}

```

```

/*::::::::::::::::::::::::::::::::::::::::::::::::::::::::::
::::::::::
:: Function:   vFeRequestRegistry_all
::
:: Purpose:   Handle to send register request fro front end
::
:: Returns:   None.
::
:: Input:    None.
::
:: Output :  none
::
:: Globals:
::
:: Called routines :
::
:: Revision:
:: WHO        --WHEN--  WHAT
:: Raju       08/28/94  Original
::::::::::::::::::::::::::::::::::::::::::::::::::::::::::
::::::::::*/

```

```

void    vFeRequestRegistry_all()
{
    MQ_HEADER *mqHeader;
    MQ_REG_REGISTRYADD *pRegistryAdd;
    long lg_addr;
    long lSize;

    vMQ_Log(NULL, NULL, 21, "[FRONTEND] registering\n");
    lg_addr = MQ_GADDR_MONITOR;
    lSize = MQ_MESSAGE_SIZE2(MQ_REG_REGISTRYADD, mqHeader);

    if((mqHeader = (MQ_HEADER *)malloc(lSize)) == NULL)
    {
        vMQ_Log(NULL, NULL, 0, "[FRONTEND] Unable to allocate
memory\n");
        vFeHandleTerminate(TERMINATE_NORMAL);
    }

    /* Update register add structure */
    mqHeader->lMessageType = MQ_MT_REGISTRY;
    mqHeader->lMessageSubType = MQ_MTS_REG_REGISTRY_ADD;
    pRegistryAdd = (MQ_REG_REGISTRYADD *)mqHeader->caBody;

    pRegistryAdd->lAddress = 0;
}

```

APPENDIX A - PAGE 209 OF 279

```

strcpy(pRegistryAdd->caName, "\0");
sprintf(pRegistryAdd->caDescription, "%ld", socket_port_num
);

vMQ_FillHeader(mqHeader, lg_addr, 0, mqHeader->lMessageType,
mqHeader->lMessageSubType, lFID );

/* Send the request to the monitor */
if( lMQ_QueueWrite( pvMQ_master, (void *)mqHeader, lSize,
0) != lSize)
{
    vMQ_Log(NULL, NULL, 0, "[FRONTEND] Unable to write
queue Register\n");
    vFeHandleTerminate(TERMINATE_NORMAL);
}

free( mqHeader );
return;
}

/*::::::::::::::::::::::::::::::::::::::::::::::::::::::::::::::::::
::::::::::
:: Function:    vFeHandleTerminate_all
::
:: Purpose: Handle to terminate the front end.
::
:: Returns:    None.
::
:: Input:      Pointer to Dispatch table, message type, message
subtype and
::              mq_header pointer.
::
:: Output : none
::
:: Globals:
::
:: Called routines :
::
:: Revision:
:: WHO        --WHEN--  WHAT
:: Raju        08/28/94  Original
::::::::::::::::::::::::::::::::::::::::::::::::::::::::::::::::::
::::::::::*/

void          vFeHandleTerminate_all(pconfig, pqwatch, ptDTable,
lMessageType,
lMessageSubType, plHeader)
void          *pconfig, *pqwatch, *ptDTable;
long lMessageType, lMessageSubType;
void *plHeader;
{
    MQ_HEADER          *mqHeader;
    MQ_TERMINATE       *mqTerminate;

```

APPENDIX A - PAGE 210 OF 279

```

    /* receive the Terminate request */
    mqHeader = (MQ_HEADER *)plHeader;
    mqTerminate = (MQ_TERMINATE *)mqHeader->caBody;
    vMQ_Log(NULL, NULL, 10, "[FRONTEND] Received Terminate
request %ld\n",
        mqTerminate->lTerminateType);
    vMQ_EventLog(NULL, NULL, MQ_EVB_TERMINATE,
        &mqTerminate->lTerminateType, sizeof(long) );

    switch( mqTerminate->lTerminateType)
    {
        case MQ_MTS_TERM_NOW :
            vFeHandleTerminate(TERMINATE_ABORT);
            break;
        case MQ_MTS_TERM_GRACEFUL :
            vFeHandleTerminate(TERMINATE_NORMAL);
            break;
        case MQ_MTS_TERM_AFTERSERVICE :
            sTerm_After_Service = 1;
            break;
    }

    if( mqTerminate->lTerminateType > 0 )
    {
        sTerm_After_Service = 1;
    }

    if((pGSub != (SUBSCRIBER *)NULL) && (sTerm_After_Service ==
1))
        sSendHeader(8, -1, SPIF_FESPIF_SHUTDOWN);

    return;
}

/*::::::::::::::::::::::::::::::::::::::::::::::::::::::::::::::::::
::::::::::::
:: Function:    vFeHandleHeartbeat_all
::
:: Purpose:    Handle to receive and reply for a heart beat request.
::
:: Returns:    None.
::
:: Input:      Pointer to Dispatch table, message type, message
subtpe and
::              mq_header pointer.
::
:: Output :    none
::
:: Globals:
::
:: Called routines :
::
:: Revision:
:: WHO          --WHEN--  WHAT
:: Raju          08/28/94  Original

```

APPENDIX A – PAGE 211 OF 279

```

.....
.....*/

void      vFeHandleHeartbeat_all(pconfig, pqwatch, ptDTable,
lMessageType,
      lMessageSubType, plHeader)
void      *pconfig, *pqwatch, *ptDTable;
long lMessageType, lMessageSubType;
void *plHeader;
{
    MQ_HEADER *mqHeader;
    MQ_HEADER *mqReply;
    long      lg_addr;
    char      buffer[TEMP_BUFF_SIZE];

    /* receive the heart beat request */
    mqHeader = (MQ_HEADER *)plHeader;
    if((mqReply = (MQ_HEADER *)malloc(sizeof(MQ_HEADER))) ==
NULL)
    {
        vMQ_Log(NULL, NULL, 0,
            "[FRONTEND] Unable to allocate memory in
HandleHeartbeat \n");
        vFeGateDisconnect_all(GATEDISCONNECT_BY_OPERATOR);
        return;
    }

    sprintf(buffer, "[FRONTEND] heartbeat received\n");
    vMQ_Log(NULL, NULL, 21, buffer);

    /* Reply for the heart beat request */
    vMQ_FillReply(pqwatch, mqHeader, mqReply );

    if( lMQ_QueueWrite( pvMQ_master, (void *)mqReply,
sizeof(MQ_HEADER), 0)
      != sizeof(MQ_HEADER))
    {
        vMQ_Log(NULL, NULL, 0, "[FRONTEND] Unable to write
queue Heartbeat\n");
        vFeHandleTerminate(TERMINATE_NORMAL);
    }

    free( mqReply );
    return;
}

/*.....
.....:
:: Function:   vFeHandleValidate_all
::
:: Purpose:   Handle to receive response from the validation
process.
::
:: Returns:   None.
::

```

APPENDIX A - PAGE 212 OF 279

```

:: Input:      Pointer to Dispatch table, message type, message
subtype and
::            mq_header pointer.
::
:: Output : none
::
:: Globals:
::
:: Called routines :
::
:: Revision:
:: WHO        --WHEN--  WHAT
:: Raju       08/28/94  Original
::::::::::::::::::::::::::::::::::::::::::::::::::::::::::::::::::
::::::::::::*/

void          vFeHandleValidate_all(pconfig, pqwatch, ptDTable,
lMessageType,
lMessageSubType, plHeader)
void          *pconfig, *pqwatch, *ptDTable;
long lMessageType, lMessageSubType;
void *plHeader;
{
    SUBSCRIBER      *pSub;
    MQ_HEADER *pHeader;
    SPiF_HEADER spif, *pSpifHeader = &spif;
    MQ_EV_LOGIN      GLogin;

    pHeader = (MQ_HEADER *)plHeader;
    vMQ_Log(NULL, NULL, 21,
            "[FRONTEND] Msg from validate process
time=%ld,sequence=%ld\n",
pHeader->tReplyID.tOriginTime,pHeader->tReplyID.lOriginSequence);

    /* get the subscriber structure to whom the reply was meant
*/
    if((pSub = pFindResponse(pHeader->tReplyID.tOriginTime,
pHeader->tReplyID.lOriginSequence) ) == NULL)
    {
        vMQ_Log(NULL, NULL, 0, "[FRONTEND] Subscriber not
found\n");
        return;
    }

    pSub->sResultCode = (short)pHeader->lReturnCode ;

    /* Audit log the information */
    vHandleAuditLog(NULL, NULL, MQ_MTS_AUDIT_CLLOGIN,
lFID,pSub , NULL, 1);

    strcpy( GLogin.caName, pSub->caSCR);
    GLogin.lAccessLevel = 0;
    vMQ_EventLog(NULL,NULL, MQ_EVB_LOGIN, &GLogin, sizeof(
MQ_EV_LOGIN) );
}

```

APPENDIX A - PAGE 213 OF 279

```

/* Check if the validation is success or not */
if( pHeader->lReturnCode != 0)
{
    /* Subscriber invalid */
    vMQ_Log(NULL, NULL, 0, "[FRONTEND] Validation
failed\n");

    /*Delete subscriber from linked list */
    if( pSub->sGatewayFlag == 1)
    {
        vMQ_Log(NULL, NULL, 0, "[FRONTEND] Deleting Invalid
Gateway\n");
        pSub->lMsgtype = SPIF_NAK;
        sSendHeader( 8, pSub->lSpifID, pSub->lMsgtype );
        vFeGateDisconnect_all(GATEDISCONNECT_BY_OPERATOR);
    }
    else
    {
        i f ( p S u b - > s R e s u l t C o d e < 1 )
        pSub->sResultCode=FEERR_INNU;
        vSendErrorResponse(pSub, "Invalid Serial Number");

        pSub->lMsgtype = SPIF_SUBSCRIBER_DISCONNECT;
        pSub->sResultCode = LOGOUT_BY_OPERATOR;
        vMQ_Log(NULL, NULL, 0, "[FRONTEND] Deleting Invalid
Subscriber\n");
        vMQ_EventLog(NULL, NULL, MQ_EVB_ATTEMPT,
            pSub->caSCR, strlen(pSub->caSCR) );
        vHandleAuditLog(NULL, NULL, MQ_MTS_AUDIT_CLLOGOUT,
            lFID, (void *)pSub, NULL, 1);

        sSendHeader( 8, pSub->lSpifID,
        SPIF_SUBSCRIBER_DISCONNECT );

        /* Delete the subscriber */
        if(iDelSub( pSub->lSpifID) != SUCCESS)
        {
            vMQ_Log(NULL, NULL, 0, "[FRONTEND] Unable to
Delete Subscriber\n");
        }
    }
}
else
{
    /* Subscriber is valid check if it is a gateway or
subscriber */
    pSub->iValidated = 1;
    if( pSub->sGatewayFlag == 1)
    {
        vMQ_Log(NULL, NULL, 5,
            "[FRONTEND] Valid GATEWAY. Sending OK
Response\n");
        pSub->lMsgtype = SPIF_ACK;
    }
}

```

APPENDIX A - PAGE 214 OF 279

```

                sSendHeader( 8, pSub->lSpifID, pSub->lMsgtype );
            }
            else
            {
                vMQ_Log(NULL, NULL, 5, "[FRONTEND] Valid
SUBSCRIBER\n");
                pSpifHeader->lMsgtype = SPIF_PASS_THROUGH;
                pSpifHeader->lSpifID = pSub->lSpifID;
                vFePassThrough_all(pSpifHeader, pSub->caMsg);
            }
        }
        return;
    }
}

```

```

/*:~::~~::~~::~~::~~::~~::~~::~~::~~::~~::~~::~~::~~::~~::~~::~~::~~::~~::~:
~::~~::~~::~~::~~::~~::~~::~~::~~::~~::~~::~~::~~::~~::~~::~~::~~::~~::~:
:: Function:    sFeProcessClientMsg
::
:: Purpose:    Process the SPIF messages
::
:: Returns:    short SUCCESS or FAILURE.
::
:: Input:      Pointer to SPIF header and message.
::
:: Output :    none
::
:: Globals:
::
:: Called routines :
::
:: Revision:
:: WHO        --WHEN--  WHAT
:: Raju        08/28/94  Original
~::~~::~~::~~::~~::~~::~~::~~::~~::~~::~~::~~::~~::~~::~~::~~::~~::~~::~:
~::~~::~~::~~::~~::~~::~~::~~::~~::~~::~~::~~::~~::~~::~~::~~::~~::~~::~:
*/

```

```

short sFeProcessClientMsg(pSpifHeader, Msg )
SPIF_HEADER *pSpifHeader;
void *Msg;
{
    vMQ_Log(NULL, NULL, 20, "[FRONTEND] Clientmsg msgsize %ld
type %ld\n",
                pSpifHeader->lMsgsize, pSpifHeader->lMsgtype);

    if( sGateDisconnectFlag == 1 )
    {
        vMQ_Log(NULL, NULL, 0,
                "[FE%ld] DISCARDING message.    Waiting to
Disconnect.\n", lAddress);
        return SUCCESS;
    }

    /* Update the subscriber lascommtime */
    vFeUpdate_Sub(pSpifHeader->lSpifID);
}

```



```

:: WHO          --WHEN--  WHAT
:: Raju         08/28/94  Original
::::::::::::::::::::::::::::::::::::::::::::::::::::::::::::::::::
:::::::::*/

short sFeProcessSpifMsg(pSpifHeader, Msg)
SPIF_HEADER *pSpifHeader;
char *Msg;
{
    vMQ_Log(NULL, NULL, 20, "[FRONTEND] SPIFmsg msgsize %ld type
%ld \n",
            pSpifHeader->lMsgsize, pSpifHeader->lMsgtype);

    if( sGateDisconnectFlag == 1 )
    {
        vMQ_Log(NULL, NULL, 0,
            "[FE%ld] DISCARDING message.      Waiting to
Disconnect.\n", lAddress);
        return SUCCESS;
    }

    /* Update the subscriber lascommtime */
    vFeUpdate_Sub(pSpifHeader->lSpifID);

    /* Handle timeout */
    vFeHandleTimeout_all();

    /* Check the type of SPIF message  add process accordingly
*/
    switch( pSpifHeader->lMsgtype )
    {
        case SPIF_SUBSCRIBER_DISCONNECT:
            vFeSubDisconnect_all(pSpifHeader);
            break;
        case SPIF_GATEWAY_DISCONNECT:
            vFeGateDisconnect_all(GATEDISCONNECT_BY_SPIF);
            break;
        case SPIF_LOGIN:
            if( (pGSub == NULL) && ( Msg[0] != '\0' ) )
            {
                vFeGateConnect_all(pSpifHeader, Msg);
            }
            else
            {
                vMQ_Log(NULL, NULL, 0,
                    "[FRONTEND] ERROR: GATEWAY Already
logged in.\n");
            }
            break;
        case SPIF_AVAILABLE:
            if(pGSub != (SUBSCRIBER *)NULL)
            {
                if(sTerm_After_Service == 0)
                    sSendHeader(8, -1, SPIF_ACK);
                else

```

APPENDIX A - PAGE 217 OF 279

```

        sSendHeader(8, -1,
SPIIF_FESPIF_SHUTDOWN);
    }
    break;
    default:
        vMQ_Log(NULL, NULL, 0, "[FRONTEND] Unknown messagetype
%ld\n",
                pSpifHeader->lMsgtype);
        sSendHeader(8, pGSub->lSpifID,
GATEDISCONNECT_BY_OPERATOR);
        break;
    }
    return SUCCESS;
}

```

```

/*::::::::::::::::::::::::::::::::::::::::::::::::::::::::::
::::::::::
:: Function:   sSendMsg
::
:: Purpose:   Send the actual message to the SPIF.
::
:: Returns:   SUCCESS or FAILURE.
::
:: Input:    Pointer to Subscriber structure, message and
message length.
::
:: Output :  none
::
:: Globals:
::
:: Called routines :
::
:: Revision:
:: WHO      --WHEN--  WHAT
:: Raju     08/28/94  Original
::::::::::
::::::::::*/

```

```

short sSendMsg( pSub, pvMsg, lLength )
SUBSCRIBER *pSub;
void *pvMsg;
short lLength;
{
    int iPort, i;
    short sLen, sLength, sCompress_msglen, sCnt, sArmCnt;
    char *caCompMsg, *cp, *cpTemp, outbuf[MAX_MSG_SIZE];
    long lCrcval, lRet;
    long lFinalLength;
    SPIF_HEADER spif_header;

    iPort = pSub->iCommPort;

    /* Compute message length and CRC */
    lCrcval = lCrc16( (unsigned char *)pvMsg, lLength, 0 );

```

APPENDIX A - PAGE 218 OF 279

```

    /* Only LZ compression is supported as of now - 5/26/94 */
    if( (pSub->lStatus & SS_LZ_COMPRESS ) && !(pSub->lStatus &
SS_OVRD_MODE) )
    {
        /* If compression is not overridden, LZ compression will
be used */
        vMQ_Log(NULL, NULL, 0, "[FRONTEND] SendMsg: Compression
ON!\n");

        if( (caCompMsg = malloc(sizeof(char) * lLength)) ==
NULL )
        {
            vMQ_Log(NULL, NULL, 0,
                "[FRONTEND] Unable to allocate memory in
sSendMsg \n");
            vFeGateDisconnect_all(GATEDISCONNECT_BY_OPERATOR);
            return(FAILURE);
        }
        /* Return value of 0 or higher gives size of compressed
data
-1 - no compression */
        lRet = lCompressData( pvMsg, lLength, (void *)caCompMsg
);
        sprintf( outbuf, "|%04d%c|%04x%s", lRet,
            FE_LZ_COMPRESS, lCrcval, caCompMsg );

        lFinalLength = strlen(outbuf);
    }
    else
    {
        cp = outbuf;
        sprintf(cp, "%04d|%.4x", lLength, lCrcval);
        cp += 10;

        if ((pSub->lStatus & SS_ROUTE_DWNL) || (pSub->lStatus &
SS_SEND_BINARY))
        {
            memcpy(cp, (char *)pvMsg, lLength);
            lFinalLength = lLength+10;
        }
        else
        {
            sprintf( cp, "%s", (char *)pvMsg );
            lFinalLength = strlen(cp)+10;
        }
    }

    if( sPacketFlag & 1 )
    {
        sLen = strlen( pSub->caSCR ) + lFinalLength;
    }
    else
    {
        sLen = lFinalLength;
    }

```

APPENDIX A - PAGE 219 OF 279

```

        if( sLen > 4080)
        {
            vMQ_Log(NULL, NULL, 10, "[FRONTEND] Message longer than
4096\n");
        }

        /* write the header information first */
        sSendHeader( sLen + 8, pSub->lSpifID, pSub->lMsgtype );

        pSub->lTrx_count++;
        pGSub->lTrx_count++;

        /* Send the maneuver now */
        /* We must not send more than 250 characters at one time,
otherwise it seems
** the modem will not send the extra characters. 220 is the
norm for
** ARDIS, because we need to account for the ARDIS header
field.
*/
        sLen = strlen( pSub->caSCR );

#ifdef DEBUG
        /* file fe_spif.msgs */
        if( iDebug > 5)
        {
            fprintf( pMsgsfile, "\n SENT Msg ");
            fflush( pMsgsfile );
        }
#endif

        /* If packet header is to be written */
        if( sPacketFlag & 1 )
        {
            mod_write(iPort, pSub->caSCR, sLen);
        }

#ifdef DEBUG
        /* file fe_spif.msgs */
        if( iDebug > 5)
        {
            fprintf( pMsgsfile, "%s", pSub->caSCR);
            fflush( pMsgsfile );
        }
#endif

        /* If length of message exceeds packet size ... */
        /*
        for (cp = outbuf, sArmcnt = strlen(outbuf); sArmcnt > 0;
sArmcnt -= sCnt)
        */
        for (cp = outbuf, sArmcnt = lFinalLength; sArmcnt > 0;
sArmcnt -= sCnt)
        {
            if ((sCnt = sArmcnt) > sTransmitLimit)
                sCnt = sTransmitLimit;
        }

```

APPENDIX A - PAGE 220 OF 279

```

        if (sPacketFlag & 1)
        {
Destination ID */      mod_write(iPort, pSub->caSCR, sLen);          /*
#ifdef DEBUG
        /* file fe_spif.msgs */
        if( iDebug > 5)
        {
            fprintf( pMsgsfile,"%s", pSub->caSCR);
            fflush( pMsgsfile );
        }
#endif
    }

    mod_write(iPort, cp, sCnt);          /*
The data */

    if( sCnt < 220)
    {
        vMQ_Log(NULL, NULL, 10,
            "[FRONTEND] MSG [%s]\n", cp);
    }

#ifdef DEBUG
    /* file fe_spif.msgs */
    if( iDebug > 5)
    {
        cpTemp = cp;
        for( i = 0; i < sCnt; i++)
        {
            fprintf( pMsgsfile,"%c", *cpTemp);
            cpTemp++;
        }
        fflush( pMsgsfile );
    }
#endif

    vMQ_Log(NULL, NULL, 21,
sCnt);      "[FRONTEND] Outbound message length is %d\n",

        if (sPacketFlag & 1)
        {
trigger */      mod_write(iPort, "\r", 1);          /* The
#ifdef DEBUG
        /* file fe_spif.msgs */
        if( iDebug > 5)
        {
            fprintf( pMsgsfile,"\r");
            fflush( pMsgsfile );
        }
#endif

```

APPENDIX A - PAGE 221 OF 279

```
    }  
    cp += sCnt;  
    vMQ_Log(NULL, NULL, 21, "[FRONTEND] WROTE: [%d]\n",  
sCnt+sLen);  
    }  
  
    free( caCompMsg );  
    return(SUCCESS);  
}
```



```

extern short      sPacketFlag;
extern int        ipacketflag;
extern short      sConfirmMax;
extern short      sAckPending;
extern long       lMap_format;
extern long       lFormat_mode;
extern short      sDefaultBaud;
extern short      sPacketLimit;
extern int        iQueue_master;
extern long       lLastCommtime;
extern long       lLastCommtime;
extern long       lConstantBaud;
extern long       lCompress_mode;
extern long       lDisplay_panes;
extern short      sTransmitLimit;
extern long       lHeartbeat_wait;
extern int        socket_port_num;
extern short      sInterPacketGap;
extern struct     sockaddr_in addr;
extern short      sProcess_heartbeat;
extern short      sTerm_After_Service;
extern long       lExit_on_disconnect;
extern unsigned long ulSessionID;

extern void       *pMQU_master;
extern void       *pvMQ_master;

extern char       *cpQID;
extern char       *cpFrontID;
extern char       *cpConfigPath;
extern char       *caCommDevice;
extern char       *caDeviceConfig;
extern char       *cpDownload_dir;
extern char       *cpDictionary_dir;

extern char       caID[];
extern char       caBuff[];
extern char       caHangup[];
extern char       caOrigin[];
extern char       caOriginType[];
extern char       caLimitValue[];
extern char       caDestination[];
extern char       caNoAutoAnswer[];
extern char       caDestinationType[];
extern char       caCompression_marker[];

extern char       *caAlternative[];

extern Q_HEAD     sHead;
extern Q_HEAD     sConfig;
extern Q_HEAD     *pQhead;
extern Q_HEAD     *pQConfig;
extern FILE       *pMsgsfile;
extern SUBSCRIBER *pGSub;

```

APPENDIX A -- PAGE 224 OF 279

```

/*:.....:
:.....:
:: Function:   sMoveLatLong
::
:: Purpose:
::
:: Returns:
::
:: Input:
::
:: Output:
::
:: Globals:
::
:: Revision:
:: WHO       --WHEN--  WHAT
:: Raju      12/29/94  Original
:.....:
:.....*/

short sMoveLatLong( cppBuff, lReturn, base)
char **cppBuff;
long *lReturn;
int  base;
{
    short sLength1, sLength2;

    vMQ_Log(NULL,NULL, 30, "[FRONTEND] LatLong buffer %s \n",
*cppBuff);

    *lReturn = 0L;

    if( **cppBuff != '|')
        return FAILURE;

    if( *(*cppBuff + 1) == '\n')
        return SUCCESS;

    (*cppBuff)++;
    sLength1 = strlen( *cppBuff );

    *lReturn = strtol( *cppBuff, cppBuff, base);

    sLength2 = strlen( *cppBuff );

    if( sLength1 == sLength2 )
        *lReturn = DEFAULT_LAT_LONG;

    if( **cppBuff != '|')
        return FAILURE;
    else
        return SUCCESS;
}

```

APPENDIX A - PAGE 225 OF 279

```

/*:.....
:.....
:: Function:   fe_parse.c
::
:: Purpose:    Parse the client message
::
:: Returns:
::
:: Input:
::
:: Output:
::
:: Globals:
::
:: Revision:
:: WHO        --WHEN--  WHAT
:: DAB                Original
:: Raju            09/09/94  Modified for message queue and SPIF
:.....
:.....*/

#ifdef  ANSI
short sHandleSPIFParse(char *cpInBuff, SPIFPARSE *pServerRequest,
short method)
#else
short sHandleSPIFParse(cpInBuff, pServerRequest, method)
char   *cpInBuff;           /* The incoming string to parse */
SPIFPARSE *pServerRequest;
short   method;           /* 0=remote->server,
l=server->remote */
#endif
{
    char *cp, *cp2;
    char tbuff[TEMP_BUFF_SIZE];
    short sReturn = SUCCESS;
    short stemp = 2;
    short sublen, userlen, originlen, origintypelen,
    destlen, desttypelen, altlen;

    userlen = FE_ID_LEN + 1;
    altlen = FE_ALT_LEN + 1;
    destlen = FE_DEST_LEN + 1;
    originlen = FE_ORIGIN_LEN + 1;
    sublen = FE_SUBSCRIBER_LEN + 1;
    desttypelen = FE_DEST_TYPE_LEN + 1;
    origintypelen = FE_ORIGIN_TYPE_LEN + 1;

    cp = cpInBuff;
    _strupr(cpInBuff); /* We only want upper case letters */
    vMQ_Log(NULL, NULL, 30, "[FRONTEND] Parse len %d \n",
strlen(cpInBuff));

    /* Initialize the error code to indicate a bad parse for
syntax */
    pServerRequest->caDestinationLimitType[0] = '\0';

```

APPENDIX A - PAGE 226 OF 279

```

    /* Look for first delimiter character. This should be the
    first one,
    ** but just in case, ignore any leading garbage.
    */
    while (*cp != '|' && *cp != '\0')
        cp++;

    /* If we did not find a delimiter, we are done with a
    failure */
    if (*cp != '|')
    {
        vMQ_Log(NULL, NULL, 0, "[FRONTEND] Parse found no
delimiter\n");
        return FAILURE;
    }

    /* Start parsing the fields */
    if ((sReturn = sMoveLong(&cp, &pServerRequest->tTimeStamp,
TIME_SIZE))
        != SUCCESS)
    {
        vMQ_Log(NULL, NULL, 0, "[FRONTEND] Parse Error in
timestamp\n");
        pServerRequest->caDestinationLimitType[0] = -1;
    }
    else if ((sReturn =
sMoveField(&cp, pServerRequest->caSubscriber, &sublen))
        != SUCCESS)
    {
        vMQ_Log(NULL, NULL, 0, "[FRONTEND] Parse error in
subscriberid\n");
        pServerRequest->caDestinationLimitType[0] = -1;
    }
    else if ((sReturn = sMoveLong(&cp, &pServerRequest->lMsgid,
MSGID_SIZE))
        != SUCCESS)
    {
        vMQ_Log(NULL, NULL, 0, "[FRONTEND] Parse error
messageid\n");
        pServerRequest->caDestinationLimitType[0] = -1;
    }
    else if ((sReturn = sMoveField(&cp, pServerRequest->caID,
&userlen))
        != SUCCESS)
    {
        vMQ_Log(NULL, NULL, 0, "[FRONTEND] Parse error userid\n");
        pServerRequest->caDestinationLimitType[0] = -1;
    }
    else if (method == 0 && (sReturn =
sMoveLatLong(&cp, &pServerRequest->lLatitude, 0))
        != SUCCESS)
    {
        pServerRequest->caDestinationLimitType[0] = -2;
        vMQ_Log(NULL, NULL, 0, "[FRONTEND] Parse error
latitude\n");
    }

```

APPENDIX A - PAGE 227 OF 279

```

    }
    else if (method == 0 && (sReturn =
        sMoveLatLong(&cp, &pServerRequest->lLongitude, 0))
    != SUCCESS)
    {
        pServerRequest->caDestinationLimitType[0] = -3;
        vMQ_Log(NULL, NULL, 0, "[FRONTEND] Parse error
longitude\n");
    }
    else if ((sReturn =
        sMoveField(&cp, pServerRequest->caOrigin,
&originlen))
    != SUCCESS)
    {
        pServerRequest->caDestinationLimitType[0] = -4;
        vMQ_Log(NULL, NULL, 0, "[FRONTEND] Parse error origin\n");
    }
    else if ((sReturn = sMoveField(&cp,
pServerRequest->caOriginType,
&origintypelen)) != SUCCESS)
    {
        pServerRequest->caDestinationLimitType[0] = -5;
        vMQ_Log(NULL, NULL, 0, "[FRONTEND] Parse error
origintype\n");
    }
    else if (method == 0 && (sReturn =
        sMoveField(&cp, pServerRequest->caDestination,
&destlen))
    != SUCCESS)
    {
        pServerRequest->caDestinationLimitType[0] = -6;
        vMQ_Log(NULL, NULL, 0, "[FRONTEND] Parse error
destination\n");
    }
    else if (method == 0 && (sReturn =
        sMoveField(&cp,
pServerRequest->caDestinationType, &desttypelen))
    != SUCCESS)
    {
        pServerRequest->caDestinationLimitType[0] = -7;
        vMQ_Log(NULL, NULL, 0, "[FRONTEND] Parse error destination
type\n");
    }
    else if (method == 0 && (sReturn = sMoveLong(&cp,
&pServerRequest->lDestinationLimit, 10)) !=
SUCCESS ||
        pServerRequest->lDestinationLimit < 0)
    {
        vMQ_Log(NULL, NULL, 0, "[FRONTEND] Parse error
destinationlimit\n");
        sReturn = FAILURE;
        pServerRequest->caDestinationLimitType[0] = -8;
    }
    else if ((sReturn = sMoveField(&cp,
pServerRequest->caDestinationLimitType, &stemp))
    != SUCCESS)

```

APPENDIX A - PAGE 228 OF 279

```

    {
        vMQ_Log(NULL, NULL, 0, "[FRONTEND] Parse error
destinationlimittype\n");
        pServerRequest->caDestinationLimitType[0] = -9;
    }
    else
    {
        vMQ_Log(NULL, NULL, 30, "[FRONTEND] Parse Processing
alternate fields\n");
        /* Process alternative fields */
        for (stemp = 0; stemp < AR_MAX_ALTS; stemp++)
        {
#ifdef DEBUG
            vMQ_Log(NULL, NULL, 30, "[FRONTEND] Parsing
%s len %d \n",
                    cp, altlen);
#endif

            sReturn |= sMoveField(&cp,
pServerRequest->aAlternatives[stemp].caAlternatives, &altlen);

#ifdef DEBUG
            vMQ_Log(NULL, NULL, 30, "[FRONTEND] parsed
%s len %d \n",
pServerRequest->aAlternatives[stemp].caAlternatives,
                    altlen);
#endif

            altlen = FE_ALT_LEN + 1;
            if (sReturn != SUCCESS)
                vMQ_Log(NULL, NULL, 0, "[FRONTEND] Parse
error stemp %d \n",
                    stemp);
        }
    }

    /* NOTE: If there are more fields which may follow, place
them here */
    /* No more fields to process, do final checks. */
    if (sReturn == SUCCESS)
    {
        /* Final field is destination limit type */
        cp2 = pServerRequest->caDestinationLimitType;
        if (*cp2 == '\0')
            *cp2 = 'M';

        if (*cp2 != 'M' && *cp2 != 'D' && *cp2 != 'T')
        {
            vMQ_Log(NULL, NULL, 0, "[FRONTEND] Parse error
Invalidlimittype\n");
            sReturn = FAILURE;          /* Not a valid limit type
*/
            pServerRequest->caDestinationLimitType[0] = -9;
        }
    }
}

```

APPENDIX A - PAGE 229 OF 279

```

/* check if the firstcharacter is a delimiter | */
/* If not the message is incorrect */
if( Inbuff[0] != 0x7c )
{
    return( 0 );
}

caCompression_marker[0] = '\0';
cp = Inbuff;
cp++;

/* Parse the buffer to get message length, compression
marker if any */
/* and get the crc. Compute the crc and check if they match
*/
for( i = 1; i < strlen( Inbuff ); i++)
{
    /* If the delimiter count is 1 then we are looking for
crc */
    if( delim_count == 1 )
    {
        /* looking for crc. It cannot be greater than 4
bytes */
        if( j > 5 )
        {
            return(0);
        }

        /* untill the delimiter copy the string */
        if ( Inbuff[i] != 0x7c )
        {
            buff[j] = Inbuff[i];
            j++;
        }
        else
        {
            /* get the crc that was received */
            buff[j] = '\0';
            lCrc_sent = strtol( buff, NULL, 16);

            /* get the remaining buffer */
            for( j = 0; i < strlen(Inbuff); i++,j++)
            {
                buff[j] = Inbuff[i];
            }

            buff[j] = '\0';

            /* compute CRC */
            lComputed_crc = lCrc16( buff, msglen, 0);
            vMQ_Log(NULL,NULL, 25,"[FRONTEND] CRC sent
%ld compute %ld\n",
                    lCrc_sent, lComputed_crc);

            /* check if CRC match */
            if( lComputed_crc == lCrc_sent)

```

APPENDIX A - PAGE 231 OF 279

```

        {
            /* return message length */
            return( msglen );
        }

        /* CRC did not match */
        return(0);
    }
    continue;
}

/* look for the message length */
/* read buffer untill a delimiter */
if( Inbuff[i] != 0x7c )
{
    /* message cannot be bigger than 5 bytes */
    if(( i > 5 ) && (delim_count == 0))
    {
        return( 0 );
    }

    /* 4th or 5th byte could be a compression marker
*/
    if((( i == 4 ) || ( i == 5)) &&
        ((Inbuff[i] == 'P') || (Inbuff[i] == 'D') ||
(Inbuff[i] == 'L'))))
    {
        caCompression_marker[0] = Inbuff[i];
    }
    else if( i == 5 )
    {
        return (0);
    }
}
else
{
    /* get the message length based on compression
markers presence */
    if( caCompression_marker[0] == '\0' )
    {
        strncpy( cp_msglen, cp, i - 1);
        cp_msglen[i - 1] = '\0';
    }
    else
    {
        strncpy( cp_msglen, cp, i - 2);
        cp_msglen[i - 2] = '\0';
    }
    msglen = atoi( cp_msglen );
    delim_count++;
#ifdef DEBUG
    vMQ_Log(NULL,NULL, 30, "[FRONTEND] compress %s msg
%s msglen %d\n",
            caCompression_marker, cp_msglen, msglen);
#endif
}
}

```

APPENDIX A - PAGE 232 OF 279

```
    }  
    /* Invalid input buffer */  
    return(0);  
}
```

```

static char * _ s c c s _ = { " $ S o u r c e :
/ids/cvs/host/fe_spif/src/fe_spif.c,v $ Ver: $Revision: 1.5 $
Date: $Date: 1995/04/24 15:54:32 $" };
/* Copyright (C) 1994,1995 SEI Information Technology, Inc. */

/*:::::::::::::::::::::::::::::::::::::::::::::::::::
:::::::::::::::::::
:: Filename:          fe_spif.c
::
:: Purpose:          This module contains functions that provide
the
::                   RESET function, accept and listen
functions
::                   for the front-end.
::
:: Revision:
:: WHO              --WHEN--  WHAT
:: Raju              09/09/94  Original
:::::::::::::::::::
::::::::::::::::::*/

#include <stdio.h>
#include <signal.h>
#include <fcntl.h>
#include <errno.h>
#include <netinet/in.h>
#include <sys/socket.h>

#include "gdefines.h"
#include "gerror.h"
#include "utdispm.h"
#include "mq_pub.h"
#include "queue.h"
#include "spif.h"
#include "fe_common.h"
#include "fe_spif.h"

extern long      lQID;
extern long      lFID;
extern long      lSize;
extern int       iDebug;
extern int       argcnt;
extern long      lg_addr;
extern int       bit_map;
extern long      lfe_tcp;
extern long      lFrontID;
extern long      lAddress;
extern int       iDataPort;
extern int       last_baud;
extern time_t    start_time;
extern long      lHeartbeat;
extern int       iListenPort;
extern short     sMaxPackets;
extern short     sPacketFlag;
extern int       ipacketflag;
extern short     sConfirmMax;

```

APPENDIX A — PAGE 234 OF 279

```

extern short      sAckPending;
extern long       lMap_format;
extern long       lFormat_mode;
extern short      sDefaultBaud;
extern short      sPacketLimit;
extern int        iQueue_master;
extern long       lLastCommtime;
extern long       lLastCommtime;
extern long       lConstantBaud;
extern long       lCompress_mode;
extern long       lDisplay_panes;
extern short      sTransmitLimit;
extern long       lHeartbeat_wait;
extern int        socket_port_num;
extern short      sInterPacketGap;
extern struct     sockaddr_in addr;
extern short      sProcess_heartbeat;
extern short      sTerm_After_Service;
extern long       lExit_on_disconnect;
extern unsigned long ulSessionID;
extern short      sGateDisconnectFlag;

extern void       *pMQU_master;
extern void       *pvMQ_master;

extern char       *cpQID;
extern char       *cpFrontID;
extern char       *cpConfigPath;
extern char       *caCommDevice;
extern char       *caDeviceConfig;
extern char       *cpDownload_dir;
extern char       *cpDictionary_dir;

extern char       caID[];
extern char       caBuff[];
extern char       caHangup[];
extern char       caOrigin[];
extern char       caExtBuff[];
extern char       caOriginType[];
extern char       caLimitValue[];
extern char       caDestination[];
extern char       caNoAutoAnswer[];
extern char       caDestinationType[];

extern char       *caAlternative[];

extern Q_HEAD     sHead;
extern Q_HEAD     sConfig;
extern Q_HEAD     *pQhead;
extern Q_HEAD     *pQConfig;
extern FILE       *pMsgsfile;
extern SUBSCRIBER *pGSub;

extern int optind;
extern char *optarg;

```

APPENDIX A -- PAGE 235 OF 279

```

        vFeHandleTerminate(TERMINATE_ABORT);
    }
    /* the debug level, external device , config file are
supplied */
    /* by the reset request by the monitor. */
    while(again)
    {
        switch (getopt(pReset->lArgc + 1, argv, "c:d:e:"))
        {
            case 'c': /* The config file */
                caDeviceConfig = optarg;
                break;
            case 'd': /* The debug level */
                iDebug= strtol(optarg, NULL, 0);
#ifdef DEBUG
                if( ( iDebug > 5 ) && ( pMsgsfile ==
NULL ) )
                {
                    s p r i n t f (
caTempFilename,"msgs.%ld",getpid());
                    i f ( ( p M s g s f i l e =
fopen(caTempFilename,"w")) == NULL)
                    {
                        o p e n m s g s . p i d \ n " ) ;
                        f p r i n t f ( s t d e r r , "\n Unable to
                        f p r i n t f ( s t d e r r , " E x i t i n g \ n " ) ;
                        e x i t ( 0 ) ;
                    }
                }
#endif
                break;
            case 'e':
                caCommDevice = optarg;
                break;
            default:
                again = 0;
                break;
        }
    }

    vMQ_Log(NULL,NULL, 10,
        "[FRONTEND] config %s device %s\n",
caDeviceConfig, caCommDevice);

    /* Read the appropriate device config file */
    if ((fp = fopen(caDeviceConfig,"r")) == (FILE*)NULL)
    {
        vMQ_Log(NULL,NULL, 0, "[FRONTEND] Unable to open
caDeviceConfig\n");
        vFeHandleTerminate(TERMINATE_ABORT);
    }

    if ( lRead_config(fp) == -1 )
    {
        vMQ_Log(NULL, NULL, 0,

```

APPENDIX A - PAGE 238 OF 279

```

errno);
    }
    vFeHandleTerminate(TERMINATE_ABORT);

    fclose( fp );

    if(pGSub != NULL)
    {
        vFeGateDisconnect_all(GATEDISCONNECT_BY_OPERATOR);
    }

    /* Open the communications port */
    /* iCommPort is initially -1, but subsequent usages will be
> 0 */
    if ((iFeOpenCommPort(pvMQ_master, caCommDevice)) < 0)
    {
        vMQ_Log(NULL, NULL, 0,
errno);
            "[FRONTEND] iOpenCommPort failed [%d]\n",
            vFeHandleTerminate(TERMINATE_ABORT);
        }

        if ((itest=sInitKnownLanguages(".")) < 0)
        {
            vMQ_Log(NULL, NULL, 0, "[FRONTEND] Cannot init
languages\n");
            vFeHandleTerminate(TERMINATE_ABORT);
        }

        vMQ_Log(NULL, NULL, 0, "[FRONTEND] [%d]
Languages.\n",itest);

        if (( iMQU_QueryServices(pMQU_master, pvMQ_master)) ==
FAILURE )
        {
            vMQ_Log(NULL, NULL, 0, "[FRONTEND]
iMQU_QueryServices Failed.\n");
            vFeHandleTerminate(TERMINATE_ABORT);
        }

        vCreate_Configtable();
        vFeRequestRegistry_all();

        vMQ_Log(NULL, NULL, 5, "[FRONTEND] Processed Full Reset
\n");
    }
    else
    if ( pReset->lResetType == 1)
    {
        vMQ_Log(NULL, NULL, 25, "[FRONTEND] calling
iMQU_QueryServices.\n");
        /* query the available services. */
        if (( iMQU_QueryServices(pMQU_master, pvMQ_master)) ==
FAILURE )
        {

```

APPENDIX A - PAGE 239 OF 279

```

:: Input:
::
:: Output:
::
:: Globals:
::
:: Revision:
:: WHO --WHEN-- WHAT
:: Raju 09/09/94 Original
:::
:::*/

int iFeAccept()
{
    int len;

    if( iDataPort == -1)
    {
        len = sizeof(addr);

        vMQ_Log(NULL, NULL, 20, "[FRONTEND] About to accept
socket %d port %d\n",
            addr.sin_port, iListenPort);
        if ( (iDataPort =
            accept(iListenPort, (struct sockaddr *)&addr,
&len)) < 0)
        {
            /* Oops - shouldn't happen */
            vMQ_Log(NULL, NULL, 0,
                "[FRONTEND] Accept on socket failed [%d]\n",
errno);
            vFeHandleTerminate(TERMINATE_ABORT);
        }

        /* Have a connection - switch to it */
        vMQ_Log(NULL, NULL, 5,
            "[FRONTEND] Have a connection from %d.%d.%d.%d\n",
            (addr.sin_addr.s_addr >> 24) & 0xff,
            (addr.sin_addr.s_addr >> 16) & 0xff,
            (addr.sin_addr.s_addr >> 8) & 0xff,
            addr.sin_addr.s_addr & 0xff);

        /* Remove the listen port from the queue */
        if(iMQ_DelQueueWatch(pvMQ_master, iListenPort) !=
SUCCESS)
        {
            vMQ_Log(NULL, NULL, 0,
                "[FRONTEND] DelQueueWatch failed for listen
port\n");
            return FAILURE;
        }

        /* Add the data port to queue */
        if( iMQ_AddQueueWatch(pvMQ_master, iDataPort,
caExtBuff,
            MAX_MSG_SIZE, MQ_NORMAL_EXTERNAL) != SUCCESS)
APPENDIX A - PAGE 242 OF 279

```

```

        {
            vMQ_Log(NULL, NULL, 0,
                "[FRONTEND] AddQueuwatch failed for data
port\n");
            return FAILURE;
        }

        sGateDisconnectFlag = 0;
        vMQ_Log(NULL, NULL, 10,
            "[FRONTEND] External dataport added to queue watch
%d\n",
            iDataPort);
    }

    return(SUCCESS);
}

```

```

/*:.....:
:.....:
:: Function: iFeListen
::
:: Purpose: After all the subscribers and the Gateway are
disconnected then
::         the dataport is removed from the queue and the
listen port is added
::         to the queue.
::
:: Returns:
::
:: Input:
::
:: Output:
::
:: Globals:
::
:: Revision:
:: WHO          --WHEN--  WHAT
:: Raju          09/09/94  Original
:.....:
:.....:*/

```

```

int iFeListen()
{
    /* All subscribers and gateways are disconnected so delete
dataport */
    if(iMQ_DelQueueWatch(pvMQ_master, iDataPort) != SUCCESS)
    {
        vMQ_Log(NULL, NULL, 0,
            "[FRONTEND] DelQueuwatch failed for data
port\n");
        return FAILURE;
    }

    close( iDataPort);
    iDataPort = -1;
}

```

APPENDIX A - PAGE 243 OF 279

```

    /* Add the listen port to the queue */
    iMQ_AddQueueWatch(pvMQ_master, iListenPort, caExtBuff, MAX_MSG_SIZE,
                      MQ_LISTEN_EXTERNAL);

    sGateDisconnectFlag = 0;

    vMQ_Log(NULL, NULL, 10,
             "[FRONTEND] Dataport deleted and listenport added to
             queuwatch\n");
    return SUCCESS;
}

/*::::::::::::::::::::::::::::::::::::::::::::::::::::::::::::::::::
::::::::::::::::::::
:: Function: mod_write
::
:: Purpose: Like write() but handles if the write does not
::           output all of the characters.
::
:: Returns:
::
:: Input:
::
:: Output:
::
:: Globals:
::
:: Revision:
:: WHO           --WHEN--   WHAT
:: DAB            09/09/94   Original
:: Raju           09/09/94   Modified for msg queue and SPIF
::::::::::::::::::::::::::
::::::::::::*/

int mod_write(fd, buff, len)
int fd;
char *buff;
int len;
{
    int cnt;
    int total = 0;

    errno = 0;
#ifdef DEBUG
    vMQ_Log(NULL, NULL, 30, "[FRONTEND] In mod_write %d\n",
fd);
#endif

    while (len > 0)
    {
        cnt = write(fd, buff, len);
        if (cnt > 0)
        {
            if (len > 0)

```

APPENDIX A — PAGE 244 OF 279

```

    {
#ifdef DEBUG
    vMQ_Log(NULL, NULL, 30, "[FRONTEND] mod_write
wrote %d\n", cnt);
#endif
    }
    len -= cnt;
    total += cnt;
    buff += cnt;
}
else if (cnt < 0)
{
    /* Some error - report it */
    vMQ_Log(NULL, NULL, 0, "[FRONTEND] mod_write
failed\n");
    break;
}
else
{
    vMQ_Log(NULL, NULL, 0, "[FRONTEND] mod_write wrote
0\n");
}
}
return total;
}

```

```

/* _sccs_ $Source: /ids/cvs/host/fe_spif/src/fe_spif.h,v $ Ver:
$Revision: 1.2 $ Date: $Date: 1995/04/24 15:54:33 $ */
/*::::::::::::::::::::::::::::::::::::::::::::::::::::::::::
:::::::::::::
:: Filename:      fe_spif.h
::
:: Purpose:      This file defines structures that are global
::               to the spif.
::
:: Revision:     08/18/94   Raju   Original
:::::::::::::
:::::::::::::*/

void   vFeHandleRoute_all();
void   vFeHandleReset_all();
void   vFeHandleStatus_all();
void   vFeHandlePOIQuery_all();
void   vFeHandleValidate_all();
void   vFeHandleHeartbeat_all();
void   vFeHandleTerminate_all();
void   vFeHandleAcknowledge_all();
void   vFeHandleSetdebug_all();
void   vFeHandleAddservice_all();

char *cpDownload_dir = "./download";

/* DISPATCH TABLE with messagetype, messagesubtype and handle
name */
UT_DISPATCHTABLE   DTable[] = {
    MQ_MT_HEARTBEAT,      -1,
    vFeHandleHeartbeat_all,
    MQ_MT_RESET,         -1,
    vFeHandleReset_all,
    MQ_MT_TERMINATE,     -1,
    vFeHandleTerminate_all,
    MQ_MT_ACKNOWLEDGE,   -1,
    vFeHandleAcknowledge_all,
    MQ_MT_QUERY,         MQ_MTS_QUERY_STATUS,
    vFeHandleStatus_all,
    MQ_MT_OPCOMMAND,     MQ_MTS_OP_ROUTE,
    vFeHandleRoute_all,
    MQ_MT_OPCOMMAND,     MQ_MTS_OP_POIQUERY,
    vFeHandlePOIQuery_all,
    MQ_MT_OPCOMMAND,     MQ_MTS_OP_VALIDATE_Q,
    vFeHandleValidate_all,
    MQ_MT_OPCOMMAND,     MQ_MTS_OP_SETDEBUG,
    vFeHandleSetdebug_all,
    MQ_MT_OPCOMMAND,     MQ_MTS_OP_ADDSERVICE,
    vFeHandleAddservice_all,
    0,                    0,                    NULL
};

```

APPENDIX A — PAGE 246 OF 279

```

extern int          iListenPort;
extern short       sMaxPackets;
extern short       sPacketFlag;
extern int         ipacketflag;
extern short       sConfirmMax;
extern short       sAckPending;
extern long        lMap_format;
extern long        lFormat_mode;
extern short       sDefaultBaud;
extern short       sPacketLimit;
extern int         iQueue_master;
extern long        lLastCommtime;
extern long        lLastCommtime;
extern long        lConstantBaud;
extern long        lCompress_mode;
extern long        lDisplay_panes;
extern short       sTransmitLimit;
extern long        lHeartbeat_wait;
extern int         socket_port_num;
extern short       sInterPacketGap;
extern struct      sockaddr_in addr;
extern short       sProcess_heartbeat;
extern short       sTerm_After_Service;
extern long        lExit_on_disconnect;
extern unsigned long ulSessionID;

extern void        *pMQU_master;
extern void        *pvMQ_master;

extern char        *cpQID;
extern char        *cpFrontID;
extern char        *cpConfigPath;
extern char        *caCommDevice;
extern char        *caDeviceConfig;
extern char        *cpDownload_dir;
extern char        *cpDictionary_dir;

extern char        caID[];
extern char        caBuff[];
extern char        caHangup[];
extern char        caOrigin[];
extern char        caOriginType[];
extern char        caLimitValue[];
extern char        caDestination[];
extern char        caNoAutoAnswer[];
extern char        caDestinationType[];

extern char        *caAlternative[];

extern Q_HEAD      sHead;
extern Q_HEAD      sConfig;
extern Q_HEAD      *pQhead;
extern Q_HEAD      *pQConfig;
extern FILE        *pMsgsfile;
extern SUBSCRIBER *pGSub;

```

APPENDIX A — PAGE 248 OF 279

```

#define POI_EXTNAME_SIZE      64
#define POI_INTNAME_SIZE     64
#define BUFF_SIZE            256

typedef struct poimap
{
    char    caExtName[POI_EXTNAME_SIZE+1];
    char    caIntName[POI_INTNAME_SIZE+1];
} POIMAP;

char    *cpPOIMapConfig = "POIMAP.DAT";
Q_HEAD    qhPOIMap;
void vFeCreatePOIMapping();

/*::::::::::::::::::::::::::::::::::::::::::::::::::::::::::
::::::::::::::::::
:: Function:          vPrint_Subq
::
:: Purpose: This routine is just for debug purposes to check the
subscriber
::                list elements
::
:: Returns:
::
:: Input:
::
:: Output:
::
:: Globals:
::
:: Called Routines:
::
:: Revision:
:: WHO          --WHEN--  WHAT
:: Raju          09/06/94  Original
::::::::::::::::::
::::::::::::::::::*/

void vPrint_Subq()
{
    Q_ELEM        *pq_elem;
    Q_HEAD        *pq;
    SUBSCRIBER    *pSub;

    vMQ_Log(NULL,NULL, 30,"[FRONTEND] Printing Subq\n");
    if( !pqhead == NULL)
    {
        vMQ_Log(NULL,NULL, 10,"[FRONTEND] Subq empty \n");
        return;
    }

    /* Get the global pointer to the subscriber list */
    pq = pqhead;

    /* Traverse the subscriber list */

```

APPENDIX A - PAGE 249 OF 279

```

    Q_FORWTRAV(pq_elem,pq)
    {
        pSub = (SUBSCRIBER *) q_data(pq_elem);

        /* Print each list elements */
        vMQ_Log(NULL,NULL, 30,"[FRONTEND] Subq elem %ld %ld
%s\n",
            pSub->lSpifID, pSub->lSequence, pSub->caSCR);
    }

    vMQ_Log(NULL,NULL, 30,"[FRONTEND] End of Subq\n");
    return;
}

```

```

/*::::::::::::::::::::::::::::::::::::::::::::::::::::::::::
::::::::::::::::::
:: Function:          pFindSpifID
::
:: Purpose: Traverses through the list of subscribers and returns
a pointer to
::              the subscriber structure if it is found based on
the SPIFID. If
::              subscriber is not found NULL is returned.
::
:: Returns:
::
:: Input:
::
:: Output:
::
:: Globals:
::
:: Called Routines:
::
:: Revision:
:: WHO          --WHEN--  WHAT
:: Raju          09/06/94  Original
::::::::::::::::::::::::::::::::::::::::::::::::::::::::::
::::::::::::::::::*/

```

```

SUBSCRIBER *pFindSpifID(long spifid)
{
    Q_ELEM          *pq_elem;
    Q_HEAD          *pq;
    SUBSCRIBER     *pSub;

    vMQ_Log(NULL,NULL, 21,"[FRONTEND] In pFindSpifID looking for
%ld\n",spifid);

    if( pQhead == NULL)
    {
        vMQ_Log(NULL,NULL,0,"[FRONTEND] Qhead null in
pFindSpifID \n");
        return NULL;
    }
}

```

APPENDIX A - PAGE 250 OF 279

```

/* Get the global pointer to the subscriber list */
pq = pQhead;

/* Traverse the subscriber list */
Q_FORWTRAV(pq_elem, pq)
{
    pSub = (SUBSCRIBER *) q_data(pq_elem);
    vMQ_Log(NULL, NULL, 30,
        "[FRONTEND] pFindSpifID found
%ld\n", pSub->lSpifID);

    /* check if the SPIFID matches */
    if ( spifid == pSub->lSpifID )
    {
        vMQ_Log(NULL, NULL, 21, "[FRONTEND] pFindSpifID
found match %ld\n",
            pSub->lSpifID);
        pSub->lLastCommtime = time(0L);

        if( pGSub != NULL)
            pGSub->lLastCommtime = pSub->lLastCommtime;
        return ((SUBSCRIBER *)pSub);
    }

    /* Matching SPIFID is not found */
    vMQ_Log(NULL, NULL, 20, "[FRONTEND] pFindSpifID returning
Null\n");
    return NULL;
}

```

```

/*:::.....
:::.....
:: Function:          pFindResponse
::
:: Purpose: Traverses through the list of subscribers and returns
a pointer to
::              the subscriber structure if it is found based on
the Sequence
::              number and replytime. If subscriber is not found
NULL is returned.
::
:: Returns:
::
:: Input:
::
:: Output:
::
:: Globals:
::
:: Called Routines:
::
:: Revision:
:: WHO          --WHEN--  WHAT
:: Raju          09/06/94  Original

```

```

.....
.....*/
SUBSCRIBER *pFindResponse(time_t ltime, long lsequence )
{
    Q_ELEM          *pq_elem;
    Q_HEAD          *pq;
    SUBSCRIBER      *pSub;

    vMQ_Log(NULL,NULL,21,"[FRONTEND] In FindResponse time %ld
seq %ld\n",
        ltime, lsequence);

    if( pQhead == NULL)
    {
        vMQ_Log(NULL,NULL,0,"[FRONTEND] No elements in queue
\n");
        return NULL;
    }

    /* Get a pointer to global subscriber list */
    pq = pQhead;

    /* Traverse the subscriber list */
    Q_FORWTRAV(pq_elem,pq)
    {
        pSub = (SUBSCRIBER *) q_data(pq_elem);
        vMQ_Log(NULL,NULL,30,"[FRONTEND] FindResponse found
time %ld seq %ld\n",
            pSub->tReplyTime, pSub->lSequence);

        /* compare the sequencenumber and replytime for reply
match */
        if ( (lsequence == pSub->lSequence) && (ltime ==
pSub->tReplyTime) )
        {
            vMQ_Log(NULL,NULL,21,"[FRONTEND] FindResponse
match t %ld s %ld\n",
                pSub->tReplyTime, pSub->lSequence);
            return ((SUBSCRIBER *)pSub);
        }
    }

    /* Matching sequence number and replytime is not found */
    vMQ_Log(NULL,NULL,0,"[FRONTEND] FindResponse No match \n");
    return NULL;
}

/*.....
.....:
:: Function:          iDelSub
::
:: Purpose: Traverses through the list of subscribers and delete
a subscriber

```

APPENDIX A - PAGE 252 OF 279

```

::          based on the SPIFID and return SUCCESS. If
subscriber is not found
::          FAILURE is returned.
::
:: Returns:
::
:: Input:
::
:: Output:
::
:: Globals:
::
:: Called Routines:
::
:: Revision:
:: WHO          --WHEN--  WHAT
:: Raju          09/06/94  Original
::
::
::
::
::
::
::
::
::
::
::

```

```

int iDelSub(long spifid)
{
    Q_ELEM          *pq_elem;
    Q_HEAD          *pq;
    SUBSCRIBER     *pSub;
    char           buff[128];

    vMQ_Log(NULL, NULL, 21, "[FRONTEND] In iDelSub looking for id
%d \n", spifid);

    if( pQhead == NULL)
    {
        vMQ_Log(NULL, NULL, 0, "[FRONTEND] No elements in queue
\n");
        return FAILURE;
    }

    /* Get the pointer to global subscriber list */
    pq = pQhead;

    /* Traverse the subscriber list */
    Q_FORWTRAV(pq_elem, pq)
    {
        pSub = (SUBSCRIBER *) q_data(pq_elem);
        vMQ_Log(NULL, NULL, 30, "[FRONTEND] iDelSub found %d \n",
pSub->lSpifID);

        /* look for a match for the SPIFID and not a gateway
*/
        if (( spifid == pSub->lSpifID ) && ( pSub->sGatewayFlag
!= 1))
        {
#ifdef DELETE
            sprintf( buff, "tmp.%ld.%ld",    getpid(),
pSub->lSpifID);
            if( strcmp(buff, pSub->caTmpfile) != 0)

```

APPENDIX A - PAGE 253 OF 279

```

    vMQ_Log(NULL,NULL,21," [FRONTEND] Creating Gateway structure
\n");
    pSub = &sSub;
    memcpy((char *)&pSub->ServerRequest, (char *)&ServerRequest,
        sizeof(SPIFPARSE));

    pSub->lStatus = 0;
    pSub->bit_map = 0;
    pSub->sStateflag = 0;
    pSub->lTrx_count = 0;
    pSub->sItemCount = 0;
    pSub->lRcv_count = 0;
    pSub->iValidated = 0;
    pSub->lRoute_count = 0;
    pSub->sManeuverCount = 0;
    pSub->lRequestPending = 0;
    pSub->lResponsePending = 0;
    pSub->lExternalQuery_count = 0;
    pSub->lInternalQuery_count = 0;

    memset((char *)&pSub->OriginLocus, -1, sizeof(ALOCUS));
    memset((char *)&pSub->DestinationLocus, -1, sizeof(ALOCUS));

    pSub->lMsgtype = SPIF_LOGIN;
    pSub->iCommPort = iDataPort;
    pSub->lSessionID = ulSessionID;
    pSub->sBurstCount = sConfirmMax;
    pSub->sPacketLimit = sPacketLimit;
    pSub->lLastCommtime = pSub->tstart_time = time(0L);
    pSub->lMsgid = 0;

    strcpy(pSub->caSCR, Msg);
    vMakeUpper(pSub->caSCR);

    strcpy(pSub->caMsg, Msg);
    strcpy(pSub->caConfig, "\0");
    strcpy(pSub->caLanguage, "ENGLISH.FEB");
    sprintf(pSub->caTmpfile, "tmp.%ld.GATEWAY", getpid());

    pSub->lSpifID = -1;
    pSub->sGatewayFlag = 1;
    strcpy(pSub->ServerRequest.caID, "***GATEWAY**");

    vMQ_Log(NULL,NULL,21, " [FRONTEND] user %s, file %s, msgid
%ld scr %s\n",
        pSub->ServerRequest.caID,    pSub->caTmpfile,
    pSub->lMsgid, pSub->caSCR);

    /* add this to the q */
    pq_elem = (Q_ELEM *)q_new(pSub, sizeof(SUBSCRIBER));
    pq = pqhead;
    q_atail(pq, pq_elem);
    vMQ_Log(NULL,NULL,21, " [FRONTEND] Added Gateway\n");

    /* Create POI Mapping queue */
    vFeCreatePOIMapping();

```

APPENDIX A — PAGE 255 OF 279

```

        return (NULL);
    }

/*:.....
:.....
:: Function:          pAddSub
::
:: Purpose: Traverses through the list of subscribers and return
a pointer to
::           the subscriber if already exists. If subscriber
does not exist
::           already then create a new structure element in the
list a return
::           a pointer to the subscriber. If this is the first
element to the
::           structure then it is the gateway structure
otherwise it is a
::           subscriber element.
::
:: Returns:
::
:: Input:
::
:: Output:
::
:: Globals:
::
:: Called Routines:
::
:: Revision:
:: WHO           --WHEN--  WHAT
:: Raju          09/06/94  Original
:.....
:.....*/

SUBSCRIBER *pAddSub(SPIF_HEADER *spif_header, char *cpMsg)
{
    SUBSCRIBER sSub, *pSub;
    SPIFPARSE ServerRequest;
    Q_ELEM     *pq_elem;
    Q_HEAD     sHead, *pq;
    char       *cp, *cpalt;
    int        i, j;
    short      sCount;
    short      sStartLen, sEndLen;

    vMQ_Log(NULL, NULL, 21, "[FRONTEND] AddSub calling sFindSpifID
%d\n",
            spif_header->lSpifID);

    if( (pSub = pFindSpifID(spif_header->lSpifID)) != NULL)
    {
        vMQ_Log(NULL, NULL, 0, "[FRONTEND] Found subscriber in
AddSub\n");
        return ((SUBSCRIBER *)pSub);
    }
}

```

APPENDIX A - PAGE 256 OF 279

```

    }
    else
    {
        /* Initailize the subscriber structure */
        vMQ_Log(NULL,NULL,21," [FRONTEND] Creating new structure
%ld\n",
            spif_header->lSpifID);
        pSub = &sSub;
        memcpy((char *) &pSub->ServerRequest, (char
*)&ServerRequest,
            sizeof(SPIFPARSE));

        pSub->lStatus = 0;
        pSub->bit_map = 0;
        pSub->sStateflag = 0;
        pSub->lTrx_count = 0;
        pSub->lRcv_count = 0;
        pSub->sItemCount = 0;
        pSub->iValidated = 0;
        pSub->lErrorCount = 0;
        pSub->lRoute_count = 0;
        pSub->sManeuverCount = 0;
        pSub->lRequestPending = 0;
        pSub->lResponsePending = 0;
        pSub->lExternalQuery_count = 0;
        pSub->lInternalQuery_count = 0;

        memset((char *) &pSub->OriginLocus, -1, sizeof(ALOCUS));
        memset((char *) &pSub->DestinationLocus, -1,
sizeof(ALOCUS));

        pSub->sGatewayFlag = 0;
        pSub->iCommPort = iDataPort;
        pSub->lSessionID = ulSessionID;
        pSub->sBurstCount = sConfirmMax;
        pSub->sPacketLimit = sPacketLimit;
        pSub->lMsgtype = SPIF_PASS_THROUGH;
        pSub->lSpifID = spif_header->lSpifID;
        pSub->lLastCommtime = pSub->tstart_time = time(0L);

        strcpy(pSub->caMsg, cpMsg);
        strcpy(pSub->caConfig, "\0");
        strcpy(pSub->caLanguage, "ENGLISH.FEB");

        sCount = 0;
        while( 1 )
        {
            cp = strchr(cpMsg, '|');
            cp++;
            cpMsg = cp;
            sCount++;
            if( sCount == 4 )
                break;
        }
        sStartLen = strlen(cp);
        cp = strchr(cpMsg, '|');

```

APPENDIX A - PAGE 257 OF 279

```

sEndLen = strlen(cp);
strncpy(pSub->caSCR, cpMsg, (sStartLen - sEndLen));
pSub->caSCR[sStartLen - sEndLen] = '\0';

cpMsg = cp;
if( sMoveLong(&cpMsg, &pSub->lMsgid, 16) != SUCCESS)
{
    vMQ_Log(NULL, NULL, 0, "[FRONTEND] Invalid
messageID\n");
}
else
    pSub->ServerRequest.lMsgid = pSub->lMsgid;

cpMsg = cp + 6;
sStartLen = strlen(cpMsg);
cp = strchr(cpMsg, '|');

/*****
cp--;
if( *cp == '\\ ' )
{
    cpalt = cp + 2;
    cp = strchr(cpalt, '|');
}
else
    cp++;
*****/

sEndLen = strlen(cp);
strncpy(pSub->ServerRequest.caID, cpMsg, (sStartLen -
sEndLen));
pSub->ServerRequest.caID[sStartLen - sEndLen] = '\0';

/*****
if( strchr(pSub->ServerRequest.caID, '\\ ' ) != NULL )
{
    for( i=0, j=0; i<strlen(pSub->ServerRequest.caID);
i++)
    {
        if( pSub->ServerRequest.caID[i] != '\\ ' )
        {
            pSub->ServerRequest.caID[j] =
pSub->ServerRequest.caID[i];
            j++;
        }
    }
    pSub->ServerRequest.caID[j] = '\0';
}
*****/

sprintf(pSub->caTmpfile, "tmp.%ld.%ld", getpid(), pSub->lSpifID);
vMakeUpper(pSub->caSCR);
vMakeUpper(pSub->ServerRequest.caID);

```

```

        vMQ_Log(NULL, NULL, 21, "[FRONTEND] user %s, file %s,
msgid %ld scr %s\n",
        pSub->ServerRequest.caID,    pSub->caTmpfile,
pSub->lMsgid, pSub->caSCR );
    }

    /* add this to the q */
    pq_elem = (Q_ELEM *)q_new(pSub, sizeof(SUBSCRIBER));
    pq = pQhead;
    q_atail(pq, pq_elem);
    vMQ_Log(NULL, NULL, 21, "[FRONTEND] Added subscriber\n");

    return (NULL);
}

```

```

/*:.....
:.....
:: Function:          vFeUpdate_Sub
::
:: Purpose: Update the subscriber lastcommtime for the appropriate
subscriber
::
:: Returns:
::
:: Input:
::
:: Output:
::
:: Globals:
::
:: Called Routines:
::
:: Revision:
:: WHO          --WHEN--  WHAT
:: Raju         09/06/94  Original
:.....
:.....*/

```

```

void vFeUpdate_Sub(long lSpifID)
{
    time_t      now;
    Q_ELEM      *pq_elem;
    Q_HEAD      *pq;
    SUBSCRIBER  *pSub;

    time(&now);

    if( pQhead == NULL )
    {
        return;
    }

    pq = pQhead;

    /* Traverse the subscriber list */

```

APPENDIX A – PAGE 259 OF 279

```

Q_FORWTRAV(pq_elem,pq)
{
    pSub = (SUBSCRIBER *) q_data(pq_elem);

    /* Look for matching SPIFID and not a gateway */
    /* Update Lastcommtime and heartbeat sent and send
status fields */
    if((pSub->lSpifID == lSpifID) && (pSub->sGatewayFlag
!= 1))
    {
        pSub->lLastCommtime = now;
        pSub->lStatus &= ~SS_SEND_HBEAT;
        pSub->lStatus &= ~SS_HBEAT_SENT;
        pGSub->lLastCommtime = now;
        pGSub->lStatus &= ~SS_SEND_HBEAT;
        pGSub->lStatus &= ~SS_HBEAT_SENT;
    }
    return;
}

```

```

/*:.....:
:.....:
:: Function:          vFeLogout_Sub
::
:: Purpose: Logout any given spifid.
::
:: Returns:
::
:: Input:
::
:: Output:
::
:: Globals:
::
:: Called Routines:
::
:: Revision:
:: WHO          --WHEN--  WHAT
:: Raju         09/06/94  Original
:.....:
:.....:*/

```

```

void vFeLogout_Sub(lSpifID, sCode)
long lSpifID;
short sCode;
{
    char      *cp;
    long      lLen;
    time_t    now;
    Q_ELEM    *pq_elem;
    Q_HEAD    *pq;
    SUBSCRIBER *pSub;

    time(&now);

```

APPENDIX A - PAGE 260 OF 279

```

    if( pQhead == NULL)
    {
        return;
    }

    pq = pQhead;

    /* Traverse the subscriber list */
    Q_FORWTRAV(pq_elem,pq)
    {
        pSub = (SUBSCRIBER *) q_data(pq_elem);

        /* Look for a matching subscriber ID */
        if((pSub->lSpifID == lSpifID) && (pSub->sGatewayFlag
!= 1))
        {
            /* send a subscriber disconnect message ok to SPIF
*/
            pSub->lMsgtype = SPIF_SUBSCRIBER_DISCONNECT;
            sSendHeader( 8, pSub->lSpifID, pSub->lMsgtype);
            pSub->sResultCode = sCode;
            vHandleAuditLog(NULL, NULL, MQ_MTS_AUDIT_CLLOGOUT,
lFID,
                (void *)pSub, NULL, 1);
            vMQ_EventLog(NULL,NULL, MQ_EVB_LOGOUT,
                pSub->caSCR, strlen(pSub->caSCR));
            vMQ_Log(NULL,NULL,10,"[FRONTEND] Deleting
subscriber\n");

            /* Delete the subscriber */
            if( iDelSub( pSub->lSpifID) != SUCCESS)
            {
                vMQ_Log(NULL,NULL,0,"[FRONTEND] Unable to
delete subscriber\n");
            }
        }
    }

/*::::::::::::::::::::::::::::::::::::::::::::::::::::::::::
::::::::::::::::::
:: Function: vFeHandleSigUsr1
::
:: Purpose: Signal handler for USR1
::
:: Returns:
::
:: Input:
::
:: Output:
::
:: Globals:
::
:: Called Routines:
::

```

APPENDIX A - PAGE 261 OF 279

```

    {
        pSub = (SUBSCRIBER *) q_data(pq_elem);
        vMQ_Log(NULL, NULL, 30, "[FRONTEND] SPIFID %ld, Subid
%s, seq %ld\n",
            pSub->lSpifID, pSub->caSCR, pSub->lSequence);

        /* If it is a gateway do not timeout */
        if( pSub->sGatewayFlag == 1)
        {
            continue;
        }

        count++;

        /* change for timeout of serverguide response */
        if( ( pSub->lResponsePending == 1 ) &&
            ( pSub->tReplyTime + lDBETimeout ) < now )
        {
            vMQ_Log(NULL, NULL, 0, "[FRONTEND] serverguide
TIMEDOUT\n");
            pSub->sResultCode = FEERR_SGTO;
            vSendErrorResponse(pSub, " Route Failed ");
            pSub->tReplyTime = now;
            pSub->lResponsePending = 0;
        }

        /* Check if heartbeat has already been sent */
        if( (pSub->lStatus & SS_HBEAT_SENT ) &&
            ((pSub->lLastCommtime + lHeartbeat_wait) < now))
        {
            /* Heart beat has been sent already so logout the
subscriber */
            vMQ_Log(NULL, NULL, 5, "[FRONTEND] Hangup on
timeout\n");
            vFeLogout_Sub(pSub->lSpifID, LOGOUT_BY_HEARTBEAT);
        }
        else if(( pSub->lStatus & SS_SEND_HBEAT ) ||
            ((pSub->lLastCommtime + lHeartbeat) < now))
        {
            if( pSub->lResponsePending != 1 )
            {
                cp = &buff[0];
                pSub->lmsgtype = SPIF_CLIENT_HEARTBEAT;
                /* Send Heartbeat message */
                vMQ_Log(NULL, NULL, 10, "[FRONTEND] Sending
HEARTBEAT=Y\n");
                lLen = lFillMsgFields(pSub, cp);
                strcpy(cp+lLen, "E|OK|HEARTBEAT=Y|\n\r");
                sSendMsg(pSub, (void *)buff, strlen(cp));
                pSub->lStatus |= SS_HBEAT_SENT;
                pSub->lStatus &= ~SS_SEND_HBEAT;
                pSub->lLastCommtime = now - lHeartbeat +
lHeartbeat_wait;
            }
        }
    }
}

```

APPENDIX A - PAGE 266 OF 279

```

q_newlist(pQConfig);
pconfig = pQConfig;
pTable = &sTable;
vMQ_Log(NULL, NULL, 21, "[FRONTEND] calling Get
FirstService\n");

/* read the first element in the services */
if(iMQU_GetFirstService( pMQU_master, &cpName, &laddress,
&cpDescription, &lstatus, &cpFile) == SUCCESS)
{
    vMQ_Log(NULL, NULL, 21,
" [ F R O N T E N D ] F i r s t S e r v i c e
n=%s,d=%s,a=%ld,s=%ld,f=%s\n",
cpName, cpDescription, laddress, lstatus, cpFile);

    if((lstatus & MQU_STATUS_DBE) && ( lstatus &
MQU_STATUS_AVAILABLE))
    {
        strcpy(pTable->caName, cpName);
        strcpy(pTable->caDescription, cpDescription);

        /* add this to the q */
        pconfig_elem = q_new(pTable, sizeof(CONFIGTABLE));
        q_atail(pconfig, pconfig_elem);
    }

    /* read next available services upto the end */
    while(iMQU_GetNextService( pMQU_master, &cpName,
&laddress,
&cpDescription, &lstatus, &cpFile) == SUCCESS)
    {
#ifdef DEBUG
        vMQ_Log(NULL, NULL, 21,
" [ F R O N T E N D ] N e x t S e r v i c e
n=%s,d=%s,a=%ld,s=%ld,f=%s\n",
cpName, cpDescription, laddress, lstatus,
cpFile);
#endif

        /* copy available services to the table */
        if((lstatus & MQU_STATUS_DBE) && ( lstatus &
MQU_STATUS_AVAILABLE))
        {
            vMQ_Log(NULL, NULL, 10,
" [ F R O N T E N D ] V A L I D D B E
n=%s,d=%s,a=%ld,s=%ld,f=%s\n",
cpName, cpDescription, laddress,
lstatus, cpFile);

            strcpy(pTable->caName, cpName);
            strcpy(pTable->caDescription, cpDescription);
            p c o n f i g _ e l e m =
q_new(pTable, sizeof(CONFIGTABLE));
            q_atail(pconfig, pconfig_elem);
        }
    }
}
else

```

APPENDIX A - PAGE 268 OF 279

```

    {
        vMQ_Log(NULL, NULL, 0, "[FRONTEND] No Services
available\n");
        vFeHandleTerminate(TERMINATE_NORMAL);
    }
}

```

```

/*:.....:
:.....:
:: Function: sGenerateConfigQuery
::
:: Purpose: Query for the list of valid DBEs write the output
into a file
::         whose filepointer is provided. Returns a count of
valid DBEs.
::
:: Returns:
::
:: Input:
::
:: Output:
::
:: Globals:
::
:: Called Routines:
::
:: Revision:
:: WHO      --WHEN--  WHAT
:: Raju     09/06/94  Original
:.....:
:.....:*/

```

```

short sGenerateConfigQuery(FILE *fp)
{
    short          count = 0;
    Q_HEAD        *pconfig;
    Q_ELEM        *pconfig_elem;
    CONFIGTABLE   *pTable;

    pconfig = pQConfig;

    /* check if it is the first element in the queue */
    if( pconfig == NULL )
    {
        return 0;
    }

    Q_FORWTRAV(pconfig_elem, pconfig)
    {
        count++;
        pTable = (CONFIGTABLE *) q_data(pconfig_elem);

phase 0 */ /* .CFG has been added to maintain compatibility with

```

APPENDIX A — PAGE 269 OF 279

```

/* Copyright (C) 1994,1995 SEI Information Technology, Inc. */
/*.....:
:
:
:: Filename:          ids_defs.h
: Purpose:           General program defines.
: Revision:          08/31/94      RPD      Original
:.....:
:.....:*/
#ifndef _IDS_DEFS_H
#define _IDS_DEFS_H

#ifdef _WINDOWS
#include <windows.h>
#define SPRINTF      wsprintf
#ifdef WINDLL
#define FUNC_DECL    _pascal _loadds
#else
/* _WINDLL */
#define FUNC_DECL
#endif
/* _WINDLL */
/* _WINDOWS */
#define SPRINTF      sprintf
#define FUNC_DECL
#define min(a,b)    (((a) < (b)) ? (a) : (b))
#endif
/*
 * Basic Type defines:
 */
#define CHAR        char
#define UCHAR       unsigned char
#define SHORT       short
#define USHORT      unsigned short
#define INT         int
#define UINT        unsigned int
#define LONG        long
#define ULONG       unsigned long
#define VOID        void
#define BYTE        unsigned char
#define DOUBLE      double
#define FLOAT       float
#ifndef BOOL
#define BOOL        int
#endif
/* BOOL */

#define STRCAT      strcat
#define STRCHR      strchr
#define STRCMP      strcmp
#define STRCPY      strcpy
#define STRLEN      strlen
#define STRNCAT     strncat
#define STRNCMP     strncmp
#define STRNCPY     strncpy
#define STRSTR      strstr
#define STRTOL      strtol

```

APPENDIX A — PAGE 273 OF 279

```
/*
 * Public defines:
 */
#ifndef TRUE
#define TRUE 1
#endif /* TRUE */

#ifndef FALSE
#define FALSE 0
#endif /* FALSE */

#define SUCCESS 0
#define FAILURE -1
#define ABORT 1

#endif /* _IDS_DEFS_H */
```

```
/*  
  cvs id: $Id: ut_parse.h,v 1.2 1995/04/27 20:38:16 rajub Exp $  
  source: $Source: /ids/cvs/host/libut/src/ut_parse.h,v $  
*/  
/* Copyright (C) 1994,1995 SEI Information Technology, Inc. */  
  
typedef struct {  
    short    rank;  
    short    x[3];  
    short    y[3];  
}    VB_ARMS;
```

```

static char * _ s c c s _ = { " $ S o u r c e :
/ids/cvs/host/libut/src/ut_vlog.c,v $ Ver: $Revision: 1.1 $ Date:
$Date: 1994/12/20 16:19:09-$";
/* Copyright (C) 1994,1995 SEI Information Technology, Inc. */

/*::::::::::::::::::::::::::::::::::::::::::::::::::
::::::::::
:: Filename:   ut_vlog.c
::
:: Purpose:    Provides the vLog function
::
:: Revision:
:: WHO      --WHEN--  WHAT
:: DAB   07/22/94   Creation
::
::::::::::::::::::::::::::::::::::::::::::::::::::
::::::::::*/

#include <stdio.h>
#include <stdlib.h>
#include <stdarg.h>
#include <time.h>

extern int iDebug;

/*****
**
** vLog:      Log info for debug purposes
**
*****/

void vLog(int tflag, char *format, ... )
{
    va_list alist;
    FILE *fp;
    time_t now;
    struct tm *ptm;

    now = time(0L);
    ptm = localtime(&now);

    if (iDebug >= tflag)
    {
        va_start(alist, format);

        if ((fp = fopen("flog.out", "a")) != (FILE *)NULL)
        {
            /* if (tflag & 1) */
            fprintf(fp, "[% .5d]   %.2d/%.2d/%.2d
%.2d:%.2d:%.2d ",
                    getpid(),
                    ptm->tm_mon+1,
                    ptm->tm_mday,
                    ptm->tm_year,

```

APPENDIX A — PAGE 276 OF 279

```
        ptm->tm_hour,  
        ptm->tm_min,  
        ptm->tm_sec);  
    vfprintf(fp, format, alist);  
    fclose(fp);  
    }  
    }  
}
```



```

short      sUtDispatchMessage ( pMQ, pMQU, pDTable, lMessageType,
lMessageSubtype,
          pData )
void          *pMQ;
void          *pMQU;
UT_DISPATCHTABLE *pDTable;
long         lMessageType;
long         lMessageSubtype;
void          *pData;
{
    /* Validate the incoming parameters */
    if (pMQ == NULL || pMQU == NULL || pDTable == NULL)
        return FAILURE;

    for ( ; pDTable->vDispatchFunction != NULL; pDTable++ )
    {
        if ( pDTable->lMessageType == (lMessageType &
MQ_MT_MSGTYPE_MASK) &&
            (pDTable->lMessageSubtype == lMessageSubtype
||
            pDTable->lMessageSubtype == -1))
        {
            /* We have a match - execute the function */
            (*(pDTable->vDispatchFunction))(pMQ, pMQU,
pDTable, lMessageType,
            lMessageSubtype, pData);
            return SUCCESS;
        }
    }

    /* Here because there was not match before end of table
marker */
    return FAILURE;
}

```

What is claimed is:

1. A method of transmitting route directions in a compact form, comprising the steps of:
 - (a) generating a first set of maneuver arms for providing a graphical representation of a calculated route to be taken by a vehicle through an intersection and geometric representations of a plurality of segments of roads to be traveled about an intersection along the route, wherein the intersection is an origin, and said representations of each of said plurality of segments of roads starts at the origin and radiates outward to an endpoint Xi, Yi to approximate the angles at which the roads approach the intersection, to depict a first intersection on a display, each maneuver arm of the first set of maneuver arms being represented by at least one endpoint;
 - (b) generating a second set of maneuver arms to depict a second intersection on a display, each maneuver arm of the second set of maneuver arms being represented by at least one endpoint;
 - (c) comparing the proximity of the first intersection and the second intersection and, if the first intersection and the second intersection are within a predetermined range of each other, combining the first set of maneuver arms with the second set of maneuver arms to produce a combined set of endpoints to depict the first set of maneuver arms and the second set of maneuver arms on a common display; and
 - (d) transmitting the combined set of endpoints to a remote unit in electromagnetic form.
2. A method of efficiently transmitting routing directions and driving actions, said method comprising the steps of:
 - (a) generating a routing direction and a driving action for a user;
 - (b) expressing the routing direction and the driving action in at least one of a plurality of tokenized forms, each of said plurality of tokenized forms representing a pre-defined routing direction and driving action in compact form;
 - (c) electromagnetically transmitting said at least one of said plurality of tokenized forms to a remote unit;
 - (d) receiving said at least one of said plurality of tokenized forms at said remote unit; and
 - (e) at said remote unit, expanding said at least one of said plurality of tokenized forms received in step (d) into a textual driving instruction indicating what direction a vehicle should proceed at an intersection and what additional driving action should be taken, for display to a user at said remote unit.
3. A method as set forth in claim 2, further comprising the steps of:
 - (f) receiving instructions from said user specifying that textual driving instructions be displayed in one or more languages; and
 - (g) at said remote unit, expanding said at least one of said plurality of tokenized forms, received in step (d), into a textual driving instruction for each of said one or more languages specified in step (f).
4. A method as set forth in claim 2, further comprising the steps of:
 - (f) in step (c), transmitting a road name to said remote unit along with said one of said plurality of tokenized forms; and
 - (g) in step (e), inserting the road name transmitted in step (f) into expanded text corresponding to said at least one of said plurality of tokenized forms received in step (d).

5. A system for generating and transmitting route directions in a compact form, comprising:
 - (a) a base unit which
 - (i) generates a first set of maneuver arms for providing a graphical representation of a calculated route to be taken by a vehicle through an intersection and geometric representations of a plurality of segments of roads to be traveled about an intersection along the route, wherein the intersection is an origin and said representations of each of said plurality of segments of roads starts at the origin and radiates outward to an endpoint Xi, Yi to approximate the angles at which the roads approach the intersections, to depict a first intersection on a display, each maneuver arm of the first set of maneuver arms being represented by at least one endpoint,
 - (ii) generates a second set of maneuver arms to depict a second intersection on a display, each maneuver arm of the second set of maneuver arms being represented by at least one endpoint, and
 - (iii) compares the proximity of the first intersection and the second intersection and, if the first intersection and the second intersection are within a predetermined range of each other, combines the first set of maneuver arms with the second set of maneuver arms to produce a combined set of endpoints to depict the first set of maneuver arms and the second set of maneuver arms on a common display; and
 - (b) a communications link to transmit the combined set of endpoints to a remote unit in electromagnetic form.
6. A system for generating and transmitting routing directions comprising:
 - (a) a base unit which
 - (i) generates a routing direction and driving action for a user and
 - (ii) expresses the routing direction and driving action in at least one of a plurality of tokenized forms, each of said plurality of tokenized forms representing a pre-defined routing direction and driving action in compact form;
 - (b) a communications link to electromagnetically transmit said at least one of said plurality of tokenized forms; and
 - (c) a remote unit which
 - (i) receives said at least one of said plurality of tokenized forms from the communications link, and
 - (ii) expands said at least one of said plurality of tokenized forms into a textual driving instruction indicating what direction a vehicle should proceed at an intersection and what additional driving action should be taken, for communication to a user at said remote unit.
7. A system as set forth in claim 6, wherein:

the remote unit receives instructions from the user specifying that textual driving instructions be displayed in one or more languages; and

the remote unit expands said at least one of said plurality of tokenized forms into a textual driving instruction for each of said one or more languages specified by the user.
8. A system as set forth in claim 6, wherein:

the communications link transmits a road name to said remote unit along with said one of said plurality of tokenized forms; and

the remote unit inserts the road name transmitted by the communications link into expanded text corresponding to said at least one of said plurality of tokenized forms.

583

9. A system as set forth in claim 6, wherein the remote unit includes a display for said communication to said user at said remote unit.

10. A system as set forth in claim 6, wherein the remote unit includes an annunciator for said communication to said user at said remote unit. 5

11. A method of efficiently transmitting routing directions and driving actions, said method comprising the steps of:

- (a) generating a routing direction and driving action for a user; 10
- (b) expressing the routing direction and driving action in at least one of a plurality of tokenized forms, each of said plurality of tokenized forms representing a pre-

584

-defined routing direction and driving action in compact form;

- (c) electromagnetically transmitting said at least one of said plurality of tokenized forms to a remote unit;
- (d) receiving said at least one of said plurality of tokenized forms at said remote unit; and
- (e) at said remote unit, expanding said at least one of said plurality of tokenized forms received in step (d) into a textual driving instruction indicating what direction a vehicle should proceed at an intersection and what additional driving action should be taken, for annunciation to a user at said remote unit.

* * * * *