

Apple Inc. (Petitioner)
v.
GUI Global Products, LTD. (Patent Owner)
Petitioner Demonstratives

Case Nos. IPR2021-00471, -00472, -00473
U.S. Patent Nos. 10,259,021, 10,562,077, 10,589,320
Before Hon. Sally C. Medley, Sheila F. McShane, Monica S. Ullagaddi
Administrative Patent Judges

FISH.

DEMONSTRATIVE EXHIBIT – NOT EVIDENCE

Table of Contents

Issue 1: A POSITA Would Have Combined Gundlach and Lee	3
Issue 2: Gundlach-Lee Renders Obvious “selectively couple...employing magnetic force”	50
Issue 3: Gundlach-Lee Renders Obvious “activate, deactivate, or send into hibernation”	59
Issue 4: Gundlach-Lee Renders Obvious the lid “recessed to configure to the electronic device”	70
Issue 5: The POSITA Would Have Combined Mak-Fan With Gundlach-Lee	75
Issue 6: Gundlach-Lee-Mak-Fan Renders Obvious “the lid has a second magnet disposed within it”	84
Issue 7: Gundlach-Lee-Mak-Fan Renders Obvious “the second or a third magnet is employed in the lid to actuate the electronic circuit”	87



DEMONSTRATIVE EXHIBIT – NOT EVIDENCE

Issue 1

A POSITA Would Have
Combined Gundlach and Lee

FISH.

DEMONSTRATIVE EXHIBIT – NOT EVIDENCE

Overview of Gundlach

Dr. Cooperstock's First Declaration

charged." (*Id.*, [0055].) Gundlach's disclosure includes a variety of embodiments consistent with the theme of an expandable/collapsible wireless headset having a "relatively thin shape [that] may allow the headset to be stored and charged in a portable cradle," such as "a holder, clip, case or card." (*Id.*, [0055-0056].)

IPR2021-00473 ("473") APPLE-1003, ¶ 26.

27. Gundlach describes the basic components of its wireless headset with reference to a schematic view provided in Figure 1 (below). (See Gundlach, [0058].) As was conventional at the time, Gundlach's wireless headset 100 includes a housing 101 for supporting various functional components, including a microphone 102 and a speaker 105 directing sound through an earpiece 104. (*Id.*) The housing 101 further supports "a transceiver 106 for sending and receiving information 108 from a host device 110, such as a computer, a cell phone or a media player," and a power source 111 in the form of a rechargeable battery. (*Id.*)

473 APPLE-1003, ¶ 27.

Gundlach

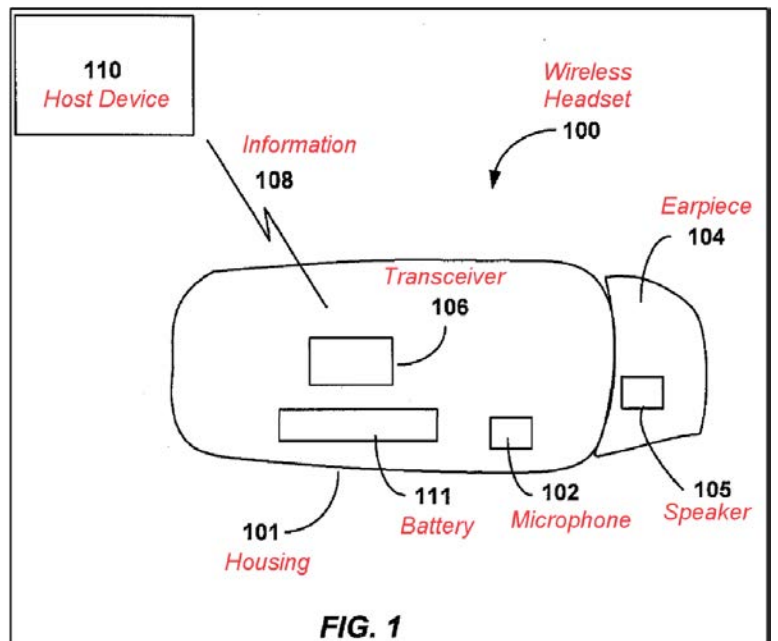

APPLE-1005 (Gundlach), Figure 1
473 Pet., 7-9; 472 Pet., 8-10; 471 Pet., 9-11.

Overview of Gundlach

Dr. Cooperstock's First Declaration

26. Gundlach's disclosure—entitled "WIRELESS HEADSET"—was inspired by the demand for "wireless technologies" that emerged when the industry sought to eliminate the burden of "managing the wires" on mobile device peripherals. (Gundlach, [0003].) But wireless peripherals brought about their own problems—e.g., "keeping track of [them] and keeping them charged and ready to use." (*Id.*, [0005].) Gundlach set out to address these problems, and did so by providing "a device that when in [an expanded] configuration . . . becomes a wireless mono or stereo headset and when in a [collapsed] configuration . . . may be stored and charged." (*Id.*, [0055].) Gundlach's disclosure includes a variety of embodiments consistent with the theme of an expandable/collapsible wireless headset having a "relatively thin shape [that] may allow the headset to be stored and charged in a portable cradle," such as "a holder, clip, case or card." (*Id.*, [0055-0056].)

473 APPLE-1003, ¶ 26.

28. Gundlach's Figures 2a-2d (below) provide perspective, front, bottom, and top views of the wireless headset 200, highlighting its compact design.

473 APPLE-1003, ¶ 28.

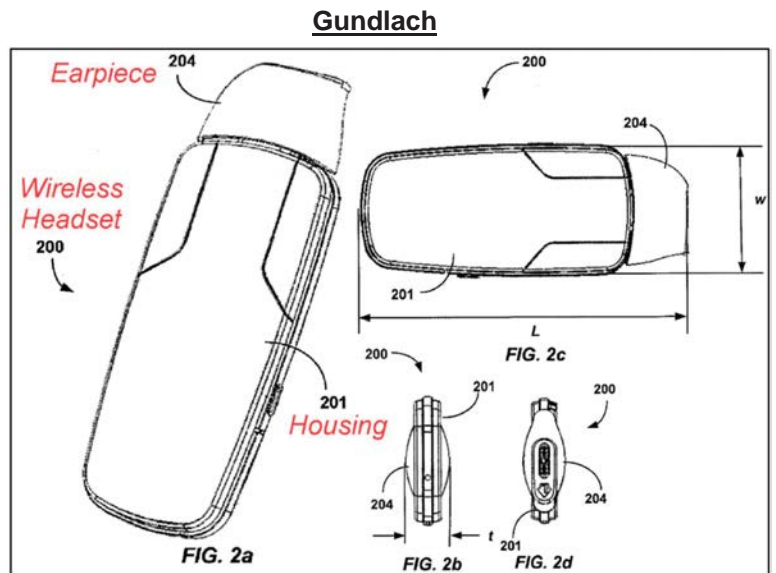

APPLE-1005 (Gundlach), Figures 2a-2d
473 Pet., 7-9; 472 Pet., 8-10; 471 Pet., 9-11.

Overview of Gundlach

Dr. Cooperstock's First Declaration

30. Gundlach's disclosure is expansive on the topic of "storage," noting broadly at the outset that the wireless headset can be "stored and charged in a portable cradle," such as "a holder, clip, case or card." (Gundlach, [0056].) Gundlach then goes on to illustrate and describe a variety of exemplary cradle designs with embedded magnets and/or mechanical elements for retaining the wireless headset. (E.g., *id.*, [0068], [0073], [0075], Figures 10a-19b.) As one example, in Figures 18a-18b (below) the "portable cradle" is a clamshell case 1860 that retains the wireless headset 1800 within a contoured recess 1846 in one of two opposing lids. (*Id.*, [0080].)

473 APPLE-1003, ¶ 30.

Gundlach

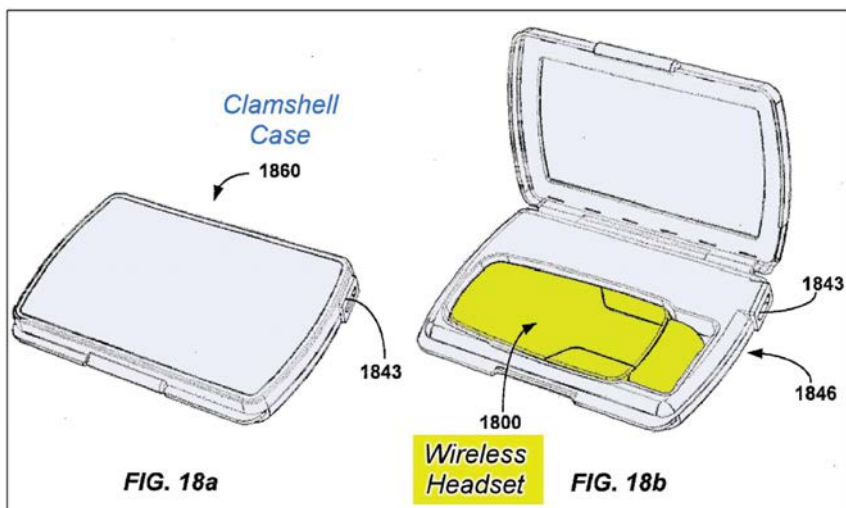

APPLE-1005 (Gundlach), Figures 18a-18b
473 Pet., 7-9; 472 Pet., 8-10; 471 Pet., 9-11

Overview of Lee

Dr. Cooperstock's First Declaration

31. Lee is entitled "WIRELESS BATTERY CHARGING OF ELECTRONIC DEVICES SUCH AS WIRELESS HEADSETS/HEADPHONES." Similar to Gundlach, and as its title suggests, Lee "relates to wireless battery charging of wireless headphones/headsets." (Lee, 3:21-22; see also *id.*, 1:14-29.) And while Gundlach was more concerned with the physical form factor and envelope of the wireless headset and charging case, Lee sought improvements relating to energy transfer. Specifically, Lee recognized that conventional conductive charging techniques (such as described by Gundlach) "add size [to the wireless headset] by way of the necessity of connectors and increase the risk of failure via failure of mechanical components caused by fatigue and corrosion of contact elements." (*Id.*, 1:62-2:2.) In Lee's words, "[w]hat is needed in the art is a mechanism to re-charge batteries in wireless headphones/headsets in order to minimize size and weight, maximize reliability, and improve end user experience." (*Id.*, 3:17-20.)

473 APPLE-1003, ¶ 31.

Lee

As improvements of technology become available, there is an opportunity for further reduction of size and weight of wireless headphones/headsets. Wired methods of recharging batteries in wireless headphones/headsets add size by way of the necessity of connectors and increase the risk of failure via failure of mechanical components caused by fatigue and corrosion of contact elements. Furthermore, the end user complexity is increased by a wired-based recharging procedure.

APPLE-1006 (Lee), 1:62-2:2.

What is needed in the art is a mechanism to re-charge batteries in wireless headphones/headsets in order to minimize size and weight, maximize reliability, and improve end user experience.

APPLE-1006 (Lee), 3:17-20.

Overview of Lee

Dr. Cooperstock's First Declaration

32. The basic paradigm of Lee's solution is illustrated in Figures 5 and 18 (below), where "[t]he power source 200 provides energy via a conductive means 202 to a power adapter 201," and "[t]he power adapter 201 provides power to the wireless headphone/headset apparatus 204 via non-conductive means 203, typically inductive coupling." (Lee, 3:32-37.) Notably, and consistent with Gundlach, Lee's "power adapter" is illustrated in certain embodiments with the physical form factor of a protective case. (*Id.*, 6:31-38.)

473 APPLE-1003, ¶ 32.

Lee

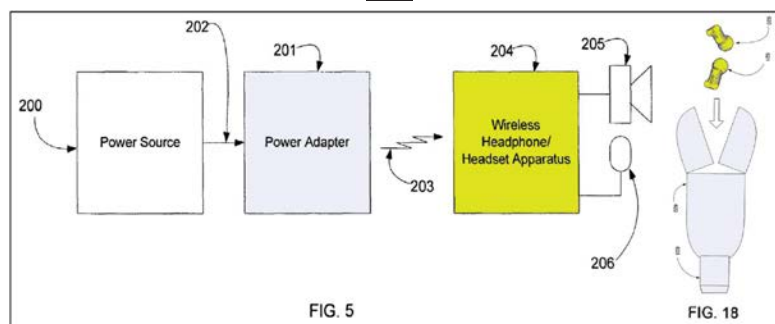

APPLE-1006 (Lee), Figures 5, 18.

FIG. 17 describes, by way of a non-limiting example, a method for wirelessly charging the battery in a wireless headphone/headset apparatus 610, 611. Power adapter 612 provides energy through a wireless means to the headphone/headset apparatus 610, 611. Power adapter 612 provides charging, physical protection, and storage of the headphone/headset apparatus 610, 611. Input power is provided via connector 612.

APPLE-1006 (Lee), 6:31-38.

8

Overview of Lee

Dr. Cooperstock's First Declaration

33. Lee provides more detail about the disclosed inductive charging solution with reference to Figure 12 (below). As shown, energy transferred to the headset apparatus 460 is received by an energy collection element 465 via inductive coupling 461. (Lee, 4:51-57.) Energy received by collection element 465 is converted from AC voltage to DC voltage by rectifier 464 and filtered using an energy storage capacitor 469 en route to a battery charging circuit 462 that provides the proper voltage to the battery 463. (*Id.*, 4:59-5:66.)

473 APPLE-1003, ¶ 33.

34. Recognizing that "audio distortion" may occur when the energy collection element 465, a speaker transducer coil, is connected to the above-discussed charging components, Lee provides an isolation switch 470. (Lee, 5:12-26.) Closing switch 470 places the headset apparatus 460 in a "charging mode" and opening switch 470 places headset apparatus 460 in a "non-charging mode." (*Id.*) Operation of switch 470 occurs either automatically when the power adapter is "sense[d]" near the headset apparatus 460, or in response to a wireless control signal from the power adapter. (*Id.*, 5:30-40.)

473 APPLE-1003, ¶ 34.

Lee

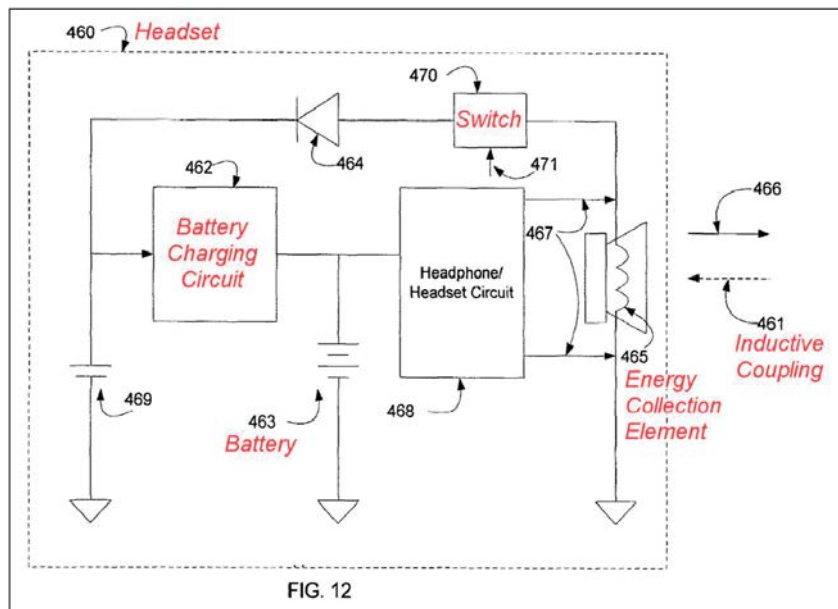

APPLE-1006 (Lee), Figure 12
473 Pet., 10-12; 472 Pet., 11-13; 471 Pet., 12-14.

The Gundlach-Lee Combination

Dr. Cooperstock's First Declaration

35. As I've explained (§ VIII.A), Gundlach is focused on providing a wireless headset that, when not in use, collapses down to a "relatively thin shape" for storage and charging. (Gundlach, [0055-0056].) Consistent with this theme, Gundlach teaches a variety of embodiments featuring "a wireless mono or stereo headset" that is "stored and charged" in a "portable cradle," such as "a holder, clip case or card that may fit inside" a slot or cavity "designed into a laptop or cell phone." (*Id.*) While robust on structural aspects of the wireless headset and storage solutions, Gundlach provides significantly less guidance and implementation details on the subject of charging. I note a handful of remarks by

473 APPLE-1003, ¶ 35.

36. A POSITA would have immediately noted Lee's similarity to Gundlach. Like Gundlach, Lee also discloses multiple embodiments for storing and charging a wireless headset in a "power adapter" illustrated as a protective case. (*Compare* Lee, 3:32-37, 3:50-62, 6:39-46 with Gundlach [0080].)

473 APPLE-1003, ¶ 36.

Lee & Gundlach

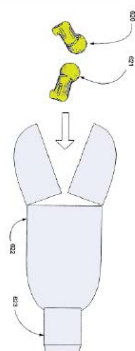

FIG. 18

FIG. 18 describes, by way of a non-limiting example, a method for wirelessly charging the battery in a wireless headphone/headset apparatus 620, 621. Power adapter 622 provides energy through a wireless means to the headphone/headset apparatus 620, 621. Power adapter 622 provides charging, physical protection, and storage of the headphone/headset apparatus 620, 621. Input power is provided via connector 623.

Lee, 6:39-46

[0080] In another embodiment, as illustrated in FIG. 18, the wireless device 1800 may be provided in a case 1860, such as a clamshell case. The case may have a recess 1846 defined therein to accommodate the wireless device. The case may contain a reserve power supply, such as a reserve battery and charging circuitry. The case may include a power supply adapter 1843 for receiving power embedded in the case. The

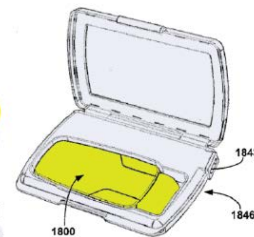

FIG. 18b

Gundlach, [0080]

APPLE-1006 (Lee), 6:39-46, Figure 18; APPLE-1005 (Gundlach), ¶ [0080], Figure 18b
473 APPLE-1003, ¶36.

10

The Gundlach-Lee Combination

Dr. Cooperstock's First Declaration

37. Similarity aside, one notable distinction between Gundlach and Lee is the technology used to effect charging. As I've explained, multiple embodiments described in Gundlach include electrical contacts, which implies conductive charging. (See Gundlach, [0066], [0069], [0073], [0079].) Lee, on the other hand, is explicit in teaching that its charging case and headset employ inductive charging. (See Lee, 3:32-37, 3:50-62, 4:11-5:40.) With this understanding of Gundlach and Lee, it would have been relatively simple for a POSITA to simply exchange the conductive charging components hinted at by Gundlach with the more thoroughly explained inductive charging components of Lee.

473 APPLE-1003, ¶ 37.

38. These modifications would have been well within a POSITA's skill level and relatively straight forward given, for example, that (i) Gundlach does not suggest its embodiments are strictly limited to conductive charging; (ii) the remaining structural aspects of the clamshell charging case and wireless headset would remain unchanged; and (iii) Lee provides clear circuit diagrams to guide implementation in the same context as Gundlach—wireless headsets.

473 APPLE-1003, ¶ 38.

Gundlach-Lee

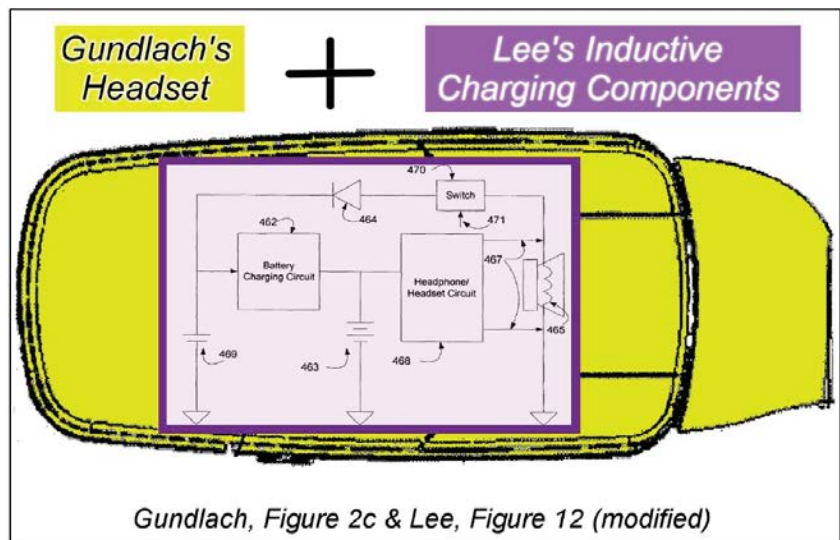

APPLE-1005, Figure 2c; APPLE-1006, Figure 12
473 Pet., 12-14; 472 Pet., 13-15; 471 Pet., 14-16

The Gundlach-Lee Combination

Dr. Cooperstock's First Declaration

40. A POSITA would have had ample motivation to pursue the Gundlach-Lee combination as I've outlined it above. The following reasons are exemplary:

473 APPLE-1003, ¶ 40.

41. First, a POSITA would have known that inductive charging was an industry-recognized alternative to conductive charging that produced substantially similar results, particularly in the context of low-power portable devices. By the Critical Date in 2011, inductive chargers for smart phones and media players were already established as commercial products. The Powermat is a particularly salient example, as is the Palm Touchstone charger. (See APPLE-1020; APPLE-1021, APPLE-1022.) With this background knowledge, it makes sense that the routine

473 APPLE-1003, ¶ 41.

42. Second, given the clear similarities between Gundlach and Lee—i.e., both disclose a charging case for a wireless headset—a POSITA would have appreciated that the benefits of inductive charging disclosed by Lee also would apply to Gundlach's embodiments. Perhaps the most compelling advantage of inductive charging noted by Lee is enhanced "reliability." (Lee, 3:17-20.)

473 APPLE-1003, ¶ 42.

44. Third, a POSITA would have appreciated that Lee's approach was consistent with the expressly stated design goal of Gundlach to provide a compact form factor. (See Gundlach, [0056-0057] (noting the headset's "relatively thin shape").) Indeed, like Gundlach, Lee sought a charging solution for wireless headsets that achieved "a reduction of size and weight." (Lee, 2:62-66.) Lee furthered this shared design goal by utilizing a single coil to serve the "dual role" of an "energy collection element" for inductive charging and also "the transducer coil of the headphone/headset/audio speaker." (Lee, 4:55-57, Figure 12.) This

473 APPLE-1003, ¶ 44.

45. Fourth, a POSITA would have viewed Lee's inductive charging solution as providing yet another advantage to Gundlach's "relatively thin" wireless headset in terms of charger interoperability. Without interoperability, for example, the user would be unable to recharge in a situation where the case and headset became separated from one another (e.g., the user inevitably misplaces the case). While interoperability could be achieved using a standardized power

473 APPLE-1003, ¶ 45.

12

FISH

DEMONSTRATIVE EXHIBIT – NOT EVIDENCE

1. Inductive Charging Was a Known Alternative to Conductive Charging

Dr. Cooperstock's First Declaration

41. First, a POSITA would have known that inductive charging was an industry-recognized alternative to conductive charging that produced substantially similar results, particularly in the context of low-power portable devices. By the Critical Date in 2011, inductive chargers for smart phones and media players were already established as commercial products. The Powermat is a particularly salient

473 APPLE-1003, ¶41; 472 APPLE-1003, ¶41; APPLE-1003, ¶41



Dr. Cooperstock's Second Declaration

11. Inductive Charging: The principles of inductive charging were discovered in the 19th century by Nikola Tesla. These century-old principles were well understood and practiced in many different applications decades before the '320 Patent. As illustrated below, patent literature from the 1970s and 1980s shows that inductive charging technology was applied as a substitute for conductive charging in small handheld electronic devices like toothbrushes, hearing aids, and watches.

473 APPLE-1089, ¶¶11-17; 472 APPLE-1089, ¶¶11-17; APPLE-1089, ¶¶11-17



APPLE-1080 (Hansaton AQ ITE)



473 Pet., 14; 472 Pet., 15; 471 Pet., 16
473 Reply, 9-10; 472 Reply, 9-10; 471 Reply, 9-10

DEMONSTRATIVE EXHIBIT – NOT EVIDENCE

1. Inductive Charging Was a Known Alternative to Conductive Charging

Corroborating Evidence

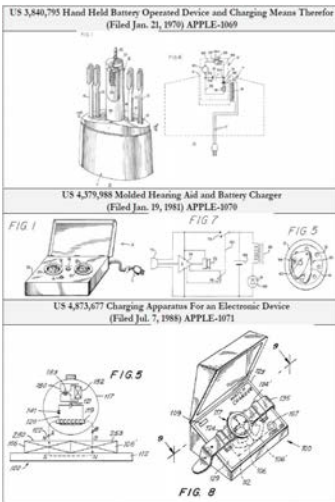

Pat. Pub. No.	Filing Date	Exemplary Citations	Exemplary Quotes
US 6,310,960 (APPLE-1072)	Oct. 7, 1999	Abstract, 1:7-11, 4:2-22, 14:18-20	"A contactless rechargeable hearing aid system in which a rechargeable hearing aid may be ... inductively recharged from an inductive charging source."
US 6,661,197 (APPLE-1074)	Sep. 27, 2002	Abstract, 1:19-21, 2:19-20, 3:21, 4:6	"[T]he battery is actively charged by means of an inductor circuit ... The hearing aid may simply be adapted within the hearing aid housing to be inductively recharged from an inductive charging source."
US 4,379,988 (APPLE-1080)	Jan. 19, 1981	1:39-55, 2:21-37, 4:39-50, 5:13-26	"It is still another object of the invention to provide a charging system for a self-contained rechargeable battery in a miniature hearing aid having an oscillator which can be coupled to an inductor disposed within the hearing aid to transfer energy thereto." (2:21-26). "[T]he coupling between the charging unit and the hearing aid is purely inductive. [so] no trouble will be experienced in poor or broken connections as in prior art units." (5:23-26).
US (AI)		[0046]	field ... [that] can induce a current. This current can be used to charge the battery 17 [of a hearing device] with the aid of a charging circuit." (0032). aid battery is provided through inductive coupling of a primary coil in a charging reservoir and a secondary coil in the hearing aid." (2:25-30.)

Pat. Pub. No.	Filing Date	Exemplary Citations	Exemplary Quotes
US 2003/0211871 (APPLE-1076)	May 9, 2002	Abstract, [0022], [0025], [0034], [0051], [0065], claim 1	"The battery in the base transceiver unit, and the battery in the headset, are both inductively recharged." ([0022].)
US 2003/0048254 (APPLE-1077)	Jul. 4, 2002	[022-0025], Figs. 3-4	"FIG. 3 is a perspective view of another embodiment of the present invention in which a wireless earphone 50 is charged by an induction power device." ([0222].)
EP1942570 (APPLE-1078)	Dec. 24, 2007	Abstract, [0001], [0004]-[0005], [0027]	"A headset with a rechargeable battery is charged inductively via a secondary coil, which is coupled to a primary coil which is incorporated in a base unit." (Abstract).
US 2011/0115429 (APPLE-1079)	Nov. 13, 2009	Abstract, [0003], [0041]-[0042], [0062]	"Example embodiments are disclosed for wirelessly charging batteries of relatively small devices, such as wireless headsets, using a relatively large wireless charging plate ... using contact-less electromagnetic induction." (Abstract).

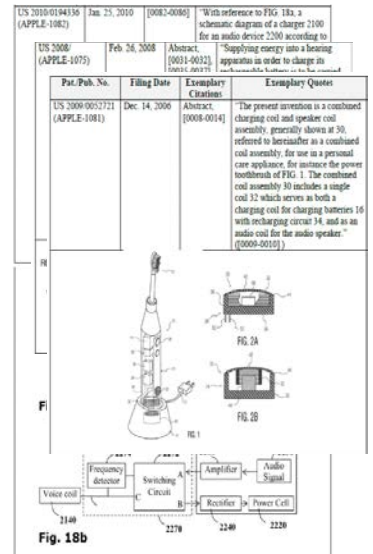

473 APPLE-1089, ¶¶11-17, 24; 472 APPLE-1089, ¶¶11-17, 24; APPLE-1089, ¶¶11-17, 24
473 Pet., 14; 472 Pet., 15; 471 Pet., 16
473 Reply, 9-10; 472 Reply, 9-10; 471 Reply, 9-10

DEMONSTRATIVE EXHIBIT – NOT EVIDENCE

1. Inductive Charging Was a Known Alternative to Conductive Charging

Corroborating Evidence

Introduction

Wireless power is beginning to show great potential in the consumer market. The ability to power an electronic device without the use of wires provides a convenient solution for the users of portable devices and also gives designers the ability to develop more creative answers to problems. This technology's benefits can be seen in the many portable devices, from cell phones to electric cars, that normally operate on battery power.

Inductive coupling is the method by which efficient and versatile wireless power can be achieved. For ease of use and the benefit of both designers and consumers, the Wireless Power Consortium (WPC) has developed a standard (see Reference 1) that creates interoperability between the device providing power (power transmitter, charging station) and the device receiving power (power receiver, portable device). Established in 2008, the WPC is a group of Asian, European, and American companies in diverse industries, including electronics manufacturers and original equipment manufacturers (OEMs). The WPC standard defines the type of inductive coupling (coil configuration) and the communications protocol to be used for low-power wireless devices. Any device operating under this standard will be able to pair with any other WPC-compliant device. One key benefit to this approach is

EX2032, p.1

Power Management

Texas Instruments Incorporated

An introduction to the Wireless Power Consortium standard and TI's compliant solutions

By Bill Johns
Senior Applications Engineer

473 APPLE-1089, ¶16; 472 APPLE-1089, ¶16; APPLE-1089, ¶16
473 Pet., 14; 472 Pet., 15; 471 Pet., 16
473 Reply, 9-10; 472 Reply, 9-10; 471 Reply, 9-10

15

FISH

DEMONSTRATIVE EXHIBIT – NOT EVIDENCE

2. Inductive Charging Enhances Reliability

Dr. Cooperstock's First Declaration

42. Second, given the clear similarities between Gundlach and Lee—i.e., both disclose a charging case for a wireless headset—a POSITA would have appreciated that the benefits of inductive charging disclosed by Lee also would apply to Gundlach's embodiments. Perhaps the most compelling advantage of inductive charging noted by Lee is enhanced "reliability." (Lee, 3:17-20.) According to Lee, exposed electrical contacts—such as suggested by Gundlach—"increase the risk of failure . . . caused by fatigue and corrosion." (Lee, 1:62-2:2.) A POSITA would have been motivated to eliminate a failure-prone component to achieve a more reliable design.

473 APPLE-1003, ¶¶42-43; 472 APPLE-1003, ¶¶42-43; APPLE-1003, ¶¶42-43

Dr. Cooperstock's Second Declaration

19. As to reliability, Lee notes the "fatigue and corrosion" challenges of conductive charging connectors. (Lee, 1:64-2:1.) And Lee is but one of multiple prior art references that recognized the reliability benefit associated with inductive charging. For example, as explained by APPLE-1023 (U.S. 7,211,986) at 1:39-60:

473 APPLE-1089, ¶¶18-21; 472 APPLE-1089, ¶¶18-21; APPLE-1089, ¶¶18-21

Lee

As improvements of technology become available, there is an opportunity for further reduction of size and weight of wireless headphones/headsets. Wired methods of recharging batteries in wireless headphones/headsets add size by way of the necessity of connectors and increase the risk of failure via failure of mechanical components caused by fatigue and corrosion of contact elements. Furthermore, the end user complexity is increased by a wired-based recharging procedure.

APPLE-1006, 1:62-2:2

What is needed in the art is a mechanism to re-charge batteries in wireless headphones/headsets in order to minimize size and weight, maximize reliability, and improve end user experience.

The invention relates to wireless battery charging of wireless headphones/headsets. The following description is pre-

APPLE-1006, 3:17-22

473 Pet., 14-15; 472 Pet., 15-16; 471 Pet., 16-17
473 Reply, 10-11; 472 Reply, 10-11; 471 Reply, 10-11

DEMONSTRATIVE EXHIBIT – NOT EVIDENCE

2. Inductive Charging Enhances Reliability

Dr. Cooperstock's Second Declaration

19. As to reliability, Lee notes the "fatigue and corrosion" challenges of conductive charging connectors. (Lee, 1:64-2:1.) And Lee is but one of multiple prior art references that recognized the reliability benefit associated with inductive charging. For example, as explained by APPLE-1023 (U.S. 7,211,986) at 1:39-60:

473 APPLE-1089, ¶¶19-20; 472 APPLE-1089, ¶¶19-20; APPLE-1089, ¶¶19-20

Corroborating Evidence

However, use of surface contacts and a charging base station with a headset presents problems due to the smaller physical size and design of headsets. Exposed metal contacts on headsets also risk contamination by oils and moisture from the skin of the wearer. This may cause corrosion and hence poor contact with the base station. Contamination also may cause an electrical leakage path that may cause power loss from the battery and electrolytic activity. Exposed metal

APPLE-1023 (U.S. 7,211,986), 1:39-60

External electrical connections may be difficult to physically implement on an object as small as a hearing aid, and moreover, may present a shock hazard to the user (as well as potential corrosion problems when placed in contact with the alimentary canal). Removable battery packs present the

APPLE-1074 (US 6,661,197), 1:56-60

is optimum and that charging is taking place. Since I provide no plugs or electrical contacts and the coupling between the charging unit and the hearing aid is purely inductive, no trouble will be experienced in poor or broken connections as in prior art units.

APPLE-1070 (US 4,379,988), 5:22-26

473 Pet., 14-15; 472 Pet., 15-16; 471 Pet., 16-17
473 Reply, 10-11; 472 Reply, 10-11; 471 Reply, 10-11

FISH

DEMONSTRATIVE EXHIBIT – NOT EVIDENCE

17

2. Inductive Charging Enhances Reliability

Dr. Cooperstock's Second Declaration

21. Gundlach's disclosure also supports the reliability challenges of the electrical connections involved in conductive charging. For example, with reference to Figures 9a and 9b (below), Gundlach explains that the embodiment involving a USB charging cable requires a special adapter [green]"formed in a manner that may reduce stress on the electronic connection [yellow]" that might otherwise be caused by "torsional motion" during use. (Gundlach, [0066].) As Gundlach notes, the adapter only "reduce[s] stress on the electronic connection." However, a POSITA would have understood that the adapter does not eliminate stress on the connection altogether. I am unaware of any plug-in electronic connections that totally prevent mechanical stress during use (such as plugging/unplugging the connections and handling the device while plugged-in). Inductive charging, on the other hand, bypasses this issue by eliminating the connections. Moreover, as a matter of common sense, a POSITA would have appreciated that the USB port on Gundlach's headset also would be susceptible to ingress of water, dust, or other foreign objects that could cause damage and inhibit charging.

473 APPLE-1089, ¶21; 472 APPLE-1089, ¶21; 471 APPLE-1089, ¶21

Gundlach

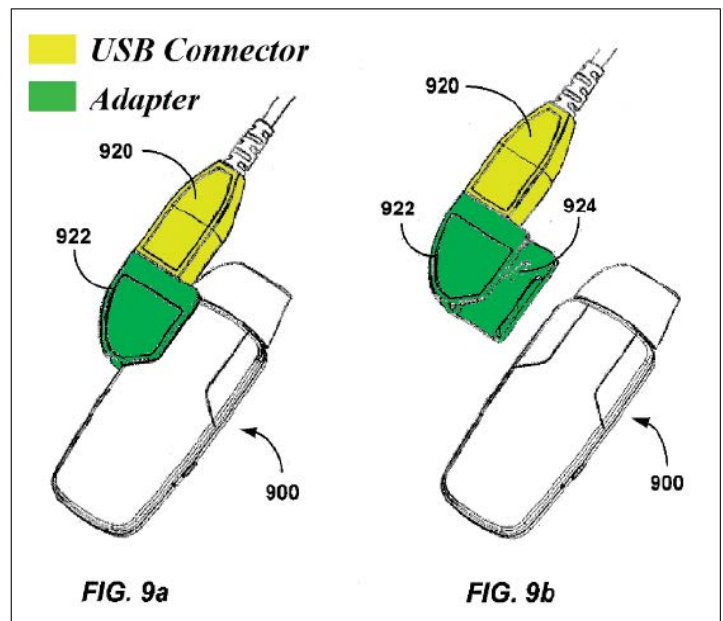

APPLE-1005, Figures 9a-9b

473 Pet., 14-15; 472 Pet., 15-16; 471 Pet., 16-17
473 Reply, 10-11; 472 Reply, 10-11; 471 Reply, 10-11

18

2. Inductive Charging Is More Convenient for the User

Dr. Cooperstock's Second Declaration

22. Basic common sense supports Lee's reference to the "end user complexity" caused by wired conductive charging and alleviated by wireless inductive charging. As nearly anyone can attest, the USB cables employed in Gundlach's embodiment of Figures 9a and 9b can be a pain point in the user experience. The long cables add extra clutter to a workspace, and it can be difficult to align and mate the connectors. Especially in the context of small wireless headsets, mating mini or micro-USB connections would be a hassle. (E.g., APPLE-1023, 1:33-35 (describing a "convenience feature" that avoids users "fumbling with a plug").) Patent Owner's Exhibit 2032 supports this point, stating (at p.1):

473 APPLE-1089, ¶22; 472 APPLE-1089, ¶22; APPLE-1089, ¶22

Corroborating Evidence

Power Management

Texas Instruments Incorporated

An introduction to the Wireless Power Consortium standard and TI's compliant solutions

By **Bill Johns**
Senior Applications Engineer

Introduction

Wireless power is beginning to show great potential in the consumer market. The ability to power an electronic device without the use of wires provides a convenient solution for the users of portable devices and also gives designers the ability to develop more creative answers to problems. This technology's benefits can be seen in the many portable devices, from cell phones to electric cars, that normally operate on battery power.

EX2032, p.1

2. Inductive Charging Is Safer for the User

Dr. Cooperstock's Second Declaration

23. One further benefit of inductive charging noted by the prior art is increased safety to the user. For example, APPLE-1023 (U.S. Pat. No. 7,211,986) notes that “[e]xposed metal contacts [used in conductive charging] may also result in an allergic reaction to the user if in prolonged contact with the user’s skin.” (1:46-48.) Moreover, APPLE-1074 (US 6,661,197) explains that “[e]xternal connections . . . may present a shock hazard to the user.” (1:56-60.) Inductive charging solves these problems by removing external connections/contacts from the equation.

473 APPLE-1089, ¶23; 472 APPLE-1089, ¶23; APPLE-1089, ¶23

Corroborating Evidence

However, use of surface contacts and a charging base station with a headset presents problems due to the smaller physical size and design of headsets. Exposed metal contacts on headsets also risk contamination by oils and moisture from the skin of the wearer. This may cause corrosion and hence poor contact with the base station. Contamination also may cause an electrical leakage path that may cause power loss from the battery and electrolytic activity. Exposed metal contacts may also result in an allergic reaction to the user if in prolonged contact with the user’s skin. During the

APPLE-1023 (U.S. 7,211,986), 1:39-48

External electrical connections may be difficult to physically implement on an object as small as a hearing aid, and moreover, may present a shock hazard to the user (as well as potential corrosion problems when placed in contact with the alimentary canal). Removable battery packs present the

APPLE-1074 (US 6,661,197), 1:56-60

473 Pet., 14-15; 472 Pet., 15-16; 471 Pet., 16-17
473 Reply, 10; 472 Reply, 10; 471 Reply, 10

FISH

DEMONSTRATIVE EXHIBIT – NOT EVIDENCE

20

3. Lee's Dual-Purpose Coil Was Advantageous, Predictable, and Feasible

Dr. Cooperstock's First Declaration

44. Third, a POSITA would have appreciated that Lee's approach was consistent with the expressly stated design goal of Gundlach to provide a compact form factor. (See Gundlach, [0056-0057] (noting the headset's "relatively thin shape").) Indeed, like Gundlach, Lee sought a charging solution for wireless headsets that achieved "a reduction of size and weight." (Lee, 2:62-66.) Lee furthered this shared design goal by utilizing a single coil to serve the "dual role" of an "energy collection element" for inductive charging and also "the transducer coil of the headphone/headset/audio speaker." (Lee, 4:55-57, Figure 12.) This arrangement avoids a dedicated inductive charging coil that might introduce unnecessary bulk to the "relatively thin shape" desired by Gundlach. (Gundlach, [0056].) Even before Lee, other publications had already recognized the benefit of using inductive charging with a multi-purpose coil so that "[t]he earbud advantageously does not require charging contacts on its small exterior surface." (APPLE-1029, 8:35-42.)

473 APPLE-1003, ¶44; 472 APPLE-1003, ¶44; APPLE-1003, ¶44

Lee

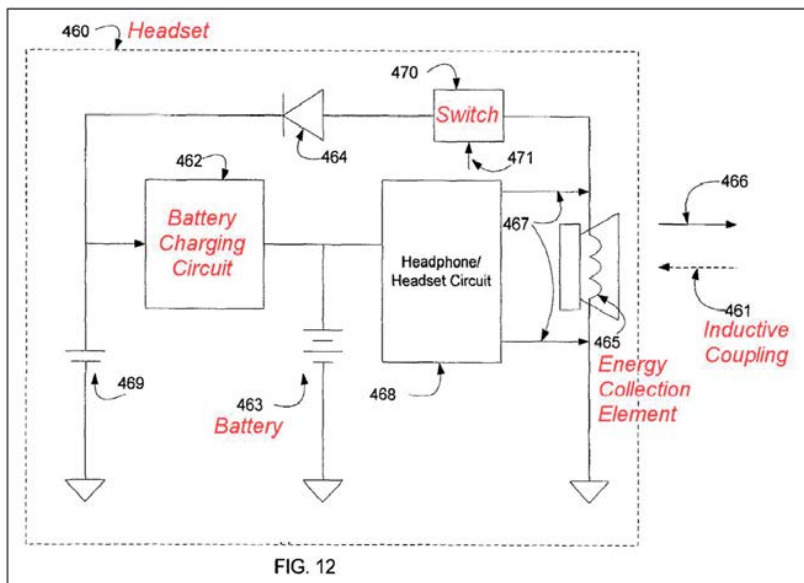

APPLE-1006, Figure 12

473 Pet., 15; 472 Pet., 16; 471 Pet., 17
473 Reply, 11-14; 472 Reply, 11-14; 471 Reply, 11-14

DEMONSTRATIVE EXHIBIT – NOT EVIDENCE

3. Lee's Dual-Purpose Coil Was Advantageous, Predictable, and Feasible

Dr. Cooperstock's Second Declaration

24. The notion of a single, dual-purpose coil design for inductive charging is not unique to Lee. In fact, the general idea of using a single inductive charging coil to serve multiple purposes—namely, power and data transfer—was part of the Wireless Power Consortium's standard for inductive charging. (See Ex.2032, pp.1-2.) Relatedly, APPLE-1029 (US 7,627,289) describes embodiments of a headset with a multi-purpose coil that “functions multiply to receive charging power for [the] battery, generate a wake up signal, or receive an audio signal carrier.” (8:35-46.)

473 APPLE-1089, ¶¶18-21; 472 APPLE-1089, ¶¶18-21; APPLE-1089, ¶¶18-21

Corroborating Evidence

US 2009/0052721 (APPLE-1081)
Electric Toothbrush

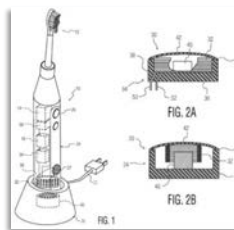

US 2008/0205678 (APPLE-1075)
Wireless Hearing Aid

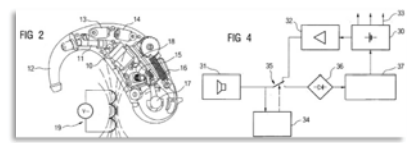

US 2010/0194336 (APPLE-1082)
Headphones

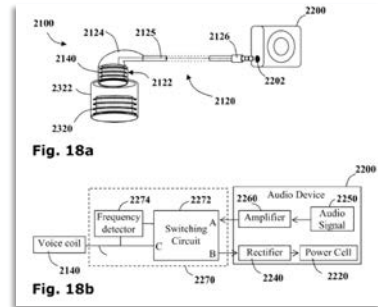

4. Interoperability: A Benefit of Lee's Inductive Charging

Dr. Cooperstock's First Declaration

45. Fourth, a POSITA would have viewed Lee's inductive charging solution as providing yet another advantage to Gundlach's "relatively thin" wireless headset in terms of charger interoperability. Without interoperability, for example, the user would be unable to recharge in a situation where the case and headset became separated from one another (e.g., the user inevitably misplaces the case). While interoperability could be achieved using a standardized power connection, such as the "micro or mini USB" connections described by Gundlach, the POSITA would have appreciated that incorporating an added connection may increase the size of the design. (See Gundlach, [0066].) But Lee's approach for implementing inductive charging with a single dual-purpose charging/audio coil would enable the wireless headset to be recharged using various types of inductive chargers (e.g., a charging pad) in addition to the clamshell case without the potential size penalty of additional hardware. Lee's figures illustrate this benefit by depicting the same set of earbuds being charged by multiple different types of chargers.

473 APPLE-1003, ¶45; 472 APPLE-1003, ¶45; 471 APPLE-1003, ¶45

Lee

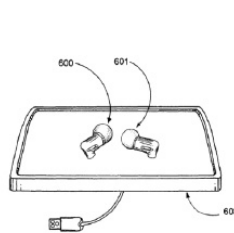

Figure 16

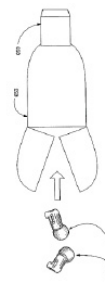

Figure 18

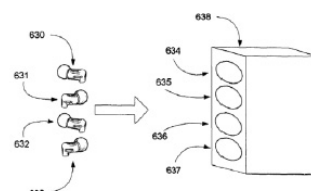

Figure 19

4. Interoperability: A Benefit of Lee's Inductive Charging

Patent Owner's Response

Apple's expert Dr. Cooperstock argues that without wireless "interoperability," a user would be unable to recharge in a situation of a misplaced case. Ex. 1003, 45. A POSITA would not see this as a need or a benefit. First, the headset its own mini-USB connection. Second, in 2011, as today, there are many more options for charging a device from an expansion slot or mini USB than there are wireless charging options. Ex. 2022, 111. A POSITA would further appreciate

473 POR, 17-18; 472 POR, 17-18; 471 POR, 17-18

Corroborating Evidence

Introduction

Wireless power is beginning to show great potential in the consumer market. The ability to power an electronic device without the use of wires provides a convenient solution for the users of portable devices and also gives designers the ability to develop more creative answers to problems. This technology's benefits can be seen in the many portable devices, from cell phones to electric cars, that normally operate on battery power.

Inductive coupling is the method by which efficient and versatile wireless power can be achieved. For ease of use and the benefit of both designers and consumers, the Wireless Power Consortium (WPC) has developed a standard (see Reference 1) that creates interoperability between the device providing power (power transmitter, charging station) and the device receiving power (power receiver, portable device). Established in 2008, the WPC is a group of Asian, European, and American companies in diverse industries, including electronics manufacturers and original equipment manufacturers (OEMs). The WPC

Ex. 2032, p.1

473 Pet., 15; 472 Pet., 16; 471 Pet., 17
473 Reply, 14-15; 472 Reply, 14-15; 471 Reply, 14-15

24

FISH

DEMONSTRATIVE EXHIBIT – NOT EVIDENCE

4. Interoperability: A Benefit of Lee's Inductive Charging

Patent Owner's Response

Apple's expert Dr. Cooperstock argues that without wireless "interoperability," a user would be unable to recharge in a situation of a misplaced case. Ex. 1003, 45. A POSITA would not see this as a need or a benefit. First, the headset its own mini-USB connection. Second, in 2011, as today, there are many more options for charging a device from an expansion slot or mini USB than there are wireless charging options. Ex. 2022, 111. A POSITA would further appreciate

473 POR, 17-18; 472 POR, 17-18; 471 POR, 17-18

Patent Owner's Sur-Reply

embodiment. At most, Lee's advocacy of inductive charging versus "[w]ired methods of recharging batteries" might arguably suggest, if anything, some advantage, if any, over a USB cord. EX1006, 1:62-2:2. However, in Petitioner's proposed Gundlach-Lee combination, the Gundlach Fig. 18 embodiment relies on conductive contacts between the headset and the case, not charging cords. *E.g.*,

473 Sur-Reply, 9; 472 Sur-Reply, 9; 471 Sur-Reply, 9

Dr. Cooperstock's Second Declaration

48. To explain further, as illustrated by Lee's Figures 16, 18 and 19, inductive charging offers the advantage of interoperability of different types of inductive chargers to recharge the wireless device battery, whereas specially designed conductive mating contacts, as described by Gundlach, would require a matching connector or specially designed case. Although mini and micro USB connectors are widely available to facilitate conductive charging, the specific design solution disclosed in Gundlach's Figure 9 involves a special "adapter" that mitigates the risk of mechanical failure but also worsens the headset from an interoperability perspective. (Gundlach, [0066].) Without the adapter, Gundlach's headset cannot be charged by ubiquitous mini/micro cables. Accordingly, if the user misplaces the adapter or leaves the adapter behind, the headset is no longer interoperable.

473 APPLE-1089, ¶48; 472 APPLE-1089, ¶48; APPLE-1089, ¶48

473 Pet., 15; 472 Pet., 16; 471 Pet., 17
473 Reply, 14-15; 472 Reply, 14-15; 471 Reply, 14-15

25

FISH

DEMONSTRATIVE EXHIBIT – NOT EVIDENCE

4. Interoperability: A Benefit of Lee's Inductive Charging

Patent Owner's Sur-Reply

charging. Reply, 13. To the contrary, Gundlach teaches that a headsets may have both USB-type connections and electrical contacts. EX1005, [0066]. Petitioner argues that Gundlach's USB adapter for charging contacts "undermines interoperability," (Reply, 14); however, Petitioner fails to appreciate that such adapters plug into USB ports and Gundlach's headsets have direct USB ports as well. EX1005, [0066].

473 Sur-Reply, 24-25; 472 Sur-Reply, 24-25; 471 Sur-Reply, 24-25

Gundlach

[0066] The wireless device may be stored and charged by a number of devices. In one example, the device may be directly charged by a micro or mini USB. The USB connector may be inserted into the device or an adapter for communication between the wireless device and USB may be provided. FIGS. 9a and 9b illustrate the use of a mini USB connector 920 provided with an adapter 922. The adapter may slide over a shoulder of the device in a detent left by the shoulder cap. The USB connector 920 may apply power to the adapter 922, which may then apply power to the wireless headset 900 via electrical contacts 924 on the adapter and electrical contacts located on the wireless headset, illustrated in FIG. 3b as 326. As illustrated, the adapter may be formed in a manner that may reduce the stress on the electrical connection between the adapter and wireless device. For example, the adapter may be formed so as to slide or latch onto a portion of the wireless device, preventing, e.g., torsional motion between the adapter and device.

APPLE-1005, [0066]

4. Interoperability: A Benefit of Lee's Inductive Charging

Patent Owner's Sur-Reply

charging. Reply, 13. To the contrary, Gundlach teaches that a headsets may have both USB-type connections and electrical contacts. EX1005, [0066]. Petitioner argues that Gundlach's USB adapter for charging contacts "undermines interoperability," (Reply, 14); however, Petitioner fails to appreciate that such adapters plug into USB ports and Gundlach's headsets have direct USB ports as well. EX1005, [0066].

473 Sur-Reply, 24-25; 472 Sur-Reply, 24-25; 471 Sur-Reply, 24-25

Gundlach

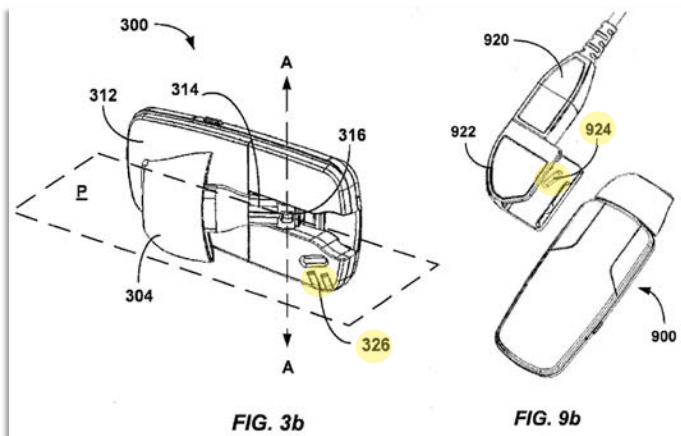

APPLE-1005, Figures 3b, 9b

473 Pet., 15; 472 Pet., 16; 471 Pet., 17
473 Reply, 14-15; 472 Reply, 14-15; 471 Reply, 14-15

27

Patent Owner's Arguments Do Not Undermine the Petition

- i. Lee Teaches and Suggests the Combination
- ii. Lee's Approach Improves Gundlach's Similar Headset in the Same Way
- iii. The Combination Involves Simple Substitution of Known Elements
- iv. Aligning Lee's Dual-Purpose Coil Is a Routine Design Problem
- v. Gundlach's Form Factor Does Not Preclude Lee's Dual-Purpose Coil
- vi. Lee's Dual-Purpose Coil: No Evident Heat or Vibration Problems
- vii. Lee's Dual-Purpose Coil: No Evident Eddy Current Problems
- viii. The Efficiency Design Tradeoff Does Not Preclude Motivation

[i] Lee Teaches and Suggests the Combination

Dr. Cooperstock's First Declaration

42. Second, given the clear similarities between Gundlach and Lee—i.e., both disclose a charging case for a wireless headset—a POSITA would have appreciated that the benefits of inductive charging disclosed by Lee also would apply to Gundlach's embodiments. Perhaps the most compelling advantage of inductive charging noted by Lee is enhanced "reliability." (Lee, 3:17-20.)

473 APPLE-1003, ¶42; 472 APPLE-1003, ¶42; 471 APPLE-1003, ¶42

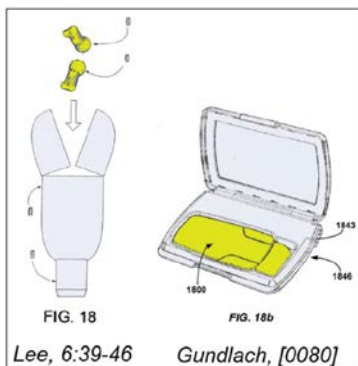

Dr. Cooperstock's Second Declaration

9. Lee's solution to the above-discussed challenges with conductive charging for wireless headsets is to implement inductive charging. Lee describes several embodiments to this effect. (See generally Lee, 3:32-7:36, Figures 5-24.) Accordingly, a POSITA reading the disclosure would have noted Lee's express teaching to modify wireless headsets employing older conductive charging technology by employing newer inductive charging technology. (*Id.*, 1:14-2:2, 3:15-6:4). The picture Lee painted would have prompted a POSITA to pursue design options that employ inductive charging technology to substitute for the existing conductive charging architecture in Gundlach's embodiments. Indeed, the fact that

473 APPLE-1089, ¶9; 472 APPLE-1089, ¶9; 471 APPLE-1089, ¶9

473 Pet., 14-15; 472 Pet., 15-16; 471 Pet., 16-17
473 Reply, 1-2; 472 Reply, 1-2; 471 Reply, 1-2

29

FISH

DEMONSTRATIVE EXHIBIT – NOT EVIDENCE

[i] Lee Teaches and Suggests the Combination

Dr. Cooperstock's Second Declaration

conductive charging architecture in Gundlach's embodiments. Indeed, the fact that Lee describes an analog to Gundlach as prior art—i.e., conductive charging via USB connections—supports my understanding that Lee's teachings would have led the POSITA to the Gundlach-Lee combination. In short, the POSITA would have arrived at the Gundlach-Lee combination by simply following the guidance provided in Lee.

473 APPLE-1089, ¶9; 472 APPLE-1089, ¶9; 471 APPLE-1089, ¶9

Gundlach & Lee

Lee's Depiction of a USB Conductive Charging Prior Art Embodiment

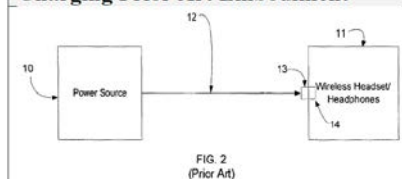

Gundlach's Depiction of a USB Conductive Charging Embodiment

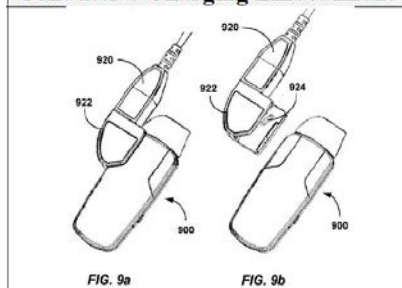

APPLE-1005, Figures 9a-9b; APPLE-1006, Figure 2
473 Reply, 1-2; 472 Reply, 1-2; 471 Reply, 1-2

DEMONSTRATIVE EXHIBIT – NOT EVIDENCE

[i] Lee Teaches and Suggests the Combination

Dr. Cooperstock's Second Declaration

conductive charging architecture in Gundlach's embodiments. Indeed, the fact that Lee describes an analog to Gundlach as prior art—i.e., conductive charging via USB connections—supports my understanding that Lee's teachings would have led the POSITA to the Gundlach-Lee combination. In short, the POSITA would have arrived at the Gundlach-Lee combination by simply following the guidance provided in Lee.

473 APPLE-1089, ¶9; 472 APPLE-1089, ¶9; 471 APPLE-1089, ¶9

Lee

In FIG. 2, representing prior art, the power source 10 can be a regulated DC source, removing the need for a separate power adapter. In this case, DC power is delivered to the wireless headset/headphones 11 via a conductive means, typically a power cable 12. The cable is connected to the wireless headphone/headset via a mating connector pair 13, 14. The power source 10 can be the regulated DC output of a powered Universal Serial Bus (USB) socket.

APPLE-1006, 1:39-46

What is needed in the art is a mechanism to re-charge batteries in wireless headphones/headsets in order to minimize size and weight, maximize reliability, and improve end user experience.

The invention relates to wireless battery charging of wireless headphones/headsets. The following description is pre-

APPLE-1006, 3:17-22

As improvements of technology become available, there is an opportunity for further reduction of size and weight of wireless headphones/headsets. Wired methods of recharging batteries in wireless headphones/headsets add size by way of the necessity of connectors and increase the risk of failure via failure of mechanical components caused by fatigue and cor-

APPLE-1006, 1:62-67

APPLE-1005, Figures 9a-9b; APPLE-1006, Figure 2
473 Reply, 1-2; 472 Reply, 1-2; 471 Reply, 1-2

31

FISH

DEMONSTRATIVE EXHIBIT – NOT EVIDENCE

[ii] Lee's Approach Improves Gundlach's Similar Headset in the Same Way

Dr. Cooperstock's First Declaration

36. A POSITA would have immediately noted Lee's similarity to Gundlach. Like Gundlach, Lee also discloses multiple embodiments for storing and charging a wireless headset in a "power adapter" illustrated as a protective case. (*Compare* Lee, 3:32-37, 3:50-62, 6:39-46 with Gundlach [0080].)

473 APPLE-1003, ¶36; 472 APPLE-1003, ¶36; APPLE-1003, ¶36

42. Second, given the clear similarities between Gundlach and Lee—i.e., both disclose a charging case for a wireless headset—a POSITA would have appreciated that the benefits of inductive charging disclosed by Lee also would apply to Gundlach's embodiments. Perhaps the most compelling advantage of

473 APPLE-1003, ¶42; 472 APPLE-1003, ¶42; APPLE-1003, ¶42

Gundlach & Lee



FIG. 18

FIG. 18 describes, by way of a non-limiting example, a method for wirelessly charging the battery in a wireless head- phone/headset apparatus 620, 621. Power adapter 622 provides energy through a wireless means to the headphone/ headset apparatus 620, 621. Power adapter 622 provides charging, physical protection, and storage of the headphone/ headset apparatus 620, 621. Input power is provided via connector 623.

Lee, 6:39-46

[0080] In another embodiment, as illustrated in FIG. 18, the wireless device 1800 may be provided in a case 1860, such as a clamshell case. The case may have a recess 1846 defined therein to accommodate the wireless device. The case may contain a reserve power supply, such as a reserve battery and charging circuitry. The case may include a power supply adapter 1843 for receiving power embedded in the case. The



FIG. 18b

Gundlach, [0080]

APPLE-1005, [0080], Figure 18b; APPLE-1006, 6:39-46, Figure 18
473 Pet., 13; 472 Pet., 14; 471 Pet., 15
473 Reply, 2-3; 472 Reply, 2-3; 471 Reply, 2-3

FISH

DEMONSTRATIVE EXHIBIT – NOT EVIDENCE

[iii] The Combination Involves Simple Substitution of Known Elements

Dr. Cooperstock's First Declaration

37. Similarity aside, one notable distinction between Gundlach and Lee is the technology used to effect charging. As I've explained, multiple embodiments described in Gundlach include electrical contacts, which implies conductive charging. (See Gundlach, [0066], [0069], [0073], [0079].) Lee, on the other hand, is explicit in teaching that its charging case and headset employ inductive charging. (See Lee, 3:32-37, 3:50-62, 4:11-5:40.) With this understanding of Gundlach and Lee, it would have been relatively simple for a POSITA to simply exchange the conductive charging components hinted at by Gundlach with the more thoroughly explained inductive charging components of Lee.

473 APPLE-1003, ¶37; 472 APPLE-1003, ¶37; APPLE-1003, ¶37

39. The resulting Gundlach-Lee combination would facilitate inductive charging in the manner described by Lee. While I've already explained Lee's

473 APPLE-1003, ¶39; 472 APPLE-1003, ¶39; APPLE-1003, ¶39

Gundlach-Lee

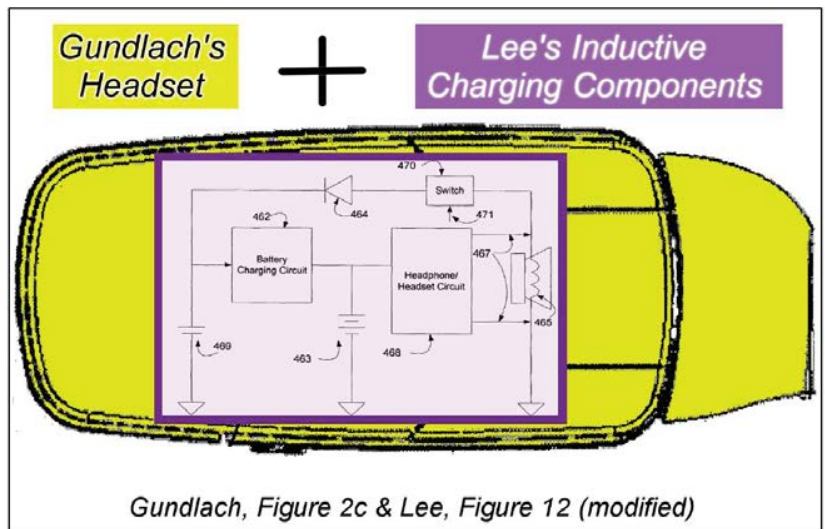

APPLE-1005, Figure 2c; APPLE-1006, Figure 12
473 Pet., 12-14; 472 Pet., 13-15; 471 Pet., 14-16
473 Reply, 3; 472 Reply, 3; 471 Reply, 3

[iii] The Combination Involves Simple Substitution of Known Elements

Dr. Cooperstock's Second Declaration

13. Given the application of inductive charging to hearing aids, it is unsurprising to see the same technology applied to similar devices like wireless headsets. As I explained in my First Declaration and above, Lee, APPLE-1023 (U.S. Pat. No. 7,211,986), and APPLE-1029 (U.S. Pat. No. 7,627,289) disclosed implementations of inductive charging in the context of wireless headsets. And like hearing aids, the prior art patent literature was replete with other examples of inductively charged wireless headsets, a sampling of which are identified in the table below.

473 APPLE-1089, ¶13; 472 APPLE-1089, ¶13; APPLE-1089, ¶13

Corroborating Evidence

In APPLE-1029, “[t]he system generally includes a first headset component and a second headset component. Both the first headset component and the second headset component may be wireless devices.” (Abstract.)

APPLE-1029 further describes embodiments with a multi-purpose coil so that “[t]he earbud advantageously does not require charging contacts on its small exterior surface.” (8:35-46.) The coil “functions multiply to receive charging power for [the] battery, generate a wake up signal, or receive an audio signal carrier.” (*Id.*)

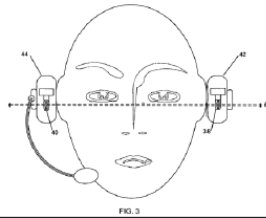

473 APPLE-1089, ¶10; 472 APPLE-1089, ¶10; APPLE-1089, ¶10

APPLE-1023 explains that “[w]ireless headsets and other portable communications devices are often battery powered such that a user can use the wireless headset or other such device without being directly connected to [a] larger power source such as an a/c outlet or automobile battery. This allows wireless headset users flexibility and convenience to move about without being tied to a power cord. Wireless headset batteries are generally rechargeable so that the batteries can be recharged and need not be discarded after use.” (1:10-19.)

APPLE-1023 also describes as its solution “an inventive inductive battery charger” (3:25-29) for use with wireless headsets (5:1-4).

[iii] The Combination Involves Simple Substitution of Known Elements

Dr. Cooperstock's Second Declaration

13. Given the application of inductive charging to hearing aids, it is unsurprising to see the same technology applied to similar devices like wireless headsets. As I explained in my First Declaration and above, Lee, APPLE-1023 (U.S. Pat. No. 7,211,986), and APPLE-1029 (U.S. Pat. No. 7,627,289) disclosed implementations of inductive charging in the context of wireless headsets. And like hearing aids, the prior art patent literature was replete with other examples of inductively charged wireless headsets, a sampling of which are identified in the table below.

473 APPLE-1089, ¶13; 472 APPLE-1089, ¶13; APPLE-1089, ¶13

Corroborating Evidence

Pat./Pub. No.	Filing Date	Exemplary Citations	Exemplary Quotes
US 2003/0211871 (APPLE-1076)	May 9, 2002	Abstract, [0022], [0025], [0034], [0051], [0065], claim 1	"The battery in the base transceiver unit, and the battery in the headset, are both inductively recharged." ([0022].)
US 2003/0048254 (APPLE-1077)	Jul. 4, 2002	[022-0025], Figs. 3-4	"FIG. 3 is a perspective view of another embodiment of the present invention in which a wireless earphone 50 is charged by an induction power device." ([0022].)
EP1942570 (APPLE-1078)	Dec. 24, 2007	Abstract, [0001], [0004]-[0005], [0027]	"A headset with a rechargeable battery is charged inductively via a secondary coil, which is coupled to a primary coil which is incorporated in a base unit." (Abstract.)
US 2011/0115429 (APPLE-1079)	Nov. 13, 2009	Abstract, [0003], [0041]-[0042], [0062]	"Example embodiments are disclosed for wirelessly charging batteries of relatively small devices, such as wireless headsets, using a relatively large wireless charging plate ... using contact-less electromagnetic induction." (Abstract.)

[iv] Aligning Lee's Dual-Purpose Coil Is a Routine Design Problem

Dr. Cooperstock's Second Declaration

28. The coil alignment challenge Patent Owner raised is a routine design problem with inductive charging systems that a POSITA would have been prepared to solve. The general goal is to [1] bring a primary coil in the charger as close as possible to a secondary coil in the device being charged; and [2] to establish a relative position between the coils that appropriately directs the magnetic field emitted by the primary coil towards the secondary coil. In many inductive charging systems, the desired relative position is for the coils to be parallel to one another and separated by an axial distance, though other arrangements are also feasible.

473 APPLE-1089, ¶¶26-33; 472 APPLE-1089, ¶¶26-33; APPLE-1089, ¶¶26-33

Corroborating Evidence

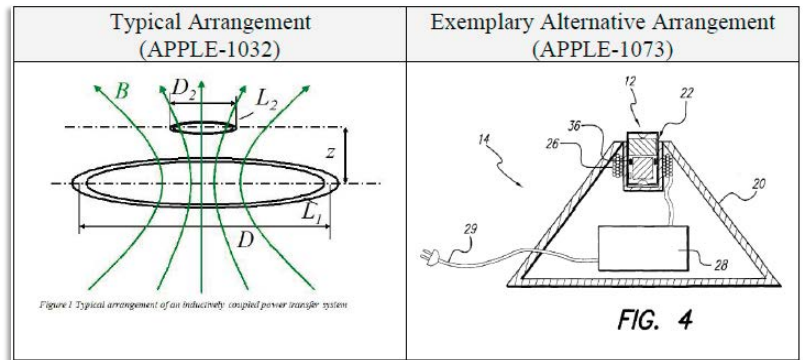

[iv] Aligning Lee's Dual-Purpose Coil Is a Routine Design Problem

Dr. Cooperstock's Second Declaration

29. In the context of Gundlach-Lee, the most logical position for the primary coil is in the floor of the contoured recess of the clamshell case. And the most logical position for the secondary coil is along the bottom face of the headset's main housing. Patent Owner provides a mock-up (pictured below, left) that demonstrates this arrangement,¹ which is consistent with various inductive charging systems in the patent literature and on the market (example below, right).

473 APPLE-1089, ¶¶26-33; 472 APPLE-1089, ¶¶26-33; APPLE-1089, ¶¶26-33

Corroborating Evidence

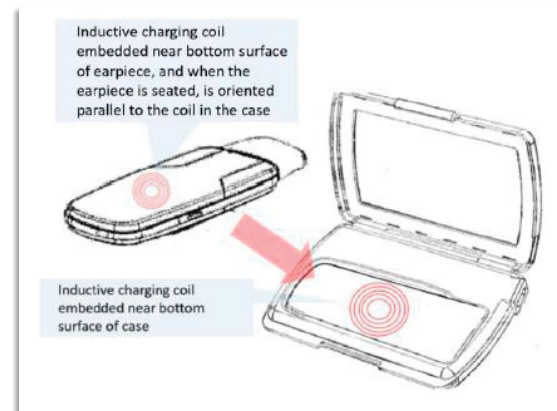

473 Pet., 15; 472 Pet., 16; 471 Pet., 17
473 Reply, 11-14; 472 Reply, 11-14; 471 Reply, 11-14

DEMONSTRATIVE EXHIBIT – NOT EVIDENCE

[iv] Aligning Lee's Dual-Purpose Coil Is a Routine Design Problem

Dr. Cooperstock's Second Declaration

31. Placement of the acoustic driver in the headset body rather than the earpiece necessitates channeling of the output of the acoustic driver to the listener's ear. Such a design is readily feasible, as described in numerous prior art references, including "an acoustic pathway for receiving or delivering audio content" (US 2009/0067661; APPLE-1083), an "acoustic passageway" (US 2010/0310106; APPLE-1084), and an ear insert with a solid or hollow stem, or a hollow tube, which allows "sound to travel though from a speaker to the eardrum" (US 2008/0181441; APPLE-1085).

32. Gundlach describes an exemplary embodiment in which the "the device itself may be 24mmx60mmx5 mm when folded for storage purposes" (*id.*, [0057]). In contrast with the limited size (and further constraints on materials) of the earpiece, the dimensions of the headset body would easily be sufficient to accommodate a typical voice coil and the accompanying speaker diaphragm. A POSITA, seeking to

473 APPLE-1089, ¶¶26-33; 472 APPLE-1089, ¶¶26-33; APPLE-1089, ¶¶26-33

Corroborating Evidence (APPLE-1083)

[0032] In one exemplary embodiment, earpiece 90 includes an Ambient Sound Microphone (ASM) 120 to capture (measure) ambient sound (acoustic energy), an Ear Canal Receiver (ECR) 114 to deliver audio (acoustic energy) to an ear canal 124, and an Ear Canal Microphone (ECM) 106 to capture and assess a sound exposure level within the ear canal 124. The

[0033] Sealing unit 108 can be an acoustic barrier (e.g., producing acoustic isolation or reducing acoustic energy across the sealing unit), having a first side coupled to ear canal 124 and a second side coupled to the ambient region or ambient environment. In at least one exemplary embodiment, sealing unit 108 includes at least one acoustic tube. The at least one acoustic tube is an acoustic pathway for receiving or delivering audio content. Sealing unit 108 can create a closed

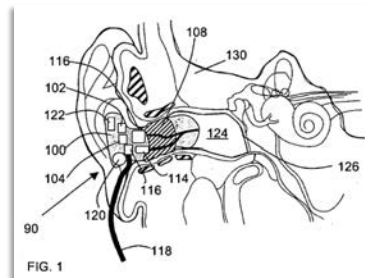

473 Pet., 15; 472 Pet., 16; 471 Pet., 17
473 Reply, 11-14; 472 Reply, 11-14; 471 Reply, 11-14

38

FISH

DEMONSTRATIVE EXHIBIT – NOT EVIDENCE

[v] Gundlach's Form Factor Does Not Preclude Lee's Dual-Purpose Coil

Patent Owner's Response

From the straightforward understanding of the use of speaker transducer coils, a POSITA would understand that the coil of a Lee Fig. 12 transducer coil would have a diameter of less than 5 mm and likely about 3-4 mm (when one accounts for case materials protecting and allowing movement of the coil), as depicted by the following:

473 POR, 28; 472 POR, 28; 471 POR, 28

It appears there has never been a commercially available portable consumer product with an inductive charging coil with a diameter as small as 3-4 mm. Ex. 2022, 141. A POSITA, especially in 2011, would see this approximately 3-4 mm diameter as a significant constraint on the charging ability of WPT coils. Ex. 2022, 142. A POSITA would understand that such small coils, if they could be induced to carry a charge in view of the air gap versus diameter, would charge very slowly compared to conductive contacts, which are known to be highly efficient in conducting current. Ex. 2022, 142.

473 POR, 29; 472 POR, 29; 471 POR, 29

Dr. Cooperstock's Second Declaration

36. This argument is without merit, since it is predicated upon Patent Owner's assumption that Gundlach's voice coil (and thus the Gundlach-Lee dual-purpose coil) must be housed within the earpiece and could not be located elsewhere. As I have explained above, however, a POSITA, implementing the Gundlach-Lee wireless headset in the form of a canalphone would more likely have adopted a design in which the acoustic driver (including the dual-purpose coil) is located in the main housing, where ample space is available to house this component. The acoustic output would then be channeled to the listener's ear, using conventional design techniques that were widely known from the prior art.

37. Patent Owner incorrectly assumes that Gundlach strictly requires the wireless headset ("device") to conform to the size constraints of a standard expansion slot. This is wrong for several reasons.

38. Gundlach suggests a form factor with certain dimensions as but one possibility⁴ and explicitly notes the possibility of "different form factors."⁵

473 APPLE-1089, ¶¶36-38; 472 APPLE-1089, ¶¶36-38; APPLE-1089, ¶¶36-38

[v] Gundlach's Form Factor Does Not Preclude Lee's Dual-Purpose Coil

Patent Owner's Response

From the straightforward understanding of the use of speaker transducer coils, a POSITA would understand that the coil of a Lee Fig. 12 transducer coil would have a diameter of less than 5 mm and likely about 3-4 mm (when one accounts for case materials protecting and allowing movement of the coil), as depicted by the following:

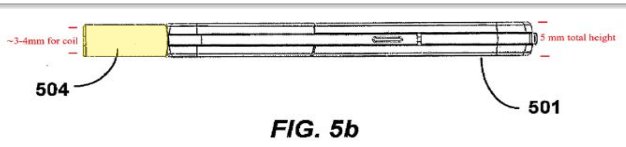

473 POR, 28-29; 472 POR, 28-29; 471 POR, 28-29

Patent Owner's Sur-Reply

obviousness"). The theories in the Petition were based upon the starting point of the Gundlach headset, e.g., headset 100 in the Petition's Fig. 1, which has the same geometry as headset 1800 in Fig. 18, which has a speaker, and thus a speaker transducer coil, in the earpiece of the wireless headset. See, e.g., EX1005, [0058], [0060].

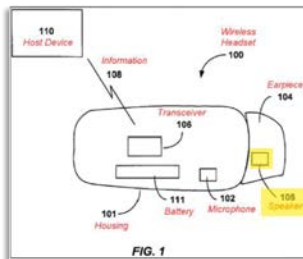

473 Sur-Reply, 5-6; 472 Sur-Reply, 5-6; 471 Sur-Reply, 5-6

Dr. Cooperstock's Second Declaration

36. This argument is without merit, since it is predicated upon Patent Owner's assumption that Gundlach's voice coil (and thus the Gundlach-Lee dual-purpose coil) must be housed within the earpiece and could not be located elsewhere.

As I have explained above, however, a POSITA, implementing the Gundlach-Lee wireless headset in the form of a canalphone would more likely have adopted a design in which the acoustic driver (including the dual-purpose coil) is located in the main housing, where ample space is available to house this component. The acoustic

473 APPLE-1089, ¶36; 472 APPLE-1089, ¶36; APPLE-1089, ¶36

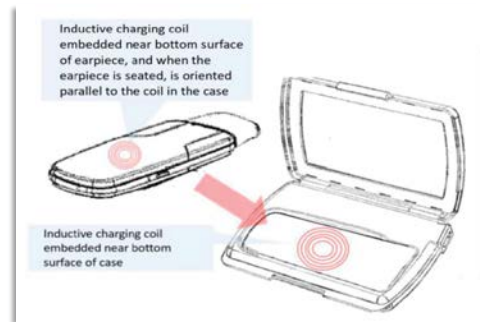

473 Reply, 12-13; 472 Reply, 12-13; 471 Reply, 12-13

[v] Gundlach's Form Factor Does Not Preclude Lee's Dual-Purpose Coil

Dr. Cooperstock's Second Declaration

37. Patent Owner incorrectly assumes that Gundlach strictly requires the wireless headset ("device") to conform to the size constraints of a standard expansion slot. This is wrong for several reasons.

38. Gundlach suggests a form factor with certain dimensions as but one possibility⁴ and explicitly notes the possibility of "different form factors."⁵

39. Even if Gundlach required that the wireless headset fit within the dimensions of an ExpressCard, the ExpressCard standard is not uniformly constrained to a particular length and height, but "is for reference only. Module manufacturers can decide their own extended module heights." APPLE-1086 (ExpressCard Standard, Release 2.0), 48.

473 APPLE-1089, ¶¶37-39; 472 APPLE-1089, ¶¶37-39; 471 APPLE-1089, ¶¶37-39

Gundlach

portable cradle or with a mini USB charger. The portable cradle may be a holder, clip, case or card that may fit inside a standard expansion slot conforming to any expansion slot standard including, for example, PCMCIA, ExpressCard54 and ExpressCard34, etc. Additionally a unique slot or cavity may be designed into a laptop or cell phone or any other communication device that may utilize a speaker and microphone to accommodate such as a wireless headset.

APPLE-1005, [0056]

[0057] Expanding on the above, the overall size and shape of the headset may be designed to accommodate or fit within the form factor of a standard expansion slot. For example, the device itself may be 24 mm×60 mm×5 mm when folded for storage purposes. A 34 mm×75 mm×5 mm headset cradle may be provided which may accommodate and fit within the size of a standard Expresscard 34 card. Such device may fit into the 34 mm Expresscard slot for storage and charging inside a portable computer. Once again, it should be appreciated that different form factors are also contemplated and may include the ExpressCard 54 or PCMCIA form factors as well as a form factor that may be later specifically developed for such a wireless device. Furthermore, the device itself may be

APPLE-1005, [0057]

41

FISH

473 Reply, 12-13; 472 Reply, 12-13; 471 Reply, 12-13

DEMONSTRATIVE EXHIBIT – NOT EVIDENCE

[v] Gundlach's Form Factor Does Not Preclude Lee's Dual-Purpose Coil

Dr. Cooperstock's Second Declaration

40. Gundlach describes alternatives, both of "a cradle 1740" that "may be provided that may be retained onto the host device" (*id.*, [0079], Fig. 17) and "another embodiment" "in a case 1860, such as a clamshell case" (*id.*, [0080], Fig. 18), neither of which require that the wireless headset fit within an expansion slot.

41. In implementing the circuit of Lee's Figure 12 in the proposed combination of Gundlach and Lee, a POSITA would not be constrained to adopt a specific set of dimensions from a particular Gundlach embodiment but would be free to vary these dimensions as appropriate. If it were necessary to increase the dimensions, for example, of the wireless headset body, to realize the benefits of inductive charging, this would represent a design choice available to the POSITA. The increased size would be a simple design tradeoff, which a POSITA would have been willing to make for the benefits that come along with inductive charging.

473 APPLE-1089, ¶¶40-41; 472 APPLE-1089, ¶¶40-41; 471 APPLE-1089, ¶¶40-41

Gundlach

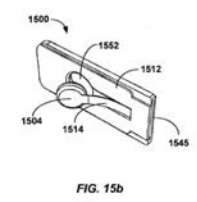
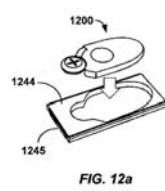
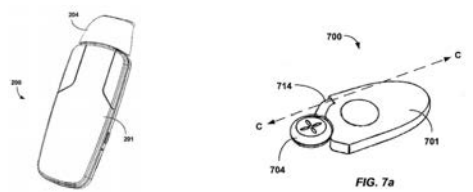
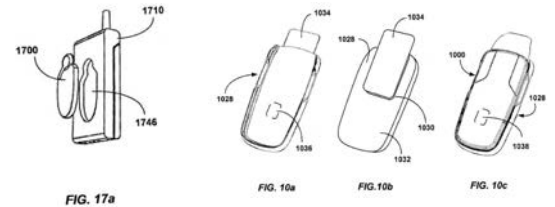

473 Reply, 12-13; 472 Reply, 12-13; 471 Reply, 12-13

DEMONSTRATIVE EXHIBIT – NOT EVIDENCE

[vi] Lee's Dual-Purpose Coil: No Evident Heat or Vibration Problems

Patent Owner's Response

Nor would a POSITA be motivated to increase the frequency of Lee's inductive charging beyond the maximum 20 kHz at which Lee would have been designed for audio functionality. Ex. 2022, 145. Rather, POSITA would be concerned that using a higher frequency for Lee's inductive charging would rapidly heat and vibrate Lee's speaker magnet and would likely damage Lee's internal components. Ex. 2022, 145.

Further, a POSITA would appreciate that in an inductive charging system the energy inefficiency translates into heat loss. Ex. 2022, 146. A POSITA would be concerned about heat loss from any alleged Gundlach-Lee inductive charging taking place in closed clamshell case. Ex. 2022, 146.

473 POR, 30-31; 472 POR, 30-31; 471 POR, 30-31

Dr. Toliyat's Declaration

145. Nor would a POSITA be motivated to increase the frequency of Lee's inductive charging beyond the maximum 20 kHz at which Lee would have been designed for audio functionality. This is because a POSITA would be concerned that using a higher frequency for Lee's inductive charging would rapidly heat and vibrate Lee's speaker magnet and would likely damage Lee's internal components.

146. Further, a POSITA would appreciate that in an inductive charging system the energy inefficiency translates into heat loss. A POSITA would be concerned about heat loss from any alleged Gundlach-Lee inductive charging taking place in closed clamshell case, because the devices would both likely get very warm from the heat retained in the clamshell case. Although Dr. Cooperstock has not

473 Ex.2022, ¶¶145-146; 472 Ex.2022, ¶¶145-146; 471 Ex.2022, ¶¶144-145

[vi] Lee's Dual-Purpose Coil: No Evident Heat or Vibration Problems

Patent Owner's Response

Nor would a POSITA be motivated to increase the frequency of Lee's inductive charging beyond the maximum 20 kHz at which Lee would have been designed for audio functionality. Ex. 2022, 145. Rather, POSITA would be concerned that using a higher frequency for Lee's inductive charging would rapidly heat and vibrate Lee's speaker magnet and would likely damage Lee's internal components. Ex. 2022, 145.

Further, a POSITA would appreciate that in an inductive charging system the energy inefficiency translates into heat loss. Ex. 2022, 146. A POSITA would be concerned about heat loss from any alleged Gundlach-Lee inductive charging taking place in closed clamshell case. Ex. 2022, 146.

473 POR, 30-31; 472 POR, 30-31; 471 POR, 30-31

Dr. Cooperstock's Second Declaration

34. Patent Owner and its expert do not explain how or why a higher frequency would cause undue heat and vibration problems. They simply assert in conclusory fashion that this would somehow likely occur. Patent Owner's theory also fails to account for the fact that wireless headsets are low-power devices. Thus, while a POSITA might consider the effects of heating of the speaker magnet due to a high-frequency oscillating magnetic field, the POSITA would have expected that at low power these effects are negligible or easily mitigated. Indeed, permanent magnets are found in many wireless chargers, often to facilitate positioning of the device being charged, and do so without generating excessive heat or damaging the internal components. Moreover, above, I have listed multiple references in the prior art patent literature that have employed the same style of dual-purpose speaker/charger coil that Lee prescribed, and these references do not mention any heat or vibration concerns.

473 APPLE-1089, ¶34; 472 APPLE-1089, ¶34; 471 APPLE-1089, ¶34

44

FISH

473 Reply, 12; 472 Reply, 12; 471 Reply, 12

DEMONSTRATIVE EXHIBIT – NOT EVIDENCE

[vii] Lee's Dual-Purpose Coil: No Evident Eddy Current Problems

Patent Owner's Response

A POSITA would have been even less motivated to use the dual purpose coil relied upon by Apple and depicted in Lee's Fig. 12 due to additional energy loss at the speaker magnet, which would capture eddy currents from the inductive charging field, further lowering charge efficiency of the asserted Gundlach-Lee combination.

473 POR, 27; 472 POR, 27; 471 POR, 27

Dr. Toliyat's Declaration

136. A POSITA would have been even less motivated to use the dual purpose coil relied upon by Dr. Cooperstock and depicted in Lee's Fig. 12 due to additional energy loss at the speaker magnet, which would capture eddy currents from the inductive charging field, further lowering charge efficiency of the asserted Gundlach-Lee combination. A POSITA would understand that energy

473 Ex.2022, ¶136; 472 Ex.2022, ¶136; 471 Ex.2022, ¶136

[vii] Lee's Dual-Purpose Coil: No Evident Eddy Current Problems

Patent Owner's Response

A POSITA would have been even less motivated to use the dual purpose coil relied upon by Apple and depicted in Lee's Fig. 12 due to additional energy loss at the speaker magnet, which would capture eddy currents from the inductive charging field, further lowering charge efficiency of the asserted Gundlach-Lee combination.

473 POR, 27; 472 POR, 27; 471 POR, 27

Dr. Cooperstock's Second Declaration

35. For similar reasons, Patent Owner's related theory that the speaker magnet would capture eddy currents from the inductive charging field and, thus, further lower the charge efficiency is unsubstantiated. Patent Owner and its expert do not explain or support this theory, and it is not discussed in the literature I have reviewed.

473 APPLE-1089, ¶35; 472 APPLE-1089, ¶35; APPLE-1089, ¶35

[viii] The Efficiency Design Tradeoff Does Not Preclude Motivation

Patent Owner's Response

A POSITA would understand that the high WPT charging inefficiency, which would be aspirational at best for Lee's dual use Fig. 12 design, would require the Gundlach devices to have larger batteries, and that for earpiece devices of this type and geometry, the battery is likely the largest contributor to size and weight. Ex. 2022, 128. At 30% inefficiency, having a 33% larger battery and 33% longer charge time (as compared to conductive charging) for Gundlach's earpieces would be highly undesirable. Ex. 2022, 128.

473 POR, 26; 472 POR, 26; 471 POR, 26

Dr. Cooperstock's Second Declaration

26. As a threshold matter, charging efficiency was a known design tradeoff between inductive and conductive charging. It would not have come as a surprise to a POSITA that inductive charging designs introduced an efficiency cost. This well-known fact would not have dissuaded a POSITA from pursuing Lee's Figure 12 embodiment, just as it did not dissuade all of the other prior art from pursuing inductive charging designs. Moreover, a POSITA would have been willing to take on the efficiency cost given the countervailing benefits—e.g., the reliability, convenience, and safety benefits of inductive charging that I discussed above. Additionally, as I explained in my First Declaration, Lee's dual-purpose coil embodiment of Figure 12 provides the unique advantage of reducing/simplifying the assembly by using a single coil for both charging and audio.

27. Tradeoffs are intrinsic to the design process. Virtually any choice between alternative design options—here, inductive charging versus conductive charging—would present pros and cons. But tradeoffs typically do not prevent POSITAs from investigating and implementing known options.

473 APPLE-1089, ¶¶26-27; 472 APPLE-1089, ¶¶26-27; APPLE-1089, ¶¶26-27

[viii] The Efficiency Design Tradeoff Does Not Preclude Motivation

Patent Owner's Response

A POSITA would understand that the high WPT charging inefficiency, which would be aspirational at best for Lee's dual use Fig. 12 design, would require the Gundlach devices to have larger batteries, and that for earpiece devices of this type and geometry, the battery is likely the largest contributor to size and weight. Ex. 2022, 128. At 30% inefficiency, having a 33% larger battery and 33% longer charge time (as compared to conductive charging) for Gundlach's earpieces would be highly undesirable. Ex. 2022, 128.

473 POR, 26; 472 POR, 26; 471 POR, 26

Refuting Evidence Submitted by Patent Owner

Wireless power is beginning to show great potential in the consumer market. The ability to power an electronic device without the use of wires provides a convenient solution for the users of portable devices and also gives designers the ability to develop more creative answers to problems. This technology's benefits can be seen in the many portable devices, from cell phones to electric cars, that normally operate on battery power.

Inductive coupling is the method by which efficient and versatile wireless power can be achieved. For ease of use

Ex.2032 at p.1

Traditional chargers rely on the contact of metals, oxidation or corrosion frequently occur on the contacting point of metals, causing the increase in the resistance between two contacting points and thus causing heat consumption or inefficiency in charging. In recent years, electromagnetic induction theory is adopted to develop contactless inductive power system, and successfully applied on electronic toothbrush, electronic shaver, cell phone, telephone and other portable electronic products [1-6].

Ex. 2033 at p.1

48

[viii] The Efficiency Design Tradeoff Does Not Preclude Motivation

Patent Owner's Response

A POSITA would understand that the high WPT charging inefficiency, which would be aspirational at best for Lee's dual use Fig. 12 design, would require the Gundlach devices to have larger batteries, and that for earpiece devices of this type and geometry, the battery is likely the largest contributor to size and weight. Ex. 2022, 128. At 30% inefficiency, having a 33% larger battery and 33% longer charge time (as compared to conductive charging) for Gundlach's earpieces would be highly undesirable. Ex. 2022, 128.

473 POR, 26; 472 POR, 26; 471 POR, 26

Reply

"[A] given course of action often has simultaneous advantages and disadvantages, and this does not necessarily obviate motivation to combine." *Allied Erecting & Dismantling Co. v. Genesis Attachments, LLC*, 825 F.3d 1373, 1381 (Fed. Cir. 2016). Additionally, "obviousness" does not require that the motivation be the best option, only that it be a suitable option from which the prior art did not teach away." *Bayer Pharma AG v. Watson Labs., Inc.*, 874 F.3d 1316, 1328 (Fed. Cir. 2017); accord *GE v. Raytheon Techs. Corp.*, 983 F.3d 1334, 1351 (Fed. Cir. 473 Reply, 5; 472 Reply, 5; 471 Reply, 5

Lee's teachings alone are sufficient to establish the suitability of inductive charging in the context Gundlach. After all, Lee and Gundlach are both directed to wireless headsets, and Lee makes clear that inductive charging is suitable—even preferred—in certain respects. But Lee is not the only relevant evidence on this point. Dr. Cooperstock cited at least ten other prior art examples of inductively charged wireless audio devices like headsets and hearing aids. APPLE-1089, ¶¶12-15 (citing APPLE-1023; APPLE-1029; APPLE-1070 through APPLE-1080). By comparison, Patent Owner and its expert, Dr. Toliyat, have not produced a single document that says inductive charging is unsuitable for such applications. All Patent

473 Reply, 6; 472 Reply, 6; 471 Reply, 6

49

FISH

DEMONSTRATIVE EXHIBIT – NOT EVIDENCE

Issue 2

Gundlach-Lee Renders Obvious
“selectively couple...employing magnetic force”

FISH.

DEMONSTRATIVE EXHIBIT – NOT EVIDENCE

Gundlach-Lee's Case and Headset Are Inductively and Physically Coupled

Dr. Cooperstock's First Declaration

51. The Gundlach-Lee charging case (*switching device*) is *coupled* to the wireless headset (*electronic device*) in at least two ways. First, the headset and case are inductively coupled to effect charging of the headset—i.e., power transfer from a power source, through the case (serving as a power adapter), and to a battery of the headset. (E.g., Lee, 3:31-62, Figures 5-7.) Second, the headset and case are also physically coupled to effect storage of the headset. (E.g., Gundlach, [0055-0056], [0080], Figures 18a-18b.) As shown in the graphic below, the headset is fully contained—and thus *coupled*—within the clamshell case. (*Id.*)

473 APPLE-1003, ¶ 51.

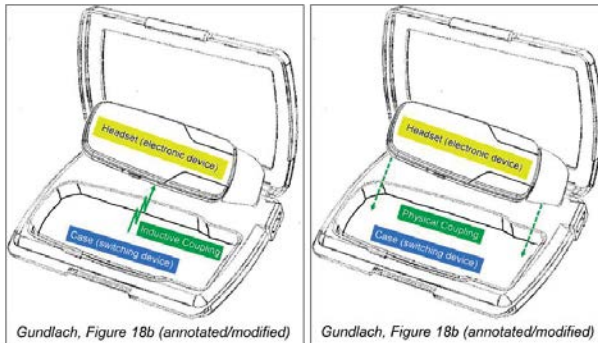

473 APPLE-1005 (Gundlach), Figure 18b; 473 APPLE-1003, ¶ 51.

'320 Patent

I. A system comprising:
a portable switching device coupled to a portable electronic device;
wherein:
the switching device and the electronic device are configured to selectively couple to each other employing magnetic force;
the switching device comprises a first case;
the electronic device comprises a second case and an electronic circuit that is responsive to the switching device;
a first magnet is fully disposed within the electronic device;
the electronic device comprises at least one element selected from the group consisting of beveled edges, ridges, recessed areas, grooves, slots, indented shapes, bumps, raised shapes, and combinations thereof; configured to correspond to complimentary surface elements on the switching device;
wherein the second case is decoupled from the first case by overcoming magnetic force the portable switching device is configured to activate, deactivate, or send into hibernation the portable electronic device;
the electronic device plays or pauses a remote device;
the switching device includes a lid and hinge attaching the lid to the switching device;
the lid is recessed to configure to the electronic device;
and
when coupled, the first case functions to protect the second case.

473 APPLE-1001 ('320 Patent), 21:38-22:18.

51

FISH

DEMONSTRATIVE EXHIBIT – NOT EVIDENCE

Gundlach-Lee's Selective Inductive Coupling Employs Magnetic Force

Dr. Cooperstock's First Declaration

53. A POSITA would have understood that the inductive/physical *coupling* of Gundlach-Lee is *configured to be selective*. The POSITA, for example, would have appreciated that the inductive/physical *coupling* exists only when a user chooses (*selects*) to install the wireless headset in the charging case. The user can then reverse the *selective coupling* by removing the headset from the case. It would have been clear to a POSITA that installing and removing the headset from the case are typical, indeed necessary, operations of the Gundlach-Lee system.

54. The POSITA would also have understood that the inductive *coupling* between the wireless headset and charging case *employs magnetic force*. In Lee's words, the "inductive *coupling*" involves a "*magnetic field*." (E.g., Lee, 4:25-39 (referencing the "magnetic field" of Figure 11).) And a POSITA would have known that a magnetic field is a region in which *magnetic forces* are observable. This is a basic principle of physics learned in any undergrad level physics course. (E.g., APPLE-1028, p.2 (defining "the force that arises when a charge moves through this [magnetic] field"), p.4 ("a magnetic field will exert a force upon any flowing current".))

473 APPLE-1003, ¶¶ 53-54.

Gundlach-Lee

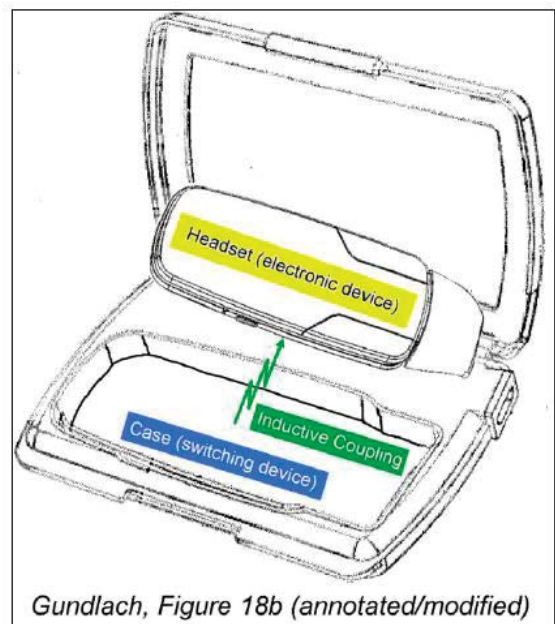

Gundlach, Figure 18b (annotated/modified)

473 APPLE-1005 (Gundlach), Figure 18b; 473 APPLE-1003, ¶ 51.

52

FISH

DEMONSTRATIVE EXHIBIT – NOT EVIDENCE

Gundlach-Lee's Selective Physical Coupling Employs Magnetic Force

Dr. Cooperstock's First Declaration

55. As to the physical *coupling*, Gundlach describes an embodiment where a wireless headset is secured within a cradle by both "mechanical means" and the attractive *magnetic force* between respective embedded magnets.

(Gundlach, [0067-0068], Figures 10a-10c (below).)

56. For at least the following reasons, a POSITA would have been motivated to incorporate the embedded magnets disclosed in Gundlach's cradle embodiment of Figures 10a-10c ("Figure 10") into the clamshell case embodiment of Gundlach's Figures 18a-18b ("Figure 18"). A graphical representation of this modification is depicted below.

473 APPLE-1003, ¶¶ 55-56.

Gundlach-Lee

[0068] The device 1000 may be held to the cradle by a magnet 1036, which may be embedded in the cradle 1028. The wireless device 1000 may also include a ferromagnetic portion 1038, such as another magnet or ferrous material to which the magnet in the cradle may be attracted. The wireless device may also be held to the cradle by mechanical means, such as a bendable clip or protrusion that retains the wireless headset to the cradle.

Gundlach, [0068]

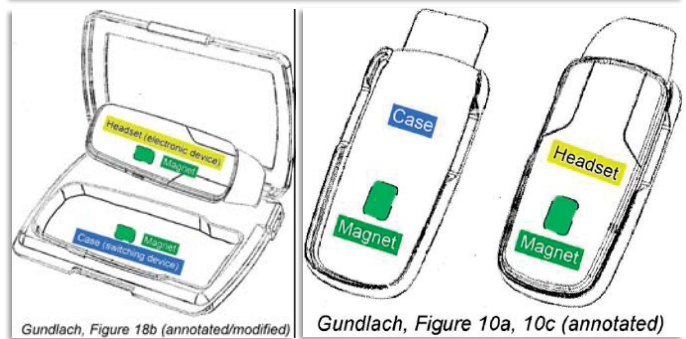

473 APPLE-1005, Figures 10a, 10c, ¶ [0068]; 473 APPLE-1003, ¶ 55.

473 APPLE-1005 (Gundlach), Figure 18b; 473 APPLE-1003, ¶ 56.

53

FISH

DEMONSTRATIVE EXHIBIT – NOT EVIDENCE

The POSITA Would Have Embedded Magnets in the Gundlach-Lee Case

Dr. Cooperstock's First Declaration

56. For at least the following reasons, a POSITA would have been motivated to incorporate the embedded magnets disclosed in Gundlach's cradle embodiment of Figures 10a-10c ("Figure 10") into the clamshell case embodiment

473 APPLE-1003, ¶ 56.

57. First, a POSITA would have been prompted to include embedded magnets in the clamshell case embodiment by the disclosures within Gundlach itself. As a general matter, a POSITA reading Gundlach as a whole would have concluded that the features of Gundlach's various embodiments are not intended to be mutually exclusive. Several of the embodiments are similar in nature, which would have led the POSITA to appreciate that certain features are interchangeable. Turning specifically to the matter of incorporating magnets in the clamshell case embodiment, I'll explain a line of reasoning that would have led the POSITA to such an arrangement.

473 APPLE-1003, ¶ 57.

59. Second, a POSITA would have viewed inclusion of embedded magnets in a clamshell case as merely the use of a known technique—i.e., magnetic force to achieve a physical coupling, per the Figure 10 cradle embodiment—to improve a similar device—i.e., the Figure 18 clamshell case embodiment—in the same way. As Gundlach suggests, in the Figure 10 embodiment, embedded magnets serve as a supplement to "mechanical means" for holding the wireless headset to the cradle. (Gundlach, [0068].) The Figure 18 embodiment likewise includes a mechanical solution for retaining the wireless headset—i.e., folding clamshell lids—that would be supplemented in a substantially similar way by embedded magnets. Moreover, it would have been clear to a POSITA that magnets would function similarly in Gundlach's Figure 18 embodiment as in Gundlach's Figure 10 embodiment, and it would have been well within the POSITA's skill level to incorporate magnets into a clamshell case.

473 APPLE-1003, ¶ 59.

60. Third, a POSITA would have appreciated the predictable advantages of adding embedded magnets to the Figure 18 clamshell case embodiment. As one example, a POSITA would have understood that incorporating embedded magnets would promote retention of the wireless headset within the clamshell case in an event where the case was opened inadvertently (e.g., dropped or otherwise jarred).

Beyond basic common sense, the POSITA would have known that magnets were useful for retaining portable electronic devices based on their use for this purpose in other related applications. For example, magnets were commonly used long before the Critical Date in 2011 to retain mobile phones in vehicle dashboard mounts with sufficient force to prevent inadvertent detachment when jostled during use. (E.g., APPLE-1030, 1:59-64 (describing a mobile phone vehicle mount where "[t]he magnetic forces are sufficient to firmly hold the [phone] in engagement . . . so that the [phone] will not move unintentionally . . ."). From a POSITA's perspective, embedded magnets would inhibit users from losing or damaging the headset by working to retain the headset in the protective case.

473 APPLE-1003, ¶ 60.

Patent Owner's Arguments Disregard Gundlach's Text

Petitioner's Reply

a) *Physical coupling via embedded magnets*

Each of the Petition's three independent rationales for employing embedded magnets in Gundlach's clamshell case withstands Patent Owner's critiques.³ And yet, the Board need only adopt one of them to find Element [1b] satisfied.

First Petition Rationale: A POSITA would have understood that Gundlach's teaching in the Figure 10 cradle embodiment of securing the headset with embedded magnets also applies to the Figure 18 clamshell case embodiment. Pet., 22-24 (citing APPLE-1005, [0056], [0067-0068]; APPLE-1003, ¶¶55-58). This proposition finds support in Gundlach's teaching that a "case" (species)—such as the Figure 18 clamshell case—is an exemplary type of "cradle" (genus)—such as the Figure 10 cradle. APPLE-1005, [0056] (The headset may "be stored and charged in a portable cradle" and "[t]he portable cradle may be a holder, clip, case or card."). Patent Owner's argument that Gundlach's clamshell case cannot be considered a type of cradle because "a POSITA [would not] understand something with a lid to be a cradle" (POR, 43) flouts Gundlach's plain text and should be rejected.

473 Reply, 18.

Gundlach

[0056] In an exemplary embodiment the device may have an articulating ear piece that when expanded may fit into or over the ear. When collapsed the earpiece may be situated in a plane with the housing of the headset creating a product thickness of, e.g., about 5 mm or less. The relatively thin shape may allow the headset to be stored and charged in a portable cradle or with a mini USB charger. The portable cradle may be a holder, clip, case or card that may fit inside a standard expansion slot conforming to any expansion slot standard including, for example, PCMCIA, ExpressCard54 and ExpressCard34, etc. Additionally a unique slot or cavity may be designed into a laptop or cell phone or any other communication device that may utilize a speaker and microphone to accommodate such as a wireless headset.

473 APPLE-1005 (Gundlach), [0056].

Patent Owner's Arguments Disregard Gundlach's Text

Petitioner's Reply

Second Petition Rationale: Inclusion of embedded magnets in the Figure 18 clamshell case embodiment involves using a known technique to improve a similar device in the same way. Pet., 24-25 (citing APPLE-1005, [0068]; APPLE-1003, ¶59). Patent Owner's claim that "a POSITA would have no motivation to add an unnecessary magnet to further secure an already well secured earpiece in a clamshell case" (POR, 43), fails to account for the fact that Gundlach's Figure 10 cradle embodiment employs both magnets and "mechanical means" to secure the wireless headset. APPLE-1005, [0068]. A POSITA noting the dual securement mechanisms used in the cradle embodiment would have pursued a similar implementation in the clamshell case embodiment. APPLE-1003, ¶59.

473 Reply, 19.

Gundlach

[0068] The device 1000 may be held to the cradle by a magnet 1036, which may be embedded in the cradle 1028. The wireless device 1000 may also include a ferromagnetic portion 1038, such as another magnet or ferrous material to which the magnet in the cradle may be attracted. The wireless device may also be held to the cradle by mechanical means, such as a bendable clip or protrusion that retains the wireless headset to the cradle.

473 APPLE-1005 (Gundlach), [0068].

Patent Owner Fails to Address Predictable Advantages

Petitioner's Reply

Third Petition Rationale: The addition of embedded magnets to the Figure 18 clamshell case embodiment would offer multiple predictable advantages. Pet., 25 (citing APPEL-1003, ¶¶60-62; APPLE-1020; APPLE-1030 through APPLE-1032). Even assuming the merit of Patent Owner's rebuttal *arguendo* does not undermine the Petition's predictable advantages rationale. POR, 44 ("adding an extra magnet would add no additional protection"). Patent Owner fails to address that: [1] "magnets would assist users with fitting the headset into the case"; and [2] "magnets would facilitate inductive charging by holding the headset firmly in place within the case." Pet., 25. These points stand as uncontroverted facts that would have prompted a POSITA to use embedded magnets in Gundlach's clamshell case.

473 Reply, 19.

Patent Owner fares no better with its additional arguments that "adding magnets would increase the weight and potentially increase the size of Gundlach's earpieces" and "risk getting the device stuck in the [laptop] expansion slot." POR, 44. Size and weight penalties are design tradeoffs that do not preclude obviousness. *Allied Erecting & Dismantling*, 825 F.3d at 1381; *Bayer Pharma*, 874 F.3d at 1328; *supra* Section II.A.2.a. And Gundlach's clamshell case embodiment is not limited to fitting within the expansion slot of a laptop. *See supra*, Section II.A.3.c.

473 Reply, 20.

The False Premise of Patent Owner's Argument Against Inductive Coupling

Petitioner's Reply

b) *Inductive coupling via primary and secondary coils*

Patent Owner's argument against inductive coupling suffers a false premise.

Simply put, there is no support in the record for Patent Owner's implied claim construction requiring "selectively couple to each other employing magnetic force"

to include "a magnetic attraction."⁴ POR, 46. Patent Owner fails to justify its proposed addition of the missing word "magnetic attraction force" to the claims.

Retractable Techs. v. Becton, Dickinson & Co., 659 F.3d 1369, 1372-73 (Fed. Cir. 2011) ("Absent clear lexicography or disclaimer in the specification, [courts] cannot import [a] limitation into the claims").

⁴Tellingly, Patent Owner now only implies its construction after raising it expressly before institution. Compare POR, 44-46 with POPR, 12, 36-38; see also ID, 24.

473 Reply, 20.

'320 Patent

I. A system comprising:
a portable switching device coupled to a portable electronic device;
wherein:
the switching device and the electronic device are configured to selectively couple to each other employing magnetic force;
the switching device comprises a first case;
the electronic device comprises a second case and an electronic circuit that is responsive to the switching device;
a first magnet is fully disposed within the electronic device;
the electronic device comprises at least one element selected from the group consisting of beveled edges, ridges, recessed areas, grooves, slots, indented shapes, bumps, raised shapes, and combinations thereof; configured to correspond to complimentary surface elements on the switching device;
wherein the second case is decoupled from the first case by overcoming magnetic force the portable switching device is configured to activate, deactivate, or send into hibernation the portable electronic device;
the electronic device plays or pauses a remote device;
the switching device includes a lid and hinge attaching the lid to the switching device;
the lid is recessed to configure to the electronic device;
and
when coupled, the first case functions to protect the second case.

473 APPLE-1001 ('320 Patent), 21:38-22:18.

58

Issue 3

Gundlach-Lee Renders Obvious
“activate, deactivate, or send into hibernation”

Gundlach-Lee's Case Activates/Deactivates the Wireless Headset

Dr. Cooperstock's First Declaration

[1h] the portable switching device is configured to activate, deactivate, or send into hibernation the portable electronic device;

75. The Gundlach-Lee combination satisfies Element [1h]. As I've explained (§ VIII.C), the combined teachings of Gundlach and Lee yield a clamshell case that stores and inductively charges a wireless headset. (*E.g.*, Gundlach, [0056] ("portable cradle" in the form of a "case" where the headset is "stored and charged"), [0080] (clamshell case), Figures 18a-18b; Lee, 3:50-62 (inductive charging a wireless headset), Figure 7.) These combined teachings satisfy Element [1h] in at least four different ways.

473 APPLE-1003, ¶ 75.

'320 Patent

1. A system comprising:
a portable switching device coupled to a portable electronic device;
wherein:
the switching device and the electronic device are configured to selectively couple to each other employing magnetic force;
the switching device comprises a first case;
the electronic device comprises a second case and an electronic circuit that is responsive to the switching device;
a first magnet is fully disposed within the electronic device;
the electronic device comprises at least one element selected from the group consisting of beveled edges, ridges, recessed areas, grooves, slots, indented shapes, bumps, raised shapes, and combinations thereof; configured to correspond to complimentary surface elements on the switching device;
wherein the second case is decoupled from the first case by overcoming magnetic force the portable switching device is configured to activate, deactivate, or send into hibernation the portable electronic device;
the electronic device plays or pauses a remote device;
the switching device includes a lid and hinge attaching the lid to the switching device;
the lid is recessed to configure to the electronic device; and
when coupled, the first case functions to protect the second case.

473 APPLE-1001 ('320 Patent), 21:38-22:18.

60

FISH.

DEMONSTRATIVE EXHIBIT – NOT EVIDENCE

Gundlach-Lee's Case Activates/Deactivates the Wireless Headset

'320 Patent

[1h] the portable switching device is configured to activate, deactivate, or send into hibernation the portable electronic device;

473 APPLE-1001 ('320 Patent), 21:38-22:18.

Petitioner's Reply

The Petition offered four alternative mappings regarding the Gundlach-Lee combination, any one of which would be sufficient to find Element [1h] satisfied: (1) activating a battery charging circuit; (2) activating/deactivating a switch to activate/deactivate a charging mode; (3) activating a headset with a depleted battery via insertion into the charging case; and (4) placing the headset in a hibernation mode by deactivating the headset circuit during charging via control signals from the charging case. Pet., 33-37.

473 Reply, 22.

61

1. Gundlach-Lee's Case Activates the Battery Charging Circuit

Dr. Cooperstock's First Declaration

76. First, as taught by Lee, the wireless headset (*electronic device*, per analysis at Element [1a]) includes a "battery charging circuit" that "manages charging of the battery by taking the raw energy received by the [energy collecting] coil and providing the proper voltage to the battery based on its type." (Lee, 4:62-66 (reference numbers omitted).) In Gundlach-Lee, the battery charging circuit of the headset (*electronic device*) is *activated* by the clamshell charging case (*switching device*, per analysis at Element [1a]) insofar as the case (*switching device*) provides "[t]he energy received by the coil [and] transferred via the battery charging circuit to the battery." (Lee, 4:57-59 (reference numbers omitted).) From a POSITA's perspective, this disclosure by Lee suggests that the battery charging circuit of the headset (*electronic device*) is *activated* to an operative state—i.e., transferring energy to the battery—from an inoperative state—i.e., not transferring energy to the battery—in response to receiving energy from the clamshell case (*switching device*).

473 APPLE-1003, ¶ 76.

Gundlach-Lee

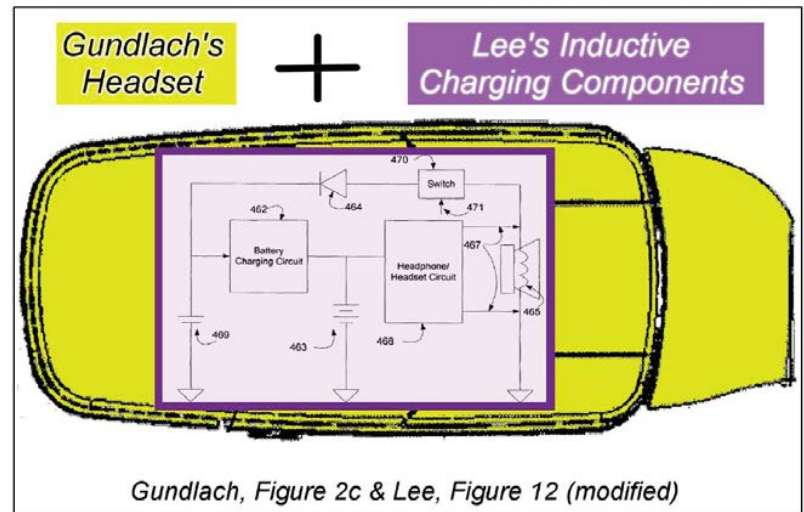

APPLE-1005, Figure 2c; APPLE-1006, Figure 12
473 Pet., 12-14; 472 Pet., 13-15; 471 Pet., 14-16

2. Gundlach-Lee's Case Triggers a Switch That Activates the Headset

Dr. Cooperstock's First Declaration

77. Second, Lee discloses that the wireless headset (*electronic device*) includes a "switch" for controlling the mode of operation with respect to charging. (Lee, 5:12-40.) When the switch is open, the battery charging circuit is isolated from the energy-receiving coil and thus inoperative to charge the battery—"a non-charging mode." (*Id.*) When the switch is closed, the battery charging circuit is connected to the energy-receiving coil and thus operative to charge the battery—"a charging mode." (*Id.*) According to Lee, the switch either (i) "automatically closes to the charge position when near the power adapter [clamshell case in Gundlach-Lee] . . . and automatically opens to the non-charge position when away from the power adapter [clamshell case]"; or (ii) opens/closes in response to a wireless control signal from the power adapter [clamshell case]. (Lee, 5:30-40.)

473 APPLE-1003, ¶ 77.

78. From a POSITA's perspective, Lee provides a switch triggered by the charging case (*switching device*) that *activates* the headset (*electronic device*) in multiple different respects that find support in the '320 patent's specification. In

473 APPLE-1003, ¶ 78.

'320 Patent

In one aspect, the invention is a switching device for use with a portable electronic device having a view screen and at least one switch that can be activated or de-activated by introducing a magnetic field to the at least one switch wherein the switching device has at least one magnet and at least one surface that is non-abrasive to the surface of the view screen.

473 APPLE-1001 ('320 Patent), 4:1-7.

Lee

The wireless headphone/headset apparatus 460 in this embodiment also comprises a switch 470 controlled by a switch control signal 471. The switch control signal 471 causes the switch 470 to close when in charging mode and to open when in non-charging mode. When the switch 470 is open (in non-charging mode), the coil 465 is isolated from the battery charging circuit 462, the rectifier 464, and the energy storage capacitor 469. Disconnecting these components reduces the load on the coil 465 and eliminates audio distortion caused by these component (e.g., when a stray magnetic field causes the coil 465 to deliver energy to these components). When the switch 470 is closed (in charging mode), the coil 465 is in communication with the battery charging circuit 462 and other components, and energy received by the coil 465 is used to re-charge the battery 463. The switch 470 can

APPLE-1006, 5:12-26.

FISH

DEMONSTRATIVE EXHIBIT – NOT EVIDENCE

63

3. Gundlach-Lee's Case Activates the Wireless Headset

Dr. Cooperstock's First Declaration

79. Third, a POSITA would have appreciated that the entire Gundlach-Lee headset (*electronic device*) would transition from a deactivated state to an *activated* state when inserted into the charging case (*switching device*) with a fully depleted battery. With the battery depleted, the headset would be entirely without power, and thus completely deactivated. When subsequently placed in the charging case, energy would flow from the energy-receiving coil to the battery via the battery charging circuit (just as I explained above at § VIII.B), *activating* the headset to a charging mode. A POSITA would have known that it was common for users to inadvertently leave headsets separated from their chargers for long periods of time, allowing the battery to become fully depleted.

473 APPLE-1003, ¶ 79.

Gundlach-Lee

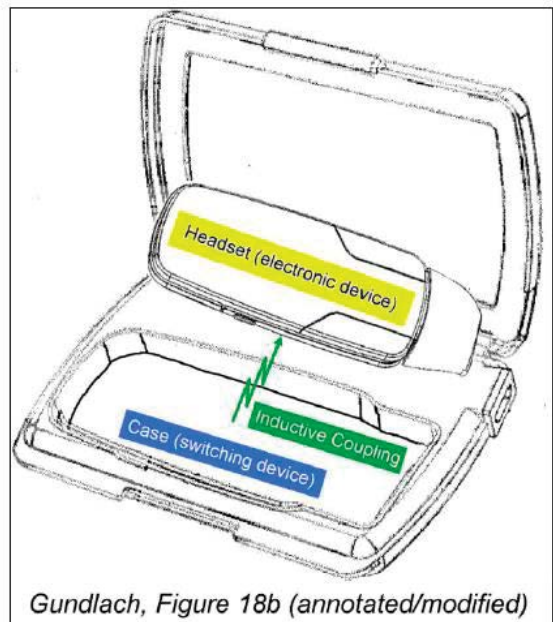

473 APPLE-1005 (Gundlach), Figure 18b; 473 APPLE-1003, ¶ 51.

4. Gundlach-Lee's Case Deactivates the Headset Circuit

Dr. Cooperstock's First Declaration

80. Fourth, a POSITA would have been motivated to configure the clamshell charging case (*switching device*) of Gundlach-Lee to *deactivate* at least the battery-powered "headset circuit" of the wireless headset (*electronic device*) when stored and charging. According to Lee, the "headset circuit" is what draws power from the battery to, among other things, operate an RF transceiver and provide a drive signal to the speaker coil. (See Lee, 4:51-5:11 ("The energy stored in the battery is used to power the headphone/headset circuit." (reference numbers omitted)) ("In one embodiment, the headphone/headset circuit includes an RF receiver (or transceiver) . . . and a power amplifier circuit to provide a drive signal to the speaker coil.") (reference numbers omitted).)

473 APPLE-1003, ¶ 80.

Gundlach-Lee

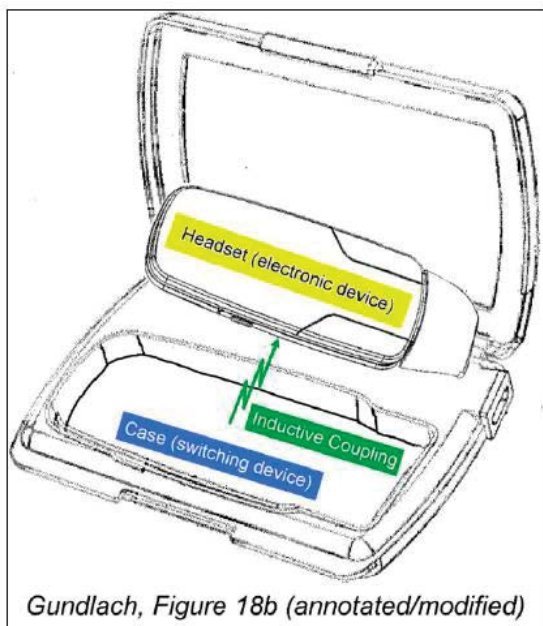

Gundlach, Figure 18b (annotated/modified)

473 APPLE-1005 (Gundlach), Figure 18b; 473 APPLE-1003, ¶ 51.

Patent Owner Leaves Petition Mappings Unrebutted

Petitioner's Reply

Patent Owner offers the same unpersuasive response to the Petition's first, second, and third mappings: "[T]he portion of Lee relied upon by Apple again discloses nothing more than the passive receipt of a charge by the headset battery." POR, 49-52. But the Petition does not rely on "passive receipt of a charge." Instead, it shows how a POSITA would have understood various aspects of the Gundlach-Lee wireless headset to transition to an operative state (activation) or inoperative state (deactivation). Patent Owner's mischaracterization leaves the Petition's true assertions unrebutted.

473 Reply, 22.

Gundlach-Lee

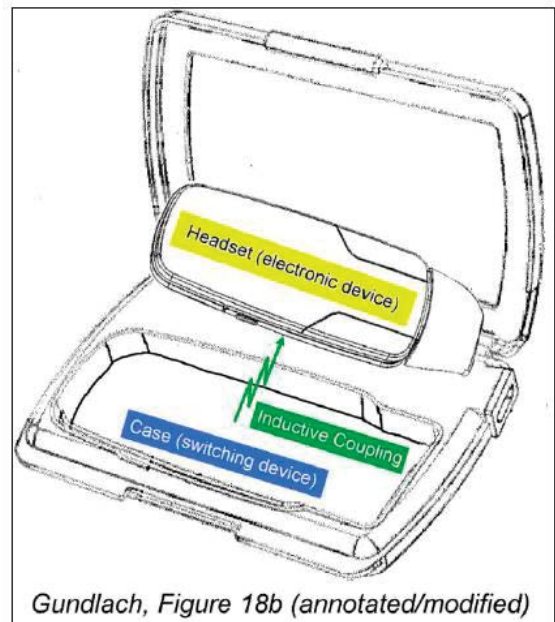

Gundlach, Figure 18b (annotated/modified)

473 APPLE-1005 (Gundlach), Figure 18b; 473 APPLE-1003, ¶ 51.

Patent Owner Leaves Petition Mappings Unrebutted

Petitioner's Reply

For example, regarding the Petition's second mapping (activating/deactivating a switch to activate/deactivate a charging mode), Patent Owner does not contest that Lee's disclosure of opening/closing a switch comports with the '320 Patent's specification. Pet., 35 (citing APPLE-1001, 4:1-7, 18:13-18). The '320 Patent's ancestor U.S. Appl. 14/343,665 lends further support to the Petition's second mapping given its claim to "A method of activating or deactivating an electronic device comprising employing a cleaning component having a magnet element to activate or deactivate a magnetic switch." APPLE-1087, 58; *Andersen Corp. v. Fiber Composites, LLC*, 474 F.3d 1361, 1368 (Fed. Cir. 2007) ("The prosecution history of that parent application is highly instructive in light of the similarity between the claims of the application and those of the patents in suit.").

473 Reply, 23.

'320 Patent

In one aspect, the invention is a switching device for use with a portable electronic device having a view screen and at least one switch that can be activated or de-activated by introducing a magnetic field to the at least one switch wherein the switching device has at least one magnet and at least one surface that is non-abrasive to the surface of the view screen.

473 APPLE-1001 ('320 Patent), 4:1-7.

In employing the method of the application, the switching component may be picked up and, depending upon the model and functionality of the magnetic switch, the switching device is either applied directly to the magnetic switch or applied to either side of the switch and then slid past it to activate or deactivate the portable electronic device.

473 APPLE-1001 ('320 Patent), 18:13-18.

Patent Owner Leaves Petition Mappings Unrebutted

Petitioner's Reply

Patent Owner's argument against the Petition's fourth mapping is also unpersuasive. Indeed, it is a red herring. The fact that Lee's Figure 12 "lacks any disclosed means for such control signals to be sent or received" is immaterial. POR, 52. After all, the Petition does not rely on disclosure in Figure 12. The Petition presents a theory of obviousness where the POSITA would have been motivated to utilize the control signals Lee discussed regarding Figure 15 to deactivate the headset circuit and/or place the wireless headset in hibernation mode. Pet., 36-37 (citing APPLE-1003, ¶¶80-83; APPLE-1033; APPLE-1060; APPLE-1061).

473 Reply, 23-24.

Dr. Cooperstock's First Declaration

82. A POSITA contemplating Gundlach-Lee would have recognized Lee's teaching of a "wireless data communication channel" for "provid[ing] control signals" between the power adapter [clamshell case in Gundlach-Lee] and the headset. (Lee, 6:5-21, Figure 15.) The POSITA also would have appreciated that it was well known in the art to utilize a control signal for triggering component *deactivation* in a portable device, and that such a signal could be easily leveraged to *deactivate* the "headset circuit" described by Lee. For example, in a related context, U.S. Publication No. 2011/0151941 describes a wireless headset with a controller that "deactivates the audio circuit" in response to receiving a "deactivation signal" generated by a Hall effect sensor. (APPLE-1033, [0030].) While the control signal in this patent publication is transmitted by a wired connection, as opposed to the wireless control signals disclosed by Lee, that does not change the fact that deactivation signals were known to those of skill in the context of headsets. Moreover, as mentioned, a POSITA would have appreciated that it was known in the art to place portable devices into a *hibernation* mode by depowering functional components. (APPLE-1060, [0005]; APPLE-1061, [0043].)

473 APPLE-1003, ¶ 82.

Patent Owner Chose Not To Address the Institution Decision

Institution Decision

Patent Owner argues that charging a battery does not activate a device because "it merely charges the battery." Prelim. Resp. 42 (citing Ex. 2001

Patent Owner's arguments are unavailing on this record. As to whether starting or stopping battery charging meets the limitation, Lee discloses that when a switch is open or closed, a circuit becomes activated/deactivated and Patent Owner does not explain why this disclosure is insufficient to constitute the claimed activation/deactivation even if the circuitry is for battery recharging. Prelim. Resp. 42; see Ex. 1003 ¶ 78. On

473 ID, 28-29.

Petitioner's Reply

As to the Petition's first mapping (activating a battery charging circuit), Patent Owner defaulted on this issue by choosing not to address the Board's reasoning in the Institution Decision. ID, 29 ("Patent Owner does not explain why this disclosure is insufficient[.]"); POPR, 42; APPLE-1088, 45:5-46:2 (Dr. Toliyat affirming that Patent Owner's current position mimics the "merely charges the battery" argument in the Preliminary Response).

473 Reply, 23.

Patent Owner's Response

would not agree. Ex. 2022, 193. To a POSITA, the portion of Lee relied upon by Apple again discloses nothing more than the passive receipt of a charge by the headset battery. Ex. 2022, 193. In other words, electrons are flowing through Lee's earpiece to the positively charged pole of its embedded battery. Ex. 2022, 193.

473 POR, 50.

Dr. Toliyat's Deposition Testimony

19 Q. And it's your position here that
20 essentially charging a battery does not activate a
21 device because it merely charges the battery?
22 A. That's correct. And we don't know what

473 APPLE-1088, 45:19-22.

Issue 4

Gundlach-Lee Renders Obvious
the lid “recessed to configure to the electronic device”

FISH.

DEMONSTRATIVE EXHIBIT – NOT EVIDENCE

Gundlach-Lee's Case Includes a Lid Recessed to Accommodate the Headset

Dr. Cooperstock's First Declaration

[1k] the lid is recessed to configure to the electronic device; and

91. The Gundlach-Lee combination satisfies Element [1k]. As I've explained at Element [1j], Gundlach teaches a clamshell charging case with opposing cover sections (*lids*). As shown below, each of the cover sections (*lids*) includes a *recess* that accommodates (*configures to*) the wireless headset (*electronic device*, per analysis at Element [1a].) (Gundlach, [0080], Figures 18a-18b.) One cover section (*lid*) provides a *recess* that accommodates (*configures to*) the *thickness* of the wireless headset (*electronic device*), while the *recess* of the other cover section (*lid*) accommodates (*configures to*) both the *thickness* and *contour* of the wireless headset (*electronic device*).

473 APPLE-1003, ¶ 91.

'320 Patent

1. A system comprising:
a portable switching device coupled to a portable electronic device;
wherein:
the switching device and the electronic device are configured to selectively couple to each other employing magnetic force;
the switching device comprises a first case;
the electronic device comprises a second case and an electronic circuit that is responsive to the switching device;
a first magnet is fully disposed within the electronic device;
the electronic device comprises at least one element selected from the group consisting of beveled edges, ridges, recessed areas, grooves, slots, indented shapes, bumps, raised shapes, and combinations thereof; configured to correspond to complimentary surface elements on the switching device;
wherein the second case is decoupled from the first case by overcoming magnetic force the portable switching device is configured to activate, deactivate, or send into hibernation the portable electronic device;
the electronic device plays or pauses a remote device;
the switching device includes a lid and hinge attaching the lid to the switching device;
the lid is recessed to configure to the electronic device;
and
when coupled, the first case functions to protect the second case.

473 APPLE-1001 ('320 Patent), 21:38-22:18.

71

Gundlach-Lee's Case Includes a Lid Recessed to Accommodate the Headset

Dr. Cooperstock's First Declaration

[1k] the lid is recessed to configure to the electronic device; and

91. The Gundlach-Lee combination satisfies Element [1k]. As I've explained at Element [1j], Gundlach teaches a clamshell charging case with opposing cover sections (*lids*). As shown below, each of the cover sections (*lids*) includes a *recess* that accommodates (*configures to*) the wireless headset (*electronic device*, per analysis at Element [1a].) (Gundlach, [0080], Figures 18a-18b.) One cover section (*lid*) provides a *recess* that accommodates (*configures to*) the *thickness* of the wireless headset (*electronic device*), while the *recess* of the other cover section (*lid*) accommodates (*configures to*) both the *thickness* and *contour* of the wireless headset (*electronic device*).

473 APPLE-1003, ¶ 91.

Gundlach-Lee

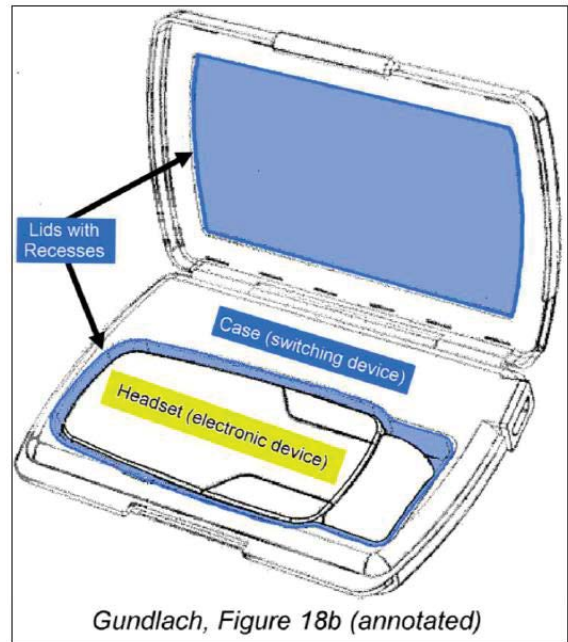

Gundlach, Figure 18b (annotated)

473 APPLE-1005 (Gundlach), Figure 18b; 473 APPLE-1003, ¶ 91.

Gundlach-Lee's Case Includes a Lid Recessed to Accommodate the Headset

Petitioner's Reply

As to Gundlach's top lid, Patent Owner does not dispute that it is recessed, but argues instead that it does not "configure to" the headset because it is "flat" as compared to "the beveled earpiece." POR, 54. Here again, by implicitly interpreting "configure to the electronic device" as requiring the lid to have a recess that tracks the contour of the electronic device, Patent Owner seeks to narrow a facially broad limitation without support in the intrinsic record. APPLE-1088, 54:12-55:7 (Dr. Toliyat describing Patent Owner's position as "the claim requires...that the lid, basically [the] shape of the electronic device would match the lid."), 55:1-57:11 (Dr. Toliyat conceding that the claim language "doesn't spell, out the shape" of the lid recess."), 60:15-18 (similar). The attempt is particularly glaring here because the '320 Patent does not describe a switching device with a lid having a recess matching the shape of the electronic device.

473 Reply, 24.

'320 Patent

1. A system comprising:
a portable switching device coupled to a portable electronic device;
wherein:
the switching device and the electronic device are configured to selectively couple to each other employing magnetic force;
the switching device comprises a first case;
the electronic device comprises a second case and an electronic circuit that is responsive to the switching device;
a first magnet is fully disposed within the electronic device;
the electronic device comprises at least one element selected from the group consisting of beveled edges, ridges, recessed areas, grooves, slots, indented shapes, bumps, raised shapes, and combinations thereof; configured to correspond to complimentary surface elements on the switching device;
wherein the second case is decoupled from the first case by overcoming magnetic force the portable switching device is configured to activate, deactivate, or send into hibernation the portable electronic device;
the electronic device plays or pauses a remote device;
the switching device includes a lid and hinge attaching the lid to the switching device;
the lid is recessed to configure to the electronic device;
and
when coupled, the first case functions to protect the second case.

473 APPLE-1001 ('320 Patent), 21:38-22:18.

73

Gundlach-Lee's Case Includes a Lid Recessed to Accommodate the Headset

Petitioner's Reply

The only discussion of a "lid" in the specification relates to a smartphone case with a hinged lid covering the phone. APPLE-1001, 10:13-18, Figure 5 (right). Critically, this discussion makes no mention of a recess that matches the contour of the electronic device, and the lid appears to be flat.

APPLE-1088, 57:12-60:14 (Dr. Toliyat conceding his inability to locate support in the specification for Patent Owner's narrow interpretation).

As to Gundlach's bottom lid, Patent Owner argues that it is not a lid at all, but is instead a "base." POR, 54. This semantic argument fails. Nothing in the '320 Patent's specification limits the term "lid" to a covering on the topside of the case, nor does the specification exclude a case with two lids. Like an eyelid, a clamshell case has both a top lid and a bottom lid, either of which are properly mapped to the '320 Patent's broad claim language.

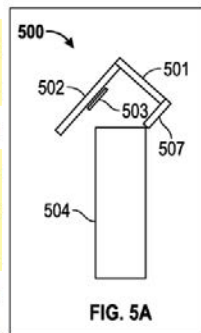

FIG. 5A

473 Reply, 25.

'320 Patent

While many of the cleaning components have a single magnet or ferromagnetic or ferrimagnetic substrate, this is not a limitation of the application. In some embodiments, it may be desirable to have multiple magnets in a cleaning component. For Example, at FIG. 5, a case having two magnets to hold it closed 500 is shown. This case consists of a body 504 which functions to hold a smartphone; and a lid having a top 501, a side 502, and a hinge 507. Also shown is the cleaning component 503 adhering to the inside of the side of the lid. The side is shown again at 502a from lateral perspective with the magnets visible 506. The cleaning component 503a is also shown from a lateral perspective, again showing two magnets 506. The two magnets of the case line up with the two magnets of the cleaning component in some embodiments to allow for a more secure fit to the case.

473 APPLE-1001 ('320 Patent), 10:9-24.

Issue 5

The POSITA Would Have
Combined Mak-Fan With Gundlach-Lee

FISH.

DEMONSTRATIVE EXHIBIT – NOT EVIDENCE

Overview of Mak-Fan

Dr. Cooperstock's First Declaration

130. Mak-Fan's disclosure entitled "HOLSTER FOR HAND HELD ELECTRONIC DEVICE" includes an embodiment (Figure 4, below) featuring an electronic device 2 held in a holster 1 with a fold-over flap 10. (Mak-Fan, [0014]; [0019].) The fold-over flap 10 includes a metal element 11 engaging a magnet 4' to hold the holster 1 closed. (*Id.*) The electronic device 2 includes a Hall effect sensor (not shown), and "[t]he device is programmed so that when the Hall effect sensor detects the magnet, the device is disabled." (*Id.*, [0014], Figure 1.)

473 APPLE-1003, ¶130; 472 APPLE-1003, ¶129; 471 APPLE-1003, ¶126

Mak-Fan (APPLE-1010)

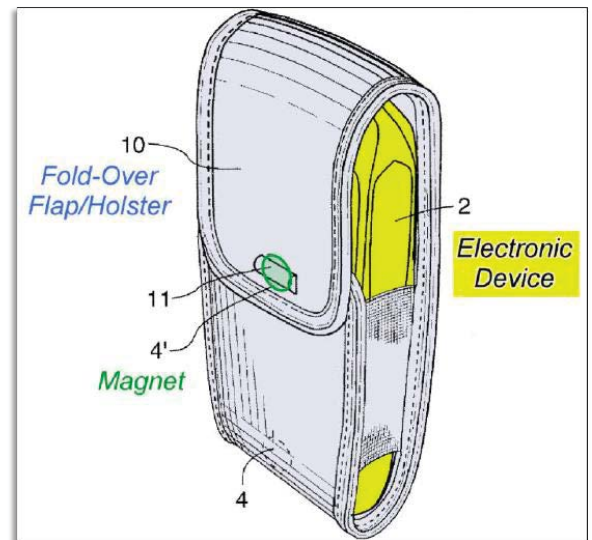

473 APPLE-1005 (Gundlach), Figure 1

The Combination of Mak-Fan With Gundlach-Lee

Dr. Cooperstock's First Declaration

127. A POSITA contemplating the Gundlach-Lee system, and specifically the clamshell case, would have been motivated to integrate Mak-Fan's above-discussed teaching of a magnet closure element. The POSITA's exploration of the prior art for design options relevant to the subject of Gundlach's clamshell case would have led to references like Mak-Fan that are directed to cases for "portable handheld electronic devices." (Mak-Fan, [0001].) In considering Mak-Fan (and

473 APPLE-1003, ¶¶131-134; 472 APPLE-1003, ¶¶130-133; 471 APPLE-1003, ¶¶127-130

Gundlach-Lee + Mak-Fan

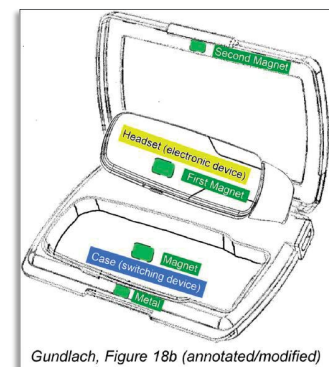
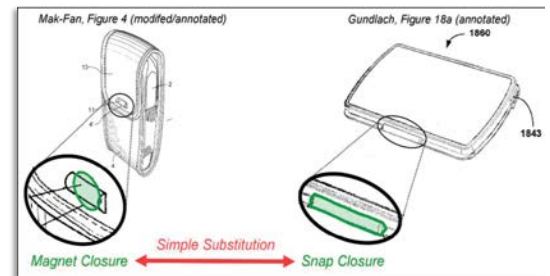

Gundlach, Figure 18b (annotated/modified)

Mak-Fan's Magnetic Closure Is Applicable to Gundlach's Case

Dr. Cooperstock's First Declaration

handheld electronic devices.” (Mak-Fan, [0001].) In considering Mak-Fan (and other references), the POSITA would have appreciated, as demonstrated below, that cases for various types of portable electronic devices were ubiquitous by the time of the Critical Date in 2011. (E.g., APPLE-1040/1041 (a fold-over case for a wireless headset); APPLE-1009 (a clamshell case for a mobile phone); APPLE-1052 (a clamshell case for a headset); APPLE-1053 (a clamshell case for a laptop); APPLE-1056 (a sleeve with magnetic closure for a laptop).)

473 APPLE-1003, ¶131; 472 APPLE-1003, ¶130; 471 APPLE-1003, ¶127

132. The POSITA also would have appreciated that general-purpose components used in one type of case design could be used interchangeably with another. The POSITA therefore would have understood that certain features of Mak-Fan's holster-style case would be equally applicable to the clamshell case described by Gundlach. The magnet closure element would have been readily apparent as one such feature, as its functionality is not uniquely associated with Mak-Fan's holster design. Not only would a POSITA have known that Mak-Fan's

473 APPLE-1003, ¶132; 472 APPLE-1003, ¶131; 471 APPLE-1003, ¶128

Corroborating Evidence

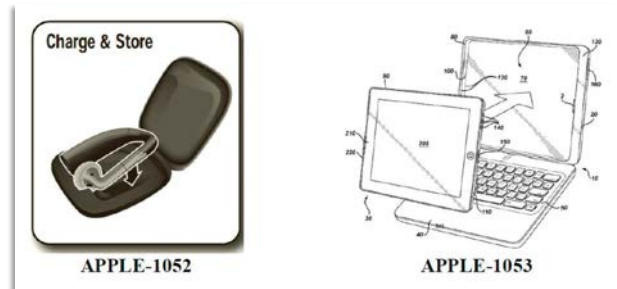
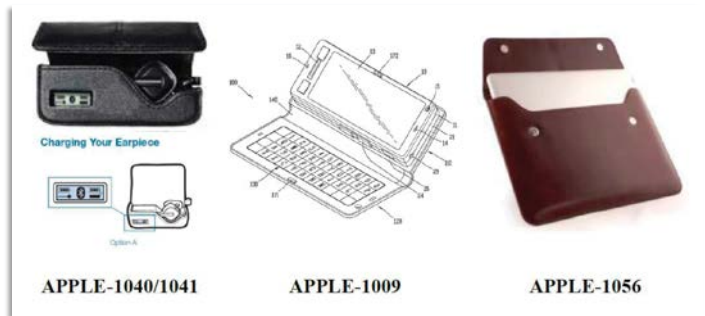

473 Pet., 59-61; 472 Pet., 59-61; 471 Pet., 61-63.

The Combination Involves Simple Substitution of Known Elements

Dr. Cooperstock's First Declaration

133. First, a POSITA would have appreciated that replacing what are depicted as snap elements in Gundlach's Figures 18a-18b with Mak-Fan's magnet was nothing more than the simple substitution of one known closure element for another to achieve an exceedingly predictable result. From a POSITA's perspective, although the components of Gundlach-Lee would change, the functionality would remain the same—i.e., the clamshell case would be held in the closed position by the snap or magnet closure until the user manually separated the lids.

473 APPLE-1003, ¶133; 472 APPLE-1003, ¶132; 471 APPLE-1003, ¶129

Gundlach-Lee + Mak-Fan

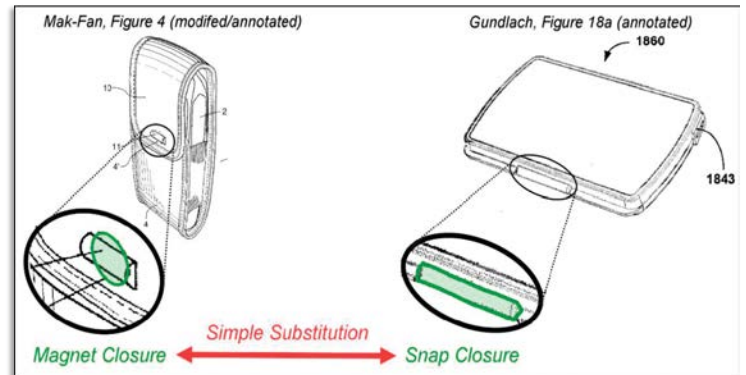

Mak-Fan's Magnetic Closure Has Unique Benefits

Dr. Cooperstock's First Declaration

134. Second, a POSITA would have understood that Mak-Fan's magnetic closure has certain unique benefits as compared to Gundlach's snap closure. For example, the POSITA would have known that magnetic closures can be easier for users to operate than snap closures (e.g., a lesser closure force) and also less susceptible to fatigue failure modes. (E.g., APPLE-1054, pp.1-2 (noting that magnetic closures provide an answer to design incentives for "easy-to-open devices, and strong repeat closure technologies".)) Third, a POSITA would have

473 APPLE-1003, ¶134; 472 APPLE-1003, ¶133; 471 APPLE-1003, ¶130

Corroborating Evidence (APPLE-1054)



To cut through the clutter on retail shelves, designers, manufacturers and retailers are competing to develop innovative packaging that enhance the consumer's product experience. Magnetic closures provide unique solutions for creative ingenuity. Winning designs of the 2008 Flexible Packaging Association's Packaging Achievement Awards demonstrate a trend toward value-added features such as easy-to-open devices, and strong repeat closure technologies. Responding to this opportunity, Adams' magnetic closures are available as two-piece magnetic assemblies that are suitable for a variety of surfaces.

Mak-Fan's Magnetic Closure Has Unique Benefits

Dr. Cooperstock's First Declaration

devices, and strong repeat closure technologies”).) Third, a POSITA would have considered Mak-Fan's magnetic closure to be an obvious variant of Gundlach's snap closure that would have been considered as part of a routine product design process. Magnetic closures were among a limited number of conventional solutions for retaining a clamshell case in the folded/closed state. (See APPLE-1055, Abstract, Figure 1 (disclosing a magnetic closure for a clamshell case nearly 40 years before the Critical Date in 2011).) And, while a POSITA would have appreciated the design tradeoffs between different closures, their interchangeability would have been equally apparent.

473 APPLE-1003, ¶134; 472 APPLE-1003, ¶133; 471 APPLE-1003, ¶130

Corroborating Evidence (APPLE-1055)

[57]

ABSTRACT

A magnetic closure for keycases, pocketbooks, wallets, and other containers which provides a positive opening as well as a closing by means of magnets with respective North and South poles so positioned as to bring opposite poles into proximity for positive closing and like poles into proximity for opening. One panel of the keycase or other container is provided with the sliding magnet and another panel of the keycase has the fixed magnet whereby manually sliding one with respect to the other causes the magnets to assume the position of similar or dissimilar polarity.

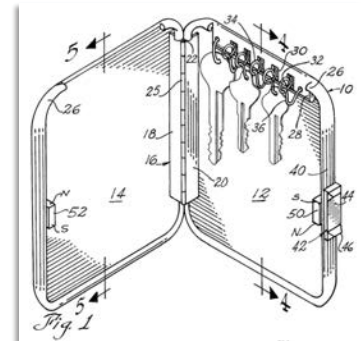

81

Patent Owner Left Multiple Motivation Rationales Unaddressed

Patent Owner's Response

Contrary to Apple's assertion, a POSITA contemplating the alleged Gundlach-Lee combination comprising a clamshell case would not have been motivated to integrate Mak-Fan's above-discussed magnet closure element. Ex. 2022, 230. A POSITA would readily understand, including based upon size limitations inherent in the lip of the clamshell case, that Mac-Fan's magnetic closure would be significantly less secure than Gundlach's mechanical snap fastener:

473 POR, 62; 472 POR, 62; 471 POR, 65.

Apple acknowledges that a magnetic fastener would have a "lesser closure force." Pet, 61. A POSITA would have no motivation to replace a secure mechanical fastener for Gundlach's case with a less secure magnetic one. Ex. 2022, 231. Such a

473 POR, 63; 472 POR, 62; 471 POR, 62.

Reply

The Petition presents three independent rationales to support the proposition that a POSITA would have been motivated to incorporate Mak-Fan's teachings with the Gundlach-Lee combination:

- [1] simple substitution of one known element (Mak-Fan's magnetic closure) for another (Gundlach's snap closure) with predictable results;
- [2] the unique benefits of Mak-Fan's magnetic closure compared to Gundlach's snap closure; and
- [3] consideration of predictable variations on Gundlach's snap closure as part of a routine design process.

Pet., 59-61 (citing APPLE-1003, ¶¶131-134).

Arguing from the premise that "Ma[k]-Fan's magnetic closure would be significantly less secure than Gundlach's mechanical snap fastener," Patent Owner focuses its attack on the Petition's second rationale, leaving the first and third unaddressed. POR, 62. For these reasons alone, the Board should uphold the Petition's combination of Mak-Fan with Gundlach-Lee.

473 Reply, 16; 472 Reply, 16; 471 Reply, 16.

82

Mak-Fan's Lesser Closure Force Provides Predictable Advantages

Patent Owner's Response

Contrary to Apple's assertion, a POSITA contemplating the alleged Gundlach-Lee combination comprising a clamshell case would not have been motivated to integrate Mak-Fan's above-discussed magnet closure element. Ex. 2022, 230. A POSITA would readily understand, including based upon size limitations inherent in the lip of the clamshell case, that Mac-Fan's magnetic closure would be significantly less secure than Gundlach's mechanical snap fastener:

473 POR, 62; 472 POR, 62; 471 POR, 65.

Apple acknowledges that a magnetic fastener would have a "lesser closure force." Pet, 61. A POSITA would have no motivation to replace a secure mechanical fastener for Gundlach's case with a less secure magnetic one. Ex. 2022, 231. Such a

473 POR, 63; 472 POR, 62; 471 POR, 62.

Reply

As to the Petition's second rationale, the parties agree that a magnetic closure provides a lesser closure force as compared to a snap closure. And the Petition explained why this is advantageous: "magnetic closures can be easier for users to operate than snap closures (e.g., a lesser closure force)." Pet., 61 (citing APPLE-1003, ¶134; APPLE-1054); see also APPLE-1009, [0044], Figure 1 (an electronic device case secured by magnets); APPLE-1056, 2 (same). Rather than challenging

473 Reply, 16-17; 472 Reply, 16-17; 471 Reply, 16-17.

Issue 6

Gundlach-Lee-Mak-Fan Renders Obvious
“the lid has a second magnet disposed within it”

The Addition of Mak-Fan to Gundlach-Lee Provides a Magnet in the Lid

Dr. Cooperstock's First Declaration

135. The Gundlach-Lee-Mak-Fan combination satisfies Element [4]. As I've explained (*see* § XII.B), a POSITA would have been motivated to integrate Mak-Fan's teachings with Gundlach-Lee to produce a clamshell case with a (second) magnet installed on one of the protective lids and a piece of metal in the other lid (*see* analysis at Elements [1j] and [1k]). A visual aid depicting this arrangement is provided below. The designations of "first" and "second" as to the magnets in the visual aid below are provided for consistency with the claim language (e.g., the "first magnet" was introduced at Element [1e]) and the "second magnet" here at Element [4]).

473 APPLE-1003, ¶135; 472 APPLE-1003, ¶134; 471 APPLE-1003, ¶131

'320 Patent (Representative Language)

4. The system of claim 1 wherein the lid has a second magnet disposed within it.

473 APPLE-1001 ('320 Patent), 22:24-25; 472 APPLE-1001 ('077 Patent), 22:24-25; 471 APPLE-1001 ('021 Patent), 22:22-23.

Gundlach + Lee + Mak-Fan

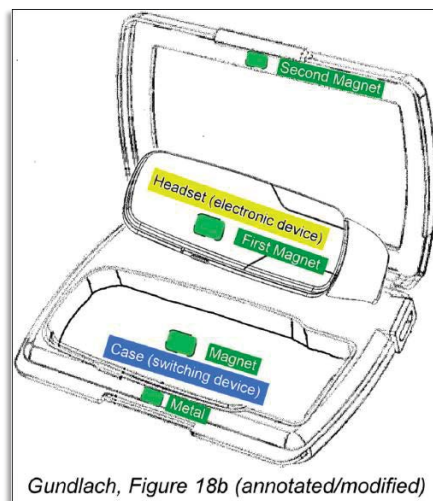

Gundlach, Figure 18b (annotated/modified)

The Petition Did Not Misinterpret Mak-Fan

Patent Owner's Response

Moreover, even if the teachings of Mak-Fan were applied to the alleged Gundlach-Lee combination, Apple's analysis, Pet., 62-63, is premised upon his mistaken belief that Mak-Fan discloses a magnet in its lid flap. To the contrary, as depicted above, Mak-Fan discloses a magnet 4 in the main body of its case and metal element 11 in the flap or lid. Ex. 1010, [0014], [0019], Fig. 1; Fig. 4; Ex. 2022, 236.

473 POR, 65; 472 POR, 64; 471 POR, 68.

Reply

a magnet in its lid flap." POR, 65. Not so. The Petition correctly interpreted Mak-Fan as describing an embodiment where "[t]he fold-over flap includes a metal element engaging a magnet to hold the holster closed." Pet., 58 (citing APPLE-1010, [0014], [0019]). The Petition then reasoned that a POSITA would have applied this teaching of Mak-Fan's to modify the Gundlach-Lee clamshell case by installing a magnet on one of the lids and a piece of metal on the other lid. Pet., 62.

This further step in the analysis stands rebutted.

473 Reply, 26; 472 Reply, 26; 471 Reply, 26.

Petition

Mak-Fan's disclosure includes an embodiment (Figure 4, below) featuring a portable electronic device held in a holster with a fold-over flap. (APPLE-1010, [0014], [0019]; APPLE-1003, ¶130.) The fold-over flap includes a metal element engaging a magnet to hold the holster closed. (*Id.*) The electronic device includes a Hall effect sensor (not shown), and "[t]he device is programmed so that when the Hall effect sensor detects the magnet, the device is disabled." (*Id.*, [0014], Figure

473 Pet., 58-59; 472 Pet., 58-59; 471 Pet., 60.

86

Issue 7

Gundlach-Lee-Mak-Fan Renders Obvious
“the second or a third magnet is employed in
the lid to actuate the electronic circuit”

Mak-Fan's Hall Effect Sensor Actuates the Gundlach-Lee Switch

Dr. Cooperstock's First Declaration

140. In my previous analysis at Element [1h], I noted Lee's teaching that the wireless headset includes a "switch" that automatically closes to *actuate* the battery *circuit* when positioned "near" the clamshell case. (Lee, 5:30-40.) While Lee does not disclose the implementation details of the switch, a POSITA would have viewed the Hall effect sensor described by Mak-Fan as a suitable solution. (See APPLE-1057, pp.2-4 (explaining that Hall effect sensors were a common solution for presence sensing applications in mobile devices).) Recognizing that the (*second*) magnet embedded in the lid could be detected to *actuate* the battery *circuit* and initiate charging would have been well within the skill level of a POSITA. And the POSITA would have been motivated to employ a Hall effect sensor for this purpose based on (i) Mak-Fan's disclosure of detecting magnets to determine when a device is holstered; and (ii) the known benefits of Hall effect sensors (e.g., high reliability and durability). (See APPLE-1057, pp.2-4 (explaining that Hall effect sensors are a reliable, long-life, and low-cost solution).)

473 APPLE-1003, ¶140; 472 APPLE-1003, ¶139; 471 APPLE-1003, ¶136

'320 Patent (Representative Language)

10. The system of claim 4 wherein the second or a third magnet is employed in the lid to actuate the electronic circuit.

473 APPLE-1001 ('320 Patent), 22:40-42; 472 APPLE-1001 ('077 Patent), 22:40-42; 471 APPLE-1001 ('021 Patent), 22:44-46.

Mak-Fan (APPLE-1010)

[0014] FIG. 1 shows a holster 1 for an electronic device 2, according to one aspect of the invention. The device has a Hall effect sensor 3 embodied therein and the holster has a first magnet 4 positioned to align with the sensor when the device is fully holstered. The device is programmed so that when the Hall effect sensor detects the magnet, the device is disabled, or at least certain elements thereof are disabled, for example the keyboard 5 and display 6, and other elements as applicable, for example a trackball (not shown).

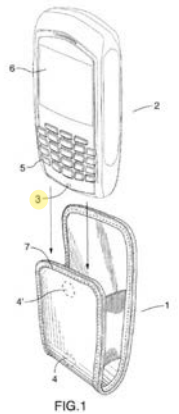

Integrating Mak-Fan's Hall Effect Sensor Is Consistent With Gundlach-Lee

Patent Owner's Response

A POSITA would further appreciate that a significant part of Apple's theory for the alleged Gundlach-Lee combined clamshell case being a switching device of element [1a] is the automatic opening of switch 470 when the earpiece is in proximity to a wireless charging coil, and the automatic closing of switch 470 when the earpiece is in not in proximity to a wireless charging coil. Ex. 2022, 254. Apple's proposed Gundlach-Lee-Mak-Fan Combination for dependent claims 4, 5, 10, 12, and 13 is thus apparently opposed to the proposed Gundlach-Lee combination with respect to these at least the switching device element of independent claim 1. Ex. 2022, 254.

473 POR, 70; 472 POR, 69-70; 471 POR, 73.

Reply

Though Patent Owner argues otherwise (POR, 69-70), there is no dissonance between the combination with Mak-Fan and Lee's teaching that "the switch 470 can sense when the headphone/headset apparatus 460 is near the power adapter [i.e., case], so that it automatically closes to the charge position when near the power adapter." APPLE-1006, 5:30-34. To the contrary, Mak-Fan teaches the use of a Hall effect sensor as a known solution to Lee's suggestion of sensing proximity. Pet., 64 (citing APPLE-1003, ¶140 (citing APPLE-1057)). The combination with Mak-Fan does not change Lee's functionality, but rather enables it.

Patent Owner's remaining arguments are also flawed for reasons discussed above. Design tradeoffs in "charging criteria" between conductive and inductive charging are not sufficient to preclude a finding of obviousness (*see* Section II.A.2.a and II.A.3.a), and the Gundlach-Lee-Mak-Fan combination is not limited to a design that fits within the expansion slot of a laptop (*see* Section II.A.3.c).

473 Reply, 27; 472 Reply, 27; 471 Reply, 27-28.

89