



US006809765B1

(12) **United States Patent**
Tao

(10) **Patent No.:** **US 6,809,765 B1**
(45) **Date of Patent:** **Oct. 26, 2004**

(54) **DEMOSAICING FOR DIGITAL IMAGING DEVICE USING PERCEPTUALLY UNIFORM COLOR SPACE**

5,778,106 A *	7/1998	Juenger et al.	382/275
6,249,797 B1 *	6/2001	Kovacevic et al.	708/300
6,295,087 B1 *	9/2001	Nohda	348/273
6,392,699 B1 *	5/2002	Acharya	348/273
6,404,918 B1 *	6/2002	Hel-or et al.	382/167

(75) Inventor: **Bo Tao**, Sunnyvale, CA (US)

(73) Assignees: **Sony Corporation**, Tokyo (JP); **Sony Electronics Inc**, Park Ridge, NJ (US)

(*) Notice: Subject to any disclaimer, the term of this patent is extended or adjusted under 35 U.S.C. 154(b) by 0 days.

(21) Appl. No.: **09/412,187**

(22) Filed: **Oct. 5, 1999**

(51) **Int. Cl.**⁷ **H04N 5/335**; H04N 1/46; G06K 9/36; G06K 9/32; G03F 3/08

(52) **U.S. Cl.** **348/273**; 382/276; 382/300; 358/515; 358/518; 358/525

(58) **Field of Search** 348/273, 277, 348/278, 280, 222.1; 382/275, 276, 277, 300; 358/515, 518, 525

(56) **References Cited**

U.S. PATENT DOCUMENTS

4,743,960 A *	5/1988	Duvic et al.	348/660
5,053,861 A *	10/1991	Tsai et al.	375/240.01
5,172,227 A *	12/1992	Tsai et al.	375/240.2
5,185,661 A *	2/1993	Ng	358/505
5,528,292 A *	6/1996	Ikeda	348/273
5,596,367 A *	1/1997	Hamilton et al.	348/272

OTHER PUBLICATIONS

Ron Kimmel, Sep. 1999, IEEE, vol. 8, No. 9, pp. 1221-1228.*

Ping Wah Pong et al., 1997, IEEE, 1063-6390/97, pp. 280-285.*

* cited by examiner

Primary Examiner—Andrew Christensen

Assistant Examiner—Nhan Tran

(74) *Attorney, Agent, or Firm*—Valley Oak Law

(57) **ABSTRACT**

A digital camera is provided having a lens for focusing light from an image through a RGB mosaiced filter on to a solid state photosensor array containing a matrix of CCDs. The CCDs provide a single-channel mosaiced image output. A demosaicing process includes a first color transformation after separation for determining luminance and a luminance interpolation for interpolation of missing luminance components. The demosaicing process further includes a second color transformation for obtaining chrominance components. A chrominance interpolation for interpolation of missing chrominance components and an inverse color transformation transforms the components into the RGB space for combination into an image output.

24 Claims, 6 Drawing Sheets

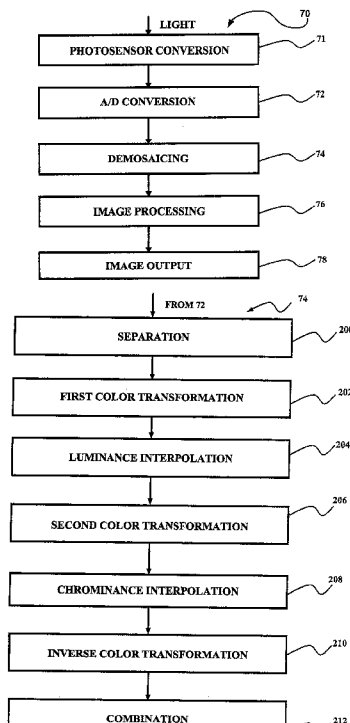

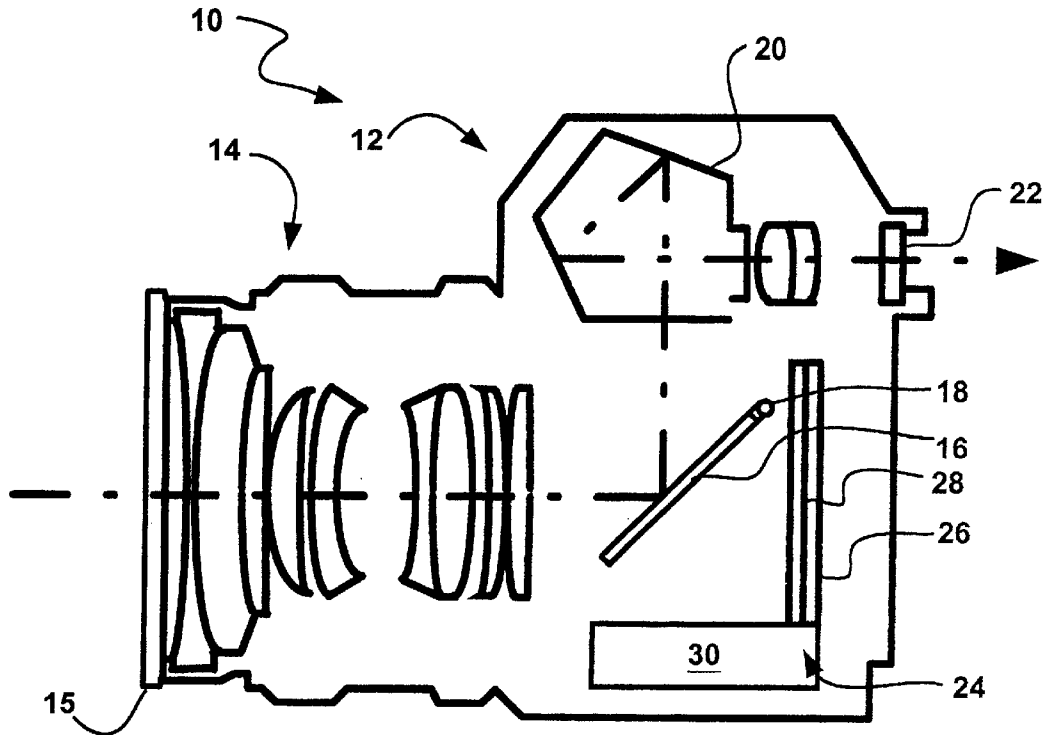

FIG. 1

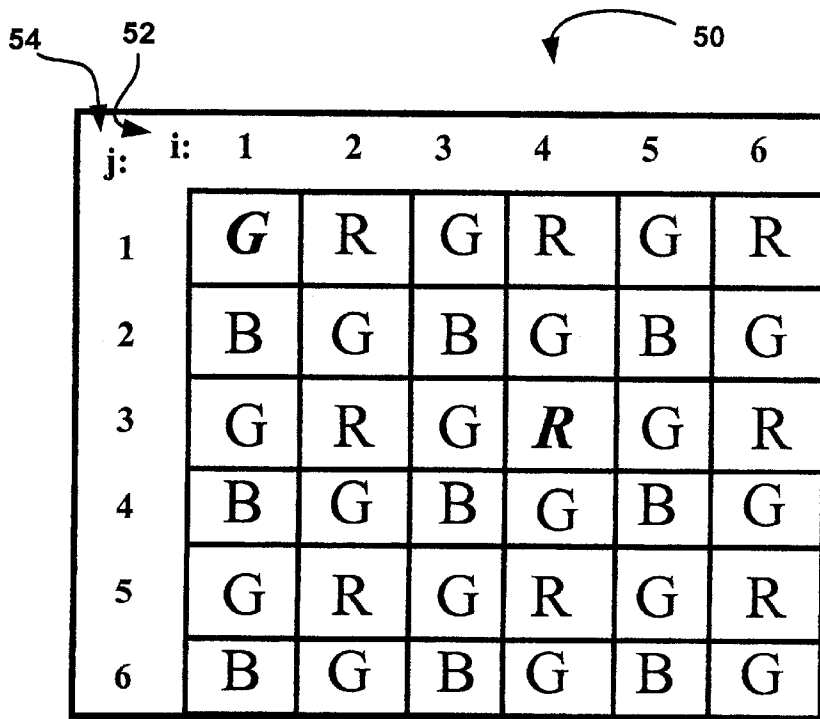

FIG. 2 (PRIOR ART)

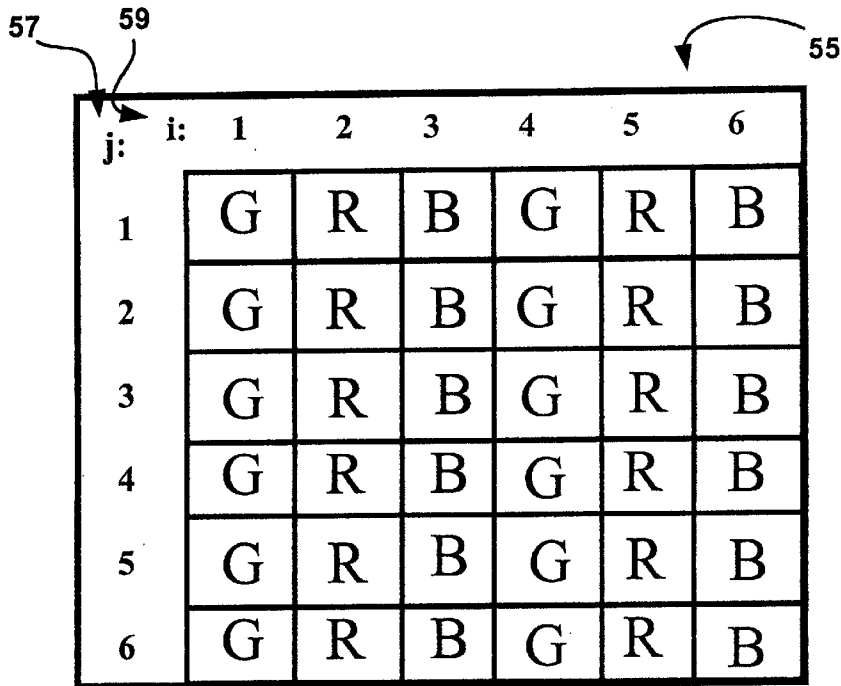

FIG. 3 (PRIOR ART)

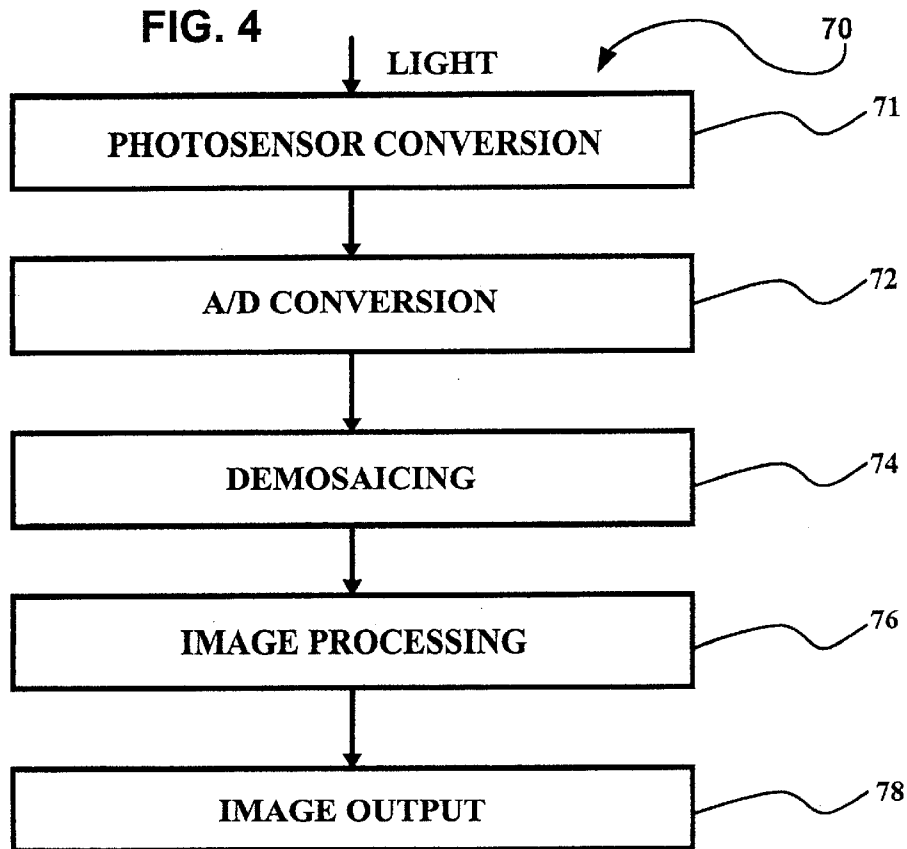

FIG. 4

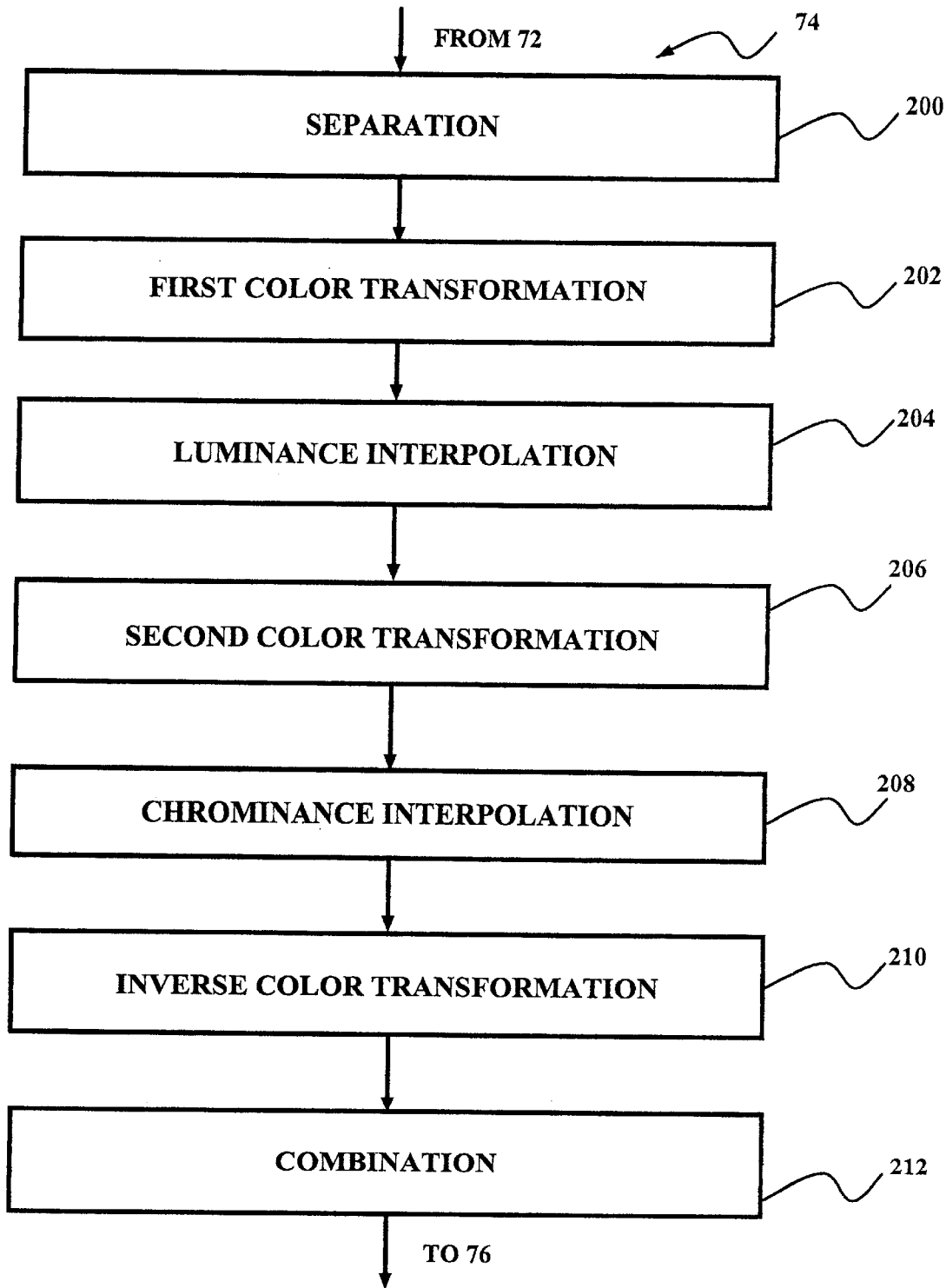

FIG. 5

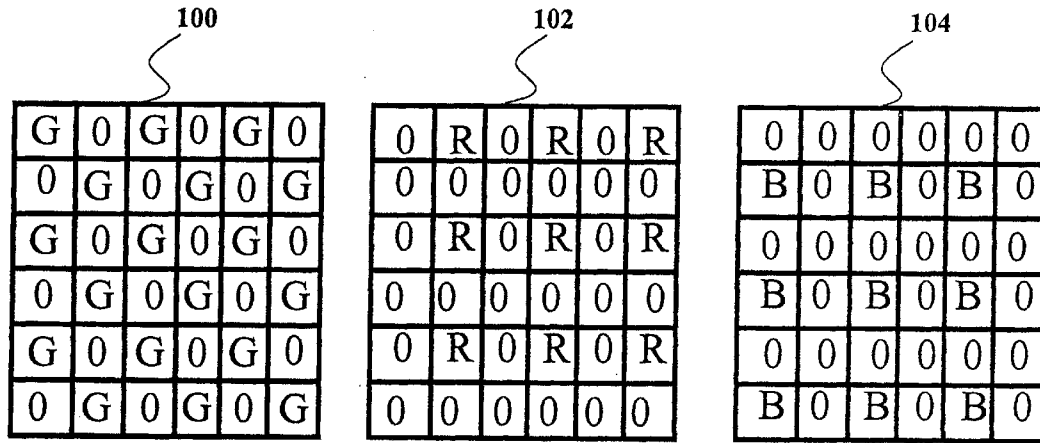

FIG. 6

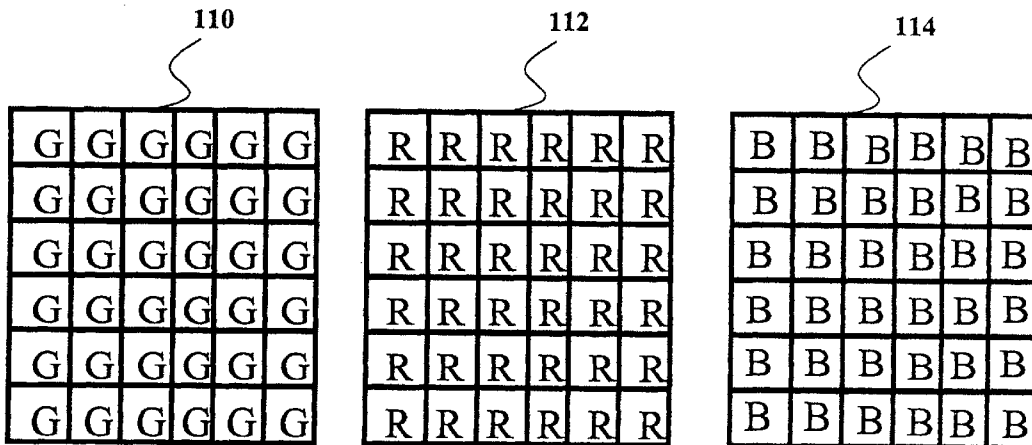

FIG. 7

Explore Litigation Insights

Docket Alarm provides insights to develop a more informed litigation strategy and the peace of mind of knowing you're on top of things.

Real-Time Litigation Alerts



Keep your litigation team up-to-date with **real-time alerts** and advanced team management tools built for the enterprise, all while greatly reducing PACER spend.

Our comprehensive service means we can handle Federal, State, and Administrative courts across the country.

Advanced Docket Research



With over 230 million records, Docket Alarm's cloud-native docket research platform finds what other services can't. Coverage includes Federal, State, plus PTAB, TTAB, ITC and NLRB decisions, all in one place.

Identify arguments that have been successful in the past with full text, pinpoint searching. Link to case law cited within any court document via Fastcase.

Analytics At Your Fingertips



Learn what happened the last time a particular judge, opposing counsel or company faced cases similar to yours.

Advanced out-of-the-box PTAB and TTAB analytics are always at your fingertips.

API

Docket Alarm offers a powerful API (application programming interface) to developers that want to integrate case filings into their apps.

LAW FIRMS

Build custom dashboards for your attorneys and clients with live data direct from the court.

Automate many repetitive legal tasks like conflict checks, document management, and marketing.

FINANCIAL INSTITUTIONS

Litigation and bankruptcy checks for companies and debtors.

E-DISCOVERY AND LEGAL VENDORS

Sync your system to PACER to automate legal marketing.