



US 20060002466A1

(19) **United States**

(12) **Patent Application Publication**
Park

(10) **Pub. No.: US 2006/0002466 A1**

(43) **Pub. Date: Jan. 5, 2006**

(54) **PREDICTION ENCODER/DECODER AND PREDICTION ENCODING/DECODING METHOD**

(75) Inventor: **Gwang-hoon Park, Seongnam-si (KR)**

Correspondence Address:
STAAS & HALSEY LLP
SUITE 700
1201 NEW YORK AVENUE, N.W.
WASHINGTON, DC 20005 (US)

(73) Assignees: **Samsung Electronics Co., LTD., Suwon-si (KR); Industry Academic Cooperation Foundation Kyunghee University, Youngin-Si (KR)**

(21) Appl. No.: **11/141,263**

(22) Filed: **Jun. 1, 2005**

(30) **Foreign Application Priority Data**

Jun. 1, 2004 (KR) 2004-0039807

Publication Classification

(51) **Int. Cl.**
H04B 1/66 (2006.01)
H04N 11/02 (2006.01)
H04N 11/04 (2006.01)
H04N 7/12 (2006.01)
(52) **U.S. Cl. 375/240.03; 375/240.12; 375/240.24; 375/240.2; 375/240.23**

(57) **ABSTRACT**

A prediction encoder/decoder and a prediction encoding/decoding method. The prediction encoder includes a prediction encoding unit starting prediction from a origin macroblock of an area of interest of a video frame, continuing prediction in a direction of ripple scanning with respect to a square ring that includes macroblocks and surrounds the origin macroblock, and encoding video by performing intra-prediction in 8x8 block units using information about a macroblock that has been just coded in a square ring including a macroblock to be coded and at least one of macroblocks that are adjacent to the macroblock to be coded in a square ring that has been just coded.

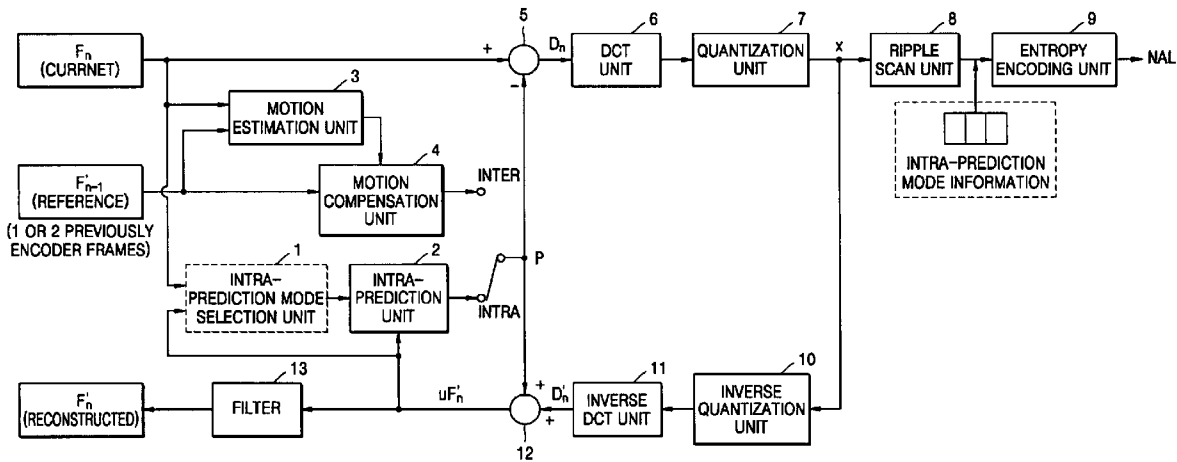

FIG. 1 (PRIOR ART)

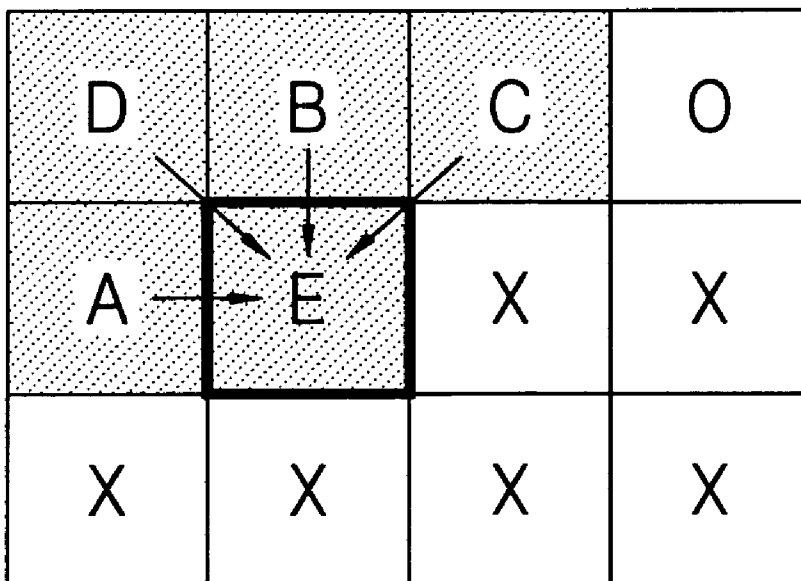

FIG. 2 (PRIOR ART)

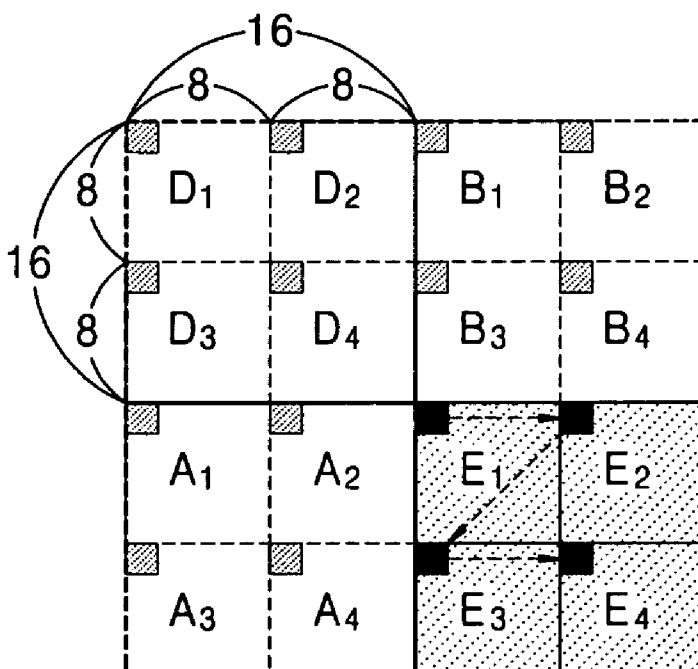

FIG. 3A (PRIOR ART)

FIG. 3B (PRIOR ART)

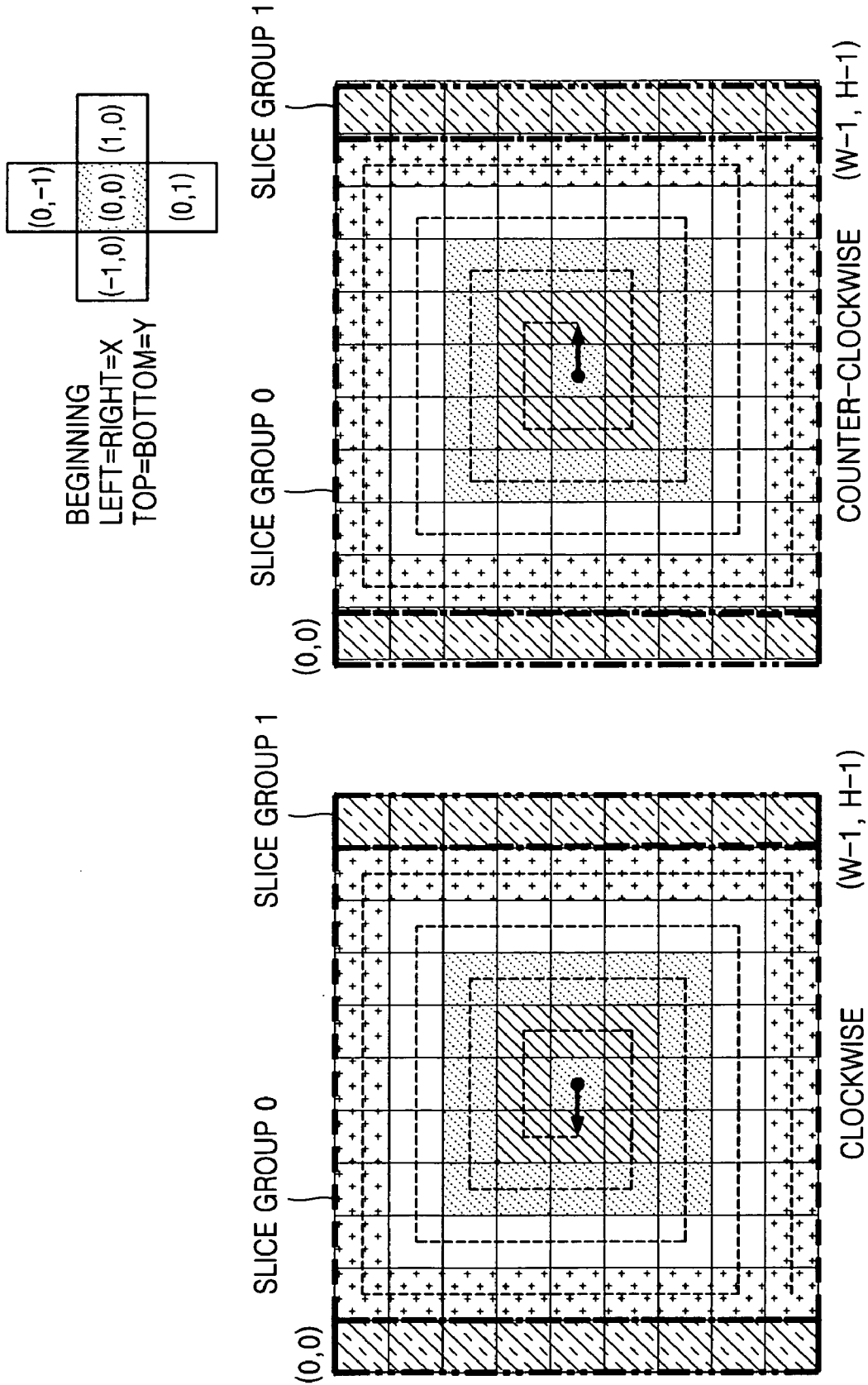

FIG. 4

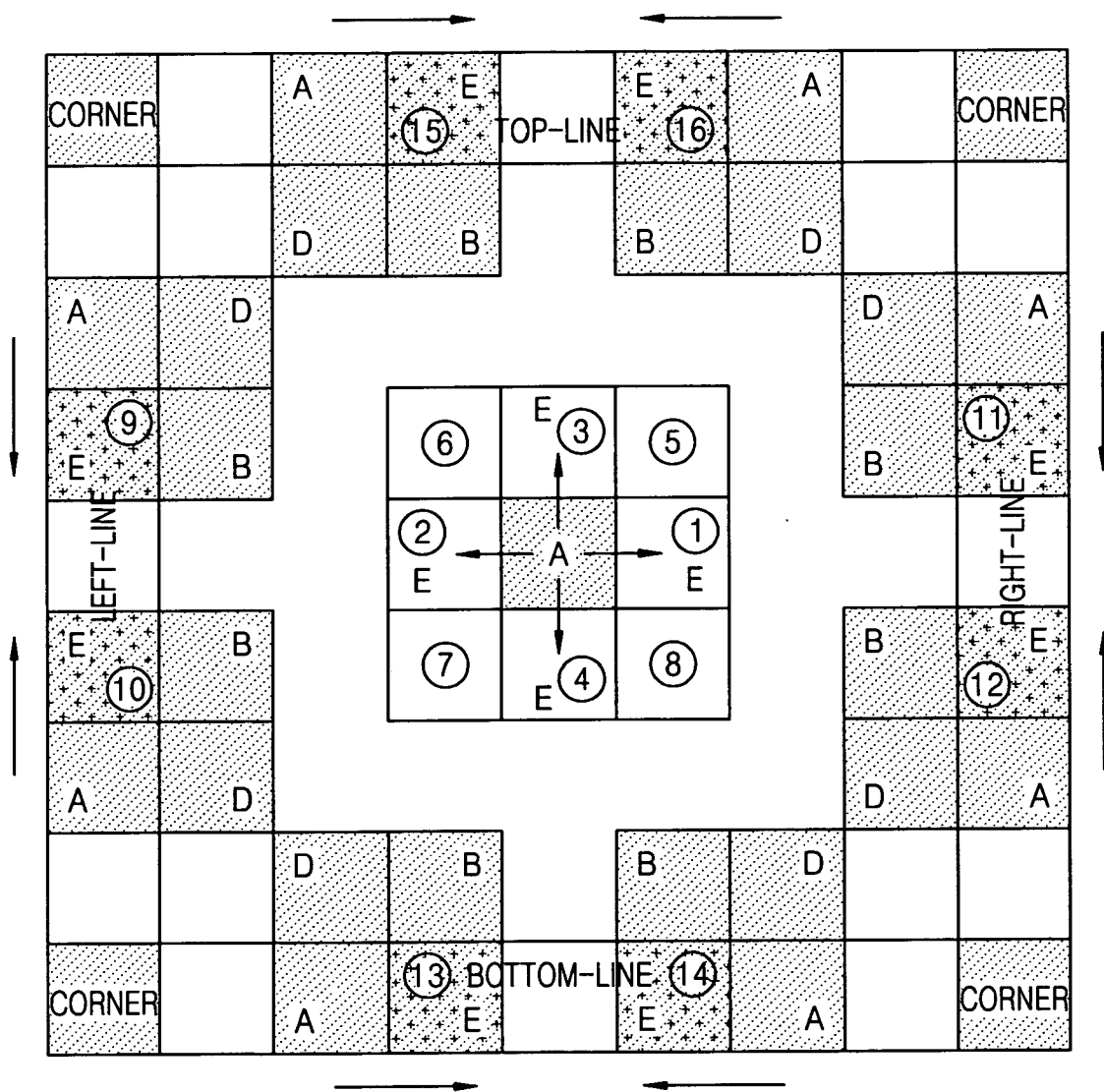

FIG. 5A

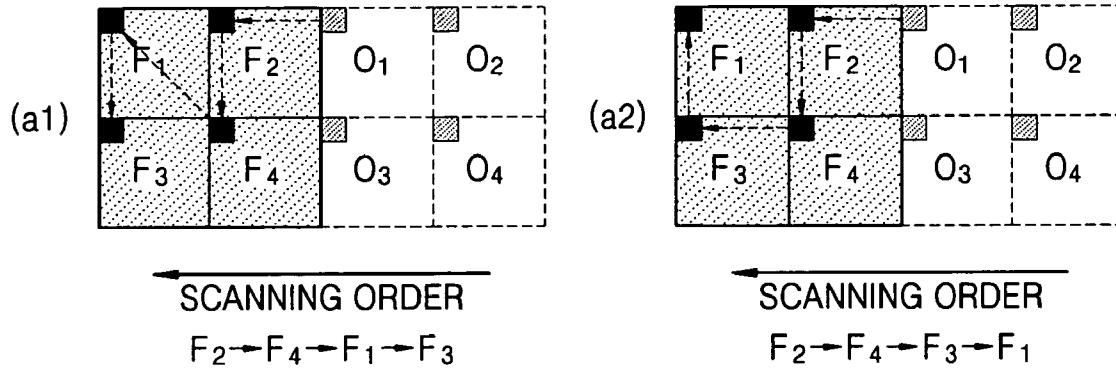
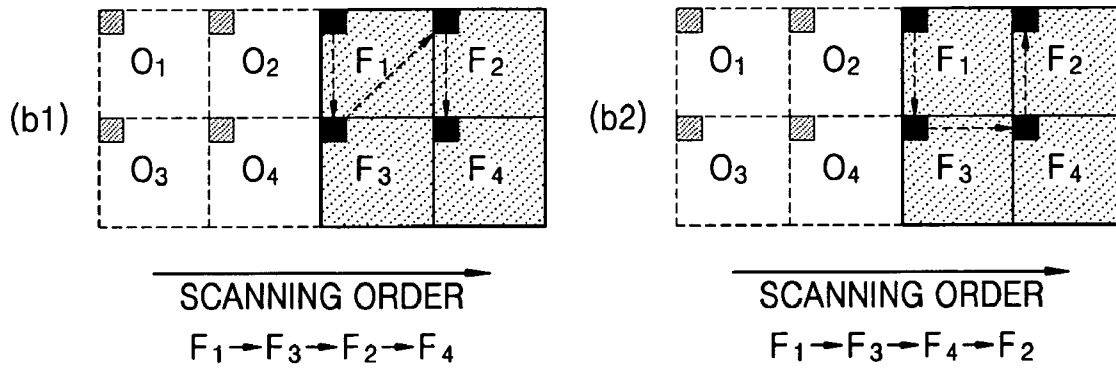

FIG. 5B



Explore Litigation Insights

Docket Alarm provides insights to develop a more informed litigation strategy and the peace of mind of knowing you're on top of things.

Real-Time Litigation Alerts



Keep your litigation team up-to-date with **real-time alerts** and advanced team management tools built for the enterprise, all while greatly reducing PACER spend.

Our comprehensive service means we can handle Federal, State, and Administrative courts across the country.

Advanced Docket Research



With over 230 million records, Docket Alarm's cloud-native docket research platform finds what other services can't. Coverage includes Federal, State, plus PTAB, TTAB, ITC and NLRB decisions, all in one place.

Identify arguments that have been successful in the past with full text, pinpoint searching. Link to case law cited within any court document via Fastcase.

Analytics At Your Fingertips



Learn what happened the last time a particular judge, opposing counsel or company faced cases similar to yours.

Advanced out-of-the-box PTAB and TTAB analytics are always at your fingertips.

API

Docket Alarm offers a powerful API (application programming interface) to developers that want to integrate case filings into their apps.

LAW FIRMS

Build custom dashboards for your attorneys and clients with live data direct from the court.

Automate many repetitive legal tasks like conflict checks, document management, and marketing.

FINANCIAL INSTITUTIONS

Litigation and bankruptcy checks for companies and debtors.

E-DISCOVERY AND LEGAL VENDORS

Sync your system to PACER to automate legal marketing.