



US 20110211297A1

(19) **United States**

(12) **Patent Application Publication**
Griffin et al.

(10) **Pub. No.: US 2011/0211297 A1**

(43) **Pub. Date: Sep. 1, 2011**

(54) **MOBILE COMMUNICATION DEVICE WITH
DISPLACEABLE LID MEMBER**

Publication Classification

(75) Inventors: **Jason Tyler Griffin**, Waterloo (CA); **Julia Allwright**, London (GB); **Benjamin Henley**, London (GB); **Martin Riddiford**, London (GB)

(51) **Int. Cl.**
H05K 7/00 (2006.01)
B23P 11/00 (2006.01)
(52) **U.S. Cl.** **361/679.01; 29/428**

(73) Assignee: **RESEARCH IN MOTION LIMITED**, Waterloo (CA)

(57) **ABSTRACT**

(21) Appl. No.: **12/713,510**

A mobile communication device, a corresponding connecting mechanism and method are provided. The device comprises a connecting mechanism which rotatably couples a lid member and a base member at a linked end of the device. The connecting mechanism also translationally couples the lid and the base member. When the device is in the closed position, displacing the lid member of the device in the direction of the free end of the device may initiate movement of the device to the opened position.

(22) Filed: **Feb. 26, 2010**

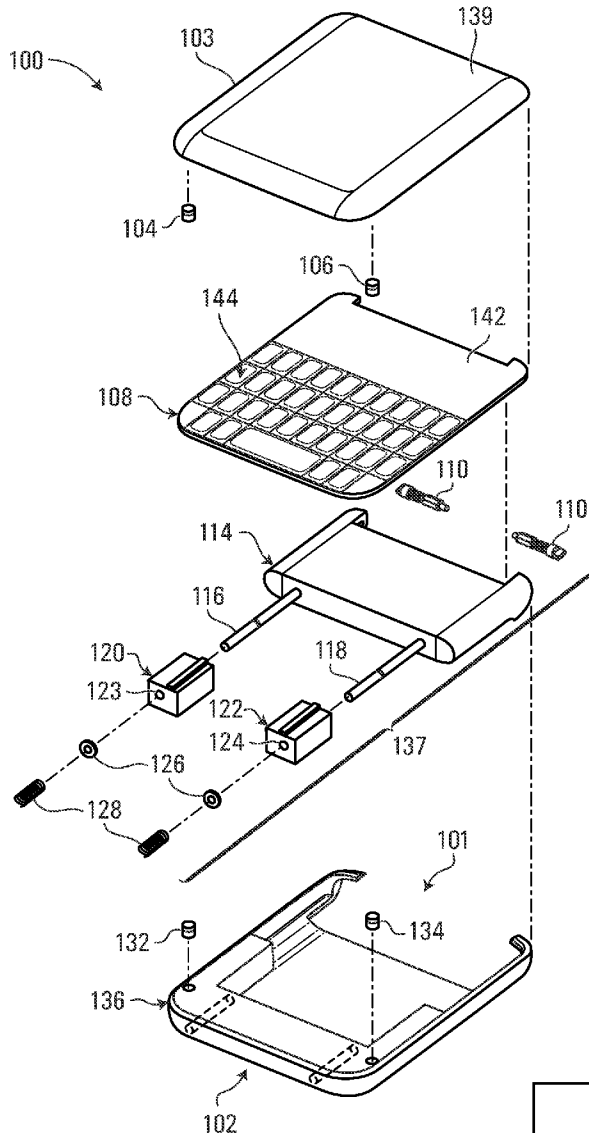

Samsung v. GUI
IPR2021-00338
Exhibit 1021

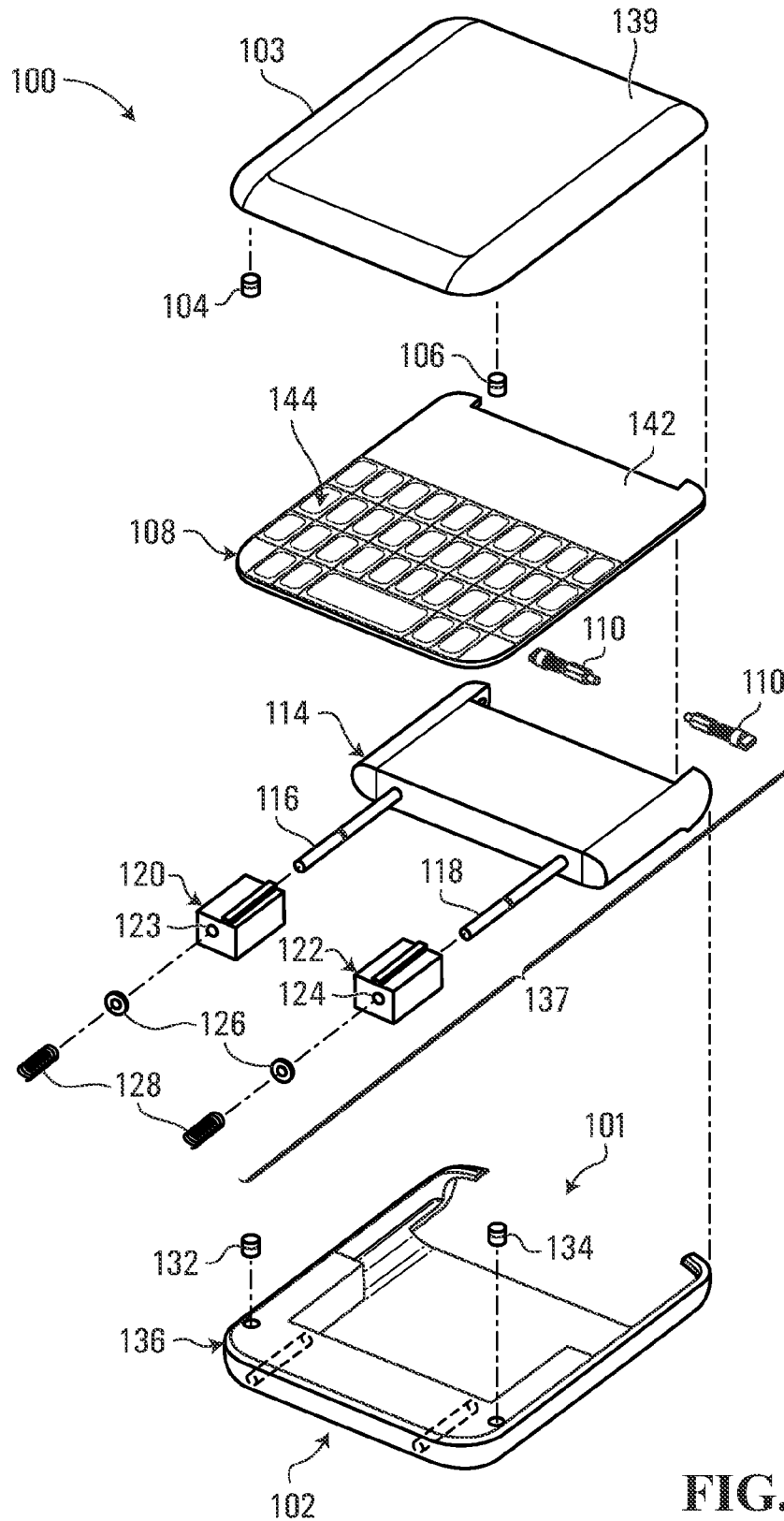

FIG. 1

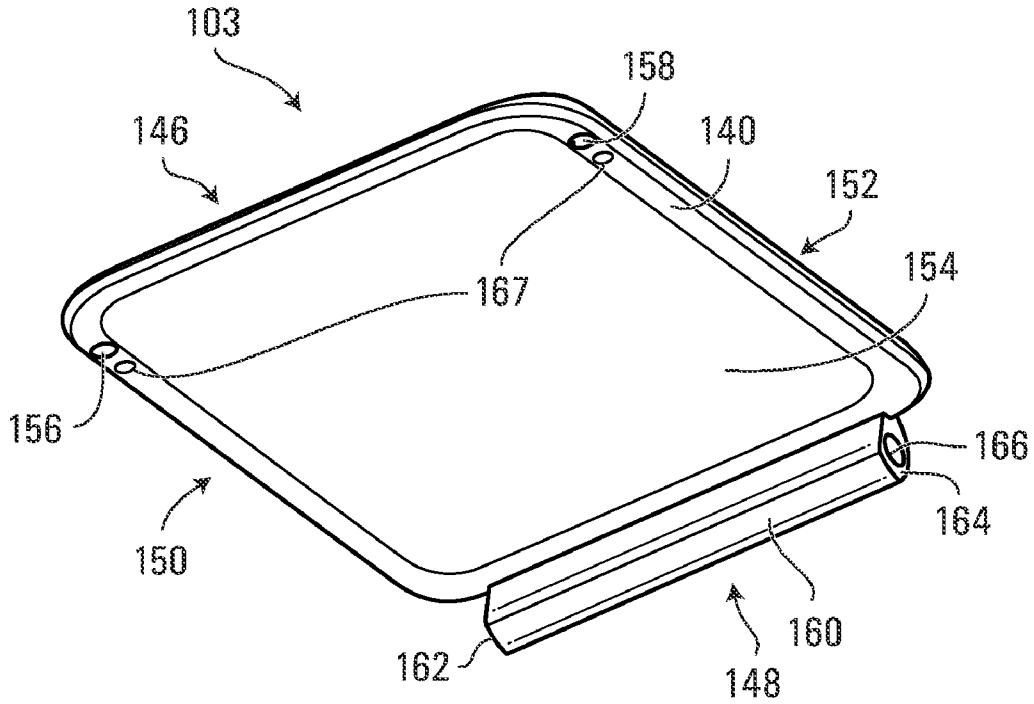

FIG. 2

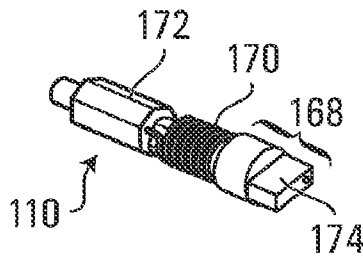

FIG. 3

FIG. 4A

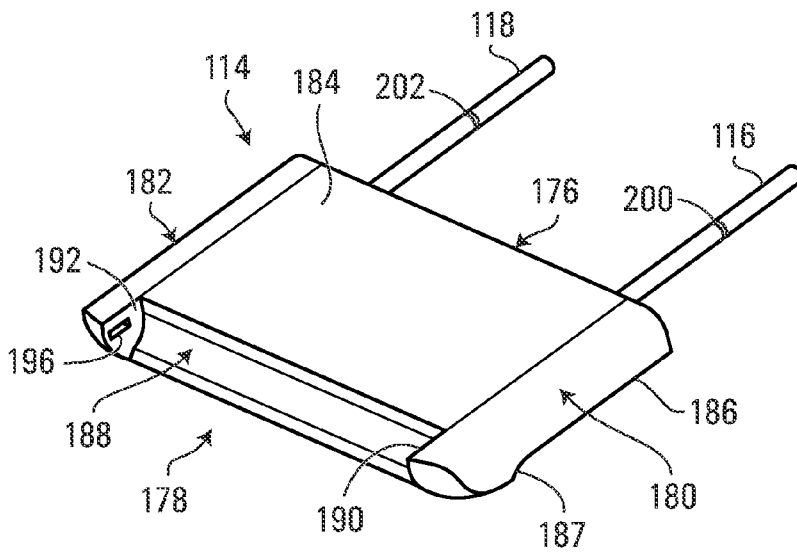
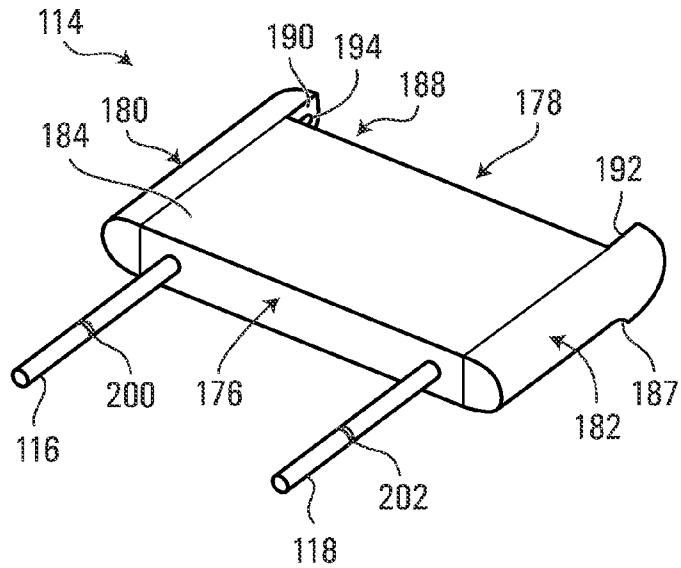

FIG. 4B

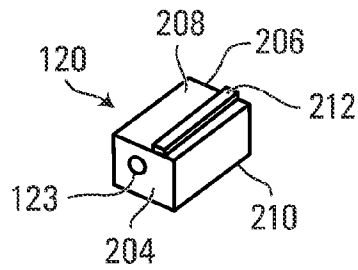

FIG. 5A

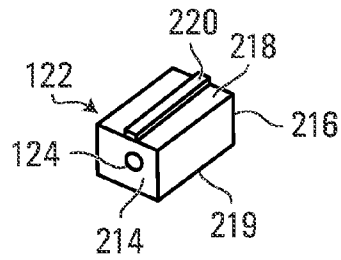

FIG. 5B

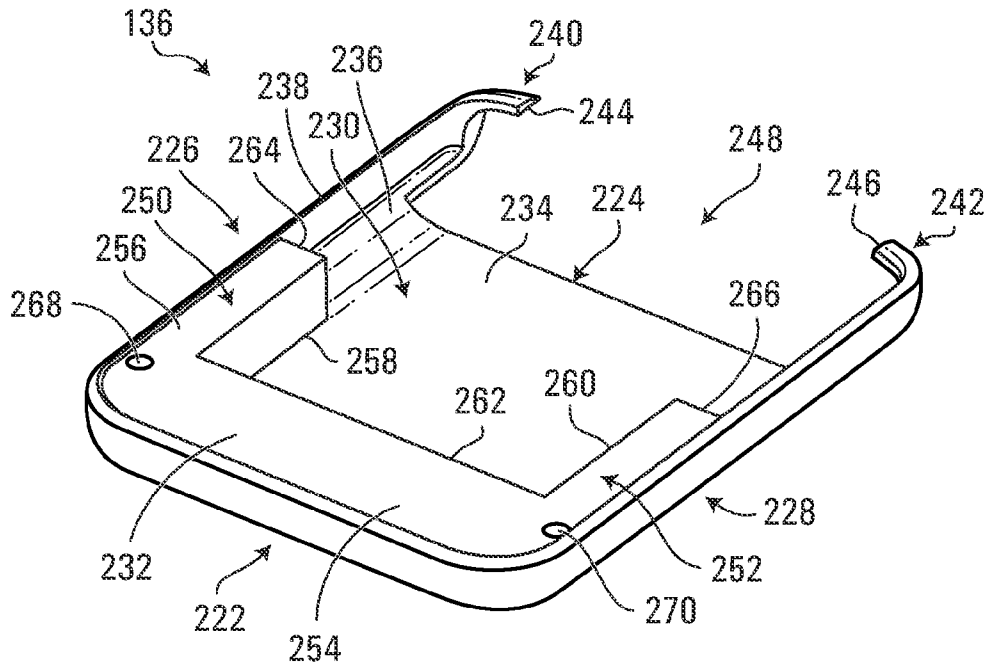

FIG. 6A

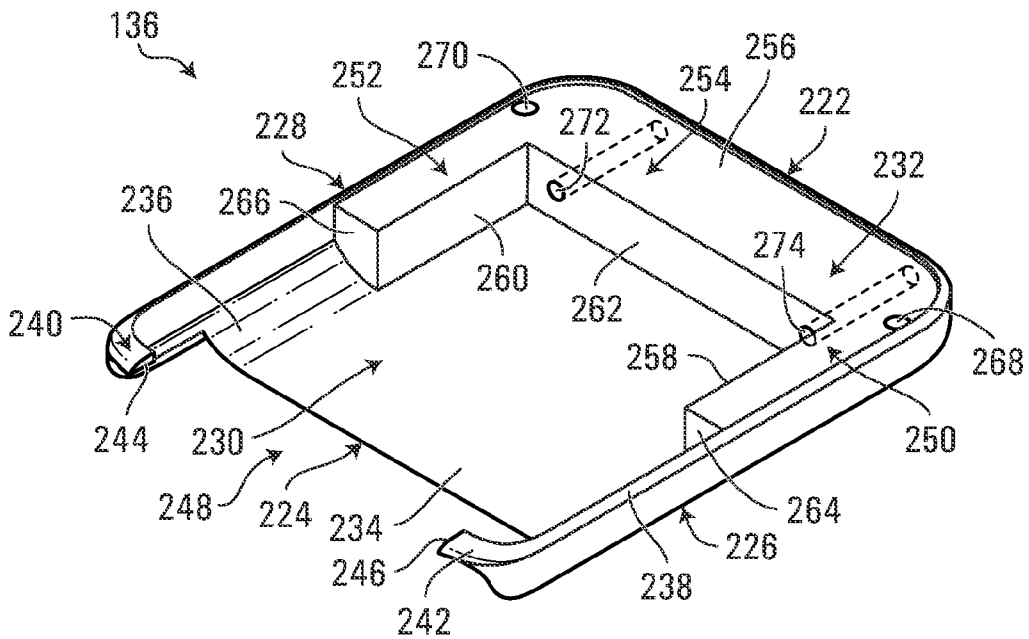

FIG. 6B

Explore Litigation Insights

Docket Alarm provides insights to develop a more informed litigation strategy and the peace of mind of knowing you're on top of things.

Real-Time Litigation Alerts



Keep your litigation team up-to-date with **real-time alerts** and advanced team management tools built for the enterprise, all while greatly reducing PACER spend.

Our comprehensive service means we can handle Federal, State, and Administrative courts across the country.

Advanced Docket Research



With over 230 million records, Docket Alarm's cloud-native docket research platform finds what other services can't. Coverage includes Federal, State, plus PTAB, TTAB, ITC and NLRB decisions, all in one place.

Identify arguments that have been successful in the past with full text, pinpoint searching. Link to case law cited within any court document via Fastcase.

Analytics At Your Fingertips



Learn what happened the last time a particular judge, opposing counsel or company faced cases similar to yours.

Advanced out-of-the-box PTAB and TTAB analytics are always at your fingertips.

API

Docket Alarm offers a powerful API (application programming interface) to developers that want to integrate case filings into their apps.

LAW FIRMS

Build custom dashboards for your attorneys and clients with live data direct from the court.

Automate many repetitive legal tasks like conflict checks, document management, and marketing.

FINANCIAL INSTITUTIONS

Litigation and bankruptcy checks for companies and debtors.

E-DISCOVERY AND LEGAL VENDORS

Sync your system to PACER to automate legal marketing.