



US 20100298032A1

(19) **United States**

(12) **Patent Application Publication**

Lee et al.

(10) **Pub. No.: US 2010/0298032 A1**

(43) **Pub. Date: Nov. 25, 2010**

(54) **MOBILE TERMINAL AND METHOD OF PROVIDING GRAPHIC USER INTERFACE USING THE SAME**

(30) **Foreign Application Priority Data**

May 22, 2009 (KR) 10-2009-0044915

Jul. 6, 2009 (KR) 10-2009-0061270

(75) Inventors: **Khwanhee Lee, Seoul (KR);
Woochul Song, Seoul (KR)**

Publication Classification

Correspondence Address:

**LEE, HONG, DEGERMAN, KANG & WAIMEY
660 S. FIGUEROA STREET, Suite 2300
LOS ANGELES, CA 90017 (US)**

(51) **Int. Cl.**
H04M 1/00 (2006.01)
G06F 3/00 (2006.01)
G06F 3/041 (2006.01)

(52) **U.S. Cl.** **455/566; 715/700; 345/173**

(57) **ABSTRACT**

Provided are a mobile terminal and a method of providing a graphic user interface using the same. The mobile terminal includes a plurality of bodies. Various graphic user interfaces are provided according to a posture of the mobile terminal, which is formed by the plurality of bodies of the mobile terminal.

(73) Assignee: **LG Electronics Inc.**

(21) Appl. No.: **12/569,355**

(22) Filed: **Sep. 29, 2009**

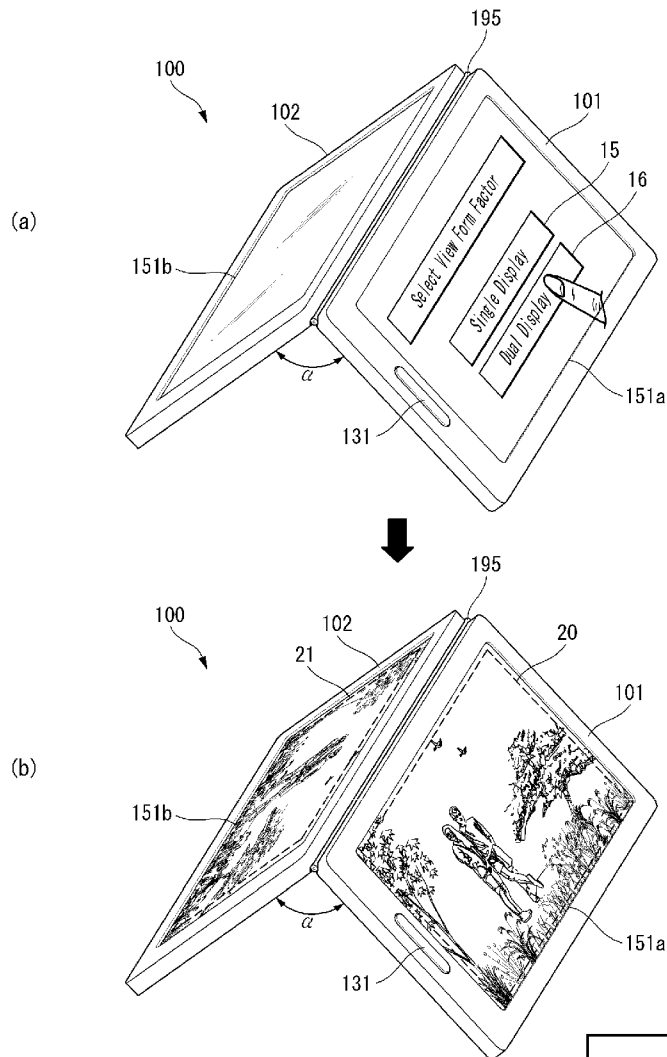

**Samsung v. GUI
IPR2021-00338
Exhibit 1013**

FIG. 1

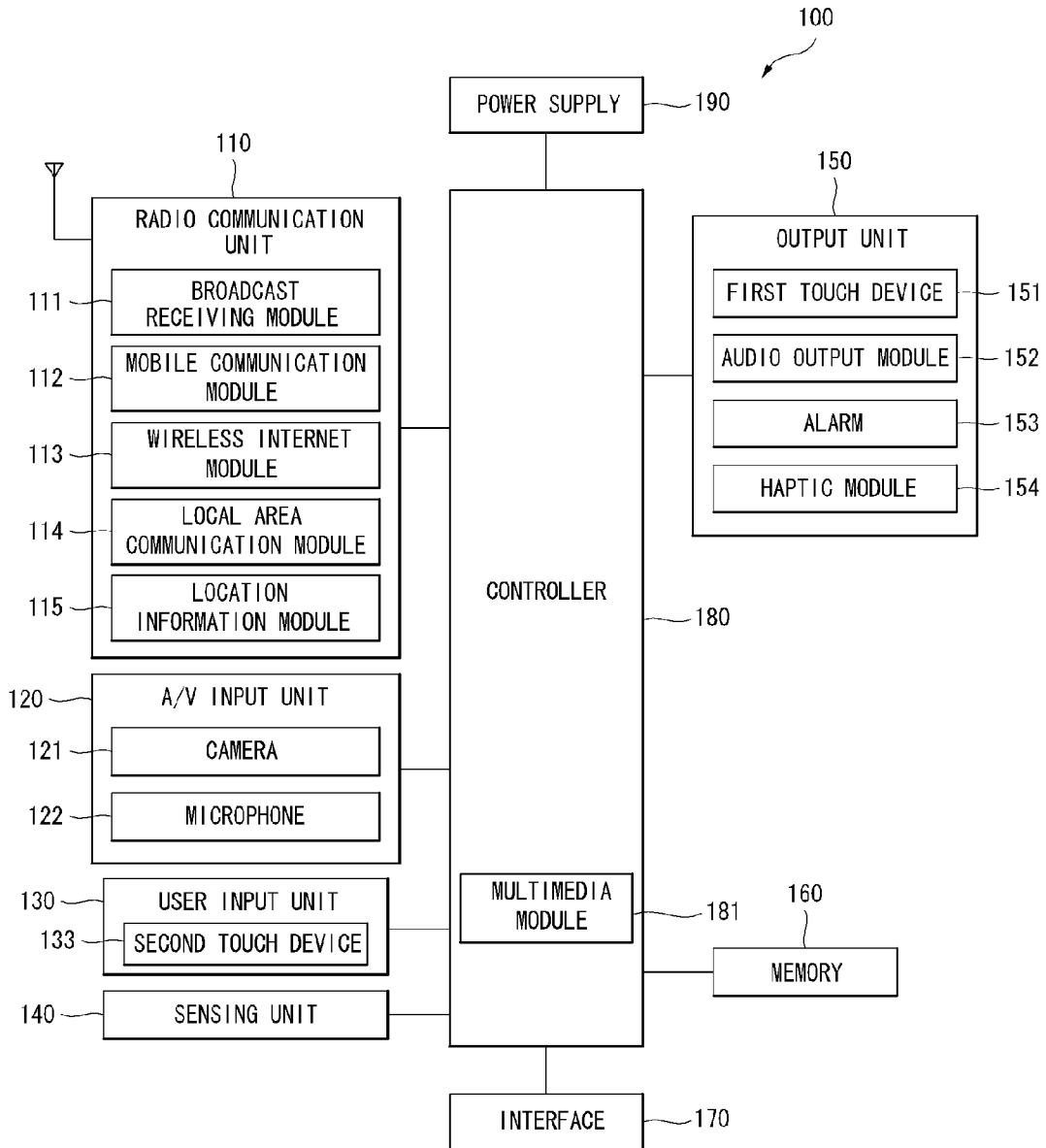
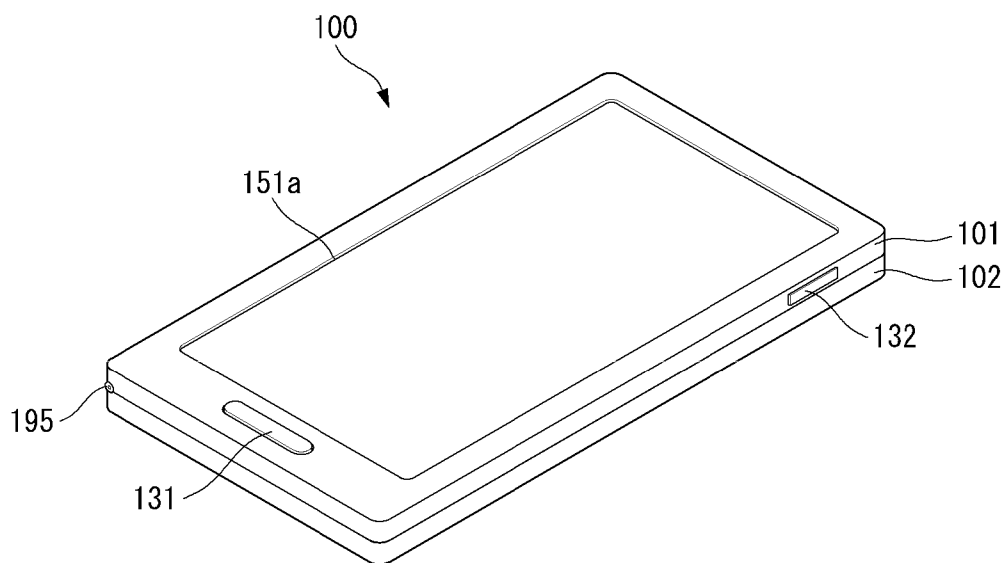
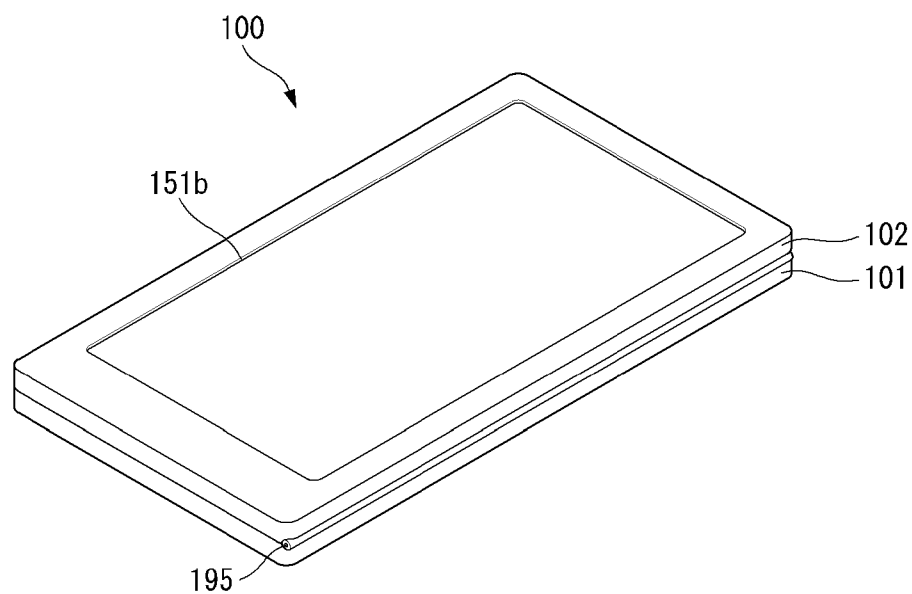

FIG. 2



(a)



(b)

FIG. 3

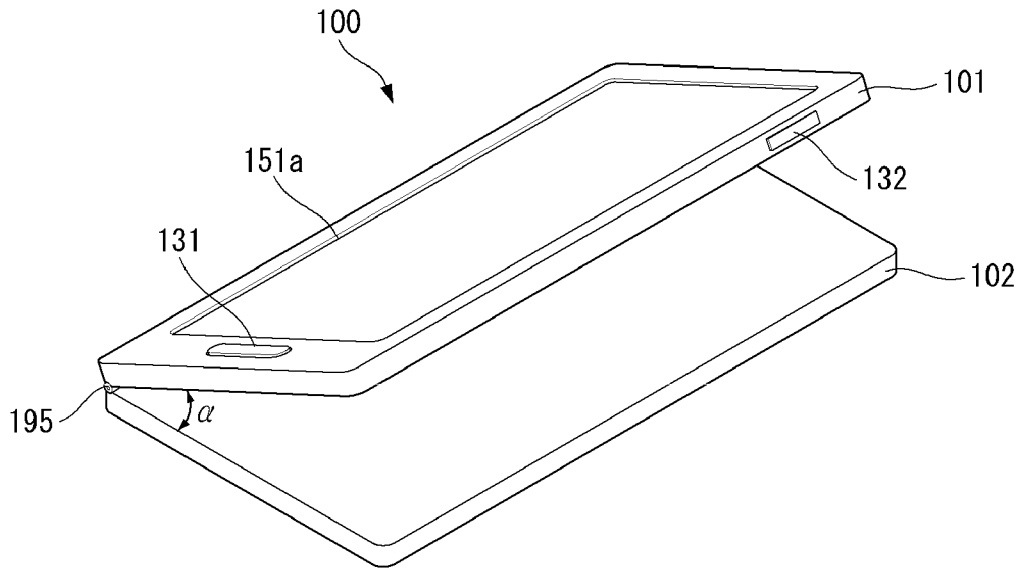

(a)

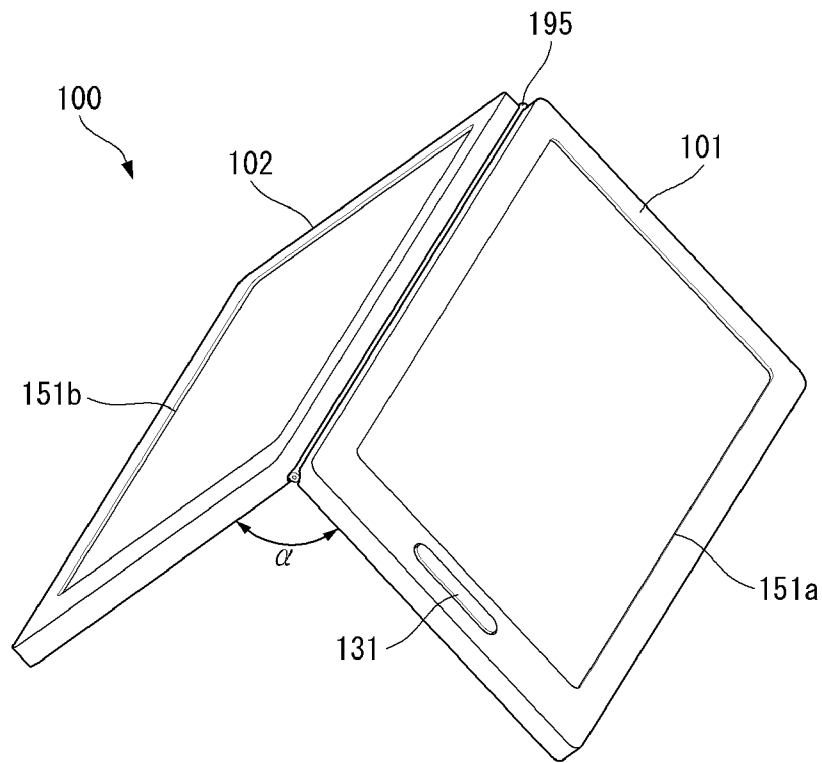

(b)

FIG. 4A

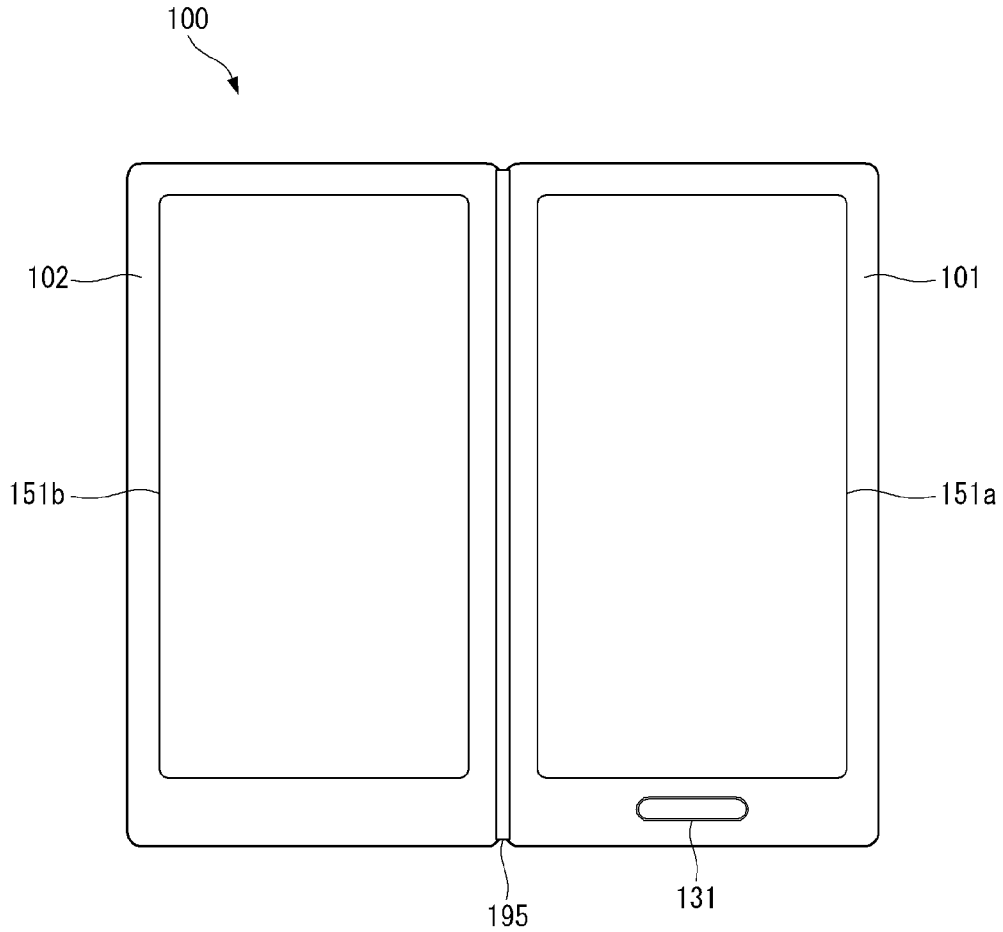
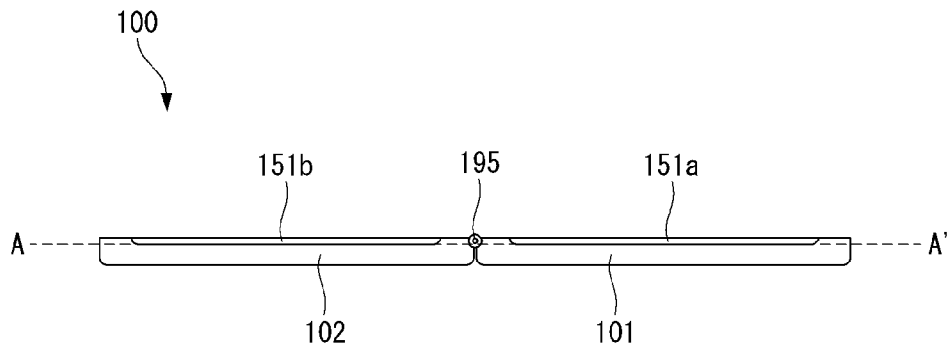

FIG. 4B



Explore Litigation Insights

Docket Alarm provides insights to develop a more informed litigation strategy and the peace of mind of knowing you're on top of things.

Real-Time Litigation Alerts



Keep your litigation team up-to-date with **real-time alerts** and advanced team management tools built for the enterprise, all while greatly reducing PACER spend.

Our comprehensive service means we can handle Federal, State, and Administrative courts across the country.

Advanced Docket Research



With over 230 million records, Docket Alarm's cloud-native docket research platform finds what other services can't. Coverage includes Federal, State, plus PTAB, TTAB, ITC and NLRB decisions, all in one place.

Identify arguments that have been successful in the past with full text, pinpoint searching. Link to case law cited within any court document via Fastcase.

Analytics At Your Fingertips



Learn what happened the last time a particular judge, opposing counsel or company faced cases similar to yours.

Advanced out-of-the-box PTAB and TTAB analytics are always at your fingertips.

API

Docket Alarm offers a powerful API (application programming interface) to developers that want to integrate case filings into their apps.

LAW FIRMS

Build custom dashboards for your attorneys and clients with live data direct from the court.

Automate many repetitive legal tasks like conflict checks, document management, and marketing.

FINANCIAL INSTITUTIONS

Litigation and bankruptcy checks for companies and debtors.

E-DISCOVERY AND LEGAL VENDORS

Sync your system to PACER to automate legal marketing.