



US006809774B1

(12) **United States Patent**
Yamazaki et al.

(10) **Patent No.:** **US 6,809,774 B1**
(45) **Date of Patent:** **Oct. 26, 2004**

(54) **WRIST-CARRIED CAMERA AND WATCH-TYPE INFORMATION EQUIPMENT**

(75) Inventors: **Akihisa Yamazaki**, Asaka (JP); **Koji Sagae**, Asaka (JP)

(73) Assignee: **Fuji Photo Film Co., Ltd.**,
Minami-Ashigara (JP)

(*) Notice: Subject to any disclaimer, the term of this patent is extended or adjusted under 35 U.S.C. 154(b) by 0 days.

(21) Appl. No.: **09/432,090**

(22) Filed: **Nov. 2, 1999**

(30) **Foreign Application Priority Data**

Nov. 6, 1998 (JP) 10-316054

(51) **Int. Cl.**⁷ **H04N 5/225**

(52) **U.S. Cl.** **348/373; 348/376**

(58) **Field of Search** 348/373, 374,
348/375, 376, 61, 73, 207.99; 396/318,
56, 336; 368/10, 71, 21; 340/5.82, 7.55;
455/556.1, 11.1, 344

(56) **References Cited**

U.S. PATENT DOCUMENTS

4,362,398 A * 12/1982 Jackson 368/240
5,329,501 A * 7/1994 Meister et al. 368/10
5,475,653 A * 12/1995 Yamada et al. 368/10
5,572,196 A * 11/1996 Sakumoto et al. 340/7.55

5,572,488 A * 11/1996 Yamada et al. 368/10
5,977,535 A * 11/1999 Rostoker 250/208.1
6,359,837 B1 * 3/2002 Tsukamoto 368/10
2001/0011025 A1 * 8/2001 Ohki et al. 455/556
2001/0017663 A1 * 8/2001 Yamaguchi et al. 348/373
2002/0180586 A1 * 12/2002 Kitson et al. 340/5.82

FOREIGN PATENT DOCUMENTS

JP 62009289 A * 10/1987 G04G/1/00
JP 05-209973 * 8/1993
JP 8278382 10/1996
JP 1090442 4/1998
JP 10108152 4/1998

* cited by examiner

Primary Examiner—Aung Moe

(74) *Attorney, Agent, or Firm*—Birch, Stewart, Kolasch & Birch, LLP

(57) **ABSTRACT**

In a wrist-carried camera having a watch function, a body including a taking lens is provided in such a manner as to freely rotate with respect to a band part through a rotation mechanism, and a release switch is provided at the unrotated band part. Setting a camera mode stops the hands of the watch in the direction of a taking lens so as to display an image-capturing direction. A rotary bezel is arranged around a display part, and marks indicating modes of the camera are formed on the bezel. A hand of the watch is also used as an indicator for pointing the mode display mark in the bezel. Setting the mark in the bezel to the indicator switches and displays the operation modes.

19 Claims, 9 Drawing Sheets

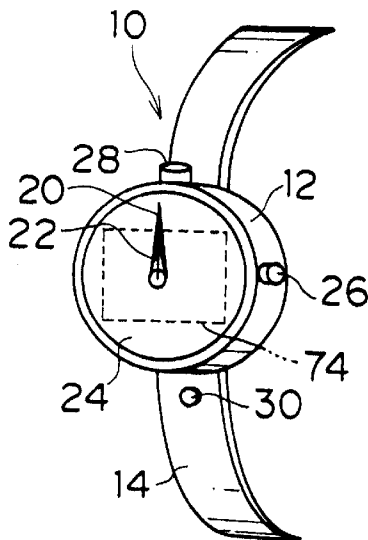

Samsung v. GUI
IPR2021-00338
Exhibit 1019

FIG. 1

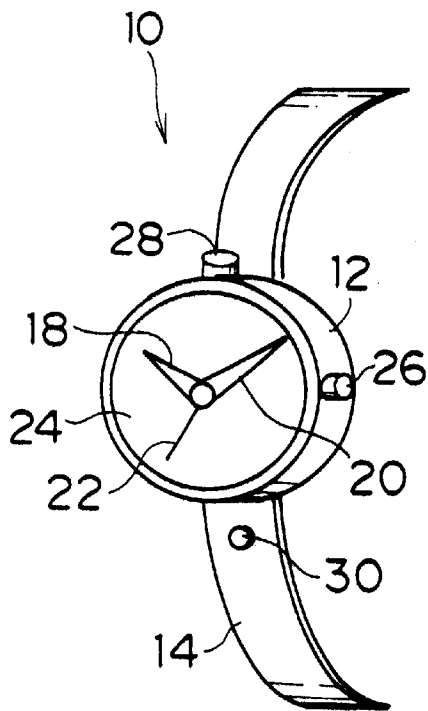
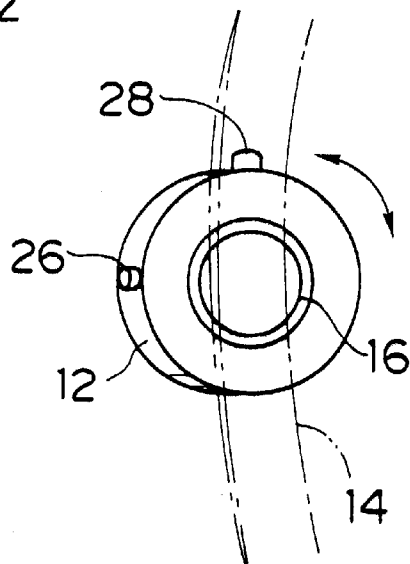
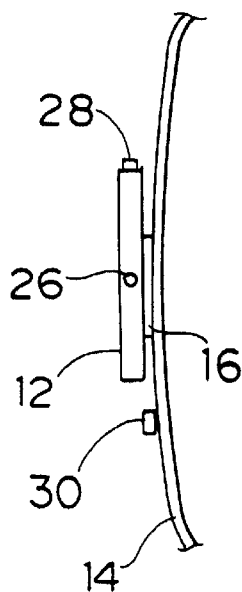

FIG. 2



F I G. 3



F I G. 4

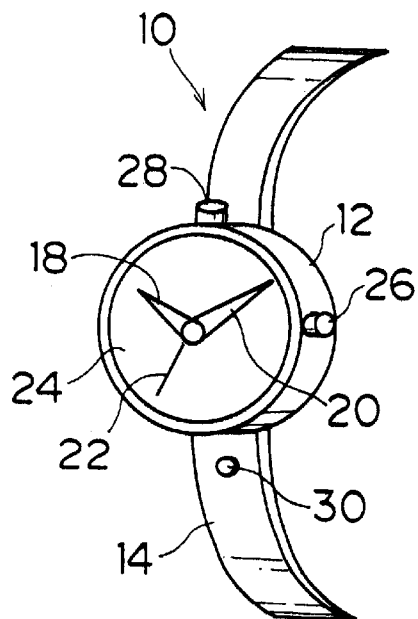

FIG. 5

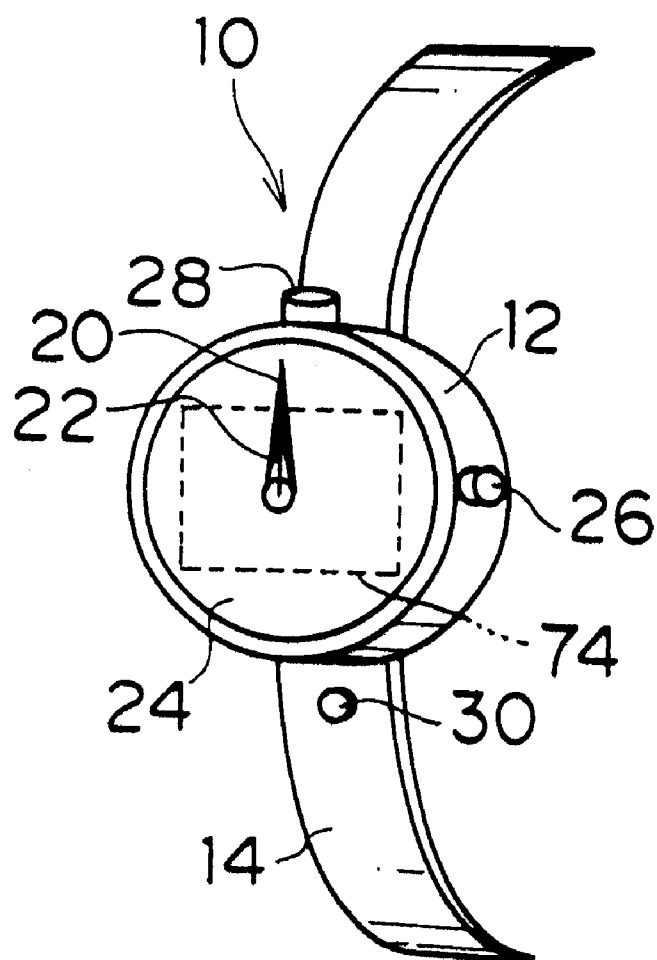
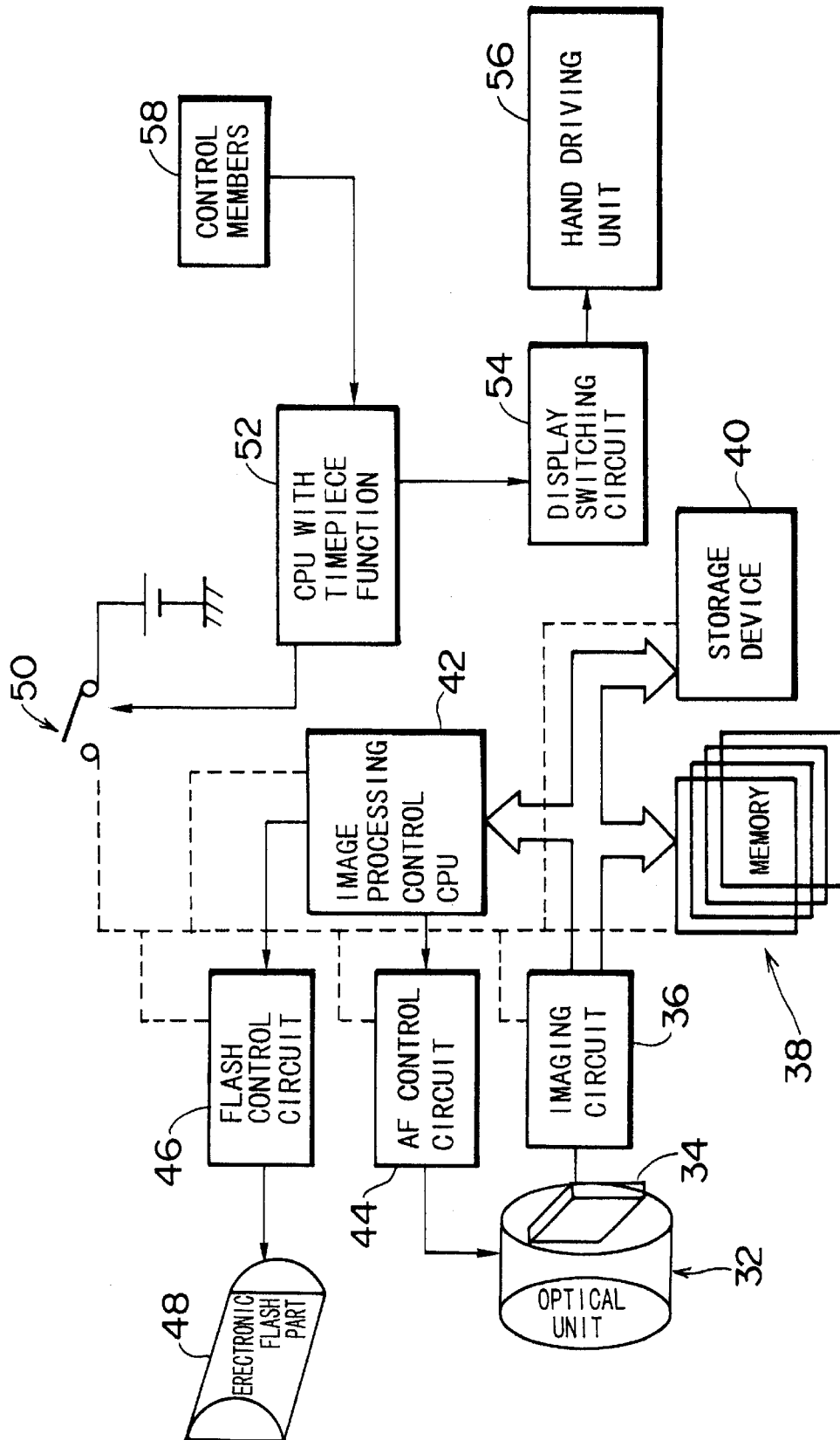

FIG. 6



Explore Litigation Insights

Docket Alarm provides insights to develop a more informed litigation strategy and the peace of mind of knowing you're on top of things.

Real-Time Litigation Alerts



Keep your litigation team up-to-date with **real-time alerts** and advanced team management tools built for the enterprise, all while greatly reducing PACER spend.

Our comprehensive service means we can handle Federal, State, and Administrative courts across the country.

Advanced Docket Research



With over 230 million records, Docket Alarm's cloud-native docket research platform finds what other services can't. Coverage includes Federal, State, plus PTAB, TTAB, ITC and NLRB decisions, all in one place.

Identify arguments that have been successful in the past with full text, pinpoint searching. Link to case law cited within any court document via Fastcase.

Analytics At Your Fingertips



Learn what happened the last time a particular judge, opposing counsel or company faced cases similar to yours.

Advanced out-of-the-box PTAB and TTAB analytics are always at your fingertips.

API

Docket Alarm offers a powerful API (application programming interface) to developers that want to integrate case filings into their apps.

LAW FIRMS

Build custom dashboards for your attorneys and clients with live data direct from the court.

Automate many repetitive legal tasks like conflict checks, document management, and marketing.

FINANCIAL INSTITUTIONS

Litigation and bankruptcy checks for companies and debtors.

E-DISCOVERY AND LEGAL VENDORS

Sync your system to PACER to automate legal marketing.